

3+Open™ MS™ OS/2 LAN Manager  
User Reference

3

+

Open

# **3+Open MS OS/2 LAN Manager User Reference**

---

**A member of the 3+Open family of products. For use with OS/2,  
version 1.0 or higher, and DOS, version 3.1 or higher.**

Copyright © 3Com Corporation, 1988. All rights reserved.  
3165 Kifer Road  
Santa Clara, CA 95052-8145  
Printed in the U.S.A.

Manual Part No. 4700-01  
First published October, 1988  
Reprinted January, 1989

---

## Copyright Statement

No part of this manual may be reproduced in any form or by any means or used to make any derivative work (such as translation, transformation or adaptation) without permission from 3Com Corporation by the United States Copyright Act of 1976, as amended.

Changes are made periodically to the information herein; these changes will be incorporated in new editions of this publication. Contents are property of 3Com Corporation. All rights reserved.

3Com Corporation provides this guide without warranty of any kind, either implied or expressed, including, but not limited to, the implied warranties of merchantability and fitness for a particular purpose. 3Com may make improvements or changes in the product(s) and/or the program(s) described in this manual at any time.

Portions of this manual are reproduced in whole or in part with permission from Microsoft Corporation.

---

## Trademarks

3+®, 3+Backup®, 3+Remote®, 3+Route®, 3+Share®, 3Server®, 3Server3®, 3Server386®, 3Wizard®, 3+TurboShare®, Etherlink®, Etherlink Enhanced®, and EtherLink Plus® are all registered trademarks of 3Com Corporation. 3+Open™, 3+NetConnect™, 3+Start™, 3Station™, EtherLink II™, EtherSeries™, EtherSeries Enhanced™, EtherStart™, TokenLink™, TokenLink Plus™, and 3Plus™ are trademarks of 3Com Corporation.

Microsoft, Microsoft Word, MS, and MS-DOS are registered trademarks of Microsoft Corporation.

IBM PC and PC-DOS are registered trademarks of International Business Machines Corporation.

Ethernet is a registered trademark of Xerox Corporation.

Apple, LaserWriter, LaserWriter Plus, Macintosh Plus, Macintosh SE, Macintosh II, and MacDraw are trademarks of Apple Computer, Inc. Macintosh is a trademark licensed to Apple Computer.

---

## Recognition

Thanks to Alan Kessler.

Production by Lori Eng, Cate Lush, Adrian Boyer, Cindy Yates, Christa Schmidt, and Nancy Newlin.

Manual editing by Liz Kroha and Beth Dorrell.

This manual was produced by 3Com using 3+ for Macintosh (3Com), Microsoft Word, and MacDraw software with the Apple LaserWriter Plus on a Macintosh netstation.

# Table of Contents

## Introduction

Before You Begin	xiii
Contents of This Reference	xiv
Notational Conventions	xiv
Notational Convention Examples	xv
Finding Further Information	xvi
Conventions Used in This Guide	xvii
Keys	xvii
Key Combinations	xvii
Procedural Conventions	xvii

## Chapter 1: About LAN Manager

Starting LAN Manager	1-1
Logging on to the Local Area Network	1-2
Automatic Startup	1-2
Using LAN Manager	1-3
The LAN Manager Screen	1-3
LAN Manager Commands	1-4
Getting More Information	1-4
On-Line Help	1-4
Error Messages	1-5

## **Chapter 2: LAN Manager Screen Reference**

Using the LAN Manager Screen	2-2
Netstation Information	2-3
Logging On	2-4
Selecting Menus and Menu Items	2-5
Using Help	2-6
Using Dialog Box Elements	2-7
Menus and Dialog Boxes in This Chapter	2-8
View Menu	2-10
Network Servers	2-10
This Workstation	2-10
Print Queues	2-11
Comm Queues	2-11
Exit	2-11
Servers Available on the Network	2-12
Listing a Server's Shared Resources	2-13
Resources at (Server)	2-14
Using a Shared Resource	2-15
Stop Using a Shared Resource	2-15
Use the Resource (Network Path)	2-16
Connecting to a Shared Resource	2-17
Network Resources in Use at Your Workstation	2-17
Adding a New Connection	2-19
Deleting a Connection	2-19
Getting More Information About a Resource	2-19
Use a Network Resource	2-20
Connecting to the Shared Resource	2-21
Accessing (Network Path)	2-22
Supplying a Password	2-23
Usage Information for a Network Resource	2-23
Show Print Queues For	2-25
Listing a Server's Print Queues	2-26
Print Queues for (Server)	2-26
Changing the Status of Your Print Job	2-28
Getting More Information About a Job or Queue	2-28
Printing Options for Job	2-29
Changing the Position of a Print Job	2-30
Printing Options for Queue	2-31

- Show Comm Queues For 2-33
  - Listing a Server's Comm Queues 2-34
  - Listing a Comm Queue Linked to a Local Device 2-34
- Comm Queues for (Server) 2-34
  - Getting More Information About a Queue 2-36
- Options for Comm Queue 2-36
- Message Menu 2-37
  - Send 2-38
  - Read 2-38
  - Log File 2-39
  - Aliases 2-39
- Send a Message 2-39
  - Sending a Message 2-41
- Contents of Current Message Log 2-42
  - Reading Logged Messages 2-43
  - Clearing the Message Log 2-43
- Specify Message Log File 2-43
  - Specifying a New Message Log 2-45
  - Pausing Message Logging 2-45
  - Continuing Message Logging 2-46
- Aliases for Messaging 2-46
  - Adding Message Aliases 2-47
  - Deleting Message Aliases 2-47
- Add an Alias 2-48
- Forward an Existing Alias 2-50
- Config Menu 2-51
  - Logon 2-51
  - Logoff 2-52
  - Load Profile 2-52
  - Save Profile 2-52
  - Change Password 2-52
  - Stop Net Services 2-52
- Log into Network 2-53
  - Logging on to LAN Manager 2-54
- Load Configuration 2-55
  - Loading a Profile 2-56
- Save Configuration 2-57
  - See Also 2-58

- Change Logon Password at a Server 2-59
  - Changing Your Password 2-60
  - See Also 2-61
- Status Menu 2-61
  - Workstation Statistics 2-62
  - Error Log 2-62
- Workstation Statistics Information 2-62
  - Reviewing Workstation Statistics 2-64
  - Resetting the Statistics Log 2-64
  - See Also 2-64
- Network Error Log 2-65
  - Getting More Information About an Error 2-66
  - Saving Recorded Errors to a File 2-66
  - Clearing the Error Log 2-67
- Error Log Record 2-67

### **Chapter 3: LAN Manager Command Reference**

- Using LAN Manager Commands 3-2
  - Service Name Abbreviations 3-2
  - Option Names 3-3
  - Commands that Start Services Automatically 3-3
  - Workstation Service 3-3
  - Your Log-On 3-4
  - Using Passwords with Commands 3-4
  - Using the \* Option 3-5
  - Using /Yes and /No 3-5
- Command Information 3-6
  - Command Name and Purpose 3-6
  - Syntax 3-7
  - Comments 3-8
  - Example 3-8
  - See Also 3-8
  - Commands in This Manual 3-8
- NET 3-10
  - Syntax 3-10
  - Comments 3-10
  - Example 3-11
  - See Also 3-11

NET COMM 3-11  
    Syntax 3-11  
    Comments 3-12  
    Example 3-14  
    See Also 3-14  
NET CONFIG WORKSTATION 3-15  
    Syntax 3-15  
    Comments 3-16  
    Example 3-17  
    See Also 3-17  
NET CONTINUE 3-18  
    Syntax 3-18  
    Comments 3-18  
    Example 3-19  
    See Also 3-19  
NET COPY 3-20  
    Syntax 3-20  
    Comments 3-21  
    Example 3-23  
    See Also 3-23  
NET ERROR 3-24  
    Syntax 3-24  
    Comments 3-25  
    Example 3-25  
    See Also 3-25  
NET FORWARD 3-26  
    Syntax 3-26  
    Comments 3-26  
    Example 3-27  
    See Also 3-27  
NET HELP 3-28  
    Syntax 3-28  
    Comments 3-28  
    Example 3-29  
    See Also 3-29



NET LOAD 3-30  
  Syntax 3-30  
  Comments 3-30  
  About Profile Files 3-31  
  Example 3-31  
  See Also 3-32

NET LOG 3-32  
  Syntax 3-32  
  Comments 3-33  
  Example 3-34  
  See Also 3-35

NET LOGOFF 3-35  
  Syntax 3-35  
  Comments 3-35  
  Example 3-36  
  See Also 3-36

NET LOGON 3-37  
  Syntax 3-37  
  Comments 3-37  
  Example 3-38  
  See Also 3-39

NET MOVE 3-39  
  Syntax 3-39  
  Comments 3-40  
  Example 3-40  
  See Also 3-41

NET NAME 3-41  
  Syntax 3-41  
  Comments 3-42  
  Example 3-43  
  See Also 3-43

NET PASSWORD 3-43  
  Syntax 3-43  
  Comments 3-44  
  Example 3-45  
  See Also 3-45

NET PAUSE 3-45  
  Syntax 3-45  
  Comments 3-46  
  Example 3-46

- NET PRINT 3-47
  - Syntax 3-47
  - Comments 3-48
  - Comments 3-48
  - Example 3-49
  - See Also 3-50
- NET RUN 3-50
  - Syntax 3-50
  - Comments 3-50
  - Example 3-51
  - See Also 3-51
- NET SAVE 3-52
  - Syntax 3-52
  - Comments 3-52
  - About Profile Files 3-53
  - Example 3-53
  - See Also 3-53
- NET SEND 3-54
  - Syntax 3-54
  - Comments 3-54
  - Example 3-55
  - See Also 3-56
- NET START MESSENGER 3-56
  - Syntax 3-56
  - Comments 3-57
  - Example 3-58
  - See Also 3-58
- NET START NETPOPUP 3-59
  - Syntax 3-59
  - Comments 3-59
  - Example 3-59
  - See Also 3-60
- NET START WORKSTATION 3-60
  - Syntax 3-60
  - Comments 3-63
  - Example 3-64
  - See Also 3-64

NET STATISTICS 3-65

Syntax 3-65

Comments 3-65

Example 3-66

See Also 3-66

NET STOP 3-67

Syntax 3-67

Comments 3-67

Example 3-67

See Also 3-68

NET USE 3-68

Syntax 3-68

Comments 3-70

Example 3-71

See Also 3-72

NET VIEW 3-72

Syntax 3-72

Comments 3-73

Example 3-75

See Also 3-75

## **Appendix A: Error Messages**

LAN Manager Network Error Messages A-1

Alerter Service Messages A-5

NetService Messages A-6

Command Syntax Messages A-6

LAN Manager Application Error Messages A-6

## Table of Figures

<b>Page</b>	<b>Figure</b>	<b>Title</b>
2-2	Figure 2-1	Initial LAN Manager Screen
2-4	Figure 2-2	Initial LAN Manager Screen with Log Into Network Dialog Box
2-5	Figure 2-3	View Menu
2-6	Figure 2-4	Using [F1] for Help
2-7	Figure 2-5	Dialog Box Name Sample
2-12	Figure 2-6	Servers Available on Network Dialog Box
2-14	Figure 2-7	Resources at (Server) Dialog Box
2-16	Figure 2-8	Use the Resource (Network Path) Dialog Box
2-18	Figure 2-9	Network Resources in Use at Your Workstation Dialog Box
2-20	Figure 2-10	Use a Network Resource Dialog Box
2-22	Figure 2-11	Accessing (Network Path) Dialog Box
2-24	Figure 2-12	Usage Information for a Network Resource Dialog Box
2-25	Figure 2-13	Show Print Queues For Dialog Box
2-27	Figure 2-14	Print Queues for (Server) Dialog Box
2-29	Figure 2-15	Printing Options for Job Dialog Box
2-31	Figure 2-16	Printing Options for Queue Dialog Box
2-33	Figure 2-17	Show Comm Queues For Dialog Box
2-35	Figure 2-18	Comm Queues for (Server) Dialog Box
2-36	Figure 2-19	Options for Comm Queue Dialog Box
2-38	Figure 2-20	Message Menu
2-40	Figure 2-21	Send a Message Dialog Box
2-42	Figure 2-21	Contents of Current Message Log Dialog Box
2-44	Figure 2-22	Specify Message Log File Dialog Box
2-46	Figure 2-23	Aliases for Messaging Dialog Box
2-49	Figure 2-24	Add an Alias Dialog Box
2-50	Figure 2-25	Forward an Existing Alias Dialog Box
2-51	Figure 2-26	Config Menu
2-53	Figure 2-27	Log Into Network Dialog Box
2-55	Figure 2-28	Load Configuration Dialog Box
2-57	Figure 2-29	Save Configuration Dialog Box
2-59	Figure 2-30	Change Logon Password at a Server Dialog Box
2-61	Figure 2-31	Status Menu
2-63	Figure 2-32	Workstation Statistics Information Dialog Box
2-65	Figure 2-33	Network Error Log Dialog Box
2-67	Figure 2-34	Error Log Record Dialog Box

## Table of Figures

<b>Page</b>	<b>Table</b>	<b>Title</b>
2-7	Table 2-1	LAN Manager Dialog Box Elements
2-9	Table 2-2	LAN Manager Menus and Dialog Boxes

# Introduction

This *3+Open MS OS/2 LAN Manager User Reference* describes individual commands and operations of the Microsoft® OS/2 LAN Manager. You should use this reference if you operate a **netstation** with LAN Manager. (A netstation is a computer that uses local area network resources but does not offer its own resources to others.) This introduction describes how to best use this reference. It also describes the other manuals in the 3+Open MS® OS/2 LAN Manager documentation set and provides an overview of LAN Manager.

---

## Before You Begin

This reference is designed to supplement the *3+Open MS OS/2 LAN Manager User Guide*. Before using this reference, you should feel comfortable using MS OS/2. You should be able to create and work with files and directories. You should have LAN Manager installed on your computer and be familiar with it. You should be comfortable either using the LAN Manager Screen or typing LAN Manager commands at the OS/2 prompt. In addition, you should have read the *3+Open MS OS/2 LAN Manager User Guide* which teaches general LAN Manager concepts, procedures, and terms not explained in this reference.

For information about other manuals in the 3+Open MS OS/2 LAN Manager documentation set, see “Finding Further Information” in this chapter.

---

---

## Contents of This Reference

The following list is a quick overview of the chapters in this reference:

- Chapter 1: About LAN Manager describes the features of 3+Open MS OS/2 LAN Manager and provides an overview of it.
- Chapter 2: LAN Manager Screen Reference describes the LAN Manager Screen, its menus, and dialog boxes. The reference is arranged by the menus as they appear across the menu bar. The dialog boxes are presented in hierarchical order after their menus.
- Chapter 3: LAN Manager Command Reference describes the LAN Manager commands you can type at the OS/2 prompt. The command names are presented in alphabetical order.
- Appendix A: Error Messages lists all of the LAN Manager error messages and comments that can appear at the OS/2 prompt or in LAN Manager Screen message boxes.

---

---

## Notational Conventions

Throughout this manual, the following conventions are used to distinguish elements of text:

Text Element	Indicates
ALL CAPITAL LETTERS	Command names and filenames.
<b>Bold</b>	New terms.
<b>Bold Courier typeface</b>	Input.
Regular Courier typeface	Screen text.
[Brackets]	Nonalphabetic key names such as [Enter] or optional options.
<i>Italics</i>	Variable command option names.
Plain text: /delete	Command options to be typed as is.

## Notational Convention Examples

From the LAN Manager Screen, you perform tasks by selecting options from a series of menus and dialog boxes. Each task has its own access path that begins with a menu, a menu device, and then one or more actions that bring you to that dialog box. Each dialog box reference page in Chapter 2: LAN Manager Screen Reference shows the path to take to arrive at that dialog box. For example, if you select the View menu and then choose This workstation, the access is shown as View->This workstation.

At the OS/2 prompt, you perform tasks by typing a LAN Manager command. The command reference pages in Chapter 3: LAN Manager Command Reference show the syntax for each command with the use of a bubble diagram. For example, the NET COPY command has the following syntax:

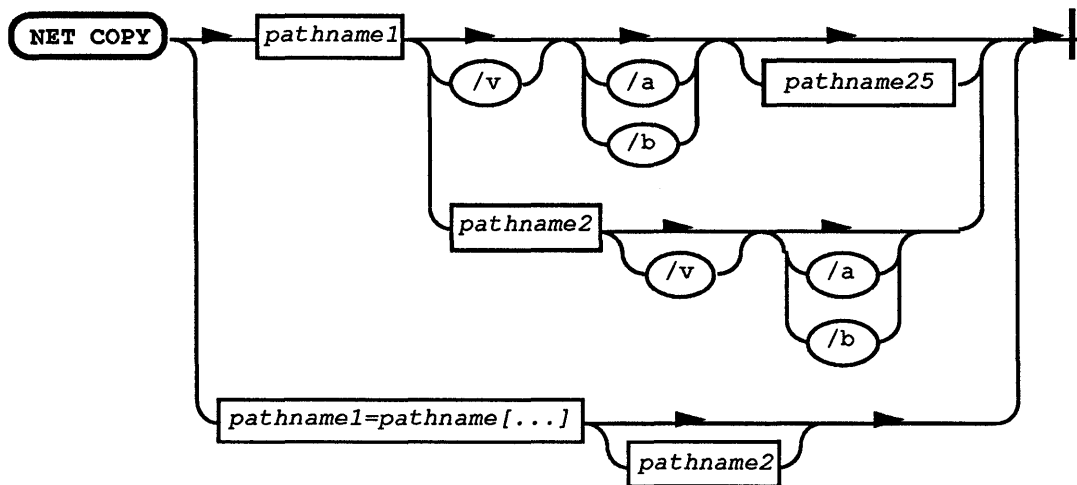

This means that to copy files you must type the words NET COPY followed by the pathname of the file or files you want to copy. (If you want, you can also specify the pathname to which you want files copied.)



---

## Finding Further Information

The following manuals are included with 3+Open MS OS/2 LAN Manager:

- *3+Open MS OS/2 LAN Manager Installation and Setup Guide*, a short guide to installing 3+Open MS OS/2 LAN Manager.
- *3+Open MS OS/2 LAN Manager User Guide*, a procedural guide to using LAN Manager on a netstation. This guide provides users with tutorials and instructions for LAN Manager tasks.
- *3+Open Network System Guide*, a reference guide for experienced (3Wizard) technical network users on tuning networks for optimum performance and memory usage.
- *3+Open MS OS/2 LAN Manager User Reference*, a reference for users working with LAN Manager commands and the LAN Manager Screen on a netstation. This reference describes each command and dialog box available to the local area network user.
- *3+Open MS OS/2 LAN Manager Administrator Guide*, a procedural guide for the administrator using LAN Manager on a server. This guide describes how to perform administrative tasks on a local area network.
- *3+Open MS OS/2 LAN Manager Administrator Reference*, a reference for the administrator working with LAN Manager commands and the LAN Manager Screen on a server. It describes how to use additional commands and dialog boxes available to administrators.
- *3+Open MS-DOS® LAN Manager User Guide*, a guide to the command-oriented LAN Manager that runs on DOS netstations. This manual includes a complete reference to the commands available on MS-DOS netstations.

---

---

## Conventions Used in This Guide

The following conventions are used throughout the guide.

---

### Keys

The following table shows the symbols used to represent the keys on your PC compatible keyboard:

Spelling	Key Represented
[Esc]	Escape
[Alt]	Alternate
[Ctrl]	Control
[Backspace]	Backspace
[Space bar]	Space bar
[F1]-[Fx]	Function keys F1 through Fx
↵ or [Return]	Return key
[Enter]	Enter key

---

### Key Combinations

If two or more keys are to be pressed simultaneously, the keys are linked with a "+" sign. For example, the following key combination resets a netstation:

[Ctrl]+[Alt]+[Del]

---

---

### Procedural Conventions

Terms shown in italics should be replaced with specific information. For example:

***makedisk*** *n*:↵

means that you type the command **MAKEDISK** followed by a drive identifier and press [Return].



## **Chapter 1: About LAN Manager**

3+Open MS OS/2 LAN Manager provides networking capability to computers running MS OS/2. While 3+Open MS OS/2 LAN Manager is compatible with other PC networking products like 3+, MS Net® for MS-DOS and IBM® PC-LAN version 1.2, it offers significant new capabilities, including the following features:

- The LAN Manager Screen, an easy-to-use, menu-oriented interface.
- Nondedicated servers-servers that may be used simultaneously as netstations.
- Advanced security system, user-level access control that allows different users different access permissions.
- Full integration with MS OS/2, including support for running advanced, distributed local area network applications.

---

### **Starting LAN Manager**

To use a local area network, you must first start the 3+Open MS OS/2 LAN Manager software on your computer. LAN Manager software includes a number of services that allow you to do certain functions on the local area network. To

connect your computer to the local area network as a netstation, you must start the Workstation service. To do this, type the following command:

```
net start workstation
```

The NET START WORKSTATION command identifies your computer to the local area network so that you can perform networking tasks using either LAN Manager commands or the LAN Manager Screen.

You can also start two other services on This workstation—the Messenger service and the Netpopup service. For more information about these services, see the NET START MESSENGER, NET START NETPOPUP, and NET START WORKSTATION commands in Chapter 3.

---

## Logging on to the Local Area Network

Not only must you identify your computer to the local area network, but you must also identify yourself. To identify yourself to the local area network, you must log on using your user name and log-on password. For example, Mary Sullivan, whose user name is *marys* and whose log on password is *wanderer*, uses the following command to log on to the local area network:

```
net logon marys wanderer
```

Once you start the Workstation service and log on to the local area network, you can use local area network resources and perform other tasks using 3+Open MS OS/2 LAN Manager.

---

## Automatic Startup

3+Open MS OS/2 LAN Manager recognizes when you need to start a particular service to accomplish a certain task. If you have not started a necessary service before typing a LAN Manager command, 3+Open MS OS/2 LAN Manager starts that service for you. For example, if you want to send a message to another user but haven't started the Messenger service, LAN Manager prompts you to make sure

starting the service is all right. Chapter 2: LAN Manager Screen Reference and Chapter 3: LAN Manager Command Reference explain this in more detail.

3+Open MS OS/2 LAN Manager also performs some log-on tasks for you automatically. LAN Manager remembers your user name and password and uses them when you need to log on to a server. When you request use of a server, 3+Open MS OS/2 LAN Manager automatically sends along your user name and password for verification. See Chapter 2: LAN Manager Screen Reference and Chapter 3: LAN Manager Command Reference for more detail.

---

## Using LAN Manager

Once you have started the Workstation service, you can perform local area network tasks. There are two ways to perform tasks using LAN Manager:

- Typing LAN Manager commands at the OS/2 prompt.
- Selecting options from menus and dialog boxes contained in the LAN Manager Screen.

---

## The LAN Manager Screen

The LAN Manager Screen is a graphical user interface. Menus and dialog boxes provide you with various options from which you can choose without having to remember specific commands. Many people find that performing tasks using the LAN Manager Screen is easier and more convenient than typing commands.

For more information about menus and dialog boxes contained within the LAN Manager Screen, see Chapter 2: LAN Manager Screen Reference. For more information about using the LAN Manager Screen, see the *3+Open MS OS/2 LAN Manager User Guide*.

---

## LAN Manager Commands

If you are already familiar with Networks for MS-DOS or IBM PC-LAN version 1.2, you may prefer to type LAN Manager commands at the OS/2 prompt instead of using the menus and dialog boxes of the LAN Manager Screen. LAN Manager commands are similar to the commands used for Networks for MS-DOS or IBM PC-LAN. And, if you are well acquainted with the commands and their options, typing LAN Manager commands could be the quicker alternative when you perform certain local area network tasks.

To automate local area network tasks, you can place LAN Manager commands in batch files, including in your STARTUP.CMD file.

For more information about LAN Manager commands and how to use them, see Chapter 3: LAN Manager Command Reference.

See also the *3+Open MS OS/2 LAN Manager User Guide* for more information about performing local area network tasks using LAN Manager commands.

---

## Getting More Information

3+Open MS OS/2 LAN Manager provides more information when you need it by displaying information or error messages and providing on-line help for both the LAN Manager Screen and LAN Manager commands.

---

## On-Line Help

Whether you are performing local area network tasks using the LAN Manager Screen or LAN Manager commands, you can get additional information to help you with what you are doing. When you are working in the LAN Manager Screen, you can press [F1] to get context-sensitive help. This means, for example, that if you are working in the Device Status dialog box and press [F1], information is displayed about using that particular dialog box. The Help facility also includes an index from which you can choose topics of interest, including general information about how to use menus and dialog boxes.

3+Open MS/OS2 LAN Manager also provides a special help command to assist you in using LAN Manager commands. To get information about using a particular LAN Manager command, type NET HELP followed by the command name. If the command begins with the word *net*, type NET HELP followed only by the second word of the command. For example, if you want more information about using the NET USE command, type the following:

```
net help use
```

LAN Manager displays the following information:

The syntax of this command is :

```
NET USE [device | \\computername\sharename]
NET USE [device] \\computername\sharename [password]
[/PRINT | /COMM]
NET USE [device | \\computername\sharename] /DELETE
```

You can also type NET HELP by itself to get a listing of topics for which NET HELP is available:

Help is available on:

```
AT          COMPACT      NET
```

Help on the following NET commands is available:

```
ACCESS      ADMIN        AUDIT        COMM         CONFIG
CONSOLE     CONTINUE     COPY         DEVICE       ERROR
FILE        FORWARD     GROUP        HELP         LOAD
LOG         LOGOFF      LOGON        MOVE         NAME
PASSWORD    PAUSE       PRINT        RUN          SAVE
SEND        SEPARATOR   SESSION     SHARE        START
STATS       STATUS      STOP         USE          USER
VIEW
```

---

## Error Messages

If you type a LAN Manager command with an option that 3+Open MS OS/2 LAN Manager doesn't recognize, you will see an error message in this form:



NET####: Message text

#### is a four-digit number that uniquely identifies the LAN Manager message.

**Message text** is a short message that describes the error.

You can use the MS OS/2 HELPMSG command to get further information about any LAN Manager message that appears at the OS/2 prompt. To get more information, type the HELPMSG command followed by the message identification (NET####). For example, suppose you meant to type the NET START command, but instead typed the following:

```
net strat
```

This message would display the following:

```
NET2622: This command is unknown.  
Type NET HELP to view a list of commands.
```

To get more information about the message itself, type the following:

```
helpmsg net2622
```

LAN Manager then displays an explanation of the message and a suggestion for the next action you should take.

For a complete listing of LAN Manager error messages that may display at the OS/2 prompt, see Appendix A: Error Messages.

When you are working in the LAN Manager Screen, messages are displayed by **message boxes**. Some of the messages displayed are the same as those LAN Manager displays at the OS/2 prompt. (See Appendix A: Error Messages, for a list of these messages.) Other messages displayed are specific to the LAN Manager Screen. To get more information about a message displayed by the LAN Manager Screen, press [F1].

## Chapter 2: LAN Manager Screen Reference

With the LAN Manager screen, you use menus and dialog boxes to perform LAN Manager operations. This chapter contains individual reference pages that describe how to use many of the menus and dialog boxes of the LAN Manager screen.

This chapter is arranged as follows:

- Information about using the LAN Manager screen and its menus, dialog boxes, and Help facility.
- A reference page for the View menu, followed by reference pages for dialog boxes associated with that menu.
- Reference pages for the Message menu and related dialog boxes.
- Reference pages for the Config menu and related dialog boxes.
- Reference pages for the Status menu and related dialog boxes.

You can take full advantage of all of LAN Manager's capabilities by using the menus and dialog boxes of the LAN Manager screen or by using the commands described in Chapter 3: LAN Manager Command Reference.

For more information about how to use the 3+Open MS OS/2 LAN Manager menus and dialog boxes, see the *3+Open MS OS/2 LAN Manager User Guide*.

## Using the LAN Manager Screen

To display the LAN Manager screen, type the following command from the MS OS/2 command line:

```
net
```

Your screen will look something like Figure 2-1:

```
View  Message  Config  Status                                F1=Help
----- Microsoft OS/2 LAN Manager 1.0 -----
Your username:                                BENP
Your computername:                            \\PRINT1

0 network files are open.
```

Press the ALT key to select a menu

**Figure 2-1. Initial LAN Manager Screen**

The LAN Manager screen includes the following elements:

- Menu bar.
- Action area.
- Message line.

The menu bar lists the names of all LAN Manager screen menus and a special item, [F1]=Help.

The action area has two functions:

- It provides information about your server.
- It provides a place for menus, dialog boxes, help boxes, and message boxes to be displayed.

The message line provides a short description of the selected option.

---

## **Netstation Information**

The LAN Manager screen includes the following display fields:

<b>Your username</b>	Shows the name you used to log on.
<b>Your computername</b>	Shows the name of your netstation. A computer name is always preceded with two backslashes (\\).
<b>(Number of) network files are open</b>	Shows the number of local area network files you are currently using.

## Logging On

The Log Into Network dialog box appears automatically when you start the LAN Manager screen if you are not already logged on (see Figure 2-2).

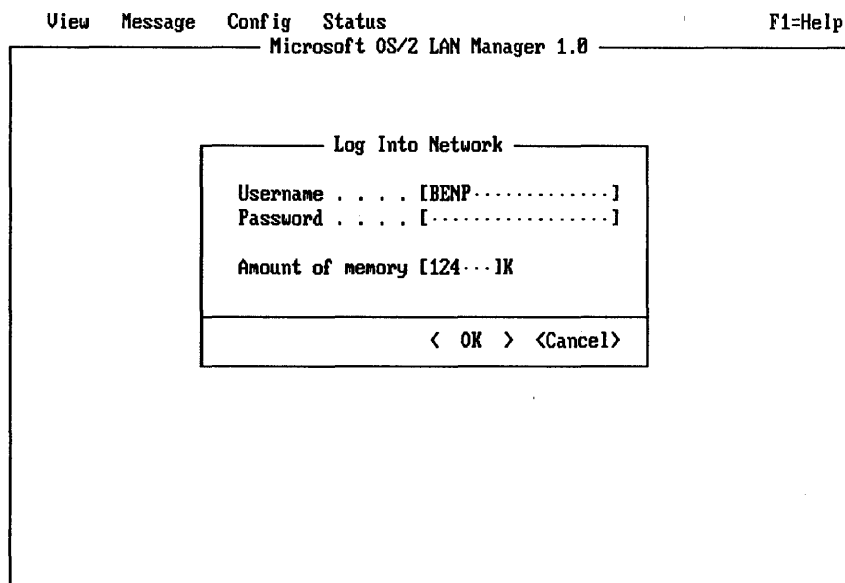

**Figure 2-2. Initial LAN Manager Screen with Log Into Network Dialog Box**

The Log Into Network dialog box allows you to log on to the local area network or to set your user name and password. Once your user name and password are set, you can access resources such as printers and files on the local area network.

For complete information about this dialog box, see the Log Into Network dialog box reference page (access path Config->Logon).

## Selecting Menus and Menu Items

To view a menu, press [Alt] followed by the first letter of the menu name. A menu appears below the menu name. For example, if you type [Alt]+V, the View menu appears (see Figure 2-3).

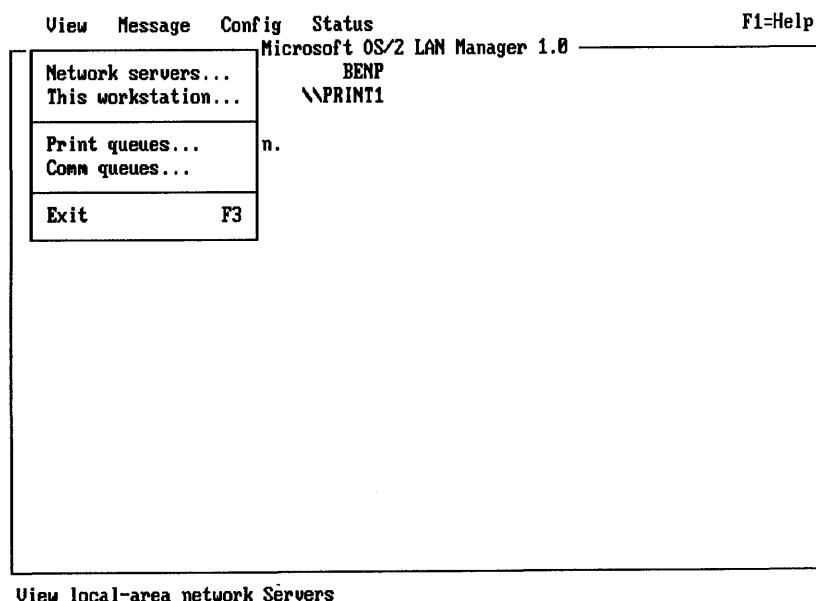

**Figure 2-3. View Menu**

A menu contains one or more options, called **menu items**. Except for the Exit menu item, any menu item you select leads to a dialog box. Use the arrow keys to select a menu item.

(To exit the LAN Manager screen, select the View menu and choose the Exit menu item, or press [F3].)

## Using Help

You can use the LAN Manager screen Help facility to get more information about an option you have selected. When you press [F1], a help box like the one shown in Figure 2-4 displays information about the task that you are performing.

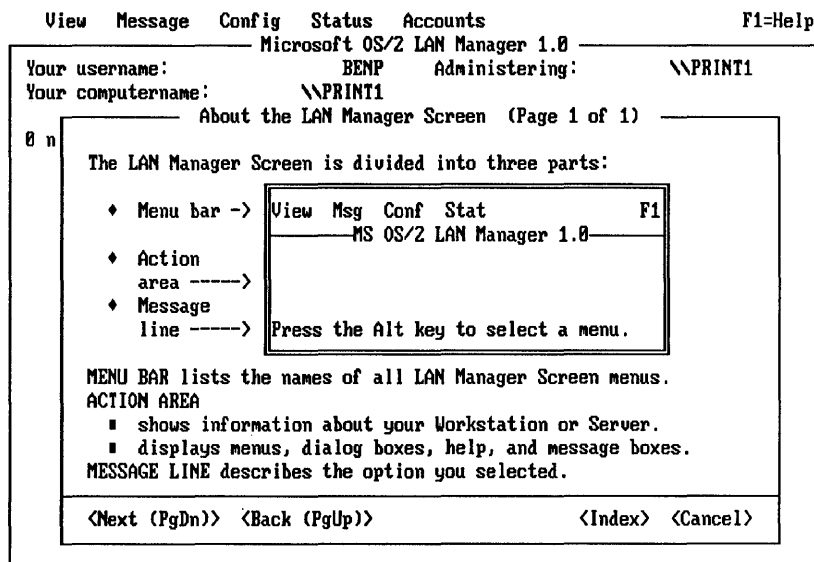

Press the ALT key to select a menu

**Figure 2-4. Using [F1] for Help**

Help is context-sensitive, meaning that it provides you with information about what you are doing. For example, if you select the This workstation menu item and press [F1], a help box appears, showing information about how to use this option. If you have not selected a menu, menu item, or dialog box, Help displays general information about the LAN Manager screen.

By selecting the Index command button from any help box, you can see the Help index. From the Help index, you can choose to see information about other topics.

## Using Dialog Box Elements

When you select a menu item, a corresponding dialog box appears (see Figure 2-5).

Dialog Box Name

Display field	20 sessions	
Text box	[Name            ]	
List box	( ) Option 1	
1st list-box item	(.) Option 2	
2nd list-box item	[X] Check box	
<Zoom>	<Delete>	<OK>

**Figure 2-5. Dialog Box Name Sample**

Dialog boxes include one or more elements. Table 2-1 lists all possible dialog box elements and how to use them:

**Table 2-1. LAN Manager Dialog Box Elements**

Element	How To Use It
List Box	Use the arrow keys to select a list-box item. Typing the first letter of a list box item will also bring the highlight on this item.
Text Box	Type in information, or select information from a list box.
Command Button	Use [Tab] to select a command button.
Option Button	Use arrow keys to mark (enable) one option button in a set.
Check Box	Use [Space bar] to mark or unmark a check box. Or use the Up arrow key ↑ to mark and the Down arrow key ↓ to unmark.
Display Field	The display field contains information only; cannot be selected or changed.



Each dialog box reference in this chapter identifies the dialog box by the following items:

- The name of the dialog box.
- The series of options you must select to access the dialog box.

---

### **Dialog Box Access Paths**

The access path for a dialog box is documented in this form:

Menu -> Menu Item -> Command Button

The access path shows how to reach the dialog box by selecting a series of options. Options are separated by arrows. For example, a typical access line might look like this:

View-> Print queues -> Zoom

In other words, to get to this dialog box, you would perform these steps:

1. **Select the View menu.**
2. **Choose the Print queues menu item.**
3. **From the dialog box that appears, choose the Zoom command button.**

---

### **Menus and Dialog Boxes in This Chapter**

The remainder of this chapter contains reference pages to the LAN Manager menus and dialog boxes shown in Table 2-2, which also shows their access paths. Note that menus and dialog boxes are arranged in this chapter according to access path.

Table 2-2 shows the access path and name of each menu and dialog box documented in this chapter.

**Table 2-2. LAN Manager Menus and Dialog Boxes**

Select	To see
View	View menu.
Network servers...	Servers available on the Network.
-> Zoom	Resources at (server).
-> Use	Use the resource (network path).
This workstation...	Network Resources in Use at Your Workstation.
-> Add use	Use a Network Resource.
-> OK	Accessing (network path).
-> Zoom	Usage Information for a Network Resource.
Print queues...	Show Print Queues For....
-> Zoom	Print Queues for (server).
-> Zoom	Printing Options for Job.
-> Zoom	Printing Options for Queue.
Comm queues...	Show Comm Queues For....
-> Zoom	Comm Queues for (server).
-> Zoom	Options for Comm Queues.
Message	Message menu.
Send...	Send a Message.
Read...	Contents of Current Message Log.
Log file...	Specify Message Log File.
Aliases...	Aliases for Messaging.
-> Add alias	Add an Alias.
-> Forward	Forward an Existing Alias.
Config	Config menu.
Logon...	Log into Network.
Load profile...	Load Configuration.
Save profile...	Save Configuration.
Change password...	Change Logon Password at a Server.
Status	Status menu.
Workstation Statistics...	Workstation Statistics Information.
Error Log...	Network Error Log.
-> Zoom	Error Log Record.

---

## View Menu

The View menu items let you use dialog boxes with information about resources on the local area network. Some of these dialog boxes show the resources being shared by servers. Others show the status of the resources you are using.

A resource can be a print queue, a communication-device queue, or a disk directory that can be shared by a server to the local area network.

The following sections describe the menu items for the View menu.

---

### Network Servers

The Network Servers menu item displays the Servers Available on Network dialog box, which shows the names and comments for servers that are part of your LAN group. You can do the following things from this dialog box:

- Select the computer name of a server to list its shared resources.
- Type the computer name of any server on the local area network to list its shared resources.
- Use a shared resource from a local area network server.
- Stop using a shared resource.

---

### This Workstation

The This Workstation menu item displays the Network Resources in Use at Your Workstation dialog box, which shows all shared resources the local netstation is using. From this dialog box you can do the following things:

- Get more information about one of your netstation's current connections.
- Pause temporarily the use of shared printers and communication devices from your netstation.
- Add a connection to a shared resource.
- Delete a connection to a shared resource.

---

## **Print Queues**

The Print queues menu item displays the Show Print Queues For dialog box, which lists all servers and the print queues they own. It also lists all of your netstation's local devices that are connected to print queues. From this dialog box you can do the following things:

- List the contents of a print queue connected to a local device.
- List the print queues made available by a specific server.
- List the options of a print queue.
- Modify the status of your print job.

---

## **Comm Queues**

The Comm queues menu item displays the Show Comm Queues For dialog box, which lists all servers and the communication-device queues they own. It also names the local devices currently connected to shared communication-device queues. You can do the following things from this dialog box:

- List the communication-device queues for a specified server.
- Check the status of communication-device queues currently connected to a local device.
- List the options of a communication-device queue.

---

## **Exit**

The Exit menu item exits the LAN Manager screen and returns you to the OS/2 prompt.

## Servers Available on the Network

Access: View -> Network servers

The Servers Available on Network dialog box shows the servers available on the local area network. These servers can control resources such as disks, print queues, and communication-device queues. If a server is sharing resources, you can use a shared resource by redirecting a local device to the network resource. Select the name of a server and the Zoom command button to see a list of resources being shared by a particular server. Figure 2-6 shows the Servers Available on Network dialog box.

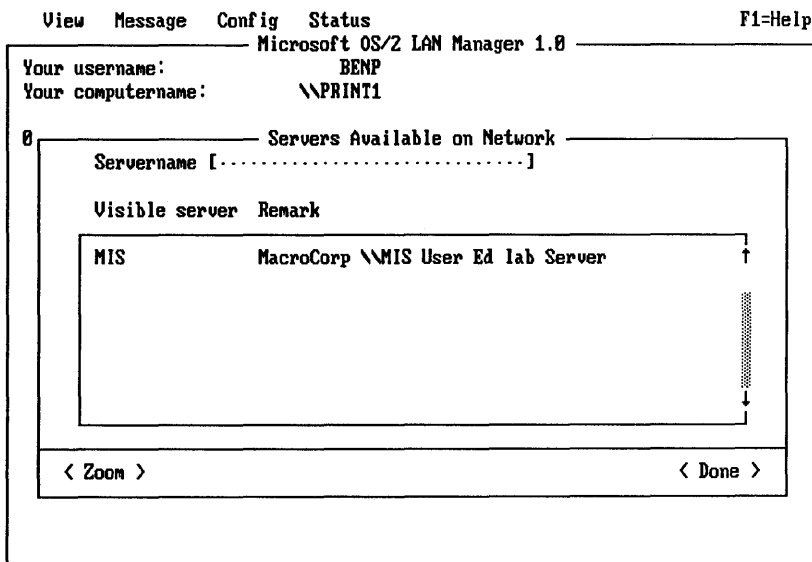

Press the ALT key to select a menu

**Figure 2-6. Servers Available on Network Dialog Box**

**Server name** Specifies the name of a server that you want to display more information about.

The dialog box contains one list box with two columns. If you are using the Entry Level LAN Manager product, this list box should contain only one entry.

<b>Column</b>	<b>Contents</b>
Visible server	The names of all visible servers.
Remark	A descriptive comment about each server.

- Zoom**                      Displays the Resources at (Server) dialog box, shown in Figure 2-7.  
(You must have access permission for a server in order to do this.)
- Done**                        Exits the dialog box and returns to the LAN Manager screen.

---

### **Listing a Server's Shared Resources**

To see detailed information about a particular server, perform the following steps:

- 1. Specify the name of the server you want information about by doing one of the following:**
  - From the list box, select the name of a server.
  - In the text box, type in the name of a server.
- 2. Choose the Zoom command button.**

The Resources at (Server) dialog box appears.

## Resources at (Server)

Access: View -> Network servers -> Zoom

The Resources at (Server) dialog box shows the shared resources controlled by a server. It shows the local area network name, device type, redirected device name, and a comment about the server. With this dialog box, you can use, or stop using, a shared resource.

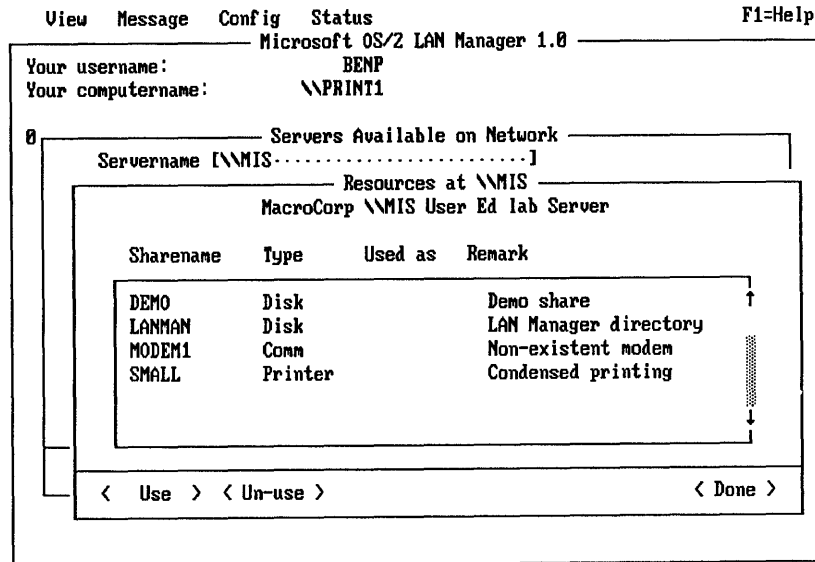

Press the ALT key to select a menu

**Figure 2-7. Resources at (Server) Dialog Box**

The list box contains four columns:

Column	Contents
Sharename	The name of each shared resource controlled by the server.
Type	The type of resource shared. A shared resource can be a disk, a printer, or a communication device.

Column	Contents
Used as	The name of a local device redirected to the shared resource. (If you have redirected more than one local device to the shared resource, the first local device name, followed by ellipses [\ . \ . \ .], appears here.)
Remark	A descriptive comment about the shared resource.

<b>Use</b>	Displays the Use the resource (network path) dialog box (see Figure 2-8).
<b>Un-use</b>	Disconnects the local device from the shared resource.
<b>Done</b>	Returns to the Servers Available on the Network dialog box.

---

### Using a Shared Resource

To use a shared resource, perform these two steps:

1. From the list box, select the name of that resource.
2. Choose the Use command button.

The Use the Resource (network path) dialog box appears. You can then redirect a local device to the shared resource.

---

### Stop Using a Shared Resource

To stop using a shared resource, perform these three steps:

1. From the list box, select the resource.
2. Choose the Un-use command button.

A message box appears, asking you to confirm your decision.

3. Choose the OK command button to unlink your local device from the shared resource.



## Use the Resource (Network Path)

Access: View -> Network Servers -> Zoom -> Use

The Use the resource (network path) dialog box allows you to use a shared resource on a server (see Figure 2-8). Depending upon the type of the shared resource you selected before entering this dialog box, a default local device name may appear in the first edit field.

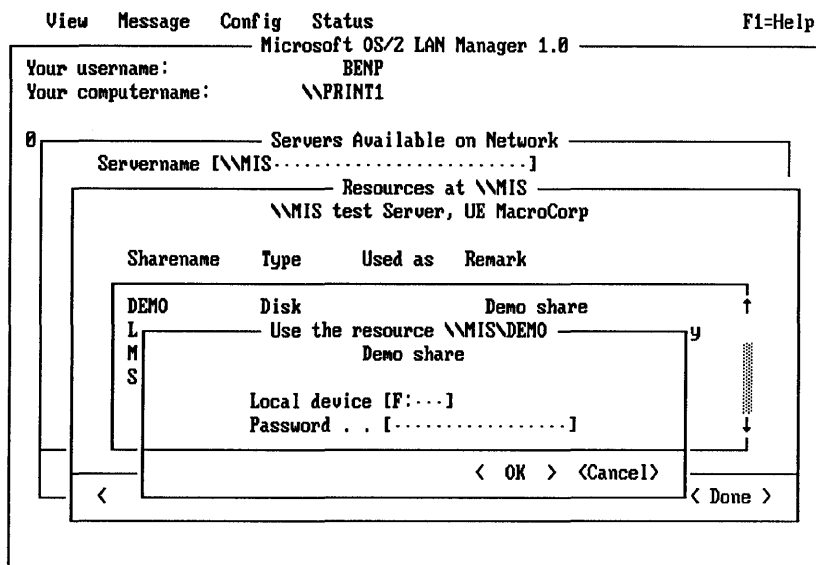

View local-area network Servers

**Figure 2-8. Use the Resource (Network Path) Dialog Box**

### Local device

Specifies the name of a local device you selected to be redirected to the shared device (*drive*: for disk devices; LPT# for printers; and COM# for communication devices). More than one local device name—separated by commas (,), semicolons (;), or spaces—may be specified here.

- Password** Provides a place for you to type a password for the shared resource, if required. A server requires passwords when share-level security is running. A password is also required if you did not specify a password when logging on and if this is the first shared resource to which you are connecting.
- OK** Redirects the local device to the shared resource.
- Cancel** Exits the dialog box without redirecting to the resource and returns to the Resources at (server) dialog box.

---

### **Connecting to a Shared Resource**

To use the selected shared resource, perform these three steps:

1. **Type the local device name (for example, E: or LPT2) in the Local device text box.**

LAN Manager typically suggests an available local device name for you to use.

You may accept the default device name or type in another one.

2. **Type the password in the Password text box if necessary.**
3. **Choose the OK command button.**

---

### **Network Resources in Use at Your Workstation**

Access: View -> This Workstation

The Network Resources in Use at Your Workstation dialog box shows the local device names for the shared resources that you are using (see Figure 2-9). These resources are listed according to the local device name that you have assigned to the shared resource. From this dialog box, you can add or delete a resource from this list. You can also select a resource name and choose the Zoom command button to see more information about a resource.

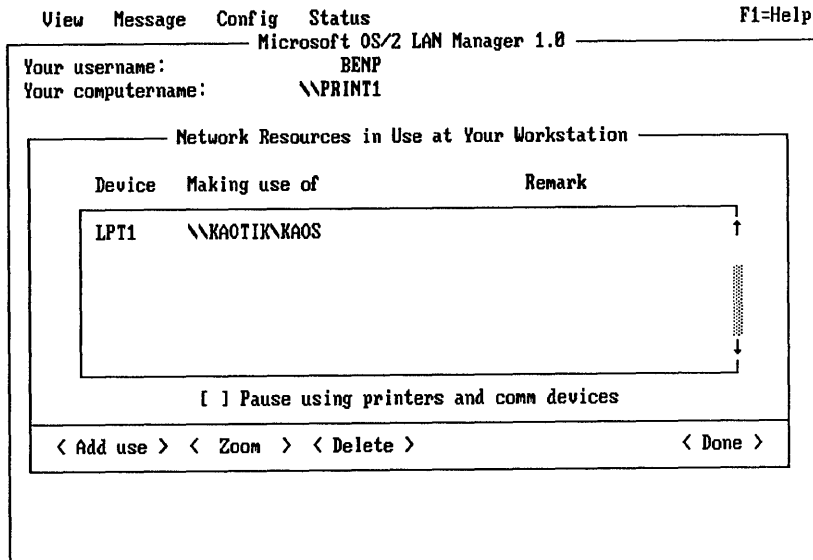

Press the ALT key to select a menu

**Figure 2-9. Network Resources in Use at Your Workstation Dialog Box**

This dialog box contains one list box with three columns:

Column	Contents
Device	The local device name.
Making use of	The network path of the shared local area network resource (in the format <i>\\server\resource</i> ).
Remark	A descriptive comment about the shared resource.

**Pause using  
printers and  
comm devices**

Suspends redirection of local devices (parallel and serial ports) to shared resources and frees them for local use.

<b>Add use</b>	Displays the Use a Network Resource dialog box.
<b>Zoom</b>	Displays the Usage Information for a Network Resource dialog box.
<b>Delete</b>	Disconnects a local device from a shared resource.
<b>Done</b>	Exits the dialog box and returns to the LAN Manager screen.

---

### **Adding a New Connection**

To connect to a new shared resource, perform this step:

1. **Choose the Add use command button.**

The Use a Network Resource dialog box appears, allowing you to use the shared resource you specify.

---

### **Deleting a Connection**

To disconnect a local device from a shared resource, perform these two steps:

1. **Select the device from the list box.**
2. **Choose the Delete command button.**

---

### **Getting More Information About a Resource**

To get more information about a shared resource, perform these two steps:

1. **From the list box, select the name of the shared resource.**
2. **Choose the Zoom command button.**

The Usage Information for a Network Resource dialog box displays detailed information about the selected local device.

## Use a Network Resource

Access: View -> This workstation -> Add use

The Use a Network Resource dialog box allows you to connect one of your local device names (such as LPT1 and COM1) to a shared resource (see Figure 2-10).

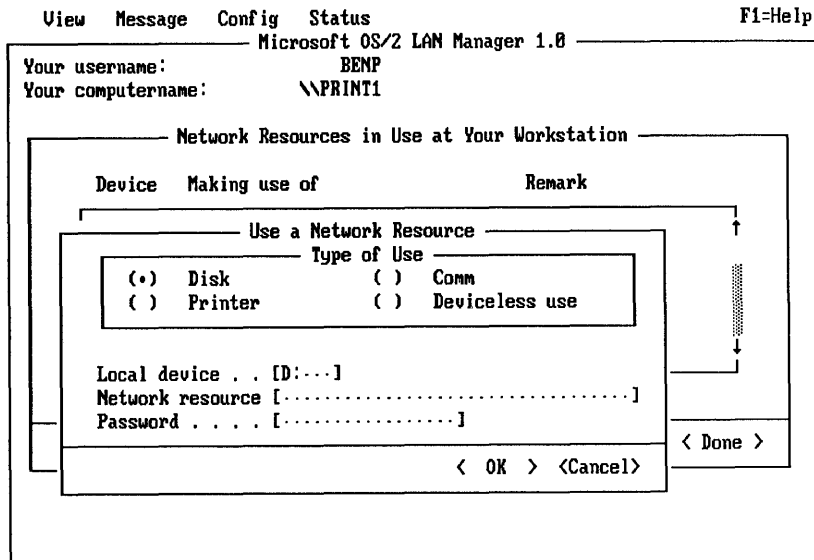

Press the ALT key to select a menu

**Figure 2-10. Use a Network Resource Dialog Box**

The Use a Network Resource dialog box includes four option buttons:

Button	Function
Disk	Defines the local device as a disk.
Printer	Defines the local device as a spooled printer.
Comm	Defines the local device as a communication device.
Deviceless use	Allows you to connect to a shared resource without redirecting a local device.

<b>Local device</b>	Specifies the name of the local device to be redirected to the shared resource. The default is the next available device name ( <i>drive:</i> for disk devices; <i>LPT#</i> for print queues; and <i>COM#</i> for communication-device queues).
<b>Network resource</b>	Specifies the network path of the shared resource (use the format <i>\\server\resource</i> ).
<b>Password</b>	Specifies a password for the shared resource (if the resource requires a password).
<b>OK</b>	Redirects the local device to the shared resource.
<b>Cancel</b>	Exits the dialog box and returns to the Network Resources in Use at Your Workstation dialog box without redirecting the shared resource.

---

### **Connecting to the Shared Resource**

To connect a local device name to a shared resource, perform these five steps:

- 1. Select the Disk, Printer, Comm, or Deviceless use option button.**

LAN Manager finds the first available local device name for the device type you select and displays that device name in the Local device text box. (No device name displays if you select Deviceless use.)

- 2. In the Local device text box, type in a new device name (such as E:, LPT2, or COM1) if you want to assign another local device name to the shared resource.**
- 3. In the Network resource text box, type the network path of the shared resource.**

A network path includes the name of the server and the shared resource in the format *\\server\resource* (for example, *\\mis\modems*).

4. If the server or shared device requires a password, type the password in the Password text box.
5. Choose the OK command button.

## Accessing (Network Path)

**NOTE:** Network path is the name of a server followed by the name of a resource in the format `\\server\resource`.

Access: View -> This workstation -> Add use -> OK

The Accessing (network path) dialog box appears if you did not specify a password when connecting to a shared resource that requires a password. It asks you to supply a password for the resource specified (see Figure 2-11).

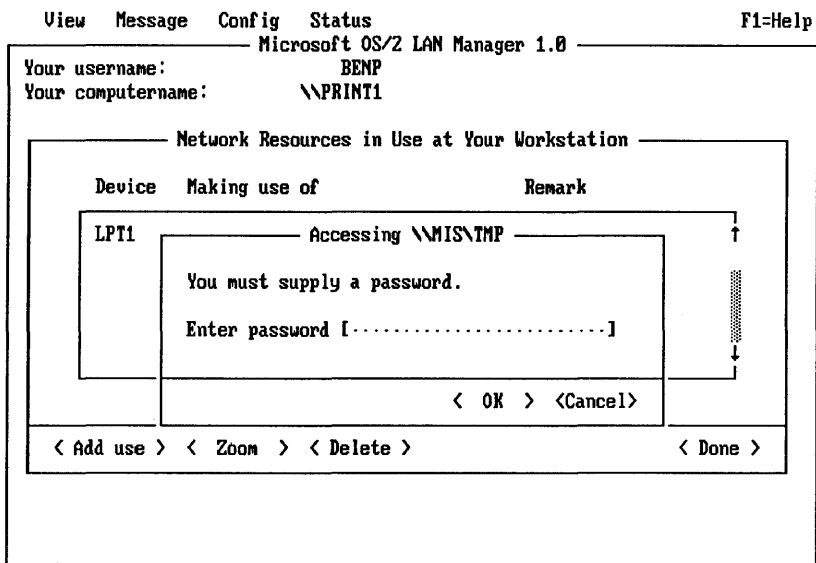

Press the ALT key to select a menu

**Figure 2-11. Accessing (Network Path) Dialog Box**

<b>Enter password</b>	Provides a place for you to type the password for the shared resource. This is not the same as your log-on password.
<b>OK</b>	Redirects your local device to the shared resource if the password you typed is correct.
<b>Cancel</b>	Exits the dialog box and returns to the Use a Network Resource dialog box.

---

### **Supplying a Password**

To specify a password for a shared resource on a share-level server, perform these two steps:

1. **Type in the password.**
2. **Choose the OK command button.**

---

### **Usage Information for a Network Resource**

Access: View -> This workstation -> Zoom

The Usage Information for a Network Resource dialog box displays information about a local device connected to a shared resource (see Figure 2-12). The local device can be a disk, print queue, or communication-device queue.



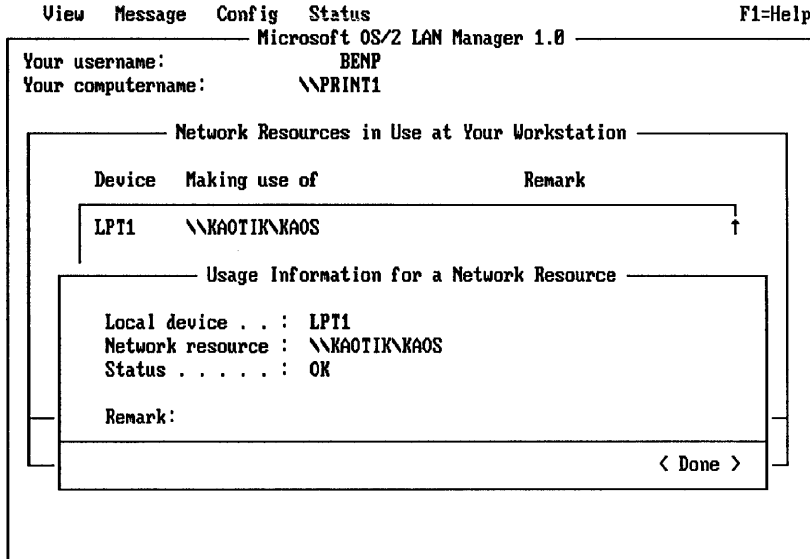

Press the ALT key to select a menu

**Figure 2-12. Usage Information for a Network Resource Dialog Box**

- Local device**            Displays the local device name assigned to the resource (*drive*: for disk devices; LPT# for print queues; and COM# for communication-device queues).
- Network resource**    Displays the network path of the shared resource (in the format \\server\resource ).
- Status**                Displays the status of the local device. The status can be OK, Disconnected, Error, Connecting, or Reconnecting.
- Remark**                Displays a comment about the shared resource.
- Done**                  Returns to the Network Resources in Use at Your Workstation dialog box.

## Show Print Queues For

Access: View -> Print queues

The Show Print Queues For dialog box lists the names of servers in your LAN group and the print queues each is sharing with the local area network. This dialog box also shows local device names that are redirected to shared print queues (see Figure 2-13). From this dialog box, you can select the name of a queue and the Zoom command button to see more information about a particular queue (see Figure 2-14).

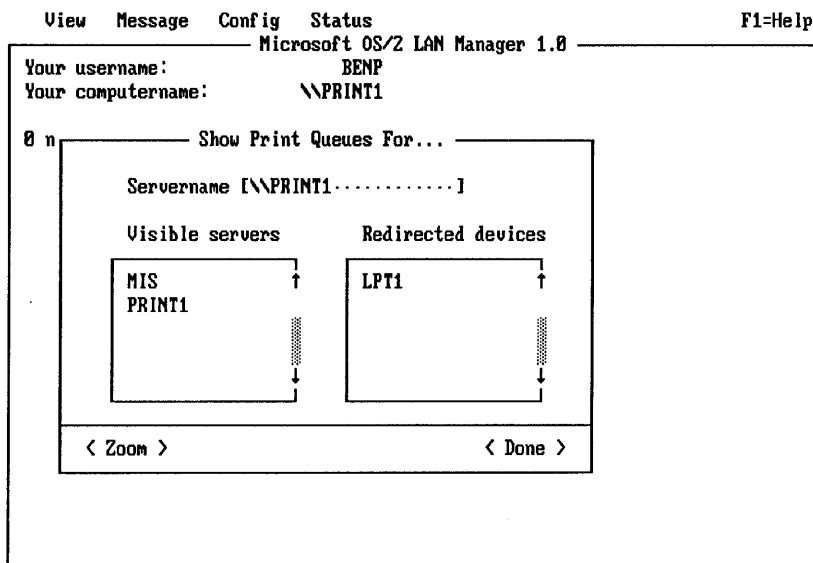

Press the ALT key to select a menu

**Figure 2-13. Show Print Queues For Dialog Box**

- Servername** Specifies the name of the server you want more information about.
- Visible servers** Lists all servers in your LAN group. If you are using the Entry Level LAN Manager product, this list box should contain only one entry.
- Redirected devices** Lists all of the local device names redirected to print queues.

- Zoom** Displays the Print Queues for (server) dialog box (see Figure 2-14). You must have access permission for a server in order to see information about its shared print queues.
- Done** Exits the dialog box and returns to the LAN Manager screen.

---

## Listing a Server's Print Queues

To list all print queues shared by a server, perform these two steps:

1. **Specify the name of the server one of two ways:**
  - Select the name of the server from the server list box.
  - Type in the name of the server in the server text box.
2. **Choose the Zoom command button.**

---

## Print Queues for (Server)

Access: View -> Print queues -> Zoom

The Print Queues for (server) dialog box shows the print queues on a server. It also shows the jobs in each print queue and the status of each queue and job (see Figure 2-14). The status of a print queue can be OK, Held, Held until, Pending delete, or Error.

The status of a print job can be listed as Spooling, Held, Printing on (device), Held on (device), Out of paper on (device), Error on (device), Off line on (device), or Waiting.

Print queues are listed in order of priority. Print queues with lower numbers have higher priority. Jobs in print queues with high priority are printed before jobs in print queues with low priority. From this dialog box, users can hold or restart a print job. Administrators can also hold or continue a queue.

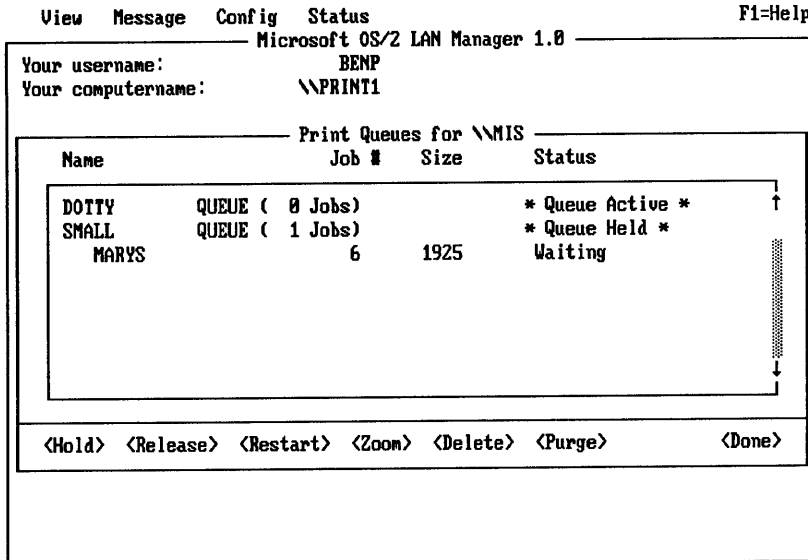

Press the ALT key to select a menu

**Figure 2-14. Print Queues for (Server) Dialog Box**

The Print Queues for (Server) dialog box contains a list box with four columns:

Column	Contents
Name	Name of the print queue or owner of the print job.
Job #	Identification number assigned to the print job.
Size	Size (in bytes) of the print job.
Status	Status of the print queue or job.

**Hold** Holds the selected print job in the print queue so it doesn't print.

**Release** Releases the job from its held state.

**Restart** Reprints the selected document from the beginning.

<b>Zoom</b>	Displays the Printing Options for Job or Printing Options for Queue dialog box with detailed information about the selected item.
<b>Delete</b>	Removes the selected print job.
<b>Purge</b>	Is available to administrators only.
<b>Done</b>	Exits the dialog box and returns to the Show Print Queues For dialog box.

---

### **Changing the Status of Your Print Job**

To change the status of print jobs you own, perform these two steps:

1. **Select the job from the list box.**
2. **Choose one of the following command buttons:**
  - **Hold**—to hold the job in the queue and not print it.
  - **Release**—to allow a held job to be sent to the printer.
  - **Restart**—to begin reprinting from the beginning a document that was interrupted due to some error.
  - **Delete**—to remove the print job so that it won't be printed.

---

### **Getting More Information About a Job or Queue**

1. **Select the print job from the list box.**
2. **Choose the Zoom command button.**

The Printing Options for Queue or Printing Options for Job dialog box appears.

- When you are finished reading the information, choose the OK command button.

**NOTE:** administrators can change the status of print queues. For more information, see the 3+*Open MS OS/2 LAN Manager Administrator Reference*.

## Printing Options for Job

Access: View -> Print queues -> Zoom-> Zoom

The Printing Options for Queue dialog box displays printing options for a selected job (see Figure 2-15). From this dialog box, you can move the job to the beginning or the end of a queue.

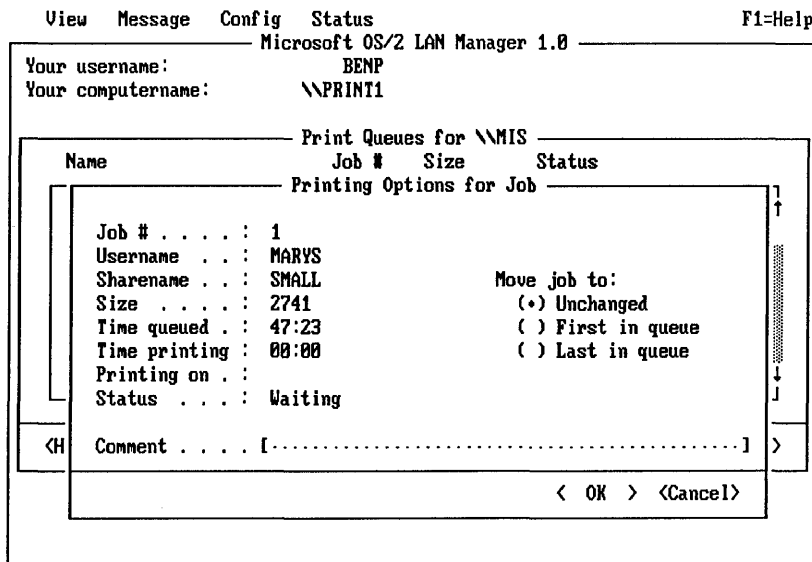

View spooled print queues

**Figure 2-15. Printing Options for Job Dialog Box**

**Job #** Displays the job's current position in the queue.

<b>Username</b>	Displays the name of the user who submitted the job for printing.
<b>Sharename</b>	Displays the name of the print queue containing the job.
<b>Size</b>	Displays the size (in bytes) of the print job.
<b>Time queued</b>	Displays the length of time the job has been in the print queue.
<b>Time printing</b>	Displays the length of time the print job has been printing.
<b>Printing on</b>	Displays the name of the printer.
<b>Status</b>	Displays the job's status.
<b>Comment</b>	Provides a space for you to type the description of the print job.

The Printing Options for Job dialog box includes three option buttons:

<b>Button</b>	<b>Function</b>
Unchanged	Print job maintains its original position in the queue.
First in queue	Moves the print job to the beginning of the print queue. This job is printed next.
Last in queue	Moves the print job to the end of the print queue. This job is printed last.

<b>OK</b>	Saves the current options and the dialog box before exiting and returning to the Print Queues for (Server) dialog box.
<b>Cancel</b>	Exits the dialog box without saving the options and returns to the Print Queues for (server) dialog box.

---

### **Changing the Position of a Print Job**

To change the position of your job in a print queue, perform these two steps:

1. Select one of the following option buttons to change the position of the job in the print queue:
  - First in queue.
  - Last in queue.
2. Choose the OK command button.

## Printing Options for Queue

Access: View > Print queues -> Zoom -> Zoom

The Printing Options for Queue dialog box displays information for a print queue (see Figure 2-16). Print queue options affect how the queue spools print jobs to its printers. From this dialog box, an administrator can change the options for a print queue.

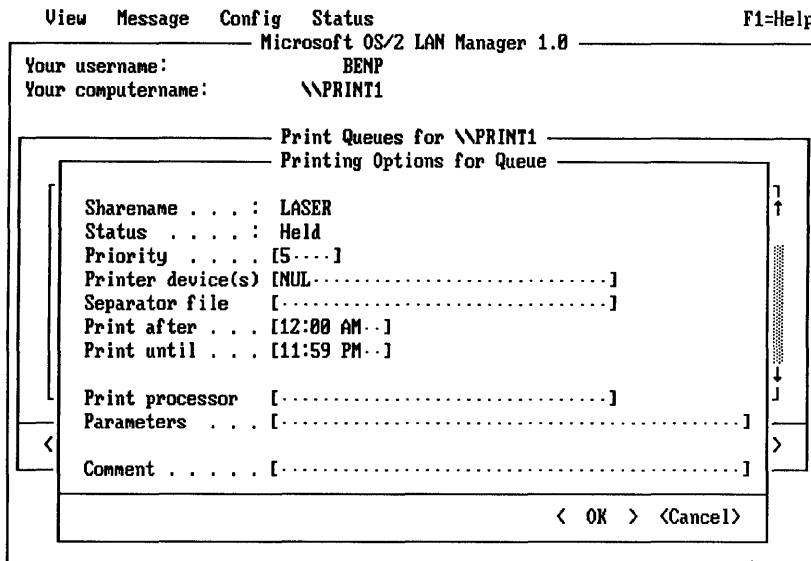

Press the ALT key to select a menu

Figure 2-16. Printing Options for Queue Dialog Box



<b>Sharename</b>	Displays the name of the print queue.
<b>Status</b>	Displays the status of the print queue.
<b>Priority</b>	Specifies the priority setting for the print queue. The highest priority is 1; the lowest is 9. (The default is 5.)
<b>Printer device (s)</b>	Specifies the names of the one or more printers to which the print queue can spool print jobs. Multiple device names are separated by semicolons (;), commas (,), or spaces.
<b>Separator file</b>	Specifies the name of the file that contains the print job separator page. The print queue prints this page following each print job.
<b>Print after</b>	Specifies the time of day (in <i>hh:mm</i> format) the print queue is to begin spooling print jobs to printers. (The default is 00:00.)
<b>Print until</b>	Specifies the time of day (in <i>hh:mm</i> format) after which the print queue no longer spools print jobs. (The default is 23:59.)
<b>Print processor</b>	Specifies the name of the print preprocessor (a program that prepares certain document files for the printer).
<b>Parameters</b>	Specifies different parameters used by the print preprocessor.
<b>Comment</b>	Provides a description of the print queue.
<b>OK</b>	Saves the options in the text boxes and returns to the Print Queues for (server) dialog box (if you arrived here through that dialog box).
<b>Cancel</b>	Exits the dialog box without saving the options in the text boxes and returns to the Print Queues for (server) dialog box.

**NOTE:** Administrators can use the Printing Options for Queue dialog box to change the status of print queues. For more information, see the *3+Open MS OS/2 LAN Manager Administrator Reference*.

## Show Comm Queues For

Access: View -> Comm queues

The Show Comm Queues For dialog box lists the names of servers controlling communication-device queues. From this dialog box, you can examine a particular server to see which communication-device queues, if any, it is controlling (see Figure 2-17).

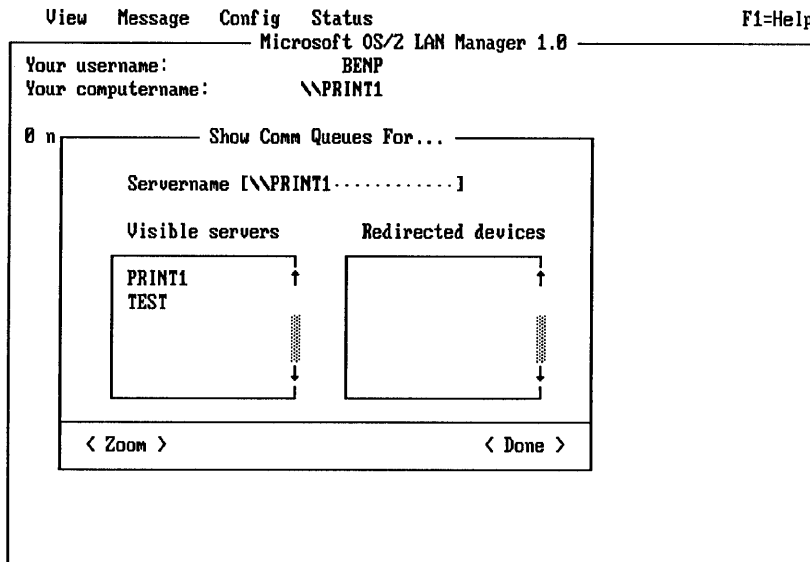

Press the ALT key to select a menu

**Figure 2-17. Show Comm Queues For Dialog Box**

- |                           |  |
|---------------------------|--|
| <b>Servername</b>         | Specifies the name of a server you want more information about.  |
| <b>Visible servers</b>    | Lists the names of all servers in your LAN group. If you are using the Entry Level LAN Manager product, this list box should contain only one entry. |
| <b>Redirected devices</b> | Lists the names of all local devices redirected to communication-device queues.  |

<b>Zoom</b>	Displays the Comm Queues for (Server) dialog box (see Figure 2-18).
<b>Done</b>	Exits the dialog box and returns to the LAN Manager screen.

---

### **Listing a Server's Comm Queues**

To list all communication-device queues shared by a server, perform these two steps:

1. **Specify the name of the server one of two ways:**
  - Select the name of the server from the server list box.
  - Type in the name of the server in the server text box.
2. **Choose the Zoom command button.**

---

### **Listing a Comm Queue Linked to a Local Device**

To find out which communication-device queue is linked to a particular local device name, perform these two steps:

1. **From the Redirected devices list box, select the device name (for example, COM2).**
2. **Choose the Zoom command button.**

---

### **Comm Queues for (Server)**

Access: View -> Comm queues -> Zoom

The Comm Queues for (Server) dialog box displays a list of all communication-device queues on a server and shows the users' requests waiting in the queue (see Figure 2-18). Alternately, if you specified a particular local device name, this dialog box shows information about the one queue to which the local device is redirected. Administrators can change the status of communication-device queues. For more information, see the *3+Open MS OS/2 LAN Manager Administrator Reference*.

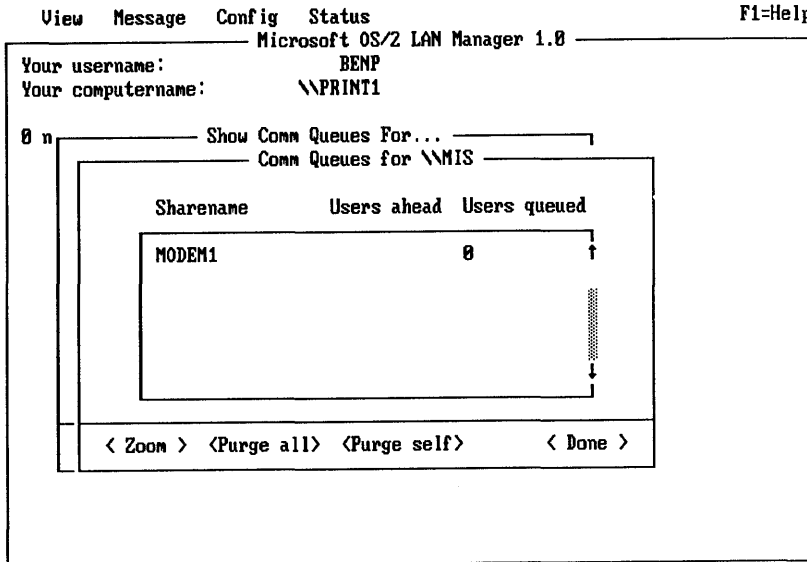

Press the ALT key to select a menu

**Figure 2-18. Comm Queues for (Server) Dialog Box**

This dialog box displays a list box with three columns:

Column	Contents
Sharename	Name of the communication-device queue.
(Number of) Users ahead	Number of requests preceding the specified request in the queue.
(Number of) Users queued	Number of requests waiting in the communication-device queue.

- Zoom** Displays the Options for Comm Queues dialog box.
- Purge all** Deletes all jobs in a queue; this command button is available to the administrator only.
- Purge self** Deletes all jobs submitted from this computer.

**Done** Exits the dialog box and returns to the Show Comm Queues For dialog box.

## Getting More Information About a Queue

To find out more about a particular communication-device queue, perform these two steps:

1. From the Comm Queues for (server) list box, select the queue.
2. Choose the Zoom command button.

## Options for Comm Queue

Access: View -> Comm queues -> Zoom -> Zoom

The Options for Comm Queue dialog box displays information about the communication-device queue you selected. From this dialog box, administrators can change the queue's local devices and priority (see Figure 2-19).

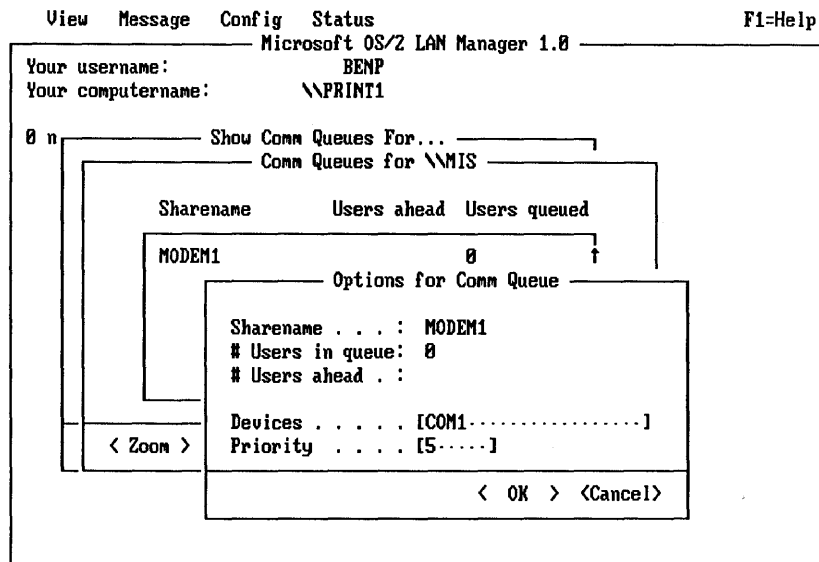

Press the ALT key to select a menu

**Figure 2-19. Options for Comm Queue Dialog Box**

<b>Sharename</b>	Displays the name of the communication device.
<b># Users in queue</b>	Displays the number of requests in the queue.
<b># Users ahead</b>	Displays the number of requests that precede the request from your computer in the queue.
<b>Devices</b>	Specifies one or more communication devices to which the communication-device queue can route requests. Multiple device names are separated by semicolons (;), commas (,), or spaces.
<b>Priority</b>	Specifies the priority for the communication-device queue. The highest priority is 1; the lowest is 9. (The default is 5.)
<b>OK</b>	Saves the information in the text boxes and returns to the Comm Queues for (server) dialog box.
<b>Cancel</b>	Exits the dialog box without saving the information in the text boxes and returns to the Comm Queues for (Server) dialog box.

**NOTE:** Administrators can use this dialog box to change the status of communication-device queues. For more information, see the *3+Open MS OS/2 LAN Manager Administrator Reference*.

---

## Message Menu

The Message menu items let you use the LAN Manager Messenger service. The Message service allows you to send and receive messages over the local area network. It also allows you to keep a log of the messages you receive (see Figure 2-20). The following sections describe the Message menu items .

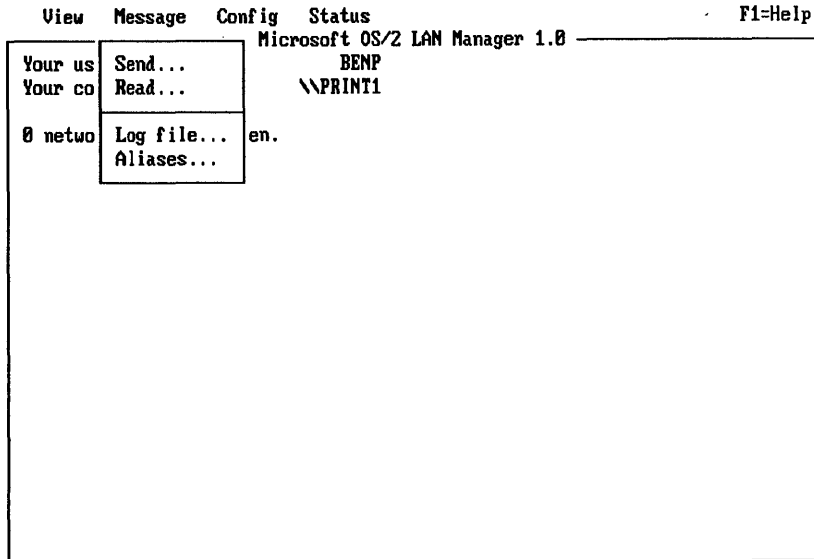

Send a message

**Figure 2-20. Message Menu**

## **Send**

The Send menu item displays the Send a Message dialog box from which you can send a message to one or more users on the local area network. You may type the text of the message in this dialog box or specify a file containing the message.

## **Read**

The Read menu item displays the Contents of Current Message Log dialog box from which you can do the following things:

- Read messages sent to you by others on the local area network.
- Clear the contents of the message log.

## **Log File**

The Log file menu item displays the Specify Message Log File dialog box from which you can do the following things:

- Type the filename of the message log to store incoming messages.
- Pause or continue message logging.
- Start or stop the Netpopup service.

## **Aliases**

The Aliases menu item displays the Aliases for Messaging dialog box from which you can do the following things:

- Add message aliases to the list for your netstation.
- Forward your messages to another user's alias.
- Receive messages for another user.
- Delete an alias.
- Stop forwarding your messages.

## **Send a Message**

Access: Message -> Send

The Send a Message dialog box allows you to send a message or file to a user on the local area network (see Figure 2-21). The user's alias identifies the destination of your message. If your message is short (less than 255 characters), you can type your message in the space provided. Or, you can use a text editor to create a message file.



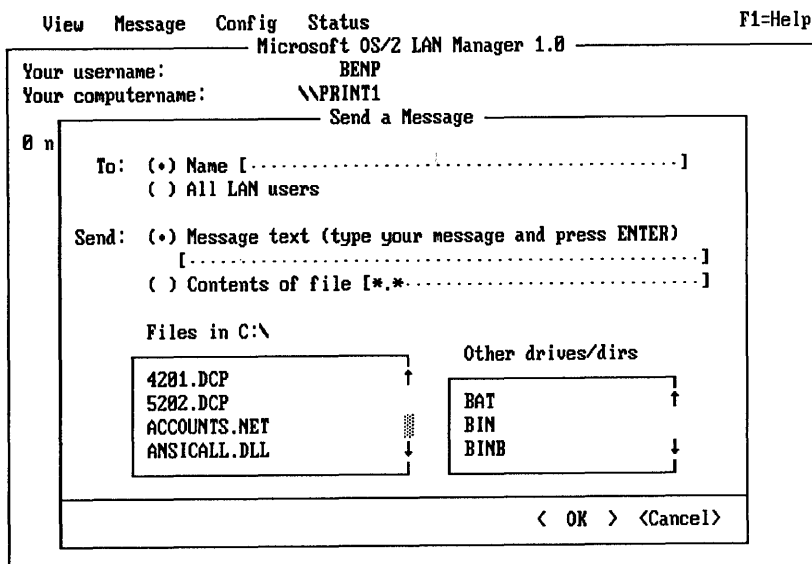

Press the ALT key to select a menu

**Figure 2-21. Send a Message Dialog Box**

**To** Allows you to select from two options to specify the recipient:

Button	Function
Name	Sends the message to one or more aliases you type in the text box. Aliases must be separated by semicolons (;), commas (,), or spaces.
All LAN Users	Sends the message to all users on the local area network.

**Send** Specifies the type of message you are sending:

Button	Function
Message text	Sends a message you type in the Message text box.
Contents of file	Sends a message contained in the file specified in the Contents of file text box.

<b>Message text</b>	Specifies message text up to 255 characters long. For a local area, network-wide broadcast, the message may be up to 128 characters long.
<b>Contents of file</b>	Specifies the pathname of a file you want to send.
<b>Files in (directory)</b>	Lists the names of files in the current directory. If you specify a wild-card character (* or ?) in the Send Contents of file text box and choose the OK command button, this list box displays filenames that match the wild-card search.
<b>Other drives/dirs</b>	Lists the names of disks and directories containing possible message files. Selecting an item changes the contents of the Send Message text box. When you select an item from this list box and also select the OK command button, the contents of the Files in (directory) list box change.
<b>OK</b>	Sends the message or file to the specified recipient(s) and returns to the LAN Manager screen.
<b>Cancel</b>	Exits the dialog box without sending the message or file and returns to the LAN Manager screen.

---

## **Sending a Message**

To send a message to one or more users of the local area network, perform these three steps:

- 1. Specify the recipient(s) of your message by selecting one of the To options.**
- 2. Identify the type of message you want to send:**
  - Select the Message text option and type your message if you want to send a short message.
  - Select the Contents of file option and specify the filename if you are sending the contents of a file.

**NOTE:** If you use a ? or \* wild-card in the Contents of file text box, then select the Send Contents of file option button and choose the OK command button; a list of files that match the wild-card search will appear in the Files in (directory) list box.

3. Choose the OK command button.

## Contents of Current Message Log

Access: Message -> Read

The Contents of Current Message Log dialog box displays the contents of the current message log file and allows you to clear the contents of the file (see Figure 2-21).

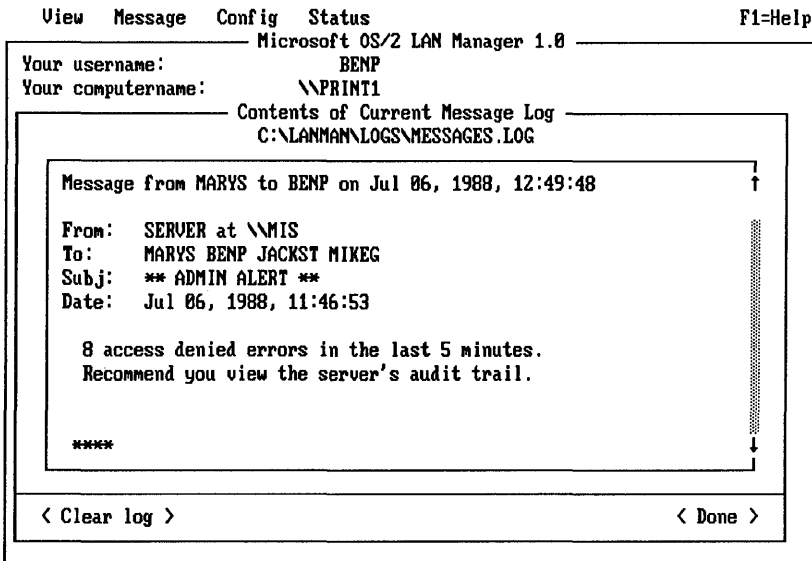

Press the ALT key to select a menu

**Figure 2-21. Contents of Current Message Log Dialog Box**

<b>List box</b>	Lists the messages in the message log.
<b>Clear log</b>	Clears all of the messages in the current log file.
<b>Done</b>	Exits the dialog box and returns to the LAN Manager screen.

---

## **Reading Logged Messages**

To read the messages in the message log, perform these two steps:

1. Use the Arrow keys to scroll through the contents of the message log.
2. Choose the Done command button to exit the dialog box.

---

## **Clearing the Message Log**

To erase the contents of the message log, perform this step:

1. Choose the Clear log command button.

All messages are deleted.

---

## **Specify Message Log File**

Access: Message ->Log file

The Specify Message Log File dialog box allows you to pause message logging or change the file in which your messages are recorded. The default message log file is \LANMANLOGS\MESSAGE.LOG (see Figure 2-22).

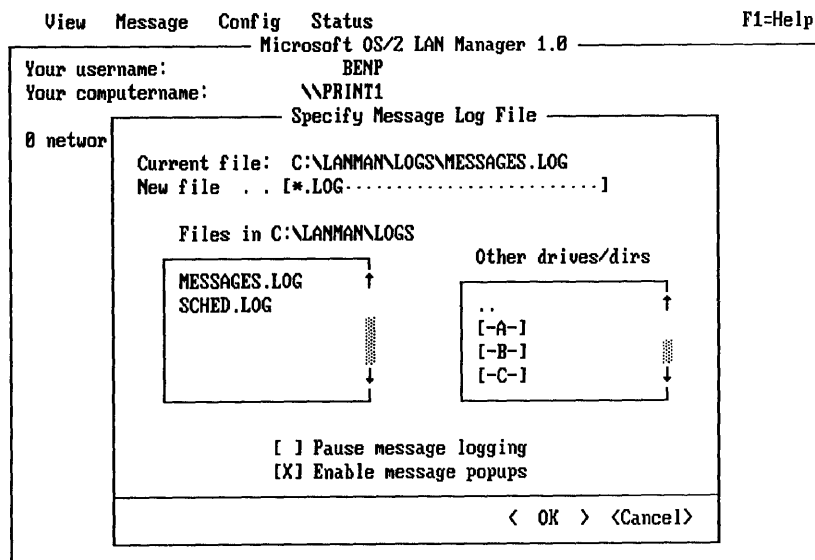

Press the ALT key to select a menu

## Figure 2-22. Specify Message Log File Dialog Box

- Current file** Displays the filename of the current message log.
- New file** Specifies the pathname of a new message log file. Note that if you specify only a filename, LAN Manager creates that file in the LANMANLOGS directory. If you do not specify a filename extension, LAN Manager assigns an extension of .LOG.
- Files in (directory)** Lists the files in the LANMANLOGS directory. If you specify a wild-card character (\* or ?) in the New file text box and choose the OK command button, this list box displays filenames that match the wild-card search.
- Other drives/dirs** Lists the names of drives and directories on your computer. Use this list box to search for the name of the new log file for your computer. Selecting an item changes the contents of the New file text box. When you select an item from this list box and then choose the OK command button, the contents of the Files in (directory) list box change.

<b>Pause message logging</b>	When marked, stops writing messages received by your netstation to the message log file. When unmarked, it enables message logging.
<b>Enable message popups</b>	If marked, starts the Netpopup service. If unmarked, it stops the Netpopup service.
<b>OK</b>	Changes the message log file to the specified file and returns to the LAN Manager screen.
<b>Cancel</b>	Exits the dialog box without changing files and returns to the LAN Manager screen.

---

## **Specifying a New Message Log**

To specify a new message log file, perform these two steps:

1. **Specify the name of the new message log file in one of two ways:**
  - In the New file text box, type the filename.
  - From the Files in (directory) list box, select the filename.
2. **Choose the OK command button.**

---

## **Pausing Message Logging**

To stop the messages you receive from being appended to the messages log, perform these two steps:

1. **Mark the Pause message logging check box.**
2. **Choose the OK command button.**

## Continuing Message Logging

To continue logging messages after message logging has been paused, perform these two steps:

1. Unmark the Pause message logging check box.
2. Choose the OK command button.

## Aliases for Messaging

Access: Message -> Aliases

The Aliases for Messaging dialog box lists aliases for users currently permitted to receive messages at this computer (see Figure 2-23). Next to each alias, it shows the aliases that the user forwards messages to, or for whom the user receives forwarded messages. You can add or delete an alias from the list, and you can forward or stop forwarding messages.

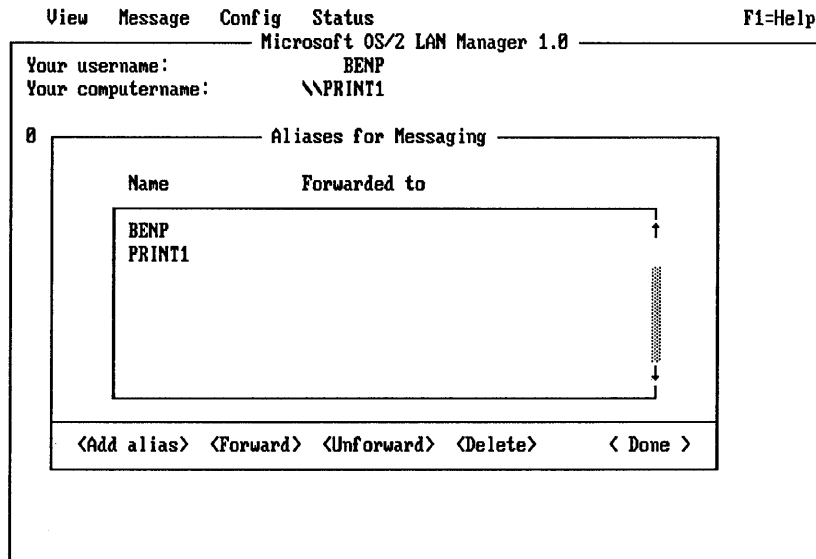

Press the ALT key to select a menu

**Figure 2-23. Aliases for Messaging Dialog Box**

The Aliases for Messaging dialog box contains one list box with two columns:

<b>Column</b>	<b>Contents</b>
Name	The message aliases of users permitted to receive messages
Forwarded to	The alias to which the specified user has forwarded messages.

<b>Add alias</b>	Displays the Add an Alias dialog box.
<b>Forward</b>	Displays the Forward an Existing Alias dialog box.
<b>Unforward</b>	Stops forwarding messages to the selected user.
<b>Delete</b>	Removes the selected message aliases from the list of users permitted to receive messages.
<b>Done</b>	Exits the dialog box and returns to the LAN Manager screen.

---

### **Adding Message Aliases**

To add a new alias to your netstation, perform these three steps:

- 1. Choose the Add Alias command button.**  
The Add an Alias dialog box appears.
- 2. Type the name in the text box.**
- 3. Choose the OK command button.**

---

### **Deleting Message Aliases**

To delete an alias from the list of names that can receive messages at your netstation, perform these two steps:

- 1. From the list box, select the alias.**
- 2. Choose the Delete command button.**



---

## Start or Stop Forwarding Messages

To forward your messages to another netstation or server, perform these three steps:

1. From the list box, select your message alias.
2. Choose the Forward command button.
3. The Add an Alias dialog box appears, allowing you to specify the alias of the person or computer to receive the forwarded messages.

When you are ready to stop forwarding your messages, perform these two steps:

1. From the list box, select your alias.
2. Choose the Unforward command button.

---

## Add an Alias

Access: Message -> Aliases -> Add alias

The Add an Alias dialog box allows you to add a message alias to the list of users allowed to receive messages at this computer (see Figure 2-24). Until a user's alias is on this list, the user cannot receive any type of message at this computer.

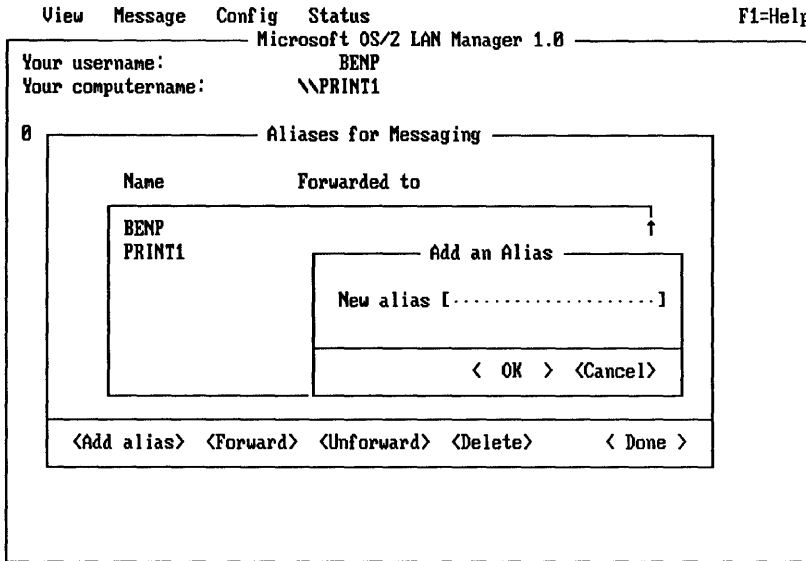

Press the ALT key to select a menu

**Figure 2-24. Add an Alias Dialog Box**

- New alias** Specifies the message alias of a user. This can be an established user name or any other alias for which this netstation should receive messages.
- OK** Adds the specified alias to the list of users permitted to receive messages and returns to the Aliases for Messaging dialog box.
- Cancel** Exits the dialog box and returns to the Aliases for Messaging dialog box without making changes to the list of aliases allowed to receive messages.

## Forward an Existing Alias

Access: Message -> Aliases -> Forward

The Forward an Existing Alias dialog box allows you to forward your messages to another user (see Figure 2-25). You can forward messages to any user, unless a user is already forwarding messages to you. If you are already forwarding messages to one user and you want to forward to a different user, you must first stop forwarding your messages to the original user.

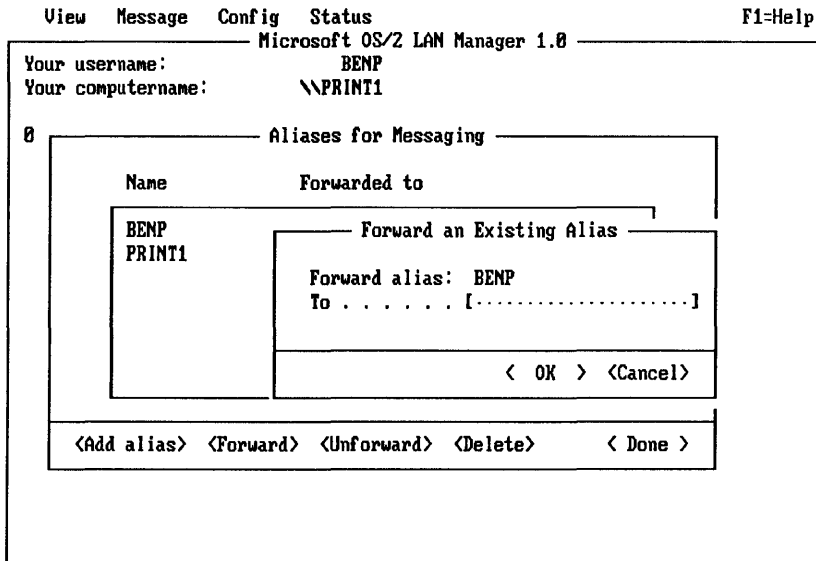

Press the ALT key to select a menu

**Figure 2-25. Forward an Existing Alias Dialog Box**

<b>Forward alias</b>	Displays the message alias whose messages are to be forwarded.
<b>To</b>	Specifies the recipient of the forwarded messages.
<b>OK</b>	Starts forwarding your messages to the specified user and returns to the Aliases for Messaging dialog box.
<b>Cancel</b>	Exits the dialog box without making any changes and returns to the Aliases for Messaging dialog box.

## Config Menu

The Config menu items let you access the LAN Manager configuration dialog boxes. Config, short for Configuration, is the way in which your computer's hardware and software are set up (see Figure 2-26).

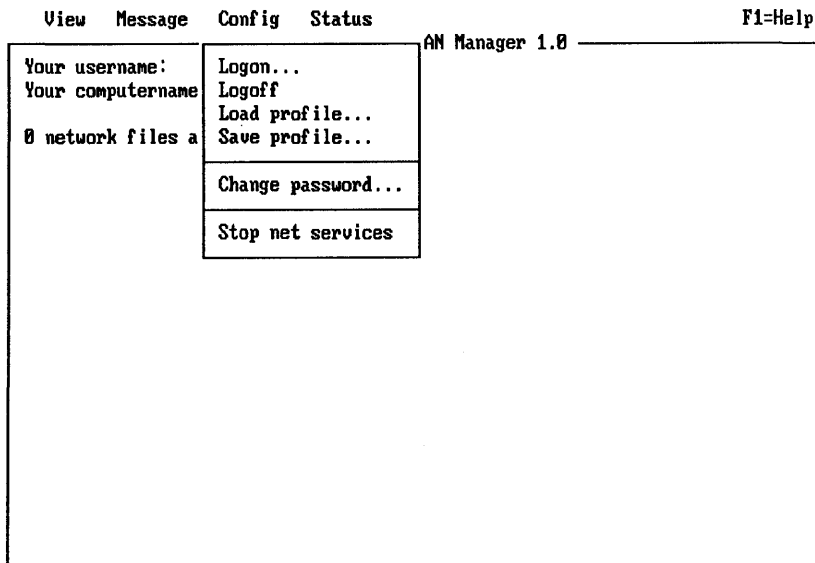

Log on to the local-area network

**Figure 2-26. Config Menu**

The following sections describe the Config menu items.

## Logon

The Logon menu item displays the "Log into Network" dialog box. This allows you to log on to the local area network .

---

**Logoff**

Use the Logoff menu item to log off the local area network.

---

**Load Profile**

The Load profile menu item displays the Load Configuration dialog box, which allows you to load a profile file into the netstation. This file typically includes a set of NET USE commands that configures your netstation by connecting your netstation to shared resources on the local area network.

---

**Save Profile**

The Save profile menu item displays the Save Configuration dialog box, which allows you to store the netstation's current configuration as a profile file.

---

**Change Password**

The Change password menu item displays the Change Logon Password at a server dialog box, which allows you to change your password on a remote or local server.

---

**Stop Net Services**

The Stop net services menu item allows you to end all LAN Manager services at your computer. When you do this, LAN Manager does the following things:

- Disconnects any shared resources on other servers.
- Logs you off from the local area network.
- Disconnects your computer from the local area network.
- Frees up memory on your computer.

## Log into Network

Access: Config->Log On

If you are not already logged on, the Log Into Network dialog box appears automatically when you start the LAN Manager screen by typing NET. You can also access the Log Into Network dialog box via the Config menu.

The Log Into Network dialog box allows you to log on to the local area network. You can use this dialog box to set your user name and password (see Figure 2-27). Once your user name and password are set, you can access resources such as printers and files on the local area network.

If Logon is shaded in the Config menu, then a user is already logged on. Use Logoff to log off before logging on.

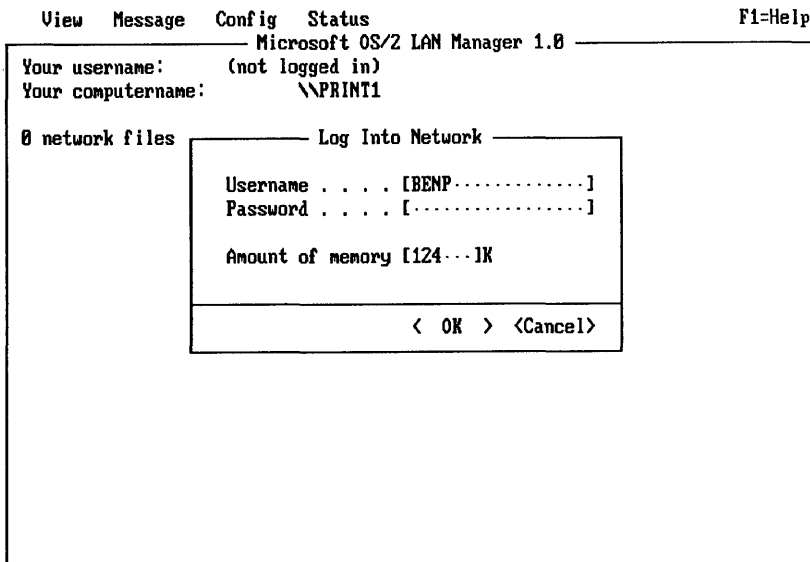

Press the ALT key to select a menu

**Figure 2-27. Log Into Network Dialog Box**

<b>Username</b>	Specifies your user name for the local netstation. If your LANMAN.INI file contains your user name, it is proposed as the default name. User names may be up to 20 characters long.
<b>Password</b>	Specifies your password. Note that LAN Manager makes no distinction between uppercase and lowercase letters for user names and passwords. Passwords may be up to 14 characters long.
<b>Amount of memory</b>	Specifies the amount of memory to be allocated to LAN Manager for caching.
<b>OK</b>	Logs on to the local area network and returns you to the LAN Manager screen.
<b>Cancel</b>	Exits the dialog box and returns to the LAN Manager screen. If you accessed this dialog box when you first started the LAN Manager screen, the Cancel button returns you to the OS/2 prompt.

---

## Logging on to LAN Manager

When you establish a session on the local area network, the netstation supplies your user name to the network server. Servers require all netstations requesting a session to supply the name of the current user.

To log on to LAN Manager, perform these five steps:

1. **At the OS/2 prompt, type net or, from the LAN Manager screen, select the Config menu and choose the Log On menu item.**
2. **In the Username text box, type in your user name if necessary.**
3. **In the Password text box, type your password.**
4. **In the Amount of memory text box, type the amount of memory to be allocated for caching.**  
(LAN Manager provides a default amount.)
5. **Choose the OK command button.**

## Load Configuration

Access: Config -> Load Profile

The Load Configuration dialog box loads a set of configuration parameters from a file (see Figure 2-28). Configurations are stored in profile files containing NET USE commands. These profile files are normally stored in the \LANMAN\PROFILES directory and typically include a filename extension of .PRO. The default configuration file is NETLOGON.PRO.

Once you load a profile file with this dialog box, the netstation first deletes all current connections and then runs each local area network command in the profile file. The netstation uses all of the resources defined by the profile file. If LAN Manager has a problem running any command in the file, an error message displays.

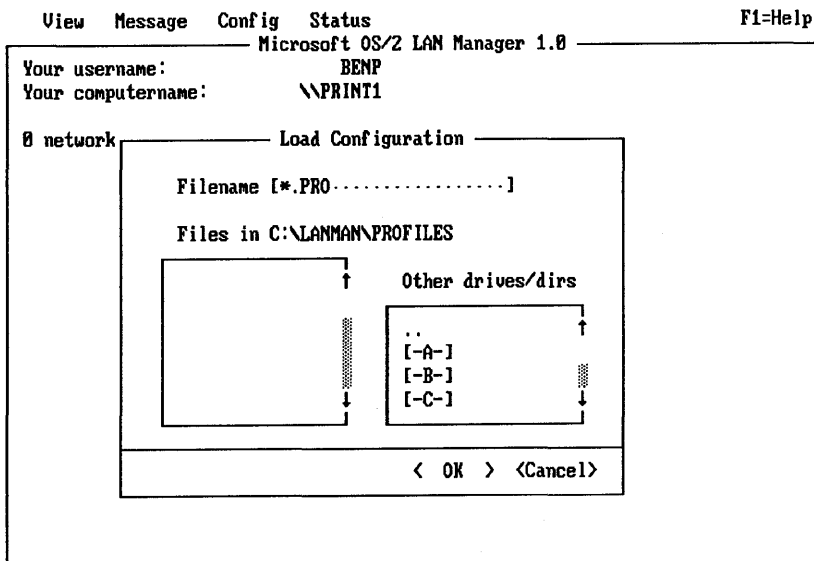

Press the ALT key to select a menu

Figure 2-28. Load Configuration Dialog Box



<b>Filename</b>	Specifies the pathname of the profile file to load.
<b>Files in (directory)</b>	Lists the files in the Lanman\Profiles directory. If you specify a wild-card character (* or ?) in the Filename text box and choose the OK command button, this list box displays filenames that match the wild-card search.
<b>Other drives/dirs</b>	Lists the disk drives and directories on your computer. Selecting a drive or directory changes the contents of the Filename text box. When you select an item from this list box and choose the OK command button, the contents of the Files in (directory) list box change.
<b>OK</b>	Loads the specified configuration file into the netstation and returns to the LAN Manager screen.
<b>Cancel</b>	Exits the dialog box without loading a file and returns to the LAN Manager screen.

---

### **Loading a Profile**

To load a profile file for your netstation, perform these two steps:

- 1. From the Files in (directory) list box, select the filename.**  
Select a different directory from the Other drives/dirs list box if necessary.
- 2. Choose the OK command button.**

## Save Configuration

Access: Config -> Save Profile

The Save Configuration dialog box saves a list of the netstation's current local area network connections to a specific profile file (see Figure 2-29).

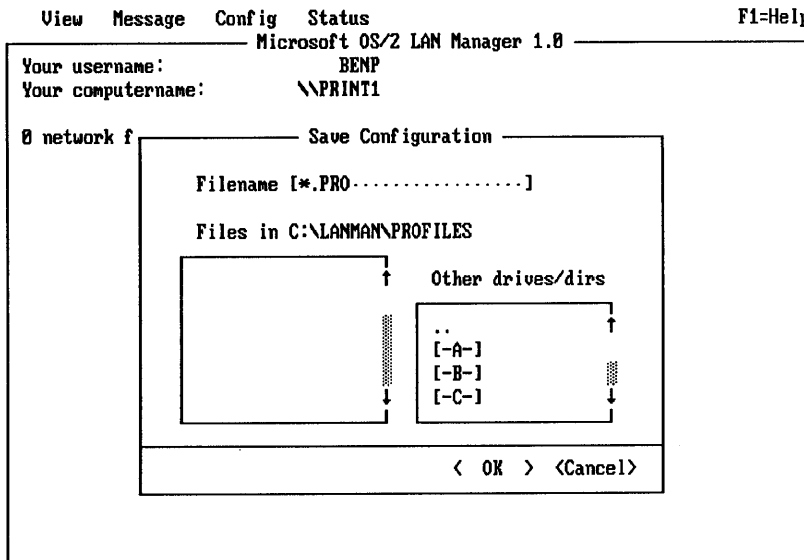

Press the ALT key to select a menu

**Figure 2-29. Save Configuration Dialog Box**

**Filename** Specifies the pathname of the profile file.

**Files in (directory)** Lists the files in the Lanman\Profiles directory. If you specify a wild-card character (\* or ?) in the Filename text box and choose the OK command button, this list box displays filenames that match the wild-card search.

<b>Other drives/dirs</b>	Lists the disk drives and directories on your computer. Selecting an item in this list box changes the contents of the Filename text box. When you select an item from this list box and choose the OK command button, the contents of the Files in (directory) list box change.
<b>OK</b>	Stores the server's current configuration to the specified file before exiting the dialog box and returning to the LAN Manager screen.
<b>Cancel</b>	Exits the dialog box and returns to the LAN Manager screen without saving the configuration to the profile file.

---

### **Saving Your Current Configuration**

To save a list of your netstation's current local area network connections to a profile file, perform these two steps:

- 1. Specify the filename of the profile in one of two ways:**
  - Type the name of the file in the Filename text box.
  - Select the name of an existing file from the Files in (directory) list box. The contents of this file will be replaced with the new profile information.
- 2. Choose the OK command button.**

---

### **See Also**

For more information about configuration commands, see the following sources:

- Chapter 3: LAN Manager Command Reference; see the NET USE command for information about connecting to a shared resource using this LAN Manager command.
- Chapter 3: LAN Manager Command Reference; see the NET SAVE command for information about saving your current netstation configuration to a profile file.
- Chapter 2: LAN Manager Screen Reference; see the "Load Configuration" dialog box.
- In the *3+Open MS OS/2 LAN Manager User Guide*, look for information on how to save or load a configuration file.

## Change Logon Password at a Server

Access: Config -> Change password

The Change Logon Password at a Server dialog box changes your account's password on a network or local server running with user-level security (see Figure 2-30). To change your password, you must have an account on the server. It is a good idea to change passwords regularly; this makes it difficult for other users to use your account without your authorization.

**NOTE:** If you try to change your password on a share-level server, an error message displays because share-level servers do not maintain user passwords.

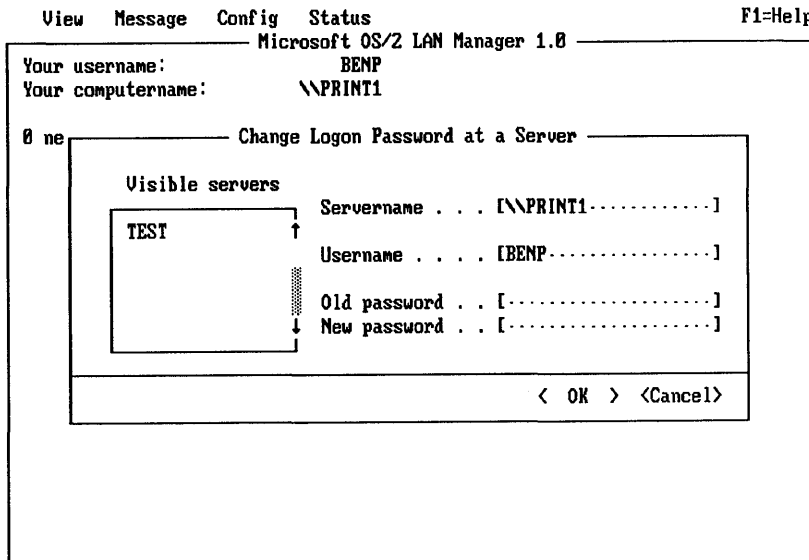

Press the ALT key to select a menu

**Figure 2-30. Change Logon Password at a Server Dialog Box**

**Visible servers**

Lists the names of all visible servers for this local area network. If you are using the Entry Level LAN Manager product, this list box should contain only one entry.

<b>Servername</b>	Displays the name of the server selected from the Visible servers list box. You can also type the name of the server here.
<b>Username</b>	Specifies your user name. If you are currently logged on to LAN Manager, your user name automatically appears in this text box.
<b>Old password</b>	Specifies the old password to your account.
<b>New password</b>	Specifies the new password to your account.
<b>OK</b>	Changes your password and returns to the LAN Manager screen.
<b>Cancel</b>	Exits the dialog box without changing your password and returns to the LAN Manager screen.

---

### **Changing Your Password**

To change your password on a server, perform these five steps:

- 1. Select the server from the Visible servers list box or type the server name in the server name text box.**
- 2. Type your user name in the Username text box if necessary.**
- 3. Type your current password in the Old password text box.**
- 4. Type the new password in the New password text box.**
- 5. Choose the OK command button.**

## See Also

For more information about passwords, see the following sources:

- "Log on to the Local Area Network" for information on using a password to log on to the local area network netstation.
- The *3+Open MS OS/2 LAN Manager User Guide* for information on using a password to access server resources.

## Status Menu

The Status menu lets you access information about netstation operations and errors (see Figure 2-31).

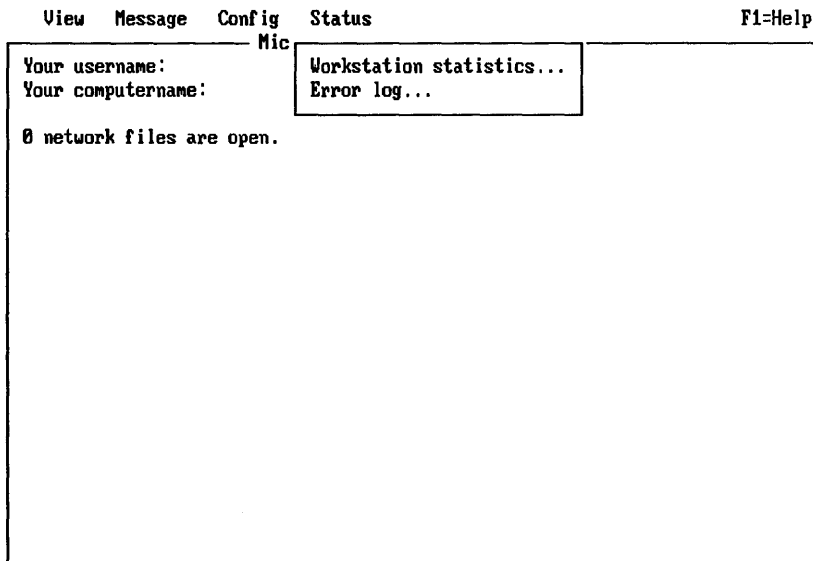

Check the Workstation statistics for your computer

### Figure 2-31. Status Menu

The following sections describe the Status menu items.

---

## Workstation Statistics

The Workstation Statistics Information menu item displays the Workstation Statistics Information dialog box, showing statistics about your netstation's activities on the local area network.

---

## Error Log

The Error Log menu item displays the Network Error Log dialog box, listing error messages you have received from LAN Manager. You can do the following things from this dialog box:

- Get more information on the errors recorded.
- Save the recorded errors to a file.
- Clear the messages from the error log.

---

## Workstation Statistics Information

Access: Status -> Workstation Statistics

The Workstation Statistics Information dialog box displays a list of statistics for LAN Manager activities at your netstation. The list includes numbers for server sessions (and interruptions of those sessions) and local area network transactions (I/O). This display tells you at a glance the level of LAN Manager activity at your netstation (see Figure 2-32).

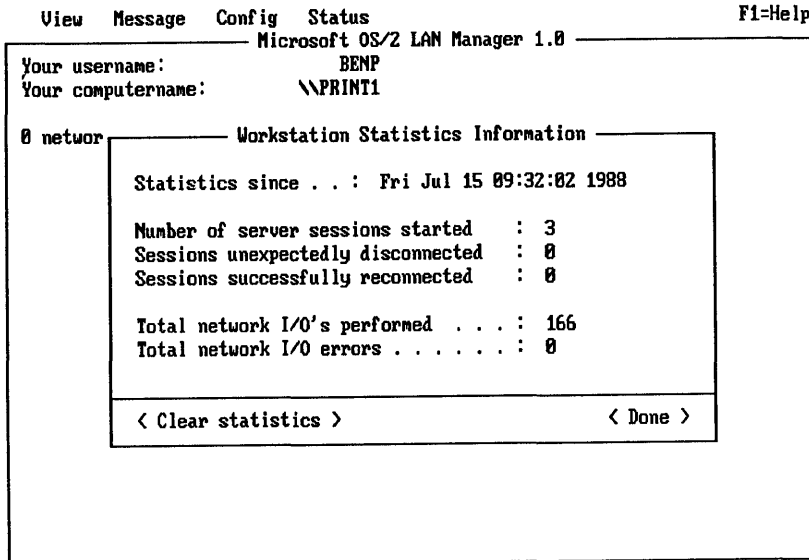

Press the ALT key to select a menu

**Figure 2-32. Workstation Statistics Information Dialog Box**

- |   |  |
|---|--|
| <b>Statistics since</b>                   | Displays the time this set of statistics began. This is either the time that you started the netstation or the last time that you cleared the statistics display.              |
| <b>Number of server sessions started</b>  | Displays the number of servers to which you have linked, either by deliberately linking or by specifying a network pathname as part of a command you typed at your netstation. |
| <b>Sessions unexpectedly disconnected</b> | Displays the number of times a server disconnected one of your sessions, either deliberately or by an automatic time-out.  |
| <b>Sessions successfully reconnected</b>  | Displays the number of times your netstation automatically reestablished a disconnected session.   |



<b>Total network I/O's performed</b>	Displays the number of times your netstation has sent or received data on the local area network.
<b>Total network I/O errors</b>	Displays the number of times that sending or receiving data on the local area network resulted in an error. This is not the same as the larger class of LAN Manager errors that appear in the error log.
<b>Clear Statistics</b>	Resets all statistics to zero. The Statistics since date and time is set to the current date and time.
<b>Done</b>	Exits the dialog box and returns to the LAN Manager screen.

---

### **Reviewing Workstation Statistics**

To view the statistics logs for your netstation, perform these two steps:

1. **Select the Status menu and choose Workstation statistics.**
2. **When you have finished reviewing your statistics, choose the Done command button.**

---

### **Resetting the Statistics Log**

To reset the statistics log for your netstation, perform this step:

1. **From the Workstation Statistics Information dialog box, choose the Clear Statistics command button and confirm by choosing the OK command button in the Reset LAN Manager statistics dialog box.**

---

### **See Also**

For more information about LAN Manager statistics, see the following sources:

- "Error Log" for information about displaying the log of LAN Manager errors received by the netstation.
- The *3+Open MS OS/2 LAN Manager User Guide* for detailed information on how to interpret these statistics.

## Network Error Log

Access: Status -> Error Log

The Network Error Log dialog box lists error messages received by this netstation. Each message line shows the origin of the message, the message number, and the date and time the message was received (see Figure 2-33).

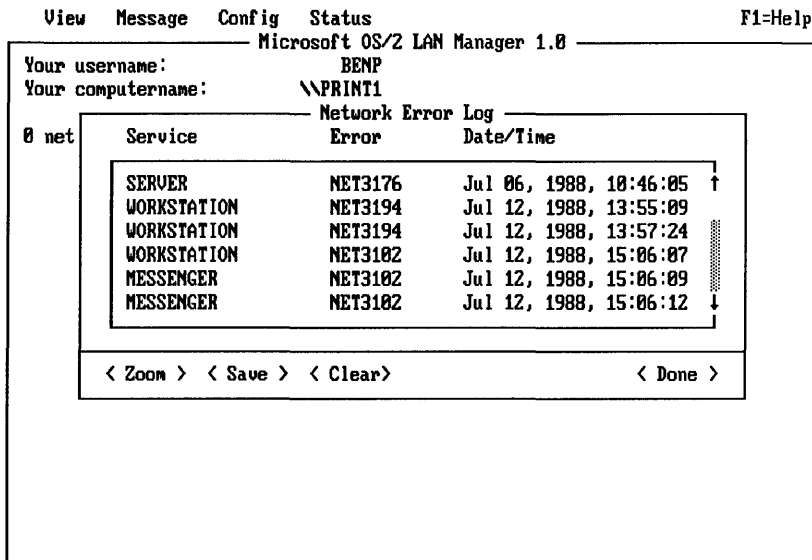

Press the ALT key to select a menu

**Figure 2-33. Network Error Log Dialog Box**

The Network Error Log dialog box contains one list box with three columns:

Column	Contents
Service	The LAN Manager service that generated the error. For a netstation, the services are Workstation, Messenger, or Netpopup.
Error	The error message number.
Date/Time	The date and time that the error was logged.

- Zoom** Displays the Error Log Record dialog box.
- Save** Saves the contents of the error log in the file LANMANLOGS\ERRORS.SAV. This does not clear the log.
- Clear** Erases the contents of the error log and clears the list box. This does not erase the contents of the file LANMANLOGS\ERRORS.SAV.
- Done** Exits the dialog box and returns to the LAN Manager screen.

---

### Getting More Information About an Error

To see detailed information related to an error displayed in the Error Log dialog box, perform these two steps:

1. From the list box, select the error record.
2. Choose the Zoom command button.

The Error Log Record dialog box appears.

---

### Saving Recorded Errors to a File

To save the logged error records to the ERRORS.SAV file, perform this step:

1. Choose the Save command button.

## Clearing the Error Log

To clear the contents of the error log displayed by this dialog box, perform this step:

1. Choose the Clear command button.

## Error Log Record

Access: Status -> Error Log-> Zoom

The Error Log Record dialog box shows the full text and associated data for the selected error message (see Figure 2-34).

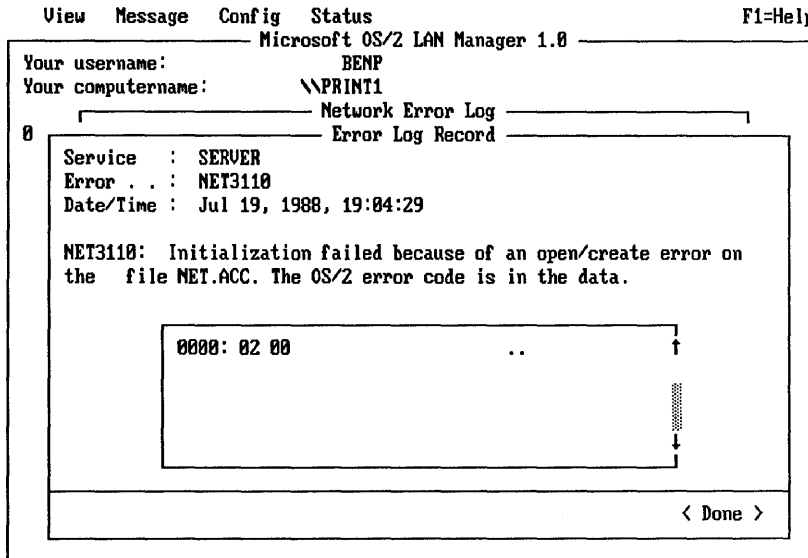

Press the ALT key to select a menu

**Figure 2-34. Error Log Record Dialog Box**

# 2

<b>Service</b>	Displays the LAN Manager service that generated the error. For a netstation, the component is Workstation, Messenger, or Netpopup.
<b>Error</b>	Displays the error message number.
<b>Date/Time</b>	Displays the date and time that the error was logged.
<b>Error Message</b>	Displays the full text of the error message, usually including an explanation of the cause.
<b>Hexadecimal display</b>	Displays a hexadecimal listing of the error buffer associated with this occurrence of the error message.  If the error buffer is empty, this list box is empty. The data in this list box is for the convenience of LAN Manager programmers.
<b>Done</b>	Exits the dialog box and returns to the Network Error Log dialog box.

## **Chapter 3: LAN Manager Command Reference**

LAN Manager commands let you perform LAN Manager operations from the MS OS/2 command line. (You can perform the same operations by using the LAN Manager Screen, described in Chapter 2: LAN Manager Screen Reference.) The option of typing LAN Manager commands at the OS/2 prompt is especially useful under the following conditions:

- You are familiar with 3+, Microsoft networks for MS-DOS, and IBM PC-LAN version 1.2 command-line interfaces.
- You are an expert user who feels more comfortable typing commands than using a graphical, full-screen interface (LAN Manager Screen).
- You want to add LAN Manager commands to batch files.

This chapter provides information about LAN Manager commands that are available to the user. Information includes how to use the command with its purpose and options, and a syntax diagram. The commands are arranged in alphabetical order by command name. This chapter also contains a list of these commands, along with a brief description of their functions.

---

## Using LAN Manager Commands

This section provides a few rules and guidelines to help you best use the MS OS/2 LAN Manager commands described in this chapter.

For example, this section lists which commands must be run before certain other commands. It also describes LAN Manager prompts that help you to remember these dependencies. And, it tells you about options you can use with LAN Manager commands in batch files to automatically respond to LAN Manager prompts.

This section also describes abbreviations you may use when typing LAN Manager commands. Although the command information in this chapter spells out all command names, option names, and service names, LAN Manager allows you to abbreviate many of these for your convenience.

---

## Service Name Abbreviations

LAN Manager allows you to use abbreviations and synonyms for the following LAN Manager services:

Service	Acceptable abbreviations, synonyms
Workstation	wksta, work, redirector, redir, rdr, prdr, devrdr
Messenger	msg, receiver, rcv

---

## Option Names

LAN Manager also allows you to type any unambiguous abbreviation for a command option. This means you must type enough letters in the option's name to distinguish the option you choose from other options for that command. For example, if you are using a command whose possible options are /Read and /Send, you may type /r instead of /Read and /s instead of /Send. But if the command options were /Read and /Redo, LAN Manager would not accept /r, but would accept either /rea for /Read or /red for /Redo.

The command options for each command in this chapter are listed in alphabetical order, making it easier for you to compare similar option names.

---

## Commands that Start Services Automatically

Certain LAN Manager commands depend on one or more services being started before they can run. For example, LAN Manager includes the following interdependencies:

- You must start the Workstation service before you can display the LAN Manager Screen.
- You must log on before you can use a shared network resource.

LAN Manager asks to perform the prerequisite task automatically in many cases.

---

## Workstation Service

When you type a command that requires the Workstation service to be started, LAN Manager checks to see if the netstation is running. If it is not, LAN Manager displays this prompt:

```
WORKSTATION not started.  
OK to start it? (Y/N) [Y]:
```

If you type Y (or press [Enter] since Y is the default response in this case), LAN Manager first starts the Workstation service, then runs the command you typed. If you type N, LAN Manager neither starts the Workstation service nor runs the command you typed.



The Workstation service must be started before any of the following commands can run:

```
net          net log          net send
net comm     net logon       net statistics
net config   net name        net use
net forward  net print       net view
net load
```

---

### Your Log-On

When you type a command that requires you to be logged on to the local area network first, LAN Manager checks to see if you are logged on. If you are, LAN Manager runs the command you typed. If you aren't logged on, LAN Manager offers to log you on to the local area network by reading your user name from the LANMAN.INI file on your computer:

```
Type your username, or press [Enter] for <username>:
Type your password:
```

You must be logged on to the local area network before any of the following commands can run:

```
net
net use
net view
```

---

### Using Passwords with Commands

Some commands require a password as an option. There are two ways for you to provide a password as a command option. The first way is to type the password on the same line as the command itself. For example, to use a shared resource called *plotter* on a server (*\\admin*) that requires a password of *Mary*, you type:

```
net use lpt2 \\admin\plotter kahuna
```

---

### Using the \* Option

You can also ask LAN Manager to prompt you for your password, replacing the password with an asterisk (\*) when you type the command. For example, Mary could type the following to log on to the local area network and then connect to a shared resource:

```
net use lpt2 \\admin\plotter *
```

LAN Manager then displays this prompt:

```
[Enter] the password for \\ADMIN\PLOTTER:
```

When you type a password at this prompt, the password does not display as you type. This allows you to keep your password confidential. Although this option may prove a little less convenient than typing your command and password together, it provides added security.

You can use the asterisk (\*) option with the following commands to cause LAN Manager to prompt you for a password:

```
net logon  
net password  
net use
```

Depending on the command you type, LAN Manager may also prompt you for other pertinent information, such as your user name.

**NOTE:** LAN Manager will also prompt you for a password if you forget to type a password with a command that requires one.

---

### Using /Yes and /No

Many LAN Manager commands cause LAN Manager to prompt you for a decision. For example, if you use the NET LOGOFF command to log off from the local area network with connections to remote shared resources intact, LAN Manager displays a prompt like this one:

You have the following remote connections:

```
LPT1
```

Continuing will cancel the connections.

Do you want to continue this operation? (Y/N) [N]

You can use the /YES and /NO options with any LAN Manager command to anticipate and respond to a prompt like the one just shown. For example, if you include the NET LOGOFF command in a batch file, and know that you want to respond with a Y to the prompt, you can type the following line in your batch file:

```
net logoff /yes
```

Using the /Yes and /No options helps expedite LAN Manager functions. When LAN Manager reads one of these options, LAN Manager does not pause to display the corresponding prompt. Instead, LAN Manager accepts the /Yes or /No option as your response to the prompt. You can use LAN Manager commands with /Yes and /No options to create batch files that are not interrupted by LAN Manager prompts.

---

## Command Information

The information for each command includes the topics described in the following sections. For information about the meaning of text elements such as boldface and italic type, see the Notational Conventions section of the Introduction.

---

### Command Name and Purpose

Each command listing shows the name of the LAN Manager command followed by a brief description of what the command does. Generally, this description includes information the command displays and the functions it performs.

**Syntax**

This section shows how to use a command: which elements are required, which are optional, and which only work with other elements. The Syntax section shows a general bubble diagram of the command using these notational conventions:



**NET USE**

A bold, rounded-corner rectangle surrounds the command name. The command name is in all capital letters and bold type.

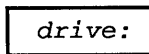

*drive:*

A rectangle surrounds variables. The variable is in lowercase italics. This shape says "substitute something here."

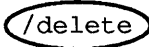

*/delete*

An oval surrounds arguments that you type as is.

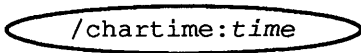

*/chartime:time*

Sometimes an oval surrounds an argument that has a variable portion. You replace the italicized text with an appropriate value.



;

A circle surrounds punctuation.



Arrows indicate direction.



A vertical line indicates a return.

Each element must be separated by a space.

To read a bubble diagram, start at the command name, in the bold, rounded-corner rectangle. You may follow any line through the command, as long as you follow the direction of the arrows. For example, when you come to the first decision point in the NET USE diagram shown below, you could enter either a drive or a printer name, which must then be followed by a path. After the path, you have the choice of entering a password (which is not required by the command, although it might be required by the shared resource). Then you must press [Enter].

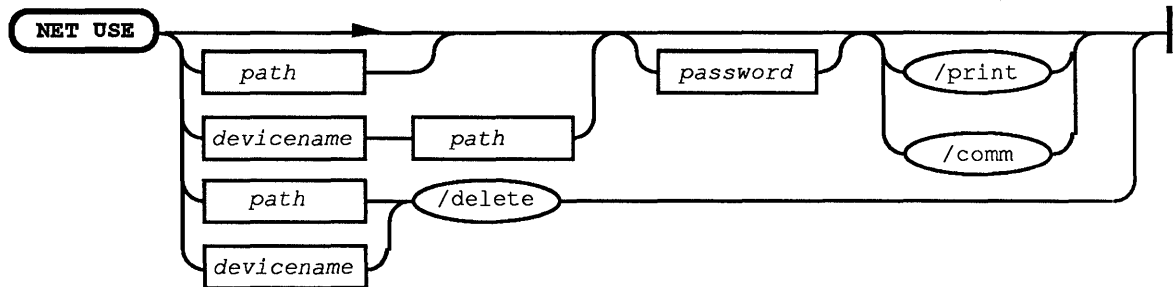

## Comments

This section describes how to use the command, when to use it, and why. It describes the command's options, and explains which options may be used in combination. It may also contain warnings or suggestions about using the command.

## Example

This section gives an example showing how the command is used. In the *3+Open MS OS/2 LAN Manager Administrator Guide*, you were introduced to employees of a fictitious company, MacroCorp, Inc. The examples in this chapter use the names of MacroCorp employees.

## See Also

This section lists the titles of commands and references to Chapter 2: LAN Manager Screen Reference that you can read for more information about this command.

## Commands in This Manual

The following list shows the commands discussed in the remainder of this chapter and the function of each command.

<b>Command</b>	<b>Purpose</b>
NET	Starts the user version of the LAN Manager Screen.
NET COMM	Controls and displays information about shared communication-device queues.
NET CONFIG WORKSTATION	Displays and changes the configuration of a netstation.
NET CONTINUE	Continues local area network functions suspended by the NET PAUSE command.
NET COPY	Copies files both locally and via network.
NET ERROR	Lists the most recent local area network errors and the times they occurred.
NET FORWARD	Reroutes one user's incoming messages to another user.
NET HELP	Displays information about the purpose and use of LAN Manager commands.
NET LOAD	Loads a saved configuration from a file.
NET LOG	Starts or stops saving messages to a file or printer.
NET LOGOFF	Disconnects all local area network sessions and logs a user off the local area network.
NET LOGON	Logs a user on to the local area network and sets the user name and password for the netstation.
NET MOVE	Moves files from one place to another on the local area network.
NET NAME	Displays the aliases currently defined in a computer's list of aliases, and adds or deletes aliases from that list.
NET PASSWORD	Changes the password for logging on to a server.
NET PAUSE	Suspends the specified LAN Manager functions.
NET PRINT	Displays and controls the contents of a shared printer's queue.
NET RUN	Runs a command locally or on a server.
NET SAVE	Saves the current local area network configuration into a file for later use.
NET SEND	Sends messages and files to other users.

Command	Purpose
NET START	Starts LAN Manager services. (See also information on the NET START MESSENGER, NET START NETPOPOP and NET START WORKSTATION commands.)
NET STATISTICS	Displays and clears a server's list of usage statistics.
NET STOP	Stops LAN Manager services.
NET USE	Connects users to resources shared from a server.
NET VIEW	Displays the computer names of servers and the resources being shared by any server.

---

## NET

This command displays the LAN Manager Screen.

---

## Syntax



---

## Comments

The LAN Manager Screen provides users access to all LAN Manager operations through menus and dialog boxes.

To learn more about the LAN Manager Screen, see Chapter 2: LAN Manager Screen Reference.

If the workstation service is not yet started, this command automatically starts it.

### Example

To run the user version of the LAN Manager Screen, Mike types the following command at the OS/2 prompt:

```
net
```

The LAN Manager Screen appears.

### See Also

For more information about this command, see the following sources:

- Chapter 2: LAN Manager Screen Reference, for a description of each LAN Manager Screen menu and dialog box.
- *The 3+Open MS OS/2 LAN Manager User Guide* for how to use the LAN Manager Screen.

## NET COMM

This command displays information about shared communication-device queues, such as queues set up to share modems. It also lets you remove requests you own from a communication-device queue.

### Syntax

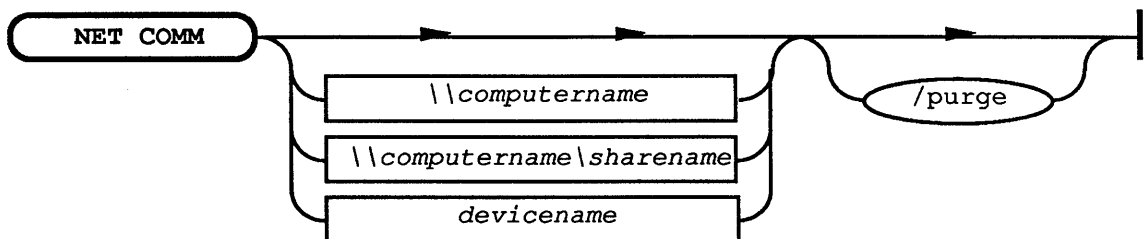



Option	Purpose
<i>\\computername</i>	Specifies the server about whose communication-device queues you want information.
<i>\\computername \\sharename</i>	Specifies the shared resource about whose shared communication-device queues you want information.
<i>devicename</i>	Specifies the local device name that is redirected to the shared queue.
<i>/purge</i>	Cancels all outstanding requests from the netstation at a specified server, queue, or for a specified device name.

### Comments

When you want to see information about shared communication-device queues for a specific server, type the NET COMM command with the *\\computername* option. For example:

```
net comm \\mis
```

If you are using the 3+Open LAN Manager Entry System (referred to as the Entry Level LAN Manager in the rest of this chapter), the computer name must be Server.

Specifying the computer name of a server with the NET COMM command displays all the shared communication-device queues on that server:

```
Communication-device Queues at \\MIS
```

Net Name	Local Device	Users Ahead	Users Waiting
MODEM	com1	1	2
RESERVED	(null)		0

```
Command completed successfully.
```

This display presents four kinds of information:

Column	Contents
Net Name	The sharename of the shared communication-device queue.
Local Device	The local device name that is connected to the shared communication-device queue.
Users Ahead	The number of user requests ahead of yours in the communication-device queue. This column has a number in it only if you are connected to a communication-device queue.
Users Waiting	The number of user requests ahead of yours in the communication-device queue. This column has a number in it only if you are connected to a communication-device queue.

If you would like information only about a particular communication-device queue, specify the server's computer name and the sharename of the queue. For example, you could type this command line:

```
net comm \\mis\modem
```

This type of command produces the same type of display as specifying just the name of the server. However, only the information about a specific queue is shown.

You can also specify the name of a local communication device to see information about the queue to which that device is redirected. For example, you could type:

```
net comm com1
```

A display like this one appears:

```
Communication-device Queues at \\MIS

Net Name    Local Device  Users Ahead  Users Waiting
-----
MODEM      com1          1             2
```

Command completed successfully.

---

## Example

Jack Starkey redirected his netstation's local device name COM2 to the *postscrp* queue shared by the *\print1* server. (He used the command `NET USE com2\print1\postscrp` to do this.) To find out the status of that queue, Jack types the following command:

```
net comm com2
```

Jack could also find out the status of this queue by typing the following:

```
net comm \\print1\postscrp
```

Jack also wants to see the status of a communication-device queue *\mis\modem* even though his netstation is not connected. He can get a report about that queue's status by typing this command:

```
net comm \\mis\modem
```

---

## See Also

For more information about this command, see the following source:

- In Chapter 2: The LAN Manager Screen Reference see "Communication-device Queues for (server)" for how to control communication-device queues using the LAN Manager Screen.

## NET CONFIG WORKSTATION

This command displays information about, or changes the configuration of, a netstation.

### Syntax

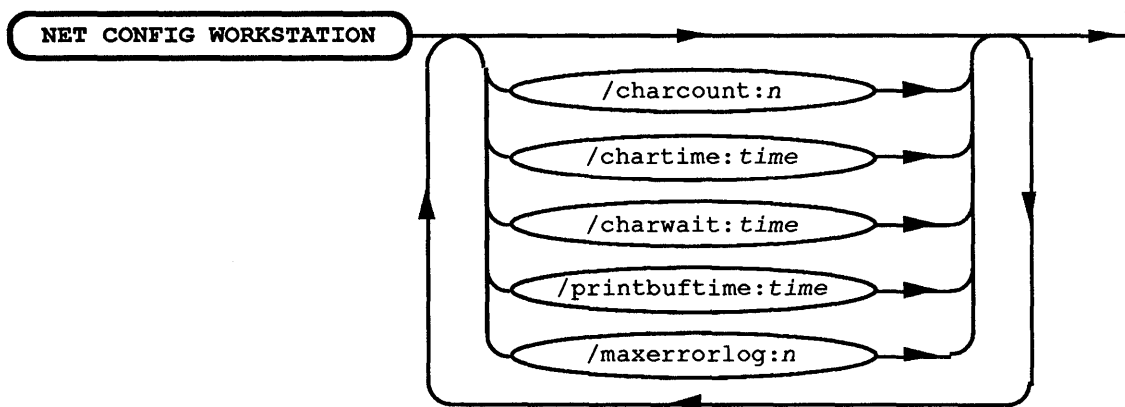

Option	Purpose
<code>/charcount:n</code>	Specifies the number of bytes of data that the netstation stores in a buffer before sending it to a specified communication device. Increasing the number of bytes improves performance, but may cause some delay in character transmission.
<code>/chartime:time</code>	Specifies the amount of time, in milliseconds, that the netstation stores data before sending it to a specified communication device. By specifying a larger increment of time, you can improve local area network performance, but may cause some delay in character transmission.

Option	Purpose
<i>/charwait:time</i>	Specifies the maximum amount of time, in seconds, that the netstation waits for a requested communication device to become available.
<i>/printbuftime:time</i>	Specifies the amount of time, in seconds, that the netstation will wait before ending the transmission when transmitting print requests from the DOS session.
<i>/maxerrorlog:n</i>	Specifies the size, in kilobytes, of the netstation's error log.

NET CONFIG WORKSTATION may be abbreviated as follows:

```
net config wksta
```

```
net config rdr
```

### **Comments**

The NET CONFIG WORKSTATION command allows you to make a change to certain configuration settings for your netstation for your current LAN Manager session. If you want to change your netstation's configuration to be in effect each time you start the netstation service, you should modify the LANMAN.INI file. The LANMAN.INI file contains all the default configuration values for starting and running the netstation. To learn more about using the LANMAN.INI file, see the *3+Open MS OS/2 LAN Manager Installation and Setup Guide*.

After you've started the netstation service, most options cannot be changed unless you stop the netstation service. However, you can change the configuration values associated with the NET CONFIG WORKSTATION command after the netstation service is started.

The following table shows each NET CONFIG WORKSTATION option and its related LANMAN.INI entry:

Command option	Equivalent LANMAN.INI entry
<code>/charcount:<i>n</i></code>	<code>charcount=</code>
<code>/chartime:<i>time</i></code>	<code>chartime=</code>
<code>/charwait:<i>time</i></code>	<code>charwait=</code>
<code>/maxerrorlog:<i>n</i></code>	<code>maxerrorlog=</code>
<code>/printbuftime:<i>time</i></code>	<code>printbuftime=</code>

To change other configuration settings for your netstation, you should change the appropriate entries in the LANMAN.INI file, then restart the netstation service.

### **Example**

Mike Greenwood wants to set the size of his error log to be a maximum of 3 K. To do this, Mike types the following:

```
net config workstation /maxerrorlog:3
```

### **See Also**

For more information about this command, see the following sources:

- The NET START WORKSTATION command for how to change the netstation's configuration for your current LAN Manager session.
- The *3+Open MS OS/2LAN Manager Installation and Setup Guide* for how to use the LANMAN.INI file.

## NET CONTINUE

This command continues LAN Manager services suspended by the NET PAUSE command.

### Syntax

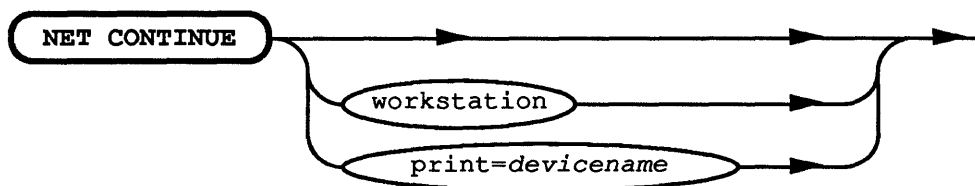

Option	Purpose
workstation	Continues local area network use of all serial (COM) and parallel (LPT) ports.
print[= <i>devicename</i> ]	Continues a shared printer (where <i>devicename</i> specifies a single print device; omitting <i>devicename</i> continues all print devices).
Net continue	May be abbreviated net cont.
Workstation	May be abbreviated as wksta, prdr, work, or rdr.

### Comments

The NET CONTINUE command reinstates the Workstation service after it is paused using the NET PAUSE command. When you pause the Workstation service, you suspend the ability to use the local area network. The NET CONTINUE WORKSTATION command restores this ability.

When you continue local area network connections to network printers, the connections to local area network resources are restored and any local connections to parallel (LPT) ports are ignored. For example, you may have a dot-matrix printer connected to LPT1 of your netstation. You may choose to redirect LPT1 to

a laser printer on the local area network, then pause your local area network connections when you want to use the dot-matrix printer. When you are ready to use the laser printer again, the NET CONTINUE command causes your netstation to reassign LPT1 to the network laser printer (and reconnect any other connections you made to network printers) and ignore the local dot-matrix printer connection.

---

**Example**

Mike Greenwood paused the Workstation service on his computer earlier in the day. Now he wants to use local area network resources, so he continues the workstation service by typing

```
net continue workstation
```

---

**See Also**

For more information about this command, see the following sources:

- The NET PAUSE command for how to pause LAN Manager services.
- In Chapter 2: LAN Manager Screen reference see "Network Resources in Use at Your Workstation" for how to pause and continue your local area network connections from the LAN Manager Screen.





Option	Purpose
<i>pathname1</i>	Names the file being copied.
+ <i>pathname</i> [...]	Appends one or more files to <i>pathname1</i> and places the result in <i>pathname2</i> .
<i>pathname2</i>	Specifies the pathname the file is copied to. If <i>pathname2</i> is omitted, NET COPY copies the file into the current directory.
/v	Causes LAN Manager to verify that information was properly recorded on the destination drive.
/a	Copies files in ASCII (text) format.
/b	Copies files in binary format.

### Comments

The NET COPY command is similar to the MS OS/2 COPY command, allowing you to copy files over the local area network. You can copy files in the following ways:

- From one location to another on your local computer.
- Between a network server and your local computer.
- From one location to another on a network server.
- From one remote server to another network server.

If you do not specify the *pathname2* option, the copy is created in the working directory on the disk in the default drive of your local computer. This copy has the same name, creation date, and creation time as the original file (*pathname1*). If the original file is on the default drive and you do not specify *pathname2*, the NET COPY command quits (you are not allowed to copy a file to itself), and LAN Manager displays the following error message:

```
File cannot be copied onto itself
0 File(s) copied
```

The `/v` option lets you verify that critical data has been correctly recorded; it also causes the NET COPY command to run more slowly, because LAN Manager must check each entry recorded on the disk. If LAN Manager cannot verify that the file was copied successfully, it displays an error message.

The NET COPY command options `/a` and `/b` perform differently depending on whether they are placed following the source filename or the target filename.

When placed after the source filename (*pathname1*), they do the following:

- The `/a` option causes the file to be treated as an ASCII (text) file. Data in the file is copied up to but not including the first end-of-file mark. The remainder of the file is not copied.
- The `/b` option causes the entire file to be copied, including any end-of-file marks.

When placed after a target filename (*pathname2*), they do the following:

- The `/a` option causes an end-of-file character to be added as the last character of the file.
- The `/b` option does not add an end-of-file character.

If you use the NET COPY command to copy files from one place to another on your local computer, or from one computer to another on the local area network, the names of the files are listed as they are copied. When you copy files from one place to another on a single network server, only the number of files copied is displayed; the names of the files are not displayed.

You can use full network pathnames, including computer names, with the NET COPY command. You don't need to connect to a network file or directory to copy it with the NET COPY command; connections are made automatically. However, you must have the necessary permissions (that is, read permission) for making connections.

Using NET COPY to copy a file from one place to another on a network server is quicker than connecting to that network server, then copying files with the MS OS/2 COPY command.

---

**Example**

To copy a mailing list from the directory *lists* on the *\sales* server to the *address* directory on the same server, Olga types this:

```
net copy \\sales\lists\mail.txt \\sales\address\mail.txt
```

To copy an interoffice memo from one server (*\humanr*) to another (*\print1*), Olga types this:

```
net copy \\humanr\olga\memo0513.doc \\print1\public\annual.mtg
```

This command copies the file MEMO0513.DOC from the *olga* directory on the *humanr* server, creating a file called ANNUAL.MTG in the *public* directory of the *print1* server.

---

**See Also**

For more information about this command, see the following source:

- The NET MOVE command to learn how to move, rather than copy, files.

## NET ERROR

This command lists the most recent local area network errors and the times that they occurred.

### Syntax

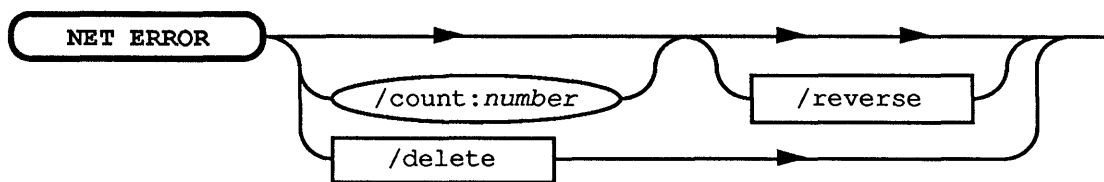

Option	Purpose
<i>/count: number</i>	Displays the <i>number</i> of oldest entries in the error log. When used with the <i>/reverse</i> option, this displays the <i>number</i> of most recent errors in the error log.
<i>/reverse</i>	Displays the error log entries in order of oldest to newest.
<i>/delete</i>	Removes all entries from the error log.
	When used without options, the NET ERROR command displays the full error log of the local server in chronological order. The NET ERROR command produces the following display:

```

Program      Message      Time
-----
NETPOPUP    2851      Mar 07, 1988, 16:03:30
NET2851:  Unable to display message POPUP due to
OS/2 VIO call error
E3 01 01 00
      ....
WORKSTATION 2890      Mar 08, 1988, 14:13:57
NET2890:  A NetWksta internal error has occurred:
DecrNCBNeed: nbi_NCBneed going negative?
3A 26                                     :&
  
```

This display lists the following:

Column	Contents
Program	The name of the program that encountered the error.
Message	The message generated by the error.
Time	The date and time the error occurred.

Some error log entries may also include a raw data listing to help a technician resolve the problem.

This command can also be typed NET ERRORS.

---

## Comments

The text of the error log is kept in the LANMANLOGS\NET.ERR file. When the error list becomes full, the oldest error is deleted to make room for the next error to be added to the list.

The size of your netstation's error log is set by the `sizerror=` entry in the LANMAN.INI file or with the `/maxerrorlog` option to the NET CONFIG NETSTATION command.

---

## Example

To see the error log for his netstation, Mike types the following:

```
net error
```

Looking at the error log, Mike sees there is no need to keep the current list. To clear all the entries from the log, he types this:

```
net error /delete
```

---

## See Also

For more information about this command, see the following sources:

- The NET CONFIG WORKSTATION command for how to set the size of the error log with this command.
- Appendix A: Error Messages for how to set the size of the error log in the LANMAN.INI file.

## NET FORWARD

This command reroutes incoming messages for one user's alias to another user's netstation.

### Syntax

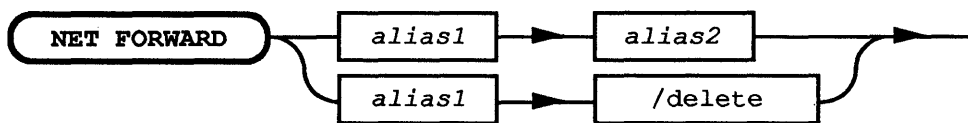

Option	Purpose
<i>alias1</i>	Specifies the alias for which messages are to be forwarded.
<i>alias2</i>	Specifies the alias to receive the forwarded messages.
<i>/delete</i>	Cancels forwarding. This switch must be used with the <i>alias1</i> option only.

NET FORWARD may be abbreviated NET FOR.

### Comments

With the NET FORWARD command, you can specify the name of another person to receive your messages instead of yourself. All messages that are sent to your netstation, whether they are sent directly to you or are forwarded to someone else, are stored in the same log file. This file is called LANMANLOGS\MESSAGES.LOGS. There are two ways to cancel forwarding:

- If you used the NET FORWARD command to forward messages to another computer, you can use the /delete switch with the NET FORWARD command to cancel forwarding.

- If someone else has forwarded messages to you, you can stop receiving the forwarded messages at your netstation by using the NET NAME command with the /delete option. This removes the person's alias from your netstation.

If you want to change the recipient of your forwarded messages, you do not have to cancel forwarding to the previous recipient first. Instead, you can simply type a new alias for the *alias2* option. This is possible because LAN Manager acknowledges only one recipient per alias (unless a group name is used). Note that you cannot forward messages for an alias that is already forwarded to your netstation. And, you cannot forward one alias on your netstation to another alias on the same netstation.

---

**Example**

For Jack to forward his messages to Olga, he types the following:

```
net forward jackst olgar
```

If Jack wants to start forwarding to Ben instead of Olga, he uses a new *alias2*:

```
net for jackst benp
```

Jack does not need to cancel the current forwarding assignment, because a subsequent forwarding command cancels a previous command.

To cancel forwarding, Jack uses his alias and the /delete switch:

```
net forward jackst /delete
```

---

**See Also**

For more information about this command, see the following sources:

- The NET NAME command concerning aliases.
- The NET SEND command for how to send messages.
- The NET LOG command for how to save messages sent to your netstation.
- In Chapter 2: LAN Manager Screen Reference see "Send a Message" for how to send messages using the LAN Manager Screen.



---

## NET HELP

This command provides information at the OS/2 prompt about how to use LAN Manager commands.

---

### Syntax



Option	Purpose
<i>command</i>	Specifies the command that you need help with.

When used without options, the NET HELP command displays a list of all LAN Manager commands. When used with the name of a command, the NET HELP command displays the various possible uses of the command.

---

### Comments

You can type NET HELP followed only by the second word of the LAN Manager command. For example, if you want help in using the NET USE command, type:

```
net help use
```

In response, NET HELP displays information about the NET USE command:

```
net help use
```

The syntax of this command is :

```

NET USE [devicename | \\computername\sharename]
NET USE [devicename] \\computername\sharename [password] [/COMM]
NET USE [devicename| \\computername\sharename} /DELETE
  
```

Command completed successfully.

The NET USE command connects a netstation's local device name to a server's shared resource. See the NET USE command reference for more information.

**NOTE:** You can also see Help information for a LAN Manager command by typing the command in this form:

```
command /help
```

For example, you could see information about the NET LOAD command by typing either of the following commands:

```
net help load
net load /help
```

You can type a command in the following form to see only information about syntax for that command:

```
command /?
```

For example, if you were only interested in seeing what the proper syntax for the NET PRINT command is, you could type the following:

```
net print /?
```

---

**Example**

To receive help with the syntax of the NET PRINT command, Mike types the following:

```
net help print
```

---

**See Also**

For more information about this command, see the following source:

- *The 3+Open MS OS/2 LAN Manager Administrator Guide.*

## NET LOAD

This command loads a specified profile file that contains LAN Manager commands to configure the netstation's local area network connections.

### Syntax

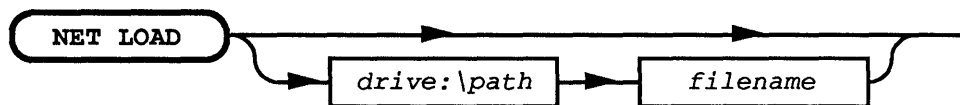

Option	Purpose
<i>drive:\path</i>	Specifies the location of the profile file. If no drive letter and path are specified, LAN Manager assumes the profile file is located in the default LANMAN.PROFILES directory.
<i>filename</i>	Specifies the pathname of the profile file.

When used without options, the NET LOAD command loads the LANMAN\PROFILES\NETLOGON.PRO default profile file.

### Comments

The NET LOAD command loads a profile file for your netstation. A PROFILE file is like a batch file that contains NET USE commands that configure your netstation's local area network connections. (Profile files on servers may also include NET PRINT, NET COMM, and NET SHARE commands.)

The NET LOAD command cannot run if the netstation service is not started. But, if you type the NET LOAD command before starting the netstation service, LAN Manager offers to start the netstation service automatically:

```

netstation is not started.
OK to start it? (Y/[N])
  
```

Type **Y** to start the netstation service and load your profile file. If any connections to shared resources exist when **NET LOAD** is used, LAN Manager prompts for confirmation before canceling the existing connections and establishing the ones specified in the profile file. If any connections are actually in use when you type the **NET LOAD** command, LAN Manager displays an error message and does not load the new profile.

---

### About Profile Files

By default, LAN Manager assumes profiles are stored in the *lanman\profiles* directory. Storing all profiles in one directory makes it easy for users to create, find, and use profiles. LAN Manager also assumes a filename extension of **.PRO** unless you specify otherwise. From the **OS/2** prompt, you can use the **NET SAVE** command to create a profile file.

Typically, your administrator will create a default **NETLOGON.PRO** file on your netstation when the netstation is first connected to the local area network. If you wish, you can later modify the default profile to fit your specific needs.

---

### Example

Jenny is working on a new project this week and needs to use the printer in the computer room. She uses the **NET SAVE** command to create a new profile file called **NETPRINT.PRO** that connects her netstation to the line printer in the computer room:

```
net save netprint.pro
```

Normally Jenny has no need to use this printer, so she did not want to alter her default **NETLOGON.PRO** file. When Jenny wants to print with the line printer, she types

```
net load netprint.pro
```

## See Also

For more information about this command, see the following sources:

- The NET SAVE command for more information about how to create profiles.
- The NET LOGON command for more information about how the default profiles may be loaded automatically when you log on.
- The NET COMM command for more information about controlling connections to shared communication-device queues.
- The NET PRINT command for more information about controlling connections to shared printer queues.
- In Chapter 2: LAN Manager Screen Reference see "Loading a Profile" for more information about loading profiles using the LAN Manager Screen.

## NET LOG

This command starts or stops saving messages to a file or printer or displays information about message logging.

### Syntax

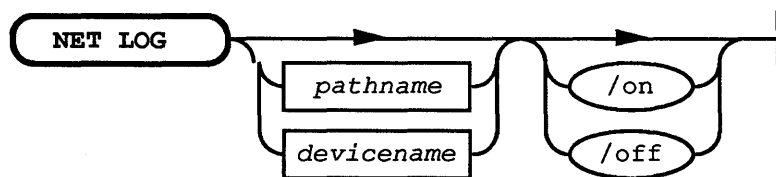

Option	Purpose
<i>pathname</i>	Specifies the pathname to the log file. LAN Manager assumes this file is in the LANMANLOGS directory unless otherwise specified. It also assumes a filename extension of .LOG unless you type another.
<i>devicename</i>	Specifies the netstation's parallel (LPT) or serial (COM) device connected to the printer that is to receive and print out messages.
/on	Turns on message saving. (This is the default; you do not have to type /On.)
/off	Turns off message saving.

When used without options, the NET LOG command displays information about message logging:

```
Message logging is ON.  
Log file name: C:\LANMAN\LOGS\MESSAGES.LOG.
```

This display lists the following:

Field	Contents
Message logging Is	Shows whether message logging is on or off.
Log filename	The name of the file to which your messages are being logged.

## Comments

To receive messages, you must have the Messenger service running and either message logging turned on or the Netpopup service running.

When you start the Messenger service, message logging is automatically turned on, and your messages are stored in the default LANMANLOGS\MESSAGES.LOG file. All messages sent to your netstation, whether they are sent to your alias or to another alias, are logged to the same file or printer.

**NOTE:** The default message-log file is specified by the logfile= entry in your LANMAN.INI file. If the logfile= entry does not include a filename, the Messenger service will start with logging off and no default log file.

To read the messages you have stored in your message file, use a word processing program or use the MS OS/2 TYPE command from the OS/2 prompt. You can also use the Contents of Current Message Log dialog box from the LAN Manager Screen to read logged messages.

### **Example**

Jack starts logging his messages to the C:\MESSAGES.LOG file by typing

```
net log c:\messages.log /on
```

Later Jack decided to start the Netpopup service to see what would happen. He liked seeing his messages displayed on his screen, so he stopped saving messages in his log file by typing the following:

```
net log /off
```

Then Jack decided he wanted both message logging turned on and the Netpopup service started. Since he previously started message logging and specified a file to store his messages, Jack can resume saving his messages in the specified file by typing this:

```
net log /on
```

Now his messages are displayed on his screen when they arrive and are also saved in his log file.

---

**See Also**

For more information about this command, see the following sources:

- The NET SEND command for how to send messages to other users on the local area network..
- The NET START command for how to specify a message log file when you start the Messenger service and how to star the Netpopup service.
- In Chapter 2: LAN Manager Screen Reference, see "Specify Message Log File" for how to specify a log file using the LAN Manager Screen.
- In Chapter 2: LAN Manager Screen Reference see "Contents of a Current Message Log" for how to read your message log using the LAN Manager Screen.
- The *3+Open MS OS/2LAN Manager User Guide* for information about the Messenger and Netpopup services.

---

**NET LOGOFF**

This command ends a computer's connection with the local area network and logs a user name off of the local area network.

---

**Syntax**

**NET LOGOFF** |

---

**Comments**

The NET LOGOFF command is used to end a user's local area network session. Since only one user can be logged on to the local area network from a netstation at a time, when you log off one user name, it frees the netstation to be used by someone else.



If you are actively using any shared resources (for example, your current drive is a redirected drive), you cannot log off. If you have any connections to a server's shared resources when you use the NET LOGOFF command, LAN Manager warns you that logging off deletes those connections. You are then asked to confirm your request to log off. If you confirm your request, you will see the following message on your screen:

```
username successfully logged off
```

Once the NET LOGOFF command has been completed, you no longer have active user name, password, or local area network sessions, and you cannot receive messages sent to your user name.

---

## Example

At the end of the day, to log off of the local area network, Jenny types this:

```
net logoff
```

---

## See Also

For more information about this command, see the following sources:

- The NET LOGON command for how to log on.
- In Chapter 2: LAN Manager Screen Reference see "Logging into Network" for how to log on to LAN Manager using the LAN Manager Screen.



account, LAN Manager runs the script on your netstation when you log on to the local area network. (This script is contained in a file on the log-on server.) Then if the default profile, NET LOGON.PRO, exists, NET LOGON loads this profile on your netstation.

When prompting for a user name, the NET LOGON command displays a default user name. This name is taken from the `username=` entry of the LANMAN.INI file. If this entry has no value, NET LOGON uses the computer name of the netstation (from the `computername=` entry in LANMAN.INI) as the default user name. Instead of typing your password, you can type an asterisk (\*). This causes LAN Manager to prompt you for your password. When you type your password at the prompt, it is not displayed on the screen. This helps you to keep your password confidential.

You can use the NET LOGON command at any time to change a netstation's user name and password. To do this, simply type the NET LOGON command with the new user name and password.

If someone is already logged on to the local area network from your netstation, the NET LOGON command displays a prompt saying the first user name must be logged off before the second can be logged on.

The NET LOGON command also tries to add the specified user name as an alias for the netstation. If the user name cannot be added as an alias, LAN Manager logs you on to the local area network but displays a warning message.

---

## Example

For Jenny to establish her user name, *jennyt*, and password, *babaloo*, as the default on a netstation, she types the following:

```
net logon jennyt babaloo
```

If the netstation already had a default user name and password, Jenny would see the following prompt on her screen:

```
You are currently logged on as USER1
You must logoff before logging on.
Proceed with logoff? (Y/[N]):Y
USER1 logged off successfully
JENNYT logged on successfully
```

She types Y for yes, and her user name and password become the default for the netstation.

---

**See Also**

For more information about this command, see the following sources:

- The NET LOGOFF command for how to log off from LAN Manager.
- The NET START WORKSTATION command for how to specify a user name and password when starting the netstation.
- In Chapter 2: LAN Manager Screen Reference see "Log into Network" for how to log on to LAN Manager using the LAN Manager Screen.
- The *3+Open MS OS/2LAN Manager Installation and Setup Guide* for more information about the LANMAN.INI file.

---

**NET MOVE**

This command moves files, both locally and remotely.

---

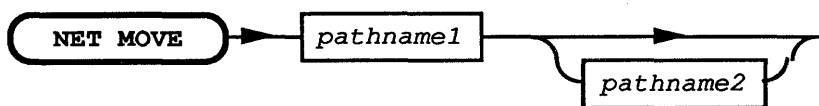
**Syntax**

Option	Purpose
<i>pathname1</i>	Names the file(s) to be moved. This pathname can include wild-card characters (* or ?).
<i>pathname2</i>	Identifies the directory or filename of the file(s) to which the files are moved. If <i>pathname2</i> is not specified, the files are moved to the current directory. If wild-card characters are used in <i>pathname1</i> , then <i>pathname2</i> must be a directory.

### Comments

The NET MOVE command moves files between any two directories you have permission to use. You can move files between two network computers. While working at netstation A, you can move files between servers B and C. You don't have to make connections to servers to move network files. The NET MOVE command makes the connections for you.

Moving a file is not the same as copying a file. Copying makes a duplicate of the specified file and leaves the original in place; moving relocates a file from one place to another.

To move files, you must have create and delete permission for both the source files and the destination directory.

### Example

To move all the document files from the *\text* directory on drive C of her netstation to the *\reports\budget* directory on the *\general* server, Olga types the following:

```
net move c:\text\*.doc \\general\reports\budget
```

All Olga's files that match the *c:\text\\*.doc* pathname are now on the *\general* server and have been deleted from Olga's *c:\text* directory.

## See Also

For more information about this command, see the following sources:

- The NET COPY command for how to copy files.
- The *MS OS/2 Beginning User's Guide* for more information about wild-card characters.

## NET NAME

The NET NAME command displays, adds, or deletes the aliases defined in a netstation's list of aliases.

## Syntax

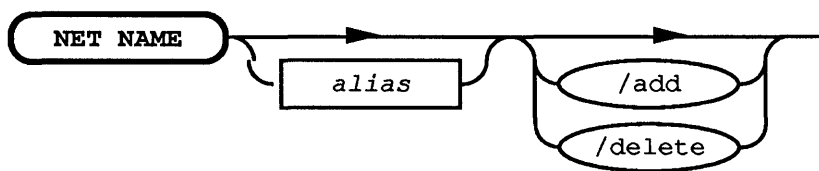

Option	Purpose
<i>alias</i>	Specifies an alias you want to add or delete.
<i>/add</i>	Adds an alias to the local netstation.
<i>/delete</i>	Removes an alias previously added to your netstation.
	When used without options, the NET NAME command lists all the aliases currently active on the local netstation and, if they have been forwarded, where they have been forwarded to.

```
Name          Forwarded To
-----
JIMMYW        LESLIEJ
WALTERK
GUEST         forwarded to you from \\PRINT1
```

Command completed successfully.

This display shows the following:

Column	Contents
Name	Each alias for this netstation.
Forwarded To	The recipient of forwarded messages for this alias, if any, is specified.

## Comments

A netstation can have three types of names:

- One computer name.
- One user name.
- One or more aliases.

Your netstation can receive messages sent to all three types of names. It saves all messages received to the same message log file or prints them all on the same printer, as specified by the NET LOG command. If you do not specify another filename or the device name of a printer, LAN Manager logs all messages received by your netstation to the default message-logging file, LANMANLOGS\MESSAGES.LOG. (This filename is specified by the logfile= entry in your LANMAN.INI file.)

The /add switch is optional; you can add a new alias by typing NET NAME and the alias without the /add switch. Thus, the following two commands do the same thing, assuming *jackst* is a new alias:

```
net name jackst
```

```
net name jackst /add
```

### Example

Jimmy Wilson just started working in the mail room. He wants Leslie to receive his messages until he gets a netstation of his own. At Leslie's netstation, she types the following:

```
net name jimmyw
```

Now Leslie's netstation is ready to receive all messages sent to *jimmyw*. When Jimmy gets his own netstation, Leslie can stop receiving his messages by typing:

```
net name jimmyw /delete
```

### See Also

For more information about this command, see the following sources:

- The NET SEND command for how to send messages to other users.
- The NET LOG command for how to save your messages in a file.
- In Chapter 2: LAN Manager Screen Reference see "Aliases for Messaging" for how to add and delete aliases using the LAN Manager Screen.

## NET PASSWORD

The NET PASSWORD command changes the password for accessing a server.

### Syntax

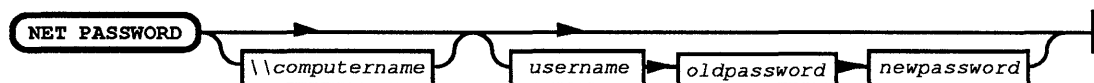



Option	Purpose
<i>\\computername</i>	Names the server on which the password will be used.
<i>username</i>	Names the user who has the password on the server.
<i>oldpassword</i>	Specifies the user's current password. (Your password may be up to 14 characters long.) You may type an asterisk (*) instead of your password to cause LAN Manager to prompt you for your password.
<i>newpassword</i>	Specifies the user's new password.

When used without options, the NET PASSWORD command prompts you for all the information it needs. The following prompts are displayed:

```
net password
```

```
Server on which to change password, or CR for local:
```

```
[Enter] your username:
```

```
[Enter] your old password:
```

```
[Enter] your new password:
```

```
Confirm your password:
```

```
Command completed successfully.
```

---

## Comments

The NET PASSWORD command changes the password for a user's account on a particular server running with user-level security. This command cannot be used for servers running with share-level security.

If you are using the Entry Level LAN Manager product, the computer name must be Server.

The NET PASSWORD command prompts for any option not typed on the command line. If you type an asterisk (\*) instead of a password, LAN Manager prompts you for the password. When you type your password at the prompt, it is not displayed on the screen. This helps you to keep your password confidential.

### Example

When Jenny wants to change her password on the \\mis server from *babaloo* to *duwamps*, she types the following:

```
net password \\mis jennyt babaloo duwamps
```

If there is another person in her office when Jenny changes her password, she types the NET PASSWORD command without options. This way, when she types in her old and new passwords, they are not displayed on her screen.

### See Also

For more information about this command, see the following source:

- In Chapter 2: LAN Manager Screen Reference see "Change Logon Password at a Server" for how to change passwords using the LAN Manager Screen.

### NET PAUSE

This command suspends a LAN Manager service or connection with a shared resource and frees up memory used by a service.

### Syntax

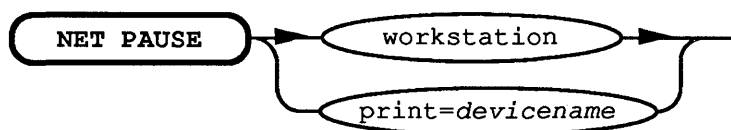

Option	Purpose
workstation	Continues local area network use of all serial (COM) and parallel (LPT) ports.
print[= <i>devicename</i> ]	Continues a shared printer (where <i>devicename</i> specifies a single print device; omitting <i>devicename</i> continues all print devices).

---

**Comments**

When you pause the netstation service, you temporarily suspend connections from your netstation to printer and communication-device queues and free memory on your computer for use by other programs you want to run.

In some ways, NET PAUSE WORKSTATION affects your netstation in the same way as NET STOP WORKSTATION. Both stop redirection of local printer and communication device names to local area network resources, and both free up memory on your netstation. However, unlike NET STOP WORKSTATION, NET PAUSE WORKSTATION does not delete user names specified with the NET START command.

You can restore the paused netstation service with the NET CONTINUE WORKSTATION command.

---

**Example**

To pause the netstation service, Ben types the following:

```
net pause workstation
```

When Ben is ready to resume this local area network connection, he types this:

```
net continue print=1pt2
```

See Also

For more information about this command, see the following source:

- The NET CONTINUE command for more information about continuing a paused netstation service.

## NET PRINT

This command displays and controls the contents of a shared print queue.

### Syntax

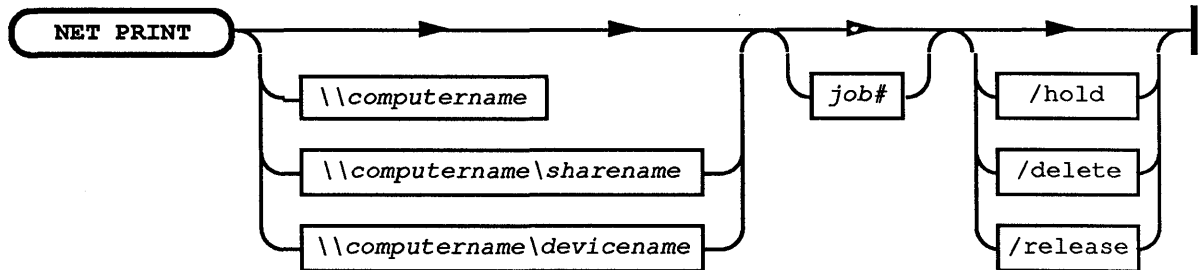

Option	Purpose
<i>\\computername</i>	Specifies the server sharing the queue.
<i>\sharename</i>	Specifies the shared print queue.
<i>\devicename</i>	Specifies the local print device connected to the queue.
<i>job#</i>	Specifies the identification number assigned to a file in a queue.
<i>/hold</i>	Keeps a print job from printing. Print jobs held in the queue with the <i>/hold</i> option stay in the queue and are not printed until released with the <i>/release</i> option.
<i>/release</i>	Releases a held job from the queue.
<i>/delete</i>	Removes the print job from the print queue.

## Comments

When used with the `\\computername` option, the NET PRINT command displays information about the server's print queues:

```
Printer Queues at \\PRINT1
```

Name	Job#	Size	Status
FAST_PRT Queue	3 jobs		*Queue Active*
JACKST	1	2509	Printing on LPT1
JENNYT	3	75	Waiting
JENNYT	4	75	Waiting
PRT Queue	2 jobs		*Queue Active*
BENS	5	180	Printing on LPT2
JOHNOC	6		Spooling

Command completed successfully.

This display lists the following:

Column	Contents
Name	Sharename of the print queue and the user name of the owner for each job sent to the queue
Job#	Identification number of each print job
Size	Size in bytes of each print job
Status	Status of each print job (Printing, Paused, Error, Spooling) or the status of each queue and the number of jobs in it

If you are using the Entry Level LAN Manager product, the `\\computername` must be `\\server`.

## Comments

When used with the computer name and sharename of a queue or with the redirected device name, the NET PRINT command displays only information about the specified queue. This display includes the status of the queue itself and a list of the jobs in the queue, including the size and status of each job. Print jobs for printers controlled by MS-DOS servers are listed under one heading, appearing as only a large print queue.

The status of a print queue can be OK, Held, Held until, Pending delete, or Error. The status of a print job can be Spooling, Held, Printing on (device), Held on (device), Out of paper on (device), Error on (device), Offline on (device), or Waiting.

Print jobs to be held or released (with the /hold and /release options) can be specified either by the device name or by the computer name of the server plus the sharename of the queue. For example, if your netstation's LPT2 device name is redirected to a queue named `\\mis\print`, either of the following commands will hold a job (identification number 24):

```
net print lpt2 24 /hold
net print \\mis\print 24 /hold
```

**NOTE:** You can only hold, release, or delete a print job that you submitted.

### **Example**

Realizing that he sent the wrong monthly budget to print, Jack wants to delete his print request. First, he types the following to see what identification number is assigned to his print request:

```
net print \\print1\laser
```

This display appears on Jack's screen:

```
Print Queues at \\PRINT1
```

Name	Job#	Size	Status
LASER Queue	2 jobs		*Queue Active*
BENS	6	2527	Printing on COM1
JACKST	7	3074	Waiting

He sees that his is request number 7. Next, Jack deletes his print request by typing:

```
net print \\print1\laser 7 /delete
```

## See Also

For more information about this command, see the following source:

- In Chapter 2: LAN Manager Screen Reference see "Print Queues for (Server)" for how to work with print queues using the LAN Manager Screen.

## NET RUN

This command runs a program or command on a network server.

## Syntax

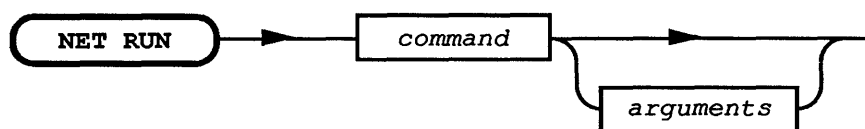

Option	Purpose
<i>command</i>	Specifies the command to be run.
<i>arguments</i>	Includes any options that are valid for command.

## Comments

The NET RUN command lets you run large or time-consuming programs on network servers and save the resources of your netstation for other work. To use the NET RUN command, you must do the following things:

- Start the Netrun service at the server.
- Be connected to the server via the NET USE command.
- Have as your current drive a shared drive connected to the server.
- Be sure the program you want to run on the server is available to you. (The program must be on the server's runpath, and you must have access permission for that program.)

You cannot specify a drive letter in the pathname of a command to be run with NET RUN. However, you can use drive letters when supplying arguments to and redirecting output from, commands run with the NET RUN command. When you use drive letters as part of the arguments option, LAN Manager assumes you are providing one of the server's local drive letters.

---

**Example**

The *\personnel* server has a file-comparison program called *diff* included in its runpath. To have the *\personnel* server compare two mailing lists, MAILLIST.TXT and ADDRESS.LST, Leslie types the following to connect a drive to the *\personnel* server and the *lists* shared directory:

```
net use d: \\personnel\lists
```

Then she makes drive D the current drive and types the following command to compare the two files:

```
net run diff maillist.txt address.lst
```

The output of the *diff* program is displayed on Leslie's screen.

---

**See Also**

For more information about this command, see the following sources:

- The NET USE command for how to connect to a server's shared drive.
- The *3+Open MS OS/2 LAN Manager Administrator Guide* for how to start and stop the Netrun service on a server.
- In Chapter 2: LAN Manager Screen Reference see "Shared Resources at (Server)" for how to connect to a server's shared drive using the LAN Manager Screen.



## NET SAVE

This command creates a profile file that defines the netstation's current local area network connections for later use.

### Syntax

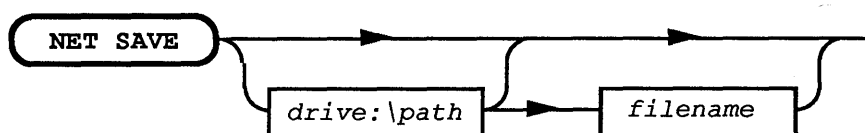

Option	Purpose
<i>drive:\path</i>	Specifies the location of the profile file. If the drive letter and path are not specified, LAN Manager assumes that the file is to be created in the default LANMANPROFILES directory.
<i>filename</i>	Specifies the filename of the profile file to contain the saved information.

When used without options, the NET SAVE command stores the current local area network configuration in the LANMANPROFILES\NETLOGON.PRO file. If the NETLOGON.PRO file already exists, LAN Manager displays this warning message:

```
The file you have chosen already exists.  
Overwrite? (Y/N) [N]:
```

### Comments

The NET SAVE command saves a profile of your netstation's current connections to a profile file. (Profile files on servers may also include NET SHARE, NET COMM, and NET PRINT commands.) You can use the NET LOAD command to load a profile file you save with the NET SAVE command. When you do this, you reestablish the local area network connections defined by the profile file.

---

## About Profile Files

By default, LAN Manager assumes profiles are stored in the LANMAN\PROFILES directory. Storing all profiles in one directory makes it easy for you to create, find, and use profiles. LAN Manager also assumes a filename extension of .PRO unless you specify otherwise.

Typically, your administrator will create a default NETLOGON.PRO file on your netstation when the netstation is first connected to the local area network. If you wish, you can later modify the default profile to fit your specific needs. Note that profile files have a different format from batch files. Using a word processing program, you can convert a profile into a batch file. If you do so, you should give the converted file the .CMD extension and use it as a batch file rather than a profile file.

---

## Example

John O'Clare most often uses two shared directories: the *shipping* directory on the *\print1* server and the *accounts* directory on the *\billing3* server. He also likes to use the *\print1\draft* printer. Once he has connected to shared resources, he saves these connections to shared resources in the C:\BESTUSES.PRO by typing:

```
net save c:\bestuses.pro
```

The C:\BESTUSES.PRO file contains the following commands:

```
net use d: \\print1\shipping
net use e: \\billing3\accounts
net use lpt1: \\print1\draft
```

When John wants to establish the connections defined in BESTUSES.PRO, he uses the NET LOAD command to load this profile file.

---

## See Also

For more information about this command, see the following source:

- The NET LOAD command for how to load a profile.
- In Chapter 2: LAN Manager Screen Reference see "Save Configuration to a Profile File" for how to save a profile using the LAN Manager Screen.

## **NET SEND**

This command sends messages and files to other users.

### **Syntax**

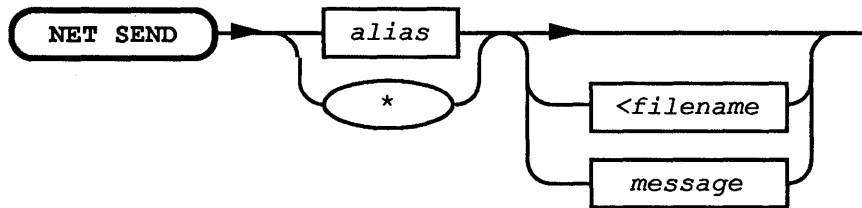

Option	Purpose
<i>alias</i>	Specifies the user name, group name, or computer name to which the message is to be sent.
*	Indicates that all computers on the local area network are to receive the message (a broadcast message).
<i>&lt;filename&gt;</i>	Names the file to send as a message.
<i>message</i>	Specifies text to be sent as a message. This option and the <i>&lt;filename&gt;</i> option are mutually exclusive.

### **Comments**

To send a short message to someone else on the local area network, type the NET SEND command using the following form:

```
net send alias text
```

The text of your message may optionally be contained within quotation marks.

If the message you want to send is longer than one line, type the NET SEND command followed by an alias and press [Enter]. LAN Manager will allow you to type a message of any length; you may include several lines, including carriage returns (produced when you press [Enter]). When you have typed your message,

press [Enter], then [Ctrl]+Z to add an end-of-line character to your message. Then press [Enter] again to send your message.

If you use the \* option to send a broadcast message (that is, a message sent to all computers on the local area network), that message is limited to 128 characters. If you try to send a longer broadcast message, excess characters are lost and the receiver is not notified that the message is incomplete.

Files of up to 64K can be sent as messages. However, most netstations have only enough memory to receive files smaller than 2K in size. (The size of a netstation's message buffer is set by the `sizmessbuf=` entry in the LANMAN.INI file or with the `NET START MESSENGER/sizmessbuf:n` command.) If you send a message longer than the recipient can receive, the following error message appears on your screen:

```
Message sent but not received
```

In order for you to successfully send a message to another person on the local area network, the Messenger service must be running both on your computer and on the recipient's computer. When your message is successfully received, LAN Manager displays this message:

```
Message successfully sent to username.
```

If you use an alias that LAN Manager doesn't recognize, or if the Messenger service is not running on the recipient's computer, an error message appears.

---

### Example

To send a message to the alias `jacks+`, Debbie types the following:

```
net send jacks+ Meeting changed to 3 p.m. Same place.
```

After the 3 p.m. meeting, Debbie uses a word processor to type the minutes of the meeting, then sends the file as a broadcast message to all computers connected to the local area network:

```
net send * < notes.mtg
```

## See Also

For more information about this command, see the following sources:

- The NET LOG command for how to save the messages sent to you.
- The NET FORWARD command for how to forward your messages to another computer.
- The NET NAME command for adding extra aliases to your netstation.
- The NET START MESSENGER command for starting the Messenger service.
- In Chapter 2: LAN Manager Screen Reference see "Send a Message" for more information on how to send a message using the LAN Manager Screen.

## NET START MESSENGER

This command starts the LAN Manager Messenger service.

## Syntax

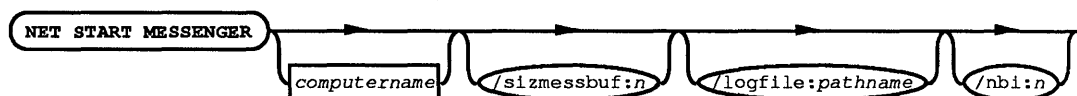

Option	Purpose
<i>computername</i>	Specifies the computer name of your netstation if the netstation service is not yet started.
<i>/sizemessbuf:n</i>	Sets the size of the message buffer, in bytes. (The maximum size allowed is 62000.)
<i>/logfile:pathname</i>	Sets the pathname of the default message log file.
<i>/mbi:n</i>	This option is provided for compatibility with the NET START MESSENGER command in Microsoft Networks for MS-DOS version 1.0 and IBM PC-LAN version 1.2. It specifies the size, in bytes, of the message buffer.

**NOTE:** This command also accepts any options you can specify with the NET START WORKSTATION command. If the netstation service is not yet started. See the NET START NETSTATION command for a complete listing.

---

## Comments

There are three services you may run on your netstation: netstation, Netpopup, and Messenger. The Messenger service allows you to send messages to others on the local area network and to receive messages.

The services section of the LANMAN.INI file contains the pathnames for all of the services.

**NOTE:** To start the Messenger service automatically when you start the netstation service, add "Messenger" to the services listed by the wrkservices= entry in your LANMAN.INI file.

If the netstation service has not yet started, LAN Manager automatically starts the netstation service before starting the Messenger service. (The Messenger service cannot run without the netstation service.) If the computername= entry in your LANMAN.INI file is blank and the netstation service is not started, you can type the *computername* option with the NET START MESSENGER command to start both the netstation and Messenger services.

You can use the /sizemessbuf:*n* option to specify the size of your message buffer. A message buffer of the size you specify remains in your netstation's memory until you stop the Messenger service. You can use the sizemessbuf= entry in the LANMAN.INI file to set the size of your netstation's message buffer each time you start the Messenger service on your netstation.

Typically, the logfile= entry in your LANMAN.INI file specifies the name of a default message log file in your LANMAN.LOGS directory. You can use the /logfile:*pathname* option to specify an alternate message log file if you prefer.

---

**Example**

John wants to be able to send and receive messages over the local area network. To start the Messenger service, he types the following:

```
net start messenger
```

---

**See Also**

For more information about this command, see the following sources:

- The NET START WORKSTATION command for starting the netstation service.
- The NET START NETPOPUP command for starting the Netpopup service.
- The NET STOP command for stopping the Messenger service.
- The NET SEND command for sending messages to others on the local area network.
- The NET LOG command for message logging.
- The NET NAME command for creating aliases on your netstation.
- The NET FORWARD command for forwarding your messages to some other computer on the local area network.
- In Chapter 2: LAN Manager Screen Reference see "Message Menu" and related dialog-boxes for sending and receiving messages while working from the LAN Manager Screen.
- The *3+Open MS OS/2 LAN Manager User Guide* for using the Messenger service.
- The *3+Open MS OS/2 LAN Manager Installation and Setup Guide* for using the LANMAN.INI file.

---

## NET START NETPOPUP

This command starts the LAN Manager Netpopup service.

---

### Syntax

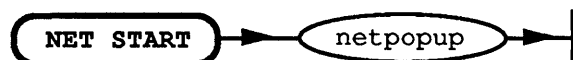

---

### Comments

Services are the main components of LAN Manager. The Netpopup service is one of three services you may run on a netstation. The other two are workstation and Messenger. Before you can start the Netpopup services, the Workstation service must be running. If you try to start the Netpopup service first, LAN Manager offers to start the workstation service first.

The Netpopup service displays messages sent to you via the local area network as soon as they are received. Each message appears in a message box that is displayed on top of the current contents of your screen. After you read your message, you can press [Esc] to remove the message box from your screen. If you do not press [Esc], the message box will disappear after one minute.

The services section of the LANMAN.INI file contains the pathnames for all of the services.

---

### Example

John wants to see a message on his screen as soon as someone sends it. John types the following to start the Netpopup service:

```
net start netpopup
```



---

## See Also

For more information about this command, see the following sources:

- The NET START WORKSTATION command for starting the netstation service.
- The NET START MESSENGER command for starting the Messenger service.
- The NET STOP command for stopping the Netpopup service.
- The NET NAME command for creating aliases on your netstation.
- The NET FORWARD command for forwarding your messages to some other computer on the local area network.
- In Chapter 2: LAN Manager Screen Reference see "Messages Menu" and related dialog boxes for how to send and receive messages while working from the LAN Manager Screen.
- The 3+*Open MS OS/2 LAN Manager Installation and Setup Guide* for more information about the LANMAN.INI file.
- The 3+*Open MS OS/2 LAN Manager User Guide* for instructions on using the Netpopup service.

---

## NET START WORKSTATION

This command starts the LAN Manager Workstation service and sets other options for the netstation.

---

## Syntax

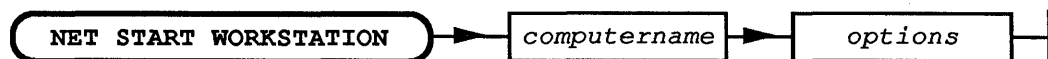

Option	Purpose
<i>/charcount:bytes</i>	Specifies, in bytes, the maximum amount of data bound for a network communication device that your netstation is to store before actually sending the data to the device. Increasing the amount increases local area network efficiency, but may cause some delay in character transmission.
<i>/chartime:time</i>	Specifies the maximum interval, in milliseconds, that your netstation is to store data bound for a remote communication device before actually sending the data to the device. Increasing the interval increases local area network efficiency, but may cause some delay in character transmission.
<i>/charwait:time</i>	Specifies the maximum interval, in seconds, that the local netstation is to wait for a requested communication device to become available when a program tries to use the device.
<i>/computername:name</i>	Specifies the computer name for the netstation. If this netstation is also an Entry Level LAN Manager server, you must use the computer name Server.
<i>/keepconn:n</i>	Specifies how long inactive local area network connections are to be maintained.
<i>/keepsearch:n</i>	Specifies how long, in seconds, inactive search requests are to be maintained. Directory search requests made from DOS mode that are inactive for more than this interval are discarded.
<i>/logonserver:name</i>	Specifies the computer name of the server on which log-on information (that is, user name, password, and log-on script) for this user may be found. <i>Name</i> is a specific computername when centralized log-on security is used on the local area network, and is an asterisk (\*) when distributed log-on security is used. If you are using the Entry Level LAN Manager product, the computer name must be Server.

Option	Purpose
/mailslots:[yes no]	Specifies whether to perform nonguaranteed mailslot delivery. (The default is yes.)
/maxerrorlog: <i>n</i>	Specifies the maximum size of the error log in kilobytes.
/maxworkcache: <i>n</i>	Sets the size limit, in kilobytes, for the netstation memory cache size.
/numalerts: <i>n</i>	Specifies the size of the alert table.
/numcharbuf: <i>n</i>	Specifies the number of character and pipe buffers for the netstation.
/numservices: <i>n</i>	Specifies how many LAN Manager services may run on this computer at the same time.
/numworkbuf: <i>n</i>	Specifies the number of netstation buffers to allocate.
/printbuftime: <i>time</i>	Specifies the amount of time after which LAN Manager will truncate a print job spooled from the DOS session.
/sesstimeout: <i>time</i>	Specifies how long the netstation will try to connect to a local area network resource.
/sizcharbuf: <i>n</i>	Specifies the size of the character/pipe buffer.
/sizerror: <i>n</i>	Specifies the size of the netstation's internal error buffer.
/sizworkbuf: <i>n</i>	Specifies the size in bytes of each netstation buffer.
/wrkheuristics: <i>string</i>	Provides for special netstation heuristics. For more information, see the description of the wrkheuristics= entry in the LANMAN.INI file in the <i>3+Open LAN Manager Installation and Setup Guide</i> .
/wrknets: <i>name</i>	Specifies the name of the default local area network.
/wrkservices: <i>list</i>	Lists services to start, along with the netstation.

**NOTE:** The following options are provided for compatibility with the NET START WORKSTATION command in Microsoft Networks for MS-DOS version 1.0 and IBM PC-LAN version 1.2:

Options	Purpose
<code>\z:n</code> <code>\nbs:n</code>	Specifies the size, in bytes, of netstation buffers. (Same as <code>\sizework buf:n</code> .)
<code>\B:n</code>	Specifies the number of netstation buffers.
<code>\nbc:n</code>	(Same as <code>/numworkbuf:n</code> .)

## Comments

If *computername* is not specified with the NET START command, the computer name listed in the computer name= entry of the LANMAN.INI file is used.

The LANMAN.INI file defines your netstation's default configuration values. In particular, the wrkservices= entry of the LANMAN.INI file allows you to specify which services to start along with the netstation.

All of the NET START WORKSTATION options have equivalent entries in your LANMAN.INI file. By including one or more options with the NET START WORKSTATION command, you can override the values set by the corresponding LANMAN.INI entries.

The following lists each NET START WORKSTATION option and its related LANMAN.INI entry:

Command option	Equivalent LANMAN.INI entry
<code>/charcount:bytes</code>	charcount=
<code>/chartime:time</code>	chartime=
<code>/charwait:time</code>	charwait=
<code>/computername:name</code>	computername=
<code>/keepconn:n</code>	keepconn=
<code>/keepsearch:n</code>	keepsearch=
<code>/langroup:name</code>	langroup=
<code>/logonserver:name</code>	logonserver=
<code>/mailslots:[yes no]</code>	mailslots=
<code>/maxerrorlog:n</code>	maxerrorlog=
<code>/maxworkcache:n</code>	maxwrkcache=
<code>/numalerts:n</code>	numalerts=
<code>/numcharbuf:n</code>	numcharbuf=

Command option	Equivalent LANMAN.INI entry
/numservices: <i>n</i>	numservices=
/numworkbuf: <i>n</i>	numworkbuf=
/printbuftime: <i>time</i>	printbuftime=
/sesstimeout: <i>time</i>	sesstimeout=
/sizcharbuf: <i>n</i>	sizcharbuf=
/sizerror: <i>n</i>	sizerror=
/sizworkbuf:	sizworkbuf
/wrkheuristics: <i>string</i>	wrkheuristics=
/wrknets: <i>name</i>	wrknets=
/wrkservices: <i>name</i>	wrkservices=

To learn more about using the LANMAN.INI file, see the *3+Open MS OS/2 LAN Manager Installation and Setup Guide*.

For convenience, NET START commands can be placed in your netstation's STARTUP.CMD file.

All options that work with the NET START WORKSTATION command also work with the NET START MESSENGER command if the netstation is not yet started.

### Example

When John arrives in the morning, he turns on his computer and types the following to start the Workstation service:

```
net start workstation
```

To start his netstation with a different computer name, John could type the following:

```
net start workstation /computername:john_o'clare
```

### See Also

For more information about this command, see the following sources:

- The NET CONFIG NETSTATION command for changing the configuration of the Workstation once the netstation service is started.
- The *3+Open OS/2 LAN Manager Installation and Setup Guide* for using the LANMAN.INI file.

---

## NET STATISTICS

This command displays and clears a netstation's list of usage statistics.

---

### Syntax

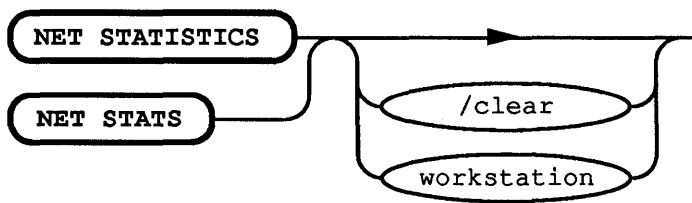

Option	Purpose
/clear	Clears the list of statistics

When used without options, the NET STATISTICS command shows a display like the following:

```
Statistics are available for the following running services:
WORKSTATION
Command completed successfully.
```

This command can also be typed NET STATS.

---

### Comments

When you type the NET STATISTICS WORKSTATION command, it displays statistics about the netstation:

```
Network Statistics for \\ADMSVC
Statistics since Jul 28, 1988, 12:27:12
Network I/O's performed      848   Network I/O errors          0
Server sessions opened       2    Server sessions failed     1
Sessions reconnected         0
Command completed successfully.
```

This display shows the following:

Field	Contents
Network I/O's performed	The number of local area network transactions originating from this netstation.
Server sessions opened	The number of sessions opened from this netstation at local area network servers.
Network I/O errors	The number of errors and violations related to local area network transactions.
Server sessions failed	The number of errors and violations related to server sessions.
Sessions reconnected	The number of disconnected sessions that were reconnected

### **Example**

To display a list of usage statistics for his netstation, Mike types the following:

```
net statistics workstation
```

### **See Also**

For more information about this command, see the following sources:

- The NET ERROR command for displaying the server's list of errors.
- The STATUS MENU command for displaying status information using the LAN Manager Screen.

---

**NET STOP**

This command stops LAN Manager services.

---

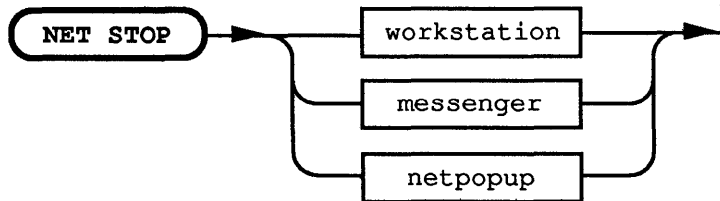
**Syntax**

---

**Comments**

Stopping the Workstation service stops all other LAN Manager services running on your computer. If you type `NET STOP WORKSTATION` with the Messenger or Netpopup service also running on your netstation, LAN Manager prompts you for confirmation before stopping either of these services. Also, if your netstation is connected to one or more shared resources, LAN Manager reminds you of these connections and asks for reconfirmation before stopping the netstation.

When you stop the Messenger service, you are no longer able to send or receive messages over the local area network.

If you stop the Netpopup service, be sure to have message logging turned on. Otherwise, you will have no way of receiving messages at your netstation. Stopping the Netpopup service means that you will not see your messages immediately on your screen when they are received.

---

**Example**

To stop messages from popping up on the screen of her netstation, Jenny types the following:

```
net stop netpopup
```



## See Also

For more information about this command, see the following sources:

- The NET START MESSENGER, NET START NETPOPOP, and NET START WORKSTATION commands for how to start and use LAN Manager services.
- The NET LOG command for saving messages sent to you.

## NET USE

This command redirects a netstation's local device name to a server's shared resource.

## Syntax

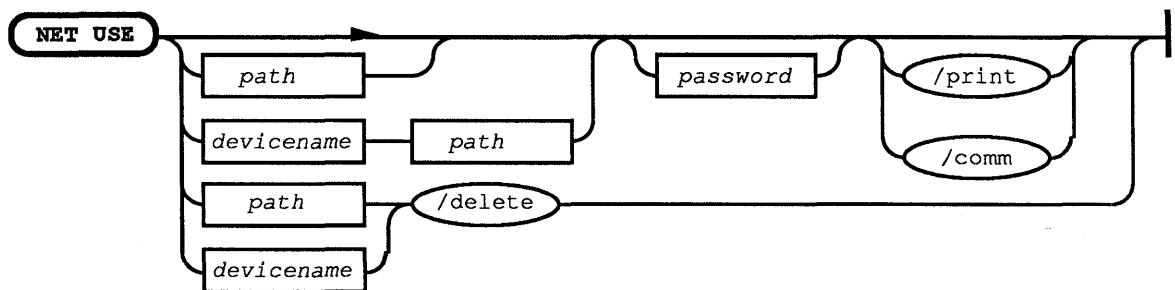

Option	Purpose
<i>devicename</i>	Specifies the name of the parallel port (for example, LPT1), serial port (for example, COM1), or disk drive (for example, G:) you are using locally to identify a shared printer, communication device, or directory.
<i>password</i>	For servers with share-level security, this specifies the password assigned to the shared resource. For servers with user-level security, this specifies the user's password to the server controlling the requested resource if it is different from the password set with the NET LOGON command.
<i>path</i>	Specifies a network path to a shared resource which is a <i>\\computername\sharename</i> .
<i>/comm</i>	Specifies that a local print device name (LPT) is to be redirected to a communication-device queue.
<i>/delete</i>	Disconnects a local area network connection.
<i>/print</i>	Specifies that a local communication device name (COM) is to be redirected to a print queue.

When used without options, the NET USE command lists the netstation's connections. The display lists the status, associated device, and sharename of each connection:

Status	Local name	Remote name
DISCONNECTED	G:	\\GENERAL\C
OK	M:	\\MIS\SCRATCH
ERROR	LPT1	\\PRINT1\LASER

Command completed successfully.

## Comments

When used with just the device name or just the server's computer name and sharename (assuming you are already connected to the resource), the NET USE command displays information about a specific connection:

```
net use \\admsvc\requests
```

```
Local name      R:  
Remote name    \\ADMSVC\REQUESTS  
Type           Disk  
Status         OK  
Open count     1  
Use count      1
```

Command completed successfully.

This display shows the following:

Field	Contents
Local name	The device name of the device connected to the shared resource.
Remote name	The sharename of the shared resource.
Type	The type of shared resource being used: Disk, Printer, Communication device, or Interprocess communication.
Status	The status of the connection: OK, Error, or Disconnected.
Open count	The number of times a file was opened via this connection.
Use count	The number of connections you have to the shared resource.

If you are using the Entry Level LAN Manager product, the `\\computername` option must be `\\server`.

If you type the NET USE command before you log on to the local area network, LAN Manager prompts you to log on. (This is because LAN Manager must validate your user name and password before allowing you access to shared resources.)

You cannot disconnect a local device name from a server if that is your current drive. You must first change to another drive. Also, if you try to disconnect from a shared disk resource when files are still open on the server, LAN Manager displays a warning message and asks you to confirm your decision.

A connection listed as disconnected means that a server ended your session due to inactivity. In most cases, LAN Manager automatically reestablishes this connection the next time you try to use the resource. You do not have to retype the NET USE command to reestablish the connection.

---

**Example**

To connect her netstation to a shared directory with the sharename *letters* controlled by the *\general* server, Debbie types the following:

```
net use e: \\general\letters
```

To connect her netstation to a shared directory with the sharename *drv\_c* (most likely the entire contents of a server's drive C), Debbie types this:

```
net use d: \\general\drv_c
```

To connect her netstation's print device LPT1 to the shared printer with the sharename *laser2* controlled by the *\print2* server, Debbie types this command:

```
net use lpt1 \\print2\laser2
```

When Debbie is ready to disconnect from this resource, she types this:

```
net use lpt1 /delete
```

## See Also

For more information about this command, see the following sources:

- The NET LOGON command for logging on to the local area network.
- The NET SAVE command for saving your netstation's current resource connections to a profile file.
- The NET LOAD command for restoring saved resource connections from a profile file.
- In Chapter 2: LAN Manager Screen Reference see "Use a Shared Resource" for connecting a device to shared resource using the LAN Manager Screen.

## NET VIEW

This command displays the computer names of all local area network servers in your LAN group or, alternately, the resources being shared by a server.

## Syntax

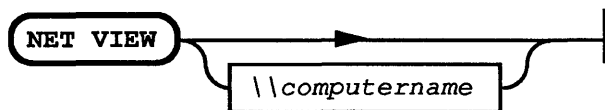

Option	Purpose
<i>\\computername</i>	Specifies the server whose shared resources you want to view.

When used without options, the NET VIEW command displays the computer name of all servers visible on the local area network:

server Name	Remark
\\MIS	Mary Sullivan's office
\\PRINT1	Printer room, first floor
\\PRINT2	Printer room, second floor

Command completed successfully.

---

## Comments

The NET VIEW command is provided so you can see this information:

- Which servers in your LAN group are available for you to use.
- What each available server is sharing with the local area network.

The NET VIEW command displays information about servers in your LAN group that are running MS OS/2. (Your LAN group is specified by the langroup= entry in the LANMAN.INI file.). Servers running MS-DOS or another operating system are not listed by the NET VIEW command.

If you are using the Entry Level LAN Manager product, the *computername* option must be Server. If you type NET VIEW with no options, you should see only \\server.

Once you know the computer name of a server, you can type the NET VIEW command followed by the server's computer name to see what resources the server is sharing with the local area network:

```
net view \\print1
```

```
Resources at \\PRINT1  
Printer room, first floor
```

Net Name	Type	Used as	Remark
PRT	Print	LPT2	Printer pool
FAST_PRT	Print	LPT1	High priority printer
PORT	Comm		Shared Modem
FAX	Comm	COM1	Fax machine
D	Disk	R:	Drive D Root

Command completed successfully.

This display shows the following:

Column	Contents
Net Name	The sharename of a shared resource
Type	The type of resource being shared
Used as	Your netstation's local device name that is currently redirected to this shared resource
Remark	A descriptive comment about the resource

---

**Example**

To see the computer names of the servers available in her LAN group, Jenny types the following:

```
net view
```

One of the servers listed is `\\mis`. To see the resources being shared by `\\mis`, Jenny types this:

```
net view \\mis
```

Now that she knows the computer name of the server and what it is sharing, Jenny can use the NET USE command to actually connect to `\\mis` and use its shared resources.

---

**See Also**

For more information about this command, see the following sources:

- The NET USE command for how to use a resource shared by a server.
- In Chapter 2: LAN Manager Screen Reference, see "Servers Available on the Local Area Network" for seeing the computer names of available servers using the LAN Manager Screen.





## Appendix A: Error Messages

This appendix shows all error messages that may be displayed on your screen by 3+Open MS OS/2 LAN Manager.

---

### LAN Manager Network Error Messages

- NET2102: The Workstation driver  
NETWKSTA.SYS is not installed.
- NET2103: The Server cannot be located.
- NET2104: An internal error occurred. The network cannot access a shared memory  
segment.
- NET2105: A network resource shortage occurred .
- NET2106: This operation is not supported on Workstations.
- NET2107: The device is not connected.
- NET2109: This UNC sharename does not exist.
- NET2114: The Server has not been started.
- NET2115: Requested item does not exist
- NET2116: The device or directory does not exist.
- NET2117: Redirected devices cannot be shared.
- NET2118: The name has already been shared.
- NET2119: The Server is currently out of the requested resource.

- NET2121: Requested add of item exceeds maximum allowed.
- NET2123: The API return buffer is too small.
- NET2127: A remote API error has occurred.
- NET2131: An error occurred when opening or reading LANMAN.INI.
- NET2134: An internal error occurred when calling the Workstation driver.
- NET2136: A generic network error has occurred.
- NET2138: The Workstation service has not been started.
- NET2139: The requested Server information is not available.
- NET2140: An internal LAN Manager error has occurred.
- NET2141: The Server is not configured for transactions.
- NET2142: The requested API is not supported on the remote Server.
- NET2143: The event name is poorly formed.
- NET2146: The program could not find the specified component in LANMAN.INI.
- NET2147: The program could not find the specified parameter in LANMAN.INI.
- NET2149: A line in LANMAN.INI is too long.
- NET2150: The printer queue does not exist.
- NET2151: The print job does not exist.
- NET2152: The printer destination cannot be found.
- NET2154: The printer queue already exists.
- NET2155: No more printer queues can be added.
- NET2156: No more print jobs can be added.
- NET2157: No more printer destinations can be added.
- NET2158: This printer destination is idle and cannot accept control operations.
- NET2159: This printer destination request contains an invalid control function.
- NET2160: The printer processor is not responding.
- NET2161: The Spooler service has not been started.
- NET2163: This operation cannot be performed on the printer queue in its current state.
- NET2164: This operation cannot be performed on the print job in its current state.
- NET2165: A Spooler memory allocation failure has occurred.
- NET2180: There is a timeout on the service table semaphore.
- NET2181: The service table is full.
- NET2182: The requested service has already been started.
- NET2183: There is a service entry semaphore timeout.
- NET2184: The service has not been started.
- NET2185: The service name is invalid.
- NET2186: The service is not responding to the control function.
- NET2187: The service control is busy.

- NET2188: LANMAN.INI contains an invalid service program name.
- NET2189: The service cannot be controlled in its present state.
- NET2190: The service would not respond to normal service control functions and was stopped with the DosKillProc function.
- NET2191: The requested pause or stop is not valid for this service.
- NET2200: This Workstation is already logged on.
- NET2201: This Workstation has not been logged on yet.
- NET2202: The username or groupname parameter is invalid.
- NET2203: The password parameter is invalid.
- NET2204: The logon processor did not add the message alias.
- NET2205: The logon processor did not add the message alias.
- NET2206: The logoff processor did not delete the message alias.
- NET2207: The logoff processor did not delete the message alias.
- NET2210: A centralized logon Server conflict has occurred.
- NET2211: The Server is configured without a valid user path.
- NET2212: An error occurred while loading or running the logon script.
- NET2213: The network is unable to use the resources provided for centralized logon.
- NET2214: The logon Server was not specified. Standalone logon will occur.
- NET2215: The logon Server cannot be found.
- NET2220: The groupname cannot be found.
- NET2221: The username cannot be found.
- NET2222: The resource name cannot be found.
- NET2223: The group already exists.
- NET2224: The user account already exists.
- NET2225: The resource permission list already exists.
- NET2227: The server is not running with user-level security.
- NET2228: There are too many names in the access control file.
- NET2229: A disk I/O failure has occurred.
- NET2230: There were too many lists specified.
- NET2232: The parent directory cannot be located.
- NET2234: This operation is not allowed on this special group.
- NET2236: The user already belongs to this group.
- NET2237: The user does not belong to this group.
- NET2250: The connection cannot be found.
- NET2251: This msg\_type is invalid.
- NET2252: This device is already being shared.
- NET2270: A computername has not been configured.

- NET2271: This message Server has already been started.
- NET2272: The message Server initialization request has failed.
- NET2273: The message alias cannot be found on the local-area network.
- NET2274: This message alias has already been forwarded.
- NET2275: This message alias has been added but is still forwarded.
- NET2276: This message alias already exists locally.
- NET2277: The maximum number of added message aliases has been exceeded.
- NET2278: The computername cannot be deleted.
- NET2279: Messages cannot be forwarded back to the same Workstation.
- NET2280: The log file or device has not been specified.
- NET2281: The message has been sent but the reception is currently paused.
- NET2282: The message was sent but not received.
- NET2283: The message alias is currently in use. Try again later.
- NET2284: The Messenger service has not been started.
- NET2285: The name is not on the local computer.
- NET2286: The forwarded message alias cannot be found on the network.
- NET2287: The message alias table on the remote station is full.
- NET2288: Messages for this alias are not currently forwarded.
- NET2289: The broadcast message was truncated.
- NET2291: The log name contains invalid characters.
- NET2294: This is an invalid device.
- NET2295: A write fault has occurred.
- NET2297: A duplicate message alias exists on the local-area network.
- NET2298: This message alias will be deleted later.
- NET2310: This shared resource does not exist.
- NET2311: This device is not shared.
- NET2312: A session does not exist with that computername.
- NET2314: There isn't an open file with that ID number.
- NET2315: A failure occurred when executing a remote administration command.
- NET2316: A failure occurred when opening a remote temporary file.
- NET2317: The data returned from a remote administration command has been truncated to 64K bytes.
- NET2318: This device cannot be shared as both a spooled and a non-spooled device.
- NET2319: The Server table was initialized incorrectly.
- NET2331: The operation is invalid for this device.
- NET2332: This device cannot be shared.
- NET2333: This device was not open.

- NET2334: This device name string is invalid.
- NET2335: The queue priority is invalid.
- NET2337: There are no shared communication devices.
- NET2338: A queue doesn't exist for this request.
- NET2340: This list of devices is invalid.
- NET2341: The requested device is invalid.
- NET2342: This device is already in use by the spooler.
- NET2343: This device is already in use as a communications device.
- NET2351: This computername is invalid.
- NET2354: The string and prefix specified are too long.
- NET2356: This path component is invalid.
- NET2357: Cannot determine type of input.
- NET2362: The buffer for types is not big enough.
- NET2370: Profile files cannot exceed 64K bytes.
- NET2371: The start offset is out of range.
- NET2372: The system cannot delete current connections to network resources.
- NET2373: The system was unable to parse the command line in this file.
- NET2374: An error occurred while loading the profile file.
- NET2377: This log file exceeds the maximum defined size.
- NET2380: The source path cannot be a directory.
- NET2381: The source path is illegal.
- NET2382: The destination path is illegal.
- NET2383: The source and destination paths are on different servers.
- NET2385: The Run Server you requested using the NET RUN command is paused.
- NET2389: An error occurred when communicating with a run Server.
- NET2391: An error occurred when starting a background process.
- NET2392: The shared resource you are connected to could not be found.
- NET2400: The LAN adapter number is invalid.
- NET2401: There are open files on the connection.
- NET2402: Active connections still exist.
- NET2403: This netname or password is invalid.
- NET2404: The device is being accessed by an active process.
- NET2405: The drive letter is in use locally.

# A

## Error Messages

---

A-6

---

---

### **Alerter Service Messages**

- NET2430: The Alerter service has already been started.
- NET2431: The Alerter service table is full.
- NET2432: The Alerter service has not been started.
- NET2433: The Alerter service recipient is invalid.

---

---

### **NetService Messages**

- NET3051: LANMAN.INI or the command line has an illegal value for <variable>.
- NET3052: The required parameter <variable> was not provided on the command line or in LANMAN.INI.
- NET3053: The unknown parameter <variable> was provided on the command line or in LANMAN.INI.
- NET3054: A request for <variable> resources could not be satisfied.
- NET3055: A problem exists with the system configuration: <variable>.
- NET3056: A system error has occurred.
- NET3057: An internal consistency error has occurred.
- NET3058: LANMAN.INI or the command line has an ambiguous parameter <variable>.
- NET3059: LANMAN.INI or the command line has a duplicate parameter <variable>.
- NET3060: The service did not respond to control and was stopped with the DosKillProc function.
- NET3061: An error occurred when loading the service.
- NET3062: The sub-service <variable> failed to install.

---

---

### **Command Syntax Messages**

- NET3500: Server is not configured for administration.
- NET3501: An invalid switch was used.
- NET3503: The command contains an invalid number of arguments.
- NET3505: A switch was used with an invalid argument.
- NET3506: The switch <variable> is unknown.
- NET3507: The switch <variable> is ambiguous.

---

## LAN Manager Application Error Messages

- NET3710: There was an error opening the help file.
- NET3711: The help file is empty.
- NET3712: There is an error in the help file syntax.
- NET3713: An error occurred while sending a message.
- NET3714: An error occurred while opening a temporary file.
- NET3715: An error occurred while writing a temporary file.
- NET3716: The device type is unknown.
- NET3717: The log file has been corrupted.
- NET3718: Program file names must end with .EXE.
- NET3719: A matching share could not be found so nothing was deleted.
- NET3720: The device type is unknown.
- NET3721: The password is invalid for <variable>.
- NET3722: An error occurred while sending a message to <variable>.
- NET3723: An error occurred while opening a temporary file.
- NET3724: An error occurred when writing a temporary file.
- NET3725: An error occurred when the share was deleted.
- NET3726: The username is invalid.
- NET3727: The password is invalid.
- NET3728: The passwords do not match.
- NET3729: The profile could not be loaded.
- NET3730: This computername is invalid.
- NET3731: The command was not found at the remote Server.
- NET3732: Default permissions cannot be set for that resource.
- NET3733: The NETRUN command looks for the program name on the runpath. You cannot specify path characters when using NETRUN.
- NET3734: A valid password was not entered.
- NET3735: A valid name was not entered.
- NET3736: The resource named cannot be shared.
- NET3737: The permissions string contains invalid permissions.
- NET3738: This operation is only valid on LPT and COM devices.
- NET3739: <variable> already has rights for the resource.
- NET3740: <variable> has no rights for the resource.
- NET3741: <variable> is an invalid rights string.
- NET3742: <variable> is an invalid username or groupname.



# A

## Error Messages

---

A-8

- NET3744: A failure occurred while starting CMD.EXE.
- NET3745: An error was encountered processing the file <variable>.
- NET3746: <variable> is an invalid source file.
- NET3747: <variable> is an invalid destination file.
- NET3748: An error occurred while copying <variable>.
- NET3749: An error occurred while deleting <variable>.
- NET3750: An error occurred while moving <variable>.
- NET3751: An error occurred while searching a directory.
- NET3752: No users are logged on to this Server.
- NET3753: User <variable> is not a member of group <variable>.
- NET3754: User <variable> is already a member of group <variable>.
- NET3755: There is no such user: <variable>.
- NET3757: No valid response was provided.
- NET3800: This command line option is invalid.
- NET3801: This schedule update is invalid.
- NET3802: This schedule date is invalid.
- NET3803: The LANMAN root directory is unavailable.
- NET3804: The SCHED.LOG cannot be cleared.
- NET3805: Server shared memory cannot be accessed.
- NET3806: The AT job ID does not exist.
- NET3807: The schedule file is corrupted.
- NET3808: The delete failed due to a problem with the schedule file.
- NET3809: The command line cannot exceed 128 characters.
- NET3810: The schedule file cannot be updated because the disk is full.
- NET3811: The command line option is invalid.
- NET3812: The AT schedule file is invalid. Clear it and create a new one.
- NET3813: The AT schedule file was cleared.
- NET3850: Usage: growacc new-number-of-users
- NET3851: The new number of users argument is too big.
- NET3852: The new number of users must be numeric.
- NET3853: NET.ACC cannot be opened.
- NET3854: NET.ACC is not valid -- please reload from backup.
- NET3855: ACCESS.NET cannot be created.
- NET3856: Writing the signature to USERS.NET failed.
- NET3857: Writing to USERS.NET failed.
- NET3858: There are more active users in the old accounts file than in the new.
- NET3859: The accounts file was configured too small.

- NET3860: Re-encryption of password failed.
- NET3861: Writing to NET.ACC failed.
- NET3862: Reading from new accounts file failed.
- NET3863: The new NET.ACC is full.
- NET3864: Reading from NET.ACC failed.
- NET3865: Writing to NEWNET.ACC failed.
- NET3866: Renaming NET.ACC failed.
- NET3867: Renaming the old NET.ACC to BAK.ACC failed.
- NET3868: The update was destroyed. Please restore from backup.
- NET3869: Renaming NEW.ACC to NET.ACC failed.
- NET3870: <variable> is not a valid computername.



# Index

## A

### Aliases

- add, 2-47, 3-41
- delete, 2-47, 3-41
- list, 3-41

Aliases menu item, 2-39, 2-50

Automatic startup, 1-2

## B

### Batch file

- command, 1-4

## C

Change Logon Password at a Server dialog box, 2-52

Change Password menu item, 2-52

Comm-device Queues menu item, 2-33, 2-37

### Command

- asterisk option, 3-5
- batch file, 1-4
- HELPMSG, 1-6
- introduction, 1-4, 3-1
- NET, 3-10
- NET CONFIG command, 3-15
- NET COMM, 3-11
- NET CONTINUE, 3-18
- NET COPY, 3-20
- NET ERROR, 3-24
- NET FORWARD, 3-26
- NET HELP, 1-5, 3-28
- NET LOAD, 3-30
- NET LOG, 3-32

### Command (Continued)

- NET LOGOFF, 3-35
- NET LOGON, 3-36
- NET MOVE, 3-39
- NET NAME, 3-41
- NET PASSWORD, 3-43
- NET PAUSE, 3-45
- net print, 3-47
- NET RUN, 3-50
- net save, 3-52
- NET SEND, 3-54
- NET START MESSENGER, 3-56
- NET START NETPOPOP, 3-59
- net start workstation, 3-60
- NET STATISTICS, 3-65
- NET STOP, 3-67
- NET USE, 3-68
- NET VIEW, 3-72
- no option, 3-6
- option names, 3-3
- password in, 3-4
- references in this manual, 3-6
- start services automatically, 3-3
- syntax, 3-7
- using, 3-2
- yes option, 3-6

### Communication-device queue

- cancel request, 3-12
- connected to local device, 2-34
- get information about, 2-36
- list of a Server's, 2-34, 3-12
- options, 2-36

## Config menu

- Change Password menu item, 2-52
- Load Profile menu item, 2-52
- Log On menu item, 2-51, 2-53
- Save Profile menu item, 2-52
- Stop Services menu item, 2-52

## Configuration

- change, 3-15, 3-16
- display information about, 3-15
- profile file, load, 2-56, 3-30
- profile file, save, 2-58, 3-52
- save current, 2-58

Contents of Current Message Log dialog box, 2-38

## D

### Dialog box

- access path, 2-8
- elements, 2-7
- list of, with menus, 2-8
- reach by selecting menu item, 2-7

Disconnect, defined, 3-71

## E

Error Log dialog box, 2-62

Error Log menu item, 2-62, 2-68

Error message, 1-5

- clear log, 2-67, 3-24
- delete from log, 2-67, 3-24
- display log, 2-62, 3-24
- get more information, 1-6, 2-66
- save, 2-66

## **F**

### File

- batch file for commands, 1-4
- copy, 3-20
- move, 3-39

Finding further information, xvi

## **G**

Getting more information, 1-4

## **H**

### Help

- HELPMSG command, 1-6
- LAN Manager screen Help facility, 2-6
- NET HELP command, 1-5, 3-28

HELPMSG command, 1-6

## **I**

Information about a Shared Resource dialog box, 2-19

## **L**

LAN Manager Screen, 1-3

display, 2-2, 3-10

elements, 2-3

Help facility, 2-6

Load a Profile File dialog box, 2-52

Load Profile menu item, 2-52

Log off, 3-35

Log on, 1-2, 2-51, 2-54, 3-4, 3-36

change password, 2-60, 3-43

Config menu, 2-53

tasks, start automatically, 1-3

Log On menu item, 2-51, 2-53

Log on to the Local-Area Network dialog box, 2-51, , 2-53

## **M**

### **Menu**

- list, 2-8
- select, 2-5
- select menu item, 2-5

### **Message**

- add alias, 2-47, 3-41
- clear, 2-43
- continue logging, 2-46, 3-33
- delete alias, 2-47, 3-41
- forward, change recipient, 3-27
- forward to another Workstation, 2-48, 3-26
- list of aliases, 3-41
- pause logging, 2-45, 3-33
- read, 2-43, 3-34
- send, 2-41, 3-54
- send to all computers, 3-55
- specify new log file for, 2-45
- stop forwarding to another Workstation, 2-48, 3-26
- stop receiving forwarded messages, 3-27

### **Message Aliases dialog box, 2-39**

### **Message menu**

- Aliases menu item, 2-39, 2-50
- Read menu item, 2-38
- Send menu item, 2-38

### **Messenger Service**

- defined, 3-57
- start, 3-56
- stop, 3-67

## **N**

**NET COMM** command, 3-11

**NET** command, 3-10

**NET CONFIG WORKSTATION** command, 3-15

**NET CONTINUE** command, 3-18

**NET COPY** command, 3-20



- NET ERROR command, 3-24
- NET FORWARD command, 3-26
- NET HELP command, 1-5, 3-28
- NET LOAD command, 3-30
- NET LOG command, 3-32
- NET LOGOFF command, 3-35
- NET LOGON command, 1-2, 3-36
- NET MOVE command, 3-39
- NET NAME command, 3-41
- NET PASSWORD command, 3-43
- NET PAUSE command, 3-45
- Net print command, 3-47
  - list queue contents, 3-49
  - sample list, 3-49
- NET RUN command, 3-50
- Net save command, 3-52
- NET SEND command, 3-54
- NET START command, 1-1
- NET START MESSENGER command, 3-56
- NET START NETPOPUP command, 3-59
- Net start workstation command, 3-60
- NET STATISTICS command, 3-65
- NET STOP command, 3-67
- Net use command, 2-52, 2-55, 3-68
- NET VIEW command, 3-72
- Netpopup Service
  - defined, 3-59
  - start, 3-59
  - stop, 3-67
- Network Servers menu item, 2-17
- Notational conventions, xiv

## O

- Option name in command, 3-3

## **P**

### **Password**

- logon, change, 2-60, 3-38, 3-43
- replace with asterisk, 3-5
- shared resource, 2-23
- use with command, 3-4

### **Print device**

- NET CONTINUE command, 3-18, 3-45

### **Print job**

- change position in printer queue, 2-30
- change status, 2-28, 3-49
- get information about, 2-28
- status, 2-26

### **Printer queue**

- get information about, 2-28, 3-48
- sample listing of contents, 3-49
- shared by a Server (list), 2-26, 3-48
- status, 2-26, 3-48

### **Printer Queues menu item, 2-11, 2-32**

### **Profile file, 3-52**

- about, 3-31, 3-53
- defined, 3-30
- load, 2-56, 3-30
- save, 2-58, 3-52

## **R**

### **Read (message) menu item, 2-38**

## **S**

Save Configuration to a Profile File dialog box, 2-52

Save Profile menu item, 2-52

Send (message) menu item, 2-38

Send a Message dialog box, 2-38

Server

- list, 3-73

- list of shared resources, 3-73

- list shared resources of, 2-13

- run remote programs on, 3-50

Service

- Message, start, 3-56

- Netpopup, start, 3-59

- start automatically, 1-2, 3-3

- stop, 3-67

- Workstation, start, 3-60

Service, defined, 1-1

Service name in command, 3-2

Shared resource

- connect, 2-17, 2-21, 3-68

- connect to new resource, 2-19

- continue, 3-18

- disconnect, 2-19, 3-69

- get information about, 2-19

- list of, 3-69

- list of a Server's, 2-13, 3-74

- passwords for, 2-23

- pause, 2-18, 3-45

- status, 3-69

- stop using, 2-15

- using, 2-15

Show Printer Queues for dialog box, 2-11

Start LAN Manager, 1-1

- automatic startup, 1-2

- log on, 1-2

Start services automatically, command, 3-3  
Status menu  
    Error Log menu item, 2-62, 2-68  
Stop Services menu item, 2-52

## **U**

Use a Shared Resource dialog box, 2-19

## **V**

View menu  
    Comm-device Queues menu item, 2-33, 2-37  
    Network Servers menu item, 2-17  
    Printer Queues menu item, 2-11, 2-32  
    Your Workstation menu item, 2-24

## **W**

Workstation name, 3-42  
Workstation Service  
    options, 3-60  
    start, 1-1, 3-60  
    stop, 3-67  
Workstation statistics  
    clear, 2-64, 3-65  
    display, 2-64, 3-65  
    reset log, 2-64  
    view, 2-64

## **Y**

Your Workstation menu item, 2-24



# Reader Comment Form

3Com Corporation

Please take the time to complete this form. Your suggestions and comments will help us to improve our future publications. Thank you.

Publication 3+Open MS OS/2 LAN Manager Part # 4700-01  
User Reference

Please rate the product's documentation in each of the following areas:

	Excellent	Good	Fair	Poor
<b>Technical Accuracy</b>				
Does the documentation reflect the product's functionality?	<input type="checkbox"/>	<input type="checkbox"/>	<input type="checkbox"/>	<input type="checkbox"/>
<b>Reliability</b>				
Is the publication easy to read and understand?	<input type="checkbox"/>	<input type="checkbox"/>	<input type="checkbox"/>	<input type="checkbox"/>
<b>Clarity</b>				
Are the procedures easy to follow?	<input type="checkbox"/>	<input type="checkbox"/>	<input type="checkbox"/>	<input type="checkbox"/>
<b>Examples</b>				
Are they helpful? Are there enough of them?	<input type="checkbox"/>	<input type="checkbox"/>	<input type="checkbox"/>	<input type="checkbox"/>
<b>Organization</b>				
Is it easy to locate information?	<input type="checkbox"/>	<input type="checkbox"/>	<input type="checkbox"/>	<input type="checkbox"/>
<b>Graphics</b>				
Are they clear and useful?	<input type="checkbox"/>	<input type="checkbox"/>	<input type="checkbox"/>	<input type="checkbox"/>

### How did you use this publication?

Installation manual

Introduction to the subject

Self-study

Operating instructions

Reference

Training aid

Other \_\_\_\_\_

### How did you receive this publication?

With Equipment/Software

Company Representative

Another User

Other \_\_\_\_\_

After reading this publication were you able to use the product? Yes \_\_\_ No \_\_\_

If you noticed errors, please list page number(s). \_\_\_\_\_

Any comments or suggestions? \_\_\_\_\_

Name \_\_\_\_\_ Title \_\_\_\_\_

Company \_\_\_\_\_

Address \_\_\_\_\_

City \_\_\_\_\_ State/Zip \_\_\_\_\_

Phone (\_\_\_\_) \_\_\_\_\_

All information becomes the property of 3Com Corporation

CUT HERE





No Postage  
Necessary  
if mailed  
in the  
United States

**BUSINESS REPLY MAIL**  
FIRST CLASS PERMIT NO. 1883 SANTA CLARA, CA

**POSTAGE WILL BE PAID BY ADDRESSEE**

3Com Corporation  
3165 Kifer Road  
Santa Clara, CA 95052-8145 USA

Attn: SPD Publications Department

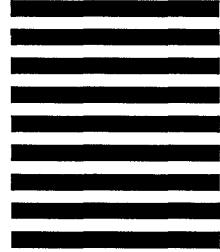

*please fold here*

PLEASE TAPE. POSTAL REGULATIONS PROHIBIT  
USE OF STAPLES.

CUT HERE





3Com Corporation  
3165 Kifer Road  
Santa Clara, CA 95052-8145