

1 Hardware

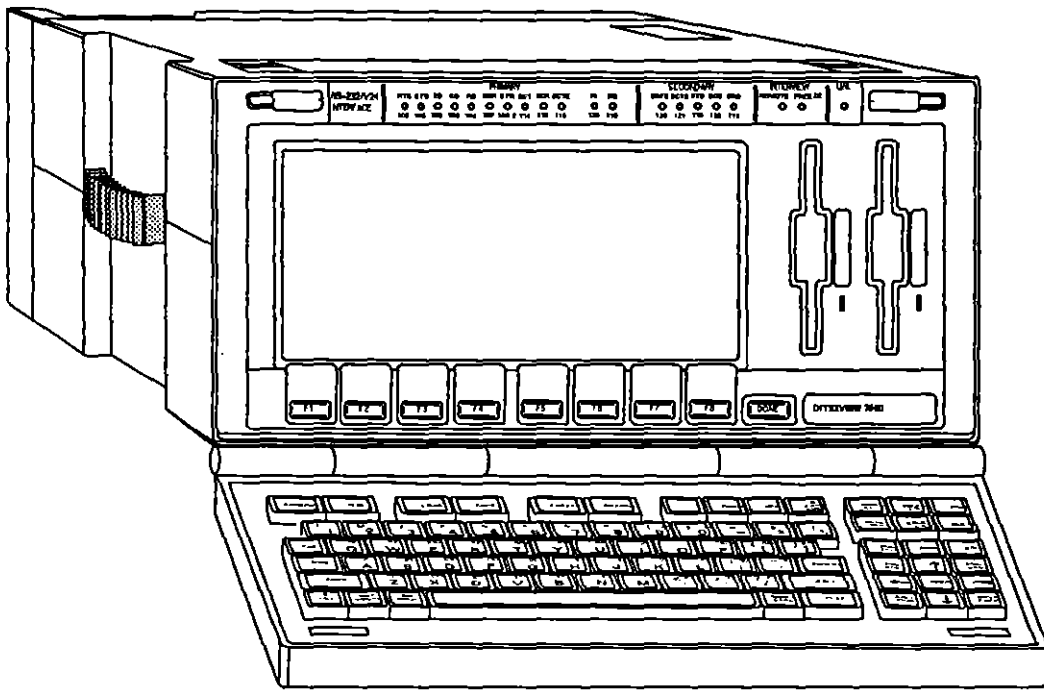

Figure 1-1 INTERVIEW 7500.

1 Hardware

1.1 Physical Dimensions

The protocol analyzers in the INTERVIEW 7000 Series, represented by the INTERVIEW 7500 in Figure 1-1, measure 7 inches high by 14 inches wide by 18.5 inches deep. The unit weighs approximately 29–32 pounds.

1.2 Keyboard

The INTERVIEW has a 94–key keyboard containing ASCII keys and special keys separated into pads according to function. The keyboard is described in detail in Section 3.

1.3 Front Panel

(A) Plasma Display

The INTERVIEW's flat plasma display screen measures 3.7 inches high by 8.4 inches wide. The high-resolution display (576 X 256 pixels) is black and red. No brightness adjustment is required for the plasma display.

The screen has 21 display lines, 16 of which are devoted to data display. Data is displayed in lines 64 characters long, making the capacity of the screen 1344 characters (of which 1024 characters are devoted to line data). The top 2 lines of the data screen are devoted to status information; the bottom 3 lines to function key identification (see Figure 1-2).

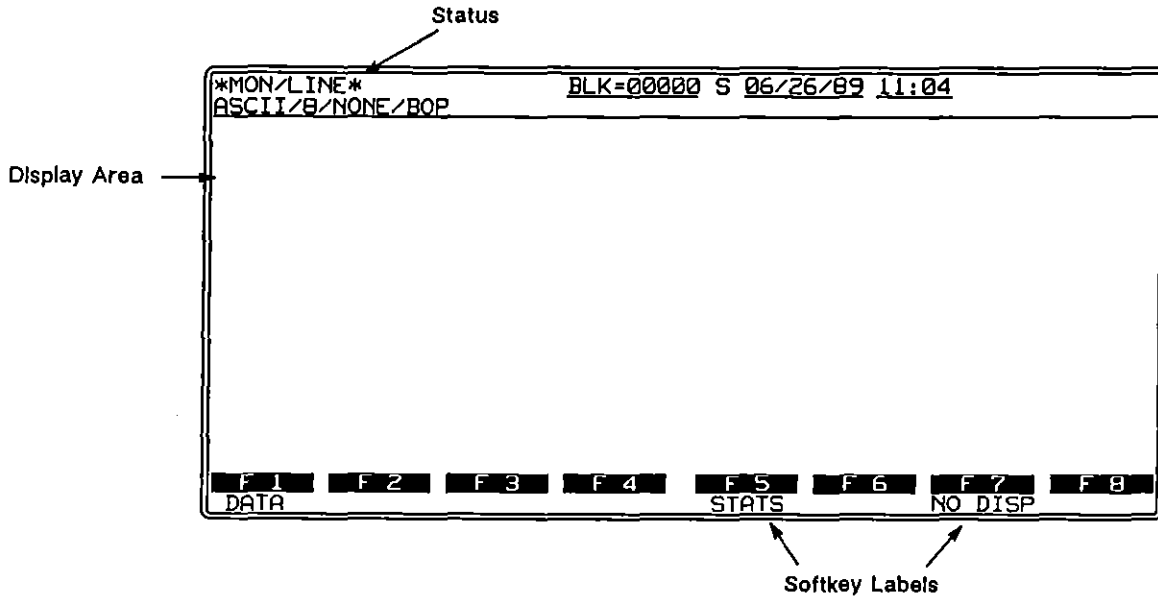

Figure 1-2 INTERVIEW display screen.

(B) Function Keys

Eight function keys and the **[DOWN]** key are located directly below the display screen. The uses of the function keys vary from program menu to program menu; however, their function is always defined on the screen in rectangular windows located above the keys. (Refer to Section 3 for a discussion of their use.)

(C) LED's

Twenty LED's are placed above the display screen. These LED's are divided into three banks: interface status LED's, INTERVIEW status LED's, and the U/A LED. Figure 1-3 shows the assignment of LED's for an RS-232 interface.

RS-232/V24 INTERFACE	RTS	CTS	TD	CD	RD	PRIMARY					RI	SQ	SECONDARY					INTERVIEW		U/A
	105	106	103	109	104	DSR	DTR	SCT	SCR	SCTE	113	125	110	SRTS	SCTS	STD	SCD	SRD	REMOTE	
						107	108.2	114	115	113				120	121	118	122	119		

Figure 1-3 There are 20 LED's, divided by function, above the plasma display.

1. *Interface status indicators.* Interface status indicators may be assigned to different signals, depending on the Test Interface Module which is installed in the rear panel. An overlay accompanies each module and should be

placed over the front panel LED's whenever the module is installed. Assignment of each of the front panel indicators is illustrated in Appendix I, which also gives the interface specifications for each Test Interface Module.

Primary and Secondary indicators on the front panel glow red to indicate that the lead is on (space voltage) and green to indicate that the lead is off (mark voltage). U/A lead indicators on Test Interface Modules operate differently. See Section 1.5(F).

2. *INTERVIEW status indicators.* There are three status indicators: REMOTE, FREEZE, and U/A. The REMOTE indicator is red when the INTERVIEW is under remote control. The FREEZE indicator is red when the display screen has been frozen (with the  key) while in Run mode. Both REMOTE and FREEZE LED's are dark when off.
3. *U/A LED.* The last indicator, U/A, is user-assigned and may be programmed to track any lead of the operator's choosing. See Section 12.3(C) for the use of the UA-input jack in RS-232/V.24 testing.

(D) The Test Interface Overlay

Each Test Interface Module is accompanied by a front panel overlay. The overlay is placed over the interface status LED's and identifies the lead tracked by that LED when that particular Test Interface Module is installed. The overlay masks out any unused LED's. Replace the overlay each time that you change the Test Interface Module.

1.4 Disk Drives

The INTERVIEW uses 3.5 inch double-sided, high-density microfloppy diskettes (see Figure 1-4). Each formatted microfloppy has a storage capacity of 1.4 Mbytes.

Each disk has a write-protect window (see Figure 1-4). To write-protect a disk, slide the window open so that you can see through the disk.

If a high density disk has been used on another piece of equipment which has a 1 Mbyte drive, it must be reformatted before it is used on the INTERVIEW. The data it contains cannot be read.

There are two 3.5 inch microfloppy disk drives immediately to the right of the display screen. An LED just to the right of each drive is lit to indicate that the microfloppy in the drive is being accessed. Insert disks in the direction shown in Figure 1-5.

To remove a disk, press in the black bar next to the drive containing the disk.

CAUTION: Never remove a disk from its drive when the LED indicates that the disk is being accessed.

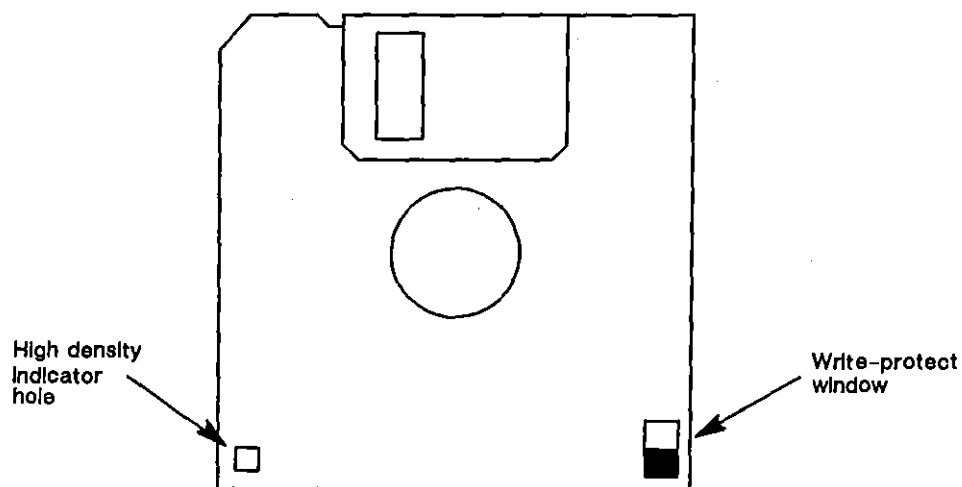

Figure 1-4 The INTERVIEW uses 3.5 inch quad- or high-density, double-sided microfloppy diskettes.

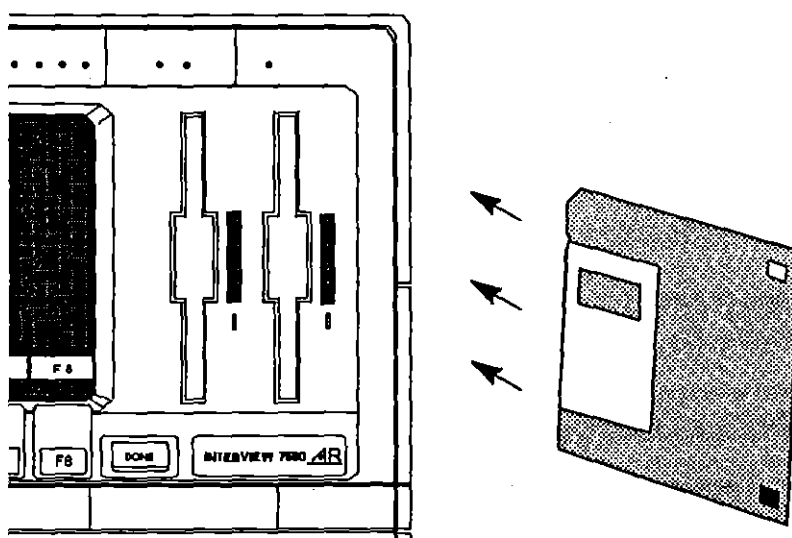

Figure 1-5 The INTERVIEW is equipped with two micro-floppy disk drives. Hard disk is standard in the 7200 *TURBO*, 7500, and the 7700 *TURBO*. It is available as an option in the 7000.

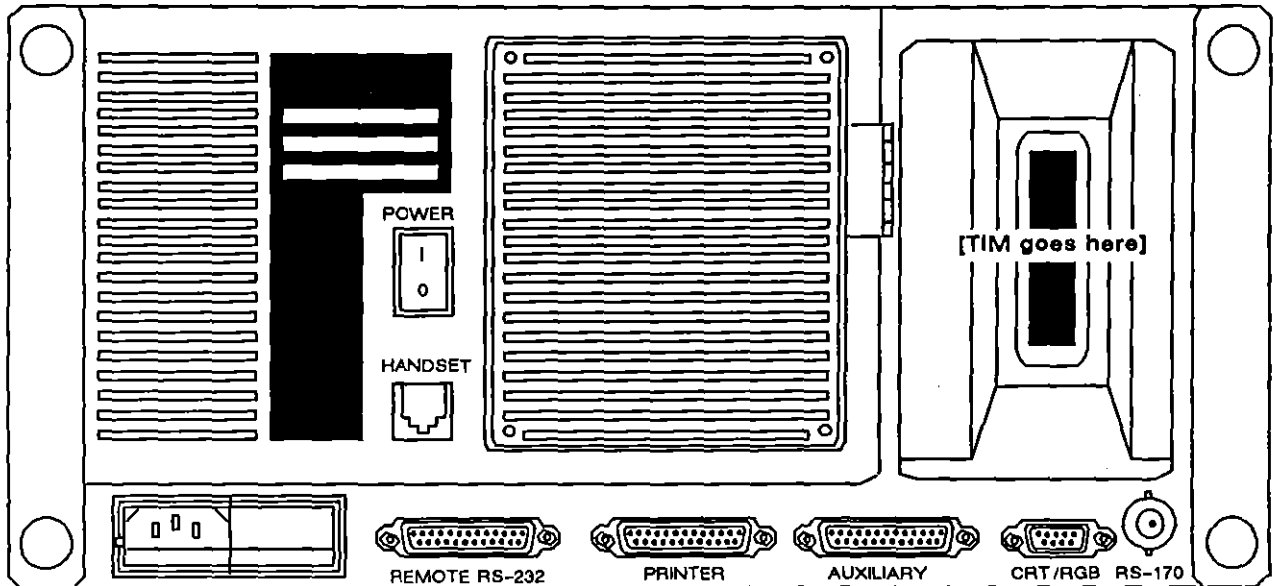

Figure 1-6 Back panel and connectors.

The INTERVIEW 7500, 7200 *TURBO*, and the 7700 *TURBO* are equipped with a Winchester hard disk. The hard disk has a total storage capacity of 20 Mbytes in the 7500 and 44 Mbytes in the 7200 *TURBO* and 7700 *TURBO*. The 20-Megabyte hard disk is available as an option in the INTERVIEW 7000.

Since the hard disk cannot be write-protected, you may wish to save its contents to microfloppy backup disks on a regular basis.

1.5 Back Panel

The back panel and its various connectors are shown in Figure 1-6.

(A) Power Module

The power connector is located at the bottom left of the rear panel. It is a standard three-wire grounded male connector, with selectable voltage.

(B) Voltage Selection

To determine the voltage currently selected, slide the transparent window of the power connector module to the left (see Figure 1-7). You will see the line voltage selector card at the bottom of the window. Current voltage selection is visible—and right side up.

The INTERVIEW is designed to operate at 95 to 130 Volts ac when 115 V is selected; or from 190 to 260 Volts ac when 230 V is selected.

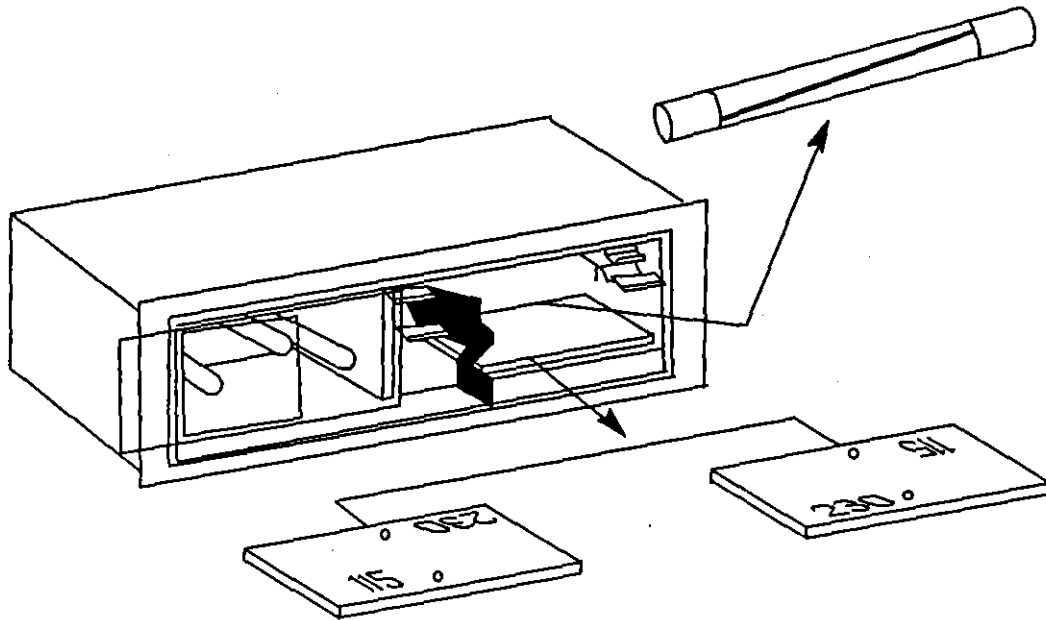

Figure 1-7 Voltage is selectable in the power connector module.

To change the line voltage selection, swing the fuse extractor handle (labeled FUSE PULL) out toward the left, and remove the fuse. The voltage selector card can then be removed and turned so the correct line voltage can be read right side up in the window. When the voltage selector card has been seated correctly, rotate the fuse extractor handle to the right and in, and replace the fuse.

Included in your shipment is a detachable power-supply cord with a NEMA 5-15 attachment plug rated 15 A, 125 V. If you configure the unit for 220-240 V operation, you should employ a UL-listed power-supply cord set furnished with a grounding plug suitable for connection to the 220-240 V source of supply.

The unit will operate the display at either 50 or 60 Hz refresh rate. It defaults to 60 Hz *unless* a file named `/sys/fifty_hertz` is listed on the boot-drive disk. If a file with this name is created, the unit will operate at 50 Hz. (The content of the file is irrelevant and will be ignored by the boot-up software.)

(C) On/Off Switch

The power switch is located above the power connector and to the right. Press the side of the switch marked "1" to turn power on. Press the side marked "0" to turn power off.

(D) The Fan

The INTERVIEW is cooled by a fan which may be accessed through the rear panel.

A fan filter prevents dust and dirt from getting into the INTERVIEW. As the filter gets dirty, less cooling air gets to the unit. To prevent your INTERVIEW from overheating, we recommend that you periodically clean the filter. A plastic grill on the rear of the unit covers the fan filter.

CAUTION: Do not insert objects through the grill covering the fan. Do not remove the grill without turning off the unit and disconnecting power.

Turn the INTERVIEW off, disconnect the power, and remove the screws holding the grill in position. Remove the filter, rinse it in clean water, dry it thoroughly, and replace it. Screw the grill back on the the unit.

If your INTERVIEW is overheating and cleaning the filter does not alleviate the problem, contact Customer Service.

(E) Connectors

The following is a brief description of all I/O connectors on the rear panel of the INTERVIEW. Interface specifications for each of the connectors are given in Appendix I.

1. *Handset connector.* The ISDN Handset Connector is just below the power switch. It is a standard RJ-11C connector. This interface is intended for a future ISDN handset.
2. *Remote RS-232 connector.* This is an RS-232/V.24 25-pin connector located just to the right of the power connector. It provides access to an external modem (or directly to another INTERVIEW unit).
3. *Printer connector.* The RS-232/V.24 25-pin printer connector is located directly to the right of the Remote connector. It allows access to most serial printers. The connector acts as DCE and transmits on RD. Printer operations are described in Section 15.
4. *Auxiliary connector.* The Auxiliary I/O connector is a 16-bit bidirectional TTL connector which allows access to external peripheral devices. Use the C routines discussed in Section 71 to control and monitor this interface. Other references to AUX leads in this manual pertain to the four AUX pins on the TIM. See discussion, Section 12.6(C).

CAUTION: Never plug an RS-232/V.24 cable into the Auxiliary connector, as the signal voltage is likely to damage the interface.

5. *CRTIRGB connector.* This is the color video connector. Signals from the INTERVIEW display can be passed through this connector to a color monitor to produce color graphics and other displays in color. Color, vertical sync, horizontal sync, and intensity signals can be controlled from the external monitor. Use of color in displays is described in Section 17.

6. *Composite video connector.* This connector provides RS-170 video output to an external monitor or camera.

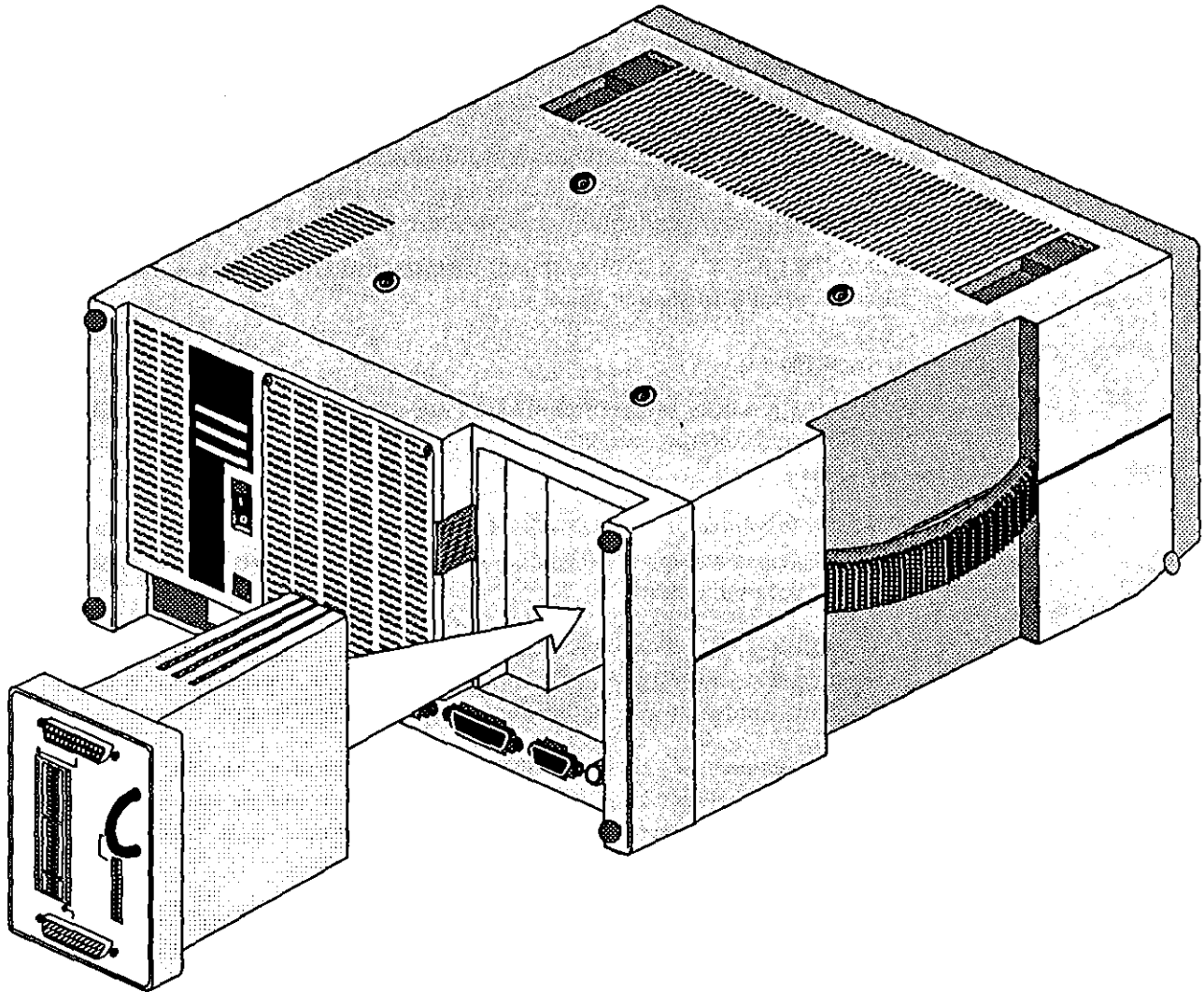

Figure 1-8 The right rear panel accommodates interchangeable Test Interface Modules.

(F) The Test Interface Module

The empty receptacle to the right of the rear panel (see Figure 1-6) accommodates interchangeable Test Interface Modules (TIM's). Whenever the INTERVIEW monitors a data line or emulates a DTE or DCE, the correct TIM must be installed. The RS-232/V.24 Test Interface Module is standard with any unit in the INTERVIEW series. V.35, RS-449, X.21, RC-8245 (RS-485), ISDN, T1, and G.703 test interfaces are available as options. Most Test

Interface Modules are equipped with two connectors, a TO DTE and a TO DCE connector. Figure 1-8 shows an RS-232 module being inserted into the unit. Connect to the data line as described in Section 1.10.

CAUTION: To connect the data line, you must interrupt the flow of data on the line. Be sure you have permission to break the line before doing so.

NOTE: It is possible to monitor data previously recorded on disk, whether or not any TIM or the correct TIM is installed.

1. *Software control of TIM connectors.* When Mode: **MONITOR** or **AUTOMON** is the program selection, the INTERVIEW passively monitors data through either (or both) TO connectors on the Test Interface Module.

When the INTERVIEW is operating in **EMULATE DCE** or **BERT DCE** modes, the TO DTE connector is active. The INTERVIEW is transmitting and receiving data through the TO DTE connector. When Mode: **EMULATE DTE** (or **BERT DTE**) is the program selection, the INTERVIEW transmits and receives data through the TO DCE connector. The interface specifications for each Test Interface Module are given in Appendix I.

Break-out switches on each Test Interface allow any pin to be patched. See Section 12.3 for an explanation of the RS-232 breakout switches.

2. *Test interface LED's.* There are four LED's on the Test Interface Module. Two, labeled EMULATE DTE and EMULATE DCE, indicate the operating mode of the unit. When EMULATE DCE is red, the TO DTE connector is active; when EMULATE DTE is red, the TO DCE connector is active. When the INTERVIEW is monitoring or auto-monitoring, both EMULATE LED's are black.

The two LED's above the U/A input on the patch panel track the voltage level on the lead patched to U/A. The red LED above the U/A panel is lit to indicate space voltage (positive voltage above a minimum threshold). When the green LED above this panel is lit, it indicates a mark voltage (negative voltage within a specified acceptable range). For intermediate voltages, the U/A LED's are off (see Figure 1-9).

CAUTION: Power off the INTERVIEW before installing or removing a TIM.

Remember to change the front panel overlay each time that you change the TIM.

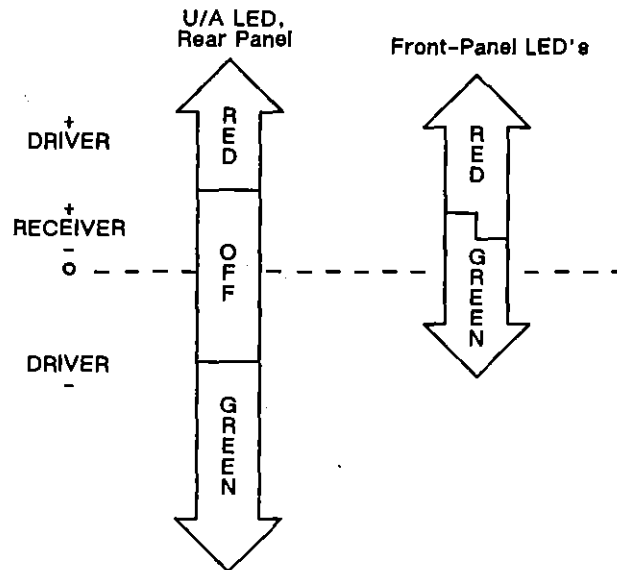

Figure 1-9 Color phases in green-red LEDs.

1.6 Storage Capacity

(A) RAM

RAM capacity for line data in the screen buffer is 64 Kbytes—a maximum of 32 Kbytes of characters plus 32 Kbytes of attributes for character data. EIA leads and time ticks are stored in RAM with the characters, if these options were selected on the Front-End Buffer menu (see Section 9.1). Each byte devoted to EIA leads and time ticks reduces the number available for characters. Bit-image RAM is 256 Kbytes in the 7000 and 7200 *TURBO* and 1 Mbyte in the 7500 and 7700 *TURBO*. (Bit-image RAM may be increased. See Section 7.4.)

(B) Microfloppy Diskettes

Each diskette has a 1.4 Mbyte storage capacity (formatted); thus, total diskette capacity is 2.8 Mbytes.

(C) Winchester Disk

The Winchester Disk has a storage capacity of 20 Mbytes in the 7500 and 44 Mbytes in the 7200 *TURBO* and 7700 *TURBO*. The 20-Megabyte hard disk is available as an option in the INTERVIEW 7000.

(D) Maximum Data Rates

Maximum rates for data recording are as follows:

- Recording to bit-image RAM
(full-duplex, 100% line use): 2.048 Mbits per second
- Bit-image recording to 20-Mbyte hard disk
(full-duplex, 100% line use): 256 Kbits per second
- Bit-image recording to 44-Mbyte hard disk
(full-duplex, 100% line use): 384 Kbits per second
- Recording to microfloppy
(full-duplex, 100% line use): 64 Kbits per second

Figure 1-10 shows maximum rates for data analysis for the various units in the INTERVIEW 7000 Series. The speed your INTERVIEW actually achieves may vary. Factors which will influence data-analysis rates are line speed, percentage of line utilization, average frame length, the layer packages and user program loaded, suppression of idle, and the time-stamp resolution. Refer to Section 2.9 on how to optimize the INTERVIEW's speed of operation.

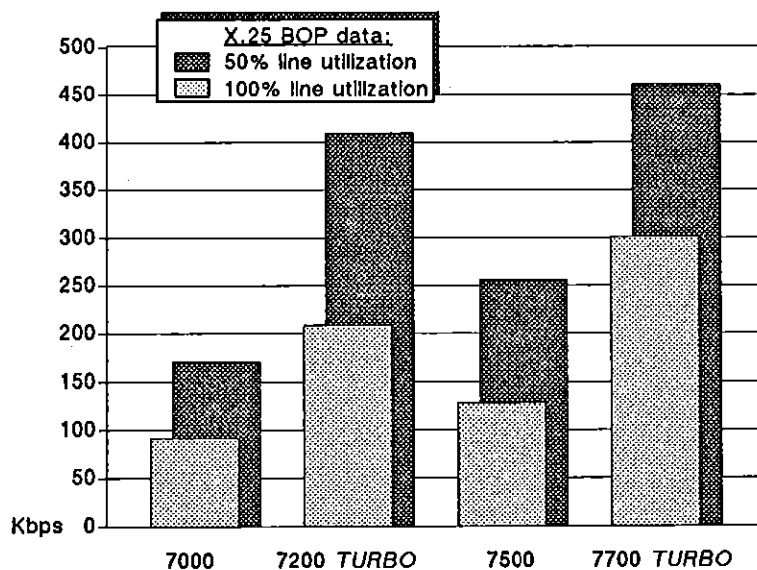

Notes: The margin of error is 5% on the utilization and speed measurements. These figures were generated using software revision 7.00.

Figure 1-10 Continuous real-time rates for display of raw data.

1.7 Clock

Data clocking is provided by a set of high-frequency crystals. The various data speeds that can be selected are listed in Appendix C.

The INTERVIEW is also equipped with a time-of-day clock which provides readings of time (hours, minutes, seconds), day, month, and year. Time may be used as an INTERVIEW program condition. Refer to Section 16 for instructions on setting the time-of-day clock. Refer to Sections 24 and 30 for a description of Time as a program condition.

1.8 Operating Environment

The INTERVIEW is designed to operate in an atmospheric temperature ranging from 50 to 90 degrees Fahrenheit (10 to 32 degrees Celsius). At these temperatures, the unit can operate in (uncondensed) humidity ranging from 30 to 90 percent.

CAUTION: Avoid dropping the unit.

Avoid getting the unit wet.

Do not operate the unit with the fan covered.

Avoid operating the unit immediately after exposure to drastic changes in temperature and humidity.

Avoid placing the INTERVIEW on a radiator or near a source of heat.

1.9 Operating Positions

The INTERVIEW is designed to operate on a desktop (Figure 1-1) or in a standing position, with the display facing upwards (Figure 1-11). The unit may also be shelf-mounted in an equipment rack or cabinet. Allow for adequate air flow when mounting the INTERVIEW in a rack.

CAUTION: To protect the hard disk, do not move the unit with the power on. Turn the power off first to position the hard disk in a protected state.

1.10 Power Up

Before you power up the INTERVIEW, make sure you have performed the preliminary steps listed below.

(A) Install the Test Interface Module

Check the rear panel to be certain that you are using the correct Test Interface Module before you test any data. A Test Interface Module is shown in Figure 1-8 and described in Section 1.5(F).

CAUTION: Never install or remove a TIM unless the INTERVIEW is powered off.

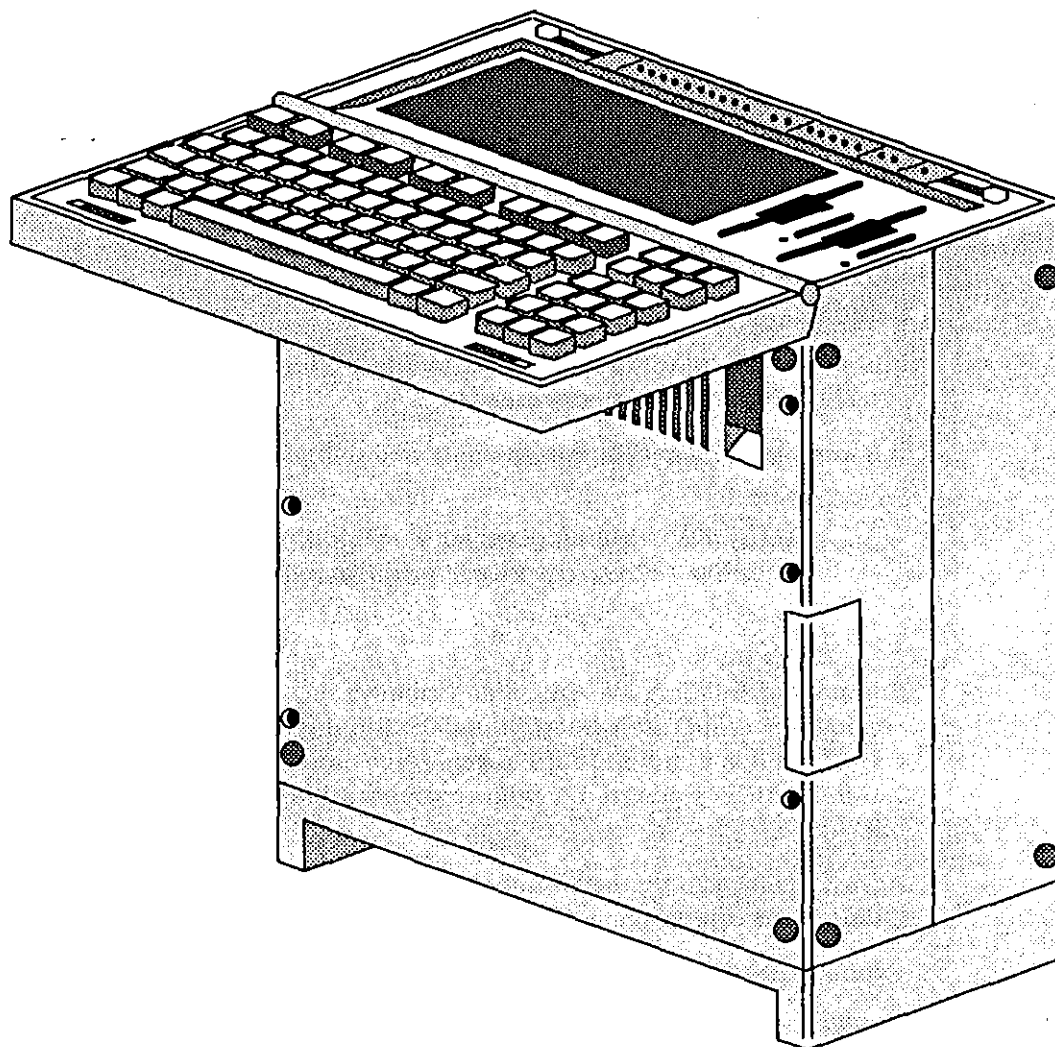

Figure 1-11 The INTERVIEW may be operated on a desk top or in a standing position.

Remove the Test Interface Module by pressing the button to the left of the module with the thumb of your left hand. Hold the button in as you pull firmly on the TIM handle with the thumb and forefinger of your right hand.

Install the Test Interface Module right-side-up in the receptacle provided at the right of the rear panel. Press firmly on the top and bottom of the module until it is secured and the button to the left clicks into place.

(B) Insert the Correct TIM Overlay

Be certain that the overlay over the front-panel LED's matches the Test Interface Module installed.

To remove the overlay, grasp the top and bottom edges with the thumb and forefinger of both hands and bow the strip slightly in the center. The overlay should slip out.

To insert an overlay, bow it slightly. Insert the tabs on either side of the overlay into the notches on each side of the LED panel. Make sure that the holes on the underside of the overlay are placed over the small posts at the top of the empty LED panel, and press the overlay into place.

(C) Connect to a Data Source

It is not necessary to install a Test Interface Module or connect to a data line if you are reviewing data stored on disk.

If you plan to test a data line, connect to the line as described below.

CAUTION: You must interrupt the flow of data when you connect to a data line. Be sure you have permission to break the line before doing so.

Break the data line for testing, and connect one end of the line to the TO DTE connector on the Test Interface installed in the rear panel. Connect the other end of the line to the TO DCE connector on the TIM. Even when the INTERVIEW is powered off, this provides a through connection for the data line.

An LED next to the connector will be lit if the INTERVIEW is actively testing—or is programmed to test—on that connector.

Refer to Section 1.5(F) for a description of TIM connector functions.

Check the voltage selection on the card in the small window on the rear panel.

If the voltage is incorrect, refer to Section 1.5(B) for instructions.

(D) Open the Keyboard

Place the INTERVIEW on a stable surface. Support the back of the keyboard with one hand. Unlatch the keyboard by pushing the blue latches on the top of the unit all the way back. Then lower the keyboard to operating position.

(E) Power On

Connect the female end of the power cord provided to the back of the unit; connect the other end to a standard power outlet. Depress the side of the power switch marked "1." A Start Up screen similar to that in Figure 2-1 or Figure 2-2 should appear. Refer to Section 2 for a discussion of the Start-Up screen, system initialization, and general operations.

2 General Operation

This section discusses the general operation of the INTERVIEW and covers such topics as updating system software, configuring the menus, starting and stopping a test program, locating errors detected when the test is compiled, using both the pre-existent trigger setup menus and the free-form spreadsheet to create test programs, and using the INTERVIEW's analysis features.

For a hands-on introduction to the INTERVIEW, see *30 Minutes to Programming the INTERVIEW 7000*, ATLC-107-951-101.

2.1 Power Up

As you power up the INTERVIEW, perform the preliminary steps listed below. The procedures for each step are described in Section 1 on Hardware.

- Install the Test Interface Module.
- Select the correct voltage.
- Open the keyboard.
- Insert the proper TIM overlay.
- Install the initialization disk if you are not booting from hard disk.
- Connect a power cord and turn power on.
- Connect to a data source.

(A) Self Tests

When you turn on the unit, you initiate a series of self tests: first, the CPM Module DRAM, then the MPM Module DRAM, and finally, the MPM to CPM connections. Any self-test errors will be reported on this screen. Refer to the Appendices for an explanation of error messages. You may abort the self tests by pressing **PROGRAM**. (However, we recommend that you allow the tests to run their course.)

Once the self test cycle is complete or once you have aborted the tests, the INTERVIEW begins to initialize its software. The message **BOOTING** appears on the screen. The INTERVIEW 7000 has no hard disk (unless it has been added as an option) and will boot up from a system floppy disk. This process is described in Section 2.2.

The XDRAM module (if present) will also be tested. Depending on the unit's firmware version, self-testing for XDRAM either follows MPM Module DRAM testing or occurs after the unit has booted up.

When self tests are complete, a Start Up screen similar to that in Figure 2-1 or Figure 2-2 may appear. Notice that the number of processors in your unit, the software and firmware versions, the options installed, and the Test Interface Module in place when you powered on all appear on this screen.

```
          ** INTERVIEW 7700 TURBO **  
  
DISKS: FLOPPY 1 FLOPPY 2 HARD DISK(44M)  
PROCESSORS: 4  
SELF TEST ERRORS: NONE  
  
Press:  
[PROGRAM] to enter the menu page  
[RUN]     to run the default program  
  
Software Version: 8.00  
Firmware  Version: 6.00  
  
OPTIONS:  
  
TIM: RS-232/V.24  
  
Copyright (c) 1987, 1990  
Telenex Corporation
```

Figure 2-1 Power-up screen, INTERVIEW 7700 TURBO.

(B) File Searches

During power-up, the INTERVIEW searches specific directories for the files described below.

1. *print_setup*. During boot-up, the */sys* directory on the boot drive is searched for the file *print_setup*. If it exists, the configured Printer Setup in this file is automatically loaded. Otherwise, the INTERVIEW loads the default Printer Setup. See Section 15.3.
2. *user_intrf*. If you have a file named *user_intrf* in the */usr* directory on the hard disk, the program in *user_intrf* will be compiled and run as soon as boot-up is complete, bypassing the Start Up screen as shown above. See Section 2.2(B).
3. *default*. The Start Up screen will appear only briefly if you have a file named *default* in the */usr* directory of your boot-up disk. If you do not press **PROGRAM** within five seconds of power-up, the program in *default* will be compiled and run. See Section 2.2(C).
4. *ezview_setup*. During boot-up, the INTERVIEW tries to locate the file *ezview_setup* in the */sys* directory on the boot-up disk. The INTERVIEW's Easy View operation is configured according to the parameter settings in this file. See Section 18. If the file is not located, the INTERVIEW is

configured with all default **YES** selections on the Easy View Setup menu. If this menu shows the selection **Enter Easy View After Power-Up: YES**, and neither *user_intrf* nor *default* is located, the Start Up screen appears for five seconds. Then, the first menu in the Easy View system is displayed. See Section 4. (If *user_intrf* or *default* is located, the unit does not enter Easy View following boot-up regardless of the setting of this parameter.)

2.2 Initializing System Software (Booting Up)

(A) Insert System Disk

If you have an INTERVIEW 7000, you will see a slightly different start-up screen. A message instructing you to insert the system disk should appear (see Figure 2-2).

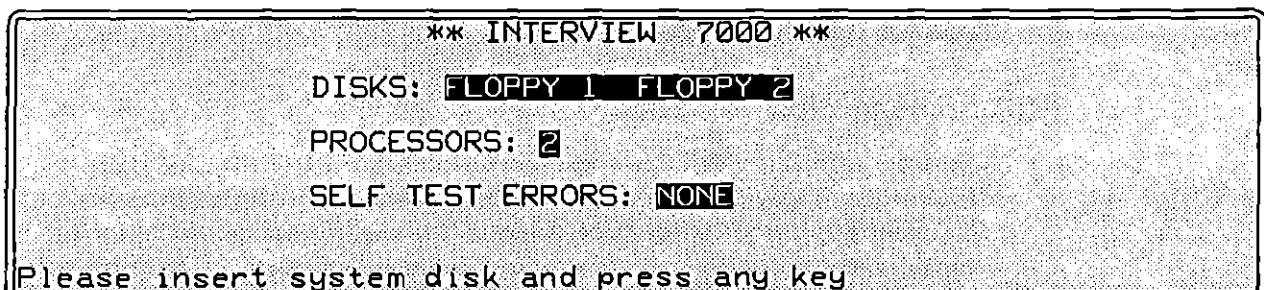

Figure 2-2 Power-up screen, INTERVIEW 7000.

Once you have powered on the unit and this message appears, insert the system disk (DSK-951-001-1.X) into either drive as shown in Figure 2-3. (Insert the metal head of the disk first. Keep the metal hub on the back of the disk facing away from the screen. The disk should lock in place, and the button to the right should pop out.) Then press any key to cause the INTERVIEW 7000 to complete its own initialization. The LED immediately to the right glows to indicate the active drive (in this case, the drive from which the system is being initialized). Do not remove the system disk until the LED has stopped glowing. Then it is safe to press the button next to the drive and eject the disk. A message will inform you when the 7000 is ready for operation.

The INTERVIEW 7200 *TURBO*, 7500, and 7700 *TURBO* normally do not require a system disk, since all initialization software is installed on the Winchester hard disk. If you need to install new system software from a floppy disk, refer to subsection 2.3.

NOTE: We recommend that you make a copy of system software to use as your boot disk. Use the Duplicate Disk command on the Disk Maintenance screen as explained in Section 13.4(D). Then store your original floppy in a safe place.

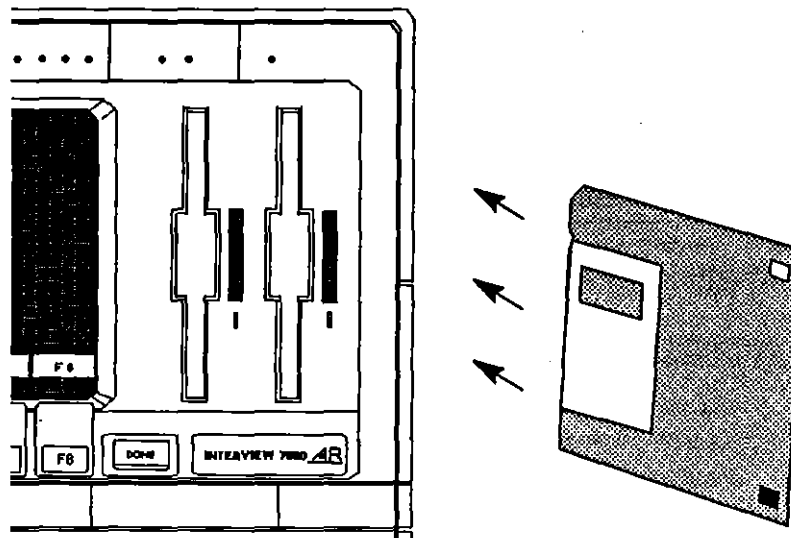

Figure 2-3 Insert microfloppy disks as shown.

(B) Creating a User Interface

Regardless of which disk drive you use for boot-up, FD1, FD2, or HRD, the *HRD/usr* directory—and only that directory—is searched during power-up for a file named *user_intrf*. If the file is located, the unit will automatically load, compile, and run the program as soon as boot-up is complete. Each time the operator presses **PROGRAM**, the program in *user_intrf* will be loaded, compiled, and run again. Use this feature when you want to bypass the INTERVIEW's menus and create your own user interface for specific applications.

CAUTION: Avoid saving emulation programs in user_intrf. Booting up and automatically running an emulation program may result in an inadvertent break of the line.

To enter Program mode, press **SHIFT-PROGRAM** or **CTRL-PROGRAM**. Perform any Program-mode operation you wish: make selections on menus, execute File or Disk Maintenance commands, or create a Protocol Spreadsheet program. To enter Run mode again, press **RUN**. Each time you execute the **PROGRAM** key during Run mode, *user_intrf* will be loaded, compiled, and run.

To prevent the program in *user_intrf* from automatically running upon power-up, change the name of the file. Simply capitalizing the first letter in the file name (*User_intrf*) is sufficient. If *user_intrf* is not found during power-up, the **PROGRAM** key cannot be used to enter Run mode, even if *user_intrf* is saved to the *HRD/usr* directory and manually loaded, compiled, and run. Turn off the INTERVIEW and power up again to activate the user-interface feature.

NOTE: References to the **PROGRAM** key throughout this manual assume that the *user_intrf* file was not located during power-up. In other words, the **PROGRAM** key is used to enter Program mode only.

To create a *user_intrf* program:

1. Configure the menus to the selections you want.
2. Use Protocol Spreadsheet softkey entries or C regions on the spreadsheet to develop your user-interface program. All of the C structures, variables, and routines available to the INTERVIEW user are explained in Part II of this manual, *Advanced Programming*.
3. Press **SAVE** to call up the File Maintenance screen.
4. Check the hard disk for any existing user-interface program. Press **F3** for **Command:** **CHANGE DIR**. Select **Drive:** **HRD**. After **Name:** type in */usr* and then press **YES**. Check for a file named *user_intrf*.

Unless the old file is write-protected, any program already stored under this filename will be overwritten when you save your new file. To keep the old file for later reference, save it to a new name (its contents will have to be loaded manually). For a detailed discussion of file-maintenance commands, see Section 14.

5. Select **Command:** **SAVE**. Select **Type:** **OBJECT** or **PROGRAM**. Then select the hard disk.

NOTE: The more complex a program is, the longer it takes to compile. To eliminate compilation each time you use the **PROGRAM** key, therefore, we recommend that you save *user_intrf* as an object file.

6. In the **Name:** field, type in the filename *usr/user_intrf*. Only this name can be used. (Program or object files saved to any other name or directory must be loaded manually.)
7. Execute the **SAVE** command by pressing **YES**.
8. *user_intrf* will appear in the Directory Listings when *HRD/usr* is the current directory. (The name of the current disk appears as a prefix to the absolute pathname of the current directory. The name of the current directory appears on the fourth line of the File Maintenance screen.)
9. You may alter the *user_intrf* program again at any time by saving a new program to the same filename.

(C) Running the Default Program

When the INTERVIEW boots up, the */usr* directory on the boot-up disk is searched for a file named *default*. Once the start-up screen (Figure 2-1 or Figure 2-2) appears, the program in *default* (if it exists) will be compiled and run automatically after five seconds, or immediately if you press **[RUN]**. You may prevent the default program from running by pressing **[PROGRAM]** before the five-second timeout expires.

Develop a default program to suit your particular needs. One application of the default program might be defining a new set of default menu selections.

CAUTION: Avoid saving emulation programs in default. Booting up with a default emulation program may result in an inadvertent break of the line.

Upon boot-up all menu selections in the INTERVIEW are set to certain values. You may change these default selections if you wish by utilizing the default program. Follow these steps:

1. Configure the menus using the default selections you want.
2. Press **[SAVE]** to call up the File Maintenance screen.
3. Check your disk for any existing default program. Press **[F3]** for Command: **CHANGE DIR**. Select the boot disk you want to use. After Name: type in */usr* and then press **[END]**. Check for a file named *default*.

Unless the old file is write-protected, any set of defaults already stored under this filename on the disk you have selected will be overwritten when you save your new default file. To keep the old file for later reference, save it to a new name (its contents will have to be loaded manually), or use a different disk for your new defaults. For more assistance, refer to Section 14.

4. Select Command: **SAVE**. Select Type: **PROGRAM**, **SETUP**, or **OBJECT**. Then select the disk from which the system will be initialized.
5. In the Name: field, type in the filename */usr/default*. Only this name can be used as the new set of defaults. (Program files saved to any other name or directory must be loaded manually.)
6. Execute the SAVE command by pressing **[END]**.

7. The name of the file you have saved will appear in the Directory Listings when */usr* is the current directory and the selected disk is the current disk. (The name of the current disk appears as a prefix to the absolute pathname of the current directory. The name of the current directory appears on the fourth line of the File Maintenance screen.)
8. You may alter these defaults again at any time by saving a new default program to the same filename.
9. Be sure that you initialize the INTERVIEW from the disk which contains *default*. The unit will load, compile, and run the default program automatically (unless you press **PROGRAM**). The Run-mode screen displayed will be the one selected in the Display Setup menu in *default*. Likewise, all other menus will reflect your customized defaults.

Refer to Section 14 for more information on the filing system or file maintenance commands.

2.3 Installing New System Software on Hard Disk

From time to time, you may need to install new system software on the hard disk of the INTERVIEW 7200 *TURBO*, 7500, and the 7700 *TURBO*. Use the Duplicate Disk command from the Disk Maintenance utility. (See Section 13.4(D) for more information on this command.) The steps are as follows:

1. Write-protect the master copies of the new system and user disks. Slide the plastic tab so that you can see through the rectangular write-protect hole.

NOTE: There should also be a second rectangular hole which does not have a sliding tab. If you have any 3.5 inch disks which do not have this second hole, they are not compatible with the INTERVIEW.

2. Insert the new system floppy disk (DSK-951-001-1.X) into Floppy Drive 1 (**FD1**), the left-hand floppy drive.
3. From the Main Program menu, press **F7** to access the Utilities, then **F9** for Disk Maintenance. Select the softkey labeled DUPDISK to bring up the Duplicate Disk command screen.
4. Select From Disk Number: **FD1** and To Disk Number: **HD** on the command screen. Then press **GO**. The system will prompt you to insert a disk. Since the system disk is already in FD1, press the **F1** softkey (GOAHEAD). When the duplication is completed, the system will prompt you again to insert the next disk. Remove the system disk from FD1 and insert the user floppy disk (DSK-951-001-2.X) for duplication. Press **F1**.

The only files overwritten on the hard drive will be the system software files in the `/sys` directory and files from the `/usr/layer_pkgs` directory. These files comprise the new system software.

5. Once copying is complete, take the master copy of the user disk out of Drive 1, and store it and the master copy of the system disk in a safe place.

NOTE: We recommend that you make a working copy of the new software on floppy disks which can be kept with the INTERVIEW.

6. Turn off the power switch for the unit, and wait ten seconds. Then turn the power on again to reboot the INTERVIEW. Following the self-test, the unit should boot without error. The new software version should appear on the screen. If there are errors or the unit will not reboot, repeat Steps 2 through 6. If problems persist, contact Customer Service.

2.4 Backing Up the Hard Disk

Periodic back-up of the hard disk is strongly recommended.

1. Install a formatted diskette in Drive 1. This disk should not contain operating system software. For formatting instructions, see Section 13.4(A).
2. Go to the File Maintenance screen. (From the Main Program menu, press **F8**.) Use the File Maintenance Copy command to copy any files you wish from the hard disk to floppy.

NOTE: Do not copy files of type SYS or any files from the `/sys` directory or the `/usr/layer_pkgs` directory to the backup disk. These files reside on the master copies of your system and user software disks.

3. Once copying is complete, take the backup disk out of Drive 1 and write-protect it. Slide the plastic tab so that you can see through the rectangular write-protect hole. Store the disk in a safe place.

Select from the following methods if you need to recopy files from the backup disk to the hard disk. *Keep in mind that files on the hard disk with the same name as those on the floppy will be overwritten.*

- Copy files or directories one at a time using the File Maintenance Copy command.
- Copy the root directory from the floppy to the root directory of the hard disk. The name to enter for the root directory—once you have selected the correct origin or source drive in the rotating field—is simply the slash character, `/`.

- Use the Dupdisk command on the Disk Maintenance screen to duplicate the contents of the backup disk on the hard disk.

NOTE: Do not recopy files from the */sys* directory, files whose type is SYS, or files from the directory */usr/layer_pkgs*. If you need to reinstall these files, use the master copies of system and user software disks to avoid inadvertently overwriting more recent software version files with older ones.

2.5 The Menus

The INTERVIEW is used to monitor data as it is received through a data line or to playback and monitor data as it was recorded from the line. The INTERVIEW may also be set up to emulate one side of a communication, sending data and responding to the data it receives. A series of menus are used to set the unit for the data you expect to receive or send and the type of analysis you wish to perform. These menus are categorized on the main Program menu. Select one of these menus by using the **ROLL FWD** or **ROLL BCK** key, or by pressing the labeled softkey. Enter the menu by pressing the highlighted function key or **RETURN**.

(A) The Program Menu

Press **PROGRAM** to see the Program menu. Notice that the Software and Firmware Versions are posted at the top of the screen. They are always available to you when you return to this menu.

```

** Program Menu **
Software Version: 8.00          Firmware Version: 6.00
SETUP  Test Setup Screens:
          Line Setup           BCC Setup           BERT Setup
          Display Setup        Front End Buffer
          Record Setup         Interface Control
TRIGS  Triggers - Conditions & Actions
SPDSHT Protocol Spreadsheet
STATS  Statistics Results:
          Tabular Display      Graphics Display      BERT Results
LAYER  Layer Setup & Protocol Configuration
FMAINT File Maintenance Functions
UTIL   Utilities:
          Disk Maintenance     Time/Date Setup
          Printer Setup        Miscellaneous Utilities
          Easy View Setup

Select Program Function
F1  F2  F3  F4  F5  F6  F7  F8
SETUP TRIGS SPDSHT STATS LAYER FMAINT UTIL

```

Figure 2-4 Main Program menu.

Think of the Program menu as the top level for every menu selection. Each time you prepare the INTERVIEW for the communications environment, you will start with the Program menu and move down into the other menus.

All setup, trigger, and programming menus are accessible from this main menu. In general, use the **PROGRAM** key from other Program-mode screens or from Run mode to access this menu.

NOTE: There are two exceptions to this rule about the **PROGRAM** key. First, if the file named *user_intrf* is located in the */usr* directory of the hard disk during power-up, pressing **PROGRAM** loads, compiles, and runs the program in *user_intrf*. See Section 2.2(B). Secondly, if you select and run a program from an Easy View menu, pressing **PROGRAM** from Run mode returns you to the Easy View menu instead of the main Program menu. See Section 4 on Easy View operation.

(B) Configuring Menus

You may configure menus in any order you wish; however, we suggest you configure the Layer Setup screen before programming on the Protocol Spreadsheet or the Display Setup screen, since the selections available to you are governed by the protocols loaded on the Layer Setup screen.

All options on a particular menu are summarized as a diagram which appears in this manual at the beginning of the section which covers that menu. Programming options available in each protocol package are discussed in a section pertinent to the protocol and layer.

To select a sub-menu from the main Program menu, use **PGM** or **PGM** key, or press the labeled softkey. Enter the menu by pressing the highlighted function key or **RETURN**. The labels on the screen guide you through each step. For example:

- Access the Layer Setup screen from the main Program menu by pressing **F8**.
- Access the Disk Maintenance screen from the main Program menu by pressing **F7** for utilities, then **F3** for Disk Maintenance.

Other uses of the function keys are described in Section 3 and in sections pertinent to the various sub-menus.

Once you have reached the menu you want, the function keys lead you through selections, down to the smallest level of detail. You may also use cursor keys **↑** and **↓** to move up and down through the menu fields. **←** and **→** move the cursor across a menu from field to field.

If you wish to return to the last screen, press **ESC**. Should you wish to review the menus you have configured, this key takes you back one screen at a time until you reach the main Program menu. Of course, you may press **PROGRAM** to start again from the top of the menus. When you are ready, press **RUN** to start a testing session, no matter what menu is displayed.

Read Section 3 for a further discussion of these and other keys.

(C) The Setup Menus

The menus in the setup group (listed at the top of the Program menu) are used to specify how data is sent, received, recorded, and displayed.

The Line Setup screen allows you to designate the role which the INTERVIEW is to play in testing—whether it is to monitor passively or participate in an active dialogue as DTE or DCE. Menu settings also determine the source of the data and the data clock as well as the characteristics of the data stream you expect to receive or send. These characteristics include the scheme for character encoding/decoding and the format in which blocks of data are sent and received (i.e., synchronous, asynchronous, bit-oriented, or isochronous). The Line Setup screen is described in Section 5.

The Display Setup screen provides alternative types of display to aid in analysis. On this screen, designate how you want data to appear. (Data may be displayed as a stream of bytes alone or in conjunction with lead transitions; summarized in a protocol trace or customized trace format; or tracked on one of two statistical displays.) Then, as you require different types of analysis, use function keys to change from one type of display to another while testing, without returning to the menu. The Display Setup screen and the different types of displays are described in Section 6.

The Record Setup screen defines recording conditions for data acquisition tracks on disk; or for RAM (RAM capacity is 256 Kbytes in the 7000 and the 7200 *TURBO*; 1 Mbyte in the 7500 and 7700 *TURBO*). This screen does not influence the data stored in the character buffer. Storage of data in the screen's character buffer can be controlled from the Protocol Spreadsheet using the Capture command. The Record Setup screen is described in Section 7.

Data and control-lead signals entering the INTERVIEW or generated internally are routed from the receivers through a front-end buffer (FEB) before being presented to the screen and to the trigger program. Data bits are buffered automatically in the FEB. The buffering of other events—control leads, idle bits, and time ticks—can be enabled or disabled on the Front-End Buffer Setup menu, explained in Section 9.

The BCC Setup Menu controls and displays the values of the INTERVIEW's block-check parameters. For more information on block checking, refer to Section 10.

The INTERVIEW can transmit and analyze Bit Error Rate Tests (BERT). Once you have selected the BERT mode on the Line Setup menu, select appropriate parameters on the BERT Setup menu. See Section 11.

(D) The Trigger Setup Menus

The next three groups of menus, Triggers, Spreadsheet, and Statistics, are programming menus which you use to establish interactive dialogues, create test scenarios, and make and display measurements.

NOTE: BERT testing is handled separately, on the BERT Setup screen. See Section 11.

The 16 identical Trigger Setup screens are a limited set of test conditions and actions grouped in a standard menu format. The set of conditions offered on these screens are described in Section 24. Trigger Setup actions are described in Section 25. The Protocol Spreadsheet provides a wider range of conditions and actions which vary, according to the layer and the protocol you are programming. Conditions and actions available on the spreadsheet are covered in Sections 30 and 31 and in sections dedicated to each layer protocol.

Trigger Setup screens and the Protocol Spreadsheet may be used together as described in Section 22. Counters and timers of the same name may be shared between the two, as can the flag bits from the Trigger Setup screens, which are accessed as flags on the spreadsheet under the name `trig_flags`.

(E) The Protocol Spreadsheet

The Protocol Spreadsheet, a more flexible programming tool with more options than the Trigger Setup screens, is initially a blank menu. Legal programming options are presented as function key labels at the bottom of the screen. Create your program by pressing the necessary function keys. Your entries will be posted on the screen. As you make entries, the function keys reflect the new options enabled.

You may also type your program directly onto the screen, as long as you observe syntax and use exact keywords (as they are posted on the screen; *not* as they are abbreviated in function key labels.) Programming options and errors will still be tracked.

Syntax errors are indicated by strike-throughs when you have completed an entry. (If you are typing onto the spreadsheet, completing an entry usually means pressing the space bar, pushing `done` or `return`, or moving the cursor to a different location.)

1. *The spreadsheet pattern.* The Protocol Spreadsheet expects a certain pattern of entries. To gain access to the set of trigger conditions and actions at each layer, you must first identify what layer you are programming, then what test you are developing, and finally the name of the state which will contain the triggers you create. Once you have named the state, press the function key

for **CONDITIONS:**. At this point, actual programming options will appear. When you complete the Conditions portion of a trigger, press **[DONE]** and then press the function key for **ACTIONS:** to display possible trigger actions. Use the **NEXT_STATE:** action to indicate movement to another state. The **NEXT_STATE:** action must be followed by a state name. It can move to any state within the test; the **NEXT_STATE: NEXT** action moves the test to the following state on the spreadsheet. Programming concepts related to these selections are described in Sections 22, 23, and 27.

Here is an example of the spreadsheet pattern you will see repeatedly:

```
LAYER: 1
TEST: example
STATE: begin
CONDITIONS: One or more conditions appear here.
ACTIONS: One or more actions appear here.
NEXT_STATE: second

(NEXT STATE will not follow every trigger. Also, it may replace
ACTIONS)
```

2. *Additional spreadsheet capabilities.* Constants may be used on the spreadsheet to represent repeated values or text, and they may be placed so that they apply to all or part of a program. Constants are explained in Section 28. C programming language can be introduced at any location on the spreadsheet to create new testing conditions and actions and generally increase program flexibility. C is introduced in Section 59.
3. *Increasing the spreadsheet buffer.* INTERVIEWs with an XDRAM board (OPT-951-23-1) installed may have a spreadsheet buffer five times larger than those units without XDRAM. This option makes possible significantly larger Protocol Spreadsheet programs. If a file named *xdram_rcrd* resides in the /sys directory of the boot-up disk during power-up, however, XDRAM will be dedicated to another purpose. See Section 7.4(A).

(F) The Statistics Screens

The INTERVIEW has two different statistics menus, one in tabular form, the other in bar-graph format. Both are accessible by softkey while you are analyzing data. The value of counters and timers named in triggers can be tracked in statistical screens, once their names have been entered on the corresponding menus. Current, last, minimum, maximum, and average values are tabulated. Values for several counters and timers may be totaled by an accumulator. Bar graphs can be scaled and color-keyed. Refer to Sections 20 and 21 for information on statistics menus and displays.

(G) The Layer Setup Screen

Before you program the Protocol Spreadsheet, you are advised to load the protocols you intend to use. Protocols are selected and loaded from the Layer Setup screen. Your selections, once loaded, determine the set of program conditions and actions which appear on the spreadsheet.

With most protocols, a secondary screen loaded with the protocol allows you to modify common parameters for the protocol.

For more information on the Layer Setup screen, see Section 8.

(H) The File Maintenance Screen

The File Maintenance screen is the user's interface with the filing system. The menu facilitates saving and loading programs, renaming or deleting files. It allows you to consult the contents of any directory, create a new directory, and write-enable or write-protect a file. From this menu, you may structure your own filing system according to your needs.

NOTE: The files pertaining to the operating system and menu selections are stored primarily in the */sys* directory, with some files stored in the */usr* directory. These files should not be deleted or moved. You are otherwise free to manipulate the filing system as you wish.

Section 14 explains file and directory pathnames, how to set up a file hierarchy, how to move through the filing system, and how to use the various maintenance commands.

(I) The Utilities Menus

The last group of menus listed on the Program menu are the utility menus, used to manage peripherals: disk, printer, the internal time-of-day clock, and color monitor.

Consult the time or modify it on the Time/Date Setup screen. The time and date which appear here are used in time-stamping data blocks and user files. See Section 16 for details on this screen.

The Disk Maintenance menu allows you to allocate disk space for data and programs, to transfer data from one storage medium to another, and to duplicate the contents of one disk onto another. Section 13 describes disk maintenance commands and their use in detail.

The Miscellaneous Utilities screen provides mapping of black and white to color enhancements for external monitors. Once the mapping is completed, these enhancements may be placed under trigger control for the production of highlighted data. Refer to Section 17 for further information on this screen.

The Easy View Setup screen governs the operation of the Easy View system. Use the menu selections to: enable Easy View, automatically enter Easy View after power-up, keep Easy View menu information in memory, and display a warning message before running programs from Easy View. See Section 18.

2.6 Running a Test Program

Press **[RUN]** to compile and execute a test program. As the program is compiled, a message appears at the top of the screen to indicate the phase that the compiler is in. The longer and more complex the program, the greater the compile time that is required. The preparations being made in each phase are briefly outlined below.

(A) Test Preparation

1. *Phase 1.* Trigger Setup screens are converted to the Protocol Spreadsheet format, the Protocol Spreadsheet is converted to C, and the C Preprocessor directives are acted upon.

NOTE: Compilation time is somewhat faster if all triggers are programmed directly on the Protocol Spreadsheet.

2. *Phase 2.* The Program is compiled.
3. *Phase 3.* The number of processors and the configuration of the equipment (into which the program is to be loaded) are determined, and internal packages to support the user's program are structured. Also during this phase, linkable-object files referenced on the Protocol Spreadsheet are found and the compiled code in them combined with the compiled spreadsheet program.
4. *Phase 4.* Resources are allocated for each separate task in the program.
5. *Phase 5.* The run-time operating system is generated.
6. *Phase 6.* All code is linked.
7. *Phase 7.* A memory image of the code which can be run by the processors is built.

(B) Rerun Without Recompiling

After a program has compiled once, it will enter Run mode "immediately" (within 2 seconds) after **[RUN]** is pressed in subsequent executions of the program—assuming that no substantive changes have been made in the program in between the two runs. Substantive changes may be defined as those changes not to menus and fields listed in Table 2-1. That is, changes to fields covered in Table 2-1 will not necessitate a recompile and will not prevent the unit from entering Run mode immediately.

Any changes to the Trigger Setup menus or to the Protocol Spreadsheet will be considered substantive and will necessitate a new compile.

Changes to the tabular or graphic statistics screens will not cause the program to recompile. If a counter or timer is added to the screen, however, it will not update until the program is recompiled. You can force a recompile by holding down **[CTRL]** and pressing **[RUN]**.

**Table 2-1
Fields That Can Be Changed Without Causing Recompile**

Menu	Field
Line Setup	Disk No (recorded data must be same type) Block No Clock Source Speed NRZI MIL
Display Setup	Display Mode Type RTS/CTS? CD? DTR/DSR? C/I? Layer (Protocol or User Trace; not Program) Statistics Type
Record Setup	Disk No Initial Cond Stop At
Front-End Buffer Setup	Idle Suppress DTE DCE
T1 Transmit Setup	(all fields)
T1 Data Path Setup	(all fields)
T1 Line Setup	(all fields)
Tabular Statistics	(all fields)
Graphical Statistics	(all fields)
File Maintenance	(all functions except LOAD)
Date/Time Setup	(all functions)
Printer Setup	(all fields except Redirect Run Mode Output)
Disk Maintenance	(all functions)
Misc Utilities	(all fields)
Easy View Setup	(all fields)

(C) Errors Detected When A Program Is Compiled

Trigger programs and spreadsheet programs with syntax errors or other errors will not compile successfully and will prevent the unit from executing the test program.

If an error is detected during the compiling phases (after you have pressed **END**), the user is returned automatically to the Protocol Spreadsheet.

While a program is being compiled, errors are flagged and diagnostic information is stored. This information is made available to the user when the unit is returned to Program mode. A diagnostic message for the first error found is automatically displayed at the top (second line) of the Protocol Spreadsheet screen. The cursor is automatically moved to the error.

Press GO-ERR once more to move to the next error. For each error, a diagnostic message is displayed. The search for errors stops at the end of the file and the message "No more errors" is displayed.

GO-ERR also calls up diagnostic information on trigger-menu errors.

Error messages are listed in Appendix A of this manual.

(D) Recoverable Errors During Run Mode

The following messages indicate MPM processor errors:

MPM -- Processor Fault
MPM -- Divide Fault
MPM -- Bus Error
MPM -- Stack Fault
MPM -- Memory Fault

Do not turn off the INTERVIEW when any one of these errors is displayed in Run mode. Instead, press **PROGRAM** and check your program, since these messages indicate programming problems that cannot be displayed as syntax errors but which do prevent your test from running properly. Consult Appendix A1 for an explanation of these messages. Once you have revised the test, try running it again. If you cannot resolve the problem, save a copy of the program and contact Customer Service.

2.7 Data Flow

Figure 2-5 diagrams the movement of data between the various functional components of the INTERVIEW. The diagram provides "clues" to many of the operating characteristics of the unit. For example:

- The front-end buffer (FEB) lies squarely in between the line interface and (1) the recording medium and (2) the program logic. This means that control leads may or may not be recorded and may or may not be seen by the triggers—depending on the FEB setup (Section 9).
- Line data may be recorded directly to disk as bit-image data, recorded to bit-image RAM and then transferred to disk, or captured as character data in the display buffer and transferred to disk.
- Once control leads and time ticks (that is, the original timing values) are recorded alongside character data, they are locked in. Since the FEB is not on the playback path for character data, FEB selections do not apply.
- Bit-image data, however, does pass through the FEB during playback. Except for the **Idle Suppress** field, FEB selections apply. This means that control leads and time ticks, if recorded with the data, *must* be enabled in order for the program logic to detect them. (For playback of bit-image data, the **NRZI** selection on the Line Setup menu also does not apply.)
- Only data on disk may be played back.
- Front-panel green-red LED's are never disabled for line data and never blink for recorded data.
- Not only characters but also leads and time ticks, if enabled in the FEB setup, are captured automatically in the display buffer (that is, the screen buffer or character RAM).

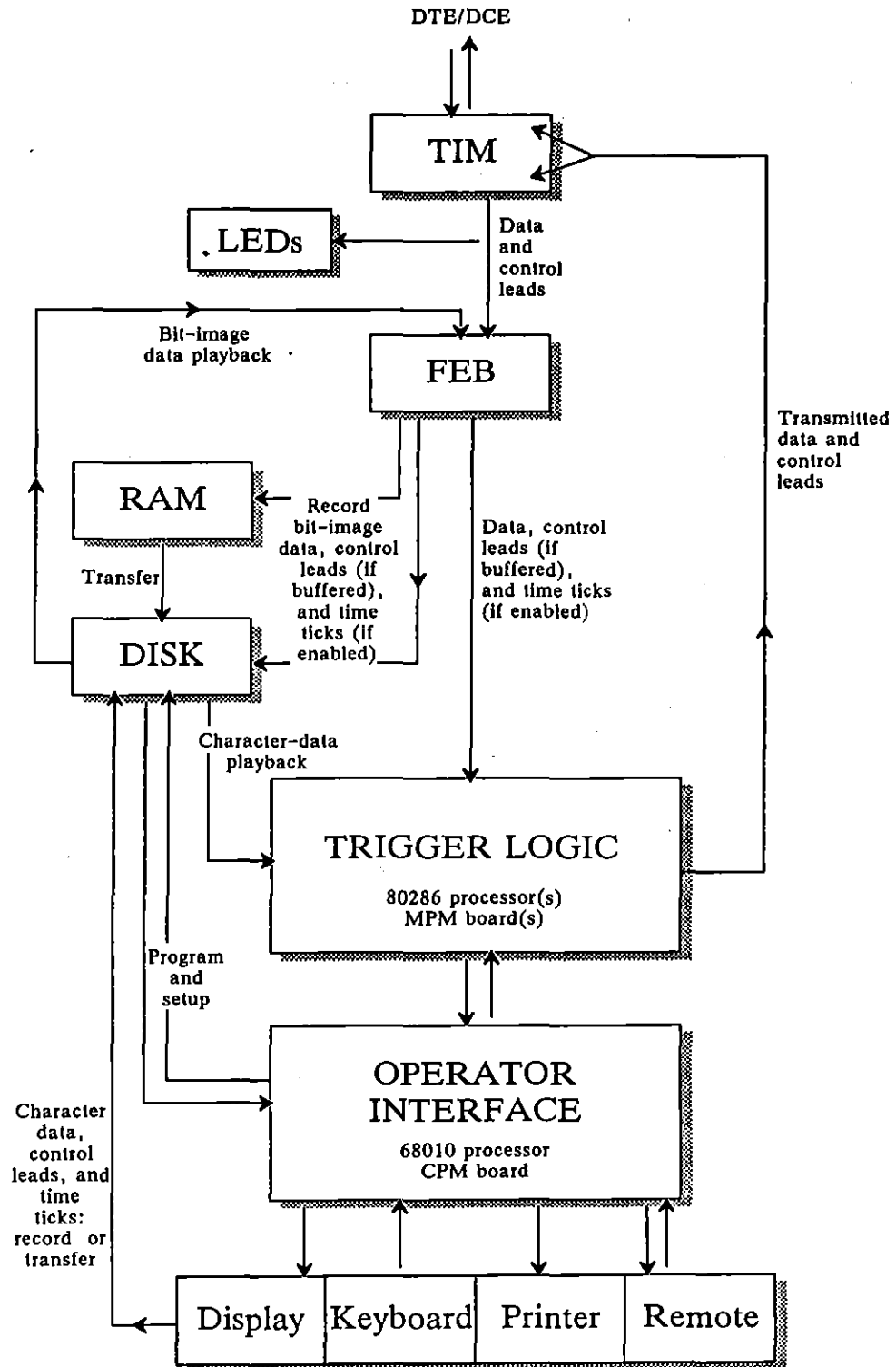

Figure 2-5 INTERVIEW 7000 Series functional diagram.

2.8 How to Correct Common Problems

(A) Unit enters Run mode even though I press the Program key.

A file called *user_intrf* was located in the */usr* directory of the hard disk during boot-up. In this situation, the program in *user_intrf* is automatically loaded, compiled, and run each time the **PROGRAM** key is pressed. Press **SHIFT-PROGRAM** to enter Program mode, or rename *user_intrf* and power-up again. See Section 2.2(B).

(B) Unit does not execute Run: Protocol Spreadsheet returns to screen instead.

An error was detected during the compiling phases (after you pressed **RUN**). See Section 2.6(C).

(C) My program does not run, and instead I get a message about an "unresolved reference."

Your program is asking the compiler for a send routine that is not available in Monitor mode. Switch to an Emulate mode, or modify the program. For programs with C coding, this message usually means that a routine has not been declared or defined.

(D) Protocol Spreadsheet program which was just loaded shows syntax error strikethroughs which weren't there before.

Missing softkey selections and pervasive strike-through's on the Protocol Spreadsheet indicate that the correct Layer Personality Package has not been loaded. To correct the problem, return to the Layer Setup screen, insert disks if necessary, and check Personality Package and drive selections. Then press **END** to load the packages manually.

(E) EIA trigger condition does not come true, even though the front-panel LED indicates a status that makes the condition true. For example, an EIA RTS ON condition is not coming true, even though the RTS LED is bright red.

EIA status is not detected by the triggers if **Buffer Control Leads: NO** is the selection on the Front-End Buffer Setup menu. See Section 9.

If the data is being played back from disk and the FEB Setup menu was not configured to buffer control leads at the time the data was recorded, the leads are no longer available for triggering.

Front-panel LEDs *always* reflect line status, never the status of recorded leads.

Note also that an EIA condition that is the only condition on a trigger menu (or the only condition associated with an action or set of actions on the Protocol Spreadsheet) is *transitional*. It is only true when it changes to true. To check

the current *status* of an EIA lead regardless of transitions, pair the EIA condition with a don't-care character condition (see Section 24.4) or with an ENTER_STATE condition on the Protocol Spreadsheet. See Section 30.3(A).

- (F) Lead lines on the data-plus-leads display are not transitioning, even though the front-panel LEDs for the same control leads are blinking.**

The leads on the data-plus-leads display are also enabled/disabled by the Buffer Control Leads field on the FEB Setup menu. See (E), directly above.

- (G) My "current" timers seem to be incrementing on the Tabular Statistics screen, but the other statistical columns always show 0, even when I take statistical samples.**

The "current" column is derived from a millisecond "clock on the wall," while the statistical values may be calculated on the basis of time ticks that occur at one-second intervals. Your timer samples may be less than .5 seconds, in which case they are rounded to zero.

Check the FEB Setup menu, and solve the problem in either of two ways. Turn Time Ticks off, and the statistical columns will use the wall clock. Or change the Tick Rate from 1 second to 10 milliseconds or smaller (down to 10 microseconds).

- (H) I am trying to send a transmit string from a trigger menu (or from Layer 1), but my data does not appear on the screen.**

When you are having trouble transmitting, always go to the Line Setup menu and look at the Clock Source field first. You must have clock to transmit, whether internal or supplied by an external DCE.

Another frequent problem is receiver synchronization. When you try to transmit, does the front-panel LED for your transmit lead (TD or RD) blink rapidly? If it does, then you are transmitting successfully, but your receivers may not be synchronizing with the data.

Check the Sync Char field on the Line Setup menu. Also be sure that the sync pattern is part of your transmit string. You must supply these characters yourself.

- (I) I have loaded in X.25 packages at Layer 2 and Layer 3, and I am trying to send a data packet from Layer 3; but my data does not appear on the screen.**

The INTERVIEW is a *layered* emulator. The significance of this is that Layer 3 and higher layers (in Emulate modes) have no direct access to the physical layer, Layer 1. In practice this means that a RCV condition at Layer 3 *does not see packets on the line*. It only sees packets that are delivered up from Layer 2 by a *user program* at that layer.

Similarly, a SEND action at Layer 3 does not in itself send a packet out onto the line. A SEND action merely delivers the packet to Layer 2—provided that Layer 2 has indicated its readiness to receive data from above.

The following program is not any sort of complete Layer 2 emulation. It is the *minimum* program that must be entered at spreadsheet Layer 2 in order for a Layer 3 program to have access to the data line. Once this Layer 2 program is entered, Layer 3 can send packets out onto the line and receive packets from the line.

```
LAYER: 2
STATE: datalink
CONDITIONS: DL_CONNECT_REQ
ACTIONS: DL_CONNECT_CONF
CONDITIONS: DL_DATA_REQ
ACTIONS: SEND_INFO "<>"
CONDITIONS: RCV_INFO
ACTIONS: GIVE_DATA
```

The elements of this program are discussed in Section 33, OSI Primitives on the Protocol Spreadsheet, and in the programming example in Section 36.9.

(J) I'm trying to load a program, but instead I get an error message about loading a layer package.

When a program or object file is loaded from the File Maintenance screen, the system must be able to locate any layer personality package that the program requires. If the necessary layer package cannot be found, the file will not be loaded.

NOTE: Optional applications programs are available for the INTERVIEW 7000 Series. Make sure that necessary layer packages are accessible when you load these programs.

In the INTERVIEW 7500, 7200 *TURBO*, and 7700 *TURBO*, all layer packages are always accessible since they reside in the *usr/layer_pkgs* directory on the hard disk. In the INTERVIEW 7000, layer packages are located in the same directory on the user disk (DSK-951-001-2.X). See Section 8. Place the user disk in the other floppy disk drive and try loading the program (or object) file again.

(K) My INTERVIEW is overheating.

Collected dust and dirt on the fan filter may be blocking the flow of air into the unit. Follow the instructions in Section 1.5(D) on cleaning the fan filter. If the problem persists, contact Customer Service.

(L) I'm trying to run an application program that has worked before, but it won't compile or run.

If you have a non-*TURBO* unit with software revision 8.00 (or higher) installed, there may not be enough system memory available to run large application programs. The optional XDRAM board, available as OPT-951-32-1, provides additional system memory.

(M) I power up my INTERVIEW and it gives a message about not being able to find *mstrmenu.cmp*.

You have a *TURBO* unit that is trying to load the menu information for the Easy View system. If you have the Easy View disks, duplicate their contents onto your hard disk. (See Section 13 for information on the Duplicate Disk command.) If you do not have the Easy View disks, go to the Easy View Setup screen, select **Enter Easy View After Power-Up: NO**, and save the setup. (See Section 18.)

(N) I power up my INTERVIEW and it gives a warning message about the CPM.

During power-up, *TURBO* units check the revision levels of all boards for compatibility. Even if the revision levels are not as expected, the general operation of the unit is unaffected. Contact Customer Service for further information.

2.9 Optimizing High-Speed Operation

It is a simple fact that the more tasks there are to accomplish, the longer it takes to complete them—time is a relative factor. This is also true of the INTERVIEW. When line rates are relatively high, it may be best to strip your program of extraneous tasks which would slow down the unit.

(A) Record

One option is to record the data for playback and analysis at a slower rate.

Three sets of program selections for optimizing high-speed recording of data follow. All three versions assume that you are not loading in any program that will look at the TD or RD data, BCC, frames, packets, or EIA leads. All three versions record the data so that it can be run against more complex programs later on.

The fastest version records data without displaying the character data to the screen. The next version records data at maximum speed while still displaying data. The third version records data with personality packages loaded in the unit so that a protocol trace is displayed in real-time.

1. *Recording without displaying character data.* The first set of programming selections records all of a data line (including idle and time ticks) in bit-image data format. This is the fastest of the three recording scenarios.

Beginning with the default screens, make the following selections:

SETUP: LINE:

Sync Char: delete both sync characters

DISPLAY:

Display Mode: NO DISPLAY

RECORD:

Capture Memory: user choice

Data To Record: BIT IMAGE

Stop at: user choice

FEBUFF:

Buffer Control Leads: YES or NO

Time Ticks: OFF or ON with 1 second to 1 millisecond selected

Using 1 millisecond time ticks, the maximum normal recording speeds for each of the disk types on the Record setup screen are as follows:

Single Floppy Disk	64 Kbps
Multiple Floppy Disks	56 Kbps
20-Mbyte Hard Disk	256 Kbps
44-Mbyte Hard Disk	384 Kbps
RAM	256 Kbps

TRIGGERS:

For SYNC format, the following triggers will keep the unit out of sync; the unit works at optimum speed when it is not in sync. Enter these conditions and actions on a Trigger Setup screen:

CONDITION: DTE 1 OF ("don't care")

ACTION: OUT_SYNC BOTH

CONDITION: DCE 1 OF ("don't care")

ACTION: OUT_SYNC BOTH

NOTE: When line rates approach the maximum recording speed, consider using high-speed RAM recording. See Section 7.4(A).

2. *Recording while displaying character data.* The second scenario records data at optimum speed while still preserving the character display.

Beginning with the default screens, make the following selections:

SETUP: LINE/RECORD:

Capture Memory: user choice for type of DISK
(do not select RAM recording)

FEBUFF:

Suppress the idle line pattern under **Idle Suppress** using the following patterns:

BOP: DTE : T_E
 DCE : T_E
 SYNC: DTE : F_F
 DCE : F_F

On the Front End Buffer screen, turn off **Buffer Control Leads** and **Time Ticks**:

Buffer Control Leads: NO
Time Ticks: OFF

LAYER:

Do not load any layer personality packages.

TRIGGERS AND PROTOCOL SPREADSHEET:

Do not load in any program that will look at the received data, BCC, or EIA leads.

3. *Recording while displaying character data or protocol trace.* The third setup version records data at maximum speed with layer personality packages loaded.

Beginning with the default screens, check the following selections:

SETUP: LINE/RECORD:

Capture Memory: user choice for type of DISK
 (do not select RAM recording)

FEBUFF:

Suppress the idle line pattern under **Idle Suppress** using the following patterns:

BOP: DTE : T_E
 DCE : T_E
 SYNC: DTE : F_F
 DCE : F_F

On the Front End Buffer screen, turn off **Buffer Control Leads** and **Time Ticks**:

Buffer Control Leads: NO
Time Ticks: OFF

LAYER:

When running SS7 layer personality packages, load Layer 1 Compression package.

TRIGGERS and PROTOCOL SPREADSHEET:

Do not load in any program that will look at the received data, BCC, frames, packets, or EIA leads.

(B) Monitor

If you want to monitor the data in real time, but still optimize speed, select **Time Ticks: OFF** and **Buffer Control Leads: NO** on the FEB Setup menu.

(C) TURBO

The INTERVIEW 7200 *TURBO* and the 7700 *TURBO* can monitor data at high rates. To achieve the maximum operation speed, however, the active spreadsheet program should not: 1) load in any personality package; 2) look at (TD or RD) data, BCC's, (EIA) leads, frames, or packets; or 3) include OSI or other conditions which require a frame to be passed up to higher layers.

This means that the following Layer 1, line-related C variables should not be referenced:

Event Variables:

fevar_rcvd_char_rd
fevar_rcvd_char_td
fevar_gd_bcc_rd
fevar_gd_bcc_td
fevar_bd_bcc_rd
fevar_bd_bcc_td
fevar_abort_rd
fevar_abort_td
fevar_eia_changed

Non-Event Variables:

rcvd_char_rd
rcvd_char_td
current_eia_leads
previous_eia_leads
ll_tick_count
rd_modifier
td_modifier

Other C variables at higher layers are either specific to various protocol packages or have meaning only if a frame has been passed up the layers. In either case, they should not be referenced in your spreadsheet program.

3 Keyboard

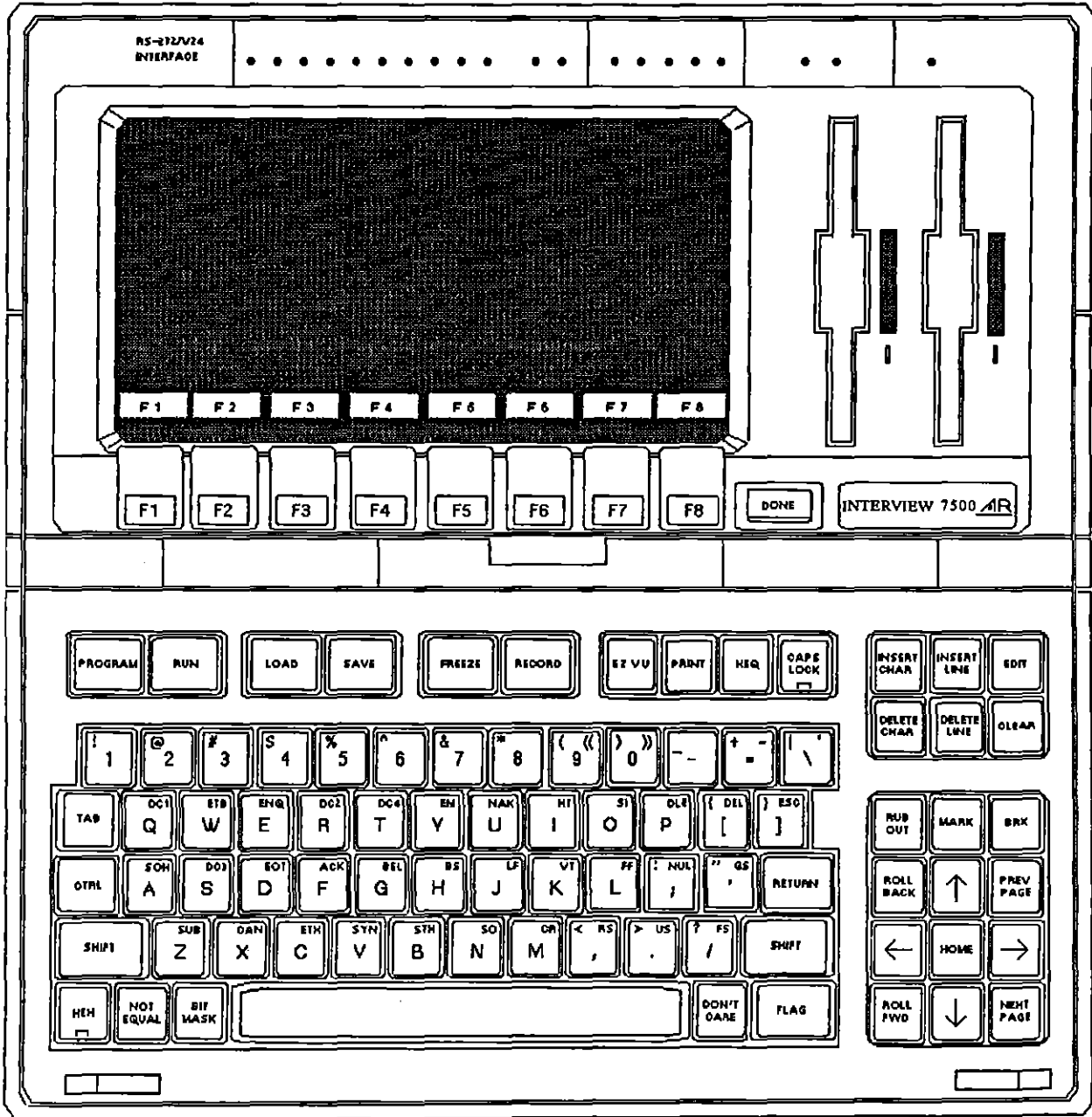



Figure 3-1 The INTERVIEW keyboard.

3 Keyboard

3.1 Hard Keys and Softkeys

The ninety-four keys of the INTERVIEW include nine keys (eight variable or *softkeys* and a  key) that are positioned not on the keyboard itself but rather above the keyboard on the front panel, just below the monitor. The softkeys are placed directly below their (changing) screen legends, in order that the user will not have to take his eye off the screen to locate one of these keys.

In Program mode, softkeys can move the cursor around menu screens and change selections in menu fields. On the Protocol Spreadsheet screen, softkeys are an alternative to direct keyboard entry: programming levels from layer down to specific conditions and actions are softkey-selectable. In Run mode, the softkeys serve as an extended keyboard for functions such as changing the display (from data to protocol trace or to a statistics graphic, for example).

The keyboard itself consists of an ASCII keyboard and several special-function keypads, including a cursor keypad and an editing keypad that is used to modify all entries on the Protocol Spreadsheet screen as well as text entries on various menu screens. The ASCII keyboard includes five special, non-ASCII characters arranged on either side of the space bar that are used primarily to enter nonstandard characters in search strings.











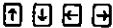

Most keyboard functions are explained in detail elsewhere in the manual. The editing keypad, for example, is covered in Section 29, Editor. The present section is intended primarily to indicate the range of keys available when the operator has placed the unit in Program, Run, or Freeze mode.

NOTE: For an explanation of the keys valid in the Easy View menus, refer to Section 4.

3.2 Programming Keys



Table 3-1 is a brief listing of some of the frequently used programming keys. The keyboards in Figure 3-2 and Figure 3-3 indicate all of the keys that are valid in Program mode.

Table 3-1
Frequently Used Programming Keys

	If In Program mode, enter Easy View system. If In Easy View, exit to Program mode. Functional only In <i>TURBO</i> units when enabled on the Easy View Setup screen. See Sections 4, 18, and 19 for more information on Easy View operation.
	In Program mode, always returns to the master menu from any other menu or screen. (In Run mode, either returns to Program-mode master menu, returns to an Easy View menu, or loads, compiles, and runs program in <i>HRDiusrluser_intrf</i> . See Section 2.2(B).)
	Move cursor from field to field.
 	Change rotating-field selections.
	Completes an entry and tabs to next field.
	Moves cursor to beginning of menu screen.
	Goes back up to previous menu in program-menu tree.
	Loads and saves files; loads in protocol packages; executes other commands.
   	Edit text entries.

(A) ASCII Keys

The set of ASCII keys is used in Program mode to provide names for files and directories, to identify counters, timers, accumulators, and programming flags, to type in operator-defined messages called prompts and traces, to enter search and transmit strings on trigger menus, and to enter text on the spreadsheet screen. The ASCII character that appears on the screen is always the character shown on the keycap, with shifted characters shown at the top left corner of the keycap and control characters shown at the top right.

It is important to note, however, that there may be a difference between the display of keyboard input in Program mode versus Run mode. In Program mode, a particular keystroke ( pressed in conjunction with , for example) will always produce the same character ("-") in a data-entry field. In Run

mode, a particular code-translate chart will be consulted and the character ("-" in our example) may not belong to the code set and therefore may be missing on the chart. Such a character cannot be trapped, transmitted, or displayed in Run mode: it is "untranslatable" (see Note, Appendix D1). Run-mode encoding of keyboard input is given in Appendix D1, Keyboard-to-Hex Translation.

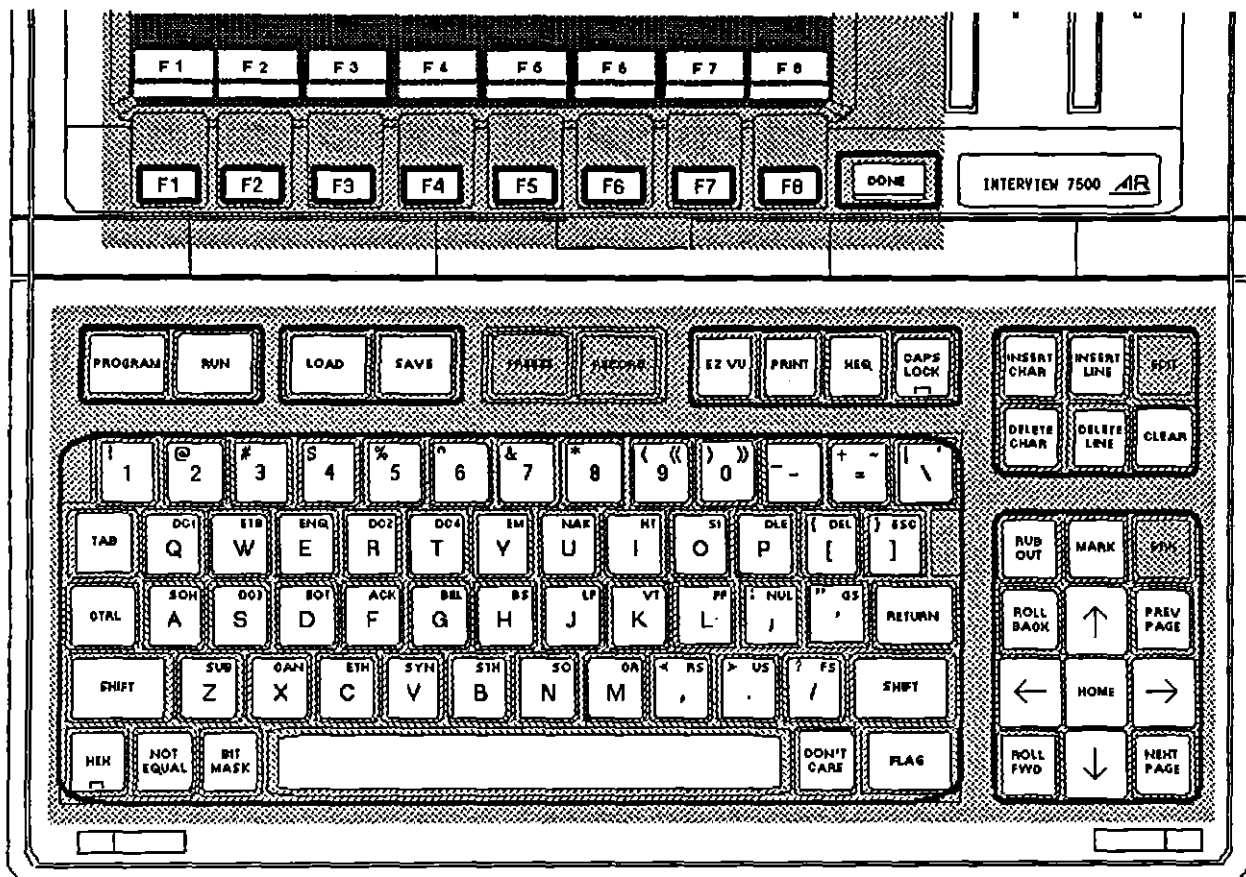

Figure 3-2 Menu-screen keys.

Two characters on the ASCII keyboard are part of the spreadsheet programming language but do not belong to any standard code set. They are « and ». These characters are produced by the combination of **Ctrl** and **9** or **0** and can be entered only on the Protocol Spreadsheet, and in the **Xmlt:** field on Trigger Setup menus. They are never transmitted.

For examples of how these double-parens are used, see Section 28, Constants, and Section 32, Strings.

Three standard ASCII characters have special meaning on the Protocol Spreadsheet. The double-quotation mark (") opens or closes a text list or string; see Section 32, Strings. The backslash (\) is an escape character. And the ASCII space produced by the space bar indicates the completion of a "keyword" (or "token") and normally changes the rack of programming softkeys along the bottom of the screen.

RETURN does not produce an ASCII control character in the INTERVIEW. It is always a cursor-movement key. Press **CTRL-M** to enter the $\$$ character.

(B) Special Characters

NOT EQUAL, **IN MASK**, **CONT. CARE**, **FLAG**, and **SHIFT-FLAG** produce entries only in search fields in trigger conditions and in spreadsheet conditions. **HEX** is an on-off function. In the "on" condition it lights the LED on the keycap and produces hexadecimal entries both in search fields and in transmit strings. The function works as follows: with the hex function off, the key sequence **A**, **A**, **HEX**, **7**, **E**, **7**, **E** yields the screen entry of **A A 7 E**. Hex is also a valid data-entry function in the **Sync Char**, **Outsync Char**, and **Xmit Idle Char** fields on the **Line Setup** menu, in text-entry fields on the **BCC Setup** menu, and in the **Preamble** and **Sync Pattern** fields on the **BERT Setup** screen.

(C) Load/Save

LOAD and **SAVE** call up the File Maintenance menu directly from any other programming screen. **LOAD** selects **Command: LOAD** on the File Maintenance menu, while **SAVE** selects **Command: SAVE**.

(D) EZ VU

This key is operational in *TURBO* units only. Enable/disable the key on the Easy View Setup screen. (See Section 18.)

EZ VU is a toggle key. Use it to move back and forth from Program-mode screens to Easy View.

(E) Shift-Save

Press **SHIFT-SAVE** to save the configured Printer Setup or Easy View Setup menu. The Printer Setup is saved to a file called *print_setup* in the */sys* directory of the boot drive. The Easy View setup is saved to a file called *ezview_setup* in the */sys* directory of the boot-up disk.

(F) Print

Press **PRINT** to send the program menu (or spreadsheet page) that is currently displayed to a serial printer attached to the INTERVIEW. **CTRL-PRINT** will print the full set of programming menus (or the full spreadsheet program).

(G) Execute

EXEC is the key that performs the actual load or save. **EXEC** also performs other commands on the File Maintenance menu as well as various functions on the Disk Maintenance, Date/Time Setup, and Layer Setup screens. On the Protocol Spreadsheet, **EXEC** may be used to perform a "write" operation from the screen to a file, or a "read" operation from a file to the screen. See Section 29, Editor.

(H) Mark

MARK has a special function on the File Maintenance Screen. When you have cursoried down to a particular file in the File Maintenance directory, **MARK** selects that file for the next operation. Several files may be "marked" prior to the execution of a command. The **MARK** key also unmarks rows in the directory that have been marked already.

MARK has a "program tab" function on the Protocol Spreadsheet: see (L), below.

(I) Editing Keys, Menu Screens

The editing keys that operate within text-entry fields on menu screens are shown in Figure 3-2. **INSRT CHAR** inserts a space at the cursor position. A character can then be typed over the space. **DEL** deletes the character that is under the cursor. Characters in the same field to the right of the cursor move left to fill the column vacated by the deleted character. **CLEAR** removes the entire data entry.

DEL deletes the character just to the left of the cursor position. The cursor moves left as successive characters are deleted. Use **DEL** to correct a typographical error on the most recent keystroke (or the last several keystrokes).

CTL-CLEAR restores the default selections for the entire menu screen.

On the multipage tabular and graphic statistics screens, **PREVT LINE** adds a blank statistics row above the cursor. **PREVT LINE** removes the row that has the cursor.

(J) Editing Keys, Spreadsheet Program

These keys are shown in Figure 3-3. The operation of **PREVT LINE** and **DEL** is the same as on menu screens, except that here the use of these keys is not restricted to particular fields.

INSRT LINE adds a blank line above the cursor. **PREVT LINE** removes the line that has the cursor. **CLEAR** erases the cursor character and everything to the right of the cursor on a given line. **EDIT** enables/disables the spreadsheet editor. Refer to Section 29, Editor, for editing softkeys and their functions.

There is a separate insert *mode* in the spreadsheet editor. This mode is invoked by two keys, **INSRT CHAR** and **INSRT LINE**. When the mode is enabled, the word <insert>

appears at the top left of the spreadsheet screen. In insert mode, the operator types in a block of data while succeeding text is pushed forward with every keystroke.

Press **INSERT CHAR** a second time to exit *insert* mode and return to *overstrike* mode.

NOTE: **INSERT LINE** is not an alternate-action key that toggles the spreadsheet from *insert* to *overstrike* mode. Only **INSERT CHAR** accomplishes this function.

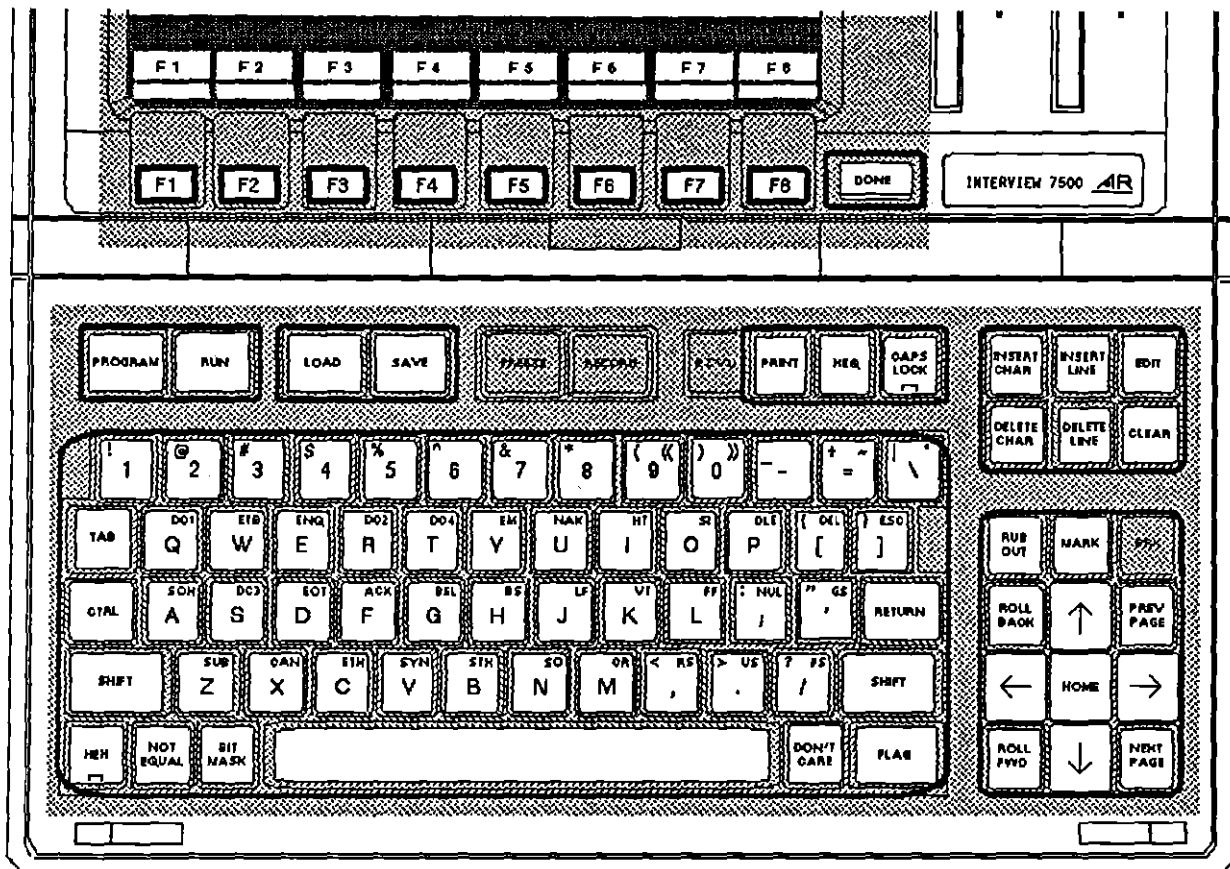

Figure 3-3 Spreadsheet keys.

(J) Cursor Keys, Menu Screens

See the bottom right of Figure 3-2. **F1** and **F2** move the cursor from line to line on programming menus (including triggers). **SHIFT-F1** moves the cursor to the first field in the menu. **SHIFT-F2** places the cursor in the last field in the menu. **F3** and **F4** move the cursor from field to field on the same line. In text-entry fields, they move nondestructively right and left over text that has already been entered. **ROLL PAGE** and **ROLL PAGE** rotate the selections at the cursor position.

RETURN and **DOWN** are field oriented. They move the cursor down or to the right, depending on where the next menu field is located.

Whenever a programming menu is first entered, the cursor is in the "home" position. **HOME** moves the cursor back up to this position. Home may be the first field on the menu. Or it may be a softkey rack that selects among menus or among fields on a lengthy menu. Several screens have more than one home position that are accessed consecutively when you "home upwards" from below. See, for example, the Line Setup or Trigger or Misc Utilities screens.

When you are accessing a programming screen (except the main-menu screen or the two Statistics menus), the **BACK** key will return you to your previous menu. You may use this key to backtrack through several previous screens.

On the two multipage Statistics screens, **PAGE** and **PAGE** cause a page-by-page scroll.

(K) Cursor Keys, Spreadsheet Program

In a spreadsheet program, the cursor-arrow keys move the cursor by one column or one row. **RETURN** moves the cursor to the current indent position on the next line. **ROLL** and **ROLL** cause the screen to scroll one line at a time, while **PAGE** and **PAGE** cause a page-by-page scroll. Roll and page keys do not affect the cursor.

"Home" is the top left of the current screen. To cursor to the beginning of the spreadsheet program, press **SHIFT-F1**. Press **SHIFT-F2** to go one line below the last line of the program.

To cursor to the beginning of a given line, press **CTRL-F1**. To "express" the cursor to the end of the data-entry on a line, press **CTRL-F2**.

To cause the cursor to skip forward from keyword (or "token") to keyword, press **SHIFT-F3**. **SHIFT-F4** causes a reverse skip.

Any cursor movement across keyword boundaries will change the softkey-option rack along the bottom of the screen.

MARK may be used as a kind of "program tab" to mark a place in the Protocol Spreadsheet where the cursor will automatically revert on command. With the cursor in a position you will want to return to quickly and conveniently, press **MARK** followed by a number key—**2**, for example. Then go ahead and move the cursor any distance in either direction from the marker.

When you wish to return to the "mark 2" position, press **SHIFT**-**MARK** followed by **2**. Up to ten numbered cursor-markers may be reserved in the spreadsheet program.

(M) Softkeys and **DONE**

Depending on which menu field has the cursor, all selections are mapped to softkeys at various times. On menu fields, the **DONE** key has the same function as **RETURN**: it moves the cursor to the next field. So there is a way to move around the menu and make selections without using the cursor-arrow and other keyboard keys.

When the operator is using softkeys to enter a spreadsheet program, he uses **DONE** to mean, "Escape to the previous (higher) level of programming." Figure 3-4 illustrates how two depressions of the **DONE** key can take the program from a specific EIA condition all the way to the highest level of softkeys.

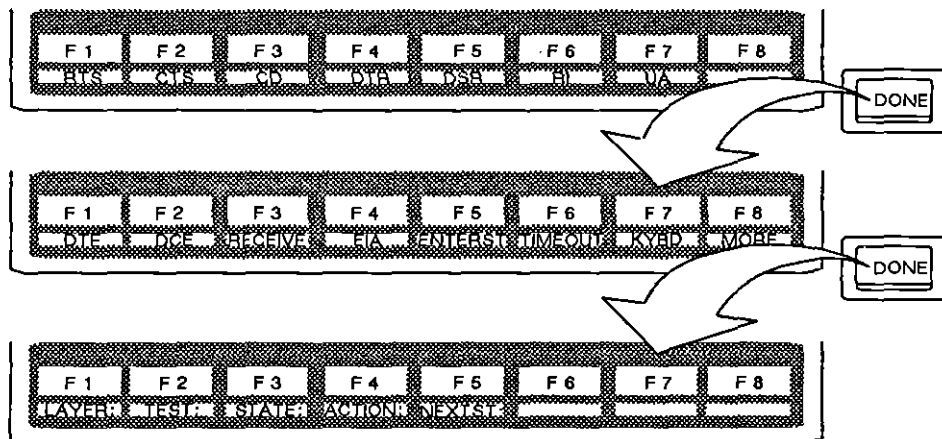

Figure 3-4 Moving to a higher rack of softkeys on the Protocol Spreadsheet.

3.3 Real-Time Keys

The keyboard in Figure 3-5 indicates the keys that are valid in Run mode when the data is displayed in real time (rather than frozen). In addition to the keys highlighted in this figure, the C programmer may use the variable *keyboard_any_key* to monitor input from every key except **EDIT**, **SAFE LOCK**, and **DONE**. See Section 72, Other Library Tools.

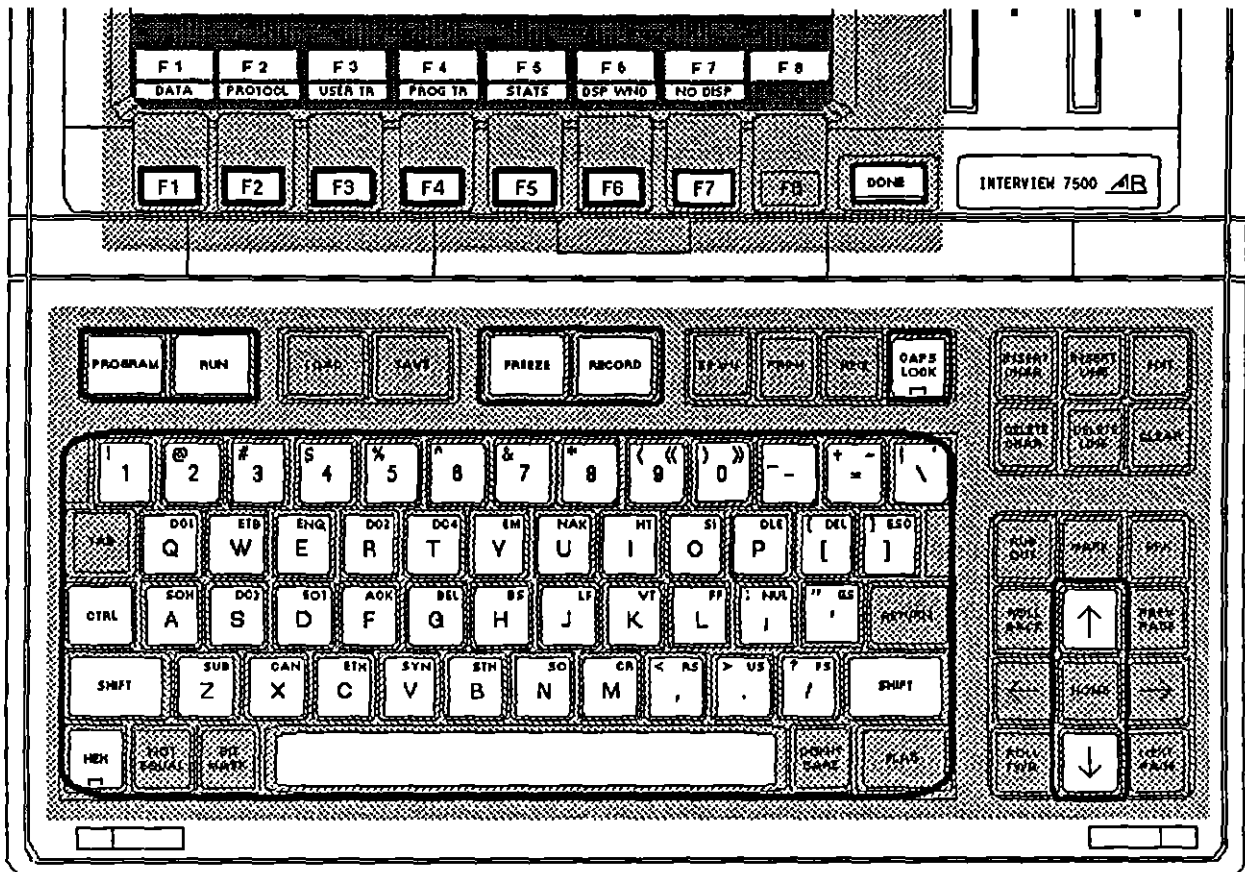

Figure 3-5 Real-time keys.

(A) Hex

In normal Run-mode operation, the **HEX** key controls an on/off decoding function that converts all the data on the screen to hexadecimal. Note that the screen-decoding function of **HEX** does not light the LED on the keycap. Only the data-entry function turns on the LED.

(B) Freeze

FREEZE controls an on/off function that freezes the screen display. For line data, program activity and bit-image recording continues. Character recording will not continue since the display buffer (character RAM) is frozen.

A similar freeze function can be activated when a Capture: **BOTH OFF** action is performed by a trigger. The difference is that while the manual (keyboard) freeze permits you to scroll through the data buffer, trigger freeze does not.

(C) Record

For line data, **RECORD** controls a manual start/stop function that records data according to the parameters selected on the Record Setup menu. For disk data, press **RECORD** to suspend/resume playback.

NOTE: Although playback is immediately suspended when you press **RECORD**, the screen display continues until the character buffer's contents are fully displayed. (For bit-image data, the FIFO must empty.) At slower playback speeds, you may notice a slight delay before the display actually freezes.

Notice the record/playback status field next to the block number field in the status area of the Run-mode display screens. See Section 6.2. The initial status indicator displayed in this field is determined by Line and Record Setup selections. See Sections 5.2 and 7. It is subsequently controlled via the **RECORD** key.

(D) Cursor Keys

When a multipage Statistics display (tabular or graphic) is presented in Run mode, **UP** and **DN** cause the rows of values (or bars) to scroll up or down one line at a time, while **PGUP** and **PGDN** cause a page-by-page scroll.

Q and **T** serve two purposes. When the Run-mode display screen is the Display Window, **Q** and **T** are under the programmer's control. (Refer to Section 72, Other Library Tools, for information on keyboard variables and the *send_key* routine.) For example, these keys could be used to move from field to field on a menu created in the Display Window. For all other Run-mode screens, **Q** and **T** control the playback speed of data from a disk. **Q** slows the data speed by half, while **T** doubles the current speed.

(E) Softkeys

In Run mode, the softkeys will change the display selection. Selectable display modes include character data, character data plus control-lead timing, protocol trace, program trace of state-to-state movement and of user-entered messages called "traces," an application-specific "display window," and statistical tabulation or graphic display of counters and timers.

There is also a Run-mode softkey selection called NO DISP. This suppresses the writing of data to the screen (though not to the screen buffer). See Section 6.11 for an explanation of this display mode.

3.4 Freeze-Mode Keys

The keyboard in Figure 3-6 indicates the keys that are valid in Run mode when the data display has been frozen.

In addition to the keys highlighted in Figure 3-6, the C programmer may use the variable *keyboard_any_key* to monitor input from every key except **EDIT**, **LOCK**, and **DONE**. See Section 72, Other Library Tools.

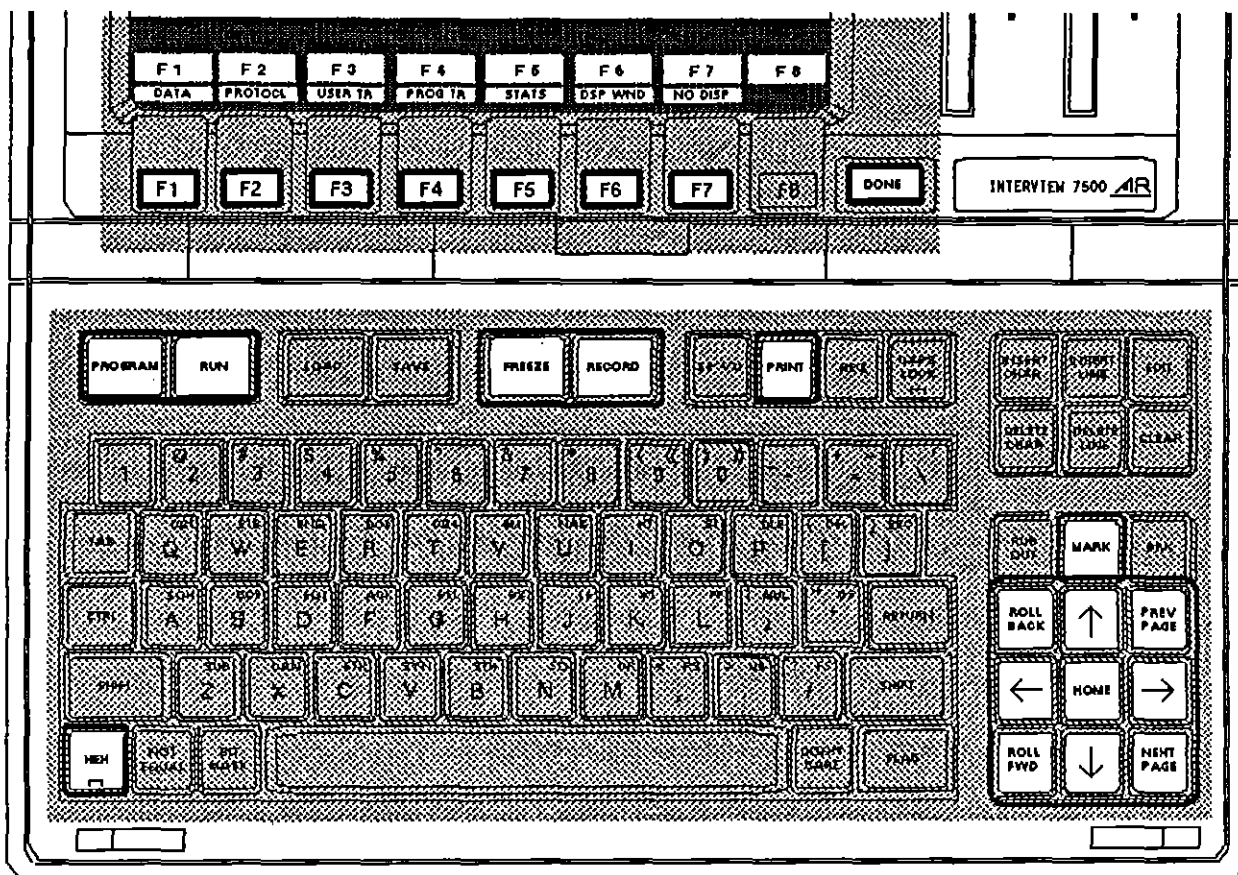

Figure 3-6 Freeze-mode keys.

(A) Hex

In Freeze mode, **HEX** controls an on/off decoding function that converts all the data on the screen to hexadecimal.

(B) Freeze

FREEZE will also unfreeze a frozen display. For disk data, it will resume playback and program activity.

(C) Record

The recording of live data can be stopped and started even while the display is frozen. The **RECORD** key will not resume playback of disk data that was frozen via the **FREEZE** key.

(D) Print

Press **PRINT** to send the current frozen screen to a serial printer attached to the INTERVIEW. **PRINT** together with **CTRL** will send the entire data buffer.

(E) Cursor Keys

The cursor keys work on the frozen data buffer the same way they work on the spreadsheet screen. Cursor-arrow keys move the cursor by one column or one row. **ROLL** and **ROLL** cause the screen to scroll one line at a time, while **PAGE** and **PAGE** cause a page-by-page scroll. Roll and page keys do not affect the cursor.

HOME will move the cursor to the first (and oldest) character in the character (screen) buffer. When **HOME** is pressed together with **CTRL**, the screen and cursor move to the last (or newest) character in the buffer.

When a multipage Statistics display (tabular or graphic) is presented in Freeze mode, **ROLL** and **ROLL** cause the rows of values (or bars) to scroll up or down one line at a time, while **PAGE** and **PAGE** cause a page-by-page scroll.

(F) Mark

The **MARK** key enables/disables the cursor timing feature of three Freeze-mode data displays (all except dual-line). When you first enter Freeze mode, cursor timing is disabled. Press **MARK** to enable it.

The **MARK** key is also used to mark the position of an event in the display buffer. The marked character is replaced by the **M** symbol. Each time you press **MARK**, you move the marked position—i.e., you redefine the event.

To disable the cursor timing display, return the cursor to the marked character and press **MARK**.

For additional information on cursor timing, see Section 6.4(E).

(G) Softkeys

All softkeys are valid in Freeze mode and serve the same functions as in real time.

4 Easy View

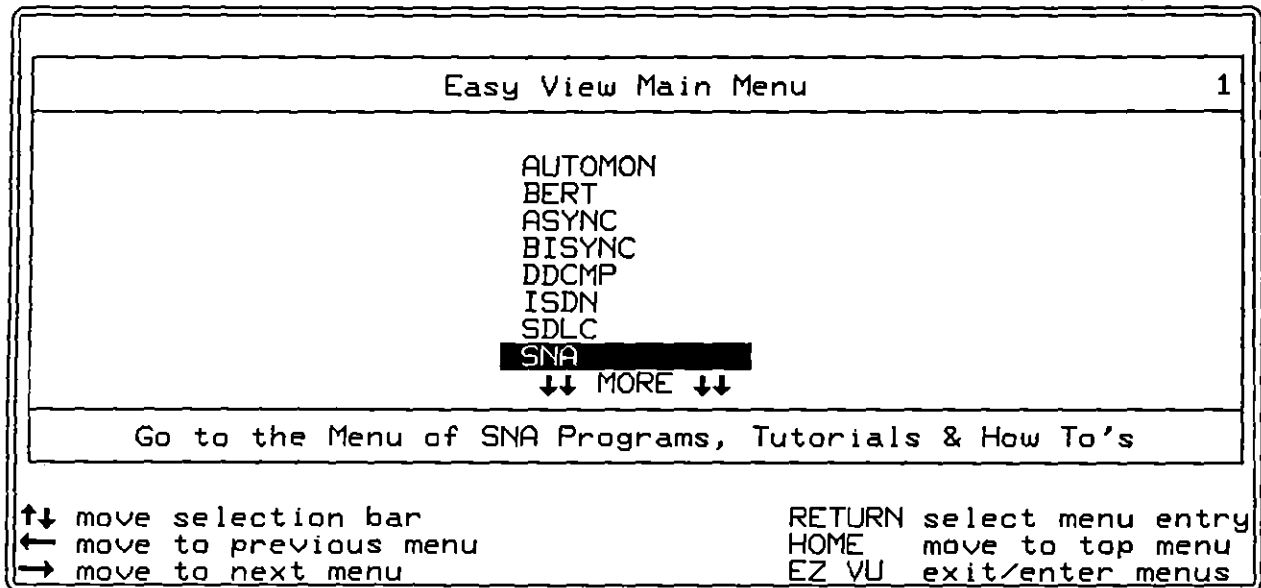

Figure 4-1 The main menu in the Easy View system.

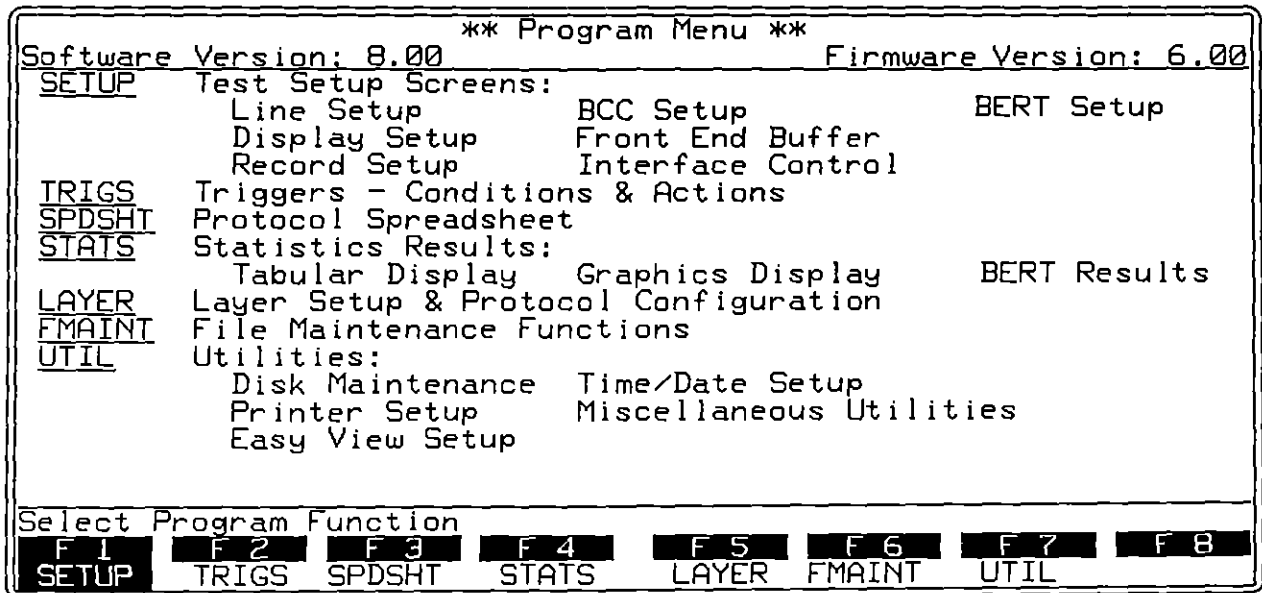

Figure 4-2 The main Program menu screen in Program mode.

4 Easy View

This section provides an overview of the Easy View system. It describes the appearance of screens and the keys used to interact with those screens. Use the menus in Easy View to quickly load and execute programs or to access help information or tutorials about INTERVIEW screens, menu selections, and protocols.

There is one hardware requirement for the Easy View Operating System: *the INTERVIEW must be a TURBO unit*. Non-TURBO units will not provide users access to the system. In these units, pressing **[EZ VU]** causes an alarm to sound.

4.1 Booting Up

By default, TURBO units automatically enter Easy View after boot-up. There is a five-second pause at the power-up screen before you see the first Easy View menu, shown in Figure 4-1. Use this pause to obtain any pertinent information you need from the power-up screen. If you want to bypass this brief timeout and enter Easy View directly, press **[PROGRAM]**. From this point on, toggle between Easy View and Program mode by pressing **[EZ VU]**.

NOTE: If the boot-up disk contains the file */usr/default* or the hard disk contains the file */usr/user_intrf*, the INTERVIEW does not automatically enter Easy View following boot-up, even if it is configured to do so. These are user-created programs that automatically start the INTERVIEW in Run mode. See Sections 2.1 and 2.2 for more information on these files.

The INTERVIEW may be configured to enter Program mode instead of Easy View following boot-up. Go to the Easy View Setup screen and modify (and save) the configuration. See Section 18.

4.2 Entering and Exiting Easy View

If you entered Easy View automatically after boot-up, you may exit (from any of its screens) by pressing **[EZ VU]**. When you exit Easy View after boot-up or after you run a program from an Easy View menu, the main Program menu screen shown in Figure 4-2 is displayed. In general, however, whenever you exit Easy View, you are returned to the same location in the Program-mode screens where you were when you accessed Easy View.

To re-enter Easy View, press **[EZ VU]** again. You are returned to the same location in the Easy View menus where you were when you exited. Repeatedly pressing **[EZ VU]**

moves you back and forth between Easy View and a Program-mode screen. Use this feature to access help information about the selections you see on Program-mode menus. Section 4.4(C) explains how to find help information.

If the unit is configured to enter Program mode following boot-up, the main Program menu is displayed, as shown in Figure 4-2. Whenever this or any other Program-mode screen is visible, access the Easy View system by pressing **[EZV]** (unless the key has been disabled—see Section 18).

NOTE: If you press **[EZV]** while the INTERVIEW is performing an extended disk or file operation from the Disk Maintenance or File Maintenance screen—such as copying files, formatting a disk, or obtaining the contents of a directory—an alarm sounds and the screen remains unchanged. Once the operation has been completed, the **[EZV]** key functions normally.

4.3 Easy View Menus

The Easy View menus are organized into a tree-structured hierarchy. See Figure 4-3. The first time you enter Easy View following boot-up, the menu at the root of the tree, the Easy View Main menu, is displayed. See Figure 4-1. The root is level one of the hierarchy. Any menus entered directly from the root menu are level two. Menus entered from level two menus are level three, and so on.

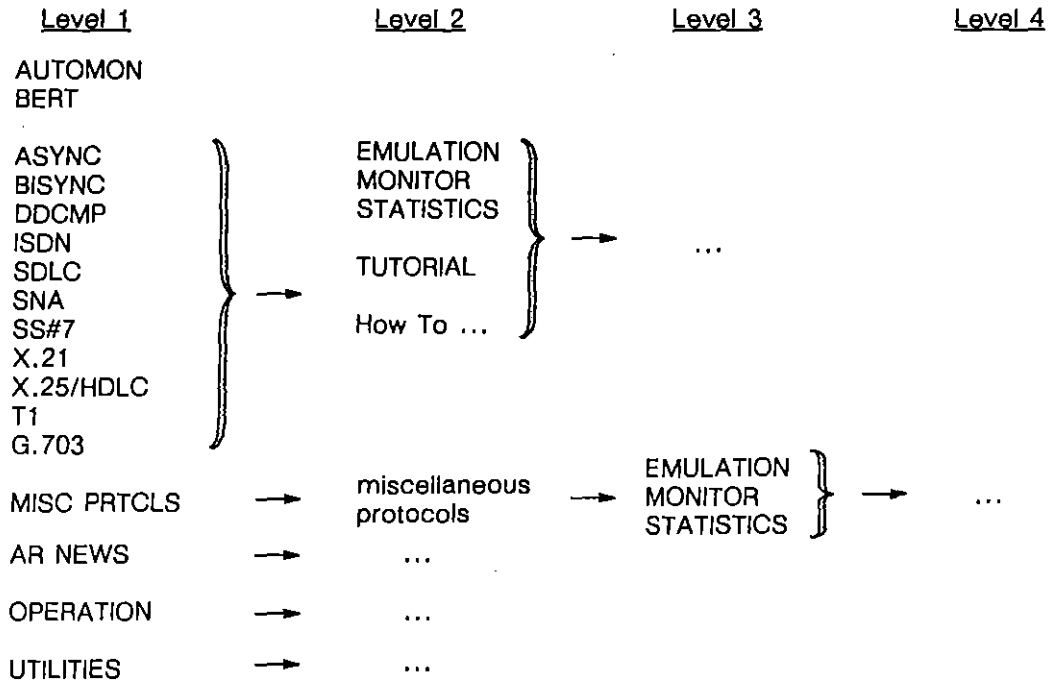

Figure 4-3 The Easy View system has a tree-structured menu hierarchy.

(A) Menu Format

Easy View menu screens have the format shown in Figure 4-4.

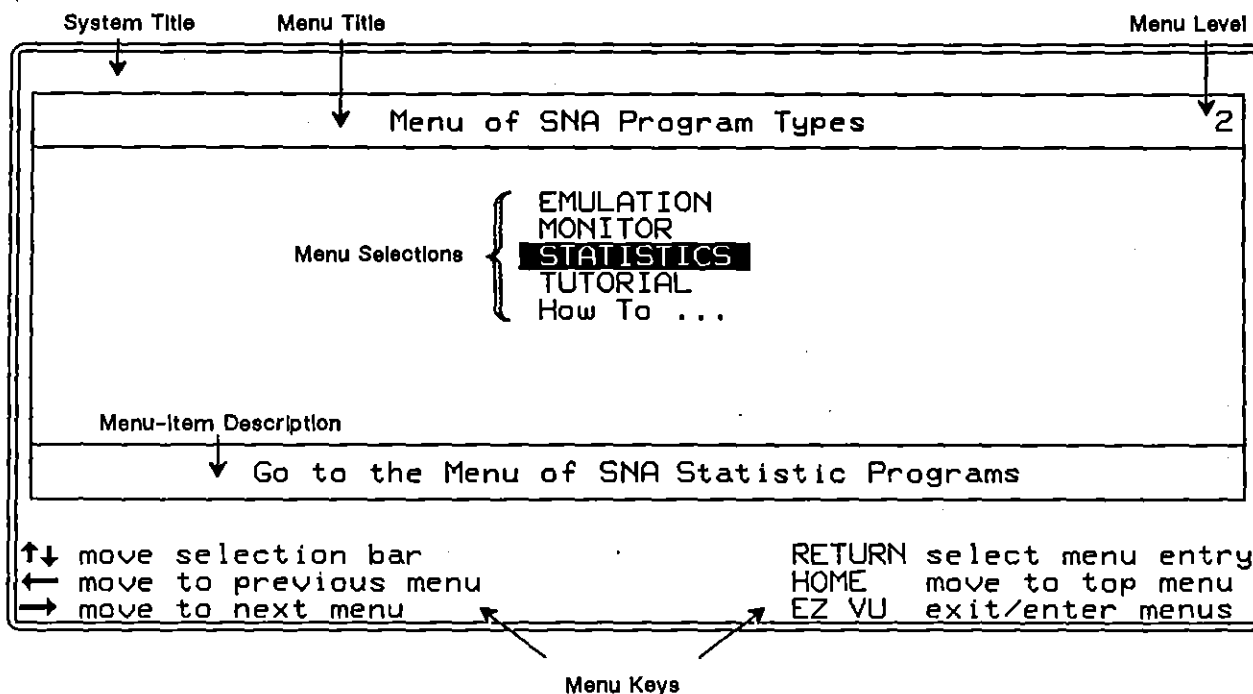

Figure 4-4 A second-level Easy View menu screen.

1. *System title.* The top line of each menu screen contains a system title. This title is centered on the screen. In Figure 4-4, it is blank. See Section 19.5 for information on defining a system title.
2. *Menu title.* In addition to the system title, each menu has an individual title centered in the top box of the screen.
3. *Menu level.* A number indicating the menu's level in the menu hierarchy is displayed at the right end of the menu title line.
4. *Menu selections.* The center box on the screen displays the menu selections. A reverse-video cursor bar highlights the selected menu item. In Figure 4-4, STATISTICS is selected for SNA protocol.

Not all menus contain selections. These empty menus have been included for the addition of optional AR programs. You may also use them for your own programs.

Although a menu has no maximum number of selections, each screen displays no more than eight menu items at a time. If there are more than eight items in the menu, the word "MORE" is displayed in a position that indicates where the additional items fall in the list. Refer again to Figure 4-1.

5. *Menu item description.* Each menu item can have an associated line of descriptive text, centered in the bottom box on the screen. This text is displayed automatically when the selection bar is over the menu item. See Figure 4-5.

If the selection bar is over a program item that is available as an option, but not currently installed in the INTERVIEW, a message to that effect is displayed.

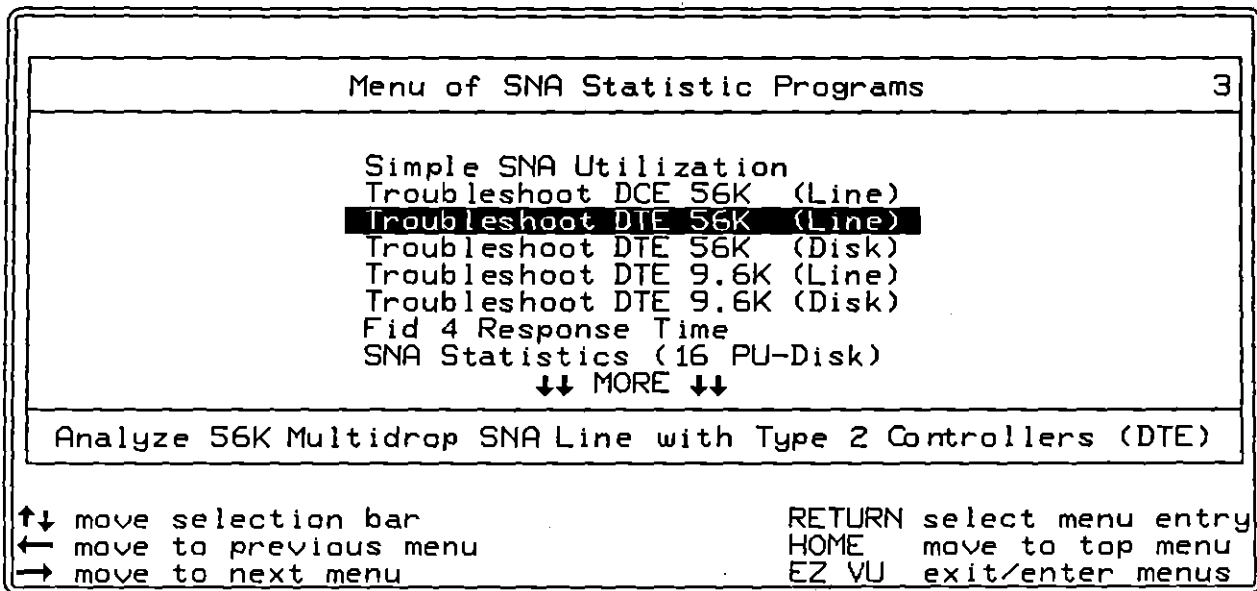

Figure 4-5 Statistic program selections for SNA protocol.

6. *Menu keys.* At the bottom of each menu screen is a list of the keys you may use to interact with the menu.

(B) Menu Keys

Several keys are used to interact with the Easy View menus. Most of them are listed at the bottom of each menu screen.

- ⌈ Moves the selection bar up one menu item on the screen. If the selection bar is on the top menu item and there are prior items out of view, the list scrolls down one item and the selection bar remains in position.
- ⌋ Moves the selection bar down one menu item on the screen. If the selection bar is on the bottom menu item and there are additional items out of view, the list scrolls up one item and the selection bar remains in position.
- ⌂ Returns to the previous, or "parent," menu in the menu hierarchy.

- ⌄ If the action associated with the menu item under the selection bar is to go to a menu, you may use the ⌄ key to move down one menu in the menu hierarchy. Otherwise, the ⌄ key has no effect.
- ⌄ Executes the action associated with the menu item under the selection bar: move to another menu, load and run a program, or view a text file. The ⌄ key can be used instead of the ⌄ key to move to another menu. It is the only means available to run a program or view a text file.
- ⌄ As you move through the menu hierarchy, Easy View records the selections you make. Use the ⌄ key to move immediately to the root menu and clear your selections from memory. The system now acts as if it is entering each menu for the first time.
- ⌄ If enabled, toggles between Easy View and Program mode.
- ⌄ When a menu contains more than eight selections, press ⌄ to scroll up eight items.
- ⌄ When a menu contains more than eight selections, press ⌄ to scroll down eight items.
- ⌄ Accesses help information available about a selected menu item. The help file presents additional information about the selected menu item.

4.4 Using Easy View

The first time you enter a menu, the initial eight menu items are displayed on the screen. A reverse-video selection bar is positioned over the top item. Use the cursor keys to move the selection bar over a menu item and press ⌄ to perform the action associated with that item.

When you select a menu item, one of three actions occurs: another menu is displayed, a program is loaded and run, or a text file is presented for viewing on the screen.

(A) Moving through the Menus

As you move through the menu hierarchy, Easy View records all the selection paths you make from its menus. When you return to each menu, its previous state is restored. This feature allows you to retrace any selection path up (or down) the menus by repeatedly pressing ⌄ (or ⌄).

Press ⌄ to clear the record of menu selections and return you to the Easy View Main menu. The system now acts as if it is entering each menu for the first time.

(B) Running Programs

Once you have made a program selection on an Easy View menu, press **RETURN** to load, compile, and run the program.

By default, the message shown in Figure 4-6 is displayed when you select a menu item whose action is to run a program. If you do not want to have this warning message presented for the rest of your working session (i.e., until the INTERVIEW is turned off), disable it by pressing **@**. Then decide whether to run the program or return to the menu without running it.

NOTE: To disable the warning message completely, go to the Program-mode Easy View Setup screen. See Section 18.

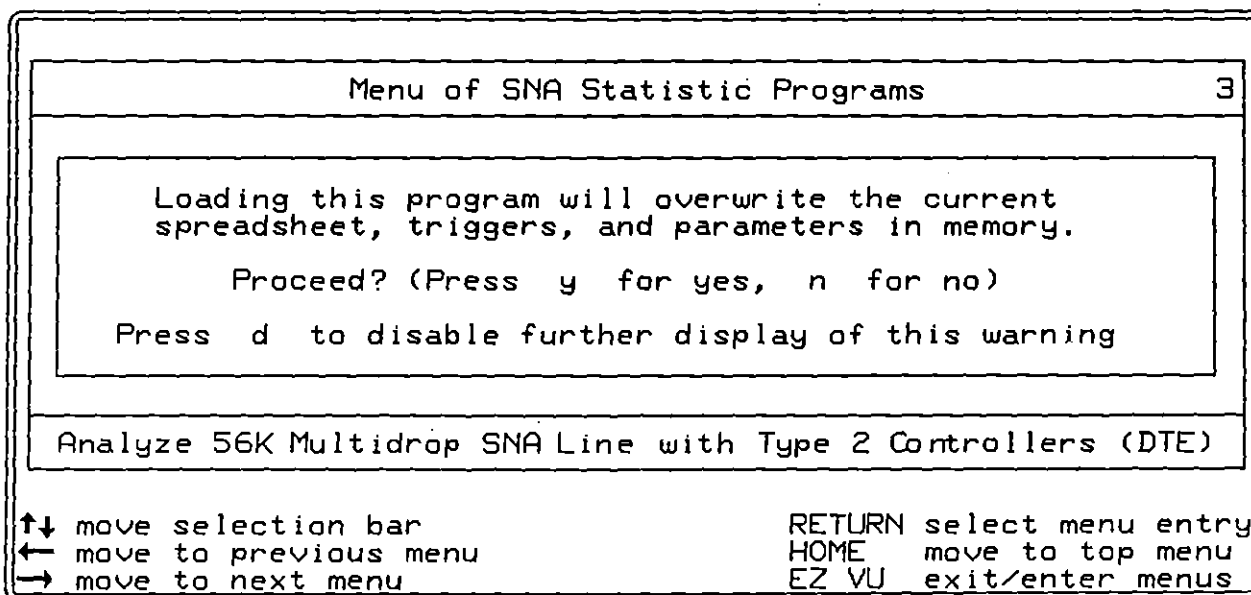

Figure 4-6 A warning message is presented before running a program.

If you decide to proceed, the INTERVIEW attempts to load, compile, and run the program. If an error occurs at any step in this process, an error message is displayed and you are automatically returned to the menu screen from which the selection was made. (You are *not* automatically taken to the spreadsheet screen if a compilation error occurs—as you are when you run a program from Program mode.)

If you exit the program by pressing **PROGRAM** (and the Easy View Setup screen shows **Keep Easy View Menu Information in Memory: YES**), you are also automatically returned to the menu screen from which the program was launched.

Figure 4-7 shows the first Run-mode display for an SNA statistic program that was loaded and run from the Easy View menu. (The program was selected in Figure 4-5).

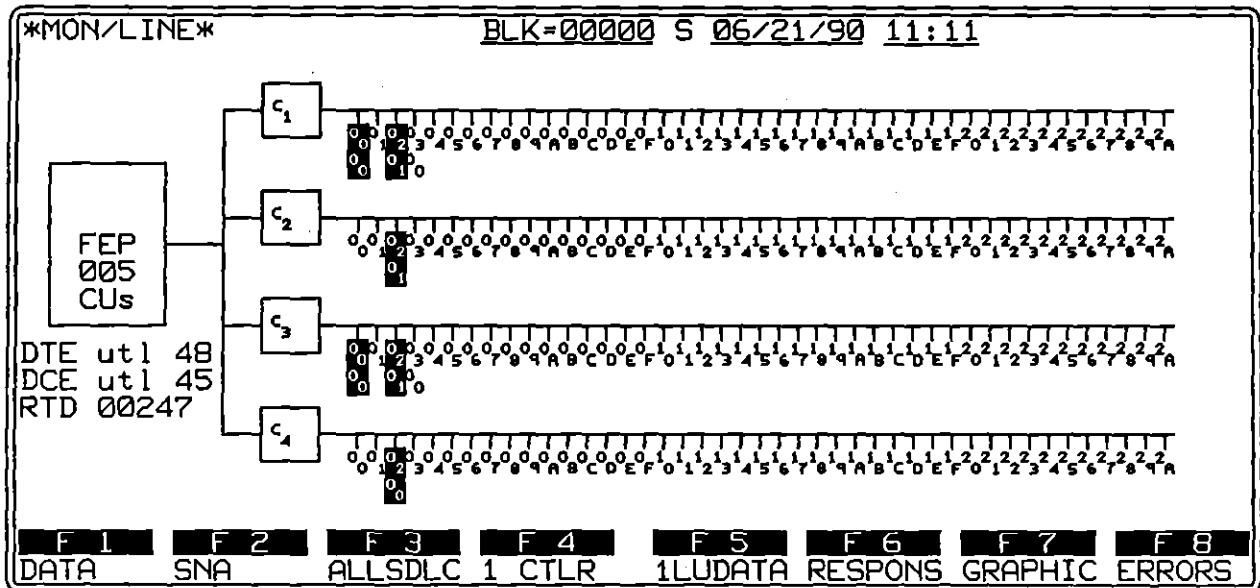

Figure 4-7 Run-mode display of controller and LU activity on an SNA multidrop line.

1. *Changing program setup parameters.* In some cases, you may want to change the default Setup menus for a selected program. Changes to the configuration of setup menus are made in Program mode.
 - (a) Select the program from an Easy View menu and press **RETURN** to load the program.
 - (b) Once the initial Run-mode screen is displayed, press **PROGRAM** and then **EZ VU** to enter Program mode.
 - (c) Enter the appropriate setup screens and make any necessary changes.
 - (d) Press **RUN**. The program will run using the new setup criteria. Since Easy View always loads and runs the disk version of a program, do not re-enter Easy View to run the program or these changes will be overwritten by the default parameters stored with the original program.
2. *Saving new setup parameters.* All AR-supplied application programs that you can load and run from Easy View are stored on disk as linkable-program (LPGM) files. If you anticipate frequent use of a program with changes to the Setup menus, you may *replace* the original LPGM file with your newly configured version *using the same pathname*. Then, you can select and run the new version from Easy View. See Section 14 for information on the File Maintenance Save command and linkable-program files.

NOTE: You may also create multiple versions of a program to appear as separate entries in the same Easy View menu. See Section 18.

(C) Viewing Help and Text Files

When you press `[F]` (the `[F]` or `[F1]-[F]` keys) or select a menu item whose designated action is to present a text file for viewing, Easy View attempts to load the proper file into memory.

If the file is not found, an error message is displayed. Press any key to return to the menu screen. If the file is located, it is presented for viewing. Both help and information text files are presented in the same format.

1. *Format.* The format of the screen used to present text is shown in Figure 4-8. The top twenty screen lines form a scrolling window. The value at the right end of the bottom line is the percentage of the text file preceding the last character on the screen.

```
Program Item Names: Troubleshoot DCE 56K (Line)
                   Troubleshoot DTE 56K (Line)
                   Troubleshoot DTE 56K (Disk)
                   Troubleshoot DTE 9.6 (Line)
                   Troubleshoot DTE 9.6 (Disk)

Program File Names: SNAstaC56   SNAstaT56   -linkable programs
                   SNAstaT56d   -linkable programs
                   SNAstaT96   SNAstaT96d -linkable programs

Associated File:   SNAstaUsr.s           - source file
                  tech_stats.o         - linkable object

Description:
This application provides several screens which assist in
identifying problems on Multidrop SNA lines where type 2
controllers are used. A dynamic graphical presentation of all
activity for up to four active controllers is also provided.

(more)
Press ? for instructions 8%
```

Figure 4-8 Information on SNA statistic program selected in Figure 4-5.

2. *Keys.* Instructions for scrolling through information files are displayed when `[F]` is pressed. These are shown in Figure 4-9.
3. *Operation.* When you first enter a text viewing screen, the initial twenty lines of the file are presented. See Figure 4-8. Use the keys described above to scroll through the file. If you subsequently leave Easy View (via the `[EW]` key), the system records which portion of the file was being displayed at the time of exit. When you re-enter Easy View, you are automatically returned to the same position in the text viewing screen as when you exited. Use this feature and the `[EW]` key to flip rapidly between Program-mode screens and help information about the screens.

Keys Available While Viewing Text	
↑	Scroll up one line
↓	Scroll down one line
PREV PAGE	Scroll up 20 lines
NEXT PAGE	Scroll down 20 lines
HOME	Move to beginning
CTRL-HOME	Move to end
CTRL-PRINT	Print all of the text
SPACE or RETURN	Return to menus
EZ VU	Exit from menu system

Press any key to continue

Figure 4-9 Instructions for viewing text files.

5 Line Setup

Line Setup

MODE: Select Mode:
AUTOMON MONITOR EM DTE EM DCE
BERT DTE BERT DCE

SOURCE: Select Source of Data:
LINE DISK
FLOPPY1 FLOPPY2 HRD DSK
Block No.: _____

CODE: Select Code Set:
EBCDIC ASCII EBCD XS_3 IPARS BAUDOT SELCTRC

BITS: Select Number of Bits Per Character:
8 BITS 7 BITS 6 BITS 5 BITS
Select Parity:
Even Odd Space Mark None

FORMAT:

<p>Select Format:</p> <p style="text-align: center;"><u>SYNC</u></p> <p>Enter Sync Character: <u>S_rS_r</u></p> <p>Select Outsync Condition: <u>ON</u> OFF</p> <p style="border: 1px solid black; padding: 2px;">Enter Outsync Character: <u>F_F</u></p> <p style="border: 1px solid black; padding: 2px;">Enter Number of Chars To Produce Outsync: <u>1</u></p> <p>Display Idle Characters? OFF <u>ON</u></p> <p>Turn On Autosync? OFF <u>ON</u></p> <p>Xmit Idle Character: <u>F_F</u> (emulate only)</p> <p>Select Receive Block Check <u>ON</u> OFF</p>	<p style="text-align: center;"><u>BOP</u></p> <p>Display Abort Symbols OFF <u>ON</u></p> <p>Xmit Idle Character: <u>F_F</u></p>	<p style="text-align: center;"><u>ASYNC</u> <u>ISOC</u></p> <p>Select Number Of Stop Bits: 1 2</p> <p>Select Receive Block Check <u>ON</u> OFF</p>
--	---	--

CLOCK SOURCE:

Select Clock Source: EXTERNAL INTERNAL INTERNAL SPLIT

Enter Internal Speed: 2400

Enter DTE Speed: 9600

Enter DCE Speed: 9600

**BIT ORDER/
POLARITY:**

Select Bit Order (normal or reverse)

Polarity (normal or inverted)

NORMAL REV-NOR NOR-INV REV-INV

NRZI:

NRZI Selected?

NRZI: NO YES

MIL: NO YES

Figure 5-1 Line Setup menu.

5 Line Setup

The Line Setup menu is the configuration menu for line parameters such as data format (synchronous or start-stop), code, clock, bit order, and bit polarity. The data may be received at a modular test interface, generated internally, or played back from disk. Figure 5-1 shows the fields and selections on this menu.

The Line Setup menu is on the left half of the Line Setup screen. Press **PROGRAM**, **F1**, **F1** (or **PROGRAM**, **RETURN**, **RETURN**) to access the first field on this screen.

5.1 Mode

The first field on the Line Setup menu is **Mode**. In this field you select the type of operation you intend to perform with the INTERVIEW.

Available modes are Automonitor, Monitor, Emulate DTE, Emulate DCE, BERT DTE and BERT DCE.

Select **AUTOMONITOR** (the default mode) if you are not certain of the line characteristics. When you press **RUN**, the unit will test samples of line data, autoconfigure, and begin to monitor. Once the unit is configured, change the mode to **MONITOR**. This is to prevent the unit from autoconfiguring every time you go into Run mode.

To use Automonitor, you must also select **Source: LINE**. **Source: DISK** does not provide data samples for the unit to test. In this instance, it cannot autoconfigure.

Select **Mode: MONITOR** if you intend simply to monitor data, and you wish to enter the configuration parameters yourself. The INTERVIEW is a passive monitor (that is, it does not regenerate signals). Once the unit's DTE and DCE connectors are attached to the data line, the unit will not interfere with data transmissions when it is in Automonitor or Monitor mode. Select **Mode: MONITOR** also when you want to play back data from a disk.

NOTE: Before data can be played back or the line monitored, all transmit actions must be cleared from the trigger menus, and all SEND actions and RECEIVE or RCV conditions must be deleted from the Protocol Spreadsheet. These conditions and actions are for emulate mode only.

EMULATE DTE. Make this selection for interactive testing of a modem or testing of a DTE *across* modems. Break the data line from the DTE and connect the modem to the TO DCE interface on the interface module at the rear of the INTERVIEW.

Note on synchronous and BOP operation: The INTERVIEW can transmit using internal clock (SCTE) when it is emulating a DTE; but in order to display its own transmit data as well as receive data, it must be connected to a modem or other DCE device that is providing SCT and SCR clock.

If you are emulating DTE and external clock is not available for synchronous or BOP operation, select **Clock Source:**

INTERNAL and patch SCTE to SCT.

EMULATE DCE. This mode is for direct, local testing of a DTE (such as a terminal, PAD, or front end). Break the data line from the modem and connect the DTE to the TO DTE connector on the interface module at the rear of the unit.

BERT DTE. In this mode you will run the BERT test that is configured on the BERT Setup screen, using the TD lead to transmit and RD to receive and analyze.

BERT DCE. In this mode you will run the BERT test that is configured on the BERT Setup screen (Section 11), using the RD lead to transmit and the TD lead to receive and analyze.

5.2 Source

This selection field determines the source of the data to be monitored or tested.

LINE is the default selection. In Monitor or Automonitor mode when **LINE** is selected, the INTERVIEW will monitor data received at either of the line-interface connectors on the interface module at the rear of the unit.

In Emulate DTE mode when **LINE** is selected, the INTERVIEW will transmit on pin 2 (TD) and expect to receive data on pin 3 (RD). In Emulate DCE mode, the unit will transmit on pin 3 (RD) and monitor pin 2 (TD).

Part of any disk may be set aside for the recording of live data. Line data may be recorded directly to disk, recorded to RAM and then transferred to disk, or captured in the screen buffer (RAM) and transferred to disk. To record to disk or RAM, use the fields of the Record Setup menu on the Line Setup screen (see Section 7, Record Setup). Capture in the screen buffer (character RAM) is discussed in Section 25.9.

For data to be available for playback, it must reside on a disk. Therefore, data stored in bit-image RAM or screen buffer RAM must be transferred to disk using the Data Transfer command. See Section 13.4(C).

On the Line Setup menu, the **Source: DISK** selection allows data that has been recorded to the data-acquisition track to be played back for testing and display. Selecting **DISK** brings up two new fields. Choose from **FDT** (FLOPPY1), **FDT2** (FLOPPY2), and **HRD** (HRD DSK) in the **Disk No.** field.

Enter the starting block number in the **Block No.** field. Valid entries are 0 to 99999. If you do not enter a value, the value will default to zero. Block 0 means that playback will start from the beginning of the data source, regardless of the actual block number. All other entries represent actual block numbers.

NOTE: It is not necessary to enter leading zeroes in this field. For example, you may enter 10 instead of 00010.

When **DISK** is the source selection, a record/playback field (on the top line in the status area) on Run-mode screens will indicate whether playback is in progress or has been suspended. If playback is ongoing, a "P" appears next to the block-number field. If you suspend playback by pressing **PAUSE** or using a program action, "S" will be displayed. The record/playback field will be blank if a disk is not present in the selected drive or when the end of the data-acquisition tracks is reached. This field will also be blank if you enter a starting block number on the Line Setup menu that a) precedes the block number at which data actually begins, or b) exceeds the block number at which data actually ends. Change your entry to zero.

NOTE: An "R" in the record/playback field indicates that line-data recording is in progress. See Section 7.

5.3 Code

The standard **Code** selections are **EBCDIC**, **ASCII**, **EBCD**, **XS.3**, **PARIS**, **BAUDOT**, and **SELECTRIC**. Default is **EBCDIC**.

Appendix D1 gives keyboard-translation tables for all the codes that are standard in the INTERVIEW. These tables indicate the hex byte that is transmitted (or searched for) and the actual character displayed in Run mode as a result of a given keystroke (unshifted, shifted, or control) made while the cursor is in a data-entry field.

Note the difference between Run-mode display and Program-mode display of keyboard input. In Program mode, a particular keystroke (**Ctrl** pressed in conjunction with **Q**, for example) will always produce the same character ("-") in a data-entry field. In Run mode, a particular code-translate chart will be consulted and the character ("-") in our example) may not belong to the code set and therefore may be missing on the chart. Such a character cannot be trapped, transmitted, or displayed in Run mode: it is "untranslatable" (see note, Appendix D1).

Appendix D2 gives an input-to-display translation table for all of the standard codes. Next to each hexadecimal value (input) is the ASCII-keyboard character or control character (display) in each of the various codes. "Input" refers to bytes, both received and transmitted, in hexadecimal notation before they are converted to characters and displayed on the monitor.

5.4 Bits

Identify the number of information bits for the selected code in the **Bits** field. Do not include the parity bit. Options are **8**, **7**, **6**, and **5**.

5.5 Parity

In the **Parity** field select the type of parity used in the system being tested. The choices are **NONE**, **EVEN**, **ODD**, **SPACE**, and **MARK**. The parity bit is additional to the information bits.

A data character received with a parity error will appear on the display with a bar through it.

NOTE: 8-bit odd or 8-bit even parity is a functional choice for **ASYNC** or **ISOC** format. Eight bits plus mark or space parity is not a valid selection for any format.

5.6 Format

The **Format** selection field allows you to program the INTERVIEW correctly for the protocol to be monitored. The selection in the **Format** field determines many of the selection subfields that follow.

(A) Sync Selections

Selecting **BYNC** for **Format** results in the group of subfields shown in Figure 5-2. Choose **BYNC** for Bisync format.

```

** Line Set
LINE SETUP
Mode: EMULATE DTE
Source: LINE
Code: EBCDIC
Bits: 8 Parity: NONE
Format: SYNC Sync Char: 55
Outsync: ON Char: r #: 1
Display Idle: OFF Autosync: OFF
Xmit Idle Char: r Rcv Bk Chk: ON
```

Figure 5-2 There are eight subfields under **Format: SYNC**.

1. *Sync characters.* Sync Char is a data-entry field that determines the synchronization pattern for synchronous data protocols. When the receivers are looking for synchronization, every occurrence of the sync pattern results in a \square (sync) symbol on the data display. Refer to *Outsync* and *Autosync*, below, for the conditions under which the receivers *look for sync*.

The synchronization characters default to $\text{^}\text{^}$. Adjustments for your parity selection are automatic. For example, ^ in odd-parity ASCII is ^ but in even-parity ASCII the INTERVIEW converts ^ to ^ . For most cases, therefore, you will not have to make any entry in the Sync Char field.

IPARS and **X6.3** are exceptions in that the control character ^ does not occur on their translation tables. If ^ is entered as a sync character for these two codes, it is treated like any other untranslatable character and converted to SPACE or NULL, inappropriate for synching.

For **IPARS**, the hexadecimal value $\text{^}\text{^}$ should be entered manually in the Sync Char field (see Figure 5-3). In the case of **X6.3**, the correct sync pattern is $\text{^}\text{^}$.

```
Code: IPARS
Bits: 6 Parity: NONE
Format: SYNC Sync Char: ^
Outsync: ON Char: % #: 1
Display Idle: OFF Autosync: OFF
Xmit Idle Char: % Rcv Blk Chk: ON
```

Figure 5-3 Different codes have different sync parameters.

The correct synchronization patterns for the various standard codes in the INTERVIEW are listed in Table 5-1. Any other one- or two-character sequence may be entered, using alphanumeric keys, control characters, or hexadecimals.

The character entered will be adjusted for parity unless Parity: **NONE** has been selected or unless the entry has been made in hexadecimal. *For hexadecimal entries no parity adjustment is made. You must adjust hexadecimal entries yourself to take parity into account.* (Do not adjust parity for the default hexadecimal sync characters in IPARS or XS-3).

To enter a one-character synchronization pattern, position the cursor in the Sync Char field and depress **CLR**. This will clear the field. Enter the desired character.

Table 5-1
Synchronization Parameters for Standard Codes

Code	Info Bits	Parity	SY1 SY2
EBCDIC	8	None	$^3_2^3_2$
ASCII	7	Odd (Space (Even or Mark	$^1_6^1_6$ $^1_6^1_6$ $^9_6^9_6$)
EBCD	6	Odd (Space (Even or Mark	$^3_0^3_0$ $^3_0^3_0$ $^7_0^7_0$)
XS-3	6	Odd	$^3_5^3_5$
IPARS	6	None	$^3_F^3_E$
SELECTRIC	6	Odd	--

2. *Outsync.* When the unit enters Run mode in synchronous format, the receivers are always *out of sync, looking for sync*. After initial synchronization, the receivers stop looking for sync. **Outsync: ON** means that the receivers can *return* to the original outsync, looking-for-sync condition as soon as a particular outsync pattern is encountered. Unless this pattern is encountered (or unless **Autosync: ON** is selected), synchronization can occur only once during Run mode.

The default **Outsync** sequence is one $\#$ (pad) or hex F_F character. Any character may be entered in the **Char** field. The **#** field is a decimal field. It allows you to specify how many times the character must occur consecutively (from one to 255 times) before outsync will take effect. In transparent text, there is a possibility that legitimate data F_F will occur. Also, the block-check character may occasionally mimic the outsync character. Normally these problems are solved by turning outsync off (and autosync on) or by increasing the number of outsync characters to 2.

3. *Display idle.* **Display Idle: OFF** prevents display and buffer-storage of idle characters from the time the receivers go out of synchronization until they see the synchronization pattern again. If you select **ON**, the idle characters will be displayed on the monitor and also saved in the data buffer.
4. *Autosync.* When **Autosync** is **ON**, the receivers will resynchronize every time they see the selected synchronization pattern, *even if they are in sync already*. When autosync is enabled, the logic constantly tests for the one- or two-character pattern on a bit-by-bit basis. When a match is found, it becomes the new reference point for character framing.

This is a useful selection when data does not have a unique outsync character (as when a transmitter idles the sync character, for example). Autosync is also useful where one block of data follows another by less than a full character interval. Autosync will detect the synchronization pattern and adjust to it even though it is skewed in relation to the previous sync.

As long as autosync is off, there is no danger of accidental syncing in the middle of a block of data, since receivers that are already in sync do not look for sync. While autosync is on, accidental syncing may happen when a sequence of bits in the data mimics the sync pattern. You may reduce the chance of random syncing in the middle of a block of data by always using a two-character synchronization pattern whenever autosync is turned on.

In normal synchronous operation, outsync is on and autosync is off. Once the receivers go out of sync, the receiver logic tests for the one- or two-character sync pattern one bit at a time, just as when autosync is on. Enabling autosync means that the bit-by-bit search is conducted all the time, even when the receivers are already in sync.

5. *Block-check overlays.* Rev Blk Chk is a subfield of Format: `SYNC`, `ASync`, and `ISOC`. This field is discussed in Section 10, Block Checking.
6. *Transmit idle character.* The Xmit Idle Char field is valid for both `SYNC` and `BOP` formats. It allows you to specify what idle-line condition will be applied by the INTERVIEW in Emulate modes. Alphanumeric, control, or hexadecimal characters may be entered in this field. The default idle-line condition for `SYNC` format is steady mark (hex `FF`).

(B) Bit-Oriented Protocols

Format: `BOP` selects bit-oriented protocols that use `7E` framing and zero-insertion. Examples are X.25, X.75, and SDLC.

In BOP protocols, the synchronization flag pattern, conditions for outsync, and block-check calculation are always defined. Any fields on the Line Setup menu that pertain to synchronization and block-checking disappear when `BOP` is the Format selection. The subfields under Format: `BOP` are Display Abort and Xmit Idle Char. See Figure 5-4.

```
Code: ASCII
Bits: 8 Parity: NONE
Format: BOP
Display Abort: OFF
Xmit Idle Char: 7E
```

Figure 5-4 Synchronization and frame-check parameters are automatic (and therefore not selectable) under Format: `BOP`.

1. *Display abort.* The seven 1-bits in a row that signal an "Abort" to BOP receivers can occur during τ_e idle as well as in the middle of a frame. Since these idle aborts are not aborted frames but merely indicate missing zeroes in the τ_e -idle bitstream, you may want to suppress the display of these "glitches" by selecting **Display Abort: OFF**. This is the default selection. **Display Abort: OFF** does not pertain to aborted frames, which will be displayed in any case.
2. *Transmit idle character.* This field is valid for both **SYNC** and **BOP** formats. See under **SYNC**, above. The default idle character for **BOP** format is the τ_e flag. Press **[DEL]**, **[7]**, **[E]**, (not **[FAD]**) to enter this idle character. Only τ_e or τ_f idle is valid for BOP.

(C) Start-Stop Format

For start-stop data, choose **Format: ASYNC** or **ISOC**. Then you may choose either 1 or 2 **Stop Bits**, as shown in Figure 5-5. **ASYNC** is the correct **Format** selection for data that has start/stop-bit framing if both digital devices rely on internal clock. If clock is provided on the interface for one of the devices (isochronous operation), select **Format: ISOC**.

```
Code: ASCII
Bits: 8 Parity: NONE
Format: ASYNC
Stop Bits: 1
Rcv Blk Chk: ON
```

Figure 5-5 Async receivers go out of sync when a selectable number of stop bits are received.

5.7 Clock Source

Clock Source and **Speed** apply to data in any format. Selections for **Clock Source** are **EXTERNAL**, **INTERNAL**, and **INTERNAL SPLIT**. If **Format: ASYNC** has been selected, the clock source *must be internal* (or internal-split). Async means that there is no clock on the interface leads, and the INTERVIEW will not look for external clock nor recognize the clock signals if they are there.

Note on synchronous and BOP operation: The INTERVIEW can transmit using internal clock (SCTE) when it is emulating a DTE; but in order to display its own transmit data as well as receive data, it must be connected to a modem or other DCE device that is providing SCT and SCR clock.

If you are emulating DTE and external clock is not available for synchronous or BOP operation, select **Clock Source:** `INTERNAL` and patch SCTE to SCT.

`INTERNAL SPLIT` allows you to monitor or emulate in *asynchronous* systems that have different baud rates for Receive Data and Transmit Data, and to emulate a modem on dual-speed, *synchronous* lines. When `INTERNAL SPLIT` rotates into the selection field, speed settings for both DTE and DCE appear below it. See Figure 5-6.

```

Clock Source: INTERNAL SPLIT
Speed: DTE:2400 DCE:1200
Bit Order/Polarity: NORMAL
NRZI: NO MIL: NO
-----
Select Clock Source
F 1 F 2 F 3 F 4
EXTRN INTRN SPLIT

```

Figure 5-6 Internal clock may be split into DTE and DCE speed settings.

If you are monitoring or emulating a DTE on a dual-speed, synchronous line, the proper clock-source selection is `EXTERNAL`, since the modem is already supplying both clocks.

5.8 Bit-Order/Polarity

Bit Order/Polarity: `NORMAL` means that both the bit order and the bit polarity are "normal." `REVERSE-NORM` means that the bit order is reversed while the polarity is normal. Other selections are `NORM-INVERT` and `REV-INVERT`.

Normal bit order means that when a character is encoded into binary for transmission (or decoded from binary for display), the first bit transmitted (or received) will correspond to the rightmost bit in the INTERVIEW's hexadecimal value for that character and code. The code-conversion for every hexadecimal value is given in Appendix D2, Hex-to-Display Translation Tables.

When reverse bit order is selected, the hexadecimal display for each byte does not change; but now the first bit to be transmitted and received will be the leftmost bit in the binary version of the hexadecimal. (Leftmost, that is, except for the parity bit. For obvious reasons, the parity bit always is the last bit transmitted.) Reverse bit order is appropriate for certain standard codes such as IPARS and EBCD (which then becomes REV EBCD).

Usually the rightmost bit for the hex bytes on a translation table is the least-significant bit, but not always: the right-hand bit is the most-significant bit in two older IBM code sets, EBCD and SELECTRIC. But whatever the code set, normal bit order establishes a correspondence between the rightmost bit on the hexadecimal table and the first bit transmitted or received.

For normal bit polarity, the INTERVIEW's RS-232/V.24 transmitters define logic 1 as more negative than -3 V and logic 0 as more positive than +3 V. When you invert the bit polarity by selecting Bit Order/Polarity: NORM-INVERT or REV-INVERT, logic 1 becomes +3 V and logic 0 switches to -3 V. Logical inversion changes the voltages for bits in data characters (i.e., the ASCII sync character, becomes ----+--- instead of +++-+---) but the inversion does not affect voltages for start/stop-bit framing and mark idle. The start bit still signals the transition from negative to positive voltage. Stop bit and idle are still negative voltages, but now they are read as logic 0 instead of logic 1.

Note that the display LEDs above the INTERVIEW monitor always shine red when the voltage level is +3 V or greater. This is true for data leads as well as control leads, regardless of the data logic (polarity).

5.9 NRZI

When NRZI: YES is selected, INTERVIEW transmitters and receivers use the Non Return to Zero (Inverted) mode of signal sense. In this mode, logic 0 is defined not as a plus-voltage threshold, but rather as any transition from plus to minus or from minus to plus. Logic 1 is defined as an absence of transition.

NOTE: Since the hardware that accomplishes NRZI formatting is not on the playback path for disk data, NRZI: YES must be selected when the original line data enters the FEB. The NRZI selection will have no effect during playback, whether the data was recorded in character or bit-image format.

5.10 MIL

MIL: YES designates MIL-188 operation, which inverts all signals on the data leads (including idle). In MIL operation there is no need to invert bit polarity. Note that MIL operation does not convert the voltage levels to MIL-188 specifications.

5.11 Sample Line Setups

Figure 5-12 shows typical Line Setup configurations for various protocols.

```
Code: ASCII
Bits: 8 Parity: NONE
Format: ASYNC
Stop Bits: 1
Rcv Blk Chk: ON

Clock Source: INTERNAL
Speed: 9600
Bit Order/Polarity: NORMAL
NRZI: NO MIL: NO
```

ASYNC

```
Code: EBCDIC
Bits: 8 Parity: NONE
Format: SYNC Sync Char: yy
Outsync: ON Char: F #: 1
Display Idle: OFF Autosync: OFF
Rcv Blk Chk: ON

Clock Source: EXTERNAL
Bit Order/Polarity: NORMAL
NRZI: NO MIL: NO
```

BISYNC

```
Code: ASCII
Bits: 8 Parity: NONE
Format: BOP
Display Abort: ON
Xmit Idle Char: F

Clock Source: EXTERNAL
Bit Order/Polarity: NORMAL
NRZI: NO MIL: NO
```

X.25

```
Code: EBCDIC
Bits: 8 Parity: NONE
Format: BOP
Display Abort: OFF
Xmit Idle Char: F

Clock Source: EXTERNAL
Bit Order/Polarity: NORMAL
NRZI: NO MIL: NO
```

SNA

```
Code: ASCII
Bits: 8 Parity: NONE
Format: BOP
Display Abort: OFF
Xmit Idle Char: F

Clock Source: EXTERNAL
Bit Order/Polarity: NORMAL
NRZI: NO MIL: NO
```

ISDN

```
Code: ASCII
Bits: 8 Parity: NONE
Format: BOP
Display Abort: ON
Xmit Idle Char: F

Clock Source: EXTERNAL
Bit Order/Polarity: NORMAL
NRZI: NO MIL: NO
```

SS#7

Figure 5-7 Sample Line Setup configurations for the following protocols: X.25, SNA, ASYNC, BISYNC, ISDN, and SS#7.

6 Run-Mode Display

Display Setup

DISPLAY
MODE:

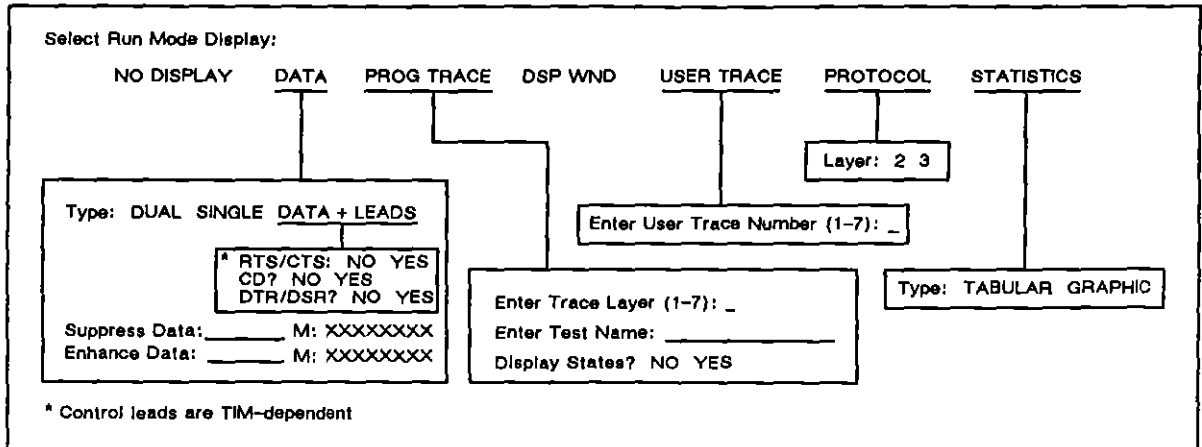

Figure 6-1 The Display Setup menu.

6 Run-Mode Display

Press **RUN** to compile and execute a test program. The compilation phases are discussed in Section 2.6.

If **AUTOMON** is the Mode selected on the Line Setup menu, the compilation will be delayed until the unit has configured its line setup parameters automatically.

6.1 Auto Configure

When the operator presses **RUN** with Mode: **AUTOMON** (the default mode) selected on the Line Setup menu, an Auto Configure program is loaded in that displays the screen in Figure 6-2. A Status field appears at the bottom of the screen, identifying the stage in the auto-configure procedure. The first stage is a clock-sampling phase that is reflected in the Status field as Capturing Sample #1. Once clock source and clock speed have been determined, these parameters are posted to the screen (see Figure 6-2) and the autolearn process moves to its second phase, Capturing Sample #2.

** Auto Configure **							
Code: ██████████	Bits: █						
Format: ██████	Parity: ██████						
Sync Chars: █	BCC: ██████						
Clock: EXT	Speed: 4800						
Status: Capturing Sample #2							
F1	F2	F3	F4	F5	F6	F7	F8

Figure 6-2 Clock and Speed are analyzed during the capture phase.

The unit remains in this stage from 1 to 6 seconds, depending on the data speed—one second for data captured at 19.2 Kbits per second or higher, a longer duration for captures at lower speeds. When the sample period ends, the sample is evaluated for its suitability as the basis for a new configuration.

If the sample is adequate—if it contains a high enough number of “meaningful transitions” and meets other similar criteria—the unit enters its configuring phase and arrives quickly at an estimate of all the line-setup parameters.

The unit does not try to configure itself if the first sample does not meet the criteria for adequacy. Rather it returns to sampling data, this time Capturing Sample #3; and so on until a good data sample is found.

NOTE: If an autoconfiguration is attempted on a line with no data or clock, the data-sampling will go on indefinitely. If the operator presses **PROGRAM** and checks the Line Setup menu, he will find the **Clock Source** field set at **INTERNAL** and the **Speed** at 168000 bits per second. This is the first (highest) internal clock speed that is tested. Without data, the software will have had no reason to reject this speed and try the next lower one.

The initial data sample is very important. If at any time you wish to restart the autolearn process and try for a “better” initial data sample, press **PROGRAM** to terminate Automonitor and press **RUN** to begin again.

Clock and **Speed** (see Figure 6-2) are analyzed during the capture phase. Other parameters are analyzed during the configuring or “learning” phase. When the unit has arrived at an estimate of all the parameters, the Status changes to Unit Configured. The complete set of parameters is displayed for one second (see Figure 6-3), and the selections on the Line Setup menu screen are updated. After one second, the unit shifts to Run mode, compiles the program that is entered on the setup screens (including the new Line Setup), the Trigger Menu, and the Protocol Spreadsheet, and begins monitoring with its new configuration.

If the operator presses **PROGRAM** while the unit is in the learning phase, the Line Setup fields will be updated to include any parameters already registered on the Auto Configure screen. Pressing **RUN**, however, will always initialize the autolearn process.

NOTE: In order for the unit to configure itself successfully to monitor synchronous data, the sync characters should be preceded by two or more idle-time characters.

```

** Auto Configure **

Code: ASCII      Bits: 8
Format: BOP      Parity: NONE
Sync Chars:      BCC: CCITT
Clock: EXT       Speed: 4800

Status: Unit Configured

F1 F2 F3 F4 F5 F6 F7 F8

```

Figure 6-3 The entire set of parameters is displayed when autoconfiguration is completed.

The INTERVIEW's Automonitor mode has been designed to be (1) fast, and (2) 90% accurate. To satisfy the first criterion, the software acts on two assumptions: first, that the protocol is a fairly typical one; and also that the data sample is typical. (For example, an X.25 line without traffic cannot be distinguished from an SDLC line that also merely is idling 7E flags. In the absence of valid data, the Automonitor logic will not configure the unit.) Automonitor is designed as a tool for setting up a piece of test equipment properly, to be used with other tools. These tools include the Line Setup menu and the operator's own knowledge and experience.

6.2 Entering Run Mode

Figure 6-4 shows the screen of the INTERVIEW after Run mode has been entered. In any display mode, the *data* screen has three basic divisions.

The top two lines of the screen are status lines that provide setup information including test mode (monitor, emulate, or BERT), data source (line or disk), disk drive (hard, floppy 1, floppy 2—when source is disk), block number (for data recording or playback), record/playback status ("R"ecording line data, "P"laying back disk data, or "S"uspended record/playback), date and time, code, number of data bits, parity, synchronization format (synchronous, BOP, or async/isoc), and sync pattern if the format is synchronous. (The second line of the status area is also the prompt line.)

The bottom three lines of the screen are given to softkey prompts and a group of softkey functions that control the actual mode of display as long as the unit is in real-time or frozen Run mode. The remaining sixteen lines display test data or user-generated messages in a mode selected by the user.

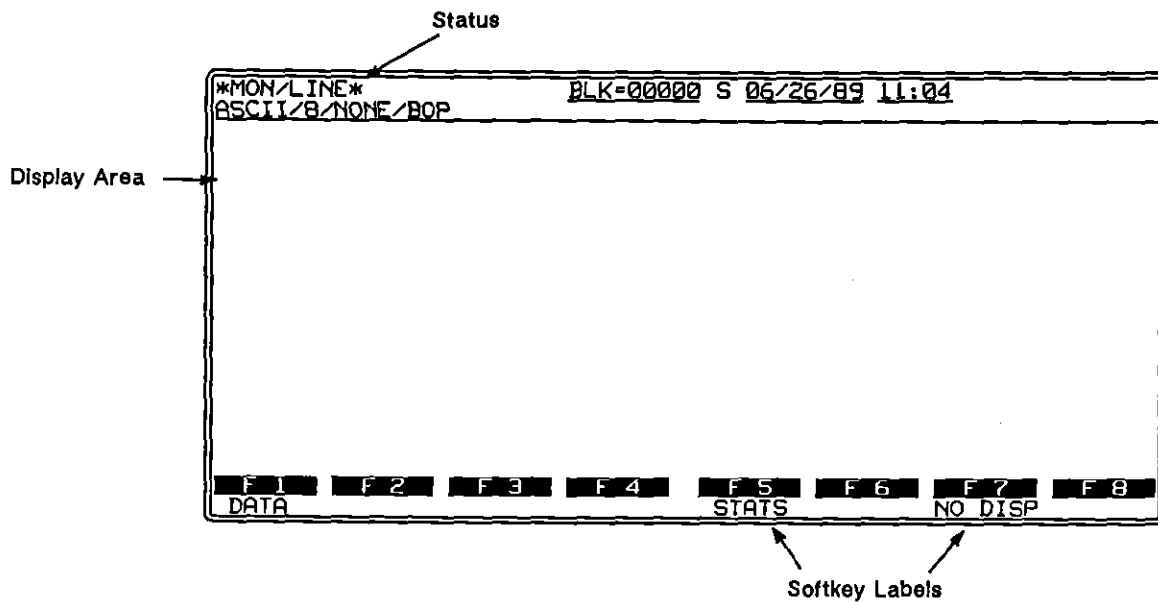

Figure 6-4 The three divisions of the data screen.

During programming, the user selects the display mode on the Display Setup menu (Figure 6-1), the top right sector of the Line Setup screen. In Run mode, the softkeys will change the display selection. Selectable display modes include character data, character data plus control-lead timing, protocol trace, program trace of state-to-state movement and of user-entered messages called "traces," and statistical tabulation or graphic display of counters and timers.

All data and statistics displays are available at *all* times during Run mode. Other special displays, Program Trace for example, are conditionally present. Figure 6-5 shows the two consecutive racks of softkeys that make the various data displays accessible to the user. To return to the first softkey rack, press **Done**.

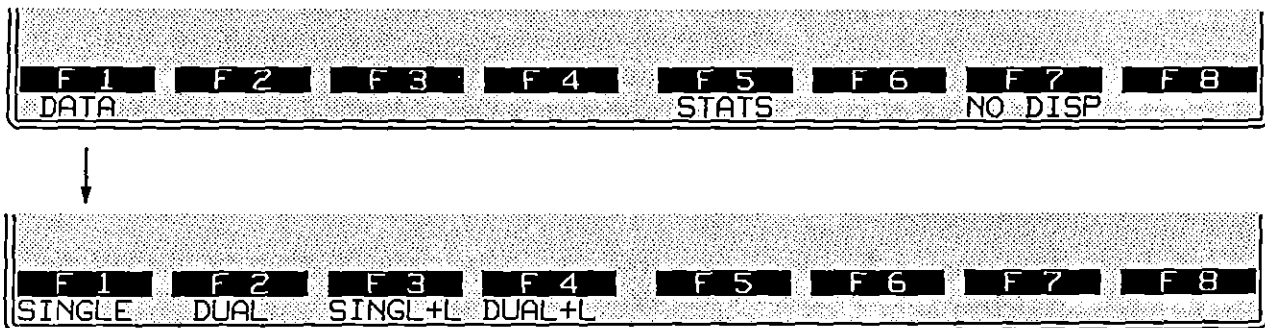

Figure 6-5 Two banks of softkeys give access to data display modes during a run.

There is also a Display Mode selection called **NO DISPLAY**. This suppresses the writing of data to the screen (though not to the screen buffer). See Section 6.11 for an explanation of this display mode.

The final Display Mode selection on the Display setup menu will be the first display mode presented to the screen in Run mode. All other available display modes can then be accessed in real time via Run-mode softkey.

Certain Display Setup menu selections cannot be changed in real time via softkey. Under Display Mode: **DATA**, regardless of the Type field selection, the **Suppress** and **Enhance** entries remain in effect during Run mode. When you choose Type: **DATALEADS** as the display mode, control-lead subfields appear. Only the control leads you select with a **YES** will be displayed during Run mode. Under Display Mode: **PRGG TRACE**, you will see the subfield **Display States**. You may not change your selection for this field during Run mode.

6.3 Selecting Character-Data Display

Character data may be displayed in single or dual lines, with or without control-lead transitions. All four combinations of data leads and control leads are selectable on the lower rack of softkeys in Run mode. See Figure 6-5.

The Type of data display is also a selection field on the Display Setup menu. See Figure 6-6. The **DATA** softkey (Figure 6-5, top) enables the last Type option selected, even if that selection was dormant—not visible—on the Display Setup menu when the user pressed **AWK**. Other Type options can be accessed from the secondary rack of softkeys (Figure 6-5).

Fields on the Display Setup menu also accommodate lists of characters to be suppressed or enhanced.

```

tup **
-----
DISPLAY SETUP
Display Mode: DATA
Type: DUAL
Suppress: _____
Enhance:  _____

```

Figure 6-6 Type is a subfield under Display Mode: DATA.

In both single and dual display, fresh data is written to the screen beginning at the top left and moving to the right before retracing horizontally, and down to the bottom of the screen before retracing vertically. At a given moment during real-time display, there are always two blank lines on the screen. These two lines move just ahead of the freshest data and continuously overwrite the oldest data.

```

ntained in three compact listings
The complete package costs $1
  
```

Figure 6-9 Avoid single-line display for full duplex data.

(B) Data Plus Leads

By pushing the softkey labeled SINGL+L or DUAL+L (Figure 6-5), the user can monitor not only two data leads, but also a timing pattern for up to five control leads. A display of single-line data plus all five leads is illustrated in Figure 6-10. The two states of the timing pattern can be defined in visual terms as low/high, in "handshake" terms as off/on, and in electrical terms as minus/plus voltage.

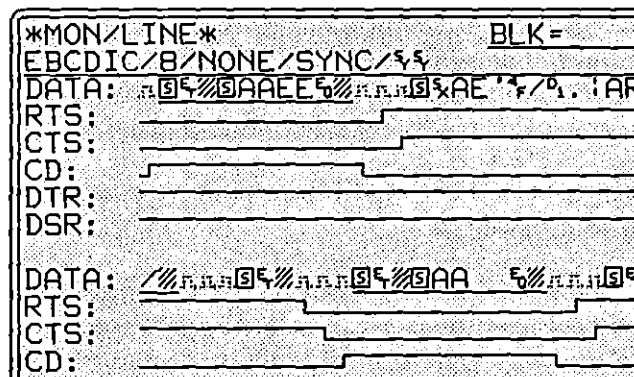

Figure 6-10 Control-lead transitions are displayable.

Control leads are selected for display on the Display Setup menu. EIA leads available for screen monitoring are RTS-CTS (selectable as a pair), DTR-DSR (also selectable only as a pair), and CD (carrier detect). See Figure 6-11 for the selection subfields under Type: **DATA+LEADS**.

If control leads are not set to be buffered on the Front-End Buffer Setup screen, control-lead status will not be available for data-plus-leads display and triggering. See Section 9.1(B) on buffering control leads.

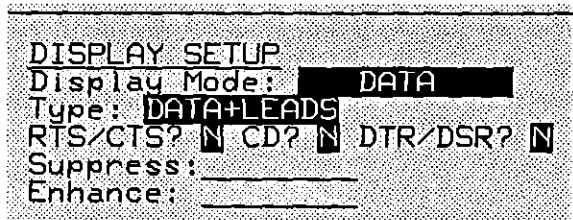

Figure 6-11 Five control leads are selectable under *Type: DATA+LEADS*.

A full set of leads is written to the bottom of the sixteen-line display area only if it fits completely. A full set is one or two lines of TD/RD data (with RD underlined) and a state-and-timing line for each of the control leads specified previously on the Display Setup menu. If a set is six lines and only four display lines remain on the screen, the entire set is displayed at the top of the next screen.

If the set is comprised of six lines (one data line and one line each for five control leads), two full sets of lines will be written to each successive screen. If a full set equals three lines, five sets will be written per screen.

The purpose of the data-plus-leads display is to show the *sequence* of events. Two data bytes (or a data byte and a control-lead transition) are never displayed in the same vertical column. Otherwise, the order of their occurrence would be lost to the display. Even if the events were detected a millisecond or a microsecond apart, they are displayed in sequence.

Turn **Display Idle**: if you wish to preserve a visual record of time intervals between lead transitions.

Precise timing intervals, to a resolution of ten microseconds, between lead and data and between two leads can be attained both for live and recorded data with a simple trigger program that uses timers or via cursor timing on the data-plus-leads display. See Section 6.4(E). Timer increments are discussed in Section 9, FEB Setup, and Section 20, Tabular Statistics.

(C) Suppress

A data-entry field labeled **Suppress** appears on the Display Setup menu along with **Display Mode**: DATA. For single- or dual-line display mode, you may choose up to eight characters to be suppressed from the screen display. The suppressed characters will not appear on the screen or be available in the character buffer for playback. They will, however, be considered by the triggers, included in counting and timing where applicable, and recorded if bit image data is being recorded.

The characters to be suppressed are entered directly from the keyboard and may include:

- Upper- and lower-case alpha characters and numerals;
- Control characters;
- Hexadecimal entries;
- Flag bytes (BOP format only);
- One bit mask;
- All characters not equal to a given character or bit mask.

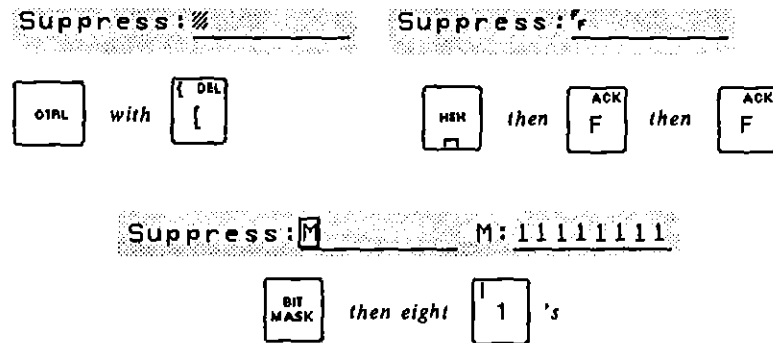

Figure 6-12 FF idle can be suppressed as a character, a hexadecimal, or a bit mask.

Figure 6-12 shows three different ways to suppress idle F_F on the data display. The idle character may be entered as an ASCII character, a hexadecimal, or a bit mask. Use `HEX` to turn on the hexadecimal function for all hex entries. Press `CTRL` to bring up a string of X's that you may overwrite with ones or zeroes.

Figure 6-13 shows the **Suppress** field when T_E flags are suppressed. Note that the `FLAN` key must be used for this entry. If literal T_E is entered with hex turned on, the logic will not read this as a flag, but instead as data (zero-stuffed) T_E .

You can use the `CTRL` key-function in the **Suppress** field to *display only* a specific character (or set of characters represented by a bit mask). Press `CTRL` followed by one ASCII character, hex character, or bit mask. The suppressed character will appear in the **Suppress** list with a horizontal bar through it to indicate "not equal."



Figure 6-13 The *flag* key must be used to suppress 7E flags.

Figure 6-14 gives two examples of the Suppress Not Equal ("display only") function. The top entry is used to display only the X-OFF (DC3) character. The Not Equal Bit Mask on the bottom will display four possible bytes only: 1 , or 1 (DC1 in ASCII code) and 1 or 1 (DC3).

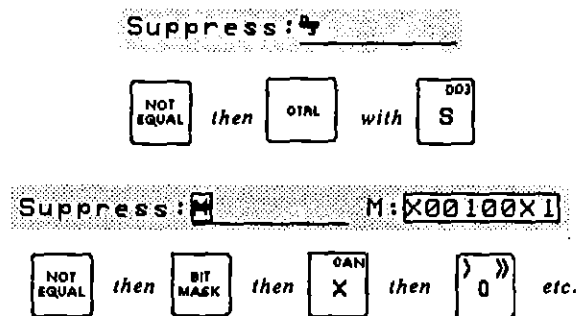

Figure 6-14 Display *only* X-OFF (top); display *only* X-ON/X-OFF (bottom).

When two or more Not Equal entries are combined in the **Suppress** field, only the listed not-equal characters are displayed. Refer to Section 24.3(I).

(D) Enhance

A data-entry field labeled **Enhance** appears on the Display Setup menu when the Display Mode is **DATA**. The enhancement that results on the data display is blinking reverse video, dark lettering inside a light rectangle. Up to eight characters may be enhanced, including ASCII-keyboard characters, control characters, hexadecimals, and one bit mask.

Figure 6-15 shows a bit mask that enhances control characters in EBCDIC code. (Control characters are the only EBCDIC characters with zero-zero as the two high-order bits.) Beneath the bit mask is a data sample in which screen-formatting orders (always control characters) within the 3270-data stream have been enhanced.

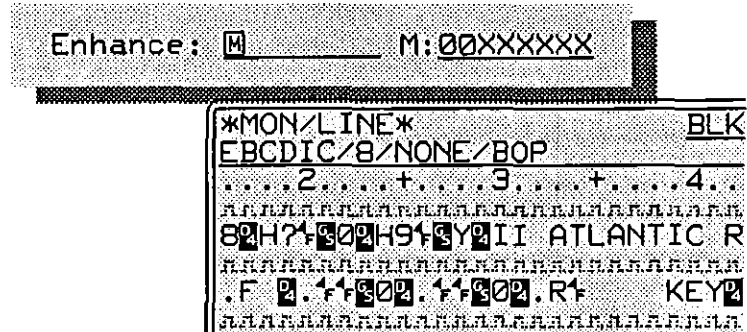

Figure 6-15 This bit mask enhances EBCDIC control characters only.

6.4 Special Features of Data Display







When character data is displayed on the INTERVIEW monitor, the bit stream is first divided into bytes according to the format (synchronous, bit-oriented, or start-stop) that the operator has selected on the Line Setup menu. Then the bytes are converted to displayable characters according to the code selected on the same setup menu. See Appendix D2 for the various byte-to-character translations. When a byte does not occur on the particular code-translation table and therefore cannot be decoded as a character, it is presented to the screen as a hexadecimal. All bytes are displayable, in hexadecimal at least.

In synchronous formats, display is suppressed automatically *before* synchronization and *after* outsync. Idle is usually suppressed, as a result of the receivers going out of sync; but idle display can be enabled on the Line Setup menu. In BOP (bit-oriented) formats, mark idle is suppressed automatically and cannot be displayed. τ_e flags are not normally suppressed but they may be designated for suppression in the **Suppress** field on the Display Setup menu.



(A) Special Characters



Table 6-1 shows the special non-ASCII, non-hex characters that appear on the data display. \square and \square are overlays that cover the last-received byte in the block-check (or frame-check) calculation. \square is an overlay that *covers* the last full character received before a BOP abort, defined as seven consecutive one-bits anywhere inside a frame. The \square symbol represents a τ_e flag, the literal (nonzero-stuffed) sequence 01111110 anywhere in the BOP bitstream. \square stands for "sync." It indicates that the receivers have identified the sync pattern in the synchronous bitstream and locked on it as a new reference for character framing.

**Table 6-1
Special Display Symbols**

Screen Symbol	Printed Symbol	Meaning
	[S]	synchronization
	[F]	BOP flag
	[G]	good BCC or FCS
	[B]	bad BCC or FCS
	[A]	BOP abort
	...	fill

(B) Hexadecimal Translation

In real-time or frozen Run mode, press  to display every data character on the screen as a hexadecimal. The hex translation is applied to the entire character buffer and not merely to characters written to the screen subsequent to the depression of the  key.

The hex display is an on/off function: press  again to restore normal decoding to the data. The LED on the cap of the  key lights up for hexadecimal data-entry, not display.

Hexadecimal notation divides each byte into two quartets or "nibbles."

Figure 6-16 indicates the order in which the nibbles are transmitted/received when normal bit order is indicated on the Line Setup menu.

Note that the actual order of transmission of nibbles is not the order that we see when we read hexadecimal data casually from left to right: 2, 1, 4, 3, 6, 5, etc. Many protocol fields are designed around the *apparent* order of the nibbles rather than the actual order. The twelve-bit logical channel number, for example, in an X.25 packet-header is composed of twelve bits that are not contiguous in the bitstream but appear to form contiguous nibbles in hexadecimal display.

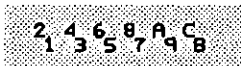

Figure 6-16 Hexadecimal series with digits indicating normal order of "nibble" transmission.

(C) Trigger Hex

Hexadecimal translation can be turned on and off by a trigger action on a Trigger Menu or on the Protocol Spreadsheet. Trigger hex is useful when you want to display some data in hex and some in translated characters.

In X.25, for example, frame and packet headers are bit-oriented and are more meaningful when they are displayed in hexadecimal. Once you are past the packet header in a normal (not "qualified") data packet, the data is character-oriented and the hexadecimal enhancement should be turned off. Figure 6-17 shows a display in which trigger hex has been used selectively on BOP data to convert protocol characters to hexadecimal. See Section 36.8 for the short trigger program that is controlling the display in Figure 6-17.

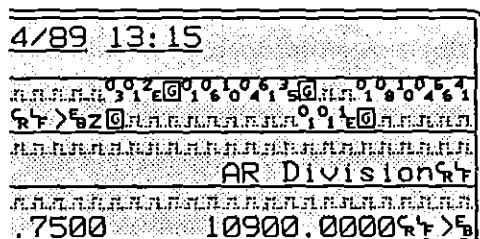

Figure 6-17 A set of four triggers is turning hex translation *on* for protocol characters and *off* for user data.

(D) Binary Expansion

By pressing **PRESET** with character data on the screen, the operator freezes the display and activates the automatic character expander. Now the cursor appears on the monitor, under the control of the cursor-arrow keys. In the middle of the second line on the screen, the character at the cursor position is expanded in binary, with the DTE expansion on the left and the DCE expansion on the right. Figure 6-18 shows a simultaneous DTE and DCE expansion.

The rightmost bit in the binary expansion is the first bit received or transmitted when normal bit order has been selected on the Line Setup menu. The four right-hand bits compose the right-hand (lower) nibble in the hex byte that is expanded.

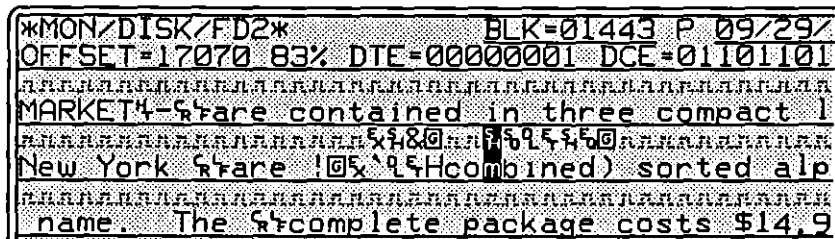

Figure 6-18 In Freeze mode, cursor characters are expanded in binary at the top of the screen.

(E) Cursor Timing

Cursor timing is another Freeze-mode display feature. It allows the operator to view the elapsed time between two events in the two data-plus-leads buffers and the single-line data display. It is not available in the dual-line data display. To use cursor timing, first enable time ticks on the Front End Buffer Setup screen. Refer to Section 9.

The cursor-timing display is enabled/disabled via the **MARK** key. When you first enter Freeze mode, cursor timing is disabled. To set the location of the first event, press **MARK**. The character in the marked position is replaced by the **M** symbol. (In the data-plus-leads displays, **M** appears in all rows of the display.) Now use the cursor keys again to move the cursor to the next event. The elapsed time between the marked event and the cursor event is shown in the upper right-hand corner of the display screen. See Figure 6-19. The unit of time used in the cursor-timing display is the same as the one you selected when you enabled time ticks on the FEB Setup screen.

NOTE: The sign the time value takes depends on which direction the cursor moves from the marked event. If the cursor moves forward from the marked event, the elapsed time is displayed as a positive value. If the cursor moves backward from the marked event, the time value is negative.

Each time you press **MARK**, you move the marked position—i.e., you redefine the first event. The previous **M** symbols are removed from the display and new ones appear at the cursor location. To disable the cursor timing display, return the cursor to the marked character and press **MARK**.

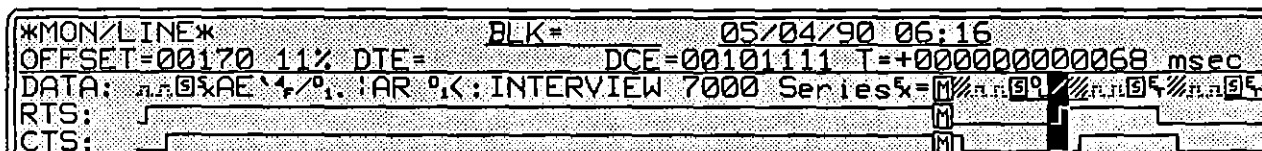

Figure 6-19 In this single-line, data-plus-leads display, cursor timing is used to display the elapsed time between state changes in the RTS lead.

6.5 Protocol Trace

The Display Setup menu and the softkeys associated with Run mode can present data to the user in forms other than raw character form. One of these alternate displays is a protocol trace. A protocol trace is enabled when a protocol "personality package" is loaded into the system from a disk via the Layer Setup screen. See Section 8.1, Personality Packages. Figure 6-20 shows sample data from a protocol analysis for X.25 Layer 3.

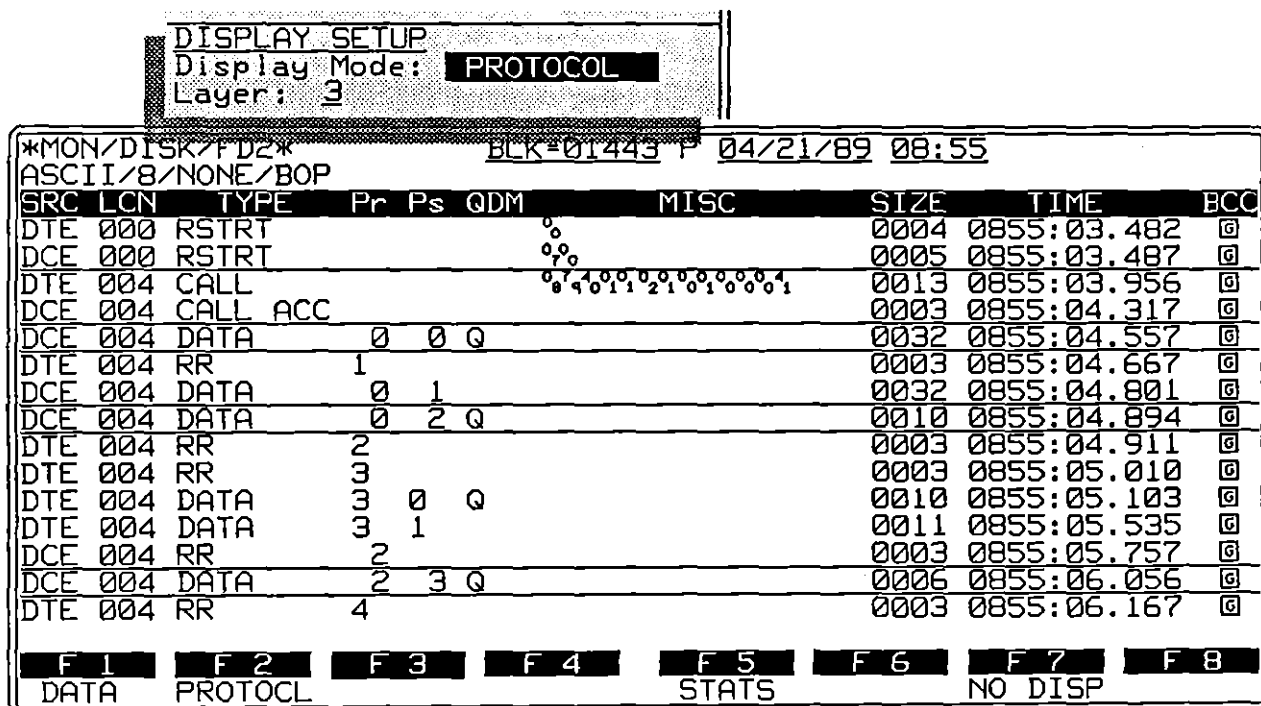

Figure 6-20 Protocol analysis for X.25 Layer 3.

To display the data in Figure 6-20, the operator first loaded in the X.25 Layer 3 package on the Layer Setup screen. Then he selected Display Mode: **PROTOCOL** and Layer: **3** on the Display Setup menu. When the INTERVIEW entered Run mode, the Layer 3 analysis was the active display mode.

If another display mode had been selected on the Display Setup menu, the Layer 3 analysis still would have been accessible after **END** was pressed. The **PROTOCOL** and Layer selections merely designate the display mode entering a run. They do not limit the display options during the run.

To access the Layer 3 protocol trace during Run mode, press **PROTOCOL** on the first rack of softkeys. See Figure 6-21.

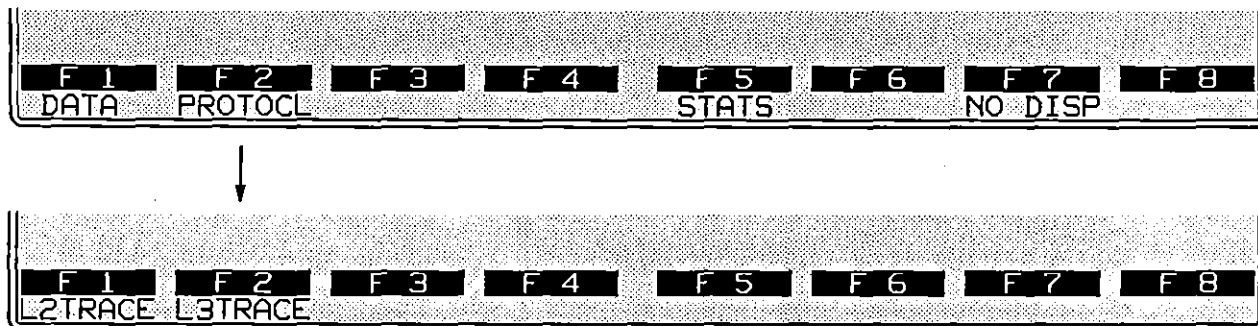

Figure 6-21 To access Layer 2 and Layer 3 protocol traces, press **PROTOCL**.

The location of the L2TRACE softkey depends on the layer packages loaded. When a Layer 2 package is loaded without a Layer 3 package, L2TRACE will appear on the first rack of softkeys. See Figure 6-22.

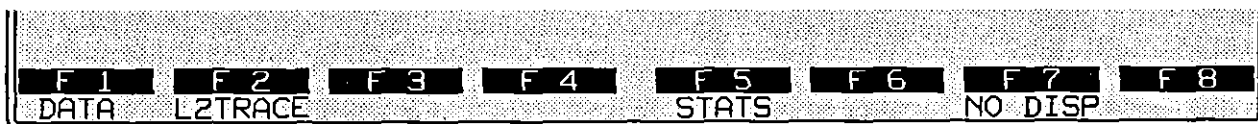

Figure 6-22 When a Layer 2 package is loaded without a Layer 3 package, **L2TRACE** will appear on the first rack of softkeys.

If both Layer 2 and Layer 3 packages are loaded, L2TRACE and L3TRACE appear on the second rack of Run-mode softkeys, as shown in Figure 6-21.

Note to C Programmers: You can modify Run-mode softkey labels for the Protocol Traces via the `set_ltrace_fkey_label` routine. See Section 64.6(C).

6.6 Program Trace

Program Trace is another mode of data presentation. See Figure 6-23. The Run-mode softkey PROG TR is present if you enter a TRACE spreadsheet action, if you write to the trace buffer *prog_trbuf* in C (see Section 64 for an explanation of trace routines in C), or if you select Display States: **YES** on the Display Setup menu.

As a program moves from state to state within the various tests and layers, the INTERVIEW maintains a log of user-assigned state and test names and user-entered messages called "traces." When the Program Trace is accessed (entering Run mode or via softkey) the sixteen data lines are dedicated to this log of states and traces. Unless its size is increased, the Program Trace buffer maintains a maximum of 4096 characters, equivalent to four full screens when every character space is used. (The size of the Program Trace buffer may be increased to a maximum of 16,381 elements via the *#pragma tracebuf* preprocessor directive, also discussed in Section 64.) When this limit is reached, new characters written to the end of the buffer force out the same number of characters from the beginning of the buffer. In Freeze mode, you may scroll through the Program Trace buffer via the **F1**, **F2**, **F3**, **F4**, **F5**, **F6**, **F7**, **F8**, and **HOME** keys.

```

DISPLAY SETUP
Display Mode: PROG TRACE
Layer: 3
Test: fips_module_a20
Display States? YES

```

MON/LINE	BLK=	06/28/89 11:18
ASCII/8/NONE/BOP		
Layer 3	Test fips_module_a20	State begin_init restart_req sent restart_con recvd
Layer 3	Test fips_module_a20	State call incoming call sent
Layer 3	Test fips_module_a20	State p3 call_accept recvd
Layer 3	Test fips_module_a20	State bad_PR invalid P(R) sent
Layer 3	Test fips_module_a20	State complete_init reset_req recvd
Layer 3	Test fips_module_a20	State test_06 reset_c too long sent
Layer 3	Test fips_module_a20	State pass_or_fail timeout: no reset_req ** test failed **

```

F1 F2 F3 F4 F5 F6 F7 F8
DATA PROG TR STATS NO DISP

```

Figure 6-23 The user may select a specific layer and test for a Program Trace.

(A) Layer, Test, and State

States are the third level from the top in the programming hierarchy on the Protocol Spreadsheet screen. Inside of states are *triggers*, comprised of *conditions* and *actions*. Above states are *tests*. At the top of the hierarchy are *layers*, corresponding to OSI protocol layers. See Section 23, The Layered Program Model.

Numerous layers and numerous tests per layer can be active concurrently in the INTERVIEW. The Program Trace can be set up to track state-to-state movement only in a particular **Layer** and **Test** identified by the operator on the Display Setup menu. Figure 6-23 gives the Display Setup necessary for the Program Trace shown. In the default setup, the **Layer** and **Test** fields are blank. In this configuration, the Program Trace will track all tests and layers.

Traces are trigger actions in Protocol Spreadsheet programs (see Section 30, Layer-Independent Conditions and Actions). They are simply user-entered ASCII data strings, identical to prompts except in their mode of display: traces are posted one to a line in the sixteen-line Program Trace display, while prompts appear on the second status line in all data-display modes (including the Program Trace). At a given moment during real-time display, there is always one blank line on the screen. This line moves just ahead of the freshest trace message and (once the trace buffer is full) continuously overwrites the oldest one.

State names can be included in the Program Trace via the **Display States:** selection on the the Display Setup menu (Figure 6-23). You will find the state log highly useful for locating dead ends, states that the test can enter but cannot exit due to a programming glitch. Traces are debugging tools, also. Inside a dead-end state they can inform you whether a particular condition that you are expecting is coming true.

Traces also allow you to keep a record of selected protocol events—to design your own protocol analysis. Figure 6-24 shows a user-designed trace for X.29 and X.3 protocols. Unlike prompts, traces are not immediately overwritten by other traces, so they are highly useful when you are trying to track protocol events that occur in quick succession. In Freeze mode, you may use the cursor keys to scroll through the Program Trace buffer.

```

*MON/LINE*          BLK=      06/28/89 11:18
ASCII/B/NONE/BOP
DCE
SET
  PAD Recall
  q
  Data Forwarding
  r
  Idle Timer Delay
  No data forwarding on timeout
  Ancillary Device
  Data transfer (X-ON)
  Service Signals
  Other than prompt (std form)
  Action On Break
  Int
  Ind Brk
  Discard output
  F 1  F 2  F 3  F 4  F 5  F 6  F 7  F 8
  DATA  PROG TR  STATS  NO DISP

```

Figure 6-24 Program Trace for X.29 PAD parameters.

(B) Line and Percentage

When you press **FREEZE**, the second status line at top of the screen changes. Two new fields, LINE and PERC, replace the code, parity and format indications. These fields provide information about the location of the cursor within the data written to the trace buffer. As you scroll through the buffer via the cursor keys, the values in both fields change. LINE indicates the line number of the current cursor position in the data. PERC reflects the percentage of the data in the trace buffer past which the cursor is located.

6.7 Statistics Display

There are two statistics displays in the INTERVIEW, tabular and graphic. Both of these displays can be accessed by softkey at any time during Run mode. Figure 6-25 shows the softkeys for TABULAR and GRAPHIC statistics displays.



Figure 6-25 The two types of statistics display are accessible in Run mode on the second rack of softkeys.

When statistics are displayed in tabular form, horizontal rows in the table are labeled with user-assigned names. Each name represents a counter, a timer, or a set of counters or timers combined for statistical purposes in an "accumulator." The first column next to the name contains the current *value* of a counter or timer. (Accumulators neither count nor time and therefore have no current value.) The values in the next four tabular columns (Last, Minimum, Maximum, Average) are derived from *previous* current values and are updated each time the counter or timer is sampled (read and reset). The tabular display is illustrated in Figure 6-26.

MON/LINE		BLK=		06/28/89 11:18		
ASCII/B/NONE/BOP						
Name	Current	Last	Minimum	Maximum	Average	Unit
hostfrm	106	16	2	256	84.03	
goodfrm		16	2	256	85.22	
badfrm		11	11	11	11.00	
abort						

Figure 6-26 The tabular display.

In the graphic display, the values that are shown as numbers on the tabular display—up to 48 of them, sixteen on the screen at any given time, selected by the user out of 400 possible values on the scrolling tabular screen—are represented as horizontal bars. See Figure 6-27. The two statistics screens are discussed in detail in Section 20, Tabular Statistics, and Section 21, Graphic Statistics.

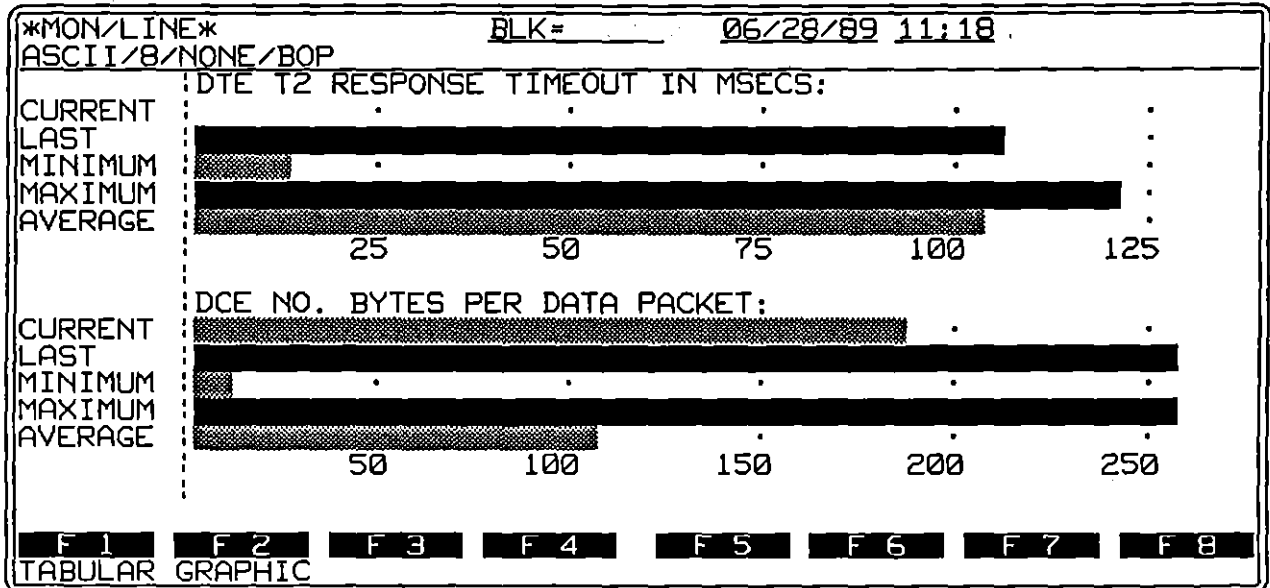

Figure 6-27 The graphics display.

6.8 Display Window

Figure 6-28 shows the Display Setup menu when **Display Mode:** `DSP WND` is selected. Display Window displays and preserves one screen, including the prompt line, of user-entered messages. When the end of the display screen is reached, the previous messages are overwritten, beginning at row one (the line below the prompt line). Messages are presented to the Display Window primarily via C display routines. See Section 64 for an explanation of these routines.

Figure 6-28 Display Window is a selection under *Display Mode*.

The Display Window lends itself to table or menu creation. The cursor may be positioned anywhere in the sixteen-line display area of the screen, or on the prompt line. Entries to a table, for example, may be updated by repositioning the cursor to a certain location.

Also, the programmer controls the use of certain Run-mode keys. The function of the cursor keys `↑` and `↓` can be programmed via the keyboard variables and the `send_key` routine explained in Section 72, Other Library Tools. (For other Run-mode screens, these keys control the playback speed of disk data.) For example, use `↑` and `↓` to move from field to field on a menu created in the Display Window.

Use the *set_dw_fkey_label* routine to assign a rack of Run-mode softkey labels to the Display Window. Additional C routines control the display and highlighting of these labels. See Section 64.3(C).

Figure 6-29 shows a Display Window created by the SNA Statistics application program (OPT-951-19-1).

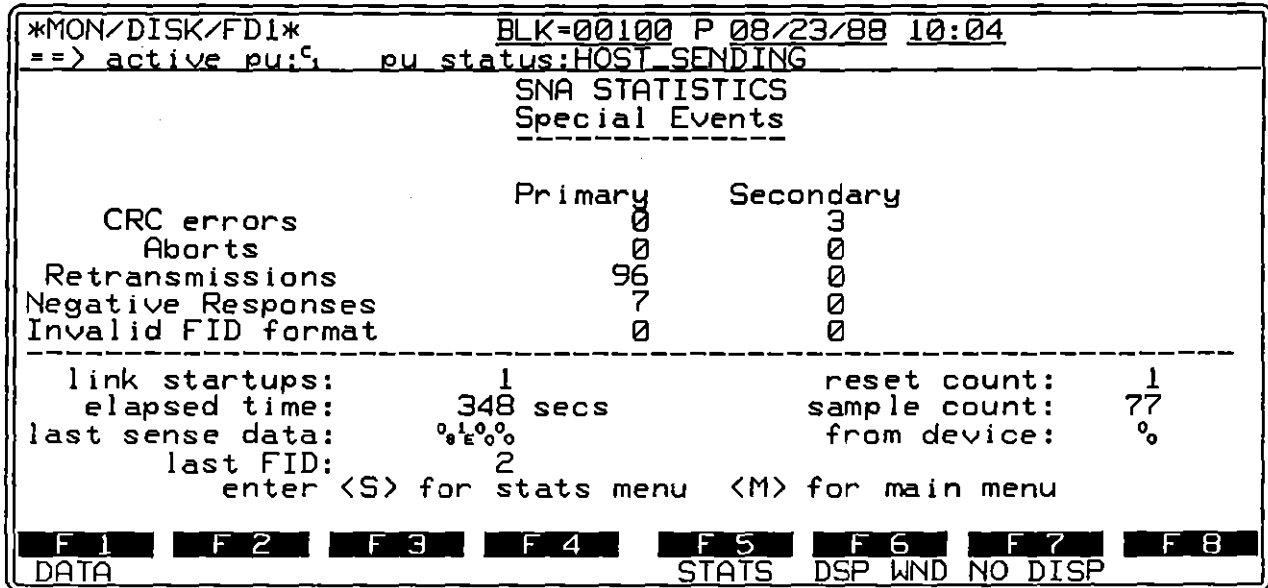

Figure 6-29 Display Window is useful for tables, as in this SNA Statistics example.

The DSP WND token, when present, is located on the first rack of Run-mode softkeys, as shown in Figure 6-30.

NOTE: In the absence of display routines (or softkey prompts) in a spreadsheet program, the Run-mode DSP WND token will not appear on any softkey rack. In this instance, if you select **DSP WND** as the display mode on the Display Setup menu, the Display Window will be the initial screen during Run mode, but it will be blank. If you move to a different display screen, you will not be able to return to the Display Window.

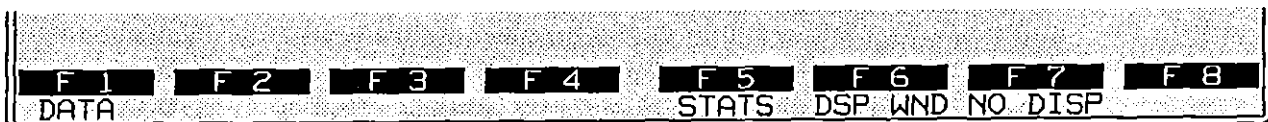

Figure 6-30 Including display routines or PROMPT actions in a program causes the DSP WND token to appear in Run mode.

6.9 User Trace

There are seven trace buffers in addition to Program Trace. Select any one by specifying a user-trace number under **USER TRACE** display mode on the Display Setup menu, as shown in Figure 6-31. These buffers are similar to the Program Trace buffer. Messages are appended to the end of the buffer. Unless its size is increased, a user-trace buffer maintains a maximum of 4,096 characters, equivalent to four full screens when every character space is used. (The size of user-trace buffers may be increased to a maximum of 16,381 elements via the *#pragma tracebuf* preprocessor directive.) In Freeze mode you may scroll through the buffer using the cursor keys. The difference between user traces and Program Trace is that user traces are created only via *C tracef*, *tracec*, and *traces* routines. See Section 64 for an explanation of the trace routines and the *#pragma tracebuf* directive.

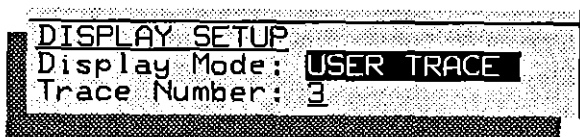

Figure 6-31 The initial display in Run mode will be user trace number three.

NOTE: In the absence of spreadsheet-program uses of user traces, a Run-mode trace token will not appear on any softkey rack. In this instance, if you select **USER TRACE** as the display mode on the Display Setup menu, the specified user trace will be the initial screen during Run mode, but it will be blank. If you move to a different display screen, you will not be able to return to any user trace.

When a user-trace buffer is written to in a spreadsheet program, a Run-mode token will appear for that buffer. The location of the token depends on the number of user buffers used. If only one user trace is used, a token indicating the trace number will appear on the first rack of softkeys, as shown in Figure 6-32.

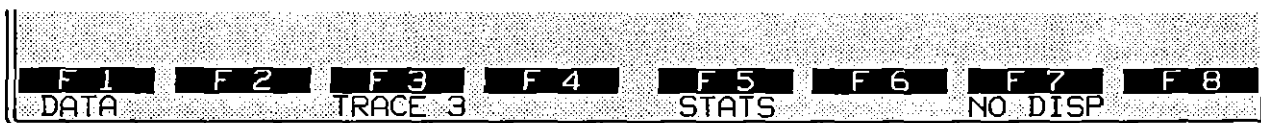

Figure 6-32 When only one user trace is used, its token appears on the first rack of softkeys.

If more than one user trace is written to, a USER TR token on the first rack provides access to the next rack containing tokens for all used buffers. See Figure 6-33.

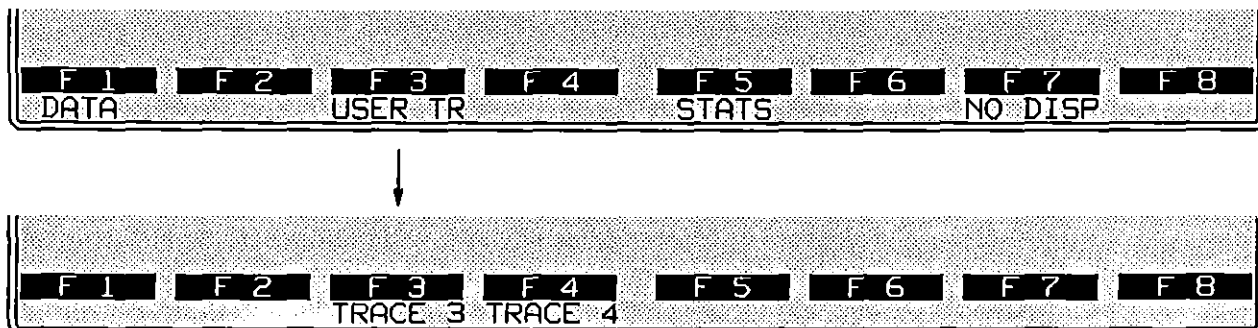

Figure 6-33 To access trace buffers when more than one has been written to, press *USER TR*.

Use the *set_ustrace_fkey_label* routine to modify Run-mode softkey labels for the user traces. See Section 64.4(C).

Figure 6-34 shows a trace created via *C tracef* routines. Note the fields in reverse video, one of the attributes available to the user with *tracef* and *displayf*. Attributes are not available with softkey TRACE and PROMPT actions. Another advantage of the user (*tracef*) trace is that it can use the screen more economically. Where the softkey TRACE action assigns each message to a new line, *tracef* does not automatically generate a new line. A series of *tracef* messages may be written across the width of the screen. More information can be stored on a single screen.

```

*MON/LINE*                BLK=00000 S 06/28/89 11:18
ASCII/8/NONE/BOP
SRC  PAD MSG  REFERENCE  VALUE
DCE SET  PAD Recall  0
          Data Forwarding  1
          Idle Timer Delay  No data forwarding on timeout
          Ancillary Device  Data transfer (X-ON)
          Service Signals   Other than prompt (std form)
          Action On Break   Int, Ind Brk, Discard output
          Terminal Flow Cntrl X-ON/X-OFF
DCE READ  PAD Echo
DTE PARAM IND PAD Echo  Echo
DCE SET  PAD Echo      No echo
DCE INV CLEAR
    
```

The table displays a trace with columns for SRC, PAD MSG, REFERENCE, and VALUE. The REFERENCE and VALUE columns are shown in reverse video. At the bottom of the screen, function keys are labeled: F1 DATA, F2, F3 TRACE 3, F4, F5 STATS, F6, F7 NO DISP, and F8.

Figure 6-34 X.29/X.3 trace generated via *C tracef* routines.

NOTE: The heading displayed in reverse image in Figure 6-34 is written to the first line of the trace buffer. It is not a constant screen heading like those in the Protocol Traces. When you scroll forward through the buffer, the heading will disappear from the screen. It will reappear when you return to the beginning of the trace buffer.

6.10 Display Correlation in Freeze Mode

During Run mode, buffers are maintained for character data, protocol traces at each layer, one program trace, and seven user traces. When the operator presses **FREEZE** to stop the display, all of the buffers used are accessible by softkey and may be scrolled through. Certain buffers are correlated. The Layer 3 Protocol Trace buffer correlates to the Layer 2 Protocol Trace buffer. Either Protocol Trace buffer correlates to the 64-Kbyte character-data buffer. "Correlate" means that the packet displayed at the top of the Layer 3 Protocol Trace is contained in the frame displayed at the top of the Layer 2 Protocol Trace. This frame will begin—i.e., will be positioned in the upper left corner of—the corresponding data-display.

Figure 6-35 shows three Freeze-mode displays that relate to the same sample of raw data. The top display is a Layer 3 X.25 trace, the middle is a Layer 2 X.25 trace, and the bottom display is dual-line data. The operator uses the cursor-arrow, roll, and page keys to move freely around the buffers in Freeze mode. For example, when he presses a softkey to change the display from L2TRACE to DATA, the INFO frame at the *top line* of the Layer 2 Protocol Trace is also the first frame on the data-display screen.

(A) Offset and Percentage

OFFSET= and percentage readings are given on the second line of data displays in Freeze mode. Character-offset is the number of characters *previous to* the cursor-character in the 64-Kbyte character buffer. The percentage value immediately following the offset tells the percentage of the current buffer that contains data that was previous to the cursor character.

At two bytes of code and attributes per character, the character buffer holds an optimum number of 32,768 (or 32 K) characters. This translates to 32 screens of data in single-line display. Note, however, that if the Front-End Buffer Setup menu is configured to buffer time ticks or EIA leads (Section 9), the maximum number of characters in the character buffer will be reduced.

When the character buffer is full, it wraps to the beginning and new characters overwrite the oldest characters. The character buffer is likely to wrap much sooner than any of the trace buffers. There may be instances when a protocol element (a frame, for example) is shown on the trace display but the data version of the same element has been overwritten in the character buffer.

```
*MON/LINE*          BLK=00000 S 06/24/89 14:20
ASCII/B/NONE/BOP
SRC LCN  TYPE      Pr Ps QDM      MISC      SIZE      TIME      BCC
DCE 01F DATA      4 6              0128 1420:08.382 @
DTE 01E DATA      0 0              0003 1420:08.701 @
DCE 001 DATA      0 0              0003 1420:08.810 @
```

```
*MON/LINE*          BLK=00000 S 06/24/89 14:20
ASCII/B/NONE/BOP
SRC  ADDR  TYPE      Nc  Ns  P/F  SIZE      TIME      BCC
DCE   03   INFO      7   3   0    0131 1420:08.382 @
DTE   03   RR         4   3   0    0000 1420:08.475 @
DTE   01   INFO      4   7   0    0006 1420:08.701 @
DCE   01   RR         0   0   0    0000 1420:08.799 @
DCE   03   INFO      0   4   0    0006 1420:08.810 @
DTE   03   RR         5   0   0    0000 1420:08.903 @
```

```
*MON/LINE*          BLK=00000 S 06/24/89 14:20
OFFSET=00568 13% DTE= DCE=00000011
HEADING: FINANCIAL & CREDIT INFORMATION
HEADING: FIRE PROTECTION FLIGHT INFORMATION & SC
HEADING: HEDUL 50 1 2 3 4 5 6 7 8 9 10 11 12 13 14 15 16 17 18 19 20 21 22 23 24 25 26 27 28 29 30 31 32 33 34 35 36 37 38 39 40 41 42 43 44 45 46 47 48 49 50 51 52 53 54 55 56 57 58 59 60 61 62 63 64 65 66 67 68 69 70 71 72 73 74 75 76 77 78 79 80 81 82 83 84 85 86 87 88 89 90 91 92 93 94 95 96 97 98 99 100
```

Figure 6-35 The first packet on the Layer 3 screen (top) correlates with the first frame on the Layer 2 screen (middle) and also with the first character-data frame (bottom).

6.11 No Display

If Display Mode: **NO DISPLAY** is the selection on the Display Setup menu, a blank screen will be displayed when the unit enters Run mode. The screen will remain blank until one of the display-mode softkeys (DATA, STATS, and so on) is depressed. Unlike Freeze mode, this mode does not prevent the writing of data to the screen buffer (also referred to in this manual as the "character buffer"). If you enter Run mode in No-display mode and then press a data softkey, all data will be present in the buffer (unless it is old data that has been overwritten).

The **NO DISPLAY** selection can be used to maximize efficient capture of data at very high speeds.

7 Record Setup

Record Setup

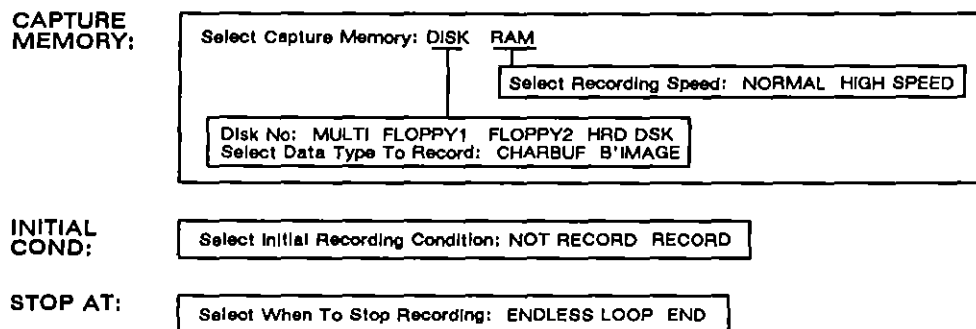

Figure 7-1 Record Setup menu.

7 Record Setup

The INTERVIEW provides storage of line data for later analysis. Recording of data can be initiated in three ways: through selections on the Record Setup menu, through manual control of the unit in Run mode, and through the RECORD action on the Protocol Spreadsheet. In addition, data is continuously saved to and can be retrieved from a temporary display buffer.

7.1 Format of Recorded Data

Data may be recorded to disk in one of two formats: as Character-oriented data, or as Bit-image data. It may be *recorded* to RAM as bit-image data only. Data is captured to character RAM (the screen buffer) automatically: this "capture" has nothing to do with the Record Setup.

(A) Character-oriented Data

Character-oriented data is data which is already formatted as specified by the user. This data is recorded as it was presented to the screen. (See Figure 2-5.) Character-oriented data is stored with programmed enhancements which may later be reviewed or replaced by the user. Superfluous data may be suppressed from character-oriented data, which allows more efficient storage. Except for code selection, line-setup parameters (described in Section 5) will not be applied to recorded character-oriented data.

(B) Bit-image Data

Bit-image data is bit-accurate data which is not preformatted. All line-setup parameters can be applied and reapplied to such data. This fact makes possible reinterpretation of data which would otherwise be unusable, because, for example, the wrong code, format, or block check calculation had been selected.

Bit-image data is stored prior to presentation to the screen. (Refer again to Figure 2-5.) This means that the data contains no enhancements and that it remains a complete record of all data as originally captured with the exception of idle, which can be discarded from the Front End Buffer. (See Section 9 for information on idle-suppression in the FEB.)

7.2 Recording Medium

Line data may be recorded directly to disk in bit-image format, recorded to bit-image RAM and then transferred to disk, or captured in the screen buffer (character RAM) and transferred to disk.

The recording medium to be used in Run mode is chosen on the Record Setup menu. By default, data is not recorded when you enter Run mode. To activate recording from Run mode, press **RECORD**. (Otherwise, you may reconfigure the Record Setup menu to enter Run mode recording, or add a RECORD action to a Protocol Spreadsheet program.) At that point, data is recorded in the format and to the medium specified on the Record Setup screen. By default, data is recorded in character-oriented format onto the data acquisition tracks of FD1 (since **FD1** is the default Disk No selection). If Capture Memory: **RAM** is selected, data will be recorded in bit-image format.

Before it is played back in Run mode, data stored in bit-image RAM must be transferred to disk. Go to the Disk Maintenance menu: press **PROGRAM**, **F7**, **F3** (program, utilities, disk maintenance). Then execute a data transfer from RAM to disk. To transfer all or part of the RAM buffer, select From: **RAM** and Type: **BIT IMAGE**. Once the data has been transferred to disk, monitor the data by selecting Mode: **MONITOR** and Source: **DISK**. See Section 5 for a further description of Source and other Line Setup selections.

NOTE: Before data can be played back, all transmit actions must be cleared from the trigger menus, and all SEND actions and RECEIVE or RCV conditions must be deleted from the Protocol Spreadsheet.

7.3 The Screen Buffer

There is a third, alternative method of data capture always active in Run mode. A 64-Kbyte data buffer is provided for constant recording of character-oriented data as it is displayed on the screen. This means that, even though he has opted not to record data in real-time, the operator may still store the contents of the screen buffer to a file, once he places the INTERVIEW in Program mode, and review the data later. To control the capture of data to the screen buffer, use the Capture (**ON/OFF**) selection on the trigger-actions menu (see Section 25.9) or the Layer 1 CAPTURE action on the Protocol Spreadsheet (Section 31.2(F)).

Before it is played back in Run mode, screen data must be transferred from character RAM to the data acquisition tracks of a disk. Go to the Disk Maintenance menu: press **PROGRAM**, **F7**, **F3** (program, utilities, disk maintenance). Then execute a data transfer from RAM to disk. To transfer all or part of the screen buffer, select From: **RAM** and Type: **CHARBUFFER**. The contents of the screen buffer can then be played back by selecting Mode: **MONITOR** and Source: **DISK**.

NOTE: The screen buffer is erased each time **RUN** is pressed, so the data must be transferred to disk before the INTERVIEW returns to Run mode.

Of course, if the unit stays in Run mode, you can freeze the screen and review data without any transfer procedure. Freeze mode analysis is described in Section 3.4.

If you need to record a large amount of data for analysis, it might be preferable to employ the Record Setup features of the INTERVIEW, since the screen buffer is limited in size, and its contents are automatically overwritten once it is full.

NOTE: Data in the screen buffer is stored exactly as displayed. Suppressed data is not stored in the buffer and, as a consequence, is not available for triggering. Programming techniques must take this into account.

NOTE: Enhancements *are* stored with the data. The data is presented with the enhancements in playback, unless active triggers contain potential Enhance actions. If the INTERVIEW detects Enhance actions when a test is compiled, then old enhancements stored with source data are stripped to allow new enhancements.

7.4 The Record Setup Screen

The parameters for real-time data capture are selected on the Record Setup menu, which resides on the same screen as the Line Setup and Display Setup menus. All possible Record Setup selections on this menu are shown in Figure 7-1. The default menu is shown in Figure 7-2.

NOTE: Bit-image data is subject to idle-suppression in the Front-End Buffer *prior* to recording. See Section 9 for details.

```
RECORD SETUP
Capture Memory: DISK
Disk No: MULTI
Data To Record: CHARACTER
Initial Cond: NOT RECORD
Stop At: ENDLESS LOOP
```

Figure 7-2 Default Record Setup screen.

(A) Capture Memory

Either **DISK** or **RAM** can be selected in this field.

1. **Disk.** **DISK** is the default selection. When **DISK** is selected, two additional fields, **Disk No** and **Data To Record**, appear immediately below. Refer again to Figure 7-2. See Section 1.6(D) on maximum line rates for recording data to disk. Also consult Section 2.9 for information on optimizing recording of data to disk.

NOTE: Data can only be saved to formatted disks. See Section 13 for instructions on formatting.

- (a) **Disk no.** Available selections in the **Disk No** field are **FD1** (Floppy Disk 1); **FD2** (Floppy Disk 2); **HDD** (Hard Disk); and **MULTI** (Multiple disks). The default selection is **MULTI**.

MULTI causes recording to begin on the floppy disk inserted in Drive 1 and to continue on the disk in Drive 2 when the first disk is completely full. Once this second disk is full, recording reverts to Drive 1, and the process continues. You may manually replace disks in the nonactive drive to record data alternately on a new disk. If no disk is inserted in the next drive, recording continues from the beginning of the last-recorded disk.

CAUTION: Do not remove a disk from an active drive. You can always identify the active drive by the glowing LED just to the right of the drive.

When **FD1**, **FD2**, or **HDD** is the selected **Disk No**, recording proceeds continuously or stops when the disk is full in accordance with the **Stop At** selection, described later in this section.

- (b) **Data to record.** The two selections in this field are **CHARACTER** and **BIT IMAGE** data. This selection specifies the format of recorded data. The differences between these two data formats are explained at the beginning of this section. This field disappears when **Capture Memory: RAM** is selected, since the format will always be bit-image.

2. **RAM.** **RAM** refers to the portion of the INTERVIEW's internal memory reserved for bit-image data recording directly from the data line.

When **RAM** is selected, the **Disk No** and **Data to Record** fields disappear. A new field, **Record Speed**, may appear. See Figure 7-3. If this field does not appear, RAM size is 1 Mbyte in the 7500 and the 7700 **TURBO** and 256 Kbytes in the 7000 and 7200 **TURBO**. See Table 7-1.

```

RECORD SETUP
Capture Memory: RAM
Record Speed: HIGH SPEED
Initial Cond: RECORD
Stop At: END

```

Figure 7-3 Record Setup menu configured for high-speed recording.

- (a) *Record speed.* The **Record Speed** field is present only when 1) **Capture Memory: RAM** is selected; 2) the **Line Setup Mode** is **MONITOR**; 3) software revision 5.02, or higher, is installed; and 4) the unit is equipped with an FEB board capable of high-speed recording (available as OPT-951-28-1, or with current software as OPT-951-27-1). "High-speed" means a line rate faster than 256 Kbps.

NOTE: The C variable *feb_type* in the *unit_config* structure shown in Table 69-1 identifies your FEB version. Your INTERVIEW will support high-speed recording if *unit_config.feb_type* has a value of two, or higher. (Other variables in the same structure contain additional hardware and software information specific to your unit.)

There are two **Record Speed** selections, **NORMAL** and **HIGH SPEED**. The default entry is **NORMAL**. Normal recording can support a speed up to 256 Kbps. When line speeds approach this threshold, you may need to record according to the guidelines set forth in Section 2.9. High-speed recording is required when line rates exceed 256 Kbps.

For normal and high-speed recording, RAM size is determined by the number of MPMs and the presence of an optional XDRAM board in your unit. See Table 7-1 and Table 7-2 for RAM size based on various INTERVIEW configurations.

When **HIGH SPEED** is selected, record RAM is automatically increased to 2 Mbytes in the 7500 and 7700 *TURBO*. You may increase high-speed record RAM size to 2 Mbytes in the 7000 and the 7200 *TURBO* by adding an optional XDRAM board, (OPT-951-23-1). In the 7500 and 7700 *TURBO*, an XDRAM board can increase record RAM for high-speed recording up to 4 Mbytes. Record RAM for normal recording can reach 2 Mbytes when an XDRAM board is installed. (XDRAM requires software revision 6.00, or higher.)

Table 7-1
RAM Size (bytes) for Normal and High-Speed Recording
In the INTERVIEW 7000 and the 7200 TURBO

	1 MPM only	MPM w/XDRAM*	MPM w/XDRAM w/file**
Normal	256K	256K	2M
High-Speed	256K	256K	2M

* When the file *lsysixdram_rcrd* does not reside on the boot-up disk during power-up, XDRAM is used to increase the spreadsheet size. See Section 2.5(E).

** The file *lsysixdram_rcrd* resides on the boot-up disk during power-up.

Table 7-2
RAM Size (bytes) for Normal and High-Speed Recording
in the INTERVIEW 7500 and the 7700 TURBO

	3 MPMs only	MPMs w/XDRAM*	MPMs w/XDRAM w/file**
Normal	1M	1M	2M
High-Speed	2M	2M	2M††

* When the file *lsysixdram_rcrd* does not reside on the boot-up disk during power-up, XDRAM is used to increase the spreadsheet size. See Section 2.5(E).

** The file *lsysixdram_rcrd* resides on the boot-up disk during power-up.

†† Increase record RAM to 4 Mbytes by adjusting the switches on the MPMs in slots 7 and 8. See also Table J3-1.

Choose **Record Speed:** **HIGH SPEED** when the line rate is between 256 Kbps and 2.048 Mbps full duplex. Two interfaces which may require high-speed record capability are T1 and G.703. To record the aggregate T1 data stream, for example, you must select **HIGH SPEED**. Refer to Sections 52.1(E) and 53 for more information on T1 and G.703 aggregate record. (There is no aggregate record for ISDN.)

At high speeds, data cannot be processed quickly enough to be displayed or monitored accurately. The **HIGH SPEED** selection, therefore, automatically turns off the monitoring function by disabling the line receivers. The following message is displayed on the status line of the Run-mode screen: *"Monitoring is disabled for high speed ram recording."* The display process continues, even though the line receivers are not supplying data for display. Stop the display process by selecting **Display Mode:** **NO DISPLAY** on the Display Setup menu, or by pressing NO DISP during Run mode.

Without active line receivers, data cannot be displayed and program conditions (or triggers) based on incoming data or leads can never come true. Data analysis must be performed during slower playback of recorded data. With this consequence of high-speed record in mind, you may still opt to use it at speeds less than 256 Kbps.

NOTE: For data to be available for playback, it must reside on a disk. Transfer data captured in RAM to a disk via the Data Transfer command on the Disk Maintenance screen. See Section 13.4(C).

High-speed recording formats data differently than normal recording. When recording ends (or you exit Run mode via the **normal** key), the data is converted from high-speed format to normal-data format. The following message is displayed: *"Reformatting ram record buffers - Please wait ..."*

(B) Initial Condition

The two selections available in this field are **RECORD** and **NOT RECORD**. When **RECORD** is selected, data recording begins the "instant" you place the INTERVIEW in Run mode. When **NOT RECORD** is selected, no recording takes place until one of three events occurs: a new program with Initial Condition: **RECORD** is loaded, a spreadsheet trigger activates recording, or the operator initiates recording manually. Trigger and manual control of recording are described later in this section.

A record/playback field (on the top line in the status area) on Run-mode screens will indicate whether recording is in progress or has been suspended. If recording is ongoing, an "R" appears next to the block-number field. If your initial condition is **NOT RECORD** or you suspend recording, "S" will be displayed.

The field will be blank when the end of RAM or the data-acquisition tracks is reached. The record/playback field also will be blank if the **Capture Memory** field indicates that you will record to disk, but no disk is present in the selected drive or data-acquisition tracks are not available on the disk.

NOTE: A "P" in the record/playback field indicates that data playback is in progress. See Section 5.2.

(C) Stop At

This field defines the action which the INTERVIEW takes when bit-image RAM or disk is full. **ENDLESS LOOP** causes recording to continue from the beginning of disk or RAM, whichever is designated as **Capture Memory**. **ENDLESS LOOP** causes old data to be overwritten. As a result, only the most current data is accessible for playback.

Stop At: **END** indicates that no further data will be recorded once bit-image RAM or disk is full.

NOTE: This selection does not influence recording when **MULTI** is selected as **Disk No.** **MULTI** causes data to be recorded continuously, without stopping.

7.5 Trigger Control of Capture

Capture to the screen's character buffer can be placed under trigger control. The trigger action **Capture:** **OFF** (or the Layer 1 **CAPTURE OFF** action on the Protocol Spreadsheet) stops the buffering of character data and freezes the screen display. **Capture:** **ON** (or **CAPTURE ON**) restarts data display and capture. Capture can be applied to one or both sides of the display (TD and/or RD).

When the character buffer has been frozen by trigger rather than by the **FREEZE** key, you will not be able to scroll through data on the screen. See Section 25.9 or 31.2(F) for a further discussion of capture.

7.6 Spreadsheet Control of Recording

Recording to RAM or disk also can be placed under trigger control. The layer-independent action **RECORD OFF** on the Protocol Spreadsheet stops the recording of line data. **RECORD ON** restarts recording. See Section 30 for a discussion of **RECORD**.

You can ascertain whether data is being recorded by looking at the status lines at the top of the display. Incrementing block numbers and an "R" in the record/playback field (next to the block number) indicate that data is being recorded.

7.7 Manual Control of Recording

The operator can manually initiate recording in Run mode using the RECORD key. RECORD is a toggle key which will alternately start or stop recording to RAM or disk. The selections on the Record Setup screen and trigger actions influence the function of RECORD.

During recording, the top status line of Run-mode screens will show incrementing block numbers and an "R" displayed in the record/playback field.

8 Layer Setup

```

** Layer Setup **

DRIVE: HRD   Layer 1 Package: NO PACKAGE   Packages Loaded
DRIVE: HRD   Layer 2 Package: NO PACKAGE   NO PACKAGE
DRIVE: HRD   Layer 3 Package: NO PACKAGE   NO PACKAGE
DRIVE: HRD   Layer 4 Package: NO PACKAGE   NO PACKAGE
DRIVE: HRD   Layer 5 Package: NO PACKAGE   NO PACKAGE
DRIVE: HRD   Layer 6 Package: NO PACKAGE   NO PACKAGE
DRIVE: HRD   Layer 7 Package: NO PACKAGE   NO PACKAGE

Depress XEQ Key To Load The Selected Packages

Select Layer
F1 F2 F3 F4 F5 F6 F7 F8
LAYER-1 LAYER-2 LAYER-3 LAYER-4 LAYER-5 LAYER-6 LAYER-7 PROTSEL
    
```

Figure 8-1 Default Layer Setup screen.

```

** Layer Setup **

DRIVE: HRD   Layer 1 Package: NO PACKAGE   Packages Loaded
DRIVE: HRD   Layer 2 Package: SDLC         X.25      HRD
DRIVE: HRD   Layer 3 Package: SS7         X.25      HRD
DRIVE: HRD   Layer 4 Package: NO PACKAGE   NO PACKAGE
DRIVE: HRD   Layer 5 Package: NO PACKAGE   NO PACKAGE
DRIVE: HRD   Layer 6 Package: NO PACKAGE   NO PACKAGE
DRIVE: HRD   Layer 7 Package: NO PACKAGE   NO PACKAGE

Depress XEQ Key To Load The Selected Packages

Select Layer
F1 F2 F3 F4 F5 F6 F7 F8
LAYER-1 LAYER-2 LAYER-3 LAYER-4 LAYER-5 LAYER-6 LAYER-7 PROTSEL
    
```

Figure 8-2 A Configured Layer Setup screen.

8 Layer Setup

The Layer Setup screen is directly accessible from the Main Program menu. A default Layer Setup screen is shown in Figure 8-1 and a configured Layer Setup screen in Figure 8-2.

Most protocols available to the user also have certain definable parameters. These parameters are grouped on the Protocol Configuration screen described later in this section.

8.1 Personality Packages

The INTERVIEW provides layer-specific protocol packages called Personality Packages. These packages contain automatic selections for trigger conditions and actions. Automatic selections appear on the Protocol Spreadsheet once the Personality Package is loaded.

The Layer Setup screen gives the user access to the Personality Packages residing on disk in his system. Personality Packages are identified on the Layer Setup screen by protocol name and are categorized by layer and by the disk on which they reside. Since protocols are selectable by layer, it is possible to "mix and match" them.

A rotating field on the Layer Setup screen is assigned to each OSI layer. In the field, the user may choose from available protocols. The protocol chosen (displayed) in each field and then loaded will be the one used for monitoring and emulating that layer in Run mode.

8.2 Selecting and Loading Protocols

Two disks are supplied with the INTERVIEW or with software upgrades. The system disk (DSK-951-001-1.X) may be used for boot-up. The personality packages reside in the *usr/layer_pkgs* directory of the user disk (DSK-951-001-2.X). The same directory on the hard disk also contains the personality packages.

If your boot drive is one other than the hard drive (either floppy drive 1 or 2), place the user disk in the boot drive. Press **CTRL**-**CLEAR** to read the disk. Available personality packages will appear as softkey selections at appropriate layers.

For convenience, the OSI layers appear on the screen from lowest to highest. Access a layer in one of two ways: by moving the cursor up and down the Drive column with the **↑** and **↓** keys; or by pressing the function key for the appropriate layer when the prompt above the function keys reads "Select Layer." The Drive field for that layer blinks.

When you have selected a layer, press the appropriate function key or press **F24** or **F25** to display the options for the source drive. A rotating field at the left identifies the active drive for each Layer. Once you have selected a drive (Hard Disk is selected for each layer in Figure 8-2), it is the only drive from which the Personality Packages for that layer can be loaded.

Only the names of the Personality Packages for the selected drive appear in the **Selections** column. Select the correct drive, then press **DOONE**, **RETURN**, or **→** to move to **Selections**. Pressing the function key for a protocol or pressing the **DOONE** key moves you to the rotating field for the next layer.

In the **Selections** column, display all the protocols you wish to use in Run mode. (If you don't want any protocol loaded at a certain layer, leave "NO PACKAGE" in its **Selections** field.) Then press the **YES** key. This loads all selected protocol packages from disk. Once the process is complete, the names of loaded protocols appear in the column labeled **Packages Loaded** on the right of the screen.

NOTE: Protocols used should be compatible with the data format you have selected on the Line Setup screen (see Section 5). For example, if you are using SDLC, X.25, or SS#7 at Layer 2, you must have selected Bit-Oriented Protocol (BOP) as the Format.

8.3 The Protocol Configuration Screen

Typically, a protocol available on the setup screen has its own submenu, the Protocol Configuration screen, accessible from the Layer Setup screen. The contents of each protocol's configuration screen are explained in a section devoted to that protocol and layer.

(A) Accessing the Screen

Once the protocols you will be testing are loaded, you may call up the Protocol Configuration screen, in turn, for each protocol. Press **PROTSEL**. (You may always access the **PROTSEL** softkey by first pressing **DOONE**.) Then select a layer by pressing the appropriate function key. This takes you immediately to the configuration screen for that protocol. If, for example, you are using X.25 at Layer 2, you will see the screen shown in Figure 8-3.

Make appropriate parameter selections. Return to the Layer Setup screen, if necessary, by pressing the **F24** key. If you have additional parameters to set, press **F8** (**PROTSEL**) and select another layer to call up the new parameters screen.

```

** X.25 Frame Level Setup **

T1 (for INFO frame): 1.0 sec
Emulate: LOGICAL DTE
Mode of operation: MOD 8
Window size: 7

Enter Window Size (1 to 7) For Outstanding Frame: 7
F1 F2 F3 F4 F5 F6 F7 F8

```

Figure 8-3 Most protocols have definable parameters, selected on a separate screen accessed from the Layer Setup screen.

(B) Default Parameters

Default parameters, loaded with each personality package, are displayed on the Protocol Configuration screen until you modify them. You can always recall these defaults to the screen by displaying the appropriate parameters menu and pressing **CTRL-CLEAR**.

8.4 Saving the Layer Setup Screen

You can save a configured Layer Setup screen and load it later so that you don't have to make selections on the screen each time you use the equipment. This is done by configuring the Layer Setup screen and then saving it along with all other screens as part of a program or object file (see Figure 8-4). (Program and object files are saved and loaded from the File Maintenance screen as explained in Section 14.) When loaded into the unit, a program (or object) file overwrites all screens.

To use a program or object file with layer packages loaded, be sure that you also make those layer packages accessible to the system when the file is loaded. The INTERVIEW 7200 TURBO, 7500, or 7700 TURBO (and the 7000 with an optional hard disk) always has access to the layer packages since they reside on the hard disk. For the INTERVIEW 7000 without the optional hard disk drive, place the user disk into the second floppy drive when the program (or object) file is loaded.

To use a program or object file with personality packages, simply load the file in any drive. All drives will be searched, if present, in the following order for necessary

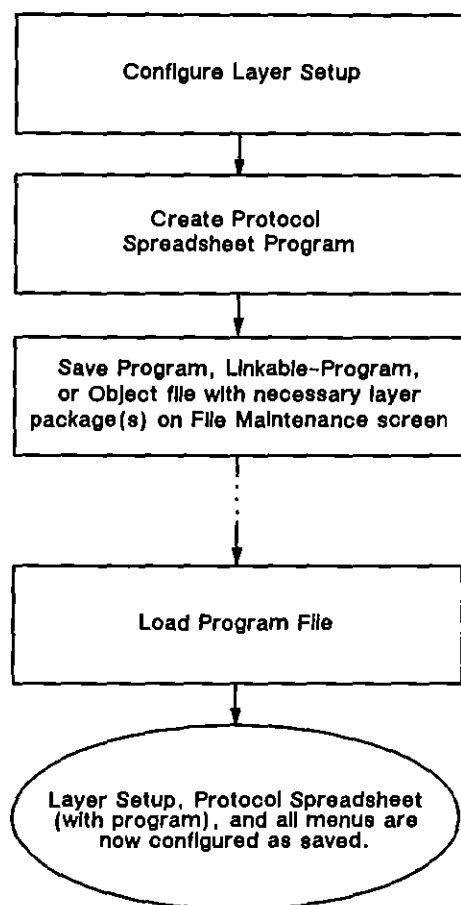

Figure 8-4 Saving and loading the Layer Setup screen.

layer personality packages: boot drive, F1, F2, hard disk. (Of course, the boot drive is F1, F2, or hard disk.) This order is important when unique names have not been used. The first occurrence of the specified protocol package will be used. All protocol packages previously resident in the INTERVIEW will be replaced automatically, as long as the INTERVIEW can access the protocol packages specified in the program file. The personality package need not appear in the same drive from which it was originally loaded.

If the INTERVIEW does not find the Personality Package on any drive, nothing will be loaded. Missing softkey selections and pervasive strike-through's on the Protocol Spreadsheet also indicate that the correct Layer Personality Package has not been loaded.

To correct the problem, reload the program and packages. Return to the File Maintenance screen, insert the user disk containing the personality packages if necessary, and press **END**.

9 FEB Setup

9 FEB Setup

Data and control-lead signals entering the INTERVIEW or generated internally are routed from the receivers through a front-end buffer (FEB) before being presented to the screen and to the trigger program. Since it holds onto data longer during times of peak processing, the FEB may shorten or lengthen slightly the time interval between signal "events." Buffering will not necessarily affect timer measurements, however, since the FEB has a mechanism that recreates real time to an accuracy of ten microseconds for all time-related measurements that the unit performs.

The mechanism of time-recreation is the time tick, counted and encoded in the FEB and decoded during processing. Time ticks are encoded in recorded data whether in bit-image or character format. Very precise timing measurements are available for data in either format when it is played back.

Time ticks are enabled and their rate selected on the Front-End Buffer Setup screen. Figure 9-1 is an overview of this menu.

Time ticks may also be disabled on the FEB Setup screen. When they are turned off, timing measurements are always based on an internal "clock on the wall" that gives timings to the millisecond. During playback, such timings will be influenced by "local conditions" such as playback speed, idle suppression, etc.

NOTE: The "clock on the wall" is the timing mechanism used in other INTERVIEWs such as the COMSTATE series and the 4600, and many users will feel comfortable in turning time ticks off and relying on the wall clock for all normal operations.

9.1 Buffering Idle, Control Leads, and Ticks

Data bits are buffered automatically in the FEB. The buffering of other events—control leads, idle bits, and time ticks—can be enabled or disabled on the Front-End Buffer Setup menu.

Suppressing events in the FEB means intercepting them directly from the line so that they are not passed to the screen or to the program. Suppressing control leads means, for example, that neither EIA trigger conditions nor the data-plus-leads

display will be available in real time or playback. Suppressing idle means that idle characters are not displayed even when **Display Idle: ON** is selected on the Line Setup menu. Suppressing time ticks means that timers lose some precision, especially when recorded data is being played back. The advantage of these suppressions is that when the user does not care about EIA leads or idle characters or playback timings, he can dispense with them in order to save processing time and also memory space in RAM or on disk.

(A) Suppressing Idle

Idle characters from the line can be suppressed in the FEB before they consume valuable space in RAM and on disk. Figure 9-2 shows the selection subfields that allow suppression of separate idle characters for DTE and DCE, as, for example, when a host idles r_e while multidropped terminals are idling r_r . If **Idle Suppress: YES** is selected on the Front-End Buffer Setup screen, nothing can be done in the **Display Idle** field on the Line Setup menu to restore the lost idle characters.

Once recorded, idle characters are locked into the data. Since the hardware that suppresses idle is not on the playback path for disk data, the **Idle Suppress** selection on the FEB setup does not apply. You can still suppress idle from the display via the **Display Idle: OFF** selection on the Line Setup menu or the **Suppress** field on the Display Setup menu.

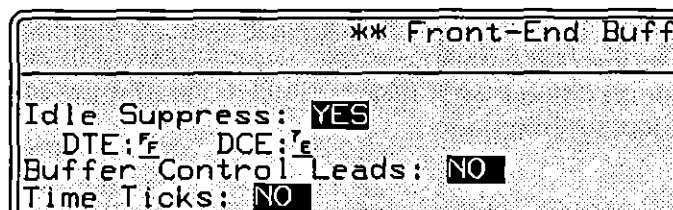

Figure 9-2 The FEB menu allows suppression of separate idle characters for DTE and DCE.

Although they are expensive to record, idle characters can be useful, chiefly to preserve idle time in between data transmissions when recorded data is sent to the screen display. Idle time also is preserved in time ticks if they are enabled; but while they do drive timers, these ticks do not drive the screen display. Figure 9-3 illustrates how idle time may be used to advantage on the screen.

In this figure, the data sample on the top was recorded with idle suppressed, the bottom sample with idle buffered. The time between **RTS on** and **CTS on** was the same in both samples, but only the display that included idle characters retains a picture of the handshake interval.

```

*MON/LINE*          BLK=          05/04/89 06:16
EBCDIC/8/NONE/SYNC/3,3
DATA:  A.A.05AE^4/P.1.AR^0K:INTERVIEW 7000 Series5=0//n.f.09//.f.l.05//l.n.05
RTS:  _____
CTS:  _____

```

```

*MON/LINE*          BLK=          05/04/89 06:30
EBCDIC/8/NONE/SYNC/3,3
DATA:  A.A.05AE^4/P.1.AR^0K:INTERVIEW 7000 Series5=0//n.f.09//.f.l.05//l.n.05
RTS:  _____
CTS:  _____

```

Figure 9-3 In the lower example, idle has *not* been suppressed in the FEB or in the line setup. Note that the interval between RTS on and CTS on is clearly preserved.

(B) Buffering Control Leads

The next field on the Front-End Buffer Setup screen is **Buffer Control Leads**: NO or YES. See Figure 9-4. Buffering control leads means that control-lead status will be available for data-plus-leads display and triggering. See Section 6.3(B) for a description of the data-plus leads display mode. Data-plus-leads will also be available during playback of bit-image or character data, whether or not this mode of display was used when the data was first recorded.

```

** Front-End B
Idle Suppress:  NO
Buffer Control Leads:  YES
Time Ticks:  OFF

```

Figure 9-4 Control-lead status, time ticks, and idle characters can be buffered or suppressed in the FEB.

During data recording, a **Buffer Control Leads**: YES selection means that control leads will be recorded with the data. Once control leads are recorded alongside *character* data, they are locked in. Since the FEB is not on the playback path for character data, FEB selections do not apply during playback. (See Figure 2-5.) *Bit-image* data, however, does pass through the FEB during playback. Except for the **Idle Suppress** field, FEB selections apply. This means that control leads *must* be enabled in order for the program logic to detect them.

This field does not affect the front-panel green-red LEDs, which are *always* active for line data and *never* active when recorded data is played back. (If the LEDs are active during playback, they are reflecting line activity and not the data that is being played back.)

(C) Time Ticks in Relation to Timer Units

Another field on the menu allows you to turn time ticks on or off. When **Time Ticks: ON** is selected, time values are incorporated *into the data itself* in the front-end buffer. As a result, internal time measurements such as programmable timer readings, **TIME**-column values on the protocol-trace screens, and so forth, will not be affected when recorded data is played back, even at varying speeds.

NOTE: Once time ticks are recorded alongside *character* data, they are locked in. Since the FEB is not on the playback path for character data, FEB selections do not apply during playback. (Refer again to Figure 2-5.) *Bit-image* data, however, does pass through the FEB during playback. Except for the **Idle Suppress** field, FEB selections apply. This means that time ticks *must* be enabled in order for the program logic to detect them.

If **Time Ticks: OFF** is selected, time values will not be incorporated into the data and timing measurements will always be based on an internal "wall" clock in the INTERVIEW that gives timings to the millisecond. During playback, such timings will be influenced by "local conditions" such as playback speed, idle suppression (on the Display Setup menu), etc.

When **Time Ticks: ON** is selected, a **Tick Rate** field appears just below it with six selections, **1SEC**, **100ms**, **10ms**, **1ms**, **100us**, and **10us**. Tick rate is the interval between ticks. This interval is the smallest unit of measurement attainable by the INTERVIEW's timers.

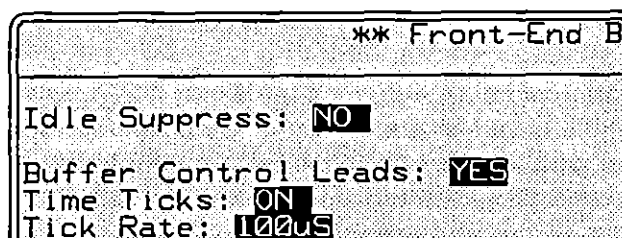

Figure 9-5 The user specifies the degree of timing precision when he selects the *tick rate*, the intervals at which time-ticks are stored with the data.

Ticks are indivisible. A Unit of time selected on a statistics screen should not be smaller than the tick rate on the FEB-setup screen. Figure 9-6 shows a mismatch between units on one screen and ticks on the other. Unit: **MILLI-SECS** is selected for a timer on the Tabular Statistics screen; but because the Tick Rate entry on the FEB-setup screen is **1SEC**, the timer will advance in units no smaller than one thousand milliseconds (or one second). **SECONDS** would have been a more appropriate unit for this timer.

** Tabular Statistics **						
NAME: 02	TYPE: TIGER		Units: MILLI-SECS		Unit	
Name	Current	Last	Minimum	Maximum	Average	MSECS
02						

** Front-End B

Idle Suppress: **NO**

Buffer Control Leads: **YES**

Time Ticks: **ON**

Tick Rate: **1SEC**

Figure 9-6 This is a mismatch: the Unit of time on the statistics screen should not be smaller than the tick rate on the FEB screen.

INTERVIEW 7000 Series Basic Operation: ATLC-107-951-100