

IS-488/LM-488C

Workstation

User's Manual



B000401045-02

This User Guide contains proprietary information of IIS, Ltd. and may not be reproduced in any form without prior written consent from IIS Ltd.

The manufacturer reserves the right to change specification without prior notice, in line with policy of constant product improvement.

2nd Edition April 1998

Preface

The IS-488 is a plug-compatible workstation, interchangeable with the IBM 3488 terminal. This workstation is directly attached using Twinax cable, to IBM SYS/3X, AS/400 or 5294/5394 Communication Controllers.

This manual provides detailed instructions for installing, configuring and operating the IS-488 Monochrome and LM-488C color workstation.

This User Guide is divided as follows:

- Chapter 1:** Features
 - Chapter 2:** Installation
 - Chapter 3:** Offline Setup
 - Chapter 4:** Online Setup
 - Chapter 5:** Entering Session
 - Chapter 6:** Record and Play Operation
 - Chapter 7:** Mouse and Editing Functions
 - Chapter 8:** Printing
 - Chapter 9:** Alice's Paperless Desk
 - Chapter 10:** Troubleshooting
-
- Appendix A:** Default Setup Values
 - Appendix B:** Printer Emulation Modes
 - Appendix C:** 5219 & 3812 Font Support
 - Appendix D:** Operator Messages and Error Codes
 - Appendix E:** Pin Assignments
 - Appendix F:** Keyboard Layouts
 - Appendix G:** Specifications

Warranty/Copyright/Trademarks

Copyright May 1998. All rights reserved. No part of this document may be reproduced without permission. The material contained in this document is for informational purposes only and is subject to change without notice. No responsibility is assumed for errors or omission which may appear in this document.

All product and company names mentioned in this manual are brand names or patented names of the respective companies.

Table of Contents

Preface	III
1. INTRODUCTION.....	1-1
1.1 Configuration	1-1
1.2 Capabilities.....	1-1
2. GETTING STARTED.....	2-1
2.1 Selecting A Location.....	2-1
2.2 Unpacking Instructions	2-1
2.3 Assembling the IS-488 Monochrome Workstation	2-2
2.4 Assembling the LM-488C Color Workstation	2-4
2.5 What to do Next ?.....	2-5
2.6 Connecting the Workstation to the Twinax Line	2-5
2.7 Workstation Maintenance.....	2-6
2.7.1 Cleaning the Workstation	2-6
2.7.2 Screen Saver Option	2-6
2.7.3 Power Saver.....	2-6
3. OFFLINE SETUP	3-1
3.1 Overview	3-1
3.1.1 Entering Offline Setup	3-1
3.1.2 OFFLINE Setup Function Keys and Indicators	3-2
3.2 Offline Customization Setup.....	3-2
3.2.1 Defining Sessions, Addresses and Modes.....	3-2
3.2.1.1 Display Sessions	3-3
3.2.1.2 Printer Sessions	3-3
3.2.1.3 Shared Addressing.....	3-3
3.2.1.4 Display Address 1 to 4.....	3-4
3.2.1.5 Printer Address.....	3-4
3.2.1.6 Character Set	3-4
3.2.1.7 Printer Emulation.....	3-4
3.2.2 ASCII Printer Model Type.....	3-5
3.2.2.1 Printer Model/Type	3-5
3.2.2.2 Symbol Code Page.....	3-6
3.2.3 Keyboard And Country	3-7
3.2.3.1 Keyboard Type	3-7

3.2.3.2 Country	3-7
3.2.4 ASCII Printer Type	3-8
3.2.4.1 ASCII Printer Type.....	3-8
3.2.4.2 Paste Start Position	3-8
3.2.5 Alternate Addresses for Display Sessions	3-9
3.2.5.1 Alternate addresses	3-9
3.2.6 Model ID and Alternate Addresses for the Printer Session	3-10
3.2.6.1 Model Id.....	3-10
3.2.6.2 Alternate Addresses	3-10
3.3 Serial Number	3-11
3.3.1.1 Plant of manufacture	3-11
3.3.1.2 Serial number	3-11
3.4 Test Menu	3-12
3.4.1 Set Factory Defaults.....	3-12
3.4.2 Record/Play Options	3-13
3.4.3 Display Attributes	3-13
3.4.4 Display Char Set	3-13
3.4.5 Display Version	3-14
3.4.6 Twinax Line Test	3-14
3.4.7 Keyboard Test.....	3-15
3.4.8 Printer Test.....	3-15
3.4.9 Monitor Test	3-16
3.4.10 Scroll Test	3-17
3.4.11 Mouse Test (for PS/2 mouse)	3-17
3.4.12 Keyboard Mapper.....	3-17

4. ONLINE SETUP MENU 4-1

4.1 Overview	4-1
4.1.1 Entering Online setup menu.....	4-1
4.1.2 ONLINE Setup Function Keys and Indicators	4-2
4.2 Setup Display	4-3
4.2.1 Setup Display Screen-1.....	4-3
4.2.1.1 Alarm Volume	4-3
4.2.1.2 Cursor.....	4-3
4.2.1.3 Row/Column Indicator	4-4
4.2.1.4 Rule Line	4-4
4.2.1.5 Auto Dim.....	4-4
4.2.1.6 Enable Keyboard Mapper.....	4-4

4.2.2 Setup Display Screen-2.....	4-5
4.2.2.1 Extended Display.....	4-5
4.2.2.2 Split Screen	4-5
4.2.2.3 Buzzer Time	4-5
4.2.2.4 Separator.....	4-5
4.2.2.5 Column Sep.....	4-5
4.2.2.6 Reverse Image	4-5
4.2.3 Setup Display Screen-3.....	4-6
4.2.3.1 Local Tabs	4-6
4.2.3.2 Type Ahead	4-6
4.2.3.3 Message Wait.....	4-6
4.2.3.4 Dual 132	4-6
4.2.3.5 Local Cut and Paste	4-6
4.2.3.5 and Paste	4-7
4.2.4 Setup Display Screen-4.....	4-8
4.2.4.1 Lock Sessions Password	4-8
4.3 Browse Display Information.....	4-9
4.4 Setup Printer	4-10
4.4.1 Setup Printer Screen-1	4-10
4.4.1.1 Lines per Inch.....	4-10
4.4.1.2 Characters Per Inch.....	4-10
4.4.1.3 Print Quality	4-10
4.4.1.4 Printer Key Function	4-11
4.4.2 Setup Printer Screen-2 (5219 & 3812 Emulations Only).....	4-11
4.4.2.1 Type Style.....	4-11
4.4.2.2 System Code Page.....	4-11
4.4.2.3 Paper Feed.....	4-12
4.4.2.4 Source Drawer.....	4-12
4.4.2.5 Form	4-12
4.4.2.6 Attention	4-12
4.4.3 Setup Printer Screen-3 (for 3812 Emulation only).....	4-13
4.4.3.1 Default Orientation:.....	4-13
4.4.3.2 Paper:	4-13
4.4.3.3 Automatic Orientation:	4-13
4.4.4 Setup Printer Screen-4.....	4-14
4.4.4.1 Print Key	4-14

4.4.4.2 Local Form Feed	4-14
4.4.4.3 Local Condensed	4-14
4.4.4.4 Buffer Print	4-14
4.4.4.5 Hex Print.....	4-15
4.4.5 Screen Print Setup	4-15
4.4.5.1 Lines Per Inch	4-15
4.4.5.2 Characters Per Inch	4-15
4.4.5.3 Print Quality	4-15
4.4.5.4 6.12.4 Source Drawer	4-15
4.4.5.5 Form Length In Inches	4-15
4.4.5.5 Inches	4-16
4.4.5.6 Form Length In Millimeters	4-16
4.4.5.7 First Print Line	4-16
4.4.5.8 Print First Column.....	4-16
4.5 Browse Printer Information.....	4-17
4.5.1.1 Example	4-18
4.6 Setup Input Devices	4-19
4.6.1 Setup Input Devices Screen-1.....	4-19
4.6.1.1 Clicker	4-19
4.6.1.2 Keyboard Typematic.....	4-19
4.6.1.3 Mouse Speed	4-19
4.6.1.4 Mouse Double Click	4-20
4.6.2 Setup Input Devices Screen-2.....	4-20
4.6.2.1 Mouse Primary Button	4-20
4.7 Calculator Setup.....	4-21
4.7.1.1 Decimal Point	4-21
4.8 Lock Sessions	4-21
4.9 Setup Color	4-22
4.9.1 Customizing the Foreground and Background Color Palettes	4-23

5. ENTERING SESSIONS.....	5-1
5.1 Split Screen Description	5-1
5.1.1 Status Line Description	5-2
5.1.2 Scrolling and the Divider Bar.....	5-2
5.1.3 Mouse Functions	5-3
6. RECORD AND PLAY OPERATION	6-1
6.1 Record Play Operation	6-1
6.1.1 Recording a Sequence.....	6-1
6.1.2 Displaying a Recorded Sequence.....	6-2
6.1.3 Deleting Recorded Key Sequences	6-2
6.1.4 Pause Feature.....	6-2
6.2 Play Mode Procedure.....	6-3
6.3 Record/Play Limitation Keys	6-3
7. MOUSE AND EDITING FUNCTIONS	7-1
7.1 Copy and Paste.....	7-1
7.1.1 Copying and Pasting a Character String.....	7-1
7.2 Using the TAB Key	7-2
7.2.1 To Enter the TAB Setup Panel	7-2
7.2.2 Hot Spot Highlighting Using the Mouse.....	7-3
7.2.3 Automatic Cursor Position.....	7-3
8. PRINTING	8-1
8.1 Bypass Feature	8-1
8.2 Gate Feature	8-1
8.3 Bypass Table.....	8-2
8.3.1 Example - 1: Using the Bypass Feature.....	8-3
8.3.2 Example 2- Using the Gate Feature.....	8-3
8.4 Printer Control Editor.....	8-3
8.5 Printer EBCDIC to ASCII Translation Table	8-6
8.6 LOCAL PRINT FEATURE	8-7
8.6.1 To Perform a Local Print	8-7
8.6.2 Trim Area.....	8-7
8.7 Printer Status Symbols on Status Line.....	8-8

9. ALICE'S PAPERLESS DESK.....	9-1
9.1 Alice Main Menu.....	9-1
9.2 Telephone Directory.....	9-2
9.3 Alarm Calendar.....	9-3
9.4 Character Set Screen.....	9-4
9.5 Alarm Clock.....	9-5
9.5.1 Play Command.....	9-6
9.6 Alice's Setup.....	9-6
9.7 Calculator.....	9-8
9.7.1 Calculator Help screen.....	9-8
9.7.2 Calculator Operation.....	9-9
9.7.2.1 Editing Keys.....	9-10
9.8 Note Pad.....	9-11
9.8.1 Editing Functions.....	9-11
9.8.2 Word Wrap and Justification Feature.....	9-12
9.8.3 Status Line.....	9-12
9.8.4 Editing Blocks.....	9-13
10. TROUBLESHOOTING.....	10-1
10.1 Blank Display.....	10-1
10.2 Unstable Display.....	10-2
10.3 Communication Failure.....	10-3
10.4 Communications Problems:.....	10-4
10.4.1 General Troubleshooting: Disturbances, Communication Failure.....	10-4
10.4.2 Keyboard Produces Incorrect Characters for Some of the Keys.....	10-4
10.5 Printer Problems.....	10-5

APPENDIX.A DEFAULT SETUP VALUES A-1

Offline Setup Default A-1
Online Setup Defaults A-2
 Setup Display A-2
 Setup Host-Addressable Printer A-2
 Setup Printer A-2
 Screen Print Setup A-3
 Setup Input Devices A-3
 Setup Calculator A-3
 If 5219/3812 Emulation is Selected A-3
 If 3812 Emulation is Selected A-4

Appendix B. PRINTER EMULATION MODES B-1

Printer Emulation Table B-1
Printer Character Sets B-4
Code Page 500, Multinational B-4
Printable Characters B-12
Differences Which Apply to All Emulations B-20
Differences From IBM 5256 Operation B-21
Differences From IBM 4214 Operation B-21
Differences From IBM 5219 Operation B-21
Differences From IBM 3812 Operation B-21

Appendix C. 5219 & 3812 FONT SUPPORT C-1

Adobe PostScript C-1
Canon LBP-4, LBP-8 and CaPSL C-4
Canon Bubble Jet BJ-300 and BJ-330 C-6
Epson LQ-850, LQ-1050, LQ-2550, LQ Series C-6
Epson LQ-870, LQ-1170, LQ-570, LQ-1070, LQ ESC/P2 C-9
Epson FX-286e, FX-86e C-10
Epson FX-850, FX-1050 C-10
Epson LQ-1500 C-10
HP Deskjet 500 and 500C C-11
Laserjet II, Offset Positioning C-11
HP LaserJet II & LaserJet III C-12
HP RuggedWriter 480, PCL C-19
IBM Personal Printer Data Stream (PPDS) C-21
IBM 5204 Quickwriter, 5202 Quitewriter III C-22
IBM 4019 LaserPRinter, LaserPrinter E, PPDS C-22

IBM Personal Printer Series II 2380 and 2381	C-22
IBM Personal Printer Series II 2390 and 2391	C-22
IBM ExecJet 4072	C-22
Pinwriter P9300, P6200/P6300 and P3200/P3300	C-23
NEC Pinwriter P5, P6 and P7	C-23
Okidata Microline 383C+ and 393+, ML 390+ and 391+, ML 380.....	C-23
Okidata Microline 320 and 321.....	C-23
Panasonic KX-P1624 and KX-P1124.....	C-24
Panasonic KX-P1695	C-24
Star Micronics XR-1020 Multi-Font, XR-1520 Multi-Font	C-24
Toshiba and Expresswriter.....	C-24

Appendix D. OPERATOR MESSAGES AND ERROR CODES..... D-1

Operator Messages.....	D-1
Error Codes.....	D-3

Appendix E. PIN ASSIGNMENTS..... E-1

DB-9 Connector.....	E-1
Parallel Interface	E-2
DB-15 Connector.....	E-3
Keyboard DIN Connector	E-4
PS/2 Mouse Connector	E-5

Appendix F. KEYBOARD LAYOUTS F-1

Appendix G. SPECIFICATIONSG-1

1. INTRODUCTION

The Model IS-488/LM-488C workstation is plug compatible and interchangeable with the IBM 3487 and IBM 3488 terminals. The logic box can be connected to any standard color SVGA monitor. The workstation can enable various terminal and printer emulation modes.

It is capable of supporting four displays sessions (two of which can be displayed simultaneously on the screen), and an additional printer session. The printer directly connected to the display station performs as a host printer.

Alice's Paperless Desk is an application that is integrated into the workstation and provides convenient on-line office services that save time and desk space. Among the services offered are: telephone directory, calendar, character set table calculator and notepad.

1.1 Configuration

IS-488	14" Monochrome display supplied with the workstation
LM-488C	Logic Box that can be connected to any standard color SVGA monitor.

1.2 Capabilities

Session Display Supports up to four sessions, two of which may be displayed either simultaneously (with a vertical or horizontal split), or alternately on a full screen. Only one session may be active at a time.

Screen Modes Supports up to five screen modes including status line ;

- 24 x 80
- 32 x 80
- 43 x 80
- 49 x 80
- 27 x 132

Address Sharing A single address may be shared by all the display sessions, allowing you to reserve addresses for other displays or printers on the same port.

Enhanced User Interface	<p>Enhanced user interface with special symbols that can be manipulated.</p> <p>Mouse Copy and Paste editing functions</p>
PS2 Mouse Support	<p>Hot Spots highlighting, setup and various local functions like Zoom and Jump.</p>
Power Saver	<p>When the display is not in use, its power consumption is automatically reduced.</p>
Record/Play/Pause	<p>Allows you to store up to 4000 commonly used keystrokes in nonvolatile memory for playback at any time.</p> <p>Use the Pause key to stop the record or playback and temporarily resume normal operations.</p>
Password Security	<p>Allows you to lock sessions using a user defined password, and prevent unauthorized use of the display.</p>
PC Keyboard	<p>Plug-and-play PC keyboard support.</p>
Keyboard Mapper	<p>Allows you to reassign a key function to another key.</p>
Printer Capabilities	<p>Printer Session</p> <ul style="list-style-type: none">• Printer Emulation 5256, 4214, 5219 and 3812 SCS.• The 3812 SCS emulation includes the support for the Computer-Output Reduction (COR) function <p>ASCII Printer Model / Type Supports up to 40 ASCII printer Models / Types and HPLJ4.</p> <p>Printer Symbol Code Page ASCII, 437, ECMA-93, 850, Roman-8, DLIBM, DL Epson-9.</p> <p>Printer Definition Table Download (PDT) Enables printer customization by creating a PDT using AS/400 Workstation Customization Utility, and downloading it to the display.</p> <p>Printer Commands Control Editor Allows you to edit ASCII printer control commands such as lines</p>

and characters per inch.

Printer ASCII Table Editor

Allows you to change the printer EBCDIC to ASCII translation table and print some special characters.

Printer Bypass Table

Allows the host application to transparently send controls commands to the attached ASCII printer, and enables special printer features such as bar-code.

Gate Table

The Gate feature is similar to Bypass feature, however, it provides the capability to use unlimited number of printer codes.

**Colored Terminals
Capabilities**

Supported colors

The LM-488C supports up to 16 colors, that can be chosen from a 64 color palette.

Any one of the palette colors may be assigned to the sessions background, screen border, mouse pointer and ruler.

2. GETTING STARTED

The IS-488 installation is designed to be simple and fast. Follow the instructions given below for selecting a location, unpacking and installing the workstation.

2.1 Selecting A Location

- a. The area should be clean, free from shock and vibrations, extreme temperatures and high humidity.
- b. The workstation should be placed on a flat surface.
- c. The site should include a wall socket, incoming and outgoing Twinax cable (for additional workstations on the line).
- d. Sufficient space should be left at the back of the workstation to allow free access to the connected cables.
- e. The workstation should be connected directly to the wall socket, and not via an extension cable.
- f. Make sure that the power source is +/-10% of rated power (either 115 or 220 VAC) and the frequency is 50/60 Hz +/- 2 Hz.

2.2 Unpacking Instructions

Before opening the shipping package or the protective case, check to make sure that there is no visible external damage. If any such damage was incurred contact your distributor before opening the package.

Make sure that the following items have been included:

1. Keyboard: 122 or 102/103 keyboard
2. PS/2 mouse (option)
3. T-cable
4. Power cord
5. User's Manual
6. **For IS-488 :** Display Monitor and base with integrated Electronic Logic Board
7. **For LM-488C:** Electronic Box.

2.3 Assembling the IS-488 Monochrome Workstation

To setup for the 14-inch monochrome monitor, DSM 1426, perform the following series of steps:

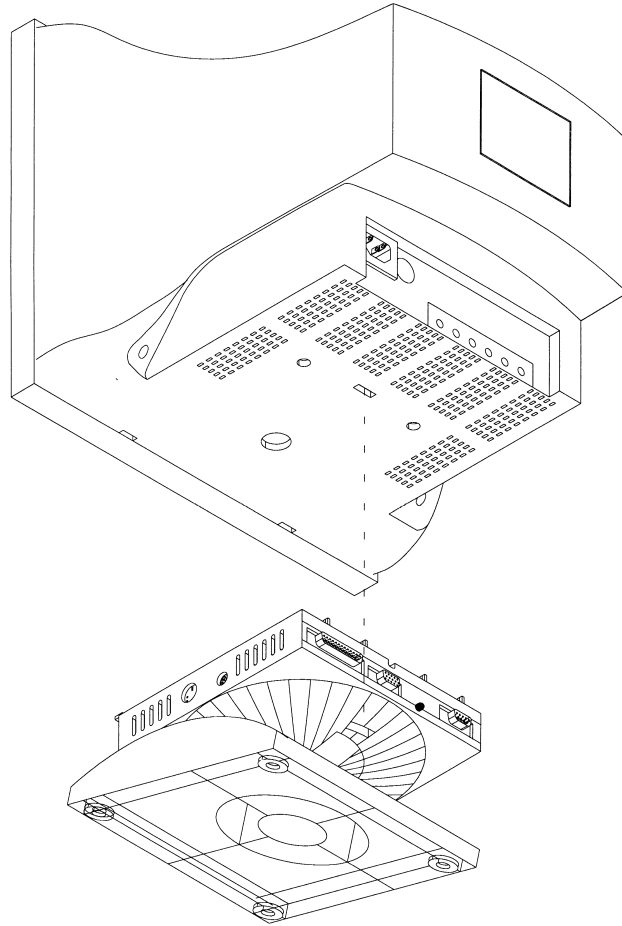

1. Place the monitor upside down on a flat surface.
2. Align the base with the slots in the underside of the and insert the Tilt/Swivel Base into the slots. Refer to the above figure.
3. Pull the Tilt/Swivel Base toward the front of the display until the hook clicks into the slot.

NOTE: To disconnect the base from the monitor, insert a screwdriver into the slot marked with an arrow in the above diagram, and depress the hook towards the front of the monitor.

4. Turn the assembled unit rightside up and connect the cables according to the following illustration:

1. Set the power switch on the monitor to OFF.
2. Face the back of the workstation.
3. Connect the keyboard cable to the keyboard port.
4. If a printer is to be installed, connect the printer cable to the printer port.
5. Connect the mouse (**option**) cable to the mouse port.
6. Connect the monitor interface cable to the monitor connector.
7. Connect the power cable between the rear of the monitor and power outlet.

2.4 Assembling the LM-488C Color Workstation

An LM-488C workstation includes an SVGA color monitor which is assembled according to the manufacturer's instructions.

NOTE: On an LM-488C workstation, the monitor power switch turns on the workstation.

1. Set the power switch to OFF.
2. Face the back of the workstation.
3. Connect the keyboard cable to the keyboard port.
4. If a printer is to be installed, connect the printer cable to the printer port.
5. Connect the mouse (**option**) cable to the mouse port.
6. Connect the monitor interface cable to the monitor connector in the box.
7. Connect the one power cable between the rear of the box and power outlet and the other between the rear of the monitor and the power outlet.

2.5 What to do Next ?

1. Power-ON the workstation.
2. Perform the OFFLINE setup (chapter-3).
3. Power-OFF the workstation and connect the Twinax cable (section 2.6).

2.6 Connecting the Workstation to the Twinax Line

The following steps show how to connect the workstation to the Twinax line:

CAUTION!!!

To avoid electrical shock, turn off the workstation and unplug it from the wall socket before you connect it to the Twinaxial line.

1. Make sure there are no users working on the specific line you are going to connect.
2. Connect the T cable to the appropriate connector on the rear of the workstation. Secure the T cable with two screws.
3. Connect the incoming cable to one of the sockets on the T cable. Connect the outgoing cable (if one exists) to the other socket.
4. If twisted pair cabling is used, then attach an RJ45 connector to the Twinax adapter and attach the adapter to one of the sockets on the T cable. Do not connect an adapter or Twinax cable to the other T-cable socket.

NOTE: The cable is equipped with a built-in terminator. This eliminates the need for a special terminator part for the last terminal on the line.

5. Connect the workstation to the power outlet.
6. Power on the workstation and wait until "SIGN ON SCREEN" appears on the display. If the screen does not appear, refer to Troubleshooting (Chapter-11).
7. Perform the ONLINE setup (chapter-4).

2.7 Workstation Maintenance

Regular cleaning and maintenance procedures are required to keep your workstation in good operating condition. It is recommended to clean the workstation regularly and make use of the screen saving options.

2.7.1 Cleaning the Workstation

Clean the screen surface with a soft, lint-free cloth, dampened with an ammonia or alcohol-based glass cleaner.

Alternatively, use a mild detergent solution in water as a glass cleaner, then wipe with a water-dampened cloth.

ATTENTION!!

Avoid the use of petroleum-based cleaners.

2.7.2 Screen Saver Option

The option is enabled in the Setup display of the Online Setup. Enabling this option prolongs CRT life.

It causes the screen to dim automatically if for a preset time (5 to 20 minutes), no key is pressed or there is no host command input. An indicator will appear on the status line indicating that the screen has been dimmed. To display is restored when a key is pressed.

2.7.3 Power Saver

This is a built-in function to save power. If the workstation is ON and not active (i.e. no keyboard or host input) for more than two hours the screen dims indicating that the power saver function is enabled.

Power consumption is reduced by up to 50% and emission of radiation from the workstation is also greatly reduced.

The green LED on the front of the workstation turns to orange. When a key is pressed, the optional mouse is moved or data is received from the host, the workstation automatically returns to normal, full power operation. Existing data on the screen remains untouched.

3. OFFLINE SETUP

Offline setup allows you to configure the following: number of sessions and their addresses, display character set, printer address and emulation, type of ASCII printer, printer symbol code page and workstation language. In addition, the offline setup defines the display sessions model ID and alternate addresses.

The default parameters for all the offline setup screens are given in Appendix-A.

IMPORTANT !!!
Perform the offline setup *before* connecting the workstation to the Twinax line.

3.1 Overview

3.1.1 Entering Offline Setup

1. Power-on the workstation (turn the switch on the electronics box ON) and *keep the Spacebar pressed* during initialization.
2. An indicator light (on the monitor or box depending on the type of workstation) will be turned on and within a few seconds the Offline Setup screen will be displayed:

Offline Setup	More+
Move cursor to desired selection and press ENTER.	
Customize Workstation Update Serial Number Test Workstation	
F3=Exit	Version xxxx
SETUP	

Parameter Definitions:

Customize Workstation	Provides access to screens for configuring the number of sessions, their type and addresses, in addition to defining the character sets and language definitions.
Update Serial Number	Enables you to set the workstation serial number.
Test workstation	Provides test screens for testing functions for system devices (keyboard or mouse, monitor).

3.1.2 OFFLINE Setup Function Keys and Indicators

Key or indicator	Description
F7	Page backward
F8	Page forward
F3	Save changes and exit to the Offline Main setup screen.
More+ indicator on the top right corner.	Additional configuration screens for that option.
More- indicator on the top right corner.	Last configuration screen for that option.
To define a parameter	Place the cursor on the desired value and press the Spacebar. The defined parameter value will be highlighted.
Exiting Offline Setup Mode	Press F3

3.2 Offline Customization Setup

3.2.1 Defining Sessions, Addresses and Modes

The workstation supports up to four sessions and an additional printer session. You may assign each session a unique address, or select one address to be shared by *all* the defined sessions (not including the printer).

To enter the screen

From the Offline Setup menu, select Customize Workstation and press Enter. The following screen will appear.

Customization				More+		
Move cursor to desired selection and press SPACEBAR to select.						
Display Sessions.....	1	2	3	4		
Printer Sessions	Yes	No				
Shared Addressing	Yes	No				
Display Address 1	0	1	2	3	4	5 6
Display Address 2	0	1	2	3	4	5 6
Display Address 3	0	1	2	3	4	5 6
Display Address 4	0	1	2	3	4	5 6
Character Set	Country Specific				Multinational	
Printer Address.....	0	1	2	3	4	5 6
Printer Emulation	5256	5214	5219	3812		
F3=Exit	F8=Forward	T=ASCII	B=Bypass			
SETUP						

This screen allows you to define the number of sessions, session addresses and character sets. In addition, the printer session is enabled and defined in this screen. Enabling the printer sessions option, displays the printer related parameters such as *emulation type* and *address*.

The various options are described in the following sub-sections.

3.2.1.1 Display Sessions	<p>Sets the Number of Display Sessions supported by the workstation.</p> <p>Value = 1 to 4</p>
3.2.1.2 Printer Sessions	<p>Enables a printer session. The printer is directly connected to the display station and acts as a host printer.</p> <p>Enabling this parameter (Yes), activates the <i>printer address</i> and <i>Printer emulation mode</i> which must be defined as well.</p> <p>In addition, you may access the Printer EBCIDIC to ASCII translation table by pressing T, and the Bypass Table by pressing B. These functions are described in chapter 6.</p> <p>A “Help” screen is provided by pressing Help while displaying either EBCIDIC or Bypass screen.</p>
3.2.1.3 Shared Addressing	<p>Each of the assigned terminal addresses may be defined as a <i>shared</i> address and used by all the terminal sessions. Sessions sharing a single address are independent of each other. The host and application must support shared addressing for this function to work.</p> <p>Device addresses should be provided by the System Manager.</p> <p>Set the parameter to No, for multiple sessions where the host system or controller will communicate with the workstation as if two/three independent workstations are attached.</p>

3.2.1.4 Display Address 1 to 4	<p>The unique host connection address for each defined display station 1 to 4 (depending on the number of enabled sessions).</p> <p>The address is defined as 'occupied' by an 'asterisk' to all other sessions addresses including that of the printer.</p> <p>A maximum of 7 addresses are available per port, enabling the user to connect sessions of more than one display station to a port. Up the 28 sessions can be assigned to each port when shared addressing is enabled.</p>
3.2.1.5 Printer Address	<p>The unique host connection address for the printer.</p> <p>The address is defined as 'occupied' by an 'asterisk' to all other sessions addresses including that of the printer.</p> <p>Value: 0 to 7</p>
3.2.1.6 Character Set	<p>The character set used by the workstation.</p> <p>Multinational: A standard set of multinational characters.</p> <p>Country Specific: A character set specific for your country. The character set and language used on your workstation, is selected in the Country Specific screen.</p>
3.2.1.7 Printer Emulation	<p>Four Printer Emulation options are available: 5256; 4214; 5219; 3812</p> <p>Refer to the tables in Appendix-B to select the appropriate printer emulation (listed in descending order of preference).</p>

3.2.2 ASCII Printer Model Type

This screen enables you to define the printer emulation mode and character code.

To enter the screen

From the **Offline Setup** menu, select **Customize Workstation** and page forward until the following screen is displayed.

Customization			
Move cursor to desired choice, then press SPACE BAR to select.			
Printer Model/Type			
Nulldriver	Other	Postscript	Canon LBP
Canon-BJ330	Diablo-630	Epson-JX80	Epson-FX286
Epson-FX1050	Epson-LQ1500	Epson-LQ1000	Epson-LQ2550
Epson-LQ1170	HP-Thinkjet	HP-RugWtr	HP-Deskjet500
HP-LaserjetII	HP-LJ2-Offset	HP-Laserjet3/4/5	IBM-PcGr-5150
IBM-ProXL	IBM-XL24-4207/8	IBM-Quickwtr-5204	IBM-4019
IBM-2381	IBM-2391	IBM-4072	IBM-PPDS
Ithaca-PcOS-S.50	NEC-P5/6/7	NEC-P9300	OKI293
OKI321S	OKI 393M	Panasonic-1624	Panasonic-1695
Qume-S-11P	Star 1520	Toshiba-3X1S	Boca
Symbol Code Page			
ASCII	437	ECMA-94	Roman-8
850	DL-IBM-Pro-9	DL-Epson-9	
F3=Save and Exit	F7=Backward	F8=Forward	E=Editor
SETUP			

Define the parameters according to the explanations given below.

3.2.2.1 Printer Model/Type

Type of printer or printer emulation.

Other: Select *Other* if your printer is not listed above.

When *Other* is selected as *Printer Type* and the key **E** is pressed, a **Printer Control Editor** screen is displayed where the printout can be customized (LPI, CPI etc.).

Refer to chapter 6 for a detailed explanation.

3.2.2.2 Symbol Code Page

Defines the printer character set as follows:

ASCII 7-bit character set.

437 Also referred to as IBM Character Set 2.

ECMA-94 European Standard.

850 IBM Standard providing the complete range of accented alpha characters required for international language support.

Roman-8 Hewlett-Packard Roman 8 character set with Roman 8 symbol extension.

DL-IBM Character set downloaded to the Proprinter printer by the workstation via the escape strings which are specifically formatted for the Proprinter XL. These escape strings set up the dot patterns for the character set. The set formed in this way is equivalent to the 850 set.

DL Epson 9 Downloaded to the printer by the workstation via escape strings which are specifically formatted for the Epson FX series of printers. The set formed in this way is equivalent to the 850 set.

3.2.3 Keyboard And Country

This screen enables you to define the type of keyboard and language used on the workstation.

To enter the screen

Select **Customize Workstation** from the **Offline Setup** menu and page forward until the following screen is displayed.

Customization		More:+	
Move cursor to desired choice, then press SPACE BAR to select.			
Keyboard Type	Standard	User Defined	
Keyboard ID	00 01 02 03 04 05 06 07 08 09		
	10 11 12 13 14 15 16 17 18 19		
	20 21 22 23 24 25 26 27 28 29		
	30 31 32 33 34 35 36 37 38 39		
	40 41 42 43 44 45 46 47 48 49		
	50 51 52 53 54 55 56 57 58 59		
	60 61 62 63		
Country	Belgium	Denmark	Finland/Sweden
	France	Germany/Austria	Greece
	Holland	Iceland	Italy
	Norway	Portugal-037	Portugal-282
	Spain	Spain, L/A	Swiss(France)
	Swiss (Germany)	Turkey-905	UK
	US/Canada	Turkey-1026	France/Canada
	Latin2	Poland	Hungary
F3=Save and Exit	F8=Forward	F7=Backward	
SETUP			

3.2.3.1 Keyboard Type

Type of keyboard installed on the workstation.

Standard keyboard: Assigns a standard keyboard configuration.

User Defined: Selecting this option enables the Keyboard ID options from which you can select the keyboard.

Keyboard ID: A number representing a user defined keyboard.

3.2.3.2 Country

Defines the language in which the workstation screens are displayed.

3.2.4 ASCII Printer Type

This screen allows you to define either a standard ASCII printer type or a user defined printer. In addition this screen defines the start position corresponding to the *Paste* command.

To enter the screen

Select **Customize Workstation** from the **Offline Setup** menu and page forward until the following screen is displayed.

Customization		More:+
Move cursor to desired choice, then press SPACE BAR to select.		
ASCII Printer Type.....	Standard	User Defined
ASCII Printer ID.....	00 01 02 03 04 05 06 07 08 09 10 11 12 13 14 15 16 17 18 19 20 21 22 23 24 25 26 27 28 29 30 31 32 33 34 35 36 37 38 39 40 41 42 43 44 45 46 47 48 49 50 51 52 53 54 55 56 57 58 59 60 61 62 63 64 65 66 67 68 69 70 71 72 73 74 75 76 77 78 79 80 81 82 83 84 85 86 87 88 89 90 91 92 93 94 95 96 97 98 99	
Paste Start Position	Text Cursor	Mouse Pointer
F3=Save and Exit F8=Forward F7=Backward		
SETUP		

3.2.4.1 ASCII Printer Type

Defines the type of printer connected to the workstation.

Standard: A standard printer

User Defined: Enables the selection of an ASCII Printer ID for downloading a PDT (Printer Definition Table) identified by the selected ASCII printer ID from the AS/400. Your System Manager can help select the correct option.

ASCII Printer ID: This field represents the ID of a PDT downloaded from the AS/400.

3.2.4.2 Paste Start Position

This option defines the starting position where copied data will be pasted (chapter-8).

Text cursor: Pastes the data according to the position of the Text Cursor.

Mouse Pointer: Pastes the data according to the position of the Mouse Pointer.

3.2.5 Alternate Addresses for Display Sessions

This screen enables you to define the alternate addresses for each session.

To enter this screen

Select **Customize Workstation** from the **Offline setup** menu, and page forward until the following screen is displayed.

CUSTOMIZATION								More+
Move cursor to desired selection and press SPACEBAR to select.								
Alternate addresses for Session 1								
Alt Address 1.....	0	1	2	3	4	5	6	No
Alt Address 2.....	0	1	2	3	4	5	6	No
Alt Address 3.....	0	1	2	3	4	5	6	No
Alt Address 4.....	0	1	2	3	4	5	6	No
Alternate addresses for Session 2								
Alt Address 1.....	0	1	2	3	4	5	6	No
Alt Address 2.....	0	1	2	3	4	5	6	No
Alt Address 3.....	0	1	2	3	4	5	6	No
Alt Address 4.....	0	1	2	3	4	5	6	No
Alternate addresses for Session 3								
Alt Address 1.....	0	1	2	3	4	5	6	No
Alt Address 2.....	0	1	2	3	4	5	6	No
Alt Address 3.....	0	1	2	3	4	5	6	No
Alt Address 4.....	0	1	2	3	4	5	6	No
F3=Save and Exit F7=Backward								
SETUP								

3.2.5.1 Alternate addresses

After power up, the Workstation will test the line to check for busy addresses.

If the address defined in Setup is occupied by another workstation, this terminal will set the station address to the first "not busy" address from the *alternate list*.

If all alternate addresses are busy, a message will be displayed and the session will go offline.

3.2.6 Model ID and Alternate Addresses for the Printer Session

This screen enables you to define the Model ID and alternate address for the printer session and for display session-4.

To enter this screen

Select **Customize Workstation** from the **Offline setup** menu, and page forward until the following screen is displayed.

NOTE: This is the last screen in the Customization menu. Press F3 to return to the Main offline setup menu where you may select the next option.

Customization	More-					
Move cursor to desired selection and press SPACEBAR to select.						
Model ID	3487	3197C	3197D	3180	5291	
Alternate addresses for Session 4						
Alt Address 1	0	1	2	3	4	5 6 No
Alt Address 2	0	1	2	3	4	5 6 No
Alt Address 3	0	1	2	3	4	5 6 No
Alt Address 4	0	1	2	3	4	5 6 No
Alternate Addresses for Printer						
Alt Address 1	0	1	2	3	4	5 6 No
Alt Address 2	0	1	2	3	4	5 6 No
Alt Address 3	0	1	2	3	4	5 6 No
Alt Address 4	0	1	2	3	4	5 6 No
F3=Exit		F8=Forward				
SETUP						

3.2.6.1 Model Id

If connected to:

AS/400
System 36;
System 38;

Define the workstation as:

3487, 3197C, 3197D, 3180, 5291
3197C, 3197D, 3180, 5291
3180, 5291

NOTE: Select 5291 if the workstation is connected to an old controller since these support only Model ID 5291 and a 122-key keyboards.

3.2.6.2 Alternate Addresses

Up to four alternate addresses can be defined for display sessions and the printer.

Selecting *No* disables this function.

3.3 Serial Number

This screen allows you to enter the number used for network control, workstation manufacturing plant and the machine serial number printed on the label located at the underside of the Logic Box.

To enter this screen

Select **Update Serial Number** from the **Offline setup** menu, press enter.

Serial Number	
Move cursor to desired choice, then press SPACE BAR to select.	
	1 2 3 4 5 6 7 8 9
Machine Serial	00 0000000
Plant of Manufacture	
First position	0123456789ABCDEFGHIJKLMNOPQRSTUVWXYZ
Second position	0123456789ABCDEFGHIJKLMNOPQRSTUVWXYZ
Serial Number	
Third position	0123456789ABCDEFGHIJKLMNOPQRSTUVWXYZ
Fourth position	0123456789ABCDEFGHIJKLMNOPQRSTUVWXYZ
Fifth position	0123456789ABCDEFGHIJKLMNOPQRSTUVWXYZ
Sixth position	0123456789ABCDEFGHIJKLMNOPQRSTUVWXYZ
Seventh position	0123456789ABCDEFGHIJKLMNOPQRSTUVWXYZ
Eighth position	0123456789ABCDEFGHIJKLMNOPQRSTUVWXYZ
Ninth position	0123456789ABCDEFGHIJKLMNOPQRSTUVWXYZ
F3=Save and Exit	
SETUP	

3.3.1.1 Plant of manufacture	Select a character from each row. The corresponding characters will be highlighted in the Machine Serial field.
3.3.1.2 Serial number	This is the number used for network control. Select a character from each row. The corresponding characters will be highlighted above the Machine Serial field.

3.4 Test Menu

This menu is used for testing various options and resetting to factory defined values.

To enter this screen

Select **Test Workstation** from the **Offline setup** menu and press enter. The following screen will be displayed. Select and enter each option to be tested.

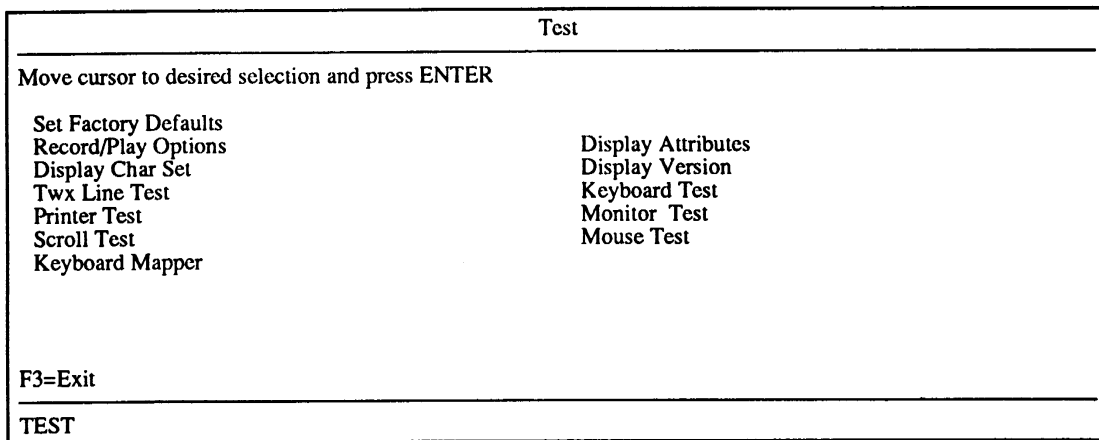

NOTE: You may set the Factory Defaults and the Record/Play options. It is recommended that all the other test options are used only by service personnel.

3.4.1 Set Factory Defaults

This screen enables you to reset or clear the following parameters: Addresses, system printer emulation, printer model/type, code page, display language, keyboard mapper, as well as gate codes, bypass codes and record/play keys.

1. Press **Enter**. Respond with **Yes** to the verification message “Are you sure (Y/N)?”
2. The message “Restoring Factory Defaults, Please Wait.”, will be displayed.

3.4.2 Record/Play Options

The **Record/Play Options** panel with the following three options will be displayed:

R0 - The full record/Play function is available.

R1 - Non display input is prohibited.

R2 - The Record/Play function is disabled.*

***IMPORTANT!! If you select R2, the Record/Play option can only be re-enabled by a company representative.**

The Record/Play function is fully described in Chapter-6.

3.4.3 Display Attributes

The Attribute screen will display.

The following six attributes are shown on screen:

For monochrome monitors: NORMAL; COLUMN SEP; REVERSE; BLINK; HIGH INTENS;
UNDERScore

For color monitors: Seven color attributes.

3.4.4 Display Char Set

This option enables you to display the character sets for all the following models:

- 80 columns x 25 rows
- 80 columns x 33 rows
- 80 columns x 44 rows
- 132 columns x 28 rows
- 80 columns x 50 rows

To display the character set

1. Select **Display Char Set** from the Test menu.
2. Press Enter to display the first character set, and the Spacebar to view other sets.
3. Press F3 to exit to the Test menu.

3.4.5 Display Version

This screen displays the workstation version.

1. Select **Display Version** from the Test menu.
2. Press Enter to display the workstation version.
3. Press F3 to exit to the Test menu.

3.4.6 Twinx Line Test

This screen enables the initiation of a Line test. The online test is performed continually and updates its status continually until it is terminated (by pressing F3).

1. Select **Twinox Line Test** from the Test menu.
2. Press Enter to initiate the test.

Device addresses from 0 to 6 are listed and their status determined. A blinking *Line Testing...* message appears at the bottom of the screen.

- * will appear bellow each listed address of a device that is communicating with the host controller.
- = will appear bellow each listed address of a device that is not present on the system or which did not communicate with the host controller.
- will appear bellow each listed address of a device that the host controller did not attempt to communicate with (Polling).

3. Press F3 to exit to the Test menu.

The test is being continuously performed, that is to say, if the status of any device on the line, or the status of the line itself changes, after a few seconds the status message on the screen will change accordingly.

The addresses of the devices are the addresses set in the SETUP as the address of the workstation/printer, with no relation to the logic address defined on the computer, such as P1, W12, etc.

3.4.7 Keyboard Test

Enables the Keyboard Test screen.

1. Select **Keyboard Test** from the Test menu.
2. Press Enter to display the keyboard test screen.
3. A keyboard map is displayed. When a key is depressed, the parallel key on the screen is highlighted.
4. Press F3 to exit to the Test menu.

3.4.8 Printer Test

Enables the test screen for a parallel printer.

1. Select **Printer Test** from the Test menu.
2. Press Enter to display the printer test screen.
3. Press Enter to initiate the test.
4. Press F3 to exit to the Test menu.

3.4.9 Monitor Test

Enables the Monitor Test screen.

1. Select **Monitor Test** from the Test menu.
2. Press Enter to display the Monitor test screen.

MONITOR TEST	
Press ENTER to start testing, then press one of the following keys:	
F8	for next test
F3	to Exit
F9	Reverse Video toggle test
F4	Power Saver Toggle Test
F5	Horizontal Sync Toggle Test
F6	Vertical Sync Toggle Test
F7	Horizontal and Vertical Sync Toggle Test
TEST	

3. Press Enter to display the first screen model. If it is not the required model, press the Spacebar to page through all the other available models.
4. Once the desired model is displayed, perform the display test according to the following table, pressing the same key again to end the specific test:

Key	Test
F9	Reverse Video Toggle test (Monochrome Display Only)
F4	Power saver test
F5	Horizontal Sync test
F6	Vertical Sync test
F7	Horizontal and Vertical Sync test

5. Press F8 to access the following pattern and repeat step-3.
6. Press F3 to exit to the Test menu.

3.4.10 Scroll Test

Enables the Scroll Test screen.

1. Select **Scroll Test** from the Test menu.
2. Press Enter to enter the test which displays a continually rolling screen.
3. Press F3 to exit to the Test menu.

3.4.11 Mouse Test (for PS/2 mouse)

Enables the Mouse Test screen.

1. Select **Mouse Test** from the Test menu, and press Enter.
2. Press Enter to enter the test.

Moving the mouse in any direction will cause a similar movement of the mouse icon on the display. Clicking either mouse button will highlight the parallel button on the screen simulation.

3. Press F3 to exit to the Test menu.

3.4.12 Keyboard Mapper

This option enables the redefinition of a key function.

To enter the test

Select **Keyboard Mapper** from the Test menu and press Enter.

To Map a Key

1. Select the key to be redefined (i.e. F12). The corresponding key on the screen will be highlighted.
2. Press the Record key on the keyboard
3. Press the key (ie. Dup PA1).whose function is to be transferred to the first key (F12).
4. Repeat steps 1 to 3 for any additional keys.
5. To exit after mapping your selected keys, press Reset.
6. To activate the keyboard mapper press the Setup key to enter **Online Setup**.
7. Choose *Setup Display*. Press Enter.
8. Move cursor to *Enable Keyboard Mapper*, highlight **YES** and press the Space bar.
9. To exit **Online Setup** press F3 twice. This will return you to the sign on screen. ("KM" will be displayed under the status bar indicating the Keyboard Mapping is activated.)

To Clear All Mapped Keys:

1. Enter Offline Setup. (turn the workstation ON while depressing the Space bar.)
2. Select Test Workstation. Press Enter.
3. Select Keyboard Mapper and press Enter. Press **Alt + F1** to clear all mapped keys and return the keyboard to the factory preset conditions.

NOTE: The mapped keys may also be temporarily disabled by setting the enable Keyboard Mapper parameter in Online Setup to NO.

4. ONLINE SETUP MENU

Online setup enables you to set or reset some of the Workstation's features at any time during operation. It also enables you to view what values have been selected in Offline Setup. Online Setup can be accessed at any time during a work session.

This chapter will provide a brief description of the options available in the online setup menu.

4.1 Overview

4.1.1 Entering Online setup menu

Power on the workstation, wait for the initialization to be completed and press the **Setup** key. The **Online Setup** menu will be displayed.

Online Setup
Move cursor to desired selection and press ENTER.
Setup Display
Browse Display Information
Setup Printer
Browse Printer Information
Setup Input Devices
Setup calculator
Lock Sessions
Setup color
F3=Exit
SETUP

Parameter	Description
Setup Display	Defines the display mode
Browse Display Information	Provides a summary of the sessions, addresses, emulation mode, character sets and keyboard definitions set in the Offline setup (chapter 3).
Setup Printer	Defines the printed density of lines and characters as well as printing resolution.
Browse Printer Information	Provides a summary of the printer address, emulation mode, paper related options.
Setup Input Devices	Enables keyboard and mouse related options such as sound and response speed.

Parameter	Description
Setup calculator	Defines the calculator decimal point as either a period or a comma.
Lock Sessions	Enables you to define a security password for the workstation.
Setup color	Enables you to select the 16 color palette and define session and screen border colors, mouse pointer and ruler colors.

4.1.2 ONLINE Setup Function Keys and Indicators

Key or indicator	Description
F7	Page backward
F8	Page forward
F3	Save changes and exit to the Offline Main setup screen.
More+ indicator on the top right corner.	<i>Additional</i> configuration screens for that option.
More- indicator on the top right corner.	<i>Last</i> configuration screen for that option.
To define a parameter	Place the cursor on the desired value and press the Spacebar.
Exiting Online Setup Mode	Press F3 or Setup (for 122 keyboard) Press F3 or Shift + Setup (for 103 and PC keyboards)

4.2 Setup Display

This menu group customizes the appearance of the screen (i.e. cursor style, split screen format, etc.) and some responses (auto dim, password, etc.). The options are located on four consecutive screens which will be described in this section in the order in which they appear.

NOTE: Press **F8** to access consecutive screens and **F7** to return to previous screens.

4.2.1 Setup Display Screen-1

This screen defines the alarm, cursor, screen indicator and ruler. In addition it enables the screen dimmer and keyboard mapper options.

To Enter this screen

Select **Setup Display Information** from the **Online Setup** menu.

Press F8 to access the following screen.

Setup Display						More:+
Move cursor to desired choice, then press SPACE BAR to select.						
Alarm Volume.....	Off	1	2	3	4	High
Cursor						
Style	Underline					Block
Blink	Yes					No
Row/Column Indicator.....	On					Off
Rule Line						
Style	Horizontal		Vertical			Cross
Intensify	Yes					No
Follows cursor	Yes					No
Auto Dim.....	Yes					No
Delay (minutes)	5		10			20
Enable Keyboard Mapper	Yes					No
F3=Save and Exit F8=Forward						
SETUP						

4.2.1.1 Alarm Volume	Set the workstation's alarm to any one of five different intensity levels, or turn it off.
4.2.1.2 Cursor	Set the cursor shape to be either an Underline or a Block, and determine whether or not it blinks.

4.2.1.3 Row/Column Indicator	If ON is selected, the line and column number on which the cursor is currently located are indicated at the bottom right corner of the screen.
4.2.1.4 Rule Line	A horizontal and/or vertical line displayed on the screen, which enables easy editing of large columns/rows. Style: Horizontal, Vertical or both (cross). Intensify (monochrome models only): Determines whether the Rule Line appears bold or normal. Follows cursor: Determines if the Rule Line will move with the cursor or remains a static marker on the screen.
4.2.1.5 Auto Dim	When selected, the screen will blank out if no input has been entered for a predefined period of time (<i>Delay</i>) of 5, 10 or 20 minutes.
4.2.1.6 Enable Keyboard Mapper	Enables the Keyboard Mapper.

4.2.2 Setup Display Screen-2

This screen defines the display format, buzzer time and column separators.

To access this screen

Select **Setup Display Information** from the **Online Setup** menu and page forward.

Setup Display		More+				
Move cursor to desired selection and press SPACEBAR to select.						
Extended Display	Off	PS	ECB1			
	ECB2	ECB3				
Split Screen Format (Screen rows X columns)						
Horizontal	24 X 80	32 X 80	43 X 80	49 X 80		
Vertical	24 X 80	27 X 132				
Buzzer Time	0.4	0.6	0.8	1.0	1.2	1.4
	1.6	1.8	2.0			
Separator	Yes			No		
Column Sep.....	Dot			Line		
F3=Save and Exit F8=Forward F7=Backward						
SETUP						

4.2.2.1 Extended Display	PS, ECB1, ECB2 and ECB3 enable the display of attributes in the Presentation Space, primary ECB (ECB1), text ECB (ECB2) or color ECB (ECB3). OFF displays text normally.
4.2.2.2 Split Screen	Determines the mode of the split screen when viewing two sessions.
4.2.2.3 Buzzer Time	Duration of the buzzer sound may be programmed from 0.4 to 2.0 seconds in 0.2 second steps.
4.2.2.4 Separator	Enables a separation line between screen and status line.
4.2.2.5 Column Sep	Defines the appearance of the columns separator.
4.2.2.6 Reverse Image	For monochrome only. Provides a negative of the screen. NO: Black characters on a white background YES: White characters on a black background.

4.2.3 Setup Display Screen-3

This screen defines the editing functions such as tabs, type ahead and cut-and-paste.

To access this screen

Select **Setup Display Information** from the **Online Setup** menu and page forward.

Setup Display		More+
Move cursor to desired selection and press SPACEBAR to select.		
Local Tabs	Yes	No
Type Ahead	Yes	No
Message Wait	Off	Beep Video
Dual 132	Yes	No
Local Cut&Paste Enable	Yes	No
F3=Save and Exit F8=Forward F7=Backward		
SETUP		

4.2.3.1 Local Tabs	Enables local tabs that allow the user to advance the cursor from column to column on a screen.
4.2.3.2 Type Ahead	Enabling this feature allows you to keep on typing even though "Input Inhibited" indicator is lit. Data will be transmitted to the host controller as soon as the "Input Inhibited" indicator goes off. Data quantity is dependent on the host controller.
4.2.3.3 Message Wait	Enables an Indicator/Reminder that a unit in the system needs corrective action. Two kinds of indicators are available: Beep: Enables the a buzzer that goes off every 8 seconds. Video: The screen display is inverted every 8 seconds.
4.2.3.4 Dual 132	Displays two session in horizontal split mode even if one of them is altered to 132 character mode. Yes: Two session, one in 80 character mode and the other in 132 character mode. No: When one session is in 132 character mode, both sessions cannot be seen simultaneously in horizontal split.
4.2.3.5 Local Cut and Paste	Enables cut and paste options. Yes: Enables local cut-and-paste. No: Disables local cut-and-paste.

4.2.4 Setup Display Screen-4

This screen defines the password used when the screen is locked (by selecting **Lock Sessions** from the **Online Setup** menu).

To access this screen

Select **Setup Display Information** from the **Online Setup** menu and page forward.

Online Setup	More+
Specify pasword twice and press ENTER	
Lock Sessions	
Password	(_____)
Password	(_____)
F3=Save and Exit F7=Backward	F10=Clear Password
SETUP	

<p>4.2.4.1 Lock Sessions Password</p>	<p>Defines the password used when the screen is locked.</p> <p>To enter the password</p> <p>Enter a password consisting of 5 alphanumeric characters and press Enter. Repeat for the second field.</p> <p>To clear the password</p> <p>Press F10.</p>
--	--

4.3 Browse Display Information

Provides a summary of the sessions, addresses, emulation mode, character sets and keyboard definitions set in the offline setup (chapter 3). In addition, this screen displays the software version.

NOTE: The information in this screen cannot be modified.

To Enter this screen

Select **Browse Display Information** from the **Online Setup** menu.

Display Information						
Display Sessions.....	1	2	3			
Shared addressing.....	Yes	No				
Display Address 1	0	1	2	3	4	5
Display Address 2	0	1	2	3	4	5
Display Address 3	0	1	2	3	4	5
Display address 4.....	0	1	2	3	4	5
Character Set.....	Country Specific			Multinational		
Keyboard Type	Standard			User Defined		
Model ID	3487	3197D	3197C	3180	5291	
Country	Belgium		Denmark		Finland/Sweden	
	France		Germany/Austria		Greece	
	Holland		Iceland		Italy	
	Norway		Portugal-037		Portugal-282	
	Spain		Spain, L/A		Swiss (France)	
	Swiss (Germany)		Turkey-905		UK	
	US/Canada		Turkey-1026		France/Canada	
	Latin 2		Poland		Hungary	
F3=Exit					Release No 1.0	
SETUP						

4.4 Setup Printer

The Setup Printer menu consists of up to five screens that allow you to define all printer related options.

4.4.1 Setup Printer Screen-1

This screen enables you to define the print density on the page.

To access this screen

Select **Setup Printer** from the **Online Setup** menu.

Setup Printer				More:+
Move cursor to desired choice, then press SPACE BAR to select.				
Lines per inch.....	System	3	4	6
Characters per inch.....	System	5	10	12
Print Quality	System	Draft	Letter	Compressed
F1=Reset F2=Form Feed F4=Line Feed F5=Cancel				
F3=Save and Exit F8=Forward				
SETUP				

4.4.1.1 Lines per Inch	Set the printed lines per inch to either System, in which the setting is controlled by the host or 3, 4, 6, or 8 LPI (Lines Per Inch).
4.4.1.2 Characters Per Inch	Set the number of characters per inch to either System (host controlled), 5, 10, 12 CPI (Characters Per Inch) or <i>Compressed</i> . The default setting is '10'.
4.4.1.3 Print Quality	The print quality may be selected in three levels: <i>System</i> (host controlled), <i>Draft</i> , or <i>NLQ</i> . Print speeds are reduced when higher print qualities are selected.

NOTE: If the selected printer is 5256, then the "System" option does not exist for the above parameters.

4.4.1.4 Printer Key Function

To	Press
Resets the parallel port Printer.	<i>F1=Reset</i>
Sends a Form Feed to the parallel port printer.	<i>F2=Form Feed</i>
Sends a Line Feed to the Parallel port printer.	<i>F4=Line Feed</i>
Sends a Cancel request to the Host.	<i>F5=Cancel</i>

4.4.2 Setup Printer Screen-2 (5219 & 3812 Emulations Only)

This screen enables you to select the type style and paper related options.

To Enter this screen

Select **Setup Printer** from the **Online Setup** menu and page forward.

Setup Printer				More:+	
Move cursor to desired choice, then press SPACE BAR to select.					
Type Style	System			Local	
System code page.....	System			Local	
Paper feed.....	System	Pause		Local	
Form	System	Pause		Paper	
Source Drawer.....	System	Pause		1	2
Attention.....	Yes				Envelope Fixed No
F1=Reset F2=Form Feed F4=Line Feed F5=Cancel F3=Save and Exit F7=Backward F8=Forward					
SETUP					

4.4.2.1 Type Style	Type Style determines the typeface which will be used while printing. It may be set to System (host controlled), or (locally controlled).
4.4.2.2 System Code Page	If set to System, the Code page designated by host is applied to the printer. If set to Local, the Code page selected on the Local printer is applied.
4.4.2.3 Paper Feed	Determines how the paper feed is controlled. System: Controlled by host.

	<p>Pause: Temporarily suspends operation until the appropriate action is taken according to system message. Operation is then resumed.</p> <p>Local: Controlled locally.</p>
4.4.2.4 Source Drawer	<p>Specifies the location of the paper in the printer.</p> <p>System: Paper location is determined by the host.</p> <p>Pause: Temporarily suspends operation until the appropriate action is taken according to system message. Operation is then resumed.</p> <p>1 : The first paper bin is selected.</p> <p>2 : The second paper bin is selected.</p> <p>Fixed: According to the configuration on the printer.</p>
4.4.2.5 Form	<p>The format of the paper.</p> <p>System: Host controlled.</p> <p>Pause: Temporarily suspends operation until the appropriate action is taken according to system message. Operation is then resumed.</p> <p>Paper: Printing on paper.</p> <p>Envelope: Printing on envelopes.</p>
4.4.2.6 Attention	<p>Warning of a change in some printing parameters such page or font definitions. Printing is resumed only after there is a response to this prompt.</p> <p>Default: OFF</p>

4.4.3 Setup Printer Screen-3 (for 3812 Emulation only)

These additional parameters are optional and are displayed only if 3812 printer emulation was selected in the Offline Setup Customization panel. It enables the selection and orientation of paper in each of the three 'Drawers'.

To enter this screen

Select **Setup Printer** from the **Online Setup** menu and page forward.

Setup Printer				More:+
Move cursor to desired choice, then press SPACE BAR to select.				
Drawer 1				
Default orientation.....	COR	Portrait	Landscape	
Paper.....	Letter A5	Legal Half-Letter	A4 Executive 2	B5
Drawer 2				
Default orientation.....	COR	Portrait	Landscape	
Paper.....	Letter A5	Legal Half-Letter	A4 Executive 2	B5
Drawer 3				
Default orientation.....	COR	Portrait	Landscape	
Paper.....	Letter A5	Legal Half-Letter	A4 Executive 2	B5
Automatic orientation	Yes		No	
F1=Reset F2=Form Feed F4=Line Feed F5=Cancel F3=Save and Exit F7=Backward F8=Forward				
SETUP				

<p>4.4.3.1 Default Orientation:</p>	<p>Select COR, Portrait or Landscape for each of sources. This parameter is effective only on a printer that has the capability of rotating the paper (3812 emulation must be selected).</p>
<p>4.4.3.2 Paper:</p>	<p>Seven paper sizes are available for selection. This parameter determines whether the paper will be rotated for the COR option in Default Orientation as well as for the Automatic Orientation function.</p>
<p>4.4.3.3 Automatic Orientation:</p>	<p>Set to YES for automatic orientation selection by the workstation according to the printing job.</p>

4.4.4 Setup Printer Screen-4

This screen will display for any printer emulation selected in Offline setup.

To enter this screen

Select **Setup Printer** from the **Online Setup** menu and page forward.

Setup Printer			
Move cursor to desired choice, then press SPACE BAR to select.			
Print Key.....	Local	System	
Local Form Feed.....	Yes	No	
Local Condensed.....	Yes	No	
Buffer Print.....	Yes	No	
Hex Print.....	Yes	No	
F1=Reset	F2=Form Feed	F4=Line Feed	F5=Cancel
F3=Save and exit	F7=Backward	F8=Forward	
SETUP			

4.4.4.1 Print Key	<p>The printer that responds to the Print Screen command is either the <i>Local</i> screen printer which is attached to the display station or the <i>System</i> printer.</p> <p><i>Local:</i> Allows you to define the region on the screen and print it locally.</p> <p><i>System:</i> Sends the print request to be printed by the host.</p>
4.4.4.2 Local Form Feed	<p>When using the local print option (screen copy), enabling this option performs automatic Form Feed after screen dump. Page ejection may be selected at the ending of local screen print.</p>
4.4.4.3 Local Condensed	<p>Enables you to print a document without the blank lines.</p> <p>Yes: Will not print blank lines (condensed).</p> <p>No: Blank lines will be printed.</p>
4.4.4.4 Buffer Print	<p>Buffer print contains EBCDIC Hexadecimal codes which can be used by technicians for troubleshooting application programs.</p> <p>YES: Enables buffer print.</p> <p>Not: Disables buffer print.</p>
4.4.4.5 Hex Print	<p>Hex print contains the ASCII hexadecimal codes sent to the attached</p>

	printer.
Yes:	Enables Hex print.
No:	Disables Hex print.

4.4.5 Screen Print Setup

The necessary parameters for a screen print are set here.

To enter this screen

Select **Setup Printer** from the **Online Setup** menu and page forward to the last screen.

4.4.5.1 Lines Per Inch	Defines the line density for a local screen print job. Value = 3,4,6,8 lines per inch (LPI).
4.4.5.2 Characters Per Inch	Defines the character density for a local print job. Value = 5, 10, 12 or compressed (blank lines are not printed).
4.4.5.3 Print Quality	Defines the print quality. Value = Draft or Near Letter Quality
4.4.5.4 6.12.4 Source Drawer	Enables selection of paper from <i>Drawer 1</i> or <i>Drawer 2</i> . <i>Fixed</i> indicates that no attempt at all should be made to specify a drawer.
4.4.5.5 Form Length In Inches	Maximum value = 24 inches. To change a form length:

	<ol style="list-style-type: none">1. Press the Spacebar to enter Edit mode.2. To exit Edit mode press the Up or Down arrow keys. <p>NOTE: Automatically changes the <i>Form Length In Millimeters</i> parameter to the corresponding value.</p>
4.4.5.6 Form Length In Millimeters	<p>Maximum form length value = 609.60 millimeters.</p> <p>To change a form length:</p> <ol style="list-style-type: none">1. Press the Spacebar to enter Edit mode.2. To exit Edit mode press the Up or Down arrow keys. <p>NOTE: Automatically changes the <i>Form Length In Inches</i> parameter to the corresponding value.</p>
4.4.5.7 First Print Line	<p>Specifies the line on which the next screen print operation should begin.</p> <p>To change the value:</p> <ol style="list-style-type: none">1. Press the Spacebar to enter Edit mode.2. To exit Edit mode press the Up or Down arrow keys. <p>NOTE: If a line which is beyond the specified form length is specified, then unpredictable results can occur.</p>
4.4.5.8 Print First Column	<p>Specifies the column on which each line of the screen print will start:</p> <p>To change the value:</p> <ol style="list-style-type: none">1. Press the Spacebar to enter Edit mode.2. To exit Edit mode press the Up or Down arrow keys. <p>NOTE: If a column position which is beyond the maximum print position for a given form width and given character density is specified, then unpredictable results can occur.</p>

4.5 Browse Printer Information

Provides a summary of the printer information and customization options. An example is given following the explanations on the screen.

To enter this screen

Select **Browse Printer Information** from the **Online Setup** menu and page forward to the last screen.

Printer Information							More:+
Printer Address	0	1	2	3	4	5	6
Printer Emulation.....	5256		4214	5219	3812		
System Available.....	Yes			No			
Type Style.....	011 Courier 10						
System Code Page	IBM Char 2						
Paper Feed	Manual		Tractor		ASF		
Form.....	Paper						
Source Drawer	1						
F3=Exit	F2=Resume	F8=Forward					
SETUP							

Printer parameters selected in Setup are highlighted for each of the above settings. The selected parameters cannot be changed in this panel.

Type Style, System Code Page, Paper Feed, Form, Source Drawer and the option *F2=Resume* are displayed only if 3812 or 5219 printer emulation option has been selected in the Offline Setup **Customization** screen.

When the following four conditions are selected simultaneously, the host can suspend the print operation and display the request for changing the current type style, system code page, paper feed technique, form or source drawer on the 22nd line of the Printer Information panel.

- Display-Printer terminal mode
- 3812 or 5219 emulation type
- Setup Printer panel, **Attention** is enabled.
- Any of the following five setup printer parameters are set to *System*:
 - System code page,
 - Type style,
 - Paper feed,
 - Form, and
 - Source drawer

4.5.1.1 Example

Assuming that a host system requests a type style change from *011 Courier 10* specified in the Printer Information screen, to *087 Letter Gothic*, and the other items are unchanged, the type style on the Printer Information screen will automatically change to *087 Letter Gothic*, and the change request will be displayed at the bottom of the screen.

If the font cartridge on the attached printer does not include *087 Letter Gothic*, change it to one that does, and then press '. The print operation with the type style will start. If the requested cartridge is not available, press ' to ignore the host request.

For detailed information on how to change the type style, system code page, paper feed mechanism, form type, or source drawer type, refer to your printer's Operation Manual.

If you do not want the print operation to be suspended by the host system, select No for the Attention parameter in the Setup Printer screen.

If the printer is printing data when it receives a request for changing the type style, system code page, paper feed mechanism, form type, or source drawer, the data transmission from the workstation to the printer will be immediately suspended but the printer may continue printing data stored in the print buffer.

If the printer is defined as "Other" and the Source Drawer codes are set in the Printer Editor, the drawers will be selected automatically.

4.6 Setup Input Devices

Enables keyboard and mouse related such as sound and response speed.

4.6.1 Setup Input Devices Screen-1

To enter this screen

Select **Setup Input Devices** from the **Online Setup** menu.

Setup Input Devices					More:+
Move Cursor to desired choice, then press SPACE BAR to select.					
Clicker					
Click.....	Yes				No
Volume	Off	1	2	3	4 High
Keyboard Typematic					
Rate	Slow		Normal		Fast
Delay.....	Short		Normal		Long
Mouse Speed					
Horizontal.....	Slow	1	2	3	Fast
Vertical	Slow	1	2	3	Fast
Mouse Double Click					
Interval (seconds).....	0.25	0.5	0.75	1.0	2.0
Mouse Primary Button.....					
	Left		Right		
Mouse Hot Spot.....					
	Yes	No			
F3=Save and Exit					
SETUP					

4.6.1.1 Clicker	Clicker: Enables the keyboard click sound. Volume: Sets the click sound intensity at levels 1 - 4, Off or On.
4.6.1.2 Keyboard Typematic	Rate: Typing speed for repeated keying. E.g. when a key is pressed and held down. Three speed options are available: Slow, Normal and Fast. Delay: Time interval from pressing the key until it starts repeating.
4.6.1.3 Mouse Speed	Horizontal: Changes the Horizontal speed of the mouse pointer on the screen. Five settings are available: Slow, 1, 2, 3 and Fast. Vertical: Changes the Vertical speed of the mouse pointer on the screen. Five settings are available: Slow, 1, 2, 3 and Fast. NOTE: This parameter will be displayed only if a PS/2 mouse is

	attached to the workstation.
4.6.1.4 Mouse Double Click	Interval: Sets the Double Click Interval within 0.25, 0.5, 0.75, 1.0 or 2.0 sec.

4.6.2 Setup Input Devices Screen-2

Defines the mouse Primary button. This option can be used by left handed people to define the primary button as Left.

To enter this screen

Select **Setup Input Devices** from the **Online Setup** menu and page forward.

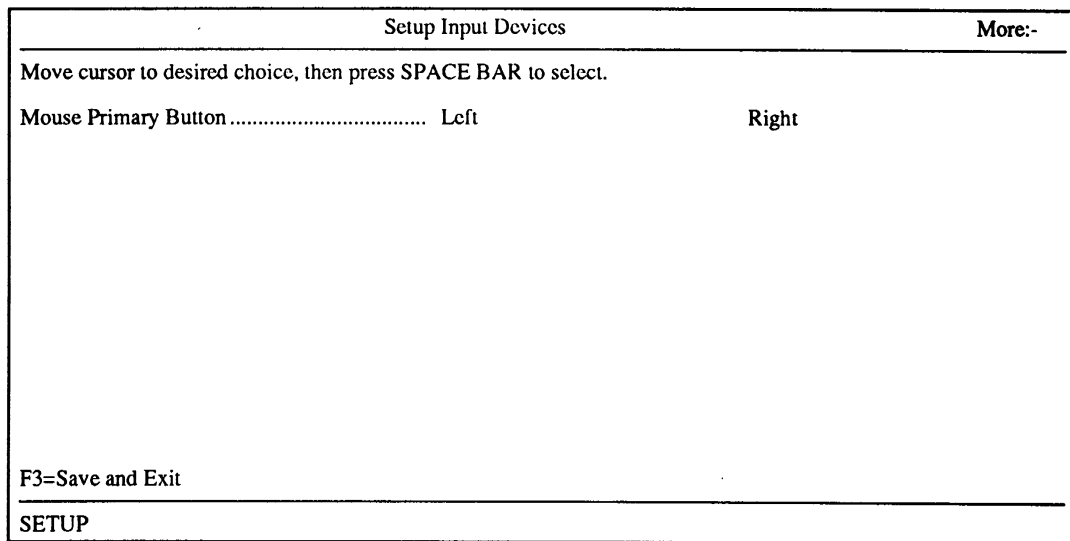

4.6.2.1 Mouse Primary Button	<p>Left: Sets the Left button of the mouse as the main button.</p> <p>Right: Sets the Right button of the mouse as the main button</p>
-------------------------------------	--

4.7 Calculator Setup

Defines the calculator decimal point as either a period or a comma.

To enter this screen

Select **Setup Calculator** from the **Online Setup** menu.

4.7.1.1 Decimal Point	Period: Sets the decimal point as a period ..
	Comma: Sets the decimal point as a comma

4.8 Lock Sessions

This screen enables you to lock a session if a password has been assigned, or assign a password and then lock the session.

To lock a sessions

1. Select **Lock Session** from the **Online Setup** menu.
2. If a password has not been set, the **Lock sessions password** screen will be displayed. Assign a password (enter up to five character password twice, pressing Enter each time).
3. The screen will now be locked.

To unlock a session







1. Press any key and enter the password.
2. If the workstation is locked and you do not know the password and want to change it then turn off the workstation, wait ten seconds, then turn on the workstation. Now follow the procedure in *To set the password*.

4.9 Setup Color

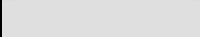
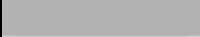
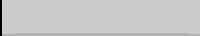
This screen enables you to uniquely identify each defined session with a background color and define the color of the screen border.

To access the screen

Select the Setup Color from the Online Setup Menu:

SETUP COLOR PALETTS		More+
Move cursor to desired selection and press SPACEBAR to select.		
Setup color Palette		
	Background Session 1	
	Background Session 2	
	Background Session 3	
	Background Session 4	
	Background Inactive	
	Screen Border	
	Trim Border/ruler Line	
	Mouse Pointer	
	Status Line	
F3=Exit	F8=Forward	
SETUP		

Option Descriptions

Background Session 1 to 4	<ul style="list-style-type: none"> • Sets the background color of each session in its active state. It is recommended to select a dull color (i.e.olive).
Background Inactive	<ul style="list-style-type: none"> • Sets the background color for the inactive session. 'black' is the default setting.
Screen Border	<ul style="list-style-type: none"> • Sets the color of the screen border.
Trim Border/ruler line	<ul style="list-style-type: none"> • Sets the color of the ruler, trim line, push button and status line separator.
Mouse Pointer	<ul style="list-style-type: none"> • Sets the color of the mouse pointer

1. Select an option and press the Spacebar.
2. Upon pressing the Spacebar, a color palette will be displayed. Use the Arrow keys to choose the desired color and press the Spacebar to enable the selection. Refer to the following section for instructions on redefining the color palette.
3. To define a black background color, selecting the color and press the Spacebar again.
4. Repeat steps 1 to 2 for each option.

4.9.1 Customizing the Foreground and Background Color Palettes

This option enables you to define the colors on your color palette.

1. Page forward (**F8**) from the **Setup Color** screen, to display the **Setup Background Color Palette** screen. The assigned colors are displayed above the color bars.
2. Use the *left* and *right* Arrow keys to move the cursor to the desired color bar.
3. Press the Spacebar to mark the bar with two arrow.
4. Use the *up* and *down* arrow keys to select the desired shade and press the Spacebar to enable the selection.
5. Repeat steps 2 to 4 for every color you wish to assign to the color palette.
6. Press **F8** to display the **Setup Foreground Color Palette**
7. Repeat steps 2-4 for every color you wish to assign to the Foreground Color Palette.
8. Press **F7** to return to the **Color Setup** screen, or **F3** to return to the **Online main setup** menu.
9. Press **F10** to apply the default pallet.

NOTE: Ensure that the color *names* displayed above the bars, correspond to the color they represent.

5. ENTERING SESSIONS

The workstation can operate up to four sessions with either unique or shared addresses. Two sessions may be displayed simultaneously in *Split Screen* mode; however, only one session can be active at a time and the cursor will appear in that session. Sessions may also be displayed in *Full Screen* mode where one session occupies the full screen.

5.1 Split Screen Description

The screen may be split either horizontally and vertically. The status line corresponds to the active session.

In order to enable split screens, the *Display Sessions* parameter in the *Customization* panel of **Offline Setup** must be set to display more than one sessions (2, 3, or 4). Setup parameters can be viewed in *Browse Display Information* of **Online Setup**.

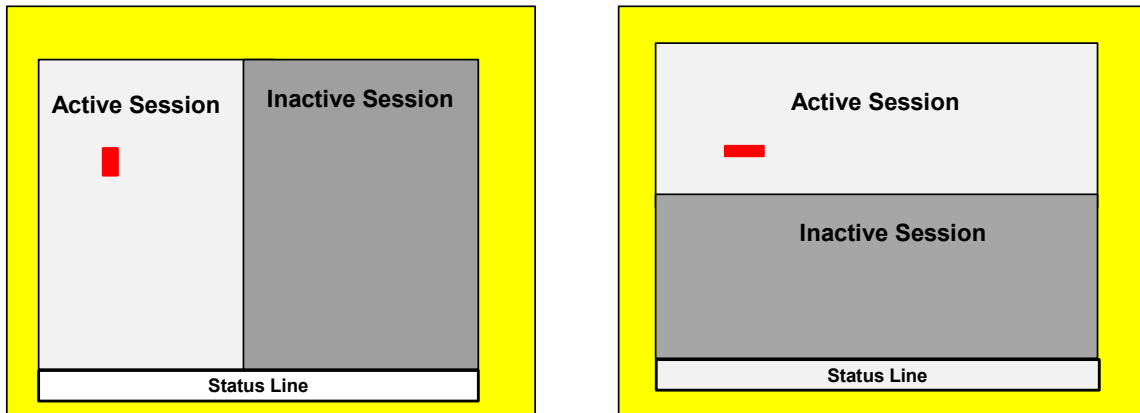

To	On the keyboard press:	On the status line click:
Cyclically toggle between full screen, horizontal and vertical split screens.	Alt + 	Zoom on the status line.
Jump between displayed sessions	Alt + Jump	Click on the desired session.
Jumps between all sessions	Alt + F11	Click on the number of the desired session on the status line.
Switch session positions on a split screen	Alt + F8	

5.1.1 Status Line Description

The status line indicates existing sessions and active session number (either 1, 2, 3 or 4) on the left and various indicators like system available, keyboard shift, input inhibited, etc. This line is common to all sessions.

The active session number is displayed in reverse video and is highlighted. If two sessions are displayed in the screen, both session numbers will be displayed in reverse video but only the active session will be highlighted.

Two screen buttons will be displayed on the status line when the mouse is enabled: **ZOOM** for toggling between full and split sessions; **SETUP** for entering **Online Setup**.

5.1.2 Scrolling and the Divider Bar

The line dividing the screen into two sessions is called the **Divider Bar**. The divider can be moved, and the number of lines per session altered.

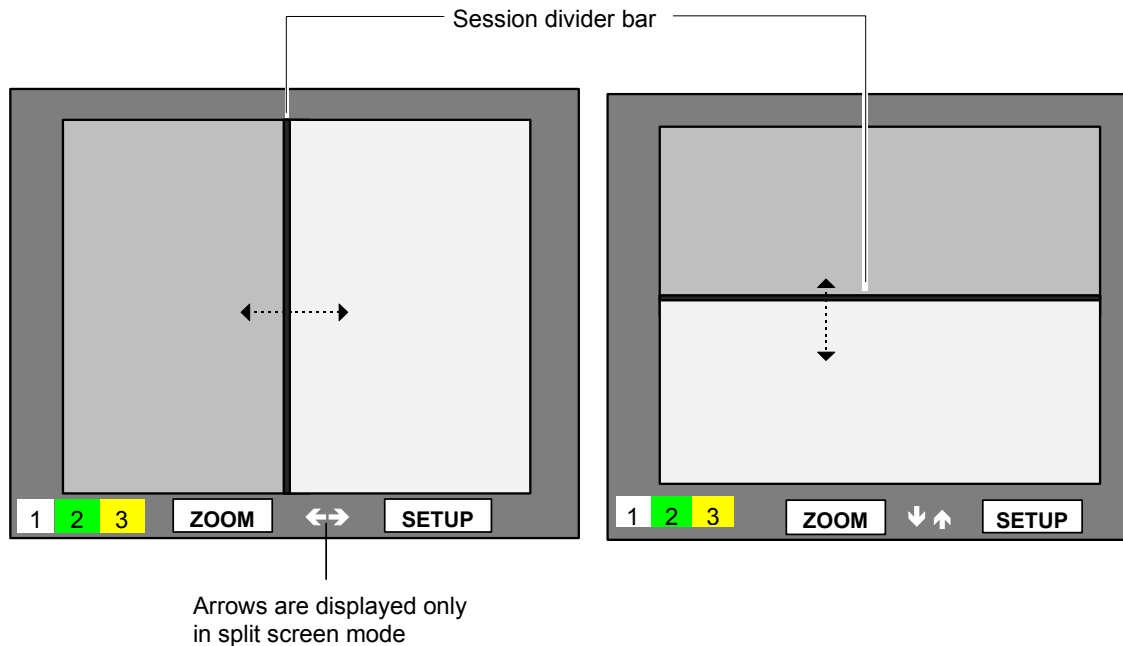

NOTE: Error 9034 will display on the status line when the separator line reaches the logical screen boundaries and cannot be moved further.

To:	On the keyboard press:
Move the divider bar.	<ul style="list-style-type: none"> • Press Alt + Setup and move the Separator line using the arrow keys on the keyboard, or • press Alt + F2 or Alt + F3 or • drag the divider bar with the mose
To return to normal operation	Press Alt + Setup
Scroll with the keyboard	Press Alt + F9 and Alt + F10 .

5.1.3 Mouse Functions

To:	Do the following:
Alternate between horizontal and vertical split screens and a full screen.	Click on Zoom in the status line.
Jump between two displayed sessions:	<ol style="list-style-type: none"> a. Position and click with the mouse on the required session, or b. Click on the number of the required session on the status line.
Change the active screen:	Click on the number of the required session on the status line. The current active screen will be replace.
Scroll with the mouse.	Click-and-hold on the arrow symbols displayed on the status line.

6. RECORD AND PLAY OPERATION

6.1 Record Play Operation

The Record/Play option enables you to record frequently used text or keystrokes and assign them any of the 24 available function keys. The recorded sequences can be “played-back” by pressing the corresponding function key. Approximately 4000 keystrokes can be recorded including **Shift** and **Alt** keys.

6.1.1 Recording a Sequence

1. Press either the **Record** key (122-key keyboard) or Alt + Record key (102/103-key keyboard).

A “Record” indicator appears in the status line together with a number indicating the approximate number of keystrokes that can be recorded and the function keys (record ID keys).

2. Press the function key to be assigned to the key sequence. The selected function key is displayed on the status line.

An alarm will sound if this key has already been assigned. Press either the Record key (122-key keyboard) or Alt + Record key (102/103-key keyboard) to exit the Record mode without changing the prior key sequence.)

3. Enter the keystrokes.

NOTE: All the recorded keystrokes of the selected function key can be deleted by pressing **Alt +Reset**.

4. Press **Record** to Exit the Record.

NOTE: For 102/103-key Keyboards, twenty-four function keys are available based on F1 to F12 and Shift + F1 to F12.

6.1.2 Displaying a Recorded Sequence

1. Press **Shift + Play** (for 122-key keyboard) **Alt + F6** (for 102/103-key keyboard).
2. The prompt **Fkey No.?** is displayed. Press the appropriate key. The sequence is displayed on the screen message line.
3. To view additional key sequences, press another function (Fx) key. Each key sequence is displayed as the corresponding function (Fx) key is pressed.
4. To return to normal operation press **Shift + Play** (for 122-key keyboard) **Alt + F6** (for 102/103-key keyboard).

6.1.3 Deleting Recorded Key Sequences

To delete the recorded key sequences in a function keys

1. Press the **Record** key.
2. Press **Shift + Erase Input** for 122-key keyboard or for the 102/103-key keyboard, press **Alt + Record**.
3. Press **Alt + Erlnp**.

6.1.4 Pause Feature

Use the Pause feature to enter data while replaying the key sequence.

1. Press the **Alt + Pause** keys (122-key keyboard) or **Shift + Pause** (102/103-key keyboard) as part of the recorded key sequence.
2. A Pause symbol appears on the status line indicating that you may enter data in normal operation, without recording.
3. To renew the recording of keystrokes, press the **Alt + Pause** keys (122-key keyboard) or **Shift + Pause** (102/103-key keyboard) again and enter the required keystrokes.
4. **NOTE:** When playing back the keystrokes in the Play Mode, the replaying temporarily stops (pauses) at the position that the Pause was recorded. The Pause symbol appears on the status line.
5. The user can enter the required data in normal operation. To resume playback, simply press **Play**. The display station continues with the recorded sequence.

6.2 Play Mode Procedure

To “Play” the key sequence:

1. Move the cursor to the desired input position.
2. Press **Play** (122-key keyboard) or press **Alt + F5** (102/103-key keyboard). The “Play” indicator appears in the status line together with a representation of function keys (record ID keys).
3. Press the required function key to begin playback.
4. To return to normal operation, press **Play**(122-key keyboard) or press **Alt + F5** (102/103-key keyboard).

Pause In Play Mode

If the playback stops and “**Play**” appears on the status line, enter the Pause Mode. Type the required data in normal mode. Return to playback by pressing **Play** (122-key keyboard) or press **Alt + F5** (102/103-key keyboard).

The Play message disappears from the status line.

6.3 Record/Play Limitation Keys

The record/play function may be changed to prohibit input in a non-display field (like a password input) or the record/play function may be totally disabled.

To limit the record/play functions for data security purposes, enter the Test screen and select the Record/Play option. Select one of the following:

- R0 - No protection (default)
- R1 - Non-display field protection
- R2 - Record/Play Function disabled.

When **R0** - *No protection* is selected, any data can be recorded and played without any restriction. The workstation defaults to this value.

When **R1** - *Non-display field protection* is selected, data keys marked “XX” cannot be entered in non-display fields on the following keyboard layouts. If this is attempted, the workstation automatically exits record mode and an error code, 9021, will be displayed on the operating status line.

When **R2** - *Record/Play function disabled* is selected, access to the record/play function is denied. If this is attempted, the error code 9020 is displayed.

7. MOUSE AND EDITING FUNCTIONS

7.1 Copy and Paste

Copy and Paste enables you to copy a selected or 'marked' section and insert it elsewhere either in the same or different session.

This feature can be activated by keyboard or mouse. However, the keyboard limits the function to a character string mode only.

7.1.1 Copying and Pasting a Character String

To copy and paste a character string using the keyboard:

NOTE: This feature must be enabled in the Display Online Setup.

1. Position the cursor on the first character to be marked.
2. Press **Alt + 1** (on numeric keypad).
3. Move cursor to the end of the character string to be marked and press **Alt + 1** (on numeric keypad).
4. Position the cursor where the string is to be inserted and press **Alt + 2** (on numeric keypad). The character string will be copied to the new place and the marked region will return to normal.

To insert the string in a different session, press **Alt + Jump** and position the cursor.

5. To *Unmark* a character string without copying, press **Alt + 3** (on numeric keypad).

To copy and paste a character string or block using the mouse:

NOTE: This feature must be supported by the host in order to be enabled.

1. To define the section, press on **Shift** and click-and-hold the left mouse button over the defined text. Release the button.

To insert the section in a different session, press **Alt + Jump** or click on the required session number on the status line to make it active.

2. The starting position of data pasted will be the position of the text cursor or mouse pointer depending on the selection made in Offline Setup. Move the text cursor or mouse pointer to the position where the data is to be pasted.

3. To paste the string, press **Shift** and click the right mouse button.
4. The data will be pasted. The same data can be pasted an unlimited number of times or until the workstation is switched OFF or until another string or block is copied.





7.2 Using the TAB Key

Use the Tab feature to move the cursor between columns (similar to a word processor screen). The tabs are displayed as vertical lines on the session's last line.

Press **Alt + Field Advance** to advances to the next tab position (after you release the keys). The cursor will stop at the end of a line if there are no more Tabs.

7.2.1 To Enter the TAB Setup Panel

1. In Online Setup, Setup Display – Local Tabs, select Yes.
2. Press **Alt + Setup**.
3. The status line at the bottom of the screen will display options available and keys for the following functions:

Function	Operation
Set a tab	Use the arrow keys to set the tab position and press 
Clear a tab	Move the cursor to the tab which you want to delete and press Alt + 
Clear all tabs	Shift + 
Save tab setting.	Tab settings may be stored in volatile memory for future sessions. Press S
Exit	Alt + Setup
Move to the next tab position	Alt + 

7.2.2 Hot Spot Highlighting Using the Mouse

To perform the operation assigned to the menu item on the system menus, move the mouse pointer next to the menu item; then, click the primary mouse button.

To perform the operations assigned to the F1 to F24 keys and the “+” or “-” characters, position the pointer on them and click.

7.2.3 Automatic Cursor Position

To move the text cursor to the mouse pointer position, click the primary mouse button.

8. PRINTING

This chapter describes printer related options such as the *Bypass* and *Gate* features, that enable implementing special features (barcode printing, portrait/landscape mode, etc.) of the attached printer, on the host application.

In addition, this chapter describes the local print options.

8.1 Bypass Feature

The Bypass Feature is used to transparently send controls from a host application to the ASCII printer enabling special printer features such as, bar code printing, portrait/landscape modes, etc., on the attached ASCII or laser printer to be implemented in the host application.

Up to eight hexadecimal key sequences of ten bytes each can be defined and stored in the “Bypass Table”. The sequence is represented by a one or two character bypass code.

The Bypass codes and the corresponding hexadecimal sequences are configured in the Bypass Table within the Printer Control screen. Refer to your printer’s user manual for the printer escape sequences.

To disable/enable the Bypass feature

Position the cursor to *Bypass - Printer Substitution Enable YES* and press the Spacebar to toggle it between YES and NO.

8.2 Gate Feature

The Gate feature is similar to the Bypass feature and uses the same configuration table to configure the Gate code. However, this feature enables entering the printer sequences directly into the host application as opposed to the above-mentioned Bypass sequences.

The *Gate* feature allows using an unlimited number of printer codes, instead of a single 10-character sequence. The printer codes are delimited by the Gate code before and after the sequences.

To disable/enable the Gate feature

Position the cursor to *Gate - ASCII Pass Thru Enable (Yes)* on the Bypass Table screen and press the Spacebar to toggle it between YES and NO.

8.3 Bypass Table

To display the Bypass Table

Press 'B' in the Offline Setup screen.

487 - BYPASS TABLE

Gate - ASCII Pass Through Enable - (Yes)
 Bypass - Printer Substitution Enable - (Yes)

BYPASS - PRINTER SUBSTITUTION

No.	Hex	Chars	Printer Commands	Comments
1.	(6CF1) - (%1)	(1B2873315329)	(Start Italic)	
2.	(6CF2) - (%2)	(1B2873315328)	(Stop Italic)	
3.	() - ()	()	()	
4.	() - ()	()	()	
5.	() - ()	()	()	
6.	() - ()	()	()	
7.	() - ()	()	()	
8.	() - ()	()	()	

Gate - pass through delimiter (6c) (50) - (%&)

F3=Exit F5=Save F10=Init Del=Del Char HELP=Help

Use the arrow keys to move the cursor to the desired line and enter EBCDIC hexadecimal representation of the Bypass code characters into the first two fields in the table. Both the characters and the hex codes appear on the screen.

Enter the hexadecimal representation of the printer escape sequence into the following ten fields:

To	Press
Exit	F3
Save changes	F5
Clear the table	F10 Init

8.3.1 Example - 1: Using the Bypass Feature

To send the commands *Start Italics* and *Stop Italics* on an HP LaserJet Plus laser printer:

1. Display the Bypass Table by entering the Offline setup and pressing 'B'.
2. Use the arrow keys to position the cursor on the Bypass Number Field.
3. Enter "%" and "1".
4. The ASCII sequence for Start Italics is 1B 28 73 31 53 29. Enter this sequence into the following field.
5. Use the arrow key to move the cursor to the next line. Enter "%" and "2".
6. Enter the escape sequence: 1B 28 73 30 53 28 (Stop Italics command for HP LaserJet Plus) into the following field.
7. Implement the Start Italics code in the host application by entering the Bypass code characters "%1" before the text that is to be italicized. Enter the code "%2" to stop italics after the desired text. The commands are sent to the printer during the print session.. In this example, the bypass code for Start Italics is "%1". The bypass code for Stop Italics is "%2".

8.3.2 Example 2- Using the Gate Feature

In this example, a Reset command is sent to an Epson printer. (The escape sequence is 1B 40.)

1. Define the Gate code as "%&".
2. In the application file, enter the Gate code followed by the Reset command and end with the Gate code again. "%& 1B 40 %&".

8.4 Printer Control Editor

A printer not listed in the *Printer Type* options (Customization panel) can be defined with the help of this Editor.

1. Enter *Customize Workstation* in Offline Setup. The *Customization* screen is displayed.
2. Press **F8** to display the next screen.
3. Select *Other* for printer type and press **E**. The Printer Control Editor screen is displayed.

Enter control codes of printer as described in your printer manual. If your printer does not support some of the functions, delete those function fields. After you finish editing Control codes, press **S** to save changes in non-volatile memory.

386E - PRINTER CONTROL EDITOR	
I - Clear Printer Commands Table, H - Load HP Laser Jet Escape Sequences L - Load Epson Escape Sequences, P - Load ProPrinter Escape Sequences	
Double Width On () Off ()	HELP - Help.
CPI Control 10 () 12 () 15 () 17 () PS ()	F3 - Quit. S - Save & Exit. DEL - Delete Char.
LPI Control 3 () 4 () 6 () 8 ()	F8 - Next Page
Variable Line Spacing ()	Var offset ()
Page length in lines ()	Var offset ()
No. of Source Drawers ()	

386E - PRINTER CONTROL EDITOR	
I - Clear Printer Commands Table, H - Load HP Laser Jet Escape Sequences L - Load Epson Escape Sequences, P - Load ProPrinter Escape Sequences	
Init Printer - () Source Drawer 1 - () Source Drawer 2 - () Envelope Drawer - () Draft Letters - () Quality Letters - () Enhanced Letters - () Reset Pro Spacing - () Set Underline - () Reset Underline - () Bold On - () Bold Off - () Sub Script - () Super Script - () Reset Script - () Double Height ON - () Double Height OFF - () Landscape Orient - () Portrait Orient - ()	HELP - Help. F3 - Quit. S - Save & Exit. DEL - Delete Char. F7 - Previous Page

To	Press
Display a pop-up Help panel	Help
Quit Help	Q
Load HP Laserjet, Epson and ProPrinter Escape Sequences	H - HP Laserjet Escape Sequences L - Epson Escape Sequences P - ProPrinter Escape Sequences
Clear these Escape Sequences.	I

8.5 Printer EBCDIC to ASCII Translation Table

IBM 3X/AS 400 computers perform printing in EBCDIC code. Parallel printers work with ASCII codes. The workstation's printer emulation performs EBCDIC to ASCII translation according to the Translation Table stored in memory. When you get a new workstation, it's EBCDIC to ASCII translation table is preset to the Standard Table matching your country's EBCDIC and ASCII codes. If you need to print some special characters or you have a printer with a non-standard character set, you can change the Translation Table as you wish.

Model 386E Printer EBCDIC to ASCII Translation Table												
	MSB											
LSB	40	50	60	70	80	90	A0	B0	C0	D0	E0	F0
00	20	26	2D	00	00	F8	E6	5E	7B	7D	5C	30
01	80	89	2F	9A	61	6A	7E	9C	41	4A	00	31
02	81	8A	92	00	62	6B	73	9D	42	4B	53	32
03	82	8B	93	00	63	6C	74	F9	43	4C	54	33
04	83	8C	94	20	64	6D	75	9F	44	4D	55	34
05	84	8D	95	00	65	6E	76	15	45	4E	56	35
06	85	8E	96	00	66	6F	77	E3	46	4F	57	36
07	86	8F	97	00	67	70	78	AC	47	50	58	37
08	87	90	98	78	68	71	79	AB	48	51	59	38
09	88	91	99	60	69	72	7A	20	49	52	5A	39
0A	9B	21	7C	3A	AE	83	87	5B	C4	00	FD	20
0B	2E	24	2C	23	AF	84	88	5D	8C	91	96	00
0C	3C	2A	25	40	80	85	89	C4	8D	92	97	00
0D	28	29	5F	27	81	2C	8A	FA	8E	93	98	00
0E	2B	3B	3E	3D	82	86	8B	27	8F	94	99	00
0F	7C	AA	3F	22	F1	20	72	3D	90	95	9A	00

Use Arrow Key to move the cursor. I - Set initial values. F3 - Quit

SETUP

1. Press **Enter** with the cursor on *Customize Workstation* in Offline Setup. The *Customization* screen is displayed.
2. Press **T**. The *486 - Printer EBCDIC to ASCII Translation Table* is displayed.
3. Move the cursor to EBCDIC location that you want to change and enter ASCII value of the character.
4. Press **I** to restore default values.

8.6 LOCAL PRINT FEATURE

The Local Print feature allows printing the contents of the currently active session displayed on screen to an attached parallel printer without host intervention.

8.6.1 To Perform a Local Print

1. Select LOCAL for Print Key in Online Setup.
2. Verify that the attached parallel printer is turned on and is ready to receive a print job from the workstation.
3. Press **Print** to display the Print screen. The print screen will have a Status line at the bottom displaying printer messages in the form of symbols and Print operation keys.
4. Press **F13** (Only if the Status line displays *F13 = Screen.*)
5. Press **Enter** to print screen contents.

8.6.2 Trim Area



The region to be printed, known as the *Trim Area*, can be selected on screen:

1. Press **Print** to display the Print screen.
2. Press **F13**. (Only if the Status line displays *F13 = Trim.*) A rectangle with a cursor at the top left corner will display. This represents the region to be printed.
3. Use the arrow keys to define the print region.
4. Press **F14** to move the cursor in the rectangle from the top left corner to the bottom right corner.
5. Press arrow keys to increase or decrease print region as required.
6. Press **Enter** to print the screen region selected.
7. Press **Print** to exit without printing.

NOTE: If SYSTEM is selected for Print Key in Online Setup, you can still perform LOCAL PRINT by pressing **Shift + Print** simultaneously.

8.7 Printer Status Symbols on Status Line

The following symbols indicate the current status of the printer. They are displayed on the status line during a local print function.

	Printer OK.
	Error with Printer.
	Printer busy. Previous print job not complete.

9. ALICE'S PAPERLESS DESK

Alice's Paperless Desk offers convenient on-line office services that save time and space. Among the features provided are: Telephone Directory, Alarm Calendar, Character Set Table, Alarm Clock, Calculator and Note Pad.

9.1 Alice Main Menu

The Alice Main Menu lists the available features and shows the key sequences used to display a specific feature.

To enter and exit the Alice Main Menu

Press the **Alice** hot-key on the numeric keypad the following screen will be displayed.

488 ALICES'S PAPERLESS DESK - MAIN MENU			
Use Up and DOWN arrow keys to move the cursor to the desired field and type ENTER to display a feature, or press ALT and the corresponding number. Press HELP to display operating instructions for features on display.			
ALT 0	Main Menu	ALT 4	Alarm Clock
ALT 1	Telephone Directory	ALT 5	Alice's Setup
ALT 2	Alarm Calendar	ALT 6	Calculator
ALT 3	Character Set	ALT 7	Note Pad
HOT KEY - RETURN TO NORMAL OPERATION			

Alice Operational Keys

To:	Press:
Enter an option	Alt + (1 to 7)
Move the cursor	Arrow keys
Return to the Main Menu	Alt + 0
Acquire Help on Alice features	Help
Exit from "Alice"	(Press hot key)

9.2 Telephone Directory

The computerized Telephone Directory can automatically store and alphabetically sort up to forty entries.

To enter the Telephone Directory

Press the **Alice** hot key and from the **Alice Main** menu press Alt+1 (on the numeric keypad). A sample screen is illustrated below.

488 - Telephone Directory			
Use arrow keys to move cursor to desired field. Press ENTER to update.			
HOT KEY - EXIT. ALT 0 - Return to Main Menu. ALT D - Delete entry			
Name	Phone	Name	Phone
_____	_____	_____	_____
_____	_____	_____	_____
_____	_____	_____	_____
_____	_____	_____	_____
_____	_____	_____	_____
_____	_____	_____	_____
_____	_____	_____	_____
_____	_____	_____	_____

To operate the Telephone Directory

1. Enter your five-digit session lock password (if that feature was enabled).
2. Use the Arrow keys to move the cursor to the *name* field, type the name and use the Tab key to move to the *Phone* field.
3. Enter the phone number and press Enter to save the data and access the next *Name* field.
4. Use the following keys to modify data, save and return to the active session.

To:	Press:
Switch between Insert and Overwrite modes	Insert
Delete a character	Delete
To delete an entire entry	Alt + D
To move cursor between <i>Name</i> and <i>Phone</i> ..	Tab
Return to the active session	Alice hot-key

9.3 Alarm Calendar

The *Alarm Calendar* Screen (shown below) is used to automatically display a pre-entered message at the set time and date. The messages are automatically sorted according to time and date.

To enter the Alarm Calendar

Press the **Alice** hot key and from the **Alice Main** menu press Alt+2 (on the numeric keypad). A sample screen is illustrated below.

488 - Alarm Calendar		
Use TAB and Up/Down arrow keys to move the cursor. Press ENTER to update. HOT Key - Exit. ALT 0 - Return to Main Menu. ALT D - Delete entry.		
Event	Time	Date
_____	_____	_____
_____	_____	_____
_____	_____	_____
_____	_____	_____
_____	_____	_____
_____	_____	_____
_____	_____	_____
_____	_____	_____
_____	_____	_____
_____	_____	_____

To enable the Alarm Calendar	Enter the correct time and date each time you turn on the workstation so that pre-entered messages will be displayed.
To customize the display	If in Alice's Setup Screen, <i>Private</i> was enabled, then only "You have a message" will be displayed at the pre-entered time to protect the user's privacy. If in Alice's Setup Screen, <i>Pop</i> was disabled, then the messages will not be displayed.
To disable the Alarm Calendar operation:	Respond to the date and time request by pressing Enter. You can cancel the 'Date and Time' request in Alice's Setup Screen.

To enter a message

1. Enter your three-digit Logic Lock password (if that feature was enabled).

2. Use the Arrow keys to move the cursor to the desired field, and type in the date and time the message should appear and then the message. Press Enter.

To:	Press:
Switch between Insert and Overwrite modes	Insert
Delete a character	Delete
To delete an entire entry	Alt + D
To move the cursor from the <i>Event</i> to the <i>Time and Date</i> fields in a circular manner.	Press Tab
Return to Host	Hotkey

Responding to displayed messages

When a message is displayed on the screen , you can either save it again by pressing Enter or delete it from the Alarm Calendar by pressing Del.

When turning on the workstation, messages from earlier dates and times will be displayed on the screen, in sorted order, as reminders until you delete them from the list.

9.4 Character Set Screen

This feature displays the hexadecimal values for the characters of the EBCDIC character set.

To enter the Character Set Screen

Press the **Alice** hot key and from the **Alice Main** menu press Alt+3 (on the numeric keypad). The EBCDIC character set screen is displayed.

9.5 Alarm Clock

The Alarm Clock can be set to ring at a specific time.

To enter the Alarm Clock Screen

Press the **Alice** hot key and from the **Alice Main** menu press Alt+4 (on the numeric keypad).

488 - Alarm Clock	
Use Arrow keys to move cursor to the desired field. Press ENTER to update.	
ALT 0 - Return to Main menu. HOT KEY - Exit	
ALT D - Delete entry.	
Current time : 00:00	PLAY COMMAND KEY (NO).
	Press P followed by:
	■ A command key to update
	■ D - to disable option
Alarm time : 00:00	

To enable the Alarm Clock	Enter the correct time and date each time you turn on the workstation.
To disable the Alarm Clock	Disable <i>Pop</i> in Alice's Setup Screen.
To enter an alarm time	Use the Arrow keys to move the cursor to the desired field, type in the alarm time and press Enter

To:	Press:
Delete the alarm time	Alt + D
Update an entry	Enter or move the cursor to the next field.
To move the cursor from the <i>Event</i> to the <i>Time and Date</i> fields in a circular manner.	Press Tab
Return to Host	Hot-key

NOTE: The clock stops while the cursor is positioned in the time fields.

9.5.1 Play Command

The 'Alarm Clock' can automatically trigger the playback of a pre-recorded key sequence at the preset alarm time. This feature can be used, for example, to perform a large print job late at night when there is less demand on the computer's time.

To enter a Play Command:

1. Press P to designate the Play Command key.
2. Press the desired command key to enter that number in the PLAY COMMAND KEY [number] field (see the above screen).

To disable the command:

Press D to disable the option.

9.6 Alice's Setup

This screen allows you to set the time used by all clock related activities, enable the display of pop-up messages and set some security related features.

To enter the Alice Setup screen

Press the **Alice** hot key and from the **Alice Main** menu press Alt + 5 (on the numeric keypad). The following screen is displayed.

488 ALICE'S SETUP		
Use ARROW KEYS to move the cursor from field to field.		
HOT KEY - Exit. ALT 0 - Return to Main Menu. HELP - Help.		
Date and Time	YES	NO
Display Clock	YES	NO
Pop Message	YES	NO
Private	YES	NO
Logic Lock	<ENTER>	

Parameter Definitions

Date and Time	<p>This information is the time base for all clock-based activities.</p> <p>NO: Time request will not appear and clock based activities will be disabled.</p> <p>Yes: Date and time request appears on the screen right after power on.</p>
Display Clock	<p>Displays the time on the status line. If the time is not entered when turning on the workstation, 00:00 is displayed</p> <p>Yes: Enables the display.</p> <p>No: Disables the display.</p>
Logic Lock	<p>Allows you to use a three digit number as a password for the Alarm Calendar and Phone List.</p> <p>Press Enter to access the Logic Lock screen.</p> <p>Press D: To delete the password</p> <p>Press E: To set the password.</p>
Pop Message	<p>YES - Enables the Alarm Calendar and the Alarm Clock to display messages.</p> <p>NO - Disable</p>
Private	<p>YES - Causes the Alarm Calendar to display "You have a message" at the preset message time, instead of the actual message.</p>

9.7 Calculator

The built-in calculator can be used to add, subtract, multiply, divide, calculate percentages and use memories. Numbers on the screen can be used to perform calculations and answers can be pasted on the screen.

The calculator *functions* can be enabled from a session (Alt + F1) and calculations performed and viewed on the status line, without affecting the screen or communication.

The calculator *help* screen is accessed from the Alice menu.

9.7.1 Calculator Help screen

To enter the Calculator Help screen

Press the **Alice** hot key and from the **Alice Main** menu press Alt + 6 (on the numeric keypad). The following screen is displayed.

Calculator help Information (Decimal Base)											
PF1	PF2	PF3	PF4	PF5	PF6	PF7	PF8	PF9	PF10	PF11	PF12
	ChgFT		ChgBS	MC	MS-E	MR-E	Import	Export			
AC	All Clear				Upper Shift →			AC	MS	÷	↑
CE	Clear Entry				Lower Shift →			CE	MR	/	X
MS	Clear Store							()	@	Table
MR	Memory Read							7	8	9	-
ChgFT	Change Number Format									M	√
ChgBS	Change Base Number							4	5	6	+
MC	Memory clear							1	2	3	%
MS-E	Memory Store - Expression										
MR-E	Memory Read - Expression										
Import	Import							0		,	=
Export	Export										
↑	Retrieve Previous Expression										
Number Memory (M) 1256.84											
Expression memory (E) 567.00 X (-96+254)+M											
Current Expression 523-(3412/8) + 5682 + 5683.1 + 7894.4 + 2376											
PF3/help=Exit Alt + F1 = Exit calculator											
CALC 523-(3412/8) + 5682 + 5683.1 + 7894.4 + 2376 = 27008 ME											

9.7.2 Calculator Operation

To:	Do the following:
Enter calculator mode	Press Alt + F1 (from any session). The status line will be available for calculations.
Exit calculation mode	Press Alt + F1
Perform calculations	Use the <i>numeric</i> keypad according to the Help screen (note that some key functions have changed)
Clear an entry	Press CE
Clear an expression	Press AC
Perform memory functions	Press MS to save to memory Press MC to clear memory Press MR to recall saved value
Import (copying a number on the screen to a specified position of the expression field)	<ol style="list-style-type: none"> 1. Use the arrow keys to position the cursor on the number. Move the cursor to the number on the screen to be used. Use the arrow keys - \uparrow, \leftarrow, \downarrow and \rightarrow to move. The cursor may be on any digit of the number to be imported. 2. Press = to copy the number to the position of the expression field where the calculator cursor is located. The calculator will automatically exit the Import mode after this step. 3. Press +, -, x or / to enter the character in the next right-hand position of the imported field. The selected number will be imported in the same way as above with the exception that the calculator will not automatically exit the Import Mode after this step.
Display Import/Export Help	Press the Help key while in the corresponding mode.

9.7.2.1 Editing Keys

In addition to the keys on the numeric keypad and the keys displayed on the Help screen, the following keys can be used to edit an expression:

Press:	To:
Backspace	Delete the character entered last.
ErInp	Delete all characters from the cursor position.
Delete	Delete the character at the current cursor position.
Field Exit, New Line, Spacebar	Put a space between two expressions.
←, →	Move the cursor left or right.
Insert	Set/reset Insert mode.
Tab	Move the cursor to the first character in the nearest expression on the right.
BackTab	Move the cursor to the first character in the current expression.
ChgBS	Select the numerical base for calculation: decimal - 10 (no ID), hexadecimal - 16 (HEX), or binary - 2 (BIN).

9.8 Note Pad

The Note Pad is a simple text-editor that can be used to write, edit and print notes that are no longer than a page.

To enter the Note Pad screen

Press the **Alice** hot key and from the **Alice Main** menu press Alt + 7 (on the numeric keypad). The following screen is displayed.

```

                                488 NOTE PAD
3          10          20          30          40          50          60          70          78
x -----L-----T-----T-----T-----T-----T-----R-----x

For tabulator setting move cursor to necessary position.

L -    Press L for Left margin of page.
R -    Press R for Right margin of page.
T -    Press T for Tab-positions (second T: erase Tab-positions).
        Press Enter to exit.

```

The screen contains a Ruler on which the Left Margin, Right Margin and Tabs can be set. The maximum width of the Ruler is 778 characters.

9.8.1 Editing Functions

1. Use the left and right arrow keys to position the cursor on the left and right margins and set them by pressing **L** (on the left margin) and **R** (on the right margin).
2. Press **T** to set tabs and clear tabs.
3. Press Enter to begin editing.
4. Press **Help** to display the help screen for editing functions such as **bold**, underline, block markers, etc.

9.8.2 Word Wrap and Justification Feature

Note Pad has automatic word wrap. In addition, if the cursor is moved to a point other than the left margin and then you begin typing, each of the following lines will begin from the same point (text is always justified left). To begin a line in a different position, simply position the cursor on the desired point and begin typing.

9.8.3 Status Line

Press Enter to display a status line indicating the cursor position, editing mode (**insert/replace**) and attributes (**bold** or/and underline).

Insert: Inserted text will be typed next to existing text.

Replace: Inserted text will replace existing text.

21.8.7 Deleting

Text may be deleted one character at a time, one line at a time, or a defined region (Block) at a time.

To delete one character at a time

Press **Del**, to delete one right character at a time.

Press **Backspace**, to delete one left character at a time.

To delete one line at a time

Press **Alt + E**

9.8.4 Editing Blocks

The Note Pad allows you to delete, copy and paste sections (blocks) of text.

To delete a block

1. Mark the block by positioning the cursor on the beginning of the block, pressing **Alt + M**, moving the cursor to the end of the region to be defined as a block and pressing **Alt + M** again.
2. Press **Alt + D** to delete the block.
3. **To unmark the block**, press **Alt + R**.

To copy a block

1. Mark the block by positioning the cursor on the beginning of the block, pressing **Alt + M**, moving the cursor to the end of the region to be defined as a block and pressing **Alt + M** again.
2. Move the cursor to the place in the document where you want the block to be inserted and press **Alt + S** to insert the block.

To unmark the block

Press **Alt + R**.

10. TROUBLESHOOTING

The following table will help you in case you have trouble operating the workstation or connecting it to the computer.

10.1 Blank Display

<p>Picture does not appear on the screen, the indicator light is ON.</p>	<p>Turn the Contrast and Brightness control knobs to maximum. If the picture does not appear within 30 seconds, turn the workstation off and call a service representative.</p>
<p>Picture does not appear on the screen, the indicator light is OFF.</p>	<p>Make sure that the power switch is ON. Make sure that the workstation is connected properly to the socket (connect any other electrical device and check if it works).</p>
<p>There is a light horizontal or vertical line on the screen.</p>	<p>Call a Service Representative.</p>
<p>9022 appears on the status line while turning the workstation on, or the keyboard does not react.</p>	<p>Make sure the keyboard is connected to the workstation. Don't connect the keyboard to the workstation while the workstation is on.</p>
<p>The workstation enters figures and characters by itself.</p>	<p>Lift the keyboard and move it gently. If the workstation reacts as if you were pressing a key, (clicks, figures and/or characters appear on the screen) try to find the loose key tops and insert them into place by pressing them down hard. If this does not work call the service representative.</p>

10.2 Unstable Display

<p>The picture “swims” to the right or to the left in waves.</p>	<p>Move any other electrical devices such as printers, calculators, etc. away from the workstation. If this does not work, call a Service Representative.</p>
<p>The alarm does not work.</p>	<p>Set the alarm volume to the maximum (4.2.1.1)</p>
<p>There are no clicks when pressing keys.</p>	<p>Refer to clicker volume (4.6.1.1)</p>
<p>Small figures and/or letters appear on different places on the screen.</p>	<p>Set the Extended Display to OFF. Refer to Extended Displa (4.2.2.1).</p>

10.3 Communication Failure

1. Make sure the workstation is connected to the Twinax line.
2. Check that the unit is physically connected to the cable before the workstation actually works; if it has a termination switch, make sure it is in position 2.
3. Check that the address of the workstation is correct, defined on the computer and that the workstation is ON LINE (VARY ON PENDING).
4. Check that the termination switch of the last device on the line (if it has one) is in position 1.
5. Turn the workstation on while holding a key depressed and perform the *Twx Line Test*. If "NO LINE ACTIVITY" appears, check the cable contact and interchange the cables.

If the previous test was successful (i.e. you see line activity and identify the active units), the problem may be in the definition or identification of the workstation towards the computer.

10.4 Communications Problems:

10.4.1 General Troubleshooting: Disturbances, Communication Failure

- Check that there are two units on the same line with the same address.

»»»The workstation identifies itself also as a printer that occupies an address, even if there is no printer physically connected to the workstation. In order to prevent the workstation from being identified as a printer, set the terminal mode to one display or two display. Refer to Section 4.3.

- Check that the termination switch of the last device on the line is in position 1.
- A problem with the electrical system of a lack of grounding may be the cause of communication disturbances.
- Damaged cables between the units may cause disturbances in communication.

10.4.2 Keyboard Produces Incorrect Characters for Some of the Keys

1. The workstation is defined in the computer as 5251 or 5291 instead of 3487 or 3486.
2. The keyboard type defined in the computer is not correct.
3. The keyboard ID defined in the computer is not correct.
4. Refer to above text.
5. Disable the keyboard mapper, go to Offline Setup and check the keyboard mapping.

10.5 Printer Problems

Some of the characters are not printed correctly, or extra characters are inserted in the printout.

- Check that Bypass Table is cleared and EBCDIC to ASCII table is correct. Load default EBCDIC to ASCII table. Refer to Section 9.7.

- If the problem is not solved, Reset Factory Defaults. Refer to Section 4.9. This will clear your terminal setup. You will have to define all your setup parameters in Offline and Online Setup.

- Define the printer driver as Null.

- Change the printer cable.

To check the printer driver and printing character set:

1. Initialize EBCDIC to ASCII table to default.
2. Select the Code Page 850.
3. Enter the Workstation test menu and select Printer test run. Check the results.

APPENDIX.A DEFAULT SETUP VALUES

Setup Panels are provided for setting up the display station characteristics. The values entered are stored in non-volatile memory allowing parameter retention when the display is powered off. There are two types of setups: Offline and Online.

Offline setup defines the number of sessions and their addresses, as well as printer session and emulation mode. In addition, offline setup defines language and keyboard related characteristics.

Online setup defines the visual display characteristics (session colors, cut-and-paste mode, etc.) and security options, setup of devices (printer), and the calculator.

This appendix provides defaults of all the setup panels.

Offline Setup Default

Display Sessions:	1
Printer Sessions:	No
Display Address 1:	0
Character Set:	Country Specific
Printer Emulation:	5256 (If printer session is configured)
Printer Model/Type:	Other
Symbol Code Page:	ASCII
Keyboard Type:	Standard
Country:	US/Canada
ASCII Printer Type:	Standard
Paste Start Position:	Text Cursor
Model ID:	3487
Alternate Addresses:	No
Machine Serial Type:	00 0000000
Keyboard Mapper:	No Keys Mapped
Printer EBCDIC-ASCII Translation Table:	Standard ASCII Table
Gate-ASCII Pass Thru Enable:	No
Bypass Printer Substitution Enable:	No
Gate-Pass Thru Delimiter:	%&

Online Setup Defaults

Setup Display

Alarm Volume:	3
Cursor Style:	Underline
Cursor Blink:	No
Row/Column Indicator	On
Rule Line Style:	Cross
Rule Line Intensity:	No
Rule Line Follows Cursor:	Yes
Auto Dim:	No
Enable Keyboard Mapper:	No
Extended Display:	Off
Buzzer Time:	1.0
Separator:	Yes
Column Separator:	Dot
Reverse Image:	No
Local Tabs:	No
Type Ahead:	No
Message Wait:	Off

Setup Host-Addressable Printer

Lines Per Inch:	6
Characters Per Inch:	10
Print Quality:	Draft

Setup Printer

Print Key:	System
Trim Border:	Normal
Local Form Feed:	Yes
Local Condensed:	No
Buffer Print:	No
Hex Print:	No

Screen Print Setup

Lines Per Inch:	6
Characters Per Inch:	10
Print Quality:	Draft
Source Drawer:	1
Form Length In Inches:	11.000
Form Length In Millimeters:	279.40
First Print Line:	001
First Print Column:	001

Setup Input Devices

Clicker Click:	No
Clicker Volume:	3
Keyboard Typematic Rate:	Normal
Keyboard Typematic Delay:	Normal
Mouse Speed Horizontal:	2 (If mouse is connected)
Mouse Speed Vertical:	2 (If mouse is connected)
Mouse Double Click Interval:	.25 (If mouse is connected)
Mouse Primary Button:	Left

Setup Calculator

Decimal Point:	Comma
----------------	-------

If 5219/3812 Emulation is Selected

Type Style:	System
System Code Page:	System
Paper Feed:	System
Form:	System
Source Drawer:	System
Attention:	No

If 3812 Emulation is Selected

Drawer 1 Default Orientation:	COR
Drawer 1 Paper:	Letter
Drawer 2 Default Orientation:	COR
Drawer 2 Paper:	Letter
Automatic Orientation:	No

APPENDIX B. PRINTER EMULATION MODES

Printer Emulation Table

Attached Printer	Emulations (see note)	Character Set
Basic ASCII Printer (NULLDRIVER)	5256	Any
Programmer's Printer Driver (Other)	Any	Any
Adobe PostScript	3812	ECMA-94
Canon LBP-4, LBP-8 (all series), CaPSL	3812	850, 437 ASCII
Canon BJ-300, BJ-330	5219, 4214, 5256	850, 437 ASCII
Diablo 630	5219, 4214, 5256	Any
Epson JX-80	4214, 5256	DL Epson 9, ASCII
Epson FX-286E, FX86E	5219, 4214, 5256	DL Epson 9, ASCII
Epson FX-850, FX-1050	5219, 4214, 5256	DL Epson 9, 437, ASCII, 850
Epson LQ-1500	5219, 4214, 5256	ASCII
Epson LQ-800, ver.1.03, LQ-1000 ver.1.00	5219, 4214, 5256	437, ASCII
Epson LQ-850, LQ-1050, LQ-2550, LQ Series	5219, 4214, 5256	437, ASCII, 850
Epson LQ-870/1170, LQ-570/1070, LQ ESC/PS2	5219, 4214, 5256	437, ASCII, 850
Hewlett-Packard ThinkJet, PCL	4214, 5256	Roman-8, 437, ASCII
Hewlett-Packard RuggedWriter 480, PCL	5219, 4214, 5256	Roman-8, 437, ASCII
Hewlett-Packard DeskJet 500 and 500C	3812, 5219, 4214, 5256	850, ECMA-94, Roman- 8, 437, ASCII

Note: Emulations are listed in order of preference.

Attached Printer	Emulations (see note)	Character Set
Hewlett-Packard Laserjet Series II	3812, 4212, 5256	ECMA-94, Roman-8, 437, ASCII
Hewlett-Packard Laserjet Series II, Offset Positioning	3812, 4212, 5256	ECMA-94, Roman-8, 437, ASCII
Hewlett-Packard Laserjet Series III	3812	850, ECMA-94, Roman-8, 437, ASCII
IBM PC Graphics Printer 5150	4212, 5256	437, ASCII
IBM Proprinter XL, II, IIXL, III, IIIXL	4212, 5256	850, DL IBM Pro 9, 437, ASCII
IBM 4208 XL24, , 4207, XL24	5219, 4212, 5256	850, 437, ASCII
IBM 5204 QuickWriter, 5202 QuietWriter III	5219, 4212, 5256	850, 437, ASCII
IBM 4019 LaserPrinter, LaserPrinter E, PPDS	5219, 4212, 5256	850, 437, ASCII
IBM Personal Printer Series II 2380 and 2381	5219, 4212, 5256	850, 437, ASCII
IBM Personal Printer Series II 2390 and 2391	5219, 4212, 5256	850, 437, ASCII
IBM ExecJet 4072	5219, 4212, 5256	850, 437, ASCII
IBM Personal Printer Data Stream	Any	850, 437, ASCII
Ithaca Peripherals PCOS Series 50 Receipt Printers	4212, 5256	ASCII
NEC Pinwriter P5, P6 and P7	5219, 4212, 5256	437, ASCII
NEC Pinwriter P9300, P6200/P6300, P3200/P3300	5219, 4212, 5256	850, 437, ASCII
Okidata Microline 292, 393, IBM Compatible	5219, 4212, 5256	437, ASCII

Note: Emulations are listed in order of preference.

Attached Printer	Emulations (see note)	Character Set
Okidata Microline 320, 321, Microline Standard	5219, 4212, 5256	437, ASCII
Okidata Microline 393C+, 393+, ML 390+, 391+, ML 380, (Epson LQ)	5219, 4212, 5256	437, ASCII
Panasonic KX-P1624, KX-P1124, Proprinter XL24 Mode	5219, 4212, 5256	
Panasonic KX-P1695 (Epson FX-1050)	5219, 4212, 5256	DL Epson 9, 437, ASCII
Qume Sprint 11 Plus	5219, 4212, 5256	Any
Star Micronics XR-1020 Multi-Font, XR-1520 Multi-Font, Standard Mode	5219, 4212, 5256	850, 437, ASCII
Toshiba 321SL, 321SLC, 341SI, 351SX, Expresswriter 301 and 311	5219, 4212, 5256	437, ASCII
BOCA Ticket Printer	4212, 5256	ASCII

Note: Emulations are listed in order of preference.

Printer Character Sets

This section lists all characters printable by the system printer emulations. The Multinational set contains all characters that appear in the national language character sets.

Code Page 500, Multinational

Hex Code	Character	Printer Character Name
40		Variable Space
41		Required Space
42	â	Lowercase a Circumflex Accent
43	ä	Lowercase a Dieresis Accent
44	à	Lowercase a Grave Accent
45	á	Lowercase a Acute Accentφ
46	ã	Lowercase a Tilde Accent
47	å	Lowercase a Angstrom Accent
48	ç	Lowercase c Cedilla Accent
49	ñ	Lowercase n Tilde Accent
4A	[Open Square Bracket
4B	.	Period
4C	<	Math Less Than Sign
4D	(Open Parenthesis
4E	+	Math Plus Sign
4F	!	Exclamation Point

Hex Code	Character	Printer Character Name
50	&	Ampersand
51	é	Lowercase e Acure Accent
52	ê	Lowercase e Circumflex Accent
53	ë	Lowercase e Dieresis Accent
54	è	Lowercase e Grave Accent
55	í	Lowercase i Acute Accent
56	î	Lowercase i Circumflex Accent
57	ï	Lowercase i Dieresis Accent
58	ì	Lowercase i Grave Accent
75	ß	Lowercase German Sharp s
5A]	Close Square Bracket
5B	\$	Number Dollar Sign
5C	*	Asterisk
5D)	Close Parenthesis
5E	;	Semicolon
5F	^	Circumflex Accent
60	-	Hyphen
61	/	Oblique Slash
62	Â	Uppercase A Circumflex Accent
63	Ä	Uppercase A Dieresis Accent
64	À	Uppercase A Grave Accent
65	Á	Uppercase A Acute Accent
66	Ã	Uppercase A Tilde Accent
67	Å	Uppercase A Angstrom Accent
68	Ç	Uppercase C Cedilla Accent
69	Ñ	Uppercase N Tilde Accent
6A		Broken Vertical Bar
6B	,	Comma
6C	%	Percent Sign
6D	_	Underscore
6E	>	Math Greater Than Sign
6F	?	Question Mark
70	φ	Lowercase o Bar

Hex Code	Character	Printer Character Name
71	É	Uppercase E Acute Accent
72	Ê	Uppercase E Circumflex Accent
73	Ë	Uppercase E Dieresis Accent
74	È	Uppercase E Grave Accent
75	Í	Uppercase I Acute Accent
76	Î	Uppercase I Circumflex Accent
77	Ï	Uppercase I Dieresis Accent
78	Ì	Uppercase I Grave Accent
79	`	Grave Accent
7A	:	Colon
7B	#	Number Pound Sign
7C	@	At Symbol
7D	'	Single Quote
7E	=	Math Equal Sign
7F	“	Double Quote
80	Ø	Uppercase O Bar
81	a	Lowercase a
82	b	Lowercase b
83	c	Lowercase c
84	d	Lowercase d
85	e	Lowercase e
86	f	Lowercase f
87	g	Lowercase g
88	h	Lowercase h
89	i	Lowercase i
8A	«	Open European Quote
8B	»	Close European Quote
8C	ð	Lowercase Icelandic Eth
8D	ý	Lowercase y Acute Accent
8E	þ	Lowercase Icelandic Thorn
8F	±	Math Plus Minus Sign
90	°	Degree, Angstrom
91	j	Lowercase j
92	k	Lowercase k

Hex Code	Character	Printer Character Name
93	l	Lowercase l
94	m	Lowercase m
95	n	Lowercase n
96	o	Lowercase o
97	p	Lowercase p
98	q	Lowercase q
99	r	Lowercase r
9A	ǎ	Ordinal a
9B	ǒ	Ordinal o
9C	æ	Lowercase ae Diphthong
9D	¸	Cedilla Accent
9E	Æ	Uppercase AE Diphthong
9F	¤	International Currency Symbol
A0	μ	Greek Lowercase Mu
A1	~	Tilde Accent
A2	s	Lowercase s
A3	t	Lowercase t
A4	u	Lowercase u
A5	v	Lowercase v
A6	w	Lowercase w
A7	x	Lowercase x
A8	y	Lowercase y
A9	z	Lowercase z
AA	¡	Spanish Open Exclamation Point
AB	¿	Spanish Open Question Mark
AC	Ð	Uppercase Icelandic Eth
AD	Ý	Uppercase Y Acute Accent
AE	Þ	Uppercase Icelandic Thorn
AF	®	Registered Trademark Symbol
B0	¢	Cent Sign
B1	£	Pound Sterling, Lira
B2	¥	Yen
B3	•	Solid Bullet
B4	f	Florin, Guilder

Hex Code	Character	Printer Character Name
B5	§	Section Symbol
B6	¶	Paragraph Symbol
B7	¼	Fraction, One-Fourth
B8	½	Fraction, One-Half
B9	¾	Fraction, Three-Fourths
BA	¬	Math Logical NOT Sign
BB		Solid Vertical Bar (Logical OR)
BC	¯	Overscore
BD	¨	Dieresis Accent
BE	´	Acute Accent
BF	=	Double Underscore
C0	{	Open Brace
C1	A	Uppercase A
C2	B	Uppercase B
C3	C	Uppercase C
C4	D	Uppercase D
C5	E	Uppercase E
C6	F	Uppercase F
C7	G	Uppercase G
C8	H	Uppercase H
C9	I	Uppercase I
CA	-	Syllable Hyphen
CB	ô	Lowercase o Circumflex Accent
CC	ö	Lowercase o Dieresis Accent
CD	ò	Lowercase o Grave Accent
CE	ó	Lowercase o Acute Accent
CF	õ	Lowercase o Tilde Accent
D0	}	Close Brace
D1	J	Uppercase J
D2	K	Uppercase K
D3	L	Uppercase L
D4	M	Uppercase M
D5	N	Uppercase N
D6	O	Uppercase O

Hex Code	Character	Printer Character Name
D7	P	Uppercase P
D8	Q	Uppercase Q
D9	R	Uppercase R
DA	ı	Lowercase Dotless i
DB	û	Lowercase u Circumflex Accent
DC	ü	Lowercase u Dieresis Accent
DD	ù	Lowercase u Grave Accent
DE	ú	Lowercase u Acute Accent
DF	ÿ	Lowercase y Dieresis Accent
E0	\	Oblique Back Slash
E1		Numeric Space
E2	S	Uppercase S
E3	T	Uppercase T
E4	U	Uppercase U
E5	V	Uppercase V
E6	W	Uppercase W
E7	X	Uppercase X
E8	Y	Uppercase Y
E9	Z	Uppercase Z
EA	²	Superior 2 (Square)
EB	Ô	Uppercase O Circumflex Accent
EC	Ö	Uppercase O Dieresis Accent
ED	Ò	Uppercase O Grave Accent
EE	Ó	Uppercase O Acute Accent
EF	Õ	Uppercase O Tilde Accent
F0	0	Number 0
F1	1	Number 1
F2	2	Number 2
F3	3	Number 3
F4	4	Number 4

Hex Code	Character	Printer Character Name
F5	5	Number 5
F6	6	Number 6
F7	7	Number 7
F8	8	Number 8
F9	9	Number 9
FA	³	Superior 3 (Cube)
FB	Û	Uppercase U Circumflex Accent
FC	Ü	Uppercase U Dieresis Accent
FD	Ù	Uppercase U Grave Accent
FE	Ú	Uppercase U Acute Accent
FF		Undefined

Printable Characters

This section lists the printable characters for each of the attached printer character sets. The Multinational character set contains all characters contained in the national language character sets.

Printable Characters
for
850; DL, IBM Pro 9;
and DL, Epson 9
Attached Printer Character Sets
Code Page 500, Multinational

	4x	5x	6x	7x	8x	9x	Ax	Bx	Cx	Dx	Ex	Fx
x0		&	-	ø	Ø	°	μ	¢	{	}	\	0
x1		é	/	É	a	j	~	£	A	J		1
x2	â	ê	Â	Ê	b	k	s	¥	B	K	S	2
x3	ä	ë	Ä	Ë	c	l	t	•	C	L	T	3
x4	à	è	À	È	d	m	u	f	D	M	U	4
x5	á	í	Á	Í	e	n	v	§	E	N	V	5
x6	ã	î	Ã	Î	f	o	w	¶	F	O	W	6
x7	â	ï	Å	Ï	g	p	x	¼	G	P	X	7
x8	ç	ì	Ç	Ì	h	q	y	½	H	Q	Y	8
x9	ñ	ß	Ñ	˘	i	r	z	¾	I	R	Z	9
xA	[]		:	«	ª	ı	¬	-	ı	²	³
xB	.	\$,	#	»	º	ı		ô	û	Ô	Û
xC	<	*	%	@	ð	æ	Ð	—	ö	ü	Ö	Ü
xD	()	_	'	ý	,	Ý	¨	ò	ù	Ò	Ù
xE	+	;	>	=	þ	Æ	Þ	´	ó	ú	Ó	Ú
xF	!	^	?	"	±	□	®	=	õ	ÿ	Õ	

All characters are printed.

Printable Characters
for
437 Attached Printer Character Set
Code Page 500, Multinational

	4x	5x	6x	7x	8x	9x	Ax	Bx	Cx	Dx	Ex	Fx
x0		&	-	ø	Ø	°	μ	¢	{	}	\	0
x1		é	/	É	a	j	~	£	A	J		1
x2	â	ê	À	E	b	k	s	¥	B	K	S	2
x3	ä	ë	Ä	E	c	l	t	•	C	L	T	3
x4	à	è	A	E	d	m	u	f	D	M	U	4
x5	á	í	A	I	e	n	v	§	E	N	V	5
x6	a	î	A	I	f	o	w	π	F	O	W	6
x7	å	ï	Å	I	g	p	x	¼	G	P	X	7
x8	ç	ì	Ç	I	h	q	y	½	H	Q	Y	8
x9	ñ	ß	Ñ	`	i	r	z		I	R	Z	9
xA	[]		:	«	ª	ı	¬	-		²	
xB	.	\$,	#	»	º	ı		ô	û	ô	Û
xC	<	*	%	@	d	æ	D		ö	ü	Ö	Ü
xD	()	_	'	y	,	Y	"	ò	ù	ò	Ù
xE	+	;	>	=		Æ		'	ó	ú	ó	Ú
xF	!	^	?	"	±				o	ÿ	O	

These characters appear as spaces:

Lowercase Icelandic Thorn

International Currency Symbol

Uppercase Icelandic Thorn

Registered Trademark Symbol

Fraction Three Fourths

Overscore

Double Underscore

Lowercase dotless i

Superior Three (Cube)

These accented characters are replaced by their unaccented counterparts.

Uppercase A Acute Accent

Uppercase A Circumflex Accent

Uppercase A Grave Accent

Uppercase A Tilde Accent

Lowercase a Tilde Accent

Uppercase E Circumflex Accent

Uppercase E Dieresis Accent

Uppercase E Grave Accent

Uppercase I Acute Accent

Uppercase I Circumflex Accent

Uppercase I Dieresis Accent

Uppercase I Grave Accent

Uppercase O Tilde Accent

Lowercase o Tilde Accent

Uppercase Y Acute Accent

Lowercase y Acute Accent

These accented uppercase characters are replaced by their accented lowercase counterparts.

Uppercase O Acute Accent

Uppercase O Circumflex Accent

Uppercase Grave Accent

Uppercase U Acute Accent

Uppercase U Circumflex Accent

Uppercase U Grave Accent

Lowercase Icelandic Eth is replaced by Lowercase d

Uppercase Icelandic Eth is replaced by Uppercase D.

Acute Accent is replaced by Single Quote.

Cedilla Accent is replaced by Comma.

Dieresis Accent is replaced by Double Quote.

Paragraph Symbol is replaced by Greek Lowercase Pi.

Broken Vertical Bar is replaced by Solid vertical Bar (on most attached printers).

Printable Characters
for
ASCII Attached Printer Character Set
Code Page 500, Multinational

	4x	5x	6x	7x	8x	9x	Ax	Bx	Cx	Dx	Ex	Fx
x0		&	-	o	O				{	}	\	0
x1		e	/	E	a	j	~		A	J		1
x2	a	e	A	E	b	k	s		B	K	S	2
x3	a	e	A	E	c	l	t		C	L	T	3
x4	a	e	A	E	d	m	u		D	M	U	4
x5	a	i	A	I	e	n	v		E	N	V	5
x6	a	i	A	I	f	o	w		F	O	W	6
x7	a	i	A	I	g	p	x		G	P	X	7
x8	c	i	C	I	h	q	y		H	Q	Y	8
x9	n		N	`	i	r	z		I	R	Z	9
xA	[]		:					-			
xB	.	\$,	#				l	o	u	O	U
xC	<	*	%	@					o	u	O	U
xD	()	_	'	ý	,	Ý	"	o	u	O	U
xE	+	;	>	=				'	o	u	O	U
xF	!	^	?	"					o	y	O	

These characters appear as spaces:

Lowercase German Sharp s

Open European Quote

Close European Quote

Lowercase Icelandic Eth

Lowercase Icelandic Thorn

Math Plus Minus Sign

Degree, Angstrom

Ordinal a

Ordinal o

Lowercase ae Diphthong

Uppercase AE Diphthong

International Currency Symbol

Greek Lowercase Mu

Spanish Open Exclamation Point

Spanish Open Question Mark

Uppercase Icelandic Eth

Uppercase Icelandic Thorn

Registered Trademark Symbol

Cent Sign

Pound Sterling, Lira

Yen

Solid Bullet

Florin, Guilder

Section symbol

Paragraph Symbol

Fraction, One-Fourth

Fraction, One-Half

Fraction, Three-Fourths

Math Logical NOT Sign

Overscore

Double Underscore

Lowercase Dotless i

Superior 2 (Square)

Superior 3 (Cube)

All accented characters appear as their unaccented counterparts.

Acute Accent is replaced by Single Quote.

Cedilla Accent is replaced by Comma.

Dieresis Accent is replaced by Double Quote.

Broken Vertical Bar is replaced by Solid Vertical Bar (on most attached printers).

Printable Characters
for
ECMA-94 Attached Printer Character Set
Code Page 500, Multinational

	4x	5x	6x	7x	8x	9x	Ax	Bx	Cx	Dx	Ex	Fx
x0		&	-	ø	Ø	°	μ	¢	{	}	\	0
x1		é	/	É	à	á	~	£	A	J		1
x2	â	ê	Â	Ê	b	k	s	¥	B	K	S	2
x3	ä	ë	Ä	Ë	c	l	t	•	C	L	T	3
x4	à	è	À	È	d	m	u		D	M	U	4
x5	á	í	Á	Í	e	n	v	§	E	N	V	5
x6	ã	î	Ã	Î	f	o	w	¶	F	O	W	6
x7	å	ï	Å	Ï	g	p	x	¼	G	P	X	7
x8	ç	ì	Ç	Ì	h	q	y	½	H	Q	Y	8
x9	ñ	ß	Ñ	˘	i	r	z	¾	I	R	Z	9
xA	[]		:	«	ª	ı	¬	-		²	³
xB	.	\$,	#	»	º	ı		ô	û	Ô	Û
xC	<	*	%	@		æ	Ð	—	ö	ü	Ö	Ü
xD	()	_	'	ý	,	Ý	..	ò	ù	Ò	Ù
xE	+	;	>	=	þ	Æ	þ	'	ó	ú	Ó	Ú
xF	!	^	?	"	±	α	®		õ	ÿ	Õ	

These characters appear as spaces:

Lowercase Icelandic Eth

Florin, Guilder

Double Underscore

Lowercase Dotless i

Printable Characters
for
Roman 8 Attached Printer Character Set
Code Page 500, Multinational

	4x	5x	6x	7x	8x	9x	Ax	Bx	Cx	Dx	Ex	Fx
x0		&	-	ø	Ø	°	μ	¢	{	}	\	0
x1		é	/	É	á	¡	~	£	A	J		1
x2	â	ê	Â	Ê	b	k	s	¥	B	K	S	2
x3	ä	ë	Ä	Ë	c	l	t	•	C	L	T	3
x4	à	è	À	È	d	m	u	f	D	M	U	4
x5	á	í	Á	Í	e	n	v	§	E	N	V	5
x6	ã	î	Ã	Î	f	o	w	¶	F	O	W	6
x7	â	ï	Å	Ï	g	p	x	¼	G	P	X	7
x8	ç	ì	Ç	Ì	h	q	y	½	H	Q	Y	8
x9	ñ	ß	Ñ	˘	i	r	z		I	R	Z	9
xA				:	«	²	ı	-				
xB	.	\$,	#	»	³	ı	ı	ô	û	Ô	Û
xC	<	*	%	@	ð	æ	Ð	—	ö	ü	Ö	Ü
xD	()	_	'	ý	,	Ý	¨	ò	ù	Ò	Ù
xE	+	;	>	=	þ	Æ	Þ	´	ó	ú	Ó	Ú
xF	!	^	?	"	±	□			õ	ÿ	Õ	

These characters appear as spaces:

Registered Trademark Symbol

Math Logical NOT Symbol

Double Underscore

Lowercase Dotless i

Superior 2 (Square)

Superior 3 (Cube)

Cedilla Accent is replaced by Comma

Broken Vertical Bar is replaced by Solid Vertical Bar

20 DIFFERENCES FROM IBM SYSTEM PRINTERS

This section describes the differences between the workstation's system addressable printer and the actual IBM system printers which are emulated.

Differences Which Apply to All Emulations

All workstation system addressable printer emulations support the ASCII Transparent (ATN) SCS command. The ATN command performs a function similar to the ASCII Transparent and Printer Substitution features at the SCS command level. The ATN command must appear in the data stream in binary hex form. This requires special application programming. The ATN command has the following format:

03 nn data

Where:

nn The number of data bytes following NOT including nn.

Data The data bytes to be passed through to the attached printer.

The workstation system addressable printer does not report graphic check errors. The workstation system addressable printers do not stop upon receiving the SCS BELL Command. For the workstation, the BELL command will cause the alarm to sound in the attached printer but no unavailable status will be reported to the host and printing will continue. IBM system printers will print all buffered data, sound the alarm and go unavailable to the host. On an IBM system printer, printing will not resume until the start button is pressed at the printer.

The actual IBM system printers have small print buffers, and the data remains in the host spool file until it is printed. The attached printers, and therefore, the workstation system addressable printers, have large print buffers, which are quickly filled with the print data. The workstation may be receiving print data from the host spool file several pages ahead of what is actually printing. Therefore, a print job may be deleted from the host spool file long before it is actually printed. Once a print job has been deleted from the host spool file, the print job cannot be restarted unless the job is rerun. The maximum form length supported by the workstation system addressable printer is 45.5 inches.

Differences From IBM 5256 Operation

The 5256 emulation provided by the workstation uses the same character sets as the IBM 4214 system printer. Several characters are missing from the IBM 5256 system printer's character sets. These characters are replaced with the 4214 characters. The characters affected are as follows:

The "Less Than or Equal Sign" is replaced by a lower case "y" with an acute accent.

The "Up Arrow" is replaced with an upper case "Y" with an acute accent.

The "Not Equal Sign" is replaced by an "Overscore".

The "Peseta" symbol is replaced by a "Bullet".

The "Greater Than or Equal Sign" is replaced by a "Dot-less i".

Differences From IBM 4214 Operation

The workstation's 4214 emulation does not support BGR and APF graphics. The workstation's emulation also ignores Load Alternate Characters (LAC) and Transparent (TRN) SCS commands. In some cases, invalid data may be printed.

The workstation 4214 printer supports line densities in 1/72nds of an inch. All vertical margins and line densities are truncated to the nearest 1/72nd of an inch. To avoid alignment problems, specify line density in even multiples of 1/72nds (i.e., 20/1440ths).

Differences From IBM 5219 Operation

The workstation 5219 printer supports horizontal motion in 1/120ths of an inch. All horizontal positions are truncated to the nearest 1/120th of an inch. To avoid alignment problems, specify horizontal margins in even multiples of 1/120ths (i.e., 12/1440ths). Neither the IBM 5219 system printer nor the workstation 5219 printer support orientation changes.

If a PSM font is selected, the workstation 5219 printer assumes that the character widths of the resulting font are equivalent to the character widths of the 5219 printer's PSM fonts.

Differences From IBM 3812 Operation

The Set Form Feed Control (SFFC) and Execute PMP SCS commands are not supported. Orientation changes not occurring on a page boundary may cause unpredictable results. Character set support is limited to the character sets listed in section 19.

Appendix B. PRINTER EMULATION MODES	B-1
Printer Emulation Table	B-1
Printer Character Sets	B-4
Code Page 500, Multinational	B-4
Printable Characters	B-11
Differences Which Apply to All Emulations	B-19
Differences From IBM 5256 Operation	B-20
Differences From IBM 4214 Operation	B-20
Differences From IBM 5219 Operation	B-20
Differences From IBM 3812 Operation	B-20

APPENDIX C. 5219 & 3812 FONT SUPPORT

This section lists all IBM Global Font IDs (GFIDs) supported by the 486 print drivers and includes special application notes.

NOTE: Some printers do not have font substitution lists; only general guidelines are given for these printers.

Adobe PostScript

The PostScript driver supports the 35 standard Adobe PostScript fonts. Monospace GFIDs will cause the PostScript proportional fonts to simulate monospace printing. All other GFIDs use the monospace Courier, Courier Bold or Courier Oblique fonts. Printing which requires precise placement of text, such as tables of data created with tabs, should be printed using a Courier GFID. Proportional spaced GFIDs (PSM) are not fully supported; most PSMs will use Times or Helvetica.

PostScript Font	IBM GFIDs
Courier	11 85 223 252 and Monospace Default
Courier Bold	46 108 245 253
Courier Oblique	18 92 215
Times Roman	41 42 70 229
Times Roman Bold	72
Times Roman Italic	43 71
Helvetica	26 36 40 51 66 74 87 222 232 255
Helvetica Bold	39 69 110 243
Helvetica Oblique	68 109
Century Schoolbook	12 86 221 256
Century Schoolbook Bold	60 111
Century Schoolbook Italic	06 91 112
ITC Avant Garde Book	05 25 459-462 464-467
ITC Avant Garde Demi	38 434 435
Palatino Roman	13 81
Palatino Bold	56
ITC Bookman Light	20 83 107
ITC Bookman Light Italic	23 97
Zapf Chancery Medium Italic	84 468-472

The following scalable typographic fonts are supported at a point height 80% of the single line spacing.

PostScript Font	IBM GFIDs
Times Roman	5687
Times Bold	5707
Times Italic	5815
Times Bold Italic	5835
Helvetica Light	34083
Helvetica	34103
Helvetica Bold	34123
Helvetica Black	34143
Helvetica Light Oblique	34211
Helvetica Oblique	34231
Helvetica Bold Oblique	34251
Helvetica Black Oblique	34271
Helvetica Narrow	34101
Helvetica Narrow Bold	34121
Helvetica Narrow Oblique	34229

Helvetica Narrow Bold Oblique	34249
Century Schoolbook Roman	16951
Century Schoolbook Bold	16971
Century Schoolbook Italic	17079
Century Schoolbook Bold Italic	17099
ITC Avant Garde Gothic Book	33837
ITC Avant Garde Gothic Demi	33857
ITC Avant Garde Book Oblique	33965
ITC Avant Garde Demi Oblique	33985
Palatino Roman	5175
Palatino Bold	5195
Palatino Italic	5303
Palatino Bold Italic	5323
ITC Bookman Light	6435
ITC Bookman Demi	6465
ITC Bookman Light Italic	6563
ITC Bookman Demi Italic	6593
Zapf Chancery Medium Italic	43447
Goudy Old Style Roman	4919
Goudy Old Style Bold	4939
Goudy Old Style Italic	5047
Goudy Old Style Bold Italic	5067
Optima	33335
Optima Bold	33355
Optima Italic	33463
Optima Bold Italic	33483
Futura Book	33591
Futura Heavy	33601
Futura Book Italic	33719
Futura Heavy Italic	33729
University Roman	5943

Canon LBP-4, LBP-8 and CaPSL

GFIDs are not mapped to specific fonts for these printers. Instead, a “character attribute” method is used to determine which printer font will represent specific GFIDs. The driver will examine the characteristics of the GFID font and will compare these characteristics to the fonts available to your printer. It will then attempt to match the requirements of the GFID font as closely as possible to one of the available fonts. Usually, an exact match of all characteristics can be made; if an exact match cannot be made; the font with the closest match will be used.

This *Character attribute* method of font selection will be used for all GFIDs except those listed below. For the fonts listed below, horizontal spacing will match the spacing received from the host for monospace fonts.

Scalable Font Selection and Character Set Rotation must be Enabled using the FONT/FEED menu on the printer. The BM-3 Font Card is strongly recommended.

Canon LBP Font	IBM GFID
Line Printer (0)	222 230 232 255 258 259 13.2 and 20 cpi default
Pica (1)	12 20 Bold: 60 Italic: 6 91
Elite (2)	86 221 256 300 400 Bold: 11 Italic: 112
Courier (3)	All other monospace fonts

The following scalable typographic fonts are supported at a point height 80% of the single line spacing. GFIDs in parentheses denote other additional fonts which are mapped to the Canon LBP typeface.

Canon LBP Font	IBM GFID
Dutch Roman	5687
Dutch Bold	5707
Dutch Italic	5815
Dutch Bold Italic	5835
Swiss	34103
Swiss Bold	34123
Swiss Oblique	34231
Swiss Bold Oblique	34251
Swiss Narrow	34101
Swiss Narrow Bold	34121
Swiss Narrow Oblique	34229
Swiss Narrow Bold Oblique	34249
Century Schoolbook Roman	16951
Century Schoolbook Bold	16971
Century Schoolbook Italic	17079
Century Schoolbook Bold Italic	17099
ITC Avant Garde Book	33837 (33591)
ITC Avant Garde Demi	33857 (33601)
ITC Avant Garde Book Oblique	33965 (33719)
ITC Avant Garde Demi Oblique	33985 (33729)
Zapf Calligraphic - Roman	5175
Zapf Calligraphic - Bold	5195
Zapf Calligraphic - Italic	5303
Zapf Calligraphic - Bold Italic	5323
ITC Bookman Light	6435 (8503)
ITC Bookman Demi	6465 (8523)
ITC Bookman Light Italic	6563 (8631)
ITC Bookman Demi Italic	6593 (8651)
Zapf Chancery Medium Italic	43447

Canon Bubble Jet BJ-300 and BJ-330

This driver supports the GFIDs in their original form. All characteristics are passed through.

Epson LQ-850, LQ-1050, LQ-2550, LQ Series

Changes of typeface only occur when letter quality printing is specified. Typographic Fonts are not supported by the Epson LQ Series driver. Selection of a typographic GFID will result in 12 cpi printing with the Epson Roman (0) font.

IBM GFID	Font Name	Epson LQ Font Name (ID)	Italic	Enhanced
03	OCR-B	OCR-B (5)		
05	Orator 10	Orator (7)		
06	Light Italic 10	Prestige (3)	Italic	
11	Courier 10	Courier (2)		
12	Prestige Pica	Prestige (3)		
18	Courier Italic 10	Courier (2)	Italic	
19	OCR-A	OCR-A (6)		
20	Pica	Prestige (3)		
25	Presentor 10	Orator-S (8)		
26	Gothic 10	Sans-Serif (1)		
36	Letter Gothic 10	Sans-Serif (1)		
38	Orator Bold 10	Orator (7)		Enhanced
39	Letter Gothic Bold 10	Sans-Serif (1)		Enhanced
40	Gothic Text 10	Sans-Serif (1)		
41	Roman Text	Roman (0)		
42	Serif Text	Roman (0)		
43	Serif Italic 10	Roman (0)	Italic	
46	Courier Bold 10	Courier (2)		Enhanced
51	Gothic 10	Sans-Serif (1)		
52	Courier 10	Courier (2)		
60	Prestige Pica Bold	Prestige (3)		Enhanced
	Default (all others)	Roman (0)		
66	Gothic Text 12	Sans-Serif (1)		
68	Gothic Italic 12	Sans Serif (1)	Italic	
69	Gothic Bold 12	Sans-Serif (1)		Enhanced

IBM GFID	Font Name	Epson LQ Font Name (ID)	Italic	Enhanced
70	Serif Text 12	Roman (0)		
71	Serif Italic 12	Roman (0)	Italic	
72	Serif Bold 12	Roman (0)		Enhanced
75	Courier 12	Courier (2)		
84	Script 12	Script (4)		
85	Courier 12	Courier (2)		
86	Prestige Elite	Prestige (3)		
87	Letter Gothic 12	Sans-Serif (1)		
91	Light Italic 12	Prestige (3)	Italic	
92	Courier Italic 12	Courier (2)	Italic	
108	Courier Bold 12	Courier (2)		Enhanced
109	Letter Gothic Italic 12	Sans-Serif (1)	Italic	
110	Letter Gothic Bold 12	Sans-Serif (1)		Enhanced
111	Prestige Elite Bold	Prestige (3)		Enhanced
112	Prestige Elite Italic	Prestige (3)	Italic	
	Default (all others)	Sans-Serif (1)		
215	Courier Italic 15	Courier (2)	Italic	
221	Prestige 15	Prestige (3)		
222	Letter Gothic 15	Sans-Serif (1)		
223	Courier 15	Courier (2)		
229	Serif Text 15	Roman (0)		
230	Gothic Text 15	Sans-Serif (1)		
233	Courier 15	Courier (2)		
244	Courier 5	Courier (2)		
245	Courier Bold 5	Courier (2)		Enhanced
252	Courier 17.1	Courier (2)		
253	Courier Bold 17.1	Courier (2)		Enhanced
254	Courier (sub/sup) 17.1	Courier (2)		
255	Letter Gothic 17.1	Sans-Serif (1)		
256	Prestige 17.1	Prestige (3)		
260	Courier 8.55	Courier (2)		
281	Gothic 20	Sans-Serif (1)		
434	Orator Bold 8.1	Orator (7)		Enhanced
435	Orator Bold 6.5	Orator (7)		Enhanced
459	Orator 12	Orator (7)		
460	Orator 15	Orator (7)		
461	Orator 17	Orator (7)		

IBM GFID	Font Name	Epson LQ Font Name (ID)	Italic	Enhanced
462	Orator 20	Orator (7)		
464	Presentor 12	Orator-S (8)		
465	Presentor 15	Orator-S (8)		
466	Presentor 17.1	Orator-S (8)		
467	Presentor 20	Orator-S (8)		
468	Script 10	Script (4)		
469	Script 12	Script (4)		
470	Script 15	Script (4)		
471	Script 17.1	Script (4)		
472	Script 20	Script (4)		
	Default (all others)	Sans-Serif (1)		
154	Essay	Sans-Serif (1)		
155	Boldface Italic	Roman (0)	Italic	Enhanced
158	Modern	Roman (0)		
159	Boldface	Roman (0)		Enhanced
160	Essay	Sans-Serif (1)		
162	Essay Italic	Sans-Serif (1)	Italic	
163	Essay Bold	Sans-Serif (1)		Enhanced
171	Courier PS	Roman (0)		
172	Courier Italic	Roman (0)	Italic	
173	Essay Light	Sans-Serif (1)		
174	Gothic Mixed	Sans-Serif (1)		
185	Courier Bold Italic	Roman (0)	Italic	Enhanced
186	Press Roman	Roman (0)		
187	Press Roman Bold	Roman (0)		Enhanced
188	Press Roman Italic	Roman (0)	Italic	
189	Press Roman Bold Italic	Roman (0)	Italic	Enhanced
	Default (all others)	Roman (0)		

Epson LQ-870, LQ-1170, LQ-570, LQ-1070, LQ ESC/P2

In addition to the font support already described for other Epson LQ Series printers, the following GFID to Epson LQ font mappings are supported.

Prestige PS 164

Courier PS 171

Courier Italic PS 172

Courier Bold Italic PS 185

Script C PS 200

Roman (scaled): 751, 760-765, 1051, 1056, 1351, 1653, 1803, 2103

The Epson LQ ESC/P2 printers do not print buffered data until vertical motion is detected. Bold text from Display Write /36 and text generated by some programs may not appear bold. To achieve bold, use a bold font, for example GFID 46, Courier Bold 10. Bold may also be achieved by using the Printer substitution or ASCII Pass Through Features.

Epson FX-286e, FX-86e

These printers only have one typeface which is used for all GFIDs. However, this one typeface supports bold and italic attributes for GFIDs that use them. (In some cases, your printer may actually have two faces available: a serif face and a sans-serif face. This will vary from printer to printer.)

Epson FX-850, FX-1050

See description of Epson FX-286e and FX-86e printers.

Epson LQ-1500

See description of Epson FX-286e and FX-86e printers.

HP Deskjet 500 and 500C

GFIDs are not mapped to specific fonts for these printers. Instead, a *character attribute* method is used to determine which printer font will represent specific GFIDs. The driver will examine the characteristics of the GFID font and will compare these characteristics to the fonts available to your printer. It will then attempt to match the requirements of the GFID font as closely as possible to one of the available fonts. Usually, an exact match of all characteristics can be made; if an exact match cannot be made; the font with the closest match will be used.

The following HP fonts are available for character attribute matching on the Deskjet 500 and 500C:

- Courier
- Gothic
- Letter Gothic
- Prestige
- Presentations
- Helvetica
- Times

Laserjet II, Offset Positioning

This driver is identical to the *HP Laserjet II* driver except that all vertically positioning is relative to the default top margin rather than the top edge of the paper. The default top margin for HP Laserjet Series II is one half inch.

HP LaserJet II & LaserJet III

HP LaserJet Font Characteristics

IBM FONT GFID	NAME	PITCH	POINT HEIGHT	STYLE	BASE WEIGHT	BOLD WEIGHT	TYPEFACE
3 *	OCR-B	10	12	uprgt	0	3	OCR-B (104)
5	Orator 10	10	14	uprgt	3	5	Presentation (11)
11	Courier 10	10	12	uprgt	0	3	Courier (3)
12	Prestige Pica	10	12	uprgt	0	3	Prestige (8)
18	Courier Italic 10	10	12	uprgt	0	3	Courier (3)
19 *	OCR-A	10	12	uprgt	0	3	OCR-A (104)
20	Pica	10	12	uprgt	0	3	Prestige (8)

- Symbol set will be changed to "10" for OCR-B and "00" for OCR-A. The symbol set matching the Attached Printer Character Set selection will be restored when a non-OCR GFID is received.

IBM FONT GFID	NAME	PITCH	POINT HEIGHT	STYLE	BASE WEIGHT	BOLD WEIGHT	TYPEFACE
25	Presentor 10	10	14	uprgt	0	3	Orator (10)
26	Gothic 10	10	14	uprgt	0	3	L. Gothic (6)
36	Letter Gothic 10	10	14	uprgt	0	3	L. Gothic (6)
38	Orator Bold 10	10	14	uprgt	3	5	Presentations (11)
39	Letter Gothic Bold 10	10	14	uprgt	3	5	L. Gothic (6)
40	Gothic Text 10	10	14	uprgt	0	3	L. Gothic (6)
46	Courier Bold 10	10	12	uprgt	3	5	Courier (3)
60	Prestige Pica Bold	10	12	uprgt	3	5	Prestige (8)
	Default (all others)	10	12	uprgt	0	3	Courier (3)
66	Gothic Text 12	12	12	uprgt	0	3	L. Gothic (6)
68	Gothic Italic 12	12	12	italic	0	3	L. Gothic (6)
69	Gothic Bold 12	12	12	uprgt	3	5	L. Gothic (6)
75	Courier 12	12	10	uprgt	0	3	Courier (3)
85	Courier 12	12	10	uprgt	0	3	Courier (3)
86	Prestige Elite	12	10	uprgt	0	3	Prestige (8)
87	Letter Gothic 12	12	12	uprgt	0	3	L. Gothic (6)
91	Light Italic 12	12	10	italic	-3	0	Prestige (8)
92	Courier Italic 12	12	10	italic	0	3	Courier (3)
108	Courier Bold 12	12	10	uprgt	3	5	Courier (3)
109	Letter Gothic Italic 12	12	12	italic	0	3	L. Gothic (6)
110	Letter Gothic Bold 12	12	12	uprgt	3	5	L. Gothic (6)
111	Prestige Elite Bold	12	10	uprgt	3	0	Prestige (8)
112	Prestige Elite Italic	12	10	italic	0	3	Prestige (8)
	Default (all others)	12	10	uprgt	0	3	Prestige (8)
155	Boldface Italic	PS	10	italic	3	5	Times Roman (5)

IBM FONT GFID	NAME	PITCH	POINT HEIGHT	STYLE	BASE WEIGHT	BOLD WEIGHT	TYPEFACE
158	Modern	PS	10	uprpt	0	3	Times Roman (5)
159	Boldface	PS	10	uprpt	3	5	Times Roman (5)
160	Essay	PS	10	uprpt	0	3	Helvetica (4)
162	Essay Italic	PS	10	italic	0	3	Helvetica (4)
163	Essay Bold	PS	10	uprpt	3	5	Helvetica (4)
173	Essay Light	PS	10	uprpt	-3	0	Helvetica (4)
186	Press Roman	PS	10	uprpt	0	3	Times Roman (5)
187	Press Roman Bold	PS	10	uprpt	3	5	Times Roman (5)
188	Press Roman Italic	PS	10	italic	0	3	Times Roman (5)
189	Press Roman Bold Italic	PS	10	italic	3	5	Times Roman (5)
	Default (all others)	PS	10	uprpt	0	3	Helvetica (4)
204	Gothic Text 13	16.66	8.5	uprpt	0	3	Line Printer (0)
205	Gothic 13	16.66	8.5	uprpt	0	3	Line Printer (0)
223	Courier Italic 15	16.6	7	italic	0	3	Courier (3)
222	Letter Gothic 15	16.6	9.5	uprpt	0	3	L. Gothic (6)
221	Prestige 15	16.6	7	uprpt	0	3	Prestige (8)
223	Courier 15	16.6	7	uprpt	0	3	Courier (3)
230	Gothic Text 15	16.66	8.5	uprpt	0	3	Line Printer (0)
232	Courier 15	16.6	7	uprpt	0	3	Courier (3)
	Default (all others)	16.6	8.5	uprpt	0	3	Line Printer (0)
244	Courier 5	5	16	uprpt	0	3	Courier (3)
245	Courier Bold 5	5	16	uprpt	3	5	Courier (5)
	Default (all others)	5	16	uprpt	0	3	Courier (3)
244	Courier 5	5	16	uprpt	0	3	Courier (3)
252	Courier 17	16.6	7	uprpt	0	3	Courier (3)

IBM FONT GFID	NAME	PITCH	POINT HEIGHT	STYLE	BASE WEIGHT	BOLD WEIGHT	TYPEFACE
253	Courier Bold 17	16.6	7	uprpt	3	5	Courier (3)
254	Courier 17 (sub/super)	16.6	7	uprpt	0	3	Courier (3)
255	Letter Gothic 17	20	6	uprpt	0	3	L. Gothic (6)
256	Prestige 17	16.6	7	uprpt	0	3	Prestige (8)
258	Gothic 18	20	6	uprpt	0	3	L. Gothic (6)
259	Gothic 18	20	6	uprpt	0	3	L. Gothic (6)
	Default (all others)	16.6	8.5	uprpt	0	3	Line Printer (0)
260	Courier 8.55	8.55	16	uprpt	0	3	Courier (3)
281	Gothic Text 20	20	6	uprpt	0	3	L. Gothic (6)
284	Gothic Text 24	27	3.6	uprpt	0	3	L. Gothic (6)
285	Gothic Text 25	27	3.6	uprpt	0	3	L. Gothic (6)
290	Gothic Text 27	27	3.6	uprpt	0	3	L. Gothic (6)
434	Orator Bold 8.1	8.1	16	uprpt	3	5	Presentations (11)
435	Orator Bold 6.5	6.5	18	uprpt	3	5	Presentation (11)
	Default (all others)			uprpt	0	3	Courier (3)
	Pitch: Host character width Height: 60% of character width						
751	Sonoran-Serif 8-pt Medium	PS	8	uprpt	0	3	Times Roman (5)
760	Sonoran-Serif 6-pt Medium	PS	6	uprpt	0	3	Times Roman (5)
761	Sonoran-Serif 12-pt Bold	PS	12	uprpt	3	5	Times Roman (5)
762	Sonoran-Serif 14-pt Bold	PS	14	uprpt	3	5	Times Roman (5)

IBM FONT GFID	NAME	PITCH	POINT HEIGHT	STYLE	BASE WEIGHT	BOLD WEIGHT	TYPEFACE
763	Sonoran-Serif 12-pt Italic	PS	12	italic	0	3	Times Roman (5)
764	Sonoran-Serif 10-pt Bold Italic	PS	10	italic	3	5	Times Roman (5)
1051	Sonoran-Serif 10-pt Medium	PS	10	uprgrt	0	3	Times Roman (5)
1053	Sonoran-Serif 10-pt Bold	PS	10	uprgrt	3	5	Times Roman (5)
1056	Sonoran-Serif 10-pt Italic	PS	10	italic	0	3	Times Roman (5)
1351	Sonoran-Serif 12-pt Medium	PS	12	uprgrt	0	3	Times Roman (5)
1653	Sonoran Serif 16-pt Bold	PS	16	uprgrt	3	5	Times Roman (5)
2103	Sonoran-Serif 24-pt Bold	PS	24	uprgrt	3	5	Times Roman (5)

GFIDs that are mapped to Helvetica (4) for the LaserJet II are mapped to Univers (52) for the LaserJet III. Other than that one exception, all of the fonts in the preceding list apply to both the LaserJet II and the LaserJet Series III. However, the LaserJet III also supports the following typographic fonts at a point height 80% of the single line spacing.

HP LaserJet 4 Fonts	IBM GFIDs
Goudy Old Style (42)	4919
Goudy Old Style Bold	4939
Goudy Old Style Italic	5047
Goudy Old Style Bold Italic	5067
Palatino (15)	5175
Palatino Bold	5195
Palatino Italic	5303
Palatino Bold Italic	5323
Times Roman (5)	5687
Times Bold	5707
Times Italic	5815
Times Bold Italic	5835
Testimonial (24)	5943
Baskerville (39)	8503
Baskerville Bold	8523
Baskerville Italic	8631
Baskerville Bold Italic	8651
Century Schoolbook (23)	16951
Century Schoolbook Bold	16971
Century Schoolbook Italic	17079

s

HP LaserJet 4 Fonts	IBM GFIDs
Century Schoolbook Bold Italic	17099
Optima (17)	33335
Optima Bold	33355
Optima Italic	33463
Optima Bold Italic	33483
Futura (14)	33591
Futura Bold	33601
Futura Italic	33719
Futura Bold Italic	33729
Helvetica (4)	34103
Helvetica Bold	34123
Helvetica Italic	34231
Helvetica Bold Italic	34251
Coronet (20)	41783
Coronet Bold	41803
Englische Schreibschrift (106)	37431

HP RuggedWriter 480, PCL

All draft quality printing will be in the Line Printer font. The RuggedWriter prints 15, 17.1 and 16.7 cpi fonts in draft quality only.

IBM GFID	HP RuggedWriter Font Name (ID)
DP (all)	Line Printer (0)
LQ (default)	Courier (3)
6	Prestige Italic
11	Courier (3)
12	Prestige (8)
18	Courier Italic
20	Prestige (8)
26	Helvetica (4)
36	Letter Gothic (6)
39	Letter Gothic Bold
40	Helvetica (4)
41	Times Roman (5)
42	Times Roman (5)
43	Times Roman Italic
46	Courier Bold
51	Helvetica (4)
60	Prestige Bold
66	Helvetica (4)
68	Helvetica Italic

IBM GFID	HP RuggedWriter Font Name (ID)
69	Helvetica Bold
70	Times Roman (5)
71	Times Roman Italic
72	Times Roman Bold
74	Helvetica (4)
75	Courier (3)
85	Courier (3)
86	Prestige (8)
87	Letter Gothic (6)
91	Prestige Italic
92	Courier Italic
108	Courier Bold
109	Letter Gothic Italic
110	Letter Gothic Bold
111	Prestige Bold
112	Prestige Italic
154	Helvetica (4)
155	Times Roman Bold Italic
159	Times Roman Bold
160	Helvetica (4)
162	Helvetica Italic
163	Helvetica Bold
164	Prestige (8)
171	Courier (3)
172	Courier Italic

IBM GFID	HP RuggedWriter Font Name (ID)
173	Helvetica (4)
174	Helvetica (4)
175	Times Roman (5)
185	Courier Bold Italic
221	Prestige (8)
222	Letter Gothic (6)
223	Courier (3)
229	Times Roman (5)
230	Helvetica (4)
232	Helvetica (4)
233	Courier (3)
244	Courier (3)
245	Courier Bold
252	Courier (3)
253	Courier Bold
254	Courier (3)
255	Letter Gothic (6)
256	Prestige (8)
260	Courier (3)

IBM Personal Printer Data Stream (PPDS)

This driver supports the GFIDs in their original form. All characteristics are passed through. In addition to full GFID support, additional fonts may be available.

IBM 5204 Quickwriter, 5202 Quitewriter III

See IBM Personal Printer Data Stream for more information.

IBM 4019 LaserPRinter, LaserPrinter E, PPDS

See IBM Personal Printer Data Stream for more information.

IBM Personal Printer Series II 2380 and 2381

See IBM Personal Printer Data Stream for more information.

IBM Personal Printer Series II 2390 and 2391

See IBM Personal Printer Data Stream for more information.

IBM ExecJet 4072

See IBM Personal Printer Data Stream for more information.

NEC

Pinwriter P9300, P6200/P6300 and P3200/P3300

These printers only support 5219 emulation font changes when they are operating in Epson LQ emulation mode. The driver for this printer contains the optimal host GFID-to-printer font mapping available. For specific GFID information, refer to the font listings for Epson LQ Series.

NEC Pinwriter P5, P6 and P7

These printers only have one typeface which is used for all GFIDs. However, this one typeface supports bold and italic attributes for GFIDs that use them. (In some cases, your printer may actually have two faces available: a serif face and a sans-serif face. This will vary from printer to printer.)

Okidata Microline 383C+ and 393+, ML 390+ and 391+, ML 380

These printers only support 5219 emulation font changes when they are operating in Epson LQ emulation mode. The driver for this printer contains the optimal host GFID-to-printer font mapping available. For specific GFID information, refer to the font listings for Epson LQ Series printers.

Okidata Microline 320 and 321

These printers only have one typeface which is used for all GFIDs. However, this one typeface supports bold and italic attributes for GFIDs that use them. (In some cases, your printer may actually have two faces available: a serif face and a sans-serif face. This will vary from printer to printer.)

Panasonic KX-P1624 and KX-P1124

These printers only support 5219 emulation font changes when they are operating IBM Proprinter XL24 emulation mode. The driver for this printer contains the optimal host GFID-to-printer font mapping available. For specific GFID information, refer to the font listings for the Epson LQ Series printers.

Panasonic KX-P1695

This printer only supports 5219 emulation font changes when it is operating in the Epson FX emulation mode. The driver for this printer contains the optimal host GFID-to-printer font mapping available. For specific GFID information, refer to the font listings for Epson LQ Series printers.

Star Micronics XR-1020 Multi-Font, XR-1520 Multi-Font

These printers only support 5219 emulation font changes when they are operating in Epson emulation mode. The driver for this printer contains the optimal host GFID-to-printer font mapping available. For specific GFID information, refer to the font listings for the LQ Epson Series printers.

Toshiba and Expresswriter

Toshiba 321SL, 321SLC, 341SL, 351SX, Expresswriter 301 and 311





These printers only support 5219 emulation font changes when they are operating in Epson emulation mode. The driver for this printer contains the optimal host GFID-to-printer font mapping available. For specific GFID information, refer to the font listings for the LQ Epson Series printers.







APPENDIX D. OPERATOR MESSAGES AND ERROR CODES

Operator Messages

This section describes the meaning of the various operator symbols that appear on the status line during operation. These messages indicate:

- Display station operational status.
- Functions selected.
- Operational errors or machine failures detected by the display station or the host system.

Symbol	Symbol Name	Message
■	System Available	Host system connected to the display station is operating and available.
N	Logical Display Station Number	Indicates which logical screen is currently active with a number, 1 or 2.
 or 	Message Waiting 1	The blank symbol indicates that the host has one or more messages for logical display station 1; it also indicates that the logical display station 1 is active. If the logical display station 1 is inactive, the symbol is solid.
 or 	Message Waiting 2 (appears only if a second logical station is defined)	The blank symbol indicates that the host has one or more messages for logical display station 2; it also indicates that the logical display station 2 is active. If the logical display station 2 is inactive, the symbol is solid.
X	Input Inhibit	The system will not accept input: <ul style="list-style-type: none">– the host system is processing input.– the host system is busy. The host system detects an error condition. (If the condition is not an error and this symbol remains for an abnormal length of time, contact the supervisor.)

Symbol	Symbol Name	Message
	Keylock Locked	The security key lock on the display station is locked. Nothing can be displayed until it is unlocked.
	Type Ahead	Continue keying while the keyboard is locked.
+	Extended Graphics	Extended keyboard layout has been selected.
	Keyboard Upper Shift	The keyboard is in upshift or locked in upshift.
A	Caps Lock	The keyboard is in Caps Lock. The alphabetic characters are entered in uppercase.
	Insert	Indicates when ± is pressed.
	Printer Status	Indicates one of the following conditions on the printer defined in the printer session of the workstation: (1) Printer Error, (2) Printer Offline or (3) Printer Out. Note: this message does not display if the printer session is not defined in the workstation.
KM	Keyboard Mapper	The Keyboard Mapper function is enabled. Certain keys may perform different functions.
	Diacritic Mode	Indicates that the display station is in Diacritic Mode. this symbol appears when the following accent keys are pressed: circumflex (^), grave accent (`), tilde (~), cedilla (,), dieresis (¨), or acute accent (´). Diacritic Mode is a function of the host program and not the display station.
	Dim Indicator	Indicates that "Auto Dim" has been selected and there has been no activity for more than 5, 10 or 20 minutes. (The screen is blank except for the status line.)
R	Record Mode	Indicates that the display station is in Record Mode. While 'Recrd' is displayed, the current acceptable number of keystrokes are indicated next to the 'Recrd'.

Symbol	Symbol Name	Message
P	Play Mode	Indicates that the display station is in Play Mode.
RR/CC	Cursor Locator	Indicates the position (row and column) of the cursor.

Error Codes

Error Code	Cause	Corrective Action
0000	You keyed Help but, 1. No error code was displayed or 2. The error was sent by a program which does not support Help.	Key Reset. Either enter more data or find meaning of previously displayed error code and perform suggested remedy.
0001	You entered data faster than the host or remote controller could process it and the last character entered was not recognized.	Key Reset. Continue entering data.
0002	The host or remote workstation controller does not recognize which key was pressed because it received an invalid key code.	Key Reset. If the problem persists when you continue to enter data, consult with your system operator.
0003	An invalid Alt + "key" combination was keyed.	Key Reset.
0005	You tried to enter information into a field which does not accept keyboard input.	Key Reset.
0007	Before the display can change or move, you must enter data into a minimum of one field. The cursor jumps to the first character location of the required-entry field.	Key Reset. Enter necessary data.

Error Code	Cause	Corrective Action
0010	You attempted to enter data into a field which accepts only the assigned numeric characters 0-9.	Key Reset . Enter valid characters 0-9 only.
0011	You tried to enter data into the last location of a signed numeric field.	Key Reset . Verify that the data is correct and key Field- , Field+ or Field exit to leave the field.
0012	There is no space left in the field or the cursor is in the field's last position. Do not use Ins to alter data or to enter the field's last character.	Key Reset . Continue after correcting the field, if needed.
0013	You tried to exit from a field after keying Ins .	Key Reset .
0014	A key function was pressed that moves the cursor from a mandatory-fill field without filling it completely or leaving it blank.	Key Reset . Fill the entire field with data or move the cursor to the beginning of the field and blank it out by keying Field- , Field+ or Field exit .
0015	The number and check digit entered in a self-check field don't match.	Key Reset . Verify that the number and check digit were correctly entered. If so, verify that the number is valid for a self-check field. Consult with your system operator if error occurs after checking the above.
0016	Field- was keyed, but you were not in a signed numeric field (or in some systems, a numeric-only field).	Key Reset . Continue entering data or key Field exit to blank out the entire field.
0017	Keying Field- , Field+ or Field exit was keyed before a mandatory-fill field was completely filled. You can also exit from the first position of the field.	Key Reset . Fill in data till the end of the field or position the cursor at the start of the field and key Field- , Field+ or Field exit to blank out the field.
0018	You can also use a non-data key such as Field exit or cursor-move key to exit from this field.	Key Reset . Use non-data key to leave this field.

Error Code	Cause	Corrective Action
0019	You keyed Dup in a field where it is not permitted.	Key Reset .
0020	A non-permitted key was pressed in this field. You must leave this right-adjust or signed numeric field before keying Command/Function keys: Character Backspace, Enter, Print, Help, Roll or Home (when cursor is in home position).	Key Reset . The cursor is in the same position as when an invalid key was pressed. Continue by pressing Field- , Field+ or Field exit .
0021	The cursor is in a mandatory-enter field which requires that you enter data before you can leave the field by pressing Field- , Field+ or Field exit .	Key Reset . Enter necessary data.
0022	System error: status of current field unknown. Occurs during insert or delete operation.	Key Reset . Correct the field if the insert or delete function was performed improperly.
0023	Hex plus number combination was invalid. First key must be A-F or 4-9. Second key must be A-F or 0-9. Error also occurs if hex code is used in numeric-only, signed numeric, alpha-only or feature I/O field.	Key Reset . Enter data using permitted keys.
0026	The last field position was not a number 0-9 when you keyed Field- to leave a numeric-only field.	Key Reset .
0027	You pressed a key not in use on this workstation.	Key Reset . Use only correct keys when you continue.
0028	You pressed a key not in use on this workstation.	Key Reset . Use only correct keys when you continue.
0029	An invalid key combination was produced by pressing the second key in a diacritic-key combination.	Key Reset . Enter a valid combination.

Error Code	Cause	Corrective Action
0040	You need to activate the 'data set ready' line.	You can only recover from this error at the 5294 Control Unit.
0042	The receive clock signal failed during a receive operation.	You can only recover from this error at the 5294 Control Unit.
0044	No valid data was received after 30-sec. Communications time-out.	You can only recover from this error at the 5294 Control Unit.
0050	<ol style="list-style-type: none"> 1. 'Clear to send' line was inactive when 'request to send' was active, or 2. 'Clear to send' line was active when 'request to send' line was inactive. 	You can only recover from this error at the 5294 Control Unit.
0051	The transmit clock signal failed during a transmit operation.	You can only recover from this error at the 5294 Control Unit.
0052	The 5294 Control Unit detected an internal error.	You can only recover from this error at the 5294 Control Unit.
0054	The system sent an invalid command to the 5294 Control Unit.	You can only recover from this error at the 5294 Control Unit.
0097	An attempt was made to run on-line verification tests which the host program does not support.	Key Reset . You can use the workstation but don't perform verification tests.
0099	The key function you pressed is not presently valid due to an error which occurred before sign-on.	Key Reset . Perform correct sign-on procedure. Keying SysRq will start sign-on for most systems.
	An error occurred during sign-on.	Key Reset . perform correct sign-on procedure. Consult system operator to verify system is functioning if problem persists.

Error Code	Cause	Corrective Action
	An error occurred after sign-on. The program utility didn't recognize the key you pressed.	Key Reset . Attempt to run a different job type or procedure. If error occurs, consult system operator to find out if problem exists with the system. If the problem does not reoccur, you have a system programming problem or keying error.
9001	Your record table has filled up. You cannot enter any more keystrokes.	Key Record . Entering a new keystroke sequence: first, remove an existing key sequence defined under <u>one</u> command key by: keying Record and that command key, then enter the <u>new</u> key sequence. Alternatively, to erase the recorded key sequence, key Record , key that command or function key, then key Del .
9002	Invalid record table format.	Key Reset and proceed with the record/play operation.
9003	While using the record or play function, you pressed a key other than Alt , Record or Shift before pressing a valid command key.	Key Reset or valid command key.
9004	You pressed one of the command keys while holding down Alt during record or play operation.	Press the command key only.
9007	You keyed either Play or Setup while recording a key sequence. They are invalid sequence keys.	Key a valid sequence key.
9010	A command key was pressed which does not have a key sequence under it during a Play operation.	Key Reset or a command key which a key sequence has been assigned.
9011	You attempted to key Setup with Shift pressed.	Key Setup only.

Error Code	Cause	Corrective Action
9015	You keyed Reset together with Alt or keyed Pause in normal communication mode.	Key Reset without pressing Alt at the same time.
9016	Several keys were pressed simultaneously.	Press one key at a time. If the problem continues, the keyboard element is failing.
9019	During Record Mode: You keyed Setup or Play after keying Pause .	Press a valid key.
	During Play Mode: You keyed Setup or Record after keying Pause .	Press a valid key.
9020	You keyed Record or Play and Record function is disabled in Setup.	Key Reset . You cannot use Record/Play function.
9021	You operated Record/Play function in non-display field while option R1 is selected in Record Setup.	Key Reset . You can work with Record/Play function in non-protected fields.
9030	You keyed Jump while not in two-display mode.	Key Reset .
9032	You keyed SYM while not in the two-display mode.	Key Reset .
9033	You keyed ↑ or ↓ but you have exceeded the limit of the size adjustment of the separation line between the two sessions.	Key Alt + Setup to exit separation line setup.
9034	You keyed Alt + 1 or Alt + 2 in a non-display field.	Key Reset .
9060	While in Calculator mode, the expression filed contains an incorrect mathematical expression.	Correct the mathematical expression.

Error Code	Cause	Corrective Action
9061	While in Calculator mode, an incorrect key was used.	Press any correct key.
9062	While in Calculator mode - the expression field contains the maximum number of permitted characters.	A complete expression or a part of it should be deleted.
9064	While in Calculator mode, the required string cannot be imported.	Move the cursor to the correct position.
9065	While in Calculator mode, an overflow error occurred during the calculation or base number change.	Key Reset .

APPENDIX E. PIN ASSIGNMENTS

DB-9 Connector

PIN #	DESCRIPTION
1	+ 5 Volts
2	Twinax A
3	No Connection
4	Twinax B
5	No Connection
6	Twinax A
7	Ground
8	Ground
9	Twinax B

Parallel Interface

To ensure proper operation, use a fully-loaded 25 conductor cable with shield.

Signal Name	PIN #	Source	Description
$\overline{\text{STROBE}}$	1	Host	Clock signal controlling data transmission. Active low signal.
Data Bit 1	2	Host	Represents the code of a character to be printed or a control to be executed. Logical "0" is represented by a LOW level signal; Logical "1" is represented by a HIGH level signal. Data BIT 1 (pin 2) is the Least Significant Bit; Data BIT 8 (pin 9) is the Most Significant Bit.
Data Bit 2	3		
Data Bit 3	4		
Data Bit 4	5		
Data Bit 5	6		
Data Bit 6	7		
Data Bit 7	8		
Data Bit 8	9		
$\overline{\text{ACK}}$	10	Printer	Active LOW level signal that indicates that data has been received and stored in the buffer.
BUSY	11	Printer	An active HIGH level signal which indicates that the printer cannot accept input data or control codes.
PE	12	Printer	An active HIGH level which indicates that no paper is loaded or a paper jam exists.
SLCT	13	Printer	An active HIGH level which indicates the printer is selected, online and is ready to receive data.
AUTOFEEDXT	14	Host	Active HIGH level.
$\overline{\text{ERROR}}$	15	Printer	Active LOW level signal that indicates that one of the Paper Empty conditions has occurred.
$\overline{\text{INIT}}$	16	Host	Active LOW level signal that starts a printer initialization cycle.
$\overline{\text{SLCTIN}}$	17	Host	Active LOW level signal that allows data to be transmitted to the printer.
GND	18-25	-	Common ground signal. <i>To ensure proper operation, use a fully-loaded 25 conductor cable.</i>
Chassis Ground	-	-	Frame ground for the cable shield.

DB-15 Connector

PIN #	LM-488C	IS-488
1	Red Video	NC
2	Green Video	Video
3	Blue Video	NC
4	Horizontal Sync Ret.	+ 5 Volts
5	NC	NC
6	Red Video Ret.	+ 12 Volts
7	Green Video Ret.	GND
8	Blue Video Ret.	NC
9	NC	- 12 Volts
10	Vertical Sync Ret.	GND
11	NC	NC
12	NC	NC
13	Horizontal Sync	Horizontal Sync
14	Vertical Sync	Vertical Sync
15	NC	NC

Keyboard DIN Connector

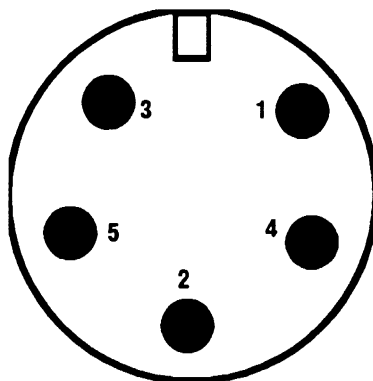

PIN #	DESCRIPTION
1	Clock
2	Data
3	Not Used
4	Ground
5	+ 5 Volts

PS/2 Mouse Connector

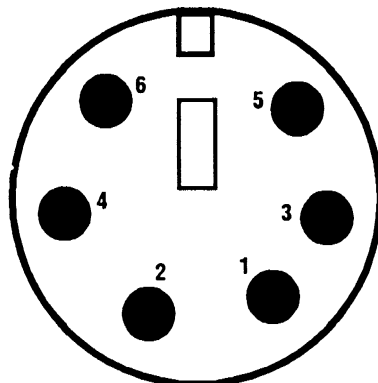

PIN #	DESCRIPTION
1	Data
2	Not Used
3	Ground
4	+ 5 Volts
5	Clock
6	Not Used

APPENDIX F. KEYBOARD LAYOUTS

APPENDIX G . SPECIFICATIONS

Connectors:

Printer Parallel Port	DB 25
Mouse Port	PS/2
Display Port	15 Pin D-SUB
Keyboard Port	DIN
Twinax Port	DB 9

Cabling:

Twinax Cable
Twisted Pair

Display Parameters:

Vertical Refresh Rate (Hz)	75
Horizontal Frequency (KHz)	37.5
Screen Modes	24x80, 27x132, 32x80, 43x80, 49x80
Emulations	IBM3488/IBM3487

Power Requirements:

Voltage (VAC)	110/220
Frequency (Hz)	47-63
Power (Watts)	10

Environmental:

Operating

Temperature Range	10 - 40°C 50 - 104°F
Maximum Temp. Gradient	10°C/hour 18°F/Hour
Relative Humidity	10 - 80% non condensing

Non Operating

Temperature Range	0 - 50°C 32 - 122°F
Maximum Temp. Gradient	20°C/hour 36°F/Hour
Relative Humidity	10 - 80% non condensing

Physical	LM-488C		IS-488	
Weight	7.5 kg	16.5 Lb.	1 Kg	2.2 Lb.
Dimensions				
Height	25 cm	10 in.	36 cm	14 in
Width	6 cm	2.4 in	32 cm	13 in
Depth	18 cm	7 in	32 cm	13 in

Regulatory Agencies:

Product Safety

Underwriters Laboratories (UL) for the United States Safety.
UL 478 5th Edition

Canadian Standards Association (CSA) for Canadian Safety.
CSA C22.2 220

IEC Certification for European Safety.
IEC 950/EN 60950

Emissions

Federal Communications Commission (FCC)
for United States Emissions
Part 15, Subpart J, Class A
EN 55022-Class A

European

CE Mark