



WORKSTATIONS

Tandy 4000/PCSA

APRIL • 1989

DEC

\$4.00 • VOL. 8, NO. 4

■ Close-Up
On Compound
Document
Architecture

■ VMS™ Meets
UNIX™: How
They Can Learn
To Interact

■ Security
Checklist—
Are You
Vulnerable
To Break-In?

Professional

An Independent Magazine from Professional Press

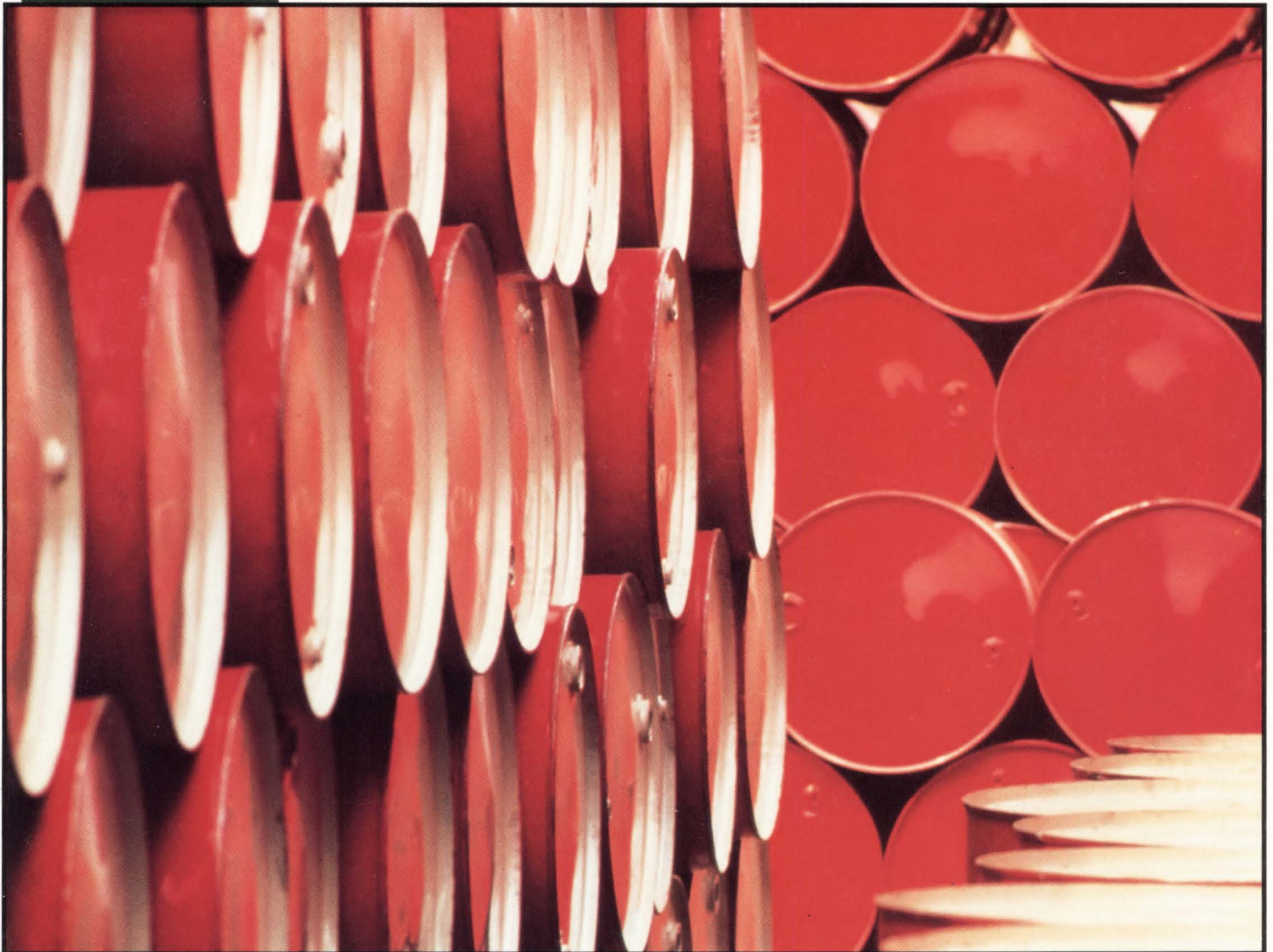

Storage Technology

LOOK INTO THE FUTURE

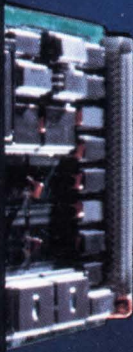
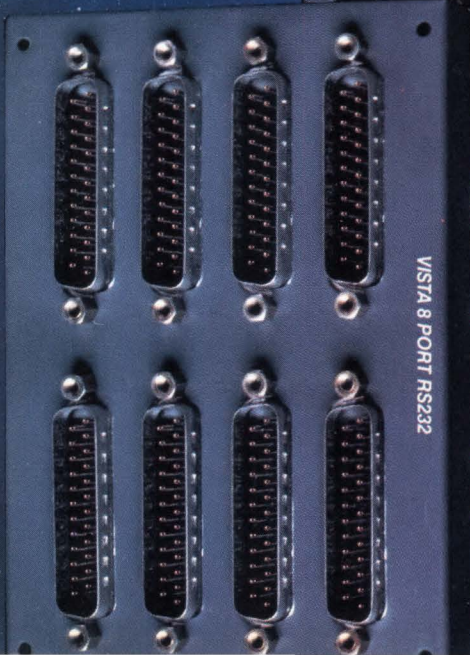
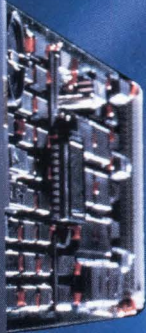

...DISCOVER VISTA.™



THE 100% LAT COMPATIBLE TERMINAL SERVER THAT DEFINES COMMUNICATIONS INTO THE 21ST CENTURY

Presenting VISTA, a revolutionary new communications server that provides unparalleled capabilities for today and remarkable options for tomorrow.

Unlike existing servers, VISTA's modular architecture enables you to choose from a number of network and connectivity interface options, allowing you to customize VISTA to meet your specific networking needs.

UNMATCHED EXPANSION CAPABILITY

VISTA's slide-in expansion line cards allow you to add capacity easily and economically as your network grows. A single VISTA Server can be configured to support from 1 to 128 users in a single, 5-1/4" high, free-standing or rack-mountable unit.

A SINGLE PLATFORM WITH MANY OPTIONS

With a variety of connectivity interfaces, RS232, RS423, On-Board Modems, X.25 and

more, VISTA allows you to build your own, custom-tailored, communications platform. Imagine being able to configure a single LAT compatible terminal server with 64 ports, eight 2400 Baud dial in/dial out modems

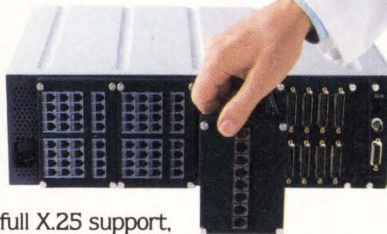

and full X.25 support, all in the space of a single DECserver 200.

EASY TO MANAGE AND USE

Users familiar with the DECserver command interface will need no retraining to use VISTA. And VISTA is compatible with DEC management software, including NCP and TSM, requiring no modification to existing administrative controls.

Plus, VISTA's highly interactive front panel incorporates complete management and diagnostic capabilities.

PRICE PLUS PERFORMANCE

Whether you configure VISTA with 8 ports or fully loaded with 128 ports, VISTA gives you higher performance than a DECserver 500 at per port costs that are the lowest in the industry.

NETWORKING FOR TODAY AND TOMORROW

VISTA is completely network-independent. So you can begin now by using its fully LAT compatible Network Interface Card (NIC), cable-ready for standard Ethernet, thin-wire Ethernet and SynOptics unshielded twisted pair connections. And if you want to change strategies in the future, you can simply change the NIC to implement an entirely new networking approach, such as TCP/IP, OSI, or a combination of protocols.

IT'S TIME TO ACT

Whether its power, price or performance, current needs or future plans, there's simply no other strategy that competes with VISTA.

For more information, call us toll-free at 1-800-342-5377, or in New York City at 212-807-7800.

VISTA™

DATABILITY Taking communications into the 21st Century.

1-800-DIAL-DSS

(in NY: 212-807-7800)

Datability Systems, 322 Eighth Ave. New York, NY 10001

All product names are registered trademarks of their respective manufacturers.

CIRCLE 107 ON READER CARD

Equinox Data Switches Simply the Best

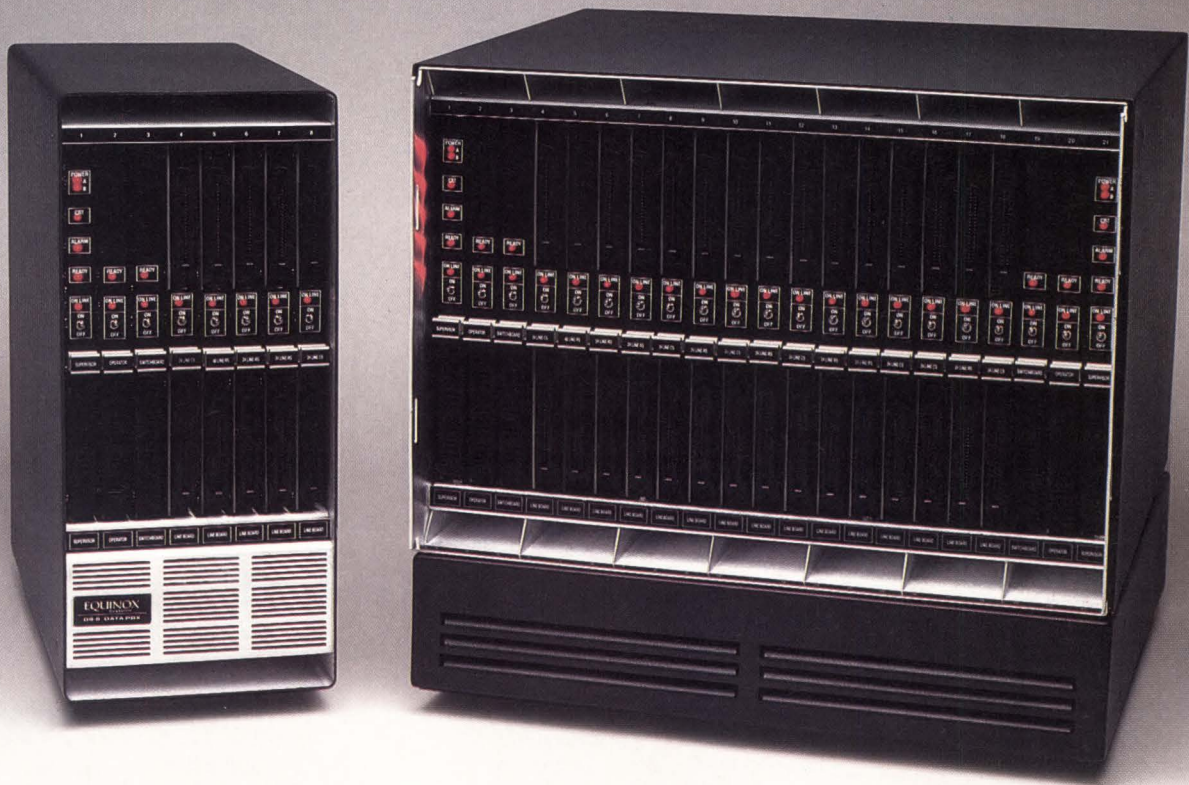

Simple Reliable Solutions

Whether you need Port Contention, Port Selection, Fall-Back Switching, Peripheral Sharing, or just want to replace your aging patch panel - a dependable Equinox data switch is the answer. Our data switches connect terminals, PCs, hosts and peripherals together quickly and easily.

Our custom cabling accessories and menu-driven configuration reduce installation to a simple plug-and-play affair. So your network is up and running in no time, and our ultra-reliable, fail-safe architecture will keep it running flawlessly.

Simple Switching

Equinox data switches use reliable time-proven TDM circuit switching for transparent connections with no delay, distortion or errors. So data out always matches data in. Bit-for-bit.

Simple Sophistication

We know you want a powerful, feature-rich data switch without a lot of complexity. So even though we provide sophisticated features like speed and parity conversion, multi-node routing and dial-back security, building a complex network isn't a complicated chore.

An Equinox data switch simplifies PC networking too. Our SwitchLAN PC software provides sophisticated printer sharing, file transfer and terminal emulation without the high cost and complexity of a LAN.

Simple Choice

If you're thinking about a data switch or would like to learn more about how a data switch can help simplify your network, simply call us.

Call 1-800-328-2729

(In Florida 305-255-3500)

EQUINOX

14260 S.W. 119 Avenue, Miami, Florida 33186 Fax: 305 253-0003

DEC PROFESSIONAL APRIL 1989

CIRCLE 239 ON READER CARD

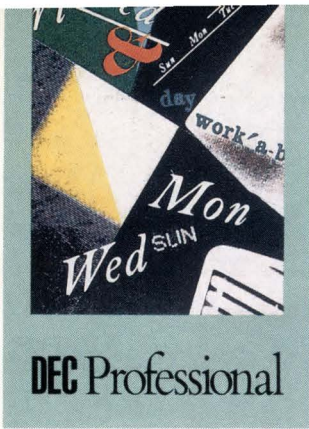

DEC Professional

C CONTENTS

APRIL 1989

VOL. 8, NO. 4

STORAGE

38 VAXCLUSTER™ TAPE SUBSYSTEMS

by Bradford T. Harrison

DEC's storage architecture opens the door to third parties for high-performance, standards-based tape products for connection to the HSC™ VAXcluster controller.

48 I/O SUBSYSTEM PERFORMANCE

by Kenneth H. Bates

A look at four measurements: response time, request rate, data rate and seek times. This is the first in a series of articles that will explore I/O subsystem performance issues.

58 CAPACITY PLANNING WITH THE VAX PERFORMANCE ADVISOR

by Lawrence L. Baldwin Jr.

Capacity planning is an important yet difficult and time-consuming task. DEC's performance analysis product, VPA, assists system managers in isolating and solving temporary performance problems.

66 VAXCLUSTER BACKUP

by Dr. James Meade

An unglamorous technology, backup lags in terms of performance and product development. But there are ways to get more bytes for your backup.

ON THE COVER:

Photo by Four By Five

This magazine is not sponsored or approved by Digital Equipment Corporation. "DEC" and "VAX" are trademarks of Digital Equipment Corporation. Digital Equipment Corporation is the owner of the trademark "DEC" and is the source of all "DEC" products. For other Digital trademarks, see page 167.

FEATURES

72 SECURITY: SECURITY CHECKLIST

by Philip A. Naecker

DEC PROFESSIONAL editors assemble their expertise to create a security checklist designed to help system managers, security managers and others involved in computer security evaluate their systems' vulnerability.

84 UNIX: VMS MEETS UNIX

by John D. Deans

In the scientific community, the two most widely used operating systems are VMS and UNIX. Now, these quite different operating systems have been pushed into near cohabitation.

Continued on page 4.



DEC Professional

Continued from page 3.

DEPARTMENTS & COLUMNS

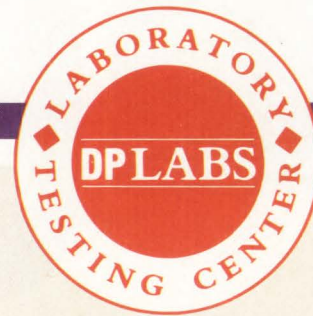

Publisher

by Carl B. Marbach

There Doesn't Have To Be A Loser.....10

Editorial

by Dave Mallery

Nine-Month Generations.....14

Networking Editor

by Bill Hancock

DEC's New Compound Document Architecture94

Let's C Now

by Rex Jaeschke

The C Preprocessor, Part 3104

Workstations

by David W. Bynon

Tandy/DECnet™-PCSA: Bliss And Frustration110

The Mac Connection

by Al Cini

The Evolution Continues.....142

Back End

by John C. Dvorak

Hardware Versus Software176

Letters.....16

ARISTALK20

Product Watch24

Products148

Classified.....173

Product Showcase.....171

Used Equipment.....170

Advertisers Index.....174

From The Lab

Cluster Chronicles: Life Extension For Older Drives

by Dave Mallery114

Our Lab is using a Lago Systems box that converts SMD drives into standard DEC DSI cable compatibles.

Eigen Corporation's Eigen Utilities

by David B. Miller118

The Eigen Utilities are used like VAX/VMS commands.

Innovative Computer Technologies' DiskView V1.1

by David W. Bynon124

DiskView is a data collector and reporter.

Compu-Share Accounts Receivable

by Evan Birkhead.....126

Accounts Receivable provides screen and report customization.

Recital Corporation's Recital

by David B. Miller129

If you have dBase applications you'd like to move to your VAX, Recital may be for you.

Marc Software's

WordMarc Composer +

by David B. Miller134

A system with features for publishing simple to complex documents.

The lab seal indicates that the product reviewed has been tested by one of our experts in our Laboratory and Testing Center.



The ARIS symbol on an article indicates that the program segments are available electronically on our Automated Reader Information Service. The download file name is indicated below the ARIS symbol. Dial (215) 542-9458; Southern California (818) 577-9100; Northern California (415) 873-2135

We will consider for publication all submitted manuscripts and photographs, and welcome your articles, photographs and suggestions. We cannot be responsible for loss or damage. All materials presented are believed accurate, but we cannot assume responsibility for their accuracy or application. DEC PROFESSIONAL Magazine ISSN 0744-9216 is published monthly by Professional Press, Inc., 921 Bethlehem Pike, Spring House, PA 19477. Printing and binding by R. R. Donnelley & Sons Company. Subscriptions are complimentary for qualified U.S. and Canadian sites. Single copy price, including postage, \$4. One year subscription rate \$30 in the U.S. and Canada; and \$60 foreign. All orders must be prepaid. Second Class postage paid at North Wales, PA, and additional mailing offices. POSTMASTER: Send all correspondence and address changes to: DEC PROFESSIONAL, P.O. Box 503, Spring House, PA 19477-0503. COPYRIGHT © 1989 by Professional Press, Inc. All rights reserved. No part of this publication may be reproduced in any form without written permission from the publisher.



Outperform VT240/241 Graphics Terminals By Trading 4 Old Colors For 16 New Ones.

Presenting a fresh set of enhancements to the leading DEC® VT240/241 terminal emulation software. New SmartTerm® 240 version 3.0 has a range of VT340 ReGIS® graphics features. So when running on a PC with an EGA or VGA, it actually outperforms a dedicated VT240/241 terminal.

Sixteen different colors can be specified from available palettes. Which makes working with 3-D images and complex filled regions in powerful ReGIS color graphics

programs as easy as pie charts. Rubber band cursor actions, curves through data points, and text drawn to virtually any size, shape, or angle are also available.

The vivid display of advanced software engineering in version 3.0 goes beyond colorful VT340 features. We've also made version 3.0 faster, easier, and more comfortable to use.

Automatic keyboard remapping has been added. The PC num lock, for example, becomes the DEC PF1 key. Now, no matter which style PC keyboard you use, the best physical representation of the DEC keypad will be at your fingertips.

On-line help has been expanded. Softkey enhancements include conditional branching and faster action. We've even managed to improve the performance of our state-of-the-industry communications and file transfer features.

Some things haven't changed. Installation is still automatic. Our technical support group still provides free solutions to problems and answers to your questions. And our 30-day return policy continues to make a complete on-site evaluation risk-free.

So if you're already a SmartTerm software user, call us today at 608-273-6000 to trade up. And if you're not a SmartTerm user, now's the time to become one.

Because going to the top of our line puts you at the top of the spectrum.

Emulate The Best With The Brightest.

CIRCLE 132 ON READER CARD

persoft®

©1988 Persoft, Inc. All Rights Reserved. Persoft and SmartTerm are registered trademarks of Persoft, Inc., 465 Science Drive, Madison, WI 53711. Specifications subject to change without notice. DEC, VT, and ReGIS are registered trademarks of Digital Equipment Corporation.

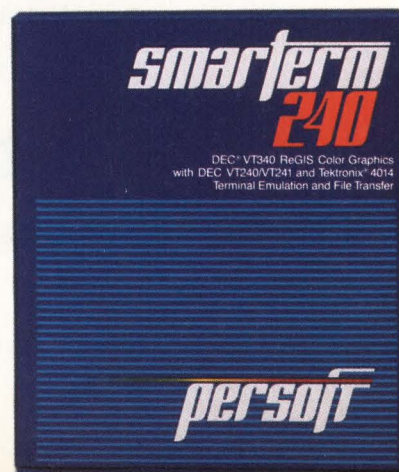

NISSHO
ELECTRONICS

Twice the performance
at half the price!

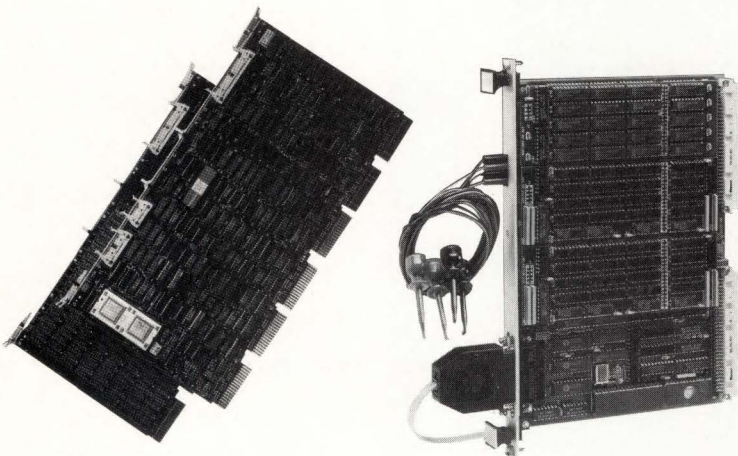

MARKET PROVEN
N1100 PLUS
UNIBUS* USERS
FEATURES

- 4 Mbytes DRAM
- 8 KBytes Cache
- Hardware Floating Point
- Memory Management
- J-11.* Power for optimum performance
- Fits all existing CPUs
— No backplane change

NEW
N9200
VMEbus ANALYZER
FEATURES

- 2K trace buffer stores 96 VMEbus signals
- 4 user defined events which control trace storage
- Synchronous/asynchronous sampling at 20 MHz
- Bus interval and events elapsed timer
- Direct Read of power supply voltage
- Standard RS232 ASCII interface

FOR SPECIAL PRICING ON N1100, CALL OLIVIA AT
(800) 233-1837 IN CALIFORNIA (714) 261-8811

*UNIBUS and *J-11 are registered trademarks of DIGITAL EQUIPMENT CORPORATION

NISSHO
ELECTRONICS

17320 Red Hill Avenue, Suite 200, Irvine, California 92714 · FAX (714) 261-8819, TLX 181-308

CIRCLE 163 ON READER CARD

DEC Professional

Publisher: Carl B. Marbach
Editorial Director: R. D. Mallery

Editorial

MANAGING EDITOR Lou Pilla
SENIOR EDITOR Evan Birkhead
ASSISTANT EDITORS Pamela F. Fullerton,
Eric Schoeniger
BACK END EDITOR John C. Dvorak
C EDITOR Rex Jaeschke
DCL EDITOR Kevin G. Barkes
FIELD SERVICE EDITOR Ron Levine
MACINTOSH EDITOR Al Cini
NETWORKING EDITOR Bill Hancock
TECHNICAL EDITOR Elaine L. Appleton
TECHNOLOGY EDITOR Philip A. Naecker
WORKSTATIONS EDITOR David W. Bynon
EDITORIAL SYSTEMS COORD. Anne Schrauger
EDITORIAL ASSISTANT Nadina R. Chapman
CONTRIBUTORS Lawrence L. Baldwin Jr.,
Kenneth H. Bates, John D. Deans,
Bradford T. Harrison, Dr. James Meade
MANAGING EDITOR, Buyers Guide
Anne E. Maher

DP Laboratory and Testing Center

DIRECTOR R.D. Mallery
SENIOR TECHNICAL EDITOR David B. Miller
TECHNICAL EDITOR Sheldon Green
TECHNICAL EDITOR Del Lukens
MIS SOFTWARE MANAGER Bonnie Auclair
MIS SYSTEMS MANAGER Kevin J. Kennelly

Design & Production

DESIGN/PRODUCTION MANAGER Ruth Ann Leiby
DESIGN/PRODUCTION ASST. Pat Messina
ADVERTISING BOOKING COORD. Lori Goodson
ADVERTISING PROD. COORD. Suzanne Garr
TRAFFIC/PRODUCTION ASST. Kim Macheski
PROMOTIONS MANAGER Timothy M. Kraft
GRAPHIC DESIGNERS Richard Kortz,
Thomas Owen, Sue Ann Rainey
PRODUCTION ARTISTS Patricia P. Kraeckel,
Kristy Yates
TYPESETTER MaryEllen Coccimiglio

Circulation

CIRCULATION DIRECTOR Carrie Eisenhandler
CIRCULATION MANAGER Betsy Ellis
FULFILLMENT MANAGER Margie F. Pitrone
CIRCULATION DBA Rebecca Schaeffer

PROFESSIONAL PRESS, INC.

PRESIDENT Carl B. Marbach
VICE PRESIDENT R. D. Mallery
VICE PRESIDENT Peg Leiby
VICE PRESIDENT Helen B. Marbach
EXECUTIVE EDITOR Linda DiBasio
EXECUTIVE DESIGN DIRECTOR
Leslie A. Caruso

DIRECTOR OF MARKETING Mary Wardlaw
CONTROLLER Andrea Beneke
ASSISTANT TO THE PRESIDENT
Jan Krusen

For information on how to contact your sales representative, see page 174. Editorial, Advertising Sales, and Executive Offices at 921 Bethlehem Pike, Spring House, PA 19477. (215) 542-7008. TWX 910 333 9522. FAX (215) 628-2845. Easylink 62805174. ARIS (Automated Reader Information Service) (215) 542-9458; Southern California (818) 577-9100; Northern California (415) 873-2135. Additional Editorial Offices: East Coast Office at 238 Bedford St., Suite 3, Lexington, MA 02173. (617) 861-1994. West Coast Office at 1010 E. Union St., Suite 101, Pasadena, CA 91106. (818) 577-5970. Northern California and Northwest Office at 903 Sneath Lane, Suite 220, San Bruno, CA 94066. (415) 873-3368. Southern Texas Office at 11782 Jollyville Rd., Suite 203, Austin, TX 78759. (512) 258-4800.

Free from Clearpoint:

Everything you need to know about memory

The Expanded 80-Page
Designer's Guide to
Add-In Memory

The New 30-Minute
Applications Video

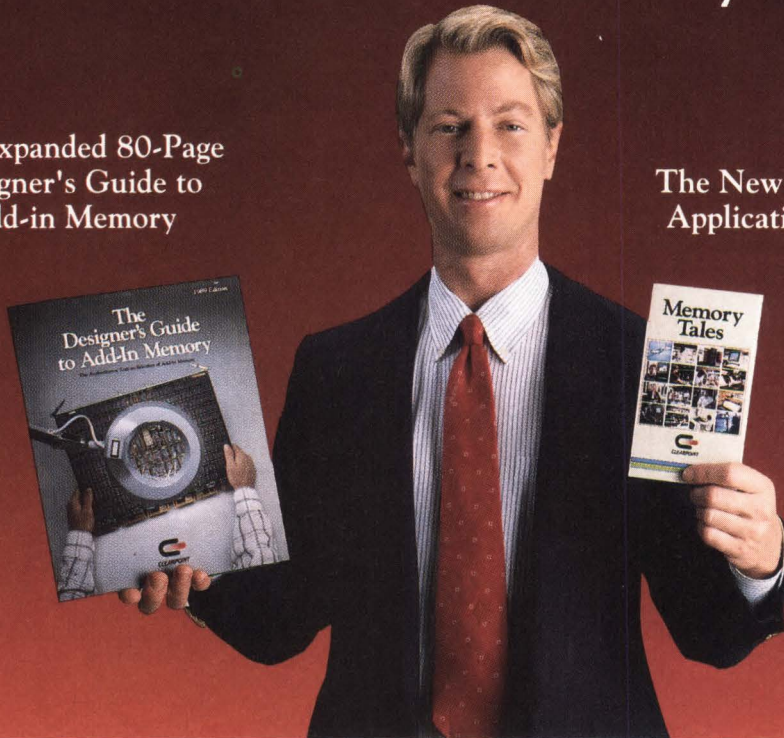

in text and video

Memory Tales, An Inside Look at Memory

Memory Tales is the first video ever produced that explains objectively the important issues of memory design.

Request your free copy and discover how some of the most demanding customers across the USA evaluate and select memory. Witness first-hand the vital applications of memory products at an FAA Flight Center, a supercomputer center, a lumber mill and at other facilities with memory-intensive applications.

Get the inside look, from design through finished product, and learn the crucial relationship of computer-aided design, compatibility, testing and customer support. Meet the company that's pushed add-in memory to the highest quality and service standards—you'll agree, there's more to memory than its price tag.

Write or Call for your
Free Copies Today!

1-800-CLEARPT
(1-800-253-2778)

The Designer's Guide to Add-In Memory

The Third Edition of the Designer's Guide is still "perfect for someone who understands the basics but needs essential information to make decisions."* An authoritative reference on a broad range of memory issues, this objective text covers purely technical issues as well as management-oriented concerns.

The expanded 80-page third edition includes important new information on memory issues:

- the confrontation between NuBus, Micro Channel and EISA
- why the 386 machines excel
- the risks of RISC
- the impact of parallel processing
- the next generation of memory technology, FRAMs
- the latest about VME and Multibus II

Get thorough updates on major new systems, considered from the memory perspective:

- the VAX 6200
- the Compaq Deskpro 386
- the Macintosh IIx
- the Apollo DN 4000
- the Sun 4/110 and 386i



Clearpoint Research Corporation
99 South Street,
Hopkinton, MA 01748

(508) 435-2000 Telex: 298281

EUROPE: Clearpoint Europe B.V. 31-23-273744

CANADA: Clearpoint Canada (416) 620-7242

JAPAN: Clearpoint KK 03-221-9726

The following are registered trademarks of the noted companies:
Apollo, Domain/Apollo Computer Corporation; Macintosh/
Apple Computer Company; Clearpoint/Clearpoint Research
Corporation; Compaq, Deskpro/Compaq Computer Corporation;
DEC, VAX, MicroVAX, Q-bus, Unibus / Digital Equipment
Corporation; Sun/Sun Microsystems. IBM/International
Business Machines

*Christopher Kreager, Systems Specialist,
UNITED DATA SYSTEMS

MASTER CONSOLE. THE MASTERMIND OF MONITORING.

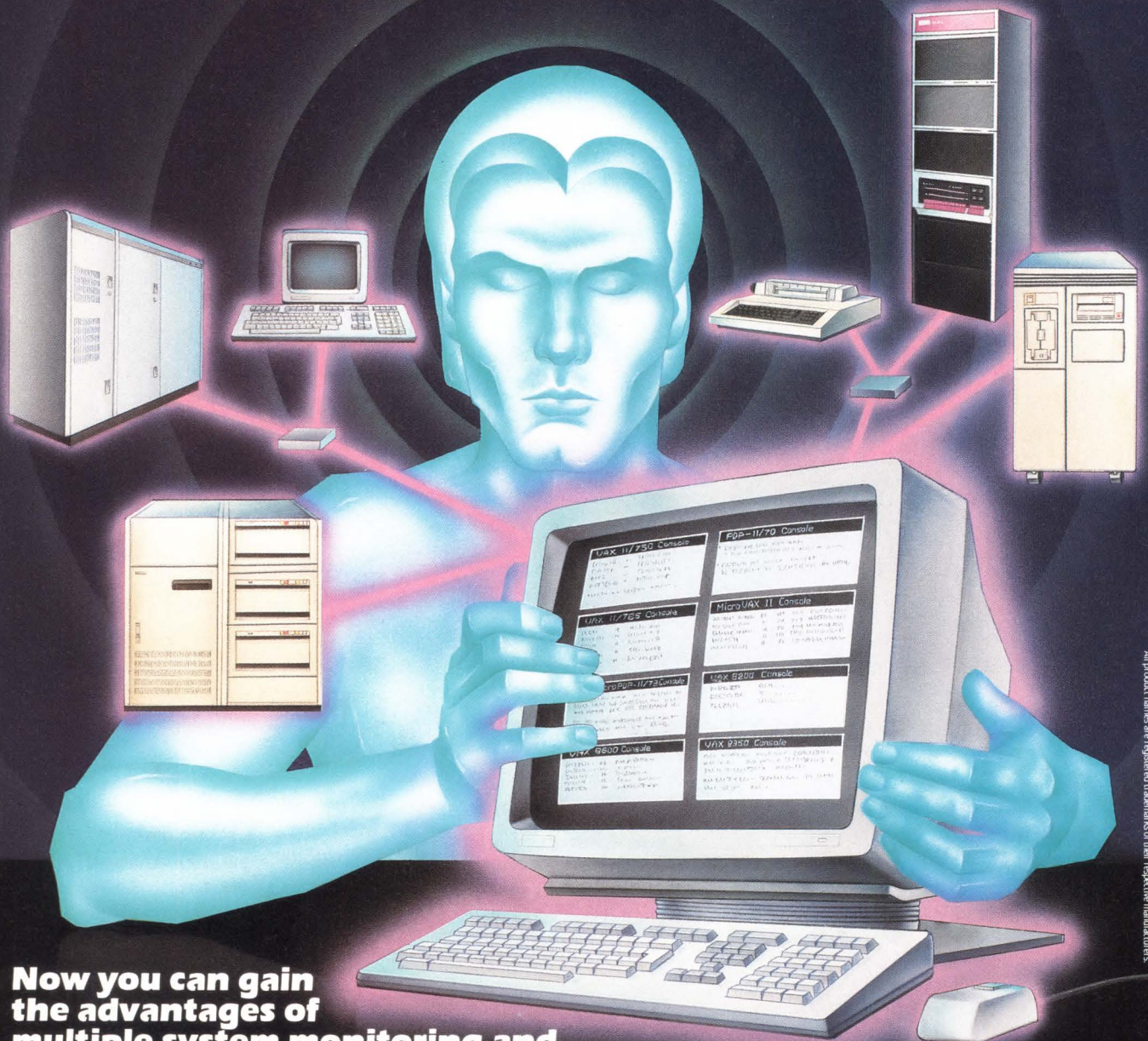

Now you can gain the advantages of multiple system monitoring and control from a single location.

Maintech introduces "Master Console," an innovative product from Volt Delta Resources that can streamline your operation and effect major savings.

With Maintech's "Master Console" you can monitor and control up to 8 DEC processors from a single location. Through a dynamic windowing process, "Master Console" creates a scrolling mini-terminal for each processor, all on a single high resolution monitor. The immediate benefit to management: centralized control, elimination of stored console logs and huge gains in individual productivity.

Other cost efficiencies are gained by eliminating the space requirements and clutter of consoles and console printouts on the computer room floor. Equally impressive, "Master Console" lets you archive your console logs on tape and prints out what you want to see.

Other features:

- Supports PDP, MicroVAX and VAX systems
- String search for user defined critical messages
- Audible and visual alarm and prioritized error reporting
- Concurrent local console operation
- Tiled windows and special purpose function keys
- Console log with scrolling, historical archive and restore

For your convenience, hardware leases and purchase plans are available.

"Master Console." Another powerful product from Maintech, the innovative leader in the independent service marketplace.

MAINTECH
GUARDIAN MAINTENANCE SERVICES
A DIVISION OF VOLT DELTA RESOURCES INC.
1 800-426-TECH
1133 Avenue of the Americas
New York NY 10036
212 827-2600
A VOLT INFORMATION SCIENCES COMPANY

All product names are registered trademarks of their respective manufacturers.

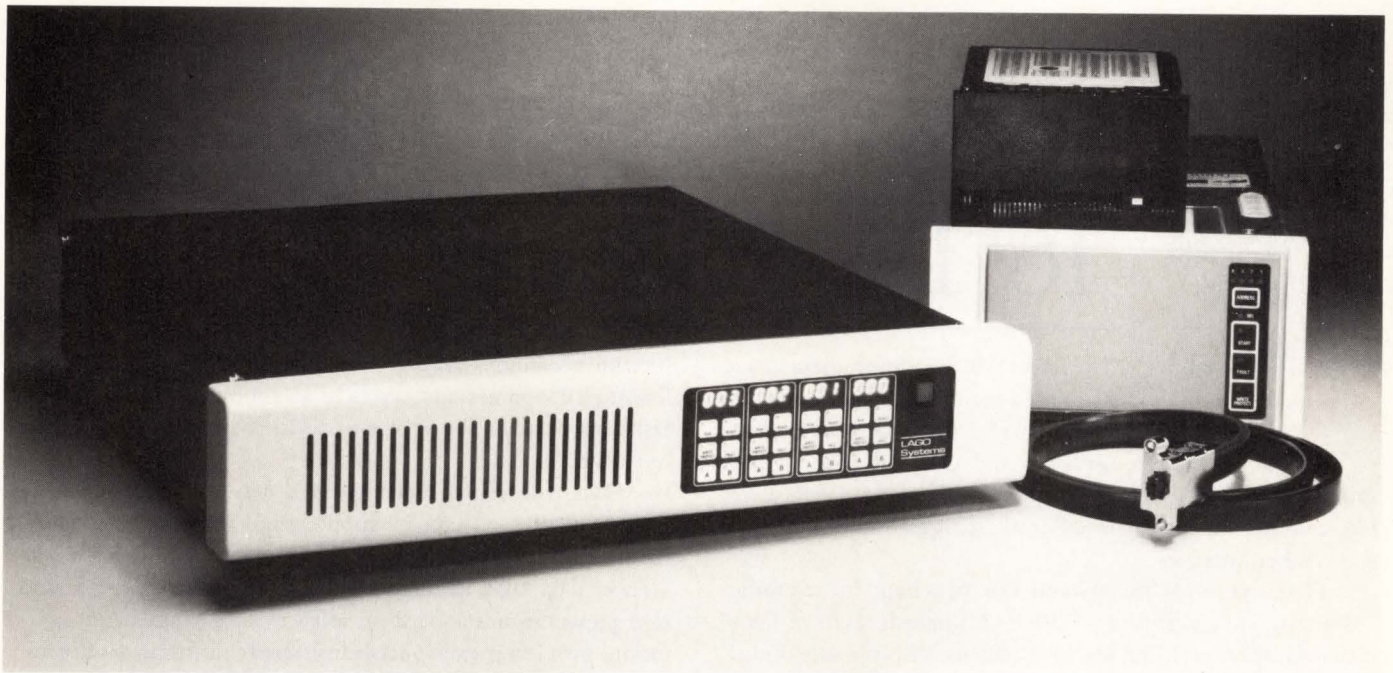

Now, DEC RA Compatible Disk Storage To Match The Power Of Your VAXBI and VAXcluster Systems

Lago Systems' LS/100 Disk Adapter.

Bring the performance and reliability of industry standard disk drives to your DEC VAXBI and VAXcluster systems.

SMD and ESDI Disk Drives.

With the LS/100, you can attach both SMD and ESDI disk drives directly to your DEC MSCP disk controller. The LS/100 gives you complete flexibility in configuring the disk storage subsystem that is best suited to your application. SMD drives where performance and reliability are important. Or compact 5¼" ESDI drives for low cost and removeability.

DEC DSA Compatible.

When we say compatible we mean fully compatible. The LS/100 makes industry standard disk drives look like DEC RA series drives to your system. They can even be mixed with DEC drives on your HSC50/70, KDB50, KDA50 and UDA50 disk controller. And, you won't have to change any of your systems or applications software.

Large Capacity.

With disk subsystems offering over twelve gigabytes of formatted data, the LS/100 can eliminate your storage capacity problems. And when you need more storage capacity but are running out of ports on your disk

controller, it can provide configurations that have more than 2 gigabytes of data on one logical spindle.

High Performance.

High Performance is average seek times as low as 15 milliseconds and data transfer rates up to 2.8 megabytes per second. Now you don't have to settle for less.

Easy Installation and Maintenance.

Installation couldn't be easier. It's as simple as plugging in a DEC RA series disk drive. What's more, you can use your DEC diagnostics to check out disk drive problems. Error logs and fault identification procedures don't change, just drive reliability.

Whether you're adding to the storage capacity of a VAXBI system or moving up to a VAXcluster, the LS/100 Disk Adapter should be on your check list. Call us at 408/374-1818 for the name of the Lago Systems distributor nearest you. Or write Lago Systems, Inc., 160E Albright Way, Los Gatos, CA 95030.

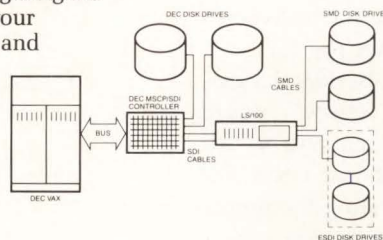

LAGO Systems

DEC, VAXBI, VAXcluster, HSC50, HSC70, UDA50, KDA50 and KDB50 are trademarks of Digital Equipment Corp.

CIRCLE 309 ON READER CARD

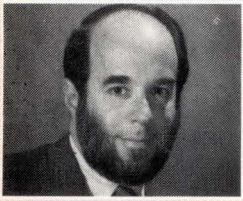

PUBLISHER

Carl B. Marbach

There Doesn't Have To Be A Loser

The latest DEC announcements have prompted many analysts to conclude that, in the next five years, either DEC will win and IBM will lose, or IBM will win and DEC will lose. Fortunately, these two giants aren't like two insects locked in a "death struggle" in which only the winner survives.

First, we must understand our penchant for winning. "Winning isn't everything," Vince Lombardi, Hall of Fame coach for the Green Bay Packers, told us. "It's the *only* thing." Leo Durocher, former shortstop and manager, observed, "Nice guys finish last." But while the Cincinnati Bengals recently lost the Super Bowl to the San Francisco 49ers, it's hard to classify as losers a team that came from a losing season a year ago to the championship this year.

Corporate competitive cultures sometimes cultivate the team approach to rally spirit and morale to beat the other guy. For example, would Macy's tell Gimbels? Does Hertz like Avis? Isn't Continental trying to steal United passengers at Denver's Stapleton International airport? Yet people still rent from Avis, even though it's number two. And Eddie the Eagle, who finished last in the Olympic ski jump, is a national hero in England.

Horse races repeatedly prove that people can't agree on a winner. And successful companies prove that you can be successful with *either* DEC or IBM computers. Some even succeed with systems from Hewlett-Packard, Unisys and others.

With computers, there are choices to be made every day, such as how to design the next database, or which CRT, network and sometimes even which computer system to choose. It's fortunate that we have these choices to make, because it's exactly this kind of competition that guarantees that we'll get the most bang for our buck. Only in markets in which there's no competition do we get less than what we pay for.

Today, there are more choices than ever. Besides the proprietary architectures, there's "standard UNIX," which promises to bring a level of compatibility to our systems that we haven't seen before. Even if we don't choose UNIX, the proprietary operating systems are incorporating the proper hooks to make networking with UNIX just as easy as networking similar systems.

IBM and DEC compete for our computing dollars and they do a fine job battling it out, each pushing the other to

provide the innovative answers we need. They've chosen different philosophies and styles to accomplish our computing tasks and that has allowed us to decide which culture best fits our own.

DEC will transparently tie VAX networks together with UNIX (ULTRIX) systems by supporting various network protocols and will use standard file conventions to access networked data. IBM, through SAA, will impose strict coding and user presentation standards in software design and implementation, providing transportability across differing platforms. There's no reason why both methods can't work.

For us, the battle is to integrate our computer systems throughout our companies. You can't do real electronic mail unless everyone has a "piece of glass" on his desk. We have to break down the idea that executives don't type, that the more important you are the larger your dictating machine, or that bosses can't work an electronic calendaring system.

The recognition that standalone PCs can't be the corporate computing resource is the real win. And the knowledge that, in the next generation of computers, everything is going to work together in a coherent fashion should give us comfort that we have a lot to do in the next few years.

There will be no losers on this battlefield, just winners: IBM, HP, DEC — and maybe some others. But best of all, as Pogo might have said, "I have met the winner — and it is *us*."

UNATTENDED BACKUP

If backing up your VAX Cluster keeps you reeling all night, try the new MA-24 two gigabyte tape cartridge backup system from Micro Technology.

Just turn it on and say good night. Because with the MA-24, you don't have to be there. Nobody does.

Unattended backup for VAX Cluster environments isn't just a dream anymore. It's real. And it's called the MA-24.

100% HSC compatible with pure DEC TA emulation, the MA-24 can back up 2 gigabytes of data on one cartridge. And because the MA-24 subsystem is so economical, you can finally afford to back up your entire VAX Cluster without changing anything except the time you go home. Just turn it on and let it run.

Configured in 2 gigabyte units, the MA-24 can back up 32 gigabytes of data in a VAX Cluster, using just one footprint and one HSC5X-CA card.

With its own 512 KB buffer, the MA-24 can keep streaming at 246 KB/sec. With peak transfer rates of 1.5 MB/sec. That means with a fully configured HSC5X-CA card you can back up a full 32 gigabytes in just three hours unattended.

So why fight it? Try a few gigabytes of unattended backup for your VAX Cluster and turn nonproductive time into productive time.

For more information on the MA-24 tape subsystem, call Micro Technology, Inc. 800 999-9MTI.



Micro Technology

1620 Miraloma Avenue
Placentia, California 92670
1-800-999-9MTI

CIRCLE 124 ON READER CARD



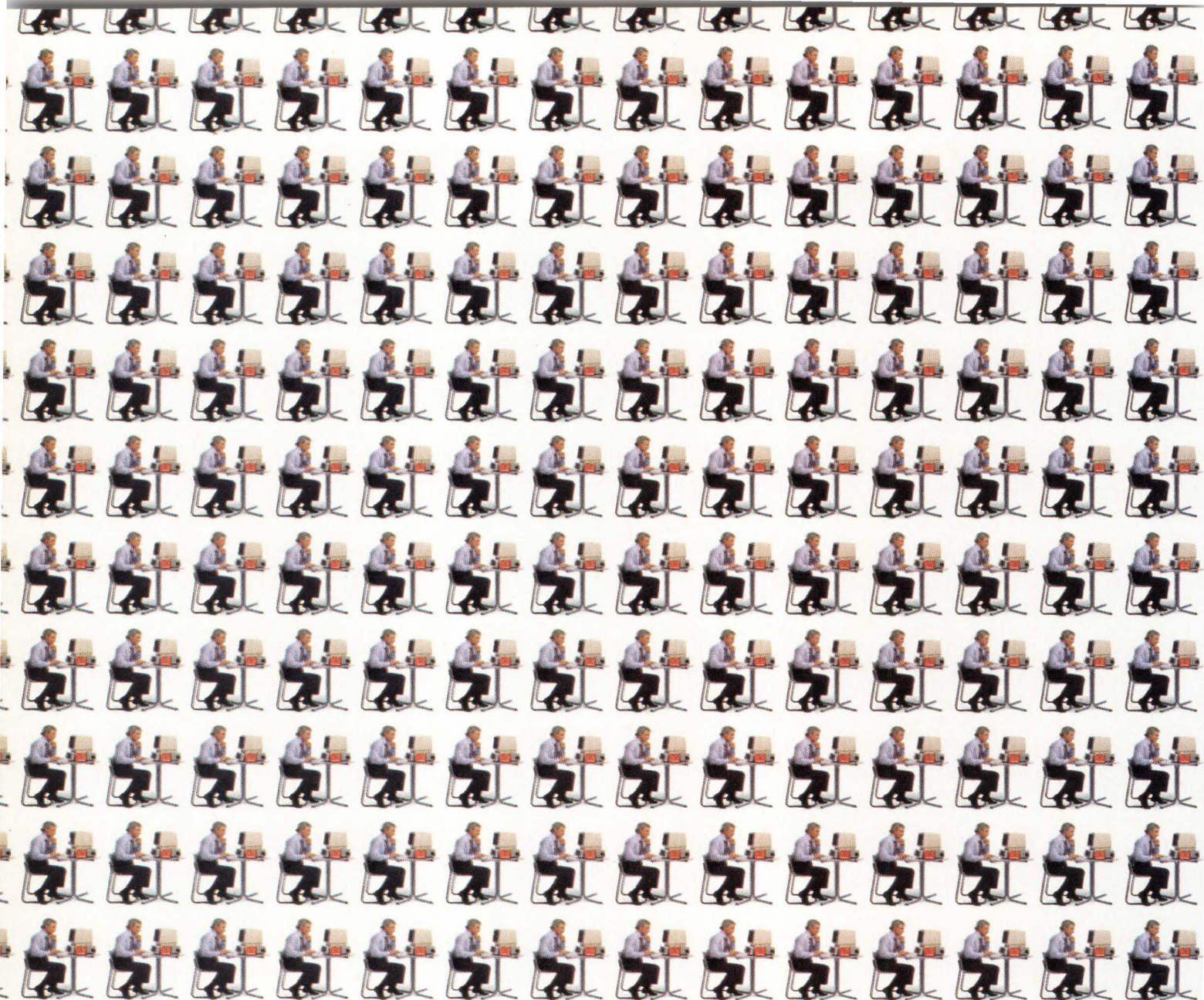

2,000,000 good reasons to add

Today, over two million people use Novell NetWare® to drive their PC networks. Not surprisingly, many of them are in companies which also have one or more DEC VAX minicomputers. Companies like yours.

Now Novell makes it easy for you to integrate PC users into your VAX network—and still maintain control of network information and resources.

PC-to-VAX connectivity. With NetWare for VMS, PC users can transparently access data, print services and applications on the VAX. Yet, because it runs as a single process

within the VAX, NetWare allows you to install, configure and control the network with standard VMS facilities.

Network security is enhanced by combining NetWare and VMS security features, while maintaining existing VAX security definitions set by the VAX system manager. And NetWare for VMS gives you the power of Advanced NetWare, plus full DECnet compatibility and connections to over 30 network topologies, including Token Ring and Ethernet.

Total network integration. As more and more users choose different desktop comput-

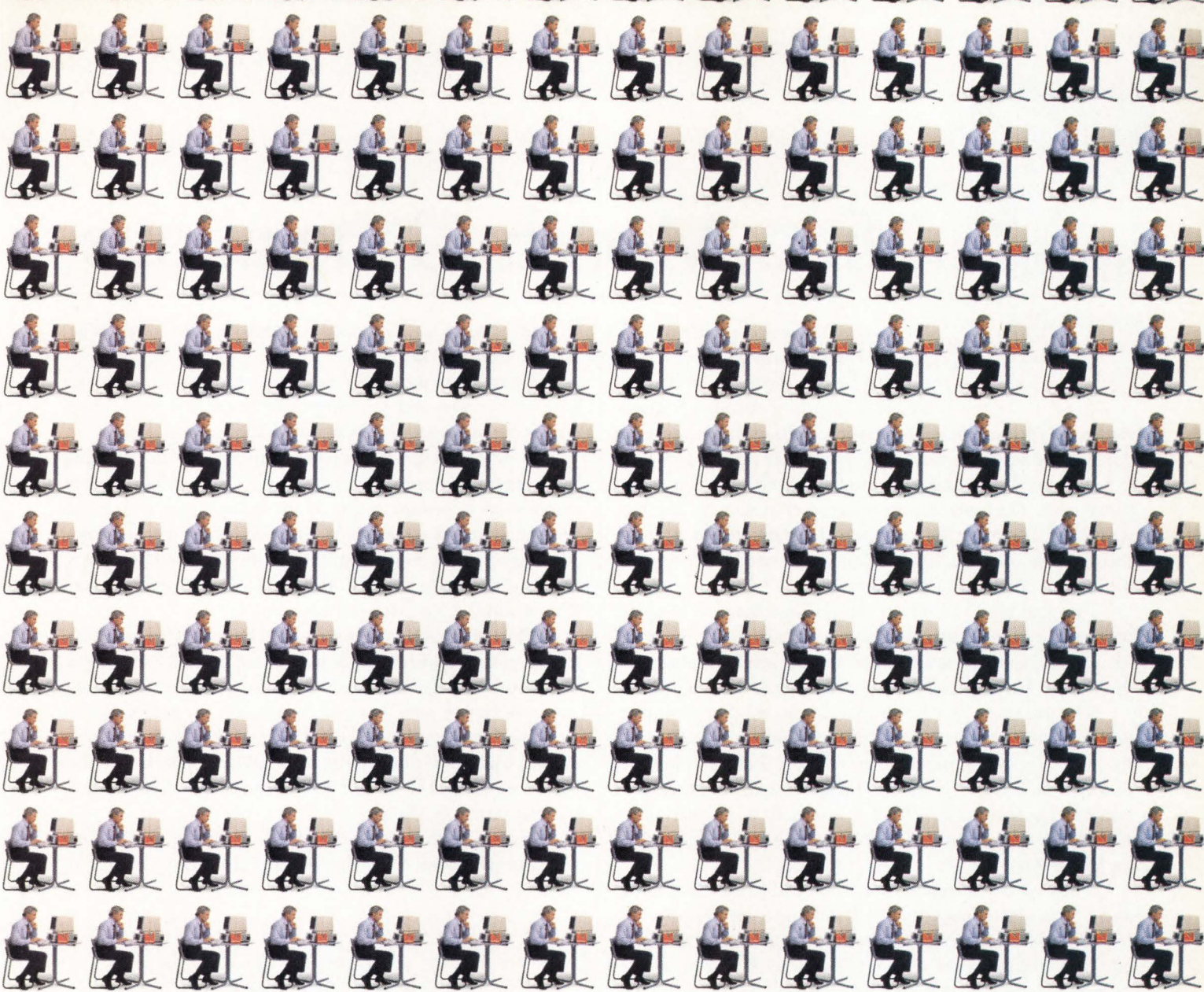

NetWare for VMS to your VAX.

ing environments, system managers face a tricky task: integrate all of these diverse computers into a single workable network.

Choosing NetWare for VMS provides a simple solution. Not only does NetWare let you link PCs to your VAX, but it also gives you the freedom to connect to other important environments. So all of your departmental and corporate computing resources can work together as one seamless system.

Add value to your VAX by adding a powerful connection to the more than two million NetWare users worldwide. Get NetWare for

VMS. See your Novell VMS Certified Reseller, or call 1-800-LANKIND.

For more information, call from your modem 1-800-444-4472 (8 bit, no parity, 1 stop bit) and enter the access code NVVMS22.

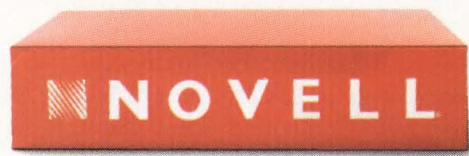

For network solutions, you should be seeing red.

CIRCLE 127 ON READER CARD

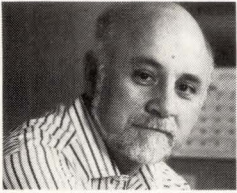

EDITORIAL

Dave Mallery

Nine-Month Generations

Welcome to the world of nine-month generations and flash obsolescence. It used to be that machines still were usable even when obsolete, but not any more. The minimum horsepower necessary to get anything done continues to increase. Recently I was offered a chance to buy some VAXstation 2000s from a truckload sale at about \$2,000 each. They were being replaced en masse at a big site with 3100s. It struck me that they were being offered at about their true value. They're just adequate to run an X environment for a single busy programmer.

I'm glad that I'm not in the leasing business. Imagine writing a lease on a \$1 million 63xx system with a five-year life span or writing a lease based on some residual value after three years! How do you depreciate a system for tax purposes?

The 63xx box may be able to sustain another transition (say to 6-mip 64xx processors in nine months), but after that the 100 MHz XMI backplane interconnect will be swamped, or you'll be severely limited as to the number of processors you can put in the box. That translates to a life span of 27 months for the box or to a backplane upgrade, and probably memory, too.

I hear you muttering "but I don't need all those mips, and I won't need them then." Before you say that for the record, wait and see what the overhead generated on the client end of a DECwindows session adds up to. If you're saying, "I'll never use DECwindows, all I need are VTs," wait and see. DEC didn't do the largest project in its history just for fun.

These are interesting times. There's a lot of change in the world of processors. DECwindows is providing true interoperability. DEC is spending as much on ULTRIX as on VMS. The price of a workstation mip has been capped forever at \$850. Aren't you glad you have to make these decisions for your company?

Uniform Musings

I don't want to lead you to any conclusions, but look at the following machines and see if you notice a trend.

From DEC: The DECstation 3100, a 14-mip wonder and old news.

From DEC at Uniform: The DECsystem 3100 four- to 64-user server with up to 1.5 GB of storage. It costs \$20,000 to \$75,000 and uses Mips Computer Systems' chip at 14 mips with synchronous SCSI.

From Data General: AViiON systems workstations and

servers, at 20 to 40 mips using Motorola 88000 chips. The 40-mip version features SMP.

The two new products mentioned above feature workstations and servers and are compatible at the X11 level. They feature performance that was unthinkable a year ago.

From Intel: The i860 processor chip (no systems yet) with an integer processor that loafes along at 33 mips and a cofloater that delivers 80 Mflops of simultaneous single precision. It has a 64-bit address space and cache (instruction and data) on chip, eliminating those nasty, expensive SRAMs. A 3-D graphics engine is thrown in, as well. It features Cray-1 performance. The quantity-1,000 price is \$750.

While at Uniform, I met a man whose VMS upgrade cost for his personal MicroVAX from version 4.5 to 5.1 was just a few thousand dollars less than the cost of a fully licensed four-user DECsystem 3100. I wonder what was on his mind?

Another marvel was the presence of at least three X terminals. That's a terminal with a ThinWire connector on the back, a mouse and all of X in ROM on board. It's diskless, simple and relatively cheap.

For the DEC market, the phrase "just the VAX" is no longer fully relevant. Maybe we should brush up on C.

“Our 1400 DEC terminals now offer full MS-DOS emulation, thanks to Logcraft.”



Thomas M. Costello, Ph.D.
Vice President
University of Lowell



Hundreds of the world's largest banks, universities and businesses rely on Logcraft instead of PCs. With 386Ware from Logcraft, VT terminals and VAXstations can run MS-DOS software at high speed, at a fraction of the cost of buying individual PCs.

386Ware allows files to be shared back and forth, and gives PC applications full access to your existing VAX peripherals and printers.

386Ware from Logcraft. It not only saves you money. It makes your networks a lot more manageable.

LOGICRAFT®

22 Cotton Road
Nashua, NH 03063
(603) 880-0300
FAX: (603) 880-7229

DEC, VAX, VAXstation and VT are trademarks of Digital Equipment Corporation. MS-DOS is a registered trademark of Microsoft Corporation. Logcraft is a registered trademark of Logcraft, Inc.

CIRCLE 156 ON READER CARD

LETTERS

STOP THE WASTE

While the pointy-headed politicians and bureaucrats are preaching petroleum tax to solve our economic ills, your insights are the clearest I've read on the subject ("Economic Colonization: Here And Now," January 1989). Each Stealth bomber costs as much as an electronics assembly plant. Keeping the military in Europe for 1989 requires approximately \$525 of income tax money from every man, woman and child in this country. What do we have to do to get Washington to stop the waste?

Thank you for telling it like it is.

Wendell Cockrell
Beaverton, Oregon

VT330/340 AND SSU

Steven Salemi's "Two Terminals Or One?" (January 1989) gave a good description of the capabilities of VT330/340 terminals. However, a reader could be left with the impression that the SSU software is required to get dual-session capability.

I've had a VT330 for some months and, using the two-cable/port approach, I get dual sessions without the SSU software. Local panning doesn't work for me, so I assume the SSU provides this as well as allows dual sessions over one wire.

With a two-VAX cluster to manage, I find it convenient to have a cable/session going to each processor and prefer this solution for my environment.

Robert E. Gibbons
Honolulu, Hawaii

SOFTWARE-ONLY APPROACH

Your listing of Communications Research Group's BLAST II UNIX and XENIX versions (Products, December 1988, page 150) mistakenly claims that BLAST requires "add-on boards or other

Please address letters to the editor to *DEC PROFESSIONAL* magazine, P.O. Box 503, Spring House, PA 19477-0503. Letters should include the writer's full name, address and daytime telephone number. Letters may be edited for purposes of clarity or space.

hardware" for file transfer and terminal emulation. Actually, BLAST links VAXs to many other systems, including UNIX and XENIX, with no more than a modem and cable for each system involved. This software-only approach leaves users' slots open for other applications — a boon to overloaded PC and Mac installations.

Also, Communications Research Group recently installed a new information line: (800) 24-BLAST.

Burk Murray
Technical Communications
Baton Rouge, Louisiana

VIRUS WITH A MOTIVE

I've read many letters in magazines concerning computer viruses. I've noticed that everyone assumes that viruses are the result of sick minds with nothing better to do than to destroy computer systems.

I'd like to suggest another possibility. Let's suppose that a software developer wants to discourage people from being satisfied with free or low-cost software (shareware or freeware). One way to accomplish this is to create

a virus program and enter it into a bulletin board system.

If someone were worried about being discovered, he could just use a name randomly picked from the phone book. Most operators of bulletin board systems I've seen allow free use and only check for valid names and addresses. Even if people didn't become terrified of free programs, many would pay to buy a program that would protect them from such a disaster.

Of course, some people might argue that creating a virus for profit is still the result of a sick mind.

Harry Myer
Kentville, Nova Scotia

VAX TO VAX TO VAX

We tend to overlook the differences between theory and practice. In theory, implied options should work. In my case, they do: With a VT220 and modem, I dial into a dialback security system (Defender II) from home, which connects me to a MicroVAX II. I SET HOST to our 785 and then SET HOST/DTE/LOG to a modem on a DECserver on the Ethernet and dial out to ARIS.

Think about it! I'm in three separate VAXs that don't know much about one another, offering this letter. I even have a hardcopy. The response, at 2,400 baud, is usable.

Thank you, DEC. I almost hate to say it, but the network is the system, and the system is working.

K.W. Jensen
Portland, Oregon

MAPPING MILLSTONE

In Letters (January 1989), Bob Heath describes the use of the Create Map Section (\$CRMPSC) as an I/O tool. We've found that technique can lead to major system problems.

When a disk file is mapped into

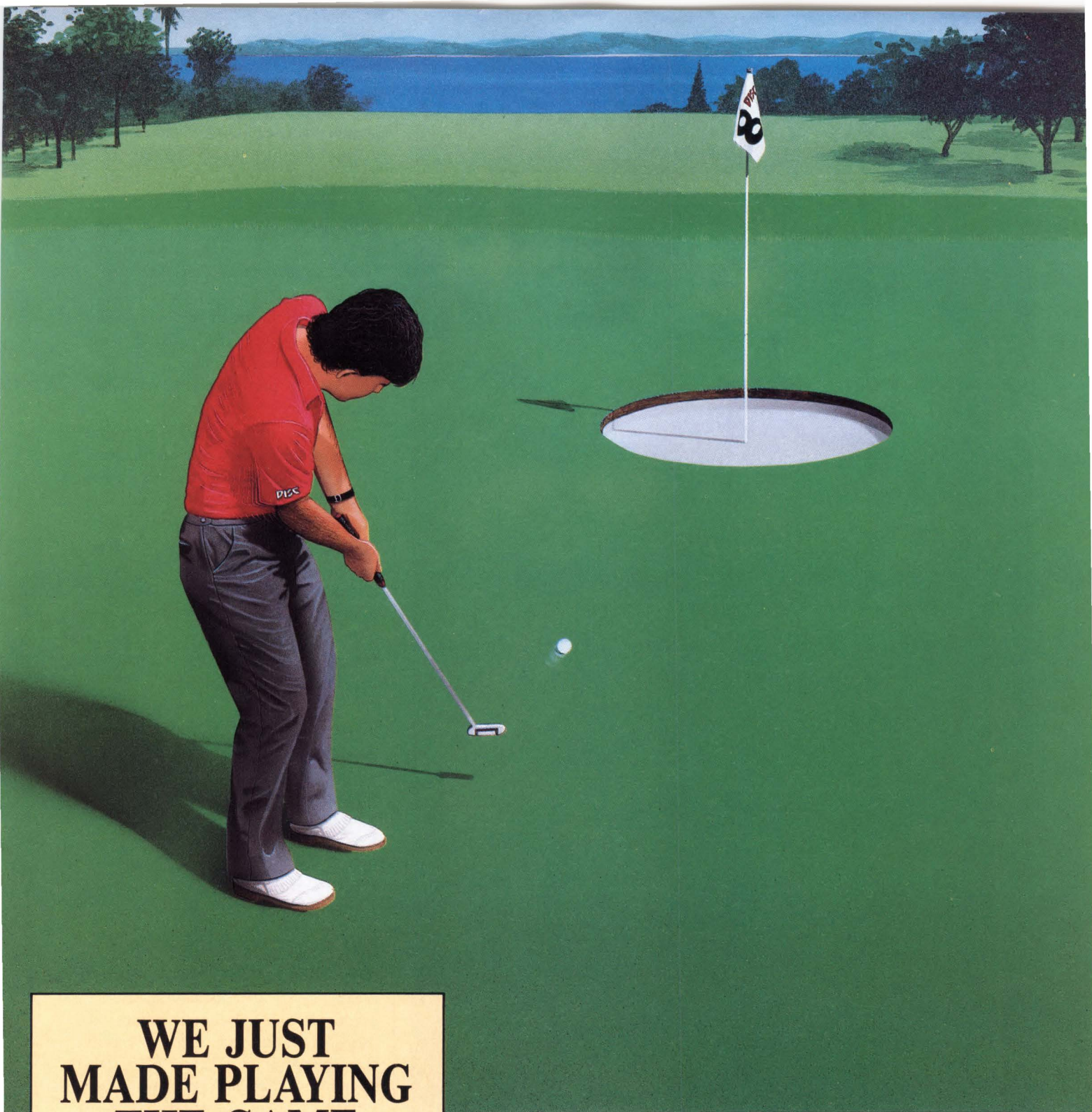

**WE JUST
MADE PLAYING
THE GAME
A LITTLE
EASIER**



When you're developing an application, every shot has to count. There's some tough competition in the software application marketplace, but we can give you that winning edge. Try our game plan if you need...

- the best of both worlds: the versatility of 4GL utilities, plus the power of a 3GL
- a state-of-the-art user interface to make your existing applications compete more effectively
- the portability to run on multiple hardware platforms without rewriting your code

For 13 years, DISC has been the leader in providing productive and efficient tools for application developers. **DBL Synergy** is a collection of new generation tools that make developing state-of-the-art applications easier than a short putt into a big hole. Give it **your** best shot...call us today!

CIRCLE 176 ON READER CARD

1-800-DBL-DISC
DISC products "Take Part In Creating Success!"
DISC, 11070 White Rock Road, Rancho Cordova, CA 95670.
In California call 016/625 7300 FAX 016/625 6640



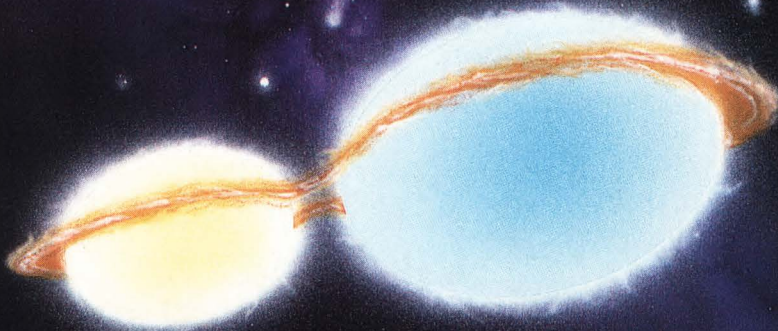

VAX/VMS Network Software

A NEW STAR IN NETWORK SOFTWARE.

The investment you've made in your VAX is too substantial not to demand the most out of each and every node. FUSION® Network Software (FNS), by Network Research Corporation, helps you do just that. FUSION implements the popular TCP/IP and XNS network software protocols, and it runs on all DECnet and Ethernet environments. With optional support for NFS and SMTP.

FUSION is the first network software that allows users to boot diskless Sun workstations directly from a VAX (using NFS). FUSION is also one of the first network software packages to support DEC's new Symmetric Multi-Processor Systems (SMP). And FUSION runs on a wide range of VAX/VMS 5.0 and 4.X machines, from a single MicroVAX to the powerful 6220 and 8840 systems.

Reviewers and users alike have hailed FUSION as a powerful breakthrough. "By using the NRC software today," wrote Digital Review, "DEC could maintain an edge over IBM." And FUSION's C-based architecture and socket Program Development System makes it easy to port your applications to and from PC's, mainframes, minicomputers, even supercomputers, without losing functionality or control.

FUSION works with multiple Ethernet controllers and features remote log-in, remote execution, quick and easy file transfer and E-mail. Plus network management utilities, point-to-point communication over Wide Area Networks, and connectivity to DDN X.25 networks. Network Research Corporation also provides exceptional customer support, customization alternatives, upgrades, training and aftermarket products.

See the light. FUSION Network Software.



2380 North Rose Avenue, Oxnard, CA 93030
Toll Free: (800) 541-9508 ■ In CA: (805) 485-2700
FAX: (805) 485-8204 ■ TELEX: 297579 NRCO UR

FUSION is a licensed trademark. Other trademarks: DEC, VAX, VMS, MicroVAX, DECnet, SMP, Digital Equipment Corporation, NFS, Sun Microsystems, XNS, Ethernet, Xerox Corp.

CIRCLE 292 ON READER CARD

memory via \$CRMPSC, it's treated like a little pagefile. I/O to the file goes through the Modified Page List (MPL) via the Modified Page Writer. If the data file is large relative to the size of the MPL, if there are many users on the system so that there's a lot of throughput on the MPL, or if the addresses referenced in the file are scattered widely so that many pages are needed, then the MPL is converted from a cache to a pipeline. It performs this job with neither efficiency nor grace.

Because useful pages from other processes are being written to the page file while the mapped section flushes through the MPL, the hard-fault rate skyrockets. The whole system can be bogged down by one user. Several users can bring an 8650 to a halt. We haven't tested our code on VMS version 5.0's multithreaded page writer. I'd guess that with multithreading the I/O may be faster, but the pages on the MPL still will be churned at an accelerated rate.

Using mapped sections for I/O can be an effective tool. But like any tool, you must consider the materials and environment in which it will be used. For a dedicated system, a single-user workstation or with small files, it works well. For a multiuser configuration with large image files, it can be a millstone.

John Reynolds
Rochester, NY

CAN'T SEE THE FOREST . . .

Despite Forest Computer Inc.'s prominence in the DEC/IBM connectivity marketplace, it was omitted from the listing of DEC/IBM connectivity vendors that appeared with "DEC/IBM Interoperability" (January 1989) by Robert Philips.

Jim Antonucci
Vice President Marketing
Okemos, Michigan

Forest Computer Inc.
1749 Hamilton Rd.
Okemos, MI 48864
(517) 349-4700

CIRCLE 458 ON READER CARD ■

MEET THE GUYS WHO CHEATED DIGITAL EQUIPMENT CORPORATION OUT OF \$60,000,000.



With their software, you can do everything a \$1000 DEC terminal does — on your PC — for a mere \$245.

The suave and debonair gentlemen bandits who sit before you virtually invented DEC terminal emulation for the IBM personal computer.

To the uninitiated, what that means is this.

With their software, you can do everything a \$1,000 DEC terminal can do — right on your own PC — for the paltry sum of only \$245.

Has business been good for our heroes?

You bet: to the tune of 60,000 users, who would otherwise have blithely gone out and bought DEC terminals.

Does this make DEC happy? What do you think.

Heavy DEC Experience + Heavy IBM Experience = Perfect Emulation.

The product these wizards invented is VTERM/220. And the reason it's so good, frankly, is that nobody has more experience than they do in DEC emulation on a PC.

With VTERM/220, you can emulate DEC's VT220, VT102, VT101, VT100, and VT52 terminals.

Of course, there's emulation and then there's EMULATION. This is *TRUE EMULATION*. Complete! Comprehensive! Thorough! Fast! Accurate!

Installation's a snap. Setup is a simple full-screen operation. You can toggle between DOS and the terminal screen and put mainframe data directly into PC spreadsheet and data base products such as Lotus 1-2-3™, dBase™, and Multiplan™. And for file transfer, there's XMODEM, ASCII, Kermit or VTRANS, our own high-speed, error-correcting protocol.

One last word from the Robin Hoods of software.

Are there other terminal emulators?

Of course there are.

But, we invented DEC terminal emulation at Coefficient. We know the subtleties, the little features (and the big ones) that make an emulator a joy to use. And we've incorporated them all into VTERM/220.

Just ask any of our 60,000 users.

They paid us the highest compliment of all.

They chose our software over the real thing.

CIRCLE 105 ON READER CARD

A free working copy of their software. *Free? Yes, free.*

There's only one way to experience the speed, power, and simplicity of VTERM/220. Try it.

- Send me a free, time-limited, full-blown working copy of VTERM/220, which is mine to keep.
- Send me a free, time-limited full-blown working copy of your new VTERM/4105 or VTERM/4208 Tektronix graphics terminal emulators.

Name _____

Title _____

Company _____

Address _____

Telephone (____) _____

I am a user dealer.

Coefficient Systems Corporation

611 Broadway, New York, New York 10012
Voice: (212) 777-6707, ext. 604 Fax: (212) 228-3137
Telex: 6503156498 MCI Mailbox: CSC

DP0489

TUNING AND PERFORMANCE BENCHMARKING

QUERY:

Jim Shelly (SIG 13/MESS 200): I'm system manager of a cluster of two 11/785s, a 6220 and two HSCs, with an assortment of disks. We have approximately 100 users with 50 or 60 logged on at any given time. With 32 MB on both 785s and 64 MB on the 6220, most tuning problems can be solved by increasing memory.

As we add more users and tuning becomes a bigger issue, I need to measure the results of tuning efforts. I hope to create a procedure that will create an artificial workload of my choosing and then gather performance statistics before and after tuning. Is there something like this already available? If you use SPM to test the results of tuning, what information do you find most valuable, and in what format do you report it? Otherwise, what statistics would you suggest gathering?

REPLIES:

Robert G. Schaffrath (SIG 13/MESS 201): Have you considered the User Environment Test Package (UETP)? It can simulate a system full of users. Check the *VMS Installation and Operations Manual* for your processor.

Phil Anthony (SIG 13/MESS 202): Until the users are experiencing a problem, it's best to leave the system parameters alone. If you think you can squeeze more out of your system by tweaking a parameter, run SPM under your artificial workload with the current parameters, making the change, and rerunning SPM with the artificial workload to see if there's an improvement in the metrics

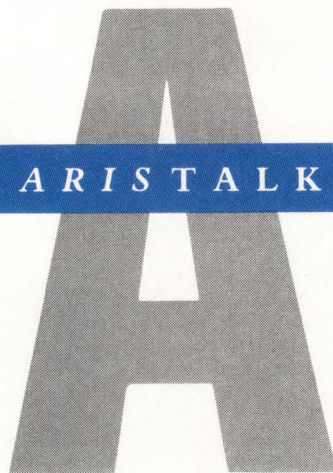

How To Use ARIS

Subscribers to *DEC PROFESSIONAL* can call up our VAX and log into ARIS, our Automated Reader Information Service. In ARIS, you can download programs from this publication, communicate with our editors, request a change of address, find additional information about advertisers, order books and back issues, check the guidelines for submitting articles, take a peek at our editorial calendar for the year and communicate with other VAX users.

To log in, you'll need your subscription number from your mailing label. Set your terminal to seven data bits, one stop bit and space parity, or eight data bits, one stop bit and no parity, and dial:

- (215) 542-9458 - Pennsylvania
 - (818) 577-9100 - Southern California
 - New! ■ (415) 873-2135 - Northern California
- Baud rates: 300, 1,200 or 2,400.

As a *DEC PROFESSIONAL* subscriber, you can download any of the programs marked with an ARIS symbol. *VAX PROFESSIONAL* programs are available only to subscribers of *VAX PROFESSIONAL*. For subscription information, contact Karol Hughes at (215) 542-7008. Use these recommendations at your own risk. Professional Press is not liable for any damages to your system that might be caused by the hardware, software, programs or procedures discussed here.

XMODEM and KERMIT are available.

SIG Identification

The SIG categories referenced in this month's *ARISTalk* are:

- 13System Performance
- 25Terminals/Plotters/Printers
- 42Communications/File Transfer
- 92Open Forum, Third-Party
- 101Miscellaneous

affected by the change. But the real test will be whether or not the users are getting their work accomplished faster and better.

Before tuning, run SPM and gather the information it will give you in the real working environment. The printouts are horrendous, but careful examination of the metrics during peak processing periods will indicate whether or not you have a problem.

If there is a problem, examine SPM dumps when a system slowdown occurs to find out what values are out of range. If tuning is called for, rather than adding or upgrading hardware, tinker with the system parameters and run SPM again under the same workload to find out whether or not, and how much, the situation has improved.

If there aren't any problems at present, the printouts still will provide a baseline from which you can estimate future requirements and isolate future problems when the workload increases.

Artificial workloads can be helpful for benchmarking different systems, but they generally aren't all that good in simulating real, especially interactive, workloads.

/FOREIGN PERIPHERAL

QUERY:

Dan Klenke (SIG 92/MESS 86): We want to install an Abekas Video Systems Inc. Digital Disk Recorder as a peripheral to our MicroVAX. It has a SCSI port we're using through a TD Systems VAX-SCSI interface to connect to the VAX. Unfortunately, it knows nothing of being a VAX peripheral and has no file structure. How can I access this in FORTRAN or

TRIMM INDUSTRIES A Global View...

DISK EXPANSION

In a world of continuing disk expansion, TRIMM Industries offers a comprehensive range of enclosure products. Enclosures from single drive expansion to disk farm applications are available. Dec write protection functions are available in most configurations as well as fully regulated individual peripheral power supplies. Thermal protection and a variety of options make TRIMM the choice for a world full of configurations.

Q-BUS SYSTEM EXPANSION

TRIMM Industries allows the system integrator a world of options for configuring Q-bus based systems. Trimm offers a CD backplane available in either eight or twelve slots as well as an eight slot Q22 backplane. Fully regulated 350 or 500 watt (continuous) power supplies run the systems. Rack-mount, pedestal, and roll-around models allow configurations for all applications and with our variety of options, the world is the limit.



DA 5 PERIPHERAL ENCLOSURE



DEC COMPATIBLE CABINETS

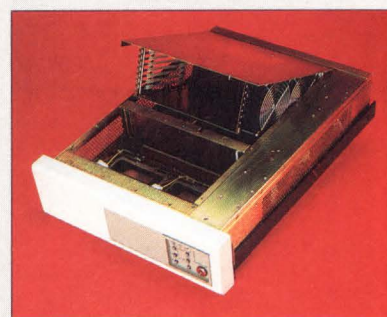

DA 23 SYSTEM ENCLOSURE

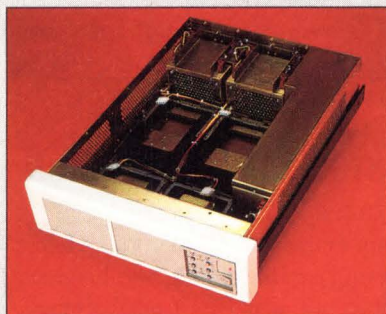

DA 50 DISK STORAGE ENCLOSURE



DA 523 SYSTEM ENCLOSURE

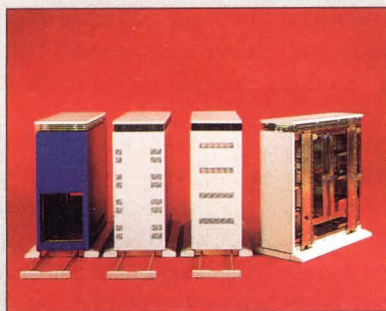

TWR DISK EXPANSION

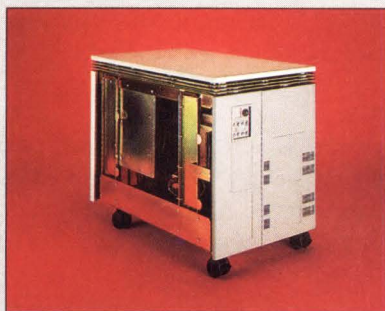

DA 123

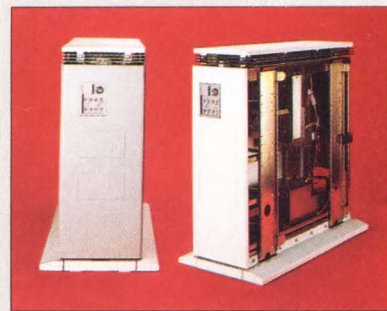

TWR SYSTEM ENCLOSURE

TRIMM INDUSTRIES



11949 Sherman Road, North Hollywood, CA 91605
Phone: 818 983-1833
Call toll-free: 800 423-2024 outside CA, 800 272-3557 inside CA
Fax: 818 503-0438 TWX: 910 499 4745

TRIMM INDUSTRIES LIMITED



2-6 Giltway, Giltbrook, Nottingham, NG16 2GN England
Phone: (0602) 385485
Fax: (0602) 389973 TLX: 379317

DEC, CD, and Q22 are registered trademarks of Digital Equipment Corporation

CIRCLE 282 ON READER CARD

“ We’ve cut our training time by 33% with custom keys. ”

THE ULTIMATE KEYBOARD ENHANCEMENT.

Maximize your software investment with custom key sets displaying any symbol, language, code or legend. Custom keys from Synctronics enable you to:

- Reduce training time
- Instantly increase user productivity
- Promote on-the-job user satisfaction
- Increase hardware utilization

Stock and custom keys available for DEC, IBM, WYSE, COMPAQ, and other systems.

For complete product information and quantity discounts call
(800) 444-KEYS



Synctronics

4901 Morena Blvd., Suite 302
San Diego, CA 92117, (619) 581-6303

CIRCLE 141 ON READER CARD

C? I tried a useropen and setting the NFS bit in the FAB, but when I tried to read, it still looked for 010.dat and crashed.

REPLY:

Richard B. Gilbert (SIG 92/MESS 89): Try mounting the disk /FOREIGN. This will tell the system not to expect any labels for file structure. I think you'll have to read the disk via calls to SYSS\$QIOW with the IO\$_READPBLK function.

EMPIRE FOR VMS

QUERY:

Bob Hospadaruk (SIG 101/MESS 444): I've become addicted to a game called Empire. My only code is an executable that runs on a PDP. Does anyone know where the source code can be obtained for this? I'd like to port it to VMS.

REPLY:

Marty Chamberlain (SIG 101/MESS 446): Sorry to hear of your terrible addiction. Empire is available for VMS on an old DECUS tape called VAX-12 EMPIRE: War Game of the Century, Version 4, January 1981. Unfortunately, the source code isn't included. I believe Empire is also available on VAX-LIB-1.

Have fun.

SUBMIT/REMOTE OUTPUT

QUERY:

George Dawson (SIG 101/MESS 443): We have four MicroVAX IIs connected by DECnet running VMS V4.6. Is there any way to suppress the output of SUBMIT/REMOTE? When the /REMOTE qualifier is used, all others are ignored.

REPLY:

Wayne Steffen (SIG 101/MESS 451): DCL Dialogue (January 1989) has a procedure for executing DCL on a remote system. Its original use was to pass qualifiers to the PRINT command.

DUAL SESSIONS

QUERY:

Brett Bump (SIG 25/MESS 261): After reading the article, "Two Terminals Or One?" by Steven Salemi (January 1989),

I wonder how many people actually use VT330/340s for dual sessions.

When the VT3xx series came out, we already were running our own PC-style overlapping-windows-approach software. Our current in-house version is designed for a maximum of nine separate windowed jobs.

REPLIES:

Philip Gravel (SIG 25/MESS 262): I use the dual-session capability of the VT340 and like it. My dual sessions run through two physical connections. It's nice to watch the progress of a job (e.g., MONITOR or SHOW PROCESS/CONTINUOUS) on one system while working on another.

Stan Barndt (SIG 25/MESS 264): I have SSU on a VT340 and love it! It's the single-wire configuration because there are no extra ports. I'm a department of one, and it's very useful to the small-shop manager to be able to flip out of one session and take care of day-to-day problems.

If only DEC would enable SSU to support something at the cost of a VT320.

\$\$SYSTEM-DATA-OVERRUN

QUERY:

Dan Fraser (SIG 42/MESS 426): Help! I'm having trouble dialing out. I connect to BBSs, but at points I get bumped out with the error message %SYSTEM-W-DATAOVERUN. I'm using a Hayes-compatible modem, and the terminal setup is NOHOSTSYNC and NOREADSYNC. Otherwise, the line hangs up, and I can't get anything through to the modem.

REPLIES:

J. Scott Viaian (SIG 42/MESS 429): I got the same message when trying to call DSIN. Do a SET TERM/PERM/ALTYPEAHD: this was the only thing I had to change.

Dan Fraser (SIG 42/MESS 430): Thanks for the help. I now can access this BBS and stay on-line through more than one message. The SET TERM/PERM/ALTYPEAHD worked great. ■

If you used INGRES on your backlogs, you'd be home by now.

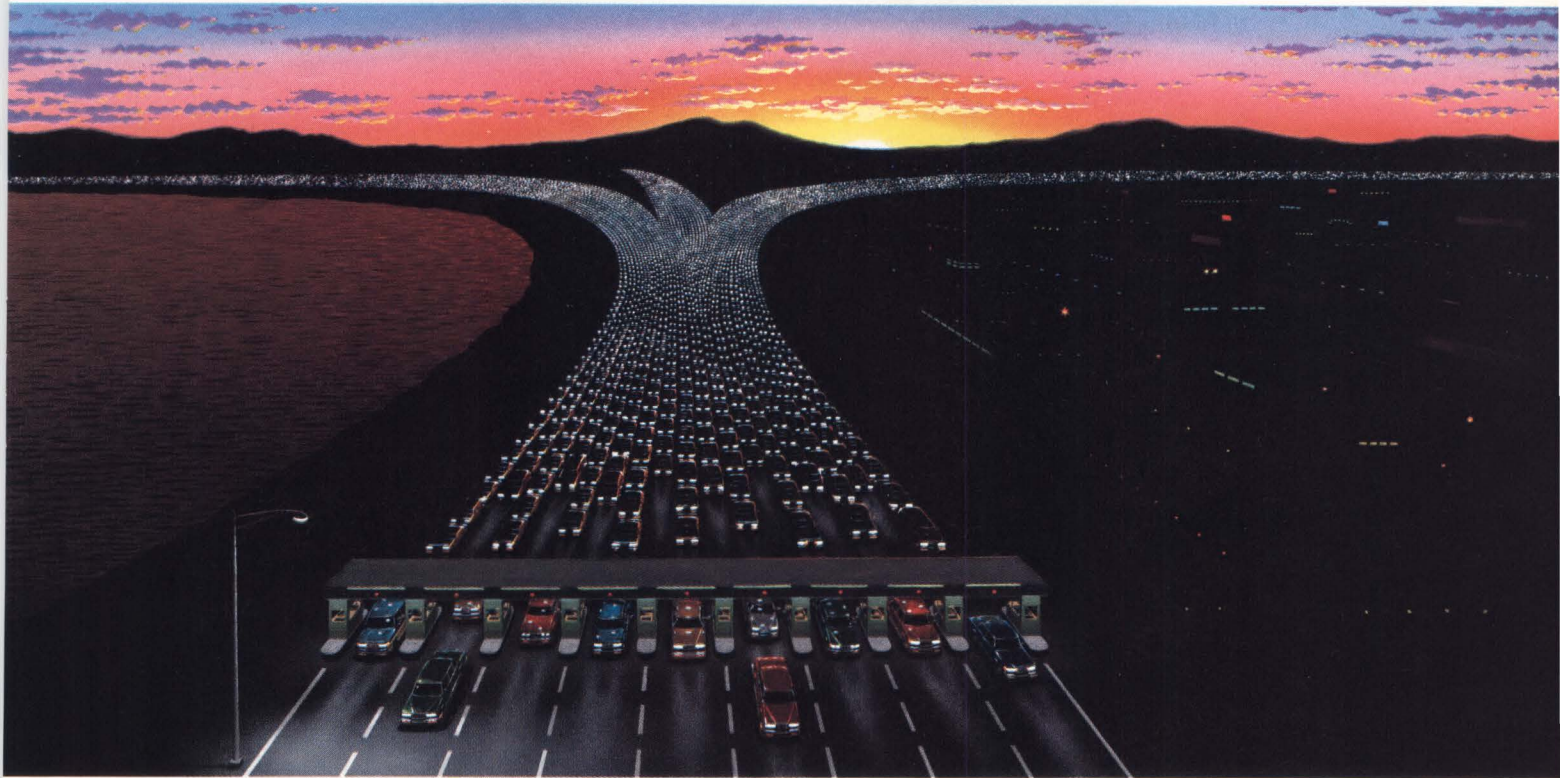

INGRES Tools provide the fastest path through your applications jams.

It's a fact of every MIS manager's life. Backlogs will happen. But the problem isn't the volume of applications traffic. It's how your development tools handle the load.

The solution is INGRES. INGRES Tools are part of a fully integrated environment that ties together SQL, 4GL, host languages, visual forms, and report editors in a way that dramatically accelerates the entire development process.

Shift into high gear. With INGRES, there's no slowing to switch tools. No need to fabricate tricky solutions. No road blocks. And once your applications are finished, they're ready to go places. Because your INGRES applications are easily portable across multiple hardware platforms.

What's more, INGRES open architecture allows you to integrate data from other data bases and systems in your applications—easily and transparently. All of which makes INGRES Tools the surest way to maneuver through applications development gridlock.

The tools of choice. Don't take just our word, ask DEC. They've chosen to distribute INGRES Tools to their users. You'll also find INGRES among the solutions preferred by IBM, Sun, Apple, and a long list of industry leaders. Our clients include two of the Big Three auto manufacturers, major financial institutions, oil companies, and service organizations worldwide.

Take the fast lane. Don't let backlogs bring your company to a standstill. Choose INGRES, and take the fast way home. For more information or to attend a free INGRES seminar in your area, call 1-800-4-INGRES.

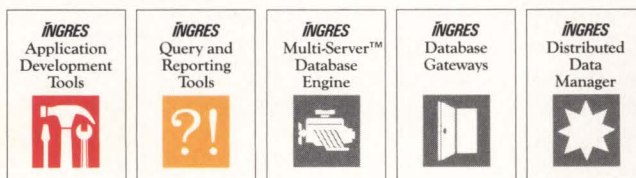

INGRES
RELATIONAL TECHNOLOGY

Call 1-800-4-INGRES

Corporate Headquarters: 1080 Marina Village Parkway, Alameda, CA 94501, (415) 769-1400
International Headquarters: 99 Kings Road, London SW3 4PA, UK, 44-(1) 351.7733

INGRES, INGRES TOOLS, INGRES OPEN ARCHITECTURE and RELATIONAL TECHNOLOGY are registered trademarks of Relational Technology, Inc. DEC, IBM, Sun and Apple are registered trademarks of respectively Digital Equipment Corporation, International Business Machines, Sun Microsystems, Inc., Apple Computers, Inc. ©1989 Relational Technology, Inc. Printed in USA.

CIRCLE 137 ON READER CARD

Optical Goes Erasable

Alphatronix Offers Erasable Optical Disk Subsystems For DEC Workstations

Although highly regarded as an excellent medium for archival data storage, their inability to randomly read and write data has kept optical disks out of the mainstream of computer storage. Alphatronix Inc. of Research Triangle Park, North Carolina, has broken that barrier by introducing the Inspire series of erasable, optical disk drives.

The Inspire series is based on a 5¼-inch form factor. Using erasable optical cartridges, each drive can store up to 650 MB of data on a disk that's about the same size as a 5¼-inch floppy disk. The new drives boast a maximum data rate of 7.0 Mbits per second and an average seek time of 83 ms. They are designed to conform with international standards as defined by ANSI, ECMA, ISO and the Japan Study Committee 23.

The drives emulate

DEC's DU series of drive systems. A single-slot host adapter emulates DEC's Mass Storage Control Protocol (MSCP) controllers. All MSCP commands are supported. Designed to be plug-and-play systems, Inspire drives require no software changes or conversions.

The line is available for Q-bus and UNIBUS VAX systems. Single and dual-drive configurations are available.

Each system includes the drive, controller, host adapter, proprietary integration firmware and software, cables and connectors. Diagnostics and utility programs can be accessed via an on-board RS-232 port. Desktop, rack-mount and tower configurations are available.

Longer media life span and reliability are enhanced by the use of magneto-optical technology. Because a non-contact laser beam is used for recording and reading, wear and tear is



The Inspire series of erasable optical disks from Alphatronix Inc. emulates Digital Equipment Corporation's DU series of drives. They're available with one or two drives in desktop, tower or rack-mount configurations.

reduced greatly. There are no heads to crash or tapes that can stretch.

Large archival applications in fields such as CAD/CAM, accounting, law, medical imaging and banking can enjoy new functionality with the erasable capability. Storage space is also conserved. One optical disk can hold the same amount of data as 3.5 reels of

tape at 6250 bpi or 14 reels of tape at 1600 bpi. It would take over 500 1.2-MB floppy disks to store the same amount of data as one optical disk.

For more information, contact Alphatronix Inc., 4900 Prospectus Dr., Ste. 1000, P.O. Box 13687, Research Triangle Park, NC 27709-3687; (919) 544-0001.

Circle 563 on reader card

— David B. Miller

It takes a lot of drive to be an American.

2 Year Warranty

We're so confident of American Digital Systems' MasterDisk® drives that we put it on paper—in a big way: a two-year warranty with 24 hour replacement service and a 30-day money-back guarantee.

American Digital Systems' full line of disk and tape drives are fast becoming the standard. Compared to other drives, including DEC's, they offer far greater performance per dollar.

Read about our products, then write or call American Digital Systems, 490 Boston Post Rd., Sudbury, MA 01776. (508) 443-7711.

MasterDisk:

Industry-leading speed and reliability.

- 6.39 msec average disk access time.
- High reliability—40,000 hrs MTBF.
- Complete system, includes drives, controller, cabinetry, utilities, diagnostics, tool kit and all necessary cables.
- For Q-Bus and Unibus computers.

MasterDisk Removable:

A removable drive with positive data/disc protection.

- 6.39 msec average access time.
- Unique positive locking mechanism.
- Up to 677 MB in a single drive module.
- For Q-Bus, Unibus and BI bus computers and VAXclusters.

MasterDisk /SDI:

The price leader for large VAX systems.

- Cluster compatible with HSC 50/70.
- Compatible with KDB50, KDA50, UDA50 controllers.
- Low cost, about 1/3 less than DEC's RA81.
- High capacity in a compact size.
- Minimum data channel requirement.

MasterTape II:

High-capacity backup in a low-cost tape system.

- 2.332 gigabytes of storage on a single low-cost tape.
- 1.5 megabytes/second peak transfer rate.
- Fully TMSCP compatible.
- Uses new ANSI standard for data formatting.

DEC, VAX, Q-Bus, Unibus and BI bus are trademarks of Digital Equipment Corp.



American Digital Systems Inc.

CIRCLE 149 ON READER CARD

The TCP/IP Connection

VXM Technologies' TIM Makes Networking Connections A Breeze

If the prospect of developing TCP/IP-based distributed applications has you shaking in your boots, a new product from VXM Technologies, Boston, Massachusetts, will steady you.

TIM, short for TCP/IP Interface Module, provides a number of key features to help make networked application development easier (see Figure). TIM has three components:

1. TIMtool, which provides utilities to exercise and troubleshoot a TCP/IP network interactively from your terminal.
2. TIMtalk, a live, ready-to-use application that demonstrates some of TIM's features. It allows several users to conference back and forth over a TCP/IP network.
3. TIMfunctions, a C language object library that

programmers can use to develop their own distributed applications.

TIMtool utilities feature single-letter commands. Utilities exist to send and receive strings, create and close client and server sockets, and obtain the status of current messages and connections. On a remote node, you can connect to an application under development to troubleshoot and debug it. The systems over which the application is distributed can be heterogeneous or similar. In addition to application testing, TIMtool can be used to exercise and troubleshoot remote nodes on a network.

TIMtalk provides not only a live application, but also a good example of how TIMfunctions can be used to develop distributed applications. By allowing users to talk to each other over

TCP/IP, programmers and developers can get a good idea of how to set up their own applications.

TIMfunctions is the heart of TIM. This C language library provides all the tools needed to develop distributed applications across TCP/IP networks. TIMfunctions modules can be used to develop new applications. Some older applications can be modified to take advantage of the networking capabilities TIM offers.

TIMfunctions modules parallel TIMtool utilities. C modules exist to create and close connections, send strings across the network and check for various network settings.

TIM provides TCP/IP applications with OSI Session Layer transmission capabilities. Above TIM, developers can create their own presentation protocols. TIM doesn't enforce any presentation protocol of its own.

The Berkeley UNIX socket mechanism is used to create a stream mode to transfer data between applications. Applications can be created for either client or server modes, depending on how you set up TIM functions within your application. Up to four socket connections can be supported simultaneously, allowing TIM-based servers to support multiple clients. Complete control over network operations helps TIM prevent client/server lockup and other network communication problems.

TIM's capabilities are provided without adding undue burdens to program-

mers and developers. The time required to learn the mysteries of TCP/IP interfacing is reduced, allowing for higher productivity and application turnaround rates.

TIM-based applications also can be used to communicate with applications that use TCP/IP but don't use TIM.

This allows you to create a TIM-based environment throughout your organization, which helps to maintain coherence and consistency.

Applications that aren't distributed also can use TIM. TIM can replace UNIX pipes or VMS mailboxes to do intertask communications, thus providing a more consistent environment, especially for sites with dissimilar hardware and operating systems.

An OSI version of TIM also is planned. Users will be able to swap TIM/TCP with TIM/OSI, relink their applications and continue to run their applications undisturbed.

TIM is available for a wide variety of vendor hardware and operating systems from DEC, Apple, Sun, Apollo, IBM, Hewlett-Packard and others. Workstation, micro, mini and mainframe platforms are supported. Third-party TCP/IP systems from CMC, Excelan, Wollongong and 3Com/Sun NFS are supported.

For more information, contact VXM Technologies, P.O. Box 9121, Kenmore Station, Boston, MA 02215-9121; (800) 627-5221.

Circle 425 on reader card

—David B. Miller

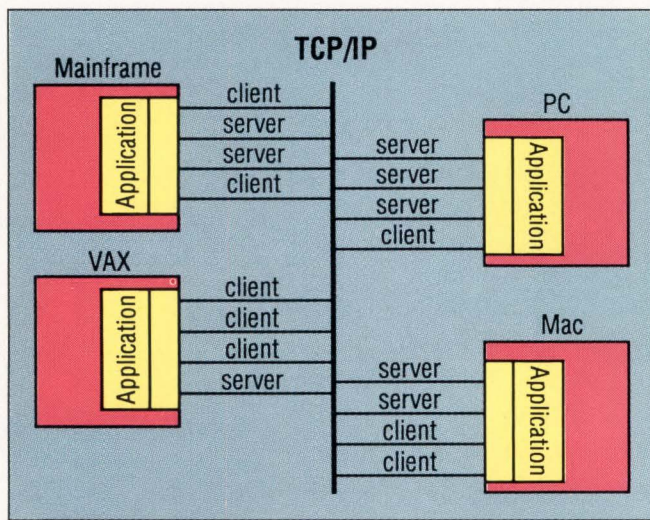

TIM-supported applications can have four full-duplex asynchronous connections acting as a client or server.



This freehand drawing was created using DRAW's tablet mode.

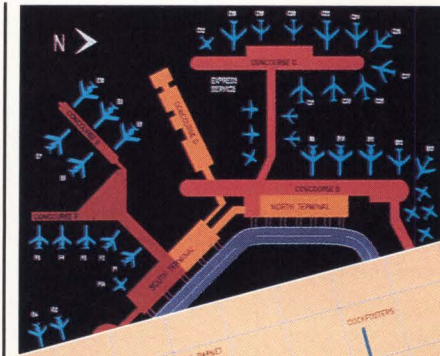

This airport terminal layout illustrates the placement of user-defined symbols with object-snapping.

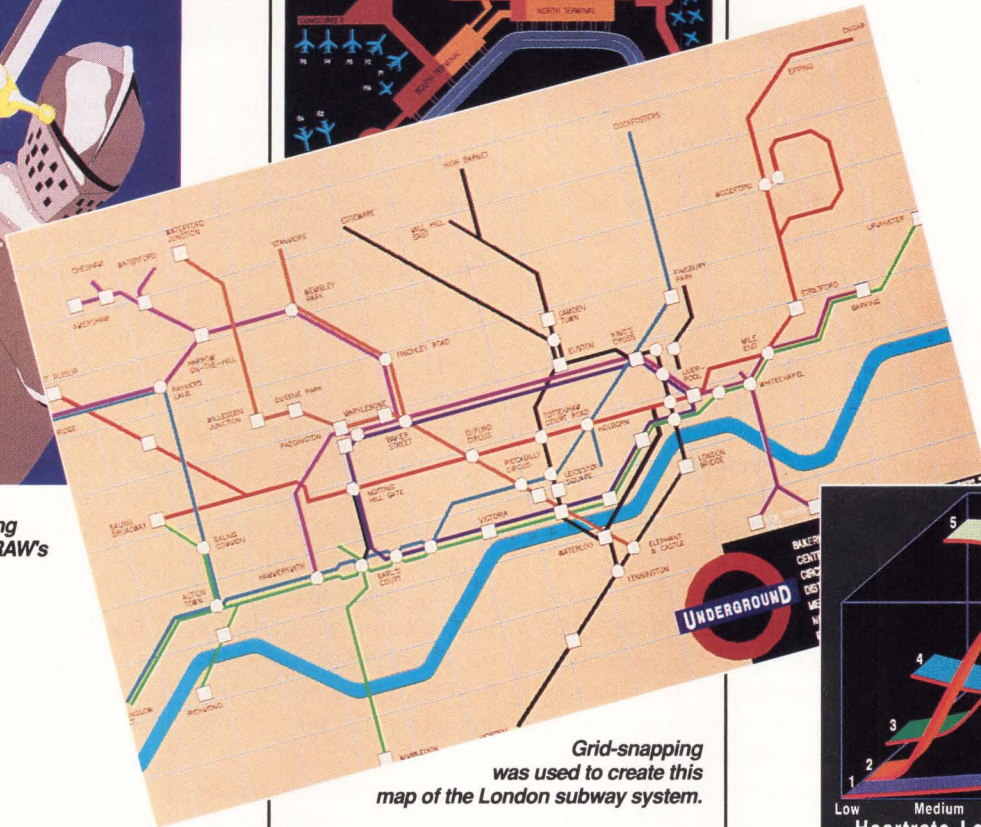

Grid-snapping was used to create this map of the London subway system.

DRAW's extrusion feature allows the user to generate complex graphs and drawings.

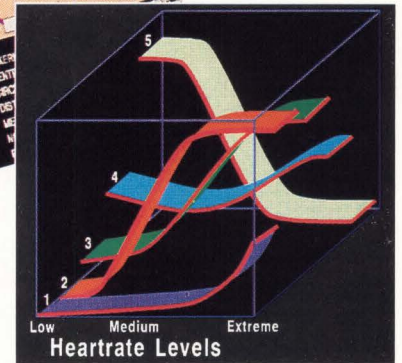

It's Like Having MacDraw® on Your VAX

DRAW: The Precision Visuals Drawing System™

A drawing environment for your VAX with features you'd expect from MacDraw? That and more. Precision Visuals' DRAW delivers a device-independent system built for all levels of users to quickly create color illustrations interactively.

Because DRAW offers you your choice of menu, command, or tablet driven interfaces, the system is easy to learn which makes training a snap. Engineers, scientists, project managers, researchers, technical writers and graphic artists can use DRAW to make their plans, proposals, and presentations come to life with publication-quality artwork.

To make your illustration creation even easier, DRAW has a symbol library with more than 400 elements — from geographical boundaries and icons for computer equipment to circuits and logic symbols. You can easily add to this li-

brary with your own custom symbols for every day use.

With DRAW you can export picture metafiles to other CGM-compatible systems so you can incorporate line drawings with charts or any other graphics. You can also use DRAW to route images through POSTSCRIPT, HPGL, and other publishing formats to merge illustrations with text output.

DRAW provides user control over every attribute with a feature set that includes color table support, layering, mirroring, 3D extruding, variable

line width, 48 hatch patterns and publication-quality text fonts. And because DRAW operates on all VAX/ VMS systems with Tektronix graphics or VT-240, VT-340 terminals and all popular hardcopy devices you are not tied to the hardware.

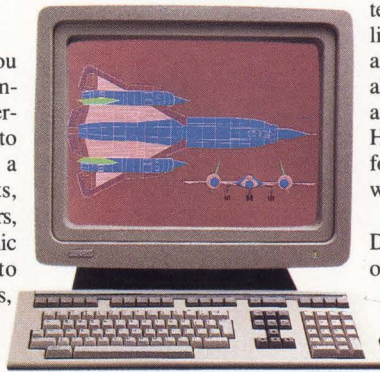

Precision Visuals

Precision Visuals, Inc.
6260 Lookout Road
Boulder, Colorado 80301 USA
Phone: 303/530-9000 Telex: (RCA) 296428
Fax: 303/530-9329

PVI Precision Visuals International GmbH
West Germany
Phone: 49-69/6 66 65 97 Telex: 176 997 150
Fax: 49-69/6 66 67 38

Precision Visuals International Ltd.
United Kingdom
Phone: (0895) 35131 Telex: 51826715
Fax: (0895) 72299

MacDraw, PostScript, VAX/VMS, VT-240, VT-340, and DRAW are trademarks of Claris, Corp., Adobe Systems, Inc., Digital Equipment Corporation, and Precision Visuals, Inc., respectively

Dishing Up Disk Subsystems

Emulex Introduces Host Adapters And A SCSI-Based Disk Controller

With a flurry of new product introductions, Emulex Corporation of Costa Mesa, California, is headed full-throttle into the SCSI world, but continues to augment its VAX storage subsystems with upgrades, controllers, communications devices, and disk and tape host adapters.

Hot on the heels of DEC's endorsement of the SCSI standard with its new desktop systems strategy, Emulex has produced the Mac 200, a high-performance SCSI chip that's a combination disk controller/buffer controller. The Mac 200 is designed to interface with high-capacity, high-performance magnetic disk drives.

The Mac 200 processes disk transfers at a rate of 28 MHz and has address capabilities from 64 KB to 4 MB. The processor's multi-sector disk transfer capability features single interrupts that further accelerate the transfer rate.

Emulex reports that the "data-flow" structure of the chip improves the data transfer into and out of buffer memory. This increased buffer control functionality lets you adjust to and get maximum use from system RAM.

Anticipating the needs of OEMs and systems integrators, the company built features into the chip that will accommodate large data buffers and more automated DP requirements. The combination of the ESP 200 chip

(Emulex's previous SCSI processor) and the Mac 200 provides support for both the SCSI 1 or SCSI 2 requirements. In quantities of 5,000, the Mac 200 costs \$28 per chip.

Emulex also announced that it will ship new versions of its MicroVAX 3500/3600 host adapters for LSI-11, MicroPDP-11 and MicroVAX II computers. The SCSI-to-Q-bus UC07 and UC08 use DEC's disk (MSCP) and tape (TMSCP) protocols.

The UC07 is a single controller with one SCSI bus connection. The dual-SCSI connections of the UC08 support MSCP on one port and TMSCP on the other. The UC07 is priced at \$1,600, the UC08 at \$2,050. The quad-wide devices are Digital Storage Architecture (DSA) compatible.

The SCSI products complement a wide range of storage subsystems Emulex has developed in the last two quarters. Among these is a new series of eight-inch Winchester subsystems for the Q-bus and UNIBUS. Called the Emulex Pedestal Subsystem (EPS) family, the systems are designed for non-clustered environments with large storage requirements.

The series ranges from a one- to four-drive configuration, with formatted capacities ranging from 741 MB to more than 4 GB. The SMD/SMD-E drives use different Emulex disk controllers, depending on the host system: the QD33 for the MicroVAX II, the QD34 for the MicroVAX 3500/3600 and the UD33 for UNIBUS computers.

All controllers can be used with any MSCP drive that transfers data up to 3 MB per second. They use non-volatile RAM and firmware-

resident diagnostics and a set of on-board, menu-driven utilities that let you configure, test and format subsystems from a host terminal. Prices for the EPS series begin at \$5,625.

Emulex's SM700 series of eight-inch disk subsystems for single VAXs or VAXclusters has six SDI ports and supports disk capacities up to 10.48 GB per cabinet. These systems are compatible with DEC's RA series drives.

Emulex offers a variety of fixed, removable and internal 5¼-inch disk and ½-inch tape subsystems for the MicroVAX 3500/3600. In the communications area, Emulex introduced the QS09, a 16-line multiplexer for the MicroVAX 3500/3600.

For more information, contact Emulex Corp., 3545 Harbor Blvd., P.O. Box 6725, Costa Mesa, CA 92626; (714) 662-5600.

Circle 405 on reader card

—Evan Birkhead

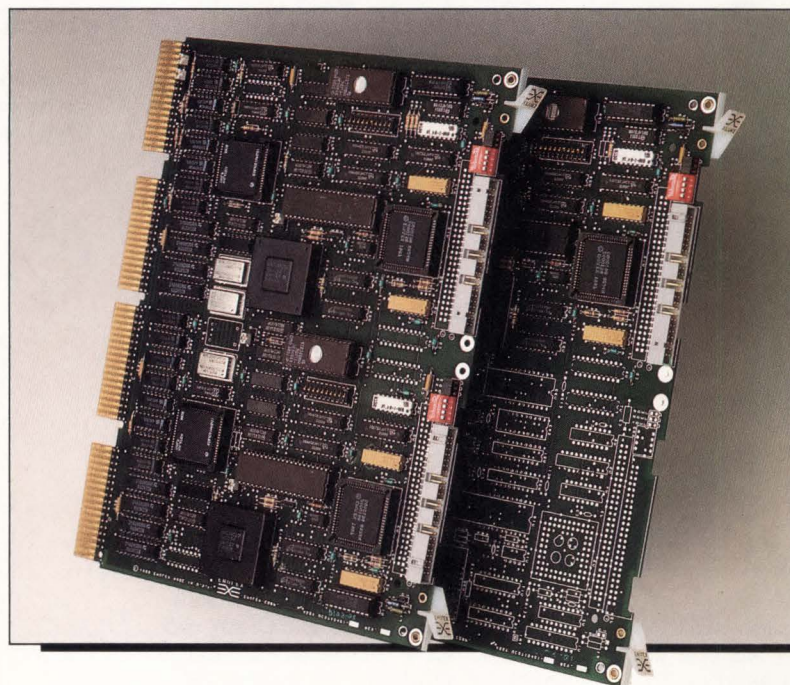

**The Mac 200
SCSI chip
performs data
transfers at
28 MHz.**

Colleague™

LAPTOP VT 220 TERMINAL

Colleague
\$995
Colleague Plus
\$1295

*Includes battery
and modem*



*"Keeping
you in
touch"*

\$995 Colleague Portable Terminal includes:

- 20 Auto Connect/Auto Dial Channels
- 20 Programmable Function Keys per channel with numeric/application keypad support
- Full 25 Line x 80 Column Supertwist Display
- Internal 300/1200 bps Auto Answer/Auto Dial Modem with **MNP* error-correcting protocol**
- 150-19.2K bps RS-232 Port & Parallel Printer Port
- Internal 15-Hour Battery with Recharger
- VT-52/100/220 Emulation
- Compact — 7.5 lbs.; 13" x 10" x 2½"

\$1295 Colleague PLUS also includes:

- Full-Featured Internal Word Processor
- Data Capture/Send/Screen-Snap
- Session Record/Playback
- 65K of Non-volatile RAM Storage

Also Available:

- External Numeric/Application Keypad — \$95.00
- 2400 Baud Internal Modem — \$200.00
- Backlit Screen — \$200.00
- Ink Jet Printer
- Carrying Cases

Evaluation Colleagues available. **Call 1-800-553-6773** (in Ohio: 513-825-0880)

581 Northland Boulevard **Random™** Cincinnati, Ohio 45240
CORPORATION

© 1988 Random Corporation VT is a Registered Trademark of Digital Equipment Corp. Random and Colleague are trademarks of Random Corporation.

*MNP is a Registered Trademark of Microcom, Inc.

CIRCLE 135 ON READER CARD

COMPANY: Athena Development Corp.
 ADDRESS: 5800 S.W. Washington St.

SALES REP#: 7
 NAME: G Moore
 PHONE: (415) 645-1214

CITY: Portland
 MAIN PHONE: (503) 246-2400

STATE: OR ZIP: 97210

CONTACT:
 M Bennett
 Purchasing Ma
 ext. 2406

ORDER #: 10003 ENTERED: 08/15/86 FILL CODE: P
 TERMS: 3% 10, net 60 days SHIP VIA: Best way

ALTERNATE SHIP-TO ADDRESS

FIRM NAME: William Santos Associates
 ADDRESS: 5711 Florin-Perkins Rd.

Suite 999

CITY: Seattle

STATE: WA ZIP: 98109

ALT ADDR#: 1

MAP:

F1 -Prv Form

F2 -Nxt Form

F3 -Prv Rec

F4 -Nxt Rec

F5 -Fld Help

F10-More Key

MAP:

F15-Prv Set

F16-Nxt Set

F17-1st Set

F18-0xt Rec

F19-Last Rec

F20-Zoom On

Enter the second line of street address.

Accell/SQL accommodates the 24-hour uptime requirements of OLTP environments.

Unify's Accell/SQL Integrates 4GL And Generator

Underlying RDBMS Is SQL Compliant

In the world of UNIX-based RDBMSs, the marketplace for commercial and government applications continues to grow rapidly. And because the competition includes Oracle, Ingres, Sybase and Informix, business is cutthroat. The plans of one contender, Unify Corporation of Sacramento, California, include following the market by moving into the workstation arena while protecting its strength, which the company feels is at the UNIX midrange.

Additionally, Unify introduced Accell/SQL for Unify 2000, its next generation of software tools. Accell/SQL is a 4GL application development tool that supports multiple SQL-compatible RDBMSs, in-

cluding Unify 2000, Unify's proprietary back-end engine, SCO Integra from the Santa Cruz Operation, and Sybase. Unify 2000 is compatible with ANSI SQL.

According to the company, the combination of components is well-suited to large business applications such as OLTP. The system will perform with a wide range of interfaces, including Microsoft Windows.

David Saykally, president and CEO of the nine-year-old corporation, says that Unify's goal is to make Accell/SQL "the industry-standard 4GL for commercial UNIX applications."

Accell/SQL integrates an application generator with a 4GL, which the company reports precludes the need for programming in a 3GL. The generator, called Accell/

Generator, uses interactive, visual tools to facilitate repetitive programming tasks. Field and form definitions are completed by filling in blanks, e.g., screen attributes, window size and location, and field type and length. A "compile by exception" utility streamlines the compilation process by updating only programs or forms that have been modified.

The 4GL code, which can function independently as a standalone development tool for some applications, also can be used for complex operations the generator can't handle, such as screen-intensive applications. The 4GL is intuitive and non-procedural.

Accell/SQL also has a windowing system, Zoom-View, that lets you find and display data from anywhere in the application. NEXT FORMS options allow movement through different forms in the application.

These components are designed to manipulate data within the Unify 2000 RDBMS. This SQL-based system features five data-access methods, five levels of security, on-line backup and automatic recovery. By integrating with several RDBMSs, Unify hopes to provide the developer a choice of RDBMSs with a single set of development tools.

Portions of applications built with Accell can be off-loaded from a UNIX host to MS-DOS-based systems with a cooperative processing utility called Accell/CP.

According to Michael Simon, vice president of marketing at Sequent Computer Systems, Accell/SQL takes advantage of the power and performance of multiprocessor architectures. "To the developer," he explains, "this software/hardware combination adds up to a potential 10-fold increase in productivity when compared to traditional development approaches."

Unify 2000 is available for the major variations of UNIX, including AT&T System V, Berkeley 4.3 BSD and DEC's ULTRIX, on a range of platforms from the MicroVAX II to the VAX 8900.

The VAX ULTRIX version of Accell/SQL will be available in May. On Sequent, AT&T and Pyramid platforms, the price ranges from \$2,995 to \$120,000, depending on the CPU.

For more information, contact Unify Corp., 3870 Rosin Ct., Sacramento, CA 95834; (916) 920-9092.

Circle 420 on reader card

—Evan Birkhead



JOB TRAINING FOR EXPERT SYSTEMS

Our job at Bell Atlantic Knowledge Systems is putting expert systems to work...as problem-solving tools in business, industry, and government...every application where improved quality and efficiency are the goals.

Our development tool is LASER™...a modular, portable, C-based programming environment...designed to develop and deliver knowledge-based applications on a wide range of computers from micros to mainframes.

Bell Atlantic Knowledge Systems offers you a full range of expert system services...regardless of your company's prior experience, scale, or technology base. You can choose from seminars...consulting...in-depth training...and, using LASER, we can customize knowledge-based solutions for your application.

We give you the expertise of our Bell Atlantic Knowledge Systems teams — experienced in analyzing and building expert system applications — plus the information-management resources of our parent company, Bell Atlantic.

Call now — to find out what LASER can do for you.

1-800-552-2257

 **Bell Atlantic**™
Knowledge Systems, Inc.

P.O. Box 3528
Princeton, New Jersey 08543-3528

CIRCLE 226 ON READER CARD

Word Processing En Masse

MEC's Mass-11 V8.0 Provides Live Links To Graphics And Other Files

As the trend in publishing documents, reports, newsletters and even magazines moves toward the desktop, one of the industry's leading word processing systems, Mass-11, is moving with it. With its Mass-11 Word Processor version 8.0, Microsystems Engineering Corporation (MEC) of Hoffman Estates, Illinois, maintains its role as an important vendor in this arena.

Version 8.0 has been released simultaneously on the VAX and PC and features enhancements that make it appropriate for specifications, proposals and documentation. Among the most notable enhancements are an on-screen Preview Mode and a live link to the source graphic, saving time, memory and money when preparing compound documents (see Figure).

Referencing the graphic at print or preview time, rather than storing it directly in a document, conserves disk space: The source graphic doesn't have to be edited in every document containing that graphic.

MEC's live link supports specifications defined by DEC's Compound Document Architecture (CDA) containing live links to text, graphics, images, spreadsheets, charts and tables. Version 8.0 provides live links to many graphics formats, including MDL metafiles, HPGL, AutoCAD, Tektronix,

Mac.PICT and Lotus.PIC and IGES.

According to MEC, Version 8.0 is the only product integrated with ALL-IN-1 at the DSAB level to provide live links. Using the DSAB as a translator, you can create, edit and send documents to any ALL-IN-1 user working with any type of word processor. This level of integration allows these documents to be sent using DEC's message router or mail system.

With this integration, ALL-IN-1 users can access more powerful document processing functionality to integrate text and graphics, double the number of con-

currently running word processing users, print to a wide variety of third-party printers and communicate seamlessly between VAXs and PCs.

According to Carol Karels, communications manager, by January 1, 1990, all government contracts submitted to the U.S. Department of Defense must comply with Computer-Aided Acquisition Logistics and Support (CALs), the government-defined structure for compound documents. Live links are a major part of CALs. "With this government decision and DEC's support of live links with CDA, we can see an emerging trend in this area," says Karels.

The Preview Mode allows you to look at a document page by page, seeing

correct line and page endings for proportionally spaced documents. The document, or specified pages, can be printed from the Preview Menu. PC users see on-screen text and graphics integration and correct point sizes, and can zoom in on the page. VAX users see a graphic representation to conserve system resources.

Version 8.0 also offers a new thesaurus, from Proximity Technology Inc., enhanced macros and hot printing, which lets you work in other programs or applications while the document is printing. Other features of V8.0 include leading, absolute positioning of graphics on a page, horizontal and vertical rules in inches or centimeters and the ability to scale a document.

Mass-11 offers full support for clustered and networked VAX installations, letting you edit, copy and print anywhere on the network. For installations using both VAXs and PCs, Mass-11 provides a communications package that allows users to transfer documents, print files and ASCII files to and from the VAX via modem or RS-232 direct connect.

Prices for Mass-11 Word Processor version 8.0 range from \$495 for the IBM PC to \$5,750 for the MicroVAX II and \$17,250 for high-end VAXs.

For more information, contact Microsystems Engineering Corp., 2400 W. Hassell Rd., Ste. 400, Hoffman Estates, IL 60195; (312) 882-0111.

Circle 427 on reader card
—Eric Schoeniger

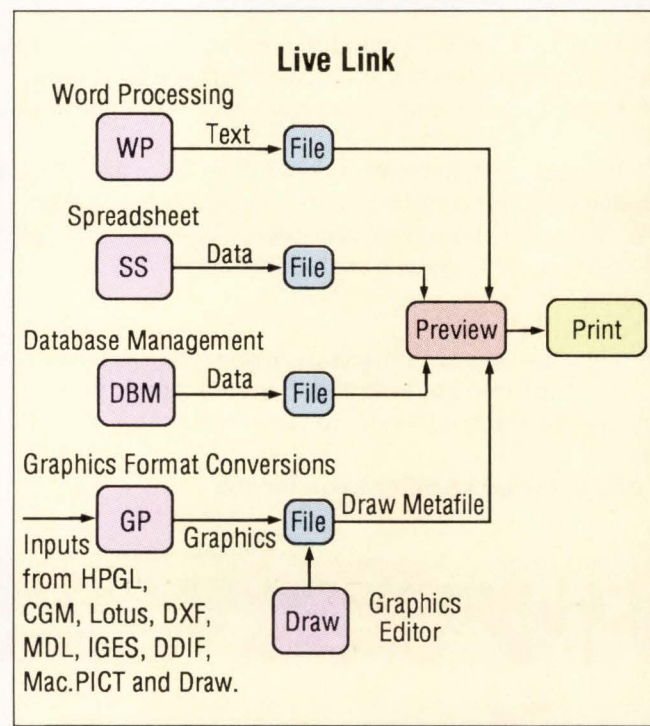

In Mass-11 V8.0's live-link approach, document files include pointers to graphics, spreadsheets, images, charts and tables.

VAXBI BUS EXCLUSIVE: NOW MEGATAPE OFFERS "DIRECT ATTACHMENT" 8MM CARTRIDGE BACKUP SUBSYSTEMS.

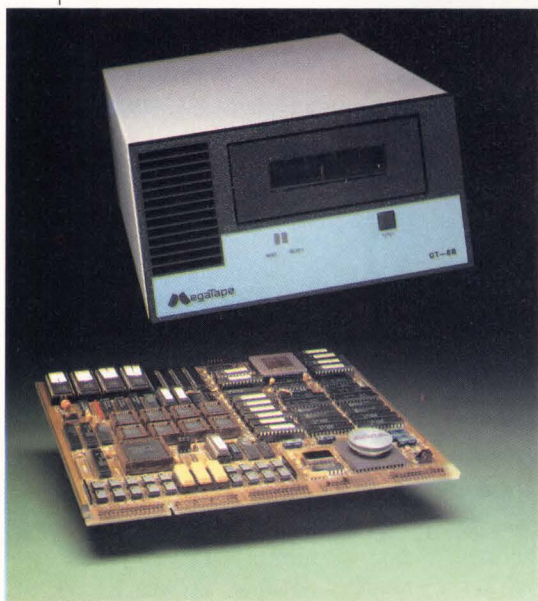

Interfacing our 1/2" tape cartridge system to the VAXBI bus was an amazing technical accomplishment all by itself.

But now we've gone a step further. Introducing the MegaTape GT-88 VAXBI backup subsystem. The only, repeat

only, 8mm cartridge system with a direct connection to the VAXBI bus.

So now high-end VAX users have a choice for convenient, low-cost disk backup: an astounding 2.3 gigabytes on an 8mm cartridge. Or 630 megabytes on our proven 1/2" linear-format cartridge. Both

priced dramatically lower than anything available from DEC.

MegaTape's proprietary VAXBI controller is completely TMSCP-compatible, and lets your system zip through backup chores using your standard VMS or Ultrix backup utilities.

MegaTape offers something

else that's crucially important, too: support capability built on nearly a decade of advancing the state of the backup art.

So if you'd like reliable backup—fast—there's only one place to call: MegaTape. P.S. We also offer the industry's "best buy" QBUS and Unibus subsystems, too!

VAX, VAXBI, QBUS, Unibus, VMS and Ultrix are trademarks of Digital Equipment Corp. © 1989 MegaTape Corporation.

MEGATAPE CORPORATION

1041 Hamilton Road
Duarte, CA 91010-0317
(818) 357-9921 • Telex: 510 600 7131
Telefax: (818) 357-2369

THE GREAT LEAP
FORWARD IN BACKUP.

Perfect Timing

Simpect's Real-Time Clock Provides Interval Timing And Event Counting

Owners of 6000 and 8000 series VAXs in real-time environments now have a way to use their machines reliably with real-time applications.

Simpect Associates Inc. of San Diego, California, has developed the RTC, a programmable real-time clock option for DEC BI-based computers. The RTC provides high-resolution, precise interval-timing and high-frequency event-counting capabilities that real-time applications require.

The RTC resides on a single board that is easy to install. It simply plugs into a slot in the backplane of any BI-based machine. It can be used to time internal or external events, count events and trigger devices or software processes.

A backplane-to-panel cable with a DB-25 connector is provided. A DEC-supplied Universal Data Interface Panel (UDIP) can be connected to the distribution channel to connect, select and adjust I/O signals on the RTC. The RTC features BNC connections for I/O signals, switches to select Schmitt trigger slopes and potentiometers to adjust Schmitt trigger thresholds.

It contains a 32-bit counter-timer that operates at a maximum speed of 10 MHz, which provides 100-nanosecond resolution.

Input for the timer can originate from an external source with a maximum signal rate of 5 MHz or from any of six internal frequencies, ranging from 10 MHz down to 100 Hz. Clock accuracy is rated at 0.01 percent over the operating temperature range.

One of the two Schmitt trigger input lines can be set up to accept an external signal to be counted. The other can be used to start the

Four modes of operation are available. Single Interval mode can be used to generate a delay for an application. The counting can start immediately or can be delayed until the completion of an external event signaled through one of the Schmitt triggers.

Repeated Interval mode generates a fixed frequency pulse. Overflow outputs continually are set at fixed intervals. It can be used to trigger devices such as digital-to-analog or analog-to-digital boards.

External Event Timing mode measures the time be-

operation. However, each external pulse through the Schmitt trigger causes the counter to be reset to zero before counting continues.

Software drivers are available for both the VMS and ELN operating systems. DEC's VAXlab Software Library (VSL) provides VMS support. In lieu of VAXlab, Simpect can provide driver and I/O routines that are compatible with DEC's Real-Time Calling Standard (RTCS). ELN support is available for ELN release 3.1.

Migration from a Q-bus-based environment to a BI environment is easily facilitated. The RTC is functionally equivalent to DEC's real-time clock for the Q-bus, the KWV11-C. The user interface to both clocks is nearly identical. Both clocks perform the same timing and counting functions. The RTC's registers form a superset of the KWV11-C's registers.

To enhance DEC compatibility further, the RTC supports DEC's VAX Real-Time Accelerator (VAX RTA) coprocessor.

A software diagnostic package also is included and runs under the VAX Diagnostic Supervisor (VDS). The diagnostic tests the RTC's registers, clocking modes, frequencies and interrupts, as well as the BI bus.

Prices for the RTC range from \$4,990 to \$5,890.

For more information, contact Simpect Associates Inc., 9210 Sky Park Ct., San Diego, CA 92123; (619) 565-1865.

Circle 424 on reader card

— David B. Miller

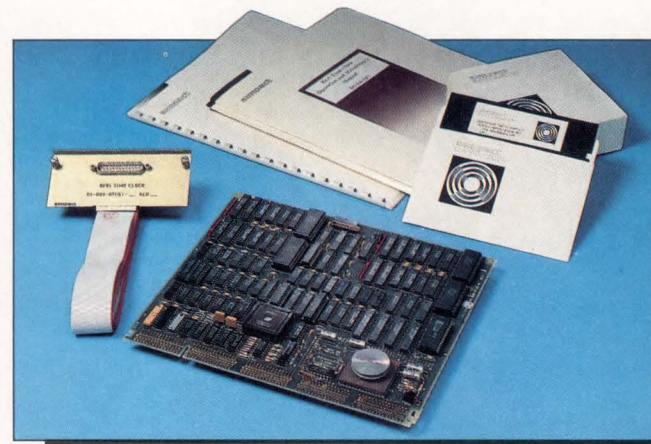

Simpect Associates' RTC, a programmable real-time clock option for DEC BI-based computers.

counter on an external event, to time events, or to generate VAXBI interrupts from the RTC to the host. The Schmitt circuitry accepts TTL- or analog-level voltages. Voltage slope and threshold are fully adjustable.

Four TTL output signals are provided. Two are the outputs from the Schmitt triggers and the others are counter overflow pulses of 50 nanoseconds and 500 nanoseconds duration, respectively.

Between events or counts the events themselves. Either software control or an external signal through a Schmitt trigger can be used to start the timing. Pulses coming from the Schmitt trigger can cause up to 512 counter values to be stored in a buffer for later use while counting continues.

The External Event Timing From Zero Base mode is similar to the External Event Timing mode in

Only ARSAP™ lets you automate your entire system accounting process.

ARSAP is the most automated system accounting software you can get for use in the VAX/VMS environment. While some systems require repetitive manual procedures, ARSAP does all the work, using command procedures to automate the entire system accounting process.

ARSAP comes with all the features you need—project accounting, capacity planning, resource management, organization accounting, software reporting, terminal/LAT accounting, selective image accounting, and more.

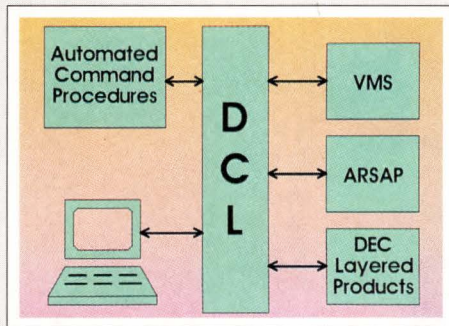

DCL interface is faster and easier than menus.

▲ There is no system accounting interface that is more automated than ARSAP's DCL. This feature alone sets ARSAP years ahead of those products with menu-driven interfaces. Menus are repetitive, tedious and can hinder productivity. With ARSAP's uniquely flexible design, you can run either interactively—or automatically!

ARSAP's DCL interface is fully compatible with the VMS environment and meets VAX/VMS standards. Your staff uses familiar, powerful wildcards, standard online HELP, and even 20-line command recall of VMS V5. These unique features mean your staff feels an immediate comfort level with ARSAP, and you save valuable training time and expense.

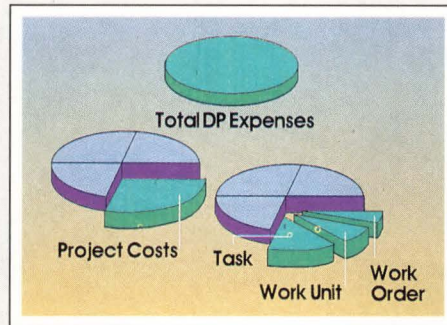

Accurate, detailed project accounting.

▲ Project accounting with ARSAP is more automated, flexible and accurate than you thought possible. You can use project codes up to 96 characters and five custom groupings to track project charges. Custom-fit ARSAP, using five-level, user-definable prompting and automated defaults for all or parts of a project code.

Only ARSAP includes features for printer forms charging, Intergraph plot charges, selective image surcharging and consistent disk charges even when samples are missing.

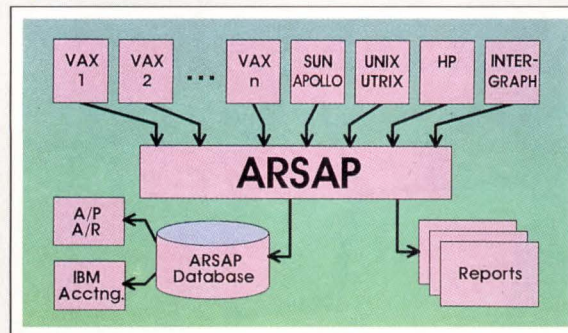

If there's a more automated system accounting product than ARSAP, it's still on the drawing board.

Call for more information on:

- User Chargeback
- Resource Management
- Performance Management
- Software Package Reporting
- Organization Accounting
- Project Accounting
- Capacity Planning
- Printer Forms Accounting
- Selective Image Accounting
- Intergraph Accounting

Track your entire organization automatically.

▼ ARSAP's automated accounting capability extends to nine organizational levels. You can track their usage and generate reports with the detail amount automatically tailored to each management level.

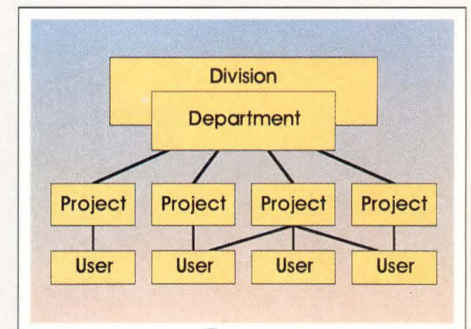

ARSAP can handle any situation—whether a company division contains five or 5,000 users; users belong to one department or several; a project consists of one or multiple users; or users from several departments are working on the same project.

ARSAP is never obsolete.

◀ ARSAP's open architecture means it seamlessly fits any software and hardware environment.

You can include data from systems other than your own and report using a single centralized database.

You're not limited only to foreign accounting inputs. Using ARSAP's VAX database, you'll interface with a wide variety of financial and management reporting software, including mainframe accounting.

1-800-43ARSAP

(1-800-432-7727) • (301) 725-2500

GEJAC
INCORPORATED

8643 Cherry Lane, Laurel, MD 20707



◁ KINETICS ▷ DOS ▷ KINETICS ▷ UNIX ▷ KINETICS ▷ VMS ▷ KINETICS ▷ MAC ▷ KINETICS ▷ OS/2 ▷ KINETICS ▷ XENIX ▷ KINETICS ▷ A/UX ▷ KINETICS ▷

▷ KINETICS ▷ DOS ▷ KINETICS ▷ UNIX ▷ KINETICS ▷ VMS ▷ KINETICS ▷ MAC ▷ KINETICS ▷ OS/2 ▷ KINETICS ▷ XENIX ▷ KINETICS ▷ A/UX ▷ KINETICS ▷ DOS ▷ KINETICS ▷ UNIX ▷ KINETICS ▷ VMS ▷



The brands or product names mentioned are trademarks or registered trademarks of their respective holders.



▷ KINETICS ▷ DOS ▷ KINETICS ▷ UNIX ▷ KINETICS ▷ VMS ▷ KINETICS ▷ MAC ▷ KINETICS ▷ OS/2 ▷ KINETICS ▷ XENIX ▷ KINETICS ▷ A/UX ▷ KINETICS ▷



IS A MACINTOSH NETWORK THE END, OR MERELY THE BEGINNING?

How big is your imagination?

There's a LocalTalk network built-in to every Macintosh. So, if your needs are small and you only need to connect a few Macs, share a couple of peripherals, and speed is not of the essence, then a LocalTalk network will work just fine.

If, however, you take the longer view and see your LocalTalk network as only the start of a larger, more productive network, then you're at the beginning of the extraordinary opportunities that open up with the Mac.

YOUR OPTIONS NEED TO BE OPEN.

Which is where we come in, because Kinetics was the first company dedicated to giving the Macintosh total access to today's information environments.

We can open all your options now, and we can keep them open in the future, while we protect your investment.

With a complete range of Ethernet hardware and software connectivity solutions we can increase the speed, power and performance of your Macintosh networks.

And we can connect those LocalTalk networks or individual Macintoshes into diverse computing environments, including DEC VAX/VMS, UNIX, PC and OS/2 systems.

THE BEST CONNECTED MACINTOSHES.

We connect Macs better than anyone, because we adhere to open system principles and networking standards. This means you can run on AppleTalk, TCP/IP, DECnet or OSI protocols, accessing all your information resources today, without worrying about your system needs tomorrow.

It's also why no one has more solutions for networking the Macintosh to diverse computing environments than Kinetics.

And why no one has more experience.

It's a smart business move to get a basic grounding in networking before you commit yourself. So, please call for a free copy of Kinetics' Network Primer, our user oriented introduction to networking.

And, of course, feel free to call us anytime and ask for more information about connecting Macintoshes to Ethernet LANs: call 1-800-433-4608; in California, call 415-947-0998.

It could be the start of a new beginning.

KINETICS
WE NETWORK NETWORKS.

A Division of Excelan
Kinetics/Excelan, 2540 Camino Diablo
Walnut Creek, CA 94596
Tel: (415) 947-0998 Fax: (415) 947-1238

CIRCLE 218 ON READER CARD



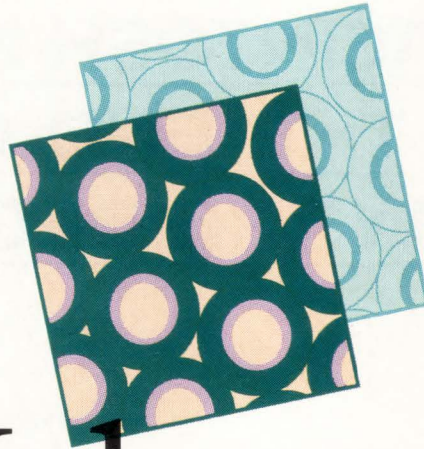

VAXcluster Tape Subsystems

SCSI-based alternatives to tape drives provide

needed capabilities. BY BRADFORD T. HARRISON

AS STANDARDS GROWTH brings to market an ever-greater range of compatible products from third-party suppliers and manufacturers, system managers are under increasing pressure to select between equipment from their system vendor and third-party sources. Purchasing products from the system vendor may seem a safer choice. But with the technical skill, support capabilities and marketing strength that standards growth has fostered among third parties, the capabilities of third-party products prove attractive.

Nowhere is this seen more clearly than in tape drives for VAXcluster systems. DEC's limited choices in the TA79 and TA81 products fall far short of more innovative drives from such com-

panies as Fujitsu, Storage Technology Corporation and Exabyte Corporation. Drives from these companies are finding widespread market acceptance because of their technical sophistication, performance, reliability and support of industry-standard interfaces, such as SCSI. With these drives, a much wider range of capabilities becomes available at a lower cost than the DEC drives — capabilities such as large capacity, unattended backup, transfer rates as high as 3 MB per second and DEC-to-IBM interchange.

An Open Invitation

Tape products in general have proved a thorn in DEC's side, culminating in the problems the ill-fated TK50 experienced

in the field shortly after shipping. DEC's tape offerings serve more to round out its product line than to offer innovative storage solutions.

This lack of technical sophistication in tape products is an exception to the rule that DEC strives to operate on the leading edge of commercial technology. But it points out a major discrepancy in the company's approach to handling customers' data storage and access needs. DEC's Digital Storage Architecture (DSA) encourages replacement of older hardware with up-to-date products. But DEC often fails to offer those products in a timely manner, or with the enhancements that are the hallmark of third-party companies, such as System Industries and others.

DSA offloads all device-specific functions to the peripheral subsystem itself, handling disk and tape as classes of intelligent devices rather than as specific devices with specific geometries. Peripherals thus can be added or re-

MicroVAXs, VAXstations and UNIBUS VAXs with a wide variety of SCSI-based products.

Currently, the ANSI-standard synchronous version of SCSI that follows the Common Command Set is the

THIRD PARTIES ARE making SCSI-based tape drives available to large DEC systems even though DEC provides no native SCSI interface on VAXclusters.

placed in the system with no changes to operating system software or applications. It would follow that DEC would equip all of its systems with industry-standard intelligent interfaces, such as SCSI, so that customers immediately could take advantage of new storage technology.

But this isn't the case. In fact, in recent years DEC has moved in the opposite direction, attempting through specialized interface hardware to close off its systems to the industry. System managers, therefore, need to pay close attention to the development of standards and the products that standards are helping bring to market. Currently, SCSI-based products provide a good hardware example of the trend, and a wealth of products exists. Third parties are making SCSI-based tape drives available to large DEC systems even though DEC provides no native SCSI interface on VAXclusters. These drives are added to the system to increase performance and reliability over similar products from DEC, and to provide the customer with important capabilities not obtainable from DEC's VAXcluster tape products.

SCSI And VAXclusters

SCSI host adapters have been available for Q-bus and UNIBUS systems for more than three years, and many DEC customers have outfitted their PDPs,

specification to which most third-party companies are designing product. This version of SCSI is yielding transfer rates as high as 4 MB per second, a more than two-fold increase in performance over earlier asynchronous SCSI. This throughput is acceptable for support of high-speed fixed Winchester drives, but the vast majority of manufacturers continue to implement the Storage Module Drive (SMD) interface for high-end systems, including VAXclusters.

The situation is different for tape. Tape drives are slower devices, accepting data at about 1 MB per second at most. Therefore, SCSI for high-end systems got its start with these drives and will continue to offer the required performance as tape-drive throughput increases. Equipping VAXclusters with SCSI-based tape products occurs with absolutely no interface performance penalty for any available tape drive. In fact, the interface opens these systems to the highest tape drive transfer rates the industry has to offer. This is exemplified in the recent System Industries' introduction of an IBM 3480-compatible product that features a throughput approaching 3 MB per second across a SCSI interface.

Transparent Integration

Integration of SCSI tape drives into the operating system environment of a VAXcluster is a simple matter. This is because DSA allows subsystem-based

intelligence to offload the CPU of all I/O tasks specific to the peripheral device. As far as the operating system is concerned, peripheral storage consists of some number of logical units, and each logical unit consists of some number of 512-byte logical blocks. The operating system polls at boot time to discover the number and sizes of logical units on the system. The standard peripheral drivers under VAX/VMS are the Mass Storage Control Protocol (MSCP) disk driver (DUDRIVER) and Tape Mass Storage Control Protocol (TMSCP) tape driver (TUDRIVER). To the MSCP driver, disk storage consists of some number of randomly accessible logical units filled with some number of logical blocks. The same is true of the TMSCP driver, but it views its storage blocks as sequentially accessible only.

The MSCP and TMSCP drivers communicate with their intelligent peripheral controllers via MSCP and TMSCP command and message packets. Typical packets send and receive data, cause formatting and request diagnostics. Again, the drivers know nothing of the specific characteristics and geometries of the devices with which they're doing business.

The advantages to this architecture are many, but two of the most important are:

1. Peripherals can be added or replaced with no change to system software.
2. Peripherals can be shared by multiple processors with full file sharing, including record-locking capabilities.

These are two of the most important features of VMS and allow for construction of clusters.

VAXclusters And VMS V5.0

The VAXcluster originally consisted of two or more VAX processors, a star coupler and one or more HSCs supporting some number of disk and tape drives. Two years ago, DEC introduced LAVCs, which didn't use a Computer Interconnect (CI) bus but rather accomplished all clustering over Ethernet.

Now, with VMS version 5.0, the

Figure 1.

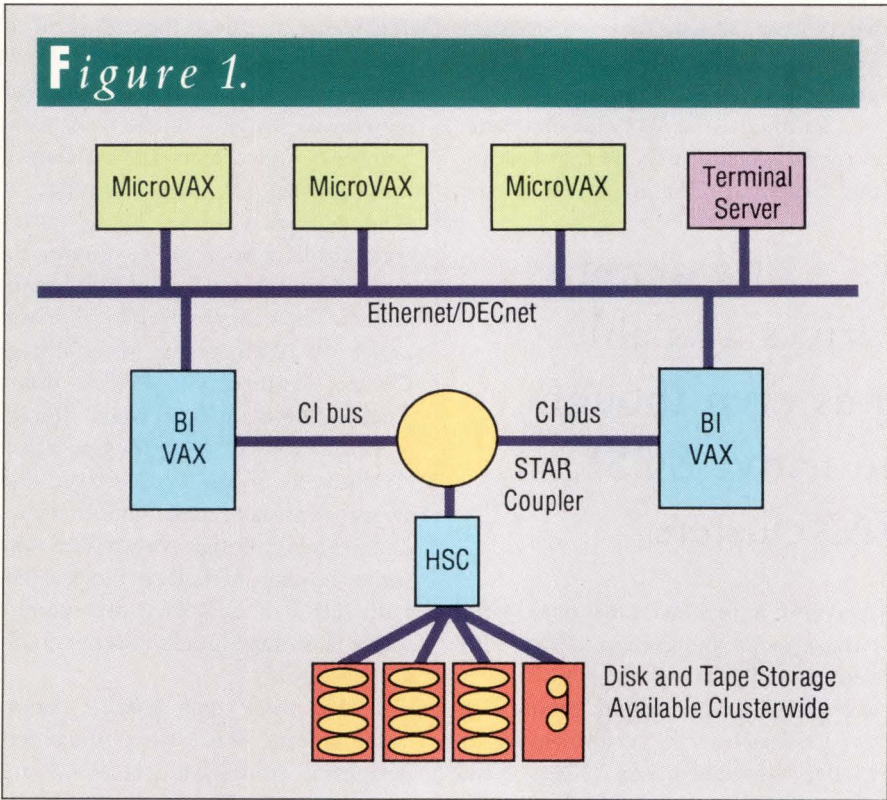

The VMS version 5.0 VAXcluster.

Figure 2.

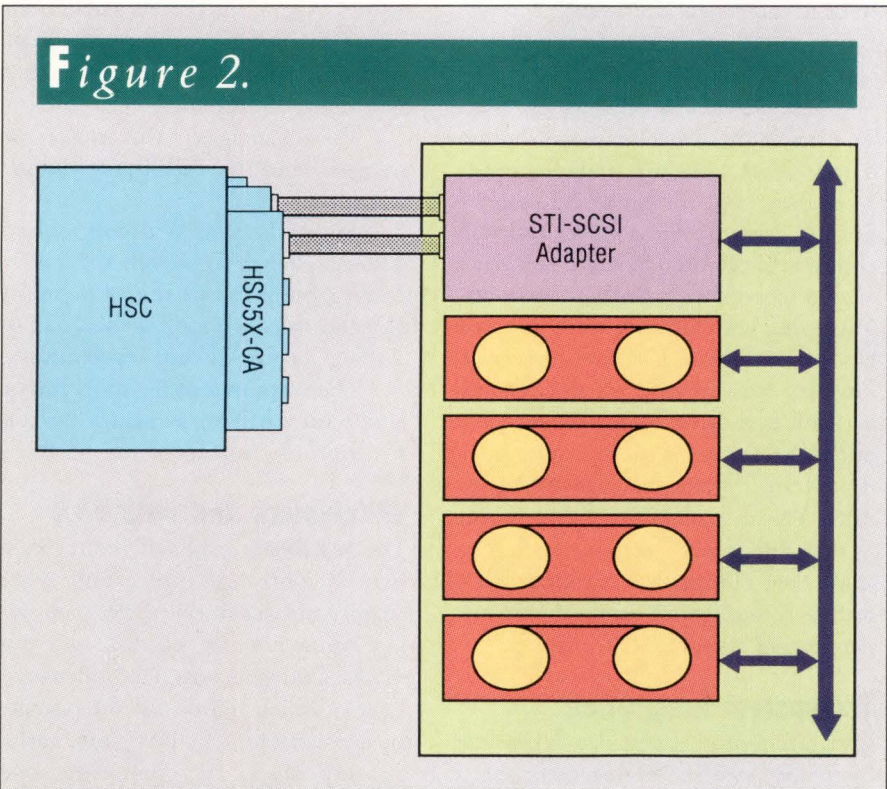

Connection of SCSI tape drives to HSC and SCSI bus.

two types of clusters have been combined, serving one, large base of mass storage to as many as 42 processors running VMS (see Figure 1). A single copy of VMS can be kept on the system disk and served to all processors in the cluster. Similarly, all files are served down to the record level clusterwide from the single bank of storage peripherals. This kind of centralized storage solution for the entire enterprise is finding greater utility than configurations using widely distributed storage units.

In VAXclusters, tape plays an important role as a backup device, although tape often is used for archiving, batch processing, software distribution, data interchange between systems and journaling.

In VAXclusters, the HSCs serve as the intelligent controllers that receive the MSCP and TMSCP command and message packets. HSCs use the DEC F-11 (HSC50) and J-11 (HSC40 and HSC70) 16-bit CPUs. HSCs handle such functions as command queuing, data buffering and reading and writing of data, and they contain on-board utilities for formatting, copying and archiving without host-CPU intervention.

HSCs are configured with the HSC5X-BA (disk) and HSC5X-CA (tape) channel cards to provide the Standard Disk Interface (SDI) and Standard Tape Interface (STI) connections to the supported disk and tape drives.

The HSC40 and HSC70 share the same performance, but the HSC70 comes with 32 ports, whereas the HSC40 comes with 12 ports expandable to 32. The HSC50 supports fewer I/O requests per second and supports 24 devices.

Installing SCSI Tape Drives

SCSI tape drives are installed on a VAX-cluster by cabling a single- or multiple-drive tape subsystem containing an STI-to-SCSI adapter directly to STI connectors on one or two HSC5X-CAs (see Figure 2). This must be done when the cluster is powered-down, and the cluster learns of the new subsystem during polling at the next system boot. If the

THERE'S A LOT YOU CAN GET ON 8MM VIDEOTAPE.



EXCEPT RELIABLE DATA BACKUP.

Videotape is fine for recording classic dramas. But when it comes to recording a company's irreplaceable data files, drama is the last thing you need.

Reliable data backup demands a proven, industry-standard recording media. Like the 3480 half-inch tape cartridge introduced by IBM. The cartridge performs

over a wide range of operating temperatures. It's durable

enough for well over 10,000 passes.

Now it's available in an extended-length cartridge, offering a formatted capacity of 570 MB. No wonder Cipher chose the 3480 cartridge for its 3000i family of tape drives.



The unique advantages of the cartridge, combined with the MSR format's powerful error

correction code, allow the 3000i to achieve the highest level of data integrity. Not just during backup, but in archival and software distribution applications as well.

The performance of the Cipher 3000i is superior to any non-rack mount tape drive in the world. With a transfer rate of nearly 1 MB/s, it can backup a full gigabyte of data in less than 20 minutes.

***cipher* 3000i**



The 3000i is the latest Cipher innovation. Our 1/2" reel-to-reel streaming tape systems are now the industry standard. We invented cache tape drives. And we're currently leading the industry in optical disk drive technology, subsystems and interfaces—including the new SCSI-2 technology.

For fast, reliable, high-capacity data backup, go with the name you can trust. Cipher.

For information on the 3000i family contact Cipher today. Cipher, 10101 Old Grove Road, San Diego, CA 92131-1650.

1-800-4-CIPHER

cipher[®]

Please circle 173 to mail literature.
Please circle 177 call me I'm interested.

subsystem is cabled to more than one HSC5X-CA, the channel cards may be in either the same or different HSCs.

Because SCSI is a bus-oriented in-

**UNDER SCSI,
just the master
drive resides
directly on
the SCSI bus.**

terface, a multiple-drive subsystem requires only one STI-SCSI adapter. Additionally, as is possible with the DEC TA79, some reel-to-reel drives may be configured in a master-slave relationship. Under SCSI, just the master drive resides directly on the SCSI bus. The slave drives are daisy-chained from it. This configuration is used to reduce the cost of the subsystem: Only the master drive contains the formatter. SCSI allows

each drive to be viewed separately by the operating system in either the master-slave configuration or in the configuration where each drive has a separate address on the SCSI bus. No changes in operating software are required for operation of all supported drives in either configuration.

The SCSI drives can be used for all functions the TA79 and TA81 are used for and run under all VMS software that uses the TMSCP device driver. CPU-controlled or HSC-controlled backup and restore operations work in the same way, and you can manage your tape systems with any VMS tape management software, such as DEC's Storage Library System (SLS) package.

STI-SCSI Adapter Operation

At the heart of a VAXcluster SCSI tape subsystem is the STI-SCSI adapter (see Figure 3). This adapter consists of five primary components: the STI interface, the SCSI interface, a microprocessor, firmware (EPROM) and a RAM buffer.

The STI interface supports two STI channels for high-performance dual-

ported applications and for redundancy in the event of HSC or HSC5X-CA hardware failure (at which point auto-failover occurs). The STI connectors on an HSC5X-CA provide signals meant to control DEC tape drives with the vendor-unique STI interface, but the adapter translates these signals into the appropriate SCSI commands for transmission over the SCSI bus. Operation of the STI-SCSI adapter is in fact similar to the operation of a DEC tape drive STI adapter board, which converts STI signals for operation with the native Pertec interface of the DEC drives.

STI-to-SCSI conversion operations are handled by the microprocessor under control of the firmware. During data transfer operations, the RAM is used as a data buffer in either direction and via either STI channel. Data is buffered for each drive supported. In this way, data transfers to and from the drives continue uninterrupted and at maximum drive transfer rates.

An STI-SCSI adapter can handle as many as four drives directly on its SCSI bus. SCSI bus devices are daisy-chained

Figure 3.

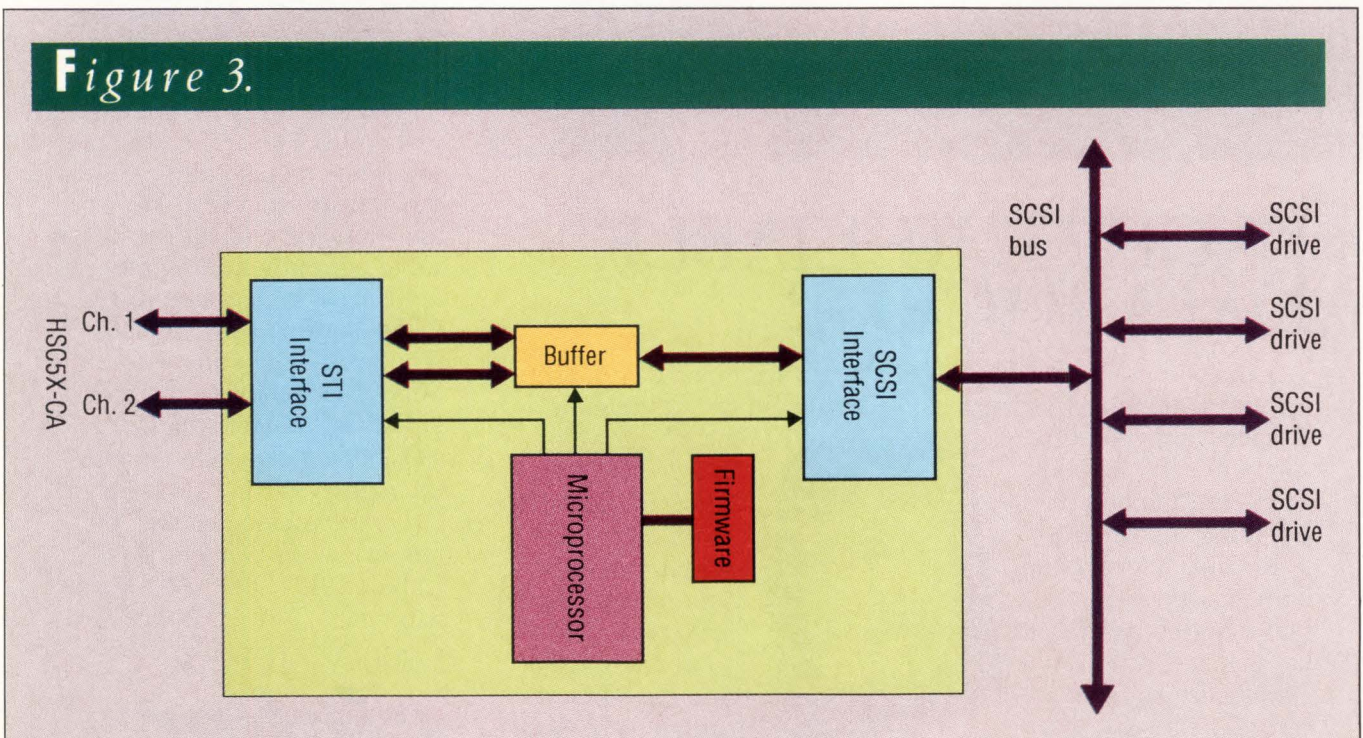

The STI-SCSI adapter.

TCP/IP for VAX and MicroVAX

Take speed to new limits.

CMC outperforms our nearest competitor, flat out, with the fastest TCP/IP Ethernet implementation in production for VAXes and MicroVAXes.

With TCP/IP software and intelligent front-end processors from CMC, DEC users can now interoperate with a wide variety of workstations—and at unheard-of rates of speed—an average of 40% faster than the competition in disk-to-disk file transfer rates. CMC's ENP-40 (for VAX) and ENP-50 (MicroVAX) Ethernet processors dramatically off-load the communications burden from the host system, leaving the host free to perform the applications it was built and bought to run. With that extra processing power, you save additional money by eliminating the need to purchase bigger, more expensive hosts.

Along with the performance package, CMC's TCP/IP for VAX and MicroVAX installs in 45 minutes, and is equipped with lots of standards such as VMSINSTAL, on-line help, TELNET, FTP, SMTP, and NetStat. Also included are programming interfaces, UNIX socket library, Q I/O calls, transparent user interface between network mail and VAXmail—and of course, the industry's best customer support.

Set LAN speed records with CMC. Call the performance standard today.

1/800/CMC/802.3

Now available for MicroVAX 3000 series.

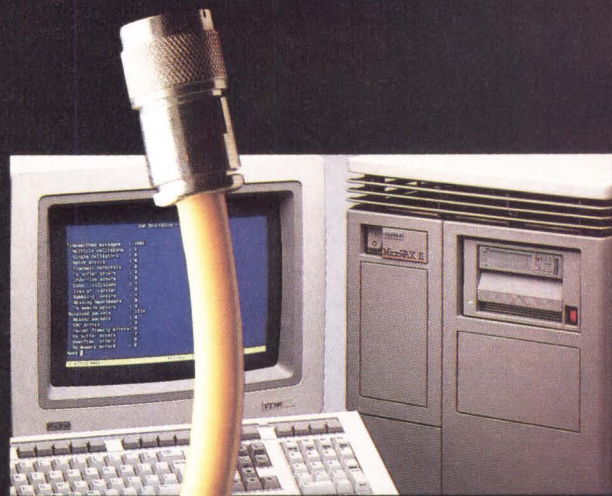

CMC

A Rockwell International Company

We set the LAN speed record.

125 Cremona Drive, Santa Barbara, CA 93117
1/805/968/4262 TWX 240876 FAX 1/805/968/6478

LAN speed record. ENP-40 and ENP-50 are trademarks of Communication Machinery Corporation. All other product names mentioned and shown are registered trademarks of their respective manufacturers. © CMC 1988

CIRCLE 225 ON READER CARD

together using a common cable, and each is assigned an address. All signals are common between all devices. SCSI-bus signals are either control signals or data signals (see Figure 4). The SCSI bus is terminated at both ends.

When the adapter is to connect with a drive, as directed by an I/O request from the HSC, it puts that drive's address out onto the SCSI bus. It's acting as initiator on the SCSI bus, and the drive then establishes itself as a target when it responds to the request for service. The adapter is assigned an address on the SCSI bus — the highest address. Distributed arbitration awards control of the bus to the device with the highest address that's contending for use of the bus. Under distributed arbitration, both the adapter and the drives compete for bus control.

Distributed arbitration radically speeds the SCSI bus. It allows for disconnect/reconnect operation by which a drive disconnects from the adapter after receiving a SCSI command and reconnects (by arbitrating for the

bus) after it's finished executing the command. In this way, overlapped operations are performed on all four drives so that the delay caused by one drive, especially during data transfer operations, won't hold up the others.

When installing the SCSI tape subsystem, it's important that the configuration of the cluster be analyzed to ensure that no hardware bottlenecks currently exist or are created. Because of the architecture of DSA, cluster bottlenecks easily are removed by simply adjusting the hardware configuration as opposed to manipulating VMS tunable parameters. When the subsystem is installed it's also important that it be cabled into the cluster in such a way that it operates at full capacity.

Configuring Cluster Storage

As intelligent controllers, HSCs can command queue I/O requests, overlap seeks and perform simultaneous data transfers to and from supported devices. If VAXcluster performance is unacceptable and the cause doesn't lie with disk

or tape drive performance, the most dramatic improvement is to upgrade to HSC70s, add additional HSCs or dual port the drives.

Mechanical aspects of computer systems ultimately prove to be the limiting factor in performance, so if all other system bottlenecks have been removed and the cluster is still sluggish, an upgrade to faster drives is necessary. In tape, the higher transfer rates offered by the new SCSI-based devices from Fujitsu and Storage Technology will reduce backup and archiving time drastically, and access time during batch processing and journaling will be much improved. Even in a fully configured subsystem consisting of four of these devices, maximum throughput can be obtained by dual porting to two HSC5X-CAs or, if necessary, two HSC5X-CAs in either the same or different HSCs.

The flexibility of the DSA architecture allows the integrator to implement the most efficient configuration.

Cluster performance improvements

Figure 4.

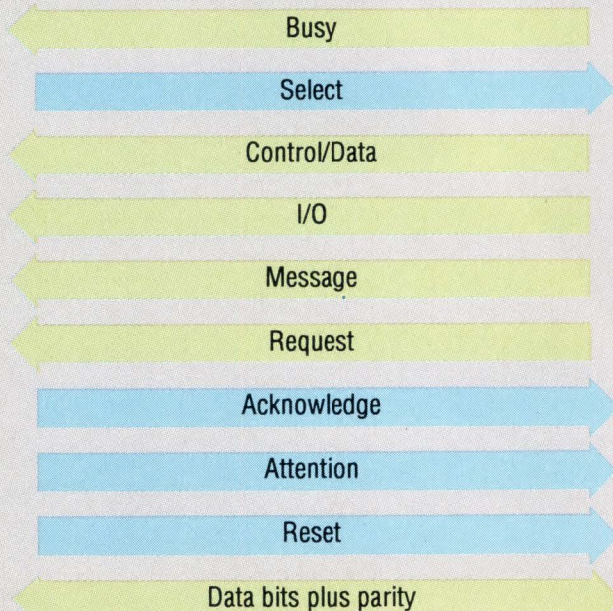

SCSI-bus signals.

Figure 5.

- Test unit ready
- Rewind
- Request sense
- Read block limits
- Read
- Write
- Write filemarks
- Inquiry
- Space
- Recover buffered data
- Mode select
- Reserve unit
- Release unit
- Copy
- Erase
- Mode sense
- Load/unload
- Receive diagnostic results
- Send diagnostics
- Prevent/allow medium removal

SCSI tape drive commands.

GOT THE WPS-PLUS® BLUES?



Don't be overwhelmed by word processing woes. MEC to the rescue.

MEC's MASS-11® 8.0 WP

- Provides text and graphic integration with preview mode
- Supports hundreds of popular printers
- Offers true right-justified proportional spacing
- Is virtually identical on the VAX and PC
- Provides seamless communication between the VAX and PC
- Offers users a choice of editing styles, including WPS and EDT
- Provides split screen editing, table creation (statistical typing), change bars
- Ability to share documents and total control of fonts and formats

WPS-PLUS®

doesn't.

With MASS-11 WP, simple procedures take seconds, not minutes. You'll cut your response time in half, and you can bring on board lots of new users without investing in more computers and memory. WPS-PLUS can't say that.

MASS-11 WP is totally integrated with ALL-IN-1® at the DSAB level, including consistent keystrokes. So there's no need to retrain. The transition takes as little as 15 to 60 minutes. And, there's no FMS® or DECpage® required for advanced features, PostScript support, proportional spacing and document formatting.

In addition to MASS-11 WP, MEC offers a wide variety of companion products for the office, like a FAX processor, technical illustrator, graphics processor, calendar, and more. To find out why major corporations are switching, call MEC at **312-882-0111**.

MASS-11 WP. The cure for the WPS-PLUS blues.

Microsystems Engineering Corporation,
2400 W. Hassell Road, Hoffman Estates, IL 60195.

MASS-11 is a registered trademark of Microsystems Engineering Corporation.
WPS-PLUS, DECpage, DECdx, ALL-IN-1 and FMS are registered trademarks of Digital
Equipment Corporation. All other products listed are registered trademarks of their respective companies.

MEC
THE WORLD IS MOVING TO MASS-11

CIRCLE 170 ON READER CARD

also can be obtained through the use of on-board HSC utilities. For example, the backup/restore utility on-board these controllers dramatically decreases backup time, because the data doesn't pass through VAX main memory. Multiple disk and tape drives can be supported simultaneously. However, with this utility, data compression during restore doesn't occur. Only physical backup can be performed — not image or incremental. For data compression to occur, the data will have to pass through a VAX processor and memory.

SCSI Tape Drives On VAXclusters

Figure 5 lists the SCSI commands used for tape storage. All commands have counterparts in the TMSCP command

set, enabling compatibility. Standardized use of the commands allows any SCSI device to be replaced by or operate alongside any other. Devices can be mixed and matched on the same SCSI bus according to the requirements of applications. And no matter what the configuration, all devices will operate at maximum performance if properly integrated into the system.

In the tape industry, another kind of compatibility exists: media interchange compatibility. SCSI tape devices support this capability insofar as it's available. In the VAXcluster environment, this is done via support of three popular tape formats: nine-track reel to reel, IBM 3480-compatible cartridges and 8mm cassettes.

Tape standards for recording and file formats historically have been set by volume sales of IBM products. The rest of the industry then embraces and improves upon the standard. This is the case with nine-track tape and, more recently, 3480 cartridge tape products.

Nine-track tape has been the staple medium of data processing for many years, and nine-track tape drives continue to provide some of the best, fastest and most reliable technology. Recording density has stabilized at 6,250 bpi with the group-coded recording (GCR) format, and recording speeds reach as fast as 200 ips. Additionally, file storage formats and blocking factors have been established for nine-track by ANSI, so tapes are interchangeable industrywide,

Tape Storage Manufacturers

American Data Systems
Marketing Inc.
53 Elderwood Dr.
Stoughton, MA 02072
(617) 341-0171

CIRCLE 473 ON READER CARD

American Digital Systems Inc.
490 Boston Post Rd.
Sudbury, MA 01776
(508) 443-7711

CIRCLE 474 ON READER CARD

Applied Data Communications
14272 Chambers rd.
Tustin, CA 92680
(714) 731-9000

CIRCLE 475 ON READER CARD

Aviv Corp.
26 Cummings Park
Woburn, MA 01801
(617) 933-1165

CIRCLE 477 ON READER CARD

Cipher Data Products Inc.
9715 Business Park Ave.
San Diego, CA 92131
(619) 693-7084

CIRCLE 478 ON READER CARD

CMD Technology Inc.
3851 S. Main St.
Santa Ana, CA 92707
(714) 549-4422

CIRCLE 479 ON READER CARD

CMS Enhancements Inc.
1372 Valencia Ave.
Tustin, CA 92680
(714) 259-9555

CIRCLE 480 ON READER CARD

Codar Technology Inc.
1500 Kansas Ave.
Longmont, CO 80501
(303) 776-0472

CIRCLE 481 ON READER CARD

Contemporary Cybernetics
Group Inc.
11830 Canon Blvd.
Newport News, VA 23606
(804) 873-0900

CIRCLE 482 ON READER CARD

Digi-Data Corp.
8580 Dorsey Run Rd.
Jessup, MD 20794
(301) 498-0200

CIRCLE 483 ON READER CARD

Digital Equipment Corp.
146 Main St.
Maynard, MA 01754
(508) 897-5111

CIRCLE 403 ON READER CARD

EMC Corp.
171 South St.
Hopkinton, MA 01748
(508) 435-2541

CIRCLE 404 ON READER CARD

Emulex Corp.
3545 Harbor Blvd.
Costa Mesa, CA 92626
(714) 662-5600

CIRCLE 405 ON READER CARD

Exabyte Corp.
1748 38th St.
Boulder, CO 80301
(303) 442-4333

CIRCLE 440 ON READER CARD

Exsys Storage Systems
1340 Tully Rd.
San Jose, CA 95122
(408) 292-0343

CIRCLE 484 ON READER CARD

First Computer Corp.
8230 S. Madison St.
Burr Ridge, IL 60521
(312) 920-1050

CIRCLE 485 ON READER CARD

Fujitsu America Inc.
3055 Orchard Dr.
San Jose, CA 95134
(408) 432-1300

CIRCLE 441 ON READER CARD

Gigatrend Inc.
2234 Rutherford Rd.
Carlsbad, CA 92008
(619) 931-9122

CIRCLE 486 ON READER CARD

Group Three Electronics Inc.
4715 Viewbridge Ave.,
Suite 150
San Diego, CA 92123
(619) 292-0525

CIRCLE 555 ON READER CARD

Honeywell Inc.
P.O. Box 5227
Denver, CO 80217
(303) 773-4491

CIRCLE 487 ON READER CARD

Continued.

facilitating program distribution and data sharing between systems.

The IBM 3480 18-track standard is challenging reel to reel with a much greater density (37,000 characters per inch) at a read/write speed of 79 ips. File storage formats again have been standardized by IBM, and third-party products are designed to read and write in these formats, making interchange between systems as standardized and transparent as for nine-track. Installation of both nine-track and 3480 products allows for complete transportability of media between systems without the need for special driver utilities to use the tapes.

Another kind of tape compatibility between systems results when a tape

drive that hasn't been standardized suddenly finds widespread application. Such is the case with the 8mm EXB-8200 helical-scan product from Exabyte, a spin-off of Storage Technology. The extremely high-capacity cassettes (2.3 GB) used by this product can be transferred between systems implementing the drive. Helical-scan technology, based on the same hardware used in videocassette recorders, has met with strong success for backup applications since its introduction in 1987.

A proposal stating the electronic recording specifications and characteristics for the 8mm helical-scan media is currently before ANSI, and a standard is expected soon. At that time, more 8mm helical-scan drives will become available

from a variety of manufacturers, but the issue of file format compatibility still will need to be resolved.

WITH WIDELY SUPPORTED STANDARDS such as SCSI, there are few risks in choosing third-party VAXcluster storage peripherals instead of the DEC offerings. These peripherals are easy to cable and integrate into the operating environment, and offer "big-company" performance and support because of collective industry backing of standards. —Bradford T. Harrison is a free-lance writer specializing in DEC systems.

ARTICLE INTEREST QUOTIENT
Circle On Reader Card
High 455 Medium 456 Low 457

Tape Storage Manufacturers (continued)

IBM Corp.
Old Orchard Rd.
Armonk, NY 10504
(914) 765-1900

CIRCLE 407 ON READER CARD

Innovative Data Technology
5340 Eastgate Mall
San Diego, CA 92121
(619) 587-0555

CIRCLE 488 ON READER CARD

Iomega Corp.
1821 W. 4000 S.
Roy, UT 84067
(801) 778-3000

CIRCLE 489 ON READER CARD

IPS Technology
11201 Richmond Ave.,
Ste. A102
Houston, TX 77082
(713) 870-0880

CIRCLE 536 ON READER CARD

Kennedy Co.
9292 Jeronimo Rd.
Irvine, CA 92718
(714) 770-1100

CIRCLE 537 ON READER CARD

Laser Magnetic Storage Int'l.
4425 ArrowsWest Dr.
Colorado Springs, CO 80907
(719) 593-7900

CIRCLE 538 ON READER CARD

Megatape Corp.
1041 Hamilton Rd.
Duarte, CA 91010
(818) 357-9921

CIRCLE 442 ON READER CARD

Micro Technology Inc.
1620 Miraloma Ave.
Placentia, CA 92670
(714) 632-7580

CIRCLE 443 ON READER CARD

Miltope Corp.
1770 Walt Whitman Rd.
Melville, NY 11747
(516) 420-0200

CIRCLE 539 ON READER CARD

Scientific Micro Systems Inc.
777 E. Middlefield Rd.
Mountain View, CA 94043
(415) 964-5700

CIRCLE 553 ON READER CARD

Storage Technology Corp.
2270 S. 88th St.
Louisville, CO 80028
(303) 673-5151

CIRCLE 445 ON READER CARD

Summus Computer Systems
17171 Park Row, Ste. 300
Houston, TX 77084
(713) 492-6611

CIRCLE 541 ON READER CARD

System Industries
560 Cottonwood Dr.
Milpitas, CA 95035
(408) 432-1212

CIRCLE 414 ON READER CARD

Telebyte Technology Inc.
270 E. Pulaski Rd.
Greenlawn, NY 11740
(516) 423-3232

CIRCLE 542 ON READER CARD

3M Data Products
8200 Highwood Dr.
Minneapolis, MN 55438
(800) 888-1889

CIRCLE 543 ON READER CARD

Total Tec Systems Inc.
2 Gourmet Ln.
Edison, NJ 08837
(201) 906-6500

CIRCLE 544 ON READER CARD

Transitional Technology Inc.
1411 N. Batavia Ste. 203
Orange, CA 92667
(714) 744-1030

CIRCLE 545 ON READER CARD

Trimarchi Inc.
P.O. Box 560
State College, PA 16804
(814) 234-5659

CIRCLE 546 ON READER CARD

Tristar Technology
10 Reuten Dr.
Closter, NJ 07624
(201) 784-1557

CIRCLE 547 ON READER CARD

TSA/Advet
P.O. Box 44145
4722 Campbells Run Rd.
Pittsburgh, PA 15205
(412) 787-0980

CIRCLE 554 ON READER CARD

U.S. Design Corp.
4311 Forbes Blvd.
Lanham, MD 20706
(301) 577-2880

CIRCLE 548 ON READER CARD

I/O Subsystem Performance

Part 1: The four primary performance measurements.

BY KENNETH H. BATES

THIS ARTICLE IS the first in a series that explores the issues surrounding I/O subsystem performance. Although the series will concentrate on the high-end systems using RA disks and the HSC controller, much of the information is applicable to other systems.

To evaluate I/O subsystem performance properly, you need a good understanding of how the individual pieces fit together, what the key performance metrics are, how different applications can make different demands on the I/O subsystem and how to best measure the performance. The first articles will concentrate on basic terminology and theory before moving on to more practical topics, such as measuring performance, choosing the best system for a particular need and configuring the I/O subsystem for the best performance.

This article investigates the various performance metrics that commonly are quoted, explaining what these metrics really mean, when they should be used and when they may be unimportant. This should not only provide the necessary information to evaluate I/O performance properly, it also should offer suggestions concerning which storage subsystems might be appropriate for a particular application.

Concerning Measurement

When discussing the performance of the I/O subsystem, there are four primary measurements of concern. Each deals with a different aspect of the I/O subsystem, and one or more of these measurements may be important for a given application.

As an example, an application that

collects large amounts of data from a satellite would be concerned with obtaining the highest possible megabyte-per-second rate, while an OLTP system would be more interested in the fastest response time and would care little about how many megabytes per second the subsystem could provide. The metrics discussed in this article include the response time, the request rate, the data rate and the different ways to measure seek times.

Because the I/O subsystem deals with the request at QIO level, the performance seen by the I/O subsystem may differ from that measured by the host. As an example, a single transaction that updates a database file may require RMS operations not only to the data and index files, but also to a journaling file. Each of these individual RMS operations

**Reflection 4 PLUS has
a color-fast guarantee.**

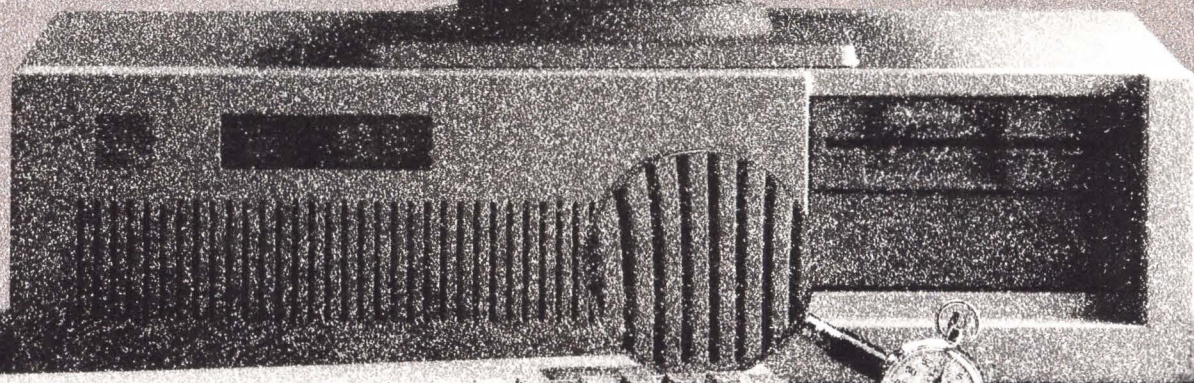

We deliver 16 brilliant ReGIS

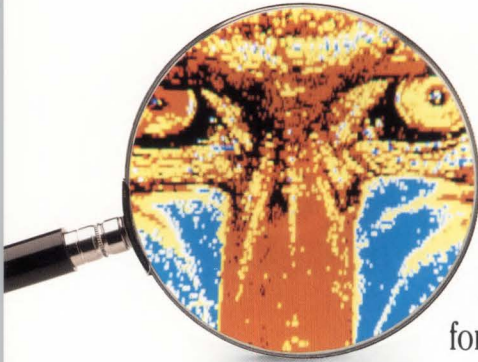

Walker Richer & Quinn, the industry leader in terminal emulation software, invites you to take a good close look at Reflection 4 PLUS, the first software to emulate the 16-color graphics in VT340 terminals. With Reflection 4 PLUS you can combine all the computing power and versatility of a PC with the sophisticated graphics written for Digital's ReGIS terminals.

Tests have proven Reflection 4's superior speed.* Reflection generates the stopwatch image on the cover in just 11 seconds. The competition just can't match Reflection's impressive graphics display.



Reflection uses less RAM. Where others gobble up RAM, we offer ways to reduce memory reserved for macrographs, downloadable character sets and saving graphics. Reflection 4 PLUS displays VT340 color graphics using as little as 220K RAM.



Reflection 4 is a winner. We are proud to accept the *1989 Digital Review Target Award for Best Terminal Emulation Software* for connecting to DEC VAXes.

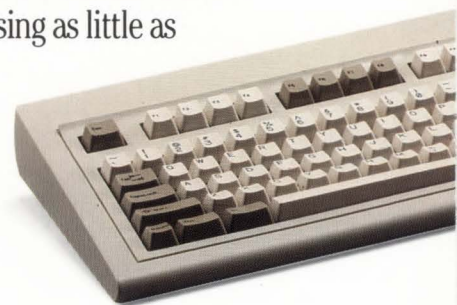

Reflection's programmable script language gives you full control of programs and data on the PC.

With more than 80 BASIC-like commands, you can use Reflection to automate routine or complex tasks. More than 70 additional SET parameters provide a Reflection operating environment that you can change during a routine. Only Reflection lets you use subroutines *and* up to 800 text or numeric variables.

*Test referenced was run on an IBM AT with an EGA and a high-resolution color monitor. Screens were timed locally using a single data file. Software versions timed: Reflection 4-3.3, SmarTerm 240-2.0b, polySTAR/240-1.1.

colors faster than the others.



With multitasking, Reflection doesn't need the limelight to perform. You can hot-key Reflection 4 PLUS into background and bring up another PC application. It works just as diligently in the background as in foreground. Reflection 4 continues to receive a complicated graphics image, transfer a large file, or run a script program.

File transfer to VAX and UNIX hosts is swift and secure with Reflection. Host file transfer software is uploaded automatically and is included free of charge. Reflection's flexible user interface offers you three ways to initiate the transfer: from a menu, from the command line, or by a host program.

Reflection maps VT240 terminal keys to the closest PC key. Maps are included for the PC, AT, Enhanced, DEC LK250 and Key Tronic™ 5151 keyboards which you can customize easily to meet your own needs. Keyboard remapping lets you attach text strings up to 127 characters long to one PC key, reducing complex routines to a single keystroke. With keyboard remapping, a script program can be started with one key, giving less sophisticated users easy access to automated tasks.



Reflection supports the LAT protocol with Digital's PCSA or DECnet-DOS, or with WRQ's R-LAT. Reflection provides up to 8 LAT sessions.

Reflection's PLUS option supports popular networks such as Novell, 3Com, IBM TokenRing and others. PLUS also lets you back up your PC files to the VAX or UNIX host. Like file transfers, automatic backups can be initiated by a host program.

Reflection 4 offers all of its fast, colorful features with a 60-day satisfaction guarantee. Call us at **1-800-8PC-2VAX** (800-872-2829) and...

Show your true colors with Reflection 4.

Walker Richer & Quinn leads the industry in connectivity solutions to integrate PCs and Macintosh computers into Digital, UNIX and Hewlett-Packard environments. Related products:

Reflection 2 PLUS — VT220 emulation with the same file transfer, multitasking, command language and keyboard remapping featured in Reflection 4 PLUS.

These connectivity Complements work with Reflection:

R-LAT — A PC LAT driver which achieves an Ethernet connection to VAXes without PCSA. Features a multi-session LAT interface.

RSVP — Routes print output from PC applications to printers connected to the VAX.

3270 FileExchange — Transfers PC files asynchronously through protocol converters to IBM mainframes using INDS\$FILE.

TelnetManager — Maintains terminal sessions with one or more hosts on TCP/IP networks.

MNP SoftModem — Lends MNP error-checking to ordinary PC modems.

Walker Richer & Quinn, Inc. 

2825 Eastlake Avenue East

Seattle, WA 98102

(206) 324-0350

FAX: (206) 322-8151

can result in more than one low-level QIO request to the I/O subsystem. From the user's viewpoint, only one I/O operation has occurred, i.e., the database update. At a lower level, there are several RMS operations required to complete the file update, with each operation requiring several QIO functions.

Because current I/O subsystems deal with requests from the host for individual logical blocks, we'll concentrate on the measurement at the QIO level.

Response Time

The response time of the I/O subsystem (more properly referred to as service time) measures the time from the host issuing the I/O request to completion of that I/O request. Although this time includes processing of the I/O initiation and completion by the host processor, we'll ignore those effects and only consider the contributions of the I/O subsystem itself. As illustrated in Figure 1, the response time of the I/O subsystem can be broken into several distinct parts. The first component is the controller that receives the I/O request from the host. The time this takes varies not only from one controller to another, it also varies depending on the command itself, with longer transfer sizes taking longer to process. For an HSC70 running V370,

this time is approximately 1 ms.

The next component is the time required for the disk heads to move to the desired cylinder. This time varies, depending on the length of the seek and the type of disk drive. In Figure 1, the time shown is the specification for an average seek on an RA82, or 24 ms.

Concentrating only on this time can be misleading for an actual application on your system. Having arrived on cylinder, the disk now must wait for the platter to rotate so that the desired logical block (LBN) is under the disk head. Although this time varies depending on the current rotational position, on average the platter must move a half revolution: With an RA82 rotating at 3,600 rpm, this time is 8.33 ms. (The RA70 spins at 4,000 rpm, giving an average time of 7.5 ms, or 10 percent shorter.)

After you're at the correct location on the disk, the only task left is the actual transfer of the data. Obviously, the amount of time this takes varies depending on the length of the data transfer, but it's close to 0.287 ms for a 512-byte transfer on an RA82. There's additional overhead because of the controller and transit times over the I/O bus, but it's generally small enough to be ignored.

It should be clear that the major portion of the response time is the time

taken for the seek, and any action that reduces this will yield major benefits. Although the time for the rotation is also a major contributor, all disks (with the exception of the RA70) spin at 3,600 rpm, so there's no difference among different disk types. It also should be clear that for small byte counts, the time taken for the actual transfer of data is quite small. It follows that a disk with a transfer rate higher than the RA82 will show very little difference in the response time for small byte counts.

As an example, the total time shown in Figure 1 is 33.62 ms. If another disk were used that transferred data twice as fast (which is impossible, because it's well above the bandwidth of the SDI), the resulting response time would be 33.47 ms, a reduction of only 0.4 percent. In general, response time is the major item of interest for interactive applications. These might include time-sharing systems, OLTP applications and office automation systems. In these arenas, a reduction in the response time means faster response when a user is interacting with the terminal and should be the primary metric of interest.

Request Rate

Request rate is a measurement of how many I/O requests can be processed over

Figure 1.

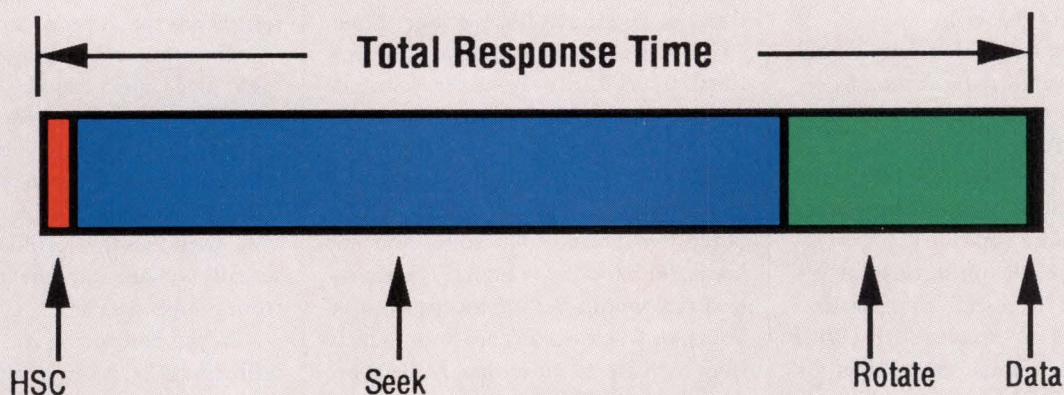

Response-time components.

Figure 2.

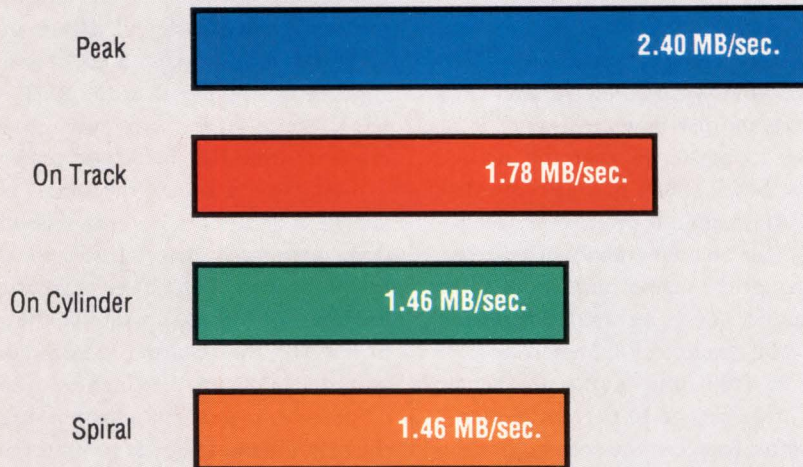

RA82 data-transfer rates.

a period of time and generally is measured in requests per second. As with the response time, all components in the I/O path contribute to this, with the slowest link in the chain being the bottleneck.

Although this metric is one of the most commonly quoted, its main application is on batch systems on which the response time of individual I/O requests isn't important. In such a system, it may be acceptable to delay the response of one or more requests if that delay would increase the overall request rate. In effect, if the total number of jobs per hour is more important than the length of time for any particular job, then the request rate is probably more important than the response time.

An example of optimizing for request rates is the seek optimization routines used in DSA controllers. With a scheme such as this, certain requests may be delayed to service a request that arrived later. By doing this, the total distance traveled by the disk heads may

be shortened, with a corresponding reduction in the overall time yielding an increase in the request rate.

As an example, consider a trip from Maynard, Massachusetts, to Los Angeles, then to New York, then to Colorado Springs, Colorado, and finally back to Maynard. If the travel times are seven hours, seven hours, five hours and four hours respectively, then the total trip will take 23 hours for all five locations, or about 5/23 locations per hour.

If the visits were arranged for optimal travel times, however, the trip would go from Maynard to New York, then to Colorado Springs, then to Los Angeles, then back to Maynard. The travel times in this case might be one hour, five hours, two hours and six hours, for a total of 14 hours. The visitation rate would be five locations in 14 hours, or 5/14 locations per hour, which is an increase of more than 64 percent. As a result of this rearrangement, however, Los Angeles wouldn't be visited until eight hours after the start of the

trip, instead of seven hours with the first arrangement.

In much the same manner that travel arrangements are dictated by either the need to visit a certain number of locations in the minimum amount of time (request rate) or with a minimum amount of waiting after the need to visit is known (response time), a decision must be made as to the need of a particular application on the I/O subsystem. If the need is for request rates, then a high-performance controller, such as the HSC70, is appropriate. If the request rate isn't of primary interest, then the performance of an HSC50 may be adequate. The HSC controller contains code that alternates between response time and request rate optimization, depending on the I/O load.

Data Rate

The third metric deals with the amount of data the I/O subsystem can transfer over a given period of time and is referred to as the data rate. This generally is measured in MB or KB per second and usually is associated with applications that request data transfers with very high byte counts. Because of the high amount of data transferred per request, the portion of Figure 1 dealing with the transfer time is considerably higher. At the same time, the data usually is written to a large, contiguous file, reducing the seek time to a negligible amount. As a result, the transfer time tends to dominate the response time, and disks with higher transfer speeds are the appropriate choice.

Examples of applications requiring high data rates include seismic data acquisition, image processing and the downloading of large amounts of data, as might be encountered in satellite data links. In general, less than 5 percent of VMS users fit this profile and would actually obtain any practical benefits from a high data rate.

When comparing the data rates of different disks, it's imperative to realize that there are many ways of measuring the data rate a disk is capable of, all of which are technically correct. Because



Only one 8mm tape backup system comes with full instrumentation. Not idiot lights.

The problem with idiot lights on tape drives is the same as it is on cars. Instead of warning you in advance that something is slowly going wrong, you learn there's trouble just about the time you've got a crisis on your hands.

In the case of tape backup, that means returning to the office in the morning, only to find your unattended backup system either ran out of tape, or didn't record at all because of lousy tape or dirty heads.

Fortunately, there is a solution. The new CTS-8000 from TTI features a built-in status display. It lets you catch problems before they happen — not after.

A digital readout tells you how many

megabytes of unused storage remain on a tape. When you put in a cartridge, you'll know for sure that you've got enough tape to finish the job.

The CTS-8000 also tells you the ECC error correction rate. By watching it for a minute or two, you can determine if the tape is in good enough condition to properly record your data. If the tape is unacceptable, you'll know before you go home — not when you return in the morning.

Still another first on the CTS-8000 is multi-host capability.

It's also TMSCP compatible and works with all of your applications without any modifications.

And thanks to TTI's long line option,

you can place the CTS-8000 up to 80 feet away from the host.

Don't settle for unattended backup with less than full instrumentation. For complete information on the CTS-8000, call (714) 744-1030. Or write Transitional Technology, Inc., 1411 N. Batavia, Suite 203, Orange, CA 92667.

In Europe, call 0865 741345. Or write Transitional Technology, Suite 2, Kennett House, 108/110 London Road, Headington, Oxford OX3 9AW.

TTI
TRANSITIONAL
TECHNOLOGY, INC.

of the wide variations in the resulting rate, however, it's important to understand the different measurements and to ensure that, when comparisons are made, similar figures are used.

The first technique of data-rate measurement deals with the number of bits passing under the disk head and is referred to as the peak rate. For the RA82, this rate is 2.40 MB per second. This rate is shown as the top bar graph in Figure 2.

Although this rate is quoted widely, it doesn't accurately represent the ability of the drive to deliver data to the user program. This is because there's a large amount of information that's present on the disk over and above the actual 512 bytes of user data. This information consists of the ECC field, the EDC, multiple copies of the sector header and servo information, among other things. Because of this, the actual 512-byte user data is only a percentage of the total data

that's present for each sector (about 72 percent for an RA82).

A more representative data-transfer rate is the on-track rate and is shown as the second bar in Figure 2. This rate is determined by taking the number of actual user data bytes that can be transferred in one revolution, and is 1.78 MB per second for the RA82.

Because data may span track boundaries, a third rate, referred to as the on-cylinder rate, is also possible. This rate

The State Of Solid State

A solid-state disk (SSD) is a storage device based on solid-state memory technology that combines the very fast access times of DRAM with the ease of use of magnetic disks. Users see increased performance for I/O-bound applications while programmers and system managers don't need to change the way they view and manage storage. Accessed by standard RMS and \$QIO methods, an SSD is mounted, backed up and managed like magnetic storage.

An SSD complements magnetic disk storage in the storage hierarchy. It's a smaller-capacity, significantly faster storage device than a magnetic disk. SSDs range in capacity from 1 MB to 512 MB and have average access times of less than 5 ms. Because of the very fast access times, SSDs can service I/O requests more rapidly and can eliminate I/O queues. Used properly, they can eliminate I/O bottlenecks and enhance overall performance in I/O-intensive applications.

SSDs are most effective in applications that perform a large percentage of I/O on a limited number of files. For example, VAXcluster system performance could benefit by placing the heavily accessed VMS system files JBCSYSQUE.DAT, RIGHTSLIST.DAT and SYSUAF.DAT on an SSD. Similarly, DAF.DAT, DOCDB.DAT and PENDING.DAT are frequently accessed ALL-IN-1 files that are candidates for placement on an SSD.

SSDs also are useful in improving the performance of applications that do large amounts of synchronous I/O. Many scientific and engineering applications fall into this category. By strategically locating the frequently used files on an SSD, a system manager can improve overall performance in terms of increased throughput, better response times, reduced run times or additional number of users supported.

To determine whether an SSD will improve system performance and to evaluate whether it's the best alternative, a system manager has to understand his applications thoroughly. For example, an SSD can improve performance in some I/O-bound applications, but can be ineffectual in a compute-bound situation. To measure the I/O intensity of an application, the system manager can monitor the number of I/Os per second and the average I/O queue length. CPU use is also very important. If use is low, the CPU can support the increased throughput generated by an SSD.

Caching and RAM disk are other alternatives used to reduce

I/O bottlenecks. To ascertain whether an SSD or another alternative is the optimum choice, it's crucial to evaluate the characteristics of the applications in relation to the strengths and weaknesses of each approach. For example, caching is effective only for applications that exhibit good locality of disk reference. Applications running on a VAXcluster require a solution that provides efficient sharing across nodes — a facility not provided by RAM disk.

DEC's family of storage arrays offers another high-performance storage option. These arrays differ from solid-state disks in the way they improve performance and in the types of applications in which they're most effective. Storage arrays offer high aggregate performance in a convenient package. Performance improvement is achieved by properly allocating multiple files among the individual drives in the storage array to eliminate a bottleneck at any one drive.

Applications that have high disk-access demands spread among a group of several files can benefit from implementation of storage arrays. In contrast, solid-state disks offer high single-stream performance. They optimize performance in applications with a high access rate to a small number of files or to a group of files that must, by design, reside on the same disk device. An SSD would, for example, be a good choice for any application in which the I/O demand to a single file exceeds the capability of a single magnetic disk drive.

Not all SSDs have the same features. For example, some are non-volatile. A non-volatile SSD retains the stored data during a power loss. A volatile device doesn't. Depending on the application and the nature of the data stored, this feature can be critical. Another distinguishing feature is how the device interfaces to the controller and ultimately to the application. SSDs with native-mode interfaces generally outperform those interfaced through protocol adapters.

Within the overall storage hierarchy, SSD technology can play an important role in optimizing performance for certain applications. OLTP and other time-critical applications could benefit from the predictable, fast access times the technology provides. In addition, its capacity for efficient sharing makes it a viable alternative in VAXcluster environments.—*Charlie Cassidy, principal engineer, electronic storage development, Digital Equipment Corporation*

WYSE AND GLASGAL A BIG PARTNERSHIP

Feature-rich display terminals and PC's that can support every data processing function you will ever need. Cost-effective and quality entrance to the PC or DEC world, IBM color graphics and the most comprehensive list of "personalities" found anywhere.

Wyse and Glasgal provide it all, right now.

Call a Glasgal engineer to specify a Wyse terminal, PC or graphics adapter and you're opening doors to customization, wiring design, and expert advice on future compatibility.

We offer one-point, one-source provision, design and integration

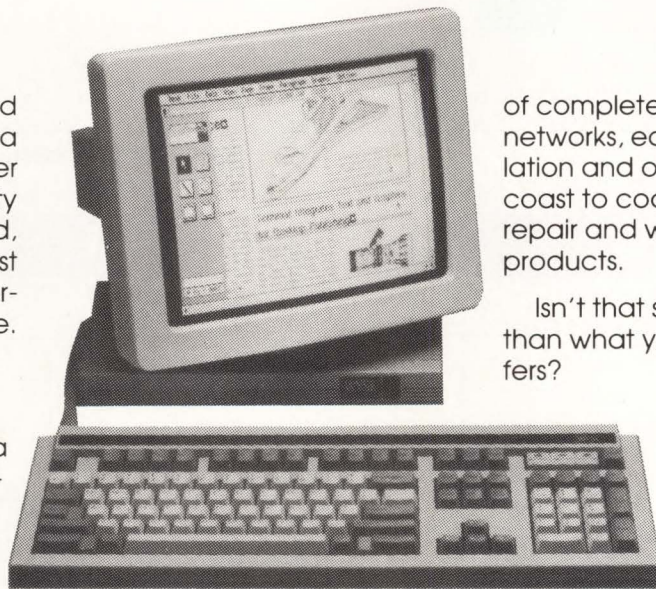

of complete local and wide area networks, equipment, wiring, installation and on-site field service from coast to coast. And we stock, repair and warranty over 3000 products.

Isn't that somewhat more useful than what your current supplier offers?



GLASGAL
COMMUNICATIONS, INC.

Worldwide Corporate Headquarters: 151 Veterans Drive, Northvale, New Jersey 07647

Wyse and Glasgal. Representing one of America's most productive data communications partnerships.

To speak with one of our consulting engineers, just call : N. California, 415-935-8727; S. California, 714-380-0161; Colorado, 303-933-9639; Texas, 214-578-8232; Missouri, 314-731-2202; Minnesota, 612-545-2625; Illinois, 312-705-3830; Michigan, 313-455-4649; Ohio, 513-298-6885; Upstate NY, 315-437-1828; Philadelphia, 215-623-9654; Massachusetts, 617-449-7470; Metro NYC & NJ, 201-768-8082; Connecticut, 203-834-1414; Washington DC, 301-964-1808; Georgia, 404-458-7100; Florida, 305-753-9600; North Carolina, 919-783-0076; Canada, 416-889-9095.

Engineering that exceeds expectations.

CIRCLE 290 ON READER CARD

takes into account that a period of time is required to switch from one disk head to another when reading data that's contained on two tracks (surfaces). Because several sectors can pass under the disk heads while they're switching, and because data isn't transferred during this time, the overall effective rate is reduced.

This time is determined by measuring the time taken to transfer an entire cylinder, thereby taking the head-switching time into account, and is shown in the third bar of Figure 2. For an RA82, this rate is 1.46 MB per second.

The final rate takes into account that in the same manner that a data

transfer may span a track boundary, it also may span a cylinder boundary, necessitating a one-cylinder seek. In conjunction with the seek, the disk heads also must switch from the last track to the first track to read the next LBN. In a disk drive designed for optimal performance, a one-cylinder

Figure 3.

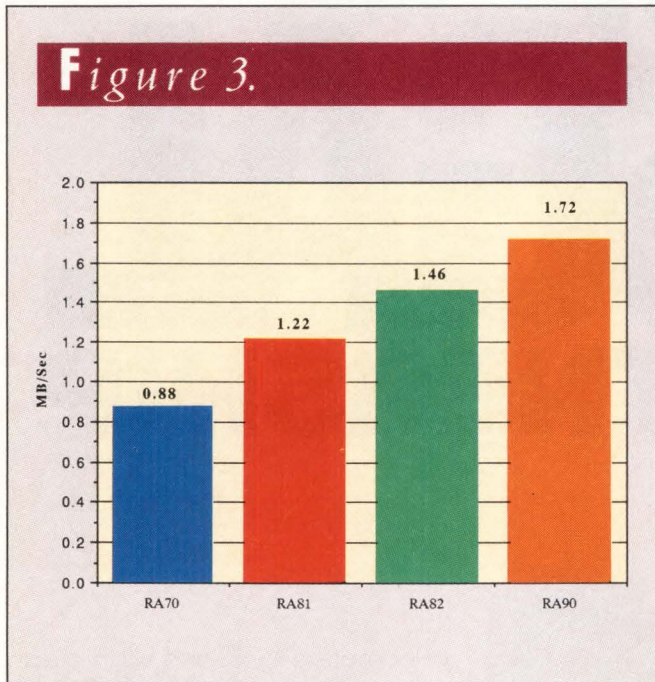

Spiral-transfer rates.

Figure 4.

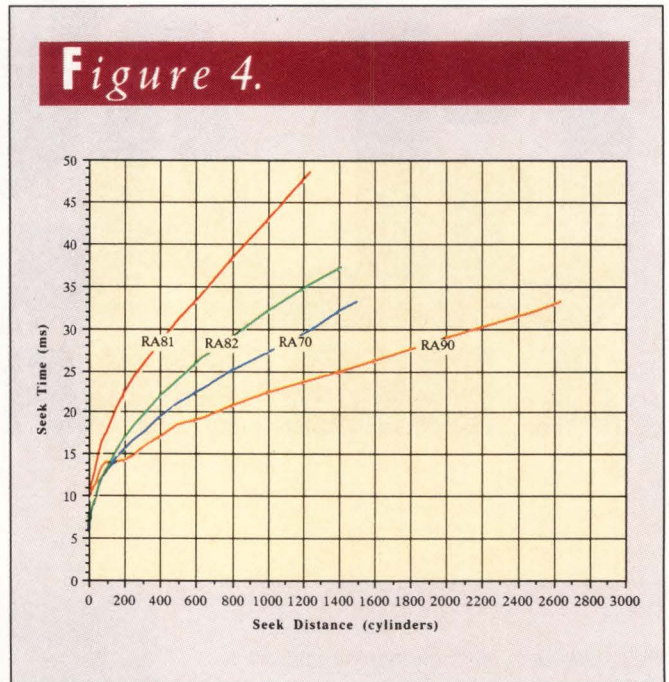

Seek times by cylinder.

Figure 5.

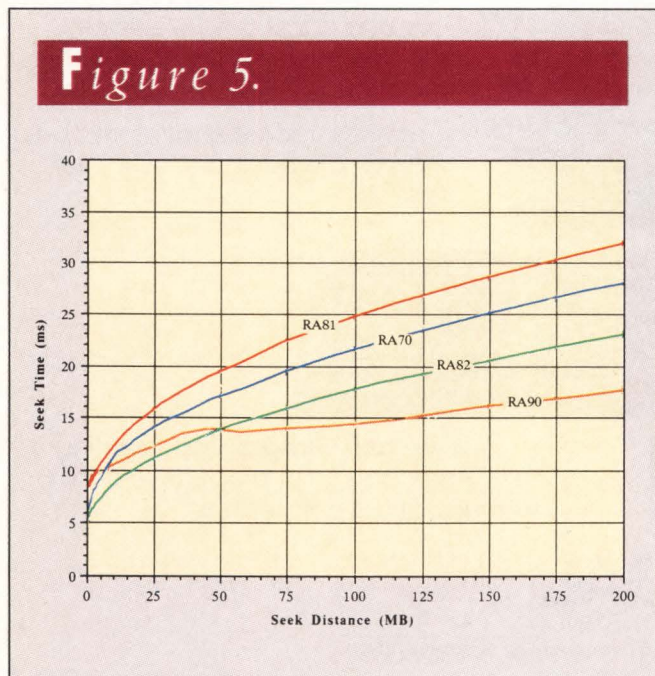

Seek times by megabyte.

Figure 6.

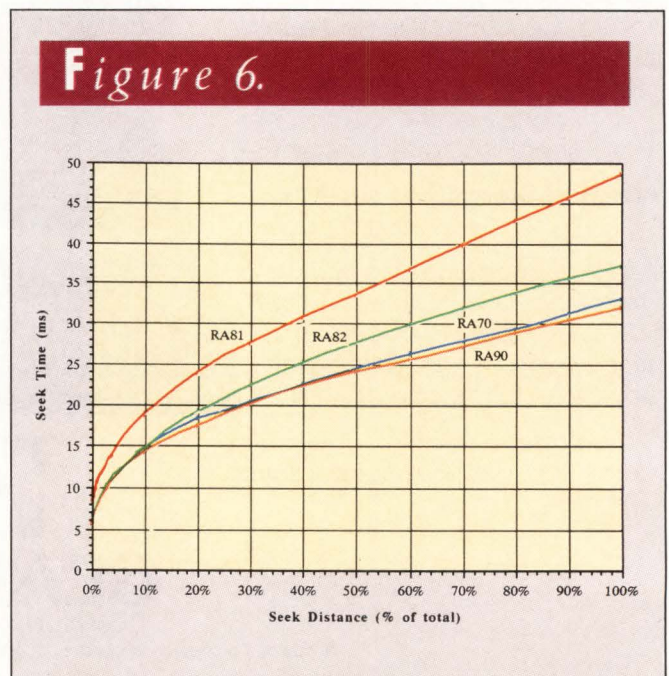

Seek times by percentage of capacity.

seek should be accomplished in less time than it takes for the heads to switch from the last track to the first. This way, no additional time is taken and the rate is the same as the on-cylinder rate. This rate is referred to as the spiral rate and is an extremely good indication of the overall disk performance, because it takes all performance factors of the disk into account.

The spiral rate for an RA82 is shown as the bottom bar in Figure 2 and is identical to the on-cylinder rate of 1.46 MB per second. As can be seen from the various RA82 data rates, there's a large difference among the individual rates. The peak rate is more than 64 percent faster than the spiral rate, so it's important to ensure that equivalent rates are used when comparing disks.

The spiral rate is one of the best ones to use when evaluating the data transfer rate, because it represents the overall disk performance. Figure 3 illustrates the spiral-transfer rates of the RA70, RA81, RA82 and RA90 disk drives.

Seek Times

In the same manner that transfer rates can be quoted based on different operations, the seek times also can be based on different measurement techniques. Unlike the data rates, however, there are good reasons for choosing different measurement criteria. Also, unlike data rates, the choice of a particular seek-time measurement can alter the standings of different disk drives with respect to each other. Because of this, it's important to understand not only the different ways to measure disk seek times, but also when and why to choose each type. Different ways to measure seek times are:

1. By Cylinder — The first measurement technique determines how much time it takes for a disk drive to seek a specific number of cylinders. By capturing this data for a large range of seek distances, you can build a profile of the disk in question. An example of this is shown for the RA70, RA81, RA82 and RA90 disk drives in Figure 4. As you can see, the RA90 is clearly the fastest-seeking drive, followed by the RA70,

RA82 and RA81.

2. By Megabyte — Because applications access data within a file, it isn't always appropriate to measure seek ability strictly by cylinder seek times. Another disadvantage of this method is that, with disks of differing sizes, comparisons can be difficult. As a means of circumventing these difficulties, another

method of measuring seek performance is to chart the seek times when seeking over a number of megabytes.

This is accomplished by taking a specific distance in megabytes, translating that distance into the appropriate number of cylinders, then measuring the time required for that seek. This is very applicable to a typical application,

Art or Industrialization?

Sometimes you have to make a choice

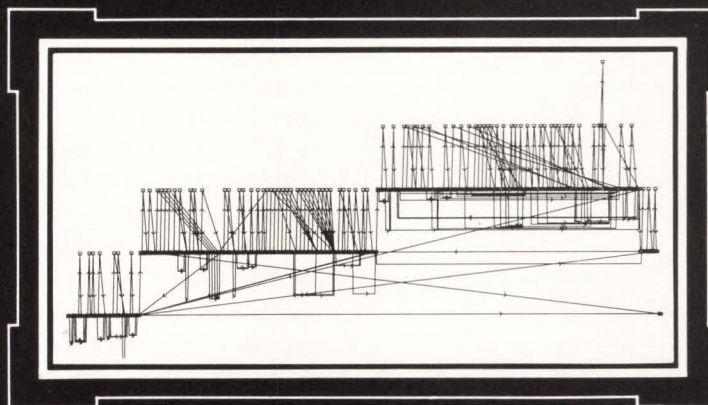

A control flow graph from LOGISCOPE

If this were the *artwork* of a deceased artist, it would likely be shown at the National Gallery of Art. If this is the *control flow (logical structure)* of one of your programs, don't wait the departure of its author to recognize the merit.

LOGISCOPE, a Source Code Analyzer from VERILOG, automatically *visualizes* the structure of programs written in over 30 different languages: *Ada, C, Cobol, Fortran...* and supports *Apollo, HP9000, IBM (vm,mvs), SUN, VAX (vms)*.

Call 800-347-0371 or 703-354-0371
for more information.



VERILOG USA
6303 Little River Turnpike
Alexandria, VA 22312

CIRCLE 302 ON READER CARD

THE MOST VERSATILE SCSI STORAGE IMAGINABLE!

"The DTSA Series"

Disk + Tape Storage Arrays
from...UNBOUND.

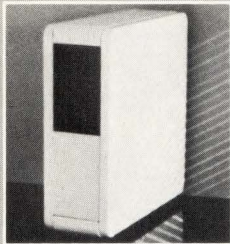

Start with a DTSA 1-2 drive module. Shown with 650 Mb. synchronous disk, 2.3 Gb. helical-scan tape and single MSCP controller.

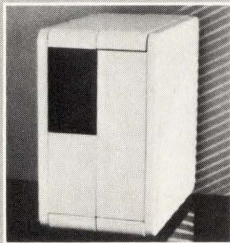

Then add a 2nd module with room for 1 or 2 extra hard disks, or options like optical, erasable and removable disk or helical-scan tape.

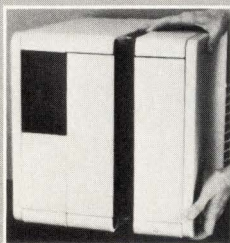

Upgrade your DTSA subsystem in the field with up to 7 devices, often using the same controller! This unique design provides ultimate flexibility and low cost.

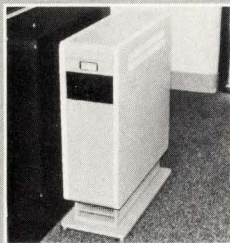

For floor-mount applications, UNBOUND's DTSA pedestal-mount offers a low cost 1-7 drive enclosure.

UNBOUND's DTSA Series offers the best solution for adding SCSI disk and tape peripherals to your DEC system. Our disks feature synchronous SCSI for throughput up to 4 Mb's per sec! And you can snap-on additional DTSA modules in minutes, without tools. For more information call UNBOUND sales today at 1-800-862-6863 or in Ca. call 1-714-895-6205.

CIRCLE 305 ON READER CARD

because it directly reflects the way most programs operate.

As an example, consider an application that accesses a 100-MB data file. The access pattern will remain the same regardless of which disk the data file is placed on, because a specific record remains the same distance (in logical blocks or megabytes) from the beginning of the file. Because of this characteristic, it's easy to see how an application will behave on different disks by taking seek-time measurements based on megabytes.

Figure 5 shows this profile for the RA70, RA81, RA82 and RA90 disk drives. In a reversal from Figure 4, the RA82 now appears to be faster than the RA70! This apparent anomaly is because the RA82 contains more data on one cylinder than the RA70. As a result, a seek of a certain number of megabytes will result in fewer cylinders on an RA82 than on an RA70. Even though the RA70 can seek over the same number of cylinders faster than an RA82, the fact that it must travel over more cylinders than the RA82 causes it to take more time. 3. By Percentage of Capacity — The final seek measurement is taken by seeking over a fixed percentage of the total disk capacity. The reasoning behind this is that most disks eventually will fill to capacity, and if random seeks are distributed over the entire surface of the disk, this is the appropriate measurement technique. The comparative seek times for this are shown in Figure 6 and now show the RA70 as faster than the RA82.

From the results of Figures 5 and 6, the natural question to ask is which disk is really better to use. The answer lies in how the measurements were taken and eventually will lead to determining how the applications will access the data.

If the disk is to contain files that are large, and the access pattern will be random seeks within the file, then the RA82 should be chosen. This is because of the large capacity of each RA82 cylinder, which gives superior performance when measured on the metric of seek times

per megabyte. The mathematical average over a given seek distance is approximately the time required for a seek of one-third the total distance, so the exact differences can be calculated easily. As an example, if a 150-MB file is accessed on a random basis, the average seek distance will be 50 MB. From Figure 5, it's easy to see that the average time for an RA70 is around 16.95 ms, while an RA82 will accomplish the same seek in 13.85 ms. The RA82 is the clear choice.

If, on the other hand, the disk contains many small files that are accessed with equal probability (such as in a time-sharing system), the disk can be accessed randomly over the entire disk surface. Because of this, it would be more appropriate to consider the seek times based on the percentage of capacity. With the average seek being one-third of total capacity, Figure 6 shows the seek times at the 33 percent point of the RA70 to be 21.1 ms and of the RA82 to be 23.45 ms. The choice is now the RA70.

THE METRICS USED to characterize I/O subsystem performance vary in importance, depending on the particular application. Within a class of metrics, there can be several techniques that are used for measurements, each of which may be valid. Because different results may be obtained, depending on which technique is used to measure the performance, it's of vital importance that any comparison be based on similar data. At the same time, it's important to understand the requirements of the application thoroughly so that performance metrics that aren't important aren't given undue weight.

Part 2 will concentrate on the optimizations possible for each of these metrics under the Digital Storage Architecture (DSA). —Kenneth H. Bates is a consulting software engineer for Digital Equipment Corporation in Colorado Springs, Colorado.

ARTICLE INTEREST QUOTIENT
Enter On Reader Card
High 560 Medium 561 Low 562

THE SOFTWARE NEWS

Total VAX/VMS Disk Solutions

RABBIT-11 Disk Caching

New!

RABBIT-11's automatic caching keeps frequently accessed files in memory. System performance improves greatly because I/O to physical disks is minimized.

RABBIT-4 Disk Management

New!

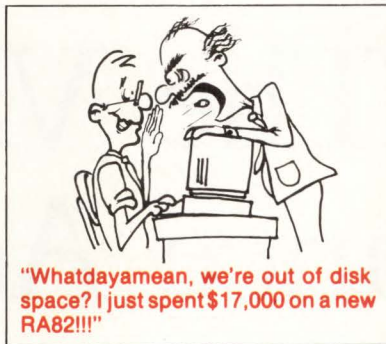

Maybe you think you're out of disk space, but you're really not. RABBIT-4 lets you free disk space for productive use. RABBIT-4 collects data on each disk or an entire disk farm, then arms you with the information you need to make the most of your disk hardware investment.

RABBIT-5 High Speed Disk Backup

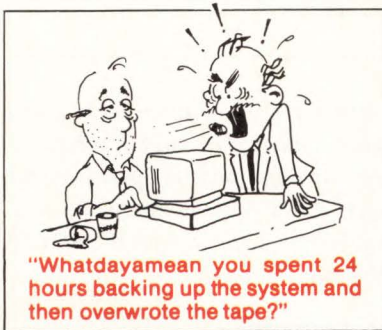

Backups are done quickly and safely with RABBIT-5. The tape librarian enforces tape labeling so there's no room for accidental overwrites. Disk to tape backup is often 3 to 5 times faster than VMS Backup in elapsed time and 90% faster in cpu time.

RABBIT-9 VAX Acceleration Software Technology

Patent Pending

RABBIT-9 works all the time and prices start at only \$1,000. Improve system performance up to 100% and more using only a few seconds of cpu daily. Continuous tuning means your system feels quick and performs great. All the time!

RABBIT-7 Disk Optimizer



Automatically eliminate file fragmentation and consolidate free space to save lots of time and money. R-7 intelligently places files to build an optimal disk structure: **one that lasts**. No need for on-line defragmenting.

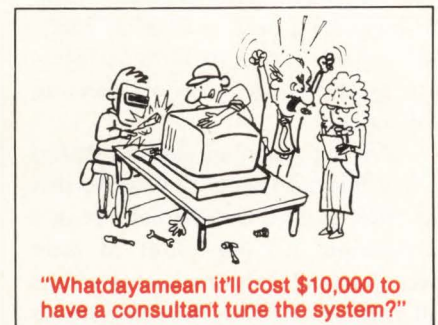

Call for Free Demos Now!

RAXCO, INC. EAST (301) 258-2620
RAXCO, INC. WEST (714) 863-0100
IN CANADA (519) 371-5020

VAX/VMS are trademarks of Digital Equipment Corporation

CIRCLE 190 ON READER CARD

Capacity Planning With The VAX Performance Advisor

Assisting system managers in isolating and solving performance problems. BY LAWRENCE L. BALDWIN JR.

CAPACITY PLANNING CAN BE one of the most important yet difficult and time-consuming tasks for a VAX system manager. A capacity plan describes the current system configurations, current use of the equipment, expected future changes in user load and new configurations to handle the expected load. Distinguishing and managing long-term growth and short-term performance problems are a major planning challenge.

Effective planning requires you to be well-informed about all variables that can affect system use. Without proper information, it's impossible to meet users' changing demands. Response time and user productivity will degrade as weeks or months are spent designing new systems.

Elements involved in capacity plan-

ning relate to who's using the system, what applications are being run, when they're run, what recent use changes have occurred, and what changes can be expected in the future. Although good communication with users and department managers usually can provide useful information, many users don't know what their impact on the system is and how that may change, and managers don't usually have enough time to provide such information. The system manager must rely primarily on the system itself for this information.

A new DEC performance analysis product, the VAX Performance Advisor (VPA), assists system managers in isolating and solving temporary performance problems. It also provides detailed system use information required to prepare long-term capacity plans.

VPA consists of three basic components: a data collector, a recommendation analyst and a performance analyst. After VPA is installed, each component is invoked with the ADVISE command.

Data Collector

The data collector is a detached process that's created at system startup or that can be started manually with the ADVISE/COLLECT/START command. As soon as VPA is started, raw performance data is written to disk every few minutes. For each day that VPA collects data, a new raw-data file containing information about CPU, I/O and memory use is created.

By default, the data collector stores data 24 hours per day. If your system is idle in the evenings and on weekends,

VPA can be configured to stop collecting data during those periods. For example:

```
ADVISE/COLLECT/SCHEDULE=(MONDAY=8-20,
TUESDAY=8-20,WEDNESDAY=8-20,THURSDAY=
8-20,FRIDAY=8-20,SATURDAY,SUNDAY)
```

will configure VPA to collect data from only 8 a.m. to 8 p.m. Monday through Friday. Even if you only collect data during the day, on weekdays you can expect to generate a 1,000- to 6,000-block file for each system collecting data. Therefore, it's important to keep a close watch on disk use when VPA is active.

Sometimes it's useful to run VPA for only a few minutes to test the impact of a new application. You can do this by manually starting VPA, running the application and then manually stopping VPA with the ADVISE/COLLECT/STOP command. As soon as the data collector has been run for several minutes, you can invoke either of the two analysts.

Recommendation Analyst

The recommendation analyst can help eliminate many short-term performance problems. These problems should be examined first, because they're typically easier and less costly to solve than capacity expansion. Generating a recommendation report involves typing the one-line command:

```
ADVISE/REPORT=ANALYSIS/START=date/
OUTPUT=report.txt.
```

This report consists of a series of numbered conclusions describing each problem and proposed solution. The recommendation analyst won't find every potential problem, but it contains rules to detect both simple and complex ones. Typical rules are simple IF-THEN-ELSE statements that simulate the methodology that a human performance analyst might use.

For example, Rule 1:

```
IF MAX-SRPCOUNT > SRPCOUNT + 5%
THEN SRPCOUNT=MAX-SRPCOUNT
```

means that if the maximum number of Small Request Packets in use at any time is greater than the SYSGEN parameter

Figure 1.

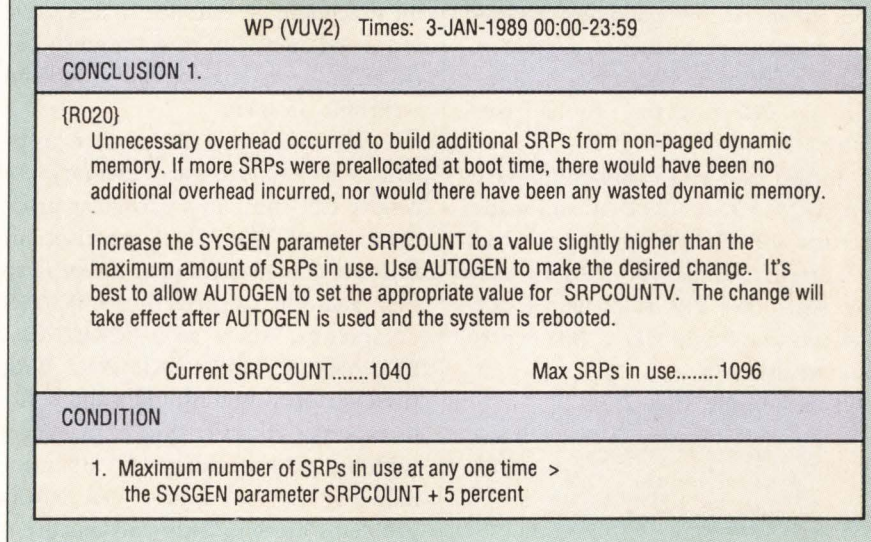

Analysis report.

Figure 2.

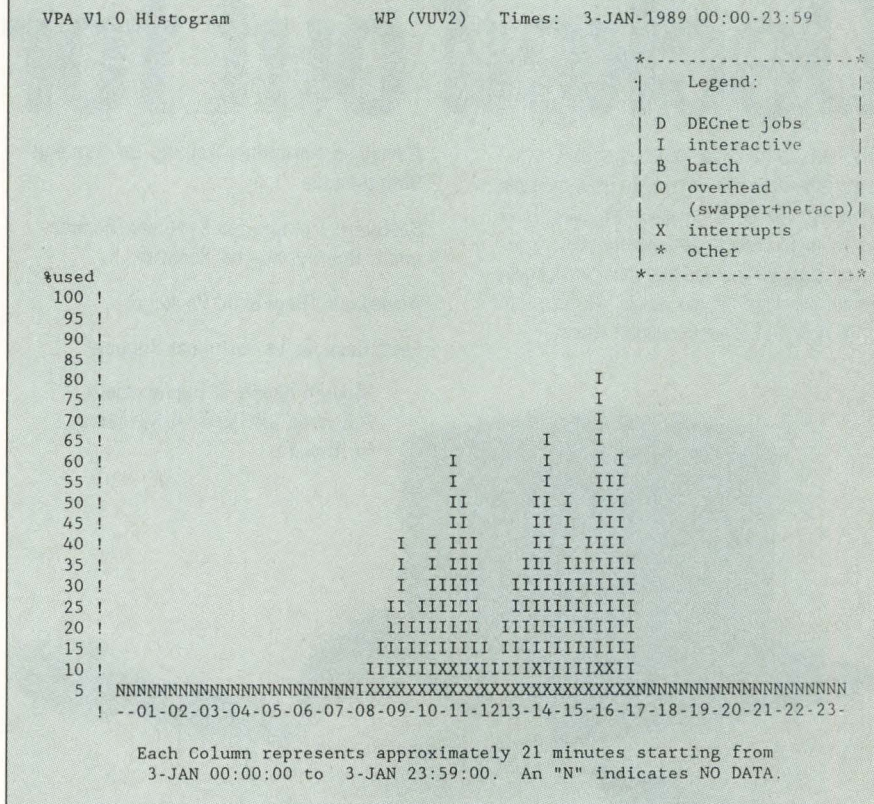

CPU utilization.

SRPCOUNT plus five percent, then increase SRPCOUNT to a value larger than the maximum number in use.

When a rule is matched, VPA states the problem, tells why and how it's impacting system performance, suggests a possible solution and describes its algorithm for detecting the problem (see Figure 1).

In this case you easily could have used SHOW MEMORY/POOL and made sure that SRPCOUNT was greater than the current number of SRPs in use. However, other VPA rules help locate problems that might take a VMS expert hours to discover.

For example, Rule 2:

```
IF DISK-I/O-RATE(DISK-X) >=
DISK-THRESHOLD(DISK-X)
THEN EXAMINE(DISK-X)
```

means that if the rate of disk I/Os to DISK-X frequently exceeds its capacity, then suggest that I/O be moved from DISK-X to some other disk.

Identifying this problem is much more involved than the SRP problem. It requires analysis of disk-use data over a period of at least a day, knowledge of the maximum I/O rates for all disk drive types and an ability to distinguish between an occasional excessive rate and a chronic problem.

VPA can detect many other problems, such as under-use of memory; excessive CPU time in a particular processor mode (Kernel, Supervisor or Executive); undersized page and/or swap files; and other incorrectly set SYSGEN parameters, such as LOCKIDTABL, RESHASHTBL and NPAGEDYN. With these features, VPA provides the built-in expertise to assist system managers with limited knowledge of VMS internals. For the VMS expert, VPA detects problems more quickly and reliably.

Performance Analyst

After the system's general performance problems are known, the performance

analyst can be used to analyze attempts to solve short-term performance problems, as well as to provide detailed system-use reports useful for long-term capacity planning.

The performance analyst produces a single report detailing hourly use of CPU, memory, terminal I/O and disk I/O with a series of bar graphs (see Figures 2 and 3). In each of these graphs, the time of day is plotted by hour on the horizontal axis and the percent use on the vertical axis. The bars in the graph are broken down in detail. For example, in the CPU Utilization graph, each stacked bar itemizes CPU for interactive, DECnet, batch, system overhead, interrupts and other.

A quick glance at these graphs and charts will indicate periods of minimum and maximum use of all system resources. If a capacity planner generated these reports over a period of several months, there'd be enough information to understand the dynamic

Decked out for DEC™

TRW puts the finishing touches on DEC systems. Whether you're a system user, manager, self-maintainer or third party maintainer, TRW has the right service solutions for you . . . for minimum downtime and maximum productivity. Let our expertise be your single, reliable source for all your DEC system support needs.

Advanced Hardware Training for Systems Maintenance

Software Training for Systems Management, Operations and Security

Affordable Diagnostic Packages

Fast, Responsive Technical Support

**Module Repair & Replacement —
A Source for Parts, A Resource
for Repairs**

Total Maintenance for Maximum Uptime Assurance

From DEC support to total maintenance service, TRW has the right finishing touches for DEC systems.

Call today! Let TRW custom design the best program for you. 1-800-255-3029 (in Virginia call 1-703-898-7555)

Or write:

TRW Technical Support Center
420 Hudgins Road
Fredericksburg, VA 22401

© 1989 TRW Inc. TRW is the name and mark of TRW Inc. DEC is a trademark of Digital Equipment Corp.



CIRCLE 294 ON READER CARD



Peritek does it with color!

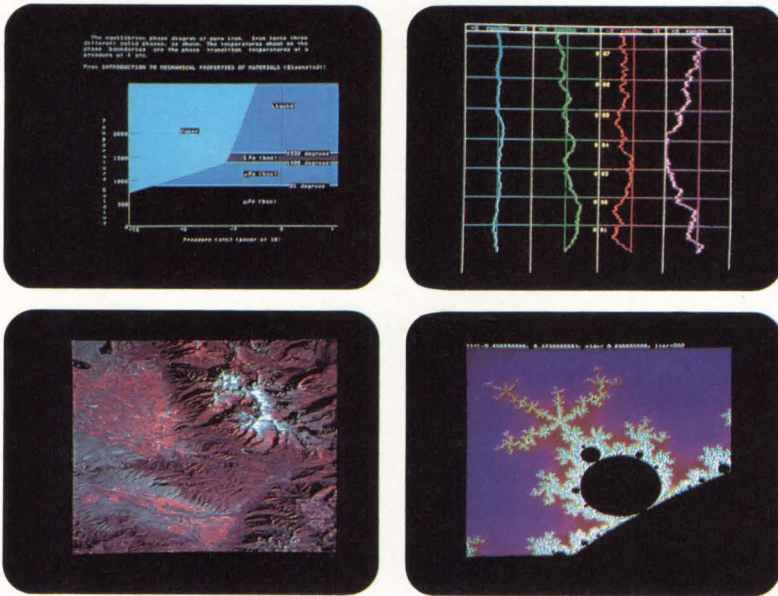

Graphics and alphanumeric for LSI, PDP, VAX and MicroVAX.

Peritek has been offering the widest range of Q-bus and Unibus display controllers available anywhere for over 10 years. Hardware and software for most applications. Color and monochrome. Low to high resolution. Software support for RT/TSX, RSX, VMS, and ULTRIX, and bit-level subroutines which interface directly to Fortran and C. Image processing software is also available.

Peritek's most powerful board, the VCK-Q/U, combines an advanced CRT controller and a 68010-based computer on one quad-height card. You get:

- 1024 x 1024 x 8 color graphics
- 1024 x 1024 x 1 graphics overlay
- 64 x 85 alphanumeric overlay
- hardware pan and zoom
- two channel DMA
- two serial I/O ports
- SCSI port

The VCK-Q/U prices range from \$3,495 to \$4,485. A complete package with software and monitor starts at \$6,500.

For your special requirements, Peritek can supply custom configurations of our standard products. We're ready to quote on custom software and hardware design projects, too.

Call or write for free catalog.

Peritek Corporation
5550 Redwood Rd.,
Oakland, California 94619.
Phone (415) 531-6500.
In the east, (516) 798-1919.

See us at:

NCGA 1989, April 17-20, Booth #4044
DEXPO South, May 9-11, Booth #610
Siggraph, July 31-August 4, Booth #1118
DEXPO West, November 7-9, Booth #223

	MODEL	Q-BUS/ UNIBUS*	PIXEL GRAPHICS	ALPHA- NUMERICS	COLORS
COLOR	VCK8	Q & U	1024 x 1024	64 x 85	256
	VCK24	Q & U	1024 x 1024	64 x 85	16 million
	VCX8	Q & U	512 x 512	48 x 80	256
	VCX24	Q & U	512 x 512	48 x 80	16 million
	VCM	Q	1024 x 1024		256
	VCW	Q	512 x 640	48 x 80	256
	VRC	Q & U		24 x 80 48 x 80	64 64
MONOCHROME	VRH	Q	1024 x 1024	64 x 128	
	VRS	Q	512 x 512	48 x 80	
	VRG	Q	512 x 512	32 x 64	
	VRA	Q & U		24 x 80 48 x 80	

*Q-BUS for LSI-11 and MicroVAX, UNIBUS for PDP-11 and VAX.



CIRCLE 131 ON READER CARD

Peritek

High Capacity Backup has entered a new Dimension.

8mm
Shown actual size

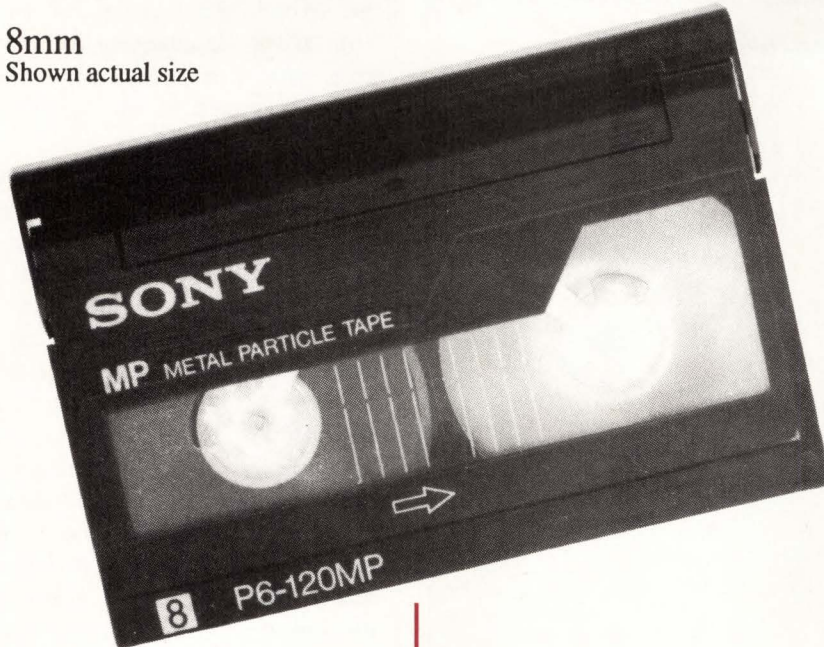

HIGH CAPACITY

- 2.3 Gigabytes per tape.

FAST

- 8 to 15 Megabytes per minute depending on your hardware configuration.

COMPATIBLE

- Interfaces exactly as a 9 track drive.
- Works with all standard backup utilities.
- Works on both Q-BUS and UNIBUS.

OPERATIONALLY EASY

- Unattended Backups are now possible.
- No more tape swapping necessary.

RELIABLE

- 1-year warranty with 48-hour Federal Express turnaround.

PORTABLE

- Industry standard 8mm tape.
- A small safe can hold as much data on 8mm tapes as a room full of 9 track tapes and with greater security.
- Ideal for data distribution.

OPERATIONALLY ECONOMICAL

- 8mm tapes cost only \$10.00 each.
- Frees resources by shortening the time required to backup.
- Lightweight tapes reduce shipping costs.
- Fewer tapes required.

FLEXIBLE FINANCING

- Subsystems cost less than \$7000.00.
- Rental, lease, and purchase terms available to match your budget, cash flow and tax considerations.

The CY-8200 is a high speed, high capacity archival subsystem based around the Exabyte Cartridge Tape System. Nothing else comes close to the price/performance ratio provided by the CY-8200. The complete subsystem may be leased for less than \$260.00 per month for 36 months including extended factory maintenance with 48 hour turnaround. To order call

CONTEMPORARY
CYBERNETICS

Group

at (804) 873-0900.

CONTEMPORARY
CYBERNETICS
Group

11830 Canon Boulevard
Newport News, Virginia 23606
Telephone: (804)873-0900 • Telex: 750605

CIRCLE 234 ON READER CARD

Figure 4.

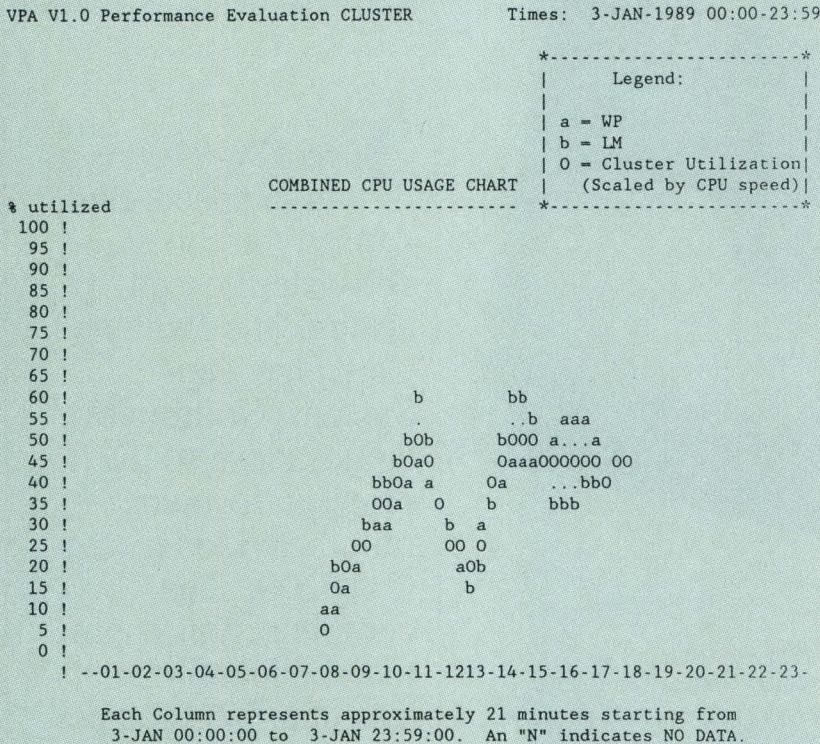

Cluster CPU utilization.

Figure 5.

The following table gives the summary of all disk activity as seen by the indicated node.

Disk Volume	Avg I/O per Sec	Avg Queue	I/O Sz (pages)	Source Node	Busy %	% Reads of Tot I/O	Type	# of Samples
\$DISK2	5.98	0.17	2.5			88	RA81	
	5.77	0.16	2.5	LM	13.88	89		300
	0.24	0.01	3.9	WP	0.93	71		270
\$DISK4	0.90	0.02	5.9			47	RA81	
	0.01	0.00	3.1	LM	0.04	79		300
	0.99	0.03	6.0	WP	2.53	47		270
LM_SYS	3.82	0.13	3.4			81	RA81	
	3.32	0.11	3.5	LM	8.28	83		300
	0.56	0.02	2.7	WP	2.11	70		270
MICROVMS	2.86	0.06	3.2			89	RA81	
	0.16	0.01	6.4	LM	0.63	85		300
	3.01	0.06	3.1	WP	5.68	89		270

Disk I/O usage.

system changes aimed at solving those problems. For instance, in Figure 5, the average I/O rate for LM-SYS is 3.82 I/Os per second. Although this isn't a problem, \$DISK4 is relatively idle. In this case, some performance improvement might be gained by moving I/O from LM-SYS to \$DISK4.

One way to do this might be to add a secondary pagefile to \$DISK4. To measure the effect of making this change, you'd first generate a performance report and make note of the disk use for LM-SYS and \$DISK4. Next, add the second page file to \$DISK4 and let the system run for a day or so. Finally, generate a second performance report and compare the new disk usages with the previous ones. If load didn't shift as you hoped, the process needs to be repeated. By using VPA in this way, actual effects of system changes are documented. Without this documentation, expected performance improvements become dangerous speculations.

VPA DOES AN EXCELLENT job of reporting the state of the system, recommending possible solutions to suspected problems and documenting system use before and after attempts to solve problems. By analyzing performance reports over a period of weeks or months, you can get a feel for more general trends of demand and plan your capacity around that information.

VPA won't find every potential system problem, nor will it provide you with all the information you need for capacity planning. However, when used in combination with other information gathering methods, such as MONITOR, ACCOUNTING and SHOW, it provides most of the information necessary to solve short-term problems and plan long-term capacity. Although VPA can't replace a human performance analyst, it's a valuable tool, even for experts. —Lawrence L. Baldwin Jr. is an independent consultant with Support Group of New Haven, Connecticut.

ARTICLE INTEREST QUOTIENT
 Circle On Reader Card
 High 549 Medium 550 Low 551

How to Protect Your DEC® Computer And Make It Last Longer

World's largest manufacturer of uninterruptible power systems for Minis, Micros, and LANs tells how

Your DEC computer is bombarded daily by spikes, sags, surges, noise, and blackouts. Bad power eats away at fragile electronic circuits, increases service costs, damages disks and causes down time.

You can eliminate these problems by investing in an Uninterruptible Power System (UPS). Your investment in a UPS will mean reduced down time, increased equipment life, and lower service costs. Typically, a UPS will pay for itself in less than one year, but not all UPS are created equal. Many are off-line, standby systems. Most won't even provide isolation from the power line or a separately derived neutral.

Shown below are three traditional UPS configurations. Each has its advantages and disadvantages.

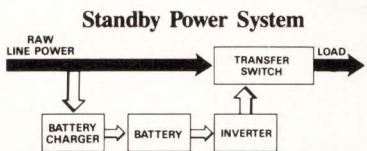

Advantages:

- Low cost
- Inverter normally off
- High efficiency

Disadvantages:

- No derived neutral
- Break in transfer
- Poor isolation
- Poor brownout protection
- Poor high line protection
- Poor lightning protection

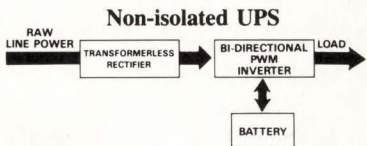

Advantages:

- Moderate cost
- Brownout protection
- High line protection
- No break system

Disadvantages:

- No derived neutral
- Poor isolation
- Inverter on continuously
- Poor lightning protection
- Non-linear load

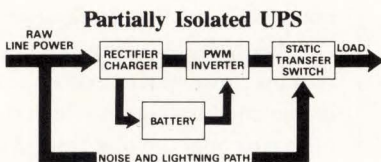

Advantages:

- Brownout protection
- High line protection
- Partial no-break system
- Separately derived neutral

Disadvantages:

- Break in transfer to line
- Poor isolation
- Poor lightning protection
- Non-linear load
- Poor efficiency
- Expensive

Best Power Technology's new Uninterruptible Power System called FERRUPS® is a breakthrough in computer power protection. FERRUPS represents a major advance over the three traditional types of UPS technology.

Advanced Technology FERRUPS (Provides True Isolation)

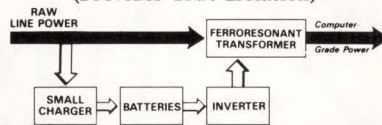

FERRUPS uses a ferroresonant transformer which is on-line continuously to provide outstanding isolation and eliminate spikes, sags, noise and brownouts. If power fails, the inverter takes over. Because of the flywheel effect of the ferro transformer, there is absolutely no break in output power. FERRUPS provides continuous on-line computer-grade uninterruptible power.

FERRUPS Provides Better Protection Than Any Other Design

- Inverter normally off
- High efficiency
- Filters non-linear loads
- High line protection
- Low cost
- Separately derived neutral
- High isolation
- No-break transfer
- Brownout protection
- Lightning protection

Advanced Interactive Communication Package Standard on Every Model

Most UPS only provide basic relay contacts for alarm and loss of line. FERRUPS

gives you even more. Every FERRUPS includes an RS232 port for full duplex TTL communication. You can control FERRUPS from your computer console or from thousands of miles away. FERRUPS has an on-board micro-processor, which keeps track of everything. It even records the time and duration of power outages. FERRUPS can even initiate a controlled shutdown for unattended operation. FERRUPS is the smartest, most communicative UPS in the world today!

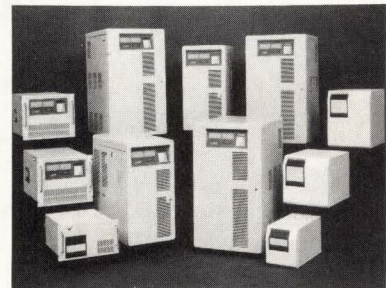

350 VA to 15 KVA uninterruptible power systems for Micros, Minis, LANs and anything else that needs clean, continuous power. BEST UPS are plug compatible with all DEC computers within its power range.

Advanced Meters and Alarms Standard on Every Model

Meter Functions: AC Volts Out, AC Volts In, Battery Voltage, AC Current Out, VA Load, DC Current In, Frequency, Heat Sink Temperature, Ambient Temperature, Time/Date, Number Power Outages, Log of Power Outages, Projected Run Time Available, System Hours, Inverter Hours, Number of Overloads, Full Load %, Log of Alarm Conditions.

Alarm Messages: Low Battery, Near Low Battery, High Battery or DC Bad, Low Run Time Left, Low AC Out, High AC Out, Output Overload, Ambient Over Temp, Heat Sink Over Temp.

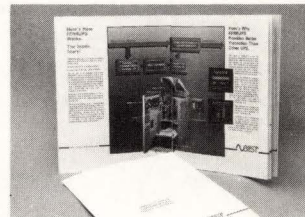

Interested? Call or send for our NEW, FREE LITERATURE today!



Best Power Technology, Inc.
P.O. Box 280 - Necedah, Wisconsin 54646
1-800-356-5794, ext. 3426
In Wisconsin (608) 565-7200, ext. 3426
Please print legibly.

Name _____ Company _____
Address _____
City _____ State _____ Zip _____
Equipment to be protected _____
Phone () _____ CHECK ONE: User Dealer Specifier OEM

©1989 Best Power Technology, Inc.
1-800-356-5794, ext. 3426

VAXcluster Backup

Eight-millimeter cartridge helps backup play catch up.

BY DR. JAMES MEADE

UNATTENDED BACKUP IS the dream of many major VAX installations. With glamorous technologies, such as disk drives and clustering, dreams become reality quite quickly. Backup, on the other hand, isn't glamorous at all.

Backup hasn't kept pace as disk and clustering capabilities have grown, creating close to a crisis for many companies. In offering disk drives such as the new RA90, DEC has tripled the amount of data generated from the same CPU that formerly used the DEC RA81 disk drive.

Clustering compounds the problem by transparently joining 10 to 15 CPUs into, effectively, one CPU. Some companies routinely accumulate up to 30 GB

of data or even more each day to back up that "one" CPU.

By building into the HSC cluster controller such features as off-line backup, DEC has made it possible for companies to back up the cluster with the same ease as backing up a small standalone CPU, at least insofar as software is concerned. Everyone has a command file like this to generate the backup:

```
BACKUP/IMAGE/BUF=5/BLO=32768/NOCRC
DUA20:
MUA0: DU20_IMA.BLK
```

The off-line backup allows a company to make an image backup (a recoverable backup of all data in the

system) onto a tape or disk without any CPU intervention.

The command file is high tech. So is the off-line backup. But the implementation is low tech. Many VAX system managers don't use off-line backup, because they must copy the whole disk. That takes a lot of time and many reels of nine-track tape.

Instead of using DEC's image backup, most system managers do daily incremental backup in which they copy onto tape only the files created that day. In the event of a head crash, incremental backup means going back as many as two weeks to the last image backup and restoring the disk from there by adding daily incremental backups to it. Another

drawback is that incremental backup takes CPU resources, a most valuable commodity.

Shortcomings

Some users, such as Internal Consultant Martin Pensak of E.I. du Pont de Nemours and Company, Newark,

night, because running backups during the day generates traffic and consumes valuable computer resources. Many companies also prefer unattended backup because of the management difficulties and costs of having people perform the tedious manual backups.

The nine-track tape drives on

32 GB, you'd need two HSC70 controllers with nothing but tape drives connected to them.

From a financial perspective, nobody would install 220 backup nine-track tape drives at \$150,000 for each set of four (a total cost of \$8,250,000), just to run unattended backup at night. It's better to have workers hauling off tapes and replacing them.

After a certain point, speed also becomes an issue. If the tape drives don't run fast enough to complete the backup during the night, backup conflicts with daytime computing. Speed and capacity considerations aside, there are reliability questions. Reliability has been a problem with the DEC TA78. DEC's product announcement for the TA79 magnetic tape drive says the offering "has replaced the TA78 and incorporates major reliability enhancements."

Questioned about reliability on the earlier series, DEC's Malcomb Krongelb, product marketing manager for tape and optical, admits that "certain [companies] did, others did not" have reliability problems with the TA78s, which DEC no longer offers. However, DEC maintains

. . . most system managers do
daily incremental backup in
which they copy onto tape only
the files created that day.

Delaware, see no viable option for backing up their data properly. "We've been looking at DEC's TA79 nine-track magnetic tape," he reports, "but we wouldn't buy it. It would take 12 to 15 reels for us to do a full backup [of 5 GB each day]. It's unreasonable in the time it would require and the management it would take for tracking and labeling it properly."

The ideal is unattended backup at

DEC's top-of-the-line TA79 magnetic tape subsystem hold 145 MB of data and operate at a speed of 125 inches per second. Adequate three years ago, they don't have the speed or the capacity to meet the needs of large databases in clustered environments using state-of-the-art drives.

To hold 32 GB of data, you'd need 220 145-MB tapes (see Figure 1). To perform unattended backup at night for

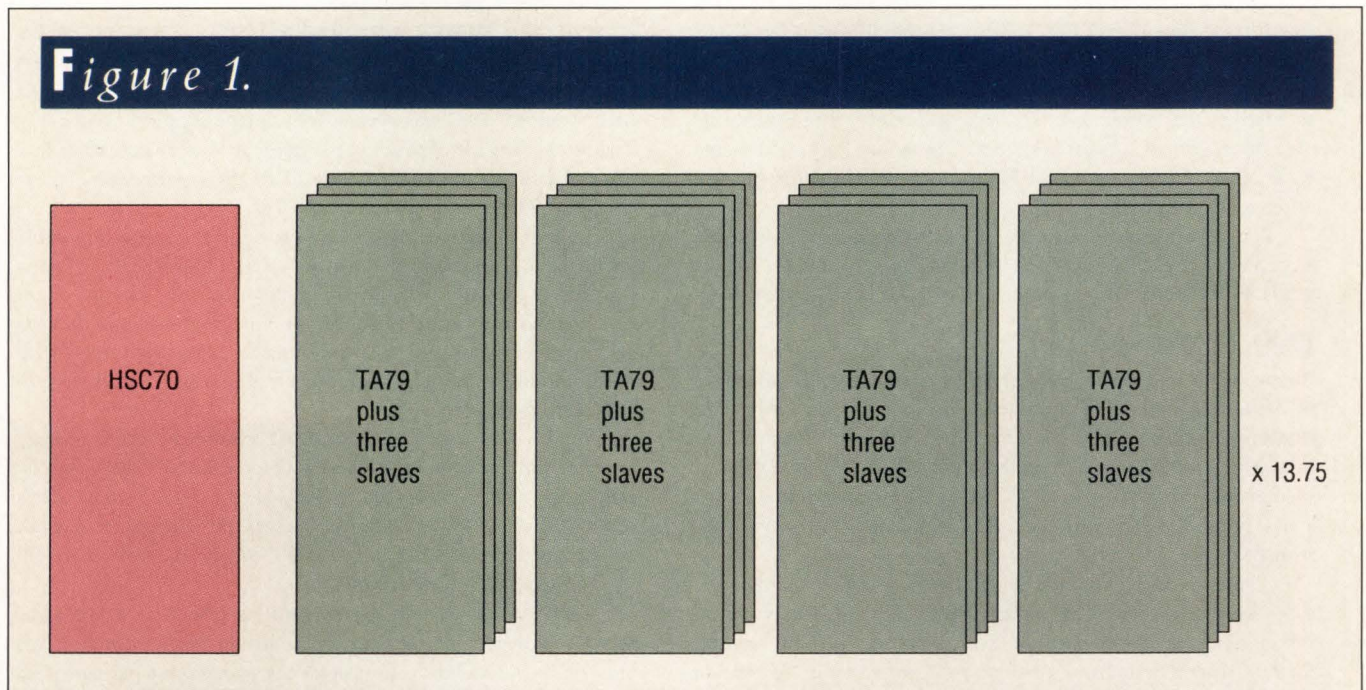

To back up 32 GB of data unattended would require 220 nine-track tapes, two HSC70 servers — one with eight HSC5X-CA cards, the other with five — and more than 1,320 square feet of floor space.

that completely redesigned read/write electronics have improved reliability for the TA79s dramatically.

Alternatives

What if you look outside the traditional DEC offering for backup technology? The option wasn't available for the cluster until late 1988, because backup drives must connect through DEC's proprietary HSC5X-CA card. But now

there are nine-track tape offerings other than those from DEC that many companies would consider.

One of the nine-tracks comes with a tape speed of 200 ips, compared with the 125 ips of the DEC TA79. This is enough to make it 38 percent faster than the TA79, fast enough to make the difference between finishing and not finishing backup overnight.

For du Pont's Pensak, the speed in-

crease from competing nine-track tapes isn't enough to convince him to deviate from the all-DEC policy his group has followed "to avoid compatibility problems." But another alternative — not offered by DEC at all — is something else again.

With 8mm tape, he has concluded, "we're not talking about a 10 percent capability difference there. Going from a 2,400-foot (nine-track) reel to VHS

DEC's TA90: Made In I.B.M.

There's a good reason that DEC's newest cartridge tape subsystem, the TA90, is compatible with IBM's 3480 recording format: it's built by IBM. Although the OEM arrangement was rumored for almost a year, DEC didn't admit to it until a formal announcement in December 1988. One month later, the TA90 was introduced with the VAX 6300 series.

For DEC's customers, the TA90 is a two-fold blessing. First, DEC had never before supplied a tape subsystem with adequate performance to back up its disk storage products, which continue to make exponential leaps in capacity. With a data-transfer rate greater than 2 MB per second and a 2.4-GB capacity (two loaders handle six 200-MB cartridges each), the TA90 will be DEC's highest-performance tape unit.

Second, DEC's larger sites, which include most of the *Fortune* 500 companies, use both VAXs and IBM mainframes. The standard tape format should help DEC penetrate more IBM sites by allowing some degree of data interchange between these systems.

Although proving it will bend over backward for industry standards, DEC continued its recent policy of going outside its own development labs for hardware. The technology agreements with Tandy Corporation and Mips Computer Systems Inc. are other major examples.

For IBM, the agreement will mean more sales of 3480s and an industry consensus on the 3480's status as a standard. Meanwhile, IBM's OEM business continues to grow stronger than ever.

TA90/3480 Characteristics

It may take the DEC market some time to get used to the amenities of 3480-style backup. The drive is read/write compatible with IBM's 3480, so users now have the same degree of compatibility they had with nine-track magnetic tape. The TA90 master subsystems can connect to two HSC VAXcluster controllers through a dual port. The drive will back up DEC's SA550, SA600 and SA650 storage devices.

The 2-MB cache implements the Digital Storage Architecture (DSA) so that instructions can be prefetched and briefly stored while the drive moves onto the next operation without waiting for new instructions from the host. Additionally, the TA90 has an 80-ms repositioning time.

These factors help it complete backups in two-thirds the time

it takes DEC's current reel-to-reel VAXcluster drives. With enhancements to the VMS backup utility, DEC expects to improve speeds to twice that of reel-to-reel systems. This is DEC users' first exposure to mainframe-class backup.

The 18-track cartridges contain 2,400 feet of 1/2-inch tape in a 4 x 5 x 1-inch package. They store 38 KB of data per inch of tape. Code characters for error correction and cyclic redundancy checks are recorded on the tape, so up to four track errors can be corrected on the fly, without host intervention.

A TA90 master has a controller cabinet and a dual-drive cabinet. Each streaming slave drive is an add-on dual-drive cabinet. Cartridge stack loaders, which allow up to six cartridges to be read or written in sequence, are optional for the master and slave.

Other Storage Products

Despite the secrecy surrounding the agreement, DEC's third-party tape storage competitors are acutely aware of the market's demand for 3480-compatible products, and have been hard at work. "DEC was never a serious tape supplier," says Larry Tashbook, director of product planning at System Industries Inc. "It also happens that 3480 is one of the best-performing, most convenient tape standards around."

System Industries has already introduced a 3480-compatible drive that tops DEC with a 3-MB-per-second transfer rate and support for 10 200-MB cartridge drives. Alan Ignatin, vice president of sales and marketing at MegaTape Corporation, says that his company will announce a 3480-compatible subsystem for VAXBI bus computers. Products from other vendors also will emerge in the next few months.

At the 6300 announcement, DEC announced other storage products for the high end. These include the SA550 array, which ranges in price from \$44,000 to \$123,000; the SA650, which starts at \$103,320; the HSC40, a new entry-level HSC controller that can be upgraded to an HSC70, priced at \$41,157; and the RV64, a 128-GB optical jukebox priced at \$205,652.

The TA90 master subsystem unit is priced at \$113,276, or \$121,784 with an automatic cartridge loader. Six optional drives are available as additions for \$38,748 per pair, \$47,256 per pair with stack loaders. A package of 30 tape cartridges costs \$360. One-year on-site warranties are also available. —*Evan Birkhead*

(8mm helical scan), you're talking about increasing by a factor of 10 to 15 in capacity."

A number of third parties offer the 2.3-GB 8mm tape drives from Exabyte Corporation on the UNIBUS and Q-bus. Micro Technology Inc. and System Industries Inc. offer them with HSC attachments. Configured systems of 16 tape cartridges can hold up to 32 GB of data, enough for unattended backup at night.

Connecting To HSC

The problem isn't finding alternatives to DEC nine-track tape subsystems. The problem is finding a way to connect non-DEC alternatives to the cluster, at least until DEC catches up with companies like Fujitsu, Storage Technology Corporation and Exabyte, in offering high-capacity, high-speed, highly reliable backup tape offerings.

The HSC5X-CA interface to the cluster is proprietary. You can't just plug into it as you could the SCSI interface on the UNIBUS and Q-bus. (For the LAVc, in which CPUs use the UNIBUS, you can use the SCSI interface to connect third-party alternatives such as 8mm and nine-track tape.)

To make matters worse, the BI bus is a closed interface. Increasingly, the BI is becoming the only bus in use in high-end clusters.

One alternative third-party backup device for BI CPUs (in a non-clustered environment) is a controller that attaches directly to the BI bus via a DEC-manufactured BI chip attached to the controller. Currently, MegaTape Corporation supplies this type of product (see "MegaTape MT-750," March 1989) The controller is made by Clearpoint Inc., which recently settled a lawsuit with DEC over using the DEC chips on its BI memory products and agreed to withdraw them.

EMC Corporation recently suffered a similar fate in a DEC lawsuit. Another alternative is to reverse engineer the BI bus, as System Industries is doing. Again, a DEC lawsuit is a possibility.

For a cluster with BI and/or non-

VSORT AND VSELECT

The fastest way to sort and extract records on a VAX.

If you spend too much time sorting with the VAX/VMS sort utility, spend less — up to 75% less — with VSORT from Evans Griffiths & Hart, Inc. Compare the following elapsed and CPU times for VSORT (V03.07) and the VAX/VMS (V4.2) sort utility running on a VAX 11/780.

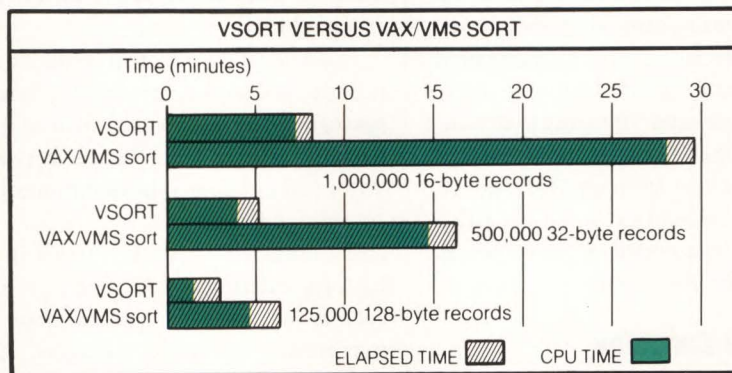

VSELECT, the fast sequential record extractor.

VSELECT is also fast and efficient. Running stand-alone on a VAX 11/780, VSELECT often exceeds scan rates of 1,000 blocks per second. It can select and reformat records from an indexed file much faster than the VAX/VMS CONVERT utility can unload the same file — often three or four times faster.

For RSTS/E, use FSORT3 and SELECT.

If you run RSTS/E on the PDP-11, we invite you to join the hundreds of users and OEMs who, for the past ten years, have relied on FSORT3 and SELECT for the fastest possible record processing.

Other software products for VAX/VMS and RSTS/E

- ROSS/V a RSTS/E operating system simulator under VAX/VMS.
- KDSS a multi-terminal key-to-disk data entry system.
- TAM an efficient screen formatter for transaction processing applications.
- DIALUP a data communications package that links VAX/VMS and RSTS/E systems to remote computers.
- BSC/DV a device driver for DEC's DV11.

For more information, call (617)861-0670 or write: Evans Griffiths & Hart, Inc. 55 Waltham Street Lexington, MA 02173 TWX: 710-326-0103

Evans
Griffiths
&
Hart, Inc.

EG&H

DEC, VAX, VMS, RSTS and PDP are trademarks of Digital Equipment Corporation.

CIRCLE 161 ON READER CARD

BI CPUs, there's a way to connect non-DEC tape backup devices in spite of the closed HSC5X-CA interface. The alternative is to reverse engineer the interface to the HSC5X-CA, as both Micro Technology and System Industries are doing.

Critics such as Tony Prigmore, Clearpoint's product manager for storage products, say that the interfaces from System Industries and Micro Technology are "not a real technology but just a way to get around" the closed interface (see Figure 2).

However, companies such as du Pont don't really care what goes on inside the interface. "Our management doesn't want 'a good computer interface,'" Pensak says. "It wants to get our business done." And du Pont has expressed hope that 8mm tape for the HSC may bring it what DEC so far has failed to bring: unattended image backup overnight for the cluster.

IBM 3480 Cartridge

Much faster than 8mm cartridges, although much lower in capacity, is 3480 cartridge technology from IBM. DEC is participating in that marketplace (see Sidebar, "DEC's TA90: Made In I.B.M.>"). The 3480 is considered a high-performance cartridge. Its speed is 10

times that of the 8mm cartridges. Holding 250 MB of data, it has from 30 to 50 percent the capacity of the 2,400-foot reel — although still only one-fifth the capacity of helical scan.

The biggest barrier to the 3480 may be cost. IBM's price for tape subsystems ranges from \$96,000 to \$216,000. Analysts are divided on how widespread the systems will become. Although slower, 8mm cartridges offer greater capacity at a cost of \$25,000 to \$50,000 for a comparable subsystem. And there are several thousand 8mm units in the field already, many of them being upgraded to HSC compatibility.

While DEC and other vendors expect the 3480 to become popular, Pensak speculates that it won't so much address backup as data interchange between VAXs and existing IBM mainframes.

DEC CLEARLY ISN'T standing still in its backup offerings. Innovative moves such as the 3480 offer renewed hope for overburdened system managers. And there's more coming. Asked what DEC was offering for unattended backup, Krongelb said, "Right now, not much. We're doing a number of things in that direction. All I can say is stay tuned."

Many companies getting buried under nine-track tape are opting not to

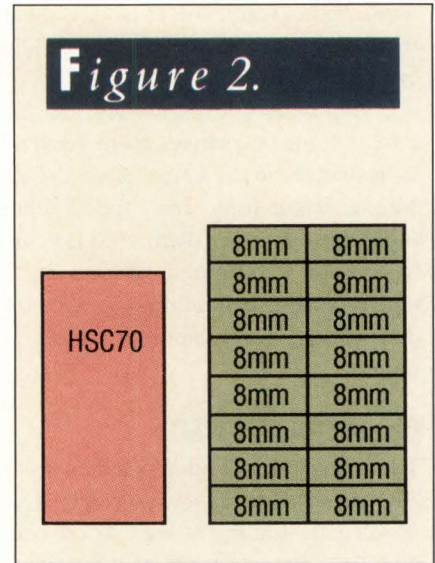

To back up 32 GB of data using 8mm technology would require 16 tape drives and one fully configured HSC5X-CA card. All of the drives fit into a 60-inch cabinet.

stay tuned but to flip the channels. Thanks to reverse-engineered interfaces to the HSC, there are some alternatives. —*Dr. James Meade is a free-lance writer, specializing in computer technology, based in Fairfield, Iowa.*

ARTICLE INTEREST QUOTIENT
Circle On Reader Card
High 436 Medium 437 Low 438

Companies Mentioned In This Article

Clearpoint Inc.
99 South St.
Hopkinton, MA 01748
(508) 435-5395
CIRCLE 439 ON READER CARD

Digital Equipment Corp.
146 Main St.
Maynard, MA 01754
(508) 897-5111
CIRCLE 403 ON READER CARD

EMC Corp.
171 South St.
Hopkinton, MA 10748
(508) 435-2541
CIRCLE 404 ON READER CARD

Exabyte Corp.
1745 38th St.
Boulder, CO 80301
(303) 442-4333
CIRCLE 440 ON READER CARD

Fujitsu Microsystems of America Inc.
3055 Orchard Dr.
San Jose, CA 95134
(408) 434-1160
CIRCLE 441 ON READER CARD

IBM Corp.
Old Orchard Rd.
Armonk, NY 10504
(914) 765-1900
CIRCLE 407 ON READER CARD

MegaTape Corp.
1041 Hamilton Rd.
P.O. Box 317
Duarte, CA 91010
(818) 357-9921
CIRCLE 442 ON READER CARD

Micro Technology Inc. (MTI)
1620 Miraloma Ave.
Placentia, CA 92670
(714) 632-7580
CIRCLE 443 ON READER CARD

Mips Computer Systems Inc.
930 Arques Ave.
Sunnyvale, CA 94086-3650
(408) 720-1700
CIRCLE 444 ON READER CARD

Storage Technology Corp.
2270 S. 88th St.
Louisville, CO 80028
(303) 673-5151
CIRCLE 445 ON READER CARD

System Industries Inc.
560 Cottonwood Dr.
Milpitas, CA 95035
(408) 432-1212
CIRCLE 414 ON READER CARD

Tandy Corp.
1800 One Tandy Center
Ft. Worth, TX 76102
(817) 390-3700
CIRCLE 446 ON READER CARD

Over 2 Gigabytes per SDI Port!

RA
compatible
drives
SMD
& ESDI



EXSYS' RACE ARRAYS

EXSYS SMD and ESDI RACE Arrays provide a formatted disk capacity of over 2 Gigabytes per connection on UDA, KDA, KDB and HSC 50/70 DSA controllers. The EXSYS arrays can replace DEC's RA80, RA81, RA82 and RA90 disk drives, with higher performance and more reliable industry-standard disk drives.

The storage array concept permits users to increase their

storage without increasing the associated controller connections and cost. A full range of transfer rates from 1.2 Mbytes per second to 2.75 Mbytes per second and capacities from 280 Mbytes to over 2 Gigabytes is possible with SMD and ESDI disks. Users may now support over 70 Gigabytes of storage on a single HSC70.



EXSYS Storage Systems, Inc.
1340 Tully Road
San Jose, CA 95122
408/292-0343

* DSA, UDA, KDA, KDB, HSC, and RA are all DEC trade marks.

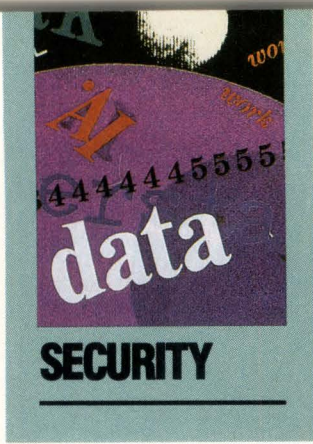

S

ECURITY

CHECKLIST

By Philip A. Naecker

Editor's note: Many of the ideas presented in this article were contributed by various technical editors of

DEC PROFESSIONAL.

Evaluating Your System's Vulnerability To Break-In.

Every time there's a widely publicized breach of computer security, the common complaint system managers hear from management and users is, "Could something like that happen here?" Typically, the answer is, "Well, not exactly like that, but of course everyone is vulnerable to some degree." The degree to which your computer system is vulnerable to a serious security breach depends on many factors, and the effects of a break-in can vary widely.

This security checklist is designed to help computer center management, system managers, security managers and others involved in computer security evaluate their systems' vulnerability. It isn't meant as a be-all and end-all checklist of computer security, but rather as a starting point to help you understand the importance and complexity of computer security. It's also not meant to be a guide for those who deal with information that requires professional computer security, such as systems handling classified government data, financial information or personal information.

However, even for those sites with very important security requirements and carefully planned computer security, there likely will be a few gems in the list that follows.

You'll note that we haven't provided any explanations, motivation or justification for

any of the items. We believe that doing so would unnecessarily reveal potential weaknesses. You should realize that a serious hacker will be fully aware of the implications of each of the checklist items, so you should make it your business to become fully aware as well. If you can't figure these items out on your own, consult with a computer security expert who can help you.

Finally, note that the level of computer security appropriate for your organization depends on the value of the assets in your computer system and the size of the threat to those assets. Thus, the checklist often will contain broad statements such as "appropriate measures" and "suitable actions." As the person responsible for implementing computer security, it's up to you to determine exactly what level of activity is required in these cases.

Basic Security Management

Who's responsible for computer security in your organization? Does everyone know who's responsible? Has management agreed to place the trust for system security in this individual or group?

Do you regularly review your security procedures? Is this scheduled review rigorously undertaken?

Are all your security measures written down? Is that document kept in a secure area with controlled access?

Do you perform a regular review of the security measures and compare them with the documented measures?

What's Wrong With This Picture?

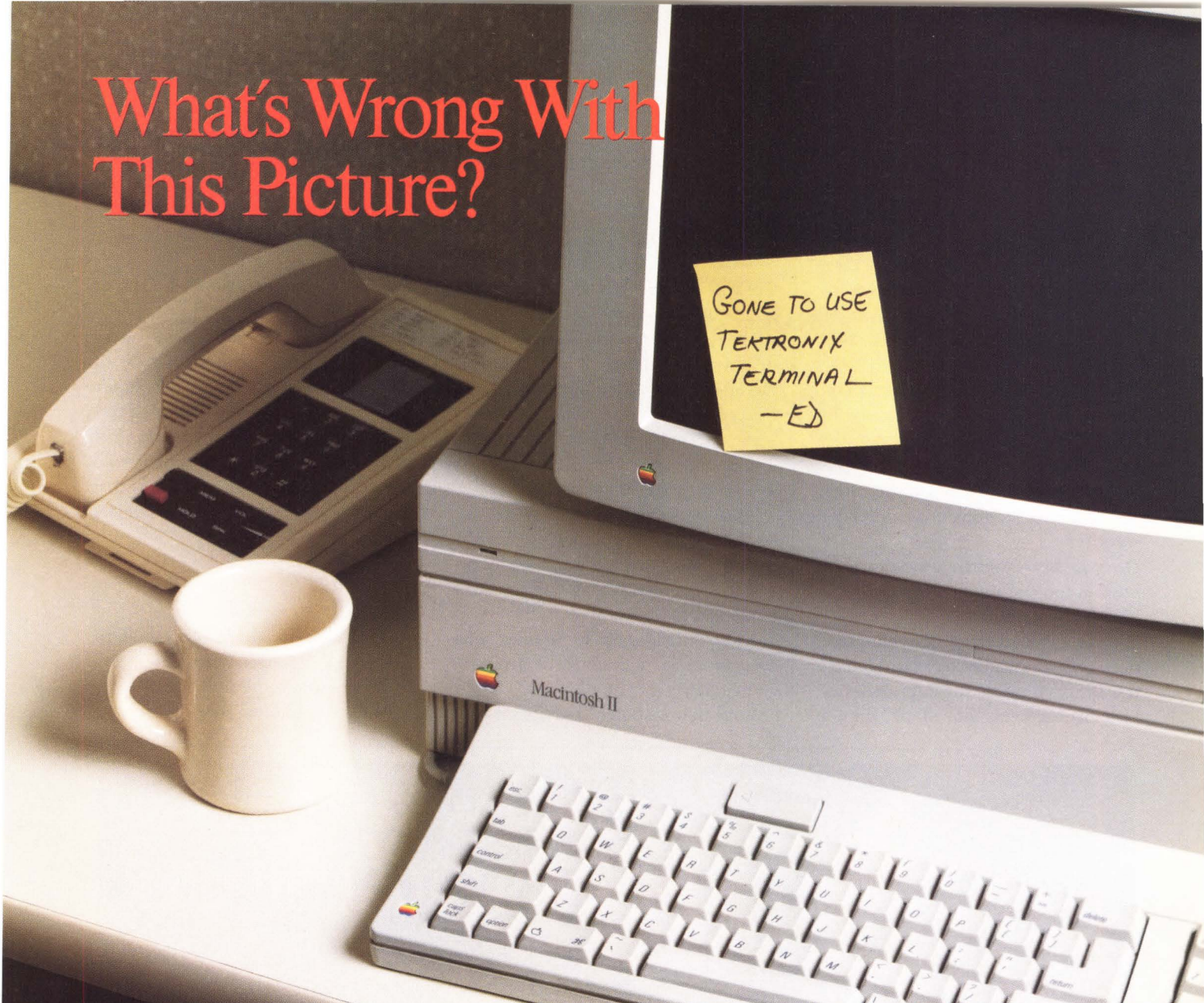

GONE TO USE
TEKTRONIX
TERMINAL
-ED

What's wrong is that Ed could be using his Macintosh II as a powerful Tektronix 4107 graphics terminal, but instead he is off using a graphics terminal in some other part of the building.

If Ed had only known about TGRAF for the Macintosh II, he could at this very instant be logged on to his company's mainframe, right from his desktop with his Macintosh II. Ed could now be running any one of a hundred or so host applications, with his MAC II and TGRAF combination operating as a powerful graphics terminal.

Grafpoint, a leader in Tektronix terminal emulation, now has a powerful 4107 software emulator for the Macintosh II. TGRAF for the Macintosh is a comprehensive emulator that supports all the display features of a Tektronix 4107 terminal in both asynchronous (RS-232-C) and networking communication environments.

TGRAF has the powerful and seamless user interface that Macintosh users have come to expect. TGRAF supports Multifinder, cut & paste, pull-down menus, separate text windows with scroll bars, plus powerful graphics terminal features such as graphics displayed in sixteen on screen colors, full 640 x 480 resolution, 12 bit addressable space, etc.

Find out today what it takes to transform your Macintosh II into a powerful, full-featured graphics terminal. Call us at 1-800-426-2230, in California 1-408-446-1919.

** 30-day no-risk trial available. TGRAF - in addition to the Macintosh product is available for PCs, PS/2s, and workstations.

Apple and Macintosh are trademarks of Apple, Inc. Grafpoint and TGRAF are trademarks of Grafpoint. Tektronix is a trademark of Tektronix, Inc.



GRAFPOINT™

1485 Saratoga Avenue
San Jose, California 95129

Please circle 114 for demonstration. Please circle 275 for additional product information.

Do you have a written protocol for changing the security measures?

Do you have written procedures for all other aspects of computer system operations, including those that may not be related directly to security? Have these written procedures been reviewed by your security manager or security team? Have you performed a complete asset inventory and threat audit?

Have you performed an inventory of the assets that might be compromised by either specific or non-specific security breaches?

Do you know what mechanisms might be used to compromise intended security?

Do you have written procedures for notification and action when a security breach is detected?

Is there a well-defined minimum level of security that the system management team is responsible for implementing? Has management "signed off" on that

security level?

Have you had an outside security audit?

Threat Assessment

Are you in a hostile environment, such as an educational institution in which students have access to either software or physical facilities?

Do other factors increase the likelihood of specific attacks on computer system security? There could be several factors:

1. Personnel problems.
2. Competitive situations.
3. Past security compromises.
4. Security compromises at similar organizations, competitors, nearby installations or installations with any other similarity to yours.

Is your system likely to be interesting to a particular individual or group of individuals?

Is there information or activity on your

system that makes it a likely target for hacking? This information could be of several types:

1. Financial.
2. Competitive.
3. Personal.
4. Confidential or classified data or activity.

Does the nature of your system require that it be exposed to known areas of high risk? For example, you may require that your system be available on a frequently compromised network, that guest accounts be provided to users with little or no background checking or that modem phone numbers be widely publicized.

Damage Potential

Are your computer systems used for:

1. Accounting?
2. Private communication?

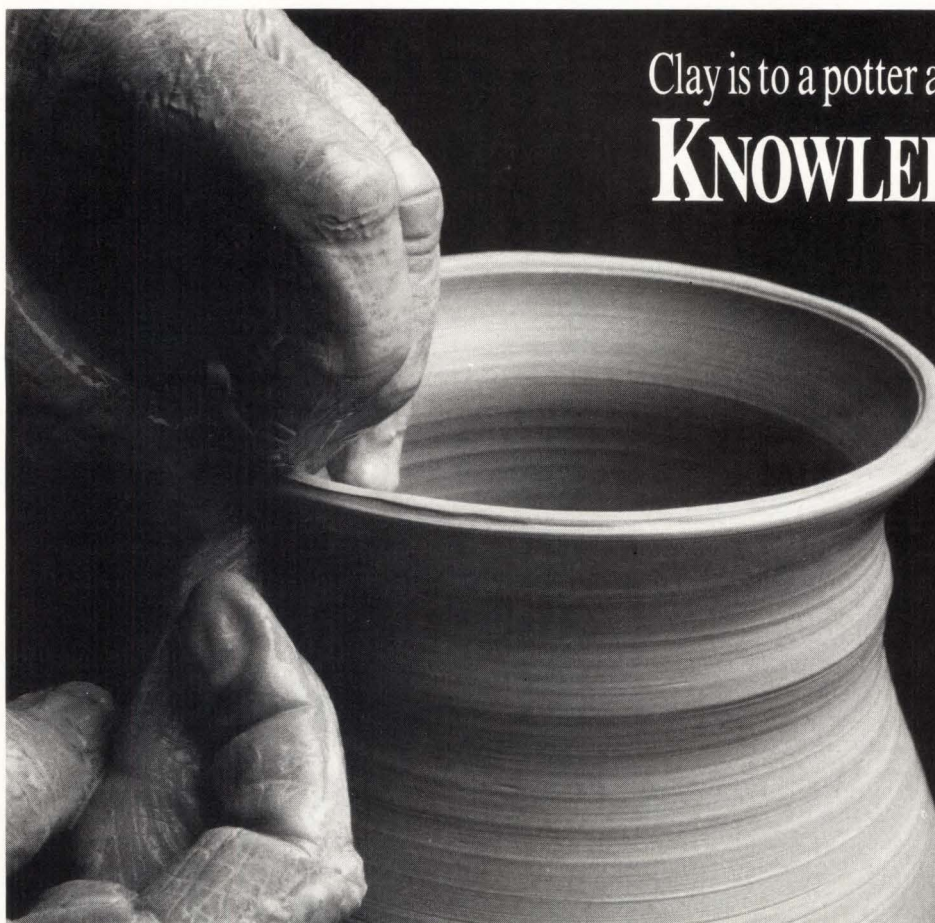

Clay is to a potter as expert knowledge is to...

KNOWLEDGE SHAPER™

- An expert systems design and development environment
- A software system for knowledge manipulation
- A knowledge base validation and verification tool
- Available for VAX/VMS and Sun/SunOs

perceptics®

A.I. Applications Division
725 Pellissippi Parkway
Knoxville, TN • 37933-0991
615/966-9200 • FAX 615/966-9330

VAX and VMS are trademarks of Digital Equipment Corporation.
Sun and SunOs are trademarks of Sun Microsystems.

CIRCLE 298 ON READER CARD

The SAS[®] System

The Graphics Tool You Won't Outgrow.

When you've got to turn those numbers into a presentation, turn to the SAS[®] System. The SAS System includes easy-to-use procedures for charts, plots, maps, and three-dimensional displays. At a glance, you can grasp detailed statistics, spot relationships among items, and trace emerging trends. And when your manager wants more, the SAS System lets you customize your graphs and present multiple displays on the same page for easy comparison. You can produce your graphs on terminals, plotters, transparencies, or slides.

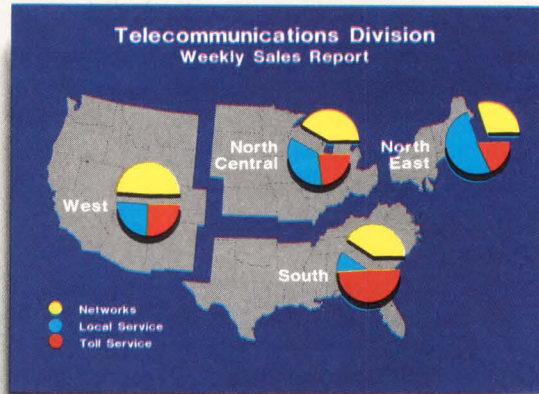

You can even use the SAS System to analyze your data before you present them. We've got tools for every kind of analysis—from simple descriptive statistics to advanced regression, analysis of variance, discriminant analysis, clustering, scoring, and more.

And as your needs grow, the SAS System grows with you. All the tools you need for full screen data entry, modeling, forecasting, "what if" analysis, project management, optimization, and quality control are

available in the SAS System. You choose the products you need, and enjoy the same easy-to-use language and syntax in each. Whether you license one product or several, you'll enjoy the same high-quality software, training, documentation, and

support we've offered for more than ten years.

For details, send us your name and address. Or call a Software Sales Representative today.

The SAS System. It's for those who need a graphics package today, and for those who have an eye on tomorrow.



SAS Institute Inc.
Box 8000 □ SAS Circle
Cary, NC 27511-8000
(919) 467-8000
Fax (919) 469-3737

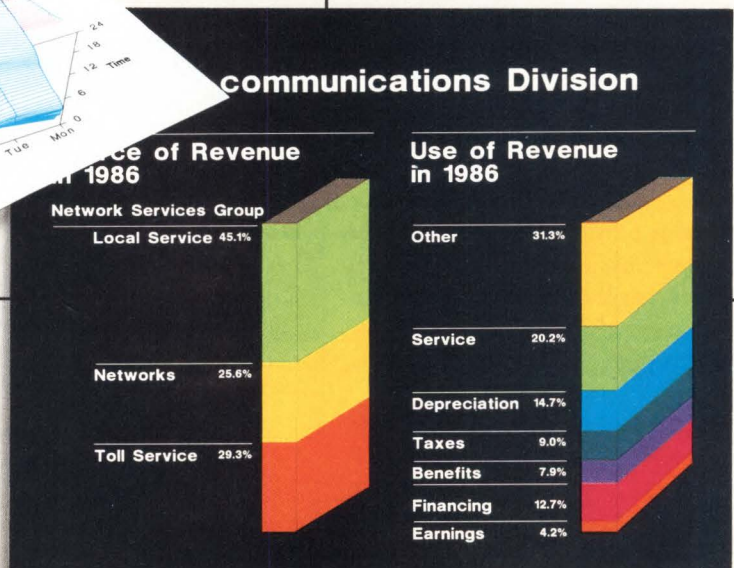
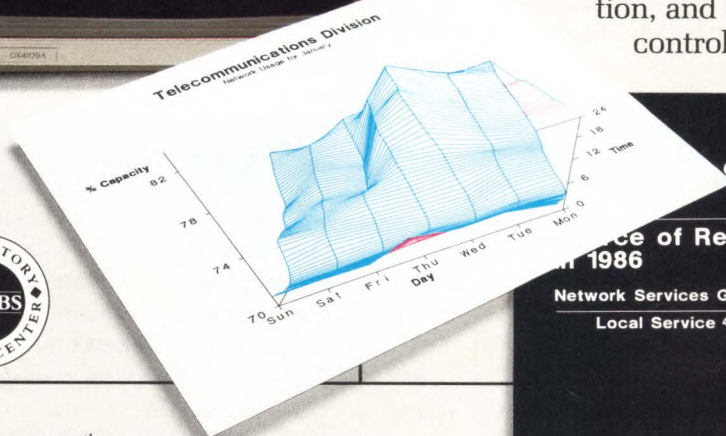
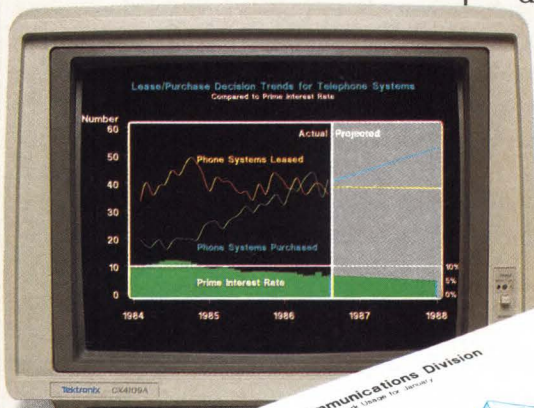

The SAS System runs on these minicomputers: Digital Equipment Corp. VAX[™] 8xxx and 11/7xx series under VMS[™] and MicroVAX II[™] under MicroVMS[™]; Prime Computer, Inc. Prime 50 series under PRIMOS[®]; and Data General Corp. ECLIPSE[®] MV series under AOS/VSE. The SAS System also runs on IBM 370/30xx/43xx and compatible machines under OS, CMS, DOS/VSE, SSX, and ICCF; IBM XT/370 and AT/370 under VM/PC; and IBM PC XT and PC AT under PC DOS. Not all products are available for all systems.

3. Project management?
4. Engineering?
5. Information that must by law be kept confidential, e.g., personal data, personnel information, government data and so on?

What's the daily operation of the company?

What's the result if data on the system is partially or totally compromised?

How frequently are backups made?

Is the original system software distribution media secure and available?

What might be the impact of multiday downtime for all computer systems in your organization?

What would be the cost of:

1. Missed production?
2. Idle facilities and personnel?
3. Possible legal implications?

Does your organization carry insurance that covers damage to computer systems operations or data? What specifically does it cover? What are your obligations under the policy? Are your obligations made part of the written system management and security procedures?

Physical Security

Is the computer room kept locked at all times?

Do you strictly limit access to physical computer facilities?

Do you have a list of the owners of keys for all secure areas? Is that list reviewed regularly?

Is the system console in a secure area? Do you have written procedures that determine who shall gain physical access to computer facilities?

Does your janitorial staff have access to secure areas?

Have you taken specific steps to minimize potential damage from vandalism, either by employees or individuals outside the company?

Does your physical security depend on electricity, telephone or other utilities to operate correctly?

Have you performed a physical security audit?

Does your physical security plan include

an evaluation of non-human compromises of physical security, such as:

1. Water damage?
2. Earthquake damage?
3. Wind damage?
4. Environmental support failure?
5. Electromagnetic discharge?
6. Rodents, insects or biological growths.

Does your physical security plan include security for and disposal of printed output that may contain sensitive information?

Backup & Data Storage Media

Is your on-site backup storage kept in a secure vault?

Do you have a written protocol for moving media into or out of your secure vault?

Do you keep written records of the movement of media? Are those records secure?

Is the media vault provided with an alarm for both fire and unauthorized entry?

Do you allow users access to media such as tape drives and removable disk drives?

Do you have written procedures that determine who shall gain physical access to media?

Where do you leave off-site backup media while awaiting pickup or taking delivery?

Does your backup plan include both archival and rotating storage?

Has your backup plan been reviewed by outside experts?

Disaster Protection

Do you have a disaster plan?

Have you performed a dry run of disaster recovery?

Do you have a specific plan for off-site backup?

Do you regularly place backups off site?

Has your disaster plan been reviewed by outside experts?

Communications & Modems

Are all wiring closets kept locked at all times?

Do you have a notification mechanism that keeps you informed of activities by telephone company employees or others who might work on the communications lines on your premises?

Do you have Ethernet? Are there ways for unauthorized persons to connect devices to your network?

Do you have modems connected to your system?

Do you have a program for regularly monitoring modem activity?

Do you regularly check modem wiring and operations to make sure that hang-up disconnects the modem properly and that a disconnected modem doesn't leave a connected user process?

Do you allow users to modify modem hang-up characteristics?

Do you have a modem connected to the system console port?

Do you have terminal ports that are accessible to non-privileged users? Can those ports also be used to log in by, for example, a modem that's used both for dial in and dial out?

Do you have a protocol for regularly changing modem phone numbers and a secure method of distributing new phone numbers to users who know them?

Do you isolate classes of modem users, or do you share a pool of modems among users of different security levels and system requirements?

Access

Do you require at least six-character-minimum passwords and at most 30-day password expiration times?

If you use VMS, do you use VMS break-in detection and evasion procedures?

Do you have a tool for testing for obvious passwords?

Do you have system passwords enabled on your modem ports?

Do you advertise your system's name or function before a user logs in, for ex-

OPTICAL ILLUSION

Solution

It's not an illusion. Perceptics Corporation, the leader in VAX/VMS optical storage subsystems, has the solution to your data storage needs. The Perceptics LaserSystem and LaserStar subsystems offer true magnetic disk emulation, and can give you hundreds of gigabytes of on-line storage from one subsystem.

The reality is that no one in the industry can give you a more proven product with these features and this much storage capacity. Perceptics has over 500 optical subsystems in use worldwide and is a leader in optical disk jukebox subsystems. The Perceptics subsystems allow the optical storage device to be used as a "plug and play" peripheral.

LaserSystem is a complete, integrated, ready-to-use optical disk subsystem, including write-once read-many (WORM) optical disk drive, SCSI host adapter and industry standard LaserWare optical disk software. Media, installation, and on-site maintenance services are also available.

LaserSystem stores up to 2.4 gigabytes of data on a removable cartridge and features true magnetic disk drive emulation, so existing software and

applications require no modification to access the massive storage capacity of optical disks.

LaserStar extends the emulation features of LaserSystem to the optical disk jukebox, allowing on-line access of up to 338 gigabytes of data, using the same VAX/VMS transparent file system as LaserSystem.

Applications include:

- CAD/CAM Storage and Retrieval
- Records Management
- Medical Imaging
- Seismological Data Storage
- Large On-Line Database
- Satellite Image Storage

perceptics

725 Pellissippi Parkway
Knoxville, TN 37922
615/966-9200
FAX 615/966-9330

LaserStar, LaserSystem and LaserWare are trademarks of Perceptics Corporation.
VAX, VMS and MicroVAX are trademarks of Digital Equipment Corporation.

Signal Processing

Financial
Modeling

Electronic
Publishing

Computational
Physics

Medical
Imaging

Remote Sensing

Image Processing

Real-Time
Simulation

Vibration
Analysis

Seismic
Processing

Well Logging

Transform your MicroVAX into a Super- Workstation

... the new MAP-4000 Application Accelerator does just that! Its three boards plug directly into the back-plane of your MicroVAX, transforming it into a formidable math engine.

MAP-4000's global optimizing FORTRAN-77 compiler and extensive VMS-like debugging software help get your program up in a hurry, and its VAST[®]-2 pre-processing compiler transparently optimizes your code with automatic calls to our Scientific Subroutine Library of over 500 functions.

The MAP-4000 performs a 1024 Complex FFT with bit reversal in 1.4 milliseconds. You get 40 MFLOPS single-precision or 20 MFLOPS double-precision performance, and your application will run 10 to 100 times faster, depending on the amount of vectorizable code.

MAP-4000's basic configurations include either 2 or 8 Mbytes of memory. Up to 40 Mbytes of additional memory are available, and there's address space for up to 1/4 gigabyte for future expansion.

MAP-4000 prices start at \$18,995* —that's \$475/MFLOPS!

Find out about the MAP-4000 advantage. To receive your free 12-page brochure, call 1 800 325-3110 (in Massachusetts, 617/272-6020), or write CSPI, 40 Linnell Circle, Billerica, MA 01821. FAX: 508/663-0150.

*quantity one, with 2 Mbytes of memory.

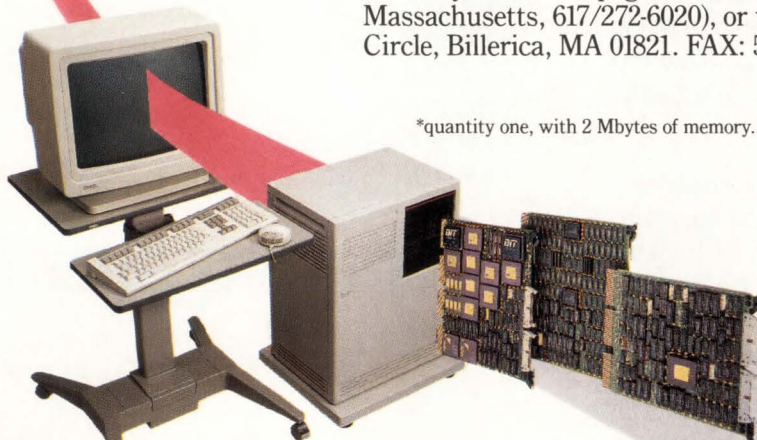

CSPI
THE ARRAY PROCESSORS

digital
Cooperative Marketing
Program

MAP-4000 is a trademark of CSP Inc.
MicroVAX and VMS are registered trademarks of Digital Equipment Corporation.
VAST-2 is a registered trademark of Pacific-Sierra Research Corporation.

CIRCLE 187 ON READER CARD

ample in a log in notice or on a terminal server?

Do you publish (electronically or otherwise) usernames and the associated people?

Are there any captive accounts on your system?

Have you taken steps to verify that captive accounts are really captive and that they will stay that way?

Do you regularly audit the important features of a captive account that keep it captive?

Who receives reports of captive account activity?

Are there any guest accounts on your system?

Do you report last log in times and log in failures to users when they log in?

✓ Network Security

Is your computer system connected to a network?

Is your network easily accessible from outside your organization? For example, do you use a public X.25 network for networking?

Are all the systems on the network professionally managed, or are there some systems that are run by users (e.g., PCs) or non-computer professionals (e.g., departmental systems)?

Does your computer security staff have regular meetings with the security staff of other systems on the network?

Do you have a way to isolate your system from the network quickly should there be a threat from the network, or do you depend on the network for basic operations?

Do you allow proxy network access to privileged accounts?

Do you share system files, software or other data with non-secure systems?

If you run a non-homogeneous VAX-cluster, do you have equal security on all nodes in the cluster?

Do you know which parts of your net-

work might be compromised? Do you keep this information up to date?

Do you have a LAN monitor or other mechanism for locating all the devices on your Ethernet?

If you need a very secure network and your physical environment may be compromised, do you have a time domain reflectometer and procedures for using it to check for unauthorized connections to the network?

✓ Public Software Security

From a privileged account, do you use software obtained from sources other than a reputable system software vendor, such as downloads or user-written code?

Do you use such software without having access to the source code?

Do you use such software without first building the executables from controlled source code?

COMPUTER
Clayton
SYSTEMS

FACTORY REFURBISHED

 CDC DISK DRIVES
 CIPHER TAPE DRIVES
 DATA PRODUCTS PRINTERS
 FUJITSU DISK & TAPE DRIVES

YOUR #1 SOURCE CALL NOW FOR BIG SAVINGS

Clayton Computer Systems
271 Opportunity Street, Suite 1
Sacramento, California 95838
916 · 925 · 5727
FAX (916) 925-7340

 DIGITAL DEALERS ASSOCIATION
 MASTERCARD
 VISA
— ACCEPTED —

CIRCLE 274 ON READER CARD

DIRTY TAPES?



MAGNETIC TAPE CLEANER/REWINDER

PERIPHERALS

A High Technology Company

1363 Logan Ave.

Costa Mesa, CA 92626

Headquarters 714-540-4925

Outside CA. 1-800-468-6888

FAX 714-540-2026

CIRCLE 287 ON READER CARD

Do you test such software in a controlled environment first?

Do you carefully check the source code before using it?

Is any public software installed with privileges?

Do you regularly review the privileges and installation parameters of installed software packages?

File & Database Management

Do you use ACLs and identifiers to protect VMS files, devices and other system resources?

Do you use ACLs to monitor access by privileges to sensitive files?

Do you use ACLs on the system authorization file?

Do you use a DBMS? Does your DBMS provide user authentication and data access protection controls beyond those provided by the operating system? Do you use this facility?

System Management

Do you have written procedures for adding and removing user accounts? Do those procedures require formal authorization and the signature of the user?

Do you have written procedures for providing elevated privileges to users? Do you follow a regular procedure for reviewing privileged accounts?

How do you delete a user's files from your system? Are you aware that there are security implications to deleting a user's files?

User Monitoring

Do you have automated procedures for ensuring that users don't leave terminals unattended for long periods of time?

Do you have procedures and tools for monitoring user activity? Are these tools sufficiently protected?

Do you audit user access by time of day, location (e.g., local or modem) and type of activity?

Do you use a resource chargeback system to recover costs of user activity?

Are those activity reports made available to responsible individuals in a timely fashion?

Do you use the available user activity tools (e.g., the SYSUAF and ACCOUNTING utilities on VMS) to monitor user activity?

Have you decomposed the user monitoring problem into small user communities so that the monitoring person is familiar with normal activity and recognizes abnormal activity?

Is it easy to associate a username with a particular user so that activity on a particular account will be suspect if the user is known to be on vacation or otherwise unavailable?

Do you have automated procedures for checking for user activity or inactivity and comparing it with established norms for each user or class of users?

Do you have both publicized and non-publicized user monitoring procedures?

Security Monitoring

Do you regularly checksum protected directories?

Do you assign unique UICs to users so that you can attribute activity specifically to a user?

Do you regularly attempt a break-in against your major known points of security vulnerability?

Do you regularly audit captive accounts activity?

Do you have appropriate levels of security alarms? Too few alarms will miss probing or the compromise of sensitive files or resources. Too many will mask important events in minutiae.

Education

Do your users get regular education on their role in computer security?

Do you educate your users on the

security controls available to them?

Do your users understand the importance of protecting the one-person-per-account rule?

Do your users understand the importance of the last log-in time and number of log-in failures messages?

Do your users know who to contact if they suspect a computer security problem?

Are both system management and security management personnel intimately familiar with the security documentation for the operating system? Do they review it regularly and with each new release of the documentation?

Do you have a mechanism to keep your system management and security management personnel apprised of security lapses in the operating system software? Have your system security personnel attended seminars and other educational opportunities to learn about computer system security?

Do you require minimum computer security education before you allow users to perform tasks that are security sensitive, such as system management, privileged account access and handling of backup media?

Have you held a computer security seminar for company management, the personnel department and the security department?

Personnel Procedures

Do your personnel handbook, employment agreement and other personnel documents cover employee use and misuse of computers and related systems?

Do job descriptions and hiring practices carefully identify employees whose responsibilities make them potential security risks?

Do you perform appropriate background checks on your employees before you hire them, especially

Three VAX problems you won't have to **JUGGLE...**

- **Disk Space**
- **Disk Performance**
- **Data Security**

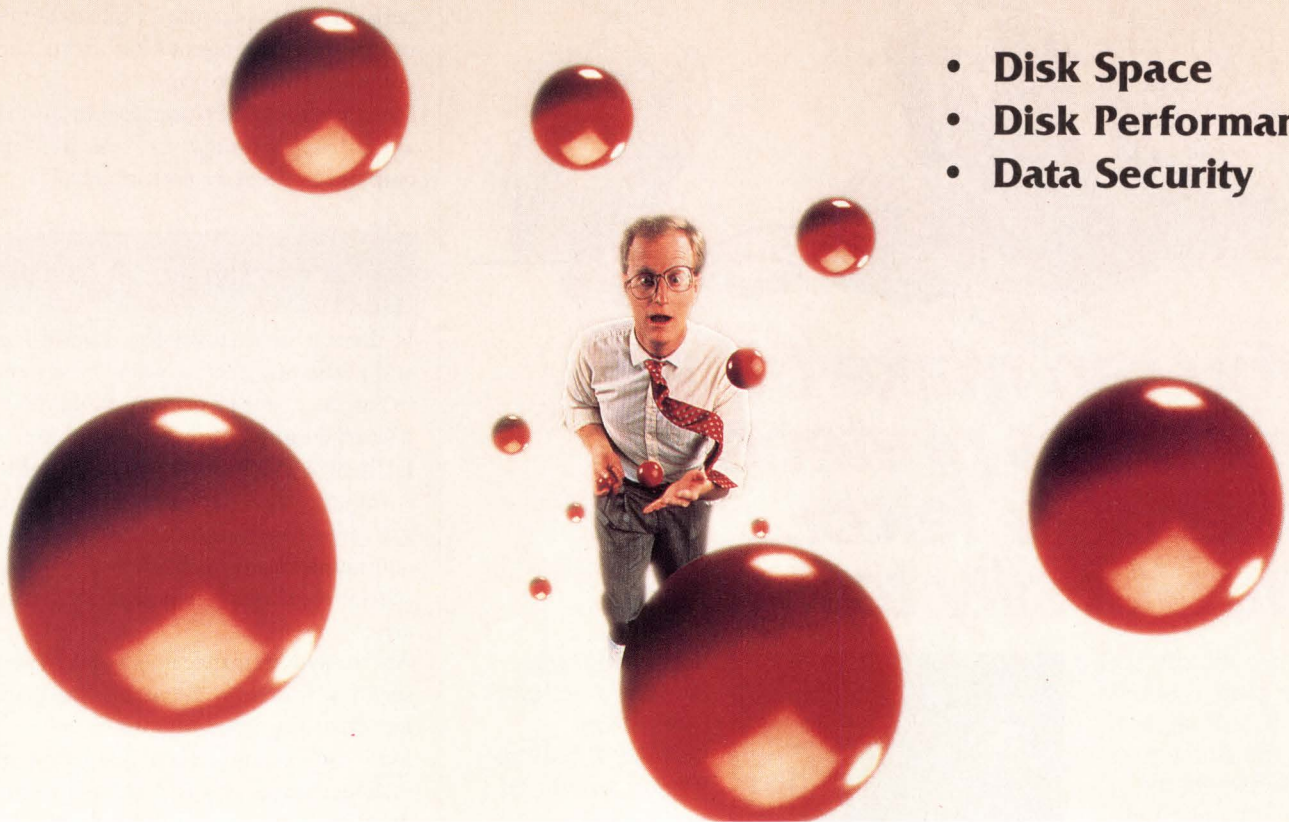

Recover Wasted Disk Space

Disk space wastage is costly in terms of both hardware expenses and VAX/VMS performance. PAKMANAGER* analyzes your disks to help you quickly pinpoint and remove those elusive space and performance "stealers" created unintentionally by system users. With PAKMANAGER, you realize major hardware savings and get the most from your valuable disk resource.

End Disk Fragmentation

Disk fragmentation is a widely recognized cause of degraded VAX/VMS performance. SQUEEZPAK*, our powerful disk defragmenter, works transparently and online to eliminate fragmentation quickly and conveniently. Simple to install and use, SQUEEZPAK is the proven, safe and effective answer to the problem of costly disk fragmentation.

Secure Your Data

Protecting valuable disk data is a prime concern at many sites. SECUREPAK simplifies and automates key aspects of your security management program, from initial setup to monitoring and audit. SECUREPAK's concise reports and powerful query functions expose and help correct weaknesses in your security setup. SECUREPAK opens the way to better security with less effort.

**See for yourself! All DEMAC products are available for a FREE trial!
Contact us today for YOUR disk management solution!**

US/Canada: 1-800-267-1590

* available under
GSA schedule

DEMAC
SOFTWARE

Excellence in System Utilities

ITALY: C.H. Ostfeld, S.A.S., Milan 545-9682 BENELUX: Computing & Systems Consultants, Eindoven 043-4957 NORWAY: Fraser & Co A.S., Oslo 51-9785 FRANCE: INFI, Viroflay 302-41344 AUSTRALIA: Kairinski & Associates, St. Leonards 436-4477 GERMANY: Tauris Data, Wiesbaden 509392 ENGLAND: XDT Computer Systems, Notts 077-5295 Zeia Systems, Bristol 279-398 ISRAEL: Shemer Computers, Ramat-Gan 724287

CIRCLE 183 ON READER CARD

employees with special access to computer systems, such as privileged users and operators?

Do you include evaluation of computer security consciousness in the regular employee performance reviews?

Do your system management procedures include procedures to be per-

formed when an employee's status changes, such as through a promotion, change of department or job function, or termination? Is your system manager automatically notified of these events by the personnel department?

Do your organization's training procedures for supervisors and other

management personnel specifically address computer security issues?

Do you regularly remind supervisors of their responsibility to report employee problems, especially employee termination with prejudice, to the computer security authorities?

Is your personnel department aware of the relationship between employee morale and computer security, especially threats to security?

Does your organization's personnel department or personnel policies committee have representation from the computer security team?

Does your organization use vacations as an opportunity to evaluate an employee's security performance?



You can make other modems pretend they're a Telcor. But it's silly to try.

Sure, you can speed up other modems with special software. And you can add expensive security and network management devices.



But why waste your time? Telcor modems provide faster and more secure access to your VAX than any other modems . . . at a remarkably low cost.

There are simply no other asynchronous dial modems like Telcor's. They're the world's fastest—up to 38.4K bps. They provide password/callback security, DES encryption and a complete audit trail of VAX

access attempts. And they conform to all major industry standards. It takes a demo to really appreciate the ease and efficiency Telcor

modems will deliver to your VAX operations, day after day. Call us toll free in the U.S. at 1-800-826-2938. Elsewhere call 1-508-653-3995. We'll have your local distributor schedule a demo right away.



TELCOR
SYSTEMS
CORPORATION

the world's fastest dial modems

VAX is a registered trademark of Digital Equipment Corporation.

CIRCLE 219 ON READER CARD

✓ System Management Security

Is there a mechanism for monitoring and evaluating the activities of system managers, security managers and other trusted computer security personnel?

Is there a mechanism for responsible computer security personnel (e.g., system managers, security managers and communications technicians) to take special measures when security issues arise?

Are the system management and system security functions separate? Do they report to the same person?

Do you compartmentalize system management access and access to production data, operations information that might be used to compromise a security system, or other sensitive information?

Does your organization have a policy of cross-training computer security personnel so that the loss of a single employee doesn't compromise computer security?

As you can see, there are many questions on our security checklist. Each points to a problem area which, if ignored, could cost you dearly.

ARTICLE INTEREST QUOTIENT
Circle On Reader Card
High 564 Medium 565 Low 566



SOFTWARE SUPPORT INCLUDES DETAILED DOCUMENTATION, PROFESSIONAL TRAINING, HOTLINE SUPPORT, FREQUENT SOFTWARE UPDATES, AND ANNUAL USER CONFERENCES.

MODELS CAN BE DIRECTLY LINKED TO THE SPATIAL DATA BASE TO SUPPORT SOPHISTICATED DECISION ANALYSIS.

MAP DATA IS STORED EFFICIENTLY IN A SIMPLE AND LOGICAL NETWORK OF RELATIONSHIPS.



ARC/INFO ■ *THE TOTAL SOLUTION FOR GEOGRAPHIC INFORMATION MANAGEMENT* ■ NOW YOU CAN EASILY MANAGE ANY FORM OF GEOGRAPHIC INFORMATION USING FRIENDLY AND POWERFUL GIS SOFTWARE TOOLS. OUR ARC/INFO SYSTEM LETS YOU EFFICIENTLY AUTOMATE, ANALYZE AND DISPLAY SPATIAL DATA FOR A WIDE VARIETY OF APPLICATIONS. THIS INFORMATION IS AVAILABLE AT YOUR FINGERTIPS FOR QUICK QUERIES OF THE DATA BASE OR FOR PRODUCING QUALITY MAPS AND TABULAR REPORTS. ■ ARC/INFO IS DESIGNED TO SUPPORT NON-TECHNICAL PERSONNEL IN MAP MAKING AND PERFORMING SPATIAL ANALYSES. THE LANGUAGE CONSISTS OF ENGLISH-LIKE TERMS SUCH AS "OVERLAY" WHICH CAN BE SELECTED USING PULL-DOWN MENUS AND POP-UP SIDEBARS. ALSO INCLUDED IS THE ARC MACRO LANGUAGE, A MACHINE INDEPENDENT COMMAND LANGUAGE USED FOR EXECUTING A SERIES OF COMMANDS AT ONE TIME. ■ ARC/INFO'S ANALYTICAL CAPABILITIES INCLUDE POLY-

GON OVERLAY, BUFFER CREATION, NETWORK ANALYSIS, ADDRESS GEOCODING, THREE-DIMENSIONAL MODELING, CIVIL ENGINEERING FUNCTIONS AND MORE. PLANNERS AND ENGINEERS USE THESE TOOLS TO MODEL REAL-LIFE SITUATIONS AND PROVIDE PROJECTIONS OF FUTURE TRENDS. ■ FOR EXAMPLE, CITIES AND COUNTIES USE ARC/INFO TO MAP PARCEL AND STREET INFORMATION AND RELATE IT TO BUILDING PERMIT DATA, SEWER AND WATER LINES, BUS ROUTES, POLICE BEATS, AND OTHER RELATED

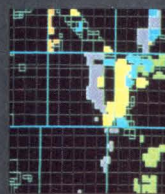

SOME OF THE MANY applications of ARC/INFO include natural resource management, marketing/demographic analysis, automated mapping/facilities management, forest management, urban and regional planning, environmental monitoring, petroleum exploration, mapping and surveying, agricultural suitability assessment, tax mapping, transportation planning, census mapping, education and research, and numerous other applications.

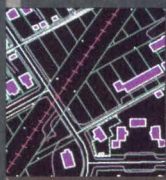

DECISION-MAKERS, AND OTHERS WHO REQUIRE UP-TO-DATE AND ACCURATE INFORMATION IN THEIR JOBS. ■ THESE ARE JUST A FEW OF THE WAYS YOU CAN USE ARC/INFO IN YOUR ORGANIZATION. FOR MORE INFORMATION, CONTACT: ESRI MARKETING DEPT., 380 NEW YORK STREET, REDLANDS, CALIF., 92373, 714-793-2853.



ARC/INFO WORKS on several mainframes, minicomputers, workstations and microcomputers. It also supports a variety of geographic hardware devices for input and display.

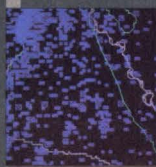

IN MAP MAKING AND PERFORMING SPATIAL ANALYSES. THE LANGUAGE CONSISTS OF ENGLISH-LIKE TERMS SUCH AS "OVERLAY" WHICH CAN BE SELECTED USING PULL-DOWN MENUS AND POP-UP SIDEBARS. ALSO INCLUDED IS THE ARC MACRO LANGUAGE, A MACHINE INDEPENDENT COMMAND LANGUAGE USED FOR EXECUTING A SERIES OF COMMANDS AT ONE TIME. ■ ARC/INFO'S ANALYTICAL CAPABILITIES INCLUDE POLY-



ESRI PROVIDES CONSULTING services for data base design, user needs assessments, data analysis and modeling, data automation and custom application programming.

GEOGRAPHIC DATA. BIOLOGISTS USE MAP MODELING TOOLS TO ANALYZE WILDLIFE BY OVERLAYING MAPS OF VEGETATION, WATER SOURCES, TOPOGRAPHY, AND LAND USE. THE RESULTING MAPS AND REPORTS PRESENT A CLEAR PICTURE OF THE INFORMATION TO FIELD RESEARCHERS,

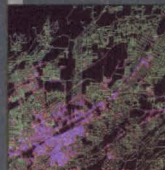

IT WORKS FOR YOU

arc/info language system
ESRI

CIRCLE 244 ON READER CARD



VMS MEETS UNIX

By John D. Deans

How The Two Operating Systems Can Learn To Interact.

In the scientific and engineering computing community, the two most widely used operating systems are VMS and UNIX. VMS runs on systems from the VAXstation 2000 to the high-end VAX 8800. Recently, the finely tweaked VMS has been learning to interact with terse, yet robust, UNIX. These two quite different operating systems have been pushed into near cohabitation over the last couple of years and will be even more so in the future. VMS and UNIX now must share and share alike.

There's just one VMS since that wimpy MicroVMS has been canned. Version 5.1 solves shortfalls associated with version 5.0: for example, it supports DECwindows and the VAX 6300 series. UNIX, on the other hand, comes in two flavors: 4.2 BSD and System V. Vendors have used both as OEMed operating systems, such as Convex UNIX, based on 4.2 BSD, and IBM AIX, based on System V. For our purposes, UNIX is a generic name.

The Ethernet Pathway

Most, if not all, VMS/UNIX configurations use TCP/IP. Ethernet is the backbone of communication between VMS and UNIX. On the hardware side, an Ethernet interface (controller board) usually is required on both ends, such as Excelan or Interlan on the UNIX/VMS side and DELNI or DELQA strictly for the VMS side.

The choices in cable have grown to four: ThickWire, ThinWire, twisted-pair and fiber

optic. The most widely used are ThickWire and ThinWire. Some configurations have a mixture of both. For example, a DELNI connecting multiple VAXs using ThickWire can have a ThinWire MESTA (ThickWire to ThinWire transceiver) to permit ThinWire to be attached to it. The ThinWire then connects a few UNIX-based systems, such as an IBM-RT and an Intel IPSC2.

Be the systems VMS or UNIX based, either can use ThickWire, ThinWire or both, as long as the correct hardware is used and its limitations are kept in mind. An advantage of ThickWire is that the LAN doesn't come down when you disconnect it. But ThickWire is bulky, more expensive than ThinWire, has clumsy vampire clamps and length and number of taps limitations. The advantages of ThinWire are lower cost, it's less bulky, and it allows farther distance and taps. But if there's a lack of proper termination (unplugged cable) in the ThinWire, the LAN hangs.

Ethernet monitoring is essential when you get both VMS and UNIX system chattering on the same LAN, especially when there's a problem. Say you have 20 VMS VAXs and a half-dozen UNIX systems plus a couple of terminal servers on one LAN, and the LAN hangs. When Ethernet LAN, your VMS-UNIX backbone, hangs, a LAN analyzer can be a life saver. Some monitoring can be done from the VMS side via MONITOR NET and NCP. Although they only display information on the DECnet protocol running among your VMS systems, you can determine if that local VMS system is the culprit.

MICROVAX III TO THE MAX!

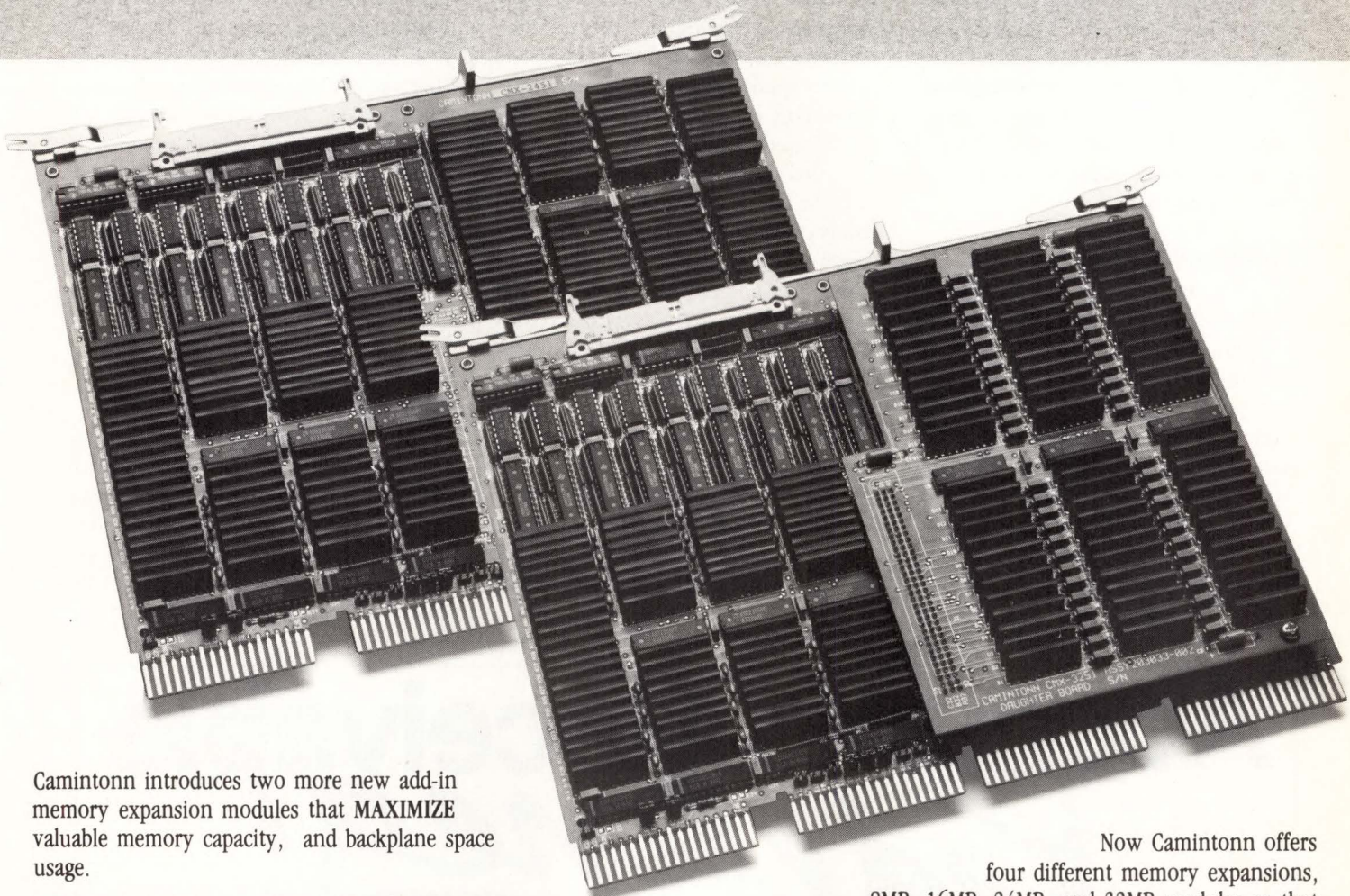

Camintonn introduces two more new add-in memory expansion modules that **MAXIMIZE** valuable memory capacity, and backplane space usage.

CMX-2451 emulates an 8MB and a 16MB board on a single low-profile module providing 24MB of memory where board space is limited.

CMX-3251 emulates two logical 16MB boards on a single DEC module with a daughter board to produce 32MB of memory.

- Hardware, software, and diagnostics compatible with DEC's MicroVax/VAXstation 3xxx Series Q-bus CPU.
- State-of-the-art design with high-speed, high-density, low-power 1 megabit DRAM technology on single quad-width modules, and a dual-width daughter board.
- 39 bit wide memory - 32 bits for data, plus seven bits for error detection and correction (EDC) for ultimate reliability and data integrity.

Now Camintonn offers four different memory expansions, 8MB, 16MB, 24MB, and 32MB modules so that you can take **MAX** advantage of your MicroVAX/VAXstation 3xxx system's 64MB memory addressing capacity.

CMX-851, CMX-1651, CMX-2451, and CMX-3251 are available for immediate shipment.

Of course you get the quality and reliability of Camintonn engineering and manufacturing; plus, a five year warranty, and the security of our 24-hour replacement or repair policy.

For more information, or to order;
CALL 1-800-843-8336

Western Regional Office (714) 553-0247

Eastern Regional Office (617) 871-7718

The Camintonn logo is a registered trademark of Camintonn Corporation.
DEC and MicroVAX/VAXstation 3xxx are trademarks of Digital Equipment Corporation. Copyright 1989
Camintonn Corp. All rights reserved.

Price/Performance leaders in memory and communications products for the DEC environment

CIRCLE 102 ON READER CARD

CAMINTONN

2332 McGaw Ave, Irvine, CA 92714

A few tools on the UNIX side can view Ethernet activity, depending on the type of system. For example, Convex and Sun offer capabilities to tell you things about your LAN. Again, a non-bias standalone LAN analyzer can be a great troubleshooting and tuning tool. There are also terminal servers on the market that connect to both VMS and UNIX systems, such as Xyplex (see Figure, pointer B).

Peripheral Sharing

Certain devices work better and are more available for certain systems. The peripherals available for VMS systems far outnumber those available for UNIX systems. UNIX peripherals, such as tape drives, printers and plotters, are out there, but interfaces and drivers usually are provided only by that UNIX system vendor, which makes the choices slim.

For argument's sake, let's take your VMS VAX with its printers and plotters that have been performing well for

years. You just got a new UNIX-based Stellar that can do amazing graphics and vector computations, but there's one problem: There was no printer or plotter purchased for it. But because both systems are on Ethernet, printer and plotter spoolers can be written or purchased to use those dependable VMS VAX-based devices.

One quick way to do this is to have a C-shell script on the UNIX system that transfers the file via File Transfer Protocol (FTP) through the Ethernet to be printed or plotted to a target spooler directory on the VMS system. Then a simple detached process (daemon) on the VMS system finds the spooler file newly transferred from the UNIX system (Stellar) and either queues it to the printer or rasterizes and plots it. Also available on the market are network printers, such as Talaris. These printers reside on Ethernet and can serve both UNIX and VMS systems (see Figure, pointer A).

Another situation could be that your software development is based on your VAX, and you need to port your code to an Apollo 3500 (UNIX-based, both 4.2 BSD and System V). The source code can remain on the VAX source disk that's accessible to the Sun via the DEC Network File System (NFS). This means that you'll soon be able to mount the VMS disk on the UNIX system and vice versa. This will provide the ability to use VMS BACKUP to back up UNIX files to tape on the VMS system or, using UNIX tape archiver (tar), to back up VMS files on the UNIX system.

Number Crunchers And Workstations

One example of dispersed capabilities is a compute-intensive system that crunches numbers and feeds the results to another system for visual display, such as a picture on a color monitor or plotter. VMS and UNIX environments offer both ends of this spectrum.

Accounts Receivable *Redefined!*

Compu-Share introduces the accounting package that makes "accounts receivable" *obsolete!*

The Receivables Management System

For more information... **CIRCLE 271 ON READER CARD**

(see it at DEXPO booth 1313)

I want to learn more about Compu-Share, the Receivables Management System, and your other accounting/distribution applications. Please:

send information call me to further explain

Name _____ Title _____

Company Name _____

Address _____

City _____ State _____ Zip _____

Business Phone _____

Annual Revenues (millions) under \$10 _____ \$10-100 _____ \$100-250 _____ over \$250 _____



Compu-Share
Business Management Systems

5214 68th Street
Lubbock, Texas 79424

1-800-356-6568

“ACC’s Ethernet bridge guarantees we’ll have access to vital patient records in critical situations.”

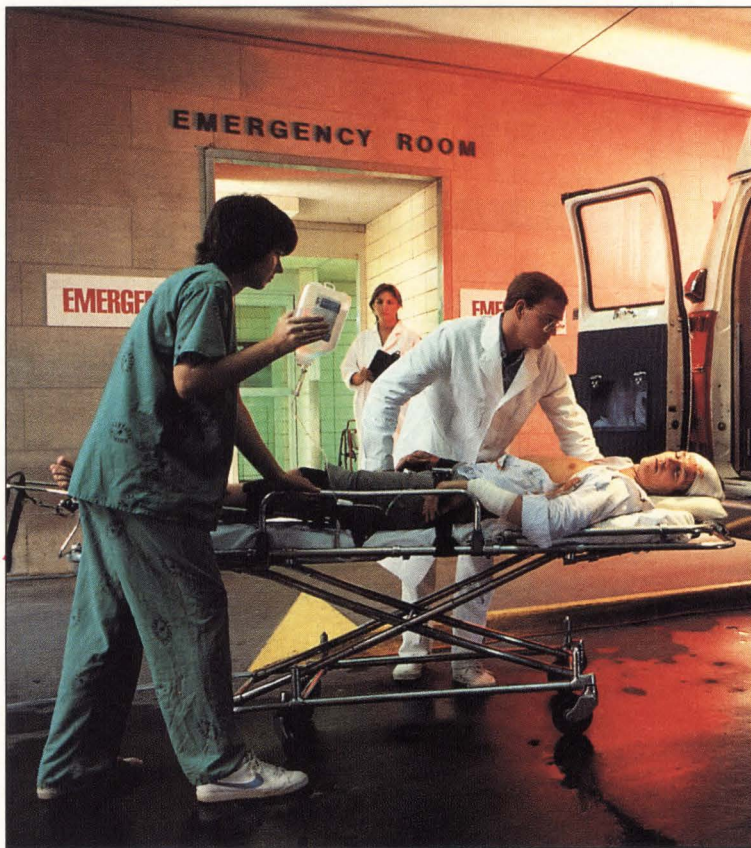
*Edward Babakian
Vice President/Information Systems, CHCC*



Community Hospitals of Central California (CHCC) stores vital patient information in a distributed database at one of its three acute-care facilities. Doctors, nurses, and support people depend on this information to help them provide effective patient care.

It's absolutely imperative all three sites have access to these records 24 hours a day, 365 days a year.

“We needed a way that would ensure if one link went down, traffic would re-route through a secondary source.” By connecting the sites with ACC remote Ethernet bridges, CHCC now has the redundant, high-performance network it needs.

CHCC increased reliability without increasing cost. It replaced multiple analog lines with one digital line and installed ACS 4030 remote Ethernet bridges from ACC.

But that's not all. After looking at other bridges, CHCC chose the ACS 4030 because “it gave us exactly what we needed for a third of the price.”

Worldwide, MIS managers depend on ACS 4030s to provide continuously reliable links between their remote Ethernets. If you want to extend your Ethernets, call **1-800-444-7854** today to learn more about ACC's complete line of bridge products.



*Advanced Computer Communications
720 Santa Barbara Street, Santa Barbara, CA 93101*

Your Interconnectivity Source

CIRCLE 184 ON READER CARD

With UNIX on the high end, we could have a Convex C210 crunching away on a seismic section at a rate of 12 MFLOPS. After this massive calculation is complete, results in the form of

floating-point number arrays are transferred via FTP to a GPX MicroVAX II (.17 MFLOPS) for display. Or, you could have a VAX 8800 (1.4 MFLOPS) doing the hard work and a Sun 3/160 (.11 MFLOPS)

performing the glory tasks.

At the low end, there's no need for heavy computing. The capability here is displaying the answers reached by the high end in a more meaningful and per-

FIGURE .

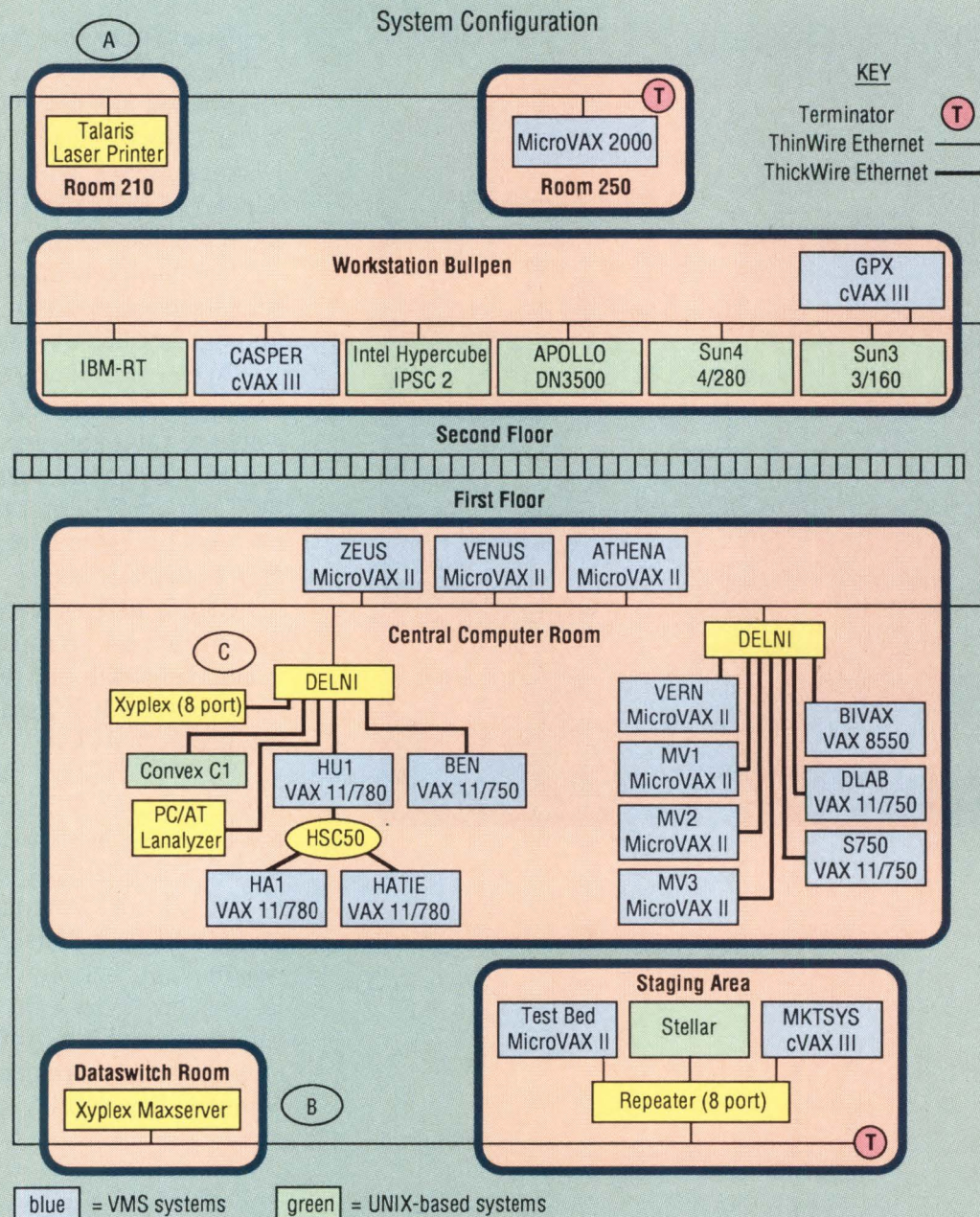

A diverse computing environment for software development.

Saved.

*Laserdrive 5 1/4" Removable 810 MB WORM Cartridges:
How they'll change the way you store data.*

Save Time.

Just plug and play. The Laserdrive Model 840 looks just like a Winchester to your MicroVAX II host. No overhead. No special utilities. No wasted time. Performance over three times faster than other optical disk sub-systems. Fast access, streaming and data caching. 810 MB formatted cartridges make backup and archiving fast and painless. And no waiting to get them. They're available today!

Save Money.

Half the cost per MB of conventional magnetic tape! And the Model 840's data security and compactness will save you a fortune in data distribution, archiving and use.

Save Peace of Mind.

Data integrity and security that will have you sleeping like a baby. Media life of 10 years for data that can't be written over or erased.

Save On-board Memory.

Unlike other optical disk sub-systems, the Model 840 uses none of your host's memory.

Save Critical Data.

No solution even compares. Simple to install and use. Easier and more secure than tape. The Model 840 will change the way you handle your CAD/CAM, engineering, database, archiving, software distribution, financial, imaging and other storage-intensive applications.

MicroVAX II is a trademark of Digital Equipment Corporation.



*The Laserdrive Model 840
Optical Disc WORM
Cartridge System.*

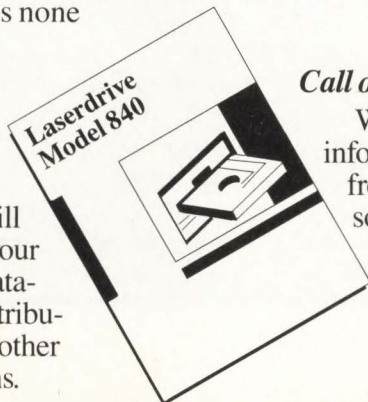

Call our hotline today!

We'll send you a Model 840 information kit that will save you from outmoded data storage solutions forever!

Call 1-800-952-6300.

Ask for Dept. L53.



LASERDRIVE
LIMITED

See us at COMDEX Spring, Booth #1251

CIRCLE 257 ON READER CARD

sonal fashion. A drawback is that the resultant data must be converted from one binary floating-point format to another. You can do this by performing the conversion on the high end before transfer or on the low end as it's received. This requires some fancy byte swapping and shifting, plus knowledge of the internal floating-point formats on both ends. One alternative is to save the results as a formatted ASCII file of floating-point numbers, then transfer this file to the low end. This method provides better portability, yet takes more time and disk space.

Your decision about which end's environment should be VMS or UNIX usually is based on resources. If you already have your application cranking on a VAX 8650 and you'd like to put those IBM clones running Xenix to work, the choice is obvious. If new system purchasing is in the picture, then maybe you could buy a couple of VAX 2000s (.17 MFLOPS) for your engineers to display reservoir simulation done on a high-end Alliant FX/80 (10.6 MFLOPS), for example.

The idea is to exploit the UNIX or VMS system for what it's meant to perform. It makes no sense to burden your high-end VAX by forcing it to feed workstation peripherals on its bus when it should be doing nothing but intense



Your decision about which end's environment should be VMS or UNIX usually is based on resources.

calculation. At the other extreme, you sure wouldn't try to push your fancy Sun 3/160 workstation with a high-resolution color display to grind for days simply to show the bending of a pipe.

Remote Log Ins

Along with sharing peripherals and shipping results to each other, an interactive VMS user may need to log in to a UNIX system. Unless he has a multisession VMS and UNIX terminal server, he'd have to log out of the VMS system, then log in directly to the UNIX system. VMS and UNIX can share interactive sessions via Telnet across your Ethernet LAN.

Telnet usually comes with the UNIX system, but is also available from third-party vendors for VMS systems. Instead of doing a \$ SET HOST VAX2, you could \$ RLOGIN SUN3. After you enter your username and password,

you're interactive on the UNIX-based Sun 3. Yet you originated and are still active on the VMS VAX. It works just as well the other way when you RLOGIN from a UNIX system into a VMS system that has Telnet running on it. Most terminal characteristics can be set on these so-called pseudo terminal ports, such as VT100 emulation and autobauding.

Security

It's great to link everyone together and share resources, but, generally, the easier and more convenient it is, the less secure it is. Managing multiple systems under different operating systems connected on an Ethernet LAN can be a nightmare. Users with system privileges on the VMS systems or logged in as root (GOD privilege) on UNIX systems who lack strong knowledge of both environments can play havoc with not only the user's local system but with the whole VMS

Companies Mentioned In This Article

Alliant Computer Systems Corp.
One Monarch Dr.
Littleton, MA 01460
(508) 486-4950
CIRCLE 472 ON READER CARD

Apollo Computer Inc.
330 Billerica Rd.
Chelmsford, MA 01824
(508) 256-6600
CIRCLE 450 ON READER CARD

Convex Computer Corp.
P.O. Box 833851
Richardson, TX 75083
(214) 952-0200
CIRCLE 451 ON READER CARD

Intel Corp.
3065 Bowers Ave.
Santa Clara, CA 95051
(408) 987-8080
CIRCLE 434 ON READER CARD

Interlan
155 Swanson Rd.
Boxborough, MA 01719
(508) 263-9929
CIRCLE 495 ON READER CARD

Stellar Computer Inc.
85 Wells Ave.
Newton, MA 02159
(617) 964-1000
CIRCLE 471 ON READER CARD

Excelan Inc.
2180 Fortune Dr.
San Jose, CA 95131
(408) 434-2300
CIRCLE 467 ON READER CARD

IBM Corp.
Old Orchard Rd.
Armonk, NY 10504
(914) 765-1900
CIRCLE 407 ON READER CARD

Talaris Systems Inc.
P.O. Box 261580
San Diego, CA 92126
(619) 587-0787
CIRCLE 470 ON READER CARD

Digital Equipment Corp.
146 Main St.
Maynard, MA 01754
(508) 897-5111
CIRCLE 403 ON READER CARD

Sun Microsystems Inc.
2550 Garcia Ave.
Mountain View, CA 94043
(415) 960-1300
CIRCLE 491 ON READER CARD

Xyplex Inc.
100 Domino Dr.
Concord, MA 01742
(508) 371-1400
CIRCLE 516 ON READER CARD

"Advantage yours."

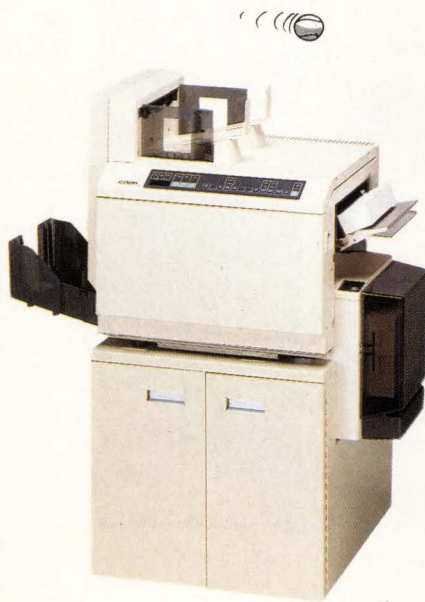

Out on the court, you have to be fast, you have to be versatile and you have to be able to really connect.

All of which, not coincidentally, are qualities of C. Itoh's remarkable new MegaServe Ion Deposition Printer.

A stroke of genius.

You want fast? The MegaServe serves up top-quality hardcopy at 30 or 45 pages per minute. You want stamina? How does a quarter-million pages a month sound? You want finesse? The MegaServe produces text and graphics with resolution up to 300x300 dots per inch.

And despite its star qualities, the MegaServe performs all that and more for less than two cents a page.

Great connections.

The MegaServe's standard interfaces

include Dataproducts parallel or Centronics parallel, SCSI, RS-232 and RS-422. So it will work—without missing a stroke—on almost any current system. For Ethernet systems, the MegaServe even has both interfacing hardware and host software.

With its Postscript interpreter and scalable fonts, MegaServe is perfect for both single-user and network applications. And for the ultimate in compatibility, it even emulates the DEC® LN03 Plus, the H-P LaserJet II®, the Diablo® 630 ECS and the Tektronics® 4014.

Top seed.

The MegaServe keeps 43 fonts resident; a built-in Winchester disk manages Postscript fonts and can endow any of them with attributes ranging from

bold or underline, to shadow, faint and reverse print.

And, of course, the MegaServe is guaranteed for a year and backed by service centers nationwide.

Call your C. Itoh distributor. And get the MegaServe advantage.

**Call (800) 227-0315 Ext. 4450
or (714) 757-4450**

for the C. Itoh distributor nearest you.

C. ITOH

C. Itoh Electronics, Inc.

2505 McCabe Way, Irvine, CA 92714

We build more in. So you get more out.

CIRCLE 231 ON READER CARD

and UNIX configuration.

For example, a UNIX system could get its TCP/IP software gummed up by a non-systems-type user logged in as root to FIX something. Bogus broadcast packets could be sprayed from the UNIX system onto the LAN. The LAN would hang all DECnet activity of the VMS VAXs that were connected to DELNI,

which also had that UNIX system connected to it (see Figure, pointer C).

Security boils down to common sense. A user's level of knowledge, integrity and track record should be considered when granting VMS privileges or giving out the root password, not how loud he complains or who he complains to. Just because a

VMS user had SYSPRV and BYPASS on the VAX 11/780 doesn't mean he knows how to be responsible on a UNIX system.

Example Configuration

The configuration shown in the Figure exists, but system names have been changed for security reasons. The UNIX-based systems are green, the VMS systems blue. This Ethernet LAN has six UNIX-based systems (three are 4.2 BSD, two are System V, and the Apollo has both); 19 VMS-based VAXs (ranging from a MicroVAX 2000 to a VAX 8550); a PC/AT (DOS) LAN analyzer; a LAN laser printer; and a couple of terminal servers that talk to all the VMS and UNIX systems.

Most of the VMS systems are linked via ThickWire Ethernet and DELNIs, but the main LAN is based on ThinWire. All users log into the systems via the two Xyplex terminal servers.

This configuration supports the following protocol activities on the LAN:

1. DECnet between VMS systems.
2. LAVc in clusters I and II.
3. Xyplex native protocol.
4. TCP/IP
 - a. FTP
 - b. Telnet (RLOGIN capability)
 - c. NFS file system sharing with UNIX-based systems.
5. Other DEC layered network products.
 - a. Distributed Queue Service (DQS) remote VMS printing.
 - b. Distributed Name Service (DNS) global DECnet logicals.
 - c. Distributed File Service (DFS) VMS version of NFS among VMS systems.

This example shows how VMS and UNIX systems can be interconnected to create a cohesive, productive environment in which each end complements the other. —John D. Deans is manager of computer operations at CogniSeis Development Corporation of Houston, Texas.

ARTICLE INTEREST QUOTIENT
Circle On Reader Card
High 447 Medium 448 Low 449

MAKE YOUR PDP-11 PERFORM LIKE A VAX!

SOLVE YOUR SYSTEM MIGRATION PUZZLE!

You can double your system's speed and triple peripheral capacity.

If you own a PDP-11/24, 11/34 or 11/44 you've probably experienced one or more of the following problems with your system:

- UNIBUS bandwidth topped-out
- System is at maximum configuration
- High data rates choke the UNIBUS
- Insufficient Device/DC load capability
- Real-Time increases out of control
- Unidentified errors

A new system would be ideal, but the cost can be prohibitive.

A UNIBUS Enhancement Package is available that will add years of life to your current data processing investment, solve phantom problems and allow for planned migration to new CPU and bus technology.

The heart of the Enhancement Package is an Ultra Fast UNIBUS Memory (UFUM) and a UNIBUS Segment Isolator/High Speed Repeater (USI/HSR).

Since 1976, Digital Data Systems Inc., has provided design, service and unique manufactured products for End-User's and OEMs. Our design engineers have developed custom memory products for many Fortune 500 Companies and the U.S. Government.

At DDS, over a decade of experience in memory design and manufacturing has contributed to a product line of unfailing reliability. Standard products are manufactured to the same stringent specifications as required for Government contracts.

Our state-of-the-art design and manufacturing capabilities enable us to offer superior products at the lowest possible cost, with a lifetime warranty and 24-hour replacement guarantee.

**THE
INTELLIGENT
SOLUTION**

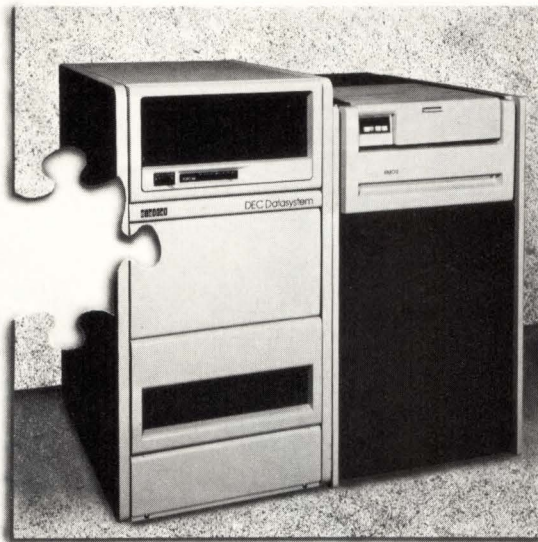

UNIBUS ENHANCEMENT PACKAGE

WORLD'S FASTEST UNIBUS MEMORY

MEMORY FEATURES

- Effective memory cycle time less than 5NS compared to the industry standard of 500NS.
- System bandwidth increase of at least a factor of 2, with certain applications realizing further improvements.
- Plug and play, requires no software or hardware changes.
- On board battery backup.
- Up to 1MB of storage on a single board.
- Designed with Static Rams.
- CSR standard.

ISOLATOR/REPEATER FEATURES

- Allows UNIBUS bandwidth to be driven up to 6MB.
- Automatically tunes the UNIBUS eliminating the need to reconfigure as the system grows.
- Plug and play, requires no software or hardware changes.
- Upgrades to UDA-50 technology with existing UNIBUS configuration.
- Allows the addition of up to 60 DC unit loads on a single UNIBUS.
- Allows the addition of two UDA controllers on one UNIBUS or UBA.
- Improves data integrity as proven under UNIX.

Note: DEC, PDP-11 and UNIBUS are registered trademarks of Digital Equipment Corp.
UNIX is a trademark of AT&T Bell Laboratories
USI/HSR is a trademark of SETASI Research & Development

DIGITAL DATA SYSTEMS INC.
1551 N.W. 65TH AVENUE • PLANTATION, FL 33313

1-800-SMART-11
(305) 792-3290

© 1987 DIGITAL DATA SYSTEMS, INC.

TWX: 910-997-4751 (DIGITAL)



CIRCLE 299 ON READER CARD

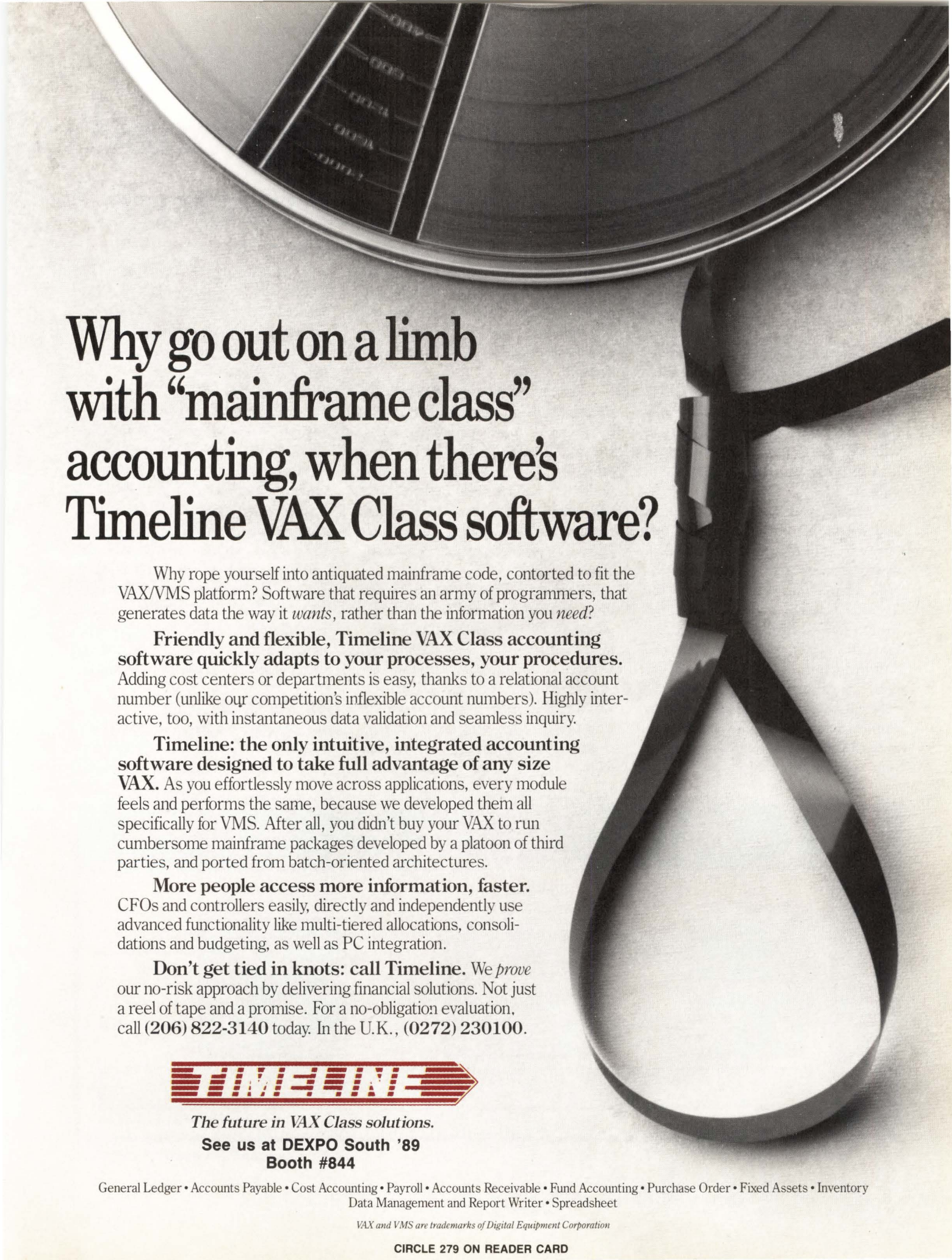

Why go out on a limb with "mainframe class" accounting, when there's Timeline VAX Class software?

Why rope yourself into antiquated mainframe code, contorted to fit the VAX/VMS platform? Software that requires an army of programmers, that generates data the way it *wants*, rather than the information you *need*?

Friendly and flexible, Timeline VAX Class accounting software quickly adapts to your processes, your procedures. Adding cost centers or departments is easy, thanks to a relational account number (unlike our competition's inflexible account numbers). Highly interactive, too, with instantaneous data validation and seamless inquiry.

Timeline: the only intuitive, integrated accounting software designed to take full advantage of any size VAX. As you effortlessly move across applications, every module feels and performs the same, because we developed them all specifically for VMS. After all, you didn't buy your VAX to run cumbersome mainframe packages developed by a platoon of third parties, and ported from batch-oriented architectures.

More people access more information, faster. CFOs and controllers easily, directly and independently use advanced functionality like multi-tiered allocations, consolidations and budgeting, as well as PC integration.

Don't get tied in knots: call Timeline. We *prove* our no-risk approach by delivering financial solutions. Not just a reel of tape and a promise. For a no-obligation evaluation, call (206) 822-3140 today. In the U.K., (0272) 230100.



The future in VAX Class solutions.

**See us at DEXPO South '89
Booth #844**

General Ledger • Accounts Payable • Cost Accounting • Payroll • Accounts Receivable • Fund Accounting • Purchase Order • Fixed Assets • Inventory
Data Management and Report Writer • Spreadsheet

VAX and VMS are trademarks of Digital Equipment Corporation

CIRCLE 279 ON READER CARD

DEC's New Compound Document Architecture

Just when I think I have things figured out, I find out how much I really don't know. Fortunately, most of my fellow computing professionals feel the same way, so I take some comfort in that. The problem is that it gets harder and harder to keep up with new things. What was known and familiar becomes strange and distant in a short time.

Take files for instance. Most of us understand the differences among different types of files, such as sequential, direct access, relative and indexed-sequential. Some of us have had the dubious pleasure of wading through many a Record Attributes Block (RAB), File Attributes Block (FAB) or Extended Attributes Block (XAB) in search of the perfect file format that would be speedy, solve all known data typing problems and be small enough to store compressed data on an RX50 floppy. If that isn't enough aggravation, we have to

deal with the Files-11 Extended QIO Processor (F11XQP) to get to the file in question and all the features and wonderfulness that it offers, such as backlink pointers, FIDs, ACLs and other irritants.

Yes, files are wonderful things. Of course, the list of aggravation factors is the same for most operating systems. UNIX/ULTRIX/Xenix/Bag-of-Trix and other compliants have their problems with files (try an indexed file sometime) and the Mac O/S has some bizarre resources that make being a files expert practically mandatory to develop applications properly.

Recently, I was taken aback by two things I thought I understood. I was reintroduced to VMS/ULTRIX file formats with DEC's new Compound Document Architecture (CDA) in version 5.1 of VMS (see Figure). That was a shock, as RMS has little to do with it. The other shock was on my laptop computer's file structure. I got a message telling me "FAT allocation exceeded."

I've learned to deal with CDA, and I know that I'm overweight. But I do *not* need a laptop telling me so. I felt better when I did some research into the PC file structure and found that FAT is the File Allocation Table, but that's another problem.

Dealing with CDA means learning an entirely new vocabulary of technical terms, understanding new concepts in file formatted I/O as it applies to VAX (under VMS or ULTRIX), using a new system service library and understanding document conversions and utilities for the same. It also means that CDA-compliant applications most likely will have a different look to them than classic VAX applications, as CDA allows graphics, text, images and other types of information to be consolidated and manipulated in a Files-11 or ULTRIX file.

On The Level

It's easier to understand CDA if you realize that there are two levels of concern. The first level is the file format

F I G U R E .

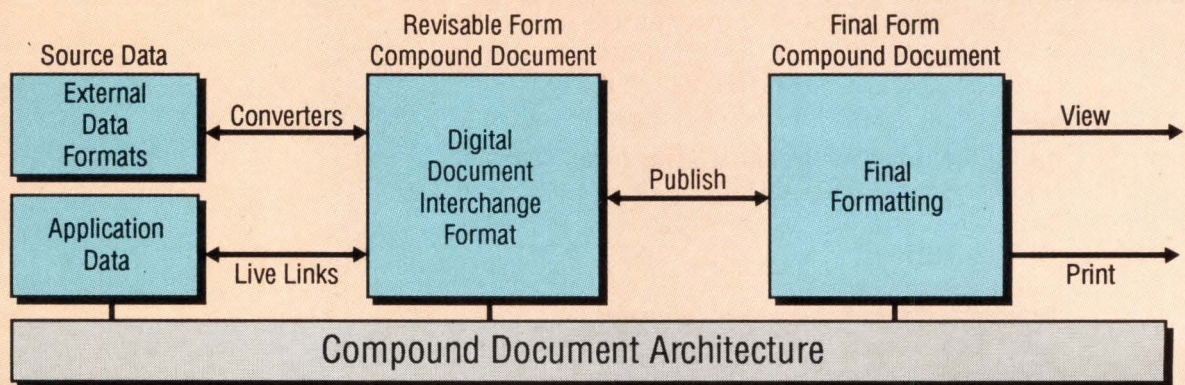

Courtesy Digital Equipment Corporation

DEC's Compound Document Architecture.

graphics terminals, designed from scratch. You can look forward to any product Pericom will bring to the graphics market. —David B. Miller is associate director of computer services at Beaver College in Glenside, Pennsylvania.

REPRINTED FROM
DEC PROFESSIONAL MARCH 1988

Well David, here's the latest

Terminal emulation software for PC's is probably not what he was expecting because we're famous for our graphic terminals.

But it shouldn't come as too much of a surprise because terminal emulation has always been our business. We've been supplying high quality Tek, DEC, and Retrographics emulators to some of the biggest names in industry for nearly a decade.

And since hardware terminal emulation is essentially a software exercise we've decided to put all that field proven experience on a floppy disk for your PC. The result: TEEM-TALK™, probably the best graphics terminal emulation package around.

TEEM-TALK™ is designed to turn a standard IBM XT, AT, 386, PS/2 or compatible into a fully loaded, powerful terminal with the largest choice of graphics emulations available, including Tek 4105, 4207, 4111, DEC VT240 ReGIS, Retrographics VT640 and Westward 3220.

Alpha emulations include VT100, VT220 and DG200, and to get over the shortcomings of other emulator packages, text mode performance can be enhanced

with TEEM-TEXT™, a slot-in dialog board providing up to 4 separate alpha planes for true, high performance text editing with full attributes, screen formats of 24, 32 and 48 lines of 80 or 132 columns and the ability to display graphics and text at the same time - just like a terminal!

Taking things one stage further, we've designed the optional TEEM-TOUCH™ keyboard so that your PC not only thinks like a graphics terminal, it also feels like one.

So TEEM-TALK™ is a range of products like nothing else available - and to make it easy to use we've installed a simple copy protect routine and offer flexible purchase arrangements including site licences and special discounts for educational users.

TEEM-TALK™ is only available from Pericom INC.

After all, it makes a lot of sense to buy terminal emulation software from a company that knows something about emulating terminals. Right David? Phone us now on our direct hot-line for a TEEM-TALK™ brochure and register for your demonstration package.

CIRCLE 130 ON READER CARD

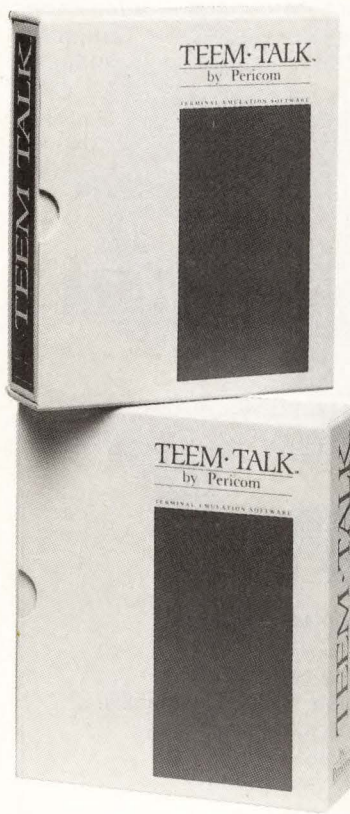

TEEM-TALK™ by Pericom

ONLY AVAILABLE FROM PERICOM ON

1-800 233 2206

DIRECT HOT LINE

PERICOM INC, 9 PRINCESS STREET SUITE D LAWRENCEVILLE NJ 08648 TELEPHONE (609) 895 0404
PERICOM INC, 2291, 205th STREET SUITE 103 TORRANCE CA 90501 TELEPHONE (213) 618 9190
PERICOM INC, 12503 EXCHANGE STREET SUITE 504 STAFFORD TX 77477 TELEPHONE (713) 240 4848

TEEM TALK is a trademark of Pericom International Ltd.

itself. CDA implements a file format, called Digital Document Interchange Format (DDIF), which allows the application to read and display document contents in a manner that's applicable to the display device being used, such as a dumb terminal, workstation, DEC-windows session, Display PostScript, some other graphics-supported terminal

or a home-grown format if supplied by the developer.

On the second level are the system routines and DDIF structures available to the application developer. The system-level routines, included in a toolkit in VMS or ULTRIX, are prefixed with CDA\$ and are called in the standard way all system service, RTL or other library

routines are called. Structures for DDIF are prefixed with DDIF\$. Both the CDA\$ and DDIF\$ functions and structure names are defined in "include" files that come with the toolkit (for C, the files are called `ddif$.def.h` and `cda$.def.h`).

To make it easier to understand, let's examine each level and how it affects the user and applications developer.

File Structure

At the first level, the internal file structure itself, CDA functions on a concept of a compound document. Compound documents are those files that contain an assortment of data, such as proportionally spaced text (according to fonts and attributes of fonts used, such as bold, italic and font size); graphical primitives (polylines, fill definitions); digitized images (color, gray scale); and computed values (values that are computed at display or print time, such as page numbers and index lines). Historically, all the data items described usually would require a self-imposed file structure to keep all items in a single file or several files per produced document that would contain the described information.

To cause even more grief, inclusion of such varied formats of data in a single file becomes problematic when updates and modifications are made to the file. What if a new graphic is included? What about more text above or below an image? How does the image get restored if it's sized differently after an edit session?

So, file structure alone is a problem. Add the ability to display and manipulate the file in various applications on various display technologies in more than one operating system and the problems mount significantly. And we haven't even begun exploring the issues of software development for the applications that would have to manipulate such files.

DDIF

To solve these problems, DEC has provided DDIF. This shouldn't be confused with DIF files from Lotus 1-2-3, Navy DIF or other types of interchange for-

"What do these industry leaders have in common...?"

Boeing Aerospace — TRW — Raytheon — Rockwell International
 ICI Pharmaceuticals — 3M — Northrop — Plessey Radar — Delco
 GTE — Kitchell — Todd Shipyards — General Electric — E-Systems
 Ball Aerospace — City of Chicago — Litton — U.S. Coast Guard
 BMY — Naval Underwater Systems — Ford Aerospace — Intergraph
 EG&G — McDonnell Douglas — Leighton Contract — Soncraft
 Aalborg Boilers — Tech Department of Defense — Lockheed
 Renison Co. — Liebherr — di. — Corp. — Olin
 NASA Ames — Santa Barbara — Battelle
 Santa Barbara — Santa Barbara — Santa Barbara
 Northrup — Northrup — Northrup — Northrup

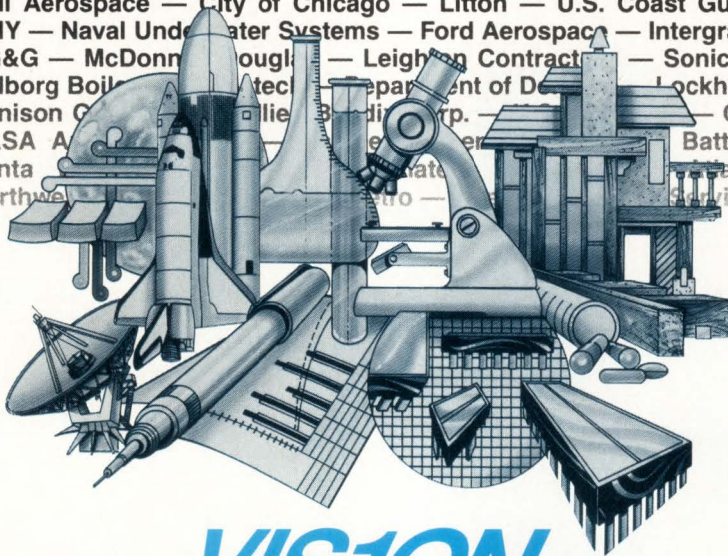

...VISION

VISION is *the* project management solution for industry leaders worldwide.

VISION can help manage your costs and schedules—with proven EZPERT graphics and complete C/SCSC capabilities.

Turn to Systonetics for project management software, support and consulting—available on DEC VAX, Prime and the IBM mainframe.

Call or write today for a free copy of "Evaluating Project Management Software."

SYSTONETICS

The Project Management Company

20TH ANNIVERSARY CELEBRATION

1561 East Orangethorpe Avenue · Fullerton, California · 92631
 (714) 680-0910 · FAX (714) 871-8440

Sales and Support Offices: San Jose, CA · Denver, CO · Houston, TX · Vienna, VA · Bellevue, WA
 and offices in Australia, Denmark, Italy, Norway, and United Kingdom

CIRCLE 301 ON READER CARD



The reality of backups is that they give you a copy of everything, whether you need it or not. And before you know it, your backups are backed up into the next room—along with the requests to find important files that *must* be restored. You're buried. And files can get lost.

Fortunately for you, there's a better way to save and restore data. It's V-X Archive from UIS, *the source for VAX management software*. V-X Archive is a completely automated file storage and retrieval system for the VMS environment. It lets system managers or end users move critical data from expensive on-line media to low-cost,

The reasons for not using a backup system to store data are piling up every day.

off-line media such as tape or optical disk and back again when needed—quickly, easily and efficiently.

With V-X Archive, you'll regain over 40 percent of your disk space, without losing the ability to access important files. You'll also improve site security and ensure that legal requirements for maintaining records are met.

So if you've had it up to here with unmanageable tapes and requests to restore files, you need V-X Archive. For more information about V-X Archive or on any of our other products, call us at 1-800-332-8650 (in California, call 1-714-895-1633).

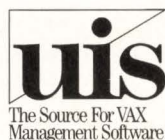

mats. DDIF is available on VAX/VMS systems (V5.1) and VAX/ULTRIX systems (V3.0).

DDIF allows the file creator (and applications such as DECwrite, DEC-paint or others) to set up a file that con-

“

**To create DDIF files,
DEC provides the CDA
toolkit as a set
of callable routines.**

”

sists of a hierarchy of internal document segments. It's almost like setting up an individualized hierarchical database for each document. A document header describes information about the document as a whole, such as DDIF version, file creator, product identifier and other information of use to the file manipulator or applications programmer. Following the header, the document takes on a decidedly hierarchical look with a single "root" (main) segment that contains zero or more elements. Each element is devoted to a particular content type, such as image, text, computed, graphics, restricted and private.

Image content elements contain raster scanned or digitized data that's stored in a frame format within a DDIF document. Images can be individual items or time-based (with the same attributes). Images have a series of attributes, or descriptive qualifiers, appended to them. These attributes describe how the image will be displayed, pixel path and aspect ratio, brightness polarity, image component space, data planes per pixel, significance of the data planes, physical format of the pixel grid, and so on.

Text content elements consist of graphical display elements and spaces from standard and private character sets.

The reason ASCII isn't specifically emphasized is because, although ASCII characters are valid, there are many graphical ways to represent individual letters in the ASCII set, depending on font, font size, font attributes and other related issues. As with image content, text content can have specific attributes associated with the segment, as well as page format directives (for the entire document), layout path and text layout formats.

Computed content elements are specific items that are computed at the time the application outputting the document actually processes and formats it (page numbers, time of day, date, and so on).

Graphics content elements consist of defined primitives and objects (such as fill areas, lines, arc and Bezier curves) that are created at display or format time. This reduces storage requirements for graphical content and also allows graphics to be scaled easily. Image data can't be scaled easily because it's usually stored using a raster or bit-mapped method. Because graphical elements essentially are stored as vectors or specified objects and interpreted at display or output time, sizing can be recomputed and displayed accordingly.

Restricted content elements consist of either private attributes and processing information for the application to use or the ability to interpret Page Description Language (PDL) on those devices that support it. Private elements are useful when product sets (various applications with the same general need to exchange DDIF documents) need to exchange specific formatting information. PDL allows for specific formatting, such as Display PostScript, on supported display and output technologies.

Private data content elements provide document information that's restricted to a particular document processing application or to a series of applications that supports mutually "known about" formats. Information that can be kept in a private data element varies greatly but is usually application specific. Examples might include the last

Digital Equipment Corp.
146 Main St.
Maynard, MA 01754
(508) 897-5111
CIRCLE 403 ON READER CARD

Lotus Development Corp.
55 Cambridge Pkwy.
Cambridge, MA 02142
(617) 577-8500
CIRCLE 408 ON READER CARD

cursor location, last insertion point, open file information, and statistics.

Elemental Relationships

So far we've examined the types of information that can be included in a DDIF document. Next is the problem of understanding the relationships among the different data elements in the document.

As a document is created and items are added to it, some defaults on formatting can be added that affect segments in a document. An example is line width of a text column. In the first instance of declaration of the width (e.g., when a ruler's right and left margins are set by the author of a document), the remaining segments in a path may inherit the format information without it being explicitly declared in element information.

Sometimes attributes may modify a single segment, but sometimes the attribute may be generic in nature. For instance, if a certain graphic is stored in one place and referred to in other places in the document, the same graphic may appear in those other places. If, however, the graphic is modified, the modifications would appear in all referenced locations. This is called generic content and allows the creator of the document to share repetitive information, as an example, or create complex relationships among various graphical and other elements that will affect the final printed or displayed form.

To create DDIF files, DEC provides the CDA toolkit as a set of callable routines. These routines allow the developer of CDA applications to create

FOCUS

Recognized as the best 4GL in the DEC marketplace.



Best Fourth
Generation Language
FOCUS
Information Builders

This is the very first year that a Digital Review Target Award has been given "for product excellence and innovation in a 4GL product."

And we're very proud that DEC users selected FOCUS for this award.

We think it says some very positive things about the FOCUS 4GL/DBMS product, and about the Information Builders company.

The judging criteria was based on technical innovation, user friendliness and price/performance. DEC users were asked to vote for the 4GL that meets those criteria and is also the premier

product in its class.

You can see why we're so proud of winning this award.

This is not the first award FOCUS has won. For the second year in a row the Software Magazine 1988 Software Market Survey has named FOCUS the number one 4GL in all three categories—minis, micros and mainframe.

If you would like to find out more about the DEC users' favorite 4GL, call 1-212-736-4433, Ext. 3700 or write to Information Builders Inc., 1250 Broadway, New York, NY 10001.

 **FOCUS**
Information Builders, Inc.
CIRCLE 235 ON READER CARD

and manipulate DDIF files without necessarily knowing the specifics of DDIF. CDA routines work on the concept of manipulation of an in-memory structure called an aggregate. The aggregate allows the developer to pass compound data between the application and the CDA toolkit routines. There isn't necessarily one aggregate per compound document, as aggregates can be defined as a member of a sequence of aggregates or are defined for specific entities, such as a document root, document descriptor, document header, segments and elements.

The CDA toolkit is used in three basic ways:

1. Within utilities provided by DEC to convert document files to and from DDIF formats by using front-end or back-end conversion routines.
2. By a programmer to develop his own front-end or back-end conversion routines.
3. By a programmer to develop applica-

tions that will use the DDIF formatted files for manipulation of document contents.

DEC provides a VMS DCL utility (CONVERT/DOCUMENT) and an equivalent ULTRIX utility (cdoc) to convert a file in a revisable format to another file in a revisable format. Through the use of command options, the user of the utility specifies the input file and the encoding format template, as well as the output file specification and the encoding format template. DEC provides two input templates (DDIF and TEXT) and four output templates (DDIF, TEXT, PS and ANALYSIS). A typical DCL command to do a conversion might be:

```
$ CONVERT/DOCUMENT
  IN_FILE.TXT/FORMAT=TEXT
  OUT_FILE.DDIF/FORMAT=DDIF
```

In the above example, IN_FILE.TXT, a text file, is converted to a DDIF file format and the output of the con-

version placed in file OUT_FILE.DDIF. There are other options, including the specification of an actual options file if there are numerous options involved in a particular conversion. For instance, if PostScript were used in an output format, a PostScript options file could be created to manipulate the conversion operation further.

Another DCL/ULTRIX shell utility provided by DEC is a DDIF file viewer. This utility (VIEW on VMS, vdoc on ULTRIX) lets you see the output of a DDIF file on a DECwindows terminal or a standard character-cell terminal. To invoke the utility in DCL, the following command is used:

```
$ VIEW OUT_FILE.DDIF/
  FORMAT=DDIF/SELECT=
  (NOGRAPHICS,NOTEXT,IMAGES)
```

The above example directs the VIEW program to display the contents of OUT_FILE.DDIF (.DDIF is the default

See us at
CASE EXPO
Booth #40

ProMod Is... The VAX Workstation CASE Environment.

- Real Time Analysis
- Object-Oriented Design
- Code Generation
- Code Maintenance
- 2167A Compliance

Now With DECwindows User Interface.

 DECwindows provides a consistent user interface in the VMS environment.

ProMod CASE tools take advantage of the DECwindows capability to improve ease of use and developers' productivity.

ProMod CASE tools were developed in the Digital VAX environment, and are also fully functional on large VAX systems as well as Workstations.

ProMod. From Requirements to Code in an integrated CASE environment. Call our toll-free numbers now.

Outside California:

1-800-255-2689

In California:

1-800-255-4310

PROMOD

23685 Birtcher Drive, El Toro, CA 92630

VAX, VMS and DECwindows are trademarks of Digital Equipment Corporation.
ProMod is a trademark of Promod, Inc.

CIRCLE 162 ON READER CARD

EasyEntry™

Full featured heads down data entry
for Digital Equipment Corporation
computers and IBM PC's

- Immediate on-screen development of fill in the blank forms. No coding, compiling, testing—non-DP users can design forms.
- Full of features—error checking, math functions, forms chaining, program calling, HELP, error messages, rekey verification, keypunch simulation, file maintenance, operator statistics...
- Creates standard files for use with other software.
- Low overhead. Supports high volume data entry.
- Low cost.
- Easy to learn. Good documentation. Technical support is just a call away.
- Installed at 1,000 sites worldwide. ICP million dollar award winner.

Call **1-800-334-5510**

applied information systems

500 Eastowne, #207, Chapel Hill, NC 27514
(919) 942-7801

CIRCLE 166 ON READER CARD

10 Years
of Excellence



APRIL 17-20, 1989

Philadelphia Civic Center
Philadelphia, Pennsylvania

Your Productivity Connection

Make connections with the products and strategies that ensure top productivity, now and in the future.

NCGA '89 puts the universe of computer graphics at your command. Explore more than 220 dazzling exhibits — the industry's top vendors of hardware, software and services. Choose from more than 100 informative conference sessions — the industry's 20 fastest-

CIRCLE 272 ON READER CARD

growing applications. See systems integration in action — like you've never seen it before.

Test drive the technologies. Master the methodologies. Absorb the energy. And bring it all home to your company for your most productive year ever.

Why speculate about greater productivity, when NCGA '89 can deliver it to you?

Sponsored by the National Computer Graphics Association

Images courtesy of West End Film,
Manufacturing and Consulting Services

YES! I'm ready to make my productivity connection! Please send me more information about NCGA '89.

Mail to: **NCGA '89**
2722 Merrilee Drive, Suite 200
Fairfax, VA 22031

Or, call **1-800-225 NCGA** today.
703-698-9600 (in Virginia only)

NAME

TITLE

COMPANY

ADDRESS

CITY

file extension) on the user screen, that the display file is DDIF formatted, and that no graphics and no text but only the images in the file should be dis-

(CDA\$) and specifies particular attributes by using DDIF\$ qualifiers.

In a typical scenario, the programmer would create or open the file if a

hierarchical aggregates may be written out totally without requiring a specific aggregate dump to file.

CDA programming is somewhat tedious and difficult for the newly indoctrinated DDIF programmer. This doesn't mean that it's impossible, only that there's much to do if the programmer wishes to make the most of the facilities provided.

Although the internal file format is somewhat complicated and the programming tedious, CDA definitely points toward consolidated, coherent document processing. CDA and DDIF represent a significant stride in the march to file format interchange among applications and among dissimilar operating environments.

By being able to manipulate the actual format of files from machine to machine, you can create a compound document on one system and simply transfer it to another and manipulate the document fairly easily without losing formatted information or graphical/image information. Although the concepts of generic access and a standardized internal file format for data aren't new, the appearance of CDA and DDIF on DEC systems shows that DEC truly is getting serious about owning the desktop. ■

CDA programming is somewhat tedious and difficult for the newly indoctrinated DDIF programmer.

played. There are other options and command delimiters available that let you manipulate what will be selected for display.

The developer who wishes to use CDA to develop file converters from the current format (whatever that is) to DDIF or some other format can write his own front or back end. This can be a fairly tedious operation, because the programming of CDA is very methodical and long. Basically, the programmer places some required "include" files at the beginning of the program segment. He then calls the CDA routines from the library routines

file is initially involved, create in memory the DDIF root aggregate and create aggregates for the document descriptor, header and content. Aggregates also may need to be created for various elements involved, such as text and graphics. The aggregates then are manipulated by the program and eventually dumped out to a file via an explicit write operation (CDA\$PUT_DOCUMENT).

Writing to a file is fairly straightforward. The root aggregate is passed as the starting address and it, in turn, tows the other aggregates with it on the PUT operation. Therefore, properly created

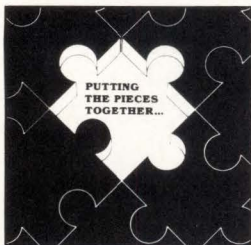

COLT SOFTWARE TECHNOLOGIES

SOLUTIONS TO THE SOFTWARE PUZZLE

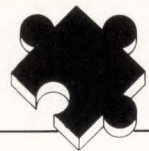

EXECUDESK - Executive/Salesman Organizer
Corporate Event Calendar, Personal Calendar/Scheduler,
Equipment Scheduler, Personal Expense Organizer,
Master Appointment Scheduler, Message and Reminder
System, Business Calculator.

**AS REVIEWED IN THE
DECEMBER 1988 ISSUE OF
DEC PROFESSIONAL.**

STARTING AT \$595

Authorized Distributor
DIGITAL BUSINESS SYSTEMS, INC.
201-542-7600
DEALER INQUIRIES WELCOME

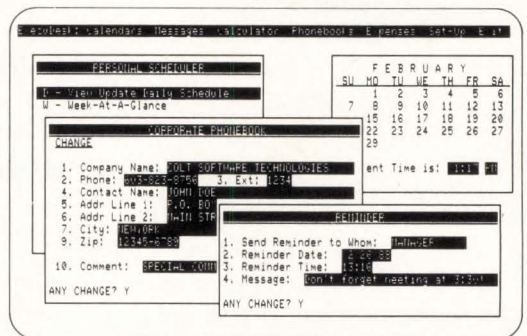

EXECUDESK allows windowing to and from all modules.

- Retail Management with POS
- EasyPage Publisher
- Distribution
- Manufacturing
- Job Costing Const.
- Service and Call Dispatch Management
- Property Management
- Mailing List
- UNIX Software

CIRCLE 207 ON READER CARD

ATTENTION: HARDWARE BUYERS

Announcing . . .

DEC Professional Buyers Guide - Hardware Edition Available May 1989

The ONE Source you need for . . .

■ PURCHASING HARDWARE

Thousands of products to choose from
Over 5,000 products from more than 600 manufacturers
Comprehensive, well-researched listings
Complete specifications and product descriptions

■ COMPARISON SHOPPING

Detailed product descriptions to evaluate
Product comparison charts
No guesswork

■ EASY TO USE AS THE YELLOW PAGES

Alphabetical listings by company name
Cross referenced throughout the book
Alphabetical vendor listings and locations
Telephone numbers with all listings

■ SAVE TIME

All the hardware products you need in one source
A ready reference anytime you need it
All information is up to date
Use it all year to buy the hardware you need

DEC Professional Buyers Guide is the
ONE SOURCE YOU NEED for all of your hardware purchases
for the next 12 months. We've done all the research so you
can have the information you need at your fingertips when you need it.
Your personal copy will be mailed May 1989.

CALL FOR MORE INFORMATION . . .

**To have your product listed: Anne Maher, Managing Editor at (215) 542-7008
To advertise: Steve Maher, Associate Publisher at (215) 542-7008**

NOTE: COMING FALL 1989
DEC PROFESSIONAL BUYERS GUIDE - SOFTWARE EDITION

**Professional Press Inc.
921 Bethlehem Pike, Spring House, Pennsylvania 19477
(215) 542-7008 FAX (215) 628-2845**

The C Preprocessor, Part 3

Editor's note: This is the third of a three-part series that covers the C preprocessor. In this installment, Mr. Jaeschke covers header inclusion, condition compilation, the

#line, #pragma and #error directives and predefined macros.

When programming non-trivial projects, you may find it useful to share certain information among multiple source files. For example, function prototypes, external data declarations and macro definitions may have some use beyond one particular source file. These shareable items can be placed in their own source file(s). Such a file is referred to as a header and usually has a file type of h. All implementations come complete with a set of headers and all ANSI C-conforming kits must contain at least 15 standard headers. One example is **stdio.h** (which we've been using from the beginning). It contains prototypes and macros used by the standard I/O library.

The ANSI C Standard headers and their purposes are shown in the Figure. The headers **errno**, **float**, **limits**, **locale** and **stdarg** are ANSI C inventions. (Actually, **stdarg** is a revamped version of the UNIX **varargs** header.)

Headers may contain any valid C source code token or preprocessor directive and they're accessed via the **#include** preprocessor directive. This directive causes header records to be considered as part of the original source code file at the line at which they're included. A header may not contain part of a token, and its last line must be terminated by a new-line.

Moving common symbolic definitions to a header reduces

the need to modify source files when porting programs to different environments or otherwise changing the value of any macro. Any changes necessary need only be made to the header files with these changes being implemented when the source files are recompiled.

ANSI C declares each standard library routine in a corresponding header and requires you either to **#include** that header or to duplicate the prototype, support macros, and so forth, in your own code. The former approach is far simpler and less error prone. Because ANSI C added function prototypes, you should include a routine's parent header even if that routine returns an **int** value (the default for undeclared functions). For this reason, we've been including **stdio.h** from the beginning.

The physical location of a header depends on the way in which you specify the **#include** directive. Two principal methods are available:

```
#include <header>
```

and:

```
#include "header"
```

ANSI C has provided a third method, **#include ID**, where **ID** is a macro that ultimately expands to one of the first two formats. This approach allows the header name to be constructed by the preprocessor using the **#** and **##** operators and macros defined at compile time via a **-d** switch, or similar.

If the **<...>** method is used, the compiler searches in a set of "system" places. Most multiuser operating systems have specially named disks and directories for placing shareable files. Usually, you use this format for the standard library headers and those provided by your implementation to give you access to your host hardware and software environments.

The **"..."** format indicates that a system-specified set of places is to be searched, generally starting with the user's default device/directory. Some implementations also search the **<...>** place if the header can not otherwise be found.

Many implementations provide a compile-time switch, such as **-i** or **/include**, to specify a hierarchy of places to search for headers included with either **"..."**, **<...>** or both. This capability eliminates the need to hard-code device and directory information in the source, thus providing more flexibility in moving headers or in compiling against different sets of headers, such as production and test.

Headers may be nested up to an implementation-defined level (ANSI C requires at least eight levels). When you design

DEC PROFESSIONAL

FIGURE .

Header	Purpose
assert.h	program diagnostic purposes
ctype.h	character testing and conversion
errno.h	various error - checking facilities
float.h	floating type characteristics
limits.h	integral type sizes
locale.h	internationalization support
math.h	math functions
setjmp.h	non-local jump facility
signal.h	signal handling
stdarg.h	variable argument support
stddef.h	miscellaneous
stdio.h	I/O functions
stdlib.h	general utilities
string.h	string functions
time.h	date and time functions

The ANSI C Standard headers and their purposes.

Choosing the Right Database Development System Just Got Easier.

db_VISTA III™ Delivers High Performance With No Hidden Costs.

For database applications development, you want a system with performance, portability, and full functionality at a competitive price. But there's more to it than that. The long term costs associated with extended development schedules, frequent maintenance, excessive royalties, or the inability to handle complex data relationships are often overlooked. These hidden costs can be quite a shock after you have made a commitment and are midway through application development, or worse yet, in production.

With db_VISTA III from Raima, there are no surprises. It provides powerful database capability with tremendous overall cost savings. The heart of the system is db_VISTA, a high performance DBMS that uses B-tree indexing and the network database model file structure to minimize overhead and provide fast data access. Our SQL-based db_QUERY provides a relational view of the network structure, without sacrificing performance. And db_REVERSE lets you easily redesign your database. The entire db_VISTA III system is fault tolerant and complete source code is available.

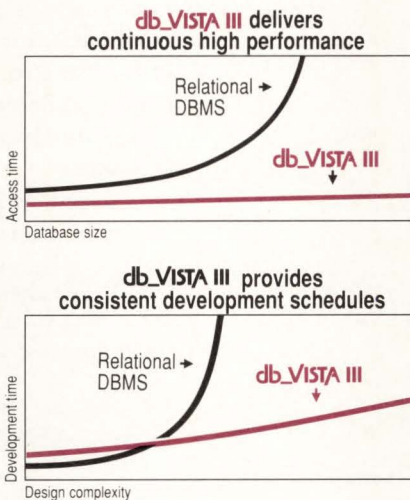

db_VISTA: High Performance DBMS

Multi-user
Fast data access: B-tree indexing, network database model, virtual memory disk caching
Multiple Database Access
Referential integrity
Automatic recovery
Record and file locking
Database consistency check
Easy-to-use interactive access programs
Data Definition Language patterned after C

db_QUERY: SQL-based Query
Relational interface to db_VISTA databases
Yields extraordinary performance
Build ad hoc queries & reports

db_REVERSE: Database Restructure Program
Redesign your database
Converts existing data to revised design
Upgrade remote end user locations easily

Add WKS Library for Lotus 1-2-3
Fast C interface to Lotus, dBASE and others

Operating Systems: VMS, ULTRIX, UNIX System V, BSD 4.2, SunOS, QNX, XENIX, OS/2, MSDOS, Macintosh, MS Windows

C Compilers: VAX, UNIX, XENIX, SunOS, Microsoft, Lattice, TurboC, LightspeedC, MPW

LANs: NFS, 3Com, NetWare, LifeNet, Banyan, and any other MS-DOS NetBIOS-compatible LAN. AppleShare and network-independent versions also.

Thousands of C programmers in over 50 countries worldwide have chosen Raima's db_VISTA III. Here are the reasons why:

- Fast data access
- Minimal data redundancy
- C source code available
- Automatic recovery
- Multi-user support
- Portable to VMS, UNIX, OS/2, MS-DOS and Macintosh
- SQL-based relational query
- No royalties
- Professional services
- Superior support
- **MS-Windows 2**
A (Well-behaved) implementation emphasizing proper usage of Windows' global memory management and multi-tasking access to databases.

Maybe it's time that you checked out db_VISTA III. Consider *all* the costs. It could be the easiest choice you ever made.

CALL:

1-800-db-RAIMA
(that's 1-800-327-2462)

Ask about the many other products and services Raima Corporation offers, including consulting, application development, and training.

RAIMA™
CORPORATION

✓ Fast Access
✓ Portable
✓ No Royalties
✓ Reliable Tech Support
✓ Clear Documentation
✓ Auto Recovery
✓ SQL
✓ Source C
✓ C Language
✓ VAX/UNIX

your own headers, you should make sure they cause no problems if they're included multiple times in the same compilation. Also, a header that relies on things in another header should explicitly **#include** that other header. This is much better than forcing the programmer to know which headers are related to which other headers. However, in doing this, it's possible that one compilation can include the same header five or six times. To save the preprocessor from doing so more than once, you can place a conditional compilation envelope around the whole header. (This will be shown in the next section.)

Conditional Compilation Directives

A series of preprocessor directives is available to allow source code to be compiled on a conditional basis. Examples of each follow:

```
/* testing if macros are defined */

#include <stdio.h>

#define DEBUG

main()
{
    int c;

    printf("Please enter a printable character: ");
    c = getchar();

#ifdef DEBUG
    printf("\nChar %c with value %d.\n", c, c);
#else
    printf("\nSymbol DEBUG is not defined.\n");
#endif

#ifndef TEST
    printf("\nMacro TEST is not defined.\n");
#endif
}
```

produces the output:

```
Please enter a printable character: A

Char A with value 65.

Macro TEST is not defined.
```

The directives **#ifdef** and **#ifndef** check whether or not a macro currently is defined. The true path for these directives includes all source lines between the **#ifxxx** and its corresponding **#else**, or **#endif** (if no **#else** exists). The false path (if any) includes all lines between the **#else** and **#endif**.

Note that **DEBUG** is defined without any particular value. Whatever the value is that it gets is irrelevant for these directives; they simply test whether or not it's defined.

If your implementation permits macros to be defined at

compile time, then the definition of **DEBUG** can be removed from the source.

When header inclusion was discussed earlier in this series, it was suggested that you ensure that headers were included only once per compilation. The following technique does this:

```
/* header head.h */

#ifndef HEAD_H
#define HEAD_H

/* contents of header go here */

#endif
```

Each header contains a condition compilation envelope based on the presence or absence of a macro. In this case, the macro name is a function of the header name. The first time this header is included, **HEAD_H** (presumably) won't be a defined macro. However, as a result of this inclusion, **HEAD_H** becomes defined. On subsequent inclusions, this macro already is defined and so the body of the header is skipped.

Sometimes it's desirable to check for specific macro values or combinations of macro values, for example:

```
/* using the #if directive */

#include <stdio.h>

#define TRACE 1
#define TRACEMSG(s) printf("TRACE entered function %s.\n",s)

main()
{
#ifdef TRACE
    TRACEMSG("main");
#else
    printf("TRACE is off.\n");
#endif

#ifdef TEST
    printf("TEST is true\n");
#else
    printf("TEST is false\n");
#endif
}
```

produces the output:

```
TRACE entered function main.
TEST is false
```

The **#if** directive evaluates the arithmetic expression following it using **long int** arithmetic. The true and false paths selected for compilation are the same as those for the **#ifdef** and **#ifndef** directives discussed above.

Note the use of **TEST** here. We are attempting to use the value of a macro that hasn't been defined. In such cases, the

Now available
for UNIX/Xenix!

In a Noisy World...

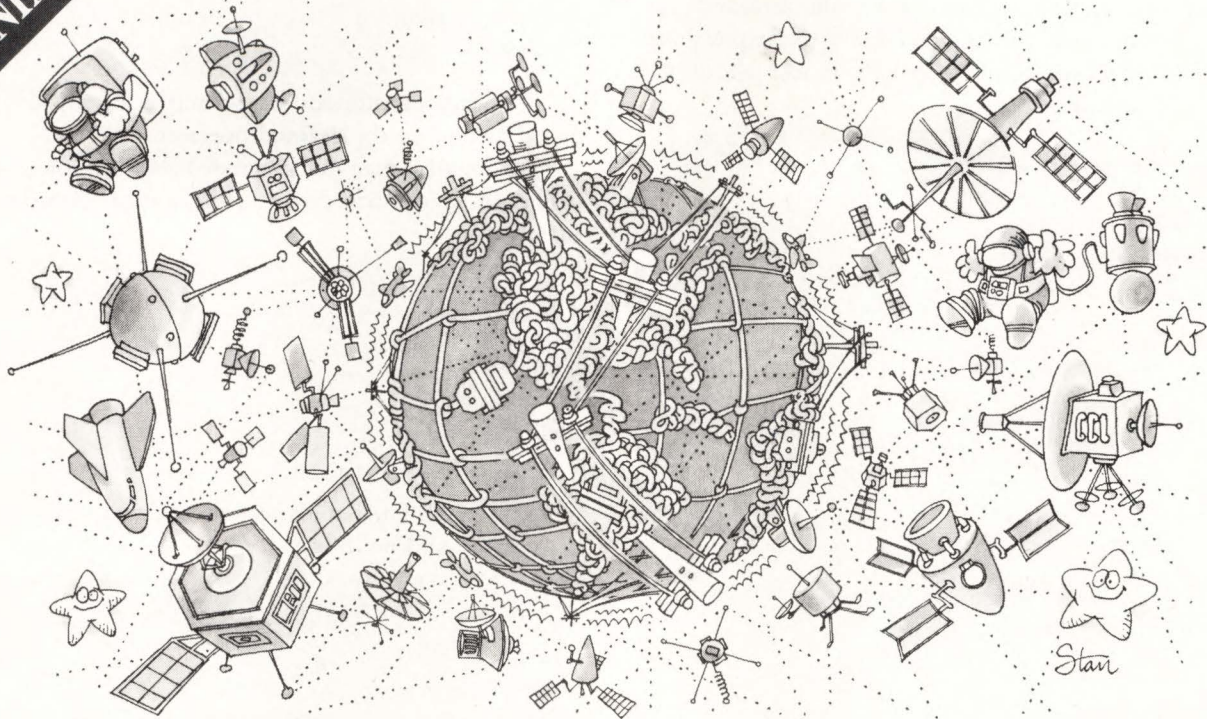

BLAST Communications Software Gets Your Data Through it All!

Performance with increasing noise.

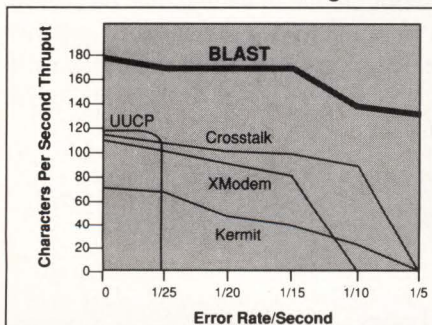

Noise simulation tests run with a 30K binary spreadsheet file at 1200 baud between IBM-PC's, using BLAST II, rev. 8.1. Comparable or better results on Mac, VAX, and others.

In today's world of noisy phone lines, complex switches, and satellite-routed calls, you need rugged communications software to get your data safely through everything, everytime.

BLAST's protected pipelining protocol won't slow to a snail's pace, drop data or disconnect due to noise. Static interference or PBXs — your valuable data quickly BLASTS through it all, saving you time and money, *without any add-on boards or other expensive hardware*. And, BLAST is X.25/DECNET/MNP compatible!

Link VAXs, PCs, MACs, and UNIX/Xenix anywhere

BLAST guarantees fast, 100% error-free file transfer and terminal emulation among VAXs, PCs, MACs, UNIX, Xenix, and others. Unite them all with *one* easy-to-use interface, *one* set of commands, *one* protocol, and *one* scripting language.

Auto-dialing and modem management sequences are built-in so you can easily set up polling, data collection, order entry and other *unattended* communications applications between *hundreds* of remote sites, all at a fraction of what you'd expect to pay. Plus, a "Private Network" feature locks out unauthorized users for data security beyond simple passwords.

The Choice of the Fortune 1000

Bankers Trust, Blue Cross, Exxon, Nabisco, and many others have chosen BLAST to cut through the noise. And now, leading communications products vendors specify BLAST, as well. Find out what BLAST can do for you. Give us a call today.

1-800-24-BLAST

Any computer with BLAST can talk to any other computer with BLAST:

IBM	VM/CMS or MVS/TSO
DEC	VAX/VMS; PDP/RX; RT-11
DATA GENERAL	RDOS; AOS; AOS/V5
WANG	VS
PRIME	PRIMOS
HEWLETT-PACKARD	3000/MPE; 1000/RTE
HARRIS	VOS
TANDEM	LXN
UNISYS	BTOS, CTOS, UNIX
IBM-PC & PS/2	MS-DOS
APPLE	MACINTOSH
UNIX/XENIX	AT&T; Altos; NCR; Sun HP; VAX & mVAX; 386 PCs.

Many others available; please inquire.
Prices start at \$250



BLAST®

Communications Research Group

5615 Corporate Boulevard • Baton Rouge, LA 70808

preprocessor pretends that macro has the value zero, and continues. However, this is only true in **#if** directive expressions.

The **#if** expressions may contain almost all of C's operators, for example:

```
/* #if expressions and #elif */

#define VAX 1
#define UNIX 101
#define VMS 102

#if CPU == VAX
    #if OPSYS == UNIX
        /* ... */
    #elif OPSYS == VMS
        /* ... */
    #else
        /* ... */
    #endif
#else
    #if CPU == M68000 && OPSYS != UNIX
        /* ... */
    #endif
#endif
```

As shown, conditional directives can be nested. ANSI C added the **#elif** directive, which is simply a more elegant way of nesting **#if** directives.

The main limitations on the contents of **#if** expressions are that they contain no floating-point expressions, type casts or enumeration constants. And, while ANSI C permits a preprocessor to recognize the **sizeof** operator here, it isn't required to.

Because comments don't nest, how do you comment out a section of code that already contains comments? The following example provides a solution:

```
/* "commenting out" code containing comments */

#if 0
    i = 10;
    printf("Has initialized i\n"); /* ... */
#endif
```

Because 0 is false, the enclosed block never is compiled.

ANSI C added a preprocessor-only operator **defined**. This adds no new value except to make Boolean criteria much simpler to read and write, for example:

```
#if defined M1 && !defined M2
    /* ... */
#endif
```

is equivalent to:

```
#ifndef M1
    #ifndef M2
        /* ... */
    #endif
#endif
```

```
#endif

#endif
```

Optional parentheses are permitted around the macro name operand of the **defined** operator.

Although it may not be immediately obvious, you can conditionally compile down to the source token level, for example:

```
int i =
#if SYS == 1
25
#else
50
#endif
;
```

This works fine, but it's not very readable. Perhaps a better approach would be to use:

```
#if SYS == 1
int i = 25;
#else
int i = 50;
#endif
```

Miscellaneous Directives

Other directives defined are:

1. The **#line** directive — **#line** is used to change the current file name and/or line number used by the preprocessor and compiler to report errors. For example, if **#include "abc.h"** is encountered during preprocessing, you would want any messages that pertained to it to be reported based on that file's name and line number, not on that of your source file. Much of this is transparent to application programmers and this directive rarely, if ever, needs to be used by them. It's used mostly by programs that directly generate C source code. Nevertheless, its format is:

```
#line line-number
```

or:

```
#line line-number file-name
```

Examples of its use are:

```
#line 100
#line 123 "test.c"
```

2. The **#** directive — The **#**, or null, directive is a relic and has absolutely no effect. Therefore, you never should use it.
3. The **#pragma** directive — ANSI C invented this implementation-defined directive. Essentially, an implementation can invent any pragmas it wishes. If an implementation comes across a pragma it doesn't recognize, it ignores it.

Pragmas are being used for all sorts of things. Examples include definition of page format for compilation listings, con-

trolling optimization and function call mechanisms. Mostly, the format and purpose of pragmas are left up to the imagination of the implementers. There are no standard pragmas in ANSI C.

The format of a pragma is:

```
#pragma preprocessor-tokens
```

4. The **#error** directive — ANSI C also invented the **#error** directive. Its format is:

```
#error preprocessor-tokens
```

and it causes the implementation to issue a diagnostic message made up of the preprocessor tokens in the directive. One example of its use is:

```
#ifdef M
/* ... */ #else
#error "Macro M is not defined"
#endif
```

Predefined Macros

I stated earlier that some implementations have one or more predefined macros indicating their host CPU, operating system, and so on. ANSI C defines only five such standard macros and they may not be the subject of an **-undef** directive. They are:

1. **__FILE__** — A string literal containing the name of the source file being compiled.
2. **__LINE__** — A numeric literal containing the number of the source line being compiled.
3. **__DATE__** — A string literal containing the date of compilation, in the form **"Mmm dd yyyy"** where months less than 10 have a leading space.
4. **__TIME__** — A string literal containing the time of compilation, in the form **"hh:mm:ss"**.
5. **__STDC__** — is set to 1 if the implementation conforms to the ANSI C Standard.

These macros (assuming they're defined) can be used in any context where literals of their type are allowed, for example:

```
char compile_date[] = __DATE__;
char compile_time[] = __TIME__;

printf("File is %s, line is %d\n", __FILE__, __LINE__);
```

Readers are encouraged to submit any C-related comments and suggestions to Rex Jaeschke, 2051 Swans Neck Way, Reston, Virginia 22091 or via the uucp address uunet!aussie!rex.

—Rex Jaeschke is an independent consultant, author and lecturer. He is the C language editor of DEC PROFESSIONAL, and our representative on the ANSI C Standards Committee.

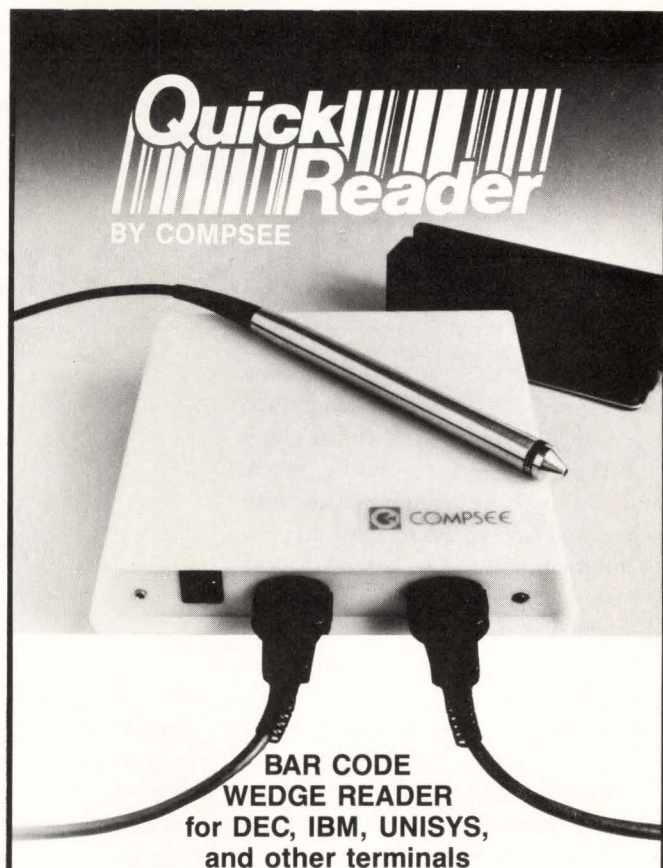

Quick Reader
BY COMPSEE

BAR CODE WEDGE READER
for DEC, IBM, UNISYS,
and other terminals

"QUICKREADER" gives you unbeatable speed and accuracy. "QUICKREADER" interfaces between the keyboard and display of DEC, DEC compatibles and most major terminals.

This state-of-the-art bar code reader simply plugs in between the keyboard and display sending data to the display as if it were keyed. The keyboard remains active at all times even when the wand system is not in use. The "QUICKREADER" is interchangeable between most terminals by simply wanding a bar code label and in some instances changing a cable.

- Keyboard interface for IBM/IBM compatibles, DEC, UNISYS and most major terminals
- Autodiscriminates between all popular codes
- User programmability of code parameters
- No auxiliary power pack required (utilizes power of keyboard)
- RS232 input port, allows uploading of data from portables
- Interchangeable between most terminals
- Light pen, laser, LED, and slot input devices are interchangeable
- Accepts dual scanner input
- Rolling buffer for fast data entry
- Phone jack for beeper amplification
- Low profile, rugged lightweight housing

FOR SALES INFORMATION CALL (305) 724-4321



OPTICAL DATA COLLECTION SYSTEMS

A Subsidiary of McRae Industries, Inc.
P.O. BOX 726
MT. GILEAD, NC 27306

WORKSTATIONS

David W. Bynon

Tandy/DECnet-PCSA: Bliss And Frustration

I've learned a lot from PCs, such as how people work

and the need to communicate with others and have access to a central pool of information. I've also learned that the PC isn't the simple desktop solution I thought it would be. Those extra features you pay big bucks for, such as expanded memory and 386 multitasking, aren't as readily put to use as they might be. And compatibility problems abound.

People who want to use the industry-standard PC as a workstation are faced with too many choices to make in a world of too many and too few standards. Currently, there are three popular workstation operating platforms: DOS, UNIX and OS/2.

The operating system is only part of the problem, however, because we also must deal with hardware compatibility issues (even within the IBM industry-standard world), mixed vendor networks, software compatibility, suitable user interfaces and more. The list of problems seems endless.

PC Integration

Several months ago, I was faced with finding or integrating several PC workstations. We needed the machines in our office for desktop publishing and training applications.

The workstations had to meet several strict requirements: high memory capacity, multitasking, remote booting from one or more VAX systems on the LAN, medium-resolution color graphics, and transparent access to our VAXcluster resources (disk storage, printing, terminal emulation and so on). Most of our requirements are network functions, so we reviewed the known

PC integration products for the capabilities we wanted. We looked at several packages for industry-standard PCs. All of the packages had very exciting features. However, the only one that could meet all of our requirements was DEC's PC Network Integration Package and DECnet/PCSA Client software (version 2.1).

To integrate the PCs, three separate line items had to be purchased: the Network Integration Package (DEPCA-KA/LX), DECnet/PCSA Client media and documentation (QBZP3-H*/LX), and VAX/VMS Services for MS-DOS media and documentation. The license to use VAX/VMS Services for MS-DOS is included with DECnet-VAX, and the license to use DECnet/PCSA Client comes with the Network Integration Package.

I was overwhelmed when the integration kits and software arrived. It was almost as bad as receiving a new VAX. There were boxes of controllers, keyboards, cables, software and DEC's typical onslaught of documentation and updates (five packed volumes).

Fortunately, selecting the PC was easier than choosing a network package. By selecting DECnet/PCSA, we already had limited ourselves to the industry-standard (IBM PC) architecture. Further, because of the multitasking and memory requirements, we knew that anything smaller than an 80386 system

**“
People who want to use the
industry-standard PC as a workstation
are faced with too many choices . . .**

would be out of the question. We looked at several machines, including the Compaq DeskPro 386S, IBM Model 70, Tandy 4000 and AST Premium/386. We decided on the Tandy 4000 for its price/performance (see Figure).

The Tandy 4000 comes with 1 MB of memory, a 101-key enhanced keyboard, a single 3.5-inch 1.44-MB floppy disk, a 32-bit memory expansion slot, eight plug-in expansion slots (six AT, two XT), one serial port and one parallel port. All other hardware is optional. I added Tandy's VGM-300 RGB analog monitor and VGA adapter, the 1-MB memory upgrade kit and 2-MB SIMM memory expansion adapter. No additional storage devices would be required on our workstations.

Each machine took about an hour to integrate. The task required unpacking the hardware, removing the cover from each of the Tandy 4000s, inserting the video and Ethernet controllers, plugging in the LK250 keyboard and DEC corporate mouse, and connecting the various cables. A single jumper had to be changed on the DEPCA Ethernet adapter to set the PCs up for remote booting. No other jumpers or switches needed to be modified.

Sweating The Software

The software, I'm sorry to say, wasn't as simple as the hardware. There were

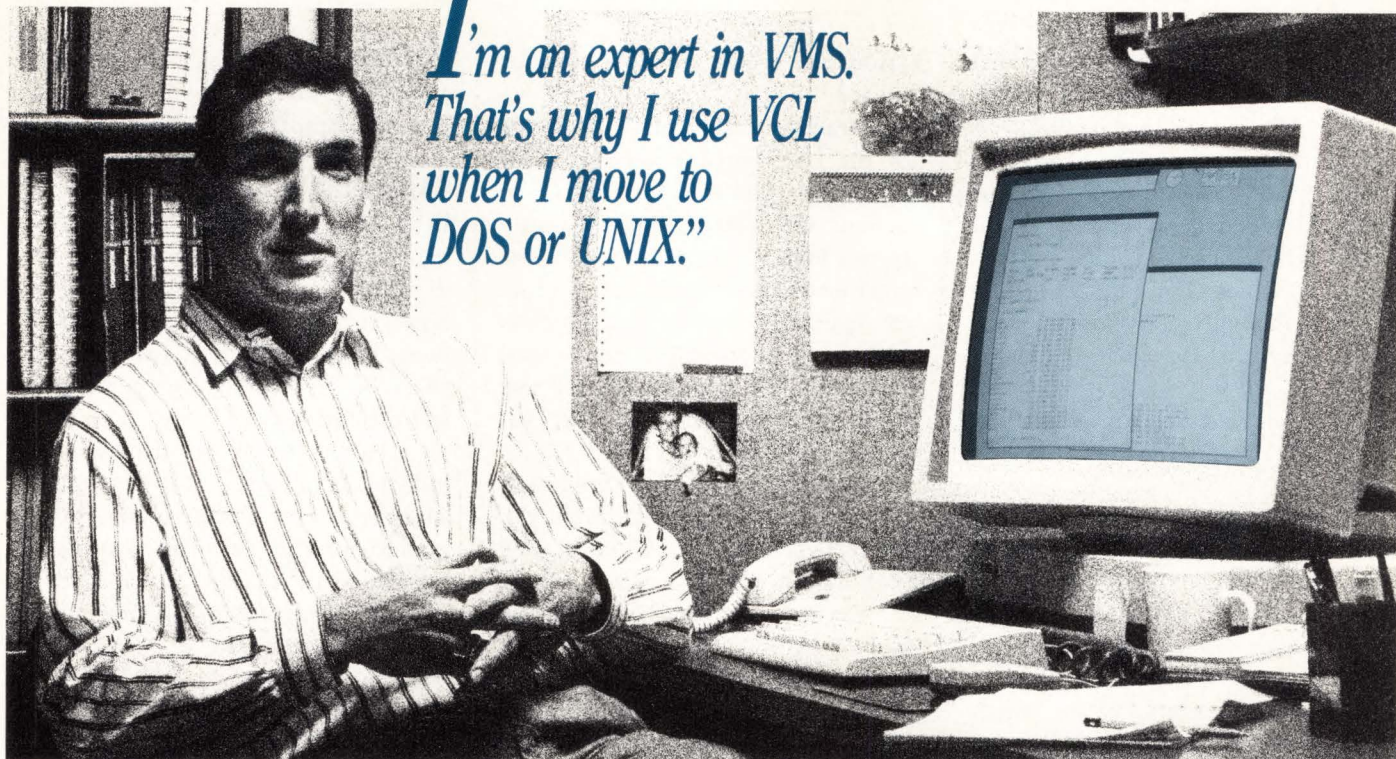

*"I'm an expert in VMS.
That's why I use VCL
when I move to
DOS or UNIX."*

Now VMS experts can use DCL commands outside of the DEC environment. VCL is a rich implementation of the Digital Command Language for DOS, UNIX, and ULTRIX environments.

VCL implements these powerful DCL commands: @, append, assign, call, close, continue, copy, create, deassign, deck, define, delete, differences, directory, dismount, dump, edit, endsubroutine, eod, eoj, exit, gosub, goto, help, if, inquire, library, logout, mail, merge, mount, on, open, phone, print, read, recall, rename, reply, return, run, search, set, show, sort, spawn, stop, submit, subroutine, type, wait, and write.

VCL also includes on-line help, logicals, symbols, command history, command editing, command files, conditional logic, and complete VMS file names.

Use VCL as your DCL interface for the IBM PC, PC COMPATIBLES, SUN, HEWLETT-PACKARD, ENCORE, ALLIANT, GOULD, ALTOS, CONVERGENT, and for other UNIX systems.

VCL is \$195 for PC's and compatibles. If you're an expert in VMS and you move to DOS or UNIX, call or write us today for more technical information on VCL.

BOSTON BUSINESS COMPUTING, LTD.

The DEC™ Compatible Software Company

Riverwalk Center • 360 Merrimack Street • Lawrence, MA 01843 • (508) 683-7920

UNIX is a trademark of AT&T.

VAX and VMS are trademarks of Digital Equipment Corporation.

VCL is a trademark of Boston Business Computing, Ltd.

CIRCLE 297 ON READER CARD

many problems, some of which don't have solutions.

The Tandy 4000 version of MS-DOS version 3.30 worked fine. There are several Tandy 4000-specific utilities included that take advantage of the special hardware. My favorite is MON386, which allows you to load as many as nine programs in memory at once and switch between them. It's a little crude, but it works. Other special Tandy 4000 utilities include a disk cache, Expanded Memory Manager and a disk optimizer (defragmenter).

The DECnet/PCSA software is full of mixed blessings, but for the most part, DECnet/PCSA works very well. The product has three major software components: DOS extensions, DECnet-DOS and MS-Windows.

The DOS extensions are mostly replacement commands that take advantage of DECnet-DOS software and the Network Integration Package. The most important extensions are BACKUP, RESTORE and BACKLIST, which allow you to back up to network drives and subdirectories.

DECnet-DOS allows the PC to participate as an end node in a DECnet Phase IV network. Additional features of the DECnet-DOS software let the PC use storage and print resources of designated VAX servers running the VMS Services for MS-DOS server. This is the most powerful feature of DECnet/PCSA.

MS-Windows is a DEC-modified version of the standard Microsoft Windows version 2.03.03. DEC's enhancements to the product include drivers for the Network Integration Kit, a VT220 emulator, a PCSA Control Utility, the MS-Windows Information System, and MS-Window Program Information Files (PIF) for most DECnet-DOS commands.

The DECnet/PCSA software worked fine, but DEC didn't include support for 80386 processors. This is a serious drawback. Without 80386 support, the multitasking and expanded memory

capabilities of the machine can't be realized.

I tried substituting MS-Windows/386 for the DEC-supplied version, but I encountered numerous problems. For example, when the PC boots remotely (from a VMS server), MS-Windows/386 won't load. It just bombs out, without any indication of what the problem might be. If bootstrapped from a local floppy disk, MS-Windows/386 will run, but executing any of the network programs supplied with DECnet-DOS/PCSA causes a fatal error. This problem is caused in part by the incompatibility of PIF files between MS-Windows and MS-Windows/386.

To compound the problem further, the DECnet-DOS/PCSA drivers and software consume about 200 KB of available DOS memory. So, if we want to use MS-Windows in the DECnet-DOS/PCSA environment, we're stuck with a small amount of memory in which to run ap-

plications (such as PageMaker) and a 3-MB RAM disk or disk cache. It's a frustrating problem.

Compatibility Conflicts

In all fairness to both Tandy and DEC, the products work as advertised and are of exceptional quality. At some point, however, software developers must address the compatibility issue of the so-called industry-standard computers and their software.

DECnet-DOS/PCSA satisfies the requirements of most PCs with 8086 and 80286 processors, but it requires 80386 performance to perform adequately. MS-Windows, the pseudo industry-standard Presentation Manager, is developed for each Intel processor (8086, 80286 and 80386) and, unfortunately, the only common denominator is the low-end version.

After DEC's January announcement of its DECstation 316 and 320 (Tandy

FIGURE		
CPU		
80386 clock rate:	16.0 MHz	
Average instruction fetch per byte:	0.19 microseconds	
Average RAM read time per byte:	0.27 microseconds, 2 wait states	
Average RAM write time per byte:	0.14 microseconds, 0 wait states	
Average ROM read time per byte:	1.07 microseconds, 15 wait states	
Average video write time:	2.01 microseconds, 30 wait states	
Refresh overhead:	11.4%	
Bus performance index:	13.03 times standard IBM PC/XT	
Norton performance index	17	
Disk		
Sequential reads	Local hard disk	DECnet-DOS virtual disk
1 sector	0.003 seconds per read	0.011 seconds per read
8 sectors	0.025 seconds per read	0.030 seconds per read
Random reads (0.10 width seeks)	Local hard disk	DECnet-DOS virtual disk
1 sector	0.034 seconds per read	0.011 seconds per read
8 sectors	0.052 seconds per read	0.027 seconds per read
Average boot time	Local floppy	DECnet-DOS virtual disk
	38 seconds	29 seconds

Tandy 4000/DECnet-DOS performance characteristics.

4000 and 4000 LX) PCs and MS-DOS DECwindows, I have to wonder if DEC will continue to support MS-Windows at all. According to the announcement, MS-DOS DECwindows would be available as part of DECnet/PCSA, which is scheduled for a new release this spring.

If DEC drops MS-Windows rather than upgrade to the 386 version, will we be able to count on DEC for applications to replace the ones we run under MS-Windows? If so, how soon? More important, will DEC's MS-DOS DECwindows support the Lotus/Intel/Microsoft standards for expanded memory and program compatibility, or will this be another incompatibility issue? And last but not least, will DEC support Microsoft's OS/2 operating system, which is sure to be a hit with its true multitasking capability and Presentation Manager window system?

DEC is touting that it will own the

Companies Mentioned In This Article		
Aldus Corp. 411 First Ave. S., Ste. 200 Seattle, WA 98104 (206) 622-5500 CIRCLE 569 ON READER CARD	Digital Equipment Corp. 146 Main St. Maynard, MA 01754 (508) 897-5111 CIRCLE 403 ON READER CARD	Lotus Development Corp. 55 Cambridge Pkwy. Cambridge, MA 02142 (617) 577-8500 CIRCLE 408 ON READER CARD
AST Research Inc. 2121 Alton Ave. Irvine, CA 92714 (714) 863-1333 CIRCLE 568 ON READER CARD	IBM Corp. Old Orchard Rd. Armonk, NY 10504 (914) 765-1900 CIRCLE 407 ON READER CARD	Microsoft Corp. 16011 N.E. 36th Way Redmond, WA 98052 (206) 882-8080 CIRCLE 410 ON READER CARD
Compaq Computer Corp. P.O. Box 692000 Houston, TX 77269 (713) 370-0670 CIRCLE 567 ON READER CARD	Intel Corp. 3065 Bowers Ave. Santa Clara, CA 95051 (408) 987-8080 CIRCLE 434 ON READER CARD	Tandy Corp. 1800 One Tandy Center Ft. Worth, TX 76102 (817) 390-3700 CIRCLE 446 ON READER CARD

desktop in the 1990s. This will require coordination and cooperation with PC industry leaders. We've counted on DEC to provide us with hardware and software compatibility in our VAX and PDP

systems. I hope we can count on the same dedication to our industry-standard PCs, because anything less than compatibility with current popular standards inevitably will be met by disaster. ■

THE FASTEST RAM DISK in the world for DEC Q-bus & Unibus computers

- Available from 16MB to 512 MB
- Ideal for use in hostile environments
- MILITARY and MANUFACTURING USES
- Fully emulates * MSCP protocol
- Eliminates rotational latency & seek time
- NOW cost effective
- Battery backup available

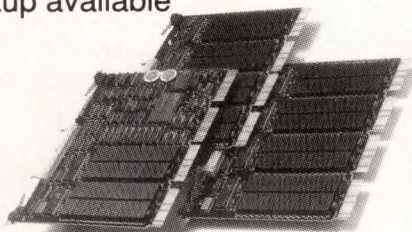

"faster than
a spinning
platter"



SEE FIRST TECHNOLOGY INC.
4655 Old Ironsides Drive, Suite 100 Telephone (408) 748-7717
Santa Clara CA 95054-3013 Facsimile (408) 748-7621
"the RAM disk & RAM drive company"

*VAX, MSCP are trade marks of DIGITAL EQUIPMENT CORPORATION

CIRCLE 240 ON READER CARD

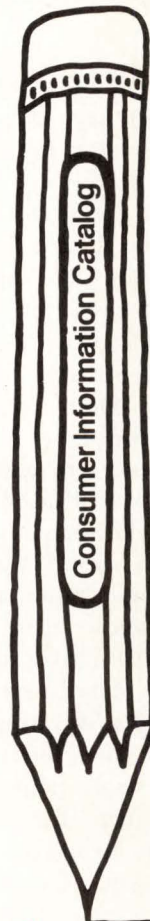

Reading worth writing for.

If you're looking for some good reading, you've just found it. The free Consumer Information Catalog.

The Catalog lists about 200 federal publications, many of them free. They can help you eat right, manage your money, stay healthy, plan your child's education, learn about federal benefits and more.

So sharpen your pencil. Write for the free Consumer Information Catalog. And get reading worth writing for.



Consumer Information Center
Department RW
Pueblo, Colorado 81009

A public service of this publication and the Consumer Information Center of the U.S. General Services Administration.

from the lab

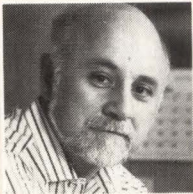

Dave Mallery

You find them in every computer room: three- to five-year-old drives, usually Fujitsu Eagles or 23xx, that are in perfect condition and give every indication of three to five more years of error-free operation. The silly things cost between \$5,000 and \$15,000 and still are being depreciated. It's too bad they're obsolete. It's too bad they're so big. It's too bad they make so much heat. It's too bad they're a DR type and their SMD interfaces don't plug into the KDB50 or the HSC.

Here's what we're doing in our shop. Lago Systems makes a box that converts SMD drives into standard DEC DSI cable compatibles. Basically, you plug the SMD cables in one end and the DEC DSI cables in the other. There are a few options. Your basic Lago board converts only one drive. We're using two basic boards, one on an Imprimis Sabre (special speed for this) and one on

Cluster Chronicles: Life Extension For Older Drives

an older (but still new) Fujitsu 2344 (671 MB). Lago offers another option that allows you to daisy chain a second identical drive to a basic board. However, this option uses an additional card slot.

The cabinet holds a total of four cards. We have a pair of Eagles that fills this bill perfectly.

The overall strategy for our cluster is to remove disks that are of the DR persuasion and are served by a single node and convert them to MSCP drives that are served by two nodes. This reduces the vulnerability to a single point of failure for the whole cluster. Getting there involves a gradual migration,

adding MSCP capacity and shifting the load over.

The biggest problem with installing the drives on the Lago box is that you have to format the drives for MSCP.

C ONTENTS

- 114 **Cluster Chronicles:**
Life Extension For Older Drives
- 118 **Eigen Corporation's Eigen Utilities**
- 124 **Innovative Computer Technologies'**
DiskView V1.1
- 126 **Compu-Share Accounts Receivable**
- 129 **Recital Corporation's Recital**
- 134 **Marc Software's WordMarc Composer +**

There are no available VAX diagnostics that do low-level drive formatting. Low level means creating a factory bad block table. We had to ship the drives and box to a friend with a PDP-11 that had a UDA50 controller and available

“
**The Fujitsu 2344 . . .
gracefully ignores
the commands from
the Lago panel.**
”

diagnostics. After that, you can hook the drives to the VAX. Formatting the 2344 took about 1½ hours. The Sabre took a little more than two hours. If you bought them from a distributor, the formatting would have been done for you.

A few points in the documentation were less than current, but our fax machine handled that. The control panel of the Lago actually controls the Sabre drive, and you aren't to use the drive control panel at all. The Fujitsu 2344 isn't as compliant and gracefully ignores the commands from the Lago panel.

Imprimis Sabre

The Sabre drive we reviewed (“CDC's Sabre,” September 1988) is made by Imprimis Technology Inc., a new subsidiary of Control Data Corporation. It's a 3-MB-per-second edition running on the Q-bus with an Andromeda controller. It has been in constant use ever since with absolutely no problems. Imprimis recently sent us a model that has been slowed and therefore downsized so that it won't overrun the DEC controllers (sad, isn't it). We're using this

<p>Companies Mentioned In This Article</p> <p>Andromeda Systems 9000 Eton Ave. Canoga Park, CA 91304 (818) 709-7600 CIRCLE 574 ON READER CARD</p> <p>Digital Equipment Corp. 146 Main St. Maynard, MA 01754 (508) 897-5111 CIRCLE 403 ON READER CARD</p> <p>Fujitsu Microsystems of America Inc. 3055 Orchard Dr. San Jose, CA 95134 (408) 434-1160 CIRCLE 441 ON READER CARD</p> <p>Imprimis Technology Inc. 8100 34th Ave. S. Minneapolis, MN 55425 (612) 851-4131 CIRCLE 577 ON READER CARD</p> <p>Lago Systems 160 E. Albright Way Los Gatos, CA 95030 (408) 374-1818 CIRCLE 575 ON READER CARD</p> <p>Mod-Tap System 285 Ayer Rd. P.O. Box 706 Harvard, MA 01451 (508) 772-5630 CIRCLE 576 ON READER CARD</p>

drive with the Lago box. It's a bit smaller in capacity and so formats down to only 828 MB under MSCP.

I like these drives. They're big enough to be credible, yet pack 2 GB into a single 5½-inch-high tray. They look and feel like they're made to run forever. They're made in the U.S. by a U.S. manufacturer.

This latest edition of the Sabre came with a fitted fan on the rear of the drive,

If you're worried
about cancer,
remember this.
Wherever you are,
if you want to talk
to us about cancer,
call us.
We're here to
help you.



**2,500,000 people
fighting cancer.**



Our Lago box allows us to use drives, such as the Imprimis (CDC) Sabre, as MSCP-served disks on our cluster.

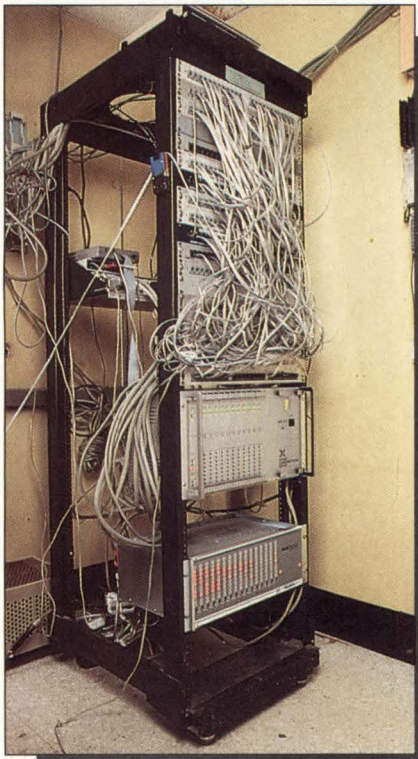

Our Mod-Tap rack was hardware's equivalent of spaghetti code. Tracing wires certainly was a challenge.

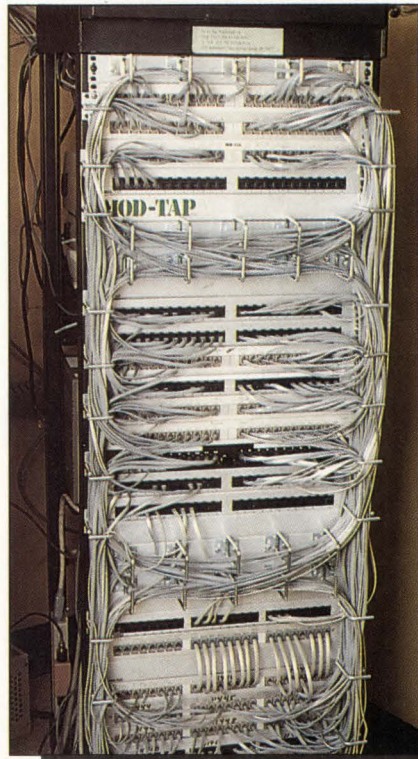

The result of six hours of labor. Grouping wires makes maintenance easier and improves the appearance.

and that's a welcome upgrade.

We'll have a progress report as these new items get properly burned in.

The Game Plan

We've spent a lot of time analyzing our LAVc and finally are reaching some conclusions about the entire LAVc idea. We find by direct measurement that our collection of 1-mip machines spends about half its capacity on cluster overhead, most of that serving MSCP on the interrupt stack. No amount of tuning by some of the most experienced wizards in the industry has been able to alter that fact. If you start a batch job on a satellite, you blow the cluster performance with 75 percent or better on the interrupt stack both on client and server.

We're planning a reconfiguration. The LAVc will be a cluster of development workstations off the main machine. The main machine will have to be big enough to carry our full interactive and batch load by itself. BILBO::, our 11/750, will be the ARIS machine and will be off the cluster for security. FRODO::, our loyal MicroVAX II, will be the boot node of our Lab cluster. He and his workstation can re-join the production cluster as needed, but they'll no longer be constrained from being absolutely current in VMS release. The third-party software we're running had a latency of up to seven months before all the version 5.0 releases were logged in.

As the photos show, our Mod-Tap rack was the victim of years of uncontrolled growth and looked like it had cancer. Mod-Tap rewired it to great effect. The individual patch cords are now a little longer and follow a more circuitous route, but at least you can see the patch panel. This panel handles all the data and voice for our Spring House, Pennsylvania, installation. All of our modems and the Ethernet goodies live in the back.

Everybody talks about
concurrent LAT and TCP/IP
support.

Xyplex delivers it.



It's the MAXserver™ family of terminal servers from Xyplex.™ With true LAT and TCP/IP support. *Multiple, concurrent sessions.* Full compatibility so there's no retraining. And it's shipping now. With Xyplex's unique non-stop performance and 3-year warranty. Find out how good a terminal server can be. Call today for a free information package.

1-800-338-5316

(In Mass., 508-371-1400)



Copyright © 1989. Xyplex, Inc. Xyplex and MAXserver are trademarks of Xyplex, Inc.

CIRCLE 150 ON READER CARD



Eigen Corporation's Eigen Utilities

David B. Miller

VMS provides a rich set of commands

and utilities for system managers and programmers. However, most of them probably would try something outside traditional VMS, especially if it meant saving time or possessing capabilities that VMS DCL commands and utilities don't give them.

Eigen Corporation of New York has created a collection of utilities it feels system managers and program developers will find helpful. The utilities were written out of necessity. Eigen's developers found them useful for their own jobs and think you'll appreciate the additional power the utilities will give you. We tested version 1.7 of the Eigen Utilities on our VAXcluster.

Installation

VMSINSTAL is used to install the software. A supplied command file must be run on a system reboot to INSTALL each utility with the proper privileges. An installation list data file can be modified to remove utilities or to restrict their use. Each user also must execute a log in command file to set up symbols and logical names.

The Utilities are used like VAX/VMS DCL commands. There's no strange syntax to learn.

Utility Groups

There are more than 60 utilities in release 1.7. Eigen classifies them into 13

```

Directory _FRODO$DUC0: [000000](4,4,0)

INDEXF.SYS;1          [00001,00001] 10702/10704 (1,1,0) 1,13

Total of 1 file, 10702/10704 blocks 1,13.

Directory _FRODO$DUC0: [CIRCLAB.DECSUB] (4977,2,0)

DECPROJAN89.SLC;1    [00202,00032] 6835/6837 (8923,7,0) 1,1

Total of 1 file, 6835/6837 blocks 1,1.

Directory _FRODO$DUC0: [CIRCOLD.HPOLD] (1083,12,0)

PROSUB.ALF; 1        [00114,00003] 42363/42363 (4174,12,0) 2,2
PROSUB.DAT;1        [00114,00003] 120000/120006 (9054,15,0) 1,1

Total of 2 files, 162363/162369 blocks 3,3.

Directory _FRODO$DUC0: [PROSPECT] (1352,8,0)

ICP0189_RAW.DAT;1   [00114,77777] 5008/5010 (8090,7,0) 1,1
MILL_RAW.DAT;1      [00114,77777] 7564/7566 (10281,3,0) 1,1
SCOPE36_RAW.DAT;1  [00114,00020] 7138/7140 (10280,4,0) 2,2

Total of 3 files, 19710/19716 blocks 4,4.

```

Screen 1: A report generated by the INDEXF utility. The name, owner UIC, size in blocks/number of blocks allocated, file ID, number of file headers and number of file mapping pointers are displayed for each file.

categories. I'll describe the categories and a utility or two from each to give you the flavor of the product. Some utilities fall into more than one category. Some utilities will be appreciated more by software developers, others by system managers and operational staff. But, everyone should find some valuable utilities in the set.

Category A contains utilities that work with event flag services. The CEB utility displays all the event flag clusters present on your system and all processes associated with them. EVENT allows event flag clusters to be modified, deleted or viewed. EVENT is useful for testing applications that use common event flags.

File Structure Services comprise Category B. FIDENTER is similar to SET FILE/ENTER except that FIDENTER lets you enter a directory entry to a file given

its file ID. For example:

```
FID DAVE.ONE / ID=(1432, 23, 0)
```

creates a directory entry for file DAVE.ONE and is given the file ID 1432, 23, 0. Files reported lost by INDEXF or ANALYZE/DISK can be restored to a directory by using this tool.

INDEXF is a Category B command that generates reports on lost files, files marked for deletion or files with bad blocks. A sample INDEXF report is shown in Screen 1. Qualifiers exist to cause INDEXF to report on files of a minimum size, to find files that can be truncated to save space and to find files marked for deletion. It's also possible to supply a UIC value to allow INDEXF to find all files in any directory that have the supplied UIC as the owner.

INTERLAN INTRODUCES
THE NETWORKING SOLUTION
THAT DEC OVERLOOKED

LAT AND TCP IN ONE TERMINAL SERVER

Announcing INTERLAN's LAT/TCP Terminal Server – a universal, dual-protocol networking product for less than the price of single protocol servers, like DECserver 200.

Now you can establish multiple sessions to both LAT and TCP/IP hosts – simultaneously.

The new LAT/TCP dual-protocol FEATUREPAK® – a plug-in software cartridge for INTERLAN NTS 100/200 Terminal Servers – supports all LAT connections, via LAT Directory Services. From the same terminal, you can also connect to any host running TCP/IP via TELNET or RLOGIN, with support for up to 64 virtual circuits per server. INTERLAN gives you a window into applications you couldn't even access before.

The high performance of LAT. The versatility of TCP/IP. Both for less than the price of either one. INTERLAN's



LAT/TCP Terminal Server is the networking solution you can't afford to overlook.

Call 1-800-LAN-TALK, Operator 1074, for immediate information. In Massachusetts, call 1-800-TELL-LAN.



INTERLAN

DEC and DECserver 200 are registered trademarks of Digital Equipment Corporation; FEATUREPAK® and INTERLAN are registered trademarks of INTERLAN, INC.
GSA pricing available.

CIRCLE 255 ON READER CARD

**DEC
Resellers
Call for our
Special Demo
System Pricing**



Category C, System Device and File Information Services, may be of particular interest to system managers. WHODEVICE and WHOFIELD provide listings of who's using a specified device or who has a specific file open. WHODEVICE can be used to find all users assigned to a specific mailbox. WHOFIELD can be used to determine which processes have a file locked and to resolve file-sharing problems.

Global Section Information is reported on by utilities in Category D. For example, the GPMAP utility creates a map of the global page table. System managers can determine the largest contiguous range of global page table entries. If more global page table space is required, the GDELETE command can be used to delete global pages.

Other commands exist to create permanent global sections outside any programming, list global section information, read and write from and to global sections, perform a section dump for later analysis and to find out what processes are using certain global sections.

Mailbox Services, Category E, allows you to create, read, write and delete mailboxes outside any programming code. Using external mailboxes eliminates the need for programs using mailboxes to be recompiled and relinked when mailboxes change characteristics.

Category F, Debugging Services, will be of interest to programmers. DETDBG places a detached process into the debugger. The debugging session can be steered to a terminal you specify

so you don't have to disrupt interactive programs that send output to the screen. DETDBG also can be used to attach to runaway detached processes to locate problems.

PROCDUMP, another debugging utility, lets you produce an image dump for a specified process while allowing the process to continue to execute normally. If you feel that it's not necessary to stop a process, you can get a dump of the image and inspect it offline while the process continues to run.

Category G's utilities let you see system lock and resource information. The RESOURCELIST utility allows programmers to examine the value of the lock value block, which can be used for interprocess communication. You also can examine any lock resource on the

Sure, You Hear

Price/performance. Advanced design. Productivity. Flexibility. Ease-of-use. Quiet operation. Software/hardware compatibility and connectivity. A and B size. Bright, detailed color. One-second RGB screen capture time. Now you really can get it all. In one neat package. To find out more, call us at 1-800-CALCOMP. Or write CalComp, P.O. Box 3250, Anaheim, CA 92803. In Canada, call (416) 635-9010.

Get It All With The

“
**Mailbox Services, Category E, allows you
 to create, read, write and delete
 mailboxes outside any programming code.**
 ”

system with the RESOURCELOCK command.

Locks associated with a resource can be displayed with the LOCKLIST utility. Clusterwide locks can be checked for equitable distribution across the cluster. For interprocess communication, programmers can verify that processes are using the correct resource

names.

Given a UIC or identifier value only, system managers can use the Category H IDENT_TO_UIC and UIC_TO_IDENT utilities to convert from one to the other. Many times, VMS utilities supply only one form of user identification. These utilities make it easy to determine the other form.

SYSTEM_INFO belongs to Category I, System Information Services. SYSTEM_INFO possesses qualifiers to display processes that own certain privileges, processes whose base priority is above a minimum you specify, those processes whose working set size is greater than or equal to a minimum value, and other criteria. Example output from SYSTEM_INFO is displayed in Screen 2.

The IMAGE utility lets you get image information by category — BATCH, NETWORK, INTERACTIVE, OTHER or for only specified processes.

Managing swap files is made easier by using LISTSWAP and MSWAP. LISTSWAP gives you a view of page and swap file usage on a per-process basis. MSWAP monitors page and swap file use

It All The Time.

Now
300 dpi



We draw on
 your imagination.™

CalComp
 A Lockheed Company

New CalComp ColorView.

CIRCLE 293 ON READER CARD



```
VAX/VMS V4.6 on node SAURON 16-JAN-1989 12:03:30.28 Uptime 9 21:56:08.00
```

Pid	Process name	Base	State	W.S.	Username	UIC
26C00080	NULL	0	COM	0		[0,0]
26C00081	SWAPPER	16	HIB	0		[SYSTEM]
26C00086	ERRFMT	7	HIB	512	SYSTEM	[1,6]
26C00087	CACHE_SERVER	16	HIB	512	SYSTEM	[SYSTEM]
26C00088	CLUSTER_SERVER	8	HIB	512	SYSTEM	[SYSTEM]
26C00089	OPCOM	6	LEF	512	SYSTEM	[SYSTEM]
26C0008A	JOB_CONTROL	8	HIB	512	SYSTEM	[SYSTEM]
26C0008B	CONFIGURE	8	HIB	512	SYSTEM	[SYSTEM]
26C0078C	MONITOR_SERVER	15	HIB	1909	DECNET	[DECNET]
26C0008E	UIS\$DISPLAYMGR	7	HIB	346	SYSTEM	[SYSTEM]
26C0008F	Emulators	5	HIB	346	SYSTEM	[SYSTEM]
26C00090	Banner	1	HIB	342	SYSTEM	[SYSTEM]
26C00091	NETACP	8	HIB	350	DECNET	[SYSTEM]
26C00092	EVL	4	HIB	342	DECNET	[SYSTEM]
26C00094	REMACP	8	HIB	342	SYSTEM	[1,3]
26C00095	XYP_SYMBIONT	10	LEF	342	SYSTEM	[SYSTEM]
26C01A9C	Peggy Schmidt	4	LEF	903	SCHMIDT	[ADVERT,SCHMIDT]
26C0199E	Lorie Vandegrif	4	LEF	400	VANDEGRIFT	[ACCNTNG,VANDEGRIFT]
26C01B9F	Dave Mallery.1	4	LEF	1601	MALLERY	[OFFICERS,MALLERY]
26C01AA2	MILLERMAIL	4	LEF	2069	MILLER	[EDIT,MILLER]
26C01B23	Jan Krusen	4	LEF	1403	KRUSEN	[OFFICERS,KRUSEN]
26C01A29	Cathy Dodies	4	LEF	903	DODIES	[ADVERT,DODIES]
26C000AC	CM_TICKLER	4	HIB	342	SYSTEM	[SYSTEM]
26C000AD	CM_SERVER	4	HIB	1024	SYSTEM	[SYSTEM]
26C01A31	Margie Pitrone	4	LEF	1406	PITRONE	[CIRC,PITRONE]
26C000B2	—tti_dlb—	10	LEF	342	SYSTEM	[SYSTEM]
26C000BD	MOBXNS_UR2	4	LEF	674	SYSTEM	[SYSTEM]
26C01951	Dave Miller	4	HIB	1669	MILLER	[EDIT,MILLER]
26C017D2	MILLER	4	HIB	1566	MILLER	[EDIT,MILLER]
26C018D3	_WTA3:	4	HIB	1566	MILLER	[EDIT,MILLER]
26C01855	_TTA2:	4	CUR	1200	MILLER	[EDIT,MILLER]
26C01B5B	Linda Diblasio	4	LEF	400	DIBIASIO	[EDIT,DIBIASIO]
26C01B5C	Dan Mainieri	4	LEF	903	MAINIERI	[ADVERT,MAINIERI]

Screen 2: Eigen's SYSTEM_INFO utility displays process ID, process name, base priority, process state, working set size, the username associated with the process and the process UIC. Qualifiers exist to zero in on selected processes, such as for processes that meet a minimum working set size or processes that possess certain privileges.

and presents the current, maximum and minimum use for each page file and swap file.

A number of utilities are included under Category J, Process-Related Services. System managers can control process execution with the FEXIT, HIBERNATE and WAKE utilities. FEXIT stops a process but allows VMS's exit handlers to execute. It can be used to stop a process that has locked up a terminal without logging out the user. HIBERNATE forces a process to enter

hibernate state to suspend process execution and to synchronize command procedure execution. WAKE forces a process out of hibernation.

PMEMORY displays a specified process's working set values and its page and swap file use as illustrated in Screen 3. PMON displays a detailed list of process information. You can let PMON run in interactive screen display mode, or you can send a snapshot of the process's data to a file. The QUOTA utility monitors quotas for the specified process. It's useful for tracking down

quota problems, because you can monitor the process's quotas while it's running.

DCL-Related Services, Category K, is made up of utilities from other categories. One I didn't mention is NOTIFY. NOTIFY allows you to receive notification when an image or process has completed. Other DCL services involve mailbox and global section monitoring and use.

Logical name can be a challenge to maintain. Category L's Logical Name Services can help. Group logical name tables can be created with the CREGLT utility. CREGLT lets you create group logical name tables without having to create a process within the group. VMS's CREATE/NAME_TABLE command doesn't have this capability. CREGLT is particularly useful when placed in system startup command procedures.

DELLOG, another logical name utility, lets you delete logical names based on wildcards. You can specify the table name from which you want to delete the logicals. You also can force a confirmation for each logical to be deleted.

Category M, Miscellaneous Services, contains a number of useful commands for the system manager. BECOME_USER lets you simulate another user in your system's UAF file. You take on the UIC, username and group logical name table of the other user. You can optionally take on the other user's quotas, privileges and default directory. BECOME_USER can help you manage group logical name tables and help resolve quota and privilege problems without having to log in to the other user's account.

CLEANQ deletes all entries from a specified queue without deleting the queue. You also can specify a username to delete queue entries associated with that username.

A batch job can be run at night to

Eigen Utilities

PLATFORMS: VAX/VMS systems

PRICE: \$500 to \$2,500 depending on CPU

EIGEN CORPORATION

HEADQUARTERS:

82 Wall St., Ste. 1105
New York, New York 10005
(212) 749-7513

FOUNDED: 1987

PRODUCT LINE: VMS System and network utilities

OWNERSHIP: Private

CIRCLE 429 ON READER CARD

execute the CLRERR utility, which clears error counts for all or specific devices. Then you easily can determine error counts on a daily basis for each device.

During system testing, it's often difficult to simulate data entry from multiple terminals. Eigen's ENTER command lets you specify a physical terminal name into which commands can be entered. A command file can be

specified to simulate the entry of a stream of commands at the terminal you specify.

In a clustered environment, it can be annoying to perform repeated commands on every node. Eigen's EXECUTE command lets you execute DCL commands on any DECnet node. A node list can be added to reduce typing time.

Locked terminals can be a problem. The FREETERM utility frees up terminals that are locked by a process that can't be terminated with the DCL STOP command. FREETERM doesn't support remote terminals.

The alphabetical listing of the Utilities is very clear. It's arranged like DEC's documentation, so it will look familiar to you. Qualifiers are explained as appropriate and the end of each Utility features a Recommended Usage section.

THE EIGEN UTILITIES contain something for everyone, from programmers to system managers. I can't possibly discuss each utility in the set, and there certainly are more to come. You can be sure that the Eigen Utilities will grow and change with VMS, to help you fill in any holes that VMS leaves.

Process-id: 26C01855 Process name: _TTA2:

Working set info	Page or entries	
Working set size:	1200	
Working set		
locked:	19	
dynamic lock:	41	
remaining:	1140	
Working set private:	432	
Working set global:	117	
Paging files usage		Used/Total
Pagefile: _SAURON\$DUA0:[SYSEXE]PAGEFILE.SYS;1		356/39992
Swapfile: _SAURON\$DUA0:[SYSEXE]SWAPFILE.SYS;1		576/39992

Screen 3: The PMEMORY utility displays memory use for a process.

INTRODUCING more Best Sellers!

DATA PRODUCTS

M9030 300 CPS
B600 600 LPM
B1000 1000 LPM
BP1500 1500 LPM
LZR1230 12 PG/MIN

EMULEX

UD33 DISK CONT. (UNIBUS)
QD33 DISK CONT. (Q-BUS)
QT14 MICROVAX 3500, 3600, TAPE CONT.
EMS/380 SUBSYSTEM
EMS/180 SUBSYSTEM

CONTROL DATA CORPORATION

9720-850 (NEW) 800 MEG 8"
9720-1.2G (NEW) 1.2GIG 8"
9720-850 (REFUR) 800 MEG 8"
9720-1.2G (REFUR) 1.2GIG 8"

MAXTOR

RD54 COMPATIBLE 5¼"
XT-4380E 380 MEG. 5¼"

HOW TO ORDER

To place your order, just call toll free 800-346-2933. In Pennsylvania call 412-745-0200.

TriLogic's sales representatives are available to assist you from 8:00 AM until 5:00 PM

FAX # 412-745-5950

TriLogic

R.D.#2 • BOX 203A • OLD ROUTE 519
CANONSBURG, PA 15317

TOLL FREE
800-346-2933



Innovative Computer Technologies' DiskView V1.1

By David W. Bynon Lately, there's been considerable media coverage on products such as defragmenters, cache controllers, archive utilities and lightning-fast memory disks, which claim to improve file system performance. All of these products will improve performance. But is that what your system needs, and how do you know?

Innovative Computer Technologies of Oakville, Ontario, offers DiskView, a tool for system managers, programmers and analysts who need a comprehensive disk file performance monitor.

DiskView is a data collector and reporter, similar to the VAX/VMS MONITOR utility. DiskView allows you to monitor disk activity by file and device or by process on the VAX computer. Like MONITOR, DiskView is DCL-command-line-driven and has the ability to monitor various classes (i.e., DISK, FILE, IO or PROCESS) and multiple entities within each class. As you might expect, you can dynamically monitor your file system similarly to monitoring your system with the MONITOR SYSTEM command. Alternately, you can collect data in batch for later analysis and reporting.

A unique feature of DiskView is its ability to monitor any I/O device on the

computer. The IO class allows you to specify any VMS device, such as a MAILBOX, tape drive, Ethernet adapter or CI adapter. Instead of reporting activity by file, the IO class reports activity by the size and type of I/O request, such as virtual I/O or paging I/O.

The PROCESS class lets you monitor the I/O activity of one or more processes. The information presented by this class is instrumental in finding system resource hogs or determining the performance of a program. Similarly, the FILE class lets you collect information on a specified file by process. The DEVICE class is used to report file activity for one or more disk volumes.

DiskView supports five basic display types: SNAPSHOT TABLE, SUMMARIZED TABLE, TOPIO, TOPREAD and TOPWRITE. The SNAPSHOT TABLE is the default display. It presents a "snapshot" of the information collected about the requested classes. Unlike the SUMMARIZED TABLE display, the SNAPSHOT TABLE doesn't display cumulative totals. The TOP??? displays, which are supported for the PROCESS class only, present the highest eight files with respect to total I/O, read I/O or write I/O. Useful information that may be collected with these DiskView displays includes read rate, write rate, global buffer hit rate, global buffer miss rate, mapping pointer count, number of processes accessing a single file and file locks.

DiskView is simple to install and use. Installation is accomplished using the VMSINSTAL utility and takes about five minutes. Your DCL tables will be modified to include DiskView's CLI information, and you must add a startup command to your site-specific startup procedure. The product was tested under VAX/VMS V4.7 but is compatible with versions 4.x and 5.x. Be aware, however, that you must reinstall the product if you upgrade from VAX/VMS V4.7 to V5.0.

VMS professionals will feel right at

home with the DiskView commands. For example, to monitor file activity for a specific disk, you would enter a command such as:

```
$ DISKVIEW DEVICE=$1$DUA1:
```

Or, to monitor several items, such as files, you would specify an item list:

```
$ DISKVIEW  
PROCESS=(ROCK,WILLIS,PENDLETON)  
/TOP10
```

With the information collected through DiskView, the systems manager or programmer can make intelligent decisions about file tuning, programming techniques, load balancing, adjusting VMS cache sizes, changing SYSUAF entries for one or more users, increasing global buffers of key data files, or purchasing the file's system performance solution. Without a tool such as DiskView, you're just groping in the dark.

DiskView V1.1

PLATFORMS: VAX/VMS Version 4.0 or later

PRICE: Single-user license, \$1,490; site license, \$3,790; MicroVAX, \$770

INNOVATIVE COMPUTER TECHNOLOGIES

HEADQUARTERS:

2861 Sherwood Heights Dr., Unit 32
Oakville, Ontario L6J 7K1
(416) 829-2020

FOUNDED: 1988

OWNERSHIP: Private

CIRCLE 552 ON READER CARD

THE WORD IS OUT.

	(Digital) WPS Plus®	WordMARC Composer+	WordPerfect®	Mass-11®
Identical Versions On VAX/PC/UNIX Platforms		●		
Full Functionality		●	●	●
Ease Of Use		●	◐	
Typestyle Support (Desktop Publishing)		●	◐	●
Scientific/Technical Typing		●		◐
Seamless ORACLE Integration		●		
20/20 Integration		●		●
Interleaf Filter		●		
ALL-IN-1 Integration	●	●	●	●

WordMARC® Composer+™ Is Already Ready For VAXstation™, DECstation, And VAX.™

It's no secret.

Over one-half million people already know the power of MARC Software. The government. Universities. The Fortune 500.

Now, thousands of new DEC® users are about to find out the reason.

WordMARC. The *only* word processing program for *all* DEC environments. VMS,™ ULTRIX,™ and MS-DOS.®

WordMARC has all the word processing features you need. Fonts, mail-merge, scientific typing, large document support, and dozens more. Plus things you've always wanted.

Such as graphics integration. So you can enliven your work with charts, graphs, and line drawings.

And integration with other software. So you can seamlessly gather data from multiple sources. Such as 20/20,™ ORACLE,® and others. And output to products such as Ventura® and Interleaf.™ WordMARC is also integrated with ALL-IN-1.™

Compatibility and connectivity? All you want. WordMARC looks the same on MS-DOS, UNIX,™ and VMS machines. And swaps documents between all of them.

Don't like things as they are? Customize

WordMARC with your own menus, style sheets, keyboard layouts, and on-line help.

All backed by some of the best support in the business. Including on-site training, free enhancements, and hotline telephone support.

For details, call 800-835-2400 (in California, 800-854-9900). And see why WordMARC is the last word in DEC word processing.



MARC Software
International, Inc.
260 Sheridan Avenue
Palo Alto, CA 94306

See us at COMDEX '89 Booth #9648

CIRCLE 254 ON READER CARD



Compu-Share Accounts Receivable

By Evan Birkhead

The series of Business Accounting Software from Compu-Share Inc. of Lubbock, Texas, is so broad in scope that it would be almost impossible to examine its capabilities in this Lab. Including the Personnel Management package there are 10 modules. The others are General Ledger, Accounts Receivable, Accounts Payable, Purchase Order, Payroll, Fixed Assets, Order Entry, Inventory Control and Job Cost.

I'll focus on one of the core modules, the Accounts Receivable Management System (A/R), which integrates with the modules for General Ledger (G/L) and Order Entry (O/E).

A/R Menus

With the introduction of A/R version 5.0, F release, many changes have been implemented in the structure of menus. There are two main menus. The first is the Management Systems menu. From here, the options include the other main menu, called the Application Manager's menu, and the Compu-Share financial modules.

Hitting RE on the first menu brings up the Receivables Management System menu. This has five mnemonic-oriented submenus (see Screen 1). Selecting DO, which has the user procedures that are implemented most often, allows you to post commissions, invoices and receipts to your customer's accounts, create reports on sales or credit figures or create other reports. For non-

accountants, posting is simply the merging of two or more files.

The GM menu is where the user or system manager might track and change files for invoice terms (see Screen 2), customers (see Screen 3), departments, sales personnel, taxes, finance charges and, most important, controls for posting to G/L.

Other RE options include PO, which configures, posts and recalculates statements for specified time periods; SS, which performs non-mainstream functions, such as sales tax and commission calculations, recurring billing and assigning credit ratings; and IS, which is the menu that system managers go to first to set parameters and controls for all files that will be used.

Tailoring

Compu-Share's A/R allows the system manager a high degree of flexibility in customizing the software to his business's specific needs. The instructions on how to set up a system make up more than half the documentation. Tailoring, the key customization procedure and a strong selling point for A/R, comes in two types:

1. Universal Codes affect the entire Compu-Share system, e.g., date formats and printing devices.
2. Application-specific codes affect only A/R.

Tailoring codes are accessed by selecting CHANGE TAILORING INFORMATION from the Application Manager's submenu. A series of codes appears that you can approve or modify. In A/R, ARDFCUS, for example, is the default customer code when adding a customer from the O/E module.

By simply approving these codes, you can set style formats for entities such as field sizes, decimals, file aging periods, tax rates, prorates, credit limits and service charges. Settings for invoice numbers also can be changed through tailoring.

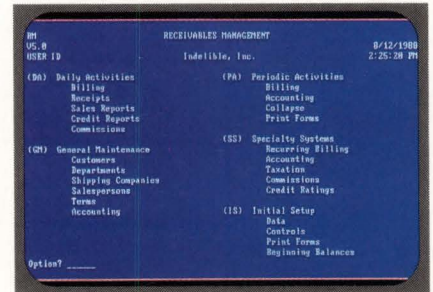

Screen 1: The top menu for Receivables Management.

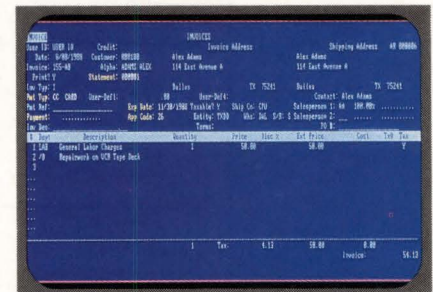

Screen 2: The invoices data-entry screen.

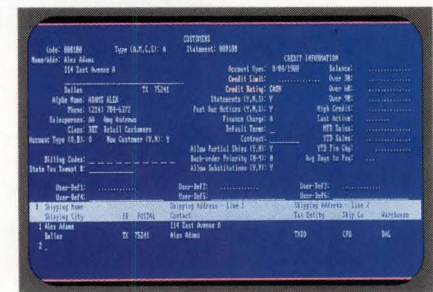

Screen 3: Customer codes are entered on this form.

You include only the fields you need, and they look the way you want them to. Your reports will come out the same. You can assign a wildcard reference to your departments so that only information you need gets reported.

The system manager can create and maintain control over the subsidiary

files Customer Classes, Departments, Salespersons, Tax Entities, Invoice Terms, Finance Charges and Shipping Companies. Each of these files supports the customer file.

The only difficulty is trying to remember which were the system screens and which were user accounts. But screen titles will remind you.

The documentation is so good that you should have no trouble running A/R. You need an elementary knowledge of accounting to keep track of what's what. But entering balances and posting files is only a matter of making menu selections and filling out forms.

For example, you don't even need to know the system interfaces with G/L. You only have to select POST A/R INVOICES or POST A/R RECEIPTS. Writing deposits, accepting cash or checks, and printing, follow the same pattern.

Documentation

Documentation can be the most important part of an accounting system. How well a product's capabilities are conveyed is a key issue. It's even more so with A/R because of the breadth of tailoring possibilities presented.

The documentation is divided into five sections: Implementing The Software (66 pages), Initial Setup (101 pages), Practicing With The Software (49 pages), Using The Software (210 pages) and Supporting The Software (56 pages). An index appears at the end of each section and at the end of the manual. This is helpful, because many new terms are used. The two pages that describe how to use the documentation are beneficial.

Implementing The Software covers designing a system (from design codes to forms), tailoring it to your business's needs, how to use menus and how to log

on and off. Initial Setup details billing, posting to G/L and creating and changing files, including files for customers. Using The Software was the most important for my purposes and is well-written and well-organized. Practicing With The Software, a late addition to the documentation set, is a good idea, but probably is only necessary for the most elementary users. The final section, Supporting The Software, covers such things as backup, troubleshooting, system manager functions and security, which features a good explanation of VMS A-to-Z.

Although this is an imposing volume in terms of size, chapters are concise and the writing is excellent. On occasion, I looked up a specific procedure in the Table of Contents, and when I turned to that page, I got a simple description of which keys to hit.

Personnel Management

The capabilities of the newest module, Personnel Management (P/M), are worth detailing. This system keeps personnel information on file, including personal information and salary. A nine-digit employee number links these files to the Payroll module to provide an employee salary history. Reports from the Payroll interface have nine sorting options.

The system can link with ALL-IN-1 files. P/M is governed by three submenus. First, a General Maintenance menu offers more than 20 options for personnel information, covering employee histories and salaries, days off, titles, supervisors and union codes. An Initial Setup menu lets the system manager tailor the order of files and fields to his preference. A Specialty Systems menu contains other reporting and printing options, as well as an EEO compliance checker.

According to Compu-Share, this is a federally acceptable EEO-1 report that sifts through personnel files and generates lists that break down

Accounts Receivable Management System, Version 5.0, F Release

PLATFORMS: VAX/VMS

PRICE: Available upon request

COMPU-SHARE INC.

HEADQUARTERS:

5214 68th St.
Lubbock, TX 79424
(806) 794-1400

FOUNDED: 1977

PRODUCT LINE: Ten modules of accounting software and distribution packages

OWNERSHIP: Private

BRANCHES: Canada

CIRCLE 570 ON READER CARD

employees by job category, ethnic origin and sex, and does equal-opportunity analyses of current employees and applicants, including salary and benefits analyses.

The P/M module rounds out the financial applications package nicely.

The nice thing about modular packages such as Compu-Share's is that your company only has to purchase what it can afford. As your company grows, you'll require other modules. Compu-Share has divided its packages so that each covers a specific, small area of accounting, while the key modules integrate at the posting level. This feature is especially useful.

THE NICEST SURPRISE in Compu-Share A/R is its software tailorability. A/R permits a degree of screen and report customization that's unusual in off-the-shelf software systems. Further, it's easy to learn.

TUNING YOUR VAX IS AS EASY AS A DAY AT THE BEACH...



WITH **DYNAMIC** LOAD BALANCER™

That's why the Dynamic Load Balancer is tuning more VAX/VMS™ systems than anyone else in the world. Period.

In fact, with thousands of users worldwide, Dynamic Load Balancer easily won Digital Réview's 1989 Target Award for "Best System Management Software"!

With the Dynamic Load Balancer dynamically tuning your VAX, you can be confident that

your VAX is tuned to its optimum... today, tomorrow, and always.

Discover for yourself what others already know. To obtain a Dynamic Load Balancer "Evaluation Kit" at \$69.95 or to receive further information, contact Touch Technologies today at:

(800) 525-2527 (619) 455-7404

TOUCH TECHNOLOGIES, INC.

"The Worldwide Leader in VAX Tuning"

9990 Mesa Rim Road, Suite 220
San Diego, California 92121 U.S.A.

Dynamic Load Balancer is a registered trademark of Touch Technologies, Inc.
DEC, VAX and VMS are registered trademarks of Digital Equipment Corp.

CIRCLE 165 ON READER CARD

Australia (03) 654 2844 • Brazil (021) 262 9694 • France (01) 47 748081 • Israel (03) 724 287 • Japan (03) 271 5252

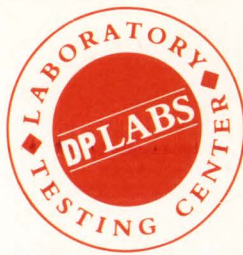

Recital Corporation's Recital

David B. Miller "Wow, dBase for the VAX!" Well, not quite. However, Recital Corporation's Recital database and 4GL come very close. In fact, if you're familiar with dBase III or dBase III+ for microcomputers, you'll have no trouble using Recital. We tested Recital on our VAXcluster.

Installation And Configuration

The media is BACKed up to a directory of your choice. A log in command file needs to be executed by each user to set up required symbols and logical names. Users need SYSCLK privilege to run Recital. However, you can INSTALL Recital as a shared image with SYSCLK privilege to avoid having to give SYSCLK privileges to individual users.

Recital users should have the following minimum values for the following quotas: ENQLM, 20; SHRILLM, 20; BYTLM, 1,500; FILLM, 50; PRCLM, 1; WSDEFAULT, 200; WSEXTENT, 1,000; and ESQUOTA, 500.

The symbol DB_PRINT executes a command file to print output. You can modify the command file to use any of your print queues. Additionally, slave printing is supported. Slave printing can be turned on and off while running Recital.

Recital can be run in Assistant mode, using menus and pop-up windows, as is the case with dBase III+. You can forego Assistant mode and type commands directly on a command line, which features the angle-bracket (>)

prompt rather than dBase's dot (.) prompt. Recital features a command history, which can store a user-specified number of commands that can be recalled with your terminal's up-arrow and down-arrow keys.

Recital commands follow the familiar dBase command format, so no relearning is necessary. All the dBase commands I used worked with Recital in the expected way with very few minor surprises. Recital's on-line help facility helped resolve any differences.

Basic Database Operations

Setting up a database starts with the CREATE command. Recital gives databases extensions of .DBF as dBase does. You then define the structure of each record. This involves supplying Recital with such information as field names, the length of each field in bytes, the type of data each field holds, the

number of decimal places, if any, and a brief description of the field. A sample structure definition for the BASEBALL.DBF database is shown in Screen 1. The help displayed at the top of the screen is very dBase-like.

Field names can be one to 10 characters long. Recital supports character, numeric, logical, data, four- and eight-byte floating point, packed decimal, quadword, and four-, two-, and one-byte data types. Maximum field widths differ according to data type. The 25 characters available for a field description make jogging your memory easier. A maximum of 128 fields per record is allowed. A database's structure can be modified later to add, delete or change fields. Recital makes a new copy of the database with the modified structure.

Records can be added to the database immediately after creating the

Database: Exit Attributes				11:53:49 am	
CURSOR <— —>	UP	DOWN	DELETE	Edit field: [Ins]	
*Char: <- ->	Row: [F13]	[F14]	*Char: Del	*Insert mode: [Ins]	
*Word: [F13][F14]	Page: [Prev]	[Next]	Field: [F19]	Refresh: [F18]	
Field: <- ->	Insert Field: [F17]		*Word:[F17]	Exit/Save: [F20]	
Help: Tab			Abandon: [F11]		
MenuBar: [Do]					
Field name	Type	Width	Dec	Field description	
LNAME	Character	20		Player's Name	
FNAME	Character	20		Player's First Name	
NICKNAME	Character	20		For the Press	
AGE	Numeric	3	0	Player's Age	
POSITION	Character	2		Position Played Most Ofte	
SALARY	Numeric	10	2	Xtra Wide For Big \$\$\$\$	
FARMCLUB	Character	20		Last Minor League Team	
BATAVG	Numeric	4	3	Batting Average	
ERA	Numeric	5	2	ERA For Pitchers	
ERRORS	Numeric	3	0	Better Not Need This	
CREATE test.dbf Field: 8/12					
Field names begin with a letter and can contain letters, digits and underscores.					

Screen 1: This editing screen displays the structure for the BASEBALL.DBF database. It should look familiar to dBase III users.



Edit: Exit Descriptions Top Bottom Order		12:01:27 pm	
CURSOR ← →	UP DOWN	DELETE	Edit field: [Ins]
*Char: < - >	Field: < - >	*Char: Del	*Insert mode: [Ins]
*Word: [F13][F14]	Record: [Prev][Next]	Field: [Rem]	Update Mode: [F17]
Help: Tab	Find: [Find]	Record: [F19]	Refresh: [F18]
MenuBar: [Do]	Find next: [Select]	*Word: [F17]	Exit/Save: [F20]
			Abandon: [F11]

LNAME	Linguini
FNAME	Richard
NICKNAME	Lefty
AGE	30
POSITION	P
SALARY	1000000.00
FARMCLUB	Haverford Haymakers
BATAVG	0.177
ERA	1.25
ERRORS	3
STOLENBASE	2
HOMERUNS	1

EDIT	test.dbf	Upd Rec: 1/3	
------	----------	----------------	--

View and Update database records.

Screen 2: The default data-entry screen. With Recital's screen-painter facility, you can make data-entry screens look like your business's forms.

structure or at any other time using the APPEND command. Screen 2 is a sample data-entry screen for the BASEBALL.DBF database. This screen is the quick and dirty way to enter data. A more elegant way is to build a screen form, which we'll discuss later.

Changing record contents can be done with the EDIT or BROWSE commands. EDIT displays one record at a time. BROWSE displays up to 11 records on your screen in a spreadsheet-like format, allowing you to edit records' contents more quickly.

To make adding and editing records easier, Recital provides a screen-building facility similar to dBase's. The CREATE SCREEN command creates a screen definition file, extension .SCR, that lets you place database fields and appropriate text, including boxes, anywhere you want on a terminal's

screen. For instance, you can create a screen that models your business's forms. You don't have to place every field in your record's structure on the form. You can impose range and editing restrictions on the form's fields to ensure that data is input correctly. For example, you can specify that the BATAVG field must be numeric and that the data-entry operator will receive an error bell if non-numeric data is entered. Screen forms help cut down on data entry errors while increasing productivity.

To speed data entry further, keyboard macros can be defined. Standard entries can be placed in the macro, saved in a file and used from within a form to eliminate unnecessary keystrokes.

The DELETE command is similar to dBase's in that a DELETED record isn't physically removed from the database; it's simply marked for deletion. Upon issuing the PACK command, all marked

records previously DELETED will be removed. Before PACKING the database, some or all marked records can be regained with the RECALL command.

A number of commands exist to maneuver around your database and to display its contents. The GOTO command places you at a specific record if GOTO is followed by an integer (e.g., GOTO 6) and provided you have that many records in your database. The commands GOTO TOP and GOTO BOTTOM place you at the first or last record in the database. The LOCATE and CONTINUE commands can be used in conjunction with each other to perform top to bottom sequential searches. For example, the command LOCATE FOR BATAVG = .250 will find the first record in the BASEBALL.DBF database with a batting average field value of .250. The CONTINUE command will search for the next record meeting the criterion.

The DISPLAY and LIST commands allow you to see your database's contents. As with dBase, conditional and scope expressions can be added to the DISPLAY and LIST commands to retrieve selected records. For example, the command LIST FOR BATAVG > .250 .AND. POSITION < > "P" lists players who bat better than .250 and who aren't pitchers. Options exist to LIST or DISPLAY certain numbers of records starting from the current position of the record pointer. Using the =, < >, >, <, > =, <, .and., .or. and .not. operators lets you build detailed queries into your database. The syntax follows dBase conventions.

Adding the TO PRINT clause to the DISPLAY or LIST command (e.g., LIST FOR POSITION = "CF" TO PRINT) directs the output to a file or to the printer queue you specified at installation. Additionally, by issuing the SET PRINT ON command, output can be directed to a slave printer attached to your terminal.

After you've created some data-

bases, you must be able to activate any one you need at the moment. The USE <database name> command does this. For example, USE BASEBALL closes any open databases and opens the file BASEBALL.DBF.

Calling This Database To Order!

Ordering Recital files is done with the INDEX and SORT commands, just as it's done in dBase.

For example, the command INDEX ON POSITION + STR(BATAVG,5,3) TO POSBAT indexes the BASEBALL.DBF database with the position field as the primary key and batting average field as the secondary key. Recital creates the index file POSBAT.NDX. Index files contain records that contain the index key and the record number for each record in the database.

Recital index key expressions must be in character format. In the example, the STR() function is used to get Recital to look at the numeric field BATAVG as a string so that the INDEX command can concatenate the POSITION and BATAVG fields to form the key. The integers, 5 and 3, indicate that the BATAVG field is five bytes wide with three decimal places. Sister functions DTOS() and LTOS() are used to convert date and logical type fields to character strings.

Keys can be up to 100 characters long. Indexes are created in ascending order. The DESCEND() function can be applied to the index expression when it's created to let you index the file in descending order. Duplicate keys can be handled with the UNIQUE qualifier. When used in an INDEX command, UNIQUE won't include duplicate keys in an index file.

You can create a number of indexes to allow you to order the file in various ways. After a file is indexed, your database will appear in the INDEXed order until you leave your session or until you create or switch to another index.

Switching among indexes is done with the SET INDEX TO <index file name> command. After adding or deleting records in your database, the REINDEX command must be used to ensure that index files are updated with new keys and records.

In addition to GOTO, LOCATE and CONTINUE, other record commands can be used after a file is INDEXed. The FIND <key> and SEEK <key expression> commands search through a file's index for the supplied key expression and positions the database file's record pointer to the first record with that key value. The command causes the function FOUND() to return a true or false value. Therefore, FIND and SEEK are valuable programming commands.

SORTing is an alternative to INDEXing. The SORT ON POSITION, BATAVG/D FOR POSITION <> "P" TO POSBAT command illustrates some of SORT's options.

Multiple SORT fields, in this case POSITION and BATAVG, can be specified. SORT field priority decreases from left

to right. Default sorting order for each key field is ascending order. The /D qualifier in BATAVG/D causes sorting for that field to be in descending order. Another qualifier, /C, forces Recital to treat all characters as uppercase. The FOR POSITION <> "P" option will select and sort only records of players who aren't pitchers.

SORTing a file creates a new database in the sorted order. In our example, the new database will be POSBAT.DBF. You aren't switched automatically to the new database. A USE POSBAT command, in our example, must be issued to close BASEBALL.DBF and activate the sorted database.

INDEXing generally is preferred over SORTing. INDEXing is more efficient, faster and uses less disk space than SORTing. Also, SORTing can't be done on logical fields or on field expressions.

Elegant Reporting

The CREATE REPORT command initiates report building via a screen-driven report format editor. If you're familiar with dBase III and dBase III+, you'll notice that Recital's report creation facility looks and feels like dBase III's version.

With CREATE REPORT, you create a report format file (extension .FRM) that contains settings for report titles, column headings, margin settings and so forth. You also tell Recital what database fields are to appear in certain columns. There's no need to include every field in your database's structure. You can modify the widths of columns to adjust for long and short fields. If your file is indexed or sorted, you can specify that Recital should perform group reporting based on the key fields of your index or sort. Summary reporting can be specified, as well. Summary reports don't print each record's contents; only subtotals are printed for each group.

To generate the report, use the

Recital

PLATFORMS: VAX/VMS environments

PRICE: Ranges from \$1,500 for the MicroVAX 2000 to \$45,000 for the VAX 8978. Options, such as the RMS and 20/20 bridges, are additional

RECITAL CORPORATION

HEADQUARTERS:

85 Constitution Ln.
Danvers, MA 01923
(508) 750-1066

FOUNDED: 1988

PRODUCT LINE: Recital RDBMS, 4GL, Encryptor, RMS bridge, 20/20 bridge, PC Server, Library and Office Automation

OWNERSHIP: Private

BRANCHES: Houston, London

CIRCLE 421 ON READER CARD



REPORT FORM <report file name> command. The TO PRINT option produces printed hardcopy. The TO FILE <filename> option creates a text file (extension .TXT) of the report's contents that can be edited and printed later.

If the screen-driven report generator can't provide everything you need, Recital's TREPORT command invokes a free-form report editor. Files can be created containing Recital Report Definition Language (RDL) commands. The commands allow you to specify headings, footings, centering and other report features. RDL files basically amount to small report programs. RDL includes features to execute other Recital commands, use variables and execute looping instructions and the like. You may never need RDL files, but they can help you generate specific reports that Recital's CREATE REPORT command can't provide.

Environmental Control

More than 60 SET commands are available to let you customize your Recital environment. For example, the SET DATE command specifies the date format, such as American, British or German. Other SET commands let you control the number of commands you want to store for recall in Recital's history buffer, govern how many decimal places to display for numeric output, specify how comparisons are to be made between two character expressions and much more.

Multiple Database Operations

Recital's JOIN command creates a new database by physically merging two files. You optionally can specify selected fields for the JOIN. You don't need to create the new database with all the fields from each original file.

Rather than physically JOINing two databases to yield a third database, data can be extracted from two or more files

and made to look as if they're put together when no new database actually has been created. Recital does this using View files. View files, created by the CREATE VIEW command, specify which databases contain the required fields, how those databases relate to each other and which fields to display.

Up to 10 databases can be active simultaneously. Between two databases, one common field of the same name and data type is selected to provide the link. Recital reads records from one database and looks in the master index of the other database for the common field with the same value. For example, if both the BASEBALL.DBF and ADDRESS.DBF files had records with the character field LNAME, LNAME could be used by the CREATE VIEW command to logically link the two databases. You need to choose common fields wisely. In a large database, many persons can share the same last name. Link fields with unique values work best.

Creating view files lets you see data from multiple databases in a variety of combinations. After a view is invoked, you can create a report format using fields from all the databases. To generate the report, you first invoke the view file to establish the relationship between the databases, then use the CREATE REPORT and REPORT FORM commands as if you were working with a single database.

Additional Features

If you have dBase applications running on PCs, there's no need to recreate them on the VAX side. Recital's DBSERVER option lets you transfer dBase files from your PC to your VAX. The files include the dBase file types .DBF, .FMT, .MEM, .NDX, .PRG and .TXT.

Recital provides a bridge to RMS indexed sequential files that meet specific format criteria. The RMS file being bridged must have fixed-length records of 4,000 characters or less. Packed decimal key fields aren't sup-

Companies Mentioned In This Article

Access Technology Inc.
6 Pleasant St.
S. Natick, MA 01760
(508) 655-9191

CIRCLE 422 ON READER CARD

Ashton-Tate
20101 Hamilton Ave.
Torrance, CA 90502
(213) 329-8000

CIRCLE 428 ON READER CARD

Digital Equipment Corp.
146 Main St.
Maynard, MA 01754
(508) 897-5111

CIRCLE 403 ON READER CARD

ported. The RMS bridge lets you use most of Recital's commands against records in the RMS file as if the RMS file were another Recital database. Commands such as PACK, INDEX and REINDEX are invalid. RMS files bridged this way remain open to other users even if they aren't using Recital.

For Access Technology's 20/20 users, Recital databases can be exported to 20/20 and the rows of 20/20 spreadsheets can be imported into Recital.

Recital's 4GL programming language is compatible with dBase's. A set of commands is provided to let you develop menu-driven applications similar to the Recital Assistant. Anyone familiar with dBase III's programming language will feel at home with Recital's language.

FOR ALL INTENTS and purposes, Recital is dBase for the VAX. We've only scratched the surface of Recital in this Lab review. Experienced dBase users will have no trouble using Recital. Managers needing database personnel could hire experienced dBase users and have them be productive immediately.

STORAGE SAFE.



SMDI VAX Storage Arrays . . . think of them as vaults for up to 10.5 gigabytes of VAXcluster data files! That's how reliable they are. Because Emulex Storage Module Disk Interconnect (SMDI) arrays incorporate iron-clad technology.

For example, we use industry-standard 8-inch drives that have *proven* their ability to perform. And we "marry" those drives to advanced Emulex controllers that have a reputation for quality worldwide!

DSA controller-compatible. With an SMDI array, you can take full advantage of DSA functionality and SMD-E disk drive flexibility. The reason: SMDI arrays convert SDI protocol to industry-standard SMD or ESDI. So they appear to your host as RA-series drives.

But instead of being confined by RA-series limitations, you get total configuration control!

More bank for your buck. Emulex SMDI arrays can provide up to 1.75 GBytes of storage per logical drive, and up to six logical drives

per cabinet. So you can plug in up to 10.5 gigabytes of additional capacity using only six of your SDI ports!

Free book of solutions! For more information about these and other Emulex products, return this magazine's reply card or call Emulex toll free!



Call (800) EMULEX-3, or
(714) 662-5600 in California

Emulex Corporation
3545 Harbor Blvd.
Costa Mesa, CA 92626



Regional Offices: Anaheim, CA (714) 385-1685 Roswell, GA (404) 587-3610
Burlington, MA (617) 229-8880 Schaumburg, IL (312) 605-0888
International Offices: Wokingham, England (44) 734-772929
Munich (49) 89-3608020 North Sydney (61) 2-957-1669 Paris (33) 134-65-9191
Tokyo (81) 3-234-8951 Toronto (416) 673-1211

VAXcluster, DSA and SDI are trademarks of Digital Equipment Corp.
©1989, Emulex Corporation, Inc.

CIRCLE 112 ON READER CARD



Marc Software's WordMarc Composer +

David B. Miller

The WordMarc Composer + full-featured document processor/publishing system, from Marc Software International Inc., Palo Alto, California, is the big brother of WordMarc Author, Marc's more limited text processing system. WordMarc Author's files are compatible with WordMarc Composer + 's, so you can finish a job with WordMarc Composer + that you started with WordMarc Author.

WordMarc Composer + provides several major improvements over its immediate predecessor, Composer. The system now supports DECwindows and mice. This permits the screen display of alternate characters and bold and italic fonts. Up to 20 fonts per document can be displayed and output on PostScript-compatible or HP LaserJet printers. You also can set up and modify style sheets that govern fonts, procedures and formats for every WordMarc Composer + user.

Additionally, the program now integrates with Oracle, 20/20 and ALL-IN-1. The ALL-IN-1 integration is at the Data Set Access Block (DSAB) level, allowing WordMarc Composer + to replace or be edited in WPS-Plus. WordMarc Composer + documents also can be converted into Interleaf or Ventura Publisher formats. File transfers to PCs are performed by LinkMarc, Marc Software's communications package. Graphics, including scaling and transformation capabilities, also can be in-

tegrated into WordMarc Composer + documents.

Marc Software provides hooks and documentation overlaying the system that guide system managers through interfacing WordMarc Composer + with many popular applications.

Installing WordMarc Composer + is simple. After mounting the media, running a command file takes care of the rest. You only need to define the printers and terminals to be used and to modify the system startup and log in command files with a few logical assignments.

Composing

Typing WMC brings up the Main Menu (see Screen 1). Basic features include CREATE, EDIT, MANAGE (for deleting and renaming documents and reviewing document profiles), SPELL and PRINT.

Before beginning a new document, you have the option of choosing one of several prefabricated formats, including LETTER, MEMO, WIDE, ASCII and REPORT (see Screen 2). These save time

by supplying settings for margins, tab stops, outline style and so on.

WordMarc Composer + takes full advantage of a terminal's keyboard by assigning various functions to individual keys. Configurations for DEC terminals include Gold Key and EDT versions.

Before printing, you can modify a number of options. Choosing a printer number from this menu allows printing to take place on any device included in the configuration file PCONFG.CFG. You can modify the range of pages to be printed, adjust the left margin, justify the right margin and eliminate headers and footers on page one. None of these adjustments affects the file; only the appearance of the document at print time is altered.

If you're unsure about the document's appearance, you can preview it on the screen before you send it to hardcopy. Additionally, a hardcopy image can be sent to disk for later printing.

Editing

As you enter text, tabs and returns are

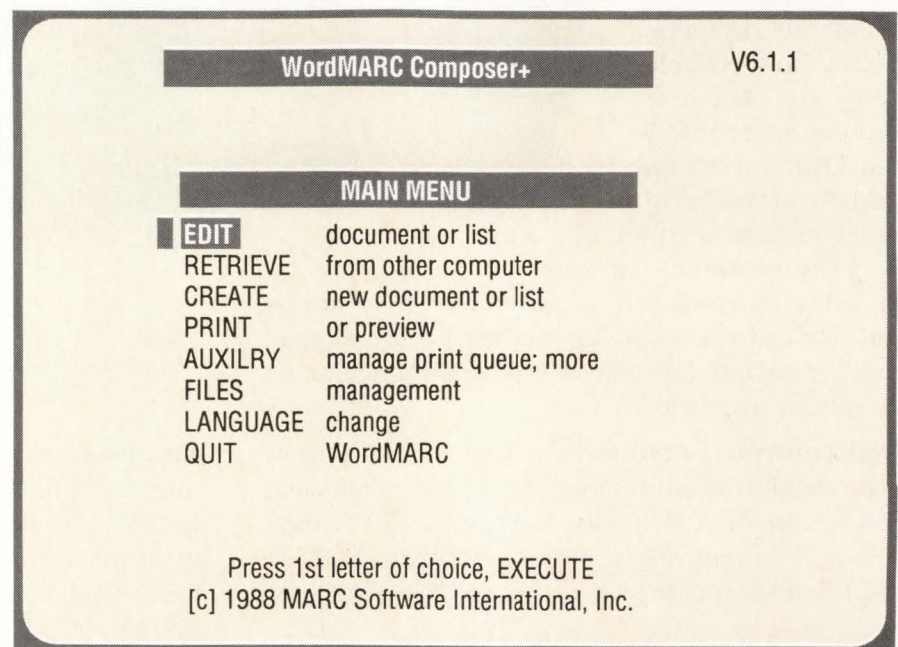

Screen 1: WordMarc Composer + 's Main Menu. Functions primarily are executed from individual keys.

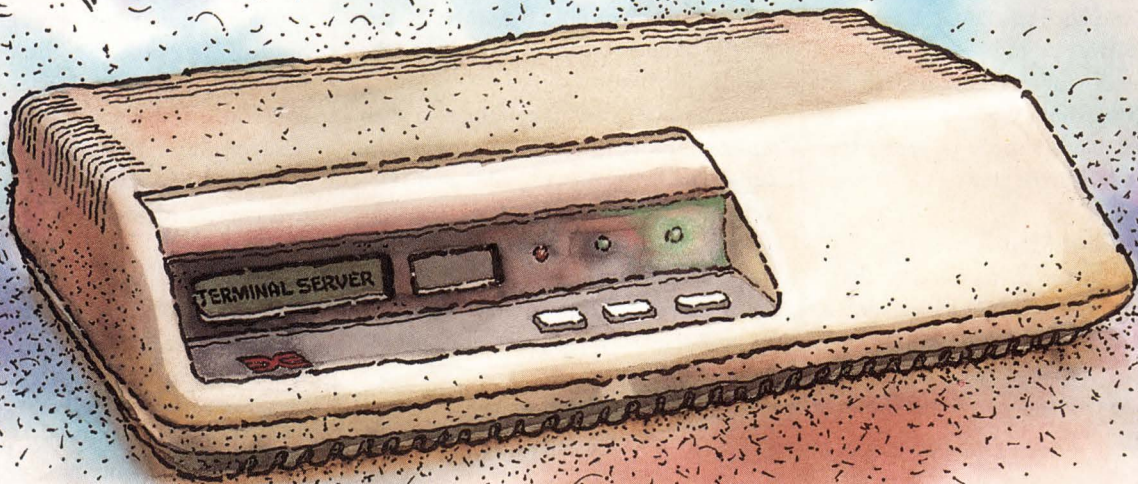

Our Ethernet Terminal Server Speaks LAT. Everywhere.

Which is good news for performance-minded companies. Our new Performance 4000 Ethernet Terminal Server is fully LAT-compatible. No special hardware interface, no new driver, no network management software required. Plug it in and put it to work. It will deliver a lot more performance than the DECserver 200, for a lot less cost per line.

It also provides more room for expansion. The Performance 4000 sup-

ports up to 32 lines, in a package only 4½ inches high. Run all 32 at 19.2Kbps, or 16 at 38.4Kbps. *Simultaneously.* You also get better multiscreen displays, enhanced security features, plus a superset of DECserver commands and VMS-like command editing.

So if you're thinking of expanding your Ethernet Local Area Network, call our Emulex offices worldwide and ask about the Performance 4000.

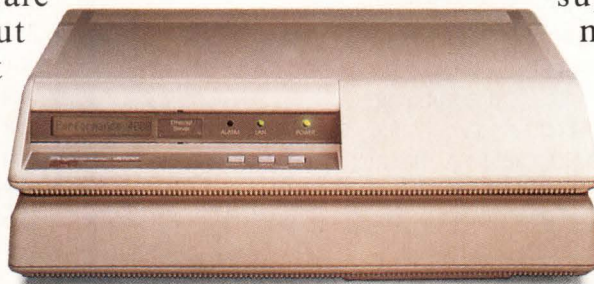

Performance 4000 Ethernet Terminal Server

Call (800) EMULEX-3, or
(714) 662-5600 in California
Emulex Corporation
3545 Harbor Blvd.
Costa Mesa, CA 92626



Regional Offices: Anaheim, CA (714) 385-1685 Roswell, GA (404) 587-3610
Burlington, MA (617) 229-8880 Schaumburg, IL (312) 605-0888
International Offices: Wokingham, England (44) 734-772929
Munich (49) 89-3608020 North Sydney (61) 2-957-1669 Paris (33) 134-65-9191
Tokyo (81) 3-234-8951 Toronto (416) 673-1211

LAT and DECserver are registered trademarks of Digital Equipment Corp.
© 1988 Emulex Corporation, Inc.



indicated by angle brackets. Word wrap is automatic. Overstrike mode is the default. Inserting text involves pressing the INSERT key. The text on the current line then is moved down. You enter the required insertions and finish with the EXECUTE key. This can take a little time to become accustomed to if you're more familiar with other text processors.

Erasing text is performed one character at a time with the DELETE key, or blocks at a time with the ERASE key, moving the cursor over the text to be deleted and finishing with EXECUTE. A third alternative is simply to type over the old text with the new.

Cursor Manipulation

Moving the cursor in ways other than the mundane presents interesting alternatives. Using the FORWARD and

REVERSE keys is similar to the EDT keypad. After you choose a direction, pressing any character causes the cursor to move to the first occurrence of that character in the specified direction. Choosing REVERSE and pressing U, for instance, would move the cursor to the "u" in "occurrence" in the third sentence of this paragraph.

Continuing to enter characters continues movement until the CANCEL key is pressed and control is returned to the regular keyboard.

The GOTO key in conjunction with a page number is useful for moving the cursor in large blocks. The BOTTOM key will GOTO the end of the file. There's no TOP key, but using GOTO Page One works as well.

You can boldface and underline text by pressing the appropriate feature key,

typing the desired text, then pressing the feature key again to turn it off. If the text already exists, press the feature key while the cursor is on the first character of the text to be affected, highlight the text by moving the cursor over it and press the feature key to complete the operation.

To center text, place the cursor on the line containing the text to be centered, and press the CENTER key. Similarly, to indent entire paragraphs, place the cursor on the line above the first one to be indented and in the desired column position. Then, press the INDENT key, which causes all lines up to the next carriage return to be indented at that point.

For assistance, the HELP key displays a menu. Help text appears one line at a time at the top of the screen. It's more convenient to remove the menu and fill the screen with help text.

Otherwise, multiple help categories appear on the same line and you must read through the text for all of them; there's no way to access individual items on the same line.

Advanced Features

The advanced features that set WordMarc Composer+ apart from simple text processors include:

1. Spell Checking — This facility was improved significantly in WordMarc Composer+. It now runs interactively while you're editing (so it's no longer a menu option) and suggests alternate words. Words, paragraphs or larger user-defined blocks of text can be searched for errors. The 100,000-word dictionary can be enlarged by saving words.
2. Hyphenation — This can be performed while editing, at print time, on a case-by-case basis or globally where WordMarc Composer+ takes care of the work.
3. Glossaries — These are macros under

Press 1st letter of choice, EXECUTE

STYLE SHEET MENU	
Pre-set for typesyles	
LETTER1	portrait
MEMO1	portrait
REPORT1	portrait, alpha outlining
REPORT2	landscape, alpha outlining
REPORT3	portrait, decimal outlining
REPORT4	landscape, decimal outlining
Non-proportional spacing	
LETTER2	10 pitch
MEMO2	10 pitch
REPORT5	10 pitch, alpha outlining
REPORT6	12 pitch, alpha outlining
REPORT7	10 pitch, decimal outlining
REPORT8	12 pitch, decimal outlining

GO BACK
(more below, press NEXT if necessary)
[c] 1988 MARC Software International, Inc.

Screen 2: Some of WordMarc Composer+ 's style sheet options. They save you time by supplying preset margins, tab stops, and so forth that suit the style you choose.

WHAT'S THE BIG NEWS IN THE 3X COMMUNITY?



COME TO THE SYSTEMS 3X EXPO AND FIND OUT.

The 1989 Systems 3X EXPO. It's the only expo to cover the entire Systems 3X and AS/400 community. The only expo to offer dozens of seminars on the industry's hottest issues. The only expo to deliver over 70 top exhibitors with the latest products designed for *your* situation.

And those aren't the only benefits. You can discover new solutions, find new suppliers, get advice from the experts, go comparison shopping and talk with fellow 3X and AS/400 users. Call or write for a free brochure including schedule, seminar details and the location nearest you: 1-508-745-6010.

Then, the only thing you'll have to do is show up.

The 1989 Systems 3X EXPO is managed by National Productions, Inc.

This show is not approved, sponsored by, or in any way connected with, the IBM Corporation. "IBM" is a trademark of IBM Corporation.

Sponsored by SYSTEMS 3X & AS World, MIDRANGE Systems, Midrange Magazine, NEWS 3X/400 and TECH EXEC.

FOR ATTENDEE INFORMATION, CIRCLE 306.
FOR EXHIBITOR INFORMATION, CIRCLE 307.

1989 Systems 3X EXPO
Feb 27 & 28 Anaheim, CA
Mar 21 & 22 Atlanta, GA
May 9 & 10 Chicago, IL
Jun 7 & 8 Boston, MA
Sep 6 & 7 New York, NY
Sep 19 & 20 Toronto, ON

Please send me detailed information on attending the 1989 Systems 3X EXPO:

Location(s): _____

I am interested in exhibiting at the following location(s): _____

Name _____

Company _____ Title _____

Address _____

City _____ State _____ Zip _____

Please return to: National Productions, Inc.
27 Congress Street, Salem, MA 01970-9864
Or call us at 508-745-6010



a different name. You can store keystroke sequences of up to 163 characters under a name of your choice and recall/execute them at any time.

4. Document Profiles — Profiles allow the recording of historical editing infor-

“

Adding footnotes and endnotes is a snap.

”

mation, such as the date and time of various editing sessions. Profiles also can be stored under keywords that allow documents under the same keyword to be grouped together. You can perform directory searches using document profiles, thus eliminating the need to display every file in a particular directory and limiting the list to those falling under the keyword category.

5. Outlining (Numbering) — This feature is available in both alphabetic and decimal flavors. Make a style choice, position the cursor and press the Number key. A numeral or letter in the appropriate style appears. Continuing in this fashion, you can generate an outline quickly and easily. If changes are made that affect numbering, such as moving a block of text containing numbers to a new location, WordMarc Composer+ automatically renumbers. If neither standard numbering format fits, the formats can be customized to meet your needs. This makes it possible to combine alphabetic and decimal numbering schemes.

6. Tables of Contents — There are two methods of generating these quickly. First, if entries in a file have been previously marked with outline numbers, you can tell WordMarc

Composer+ to use the same markers to generate a table of contents. An outline may contain multiple levels, and because it may not be desirable to generate a table of contents entry for every item in the outline, it's possible to include only certain-level entries.

In the second method, you can mark each entry by placing the cursor anywhere on the line containing the text to be marked, pressing the TOC key and indicating the desired level number. To print, simply indicate that a table of contents is to be generated for this run.

7. Cross References — Marking a cross-reference entry entails the use of keywords that associate a title or heading with a chapter or section number. Then, at the location where the cross reference is to be indicated, typing text such as “For more information, see Section . . .,” followed by the previously configured keyword, will cause the section or chapter number to be substituted for the keyword at print time.

Later, when sections are added, deleted or moved, all cross-reference numbers affected by the editing automatically will be updated to reflect the change. Inserting and deleting cross-reference entries also initiates renumbering.

8. Indexes — In a similar fashion, indexes of up to eight levels can be generated easily. Proceed to the text to be included in the index and mark it with the INDEX key. Doing this for each desired page will include all the text in the index. As entries are marked, WordMarc Composer+ places them in a list so that subsequent entries can be marked more easily. Proceed to the line containing the next entry, press the SEARCH key, which causes a list of all currently selected index keywords to be displayed, and select one. This helps you avoid entering similar keywords for the same topic, e.g., COMPUTER and COMPUTERS.

9. Endnotes and Footnotes — Adding footnotes and endnotes is a snap. After pressing the FOOTNOTE key, type the footnote text. At print time, either footnotes or endnotes can be specified. Endnotes can be produced separately if desired, leaving only the reference numbers in the document. Adding and deleting notes causes WordMarc Composer+ to update footnote numbers automatically. As in outlining, numbering schemes can be customized. The appearance of footnotes also can be modified.

10. Equations and Scientific Typing — Math, physics and science instructors take heart! If you have a VT220 (or emulator), a Televideo 922 or Wyse 85 terminal, a printer that can handle scientific fonts, and WordMarc Composer+, you can create mathematical equations that include Greek symbols, large and

WordMarc Composer+

PLATFORMS: VAX/VMS, MS-DOS, UNIX System V, Berkeley 4.3 BSD

PRICE: \$495 on DECstation PC, \$750 on VAXstation 2000, \$19,000 on VAX 8840, \$29,000 on VAX 8978. Available on all VAX platforms

**MARC SOFTWARE
INTERNATIONAL INC.**

HEADQUARTERS:

260 Sheridan Ave.
Palo Alto, CA 94306
(800) 835-2400

FOUNDED: 1971

PRODUCT LINE: Word processing and publishing systems; PC-to-VAX file transfer/communications (LinkMarc)

REVENUES: \$13 million (1988)

OWNERSHIP: Private

BRANCHES: Italy, Japan, Netherlands

CIRCLE 431 ON READER CARD

"I've got all the right connections."

Now with SSU support in all DEC compatible models.

1.

What connections!
You get ASCII,
ANSI, PC-AT in
any combination.

2.

More concurrent
connections!
6 tasks or 4 hosts
through Falco's
powerful Virtual
Terminal Windows.™
SSU support for
DEC connections.

3.

Simultaneous
132/80-column
display makes
text/spreadsheet
connections a snap.

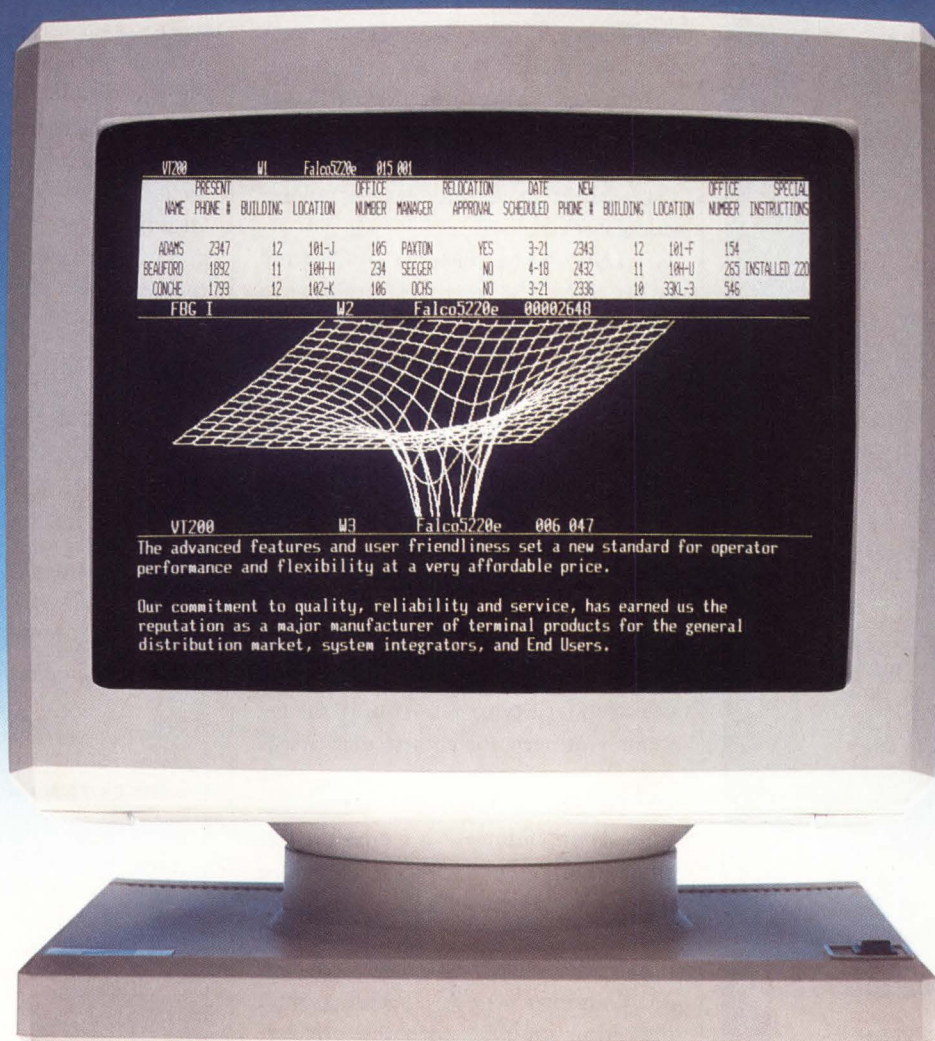

4.

Falco Business
Graphics™ makes
real-time graphics/
text connections.

5.

Productivity
connections:
Pop-up clock, calen-
dar, programmable
alarm, notepad and
calculator with
cut-and-paste.

6.

More places to
connect to!
Four ports for
printers, scanners,
mouse—even 4
different hosts.

We've put SSU™ support in all our DEC compatibles because. . .

It pays to have the right connections. Each of our 9 high-value terminal models proves it. Our connections make every dollar go further.

How much further? One Falco terminal can replace up to four dedicated terminals because our 6 Virtual Terminal Windows™ virtually redefine connectivity. And do it all with real, quantifiable efficiency. Because at up to 38.4 kilobaud, our terminals keep pace with any host. And with up to 54 pages of memory, they don't need to rely on their host connections too often.

That's why we call our Falco 5500e, 5600, 5600s, 5220e, 5220s, 500e, 580,5000, and 5330 "high value" terminals. There's another reason. The good looks it takes to carry off a good line. Sleek styling with 14", flat, non-glare, high-resolution screens. Amber, white or green monochrome at no extra charge. And ASCII, ANSI,

or PC-AT keyboards, all with 4K programmable soft key memory. But here's something even more beautiful: the Falco line doesn't break down. And that's not just a line. Our consistent, high-volume production and ASIC reduced parts count ensures it. A one year warranty guarantees it. And our customers vouch for it. Ask them. Or better yet, see for yourself.

Call toll free: (800) 835-8765. In CA only (800) 538-8383.



Falco Data Products
1294 Hammerwood Ave.
Sunnyvale, CA 94089
(408) 745-7123
Telex 4973271
FAX 408-745-7860



CIRCLE 310 ON READER CARD

Somewhere
a child lies crying

Somewhere
an old man shivers
in the dark

Somewhere
a family's dreams
burn to the ground

Somewhere
somebody needs
help.

Contact your
local chapter.



**American
Red Cross**

Because somewhere
is closer than you think.



small integral signs, summation notation, set theory symbols and chemical block diagrams. WordMarc Composer + also performs addition and subtraction of columns and rows, spreadsheet style, and has an on-line calculator.

11. Lists and Mail Merge — Creating a list file first involves building a database-like record structure in which field names and data types are defined. In the actual form letter, preceding a field name by pressing the MERGE key causes WordMarc Composer + to treat the typed text as the name of a field and not a literal word. This makes more sense than entering cryptic control symbols representing fields in the list file.

Rather than physically deleting or moving list records not desired, WordMarc Composer + provides a sort and selection facility to extract only the list items you need for a particular merge run.

12. Document Assembly — This feature allows multiple documents, like chapters or paragraphs, to be assembled into one. You can create a library of blocks of standard text, such as boilerplates, and pull them together with ease.

13. Columns — A special printer definition supplied with the software lets you place multiple columns on one standard-size sheet. This feature is useful for creating textbook- or newspaper-like documents.

14. Date/Time Stamp — This incorporates the current date and time into a document, or the date and time of the last revision.

WordMarc Composer + 's documentation, consisting of five manuals and references, is superb. VMS users will feel at home as soon as they see the size of the documentation set. A "You Are Here" introduction kicks off each manual by describing what to expect inside. For the inexperienced, Marc Software provides arrangements, at extra cost, for on-site training.

WORDMARC COMPOSER+ IS a balanced program providing features for publishing the simplest to the most complex documents. Its ability to support a large number of terminals and printers, as well as its capability for customization, are advantages. WordMarc Composer + gets high marks. —Senior Editor Evan Birkhead contributed to this article.

Companies Mentioned In This Article

Access Technology Inc.
6 Pleasant St. S.
Natick, MA 01760
(508) 655-9191

CIRCLE 422 ON READER CARD

Digital Equipment Corp.
146 Main St.
Maynard, MA 01754
(508) 897-5111

CIRCLE 403 ON READER CARD

IBM Corp.
Old Orchard Rd.
Armonk, NY 10504
(914) 765-1900

CIRCLE 407 ON READER CARD

Oracle Corp.
20 Davis Dr.
Belmont, CA 94002
(415) 598-8219

CIRCLE 411 ON READER CARD

Televideo Systems Inc.
1170 Morse Ave.
Sunnyvale, CA 94088
(408) 745-7760

CIRCLE 432 ON READER CARD

Wyse Technology
3571 N. First St.
San Jose, CA 95134
(408) 433-1000

CIRCLE 433 ON READER CARD

Xerox Corp.
P.O. Box 24
Rochester, NY 14692
(800) 832-6979

CIRCLE 430 ON READER CARD

Unlock Programmer Productivity

FIELD VALIDATION

Field _____

Unique? ___ Demand? ___ Must Fill? ___

Range _____

Custom Validation Procedure:

With System 1032 Application Facility

System 1032/AF automatically generates most of your application code from menu selections. Yet you can add custom procedures wherever you need something special.

CompuServe[®]

Data Technologies

Tel: (617) 661-9440

CIRCLE 153 ON READER CARD

Al Cini

The Evolution Continues

New product announcements mark our industry's major milestones, but computing's real progress is measured by the inch, as existing hardware and software are improved from release to release in response to customer requests. So it is at Alisa Systems and Pacer Software, where the Mac-VAX connectivity products they pioneered more than two years ago are in continuing development today.

Working independently and starting from somewhat different points of view, Alisa and Pacer both have developed families of software products that integrate the Mac into the VAX computer family.

AppleTalk For The VAX

Alisa and Pacer are in the AppleTalk networking business, providing software that runs on the VAX and offers services compatible with Apple's AppleTalk suite of networking protocols. In terms of hardware, a Mac "client" of these services may be connected directly to the VAX via Ethernet, using a Mac Ethernet interface card from Apple, 3Com or Kinetics. Macs connected to Apple's inexpensive twisted-pair LocalTalk network also can be mated with a host VAX system by way of a LocalTalk-Ethernet bridge such as Kinetics' FastPath.

After the hardware connection is made, a Mac user can select three kinds of service from a selected host VAX system on the network: interactive access to the host using a terminal emulator, use of the host's file system via a file server, or output to a DEC or Apple PostScript-compatible printer us-

ing the VAX host's print-spooling capabilities. The newest releases of Alisa's and Pacer's products (AlisaTalk version 3.2 and PacerLink version 5.3) include new capabilities in all three basic service areas.

Networked Terminal Service

AlisaTalk's terminal session feature, AlisaTerminal, uses DEC's CTERM networking protocol (not the superior LAT, because LAT is DEC-proprietary) to allow a Mac user to log onto the host VAX. The Mac user must use either White Pine's Mac240, which emulates a VT240 terminal, or Peripherals Computers & Supplies Inc.'s VersaTerm/VersaTerm PRO, which emulate

Tektronix 40xx and 41xx terminals, respectively. These terminal emulators have been modified by their vendors under special arrangement with Alisa to include the Mac client end of AlisaTerminal.

Earlier releases of AlisaTerminal didn't support such popular interactive features of VMS as DCL command line recall and command line editing, all of which are implemented correctly in AlisaTerminal's current release. The latest release doesn't, however, correct AlisaTerminal's biggest fault, which is its slow responsiveness when running single-character-interactive VAX/VMS utilities, such as the EDT text editor.

Users running text editor software

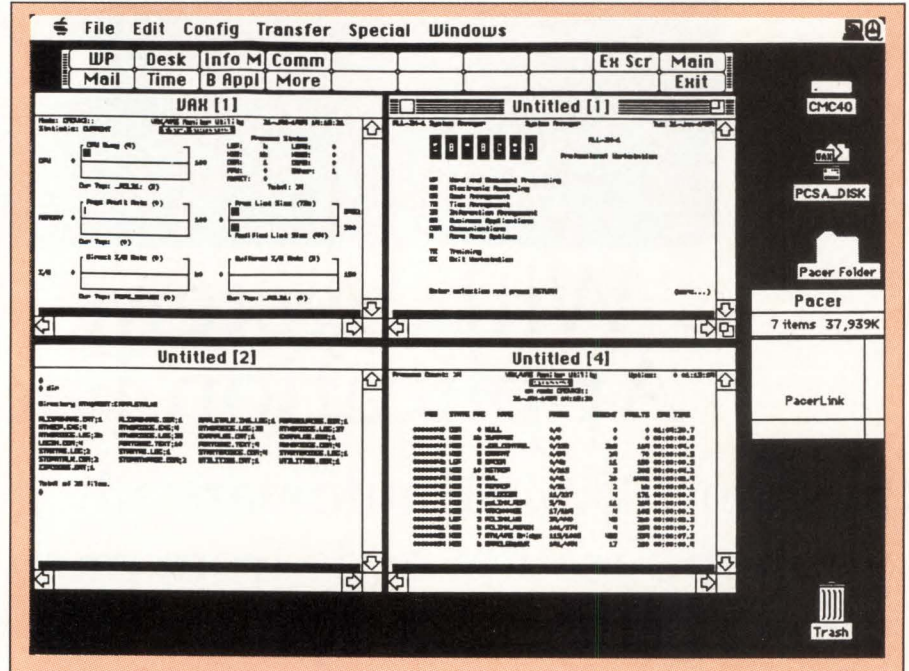

Screen 1: Four simultaneous host VAX sessions are shown, mapped into four separate PacerLink windows. Shown is its miniwindows option, which displays reduced views of each session. PacerLink's soft-key feature adapts itself as each window is selected; PacerLink's ALL-IN-1 soft keys are shown. PacerLink doesn't require Apple's Multifinder, but its windows will update in Multifinder's background mode.

OUR PRODUCTS SPEAK FOR THEMSELVES.

And they've been doing it since 1986. Ever since we began supplying total software solutions that let Apple Macintosh and Digital VAX systems talk to each other over the same network.

It had never been done before. And even three years later, no one does it as well.

Perhaps that's why 80,000 DEC users gave us the coveted Digital Review Target Award. Not just once, but the last two years running. What's even more impressive is the fact that ours is the *only* Macintosh/VAX software



ever to receive the award at all.

But then, no one else can give you products like ours. Such as AlisaTalk, a

software solution that puts AppleTalk on your VAX with no special hardware or software.

TSSnet, which lets your Mac talk over DECnet networks.

And SequeLink, which gives Macs access to VAX/VMS host SQL databases.

So when you want the right Mac-VAX connections, there's only one place to contact: Alisa.

The company that started an industry talking.

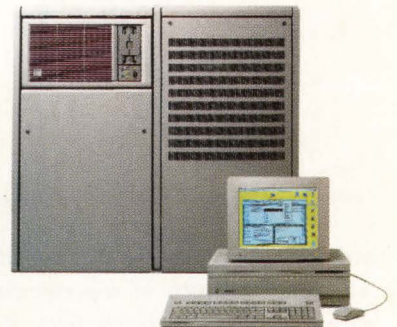

Alisa Systems Inc.
We keep everybody talking.

221 East Walnut Street, Suite 175 Pasadena, CA 91101 (818) 792-9474

Alisa and AlisaTalk are trademarks of Alisa Systems, Inc. Apple and Macintosh are trademarks of Apple Computer, Inc. DEC, VAX, and DECnet are trademarks of Digital Equipment Corp. TSSnet is a trademark of Thursby Software Systems. SequeLink is a trademark of GtOsIs.

CIRCLE 220 ON READER CARD

on their VAX through AlisaTerminal notice a slight delay between striking a cursor control key and seeing the cursor move, and this delay becomes unnervingly cumulative as cursor keys are struck repeatedly. Unfortunately, this sluggishness is a feature of Alisa's CTERM implementation, and it would take a major revision of the software to correct the problem.

Network terminal sessions are PacerLink's strong point, made stronger by PacerLink's latest release. Pacer uses its own client-server protocol to support terminal sessions over the network. It isn't true LAT, but it knows when it's running keystroke-interactive VAX/VMS software and responds to cursor control keys as crisply as over a direct asynchronous line connection.

In its latest release, the VT220 terminal emulator included with PacerLink allows a networked Mac user to create up to four separate interactive sessions with one or more host systems, mapping each into a separate on-screen window (see Screen 1). PacerLink for MS-DOS likewise allows up to four simultaneous on-screen sessions, and its latest release will support network connections over Apple's LocalTalk PC interface card as well as via Ethernet. With this feature, network managers can use Apple's inexpensive LocalTalk network wiring for their IBM PCs instead of more costly Ethernet connections without sacrificing terminal emulation over the network.

PacerLink's latest release also includes a special Mac "init" file called the

Redirector. PacerLink's Redirector allows a Mac user to run almost any terminal emulator over Pacer's network services by transparently re-routing the Mac's standard printer port driver.

File Services

Included in Alisa's AlisaTalk product, AlisaShare is an AppleShare-compatible file server that runs under VAX/VMS. With AlisaShare, standard RMS files on the VAX appear on the Mac's symbolic desktop through the "Finder." AlisaTalk V3.2 offers several important new AlisaShare features.

First, the latest release of AlisaShare is fully compatible with Apple's AppleShare version 2.0 file server. In addition to numerous internal improvements, this means that Mac users now can change their passwords through their Mac client software. This feature can be disabled if the VAX system manager prefers to control this personally. The latest AlisaShare release also will support AppleShare client software running on Apple IIs under the PRO-DOS operating system, which among other things means that schools with AppleTalk-equipped Apple IIs now can use their VAX systems as courseware servers.

Also in the latest AlisaShare, Mac users no longer are restricted to using the eight-character-or-less passwords compatible with true AppleShare. By implementing alternative User Access Methods (UAMs) supplied with AlisaShare (these UAMs simply are loaded into a client Mac's System Folder), Mac users can select eight-character "standard" AppleShare authentication, 31-character encrypted VMS password authentication, or 31-character clear text VMS passwords (see Screen 2).

Pacer's PacerShare file server, which unlike AlisaShare for AlisaTalk is an extra-cost option to Pacer's PacerLink, also provides AppleShare-compatible file services to Mac users. PacerShare's latest release corrects several problems found in previous versions but introduces no major new product features.

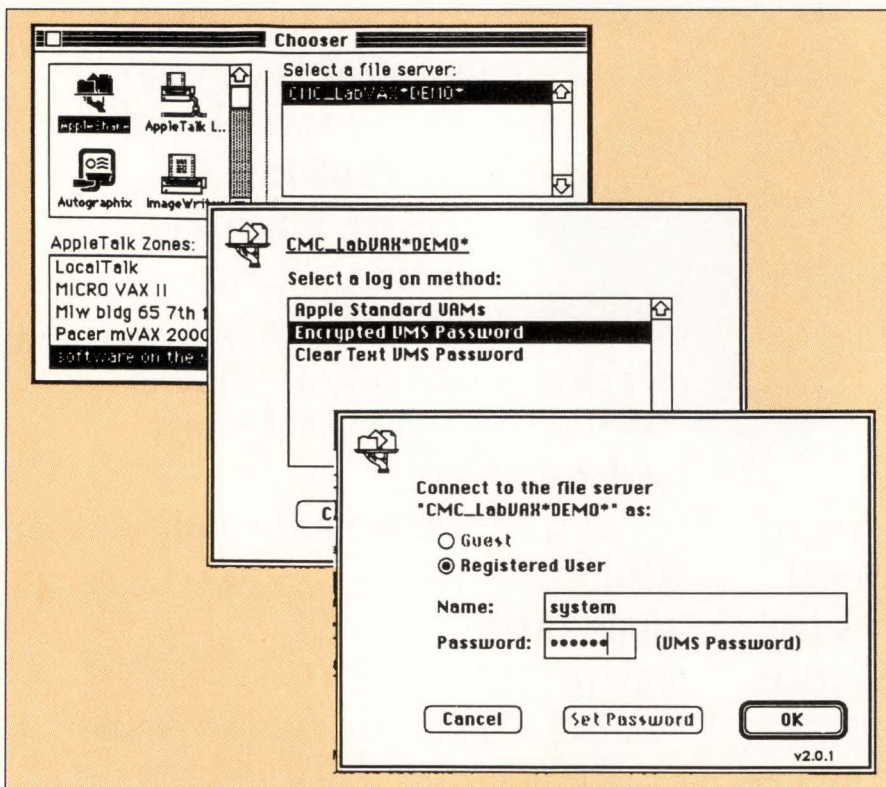

Screen 2: New user access methods (UAMs) are available in the latest release of AlisaShare. Shown in sequence from Chooser to log on, AlisaShare supports the alternate UAMs available with AppleShare V2.0 workstation software. Different alternative access methods can be enabled/disabled on a per-Mac basis by removing the associated UAM file from the system folder. Full-sized VMS passwords are supported in both encrypted and clear modes. Users of AppleShare's automatic mount-on-startup feature must use the Apple-standard UAM.

The company stresses its commitment to keeping up with developments at Apple, however, and promises AppleShare V2.0 compatibility in the near future.

Perhaps the biggest file-server news

“
... users now are
buying AlisaTalk
and PacerLink ...
”

at Pacer involves compatible support for a popular alternative Mac file server: TOPS. The TOPS division of Sun Microsystems has announced that Pacer will assume development responsibility for its TOPS for VMS file server software. When available, this software will allow a VAX/VMS system to act as a networked TOPS server.

The big Mac/VAX news of DEXPO East 89 in February was Alisa's announcement of its technology-sharing agreement with DEC. As part of this agreement, DEC will use Alisa's file and print services in its future Mac/VAX software product. Although DEC's product details weren't disclosed, its VMS Services for Macintosh should be announced by the end of this year.

Print Services

Also a standard part of AlisaTalk, the Alisa Print System allows Mac users to print to Apple's Postscript-driven LaserWriter printers through standard VMS printer queues. Likewise, ordinary VAX/VMS users can use the DCL \$PRINT command to print to Apple's LaserWriters. Pacer's PacerPrint product is an extra-cost option to PacerLink that provides similar printer services.

Previous releases of the Alisa Print System supported Apple's LaserWriters only when connected to AppleTalk networks, while early versions of PacerPrint could only access LaserWriters that were connected via asynchronous ports

Network DEC to UNIX?

What You Didn't Know--Will Help You!

TCP/IP Networking Software...

Did you know that most UNIX computers already support industry-standard TCP/IP networking protocols? And that Process Software Corporation gives you TCP/IP networking solutions for more DEC operating systems than anybody?

For VMS, RSX, RT-11, IAS, And TSX-Plus...

Network to UNIX using just our TCP/IP software and your standard DEC Ethernet hardware on the UNIBUS, Q-bus, VAXBI, or the new MicroVAX 2000. And run concurrently with DECnet, LAT, or LAVC.

Designed To Benefit You...

Say goodbye to special hardware, messy installation, and unneeded layers of software. Our TCP/IP products are modular, efficient, and designed for the operating system they run on. You benefit from ease of use, simple installation and virtually no maintenance.

For Every Application...

And we support the full range of popular TCP/IP applications, including FTP (File Transfer), TELNET (Virtual Terminal), TCP, IP, and UDP programming interfaces, and others.

You won't find a better lower-cost way to connect DEC to UNIX anywhere!

Interested? Call Process Software Corporation today.

PROCESS SOFTWARE 413-549-6994

35 Montague Road • PO Box 746 • Amherst, Massachusetts 01004

DEC, IAS, RSX, RT-11, UNIBUS, VAX, and VMS are Digital Equipment Corporation trademarks. Unix is an AT&T trademark. Ethernet is a Xerox Corporation trademark. TSX-Plus is a S&H Computers trademark.

CIRCLE 152 ON READER CARD

Data Management With a Fresh Twist.

The Situation:

As one of the fastest growing beverage distributors in the West, (the largest in the Rocky Mountain region), Western-Davis end-users needed a powerful yet easy to use report writer to accurately and almost effortlessly track their changing business patterns.

The Solution:

Western-Davis purchased a license to the User's Data Management System, from Interactive Software. UDMS is a series of advanced window-based modules for reporting, querying, exporting and updating.

The Results:

According to Dave Santistevan, Manager of Systems and Programming, "UDMS was installed easily and has become an invaluable tool for both our end-users and data processing personnel. In our evaluation, we were surprised to find a truly easy-to-use product like UDMS, that also satisfied even our most sophisticated data management and reporting needs."

UDMS supports a wide variety of file access protocols including INGRES, ORACLE, Rdb, RMS, System 1032 and VAX-DBMS for the VAX/VMS environment.

For a FREE Tele-Demonstration of UDMS
Call Toll-Free 1-800-962-UDMS or 303-987-1001

INTERACTIVE SOFTWARE

7175 West Jefferson Avenue, Denver, Colorado 80235

INGRES is a trademark of Relational Technology Inc. ORACLE is a registered trademark of Oracle Corporation. Rdb, RMS, VAX-DBMS, and VAX/VMS are trademarks of Digital Equipment Corporation. System 1032 is a registered trademark of CompuServe Data Technologies. UDMS is a trademark of Interactive Software Systems Inc.



BIGGEST VIKING DISCOVERY SINCE NORTH AMERICA

VIKING DATA ENTRY SYSTEM

Discover a whole new world of low-cost, high-speed data entry efficiency with VDE, the Viking Data Entry system that gives you more data entry capability using a mini-computer/PC. CALL TODAY FOR FREE DEMO.



CIRCLE 300 ON READER CARD

Companies Mentioned In This Article

Alisa Systems Inc. 221 E. Walnut St., Ste. 175 Pasadena, CA 91101 (818) 792-9474 CIRCLE 400 ON READER CARD	Odesta Corp. 4084 Commercial Ave. Northbrook, IL 60062 (800) 323-5423 CIRCLE 571 ON READER CARD	3Com Corp. 3165 Kifer Rd. Santa Clara, CA 95052 (408) 562-1508 CIRCLE 416 ON READER CARD
Apple Computer Inc. 20525 Mariani Ave. Cupertino, CA 95014 (408) 996-1010 CIRCLE 401 ON READER CARD	Pacer Software Inc. 7911 Herschel Ave. Ste. 402 La Jolla, CA 92037 (619) 454-0565 CIRCLE 412 ON READER CARD	TOPS A Division of Sun Microsystems 950 Marina Village Pkwy. Alameda, CA 94501 (415) 769-9669 CIRCLE 572 ON READER CARD
Digital Equipment Corp. 146 Main St. Maynard, MA 01754 (508) 897-5111 CIRCLE 403 ON READER CARD	Peripherals Computers & Supplies Inc. 2457 Perkiomen Ave. Mt. Penn, PA 19606 (215) 779-0522 CIRCLE 573 ON READER CARD	White Pine Software Inc. 94 Rt. 101A P.O. Box 1108 Amherst, NH 03031 (603) 886-9050 CIRCLE 540 ON READER CARD
Kinetics Inc. 2540 Camino Diablo Walnut Creek, CA 94596 (415) 947-0998 CIRCLE 409 ON READER CARD	Tektronix Inc. P.O. Box 1000 Wilsonville, OR 97070 (503) 685-3180 CIRCLE 415 ON READER CARD	

to a VAX multiplexer or terminal server. In response to customer requests and competitive pressures, the latest releases of PacerPrint and Alisa Print Services have crossed over. Both products now support either AppleTalk or asynchronously connected Apple LaserWriters.

Changes

AlisaTalk V3.2 uses V2.0 AppleTalk for VMS software, which will run under version 5.0 of VMS. Alisa customers who want to migrate to VMS V5.0 therefore will have to upgrade to AlisaTalk V3.2 — and when they do, many of them are in for a bit of a surprise.

AlisaTalk V3.2 introduces a “configuration key” copy protection scheme, something like DEC’s new License Management Facility, that requires that customers contact Alisa to register their software and obtain a software key that will allow the product to run on their system. Alisa’s configuration keys are tied to the size of the host VAX CPU, so if you’ve purchased a small Alisa for a MicroVAX and have since moved your server software up to a VAX 8800, have

a purchase order number handy when you call Alisa to cover the difference in cost.

The latest and greatest from Pacer, PacerLink V5.3, also runs under VMS V5.0. No “configuration keys” are needed, at least for now. Since PacerLink V5.2, the product has offered coexistence support for AppleTalk for VMS, making it possible to run Pacer’s software on the same VAX system with other AppleTalk for VMS software, such as Odesta’s Helix VMX Mac-VAX database software. A growing number of users now are buying both AlisaTalk and PacerLink to combine Pacer’s terminal emulator with Alisa’s file server.

The Mac-VAX networking world has been a little lean on major announcements for the past few months, but as the evolution of Alisa’s and Pacer’s products shows, the world still is turning. Most important, we can see that the major third-party players in this arena continue their commitment to advancing the general state of the Mac-VAX networking art. ■

We do windows.

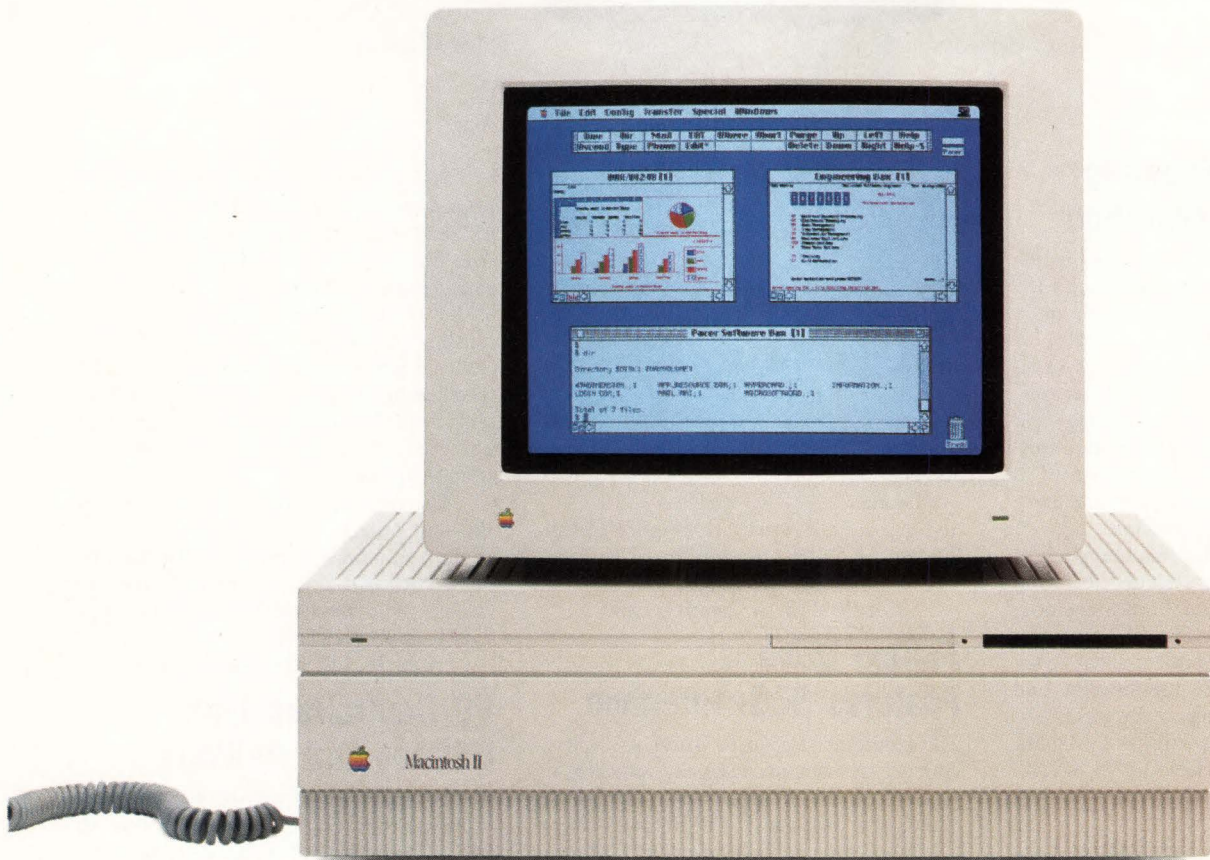

Multi-windows, actually.

With PacerLink connectivity software, Mac users can manage multiple VAX jobs by viewing multiple concurrent terminal emulation sessions. Enter data in one window and your VAX host updates all others continuously, even under MultiFinder.

Using Mac techniques, you can adjust PacerLink windows as you please. Enlarge, miniaturize, stack or just stick them in a convenient corner to keep an eye on!

To make the VT100 and VT220 terminal emulator even more useful, we've built in programmable "softkeys" that allow complicated interactions to

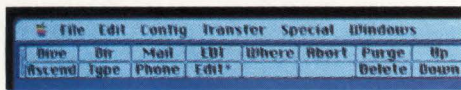

User-programmable "softkey" macros allow long VAX command streams to be executed with a single click.

be executed with a single click. Along with the pull-down menus and windows, these softkeys extend the Mac interface to the VAX.

Equally important, PacerLink integrates its terminal emulation with file transfer, virtual disk and print services to give you full functionality with one product. It connects IBM PCs (and compatibles) as well as Macs to VAX (VMS and ULTRIX) and several UNIX systems.*

PacerLink is the core of a powerful family of integrated micro to mini

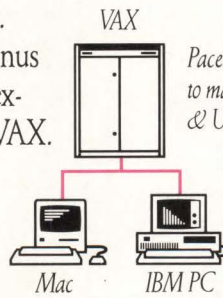

PacerLink connects Macs and IBM PCs to many hosts, including DEC VAX (VMS & ULTRIX) and several UNIX systems.

solutions. Add PacerShare, and you gain a VAX/VMS AppleShare-compatible file server that's completely transparent. Add PacerPrint, and users on either side of the network can access PostScript printers. With PacerGraph, you extend graphic emulation capabilities to the VT240/VT241 standards.

For more information on how you can plug your Mac users into VAX power, call (508) 898-3300 or (619) 454-0565.

Pacer
SOFTWARE

Control Data Expands Information Integration

Control Data Corporation extended its information integration capabilities with the introduction of a software-based product, Common Data Model*plus. CDM*plus allows multicomputer, multidatabase systems to appear to the user as a unified environment with one machine, one language and a single database. This set of integration software and consulting services is designed to help manufacturing operations achieve functional integration of information.

CDM*plus provides one approach to integrated information systems, featuring phased development and implementation, and the use of existing systems. There are five phases to a CDM*plus project: integration, definition, maintenance, application and execution. The five phases correspond to specific component tools within CDM*plus.

CDM*plus is available in VAX/VMS and UNIX versions. Prices vary according to configuration.

To find out more, contact Control Data Corp., Integration Technology Services, 2970 Presidential Dr., Ste. 200, Fairborn, OH 45324; (513) 427-6300.

Circle 402 on reader card

Brouters Combine Range Of Routing Functions

Halley Systems Inc. introduced the newest members of its ConnectLAN remote Ethernet Brouter (smart routing bridge) family. The new ConnectLAN 100 Brouters combine a wide range of advanced routing functions with the performance and protocol independence of network bridges to provide cost-effective LAN-to-LAN internetworking under the remote control of a network management system.

ConnectLAN 100 Brouters support Ethernet-to-Ethernet local or remote links. Models differ by number (0-4) and type of full-duplex communication link interface. Available interfaces are RS-422/V.11, V.35 or X.21 with data rates up to 2.048 MB per second. Optional serial-link interfaces are DS1 for high-speed T1 (1.544 mbps) applications, M1-CEPT (G.703, 2.048 MB per second) or fiber optic links for high-speed transmission up to 2.048 MB per second.

Prices range from approximately \$9,000 to less than \$13,000. Brouter system software and one-year support are available for \$1,000 per Brouter.

To learn more, contact Jack Hughes, Halley Systems Inc., 2730 Orchard Pkwy., San Jose, CA 95134; (408) 432-2600.

Circle 493 on reader card

Fujitsu Drive Features SCSI Interface

The Computer Products Group of Fujitsu America Inc. announced an embedded SCSI version of the Fujitsu 1-GB eight-inch Winchester disk drive. The M2382S offers a 4-MB-per-second synchronous SCSI data transfer rate, a 16-ms average positioning time and a single-track seek time of less than 4 ms. The unit gives users access to more than 1.3 MB of data in a single seek operation.

Fujitsu's highest-performance SCSI implementation in an eight-inch form factor, the M2382S offers programmable data block sizes from 180 to 4,096 bytes per sector. A parity-protected FIFO ring buffer provides 64 KB of storage with read-ahead caching capabilities. The unit's embedded SCSI controller meets ANSI standards and the CCS specification, including the SCSI II command set. The device uses the same SCSI protocol LSI used on other Fujitsu disk and tape storage products.

The drive is priced at \$7,260 each in 100-unit orders.

To find out more, contact Holly Bourne, Fujitsu America Inc., Computer Products Group, 3055 Orchard Dr., San Jose, CA 95134; (408) 432-1300.

Circle 441 on reader card

PC Controllers Link DECnet And NetWare

Interlan Inc. released PC workstation controllers supporting concurrent access to DECnet and Novell NetWare networks. The two versions of the NP647 protocol processor permit MS-DOS or PC-DOS workstations to communicate simultaneously with

DEC hosts using DECnet protocols as

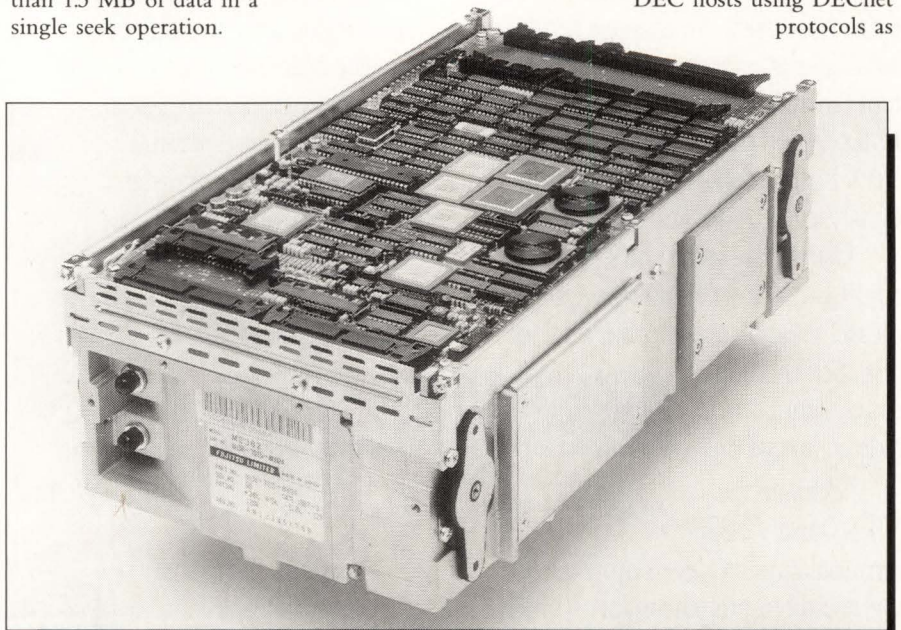

The Fujitsu M2382S eight-inch Winchester disk drive.

well as NetWare file servers using NetWare protocols.

Supplied with 512 KB of on-board RAM and an 80186 processor, the workstation controllers perform all DECnet protocol processing and require no host resources. The advantage of on-board processing is the conservation of scarce DOS memory for RAM-intensive applications. The on-board DECnet software lets you exchange files, obtain directory information, perform VT220 terminal emulation, and share peripheral devices and network utilities with any DECnet host attached to the network.

Pricing for both versions of the NP647 is \$1,395.

Find out more by contacting Richard Henkus, Interlan Inc., 155 Swanson Rd., Boxborough, MA 01719; (508) 263-9929.

Circle 495 on reader card

LC-6026 Printer Increases Throughput

Advanced Technologies International Inc. (ATI) introduced the LC-6026, a 26-ppm laser printer that increases throughput of complex text and graphics by up to 350 percent over comparable printers, allowing them to run at true rated speed. The printer uses ATI's recently introduced LC-6000 controller. It can generate any text at the 26-ppm ideal.

The product is designed for high-volume users (100,000 pages per month) in such fields as law, insurance, finance, CAD/CAM or aerospace. Output is 300 x 300 dpi. The speed increase is made possible by a math coprocessor in the controller and a high-speed input buffer that allows information to be fed to the printer at up to 2 MB per second. Further time savings are made possible by architecture that allows pages to be erased in 20 ms.

The LC6026 costs \$24,900.

To find out more, contact John Goetz, Advanced Technologies Int'l Inc., 355 Sinclair-Frontage Rd., Milpitas, CA 95035; (408) 942-1780.

Circle 505 on reader card

NAS Protects System Resources

BBN Communications Corporation announced the migration of its Network Access System (NAS) from the MicroVAX II to the MicroVAX 2000. This compact hardware base will allow BBN to reduce the price of the NAS by half while providing the same security, access control and connection management functions and performance for its networks.

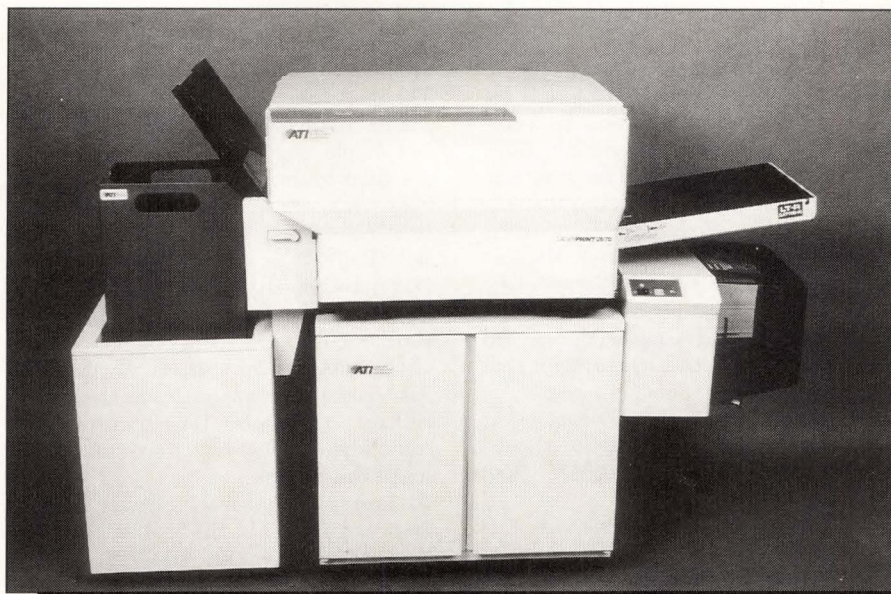

Advanced Technologies International Inc.'s LC-6026 high-speed laser printer.

The NAS protects sensitive information and valuable system resources on BBN WANs from unauthorized access. It provides network-level security by restricting network access to a predetermined set of users, by limiting each user to a predetermined set of destinations on the network, and by validating X.25 host-to-host calls. The NAS is comprised of one centralized Master Database (MDB) host and one or more distributed Access Control Server (ACS) hosts.

The NAS is priced starting at \$125,000 for a minimum configuration that includes two MicroVAX 2000 computer systems. For more information, contact Joann Santos, BBN Communications Corp., 150 Cambridge Park Dr., Cambridge, MA 02140; (617) 873-2805.

Circle 496 on reader card

Relational Ships Ingres Release 6.1

Relational Technology Inc. announced Ingres release 6.1, an on-line transaction processing implementation of the new-generation Ingres release 6 RDBMS.

Release 6.1 is capable of 30 transactions per second on a VAX 8700, which is double the performance of Ingres release 5. Building on the multiserver architecture of release 6, release 6.1 offers high-performance OLTP capabilities. It includes a modular design and a number of enhancements. Developers now can integrate pop-up windows into their applications. An improved menu and improved screen-painting tools increase productivity and ease of use.

Ingres release 6.1 is available as a no-

charge upgrade to existing Ingres users. To learn more, contact Kevin Gallagher, Relational Technology Inc., 1080 Marina Village Pkwy., Alameda, CA 94501; (415) 748-3400.

Circle 413 on reader card

Summus Subsystem Offers Data Interchange

Summus Computer Systems unveiled a family of 8mm helical-scan tape subsystems featuring the capability of data interchange between computer systems from DEC, IBM, Apple and Sun.

The line of GigaTape drives allows unattended backup of 2 GB or more. You can interchange data between IBM, DEC, Apple and Sun systems simply by moving the tape device from one unit to the other. The tape subsystems can be configured with capacities from 2.3 GB to 1 terabyte of on-line storage.

The Summus 8mm tape subsystems range in price from \$4,995 to \$192,000. For additional information, contact Dave Meitzen, Summus Computer Systems, P.O. Box 219270, Houston, TX 77218; (713) 492-6611.

Circle 498 on reader card

MMS/Plus Optimizes Sales Performance

JEB Systems Inc. announced Marketing Management System/Plus (MMS/Plus) and Report Management System (RMS). The products provide sales and marketing departments that have access to VAX/VMS computer systems with software tools offering solutions in corporate marketing support, account management, management reporting,

telemarketing and customer service programs.

MMS/Plus provides software tools to optimize sales performance. RMS adds the dimension of custom reporting for companies with unique reporting needs. JEB's original product, MMS, provides answers to basic marketing support programs from the time the lead arrives to the sale, and offers comprehensive lead analysis and sales forecasting. MMS/Plus adds new solutions by allowing 500 contacts per company record, daily transaction processing, automatic lead assignment by ZIP code, telemarketing call reporting, sales reporting and more. For more information, contact Donna Brock, JEB Systems Inc., 32 Daniel Webster Hwy., Ste. 23, Merrimack, NH 03054; (800) 821-1006.

Circle 499 on reader card

SunAccount Interfaces With Oracle And Ingres

Systems Union Inc. announced interfaces between the company's SunAccount financial accounting software for international corporations and Oracle and Ingres. The SunAccount allows multinational companies using Oracle- or Ingres-based DBMSs and

4GL development tools to have a standard, uniform accounting software, regardless of machine architecture or operating system. The SunAccount interface is fully SQL compatible, making the exchange of data smooth and simple.

SunAccount is portable across all major hardware systems, including the VAX range, IBM AS/400 and System/36, UNIX-based and XENIX-based systems, IBM-compatible PCs and networked PCs. Because of the high degree of portability, SunAccount retains the same look, feel and responsiveness, regardless of operating system or hardware platform. SunAccount is a combined ledger accounting package that automatically translates and consolidates multicurrency accounts into a single base currency.

To learn more, contact Stewart McKie, Systems Union Inc., 244 E. 48th St., New York, NY 10017; (212) 753-7777.

Circle 497 on reader card

Template 6.0 Enhances Graphical Data

Template Graphics Software Inc. (TGS) announced Template 6.0, a new version of TGS' graphics productivity toolkit. This release contains many new features and enhance-

ments that increase the functionality and flexibility of the product.

Template 6.0 is available on VAX and MicroVAX computers, and VAXstations running VMS. The new release offers more than 50 device drivers that support more than 200 graphics devices, including VAXstation displays, VT series terminals, LA34 dot-matrix printers, LN03 and LN03+ laser printers and many other plotters and terminals. Features include filled contours, hidden line removal, and legend and message areas, which enhance the presentation and visualization of graphical data.

Prices for Template 6.0 range from \$3,600 on a VAXstation to \$32,000 on a VAX 8800.

Find out more by contacting Robert Burns, Template Graphics Software Inc., 9685 Scranton Rd., Ste. 150, San Diego, CA 92121; (619) 457-5359.

Circle 501 on reader card

Pathfinder Introduces Personnel System

Pathfinder Software Inc. announced the Personnel Management system, a personnel system that handles controversial health and safety issues. Industrial relations managers

Q-BUS SYSTEM PACKAGES

Zoltech's modular design allows literally thousands of configurations to be built with its V-series family of system chassis. Zoltech will deliver anything from empty metal shells to completely tested turnkey systems: You decide what you want to do and Zoltech will do the rest. Q-Bus and VME systems are our specialty, but we also do custom designs.

VME TOO . . .

CIRCLE 262 ON READER CARD FOR VME

ZOLTECH DELIVERS — CUSTOM OR STANDARD

**Complete Systems
Empty Chassis**

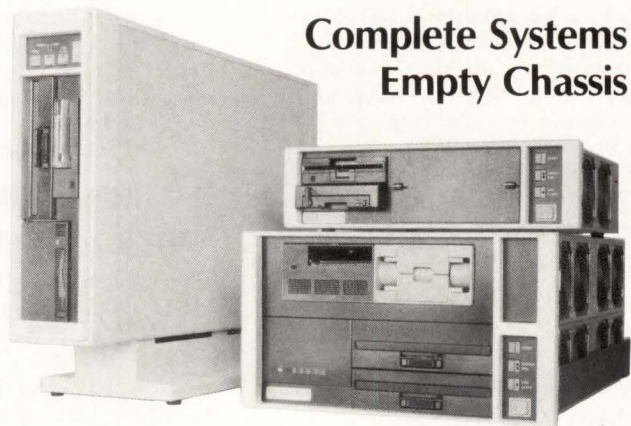

ZOLTECH CORPORATION

7023 Valjean Avenue, Van Nuys, California 91406 USA
(818) 780-1800 Telex 755451

CIRCLE 264 ON READER CARD FOR Q-BUS

MDBS III[®]

— VS —

ORACLE



OPERATION: Embedded SQL fetch program—"SELECT* into empno, ename, job, mgr, hiredate, sal, comm, deptno"

HARDWARE: Standard IBM AT with 640 K RAM.

No. of Records	ORACLE	MDBS III
1,000	*	16.43 sec.
2,000	*	32.68 sec.
4,000	*	65.31 sec.
10,000	*	165.71 sec.

* Although ORACLE's license agreement prohibits us from disclosing actual benchmark timings, we *can* say that the phrase "over 10 times faster" was heard many times in and around the **mdbs** testing center that day.

For a copy of the data on which this benchmark was performed, or for more information on MDBS III, complete and send the coupon or call **mdbs** Sales Support at (800) 344-5832. In Indiana call (317) 463-2581 and in Canada call (416) 733-4380.

- Yes! I would like to make my own benchmark comparison. Please send me a copy of the 10,000 record data base that was used for your benchmark tests.
- Please send me more information about the SQL and Distributed Data Base features of MDBS III.

Name/Title _____

Company _____

Address _____

City _____

State/Zip _____

Phone _____



Two Executive Drive • P.O. Box 248
 Lafayette, IN 47902
 (317) 463-2581 • (800) 344-5832
 FAX: (317) 448-6428
 Telex: 5106017487 (MDBS LAF UQ)

mdbs and MDBS III are registered trademarks of **mdbs**, Inc. Other trademarks contained herein are the property of their respective holders.

MUST Reading ***Computing Books From Professional Press***

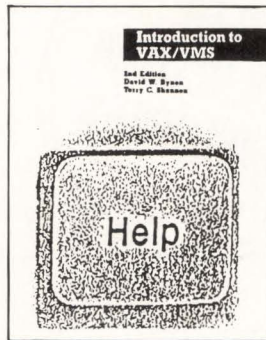

Introduction to VAX/VMS, Second Edition

Introduction to VAX/VMS is a guide for beginners and a reference for the experienced user. From the basics to systems and programming, Introduction to VAX/VMS gives easy to follow instructions about the VAX computer family, DCL command language, command procedures, mail, backup and help features and more. Through pictures, examples and programs, you get explicit instructions for everyday use of VAX/VMS and tips for problems. Plus 8 Appendices and a Glossary for added reference.

Order Introduction to VAX/VMS now. Complete the form below or call Trish at (215) 542-7008 (9-5 eastern time) with credit card information.



Let's C Now

Let's C Now is a self teaching guide to the C language in two volumes. It has all the information you need to learn C language, from the basics to expert use and understanding. Twenty-six informative chapters with tested examples, author's tips and suggestions make it easy to learn, even if you're not a computing expert. Use "C" on any operating system with DEC hardware (primarily for VAX and PDP).

Order one or both volumes of Let's C Now on the order form below, or call Trish at (215) 542-7008 (9-5 eastern time).

***Complete and mail the form below
with payment to order
1, 2 or all 3 of these
important computer handbooks
NOW!***

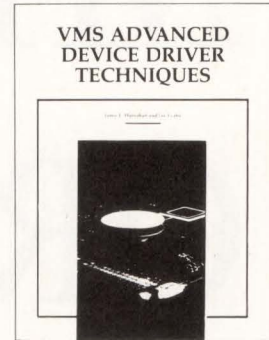

NEW . . . VMS Advanced Device Driver Techniques

By Experts Lee Leahy of Digital Equipment Corporation and Jamie Hanrahan of Simpact Associates VMS Advanced Device Driver Techniques describes how to design, implement and debug device drivers for the VMS Version 5 operating system. Learn more about simple VMS device drivers, full duplex and state machine-based drivers, VAX BI Drivers, advanced strategies and techniques you can use for debugging VMS device drivers and much more. From the low-level "building blocks" to high-level design issues, it's everything you need to become a proficient user of VMS device drivers.

Order now. Fill out the order form below or call Trish at (215) 542-7008 (9-5 eastern time).

YES! I want to complete my computing library with one or more of these important computing handbooks from Professional Press!

Name of Book	Number of copies	Shipping/Handling (per book)	Total \$
VMS Advanced Device Driver Techniques at \$59.95 each		US \$3.00, Canada \$5.00	
Introduction to VAX/VMS Second Edition at \$29.95 each		US \$2.00, Canada \$4.00	
Let's C Now Volume 1 at \$22.95 each		US \$2.00, Canada \$4.00	
Volume 2 at \$22.95 each		US \$2.00, Canada \$4.00	
Volumes 1 and 2 at \$42.95 per set		US \$2.00, Canada \$4.00	
Total Number of Books			Total \$

Check/Money Order enclosed Please charge: VISA MasterCard

Account Number _____ Exp. Date ____ / ____ Signature _____ Date _____

Name _____

Address _____

City _____ State _____ ZIP _____ Telephone () _____

Call me with multiple copy discounts

Mail or FAX this form to: Professional Press, Inc., P.O. Box 503, Spring House, PA 19477 (215)542-7008 ■ FAX (215)628-2845

and company health officers now can take advantage of the information management capabilities that are part of the health and safety module in the Personnel Management system.

Along with detailed employee health profiles, the system tracks complete medical and accident information, including medical exams, tests, accidents and injuries. Information is tracked for historical events and future scheduled events. Reporting profiles are available by employee, employee group or other organizational grouping and include every aspect of medical, accident and testing information contained in the system.

Pathfinder focuses exclusively on PowerHouse business applications for the HP 3000 and VAX minicomputers. Learn more by contacting Pathfinder Software Inc., 1577 W. Georgia St., Vancouver, BC V6G 2V3; (604) 682-6633.

Circle 500 on reader card

Voice/Data Multiplexer For Campus Environment

Canoga-Perkins announced a dual-composite T1 voice/data multiplexer. Aimed at low-end T1 multiplexer and high-end channel bank applications, Model 3140 is

designed for point-to-point, ring and multidrop nodal bypass configurations and is suitable for campus environments and tail circuits of larger T1 networks.

The dual composite feature enables the 3140 to operate on either a fiber optic link or a four-wire circuit. It will support future ISDN basic and primary services, both composite side and user channel side. Offering drop and insert, DACS/D4 compatibility, T1 or CEPT speeds and 24/30 DSO channels, the 3140 is intended to be a cost-effective T1 solution. Other features include network management, menu-driven configuration and password protection. The 3140 provides maximum reliability with redundancy, including automatic switchover, of all vital functions. Redundant T1s, processors, power supplies and composites are standard.

Obtain more information by contacting Rich Aure, Canoga-Perkins, 21012 Lassen St., Chatsworth, CA 91311; (818) 718-6300.

Circle 503 on reader card

CrossComm Adds Fault Tolerance

CrossComm Corporation added a capability called Parallel Links to its ILAN product that allows the building of fault-tolerant

backbones and WANs. ILAN, a system of special-purpose LAN devices, allows connecting multiple customers' LANs into a single corporatewide or campuswide network.

With the Parallel Link capability, corporatewide network operation isn't impacted by the failure of one component. Without Parallel Link capability, the failure of a single bridge or router disconnects the attached networks. ILAN systems with the Parallel Link capability have fully redundant links between LAN segments. IMS-1 network management software automatically detects a failure, independent of location, and reports the situation to the network administrator. IMS-1 software adds control over traffic routing based on protocol type using an automatic load-balancing algorithm.

For complete information, contact CrossComm Corp., P.O. Box 699, Marlboro, MA 01752; (508) 481-4060.

Circle 492 on reader card

Multi-Tech Ships MultiModemV32

Multi-Tech Systems Inc. is shipping its 9,600/4,800/2,400/1,200/300-bps Multi-ModemV32 modem. The MultiModemV32

IMAGINE...

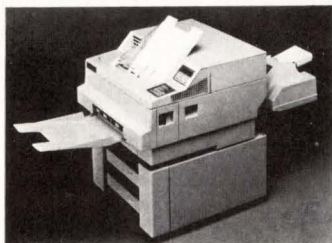

Three
12 PPM
Printers in
One for
Only...

\$3,990

 **Dataproducts.**

The **LZR 1230** can concurrently support up to three computer systems while simultaneously emulating an HP LaserJet Plus, Epson FX80 and a Diablo 630; eliminating the need for three separate printers.

With a 250 sheet tray; the **LZR1230** has as options a double bin cassette feeder for an additional 500 sheet capacity and a fully functional envelope feeder.

Intelligently priced consumables and a 600K page life cycle produce the lowest cost per page output available. The \$3,990 list price makes the **LZR1230** the most economic and ergonomic printer on the market.

The **LZR1230** is available from:

S/S/T

305 Broadway, NYC 10007
(212) 964-9600 Fax. (212) 233-4678

*Ask about Dataproduct's Adobe Postscript and Appletalk printer.

CIRCLE 185 ON READER CARD

Let Advanced Systems Engineering help your organization break out of the endless maze of ever-changing automation systems and business technologies, and find the direct line to corporate-wide compatibility, flexibility, and profit . . .

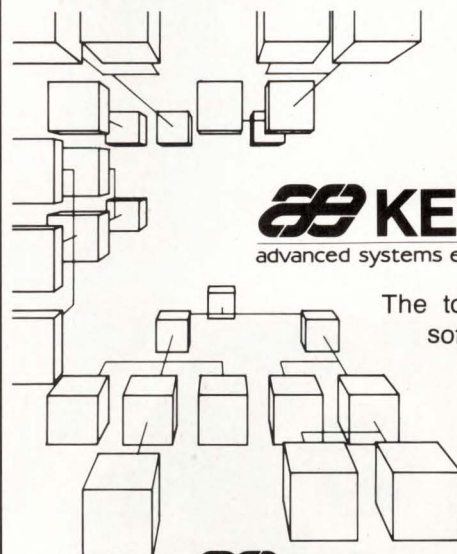

 **KERNEL**
advanced systems engineering, inc.

The total integration
software solution.



advanced systems engineering, inc.

Robinson Plaza Three, Suite 305, Route 60, Pittsburgh, PA 15205
Telephone: (412) 788-2700 FAX: (412) 788-1473

CIRCLE 296 ON READER CARD

Remember how computers remembered? Mercury delay lines? Punched cards with 90 columns and round holes? Hand-wired magnetic cores? In case your memory needs refreshing, The Computer Museum would like to share its memories with you.

The Computer Museum Memory Poster
We have created a limited edition, 20" x 32" poster of the picture shown below. Printed in

CIRCLE 237 ON READER CARD

COMPUTER MEMORIES FOR SALE

full-color, it includes an identification key to help you recall the memories you've forgotten. To get your poster, along with an information kit on museum membership, exhibits and activities, send a tax-deductible contribution of \$25 or more to:

Memory Poster, The Computer Museum,
300 Congress Street, Museum Wharf,
Boston, MA 02210.

Please allow six weeks for delivery.

YES! Please refresh my computer memories. A tax-deductible donation of \$25 or more made payable to The Computer Museum is enclosed.

Name _____

Address _____

City _____ State _____ Zip _____



**The
Computer
Museum**

Located on Museum Wharf
300 Congress Street, Boston, MA 02210
(617) 426-2800

E

Special thanks to this publication, Scitex America Corp. (color separations), Grafik Communications, Ltd. (design), David Sharpe Studio (photography) and VM Software, Inc. (poster).



is CCITT V.32 compatible at 9,600 and 4,800 bps, CCITT V.22bis compatible at 2,400 bps, CCITT V.22 and Bell 212A compatible at 1,200 bps, and CCITT V.21 and Bell 103 compatible at 300 bps. It operates full duplex, asynchronous or synchronous over both dial-up and two-wire leased lines.

The product provides MNP Class 2, 3 and 4 error correction. It provides Class 5 two-to-one data compression, which increases modem throughput significantly. The rack-mount MT932ER version is designed to mount in Multi-Tech's CC216 Modem Rack, a 7-x-19-inch central site card cage that holds up to 16 modems and one power supply.

The MultiModemV32 is priced at \$1,495 for desktop versions and \$1,395 for rack-mount versions.

For additional information, contact Multi-Tech Systems Inc., 82 Second Ave. S.E., New Brighton, MN 55112; (612) 631-3550.

Circle 506 on reader card

Power Protector Blocks Noise

Transector Systems introduced a combination suppressor/filter power line protector

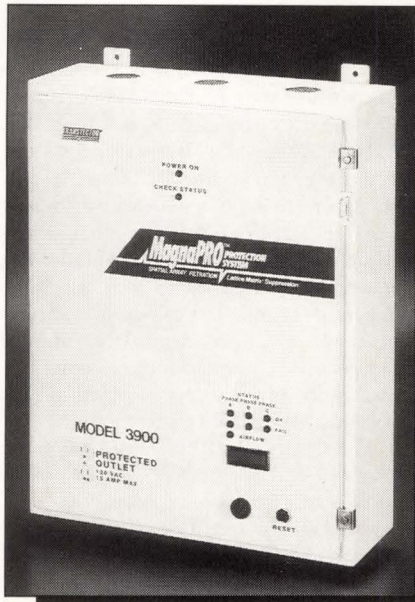

Transector Systems' MagnaPro.

that uses recently discovered electromagnetic phenomena and applied physics to control electrical interference on the ac power line. The unit is designed to protect computer and computerized electronics from disruption

and damage by transient overvoltages and severe noise problems.

The MagnaPro series of power protectors uses a proprietary Spatial Array filtration system to enhance noise attenuation across a broad frequency spectrum. The protectors provide high-performance transient overvoltage suppression using Transector Systems' Lattice Matrix solid-state technology, which delivers maximum bipolar suppression without degradation. The MagnaPro series is available in six service voltages ranging from 208Y/120 to 480VAC, 50/60 Hz. For complete details, contact Doug Hadley, Transector Systems, P.O. Box 300, Hayden Lake, ID 83835; (800) 635-2537.

Circle 507 on reader card

GDCM Speeds Access To Information

The Graphic Management Group Inc. announced the read-only version of The Graphic Data Center Manager (GDCM), which enables operations personnel to gain rapid access to information on computer room equipment. First, an operations manager using GDCM creates the computer room design on a PC screen. After the design

DON'T GET ZAPPED!

High inrush current can **destroy** your sensitive VAX CPUs and peripherals in less time than it takes to flip a switch.

THE SOLUTION?

Power up with **Z-LINE TPC 115-10 MTD™** the smallest power distribution and control system available.



POWER UP WITH

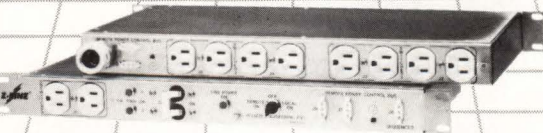

Our proprietary **Multiple Time Delay™** circuitry sequences your power-up to **protect** your systems from the spikes and surges that **destroy your hardware and erase your data**. And our remote on/off and emergency shutdown gives the **power control back to you**.

All Pulizzi Engineering MTD™ controllers are compatible with **DEC** and **UPS** systems. **PRICED FROM \$436 TO \$305**

DON'T WAIT UNTIL IT HAPPENS, CALL TODAY!

See us at **NEPCON West '89, Booth #8230**

PULIZZI ENGINEERING INC.

3260 S. Susan Street Santa Ana, CA 92704-6865 (714) 540-4229 FAX (714) 641-9062

CIRCLE 252 ON READER CARD

If you know 123...

...you already know abc!

FULL LOTUS 1-2-3 COMPATIBILITY
MACRO RECORDING AND DEBUGGER
AUTO RECOVERY
CRUISE CONTROL
PRESENTATION GRAPHICS in 3D
ORACLE and UNIVERSAL FILE INTERFACES
SIMPLIFIED PRINTING
SPREADSHEET LINKING and CONSOLIDATION
TUTORIAL: Online and Interactive

ORDER YOUR abc SPREADSHEET DEMO NOW!
CALL TOLL-FREE 1-(800) 876-4123
 ask for "operator abc"

AOK Software Products, Inc.
 1305 Wiley Road, Suite 102
 Schaumburg, IL 60173

123, Oracle and abc are registered trademarks of Lotus Development, Oracle Corp and Advent Online, respectively.

CIRCLE 270 ON READER CARD

is complete and all relevant information is entered, a copy is made. This read-only copy is loaded onto another PC screen, which usually is located in the computer room where operations personnel can query it, but not change it in any way.

GDCM enables the operations staff to document the data center completely. When problems arise, the relevant equipment, water sensors, cables and power connections can be located simply by calling up the computer room layout on the PC screen. As a result, corrective action can be taken without the delays inherent in working with engineering drawings or locating the staff member who has the required information.

For additional information, contact The Graphic Management Group Inc., 100 Summit Lake Rd., Mt. Pleasant, NY 12457; (800) 346-6828; in NY, (914) 779-7800.

Circle 502 on reader card

Okidata Modems Feature 2,400-Bps Throughput

Okidata introduced two 2,400-bps modems featuring MNP Class 5 with two-to-one data compression providing throughput up to 4,800 bps for the PC marketplace.

The Okitel 2400 Plus (external) and 2400B Plus (internal) are fully Hayes compatible. They comply with CCITT V.22bis requirements for domestic and international 2,400-bps data transmission and meet Bell Standards 212A and 103J for asynchronous data transmission at either 1,200 or 300 bps. They operate in full or simulated half-duplex mode over public or dedicated lines. Automatic dialing and answering capabilities and memory storage for up to four telephone numbers are standard. A call progress detection feature lets the modems detect line activity generated at the telephone company's central office and feed this information back to the software for user presentation.

The Okitel 2400 Plus costs \$549; the Okitel 2400B Plus costs \$499. Both modems feature extended five-year warranties.

Find out more by contacting Cliff Rockwell, Okidata, 532 Fellowship Rd., Mount Laurel, NJ 08054; (609) 235-2600.

Circle 508 on reader card

UPS Line Targets LANs

Best Power Technology Inc. added 350 VA and 750 VA units to its Ferrups line, which already includes models from 500 VA to 15 KVA. Although advanced engineered tech-

niques have been made across the entire Ferrups line, the greatest emphasis is in Micro-Ferrups, units from 350 VA to 2 KVA.

A key feature of all units is intelligent and automatic communications between the Ferrups unit and the load supported through a built-in microprocessor and standard RS-232 port. Intelligent communication is attained through built-in microprocessor controls with interrupt capabilities and almost 100 displayable readings, such as load, temperature, systems history, battery run-time remaining, and many others. Ferrups units have a standard keyboard to control the microprocessor and an LCD of information. Micro-Ferrups and Ferrups units can provide this same TTL data through the RS-232 port for output to a terminal or host computer. To learn more, contact Best Power Technology Inc., P.O. Box 280, Necedah, WI 54646; (608) 565-7200.

Circle 509 on reader card

Q-Calc Offers Lotus-Style Advantages

Quality Software Products announced Q-calc Standard, the latest version of its UNIX-based spreadsheet program. The

EDIX = POWER EDITING

"EDIX is better than EDT or Emacs. This program combines ease-of-use with advanced features."

- EDIX is faster than EDT or Emacs
- Uses less disk space and memory than EDT or Emacs
- VMS/ULTRIX/DOS compatible
- Broadcast message capture
- Multiple windows/multiple buffers
- Any window can operate as a virtual terminal
- Subprocess execution with standard output capture
- Customizable
- Multiple keyboard definitions
- On-line help and tutorials
- Free technical support, no maintenance fees

Call for pricing and free demo. Ask about our special University and Corporate discount programs.

EMERGING
TECHNOLOGY

Emerging Technology
3405 Penrose Place
Boulder, CO 80301
303-447-9495 FAX 303-447-9241

CIRCLE 171 ON READER CARD

DON'T BUY A VAX SPREADSHEET

Without trying GRAPHIC OUTLOOK from Stone Mountain Computing.

If you are looking for LOTUS-like capability on the VAX, try GRAPHIC OUTLOOK. It's powerful. It's useable. And it's affordable.

GRAPHIC OUTLOOK provides

- A LOTUS command mode that makes it as easy to operate as 1-2-3.
- Automatic transfer of worksheets to and from 1-2-3 (versions 1A and 2) and Symphony.
- High-quality business graphics on most popular graphics terminals, plotters, and laser printers.
- 2-user, 6-user licenses, a lease plan and right-to-copy discounts for clustered VAXes.
- Probably more capability than you've ever seen in a spreadsheet program.

Call about our demonstration package. GRAPHIC OUTLOOK. Tomorrow's VAX spreadsheet program that's available now.



Stone Mountain Computing
P.O. Box 1369
Goleta, CA 93116
(805) 968-3838

VAX is a registered trademark of Digital Equipment Corporation.
LOTUS and 1-2-3 are registered trademarks of Lotus Development Corporation.

CIRCLE 246 ON READER CARD

Q-calc line is a UNIX work-alike for Lotus 1-2-3 release 2.01.

Q-calc's Lotus-style advantages include read/write capability in the native 1-2-3 save file format and availability of 1-2-3's most recent macro language, including user-defined menus, prompts and subroutines with parameters. The program allows up to 16 distinct windows on the worksheet, with user-selectable synchronized scrolling of compatible windows.

Q-calc incorporates a database function that allows you to formulate information tables and to query those tables for matching user-specified criteria. Statistical functions compute such values as standard deviation of database records that match a given set of user criteria.

More information can be obtained by contacting Quality Software Products, 1730 22nd St., Santa Monica, CA 90404; (213) 659-1560.

Circle 512 on reader card

Multipoint Modems Increase Throughput

DCB introduced two multipoint modems, the DCB PL19.2FP Plus and the DCB

PL14.4FP Plus. The PL19.2FP Plus features data rates of 19,200 bps outbound from the host and 9,600 bps inbound from remote sites. In polled applications in which typically 90 percent of all data is outbound from the host, the it offers up to a 90 percent throughput increase over 9,600-bps modems. The PL14.4FP Plus offers up to a 45 percent throughput increase over 9,600-bps modems.

Both models offer a Request to Send/Clear to Send delay of 7.5 ms with optional settings of 15, 30 or 60 ms. Standard features include extensive diagnostics for proactive line testing. In addition, the PL14.4FP Plus is designed for use over unconditioned lines.

The PL19.2FP Plus is priced at \$7,900; the PL14.4FP Plus is priced at \$4,900.

For more information, contact Greg Gonda, DCB, 807 Pioneer, Champaign, IL 61820; (217) 352-3207.

Circle 510 on reader card

SDC-RQD11-RLL Emulates MSCP Protocol

Sigma Information Systems introduced a dual-wide controller that interfaces two ST-412 drives to a MicroVAX or LSI-11

system. Similar to the MSCP protocol, the SDC-RQD11-RLL controller uses 2,7 RLL encoding.

The controller provides simultaneous support of drives with different storage capabilities. Each drive can be partitioned into logical units with a maximum of 16 logical units per controller. Menu-driven, firmware-based utilities permit disk formatting and maintenance operations via the system console. Comprehensive power-up self-diagnostics report any faults to the console terminal. On-board LEDs provide a visual indication of controller status. The product automatically performs block mode DMA transfers or burst mode DMA.

The SDC-RQD11-RLL is priced at \$875, with quantity discounts available.

For more information, contact Helen Mitchell, Sigma Information Systems, 3401 E. LaPalma Ave., Anaheim, CA 92806; (714) 630-6553.

Circle 514 on reader card

Oracle*Mail Provides Office Automation

Oracle Corporation's Office Automation group announced an office information and

The Ultimate GKS/CGM Product

GRAFFPAK-GKS

for All Computing Environments

1-800-999-5711

See us at NCGA, Booth #4807-4809



Advanced Technology Center 5711 Slauson Avenue, Suite 238 Culver City, California 90230 (213) 568-9119 TWX510-101-1670

CIRCLE 222 ON READER CARD

DP0489

communications system. Oracle*Mail is a portable distributed electronic mail system designed to provide enterprisewide office automation.

The product provides transparent communication with full store-and-forward capability among heterogeneous computers, operating systems and networks. Users on different machines can exchange mail without needing to know the location or network routing of the recipient. It also

transparently sends messages to facsimile and telex addresses. Unlike conventional mail systems, it enables MIS applications to communicate with users via mail. Applications include financial, manufacturing, personnel and engineering. It uses a windowed interface with pull-down menus and context-sensitive help to speed acceptance of electronic mail by novice users. It's available on VAX/VMS and Sun UNIX systems and is shipped with the Oracle RDBMS kernel

To find out more, contact Catherine Monaco, Oracle Corp., 20 Davis Dr., Belmont CA 94002; (415) 598-8219.

Circle 411 on reader card

Advantedge 2000 Operates At 12 Mips

Integrated Solutions Inc. introduced the Advantedge 2000, a workstation developed for the OEM and systems integrator markets designed around Mips Computer Systems Inc.'s R2000 RISC chip set. It operates at 12 mips.

The Advantedge 2000 is available at various levels of integration, from the basic board level to a stand-alone workstation configuration. Customers can choose between two UNIX operating systems: Mips Computer System's RISC/os (UMIPS) or Integrated Solutions' Dual Universe, featuring both UNIX 4.3 BSD and System V.3. Among Advantedge 2000's technical features are on-board 32-KB cache memory, 1,280-x-1,024-pixel graphics resolution, an on-board SCSI controller, an Ethernet controller and an on-board 80186-compatible input/output processor.

Advantedge 2000 is priced from \$12,000 for the base system, including packaged base board and video board, to \$24,500, depending on additional peripheral and memory add-ons.

To learn more, contact Harvey Goldman, Integrated Solutions Inc., 1140 Ringwood Ct., San Jose, CA 95131; (408) 943-1902.

Circle 504 on reader card



5.4 Gigabytes Unattended Backup

Digi-Data's GIGASTORE™ provides up to 5.4 Gigabytes of data storage on a single T-120 VHS video cartridge. That permits backup of your largest disk drive on off-hours without an operator.

Utilizing true read-after-write coupled with very powerful error correction, GIGASTORE gives you an unsurpassed error rate of 1 in 10²³ bits. In addition, you get a high speed search capability not available in most 9-track drives.

GIGASTORE can be provided with an interface for IBM PC/XT/AT/PS-2™. It is available with DEC interface for VAX and MicroVAX. It is also available for backup of data on Novell LANs.

Call Digi-Data, an organization with a 25 year history of manufacturing quality tape drives, at (301) 498-0200.

™ GIGASTORE is a trademark of Digi-Data Corporation. PC/XT/AT/PS-2 are trademarks of IBM Corporation.



DIGI-DATA CORPORATION
8580 Dorsey Run Road
Jessup, MD 20794-9990
(301) 498-0200
Telex 87-580

• ... First In Value

**DEALER
INQUIRIES
INVITED**

In Europe contact: Digi-Data Ltd. • Unit 4 • Kings Grove • Maidenhead, Berkshire
England SL6 4DP • Telephone No. 0628 29555/6 • Telex 847720

CIRCLE 199 ON READER CARD

Cabletron Repeater Increases Flexibility

Cabletron Systems Inc. introduced the MR9000TPT, a multiport twisted-pair repeater that provides increased flexibility in connecting twisted-pair and coaxial cable Ethernet LAN segments.

The product is designed for applications in which small workgroups running Ethernet over twisted-pair need to be tied into existing coax or fiber LANs and backbone networks. It allows up to eight twisted-pair segments to be connected via standard RJ-45 ports. An 802.3-compatible attachment unit interface port on the rear of the unit provides a direct connection to either thick or thin coaxial or fiberoptic cable. It incorporates full IEEE 802.3 repeater functions. It retimes data packets, generates preambles and automatically partitions problem segments.

The MR9000TPT costs \$2,895.

For complete information, contact Robert Monaco, Cabletron Systems Inc., P.O. Box 6257, Rochester, NY 03867; (603) 332-9400.

Circle 515 on reader card

Power Lines.

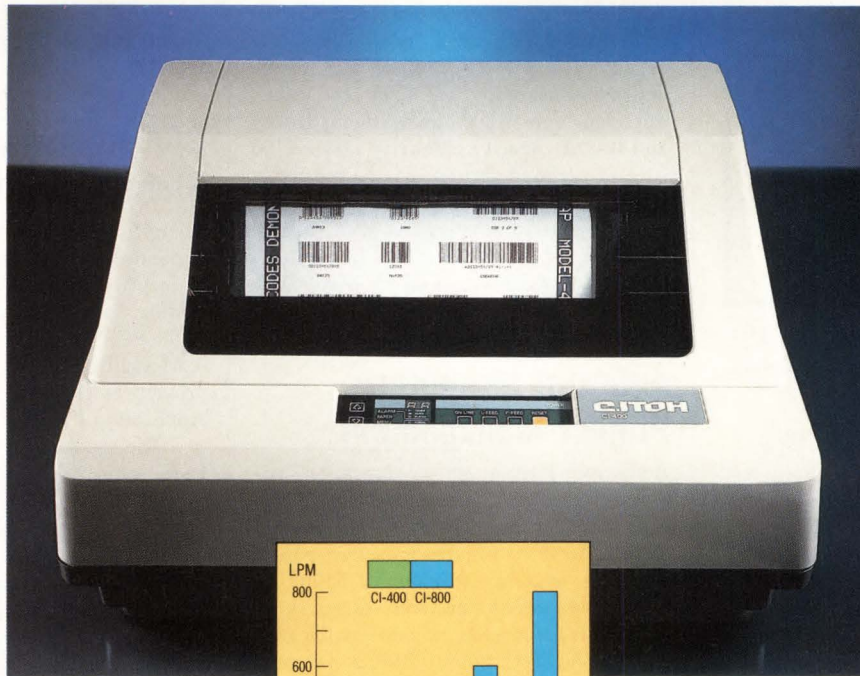

We built something special into our PowerLine CI-400 and CI-800 dot matrix printers that opens a whole new page in output opportunities. It's a fourth mode called Hi-Speed Draft. And it lets you get more out of your printer and your business than ever before.

It also makes any line printer with three speeds look old-fashioned and awkward. And a thing of the past.

Our four-speed PowerLines can print just about anything your business needs. The CI-400, for example, prints out 400 lines per minute for high-speed data processing assignments. On another line, tight and accurate letter quality at 85 lpm. In between you get 300 lpm for crisp, high-contrast bar codes and graphics, and a convenient 200 lpm memo mode.

The CI-800 PowerLine takes four speeds even

further. For greater flexibility at 170, 400, 600 and 800 lines per minute.

No matter what mode you're in, both printers use C.Itoh's proprietary long-life print head design, and a small dot wire to fill those hard-to-reach corners for corporate letter quality correspondence and solid

industry-specified bar codes.

All of which means you don't have to use one printer for one job and a different printer for another. Because the four speeds are all-in-one. Ready and waiting for your commands.

Our PowerLine CI-400 and CI-800 line printers. You'll quickly like what they can do. In four very powerful ways.

For more information on our PowerLine family of line printers, contact C.Itoh Electronics, (714) 757-4492 for the nearest reseller in your area.

C.ITOH

We Build More In So You Get More Out.

CIRCLE 285 ON READER CARD

C.Itoh Electronics, Inc., 2505 McCabe Way, Irvine, CA 92714

©1988 C.Itoh Electronics, Inc.

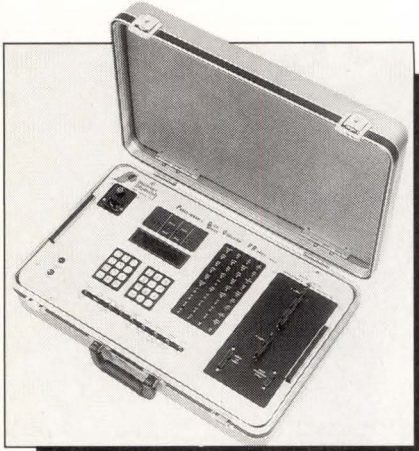

Pioneer Research's PR4003 Intelligent Exerciser tests SMD-type drives.

PR4003 Tester Monitors Drive Problems

Pioneer Research announced the PR4003 Intelligent Exerciser, a disk drive tester designed for field use. The PR4003 tests any SMD-type drive having transfer rates up to 20 MB per second, including Fujitsu, Toshiba, NEC and CDC. It monitors and diagnoses drive problems and aligns heads.

The PR4003 is programmable through a simple keyboard. Standard format includes 32-bit ECC. Multiple baud rates are available. It digitally displays test information in plain English. Numbers are in decimals; bytes are in octal and binary. Actuation of one or two switches initiates sophisticated and thorough testing. Correct index and sector pulses, write/read and head positioning are checked automatically. Built-in diagnostics include sequential or random reading of the disk, sequential or random writing and readback of the disk, special seek programs and self test.

The PR4003 is priced at \$4,995.

Learn more by contacting Steve Hershey, Pioneer Research, 1745 Berkeley St., Santa Monica, CA 90404; (800) 223-1745; in CA, (800) 848-1745.

Circle 526 on reader card

BASF Introduces Data Cartridges

BASF Corporation Information Systems introduced a complete line of 1/4-inch data cartridges. Featuring lower tangential drive force than ordinary data cartridges, the 3M-compatible products offer precise tape guidance mechanisms and accurate tape-slitting.

The BASF data cartridges are available in five configurations of the standard size 5 1/4-inch cartridge and the 3 1/2-inch mini-

cartridge, all with 1/4-inch widths: 300 feet with a 1,600-bpi recording density and a 2.9-MB capacity; 450 feet with a 1,600-bpi recording density and 4.3-MB capacity or 10,000-fpsi recording density and 45-MB capacity; 600 feet with 12,500-fpsi recording density and 60- or 120/320-MB drive-dependent capacity; and 205 feet (mini-cartridge) with 12,500-fpsi recording density and 40-MB capacity. The cartridges are 100 percent certified and are guaranteed for at least 5,000 passes.

For complete information, contact Richard C. Howland Jr., BASF Corp. Information Systems, Crosby Dr., Bedford, MA 01730; (617) 271-4064.

Circle 511 on reader card

Auto-trol Simplifies Project Management

Auto-trol Technology Corporation announced the latest version of its Engineering Information Management System (EIMS). EIMS 2.1 includes on-screen graphic interfaces to Auto-trol's Series 5000 and Series 7000 graphics products, file-tracking capabilities for graphic and non-graphic files, a project archive/restore feature and a comprehensive report-generation system.

EIMS provides critical project information for tracking production documents and data. It's used to organize and record project data, file location, history and revision level; to implement file protection; and to manage associated project information. EIMS

tracks graphics files, word-processing documents, manual drawings and other CAD vendors' drawings.

To find out more, contact Elizabeth Ford, Auto-trol Technology Corp., 12500 N. Washington St., Denver, CO 80233; (303) 252-2833.

Circle 518 on reader card

SCA Releases Statistical Software

Scientific Computing Associates (SCA) announced the SCA Statistical System for MicroVAX, Sun, HP 9000 and Apollo workstations. Encompassed in the UNIX version of the SCA System are the SCA Forecasting & Modeling Package, the SCA Quality Improvement Package and the SCA General Application Package.

The SCA Forecasting & Modeling Package provides comprehensive tools for univariate, multivariate and econometric analysis, using techniques of Box-Jenkins Modeling. The SCA Quality Improvement Package provides tools for the design and analysis of experiments using statistical methods. The SCA General Application Package provides an array of general statistical analysis capabilities, including plots and descriptive statistics, cross tabulation, ANOVA, non-parametric statistics, regression and Box-Jenkins ARIMA modeling and forecasting.

The packages can be licensed separately or in combination. Site licensing and



BASF Corp. Information Systems' line of 1/4-inch data cartridges.

is coupled with an RDBMS for an information management environment. EIMS provides tools for easy database access with pop-up menus in the graphics system and a series of prompts that automatically take the user through inquiries to reach information. It

multiple-copy discounts are available. Find out more by contacting William Latyak, Scientific Computing Associates, Lincoln Ctr., Ste. 106, 4513 Lincoln Ave., Lisle, IL 60532; (312) 960-1698.

Circle 521 on reader card

June PC EXPO: Industry's Most Important Show

Trade event reflects strong, expanding microcomputer industry

Today's microcomputers are more and more powerful and sophisticated. So, too, are the professionals who use, buy, sell, manage, and plan exactly how to make these computers integral and productive parts of their businesses. For these professionals--for those who have come to be known as volume buyers--there is one great way to stay on top of the explosion in microcomputer technology: PC EXPO in New York.

For volume buyers, the 7th Annual PC EXPO in New York, June 20-22, at the Jacob Javits Center, is one of the best opportunities of the year to see hundreds of new and improved products from a who's who in the computer industry. Over 500 exhibitors--from established powerhouses to emerging newcomers--are displaying their latest state-of-the-art products and services. In fact, it's safe to say that if it automates, expedites or integrates corporate America, you'll find it at PC EXPO.

500 Firms Exhibiting at PC EXPO

Hundreds of vendors--from established powerhouses to emerging newcomers--are exhibiting at the 7th Annual PC EXPO in New York, June 20-22, 1989 at the Javits Convention Center. In an effort to reach tens of thousands of volume buyers coming from 50 states and abroad, companies like IBM, Hewlett-Packard, DEC, Compaq, 3Com, MicroSoft and Unisys will be previewing their newest state-of-the-art products. These and scores of other companies are expected to make over 200 new product introductions at the show.

Virtually every segment of the micro-computer and micro-related industry is represented at PC EXPO. Computer professionals will be able to engage in a wide array of hands-on product evaluations concerning networking and systems integration, of hardware platforms, and an extraordinary range of software.

The extraordinary breadth and depth of the PC EXPO exhibitor list confirms the show's stature as "the industry standard." Martin Hansen, MIS director for an international financial investment firm, sums up the expectations of

the show's 50,000 volume buyers, "I know if it's something I need to see, I can see it at PC EXPO," he says. "And if it's not at PC EXPO, I probably don't need to see it."

PC EXPO is open to business and trade professionals only from 10:00 to 5:00 Tuesday through Thursday, June 20-22, 1989.

Trade show offers outstanding educational opportunity

Guided and overseen by an experienced and elite Advisory Board, the world renowned PC EXPO Seminar Series is shaping up as an unmatched educational opportunity for the show's volume buying attendees. The Series--consistently rated the tops in the industry--offers 48 sessions and runs concurrently with the exhibits portion of the show on June 20-22, 1989.

The Series is highlighted by *Connections 89--13* special connectivity and networking seminars--and a new *Mac Track* exploring integration, technical and application development challenges concerning the Macintosh.

Kicking off the conference program is David House, senior vice president, Intel Corp, who is delivering the PC EXPO Keynote Address. Mr. House's address is scheduled for 9:15 a.m., Tuesday, June 20.



The PC EXPO show floor: A veritable who's who in the computer industry.

Early registration advised

Because of long lines anticipated for on-site registrations, volume buyer attendees are urged to plan their visit early. A registration brochure may be obtained by calling (201)-569-8542 or writing to PC EXPO at 385 Sylvan Avenue, Englewood Cliffs, NJ 07632.

MDB Systems Introduces The Data Shuttle 1000

MDB Systems Inc. announced the Data Shuttle 1000. The single-canister version is being offered for users who only require a single-disk subsystem add-on. This desktop configuration of the Data Shuttle provides a single disk, mounted in a removable shock-isolating disk canister to be accessed by any computer system.

The unit provides high-capacity, high-performance removable disk capability to workstations, personal computers and micro computers. Its canister can contain any 5¼-inch form factor device with capacities from 86 to 760 MB unformatted with a SCSI interface. The shock-protecting removable canister has a switch-activated write protection and a tri-color LED that signifies when the drive is write protected and when it's safe to remove the drive canister.

The price of the Data Shuttle 1000 is targeted at \$1,195. Empty disk canisters cost \$485, removable media canisters cost \$600. For more information, contact Amos R.L. Deacon Jr., MDB Systems Inc., 1110 W. Taft Ave., Orange, CA 92613; (714) 998-6900.

Circle 534 on reader card

Owen+Davis Ports VAX Software To IBM PCs

Owen + Davis Systems Inc. announced that its Bloodhound software package is available for IBM PC XT/AT, PS/2 and compatibles and features the same functionality as the Bloodhound for VAX computers. The new Bloodhound, like the VAX version, enables companies to increase the overall productivity of anyone managing a list of business contacts. It tracks and profiles vendors, customers, prospects, associates or any vital contacts.

In addition to its standalone capabilities, the new Bloodhound can be integrated with Bloodhound for VAX to allow desktop and portable PCs to link into VAXs and VAX-clusters. It uses compatible record formats that enable information to be moved between the PC and the VAX.

Bloodhound is priced at \$295.

For complete information, contact Drew Head, Owen + Davis Systems Inc., 1335 Acacia St., Fullerton, CA 92631; (714) 956-9159.

Circle 517 on reader card

RGB's 1400M Converts Computer Graphics

RGB Technology announced a multi-input video scan converter. The model 1400M converts high-resolution computer graphics to

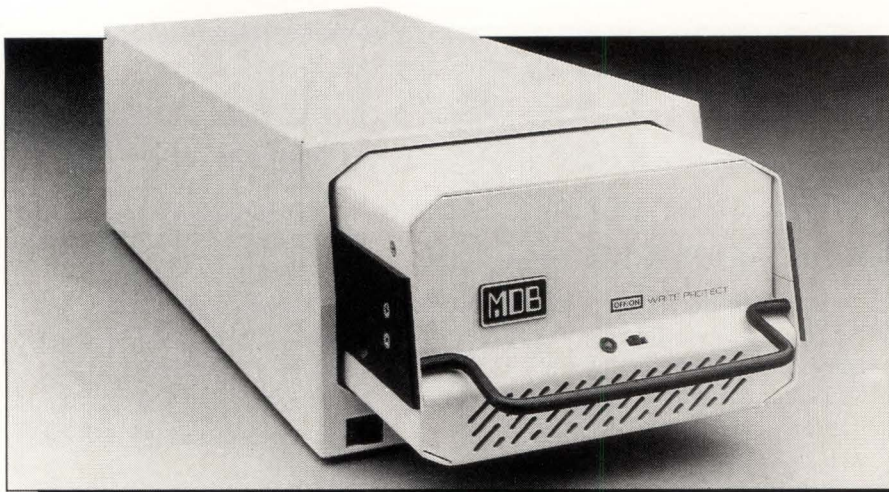

MDB Systems Inc.'s Data Shuttle 1000, a single-disk subsystem add-on.

television format (NTSC or PAL) with up to 16 user-selectable workstation inputs.

The RGB/Videolink 1400M supports all leading high-resolution workstations, including all current models from DEC, Sun, Apollo, Tektronix, Silicon Graphics and IBM, with pixel resolutions of 1,024 x 768 to 1,280 x 1,024 (45 to 75 KHz). Sixteen user-selectable presets are available at the touch of a button. With the 1400M, a company with a variety of workstations can address all of its scan conversion requirements.

The 1400M is the latest product in RGB's line of video scan converters that incorporate full 24-bit color processing, real-time operation and sophisticated flicker filtering. Essentially a dedicated image processor, the RGB/Videolink accepts full-screen, non-interlaced RGB input and provides genlock, sync generation and encoding to output television video.

Obtain additional information by contacting Carol Fogel, RGB Technology, 2550 Ninth St., Ste. 114, Berkeley, CA 94710; (415) 848-0180.

Circle 522 on reader card

MicroSim Releases PSpice 4.01

MicroSim Corporation released PSpice 4.01. The release includes two options, Analog Behavioral Modeling and Digital Simulation, as well as numerous other enhancements.

The Analog Behavioral Modeling option allows a user to describe a circuit block by giving the block's transfer function, either by formula or by table. Non-linear transfer functions make it easy to model unique devices, such as Josephson junctions. The transfer can include time, so devices such as VCOs are modeled easily. Linear transfer functions are also available.

With the Digital Simulation option,

PSpice can simulate mixed analog and digital circuits. The option contains a 28-state, event-driven logic simulation engine to efficiently process digital events. The analog and digital calculations are allowed to take different time steps. This makes it possible to do mixed-mode simulation efficiently without sacrificing accuracy in the analog waveforms.

For more information, contact Andrea L. Buanno, MicroSim Corp., 20 Fairbanks, Irvine, CA 92718; (714) 770-3022.

Circle 523 on reader card

Cinch Offers Four RS-232 Adapters

Cinch Connectors Division introduced the RS-232 Modular Jack Adapter, a slim-line, one-piece hood that provides eight-wire modular access to the RS-232 input/output connector. The adapter is designed to facilitate connections of data equipment that has RS-232 interface ports.

Cinch offers four types of RS-232 adapters: a slim-line, one-piece hood that accommodates most applications; a one-piece hood equipped with latch blocks for secure connections without screws; a two-piece adapter with latch blocks; and a two-piece hood with filler ends. The RS-232 adapter is composed of corrosion-resistant, 25-contact, all-plastic IDC D-subminiature plugs or sockets. They're pre-wired in a variety of configurations to a non-keyed, eight-wire modular jack. The adapter has an operating temperature of -55 degrees C to +85 degrees C, and can withstand voltages of 1,000 VAC rms at sea level.

For additional information, contact Ralph Knutson, Cinch Connector Division, 1501 Morse Ave., Elk Grove Village, IL 60007; (312) 981-6000.

Circle 520 on reader card

The UnVT



VT240
emulation
under MS-DOS
and UNIX.
See us at Dexpo South
booth #1112

Terminal emulation on your PC. The clear alternative to DEC terminals!

In today's computing world a VT terminal is no longer enough. Your users need an alternative. They need ZSTEM, the UnVT. ZSTEM 240 is the fastest VT240 terminal emulator available, bar none. And it comes equipped with a list of features to satisfy any discerning user:

- ▶ 132 columns on all graphics adapters
- ▶ 16 color ReGIS graphics
- ▶ full VT340 resolution on standard VGAs
- ▶ VT340 mouse and graphics tablet support
- ▶ extensive network support
- ▶ optional VT200 layout keyboard

But don't just take our word for it. Phone today for a free demo and find out why Digital News says "its performance is as perfect as an emulator can get."



KEA Systems Ltd. • Telephone: 604-732-7411 • Fax: 604-732-0715 • Toll free order desk: 800-663-8702
2150 West Broadway, Suite 412, Vancouver, B.C., Canada V6K 4L9. PowerStation and ZSTEM are trademarks of KEA Systems Ltd. All other brand and product names are trademarks or registered trademarks of their respective holders.

CIRCLE 119 ON READER CARD

Smart Card Provides Secure Systems

Dial-Guard Inc. and Micro Card Technologies announced the Micro Card smart card as a user authentication interface to the Dial-Guard in-line security systems.

The Dial-Guard security system integrates host-based security software with the Dial-Guard in-line security device and allows

for better security than standard host-based security systems. It features mainframe access control, data security, data integrity and ease of use.

The combination of Dial-Guard's security system and Micro Card's newest EEPROM smart card, the SC 4000, allows users to be positively authenticated to hosts, networks and applications using one-time encrypted passwords stored within the card. The erasable smart card expands Dial-

Guard's existing capabilities to permit use in LANs and storage of encrypted data on the card. Host software interfaces are available for DEC, IBM and Tandem hosts.

For more information, contact Lee Spelman, Dial-Guard Inc., 55 Koch Rd., P.O. Box 7045, Corte Madera, CA 94925; (415) 927-2232.

Circle 525 on reader card

BUY ONE STEAL ONE

Just purchase either Series I or Series II of B&A's Personal Trainer™ VAX/VMS computer-based training, for \$750.00 by April 30, 1989. Then, practically steal the other Series for just \$300.00.

Series I includes VAX Environment, User Environment, Files and DCL. Series II includes Logical Names, Symbols and Batch Processing.

Best of all, both are chocked-full of interactive color graphics, run on any PC or compatible and can be used over and over again. It's an incredible deal that would be a crime to miss.

**CALL (404) 392-1488
FOR YOUR FREE
DEMO DISKETTE.**

Bernstein and Associates, Inc.
3 Dunwoody Park, Suite 103
Atlanta, Georgia 30338-9819

VAX/VMS and DCL are registered trademarks of the Digital Equipment Corporation.

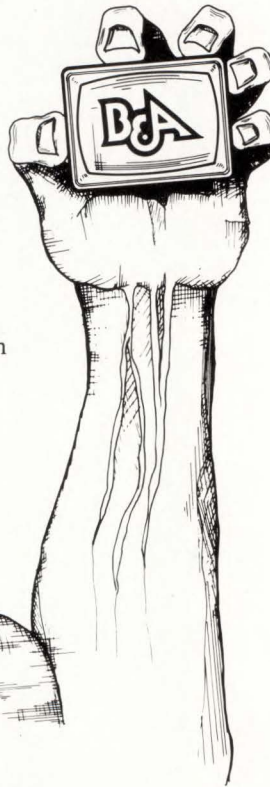

CIRCLE 236 ON READER CARD

REPRINTS?

If you would like reprints of any article or advertisement, contact Reprint Resources
155 Commerce St.
Fort Washington, PA 19034
(215) 643-9143
FAX (215) 643-9164

Xyplex Adds LAT Compatibility

Xyplex Inc. announced full LAT compatibility for its Maxserver family of products. This Xyplex LAT support, along with Xyplex TCP/IP support, allows any user connected to a Maxserver to have access to LAT and TCP/IP resources on the network.

Maxserver users concurrently can connect to any VAX/VMS, UNIX or ULTRIX host on the network. Xyplex LAT is fully compatible with DEC's LAT. All DEC management and configuration tools are supported. Reverse LAT and printer support also are included in the offering. The advantages of the Maxserver hardware base can be used in existing LAT networks. Xyplex LAT enhances the Maxserver as a multiprotocol communication server. The Maxserver features hot swap of all Maxserver plug cards and redundant Ethernet connections for automatic failover should an Ethernet component fail.

Xyplex LAT is priced at \$495. For more information, contact Paul Viau, Xyplex Inc., 100 Domino Dr., Concord, MA 01742; (617) 371-1400.

Circle 516 on reader card

66 Patch Panel Increases Performance

Mod-Tap System introduced a line of patch panels that combine the advantages of 66 blocks with the advantages of modular patch panels. The 66 patch panel interfaces directly from 66 clips to RJ-11/45 jacks.

With the Mod-Tap 66 patch panel, you can punch down directly to the back of a modular patch panel. This provides increased performance and reliability through fewer connections, lower labor cost through simplified installation, and lower parts cost, because separate 66 blocks and extra interconnecting cables no longer are required. The 66 patch panel is 19-inch rack mountable and is available in MMJ or RJ11/45 jack. It's high density, with 24 ports (six-wire) or 18 ports (eight-wire).

Learn more by contacting Scott B. Miles, Mod-Tap System, P.O. Box 706, Ayer Rd., Harvard, MA 01451; (508) 772-5630.

Circle 519 on reader card

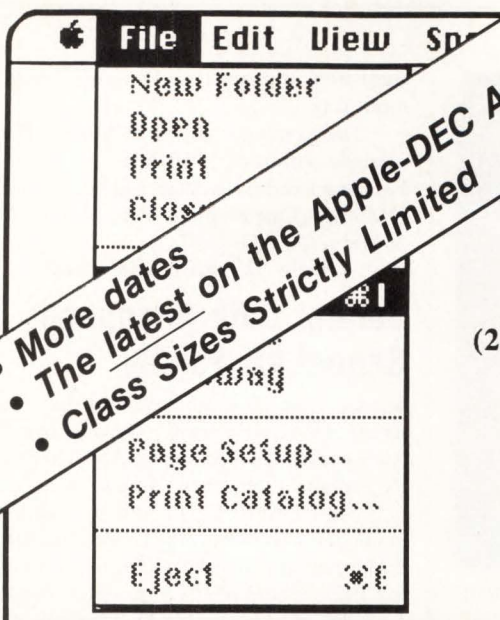

Confused?

No wonder.

Macintosh®-VAX/VMS™ Networking means a dizzying array of connectivity products, network architectures, and hardware options.

Why not join us at our office in Marlton, NJ (20 minutes from Philly, two hours from New York) to get your hands dirty and your head straight:

- January 4-6 & 18-20 1989
- February 1-3 & 15-17 1989
- March 1-3 & 15-17 1989
- April 5-7 & 19-21 1989
- May 3-5 & 17-19 1989
- June 7-9 & 21-23 1989

The Macintosh/VAX Networking Lab

Course length - 3 days

Tuition - \$950

Training Objectives:

- Find out how to connect your Macintosh and IBM PC-compatible workstations through a VAX
- Understand AppleTalk and DECnet network architectures.
- Learn how to install and use various AppleTalk network hardware products.
- Learn how to install and manage various DECnet and AppleTalk based Mac/VAX networking products.
- Learn how to use and evaluate Macintosh terminal emulators.
- Learn how to develop VAX-based macintosh database applications

Topics Covered:

Network Architectures •
DECnet, AppleTalk

Network Hardware •
Ethernet
LocalTalk
Bridges
Gateways

Network Management •

Terminal Emulators •
VT100, VT220, VT240
Tektronix

VAX/VMS File Servers •
AlisaTalk, PacerShare

Networked Databases •

Apple - DEC Development
Efforts •

CMC COMPUTER METHODS CORPORATION
 525 ROUTE 73 SOUTH • SUITE 300 • MARLTON, NJ 08053
 CONSULTING • TRAINING • SOFTWARE ENGINEERING

PHONE (609) 596-4360

FAX (609) 596-4362

Macintosh and AppleTalk are registered trademarks of Apple Computer, Inc.
 VAX and VT are registered trademarks of Digital Equipment Corporation.
 IBM and IBM PC are registered trademarks of International Business Machines, Inc.

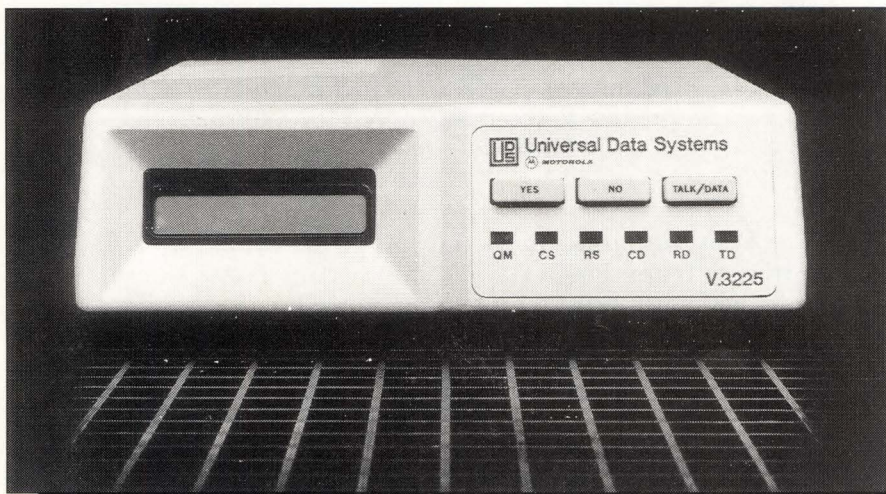

Universal Data Systems' V.3225 modem.

V.3225 Modem Features Downward Compatibility

Universal Data Systems (UDS) announced a full-duplex 9,600-bps modem that's downward compatible with 1,200- and 2,400-bps modems. The V.3225 features MNP Class 5 error correction and data compression capability. It supports both the CCITT V.32 and V.22bis communication standards, providing users with a migration path from lower-speed modems to industry-standard 9,600-bps communications.

The V.3225 is available in both rack-mount and desktop versions. The compact desktop enclosure features an LCD that monitors all modem functions and permits easy configuration and setup. The V.3225 also supports asynchronous auto answer and auto dial capability using the industry-standard AT command set. In addition, automatic dial backup is provided for leased-line operation, automatically re-establishing communication upon leased-line failure.

The V.3225 is priced at \$1,145.

To learn more, contact Bill Schlosser, Universal Data Systems, 5000 Bradford Dr., Huntsville, AL 35805; (205) 721-8000.

Circle 513 on reader card

DK312C Series Features Embedded SCSI

Hitachi America Ltd. entered the market for 3½-inch hard-disk drives by introducing the DK312C series of 3½-inch Winchester drives. The line of high-performance disk drives features fast data transfer rates, embedded SCSI and high reliability.

The three drives, the DK312C-22, the DK312C-27 and the DK312C-33, have unformatted data capacities of 222 MB, 227 MB and 333 MB respectively. Formatted

data capacities are 172 MB, 215 MB and 258 MB. Each drive has an average access time of less than 20 ms and a data transfer rate of 1.65 MB per second. The drives incorporate a digitally controlled embedded servo system that assures data read/write margins by precise head positioning and MIG heads. They feature an embedded SCSI controller with a CCS that supports disconnect/reconnect and a 48-bit error correction capability. They have a 32-KB data FIFO buffer that has a read-ahead cache function allowing flexible data transfer rates and decreased disk transaction time.

For additional details, contact David Ujita, Hitachi America Ltd., 950 Elm Ave., Ste. 100, San Bruno, CA 94066; (415) 872-1902.

Circle 524 on reader card

ColorScript Designed For Graphic Arts

QMS Inc. introduced the newest member of its ColorScript printer family, the QMS ColorScript 100 Model 20. It's designed for graphic arts and business/presentation graphics applications requiring letter/4A size output.

The Model 20's external controller is based on QMS' Advanced System Architecture for PostScript (ASAP) technology, which features a 68020 MPU/16.67-MHz-based Atlas controller board with 4 MB RAM, 1 MB ROM, 35 resident Adobe typefaces and the latest release of Adobe PostScript code. A controller upgrade is also available for customers who want to expand their output options to the 11-x-17-inch/A3 size capabilities that the QMS ColorScript Model 30 printer offers. The field-installable upgrade option includes an additional 4 MB RAM, 20-MB hard disk, PS Exec software, a downloadable HP 7475A plotter (HP-GL)

emulation and an 11-x-17-inch/A3 paper input tray.

The product is priced at \$16,995. The upgrade option costs \$5,995.

For complete details, contact Robert Owens, QMS Inc., One Magnum Pass, Mobile, AL 36618; (205) 633-4300.

Circle 527 on reader card

Sequel Data Announces SequelAN Family

Sequel Data Communications Inc. announced the development of a family of software packages called SequelAN. The family contains three basic packages.

SequelAN/PC provides terminal emulation plus menu-driven electronic mail, background file transfer and remote printing for PCs. SequelAN/Mac provides SequelAN/PC capabilities for Mac systems and features a mouse-driven graphics interface. SequelAN/UX is for electronic mail, file transfer and remote printing with UNIX, Xenix or VAX/VMS and ULTRIX systems.

SequelAN allows you to transfer a text file in background between a PC and a Mac. You just load the software, connect to another computer, modem or Sequel Data PBX, and you can work as part of a network. The package lets a PC double as a VT100/52, ANSI standard, TTY or VT/200 terminal. For more information, contact Sequel Data Communications Inc., 5246 Greens Diary Rd., Raleigh, NC 27604; (919) 790-0300.

Circle 528 on reader card

Empress Integrates 4GL And RDBMS

Empress Software Inc. introduced Empress, an RDBMS and 4GL for MS-DOS. Empress is an RDBMS and applications development system that provides features particularly suited to sophisticated users. Empress provides an SQL, a report writer (M-Writer), a forms-style screen interface, a 4GL applications builder (M-Builder) and interfaces to such programming languages as C and FORTRAN. The M-Builder 4GL is fully integrated with the RDBMS.

Empress, M-Builder and M-Writer are designed for use under MS-DOS with a minimum of 640 KB of memory and will use Lotus Intel Microsoft (LIM) expanded memory if available. Under UNIX and VMS systems, Empress requires a minimum of 1 MB of main memory. The package operates on DECnet, Sun NFS and Apollo Ring Networks. The Empress system and utilities require 8 MB of on-line disk storage.

To learn more, contact Empress Software Inc., 6401 Golden Triangle Dr., Greenbelt, MD 20770; (301) 220-1919.

Circle 531 on reader card

BSO/LSE+ Provides Multiwindow Environment

Boston Systems Office (BSO) released a language-sensitive editor called BSO/LSE+. It provides a powerful multiwindow, multi-language environment for embedded systems programmers that offers support for BSO's languages, including assembly language.

BSO/LSE+ helps developers program faster and more accurately with formatted language constructs and on-line help for BSO/C and BSO/PASCAL. It enables developers to find compilation errors faster and more easily. Because of its compiler interfaces, developers can compile source code from within BSO/LSE+. The diagnostic file output by BSO/C and BSO/PASCAL provides information about compile-time errors. When reviewing compilation errors with BSO/LSE+, the screen splits into two windows. The top window displays error information; the bottom window displays the source where the error occurred.

BSO/LSE+ runs on any VAX or VAX-station running VMS. Prices begin at \$500. To learn more, contact Eileen DeSimone, Boston Systems Office Inc., 128 Technology Cntr., Waltham, MA 02254; (617) 894-7800.

Circle 529 on reader card

IAS Version 5 Defines PC Formats

Coda Inc. announced version 5 of its Integrated Accounting System (IAS) for VAX computers, which offers significant enhancements to its single-database accounting system. The new version of IAS — which consists of general ledger, accounts payable, accounts receivable and user-defined ledgers — offers enhanced accounting capabilities while retaining its principal features.

IAS can update a complete set of books with the posting of a transaction to the system and can process transactions between separate VAX computers automatically over DECnet. Important enhancements to version 5 include the ability to define an unlimited number of periods in any fiscal year and establish different security parameters for each, and the ability to perform automated allocation of cash in the accounts-receivable area. It can define PC formats for files written from the system's report writers or inquiry screens. Reporting enhancements include additional data selection criterion keys and improved information formatting through the IAS Financial Reporting System. For more information, contact Jay Wood, Coda Inc., Numerica Bldg., 6th Fl., 1155 Elm St., Manchester, NH 03101; (603) 647-9600.

Circle 533 on reader card

People are talking about us.

When professional FORTRAN programmers develop or port large programs they use Lahey's F77L-EM/32 and F77L-EM/16, *PC Magazine's 1988 Technical Excellence Award Winners*. F77L-EM/32 is a fast 32-bit protected-mode compiler that accesses up to 4 gigabytes of memory on 80386s. F77L-EM/16 gives 80286 users the power to create 15 megabyte programs. These protected-mode FORTRANs include the features that have made them, and our F77L and Lahey Personal FORTRAN, market leaders: full ANSI 77 Standard, VAX and IBM VS extensions, fast compilation, comprehensive diagnostics, and a powerful debugger.



When people talk about FORTRAN
the name mentioned most often is

Lahey
Computer Systems, Inc.

Contact us to discuss our products and your needs. (800) 548-4778
Lahey Computer Systems, Inc. P.O. Box 6091, Incline Village, NV 89450
Tel: (702) 831-2500 FAX: (702) 831-8123 Tlx: 9102401256

CIRCLE 164 ON READER CARD

REPRINTS?

If you would like reprints of any article or advertisement, contact Reprint Resources
155 Commerce St.
Fort Washington, PA 19034
(215) 643-9143
FAX (215) 643-9164

The following are trademarks of Digital Equipment Corporation:

A-to-Z	DECnet	IAS	PDP	VAX
ALL-IN-1	DECsystem-10	I/VS	PDT	VAXBI
CDD	DECsystem-20	LAN Bridge	PIOS	VAXcluster
DATATRIEVE	DEC/Test	LA50	Q-bus	VAX DIBOL
DDCMP	DECUS	LA100	Rainbow	VAXELN
DEC	DELNI	LQP02	RALLY	VAXFMS
DECcalc	DIBOL	LSI-11	Rdb/VMS	VAXlab
DECconnect	DNA	MASSBUS	RSTS/E	VAX LISP
DECgraph	Eve	MicroPDP-11	RSX	VAX SCAN
DECmail	FMS	MicroPower/Pascal	RT-11	VAXstation
DECmate	GIGI	MicroVAX	TEAMDATA	VMS
			TOPS	VT
			ULTRIX	Work Processor
			UNIBUS	WPS

UNIX is a registered trademark of AT&T in the U.S.A. and in other countries.
MS-DOS is a trademark of Microsoft.
CP/M is a trademark of Digital Research, Inc.
Macintosh is a trademark of Apple Computer, Inc.
X Window System is a trademark of MIT.

BUILD YOUR COMPUTER LIBRARY DEC PROFESSIONAL

**ORDER NOW!
Supplies Are Limited!**

Back Issue Sets Now Available!

DEC users read our magazine from cover to cover, use it and reuse it to help solve daily problems, improve their professional skills, and widen their perspectives.

Now you can build your computer library, receive issues you missed and replace well-worn copies.

Order the 50 available back issues of DEC PROFESSIONAL, July 1983 to present, as a set and save.

Order Now! Supplies are limited!
(Offer limited to US and Canada Only.)

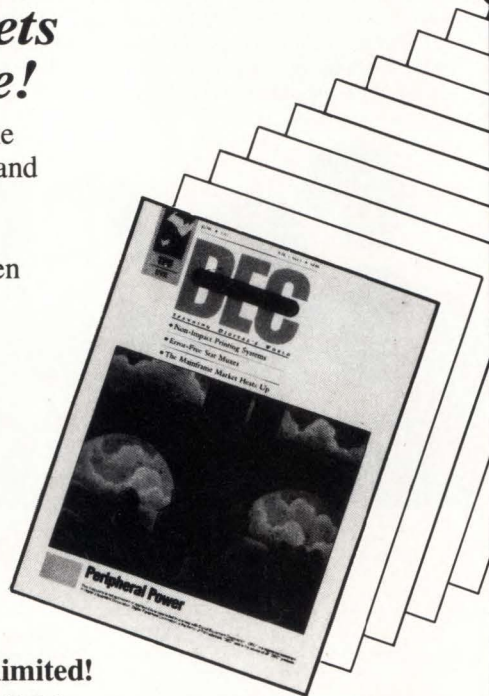

TO ORDER CALL (215) 542-7008 with your credit card information. Or complete and return the order form below. Payment must be included with your order.

▼ Clip and Send ▼

▼ Clip and Send ▼

BACK ISSUE ORDER FORM – DEC PROFESSIONAL

Please send _____ set(s) of 50 available back issues of DEC PROFESSIONAL. \$200 for each set ordered. Includes shipping by surface mail. Add \$10 for each set delivered to Canada.

PLEASE MAKE PAYMENT IN U.S. DOLLARS AND DRAWN ON A U.S. BANK.
Offer limited to US and Canada only.

Check enclosed for \$ _____

Charge to: VISA MASTERCARD

Account # _____ Ex. Date ____/____/____

Signature _____ Date _____

NAME _____ PLEASE PRINT

ADDRESS _____

CITY _____ STATE _____ ZIP _____

COUNTRY _____ TELEPHONE () _____

Mail completed form with payment to:

PROFESSIONAL PRESS INC., P.O. Box 504, Spring House, PA 19477-0504

DP0489

BBK-Q Links VAX To Transputers

Paracom Inc. announced the BBK-Q board, a high-performance bus bridge for Q-bus-based computer systems. The BBK-Q provides a high-speed interface between the Q-bus backplane and an external parallel-processing structure of 32-bit transputer processors. It lets DEC users add processing power to their existing systems.

By adding a BBK-Q interface board, Q-bus systems can be used both as local workstations and as front-end interfaces to large parallel processing structures. Q-bus-based computers can link with powerful customized subsystems configured from Paracom's family of busless transputer modules, communicate with standard transputer systems with massive computational power, or talk with other bus-based systems via its 20-megabit-per-second serial communications channels. A VAX/VMS version 5.0-compatible device driver is included with each board.

The BBK-Q costs \$2,995.

Find out more by contacting Randy Cochran, Paracom Inc., Bldg. 9, Unit 60, 245 W. Roosevelt Rd., W. Chicago, IL 60185; (312) 293-9500.

Circle 530 on reader card

Rabbit-10 Archives And Retrieves Data

Raxco Inc. announced the Rabbit-10 DATArcher, a file management system for the VAX/VMS operating environment. Rabbit-10 allows you to archive and retrieve files easily.

It combines on-line database cataloging with automatic control of standard tape mounting and operations management using VMS backup. It works with any mass-storage media, including optical disks. Its associative database catalog structure is based on catalog cards similar to a library card catalog. You fill in fields on the cards to describe the file's contents and other related files. This allows the user to search the database and easily identify files containing desired information. Unlike products relying on conventional journaling methods, users can load or alter this database simply by changing information on the catalog cards.

Rabbit-10 is available for any valid VAX/VMS configuration. It requires about 2,500 blocks for installation and an additional 100 blocks for the on-line database after installation.

Obtain more information by contacting Raxco Inc., 2440 Research Blvd., Ste. 200, Rockville, MD 20850; (301) 258-2620.

Circle 532 on reader card ■

professional press publications

Today PROFESSIONAL PRESS offers four computing publications. Two are DEC oriented magazines, one magazine is geared to Hewlett-Packard, and the fourth publication is a newspaper for IBM midrange computing. Plus two important texts about C language and VAX/VMS.

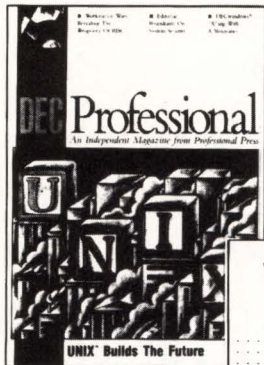

DEC PROFESSIONAL

The largest circulation DEC publication in existence with over 95,000 subscribers* — 100% buyer qualified* and dedicated to improving staff and equipment performance at DEC installations.

CIRCLE 193 ON READER CARD

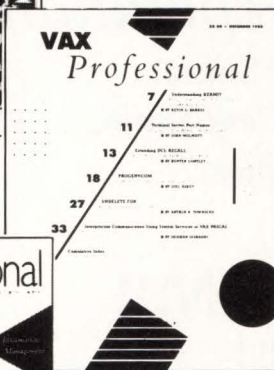

VAX PROFESSIONAL—The Technical Journal for VMS

This bimonthly publication is the only technical journal dedicated solely to users of VAX/VMS. It's the source of practical advice on how to write better software and make better use of hardware on every VAX system — from the MicroVAX to the 8800.

CIRCLE 194 ON READER CARD



HP PROFESSIONAL

A monthly magazine written for professional users and managers of Hewlett-Packard's business/commercial and technical computer systems. With over 30,000* buyer qualified-subscribers, it offers by far the largest and most clearly targeted circulation in its marketplace.

CIRCLE 195 ON READER CARD



MIDRANGE SYSTEMS — The Independent Newspaper for IBM Multiuser Computing

The only high-quality newspaper dedicated to IBM System 34, 36, 38, and AS/400 users. Its focus is on industry news and trends, new products, hardware, software, how-to features and more.

CIRCLE 196 ON READER CARD

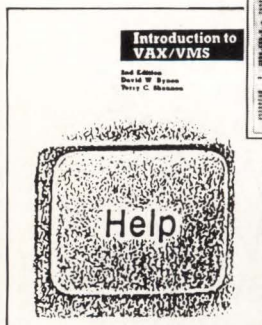

INTRODUCTION TO VAX/VMS, SECOND EDITION

This revised and expanded self-teaching text explains and illustrates how to use VAX/VMS systems. Easy to learn for the computing novice . . . an excellent reference for VAX/VMS pros. Covers the basics and teaches systems and programming as well, plus glossary and appendices. Authors: David Bynon and Terry Shannon.

CIRCLE 197 ON READER CARD

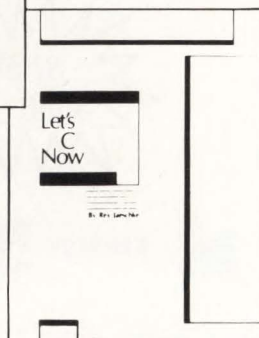

LET'S C NOW

A complete guide to learning C language in two volumes. Over 300 pages in 26 chapters in a self-instructing workbook format. All the information needed to become proficient in C. Plus chapter summaries, glossary, and author Rex Jaeschke's hints and suggestions.

CIRCLE 198 ON READER CARD

digital

digital

WHO'S ON DEC.?? WE ARE!!!

BOSTON BOARDS & SYSTEMS, INC.

55 Rear Main Street, Kingston, MA 02364

5 Years/\$5 Million+ in Annual Sales/ 10,000 Sq Ft/ Test Bays
Full Tech Support/ Outstanding Sales Engineers!!

(617) 585-7777

Our Guarantee is Our Reputation!!

Make One More Call: Ask for Sales!!

*Urgent: MVII Buyers: Any Custom Configuration
Over \$1,000,000 in MVII Inventory!!*



'89 PRICE REDUCTION!!!

READY TO SHIP!!

DRIVES!!

RA60	TU78
RA80	TU80/81/+
RA81	TK50/70
RA82	CONTROLLERS
SA/482	RD53
RA/70	RD54

CLUSTER!!

HSC5XBA	SC008AA/AC
HSC5XCA	C1750
HSC50AA/CA	C1780
HSC70	CIBCA
etc.	KDB50
	KDA50

ETHERNET!!

Too Many to List

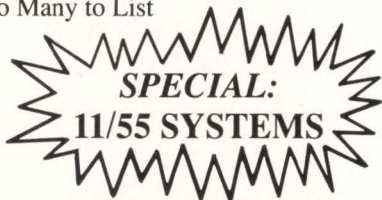

COMMUNICATIONS!!

DHU11	DMZ32
DHV11	DELQA
DZQ11	DEQUNA
DESTA	DEC SERVER
DESVA	DSRVA
	etc.

DEC SYSTEMS!!

11/03	11/725
11/23	11/730
11/73	11/780
11/24	11/785
11/44	VAX8200
11/70	VAX8300
11/83	VAX8600
11/84	VAX8700

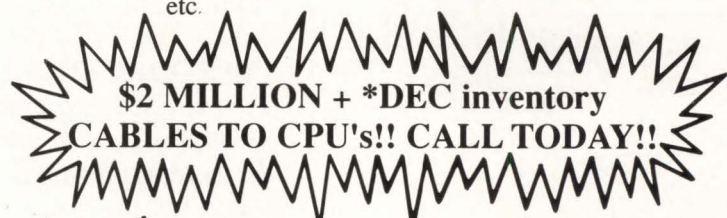

**WE ALSO BUY NEW & USED
EXCESS *DEC INVENTORY**

FAX: 617-585-6211

TELEX: #920-038BBS *Digital is a registered trademark of Digital Equipment Corporation



digital

digital

USED EQUIPMENT

We Rent VAX Systems

WANTED
VAX SYSTEMS
MVII AND 8000
SERIES

- Short term rentals on systems and peripherals
- Purchase accruals
- Sales of new and used equipment
- DEC maintenance guaranteed
- Fixed price freight/installation packages available



Selling and Leasing Computers Since 1966
Equipment Corporation

26319 I-45 North
The Woodlands, TX 77380
800-288-1846



DEC* DEPOT REPAIR • DEC* SERVICE TRAINING DEC* SPARE PARTS

New - 1-YEAR WARRANTY ON ALL EQUIPMENT SALES & REPAIRS - New

LOW
COST

QUALITY
PRODUCTS

FAST
SERVICE

- 11 YEARS IN THE DEC* BUSINESS
- PDP 8 TO VAX, AND PERIPHERALS COVERAGE
- 5 DAY STANDARD TURNAROUND ON REPAIRS
- OPTIONAL 24 HR. EMERGENCY REPAIR
- ADVANCE SWAP/EXCHANGE PROGRAM
- LEASING OR RENTALS
- FLAT RATE REPAIR PRICES/VOLUME DISCOUNTS
- UPGRADES AND ECOs AT NO ADDITIONAL COST
- TRAINING, AT YOUR FACILITY OR ESS'S
- AN INVENTORY IN EXCESS OF 100,000 ITEMS
- SAME DAY SHIPMENTS ON PURCHASES
- OPTIONAL 24/7 COVERAGE
- PERSONALIZED SERVICE/COMPETITIVE PRICES

New - CDC† DEPOT REPAIR & SPARES - New



ELECTRONIC
SERVICE
SPECIALISTS

A Bell Atlantic Company

N92 W14612 Anthony Ave.
Menomonee Falls, WI 53051

is

Your Answer for DEC* Repairs & Spares

CALL US FOR QUOTES
REPAIRS/BUYING/SELLING/
RENTING/TRAINING/LEASING

PHONE: 414-255-4634

FAX: 414-255-5418

TELEX: 260183
ESS LTD MEFS



Registered trademark of Digital Equipment Corporation
Registered trademark of Digital Equipment Corporation

PRODUCT SHOWCASE

SITE MANAGEMENT

Our VAX/VMS site support services will get your team back to applications!

- Analysis & Planning
- Performance Management
- Capacity Management
- Training

For more information, call us at:

Continuum Consulting, Limited

(809) 485-HELP (4357)

(809) 999-4VAX (4829)



CIRCLE 211 ON READER CARD

Harsh Environment CRT Terminal



Engineered for use in damp, wet, dusty or even mildly corrosive industrial environments. Meets or exceeds NEMA 4, 4X and 12 specifications.

Call (612) 941-9470 for more information.

FARGO

ELECTRONICS, INC.
7690 Golden Triangle Drive, Eden Prairie, MN 55344
(612) 941-9470 / FAX: 612-941-7836

CIRCLE 215 ON READER CARD

Look for the logo ...

The DIGITAL DEALERS ASSOCIATION was formed in 1982 as a trade association to promote ethical dealings in the used DEC* marketplace.



Buy or sell with confidence from a dda dealer!



For membership & other information:
313/475-8333
107 S. Main Street
Suite 202
Chelsea, MI 48118

*DEC is a registered trademark of Digital Equipment Corporation.

CIRCLE 208 ON READER CARD

Kill Idle Processes!

Free terminal lines and plug security leaks by killing idle processes on your VAX. No terminals left logged in overnight! HITMAN, the VMS idle process killer, is safe and easy to use. You set the idle time, HITMAN does the rest.

Only \$695

For more information, call or write:
SAIGA Systems Inc. #215-801-6 St. S.W.
 Calgary, Alberta, Canada T2P 3V8
 Ph: (403) 263-1151

CIRCLE 209 ON READER CARD

Don't Get Zapped!

High inrush current can destroy your sensitive VAX CPUs and peripherals in less time than it takes to flip a switch.

THE SOLUTION?

Power up with **Z-LINE TPC 115-10 MTD™** the smallest power distribution and control system available.

POWER UP WITH - - -

Z-LINE™

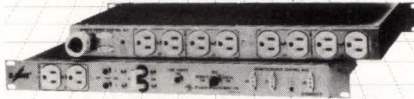

Our proprietary **Multiple Time Delay™** circuitry sequences your power-up to protect your systems from the spikes and surges, EMI & RFI, that destroy your hardware and erase your data. And our remote on/off and emergency shutdown gives the power control back to you.

All Pulizzi Engineering MTD™ controllers are compatible with DEC and UPS systems. PRICES FROM \$436 TO \$305

DON'T WAIT UNTIL IT HAPPENS, CALL TODAY!
PULIZZI ENGINEERING INC.
 3260 S. Susan Street, Santa Ana, CA 92704-6865
 (714) 540-4229 FAX (714) 641-9062

CIRCLE 210 ON READER CARD

FOR SALE

Standard Memories

1 Megabyte
 PDP 11/44 Memory
 \$500.00

Call Kevin
215-542-7008

VAX TIME

- Cluster with 8 Gigabytes
- Rates from \$8/Hour
- Timeshared/Dedicated
- Tymnet Access
- Media Conversions
- PC File Transfers
- Disaster Recovery Services

AD AMERICAN DIGITAL TECHNOLOGIES
 Laguna Hills, CA

PHONE (714) 583-2932
 FAX (714) 583-2941

CIRCLE 201 ON READER CARD

DEC® - REPAIRS?

Why wait for repair turnaround, when you could exchange your DEC® part or circuit board overnight! Same day shipment on exchanges.

(800) 443-6400

FEDERATED CONSULTANTS
(214) 278-4031

2306 Country Valley, Garland, TX 75041
 DEC® is a trademark of Digital Equipment Corp.

CIRCLE 212 ON READER CARD

BUY, SELL, RENT, LEASE, AND TRADE FROM YOUR

BEST
 DEC SOURCE!

- * We sell complete systems, peripherals, and modules at better prices and with immediate availability.
- * We are currently looking for BI systems, cluster gear, and peripherals. We buy for cash and will pay YOU the best price in the country.
- * We rent/lease systems and peripherals for 1 week to five years, including VAX, MicroVAX, terminals, and BI systems. Call us for a quote ("If you don't lease from us, you are paying too much!")

See us at DEXPO East Booth #154

MEADOWLARK ENTERPRISES

Market makers in DEC Equipment since 1981

37 High Street
 Danvers, MA 01923

(508) 777-4666

FAX (508) 777-8433

800-DEC-DLER



CIRCLE 205 ON READER CARD

VAX® RENTALS

MICROVAX II
VAX 700 SERIES
VAX 8000 SERIES
Systems & Peripherals

- Add-On Flexibility
- Purchase Options

6 Months • 12 Months • 36 Months

BROOKVALE ASSOCIATES

Digital Dealers Assoc.

EAST COAST
(516) 273-7777

WEST COAST
(206) 392-9878

CIRCLE 203 ON READER CARD

VAX CAREERS SOUTHEAST

Winning combinations of these skills can propel YOU into some of the best companies in the Southeast!!!!

PROGRAMMERS/ANALYSTS/DBAs - RDB, ORACLE, OR INGRES... COBOL, FORTRAN, OR C...
 Manufacturing a plus

SOFTWARE ENGINEERS - Knowledge of micros/minis to component level... FORTRAN, PASCAL, or C...
 PLC's a plus

SYSTEM MANAGERS - High-end clusters...
 Heavy VMS and DECNET/ETHERNET



BRENDA CAREY, C.P.C.
 Digital Recruiter

Amos & Associates

633-B Chapel Hill Road
 Burlington, NC 27215
 (919) 222-0231

CIRCLE 202 ON READER CARD

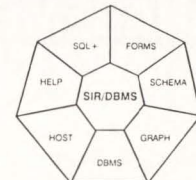

SIR/DBMS ACCEPTING APPLICATIONS

SIR/DBMS is suitable for Large-Scale DBMS Applications: Scientific, R&D, Engineering, Medical Research & Data Reduction & Analysis of Large Volumes of Data.. Apply the POWER of SIR/DBMS to Your Complex Requirements. Ask about Sun, Apollo, Vax, DG, HP, IBM, CDC, UNISYS, CRAY, and Other Versions of SIR/DBMS. SIR/DBMS delivers Unmatched Machine & Operating System Independence and a Unique Degree of True Application Level Transportability from PCs thru Supercomputers, and The Best Direct Interfaces to Popular Statistical Packages.

SIR/DBMS DEMO (7.5MB) \$49.95

SIR, A Division of Inter Systems, Inc.
 To Order Call: 703-642-1600(VA) 312-480-9270(IL)

CIRCLE 214 ON READER CARD

CORRUPT DISKS READ

"Unreadable" VMS and RSTS disks rescued via remote dial-in by our professional staff. With over 10 years experience, our satisfied customers include many Fortune 500 accounts and major Government agencies.

"When all else fails...call"

MEYER SOFTWARE
(215) 675-3890

SAVE THIS AD!

CIM & Factory/Process Automation

Positions utilizing DEC and other computers, Networking, PLC's, DCS systems etc. U.S. based technical and supervisory positions, all fee paid. Use a headhunter who specializes!

KEN COVA, COVA AUTOMATION SERVICES

5371 Shannon Park Dr., Dublin, OH 43017 (614) 792-6662

- PRO 350/380 MEMORY BOARDS
- DISK DRIVES - BIG & FAST FOR PRO
- RAM-DISK Software for Micro/RX, 11M (+) & P/OS*
Call 415-420-9579
Proto Systems
1238 Josephine St, Berkeley, CA 94703

C LANGUAGE CONSULTING AND EDUCATION by noted **DEC PROFESSIONAL** columnist. Also other languages and packages on RSX, VMS, RSTS and MS-DOS, including DBMS and DECnet. Applications experience includes real-time, process control, engineering, scientific and commercial systems. Rex Jaeschke. (703) 860-0091.

REMTEC FUJITSU 2284. 168MB, Disc Drive, \$600. Fully guaranteed. (415) 463-3511.

REMTEC FUJITSU 2294K. 336MB, \$1,800. (415) 463-3511.

MICROVAX II DATABASE MANAGEMENT SYSTEM Complete ready to use multi-user system includes KA630 CPU, 8MB RAM, 390MB hard disk, TK50 cartridge tape, 16 channel MUX, modem rack w/6 300/1200 baud modem and 2 CITHO 101 terminals. License software includes 8 users MVMS 4.6, C compiler and INFOCEN Database Management Program. Cost over \$80,000. Asking only \$34,950. (303) 444-1114.

FOR SALE PDP 11/70 3MB; 2D211E 16 port MUX; 3 RM05 disk w/controller; 1 TU77 tape w/controller; 1 LA36 console; 2 BT100 terminals; 1 disk pack. All offers considered. Contact Ron Helart (303) 792-5544.

buy, sell trade

LSI* PDP* VAX*

SYSTEMS & PERIPHERALS

- CPUs • MEMORIES
- DISC & TAPE DRIVES
- CRTs • TERMINALS • PRINTERS
- INTERFACES Etc.

dce DIGITAL COMPUTER EXCHANGE INC
2487 Industrial Parkway West, Hayward, CA 94545
CALL-(415) 887-3100
FAX (415) 887-5590 TLX 709536

* Registered trademark of Digital Equipment Corporation

CALL (215) 542-7008
NOW TO PLACE YOUR AD.

KEEP UP IN A CHANGING WORLD

Take advantage of the wealth of knowledge available from your Government. The U.S. Government Printing Office has produced a new catalog. It tells about the most popular books sold by the Government—nearly 1,000 in all. Books on agriculture, business, children, diet, energy, health, history, space, and much more. For a **free** copy of this new catalog, write—

New Catalog

Post Office Box 37000
Washington, D.C. 20013

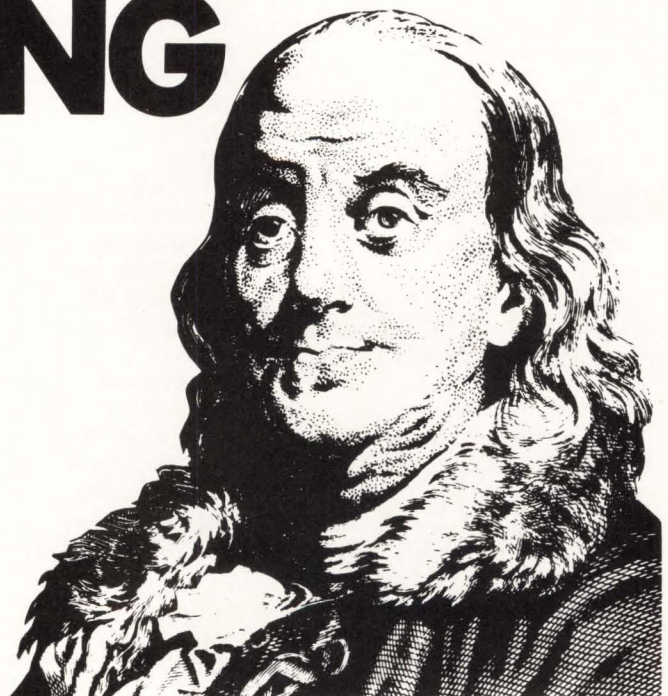

ADVERTISERS INDEX

Reader Service Number	Page	Reader Service Number	Page
184 ACC	87	309 Lago Systems	9
296 Advanced Systems Engineering	153	156 Logicaft, Inc.	15
222 Advanced Technology Center	157	120 Maintech, A Division of Volt Delta Resources	8
220 Alisa Systems	143	254 MARC Software International, Inc.	125
149 American Digital Systems, Inc.	25	146 MDBS, Inc.	151
270 AOK Software Products	155	123 MegaTape Corp.	33
166 Applied Information Systems	100	124 Micro Technology, Inc.	11
102 AST/Camintonn	85	170 Microsystems Engineering Corp.	45
226 Bell Atlantic Knowledge Systems, Inc.	31	308 National Instruments	62
236 Bernstein & Associates, Inc.	164	306 National Productions	137
103 Best Power Technology	65	307 National Productions	137
174 BLAST/Communications Research Group	107	292 Network Research Corporation	18
297 Boston Business Computing	111	272 NCGA	101
231 C. Itoh Electronics	91	163 Nissho Electronics	6
285 C. Itoh Electronics	159	127 Novell, Inc.	12-13
293 Calcomp	120-121	129 Pacer Software	147
173 Cipher Data Products	41	295 PC Expo	161
177 Cipher Data Products	41	175 Perceptics Corporation	77
274 Clayton Computer Systems	79	298 Perceptics Corporation	74
151 Clearpoint, Inc.	7	130 Pericom	95
225 CMC	43	287 Peripherals	79
105 Coefficient Systems Corp.	19	131 Peritek Corporation	61
230 Compsee Inc.	109	132 Persoft, Inc.	5
271 Compu-Share	86	172 Precision Visuals, Inc.	27
153 CompuServe/Data Technologies	141	152 Process Software Corporation Professional Press	145 169
106 Computer Methods	165	162 Promod	100
234 Contemporary Cybernetics	63	252 Pulizzi Engineering	155
187 CSPI	78	258 Raima Corporation	105
107 Datability Software Systems...I.F. Cover		135 Random Corp.	29
107 Datability Software Systems	1	190 Raxco, Inc.	57
183 DEMAC Software	81	137 Relational Technology, Inc.	23
199 Digi-Data Corp.	158	SAS Institute	75
207 Digital Business Systems, Inc.	102	240 See First Technology Signal Technology	113 supplement
299 Digital Data Systems, Inc.	92	185 SST	153
311 Dilog	175	246 Stone Mountain Computing	156
176 DISC	17	140 Summus Computer Systems...I.B. Cover	
157 EMC Corporation	C4	141 Syntronics	22
171 Emerging Technology Inc.	156	301 Systonetics	96
112 Emulex Corporation	133	219 Telcor Systems Corp.	82
109 Emulex Corporation	135	237 The Computer Museum	154
244 Environmental Systems Research Institute	83	279 Timeline	93
239 Equinox Systems	2	165 Touch Technologies	128
161 Evans, Griffiths & Hart	69	261 Transitional Technology	51
303 Exsys	71	186 TriLogic Corp.	123
310 Falco Data Products	139	282 Trimm Industries	21
113 GEJAC, Inc.	35	294 TRW/Customer Service Division	60
290 Glasgal Communications, Inc.	53	182 UIS	97
114 Grafpoint	73	305 Unbound	56
235 Information Builders	99	302 Verilog U.S.A.	55
283 Interactive Software Systems	45	300 Viking Software Services Walker Richer & Quinn	146 supplement
255 Interlan	119	150 Xyplex, Inc.	117
119 Kea Systems Ltd.	163	262 Zoltech Corporation (VME)	150
218 Kinetics	36-37	264 Zoltech Corporation (Q-Bus)	150
164 Lahey Computer Systems	167		
257 Laserdrive Limited	89		

More information about many of these advertisers is available electronically on our Automated Reader Information Service (ARIS). Dial (215) 542-7008.

ADVERTISING

ASSOCIATE PUBLISHER Jeffrey Berman

**ADVERTISING SERVICES
MANAGER** Connie Mahon

SENIOR ACCOUNT EXECUTIVE
Dan Mainieri Jr.

CLASSIFIED ADS & USED EQUIPMENT
Mary Browarek

LIST RENTAL SALES Cathy Dodies

**ASSOCIATE PUBLISHER, DEC PROFESSIONAL
BUYERS GUIDE** Steve Maher

REGIONAL SALES MANAGERS

MID-ATLANTIC Mark Durrick

INTERNATIONAL Helen B. Marbach

921 Bethlehem Pike
Spring House, PA 19477
(215) 542-7008

FAX # (215) 628-2845

REGIONAL SALES OFFICES

NEW ENGLAND

Trish McCauley
Regional Sales Manager

Kristina Wesslen
Account Executive

Professional Press, Inc.
238 Bedford St., Suite 3
Lexington, MA 02173
(617) 861-1994
FAX # (617) 861-7707

NORTHERN CALIFORNIA and NORTHWEST

A. G. Germano
Regional Sales Manager
Alonna Doucette
Senior Account Executive

Judy Courtney
Account Executive

Professional Press, Inc.
903 Sneath Lane Suite 220
San Bruno, CA 94066
(415) 873-3368
FAX # (415) 873-6608

SOUTHERN CALIFORNIA and SOUTHWEST

David Beardslee
Regional Sales Manager
Karin Altonaga
Senior Account Executive

Professional Press, Inc.
1010 East Union Street, Suite 101
Pasadena, CA 91106
(818) 577-5970
FAX # (818) 577-0073

MIDWEST AND SOUTH

Linda Liebich
Senior Account Executive

Professional Press, Inc.
11782 Jollyville Rd., Suite 203
Austin, TX 78759
(512) 258-4800
FAX # (512) 331-1351

NOBODY CAN PACKAGE 8MM TAPE LIKE DILOG.

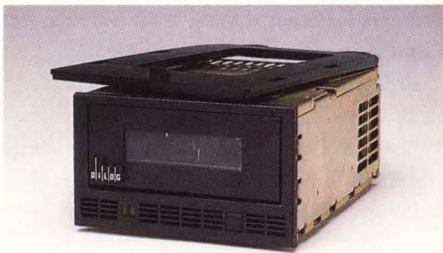

Q-Bus Add-ins



Single drive tabletop
for Q-Bus and UNIBUS



Dual drive rackmount
for UNIBUS



Dual drive rackmount
for Q-Bus



Dual drive tabletop
for UNIBUS



Dual drive tabletop
for Q-Bus

MicroVAX II & III? VAX? LSI?
PDP?

Single or multiple drive?

Tape and hard disk?

Tabletop? Rackmount?

Add-ins?

DILOG has them all.

In fact, only DILOG has completely configured-out how DEC owners can use 8mm helical tape.

To find out more, call your nearest DILOG sales office.

And remember, anyway you configure it, DILOG has the package for you.

DILOG
DISTRIBUTED LOGIC CORPORATION

1-800-DILOG32
(outside CA)

Corporate Headquarters
1555 S. Sinclair Street
Anaheim, CA 92806
(714) 937-5700
Telex 6836051
FAX: (714) 978-2420

CIRCLE 311 ON READER CARD

U.S. Sales Offices: Albuquerque, NM (505) 828-2340. Anaheim, CA (714) 937-5700. Cleveland, OH (216) 292-3475. Indianapolis, IN (317) 841-3751. Nashua, NH (603) 595-0453. Pittsburgh, PA (412) 531-5622. Raleigh, NC (919) 481-3033. San Diego, CA (619) 458-0542. Santa Clara, CA (408) 986-0224. So. Plainfield, NJ (201) 757-2211. Washington, DC (703) 742-8285. MicroVAX, VAX, LSI, PDP, Q-Bus and UNIBUS are trademarks of Digital Equipment Corporation.

Hardware Versus Software

The premise is simple and the proof is empirical: If you put a hardware engineer and a software engineer on the same project, the hardware engineer will finish it in less time and do a better and less costly job.

That's why hardware runs ahead of software. And you can't get a hardware guy to change into a software guy to increase productivity. Generally you can't because of the personality requirements (although there are people who can do both hardware and software, indicating that some personalities can adapt). Many observers believe that there's nothing more valuable than the combination hardware/software engineer, because understanding the principles and limitations of both ends of the technology spectrum means efficient and cost-effective design.

Still, the software engineer (or programmer) is the one in short supply and high demand.

I've discussed this with a few people and it's not difficult to understand why hardware and software are so isolated. The world of hardware attracts the classic engineering type: a cocky know-it-all who honestly believes that engineering principles, when applied to anything in life, will solve the world's problems. This makes an engineer take on a missionary kind of aura. The classic engineer smiles a lot, stays well-groomed and wears sensible (well-engineered) shoes.

In contrast, the classic software designer takes Salvador Dali as his model. He wears weird clothes or rags or a mish-mosh of colors and patterns with no regard for aesthetics. He wears

tennis shoes and mismatched socks. He has no known sense of humor. He's also asocial. For example, have you ever noticed how a software engineer acts on the phone? He can't initiate or acknowledge the end of a conversation. I think this is a reflection of a lifestyle in which he can't acknowledge or initiate the end of a software project. Anyway, the conversation with a coder (as you try to end it) usually goes like this:

Normal Person: *So the project is almost over?*

Programmer: Yes. I expect that we'll debug the last modules this weekend and ship to beta on Monday.

Normal Person: *Good to know. OK, I have to go.*

Programmer: I think we'll finish beta testing in a couple of weeks. It probably won't take too much work to get the bugs cleared up.

Normal Person: *Great. Oh, oh. My house is on fire! I have to call the fire department.*

Programmer: I've been given the go-ahead to hire two more coders in the department who will help. One of the guys whose stuff I've seen is pretty good.

Normal Person: *Good deal. I really have to say goodbye.*

Programmer: Of course, you never know. Many coders today are just out of school.

Normal Person: *Look, Jerry, I have to go.*

Programmer: What?

Normal Person: *I have to say goodbye.*

Programmer: Oh. (click)

I knew one guy with whom it was impossible to end a conversation, and

when I finally got him to admit that the call was over, it was as though he were irked or insulted by the notion. Even funnier is the programmer who wants to end the conversation himself. This is a real dilemma. The guy never says anything in hopes that you'll figure out that he doesn't want to talk:

Normal Person: *So, Jerry, what other projects are you doing?*

Programmer: (long pause) Nothing.

Normal Person: *I thought there was a new database you were telling me about?*

Programmer: (long pause) No.

Normal Person: *Are you coding or doing something now? You seem preoccupied.*

Programmer: (longer pause) No.

Normal Person: *Well, I'd better say goodbye.*

Programmer: OK. (click)

Who can figure these guys out? I can't. I'm convinced that working with software logic all day does something to their brains that makes them zombies. I suspect that because software is more ethereal than the rule-bound hard engineering sciences, pure engineers don't get as weird as the software folk.

TO SUMMARIZE THE differences between the worlds of hardware and software types, I have a rule called Dvorak's Edict. If you can understand Dvorak's Edict, you can understand the nature of the universe: Software engineers take longer and don't do as thorough or as good a job as hardware engineers, but they make up for it by charging more money. ■

Have your cake and eat it too.

**Gigabytes of unattended
back-up and data
interchange for DEC,
IBM, Sun, Apple...**

Finally, the winning recipe for high-capacity back-up *and* data interchange between different systems.

The **GigaTape™** will satisfy the most discriminating tastes. For DEC, IBM, Sun, Apple or other host systems, the **GigaTape** provides simple "plug and play" capability. And, with just ONE 8mm helical-scan data cartridge you can back up two Gigabytes of data, at less than two cents per Megabyte.

Make data interchange a cakewalk with two file-formatting options. Use our ANSI standard file-formatting and data interchange utility for cost-effective data distribution, or our proprietary method for increased speed and capacity.

There's a **GigaTape** designed to meet your most voracious data storage needs. We've a family of helical-scan products with capacities from 2 Gigabytes to a Terabyte or more.

Lease from \$260 a month!



The SUMMUS commitment is icing on the cake. We have more than eight years of systems integration experience, first-rate technical support, and a well-stocked inventory. That's why Lockheed, GE, Kraft, NASA and others come to us for their data storage and interchange solutions.

You *can* have your cake and eat it too with the **GigaTape**; call us toll-free today at
1-800-255-9638

SUMMUS™
COMPUTER SYSTEMS

17171 PARK ROW • SUITE 300 • HOUSTON, TX. 77084
713-492-6611 • FAX 713-492-0092

© 1989 SUMMUS COMPUTER SYSTEMS
GigaTape and GigaBox are TradeMarks of SUMMUS COMPUTER SYSTEMS. Apple, DEC, IBM, and SUN are TradeMarks of their respective companies.

CIRCLE 140 ON READER CARD

"We want a VAX disk drive that works just like this."

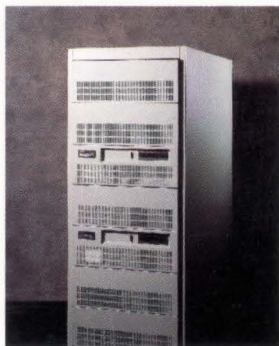
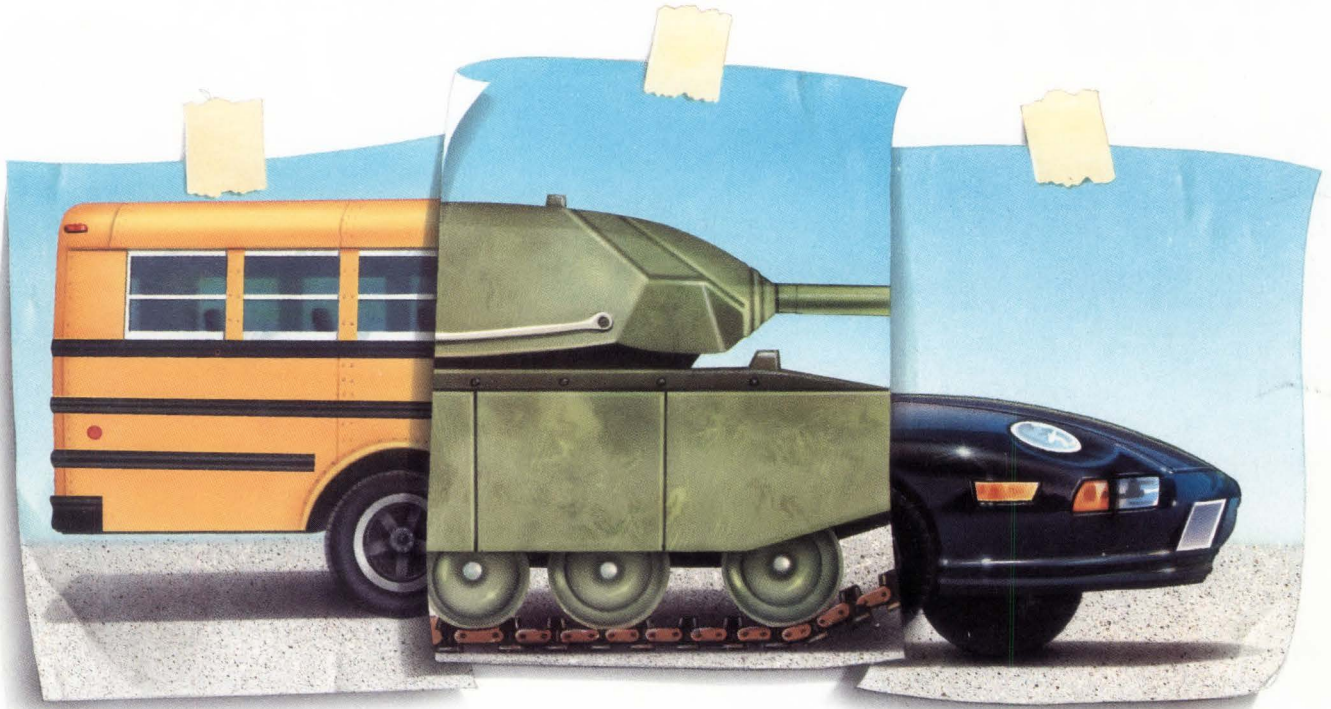

Introducing MAXPORT.

When we asked VAX owners what they wanted in a disk drive, they drew an interesting picture. The capacity of a bus. The reliability of a tank. The performance of a race car. And oh yes, they said, make it affordable.

Now EMC has put all these features together in the MAXPORT™ Series, the most powerful disk subsystems ever offered to the VAX market.

MAXPORT has enormous capacity. Up to 3.3 gigabytes for each DEC controller port. All this attaches directly to your HSC, BI, UNIBUS or QBUS disk controller to ensure 100% compatibility. Up to 11.5 gigabytes in the same footprint as DEC's SA 482 and SA 600.

Performance? MAXPORT has an average seek time of 16MS and a transfer rate of 2.8 MB/sec. That's 50% faster than DEC's RA82, and 10% faster than the RA90.

As for reliability, MAXPORT is ready for battle. EMC is a recognized leader in disk subsystems with over 5,000 disk customers worldwide. We support all DEC system-level diagnostics, and we back our disks with a full one-year warranty.

Best of all, MAXPORT costs up to 22% less than Digital's drives. Call EMC today. You'll see we've put together everybody's picture of the perfect disk drive.

Call Today

1-800-222-EMC2

EMC²

The System Enhancement Company.

MAXPORT is a registered trademark of EMC Corporation.

VAX is a registered trademark of Digital Equipment Corp.