

DATA MATIATION 62

March

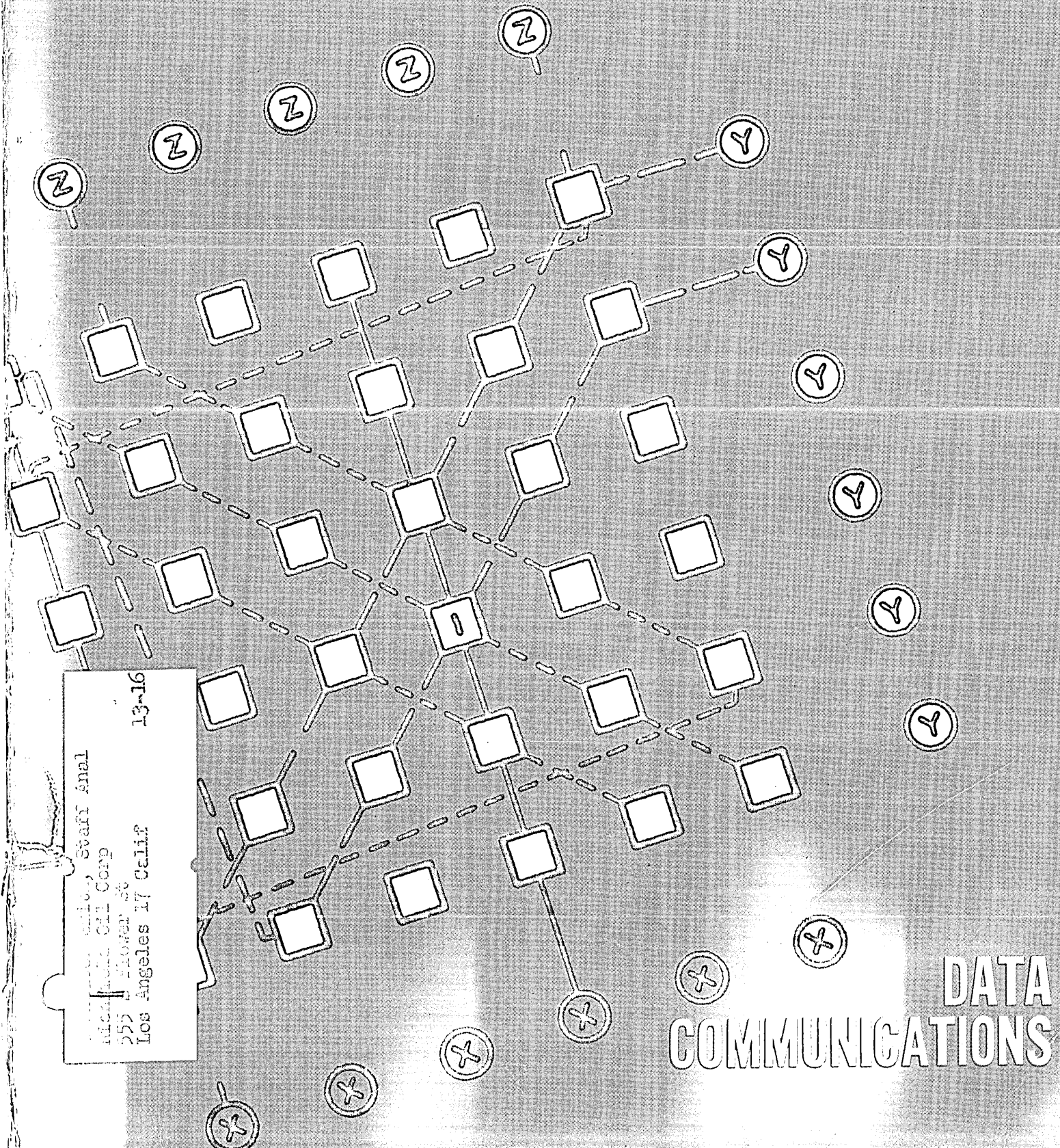

Staff Anal
13-16
555 Flower St
Los Angeles 17 Calif

DATA COMMUNICATIONS

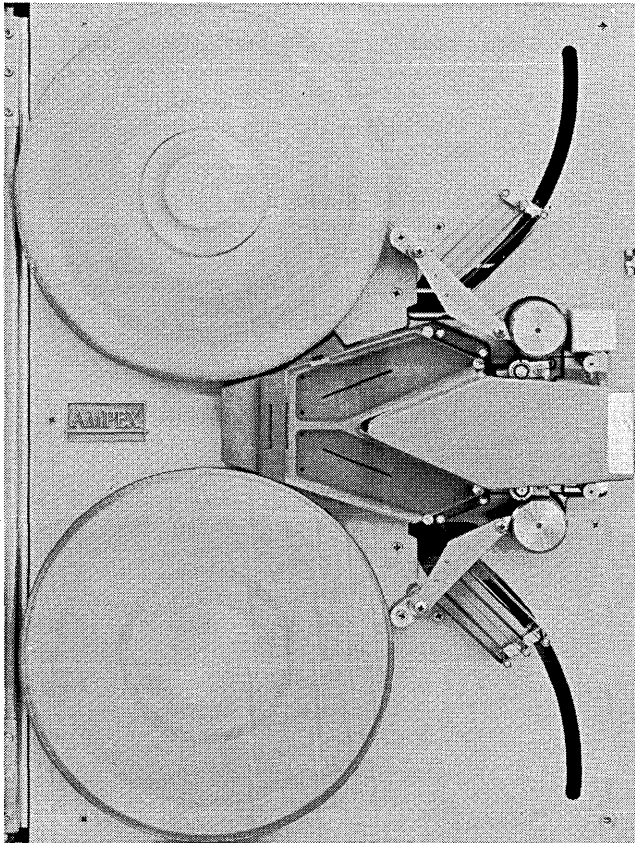

START:

3.3 milliseconds

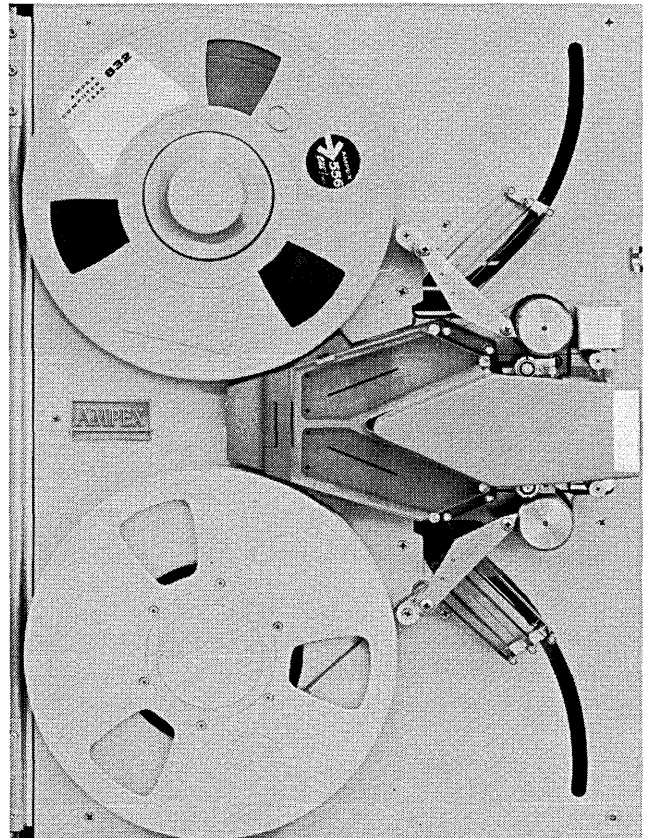

STOP:

1.8 milliseconds

The new Ampex TM-4 digital tape handler beats start times of previous medium speed transports by 2.7 milliseconds. Stop times by 3.2 milliseconds. And the tape travels only .162" to .203" to reach 75 ips. Only .030" to .100" to come to a complete stop. New vacuum chambers assure that these start/stop times remain stable. Even under the most rigorous programs. The TM-4 is also easier, gentler on your tape. A new tape guiding system, uniform tape tension and speed limits on the servo system prevent tape abuse. The



result: tape life is quadrupled. The TM-4 operates at 75, 60 or 37½ ips. And has a bit packing density of 200 to 556 bpi. The reliability of this new tape transport has been proven with exhaustive pre-testing. (It requires minimum maintenance. And it's easily accessible from the rear.) With these features, the TM-4 is destined to come

the standard by which all other medium speed tape handlers are judged. That's why it bears the name Ampex. Write for specifications. Ampex Corp., Computer Products Co., 934 Charter St., Redwood City, Calif.

NEW: DDP-19, THE FASTEST MEDIUM-SIZED COMPUTER FOR REAL-TIME ENGINEERING APPLICATIONS!!

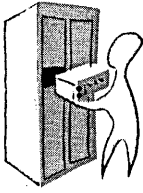

This new, high-speed DDP-19 (**D**igital **D**ata **P**rocessor) is a single address, parallel, binary, 19-bit computer with a magnetic core storage of 4096 to 8192 words!

DDP-19's fully buffered input permits continuous intake of data! DDP-19's up to 16 program addressable input/output channels (operable in both **busy** or **interrupt** mode) allow asynchronous connection to any existing system!

DDP-19's extremely flexible analog input/output units permit **immediate** tie-in to any real-time man-machine simulation! DDP-19's modular construction using 3C's customer-proven S-PAC digital modules provides ample room for expansion! Compiler, assembler, and sub-routines are available!

DDP-19 HIGH-SPEED CHARACTERISTICS

Memory cycle time
5 microseconds

Add: successive operations with instruction and operand address
10 microseconds each

Average multiply
36 microseconds

Divide
57 microseconds

Input-output
200 KC word transfer rate

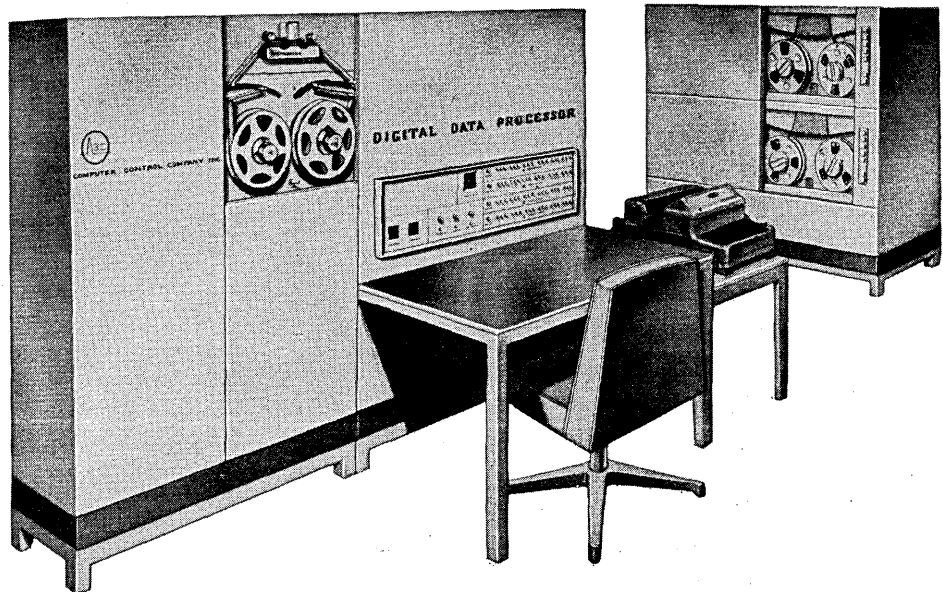

VERSATILE

(It outperforms any computer in its price range!)

HIGH-SPEED

(It handles complex on-line data reduction faster than any comparable machine!)

ECONOMICAL

(It replaces expensive, custom-built systems and large scale computers!)

A few applications of this versatile, high-speed DDP-19 computer include . . .

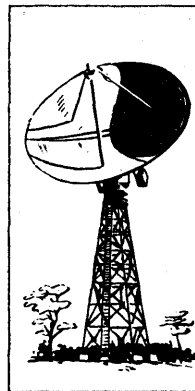

... use as a control computer for the precision tracking of high-speed targets . . .

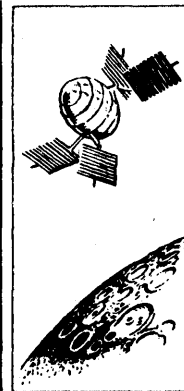

... use for real-time data acquisition and the presentation of scaled and digitally filtered results . . .

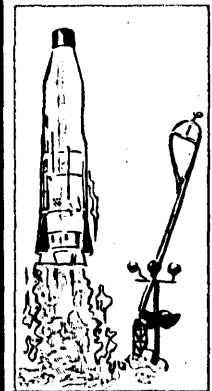

... use in real-time simulation problems involving analog and digital equipment and sub systems . . .

For more comprehensive DDP-19 information, please call or write to:

SYSTEMS DIVISION

COMPUTER CONTROL COMPANY, INC.

EASTERN PLANT: 983 CONCORD STREET/FRAMINGHAM/MASSACHUSETTS
WESTERN PLANT: 2251 BARRY AVENUE/LOS ANGELES 64/CALIFORNIA



CIRCLE 4 ON READER CARD

MORE FACTS ABOUT HONEYWELL SOFTWARE

The efficiency with which a given EDP system is operated can do more to make an installation pay off than any other single factor.

With this in mind, Honeywell has developed software that, combined with the advanced capabilities of Honeywell hardware, yields maximum operating efficiency. Honeywell software is all-encompassing, and includes:

- 1) Source languages — the problem-oriented, and machine-oriented symbolic languages in which the programmer writes his program;
- 2) Processors — the associated compilers and assembly systems that translate, compile, and assemble the programs written in source languages into the form required by the computer; and
- 3) Computer Optimization Package (COP) — a broad class of programming aids designed to increase the day-to-day efficiency of the computer.

A TRAFFIC COP AT EVERY CORNER

Source languages and their associated processors facilitate the job of coding an application for computer processing. They also reduce the number of clerical coding errors and, in most cases, they signal errors made in the use of source language. Beyond this, however, it is desirable to have additional aids to automate the diagnostic, operating, and maintenance functions associated with programs and their use. The package of programmed operating aids which Honeywell supplies to its equipment users is called "COP" (Computer Optimization Package). COP includes all software components other than source languages and their associated processors. The main function of COP is to exact the highest possible level of efficiency from the computer, and it does this in the following ways:

1. Program-tape maintenance and updating routines provide a high speed and efficient means of adding new programs to an existing file, processing corrections to existing programs, deleting programs which are no longer in use, and rearranging, if necessary, the sequence of programs on a program tape. These updating programs batch-process input data which may consist of any mixture of new programs, or requests for the deletion and rearranging of existing programs.

2. Program diagnostic routines assist the programmer in checking his work by providing for the automatic dumping of information from core storage and from tape. One of the most powerful features of Honeywell's approach to program diagnosis and checkout, a unique "Derail Technique" provides dynamic dumps at any point in a program without requiring the program to be changed from its final or production form. This way, any desired areas of core memory or magnetic records can be dumped automatically at programmer-specified points in the execution of the program. Parameters which pinpoint the requested information are entered independently of the program being tested.

The diagnostic information is printed in any of these programmer-designated formats: octal, decimal, alpha-numeric, or assembly language instruction format.

In the Derail Technique, the type, number, and extent of dumps are under the exclusive control of the programmer without affecting in

any way the integrity of the program. Thus, the Derail Technique is a powerful tool in the minimization, location, and correction of program errors.

3. Test data routines aid in the handling and distribution of test data according to programmer-supplied parameters and permit the test data to be combined with the program being tested. This eliminates the need for a separate, or operator-controlled setup of test data for programs in the debugging state.

4. Monitor routines add to the efficient use of Honeywell systems by providing the following functions:

a. Automatic loading of object programs either from a tape file or a card file. **b.** Automatic error correction using pre-coded ortho-correction routines which are also used with the object programs for correction of read errors that occur in the processing of tape data.

c. Restart provisions which facilitate the setting of restart points within each program so that processing can be repeated without having to go back to the beginning of the program. **d.** Operator-machine communication to keep the operator informed of the progress of the run and permit his control instruction to be entered and acted upon with a minimum of delay and re-working.

e. Coordination of the simultaneous running of independent programs. This relates to Parallel Processing in the Honeywell 800 and Simultaneous Peripheral Processing in the Honeywell 400.

LIBRARY OF STANDARD ROUTINES GROWS AS YOU GROW

The Honeywell library of standard routines, though part of COP, warrants special mention. It is available to all users of Honeywell EDP systems and provides for the following kinds of recurring data processing functions:

1. Sort/Merge Generators for Honeywell computers use the Honeywell-developed Cascade (N-1) and polyphase sorting techniques. The superior performance of these techniques over conventional sort methods is well established through extensive field use.

2. Automatic library facilities include an extensive collection of scientific subroutines. Additions are being made regularly to further extend the usefulness of this programming aid.

3. Tape and card input/output package relieves the programmer of the need for coding those portions of computer runs which deal with the manipulation of

punched cards or magnetic tape data files.

4. Report generators supply Honeywell system users with routines for the arrangement of reports according to parameters supplied by the programmer.

5. Utility and service programs provide for the manipulation of data tapes, including the following functions: comparing, positioning, locating, sampling, correcting, copying, or editing.

BATCH PROCESSING: A BUSINESS-LIKE APPROACH TO SOFTWARE

Batch Processing is a concept which relates to the mode in which programs are processed in a given compilation, assembly, checkout, or production run. Operationally, programs are handled in batches in the same way that data is grouped in a typical business operation, such as sales analysis or a payroll run. Because the processing of programs is automatic and sequential, manual or console-operator-controlled setup time between programs is reduced to a minimum. Batch Processing also provides facilities for proceeding from one program to the next program in the file with negligible operator intervention in the event of any kind of interruption in processing such as a programming hang-up during checkout.

The gains in efficiency due to the Batch Processing concept increase rapidly as the number of programs being batched rises. With as few as 10 programs batched in one checkout operation, efficiency gains of 5 to 1 are easily realized.

GOOD SOFTWARE MAKES GOOD HARDWARE BETTER — AND VICE VERSA

Honeywell software is designed to capitalize on, and complement the advanced capabilities of Honeywell hardware. Each extends the power of the other. The resulting gain in efficiency means far more productive processing per shift, and therefore more computing per dollar.

For more information on Honeywell software, including COP, contact your nearby Honeywell EDP office or write to Honeywell EDP, Wellesley Hills 81, Mass. In Canada, Honeywell Controls Limited, Toronto 17, Ontario.

Honeywell

 *Electronic Data Processing*

FOR A BIG COMPANY WITH A LOT OF ADDRESSES

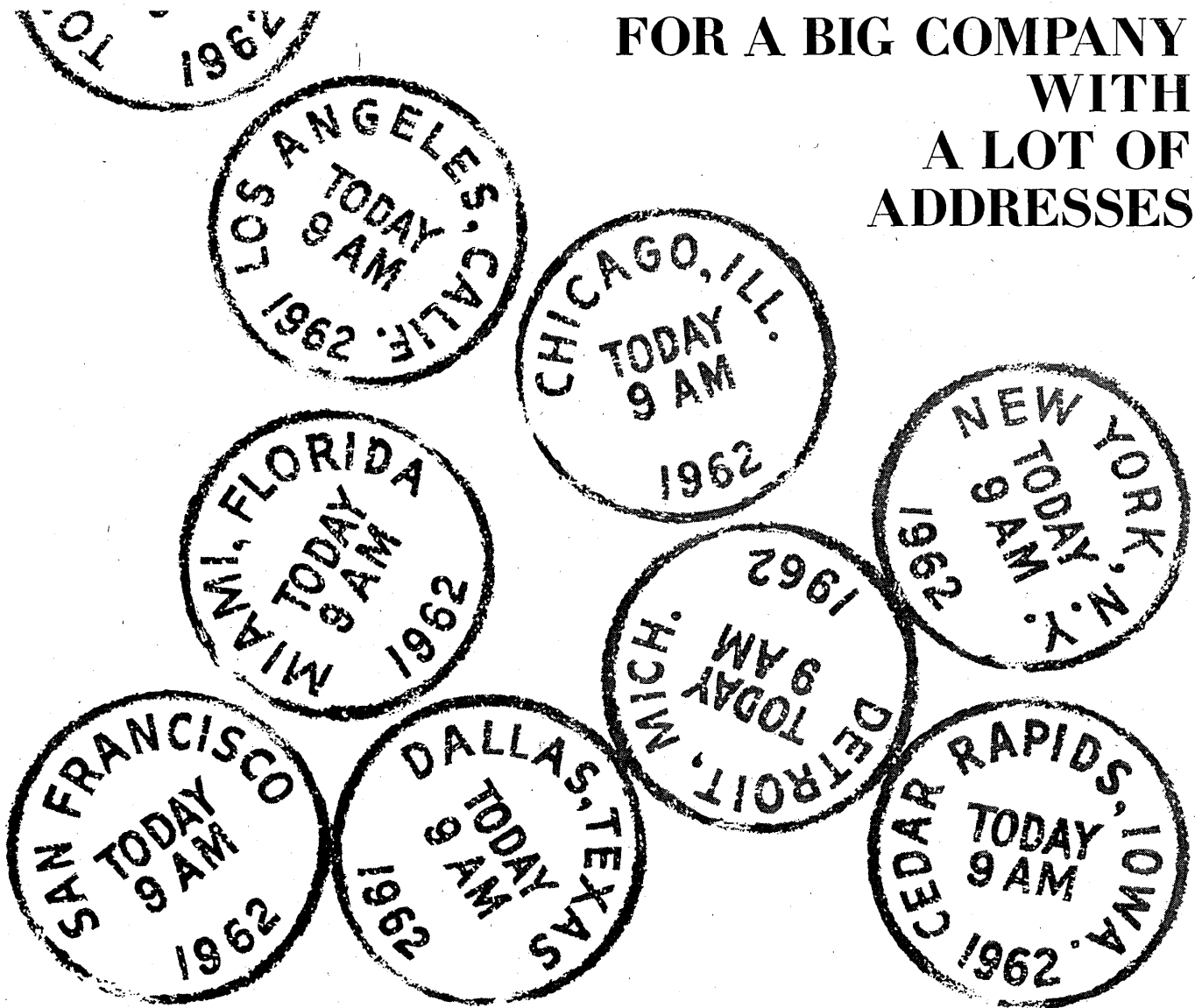

THE SHORTEST DISTANCE BETWEEN PLANTS IS KINEPLEX®

Today, some of the nation's most widely scattered organizations have the fastest reactions. They gather facts and transmit reports from coast to coast as quickly as most companies communicate from office to office in the same plant. Even outlying locations have instant access to the most powerful computers.

Kineplex makes it possible. This patented data transmission technique from Collins is the speediest way to move information over a telephone line. Kineplex terminals handle digital data at rates up to 8100 words a minute. Using wireline or radio, they form a fast, reliable information network that can span thousands of miles to link a company's plants and computers. The speed, dependability and adaptability of Kineplex has established Collins as a leading source of equipment for the new age of data communication. COLLINS RADIO COMPANY, Communication and Data Systems Division, Dallas, Texas.



volume 8, number

3

Staff

Publisher **FRANK D. THOMPSON**

Vice President & General Manager
GARDNER F. LANDON

Vice President & Publication Manager
RICHARD W. NIELSON

Editor **HAROLD BERGSTEIN**

Managing Editor & Art Director
CLEVE BOUTELL

Assistant Editor **IRWIN SCHORR**

News Editor **VALERIE GORSEN**

Contributing Editor
DR. H. R. J. GROSCH

Technical Consultant **DON B. PRELL**

Production Manager
MARILEE CORPIS

Circulation Mgr. **ALGENE TRAINA**

Editorial Advisers
DANIEL D. McCRACKEN
ROBERT L. PATRICK

Eastern District

RICHARD W. NIELSON
141 E. 44th St., New York 17, N.Y.
MUrray Hill 7-5180

New England District Manager

WARREN A. TIBBETTS
112 West Haven Rd.,
Manchester, N.H., NAional 5-9498

Midwest District Manager

JOHN BRENNAN
201 N. Wells St., Chicago 6, Ill.
Financial 6-1026

Western District Manager & Vice President

HAMILTON S. STYRON
10373 W. Pico Blvd., Los Angeles 64, Cal.
BRadshaw 2-2643

Circulation audited by
Business Publications Audit



Member, National
Business Publications



EDITORIAL OFFICES

10373 W. PICO BLVD.,
LOS ANGELES 64, CALIF.

Articles

- 25 DP Certification Program Announced by NMAA
- 26 DOCCEN: A Documentation Generator, by *T. Tancer*
- 27 A Countdown for EDP Installations
- 28 A COBOL Evaluation Test
- 28 The 900 Series from SDS, by *Henry Herold & Max Palevsky*
- 32 The Spring Joint Computer Conference
- 33 The 15th Annual So. California Business Show
- 34 EDP Highlights At BEMA Show
- 104 SkeduFlo Marketed by Mauchly

Data Communications: A Special Section

- 42 A Report on the Data Transmission Study Group,
by *Jack Strong & A. H. Lockwood*
- 45 A Survey of Current Needs and User Requirements,
by *Justin A. Perlman*
- 47 A Data Communications Systems Summary, by *F. W. Graham*
- 54 Computer Transmission at Memory Speeds, by *Neil Clark*
- 55 The TDS-90, G.E.'s High Speed Transmission Terminal
- 56 A Criticism of Inactivity, by *H. E. Rennacker*
- 57 The 7750, IBM's Programmed Transmission Control
- 58 Social Security Network Links 600 Offices
- 59 Microwave Transmission at North American, by *Kenneth Parsons*
- 61 Stock Broker Utilizes Real Time Data Transmission
- 62 Error Detection & Correction, an explanation by *R. G. Matteson*
- 66 A Data Communications Glossary
- 74 A Data Communications Equipment Catalog

THIS ISSUE — 40,010 COPIES

Departments

- 7 Important Dates in Datamation
- 10 Letters to the Editor
- 17 Datamation in Business & Science
- 23 The Editor's Readout
- 85 News Briefs in Datamation
- 99 New Literature in Datamation
- 106 New Firms and Mergers
- 111 New Products in Datamation
- 119 People in Datamation
- 123 Advertisers' Index

Cover:

Reflecting an important subset in the burgeoning field of Data Communications; namely, error detection and correction, this month's cover depicts a three coordinate code redundancy arrangement in which column parity words are indicated by the circled X and two sets of diagonal parity words are keyed by a circled Y for the first diagonal and Z for the second. Graphic design is by Art Director Cleve Boutell. Major feature treatment on Data Communications begins on page 42.



KOPPERS

ONE OF THE WORLD'S LEADING INDUSTRIES SERVING INDUSTRY



"Why we chose the NCR computer."

—KOPPERS COMPANY, INC., Pittsburgh

"An intensive study of electronic systems led us to the conviction that the NCR 390 and 315 computers will give our company an important tool for better management control of all aspects of our business.

"The NCR 390, a small-scale, but highly versatile computer, will enable us to use conventional business-type ledger records on applications where day-by-day accessibility to our accounting data is desirable. Since the records used with the NCR 390 are

also capable of storing large amounts of data electronically, they will act as their own communication with the computer.

"The NCR 315 computer was chosen because it is an expansible system and can process technical data as well as business data. With Card Random Access Memory (CRAM), the NCR 315 will speed the flow of business data and will give us new capabilities in solving many problems in research and development . . . civil, mechanical, and

chemical engineering . . . designing . . . process analysis . . . and a host of other scientific-type applications.

"We believe the NCR 390 and NCR 315 computers, as a team, will provide a highly efficient and profitable solution to our data processing problems."

Chairman of the Board

NCR PROVIDES TOTAL SYSTEMS—FROM ORIGINAL ENTRY TO FINAL REPORT— through Accounting Machines, Cash Registers or Adding Machines, and Data Processing The National Cash Register Company—1039 Offices in 121 Countries—78 Years of Helping Business Save Money

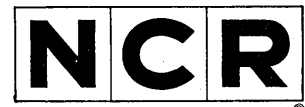

DATAMATION

important DATES

- The IRE National Convention is scheduled for March 26-29 at the Waldorf Astoria and Coliseum, N.Y.C.
- The 15th annual Southern California Business Show will be held March 20-23 at the Ambassador Hotel, Los Angeles.
- A symposium on Interactions Between Mathematical Research and High Speed Computing will be held April 16-18 at the Chalfone-Haddon Hotel, Atlantic City, N.J.
- "Information Retrieval in Action" is the subject of a conference scheduled for April 18-20 at the Center for Documentation and Communication Research, Western Reserve University, Cleveland, Ohio.
- The 1962 Spring Joint Computer Conference, sponsored by the American Federation of Information Processing Societies, will be held May 1-3 at the Fairmont Hotel, S.F.
- "Electronic Information Display Systems" is the subject on an institute to be held May 21-25 at the American University, Wash., D.C.
- A conference on Self-Organizing Systems will be held on May 22-24 at the Museum of Science and Industry, Chicago. It is co-sponsored by the Information Systems Branch, Office of Naval Research, and the Armour Research Foundation.
- The Ninth Annual Symposium on Computers and Data Processing sponsored by the Denver Research Institute of the University of Denver is scheduled for June 27-28 at the Elkhorn Lodge, Estes Park, Colorado.
- The 1962 WESCON will be held Aug. 21-24 in the California Memorial Sports Arena and Statler-Hilton Hotel, Los Angeles.
- The 1962 IFIPS Congress is set for Aug. 27-Sept. 1 in Munich, Germany.
- The ACM National Conference will be held Sept. 4-7 at the Onondaga Country War Memorial Auditorium and Hotel Syracuse, Syracuse, N. Y.
- The 1962 Fall Joint Computer Conference will be held Dec. 14-17 at the Bellevue Stratford Hotel, Philadelphia, Penna.

March 1962

G S I Analog-to-Digital Data Reduction System

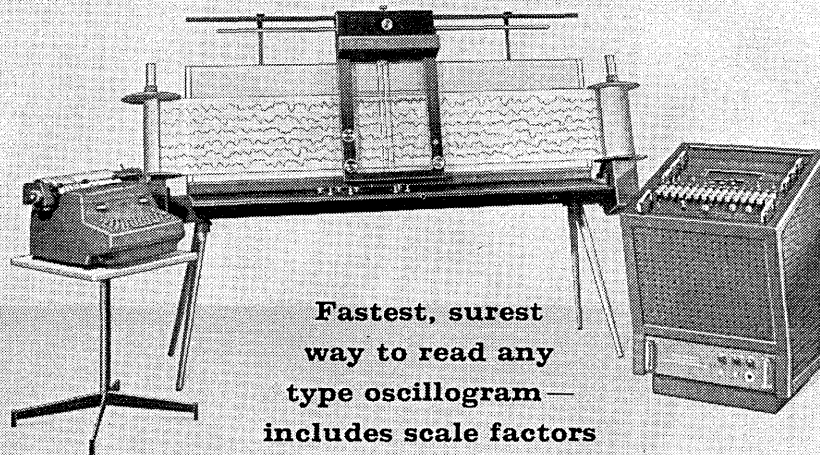

**Fastest, surest
way to read any
type oscillogram—
includes scale factors
and "O" offset for 15 channels**

YOU GET FACTS FASTER with Gerber's data-reduction systems . . . base decisions on up-to-the-minute information . . . free engineers from tedious clerical labor for the creative work they're being paid for.

For large areas, **Model S-10 Scanner** offers 16" x 66" backlighted surface (smaller scanner also available). Variable speeds from 0 to 100 fpm; instant braking; reversible. Projection system to handle 16-35-70 mm film is optional.

Newly redesigned reading head can read full width of 16" records and 20" along x axis. Variable scale is incorporated in reading head to handle frequency requirements.

Basic Control Console utilizes 4-digit voltmeter (0000 to ± 9999) accurate to .01% to measure proportional voltages of either X, Y, or frequency potentiometers; value is displayed in projection lamp banks.

Outputs: IBM typewriter, card punch, punched paper tape, plotter, etc.

Modular construction, easily expanded for increased work load or new applications.

Write today for Bulletin GADRS-2 for the full details.

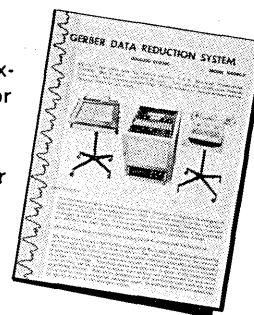

THE GERBER SCIENTIFIC INSTRUMENT CO.

P.O. Box 305 Hartford, Conn.

CIRCLE 8 ON READER CARD

don't waste our memory experience!

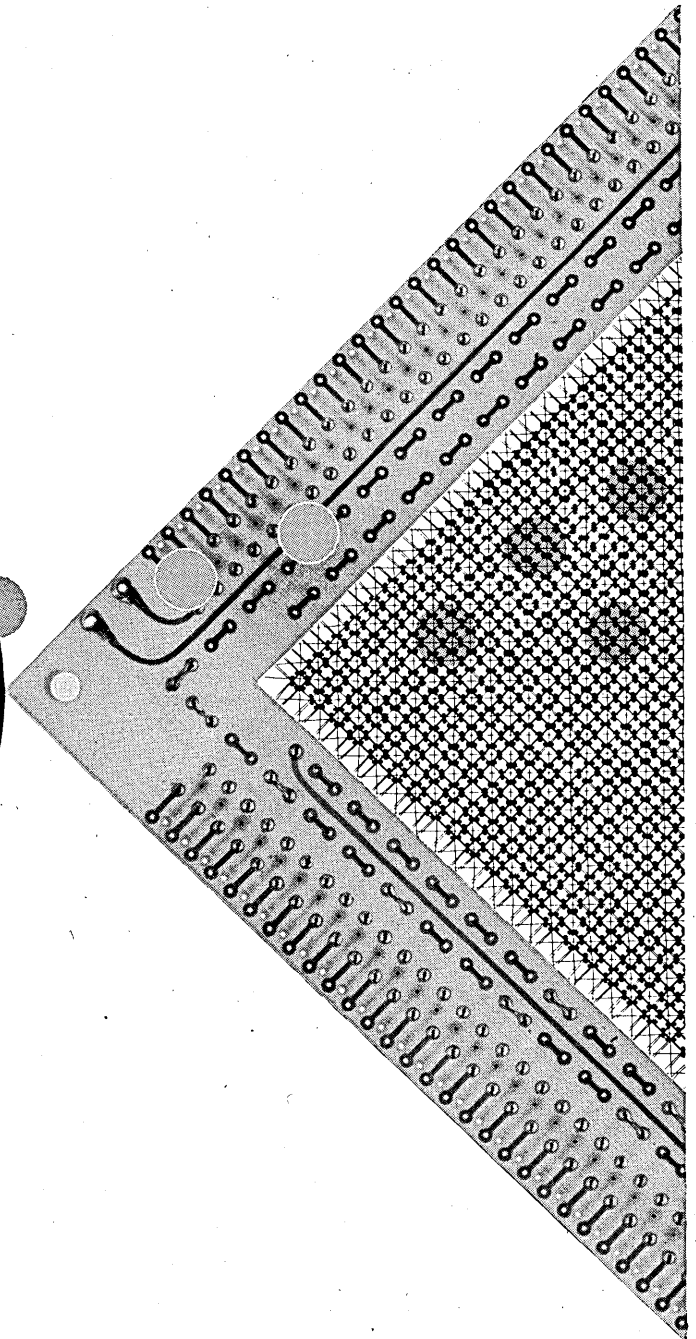

Whatever your system needs — or what you'd like it to have, you owe it to yourself and the project to see how we can help. ■
From complete memories to multi-aperture cores, magnetism is our business. For the record, we discovered and patented the first ferrite memory core, have pioneered developments in miniaturization, temperature control, switching times, logic circuitry, resistance to severe environmental conditions, and the application of multi-aperture devices to logic functions. This experience, backed by complete, specialized production and testing facilities, can help you build maximum reliability into your systems. For a complete file of engineering data on our memory products, phone or write Electronics Division, Keasbey, New Jersey.

INDIANA GENERAL

Visit us at the IRE show — Booths 1310-1316

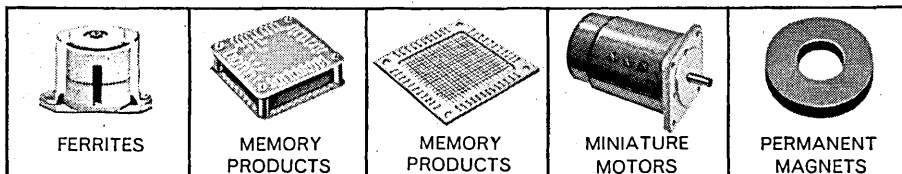

CIRCLE 9 ON READER CARD

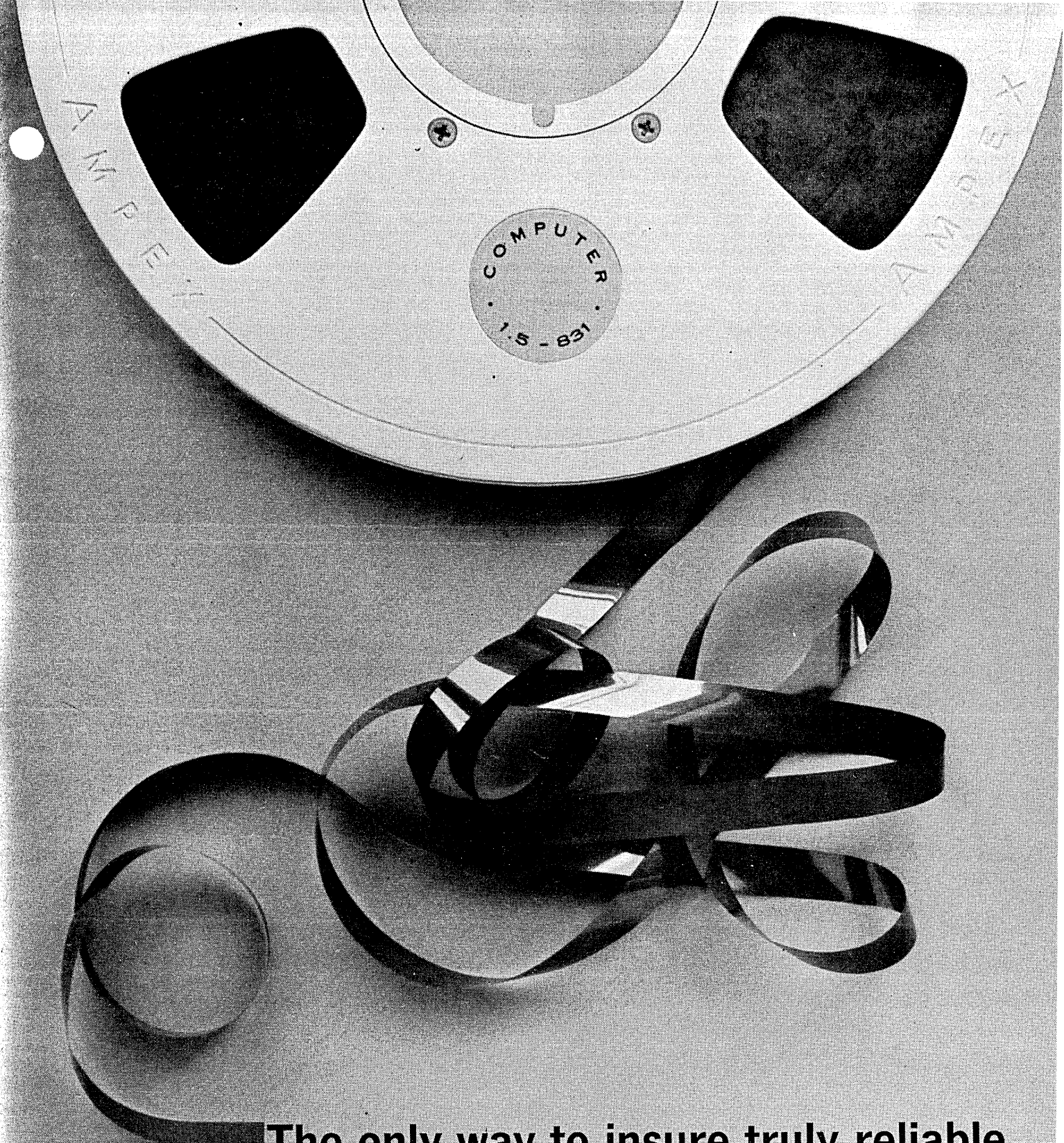

The only way to insure truly reliable computer tape is to digitally check every reel. And Ampex does just that.

Ampex computer tape performs better. Provides better protection against dropout. The reason: it's truly clean. What do we mean—truly clean? Simply this: Ampex computer tape is completely free of any extraneous material. For it is produced in a controlled atmosphere. Then a special cleaning process removes all matter that might cause even a temporary dropout. Finally, before the tape leaves the plant, it is digitally checked from end to end. Each reel is tested according to the bit packing density at which it

will be used by the customer. That way, we are sure it will perform perfectly. What's more, Ampex computer tape stays cleaner, longer. An exclusive Ferro-Sheen process—plus an improved binder system—keeps the surface smooth and thus reduces headwear and oxide build-up. Therefore, your system stays cleaner, too.

Ampex computer tape is compatible with leading computer systems. Why not try it in yours? Ampex Corporation, Magnetic Tape Division, 934 Charter Street, Redwood City, California.

AMPEX

at BENDIX

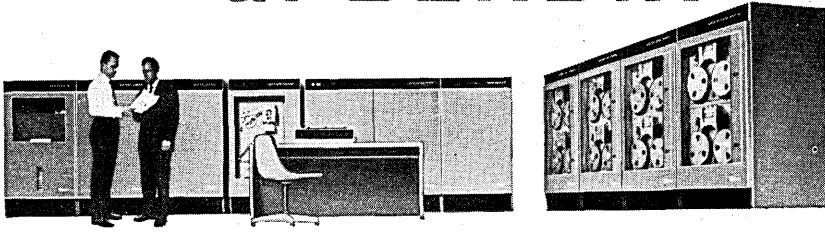

they chose **POTTER**
High Density for the G-20
Computer.

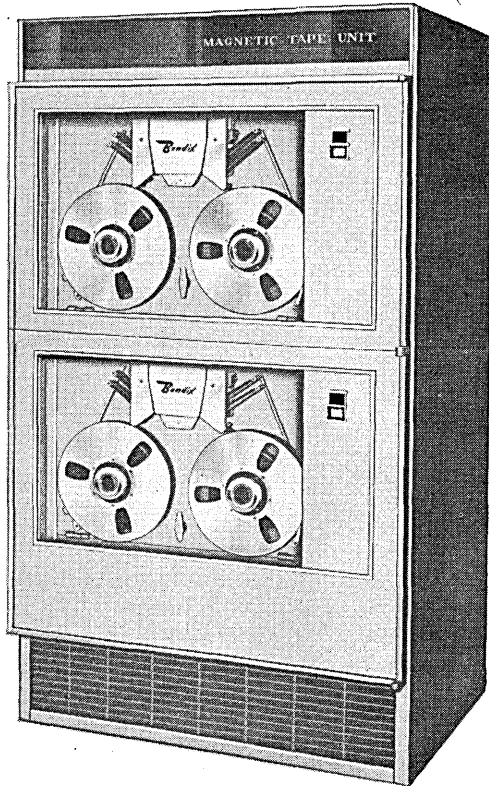

the **POTTER** High Density System

as used with the Bendix G-20 Computer results in a highly reliable computer system that sets new standards for ease of use, power and efficiency.

The Potter 906 II is the heart of the High Density Recording System. This solid-state Digital Magnetic Tape Transport provides the G-20 with recording so reliable that in 40 hours of continuous recording less than a second of re-read time is required to recover drop-outs due to transient error. With this same type of equipment data-transfer rates of 360,000 alpha-numeric characters per second at packing-densities to 1500 bits per inch are possible with transient errors fewer than 1 in 10⁸. To learn how the Potter High Density technique can be applied to your data handling problem . . . write today for your copy of "THE TOPIC IS HIGH DENSITY".

POTTER

INSTRUMENT CO., INC.

PLAINVIEW, NEW YORK

CIRCLE 11 ON READER CARD

letters

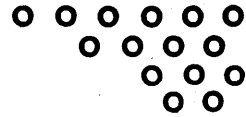

ALGOL pro

Sir,

I want to add my voice to Dan McCracken's (basic ALGOL, p. 29 December) by urging the widest possible adoption — now — of ALGOL. First, let me urge that we remember for what ALGOL is an acronym: ALGOrithmic Language. I suggest that those who dispute the worth of the language, who predict its early demise, do so without having used it extensively, either to write it or to read it (of course, they have not been helped by the lack of suitable textbooks — or even of unsuitable ones, for that matter — and literature, but that is an inadequate excuse). It just isn't possible to appreciate, or to speak knowledgeably of a language without "knowing" the language; to know a language, it is necessary to use it! . . .

ROBERT M. GORDON
Levittown, N.J.

ALGOL con

Sir,

After reading Mr. McCracken's article on ALGOL, (I feel) . . . we must keep in mind that Pure Research such as ALGOL can always be expected to eventually have its effect on the evolution of methods and conduct in Real Life. This should very likely be true even of the rather trivial convenience described by Mr. McCracken, although I suspect that program logic is often easier to follow when laid out on several lines rather than bunched up on one line.

I must admit however, to an advantage neglected by Mr. McC., namely that card costs might be cut by the latter . . .

THOMAS E. McDONNELL, JR.
Independent Consultant
Palo Alto, Calif.

meso-lucidity

Estimated Gentlemen,

On behalf of the undersigned and my own selected colleagues, might I congratulate on the article Meso-Programming (p. 30, December issue).

With frequency voluble contributions to emerging disciplines, suffering as they must from inchoate Weltanschauung, lacking also traditional

notation, hang in the air, missing reception.

Innovations we expect from such author authorities anyway, but such sidewise parallel lucidity how rare is well done. However, hard is it to believe that the most learned authors with full charge of careful thought premeditation intend to implication that, as in second reference, such broad importance theorem could be proved using only 10,000 normal deviates. Without wishing to emphasize commercially applications you should know that while pushups and thread lists lend themselves to solution of dynamic allocations we have found some procedures more useful. . .

DOSSJA ALLERHAND
Privatdozent
Agrége es lettres
New York City

a retort to the clarion

Sir:

Tarán-tarán-tarraah! The clarions sound as the would-be saviour of the computing world, H. R. J. Grosch, Ph.D., sallies forth again as the foudroyant St. George to smite down (with his loud voice instead of his gleaming sword) those evil dragons in the ACM.

It is indeed fortunate that there are such institutions as trade journals whence some of the news, life, and humor of the profession can be disseminated; for the purely scientific and technical journals seem doomed by tradition (perhaps a poor excuse) to be the recipients of the most arid academician prose. Hal Bergstein is to be congratulated on having as an aperiodical contributor that aspiring H. L. Mencken of computing, Herb Grosch, for his sparkingly pleasant magazine.

On the other hand, it is important that the readers know that it is good practice for columnists (not necessarily calumnists) to have their real or imaginary heroes and villains, issues, banners and controversies to be summoned forth to get some mileage for a column or two and maybe even more. Anyone running the risk of not knowing this and taking seriously the recent fulminations of Herb in the February issue of DATAMATION is invited to read the article beginning on page 404 of the July, 1961 issue of the JOURNAL of the Association for Computing Machinery to see the maelstrom in a thimble masterfully created by Herb. There we have an article which was

(continued on p. 12)

March 1962

at
Remington Rand

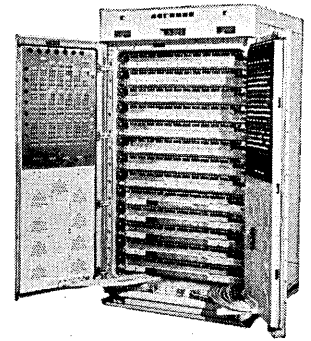
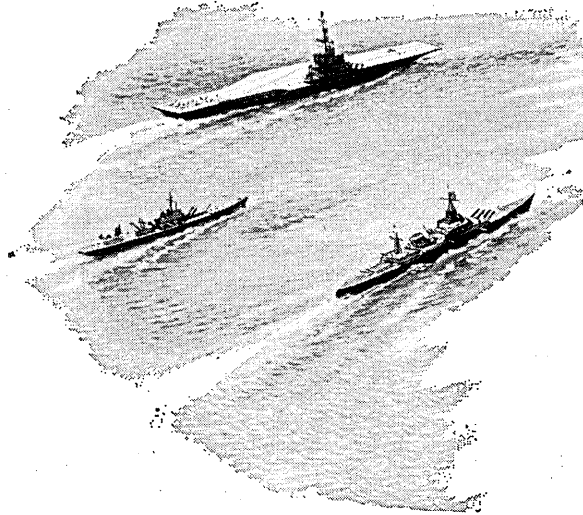

they chose
POTTER
Tape Transports
for
NTDS

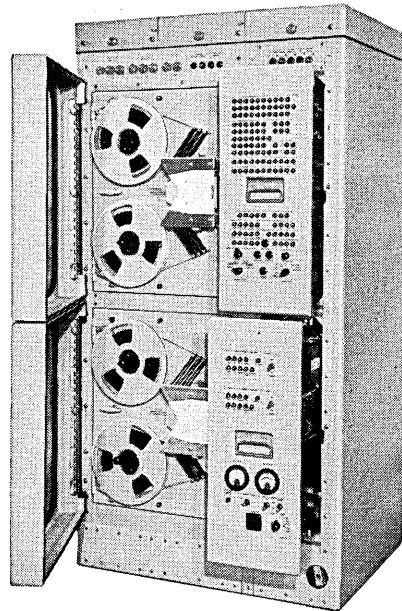

VISIT US
at Booths 3702-3704
at the IRE SHOW
March 26-29, 1962

NTDS is a shipboard computer system designed to speed the processing of tactical information. It provides rapid communication of combat data between ships—permitting them to act faster and with greater accuracy in tactical situations.

Potter M906 II Tape Transports were chosen for the NTDS 1206 Military Computer because they provide optimum reliability.

In actual operation, units like these can read or write at the fantastic rate of 360,000 alpha-numeric characters per second at packing densities to 1500 per inch on 1-inch tape . . . with drop-outs fewer than 1 in 10⁸!

To learn how Potter Digital Tape Drives can be applied to your computer system, write today for details!

POTTER

T.M.
INSTRUMENT CO., INC.

PLAINVIEW, NEW YORK

CIRCLE 12 ON READER CARD

letters

(continued from p. 11)

a mere report on a modest experiment on the use of a statistical technique in automatic indexing. A definitive, conclusive paper would be expected to contain an extensive bibliography providing at least some general historical references, perhaps not only to H. P. Luhn but also to Vannevar Bush for his early popular article in the ATLANTIC MONTHLY in July, 1945. For the article in question, the only appropriate references are not general but rather specific ones. Herb was requested twice to suggest specifically pertinent chapter and verse type references, not any general ones, for anyone knows that Luhn and others have written many general articles on the subject. He ignored the request. Honoring it would have taken seven inches of column from his editorial.

Another point for the possible few who may not know, articles in most scientific and technical journals are contributed by authors gratis (in fact,

they or their institutions or corporations pay for reprints) and are refereed gratis and thanklessly (by reason of their anonymity) by specialists in the field as a service to the profession. Rather than "little cliques passing goodies from hand to hand," we have difficulties getting ready, willing, and able referees. We are not in the dollar but rather in the scholar business; for if we were it would be a most negatively lucrative one at that.

In closing let us hope that Herb will continue his jocular contributions (perhaps he could start the first computing comic strip), and that we recognize his efforts for what they are. For, without recognition of our Don Quijote de Monaco his ego would suffer, his productive capacity would consequently atrophy, and we, as a whole, would suffer the baleful consequences of the lack of delightful stories of the good guy versus the bad guys in our professional reading matter.

Sincerely, but not too seriously,

M. L. JUNCOSA
Editor-in-Chief, the JOURNAL
of the Association for
Computing Machinery,
Santa Monica, California

hands up in horror

Sir,

Let me congratulate you on the continued quality of *Datamation* and particularly on the January issue. However, may we throw up our hands in horror at Mr. Auerbach's article on page 38 on Computing Abroad.

First, the Bull Gamma 60 computer is not a good machine and is falling short of expectations and in our opinion, will certainly not be enjoying very many more sales, if any. This failure was primarily the reason for the Bull-RCA tie-up.

Secondly, the EMI 2400 cannot be said to be in production in the sense it is meant in America because the sales of this machine are extremely limited. The ICT is in production in card form but the 1301 tape version is extremely far behind schedule and this again was one of the reasons for the RCA-ICT agreement.

R. H. WILLIAMS,
Managing Director
Computer Consultants Ltd.,
London, England

FORTRAN poetry

Sir,

We agree, the problem presented on the cover of your December issue is difficult. But for some reason we feel a three step program should contain fewer "bugs!"

Your cover's artistically done
But the FORTRAN surely won't run
Floating point U and V
Don't mix with IP

And the DO won't cycle past 1.

C. C. O'TOOLE
H. B. KUFUS
Socony Mobil Oil Co.
New York, N. Y.

correction

Sir,

On page 11 of your January issue, the U.S. Naval Weapons Laboratory is listed erroneously as "also known as the David Taylor Model Basin." Both installations are completely independent naval activities, physically separated by about 70 miles and administratively separated by Navy command channels.

ROBERT F. SELLARS
Captain U.S. Navy
Commander, U.S. Naval
Weapons Laboratory
Dahlgren, Virginia

MATHEMATICIANS & PROGRAMMERS

Positions are open at all levels for individuals experienced in applying numerical methods and large digital computers to the solution of mathematical problems of engineering and science. Interesting and varied fields of investigation include missile trajectories, space orbits, partial differential equations, calculus of variations, and mathematical programming.

Qualifications are a BS, MS, or PhD in Mathematics, a physical science, or engineering, and a minimum of one year of programming experience.

Please forward your resume to Mr. William O'Melia, Missile & Space Division, Raytheon Company, Bedford, Mass.

RAYTHEON

RAYTHEON COMPANY

MISSILE & SPACE DIVISION

An Equal Opportunity Employer

SBC's complete computing services:

AT YOUR COMMAND

The Service Bureau Corporation offers you complete computing services and facilities in 70 offices and data processing centers located throughout the country. No job is too small or too large. At SBC, you'll find the largest, most experienced data processing staff in the country...the widest choice of punched card and electronic equipment...and an ever expanding group of **Programmed Applications**.* These are established computer programs designed to simplify scientific and engineering data processing, and make computer solutions readily available.

At your service, in SBC's network of data processing centers, is a complete line of the latest IBM computing equipment, including IBM 1401, 7070 and 7090 computers. Conventional IBM equipment is available for peak load use. Computer

time, by the hour, allows you to expand your data processing facilities at economical hourly rates. Programming assistance is available.

SBC's staff of engineering, scientific and computer personnel has unparalleled experience in every kind of data processing problem, including engineering and scientific applications, advanced programming, problem analyses. As an aid to science, business and industry, SBC is at work today supplying data processing services to meet every kind of customer need.

***Programmed Applications**—computer programs designed and developed by SBC.

The Service Bureau Corporation
425 Park Avenue, New York 22, N. Y.

SBC
a subsidiary of IBM

The Most Experienced Data Processing Service in the World

At giant Chase Manhattan Bank, Mr. Robert J. Pollock, Vice-President, Systems and Standards, cites the major contribution of their RCA 301's and 501's in helping to create the nation's largest centralized electronic check handling system. RCA's planning assistance, including the highly critical problems of site planning and training machine personnel, were of primary importance in getting Chase off to a smooth start in working toward its long-term objectives.



At Travelers Insurance, one of the largest multiple line insurance companies, Mr. Russell D. Leinbach, Second Vice-President, Data Processing Department, finds that the RCA 501 Systems, operating 24 hours a day, are processing the large number of premium and loss transactions involved in the currently developed internal statement and management reporting areas at a most reasonable per hour operating cost, and shorter processing times.

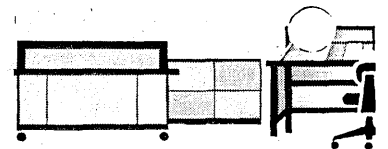

At The Chase Manhattan Bank ...The Travelers Insurance Companies

VOLUME, VARIETY, PRODUCTIVITY ...MORE REASONS FOR CHOOSING RCA ELECTRONIC DATA PROCESSING

Progress—fast and sure—is the result when America's leading commercial firms use multiple RCA EDP Systems!

Chase Manhattan, with a combination of RCA 301's and the larger 501's, is well on its way to mechanizing the handling of 400 million checks annually for accounts in its head office and 110 New York City branches. At their new headquarters, an achievement in banking architecture, Chase uses their RCA EDP Systems to keep abreast of one of the most voluminous and detailed of all banking functions... the accurate, daily updating of checking accounts. The 301's handle the input/output and conversion operations. The 501's accommodate daily posting and account updating for demand deposits. By teaming a combination of 301's to the 501's, Chase is able to keep ahead of an ever-growing load of check operations.

At Travelers, three RCA 501® Systems are on the job, around the clock, throughout the week. Data processing

volume is measured in 2,000,000 monthly transactions (and growing every day!). Job variety ranges from agency production records to complex actuarial assignments, through the full spectrum of statistical and accounting procedures. For example, the system produces an inventory of outstanding claims which is used in establishing reserves based on potential liability. New tasks are continually being developed, tested and added to the workload of the 501's. In short, Travelers' long-range EDP purposes are being accomplished, the job is getting done.

How do *you* take the measure of an efficient data processing system? Volume and variety of work handled? Systems productivity? Planning assistance? Reliability? These reasons, and more, are why leaders like Chase and Travelers chose RCA. Before you make your choice—see RCA. Or write RCA ELECTRONIC DATA PROCESSING, Cherry Hill, N.J.



The Most Trusted Name in Electronics
RADIO CORPORATION OF AMERICA

RCA STEPS-UP FILE SPEED, CAPACITY!

New Data Disc File incorporates fractional second speeds and high storage capacity in a random access bulk storage file... particularly useful in business applications requiring random reference to files, random posting for up-to-the-minute file records.

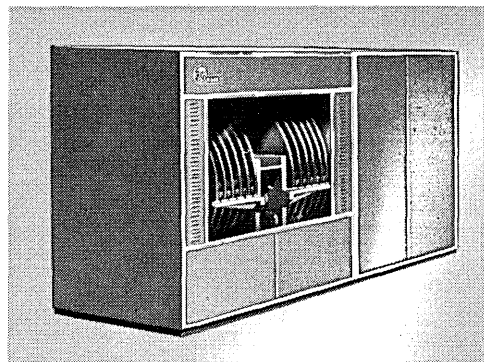
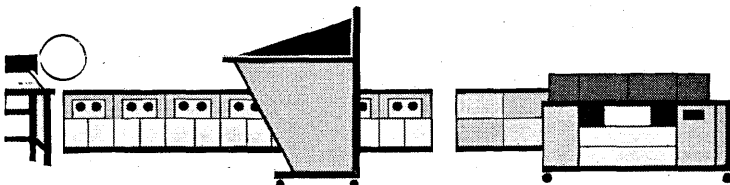

Say "Good-bye" to Tension

GET RESULTS AND RELAXATION

... DIVIDENDS FROM

STATISTICAL'S

DATA-PROCESSING

Experience

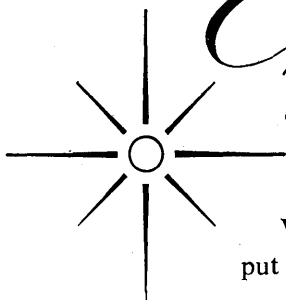

When data-processing problems put the pressure on you, you'll find the "safety valve" you need at STATISTICAL. A wealth of experience is always ready to go to work for you here. Behind every assignment is a searching understanding of management problems and solutions . . . gained in serving America's top companies since 1933.

From this experience comes the consistently-high quality service you would expect from America's oldest and largest independent data-processing and computer service. Sophisticated methods.

Responsible personnel. The latest electronic equipment. Coast-to-coast facilities. Advantages like these add up to "know-how" and "show-how" that can not be acquired overnight.

This experience-in-depth service is available to you day or night. A call to our nearest data-processing and computer center will bring you the results you want . . . and relaxation.

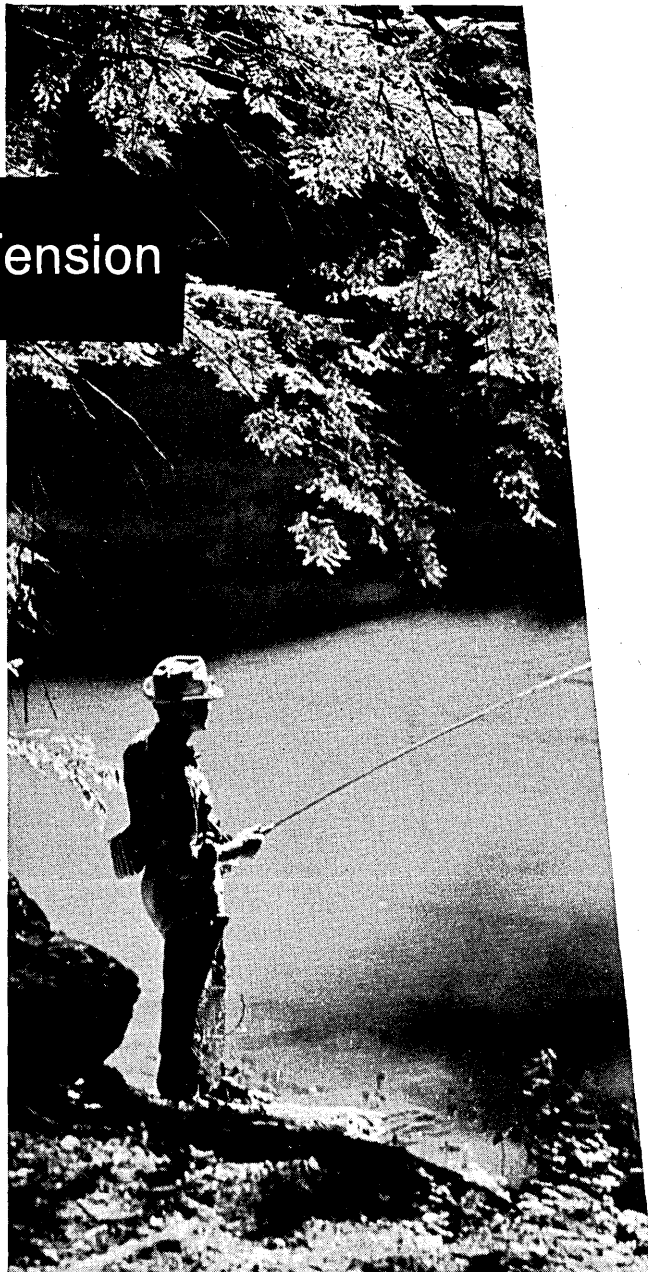

Established 1933

Statistical

TABULATING CORPORATION

NATIONAL HEADQUARTERS

104 South Michigan Avenue • Chicago 3, Illinois

OFFICES IN PRINCIPAL CITIES — COAST TO COAST



THE STATISTICAL MARK OF EXCELLENCE

ADVANCED SYSTEMS DEVELOPMENT

Emerging now from three years' intensive effort at International Electric is a computer-based communication system that equals the state-of-the-art. Our continuing progress will be determined by our ability to advance the state-of-the-art in our design and development of future systems, and in the techniques relating to systems programming. We seek to add new technical capability to assist in these efforts.

Research Specialists in Artificial Intelligence are needed to perform studies in the fields of linguistics, philology, learning theory, automatic programming, information retrieval, behavioral sciences, mathematic modeling, simulation and compilers, to discover new solutions to programming problems.

Also required are *Programming Specialists* for assignments involving program analysis and development for the requirements of the largest present real time digital system. These assignments may be in operational, utility or diagnostic programming development. Experience should encompass the development of compilers, problem-oriented computer language and advanced programming systems.

If you wish to associate yourself with the professional challenges offered by these programs, please send your resume to Manager of Technical Staffing, Dept. DA.

INTERNATIONAL ELECTRIC CORPORATION

An Associate of International
Telephone and Telegraph Corporation

Rte. 17 & Garden State Parkway
Paramus, New Jersey

An equal opportunity employer.

DATAMATION

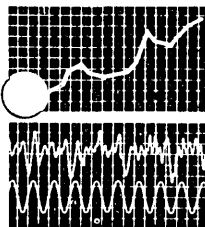

BUSINESS & SCIENCE

RCA BOOSTS 601-604 PROGRAM

Despite production problems and persistent rumors of major cutbacks in the 604 program, RCA informs DATAMATION that production on the large scale computer is still underway. The first 604 high-speed arithmetic unit will be shipped about the middle of this year from the RCA Data Systems Division, Van Nuys, to EDP headquarters in Camden where it will be tied into a 601 main frame. The 604 will then be used for RCA's internal operation and customer demonstration.

The first five 601s are now in assembly and testing in Camden with first customer deliveries scheduled for the Fall. According to T. A. Smith, executive vp for RCA's EDP division, "RCA is proceeding with the 601 program as a maximum effort," and additional 604s will be produced in the near future in response to government and commercial requirements.

FORD SUPPORT OF PHILCO O.K.'d

The Ford Motor Co. will provide "full" support for the development, manufacture and sale of Philco computers. DATAMATION learned late last month. Immediately following the long awaited announcement (made internally to Philco salesmen and externally to a limited number of prime, prospective users), the sale of three 2000 systems was closed, all of which are for customers outside of the Ford organization. The Philco Computer division will remain headquartered in the Philadelphia area and there will be no merger with Aeronutronic.

NANOSECOND COMPUTER TO COST 3-5 MEGABUCKS

Top level speculation on the cost and gestation period for nanosecond hardware was one of the more prominent highlights at the recent AIEE meeting in New York. In an unusual open and quasi-closed panel discussion following the more formal presentation of technical papers, it was generally agreed that the first commercial nanosecond machine would be available in about 4-6 years performing at approximately 100 nanoseconds or 4-5 times the speed of STRETCH and LARC. Cost of the machine was estimated at 3-5 megabucks.

For the ultra-high speed logic circuitry, tunnel diodes won the favor of the panel and thin films were suggested as a leading contender for memory.

While agreement on the 4-6 year waiting period was

ANELEX®

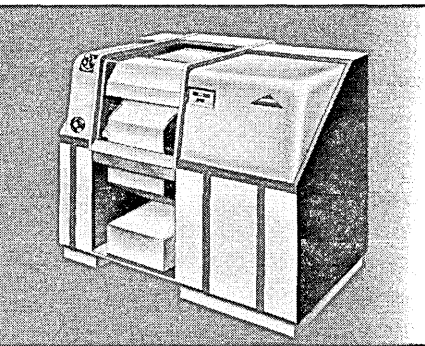
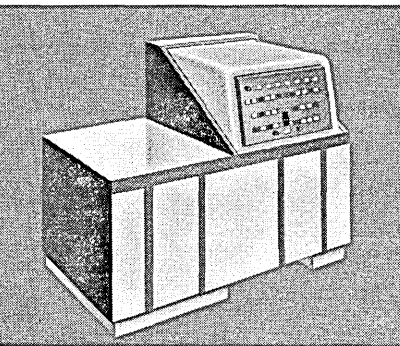
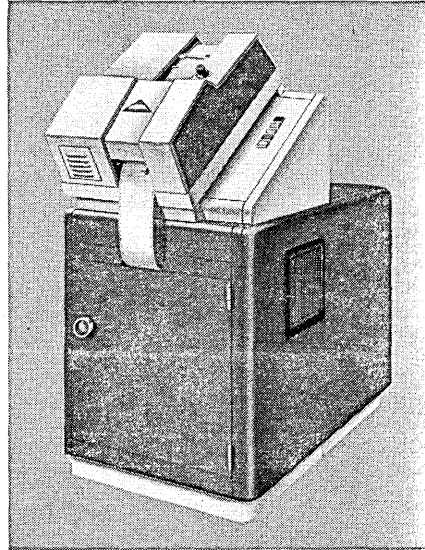
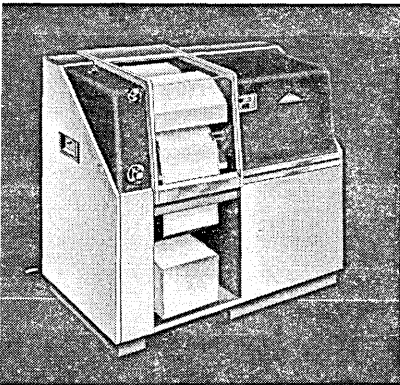
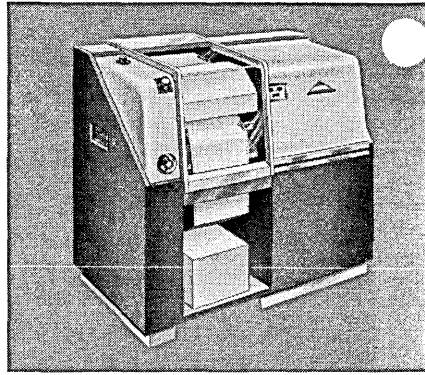
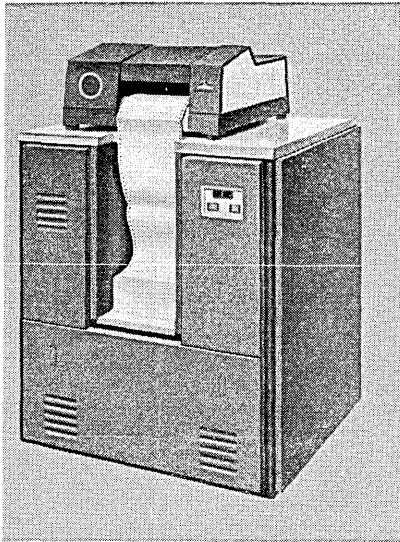

For every important type of data processing, Anelex builds a Complete High Speed Printer System. These Complete Systems...including power electronics, buffers and logic...are available in a wide range of models, printing speeds and capabilities, all with proven reliability.

For your next installation, select an Anelex Complete High Speed Line Printer System...standard equipment in the data processing systems of 33 leading computer manufacturers.

Further information available upon request

ANELEX CORPORATION

155 Causeway Street, Boston 14, Massachusetts

CIRCLE 17 ON READER CARD



There is no charge to candidates for our services.

PROGRAMMERS

Programming experience on large scale systems for Business, Scientific or Engineering applications.

MATHEMATICIANS

B.S. or M.S. to analyze scientific and engineering problems for the systems area of missile and satellite trajectories and orbits and related space communications studies.

SYSTEMS ANALYST

PERT experience to provide program design and modification capability, must be able to originate and revise program specs, also design data for simulation programs.

INFORMATION PROCESSING TECHNOLOGISTS

for advanced programming assignments, in such typical areas as System Design, Symbolic Logic, List Processing Techniques, Compiler Design, Symbol Manipulation, Artificial Intelligence and Information Retrieval. All advanced research and analytic experience in digital information processing is a qualification for these positions.

SYSTEM and PROCEDURES ANALYSTS

With 1401 or 7090 experience for staff assignments in data processing departments being expanded by clients.

MANAGER of DATA PROCESSING

requiring extensive background in all phases of Divisional and Corporate accounting methods, experience in directing programming effort in production control, job order analyses and inventory control with 650/1401 as typical experience but other computer experience will be considered.

SENIOR ENGINEERING PERSONNEL

With experience in real-time computation in connection with the design of Digital Simulation of airborne and space vehicles with specific experience in the Logical Design/Circuit Design/Digital Computer applications or Program Engineering area with B.S. or M.S. in E.E., Physics, or Aeronautics.

For these and other professional opportunities with clients on a national basis, please send your resume or an outline of your background and interests to

F. L. MANNIX & CO., INC.
Suite 1132
Park Square Building
Boston 16, Mass.

CIRCLE 76 ON READER CARD

MANAGEMENT & PERSONNEL CONSULTANTS • F. L. Mannix & Company, Inc. • EXECUTIVE & TECHNICAL PLACEMENT

MARCH

NAME _____
TITLE _____
COMPANY _____
ADDRESS _____
CITY _____

HOME _____

CITY _____

FOR MO

PROD. & EMPLOY

1	2	3	4	5
10	11	12	13	14
19	20	21	22	23
28	29	30	31	32
37	38	39	40	41
46	47	48	49	50
55	56	57	58	59
64	65	66	67	68
73	74	75	76	77
82	83	84	85	86
91	92	93	94	95
96	97	98	99	00

MARCH

NAME _____
TITLE _____
COMPANY _____
ADDRESS _____
CITY _____

HOME _____

CITY _____

FOR MO

PROD. & EMPLOY

1	2	3	4	5
10	11	12	13	14
19	20	21	22	23
28	29	30	31	32
37	38	39	40	41
46	47	48	49	50
55	56	57	58	59
64	65	66	67	68
73	74	75	76	77
82	83	84	85	86
91	92	93	94	95
96	97	98	99	00

MARCH

NAME _____
TITLE _____
COMPANY _____
ADDRESS _____
CITY _____

HOME _____

CITY _____

FOR MO

PROD. & EMPLOY

1	2	3	4	5
10	11	12	13	14
19	20	21	22	23
28	29	30	31	32
37	38	39	40	41
46	47	48	49	50
55	56	57	58	59
64	65	66	67	68
73	74	75	76	77
82	83	84	85	86
91	92	93	94	95
96	97	98	99	00

evidenced from such expert prognosticators as J. P. Eckert of RemRand; Nat Marshall of RCA, and M. C. Andrews of IBM, consultant Lou Fein ventured a 10-year guesstimate with the qualification that financial backing partly from private industry for a nanosecond machine would reduce the waiting period to five years, but since the project would most likely be largely sponsored by government money, the full 10 years would be required.

Another panelist, consultant Gary Hollander, told a press conference prior to the panel discussion that nanosecond hardware would be available "on the floor for debugging within two years."

C-E-I-R & CUC:
A \$\$\$ PERSPECTIVE

Annual reports from two competitive although opposite numbers in the computer service field emanated recently from C-E-I-R and Computer Usage Corp. (CUC). Although both firms are publicly owned, sell time, write software and otherwise purport to assist the user, their respective management approaches and subsequent economic postures are several yardsticks apart. The most flavorful comparison may be made by a review of their year-end balance sheets.

At the larger, multi-merging, machine buying, decentralizing, prospective two STRETCH user, C-E-I-R reported a net loss (before taxes) of \$927,156 for 1961. In 1960, the company dropped \$259,188. Gross income for '61 was \$10,940,358 and net loss per share of common stock was \$.68. Total assets of C-E-I-R are \$12,812,399, an increase of 10-megabucks over the previous year.

Comments C-E-I-R president Herbert W. Robinson, "During the next fiscal year, management's primary effort will be to bring into maximum profitability the immense new capability created world-wide by our investments to date."

As a substantially smaller, non-machine owning, non-merging, three branched, comparatively centralized service house, CUC's net income (before taxes) was \$77,234, for 1961, an increase of more than \$60,000 over the previous year. Gross income for '61 was \$1,299,700 and net earnings per share of common stock was \$.19. Total assets of CUC are \$687,242, more than double the assets of the previous year.

Comments CUC president Elmer C. Kubie, "It is management's belief that our rate of expansion should be controlled in order to maintain our quality of services and to insure reasonable profits even during periods of growth."

7034 IS
STRETCH SUCCESSOR

A super scale, commercialized version of STRETCH has been designated the 7034 by IBM. No announcement date has been set. As a competitor for the unannounced CDC 6600, the 7034 is currently engineered as a core machine although a major consideration is being given to third generation technology, and this decision is a source of considerable debate within IBM.

In its present configuration, the 7034 may be

considered a "small" STRETCH machine with a larger version also in the works. Specifications may include a 64 bit word size, 32 to 128K, 1 microsecond core memory with monthly rental ranging from \$150-225K. Compatibility with the limited population of 10 7030s is not expected.

Last month, IBM formally announced its entry in thin film r&d with a 60 nanosecond memory (see News Briefs, page 85). At CDC, postponement of the 6600 announcement expected last Fall, may also be attributed to possible third generation studies. Negotiations are currently underway for the acquisition of a manufacturing process by CDC which has been perfected as a comparatively inexpensive method for producing thin film memory.

While work on the 6600 is definitely moving ahead, IBM's 7034 may ultimately receive the shelving treatment afforded the 8000 series depending largely on the outcome of the second vs. third generation debate.

EPSCO READIES
GENERAL PURPOSE ENTRY

A medium to large scale entry in the general purpose computer field will be announced early this Spring by EPSCO, Inc., of Cambridge, Mass. Dubbed the 275, the main frame features a core memory expandable from 4K to 16K with a word size selectable by the user up to a maximum of 245 bits plus sign. Internal speeds are 2.5 microseconds for addition; 15 microseconds for multiplication; 27.5 microseconds for division and 2.5 microseconds for transfer control. Memory cycle time is 5 microseconds.

Digital I/O devices may include up to 30 mag tape units, 4 line printers, 30 paper tape punches and 192 communication lines.

Eight simultaneous unrelated programs may be externally controlled on the 275. There are 53 instructions and operations are in binary code with stored logic binary to decimal or decimal to binary conversion.

The system is directed at both the business and scientific markets with an approximate price tag of \$70K for the main frame and \$100-110K for a typical configuration. Chief competition for the 275 is the GE225, PDP-1, and CCC's DDP-25. An operating prototype of the 275 is planned for October with production early in '63.

THE SECRET SOCIETY
MEETS AGAIN!!
or
ROME PARLEY
MAY DEBUG ALGOL

Thirteen authors of the original ALGOL-60 report have received invitations to attend a special meeting planned for this month in Rome concurrent with the Symposium on Symbolic Languages. The stated purpose of the unpublicized gathering is "to clarify ambiguities in the language." However, the emergence of ALGOL-62 as a principal result of the meeting is more than a remote possibility since it was largely through a similar conference on ALGOL-58 that the ALGOL-60 report was published. It may also be noted that invitations were not extended to individuals known for their opposition to major changes in ALGOL-60.

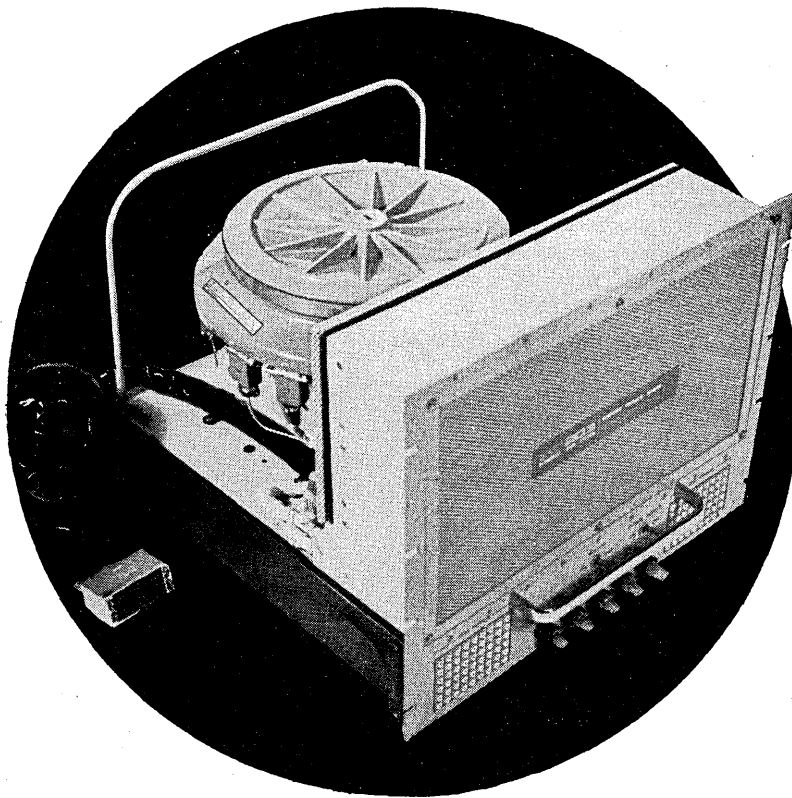

now you can buy
**COMPLETE
 MEMORY
 SYSTEMS**

**in a single package —
 matched to your requirements**

with all the inherent advantages of LFE's Bernoulli Disk principle working for you! For instance, the BD-200 Bernoulli Disk rotating storage device is available as a completely wired package — standardized design.

And yet here's the flexibility you need for your precise data storage demands.

Illustrated is a standard drawer mount, designed to fit any 19" cabinet or module. Here are standard card cages, and the capability to interface with any standard logical level. LFE standard printed circuit modules, standard recirculating registers, pre-written clocks and index markers — these too are part of the package, yours for the asking.

The BD-200 storage device has over a 200,000 bit capacity, a speed of 3450-8000 rpm, a maximum of 79 tracks. It uses phase modulation recording technique.

Similar packages are now available in capacities from 10,000 to 1,000,000 bits. Trade on this single source for complete systems, put standard techniques to work for you in building up your own systems. First step in the right direction: write for technical information.

Visit us at booths number 3003-3005 at the New York IRE Show

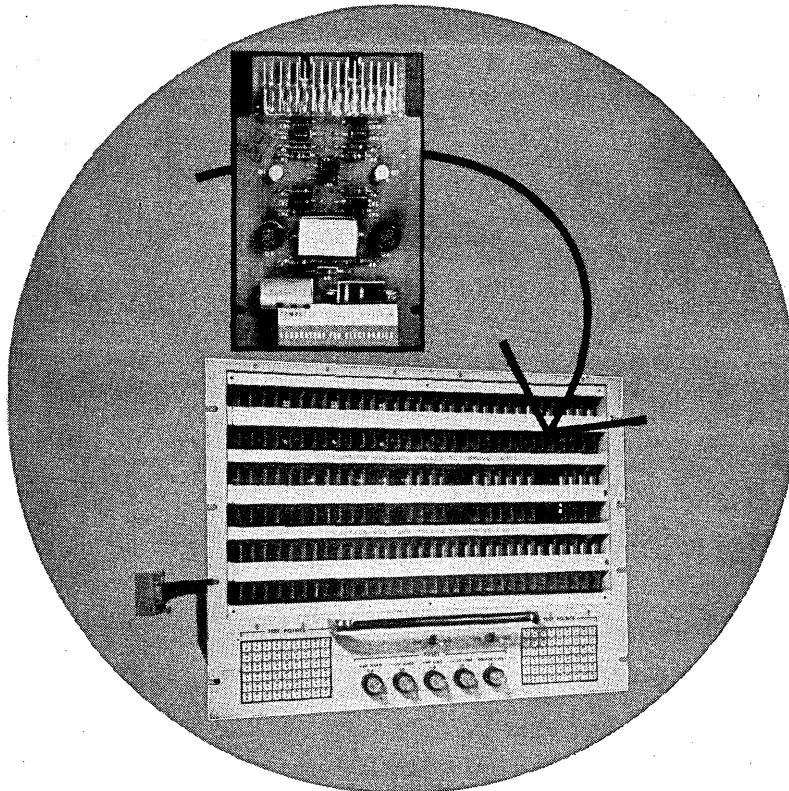

LFE ELECTRONICS

A DIVISION OF LABORATORY FOR ELECTRONICS, INC.
 BOSTON 15, MASSACHUSETTS

Now you can transmit your business data by telephone!

You do it with DATA-PHONE service—the dramatic, new Bell System development that lets business machines talk over telephone lines.

Great volumes of data—You can send production figures, payrolls, inventories, sales orders—from punched cards, paper tape or magnetic tape such as shown below.

At high speed—up to 2500 words per minute when regular telephone lines are used. When DATA-PHONE service is used with leased private lines, speeds many times this rate can be obtained.

Accurately. Data is received in the same punched-card or tape form that it was in originally.

Economically. DATA-PHONE transmission goes over regular telephone lines at regular telephone rates. Some firms accumulate a day's data, then send it after hours, when rates are lowest.

Let one of our Communications Consultants show you how DATA-PHONE service can put more speed, accuracy, economy and profit into your data handling. Just call your Bell Telephone Business Office and ask for him.

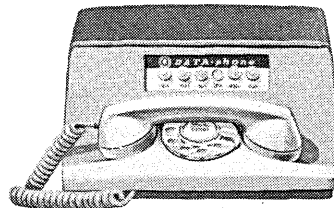

BELL TELEPHONE SYSTEM

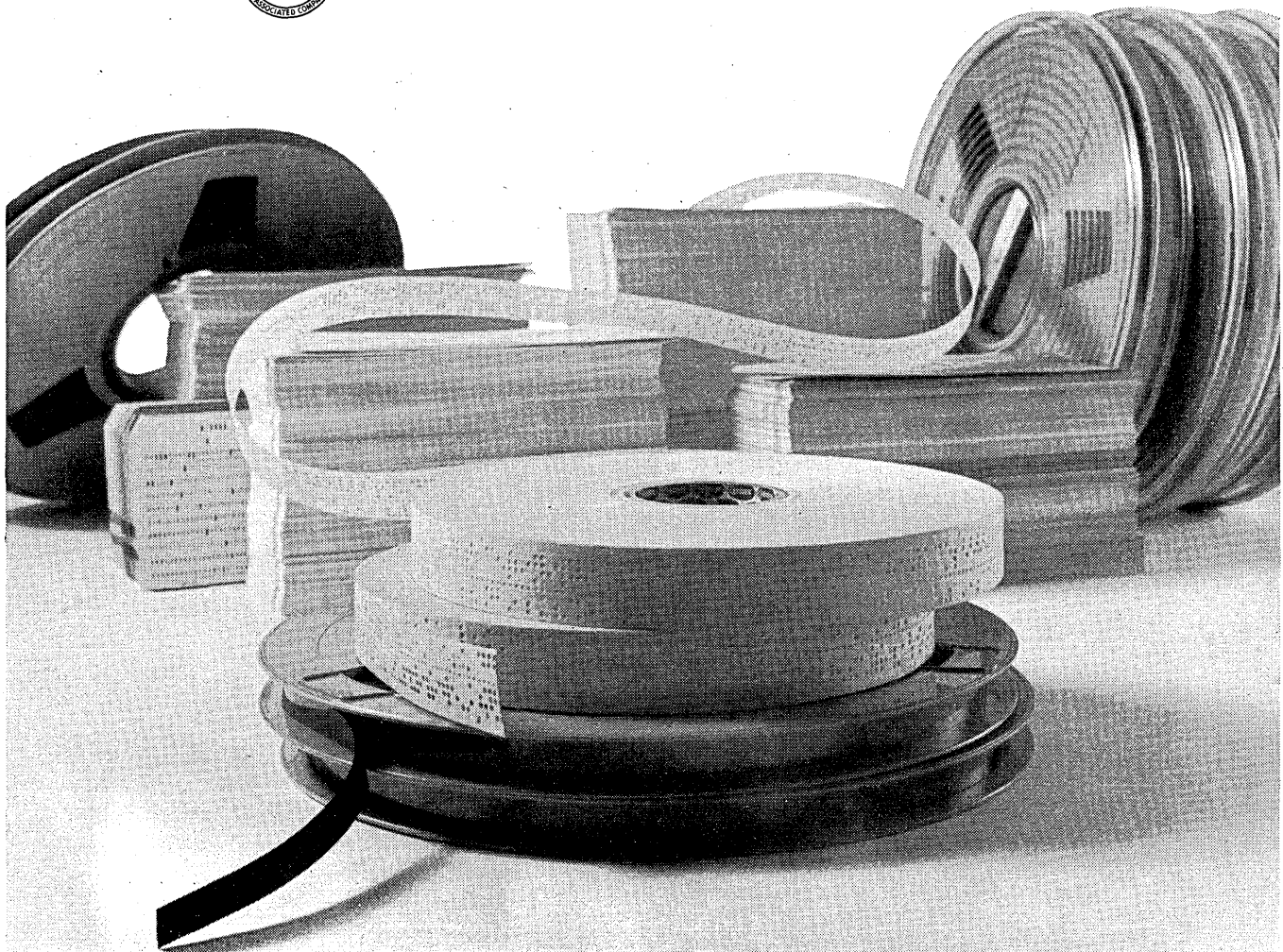

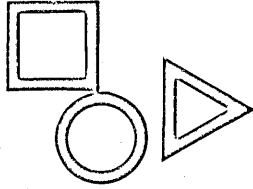

EDITOR'S READOUT

THE CERTIFIED PUBLIC PROGRAMMER

While professionalism in the computing industry has been widely encouraged as a pious and justifiable goal, the virtues which are specified as essentials of piety reek of such bold non-specifics as "maturity," "sincerity," "competence," "experience," "a kind face," "good heart" and the ability to bear wholesome, university-oriented children.

Partisans in the holy war for professionalism are generally well-intentioned, honorable sorts. They battle quietly, with vigor, but always in a non-definable vacuum.

With a mounting tide of inexperienced programmers, new-born consultants, and the untutored outer circle of controllers and accountants all assuming greater technical responsibility, a need for qualification of competence is clearly apparent.

Sound logic however, argues firmly against the practicality of a rigorous program of certification for the professional. At present, there is no established mechanism to qualify even the qualifiers. The most logical organization for this purpose, the American Federation of Information Processing Societies (AFIPS), has barely initiated its chartered functions and is certainly in no position to accept broader responsibilities. Within AFIPS, the Association for Computing Machinery (ACM), while older and well established, has shown little inclination to officiate in any area where effective decision-making is needed. Finally, the establishment of a separate organization with certification as its primary function, would seem far too costly an undertaking with few willing contributors.

Nevertheless, the concept of credentials for the computerite merits consideration and discussion. There is generous precedent in other professions and the results of a working program would be highly beneficial in the eventual progression of the industry toward well-ordered maturity.

In an approach to a program of certification, many of the problems which are embarrassingly prominent in the industry today must be overcome if the approach is to be a successful one. This fact alone stands as one of the principal virtues in consideration of this program.

First, a glossary must be established so that in the construction of a qualifying examination, a hard core of mutual understanding may be assumed and semantic debates virtually eliminated. It will be necessary for example, to define "professional competency" before the objective of a test may be properly determined. Other thorny words which may merit attention include "computer," "data processing," and "programmer."

Second, the sponsoring organization would become the industry's most effective parent with responsibilities far exceeding the preparation and administration of a certification program. By its testing standards, for example, the rate of progress for the industry will be carefully evaluated, a role unfilled at present.

Third, the public's view of the computing profession would be raised several impressive levels from its current stature of cautious bewilderment and misinterpretation to at least, confused respect.

Fourth, many of the industry's widely publicized upcoming incompetents would find their accession to financial stardom impeded by the need for specific qualification such as the passing of a reasonable test of competency.

Fifth, a senior body possessing more than a modicum of legitimacy would be created to include many capable young leaders and a far wider base of priestly lords and sub-lords. The present qualification for

admission to this ill-defined, somewhat august body is both vague and subtle to the point of discouraging many highly talented prospects.

In the beginning, certification should be propagated as a voluntary program since its value and subsequent mandatory implications must be based on individual corporate acceptance. For example, if Company X supported the certification program and boasted a high rate of CPPs in its employ, its chief competitor, Company Y, might feel persuaded to follow suit not only for the promotional virtues of a credential but also because of internal confidence in more qualified employees.

If however, the test was so poorly constructed as to appear of little value, the pressure to effect a change would stem from its lack of general acceptance. Therefore, a measure of its value would be the number of individuals and corporations voluntarily insisting that it be widely accepted in much the same manner as the American Standards Association's "voluntary" standards which are in reality, quite binding.

A second requirement is that the sponsoring organization contain a full-time salaried staff of senior professionals with voluntary counsel recruited as a supplement to, rather than as the more customary basis of the group's activities.

As to the specifics of a credential, a university degree should *not* be an initial requirement because of the obvious variance in educational backgrounds, the present state of computing education, and the influx of inexperienced personnel. At some later date, this requirement may be introduced.

At first, a program of testing should be the basic goal. This may include a general test of knowledge in such areas as computer organization, analysis, flow charting techniques, documentation, and the use of common languages. Specific questions may be directed at the advantages of internal vs. synchronous input/output; multiple vs. single addressing, etc.

Following the general portion of the test, areas of specialty may be probed such as in business data processing, scientific and engineering dp, and combinations of the two.

Finally, for upgrading the programmer to the supervisory level, a test may ultimately venture into the few known values in budgeting, accounting practices, personnel selection, corporate goals in maximizing output, etc.

As reference tools in initiating a certification program, there is certainly no shortage of tests comparable to one which might be required for the prospective CPP. Several major U.S. cities, a number of states, and a few of the larger users, provide tests for job applicants and as prerequisites for professional advancement. Universities offering courses in computing are an excellent source for questions and a few, rather complete examinations in varied segments of the programming art.

While a certification test should remain somewhat static in its basic framework, segments may be changed annually to reflect advances in computing science. Refinements may be included to test within a specialty such as for insurance within the broad field of business dp, or for a knowledge of the physical sciences as a specialty within scientific dp.

Although the title "Certified Public Programmer" may appear somewhat ludicrous at this early stage of the organizational game, it should be viewed in the context of its ultimate feasibility and advantage rather than as an impracticality for the near future. It is only through the encouragement of active discussion of this subject can its benefits be evaluated and the seed of the basic concept firmly planted. In this manner, the distance prior to implementation can be substantially narrowed and the onus of a "way out" suggestion brought into clear, constructive focus. ■

(Note: Following the writing of *The Certified Public Programmer*, announcement was received of an initial program leading to data processing certification by the National Machine Accountants Association. While this

effort understandably centers on business edp and may hardly be viewed as the ultimate in certification for the computerite, it is certainly a first and important step. A report on NMAA's program appears on page 25.)

DP CERTIFICATION PROGRAM ANNOUNCED BY NMAA

first exams
scheduled for June 20
in New York City

 An examination for a Certificate in Data Processing will be offered by the National Machine Accountants Association in conjunction with the group's International Conference in New York City on June 20th. It is the first move by any organization to establish a program of voluntary testing standards and to certify members of the data processing profession.

NMAA represents more than 16,000 members in the dp systems and management field in the U. S. and Canada. The group will award certificates largely although not exclusively, to those members who manage accounting departments.

(More than a year ago, the NMAA asked the Association for Computing Machinery if they could join ACM, as a group. The proposal was rejected.)

The Certificate Examination is open to anyone, whether an NMAA member or not, who (1) completes a prescribed course of academic study, (2) has at least three years of direct work experience in one or more punched card and/or computer installations, and (3) has high character qualifications. Until 1965, however, specific course requirements may be waived.

Among the prescribed studies under discussion are programming; numerical analysis; Boolean algebra; applications; elementary cost accounting; English, and basic mathematics (calculus optional.)

The certificate program was first planned in 1960 in consultation with a 13 member Advisory Committee. Representatives in business and education include Richard W. Hamming, past president of ACM and now with Bell Telephone Laboratories, Murray Hill, N. J.; Louis Fein, consultant; Harold R. Luxenberg, formerly with Thompson Ramo Wooldridge; David D. Merriman, past national president, Systems & Procedures Association; Norman F. Kallaus, assistant professor, School of Business Administration, State University of Iowa; and Harold R. Metcalf, dean of students, Graduate School of Business, University of Chicago. NMAA representatives on the committee included: L. W. Montgomery, past national president, and D. B. Paquin, past president, among others.

Since 1960, NMAA has attempted to formalize the course requirements and has arranged for the first Certificate examination which will be administered by an independent educational consulting and testing service. Additional testing sites and times are being scheduled for major cities.

The primary purpose of the Certificate is to advance the data processing profession by increasing the professional value of the individual. Its requirements are designed to meet the following objectives:

1. To emphasize a broad educational background as well as knowledge of the field of data processing.
2. To equip the individual to better understand larger management problems, stressing as well the person's need to communicate effectively.
3. To represent a standard of knowledge for organizing, analyzing and solving problems for which data processing equipment is especially suitable; hence, the emphasis on statistical and mathematical techniques.

Another important aim is to help establish educational standards for the dp profession. Says NMAA: "It is time to create an academic framework whereby individuals entering the field will have a guideline of study." At the same time, the Certificate requirements offer an important point of reference for those charged with the responsibility of designing secondary and higher educational programs. This is necessary, the Association continues, "if our colleges and universities are to meet government and industry needs for qualified data processing in the critical years ahead."

The nature of dp systems, the new emphasis on mathematical methods in business decision-making, and the projected national need for managers trained in techniques permitting them to make efficient use of advances in computers and communication devices, says NMAA, make a continuing program of higher education mandatory.

Further information on Certificate requirements and application forms for 1962 certification are available from local NMAA chapters or NMAA International Headquarters, 524 Busse Highway, Park Ridge, Ill. ■

DOCGEN

a documentation generator

by T. TANCER, Sophisticated Electronics, Inc.

The lag between the completion of a research or development program and the appearance of the documentation which makes the results of that program usable is becoming a serious problem and has attracted considerable attention. We have recently completed some work in this problem area which has led to a computer program capable of producing the required documentation with considerable sophistication. The purpose of this paper is to describe some of the basic ideas behind the project and the resulting program.

The document generator (henceforth referred to as DOCGEN) takes as its inputs a set of strings, in ordinary English, which roughly describe the work to be documented. This input is assumed to be far too imprecise and brief to be satisfactory for publication, but it is assumed to contain all of the major ideas resulting from the program. DOCGEN inserts additional material in the appropriate places, changes the symbology, and performs other transformations on this initial string to produce a document which compares favorably with the results of hand-coding.

The three most successful subroutines used in DOCGEN are of the types 'insert', 'translate' and 'misprint.' 'Translate,' which can call upon the other two subroutines, takes the input material and transforms it into something which has either greater precision or more heuristic content than the original input. 'Insert' places new matter inside the given material (or the result of applying 'translate') in order to provide the prospective reader with additional information. 'Misprint' is a variant of 'translate' which operates on individual words.

These subroutines, and several others which we shall not describe here, are called upon whenever the control routine encounters the appropriate pattern in the input string. Thus consider the following string:

(1) CONSIDER ALL THE COINS IN YOUR POCKET.

When this string is entered, the recognition part of the control routine immediately spots the word "ALL." This is fruitful ground for the routine 'translate' to which control is then switched. 'Translate' calls on one of its own subroutines 'sigma,' which, in turn attempts to take the whole sentence (The ends of sentences are spotted by searching for periods.) and replace it with a new sentence, or set of sentences, containing sigmas.

Suppose that in this particular case the appropriate information for the application of 'sigma' exists in the data file. This routine then automatically translates (1) into:

(2) Let C be the number of coins in your pocket of value .01 (henceforth called 'cents'), N be the number of coins in your pocket of value .05 (henceforth called 'nickels'), D be the number of coins in your pocket of value .10 (henceforth 'dimes'), and Q be the number of coins in your pocket of value .25 (henceforth 'quarters'). (We shall generalize these results to coins of higher denominations in a report to be issued subsequently.)

Define 'P(y)' (intuitively, the coins in your pocket) to equal: $\sum C, N, D, Q$
and define '\$(P(y))\$' as: $.01C + .05N + .10D + .25Q$

Now consider P(y).

Although these results are not as good as those achievable by the experienced coder, they do compare favorably with the work of the average human being.

The failure of 'sigma,' when an 'all' is encountered, turns control over to a routine called 'quantifier,' which, for the above sample (1) would produce the following output.

(3) Consider the set of $(\forall y)(y \in \text{COINS. } y \in \text{pocket} \rightarrow \text{pocket} \in \text{your pants})$

Both of these subroutines perform roughly similar functions: they translate an input which might possibly be understood into something which is both more difficult (and hopefully impossible) to understand and which impresses the cursory reader by looking formidable.

A considerably less sophisticated routine which we have included in our program is the routine called insert.

This routine is triggered by the recognition of a string for which the appropriate material exists in the data file. This recognition generally depends on the discovery of the appropriate word, but we have had considerable success with such routines which are based on the recognition of phrases. One might hypothesize that this is due to the fact that even in informal writing, standard phrases tend to be over-used. As an example of the utility of this routine even where recognition is of the less sophisticated type, consider the results of the recognition of the word 'computer' in the following string:

(4) WE OWN A COMPUTER.

This is transformed into:

(5) Modern high speed digital computers can perform a large number of operations and computations both accurately and at high rates of speed. These speeds are currently measured in microseconds, and faster speeds are anticipated. We own a computer. This high-speed, sophisticated data processing system is highly versatile, and can be used for both business and scientific computations. It is supported by a staff of highly skilled technicians and programmers, together with several programming systems which allow the user to utilize the machine without knowledge of the actual machine language.

'Insert' checks the history of the document being operated upon in order to determine that the inserted material has not been previously used.

'Misprint' is perhaps the simplest of the routines, and its operation is easily described. It contains a number of words together with other words which are obtainable by changing only single letters in the original. When an instance of one of these words is encountered the appropriate replacement is made. Furthermore, the material is scanned for mathematical formulae and additional parentheses and commas are inserted into these formula in a random manner.

Our initial runs of DOCGEN have been heartening and it has generated a number of documents which we have subsequently published. The program is recursive in the sense that it is capable of generating reports about itself. It was used to generate its own manual which has thus far proved a model of its kind. The first sentence produced, indicated that the manual was for experienced programmers only, and the next four pages presented a detailed summary of the vagaries of binary and octal notation. This part of the result alone produced an 86% impenetrability. (This figure was obtained by tests on 15 beginners and 13 expert programmers.)

We are currently working on a revised model of DOCGEN which we are referring to as 'DOCGEN II.' In this version we hope to iron out some of the bugs that have appeared in the current program that have appeared in the current program that have appeared in the current program that have appeared in the current program sdkler;l slkleris. (sic) ■

A COUNTDOWN FOR EDP INSTALLATIONS

monthly realism may help
curtail unsystematized chaos

When planning for the efficient installation and at least, an initially successful operation of an edp system, strict observance of the basic rules for virginal behaviour has long been one of the more chaotic chores facing the prospective user. While hardly the blissful, ultimate solution in organizing these machinations, the following monthly timetable may prove useful as a basic although admittedly, quite general guide.

Monthly sequential steps are not necessarily delineated in strict order, and the individual user may find certain stages incompatible with a particular objective. This of course, is a matter of the specific situation in addition to personal judgment and experience. For example, in the final phase, "Delivery Plus 1," it has been noted by some observers that the check points may prove a shade too premature and it has been suggested that they be moved ahead to "Delivery Plus 2."

This timetable was originally published by RemRand as part of a "Conversion Planning Manual" for UNIVAC users.

Delivery Minus 10

- Tentative delivery date established.
- Organization charted and Computer System Manager appointed.
- Over-all objectives defined.
- Announcement made to company employees.

Delivery Minus 9

- Systems analysts and programmers selected.
- Training programs initiated.
- Applications priorities established.

Delivery Minus 8

- Installation site selected and equipment layout planned.
- Budget established.
- Training completed; analysis and systems design initiated for first application.

Delivery Minus 7

- Physical installation plans reviewed by manufacturer's site-preparation engineer.
- Process chart completed; detailed flow charts and experimental programming initiated with feedback to analysts.
- First reviews of systems design with executive committee, department heads, and outside auditors.

Delivery Minus 6

- Systems design and programming continued.
- Forms design initiated.
- Physical installation plans approved; duct work ordered and electrical wiring started.
- Operators selected, and training initiated.

Delivery Minus 5

- Systems and forms design frozen.
- Programming continued and desk checking initiated; first estimate made of daily system utilization.
- Spare parts and test equipment requisitioned.

Delivery Minus 4

- Programming completed and testing initiated.
- Test data for comprehensive systems check prepared.
- Conversion plans initiated and conversion runs charted.

Delivery Minus 3

- Systems-check on test data; estimates of daily system utilization revised.
- Systems-check results reviewed for adequacy of audit, trial accounting controls, error recovery, and rerun points.
- Personnel and equipment requirements estimated for conversion of master and reference files.
- Departmental reorganization planned and charted.
- Procedure-writing for affected departments initiated.

Delivery Minus 2

- Program-testing and correction continued; improvements to be incorporated after cutover recorded.
- Final reviews with executive committee, department heads, and outside auditors.
- Tentative schedule for computer operation and preventive maintenance drafted.

Delivery Minus 1

- Cutover and parallel running planned.
- Training initiated for personnel in affected departments.
- Temporary quarters arranged for parallel running.
- Conversion of master and reference files initiated.

Delivery Month

- Equipment installed.
- Systems-acceptance test performed.
- Parallel running initiated.
- Initial application cutover.

Delivery Plus 1

- Management review:
 1. Results compared with objectives.
 2. Budgeted costs compared with actual costs.
 3. Statement of present operating costs drafted.
 4. Recommendations for future activities studied. ■

B. F. Goodrich runs program on 501, 225 & 1410 in

A COBOL CONVERSION TEST

A COBOL program has been run on three different dp systems by the B. F. Goodrich Chemical Co., Cleveland. Computers used were an RCA 501, GE 225, and an IBM 1410. The original program was prepared for the 501 and successfully converted to the 225 and 1410.

The COBOL programs were part of an analysis conducted by BFG Chemical to study the feasibility of integrating many of its accounting procedures and operation functions by the use of dp equipment. Computer facilities of the parent company, B. F. Goodrich Co., Akron, Ohio, were used to analyze eight medium-sized computers.

The program run on the computers involved up-dating of an inventory file and the printing of a complex inventory shortage report, and consisted of 220 data divisions and 394 procedure division statements. The test was said to result in an accurate comparison of COBOL compiling time, object program running time, COBOL diagnostics and printouts, as well as the efficiency of memory utilization. The test also defined which computers had operable COBOL compiling systems.

Another phase of the evaluation program included a detailed analysis of fifteen of BFG Chemical's accounting

and operating areas. The work included the diagramming of the interrelationships of all existing paper work as well as detailing the volume sizes and frequency of transactions. From this, computer run charts for thirteen integrated systems were developed involving about 100 machine runs. Running times were estimated for the eight systems resulting in an estimated monthly operating time for each system. ■

RW-300 WILL CONTROL LA TRAFFIC FLOW

A Thompson Ramo Wooldridge RW-300 will soon be used to help control vehicular traffic in Los Angeles. From a control center in City Hall, the system will monitor four miles of Sunset Blvd. and regulate traffic signals in response to traffic flow.

The pilot system, said to be the nation's first use of a dp system by a city for traffic signal control, will be gradually expanded to control more of the critical intersections in congested areas.

In operation, the RW-300 will receive traffic volume and movement information, transmitted by telephone lines, from automatic detectors located within and at the borders of the controlled section. By using this data and an analysis program stored in memory, the computer will continuously decide on the best settings of the traffic signals. These decisions, transmitted back to the intersections, will control the signals to provide the most effective flow of traffic.

Each controlled intersection will have its own local controller, which will time clearance intervals, pedestrian walk intervals, and other fixed-length intervals. The computer, in turn, will control the green intervals at each intersection, informing the local controller when to establish the signal pattern appropriate to existing conditions in the over-all traffic flow.

Twenty-six signal lights along Sunset Blvd., and ten lights on approach streets, will be controlled initially by the system. ■

THE 900 SERIES

by HENRY L. HEROLD and MAX PALEVSKY
Scientific Data Systems, Santa Monica, Calif.

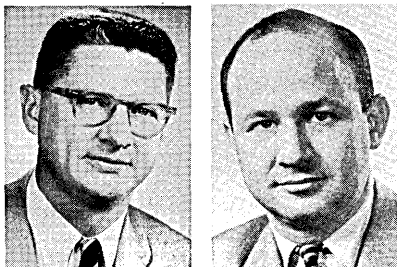

The Scientific Data Systems 900 series consists of three general-purpose digital computers—the 910, 920, and 930. This paper primarily describes the first two, the 930 is only briefly treated. All

the computers in the series are intended both for special purpose system integration and for general purpose scientific use. All sell for under \$100,000.

"symbolic homogeneity" from SDS

The computers operate with a 24-bit binary word; a twenty-fifth bit provides a parity check on all memory operations. Fourteen bits of the instruction serve to address up to 16K words of random access core storage; 6 bits are used for the code. One bit is used to signify that the address is indirect; that is, that the effective address is to be found in the location specified by the address portion of the given instruction. The location thus specified may, in turn, contain an indirect address bit. The number of iterations of this process is not limited. Another bit adds the contents of an index register to the address prior to execution of the instruction. If an indirect address bit is present, the effective address is found in

the location that results *after* indexing. A relative address bit is also provided in order to simplify the loading of subroutines, etc. The final bit in the instruction is used to signify that the op code is to be interpreted as a Programmed Operator. This requires some explanation.

There are many practical advantages to be gained from designing a series of computers such that programs for any given computer—within the limitation of memory size—can be run by any other computer in the series. For example, within a given facility a number of different computers can be employed, each of an appropriate size. If any one of these is unavailable, another can be directly employed without extensive reprogramming. This program compatibility is relatively simple to mechanize if the programs from a “smaller” computer are run on a computer with an instruction repertoire that, loosely speaking, contains the “smaller” computer’s instructions as a subset. It is the inverse problem that the Programmed Operator is intended to solve. The presence of the Programmed Operator bit causes the op code to be interpreted as a subroutine entry address. Thus, “larger” computer instructions that do not exist in the “smaller” computers are interpreted directly by subroutines in the “smaller” computers. As a result, all programs for the 900 Series are interchangeable—that is, the computers are “Symbolically Homogeneous.” An example will perhaps clarify the use of this term. All three 900 Series computers use different multiply commands. The 910 has only MULTIPLY STEP, the 920 has MULTIPLY, while the 930 has FLOATING POINT MULTIPLY as well as MULTIPLY. In running a 930 program on the 910, for example, the FLOATING POINT MULTIPLY command is identified by the loader as a programmed operator and, upon execution of this command, the op code is interpreted as the address to which the program transfers in

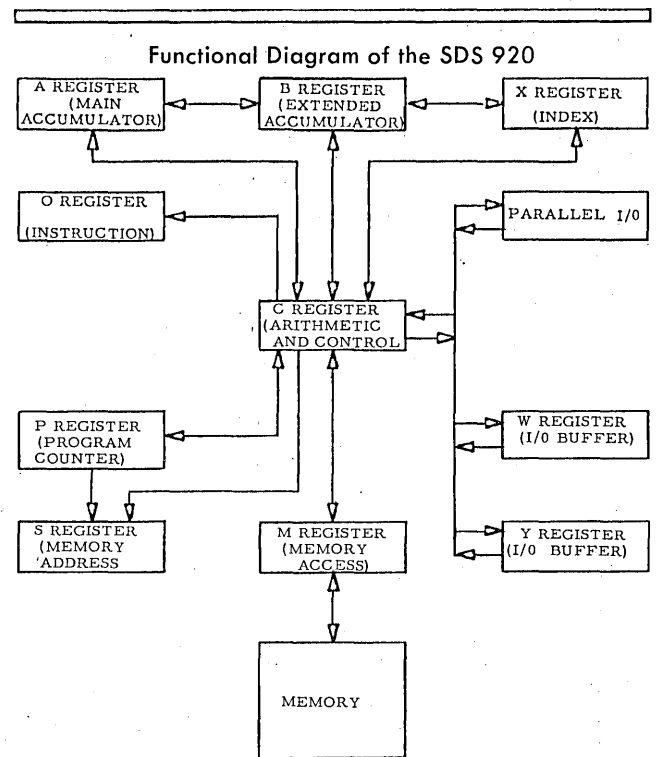

The 920 with typewriter, 300 cps paper-tape reader, spooler, and 60 cps paper-tape punch. This console contains up to 16K words of core storage. Console designs of the 910 and 930 are similar to the 920.

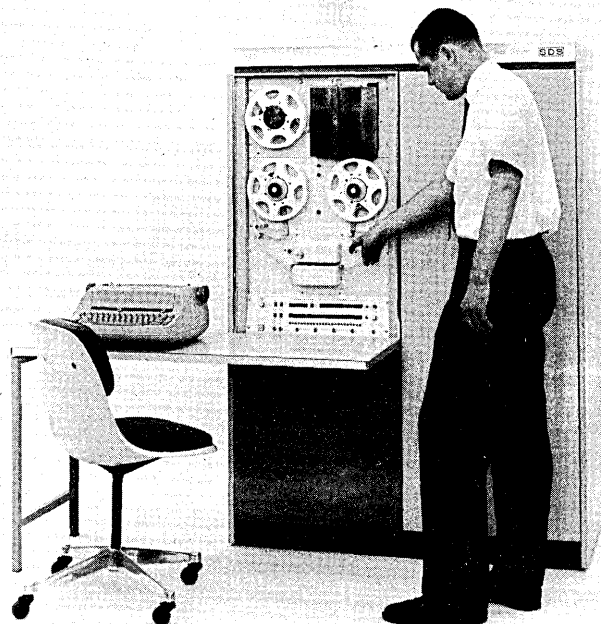

order to pick up the appropriate floating point multiply subroutine.

In addition to providing Symbolic Homogeneity, the programmed operator serves to “extend” the command list of any of the 900 series computers for a given application. For example, in some classes of programs, complex arithmetic instructions are useful. The symbol, “ADJ” (Add Complex), can be assigned an instruction code and the address portion used to specify the location of the real part of the operand. The imaginary part is stored in the adjacent memory cell. This instruction code will cause a program transfer to the subroutine while storing the return address.

Although all programs are interchangeable, the time and memory requirements for a given problem vary among the three computers. The basic execution time for addition is 16 microseconds for all computers, including indexing and all memory accesses. The 920 requires 128 microseconds to produce a 47-bit product from two 24-bit factors including memory accessing and indexing; the 910 requires 628 microseconds. The floating point (39-bit mantissa, 9-bit exponent) subroutine set requires 120 words and approximately 800 microseconds per floating point operation in the 920, while the 910 requires 180 words and approximately 300 microseconds per instruction.

Input/Output is probably one of the most critical design problems in low-cost computers that are to be used for both special purpose systems and general purpose scientific computing. All 900 Series computers have identical I/O logic which incorporates five separate methods of operation:

1. Single Bit Control

Up to 16,000 different control signals can be generated or tested by the 900 series computers. For example, a single instruction starts a specific magnetic tape unit, indicates the number of characters per word, and the buffer that is involved. A single instruction can also test the state of the Breakpoint switches, the parity error detector, or any other signal and skip as a function of the result.

2. Input/Output-Buffer

A full word plus one character buffer is provided which accepts and transmits words between the memory and external devices. The extra character minimizes timing problems and so increases programming efficiency. The buffer operates upon characters of up to seven bits, generates and checks parity, and operates simultaneously with computation. A program interrupt is provided to facilitate this simultaneous operation. The program control automatically transfers to an I/O processing routine when the buffer either is empty during output or contains a word during input. Using this scheme, 15 KC character rate magnetic tape information can be processed while permitting the computer to operate 64% of the time on other programs. The maximum transfer rate is 41.6 KC. Because the buffering hardware is integral to the computers, the cost of the 15 KC mag tape units for the 900 series are under \$20,000.

As an optional feature, a second and identical buffer is available for applications that require simultaneous input and output. Using this buffer, for example, a gapless magnetic tape can be read and an IBM-format tape written, simultaneously, at a rate of up to 5 KC.

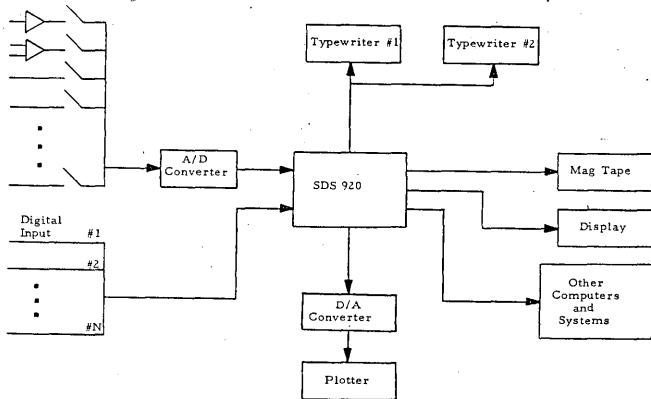

Typical Data Acquisition System

3. Parallel Input/Output

In operating with certain devices such as printers, analog-to-digital converters, and display systems, it is more convenient to process words rather than characters. For these cases, the computer can transmit or accept 24 bits in parallel along with an interlock signal to synchronize the transfer. A twenty-fifth bit is provided for parity information. Using this parallel transfer method, several 900 series computers can be interconnected to perform complex tasks that are beyond the capabilities of any single computer in the 900 series. The maximum transfer rate is 62,500 words per second.

4. External Memory Interlace

The memories of the 900 series computers can be time-shared between the computer proper and external devices.

Prior to accessing memory for each instruction, the computer automatically tests to see if an external device—such as a magnetic tape unit—requires access to the memory for either input or output. If access is required, the computer is halted for the 8 microseconds necessary to transfer a word and computation is then resumed. Character transfer rates of up to 124 KC are possible with the computer operating and 500 KC with the computer in HALT. An unlimited number of buffered I/O devices may be connected to a 900 series computer using this technique. A 30 KC magnetic tape unit with automatic search is one such device that is available.

5. Priority Interrupt

An optional feature of the 900 series is a priority interrupt system with up to 1024 channels in blocks of 16. Each channel causes the computer to interrupt to a unique memory location. Each channel has an assigned priority status such that, when it is activated, it causes the interruption of previous interrupts of a lower status and, in turn, it is interrupted by channels of higher status.

The number of I/O devices that can operate with any of the 900 series computers is essentially unlimited. Any number and combination can be employed. In addition to the magnetic tape units already discussed and the high-speed, paper-tape punch and reader and typewriter provided as standard equipment, card readers, printers, disc files, analog-to-digital converters, and digital-to-analog converters are available.

Special power failure protection is provided on all computers. Special sensing devices sense the status of the A.C. input line before each memory operation and halt the computer if the line is low or if power has failed. With priority interrupt, this sensing system can be used to store all registers before the D.C. power fails. The computer can then simply be restarted when power is again available.

A typical system that illustrates the speed, memory efficiency, and I/O flexibility of the 900 Series is the general data acquisition and evaluation problem. Analog data is multiplexed and converted to digital form under the control of the computer. The resultant data is entered into the computer and compared with high and low limits. A linear transformation is then performed in order to eliminate zero and full-scale errors and, at the same time, to translate the raw data into engineering units. The program to perform these operations requires 29 instructions in the 910 and approximately 600 microseconds per point. In the 920, 17 words and 300 microseconds per point are required.

In construction, the 900 series is unique for non-military computers in that only silicon semiconductors are employed. The 910 uses approximately 900 transistors and 800 watts of power, while the 920 has 1100 transistors and requires 1000 watts. No air conditioning is needed in either case since the computers will operate in ambients of from 0° to 55°C.

The software system for the 900 Series will include a utility package, symbolic assembler, and a FORTRAN-compatible compiler. The latter is similar to the IBM 1620 FORTRAN II compiler with the addition of magnetic tape statements. Again, because of the Symbolic Homogeneity of the 900 Series computers, any of the computers can be employed for compiling and the resultant object program run on any other of the computers.

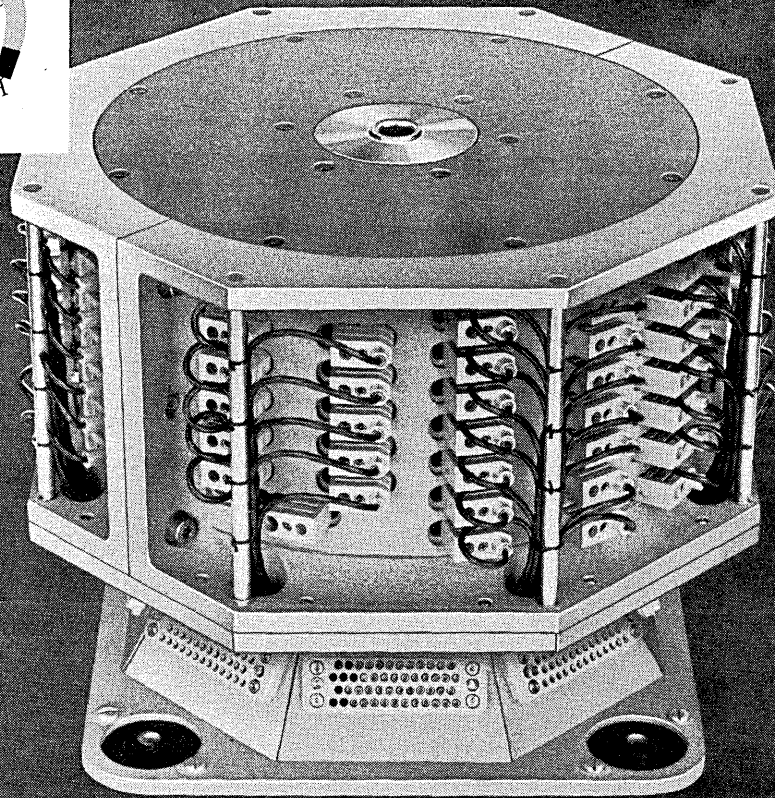
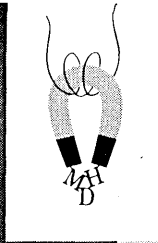

ADAPTABILITY

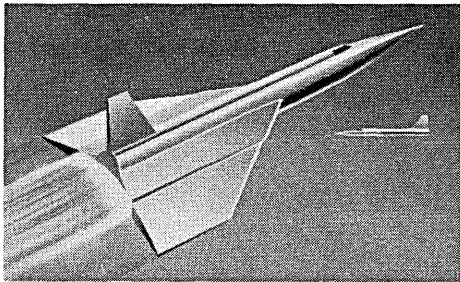

ADAPTABILITY MEANS MAGNE-HEAD...

this same basic drum is engineered so that a minimum of modification allows for it to be utilized in both aircraft and ground installations. It is capable of meeting both military and commercial specifications. Engineering adaptability is a byword of Magne-Head in the development of drums.

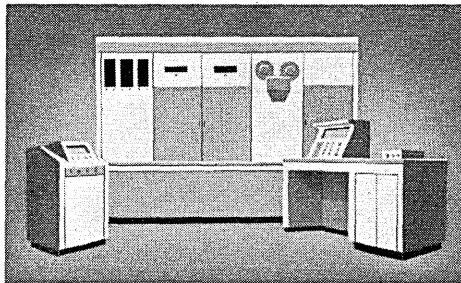

SPECIFICATIONS:

Diameters to 20 inches.

Lengths to 30 inches.

Frequencies to 1 megacycle.

Contact or non-contact heads.

Nickel cobalt or iron oxide coatings.

Head inductance as low as 40 μ h.

Bit capacities to 15 million manchester.

ADAPTABILITY + FLEXIBILITY + CAPABILITY = MAGNE-HEAD

*Magne-Head Division of General Instrument Corporation
3216 West El Segundo Boulevard, Hawthorne, California*

THE SPRING JOINT COMPUTER CONFERENCE

**37 papers selected;
3,500 registrants expected**

A technical program offering 37 papers in 11 sessions has been set for the 1962 Spring Joint Computer Conference at the Fairmont Hotel in San Francisco, May 1-3. Sponsor of the conference — which is expected to attract more than 3,500 registrants — is the American Federation of Information Processing Societies.

Dr. Richard I. Tanaka, manager of Computer Systems-Logical Design for Lockheed Missiles and Space Co., Palo Alto, Calif., is technical program chairman. He explains that the professional presentations at the conference will focus on new developments, suggest trends, and, in general, try to "nail down" the contributions computer technology are expected to make in the near and distant future.

Accordingly, one session entitled *Peace and the Role of Computers* will describe the hypothetical role computers may take in man's search for world peace. Dr. Louis Fein, Palo Alto, Calif., consultant, will serve as chairman for this symposium.

Assisting Dr. Tanaka in developing the conference program are Dr. Robert S. Minnick, senior research engineer at Stanford Research Institute, vice chairman John E. Sherman, manager of Analog Computing for Lockheed at Sunnyvale, Calif., associate chairman; and R. J. Andrews, Industry Analysis manager for IBM, San Jose, Calif., chairman of a special education program.

In addition to the "peace-by-computer" symposium, the sessions and chairmen are as follows:

Computer Systems, James H. Pomerene, IBM Research Center, Yorktown Heights, N. Y.; *Circuits and Memory Devices*, Jack I. Raffel MIT, Lincoln Laboratory, Cambridge, Mass.; *Information Retrieval*, Jacob Goldberg, Stanford Research Institute, Menlo Park, Calif.; *Man-Machine Cooperation*, Dr. Douglas C. Engelbart, Stanford Research Institute.

Theoretical Problems in Artificial Intelligence, Russell A. Kirsch, National Bureau of Standards, Washington, D. C.; *Data Analysis and Model Construction in the Study of the Nervous System*, Dr. Belmont G. Farley, MIT Lincoln Laboratory; *Programming and Coding*, Dr. Bernard A. Galler, University of Michigan Computing Center, Ann Arbor.

Study of Business Systems, Dr. Frederick M. Tone, Graduate School of Business, Stanford University; *DDA and Hybrid Computation*, Dr. Harold K. Skramstad, Naval Ordnance Laboratory, Corona, Calif., and *Analog Applications and Techniques*, Vernon L. Larrowe, Analog Computing Laboratory, University of Michigan.

In the exhibit hall, at least 65 firms, including 18 full frame manufacturers, have contracted for space in some 130 booths. Nine firms will occupy four or more booths. These are: Ampex; Bendix Computer; Collins Radio Co.; Digital Equipment Corp.; GE Computer Dept.; IBM;

National Cash Register Co.; Packard Bell Computer; and RemRand Univac.

Exhibiting from three booths will be each of the following: AT&T; Control Data Corp.; Digitronics Corp.; Friden, Inc.; General Dynamics/Electronics Information Technology Div.; Philco Computer; and Telex, Inc.

Other exhibitors will include: Aeronutronic; Anelex; Applied Dynamics; Berkeley Div. of Beckman Instruments; Brush Instruments; Bryant Computer Products; Bureau of National Affairs; California Computer Products; C-E-I-R; Comcor; Computer Control Co.; Computer Systems; Consolidated Electrodynamics Corp.; DATAMATION; Datapulse; DI-AN Controls.

Electronic Associates; Electronic Engineering Co. of Calif.; Electronic Memories; Engineered Electronics Co.; Epsco; Fabri-Tex; Fairchild Semiconductor; Indiana General; IT&T; Kearfott Division General Precision; Laboratory for Electronics; Litton Systems; Memorex Corp.; Midwestern Instruments; Moxon Electronics; Omnitronics.

Photocircuits; Raytheon; RCA Semiconductor and Materials Div.; Rheem Electronics; Royal McBee; Scientific Data Systems; The Service Bureau Corp; Soroban Engineering; Standard Instrument; Talley Register; Teletype; John Wiley & Sons; Data Display; DYMEC, div of Hewlett-Packard; Ferranti Electric; Invac; and Rotron Mfg. Co. ■

Next Month in DATAMATION

The 1962 Spring Joint Computer Conference will be featured in a special, 16-page section with a complete technical program, list of exhibitors and unusual sidelights to the three-day conference.

Also on tap for April is a study of the sociology of computerites in the East vs. West, a critical treatment of ALGOL vs. FORTRAN, a major user's plans for COBOL implementation, and a statistical round-up of current and proposed university installations of computing power.

On the lighter side, *Datamation* readers will share the visitations of a breakthrough hardware salesman (pardon—systems engineer) on an impatient and somewhat tender, prospective user.

THE 15th ANNUAL SOUTHERN CALIFORNIA BUSINESS SHOW

data acquisition equipment featured

□ "Programming for Progress" is the theme of the 15th Annual Southern California Business Show, scheduled for the Ambassador Hotel in Los Angeles, March 20-23.

Electronic data processing will hold the spotlight at the show, in which more than 60 exhibitors will display their wares in over 12,000 sq. ft. of floor space. The show is said to be the largest of its type held on the West Coast. An attendance of more than 15,000 is expected.

Sponsored by the Los Angeles Chapter of the National Association of Accountants, the Southern California Business Show will present the latest developments, both in equipment and techniques, designed to solve problems encountered in business data gathering, recording, and processing.

Members of the show committee include: general chairman, William C. Hallett, Ernst & Ernst; business manager, John H. Bergstedt, Arthur Andersen & Co.; director of sales, H. Warren White, Ernst & Ernst.

More than \$5 million worth of equipment and services will be shown. Show hours are from noon-10 p.m. daily.

THE EXHIBITORS

□ The following manufacturers will display equipment at the Southern California Business Show which will be of particular interest to members of the data processing industry (booth numbers in brackets and a map of the exhibit area is on the following page):

Addressograph-Multigraph Corp.: data recorders; optical code reader. (28-31).

C-E-I-R, Inc.: computing services. (110)
Friden, Inc.: Model 30 Collectadata system. (100-106)
IBM: 1009 data translation unit; 1013 card transmission terminal; 1401; 1410; 7702 mag tape transmission terminal; 357 data collection system; 372 manual entry system. (1-4)
Monroe Calculating Machine Co.: Monrobot XI. (23-24)
National Cash Register Co.: 390 with 385 parallel reader. (51-57)
Pacific Telephone Co.: data transmission equipment.
RCA: EDGE system; 301. (70-76)
RemRand: UNICALL and UNIVAC Unisaver; Teller Set 490. (49-50)
Service Bureau Corp.: contract services. (16-17)
Statistical Tabulating Corp.: data acquisition services. (82-83)
Victor Comptometer Corp.: comptometers. (39-40)

other exhibitors include:

American Photocopy Equipment Co.; Audograph of California; Auto-Typist Automatic Typewriter Co.; Bohn Business Machines, Inc.; Burroughs Corp.; Business Systems, Inc.; Charles Bruning Co.; Cummins-Chicago Corp.; Doodle Pad Co.; Dura Business Machines; Elite Stenorette; Filing Systems Co.; George E. Montgomery Co.; Gestetner Corp. of California; Griswold Inc.; International Office Machines; Kelly Girl Service.

Milo Harding Co.; McKenzie Co.; Rex-Rotary Distributing Corp.; Robotyping Co. of California; Smith-Corona Marchant, Inc.; Stenocord Dictation Systems; Tab Products Co.; Thermo-Fax Sales, Inc.; Totalia; Underwood Corp.; Vari-Typer Corp.; Xerox Corp.

FLOOR PLAN OF EXHIBITS

Ambassador Hotel—Los Angeles

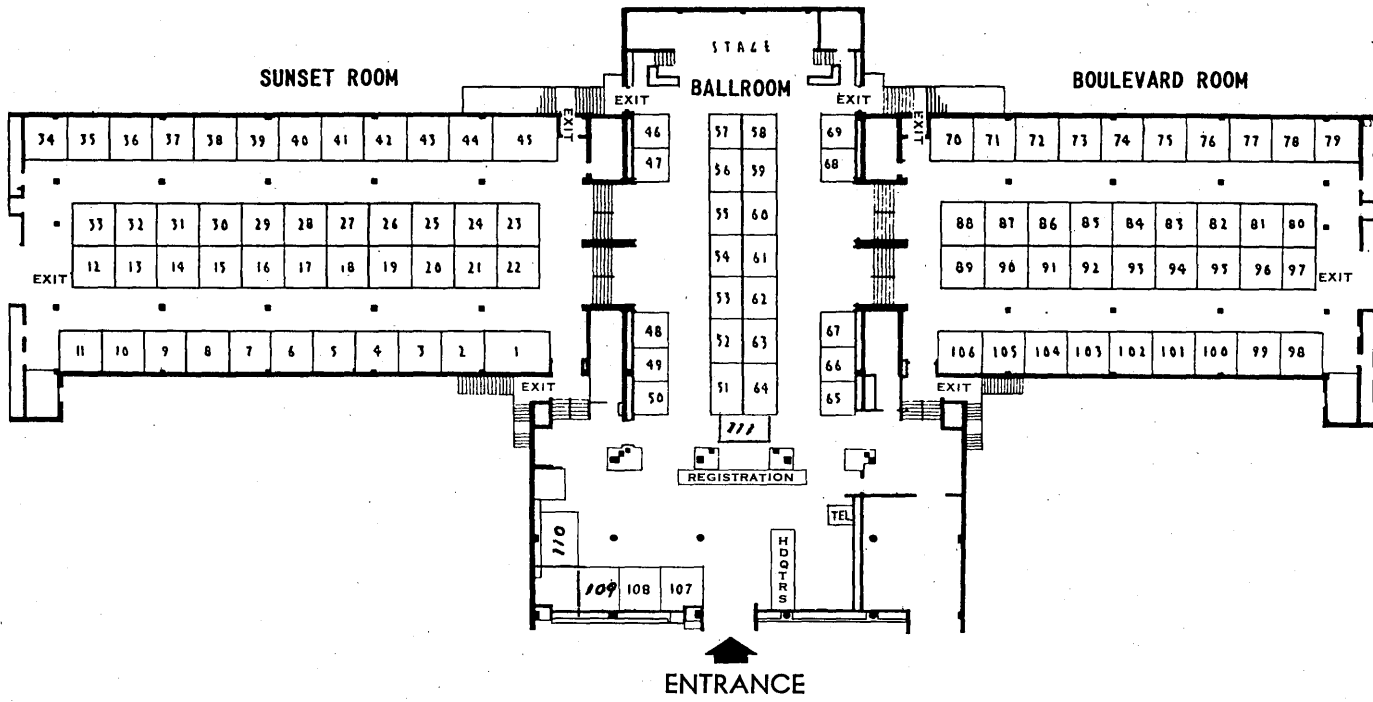

EDP HIGHLIGHTS AT BEMA SHOW

40,000 expected to attend

An attendance of about 40,000 is predicted for The Business Equipment Exposition which opens April 9th at Chicago's McCormick Place exhibition hall. More than 70 leading manufacturers of business machines, equipment and related supplies, will display their products.

Sponsored by the Business Equipment Manufacturers Association, the show will run from April 9 through April 13, noon to 10 p.m. daily. Nearly \$300 million of machines and equipment will be presented. Among the firms scheduled to exhibit in the field of edp are: AT & T; Friden; IBM; Monroe Calculating; National Cash Register; RemRand; and Victor Business Machines.

A number of meetings in conjunction with the exposition are scheduled. On April 6, the Chicago Executive's Club will hear RemRand's J. P. Eckert on "Executives 100 Feet Tall," which will cover the history, current position, and future of dp.

On April 9, the National Machine Accountants Association will meet to discuss "Data Processing as a Profit

Center." Panel members will be users of dp equipment.

The Business Equipment Manufacturers Association (BEMA) will convene on April 10 for their spring meeting. In the morning, separate meetings will be held by the Data Processing Group; Office Machinery Group; and Office Equipment Group. A general meeting will be held in the evening.

On the following day, a panel will discuss how the Common Market will affect business machine manufacturers. Scheduled panelists are H. W. Bertine, VP, Underwood Corp.; George Haynes, VP for overseas operations, National Cash Register Co.; W. E. Cornelius (or Richard Oberly) foreign operations, Sunbeam Corp.; and J. W. Sundelson, planning assistant to the vice president, Ford International Corp.

Neal J. Dean, of Booz, Allen & Hamilton will address the luncheon meeting on the future of EDP. The group's banquet will feature a talk by Walter Finke, president, EDP Div., Minneapolis-Honeywell.



733 130 00 106 70
 801 200 122 211.4
 672 150 888 600.8
 80 15 10 58 1030.2
 340 26 700 838 30
 50550 499 637 30
 245 00 105 05 22.0
 500 747 50 57 47.0
 986 650 57 70 88.8
 644 00 66 60 02.4
 356 00 56 62 40 4.0
 340 888 86 20 48.3
 678 00 60 60 63 6.0
 377 800 00 400 9.9
 130 00 203 60 65.3
 725 600 65 00 5 4.2
 306 700 0 10 6 72.7
 568 688 88 71 85.8
 75 432 11 11 2 00.0
 765 00 87 60 32 1.1
 760 50 32 11 10 35
 133 67 45 70 76 75
 642 50 58 72 73 0.2
 256 02 05 62 60 6.0
 256 07 72 46 53 15
 777 260 33 70 49
 350 04 45 52 0 4 10
 350 65 16 03 60 8.0
 732 770 60 56 65.3
 542 36 76 60 6 7 4.3
 865 45 65 43 45 6.7
 867 16 88 53 1 4 6.7
 542 32 77 57 93 4.9
 545 88 55 03 02.4
 876 54 33 45 6 78.6
 578 05 86 07 29 3.3
 673 67 31 58 27 3.2
 684 66 85 8 48 99.8
 123 45 67 89 8 76.5
 987 65 43 21 23 4.5
 236 08 40 63 34 4.4
 579 64 47 89 6 4 4.7
 405 99 30 36 90 6.4
 808 68 68 04 80 9.9
 568 57 93 69 75 6.8

1048

3 3 4 5 6 7 8 9 0 4 1
 3 4 6 7 8 9 0 1 2

Data processing design problem: FOOLPROOF FIGURES

Thanks to the figures above, designed by the NCR Electronics Division, computer systems can now read "on sight" the printed output of cash registers and business machines. As a result, data processing systems have a key to greater speed, efficiency and economy.

A unique double code within the figures eliminates the problem of incorrect readings. This code, by making the characters self-checking, also permits important reductions in the cost and complexity of the reading equipment. Even though ink splashes, skew and weak print conspire constantly to "fool" the system, infallible recognition is now possible with relatively simple equipment — at laboratory speeds to 11,000 characters per second!

CAREERS NOW OPEN IN THESE COMPUTER AREAS:

- SOLID STATE CIRCUIT DESIGN
- TRANSISTOR CIRCUITRY
- SYSTEMS ENGINEERING
- SYSTEMS TEST ENGINEERING
- PRODUCT ENGINEERING
- PRODUCT DESIGN ENGINEERING
- RESEARCH ENGINEERING

PLEASE SUBMIT RESUME IMMEDIATELY TO ARRANGE FOR INTERVIEW DURING I.R.E. CONVENTION, MARCH 26-29, IN NEW YORK. Write to Norval E. Powell, Director of Industrial Relations, at the address below.



The National Cash Register Company
ELECTRONICS DIVISION
1401 E. El Segundo Blvd., Hawthorne (Los Angeles), Calif./Phone PL 7-1811

New asynchronous* me reliability, qu

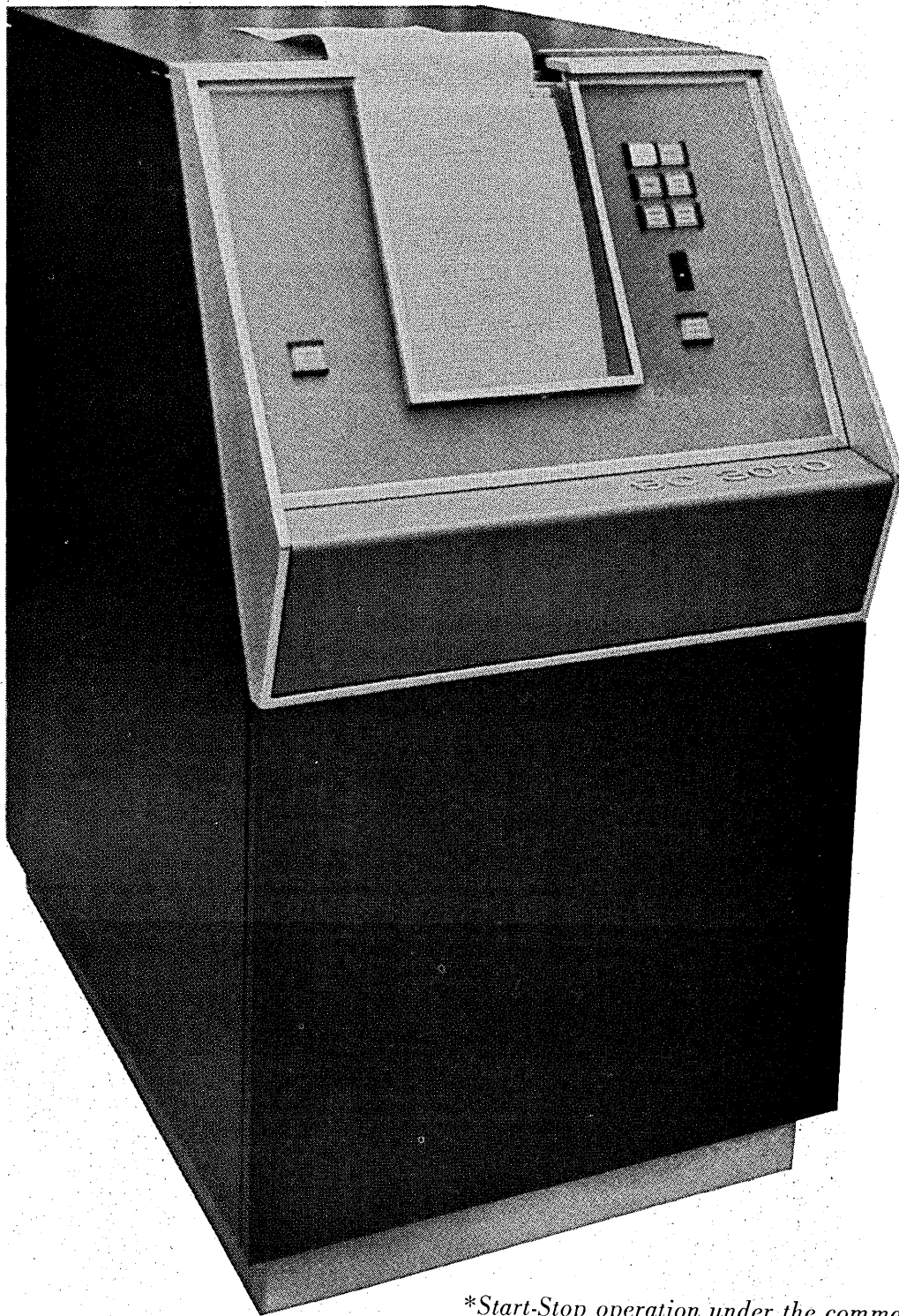

**Start-Stop operation under the command of input data.*

Message printer combines quietness and high speed

The S-C 3070 message printer utilizes an electrostatic process to produce highly legible, permanent copy. The printer is designed to operate at speeds up to 3000 words per minute using standard computer or communications codes over telephone, telegraph and microwave links. ■ Compact dimensions and quiet operation make the S-C 3070 ideal for offices and communications or command centers. Multiple copies of S-C 3070 printer output can be easily obtained by using the original as a litho offset master or by standard office copying methods. ■ Reliable, unattended operation in the S-C 3070 results from the unit's non-impact printing concept and field proven electronic circuitry. Ease of maintenance is assured through modular design and readily replaceable printed circuit boards. Replacement paper rolls can be loaded into the S-C 3070 without interrupting operation or interfering with message transmission. The S-C 3070 finds many applications in military, government, and commercial communications systems — and in the data processing field. ■ For additional information on the S-C 3070, write to Department C-24, General Dynamics | Electronics, P.O. Box 2449, San Diego 12, Calif.



GENERAL DYNAMICS | ELECTRONICS **G | I | I | I | I | I | I | I | I | I | D** SAN DIEGO

HOW PRECISE IS EP COMPUTER AUDIOTAPE Extra precise. An unscientific term but an accurate one. We know EP Computer Audiotape is extra precise (which is what EP stands for) because every step in its production is directed toward that end. From raw material to sealed container, this computer tape is measured, checked, controlled, inspected, tested. Automatic Certifiers record and play back every inch of every reel and if just one test pulse out of 40 million doesn't reproduce properly out goes the entire reel. On high density tapes, it takes 112 million perfect pulses to qualify. Is it unreasonable to call this extra precision? Try EP Computer Audiotape.

AUDIO DEVICES INC., 444 MADISON AVENUE, NEW YORK 22, NEW YORK

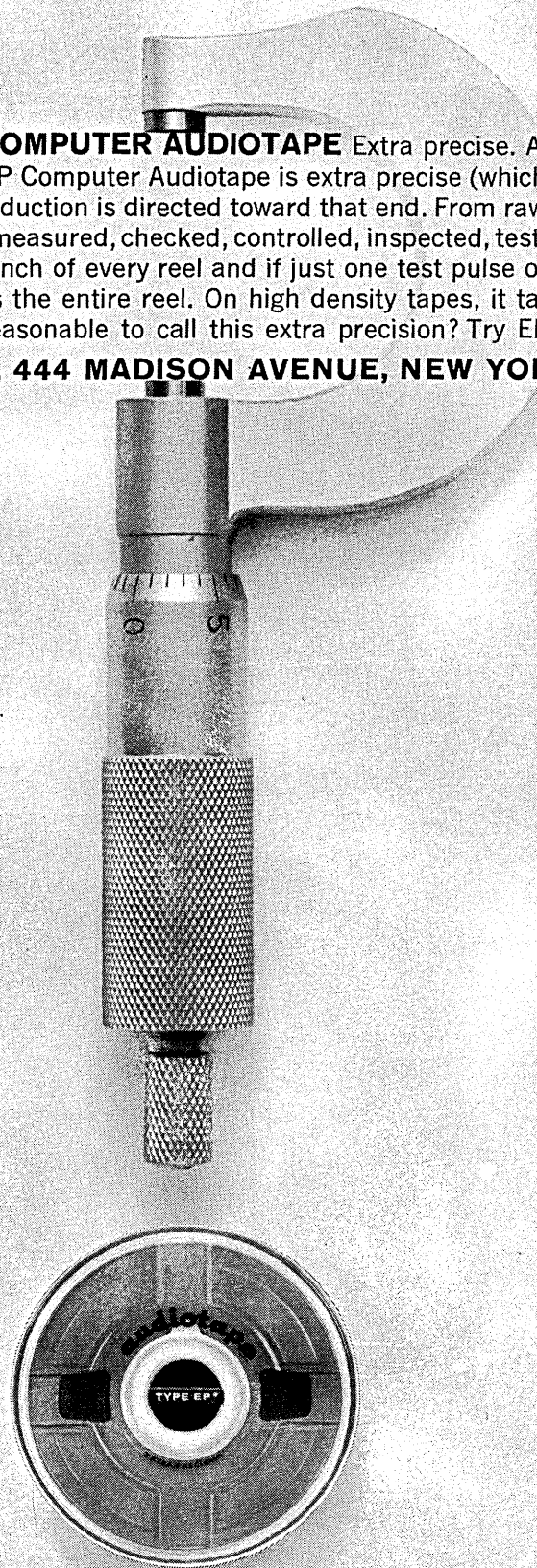

PROFIT ENGINEERED

The Bendix G-20 computing system—an integrated, advance-design hardware-software package—is profit engineered to bring you maximum results per dollar invested. ■ Designed concurrently, G-20 hardware and software blend into a system which allows you to simultaneously process engineering and business programs. Under executive program control, program priorities are automatically established. Automatic too is memory allocation and the assignment of high-speed communications channels and input-output devices. This means that your G-20 always represents the maximum-efficiency operational configuration for the jobs at hand ...without reprogramming or manual intervention. ■ The G-20 was designed for maximum uptime and ease of operation, too. Seeing that you take full advantage of G-20 speed and power is a large staff of automatic programming specialists and a nationwide team of application experts. Complete physical system support—from pre-installation planning through installation and continuing maintenance—is provided by Bendix Computer service specialists. ■ It all adds up to maximum results per dollar invested. Investigate the proven, installed G-20 at once...see how this profit engineered system can help you effectively reduce your data processing costs. Call your nearest Bendix Computer office or write: Bendix Computer Division, 5630 Arbor Vitae Street, Los Angeles 45, California. Dept. E-38.

Bendix Computer Division



THE BENDIX G-20 COMPUTING SYSTEM

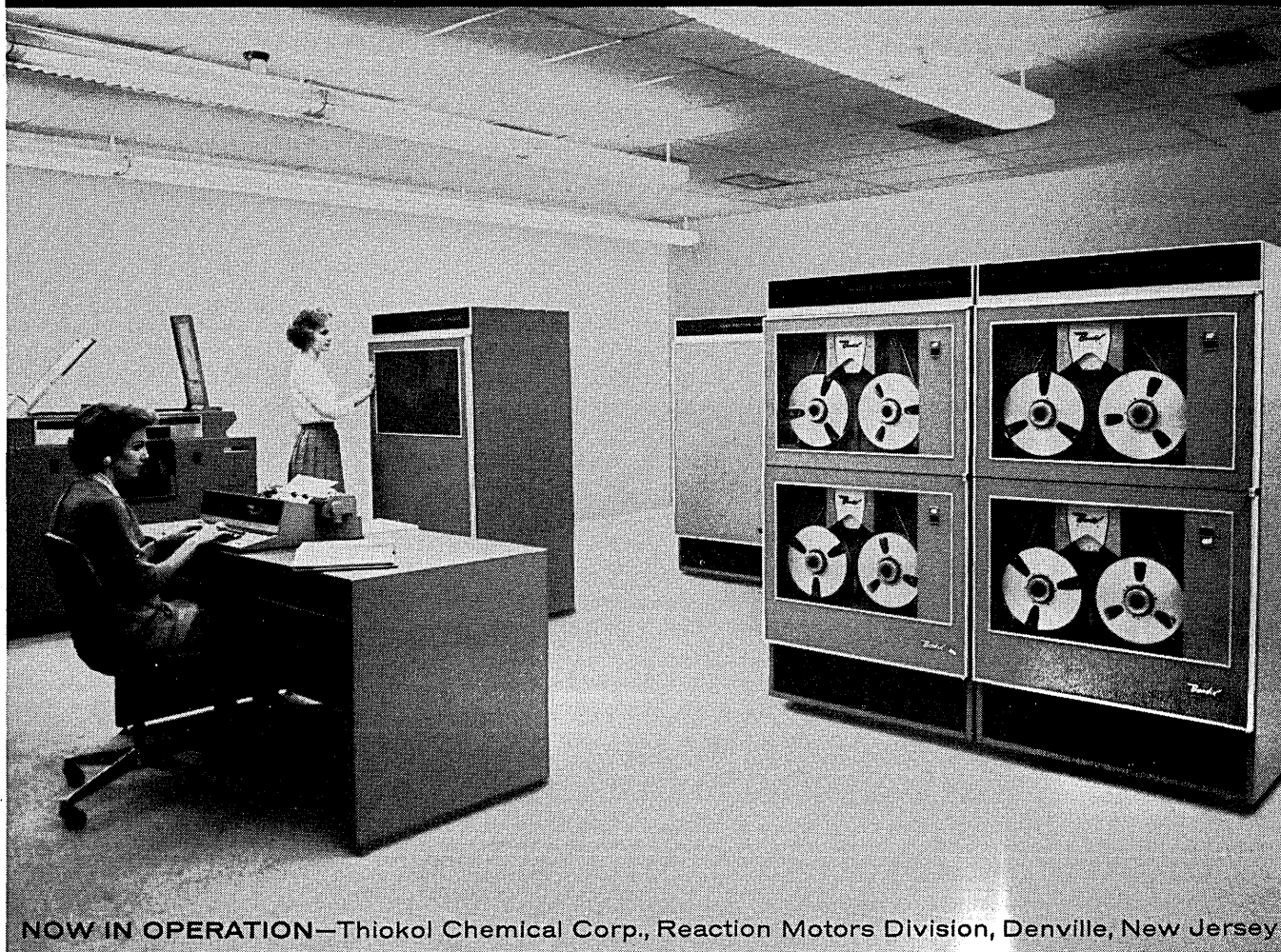

NOW IN OPERATION—Thiokol Chemical Corp., Reaction Motors Division, Denville, New Jersey

**SAVE
TIME...
SAVE
MONEY...**

CONVERT
THIS

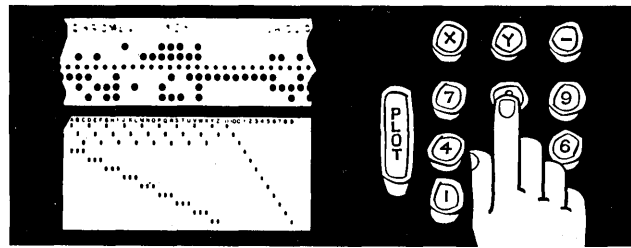

TO
THIS

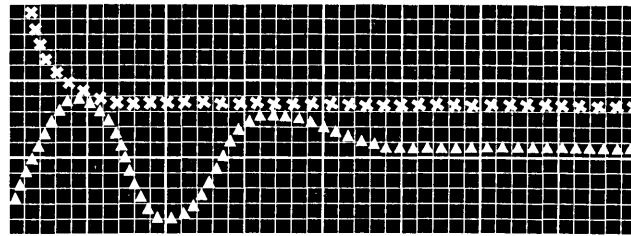

WITH
THIS

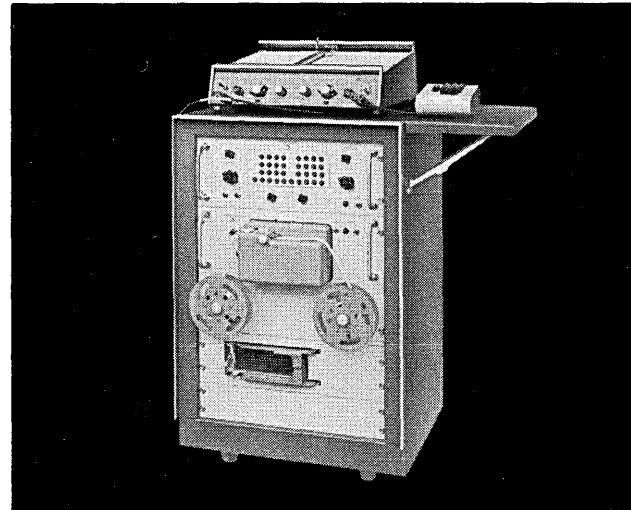

Here's rapid, economical, time-saving conversion of digital data to easy-to-read X-Y charts. Data stored on punched tape or punched cards or tabular data entered manually on a keyboard is quickly plotted with Dymec DY-6242 Digital Data Plotting System. DY-6242 system ability to accept most standard format computer tapes minimizes the need for special computer programming.

The Dymec system is ideal for rapid translation conversion and graphical presentation of data in such areas as stress analysis—verification of numerically controlled machine tool program tapes—pulse height analyzer display—business situations, profit-loss and trend data—thrust analysis—fluid flow and aerodynamic studies—space vehicle trajectory and orbit information—real-time analog parameters acquired digitally, frequency, voltage, current, transients—in any application where large amounts of digital data are more easily understood in graphical form.

Here's the DY-6242 System:

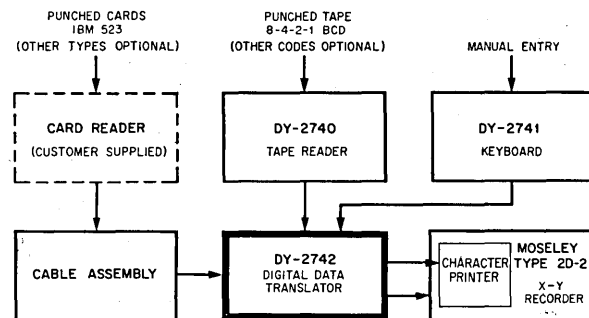

Here's what it offers: Card, perforated tape or keyboard input • Up to 50 points/min. plotted with cards • Up to 80 points/min. with tape • Plot accuracy better than 0.15% • Resolution: 4 digits and sign accepted for both X-Y axes • Zero suppression up to 10,000 counts for convenient placement of plot • All for \$8,700.00

Write or call your nearest Dymec/Hewlett-Packard representative or Dymec for full information.

See this system at New York, IRE, Dymec Booths 3015-3017. Data subject to change without notice. Prices f.o.b. factory.

DYMEC

A DIVISION OF HEWLETT-PACKARD COMPANY

DEPT. A-3, 395 PAGE MILL ROAD, PALO ALTO, CALIF. • PHONE DAVENPORT 6-1755 (AREA CODE 415) TWX-117-U



7688

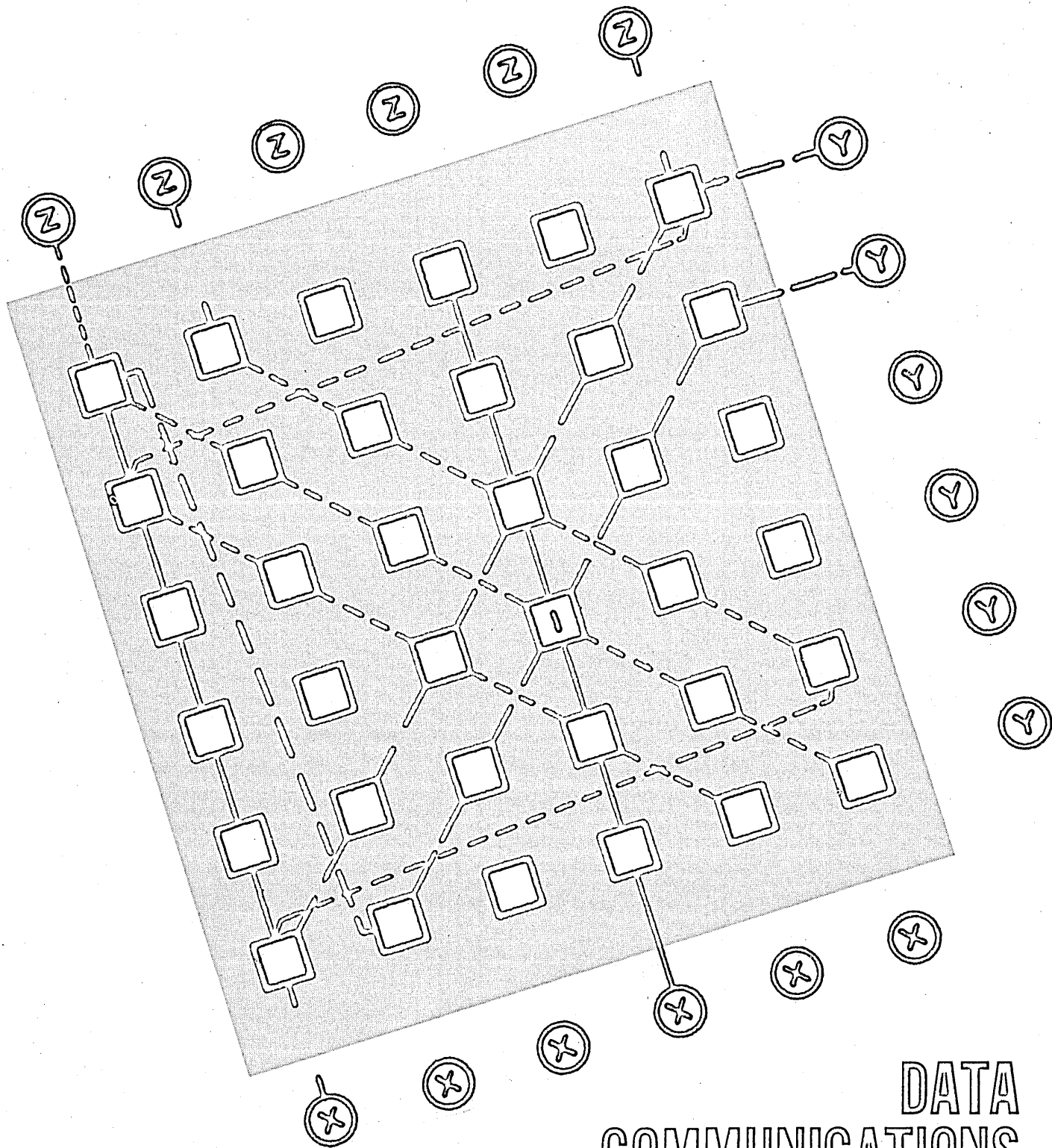

DATA COMMUNICATIONS

Instrumental in the preparation of material for this issue have been the contributions and cooperation of the Data Transmission Study Group. A report on the group's activities follows.

As the first published presentation of the efforts of the DTSG, a Systems Summary, Equipment Catalog, and Data Communications Glossary are presented not as definitive accomplishments but rather, as an initial offering open to corrections of both fact and interpretation. Nevertheless, it is hoped that DATAMATION readers will find this material of considerable value as a general reference tool and background for more specific, individual investigations.

DATA COMMUNICATIONS

a report on
the Data Transmission Study Group

by JACK STRONG, C-E-I-R, and DTSG Chairman, and
A. H. LOCKWOOD, North American Aviation, Los Angeles, Calif.



Trade has always required communication between buyer, seller and producer. In our modern civilization the complexities of government reporting, credit accounting, marketing, engineer-

ing, etc. require efficient methods to augment the basic vocal type of communication with sophisticated mechanized data transmission systems. In order to quickly process such information as credit card applications, reference stock locations, ship orders promptly and maintain a competitive position in our dynamic economy a firm must have at least an adequate data communication system. High speed transportation, branch and agency operations and remote plant facilities are forcing industry to design and use more complex communication systems.

The users of electronic computers in business, government, military and industry have a tremendous need for versatile data communication equipment. These needs range from the relatively slow speed wire transmission to the very high speed microwave transmission.

When we picture a total concept of data communication, we see a giant pipe line through which all types of data can be moved. This line should accommodate all the present communications techniques. The various manufacturers specialize in some of these techniques but the prospective user faces the problem of coordination with several of these manufacturers in the design of a total system. In order to plan and install a data communication system, the prospective user must consider the following major items:

1. Compatibility at various points.
2. Economics (speed, cost, need)
3. Scheduling
4. Alternate methods (courier, etc.)

In an attempt to promote a better understanding be-

tween prospective users, input-output equipment manufacturers and communications equipment manufacturers, the Data Transmission Study Group was formed. This group consisted of representatives from eight major firms in the aerospace industry (the group now includes selected members from other industries). At their first meeting, July 1960, it was decided that they would attempt to act as a coordinating group and effect an exchange of knowledge between users, common carriers and equipment manufacturers. Standardization of terminology, discussion of total systems requirements, development of uniform requirements for equipment and service and forecasting of long range needs were also established as objectives.

Attention has been focused on high volume information transmission to/from computer centers, existing equipment and possible future communication needs within their respective companies have been described by members. As a result of their studies a composite system has been described in an effort to approximate the requirements of all the firms represented.

The group has requested and received presentations from common carriers and equipment manufacturers. These presentations were divided into sessions on presently available equipment and sessions on equipment to be available in the medium and long range future. The group also attempted to acquaint the manufacturers with their composite requirements.

A glossary of communication and data processing terms has been compiled and is published in this issue of DATAMATION. It is felt that this will lead toward a standardization of terms used in the field of data transmission.

The firms participating in the Data Transmission Study Group have indicated the following requirements:

1. Data acquisition of the intra-plant variety using automatic data collection equipment.
2. Interplant data transmission between large scale computer centers.
3. Transmission of data between distant locations.

4. Transmission of data between local facilities and computer centers.
5. Transmission speeds ranging from 2400 bs to 1,000,000 bs peak rates and higher.

6. Provision for transmission of analog data, digital data, facsimile and voice.
7. The systems must accommodate a variety of coding e.g., columbinary, BCD, binary, etc.

LOW-SPEED and HIGH SPEED LINK SELECTION COMPARED

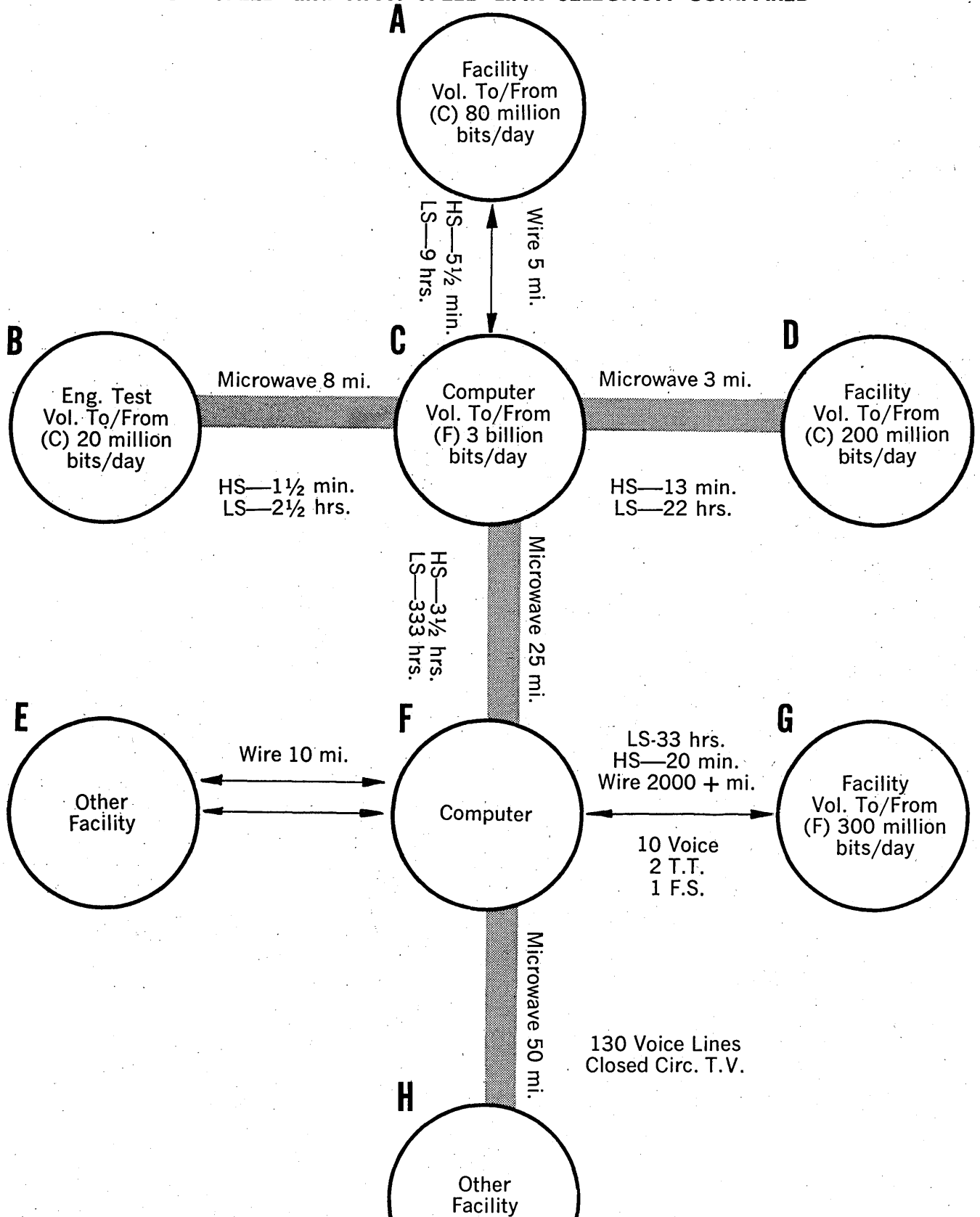

Figure 1 (above) represents a composite system of data transmission links to satisfy a typical complex data communication system. For comparison, speeds are expressed in both low-speed (LS) and high-speed (HS) transmission. For the purpose of the chart, speeds of 2,500 and 250,000 bs effective) have been used to calculate transmission times. They have no special significance. Inter-record gaps in the data and tape handling time have not been estimated. Actual transmission times would therefore be longer than shown. Abbreviations T.T. and F.S. signify Teletypesetter and facsimile devices.

8. Computing centers must have provisions for central switching of microwave to facilitate load sharing and emergency processing.
9. Speed of transmission, distance and volume are the important factors to be considered in determining the economic feasibility of an individual transmission system. Since the member firms have facilities located at varied distances from their computer centers with varied volume requirements, these requirements have been expressed in the composite data transmission study made by the group.

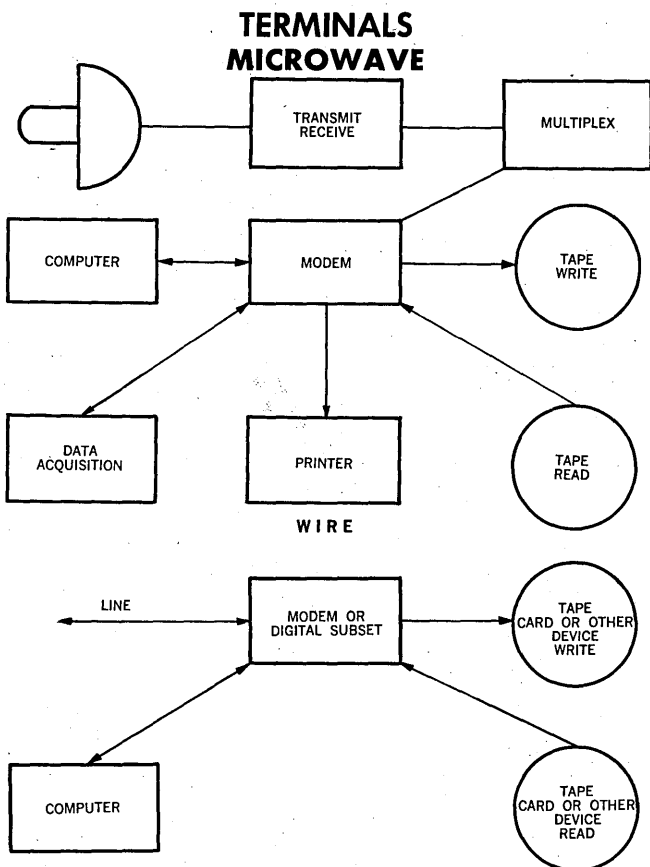

Figure 2 describes representative low-speed (wire) and high speed (microwave) terminals. Control units must be compatible with the user's existing tape units and other peripheral devices. This compatibility should be provided on a "plug-in" basis.

There is a definite need for integrated communication and data processing equipment and techniques. This need is apparent in the similarity of the digital high speed data communication requirements within member companies. Some of the firms have mentioned the desirability of being able to communicate analog information such as flight test data in real time to allow decisions to be made while tests are in progress. There are also future requirements for high volume transmission of pictorial information and other information which may be non-digital in its original form. Future communication facilities must provide efficient use of bands, higher transmission rates and more flexible terminal gear all at lower cost. The total systems concept should be available to handle all of a company's communication needs. The Data Transmission Study Group is striving to keep abreast of developments and to continue the exchange and dissemination of information to interested representatives of industry. An improved understanding of the users' needs should aid manufacturers in their product planning. ■

DATA TRANSMISSION STUDY GROUP

Prime Representatives

AEROSPACE

R. H. Scott,
Member, Technical Staff
Aerospace Corp.,
El Segundo, Calif.

AMERICAN AIRLINES

F. W. Graham,
Dir., Systems Planning,
and
W. R. Plugge,
Dir., Tech. Reservations
American Airlines,
New York, N.Y.

BOEING

G. J. Flemming,
Planning Administrator,
Data Processing,
Boeing Airplane Co.,
Seattle, Wash.

C-E-I-R

Jack Strong,
Director, Stretch
Development,
C-E-I-R, Inc.,
Beverly Hills, Calif.

CONVAIR

W. J. Schart,
Chief, Engineering
Computer
Laboratories
and
R. F. Shane
Systems &
Procedures Dept.,
Convair,
San Diego, Calif.

DOUGLAS

J. A. Fetherlin,
Administrator, Computer
Schedules,
Douglas Aircraft,
Santa Monica, Calif.

DOD

H. L. Bigelow, Jr.,
Office of Asst. Secty.
of Defense,
Directorate,
Telecommunications
Policy,
Washington, D.C.

HUGHES

K. V. Lidstrom,
Manager,
Advanced Information
Systems Development,
Hughes Aircraft,
Culver City, Calif.

LOCKHEED

R. R. Bruhn,
Corporate Com-
munications Advisor,
and
N. H. Carter,
Asst. Director of
Systems Planning,
Lockheed Aircraft,
Burbank, Calif.

NORTH AMERICAN

A. H. Lockwood,
Corporate Systems
Analyst,
North American Aviation,
Los Angeles, Calif.

NORTHROP

D. E. Hannun,
Technical Staff Asst.,
Norair,
Northrop Corp.,
Hawthorne, Calif.

SDC

L. A. Kolbo,
Technical Assistant to
Systems Training,
Computing and
Programming Branch
Manager,
System Development
Corp.,
Santa Monica, Calif.

Former Members

DOUGLAS AIRCRAFT

F. B. Ashby
C. E. Jeffries

HUGHES AIRCRAFT

J. A. Perlman

LOCKHEED AIRCRAFT

R. R. Rubin
H. W. White

SYSTEM DEVELOPMENT CORP.

J. J. Guiteras

A SURVEY OF NEEDS & USER REQUIREMENTS

in data communications

by JUSTIN A. PERLMAN, Modal Systems, Inc.
La Jolla, California*



The use of digital data transmission is still in its infancy. As with most growing fields, the time to guide growth toward desired ends is early; and in digital data transmission (DDT) that time is now.

At present, there are many tentative ventures into the field by both industrial and commercial users and by hardware manufacturers, and some long-standing applications by the military in radar warning networks. A great deal of work remains to be done, however, before present and potential computer users have available for their selection practical, economic, and flexible means of DDT to suit their specific needs. Given the current state of the art, this is only a question of necessary time for evolution, *if* the evolution is targeted rather than haphazard.

To better focus on the targets, let's look first at the variety of needs which exist to-day, and some that we may forecast for the future. In ascending order of daily volume and speed requirements we have, in industrial usage:

- a. Sales-order or inventory-level reporting from remote sales offices, retailers, distributors, etc. (While the total volume from a network of remote points might be large, in the typical case the volume per remote point would be quite small.)
- b. Periodic summary reporting from a remote plant to a company headquarters. Or periodic transmission of data by small companies to a service bureau for processing.
- c. A periodic use of a computer at "Plant A" by personnel at "Plant B". (This may be desirable simply when a particular type of computer is not avail-

able at "Plant A." This form of usage will probably become more common in the future as scientists learn how to apply larger computers to their problems. Even the biggest corporations will not find it economically feasible to place extremely large computers at more than one location; hence this form of sharing.)

- d. Daily transmission from a remote plant of all data, to be processed at a central location. Output fed back to the remote plant.
- e. Real-time processing of engineering test data. While the daily volume may not be high, the response time required (possibly for uninterrupted continuation of the test) may make extremely high speed necessary.
- f. Load-sharing among major computer centers. A major computer center in this terminology might have the equivalent of several IBM 7000-series machines.

In quantitative terms, these categories currently represent point-to-point transmission volumes ranging from the equivalent of a few punched cards per day up to 100 reels of magnetic tape** daily, and speeds from 100 bits per second to 1 megabit per second (and higher).

It's interesting to note that a company's DDT needs for a particular application may conceivably decrease over the years. Presumably as sophistication of the data processing system increases, only *change* information will have to be sent rather than the full detail of each transaction. This may have a marked effect on transmission volume, and thus on speeds required.

Most of these industrial needs have their counterparts in commercial and utility usage. For example, trucking companies have a need similar to "a," independent retailers of more than minimal size have a need similar to

*Justin Perlman was formerly secretary of the Data Transmission Study Group.

**Low-density IBM magnetic tape, for example.

"b;" branch banking systems, department stores and chains, etc. illustrate needs akin to a number of the industrial categories.

Now, what can be said about desirable characteristics of equipment to meet these needs? A very obvious first statement is that it must meet a user's specific need at time of installation. This means that he should be able to insert the DDT equipment into his data processing system without a major redesign of the system. Not so obvious is that the equipment should be flexible enough either in itself, by modification, or by addition or subtraction of units to meet the user's need over a "reasonable" period of time in the face of varying load, data medium, and format requirements. Each user, naturally, will have his own idea as to the proper length for this period of time.

The DDT equipment should be capable of accepting data in the medium, format, and coding in which it exists at the transmitting point and delivering it either in the same form or possibly in some other desired configuration at the receiving point. All this implies is that if the bulk of the data to be transmitted is recorded on magnetic tape in a certain way, the user should not be required to go through a separate process of conversion before utilizing the DDT equipment. Another general statement is that the user should not have to make modifications to his computer or peripheral hardware, or design special "marriage-box" gear to allow him to feed his data into DDT equipment. This was typical of very early equipment where only the mod-demod boxes might be provided and the user was expected to develop means of getting his data into and out of the boxes. But this requirement is fast disappearing.

Other desirable characteristics of DDT equipment are minimum need for human attendance and maintenance; error detection and error correction capability suitable to the usage; minimum transmission link bandwidth, and economic utilization of the link. For this purpose, if the link is paid for on a message basis, maximum information content of the transmitted message (ie., minimum use of non-information sync bits and other conditioning bits or rest spaces) is desirable; if the link is paid for full-time either from a common carrier or as a private installation, maximum alternate usage of the link is desirable (voice, teletype, computer inquiry, slow-speed or high-speed facsimile, closed-circuit TV, etc.).

Transmission security is a characteristic which is necessary in some military applications but questionable in typical civilian usages. The cost of security equipment or processing, plus the additional transmission time required will probably not be attractive to most non-military users.

Now that we have looked at general needs and desirable equipment characteristics, how does a user define his requirements and what are some of the choices he must resolve (or at least be aware of) in planning for DDT and selecting equipment?

First, the sophisticated user will have a thorough understanding of his total information system, and hopefully will already have given some thought to its future evolution. Of particular importance are the information demands placed on the system and the timeliness with which they must be met. The modes of processing and general types of processing equipment to be used are also of significance here.

Second, the user will know his present costs of moving data from one location to another. For quick, accurate, and reliable movement of small or large volumes, it's hard to beat messenger, mail, or air freight.

Third, the user will segregate his current and future needs according to medium, format, and coding of the

data before and after movement; and then estimate volume and time urgency for each category and sub-category.

The next step might be to try to ascribe tangible and intangible "opportunity" costs to *not* moving the data, and to moving it at slow, medium, and high speeds. This will, in effect, indicate what DDT of different types is worth, and help provide a yardstick in considering equipment and operating costs.

At this point the user has a sufficient understanding of his transmission needs to begin comparing the costs of various devices for physically moving and electrically transmitting data. If the potential cost of transmission will be significant, he will want to consider a number of the following possibilities in detail:

- a. Physical movement vs. wire transmission vs. grouped channel (Telpak) vs. private microwave transmission. For each of the electrical means there are different costs associated with different speeds of data transfer.
- b. Present data medium (punched cards, paper tape, magnetic tape, computer storage). Depending on the medium, format, and coding of the data to be transmitted, is it desirable to convert to another medium, format, or coding for transmission?
- c. Serial vs. parallel transmission. This can have a bearing on future expansibility of the transmission system to handle different data coding and different transmission speeds. Signal-to-noise ratio and consequent error rates in transmission may also be affected by this choice.
- d. Buffered vs. unbuffered transmission. This choice can have a major effect on the actual rate of data transfer vs. the nominal rate of transmission.
- e. Accuracy required of received data. The instinctive requirement for 100% accuracy is usually costly, and frequently unnecessary. A realistic appraisal should be made of the reliability required in the output. If very high reliability is needed, is it sufficient to be able to recognize and mark received errors rather than correcting them during the initial transmission? How can these errors be corrected subsequently at low cost?
- f. If high accuracy is required at the time of transmission, what type of error detecting - error correcting code - automatic retransmission scheme is necessary? Higher orders of error correcting means become increasingly expensive both in hardware, and in transmission and checking of the non-information bits.
- g. Are synchronization or other non-information bits required in one system to a greater extent than in competitive systems?
- h. Automatic monitoring and switching of inoperative equipment sub-systems may be expensive in terms of hardware but economic in terms of system utilization.
- i. Off-line vs. on-line operation of the transmission system, and ease of change. Programming difficulties and tie-up of expensive computer installations can result from a poor choice here.
- j. In the case of grouped channel or private microwave operation, availability of bandwidth for other services: telephone, teletype, computer inquiry, low and high-speed facsimile, closed-circuit TV.

This has been a brief summary of user needs and requirements. Other articles in this issue will describe specific equipments which are currently available for use and their applications. ■

A DATA COMMUNICATIONS SYSTEMS SUMMARY

organizing apples and bananas

by F. W. GRAHAM, Director, Systems Planning,
American Airlines, New York City



If you are interested in enlarging the scope of your data processing activity to include more than one geographic location, (and according to Parkinson's law you are) and if in addition your company's products are "time perishable" like yesterday's newspapers or airliner's seats, you will probably be interested in digital data transmission.

No doubt, many of you have evaluated several different data processing manufacturer's computers when the selection was made for your organization. Remember, it was like comparing apples to bananas or oranges. The area of data transmission is worse.

For example, just what is needed to transmit data from Chicago and receive it in San Francisco or Boston? The answer is, "It all depends," because there are many, and varied, user requirements which must be met — such as: attended vs. unattended operations, multi-location transmission vs. point-to-point transmission, format control,

error detection and correction, priority level, code translation, various types of input and output media, various volume of data and transmission media available, etc. There is a need to classify the various data transmission systems capabilities so that the uninitiated can separate the "bits from the bauds." Thus one problem that faces a person starting a data transmission study is, "Where and how do I start?"

Unless you have a "rich uncle," you will probably have to integrate your needs into the available communication services and utilize commercially available data transmission equipment to develop your system.

The approach used here is to list the various "black boxes" in a data transmission system and then attempt to classify by speed and input-output media.

System Description

Referring to Figure 1, **Data Flow in Data Transmission Systems**, the flow of data in most data transmission systems is as follows:¹

The input media (1) is inserted into the correct type of reader (2) or input device which is connected and controlled by a data transmitter (3). The interfaces,

¹The number in parentheses refer to the columns in the Table below the block diagram.

Figure 1. DATA FLOW IN
DATA TRANSMISSIONS SYSTEMS

INPUT MEDIA 1. →	READER 2. →	TRANSMITTER 3. →	DATA SUBSET 4. →	COMMUNICATIONS CIRCUIT 5. →	DATA SUBSET 6. →	RECEIVER 7. →	RECORDER 8. →	OUTPUT MEDIA 9.
HUMANS	KEYBOARD	TRANSMIT ONLY TRANSMIT-RECEIVE	FURNISHED BY TELEPHONE CO. ON DIAL-UP LINES	TELETYPE	FURNISHED BY TELEPHONE CO. ON DIAL-UP LINES	RECEIVE ONLY	FACSIMILE TYPEWRITER CARD PUNCH PAPER TAPE READER MAGNETIC TAPE UNIT	HARD COPY
CARD	CARD READER		FURNISHED BY TELEPHONE CO. OR OTHER ON LEASED LINES	VOICE TELEPHONE	FURNISHED BY TELEPHONE CO. OR OTHER ON LEASED LINES	TRANSMIT-RECEIVE	COMPUTER	CARDS
PAPER TAPE	PAPER TAPE READER			BROAD BAND CHANNELS				PAPER TAPE
MAGNETIC TAPE	MAGNETIC TAPE OUTPUT							MAG TAPE
	COMPUTER							

between both the transmitter (3) and receiver (7) and the communications circuit (5), are digital subsets (4) and (6). The receiver feeds the data into a recorder (8) which produces the output media (9). In the columns, in Figure 1, shown below the block diagram, are some examples of the various systems components that were considered when making the system summary tables which are discussed in the next paragraphs and can be found on pages 49 to 53.

Systems Classification

A. Group by Transmission Speed

The data transmission systems were arbitrarily divided into three groups according to transmission speed.

1. **LOW SPEED** (5 to 20 characters/sec) — Keyboard, hard copy, or paper tape—input and output via teletype and/or voice telephone circuits.
2. **MEDIUM SPEED** (60 to 300 characters/sec) — Cards or magnetic tapes — input-output via voice telephone circuits.
3. **HIGH SPEED** (2060 to 288,000 characters/sec) — Hard copy — magnetic tape communication concentrators or computers via broad band telephone channels or microwave.

These groups were then divided into subgroups according to the input-output media as follows:

B. Subgroup by Input/Output

1. **LOW SPEED**
 - a. Card to Card
 - b. Hard Copy to Hard Copy

- c. Keyboard to Computer
- d. Paper Tape to Paper Tape
or
Keyboard to Hard Copy
- e. Combination

2. MEDIUM SPEED

- a. Card to Card
- b. Computer to Computer
- c. Hard Copy to Hard Copy (not listed on summary tables)
- d. Magnetic Tape to Magnetic Tape
- e. Paper Tape to Paper Tape
- f. Combination

3. HIGH SPEED

- a. Computer to Computer
- b. Hard Copy to Hard Copy
- c. Magnetic Tape to Magnetic Tape
- d. Combination

4. MULTI-SPEED ON LINE INPUT-OUTPUT TO COMPUTER

Since this is a first attempt to consolidate a mass of information on data transmission systems, it was not possible to include all equipment manufacturers or types and variations of equipment. Any corrections, deletions or additions, as well as general comments, would be welcomed.

A survey of so-called "real time" communication computer systems and high speed communication terminals will be published at a later date. ■

A DATA COMMUNICATIONS SYSTEMS SUMMARY

LOW SPEED CARD TO CARD

TABLE I-A

1 INPUT MEDIA	2 READER	3 TRANSMITTER	4 DATA SUBSET	5 COMMUNICATIONS CIRCUIT	6 DATA SUBSET	7 RECEIVER	8 RECORDER	9 OUTPUT MEDIA	10 REMARKS		
CARD	IBM 024/026 MODIFIED CARD PUNCH	IBM RPQ E08479	AT&T 402A	VOICE TELEPHONE	AT&T 402B	IBM RPQ 811095 CARD PUNCH RECEIVER	IBM 024/026	CARD	ALPHANUMERIC		
CARD	IBM 063 CARD TO TAPE	AT&T 28T/D TRANSMITTER/ DISTRIBUTOR	NONE	TELETYPE	NONE	AT&T 28 ROTR RECEIVE ONLY TYPING REPER- FORATOR	IBM 046/047 TAPE TO CARD	CARD			
CARD	IBM 065/066 TRANSMITTER/RECEIVER CARD UNIT		IBM 67 TELEGRAPH SIGNAL UNIT	LEASED TELETYPE	IBM 67 TELEGRAPH SIGNAL UNIT	IBM 65/66 TRANSMITTER/ RECEIVER CARD UNIT.		CARD			
			IBM 68 TELEPHONE SIGNAL UNIT	OR LEASED TELEPHONE	IBM 68 TELEPHONE SIGNAL UNIT						
			IBM 68 TELEPHONE SIGNAL UNIT & AT&T 202A DIAL VOICE	OR DIAL TELEPHONE LINE	IBM 60 TELEPHONE SIGNAL UNIT & AT&T 202B LEASE LINE						
CARD	IBM 1001 DATA TRANSMISSION TERMINAL		401A	VOICE TELEPHONE	401B	IBM 1001 RECEIVING CARD PUNCH		CARD	NUMERIC ONLY		
CARD	IBM 1912		NONE NEEDED	TELETYPE	NONE NEEDED	IBM 1912		CARD			
CARD	IBM 024/026	SYSTEMATICS' K177 CARD TO PAPER TAPE CONVERTER	AT&T 28 T/D TRANSMITTER/ DISTRIBUTOR	NONE NEEDED	TELETYPE	NONE NEEDED	AT&T 28 ROTR RECEIVE ONLY TYPING REPER- FORATOR	SYSTEMATICS C750 PAPER TAPE TO CARD CON- VERTER	IBM 024/026	CARD	

LOW SPEED HARD COPY TO HARD COPY

TABLE I-B

1 INPUT MEDIA	2 READER	3 TRANSMITTER	4 DATA SUBSET	5 COMMUNICATIONS CIRCUIT	6 DATA SUBSET	7 RECEIVER	8 RECORDER	9 OUTPUT MEDIA	10 REMARKS
HARD COPY		WESTERN UNION INTRAFAX TRANSMITTER	NONE	LEASED WESTERN UNION TELETYPE LINES	NONE		WESTERN UNION INTRAFAX RECEIVER	HARD COPY	

LOW SPEED KEYBOARD TO COMPUTER

TABLE I-C

1 INPUT MEDIA	2 READER	3 TRANSMITTER	4 DATA SUBSET	5 COMMUNICATIONS CIRCUIT	6 DATA SUBSET	7 RECEIVER	8 RECORDER	9 OUTPUT MEDIA	10 REMARKS
HUMANS	IBM 1014 INQUIRY CONSOLES		NONE	SPECIAL 4-WIRE CIRCUIT PROVIDED BY USER	NONE	IBM 1414-4 TELEPROCESSING BUFFER	IBM 1410 COMPUTER	NONE	
	ANYTHING COMPATIBLE WITH TELETYPE CIRCUITS		NONE	TELETYPE	LINE ADAPTER FURNISHED BY IBM OR COMMON CARRIER			CARDS OR MAGNETIC TAPE	

LOW SPEED PAPER TAPE TO PAPER TAPE

TABLE I-D

1 INPUT MEDIA	2 READER	3 TRANSMITTER	4 DATA SUBSET	5 COMMUNICATIONS CIRCUIT	6 DATA SUBSET	7 RECEIVER	8 RECORDER	9 OUTPUT MEDIA	10 REMARKS
PAPER TAPE	AT&T TELEPRINTER OR PAPER TAPE READER		NONE	TELETYPE	NONE	AT&T TELEPRINTER OR PAPER TAPE PUNCH		HARD COPY OR PAPER TAPE	
PAPER TAPE	FLEXOWRITER PAPER TAPE READER	COMMERCIAL CONTROLS CORP. AUTOFAX	TELEPHONE HANDSET	VOICE TELEPHONE	TELEPHONE HANDSET	COMMERCIAL CON- TROLS CORP. AUTOFAX	FLEXOWRITER PAPER TAPE PUNCH	PAPER TAPE HARD COPY	
PAPER TAPE	FRIDEN TELEDATA TAPE TRANSMITTER/RECEIVER		AT&T 102A	TELETYPE	AT&T 102A	FRIDEN TELEDATA TAPE TRANSMITTER/ RECEIVER		PAPER TAPE	
PAPER TAPE	HUGHES AIRCRAFT HC-260	RADIO TRANSMITTER				RADIO RECEIVER	HUGHES AIRCRAFT HC-260	PAPER TAPE	
PAPER TAPE	FLEXOWRITER PAPER TAPE READER	RCA DASPAN TRANSMITTER/RE- CEIVER	AT&T 102A	VOICE TELEPHONE LINE	AT&T 102A	RCA DASPAN TRANS- MITTER/RECEIVER	FLEXOWRITER PAPER TAPE PUNCH	PAPER TAPE	
PAPER TAPE 5, 6, 7, 8, LEVEL	SYSTEMATICS C755 TELEPUNCH	AT&T 28 T/D TRANS- MITTER/DISTRIBUTOR	NONE	TELETYPE	NONE	AT&T 28 ROTR RECEIVE ONLY TYPING REPER- FORATOR	SYSTEMATICS C775 TELEPUNCH	PAPER TAPE 5, 6, 7, 8, LEVEL	

COMBINATION

TABLE I-E

THE TRANSMITTER/RECEIVERS ARE INTERCHANGEABLE									
1 INPUT MEDIA	2 READER	3 TRANSMITTER	4 DATA SUBSET	5 COMMUNICATIONS CIRCUIT	6 DATA SUBSET	7 RECEIVER	8 RECORDER	9 OUTPUT MEDIA	10 REMARKS
CARDS	IBM 024/026 CARD READER	SYSTEMATICS T585 CARD TRANSMITTER	AT&T 28 ASR or KSR	TELETYPE	AT&T 28 ASR, KSR or ROTR	SYSTEMATICS T 8045 TELE- PUNCH RECEIVER	IBM 024/026 CARD PUNCH	CARDS	
8-CHANNEL PAPER TAPE	SYSTEMATICS T785 PUNCHED TAPE TRANSMITTER					SYSTEMATIC T8075 TELEPUNCH-PUNCHED TAPE RECEIVER		6, 7, 8, LEVEL PAPER TAPE	

MEDIUM SPEED CARD TO CARD

TABLE II-A

1 INPUT MEDIA	2 READER	3 TRANSMITTER	4 DATA SUBSET	5 COMMUNICATION CIRCUIT	6 DATA SUBSET	7 RECEIVER	8 RECORDER	9 OUTPUT MEDIA	10 REMARKS
CARD	DIGITRONICS D-510 CARD TERMINAL OR D-515 CARD TERMINAL (READER ONLY)		AT&T 200	VOICE TELEPHONE	AT&T 200	DIGITRONICS D-510 CARD TERMINAL		CARD	SEE COMMENT ON TABLE II-F
CARD	IBM 402 CARD READER AND PRINTER	IBM 1946 HIGH SPEED CARD DATA TERMINAL	AT&T 200	VOICE TELEPHONE	AT&T 200	IBM 1946 HIGH SPEED CARD DATA TERMINAL	IBM 402 CARD READER AND PRINTER	CARD	
CARD	IBM 1013 CARD TERMINAL READER- PUNCH TRANSMITTER-RECEIVER					IBM 1013 CARD TERMINAL READER-PUNCH TRANSMITTER-RECEIVER	CARD		
CARD	IBM 1931 CARD TERMINAL READER- PUNCH	IBM 1946 HIGH SPEED CARD DATA TERMINAL				IBM 1946 HIGH SPEED CARD DATA TERMINAL	IBM 1931 CARD TER- MINAL READER-PUNCH	CARD	SEE COMMENT ON TABLE II-F

MEDIUM SPEED COMPUTER TO COMPUTER

TABLE II-B

1 INPUT MEDIA	2 READER	3 TRANSMITTER	4 DATA SUBSET	5 COMMUNICATION CIRCUIT	6 DATA SUBSET	7 RECEIVER	8 RECORDER	9 OUTPUT MEDIA	10 REMARKS
	AUTOMATIC TELEPHONE AND ELECTRIC COMPANY, LONDON WC2, ENGLAND								
	ANY COMPUTER	SWIFT	PHASE MODULATED MODEM	PUBLIC PHONE OR PRIVATE WIRE	PHASE MODULATED	SWIFT	ANY COMPUTER		
	IBM 1401 COMPUTER	IBM 1009 DATA TRANSMISSION UNIT	AT&T 200	VOICE TELEPHONE	AT&T 200	IBM 1009 DATA TRANSMISSION UNIT	IBM 1401 COMPUTER		SEE COMMENT ON TABLE II-F

MEDIUM SPEED MAGNETIC TAPE TO MAGNETIC TAPE

TABLE II-D

1 INPUT MEDIA	2 READER	3 TRANSMITTER	4 DATA SUBSET	5 COMMUNICATION CIRCUIT	6 DATA SUBSET	7 RECEIVER	8 RECORDER	9 OUTPUT MEDIA	10 REMARKS
MAGNETIC TAPE	DIGITRONICS D-520 MAGNETIC TAPE TERMINAL		AT&T 200	VOICE TELEPHONE	AT&T 200	DIGITRONICS D-520 MAGNETIC TAPE TERMINAL		MAGNETIC TAPE	SEE COMMENT ON TABLE II-F
MAGNETIC TAPE	IBM 7701 MAGNETIC TAPE TRANSMISSION TERMINAL		AT&T 200	VOICE TELEPHONE	AT&T 200	IBM 7701 MAGNETIC TAPE TRANSMISSION TERMINAL		MAGNETIC TAPE	SEE COMMENT ON TABLE II-F

MEDIUM SPEED PAPER TAPE TO PAPER TAPE

TABLE II-E

1 INPUT MEDIA	2 READER	3 TRANSMITTER	4 DATA SUBSET	5 COMMUNICATION CIRCUIT	6 DATA SUBSET	7 RECEIVER	8 RECORDER	9 OUTPUT MEDIA	10 REMARKS
PAPER TAPE	FERRANTI READER	SWIFT	PHASE MODULATED	VOICE TELEPHONE	PHASE MODULATED	SWIFT	TELETYPE BRPE 110	PAPER TAPE	
PAPER TAPE	DIGITRONICS D-505/D-506 PAPER TAPE TERMINAL		AT&T 200	VOICE TELEPHONE	AT&T 200	DIGITRONICS D-505/D-506 PAPER TAPE TERMINAL		5, 6 LEVEL/ 5, 6, 7, 8, LEVEL PAPER TAPE	SEE COMMENT ON TABLE II-F

MEDIUM SPEED COMBINATION

TABLE II-F

1 INPUT MEDIA	2 READER	3 TRANSMITTER	4 DATA SUBSET	5 COMMUNICATION CIRCUIT	6 DATA SUBSET	7 RECEIVER	8 RECORDER	9 OUTPUT	10 REMARKS
PAPER TAPE OR MAGNETIC TAPE	PAPER TAPE READER MAGNETIC TAPE READER COMPUTER	VARIES	VARIES	TELETYPE TO D TELEPAK	VARIES	A. B. DICK 904 VIDEOGRAPH PRINTER			

COMMENT—

(1) MOST DIGITRONIC EQUIPMENT LISTED ON TABLES II- A, B, D, AND E CAN BE USED IN MIXED COMBINATIONS.

(2) MOST IBM EQUIPMENT LISTED ON TABLES II-A, B, D, AND E CAN BE USED IN MIXED COMBINATIONS.

HIGH-SPEED COMPUTER TO COMPUTER

TABLE III-A

1 INPUT MEDIA	2 READER	3 TRANSMITTER	4 DATA SUBSET	5 COMMUNICATIONS CIRCUIT	6 DATA SUBSET	7 RECEIVER	8 RECORDER	9 OUTPUT MEDIA	10 REMARKS
	IBM 1410, 7070 OR 7090 COMPUTER*	IBM 1945 MULTI- CHANNEL DATA TRANSMITTER- RECEIVER	A TO D	A TO D TELEPAK	A TO D	IBM 1945 MULTI- CHANNEL DATA TRANSMITTER- RECEIVER	IBM 1410, 7070 OR 7090 COMPUTER		3-A

HIGH SPEED HARD COPY TO HARD COPY

TABLE III-B

1 INPUT MEDIA	2 READER	3 TRANSMITTER	4 DATA SUBSET	5 COMMUNICATIONS CIRCUIT	6 DATA SUBSET	7 RECEIVER	8 RECORDER	9 OUTPUT MEDIA	10 REMARKS
HARD COPY	A. B. DICK 921 VIDEOGRAPH SCANNER		C	"C" TELEPAK	C	A. B. DICK 902 VIDEOGRAPH PRINTER		HARD COPY	3-B

March 1962

HIGH SPEED MAG TAPE TO MAG TAPE

TABLE III-C

1 INPUT MEDIA	2 READER	3 TRANSMITTER	4 DATA SUBSET	5 COMMUNICATIONS CIRCUIT	6 DATA SUBSET	7 RECEIVER	8 RECORDER	9 OUTPUT MEDIA	10 REMARKS
MAGNETIC TAPE	IBM 729 MAGNETIC TAPE UNIT*	IBM 1945 MULTI-CHANNEL DATA TRANSMITTER-RECEIVER	A TO D	A TO D TELEPAK	A TO D	IBM 1945 MULTI-CHANNEL DATA TRANSMITTER-RECEIVER	IBM 729 MAGNETIC TAPE UNIT	MAGNETIC TAPE	3-C

*A COMPUTER SUCH AS THE 1401, 1410, 7070, 7090 IS REQUIRED FOR TRANSMISSION.

HIGH SPEED COMBINATION

TABLE III-D

1 INPUT MEDIA	2 READER	3 TRANSMITTER	4 DATA SUBSET	5 COMMUNICATIONS CIRCUIT	6 DATA SUBSET	7 RECEIVER	8 RECORDER	9 OUTPUT MEDIA	10 REMARKS
PAPER TAPE, CARDS, MAGNETIC TAPE, MAGNETIC DRUM, COMPUTER	VARIOUS	STANDARD ELECTRIK LORENZ ERROR DETECTION & CORRECTION EQUIPMENT (EDC)	T2-J (SRT)	TELETYPE TO "O" TELEPAK	T2-J (SRT)	STANDARD ELECTRIC LORENZ (EDC)	MAGNETIC TAPE, MAGNETIC DRUM COMPUTER	VARIOUS	3-D

MULTI-SPEED ON LINE INPUT-OUTPUT TO COMPUTER

TABLE IV

1 INPUT MEDIA	2 DEVICE	3 TRANSMITTER	4 DATA SUBSET	5 COMMUNICATION LINES	6 DATA SUBSET	7 RECEIVER	8 RECORDER	9 OUTPUT MEDIA	10 REMARKS
CARDS	IBM 65/66 CARD TRANSMITTER/RECEIVER		IBM 67 TELEGRAPH SIGNAL UNIT	TELETYPE	NONE	IBM 7750 PROGRAMMED TRANSMISSION CONTROL	1401 OR ANY IBM 7000 SERIES COMPUTER		
HUMAN PUNCHED TAPE	ANY L. S. EQUIPMENT WHICH WILL OPERATE ON TELETYPE OR TELEPHONE LINES		NONE AT&T 100 OR 200	TELETYPE OR VOICE TELEPHONE	NONE AT&T 100 OR 200				
CARDS OR MAGNETIC TAPE	1401	1009	AT&T 200	VOICE TELEPHONE LINE	AT&T 200				
	IBM 1410 OR 7000 SERIES COMPUTER 7701 7750								
HUMAN PUNCHED TAPE	ANY EQUIPMENT WHICH WILL OPERATE OVER TELETYPE OR VOICE TELEPHONE LINES		NONE	VOICE TELETYPE OR TELEPHONE LINES	NONE	IT&T AUTOMATIC MESSAGE EXCHANGE (ADX)	ANY COMPUTER WITH ADAPTER TO DATA CHANNEL		
MAGNETIC TAPE			AT&T 200		AT&T 200				

COMPUTER TRANSMISSION AT MEMORY SPEEDS

CDC system transmits at 2.5 megabits per second

by NEIL CLARK, Control Data Corp., Minneapolis, Minnesota

Control Data Corporation has developed a digital communication system designed for high-speed data transmission via microwave or coaxial cable. One element of the system is a device called the Control Data Terminal (CDT) and allows Control Data computers to communicate at rates determined by their internal memory speeds. The Control Data Terminal matches the interface characteristics of the microwave transmit-receive equipment with CDC's line of digital computers. Two CDT units are required to close a two-computer communication loop—one at each computer site. Recent tests have demonstrated a capability of transmitting more than 400,000 characters per second between two computers in a communication test program.

The Control Data Terminal accepts information in the form of twelve-bit words directly from the computer memory and transmits them serially at a peak rate of 2.5 million bits per second. The encoding used for the serial data requires a bandwidth of about 3.0 mc. Over relatively short distances (one to five miles) the microwave equipment is unnecessary, although CDT units are utilized at each end of the coaxial cable. Longer distances require microwave repeater stations.

A test system (Figure 1.) used extensively by Control Data, is the equivalent of a two-hop microwave system.

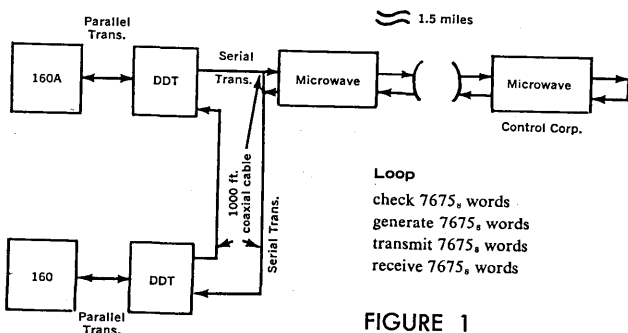

FIGURE 1

from a two-foot paraboloid antenna and passive reflector. The transmission path in this test is 2.6 miles round trip. At the terminal point, the data transmitted is de-modulated, then modulated, and beamed back over another carrier frequency in the 12 mc band. The data is again detected at the original microwave terminal and video frequency signals are then fed to the CDT over an additional thousand feet of cable. Each computer and its associated CDT may either transmit or receive data but not simultaneously. "Half-duplex" operation is achieved with one computer at each end of the channel. Although only 1.3 miles distances was used in these tests, the 0.1 watt power output of the microwave equipment is capable of 20 to 30-mile ranges with adequate gain margins using proper antennae and elevations.

During the span of the tests in which all equipments in the system were operated for several hundred computer hours, the programming sequence followed the following pattern:

- Computer A — under program control selected its CDT to "transmit." It then generated a variable number of 12-bit words, called a block, which was fed to the CDT for transmission.
- Computer B — having selected its CDT to "receive," it accepted the block of information into its core memory, counting the words as they were received. The transmission completed, B selected the "transmit" mode and transmitted the same block to Computer A which was in a "receive" condition.
- Computer A — then checked all words received with those it transmitted and tallied any errors. With this simple transmission completed, Computer A generated the next block of words and repeated the sequence.

Test results show that digital data in the Control Data system is exchanged at an average rate of 0.8×10^6 bits per second when using the CDC 160 and at 1.2×10^6 bits per second on the large-scale 1604. With this two-computer system, the average error probability achieved is less than 10^{-9} bits per bit.

One twenty-eight hour continuous run was completed without any error. In this case, had an error occurred, the error probability would have approached only 6×10^{-11}

bits per bit. The error probability factor indicates that the system reliability is more than adequate for use in high-speed and direct memory-to-memory, computer-to-computer digital communications.

In addition to its high-speed and reliability, the Control Data CDT provides several other important features that are extremely important in computer memory-to-memory communication. For one, error detection is considered extremely simple by the transmission of a redundant 12-bit word for each actual data word generated. This redundancy enables the computer at the receiving station to sense with a high-degree of probability whether an error has occurred in the transmission system.

The Control Data Terminal system can prevent the receiving computer from "hanging up" should it receive insufficient data necessary to complete the transmission of an anticipated block of information. For example, a loss of data during transmission could result because of atmospheric conditions, a lightning transient invading the microwave path, or selective fading because of temperature inversion. If the block of data received by the computer is incomplete, the receiving CDT feeds blank data to the computer until the required block length is filled out, thus enabling the system to continue functioning.

The data received, although in error, can be error-

checked by the receiving computer, which interrogates the "status" register of the CDT. The receiving computer can sense the "status" of its CDT at will to determine the presence of error. Thus, if the error has occurred, or if blank data had been supplied, the receiving computer will determine it immediately and take remedial action.

Another important feature of the CDT is its ability to interrupt a remote computer by transmitting an interrupt code. The remote CDT translates the code and issues an interrupt signal to its computer. This allows all remote computers to communicate with one another without having the receiving computer "hung up" waiting for input.

Recent experiments at Control Data have involved three computers connected to a common coaxial cable forming a "party-line" system. One computer assumes the role of traffic director or master computer. The master computer has the responsibility of addressing each party-line computer in turn and giving them instructions and assignments. Communication between each remote computer is controlled by the master computer.

In one 72-hour test of a three computer system an error probability of better than 10^{-9} bits per bit was obtained. The three computers involved were Control Data 160's. ■

THE TDS-90

G.E.'s high-speed transmission terminal

A new data communication terminal capable of transmitting up to 90KC but primarily engineered for standard tape speeds of 15-22.5KC has been put into production by GE's Communication Products Dept., Lynchburg, Va.

Initial application of the equipment, designated TDS-90, will utilize microwave as the transmission relay media. However, it also may be used with common carrier facilities. Either transmission facility will require a relatively narrow band width: 25KC can be transmitted using 230KC, for example. The equipment is designed with full duplex capability.

In operation, the operator at a remote location either places a reel of tape on the tape unit, or initiates a

write-routine addressed to it. Once the data is on tape, the operator switches the unit to the TDS-90. The TDS-90 generates and transmits "status characters" to its circuits at the computer end, permitting the computer to control the tape unit in the same manner as one located in the computer room.

The computer then executes read, backspace, rewind or unload commands. Once the tape unit is switched to the TDS-90 and is placed in the ready status, it is at the disposal of the computer located at the other end of the link. A computer can control a number of TDS-90 transmission terminals in the same manner as it controls any number of locally attached tape transports.

In a typical full duplex installation, (see diagram)

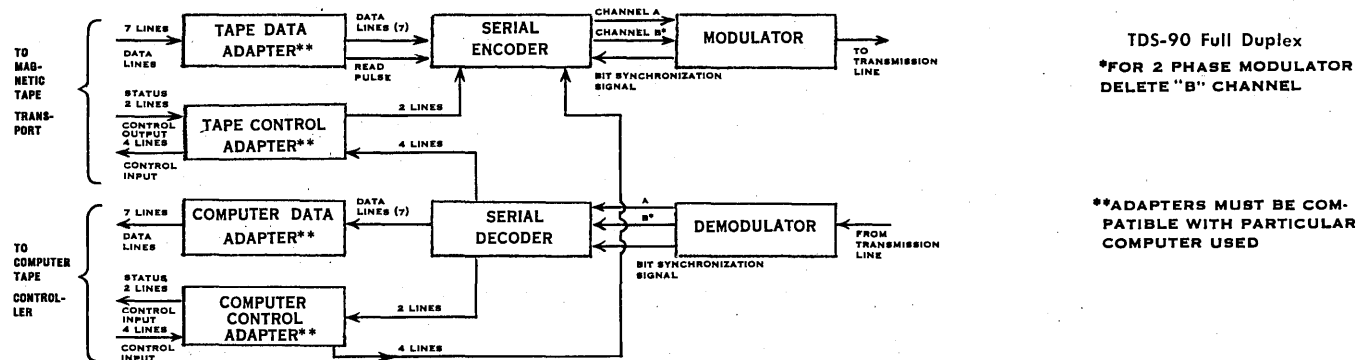

the Tape Data Adapter accepts parallel data from a magnetic tape transport, reshapes the data pulses and corrects for undesirable skew patterns permitting parallel-to-serial conversion. Parity of characters read from the tape is also checked.

Asynchronous data in parallel is accepted by the Serial Encoder, converted to synchronous serial data and multiplexed it with control signals. Depending on data speed requirements and available bandwidth, the Encoder can be wired to present one, two or four binary outputs.

The Data Modulator provides the Serial Encoder with a bit synchronizing signal, accepting serial data on either one or two serial binary data lines and converts the data to signals suitable for transmission. Two or more modulators may be used in parallel to accommodate higher data speeds.

All control functions normally supplied by a local computer tape control unit is provided by the Tape Control Adapter, converting TDS-90 control signals to signal levels required by the tape transport.

The Data Demodulator provides the Serial Decoder with a bit synchronizing signal. It receives signals from the Data Modulator via the transmission channel and converts them to serial binary data outputs. Two or more demodulators may be used in parallel for higher data speeds.

Demultiplexed data and control signals from the Demodulator are converted to parallel form by the Serial Decoder, also establishing and maintaining character synchronization. The Decoder may be wired to accept one, two or four binary inputs to accommodate higher data speeds.

The Computer Data Adapter converts the parallel binary output signals into a form acceptable by the computer tape control unit, and the Computer Control Adapter provides all the control responses normally supplied by the tape transport. It accepts control signals from the computer tape control unit and relays them, via the data transmission channel, to the mag tape unit. ■

A CRITICISM OF INACTIVITY

in data communications

by H. E. RENNACKER

Bendix Computer, Los Angeles, Calif.



The four major groups concerned with data communications have each experienced the growing pains of a burgeoning field. However, their reaction times in the face of progress have generally been slow. Let's consider each of these groups—the common carriers, communications equipment manufacturers, EDP equipment manufacturers, and the users.

The common carriers are the fellows with the telephone and teletype wires and the radio and microwave facilities. They will provide most of the path over which data will travel. It is their responsibility to assess their present facilities, determine their capabilities and limitations and make this information available to those who need it. They should strive to improve their facilities as necessary and should provide a family of terminal equipments which make the most effective use of the available facilities while providing a useful interface to the communications and EDP equipment manufacturers.

The telephone people have expanded their family of modem equipments considerably from those initially developed and made available and this is to their credit.

The carriers have traditionally been slow to develop services and expand their facilities largely because of the heavy capital investment required. They must recognize however that they stand likely to reap substantial profits if data communications develops as it should.

The communications equipment manufacturers have been slow to develop useful and economical equipment for data transmission for a number of reasons, partly be-

cause they haven't understood the problem and partly because they've been expecting others to take the lead and point the way. If they will make a real effort to understand the problem, they'll find that there are many useful terminal and peripheral equipments that they can profitably supply for the data communications market. If they prove unwilling to make the required efforts it is quite probable that the EDP equipment manufacturers will be forced to develop this equipment themselves.

The EDP equipment manufacturers have been living in a dream world where their super-duper computers were regarded as ultimates in themselves. Not so now. The current emphasis is on integrated systems to solve data gathering, data processing, and data distributing problems, elements of which may be separated by miles or hundreds of miles.

The EDP equipment people were largely responsible for generating the need for data links and must take the lead in attempting to analyze the growing needs for data communications and design computers and peripherals with broad systems concepts and interfaces which facilitate data transmission.

The user once content to stumble along and do his own systems engineering because he was so thrilled that an EDP manufacturer would actually condescend to sell him one of the products of his unchallenged genius, now demands that the fellow who makes the computer assume the burden of making it work in the system.

The users for their part, must translate their demands for data communications realistically into needs with estimates of volumes, message sizes and formats, and the

accuracy and reliability required. They should also be prepared to state the limits they can afford to pay for the communications systems they say they want.

Most users currently seem to have unrealistically high estimates of the amount and urgency of their data transmission requirements and an unrealistically low estimate of what it should cost to meet their requirements. However unrealistic he may be at times, the user is still the fellow who pays the bill and the others shouldn't forget it.

It should be apparent to anyone interested in the field that the biggest problem facing data communications today is the lack of communications among the four groups concerned. It seems imperative that an organization be established which embraces all four groups and has as its

principal objectives the fostering of intergroup intercourse and the establishment of guide lines for the future progress of data transmission.

The second major problem is the need for intelligently derived standards. These standards should be useful and should provide important savings in all four of the major data communication user areas. These standards should provide for maximum compatibility without compromising the ability to make such timely improvements as the state of the art may allow.

While the emphasis in this article has been on electronic data transmission, responsible users should never forget that a four cent stamp will move a lot of bits a long way reasonably quickly.

THE 7750

IBM's programmed transmission control

 The 7750 Programmed Transmission Control Unit, which can link a centrally-located computer with a wide network of communications lines and terminals was announced by IBM last month.

The 7750 can be field-installed with computers already in operation, or can be delivered with new systems. It is offered with core storage capacities of 4K; 8K and 16K words. A typical 8K word unit costs about \$553,000 and rents for approximately \$9,600 monthly.

The stored program enables the 7750 to perform code conversion, editing, formatting, network monitoring, error-checking, priority processing, message routing and message checking. Data is transferred to the 7750 from the host computer, which is fed through punched cards, mag tape or magnetic discs.

Up to 112 communications lines, each capable of accommodating a wide variety of terminals, can operate with the systems. These lines include the following: up to 112 low-speed half-duplex or simplex lines, 56 low-speed full-duplex lines, 16 high-speed half-duplex or simplex lines, eight high-speed full-duplex lines or a balanced combination of high and low-speed lines.

Low-speed lines, used with data transceivers and standard telegraph equipment, transmit six to ten characters per second. High-speed lines, for the IBM 1009, 1013, 7701 and 7702, transmit up to 150 characters per second. Communication can be performed by telephone, telegraph or microwave links.

The 7750 can be attached to an IBM 1410, 7040, 7044, 7070, 7074, 7080, 7090 or 7094. The terminals can include punched card, mag tape and paper tape units, telegraph transceivers, and units linking directly with another IBM computer.

In operation, the 7750 continually scans its incoming lines for messages. The data, stripped of transmission codes, is translated into computer language and assembled into message form. It is then queued into priority sequence and fed into the computer.

The unit can determine the priority of incoming messages and interrupt the computer if necessary to permit processing of inquiries requiring immediate attention.

Processed data to be sent from the computer is fed back into the 7750, which translates it into transmission code and sends it over the appropriate line to the proper terminal. These operations are controlled by the stored program.

The 7750 will be available in the fourth quarter of 1962 with deliveries depending upon specific systems requirements. ■

Memory circuitry of the 7750 is tested by IBM engineer. A 7701 mag tape transmission terminal is seen in the background.

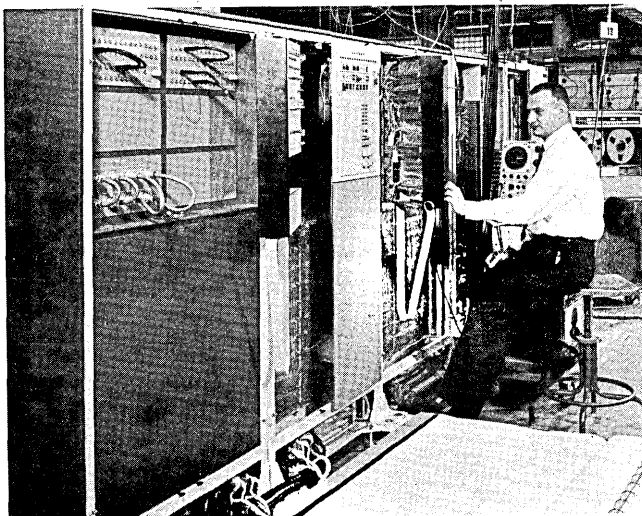

SOCIAL SECURITY NETWORK LINKS 600 OFFICES

Dial-o-verter & Bell systems utilized

A transmission network consisting of 600 district offices of the U. S. Government's Social Security Administration, plus the agency's computer center in Baltimore, will soon be in operation to speed up processing and issuance of benefit payments.

Utilizing the Dial-o-verter system of the Digitronics Corp., the facility operates with the Bell System Data-Phone datasets in the 200 series.

At each district office, claims information is converted to a machine-readable language by a Teletype operator, who transmits the data to a relay point. Each relay point gathers all the information from a number of district offices and forwards it via Teletype to a communication control center, where it is received as punched tape. (There are 48 relay centers and six control centers operating within the network.)

A Digitronics paper tape sorting device (D755) at the communications center assembles the messages on reels of paper tape, ready for transmission to the appropriate destination via Dial-o-verter. While most of the data is destined for the computer center in Baltimore, the sorter performs a similar operation on data received from Baltimore and other stations, for retransmission to various destinations.

The data is transmitted over telephone lines, utilizing Dial-o-verter D505 paper terminals directly to corresponding paper tape units in other communication control centers or to Dial-o-verter D520 mag tape terminals in the Baltimore headquarters. The resulting reels of mag tape are ready for further processing at the computing center.

The computer takes the information and arranges it into a sequence acceptable to the Bureau's searching operation. As the main files are searched, each new claim or other information is identified against the corresponding master record in the files, and the appropriate information needed by the district office is extracted on a new reel of mag tape.

When the system is ready for full operation, new reels of mag tape will be placed back on the D520 mag tape terminals the following morning for transmission to the communication control centers.

The computer will arrange the data so that when it has been separated out by the paper tape sorter at the communication control center, data will be flowing at a steady rate to the proper district office.

Keystone of the system is the D755 distributor, which can drive up to twelve output punches, and distribute incoming data to the output punches.

Paper tape is read into the D755 by connection to a photo-electric paper tape reader. As each new message is read from the input paper tape reader, the first three characters are examined. Based on plugboard wiring, these characters may select any one or more of the twelve output paper tapes. The entire message is then directed to the selected output paper tape unit (or units). The distrib-

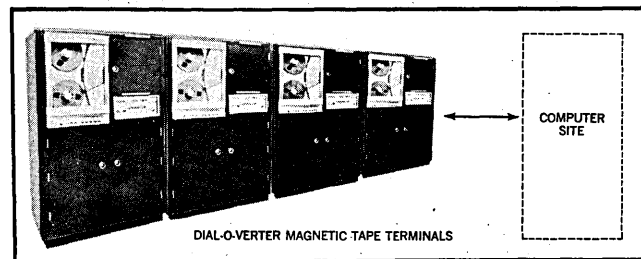
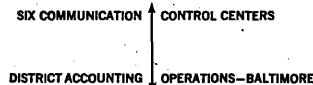
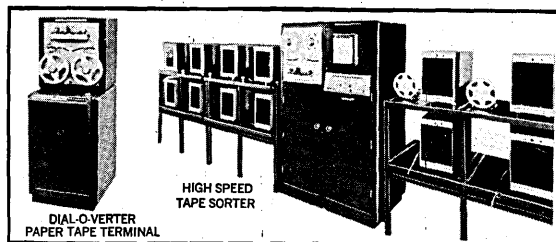
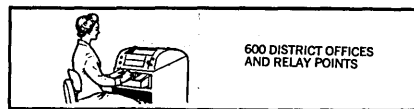

SOCIAL SECURITY COMMUNICATIONS NETWORK

utors are capable of achieving effective tape selection at speeds up to 60,000 words per hour.

CIRCLE 388 ON READER CARD

MAG TAPE LINK ACCURACY VERIFIED IN WELFARE NET

Initial retransmission doublecheck between RCA mag tape-to-mag tape units in Social Security payment centers in San Francisco and Kansas City has been eliminated, a recent RCA announcement stated.

The accuracy of the transmission was tested during the first month of the Social Security operation. A call was placed by way of New York City and "satisfactory transmission took place over a 4,500 mile link," which extended from San Francisco to New York and then back to Kansas City. Similar calls were made over a period of months to other cities as a check of the accuracy of the tape relay system. In a number of cases data was relayed "round the horn" by two or more routes and the results checked for accuracy deviation.

The mag tape terminal units are in daily use between the San Francisco and Kansas City Social Security payment centers.

MICROWAVE TRANSMISSION AT NORTH AMERICAN

an operative description

by KENNETH R. PARSONS

A microwave hookup between three divisions of North American Aviation in the Los Angeles area was placed in operation last year and has effectively tied together NAA's six 7090s (a seventh is on order), one 7070, one 709, two 705s, more than 20 1401s (36 are scheduled late this year), and three 305 RAMACs.

Since a 1401 is used for buffering, data is transmitted at 41KC although the actual transmission rate is 20KC, the speed of the 729II tape unit. Future use of 729IV tape drives and a buffered receiving unit is expected to increase transmission speed to 62KC. To balance and distribute available time in each of the computer centers, the system functions in the following manner:

One of the three centers requiring time first establishes by telephone at which of the other two centers time may be available. A reel of mag tape containing the data to be transmitted (and program, if necessary) is then mounted on a 729II attached to the IBM 1945 microwave transmission terminal. The latter is connected as one of the mag tape drives to the 1401.

Similarly, a 1401 at the receiving end has a 1945 attached to it as one of the six possible mag tape units.

When the receiving 1401 transmits a read command, the tape unit attached to the sending 1401 is started and read as if it were directly attached to the receiving computer.

Information from the tape is sent to the 1945 where it is converted from the tape code into a seven parallel broadband data channel code for microwave transmission via a parabolic (dish) antenna at the originating division's computer center. (An eighth and separate channel is used for control, such as a read command or backspace command.)

The microwave transmission is sent to one of three dishes, located on Oat Mountain (site of TV and telephone relay systems) each aimed at one of the three divisions directly tied into the system.

At Oat Mountain the transmitted data is amplified and sent out over one of the dishes to the corresponding division's computer center. The data is then received by the computing center contributing its computer time,

again routed through a 1945, converted back to the original tape code, read into a 1401 which acts as a buffer, and writes the information on tape mounted on a 729II, ultimately creating a duplicating tape of the one at the transmitting division.

Information is read into the 1401 and must then be

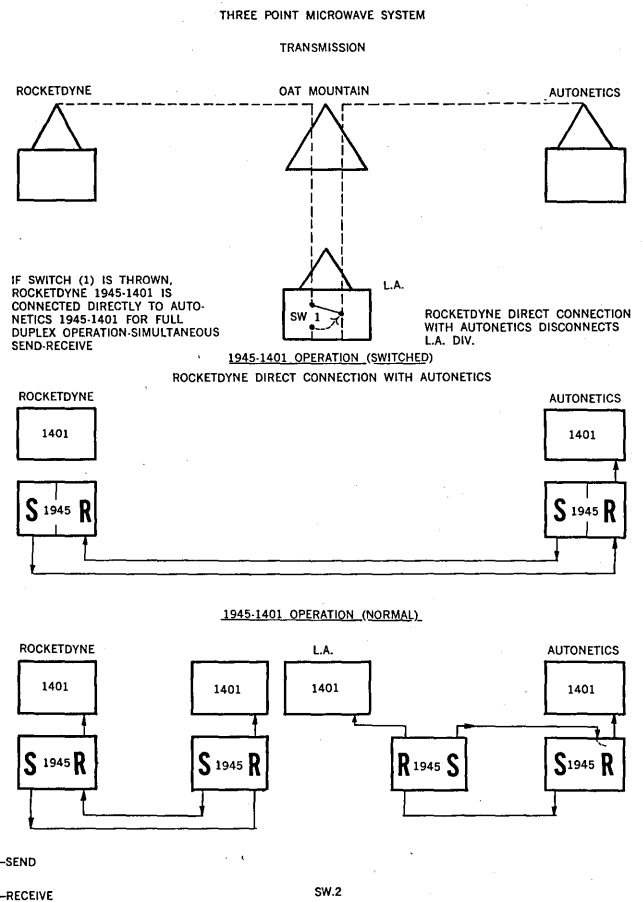

COMPUTER PROGRAMMERS

**7030 (STRETCH), 7090,
AN/FSQ-7 (SAGE)**

MITRE is expanding its effort on the design and development of computer programs for critical experiments in the area of large-scale computer-based command and control systems. Test facilities are now equipped with 7090, 1401, and AN/FSQ-7 (SAGE) computers. These facilities will soon be expanded to include a 7030 STRETCH computer.

Experienced Programmers interested in important assignments can find professional fulfillment in these areas:

- Problem-Oriented Languages
- Computer Applications
- Programming Research
- Numerical Analysis
- Real Time System Design
- Utility Program Design
- System Programming Techniques
- Information Storage and Retrieval
- Facility Operations
- Computer System Evaluation

Recent college graduates with high scholastic achievements and an interest in helping us develop these fields are also invited to apply.

Inquiries may be directed in confidence to: Vice President — Technical Operations, The MITRE Corporation, Post Office Box 208, Dept. MC9, Bedford, Mass.

MITRE is an independent, nonprofit corporation serving as Technical Advisor to the Air Force Electronic Systems Division, and chartered to work for such other Government agencies as FAA.

THE
MITRE
CORPORATION

An Equal Opportunity Employer

written on a second tape, thus cutting the transmission speed in half, since the 1401 does not permit simultaneous read write or tape buffering. The duplicate tape is then used as input on a computer in the receiving division's center, and the resulting processed data is sent to the requesting division in a similar manner.

NAA has had microwave data transmission facilities between the Los Angeles Division at International Airport and the Rocketdyne Division at Canoga Park since 1959. The present three-division hookup also accommodates the Autonetics Division at Downey. Full duplex transmission is possible.

The hookup was jointly engineered by NAA, IBM, and the Bell Telephone System. ■



A duplicated mag tape is mounted on one of NAA's six 7090s following microwave transmission from Oat Mountain.

An eight-foot dish (parabolic antenna) is inspected by George Sutton, NAA corporate communications advisor.



1410 to control message flow from 41 branches

STOCK BROKER UTILIZES REAL TIME DATA TRANSMISSION

Utilization of the IBM 1410 Brokerage Tele-processing System, one of the first of its kind for the brokerage industry, will allow any of the 41 branch offices of Thomson & McKinnon, New York brokerage house, to transmit an order to be printed out on the exchange floor — in proper format — in less than 30 seconds.

When the system is placed in full operation next year, branch offices, Thomson & McKinnon headquarters and stock exchange booths will communicate with the data processing center (at the firm's main office) via private leased lines.

The result of nearly two years of joint development by Thomson & McKinnon and IBM, two 1410s, each with a specially-developed real time channel and an IBM disk storage unit, will be in operation at the processing center. The real time channels will direct the flow of messages into and out of the two 1410s so that they will be handled as they occur.

Either of the two 1410s will be able to operate as the on-line center of the system, with the other serving as standby and performing other special tasks. Each of the two 1301 disk storage units will contain complete customer, security and accounting records that will be maintained and updated on a real time basis. The units will contain identical information and either may be used alone.

Each 1410 will include a central processing unit with core storage capacity of up to 40KC; an input-output synchronizer to permit independent operation of internal processing and input-output devices; mag tape units for permanent record of daily transactions; card-read punch; and a console for external control. A 600-line-per-minute printer is linked to the system.

Handling of a typical order originating at a branch office will proceed in the following manner (see illustration):

The order is entered as "12-34567-Buy 100 XYZ at 580 GTC." (The first group of figures is the branch code and customer account number.) The 1410 determines from filed information to which exchange (New York or American) the order should be routed.

The message is assembled, edited and coded at the computer center. After editing for format, consistency, etc., the security record is retrieved automatically from file and the order processed per file instructions, inserted in proper sequence, floor message prepared, and transmitted to the market.

The order is printed on the exchange floor as "Buy 100 XYZ 580 GTC." Although the account number has been dropped, when executed, the order will be matched within the 1410 to the buyer.

CIRCLE 389 ON READER CARD

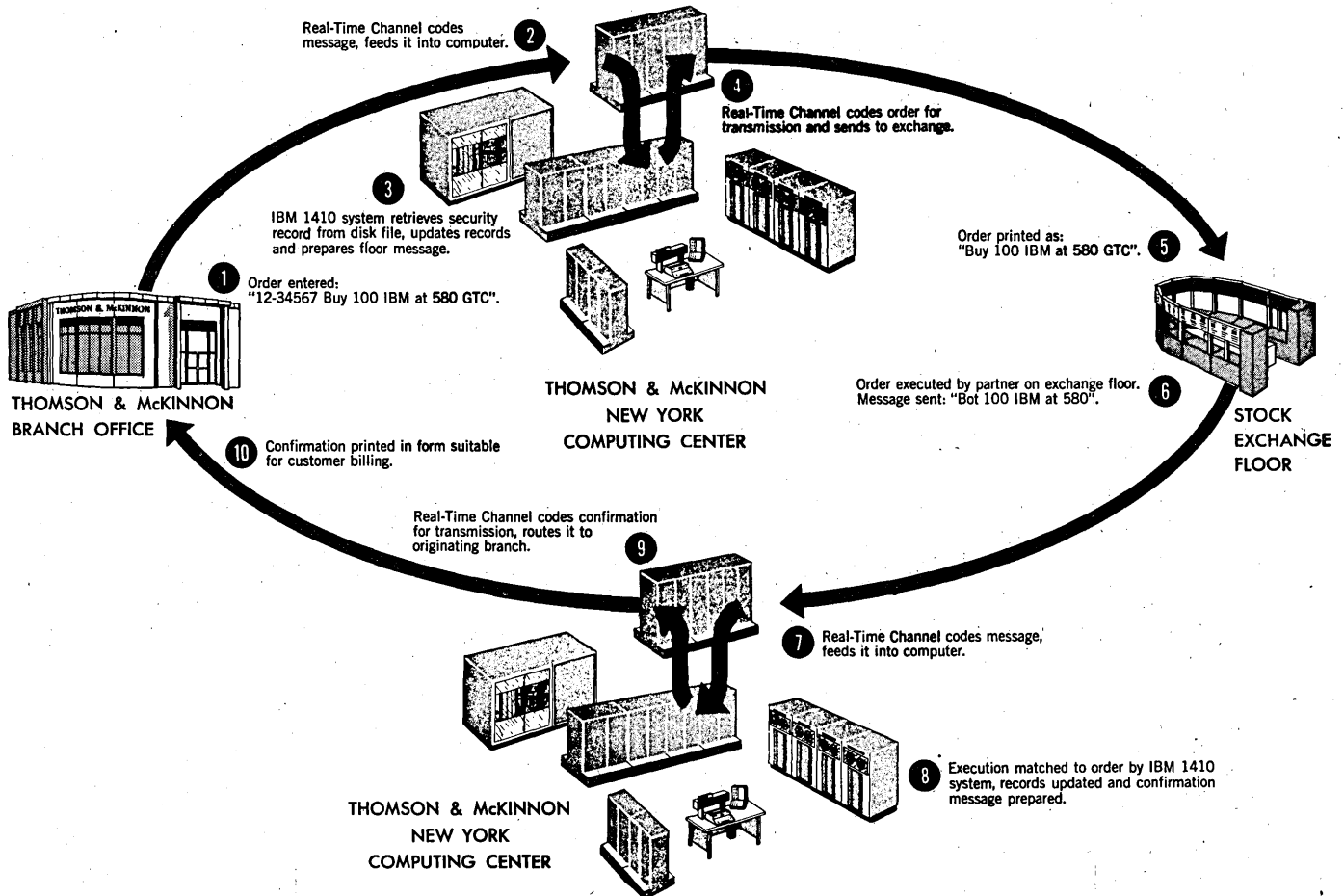

ERROR DETECTION & CORRECTION

an explanation

by R. G. MATTESON, General Dynamics/Electronics,
Rochester, New York



When considering data transmission, errors in transmission are of prime importance in many applications and means must be incorporated for detection and correction.

It has been estimated that during a voice conversation, data is transmitted at a rate of about 50 bits per second. It would be difficult to build equipment which would reduce voice communication to an actual data rate of 50 bits per second, but it has been estimated that this is the actual information content transmitted by voice. It is obvious that considerable redundancy exists, and this redundancy is used by the individual receiving the conversation for automatic error correction. If he misses a word or a part of a sentence, he can usually guess at the missing information and fill it in mentally, thus performing an automatic forward-acting error correction function. If he misses so much information that the conversation is not understandable, he will ask the person doing the talking to repeat, thus providing a feedback and retransmission system of error correction. This analogy illustrates that there appear to be two basic types of error correction schemes. One requires a decision and feedback to tell the transmitter that errors have occurred, and to request retransmission of the data. The second type is a forward-acting error correction system which operates on redundancy transmitted with the data.

A block diagram of an error correction system using decision feedback is shown in Figure 1. Error-checking circuitry in the receiving terminal checks the redundancy in the data to see if data has been transmitted correctly. If errors are detected, feedback information transmitted back to the transmitter requests retransmission. Since error correction requires the retransmission of an entire block of data, the efficiency of transmission of a system

using this type of error correction system will be highest if the error rate is low. The transmitter can send a record and wait for acknowledgement or it can send data continuously, stopping for retransmission only when an error indication has been returned from the receiver. If records are long and there is a high probability of error, it is best to wait for the acknowledgement at the end of each record. If the records are short and there is a low probability of errors, it is better to transmit continuously, stopping to go back and retransmit data only when errors are actually detected. For the decision feedback type of error control, the optimum length of record is dependent

FIGURE 1

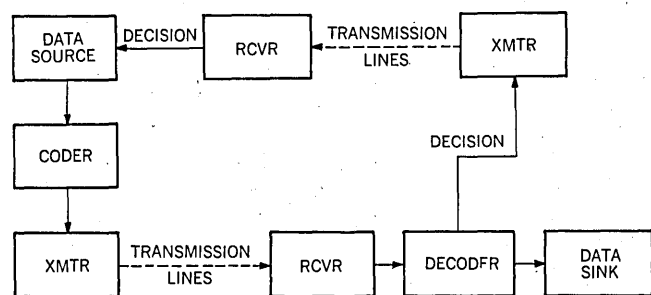

upon the error rate and error distribution to be expected, and is inversely proportional to the error rate expected. It can be seen that if records of 1 million bits each are transmitted, and there is a random distribution of errors with an error rate of one error occurring for every one million bits transmitted, there will be a 50% probability that a given record will be retransmitted.

The decision feedback method of error correction can be made more sophisticated to include adaptive control. If the error rate becomes high, changes in transmitter

FIGURE 4
SERIALIZED DATA TRANSMISSION
FROM 7-BIT TAPE FORMAT

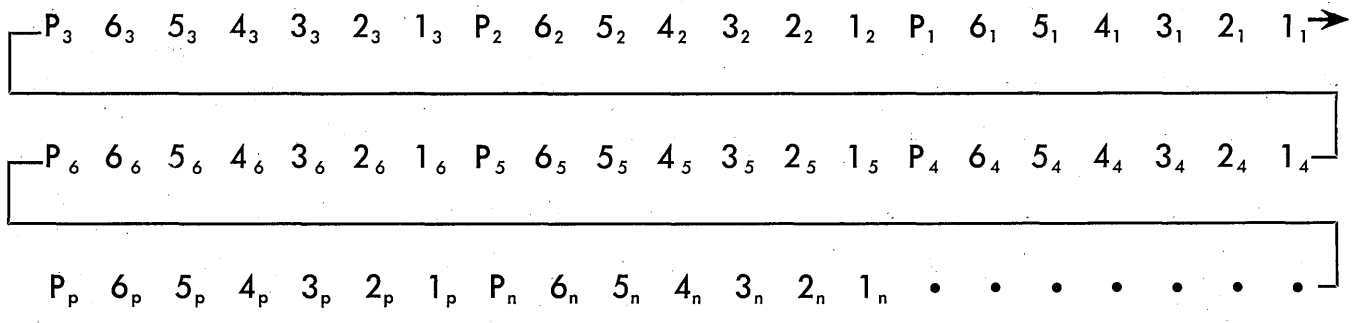

characteristics can be accomplished to reduce the error rate. For example, bit rates can be lowered, lines can be switched, and/or transmitter power can be increased. The decision feedback method for error correction is simpler to implement than a powerful type of forward-acting error correction system.

Figure 2 shows a block diagram of a system using forward-acting error correction. Redundancies are added to the transmitted data in the encoder to enable error correction at the receiver. At the receiving terminal the data is decoded and errors are automatically corrected. A considerable amount of work is being performed* to determine the optimum types of coding schemes to provide powerful error correction with a minimum amount of redundancy in the transmitted data. In general, however, encoding and decoding schemes are quite

FIGURE 2

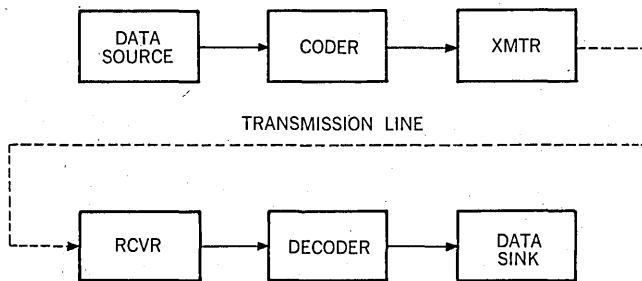

sophisticated and require considerable amounts of extra circuitry. The additional redundancy added to the transmitted data also reduces transmission efficiency. Redundancy can be incorporated to correct for single bit errors fairly simply, but considerable complexity is required to correct for bursts of errors.

The simplest type of redundant transmission involves the transmission of the entire record two or three times. If the first transmission has errors, it can be rejected and the second transmission can be recorded. If data is transmitted three times, it can be checked in a two-out-of-three circuit, and data which is the same in two out of the three transmissions is recorded. If all transmissions have errors, then obviously the error correction scheme has failed. The efficiency of transmission using such a scheme cannot be better than 50% or 33 1/3% for double or triple transmission of data. Storage is required at the

receiving terminal for storage of the redundant transmissions before recording.

A system which offers most of the practical advantages with a minimum of disadvantages appears to be a combination of the forward-acting error correction code and the decision feedback error correction system. It appears to be relatively simple to correct a single bit error that occurs during the transmission of a record. This may improve the error rate by a factor of ten or more with a minimum of equipment. Since no forward-acting error correcting system appears to be adequate for all applications, retransmission would be requested for correction of multiple errors. It could also be noted parenthetically that the type of coding and decoding scheme used for more sophisticated forward-acting error correction schemes will depend upon the characteristics of the modulator and demodulator as well as the characteristics of the transmission path. A system which provides optimum error correction in one application may actually create a worse error rate in another application.

Figure 3 indicates the type of redundancy used in a common type of data format for error detection purposes. This is the format used on IBM tape equipment. Each character consists of 7 bits, bits 1 through 6 for data and 7 for a parity bit designating whether the sum of the

FIGURE 3
CONVENTIONAL 7-BIT TAPE FORMAT
WITH ONE PARITY BIT PER CHARACTER

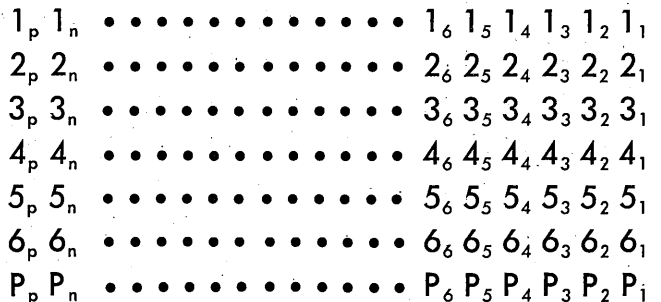

preceding bits was odd or even. At the end of a record of n characters, a longitudinal parity character is inserted to indicate whether the sum of the bits in any given column was odd or even. Figure 4 shows how data would be transmitted serially from the IBM tape format. Bits 1 through 6 of the first character are transmitted, followed by the parity bit of that character, followed by the corresponding bits in each of the other characters on the record. At the end of the transmission of that

*R. C. Bose and D. K. Chaudhuri, "A Class of Error-Correction Binary Group Codes," *Information and Control*, Vol. 3, pp. 68-79; March 1960.

FIGURE 5
INTERLACED TRANSMISSION OF
DATA FROM 7-BIT TAPE FORMAT

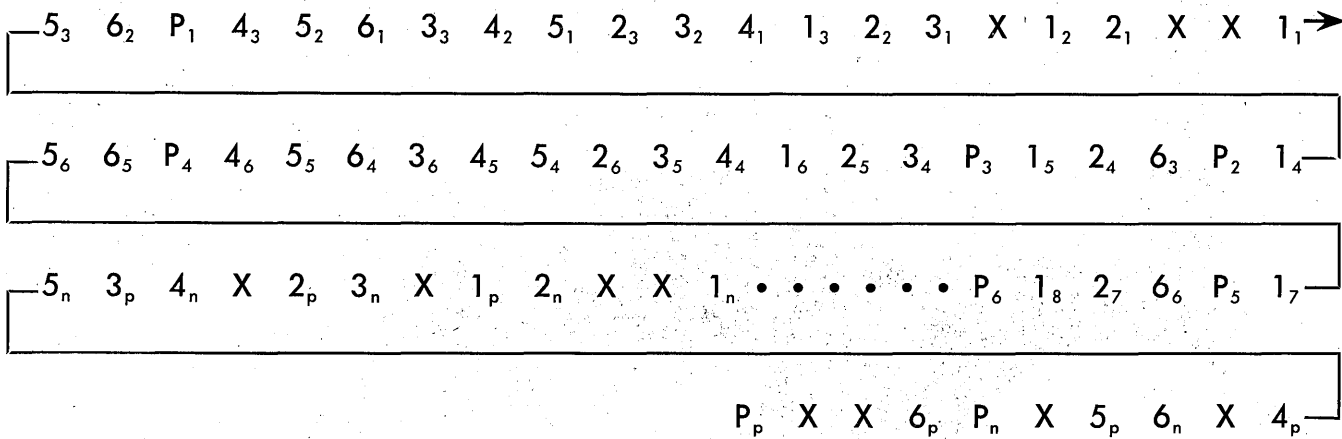

record the seven bits of the longitudinal parity character are transmitted.

Characteristics of noise occurring on telephone lines frequently cause two or more errors to occur in the same character. If an even number of bits is made to be in error in a given character, the parity bit of that character will not indicate the error. Similarly if an even number of errors occurs in the longitudinal direction, the longitudinal parity character will not indicate the errors. By interlacing the bits of more than one character, the possibility is considerably lessened for getting compensating errors. Figure 5 shows the transmission of data in the IBM format with the data interlaced from three characters. Bits of the first character are transmitted every third position. The second character and third character bits are interlaced with bits from the first character. Two consecutive bit errors will then cause errors to occur in two different characters thus providing parity bit errors in those two characters. Since the longitudinal parity character is interlaced with three other characters, there will be less chance of compensating errors occurring in that character as well.

Instead of using a single bit indicating parity for a character, two parity bits could be utilized as shown in Figure 6. Here we have each character consisting of 8 bits, 6 bits for the data, and 2 bits for the parity. One parity bit indicates the oddness or evenness of bits 1, 3, and 5 while the other parity bit indicates the oddness

FIGURE 6
DATA WITH TWO PARITY BITS PER CHARACTER
FOR INTERLACED PARITY CHECK

1 _p	1 _n	• • • • •	1 ₃	1 ₂	1 ₁
2 _p	2 _n		2 ₃	2 ₂	2 ₁
3 _p	3 _n		3 ₃	3 ₂	3 ₁
4 _p	4 _n	• • • • •	4 ₃	4 ₂	4 ₁
5 _p	5 _n		5 ₃	5 ₂	5 ₁
6 _p	6 _n		6 ₃	6 ₂	6 ₁
P _{135_p}	P _{135_n}		P _{135₃}	P _{135₂}	P _{135₁}
P _{246_p}	P _{246_n}	• • • • •	P _{246₃}	P _{246₂}	P _{246₁}

or evenness of 2, 4, 6. With this scheme, there will be a much smaller probability of compensating errors occurring in a given character due to a burst of errors. A more powerful type of longitudinal parity can also be utilized. Instead of indicating the oddness or evenness of all the bits in a given column, a total count of the bits in the entire record could be calculated and applied at the end of the record. Since in some types of modems, bits are more apt to be added than deleted, this type of count will minimize the possibility of compensating errors.

N.Y. TIMES DATA LINK TIES L.A., N.Y. & PARIS

When The New York Times starts its West Coast Edition later this year, the Los Angeles terminal will hook up with New York and Paris (publication center for The Times' International Edition) resulting in what may be the world's longest network for newspaper copy transmission.

One thousand words of newspaper copy per minute will be sent over regular telephone lines to LA—fifteen times faster than present teletype speed—and is the first use of the system by any newspaper for news transmission.

Copy for the west coast edition will be produced in LA by Teletypesetter simultaneously with the New York and Paris editions. The Times will be able to send 96,000 words of copy (120 columns) across the continent in 96 minutes of telephone time. (Actually, the circuit will be open from 3 p.m. to midnight.)

Edited copy in New York will be punched into paper tape and placed on Digitronic's D-507 Dial-o-verter, which

is linked to the Bell System Wide Area Telephone Service (WATS). The operator will call the LA newsroom, advising of the start of transmission, and the receiver will be turned on.

In LA, a duplicate tape will be produced, and fed into a Teletypesetter unit. In operation, eleven TTS units will be used to keep up with the tapes. Each will set type at 66 words per minute, for a total of 726 words per minute. The 96,000 words can be set in type in 133 minutes, as compared with two full business days, if conventional equipment were used.

Costwise, the conventional, slower (15 hours of transmission time) TTS operation would run to \$96,000 yearly. Utilizing the Digitronics equipment and six channel WATS circuit, estimated annual costs for the West Coast Edition would total less than \$60,000.

Similarly, the overseas edition's costs will be reduced. John I. Henry, director of communications for The Times, estimates the yearly costs for transmission to Paris will be reduced as much as \$125,000, using the Digitronics equipment.

BRYANT SYSTEMS AND CIRCUITS REDUCE DATA STORAGE COSTS

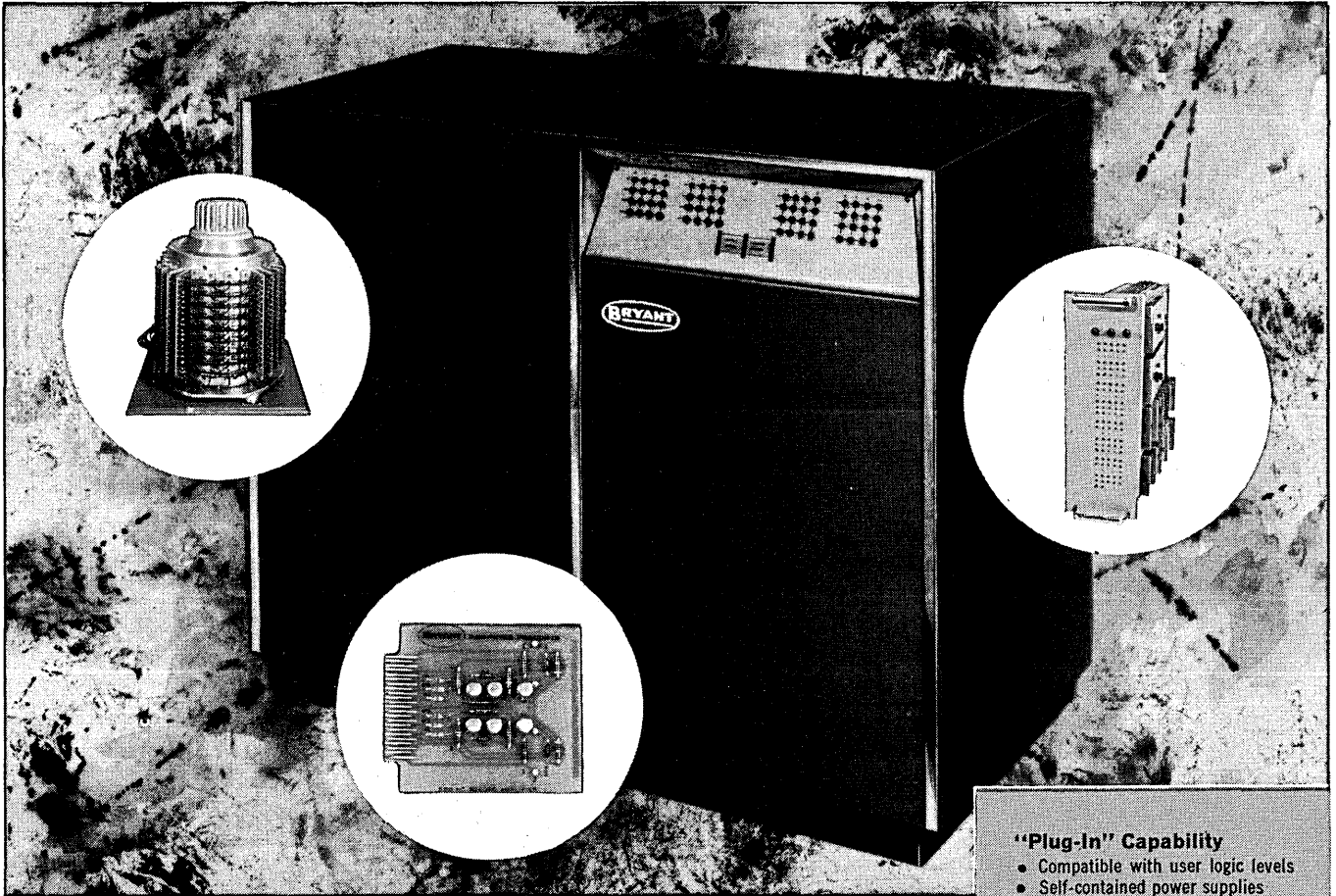

Whatever your data storage requirements, investigate Bryant's drum and disc file memory systems, and full line of modular read, write, selection, and interface circuitry. For details contact your local Bryant representative, or write direct to: 852 Ladd Road, Walled Lake, Michigan, Market 4-4571.

Typical Specifications (Read Amplifier Model 6002)

No. of Circuits per board	1	Current requirements per board	
Frequency of operation	DC min.;	@ - 20 V	30 M.A.
	500 KC max.	@ + 7V	30 M.A.
Input signal required	10 MV to 500 MV	@ - 7V (Clamp)	10 M.A.
Output drive capabilities	20 MA "And" current;	Output wave form rise time	less than .1 usec
	7 MA "Or" current	Output wave form fall time	less than .1 usec
		Logic Levels	0v and -7v
		Temperature Range	0°C to +55°C

"Plug-In" Capability

- Compatible with user logic levels
- Self-contained power supplies
- Standard rack mounting
- Choice of recording modes

Design Flexibility

- Frequencies to 1 MC
- Serial and parallel operation
- Selective alteration of data
- Custom units for every requirement

Built-In Reliability

- Complete solid state designs
- Derated components, Mil-approved connectors
- Glass epoxy printed boards
- Overload protection

Circuit Availability

- Individual circuits available include: read, write, selection, clock read, driver, inverter, flip flop, multiple gate, and power supply modules.

62-42CP

BRYANT

COMPUTER PRODUCTS

Disc File and Magnetic Drum Memories for Every Storage Application

A DIVISION OF EX-CELL-O CORPORATION



CIRCLE 25 ON READER CARD

A DATA COMMUNICATIONS GLOSSARY

Since the presumption may be made that the field of data communications is largely an alien one to many DATAMATION readers, the inclusion of the following glossary of terms should help remove some of the surface unfamiliarity if only to introduce a more sophisticated level of confusion.

Definitions are the result of collective discussions by

ACCESS, RANDOM

Access to storage under conditions in which the next position from which information is to be obtained is in no way dependent on the previous one.

ACCESS TIME

The time interval characteristic of a memory or storage device, between the instant at which information is: (a) called for from storage and the instant at which delivery is completed; e.g., the read time; or (b) ready for storage and the instant at which storage is completed; e.g., the write time. Latency plus word time.

ACCURACY

Freedom from error. Accuracy contrasts with precision; e.g., a four-place table correctly computed is accurate; a six-place table containing an error is more precise, but not accurate.

ADJACENT CHANNEL

Channel whose frequency band is adjacent to that of the reference channel (above or below) or whose time slot is adjacent to that of the reference channel (before or after).

ADJACENT CHANNEL INTERFERENCE

Interference caused by the operation of adjacent channels.

ADJACENT CHANNEL SELECTIVITY

Characteristic of a receiver which governs its ability to reject signals on channels adjacent to that of the desired signal.

AMPLIFIER, BUFFER

An amplifier used to isolate the output of any device; e.g., oscillator, from the effects produced by changes in load from subsequent circuits.

AND

A logical operator which has the property such that if P and Q are two statements, then the statement "P and Q" is true or false,

members of the Data Transmission Study Group and have no official standing although they may certainly be considered as a basis for eventual standardization. Questions, discussion and exceptions to these definitions should be addressed to Jack Strong, Chairman, DTSG, C-E-I-R, 9171 Wilshire Blvd., Los Angeles, Calif. ■

precisely according to the following table of possible combinations.

P	Q	P and Q
False	False	False
False	True	False
True	False	False
True	True	True

The AND operator is often represented by a centered (*) or by no sign as in P*Q or PQ.

"AND" GATE

A signal circuit with two or more input terminals which has the property that the terminal gives a signal only if all input terminals receive coincident signals.

ANALOG

"That which is analogous." In a scientific sense, that which obeys the same mathematical relations. Thus we speak of an electrical analogue to a mechanical system, etc.

ASYNCHRONOUS MACHINE

A machine in which the speed of operation is not related to any frequency in the system to which it is connected.

ATTENUATE

To obtain a fractional part or reduce the energy of an action or signal. Measurement may be made as percentage, per unit, or in decibels, which is 10 times \log_{10} of power ratio, or 20 \log_{10} of voltage ratio of power ratio; contrasted with "Amplify."

AUTOMATIC ELECTRONIC DATA SWITCHING CENTER

Communication center designed specifically for relaying digitized data by automatic electronic methods.

AUTOMATIC EXCHANGE

An exchange in which communication between subscribers is effected without the intervention of an operator by means of devices set in operation by the originating subscriber's instrument.

BALANCED CIRCUITS

Circuit consisting of two signal branches in the presence of ground or a neutral branch capable of being operated in such a way that the voltages of the two branches at all transverse planes are

equal in magnitude and opposite in polarity with respect to ground or the neutral branch.

BALANCED LINE

A transmission line consisting of two conductors in the presence of ground, capable of being operated in such a way that the voltages of the two conductors at all transverse planes are equal in magnitude and opposite in polarity with respect to ground, the currents in the two conductors are equal in magnitude and opposite in direction.

BAND

Range of frequency spectrum between two defined frequency limits. Used as applying to a group of radio channels assigned to a particular type of radio service. A range of frequencies (per sec.) within two definite limits.

Frequency bands as defined by article 2, Geneva 1959, Radio regulations.

The radio spectrum shall be subdivided into nine frequency bands, which shall be designated by progressive whole numbers in accordance with the following Table. Frequencies shall be expressed:

- in kilocycles per second (kc/s) up to and including 3000 kc/s
- in megacycles per second (Mc/s) thereafter up to and including 3000 Mc/s
- in gigacycles per second (Gc/s) thereafter up to and including 3000 Gc/s

However, where adherence to these provisions would introduce serious difficulties, for example in connection with the notification and registration of frequencies, the lists of frequencies and related matters, reasonable departures may be made.

Band No.	Frequency Range (lower limit exclusive, upper limit inclusive)	Corresponding Metric Subdivision
4	3 to 30 kc/s (kHz)	Myriametric waves
5	30 to 300 kc/s (kHz)	Kilometric waves
6	300 to 3000 kc/s (kHz)	Hectometric waves
7	3 to 30 Mc/s (MHz)	Decametric waves
8	30 to 300 Mc/s (MHz)	Metric waves
9	300 to 3000 Mc/s (MHz)	Decimetric waves
10	3 to 30 Gc/s (GHz)	Centimetric waves
11	30 to 300 Gc/s (GHz)	Millimetric waves
12	300 to 3000 Gc/s (GHz) or 3 Tc/s (THz)	Decimillimetric waves

NOTE 1: "Band Number N" extends from 0.3×10^N to 3×10^N c/s(Hz).

NOTE 2: Abbreviations:

c/s = cycles per second, Hz = hertz,
k = kilo (10^3), M = mega (10^6),
G = giga (10^9), T = tera (10^{12})

NOTE 3: Abbreviations for adjectival band designations:

Band 4 = VLF	Band 8 = VHF
Band 5 = LF	Band 9 = UHF
Band 6 = MF	Band 10 = SHF
Band 7 = HF	Band 11 = EHF

BAND PASS

Number of cycles/sec expressing the difference between the limiting frequencies at which the attenuation to a single frequency energy is the desired amount (usually half power or three DB) of the attenuation to single frequency energy at the mid frequency between the two limiting points.

BAND WIDTH

The difference in cycles/sec between the highest and lowest frequencies in a band.

BAUD

Unit of signaling speed. The speed in bauds is the number of code elements/sec. Term used to define the operating speed of a printing telegram system. (The total number of mark and space — on and off — code elements/sec.). A teleprinter, running at such a speed that the maximum line frequency is 22.5 cps is said to be operating at 45 bauds.

BI-POLAR (UNI POLAR)

When a logical "true" input is represented by an electrical voltage polarity opposite to that representing a logical "false" input, the signal is defined as bi-polar. If both "true" and "false" inputs are represented by the same electrical voltage polarity, the signal is defined as uni-polar.

BIT (A CONTRACTION OF BINARY DIGIT)

A whole number in the binary scale of notation. A unit of information taken with reference to the logarithm to the base two. This digit may be only 0 (zero) or 1 (one). It may be equivalent to an "ON" or "OFF" condition, a "YES" or a "NO", etc. One unit of information.

BLOCK

A group of words considered or transported as a unit; an item; a message; in flow charts, an assembly of boxes, each box representing a logical unit of programming, usually requiring transfer to and from the high speed storage; in circuits, a group of electrical circuits performing a specific function, as in a "block" diagram, in which unit, e.g., oscillator, is represented as a block. (symbol).

BRIDGE DUPLEX SYSTEM

Telegraphy duplex system based on the Wheatstone Bridge principle in which a substantial neutrality of the receiving apparatus to the sent currents is obtained by an impedance balance. Received currents pass through the receiving relay which is bridged between points which are equipotential for the sent circuits.

BUFFER

An isolating circuit used to avoid any reaction of a driven circuit upon the corresponding driving circuit; e.g., a circuit having an output and a multiplicity of inputs, so designed that the output is energized whenever one or more inputs are energized. Thus, a buffer performs the circuit function which is equivalent to the logical "OR."

CABLE

Assembly of one or more conductors within an enveloping protecting sheath so constructed as to permit use of conductors separately or in groups.

CABLE, COAXIAL

Cable, used as an unbalanced transmission line, consisting of one conductor, usually a small copper tube or wire within, and insulated from another conductor of larger diameter, usually copper tubing or copper braid. The outer conductor may or may not be grounded. Radiation from this type of line is practically zero at high frequencies.

CABLE, COMBINATION

Cable having conductors grouped in combination such as pairs and quads.

CABLE, COMPOSITE

Cable in which conductors of different gauges and types are combined under one sheath.

CABLE, PAIRED

Cable in which the single conductors are twisted together in groups of two.

CABLE, QUADDED

Cable in which some of the conductors are arranged in the form of quads.

CARRIER

Wave suitable for modulation by the intelligence to be transmitted over a communication system. The component of a transmitted wave upon which an audio signal or other form of intelligence can be impressed. The carrier can be a sinusoidal wave or a recurring series of pulses. The carrier may be a high frequency current superimposed on a voice circuit, on which can be modulated additional voice or signalling channels.

CARRIER FREQUENCY

Carrier frequency of a periodic carrier wave of any wave shape is equal to the reciprocal of its period. The frequency of a periodic pulse carrier often is called the pulse-repetition frequency.

a data communications glossary

CARRIER SHIFT

Difference between the steady state, mark and space frequencies in a data carrier system using frequency shift modulation.

CHARACTER

One of a set of elementary symbols such as those corresponding to the keys on a typewriter. The symbols may include the decimal digits 0 through 9, the letters A through Z, punctuation marks, operation symbols, and any other single symbols which a computer may read, store, or write; a pulse code representation of such a symbol.

CHARACTER CROWDING

The effect of reducing the time interval between subsequent characters read from tape caused by a combination of mechanical skew, gap scatter, jitter, amplitude variation, etc. It should be noted that these phenomena may be additive between the tape drive that writes the tape and the drive which reads it subsequently, and therefore tolerances should be maintained on any one drive which does not exceed half of the total tolerance allowed when the tape is read back.

CHECK

A means of verification of information during or after an operation.

CHECK, BUILT-IN OR AUTOMATIC

Any provision constructed in hardware for verifying the accuracy of information transmitted, manipulated, or stored by any unit or device in a computer. Extent of automatic checking is the relative proportion of machine processes which are checked or the relative proportion of machine hardware devoted to checking.

CHECK, DUPLICATION

A check which requires that the results of two independent performances (either concurrently on duplicate equipment or at a later time on the same equipment) of the same operation be identical.

CHECK, FORBIDDEN-COMBINATION

A check (usually an Automatic Check) which tests for the occurrence of a nonpermissible code expression. A self-checking code (or error-detecting code) uses code expressions such that one (or more) error(s) in a code expression produces a forbidden combination. A parity check makes use of a self-checking code employing binary digits in which the total number of 1's (or 0's) in each permissible code expression is always even or always odd. A check may be made for either even parity or odd parity. A redundancy check employs a self-checking code which makes use of redundant digits called check digits.

CHECK, MARGINAL

A system or method of determining computer circuit weaknesses and incipient malfunctions; e.g., by varying the power applied to various circuits, usually by lowering of the D.C. supply of filament voltages, or varying input signal amplitudes.

CHECK, MATHEMATICAL OR ARITHMETICAL

A check making use of mathematical identities or other properties, frequently with some degree of discrepancy being acceptable; e.g., checking multiplication by verifying that $A \cdot B = B \cdot A$, checking a tabulated function by differencing, etc.

CHECK, MODULO N

A form of check digits, such that the number of ones in each number A operated upon is compared with a check number B, carried along with A and equal to the remainder of A when divided by N; e.g., in a "modulo 4 check," the check number will be 0, 1, 2, or 3 and the remainder of A when divided by 4 must equal the reported check number B, or else an error of malfunction has occurred; a method of verification by congruences; e.g., casting out nines.

CHECK, ODD-EVEN

A check system in which a one or a zero is carried along in a word depending on whether the total number of ones (or zeros) in a word is odd or even.

CHECK, PARITY

A summation check in which the binary digits, in a character or word, are added (modulo 2) and the sum checked against a single, previously computed parity digit; i.e., a check which tests whether the number of ones is odd or even.

CHECK, PROGRAMMED

A system of determining the correct program and machine functioning either by running a sample problem with similar programming and known answer, including mathematical or logical checks such as comparing A times B with B times A and usually where reliance is placed on a high probability of correctness rather than built-in error-detection circuits or by building a checking system into the actual program being run and utilized for checking during the actual running of the problem.

CHECK, REDUNDANT

A check which uses extra digits, short of complete duplication, to help detect malfunctions and mistakes.

CHECK, SUMMATION

A redundant check in which groups of digits are summed usually without regard for overflow, and that sum checked against a previously computed sum to verify accuracy.

CHECK, TRANSFER

Verification of transmitted information by temporary storing, retransmitting and comparing.

CHECK, TWIN

A continuous duplication check achieved by duplication of hardware and automatic comparison.

CODE (AS USED IN DATA PROCESSING)

A system of symbols and their use in representing rules for handling the flow or processing of information; to actually prepare problems for solution on a specific computer.

CODE, EXCESS-THREE

A coded decimal notation for decimal digits which represents each decimal digit as the corresponding binary number plus three; e.g., the decimal digits 0, 1, 7, 9 are represented as 0011, 0100, 1010, 1100, respectively. In this notation, the nines complement of the decimal digit is equal to the ones complement of the corresponding four binary digits.

CODE, INSTRUCTION

An artificial language for describing or expressing the instructions which can be carried out by a digital computer. In automatically sequenced computers, the instruction code is used when describing or expressing sequences of instructions, and each instruction word usually contains a part specifying the operation to be performed and one or more addresses which identify a particular location in storage. Sometimes an address part of an instruction is not intended to specify a location in storage but is used for some other purpose. If more than one address is used, the code is called a multiple address code.

CODE, MULTIPLE-ADDRESS

An instruction or code in which more than one address or storage location is utilized. In a typical instruction of a Four-Address Code the addresses specify the location of two operands, the destination of the result, and the location of the next instruction in the sequence. In a typical Three-Address Code, the fourth address specifying the location of the next instruction is dispensed with, the instructions are taken from storage in a preassigned order. In a typical Two-Address Code, the addresses may specify the locations of the operands. The results may be placed at one of the addresses or the destination of the results may be specified by another instruction.

CODING, ALPHABETIC

A system of abbreviation in preparing information for input into

a computer such that information is reported in the form of letters; e.g., New York as NY, carriage return as CN, etc.

CODING, AUTOMATIC

Any technique in which a computer is used to help bridge the gap between some "easiest" form, intellectually and manually, of describing the steps to be followed in solving a given problem and some, "most efficient" final coding of the same problem for a given computer; two basic forms are Routine, compilation and Routine, interpretation.

CODING, NUMERIC

A system of abbreviation used in the preparation of information for machine acceptance by reducing all information to numerical quantities; in contrast to alphabetic coding.

COLUMN

One of the character or digit positions in a positional notation representation of a unit of information, columns are usually numbered from right to left column, zero being the right-most column if there is no point, or the column immediately to the left of the point if there is one; a position or place in a number in which the position designates the power of the base and the digit is the coefficient; e.g., in 3876, the 8 is the coefficient of 10^2 , the position of the 8 designating the 2.

COMMAND

A pulse, signal, or set of signals initiating one step in the performance of a computer operation. See instruction and order.

COMPARATOR

A device for comparing two different transcriptions of the same information to verify the accuracy of transcription, storage, arithmetic operation or other process, in which a signal is given dependent upon the relative state of two items; i.e., larger, smaller, equal, difference, etc.

CONTENTS

The information stored in any storage medium. Quite prevalently, the symbol () is used to indicate "the contents of;" e.g., (m) indicates the contents of the storage location whose address is m; (A) indicates the contents of register A; (T₂) may indicate the contents of the tape on input-output unit two, etc.

CONVERTER

A unit which changes the language of information from one form to another so as to make it available or acceptable to another machine; e.g., a unit which takes information punched on cards to information recorded on magnetic tape, possibly including editing facilities.

CORE, MAGNETIC

A magnetic material capable of assuming and remaining at one of two or more conditions of magnetization, thus capable of providing storage, gating or switching functions, usually of toroidal shape and pulsed or polarized by electric currents carried on wire wound around the material.

COUNTER

A device, register, or storage location for storing integers, permitting these integers to be increased or decreased by unity or by an arbitrary integer, and capable of being reset to zero or to an arbitrary integer.

COUNTER, CONTROL

A device which records the storage location of the instruction word, which is to be operated upon following the instruction word in current use. The control counter may select storage locations in sequence, thus obtaining the next instruction word from the following storage location, unless a transfer or special instruction is encountered.

COUNTER, RING

A loop of interconnected bistable elements such that one and

only one is in a specified state at any given time and such that, as input signals are counted, the position of the one specified state moves in an ordered sequence around the loop.

DATA

Plural term collectively used to designate alphabetic or numeric material, serving as a basis of discussion; material may or may not be technical in nature. Information, particularly that used as a basis for mechanical or electronic computation.

DATA LINK

Equipment which permits the transmission of information in data format.

DATA-REDUCTION

The art or process of transforming masses of raw test or experimentally obtained data, usually gathered by instrumentation, into useful, ordered, or simplified intelligence.

DATA-REDUCTION, ON-LINE

The processing of information as rapidly as the information is received by the computing system.

DATA TRANSMISSION UTILIZATION MEASURE

The ratio of useful data output of a data transmission system to the total data input.

DEBUG

To isolate and remove all malfunctions from a computer or all mistakes from a routine.

DECIMAL, CODED, BINARY

Decimal notation in which the individual decimal digits are represented by some binary code; e.g., in the 8-4-2-1 coded decimal notation, the number twelve is represented as 0001, 0010 for 1 and 2, respectively. Whereas in pure binary notation, it is represented as 1100. Other coded decimal notations are known as: 5-4-2-1, excess three, 2-4-2-1, etc.

DELAY DISTORTION

Distortion resulting from nonuniform speed of transmission of the various frequency components of a signal through a transmission medium.

DENSITY, PACKING

The number of units of useful information contained within a given linear dimension, usually expressed in units/inch; e.g., the number of binary digit magnetic pulses stored on a tape or drum/linear inch on a single track by a single head.

DUPLEX, FULL

Method of operation of a communication circuit where each end can simultaneously transmit and receive. When used on a radio circuit, duplex operation requires two frequencies. Two in one, as two conductors with a common overall insulation or two telegraph transmission channels over one wire.

DUPLEX, HALF

Permits one direction, electrical communications between stations. Technical arrangements may permit operation in either direction but not simultaneously. Therefore, this term is qualified by one of the following suffixes: S/O for send only; R/O for receive only; S/R for send or receive.

ECHO CHECKING

A system of assuring accuracy by reflecting transmitted information back to the transmitter and comparing the reflected information with that which was transmitted.

ERROR CORRECTION CODE

A digit or digits, carried along with a computer word or record being moved from one part of a computer to another or being

a data communications glossary

transmitted, which may be used to partially reconstruct the moved number in case of partial loss.

ERROR CORRECTION ROUTINE

A series of computer instructions programmed to correct a detected error condition.

EXCESS THREE CODE

A coded decimal notation for decimal digits which represents each decimal digit as the corresponding binary number plus three; e.g., the decimal digits 0, 1, 7, 9 are represented as 0011, 0100, 1010, 1100 respectively. In this notation, the nine's complement of the decimal digit is equal to the ones complement of the corresponding four binary digits.

FIELD

A set of one or more characters (not necessarily all lying in the same word) which is treated as a whole; a set of one or more columns on a punched card consistently used to record similar information.

FLUTTER

A recurring speed variation in a tape drive of relatively low frequency. This condition is usually considered of importance with magnetic tape used for audio or analog type recording rather than digital recording.

FORTUITOUS DISTORTION

In teletypewriter transmission systems, it is the random displacement of mark/space and space/mark transitions. Random distortion of telegraph signals such as that commonly by interference as opposed to distortion which is peculiar to the equipment.

FORTY-FOUR TYPE REPEATER

Type of telephone repeater employing two amplifiers and no hybrid arrangements. It is used in a four wire system.

FREQUENCY DIVISION MULTIPLEX

Process or device in which signal channel modulates a separate subcarrier, the subcarrier being spaced in frequency to avoid overlapping of the subcarrier sidebands, and the selection and demodulation of each signal channel on the basis of its frequency.

FREQUENCY SHIFT

System of telegraph teletypewriter operation in which the mark signal is one frequency and the space signal a different frequency. NOTE: CCITT recommends that mark is the lower frequency. Also, the difference between mark and space will vary in different systems, e.g. 170 cps U.S.A., 120 cps Europe.

FREQUENCY SHIFT KEYING

Frequency modulation of a carrier by a modulating signal which varies between a fixed number of discrete values (a digital signal).

GAP SCATTER

This term describes the deviation from true vertical alignment of the head gaps for the several parallel tracks.

HAMMING CODE

One of the error correction code systems in use today named after the inventor.

INFORMATION

An aggregation of data.

INTEGRATED DATA PROCESSING

Way to transform disjointed and repetitive paper work tasks into a correlated and mechanized production of information for any purpose.

INTER RECORD GAP

A blank space left on writing a magnetic tape following each record. This gap is used to signal on subsequent reading of the tape that the end of a record has been encountered.

INPUT

The information which is transferred from external storage into the internal storage; a modifier designating the device performing this function.

INSTRUCTION

A set of characters which defines an operation together with one or more addresses (or no address) and which, as a unit, causes the computer to operate accordingly on the indicated quantities. The term "instruction" is preferable to the terms "command" and "order;" command is reserved for electronic signals; order is reserved for "the order of the characters" (implying sequence) or "the order of the interpolation," etc.

JITTER

A tendency toward lack of synchronization caused by mechanical or electrical changes. (Mechanical) intermittent instantaneous changes of the lineal speed of moving magnetic tapes. This may cause a change in the time interval between adjacent characters on tape. Such things as eccentricity of drive capstans and slipping drive belts may contribute to this effect (electrical) changes occurring in the equipment and/or transmission system causing the delay distortion characteristics of a given circuit to change from one value to another with respect to actual time of transmission with changes in temperature. (Hence, the term jitter delay).

KEY

A group of characters usually forming a field, utilized in the identification or location of an item; a marked lever manually operated for copying a character; e.g., typewriter, paper tape perforator, card punch manual key board, digitizer or manual word generator. Hand operated switching device ordinarily formed of concealed spring contacts with an exposed handle or push button, capable of switching one or more parts of a circuit.

LAG

A relative measure of time delay between two events, states or mechanisms.

LATENCY

In a serial storage system, the access time less the word time; e.g., the time spent waiting for the desired location to appear under the drum heads or at the end of an acoustic tank.

MODEM

Contraction of the two words modulator-demodulator. The modulator and demodulator circuits of a carrier terminal are normally mounted together on a single panel and may have common elements. For this reason the term modem is widely used in referring to this portion of a carrier terminal.

MODULATION

The entire process at the transmitting end whereby the message to be conveyed is uniquely specified and unambiguously represented by information bearing signals and the corresponding entire process at the receiving end whereby in response to information bearing signals the original message is produced in the form desired.

MODULATION, AMPLITUDE

The process or method of superimposing information on a carrier such that the amplitude of the carrier wave is the parameter subject to variation.

MODULATION, ANGLE

Modulation in which the angle of a sine wave carrier is the characteristic varied. Phase and frequency modulation are particular forms of angle modulation.

MODULATION, FREQUENCY

Angle modulation in which the instantaneous frequency of a sine wave carrier is caused to depart from the carrier frequency by an amount proportional to the instantaneous amplitude of the modulating wave.

MODULATION, HIGH LEVEL

Modulation produced at a point in a system where the power level approximates that at the output of the system.

MODULATION, LOW LEVEL

Modulation produced at a point in a system where the power level is low compared with the power level at the output of the system.

MODULATION, MULTIPLE

Modulation in which the modulated wave form process becomes the modulating wave for the next.

MODULATION, PHASE

Angle modulation in which the angle of sine wave carrier is caused to depart from the carrier angle by an amount proportional to the instantaneous amplitude of the modulating wave.

ON-LINE OPERATION

A type of system application in which the input data to the system is fed directly from the measuring devices and the computer results obtained during the progress of the event; e.g., a computer receives data from wind tunnel measurements during a run, and the computations of dependent variables are performed during the run enabling a change in the conditions so as to produce desirable results.

OPERATION, FIXED-CYCLE

A type of computer performance whereby a fixed amount of time is allocated to an operation; synchronous or clocked type arrangement within a computer in which events occur as a function of measured time.

OPERATION, LOGICAL

An operation in which logical (yes-or-no) quantities form the elements being operated on (e.g. comparison, extraction). A usual requirement is that the value appearing in a given column of the result shall not depend on the values appearing in more than one given column of each of the arguments.

OPERATION, REAL-TIME, ON-LINE, SIMULATED

The processing of data in synchronism with a physical process in such a fashion that the results of the data-processing are useful to the physical operation.

OPERATION, SERIAL

The flow of information through a computer in time sequence, using only one digit, word, line or channel at a time. Contrasted with "Parallel" Operation.

OPERATION, TRANSFER

An operation which moves information from one storage location or one storage medium to another (e.g., read, record, copy, transmit, exchange). *Transfer* is sometimes taken to refer specifically to movement between different media; storage to movement within the same medium.

OPERATION, VARIABLE CYCLE

Computer action in which any cycle of action or operation may be of different lengths. This kind of action takes place in a synchronous computer.

OR, CIRCUIT

An electrical or mechanical device which will yield an output signal whenever there are one or more inputs on a multi-channel input; e.g., an OR gate is one in which a pulse output occurs whenever one or more inputs are pulsed; forward merging of pulses simultaneously providing reverse isolation.

OR, OPERATOR

A logical operator which has the property such that if P or Q are two statements, then the statement "P or Q" is true or false precisely according to the following table of possible combinations:

P	Q	P or Q
False	True	True
True	False	True
True	True	True
False	False	False

PACK

To include several brief or minor items of information into one machine item or word by utilizing different sets of digits for the specification of each brief or minor item.

PARALLEL

Handled simultaneously in separate facilities; operating on two or more parts of a word or item simultaneously; contrasted with "Serial."

PARITY CHECK

A self checking code employing binary digits in which the total number of 1's (or 0's) in each permissible code expression is always odd or even. A check may be made for either even or odd parity. This may be done in a vertical direction (across each character) or in horizontal direction (along each track).

PULSE

Variation in the value of an electrical quantity as a function of time, such that the value departs from a given datum for a time interval and then returns to this datum for a much longer time interval.

A signal characterized by the rise and decay time of a quantity, the value of which is normally constant. The duration, repetition rate and spectrum are other significant parameters of the pulse. Voltage level of a short duration used in computers to represent a bit.

PULSE AMPLITUDE

Maximum instantaneous value of a pulse.

PULSE DECAY TIME

Interval of time required for the trailing edge of a pulse to decay from 90% to 10% of the pulse amplitude.

PULSE DURATION

Time interval between the points on the leading and trailing edges at which the instantaneous value bears a specified relation to the pulse amplitude.

NOTE: Frequently the specified relation is taken as 50% (Reference: Pulse Width, Pulse Length)

PULSE LENGTH

Nominal duration of a standard pulse which is the time interval between the half amplitude points of the rise and decay points of the curve. For pulses of other shapes, the points on the curve must be stated. Time interval between the points on the leading and trailing edges at which the instantaneous value bears a specified relation to the pulse amplitude.

NOTE: Frequently the specified relation is taken as 50% (Reference: Pulse Duration, Pulse Width)

PULSE MODULATION

Unquantized modulation of a pulse train such that the amplitude, duration, position, time or frequency of occurrence of the pulse is caused to vary in accordance with some impressed signal.

PULSE MODULATION, AMPLITUDE

Modulation in which a wave is caused to control the amplitude of a pulse carrier.

PULSE MODULATION, CODE

A pulse modulation system in which sample values of the ampli-

a data communications glossary

tude of the modulating signal are converted to discrete numbers for transmission or processing.

PULSE MODULATION, FREQUENCY

Modulation in which the pulse repetition frequency of the carrier is varied in accordance with the amplitude and frequency of the modulating signal.

PULSE MODULATION, LENGTH

Pulse time modulation in which the value of each instantaneous sample of the modulating wave is caused to modulate the duration of a pulse.

NOTE: In pulse modulation, the modulating wave may vary the time of occurrence of the leading edge, the trailing edge or both edges of the pulse.

(Reference: Pulse Modulation, Width)

PULSE MODULATION, POSITION

Pulse time modulation in which the value of each instantaneous sample of a modulating wave is caused to modulate the position time of a Pulse.

PULSE MODULATION, TIME

Modulation in which the values of instantaneous sample of the modulating wave are called to modulate the time occurrence of some characteristic of a pulse carrier.

PULSE MODULATION, WIDTH

Pulse time modulation in which the value of each instantaneous sample of the modulating wave is caused to modulate the duration of a pulse.

NOTE: In pulse duration modulation the modulating wave may vary the time of occurrence of the leading edge, trailing edge, or both edges of the pulse.

(Reference: Pulse Modulation, Length)

PULSE WIDTH

Time interval between the points on the leading and trailing edges at which the instantaneous value bears a specified relation to the pulse amplitude.

NOTE: Frequently, the specified relation is taken as 50% (Reference: Pulse Duration, Pulse Width)

QUAD

Structural unit employed in a cable, consisting of four separately insulated conductors twisted together. (Two twisted pairs may also be used.)

QUADRATURE

Quadrature expresses the phase relationship between two periodic quantities of the same period when the phase difference between them is one fourth of a period.

QUADRATURE COMPONENT

Reactive component of a current or voltage due to inductive or capacitive reactance in a circuit.

REAL-TIME

The performance of a computation during the actual time that the related physical process transpires in order that results of the computations are useful in guiding the physical process.

RECORD

A listing of information, usually in printed or printable form; one output of a compiler consisting of a list of the operations and their positions in the final specific routine and containing information describing the segmentation and storage allocation of the routine; to copy or set down information in reusable form for future reference; to make a transcription of data by a systematic alteration of the condition, property or configuration of a physical medium; e.g., placing information on magnetic tape or a drum by means of magnetized spots.

REDUNDANCY

A redundant or extra piece of information to assist in determining accuracy of moved digits or words in a computer. For instance, an extra bit may be added to the bits which comprise a character in the computer in order to always have a representation of an odd number of bits (or even). After moving each character, an automatic test of this redundant bit (parity check) will help establish the accuracy of the moved character.

REPEATER STATION

Station at which a repeater is located for the purpose of building up and equalizing the strength of a telephone or telegraph signal in a long line.

Intermediate station in a microwave system which is arranged to receive a signal from an adjacent station and amplify and retransmit to another adjacent station. Usually performs the function in both directions simultaneously.

RESET

To return a device to zero or to an initial or arbitrarily selected condition.

RESPONSE, FREQUENCY

A measure of output of a system when an input sine wave is applied whose magnitude is held constant but whose frequency is changed from 0 to ∞ . Also the inverse fourier transform of the time response of the system to a unit impulse.

SELECT

To take the alternative A if the report on the condition is of another state; to choose a needed subroutine from a file of subroutines.

SENSE

To examine, particularly relative to a criterion; to determine the present arrangement of some element of hardware, especially a manually-set switch; to read holes punched in paper.

SERIAL

Handle one after the other in a single facility, such as transfer or store in a digit by digit time sequence.

SIDEBAND

A band of frequencies on either side of the carrier frequency of a modulated signal including components whose frequencies are, respectively the sum or difference of the carrier and the modulation frequencies. The sum frequencies form the upper sideband, and the difference frequencies form the lower sideband.

SIGNAL TO NOISE RATIO

Ratio of the power of the signal to that of the noise. This term is usually expressed in terms of peak values in the case of impulse noise and in terms of root mean square values in the case of random noise.

SIGNIFICANCE

The arbitrary rank, priority, or order of relative magnitude assigned to a given position or column in a number; the significant digits of a number are a set of digits, usually from consecutive columns beginning with the most significant digit different from zero and ending with the least significant digit whose value is known; e.g., 2300.0 has five significant digits, whereas 2300 probably has two significant digits.

SINGLE SIDEBAND TRANSMISSION

That system of a carrier transmission in which one sideband is transmitted and the other sideband is suppressed. The carrier wave may be either transmitted or suppressed.

SKEW

Generally used to describe the conditions which combine to cause some degree of non-synchronism of supposedly parallel bits when

bit-coded characters are read from magnetic tape. Physical skewing of the magnetic tape as it crosses the head contributes largely to this effect.

SPEED OF TRANSMISSION

The instantaneous rate at which information is processed by a transmission facility. This quantity is usually expressed in characters per unit time or bits per unit time. (Rate of Transmission is more common usage.)

SPEED OF TRANSMISSION, EFFECTIVE

The rate at which information is processed by a transmission facility expressed as the average rate over some significant time interval. This quantity is usually expressed as average characters per unit time or average bits per unit time. (Rate of Transmission, Average is more common usage.)

SPEED OF TRANSMISSION, PEAK

See Speed of Transmission. (Rate of Transmission, Instantaneous is more common usage.)

STORAGE

Preferred to memory; any device into which units of information can be copied, which will hold this information, and from which the information can be obtained at a later time; devices, such as plug-boards, which hold information in the form of arrangements of physical elements, hardware or equipment; the erasable storage in any given computer.

STORAGE, BUFFER

A synchronizing element between two different forms of storage, usually between internal and external; an input device in which information is assembled from external or secondary storage and stored ready for transfer to internal storage; an output device into which information is copied from internal storage and held for transfer to secondary or external storage. Computation continues while transfers between storage and secondary or internal storage or vice versa take place.

STORAGE, CIRCULATING

A device using a delay line, or unit which stores information in a train or pattern of pulses, where the pattern of pulses issuing at the final end are sensed, amplified, reshaped and re-inserted in the delay line at the beginning end.

STORAGE, DYNAMIC

Storage such that information at a certain position is moving in time and so is not always available instantly; e.g., acoustic delay line, magnetic drum; circulating or re-circulating of information in a medium.

STORAGE, ELECTROSTATIC

A device possessing the capability of storing changeable information in the form of charged or uncharged areas on the screen of a cathode ray tube.

STORAGE, ERASABLE

Media which may hold information that can be changed; i.e., the media can be re-used; e.g., magnetic tape, drum, or core.

STORAGE, EXTERNAL

Storage facilities divorced from the computer itself but holding information in the form prescribed for the computer; e.g., magnetic tapes, magnetic wire, punched cards, etc.

STORAGE, INTERNAL-

Storage facilities forming an integral physical part of the computer and directly controlled by the computer; the total storage automatically accessible to the computer.

STORAGE, MAGNETIC

Any storage system which utilizes the magnetic properties of materials to store information.

STORAGE, MERCURY

Columns of a liquid mercury medium used as a storage element by the delaying action or time of travel of sonic pulses which are circulated by having electrical amplifier, sharper, and timer circuits complete the loop.

STORAGE, NON-ERASABLE

Media used for containing information which cannot be erased and reused, such as punched paper tapes, and punched cards.

STORAGE, NON-VOLATILE

Storage media which retain information in the absence of power and which may be made available upon restoration of power; e.g., magnetic tapes, drums, or cores.

STORAGE, PARALLEL

Storage in which all bits, or characters, or (especially) words are essentially equally available in space, without time being one of the coordinates. Parallel storage contrasts with serial storage. When words are in parallel, the storage is said to be *parallel by words*, when characters within words (or binary digits within words or characters) are dealt with simultaneously, not one after the other, the storage is *parallel by characters* (or *parallel by bit* respectively).

STORAGE, SECONDARY

Storage facilities not an integral part of the computer but directly connected to and controlled by the computer; e.g., magnetic drum, magnetic tapes, etc.

STORAGE, SERIAL

Storage in which time is one of the coordinates used to locate any given bit, character, or (especially) word. Storage in which words, within given groups of several words, appear one after the other in time sequence, and in which access time therefore includes a variable latency or waiting time of zero to many word-times, is said to be *serial by word*. Storage in which the individual bits comprising a word appear in time sequence is *serial by bit*. Storage for coded-decimal or other non-binary numbers in which the characters appear in time sequence is *serial by character*; e.g., magnetic drums are usually *serial by word* but may be *serial by bit*, or *parallel by bit*, or *serial by character* and *parallel by bit*, etc.

STORAGE, STATIC

Storage such that information is fixed in space and available at any time; e.g., flip-flop, electrostatic, or coincident-current magnetic-core storage.

STORAGE, TEMPORARY

Internal storage locations reserved for intermediate and partial results.

STORAGE, VOLATILE

Storage media such that if the applied power is cut off, the stored information is lost; e.g., acoustic delay lines, electrostatic tubes.

STORAGE, WORKING

A portion of the internal storage reserved for the data upon which operations are being performed.

STORAGE, ZERO-ACCESS

Storage for which the latency (waiting time) is negligible at all times.

STORE

To transfer an element of information to a device from which the unaltered information can be obtained at a later time.

TRACK

In a serial magnetic storage element, a single path containing a set of pulses.

A CATALOG OF EQUIPMENT in data communications

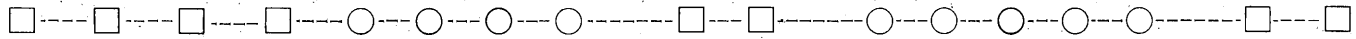

As the first published catalog of equipment in data communications, information has been arranged in a standard format to facilitate ready comprehension of salient features. In gathering this data, the Data Transmission Study Group invited a comprehensive list of equipment manufacturers to furnish specifications in conformance with a standard format. While every effort has been made to ensure accuracy, it cannot be guaranteed. Neither can the group be certain that the compilation is entirely complete and therefore welcomes any manufacturer whose

equipment is not listed or in whose listing errors may appear, to submit information for inclusion in subsequent publications of this report.

The standard format should be used for presentations and letters may be addressed to Jack Strong, Chairman, DTSG, C-E-I-R, 9171 Wilshire Blvd., Los Angeles, Calif.

Readers desiring additional information on equipment described in the catalog are requested to circle the key number appearing below each listing on the Reader Service card included between pages 106 and 109.

- M:** A. B. Dick Model 921 Video Scanner
902 Video Printer.
- I:** Graphic source documents 8½ x any length.
- O:** Hard copy reproductions that are exact facsimile of the input originals. Output copies are reproducible directly on the equipment; multiple copies can be made "off-line" without use of transmission time.
- EP:** Errors do not present much problem in facsimile transmission since any "fade" or interruption of signal results only in the drop out of a few horizontal scan lines. This usually results in a streak through the copy with the data still legible.
- ED:** Data not available.
- EC:** Data not available.
- S:** Ten document sized sheets or fifteen linear ft/min of facsimile copy.
- S/A:** Data not available.
- TM:** Requires wide band channel of 240 kc or telpak channel "C" (equivalent to 60 voice lines). Two level clipped video signal with sync pulse. 120 TV lines/in both vertically and horizontally.
- S/P:** Data not available.
- ST:** Data not available.
- A:** Data not available.
- SF:** Data not available.
- P:** Model 921 \$18,100, Model 902 \$39,500.
- D:** 9 to 12 months.
- C:** Yes.
- Q:** D & RGW Railroad seven pairs.

CIRCLE 300 ON READER CARD

- M:** A. B. Dick Model 904 Video Graph Printer.
- I:** Six channel parallel bits sequential by character.
- O:** 8½" x any length sheets of alphanumeric printout. Single copy output (multiple copies are not possible with non-impact electrostatic type printing).
- EP:** Parity error checking circuits available to meet the requirements of any data transmission system. Paper travel is 15 linear ft/min.
- ED:** Data not available.
- EC:** Data not available.
- S:** 1080 lines/min 80 characters/line.
- S/A:** Data not available.
- TM:** Printing function requires bandwidth capable of handling 8640 bits/sec when printing 1080 lines/80 characters/line each minute.
- S/P:** Data not available.
- ST:** Buffer storage is not included in printer but is available to meet format requirements as a separate unit.
- A:** Will operate in conjunction with any high speed digital transmitter; punched paper tape, magnetic tape or directly from a central processor.
- SF:** The Model 904 may be provided in a dual operating mode of operation to permit printout from both facsimile and digital transmission.
- P:** \$72,800 purchase, \$2300/mo rental.
- D:** Data not available.
- C:** Yes.
- Q:** Data not available.

CIRCLE 301 ON READER CARD

- M:** Avco Corp. Digital Data Communicator.
- I:** Up to 256 telegraph lines or lines of similar data rate (of mixed speeds)/input chan. Up to 4 chan. Up to 8 telephone data lines (100 to 300 char/sec)/HS input chan. Up to 8 channels. Paper tape, punched card, and optical or magnetic character recognition equip. may be added.
- O:** Up to 150 telegraph lines or lines of similar data rate (of mixed speeds)/output chan. Up to 4 chan. Up to 8 telephone data lines (100 to 300 char/sec)/HS output chan. Up to 8 chan. Mag. tape for computer communication. Paper tape, "anelex" type printers, input or output chan. of data rates up to 240,000 char/sec may be added.
- EP:** Improved electronic detection of received signals, with automatic of marginal lines and check.
- ED:** Long. parity checks on telegraph lines where lines permit, and lat. and long. parity checks on HS lines. Conventional parity checks on paper tape, validity checks on punched cards, and echo checks on printers. Parity preserved in magnetic core, drum and tape storage of this machine.
- EC:** By reply and retransmission only.
- S:** 60 to 100 wpm on telegraph lines. 1000 to 1500 wpm on telephone lines. Special circuits may be added of higher data rate.
- S/A:** Either.
- TM:** Wires are the transmission medium.
- S/P:** Transmission is serial mode.
- ST:** Stor. is provided consisting of core memory, lge. drum stor, mag. tape for overflow.

A: This system prepares & uses IBM format or other format computer tape, & works with a compl. tele. sys. of mixed speeds, plus HS lines. The msg. switching function is perf. as well as telecomp-tape interchg.

SF: Stored prog. flexibility of operation, immense input-output & storage capability.

P: Quotations depends on detail requirements.

D: Data not available.

C: Data not available.

Q: Data not available.

AI: An unusual log. design gives a much more economical sys. than prev. designs, where large numbers of circuits are involved.

CIRCLE 302 ON READER CARD

M: Bell System DATASPEED Tape-To-Tape System.

I: Punched paper tape.

O: Punched paper tape.

EP: None.

ED: None.

EC: None.

S: 1050 words per minute.

S/A: Start-stop system.

TM: Any standard voice telephone channel.

S/P: Input from tape is parallel. It is converted to serial for transmission. Line signal at receiver is serial and is converted to parallel output.

ST: None.

A: Off-line paper tape punches and readers.

SF: 5 level tape capabilities now. 5, 6, 7, or 8 level tape capabilities in 1962. Unattended answering and a "break" feature will be available soon.

P: Type 1 transmitter (5 level)—\$100/mo. Type 1 receiver (5 level)—\$125/mo. Type 2 transmitter (5, 6, 7, 8 level)—\$105/mo. Type 2 receiver (5, 6, 7, 8 level)—\$135/mo. All DATASPEED units require a 202 data set. Rates for the 202 should be added to DATASPEED rates.

D: Delivery date can be established through local telephone company. Shipments of type 1 transmitters and receivers began in February 1962.

C: Yes.

Q: Data not available.

AI: If two-way transmission is required, it will be necessary to have a DATA-SPEED transmitter and receiver at each end.

CIRCLE 303 ON READER CARD

M: Bell System DATA-PHONE Data Set 101A.

I: Binary.

O: Binary.

EP: None.

ED: None.

EC: None.

S: Up to 150 B/S (200 words/min).

S/A: Asynchronous.

TM: Standard voice telephone channel.

S/P: Serial.

ST: None.

A: Works with Bell System Dial TWX Service.

SF: Data not available.

P: Built into TWX rates.

D: Data not available.

C: Yes.

Q: None.

CIRCLE 304 ON READER CARD

M: Bell System DATA-PHONE Data Set 102A.

I: Binary.

O: Binary.

EP: None.

ED: None.

EC: None.

S: Up to 75 bits/second.

S/A: Asynchronous.

TM: Standard voice telephone channel. Two-way nonsimultaneous data transmission or one-way data transmission available.

S/P: Serial.

ST: None.

A: Works with standard teletypewriter and other slow speed equipment.

SF: Data not available.

P: Send and receive—\$22.50/mo., \$32.50 installation. Send or receive \$15.00/mo., \$25 installation (approximate).

D: Delivery date can be established through local telephone company.

C: Yes.

Q: 150.

CIRCLE 305 ON READER CARD

M: Bell System DATA-PHONE Data Set 103A.

I: Binary (conforms to EIA standard RS 232).

O: Binary (conforms to EIA standard RS 232).

EP: None.

ED: None.

EC: None.

S: Up to 200 B/S.

S/A: Asynchronous.

TM: Standard voice telephone channel, full duplex.

S/P: Serial.

ST: None.

A: Works with customer-owned business machines on either data-only or DATA-PHONE service.

SF: Data not available.

P: Data not available.

D: Data not available.

C: No.

AI: Incompatible with TWX and wide area data service stations.

CIRCLE 306 ON READER CARD

M: Bell System DATA-PHONE Data Set 201A.

I: Binary (conforms to EIA standard RS 232).

O: Binary (conforms to EIA standard RS 232).

EP: None.

ED: None.

EC: None.

S: 2,000 bits/second.

S/A: Synchronous (synchronizing clock is required and can be generated by the set).

TM: Standard voice telephone channel. Two-way simultaneous (full duplex) data transmission via four wire facilities and two-way non-simultaneous (half duplex) data transmission via two wire facilities are available. This set can also be used in send only or receive only operations.

S/P: Serial.

ST: None.

A: Works with Bell System Dial TWX Service.

S/P: Serial.

ST: Small buffer storage may be required by the connected business machine.

A: Used primarily in conjunction with various magnetic tape terminals although other input-output media may be used.

SF: Automatic answering. Synchronization can be provided by the connected business machine or by the data set.

P: Data not available.

D: Delivery date can be established through local telephone company.

C: Yes.

Q: Data not available.

CIRCLE 307 ON READER CARD

M: Bell System Data Set 201B.

I: Binary (conforms to EIA standard RS 232).

O: Binary (conforms to EIA standard RS 232).

EP: None.

ED: None.

EC: None.

S: 2400 bits/second.

S/A: Synchronous (synchronizing clock is required and can be generated by the set).

TM: Private line telephone channels only.

S/P: Serial.

ST: Small buffer storage may be required by the connected business machine.

A: Used primarily in conjunction with various magnetic tape terminals although other input-output media may be used.

SF: Data not available.

P: Data not available.

D: Data not available.

C: No.

Q: None.

CIRCLE 308 ON READER CARD

M: Bell System DATA-PHONE Data Set 202A.

I: Binary (conforms to EIA standard RS 232).

O: Binary (conforms to EIA standard RS 232).

EP: None.

ED: None.

EC: None.

S: 150 to 1200 bits/second.

S/A: Asynchronous.

TM: Standard voice 2-wire telephone channel. Two-way non-simultaneous (half duplex) data transmission via two wire facilities is available. This set can also be used in send only or receive only operations.

S/P: Serial.

ST: None.

A: Works in conjunction with various magnetic tape terminals, high speed paper tape readers and punches, high speed card readers and punches, and core to core applications.

SF: Unattended operation will be available in the near future.

P: \$40 per mo., inst. \$50 (approximate).

D: Delivery date can be established through local telephone company.

C: Yes.

Q: 550.

CIRCLE 309 ON READER CARD

Key to headings: M-manufacturer, name, type no.; I-input; O-output; EP-error prevention means; ED-error detection means; EC-error correction means; S-speed; S/A-synchronous or asynchronous; TM-transmission medium and requirements; S/P-serial, parallel or other transmission mode; ST-storage, needed or included; A-auxiliary equipment required and what other equipment the device will work with; SF-special features; P-purchase or rental price; D-delivery available; C-currently in production; Q-approximate quantity available in the field; AI-additional information

a catalog of equipment

M: Bell System Data Set 202B.
I: Binary (conforms to EIA standard RS 232).
O: Binary (conforms to EIA standard RS 232).
EP: None.
ED: None.
EC: None.
S: 150 to 1200 bits/second.
S/A: Asynchronous.
TM: Standard voice private line telephone channel. Two-way simultaneous (full duplex) data transmission via four-wire facilities and two-way non-simultaneous (half duplex) data transmission via two-wire facilities are available. This set can also be used in send only or receive only operations.
S/P: Serial.
ST: None.
A: Works in conjunction with various magnetic tape terminals, high speed paper tape readers and punches, high speed card readers and punches, and core to core applications.
SF: Unattended operation will be available in the near future.
P: \$40 per mo., inst. \$50 (approximate).
D: Delivery date can be established through local telephone company.
C: Yes.
Q: 75.
CIRCLE 310 ON READER CARD

M: Bell System Data Set 301.
I: Binary.
O: Binary.
EP: None.
ED: None.
EC: None.
S: 40,800 bits/sec.
S/A: Synchronous (synchronizing clock required and is generated by the set).
TM: Nominal group band as provided by command carriers (48 KC) such as TELPAK A. Either two-way simultaneous (full duplex) data transmission or two-way non-simultaneous (half duplex) data transmission, can be provided.
S/P: Serial.
ST: None.
A: Various high speed data terminals provided by other manufacturers.
SF: None.
P: Data not available.
D: Data not available.
C: No.
Q: None.
CIRCLE 311 ON READER CARD

M: Bell System DATA-PHONE Data Set 401A.
I: Binary.
O: Output to telephone circuit. Two audio tones each one of which is one of four possible frequencies.
EP: None.
ED: None.
EC: None.
S: Up to 20 char/sec.
S/A: Asynchronous.
TM: Standard voice telephone channel.
S/P: Parallel (in this subset an entire character is transmitted at once).
ST: None.
A: The DATA-PHONE set 401A (transmitter) works with the DATA-PHONE data set 401B (receiver). These sets are primarily designed to provide telephone connection of data collection equipment to a central processing point.

SF: Used in data collection systems. Transmission points can be widely dispersed. Simple and inexpensive. Limited to set of 16 characters.
P: \$5/mo., \$25 installation (approximate).
D: Delivery date can be established through local telephone company.
C: Yes.
Q: 1000.
CIRCLE 312 ON READER CARD

M: Bell System DATA-PHONE Data Set 401B.
I: Input from telephone circuit. Two audio tones each of which is one of four possible frequencies.
O: Binary.
EP: None.
ED: None.
EC: None.
S: Up to 20 char/sec.
S/A: Asynchronous.
TM: Any standard voice-bandwidth telephone channel.
ST: None.
A: The DATA-PHONE data set 401B (receiver) works with the DATA-PHONE data set 401A (Transmitter). These subsets are primarily designed to provide telephone connection of data collection equipment to a central processing point.
SF: Used in data collection systems. Transmission points can be widely dispersed. Simple and inexpensive. Unattended operation is available as an option.
P: \$40/mo., \$80 installation (approximate).
D: Delivery date can be established through local telephone company.
C: Yes.
Q: 250.
CIRCLE 313 ON READER CARD

M: Bell System DATA-PHONE Data Set 401E.
I: Binary.
O: Output to telephone circuit. Three out-of-fourteen audio tones.
EP: None.
ED: None.
EC: None.
S: Up to 20 characters per second.
S/A: Asynchronous.
TM: Standard voice telephone channel.
S/P: Parallel (transmits entire alpha-numeric character at once).
ST: None.
A: The 401E data set (transmitter) works with the Bell System DATA-PHONE data set 401F (receiver). These sets are primarily designed to provide telephone connection of data collection equipment to a central processing point.
SF: Simple and inexpensive. Transmits Alpha-numeric in data collection systems. Transmission points can be widely dispersed.
P: Data not available.
D: Data not available.
C: No.
Q: None.
CIRCLE 314 ON READER CARD

M: Bell System DATA-PHONE Data Set 401F.
I: Input from telephone circuit. Three out of fourteen audio tones.
O: Binary.
EP: None.
ED: None.

EC: None.
S: Up to 20 characters per second.
S/A: Asynchronous.
TM: Standard voice telephone channel.
S/P: Parallel (receives entire character at once).
ST: None.
A: The 401F data set (receiver) works with DATA-PHONE data set 401E (transmitter). These sets are primarily designed to provide telephone connection of data collection to a central processing point.
SF: Simple and inexpensive system used in data collection systems. Capable of receiving alpha-numeric.
P: Data not available.
D: Data not available.
C: No.
Q: None.
CIRCLE 315 ON READER CARD

M: Bell System DATA-PHONE Data Set 402.
I: Parallel binary by bit, serial by character.
O: Parallel binary by bit, serial by character.
EP: None.
ED: Not known at this time.
EC: None.
S: Up to 75 characters per second.
TM: Any voice telephone channel.
S/A: Not known at this time.
S/P: Parallel.
ST: None.
A: Can be used with paper tape punches and readers. May be extended to other types of machines later.
SF: Data not available.
P: Data not available.
D: Data not available.
C: No.
Q: None.
CIRCLE 316 ON READER CARD

M: Bell System DATA-PHONE Data Set 601A.
I: Analog.
O: Analog.
EP: None.
ED: None.
EC: None.
S: Data not available.
S/A: No synchronization required.
TM: Standard voice telephone channel.
S/P: Analog.
ST: None.
A: Works with customer provided telewriting device to transmit handwritten material.
SF: Can provide unattended answering feature.
P: Data not available.
D: Delivery date can be established through local telephone company.
C: Yes.
Q: 100.
CIRCLE 317 ON READER CARD

M: Bell System DATA-PHONE Data Set 601B.
I: Analog.
O: Analog.
EP: None.
ED: None.
EC: None.
S: Data not available.
S/A: No synchronization required.
TM: Standard voice telephone channel.
S/P: Analog.
ST: None.
A: Works with customer provided telewriting

ing device to transmit handwritten material.

SF: Can provide unattended answering feature.

P: Data not available.

D: Second quarter 1962.

C: Yes.

Q: None.

CIRCLE 318 ON READER CARD

M: Bell System DATA-PHONE Data Set 602.

I: Analog.

O: Analog.

EP: None.

ED: None.

EC: None.

S: Data not available.

S/A: No synchronization required.

TM: Any standard voice telephone channel.

S/P: Analog.

A: None.

SF: Facsimile machines by other manufacturers.

P: Data not available.

D: Data not available.

C: No.

Q: None.

CIRCLE 319 ON READER CARD

M: Bendix Pacific High Speed Data Terminal AN/TYC-3.

I: Transmitter terminal: either one serial or eight parallel lines. Nonreturn to zero code: -3V for binary 1, 0V for binary 0. The line output power is 1 milliwatt on 135 ohms.

O: Receiver terminal: either one serial or eight parallel lines. Non return to zero code: -3V for binary 1, 0V for binary 0. The line output power is 1 milliwatt on 135 ohms.

EP: None.

ED: Only in common net mode.

EC: None.

S: 19,200 information bits/sec. With the inclusion of the sync channel, the speed of the system is 21,600 bits/sec.

S/A: Synchronous.

TM: Spiral-4 cable or wide band (43.2 KC minimum), commercial carrier.

S/P: Serial.

ST: None required.

A: None. Will work with any device furnishing non return to zero code at 19,200 B/S or parallel on eight lines 2400 B/S.

SF: This system can be used in unidirectional, point-to-point or in a common net complex of a maximum of 64 terminals without requiring central station switching.

P: 1 ea. unidirectional term \$20,000. 1 ea. bidirectional term \$35,800.

D: 90 days after receipt of order.

C: No.

Q: 3 bi-directional pt. to pt. 2 common net under test.

AI: Can transmit to and receive from another station simultaneously in the bi-directional pt to pt configuration.

M: Collins Radio Company TE-210 Kineplex Serial/Parallel 2400 bit/second Duplex Data Modem.

CIRCLE 320 ON READER CARD

I: Transmit: 1 serial or up to 8 parallel lines. Receive: Composite audio signal up to 4 tones.

O: Transmit: Composite audio signal up to 4 tones. Receive: 1 serial or up to 8 parallel lines.

EP: None.

ED: None.

EC: None.

S: 600, 1200, or 2400 bits/second.

S/A: Synchronous.

TM: Schedule 4A line.

S/P: Serial-parallel.

ST: None required.

A: None. Will work with security devices and synchronous data converters.

SF: Integral test facility—Improper operation alarms—Integral phase delay compensator—Self contained timing source.

P: \$12,000.

D: 2 months.

C: Yes.

Q: 10 in service—500 on order.

AI: Supplies synchronizing timing to associated data converters. Mean time between failures greater than 3000 hours. Mean time to repair less than 15 minutes.

CIRCLE 321 ON READER CARD

M: Collins Radio Company TE-202 Kineplex Parallel 3200 bit/second Duplex Data Modem.

I: Transmit: 1 serial or up to 40 parallel lines. Receive: composite audio signal up to 20 tones PSK.

O: Transmit: composite audio signal up to 20 tones PSK. Receive: 1 serial or up to 40 parallel lines.

EP: Dual diversity reception.

ED: None.

EC: None.

S: 1800, 2200, 2400, 3000 or 3200 bits/second.

S/A: Synchronous.

TM: HF radio circuits—one 3KC voice channel.

S/P: Serial-parallel.

ST: None required.

A: Will work with synchronous data converters.

SF: Integral test facility—dual diversity reception.

P: \$60,000 to \$130,000 depending on configuration.

D: 5 months.

C: Yes.

Q: 25.

AI: Supplies synchronizing timing to associated data converters.

CIRCLE 322 ON READER CARD

M: Collins Radio Company TE-204 Synchronous FSK Data Modem.

I: Transmit: single channel synchronous binary logic 0 volts and -6 volts. Receive: time division multiplex FSK audio signal.

O: Transmit: time division multiplex FSK audio signal. Receive: single channel synchronous binary logic 0 volts and -6 volts.

EP: In-band dual diversity.

ED: None.

EC: None.

S: 75 bits/second.

S/A: Synchronous.

TM: HF, VHF, or UHF radio circuits or scheduled 4A line.

S/P: Serial.

ST: None required.

A: None. Will work with synchronous data converters.

SF: 1/4 ATR.

P: \$4100.

D: 3 months.

C: Yes.

Q: 4 in field—75 on order.

AI: Used primarily in air-ground-air communication networks. Transceiver-type operation.

CIRCLE 323 ON READER CARD

M: Collins Radio Company AN/GSC-4 Kineplex Serial/Parallel 5400 BPS Duplex Data Modem.

I: Transmit: 1 serial or up to 18 parallel lines. Receive: composite audio signal up to 6 tones phase shift keying.

O: Transmit: composite audio signal up to 6 tones PSK. Receive: 1 serial or up to 18 parallel lines.

EP: None.

ED: None.

EC: None.

S: 600, 1200, 2400, 3600, 4800, or 5400 bits/seconds.

S/A: Synchronous.

TM: Depends on data rate. At 2400 bits/second schedule 4A line.

S/P: Serial-parallel.

ST: None required.

A: None. Will work with security devices and synchronous data converters.

SF: Integral test facility—Negative, polar and positive data input/output selections—Improper operation alarms—Integral phase delay compensator—Self-contained timing source.

P: \$30,000 to \$50,000 per terminal depending upon quantity ordered.

D: 8 months.

C: Yes.

Q: 10.

AI: Supplies synchronizing timing to associated data converters.

CIRCLE 324 ON READER CARD

M: Collins Radio Company CV 786 non-synchronous FSK Converter-oscillator.

I: Transmit: single channel. Receive: FSK audio signal.

O: Transmit: FSK Audio Signal. Receive: single channel.

EP: None.

ED: None.

EC: None.

S: Up to 100 words/min. teletype.

S/A: Asynchronous.

TM: HF radio—One 3 KC voice channel.

S/P: Serial.

ST: None required.

A: None. Will work with standard 60 ma teletype loop.

SF: 1/4 ATR—No adjustments or tuning.

P: \$2350 for small quantities.

D: 30 days.

C: Yes.

Q: 600.

Key to headings: M-manufacturer, name, type no.; I-input; O-output; EP-error prevention means; ED-error detection means; EC-error correction means; S-speed; S/A-synchronous or asynchronous; TM-transmission medium and requirements; S/P-serial, parallel or other transmission mode; ST-storage, needed or included; A-auxiliary equipment required and what other equipment the device will work with; SF-special features; P-purchase or rental price; D-delivery available; C-currently in production; Q-approximate quantity available in the field; AI-additional information

a catalog of equipment

- AI:** Provide 1/2 duplex teletype communications.
CIRCLE 325 ON READER CARD
- M:** Collins Radio Company—C-8102 FSK Data & Telegraph Duplex Modem.
I: Transmit: Up to 18 channels. Receive: up to 18 channels.
O: Transmit: FSK audio signal. Receive: up to 18 channels.
EP: None.
ED: None.
EC: None.
S: 75 bits/second—equal to 100 words/min. teletype.
- S/A:** Asynchronous.
TM: Voice facility.
S/P: Serial—parallel.
ST: None required.
A: None. Will work with teletype, telemetry, remote control and other data converters.
SF: Diversity operation.
P: \$9,000 to \$11,000 depending on configuration.
D: 30 days.
C: Yes.
Q: 300 channel ends in service, 160 channel ends on order.
CIRCLE 326 ON READER CARD
- M:** Collins Radio Company TE211A Kineplex Serial/Parallel 4800 bit/second Duplex Data Modem.
I: Transmit: 1 or 2 serial or up to 16 parallel lines. Receive: composite audio signal up to 6 tones PSK.
O: Transmit: composite audio signal up to 6 tones PSK. Receive: 1 or 2 serial or up to 16 parallel lines.
EP: None.
ED: None.
EC: None.
S: 600, 1200, 2400, 2400/2 or 4800 bits/second.
- S/A:** Synchronous.
TM: Dependent upon data rate. At 2400 bits/second schedule 4A line.
S/P: Serial/parallel.
ST: None required.
A: Will work with security devices and asynchronous data converters.
SF: Integral test facility—Improper operation alarm—Integral phase delay compensator—Self contained timing source.
P: Not yet determined.
D: No.
C: No.
Q: None.
AI: 2400/2 mode provides two 2400 bits/second channels simultaneously.
CIRCLE 327 ON READER CARD
- M:** Collins Radio Company TE-206 Kineplex parallel 2400 bit/second Duplex Data Modem.
I: Transmit: 8 parallel channels. Receive: composite audio signal of 4 tones PSK.
O: Transmit: composite audio signal of 4 tones PSK. Receive: 8 parallel channels.
EP: None.
ED: None.
EC: None.
S: 2400 bits/second.
- S/A:** Synchronous.
TM: Schedule 4A line.
S/P: Parallel.
ST: None required.
- A:** None. Will work with synchronous data converters.
SF: Integral test facility—Telephone handset—Integral phase delay compensator.
P: \$15,000.
D: Superseded by TE-210 data modem.
C: No.
Q: 150.
CIRCLE 328 ON READER CARD
- M:** Communication Control Corp "Aux" Long Line Transmission Syst.
I: Any digital code which may be voltage or contact closure parallel or serial format.
O: 8421 BCD 8 level alpha-numeric code, 2421 and 10 line decimal available.
EP: If error is detected transmission stops. May also enter error identifier signal for continuous transmission.
ED: Error sensing circuits which will not process incomplete or inaccurate data. Parity both "0" and "1" bit count on char. or block basis.
EC: Retransmit.
S: Dependent on bandwidth of transmission medium up to a bit rate PF 100 KC. Standard telephone transmission; maximum 140 B/S (equiv to 20 alpha-numeric C/S). Typical land-line transmission: max 1440 B/S, higher rates possible by simple multiplexing or use of coax cable.
- S/A:** Asynchronous.
TM: Standard telephone lines, adapts to radio or microwave, land line.
S/P: Data not available.
ST: 8 bit shift register included.
A: Electric typewriters, Flexowriter, IBM, punched paper tape, card readers, special serial magnetic tape as described in type CAF system.
SF: Data not available.
P: Data not available.
D: Days.
C: Yes.
Q: 14.
CIRCLE 329 ON READER CARD
- M:** Digitronics Dial-O-Verter System for Data Transmission.
I: 6 data level magnetic tape. Magnetic tape terminal group: Model D620.
O: 6 data level magnetic tape.
EP: 1) Disconnect if failure to synch on reference characters.
2) Automatic retransmission.
ED: Longitudinal and transverse parity checks; flag error characters; flag the block with an error; print number of block-in-error; read-after-write check.
EC: Automatic retransmission and reconstruction.
S: 62kc.
- S/A:** Asynchronous.
TM: Broad band.
S/P: Parallel.
ST: Magnetic core buffer.
A: Data not available.
SF: Records number of blocks transmitted or received; can group many records into one block.
P: Individual quotation on request.
D: 9 months.
- Q:** None.
C: No.
CIRCLE 330 ON READER CARD
- M:** Digitronics Dial-O-Verter System for Data Transmission.
I: All standard Paper Tape levels including 5, 6, 7, and 8. Paper Tape Terminal Group: Model D506.
O: All standard Paper Tape levels including 5, 6, 7, and 8.
EP: 1) Disconnect if failure to synch on reference characters.
2) Automatic retransmission.
ED: Longitudinal and transverse parity checks, flag error characters; flag the block with an error; print number of block-in-error.
EC: Automatic retransmission; editing of tape.
S: Transmit 300 char/sec. Receive 100 char/sec.
- S/A:** Asynchronous.
TM: Voice channel, require modem unit.
S/P: Serial.
ST: Data not available.
A: Any other Dial-o-verter terminal including punched cards and magnetic tape.
SF: Can edit out bad blocks; records number of blocks transmitted or received; control characters and tape level handled can be varied with a plugboard insert.
P: \$510/month.
D: 3-4 months.
C: Yes.
Q: 6.
CIRCLE 331 ON READER CARD
- M:** Digitronics Dial-O-Verter System for Data Transmission.
I: 80-column cards. Card Terminal Group: Model D510.
O: 80-column cards.
EP: 1) Disconnect if failure to synch on reference characters.
2) Semi-automatic retransmission.
ED: Longitudinal and transverse parity checks; flag error characters; flag the card with an error; print number of card-in-error.
EC: Semi-automatic retransmission.
S: 100 cards/minute.
- S/A:** Asynchronous.
TM: Voice channel, require modem unit.
S/P: Serial.
ST: Buffer (magnetic core) storage provided.
A: Any other Dial-o-verter terminal including paper tape and magnetic tape. A D514 reproducing punch.
SF: Records number of cards transmitted or received. Extensive editing.
P: \$1,150/month.
D: 5-6 months.
C: Yes.
Q: 3.
CIRCLE 332 ON READER CARD
- M:** Digitronics Dial-O-Verter System for Data Transmission.
I: 6 data level magnetic tape. Magnetic Tape Terminal Group: Model

DC520.

- O: 6 data level magnetic tape.
EP: 1) Disconnect if failure to synch on reference characters.
2) Automatic retransmission.
ED: Longitudinal and transverse parity checks; flag error characters; flag the block with an error; print number of block-in-error; read-after-write check.
EC: Automatic retransmission and reconstruction.
S: 150-2,000 characters/sec.
S/A: Asynchronous.
TM: Voice channel, Telpac band, or microwave.
S/P: Serial.
ST: Magnetic core buffer storage provided.
A: Will provide variable code translation from any 5 or 6 data level code or to any 5 or 6 data level code by means of a plugboard.
SF: Records number of blocks transmitted or received; can group many records into one block.
P: \$1245/month.
D: 5 months.
C: No.
Q: Data not available.

CIRCLE 333 ON READER CARD

- M: Digitronics Dial-O-Verter System for Data Transmission.
I: 6 data level magnetic tape. Magnetic Tape Terminal Group: Model D520.
O: 6 data level magnetic tape.
EP: 1) Disconnect if failure to synch on reference characters.
2) Automatic retransmission.
ED: Longitudinal and transverse parity checks; flag error characters; flag the block with an error; print number of block-in-error; read-after write check.
EC: Automatic retransmission and reconstruction.
S: 150-2,000 characters/sec.
S/A: Asynchronous.
TM: Voice channel, Telpac band, or microwave.
S/P: Serial.
ST: Buffer storage provided. (Magnetic core)
A: Any other Dial-o-verter terminal including punched cards and paper tape.
SF: Records number of blocks, transmitted or received; can group many records into one block.
P: \$1205/month.
D: 3-4 months.
C: Yes.
Q: 6.

CIRCLE 334 ON READER CARD

- M: Digitronics Dial-O-Verter System for Data Transmission.
I: D507S. Any one of 5, 6, 7, 8 level Paper Tape. Paper Tape Terminal Group: Model D507S and D507R.
O: D507R. Any one of 5, 6, 7, 8 Paper Tape.
EP: Alarm light to indicate lack of syn-

chronization.

- ED: Data not available.
EC: Data not available.
S: 100 char/sec.
S/A: Asynchronous.
TM: Voice channel, require modem unit.
S/P: Serial.
ST: Data not available.
A: None.
SF: Manual interrupt.
P: D507S — \$130/mo. D507R — \$150/mo.
D: 2-3 months.
C: Data not available.
Q: 6.

CIRCLE 335 ON READER CARD

- M: Digitronics Dial-O-Verter System for Data Transmission.
I: Any one of 5, 6, 7, 8, level Paper Tape. Paper Tape Terminal Group: Model D505.
O: Any one of 5, 6, 7, 8 level Paper Tape.
EP: 1) Disconnect if failure to synch on reference characters.
2) Automatic retransmission.
ED: Longitudinal and transverse parity checks; flag error characters; flag the block with an error; print number of block-in-error.
EC: Automatic retransmission; editing of tape.
S: Transmit 300 char/sec. Receive 100 char/sec.
S/A: Asynchronous.
TM: Voice channel, require modem unit.
S/P: Serial.
ST: Data not available.
A: Any other Dial-o-verter terminal including punched cards and magnetic tape.
SF: Can edit out bad blocks; record number of blocks transmitted or received.
P: \$460/month.
D: 6-8 weeks.
C: Yes.
Q: 100.

CIRCLE 336 ON READER CARD

- M: Digitronics Dial-O-Verter System for Data Transmission.
I: 80-column cards. Punched Cards Terminal Group: Model D515.
O: None
EP: 1) Disconnect if failure to synch on reference characters.
ED: Longitudinal and transverse parity checks.
EC: Data not available.
S: 300 cards/minute.
S/A: Asynchronous.
TM: Voice channel, require modem unit.
S/P: Serial.
ST: Info not available.
A: Any other Dial-o-verter terminal including paper tape and magnetic tape.
SF: Data not available.
P: \$625/month.
D: 5-6 months.
C: Yes.

Q: 3.

CIRCLE 337 ON READER CARD

- M: Gen. Dyn./Elec. High Speed Binary Data Transceiver SC-301.
I: Serial mark impulses or polar binary information. Maximum spacing period-32 bits. No sync. signals required.
O: Mark impulse-rise 20US. Pulse width 24US. Amplitude 11 positive going with -11 as reference. Clock signal output.
EP: None internal to SC 301. Equipment to perform this function can be supplied as optional accessory.
ED: As above.
EC: As above.
S: 2400 bits/sec. standard military bit rate.
S/A: Synchronous.
TM: Data not available.
S/P: Serial.
ST: As no storage is required for the operation of the SC301 none is included.
A: Any equipment that can accept a synchronous binary stream.
SF: Data not available.
P: \$5700 \$150/mo rental one month.
D: Data not available.
C: Yes.
Q: None.

CIRCLE 338 ON READER CARD

- M: General Elec. High Speed Data Transmission System TDS 15.
I: Magnetic tape transport or computer tape control unit.
O: Magnetic tape transport or computer tape control unit.
EP: Squelch transmission channel at excessive noise.
ED: Lateral and longitudinal parity.
EC: Data not available.
S: 15,000 characters/sec. 120,000 bits/sec. (7 bit characters; 8th bit added for control purposes).
S/A: Synchronous by bit non-synchronous by character.
TM: 240 KC band width (one STD super-group) microwave, coaxial cable, tel-pack C channel.
S/P: Serial.
ST: Needed and included in tape to tape. Not needed in tape to core and core to tape.
A: System can be adapted to most types of mag tape transports, computers and generally to any (e.g., telemetering) device producing parallel binary inf.
SF: Modular design. Can easily be adapted to changing requirements. Uses standard communication channels.
P: Depends on application.
D: 2nd quarter 1962.
C: No.
Q: Data not available.

CIRCLE 339 ON READER CARD

- M: Gen. Tel. & Elec. Corp. Slow Speed Parallel Subset AE401A.
I: Binary conforms to EIA STD RS232.
O: Binary conforms to EIA STD RS232.

Key to headings: M-manufacturer, name, type no.; I-input; O-output; EP-error prevention means; ED-error detection means; EC-error correction means; S-speed; S/A-synchronous or asynchronous; TM-transmission medium and requirements; S/P-serial, parallel or other transmission mode; ST-storage, needed or included; A-auxiliary equipment required and what other equipment the device will work with; SF-special features; P-purchase or rental price; D-delivery available; C-currently in production; Q-approximate quantity available in the field; AI-additional information

a catalog of equipment

- EP: None.
ED: None.
EC: None.
S: Up to 20 characters/sec
S/A: Asynchronous.
TM: Any standard telephone channel.
S/P: Parallel, in this subset an entire character is transmitted at once.
ST: None.
A: The AE401A trans. wks. in conjunction with a 401B receiver (which GT&E does not currently plan to produce) to prov. a oneway data trans. sys. in assn. with req. interconnecting line facilities.
SF: Used on nonsophisticated data collection sys. trans. Widely dispersed will be simple and inexpensive. Receivers loc. at centralized data retrieval points will be more exp. and comp. Used with IBM 1001.
P: \$5/mo \$10 installation charge (estimated charges).
D: 2nd quarter 1962.
C: No.
Q: None.
AI: The model AE401A data set will be compatible with Bell System Data Phone 401 B receiver.
CIRCLE 340 ON READER CARD
- M: Gen. Tel. & Elec. Corp. Slow Speed Serial Subset AE101A.
I: Serial.
O: Serial.
EP: None.
ED: None.
EC: None.
S: Up to 200 words/min standard teletypewriter code.
S/A: Asynchronous.
TM: Any standard telephone channel. Because it is slow speed it requires considerably less than a full voice telephone channel. Full or half duplex.
S/P: Serial.
ST: None.
A: No auxiliary equip. required. Works with any standard teletypewriter machine.
SF: Allows for unattended operation (optional).
P: \$20/mo.
D: 2nd quarter 1962.
C: No.
Q: None.
AI: The model AE101A data subset will be compatible with the Bell-Sys Dataphone 101A.
CIRCLE 341 ON READER CARD
- M: Gen. Tele. & Elec. Corp Medium Speed Digital Subset AE202A.
I: Binary conforms to EIA STD #RS232. Incoming bit rate may vary from 75-1200 B/S.
O: Binary conforms to EIA STD #RS232.
EP: None.
ED: None.
EC: None.
S: 1200 bits/sec over the switched telephone network. (Higher over leased lines.)
S/A: Asynchronous. Does not require any additional sync. bits.
- TM: Any standard telephone channel. Half or full duplex transmission available.
S/P: Serial.
ST: None.
A: None req. Works in conjunction with equip. such as IBM-1009 IBM 1401, Avco/Crossley Comex 13, Teletype High Speed Equip. Telereg. Airline Reserv. Sys, etc. Having serialized digital I/O operations.
SF: Allows for unattended operations (optional).
P: \$40/mo \$50 installation charge.
D: 2nd quarter 1962.
C: No.
Q: None.
AI: The model AE202A data subset will be compatible with the Bell Sys. Data Phone 202A.
CIRCLE 342 ON READER CARD
- M: Hogan Commercial Facsimile Equip.
I: Continuous feed accepts pages 8 1/2 wide any length.
O: Facsimile reproduction on electrolytic Hogan Faxpaper.
EP: Facsimile reproduction is inherently error free.
ED: Data not available.
EC: Data not available.
S: Equipment available at three speeds/A 8 1/2 x 11 page 6 min—B 8 1/2 x 11 page 3 min.—C 8 1/2 x 11 page 1.2 min.
S/A: Synchronous.
TM: A. PG in 6 min voice or scheduled II telephone line.
B. PG in 3 min class a program circuit (At least 5 KC of useful bandwidth)
C. PG in 1.2 min 15 KC channel such as FM program line or half of Tel-pak A.
S/P: Data not available.
ST: Data not available.
A: Data not available.
SF: Data not available.
P: Data not available.
D: January 1962.
C: No.
Q: Data not available.
AI: A resolution of 100 lines/in.
CIRCLE 343 ON READER CARD
- M: Highes Aircraft Phase Data Transmission Modem HC-230.
I: Binary serial bitstream; logical levels, zero volts equals zero, plus 5 volts equals one.
O: Four channel quantized phase modulation, six kilocycle band width.
EP: Data not available.
ED: Data not available.
EC: Data not available.
S: 2400 B/sec.
S/A: Synchronous.
TM: HF, VHF, UHF radio circuits.
S/A: Serial-Parallel.
ST: None required; designed for on line operation.
A: None, operates in conjunction with wireline modems such as HC-270.
SF: Duplex terminal. Designed to overcome multipath distortion so as to provide relatively low error rates at high frequencies.
P: Data not available.
- D: Data not available.
C: Data not available.
Q: Data not available.
CIRCLE 344 ON READER CARD
- M: Hughes Aircraft Digital Data Transceiver HC 270.
I: DC logical signals; 0 volts equals zero, 5 volts equals one. (Or reverse, switch selectable.)
O: Quadrphase data signal; carrier frequency 1650 cps up to 2400 bits/sec. 2400 cps @ 4800 bits/sec.
EP: Not applicable.
ED: Not applicable.
EC: Not applicable.
S: Switch selectable 600, 1200, 2400, 4800 bits/sec. Modification possible on special order.
S/A: Synchronous.
TM: Telephone line, micro or comb. of facilities. Speeds up to & including 2400 bits/sec on Bell System or CCLIF standard toll facilities; 4800 bits/sec on Bell system schedule V facilities.
S/P: Serial.
ST: None required.
A: None. Will work with any equipment which meets input/output logical levels.
SF: Duplex terminal.
P: Data not available.
C: Data not available.
D: Data not available.
Q: 10.
AI: Has been evaluated by Radc Mitre Corp, AMR and others.
CIRCLE 345 ON READER CARD
- M: Hughes Aircraft Data Transceiver HC-260.
I: 50 or 8 level paper tape.
O: 5 or 8 level paper tape or printed copy; transmission appears as four channel quantized frequency modulation.
EP: Inherent diversity reception.
ED: Correlation detection and parity check on 8 level systems.
EC: Barker Code—correlation detection.
S: 50 BPS.
S/A: Synchronous, however can be adapted to asynchronous operation.
TM: HF, VHF or UHF radio circuits.
S/P: Serial—parallel.
ST: None needed.
A: Paper tape readers and punches/printers furnished.
SF: Duplex terminal, compatible with existing radio transmitters and receivers.
P: Contact communications division marketing.
D: Data not available.
C: Data not available.
Q: Data not available.
CIRCLE 346 ON READER CARD
- M: Hughes Aircraft Data Transmission System HC-272.
I: Serial binary bitstream. Logical level, zero volts equals "0", plus five volts equals "1".
O: Serial binary bitstream. Logical level, zero volts equals "0", plus five volts

equals "1".
EP: Diversity reception.
ED: Data not available.
EC: Data not available.
S: 2400 bits/sec.
S/A: Synchronous.
TM: HF, VHF, UHF radio circuits, wire circuits.
S/P: Serial-Parallel.
ST: None required; designed for line operation.
A: None required.
SF: Duplex terminal. Compatible with existing wire and radio voice facilities.
P: Contact communications division marketing.
D: Data not available.
C: Data not available.
Q: Data not available.
CIRCLE 347 ON READER CARD

M: IBM High Speed Card Terminal Special Product #1946.
I: Cards.
O: Cards, magnetic tape, hard copy.
EP: Pre-proven cards.
ED: Vertical and horizontal parity check.
EC: Automatic re-transmission.
S: 60-100 eighty character records/min.
S/A: Synchronous.
TM: Voice grade private or dial up line.
S/P: Serial.
ST: Drum buffer in transmitting terminal.
A: 1931 card-reach-punch, 1009, 7701, 402, 407.
SF: Data not available.
P: CRD term 1946 pur \$34,100, \$950 mo. rentl, adapter \$7,500-\$200 mo.
D: Special equipment-by agreement.
C: Yes.
Q: Data not available.
AI: Can operate on duplex facility for simultaneous two way transmission-100 cds/min each way.
CIRCLE 348 ON READER CARD

M: IBM Data Transmission Term.-Hi-Speed Serial Special Product #1945 Mod 26.
I: Computer.
O: Computer.
EP: Stored program control-all computer checks.
ED: Stored program control-all computer checks.
EC: Stored program control-all computer checks.
S: Maximum 10,000 characters/sec.
S/A: Synchronous.
TM: Telpak wide band.
S/P: Serial.
ST: Computer.
A: Data not available.
SF: Data not available.
P: Data not available.
D: RPQ.
C: No.
Q: Data not available.
CIRCLE 349 ON READER CARD

M: IBM Remote Tape Control Special Product #1945 Mod 3.
I: Magnetic tape.
O: Computer.
EP: Pre-checked tape.
ED: Stored program control.
EC: Stored program control.
S: 62,500 characters/sec.
S/A: Asynchronous.
TM: Wide band 7-100 kilocycles and 3 kilocycle control channel.
S/P: Parallel bit transmission.
ST: Computer memory.
A: Computer and tape unit.
SF: Gapless tape computer switching device.
P: Purchase \$41,000 \$1,100/mo rental.
D: Special equipment-by agreement.
C: Yes.
Q: Data not available.
CIRCLE 350 ON READER CARD

M: IBM Card/Teletype & Teletype/Card Special Product #1912.
I: Cards or teletype.
O: Cards or teletype.
EP: Pre-proven cards.
ED: Control totals.
EC: Re-transmission.
S: Maximum 10 characters/sec.
S/A: Synchronous.
TM: Teletype line.
S/P: Serial.
ST: None.
A: None.
SF: Data not available.
P: Purchase \$4,710-\$6,975 \$120-\$190/mo rental.
D: Special equipment-by agreement.
C: Yes.
Q: Data not available.
CIRCLE 351 ON READER CARD

M: IBM Magnetic Tape Transmission Terminal #7701.
I: Magnetic tape.
O: Magnetic tape, 1009, 1946, 1944.
EP: Prechecked tape.
ED: Vertical and horizontal parity check.
EC: Automatic re-transmission.
S: 150 characters/sec.
S/A: Synchronous.
TM: Voice grade private or dial up line.
S/P: Serial.
ST: Data not available.
A: 7701, 1009, 1946, 1944.
SF: Data not available.
P: Purchase \$55,000 \$1,175/mo rental.
D: Approx. 16 mo.
C: Yes.
Q: Data not available.
CIRCLE 352 ON READER CARD

M: IBM Data Transmission Unit #1009.
I: Computer.
O: Computer or 7701.
EP: Stored program control, all computer checks.

ED: Stored program control, all computer checks.
EC: Automatic re-transmission.
S: 150, 250, 300 characters/sec.
S/A: Synchronous.
TM: Voice grade private or dial up line.
S/P: Serial.
ST: Computer memory.
A: Computer or 7701.
SF: None.
P: Type 1009 pur. \$22,000, \$500/mo rental, \$267 pur. \$3,750 \$100/mo.
D: 14 months.
C: Yes.
Q: Data not available.
CIRCLE 353 ON READER CARD

M: IBM Data Transmission System #1001.
I: Cards and keyboard.
O: Cards.
EP: Pre-proven cards.
ED: Parity check, program card control with field definition, error signal.
EC: Re-transmission.
S: 12 column input, 18 or 20 column manual entry input.
S/A: Asynchronous.
TM: Voice grade private or dial up line.
S/P: Serial by character, parallel bit transmission.
ST: None.
A: Data not available.
SF: Badge input, papertape output, clock readout, adding machine attachment, typewriter output, field definition signal.
P: Send terminal \$15 mo. rental Rec. 024-\$ 95 Mo. rental 026-\$115 mo. rental
D: 4 months.
C: Yes.
Q: Data not available.
CIRCLE 354 ON READER CARD

M: IBM Data Transceiver #65 #66.
I: Cards.
O: Cards.
EP: Pre-proven cards & program card control.
ED: Parity check, character check & column position check.
EC: Re-transmit error records.
S: Type 65-telegraph 5 cards/min-telephone 11 cards/min.
Type 66-telegraph 5 cards/min-telephone 10 cards/min.
S/A: Synchronous.
TM: Telegraph, private telephone, dial up telephone.
S/P: Serial.
ST: None.
A: 67 or 68 signal unit.
SF: Typewriter output, alternate program control.
P: (Type 65 pur. \$3,700 rental \$90/mo.) (Type 66 pur. \$5,100 rental \$110/mo.) (Type 67 pur. \$4,400 rental \$85/mo.) (Type 68 pur. \$4,400 rental \$85/mo.)
D: Approx. 6 months.
C: Yes.
Q: Data not available.
CIRCLE 355 ON READER CARD

Key to headings: M-manufacturer, name, type no.; I-input; O-output; EP-error prevention means; ED-error detection means; EC-error correction means; S-speed; S/A-synchronous or asynchronous; TM-transmission medium and requirements; S/P-serial, parallel or other transmission mode; ST-storage, needed or included; A-auxiliary equipment required and what other equipment the device will work with; SF-special features; P-purchase or rental price; D-delivery available; C-currently in production; Q-approximate quantity available in the field; AI-additional information

a catalog of equipment

M: IBM. Data Communications Channel #7281-7284.

I: Communication lines.
O: Computer.
EP: Data not available.
ED: Stored program control.
EC: Stored program control.
S: Variable.

S/A: Asynchronous.

TM: Variable.

S/P: Variable.

ST: Computer.

A: Variable.

SF: Variable.

P: Data not available.

D: Special equipment—by agreement.

C: Yes.

Q: Data not available.
CIRCLE 356 ON READER CARD

M: IBM High-Speed Paper Tape RPQ #1944

I: Paper tape.
O: Paper tape, mag tape, cards, computer.
EP: Pre-proven paper tape.
ED: Vertical and horizontal.
EC: Auto re-transmission.
S: 150 char/sec.

S/A: Synchronous.

TM: Voice grade—dial up line.

S/P: Serial.

ST: None.

A: None.

SF: 5 or 8 channel.

P: Data not available.

D: Data not available.

C: Data not available.

Q: Yes.
CIRCLE 357 ON READER CARD

M: Lenkurt Electric Co., Inc. 26A Datatel.

I: Binary, conforms to voltage levels specified in EIA RS 232 (other options available).

O: Same as item 2 above.

EP: None.

ED: None.

EC: None.

S: 2400-1200-600 bits/sec. (selected by a panel switch).

S/A: Synchronous.

TM: 2-wire for simplex operations or half duplex; 4-wire for full duplex operation. Voice frequency circuit required (toll quality).

S/P: Serial; FM wave centered at 1.6 kc, modulated with a four level signal. Each level corresponds to one of four bit pair combinations.

ST: Included; required in the binary-to-quaternary converter to store bits in pairs so that the modulation rate can be reduced to 1/2 the bit rate.

A: Data not available.

SF: Utilizes binary to quaternary conversion to reduce the transmitted bandwidth to one half that of a straight binary FM system. Magnetic tape re-

coding and playback equipment can be used with this system.

P: \$7650 per transceiver net.

D: September 1962.

C: Starting prototype runs.

Q: None.

AI: Lenkurt has developed a high speed digital data transmission system for the Air Force.
CIRCLE 358 ON READER CARD

M: Motorola Digital Data Terminal Equipment, Tape-To-Core, DTE 100K.

I: Seven bit parallel output from an IBM 1945 Data Transmission Terminal.

O: A seven bit parallel signal which is acceptable to an IBM 1945 Data Transmission Terminal.

EP: Squelch transmission channel at Excessive noise.

ED: Lateral and Longitudinal parity.

EC: Data not available.

S: 15,000 characters/sec. to 62,500 characters/sec. Nominal 800,000 bits/sec. 7 bit characters (8th bit added for control purposes).

S/A: Synchronous by bit non-synchronous by character.

TM: 240 KC band width (one std supergroup) microwave, coaxial cable, Telpac C channel for 15,000 character-sec transmission. 1 megacycle band width (four supergroups) microwave, coaxial cable, Telpac D channel for 62,500 characters/sec transmission.

S/P: Serial.

ST: Computer storage used at receiving terminal.

A: An IBM 1401 with a 1945 Data Transmission Terminal.

SF: Modular design. Can easily be adapted to changing requirements.

P: Depends on application.

D: 4 months.

C: Yes.

Q: Data not available.
CIRCLE 359 ON READER CARD

M: Telautograph Comp to Teletype Code Translator 031-926.

I: Parallel 8 channel IBM code from IBM 305 Ramac "Q" track or equivalent.

O: Parallel 5 channel teletype code for 20 character/sec motorized tape punch or equivalent.

EP: Data not available.

ED: Data not available.

EC: Data not available.

S: 10 characters/sec.

S/A: Data not available.

TM: The punched tape is loop fed to an Olivetti T2TA tape reader for 7 1/2 cps teletype trans. to remote Olivetti T2CR teletype page printers. Trans. is "60 ma neutral". Requires std 75W/M teletype pair. Punched tape loop provides buffering between the 10 character Ramac output and the 7 1/2 character/sec teletype machines.

S/P: Data not available.

ST: Data not available.

A: Data not available.

SF: The translation unit may be built to accommodate various code configurations and different input-output machines.

P: Data not available.

D: Data not available.

C: Data not available.

Q: Pilot system operating at Lockheed, Burbank.
CIRCLE 360 ON READER CARD

M: Teleregister Corp Local Remote Transceiver—LRT-1B1
LRT-4A1
LRT-4B1

I: Input from keysets. Parallel 1 to 21 5 bit character queries taken from keysets; parallel 1 to 5 character replies sent to keysets. Maximum of 10 keysets per LRT.

O: Output to local central office transceiver or thru a remote line connector or line seeker and remote line connector. Output is serial on two channels over a metallic pair line & common g'nd return @ 20 to 22 bits/sec.

EP: Provisions are made for the processor to ask for repeats of message found in error.

ED: None.

EC: None.

S: 20 to 22 bits/sec with sync & data bits transmitted simultaneously.

S/A: Synchronous.

TM: 52 or 100 conductor cables from keysets. Metallic pair output to processor area or other communications equip.

S/P: Parallel bit transmissions to & from keysets serial transmission otherwise.

ST: No storage needed.

A: Compatible with Teleregister communications equipment only. Power supply (44B1) required if keysets are powered from the LRT.

SF: May handle up to 10 keysets.

P: Quoted on request.

D: Quoted on request.

C: Yes.

Q: Over 400.

AI: With slight modification parallel bit inputs and outputs can be more than doubled. When more than one keyset is used with the LRT a keyset junction box is required may circuit length is 30 miles.
CIRCLE 361 ON READER CARD

M: Teleregister Corp. Central Terminal Equip (CT).

I: Data communication line (any speeds up to 2400 b/s).

O: Data communication line (any speeds up to 2400 b/s.) The terminal can handle up to 120 duplex 100 w/m lines and as many high speed lines as can be trunked into a data processing complex or other consolidating data lines.

- EP: Provisions are made for the processor to ask for repeats of messages found in error.
- ED: (CT) adds vertical parity at pt. of entry into terminal. Parity checked before data enters processor. If in error processor displays error. Checks horiz parity which may be added before data is sent to (CT). (CT) will add parity on messages being sent from processor allowing total system check.
- EC: None.
- S: Accepts information from either serial or parallel subsets. It can handle any number of bits/character as specified.
- S/A: Functions with both synchronous or asynchronous subsets.
- TM: Teletype lines and voice lines provided with polar relays or subsets.
- S/P: The distributors in the (RT) can be ordered to function with any polar relay or subsets now on the market.
- ST: Storage is included in buffers in multiples of 128 characters each.
- A: On-line or off-line data terminals can function via data communication lines thru the (CT) to connect them either to a data processing complex or to other lines.
- SF: Works with data processing equipment of all types and in conjunction with other data communications systems such as (81D1 systems). High degree of flexibility as to no. of lines, line sync, char. coding.
- P: Quoted on request.
- D: Quoted on request.
- C: Yes.
- Q: One.

CIRCLE 362 ON READER CARD

- M: Teleregister Corp Concentrator Terminal Equip (CTE).
- I: The (CTE) has equivalent input of 15 keysets, each input feeding in parallel a max. of 80 bits. (CTE) can be fed by a max. of 15 keyset selectors, each capable of handling 10 keysets. In addition the CTE can handle 15 low speed line termination buffers; or a combination of selectors and buffers not exceeding 15.
- O: Output from (CTE) to and from the processor site is thru a high speed loop configuration where each (CTE) is connected directly or in tandem with each other to the processor by means of two full duplex high speed trunk lines.
- EP: Provisions are made for the processor to ask for repeats of messages found in error.
- ED: Extensive use of vertical and horizontal parity checking circuits.
- EC: None.
- S: Trunk lines to the processor are 1000 B/S telephone lines. Secondary lines to the (CTE) use 75 B/S teletype facilities.
- S/A: Synchronous.
- TM: The loop configuration and fallback facilities dictate use of four half duplex circuits.
- S/P: Serial.
- ST: High speed buffers required and included.

- A: The (CTE) will work with keyset selectors, slow speed line buffers and high speed trunk lines.
- SF: A group of (CTE's) in a loop configuration working with a (CTT) and data processor provides complete fallback, enabling the concentrator to operate uninterrupted despite equip or trunk failure.
- P: Quoted on request.
- D: Quoted on request.
- C: Yes in the U.A.L. "Instamatic" reservation system.
- Q: 17.
- AI: Up to 13 concentrators can be connected to a single loop.

CIRCLE 363 ON READER CARD

- M: Teleregister Corp. Central Trunk Terminal (CTT).
- I: Four half duplex 1000 b/sec communication lines. Connecting terminal equip. such as the (CTE) to the central processor or other (CTE's).
- O: Data not available.
- EP: Extensive check circuits.
- ED: Extensive use of horizontal and vertical parity checking circuits.
- EC: Repeat techniques.
- S: 1000 B/S telephone lines 5 bit characters.
- S/A: Synchronous.
- TM: Loop configuration and fallback facility require four half duplex circuits.
- S/P: Serial.
- ST: High speed buffers are included.
- A: Device works with processor and over communication lines with other terminal equip.
- SF: Fallback provisions enable the terminal to operate uninterrupted despite equip or trunk failure.
- P: Quoted on request.
- D: Quoted on request.
- C: Yes.
- Q: Two in the U.A.L. "Instamatic" reservation system.

CIRCLE 364 ON READER CARD

- M: Teleregister Corp Distant Remote Transceiver.
- I: Input from airline key agent sets, or from local central office transceivers (LCOT). Parallel 1 to 21 five bit character queries taken from keysets; parallel 1 to 5 character replies sent to keysets in addition to serial teletype transmissions switched to std teletype equip.
- O: Output to or from processor or other communications equip is serial with std teletype message formats using 7.42 five bit code at line speeds. DRT's generate and transmit identifying characters and sync pulses.
- EP: Provisions are made for the processor to ask for repeats of messages found to be in error.
- ED: The fifth bit of the five bit code is a parity bit for detecting transmission errors; when used with teletype there is no parity bit.

- EC: None.
- S: 75 wpm and 100 wpm.
- S/A: Synchronous.
- TM: 52 and 100 conductor cables from agent sets on a one conductor per bit plus 5% spares. Std transmission lines output to processor or other communications equip.
- S/P: Parallel bit transmissions to and from keysets, serial transmissions otherwise.
- ST: No storage needed.
- A: Compatible with teleregister communications and teletype equip.
- SF: All DRT's except 563 series will operate in a roll call sys. Codes A, B, C represent respectively 10, 20, 30 keyset capacities of the DRT's. 53. Series DRT's are equipped with message counters.
- P: Quoted on request.
- D: Quoted on request.
- C: Yes.
- Q: Over 100.
- AI: The 544 series DRT's will transmit to receive only model 28 teletype printers. With slight modification parallel bit inputs can be more than doubled.

CIRCLE 365 ON READER CARD

- M: Teleregister Corp. Local Remote Transceiver—LRT-580A1
LRT-585A1
- I: Input normally from banking type keysets; 16 5 bit characters received in parallel and stored in an 80 bit buffer. Replies to the keysets in parallel are normally only 10 digits in length.
- O: Output to and from the processor in a local mode is in series-parallel, 16x5 bit parallel character serial. Output to and from the processor in a remote mode is in series thru a transistorized transmit-receive distributor (TTRD); TTRD 606A1, or TTRD-607A1.
- EP: Provisions are made for the processor to ask for repeats of messages found in error.
- ED: The fifth bit of the 5 bit code is a parity bit for detecting transmission errors.
- EC: None.
- S: In the remote mode: TTRD-606A1, operates at 100 wpm in 7.5 unit code; TTRD-607A1, operated at 1330 wpm in 7.5 code.
- S/A: Synchronous.
- TM: TTRD 606A1 requires 100 wpm teletype quality line, TTRD-607A1 requires telco voice quality channel terminating in a modem.
- S/P: See above.
- ST: Eighty bit storage included.
- A: Compatible with Teleregister communications equip. and some teletype and telco units. Power units normally supplied with LRT.
- SF: Special checking circuits for keysets.
- P: Quoted on request.
- D: Quoted on request.
- C: Yes.
- Q: Over 20.

CIRCLE 366 ON READER CARD

Key to headings: M-manufacturer, name, type no.; I-input; O-output; EP-error prevention means; ED-error detection means; EC-error correction means; S-speed; S/A-synchronous or asynchronous; TM-transmission medium and requirements; S/P-serial, parallel or other transmission mode; ST-storage, needed or included; A-auxiliary equipment required and what other equipment the device will work with; SF-special features; P-purchase or rental price; D-delivery available; C-currently in production; Q-approximate quantity available in the field; AI-additional information

Grow with Control Data Corporation

From 12 to 1,700 people in 4 years, with its real growth still ahead. Our well received product line includes the large-scale 1604 Computer, the desk-size 160 and 160-A, and new developments soon to be announced.

Engineers

FOR MINNEAPOLIS LOCATION

APPLICATION ENGINEERS: Analyze, define, and solve customer data processing problems. Prepare capability reports and equipment proposals for system applications. EE degree necessary. Prefer experience with general purpose digital computers and their application in scientific, data processing, and control applications.

RELIABILITY ENGINEERS: Design studies and perform mathematical analysis to predict reliability and conformance for new product and component designs, and to predict performance with respect to reliability. Degree in Engineering or Mathematics required. Two or more years direct experience necessary.

TEST ENGINEERS: For systems final assembly, checkout, and evaluation of advanced geoballistic computer for the Polaris fire control system. EE degree required with minimum of one year electronics experience. Preferably in computers or controls.

DEVELOPMENT ENGINEERS: For design, development, and evaluation of Analog to Digital and Digital to Analog converters, servomechanism, and associated input/output equipment. EE degree and a minimum of two years experience in Analog and Digital conversion techniques. Experience with input/output equipment and logic for digital computers will be considered.

MECHANICAL ENGINEERS: For electromechanical design. ME degree required. Prefer minimum of one year experience with precision gear trains, control systems, and drawing requirements.

Programmers

FOR PALO ALTO AND NATIONWIDE LOCATIONS

SYSTEMS PROGRAMMING: Participate in the development of advanced programming systems including compiler and assembler development, monitor and executive routines, problem oriented and machine oriented systems, and language analysis.

COMPUTER CENTER SUPPORT: Supply programming assistance in both business and scientific areas to our computer center customers.

SALES SUPPORT: Support our expanding marketing activity by analyzing customer problems for computer application.

INSTALLATION SUPPORT: Be a technical representative at customer site, with duties including the training and orientation of our customers.

SOFTWARE MAINTENANCE: Maintain advanced programs for present and future computing systems.

PROGRAMMING INSTRUCTION: Develop course material and instruct Control Data and customer personnel.

LOCATION: With the exception of the nationwide sales support openings, most of the above positions are located at our new facility at Palo Alto, Calif.

EXPERIENCE: At least one year programming experience and a minimum of a BS in Math, Physics or related fields.

FOR THESE AND OTHER PROFESSIONAL OPPORTUNITIES WITH THE MOST DYNAMIC COMPANY IN THE COMPUTER SYSTEMS FIELD, RUSH RESUME TO: MR. H. M. TRADER.

An equal opportunity employer

CONTROL DATA
CORPORATION

COMPUTER DIVISION

501 PARK AVE. • MINNEAPOLIS 15, MINNESOTA • FEderal 9-0411

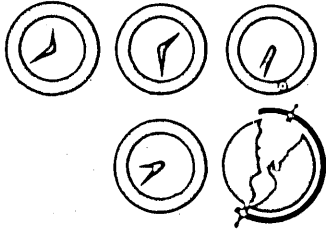

NEWS BRIEFS

RAND TO HOLD INSTITUTE ON HEURISTIC PROGRAMMING

A Research Training Institute on Heuristic Programming will be held at The RAND Corp., Santa Monica, Calif., June 18-July 27th, and will cover techniques in the programming of digital computers to solve complex problems using some of the methods observed in human problem-solving.

Instructions will consist of four overlapping phases: 1. Training in the use of Information Processing Language-V. 2. Detailed presentation and study of several existing heuristic programs. 3. General coverage of the techniques, literature and problems of heuristic programming, and coverage of other list-processing languages. 4. Supervision of original research projects formulated and programmed by the participants.

Participants will be expected to hold doctoral degrees although exceptionally qualified advanced candidates

for the doctorate will be considered. Experience in computer programming will be a requisite. Stipends and travel allowance will be offered. Deadline for applications is March 30th.

Further information may be obtained from Dr. Bert F. Green, Jr., Computer Sciences Dept., RAND Corp., Santa Monica, Calif.

AMS SCHEDULES COMPUTER SYMPOSIUM

A symposium on Interactions Between Mathematical Research and High-Speed Computing will be held in connection with the American Mathematical Society's Eastern April Meeting at the Chalfonte-Haddon Hotel, Atlantic City, N. J., April 16-19. The meetings will be co-sponsored by the ACM, with financial support from the U. S. Army Research Office (Durham) and the National Science Foundation.

The objective of the Symposium will be to enable mathematicians to

become familiar with the potentialities of current computer usage, with the problems involved in their proper exploitation, and to stimulate activity in related areas.

CDC AND SPERRY RAND SETTLE LAWSUIT

The three-year-old lawsuit filed by Sperry Rand against Control Data Corporation has been settled out of court, just prior to the case coming to trial. According to William C. Norris, president of CDC, the settlement was agreed to, not because Control Data acknowledged any of the alleged violations of Sperry Rand's rights, but because CDC could avoid a trial period which was estimated by lawyers of both parties to be about two months.

Many items of the lawsuit were dismissed. For the irrevocable right to manufacture, use and sell the remaining contested items alleged by Sperry Rand to be its trade secrets, Control Data agreed to pay Sperry Rand 5% of the manufacturing costs of these items.

While the specific items were not described, Norris pointed out that they represent only a small fraction of the total cost of CDC computers, and the cost of right to manufacture would be negligible.

IBM THIN FILM OPERATES AT 60 NANoseconds

An experimental magnetic thin film memory, built by IBM's Zurich, Switzerland, laboratory, is reported to operate at an access time of 60 nanoseconds, or more than four times faster than that of any operating thin film memory in its size previously reported.

The experimental memory holds 256 words of 72 bits each, with a total of 18,432 bits, each occupying a rectangular area of 0.12" x .026". The thin film bits are .0002" thick. The array is planar and measures 4 x 8", yielding a packaging density of 576 bits per sq. in.

Complete address register and decode circuitry, as well as a memory exercisor, is provided in order to check the memory in situations corresponding to actual computer operations. Though all information channels can be installed, only a few exist at the present. They are pluggable in order to have access to every bit channel.

In fabricating the thin films for the prototype, highly polished metal was used as the base material, on which ultra-high speed magnetic films were

deposited, through a vacuum process.

Strip line wiring patterns for sense word and bit lines, consisting of thin copper foil clad on insulating material, were placed on top of the magnetic array. In order to avoid eddy currents, which might seriously impede film switching, the strip lines were very fine-slotted.

High speed transistor circuits produce nanosecond drive pulses and cause the film to switch in less than five nanoseconds. The output signal of the film is about 3-mv and is amplified in about five nanoseconds to logic signal level.

Forerunner of the 18,432 bit memory was a smaller memory, consisting of 672 bits, each measuring .020" x .040", operating on one 2 x 2" silver substrate. This memory was operated at 100 nanoseconds read-write cycle time, and led to the development of the larger thin film memory.

The shortest cycle time which had been reported for ferrite memories is 700 nanoseconds for a 73,000 bit memory.

IRE, AIEE MERGER PROPOSED

A proposed merger of the American Institute of Electrical Engineers (AIEE) and the Institute of Radio Engineers (IRE) would result in a consolidated organization to be known as the Institute of Electrical and Electronic Engineers (IEEE).

Details of the merger were discussed at a "Town Meeting" during the Winter General Meeting of AIEE on January 31. Patrick E. Haggerty, president of IRE, and Warren H. Chase, president of AIEE, participated in the discussion, as did AIEE and IRE members serving on subcommittees that have been studying various aspects of the merger. (The Board of Directors of both organizations

This
machine
translates
human
language

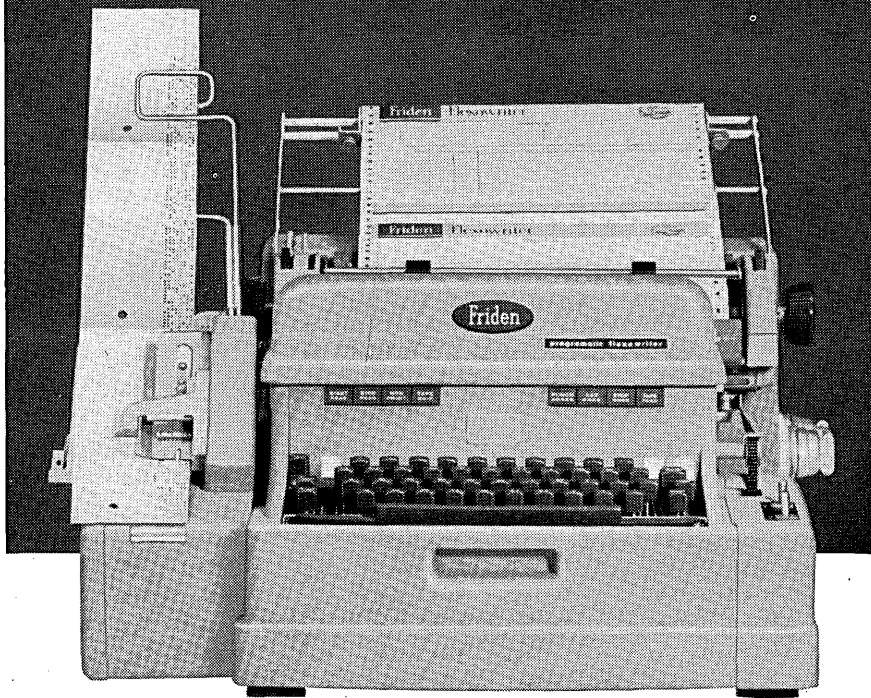

into language other machines understand

The Friden Flexowriter® performs a key task in automation. It produces punched paper tape that controls a variety of other office machines. It prepares tapes that instruct industrial machine tools. It produces tapes containing input and output information when used with electronic computers.

Yet a girl with average typing skill can operate it.

Ordinary business paperwork? The machine that talks to computers is also the machine that can reproduce an office document *at 100 words a minute*. And there is virtually no

manual effort on the operator's part after she types the first draft.

One of your own typists can easily put the Flexowriter to work for your firm. For more information, see your Friden Systems Man. Or write: Friden, Inc., San Leandro, Calif.

THIS IS PRACTIMATION: automation so hand-in-hand with practicality there can be no other word for it.

Friden

Sales, Service and Instruction Throughout the U.S. and World

CIRCLE 27 ON READER CARD

NEWS BRIEFS . . .

have not officially approved any of the proposed principles of consolidation.)

CODASYL VIEWS 1st COBOL PROCESSOR

An operational version of the COBOL processor was recently shown to the executive committee of the Conference on Data Systems Languages. (CODASYL). A COBOL program was run on an IBM 1410 at IBM's New York Datacenter.

Charles A. Phillips of the Office of the Assistant Secretary of Defense, and chairman of CODASYL, said: "The 1410 program is the first working processor demonstrated to our group for the current, accepted edition of COBOL. It represents a significant step in a two-and-a-half year old industry-wide effort . . ."

The program demonstrated was written in COBOL by the Pratt & Whitney Aircraft Div. of United Aircraft Corp. for the scheduling of preventive tool maintenance.

CIRCLE 101 ON READER CARD

GENERAL MILLS TO EXPAND DP ACTIVITIES

General Mills will step up their program to recruit personnel experienced in both development and production of digital computer systems. The decision to expand dp activities was reported by Richard A. Wilson, VP and general manager of the firm's Electronics Group, who said the company's decision was based on "the success in marketing the AD/ECS-20 and AD/ECS-37."

Named to head computer development was Irving Cohen, formerly project manager on ATLAS ICBM Digital Systems and Radio Inertial Guidance Computation Projects for Burroughs Laboratories. Richard D. Quinn will serve as Cohen's assistant.

CIRCLE 102 ON READER CARD

HONEYWELL CREATES DP ADVISORY PANEL

A flow of technological ideas between educational experts in data processing and Honeywell development engineers is the primary intent of an advisory panel established by Honeywell's EDP Division.

Academic members of the panel, which held its first meeting in Wellesley, Mass., Jan. 22-23, are: Dr. Maurice Wilkes, director of the Mathematical Laboratory, University of Cambridge (England); Dr. Philip Morse, professor of physics and di-

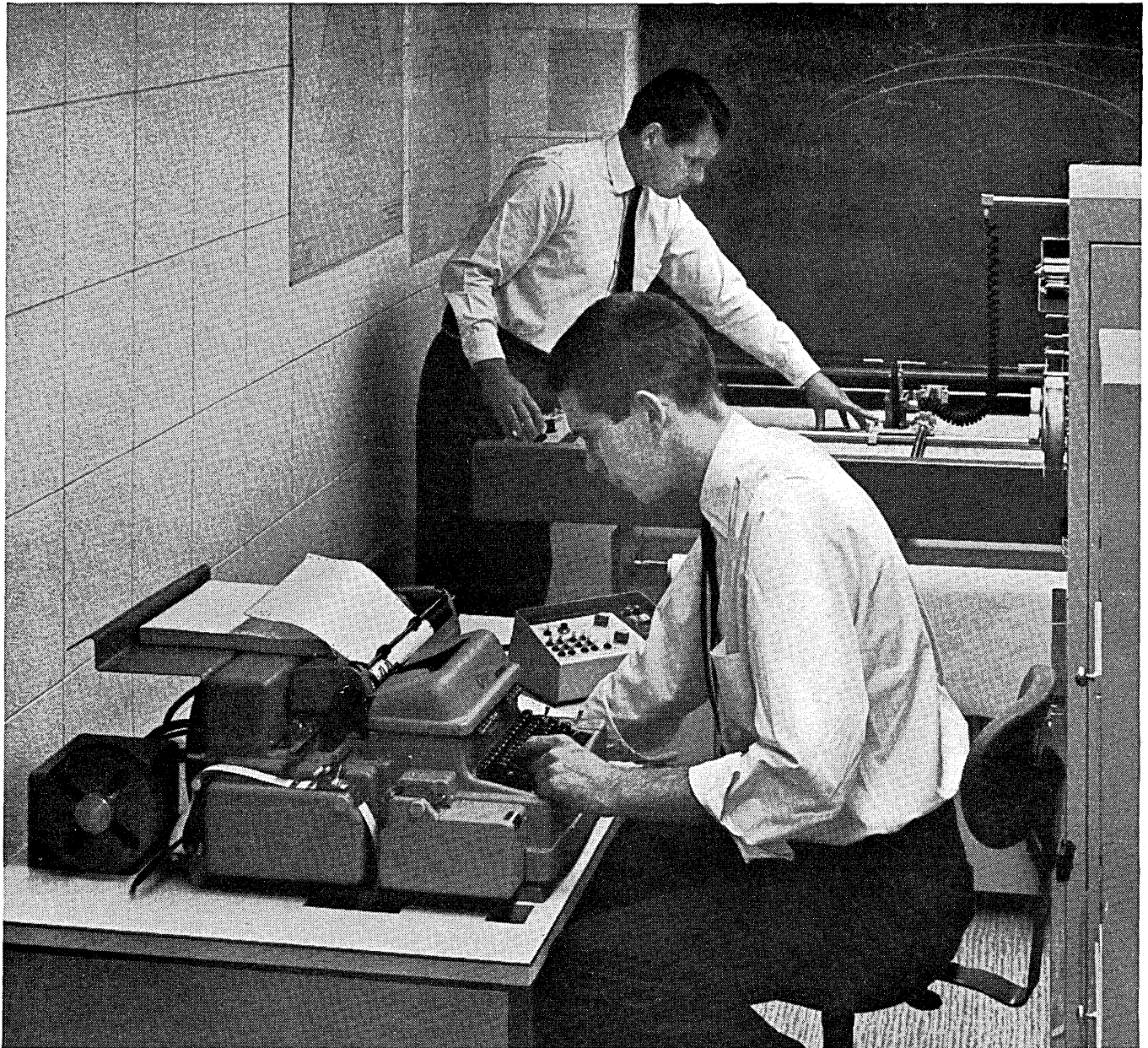

Jet Propulsion Laboratory will use Recomp III for processing data from NASA deep space tracking antennas.

Think fast.

All computers think fast. But some think faster than others.

The Recomp® computer can save 1760 hours over its nearest competitor on a given project.

This was proven in an actual feasibility study.

Recomp was designed for speed. It has many features that take the waiting out of your work.

Like built-ins.

Built-in floating point. Built-in square root command. Built-in index register. Built-in conversion from decimal to binary.

We don't know of any compact computer that has a larger word length than Recomp. 40 binary digits per word. Keep that in mind for problems such as matrix conversion.

There is a Recomp to fit your needs (and budget). You can lease one from \$1,495 (complete with no accessories required) to \$4,500 a month. Recomp II is for medium-scale users. Recomp III is perfect for small-scale needs.

Recomp's accessory line and software advantages are the most up-to-date in the computer industry. And an extensive programming library is available without charge.

There are a number of small and medium scale computers on the market today. Only a few are really outstanding. Recomp is one of them.* For the full Recomp story, write:

AUTONETICS  Industrial Products
Department 63, 3400 E. 70th Street, Long Beach, California.
Autonetics is a Division of North American Aviation.

Recomp

*No computer feasibility study is complete without Recomp.

CIRCLE 28 ON READER CARD

Here, to save you
hundreds of man-
hours of EDP
analysis . . .



STANDARD EDP REPORTS

*Objective, comparative studies of
computer hardware and software*

A data processing system, even for limited applications, can give you a powerful competitive advantage—but only if you select the right system for your operations, and utilize it properly.

Standard EDP Reports—developed by AUERBACH Corporation and the Bureau of National Affairs, Inc.—examine individually the computers and programming packages commercially available in this country in terms of . . .

TECHNICAL REPORTS describing each system as a whole, analyzing hardware, software and performance.

COMPARISON CHARTS providing *apple-to-apple* specifications and performance data.

SELECTION PROCEDURE REPORTS which will help you select the system or unit best suited to your requirements.

GUIDELINE REPORTS which keep you up-to-date on EDP trends and developments.

A primary feature of this new service is the inclusion of standardized performance analyses which enable you to make direct systems comparisons for specific applications.

Standard EDP Reports are the one best source of complete, objective operating and performance information on your present, or planned, EDP installation.

For complete information about this unprecedented service, write Department 1220 today.

AUERBACH/BNA Standard EDP Reports will be displayed at the Western Joint Computer Conference. We invite your inquiries and comments.

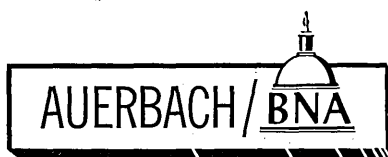

THE BUREAU OF NATIONAL AFFAIRS, Inc.
1231 24th Street, N.W. • Washington 7, D.C.

NEWS BRIEFS . . .

rector of the Computation Center, MIT; Dr. G. D. McCann, head of the electrical engineering department and director of the Computation Center, California Institute of Technology; Dr. Nicholas Metropolis, director of the Institute for the Study of Computers, University of Chicago, and Dr. Norman R. Scott, professor of electrical engineering and editor of IRE Transactions, University of Michigan.

Honeywell panel members are: Dr. J. Ernest Smith, vice president, EDP Div. (panel chairman); John W. Anderson, division VP in charge of engineering, and Richard M. Bloch, director of product planning.

COMPUTER INSTITUTE SET FOR CHAPEL HILL

The University of North Carolina, under the sponsorship of the National Science Foundation, will hold an Institute on Advanced Topics in the Computer Sciences from June 11-July 20th. The Institute is aimed at persons now working in university computation centers, in training for similar positions, or likely to assume the post of director of such a center.

Among the lecture series to be given will be courses in automatic programming applicable in universities; how to teach undergraduate and advanced numerical analysis using computers; language translation; information retrieval; and the use of ALGOL.

APPLIED DYNAMICS OPENS ANALOG CENTER

Applied Dynamics, Inc., Ann Arbor, Mich., manufacturer of analog computers, has opened a new Analog Computation Center to demonstrate the business applications of analog equipment and techniques to management.

The company is emphasizing business forecasting and trend analysis, in addition to handling scientific, industrial and engineering problems.

The Center is open to area businesses, industries, and institutions for problem solving on a rental basis, which is expected to be about \$15 per hour for the computer, and a similar amount for engineering assistance from ADI personnel.

CIRCLE 103 ON READER CARD

PERCEPTRON REPORT

Spartan Books has re-published "Principals of Neurodynamics: Perceptrons and the Theory of Brain Mechanisms,"



**IF THIS
CAN'T
PLOT IT...**

ODDS ARE NOTHING CAN

With this surprisingly versatile system, the EAI Series 3440 DATAPLOTTER[®], you can plot your digital or analog data in easy-to-read, easy-to-interpret graphic form. Far more accurate than hand plotting and many times faster, the DATAPLOTTER will convert virtually any input from almost any computer, digital or analog, into plots as large as 45 by 60 inches. It will plot from magnetic or punched paper tape, punched cards, manual keyboard or analog-type signals. It will seek plot starting point and stop automatically at a preselected value. Output modes, include point, symbol or continuous line. The host of features includes solid state reliability, speeds to 4500 line segments per minute, fully automatic commands and dial control data selection. Full information on this new standard in digital plotting equipment may be obtained by writing for Bulletin DP 6188.

EAI

Career Opportunity for Engineers — Graduate or advanced degrees in EE, Physics, Math — call or write Gordon Strout, Director-Personnel

ELECTRONIC ASSOCIATES, INC. Long Branch, New Jersey

Analog/Digital Computers Data Reduction Process Control Instruments Computation Service

CIRCLE 29 ON READER CARD

by Dr. Frank Rosenblatt. The report, published by Spartan in cooperation with Cornell Aeronautical Laboratory, Inc., and the Information System Branch of the Office of Naval Research, sets forth the principals, motivation, and accomplishments of Perceptron Theory in their entirety.

The report is divided into four main sections, and provides a self-sufficient text for those interested in a serious study of neurodynamics. Also included are several appendices, definitions, and experimental designs which are described in different chapters.

CIRCLE 104 ON READER CARD

● The first ALGOL compiler made in Sweden has been completed for the FACIT EDB computer. The language used is ALGOL 60, except for the symbol *own* and recursive procedures. There are also some restrictions on variable index bounds for arrays; expressions called by name, and length of identifiers. The present compiler uses only the central unit of the FACIT EDB with core storage of 2K words, drum storage 8K words, and input output of five-channel paper tape.

Compilation in an effective machine code program of 200 declarations and statements required about 10 minutes to compile, about five minutes of which is used for input of the compiler and output of the object program.

● The S-4 Assembly System, a new programming aid for users of UNIVAC solid state computers was announced last month by RemRand. Through exercise of a forward-search option, the Assembler will automatically search ahead through 10 instructions to determine the optimum location for a designated word in storage. S-4 is compatible with standard library routines and is claimed to facilitate development of programming testing aids during the assembly process.

CIRCLE 105 ON READER CARD

● Packard Bell's CINCH has been modified to simplify its use by personnel unfamiliar with programming techniques. The new CINCH interpreter is said to be compatible with the original routine introduced last year. Modification of CINCH includes provisions for correction of programming errors, simplification of coding, and extension of the routine for applicability of a PB 250 up to 16K in memory size. CINCH utilizes a float-

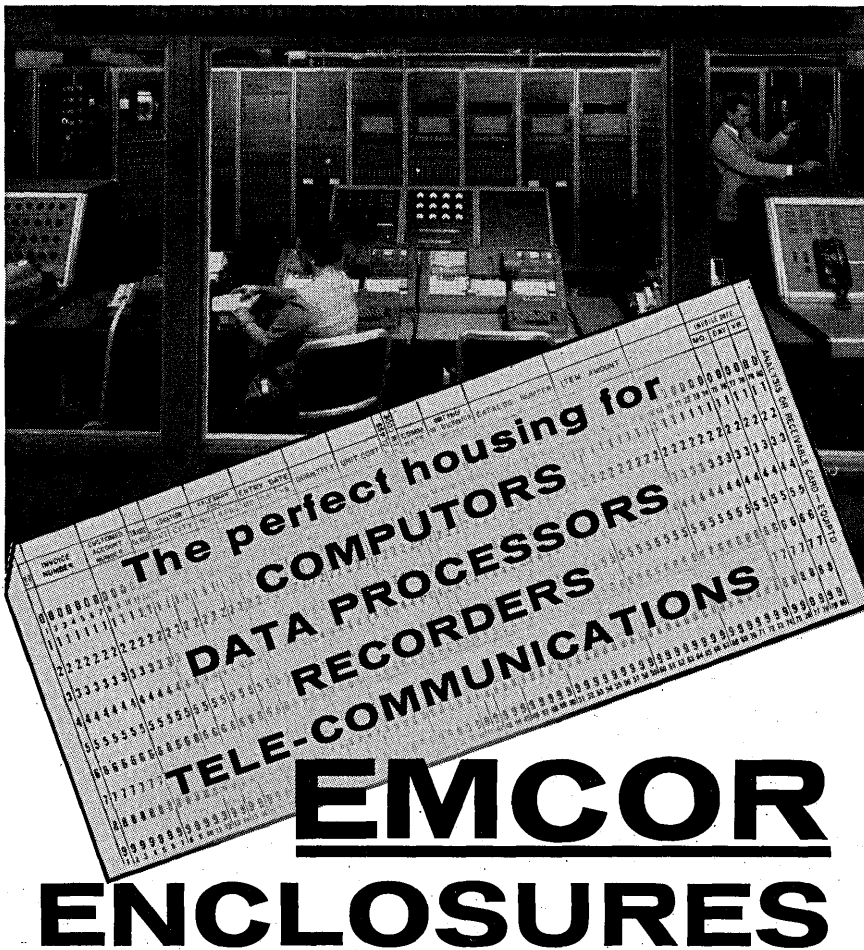

The perfect housing for
COMPUTERS
DATA PROCESSORS
RECORDERS
TELE-COMMUNICATIONS

EMCOR

ENCLOSURES

EMCOR Enclosures provide two major necessities for housing data processing type equipment . . . functional flexibility and aesthetic beauty. The "human engineering" features of EMCOR Enclosures, developed through years of research, brings all controls within easy sight and reach of the operator. The need for costly custom enclosure design time is eliminated. Housings can be easily selected from the hundreds of standard enclosure widths, depths and heights of the EMCOR Modular Enclosure System. Six standard EMCOR colors provide a wide selection for even the most discriminating tastes . . . blend with any decor. Request full details today.

Condensed version of Catalog 106 is available at your request.

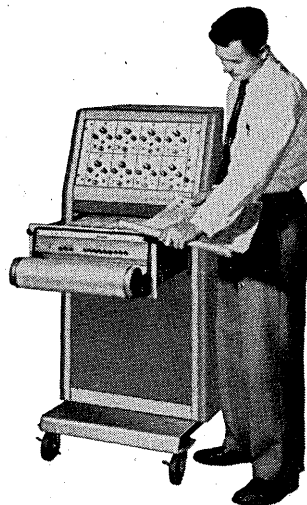

EMCOR-The Original Modular Enclosure System By
INGERSOLL PRODUCTS
Division of Borg-Warner Corporation
1000 W. 120th ST. • DEPT. 1248 • CHICAGO 43, ILL.

Most Ingersoll Products Sales Engineers also represent McLean Blowers for enclosures

CIRCLE 30 ON READER CARD

**What other computer
manufacturer can offer you
7,800,000 MAN-HOURS
of experience in applying
computers to its own
data processing problems?**

GENERAL  ELECTRIC

SYSTEMS PROGRAMMING
 SYSTEMS PROGRAMMING
 SYSTEMS PROGRAMMING
 SYSTEMS PROGRAMMING
 SYSTEMS PROGRAMMING
 SYSTEMS PROGRAMMING
 SYSTEMS PROGRAMMING
 SYSTEMS PROGRAMMING
 SYSTEMS PROGRAMMING
 SYSTEMS PROGRAMMING
 SYSTEMS PROGRAMMING

What is your program for professional growth?

To the programmer in IBM's Systems Development Department, total systems development offers unique opportunities to grow with the programming field. Systems Programmers participate in the development of new techniques and explore new applications of information processing. They have opportunities to progress into broader areas of analysis and design required to provide advanced systems for challenging new projects.

IBM's Systems Development Department is in the forefront of the development of new systems for government applications in military, civil agency and space programs. In the field of programming, this advanced professional staff has excellent assignments open in:

- Analysis of Systems Programming Requirements
- Programming Techniques Development
- Real-Time Operational Programming
- Simulation Programming and Evaluation

Among the immediate programming assignments are such tasks as:

- | | |
|-----------------------|--------------------------------------|
| Data Reduction | Numerical Analysis |
| Decision Programming | Problem-Oriented Language Processors |
| Information Retrieval | Sound Recognition |
| Logistic Simulation | Trajectory Prediction |
| Message Switching | Other Related Projects |

These are opportunities for both personal and professional growth. In addition to educational and benefit programs, IBM salaries are commensurate with ability and merit. Relocation expenses are paid. Locations are in Washington, D. C., and Omaha, Nebraska.

The qualifications desired are dependent on assignment and range from one to two or more years' experience in programming large-scale computer systems. IBM is an Equal Opportunity Employer. Qualified applicants are invited to send resumes to: **John V. Croker, Dept. 701P, IBM Systems Development Department, 7220 Wisconsin Ave., Bethesda 14, Maryland.**

IBM

INTERNATIONAL BUSINESS MACHINES CORPORATION

In addition to Washington, D.C., and Omaha, Nebraska, programming facilities are located in San Jose, California; Lexington, Kentucky; Rochester, Minnesota; and New York City, Endicott, Kingston, Owego, Poughkeepsie and Yorktown Heights, N. Y.

NEWS BRIEFS . . .

ing point interpretive system in which the scaling of numbers is handled automatically.

CIRCLE 106 ON READER CARD

● Development of a basic PERT scheduling system for the IBM 1401 and 7070 has been completed by Telecomputing Services, Los Angeles. TSI's program arranges PERT network data topologically so that network event modes can be numbered at random. Up to 99 networks containing as many as 2,500 activities each can be scheduled for each computer run. The system features restart capabilities, error diagnostics and disallowance of cyclic networks.

CIRCLE 107 ON READER CARD

● Preliminary results of earnings for 1961 have been announced by IBM. Gross income from sales, services, and rentals in the U. S. amounted to \$1,694,295,547, compared with \$1,436,053,085 the previous year. Net earnings (after U.S. taxes) came to \$207,227,597, or \$7.52 a share. Earnings during 1960 were reported at \$168,180,880, equal to \$6.12 a share.

● The Computation and Data Reduction Center (CDRC) at Space Technology Laboratories, has been reorganized to include establishment of two new labs: the Data Systems Laboratory with Herbert O. Asbury as acting director, and the Programming and Applied Mathematics Laboratory with Dr. Edward K. Blum, acting director.

● A new C-E-I-R Center in Mexico City has been established, while a Chicago center will be opened in September, 1962, the eighth in the U. S. Dr. José Nieto de Pascual is general director and chairman of C-E-I-R de Mexico, S. A.

● Control Data Corporation will establish a development laboratory in the Eau Clair-Chippewa Falls area of west central Wisconsin. The new facility, to be known as the Chippewa Laboratory, will be part of the CDC Computer Division. Completion of the 24,000 sq. ft. structure is expected in mid-summer. Seymour R. Cray, director of development for CDC, will head the laboratory's operations.

● Penn State University and IBM are offering a home-study course in computer programming, said to be the first university-sponsored program of this type. A 12-part textbook has

**You can be sure
to play an important part
in the exploration of space
...when you join NASA**

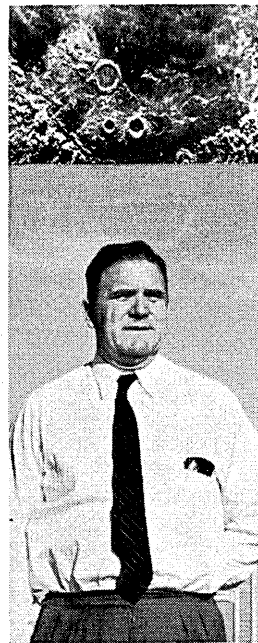

A factual statement on career opportunities for scientists and engineers from James E. Webb, head of NASA

The exploration of space, for peaceful purposes and the benefit of all mankind, is the most challenging assignment ever given to the American scientific and engineering community.

To the men of NASA, the space program has many objectives: broad scale, rapid advancement of scientific knowledge of space, the moon and planets . . . the creation of a worldwide operational network of weather satellites . . . the establishment of a global satellite system of communications . . . prompt feedback of space technology into our economy . . . and many others. Technological advances through our space effort will bring total benefits exceeding those of any other undertaking in history.

The scientists and engineers who are directly involved in NASA's space program are faced with formidable research and development problems. NASA needs—and seeks—the best

creative scientific and engineering talent our nation has to offer.

We will provide the professional men who join NASA with the tools they need: a truly intellectual atmosphere, a framework for easy communication with colleagues in universities as well as government and industry laboratories, the most advanced equipment available, and the technical and clerical support to let you concentrate on the important aspects of your work.

Still, the greatest personal satisfaction may be found in the scope of the individual assignment and in the end product of the work—breaking out from the world we know into an entire new world and uncovering a flood of new benefits not only for ourselves, but for all mankind.

James E. Webb

To scientists and engineers in all disciplines, at all levels:

The dynamic expansion of NASA has created outstanding career positions and opportunities for rapid advancement. Career appointments are available in ten different locales: Washington, D. C.; Greenbelt, Maryland; Mountain View and Edwards, California; Hampton and Wallops Island, Virginia; Cleveland, Ohio; Huntsville,

Alabama; Cape Canaveral, Florida; and Houston, Texas.

Find out how you may contribute to the American space effort. You need send only one resume—it will be reproduced and distributed to all NASA facilities for evaluation.

Write to: Director, Professional Staffing, NASA Headquarters, Washington 25, D. C.

AN EQUAL OPPORTUNITY EMPLOYER. POSITIONS ARE FILLED IN ACCORDANCE WITH AERO-SPACE TECHNOLOGY ANNOUNCEMENT 252B.



NATIONAL AERONAUTICS AND SPACE ADMINISTRATION

EXPLOSION PROOF

YOUR
WORKLOAD

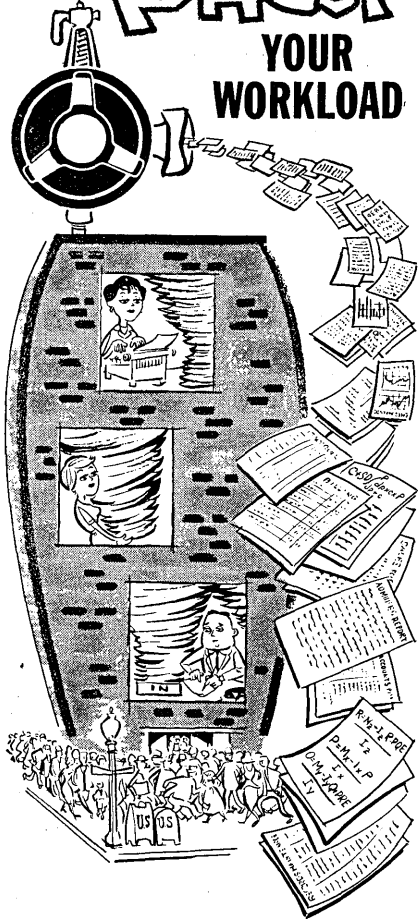

When paperwork and work-overloads push out the walls of your business, McDonnell Automation Center is the "Business Safety Valve" to relieve the pressure. It's even more ideal than a mechanical safety valve, because you don't pay for it until you use it.

The McDonnell Automation Center provides consulting, systems design, programming and data processing at "by the hour" rates.

Write or call today for a brochure and further information on how the McDonnell Automation Center can be your "Business Safety Valve."

**MCDONNELL
AUTOMATION
CENTER**

Division of MCDONNELL AIRCRAFT

St. Louis, Missouri
Phone: PErshing 1-2121

CIRCLE 32 ON READER CARD

NEWS BRIEFS . . .

been prepared by IBM for this course, while Penn State will furnish a home study guide. The curriculum introduces students to the basic elements of data processing, explains the fundamentals of hardware operation, and introduces program coding, symbolic programming, address modification, branching, etc. The entire course will be administered by mail.

CIRCLE 108 ON READER CARD

● A systems seminar for manufacturers of dp equipment is being conducted by Headquarters, Air Force Logistics Command, and the Air Force Institute of Technology's School of Logistics. Purpose of the seminar is to acquaint manufacturers and their representatives with the mission of the Logistics Command and with the Command's needs for dp equipment.

● Thirty-one representatives of International Computers and Tabulators Limited (ICT), England, are attending classes at the Cherry Hill, N. J., headquarters of RCA's EDP division. The course covers American dp methods and equipment. (ICT recently completed a trade agreement with RCA for sale of the 301 in England).

● An experimental, one-year course in dp is being conducted at Dobbins Technical High School, Philadelphia, using an IBM 1620. The course is the forerunner of a planned two-year program that will be open to selected 11th and 12th graders, some advanced students and adults in Dobbins' night school courses.

● Pennsylvania State University has installed an IBM 7074 which will replace their 650. The school also operates a 7070 for administrative purposes.

● The dp phase of the Air Force's Ballistic Missile Early Warning Systems (BMEWS) has been completed by Sylvania Electric Products Inc., subsidiary of General Telephone & Electronics Corp. The four-year, \$50 million, program included development, production and installation of the Northern Sites high-speed dp equipment. Sylvania is a major subcontractor to RCA on BMEWS.

● The Navy's Bureau of Ships has awarded a letter contract for maximum liability of 19 million to RemRand's UNIVAC Military department for production of additional hardware

AEROSPACE COMPUTER ANALYSTS

- Senior Analog •
- Digital Programmers •

Stimulating positions now available for scientists and engineers with B.S. and M.S. degrees having 2 to 5 years experience analyzing, programming, and solving advanced engineering problems in fields of control systems, structures, heat transfer, and hydro-mechanical devices.

For interview with Engineering Management, send resume to:

FRANK G. COUSINS, JR.
BENDIX PRODUCTS AEROSPACE
DIVISION

THE BENDIX CORPORATION
South Bend 20, Indiana

"An Equal Opportunity Employer"

CIRCLE 78 ON READER CARD

DATAMATION

A new science-technology supports decision-making on a global scale. How do you control world-wide forces when decisions must be made in minutes or seconds, based on huge amounts of information, which in turn must be literally up-to-the-second? Decisions of this scale are made possible by a new science-technology: systems that provide information processing assistance for military and governmental leaders.

Computer Programmers at SDC have been on the growing edge of this science-technology since it began with SAGE (the first system of this type) and SACCS (the second system). Today SDC Computer Programmers are deeply involved in a number of new systems, contributing to: system analysis, system synthesis, programming computers which are the heart of the system, training personnel in the use of the system, and in system evaluation. In these aspects of system development, Computer Programmers at SDC perform central roles, particularly in simulating many phases of the system. What does this new science-technology offer you professionally? We invite your inquiry on this score if your ambitions, background and curiosity turn you toward this new field. Address: A. C. Granville, Jr. at 2401 Colorado Avenue, Santa Monica, California. Openings are in Santa Monica, Washington, D.C., Paramus, New Jersey, and Lexington, Massachusetts. "An equal opportunity employer?"

System Development Corporation

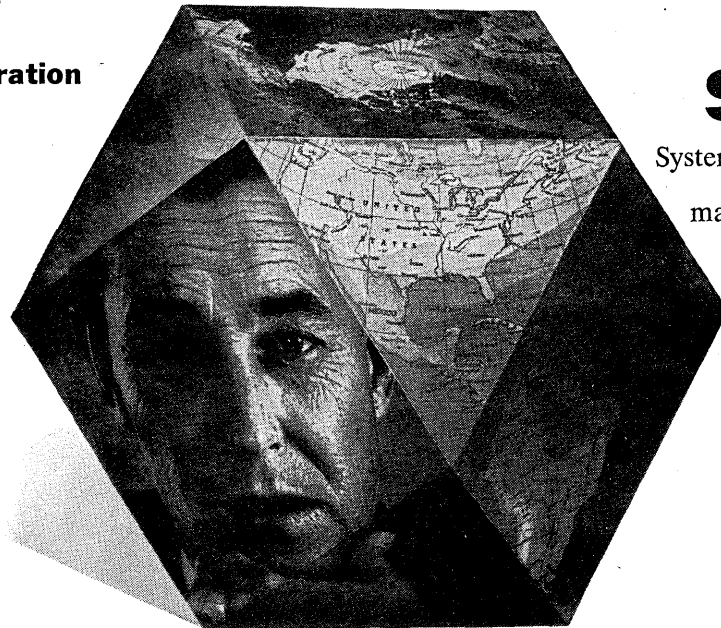

SDC

Systems that help men
make decisions and
exercise control

DECISION-MAKING ON A GLOBAL SCALE

COMPUTER MAINTENANCE ENGINEERS

465-L, the world's largest digital computer-based communications/control system is now being engineered by the International Telephone and Telegraph Corporation.

Federal Electric's role on this global system, designed to transmit, process and display SAC operational data, is the installation design and subsequent installation, check-out and maintenance of headquarters and remote equipments.

Successful applicants will first receive intensive formal training in the theory of the 465-L system, followed by a thorough indoctrination and orientation on the existing prototype system. Then, working with our engineering staff at Paramus, they will participate in the system installation planning phase. After this will come permanent relocation to operational sites, to direct the installation and carry-out continuous maintenance and user training programs.

To engineers with a degree and three to five years' experience in the maintenance of large-scale digital computer or digital data processing systems, we offer the opportunity to join this unique operation.

For consideration, send a detailed resume to Manager, Professional Staffing, Dept. DA-1.

FEDERAL ELECTRIC CORPORATION

Service Division of International
Telephone and Telegraph Corporation

Paramus Industrial Park
Paramus, New Jersey

An Equal Opportunity Employer.

CIRCLE 80 ON READER CARD

NEWS BRIEFS . . .

and peripheral equipment as well as software services for the Naval Tactical Data System (NTDS).

● The Fulton National Bank of Atlanta has ordered a GE 225 with delivery scheduled for the third quarter of this year. The bank is said to be the first in Atlanta as well as in the deep South to order a 225.

● Bad check passers in the Los Angeles area will have an IBM RAMAC 305 looking over their shoulder when they try to cash a bogus check at a business establishment subscribing to a new Telecredit service. When verification of a check is necessary, a call is made to Telecredit giving the driver's license number of the prospective cashier. The data is transmitted to the 305, which responds in four seconds with a credit report.

● Tra-Vel Data Processing Center, San Diego, has installed an NCR 390, and is said to be the first firm of its kind to install the equipment in Southern California.

● Two large Japanese firms and a Japanese government welfare agency have purchased IBM 7070s. IBM-Japan will install the equipment at Nippon Life Insurance Co., Osaka, the Takushoku Bank, Hokkaido, and the Health and Welfare Ministry, Tokyo.

● The second Clary DE-60 has recently been installed at Santa Anita Racetrack by the American Totalizator Co. The DE-60 is fed data by an analog device which registers the bets placed during the period between races. While the race is run, the DE-60 is put into operation and within a few seconds after the race is finished, it determines the prices to be paid on the winning horses.

● A piping flexibility program which required a two and a half year development period by The Service Bureau Corp., N.Y.C., has analyzed over 350,000 feet of intricate plant piping during the past year. In a typical application, the customer provides data sheets describing the piping system to be analyzed, along with an isometric drawing. The information is fed into an IBM 704 along with the SBC piping program.

ADMINISTRATIVE SYSTEMS RESEARCH SPECIALISTS

To join expanding Data Processing and Management Systems Division at AIRLIFT CENTER, U.S.A., located at Marietta, Georgia, eight miles from Atlanta.

Applicant's background should include an undergraduate degree, preferably in Mathematics, Engineering or one of the Natural Sciences, and a Masters degree in Business Administration or Industrial Management. A Ph.D. degree is desirable. Should have broad experience in computer oriented business systems and specialized experience in one of the following areas:

MANUFACTURING MANAGEMENT SYSTEMS

DATA PROCESSING EQUIPMENT DEVELOPMENT AND EVALUATION

ACCOUNTING AND FINANCIAL MANAGEMENT SYSTEMS

OPERATIONS RESEARCH (applying OR techniques to administrative and management problems).

These positions offer unusual opportunities to join an expanding organization; to make significant contributions in the field of advanced management systems and controls; and to enjoy the cultural, educational and climatic advantages of the metropolitan Atlanta area.

Also excellent opportunities for: PROGRAMMING ANALYSTS

Requires Bachelor's degree and programming experience on 7080 or 7090 computer. Write full details of training and experience to: Hugh L. Gordon, Professional Employment Manager, Lockheed-Georgia Company, Department VV-94, 834 West Peachtree Street, Atlanta 8, Georgia.

An Equal Opportunity Employer

LOCKHEED-GEORGIA COMPANY

A Division of Lockheed Aircraft Corporation

CIRCLE 86 ON READER CARD
FOR GE CIRCLE 39 ON READER CARD →

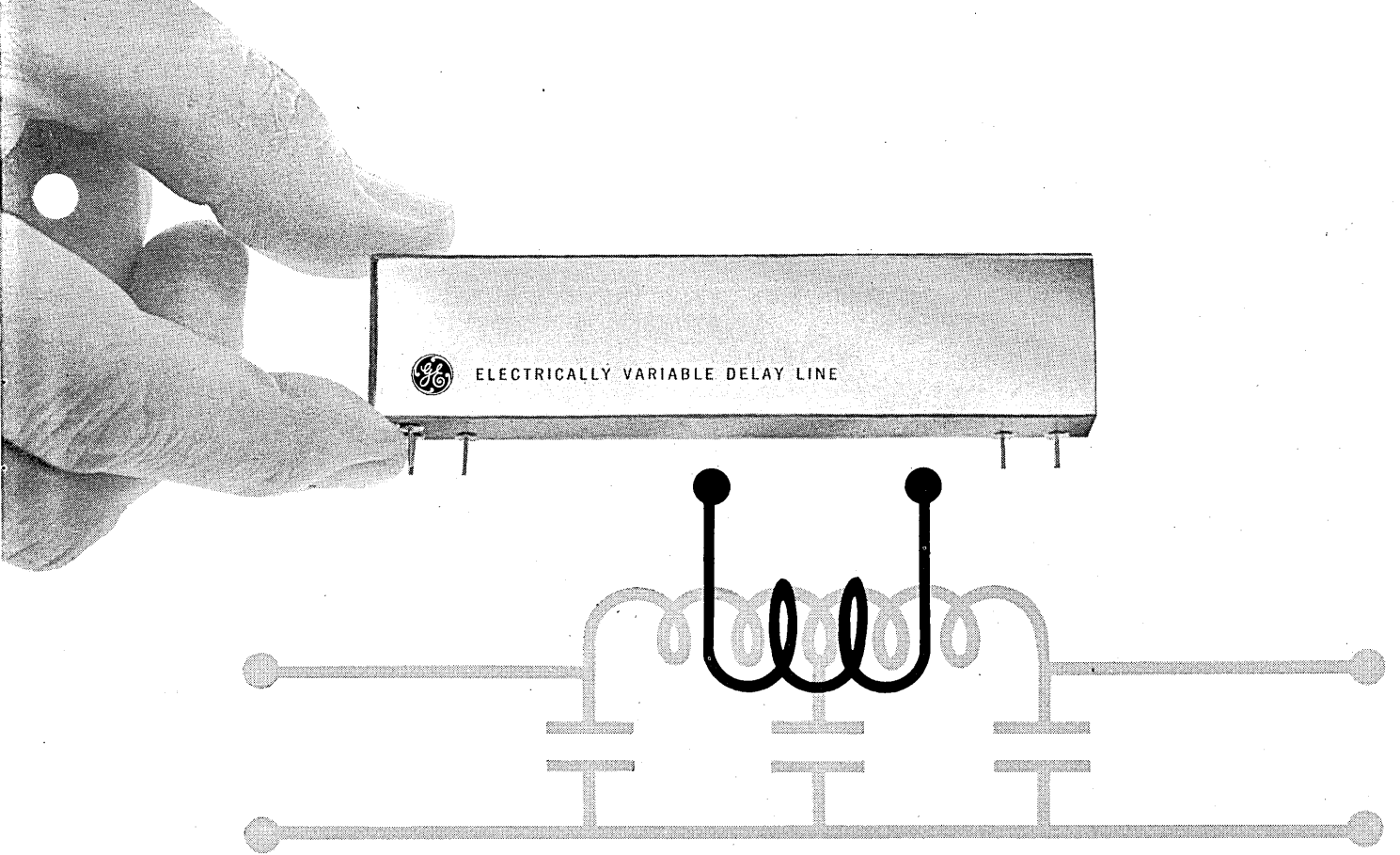

SIMPLIFIES THE CIRCUITRY NEEDED TO CONTROL DELAY

Electrically Variable Delay Lines from General Electric offer Design Engineers all the cost, time, space, and reliability advantages that accrue when a circuit design requirement can be greatly simplified. This unique device offers a new approach to pulse positioning and phase control, and features the advantages of controlling delay by electrical rather than mechanical means.

For such equipments as radar, computers, mobile communications, Electrically Variable Delay Lines are a superior method for the solution of problems in transmission time control, pulse control and shaping, high-frequency phase control, pulse time modulation, and phase or frequency modulation. These devices are available for either carrier or pulse type applications, and can be produced within a wide range of operating characteristics.

Electrically Variable Delay Lines are built to customer specifications only. Full consulting services are available from our staff of engineering specialists. *Specialty Devices, Operation of Defense Electronics Division, General Electric Company, Lemoyne Avenue, Syracuse, N. Y.*

LET US TELL YOU ABOUT THEM IN MORE DETAIL

Section A171-03, General Electric Company, Schenectady 5, N. Y.

- Please send me the specification sheet for G-E Electrically Variable Delay Lines. My interest is primarily
 - radar computer communications
 - other
 - for use with transistorized circuitry
 - environmental (extreme humidity, vibration, shock)
 - delay (variation) x bandwidth
 - Please send me information on the following integrated electronic devices available from G.E.

- Ferrite Core Memory Planes (fully encapsulated or open)
- Sonic Delay Lines (completely passive)
- Phase Modulators (available only from GE)
- Digital Readout Device (best combination of readability, flexibility, reliability)
- Magnetic Shift Registers
- Custom packaging (advanced material selection)
- Parametric Amplifiers (tuneable, even remotely)

NAME _____ TITLE _____

COMPANY _____

CITY _____ STATE _____

SPECIALTY
DEVICES
OPERATION



GENERAL ELECTRIC

Defense Electronics Division

Why is FORMSCARD the only continuous tab card that works trouble-free on all high-speed printers ?

... because it's the ONLY one with NO MEDIAL WASTE STRIPS



"WALSTON & CO.'s investment in FORMSCARDS pays off with perfect performance on the IBM 1403 high-speed printer."

VINCENT C. GUBITOSI,
Assistant Treasurer —
Director of Data Processing,
WALSTON & CO.

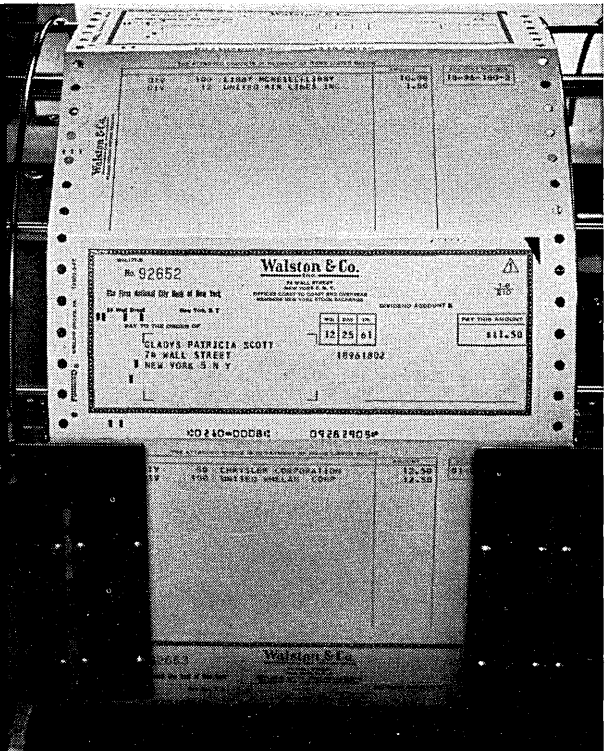

FORMSCARD®

Regardless of the number of carbon copies required, FORMSCARD is manufactured to specifications producing perfect operation on all high-speed equipment. And FORMSCARD also delivers these other outstanding advantages:

- Pre-punching
- Easy Separation manually or on any burster
- Vouchers of any length, side, top or bottom



Manufacturers of line-hole continuous business forms. Samples on request—sales representatives in principal cities.

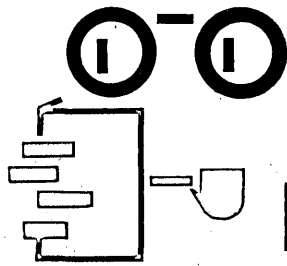

NEW LITERATURE

BANK AUTOMATION: This 18-page booklet reviews the functions and features of automated banking. MC-DONNELL AUTOMATION CENTER, Lambert-St. Louis Municipal Airport, Box 516, St. Louis 66, Mo. For copy:

CIRCLE 125 ON READER CARD

DIGITAL MODULE CATALOG: This new short-form catalog lists 86 fully coordinated solid state computer circuit modules and features a quick reference table showing modules arranged according to type and price. DIGITAL EQUIPMENT CORP., 146 Main St., Maynard, Mass. For copy:

CIRCLE 126 ON READER CARD

MERCATOR ALPHA-NUMERIC ACCOUNTING MACHINE: This pamphlet describes desk-size computer models 5000, 5020

and 5030 Mercator accounting machines, giving features of each. UNDERWOOD CORP., One Park Ave., New York 16, N. Y. For copy:

CIRCLE 127 ON READER CARD

PLANT AUTOMATION: This 16-page bulletin describes a new approach to automation by use of the 700 computing, control and information system. A step by step approach to automation as well as photographs tracing the growth of automation are included. BAILEY METER CO., 1050 Ivanhoe Rd., Cleveland 10, Ohio. For copy:

CIRCLE 128 ON READER CARD

FACT PROGRAMMING AID: This illustrated booklet lists the features of FACT, the programming aid designed for use with the 800 system. Topics

discussed include language simplicity, programming time, modifications and documentation. MINNEAPOLIS-HONEYWELL REGULATOR CO., EDP DIV., Wellesley Hills, 81, Mass. For copy:

CIRCLE 129 ON READER CARD

ANALOG COMPUTERS: This 18-page booklet presents examples of problems and their solutions by use of an analog computer. The brochure also discusses various analog computer applications, and several integration devices. KEARFOTT DIV., GENERAL PRECISION, INC., Little Falls, N. J. For copy:

CIRCLE 130 ON READER CARD

ARGUS PROGRAMMING AID: This seven-page booklet highlights ARGUS, the automatic routine generating and

Now ... maximum
data
equipment
and operator
productivity
with



Wherever automatic business machines, tabulators or computers are used, the pdp Data Integrator will save time and money. It will create a common language tape which sequentially combines Fixed Data, Variable Data, Identification Data and Time and Count Data. It is the vital link between the periphery of the data network and the processing center. Its flexibility is unlimited, its application universal.



American DATA MACHINES, INC.
7 COMMERCIAL STREET, HICKSVILLE, L. I., N. Y.

Data Systems
Equipment

MANUFACTURERS OF:
Attendance Recorders
Data Collection Systems

Digital Clocks
Digitized Plastic Plate Readers
Keybank Assemblies

Mek-A-Punch
Military Systems
Sequential Punched Card

Readers
and Scanners

CIRCLE 34 ON READER CARD

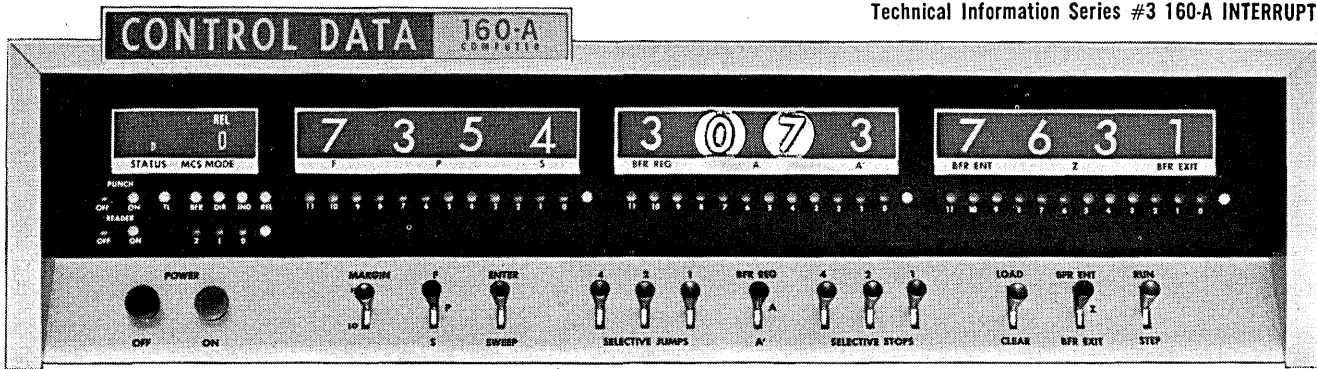

GREEN LIGHTS INDICATE INTERRUPT STATUS.

NEW CONTROL DATA 160-A COMPUTER

Desk-Size Computer with Large Computer Capabilities

In evaluating desk-size computers, the flexibility and capability of the computer to perform interrupt functions is of great importance. Similar to the interrupt feature employed in many advanced, large-scale computers, the 160-A Program Interrupt allows the normal program sequence to be interrupted by various external conditions . . . such as a peripheral equipment completing its function, operator action, and end-of-buffer sequence. Few desk-size computers on the market today have this capability.

The 160-A has four interrupt lines: two internal and two external. When an interrupt signal occurs on one of these lines, the computer executes a special RETURN JUMP instruction to one of four fixed memory locations, depending upon the line generating the interrupt.

For example, the operator can activate Interrupt Line 10 by momentarily depressing any combination of a Selective Stop Switch and a Selective Jump Switch, which are located on the 160-A console display panel. Interrupt Line 20 is activated each time a buffer operation is completed. Finally, Interrupt Lines 30 and 40 are external lines and may be activated by any peripheral device designed to provide an interrupt signal. In all cases where an interrupt occurs, the

160-A executes a special RETURN JUMP instruction to a fixed memory location.

Interrupt signals are recognized in a priority sequence, the lower-numbered lines being recognized first. Thus, where an interrupt occurs simultaneously on Lines 10 and 20, Line 10 will be recognized first. Once an interrupt signal is placed on a line, it remains until recognized or until a console MASTER CLEAR instruction is executed.

A desk-size computer, the Control Data 160-A has the speed, capability, and flexibility of many large-scale computers. For more detailed information about the 160-A Program Interrupt and other standard features, write for Publication #B12-61.

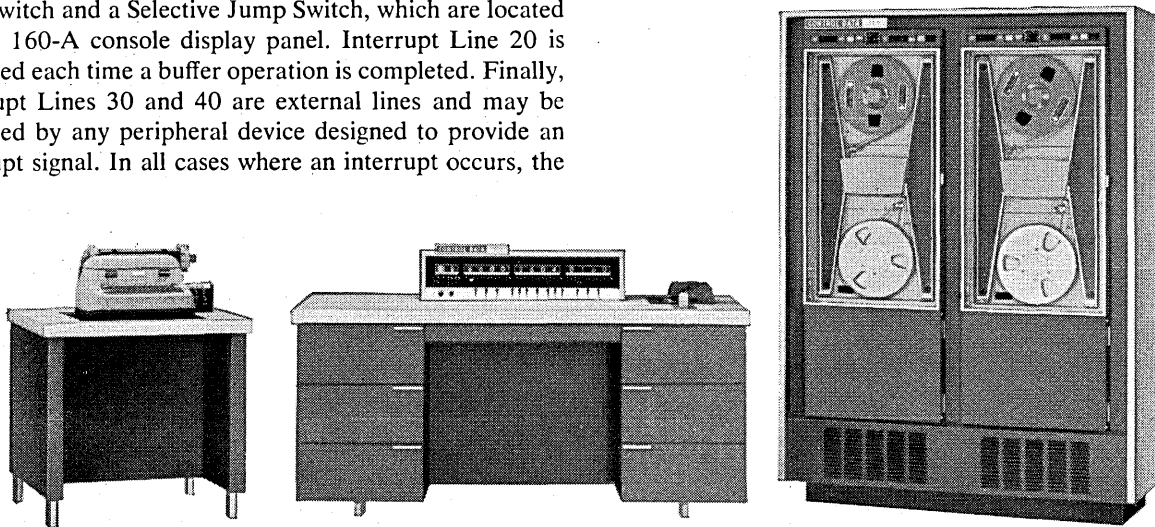

CONTROL DATA CORPORATION
 COMPUTER DIVISION
 501 PARK AVENUE, MINNEAPOLIS 15, MINNESOTA

NEW LITERATURE . . .

updating system to be used with 800s. The ARGUS assembly system, program test system, production monitor and production scheduler are described. MINNEAPOLIS-HONEYWELL REGULATOR CO., EDP DIV., Wellesley Hills 81, Mass. For copy:

CIRCLE 131 ON READER CARD

INTERNAL DIGITAL CLOCK SYSTEM:

This bulletin describes three internal digital clock systems for the IBM 704, 709 and 7090. Model 2504 features a time resolution to the nearest minute, model 2704 has a time resolution to the nearest ten seconds and model 2604 has a resolution to the nearest second. Specifications, prices and accessories are also given. CHRONOLOG CORP., 2583 West Chester Pike, Broomall, Penna. For copy:

CIRCLE 132 ON READER CARD

PROGRAMMED PULSE GENERATOR:

A four-page technical brochure details the model 1200-A programmed millimicrosecond current pulse generator which has been developed for research and development in magnetic thin films, multi-apertured ferrite devices, high speed ferrite memory cores,

cryogenic devices and high speed logic circuit development. RESE ENGINEERING INC., A & Courtland Streets, Philadelphia 20, Pa. For copy:

CIRCLE 133 ON READER CARD

COMPUTER CONTROL AND THE NEW 530:

Two brochures detail the company's experience and background in supplying computer control systems for industrial applications and also give information on the 530 stored logic control computer. THOMPSON RAMO WOOLDRIDGE INC., TRW COMPUTERS CO., 8433 Fallbrook Ave., Canoga Park, Calif. For copy:

CIRCLE 134 ON READER CARD

SPEDAC: Typical applications and features of Spedac models 220 and 310 DDA are given in this pamphlet. A chart of iteration cycle time and problem solution for the Spedac vs. the general purpose computer is presented. HAZELTINE CORP., CONTRACTS & CUSTOMER LIAISON DEPT. Little Neck 62, N. Y. For copy:

CIRCLE 135 ON READER CARD

QUANTIZER RADAR APPLICATIONS:

Radar applications of the Quantizer, a time-interval-to-digital-converter are described in this brochure. Charts and

a glossary are included. COMPUTER EQUIPMENT CORP., DEPT. G, 11612 W. Olympic Blvd., Los Angeles 64, Calif. For copy:

CIRCLE 136 ON READER CARD

QUARTER SQUARE MULTIPLIER:

This bulletin gives specifications and a description of the 7.036 high speed multiplier. A wiring schematic and several logic diagrams are included. ELECTRONIC ASSOCIATES, INC., Long Branch, N. J. For copy:

CIRCLE 137 ON READER CARD

VISION AND MAGNETISM FILMS: These booklets describe two films, the first of which, "Short Term Visual Memory" (16 mm, sound, black and white, 18 min.) describes an experiment in visual perception. The second, "Domains and Hysteresis in Ferromagnetic Materials" (16mm, sound, color, 36 min.) pertains to the theory of ferromagnetic domains and its relationship to hysteresis in magnetic materials. The origin of coercive force is also presented. BELL TELEPHONE LABS, 463 West St., New York 14, N. Y. For copy:

CIRCLE 138 ON READER CARD

PRODUCTIVITY METERING: Three new devices for monitoring and recording data processing systems (the RJ

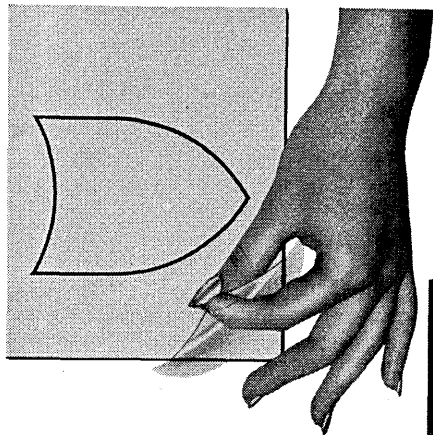

UPDATE
your logic
diagrams
with

SELECT-A-LOGIC

Preprinted
Logic
Symbols

Drawing overlays in full agreement with MIL-STD-806A, "Graphical Symbols for Logic Diagrams" and proposed industry standards.

- Each symbol individually pre-trimmed and backed with removable adhesive
- Perfect diagrams without special skills
- Easy to use; no cutting, trimming or special tools
- No waiting for results; produce professional tracings right at your own desk

INTRODUCTORY PACKAGE #LP-1L AND, OR gate, Flip-flop, delay, etc. 400 individual symbols \$8.00



Ansonia Station Box 253 · New York 23, N. Y.
CATALOG AND SAMPLES ON REQUEST

CIRCLE 38 ON READER CARD

How To Get Things Done

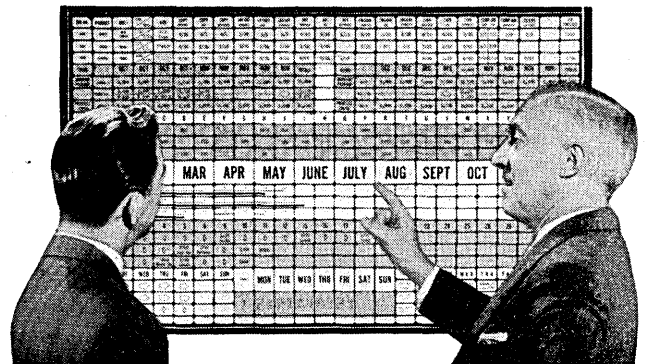

BOARDMASTER VISUAL CONTROL

Gives you a Graphic Picture of your operations, spotlighted in color. You See what is happening at a glance. Facts at eye level—saves you time, prevents errors.

Simple, flexible—easily adapted to your needs. Easy to operate. Type or write on interchangeable cards, snap in grooves. Ideal for production, scheduling, sales, traffic, inventory, etc. Made of metal. Compact, attractive.

Full price **\$49⁵⁰** with cards

FREE

24-Page Illustrated Booklet CG-50
Mailed Without Obligation

GRAPHIC SYSTEMS, Yanceyville, North Carolina

CIRCLE 37 ON READER CARD

117.50
121.00
122.99
127.99

PRINT AND PLOT SIMULTANEOUSLY

HOGAN FAXimile recorders are available with up to 2000 individual styli for simultaneous recording. A wide range of stylus spacings is offered—up to 100 to the inch for high-speed facsimile, television and radar recorders and high resolution printers and plotters. Chart widths to 30" and feed rates to 50" per second.

Hogan specializes in electrolytic techniques for event, spectrum analysis, oscillograph and facsimile recording, frequency time analysis and special purpose binary and gray scale record applications. Hogan electrolytic recording papers provide a permanent high contrast black on white record which is reproducible on most conventional office duplicators.

Whatever your recording problem may be — contact **HOGAN FAXimile**, a subsidiary of **TELautograph Corporation**, 635 Greenwich Street, New York 14, N. Y.

HOGAN FAXimile Corporation • 635 Greenwich St., New York 14, N. Y.
A SUBSIDIARY OF **TELAUTOGRAPH CORPORATION**

CIRCLE 36 ON READER CARD

NEW LITERATURE . . .

Recorder-Totalizer, TJ Multiple Function meters and the TJ Time Totalizer) are highlighted in this brochure. **STANDARD INSTRUMENT CORP.**, 657 Broadway, New York 12, N. Y. For copy:

CIRCLE 109 ON READER CARD

PLANNING ERRORS: This booklet discusses in detail ten costly mistakes often made in planning for a computer. These include ordering equipment too early, failure to plan results, failure to budget, mistakes in dealing with suppliers, inadequate internal communications, failure to break down departmental iron curtains, trying to do it all at once, omitting the feasibility study, "rolling your own" feasibility study, and dropping your plans. For a copy of this booklet send 20¢ to **MANFORD F. ETTINGER**, P. O. Box 495, Springfield, Mo.

AUTOMATIC PROCESSING AND INDEXING: This report gives information on **SAPIR**, a data processing system which classifies research and technical reports through certain keywords in the titles of the publications. For a copy of this bulletin send 75¢ to **OTS**, U. S. Dept. of Commerce, Washington 25, D. C.

MICROLOGIC ELEMENTS: This 12-page booklet deals with the applications and logic design of micrologic elements and highlights the micrologic flip-flop, gate, half-shift register, half-adder, counter adapter and buffer. **FAIRCHILD SEMICONDUCTOR**, 545 Whisman Rd., Mountain View, Calif. For copy:

CIRCLE 110 ON READER CARD

DIGITAL CLOCKS AND CALENDERS: A series of bulletins describe the company's complete line of digital clocks and digital calendars. The reports include such information as output load rating, supply voltage, size, operation, price, setting and design. **CHRONO-LOG CORP.**, 2583 West Chester Pike, Broomal, Pa. For copy:

CIRCLE 111 ON READER CARD

"BREAKTHROUGH" IN ASSOCIATIVE MEMORY: Uncovered by one of *Datamation's* more thorough readers is *The New Chain Reference Bible* published in 1908, 1917, 1929, 1934 and 1957 by The Kirkbride Bible Co., Indianapolis, Indiana. This bible makes wide use of the associative memory techniques currently in the forefront of computer research. First reference to chains and push-down lists appeared in the original 1908 edition.

APPLIED MATHEMATICIANS STATISTICIANS COMPUTER PROGRAMMERS

Challenging openings are available at Armour Research Foundation's ANNAPOLIS, MARYLAND and CHICAGO, ILLINOIS laboratories. Excellent opportunity is provided for increased professional growth as a member of an outstanding and stimulating scientific staff. Qualified mathematicians, engineers, or physicists having B.S., M.S., or Ph. D. degrees are invited to inquire about opportunities in:

ANALYSIS AND PROGRAMMING FOR LARGE SCALE DIGITAL COMPUTERS

Applied and basic research studies aimed at electronic system analysis and performance prediction; use of numerical methods; programming for UNIVAC 1103A, 1105, and more advanced large scale digital computers.

OPERATIONS RESEARCH AND STATISTICS

Methodology and applications development; industrial problem solving in areas such as assembly line balancing and production scheduling; mathematical modeling for problems in network optimization and stockastic processes.

DEVELOPMENT OF ADVANCED PROGRAMMING SYSTEMS

Automatic monitoring systems for parallel processing; compilers and assemblers; data processing systems; service routines.

Staff members receive attractive salaries, up to four weeks vacation, generous insurance and retirement benefits and tuition-free graduate study. All qualified applicants will receive consideration for employment without regard to race, creed, color, or national origin. If you are interested in one of these professional opportunities, please reply in confidence either . . .

S. M. Ream
ARMOUR RESEARCH FOUNDATION
Electromagnetic Compatibility
Analysis Center, NEES
Annapolis, Maryland

John Collins
ARMOUR RESEARCH FOUNDATION
Illinois Institute of Technology
Technology Center, Chicago 16, Illinois

CIRCLE 84 ON READER CARD

IBM extends the range of programming

Are you interested in exploring
the capabilities of the computer?

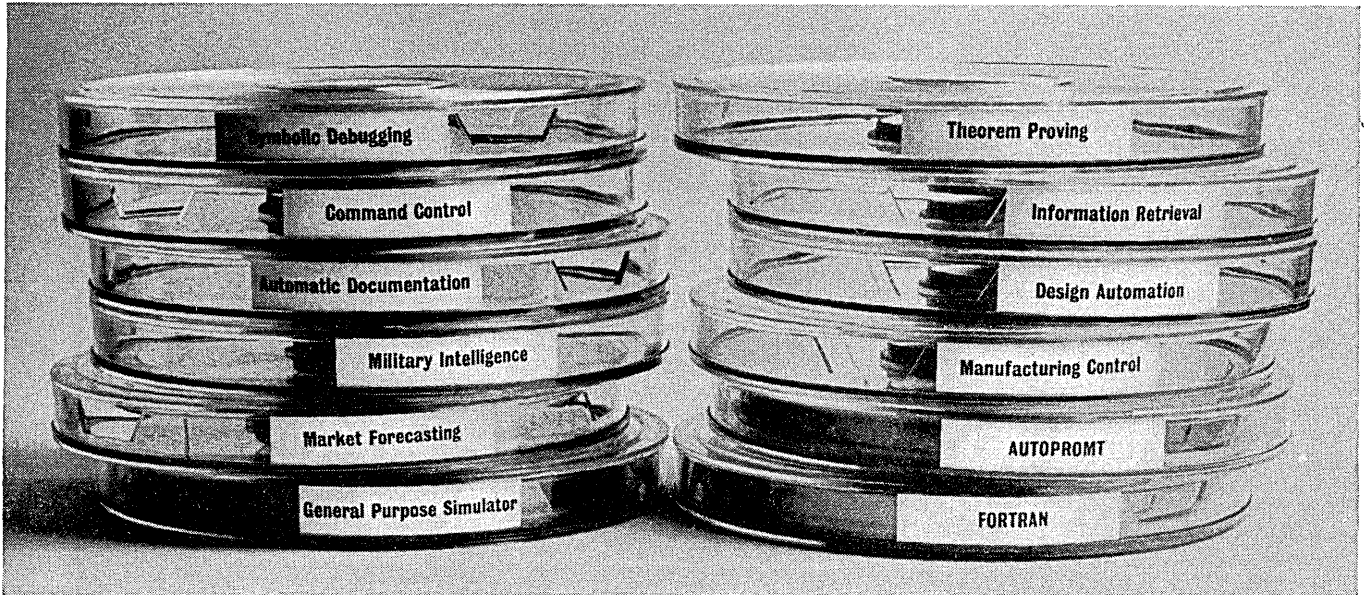

Some of the most important programming developments are taking place now at IBM.

The broad scope of work underway at IBM offers important advantages to members of our professional programming staff. They have the opportunity to work on projects taken from the broad range of programming. They are face to face with the frontiers of applied, scientific and administrative programming. For example, what advanced programming techniques interest you the most: multiprogramming systems . . . compilers . . . problem-oriented languages and processors? Programmers at IBM are exploring these techniques and many more.

Here are some other areas you might work in if you were a programmer at IBM: theory of computing . . . artificial intelligence . . . simulation systems . . . scheduling methodology . . . communications control systems . . . space systems . . . and the design of total computer systems.

At IBM, you would find yourself in the kind of atmosphere that encourages accomplishment. You would help to design new hardware systems. You would work side by side with men of eminent professional stature: scientists, engineers and mathematicians who pioneer in the

research and development that make new computing systems possible.

What's more, you would be able to give your projects the time they deserve. Time for thinking. Time for achievement.

The scope of programming at IBM stimulates professional growth. It offers possibilities which merit serious consideration whether you are a master of the skills of programming or a relative newcomer to the field. Salaries and benefits at IBM are excellent. If you have experience in scientific or commercial programming, we would like to acquaint you with the wide range of responsible positions on our programming staff.

Programming facilities are located in San Jose, Calif.; Washington, D. C., area; Lexington, Kentucky; Rochester, Minnesota; Omaha, Nebraska; and New York, Endicott, Kingston, Owego, Poughkeepsie and Yorktown Heights, New York. IBM is an Equal Opportunity Employer.

For further details, please write, outlining your background and interests, to: Manager of Professional Employment, IBM Corporation, Dept. 701P, 590 Madison Ave., New York 22, N.Y.

You'll rest easy if your data processing system is resting on

HASKELITE™ FREE-ACCESS FLOORS

Designed and engineered to your specifications, Haskelite Plymetl Free-Access Floors provide unobstructed level surfaces with easy entry to concealed wiring, heating and air-conditioning systems

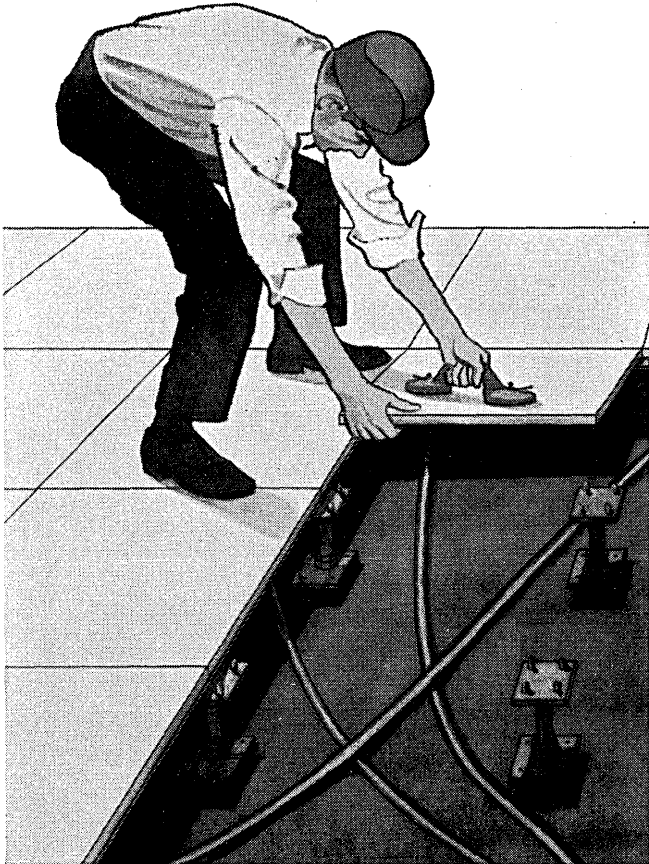

Adjustable pedestals provide strong structural support and permit proper floor leveling

PLYMETL UNITES THE BEST QUALITIES OF WOOD AND METAL

- ★ vinyl edge banding surrounds panels; no electrical feedback, no expense of grounding
- ★ vibration-resistant construction
- ★ flat, smooth surfaces
- ★ moistureproof fabrication
- ★ dimensional stability and stiffness—high impact resistance
- ★ fire-resistant protection
- ★ sound-deadening insulation

Plymetl Free-Access Floors are specifically designed for economical installation. Cables, piping and ducts can be run in any direction under the raised decking—eliminating costly runways. Plymetl floors can be installed on virtually any type subfloor. Standardization and interchangeability of basic components permit alteration, dismantling and reassembly at a new site with a minimum of time and effort. In the laboratory and in actual service, Plymetl laminated panels meet the highest standards of rigidity, strength and durability . . . Plymetl Free-Access Floors support the tremendous weight of computer units with minimum deflection and vibration. Plymetl panels can be fabricated with vinyl tile or other desired coverings of your choice. For more information, write:

Hallmark of Quality Products



HASKELITE DIVISION
GRAND RAPIDS, MICH.

SKED-U-FLO ANNOUNCED BY MAUCHLY

analog computer to be used in network scheduling



A portable analog computer called SkeduFlo has been introduced by Dr. John W. Mauchly, president of Mauchly Associates, Inc., Ft. Washington, Pa., and co-inventor of ENIAC and UNIVAC I. The device is said to be the first electronic representation of new network mathematics which are the basis of PERT and critical-path scheduling.

An important aspect of critical-path scheduling, Minimum-Cost Expediting (MCX), is a technique which enables management to determine the lowest cost of meeting various schedules for a project and to choose from among them, the most economical from an over-all point of view.

SkeduFlo is said to be specifically designed for MCX. In operation, the operator can determine the cost of meeting a number of different schedules by a quick manipulation of a basic set of parameters. A digital reader serves as an input device. Indicator lamps reveal which jobs are critical for the on-time completion of the project. Summary information, such as cost curves, are plotted automatically.

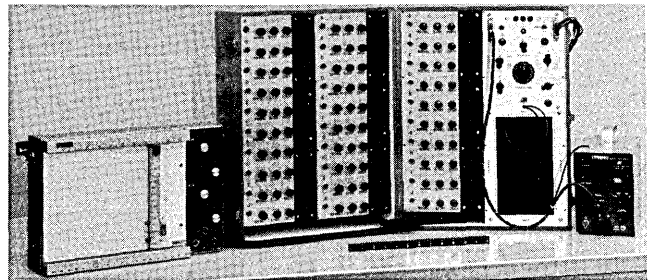

The limitations of SkeduFlo are the same as any analog computer, Dr. Mauchly pointed out. While it can give immediate answers, it cannot give all of the detailed information which a large-scale digital computer can produce. ■

LIBRASCOPE DEVELOPS DATA GATHERING SYSTEM

A computer-based data gathering and reporting system has been announced by General Precision's Librascope Division, Glendale, Calif. Called the Librascope Operations Control System (LOCS), it will ultimately join together all Librascope operations and will be linked to a display and print-out system.

As the system is further developed, an executive seeking specific information will press a button and the data desired will be displayed on a screen, relayed from a random access file.

The system is said to be equally applicable to control of a small business or control of a multi-unit industrial or military complex. In operation, an event in a company's operation is recorded and stored automatically in central computers.

Data originates through punched paper tapes that are automatically prepared whenever a document is typed, and fed into computer memory, and by data collectors located at key points within the company which transmit pertinent information. The raw data is subsequently correlated by the computer into required management reports. ■

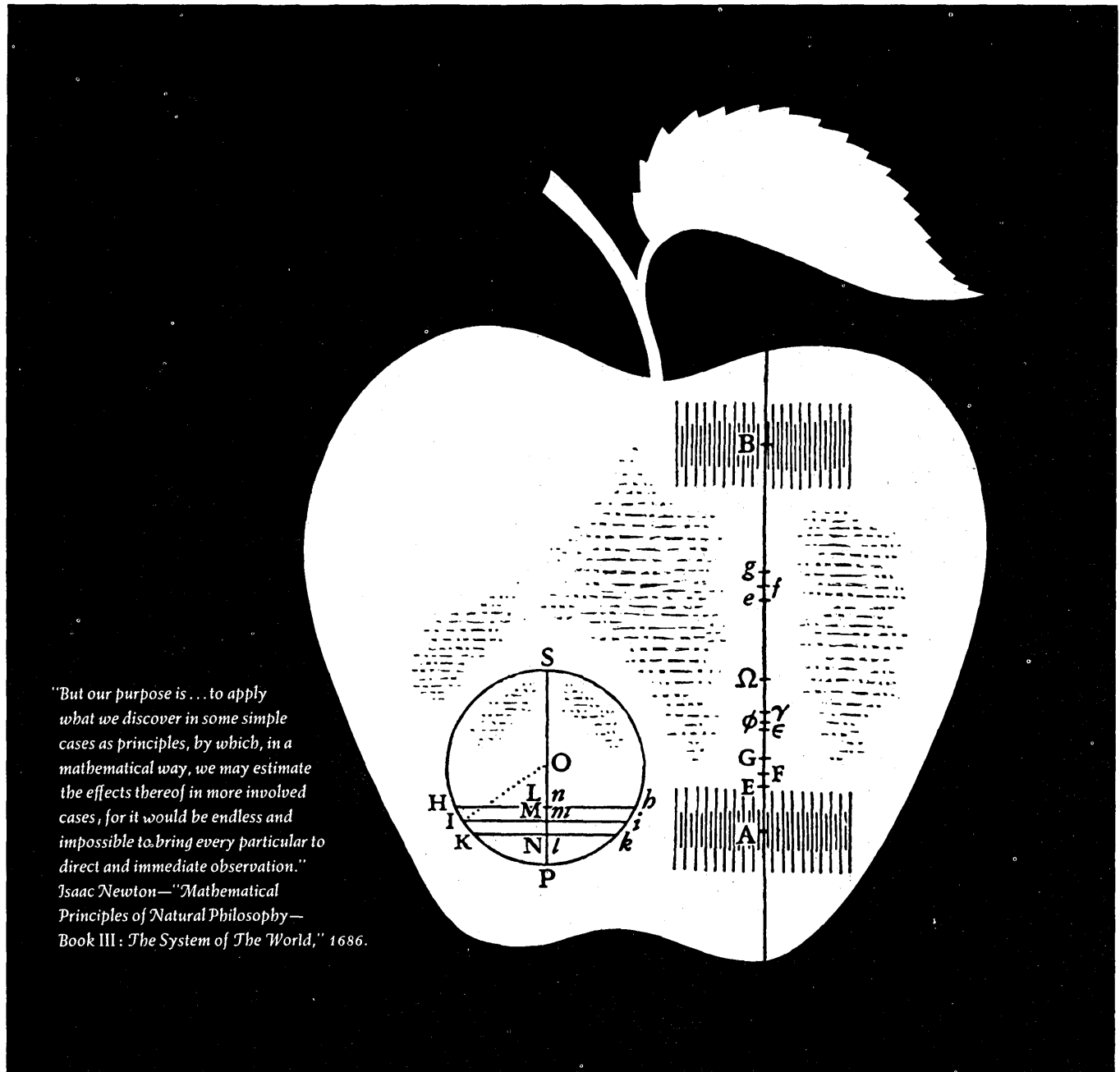

"But our purpose is ... to apply what we discover in some simple cases as principles, by which, in a mathematical way, we may estimate the effects thereof in more involved cases, for it would be endless and impossible to bring every particular to direct and immediate observation."
 Isaac Newton—"Mathematical Principles of Natural Philosophy—Book III: The System of The World," 1686.

REPRINTS OF THE DRAWINGS CREATED FOR THIS SERIES, SUITABLE FOR FRAMING, ARE AVAILABLE ON REQUEST.

In disciplines that follow the tradition of Newton, Mathematicians at Space Technology Laboratories, Inc. seek "principles" for the analysis and evaluation of complex data as a means of accelerating man's conquest of space. At STL, those responsible for Space Technology Leadership look to the Computation and Data Reduction Center to identify and evaluate applied mathematical principles from diverse observations. In so doing, STL Mathematicians may employ advanced digital processing techniques in solving problems and analyzing data acquired from ballistic missile and space vehicle programs. Mathematicians who seek greater stimulus and responsibility are invited to communicate with Dr. R. C. Potter, Manager of Professional Placement and Development, at STL, an equal opportunity employer.

SPACE TECHNOLOGY LABORATORIES, INC. P.O. BOX 95005Y, LOS ANGELES 45, CALIFORNIA
 a subsidiary of Thompson Ramo Wooldridge Inc.

Los Angeles • Vandenberg AFB • Canoga Park • Norton AFB, San Bernardino



Dayton • Cape Canaveral • Washington D.C. • Boston • Huntsville

IRE Delegates: NYC Interviews March 26-29. Call F. C. Nagel, Plaza 2-8968. Visit STL Booth 1435.



TPM

*TPM—TAPE PREVENTIVE MAINTENANCE THE MODERN APPROACH TO COMPUTER PROFITS

Wise EDP management is learning that precision magnetic tape requires scheduled preventive maintenance . . . equal to that given all other computer components.

Complete tape preventive maintenance (TPM) systems are available from General Kinetics Incorporated, pioneer in magnetic tape research.

The GKI system for TPM includes:

- An off-line TAPE TESTER to assure error-free performance.
- A KINESONIC TAPE CLEANER to remove dirt and wear products.
- An off-line precision TAPE WINDER to prevent damage in handling and storage.

Regular use of these quality GKI equipments will reduce computer errors . . . save re-run time . . . and increase tape life.

Failure to maintain computer tape wastes capital investment . . . and drains profits.

TPM systems from GKI will solve this problem for your EDP facility. Call or write us for more details on TPM . . . the modern tape approach to computer profits.

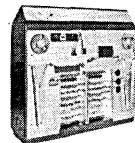

Tape Tester

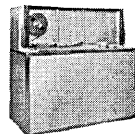

Kinesonic Tape Cleaner



Tape Winder

General Kinetics Incorporated

2611 Shirlington Road, Arlington 6, Virginia, Jackson 5-4055



CIRCLE 40 ON READER CARD

NEW FIRMS & mergers in DP

■ Computer Systems Consultants is a new Kansas City, Mo., firm designed to service small and medium-size businesses with programming and systems assistance. Edward S. Baum is sales director.

CIRCLE 383 ON READER CARD

■ A new Japanese firm, Mitsubishi-TRW Co., Ltd., has been jointly formed by Thompson Ramo Wooldridge Inc., and Mitsubishi Electric Co. The firm will manufacture and sell industrial process control computer systems, semiconductor devices, and other electronic equipment. Marketing operations will be conducted throughout Japan and southeast Asia.

The firm will be capitalized at \$3,375,000 with authorized capital of \$5 million. Mitsubishi will hold a 60% interest and TRW will hold the remaining 40%. Headquarters will be in Tokyo.

■ A new firm, Electronic Processing Center, Inc., is formed as the result of a merger between Electronic Data Processing Corp. and Punch Card Data Processing, both of Philadelphia. Executives of the new firm are Roger B. Gregory, president, and George H. Clautice, vice president, who were founders and presidents of EDP Corp. and Punch Card DP, respectively.

CIRCLE 384 ON READER CARD

■ Henry M. Semarne has established his own consulting firm in Woodland Hills, Calif. He had previously been associated with Thompson Ramo Wooldridge and Douglas Aircraft. His experience has been directed at programming research, applications and training.

CIRCLE 385 ON READER CARD

■ Signetics Corp. is a new firm specializing in the development of integrated solid-state circuits for computer logic systems. Located in Sunnyvale, Calif., the firm is headed by Dr. B. David James, president, and Lionel E. Kattner, vice president.

CIRCLE 386 ON READER CARD

■ International Computers Inc., Los Angeles, is a new firm offering consultation in the field of magnetic storage and associated techniques.

CIRCLE 387 ON READER CARD

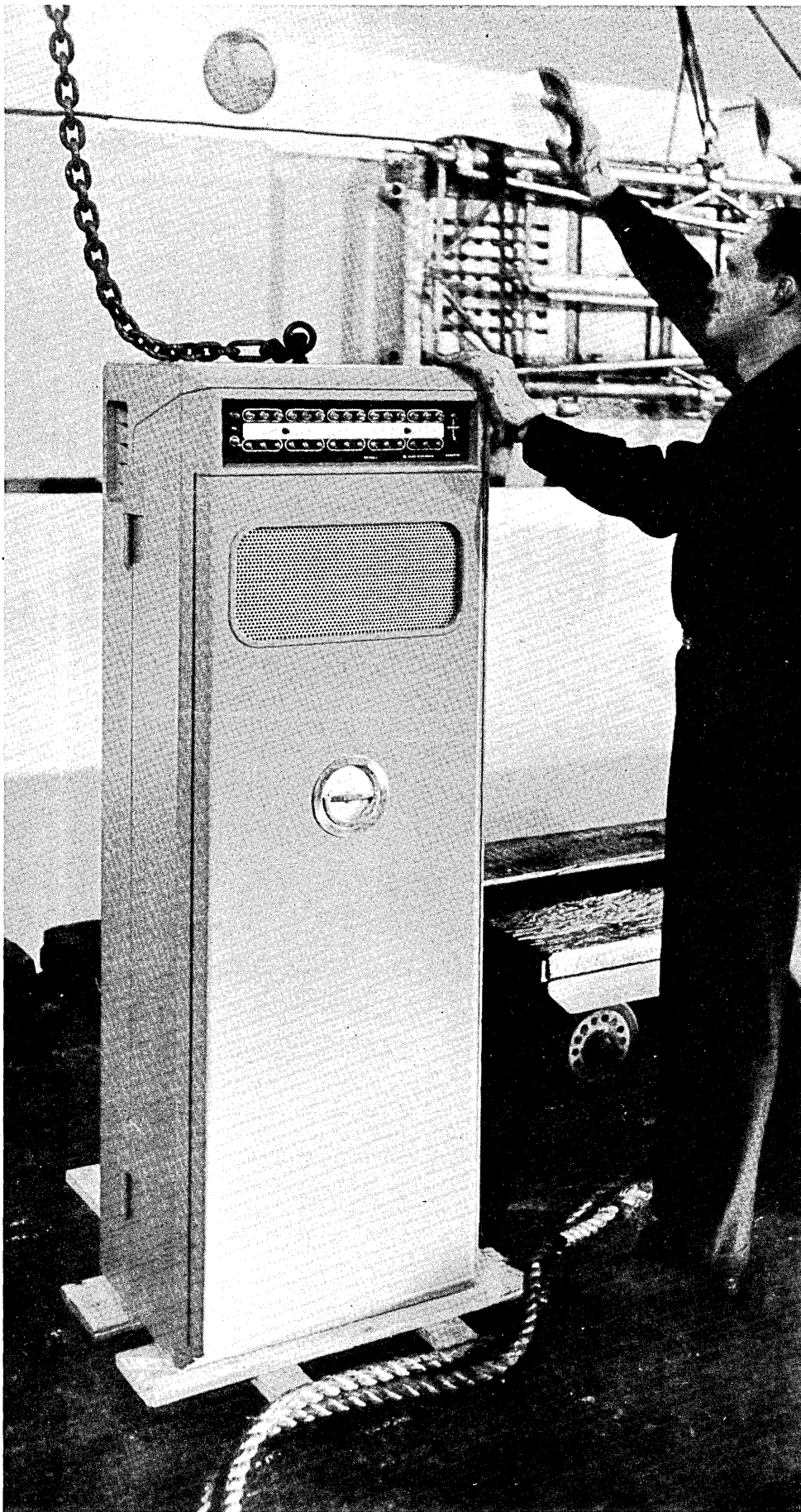

AN/UYK-1

BUILT TO BE USED

The only fully militarized parallel core computer in the medium-size class, AN/UYK-1 embodies advanced design concepts in a rugged, economical package. A team of RW engineers and programmers worked together from the earliest design phase to build a machine that can outperform any computer in its size and price class. The multiple-purpose "Stored Logic" AN/UYK-1 was developed for the Navy Bureau of Ships as a standard shipboard computer, and has been specified as the data processor for the Navy's TRANSIT Navigation Satellite program. The Air Force will also use AN/UYK-1s in the Radar Acquisition System of the Atlantic Missile Range. These programs, along with other military applications of the AN/UYK-1, have created immediate openings for practical-minded computer development engineers and programmers at RW, an equal opportunity employer. Contact Mr. R. J. Kreple at



Thompson Ramo Wooldridge Inc.
RW Division
8433 Fallbrook Avenue
Canoga Park, Calif., Diamond 6-6000

RW means Computer Technology Leadership

Computape, you never change a bit.

Penelope, you're exactly right. One can't change a bit if one expects to run around with computers all day. That's why I'm guaranteed to deliver 556 or 800 bits per inch with no dropouts in severest computer applications.

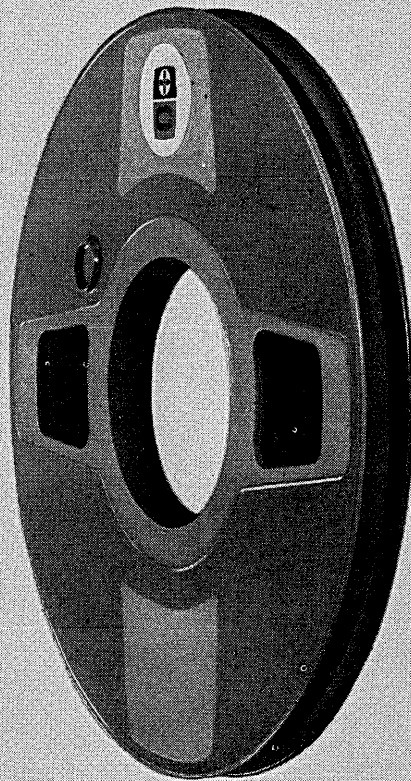

P. S. Computape doesn't really talk, of course. But in a computer, Computape *reliability* will deliver its own message. New COMPUTAPE, the premium quality computer and instrumentation tape, is the product of the only company devoted exclusively to the manufacture of quality tapes for data processing and instrumentation. *Investigate new Computape today. Better still, immediately.*



COMPUTRON INC.
122 Calvary Street, Waltham, Massachusetts

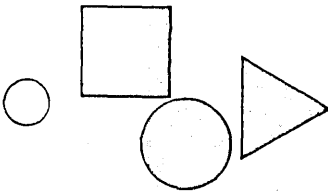

NEW PRODUCTS

linear programming for G-20

Linear programming which is now available with the G-20 system can handle problems ranging from the smallest to those twice the capacity of any known L-P routine, the company claims. Using an 8K memory and two magnetic tape units, solution of a typical linear programming problem with 100 restricting equations would take 8.8 minutes and with a 32K memory, the same problem has an iteration time of approx. three seconds and a total solution time of five minutes. BENDIX CORP., COMPUTER DIV. 5630 Arbor Vitae St., Los Angeles 45, Calif. For information:

CIRCLE 200 ON READER CARD

high-speed printer

The S-C 3070 is a new, comparatively noiseless message printer which can print at speeds up to 3,000 words per minute (six characters per word). The printer, priced in the \$15,000 range, operates asynchronously and uses standard code.

The 3070's electrostatic printing

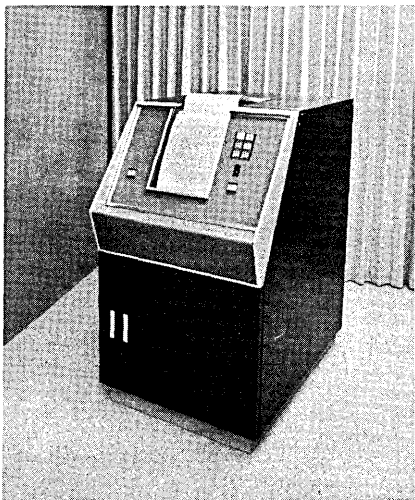

process uses the CHARACTRON Shaped Beam Tube by which beam-formed images are optically projected from the tube onto light sensitive paper. GENERAL DYNAMICS/ELECTRONICS, INFORMATION TECHNOLOGY DIV., 1895 Hancock St., San Diego 12, Calif. For information:

CIRCLE 201 ON READER CARD

linofilm unit

The Computer-Linofilm converter has been designed to transpose computer

output information into punched tape form. The converter will act as a link between large computers and a type-

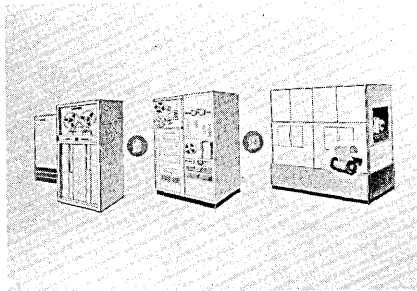

setting unit used for photocomposition. MERGENTHALER LINOTYPE CO., 29 Ryerson St., Brooklyn 5, N. Y. For information:

CIRCLE 202 ON READER CARD

paper-tape read-punch

Operating on-line with UNIVAC solid-state computers, a paper-tape read-punch reads and punches 5, 6, 7 and 8 channel chad tape (tape with complete severance of paper cutting after punching), limited to six data channels. The device is claimed to read at 500 cps and punch at 100 cps. Other features include: completely buffered system; single-unit construction; optional parity checking; program-detectable error conditions; choice of "end of message" and "end of tape" signals; uses 8½ reel, with 500' capacity. REMINGTON RAND UNIVAC, 315 Park Ave. South, New York 10, N. Y. For information:

CIRCLE 203 ON READER CARD

selected data page scanner

This electronic reading machine can select specified data from a business document and convert the information into computer language. The machine reads at the rate of 200 characters per second. FARRINGTON MANUFACTURING CO., Needham Heights 94, Mass. For information:

CIRCLE 204 ON READER CARD

hard copy option

The TD-551 is a hard copy optional accessory for the TD942 high speed microfilm printer for computer output. The 551, using the 942, can provide output at the rates of 62,500 alphanumeric characters per second and can plot random points for mathematical curves at 33k per second on both 35 millimeter microfilm as well

as 8½" wide hard copy. The hard copy option includes an on-line developer which provides a full size curve or table within three seconds after each frame is printed. TRANSDATA, INC., 1000 N. Johnson Avenue, El Cajon, Calif. For information:

CIRCLE 205 ON READER CARD

phonewriter

The Phonewriter is an electronic telewriter which will work with the DATAPHONE service to permit instantaneous two-way verbal communication and transmission of handwriting and sketches over regular local

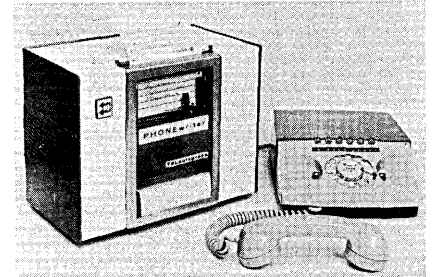
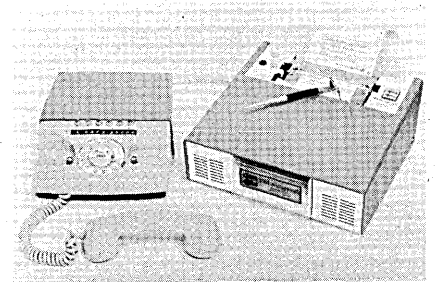

and long distance telephone lines. Also, written messages may be sent to unattended receivers. TELAUTOGRAPH CORP., 122 E. 42nd St., New York 17, N. Y. For information:

CIRCLE 206 ON READER CARD

thin-film circuits

The FF 100S is a new 1 mc digital building block which can be used as a binary counter, shift register or set-reset counter. These thin film units operate from a six volt supply, dissipating 40 mw in a 0.165 cubic inch package. ADVANCED MICROELECTRONICS CO., 2414 Reedie Drive, Silver Spring, Md. For information:

CIRCLE 207 ON READER CARD

check sorting

A new modular check sorting system has been designed around the use of building blocks, each being a plug-in unit with special capabilities. The sys-

NEW PRODUCTS . . .

tem can be expanded to accommodate up to three 18 pocket sorters to provide a combined sorting rate of up to 290K checks per hour. FERRANTI ELECTRIC INC., Industrial Park #1, Plainview, L. I., N. Y. For information:

CIRCLE 208 ON READER CARD

trimming potentiometer

Subminiature series 130 trimming potentiometer is designed for use in balancing, matching and adjusting variables over a broad range of telemetry, control and computing circuitry. DUNCAN ELECTRONICS, INC., 2865 Fairview Road, Costa Mesa, Calif. For information:

CIRCLE 209 ON READER CARD

automatic microfilming

Continuous forms from any punch-card tabulator or high-speed computer printer can be reproduced without separation by the 575 Tab-Tronic microfilm recorder. The 575 makes high-speed microfilm copies of Sunburst fan-fold continuous forms, automatically feeds, microfilms and stocks the refolded forms in their original sequence. Features include a 16mm

camera with reduction ratio of 26:1, a three digit indexing meter which allows 999 specific film locations to be noted and film protection control. BELL & HOWELL, MICRO-DATA DIV., 7100 McCormick Rd., Chicago 45, Ill. For information:

CIRCLE 210 ON READER CARD

time recorder and totalizer

This RJ Recorder-Totalizer can be used for measuring and charting the functional time of any edp main frame and can indicate when and for

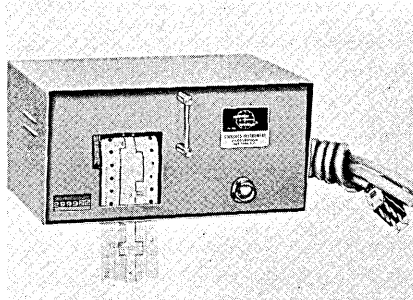

how long the console has been actually processing information. Features include a six-digit indicator and ball-point stylus. STANDARD INSTRUMENT CORP., 657 Broadway, New York 12, N. Y. For information:

CIRCLE 211 ON READER CARD

electrolytic capacitors

Type NLH Computamite capacitors are high-reliability, miniature computer-grade electrolytic capacitors which have achieved the smallest dimension in any given rating and are available in ratings of one to 300 mfd at three to 150 VDC working. The Computamite has performed over 1500 hours at 85°C and rated voltage of no more than 10% decrease in capacitance, an increase of no more than 75% in dissipation factor, and with no change in leakage current requirements. CORNELL-DUBILIER ELECTRONICS, 50 Oaris St., Newark, N. J. For information:

CIRCLE 212 ON READER CARD

tape punch

The 1012 tape punch allows 1401 users who have leased-wire systems to use facilities for the transmission of computer-processed data. The 1401, equipped with the 1012 can calculate the instructions directly and record them on punched tape at 150 cps or the 1401 can convert instructions generated on a larger computer into punched tape form. The 1012 produces both 1" and 11/16" wide punched paper tape for telegraphic transmission and punched Mylar or

COMPUTER ENGINEERS LOGIC DESIGNERS CORE MEMORY SPECIALISTS

Collins Radio Company has immediate openings for experienced digital computer design engineers at its plant in Cedar Rapids, Iowa. New programs in digital data systems offer outstanding opportunities for growth and development with a leader in the electronics field.

Recently announced development plans call for graduate engineers experienced in

Computer Systems	Memory Systems
Logic Design	Magnetic Tape Handlers

Qualified applicants interested in a career with a future, send your resume to:

L. R. Nuss, Manager
Professional Employment

COLLINS RADIO COMPANY
Cedar Rapids, Iowa



An equal opportunity employer.

CIRCLE 88 ON READER CARD

Ames Laboratory

U. S. Atomic Energy Commission
Iowa State University

has immediate openings for personnel with experience in the fields of numeric analysis, programming, and compiler construction. Opportunity to continue education toward advanced degree. For information write:

C. S. ROBERG, AMES LABORATORY,
BOX 14A, UNIVERSITY STATION,
AMES, IOWA.

U. S. Citizenship Required

An Equal Opportunity Employer

CIRCLE 89 ON READER CARD

NEW PRODUCTS . . .

paper tape for the automatic control of machine tools. IBM CORP., DATA PROCESSING DIVISION, 112 E. Post Rd., White Plains, N. Y. For information:

CIRCLE 213 ON READER CARD

photocell punched tape readers

The RR-1000 is a 1,000 character per second unit which features transistorized circuits, photovoltaic sensing cells and two speed motor drives. The standard model includes 2:1 speed ratio selectable with low level input

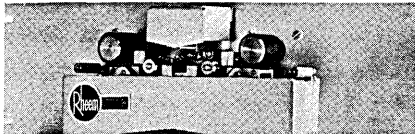

and 5, 7, and 8 tape selection. The uni-directional model is priced at \$1,450 and the bi-directional model at \$1,590. RHEEM MANUFACTURING CO., ELECTRONICS DIV., 5200 W. 104th St., Los Angeles, Calif. For information:

CIRCLE 214 ON READER CARD

converter and multiplexer

Model Mil-ADC-1 is the militarized

version of the ADC-1 analog-to-digital converter and has been designed to meet the requirements of Mil E5272 C. The standard unit incorporates a solid state three-channel multiplexer for instrumentation of full three-axis systems. Operating specifications of the combined systems include eight binary bits including sign, $\pm 0.5\%$ accuracy, 500 readings per sec., one volt full scale, and ohms input impedance. DYNAMIC SYSTEMS ELECTRONICS, 2001 N. Scottsdale Rd., Scottsdale, Ariz. For information:

CIRCLE 215 ON READER CARD

magnetic head

This high temperature magnetic head, for tape recording and reading, can be gapped to 40 microinches and remain stable to 200°F. Tests have shown a frequency response differential of plus or minus two db between outputs at ambient and up to 200°F. with packing densities of 3300 cycles per inch. GENERAL INSTRUMENT CORP., MAGNE-HEAD DIV., 3216 W. El Segundo Blvd., Hawthorne, Calif. For information:

CIRCLE 216 ON READER CARD

multi-purpose analog computers

The multi-purpose computer PC-12 analog line, assembled from stock,

solid-state modular components, are designed for applications where high



speed on-line computation must be performed on constantly changing data and for on-line control of industrial processes. ELECTRONIC ASSOCIATES, INC., Long Branch, N. J. For information:

CIRCLE 217 ON READER CARD

logic modules

Two five-megacycle, four-stage shift register logic modules have been designed for gating, serial-to-parallel inversion, and for other shift register operations in digital system applications. Data bloc model 1021 features a logically diagrammed front panel which utilizes banana-jack connectors and is to be used in basic test equipment and prototype system designing, while the printed circuit board model

UNIQUE

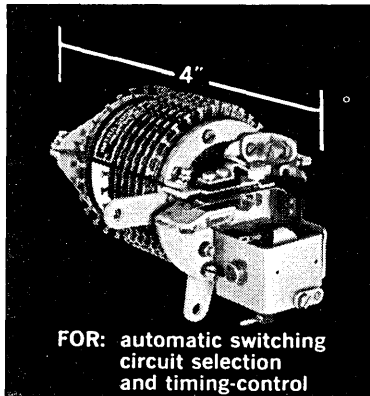

FOR: automatic switching
circuit selection
and timing-control

The
Genalex
Miniature
High-Speed
Stepping Switch

FEATURING: 80 steps per second on impulse drive **30** contacts per bank **12** banks maximum **17** oz. light-weight **7** levels sequence switching.

Over 5,000,000 Steps Without Replacements

Write today for complete data — Also, data available on Genalex one-way and two-way stepping switches.



11 UNIVERSITY ROAD, CAMBRIDGE 38, MASS.
U. S. AGENTS FOR THE GENERAL ELECTRIC COMPANY, LTD. OF ENGLAND

CIRCLE 43 ON READER CARD

March 1962

NOW! Record Computer Usage AUTOMATICALLY

WITH THE NEW SERIES

RJ TIME RECORDER

OBTAIN actual processing time of EDP systems
ELIMINATE overcharges due to inaccurate records
IMPROVE accuracy in system cost accounting

Each RJ series Time Recorder is designed to fit a particular type of computer. The RJ series Time Recorder connects directly to existing computer circuitry — readily installed. Low one-time cost.

More information is available on request

IBM 1401
RCA 7070
NCR 4000
McBee UNIVAC
G15 4000
LFC-1
IBM 1401
RCA 7070
M.H. 501
EXCLUSIVELY BY STANDARD INSTRUMENT CORP.



standard INSTRUMENT CORPORATION
657 BROADWAY, NEW YORK 12, N.Y.

CIRCLE 44 ON READER CARD

113

CORE FACT

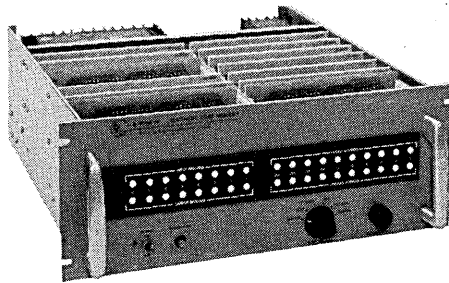

ELEPHANTS AND EECO MAGNETIC CORE MEMORIES NEVER FORGET

Built by data processing systems engineers for data processing systems engineers with greater reliability as a goal. 200-kc, 5-microsecond operation. Non-destructive unload. Separate input and output registers. Power consumption a low 120 watts. Noise rejection input circuits. Time-saving, self-check features with visual indicators; automatic test of entire memory at 200-kc rate, and manual step-by-step test. 19" x 7" x 18". 32 pounds. All solid-state circuits on plug-in cards. Write for details.

CHARACTER CAPACITY	MEMORY MODELS		
	RANDOM ACCESS	SEQUENTIAL ACCESS	SEQUENTIAL INTERLACE
128	8-128R	8-128S	8-128SI
256	8-256R	8-256S	8-256SI
512	8-512R	8-512S	8-512SI
1024	8-1024R	8-1024S	8-1024SI
2048	8-2048R	8-2048S	8-2048SI



Electronic Engineering Company of California
 1601 East Chestnut Avenue, Santa Ana, California • Kimberly 7-5501, P.O. Box 58
 Representative in Western Europe and Israel: Electronic Engineering S.A., CP. 142 Fribourg, Switzerland
 DIGITAL CIRCUIT MODULES: ENGINEERED ELECTRONICS COMPANY, SANTA ANA
 CIRCLE 45 ON READER CARD

NEW PRODUCTS . . .

2021 is intended for use in final systems. Both units have a one and zero level input and a shift pulse input. HARVEY-WELLS ELECTRONICS, INC., 14 Huron Dr., Natick, Mass. For information:

CIRCLE 218 ON READER CARD

optical scanning punch

Data designated by pencil marks on source-document cards can be read and punched by the 5440 optical scanning punch at the rate of 9,000

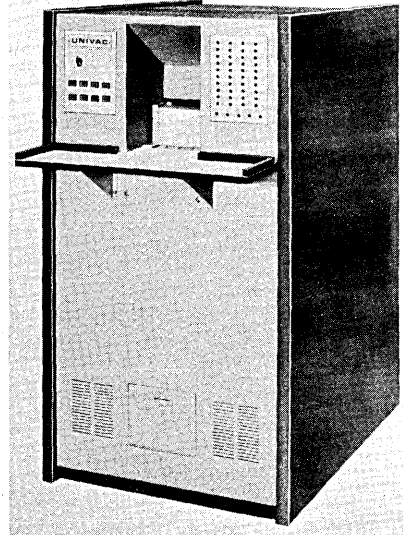

cards per hour. Forty columns is the mark scanning capacity of the 5440 which can be purchased for \$19,200. REMINGTON RAND UNIVAC, 315 Park Avenue So., New York 10, N. Y. For information:

CIRCLE 219 ON READER CARD

display system

The SAND alpha-numeric display system generates all alpha-numeric symbols by a continuous trace technique and can be used for computer readouts, tape outputs, and various system monitoring applications. Plug-in modules generate the symbols which are displayed on an x-y oscilloscope. 25k characters per second can be displayed in a variable format of up to 32 lines of 32 characters each. CONTRONICS, INC. 37 Leon St., Boston, Mass. For information:

CIRCLE 220 ON READER CARD

tape to tape translator

The type DAT has been designed to translate digital data from any recording media and format to any other without the use of an intermediate buffer storage unit. The transistorized bi-directional magnetic tape to tape converter is an off-line device which reads paper tape at 600 cps and punches paper tape at the rate of 60

DATAMATION



BINDERS

5.95
POSTPAID

FOR SET
OF TWO

Here is the easy way to protect your back copies of DATAMATION. Each of these attractive, durable binders, made of washable, simulated Morocco, will accommodate six copies of DATAMATION. The binders are the answer to fast, easily-obtainable reference material.

Send your check for \$5.95 for a set of two binders to:

DATAMATION

141 East 44th Street, New York 17, N. Y.

NAME _____ ADDRESS _____

CITY _____ ZONE _____ STATE _____

cps. GENERAL DEVICES, INC., DEPT. PB, Princeton, N. J. For information:

CIRCLE 112 ON READER CARD

resolver test set

The MST-8QSA is a new instrument designed to measure electrical characteristics of all commercially-available computing resolvers. The test set can

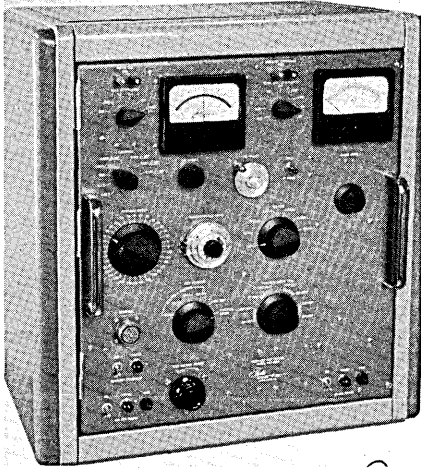

measure function error, inter-axis and null spacing error, fundamental and total null, winding phasing and phase shift. THETA INSTRUMENT CORP., 520 Victor St., Saddle Brook, N. J. For information:

CIRCLE 113 ON READER CARD

NEW PRODUCTS . . .

monitoring systems

Series TJ multiple function meters are designed to simultaneously provide various monitoring functions for edp or related equipment operation. Elapsed time and process time, both with resettable or non-resettable indicators, are available, as are counters for card read and punch units. STANDARD INSTRUMENT CORP., 657 Broadway, New York 12, N. Y. For information:

CIRCLE 114 ON READER CARD

automatic programmer-comparator

The new HYPAC, designed for automatic checkout, is suitable for any commercial or military checkout application and is also suited for diagnosis of faults in complete systems or sub-system. HYCON MANUFACTURING CO., 700 Royal Oaks Dr., Monrovia, Calif. For information:

CIRCLE 115 ON READER CARD

information storage

"Microscan" is a new information storage technique which records 100 printed pages full-size on a single piece of film. The process is said to be useful in libraries and research

centers where storage space is a problem, as well as where automatic indexing and retrieval is not feasible. SPACE-GENERAL CORP., 7777 Flower St., Glendale 1, Calif. For information:

CIRCLE 116 ON READER CARD

tape preparation unit

A new Tape Preparation Unit (TPU) has been developed for the programming, verification and automatic duplication of five to eight-level tapes. The TPU punches paper or Mylar

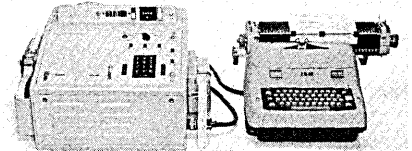

tapes in widths from 0.687 to one inch, and features the ability to read out and verify tapes simultaneously, make corrections and change codes by selection of a paper patchboard. CHALCO ENGINEERING CORP., 15126 S. Broadway, Gardena, Calif. For information:

CIRCLE 117 ON READER CARD

deposition system

A new, semi-automatic, high vacuum deposition system is able to fabricate thin film integrated microcircuitry in production quantities and deliver the

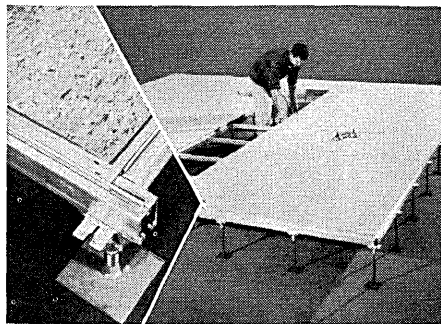

For every installation needing strength and rigidity . . .

ELAFLOOR

FREE-ACCESS FLOORING

There are several types available . . . from the top they generally look the same. Underneath, it's a different story. Visit an installation of any brand, lift a panel, rock a pedestal. You'll see the difference between ELAFLOOR and the others. But, you can save lots of time by referring to our literature . . . the facts and drawings are all there.

*Pat. App. For

LISKEY LUMINUM, INC.

Friendship International Airport, Box 506, Glen Burnie, Md.; Canadian Rep.—Cameron Windows (Aluminum) Ltd., 142 Kennedy Rd. S., Brampton, Ontario

Write for 34 page "Construction Details" Folder

CIRCLE 46 ON READER CARD

Logical Designers

Openings exist at all levels of professional responsibility in connection with proposal, specification and logical design of EDP systems. Development programs presently scheduled cover a broad range of assignment possibilities, from initial proposals to prototype test. Two or more years of related experience are required in the fields of either digital systems planning and specification or detail logical design and equipment test. Some programming, analytic and/or applications background is desired but not essential.

Other career opportunities exist for Electronic Engineers and Mechanical Engineers.

Address your resume to:

Richard Bueschel, Personnel Manager
Engineering and Research Center
151 Needham Street, Dept. 350
Newton Highlands, Massachusetts

Honeywell

 Electronic Data Processing

Opportunities also exist in other Honeywell facilities coast to coast. Send resume to H. E. Eckstrom, Minneapolis-Honeywell, Minneapolis 8, Minnesota.

"An equal opportunity employer"

CIRCLE 82 ON READER CARD

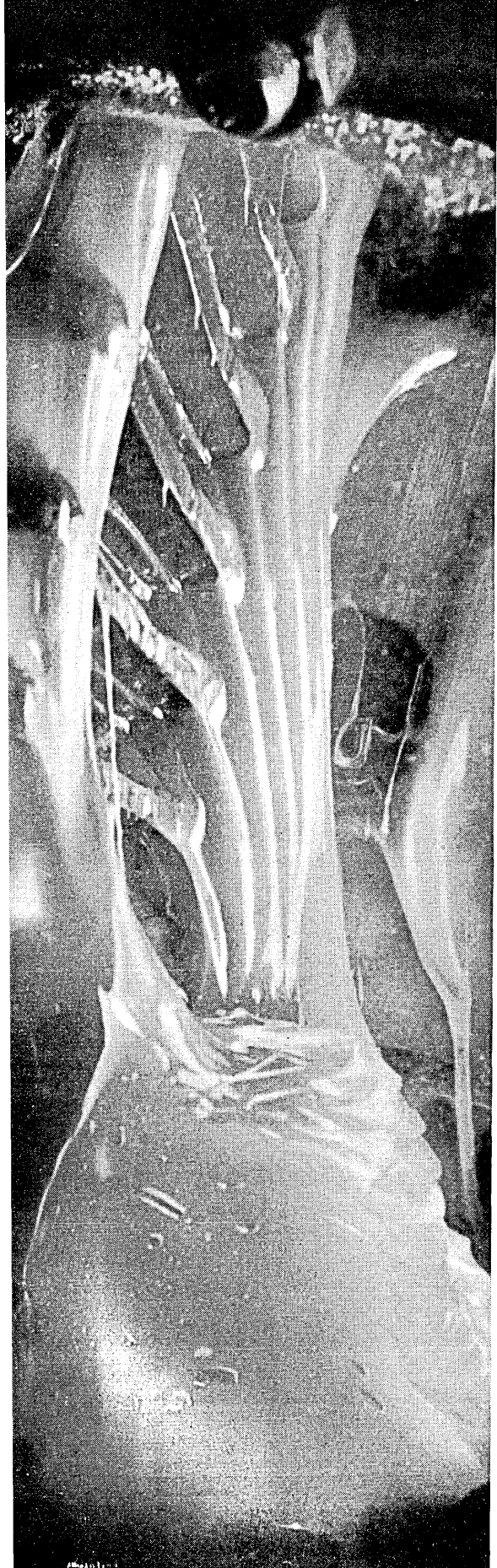

Grape Jelly and the Flow of Cold Oil

As freshly made jelly cools, a gel structure forms that resists deformation. The same thing can happen to lubricating oils in extremely cold weather.

Searching for a way to insure that lubricants will function over the complete range of operating temperatures, physical chemists at GM Research have been delving into some interesting research in rheology . . . the science dealing with flow of matter. In particular, they are examining the strange influence of polymers dissolved in mineral oil systems.

Adding long-chain polymer molecules to the already complex mineral oil produces some versatile lubricants. But the polymers further complicate the fluid's viscosity under varying shearing forces and temperatures.

Analyzing such sticky problems has led our researchers to develop new measuring techniques (including a forced-ball viscometer that readily responds to delicate gel structures) . . . to uncover new experimental data (see graph) . . . to form new theories as to why mineral oil gels are made more rigid by some polymers, less rigid by others.

This pioneering work on low temperature oil viscosity started with thoughtful consideration of a practical problem. It is yielding basic new scientific information our technical people can use. We think it typifies General Motors constant resolve to seek and find — A BETTER WAY.

General Motors Research Laboratories Warren, Michigan

At -25°F a ring gear in a car differential plows through a typical (SAE 90) gear oil.

Fluid A is termed a Newtonian fluid because its viscosity is independent of shearing forces. But note the unusual behavior of Fluid B, a non-Newtonian oil-polymer blend now being investigated.

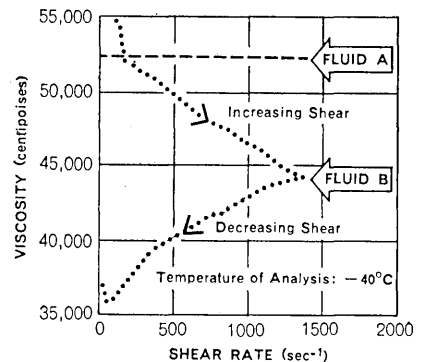

finished product within six weeks. Up to 500 tailor-made thin film microcircuits can be produced in a single two-hour vacuum cycle. LEAR, INC., 3171 S. Bundy Dr., Santa Monica, Calif. For information:

CIRCLE 118 ON READER CARD

patch panel and test stand

Patch panel model 84101 has been designed to hold and evaluate up to eight proto-card circuit modules. Cards can be inserted or removed from the test stand, which will also accommodate any printed circuit card using a standard 28-contact connector, without the use of a card puller. CIRCUIT STRUCTURES LAB., P. O. Box 36, Laguna Beach, Calif. For information:

CIRCLE 119 ON READER CARD

dry reed relay

The dry reed relay operates in the millisecond range and has a life of over 200,000,000 operations. The relay may be used in many computer and data handling applications which formerly required solid state switching. LINE ELECTRIC, 235 River St., Orange, N.J. For information:

CIRCLE 120 ON READER CARD

storage device

A new storage device consisting of two plates of photographic film positioned face-to-face records data in a

NEW PRODUCTS . . .

polka-dot arrangement and is capable of storing up to 100 full-size pages of magazine quality on a single frame of film. SPACE-GENERAL CORP., 777 Flower St., Glendale 1, Calif. For information:

CIRCLE 121 ON READER CARD

shift registers

New thin magnetic film shift registers have a capacity of 23 bits and yield up to 2 mv of electrical output signal. They can be used as non-moving part magnetic drums, pulse delay lines and

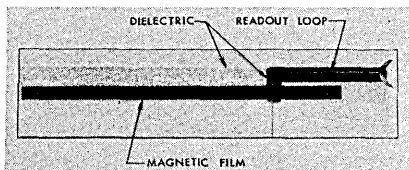

standard shift registers in computers. SERVOMECHANISMS/INC., RESEARCH DIV., Santa Barbara Airport, Santa Barbara, Calif. For information:

CIRCLE 122 ON READER CARD

internal clock

This internal clock system feeds time and date readings into the memory of the 704, 709 and 7090 under the control of the computer program. Utilizing the clock system the computer is able to automatically se-

quence several hours of work from magnetic tape without stopping for time logging. CHRONO-LOG CORP., 2583 West Chester Pike, Broomall, Pa. For information:

CIRCLE 123 ON READER CARD

digital modules case

Model MC26 accommodates 26 of the company's digital circuit modules and is also suitable for smaller systems. Modules may be inserted from either the front or back of the case which is designed for either bench top use or rack mounting. PACKARD BELL COMPUTER, 1905 Armacost, Los Angeles 25, Calif. For information:

CIRCLE 124 ON READER CARD

lens end incandescent lamps

Two lens end incandescent instrument lamps, the 253 and the 253X, have been designed for use in data processing devices. Each lamp produces a minimum of 750 footcandles of light over a 1/16" circle, 3/8" from the lamp. GENERAL ELECTRIC CO., THE MINIATURE LAMP DEPT., Nela Park, Cleveland 12, Ohio.

CIRCLE 376 ON READER CARD

operations analyzer

This chart analyzer reads and processes data recorded on event-recorder charts and permits automatic reduction of data which can be recorded in "on-off" form. Twenty channels of recorded data written in ink or by

COMPUTER (with B.S. plus experience) PROGRAMMERS

DOUGLAS Missile and Space Systems Division

offers you outstanding career opportunities in the following fields:

- Engineering Analysis
- Systems Analysis
- Programming Research
- Standards

Please forward resume to F. V. Edmonds, Chief, Engineering Personnel Section

DOUGLAS AIRCRAFT COMPANY

3000 Ocean Park Boulevard
Santa Monica, California

CIRCLE 91 ON READER CARD

jpl needs

ANALYST-PROGRAMMERS:

To develop numerical methods and digital computer programs for solution to problems from our space projects. Areas of computer applications include orbit determination, spacecraft simulation, space environment analysis, and flight data reduction.

Must have B. S. degree plus 2 years experience.

Senior level positions are also available for persons with demonstrated capability in supervision of computer programmers or mathematical analysis.

Send complete qualification resume now for immediate consideration. "An Equal Opportunity Employer"

CALIFORNIA INSTITUTE OF TECHNOLOGY
JET PROPULSION LABORATORY
4800 OAK GROVE DRIVE, PASADENA, CALIF.



CIRCLE 90 ON READER CARD

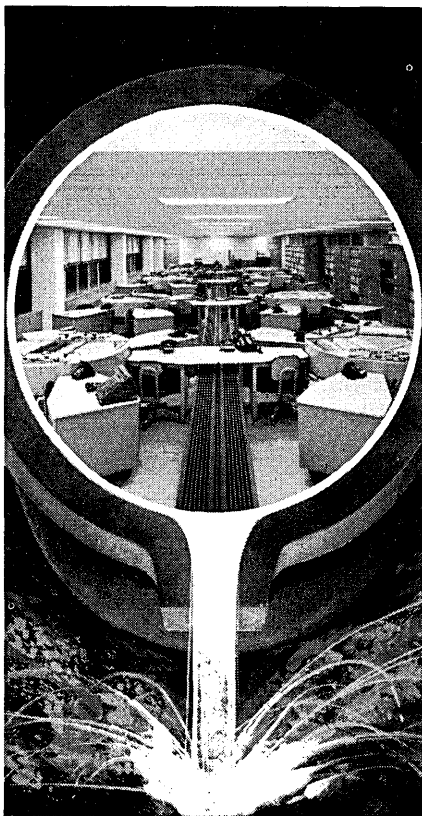

**NOW
ORDERS
FLOW
SMOOTH
AS**

MOLTEN STEEL

8 ACME ROTARIES keep order in CRUCIBLE STEEL order handling. Product men and mill order men sit side by side at Acme Rotaries... with instant, push-button access to the records they use together. Instructions radiate to mill, warehouse, shipping department in a fraction of the former time. And the whole multi-million-dollar job centralizes within a fraction of former space. If you need faster, lower-cost action from active records *anywhere* in your operation, send the coupon today.

ACME VISIBLE

ACME VISIBLE RECORDS, INC.
8803 West Allview Drive, Crozet, Va.

I would like to know more about power and manual Rotaries, and how they can put my active records in a charmed circle of savings... savings in time, space, man-hours, cost.

NAME _____ TITLE _____
COMPANY _____
ADDRESS _____
CITY _____ ZONE _____ STATE _____

CIRCLE 49 ON READER CARD

NEW PRODUCTS . . .

electrically-heated stylii on special charts can be simultaneously read by the electro-optical reading head. CONTROL EQUIPMENT CORP., 19 Kearney Rd., Needham Heights 94, Mass. For information:

CIRCLE 377 ON READER CARD

in-line resistance decades

The model 7317 fast-setting incremental resistance decade uses only five resistors to obtain 10 levels of resistance. Resistors up to $\frac{3}{8}$ " x $\frac{3}{8}$ " can be mounted on the integral printed circuit board. THE DIGITRAN COMPANY, 660 S. Arroyo Parkway, Pasadena, Calif. For information:

CIRCLE 378 ON READER CARD

digital circuit modules

New silicon logic modules are available in both DC to 1MC and DC to 250 KC operating frequencies without derating for voltage variations of $\pm 18\%$ and will tolerate 400 $\mu\mu\text{F}$ on output terminals of active circuits over and above specified lead ratings. SCIENTIFIC DATA SYSTEMS, INC., 1542 15th Street, Santa Monica, Calif. For information:

CIRCLE 379 ON READER CARD

preventive maintenance system

The model CT-2 KINESONIC tape cleaner, model seven tape tester and the model WT-183 programmed tension tape winder have been designed as a complete preventive maintenance system for magnetic tape. Defects due to dropouts, noise pulses and time-displacement errors are detected and recorded. Computer stoppages due to tape errors caused by loose oxide, tape base chips, etc., are reduced. GENERAL KINETICS INC., 2611 Shirlington Road, Arlington 6, Va. For information:

CIRCLE 380 ON READER CARD

card-to-paper tape converter

The model K1277 high speed punched card-to-paper tape converter system is said to be five times faster than conventional card-to-tape converters. The system consists of a K1274 card reader and a K1277 punch console. SYSTEMATICS, 3216 W. El Segundo Blvd., Hawthorne, Calif. For information:

CIRCLE 381 ON READER CARD

binary coded switch

The 2000 binary coded switch is one of the first fully-mechanical push-button switches made for the manual conversion of decimal to various binary code systems

CIRCLE 382 ON READER CARD

Computer Programmers Systems Engineers

Your Professional Progress Isn't Planned at

AUERBACH

Since our company's inception, management has believed that future growth depends upon the success of each individual. Our engineer-scientist oriented management has taken every step towards providing the type of environment that increases technical creativity. This corporate philosophy has been highly responsible for AUERBACH's outstanding reputation in the fields of Information Sciences and Technology, and for our receiving the responsibility for computer program design of one of the largest of complex data processing systems in the country.

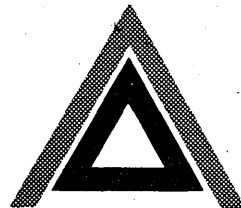

AUERBACH
corporation

SENIOR COMPUTER PROGRAMMERS and SENIOR SYSTEMS ENGINEERS are invited to discuss immediate opportunities available in Philadelphia and Washington. To discuss these professional positions in confidence, please contact - William S. Walker.

1634 Arch Street, Philadelphia 3, Pa.

A Total Capability In
INFORMATION SCIENCES & TECHNOLOGY

CIRCLE 92 ON READER CARD

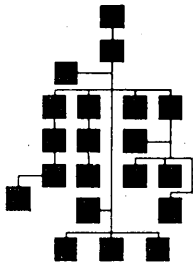

people
IN
DATAMATION

■ Charles M. Edwards has been appointed general manager of the Bendix Computer Division replacing M. W. Horrell, who resigned last month to accept a position with Rem-Rand UNIVAC. Fuller joined Bendix in 1951 as a project engineer at the corporation's Research Labs in Detroit. He became head of the department in 1955. In 1959 Fuller was appointed assistant to the corporation's executive vice president.

■ Erwin Tomash has been elected president and chief executive officer of the newly-created Teledata Corp., a wholly-owned subsidiary of Telex, Inc., Minneapolis. General offices of Teledata will be in Los Angeles. Tomash was previously vice president and general manager of the Ampex Computer Products Div., and president of Telemeter Magnetics, Inc., before the firm merged with Ampex.

■ Harry C. Anderson, president of the Business Equipment Manufacturers Association, has been elected to the board of directors of the American Standards Association.

■ Dr. Jack Moshman has been named director of the Washington Center of C-E-I-R, Inc. Formerly head of the Technical Sciences Division of the Washington Center, Dr. Moshman has been with the company since 1957 and has served as a vice president of C-E-I-R since 1960.

■ Dan L. McCurk has been promoted to general manager of TRW Computers Co., division of Thompson Ramo Wooldridge Inc. Formerly division associate general manager, he joined TRW Computers in 1958 as contracts and proposals manager, later became sales manager, and was subsequently promoted to director of marketing.

■ Paul W. Howerton has been appointed vice president and general manager of the Communication Sciences Division of Information for Industry, Inc., Washington, D.C. Howerton was formerly deputy assistant director for Central Reference, Central Intelligence Agency.



**DATA
SYSTEMS
DIVISION
FOUNDATION
FOR THOUGHT**

thinking data systems

RCA Data Systems Division, Van Nuys, California, is the foundation for much of the creative thinking taking place today in aerospace communication. In fulfilling its charter for the creation, development and production of ground based military data systems, this modern facility is making significant contributions in space age technology.

Scientists and engineers with experience and interest in expanding man's capability in military data systems are invited to inquire about the professional opportunities at RCA Data Systems Division, an equal opportunity employer. Just call or write:

Mr. M. S. Croner, EMpire 4-8111
RCA Data Systems Division
Dept. A-72, 8500 Balboa Blvd.
Van Nuys, California



The Most Trusted Name in Electronics
RADIO CORPORATION OF AMERICA

An Equal Opportunity Employer

CIRCLE 93 ON READER CARD

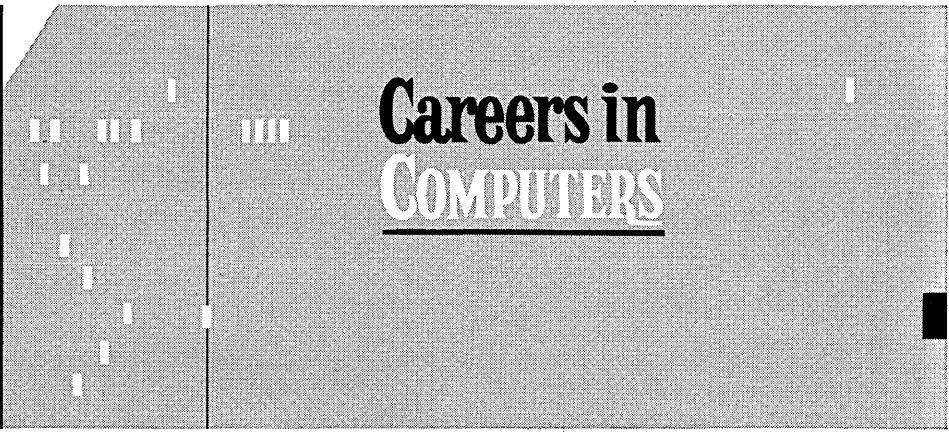
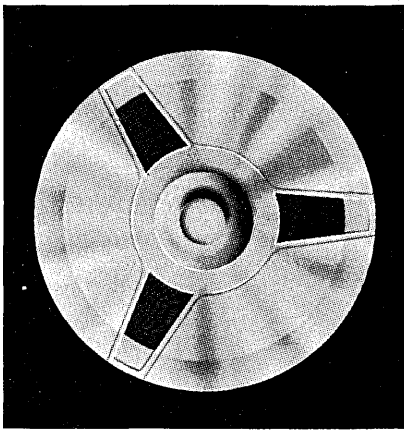

Programmers

Experience to include programming on large scale equipment with programs and applications of a Business, Scientific or Engineering nature. 7090 experience preferred.

Creative Programmers

Professionals who wish to participate in advancing the state of the art, with experience or training in:

- | | |
|----------------------------------|-------------------------|
| Compiler Writing | System Design |
| Automatic Programming | Language Analysis |
| Artificial Language Construction | Information Retrieval |
| Non Numerical Mathematics | Artificial Intelligence |
| Symbolic Manipulation | Operations Research |
| Game Playing | Symbolic Logic |
| List Processing Techniques | |

Systems Planners

Experienced men with particular "industry" background. Ability to determine the proper data processing system for a specific industry or determine if a unique system should be designed. Should have knowledge of at least one computer manufacturer's equipment and the capabilities of such equipment.

Communications Engineers

Experienced in Telegraph Systems, Data Transmission, Switching Systems, Transmission Systems, Communications Planning, to work on the development of new large-scale, communications based data processing systems for unique business and industrial applications.

Our client, a leader in the data processing field, is presently expanding a major division (East Coast location). Professionals whose interests and qualifications are in the above areas, please submit complete resume with salary requirements to:

DATAMAN*
ASSOCIATES
PERSONNEL CONSULTANTS
6 Beacon St., Boston, Mass. - Richmond 2-1932

Contact us during the IRE Show
at the Waldorf Astoria Hotel,
March 26-29.

*DATA MANAGEMENT... Recruiting Specialists for Data Processing and Computer Personnel Exclusively.

AN IMPORTANT ANNOUNCEMENT TO Operations Research Scientists

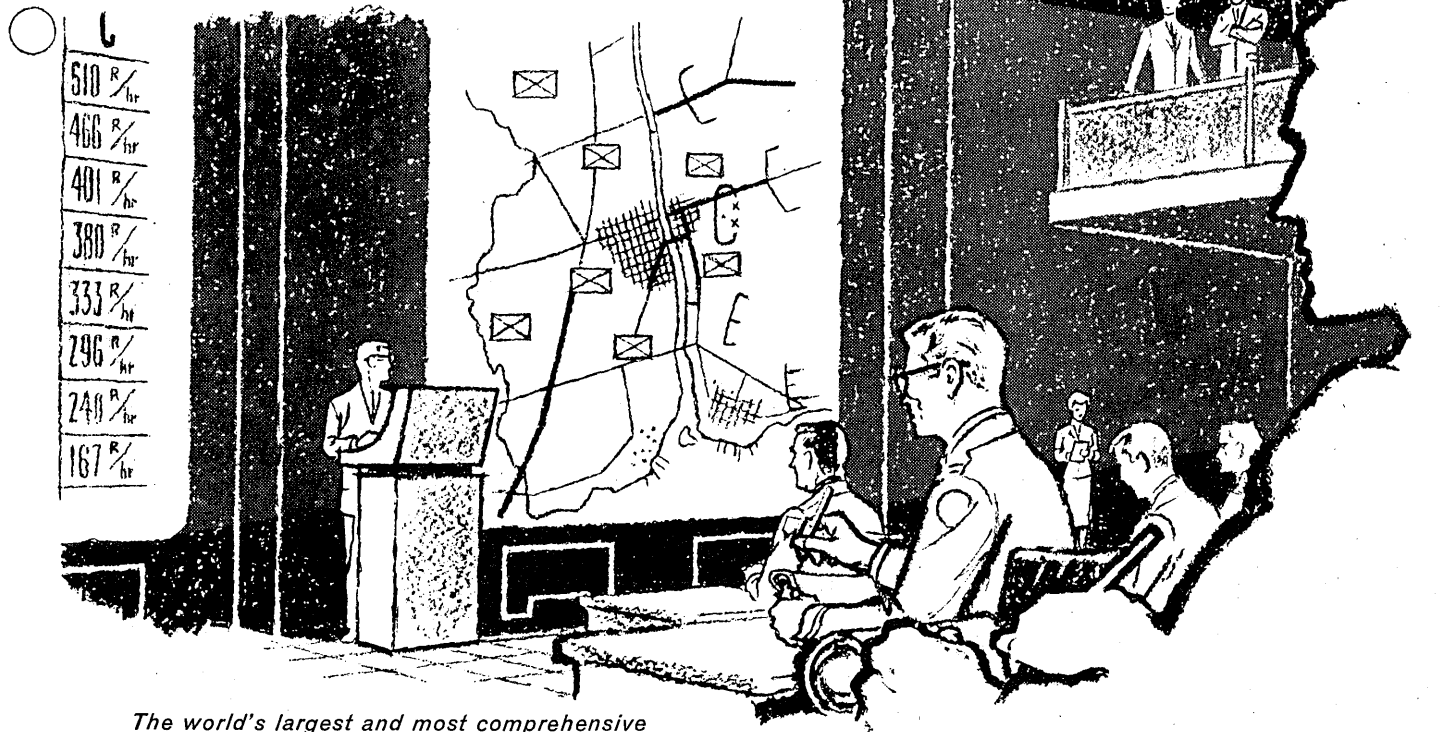

The world's largest and most comprehensive

Land Combat War Gaming Model

is being developed by **STAG**

... The U.S. Army's Strategy and Tactics Analysis Group

The Department of the Army recently established STAG to support Army operational planning and evaluation activities by war gaming and other scientific techniques, with the aid of large scale computer systems.

STAG has been assigned these specific tasks:

- 1 **Develop a Land Combat War Gaming Model with which to test Army Plans and potential.** This model will be of sufficient size, scope, and flexibility to permit war gaming of any or all phases of combat and support operations. It will be capable of handling strategic or tactical operations ranging from a single battle group or battalion up to and including the complete Theatre Army—and supporting Sea, Air and Space forces. *Programmed to be run on the IBM 7090, the Land Combat War Gaming Model will be the most ambitious and far-reaching undertaking in the science of War Gaming.*
- 2 **Conduct studies of other Army problems that will respond to War Gaming techniques, and maintain liaison with other Army and Army-supported groups.** *One such program nearing completion at STAG is a computer-programmed mathematical model of a Field Army Ballistic Missile Defense System (FABMDS).*
- 3 **Provide Army participation in joint exercises and technological advice and assistance to other war games groups.** *For example, STAG is sponsoring a War Gaming Symposium at its Bethesda, Maryland headquarters in September, 1962.*

STAG headquarters is an eight-story building newly built and especially equipped to provide the environment for War Gaming. It is ideally located in the heart of Bethesda, a select residential area just outside Washington, D.C. Already functioning are IBM 1401 and 7090 systems, and nearing completion is a two-story Command Control Penthouse featuring computer-generated visual display equipment, being developed especially for STAG to provide immediate information access to any part of a problem. The Red and Blue forces have monitoring equipment that allows instant two-way visual communication.

To build up a professional staff of Operations Research scientists to work with military experts, STAG is accepting applications for civilian members of numerous military-civilian-computer teams. These teams are being set up within STAG to provide the military, scientific and computer integration necessary for solving those problems which lend themselves to the gaming or simulation type technique. Immediate openings exist for Operations Research Analysts, Mathematicians and Mathematical Programmers.

If you are interested in participating in the most complex and comprehensive War Gaming program ever undertaken, please contact: Chief, Army General Staff, Civilian Personnel Office—STAG(E), Room 3-C-674, The Pentagon, Washington 25, D. C.



STAG

Strategy and Tactics Analysis Group

SKIRMISH OVER A COMPUTER-TO-INERTIAL-PLATFORM INTERPRETER

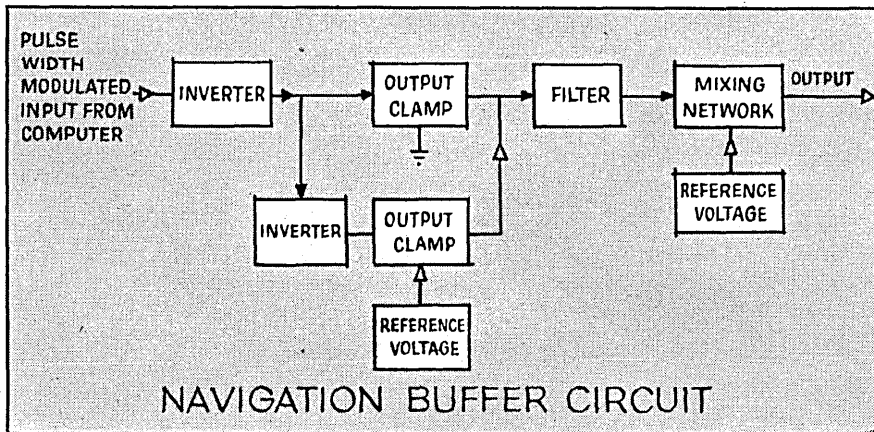

What is the best way to implement the digital-to-analog conversion circuitry required to convert binary incremental signals from a digital computer to precise d.c. voltages for gyro torquing in an airborne tactical data system? This was a problem faced by Litton data systems engineers.

Several engineers who had participated in the development of an earlier navigation buffer employing the digital servo technique were strongly inclined towards playing it safe by adopting an identical approach. To permit the navigation system to sustain the longer flights required under the new program, they proposed engineering greater accuracy into the existing buffer. Somehow, they felt, the additional requirements for lesser weight and volume could also be met. Preliminary investigation revealed that this scheme would require at least 20 pounds of hardware.

Feeling that a better way could be found, other engineers studied alternate approaches and finally proposed a scheme for generating d.c. gyro torquing voltages scaled according to width-modulated pulses linearly related to computer word length. This approach appeared to hold promise of an accuracy of at least 1 part in 4000 (0.025%), which was specified for two of the required eight signals (six for the inertial subsystem; two for the cockpit display system). The pulse width modulation/demodulation method also appeared to require far less hardware than would the digital servo technique because of the elimination of heavy electromechanical components.

Skeptics were quick to point out that the specified precision would be impossible to obtain in view of errors inherent in pulse-width modulation, delays and rise times in the precision switch, switch offset volt-

age, reference supply voltage, filter capacitor leakage and stability, filter lags, drum speed variation, and signal line ground currents.

Undaunted, the advocates of the new method pressed ahead, conducted detailed studies and laboratory investigations to nullify all objections and verified the complete feasibility of their proposed scheme.

Now functioning as part of a tactical data system installed in a carrier-based aircraft, this eight-signal navigation buffer is packaged on five 3" x 3" cards and two small assemblies. Weight and volume are about one-fifth of that required for a digital servo type of buffer. More recently, new packaging techniques have enabled reduction of the buffer unit by an additional 40% to two cards and two assemblies without degrading accuracy.

Litton management recognizes the value of results stimulated by healthy controversy. Security and proprietary restrictions preclude our discussing current activities, but new programs offering many new technical challenges are now being conducted. And Litton continues to encourage an environment in which engineers can propose and pursue other than safe approaches to problems. If you've been frustrated in your attempts to follow through on new approaches to digital data handling and display functions, try writing H. Laur, Litton Systems, Inc., Data Systems Division, 6700 Eton Avenue, Canoga Park, California; or telephone DIamond 6-4040.

An Equal Opportunity Employer

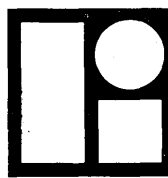
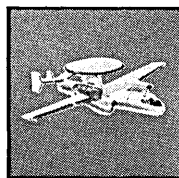
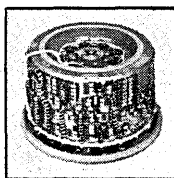
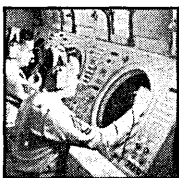

DATA SYSTEMS DIVISION
LITTON SYSTEMS, INC.

A DIVISION OF LITTON INDUSTRIES

DATA HANDLING & DISPLAY SYSTEMS • COMPUTER SYSTEMS • MODULAR DISPERSED CONTROL SYSTEMS

ADVERTISERS' INDEX

Acme Visible Records, Inc.	118
American Data Machines Inc.	99
American Telephone & Telegraph Co.	22
Ames Laboratory	112
Ampex Corporation	Cover 2, 9
Anelex Corporation	18
Armour Research Foundation of Illinois Institute of Technology ...	102
Audio Devices, Inc.	38
Auerbach/BNA	88
Auerbach Corporation	118
Autonetics, A Division of North American Aviation, Inc.	87
Bendix Computer Division	39
Bendix Products Aerospace Division, The Bendix Corporation ...	94
Bryant Computer Products, A Division of Ex-Cell-O Corporation ...	65
Collins Radio Company	4, 112
Computer Control Company, Inc.	1
Computron, Inc.	110
Control Data Corporation, Computer Division	84, 100
Dataman Associates	120
Datamation Magazine	114
Douglas Aircraft Co., Inc.	117
Dymec, A Division of Hewlett-Packard Company	40
Enscas Incorporated	101
Electronic Associates, Inc.	89
Electronic Engineering Company of California	114
Emcor Ingersoll Products Division of Borg-Warner Corporation ...	90
Evans Products Company, Haskelite Division	104
Ferroxcube Corporation of America	Cover 4
Forms Inc.	98
Frident, Inc.	86
General Dynamics/Electronics	36, 37
General Electric Company	91
General Electric Computer Department	124
General Electric Defense Electronics Division	97
General Kinetics Incorporated	106
General Motors Research Laboratories	116
The Gerber Scientific Instrument Co.	7
Graphic Systems	101
Hogan Faximile, A Subsidiary of Telautograph Corporation ...	102
Honeywell Electronic Data Processing	2, 3, 115
IBM Corporation	13, 92, 103
Imtra Corporation	113
Indiana General Corporation, Electronics Division	8
International Electric Corporation, As Associate of International Telephone and Telegraph Corporation	108
Federal Electric Corporation, Service Division of International Telephone and Telegraph Corporation	96
Jet Propulsion Laboratory	117
Laboratory for Electronics, Inc.	21
Liskey Aluminum, Inc.	115
Litton Systems, Inc., Data Systems Division	122
Lockheed-Georgia Company, A Division of Lockheed Aircraft Corporation	96
McDonnell Automation Center, Division of McDonnell Aircraft	94
Magne-Head Division of General Instrument Corporation	31
F. L. Mannix & Co., Inc.	107
The Mitre Corporation	60
National Aeronautics and Space Administration	93
The National Cash Register Company	6
The National Cash Register Company, Electronics Division ...	35
Packard Bell Computer	Cover 3
Potter Instrument Co., Inc.	10, 11
RCA Data Systems Division	119
RCA Electronic Data Processing	14, 15
Ramo-Wooldridge, A Division of Thompson Ramo Wooldridge, Inc.	109
Raytheon Company, Missile & Space Division	12
Remington Rand Univac Division of Sperry Rand Corporation ...	123
Space Technology Laboratories, Inc.	105
Standard Instrument Corporation	113
Statistical Tabulating Corporation	16
System Development Corporation	95
U.S. Army Strategy and Tactics Analysis Group	121

DERIVING majority logic NETWORKS

FUND. THM:

$$f(X, Y, Z) \equiv (X \# Y \# f_{xy}) \# (\bar{X} \# \bar{Y} \# f_{\bar{x}\bar{y}}) \# f_{xy}$$

DEFINITIONS:

$$X \# Y \# Z \equiv \text{Maj}(X, Y, Z); f_{xy} \equiv f(X, X, Z); f_{\bar{x}\bar{y}} \equiv f(X, \bar{X}, Z)$$

DERIVATION:

Let $f(X, Y, Z)$ be even-parity function P .

Then $f_{xy} \equiv \bar{Z}$ and $f_{\bar{x}\bar{y}} \equiv Z$ so

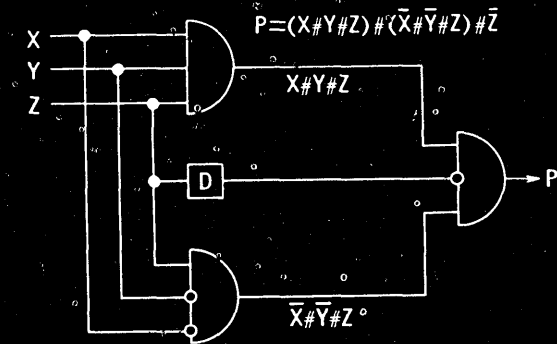

The fundamental theorem of majority-decision logic, a typical product of Univac's Mathematics and Logic Research Department, has practical as well as theoretical interest. The even-parity checker derived above from the fundamental theorem can be used to determine the parity of 3^n bits in $2n$ logic levels using only $\frac{3}{2}(3^n - 1)$ three-input majority gates.

Qualified applicants will find at Remington Rand Univac a scientific climate tuned to the intellectual curiosity of the professional man. The opportunity and the incentive for advancement are waiting for you in highly significant positions at Univac. You are invited to investigate them immediately.

■ SYSTEMS ANALYSTS ■ APPLICATIONS ANALYSTS ■ ENGINEER WRITERS ■ LOGICAL DESIGNERS ■ PROGRAMMERS

Contact the office of your choice:

R. K. PATTERSON
REMINGTON RAND UNIVAC
Univac Park
St. Paul 16, Minnesota

WILLIAM LOWE
REMINGTON RAND UNIVAC
P.O. Box 6068
San Diego 6, California

REMINGTON RAND
UNIVAC

DIVISION OF SPERRY RAND CORPORATION

There are also immediate openings in all areas of digital computer development at our other laboratories. Inquiries should be addressed to:

T. M. McCABE
Rem. Rand Univac
P.O. Box 500
Blue Bell, Penn.

D. CLAVELOUX
Rem. Rand Univac
Wilson Avenue
So. Norwalk, Conn.

(An equal opportunities employer)

New Growth Opportunities in
PHOENIX, ARIZONA with TWO computer groups:

**COMPUTER
DEPARTMENT**

Engineering

- Thin Film Computers
- Large & Small Scale Business & Scientific
- Peripheral Equipment
- Special Purchase Systems

**PROCESS
COMPUTER
OPERATION**

Process Control Systems

- Power plants
- Chemicals & Steel
- Petroleum
- Refineries
- Cement & Paper Mills
- Medical Electronics

Senior Positions Available on Above Computer Systems Projects

Required: BS or MS degree in EE or Physics

- | | |
|---------------------------|--------------------------|
| Systems Project Engineers | Diagnostic Programmers |
| Circuit & Logic Designers | Communications Engineers |
| Magnetic Memory Designers | Analog Engineers |

Programming—Senior Positions Available for Application in Above Systems

Required: BS degree in Math or General Science

- | | |
|-----------------------------|----------------------------------|
| System Programming | Compiler & Assembler Development |
| Program Package Development | Real-Time Programming |
| Customer Consultation | Computer Language Studies |

Additional Openings in these areas:

- | | |
|------------------------------|----------------------------------|
| • Product Service | • Process Analysis Modeling |
| • Quality Control | • Multivariable Controls |
| • Process Optimizing Studies | • Programming, Technical Writing |

**COMPUTER ENGINEERS
AND PROGRAMMERS**

*General Electric
Branching Out
Technologically
in Two Advanced
Commercial—*

Industrial Fields

**Large Scale Thin Film
Computer Development*

**Process Computer
Systems for Basic
Industry, Utilities,
Medical Electronics*

Five years ago, we said the G.E. Computer Department offered an unparalleled opportunity to get in on the ground floor of the computer industry. Events have not belied us. In that brief interval our facilities have tripled, our staff has quadrupled; and in sales, the momentum is so great, anticipated orders are expected to double this year alone. Clearly, here is a second opportunity to get in on the ground floor—at the inception of thin film computer technology; and at this point of expansion into new fields in basic industries and utilities. A short outline of your background and interests is invited. Write to: Mr. J. E. Torrey, General Electric Co. Room 56-C, P.O. Drawer 270, Phoenix, Arizona.



An equal opportunity employer.

NEW FROM PACKARD BELL COMPUTER:

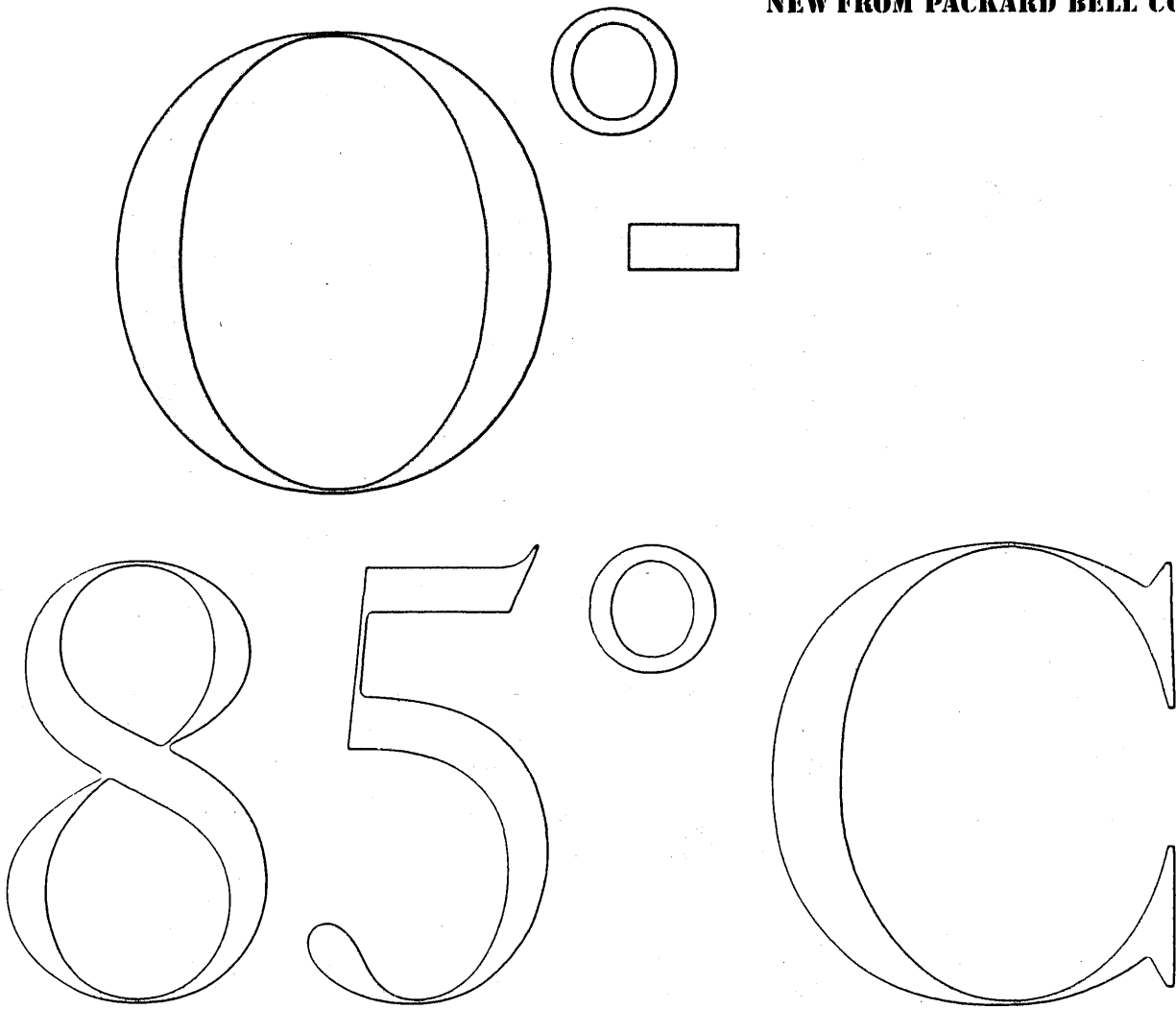

SILICON DIGITAL CIRCUIT MODULES

INCREASED RELIABILITY AT UNPRECEDENTED LOW COST. A complete new line of 1 mcps heat-resistant modules operating at full load driving power over the temperature range from 0° to 85° C. Beats hot spot problems in rack equipment—ideal for military and industrial data systems in exposed conditions. Compatible with existing circuit modules; no special power requirements; choice of connectors. Send for Bulletin SP 147.

See our latest equipment at Booths 3835, 3911 and 3913 at IRE Show

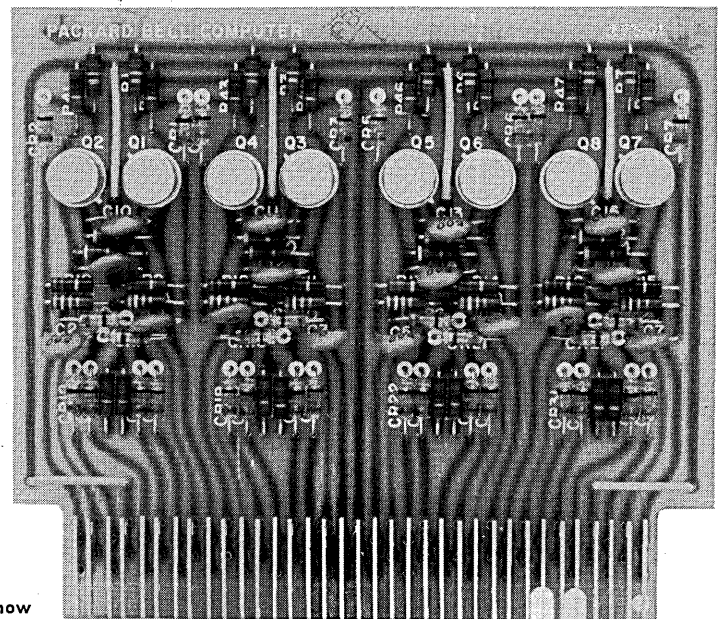

Packard Bell Computer

A SUBSIDIARY OF PACKARD BELL ELECTRONICS

1905 ARMACOST AVENUE • LOS ANGELES 25 CALIFORNIA

CIRCLE 2 ON READER CARD

FIRST FAST NON-DESTRUCTIVE READOUT IN FERRITE MEMORIES

Now, all the stability and dependability of ferrite memories with non-destructive read-outs for repeat functions. Ferroxcube Biax memory units are available in element, plane, or stack configurations for use in digital, general data processing or data reduction systems. The Biax memory core has two orthogonal holes, with related flux fields running at 90° to each other. Data storage is accomplished by saturating the ferrite material around one hole in the desired polarity direction. Upon command, an interrogating pulse is fed through the other hole, sensing the polarity, but not destroying the field, permitting an infinite number of read-outs without rewrites.

**AVAILABLE
RIGHT NOW!**

BIAX

...IN ELEMENTS, PLANES OR STACKS

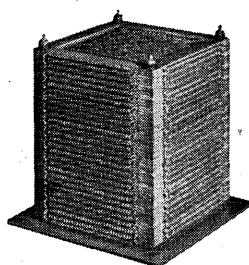
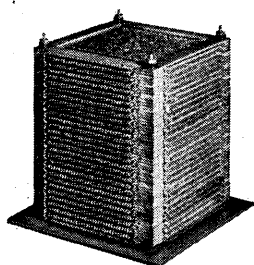
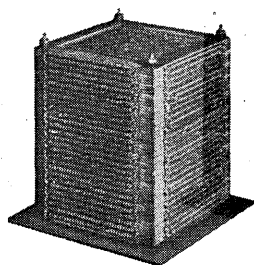

READ AS FAST AS .05 USEC / WRITE AS FAST AS 2 USEC WITH 100 mA DRIVE

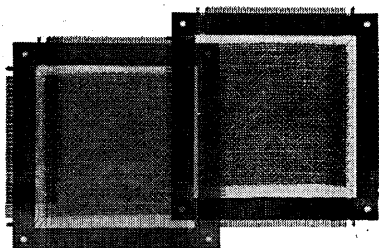
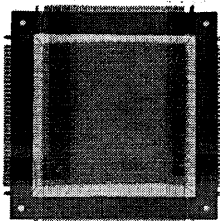

WRITE
for your copy
of complete
theory and
engineering
data on
**BIAX
MEMORIES**

**FIRST IN
FERRITES**

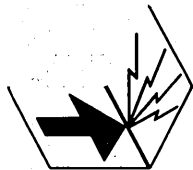

FERROXCUBE CORPORATION OF AMERICA / SAUGERTIES, N.Y.

"See Ferroxcube at New York IRE Booth 2438"

CIRCLE 3 ON READER CARD