

April
3.00
USA



SERVING UP COMPUTER SERVICES

- choosing between remote and in-house
- a consumer's check list
- user case histories: some indigestion, some satisfaction

Also: does data base pay off? Plus using the wrong language, paperwork, virtual machines, and "The Adventures of Captain Cobol" . . .

Kennedy Digital Tape Transports and the QUALITY EXPLOSION.

In every industry, one product sets a standard of quality. In tape peripherals, it's Kennedy.

Years of experience resulted in unique, exclusive — and standard features such as:

- A position arm anticipatory sensing system. An exclusive Kennedy feature, the linear, non-contact (Mag Pot) position sensor requires no lamp source and assures performance for the life of the machine.
- Interchangeable electronics on all Series 9000 transports, reduce stocking costs and down time.
- Front-accessible off-line test panel; marginal skew check; threshold scanning which automatically compensates for drop-ins or drop-outs; Read-After-Write shortened skew gate; simplified tape path and quick release hubs.

- All models are available with either 7 or 9 track, 800 NRZ1, 1600 PE or 800/1600 NRZ1/PE.
- 7 and 9 track NRZ1 and PE format/control units to simplify customer electronics. Also, a variety of popular mini-computer mag tape controllers are available. Series 9000's performance is as impressive as its features, with data transfer rates to 72KHz, and tape speeds from 10 to 45 ips.

Kennedy Digital Tape Transports have quite simply changed the industry by introducing the missing ingredient, quality of product.

KENNEDY CO.

540 W. WOODBURY RD., ALTADENA, CALIF. 91001
(213) 798-0953

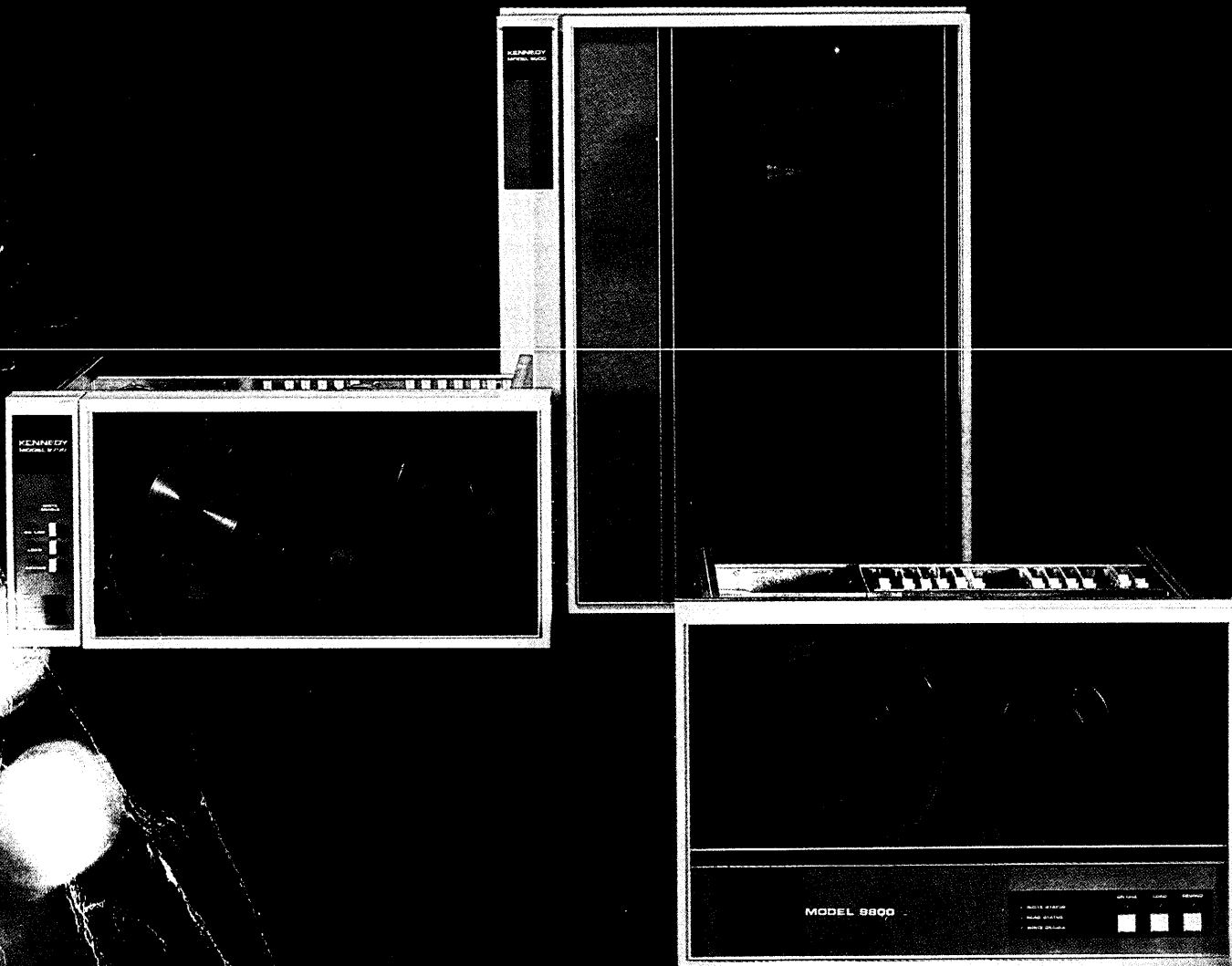

KENNEDY-QUALITY-COUNT ON IT

YOU COULDN'T NEED TIME LIPS ON ANY MACHINES!

The XL40 delivers powerful, concurrent, transaction-oriented distributed processing for your management network. With a series of new features specifically designed to solve your long-range needs.

More accessibility, with 3270-mode host interactivity to permit retrieval of data not available on local XL40 files.

More expandability, with up to 512K bytes of memory and 70 megabytes of disk, combined with our turnkey software, to offer an exceptional application range.

More versatility, with terminals and station printers that can be local or remote, and operate just as if they were XL40 cable-connected, wherever phone lines can be installed.

More flexibility, with both 480-character production screens and 2000-character large document screens, so we can configure the optimum mix for your requirements.

More source capability, with station printers under user program control that combine keyed data with disk file information to provide hard copy at local or remote sites.

XL40 DELIVERS DDP FASTER, FURTHER, EASIER

Remote Subsystem enables XL40 terminals and station printers to operate at remote locations

Large Disk increases disk capacity to a total of 70 megabytes for large-scale indexed file storage

3270 Mode offers user-transparent host interactivity for access to information not locally stored

Station Printer provides print capability at local or remote sites

Large Document 2000-character screen allows complete image display for large, complex documents

512K Memory quadruples memory for enhanced responsiveness in multi-terminal, multi-tasking environments



**PERTEC
COMPUTER
CORPORATION**

CMC Division

12910 Culver Boulevard, P.O. Box 92300
Los Angeles, California 90009
(213) 822-9914 TWX (910) 343-6451

*Bring XL40 DDP to your management network.
Call us today for more information about the
XL40 Distributed Processing System.*



ITEL LEASING. EQUIPMENT FINANCE THAT MAXIMIZES MUNICIPAL TAX DOLLARS.

Itel's Municipal Finance Program offers the most cost-effective means of acquiring the capital equipment that every state and local government needs. We handle all types of tax-exempt financing, including conditional sales as well as short term leases. Our services include:

Custom-tailoring to meet your individual equipment, budgetary and payment schedule requirements;

Interest rates comparable with municipal bond rates;

No-cost termination of the lease for non-appropriation of funds;

Financing for all types of equipment for virtually any terms (for 1 to 20 years);

Assistance with future refinancing, disposition of equipment and termination of existing leases.

Itel Leasing's record speaks for itself. In the past seven years, we've arranged financing for over \$3 billion of equipment. Our success has come

from showing our customers how to more effectively use their capital resources. Now, why not let Itel help you stretch tax dollars to fit your municipal equipment needs?

For further information about our Municipal Finance Program, call Dick Kirchner collect at (415) 955-0671.

ITEL
CORPORATION

Financial Services Group
One Embarcadero Center
San Francisco, California 94111

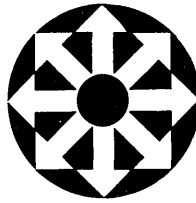

DATA INFORMATION[®] 78

VOLUME 24 NUMBER 4

This issue 141,677 copies

APRIL 1978

FEATURES

92 REMOTE COMPUTING SERVICE OR IN-HOUSE COMPUTER?
Herbert A. Seidman. It's not a cost-benefit trade-off.

96 HOW TO GET INTO REMOTE COMPUTING SERVICES (AND HOW NOT TO)
J. Richard Sherman and Abbott Ezrilov. Don't be part of the 10,001st horror story.

99 A CHECKLIST FOR USING BATCH AND REMOTE BATCH SERVICES
Michael S. Carter. Here are some of the questions to ask.

109 DOES A DATA BASE MANAGEMENT SYSTEM PAY OFF?
Gabrielle K. Wiorowski and John J. Wiorowski. Some of the indirect benefits are the best.

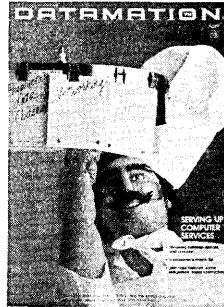

119 COMPARING PROGRAMMING LANGUAGE PERFORMANCE
Jerome W. Blaylock. Sometimes the "wrong" language isn't that bad.

129 VIRTUAL MACHINES AND THE NCR CRITERION
Tom Tang and Kenneth O'Flaherty. Right now, it's a COBOL processor.

139 REDUCING THE FEDERAL PAPERWORK BURDEN
Forest Woody Horton. Dp caused some of the problems, and dp can fix some.

148 CAPTAIN COBOL
This year's contribution to April Foolishness.

163 HOW TO PLAN SPACE FOR PEOPLE AND COMPUTERS
Kenneth A. Morrison. Computers and people can live happily in the same environment. Here's a specific approach that emphasizes compatibility.

172 WHEN MANAGEMENT IS AUTOMATED
John E. Steely, Jr. They said it couldn't be done.

NEWS IN PERSPECTIVE

179 FINANCE
Technology is not the problem.

181 WORLD MARKETS
Why IBM must withdraw from India./IBM market erosion extends around the world.

184 WORD PROCESSING
A meeting of many minds.

186 SERVICE BUREAUS
Hardware from the service firms.

187 COMPANIES
A fresh start for Wyly Corp.

187 SUPER COMPUTERS
Wanted: more power.

188 COMMUNICATIONS
Mail by computer./Interface '78 draws 8,000 to Las Vegas./IBM and AT&T getting "edgy," Lecht claims.

196 INTERNATIONAL
France election takes pressure off vendors./CII-HB enhancements aimed at System/34.

197 HARDWARE
Three get 303Xs as other wait.

198 TECHNOLOGY
From aerospace to commerce.

198 NETWORKS
Digital vs. IBM.

203 RESERVATIONS
Computer in a farmhouse.

205 SOFTWARE
Cosmetic struggles on.

208 BENCHMARKS
Honeywell drops the 66/85; But it wins a big contract; Burroughs settles suits; National champs; Quit bleeding; New type microfilm; Patent licensing agreement; Shakeout in tomography; OCR for NCR; Computer Automation in Ireland; Potter ousted.

DEPARTMENTS

8 LOOKING BACK

17 LOOK AHEAD

25 LETTERS
Rubies, ratings, risk, and a braille program.

47 PEOPLE
Raymond Kurshan: something to do with integrity; Wilfred P. Charrette: making project management easy; others in new posts.

54 CALENDAR

61 SOURCE DATA
Periodicals, references, courses, vendor lit., and April book reviews.

91 EDITOR'S READOUT
Yes, AT&T should be allowed into the data processing marketplace... but only under certain conditions.

212 HARDWARE
Turnkey COBOL development systems, an intelligent disc subsystem for micros, and distributed processing.

228 SOFTWARE
COBOL on a microprocessor, DECnet's second coming, a reference retrieval service, and a fax link to Tokyo.

241 PERSONAL COMPUTING
A distributed system of ten personal computers and a Series 1 have a reservation with a Dallas travel agency.

236 MARKETPLACE

249 ADVERTISERS' INDEX

About the cover

Select from the menu and cook your own gourmet delight of services. Soft sculpture by Susan Anson, photography by Bob Reed; Joan Lesser/Etcetera.

Only one company delivers a matrix printer with a 500,000,000-character head life warranty

Okidata

The Okidata Model 22 125-lpm, 132-column printer. No other printer can deliver so much quality for so long. . .and at so competitive a price.

Only Okidata can say that, and back it up.

With a head warranty that's unprecedented in the industry. 500,000,000 characters. At 100% duty cycle. Two years of performance. Made possible by Okidata's proprietary printing method.

With features like industry-compatible parallel interface, microprocessor RS232 serial interface (with optional current loop), electronic 12-channel VFU, 10-million-character life ribbon, and operator-controlled self-test. In stand or tabletop versions.

And it's backed by a nationwide sales-service network. A committed management team with the resources to back it up. And a growing base of installed printers throughout the world.

From Okidata. We build more than just printers. We build confidence.

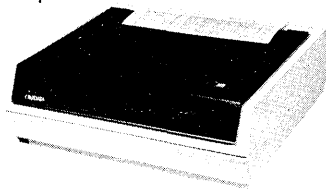

OKIDATA

Okidata Corporation
111 Gaither Drive
Mt. Laurel, New Jersey 08054
Telephone: 609/235/2600
TWX: 710/897/0792

Okidata Corporation also offers a family of 110-cps, 80-column printers; a document/passbook printer; and a series of Winchester technology disc drives.

DATAMATION

EDITORIAL STAFF

Editor	John L. Kirkley
Senior Editor	W. David Gardner
Articles Editor	Richard A. McLaughlin
International Editor	Angeline Pantages
European Editor	Ralph Emmett
Products Editor	Bill Musgrave
Copy Editor	John Waterhouse
Articles Assistant	Sarah Rolph
News Editor	Tom McCusker
Bureau Managers	
San Francisco	Edward K. Yasaki
Los Angeles	Edith D. Myers
Greenwich	Angeline Pantages
New York	Laton McCartney
Washington, D.C.	Linda J. Flato
Boston	Vin McLellan
Correspondents	
Minneapolis	James K. Johnson
Southwest	Robert F. Alexander
Australia	Ken McGregor
Editorial Advisor	Robert L. Patrick
Technical Advisor	Lowell Amdahl
Contributing Editors	Paul Armer, Ralph G. Berglund, Howard Bromberg, Philip H. Dorn, John M. Eger, William Helgason, Portia Isaacson, Louis B. Marienthal, Carl Reynolds, F. G. Withington

EDITORIAL OFFICES

Headquarters: 1801 S. La Cienega Blvd., Los Angeles, CA 90035. Phone (213) 559-5111. **Eastern:** 35 Mason St., Greenwich, CT 06830, (203) 661-5400. 420 Lexington Ave., New York, N.Y. 10017, (212) 682-7760. 134 Mt. Auburn St., Cambridge, Mass. 02138, (617) 354-2125. 6605 Burlington Pl., Springfield, VA 22152. (703) 569-3383. **Southwestern:** 11500 Stemmons North, Suite 152, Dallas, TX 75299, (214) 247-5221. **Western:** 2680 Bayshore Frontage Rd., Suite 401, Mountain View, CA 94043, (415) 965-8222. **Foreign:** 15 A St. Ann's Terrace, St. John's Wood, London, NW8, England; (01) 722-5088; 24 Stafford Road, Artarmon, Sydney, NSW 2064, Australia, 41-5748.

GRAPHIC DESIGN AND PRODUCTION

Art & Production Director	Cleve Marie Boutell
Advertising Production Manager	Marilee Pitman
Production Assistant	Alberta R. Martin
CIRCULATION	
35 Mason Street, Greenwich, CT 06830	
Circulation Manager	Suzanne A. Ryan
Marketing Research Manager	Deborah Dwelley
Publisher	James M. Morris
Assistant Publisher	F. Douglas De Carlo



Circulation audited by Business Publications Audit



Member American Business Press, Inc.

tp **DATAMATION** is published monthly on or about the first day of every month by Technical Publishing Company, A Dun and Bradstreet Company, 1301 South Grove Ave., Barrington, Illinois 60010; James B. Tafel, Chairman of the Board; John K. Abely, President. Executive and Advertising offices, 35 Mason Street, Greenwich, CT 06830, (203) 661-5400. Editorial offices, 1801 S. La Cienega Blvd., Los Angeles, CA 90035. Published at Chicago, Ill. **DATAMATION** is circulated without charge by name and title to certain qualified individuals in the United States and Canada who are employed by companies involved with automatic information handling equipment. Available to others by subscription at the rate of \$26. Reduced rate for qualified students, \$14. Foreign subscriptions \$50, or £27.50; for airmail, additional charge \$40, or £24.50. Japan and Australia \$65, or £36.50 (air shipped). Sole agent for all subscriptions outside the U.S.A. and Canada is J. B. Tratsart, Ltd. 154 A Greenford Road, Harrow, Middlesex HA13QT, England. No subscription agency is authorized by us to solicit or take orders for subscriptions. Controlled circulations paid at Columbus OH. © Copyright by Technical Publishing Company, A Division of Dun-Donnelley Publishing Corporation, A Dun & Bradstreet Company, 1978—all rights reserved. © "Datamation" registered trademark of Technical Publishing Company. Microfilm copies of **DATAMATION** may be obtained from University Microfilms, A Xerox Company, 300 No. Zeeb Road, Ann Arbor, Michigan 48106. Printed by Beslow Associates, Inc. Circulation Office: 34 East Putnam Avenue, Greenwich, CT 06830. **POSTMASTER:** Form 3579 to be sent to Technical Publishing Company, P.O. Box 2000, Greenwich, CT 06830. **Publication Number: 148800. Single copy: \$3.00 in U.S.A.**

THE TALLY PRINTER TERMINAL

Control 42 functions via the keyboard or the program

The Tally T-1612 Printer Terminal is designed for the user. It's loaded with functions and features. In addition to 42 programmable functions, which are available through the keyboard or through the user program, you get features like outstanding print quality, optimized bi-directional printing at 160 cps for bonus throughput, quiet operation for office use, lots of forms control conveniences, table top or pedestal mount and outstanding reliability that translates into low cost of ownership. And plenty more.

Unique features include six selectable type fonts in upper and lower case, LED column/line indicator, non-destructive memory providing pre-selected configuration on power up and 1k buffer standard (up to 4k optionally).

The Tally T-1612 is also available as a Receive Only printer. Both versions sustain a full 1200 Baud transmission rate. Or you can select 300, 600, 2400, 4800 or 9600 Baud operation.

Call Tally today.

TALLY®

OEM SALES OFFICES

Boston (617) 272-8070
New York (516) 694-8444
Chicago (312) 325-9788
Los Angeles (213) 378-0805
Miami (305) 665-5751

San Jose (408) 247-0897
Seattle (206) 251-6730
San Antonio (512) 733-8153
Washington, D.C. (703) 471-1145
BUSINESS SYSTEMS SALES
Orinda, CA (415) 254-8350

CIRCLE 68 ON READER CARD





Three Economic Reasons to Choose SYSTEMS 32-Bit Computers.

1. Powerful Hardware

The SELBUS transfers data at 26 megabytes per second. No other computer system in this class offers this performance. Performance which maximizes the return on your investment.

2. Choice

SYSTEMS also offers a complete family of true 32-bit computers:

SEL 32/35: processor with 900-nanosecond memory, and floating point arithmetic.

SEL 32/55: flexible single and multiple CPU configurations with up to one million bytes of 600-nanosecond memory.

SEL 32/75: supports up to 16 million bytes of memory. The only computer with independent, intelligent I/O to process and transfer data directly to and from memory.

All are upward-compatible. You select the computer which saves you the most.

3. Availability

Hundreds of SEL computers are operating in critical applications which demand availability; Simulation, Power Plant Monitoring, Telemetry. SYSTEMS means availability. And availability means reduced expenses ... increased profits.

SYSTEMS
ENGINEERING LABORATORIES

6901 West Sunrise Boulevard, Fort Lauderdale, Florida 33313 305/587-2900

The Printer Store

Digital Associates Corporation

Or, switch to ChainTrain quality.

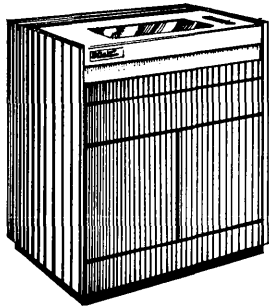

The DAC CT 6644 is a 600 LPM ChainTrain printer that replaces LP11-YA. It gives letter-quality printing, and costs about 40% less than DEC's 600 LPM drum printer. Again it comes with PDP-11 interface, installation and maintenance.

Savings for Data General Nova & Eclipse DMA Users.

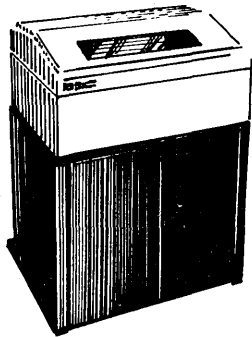

Save up to 40% on our models which are direct replacements for Data General printers. There are similar savings on all other printers, enabling you to replace Nova & Eclipse printers with higher speed or ChainTrain letter quality DAC printers. And we have the DMA Eclipse attachment.

PDP-11

USERS:
Save
40%

on your printer costs.

Join the Fortune 500 companies and other mini-computer users who have purchased over 1,000 printer systems at the Printer Store.

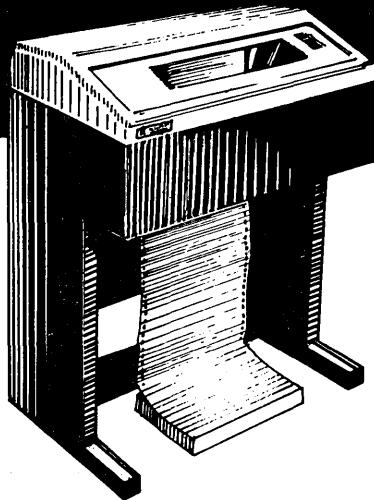

You can save 40% on your LP-11 printer costs. The DAC-2260 is a 600LPM plug-to-plug replacement for your LP11-YA. Or, for 25% less than DEC's 600LPM printer, we offer the 900LPM, DAC-2290, plug-to-plug replacement for the LP11-CA. And they both come with PDP-11 interface, installation and complete maintenance service. Whether you buy, rent or lease, you still save.

Digital Associates Corporation, 1039 E. Main St., Stamford, CT 06902
Call Toll Free 800-243-9054

Looking Back in DATAMATION.

March/April 1958

In spring, DATAMATION's fancy often turns to thoughts of national computer conferences. In 1958 the subject was the Western Joint Computer Conference (later to become the Fall Joint and still later part of the NCC). WJCC field trips were to see some of the country's most advanced computers: SAGE at SDC, the G-15 at Bendix Computer, the under-construction Datatron 220 at ElectroData, and the Univac 1103A at Ramo-Wooldridge.

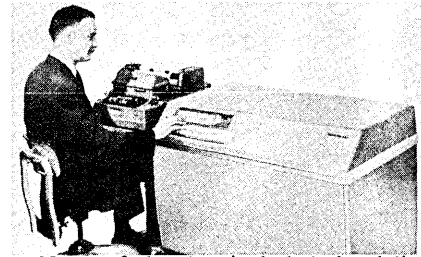

News of the day included the delivery of the first Datamatic 1000 large scale computer—40 tons worth of large scale—and the introduction of the Teletype Model 28.

A picture page of "current" small computers included the Autonetics Recomp II, Alwac III-E, Royal McBee LGP-30, ElectroData E-101, Bendix G-15, and—the only still-familiar gp computer vendor name—the IBM AutoPoint: 610.

April 1968

True to form, the April 1968 issue carried a preview of the Spring Joint Computer Conference. One of the familiar names on the program was that of DATAMATION's editor, Robert B. Forest, who chaired a panel on "Separate Pricing for Hardware and Software." The topic proved timely; IBM unbundled the next year.

In the news were rumors of an IBM supercomputer to match the CDC 7600 (it would be the 195), user worries about IBM's view of PL/I as "the language of the future," President Lyndon Johnson's memo establishing ASCII as a federal standard, Codasyl's first report on what a data base management system ought to be, and the conversion from 7094s to 360s to support Project Apollo.

Some of the issue's editorial could run today with minor changes: the discussion of the FCC inquiry into communications carriers selling dp services (we're in the rerun of that one today), an article on how the 360 could be given an address translation table ("associative store") for virtual paging, and a discussion of whether copyright was a good form of protection for software.

*

You may need more than one computer function...

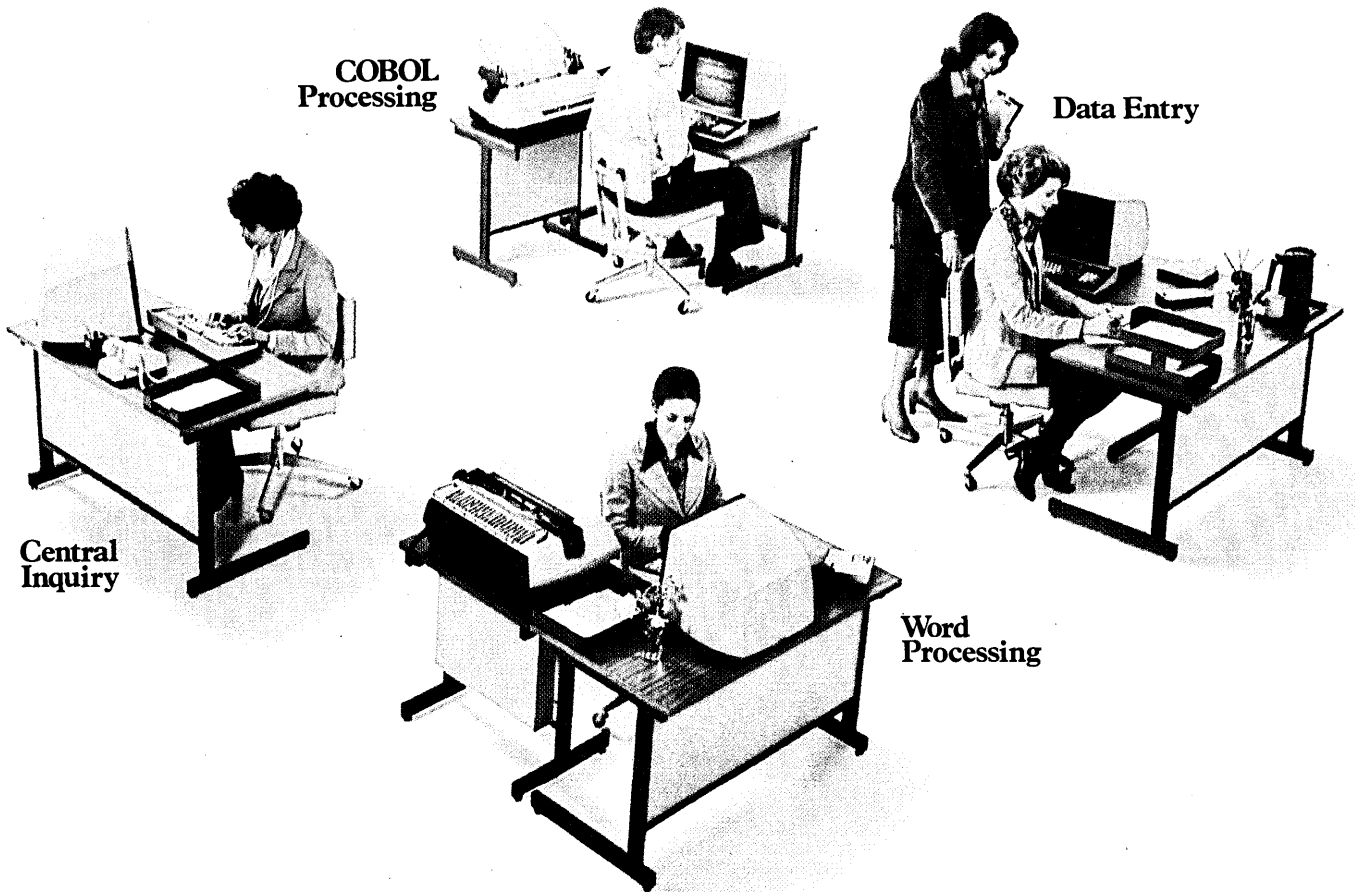

...but you don't need more than one computer system.

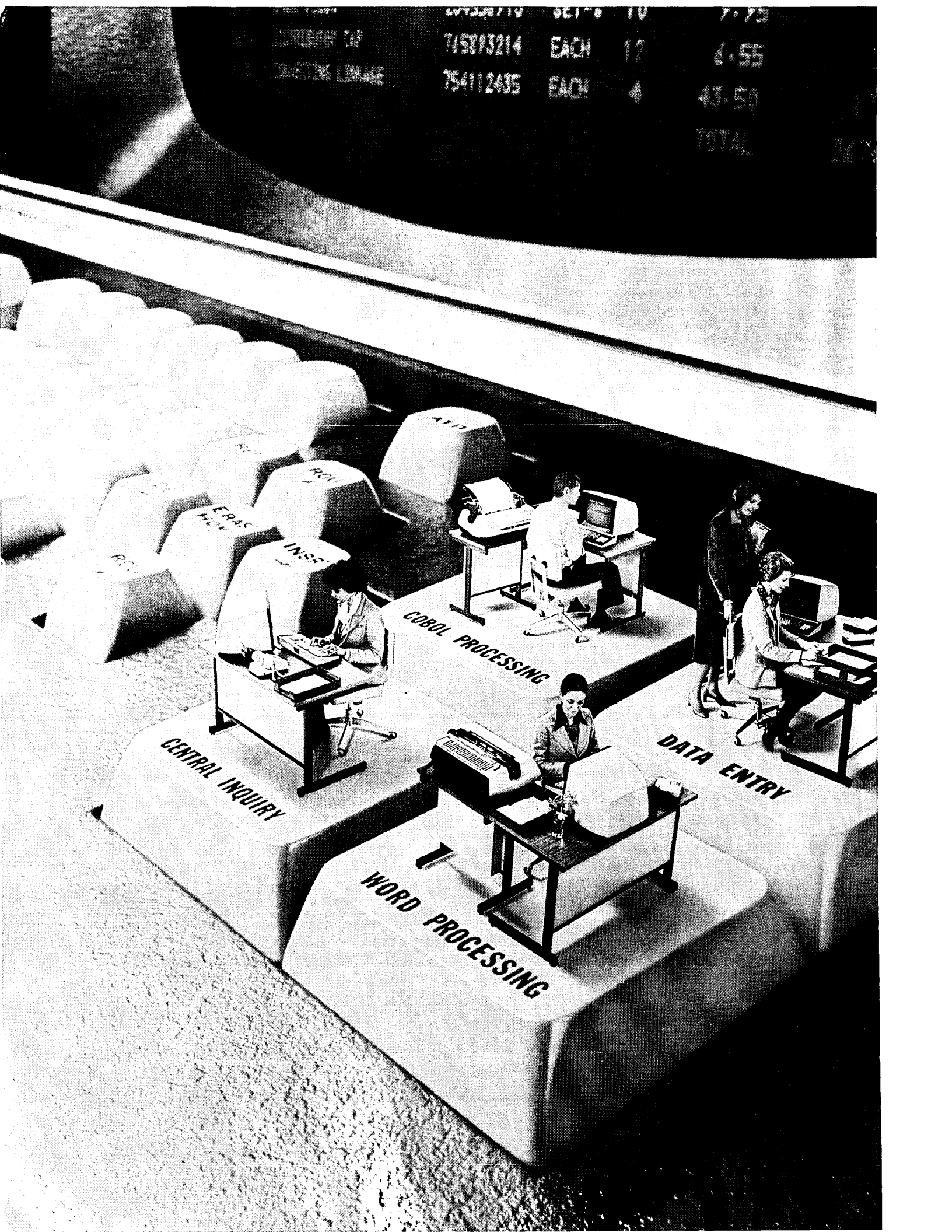

75326710	SET-8	10	7.75
75326710	SET-8	12	4.55
754112435	EACH	4	43.50
TOTAL			267

CENTRAL INQUIRY

WORD PROCESSING

DATA ENTRY

COBOL PROCESSING

ERAS

INSR

RC

You can do all four functions at the same station with our



new Multifunction Executive.

For the first time, you can perform the four primary office computing activities on a single distributed processing system. Our new MFE/IV Multifunction Executive lets operators independently handle data entry, COBOL processing, word processing, and interactive 3270 inquiry to your central mainframe. And every function is instantly available at up to 16 System IV/90 display stations with the touch of a key.

The Multifunction Executive allocates CPU and I/O resources for optimum system performance, and allows our field proven software packages to operate concurrently and independently.

Save Money.

Multifunction means bottom-line savings for your organization. No more special-purpose systems sitting idle . . . no redundant and underutilized peripherals . . . no users struggling to crosstrain on dissimilar equipment. And because each Four-Phase display replaces several dedicated terminals, you should need fewer of them.

Save Effort.

As the balance of your workload changes, your multifunction system keeps up with it . . . automatically.

In a branch office, for example, an operator using the word processing mode to generate proposals can check current product availability by transferring to inquiry mode and accessing the headquarters data base. Or while new orders are keyed in fill-in-the-blanks formats, the system can independently retrieve and enter customer data from local files . . . price and delivery data from central files . . . and print an invoice. All while other activities proceed at other displays.

Grow Step-by-Step.

Begin now to benefit from multifunction distributed processing. Start by installing an economical system, combining data entry and file management. Or word processing and batch communications. Or data entry, central inquiry, and local processing.

Then add memory—up to 384K bytes for your local applications. Add discs—up to 270M bytes of online storage. Add printers—one for each display. And add software—with the Multifunction Executive for concurrent operation. Our family of systems lets you grow at your own rate, saving time and money at each step.

For more information, call your local Four-Phase Systems office. Or write for our new brochure.

 **Four-Phase Systems**

10700 North DeAnza Blvd., Cupertino, CA 95014

CIRCLE 42 ON READER CARD

ADDS SYSTEM 70. OEM.

7 good reasons why System 70 is easy to buy and even easier to sell.

1 Buy a lot. Save a lot. Big OEM discounts mean money in the bank.

2 ADDS* PLUS Data Entry Language, Advanced Diskette Operating System (ADOS), BASIC, FORTRAN IV, Assembler, editing and debugging software are all field proven. And, this extensive software simplifies implementation and saves you dollars.

3 We build 'em for you fast. Our 45 day delivery schedule means less inventory and more money in your pocket.

4 Our Nationwide service means you've got it easy. Over 50 service locations make sure that System 70s keep on working. We provide the service. You save the dollars.

5 With more than 50,000 terminals already installed, ADDS reputation for quality and reliability is unsurpassed.

6 Our terminals fit your customers. System 70's beautiful exterior is human engineered for maximum operator convenience and ease of operation.

7 IBM 3780, Burroughs and teletypewriter communications are all available, making System 70 the right choice for almost any distributed processing environment.

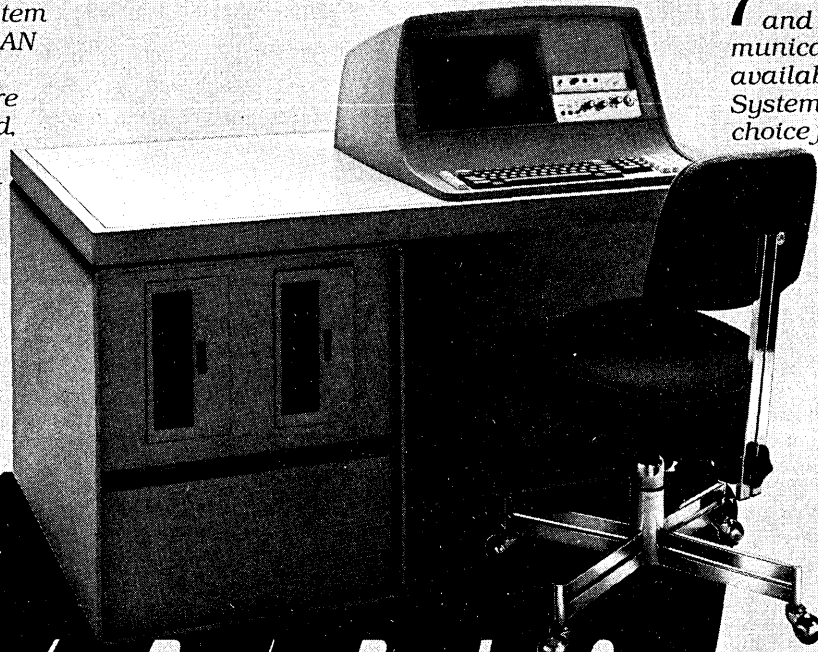

Quality, Reliability, Integrity, It all adds up to ADDS.

ADDS Applied Digital Data Systems Inc.
100 Marcus Blvd., Hauppauge,
New York 11787 516-231-540
DEPT. 70.

I need more information on the System 70. OEM.

Name _____

Firm _____

Title _____

Address _____

City _____ State _____

Phone _____

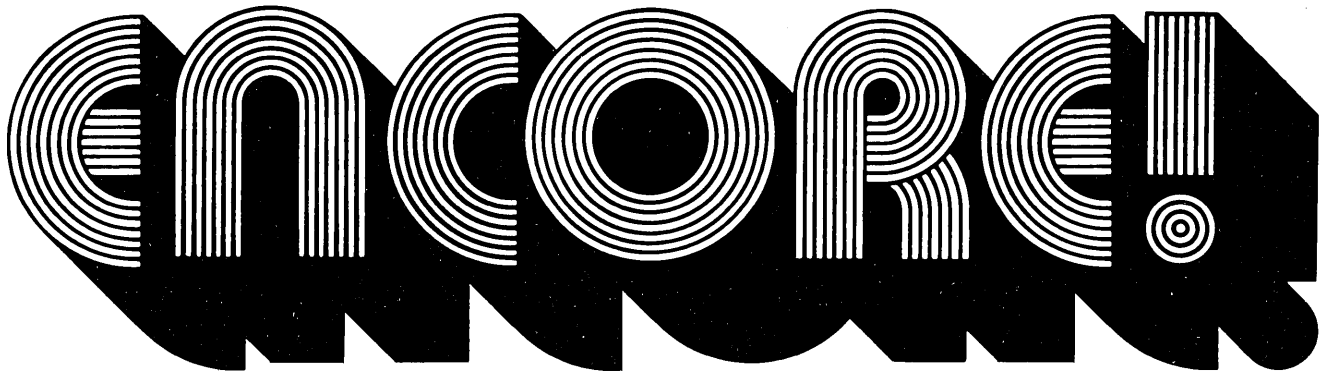

What does SyncSort DOS have in common with our OS sort?

**(Better performance than
anything IBM can offer!)**

Call (201) 568-9700.

**Ask for a
personal
introduction.**

OVERSEAS REPRESENTATIVES —

Brussels: CAP/GEMINI Belgium
Dusseldorf: CAP/GEMINI GmbH
Geneva: CAP/GEMINI Switzerland
Hague: CAP-GEMINI/PANDATA
Johannesburg: Computing Benefits Ltd.
London: GEMINI Ltd.
Melbourne: Shell Oil Co. of Australia
Milan: SYNTAX
Paris: CAP/SOGETI PRODUCTS
Stockholm: BRA
Tel Aviv: ADVANCED TECHNOLOGY, Ltd.
Vienna: CAP/GEMINI GmbH



WHITLOW

COMPUTER SYSTEMS Inc. 560 Sylvan Ave., Englewood Cliffs, N.J. 07632

How time flies! Just a few years ago, SyncSort for OS and OS/VS was an unknown young understudy to the then reigning *Diva* of the day, a slightly overweight IBM sort. Would our promising young protégé ever get the big break she needed?

We decided to help make that happen. We set up a series of exhaustive "auditions" that matched SyncSort against the Lady from IBM in every role in the sorting repertory.

The rest, of course, is history. When word began to spread around the circuit that SyncSort simply did more sorting work at less cost in machine and human resources, the sorting public began to queue up. Today, SyncSort plays the top role in over half of all OS and OS/VS installations.

But what about SyncSort DOS and DOS/VS? Would it have that kind of success against all that competition from IBM? We decided to bite the bullet and find out.

First we tested DOS/VS against the Computer Giant's leading lady, which happens to be SM2-5746 — the "top of the line" sort for DOS/VS. Well, it came as quite a shock to us, but the "top of the line" is apparently not that high. Because SyncSort did a lot more sorting, for a lot fewer resources, in every single category:

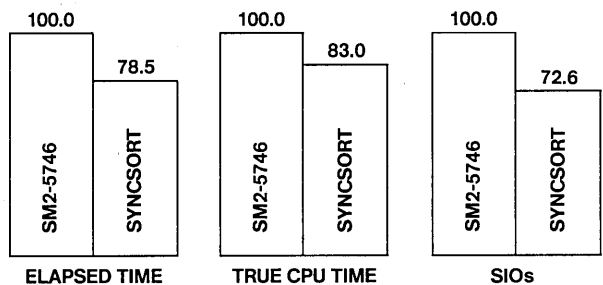

Okay, we thought, maybe we made a mistake. Maybe SM2 isn't the best the Giant has to offer. So we took a look at SM1-5746. Here are the results:

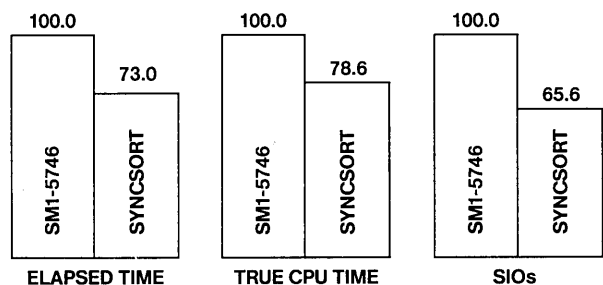

Yes, we did a full matrix of tests against all those other IBM sorts for DOS and DOS/VS — the whole thundering herd of them. (Think *quality*, IBM, not *quantity*!) But the results were just more of the same. Our test crew said it was like being trapped on a down escalator.

So we think we may have another winning sort on our hands, and we think you'll think so, too. Particularly if you like talented performers, with trim lines and no horns on their heads.

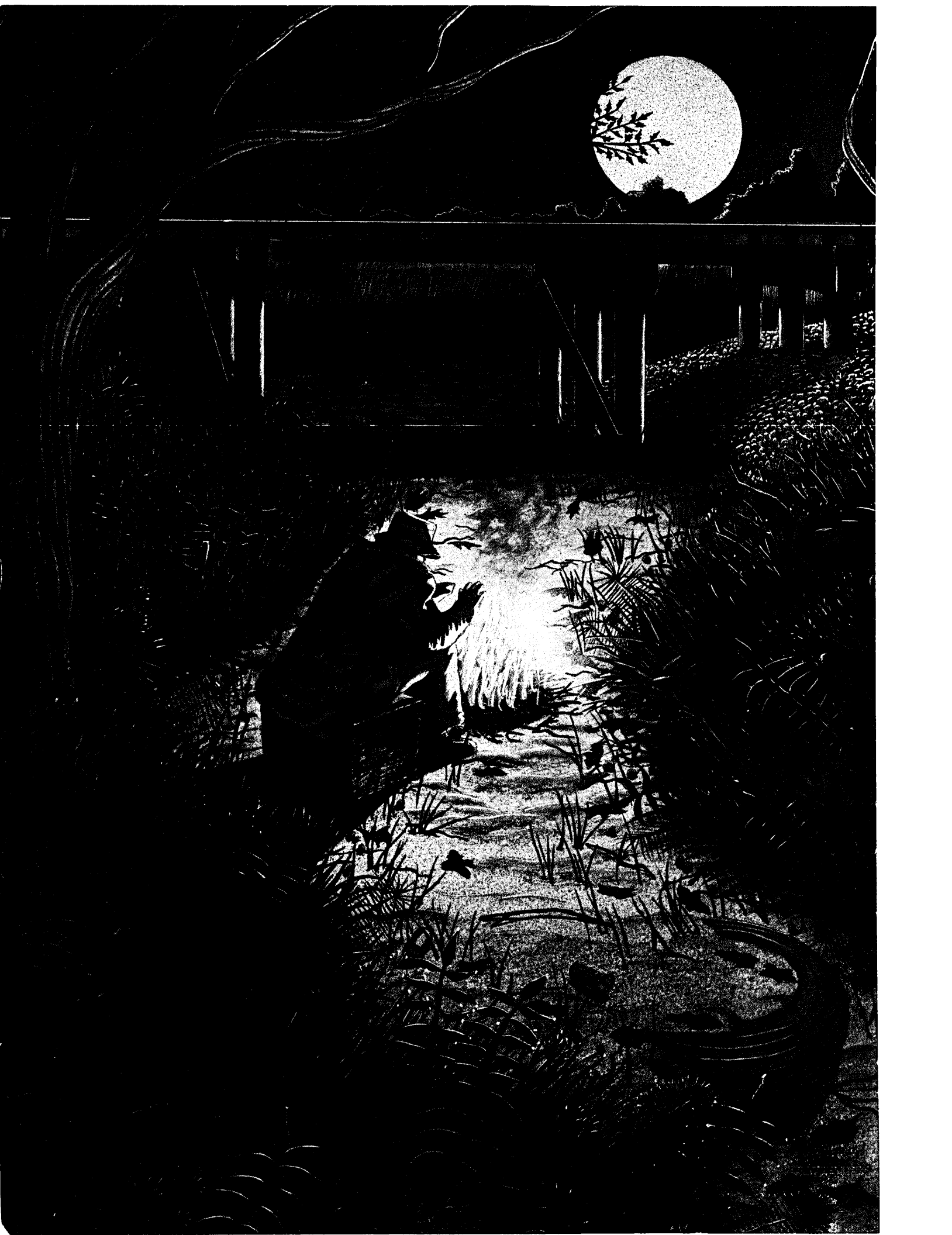

“Whatever happened to ol’ Fred after that little problem with the master file?”

With the UCC-1 Tape Management System, problems just don’t happen.

This software package effectively manages all your tapes, preventing the accidental loss or destruction of your valuable data. UCC-1 eliminates costly, handwritten records... and the expensive mistakes they breed.

There are more than 500 installations of UCC-1, representing about three-fourths of all installed OS tape management systems. To find out why, call us at 1(800)527-3250 (in Texas, call 214-688-7313) or circle 93.

And, while you’re at it, ask us about:

A DOS Under OS System that lets you use DOS programs, without reprogramming, while you convert to OS (UCC-2). Circle 94.

A Disk Management System you should look into before you buy another disk drive (UCC-3). Circle 95.

A PDS Space Management System that eliminates PDS compression (UCC-6). Circle 96.

A Data Dictionary/Manager that will really get IMS under control (UCC-10). Circle 97.

A Restart/Recovery Management System that makes restarting in a matter of seconds... a matter of fact (UCC-15). Circle 98.

A General Ledger/Financial Control System that your Accounting Department has been dreaming of (UCC-FCS). Circle 99.

Software packages like these. One more way—

We’re helping the computer to do more of the work.

UCC

P. O. Box 47911—Dallas, Texas 75247

Canada: 101 Duncan Mill Road—Don Mills, Ontario M3B 1Z3 • Europe: 1258 London Road—London, U.K. SW16 4EG

Member SIA  Software Industry Association

MORE BIG TALK ON ECLIPSE SYSTEMS.

“PL/I”

First, we brought you AOS, the most intelligent multiprogramming operating system to be found on a small computer. Now we bring you the fastest, largest and most efficient version of PL/I ever implemented on a minicomputer. And that's not just talk. It's available now on all multiprogramming Data

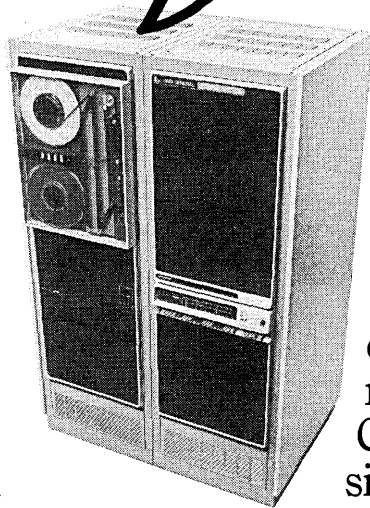

General ECLIPSE systems. So now you can take advantage of the sophistication and efficiency of big computer PL/I without having to buy a big computer. PL/I is just one more reason why Data General is the computer company that really talks sense. Call (617) 366-8911, Extension 4735. Or write.

 **Data General**

We make computers that make sense

Data General Corporation, Westboro, MA 01581, (617) 366-8911. Data General (Canada) Ltd., Ontario. Data General Europe, 61 rue de Courcelles, Paris, France, 766.51.78. Data General Australia, (03) 82-1361. Data General Ltda., Sao Paulo, Brazil, 543-0138 © Data General Corporation, 1978. ECLIPSE is a registered trademark of the Data General Corporation.

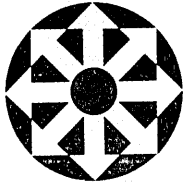

LOOK AHEAD

FIBER OPTICS GAINS INCREASING ACCEPTANCE

Look for fiber optics to gain increasing acceptance in data communications applications, particularly as a replacement for coaxial cable in configurations linking peripherals to computers. Costs for high bandwidth fiber optics links are dropping and firms in the fast-growing field boast fiber optic systems that can transmit data at tremendously high speeds. Harris Corp.'s Fiber Optics Systems group, for example, has a system it claims can transmit up to 130 megabits per second over five miles without a repeater.

Harris has already set up a link joining its own crt's and corporate computers at the firm's Melbourne, Fla., plant and it recently installed a system for a major New York City corporation linking 1,200 crt's to a series of central computers.

ITT PACKET NETWORK TO BE DELAYED

A new timetable is expected to be announced next month by International Telephone and Telegraph Corp. for its packet switching network. The first phase of ITT's new net, targeted at facsimile-to-facsimile and terminal-to-facsimile service, has been postponed until sometime next year, a source close to the company reports. ITT originally had planned the startup phase for July 1, with terminal-to-computer and computer-to-computer services slated to begin six months later.

The chief reason cited by the company for the network delay is the Japanese -- more specifically the facsimile breakthroughs that are expected out of several Japanese firms this year. By temporarily stalling its packet plans, ITT hopes to persuade the Japanese manufacturers to make their new gear compatible with the company's packet system which will include 10 computers and 14 remote concentrators.

BIG ROLE FOR DEC IN AT&T NET

Reports keep surfacing that Digital Equipment Corp. will play a big role in AT&T's planned data network, variously called Bell Data Network (BDN) and Advanced Communications System (ACS) internally. DEC's LSI-11 is considered to be a prime candidate for customer site equipment and the PDP-11/70 is likely to have the switching node role in the network. AT&T currently is struggling to complete marketing studies on the network. While the project has been widely expected to be announced this year, some of those who have seen the marketing plans don't see how Bell can be ready to announce the system before next year.

DEVELOPING NATIONS SEEK IBM ALTERNATIVES

Big means backlash for IBM, as was seen in India (page 181), and the giant is having troubles in other developing nations that make those markets ripe for competitors. IBM and Iranian officials are battling, and Intel has set up a subsidiary there -- of its own volition -- but we hear the Iranians want them there as an alternative. Israel also is anxious for an IBM compatible choice, as is Zaire.

An official from Zaire visited the U.S. recently to talk to Intel, as well as firms in the mini, small and medium scale market. He views IBM's stranglehold there and its increasing, rather than decreasing, prices as "blackmail." The problem is, who can afford to enter the very small foreign markets? Some are finding the

LOOK AHEAD

Japanese more responsive to their needs, especially in education.

THE EVOLUTION OF EVOLUTION

Evolution is the newest small business system name to come out of California's Orange County but only the name is really new -- and appropriate. The system is being produced and marketed by Richard Pick & Associates, Irvine. Pick, architect of Microdata's Reality small business system, has been marketing an unnamed Reality-like system since early last year following termination of an association with Microdata.

The beginning of the evolution of Evolution goes farther back, to 1965 when Pick was with TRW working on a software project that led to that firm's Generalized Information Management (GIM) system. This work was the basis for Pick's own system which he got up and running in November 1972 on a Microdata mini. Microdata took the system to the market in mid-1973 with Pick working with Microdata as a consultant. Pick's current systems are based on Multi Six computers produced by Intertechnique S.A., a French firm which had been offering Microdata software in Europe but now is offering Pick's. Pick last month said two lawsuits filed against him and his firm last year by Microdata, one for back payment for equipment use and one for alleged trade secret theft, were on the verge of out of court settlement but "I'm waiting for something in writing." He characterized them as "nuisance suits."

MOHAWK BEEFS UP DISTRIBUTED LINE

Mohawk Data Sciences plans to beef up its series 21 distributed processing product line with the introduction slated for late this month of the 21/50. The new three partition system will feature up to 120K bytes of main memory -- twice that of the 21/40 which until now has been the top of the MDS line. In addition, Mohawk will double its disc storage capacity with the announcement of a new 20 megabyte disc drive.

BUBBLES FOR SPORTSWRITERS

Informer, Inc., of Los Angeles, will be offering bubble memory on its model P303/5951 keyboard terminal, a device used primarily by sportswriters to file stories. Use of bubble raises the memory capacity of the machine to 20K (or close to 20 pages of copy) from its present 8K. Source of the memory is Texas Instruments, Inc., first to announce a practical application of bubbles in terminals. Although TI has been slow to deliver its bubble memories, Informer says it is promising 120-day delivery after receiving an order, one of the first going to the Chicago Sun-Times and to Dow-Jones.

SOFTWARE GETS GREATER EMPHASIS AT DATA 100

Sign of the times: Data 100, which spent about \$2 million developing the operating system for its Series 80 being introduced this month (page 214), says it now spends more research and development dollars on software than on hardware. Its 1977 fiscal year was the first in Data 100's nine year history that this was noticed. This year about 54% of its \$10.5 million R&D budget will go toward software development.

The company's R&D efforts have been helped along by an infusion of \$5 million for R&D over two years by Northern Telcom. That was part of the agreement in which the Canadian company will acquire up

(Continued on page 210)

"We couldn't live without MARK IV!"



— Pat O'Grady, Secretary-Treasurer, and Fred Hemming, Director of Data Processing, Transport Indemnity Company, Los Angeles, California

"With 16,000 claims reported annually and \$50,000,000 in annual premiums, Transport Indemnity is one of the largest and busiest truck insurers in the country. To handle this enormous load with ease and efficiency, we use MARK IV. It has reduced our programming time by 75 percent and allowed us to work with a staff one-third the size of what it would be otherwise. It's really unbelievable!

"In 1975, we developed a fully automated and truly revolutionary retrospective claims system under MARK IV, and we're absolutely thrilled with it. Essentially, retrospective claims mean that the insured shares in the lower limits of the loss, with the insured paying in advance for the loss. At year's end, according to the actual experience, additional money is requested or overpayment is refunded.

"This claims process is extremely complex, but MARK IV simplified it and gave us the exacting control we need. All current and cumulative claims information, along with pertinent statistical data, is on one master file. By simply passing our transaction file against it, we spin out all the reports we require.

"We also use MARK IV for an extremely sophisticated self-insurance administration system, and currently 90 percent of our new systems development is scheduled for MARK IV. What we like best is its flexibility.

MARK IV is so responsive that we can answer the changing needs of our insureds through timely production of specialized reports. Our DP people think of MARK IV as a 'language of love'! We couldn't live without it!"

GET THE FACTS ON MARK IV. MARK IV is the most versatile and widely used software product in the world for application implementation, data management and information processing. Six powerful models (prices start at \$12,000) are in daily use on IBM 360/370, Univac 70/90, Siemens 4004, Amdahl 470, and Intel Advanced System computers at over 1,300 installations in 44 countries. Programs in MARK IV require only about one-tenth the statements of Cobol, and users report 60 to 90% cost and time reductions on most MARK IV applications.

informatics inc.  Software Products

World's Leading Independent Supplier of Software Products

OFFICES

Los Angeles (213) 822-3552
New York (201) 488-2700
Washington (703) 821-5900
Atlanta (404) 955-2518
Chicago (312) 298-9300
Dallas (214) 750-0800
Canada (416) 493-9716

HEADQUARTERS

21050 Vanowen Street
Canoga Park, California 91304
Telephone (213) 887-9121

Member SIA  Software Industry Association

Transport Indemnity is one of the nation's largest companies specializing in motor carrier liability insurance.

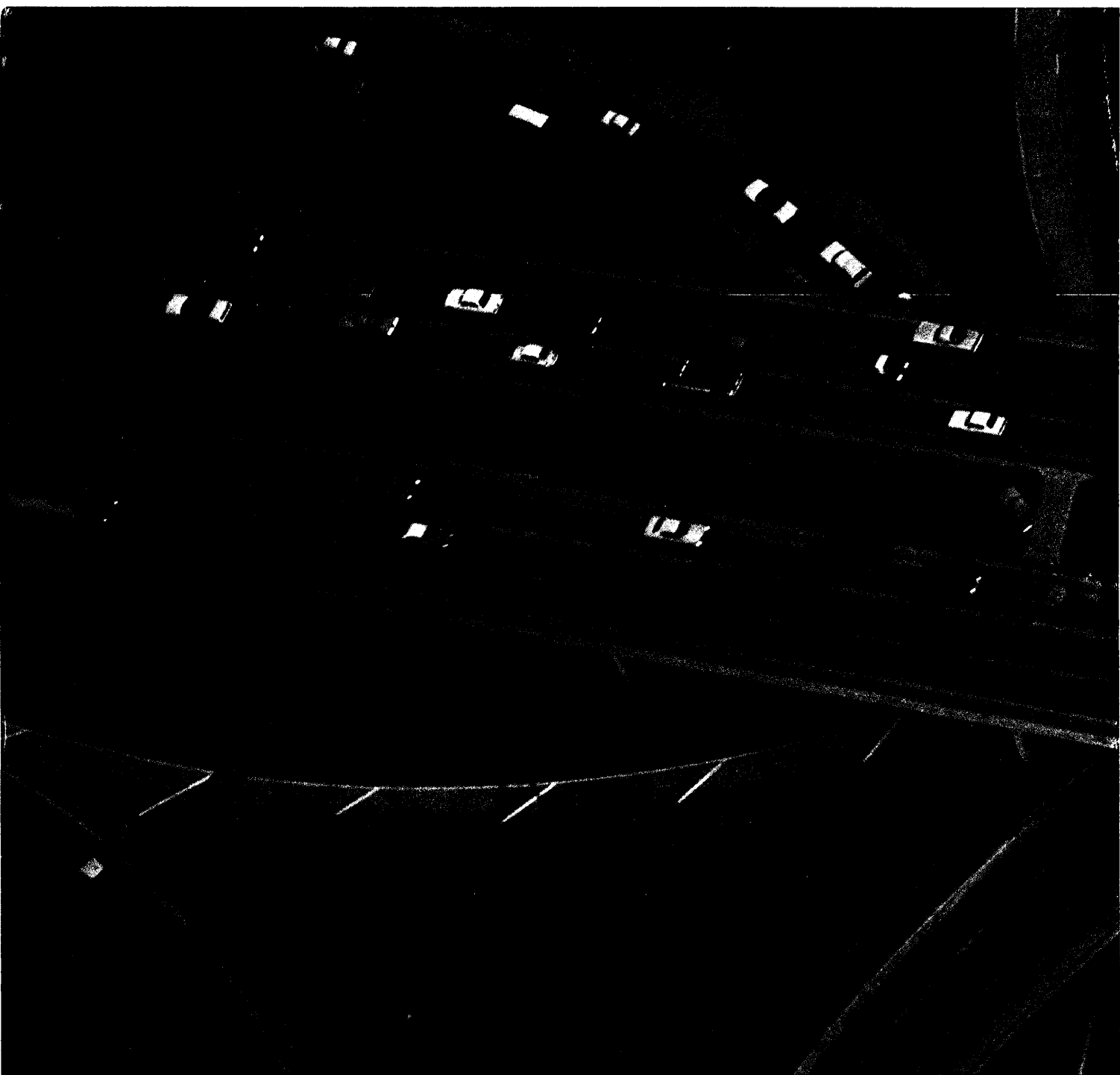

When minis are hooked up,

Sperry Univac's minis now solve the problems that curse other distributed data processing systems.

Such as the aggravating throughput problems you get from inadequate network design, limited CPU performance, and insufficient data base management capabilities.

Our PRONTO minicomputer systems have been designed to tie together simply. You can tailor your specific distributed data processing requirements to solve problems more quickly than ever before.

There's no slow down on your application — whether you're tying in one PRONTO system. Or twenty.

You can continue using the tools you already know. Like COBOL, FORTRAN, and industry standard communications protocols. What's more, our data base management system will allow you to implement efficient and user-tailored data bases.

And as your communication and data processing needs increase, you simply add more PRONTO systems. After all, they're

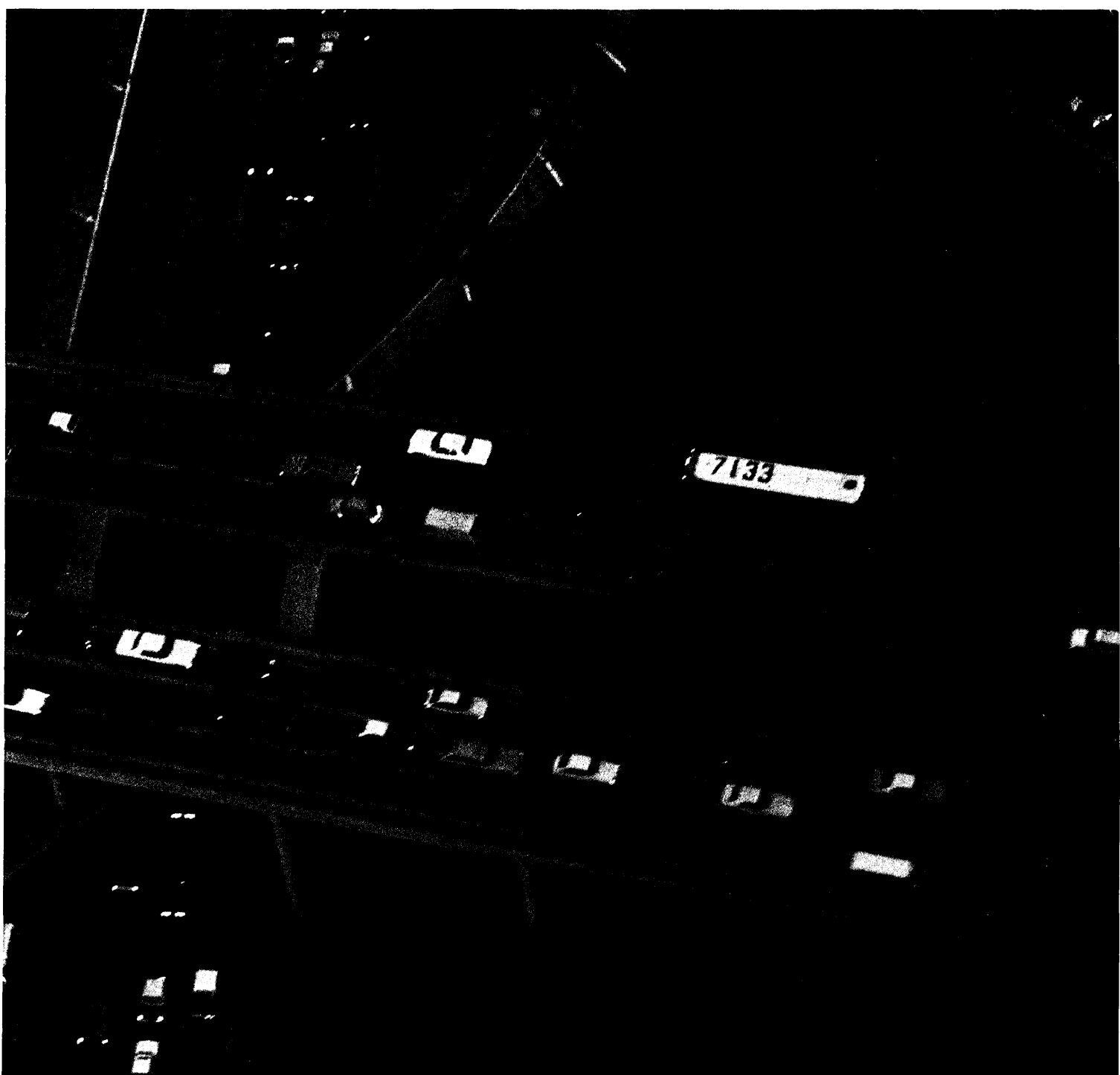

traffic shouldn't slow down.

designed to keep pace with your growth.

For more information, write Sperry Univac Mini-Computer Operations, 2722 Michelson Drive, Irvine, California 92713. Or call (714) 833-2400.

In Europe, write Headquarters, Mini-Computer Operations, London NW10 8LS, England.

Ask about our PRONTO system, a complete package of software and minicomputer hardware that can keep your traffic flowing smoothly.

SPERRY  **UNIVAC**
SPERRY UNIVAC IS A DIVISION OF
SPERRY RAND CORPORATION

TIRED OF WAITING FOR REPORTS?

With EASYTRIEVE, there is no need to wait for reports. In a matter of moments a program can be coded in English and run to provide exactly the information you require in a report you can read. EASYTRIEVE does the formatting, the figuring, the selection of just the data you need. Automatically. Quickly.

You don't have to be a wizard to learn to use EASYTRIEVE. Auditors, financial directors, secretaries, and other non-DP people use it every day. Yet, EASYTRIEVE is powerful enough to do systems housekeeping, create test data, do job accounting and forecasting. The system does multifile processing, print jobs, mailing labels, bar graphs and more. EASYTRIEVE accesses most DBMS files as well. And all without coding forms, extensive training or high overhead.

EASYTRIEVE is one of several valuable software solutions for the IBM 360/370 environment provided by Pansophic, the leading software company dedicated to solving your software problems. Call or write today for further information on our complete line of proven software products.

PANSOPHIC

709 Enterprise Drive • Oak Brook, IL 60521

East (703) 821-8370

Central (312) 986-6070

West (214) 233-0486

Member SIA  Software Industry Association

FOR RENT...NOW...

the two most advanced instruments for on-site structural and vibration analyses, Honeywell's 1858 graphic data acquisition system and their laboratory-quality 5600 magnetic tape recorder.

The 18-channel 1858 is easy-to-set-up and easy-to-use . . . anywhere . . . and it's smaller than a portable TV set. The completely self-contained 1858 packs performance-plus in a tiny (8¾" high and 65-pound) package. It gives you 18 channels (32 with the 1870 amplifier housing), each with dc to 5,000 Hz response. The 1858 also provides a choice of 42 discrete paper speeds, up to 120 inches per second. All you have to do is plug in a power cord, connect signal input cables and start recording wherever — and whatever — you need to record. You can use it in a rack, on a table, on the seat of a car, or on the ground. You don't have to mount any separate cases, nor hook up any interconnect cabling, nor fool around with any powders, inks, chemicals or heaters. Plug it in, and you're in business.

When the quality of your test data is too important to compromise, a 5600 recorder gives lab-quality results on the bench or on the move. Another rugged, take-it-anywhere portable, the 5600 is a perfect partner to the 1858. It gives you big-machine capability in a compact case, and its tripstan drive tape transport treats your tape so gently you can use ½ mil tape. The 5600 gives you monitor meters for viewing input and output signals in real-time, offers state-of-the-art record and reproduce heads, and has FM flutter compensation and good servo flutter attenuation to minimize unavoidable artifacts. It's an open-ended system allowing easy conversion of tape width, power source and recording formats. It lets you convert from intermediate-band to wideband, from direct to FM recording. The 5600 operates in hostile environments and can withstand the roughest jolts and vibrations. It's available now.

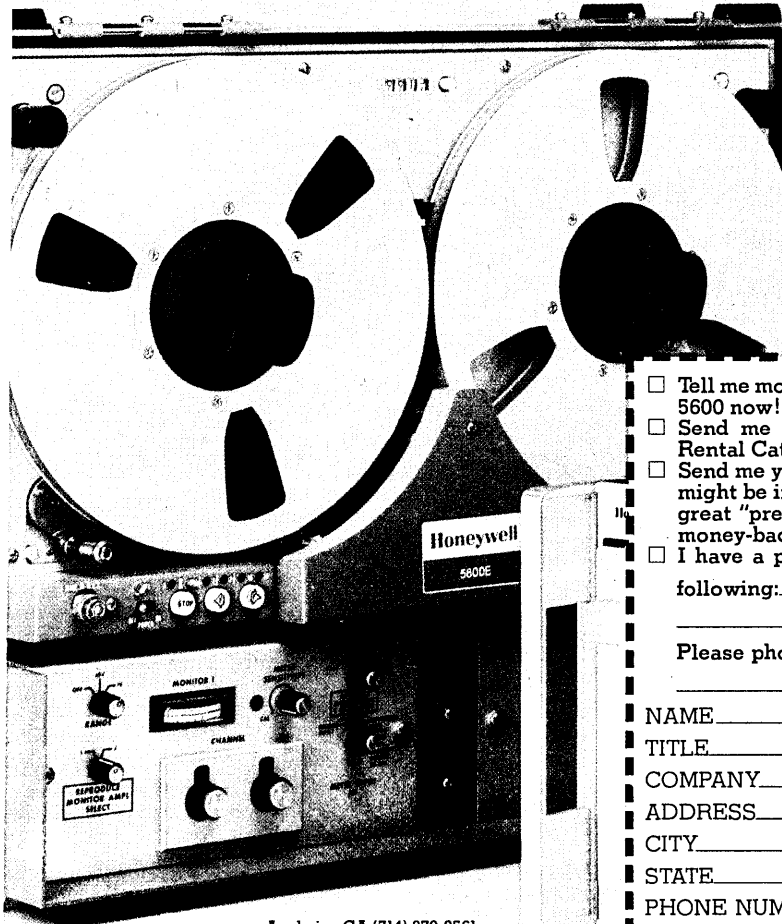

More than 12,871 state-of-the-art instruments . . . off-the-shelf, throughout North America.

Rental Electronics, Inc.
Another of the **AMERICAN** companies

- Tell me more about the Honeywell 1858 and 5600 now! Call me at _____
- Send me a copy of your free illustrated Rental Catalog.
- Send me your Equipment Sales Catalog — I might be interested in buying some of your great "previously owned" equipment on a money-back guarantee.
- I have a pressing need right now for the following: _____

Please phone me immediately at _____

NAME _____
 TITLE _____
 COMPANY _____
 ADDRESS _____
 CITY _____
 STATE _____ ZIP _____
 PHONE NUMBER _____
 EXTENSION _____

Complete this coupon and return it today to the world's oldest and largest electronic equipment rental firm, REI, 19347 Londelius St., Northridge, California 91324.

GSA #GS-04S-21963 Neg © 1978 Rental Electronics, Inc.

Anaheim, CA (714) 879-0561
 Mountain View, CA (415) 968-8845
 Fort Lauderdale, FL (305) 771-3500
 Des Plaines, IL (312) 827-6670
 Burlington, MA (617) 273-2770
 Gaithersburg, MD (301) 948-0620 • Oakland, NJ (201) 337-3757
 Cleveland, OH (216) 442-8080 • Dallas, TX (214) 661-8082
 Houston, TX (713) 780-7218 • Seattle, WA (206) 641-6444
 Northridge, CA (213) 993-RENT (7368)
 Roxdale (Toronto), Ontario (416) 675-7513
 Montreal, Quebec (514) 681-9246 • Vancouver, B.C. (604) 684-6623

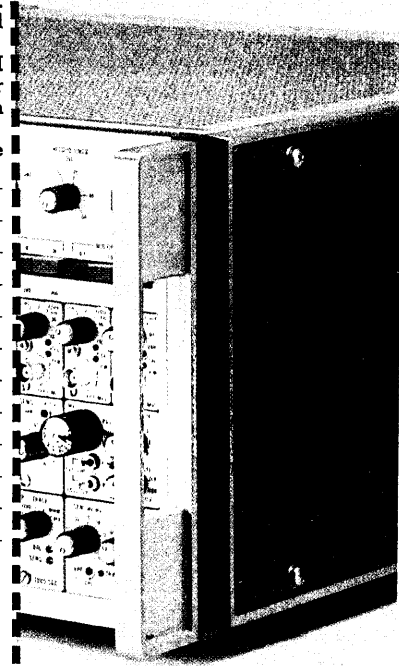

Does 85% commonality make Centronics' line printer family the best?

NO. Centronics 6000 series band printers have much more to offer than just high parts commonality; technical features like an operator-changeable print band with a choice of EBCDIC character sets and microprocessor control, for example. Four models—providing superior print quality and a range of print speeds—75, 150, 300 and 600 lpm, plus design simplicity that provides exceptional reliability and makes the 6000 series a true family of low priced, fully formed character line printers.

And, as with Centronics' matrix printers and teleprinters, the 6000 series is backed by the largest worldwide service organization of any printer company, and Centronics' reputation for reliability.

Write or call for complete 6000 series information. Centronics Data Computer Corp., Hudson, NH 03051, Tel. (603) 883-0111.

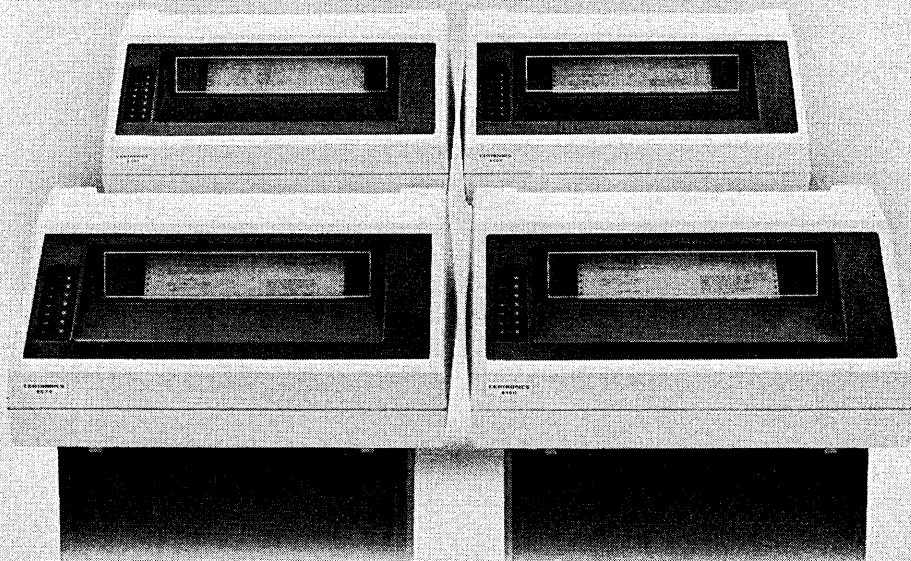

CENTRONICS® PRINTERS
Simply Better

letters

Conversion confusion

Unless there has been a drastic and completely secret ruble devaluation in the Soviet Union, your ruble to dollar conversion in the otherwise excellent article "Snapshots of Soviet Computing" (February, p. 133) is closer to the "black market" than the official ruble exchange rate.

Under the current official exchange rate, 1 ruble is worth about \$1.35. Thus the 22 million rubles becomes almost \$30 million U.S. dollars rather than \$8.25 million as indicated in the article. More importantly, the price of the RIAD ES-1022 at 400,000 rubles is more like

540,000 in dollars—almost four times as much as the article states.

I suspect that when you checked those exchange rates you got the going rate for rubles in the U.S., not in Moscow.

Buying rubles in the U.S. is quite legal; taking such rubles to the Soviet Union where they cost several times more is forbidden, except for diplomats, who are immune from currency regulations.

BOHDAN O. SZUPROWICZ

President

21st Century Research
North Bergen, New Jersey

Thanks for pointing out a confusion—your suspicion is right; we checked with Deak & Co of Los Angeles. Our figures, however, do reflect "real money," i.e., the expression in U.S. dollar terms of what Soviet money, and machines, are worth to the Soviets.

Trade vs. risk

Regarding "High Technology Trade with the Communists" (January, p. 99), the Soviet Union is still regarded in some reactionary quarters as a mortal threat to the survival of this country as a free nation; we spend close to \$130 billion to defend ourselves against the threat posed by the Soviet Union. . . Supplying the Communists important technological products enables them to divert additional resources to develop their war-making capabilities. . .

I refuse to believe that the Soviet Union is going to part with any of their "hard won" knowledge in return for Mr. Norris' computers. Mr. Norris claims that the U.S. is not spending enough on basic research but that by cooperating with the Soviet Union we would be able to take advantage of their strength in this area and "close up a gap in our program." I suggest that Mr. Norris, rather than trying to aid the Soviet

A note to the blind

While Braille line printers are available, their cost can be prohibitive: up to \$20,000. And while IBM and others have had Braille-generating assembly language programs available for years, these are system specific. Therefore, readers may be interested in the following short FORTRAN program for generating Braille on any line printer.

Braille symbols are defined in a two-dot by three-dot matrix, where the upper left dot is "1" and the upper right is "4." Some characters actually take two Braille "cells," and for ease of programming and printing these have been redefined as:

character	dot representation
=	2,4,6
%	1,2,4,5,6
\$	3,4,5,6
(1,2,3,5,6
)	2,3,4,5,6
.	5,6
,	6
"	1,2,6
&	1,2,3,4,6

Output produced by this line printer method runs 45 characters per line, and takes three "regular" lines to produce one in Braille. That is, when printing at eight lines/inch, 22 Braille lines are produced per 11-inch page. Braille readers find the line printer text to be light, but readable. The best printing has been found to require two-ply fan fold paper and overprinting five times (as set by the code in line 280).

My thanks to Mr. Forrest McMains of the MIS Directorate at The Army Research and Development Command in Dover, N.J., for his suggestions and for the use of the CDC 6500 on which the code was tested.

GARY SIVAK

Dover, New Jersey

list all

```

10= PROGRAM BRAIL(INPUT,OUTPUT,TAPE6=INPUT,TAPE7=OUTPUT)
20= DIMENSION INKLIN( 90),IBRLIN(3,135),NTAB(7,50)
30= DIMENSION LTAB(182),ICTAB(168)
40= EQUIVALENCE (LTAB(1),NTAB(1,1)),(ICTAB(1),NTAB(1,27))
50= DATA IDOT,ISPACE/".",""/
60= DATA LTAB/"A",1,0,0,0,0,0,"B",1,1,0,0,0,0,
70= &"C",1,0,0,1,0,0,"D",1,0,0,1,1,0,"E",1,0,0,0,1,0,
80= &"F",1,1,0,1,0,0,"G",1,1,0,1,1,0,"H",1,1,0,0,1,0,
90= &"I",0,1,0,1,0,0,"J",0,1,0,1,1,0,"K",1,0,1,0,0,0,
100= &"L",1,1,1,0,0,0,"M",1,0,1,1,0,0,"N",1,0,1,1,1,0,
110= &"O",1,0,1,0,1,0,"P",1,1,1,1,0,0,"Q",1,1,1,1,1,0,
120= &"R",1,1,1,0,1,0,"S",0,1,1,1,0,0,"T",0,1,1,1,1,0,
130= &"U",1,0,1,0,0,1,"V",1,1,1,0,0,1,"W",0,1,0,1,1,1,
140= &"X",1,0,1,1,0,1,"Y",1,0,1,1,1,1,"Z",1,0,1,0,1,1/
150= DATA ICTAB/"+",0,0,1,1,0,1,"-",0,0,1,0,0,1,"*",1,0,0,0,0,1,
160= &"/",0,0,1,1,0,0,"=",0,1,0,1,0,1,"&",1,1,0,1,1,1,
170= &"$",0,0,1,1,1,1,"%",0,0,0,0,0,0,"(",1,1,1,0,1,1,
180= &")",0,1,1,1,1,1,".",0,0,0,0,1,1,"",0,0,0,0,0,1,
190= &"H",1,1,0,0,0,1,"&",1,1,1,1,0,1,"0",0,0,1,0,1,1,
200= &"1",0,1,0,0,0,0,"2",0,1,1,0,0,0,"3",0,1,0,0,1,0,
210= &"4",0,1,0,0,1,1,"5",0,1,0,0,0,1,"6",0,1,1,0,1,0,
220= &"7",0,1,1,0,1,1,"8",0,1,1,0,0,1,"9",0,0,1,0,1,0/
230= DATA IBRLIN/405*1H /
250= WRITE (7,100)
260= 100 FORMAT (1HT)
270= WRITE (7,200)
280= 200 FORMAT(2HPM,*PLS PUT MAX DENSITY AND 2-PLY PAPER ON 512 PRI
NTER*)
290= WRITE (7,300)
300= 300 FORMAT (1H1)
310= 1 READ (6,400) INKLIN
320= 400 FORMAT ( 90A1)
330= IF(EOF(6) .NE. 0.0) GO TO 2
340= DO 3 IPART = 1,2
350= DO 4 J = 1,45
360= K = 45*(IPART-1) + J
370= LETTER = 1
380= 5 IF(INKLIN(K) .EQ. NTAB(1, LETTER) ) GO TO 6
390= LETTER = LETTER + 1
400= IF(LETTER .LE. 50) GO TO 5
410= 6 DO 4 ICOL = 1,2
420= DO 4 IROW = 1,3
430= IVTAB = 3*(ICOL-1) + IROW + 1
440= IHPOS = 135 - 3*(J-1) - (ICOL-1)
450= IBRLIN(IROW,IHPOS) = ISPACE
460= IF(LETTER .EQ. 51) GO TO 7
470= IF(NTAB(IVTAB,LETTER) .EQ. 1) IBRLIN(IROW,IHPOS) = IDOT
480= GO TO 4
490= 7 IBRLIN(IROW,IHPOS) = IDOT
500= 4 CONTINUE
510= DO 8 IROW = 1,3
530= 9 WRITE (7,500) (IBRLIN(IROW,J),J=1,135)
540= 500 FORMAT (1H+,135A1)
550= 8 WRITE (7,600)
560= 600 FORMAT (1H )
570= 3 WRITE (7,600)
620= GO TO 1
630= 2 STOP
640= END

```

(Continued on page 30)

There's only one thing non- It's non-stop.

Where others fail. It's simple. You must have a non-stop system to have non-stop COBOL. And only Tandem has it. A unique multiple processor on-line system which ensures protection of the data base, and that no transactions are lost or duplicated, even if a processor, I/O channel, disk controller or disk should fail. Best of all, the system keeps running.

Multiple Processor COBOL. Easy.

Bearding the Lion. You'd think that programming for a multiple processor on-line system would put you in a jungle, but Tandem COBOL purrs. Completely standard.

Because Tandem COBOL runs under our Guardian Multiple Processor Operating System, no custom system software is required. No special development tools are required. None. Our COBOL program development is standard. Our run-time software is standard. Everything you've always liked about COBOL, easy to use and trouble-free. And COBOL programs can run concurrent with other languages.

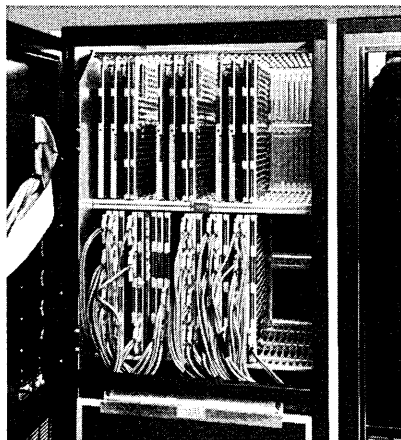

Four BILLION bytes per file. With no limit on the total data base size. Key sequenced, entry sequenced or relative file structures. With up to 255 alternate keys per file. And optional mirror copy by disk volume. It's incredible storage and tremendous flexibility in a mini-based system. And of course, it's non-stop.

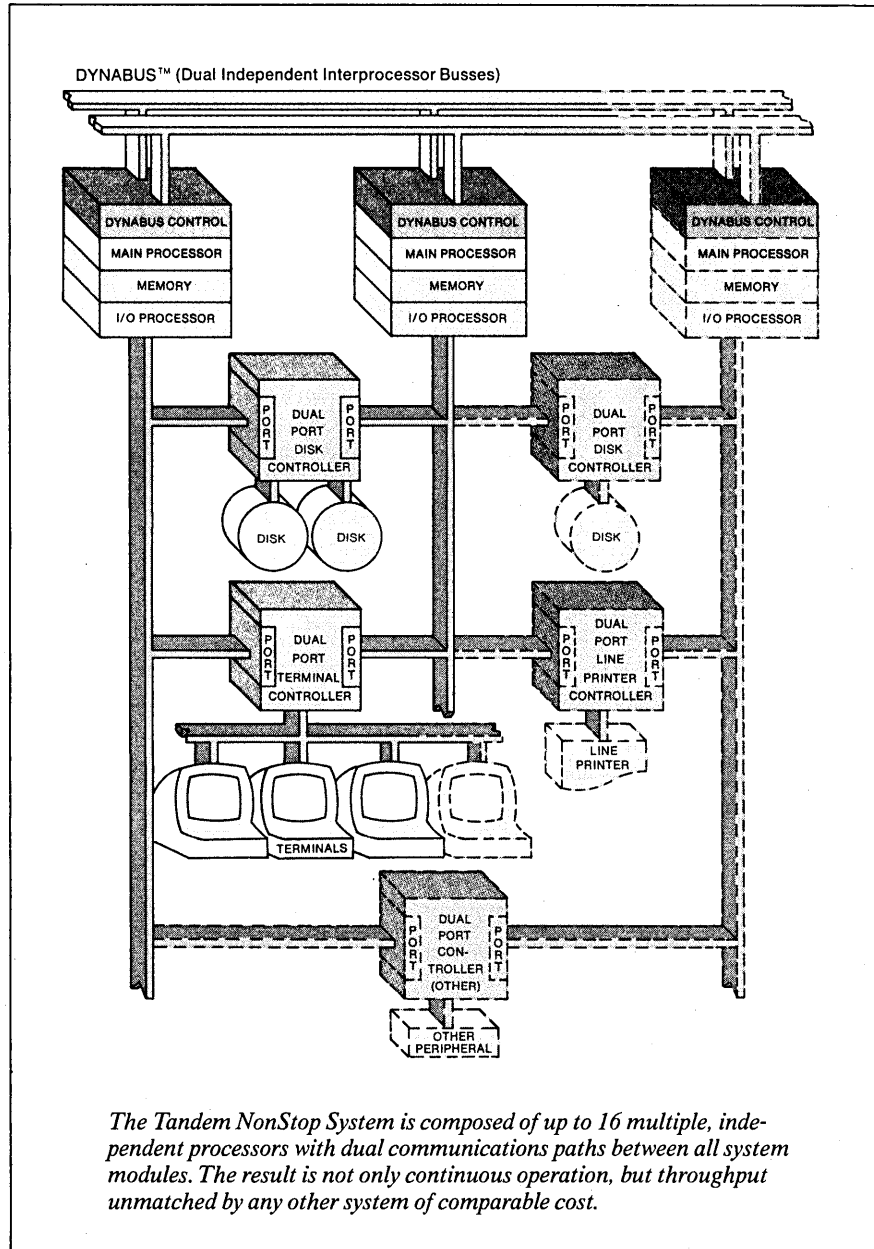

Sharing a common data base. Three new verbs, LOCKFILE, UNLOCKFILE, and UNLOCKRECORD have been introduced to the Tandem COBOL I/O facility to permit the use of corresponding system file and record locking routines, and allow separate processes to share a common data base. READ and REWRITE verbs have been extended to allow specification of LOCK or UNLOCK operation. OPEN syntax has been

extended to specify the file access, EXCLUSIVE, SHARED, or PROTECTED, and to permit the SYNCDEPTH for files opened in the OUTPUT, I/O or EXTEND mode.

With STARTBACKUP and CHECKPOINT. These are logical extensions of Tandem COBOL which implement the NonStop™ features of Guardian Multiple Processor Operating System. STARTBACKUP is called once at the

standard about our COBOL.

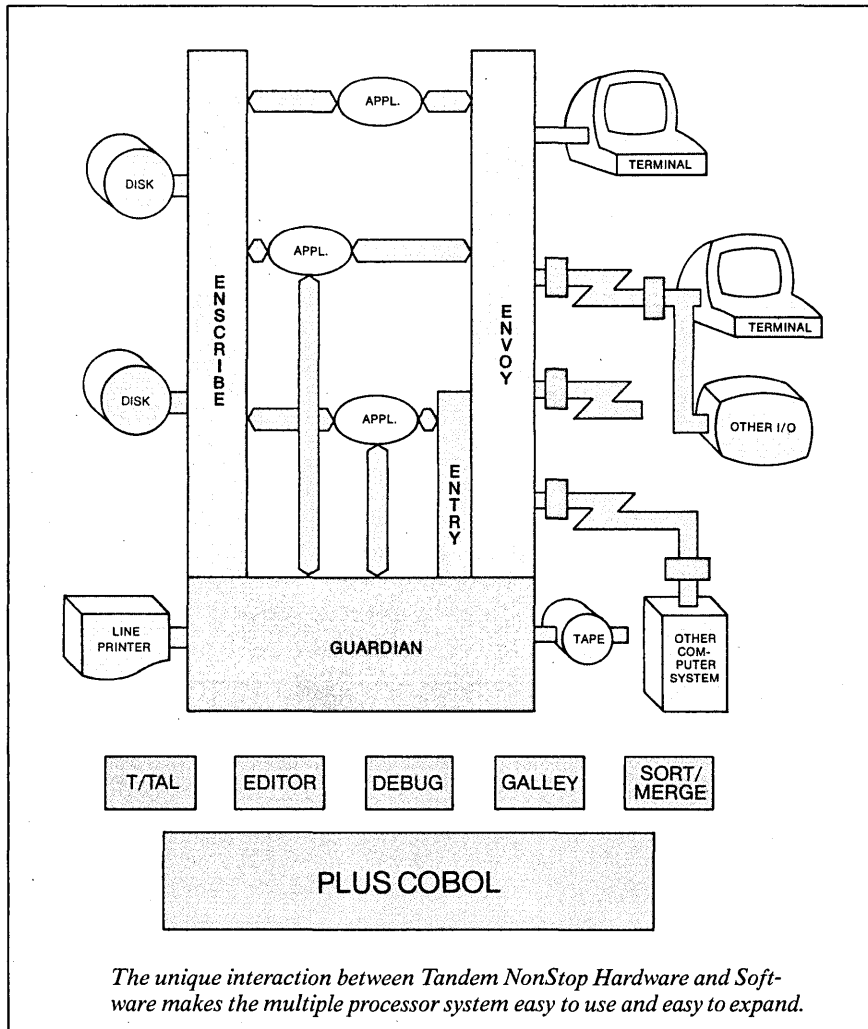

beginning of the program to set the NonStop mode. From then on, CHECKPOINT controls passing information to the backup process at critical points. CHECKPOINTS occur automatically at any OPEN or CLOSE after the backup is established. These two simple instructions eliminate the downtime, restart, and revalidation which plague any user without the Tandem NonStop capability.

ANSI X3.23 '74 to Level 2 in Nucleus, Table Handling, Sequential I/O, Indexed I/O, and Sort-Merge right now. With Communications to Level 2 this Spring. Completely standard with CVSS and that means portability.

Compiles more than 1,000 statements per minute. And that's only average. In some benchmarks, we've topped 1,250 statements per minute. It's big system COBOL at mini-based prices. And non-stop, too. Not even the largest computers can match that.

It's working now. There are more than fifty Tandem NonStop Systems installed in a variety of applications. In banking, distribution, department stores, utilities, legal firms, hospitals, universities, steel mills, even a municipal network emergency system. Wherever downtime or a system failure means a potentially unrecoverable loss.

There's only one NonStop System on the market today. It's expandable without penalty. Without reprogramming. Without one cent of loss on the original investment. And it's easy to use as COBOL. Good old standard COBOL without the operational difficulties or special expense you'd expect in an on-line multiple processor system which won't quit.

For further information, contact Tandem Computers, Inc., 19333 Valco Parkway, Cupertino, California 95014 or Tandem Computers GmbH, Bernerstrasse 50, Frankfurt 56, West Germany.

TOLL FREE 800-538-9360 or (408) 996-6000 in California.

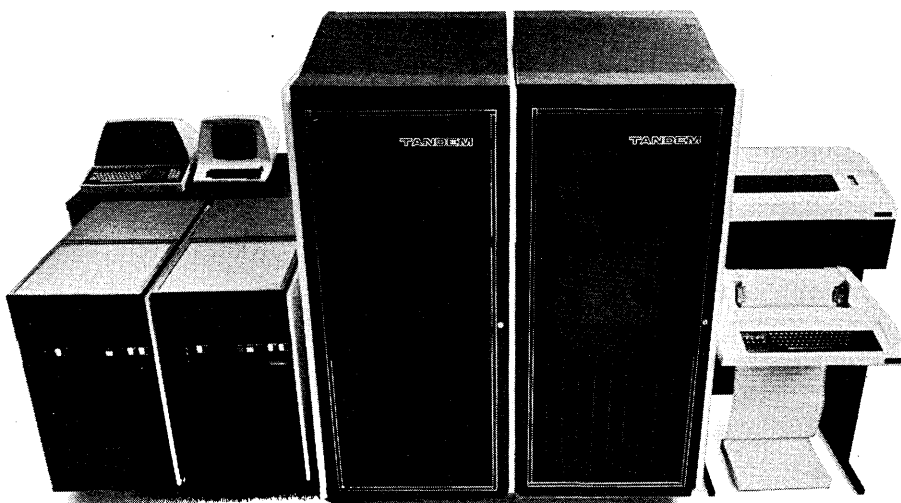

TANDEM

Don't Replace Your 3270s Without Sending For Our Kit.

So far, every company that's bitten on our free 30-day trial offer has decided to keep our equipment. Very good, but not surprising.

Because they all proved to themselves Trivex Plus 70 terminals are more versatile than IBM 3270s. And they did it without biting the bullet. Without danger of obsoleting their systems. Or hurting their user service reputations.

That's the beauty of our Mix and Match Plan: We give you one of our terminals (or a whole system if you want) to try for 30 days. Free. You just plug it in. It's *completely* compatible

with IBM 3270 units. The same goes for our controllers and printers. So you can mix and match our equipment with IBM's any way you want to.

Then you sit back and watch how well our equipment works alongside theirs. You'll see what ours gives you that IBM's doesn't. Features like in-line, on-line and off-line diagnostic capability. Local display-to-print capability. OCR wand. High-resolution, non-glare CRT. Prompting line. Cursor position indicator. Statistical package. And 10-key numeric pad. Features you won't get from IBM for years. If ever. And all Trivex 3270-compatible devices are micro-processor controlled. They're software-modifiable to future changes in network requirements.

Meanwhile, you'll find out our equipment also costs less than IBM's.

Once your 30 days are up, unplug our Plus 70 System and send it back. No problem. Or, like those who've tried it, you can keep it.

Now you've got to admit biting on an offer like this is a lot better than biting the bullet. Just call the number below or write us on your letterhead. A salesman will bring you information on our Mix and Match Plan along with an Executive Decision-Making Kit, complete with operating instructions and a real bullet.

Then we'll give you our best shot.

Write: 3180 Red Hill Ave., Costa Mesa, Ca. 92626 • Phone: (714) 546-7781, (800) 854-3810 or 854-3819.

TRIVEX

Offices in San Jose, Calif. (408) 226-3766/Oakbrook, Ill. (312) 325-8108/Detroit, Mich. (313) 528-2175/Ft. Lee, N.J. (201) 461-4712. European Distributor: Synelec, Telex: 22114 Paris, Brussels, Munich, Amsterdam.

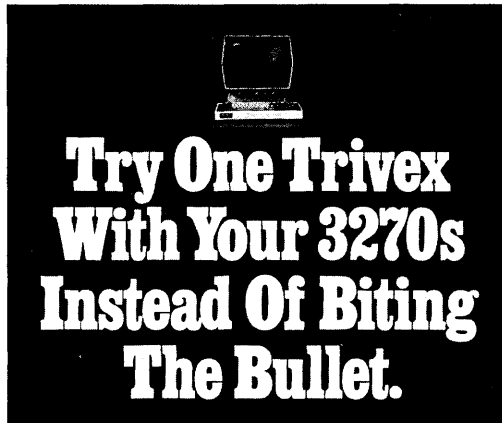

You'd like to replace your IBM 3270s with more versatile terminals. And make you a hero. But the first step is biting the bullet because things could blow up in your face. That's why Trivex invented the free 30-day Mix and Match Plan. It gets rid of the risk of obsoleting your system. Or hurting your user service reputation.

Here's how it works: We'll give you one of our Trivex Plus 70 terminals for a system if you want to try for 30 days. Free. Just plug it in. There's nothing else to do because it's completely compatible with IBM 3270 units.

Our terminals not only cost less than IBM's, you'll find that you never find out you won't get from IBM for years. If ever.

Call the number below or write us on your letterhead. Our sales rep will bring you information on our free 30-day Mix and Match Plan along with an Executive Decision-Making Kit.

It's our offer you should bite on.

Don't Replace Your 3270s Without Sending For Our Kit.



© 1985 Trivex, Inc. All rights reserved. IBM, 3270, 3270-1, 3270-2, 3270-3, 3270-4, 3270-5, 3270-6, 3270-7, 3270-8, 3270-9, 3270-10, 3270-11, 3270-12, 3270-13, 3270-14, 3270-15, 3270-16, 3270-17, 3270-18, 3270-19, 3270-20, 3270-21, 3270-22, 3270-23, 3270-24, 3270-25, 3270-26, 3270-27, 3270-28, 3270-29, 3270-30, 3270-31, 3270-32, 3270-33, 3270-34, 3270-35, 3270-36, 3270-37, 3270-38, 3270-39, 3270-40, 3270-41, 3270-42, 3270-43, 3270-44, 3270-45, 3270-46, 3270-47, 3270-48, 3270-49, 3270-50, 3270-51, 3270-52, 3270-53, 3270-54, 3270-55, 3270-56, 3270-57, 3270-58, 3270-59, 3270-60, 3270-61, 3270-62, 3270-63, 3270-64, 3270-65, 3270-66, 3270-67, 3270-68, 3270-69, 3270-70, 3270-71, 3270-72, 3270-73, 3270-74, 3270-75, 3270-76, 3270-77, 3270-78, 3270-79, 3270-80, 3270-81, 3270-82, 3270-83, 3270-84, 3270-85, 3270-86, 3270-87, 3270-88, 3270-89, 3270-90, 3270-91, 3270-92, 3270-93, 3270-94, 3270-95, 3270-96, 3270-97, 3270-98, 3270-99, 3270-100.

Everyone That Bit On Our 3270 Offer Is Now A Customer. Why?

We'll even charter a jet if necessary.

IDMS, now
the only
Database System
on the Datapro
honor roll for the
second consecutive
year.



"IDMS has the best vendor support"* *say users in Datapro study

In the fifth annual Datapro Research survey of software users, Cullinane's IDMS, the only DBMS on the Datapro Honor Roll for the second consecutive year, was again rated #1 in Vendor Support.

Many of our users are literally running their businesses with IDMS. So when they want Vendor Support, they want it now, and often on site.

To us, Vendor Support isn't just having competent people answer the phone when you call. It's going the extra mile to be on-site, as soon as possible, if need be. And that includes

weekends, holidays, Superbowl Sunday.

We do this with a dedicated team of computer trouble-shooting experts, headed by Ron McKinney. Most times the problem is not with IDMS. But like all our specialists, Ron and his group care. Care that your whole computer system works properly.

For the complete story — including technical literature on IDMS and a schedule of seminars for your area — send this coupon, or phone us at (617) 237-6600.

Think twice. You'll choose the database system with satisfied users.

Name _____

Title _____

Co. _____

Address _____

City _____ State _____ Zip _____

Tel. () _____

My computer is _____



Cullinane Corporation

Wellesley Office Park, 20 William St., Wellesley, Mass. 02181 (617) 237-6600

T-Bar MASS™

Multiple Access Switching System

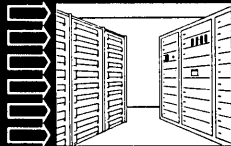

Equipment for Network Management

Brings your control up front

T-Bar MASS switching centralizes your network management, access to your communication lines, instrumentation and technical staff in a single location. MASS presents up to 512 Digital or Analog data communications lines where and when you need them for diagnostics - at a central console conveniently located remotely from the communication racks.

For further information, write T-Bar, Data Communications Switching Division, 141 Danbury Road, Wilton, CT 06897. Or call (203) 762-8351.

T-bar INCORPORATED
®

CIRCLE 154 ON READER CARD

letters

(Continued from page 25)

Union maintain their supremacy in basic research, inform his government that it should spend more on basic research because the U.S. is rapidly falling behind the Soviet Union in this vital field. . .

In my opinion our defeat by the Soviet Union can still be prevented by maintaining a clear military superiority and by not trading with the enemy in any shape or form, be it grain, ball bearing factories or CDC computers.

F.O. GULBRANDSEN
San Diego, California

Mr. Norris replies: Mr. Gulbrandsen is apparently unwilling to look for facts or accept those that are at hand. Instead he offers mostly obfuscation and woefully little in the way of solutions.

With regard to his main suggestion that I should inform my government that it should spend more on basic research; as a matter of fact, I have, including the heads of most departments and many members of Congress. But I have done much more by participating in various government committees, and for more than a year I have been working with the staff of one senator to help formulate legislation aimed at facilitating the creation and application of technology. It is planned that this legislation will be introduced later in the year.

Mr. Gulbrandsen refuses to believe that the Soviet Union is willing to part with any of their "hard won" knowledge in return for computers yet the literature is full of references to technology that the Soviet Union has sold to the West. My company has a list of over one hundred technologies that the Soviet Union is seeking to sell.

"The gut issue in high technology trade with Communists is jobs versus military risk" (the opening sentence of my article). Mr. Gulbrandsen apparently doesn't share my deep concern over unemployment. As I emphasized in the article, what we have here is basically a matter of priorities.

More on IBM user survey

The piece entitled "Too Little Too Late" in your January News in Perspective section (p. 180) refers to a recent survey of 4,200 IBM users by G. S. Grummen/Cowen. In fact, this survey was of 2,200 IBM users, a very large sample nonetheless.

The survey showed that 74% of the 303X systems these users were planning to install during the next two years would be purchased. However, while your article said this percentage is higher than that for the systems at the top end of the 370 line planned to be installed during the same timeframe, that

(Continued on page 34)

DATAMATION



The secret to success is a little bit of selfishness. And Perkin-Elmer peripherals.

We're a little bit selfish.

Let's face it.

You want to be successful. We want you to buy Perkin-Elmer peripherals.

The more successful you are, the more Perkin-Elmer peripherals you buy.

That's why we set up our entire peripherals operation to help make you more successful.

It's really quite simple. And a little bit selfish. Here's the way it works.

We make you really price competitive.

At Perkin-Elmer, we know a "stripped down" peripheral doesn't always make you competitive. And a peripheral with more features than you need can be just as bad. So at our Terminals and Wangco Divisions, we build peripherals with only the features you want, and you pay only for the features you need.

Using our peripherals in your product means your product hits the market sooner and stays on the market longer. Because, together, we thought it out. And matched it to the application. From the very beginning.

Over 200,000 quality products.

When you buy Perkin-Elmer, you buy proven quality. Right now, Perkin-Elmer has over 200,000 terminals, printers, and disk, tape, and floppy drives out there. Working. In systems just like yours. That's quality.

Support when you need it.

And, when it comes to support, we're available. For consultation. Product planning. Training (your people or your customers). And especially for service. In fact, one call to our No-Hassle Toll-Free 800 number gets you service. When you need it. Where you need it.

QC to stretch your service dollars.

Uncompromising QC. That's how we became a Fortune 500 company.

Perkin-Elmer QC people and their test procedures are the best in the industry, which means your product is more reliable and your service dollars go a whole lot further. We invite you to join us and see for yourself.

Now you be a little bit selfish.

In fact, why not get started right away? For more information, write Perkin-Elmer Data Systems Sales and Service Division, 106 Apple Street, Tinton Falls, New Jersey 07724 or telephone toll-free (800) 631-2154.

PERKIN-ELMER

Data Systems

XEROX COMPUTER SERVICES. THE MOST COMPLETE ON-LINE MANUFACTURING AND ACCOUNTING SYSTEM YOU CAN FIND.



ON-LINE SERVICES OR PACKAGED SOFTWARE.

Xerox Computer Services can handle your toughest applications. Because we have the most complete on-line system available. Capable of doing anything you require. Like Master Scheduling, MRP, Inventory Control, Production Control, Cost Accounting, Order Processing, Payroll, Financials, and Receivables.

IMMEDIATE INSTALLATION.

And you can take advantage of our Nationwide Communications Network, Business Expertise, and Integrated Manufacturing and Accounting Applications as soon as you're ready. Call us and we'll install one application or all integrated applications in your choice of locations.

SYSTEMS THAT WORK TODAY.

A System is only as good as the results it generates. Xerox Computer Services has helped over 600 companies to manage better and to increase profits. Like the film projector manufacturer who closed down a 20,000 square-foot parts warehouse while maintaining sales volume. And the scaffolding manufacturer who discovered after his first MRP run that he could meet his plan with only half the stock he had on hand.

LOCATED THROUGHOUT THE U.S.

If you're having difficulty with the tough applications on your in-house system or if you don't want the problems of installing your own computer, call us. We'll show you what we can do. Contact Ron Rich at Headquarters, 5310 Beethoven Street, Los Angeles, California 90066 or phone us at one of our branch offices. Los Angeles (213) 390-3461, San Diego (714) 239-9271, San Francisco (415) 873-2800, Dallas (214) 233-6101, Houston (713) 868-3407, Chicago (312) 833-0770, Cleveland (216) 464-4985, Milwaukee (414) 271-9990, New York (516) 938-8200, Philadelphia (215) 646-7750, New Jersey (201) 368-9300, Seattle (206) 788-3829, Winston Salem (919) 722-5167.

XEROX COMPUTER SERVICES.

XEROX

XEROX® is a trademark of XEROX CORPORATION.

Sly buy.

A CRT that costs more but actually costs less.

At \$907,* our Perkin-Elmer Model 1100 CRT Terminal has been the price-performance leader in the CRT business for almost a year. Recently, some CRT makers cut their prices to a few dollars below ours.

Don't be fooled. The Model 1100 still costs less. Here's why.

Program debugging takes less time.

You'll save the few extra dollars you spend for our CRT the first time a programmer uses it for debugging a program. The secret? A feature called Transparent Mode, which displays everything coming down the line—including control characters—and helps solve the most complicated host computer and communication link problems in seconds.

Operators make fewer errors.

You'll save money day after day with the Model 1100. Thanks to a 9 x 12 character matrix, the Model 1100 has crisp, clear, strikingly sharp characters. So operators see their work better and make fewer mistakes.

The Model 1100 also has a hooded display to eliminate reflection and end eyestrain. The display is right at eye level, too, which means no bending, no neck problems, and less fatigue.

All our standard goodies.

A big 12-inch screen, 128-character ASCII set, upper and lower case, Typamatic repeat on all keys, and a 24-line display are standard. The same goes for our exclusive No Hassle toll-free 800 number. One call gets you service. Where you need it. When you need it. Worldwide.

The Perkin-Elmer Model 1100. Feature for feature, it still costs less.

For more information, write Perkin-Elmer Data Systems Sales and Service Division, 106 Apple Street, Tinton Falls, New Jersey 07724 or telephone toll-free 1-800-631-2154.

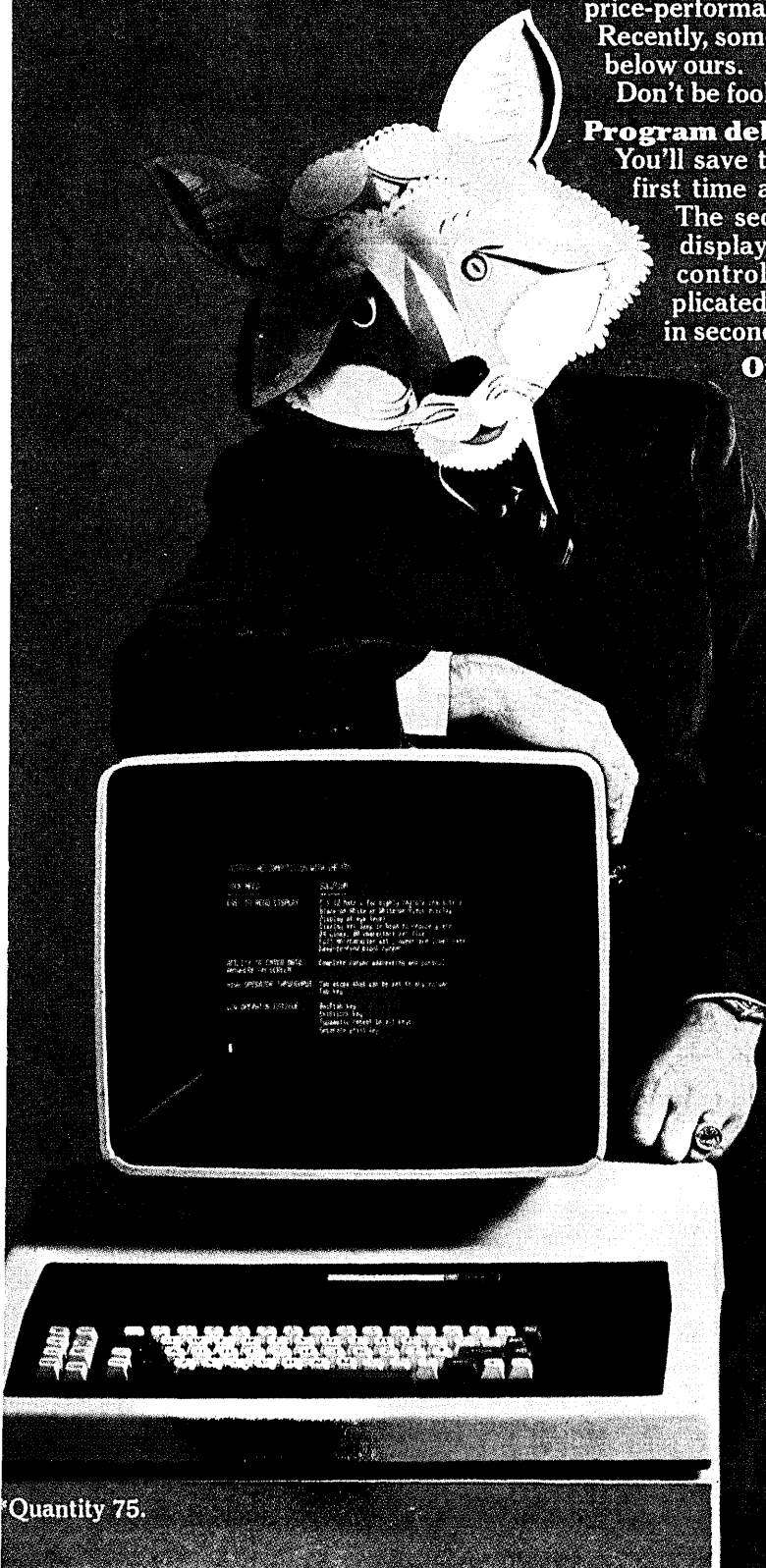

*Quantity 75.

PERKIN-ELMER
Data Systems

Now, a book for the practicing professional...

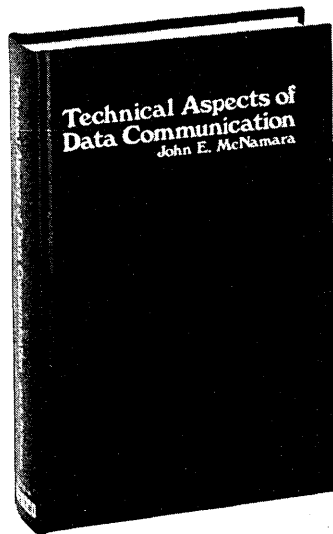

"This is the best handbook of data communications system technology that this reviewer has yet encountered." — Arvid G. Larson, *ACM Computing Reviews*, February 1978

Digital Press announces the publication of **TECHNICAL ASPECTS OF DATA COMMUNICATION** by John McNamara.

Written for the practicing professional, **TECHNICAL ASPECTS OF DATA COMMUNICATION** details the nuts-and-bolts problems and solutions in configuring communications systems. It features:

- comparison of protocols (DDCMP, BISYNC, SDLC)
- extensive explanation of interface standards (CCITT/V.24, RS232C, RS422, RS423)
- six comprehensive appendices (how far/how fast?, modem options, codes, UART, format and speed table for asynchronous communication, channel conditioning)
- 20 milliamper loop
- telephone switching systems
- error detection

• 382 pages • 125 figures • 70 pages of tables • index • hardcover

digital

D48
Digital Press
Educational Services
Digital Equipment Corp.

Crosby Drive, Bedford, MA 01730

I would like to order _____ copies of
**TECHNICAL ASPECTS OF DATA
COMMUNICATION** at \$19.95 per copy.
 Check enclosed Money Order enclosed
(Note: Minimum order for Digital Press to
process purchase order is \$35).

Name _____

Address _____

City _____ State _____ Zip _____

Prices apply in U.S. only.

letters

(Continued from page 30)

percentage is far *lower* than the percentage for the 370/158 and 168 systems already installed.

Our survey did not, as your reporters stated, "indicate that during late 1979 and 1980 the remaining bulk of the 370 line will come off lease." Rather, referring only to 370s on lease from third parties, our data indicated that the majority of these leases would still have one year or more to run as of the end of 1980.

As to 303X delivery schedules, the subject of your article, the survey respondents indicated plans to install more than 380 303X and 3032 models. The rest were 3033s. The survey was completed before IBM had assigned 3031 and 3032 delivery positions, but 3033 delivery slots had long since been determined and our data showed a substantial percentage of these being shipped to domestic users prior to the end of 1978.

BARRY ROSENBERG
G. S. Grummen/Cowen
Boston, Massachusetts

Erratum

Thank you for your recent article about INTELCOM 77, "Previewing 1978's Telecommunications Problems" (January, p. 157).

I would like to bring to your attention an error, however, in your record of the attendance (second paragraph). Your figure was 3,000 attendees, when, in fact, the event attracted 8,000 communications specialists (with 25% of them traveling from outside the U.S., by the way).

JOAN HYDE
Assistant General Manager
Intelcom
Dedham, Massachusetts

Our apologies for the typo.

By any other name

We were pleased with your article "User Ratings of Software Packages" (December, p. 117); especially since our sorting package CA-SORT was once again top-rated.

CA-SORT, however, is a *three-time* winner; not only did we place in 1977 and 1976, but in 1975, as well, when the package was marketed in the U.S. by Pansophic Systems under the name of PAN-SORT. Whether PAN-SORT or CA-SORT, the package is the same, and that is what the users have rated, not the name.

ROBERT MARCH
Public Relations Director
Computer Associates
Ain, France

In "User Ratings of Software Packages" the QPAC Payroll System was listed as "no longer marketed." Fortunately for the hundreds of users worldwide, this is not true!

The QPAC Payroll System is available from QPAC America, Inc., One Perimeter Road, Grenier Field, Manchester, NH 03103. It is being actively supported, enhanced and marketed throughout North America, and is available for IBM 360/370 mainframes from \$25,000.

DESMOND C. GERS
Director
QPAC America, Inc.
Manchester, New Hampshire

Our respondent's vendor was Software International. We're happy to hear the product is still available.

SPSS specifics

In the listing of our product in "User Ratings of Software Packages" our package SPSS/C was not specified as running on the DEC PDP-11 series of computers. It is running under the RSTS/E, RT11, and RSX11 operating systems. We would not wish readers to think it will run on other computers.

GRAHAM KIMBLE
Director of Computing Activities
Carleton College
Northfield, Minnesota

Kudos on micros

Congratulations to Portia Isaacson. I think her January column (Personal Computing, p. 224) was the best article I've seen dealing with the subject of using micros in business. I was especially pleased to see specifics as to exactly what applications were programmed, the program size, and the type and cost of hardware.

Local computer stores are the key to the success or failure of micros in small business. Businessmen are prone to buy their computers from manufacturers. It is only through articles like Dr. Isaacson's that (businessmen) will get the message that the local store is the place to acquire sales, service, and hand-tailored software.

LEROY FINKEL
Menlo Park, California

We welcome reader correspondence on subjects pertinent to the data processing field and its relation to society, or on the contents of DATAMATION. We will not publish unsigned letters, but will withhold names if necessary. Please type your letter, double-spaced, and be as brief as possible. We reserve the right to edit letters or to use excerpts. Write to 1801 S. La Cienega Blvd., Los Angeles, CA 90035.

Honeywell Series 60: Everything you need for your long range strategy.

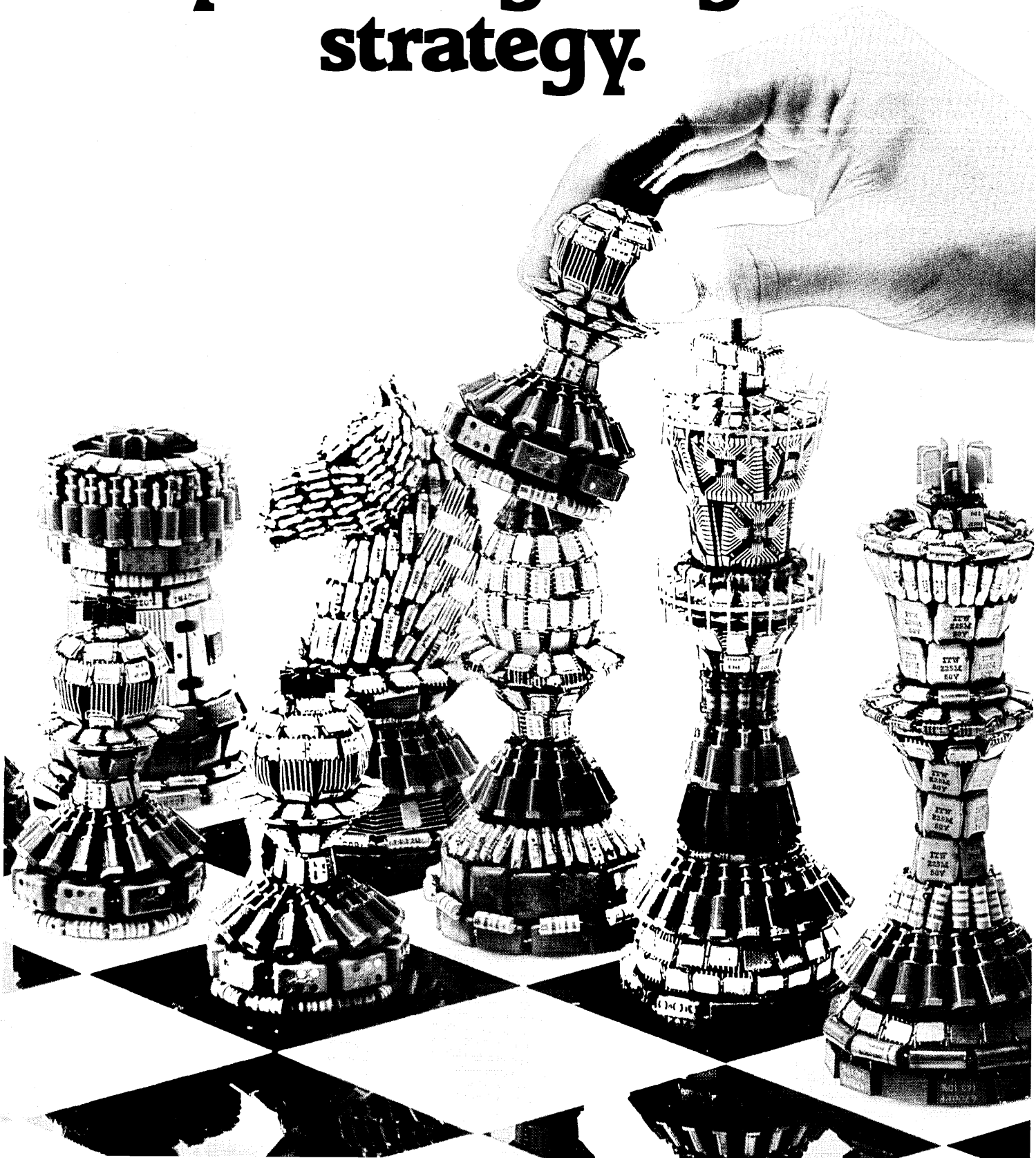

Honeywell Series 60: Steady advances on every front.

Series 60: A full family of computers, from minicomputers to large-scale systems. There are modular levels of hardware and software with lots of opportunity for growth within each level and easy transition from level to level.

Successive levels are linked by common Series 60 programming languages, compatible file formats and communications protocols. Levels 6 through 66 run under control of Honeywell's General Comprehensive Operating Supervisor (GCOS). Complete implementation at the upper end sets the overall standard. GCOS subsets provide large-system features and easy growth at lower levels and support interconnection of two or more Series 60 levels in communications networks. Level 68 operates under the Multics operating system.

Hardware and software technology includes metal-oxide semiconductor (MOS) memory, microprogramming, dual logic circuitry, automatic error detection and correction, and self-diagnosis. All levels are communication-oriented. Mini-based network processors (for all but smaller systems) yield high communications throughput, minimize overhead.

Data base management capabilities are emphasized throughout. The basis is Honeywell's Integrated Data Store/II (I-D-S/II) which embodies industry-standard data base specifications. Level 68 also has Multics Data Base Manager (MDBM) which includes a fully implemented relational data base system that offers unmatched functionality and ease of use. Special

end-user facilities make access easier. Security provisions guard against unauthorized or accidental access.

Series 60—a unified family of easily expandable levels of processing power able to meet advanced requirements in online transaction processing, networking, distributed systems. Flexible enough to incorporate technological advances, evolve with changing applications.

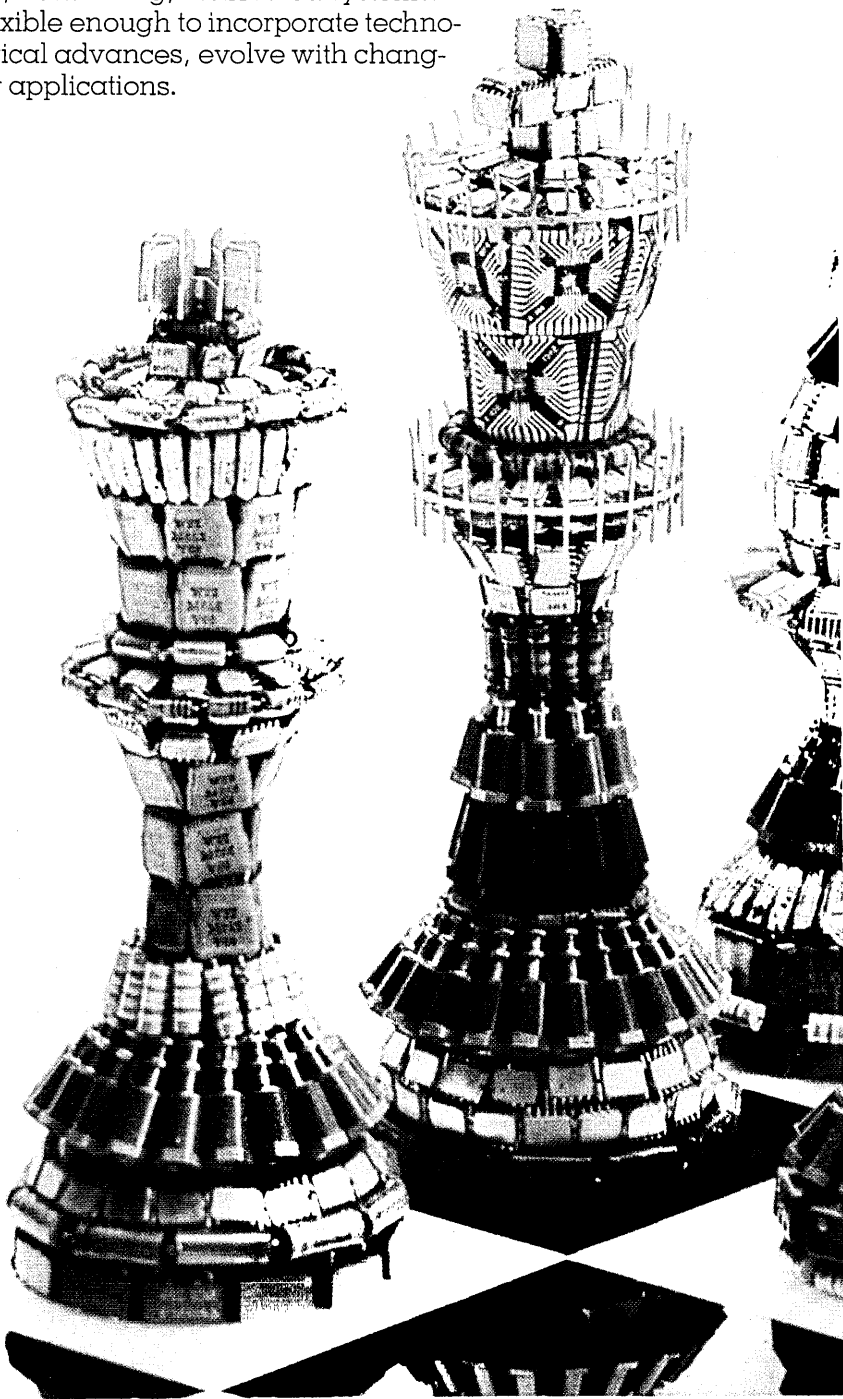

Across-the-board power in the Distributed Systems Environment.

Decentralization of processing power and establishment of data bases on two or more separated but interacting processors. That's the essence of the Distributed Systems Environment. Its promise is increased productivity: Giving more people, in more places, more processing power to work with, and more up-to-date data to work

from. But different people, different procedures, different policies, different philosophies, different organizations all require different approaches.

Honeywell's Distributed Systems Environment is a flexible, open-ended approach to distributed processing.

Off-loading the central host processor to peripheral, network and satellite processors is a fundamental concept of Series 60. Add Honeywell's multidimensional operating system software (GCOS or Multics) and you have the basic elements for implementing a distributed systems network.



Level 68/DPS

Level 68/DPS (Distributed Processing System): A combination of large-scale hardware, Multics software and firmware. Included is a powerful virtual memory capability designed specifically to answer user needs for increased productivity. The system operates simultaneously in many compatible modes – transaction processing, batch processing, time sharing, remote job entry, online inquiry, interactive graphics, and word processing – all with unrivalled system security and data integrity. Level 68/DPS provides comprehensive and easy-to-use facilities for sharing resources and coexisting in a distributed environment with computer systems of other manufacturers. The basic architecture is designed for online interactive processing and serves as an ideal vehicle for terminal driven applications.

It provides comprehensive tools for nearly everyone in a business organization. Simplified and uniform control language for all processing modes shortens the problem-solving cycle. A powerful end-user facility called Logical Inquiry and Update System (LINUS) is easy to use – by both technical and non-technical people. There are also powerful, efficient facilities for system and application

software generation, including interactive source-level debuggers and online language processors such as PL/1, APL, COBOL-74, FORTRAN, RPG, and BASIC.

Level 68/DPS is a single model available in four performance levels. Each level supports up to 16 megabytes of main memory. The fourth level is expandable to a maximum of six independent processors under control of one operating system.

The base level system includes a minicomputer-based integrated network processor (INP) for up to 96 communications links. This INP is expandable from 64 to 192 kilobytes of main memory.

Level 68/DPS and Multics – considered to be the most secure computer system available – provides a particularly safe repository for your vital mainstream records and processing software.

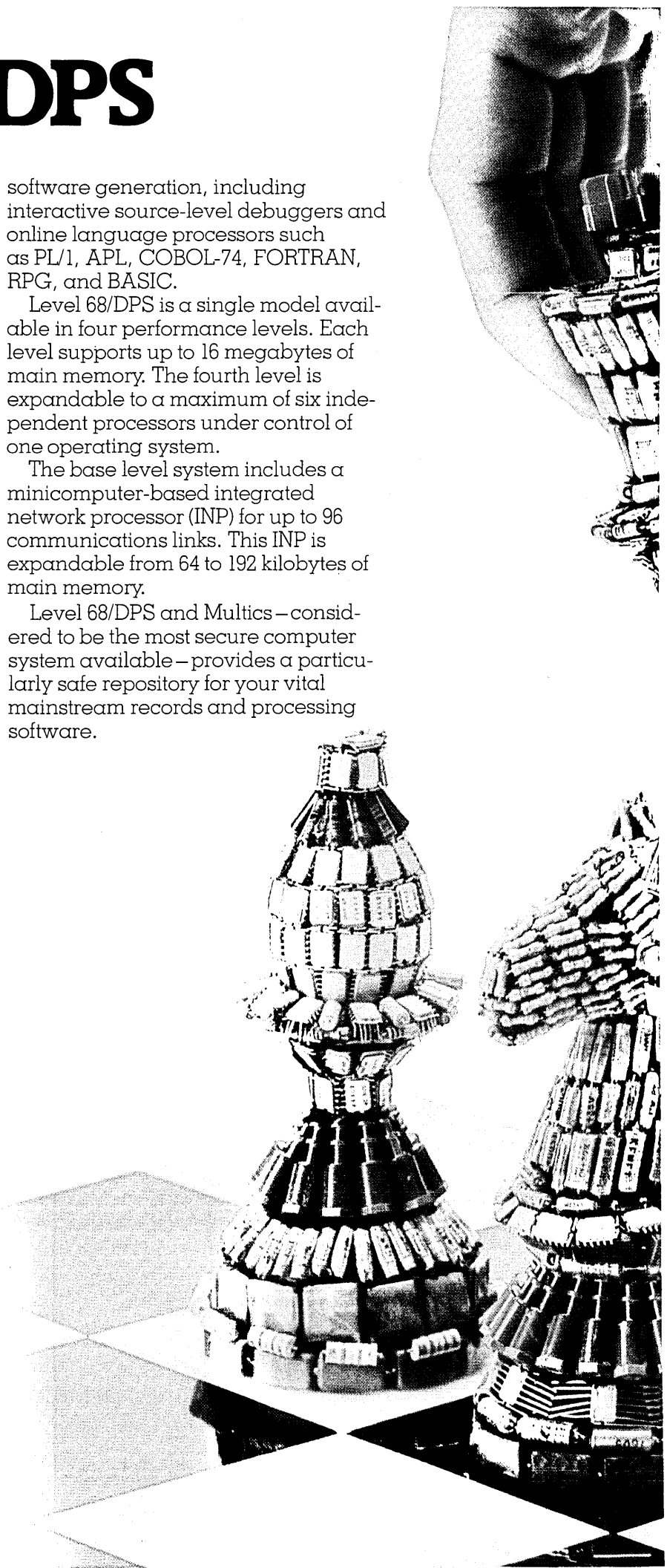
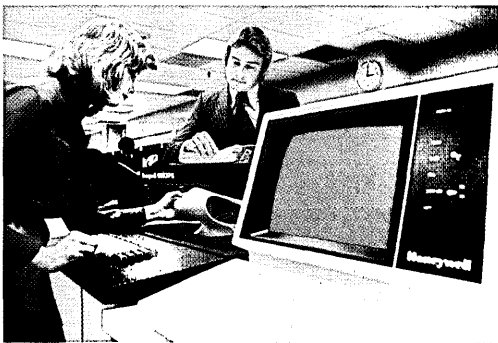

Level 66/DPS

Level 66/DPS (Distributed Processing System): A large-scale unit particularly well-suited to applications requiring high-availability, expandability, and extensive communications.

The base level includes twin separately powered information processors in one cabinet, a single system control unit, input/output multiplexer, and one megabyte of MOS memory.

Main memory can be expanded in increments up to a maximum of eight megabytes. A single GCOS operating system controls both processors, provides multiprogramming and multidimensional capabilities, including

simultaneous operation of transaction processing, batch processing, time-sharing, remote job entry, and online inquiry modes. One or two companion processors may be added.

The base level 66/DPS system includes a minicomputer-based integrated network processor (INP) for up to 96 communications links. INP memory is expandable from 64 to 192 kilobytes. Software includes the General Remote Terminal Supervisor-II (GRTS-II) or the Network Processing Supervisor (NPS). Both support visual display keyboard and printer terminals, remote job entry devices, and satellite processors. NPS also handles message-switching applications.

Honeywell's versatile data management software, Data Management-IV (DM-IV), is fully supported, including a COBOL-74 language interface and a new batch-mode FORTRAN interface. DM-IV performs all management services for large data bases — data base creation, security control, and accessing for transaction, inquiry/response, or batch activity. Level 66/DPS — versatile, expandable, reliable host processor performance for distributed system applications.

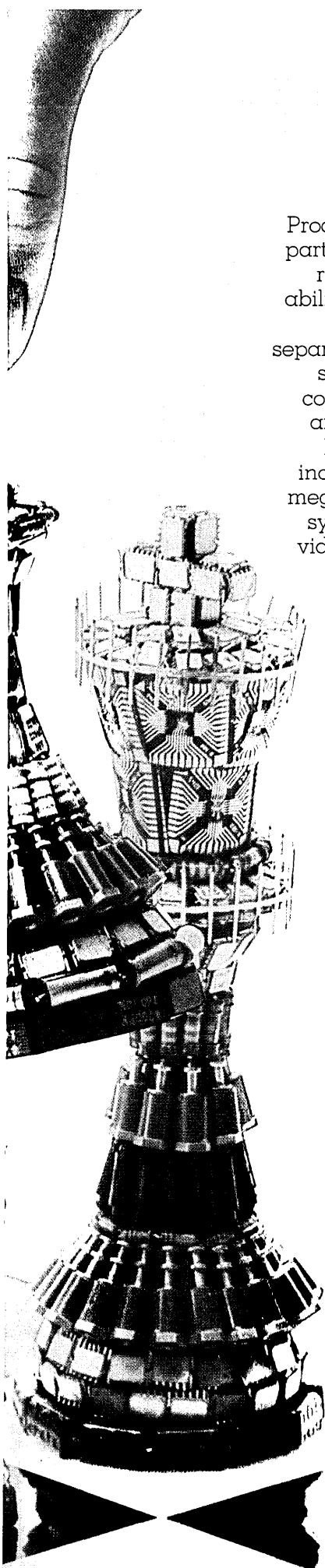

Level 64

Level 62

Level 64: A medium-scale system that delivers the functionality of most large-scale systems — multidimensional growth, data communications, transaction orientation.

Integrated, microprogrammed mass storage, unit record, and magnetic tape processors off-load time-consuming peripheral control operations from the central processor. The unit record processor also handles data communications over as many as 42 links and supports a wide variety of local or remote terminals or connections to other systems.

Level 64 GCOS is a multi-programming, virtual memory operating system with automatic memory management. It includes extensive data protection, system integrity, and job accounting provisions. Key subsystems include Interactive Operations Facility (IOF), Transaction Driven System (TDS), and Integrated Data Store/II (I-D-S/II) data base system. It supports industry-standard programming languages RPG, COBOL and FORTRAN.

Versatility, ease-of-use, communications orientation, and reliability make Level 64 a sound investment for growth-oriented, distributed-systems-minded organizations.

Level 62: The small system with a built-in future. It keeps going strong where most small systems leave off. Through field upgrades, main memory is expandable from 48K to one million bytes. Basic systems performance can be easily expanded to a level more than twice as fast. Six I/O channels support up to six independent subsystems, including integrated data communications controllers for up to 25 links.

Level 62 GCOS simplifies operation and programming. It supports industry-standard RPG, COBOL, and FORTRAN and provides data management techniques for file management, retrieval.

It allows many jobs to be run concurrently, in both batch and transactional environments. It supports online data query and remote job entry from video display or hard-copy terminals. Data communication facilities support data collection from, or distribution to, remote sites and computer-to-computer transmissions.

Program and file conversion aides, such as Liberator/3 for System/3 computers, ease transition to Level 62 from other Honeywell or competitive systems.

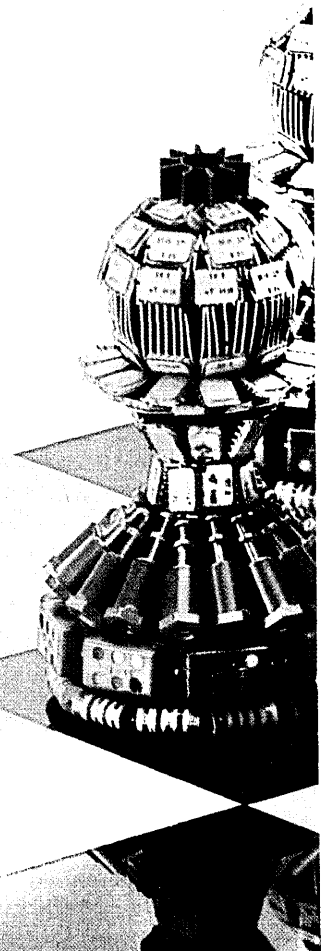
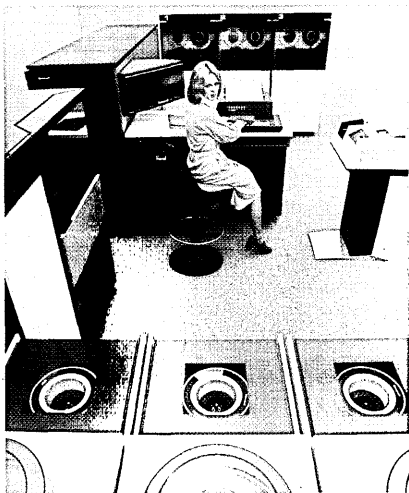

Level 6

Level 6: Building-block mini-computer hardware and software with modular, open-ended architecture that's equally at home in an OEM, system builder, or end-user environment.

Level 6 systems provide throughput of up to 6 million bytes per second on a bi-directional asynchronous Megabus communications path.

High performance semi-conductor memories are available in either 16K or 4K MOS chips providing up to 256K bytes per board. The newest models can accommodate up to 2 million bytes of main memory; all models can support billions of bytes of disk storage. A commercial model processes COBOL programs at high speed. Another model includes a high-performance cache memory and an integral memory management unit. A scientific instruction processor is optional.

The GCOS 6 operating system includes a wide variety of compatible modules that support applications such as forms data entry and remote batch with local processing, plus time-shared program development and terminal concentration. Other modules include compatible subsets of I-D-S/II data base management and TDS transaction systems. Level 6 provides direct support of Series 60 host processors through communications and compatible language file access and system applications subsets. High-level languages include industry standard COBOL and FORTRAN (incorporating reentrant code generation capability) as well as RPG.

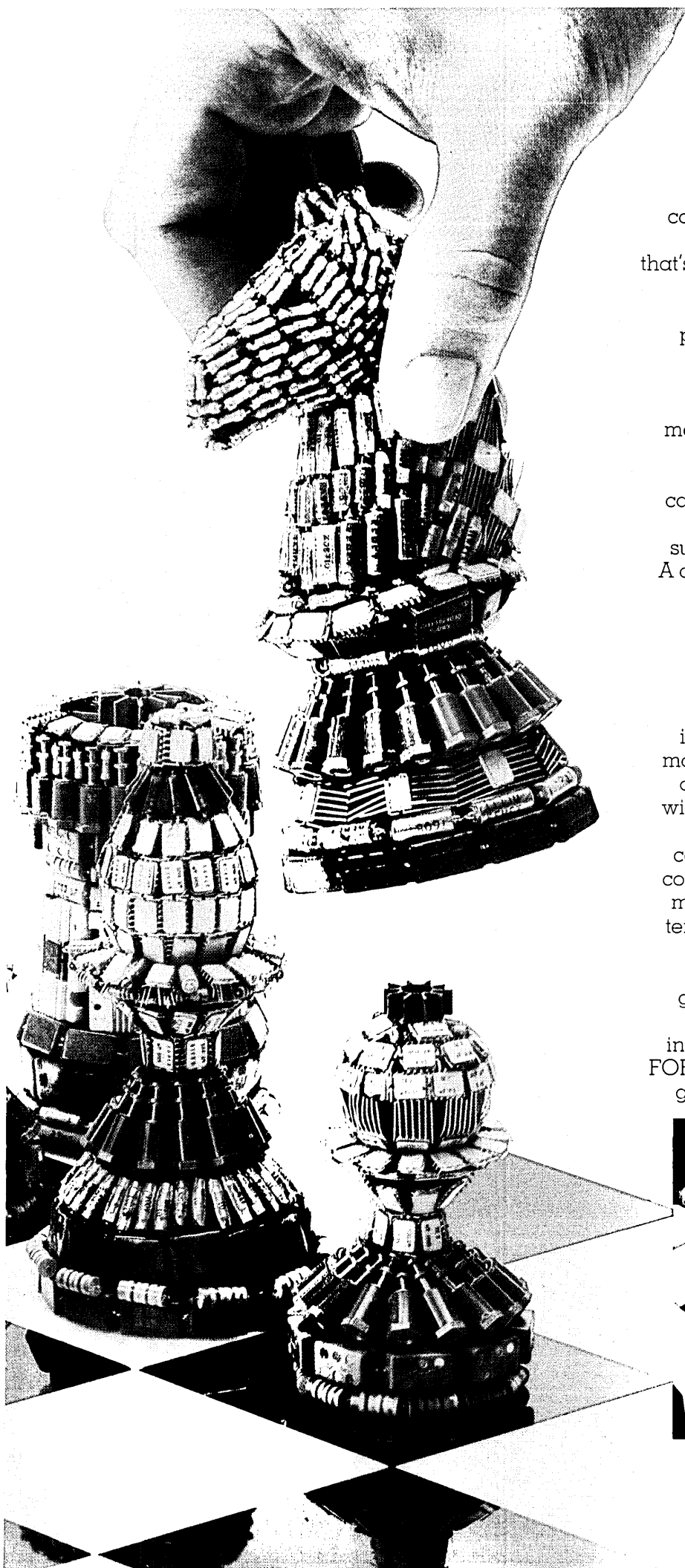

Page Printing System.

The Honeywell Page Printing System utilizes an electrostatic process to set new standards for large-volume computer output printing. High-speed turnaround. Quality carbon-less impressions. Simultaneous forms printing. Conventional size pages. Printing, punching, perforating, collating – all in the same pass. A complete output production system that can save you time and money, increase output quality and productivity.

Honeywell's Page Printing System works with IBM, Burroughs, and Univac as well as Honeywell host computers. Three models deliver 8,000, 12,000 or 18,000 lines per minute. A single PPS installation can be cost effective at an output rate as low as 400,000 pages per month, can sustain a production rate as high as four million pages a month.

Applications Software

Extensive applications software is available for industries such as manufacturing, distribution, banking and health care, and for such activities as education, government, financial management, management science, mathematics, and engineering.

It's your move.

Honeywell Information Systems
200 Smith Street (MS487)
Waltham, Massachusetts 02154

Check!

Please send me more information about Honeywell Series 60, I am interested in the following:

Distributed Systems Environment
Level 68/DPS Level 66/DPS Level 64
Level 62 Level 6 Page Printing System

Name _____

Company _____

Title _____

Address _____

City _____

State _____

Zip _____

Honeywell

CIRCLE 75 ON READER CARD

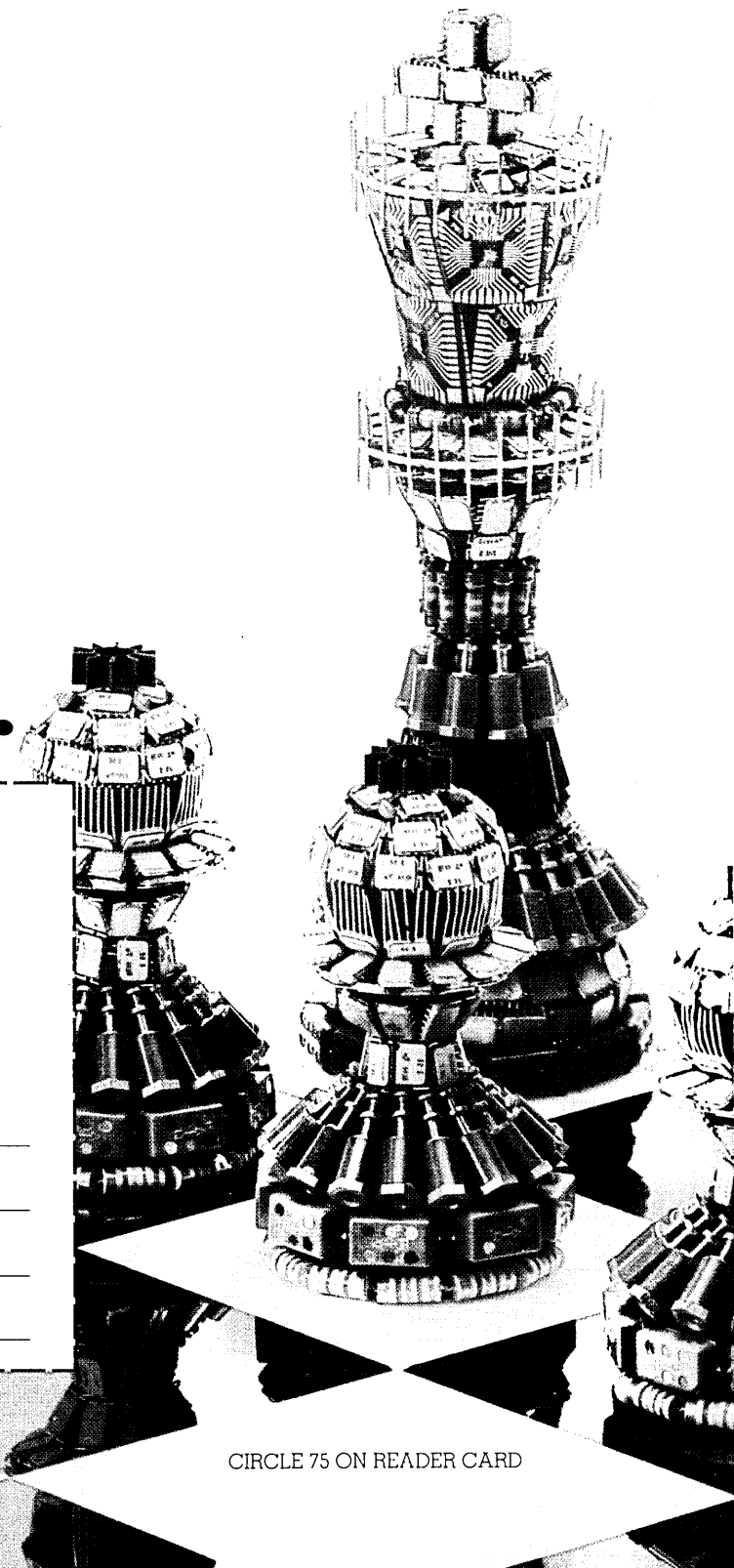

Now you can make your PDP-11 run faster than ever. It's in the cards.

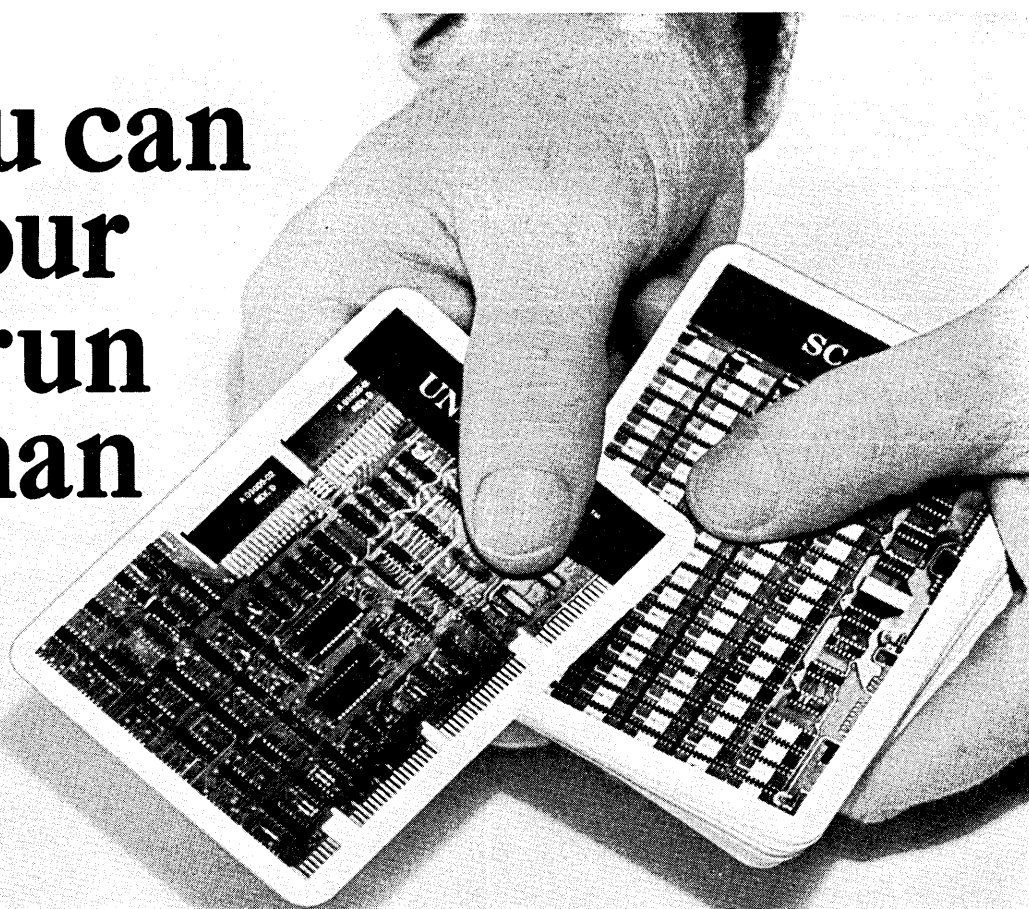

You're probably satisfied with the way your PDP-11 runs. Most people are. But if you are looking for some extra speed, we can give you the boost you need. It's in the cards. It's in the CACHE/34™, CACHE/40™ and CACHE/45™, a series of 2048-byte single-board buffer memories which increase processing speeds as much as 100% in the PDP-11/34, PDP-11/40 and PDP-11/45. And it's in the SCAT/45™, an add-in memory which installs 128K of high-speed memory on the FASTBUS of the PDP-11/45, PDP-11/50 and PDP-11/55.

Not only do we give you a chance to supercharge your present PDP-11 instead of upgrading to the next computer. We give you more time and improve your cash flow with the most sophisticated computer enhancements on the market today. They are available off the shelf. They are priced competitively. They install in minutes. They provide immediate results. And, in every instance, they outperform the competition. They should. We are the only *computer* people in the business and are clearly the most qualified to help. That's one reason why we outsell all our competition combined.

There are more cards than we've shown here and there are still more coming. We'll tell you all about them when you write for details on our present line. Write now. Able Computer Technology, Inc.
1751 Langley Avenue, Irvine, California 92714.
(714) 979-7030. TWX 910-595-1729.

Able, the computer experts

PDP and FASTBUS are registered trademarks of Digital Equipment Corporation.

CIRCLE 14 ON READER CARD



Baud rate switch — Switch from 110, 150, or 300 baud to 600 or 1200 baud transmission easily. Just flip the convenient switch and the terminal easily adapts to your communication speeds.

Front panel accessibility — All the normally used operator controls are organized into functional groups and logically arranged for maximum operator convenience.

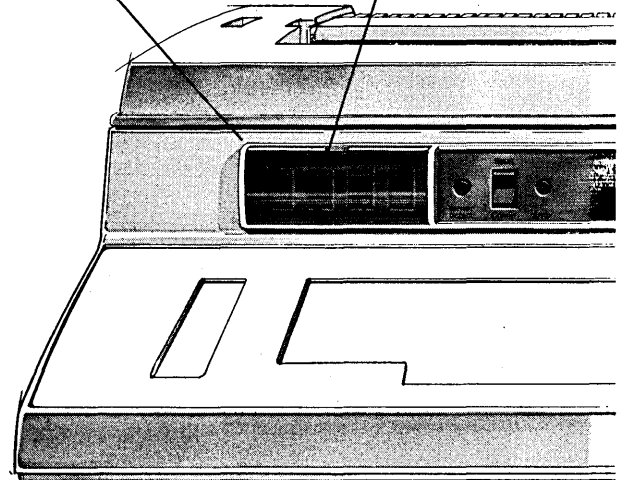

Introducing the smart daisy especially for the

It's called the Sprint 5. And it's from Qume.

That's right. Qume.

We've established quite a reputation in the word processing business. A reputation for letter quality print. And because of that, we didn't want to simply attach a keyboard to a printer and present it to the computer industry as a full blown terminal.

So we designed our Sprint 5 daisywheel terminal from the ground up to meet the needs of the computer industry. Complete with our famous print quality. And 55 cps speed.

Qume's smart microprocessor gives the Sprint 5 many capabilities not found in conventional terminals. Such as a powerful command set, self-diagnostics, memory storage of tab settings, and forms control programs.

Smart microprocessor logic — You get flexible character spacing, precise plotting resolution, and smart multi-direction carriage slewing. Not to mention high quality printing. Fast.

Interchangeable character sets — We have over 50 different character sets and typestyles. They're easy to change and include international characters, APL, and scientific symbols.

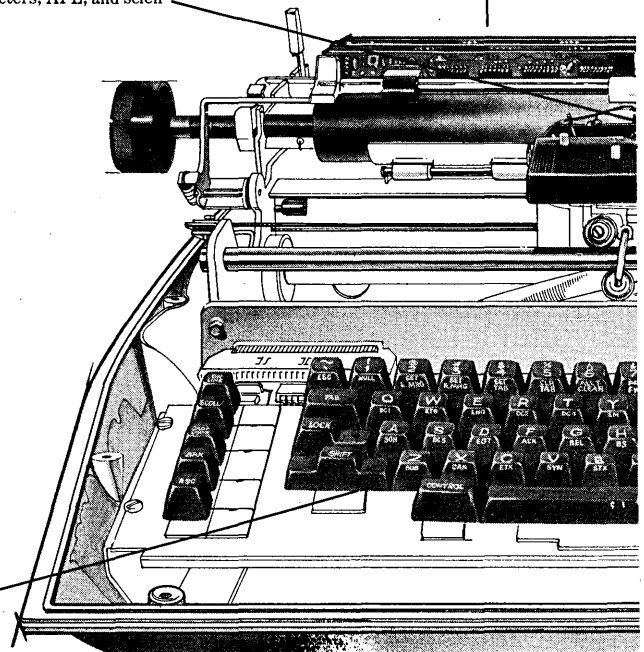

Comprehensive command set — 59 powerful user oriented commands provide format flexibility. And to make it even easier, commands are printed on the keycaps.

TwinTellect™ option — Want to use a special printwheel? Just switch on TwinTellect when you install the printwheel. Sprint 5 electronics provide the coordination between code and print characters. Available only from Qume.

Dynamic positioning — Create graphs or justify your text easily. With switch selectable 10 or 12 characters per inch spacing. Plus controlled spacing of 1/120" horizontal and 1/48" vertical.

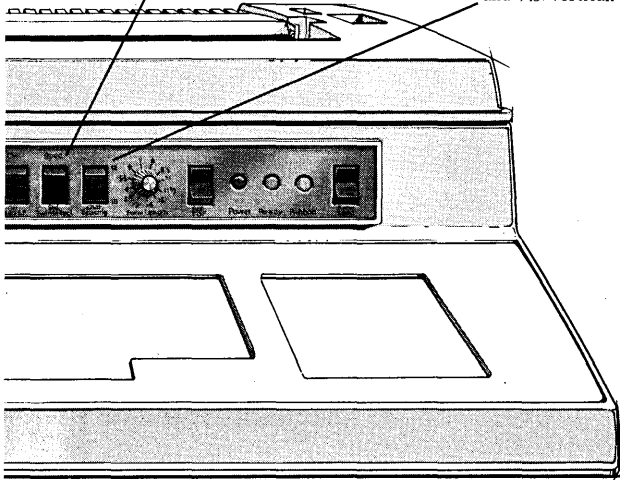

wheel terminal designed computer industry.

Serial or parallel interface — Sprint 5's can provide a standard serial RS232C interface to your system. In addition, the keyboard version is available with DC current loop interface, and the printer version is available with DC current loop or parallel interface.

Multicolor ribbons — over 15 different ribbons (10 color choices) to color your messages. Easy to handle cartridges with carbon or fabric multicolor ribbons.

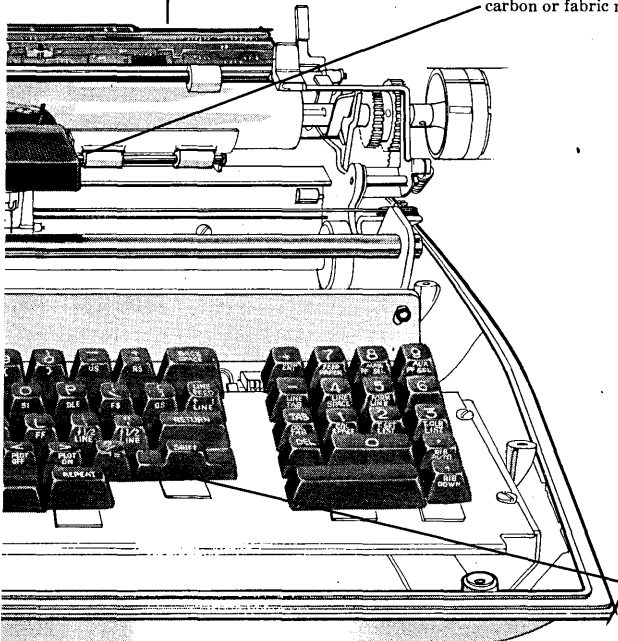

Surprisingly enough, however, the Sprint 5 costs no more than competitive terminals.

Obviously, a product that does much more but costs no more is a better buy.

And when all is said and done, that may be Sprint 5's most outstanding advantage.

For further information on how the Sprint 5 can give your computer letter quality output, contact: Qume Corporation, 2323 Industrial Parkway West, Hayward, CA 94545 or phone Lee Cannon, (415) 783-6100, Extension 338.

Qume®
the printed word



Self test — Internal self-diagnostic routines can be initiated from the keyboard or from remote sites.

"Control Data's Mass Storage System was the better business decision for us."



Each Mass Storage Cartridge holds 8 Megabytes and can be accessed in 5 seconds or less.

Charles E. Murdock, Assistant Director (Right) and Marvin J. Bates, Jr., Director of Data Processing for Southern Company Services, Inc.

Bates: "We expect almost instant access and response from our CDC Mass Storage."

"We process in a demand mode. When a request is on the console, we've got to respond quickly. That's why we're taking our small data sets on tape and putting them into Mass Storage. It means that we have almost instant access and response to users."

Murdock: "With 32,000 reels of tape and a library growing 20% annually, our tape library is getting more and more difficult to handle. Mass Storage allows us to maintain control of our data sets, without increasing our facilities, manpower or equipment. For us, it means a cost-effective way to provide good customer service."

Bates: "We want to process user jobs without personal or physical intervention. Mass Storage permits us to do this."

By converting data to Control Data Mass Storage, Southern Company Services expects to eliminate errors from pulling, handling or refiling tapes.

They will be able to supply user data in seconds for their customers—their parent company, The Southern Company, and four affiliated electric utilities. And they will eliminate waste of valuable host computer time.

Control Data's Mass Storage System saves space, too. The System holds 16 billion bytes in less floor space than a row of disk drives.

Perhaps you should investigate some of the reasons our MSS is the better business decision for you. Call us at 612/853-7600. Or write us at HQN11I, P.O. Box O, Minneapolis, Minnesota 55440.

 **CONTROL DATA CORPORATION**

More than a computer company

people

Something to Do With Integrity

Nobody would have blamed Raymond P. Kurshan for deserting the ship back in the early 1970s when Management Assistance, Inc. looked like it was on a sure course to bankruptcy.

But despite some highly attractive job offers that came his way at the time, the now 55-year-old MAI board chairman and president decided to ride out the storm. Some storm. MAI was over \$100 million in debt. It owned millions more worth of dp equipment that was rapidly becoming obsolete. And its revenues were dropping faster than the price of its once high-flying stock.

Why not make a dash for the nearest lifeboat? For Kurshan the answer had something to do with integrity. Although not at the helm when MAI began to get into trouble late in the 1960s, he had, as chief financial officer at the time, been charged with borrowing all that money the company owed. And rather than declare bankruptcy and start anew—a course some factions within the firm favored—Kurshan wanted to see MAI's creditors get their money back. "It was a matter of personal pride," he says.

Then there were the MAI employees, some 2,000 or so of them. Bankruptcy would mean the unemployment line for many. "We felt an obligation to our people, and we were trying to salvage something it took 10 to 12 years to build up," Kurshan explains. "If we went into bankruptcy, the organization would have disintegrated."

So Kurshan and the remaining MAI management had their work cut out for them: stave off the banks and creditors; get some of them to take equity in the company in lieu of collecting immediately on their debt; keep the company afloat until profits started coming in again.

During the massive refinancing effort that ensued Kurshan rarely saw his wife or two children. In fact, he was spending most evenings at meetings in MAI's New York City corporate offices rather than at his Woodmere, Long Island, home. At one point when he managed to slip away for a well-deserved Christmas vacation with his family after finally negotiating an agreement with the MAI banks and note holders, he returned to discover the agreement had fallen through. "All hell broke loose," he recalls.



RAYMOND P. KURSHAN
No longer so hectic

From 1971 to 1973 Kurshan lived from crisis to crisis. "Every week there was a new rumor that we weren't going to make our loan payments," he notes. "We were like infantrymen who never look up. We didn't even have time to enjoy our successes."

Gradually, however, the pieces began to fall together and the hard work started to pay off. The firm's service and

marketing groups, previously one entity, were broken out into two separate units: Sorbus and Genesis One respectively. Genesis began selling the unit record equipment MAI previously leased while Sorbus, previously restricted to serving MAI installations, began offering its capabilities to the industry in general.

Additionally, Kurshan, who had his own accounting firm before joining MAI in 1961, appreciated the potential of the small business market since many such businesses had been his clients. Consequently he moved the company into that arena with the formation of Basic/Four, MAI's small business systems unit. "We looked at the industry in general and perceived this was the one area that hadn't been exploited yet," he explains.

It took several years before Basic/Four began to pay off. Meanwhile Sorbus and Genesis One were generating sufficient revenues to stabilize the firm financially. The Genesis One picture was further brightened under Kurshan when the group added a G-Series video display terminal and a printer to its line. Most recently, it's added word processing capabilities which will enable MAI to pursue the "automated office" market of the future, Kurshan says.

The upshot of Kurshan's decision to ride out the storm: the company's debt is all but wiped out and last year's revenues reached the \$155 million level, a jump of 27% from 1976. And Kurshan? Life is no longer so hectic. He has time to plot out MAI's future, time for his family and even an occasional game of tennis. He has paid off a moral debt and in the process made his company viable again.

Making Project Management Easy

Wilfred P. Charette runs a small software company of about 20 persons in Anaheim, Calif., which has some 200 customers, many of whom he's had to drag kicking and screaming to become converts to his product. The product is called EZPERT after an aerospace industry production planning technique so old that most of the people who use it forget what the initials stand for (Program Evaluation and Review Technique). His software makes it easy to use.

"In selling EZPERT," says Charette, who has a PhD in electrical engineering from Pasadena's Caltech, "I'm making the whole concept of PERT more viable than it ever was." The reason: people were becoming disenchanted with the concept of PERT just as Charette was starting his company, called Systonetics, Inc., as the provider of a package that would enable users to auto-

mate the drawing of PERT charts. With it, he had the solution to one of PERT's biggest drawbacks.

Using any of many schedule analysis systems, the users could develop long listings of step-by-step things to do in carrying out a specific contract, often spanning months and years. But days and even weeks were used up turning these listings into meaningful flow charts. Often, a chart was obsolete before the drawing by a draftsman was completed. "When you consider today that in some big contracts, such as installing a nuclear plant, a contractor will pay up to \$25,000 a day in penalties for late deliveries, and such projects take several years to accomplish, the contractor is highly motivated to do a good job in planning, scheduling, monitoring and controlling his project for which automated tools such as

(Continued on page 50)

This means you're saving money!



Multi-part carbon interleaved business forms may leave a smudge. But they save you money on forms processing. They're the most economical continuous forms for minicomputer and mainframe terminals. That's because they cost 15 percent less than carbonless forms.

They're also cheaper to use than non-impact printing. Carbon interleaved forms save you between 32 percent and 35 percent off the cost of non-impact printing. Whether you use under a million copies a month or over 3 million.

The fact is: forms processing costs are lowest with multi-part carbon interleaved forms and impact printers.

It's simple arithmetic.

For some thumbs up cost comparisons and a copy of our free brochure "The Case For One-Time Carbon Paper" just complete and mail the coupon to: The One-Time Carbon Paper Council, 260 Madison Avenue
New York, N.Y. 10016

Name _____
Title _____
Company _____
Street _____
City _____ State _____ Zip _____
Telephone _____

**One-Time
Carbon
Paper
Council** 1

Dunn Paper Co., International Paper Co.,
Port Huron Paper Co., Thilmany Pulp and Paper Co.

D478

CIRCLE 83 ON READER CARD

TO BUILD A BETTER CHARACTER PRINTER, YOU NEED A BETTER PRINT ELEMENT.

WE HAVE ONE.

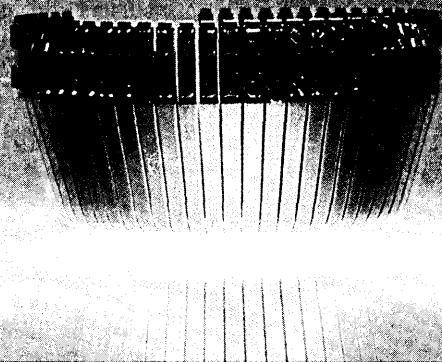

THE NEC SPINWRITER "THIMBLE"

NEC built the Spinwriter family of bidirectional character printers to be better than today's best. That required a high quality print element able to outperform "daisy wheels," and we have one.

Our unique "thimble" print element lasts up to three times longer, prints faster, offers greater applications flexibility, and costs less than daisy wheel elements.

Spinwriter thimbles are made from plastic specially reinforced with fiberglass – and specially molded – to provide normal element life of more than 30 million impressions. Thimbles are smaller in diameter and lighter in weight than daisy wheels. They have less mass, which means they can reach the next character faster and, therefore, print at a faster effective rate.

Spinwriter thimble elements can print up to 128 characters compared with 94 printable on daisy wheels. One thimble can hold two type fonts, and output those fonts with OCR quality. That means a Spinwriter can be used even in those applications normally requiring metal wheels or other modifications which slow printers down.

Spinwriter thimbles are available in a wide variety of type fonts, and are priced approximately 30 percent less than daisy wheel elements. Like Spinwriter ribbons, thimble elements are easily accessible, and can be replaced in seconds by operators using one hand.

Spinwriter thimbles are noticeably quieter than either plastic or metal daisy wheels, which means that Spinwriter printers fit well in office environments. A Diablo-compatible interface is available for Spinwriters, making direct replacement easy for original equipment manufacturers (OEMs) and end users.

The thimble is only part of what makes Spinwriters

better than today's best character printers. Consider our much longer lasting print hammer assembly: it has fewer moving parts than those on competing printers, and the voice coil actuated print hammer is strengthened with special alloys.

And consider the way highly reliable Spinwriters meet your printer needs: the Spinwriter family includes microprocessor-controlled receive-only and keyboard send/receive models, and basic mechanisms for those wishing to add their own power supply and housings.

Spinwriters feature Mean-Time-Between-Failure rates of better than 2,000 hours, and are serviced by one of the largest, most competent organizations serving the computer industry. Spinwriters are priced approximately 10 percent below competition, and we can deliver in OEM quantities in 60 days or less.

Tell me more about the Spinwriter family.

- Please have a sales representative call.
 Please send literature.

Name: _____

Title: _____

Company: _____

Street: _____

City: _____ State: _____ Zip: _____

Telephone: _____

DM4 78

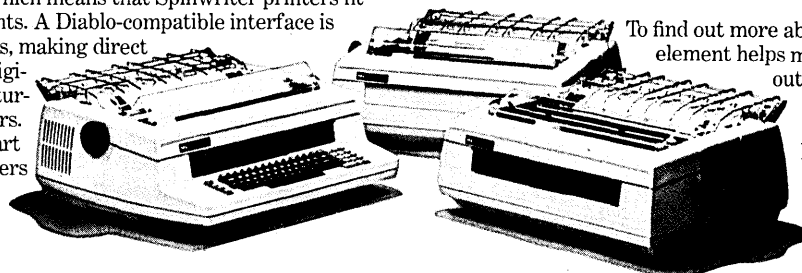

To find out more about how a better print element helps make a better printer, fill out the coupon, or call NEC Information Systems, Five Militia Drive, Lexington, Mass. 02173 (617) 862-3120.

NEC NEC INFORMATION SYSTEMS, INC.

Eastern Office: NEC Information Systems, Inc., Mr. Richard G. Gilbert, 5 Militia Drive, Lexington, Massachusetts 02173
Central Office: NEC Information Systems, Inc., Mr. Stephen A. Kadash, 3400 South Dixie Drive, Suite 105, Dayton, Ohio 45459
West Coast Office: NEC Information Systems, Inc., Mr. Marty Rubin, 8939 S. Sepulveda Blvd., Suite 330, Los Angeles, California 90045

people

(Continued from page 47)



WILFRED P. CHARETTE
He had to resell whole concept of PERT

EZPERT are essential," Charette says.

EZPERT is used to produce automatically project graphics including networks, barcharts, cost charts, and manpower charts, for example, on a digital plotter. As the project moves along it is subject to constant change and thus the graphics require frequent updating. And now it's done in a few minutes, particularly when an electrostatic plotter is used.

"Automating a previously manual process is a classical example of a quantitative improvement offering large cost and time savings," he says. But the greatest long term benefits from EZPERT are the result of its qualitative impact on the way project management is practiced.

Charette says the mystique surrounding PERT concepts is a hangover from the early 1960s when it was touted as the latest management panacea. It wasn't, primarily because the charts had to be produced manually. "I can't tell you how many times I've heard the comment 'PERT, well we tried that in 1965, but it didn't work.' That's like saying, we tried accounting systems in 1965, but we went bankrupt anyway." He says it's a very simple and powerful concept that becomes complicated when large volumes of data are involved.

"In this sense, there is nothing more complicated in automating a large project data base than in automating a large payroll, and in both cases automation is essential to sound management,"

Charette says.

Charette left the aerospace industry in 1969 to form Systonetics as a "high technology company emphasizing innovative applications of systems technology to computer implemented management information and control systems." It had been the kind of thing Charette had been doing for the previous five years at California Institute of Technology and as the science advisor to the director of management systems at Autonetics, a division of North American Rockwell Corp. At Caltech, he'd demonstrated the transferability of control system theory and computer technology to medical problems. Using mathematical modeling and computer simulation, he developed an innovative method for benign experiments on

human beings. His PhD thesis at Caltech was entitled: "Control Systems Theory Applied to Metabolic Homeostasis Systems and the Derivation and Identification of Mathematical Models."

Today he forgoes such high-sounding titles for plain talk, at least in selling EZPERT. "The toughest challenge was to explain the system to stockholders," Charette recalls. When the company went public in 1971, he asked his lawyer for a list of things that had to be done to bring the company public. The lawyer came up with a list of 80 things. Charette then asked him to put them in sequential order. Then he ran it all off automatically on a flow chart.

Using EZPERT, of course.

In New Posts

WERNER SIMON was named to the newly created post of vice president, General Systems Div., Sperry Univac . . . DEAN E. ELY joined Data-products Corp., Woodland Hills, Calif., as vice president for corporate information systems . . . DONALD E. ANDERSON was promoted to vice president of computer services at McDonnell Douglas Automation Co. in Long Beach, Calif. . . . CLAUDE ACKER, a manager on the staff of the Direction Centrale Industrielle of the Societe Nationale Industrielle Aerospatiale, Paris, France, was elected president of CAM-1, Inc. (Computer Aided

vice president and the general manager of its newly formed System's Div. . . . FREDERICK L. ZIEBER was elected vice president of Dataquest, Inc., Menlo Park, Calif. . . . KENNETH J. WHALEN, vice president-marketing of AT&T, was elected an executive vice president . . . WARREN W. SULLIVAN was appointed vice president of marketing for the Memory Products Div. of California Computer Products, Inc. . . . CHARLES A. ZRAKET was elected executive vice president and a member of the Board of Trustees of The Mitre Corp. . . . DELANIE PATRICK joined McCormick & Co., Inc., as direc-



SIMON



ELY

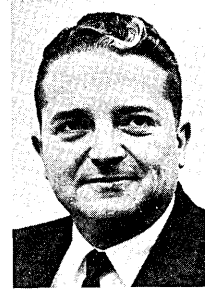

ANDERSON



ACKER

Manufacturing-International, Inc.) for 1978) . . . Aspen Systems Corp., a subsidiary of American Can Co. specializing in computer services to the legal profession, today announced the appointment of WILLIAM E. BURKE as manager for the West Coast . . . ROBERT L. RUNGE was appointed vice president-systems development of Sycor, Inc., Ann Arbor, Mich. . . . EDWARD LEE BRYAN joined Harris Corp.'s Data Communications Div. as vice president-product planning . . . ROBERT T. HEIST, JR., was promoted to manager-electronic data processing technical services for Carpenter Technology Corp., Reading, Pa. . . . WILBUR S. MANN joined The Gerber Scientific Instrument Co. as a

tor of computer services . . . HERBERT D. MONTGOMERY was named corporate vice president for operations administration at Pertec Computer Corp. . . . Unitrode Corp. promoted ROBERT R. FEIER to president of its wholly owned subsidiary, Unitrode Computer Products Corp., Methuen, Mass. . . . CARL F. FREELAND was named vice president of research and development for Pansophic Systems, Inc., Oak Brook, Ill. . . . PAUL L. BOUCHARD was appointed to the newly established position of director of operations for DBA Systems, Inc., Melbourne, Fla. . . . ROBERT D. CHISUM was named marketing manager at Micropolis Corp., Canoga Park, Calif. . . .

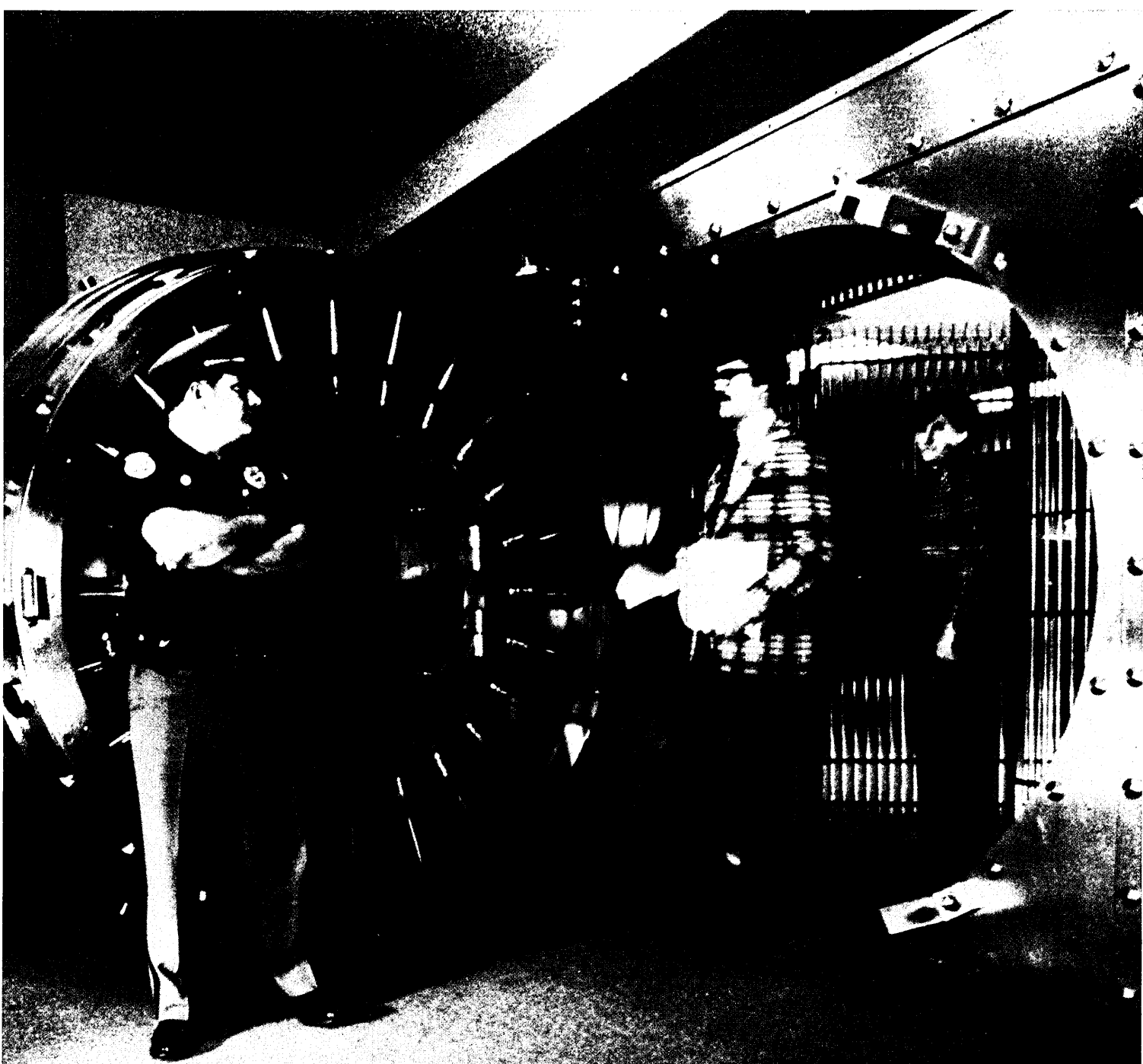

In the financial community, you have to move money to make money. Since data communications among widely dispersed locations are the lifeblood of banking, insurance, and other financial institutions, it's not surprising that many of the big ones choose Universal Data Systems as their modem supplier.

Some of these institutions choose UDS because they like the technical superiority of CMOS design in 103s, 201s, 202s or ACUs. Others select the 103s for fast, reliable 16-channel communication. For economy, others like the 201s with full-duplex 1200 bps capability of the UDS 12 • 12 and the direct access provided by FCC-approved DAAs.

If you're a datacomm user or an OEM and you have a similar need for confidence in communications, follow the smart money — discuss your modem requirements with Universal Data Systems, 4900 Bradford Drive, Huntsville, Alabama 35805. Telephone 205/837-8100; TWX 810/726-2100.

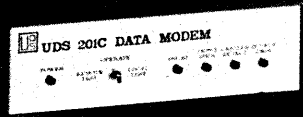

Universal Modems Make Money Move

Every once in a while something new happens that significantly alters the way we do things.

It has happened to Network Control.

Introducing **EMS-One Event Management System**

—a control system for data processing networks that functions much like the autonomic nervous system—continuously monitoring and spontaneously responding to changes. All automatically and at real-time speeds.

EMS-One is the first fully automated system for unattended network monitoring and diagnostics. It is a multi-processor based system just like the distributed data processing networks it is designed to manage.

Processing power of the EMS-One is physically located at all the data sources in a network. These remote processors continuously monitor and report any changes in the status of 14 individual test conditions existing at their locations.

Other processors constantly parallel poll all the remote processors.

Polling is simultaneous over all lines at speeds dramatically faster than conventional line-by-line, drop-by-drop methods. Any status changes are immediately reported to a control processor.

THE FIRST, THE ONLY

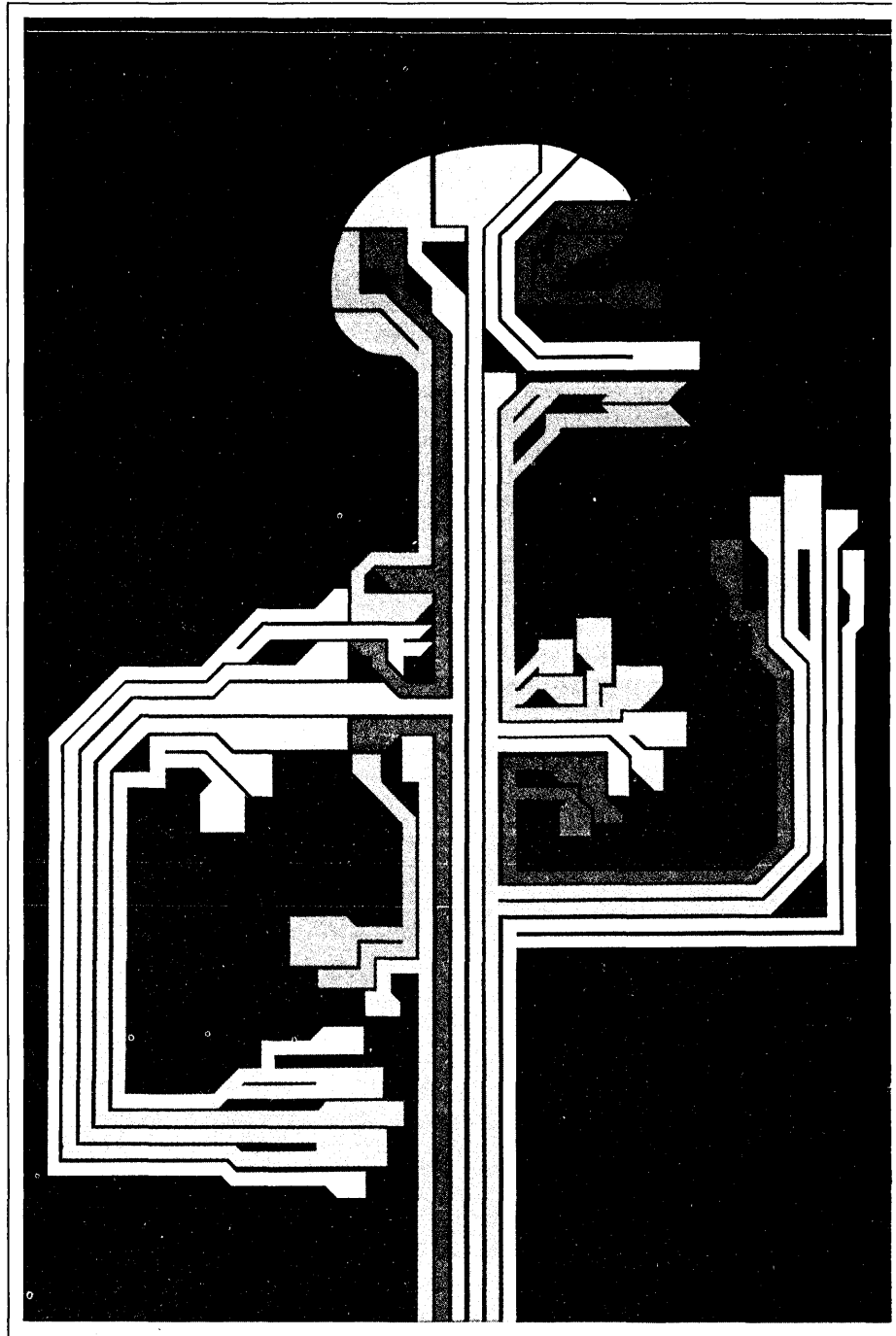

EMS-One



EMS-One's control processor interprets the status change, makes the necessary diagnosis, sounds an alarm, and reports the condition on a visual display in plain English.

Additional data can be obtained via 49 "Manual Mode" tests and control functions—even while polling continues throughout the rest of the network.

There's more. EMS-One can also make unattended on-line tests—true quantitative measurements—after hours when you're not around.

Automatically. All data is preserved in hard-copy form for review the next day—useful data for long-term observations of network performance trends and predictive failure analysis.

EMS-One is an adaptable Network Control System. Its "Self-Learn Mode" automatically learns the network whenever it is changed or added to.

No new addressing is required.

And, there's never any need for software.

Excluding modems, EMS-One is a desk-sized work station that fits anywhere. A compact printer and a high-styled, easy-to-use console with functional keyboard and gas-plasma display complete the system.

From it you can control any network. Up to as many as 160 lines supporting 6400 remote locations.

We suggested you wait and avoid a 5-year technical penalty. Aren't you glad you did?

#1 in Network Control.

intertel

6 Vine Brook Park, Burlington, Massachusetts 01803, Tel. (617) 273-0950

calendar

APRIL

Industry Conferences, April 20-24, Hannover, Germany. Four one-day conferences, each on a dp-related industry, will be offered by Dataquest concurrent with the Hannover Fair. April 20 the subject will be word processing. April 21 the minicomputer industry will be covered, with emphasis on the use of small business computers by U.S. based companies. April 22 the copying & duplicating industry will be discussed, and April 24 the topic will be the semiconductor industry. The conferences will be held at the Hannover Crest Hotel. For information contact Kathy Davis, Dataquest, Inc., 3000 Sand Hill Road, Menlo Park, CA 94025 (415) 854-7400.

ECOMA-5, April 25-27, London. The European Computer Measurement Association Conference will feature John Holt of Boeing Computer Services speaking on the application of tools for effective data center management. Also of special interest: the first European demonstration of the Univac Benchmark Monitor Display, an integrated hardware monitor built into the main central processor. Seminars to be presented by users of performance measurement tools include: "The Practical Application of Software Physics," "From Measurement Rate to Management-Controlled Evaluation," "Optimizing Throughput and Response Time," and "Important Aspects of Database Management." Contact: Scott N. Yasler, ECOMA president, c/o Union Bank of Switzerland, Bahnhofstrasse 45, CH-8021 Zurich; telephone 01 236-5946.

Seventh International Seminar on Computers in Banking, April 26-28, Geneva. 500 bankers from the U.S., Europe, and Japan will meet to discuss the evolution of data processing in banking through presentations and debates. Changes in operations such as credit card use, automatic payment will be explored; the emphasis will be on newly available services. INSIG, Interbank Research Institute, 5, rue Questin Bauchart, 75008 Paris 720.45.97.

Ninth Annual Pittsburgh Conference on Modeling and Simulation, April 27-28, University of Pittsburgh. Special emphasis will include energy, social, economic, and global modeling and simulation. Contact: William G. Vogt or Marlin H. Mickle, 348 Benedum Engineering Hall, University of Pittsburgh, Pittsburgh, PA 15261.

Institute on Federal Document and Information Accessibility, April 27-28, Washington D.C. More information is collected and disseminated by the U.S. government than by any other body in the world. The American University's conference on federal information policy will feature discussion on how and where government information is available, costs, priorities, and anticipated changes.

Proposed redesign of the census process and its database will be addressed. Paul Klingbiel of the Defense Documentation Center will give a report on computer indexing of classified technical documents in that agency, whose on-line project represents a major step forward in government information systems. Also included in the two-day event will be an open forum on federal policy, in which conference-goers may participate. James B. Rhoads, archivist of the United States, and William T. Know, director of the Dept. of Commerce's National Technical Information Service, will participate in the

forum. For information contact Lowell Hattery or Melinda Beard, College of Public Affairs, The American University, Washington, DC 20016 (202) 686-2513.

Percomp '78, April 28-30, Long Beach, Calif. This large consumer-oriented exposition and conference will include technical, educational, and hobby aspects of small computers; some sample topics of papers: "A Cosmac-Based Microprocessor for the Physically and Communicately Disabled," "Three Dimensional Microcomputer Graphics," and "Marketing for the New Manufacturer." Dr. Portia Isaacson will conduct a session for retailers, and Carol Odgin will deliver the keynote address on the subject of "proven home applications of the computer." PERCOMP '78, 1833 E. Seventeenth St., Santa Ana, CA 92701 (714) 973-0880.

MAY

Advanced Manufacturing Methods Seminar, May 2, Chicago. This will be the first open meeting of the AMM. User companies will present papers and participate in panel sessions aimed at improvement in the planning and control of manufacturing operations. Programs presently in use by member companies are: Computer Aided Machine Loading (CAMEL), Computer Aided Line Balancing (CALB), Generalized Assembly Line Simulator (GALS), and Computer Aided Batch Scheduling (CABS). Successes and failures in using these programs will be discussed at the one-day seminar. For information contact Dr. Janis Church, IIT Research Institute, 10 West 35th Street, Chicago, IL 60616 (312) 567-4632.

PRIDE Users Association Meeting, May 7-10, Cincinnati. PRIDE is a widely used information systems design method. The stated goals of the international association are to promote PRIDE's effectiveness and to provide a formal communications channel between members and the vendor. Contact Don Demers, Chairman of this year's meeting, at Borden, Inc., 180 East Broad Street, Columbus, OH 43215.

Micrographics '78, May 9-12, Boston. 27th annual conference of the National Micrographics Association, with the theme "Building Information Bridges." Some subjects to be discussed are: COM recorders, readers, reader/printers, and enlargers; retrieval devices; standards; privacy legislation and freedom of information; word processing and micrographics; computer input microfilm (CIM); cost justification; and software. **May 8** there will be a separate one-day conference on government affairs, featuring Carter Administration officials speaking on procurement policy. Attendance at the May 8 event will be limited to 100. For information on either conference contact William L. Sullivan, Director of Communications, NMA headquarters, 8728 Colesville Rd., Silver Spring, MD 20910 (301) 587-8444.

Third International Conference on Software Engineering, May 9-12, Atlanta. The conference is jointly sponsored by IEEE, ACM, and the National Bureau of Standards. Topics of discussion will include language issues, software reliability, software design, software development case studies, testing,

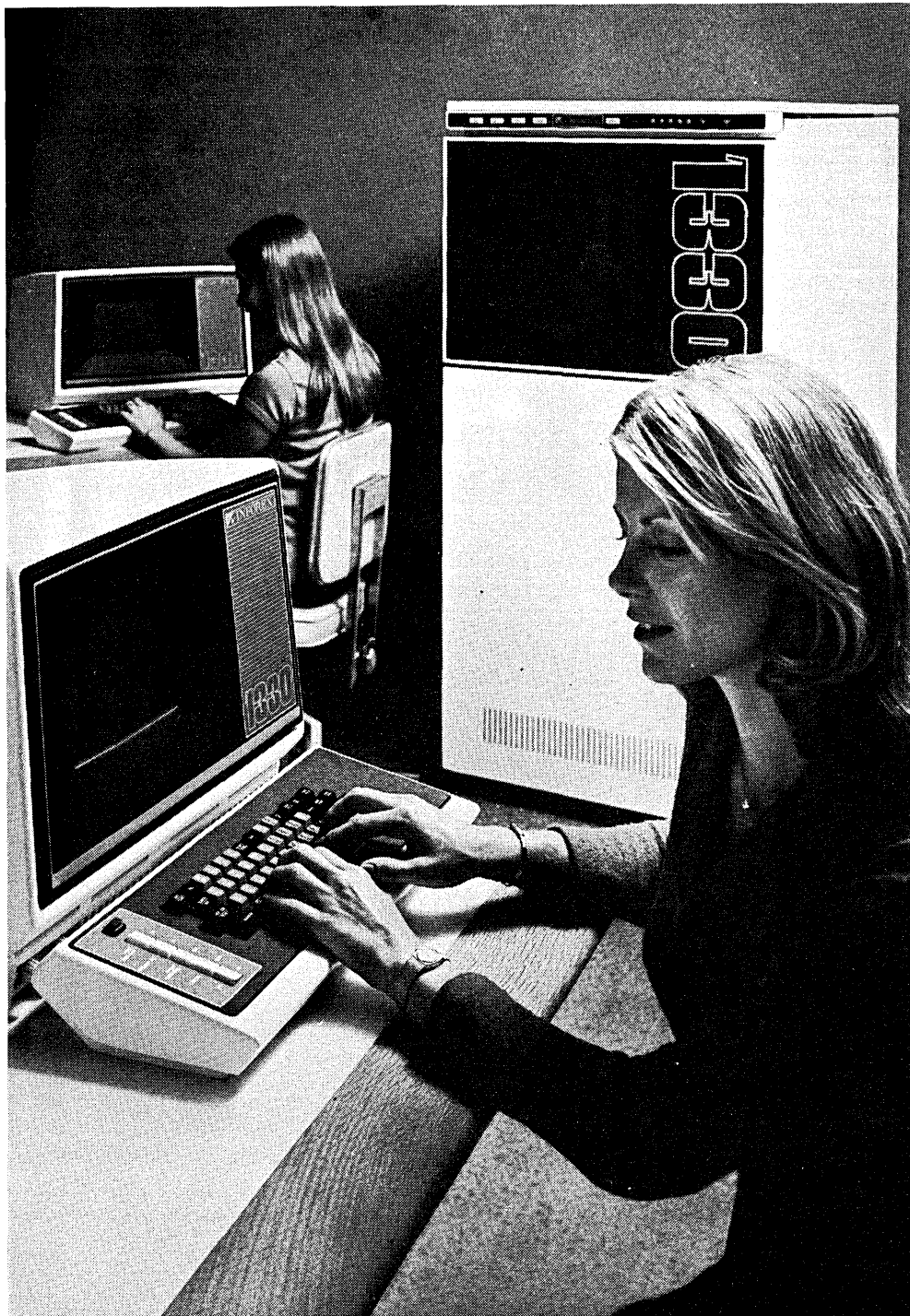

INFOREX: THE SIMPLEST SOLUTION TO ALL YOUR DATA ENTRY PROBLEMS.

The simplest and best solution to all your data entry problems is right here: the Inforex data entry family.

Simplest because we design them for ease of use and speed of throughput.

Best because we've been a leader in the innovation and development of key-to-disc data entry products and capabilities right from the start.

Which is why our family's got it all. From the basic keypunch replacement 1300 IKE System to the tremendously powerful max-editing System 3300.

So whatever your needs — modest, middling, or immense — the growing Inforex data entry family will meet them.

You don't have to settle for a compromise system. You don't have to sweat out an unsatisfactory price/performance choice. All you have to do is choose the system that's best for you.

And that's where an Inforex Support Team comes in. They'll help you select just what you need. They'll provide expert installation. And they'll give you the benefit of their years of experience in other installations.

But even after all that, you won't be left high and dry. Whenever and wherever you need help, an Inforex Support Team will be available with the support you need.

The Inforex data entry family. You shouldn't settle for anything less.

With the 1330, you can consolidate remote job entry and batch data entry applications without compromising either function. The system features expandable disc storage (up to four — 10 Mb. drives) foreground and background editing and bisync communications.



Inforex 1300 and 1301 offer highly cost effective data entry capability for smaller installations (4 to 8 keystations) or remote locations where you can take advantage of our communications capabilities.



The 1303 provides medium range data entry capacity, with about triple the disc capacity of the 1301. It supports up to 16 keystations and the addition of edits, table look-ups, range checks and cross-footing. The 1303 also offers communications capabilities such as *spooling*, *HASP* and *RJE*.

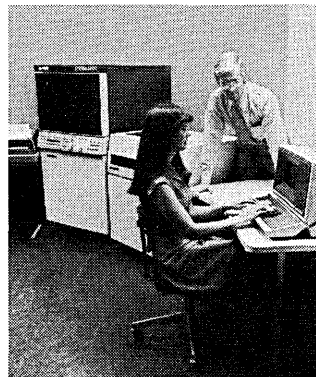

The Inforex 3300 is a powerful pre-processing system that allows you to edit data at the point of entry, enabling you to offload your mainframe. Its sophisticated editing capabilities can also handle many of those applications which you haven't had time to put on your present mainframe.

- I would like more information on the following:
- Key-to-disc data entry
 - Distributed processing
 - Computerized records management
 - I would like to talk with an Inforex Sales Representative

Name _____
 Title _____
 Organization _____
 Address _____
 City _____
 State _____ Zip _____
 Telephone _____

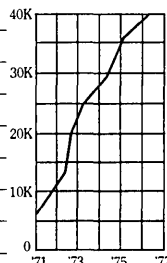

More keystations in more countries than any other company in the world.

DM-4
 Offices in major cities throughout the United States, Canada and Europe. Distributors worldwide.

INFOREX
 Inforex, Inc., Dept. 321, 21 North Avenue, Burlington, Mass. 01803

See the System 1330 at the Computer Caravan — Expo '78.

If you own a TI Silent 700®

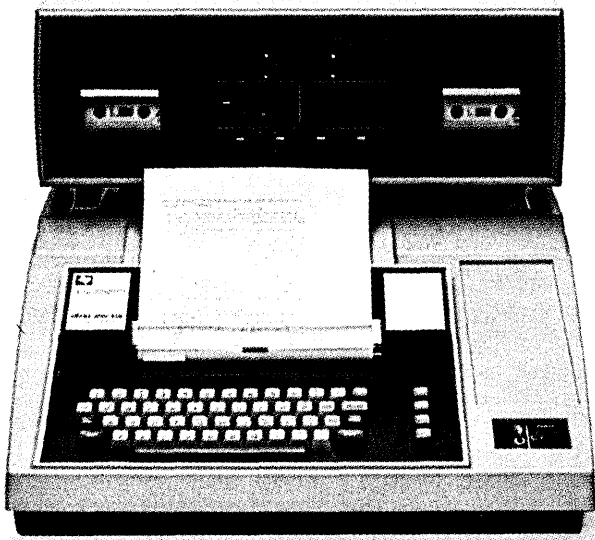

get sensitive.

For what you pay for thermal paper, you should get consistent imaging and quick delivery. No maybe's. We say you can. And pay less. Come to the Sensitive Paper People. Try our paper. Free.



Silent 700® is a trademark of Texas Instruments.

sensitivity coupon

Send one free roll for Texas Instruments Silent 700®

Annual Usage: _____ rolls Paper Number _____

Name _____ Phone _____

Firm _____

Address _____

City _____ State _____ Zip _____

Mail to Coated Products Division, Graphic Controls Corporation,
P.O. Box 1309, Buffalo, NY 14240

Or call toll free 800-828-7978.
(In New York State, call 716-847-7500.)

D-TI-4

calendar

and software portability. For information write to: Software Engineering, P.O. Box 639, Silver Spring, MD 20901.

Canadian Association for Information Science Annual Conference, May 10-13, Montreal. Computer scientists, linguists, librarians, and other information specialists are invited to join CAIS in looking at telecommunication networks, information processing and retrieval systems, data bases, and "local and long distance accessibility of documents" under the theme "To better communicate information: a new step." Contact: CAIS, Comité de publicité c/o Daniel Carroué, C.P. 539 Succursale, Place Desjardins, Montréal, Quebec H5B 1B3 (514) 875-8931.

International Communications Association Conference and Exhibition, May 14-19, Las Vegas. The theme is "Decisions 1978." Limited to ICA members and invited guests. Contact: Mr. Chester Bellairs, Jr., Director of Communications, American Broadcasting Companies, 1330 Avenue of the Americas, New York, NY 10019 (212) 581-7777 x7321.

16th Annual Convention of the Association for Educational Data Systems, May 15-19, Atlanta. Computer-aided instruction, computer-assisted test construction, administrative applications, hardware configurations and developments, software systems, and more. Contact: Dr. James E. Eisele, Office of Computing Activities, University of Georgia, Athens, GA 30602.

Conference on Management of Engineering and Scientific Data, May 18-19, Hampton, Virginia. Sponsored by NASA Langley Research Center, the Institute for Computer Applications in Science and Engineering and the George Washington University, the conference will cover recent noteworthy advances in the computer handling of engineering and scientific data, with emphasis on interaction between developers and users. Planned are four sessions with speakers and discussions of technical issues. Attendance by non-U.S. citizens requires prior approval of NASA. Contact: David D. Loendorf, Mail Stop 132C, NASA Langley Research Center, Hampton, VA 23665, (804) 827-2513.

National Operations & Automation Conference, May 21-24, Atlanta. The American Bankers Association sponsors this large exposition of dp products, systems, and services. ABA, Operations and Automation Division, 1120 Connecticut Ave. N.W., Washington, DC 20036.

Information Analysis and Its Relation to Data Base Design and Program Design, May 22-24, Amsterdam. Practical cases will be explored. Prof. B. Langefors from the Royal Institute of Technology, University of Stockholm, will be the chairman. Contact: IAG Headquarters, 40, Paulus Potterstraat, 1071 DB Amsterdam, the Netherlands, telephone: (020) 76 35 26/76 35 81.

Management of Information Systems, May 22-24, Houston. This is the seventh mid-year meeting of ASIS (American Society for Information Science). There will be a pre-conference workshop on forecasting, modeling, and simulation; other conference topics include sociological aspects of information handling in institutions, an in-depth workshop on decision making and problem solving, and a panel session on user education for on-line systems. Also featured will be a beer and barbeque supper with square dancing. The event will be held on the Rice University campus. Contact: ASIS Headquarters, 1155 Sixteenth Street NW, Washington, DC 20036.

JUNE

Pattern Recognition and Image Processing Conference, June 5-7, Chicago. IEEE Computer Society, P.O. Box 639, Silver Spring, MD 20901.

Isratech '78, June 4-8, Jerusalem, Israel. Contact: Government of Israel Investment Authority, 641 Lexington Ave., New York, NY 10022 (212) 486-8530.

NCC, June 5-8, Anaheim, Calif. Contact: AFIPS, 210 Summit Ave., Montvale, NJ 07645 (201) 391-9810.

Computers in Banking, June 13-15, Zurich, Switzerland. Contact: Secretariat, Computers in Banking, Interconvention, c/o Swissair Postfach, CH-8058 Zurich, Switzerland.

National Conference on Applications of Computers in Undergraduate College and University Education, June 12-14, Denver. Contact: Dr. William Dorn, Dept. of Mathematics, University of Denver, Denver, CO 80208.

First World Computing Services Industry Congress, June 20-23, Barcelona, Spain. ADAPSO, 210 Summit Ave., Montvale, NJ 07645.

Design Automation Conference, June 19-21, Las Vegas. Contact: ACM, 1133 Avenue of the Americas, New York, NY 10036.

CALLS FOR PAPERS

CMG (Computer Measurement Group) is seeking papers for the CMG IX conference to be held in San Francisco in early December. The focus of the conference will be Management and Evaluation of Computer Performance, including subjects such as workload forecasting, hardware/software evaluation and selection, and scheduling and controlling. Three copies of an abstract should be sent to Linda S. Wright, Sun Information Services Co., 1608 Walnut St. (14/3GP), Philadelphia, PA 19103. Deadline is May 1.

Papers describing original research in the theoretical aspects of computer science are being sought for the 19th annual Symposium on Foundations of Computer Science, to be held in Ann Arbor in mid-October. Seven copies of an extended abstract (not more than ten pages) on a subject such as data bases, analysis of algorithms, formal semantics and proof theory, etc., should be sent to: Professor Nancy A. Lynch, School of Information and Computer Science, Georgia Institute of Technology, Atlanta, GA 30332. Deadline is May 12.

Papers are invited for consideration by organizers of the 1978 Advanced Techniques in Failure Analysis Symposium, to be held in Los Angeles in November. A "hands-on" tutorial workshop will start off the conference, with three following days offering failure analysis problem-solving approaches. Submit to Philip H. Eisenberg, Northrop Electronics, 2301 W. 120th St., Hawthorne, CA 90230 (213) 757-5181, by May 30.

The Hawaii International Conference on System Sciences will be held January 4 and 5, 1979, in Honolulu. A wide variety of subjects will be considered, but special interest this year is in papers on computer based decision support systems, mini-micro systems, medical information systems, justice information systems and distributed processing. Three copies of the finished paper should be airmailed to: Dr. Ralph H. Sprague, Jr., College of Business Administration, University of Hawaii, 2404 Maile Way, Honolulu, HI 96822. Deadline July 15. *

April, 1978

To owners of these:

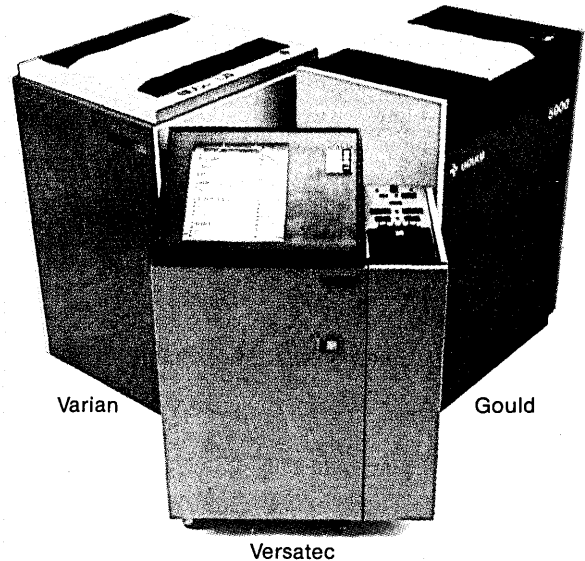

new way to get sensitive.

See green, the new tinted electrostatic paper. Easier on the eyes. Sharper on the image. Try a roll or fanfold pack free. Exclusively from the Sensitive Paper People.



sensitivity coupon

Send free roll or fanfold pack of eye-ease green to fit: Gould, Varian, Versatec

Annual Usage: _____ rolls Paper Number _____

Name _____ Phone _____

Firm _____

Address _____

City _____ State _____ Zip _____

Mail to Coated Products Division, Graphic Controls Corporation, P.O. Box 1309, Buffalo, NY 14240

D-EG-4

Or call toll free 800-828-7978.

(In New York State call 716-847-7500)

EVER WONDER WHY PRINTRONIX PRINTERS ARE WARRANTED FOR A FULL YEAR WHILE 90 DAYS IS TYPICAL FOR THE OTHERS?

Maybe you haven't given printer warranties much thought. But you should if you're concerned at all about cost of ownership.

When you get down to it, the length of a warranty reflects a manufacturer's confidence in how long his product will perform without costly failures.

Our one-year warranty is not limited to specific functional parts or assemblies as some are. And it is not something we thought of recently. We thought about it when we designed our 150 and 300 lpm impact matrix line printers.

That's why it has an elegantly simple printing mechanism with significantly fewer moving parts than other impact matrix printers, 50% fewer

parts than mechanical font printers, fewer bearing surfaces, and simple hammer drive circuits.

We were confident that our printer, with a calculated MTBF of 3000 hours,* would result in a much longer MTBF in the field than other printers. It has, as proven by more than 4000 users.

Maintenance costs are lower, too. Periodic adjustments for character alignment as required by drum, chain or belt printers are not required, and our MTTR is 30 minutes.

When you evaluate cost/performance, remember that our prices are about the same or less than other 150 and 300 lpm printers. But we include full plotting capability as an extra feature . . . at no extra cost!

Send for literature or call for a demonstration of our printer/plotters. You'll see why we've felt comfortable offering a one-year warranty right from the beginning.

Printronic Inc., 17421 Derian Ave.
Irvine, CA 92714. (714) 549-8272.

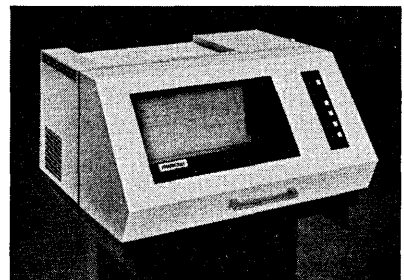

* Using MIL 217B Specifications



SEE US AT THE
COMPUTER CARAVAN EXPO 78
IN YOUR CITY

PRINTRONIX

THE RELIABLE PRINTER COMPANY

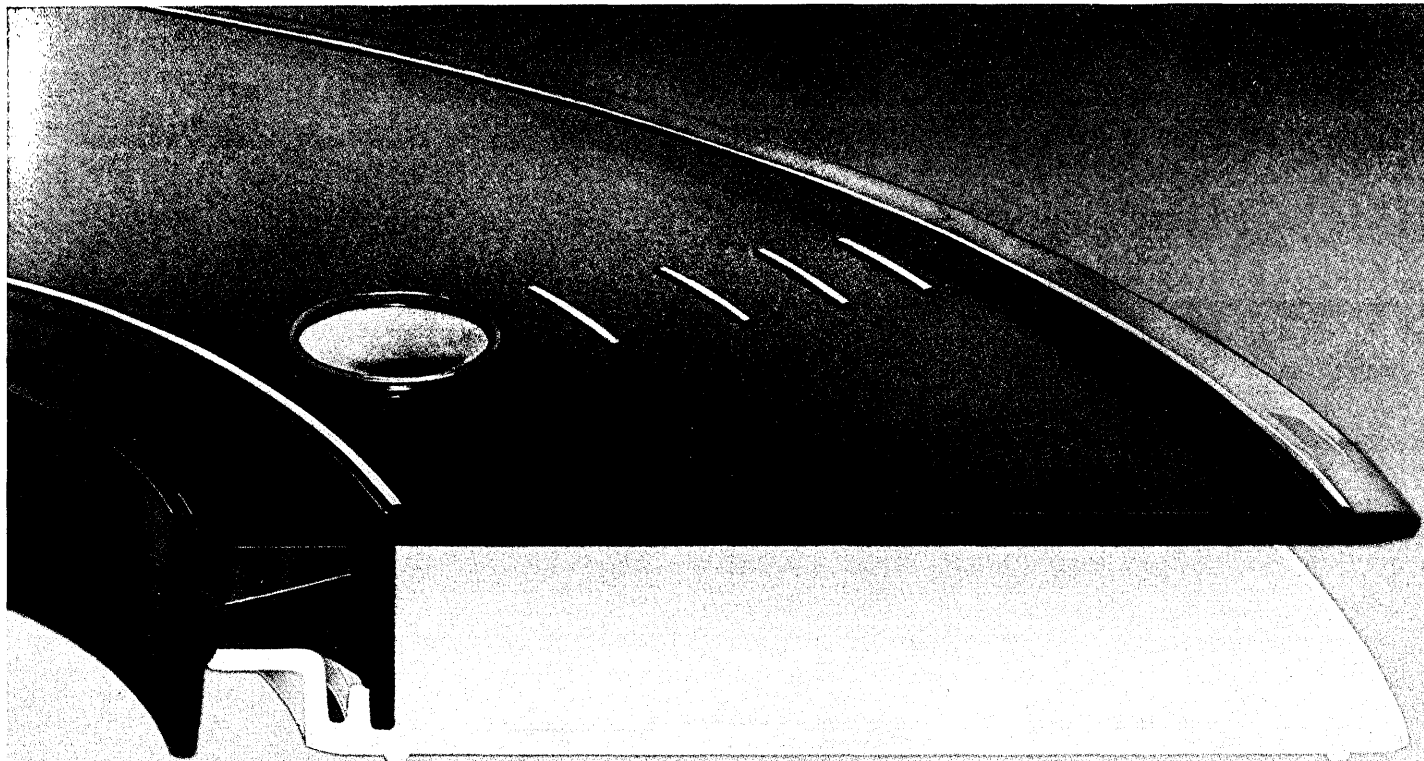

Introducing the reel shape for things to come.

Memorex SuperReel.[™] A new approach to computer tape reels. The approach that's right for tape drives here now, and for the new generations to come.

SuperReel gives you a uniquely-shaped I-Beam hub, making it 90% stronger than conventional reels, giving SuperReel the strength to withstand the higher tensions of both your current and future drives. SuperReel also has a specially-shaped tape wind surface, to prevent edge damage during rewinds. And all SuperReel components are ultrasonically welded—no glues or solvents—for improved strength, product uniformity, and lasting performance.

SuperReel is the only reel specifically designed to meet the demands of advanced drive technology. The one reel that surpasses all published specifications for high-performance drives. The one reel that performed reliably in stringent testing conditions at 15 ounces of tension and speeds up to 220 ips. The one reel with no flange expansion or contraction under stress conditions. The one reel balanced to prevent hub-to-drive fit problems.

Memorex SuperReel. A better reel, to give you better results. Better winding. Positive autoloading functioning. More accurate data transfer. Greater reliability. On the drives you're using now, and the new generations of drives to come.

Memorex SuperReel. The new shape that'll put your data processing in great shape.

Ask your Memorex representative to explain how SuperReel can dramatically reduce your data processing costs. Locations in principal cities worldwide. Or contact us at 1200 Memorex Drive, MS-0064, Santa Clara, CA 95052. Phone 408-987-1043.

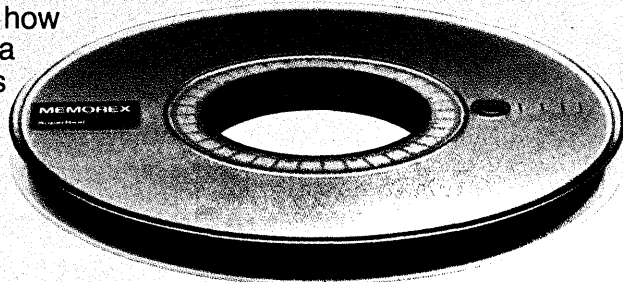

MEMOREXCELLENCE

Believe. And \$5,950 is for a quantity of one. Now you can afford a genuine Datapoint for those network applications where computer power is needed but couldn't be cost-justified.

A Real Computer

Don't let the price mislead you. The 1500 contains a powerful fully programmable business computer with 32,000 bytes (8 bits & parity) of memory. Add to that an integral keyboard, video display and dual diskette drives (over 500,000 characters on-line) and you have a complete system. And there's more. A standard, built-in communications interface requires that you add only a modem to start communicating.

With Comprehensive Software

There's much more than just hardware, too. You get a comprehensive Diskette Operating System with a utility library including sort, index and index sequential access method (ISAM), a data entry language (DATAFORM®), a data processing language (DATABUS®). Like all Datapoint systems there's a common, dynamic file structure. No time consuming file format conversion necessary. You start writing application programs immediately.

Easy Concurrent Communications or Printing

The 1500 will communicate in IBM 3780 discipline, or DATAPOLL® for Datapoint-to-Datapoint communications. Auto-answer is standard. You needn't halt an ongoing data entry operation to communicate — with the 1500 you can communicate while an operator continues to enter or process data. Or, you can elect to do concurrent printing on an optional Freedom Printer™.

More Features — And a Growth Path

You'll find the 1500 full of those features you've always wanted. Inverse video for display highlighting, user program defined function keys, simple installation, and easy operator training. Programs can be remotely loaded from a central site. A system that you can adapt to your needs, not the reverse.

Since the 1500 is part of the Datapoint family, you can easily move your application programs to larger Datapoint systems without another investment in software.

Fully Supported

Each 1500 is backed by the nationwide Datapoint Field Service organization with over 90 service centers. And when you need systems or other technical advice, the Datapoint Account Managers and Systems Engineers are ready to help.

Learn More

Call your local Datapoint Sales Office. They'll send you information on how the 1500 can start saving you money now. Or write Datapoint Corporation, Marketing Communications, 9725 Datapoint Drive, San Antonio, Texas 78284.

DATAPPOINT CORPORATION



The leader in dispersed data processing™

CIRCLE 59 ON READER CARD

Hard to believe:

The Datapoint 1500 business computer designed to meet your network needs for just \$5,950.

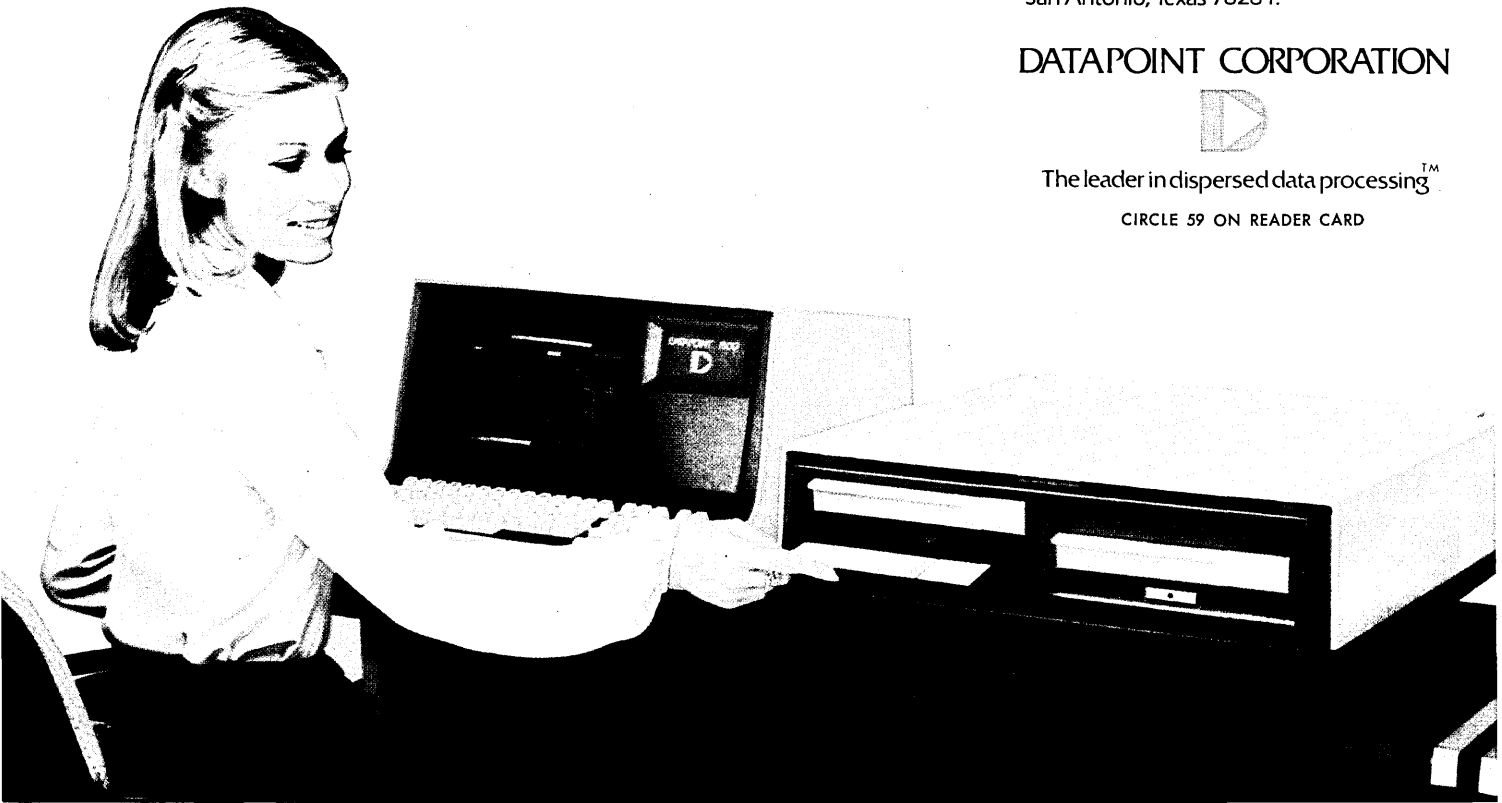

source data

SOURCE DATA provides information on books, courses, references, reports, periodicals, and vendor publications.



BOOK BRIEFS . . .

Computers and Local Government Volume I: A Manager's Guide

by Kenneth L. Kraemer and

John Leslie King

Praeger Special Studies

200 Park Avenue

New York, NY 10017

109 pages

\$12.50

The authors' wide research on data processing technology has been so clearly set forth in this guide to planning an urban information system that the book will likely be of interest to any manager or executive embarking on an installation of computers for nongovernment applications as well.

The first segment summarizes the evolution of the field, beginning with the use of the computer strictly as a tool for the automation of routine operations, and carrying forward to a discussion of the need for information management planning. Present use of computers in local government is discussed briefly in the context of how the field can be expected to change.

The rest of the book is an easy-to-follow guide to the development and management of an information system.



Future Systems

Major issues concerning the development of future computer systems are covered in Infotech International's 700 page report. Featured are discussions of trends in processor and memory prices, communications and software costs, and innovations in processor design including supercomputer developments, minicomputer design, and database processors and interpretive processor. Also addressed are the prospects for multi-processor and multicomputer systems.

The emphasis is on how to come up with sensible, workable policy. Attention is given to personnel aspects, such as attitude, specific tasks, policies, recruitment, training, and even promotion and salaries. There is a chapter on financial considerations, and one on privacy and disclosure. The concluding chapter, "Urban Information Systems as a Field of Study," focuses on problems and futures. There is a descriptive bibliography of related nontechnical sources. Volume II, *A Review of the Research*, is due to be published shortly.

Annual Review of Information (Science and Technology)

edited by Martha E. Williams

Knowledge Industry Publications

2 Corporate Park Drive

White Plains, New York 10604

361 pp.

\$35.00

The Annual Review seeks to describe and appraise the publications and trends in the field of information science and technology. Basic topics include: planning information systems and service, basic techniques and tools, applications, the profession, and special topics.

The special topic for this edition is privacy. The applications section is about European information networks. Basic techniques and tools include bibliometrics, bibliographic and information processing standards, subject analysis, numeric data bases and systems, and computer communication networks. The planning section addresses evaluation and design of bibliographic data bases.

Among the invited papers are Gene Amdahl on advances in computer technology and Isaac Auerbach on the influence of market factors in future computer development. Reports are \$215 singly or \$162 as part of the complete Infotech State-of-the-Art series. AUERBACH PUBLISHERS INC., 6560 N. Park Drive, Pennsauken, NJ 08109.

DATAMATION 1977 Subject Index

The past year's books reviewed, conference reports, editorials, news in perspective, the forum, and, of course, feature articles are conveniently listed by topic in the Subject Index, now available.

FOR COPY CIRCLE 299 ON READER CARD

Modeling and Simulation

A two-part set consisting of 196 papers from the 8th annual conference on

modeling and simulation describes a wide variety of applications. Part 1 focuses on urban modeling, power, energy transportation, and modeling and simulation theory. Part 2 addresses problems in health care, agriculture, ecology, world modeling, social systems, economics, data processing, and learning systems. \$75 for the set or \$40 singly from Instrument Society of America. Send payment to P.O. Box 34093 P, Pittsburgh, PA 15230; orders to be invoiced to 400 Stanwix Street, Pittsburgh, PA 15222.

Computer Books

According to the University of Colorado's recently published bibliography, the most significant improvement in quality of books was on the subject of program design and data base design. A 75% increase in number of books on dp management was found, and for the first time there were more books on COBOL than on FORTRAN. The bibliography, in its 11th annual printing, has been enlarged and updated. There are 12 categories of computer applications, in which a total of 35 new books were published. A special category includes security and privacy, computers and society, and the future of computing. The bibliography is available for \$4 (\$5 if invoice required) from *Computing Newsletter*, Box 7345, Colorado Springs, CO 80933.

Salary Report

A new study of starting salaries for financial and dp personnel shows record highs. Conducted annually, the Robert Half study was included in the U.S. Dept. of Labor's Employment Outlook series. The data processing categories include: programmers, systems analysts, operations managers, computer operators, and consultants. Available from Robert Half Personnel Agencies, Inc., 522 Fifth Ave., New York, NY 10036, (212) 221-6500.

World Telecommunications Directory

A 1,500 page reference in three loose-leaf volumes lists services and tariffs relevant to the design, installation, and sale of communication networks and services. Also included are government regulatory agencies, a table of world currencies, regulatory information for private networks, and information on satellite and ground stations around the world. Indexed by topic, tariff, and country, the report is \$950, with additional copies priced at \$250. FROST & SULLIVAN, Dept. R-1, 106 Fulton Street, New York, NY 10036.

(April Review of Books, p. 62. Source Data continues, p. 67.)

April Review of Literature

Computer literature falls into two broad categories: those books about computers, and those by computers. In the latter category we have some real classics, such as the first memory dump of HASP 1 (OS release 11.2, if I recall correctly), which combined in just the right doses comedy and epic tragedy, a veritable *Hamlet* of dumps. Unhappily, the last few years have seen little of note in this category. The genre is becoming increasingly technical, the language more esoteric, and the pathos of those early dumps seems to have become a thing of the past.

In the first category, literature about computers, some books of note have appeared recently. Again, nothing that quite matches or even brings to mind the classics of the vacuum tube era, but in this age of the cheapening and popularization of computers, second rate literature is apparently the best we can expect.

Books

Passages: Predictable Crises in Software Life (Ada Lovelace, Random-Yourdan: NY) is in the new style of journalism, and combines subjectivity and superficial expertise to produce a substantial volume of slick generalizations and sophomoric aphorisms, just the thing for the executive who doesn't really want to know about computers but is afraid that he has no choice.

As every programmer knows, a system's (or program's) most productive period is its middle life, that brief moment after the confusion and indecision of the initial installation and before its collapse in the face of the rapidly changing reality of its external environment. A good programmer can, by careful planning, ensure that this middle period comes before his next salary review; but conspicuous signs of ending should show up before the review after that. Still, to conclude from this premise, as the author does, that the life of all software can be fruitfully extended by decades is to bend and twist logic into sophistry and does great injustice to the integrity of algorithms everywhere.

A final word about language and style. Since this is not a volume of poetry (and Heaven preserve us from the—I fear—inevitable anthology of poems about and by computers) one would expect that flowery phrases and mediocre metaphors would be out of place here. These days the English language is prey to the most foul abuse at the hands of electric typewriter operators, but don't we have the right to ask that publishers save us from blows such as "software menopause" and "intersect abscissa-wise"?

Loops (Leonard Fibonacci and Kenneth Iferson, Vanity Press: PA) is the detailed and somewhat verbose story of how a program came to be, starting with the idea many years ago and following through to its fruition. Studying the program carefully, we can see how a far ranging variety of factors, sociological as well as economic, left their imprint on the final product. This book deserves to be read carefully, since it provides important insights into the development of software character through the generations.

Games Computers Play (Urich Burns, Apprentice Publ.: NJ) is not, as the title suggests, a compendium of chess and tic-tac-toe playing programs, but rather a humorous account of the author's experiences as a young programmer trying to get his programs up and running, despite his computer's annoying predilection for dropping bits. Some of his anecdotes are priceless, especially

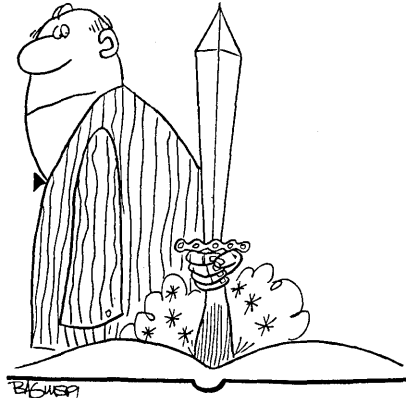

the one about the schizophrenic key-punch girl and the uninitialized DO loop index. A must for would-be computer-room Falstaffs and anyone else who enjoys a good laugh about the foibles of contemporary logic gates.

Against Our Will: Men, Women and Computers (Hilda Hollerith, Parents Magazine Press: NH) is, if the blurb on the back cover is to be believed, not only "chilling and monumental," but also "deserves a place next to those rare books which force us to change the way we feel about what we know." Given the tendency of mankind to complacently ignore anything which might upset his comfortable view of himself and his world, this volume is thus destined to gather cobwebs on the upper shelf of every intellectual's bookcase, and deservedly so. The author's contention that computers are nothing more than another weapon in man's war against woman is perhaps just what the sisters on the barricades want to hear, but its potential damage to morale in the key-punch room is incalculable.

Years ago .computer fiction confined

itself to tales of maniacal mainframes bent on taking over the world or, worse, Disneyland. These days a new genre is surfacing: computer aided and abetted crime. We have already had a computer manipulate the Zurich currency bourse, OPEC, and cocoa futures, so it was inevitable that one day a fictional computer would falsify the Nielsen ratings and drive a suspiciously Barbara Walters-like newscaster off the airwaves of a rival network.

Is *The Ratings Algorithm* (Donna Knuth, Harcourt-Brace Jorselthorthis: NY) suspense filled, as the dust jacket proclaims? If the reference is to the suspense endured by the reader as he flips page after page, searching in vain for something that looks like a credible plot, then the answer is a resounding "Yes!"

For the computer professional, the book is full of delightful though surely unintentional malaprops. One character is described in chapter four as a computer "softwear" expert. The detailed description of the central program's operation in chapter seven includes the following: "The program is initiated by a punched card reader, which is fed into the computer, supplying it with the necessary data." A rather expensive input medium, one may be tempted to conclude, but worth it if the stakes are high enough.

Periodicals

No review such as this would be complete without at least a passing mention of some of the new periodicals. A veritable flood, of rather uneven quality to say the least, has inundated the market in the last year, presumably because of the surge of interest in home computing. The deluge of paper ranges from the slick four-color cover *Better Homes and Computers* to the tabloid format *New York Review of Computing*. Little in between is worth dwelling on. The mortality rate of these publications is higher than that of the hardware firms in the mid-1960s, and given the volatility of the market, it's difficult to predict who will still be publishing next week. Half the readers may decide to go back to hang gliding and TM as soon as they come face to face with their first addressing exception.

And song

And finally, a word about a totally new concept in computer literature, the computer folk song. The few FM stations playing them now may well be the pioneers of an age when computers will not only select the songs to be played on the airwaves, but will also compose them and perform them.

—Alex Ragen

DP Dialogue

Notes and observations from IBM that may prove of interest to data processing professionals.

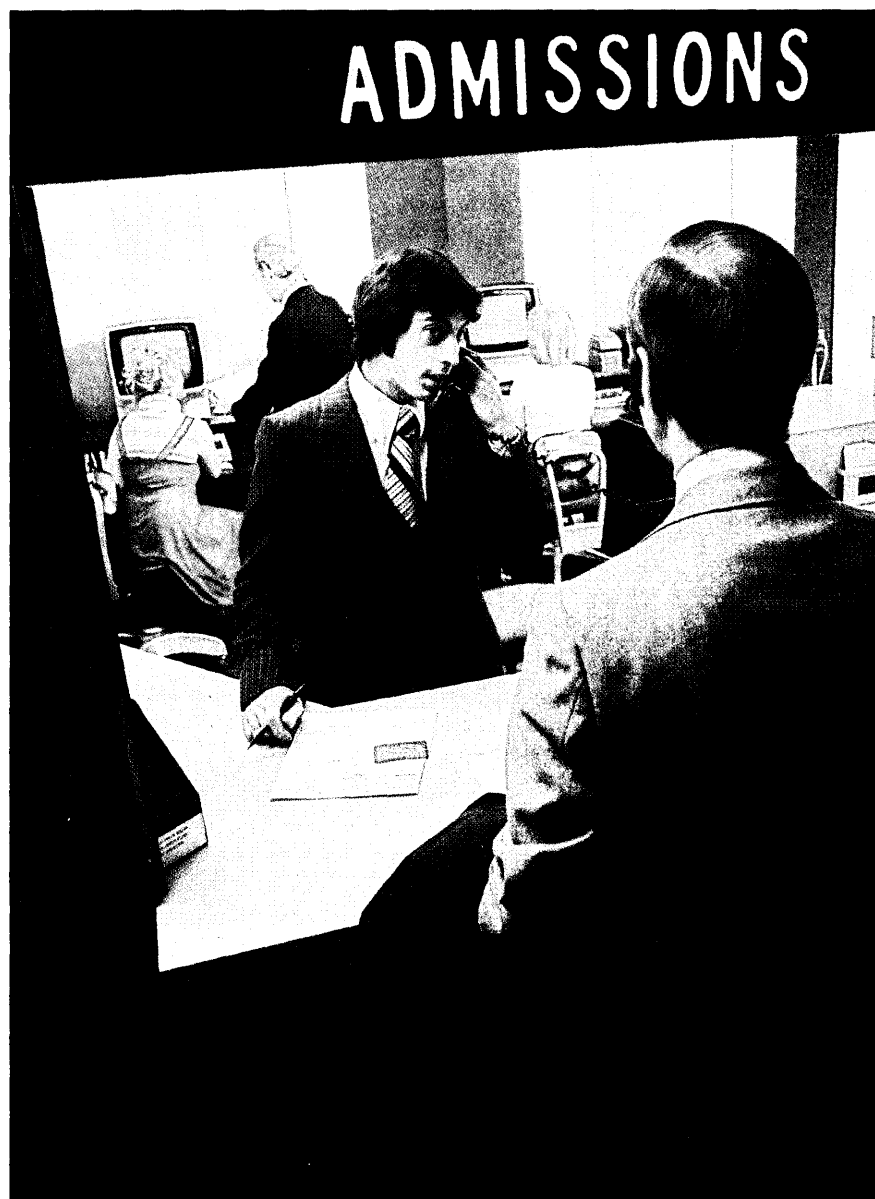

Personnel in the admissions office at Thomas Jefferson University Hospital use an online information system. IBM's DMS/VS decreases the development cycle and lets users participate in the design.

programs. It generates and displays user-defined screen formats, processes terminal transactions, and accesses an existing data base, or one newly defined under DMS/VS. Screen formats can be revised and new ones added quickly and easily, without reprogramming, by making entries on a preprinted form.

Powerful Aid

"DMS serves both as a powerful programming aid and as a medium for the exchange of ideas and information between the admissions office people and those of us in systems," says Dick Hornickle, project manager. "It enables us to allow the user to work directly with us in designing the screens to meet their needs precisely."

"The number of display formats in the system is constantly growing," says Waldren Bailey, director of admissions. "DMS aids in transforming our screen formats and transactions concepts directly into online routines. We have eliminated considerable data redundancy, our records are more accurate and complete, and we are achieving much better scheduling and operational control. Patient data, bed assignments and bed availability information are easily accessible."

Patient Management Support

"Our management plans call for extensive use of data base and data communications in our System/370, and admissions was the logical place to begin — where information on patients is initially collected," says Byron Irwin, associate director. "The medical and patient-oriented approach to the design of our systems demands heavy user participation in the design and a high degree of productivity in its development."

"The university's management services department is called upon to develop systems tailored to our needs and objectives," Irwin notes. "I wanted to monitor and participate in every step and I had that opportunity."

Thomas Jefferson University Hospital Shapes Applications with DMS/VS

At Thomas Jefferson University Hospital, Philadelphia, the admissions office reserves and assigns beds, maintains its census of patients and keeps the demographic part of the medical rec-

ord up-to-date using Display Management System/Virtual Storage (DMS/VS).

An IBM program product, DMS/VS converts information from a fill-in-the-blanks form directly into executable

Who's Zoo: A Social Register for Animals

One American zoo needed a Celebes ape not long ago. Another needed an echidna (or spiny anteater). A computer helped each identify a zoo with a surplus of the desired animal.

The American Association of Zoological Parks and Aquariums, in conjunction with Federal agencies and private foundations, sponsors a project that some day will store data on every animal in every zoo in most countries of the world. The association's International Species Inventory System (ISIS), headquartered at the Minnesota Zoological Garden, Apple Valley, has already placed in an IBM computer detailed information on 25,000 mammals and 10,000 birds located in zoos in the United States, Canada, and Europe. ISIS will someday also include data on reptiles, amphibians, and fish.

A Vital Task

Says Janice M. Olsen, systems manager of ISIS: "A vital task of modern zoos is to develop and maintain self-sustaining



The International Species Inventory System (ISIS), a computer data base of animals in zoos, is helping endangered species like this Siberian tiger.

populations of captive wild species and—in certain cases—to provide the only reservoir of species on the verge of extinction. To do this, we must collect data and share it.

"ISIS tells us the captive numbers and reproductive rates of animals on the endangered species list, such as the Indian rhinoceros, Siberian tiger and orangutan. This information aids the development of breeding management programs for captive wild animals."

Finding Rare Mates

Another valuable service of ISIS — the acronym spells the name of the Egyptian goddess of motherhood and protection — is the finding of a mate for a rare species in a zoo that does not have one of each sex. The computer, which is an IBM System/370 Model 158 in the state data processing center in St. Paul, Minnesota, helps to match animals needing mates with available candidates, to the benefit of the rare species themselves and of zoos all around the world.

Con Edison Puts 3 Million Subscriber Accounts Online

The Consolidated Edison Company supplies gas and electricity to nearly 3 million retail customers in New York City and Westchester County, where dense population, old buildings, diverse cultures and a population accustomed to

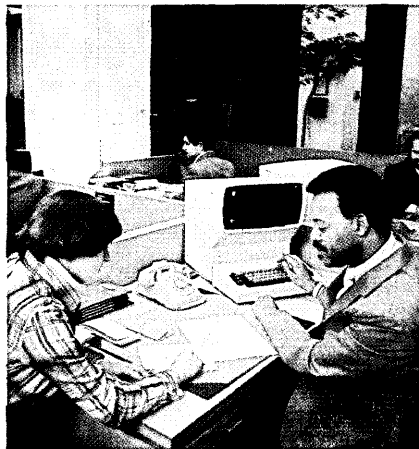

Con Edison service representatives call up details of customer accounts through desktop terminals.

frequent moving present a unique challenge to a service-oriented public utility.

Thousands of customers phone or visit the company each day, for a wide variety of transactions, such as making payments, transferring accounts to new addresses, or to ask for help in interpreting bills. To respond promptly to each requirement, a customer service representative must have access to a great deal of information, such as the payment history of the account, the date of the last meter reading, and details of the building and its energy usage.

Now the representative can retrieve, in seconds, all such information about any subscriber from the IBM 3350 Direct Access Storage Facility, by keying account number or address into a display station. All told, the system responds to 80,000 inquiries or transactions during a typical hour, and 115,000 during peak hours.

To obtain the details needed, the interviewer follows simple keyboard procedures. These are interpreted by the Customer Information Control

System/Virtual Storage (CICS/VS) in Con Edison's dual System/370 Model 168's.

Says Joseph B. Sansone, vice president for data processing: "The service representative, whether in a district office, dealing directly with the customer across his desk, or in a telephone office, can make decisions and enter transactions immediately through a desktop terminal. The representative sees and immediately corrects any error, old or new. This responsiveness has given a tremendous boost to customer satisfaction and employee morale.

"We use the Multiple Virtual Storage (MVS) operating system to couple loosely two 168's, which share the transaction load. Together they support over 1,900 3277 Display Stations, and readily handle our peak traffic loads. The online system imposes stringent requirements for error recovery and availability, which have been more than met under MVS. And the 3350 has been a cost-effective alternative for storing the details of our 3 million subscriber accounts."

SDLC at Seibels, Bruce: Flexibility and Economy

Seibels, Bruce uses one visual display station for every two professional employees. Synchronous Data Link Control lets the company add or replace terminals easily, without adding telephone lines.

The property and liability insurance business of Seibels, Bruce & Company is conducted through more than 300 online terminals — one for every two professional employees. Underwriters, claims adjusters, investment managers, and others in many locations all access a common data base, resident on an IBM System/370 Model 168 at company headquarters in Columbia, South Carolina.

The Seibels, Bruce network grew from 32 local terminals to 300 units across the continent in a period of two years. The company attributes sharp rises in productivity to the computer system. "Operating expenses were 34 percent of premiums," explains G. Larry Wilson, senior vice president. "Now they're 28 percent. Using terminals, underwriters have experienced work output gains as high as two to one, while an increase of 25 percent is typical.

Why SDLC?

"The extremely rapid growth of our network," Wilson notes, "was our reason for looking at SDLC." Synchronous Data Link Control (SDLC) is an advanced line control discipline for communication between terminals and a computer. It is a key element of Systems Network Architecture, IBM's most advanced telecommunications technology.

"SDLC accommodates a dynamic network," Wilson says. "We can add terminals or replace one type with another without adding telephone lines. We can put as many as 62 visual display terminals—more than twice as many as before—on a single line.

"The architecture permitted us to phase in SDLC one line at a time. The Network Control Program in our 3705 Communications Controller took over such functions as polling and error recovery on SDLC lines, freeing capacity in our 370/168. The 3705 can accomplish an error recovery on one line while the rest of the system continues to work normally."

Consistent Response

Response time of the system to terminal inputs, Wilson reports, was significantly improved by SDLC. "But even more important is the greatly reduced variation in response — within three seconds more than 90 percent of the time. Users work more easily and make fewer errors when the system responds consistently.



"One additional benefit relates to our data communication link via satellite to other sites. There is a propagation delay through a satellite that can be troublesome under the older line disciplines, but SDLC tolerates it without any difficulty."

Minimizing the number of leased telephone lines has also held down the required number of modems and other line-terminating equipment, Wilson points out. Today's network costs the company no more to operate than did the considerably smaller configuration, a year and a half earlier.

DP Dialogue is designed to provide you with useful information about data processing applications, concepts and techniques. For more information about IBM products or services, contact your local IBM branch office, or write Editor, DP Dialogue, IBM Data Processing Division, White Plains, N.Y. 10604.

Data Processing Division

It's no wonder
the 1500 Series
is selling
like hotcakes!

Hazeltine



No extra-cost options
... these features and more
included as standard:

Read Status!

**Standard or
Reverse Video!**

**Programmable
"Mode Selection!"**

**Numeric Pad and
Cursor Control Keys!**

Transparency!

**Programmable
"Send" Operation!**



Hazeltine puts Performance
into Economy Terminals.

**Hazeltine Corporation
Computer Terminal Equipment
Greenlawn, New York 11740
(516) 549-8800 Telex 96-1435**

**Independent Buffered
Printer Interface**

Editing!

Function Keys!

EAST: N.Y. (212) 586-1970 MIDWEST: Chicago (312) 986-1414
 SOUTH: Atlanta (404) 434-8444 WEST: San Mateo (S.F.) (415) 574-4800
 ENGLAND: Hazeltine Ltd. 01-948-3111 Telex (851)-928572
 GERMANY: Hazeltine GmbH 0611-590748 Telex (841)-416924
 FOR WORLDWIDE SALES INFORMATION CALL (516) 549-8800.

CIRCLE 44 ON READER CARD

source data

(Continued from page 61)

Facsimile Selection

More than 30 models of facsimile transceivers, receivers, and transmitters are listed in this guide by function, scanner type, resolution, recorder type and technique, input and output, speeds, compatibility, and pricing. A vendor index is included at \$10 (\$2 handling charge if payment does not accompany order). ALLTECH PUBLISHING CO., 212 Cooper Center, North Park Drive & Browning Road, Pennsauken, NJ 08109.

Home Computer Guide

A trade directory is now being compiled of small computer manufacturers, distributors, retailers, consultants, clubs, and publishers. Computer businesses that would like to be listed as part of the home business or hobby computer market should write for a listing form; send your business card to The Home Computer Guide, J&M ASSOCIATES, Box 8118, Kansas City, MO 64112.

Outside Help

New directory lists 163 user groups and trade associations, both product/vendor-oriented and professional. Each group's headquarters address and phone, objectives of the organization, number of members, and membership requirements are listed; information is provided on meetings and publications. Price: \$12. DATAPRO RESEARCH CORP., 1805 Underwood Bl., Delran, NJ 08075.

Home Computer Market

A study of current home computer use and projected future use including history, technology, industry structure, and market strategies and growth prospects predicts a real home computer market as emerging in 1978 when machines with peripherals, performance improvements and sophisticated operating systems become more widely available.

More than half of the computer hobbyists interviewed for the study do not own computers at present; games, word processing and mathematical problem solving were cited by hobbyists as favorite applications.

The home computer market is found to differ from the hobby market in the projected availability of application programs and consumer awareness of home computer capabilities. The 168 page study is \$950. VENTURE DEVELOPMENT CORP., One Washington St., Wellesley, MA 02181, (617) 237-5080.

Microprocessor Courses

Various user-oriented "how-to" courses are offered on videotape. Four seminars conducted by Dr. Rodney Zaks of

Sybox include a lecture presentation, some questions and answers with the audience, and a survey of the state of the art. Microprocessors: The Basic Hardware runs 14 hours and sells for \$3,500 (lease price \$1,750). Also separately covered by Dr. Zaks are an overview of military microprocessor systems and techniques, microprocessor interfacing techniques, and bit slice. Introductory and design courses also are available. Workbooks and texts for individual study are available in each case. Contact Charles Martin, GENESYS SYSTEMS, INC., 1121 East Meadow Drive, Palo Alto, CA 94303, (415) 494-3701.

Utilities Evaluation

Designed to help dp managers select from the leading operating system utilities now marketed, including sort/merge programs, DOS partition balancers, and disc space managers, this guide carries reports describing and evaluating each system, and catalogs the software packages according to price, systems, and capabilities. AUERBACH PUBLISHERS INC., 6560 North Park Drive, Pennsauken, NJ 08109.

COM Recorders

Bell & Howell model 3700 COM recorders were rated highest in overall satisfaction to users in a new Datapro

Only one thing's better than the terminals we lease.

The service we give them.

RCA has the best equipment there is for lease. The GE TermiNet 30.* The Teletype** teleprinter with Data-Phone.*** The Extel Printer.****

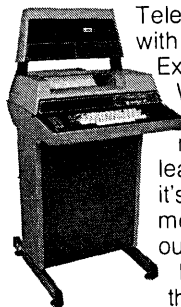

We're one of the biggest companies in the terminal leasing business. But it's not just fine equipment that brings us our customers. It's a lot of other things. RCA offers nationwide service. We have 180 service locations, coast to coast. We have 15 strategically-located warehouses — equipped for retrofitting or overhauling equipment on site. And we have expert technicians.

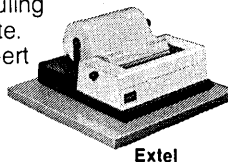

Technicians trained to RCA standards.

We service what we lease, and we offer service on equipment we don't lease... mixed or homogeneous systems.

We have a variety of plans available. We can give you whatever you want, whenever and wherever you want it. We're more flexible. So that you can be more satisfied. Finally, we're RCA. And with a name like that, we really can't afford to make mistakes.

To find out how we can help you, just write or call.

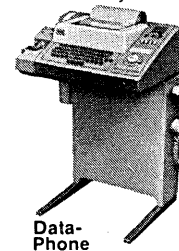

RCA Data Services

RCA Service Company, A Division of RCA
Data Services, Bldg. 204-2 Cherry Hill Offices, Camden, N.J. 08101
Phone: (609) 779-4129

Call any of these regional offices for 24-hour service:

Atlanta: (404) 934-9333/Dallas: (817) 640-0900/Boston: (617) 273-0074
Los Angeles: (213) 728-7473/Chicago: (312) 965-7550/New York: (201) 451-2222 (N.J.)
(212) 267-1550 (N.Y.) Cleveland: (216) 238-9555/Philadelphia: (215) 467-3300

*Registered trademark of General Electric Company. **Registered trademark of Teletype Corp.
Registered service mark of AT&T Co. *Registered trademark of Extel Corp.

source data

survey. The report, "All About COM," also contains specifications of 33 recorders from 10 vendors. Price: \$12. DATAPRO RESEARCH CORP., 1805 Underwood Blvd., Delran, NJ 08075.

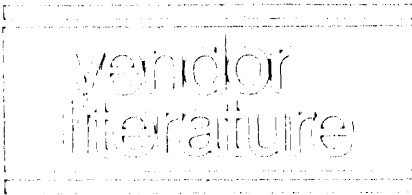

Communication Glossary

Sherry's Guide to Data Communication Buzzwords is now in its eleventh printing. The revised glossary of data communication terms now contains 183 definitions. New entries include distributed processing, conditioning, contention, and mnemonic address. This 24-page, pocket-sized booklet is not a sales pitch for the vendor; rather it's a useful little booklet, graced by the wit and wisdom of Sherry Moreau (you've probably seen her at the vendor's booth at most trade shows). The booklet does include a postage-paid postcard for re-

questing product information from the vendor. As a bonus, each copy comes with "Sherry's Buzzword Puzzle." Those who fill in the crossword puzzle correctly are entitled to a certificate proclaiming their expertise in the field of data communication buzzwords. RACAL-MILGO, INC., Miami, Fla.

FOR COPY CIRCLE 300 ON READER CARD

Personal Computers

This 16-page product catalog describes the vendor's Horizon personal computer, S-100 bus peripheral products, and software offerings. After a brief sketch of the company, the catalog concentrates on all products sold by the firm, giving both descriptive information and pricing. The Horizon is described in its several standard configurations. Several pages are devoted to software—the vendor's extended BASIC, disc operating system, and monitor. Other products include floppy disc subsystems, 16KB memory boards, Z-80A processor board, hardware floating-point board, and a crt terminal oem'ed from Soroc. The catalog is illustrated with color and black and white photographs. NORTH STAR COMPUTERS, INC., Berkeley, Calif.

FOR COPY CIRCLE 301 ON READER CARD

Data Base Management

Written for the user faced with a first-time move to a data base management

system, this booklet outlines DBMS operation, organization, and use. It provides definitions of DBMS terms, including "set," and "record," and it explains data definition languages (DDL) and data manipulation languages (DML) as defined by CODASYL. The vendor's own SEED DBMS is examined, and its features, operational characteristics, and resource utilization requirements are detailed. INTERNATIONAL DATA BASE SYSTEMS, INC., Philadelphia, Penn.

FOR COPY CIRCLE 302 ON READER CARD

Computer

The introduction of a major addition to a product line calls for a handful of new promotional literature, and this vendor has started the ball rolling with a 20-page, four-color brochure describing its new Eclipse M/600 computer. Topics include architecture, support software, peripherals, and service. The booklet gives an overview of the M/600's demand-paged storage facility, and its three-level I/O management system. In its discussion of the M/600's operating system—AOS—the booklet covers multiprogramming, paging, and security. File management software, language processors, and communications emulators also are discussed. Time-sharing and batch processing both are covered, as are reliability and support services. The booklet also contains a postage-paid

(Continued on page 74)

This Publication is Available in MICROFORM

FOR INFORMATION
WRITE:
Dept. F.A.

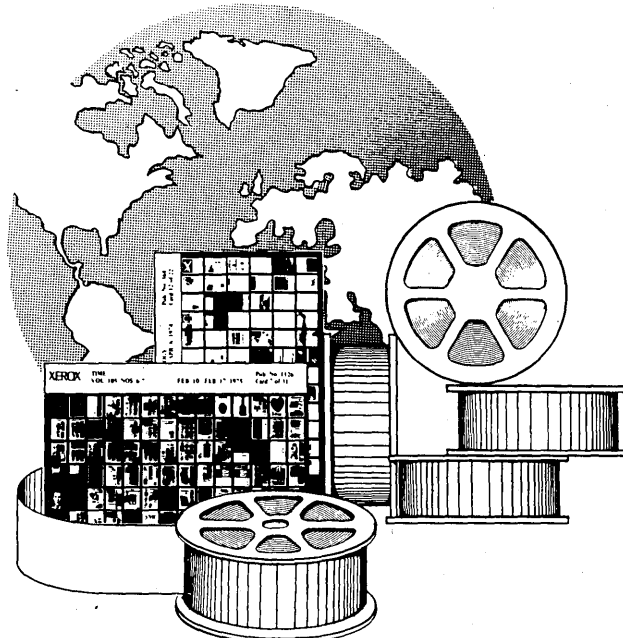

University Microfilms International

300 North Zeeb Road
Ann Arbor, Mich. 48106
U.S.A.

18 Bedford Row
London, WC1R 4EJ
England

Powerful new way to write interactive data entry programs:

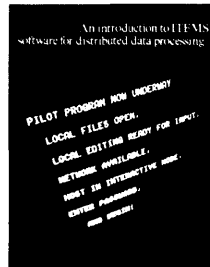

ITEMS.™

ITEMS — the INCOTERM Transaction Entry Management System — is a virtual storage operating system for distributed data processing. A powerful software development tool that can dramatically reduce the time required to create and implement versatile application programs.

ITEMS gives the system designer such operating advantages as extensive local editing, local screen format and data storage, local data entry control, interactive and stand-alone processing options, as well as security procedures. Implementation is greatly simplified. Mainframe application programs continue without workflow interruption.

User experience shows that 20% to 30% of all interactively entered data results in error. ITEMS offers an efficient solution to this costly problem while enhancing data entry throughput and reducing mainframe overhead.

ITEMS operates on standard INCOTERM Series 30 or Series 40 Intelligent Termi-

nals with diskette or rigid disk storage. Up to eight display stations and eight printers can be operated independently under sixteen concurrent programs. Operators are guided by editing attributes for each input field; 25th line messages prompt accurate keying.

Why not discover how you can use the full power of ITEMS on your existing network without extensive conversion procedures. Call or write for complete details.

More power
to your
terminal.



INCOTERM[®]
CORPORATION

A Subsidiary of Honeywell Inc.
65 Walnut Street, Wellesley Hills, Massachusetts 02181
Telephone: (617) 237-2100

Hewlett-Packard

smart, bright, simple, handy,

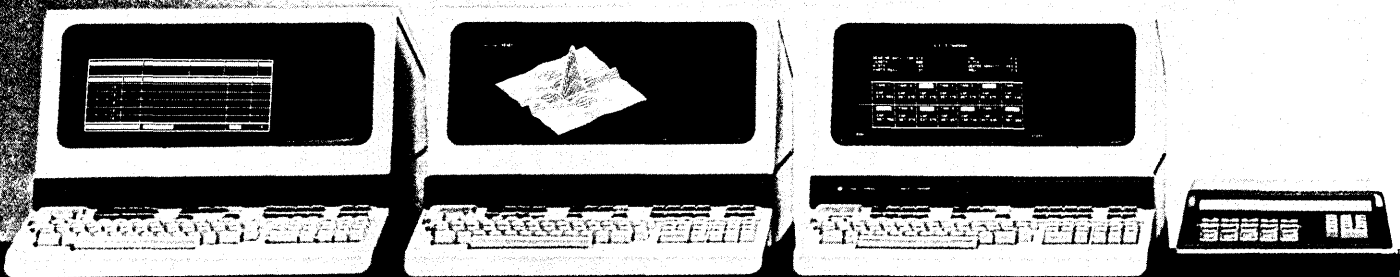

The HP 2645A is the smartest of our alphanumeric terminals. Even so, it's easy to operate. Micro-processor control gives the 2645A easy editing, scrolling and forms-building capability. User definable "soft keys" streamline repetitive jobs. Dual, plug-in cartridges provide mass storage up to 110K bytes each. And the terminal can transmit data up to 9600 baud.

The HP 2648A combines full alphanumeric and graphics capabilities. These include auto-plot, raster scan, zoom and pan, area shading, pattern definition, and rubber-band line. Dual, plug-in cartridges store up to 110K bytes each. The 2648A has independent memories, so you can display words and graphics separately or at the same time.

The HP 2649A gives OEMs a building block approach. You can make a terminal, a controller, or a graphics display station, depending on the optional cards and keyboards you choose. Starting with the basic CRT, microprocessor, I/O and backplane, you customize the 2649A and program the built-in 8080 microprocessor to fit your application.

The HP 3071A Numeric Data Entry Terminal makes it easy to input data to your computer from your warehouse, shipping dock, or production line. You customize the keys' prompting labels so anyone can operate the 3071A easily. And it's RS232C and CCITT V.24 compatible. The HP 3070A Model is IEEE 488 compatible.

Yes, I'm interested in your terminals.
Send me more information on the

- HP 2645A CRT Terminal
- HP 2648A Graphics Terminal
- HP 2649A Terminal/Controller
- HP 3071A/3070A Data Terminals
- HP 7260A Optical Mark Reader
- HP 2631A Printer
- HP 2635A Printing Terminal
- Other Peripherals
- Send details of your OEM discounts and agreements.

Name _____ Title _____

Company _____

Address _____

City _____

State/Zip _____

Mail to: Hewlett-Packard, Attn: Larry Turner,
11000 Wolfe Road, Dept. 419, Cupertino CA 95014

terminals are

flexible, hard and fast.

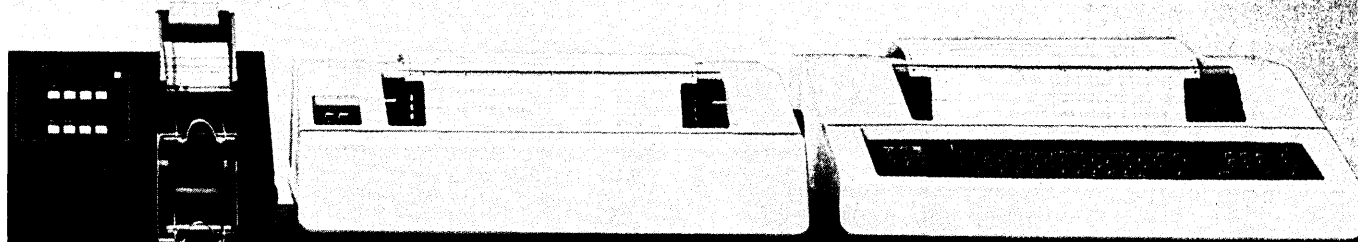

The HP 7260A Optical Mark Reader is a flexible transmission link to your computer. It reads both pencil marked and punched cards, transmits at up to 2400 baud, and with its two RS232C or CCITT V.24 connectors can easily form an integral part of a low-cost RJE station.

We've made hard copy easy with our microprocessor controlled HP 2631A Printer and HP 2635A Printing Terminal. The easy-to-read 7 x 9 dot matrix meets the 128-character USASCII Standard, allows true underlining and descenders, and prints six-part forms. A long-life drop-in cartridge makes ribbon-changing easy, and the Character Expand/Compress mode gives you three ways to print.

Both the HP 2635A Printing Terminal and the 2631A Printer zip along at 180 cps in both directions. The microprocessor determines the optimum print path. A high-speed slew speeds up printing columnar data, and the long-life, self-aligning print head makes for a quick change. Both have self-test features for quick verification of operational status.

These Hewlett-Packard terminals are compatible with all the major interface standards and work with computers from a range of manufacturers. They come with full HP support, service, training, and documentation.

To find out more about these (and others) in our growing line of terminals, call the HP office listed in the White Pages. Or send us the coupon. If you don't see exactly what you're looking for here, let us know. There are plenty more where these came from.

HEWLETT  PACKARD

Announcing OPTIMIZER III: Help at last for your most valuable system resource.

From Capex, a dramatic new approach to COBOL programming

Programmers need all the help they can get. Each day, the demand for more programs, better programs, grows.

Now at last, there's an answer. It's an exciting new program product we call OPTIMIZER III. If you use COBOL and any of the IBM OS, VS1, SVS or MVS operating systems, OPTIMIZER III can help you produce more reliable, more efficient systems... on time... at lower cost.

Works With Your Programmers

By providing key information in easy-to-use form, the new OPTIMIZER III works with each COBOL programmer to help produce better programs faster and easier. You get more programming capacity, more system capacity, better program quality.

OPTIMIZER III goes to work for you in three critical areas:

1. Expands Programming Capacity

OPTIMIZER III takes the guesswork out of programming. It shows the programmer exactly what the program did or didn't do, what was tested and what wasn't, and where opportunities exist for improving performance. It speeds program debugging by virtually eliminating the need for cryptic hexadecimal dumps. It helps you design, develop and maintain more efficient, more reliable programs

with less programmer time and effort. You get the capacity you need to develop more programs.

2. Improves Program Reliability

OPTIMIZER III shows the programmer *exactly* what the program does. It helps you find hidden logic problems and ensures adequate testing before the program goes into production. If a production program does fail, OPTIMIZER III provides the information needed to quickly diagnose and correct the problem. Result: fewer program failures, fewer missed schedules.

3. Stretches System Performance

Programs compiled with OPTIMIZER III are smaller and faster, thanks to proven automatic object code optimization. Turn-around time is improved. Programs are developed using fewer compiles, fewer test shots. Printing time is reduced. Less time is lost to program failures and reruns. Overall system capacity is expanded and performance is improved.

Results Available Immediately

With OPTIMIZER III, you get more programming capacity, more system capacity, better program quality. And you get them *immediately*. Without changing systems. Without costly retraining. Without increasing costs.

You can have new OPTIMIZER III working for you literally in a matter of minutes. To find out how, write or call now: (602) 264-7241.

CAPEX CORPORATION
Atlanta (404) 261-3553
• Boston (617) 329-6170 •
Chicago (312) 596-6550
• Dallas (214) 238-7191 •
Los Angeles (213) 923-9216
• New York (201) 262-8888
• Other offices worldwide.

Capex Corporation
2613 N. 3rd St., Phoenix, AZ 85004

Gentlemen:
Please send me more information
on OPTIMIZER III.

Name _____

Title _____

Company _____

Address _____

City _____

State _____ Zip _____

Phone _____

Model _____

System MFT MVT VSI
 SVS MVS

CB

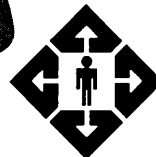
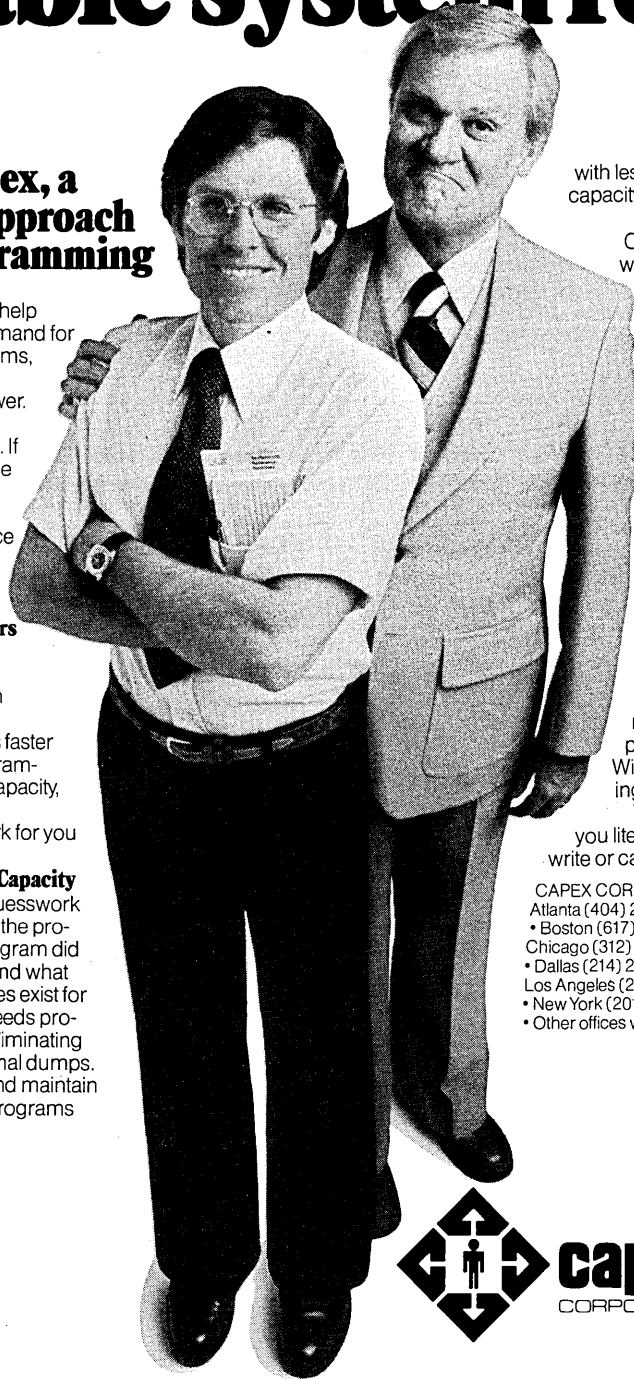

capex
CORPORATION

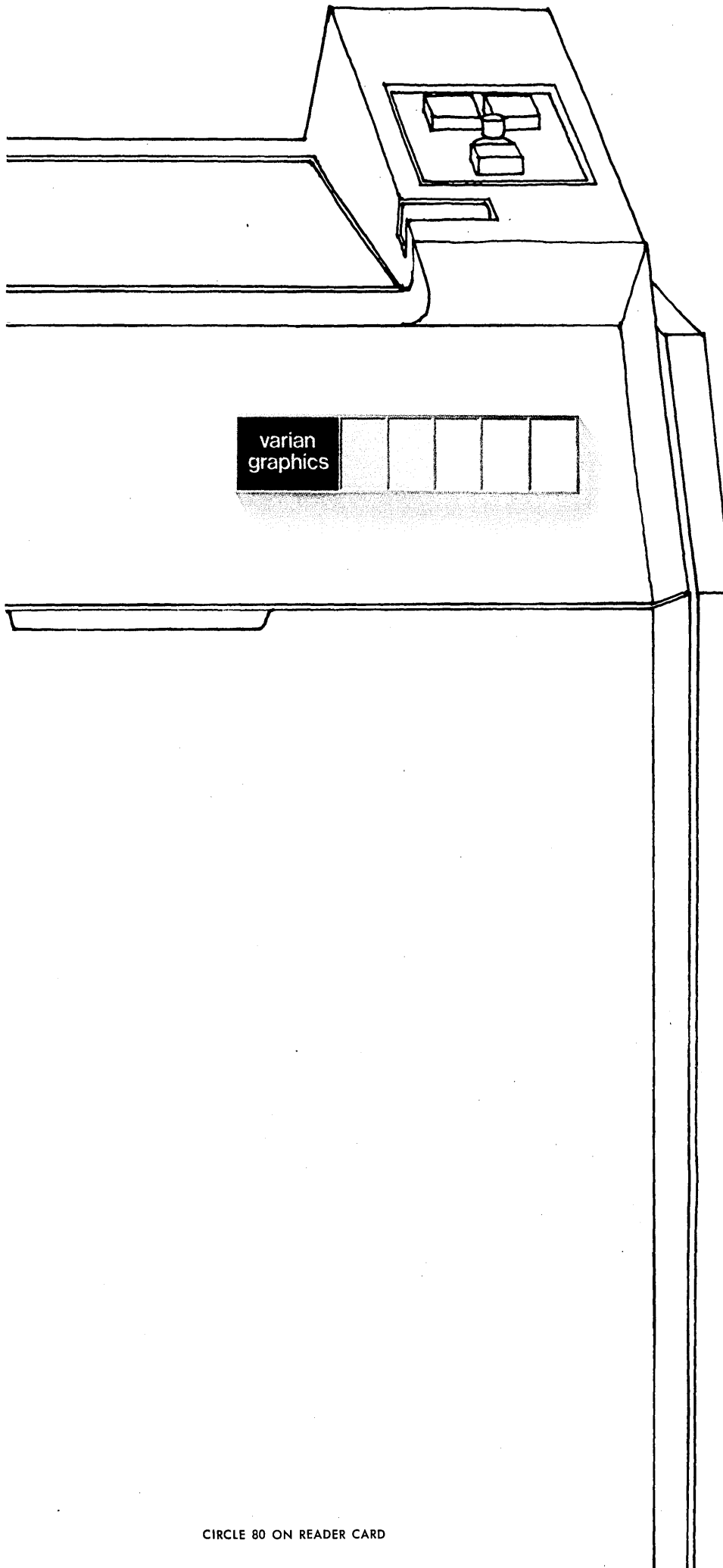

**It's true that
one printer/plotter
looks pretty much
like another.**

**But do you know
what distinguishing
mark appeared
on the first one?**

In 1967 Varian's nameplate went on the world's first electrostatic printer/plotter. And now, a decade later, it's still at the front with probably the most accurate and reliable unit around.

Several exclusive features have kept us there: Like an automatic concentrate-add package for consistent black and white. Like 1800 lines per minute printing and four inches per second plotting on an 11 inch machine. And 128 characters (upper and lower case, plus scientific symbols) in it's hardware character generator. Standard, not optional.

The others may look a little like us. But we're the only one that's pure Varian: Solid, dependable, here to stay.



P.S. We also have some new things to show you at NCC!

I'd like to know more from the ones who started it, so

- Please send "Printer/Plotter Considerations", an overview of the current state of electrostatics.
- Please have a sales engineer call to arrange for an appointment.
- Please keep me on your list for future updates and mailings.

Name _____

Address _____

City/State/Zip _____

Phone _____

Varian Graphics Division
611 Hansen Way
Palo Alto, CA 94303
(415) 494-3004

source data

(Continued from page 68)

postcard for requesting more information about the company and its other products. DATA GENERAL CORP., Westboro, Mass.

FOR COPY CIRCLE 303 ON READER CARD

Crisis Control System

KDS, a computer operated system for detecting, controlling, and preventing crisis situations in buildings, is the topic of a six-page brochure. The brochure explains how KDS can monitor fire alarms, security systems, patrol tours, sprinkler systems, and other security and safety systems. Illustrations include a sample system log, a block diagram of the system, and photographs of the system components. Douglas Randall Div. of WALTER KIDDE & CO., INC., Pawcatuck, Conn.

FOR COPY CIRCLE 304 ON READER CARD

Financial Remote Computing

"There's an Easier Way" describes a number of software packages and service offerings of this remote computing vendor. Written for financial managers, the 28-page, four-color brochure includes a description of the vendor's Currency Exchange Data Base, which tracks 46 official and floating exchange rates for foreign currency. Other sections address managers involved in securities investment, analysis and projection, financial consolidation, cash management, cash consolidation, and budgeting. There also are entries for sales reporting and analysis, financial forecasting and analysis, "what-if" analysis, and plotting capabilities. And, of course, there's an overview of the vendor's worldwide service network. GENERAL ELECTRIC CO., Information Services Div., Rockville, Md.

FOR COPY CIRCLE 305 ON READER CARD

Modems

Citing the emergence of digital data transmissions via communication satellites, this six-page booklet discusses a line of microprocessor-based modems specifically designed for satellite data links. Block diagrams illustrate the modems' modulation and demodulation hardware, while text explains how these designs accommodate a variety of modulation techniques when given appropriate microcode. Packet switching applications and error control coding also are discussed. A militarized modem is described. Diagrams, tables, and flowcharts illustrate the booklet. LINKABIT CORP., San Diego, Calif.

FOR COPY CIRCLE 306 ON READER CARD

Data Communication

This vendor's catalog of data communication products includes descriptions

of its Range Rider test sets and modular switching systems. Front-end processor switches, EIA data cables, and breakout panels for EIA, Bell 301/303, and V.35 interfaces also are described. INTERNATIONAL DATA SCIENCES, INC., Providence, R.I.

FOR COPY CIRCLE 307 ON READER CARD

Management Information

"If I only knew yesterday what I know now. . ." is the theme of this vendor's information packet describing its DMS 24 Management Information System. A six-page, four-color folder describes the system, which is designed for small- to medium-sized companies. It explains how the turnkey system can fit into a company's operations and be used by a firm's regular office staff. The folder discusses password security, audit trails, remote terminals, and distributed processing. A table summarizes the system's general specifications. Included in the folder are four applications briefs covering inventory management, accounts receivable, general accounting and management reporting, and managing primary manufacturing resources. An additional four-page spec sheet explains system configuration, and discusses peripherals and software. INFOMARK INC., Exton, Penn.

FOR COPY CIRCLE 308 ON READER CARD

5100 APL Applications

Fifty-two application packages, written in APL for IBM's 5100 and 5110 desk-top computers, are described in this catalog. Business applications include payroll, accounts payable and receivable, inventory management, forecasting, cash management, cost accounting, and financial statement analysis. Industry-specific packages are included for real estate firms, employment agencies, schools, and banks. General purpose programs for file management, mailing, and editing round out the catalog. The programs were written by Think, Inc., and are marketed on a nationwide basis by this firm of marketing representatives. APL SYSTEMS, INC., New York, New York.

FOR COPY CIRCLE 309 ON READER CARD

Micro Development Rentals

A six-page brochure describes this firm's lease and rental plans for the Tektronix 8002 microprocessor development system. Pricing is broken down by options. A variety of rental plans, lease financing, and new and used sales are explained. Training and service also are covered. LEASAMETRIC, Burlingame, Calif.

FOR COPY CIRCLE 315 ON READER CARD

Paper Sample Book

One-hundred-and-one pages of carbonless paper samples are included in this paper vendor's new sample book. Each page is perforated into four swatches,

each conveniently labeled with identifying information. A full range of colors and weights are included; the book is divided into five tabbed sections. The book contains samples of the vendor's black print, deep blue, and "Sprint" papers. ("Sprint" is an economy grade paper for roll printers.) NCR, Appleton Papers Div., Appleton, Wisc.

FOR COPY CIRCLE 316 ON READER CARD

Image Processing

This vendor of image processing equipment has prepared a pamphlet dealing with the economic, technical, and procedural aspects of computer aided scanning and writing techniques. It cites applications in more than a score of fields, including aerial photography, oil exploration, satellite and space imagery, graphic arts, and electronics. The functions of image enhancement, information extraction, and quantitative restoration are explained. Explaining that no system is typical, the booklet lists a variety of basic system components. A glossary defines 15 terms. The booklet also includes a discussion of the firm, including its founders, staff, areas of expertise, and corporate philosophy. OPTRONICS INTERNATIONAL, INC., Chelmsford, Mass.

FOR COPY CIRCLE 317 ON READER CARD

Supplies

More than 2,500 edp supplies, some 200 of them new listings, are included in this vendor's 100-page catalog for 1978. Products listed include binders and accessories for printout storage, disc pack and tape reel storage systems, word processing supplies, and minicomputer accessories. VISIBLE COMPUTER SUPPLY CORP., Westchester, Ill.

FOR COPY CIRCLE 318 ON READER CARD

COM

Computer output microfilm in the insurance industry is the topic of this eight-page booklet. The discussion centers on the experience of Home Insurance Co. when it converted many of its reports to microfilm. DATACORP, Portland, Ore.

FOR COPY CIRCLE 319 ON READER CARD

Text Editing Typewriter

A flier describes this word processing vendor's Series Q, which provides Redactor I mag card and mag tape text editors with a 55 cps correspondence-quality printer. Both the features of Series Q and Redactor I are listed. A retrofit for existing Redactor I installations, Q-Pak also is described. REDACTRON CORP., Hauppauge, N.Y.

FOR COPY CIRCLE 310 ON READER CARD

Forms Handling

Two brochures describe the forms handling equipment offerings of this

(Continued on page 82)

Wang builds a bigger giant killer.

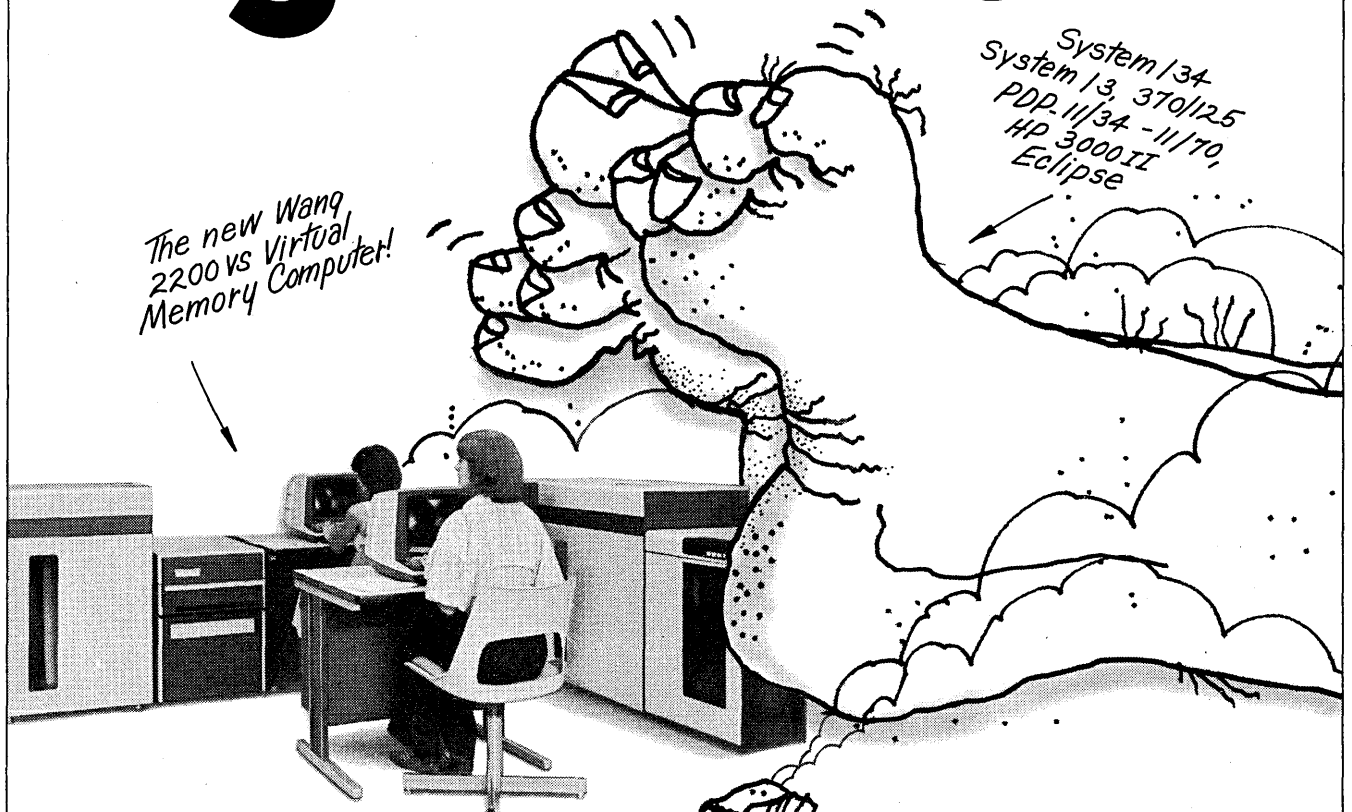

*The new Wang
2200 vs
Virtual
Memory
Computer!*

*System/34
System/3, 370/125
PDP-11/34 - 11/70,
HP 3000 II,
Eclipse*

Wang is hungrier than the giants. So, when we build a bigger computer, we build in better value. Wang's new 2200VS is the only virtual memory system at an entry level price under \$50,000.

It's interactive. Responsive. 2.3 billion bytes of online storage. ANSI '74 COBOL, RPG II, BASIC and ASSEMBLER. IBM 360/370 instructions.

Multi-terminals; multiprocessing; multiprogramming. Software automatically adapts to system size. High, immediate programmer productivity.

2200VS is the first-time computer that protects your investment. The replacement computer for the yield you never got.

The remote computer to which you distribute 90% of the application's processing.

It's modular. Expandable without system conversion.

And, Wang works directly with you, the user. Hungry to know more? Mail this coupon to Wang Laboratories, Inc., Lowell, MA 01851. Or call (617) 851-4111.

Dear David:

Send me information on the bigger giant-killer, Wang's 2200VS.

Name _____

Title _____

Company _____

Address _____

City _____ State _____ Zip _____

Phone _____



DP81/D48

source data

(Continued from page 74)

business forms manufacturer. A four-page brochure covers the mini line of decollators and detachers. A six-page brochure covers the vendor's "After-Writing" line, including decollators, detachments, and imprinters. MOORE BUSINESS FORMS, INC., Niagara Falls, N.Y.
FOR COPY CIRCLE 311 ON READER CARD

Fiber Optic Connectors

Fiber optics seem to have a promising future in harsh environments. This vendor has printed a four-color de-

scriptive note on its militarized connector system. The note discusses alignment, insertion loss, and environmental sealing. HUGHES AIRCRAFT CO., Irvine, Calif.

FOR COPY CIRCLE 312 ON READER CARD

Digitizer Notes

This vendor of sonic digitizing equipment has put out a pair of technical bulletins for users and potential users. "Converting Triangular to Cartesian Coordinates" explains how the digitizer's output of triangular coordinates can be translated into Cartesian coordinates. "While these mathematical calculations will almost always be performed by computer, it is important

that an understanding of the theory behind them be gained by operating personnel," the bulletin comments.

FOR COPY CIRCLE 313 ON READER CARD

The second bulletin discusses a sonic digitizer interface for Olivetti P-602 and P-652 programmable calculators. Both digitizer and interface are described. Programming considerations also are discussed. SCIENCE ACCESSORIES CORP., Southport, Conn.

FOR COPY CIRCLE 314 ON READER CARD

periodicals

Security

Comment, the newsletter of Coopers and Lybrand, a public accounting firm, has put out a special issue dealing with security of dp systems. Volume 19 No. 12 outlines steps designed to prevent errors and fraud through the use of both application and integrity controls. Emphasis is on control over data input; this and other security considerations are looked at from a perspective aimed at top management. From Sherwood Ross Associates, Inc., 82 Library Place, Princeton, NJ 08540.

NCC Newsletter

The first issue of *NCC Preview* contains an overview of the conference, profile of conference chairman Stephen W. Miller; travel information, and plans for the NCC Personal Computing Festival. Also in the issue is a postage-paid reply card for preregistration. The April issue will contain a preliminary listing of exhibitors and a detailed schedule covering all program sessions and seminars. Free from AFIPS, 210 Summit Avenue, Montvale, NJ 07645, (201) 391-9810.

Minicomputer Newsletter

Mini-Observer will introduce new products, systems, and product enhancement, changes in pricing, new developments in software and peripherals, and analyze major system trends. Free to subscribers of Auerbach's Minicomputer Reports, Business Minicomputer Systems Reports, and/or General-Purpose Minicomputer Reports; others may purchase a subscription for \$48 (yearly). AUERBACH PUBLISHERS INC., 6560 North Park Drive, Pennsauken, NJ 08109.

For Operations Managers

Data Center Dialog is a new bimonthly newsletter that will include news, announcements of hardware and software

If you think shipping
computer supplies
in 24 hours is a bluff,
call us on it.

800-258-1710.



The fastest way to get Digital computer supplies is to call us direct. We'll ship orders in 24 hours; in emergencies, less than 24 hours.

You'll not only get the fastest service you've ever had, you'll also be getting the most thoroughly quality tested supplies for Digital computers you can buy. All at a minimum 5% discount.

If you don't have our supplies brochure, give us a call at the same number. Monday through Friday, 8 AM to 6 PM EST.

800-258-1710. In New Hampshire, 603-884-5718. For your convenience, you can order supplies from us on your Master Charge or American Express cards.

If you think it's a bluff, all you have to do is call.

digital
SUPPLIES

(Continued on page 86)



Waste not.

Want not.

You'll see big savings in time and paper with this 132 column display from Datagraphix.

It's a whole new way of looking at things. An interactive terminal that actually lets you display computer output in a full 132 columns on a single line.

So now there's no need to waste reams of paper to check programs or to retrieve specific data. No need to waste time waiting for printouts. Or to waste computer time in reformatting data.

With the new Model 132A Display from Datagraphix, on-line programming gives you instant

feedback. And you'll get helpful features like scrolling, character and line editing and tabbing.

The exclusive Datagraphix Charactron® tube gives

you high resolution characters, upper and lower case, on an 8-1/2" x 11" screen. Bright and readable. And easy on the eyes.

If time costs and paper costs are important to you, remember that to waste not is to want not. So return the coupon to get full details on the new Model 132A Display from Datagraphix.

Datagraphix®

A General Dynamics Subsidiary

Datagraphix® and Charactron® are registered trademarks of Datagraphix, Inc.

Mail to: D4D
 Datagraphix, Inc., Display Department
 P.O. Box 82449, Dept. D4D
 San Diego, CA 92138, (714) 291-9960

Please send me information on the Model 132A Display from Datagraphix.

 Name Phone

 Title Phone

 Company

 Address

 City State Zip

**When you put
a name like Classic
on a new computer,
you've either got
a lot of nerve.
Or a lot of computer.**

**Introducing the
MODCOMP Classic.**

A lot of computer.

Forget megabytes, bits and nano-seconds for a μ sec.

Because what you really need for a successful computer installation is cost/performance, ease of implementation and reliability/maintainability.

For years, MODCOMP has led the medium class computer market in all of these critical areas.

Now we've set a new standard for super minis.

The MODCOMP Classic.

**Classic. A lot of computer.
But not a lot of money.**

The Classic costs less than any other super mini on the market. Yet, in benchmark tests, it's outperformed

the best of them. The reasons?

- A new super-fast floating point processor.
- Lightning fast context switching provided by seven MAP files and 240 general purpose registers.
- MOS or core memory with effective cycle times as low as 150 nanoseconds.
- Up to 0.5 megabytes of memory is directly addressable.
- A unique multi-word (16-80 bit) architecture.
- An enhanced instruction set, with 55 special Fortran oriented instructions.
- I/O processors that can handle up to eight million bytes per second.
- And a CPU that can execute many instructions in 200 nanoseconds.

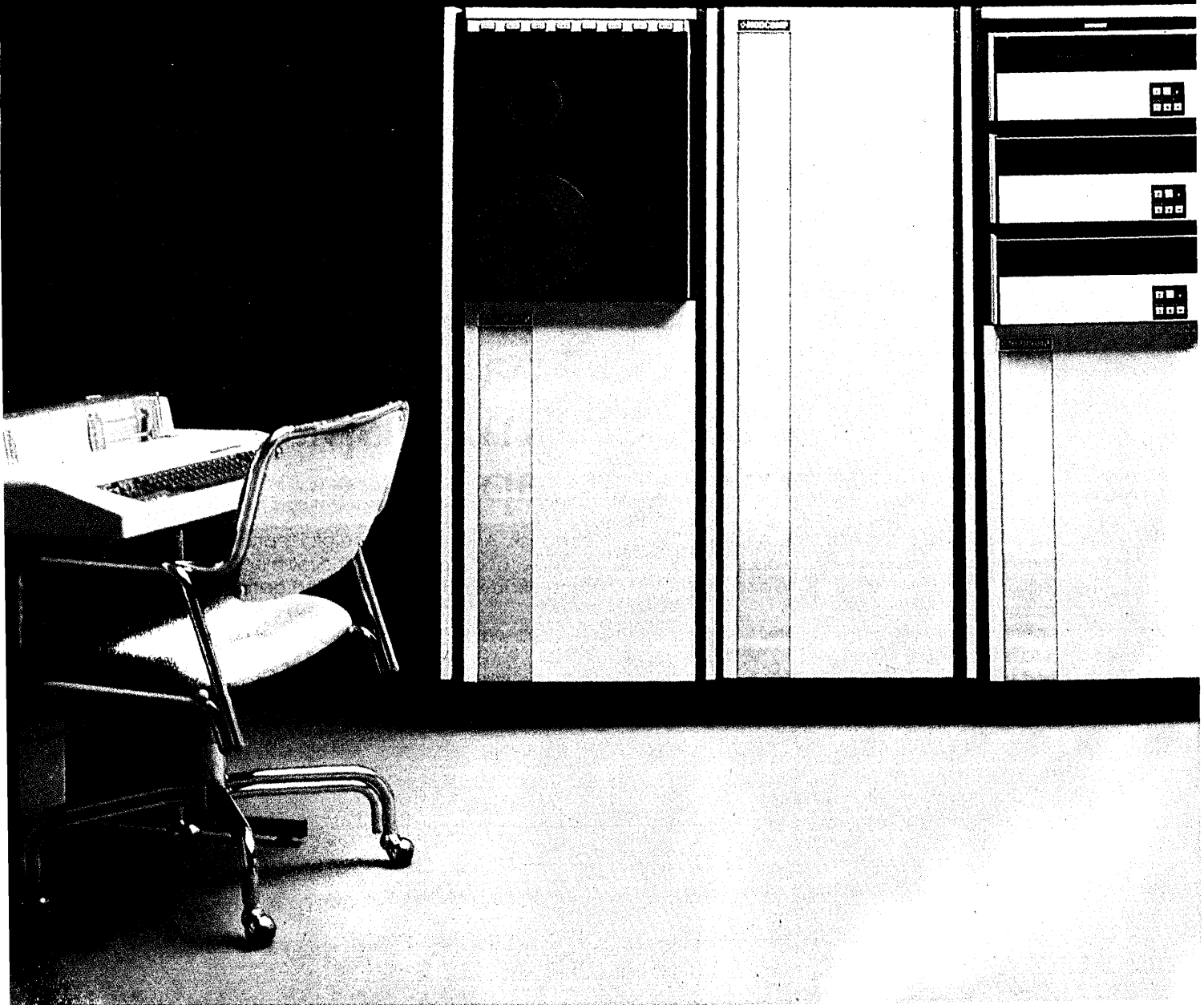

Built to save you the biggest expense of all - downtime.

The Classic will give you the performance you want. It's also designed to give you the reliability and maintainability you need.

Our exclusive wire-wrapped PC boards are more reliable and easier to service than soldered boards. Hardware diagnostics and convenient test connectors allow you to test all system components and locate faults quickly. And the PC boards plug in and out for easy, fast replacement.

When you buy a Classic, you also get our experience and product development tools to help you get your

system up and running fast. And our service and support to keep your system running, successfully.

A complete family of computers. Plus field-proven software.

The Classic is not just one new computer. It's a complete family of computers, supported by a full complement of peripherals, process I/O interfaces and software operating systems for process control, data communications, terminal-based information processing, business data processing and distributed networks. And the Classic is upward compatible with all other MODCOMP computers.

Whether you're a computer user or an OEM, if you're thinking about buying or expanding a computer system, consider cost *and* performance. Short term *and* long term.

And consider Classic. Because when you get to the bottom line, there's only one choice. Classic.

For more information, send for our brochure.

MODCOMP
Dedicated to your success

Modular Computer Systems, Inc.
1650 W. McNab Road
Ft. Lauderdale, FL 33309
Phone (305) 974-1380

CLASSIC

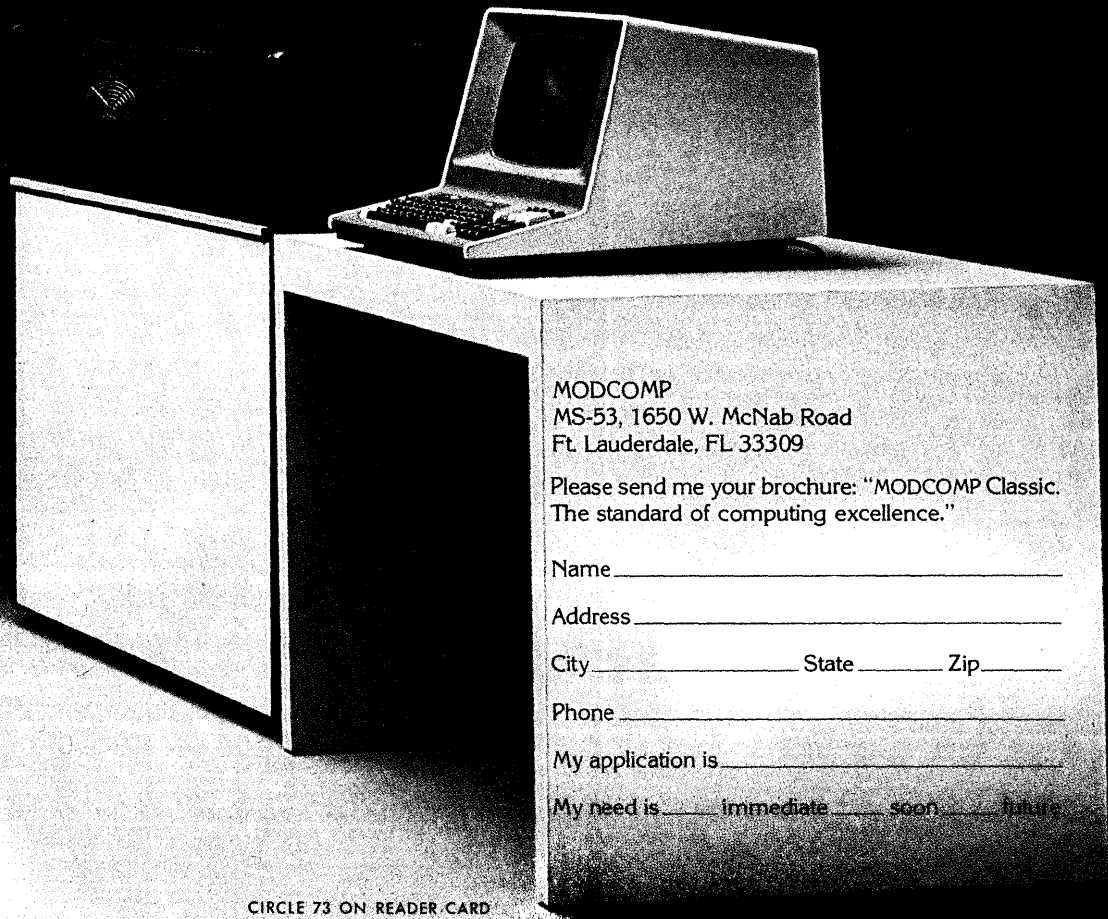

MODCOMP
MS-53, 1650 W. McNab Road
Ft. Lauderdale, FL 33309

Please send me your brochure: "MODCOMP Classic.
The standard of computing excellence."

Name _____

Address _____

City _____ State _____ Zip _____

Phone _____

My application is _____

My need is _____ immediate _____ soon _____ future

CIRCLE 73 ON READER CARD

source data

(Continued from page 82)

products for the operations function, book reviews, coming events, and an opinion section to which managers are invited to contribute opinions and views on major issues. Free to subscribers of Auerbach Data Center Operations Management; for others, yearly subscription is \$36 (prepaid). AUERBACH PUBLISHERS INC., 6560 North Park Drive, Pennsauken, NJ 08109.

Hobbyist Guide

Periodical Guide for Computerists in-

cludes articles, editorials, book reviews, and letters about personal computing. Listed by subject, the guide includes more than 2,200 articles from 25 publications. An author index by subject is



Digital Signal Processing

Fundamentals of the latest digital signal processing methods will be presented, as well as concrete design

examples. The 60 page book is available postpaid for \$5.00 from E. Berg Publications, 1360 SW 199th Ct., Aloha, OR 97005.

examples. Computer programs will be provided as part of the course material. They are FORTRAN IV source listings providing computer aided design of digital filters. To be held in Los Angeles May 2-5; Washington, D.C., May 9-12; Toronto June 6-9, and Boston June 20-23. Fee: \$595. INTEGRATED COMPUTER SYSTEMS INC., 3304 Pico Blvd., P.O. Box 5339, Santa Monica, CA 90405, (213) 450-2060.

Long Range Planning

A workshop on how to develop an effective long range dp plan is being offered May 8-12 and July 24-28 in Washington, D.C.; June 26-30 in Vail, Colorado, and September 11-15 in Jackson Hole, Wyoming. Emphasis includes techniques for projection of future user requirements, prioritization and scheduling of future systems, and system development project controls. The workshop is designed for dp managers and planning staff, and will examine the link between user demands for new applications and resulting hardware, software, and personnel expansion. Fee: \$595. KESTON ASSOCIATES, 11317 Old Club Road, Rockville, MD 20852, (301) 881-7666.

Data Entry Management

An "interactive seminar" for data entry managers, supervisors, lead operators, and technical support personnel will be held in Cherry Hill, New Jersey, on May 22-24, September 11-13, and November 13-15. Organization, control techniques, personnel communications and motivation, keying standards, operator training, improving productivity and more will be included in the course. Fee: \$425. MIC (Management Information Corporation), 140 Barclay Center, Cherry Hill, NJ 08034, (609) 428-1020.

Software Security

Robert Abbott, president of EDP Audit Controls of Oakland, Calif., is featured in a new video course offered by ASI (Advanced Systems Inc.). Entitled *Software Security: Protecting the Data*, the course is aimed at dp managers and professionals, and covers policy and techniques for reducing risks through a formal quality control function, separating functions within the program cycle, and period review. The color videotape, supplemented by a text, is available for rent or purchase from ASI, 1601 Tonne Road, Elk Grove Village, IL 60007, (312) 593-1790. *



Give your PDP-11 a Calendar.

When you equip your computer with a TCU-100, you'll automatically have the date and time available when you power up.

It's an easy way to keep track of downtime, too. Furthermore, you can use the unit like an alarm clock. Set it to interrupt at preset times—or at intervals as short as 1/2048 second.

TCU's are shipped preset to your local time, but can be set to any time you want by a simple software routine. The built-in battery back-up is good for months with out computer power.

For the LSI-11 user, we offer the TCU-50 — the same reliable timekeeper without the interrupt capability. With either unit, time is cheap. The TCU-100 is just \$495. And the TCU-50 is only \$325.

Time is only one way we can help you upgrade your PDP-11 or LSI-11 system. We'd also like to tell you about the others.

So contact Digital Pathways if you're into '11's. We are too.



DIGITAL PATHWAYS INC.

4151 Middlefield Road • Palo Alto, California 94306 • Telephone (415) 493-5544

TI's Model 810 Printer can make a big impact on your printer costs.

OMNI 800* Model 810 Receive-Only Printer has standard features designed for high throughput and reliability.

Features like bi-directional 150-cps printing of an original and five high-quality copies. A 256-character FIFO buffer so you can receive data at speeds up to 9600 baud. A reliable, low-cost printhead with a 150-million character life. An EIA interface and a self-test capability. Plus printing of reports, tickets or forms from 3 to 15 inches in width.

These and more ... for \$1895†

For added flexibility, there are options such as vertical forms control with compressed print, expanded print, international character sets, a tear bar and five different interfaces.

Add it all up and you can see why the 810 is the price/performance leader. For more information about how the 810 can impact your printer costs, fill out and mail the coupon. Or call your nearest TI sales office, or Terminal Marketing at (713) 491-5115, ext. 2124.

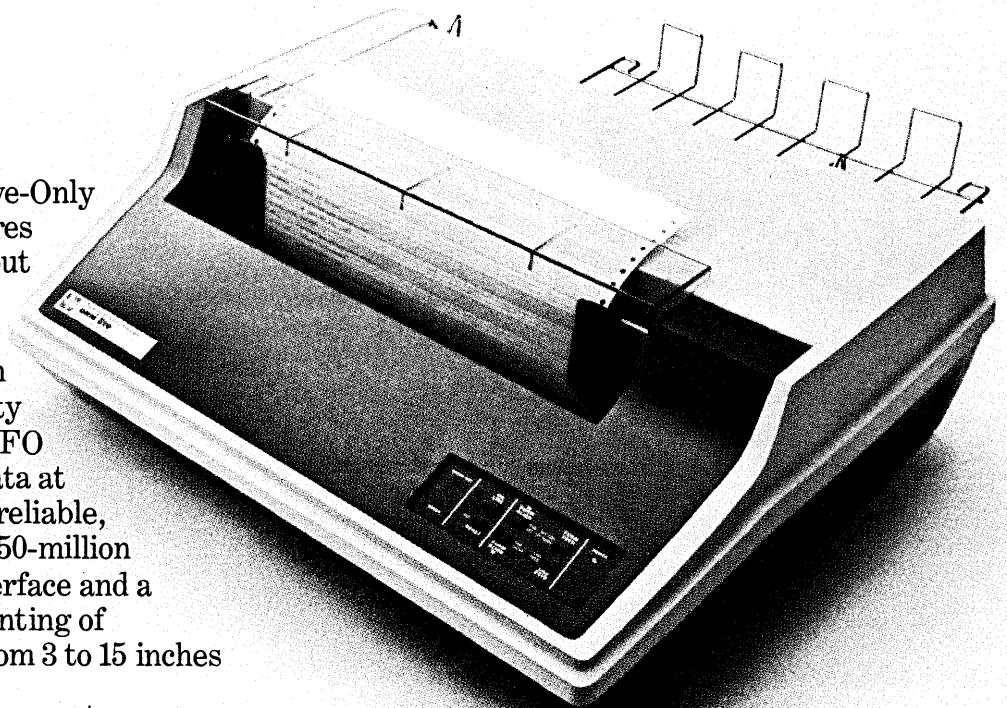

Yes! I am interested
in the Model 810 Printer.

OMNI 800
electronic data terminals

- Please have your representative call me.
 Please send me more information.

Name _____

Title _____

Company _____

Phone _____

Address _____

City _____ State _____ Zip _____

Mail to:

TEXAS INSTRUMENTS

INCORPORATED

P.O. Box 1444, M/S 784, Houston, Texas 77001

17-4-DM

*Trademark of Texas Instruments
†Quantity one, U.S. Domestic Price.

Copyright© 1978, Texas Instruments Incorporated

TEXAS INSTRUMENTS.



Don't buy a 32-bit computer.

Buy a 32-bit computer company!

Buy a 32-bit computer from some computer companies, you get a computer and a handshake. Ten days later, you get an invoice. Sometimes you don't even get the handshake.

Buy a 32-bit Interdata computer system from Perkin-Elmer and you get the most advanced 32-bit computer in the world, the hottest 32-bit software in the industry, and an entire company dedicated to one purpose: making you successful. (You also get an invoice.)

There's no substitute for experience.

When you buy an Interdata com-

puter, you buy the company that pioneered 32-bit minicomputers. We've installed plenty of 32-bit minicomputer systems since 1973. And the experience we've gained, experience our competitors simply don't have, can mean the difference between having your system on-line in a few hours. Or waiting for weeks or months.

Systems that solve problems.

And speaking of systems, we build systems for solving problems. Big problems. Small problems. Big systems. Small systems. For science. Industry. Business. Government.

In every system there is one common element. All the pieces can literally be

plugged together and running jobs the day they arrive, which is a real advantage and a timesaver.

Systems with powerhouse software.

The biggest advantage we have, however, is our software. Software, incidentally, written especially for 32-bit machines, not made over 16-bit stuff.

We have gangbusters software. A full-blown transaction oriented operating system. File management. ITC for transaction processing. Communications packages for distributed processing. And high level languages including FORTRAN, COBOL, and BASIC. All designed to make your



programming easier.

But, most important, when you buy a 32-bit system from our Interdata Division, you get service. The old-fashioned kind. The kind where we go out of our way to make sure you're successful.

Good old-fashioned service.

We'll be with you when you configure your system. While it's being built. When it's delivered and installed. While we train your people. And for years thereafter.

If you need customer service, one toll-free call reaches us. Days. Nights. Weekends. We'll be there.

Think about that. And, instead

of just buying a 32-bit computer, buy a 32-bit computer company. Perkin-Elmer.

For more information, write Perkin-

Elmer Data Systems Sales and Service Division, 106 Apple Street, Tinton Falls, New Jersey 07724 or telephone toll-free (800) 631-2154.

Here is my business card. Tell me more about computers in business
 scientific simulation OEM applications.

PERKIN-ELMER
Data Systems

Take your choice: on-line or off-line.

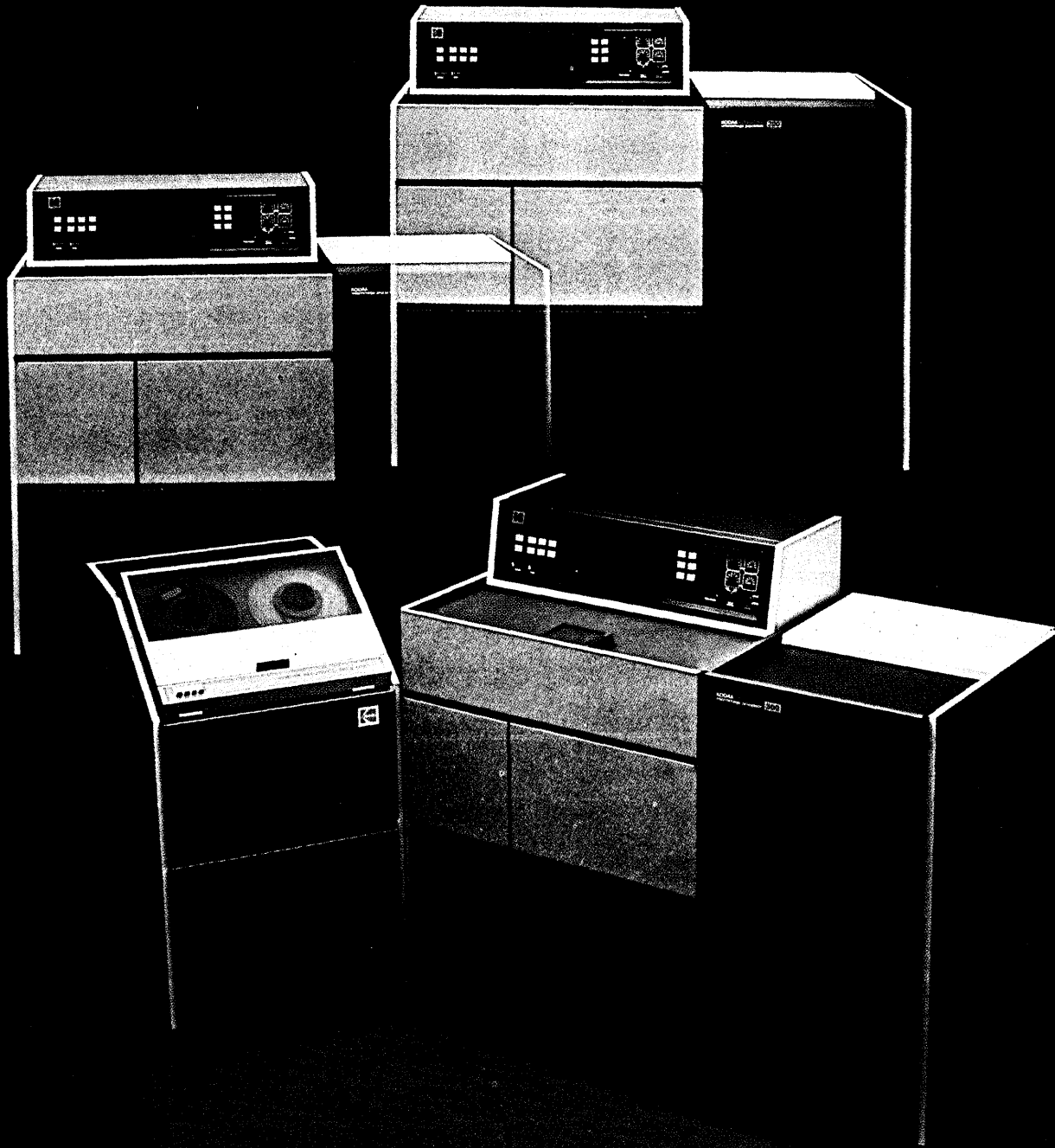

3 dry, convenient, laser printers, from Kodak.

For the detailed story, write Eastman Kodak Company,
Business Systems Markets Div., Dept. DP8579, Rochester, NY 14650.
KODAK KOMSTAR Microimage Processors



Editor's Readout

John L. Kirkley, Editor

Why You Should Be Able to Buy a Computer from AT&T

Sounds like heresy, doesn't it?

After all, our industry is already dominated by one huge firm; an imbalance so obvious that for a decade government trustbusters have been breaking their lances on the Gray Giant's seemingly impregnable hide. All we need now is for a *really big corporation* to come lumbering into the midst of the computer industry; a Gargantua with almost unlimited resources, able to trample small, innovative firms, stifle competition, and reduce the pace of technological change to glacial slowness.

The supreme irony of such a scenario is that this havoc would be wrought by a government regulated monopoly.

But, after all, it's only a scenario.

Or is it?

The Dataspeed 40/4 has been tarrified. The wall has been breached. And under the adroit marketing leadership of Archie McGill, an aggressive ex-IBM'er, Bell is sure to make other forays into the computer and data communications marketplace.

Various solutions have been proposed ranging from total deregulation to restricting Bell to transmission services only, totally excluding the phone company from the competitive arena.

In our opinion, neither of these extremes is workable or desirable. Our point of view is based on what's good for the user. It often seems that in the midst of all this regulatory and legal maneuvering, the people who have to live with the equipment and service—the data processing/data communications managers—are either trampled on or totally ignored.

Let's look at what's happening. We know that voice and data are merging. Switches, like the No. 4 ESS, are fully digitized, as are intra-city links. SBS will be offering a fully digital service that will carry both voice and data.

We know, too, that the line between computers and communications is so blurred as to make the FCC's inquiry into which is which an exercise in futility. And we know that Ma Bell is not going away; as far as we can see into the future the phone company will be the major supplier of voice and data transmission services even if the specialized carriers experience growth beyond their wildest dreams.

Yes, you should be able to buy a "computer" from AT&T. (Here's another blurring—between computers and intelligent terminals, especially in distributed nets.)

Of course there is a quid pro quo: AT&T should open the vast Bell System marketplace to outside vendors of data processing and data communications gear. Many feel that AT&T has been dragging its feet on this score.

If access to the data processing/data communications marketplace is denied to AT&T, the users will in turn be denied the substantial goods and services that Bell can provide. And Bell will continue to tie up its perceived competition through the courts and through legislation like the Bell bill and its offspring. Or try end runs like the Dataspeed 40/4. We all stand to lose.

But AT&T should only be allowed to compete through separate subsidiaries operating under the doctrine of maximum separation—an arrangement which prohibits cross-subsidization by the parent company.

Nothing short of maximum separation will do: Bell's opaque accounting system makes this mandatory. Cross-subsidization would give Bell an enormously unfair competitive advantage.

A major stumbling block is the 1956 consent decree which prohibits Bell from the unregulated marketplace. This decree must be modified to allow Bell, through separate subsidiaries, to competitively enter our rough and tumble market.

Then the user will be able to choose from a full spectrum of goods and services offered by companies engaged in free and open competition. *

QTY	PRICE	AMOUNT
1		
2		
3		
4		
5		
6		
7		
8		
9		
10		
11		
12		
13		
14		
15		
16		
17		
18		
19		
20		
21		
22		
23		
24		
25		
26		
27		
28		
29		
30		

Customer's Order No. _____ Sold by _____

KEEP THIS SLIP FOR REFERENCE
511 27 844/ym

Proprietary data (base)

Networking

Customer's Order No. _____ Sold by _____

KEEP THIS SLIP FOR REFERENCE
511 27 844/ym

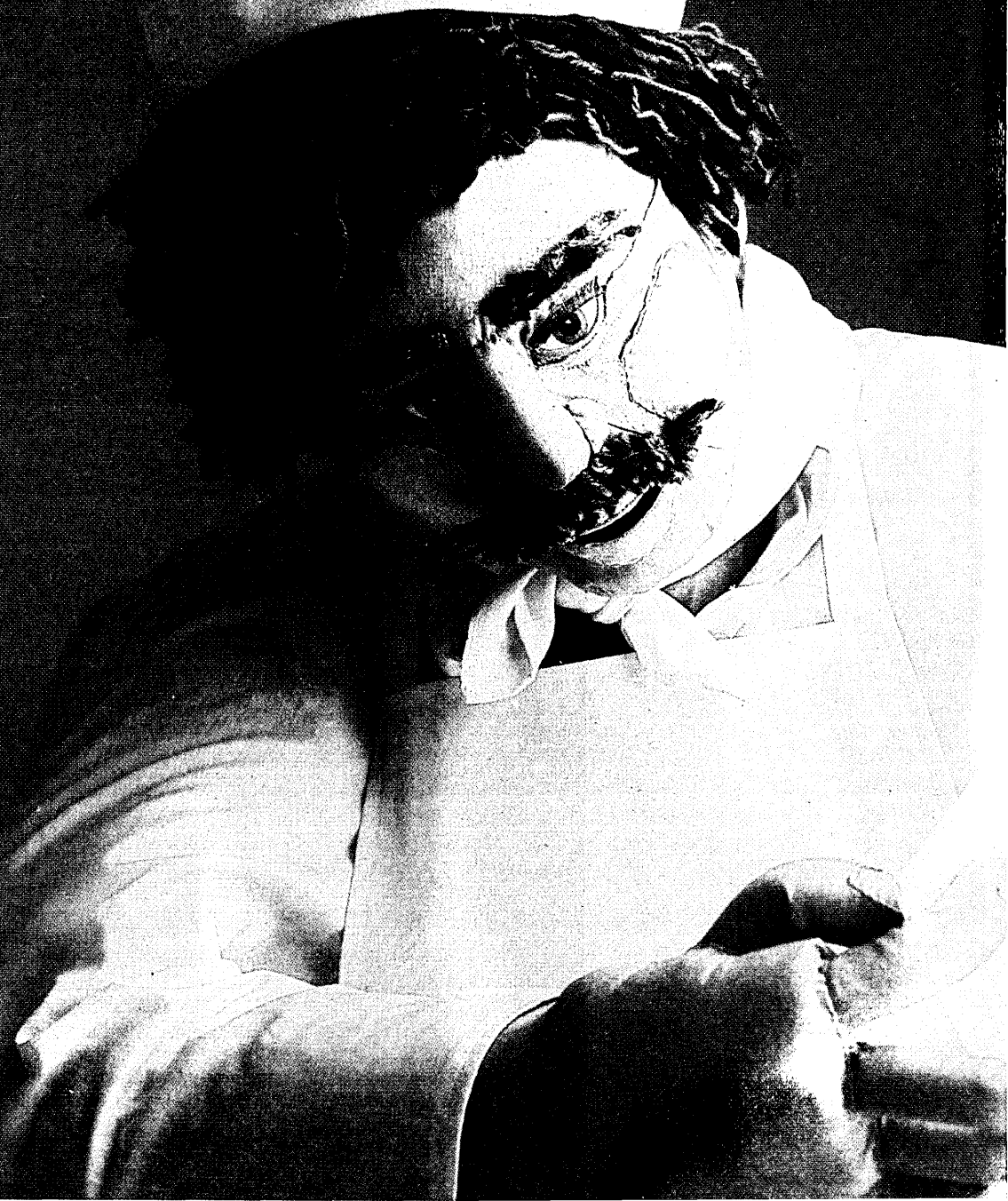

Remote Computing Service or In-House Computer?

by Herbert A. Seidman

Beginning on these pages is a set of three articles which discuss the benefits and disadvantages of remote computing services. Together they cover most of the ground between thinking about using remote services and actually doing it, with plenty of case histories to illustrate the right and the wrong paths.

Users of remote computing services or small computers do *not* usually decide which to use on financial considerations. The decision is usually based on personal or institutional preference and is supported by a *subsequent* financial justification, often prepared with the assistance of the vendor. This phenomenon is apparent, not only in small companies, but also in large companies with established computer centers when a decision on a new application is being made.

The question of how users choose between remote services and small computers is becoming more important as expenditures for minicomputers begin to outpace expenditures for such services. As can be seen in Fig. 1, 1976 expenditures for services and minis are nearly equal, being reported as \$1.9 billion and \$1.8 billion respectively. By 1981, however, minicomputer sales, growing at 35% per year, will be 75% greater than services expenditures, which are growing at 22.5% per year.

To determine the reasons why users choose remote computing over minicomputers, or vice versa, we recently interviewed 30 minicomputer and remote services users who were recommended by the vendors who sold to them. Ten were users of in-house computers exclusively; eight were users of outside services exclusively; twelve were using combinations of batch services, remote computing, and in-house computers. The users' annual revenues ranged from under \$1 million to \$175 million, and included a Big Eight CPA firm plus divisions of two Fortune 500 companies. Most users were in manufacturing or distribution, others were in transportation, banking, hospitals, a dental laboratory, and an animal farm.

A significant determination of the study is that, contrary to popular mythology, a financial analysis was found to be the determining factor less than 20% of the time. In fact, a financial analysis was not even performed in 50% of the cases!

Users who did perform a cost analysis used different formulas in building up their calculations of total costs. The extent of the detail included in the analyses often reflected the user's predisposition regarding the desired outcome. All

analyses included hardware and maintenance in the monthly cost of ownership; but attitudes vary about personnel costs, depending on whether the post-automation staff is smaller or larger than the pre-automation staff, and whether the operation of the terminal or console is seen as an additional duty or as a substitute for a manual one.

Items such as allocation for floor space, energy costs, property taxes and insurance, and management time are virtually ignored by the new user. In fact, some managers obviously consider the opportunity to get involved with their own computer, and with programming it, to be an asset rather than an expense. Even more variable is the mental attitude toward accounting of start-up costs, one-time charges for software development, tax credits, and down payments.

Most frequently, the monthly cost of hardware and maintenance alone is compared to existing or quoted charges from a remote computing services vendor. This seems especially true when the first-time user has a prejudice toward owning his own (in which case he may not do any cost analysis at all).

Is cost the determinant?

How users decide between services and in-house systems can best be shown by examples.

Consider, for one, a user of Xerox Computer Services (XCS) who started in 1970 to install a small business system for accounting and payroll applications. This 220-employee distribution company had performed a financial analysis, and decided to go in-house. But the computer vendor changed system designers three times, and the user cancelled his order when he "got tired of explaining" what he wanted. On the advice of an ex-employee, the company became one of XCS's first customers, and has been with them ever since.

Every few years, the user does a cost analysis, comparing XCS charges with bids from at least three computer manufacturers, and decides it is cheaper to stay with XCS. "It's not all that rational," says the vice president of operations, "but we feel that we have our own R&D department at XCS. They keep us current." So the distribution company stays with an outside vendor for reasons of

REMOTE

"cost," sort of.

On the other hand, another XCS client, doing \$10 million per year in lumber and plywood distribution and spending \$4,000 per month on remote services, says he suspects they could do the same job much cheaper in-house. They stay for another reason. "We don't want the headaches of our own installation, don't want to hire any dp employees, and it seems best to let a service vendor handle it."

While cost may not be the deciding factor in the original decision, a user may be triggered to switch from a batch service bureau or remote services vendor to an in-house computer on the occasion of a sudden price increase, or a feeling that gradual increases have reached the point where charges are no longer acceptable. Any deterioration of service or attention at this point will accelerate the users commitment to bring work in-house.

For example, a chemical plant of a U.S.-based international oil company was spending \$100,000/year with a major services vendor. A few years ago, a new manager arrived, and decided that much of the existing remote work could be done in a batch mode on a corporate computer. He could not bring it all in, due to a shortage of programmers.

As he began to cut back on the service usage, the vendor's representative displayed less and less interest in the account. As a result, when new applications arose which would ordinarily have gone to the outside vendor, the manager, sensing the lack of interest, adapted the programs for in-house operation.

Expenditure is now down to \$40,000/year, and falling, as the vendor's rep has virtually discontinued contact with the shrinking account. The less attention this user gets from the vendor, the more he finds ways to justify bringing work in-house. The issue is no longer one of cost, but of personal choice, supported by a lax vendor representative.

Sharing in development

In some cases, there is significant advantage for both user and vendor to deal with each other. If they have a common interest, the user may sometimes be compensated for problems of cost, particularly where expensive software development is concerned.

The *Hudson Register-Star*, a small local (Hudson, New York) daily newspaper with a circulation of 15,500, jointly developed a minicomputer based system with Vision Data Equipment, an oem systems house using Digital Equipment computers. The newspaper left a local service bureau after getting up to an annual expenditure of nearly \$20,000. Its cost for developing and installing its own system was \$25,000.

The payoff to the newspaper is having a system which performs all accounting and payroll applications, tracks reporter story count and progress, plans carrier supplying, and maintains the circulation mailing list. The payoff to the vendor for pitching in on the system's development has been its being swamped with orders from other newspapers all over the country who want to buy the same system.

According to the newspaper's developer of the system, "We never considered a remote computing services vendor; we really wanted to go in-house."

Another example involves a \$70 million manufacturer of control systems. Wanting a custom manufacturing soft-

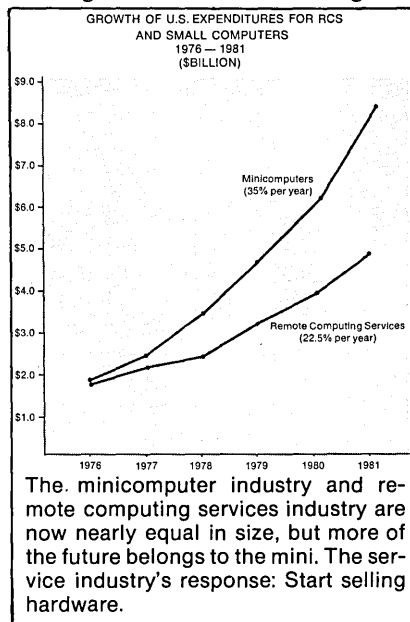

ware system which it could not afford to develop, the firm worked with A. O. Smith Data Systems to develop one. A. O. Smith now markets the system to other manufacturers. Today, the user has an IBM System/3, on which it performs its basic accounting, and uses the A. O. Smith remote computing service in another city to run "its" manufacturing system.

Big firms are little inside

A large multilocation or multidivision company is really an aggregation of potential and actual dp users. Even when the company policy is oriented toward centralized data processing and control, there are likely to be many small users of minicomputers and on-line within the firm. Generally, the larger the company,

The information in this feature was derived from a report recently completed by Mr. Seidman. Entitled "Remote Computing Services vs. In-House Computers: User's Choice," it is available from SBS Publishing Co., 4320 Stevens Creek Blvd., San Jose, CA 95129, for \$750.

the easier it is for an individual to spend \$1,000/month for a terminal without the expenditure becoming evident on the organization's cost statements. On the other hand, in companies where decentralization is part of the long-range plan, dp managers may be only too glad to have a remote location find its own local solution, dictating only the format for communications with the main site.

One of the largest U.S. retail chains is in such a position. The chain has major stores in 11 cities, each one of which has its own dp center. The corporate office does not have its own computer, and corporate personnel are supposed to use the computer in a nearby member store. However, the research department of the corporate office had found it difficult, if not impossible, to get time on the store's computer when they needed it, and corporate would not consider getting its own machine. Their solution was to get a Tymshare terminal. The vendor is located three blocks away, and provides all the necessary support. So the job is being done to everyone's satisfaction.

Another example involves a major U.S. aerospace company. Moving toward decentralized operations, the firm encouraged its manufacturing support group to consider the use of a local minicomputer system instead of the centralized service. A detailed specification was prepared, and bids taken from the central dp operation and from outside turnkey system vendors. No service firms were solicited, as company policy would not permit it.

The award went to Data Systems for Industry, a Hewlett-Packard oem, after H-P computers were selected for the job. Nobody at the company's data center could program an H-P machine, and DSI offered knowledge of both the computer and the industry the user was in. The system is now used for inventory control, warehouse input-output control, and automatic reordering. Communication with the central site is done through tape-to-tape transmission.

The vendor as an agent

The symbiotic relationship between user and service vendor takes another form, too. It is not uncommon in petrochemical and construction industries, for example, for relatively small companies with highly specialized scientific and engineering software applications to market packages through commercial service vendors.

When demand for the software is low, companies like Control Data Corp. and General Electric Information Services (GEIS) will enter into an "authorship" arrangement with the software developer, and offer the product on their national networks, for a fee. Where demand is very high, the product developer will write a large volume usage contract with the vendor, and then market the product itself, reselling the bulk-purchased

network service to the users.

Unlike the *Hudson Register-Star*, which is having its system marketed by a turnkey systems house, a major U.S. bank with over 100 offices is marketing its proprietary software to other banks through Automatic Data Processing's network services.

Communication costs

For multilocation companies, the cost of data communications is a factor in making long-range decisions on remote services versus in-house solutions, and on centralization versus decentralization. Many users see communications costs as being that element in their operations where cost controls and innovative planning can be most effectively applied.

For the larger companies, it is fairly clear that company owned networks are the rule, and will continue to be expanded, particularly for U.S. locations. When it comes to overseas communications, the convenience and lower cost offered by computer network service vendors like GEIS, and value-added network (VAN) carriers like Tymnet continue to be attractive to the multinational companies.

In medium sized companies, which do not have their own networks, the impact of VAN and satellite services is somewhat uncertain, particularly when only intra-U.S. communications are concerned. While the price of long distance and international communications promises to go down, Ma Bell's efforts to be competitive in these areas appears to be causing shorter range communications costs to go up. This is contributing to the delay in the much predicted rush to distributed computing. Service vendors, using VAN and satellite services themselves, may be able to offer the best compromise in distributed computing with reduced communications costs.

To the smaller user, it is not clear whether the increasing cost of local dial-up service will become significant enough to discourage the use of on-line services, and encourage the use of a single, free-standing small business system. ADP tells of one small client whose telephone charges increased from \$79/month to \$150/month, *due to an increase in local call rates*. At some point the increased telephone line costs could be the trigger for such a client to look at an in-house option.

Paradoxically, one of Tymnet's clients uses the network to communicate between two computers located 30 miles apart. It is cheaper than dial-up communications between the two sites since they have different telephone area codes.

If not my service . . .

Remote service vendors are aware that their smaller clients want help in solving their business problems as well as their purely dp problems. In response, many

vendors have become experts in special industries, and special business areas. In addition, to protect their existing client base and to be able to compete better for new clients, many vendors have added hardware to their offerings, and are able to provide several possible solutions to both naive and experienced dp users.

ADP is an outstanding example of such a company. Starting out as almost exclusively a payroll service company, it now also offers general ledger batch processing, remote computing services, and a line of minicomputer systems. It specializes in serving manufacturing and distribution, banks and savings and loan institutions, public accountants, automotive parts dealers, and nursing homes—if handling so broad a range can be called "specializing."

Intel Data Services offers a similar range of products and services, and "specializes" in manufacturing, distribution, securities, insurance, transportation, apparel, medical, and banking industries. Intel has an active acquisition program, which enables it to quickly enter and grow in new industries.

Control Data Corp. has for many years operated on the "firm" principle, where various data processing centers are set up to act as total-solution businesses in specific industries. For example, since its legal battle with IBM, which resulted in CDC's acquisition of IBM's Service Bureau Corp., CDC has had a "firm" which deals in litigation support services. In Houston, CDC has a petroleum industry firm. These firms have the resources to offer a potential user any appropriate hardware or software, be it batch, on-line services, or in-house computer.

Many other service vendors are offering minicomputers, along with the industry knowledge required to make those systems work. Included are XCS, which will soon announce its own mini in addition to that offered by its recently acquired Arista Manufacturing Systems; A. O. Smith's Data Systems Div., specializing in manufacturing; Informatics, which recently acquired Management Horizon Data Systems, a specialist in manufacturing and distribution; Reynolds and Reynolds, specializing in automotive parts distribution; and—recently announced—National CSS.

The competition with both remote service vendors and minicomputer systems is heavy among the batch oriented service bureaus and several have turned to offering minicomputers themselves. Among them are such firms as Computer Task Group (Buffalo, New York) whose president also presides over the Basic/Four dealers' association, and NLT Computer Services (Nashville, Tennessee), another Basic/Four dealer.

Services vendors have the problem of not competing too much with themselves in offering minicomputer options. Some of the batch service bureaus which

are minicomputer dealers do not offer the hardware option to existing clients, and make a careful assessment of future growth requirements of new clients in deciding which option to offer. In larger service companies, the minicomputer may be marketed in a separate division, or by an acquired company. The main effort goes into winning the new client, or keeping the existing one from going to a competitor, with minimum competition between members of the same company's sales forces.

Few conclusions

So, what can we conclude from these examples about how users choose between outside computing services and in-house installations? Only that there is no firm pattern.

There is heavy competitive pressure among the various vendors of minicomputers and computer services, particularly for new clients at the \$1,000 to \$2,000/month dp expenditure level. This competition extends at least up to \$7,000/month with established dp users, including departments or divisions of large companies with centralized computer facilities. And that competition is a function of the application size more than the company size.

Cost analyses vary widely as to content, and if performed are not so much a method of determining which solution to use, as of justifying the preferred solution. Preference and choice are likely to be based upon institutional or personal reasons of convenience, intuition, or just plain ego gratification. *



Mr. Seidman has been in the computer industry since 1954. He has been a computer designer (and holds two patents on computer design techniques), a systems engineer, director of operations for Scientific Data Systems, director of commercial products operations for Philco-Ford WDL, and vice president of new business planning for Rockwell International's Electronics Group.

For the past seven years he has been a consultant. His company, Innovative Information Systems, provides market research and human resources development services—specializing in Transactional Analysis—from its base in San Mateo, Calif.

How to Get Into Remote Computing Services (and How Not To)

by J. Richard Sherman and Abbott Ezrilov

Every question answered, every reality faced means one less headache later.

What does the data processing manager do when faced with problems, additional workload, or new requirements that threaten to completely overwhelm in-house dp facilities? Often, very often, the manager looks to outside remote computing services. In fact, in 1975 some 50,000 companies paid almost \$1.8 billion to about 140 suppliers of remote computing services. By 1982 the estimate is that the gross expenditure will be about \$5.7 billion and the number of client firms will have nearly tripled. Beyond a doubt, remote services have become a respectable alternative or complement to in-house data processing.

However, the prospect of letting this strange beast in-house is often viewed with understandable trepidation. In addition to the technical problems, there are problems in the politics, management, and control aspects as well. How can we reach the benefits with a minimum of trauma for the dp manager, his boss, his subordinates, and corporate management?

The answer boils down to one word: planning. So what's new? Everyone plans, right? Yes, including the designers of the Edsel. But how valid is the plan? On what assumptions is it based? How formal must it be?

Elaborate plans are not required for every service contracted, but the more significant the job, the better the plan must be. There are certain basic steps and questions to be addressed—not many—before asking any vendor to quote prices for his support services. Here's a three-step program which has proved its value over and over again.

Step one: Is this trip necessary?

Before embarking upon a plan to contract for outside remote computing services, sit back and try to answer these few questions:

The situation

- Why are we dissatisfied with present methods?
- How are we doing it now?
- Have we ever tried anything like this before?
- Who could stand in the way?

The rewards

- Is there a financial payoff?
- Is there a political payoff?
- Who am I trying to please?
- What's in it for my organization, my boss, and me?
- What will be the organizational impact?

The alternatives

- Is there a simpler solution?
- What if I did nothing?
- What would be the penalties for not doing it?

The search for a better, simpler solution sometimes leads companies into a political briar patch. A couple of years ago, a major West Coast bank, finding its dp operation growing rapidly, decided to convert it into an outside computer services subsidiary; the subsidiary would charge each in-house user for every service he received.

Computer services then became a line item on every department's budget, and soon managers of big user departments began looking at minicomputers to remedy what they considered deficiencies in the new setup: loss of control of their own files, poor turnaround, and higher costs.

Little by little the computer service base eroded, and the dp department began trying to bring all systems back

under its control as before. Now the "Mexican standoff" between nests of independently operating minis and the dp group with its unused capacity is raising data processing costs and hurting efficiency—and a solution seems years away.

An equally bad problem occurs when the existing system, whether manual or computer-based, isn't clean—when it's full of ambiguities and exceptions. An inefficient system cannot effectively be converted to some other form of processing; it gets worse.

That's why it's extremely important to know the existing system cold, including its information sources and information flows, before converting it or projecting its future requirements. Only after arming himself or herself with this knowledge and with an understanding of management's objectives, existing constraints, schedules, and resource limitations (funding or political), can a dp manager begin talking to vendors.

And then he ought to do something else for himself too. He should establish his own set of limits, determining in advance what occurrences will prompt him to suggest aborting the outside services project. All too often, a remote computing service project, like a runaway toboggan, continues just because it got started.

Once that toboggan gets started, the downhill ride can be devastating. Witness the giant eastern-based conglomerate which decided years ago to upgrade its in-house computer systems. A one-and-a-half-year study led it instead to the decision to supplement in-house capabilities with outside services. And supplement it they did. Beginning on a small scale among company subsidiaries, computer service vendors were added until one day, at the behest of staff dp people, a headquarters finan-

cial officer began adding up the cost of outside services—and came up with a multimillion dollar yearly expenditure. Twenty outside vendors, to the company's surprise, held *most* of the company's vital data. A single vendor had a dozen separate contracts with the company, with nobody taking advantage of volume discounts. The solution? More money—a three year project to figure out how to restore order in the provinces.

Fortunately for Step One of the planning process, the information needed to determine whether a dp organization can solve its own problems is almost exactly the same data needed from a service vendor.

What is your expertise in the problem area? In many cases an in-house computer organization doesn't have the specialists required for a new or growing application. That leads to one of two things: training a staff member or bringing in an outside specialist. If the problem is quite simple, both are acceptable approaches. However, when the requirement is for a relatively complex specialty, the staff member may have difficulty coping with the new subject; conversely, it may take six months to a year to locate, hire, and bring an outsider into the organization. Similarly, if the service vendor doesn't have on-staff specialists for your application, it will have the same problems acquiring that expertise.

Then there's capacity—how much excess does your system have? What turn-around times are your users seeing? What are your costs? What levels of security are you providing? What would happen if changes were made in the problem definition?

There's a balancing act to do too. Can you afford to take personnel off existing projects to handle this new one? Or, if you gear up for the new project, how do you justify keeping the people and computer resources six months from now when the project is concluded? The outside vendor has that problem too, but is often able to spread the additional manpower and computer horsepower over a larger base; that doesn't mean the problem goes away, just that it's easier to manage.

Realize that there are significant advantages from using in-house resources:

- You aren't likely to frustrate or disturb other members of your organization, especially those in dp.
- You can garner great publicity. Sometimes it is terribly important to say loudly and clearly that "we are solving the problem ourselves, using our own resources."
- Your costs may be very attractive compared to an outsider's prices. (Then too, much of the dp cost

may be absorbed in overhead or administrative budgets, making the department look even better.)

There are benefits in using an outside vendor as well:

- You gain experience in particular applications without much risk and without increasing your head count.
- If you discover something is wrong, the service personnel will be very willing to assist you, even in fixing a program they didn't write.
- The vendor can generally provide greater resources in systems and personnel, and better availability as well.

Step two: Project definition statement

Say that a remote computing service looks like the answer. Now what? Create a project definition statement. This should be a simple one-page document that picks up the results of the Step One self-examination, and serves as an initial planning document and point of reference in managing and reviewing the project.

The heading at the top should say: "What is the problem to be solved and what results do I want?" List the objectives briefly; they commonly fall into categories such as:

- Improve systems availability
- Provide growth capacity to accommodate new geographic requirements and/or increased processing load
- Improve security
- Reduce direct labor, indirect labor, equipment cost, in-house processing load
- Upgrade in-house staff
- Gain experience in new applications
- Develop greater prestige within the organization
- Improve the political situation with users, my boss, and company management
- Improve our company's competitive posture and its product quality
- Improve control over information flow

Step three: The planning worksheet

Create a planning worksheet for remote computing services. This will provide a checklist of items regarding timing, costs, benefits, and vendor interfacing. Initially it will be used for estimates as you think your way through how the project will work. Its second

use will be for actually gathering information during the investigation of the vendor's services and project startup. Its third use will be for evaluating the effectiveness of the ongoing service.

The worksheet should cover these "must" aspects, among many others:

1. *Document the existing system.* What is the source of the information? What is its flow through the system? What happens in the event of a problem at each phase?

2. *Determine the cost of outside services.* Determine the costs of equipment rental, purchase, maintenance, installation, system design, programming, file creation, conversion, training, benchmarking, testing, unit costs of each service—plus anything that may impact those costs.

Describe services included in the basic price. Give the cost of connect time, cpu time, main storage, on-line storage, off-line storage, archival storage.

It's vital to understand the pricing scheme, not only to pin down your initial costs, but also to get an idea of what will happen when your requirements change. Take the case of a major U.S. airline which decided to put its parts inventory system on an outside vendor's network in order to allow widely dispersed facilities access to the data. The original design called for only the most commonly used parts to be placed in on-line mass storage—a fraction of the total inventory. The rest went on tape. As time passed, more and more items were added to the mass storage files, and with the vendor's pricing algorithm, the cost of the application skyrocketed.

Descriptions of proprietary programs offered by the vendor should include a comment regarding whether there is a license available. Is it possible by paying a license fee to move the program to another services vendor or to bring it inside your organization? (Without this information the situation can become extremely confused, the vendor alluding to the possibility and later changing his mind.)

Determine the vendor's policy regarding the costs incurred in partially run programs and reruns.

Don't forget training costs. Consider the cost of the course itself, materials, travel, housing and the cost of a facility, the instructor's salary, overhead, and updating of course materials.

3. *Compare features.* Take advantage of every opportunity to compare vendor offerings. Each data services organization offers certain support, expertise, and application programs. Depending on the problems you have, different sets of features will better satisfy your requirements than others.

This extends to hardware. Expect a representative to offer to provide or to recommend terminals for your system. Quite often salesmen are reluctant to in-

REMOTE

clude terminal recommendations in any of their written communications. However, most would be more than happy to suggest terminals that others have used successfully.

The main reason to gather much of this information is so you can generate competition. Salesmen of scientific computer services and general business services say they have competition in 75% of their sales situations. In highly specialized services there is competition only 25% of the time. But when competition does exist the price of a service may drop as much as 20% from the original quote when the customer mentions he has talked to a competitor. (To quote one of the better specialty service salesmen we know, "75% of my customers never ask me to reduce my price; therefore they pay the list price.")

4. *Understand communications.* How do you obtain lines and modems? To whom do you talk to see that the communication requirements of your services operation are made easy for you? Vendor representatives should be knowledgeable enough to provide that information.

5. *Define the support services.* What happens if you can't get your data into the system? What happens if you have entered some information and never see it again? What happens if the job blows up while in process? The potential horrors are endless. The only way to gain any measure of security is to check the quality of the vendor's support organization and pin down his responsibilities at the outset. The average field technical support team member is approximately 30 years old, has been in the business five years, is well paid, competent, and somewhat overworked. One major concern is that most service organizations have so many products that it is very difficult for him to know much about all of them. This makes the support analyst a chameleon. One day he must be a data base management expert; two days later he must understand financial planning; and a day following that he must understand distribution systems. However, with all of the pressures, they tend to do a creditable job.

6. *Run a benchmark.* If at all possible, run benchmarks. The rationale is simple. If information is not converted and tested on the system, you are not going to know the magnitude of the problems involved with the conversion. Processing at least a small amount of information will assist in determining the cost of the anticipated processing load, the time required to process it, and the time it will take to convert all of the information for the new system.

Beware of standard or generalized benchmark reports! A large food processing company which was already

using an outside services vendor decided to increase its use of financial planning packages. Numerous competitive service firms seized the opportunity to unhorse the incumbent by touting their own financial software. To check out the competitors, the company purchased an off-the-shelf benchmark program from an independent source. But since the structure of the benchmark was inconsistent with the company's operating methods, the results could have led to erroneous conclusions—a fact that the original vendor went to great lengths to demonstrate.

The only way to construct a benchmark that provides an honest assessment of costs is to construct a "load profile" which takes into account: the amount of main memory and mass storage needed, the number of I/O operations, the amount of terminal and line time needed for each type of transaction, and the degree to which the data base will be modified by input/output operations. Build the benchmark based on that profile.

Salesmen are trained to minimize the value of a benchmark. To the vendor they are too expensive. They take a lot of time to prepare and often don't relate to anything. However, benchmarking is becoming more and more acceptable, and vendors should be expected to offer guidelines to help you develop a benchmark that accurately reflects your "real world" conditions. Any good benchmark should prove to be a learning experience and provide some of the information needed in decision making.

A benchmark also has political value. If you run effective benchmarks, it is very difficult for management or users to complain about your approach to vendor selection.

7. *Develop a timetable.* A good vendor representative will be able to discuss and develop a timetable for each major function to be accomplished in implementing the system. Most representatives are paid on billings; they don't make any money until you use the service and are invoiced for it. And you can use this as leverage in getting the system up according to the timetable. If you can't use the system, he can't make his commission.

8. *Have a conversion plan.* The job of melding an outside vendor into an organization is not trivial. You may be extremely good at systems analysis or have outside help from a dp group or from a consultant, but you'll still have to make sure you review conversion plans with your vendor. If the vendor representative doesn't want to take the time or doesn't understand the problems, be ready for future problems.

Finally

Finally, be willing to shop around for services. Prices may vary as much as 200% between vendors for the same ser-

vice, for one thing. For another, each vendor may suggest a slightly different approach to solving your problem, and you can learn from listening to them.

Self-examination, project definition, planning worksheet, shopping—it sounds like an ideal way to go, and it is. Horror stories do abound, but usually because users haven't planned this thoroughly. Dame Fortune is too fickle a companion to be trusted, so don't. Every question answered, every reality faced means one less headache later. *



Mr. Sherman is president of Info-Dyne, Inc., a firm which specializes in consulting for computer service users and in marketing for computer service vendors. His score of years in the field have been spent in positions such as national product sales manager for Univac, director of client services for The Diebold Research Program, market development manager for Boeing Computer Services, director of business planning for Genesis One Computer Corp., and vice president of Management Data Systems. He has served as president of two batch-oriented service bureaus as well, Data Systems, Inc., and AIM, Inc.



Currently a vice president with Info-Dyne, Mr. Ezrilov has been in the dp field for 12 years. His last six years were spent in sales management positions with National CSS and Computer Sciences Corp., two of the nation's largest computing service vendors. Prior to that, his experience includes roles of director of client support for U.S. Guarantee Computer, sales manager for Technalysis Corp. (a software development firm), and senior systems analyst/project engineer for First Computer Corp.

A Checklist for Using Batch and Remote Batch Services

by Michael S. Carter

These several dozen items will get the user started.

Buying computer time from an outside source always requires a sharp pencil analysis with careful planning, and a thorough understanding both of the user firm's needs and of the services offered it.

The kind of analysis applied differs depending on the kind of service being considered. A firm needing batch or remote batch time, the primary subject of this discussion, will find itself doing almost the same kind of analysis it would for acquiring additional hardware. Firms requiring interactive terminal services will find that many of the items listed here pertain to their analyses as well.

The list admittedly is slanted to users of IBM equipment, but this makes only minor translation necessary for other users.

The decision to go outside for batch or remote batch time can be justified for peak load processing or special projects; while waiting for replacement or additional hardware to be installed; during a conversion; when the workload has outgrown the installed machinery, but not by enough to justify an upgrade, or for a variety of other reasons. Whatever the reason, the following checklist items apply:

Compatibility and back-up compatibility

- Check on the software levels between what you are presently using and the levels the vendor supports. This is important for both the operating system and compilers.
- Have assurance the vendor will notify you well in advance, and in writing, of any software or hardware changes to be made in the vendor's configuration.
- Get a written commitment from the vendor for the continued support and availability of all programs and software packages you will need. For instance, if you are presently using PANVALET or MARK IV, and have the continued need for them, select a vendor who not

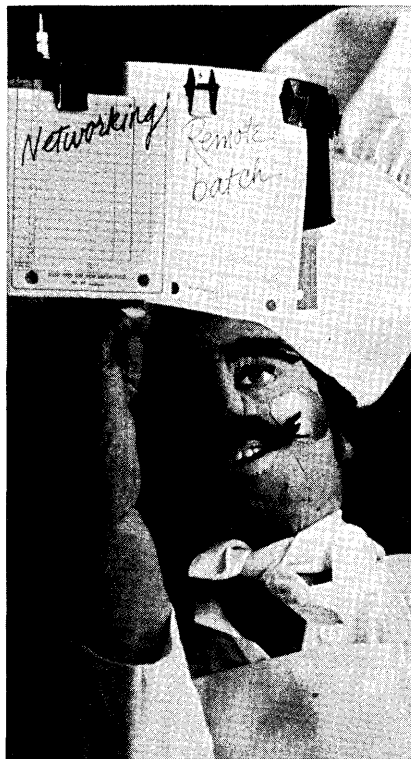

only has the packages available, but will commit to their continued availability.

- Get a copy of system generation defaults and generic names for the vendor's system. Know the defaults for the compilers and assemblers you will be using. For example, if a compiler default is to produce a cross reference, and you have no need for one, an easy JCL change will save money. Also know the default running time parameters.
- Find out how the vendor will provide you with access to system data sets such as PROCLIB and LINKLIB (and SVCLIB, if needed). Also determine who handles member changes and maintenance of these data sets.
- Find out what backup, if any, the vendor has for his primary system. If the vendor does have a backup computer, be aware of some potential prob-

lems. When the prime and backup computers are identically configured, the problems are minimized, assuming the vendor has proper procedures for fall-back situations. But serious problems can occur when the backup and primary computers are different models, such as an IBM 370/155 backing up a 370/168. In this example, programs set up to run on the 168 which have TIME parameters in the JCL, may not finish execution on the 155 before the TIME has expired.

Severe problems can also develop when the prime and backup computers are from different series. For instance, COBOL programs compiled with OBJECT COMPUTER indicating a 370, will usually ABEND on a 360 because of the different instruction set. There are, of course, other examples and considerations. Have your technical staff review the vendor's complete hardware and software configuration.

Conversion

- Conversion costs and responsibilities must be clearly defined. Prepare a detail plan with the vendor. Any vendor who tells you the conversion is "transparent" probably has not been around the block enough times to know the real world of data processing.
- JCL must be changed, possibly data sets renamed and catalogued, LINKLIB and PROCLIB set up, tape and disc volume serial numbers may need to be changed, tape labels (standard, non-standard, user, and multivolume reels) and the software routines to handle them must be checked. TIME parameters, generic names, compiler options, JOB class, MISGLEVEL, HASP/ASP commands, remote terminal I.D.s and data set security all must be reviewed. The list is longer and a well organized detail plan to handle the conversion will reduce your headaches and help you to meet your cutover date.

Performance

- Prepare your own benchmarks and ones that are representative of your

A CHECKLIST

needs. Benchmarks do not have to be large and complex. In fact, a COBOL Compile, Link and Go, possibly with an internal sort, is a good benchmark. Benchmarks need not be the same for all prospective vendors.

- Some vendors offer a guaranteed turnaround. For example, if your program has not started execution within a certain period at the priority you requested, you will be charged at the rate of a lower priority.

- Most vendors will not guarantee the up-time and availability of their system. But they should have written performance standards and a management commitment to reach and exceed the performance objectives. A realistic central site up-time objective is 97.5% of scheduled hours. Be aware that a vendor who states an objective of 100% does not understand the operation of a data center.

Remember that central site up-time and up-time to you, the customer, are not the same; the vendor's system may be up, but unavailable to you because of a failure in communication equipment or even problems with your own remote terminal.

Security

- Know the vendor's policy and practices on both physical and data security. Especially important is whether you or the vendor have responsibility for securing your critical data sets residing on tape and disc. All too often this question is asked after a disc pack has been dropped and many days or weeks are spent re-creating the data (or after that re-creation proves impossible).

- If vault storage is needed for confidential or high replacement cost data, deal with a vendor who has adequate vault storage that is properly secured physically. You can, of course, store this type of data at your own installation.

Data sets

- Discuss how the cataloging of your data sets will be handled and who has maintenance responsibility.

- If you own your own tapes and need the vendor to provide storage, make sure the vendor can handle your odd-sized reels or obsolete cannisters. The best practice is to always buy 2,400-foot reels and have the vendor supply the cannisters. This greatly helps the vendor's operations group, and can prevent your mini-reels from being thrown in a desk drawer in the back room—never to be hung again.

- Be prepared to pay for tape storage, even though you own the tapes. One

Any vendor who tells you the conversion will be transparent hasn't been around enough to know the real world.

way to reduce this cost is to have the vendor maintain an "inactive" tape library. Inactive libraries are usually somewhat remote to the vendor's computer (but typically in the same building), and have a lower storage charge. However, the customer is typically assessed an access charge to have a tape removed from the library. Even so, for infrequently used tape data sets, inactive tape libraries can save money.

- Whether you rent tapes from the vendor or supply your own, be aware of the vendor's method of tape inventory. Should the tape numbering scheme you use on your tapes conflict with that used by the vendor, you can bet the day will come when the wrong tape will be mounted because of identical volume serial numbers.

- Should you rent tapes from the vendor, clearly understand the vendor's practice on tape cycling and retention periods. Too frequently, an important tape data set is created with an incorrect or missing retention period. The vendor should have some method of changing the retention period of an already created tape data set.

- Disc storage is handled in one of three ways: renting disc space by the track or cylinder on the vendor's pack; renting an entire pack from the vendor; or supplying the vendor with your own pack. The latter is discouraged or prohibited by most vendors. Renting a vendor's entire pack can be the most economical, depending on the vendor's charges for renting storage by the cylinder. Regardless of storage method, make certain maintenance and security responsibilities are clearly defined with the vendor.

Scheduling

- Have the vendor always send you an advance schedule of the next week's hours of operation for his system, and ask for a two-week notice of long, planned outages or irregular schedules.

Remote processing

- If accessing the vendor's system remotely, know about any sign-on charges and how connect time is calculated. Rates for incidental services should be clearly understood. If programming support will be needed from the vendor, find out when the meter starts running. Some vendors have a one-time "initiation" fee, while others have monthly minimums.

- Make sure your terminal characteristics are properly identified to the vendor. Such things as transparency, horizontal forms control, multirecord feature, compress/expand, multileaving and console support should all be remembered.

- Check on modem compatibility. Because of internal timing, occasionally two modems of the same speed, but from different manufacturers, will not be compatible.

Charges

- There is no rate standardization in the industry. Every vendor has his own price algorithm. Know about volume discounts and their applications,

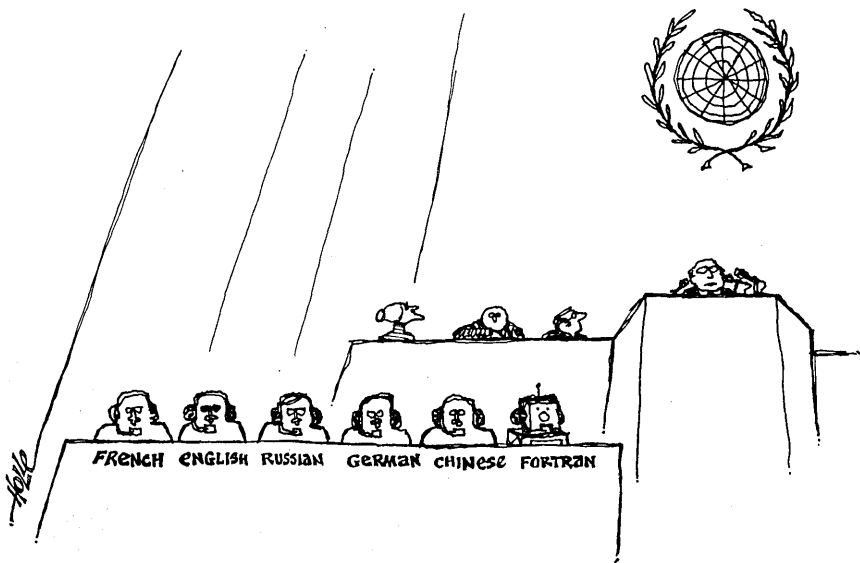

premium charges for proprietary packages, and rates for different priorities. If the vendor is using front-end software, such as HASP, find out if spooling EXCPs are a billable item. Understand how device usage charges are measured.

- Some vendors even have a minimum charge for each job submitted. If the vendor has a set-up or mount charge for private tape and disc volumes, understand what happens when an already mounted volume is used in subsequent jobs.

- Ask the vendor for protection against a price increase. Although the term on most vendor contracts is 30 days, by signing an annual agreement, you may be able to get a price increase postponed until the next contract renewal.

- If your need for additional computing resources is relatively long term (for example, nine months to a year), consider making dollar guarantees to the

Even modems of the same speed may be incompatible.

vendor of how much you will spend each month. You may be pleasantly surprised by the price concessions a vendor will make when he can count on committed income. A good rule-of-thumb to follow when determining how much to guarantee in monthly expenditures is 75%-80% of your actual estimate.

- If you are presently buying computer time and have been approached by another vendor who claims to be able to save you money, a reasonable hurdle is 10%-15%. Unless the new vendor can demonstrate savings to you of 10%-15%, the move probably is not worth the effort. Any amount less than 10% will probably be lost in conversion costs.

- Be reasonable in negotiating. Selling computer time is a tough, competitive business, and when times are lean, vendors can get very hungry. By forcing him to concede to too many of your demands, you may be placing yourself in a situation of looking for another source of computer time in a few months (assuming the vendor is making equal concessions to other customers).

- If you are talking to vendors because you want backup for emergencies, don't expect any deals. Many vendors stay away from this type of business, or make only a token effort to service it.

- Make certain you understand the vendor's rerun or credit policy relating to bad runs caused by hardware failures or bugs in the vendor's software. Probably the biggest money waster is program loops. Even when the loop is not

caused by faulty vendor software or hardware, some vendors will issue at least partial credit for a rerun.

This item is difficult and legally sensitive to get into a contract, and including such a clause that would cover all possible circumstances would not be realistic. Whatever the vendor states as his policy, orally or in writing, find out from other customers how the vendor has handled these situations in the past.

Also find out from the vendor the length of time you have to report a problem and request rerun credit. A reasonable time is 48 hours.

Determine how the rerun is credited. Some vendors credit the bad run and charge for the rerun, and other vendors do the reverse. The most equitable action from your standpoint is to be credited for the bad run and be charged for the rerun. Don't be surprised if the vendor asks for, and keeps, all output from your reported bad run.

- Ask prospective vendors for a sample invoice showing the format, organization, and amount of detail. Understand your own internal accounting requirements and make these needs known to the vendor. Most vendors have sophisticated data collection software and can include a large amount of detail as a supplement to your invoice.

Take all the detailed information the vendor offers and ask for more if your needs are not satisfied. The information can prove to be a valuable tool in evaluating and monitoring how your programming staff is using the vendor's system, and can quickly indicate how and where money is being wasted.

- Know the vendor's billing cycle, when invoices are prepared, and when you should expect to receive your bill. Not all vendors bill on a calendar month basis.

Contracting and references

- Understand completely all contract items and obtain your own legal counsel to review the agreement. Beware of a vendor who includes a cancellation for convenience clause.

- In your discussion with vendors on liability, you will find most vendor contracts have clauses releasing the vendor from all liability and responsibility. This point often cannot be negotiated, so make sure your insurance agent is up-to-date on your business plans.

- Check vendor references. Determine from existing customers the amount and depth of technical support the vendor provides. Compare this with your own needs and expertise. If you need support in MPSX, for example, talk to several of the vendor's customers using MPSX, and know what you're getting into.

Miscellaneous

- Find out if the vendor has any proprietary utilities available. Many vendors have such programs and make them available to customers at no extra charge. Even simple utilities, such as tape-to-tape and disc-to-tape, are valuable time and money saving tools.

- If you need to attend runs at the data center, make sure of the vendor's policy and procedure. Although most attended runs are just a programmer's hang-up, there are still a few legitimate needs.

A last word

The buying and selling of batch and remote batch computer time is an important and necessary part of data processing. A firm selling time can be a small company down the street with an extra shift on an IBM 360/30, or a large national company. All serve a definite need. Your concern is not only to get what you pay for, but also to not pay

A vendor who states an objective of 100% up-time does not understand the operation of a data center.

for more than you need.

Fully understand the reasons you are buying extra computer resources and clearly define the services you require before talking to vendors. You will find your vendor analysis not only easier, but you and the selected vendor will have a solid foundation upon which to build a good business relationship. *

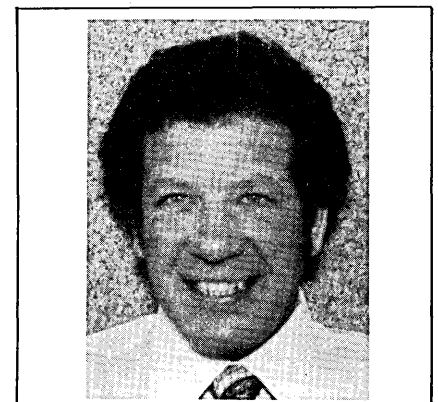

Mr. Carter is presently vp of marketing for Automated Business Applications, Inc., a Denver firm which offers minicomputer-based systems. Prior to joining Automated, he was responsible for marketing and selling dp services for United Airlines, Inc. Once the president of Systems Programming, Inc., in San Jose, Calif., he has also been a data center director responsible for two DPF, Inc., installations in the San Francisco Bay area.

Tektronix 4020 Series

How can the first name in graphics come up with the last word in alphanumeric?

By turning both to your advantage.

From Alphanumerics to Graphics . . . now your terminals can keep pace with your needs. Our new 4020 Series terminals let you plan for the day when alphanumerics isn't enough. Without trading in terminals or buying more capability than you need right now.

Our 4025, for example, is a smart, refresh device that starts with alphanumerics and grows. First into forms ruling. Then into graphics. All without one capability compromising the other. As a complement, the 4024 offers data entry and forms capabilities. So you can prepare for the future with maximum economy and Tektronix quality.

Begin with the basics: alphanumerics at its best. Both configurations include expandable memory. Complete editing. Fields. Scrolling. Familiar, user-definable keyboard. Easy-on-the-eyes screen.

Plug in the forms ruling option and either terminal can recreate just about any source document. With one keystroke entry. Easy information call-up. Ideally proportioned 34-line deep screen.

And when you're ready to add data analysis and report generation, just add our low-cost graphics option to the 4025. Almost anyone can sit down and create bar charts, pie charts and histograms, and command 8½" x 11" facsimiles off our optional copier. Our PLOT 10 Easy Graphing host software is designed for the nonprogrammer. For minimal core consumption.

Best of all, the 4020 Series comes with Tektronix reliability and support. All the more reason why they're a great long-term growth investment. Ask your local Tektronix Sales Engineer for a demonstration. Or write:

Tektronix, Inc.
Information Display Group
P.O. Box 500
Beaverton, OR 97077
(503) 682-3411
Tektronix Datatek NV
P.O. Box 159,
Badhoevedorp
The Netherlands

OEM information available
Copyright © 1977, Tektronix
All rights reserved

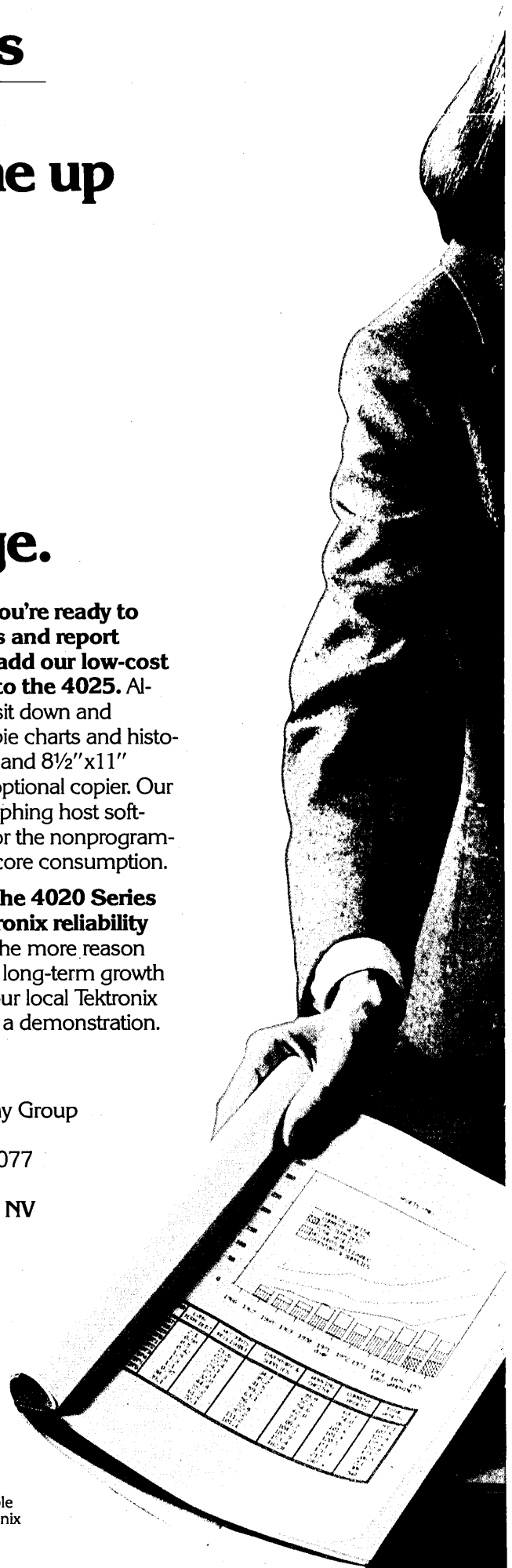

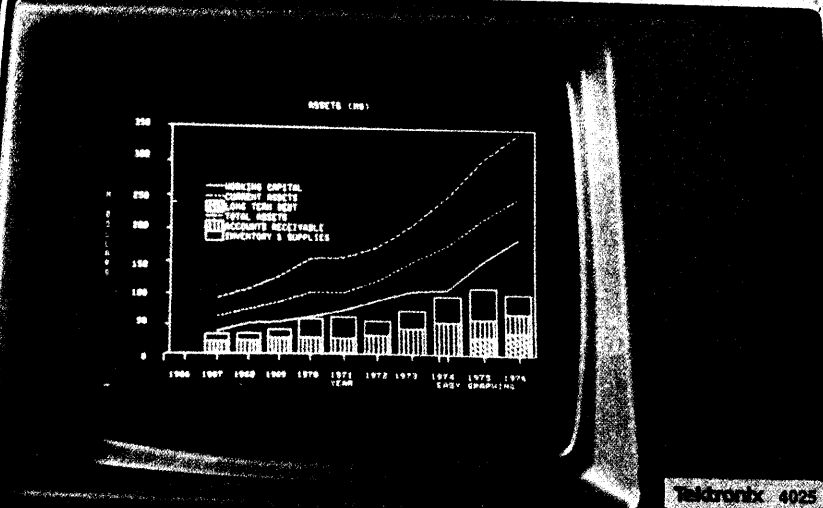
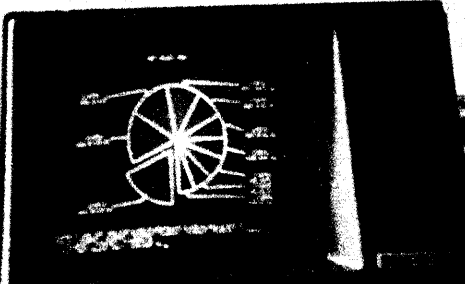
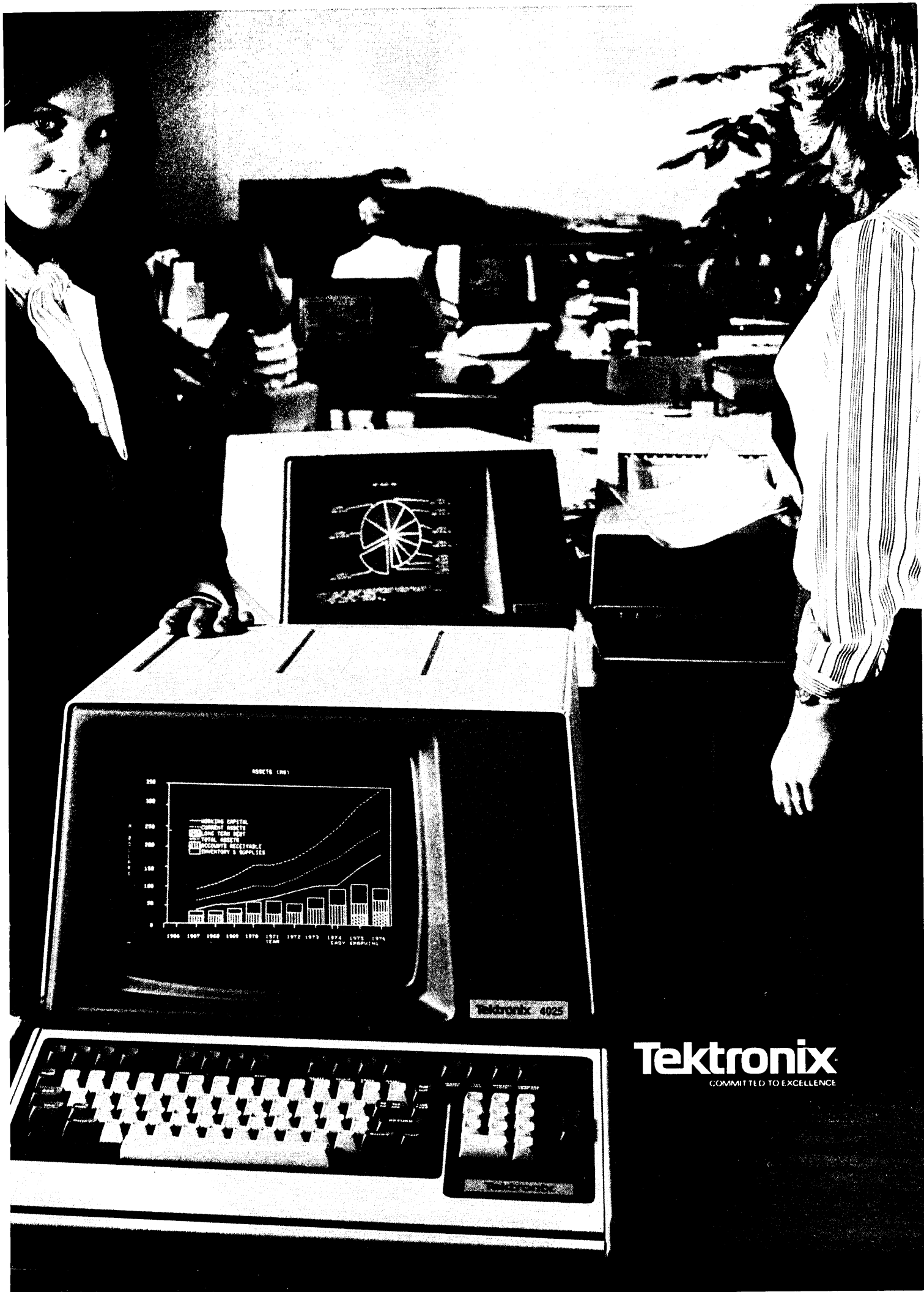

Tektronix 4025

Tektronix
COMMITTED TO EXCELLENCE

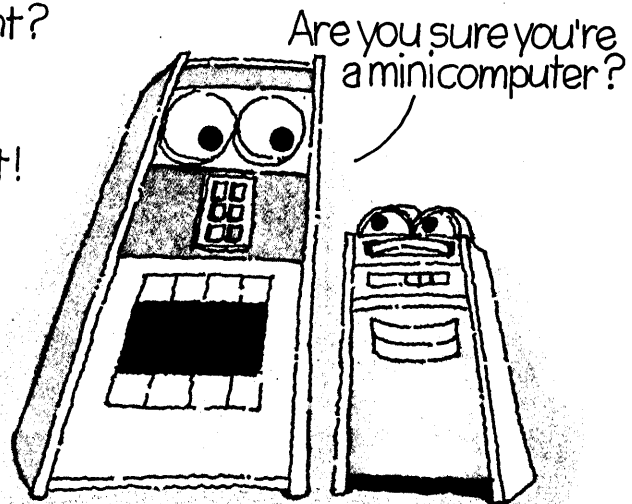
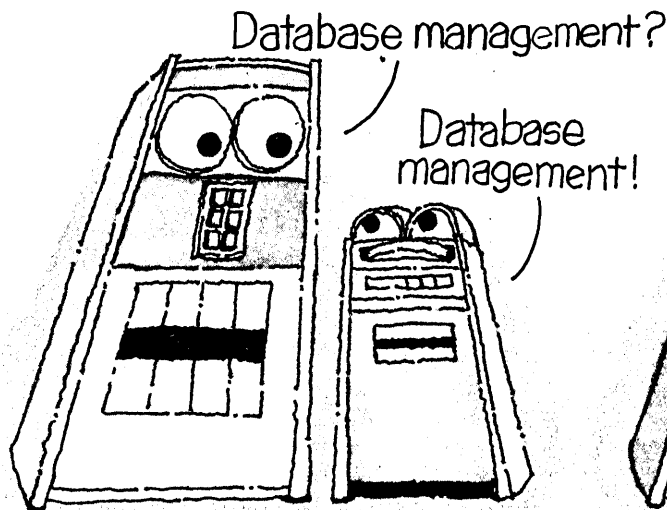
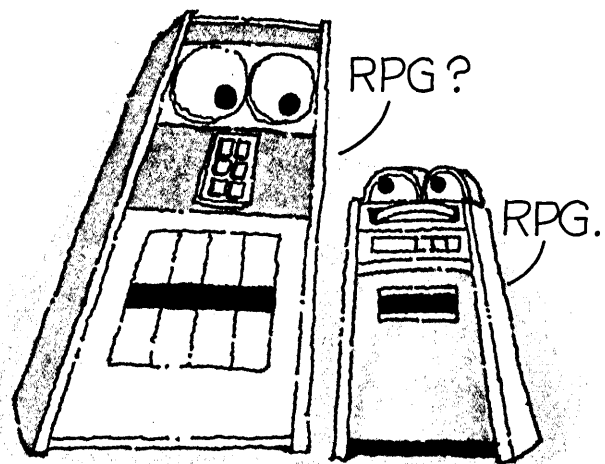
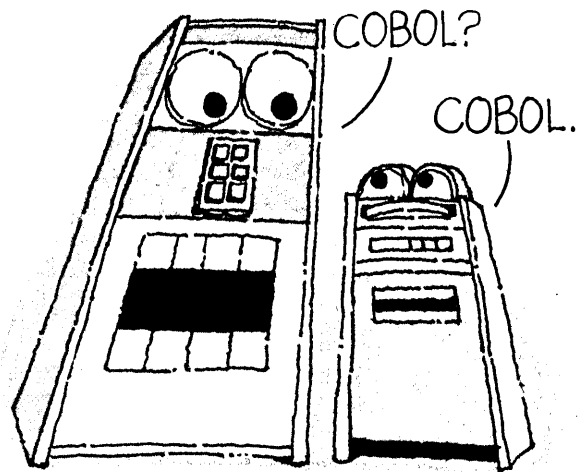

Our software speaks your language.

Now the largest manufacturer of interactive minicomputers offers the broadest spectrum of commercial software tools: ANSI '74 COBOL, DBMS, SORT, RPG, QUERY, MULTI-KEY ISAM, and more.

That means even better Datasystem functionality in commercial applications. Better because you get:

- great performance in multi-task environments with our new, easy-to-use, interactive, full-function COBOL

- advanced multi-key ISAM data management with our new RMS-11

- fast, versatile report generation with our RPG II

- super fast sorting of data files with our new SORT-11

- advanced data base facilities with our CODASYL-compliant DBMS-11

- quick easy access to data, plus flexible, selective reporting with our new COBOL-compatible DATATRIEVE-11

What's more, we've dropped our prices. And that means even better Datasystem

price performance. For details, contact the nearest Digital office, or Digital Equipment Corporation, Business Products Group, MK-2/H32, Merrimack, N.H. 03054, (603) 884-5432. European headquarters: 12, av. des Morgines, 1213 Petit-Lancy/Geneva. In Canada: Digital Equipment of Canada, Ltd.

digital

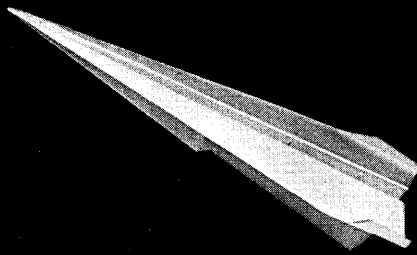

TRANSMISSION:
Page; Field; Modified Field; Prompted Transmission; Device Status; Function Keys.

INTERFACE:
EIA RS-232; Current Loop; 17 data rates (switch selectable) including 19, 200 chars/sec; Half duplex support; Line turnaround characters; Reverse channel.

EDITING FUNCTIONS:
Insert/Delete line and character; Columnar Tabbing; Cursor Addressability; Cursor Sense; Numeric Only fields; Security fields; Erase Variable/Protected fields.

OPTIONS:
Buffered Printer Interface (RS-232 and parallel), separately addressable from the CPU; Standard Polling; Paging.

VIDEO:
Normal; Reverse; Blink; Low/half intensity; Underline.

KEYBOARD:
Removable, solid state with international character layouts.



When it comes to flexibility, the Infoton 400 Data Display terminal can hand you all you need.

Designed around the Z-80 microprocessor, it offers complete control of all Blocking and Editing functions through software settable modes. One thing that's especially easy to handle about the I-400 is its cost; at \$1,095 in quantities of 100 or more, it's the most versatile terminal for the price you can get your hands on.

More information on the I-400 is quickly within your grasp. Call Infoton toll-free at (800) 225-3337 or 225-3338. Ask for Barbara Worth. Or write Barbara Worth at Infoton, Second Avenue, Burlington, MA 01803.

Prepared by Chickering/Howell, Los Angeles.



 **Infoton 400**

Documation's new breakthrough gives you all the advantages of impact printing at laser graphic throughput rates

Call John Sterling (800) 327-6424 or (305) 724-1111 or your local Documation representative: **Atlanta, GA** 955-0309
Boston, MA 890-2650 **Chicago, IL** 782-0551 **Dallas, TX** 661-9902/750-6160 **Detroit, MI** 353-8181 **East Meadow, NY** 794-1186
Greenwich, CT 869-4123 **Hartford, CT** 278-2010 **Houston, TX** 780-1432 **Irvine, CA** 752-8782 **Long Beach, CA** 595-6775
Miami, FL 592-9655 **New York, NY** 695-4195 **Newark, NJ** 686-5223 **Oak Brook, IL** 920-0551 **Philadelphia, PA** 337-2850
San Francisco, CA 574-4060 **Washington, DC** 356-2050 International Offices: **London**—Staines 61124 **Paris** 686 8607
Germany 06/762 055 **Spain** 416 87 60.

Introducing IMPACT 3000

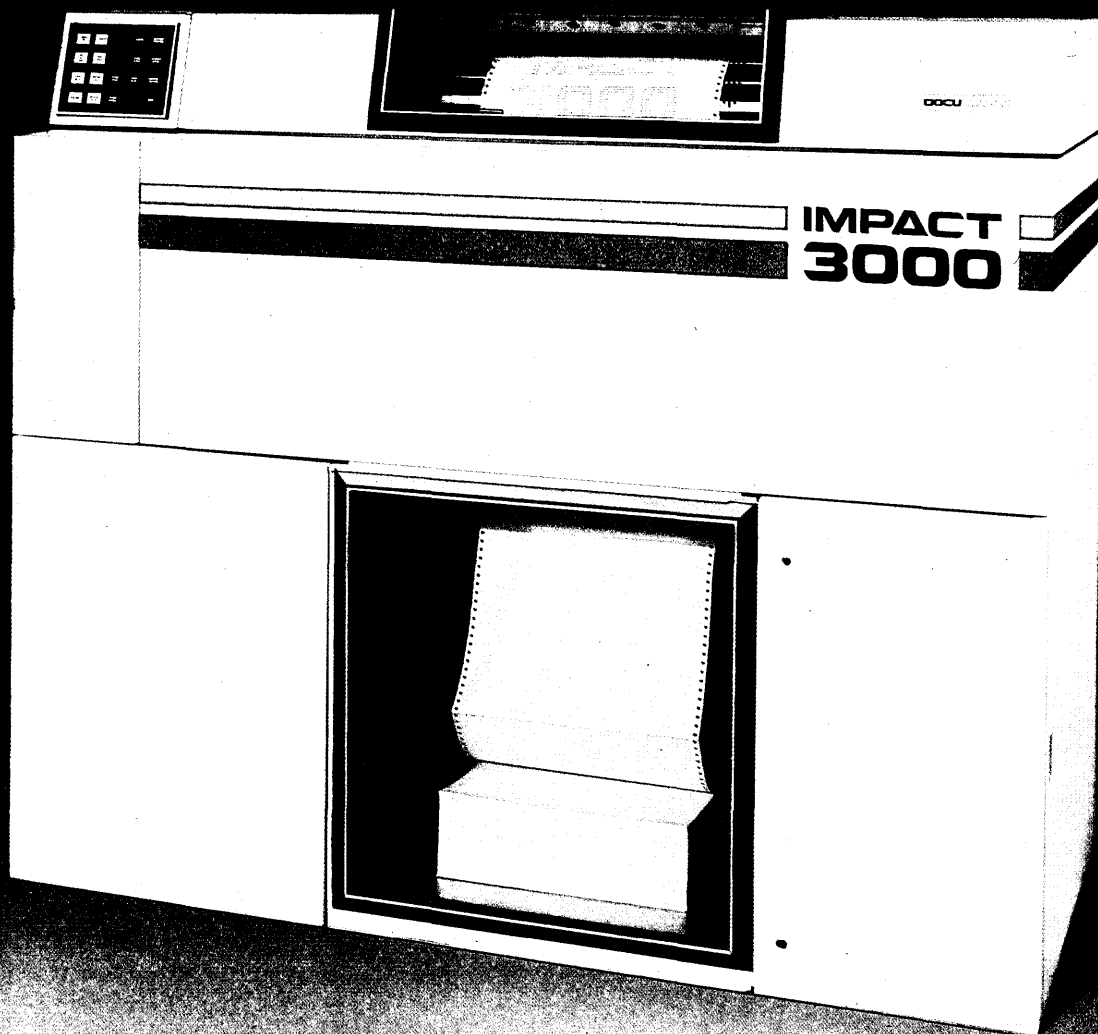

World's fastest Impact Line Printer

Documation's technology breakthroughs increase throughput to 3000 lines per minute. With 6 copy capability impact printing now yields throughput rates up to 18,000 lines per minute per printer.

More throughput per dollar invested

Cost of ownership of three IMPACT 3000 line printers is less than a single IBM 3800, providing you significantly lower cost redundant reliability. What's more, IMPACT 3000 productivity increases as the number of copies increases. Laser graphic productivity decreases.

Forms flexibility

IMPACT 3000 provides printing on any forms 3 to 18 $\frac{3}{4}$ inches wide and 3 to 24 inches deep. More than twice the form depth of laser graphic capability.

No additional programming required

One IBM channel will support multiple IMPACT 3000 line printers. The IBM 3800 requires a dedicated channel. And, IMPACT 3000 requires no additional system or application programming.

Just four of the many reasons why you should investigate Documation's IMPACT 3000 as a viable alternative to laser graphic printing.

For more information on IMPACT 3000 write Documation Incorporated, P.O. Box 1240A, Melbourne, FL 32901 or call your local Documation representative for a detailed comparative analysis.

DOCUMATION
INCORPORATED

Why Versatec?



Somebody asked us why Versatec outsells all other electrostatic printers and plotters combined. We're glad they asked.

We discovered seventeen exclusive features that made Versatec easier to use, more efficient, more adaptable to your output requirements.

1. Convenient viewing angle. (You can glance over and see the output without standing. Very important for programmers, terminal operators and other humans.)
2. Dual contrast adjustment. ("Dark" control potentiometer and exclusive concentrate pump.)
3. Bigger, disposable toner container.
4. Writing head adjustable while running. (You see the result immediately.)
5. Output basket collates and keeps paper off the floor. (Standard for all fanfold machines.)
6. Space-saving design. (Eleven-inch models require less than half the space of competitive units.)
7. Portable. (Ours weighs 20-50% less than theirs, and casters are standard.)
8. Select from three different type fonts on high-resolution machines.
9. Serial and parallel interfaces for all 8½, 11 and 20-inch models.
10. True simultaneous printing and plotting with hardware generated characters on the same scan line without losing plot speed.
11. Variable line spacing. (Example: Our 900A is set at 84 lines per page, but you can adjust line count from one line to 95 lines.)
12. Exclusive wide models: 24, 36, 42 and 72-inch paper widths. (We've been shipping wide models for over two years. Another exclusive from Versatec.)
13. Choice of three resolutions: 100, 160 or 200 dots per inch. (Competition offers two.)
14. Differential drive. (Eliminates paper tracking problems of competitive solid drive roller that can skew and tear paper.)
15. Wider environmental specification. (Operation at 32°-105° F and relative humidity of 10-95%.)
16. Lower spare parts cost. (Competitive components can cost more than eight times that of Versatec equivalents.)
17. Sealed paper compartment. (Keeps paper "fresh." Maintains quality output.)

Features aren't enough. We also supply better plotting software integrated for more popular computers, interfaces for more display terminals, the biggest service organization devoted exclusively to electrostatic printer/plotters.

But believe it or not, we've only scratched the surface. So check the readers' service number for your 24-page full color brochure. It's filled with output ideas, application data and samples.



2805 Bowers Avenue
Santa Clara, California 95051
(408) 988-2800

Fill out this coupon. We'll send along your favorite sample.

- | | |
|--|-----------------------------------|
| <input type="checkbox"/> Business graphics | <input type="checkbox"/> Halftone |
| <input type="checkbox"/> Production drawing | <input type="checkbox"/> Medical |
| <input type="checkbox"/> Scientific graphics | <input type="checkbox"/> Seismic |
| <input type="checkbox"/> Mapping | |

name _____

telephone _____

organization _____

address _____

city, state & zip _____

computer and operating system _____

Does a Data Base Management System Pay Off?

by Gabrielle K. Wiorowski and John J. Wiorowski

The advantages of DBMS have been touted for years. Are they real?

A great deal has been said about the advantage of using data base management systems. A little has even been said about the disadvantages. But the potential user has been left with little assurance that the benefits are realizable and the problems as small as they are portrayed. What follows are the results of a carefully conducted survey which was designed to test whether the potential user has been misled. Are the advantages realizable? Are the costs too high? Do the users, the end users, really benefit?

We think the answers are mostly encouraging. Experienced DBMS users have gained a significant degree of data independence in their applications. They have enjoyed improved data integrity. And this has come, generally, at an acceptable cost. But not all of it has come as a result of adopting the data base approach.

To give an idea of the ground we're covering, let's begin by describing the survey participants. First, they used a range of data base management systems, including: ADABAS (4 user sites), DATACOM/DB (5), IMS (8), SYSTEM 2000 (5), and TOTAL (5). That's 27 user sites altogether.

Second, they used a variety of hardware. Most of the installations had medium size IBM 370 hardware, ranging from the Model 145 to Model 158. A few 360s were represented, and the smallest installation had an IBM 1130. There were also two Univac 1108 sites, an Amdahl 470/V6 installation, a Control Data 6400/6600 shop, and one with

five IBM 370/168s.

The following are the highlights of what we learned. Note that a few—we hope very few—mental gymnastics are necessary in interpreting the results. For example, answers for many of the questions were solicited on a scale of 1 to 5. That is, if an increase in cost was thought to be in the range of 0% to

Data independence was seen as the most important advantage of the data base concept.

20%, a "1" was recorded. A number in parentheses means only a decrease in some item was realized.

For simplifying the data collection and reporting, we asked the respondents to refer to their most cost beneficial application when answering questions regarding increases or decreases. (Sometimes this proved especially helpful. While we found that the average installation had about three applications running on the DBMS, one site had 28—and that one would have been impossible to handle.)

Third, the companies in which these installations labored were involved in several industry groups, including: retail (3), manufacturing (5), insurance, finance, and banking (5), government (5), education and research (4), and several miscellaneous others (the last 5).

As far as experience goes, 17 of the sites had had their DBMS installed for

over one year; the remaining 10 were relative newcomers. The sites were selected from customer lists in Texas, for the researchers' convenience, and from users who had redesigned existing applications to use on the DBMS. (The latter constraint was added so that we could ask questions about changes in operation which occur as a result of redesigning for DBMS.)

Finally, our contact at each installation was an individual with a title of data base administrator or its equivalent. The people were interviewed by phone, and had answered over 60 questions each before they were done. They also volunteered comments, and these were to prove at least as interesting as the statistical data.

The advantages

Data independence was realized by the users to a large extent. The question we posed on data independence gave a functional definition of the term but the users' verbal comments are more valuable in determining what they were actually rating and how they realized data independence. The users stated that the data organization is transparent to the programmers, that data is removed from the programs, and there is increased ease of programming both during development and during maintenance of an application using a DBMS.

As data independence increases, maintenance costs and costs of adding applications should and do decrease. Prospective DBMS users can indeed anticipate a decrease in these costs.

DATA BASE

However, the few users who did not see decreases in these costs pointed out that while there are fewer maintenance problems, the problems that do occur are more difficult to find and solve. Also, a user confirmed a maintenance function of DBMS that frequently is not present with non-DBMS systems: as the usage of data changes, the data base also must be changed to maintain operational efficiency, thus increasing maintenance costs.

Data integrity was rated second in importance and third in the degree to which an item had increased as a result of the application being on DBMS. Four users stated that they had the same data integrity and that erroneous data was not a problem before or after DBMS. The single user who gave a decrease rating (of 1) stated that errors could be introduced during on-line updates but the majority of the on-line users believed there was an integrity advantage to being on-line. Several users commented that end users really look at the data now as compared with the application's voluminous reports prior to DBMS. The end user will call about an error and a

A year's experience with DBMS made a big difference in the effectiveness of backup and recovery procedures used.

correction can be made immediately.

On-line DBMS users accounted for two-thirds of those surveyed, and six of the nine off-line users plan to go on-line in the near future. The average on-line "importance" rating for the 18 on-line users was 4.4, which is the same as the highest rated item, data independence. Indeed, 12 on-line users included being on-line as an advantage when asked for the advantages of data base systems—which shows how difficult it is to separate the concepts. In their own words, the responses included: "being on-line is the most important advantage of DBMS"; "on-line contributes greatly to the advantage of the data base approach"; "ease of programming on-line"; etc.

During the ratings many users would comment that "since we are on-line" we have realized an increase (decrease) in an item, although the original question was directed toward the application before and after DBMS, not before and after going on-line.

Although one is frequently advised to implement DBMS in batch and subsequently go on-line, 15 of the on-line users did it simultaneously with installing their DBMS. The majority of the on-line users (13) are using their own application programs rather than a query

How Users Rate the Importance of DBMS Advantages
(on a scale of 1 to 5)

Advantage	Importance
Data independence	4.4
Data integrity	4.3
On-line benefits	4.0
Centralized control	3.8
Ease and flexibility in restructuring and maintaining data	3.7
Reduction in data redundancy	3.6
Integrated vs. independent applications	3.5
Quick handling of unanticipated requests	3.5
Programmers not having to know physical structure	3.5
Security and privacy	3.1

Table 1. Strangely, the data base concept is so tightly linked with being on-line, that "on-line benefits" appeared as a major advantage of DBMS.

language. Despite the use of their own programs, which presumably were written for processing efficiency, their average response time was 5.8 seconds (excluding a 2 minute response time quote but including one 10 and one 25 second response time). It seems that the end user simply cannot expect instantaneous response time.

Centralized control did not seem to be a problem. One-third of the users felt it was the same before and after DBMS. A few commented that a data dictionary greatly aided in centralized control and in the overall data base approach.

Ease and flexibility in restructuring and maintaining data: Although nothing is really easy in dp, users rated this item with a substantial increase over what they experienced before DBMS. However, user comments suggest

a word of caution. Several commented on the additional computer time required, the difficulty of recovery, and the fact that the entire application was inoperable during recovery.

Experience does make a difference. The nine users who had their application on DBMS for less than one year claimed a very small increase (0.9) in the effectiveness of backup and recovery, while the two-thirds who had been on DBMS for one year or more had a large increase (2.9). These more experienced users tended to emphasize that an advantage of DBMS was that all transactions are logged. They also stated that they were forced to develop better backup and recovery procedures.

Reduction in data redundancy is often touted as the most important advantage of DBMS. The users we interviewed did not agree. Minimizing data

Degree of Change After Installing DBMS
(on a scale of 1 to 5)

Advantage realized	Gain or (Reduction)
Data independence	3.2
Data integrity	2.5
Centralized control	2.3
Ease and flexibility in restructuring and maintaining data	2.8
Data redundancy	(1.5)
Integrated vs. independent applications	2.3
Quick handling of unanticipated requests	2.0
Programmers not having to know physical structure	2.0
Security and privacy	1.2
Other change	
Maintenance costs	(0.7)
Cost of adding applications	(1.7)
Ability to back up and recover	2.2
Number of characters stored	0.8
Timeliness of information	2.6
Usefulness of information	2.5

Table 2. Some changes realized with the installation of a data base management system are actually not directly related to it. Many users claimed, for instance, that backup and recovery was made more difficult by the installation of DBMS; the gain in recoverability actually came from their being forced into developing better procedures to make the DBMS applications work.

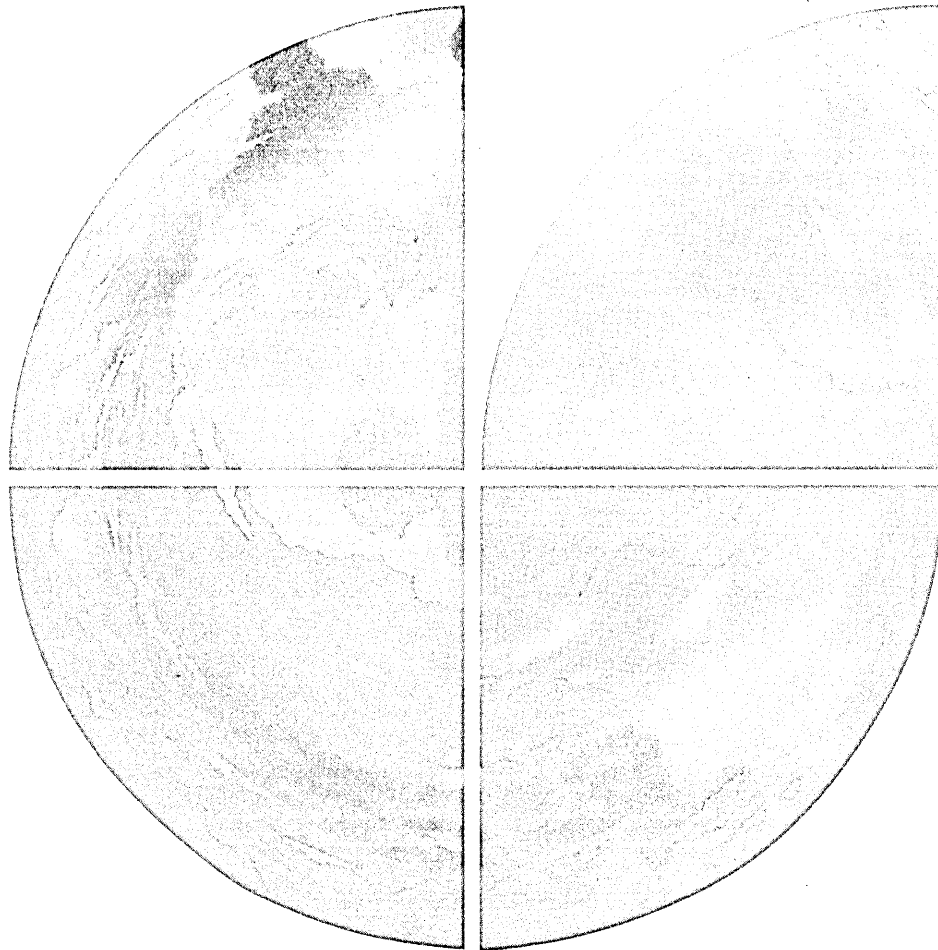

IT'S A CHANGING WORLD

And nowhere has major change been more evident than in the data processing industry. We have experienced generations of expensive equipment conversions. Frequent programming language changeovers. And increasingly complex operating systems. This dynamic environment has created an unprecedented challenge for top management to insure that each data processing dollar yields the maximum return to the organization.

Over 2,000 clients, in 18 countries, have utilized Cincom Systems' software products and services to harness that change and to provide the foundation for their management information systems.

Cincom's TOTAL Data Base Management System is a prime example, a proven DBMS, serving a large diversified installation base with one common denominator—the stability of the information resource.

It's a changing world. And that's good. Because if change is constructive and anticipated, if it is implemented in a managed environment, progress, productivity and improvement will result.

If you are concerned with your organization's position in the world of data base/on-line information systems, contact any one of Cincom's 35 worldwide support offices or write for further information.

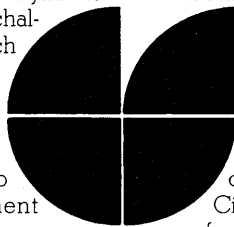

Cincom Systems, Inc.

2300 Montana Avenue, Cincinnati, Ohio 45211 513/662-2300



Thanks to our Larry Cox, a large sporting goods company doesn't depend on ballpark figures.

Larry Cox of CSC's INFONET helps Wilson Sporting Goods manage its inventories more successfully than ever before. A new system provides better forecasting and improved reporting of all inventory information.

Wilson also enjoys a significant reduction in its inventory investment plus improved scheduling and deployment at regional distribution centers.

Larry Cox is one reason why CSC is the world's leading independent firm in the information sciences. And why INFONET ranks among the top suppliers

of remote computing services worldwide. For data, financial and business management, INFONET provides superior decision-information tools.

We don't merely rent computer time. Our business is computer technology, people, and most importantly, solutions. We provide systems and specialists like our Larry Cox for immediate, uncomplicated solutions to our customers' problems.

At CSC, we give you just what you need, just when you need it. For further information, spend a little

time and write to us at CSC, INFONET Division, 650 North Sepulveda Boulevard, El Segundo, CA 90245. Or call (213) 678-0311.

**People who always have
time for your problems.**

INFONET
A DIVISION OF
**COMPUTER
SCIENCES
CORPORATION**

DATA BASE

How Users Rate the Importance of DBMS Disadvantages
(on a scale of 1 to 5)

Disadvantage	Importance
Operational inefficiency	2.8
Additional operating cost	2.4
Cost of additional hardware/software	2.3
Additional cost of storing data	2.0
End user problems in the transition	2.2
Cost of the DBMS	2.1
Cost of installing DBMS	2.0

Table 3. The disadvantages of running a data base management system, including higher operating costs, were usually seen as less important than the advantages.

redundancy ranked sixth in importance. The majority (three-fourths) did experience a sizable decrease (2.4) in data redundancy, however. Two of the three users who reported an increase in data redundancy stated that it was because some applications' functions had been only partially included in the application on DBMS, so overlap still existed between DBMS and non-DBMS data. The third user stated that data redundancy was necessary for good on-line response and overall operational efficiency.

A related question was asked about the total number of characters stored, and it seems there are several factors involved. For example, while there may be a reduction in the amount of *data* stored due to reduced redundancy, there also may be an increase in the total number of *characters* stored due to the pointers required. Another important factor mentioned by many users was that the application was extended when it was redesigned for operation under DBMS.

Overall, the consensus is that there was a small increase in the number of characters stored, but perhaps more important to the prospective users is any possible increase (decrease) in the *cost* of storing data. Unfortunately, that will be discussed under "disadvantages."

Integrated systems vs. independent applications: Obviously, conversion of an application to DBMS does not result in an integrated system. The impor-

tance of redesigning applications was stressed repeatedly.

A separate question was asked on whether the DBMS application had replaced more than one application. One-third of the users responded "yes" with specific details. One user had integrated five separate application systems for each of five zones that had multiple and different changes over the years. Another had combined payroll and personnel applications. Still another user's application files had been reduced from 19 to 5 files. (On the other side of the coin, one user commented that they had not been able to take advantage of more integrated systems due to political problems.)

Many of the users had extended their application when it was redesigned; and, much the same, 16 stated that additional systems would have been required had they not put the application on DBMS.

Unanticipated requests requiring programming can be handled more quickly. As might be expected, the on-line users had a significantly higher increase (3.2) compared to the off-line users' increase (1.4). The on-line users also believed that the information received from the application on DBMS was considerably more useful (3.1) to the end users in their daily activities than the off-line users did (1.4).

However, all this increased usefulness should not be attributed to being on-line. A batch user stated that useful-

Degree of Change After Installing DBMS
(on a scale of 1 to 5)

Disadvantage	Increase
Operational efficiency	1.1
Additional operating cost	1.4
Cost of additional hardware/software	1.1
Additional cost of storing data	0.4

Table 4. Average increases in major costs and in operational inefficiency were seen as "over 20%" by the installations polled. The low number seen for the increase in data storage costs is somewhat deceiving too, since many users extended their applications when it went on DBMS and saw costs go up by half.

ness of information to the end user had increased since the end user could use the report writer. Another batch user stated that the primary reason for DBMS was to provide quick and timely information for a decision-making process—but he had no plans to go on-line in the immediate future. So timeliness is relative, after all.

Programmers need not know the physical structure of the data, but users

Costs of operation rose about 25% on the average.

indicated that they do have programmers who know it. The DBMS experts are given the programs that require high operational efficiency, or are consulted as necessary.

Security and privacy was rated lowest in importance. Indeed, several users commented that they did not have security or privacy problems and therefore had not given any attention to the matter. Half of the users rated this item the same before and after DBMS. Eleven users gave an average increase of 3.3; and several of them remarked that the sign-on procedures and various levels of access permitted were good. The two users who gave decrease ratings (of 2) made the obvious but important point that it is more difficult to have good security and privacy with an on-line system.

Disadvantages of DBMS

One good sign for DBMS is that each of its disadvantages (Table 3) is rated lower in importance than each of its advantages (Table 1). Most of the disadvantages had less impact than the ad-

Since the benefits didn't justify the decrease in efficiency, they switched back.

vantages, too. For example, the highest increase among the disadvantages was the cost of operation, which was rated at 1.4 (around 25%) as compared with the highest increase among the advantages of 3.2 (for data independence). In general, it seems that the disadvantages were less important and impacted the application less than the advantages.

Operational efficiency was considered as the most important disadvantage of DBMS. This item had the most diverse increase (decrease) ratings of all the advantages and disadvantages. The individual ratings had the full range from a very large increase (5) to a very large decrease (5).

One reason this item was very difficult to estimate and rate is that it requires an overall rating of both computer and personnel resources involved in the daily operation of the applica-

DATA BASE

tion on DBMS. Also, "efficiency" is a nebulous word.

However, the question on operational efficiency did result in words of caution for prospective users. The most frequent comments from users who gave decrease ratings on operational efficiency were that: processing files sequentially requires excessive computer time; running updates is difficult, time consuming, and costly; processing speed for maintenance and retrieval should be improved; response times should be improved; and while logical data relationships, multiple keys and direct access have a number of benefits, they do cause performance degradation.

Three users did not believe that the benefits justified the decrease in operational efficiency for their application. Two of these were in the process of returning to their previous non-DBMS processing! They stated that the application could be performed equally effectively without DBMS and its decrease in operational efficiency. But they also stated that they plan to consider other applications for DBMS in the future.

The third user had placed a number of applications on DBMS but now has completed the conversion back to their previous applications. Even this user was in the process of planning the rede-

"The end user transition to DBMS was no problem, but systems analysts and programmers resisted the change."

sign of selected applications which would benefit from an on-line DBMS approach.

Still, for all their negativity on efficiency most of these three users' other ratings did not differ significantly from those of other users.

Cost of operation was highly correlated with operational efficiency. This does not mean that the users were getting more throughput for their dollar. Just the opposite. Their ratings indicate that you must pay more to achieve greater operational efficiency. For a small increase in operational efficiency, it would seem that an average cost increase of about 25% would be expected.

The correlation is not a perfect one and there is another significant factor involved. During the interview a large number of DBMS users stated that they had redesigned their applications and many had also extended them. Several of these users restated this fact when the cost of operation question was asked. One user stated succinctly what several had implied, that the benefits outweighed the higher costs several times

over. He further stated that although the total costs were higher, unit (per transaction) costs were lower.

Cost of additional hardware and software increased almost as much as cost of operation. Probably a large component of the increased cost of operation is attributable to additional hardware and software. Fifteen users (more than half) were running the application on a different computer than was used prior to DBMS, although only four attributed the upgrade to the application being on DBMS. Twelve users had the same computer. Of these, two stated that an upgrade (main and/or peripheral storage) was due to the application being on DBMS. Only eight had made no change to their computer since the application had been on DBMS.

Cost of storing data increased very little overall. However, the overall average is somewhat deceiving since almost

The benefits far outweighed the costs.

half of the users experienced an average increase of 2.5—roughly 50%! Again on this item several users commented that the application had been extended. Related comments were: "increased volume and the application is handling more"; "adding items to the files caused the increase"; "more data is stored"; "increased costs due to extending the system"; and "more disc and less tape is used."

The 11 who had an average decrease (1.9) in the cost of storing data commented on: "reduced data redundancy"; "efficient storage of data such as data packing and size overflow"; and "less costly disc storage" being available.

The remaining three users experienced no change.

End user transition to DBMS was important but was not a problem for most users. Many commented that they had worked closely with the end user to satisfy end user requirements and some had training programs to ease the transaction. One user did report the classic problem of the end user resisting giving up ownership of the data. Another stated that the end user transition to DBMS was no problem, but system analysts and programmers resisted the DBMS approach.

Cost of DBMS and cost of installation are not appropriate to compare before and after DBMS. The cost of DBMS and its installation rated lowest in importance of all the advantages and disadvantages. These costs were actually an advantage to one user who stated that the primary reason for going with DBMS was that it was less costly to redesign and implement the application on DBMS than to redesign with a non-data base approach.

Overall cost-benefit

One of the last questions asked was whether the overall cost-benefit had increased, decreased, or remained the same. The average rating was a sizable increase of 2.1. Many users stated that the benefits far outweighed the costs.

A further indication of whether the users believe that the benefits outweigh the costs are their plans for the future. The last question asked what applications were to be placed on DBMS over the next five years. Some users listed a few applications, others stated that all new applications would be on DBMS, and some stated that all applications eventually would be converted to DBMS.

Overall, most experienced DBMS users have realized many of the often hailed advantages of DBMS and have not found the disadvantages unmanageable. And keys to success for most DBMS users appear to be going on-line and redesigning their applications. *



Ms. Wiorowski is an independent consultant specializing in data base and data communications. Her past experience includes managing data communication planning and development at Jewel Companies, Inc. She also served on the NCC '77 Steering Committee as publications chairman.

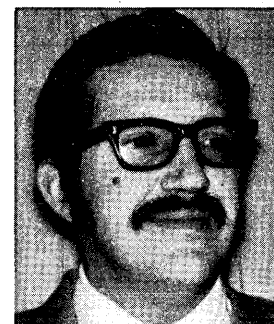

Dr. Wiorowski is an associate professor of statistics in the Program in Mathematical Sciences at the Univ. of Texas at Dallas. Previously, he was an assistant professor and director of statistical consulting in the Department of Statistics at the Pennsylvania State Univ. He is active in the development and use of statistical software, and in research at the interface of statistical methods and data processing.

Install the new SERIES 2 KEY-EDIT™ distributed data entry system today, and take care of tomorrow, too.

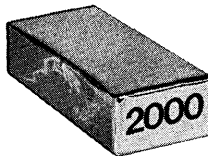
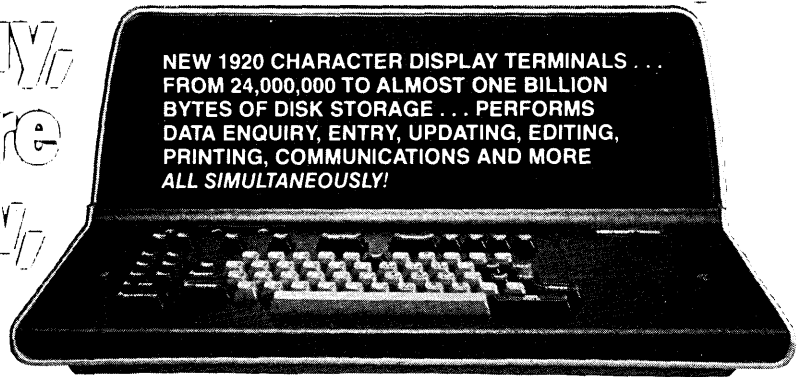

SERIES 2 — KEY-EDIT 2000

The low-cost alternative to key-punch, key-to-tape and first generation key-to-disk equipment.

As a starter data entry system, you can't do better than a new KEY-EDIT 2000. You get all the advantages of the *proven* KEY-EDIT concept and software compatibility, but at lower costs than you might expect. Once you move into the shared-processor environment, future potential growth in sophisticated editing and control techniques is assured.

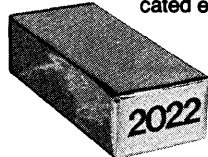

SERIES 2 — KEY-EDIT 2022

Replace remote batch and communications terminals with a multi-tasking stand-alone KEY-EDIT system.

For high-performance communications in a data entry environment, you can't ask too much of the KEY-EDIT 2022. It combines the full capabilities of a high-speed remote batch terminal with a powerful multi-tasking key-entry stand alone *processing* system. You can *do more* with a KEY-EDIT 2022 because you *get more!*

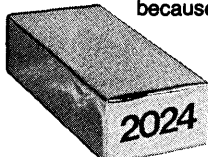

SERIES 2 — KEY-EDIT 2024

The *powerful* distributed data entry system.

System 2024 is a distributed data entry system that does it all, including transaction-oriented data collection at local or remote user operating departments. Unique file management techniques enable the user to enquire, enter, update and examine data *in real-time* without affecting the main central computer.

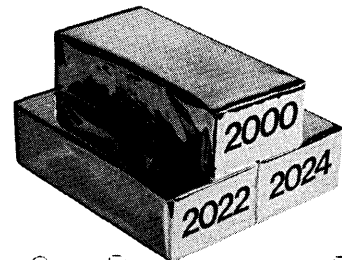

We built it that way!

Get the complete story on the new SERIES 2 KEY-EDIT family, and what it can do for you. Call Manager, Product Marketing (416) 449-1120. Or write today.

We know you can rely on your KEY-EDIT SERIES 2 system today — and tomorrow, too. Because we built it that way!



**CONSOLIDATED
COMPUTER** INTERNATIONAL
INC.

275 Wyman Street
Waltham, Mass. 02154

Consolidated Computer has already installed over 20,000 KEY-EDIT terminals.

®Registered Trademark of Consolidated Computer, Inc.

INTRODUCING THE MINI- MAINFRAME. \$195,000.

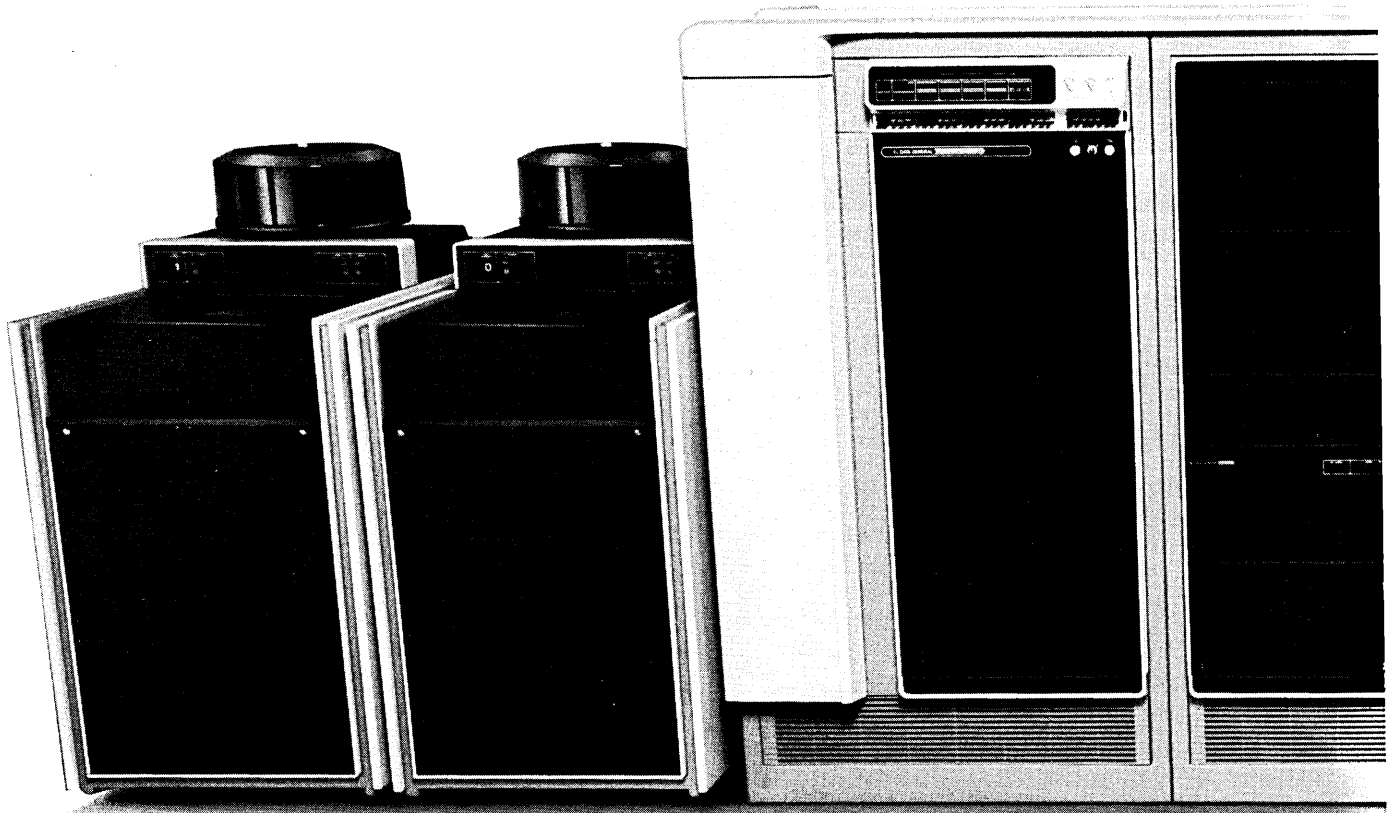

Data General Corporation, Westboro, MA 01581. (617) 366-8911. Data General (Canada) Ltd., Ontario. Data General Europe, 61 rue de Courcelles, Paris, France, 766.51.78. Data

Until now, either you opted for the capability of a mainframe or you went with the flexibility and economy of a mini. Until now.

Introducing the Data General ECLIPSE M/600 computer system. It combines the workload capability of a mainframe with the traditional advantages of a mini, such as interactive computing, distributed processing and economy.

One thing that makes the ECLIPSE M/600 like no other existing computer is an incomparable three level I/O Management System, which prohibits I/O bottlenecks. Another is an incredibly efficient Demand-Paged Memory Management, which allows you to run more jobs faster. And its new Job Processor is unmatched for speed and flexibility. Then our supremely intelligent Advanced Operating System (AOS) keeps everything speeding along for a minimal terminal response time and a maximum concurrent batch stream throughput.

Once again Data General raises the world's expectations for computers, while lowering the cost. To find out more about what you can expect from the new ECLIPSE M/600, write for our brochure. Or call (617) 366-8911, Ext. 4735.

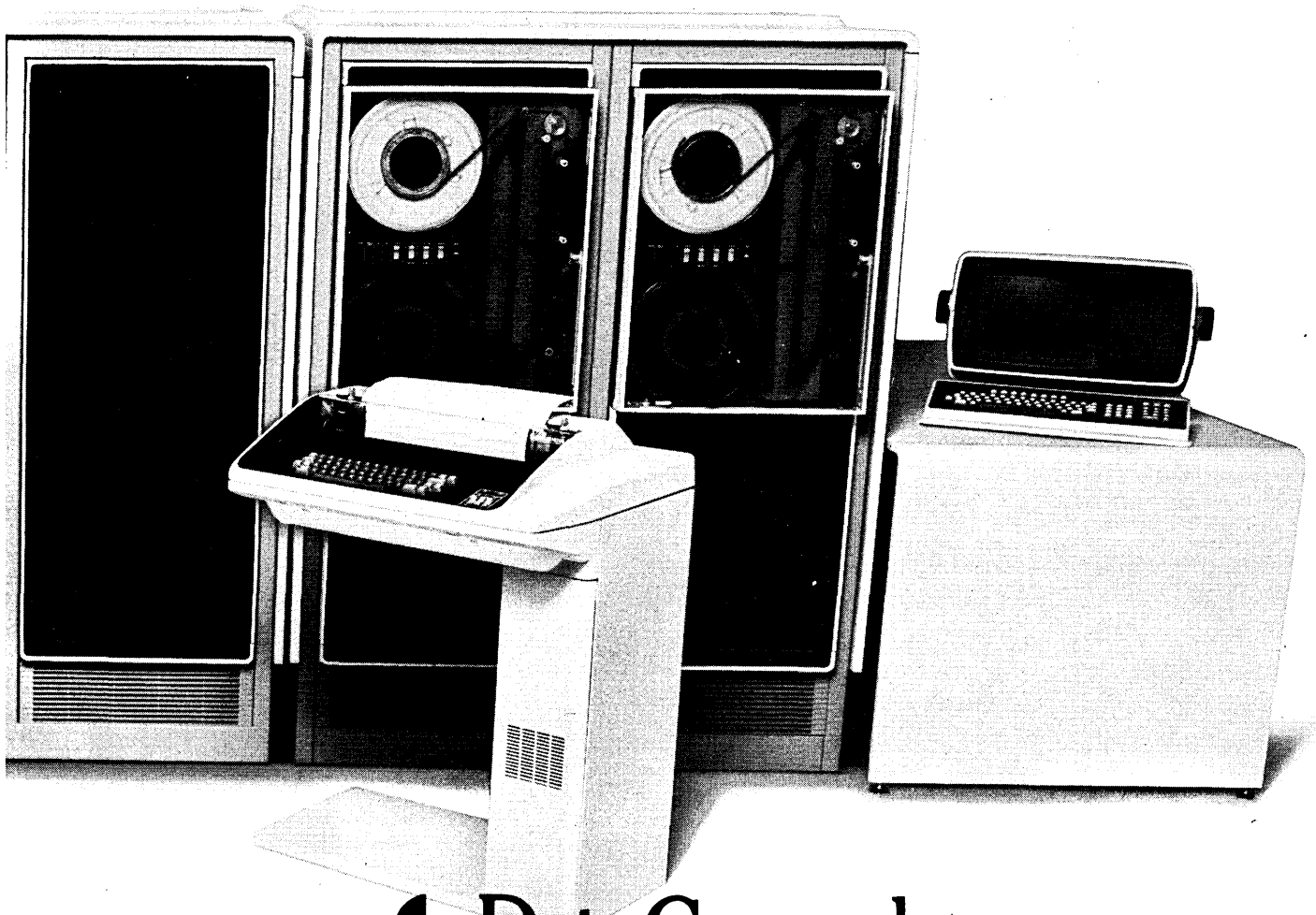

 **Data General**
We make computers that make sense.

'Nixdorf showed us complete distributed processing capability and growth flexibility with its ENTREX systems—and saved us money, too!'

General Telephone Directory Company

Paul Wills, Sales Director—National Yellow Pages Service

Bob Alread, Director of Data Processing

ENTREX 600/50

THE NIXDORF CHALLENGE

ENTREX Series 600. A Nixdorf Product.

"Tight schedules, last-minute changes and absolute accuracy are ways of life in directory publishing," asserts Wills. "Now we can finalize data at seven coast-to-coast offices, and transmit much faster... to give our customers more lead time, while meeting publication deadlines!"

"With Entrex Series 600 systems from Nixdorf," states Alread, "we don't compromise cost or capability. They perform multiple functions simultaneously. They're extremely easy to program and operate. And these flexible, clustered systems allow us to simply add terminals at about \$80 per month, vs. spending \$250-\$300 with our previous system!"

See what The Nixdorf Challenge can do for you.

Take *The Nixdorf Challenge*: Let us demonstrate our system capabilities—then compare! In data entry, distributed processing and data communications, Nixdorf is a worldwide mini computer leader... with over 100 sales and service centers coast-to-coast—dedicated to excellence and customer satisfaction.

Small business systems, too, with applications software.

That same dedication pays off if you need a stand-alone system and applications aid. Challenge us to show how NIDAS/8870 systems can provide more manageable management data than you thought possible.

Call Toll Free or write. Nixdorf Computer Corporation, 168 Middlesex Turnpike, Burlington, MA 01803.

More than 60,000 systems installed. All over the world.

MAIL THE COUPON OR CALL TOLL FREE 800/225-1484 EXT. 365.

Please send information on:
 Entrex Series 600 Systems
 NIDAS/8870 Systems
 Have a sales person call.

To:
Nixdorf Computer Corporation
 Dept. D48
 168 Middlesex Turnpike
 Burlington, MA 01803

Name _____ Title _____
 Firm _____ Phone _____
 Address _____
 City _____ State _____ Zip _____
 Type of Business/Industry _____

NIXDORF
COMPUTER

Comparing Programming Language Performance

by Jerome W. Blaylock

An installation may be better off using available compilers and programmers rather than switching to a more "appropriate" language.

Most high level programming languages are designed and developed for a particular class of programming problems. Once a language is implemented, little consideration is given to how well suited it is for the solution of other types of problems. Is it really true that "scientific" programming languages are not appropriate for business applications and "business" languages not suitable for scientific applications? Perhaps not.

Relatively little work has been done on comparing the efficiencies of more than one language for programming any given algorithm. Occasionally, an algorithm will be programmed in FORTRAN and ALGOL, but seldom in both ALGOL and COBOL. The unproven assumption has been that COBOL should not be used for complicated computations, double-precision floating-point calculations, and matrix manipulation. Likewise it has been assumed—but not proven—that FORTRAN is not well suited for I/O-bound applications, or those that involve detailed report formatting and extensive commercial data processing.

To thus compare several languages, eight experiments were run with identical algorithms coded in two or more (usually three) different languages and compiled using up to seven different compilers. Each compiled program was then tested, using identical test data. A number of programmers coded the various versions of the algorithms, and no attempt was made to optimize the programs beyond what would be expected from an experienced and prudent programmer. Stringently enforced guidelines insured that only standard techniques and procedures were used in coding. All experiments were run on a Univac 1108 located at the Univ. of Houston Computing Center, under the EXEC 8 operating system. Two ALGOL, two FORTRAN, and three COBOL compilers were involved. (Specifically, they were: ALGOL, Norwegian University's NUALG, FORTRAN V, Reentrant FORTRAN, COBOL, ANSI COBOL (which

uses Fieldata-coded data), ASCII COBOL (using ASCII data), UBASIC, Assembler, APL/1108, and SNOBOL 4. Of course, all were Univac 1108 versions.)

The algorithms chosen for the experiments were divided into scientific and business categories. The first contained arithmetic computations, iterative processes, functions, and matrix manipulations—all operations common to scientific applications. The second category included I/O processing, report processing, and logical processing.

The specific scientific algorithms included one for computing hyperbolic

Deficiencies observed may be characteristics of the compilers, and not inherent in the languages.

and exponential functions by continued fractions, a random number generator, a simple precedence grammar analyzer, and Newton's Method of approximations for solving nonlinear equations (both single- and double-precision). The business algorithms were the "Tower of Hanoi" (a logic problem), and two application programs taken from the student records system at the Univ. of Houston (a graph of grades and a freshman advising report).

Table 1 shows the characteristics attributed to each of these algorithms. (Because most algorithms contain some computations, formatting, and iteration, a characteristic is attributed to an algorithm only if it accounts for a significant part of the total processing performed.

Primary attributes measured and analyzed were the execution times for the various algorithms. Two subroutines were used: the first got the starting cpu time and stored it in Common; the second got the ending cpu time, calculated the elapsed cpu time to the nearest tenth of a millisecond, and printed it out.

The first experiment was started with the use of a single driver program to

execute the algorithms, which were compiled as subroutines, in the various languages using the various compilers. ALGOL was chosen for the driver program because ALGOL procedures can only be executed by ALGOL programs (and, of course, through Assembler instructions). This proved to be an unsatisfactory approach, because the calling sequences are incompatible between the various languages, as well as between the various compilers for the same language. Each set of driver programs and subroutines, therefore, had to be written in the same language.

Cobol vs. Fortran and Algol

The first question we sought to answer was "How does COBOL compare to FORTRAN and ALGOL as a computational language?" Generally, the execution times for the COBOL versions of the experiments with computational characteristics were greater than those for the FORTRAN and ALGOL versions. (See Tables 2 and 3.)

There were some notable exceptions where the execution times for the ASCII COBOL-compiled versions were comparable to those for ALGOL and FORTRAN versions. In the functions by continued fractions experiment, for example, the ASCII COBOL version executed in approximately one-third the time of the other two COBOL versions, and only about double the times for the fastest executions—those for the FORTRAN versions. Similar results were observed for the Newton's Method experiment. (BASIC was not used for this and many of the other experiments because it was not chosen as one of the primary languages under investigation.) Two of the COBOL versions were also somewhat competitive in the simple precedence grammar experiment.

The main problem incurred in using the EXEC 8 standard COBOL and ANSI (Fieldata) COBOL compilers for scientific programming was that they do not allow for the specification of such variable types as floating-point. All three COBOL compilers are capable of float-

Characteristics of Algorithms

Characteristic	Functions by fractions	Random number generator	Newton's (single-precision)	Newton's (double-precision)	Simple grammar analyzer	Tower of Hanoi	Graph of grades	Freshman advising report
Iterations	x	x	x	x				
Functions		x	x	x				
External subroutines					x			
Single-precision math	x	x	x					
Double-precision math				x				
Matrix manipulations					x			
I/O							x	x
Report formatting						x	x	x
Logic processing						x	x	
Sorting								x

Table 1. Most algorithms contain some computations, formatting, and iteration. The characteristics attributed to each

problem here are those which account for some significant amount of the processing performed.

ing-point arithmetic; however, the EXEC 8 standard COBOL and ANSI COBOL compilers convert all variables to floating-point prior to using them in a computation and convert the results to integer after the computation. All three also do all floating-point computations in double-precision.

The deficiencies observed in using the three COBOLs for the scientific algorithms appeared to be characteristics of the compilers and not inherent in the language. Because COBOL is not generally considered an efficient language for involved math applications, the efficient implementation of such features may take a low priority in the design and implementation of COBOL compilers. At the very least, this appears true of the three compilers used for these experiments. The fact that the only "bugs" encountered in using the ASCII COBOL compiler for these experi-

Overall Comparison of Execution Times

Language	All scientific	All commercial
ALGOL	.59	
FORTTRAN V	.26	1.00
COBOL	1.00	.85

Table 3. The overall results were not surprising, but note that they suggest FORTRAN might not be a bad fit for nonproduction commercial programs when a COBOL programmer isn't available. (ALGOL was not used on two of the commercial problems due to an incompatible input format, and thus isn't listed in the second column.)

ments appeared when attempting to perform mathematical computations supports the contention.

Fortran vs. Algol

Next we considered how programs written in FORTRAN compare to those written in ALGOL. Execution times for the ALGOL versions of the experiments were greater, almost without exception, than for the FORTRAN versions. The most extreme cases were observed in the random number generator, simple precedence grammar analyzer, and Tower of Hanoi experiments where the execution times for the ALGOL version were particularly long. With only one exception—the Newton's Method (double-precision) experiment—the Norwegian Univ. ALGOL (NVALG) version executed more slowly than the versions using Univac's other ALGOL compiler. (Aggregate results of the scientific and com-

Comparison of Execution Times

Language	Functions by fractions	Random number generator	Newton's (single-precision)	Newton's (double-precision)	Simple grammar analyzer	Tower of Hanoi	Graph of grades	Freshman advising report
ALGOL	.25	.91	.23	.47	.93	1.00		
NVALG	.23	.76	.25	.44	.28	.66		
FORTTRAN V	.15	.18	.20	.33	.20	.83	1.00	.99
REENT. FORTRAN	.16	.25	.16	.22	.36	.74		
COBOL	1.00	.78	1.00	.99	.50	.51		
ANSI COBOL	1.00	1.00	1.00	1.00	.48	.52	.90	1.00
ASCII COBOL	.33	.93		.47	1.00	.59		
BASIC	.28					.95		
ASSEMBLER		.08						
APL						.40		
SNOBOL 4						5.40		

Table 2. Where languages were applied to programs for which they were not designed, the expected mismatch was found, but often this was not as great as expected. The figures above are for execution times, expressed as frac-

tions of the longest execution time experienced. (Note that this rule was waived in the one case where SNOBOL was tried, due to its enormous execution time on that algorithm.)

Control Data OEM reader/sorters for MICR systems buyers who demand quality.

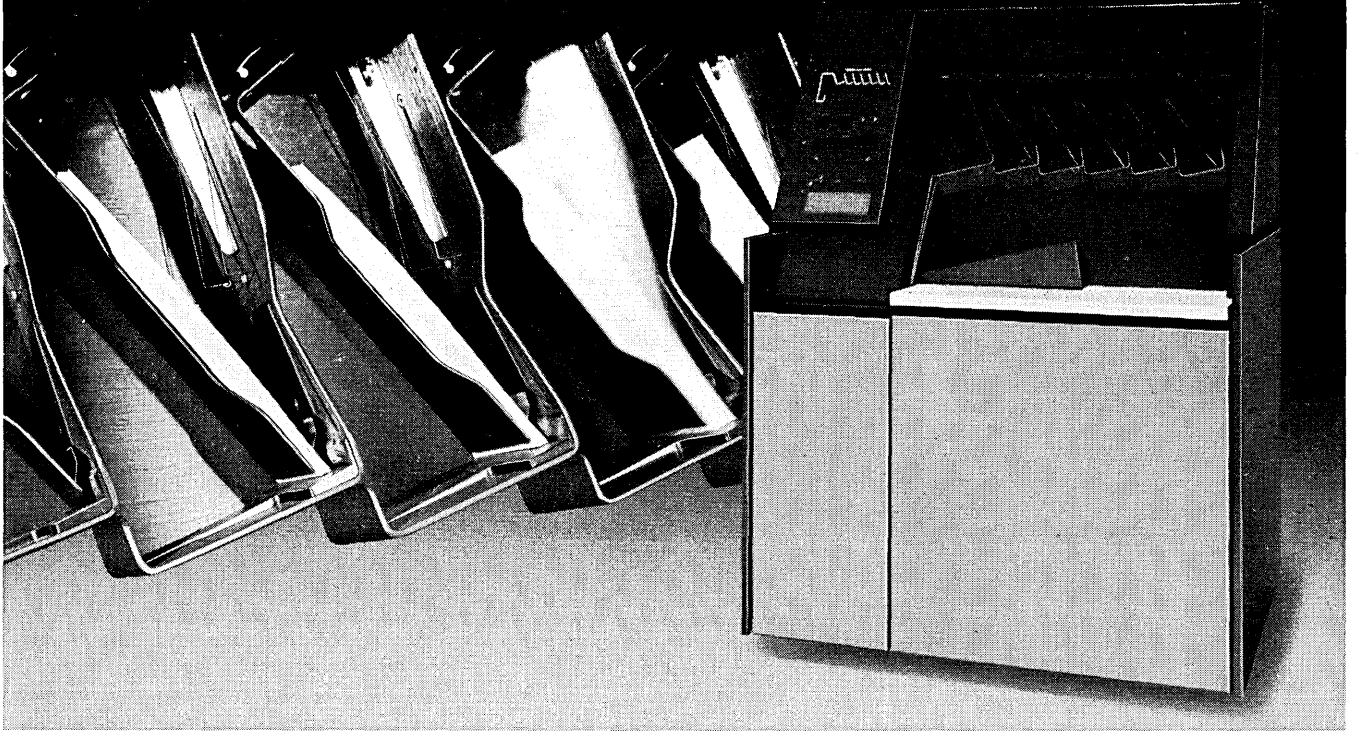

Minicomputers and lower costs in communications now make it feasible for small banks to have low-cost, in-house MICR bank systems.

Our 92660 Reader/Sorter was designed specifically for the new minicomputer systems being developed for smaller banks. Six programmable pockets, high throughput and easy operation. With fewer moving parts, you gain operational reliability.

We have a complete line of MICR, OCR and OMR equipment. We can help, whether you market to smaller banks using an in-house central system, satellite banking operations communicating with a central system, large banks needing a more efficient system, or other check processing applications.

The other models in our line offer more pockets and even higher performance and throughput. All have the quality and reliability demanded for financial processing.

Put quality behind your nameplate. Call us at 405/946-5421. Or if in Europe, contact one of our European representatives. Or return coupon to:

D48

Chet Baffa, Product Sales Manager,
Control Data Corporation, 4000 NW 39th,
Oklahoma City, Oklahoma 73112

Name _____ Title _____
Company _____ Phone _____
Address _____
City _____ State _____ Zip _____

GD CONTROL DATA CORPORATION

More than a computer company

COMPARING

mercial experiments are shown in Table 3.) Although ALGOL may well be an excellent high level language for the *expression* of mathematical algorithms, FORTRAN appears to be superior for their *execution* on the Univac 1108.

Fortran vs. Cobol

How good or how bad is FORTRAN when it invades COBOL's turf and is used as a commercial data processing and report formatting language? Our experiments indicate that FORTRAN is—or at least can be—effective compared to

COBOL. Only two compilers were used for the commercial processing experiments because of the long execution times. ALGOL was not included because the input to two of these experiments is a COBOL-formatted blocked magnetic tape file which is not compatible with ALGOL.

Execution times for the FORTRAN and COBOL versions in these experiments were relatively close (again, see Table 3).

One reason that FORTRAN compared favorably may be that the NTRAN, DECODE, and ENCODE functions were utilized for the I/O, instead of the standard FORTRAN READ and WRITE statements. FORTRAN was also compatible as

a sorting and report formatting language in the experiments. The FORTRAN versions generally compiled and mapped faster, required less main memory for their absolute elements, and required fewer source statements than did the COBOL versions.

What does it mean?

It is clear that further comparative analysis of high level programming languages ought to be done. In future experiments, the number and variety of algorithms and the number of program authors should be expanded. It would be particularly useful to have several authors write the various versions of the algorithms used in the experiments as this would help to eliminate the human element from the statistics. Detailed analysis of results should be expanded to include compile times, memory requirements, numbers of lines of source code, and time required for coding and debugging.

An expansion of the number of computer systems considered would also be very valuable, as it would provide means to determine the extent to which these experiments reflect attributes of the compilers or computers rather than the languages. In this, data on execution costs might also be examined.

But the current results tell us something. In the aggregate, they tend to support the use of scientific programming languages for computational applications, and the use of business languages for commercial data processing. However, there are sufficient exceptions to warrant considering high level languages for the solution of problems which differ from those they were designed to solve. And an installation might well be better off using available compilers and persons knowledgeable in their use rather than switching to another language just because it seems more appropriate. *

WARRANTY Execuport 3000

WARRANTY, REPAIRS AND SERVICE - For a period of 365 days from delivery, CTSI will repair or replace any parts shown to be defective and will furnish parts and labor required to maintain the equipment's operational capability, at no expense to Customer, provided that during such period Customer shall be responsible for delivering the equipment to be serviced or repaired to CTSI's plant at Paramus, New Jersey or to a service center designated by CTSI. This warranty is expressly in lieu of all other warranties, express or implied, including the warranties of merchantability and fitness. The warranty of parts and labor hereunder shall be void if Customer, within the warranty period, disassembles, repairs, attempts to repair or tamper with the equipment or permits any person unaffiliated with CTSI to do so, or if Customer uses thermal printing paper not supplied or approved by CTSI. Repairs and maintenance shall be provided during the warranty period only by CTSI authorized personnel and decisions and any other repairs shall be at the Customer's sole risk and expense. After 365 days from date of delivery, upon request by Customer, CTSI may provide maintenance service on an annual basis in accordance with its ANNUAL SERVICE AGREEMENT.

COMPUTER TRANSCIVER SYSTEMS, INC. - East 66 Midland Avenue, Paramus, N.J. 07652

Serial No. of Unit
Date Shipped

---PLEASE MAIL THIS COPY---

Company Name
User's Name Dept.
Address
City State Zip
Tel. Ext. Model Number
Serial Number
Date Shipped

Unit Received in Good Condition Yes No
Comments

I desire to order extra copies of the operating manual at additional cost.

We just re-designed our Execuport's least-used feature.

Our Execuport 3000 wide-carriage portable is so reliable, its warranty is almost never used. As a result, we've decided to increase the warranty. Make it 275 days longer. This means you get a full year of warranty protection (although, with our track record, you'll probably never get to use this warranty either).

Things you will use on our 3000 include an exclusive data logger that can print all the control characters, a wide carriage (that also takes narrow paper), plotting with 1/4-line stepping, optional ASCII/APL switchable codes, plus a typewriter-type keyboard that makes using the 3000 a pleasure.

So, there are two reasons for buying our 3000. The things you will use on it. And the things you won't.

Don't you think it warrants further investigation? Just call Charles Kaplan or Shirley Newman at (201) 261-6800. And while you're at it ask about our reduced quantity prices.

Computer Transceiver Systems, Inc., East 66 Midland Avenue, Paramus, NJ 07652.

Canadian Distributor - Ahearn & Soper • Toronto 416-245-4348 (Main Office)
European Distributor - Technitron • Offices in Major Cities

Presently the director of systems programming and operations at Texas Southern University, Mr. Blaylock was a programmer and systems analyst for ten years, and has taught college courses in COBOL, FORTRAN, BASIC, Computer Science, Business Technology, and MIS.

Single Source...

Everything you need to make your data processing operations run more efficiently, you can get from Wright Line. From simple supply items to carefully planned documentation handling systems, Wright Line is the one best source. And . . . Wright Line offers superb customer service. For

supplies or small items just call us, or order by mail and you will get prompt trouble free delivery. For assistance in planning specialized filing systems or work stations rely on one of our professional field specialists. You find them in every principal city in the U.S. and Canada.

For more information about Wright Line products and services, circle reader's service number or send today for our newly published short form catalog. Wright Line Inc., 160 Gold Star Boulevard, Worcester, Massachusetts 01606 Tel. (617) 852-4300

Super Service!!



Order by mail using the convenient DOS order forms. Delivery is on our next truck out.

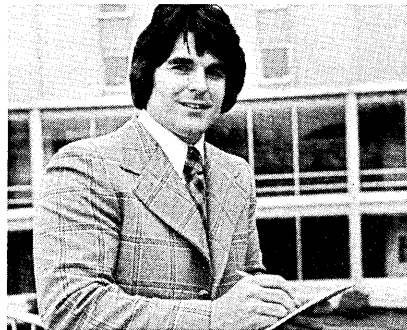

Get professional assistance in planning installations from our more than 150 highly trained field specialists.



Order by phone. Our hot line lets you place the order directly with the factory for fast delivery.



CIRCLE 58 ON READER CARD

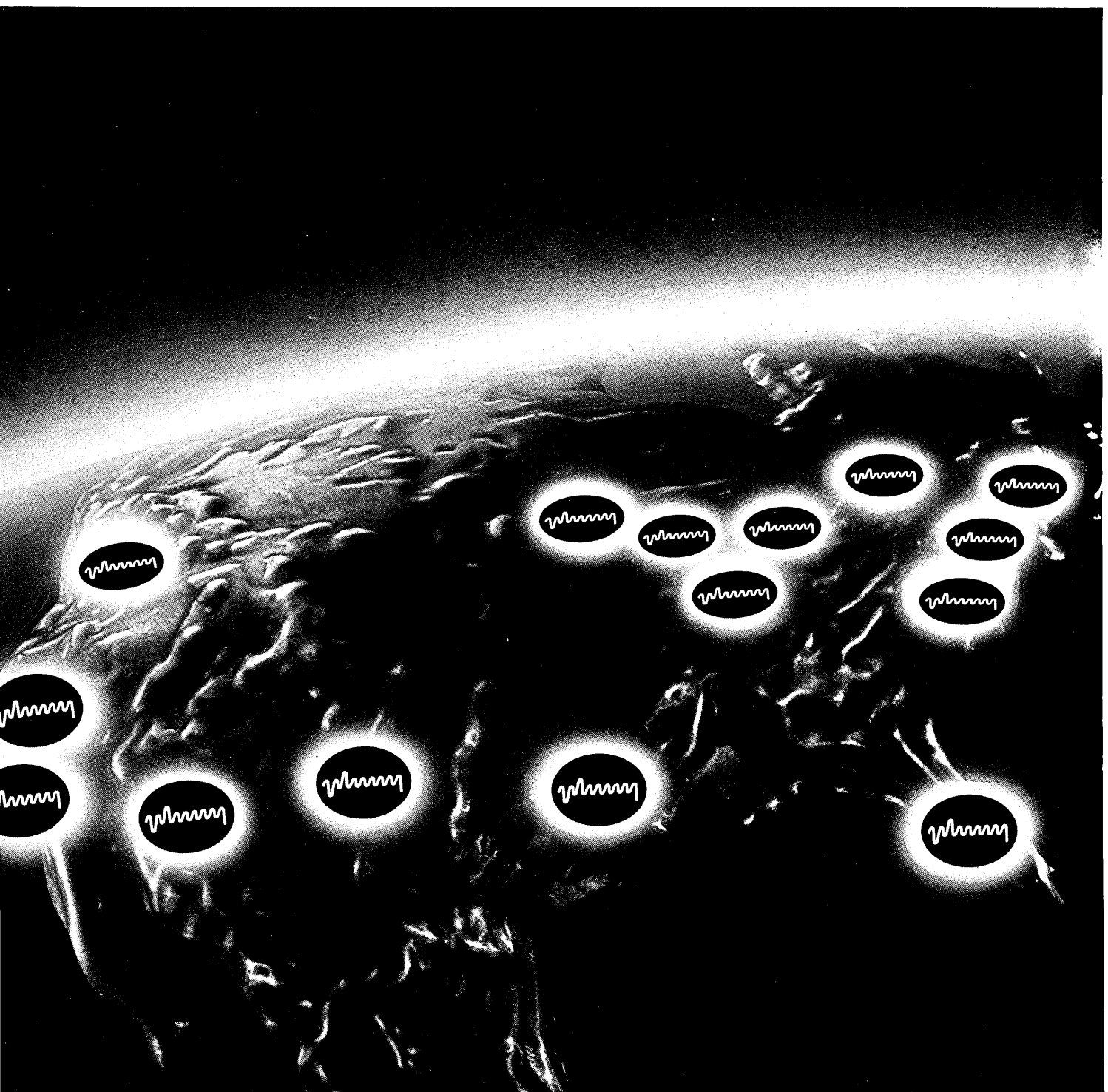

Another reason to get your

You may already know that Plessey offers a complete line of reliable DEC compatible products at substantial cost savings.

And you're probably aware that our deliveries are the best in the industry.

But just in case you missed our field sales and service support story, we'd like you to check out the map above and the list below: no other independent supplier of miniperipherals can stand behind their

NORTH AMERICAN SALES OFFICES: Phoenix, AZ (602) 265-5261/Irvine, CA (714) 540-9945/Los Angeles, CA (213) 473-4581/Mountain View, CA (415) 968-3681/Orlando, FL (305) 859-7500/Schiller Park, IL (312) 671-4554/Indianapolis, IN (317) 842-3130/Wheaton, MD (301) 949-1664/Waltham, MA (617) 890-2654/Southfield, MI (313) 644-4944/Minneapolis, MN (612) 881-0190/South Plainfield, NJ (201) 757-2211/Albuquerque, NM (505) 294-5790/Dallas, TX (214) 387-0229/Olympia, WA (206) 866-2001/Toronto, Canada (416) 661-3711

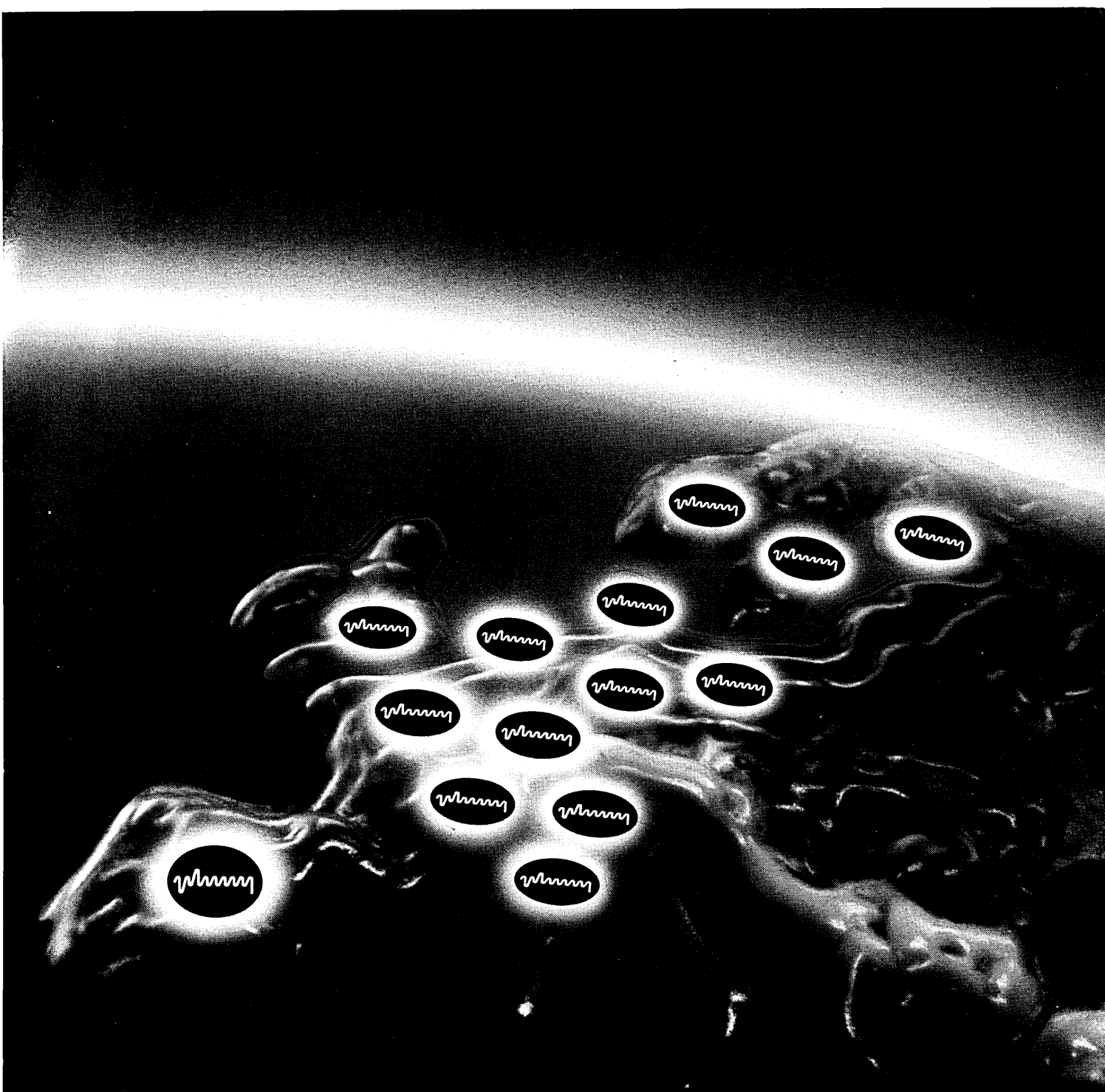

DEC peripherals from us:

products the way we can.

If any of this seems to be missing with your current supplier, call the nearest Plessey office and ask for our complete story.

It'll give you a nice warm glow, all over.



**Plessey
Peripheral Systems**

EUROPEAN SALES OFFICES: Hasselt (Antwerp) (011) 22.77.02/Copenhagen (01) 12.48.03/Helsinki (080) 542.077/Paris (01) 727-4349/Munich (089) 351-6021/Neuss (Düsseldorf) (02102) 44.091/W. Berlin (030) 24.72.12/Milan (02) 688-2324/Turin (011) 61.63.33/Zeist (Utrecht) (03404) 21.344/Oslo (02) 15.00.90/Madrid (01) 252.37.32/Stockholm (08) 23.55.40/Geneva (022) 82.55.30/Zurich (01) 50.36.55/Northampton (0604) 62.175/Tolworth (01) 330.4100/AUSTRALIAN SALES OFFICE: Sydney (02) 929-8299. SERVICE CENTERS UNDERLINED

DEC is a registered trademark of Digital Equipment Corporation.

DEC USERS

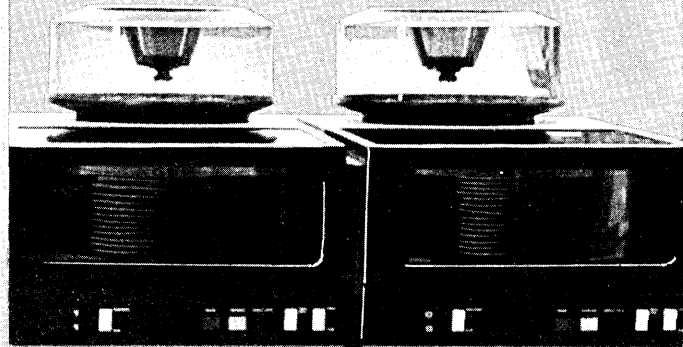
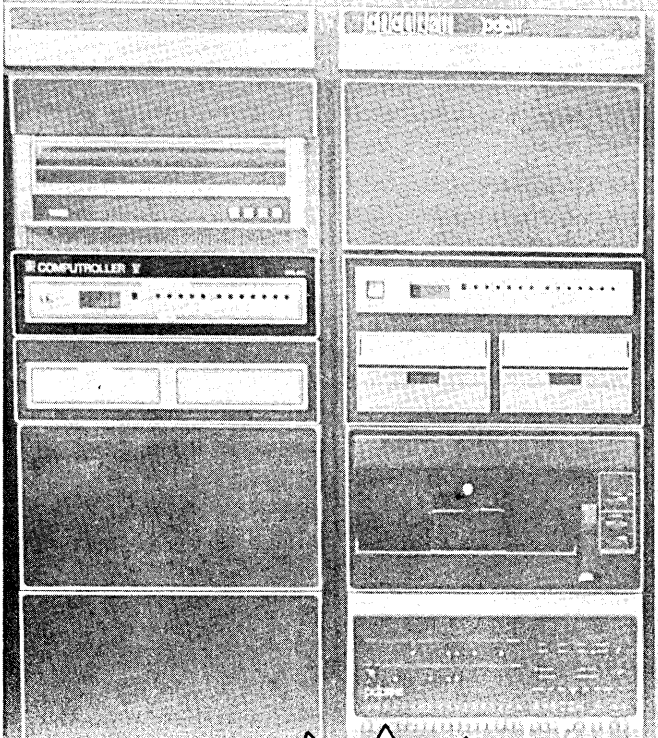

NEW DEC 11/70 DD 70 Series

High performance disc systems;
80, 100, 200 & 300 m/bytes for
cache bus interface on DEC 11/70.

DIVA SETS THE STANDARD IN DISC STORAGE SYSTEMS

80, 100, 200, 300 m/byte systems

- **Compatibility**

Plug compatible and transparent. Will run all standard operating software supplied by DEC, Interdata and Data General.

- **Reliability**

Multiwire construction, ECC and Self Diagnostic.

- **Service**

Installation, World Wide Service Support and Maintenance Contracts available.

- **Price**

OEM and Volume user discounts available. Save up to 50% relative to other mainframers pricing.



DIVA
FIRST & FOREMOST
IN DISC SYSTEMS
FOR MINICOMPUTERS
SINCE 1969

DIVA, INC. Eatontown, N.J.

Call toll free 800-631-2141

K



Both these 300 baud modems plug directly into the dial network.

Don't pick the old maid.

The Bell 113D, the industry standard, costs about \$30 a month. The new Prentice 113D performs the identical function, has more useful features, yet costs only \$17 a month.

Direct plug-in. No DAA required.

The new Prentice 113D is a two-wire, half or full duplex, Bell-compatible 300 baud modem. It plugs directly into the network the exact same way a Bell 113D does.

A full range of diagnostics plus slot transparency.

The P-113D contains nine LED indicators that automatically and continuously report operating status. That's two more than the Bell 113D. The P-113D is the same size and has the same

standard connector as all other Prentice modems. So it can fit in any position, in any sequence into any multi-unit Prentice enclosure. We call this unique feature "slot transparency," and it's not available from Bell.

Rent or buy. Either way it costs you less.

The P-113D rents for \$17 a month, or sells outright for \$370. For complete technical details, contact Prentice, 795 San Antonio Road, Palo Alto, California 94303, (415) 494-7225.

**PRENTICE
MODEMS**

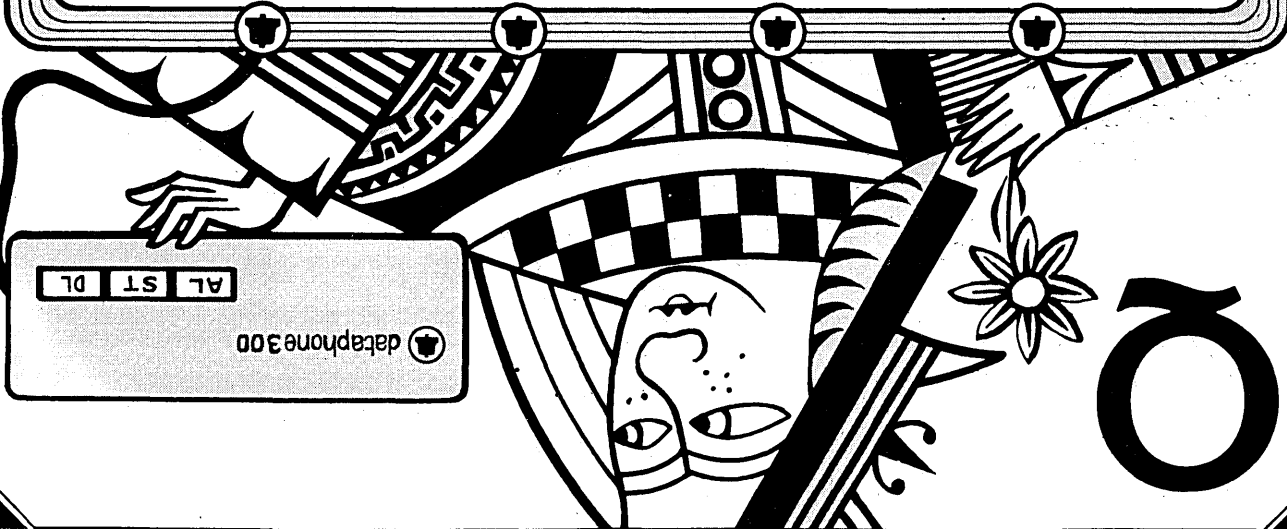

MDS Series 21. Engineered for distributed processing with or without programming.

SERIES 21: PRE-PROGRAMMED DATA ENTRY PLUS FULL USER PROGRAMMABILITY
FDEP: FORMATTED DATA ENTRY PROGRAM FOR INSTANT PRODUCTIVITY
MOBOL: MOHAWK BUSINESS ORIENTED LANGUAGE FOR CUSTOMIZED APPLICATIONS

15" DISPLAY FOR EASY SIGHT VERIFICATION

180 OR 1920 CHARACTER DISPLAY UNDER MOBOL

2 LINES FOR STATUS INFORMATION UNDER FDEP

RANGE CHECKING FOR PROPER MONTH, DAY, YEAR

DATE: SEPTEMBER 1, 1977		ORDER #52348-1983			
THE L. HELTON COMPANY ZERO STREET BOSTON, MASS.		SHIP TO: DAY ENTERPRISES 12 HAY AVENUE WELLESLEY, MASS. 02181			
VIA	BEST MEANS	DESTINATION	SALES POINT	DATE DUE: 12/15/77	
ITEM	QUAN	NUMBER	DESCRIPTION	UNIT PRICE	TOTAL PRICE
G	14	13755	TUBING	** .80	11.20
G	20	25567	PUMP BOND	*3.25	65.00
GRD. BY	GRD. REF. #	ACCOUNT #	SUPPLIER	TOTAL	
REC	4009	616074	177318	76.20	

LOAD THE FDEP FROM DISKETTE FOR:
 - KEYBOARD DATA ENTRY, VERIFICATION
 - SEARCH AND UPDATE OPERATIONS
 - JOB DEFINITION
 - PRODUCTION STATISTICS
 - DISKETTE UTILITIES

FILE LOOKUP:
 KEY, CUSTOMER, NAME OR NUMBER, RETRIEVE ADDRESS

CHECK DIGIT VALIDATION

FILE LOOKUP:
 1. KEY PART #; RETRIEVE DESCRIPTION, UNIT PRICE, ETC.
 2. MAINTAIN PERPETUAL INVENTORY BY
 - ADJUSTING QUANTITY ON HAND;
 - HANDLE PRICE CHANGES;
 - ADDITION, DELETION OF PART #S, ETC.

CALCULATE & EDIT PRICE

Today, the cost of programming a distributed processing system can easily exceed the cost of the equipment. Series 21™ from Mohawk Data Sciences solves that problem by eliminating the necessity for programming in many of those applications most common today — those requiring from one to four operator stations for use in source data entry/verification, and remote batch communications.

The MDS™ Series 21 eliminates the programming requirement through its unique Formatted Data Entry Program (FDEP). FDEP consists of

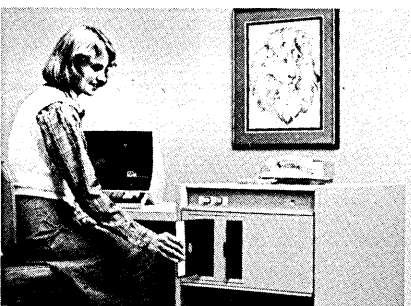

pre-programmed software routines that allow formats currently used on keypunches, key-tapes or key-disk systems to be quickly and easily converted for use on Series 21.

Within hours after installation of Series 21, remote site personnel with no previous computing experience can become productive data entry operators. When your application requires more sophisticated editing capabilities, or file management, or local transaction processing, you can upgrade from FDEP to full

programmability under MOBOL™ (Mohawk's Business-Oriented Language) without replacing any hardware.

MDS is now conducting seminars on distributed data processing in major cities throughout the country. For an invitation to a seminar and a demonstration of Series 21, call our headquarters, 1599 Littleton Road, Parsippany, N.J. 07054, (201)540-9080, and ask for James J. Byrne, VP, U. S. Sales.

™Trademarks of Mohawk Data Sciences Corp.

Mohawk Data Sciences
 1599 Littleton Road
 Parsippany, New Jersey 07054
 (201)540-9080

- Please send further information on Series 21.
- Have a salesperson call.
- Send a schedule for the next free DDP seminar in my locale.

DM 048

My application is _____

Name _____

Title _____

Company _____

Address _____

City _____ State _____

Zip Code _____ Phone _____



Mohawk Data Sciences

Virtual Machines and the NCR Criterion

by Tom Tang and Kenneth O'Flaherty

One way to take advantage of the virtual machine concept is to build a firmware engine that gobbles up programs written in higher level languages.

In all of the hoopla over the introduction—and reintroduction—of virtual memory, the significance of virtual machine architecture was largely lost on the general public. This is somewhat understandable. Virtual machines are more difficult to explain and appreciate. In fact, the term is not even well defined. Computer architects generally agree that a virtual machine's hardware can switch from one command set or "personality" to another, and generally this implies a microprogrammable processor; beyond that, there is little agreement on the definition. But the importance of this concept was not lost on any of the computer makers, and each in its own manner is finding ways to exploit its version of the idea.

NCR's implementation of the virtual machine concept is in the 8500 or "Criterion" series of computers. The Criterion line currently includes the company's most powerful general purpose business systems, competing in the performance range of the IBM System/370 Model 135 through 3031. Its use of loadable control store to give the processors different "personalities" is its most striking characteristic.

Choosing one floppy disc to load the writable control store leads to a personality which is similar to that of an NCR Century 300 machine. Loading another disc yields a dual personality, alternately a general purpose virtual memory machine and another dedicated to the efficient processing of COBOL. Therein lies the primary advantage of virtual machine architecture: the ability to tailor the computer to the type of problem being processed rather than tailoring the problem to fit the machine. It's a significant advantage, as we will demonstrate, and leads to dramatic improvements in performance.

The N-mode virtual machine is provided for those installations wishing to upgrade to the bigger 8500 series processors without adapting to a new operating system. It handles all the instructions of the NCR Century 300, and incorporates refinements in multiprogramming control, I/O control, error handling, and instrumentation. The differences are invisible to application programs; only certain parts of the older

NCS (NCR Century Software) operating systems have received minor modifications.

The Virtual Resource Executive (VRX) is the operating system which controls the V-mode personalities. It simultaneously supports one virtual machine which incorporates the Century 300 command set (but with more major extensions than present in the N-mode) and a second which is a COBOL machine. It provides an environment radically different from that of earlier NCR hard-

The primary advantage of virtual machine architecture is the ability to tailor the machine to fit the problem, rather than the reverse.

ware through capabilities like paged and segmented virtual storage, a stack-oriented linkage mechanism, a new I/O scheme, and a new task structure. It also provides new data management services (the Criterion Access Method, or CAM) and telecommunications services (the Message Control System, or MCS) which are designed to meet the requirements of the COBOL '74 language. And upon these services has been built a new set of utility programs, including a link editor, a Network Definition Language

Processor, a virtual storage sort/merge utility, an interactive program development subsystem, and the two new compilers NEATVS and COBOL '74.

Native VRX programs thus execute alongside emulated NCS programs, calling on different operating system services. NCS application programs run directly without recompilation and are automatically executed in a virtual storage environment. Conversely, VRX programs may call on many of the NCS support services if required (such as an NCS access method rather than CAM).

Control is switched between the COBOL and VRX virtual machines in a very few processor cycles (it requires about 200nsec) as a by-product of the normal interprogram linkage mechanism; switching does not involve any control store loading process, nor any program awareness of virtual machine switching.

Made to eat Cobol

How this all works to the user's advantage can best be shown by an example. Fig. 1 illustrates how a small segment of COBOL code is compiled for the NCR Century line and for the Criterion COBOL virtual machine. The example is for an editing move operation, which generates just one COBOL virtual machine command versus six Century commands. The six Century commands are by no means primitive; they include



VIRTUAL MACHINES

such complex operations as an Edit and a Decode. However, the virtual machine goes one full level higher in functional richness.

The average COBOL virtual machine instruction takes approximately twice as long to execute on the same hardware as the average Century instruction. Thus the editing move function in the example would execute in approximately one-third the time on the COBOL virtual machine. On the whole, typical COBOL statements, excluding I/O, execute up to four times faster on the virtual machine; however, since I/O is such an important factor, this instruction processing improvement does not usually translate into an equivalent gain in overall throughput.

With one major exception (Report Writer) and a few minor ones, the VRX COBOL '74 compiler implements all of the features of the Level 2 ANSI standard COBOL '74 language. The compiler is a striking example of a program written to take advantage of virtual storage; it is a single modular program containing multiple phases, and all its intermediate working files are held in virtual storage. (It is written in a subset of the NCR Software Writer's Language, SWL, which in turn is a block-structured higher level language derived from PASCAL.)

Programs executing on the COBOL virtual machine consist of three logical sections: a code section, a data section, and a "descriptor table." (See Fig. 2.) Each program also has a context block which includes pointers to the base of those three sections.

The code section contains the commands to be executed, each of which typically specifies an op code such as ADD and one or more descriptor numbers. The COBOL virtual machine understands 42 different commands, the majority of which correspond one-for-one with verbs in the COBOL '74 source language. Arithmetic commands may have two or three addresses, corresponding to COBOL statements like ADD A TO B and ADD A, B GIVING C.

A conventional sequence control register maintains the relative address in the code section of the next command to be executed. However, there are no explicit registers in the COBOL virtual machine. All commands operate on memory locations, which are addressed indirectly through the descriptors.

The descriptor number portion of the command designates a particular descriptor in the descriptor table. Descriptors correspond one-for-one with data items and supply all the information required to describe each item. This includes the length, data type, and relative address of the item within the data section. A descriptor also may include

the number and limits of dimensions, the method of addressing, and decimal position. For data items requiring editing, a pointer to an edit mask is also supplied, the mask being derived from the picture specified in the source program.

The use of descriptors provides a level of data independence to the program and permits individual commands to manipulate data items of different types. Thus, for example, an ADD may specify the addition of a binary signed integer to an unpacked, unsigned decimal field; and a MOVE may involve reformatting, data conversion, and editing of the item being moved.

Multiple personalities

All program modules generated to run in the VRX environment have associated linkage tables to assist in inter-module linkage. A call from Module A to Module B generates an indirect ref-

erence, through Module A's linkage table to the entry point control item for Module B, which is held in Module B's linkage table. The entry point control item contains control information concerning the called module; this includes the entry point address, and the identification of the virtual machine required to execute the code of Module B. The virtual machine identifier is used to select the proper emulator on entry to the called module. Thus switching between virtual machines is a simple by-product of the regular VRX linkage mechanism.

The VRX linkage mechanism uses a push-down stack to save the calling module's program context and virtual machine state. These are restored on return through the linkage mechanism to the original calling routine. A separate stack exists for each task under VRX.

Since NCR virtual machines are

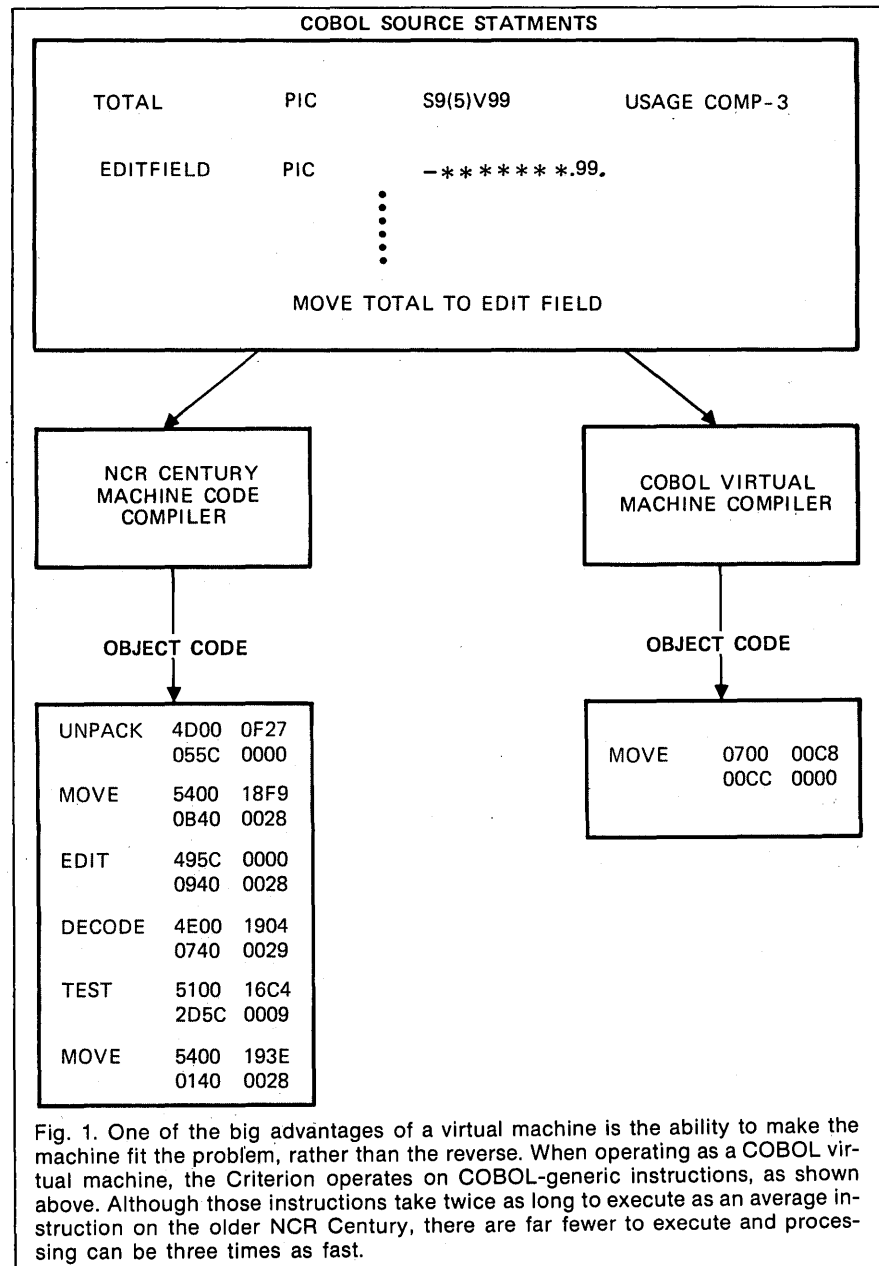

Fig. 1. One of the big advantages of a virtual machine is the ability to make the machine fit the problem, rather than the reverse. When operating as a COBOL virtual machine, the Criterion operates on COBOL-generic instructions, as shown above. Although those instructions take twice as long to execute as an average instruction on the older NCR Century, there are far fewer to execute and processing can be three times as fast.

memory oriented, rather than register oriented, there are no arithmetic register values to be saved and restored as part of this linkage. However, the CALL and EXIT commands are still complex ones, each having an execution time approximately three times that of the average COBOL virtual machine command.

VRX is a multiple virtual storage operating system, which provides each task with its own segmented, paged address space of 8MB. Each task automatically shares an additional 8MB global area containing operating system services. Segment size is 64KB. Page sizes may be 0.5KB, 1KB, 2KB, or 4KB.

Translation of virtual addresses to real addresses is achieved in a conventional manner through a segment table and a set of page tables for each task, together with a segment table origin register which points to the segment table of the currently executing task. Address translation is assisted by a 16-register associative memory in the Criterion main processor. This holds the translation information for the 16 most recently referenced pages, and handles at least 98% of all address translations in just one processor cycle.

The VRX paging supervisor includes

Switching between virtual machines is a simple (and fast) by-product of the linkage mechanism.

mechanisms to monitor the working set of each task, and to maintain in real storage those pages that make up each task's working set. This minimizes page faults, and guarantees a satisfactory level of performance for each task. Further mechanisms detect and prevent situations of "loafing" (where memory is under-utilized), and "thrashing" (where memory is over-committed). These conditions are corrected by dynamically adjusting the number of currently active tasks to balance current memory demands against available memory.

An unconventional highlight of the NCR virtual storage implementation is in its solution to the classic problem of input/output in a paged environment. This problem arises because an I/O buffer may cross page boundaries, and because the pages containing the buffer are not mapped contiguously in real storage. The typical solution to this problem (as in IBM's System/370) is for the software to build a list of real addresses of all pages containing the buffer, for use by the I/O channel; this can cause considerable software overhead on each I/O operation.

The VRX solution is to have the I/O channels use the standard address-mapping information already set up in the page tables (Fig. 3), thereby minimizing

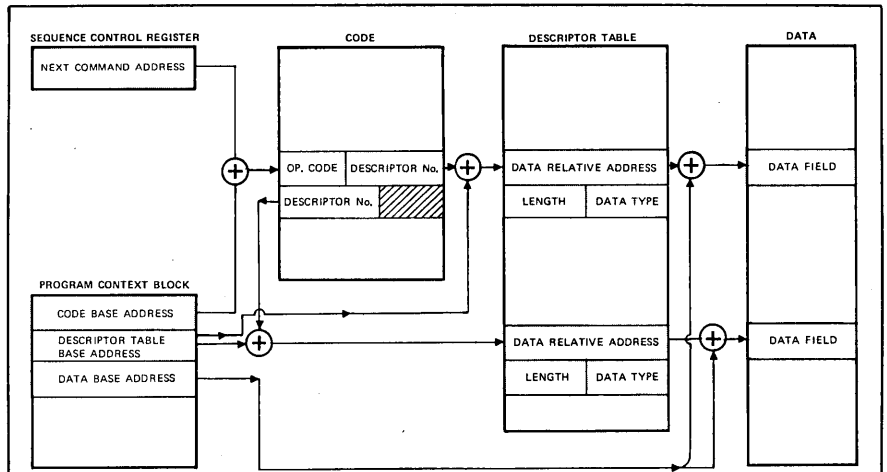

Fig. 2. Programs executing on the COBOL virtual machine consist of three main sections: code, data, and a descriptor table. Each also has a program context block which contains pointers to the bases of the other sections. The descriptors in the table correspond one-for-one with data items and contain all the information necessary to describe them (and to describe much of their processing as well).

software I/O overhead. This is sometimes referred to as "virtual channel logic."

Performance

The VRX operating system requires a minimum memory configuration of 384KB. However, its true potential only begins to be realized in 512KB, and is realized progressively more as the memory size increases.

Unlike other virtual storage operating systems, VRX offers considerably better performance than equivalent real storage operating systems (including Century series NCS operating systems), provided sufficient memory is configured. This is partially due to the

speed of the firmware-implemented linkage mechanism, but also is to a large extent directly attributable to virtual storage itself, including the ability of virtual storage to exploit large low cost memories by trading memory for I/O. (Certain code or data elements which previously were always accessed through I/O, including operating system services, now automatically become memory resident if sufficient memory is available.)

In large memory configurations, such as 1MB, these benefits typically translate into performance improvements of 20%-40%, when running NCR Century multiprogrammed benchmarks under VRX, versus running them under NCS.

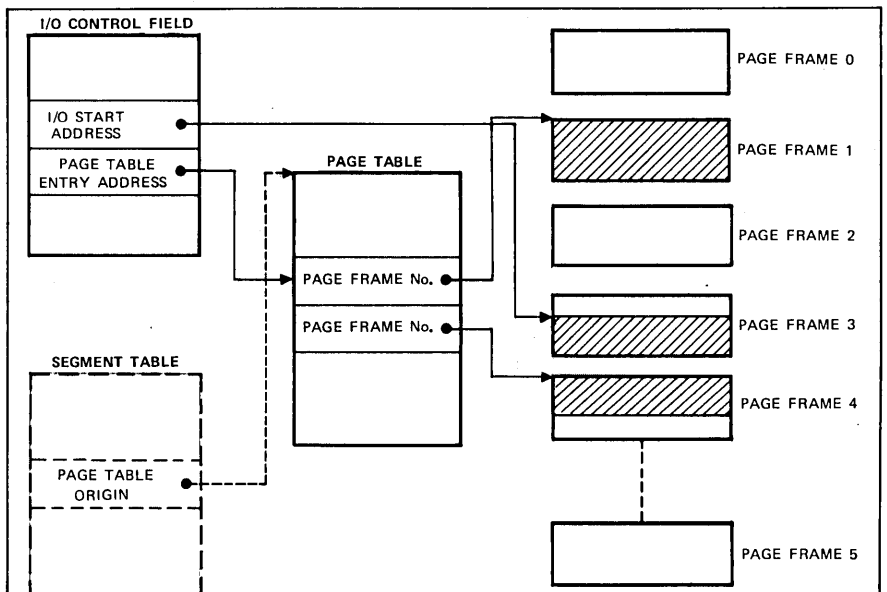
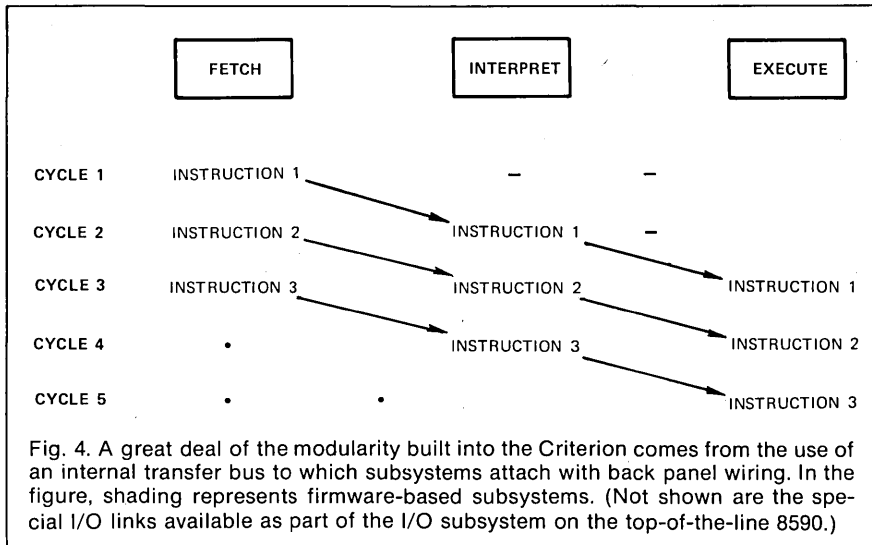

Fig. 3. The classic problem of I/O in a paged environment occurs because buffers may cross page boundaries, and pages are not mapped contiguously in real memory. Here the middle of the buffer (top shaded area) is "followed" by the beginning and end (middle and bottom areas).

The typical solution (as in the IBM 370) is to build a list of real addresses for use by the channel. NCR's "virtual channel logic" instead allows the channel to access already existing page tables.

VIRTUAL MACHINES



(And these improvements are independent of the COBOL virtual machine; conversion of the COBOL benchmarks to VRX COBOL would normally result in further performance gains.)

The hardware

Each Criterion 8500 mainframe is self-contained in a single cabinet which houses the Internal Transfer Bus and several processor, memory, and I/O subsystems which plug into it, plus power supplies. Less than 10 square feet of floor space are required. Most of the subsystems within the mainframe are implemented on 11x14-inch circuit boards; Emitter-Coupled Logic (ECL) is used throughout. The control store of each is a combination of high speed memory (the "Instruction Storage Unit") and low speed main memory.

There are several models in the series, each of which includes a 32-bit main processor, and a 16-bit service processor for I/O and microdiagnostics. The primary factor influencing the performance of the three lower models in the series (the 8550, 8560, and 8570) is the processor cycle time (112, 84, and

56nsec, respectively).

The next model, the 8580, derives additional performance over the 8570 primarily due to three factors: (1) a VRX Hardware Assist Unit, which puts some frequently used functions such as virtual command set-up in hardware; (2) increased Instruction Storage Unit size, 32Kb; and (3) a 16-byte memory access (versus 4 or 8 bytes on the smaller machines).

Finally, the 8590 tightly couples two 8580s onto the same bus, and provides 64Kb of ISU with each. An 8600 line will eventually be added to the existing 8500s; its primary differences will be in faster processing engines.

The focal point of Criterion system architecture is the *Internal Transfer Bus*. (See Fig. 4.) It provides a high speed data path across which all subsystems communicate, including the main processor, the service processor, memory, the peripheral subsystems, an integrated disc controller, and an integrated communications subsystem.

The main advantage of such a bus-oriented architecture is that it permits modular open-ended hardware design.

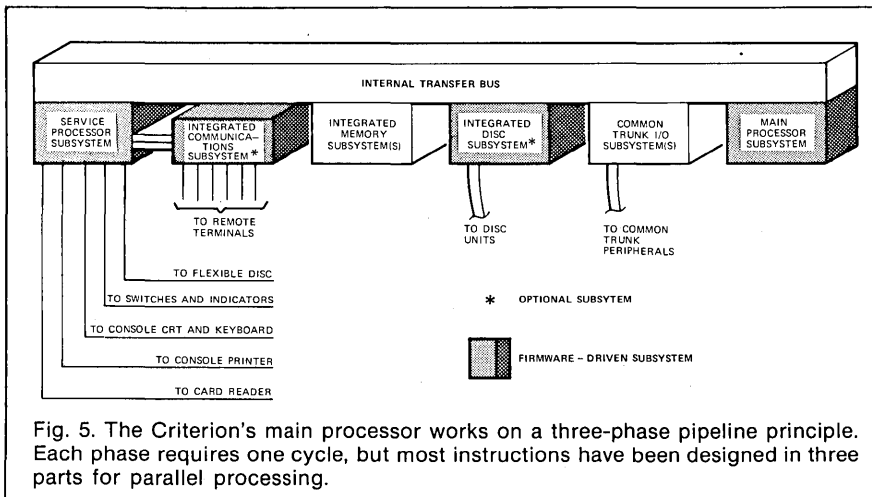

Thus, if a new hardware capability is developed for the Criterion (for example, a new type of peripheral controller or a new type of memory), it may be designed to fit on the bus and be used with any Criterion model. Future enhancements, as well as field upgrades, take the form of additional circuit boards that are plugged into the bus back panel.

An additional advantage of the hardware modularity inherent with the bus architecture is that it eases the task of fault detection and isolation.

The Criterion Internal Transfer Bus provides a 32-bit, 72MB/sec data path for intrasystem communication. Up to 16 subsystems may be connected to the bus; their multiplexing is effected by a local bus adapter designed specifically for each subsystem.

The components

The *Main Processor* includes an associative memory consisting of 16 associative registers; these provide dynamic address translation assistance to the VRX virtual storage mechanism.

Through the use of a pipeline design (Fig. 5), firmware instructions are executed effectively at the speed of one processor cycle per instruction. High speed working storage is provided by 64 registers which operate at the same cycle time as the processor; these registers are read or written by firmware instructions within the three-cycle pipeline structure.

The *Criterion Memory Subsystem* consists of 4K MOS memory chips packaged in 64Kb units on 11x14-inch boards, together with one, two, or four memory interface units which interface the memory boards to the bus. The memory operates at a 480nsec asynchronous cycle for fetch and store operations. (During 1978, a new Criterion memory board using 16K MOS memory chips packaged at 256Kb per board will become available.)

There's something old, something new in *I/O Subsystems* for Criterion. To begin with, most NCR Century common trunk peripherals may be connected to a Criterion system through one of three common trunk subsystem interfaces (low speed, medium speed, and high speed). Additionally, two new integrated controllers have been built for the Criterion, using firmware. A new integrated disc controller connects Model 658 (IBM 3330 style) and 6590 (Winchester style) discs, and a new microprocessor based integrated communications subsystem provides up to 20 communication lines.

A new bit-serial I/O discipline, "the I/O link," is available with the top-of-the-line Criterion 8590. This supports data transfers in serial bit streams at up to 2MB, and provides record buffering at each end of the link. Up to 24 such I/O links may be connected to an 8590.

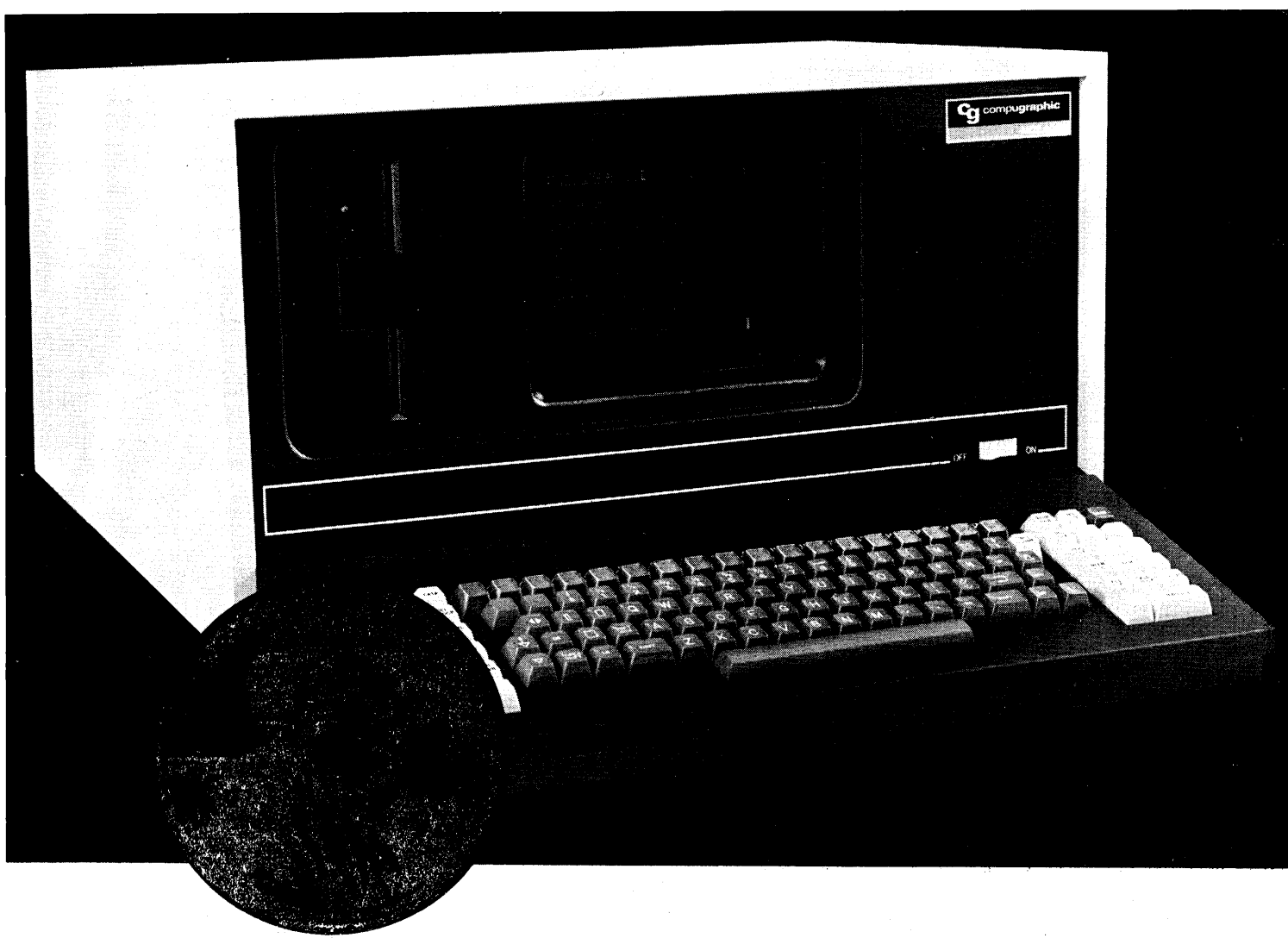

MDT-400...The sensible intelligent terminal at a sensible price,

for Text Editing, Distributed Processing or Communications.

Sensible Pricing—Less than \$4,500 list plus quantity discounts.

Sensible Packaging—Microprocessor, up to 32K bytes memory, keyboard/display, mini diskette, and communications in compact desktop cabinet.

Sensible Flexibility—Loadable keyboard formats, 18 user-defined keys, fully user programmable, optional printer, development facility and applications.

Sensible Reliability—Hundreds of MDT's installed, over 15,000 hours MTBF.

Sensible Service—Over 300 Compugraphic Service Engineers nationwide.

Sensible Company—Worldwide \$130,000,000 New York Stock Exchange corporation producing more intelligent editing terminals in a week than many competitors produce in a month.

Interested? Clip out the handy coupon and mail it today.

● MDT-400 It makes sense.

Mail to:
Compugraphic Corp., Computer Products Sales
80 Industrial Way, Wilmington, Mass. 01887

The MDT-400 makes sense. Tell me how I can use it for:

- Text Editing Distributed Processing
 Communications Other _____

Name _____

Title _____

Company _____

Address _____

City _____ State _____ Zip _____

Phone _____

DM 478

cg compugraphic

80 Industrial Way, Wilmington,
Massachusetts 01887 / (617) 944-6555

CIRCLE 18 ON READER CARD

VIRTUAL MACHINES

When operating with V-Series firmware, all I/O subsystems use command chaining, which eliminates the need for software intervention between I/O operations. I/O requests are queued by the software in I/O "pools." The firmware feeds off the pools, automatically picking up the next request on completion of each operation. Software interrupts are posted asynchronously from this command chaining operation.

The *Service Processor* is a 16-bit microprogrammed processor that operates in parallel with the main processor. Its primary functions are in-

put/output control and micro-diagnostics. It controls and drives several special low speed devices, including the card reader, flexible disc, and console devices. It also performs the firmware load function, where firmware is read from the flexible disc and distributed to each firmware-driven subsystem.

The Service Processor has primary responsibility for system diagnostics. Should a malfunction occur in the system, it provides the tools for detection and isolation of the problem. The diagnostics operate at the microprogram level, and are generally capable of diagnosing a problem down to the board level.

An idea whose time has come

As the foregoing description of the physical aspects of the architecture implies, a great deal of configuration flexibility comes from the use of the Internal Transfer Bus and the manner in which processors and other components can be attached to it. Similarly, the virtual machine concept adds an even broader dimension of flexibility. Although current Criterion systems support only two concurrent virtual machines, the design allows for implementing more. Possible future directions include the development of other high level language machines, or of emulators of other machine architectures, including those from other vendors.

The virtual machine concept is an idea whose time has come. It promises to further enrich our computing resources as we discover new applications for it.

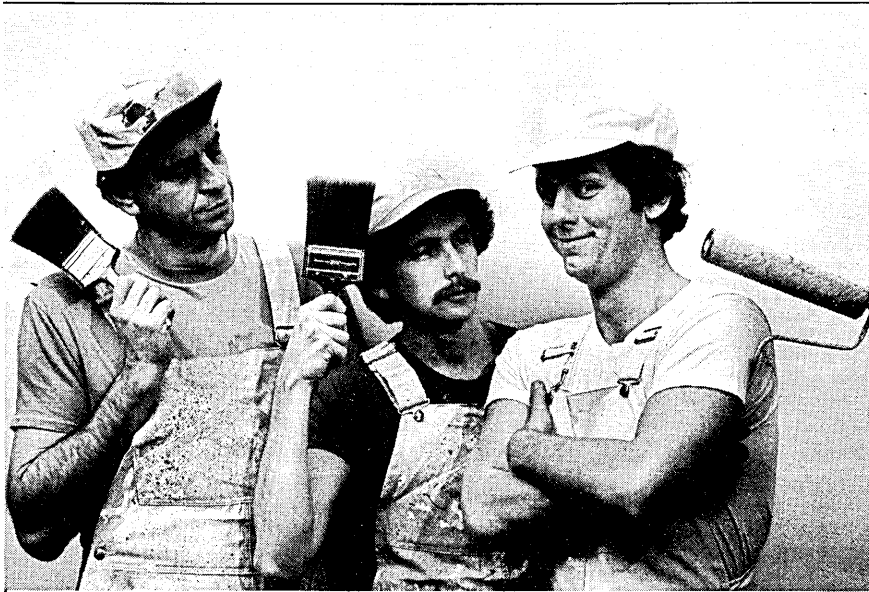

O-W-L. On-Line Without Limits. This extraordinary system gives your people total freedom of text manipulation and editing. It means unlimited creativity for the programmer. And the increased productivity that comes with it. The Moving Window breaks the 80-character barrier and allows the display to move right and left for easier comprehension. The Toggle Switch gives you the choice of either full or split-screen display with direct cursor editing. On-line Dynamic Recall summons prior revisions at a single command and highlights the most recent change in display. Editing occurs right before your eyes. It all happens with the fastest response time in the business, without monopolizing computer resources. Security (people access as well as data access) is enhanced by a unique four-level variable password system. Simplicity of design makes this the only system on the market that's user-installable. Low price and free trial (15 days) makes users out of triers. NCI is years ahead. You can be, too. Just send us the coupon.

INTRODUCING
O-W-L
THE ON-LINE PROGRAM
DEVELOPMENT SYSTEM
THAT ROLLS PAST
EVERYTHING ELSE
BECAUSE IT GIVES YOU
FULL-SCREEN TEXT EDITING.
AND A WHOLE LOT MORE.

Name _____ 0-1
Company _____
Address _____
City _____ State _____ Zip _____
Telephone: _____
Our Computer is: _____
NCI, Inc.
6075 Roswell Rd., Atlanta, Ga. 30328, (404) 252-9474

REPRESENTATIVES IN MOST COUNTRIES THROUGHOUT THE WORLD

NCI, Inc.
OUR COMPETITORS
JUST CAN'T COMPETE



Mr. Tang is the director of engineering at NCR's engineering and manufacturing plant in San Diego, where his responsibilities encompass advanced hardware development, engineering, and software development. Prior to his appointment as director, he was chief engineer on the Century 300 and managed the development of the Criterion.

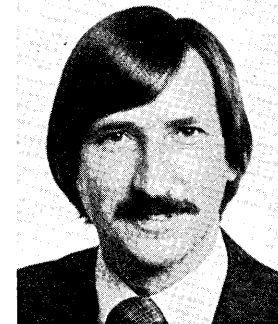

Mr. O'Flaherty is director of software development support for NCR's engineering and manufacturing group. He has been with NCR for 15 years, of which seven were spent on Criterion. Among his other posts, he has been a chief VRX performance analyst, manager of VRX teleprocessing software development, and head of VRX planning and advanced development.

Introducing Cullinane's Integrated Data Dictionary:

already proven in more than 60 locations

With more than 60 satisfied users already, IDD has proven to be an easy answer to problems and questions resulting from data change. Because, by actively monitoring the flow of data through your organization, the IDD provides readily available information to answer such questions.

Questions? Suppose your organization wants to alter its most important application system. What programs will the change affect? Which users will be impacted by the change? How much extra work will the change require? How quickly can the change be made?

The answers to these and many other questions, are easily and uniquely available with the IDD. Uniquely available because the IDD automatically captures the information to answer questions and requires minimum effort to do so.

As a result, each user department receives a complete and accurate "business

study" of the organization. It's a simple, easy, and economical tool to evaluate data change, standardize data use, monitor data flow and maintain data consistency.

Let us prove to you how easy it is to control your Data Resource. Sign up now for a free introductory seminar. Use the coupon or phone (617) 237-6600.

<u>Cities</u>	<u>Dates</u>
Los Angeles, CA	Apr. 11
San Francisco, CA	Apr. 13
Hartford, CT	Apr. 25
Toronto, ONT	Apr. 27
Washington, DC	May 2
Houston, TX	May 10
Atlanta, GA	May 16
Philadelphia, PA	May 18
New York, NY	June 6
Chicago, IL	June 8
Boston, MA	June 13

**Think twice. You'll use
the dictionary
system users rate #1.**

Name _____
Title _____
Co. _____
Address _____
City _____ State _____
Zip _____
Tel. (____) _____
My computer is _____



Cullinane Corporation

Wellesley Office Park, 20 William St., Wellesley, Mass. 02181 (617) 237-6600

Look closely.



Very closely at our new Model 85 remote information system.

How many functions do you see?

There are more than meet the eye.

Batch communications and volume data entry should be easy to spot.

And on-line file management and stand-alone processing should be apparent to those who've kept up with Data 100's continuous progress in distributed processing.

But your needs keep growing.

And so does our commitment to fulfill those needs.

Our Model 85 remote information system introduces the functions of remote file management and high level language processing at your remote sites efficiently and economically.

Model 85 is a display based system featuring up to 100MB disk storage, 15 interactive work stations, a multi-tasking operating system and concurrent communications.

For ease of use, two disk based high level languages are available: RPGII and COBOL. With COBOL, a *local* compiler lets you compile programs on your Model 85. And a *cross* compiler allows stronger central site control by permitting you to compile and debug COBOL programs on the mainframe for execution on your Model 85.

The Model 85 gives your network the best of both worlds. The degree of central site control you need *and* remote processing capabilities to reduce communications costs and mainframe processing time.

And the Model 85 can communicate with our other proven Data 100 multifunction data processing products.

Now look closely at *your* growing needs for multifunction data processing.

Then call your nearest Data 100 sales office or one of the numbers listed below.

DATA 100

CORPORATION

multifunction data processing



DATACORP 72X. 690 PAGES PER FICHE. SO EFFICIENCY GOES UP, COSTS DOWN.

With Computer Output Microfilm, the fewer the fiche, the bigger the savings. And with Daticorp's 72X reduction, you can pack 690 computer printout pages per fiche—three times more than 42X can handle.

Which means lower costs, in paper or film. In storage. And labor. Also, more efficient retrieval—up to 60 percent faster than before. With less fiche changing. Less viewer platen movement. And less handling from the holder.

For one of our major clients,

using 72X saves thousands in paper. Hundreds of manhours, filing. And untold storage space, with 8,000 daily sales invoices neatly contained on just 12 fiche.

All with 72X, from Daticorp. Another innovation from the world's largest COM service network. And the world's leader, putting it to work for you.

Call us, or write. We'll prove why we're #1.

**REMEMBER DATACORP.
WE'RE #1.**



DATACORP

P.O. Box 3460
Portland, Oregon 97208
(503) 225-5100

CIRCLE 64 ON READER CARD

SEE US AT NMA, BOOTH 1505

Reducing the Federal Paperwork Burden

by Forest Woody Horton

There are several things a dp manager can do to reduce an organization's paperwork.

On October 3, 1977, the Commission on Federal Paperwork sent its final report to the President of the United States, the Speaker of the House of Representatives, and the President of the Senate. In his transmittal letters, Congressman Frank Horton of New York, chairman of the commission, said:

"Many people feel, and the commission agrees, that a multibillion dollar wall of paperwork has been erected between the government and the people. Countless reporting and record-keeping requirements and other heavy-handed investigation and monitoring schemes have been instituted based on what we view as a faulty premise that people will not obey laws and rules unless they are checked, monitored, and rechecked."

This situation and this assumption must be reversed if we are to restore efficiency within government and confidence in government by the people and if we are to realize the potential for cooperative attainment of our goals as a nation. Many of the major conclusions and recommendations of the Commission on Federal Paperwork are aimed at this goal."

To some extent, modern information handling tools and technologies, including notably the computer, telecommunications, and microform, have contributed to this enormous paperwork millstone around the necks of small businessmen, farmers, students, veterans and the aged and disabled who apply for assistance and benefits to which they are lawfully entitled. But information technology can also help alleviate this burden, if the proper steps are taken to plan its application, evaluate alternative uses, carefully monitor

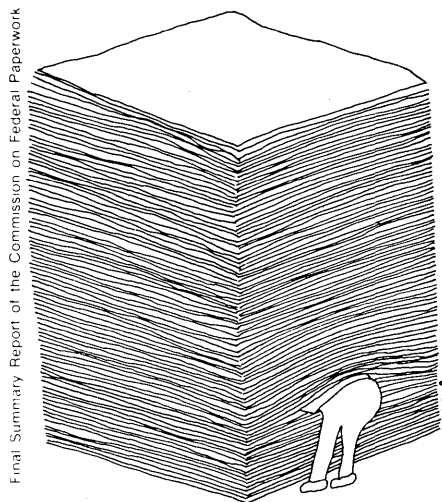

Final Summary Report of the Commission on Federal Paperwork

The information manager is being called on not just to render judgments on technical matters, but on economics and relevance as well.

its installation and operation, and periodically examine its continued effectiveness and relevance to changing priorities and needs. The question is, how? Before looking at the "cure," however, let's look more closely at the "disease."

Seven causes, and their relatives

First, to place information handling in perspective, it should be pointed out that the Commission on Federal Paperwork identified seven major "key causes of excess paperwork":

- lack of communication
- insensitivity of government officials to citizen needs
- incomprehensible government instructions and questions
- overlapping government agencies, all asking for similar information but in slightly different formats, at different times
- poor program design, leading to unnecessary and excessive information requirements
- poor information practices
- inconsistent and ineffective confidentiality practices

So we see that information handling is only a part of the total problem, but it is the part we're interested in here. What are we really talking about? For one thing, the Department of Health, Education and Welfare at one time had a student loan application, a supplement to the application, and an addendum to the supplement to the application! For another, the Occupational Safety and Health Administration and the Federal Trade Commission found that they could reduce substantially the number of people being asked questions, particularly reducing the burden for small business, by consolidating their requirements which had been overlapping and duplicative in scope, timing, and format.

The commission had hundreds, perhaps thousands of examples of this kind, which it classified under the head-

Sycor announces that's shamel (Except for

We're proud to introduce an on-line system that offers as much as the big guy's system. For a lot less.

It's the new Sycor 290—a 3270-compatible display system that can save you up to 25% over a three-and-a-half-year lease. And even more when you purchase.

An outgrowth of our long experience with on-line systems, the Sycor 290 is available in remote and local configurations that support up to 16 CRTs and printers in any combination. And in a remote mini-cluster unit that supports a combination of up to eight CRTs and printers.

Remote configurations use either Binary Synchronous (BSC) or Synchronous Data Link Control (SDLC) line protocol at speeds from 1200 to 9600 bps. This fast transmission time allows you to better control your line costs and to configure your network for optimum performance.

Our new, larger display screens are adjustable for character intensity and

contrast. And our movable keyboards and glare filters help your operators work comfortably and productively.



Special diagnostics mean fast service.

Service for the Sycor 290 can be sped up by using our sophisticated diagnostic programs. You can run them to pinpoint problems quickly and easily. And alert the Sycor field engineer to the problem when you call for service.

an on-line system essly "me, too." the price.)

Trouble-shooting is on target from the moment he walks in. With more than 400 Sycor field engineers within a half-hour drive of 1750 North American cities, downtime stays way down.

Get a reliable Sprinter running for you.

The Sycor Sprinter™ can satisfy your printer requirements, too. The bidirectional, microprocessor-controlled printer is available in 66-, 120- and 180-cps models to give you system-tailored flexibility.

Sycor builds every unit, controls every phase of Sprinter's design and production. So you're assured of more operational reliability. By eliminating many of the mechanical parts that

can go haywire, our Sprinters stay running longer.

Sycor also has light-pens, badge readers and key locks. In fact, we have just about everything you need for on-line applications.

Get a line on Sycor. Call 800-521-2838.

Most importantly, Sycor can really help you save big on your system lease or purchase costs. To find out how much, call Tony Fazio, V.P. Sales, at our toll-free number: 800-521-2838. Or write Sycor, Inc., Corporate Offices, Ann Arbor, MI 48104.

Better yet, call a nearby sales office. We're in the Yellow Pages under "Data Processing Equipment."

Sycor puts computer power where the work is.

SYCOR

PAPERWORK

ing "poor information practices." A more comprehensive, generic list looked like this:

- forms/reports difficult/complex to understand and complete
- government reports required too often
- government reporting periods irregular
- filing dates not staggered
- reporting continuous/intensive in lieu of sampling
- compilation timeframes unrealistic
- review times unrealistic
- numbers of copies of reports excessive
- little information interchange between levels of government, and between agencies at the same level
- duplication of data; agencies asking for same or similar data in different forms
- lack of centralized management of data
- few standard definitions for terms, abbreviations, names, and commonly used symbols in communication and information systems
- no comprehensive data element dictionary
- no comprehensive federal information locator system
- lack of coordination between forms and regulations and procedures
- forms of same length, regardless of respondent size and capability
- records retention schedules deficient in scope, application, and effectiveness
- irregular form sizes and other information specifications
- inadequate safeguards for confidential and proprietary data furnished in confidence to government by citizens and business
- too much information collected isn't used
- too much information "used" isn't of value in producing concrete results

What does it mean to dp?

This litany is familiar to many. The data processing manager has long been confronted with these problems and one of the tests of a good dp manager is whether the information products and services he generates serve the decision-

implications not just for the organization's budget, but in the case of government, for the citizen-taxpayer who must pick up the bill for excessive, inefficient and ineffective data handling practices and policies. In short, what can data processing managers, microdocumenta-

The Cost of Federal Paperwork

The total costs of federal paperwork are difficult to determine; but, as best we can estimate, more than \$100 billion a year, or about \$500 for each person in this country, is spent on federal paperwork. Our estimates of costs to some of the major segments of society are:

• The federal government:	\$43 billion per year
• Private industry:	\$25 to \$32 billion per year
• State and local government:	\$5 to \$9 billion per year
• Individuals:	\$8.7 billion per year
• Farmers:	\$350 million per year
• Labor organizations:	\$75 million per year

Final Summary Report of the Commission on Federal Paperwork

making and problem-solving needs of his "clients" with a minimum of paperwork and red tape. It is easy to produce a computer printout or a microfiche record. It is far more difficult to provide products and services that fulfill other criteria, such as "minimum cost," "minimum red tape," "easily understandable," "relevant," and "directly contributing to the organization's goals and objectives."

Some information managers may say, "that isn't really our responsibility; we merely provide a service; it's up to the

Over 770 recommendations were made; half have already been implemented.

client to determine whether the products and services we give him are worth the cost." Perhaps. In some organizations (the commission believes in fewer and fewer as the information age moves forward) that may be the case. But increasingly, as information technologies begin to invade and pervade more and more nooks and crannies in today's modern corporations and government agencies, the information manager is being called upon to render judgments not just on technological applicability and technical feasibility, but on questions of economics, relevancy, and goal achievement.

Clearly we can anticipate some major continuing breakthroughs in the decades ahead. So we must balance cost consciousness with the sobering knowledge that tomorrow's hardware and software developments may answer today's information problems. But in the meantime, what can we do to make sure our organization's "information handling dollar" is well spent? That has

tion department heads, word processing center chiefs, and office automation directors do about the mounting government paperwork burden, using technologies and techniques already well known to them?

Send another medium

For one, if a government agency is asking for reports to be submitted in hardcopy form, and your organization has automation capabilities and has determined that preparation, handling, and submission of the report in an automated medium would be easier and more cost effective, ask the agency to consider using the automated medium as an alternative—computer-to-computer magnetic tape submissions, punched cards, paper tape, or whatever.

For example, the Census Bureau receives many reports in huge quantities. One is the Shipper's Export Declaration, over 9.5 million of which were received each year. Companies whose data processing systems have been certified by analysts from the Census Bureau are now authorized to report on magnetic tape, punched cards, or other automated media. More than 10% of the submissions are now received annually in machine-readable form, and the amount is increasing each year.

Exporters produce the tapes as by-products of regular processing of export documents such as invoices and bills of lading, and the bureau is relieved of the burden of converting paper reports to machine-readable media. The results have saved thousands of man-hours in industry and government, and provide more timely and accurate trade statistics.

Look for piggybacking

Identifying "piggybacking" opportunities through the consolidation of simi-

lar-purpose federal, state, and local forms and reports is another way to help both the company and the government. For example, jurisdictions issuing building permits in the State of Oregon were reporting similar information to both the state and the Bureau of

the Census. But Oregon is now included in an existing cooperative federal-state program, and the previous reporting duplication has been eliminated.

Most companies file reports and records with federal, state, and local agencies which contain virtually identical, or

at least very similar, information. The proper course here is to approach the highest level of government involved and suggest the consolidation of these information requirements into a single package, including the synchronization of the submissions.

Use a data dictionary

A third approach to satisfying government's information requirements while minimizing the paperwork burden both on your own organization as well as upon third parties from whom input data must be collected, is the establishment of a central data locator system of some kind.

Many organizations have found that the development of an organization-wide data element directory is an indispensable tool to identifying duplication in internal data flows, and eliminating both duplication and overlap. The computer, of course, is an ideal tool for this purpose, and standard software packages for this are being marketed by a wide variety of firms.

Short of going all the way down to the data element level, some organizations may find that the locator concept will work for them at the subject matter level, or document level.

The Commission on Federal Paperwork itself recommended that the federal government start work immediately to design and develop a federal information locator system that would ultimately contain three components: (1) a federal data element dictionary; (2) a federal information resources locator; and (3) a national information referral service. That recommendation was based on the multiple duplication and the cumulative burden on citizens that stems from virtually dozens of Washington agencies spraying the public with shotgun requests for the same or slightly different information.

The commission found that one of the reasons agencies typically gave for justifying their "unique" requests was that there was no machinery in place that gave them an "authoritative reading" of just what information government currently collects, where it is located, and so on.

Don't store hardcopy

A fourth area examined by the Paperwork Commission was the use of microdocumentation instead of hardcopy for storing records. Many respondents were spending considerably more than they needed to on outmoded storage equipment and facilities even when microform was a demonstrably more efficient and effective way of taking care of their records needs. Company after company appears to be failing to take advantage of microdocumentation alternatives to their records programs.

Beyond the above, the commission

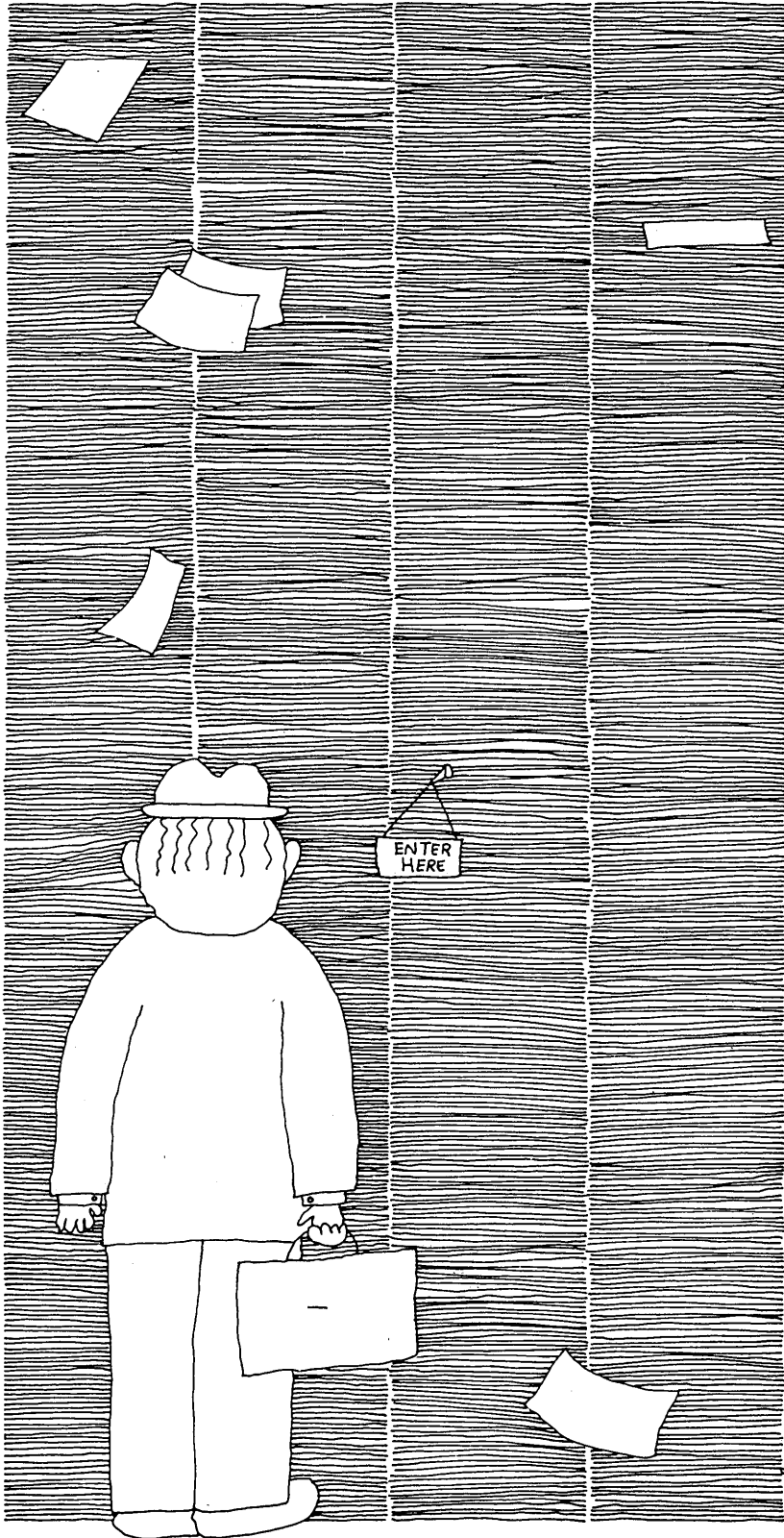

PAPERWORK

found many other applications and opportunities for bringing the computer and associated communications, miniaturization, and other information technologies into the continuing battle being waged to cut down on excessive paperwork. Readers may be interested in obtaining copies of individual commission study reports in particular subject areas, such as health, education, public works, financial business report, and so on. Some three dozen individual reports are listed below, with the Government Printing Office Stock No.

needed for sale by the Superintendent of Documents.

In all, the commission made over 770 recommendations to reduce paperwork and red tape. Already almost half the recommendations of the commission have been written into law or adopted by the executive branch. But there are no magic formulas. Nine times out of ten, what is needed is common sense, and a willingness to go that extra half mile to join in a partnership with government to cut the paperwork burden and make the information government collects serve public needs. Information technology has an important, even critical, role to play to that end.

The Commission's Paper Output

The following reports of the Commission on Federal Paperwork are now available. Contact the Superintendent of Documents, Government Printing Office, Washington, DC 20402, or call (202) 783-3238 for price lists.

GPO Stock Number	Title
052-003-00439-9	Final Summary Report
052-003-00426-7	Education
052-003-00416-0	Energy
052-003-00382-7	Environmental Impact Statements (EIS)
052-003-00428-3	Federal Health Programs
052-003-00309-1	Occupational Safety and Health (OSHA)
052-003-00326-1	The Employee Retirement Income Security Act (ERISA)
052-003-00434-8	Small Business Loans
052-003-00401-1	Anti-Paperwork Posters (7 per set)
052-003-00446-1	Consumer Credit Protection
052-003-00447-0	Employment and Training Programs
052-003-00448-8	Equal Employment Opportunity
052-003-00450-0	Housing
052-003-00451-8	Procurement
052-003-00452-6	Public Works
052-003-00453-4	Segmented Financial Reporting
052-003-00449-6	Title XX: Recommendations for Reform
052-003-00454-2	Statistics
052-003-00455-1	Taxation
052-003-00456-9	Welfare Administration Reform
052-003-00457-7	The Reports Clearance Process
052-003-00458-5	Confidentiality and Privacy
052-003-00459-3	The Federal Information Locator System
052-003-00460-7	Federal/State/Local Cooperation
052-003-00461-5	Handbook for Program Managers (Vol. 1)
052-003-00462-3	Handbook for Information Specialists (Vol. 2)
052-003-00463-1	History of Paperwork Reform Efforts
052-003-00464-0	Information Resources Management
052-003-00465-8	Information Value/Burden Assessment
052-003-00466-6	Records Management in Federal Agencies
052-003-00467-4	The Role of Congress
052-003-00468-2	Rulemaking
052-003-00469-1	Service Management
052-003-00470-4	Federal Paperwork and State and Local Governments

If your language is APL, we speak it. Clearly.

The AJ 860 desktop teleprinter terminal. If you use APL, this is the one for you.

AJ's APL option includes a full 128 character APL set, highly legible overstrike characters, and selectable double width characters. Because of our superior 9 x 12 character cell, printing is crisper and cleaner than you've ever seen on a dot matrix printer.

Standard on the 860 is a full ASCII code set with true lower case letters, underscoring capability, and selectable double width characters. You can switch from APL to ASCII from the keyboard or by remote control.

Features include complete

forms control and dual gate forms tractor, easy-to-use sculptured keyboard, 17-key numeric pad, RS 232 interface, line speeds up to 600 baud, and more. Plus important options like 1200 baud operation, Graphics character set... and APL.

Your local AJ office has all the details. Call them. Or get in touch with Anderson Jacobson, Inc., 521 Charcot Ave., San Jose, Calif. 95131. Sales and service throughout the U.S., Canada and Western Europe.



The AJ 860.
Fluent
in APL.

 **ANDERSON JACOBSON**



Between 1956 and 1977, Dr. Horton held a variety of civil service positions, the last of which was on the Commission of Federal Paperwork, for which he directed the information management study. Among other posts he held prior to that were: director of information systems, Office of the President's Special Trade Representative, director of the MIS division of the Environmental Protection Agency, assistant director of management systems for the U.S. AID Mission to Vietnam, and deputy MIS director for the Office of Management and Budget.

HOW

to keep up with what's new in
computer techniques and management
easily—and inexpensively

The Library of Computer and Information Sciences

Take any 3
books for
only \$3.95
(values to \$60.00)

if you will join now for a trial period and
accept only 3 more books—at handsome
discount prices—within the next 12 months.

62620. MICROCOMPUTER HANDBOOK. Charles J. Sippl. Detailed reference to the technology and applications of microprocessors. \$19.95

81910. SYSTEMS AND PROGRAMMING STANDARDS. Susan Wooldrige. An essential guide to establishing workable standards in any computer installation. \$12.50

82560. TECHNIQUES OF PROGRAM STRUCTURE AND DESIGN. Edward Yourdon. Over 300 illustrative problems, 90 valuable references, and four demonstration projects. \$17.50

70110. PRINCIPLES OF DATA-BASE MANAGEMENT. James Martin. Detailed introduction to the concepts, principles, and applications of data base technology. Covers data structures, security, file storage, real-time vs. non-real time, more. \$19.95

32485. ALGORITHMS + DATA STRUCTURES = PROGRAMS. Niklaus Wirth. A classic work on structured programming with practical examples. \$19.00

58085. LEARNING TO PROGRAM IN STRUCTURED COBOL. Edward Yourdon. Treats COBOL as a foreign language, and offers several dramatic, easy techniques to help you learn the basics of structured programming—process, decision, loop, CASE. \$19.50

35450-2. AUTOMATIC DATA PROCESSING HANDBOOK. The Diebold Group. Auxiliary memory, peripherals, systems design, consultant services, software packages. Counts as 2 of your 3 books. \$29.50

88000. WRITTEN COMMUNICATION FOR DATA PROCESSING. Randi Sigmund Smith. Guidelines to help prevent the leading cause of data processing catastrophes—ambiguous specifications. \$12.95

53795-2. HOW TO MANAGE STRUCTURED PROGRAMMING. Edward Yourdon. Based on the author's highly popular seminar series, this offers a detailed step-by-step presentation of just what programmer productivity techniques (PPT) can do for the DP manager. Counts as 2 of your 3 books. \$21.50

78350. SIMULATION WITH GPSS AND GPSS V. P. A. Bobillier, B. C. Kahan, and A. R. Probst. Provides a detailed approach to the effective planning and execution of simulation experiments and projects. \$18.50

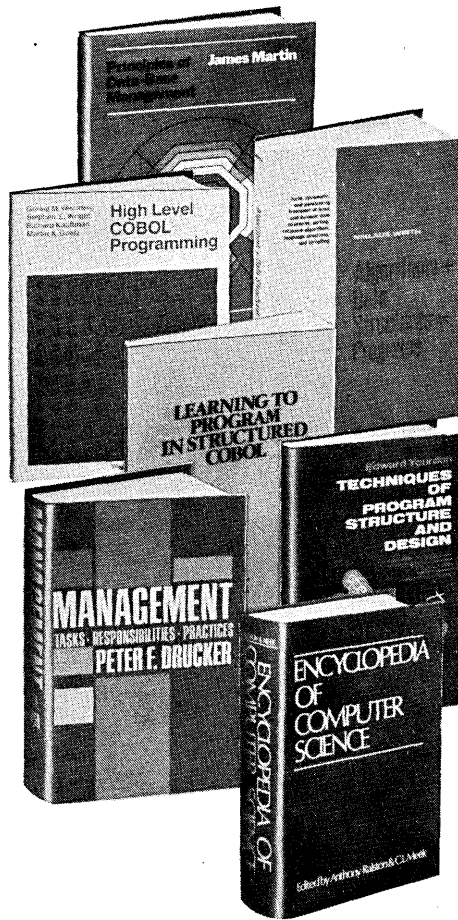

39970. COMPUTER ARCHITECTURE. Caxton C. Foster. Covers micro-programming, switching circuitry, memory speed increases in main-frames, tessellated computers, much more. \$16.95

39980. COMPUTER-COMMUNICATION NETWORK DESIGN AND ANALYSIS. Mischa Schwartz. An organized, quantitative approach to the design of communications networks. \$18.95

42303. A DISCIPLINE OF PROGRAMMING. Edsger W. Dijkstra. A world-renowned computer scientist forges some impressive new programming tools to solve problems that range from the everyday to the complex. \$18.95

52900. HIGH LEVEL COBOL PROGRAMMING. Gerald M. Weinberg, Stephen E. Wright, Richard Kauffman and Martin A. Goetz. An advanced guide to proper and efficient COBOL usage. Introduces "sheltered programming" concepts, stresses modular design and maintainability of code. \$17.95

(Publishers' Prices shown)
55920. INTERACTIVE DECISION ORIENTED DATA BASE SYSTEMS. Edited by William C. House. An extensive user's guide to the state-of-the-art in data base. A skillful blend of management planning with technology. \$19.95

41670-2. DATA BASE DESIGN. Gio Wiederhold. Excellent sourcebook for the methods, principles, and concepts relevant to the design of data base software. Useful to those without data base experience. Counts as 2 of your 3 books. \$21.50

49355. FUNDAMENTALS OF DATA STRUCTURE. Ellis Horowitz and Sartaj Sahni. A practical handbook outlining the principles of data structure design and manipulation. With detailed illustrations. \$17.95

80830. STRUCTURED COMPUTER ORGANIZATION. Andrew S. Tanenbaum. A non-mathematical approach to computer organization and assembly language programming that provides a practical look at computer architecture concepts from the microprogramming level to the operating system. \$18.50

59920. MANAGEMENT: Tasks, Responsibilities, Practices. Peter F. Drucker. A brilliant task-focused handbook of the skills, techniques and tools a good executive needs to stay effective in modern management. \$17.50

70115. PRINCIPLES OF COMPILER DESIGN. Alfred V. Aho and Jeffrey D. Ullman. A step-by-step approach to developing the "software tools" necessary to design the major component of a compiler. \$18.95

44900-3. ENCYCLOPEDIA OF COMPUTER SCIENCE. Edited by Anthony Ralston and Chester L. Meek. Accurate information on hardware, software, systems, theory, economic, social, and professional issues. Counts as 3 of your 3 books. \$60.00

84385. TOP-DOWN STRUCTURED PROGRAMMING TECHNIQUES. Clement McGowan and John R. Kelly. Practical solutions in actual code serve to introduce this revolutionary concept. \$14.95

80845. STRUCTURED SYSTEMS DEVELOPMENT. Kenneth T. Orr. A practical handbook containing the basic steps for analyzing, developing, and installing systems with the emphasis on a structured "problem-solving" approach to systems building. \$17.00

76900. SCIENTIFIC ANALYSIS ON THE POCKET CALCULATOR: 2nd Edition. Jon M. Smith. Numerical techniques and approximations, tables, graphs, and flow charts make scientific and engineering applications possible on an inexpensive electronic calculator. \$15.95

55335. INFORMATION MANAGEMENT SYSTEMS: Data Base Primer. Vivian C. Prothro. Examines every aspect of data base operations: revising software, reducing storage costs, data sharing, cost control. \$10.00

If the reply card has been removed, please write to
**The Library of Computer
and Information Sciences**
Dept. 7-A2B, Riverside, N.J. 08075
to obtain membership information and an application.

UNBEKNOWNST TO THEIR CO-WORKERS IN THE COMPUTER ROOM OF AMALGAMATED INDUSTRIES, BIG JOHN, PENNY PLENIBRIDE AND SLIGHTLY WEIRD DEXTER, THE SUPER PROGRAMMER, ARE IN REALITY **CAPTAIN COBOL**, **MICRO-MAIDEN** AND **TECH WEENY**. PLEDGED TO DEFEND **FREE WORLD TECHNOLOGY** FROM THE FORCES OF **DARKNESS** AND **ANARCHY**, THE **TREMULOUS TRIO**, SET OUT ON THEIR MOST HARROWING ADVENTURE TO DATE ... AND ENCOUNTER THEIR MOST CUNNING ADVERSARY, IN

THE CASE OF THE **INSIDIOUS DR. GROUCH**

STORY:
LATON McCARTNEY

ART:
MARTY HARRISON
CERTAIN WEIRD IDEAS:
RICHARD "BIG MAC"
McLAUGHLIN -



CAPTAIN COBOL

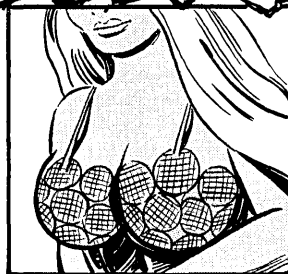

MICRO-MAIDEN



TECH WEENY

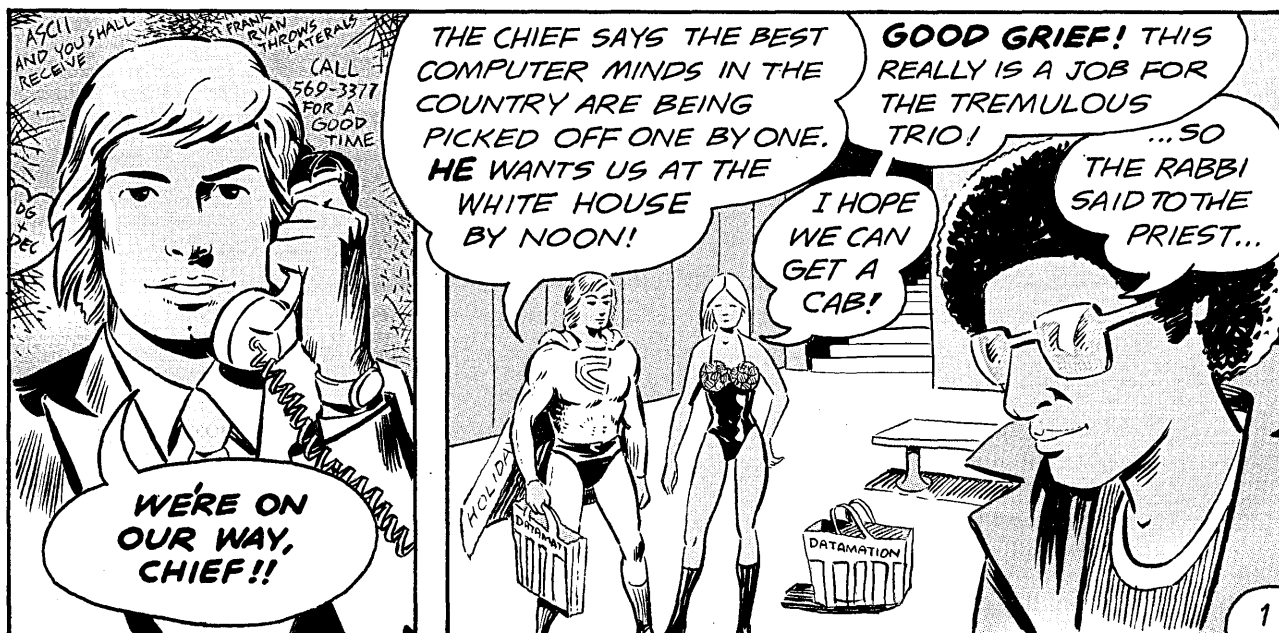

AT A TOP SECRET MEETING IN WASHINGTON



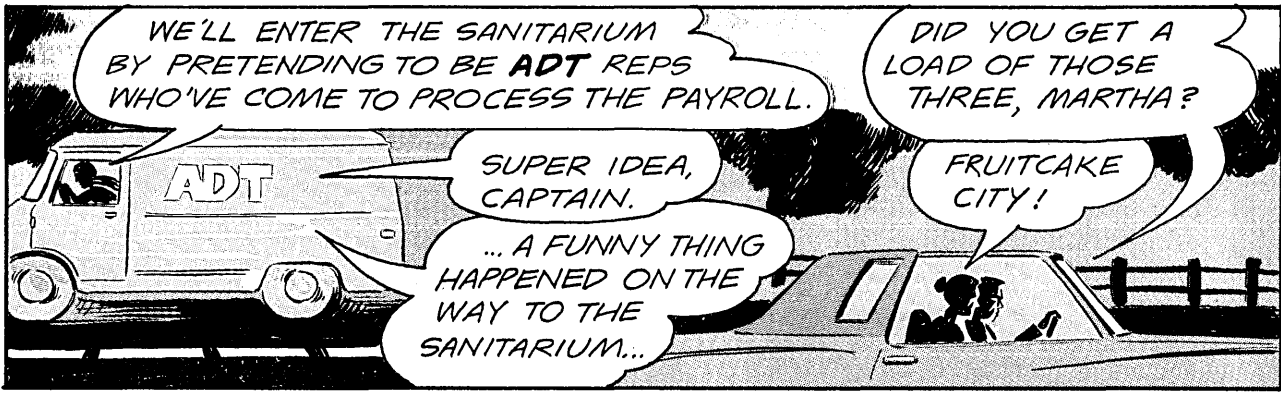

WE'LL ENTER THE SANITARIUM BY PRETENDING TO BE **ADT** REPS WHO'VE COME TO PROCESS THE PAYROLL.

DID YOU GET A LOAD OF THOSE THREE, MARTHA?

SUPER IDEA, CAPTAIN.

FRUITCAKE CITY!

... A FUNNY THING HAPPENED ON THE WAY TO THE SANITARIUM...



WE'RE HERE MICRO-MAIDEN

THIS PLACE GIVES ME THE CREEPS

COMPUTER NUTS OUR SPECIALTY-!

RING BELL TO BE COMMITTED.

ONLY \$39.95 WAVES IN CHAINS

THERE WAS A YOUNG LADY FROM BELL...

PSST... HEY... YOU FOLKS WANT SOMETHING TO READ, WHILE YOU'RE ON THE INSIDE...

AUTOGRAPHED WHILE YOU WAIT... THE UNTOLD STORY OF S+M IN THE WOMEN'S NAVY...

ALL THE GOOD PARTS UNDERLINED...



OUR TRIO GET BY THE GATE GUARD, BUT MEET STIFFER RESISTANCE WITHIN...

WE DO PAYROLL, ACCOUNTS RECEIVABLE, BIORHYTHMIC CALENDARS, WINDOWS...

YOU NAME IT, WE DO IT.

WHY IS SHE WEARING THAT ADMIRAL'S HAT?

GOT ME!

GET LOST SONNY THIS IS A PRIVATE CLINIC. WE HANDLE OUR OWN BOOKS!

DATAMATION

HOLIDAY INN



DON'T YOU RECOGNIZE OUR GUESTS NURSE HARPER? IT'S CAPTAIN COBOL AND HIS MOTLEY CREW!

THE NEFARIOUS DR. GROUCH. I SHOULD HAVE KNOWN YOU WERE BEHIND THIS!

WHAT TOOK YOU SO LONG BOOBALAH, THE TRAFFIC FROM WASHINGTON COULDN'T HAVE BEEN THAT BAD!!



WHO ELSE?! BOY OH BOY HAVE I GOT A WICKED SCHEME THIS TIME.

TAKE A LOOK IN THE NEXT ROOM, COBOL.

WHATEVER IT IS YOU'LL NEVER GET AWAY WITH IT, GROUCH!

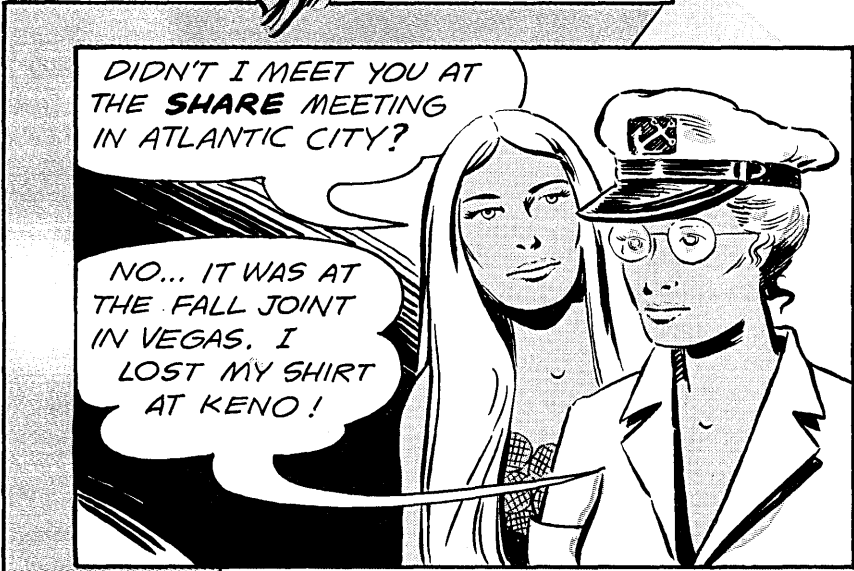
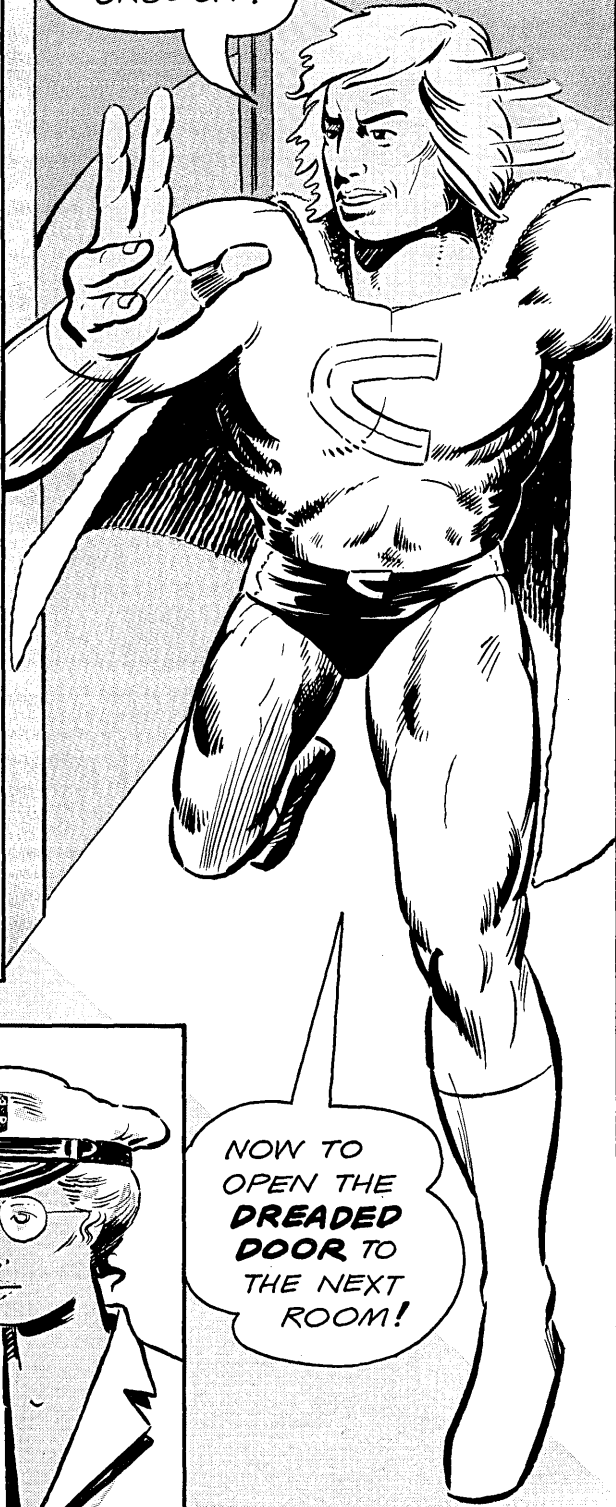

DIDN'T I MEET YOU AT THE **SHARE** MEETING IN ATLANTIC CITY?

NO... IT WAS AT THE FALL JOINT IN VEGAS. I LOST MY SHIRT AT KENO!

NOW TO OPEN THE DREADED DOOR TO THE NEXT ROOM!



VIOLA! THE GROUCHIAN BRAIN DRAIN
WHEREBY EVERY SCINTILLA OF THE
SUBJECTS' INTELLIGENCE IS TRANSFERRED
TO THE CORE MEMORY OF AN
OLD **1401** I PICKED UP
CHEAP FROM **SUNNY MONSOON!**

WOW!

TAKE MY
WIFE...
PLEASE.

AND SOLD NO DOUBT TO THE
HIGHEST BIDDER. WHO IS IT
GROUCH? **THE COMMIES? DARTH
VADER? ANITA BRYANT? BILL
NORRIS?**
**SOME ALIEN
FORCE?**

6

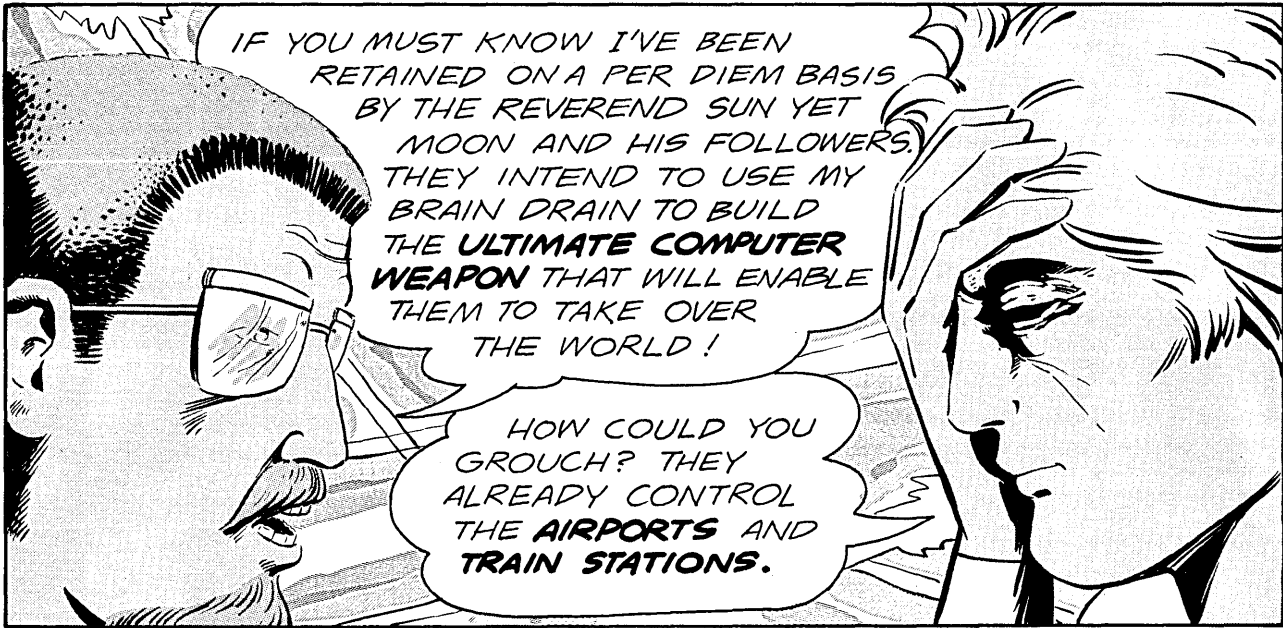



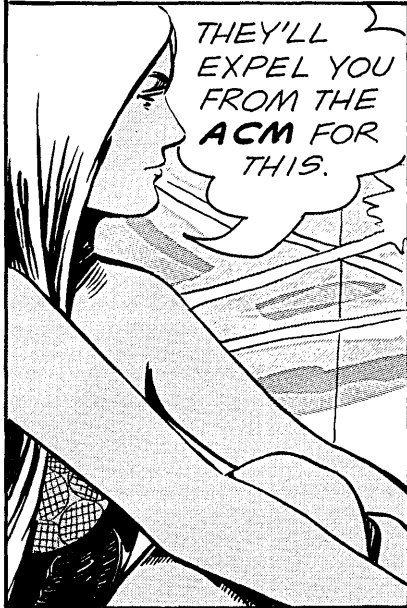

IF YOU MUST KNOW I'VE BEEN RETAINED ON A PER DIEM BASIS BY THE REVEREND SUN YET MOON AND HIS FOLLOWERS. THEY INTEND TO USE MY BRAIN DRAIN TO BUILD THE **ULTIMATE COMPUTER WEAPON** THAT WILL ENABLE THEM TO TAKE OVER THE WORLD!

HOW COULD YOU GROUCH? THEY ALREADY CONTROL THE **AIRPORTS AND TRAIN STATIONS.**

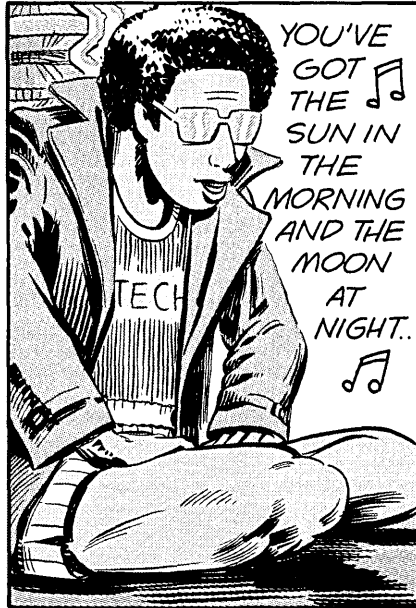

THEY'LL EXPEL YOU FROM THE **ACM** FOR THIS.



YOU'VE GOT THE  THE  SUN IN THE MORNING AND THE MOON AT NIGHT.. 



ENOUGH ALREADY! GET READY TO MEET YOUR MAKER!

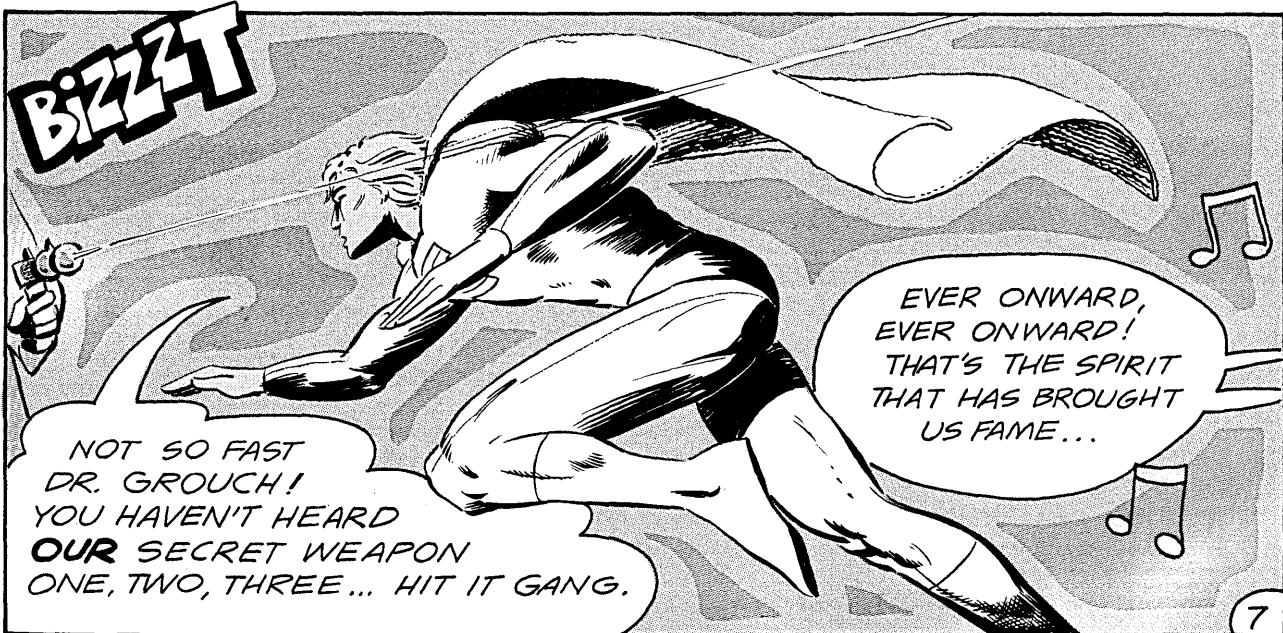

BIZZT

NOT SO FAST DR. GROUCH! YOU HAVEN'T HEARD **OUR SECRET WEAPON** ONE, TWO, THREE... HIT IT GANG.

EVER ONWARD, EVER ONWARD! THAT'S THE SPIRIT THAT HAS BROUGHT US FAME...

WHERE DOWNTIME WON'T DO...

You can always recognize a winning teleprocessing operation...downtime just won't do. The Data Line Monitor (DLM II) helps users win against downtime because it isolates data communication faults quickly and knocks them out in a hurry.

DLM II has winning features prized by users...a straightforward design for easy operation, lightweight portability and an amazingly low price — \$2945. Sophisticated, automatic troubleshooting functions, and over 1 million characters of storage capacity can be provided by a programmable endless loop magnetic tape companion called TAPETRAP™.

Score a technical knockout in your next round with downtime. Go with the champ. For more information on how you can be a winner, call or write today. Digi-Log Systems, Inc., Babylon Road, Horsham, Pennsylvania, 19044. (215) 672-0800.

...DLM II

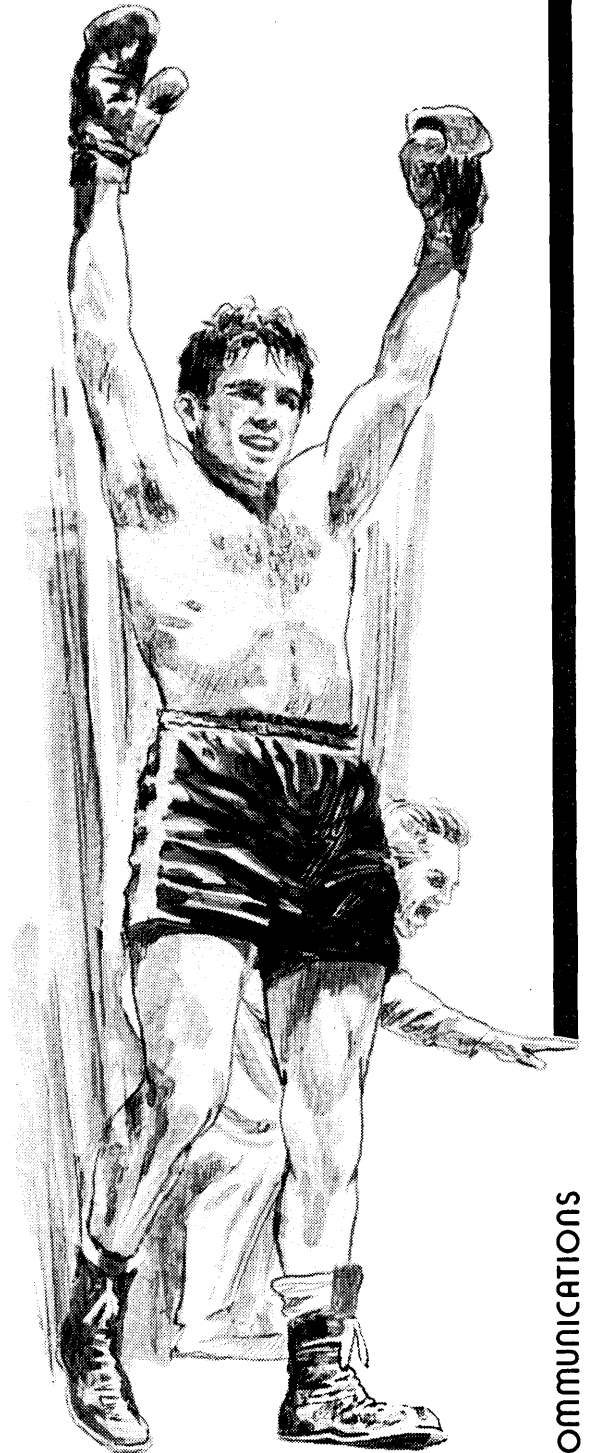

DIGI-LOG

SYSTEMS, INC

MICRO SYSTEMS FOR COMPUTER NETWORKS AND DATA COMMUNICATIONS



WE'RE BIG, BUT BIGGER
WE WILL BE.
WE CAN'T
FAIL,
FOR ALL
CAN SEE.

OH GOD! ANYTHING
BUT THAT IBM SONG!
YOU KNOW
HOW I FEEL
ABOUT
THAT!!



AAAYY!!

EVER
ONWARD!
EVER
ONWARD!

I KNEW
I SHOULD
HAVE STAYED
IN THE NAVY!

TAKE THEM
OUT TO THE
VAN, TECH, WHILE MICRO-
MAIDEN AND I FREE
THE PRISONERS!!

OUR JOB IS DONE!!

A JOB WELL DONE ...
A DASTARDLY DEED THWARTED ...
ONCE AGAIN INEPTITUDE TRIUMPHS
OVER EVIL!
THANKS TO THE TREMULOUS TRIO!

You can't judge this Diablo terminal by its cover.



The new Diablo 1641 is what you make it. Because you choose the exact combination of features to fit your particular needs. To find out more, call Colleen Curatolo at (408) 733-2300, or write her at 545 Oakmead Parkway, Sunnyvale, CA 94082. When you get a Diablo terminal you also get Xerox quality, reliability, and availability. So you see, there's a lot more to the 1641 than meets the eye.

Diablo Systems

XEROX

Diablo and XEROX[®] are trademarks of XEROX CORPORATION.

April, 1978

CIRCLE 8 ON READER CARD

157

INTRODUCING THE DECISION DATA SERIAL PRINTER AND PRINTER TERMINAL THEY'RE VERY UNLONELY.

There are no big secrets to building a serial printer. If there were, there wouldn't be so many people building them. The problem comes later, when something goes wrong and there's nobody around to fix them.

If you know that lonely feeling, meet the Decision Data 3240 Printer Terminal and 6540 Serial Printer. They come complete with a 70-city Field Engineering Force, ready to move at the drop of a dot. And they come complete with as much microprocessor and LSI technology as possible, to make service calls as infrequent and as brief as possible.

The microprocessor also makes these printers bi-directionally smart, with horizontal and vertical tabbing for high-speed stepping and skipping. Print rate for the 96-character set of 9 x 7 dot matrix characters is 120 cps, and the effective rate is even faster.

These are, moreover, exceptionally versatile units. The 3240 is an excellent time-sharing terminal or system console or console/output printer for a mini or small business system. The 6540 is an excellent

working partner for a cluster of CRT's or as the output printer for a small business system.

They're versatile in operation, too. Across their standard 132-character line-width, they'll plot charts and graphs; print mathematical expressions with all subscripts and superscripts in place; and even print double size characters for report headings, shipping labels, and tags.

And they'll keep on being versatile as your system grows: we've already built in many of the variations you're likely to want next.

Look into the unlonely 3240 and 6540, backed by Decision Data service, coast-to-coast. Their prices are about as low as any you can find. And they can be rented or purchased. For more information, call us, at 215-674-3300. Or write:

Decision Data Computer Corp.
100 Witmer Road
Horsham, PA
19044



DECISION DATA[®]
COMPUTER CORPORATION

makes computing cost less

For expensive business and commercial computers, talk to DEC®, IBM® or Data General®

**for value-priced
home or business
computers,**

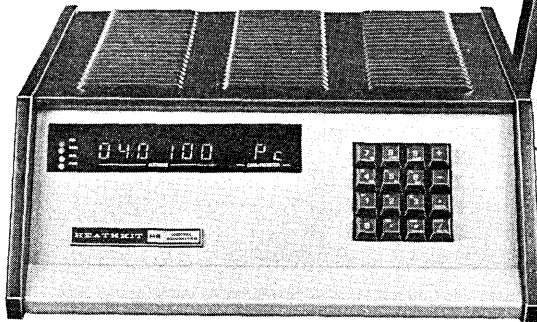

H8 Kit \$375.00

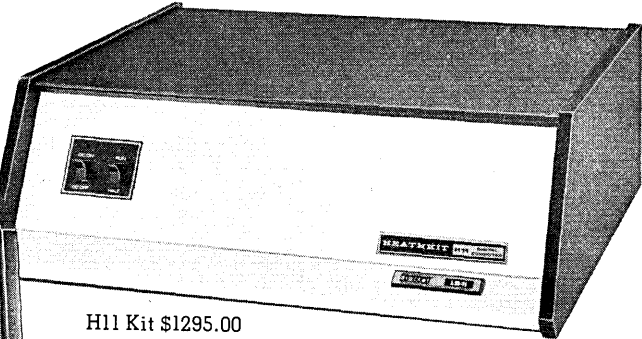

H11 Kit \$1295.00

talk to Heath!

If you work with computers, you know how much of an asset they are to your business. Fast, accurate data handling, instant retrieval of important information and storage of vital records and statistics are all part of the computer revolution. Computers mean better business, but there's another side to them as well.

Computers can work for, educate and entertain you right in your own home. Because they are true "open-end" machines, the number of ways you can use a computer at home is limited only by your imagination and programming prowess. Computers can also be an important adjunct to your children's education and an introduction to the modern technological world.

Best of all, computers happen to be FUN! There are hundreds of fascinating and challenging games that can stimulate your brain and provide hours of relaxation and recreation. And because the computer can make its own decisions, you can "compete" at any level you program into it.

Heathkit computers are designed to fit right into your home. No matter what your computer application, we have the unit for you. Our H8 is an 8080A-based machine with an "intelligent" front panel that is ideal as a

programming trainer and instruction tool. The powerful H11 is based on the most successful commercial computer in the world, the Digital Equipment Corporation® PDP-11. These two computers, along with a complete line of peripherals and I/O devices, make Heath your home computing system headquarters.

Heathkit computer systems provide the documentation you need to get up and running right – complete step-by-step assembly manuals, comprehensive operating procedures and complete and thorough rundowns of software programs. What's more, Heathkit computer systems include the systems software you need to start programming right away. The H8 includes a front panel monitor program, Benton Harbor BASIC, assembly language, text editor and console debugger. The H11 includes editor, relocatable assembler, link editor, absolute loader; debug, executive and dump programs plus BASIC and FOCAL.

Heathkit computer systems are designed to give you home computing at its very best. And since they're backed by Heath's 54-year reputation for honesty, reliability and quality, you know that a Heathkit computer system is one of the best investments you can make!

Prices are mail order net F.O.B., Benton Harbor, Michigan.
Prices and specifications subject to change without notice.



HEATHKIT COMPUTERS

**Send for your
FREE HEATHKIT
Catalog!**

Read about nearly 400
top-value electronic kits
you can BUILD yourself –
for fun, for satisfaction,
and for SAVINGS!

Heath Company, Dept. 360-400
Benton Harbor, Michigan 49022

HEATH
Schlumberger

Heath Company, Dept. 360-400
Benton Harbor, Michigan 49022

Please send me my FREE Catalog.
I am not on your mailing list.

Name _____

Address _____

City _____ State _____

CP-141 _____ Zip _____

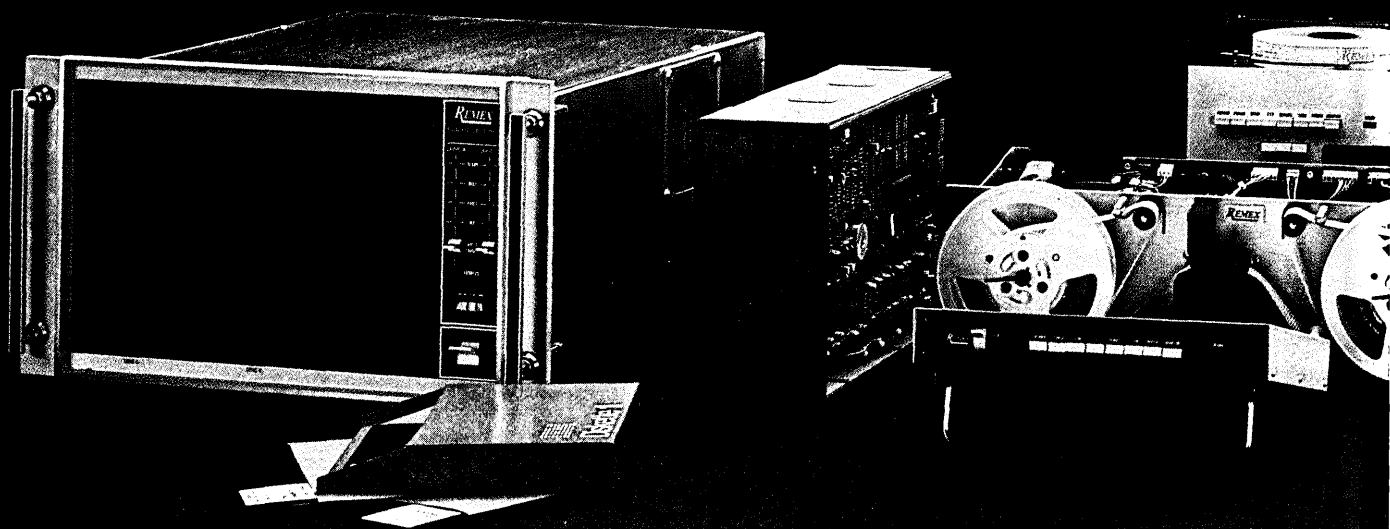

Paper isn't the only th

You think of Remex as the world leader in punched paper tape peripherals. Surveys show it. And our products and service prove it.

For nearly 20 years, we've offered the broadest selection of tape transports, readers, reader/spoolers, punches, perforators, combination units, computer interfaces, and communications gear—over 400 models in all.

Including a new family of handsome desk-top punched tape systems complete with a built-in RS232C serial interface.

Over 100,000 Remex punched tape peripherals are still operating in the field—some for over 15 years.

But paper isn't the only place where Remex looks good. We are, in fact, a leading manufacturer of quality *media handling* equipment, not just punched tape alone. Products like advanced flexible disk drives and systems you can benefit from today—not just on paper.

Our built-in formatter disk. It's like a \$50,000 rebate for small OEMs.

Instead of spending the \$50,000 or so needed to develop a good flexible disk controller/formatter, you can simply use ours—built right into the drive itself.

You save design dollars, time—and the space required by a separate formatter board. And you have the quality and good nationwide service support Remex is known for.

Remex' reputation cast in solid aluminum.

Think about it. Nearly twenty years of electro-mechanical sales and *service*. That's why the Remex drive mechanism is capable of 30,000 hours of normal use. Here's how we do it.

We use thick, solid castings instead of fabricated sheet metal. When you're talking about the densities on diskettes today, you're talking tolerances too close for bended metal.

We also use a V-groove lead screw with ball

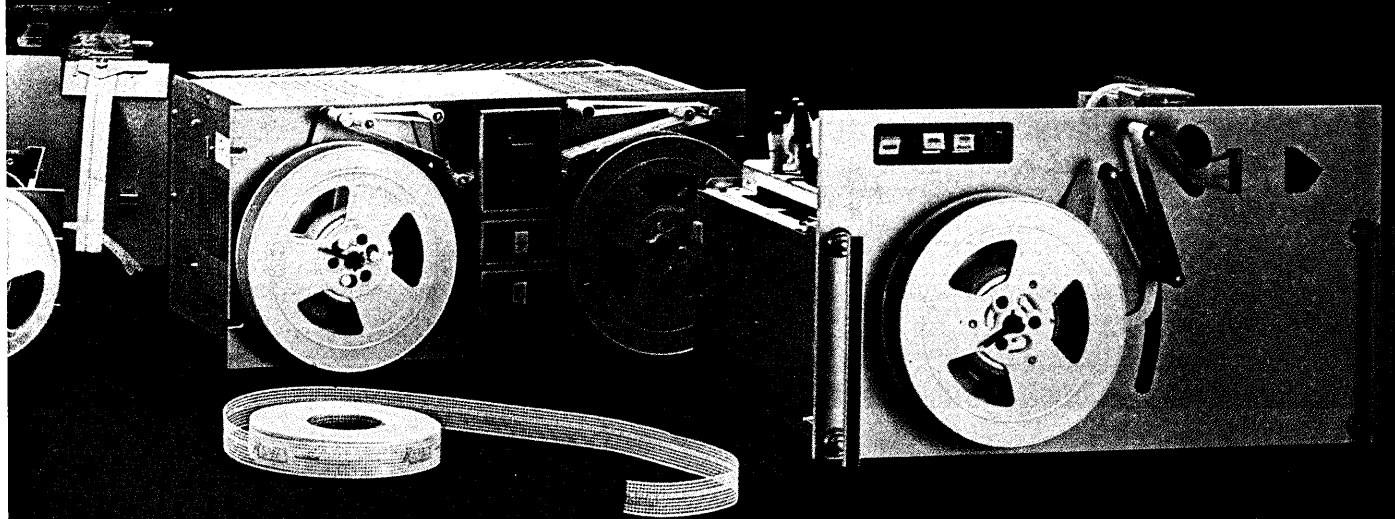

ing we look good on.

bearing groove contact. The head is always perfectly centered on each track, because the wear is *downward* instead of side to side. No slop.

Something special for PDP-11® and LSI-11® users.

A completely optimized flexible disk system dedicated to improving throughput and capacity.

With our new Remex-11 flexible disk system you get a complete hardware/software package. And a choice of operation modes:

You can operate DEC's way within the constraints of RT-11®

Or you can enhance the performance of RT-11 by switching, literally, to a 16 sector-per-track format. You gain an instant 25 percent increase in capacity and a 19 percent increase in throughput.

Or, in special applications, you can take full advantage of Remex hardware such as transferring multiple sectors of up to 65K words with just two commands. Or formatting diskettes with just one.

We've even designed the Remex-11 so you can communicate with both DEC and IBM 3740 prepared diskettes — without losing RT-11 compatibility. The system supports up to four disk drives.

In short, Remex can provide you with future capability now at no extra charge.

Specifications and other information you need regarding drives, systems, and punched tape products are yours for the asking. Write or call: Ex-Cell-O Corporation, Remex Division, 1733 East Alton Street, P.O. Box C19533, Irvine, CA 92713. Phone 714/557-6860. TWX: (910) 595-1715.

Ex-Cell-O Corporation

REMEX DIVISION

More ways to grow with EMM add-on memory.

THROUGHPUT (increased through enhancements)

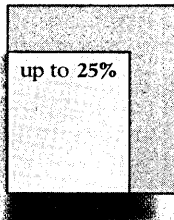

UPGRADES

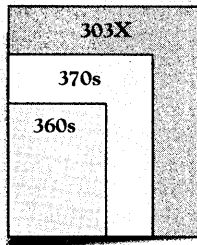

EMM add-on memories offer you the best alternatives for growing your IBM mainframe capability by adding capacity, providing faster throughput by means of enhancements, and upgrading to a newer or larger IBM CPU.

Our three generations of add-on memories provide

more models than virtually anyone else in the business. All with IBM compatible core and static RAM technology. That's not all you get with EMM. You get fast installation. Service second to none. Financial packages that enable you to grow. It all adds up to more growth flexibility for you. And more confidence in your growth potential.

Any way you look at it. The real proof is in the numbers. Over 1200 units installed. It means more people are growing in more ways with EMM add-on memory. Call or write today, for the complete EMM add-on memory story.

CAPACITY

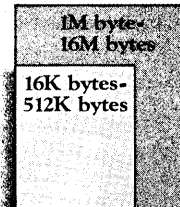

The difference in add-on memory

EMM

COMPUTER PRODUCTS

A Division of Electronic Memories & Magnetics Corporation
2311 W. El Segundo Blvd., Hawthorne, CA 90250

Computers and people can live happily in the same environment. Here's an approach that emphasizes compatibility.

How to Plan Space for People and Computers

by Kenneth A. Morrison

Planning for people as well as computers is one of the key challenges in creating a new data processing installation. The tendency is to become overly enamored with hardware systems at the expense of the staff which supports these functions. Their space requirements and working environment are frequently the last to be considered, and yet these elements comprise only an average 10%-20% of the overall project costs.

If kept in perspective during a project's earliest stages, planning for people can dramatically improve inter-departmental relationships, work efficiency, future growth patterns within the organization, and, ultimately, the profitable utilization of the computer itself.

Let's look at a computer facility from the viewpoint of the people who work there and discuss the step-by-step space planning process.

Developing space criteria

There may be a place for everyone, but is everyone in the correct place? Developing space criteria is the process of organizing the physical requirements of individuals and departments within the company into a logical and consistent system. There is no rigid format which must be followed in every case. Rather, an orderly, yet flexible, framework should be provided for collecting and evaluating large quantities of information in order to arrive at solutions that respond to the special needs of each department. The process includes gathering information through forms and interviews, developing standards for space and equipment, extending the requirements to provide for future growth, and collating the results into a usable form.

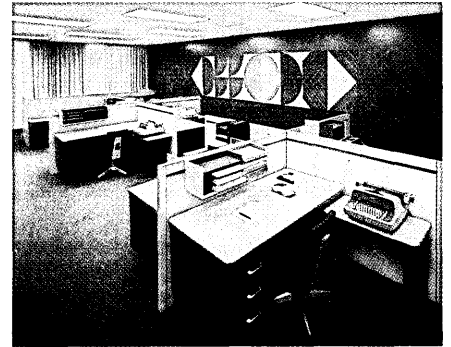

Most companies have some type of organization chart which is a useful starting point to identify reporting relationships and the functional groups or departments within the organization. The chart should be used to identify all groups to be surveyed and the person responsible for compiling the necessary information. It also will give an indication of functional groupings, but must be expanded to fully understand the flow of work through the organization.

Data is best collected and collated by the use of a detailed "Space Requirements Survey" completed by each manager. Inquiry forms in the survey should deal with external agencies (working

relationships between departments or sections); internal adjacencies (a general understanding of the work that is performed by the personnel and the most logical arrangement of people and equipment within the section); work stations (the total number of stations required in the department and the appropriate type of work station for each job function); and equipment-work area (additional equipment which will take up floor space in the department).

Pertinent questions to be answered within the survey format include:

What is the function of the group?
How and from where does work arrive, how is it processed, and where does it

SPACE

go? What is the group's relationship with others in the organization and with the public or outsiders?

How does the group operate? How much time is spent telephoning, conferencing, filing, interviewing, etc.? What are the relationships of individuals within the group?

What is the group's growth pattern? How large will it be in two years, five years, ten years beyond the planning date? What will be the impact of organizational or technological changes on the group?

What are the work station requirements for each individual? How much work surface? File space? Bookshelf space? Special equipment? Telephone or other communication equipment? Acoustical or visual privacy, or unusual lighting or air conditioning requirements?

What special facilities are required or desirable? Conference areas? File storage and reproduction areas?

A well organized survey form will provide information which is consistent in format. Information can then be easily verified by company officers and collated by the survey director.

Survey information from individual departments should be consolidated in a "Staff and Space Requirements Summary" which totals the space requirements for staff members in each department. For example, the Systems Coordination Section of the Production Control Branch may have nine employees requiring 1,091 square feet of space, while the Computer Section has 13 employees who need 1,387 square feet of space. These totals are combined with general use areas—such as reception lobby, shipping and receiving, rest rooms and office supply—to arrive at a grand total space requirement in a new facility.

Planning for adjacencies

The Space Requirements Survey data is also used to develop a graphic presentation of the essential working relationships within the organization, together with alternatives for structuring operations most efficiently in the new space. Work flow diagrams follow the step-by-step movement of people, material, and documents into and out of each department.

A traffic diagram is also useful in determining the layout of the machine room itself, within the limitations of hardware cabling and good operational principles. Careful planning of adjacencies assures that only those departments closely involved with computer operations are physically nearby. Actual steps taken by computer room personnel in transporting tapes, discs, printouts, and other media should be in-

cluded in the diagram. Heavily traveled routes may be arranged so that they do not cross each other, and areas with frequent cart traffic may be consolidated for straightforward travel from one activity to another.

Planning for security

The computer room should be among the most secure entry levels in the facility, but inadequate planning of departmental adjacencies can result in this space becoming a heavily traveled path-

A traffic diagram is useful in determining machine room layout.

way. Some machine rooms have multiple entry points with staff members passing through the space only because it is the most direct route to other departments.

Finding the mid-point between stringent security measures and a comfort-

able working environment can be difficult. On the one hand, the strictest security is required for the machine room and computer library; on the other, people function and communicate most effectively when allowed some freedom of movement.

Generally, there are four levels of security best suited to the computer facility: free access to building lobby and administrative spaces; limited access to programmers and systems maintenance areas; very limited access to the machine room itself; and tightly restricted access for the tape and disc library.

In many cases, the most effective placement of these four levels is in a linear progression with increasingly limited access from public lobby to computer library. An interface area is established between each level, with some security control system, such as a key card, to permit appropriate authorized personnel to enter. Progressively restrictive security levels assure that the machine room access is limited solely to

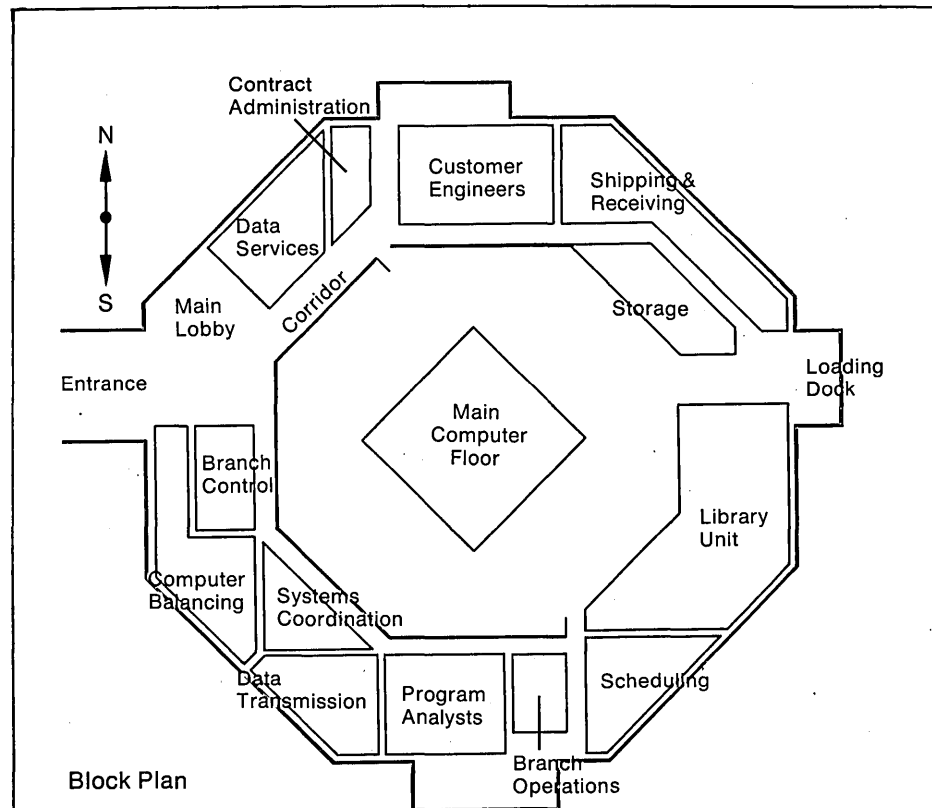

Fig. 1. Following establishment of space standards and optimum departmental adjacencies, the block plan is used to arrange space allocations in the proper order and establish circulation patterns within a specific building configuration. Here, the main computer room is completely enclosed at the center of the octagonal building. All departments are arranged on the perimeter, moving in logical sequence from administrative and customer engineer spaces near the main entrance to branch control, computer balancing and on through to program analysts and scheduling adjacent to the computer room entry. Computer storage, shipping and receiving, and loading dock are isolated from the office spaces. The main circulation corridor encircles the computer room "hub" while secondary pathways are oriented on a north-south axis. The block plan forms the basis for the more detailed space plan which places all furniture and equipment within each department.

operating personnel.

The linear approach clearly defines each individual's security status, establishes specific points of entry/exit through which work must flow, and gives most personnel the freedom of their surroundings without jeopardizing computer security.

Planning for the future

Having established the groundwork for space allocations, adjacency priorities and security levels, the next step is creation of a block plan. The actual base building plan is studied to determine the most logical flow of primary circulation from main access points throughout the building. Once circulation patterns are established, the area requirements of each department and proper adjacencies are diagrammed in block form on the building plan (see Fig. 1). This is the first conceptual step toward arriving at a final space plan.

Requirements for future expansion are especially significant. Rapid changes in hardware and software systems can

dramatically affect machine room requirements, departmental size, and interrelationships. Both systems and physical space should have the flexibility to adapt.

The tendency is to become overly enamored with hardware systems . . .

One extreme would be to design all present needs in contiguous space and allow for expansion options at either end or above or below the initial space. This would minimize initial costs but would be likely to result in a major remodeling expense when expansion does occur. The other extreme would be to incorporate enough expansion space within the initial plan to accommodate future needs. In reality, the final block plan will be a combination of the two extremes and reflect compromise with the strict adjacency requirements of the program.

It is possible, for instance, to locate small, relatively stable departments with predictable space needs between larger, more volatile groupings. In the machine room, a system of expansion quadrants will help to minimize relocation of both equipment and cabling to allow for orderly, incremental growth.

Systems flexibility may also be built in to the facility as planning details are formulated. Electrical and mechanical systems can be designed to avoid expensive future alterations. An electrical distribution system which has boxes set flush with the floor in a preset grid pattern allows fast and economical relocation of telephone and electrical outlets. A systematic approach to the placement of ceiling ducts and structural penetrations for air conditioning and heating simplifies rerouting.

Adaptation of older buildings to accommodate new computer installation presents yet another planning challenge. Systems must be upgraded to supply the extra air conditioning, electrical, and fire suppressant capabilities.

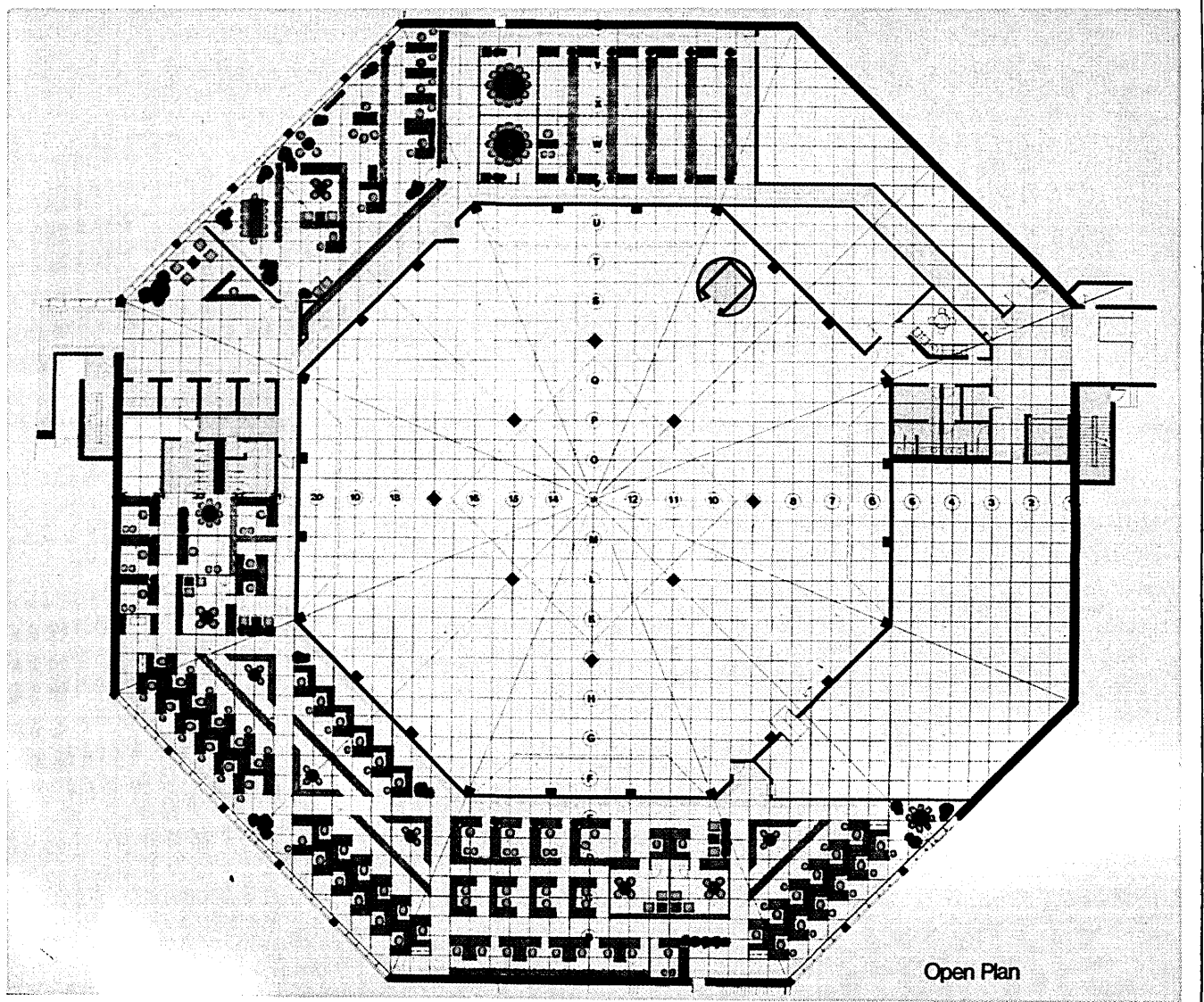

Intelligence enters the Now big-screen graphics in better time.

The 4014-1 Computer Display Terminal has just added time-saving local control. Now you can put local graphics intelligence to work on the 4014-1's 12 million viewable points. You can decrease transmission delays and time-sharing costs, while increasing throughput dramatically.

With new options, you can easily cut data transmission and computer time in half. Save graphics, symbols and alphanumerics for instant recall. Display 28K of graphics with one keystroke. Develop your own symbols and character sets locally. Then use them in your application with local scaling, rotation, and clipping.

Design. Map. Plot preview. With the depth of detail you need for sophisticated graphic applications. With optional capabilities like positioning, scaling and rotation of locally saved symbols.



These enhancements can be added into your present 4014-1. It's almost as easy as plugging in our peripheral hard copiers. Plotters. Graphic tablets and storage devices.

Complete the picture with our Plot 10 family of graphic software, our easy interfacing and excellent after-sale service. We're there when you need us. So call your local Tektronix Sales Engineer soon. Have him show you how the newly-enhanced 4014-1 can make a world of difference in your workload.

Or write:
Tektronix, Inc.
Information Display Group
P.O. Box 500
Beaverton, Oregon 97077

Tektronix Datatek NV
P.O. Box 159
Badhoevedorp
The Netherlands

Copyright © 1978, Tektronix, Inc.
All rights reserved. OEM information available.
Display courtesy of Dr. Eric Teicholz
Laboratory for Computer Graphics and
Spatial Analysis Harvard University

Get the 4014-1. Get the master of detail.

picture: does bigger jobs



SPACE

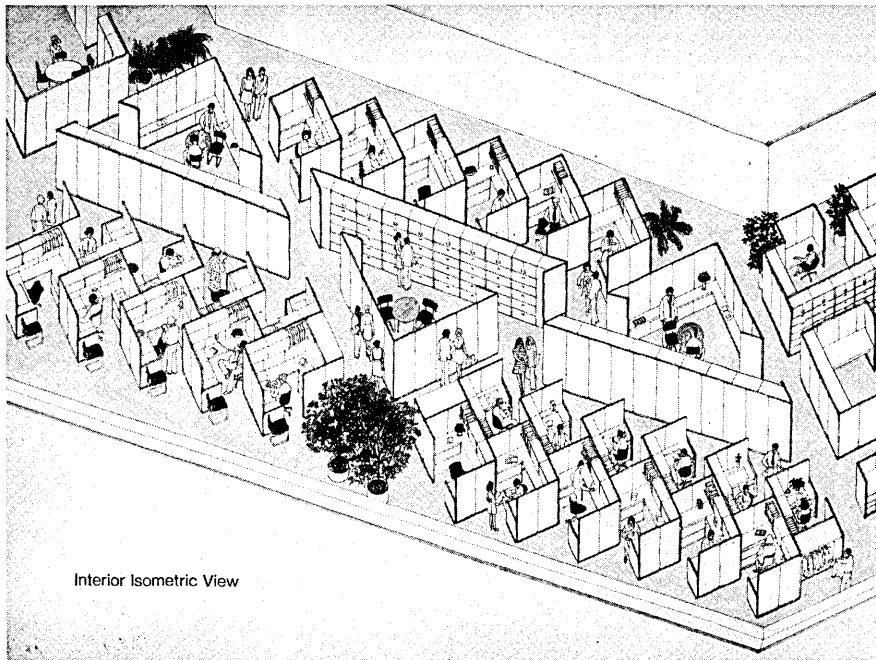

Fig. 2. This isometric view of a department within the space plan is a graphic technique used to help visualize the finished space. Indicated is the ratio of work stations to conference areas and the use of varied partition heights to make the space visually interesting.

Electrical distribution flexibility has been achieved in some projects by cutting trench ducts into the existing floor to run electrical cables throughout the space. Another recent project uses a new system of electrified partitions to overcome the problems of floor access in an older building and avoid unsightly power poles. The lower rails of the interconnecting partition system carry electrical and telephone connections. Each work station is simply plugged into the system without additional wiring, simplifying future relocation.

Planning for people

The space plan takes the block plan several steps further in locating individual work stations within each department, together with all other furniture and equipment which take up floor space. It shows the arrangement of all private offices, corridors, reception areas, conference rooms, and work areas.

Inevitably, the key decision in developing the space plan relates to the extent of "open" versus "closed" planning. "Closed" planning is the traditional approach of enclosing separate functions in separate rooms and most individuals in private offices. "Open" planning is the approach which places most functions and most people in semi-open or open space.

Most computer facilities require a high degree of interaction and intra-group communication, leading to the

possible conclusion that open planning is the universal answer. In fact, open planning, per se, should not be a catch-all design solution. Any space plan must be properly executed with the right balance of functional and aesthetic elements to create a pleasant working environment, rather than an endless sea of desks.

A mix of open and closed planning is often most suited to computer facilities, including: modular work stations of an economical yet attractive construction which are large enough to accommodate the individual and necessary work materials; enclosed conference rooms where work teams can meet in privacy; and common work areas shared by ten or more stations, providing space for reference files, sorting activity and peripheral equipment.

As a general rule, a split of 75%-25% between open areas and enclosed rooms is an acceptable division of space. The work stations should be separate rather than clustered and have seating limited to one or two visitor chairs to avoid the use of individual stations for large, noise-generating meetings. (Employees should be encouraged to use closed conference rooms for large work sessions.)

Acoustical controls are essential to the open plan, including acoustic-treated walls and work station panels, carpeting rather than vinyl or other hard surface flooring, and absorbent acoustic ceiling material.

To avoid a "sea of desks" in the open plan, screens of varying heights will

modulate the space and provide visual variety (see Fig. 2). For example, 44-inch-high screens enclosing the individual work stations establish a sense of individual location while allowing for interaction and communication between stations. Six-foot-high units might enclose general work areas, with even higher panels for conference rooms.

Movable partitions, modular work stations which can be arranged in a variety of ways to suit job functions, easily replaced carpet tiles, and other design components will also help to achieve desired flexibility for growth and change within reasonable budget guidelines. New task-lighting systems, in which fixtures are mounted on work stations to direct light on the work surface, are proving to be a highly successful lighting technique in the open plan. A departure from uniform ceiling light fixtures, task lighting provides a selective, high-quality light source that is economical, efficient, flexible, and energy-saving.

Planning for order

All successful office designs have certain elements in common. One is a sense of order. This means that as one moves through the space there should be a clear sense of location and direction. Every employee and visitor to the office should consciously or subconsciously have an understanding of the layout and design of the space.

Ironically, an open plan sometimes can be the most difficult type of space in which to locate individuals or even de-

One firm has a "road map" on the reception area bulletin board to help visitors in the maze.

partments. One firm has a "road map" on the reception area bulletin board to help visitors find the proper department in the maze of work stations!

A key planning responsibility is to establish a hierarchy of space which brings order to the total working environment, facilitates the flow of data within the space, and controls circulation through different security levels.

A planning grid approach is especially helpful in determining the proper alignment of departments within each type of building configuration. A primary circulation pathway is established with clearly designated secondary routes leading to individual departments. This logical progression may be enhanced by such identification techniques as color coding for each department, a coordinated directional graphics program, or separate color schemes for primary and secondary circulation paths.

In the sample space plan (Fig. 1), the unique octagonal-shaped building was a

A quick memory test.

Feature	Our HP 1000 and 21MX Computers	Your old favorite
Memory	High density 128K byte modules use new 16K bit RAMs—just 5¢ per byte for 595 ns speed. Capacity to 1.8 million bytes with 22-bit Hamming fault control. Cache-speed 350 ns MOS/RAMs available for all memory.	
CPU	Mapped memory addressing for large memories. Standard instruction set includes floating point, integer arithmetic and data communications. Fast FORTRAN processor optional. User microprogramming. Direct memory access rates up to 2M bytes/sec; microprogrammed burst rates to 11.4M bytes/sec. Standardized interfaces for parallel TTL, process I/O, RS232 and IEEE-488 (HP-IB).	
Reliability	Memory parity standard; fault control also available. Automatic microcoded diagnostics. High resistance to shock, vibration and temperature variations. Brown-out proof power supply. Battery backup.	
Cost	16K byte 595 ns memory : \$ 488* 128K byte 595 ns memory : \$4,160* 32K byte 350 ns memory : \$1,365* 21MX M-Series computer with 256K bytes of fault control memory : \$13,910* HP 1000 System with 21MX E-Series computer and 512K bytes of fault control memory, 15M bytes of disc storage, CRT console with dual mini-cartridges, and RTE operating system : \$62,300	
Delivery	3 to 12 weeks ARO.	

**Prices shown include 35% OEM quantity discount.
All other prices U.S. domestic list.*

It's hard to beat that kind of performance at those prices. Especially when you have one of our compatible RTE operating systems to make it all work smoothly. So if your old favorite didn't score very well in this test, maybe you should call your nearest HP sales office listed in the White Pages. Or write to Robert Puette, Hewlett-Packard, 11000 Wolfe Road, Dept. 409, Cupertino CA 95014. The quicker, the better.



HEWLETT  PACKARD

The next time you have a technological problem,

call the world!

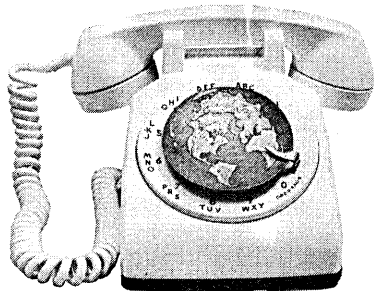

Now, for only \$10, you can get everything you need to access a billion-dollar, worldwide computer system with a data bank of technology wanted and technology for sale! You can search the system with your own computer or teletype terminal, use one of the public terminals maintained by Control Data Corporation in major cities throughout the world, or we will search the data bank for you.

This special introductory offer to our subscribers is made possible by TECHNOTEC, a technology exchange service of the Control Data Corporation. Companies worldwide use TECHNOTEC to buy and sell products, processes and expertise across all industry lines and cultures.

You can search right from your own office. Local telephone numbers are used to access the system in 120 cities. TWX, Telex and satellites give the system interactive communication throughout the world. Mail and telephone service are available if you don't have a terminal.

The cost is amazingly low. You pay only \$10 for start-up charges, instruction manuals, etc. Thereafter, you pay time-sharing charges to search the data bank on your terminal (8-10 dollars per search is average). A small surcharge is added if we conduct the search for you on our terminal. After buyers and sellers locate each other, they are free to negotiate directly. TECHNOTEC does not charge brokerage fees, royalties, etc.

TECHNOTE can save your company thousands of dollars every year, and keep you up-to-date on new products and processes available worldwide. To get started, simply mail this coupon today!

I'm interested! Enclosed is \$10.00 (or a company purchase order). Please send TECHNOTEC identification and instruction materials immediately.

NAME _____
TITLE _____
COMPANY _____
ADDRESS _____
CITY _____
STATE _____ ZIP _____

Send To:
Datamation, % TECHNOTEC
P.O. Box 1985
Twin Cities Airport Branch
St. Paul, MN 55111

SPACE

potentially disorienting configuration with multiple angles. To offset this, rectangular planning modules have been established in each quadrant and all walls are oriented on a north-south axis. Triangular work areas are placed at each corner. The primary circulation corridor encircles the computer room "hub," while well-defined secondary pathways radiate off the main corridor and into departments. Plantings are used to identify reception areas and the end of the circulation paths.

Design development

Computers don't care much about the amenities of their environment as long as proper temperature, humidity, air filtration, and other essential controls are maintained. People, of course, do care, and yet the sterility of the machine environment is often extended into office areas.

Computers don't care much about the amenities of their environment . . . people, of course, do.

The final space plan, however closely it meshes with adjacency, security and growth objectives, is still not a design. It must be developed into three dimensions before the final quality of the space emerges.

Design development is an on-going process which is facilitated by the early establishment of design criteria which can be continually referred to in the evolution of block plans and space plans. Here are the design criteria which were formulated for the sample space plan:

Function: must respond to workflow diagram, block diagram, and workteam groupings as observed and discussed.

Interest: must be an interesting space—pleasant to be in, pleasant to work in.

Circulation: major circulation path should not disrupt work; secondary circulation should be shared (work station to work station, files to work areas) to improve efficiency.

Acoustics: work station should provide noise-free privacy for occupant.

Lighting: design should provide maximum opportunity for use of furniture-mounted lighting.

Flexibility: work station should be changeable to accommodate different staff assignments by changing components.

Views: plan should take full advantage of potential views to outside gardens.

Detail: design details should reflect planning concepts.

Planting: plants should be a component of the design rather than a decoration (signify ends of circulation paths, change in direction of circulation, mark waiting areas, etc.).

Such criteria set the guidelines for the design statement including furnishings, partitions, doors, wall finishes, carpeting and floor coverings, ceilings, lighting, cabinetwork, artwork, and planting.

The finished product

No matter how knowledgeable management may be in the data processing operations of the organization, a coordinated planning and design effort is essential. In some cases, most of this work will be done in-house, while in others, it will be performed by experienced consultants.

Regardless of how the process is structured, the following steps should be taken:

Review your organizational structure and reaffirm the accuracy of departmental delineations.

Verify data on job functions and interrelationships.

Compare your facility with similar operations and understand where you differ and why.

Develop space standards necessary to assure that each function will have the correct amount of space, furniture and equipment regardless of future staff changes.

Establish design criteria simultaneously with space planning to create a uniformly high level of quality work space for all staff members.

Careful planning will result in a data processing environment responsive to the needs of the equipment and the people who operate it. *

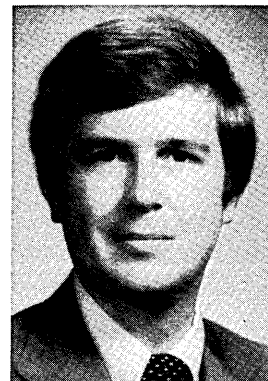

Mr. Morrison, a member of the American Institute of Architects, is with Gensler and Associates/Architects in San Francisco. He has acted as a project manager in the development of dp facilities for such diverse operations as Western States Bankcard Assn. (Mastercharge), Carter, Hawley, Hale, Inc., and the General Services Admin./Internal Revenue Service.

Performance: has your operating system got what it takes?

Feature	Our Real-Time Executive for HP 1000 and 21MX Computers	Your old favorite
Upward-compatible family	RTE-M, memory-based for 32K to 1.8 million bytes; RTE-II, compact disc-based for 48K to 64K bytes; RTE-III, disc-based for 64K to 1.8 million bytes. Programs and data are interchangeable; all systems use a common set of operator commands.	
Multi-programming	Up to 64 separate programs can execute concurrently in main memory; thousands more can swap in automatically from disc. Protected by hardware fences and optional fault control memory. Non-responding peripherals detected via time-outs.	
Multi-terminal capability	Concurrent processing, program development, system generation in conversational or batch modes. One program serves all terminals; no rewriting when you add on or change.	
Micro-programming	Up to 8.5K 24-bit words usable at one time. Microassembler, micro debug editor, loader utility, PROM tape generator and Writable Control Store available to simplify microprogram preparation.	
Other features	BASIC, FORTRAN and Assembly languages. Measurement and control support. Distributed Systems Networks. IMAGE/1000 DBM with QUERY language for \$2,500.	
Cost*	HP 1000 systems with RTE start at \$21,000 for 64K-byte memory-based Model 20. Disc-based 64K-byte Model 30 from \$31,500. Available to 1.8 million bytes of main memory.	
Delivery	12 weeks ARO.	

**All prices U.S. domestic list.*

Can your old favorite do all this and still service interrupts in as little as 100 microseconds? If not, write to Robert Puette, Hewlett-Packard, 11000 Wolfe Road, Dept. 410, Cupertino CA 95014. Or contact your nearest Hewlett-Packard sales office. When it comes to price/performance, we've really got what it takes.



HEWLETT  PACKARD

When Management Is Automated

by John E. Steely, Jr.

For 20 years managers have deluded themselves into believing their functions could not be computerized . . . but the day of management automation has finally arrived.

For the last 20 years, executives have been deluding themselves into believing that the impact of automation need not be feared at management levels, that policy decisions cannot be automated, that the manager's function is too judgmental and humanistic to be computerized. However, it was obvious from the beginning that computer systems would invade this management area some day. And that day has come.

This invasion will occur in three phases, the first of which is currently in progress:

Phase 1—management will be forced into setting new policies and changing their organizational structures, but these changes will be of a "traditional" nature in the sense they have been sought for some time.

Phase 2—Management will be forced to adopt an organizational structure parallel to that of the computer system, more logical than traditional in nature.

Phase 3—Management will be forced to describe a set of optimizing rules for the system to follow, rules based on the organization's goals and strategies. The computer system will prescribe shifts in structures, policies, and functions throughout the organization based on its observations of results reported to it.

Phase 1 is now

To appreciate how Phase 1 is occurring, consider an organization's annual planning function. Presently it involves reiterations of the cycle of estimating achievements, schedules, and budgets from the lowest levels of management to the highest. Each cycle includes tabulations, rejections, and demands for new estimates in a nightmare of number crunching, paper pushing, chart preparation, and meetings at an impossibly accelerating frequency—ending only because time runs out simultane-

ously with the exhausted collapse of managers at all levels.

Computer systems are changing this dreary picture, fortunately, through rapid communications, elimination of paperwork, report generation from a shared pool of corporate data, and through centralized automation of diverse but related activities (an example of which would be an automated administrative system). With the new tools, that annual planning can be done simultaneously at all management levels, using terminals for data entry and retrieval from a common data base, and communicating without the need of meetings.

Seizing the opportunities offered by these new systems involves a price, and

Today's planning cycle ends as time runs out simultaneously with the exhausted collapse of managers at all levels.

not just in money. There is a human price paid in the changing of habits, the alteration of jobs, and the substitution of a machine's rigor for personal contact.

For example, one very large corporation recently installed a centralized, automated administrative system for its nationwide marketing force. There were organizational and operational changes in every branch office. Salesmen who once relied on personal contacts within the company had to learn to cope with the rigorous rules of the machine. Schedules for filing reports and receiving them, even for receiving commissions, changed. Branch office record-keeping functions disappeared. And

suddenly, the person who always used to find the missing document wasn't there anymore.

Sometimes the price is too high. New system designs require redesign of other parts of an organization, and operational changes too. Long-established methods, careers, and organizational boundaries are threatened. In the face of these pressures, an executive may back off, make more decisions in favor of the existing organization, fewer in favor of the new design. Sometimes the result is an expensive array of new equipment performing old-fashioned functions, perhaps with greater economy, perhaps not.

And when tough managers do make it work, they find that selection of some of the new computer system strategies—data base, interactive planning and reporting, on-line monitoring and control, functional integration—requires a balancing of corporate goals different from that of the past. Specifically, goals involving quality, integrity, security, and continuity gain increased importance.

This rebalancing is demanded partly by the unforgiving and mechanistic nature of automation. When something like quality control is automated, suddenly there is no way to pretend to do it, or to claim that all the procedures were carried out—either they are in the code or not. Claims and counterclaims dissolve.

Also, in balancing productivity with the other goals of quality, integrity, security, and continuity, some of the new computer systems require that control over operations serving these other goals be located in the computer system itself. For instance, if response time is important, security checks during data references must be performed in-line. New security provisions such as en-

Data Base Management: is your small computer on the right track?

Feature	Our IMAGE/1000 DBM on HP 1000 Model 80	Your old favorite
Inquiry language	"Free Form" QUERY lets almost anyone access data or create reports with simple English-like commands instead of special subroutines.	
Data access	Application programs in FORTRAN IV, BASIC or HP Assembly can access data sequentially, directly or randomly by key word value.	
Privacy	Passwords definable for any part of data base, down to smallest unit of information.	
Data maintenance	Define, build, use and restructure data base. Multiple data bases can reside in same computer system.	
Data base structure	CODASYL-type schema eliminates redundant entries, makes data base independent of user programs.	
Data Communications	Multiple IMAGE/1000 systems can be inter-connected with HP's Distributed Systems Network. Also 2780 emulator.	
Performance	Supports 4 to 8 terminals with 1.5 to 3 second response time. Up to 1000 transactions per minute. Concurrent DBM and real-time processing.	
Cost*	IMAGE/QUERY data base management software: \$2,500 With HP 1000 Model 80, including 128K byte CPU, 15M byte cartridge disc, mag tape, printer, dual cartridge CRT terminal, RTE operating system: \$61,700.	
Delivery	12 weeks ARO.	

**All prices U.S. domestic list.*

No wonder our DBM software was named to the Datapro Honor Roll. So if your system can't get untracked, call your nearest HP sales office listed in the White Pages. Or write to Robert Puette, Hewlett-Packard, 11000 Wolfe Road, Dept. 411, Cupertino CA 95014.

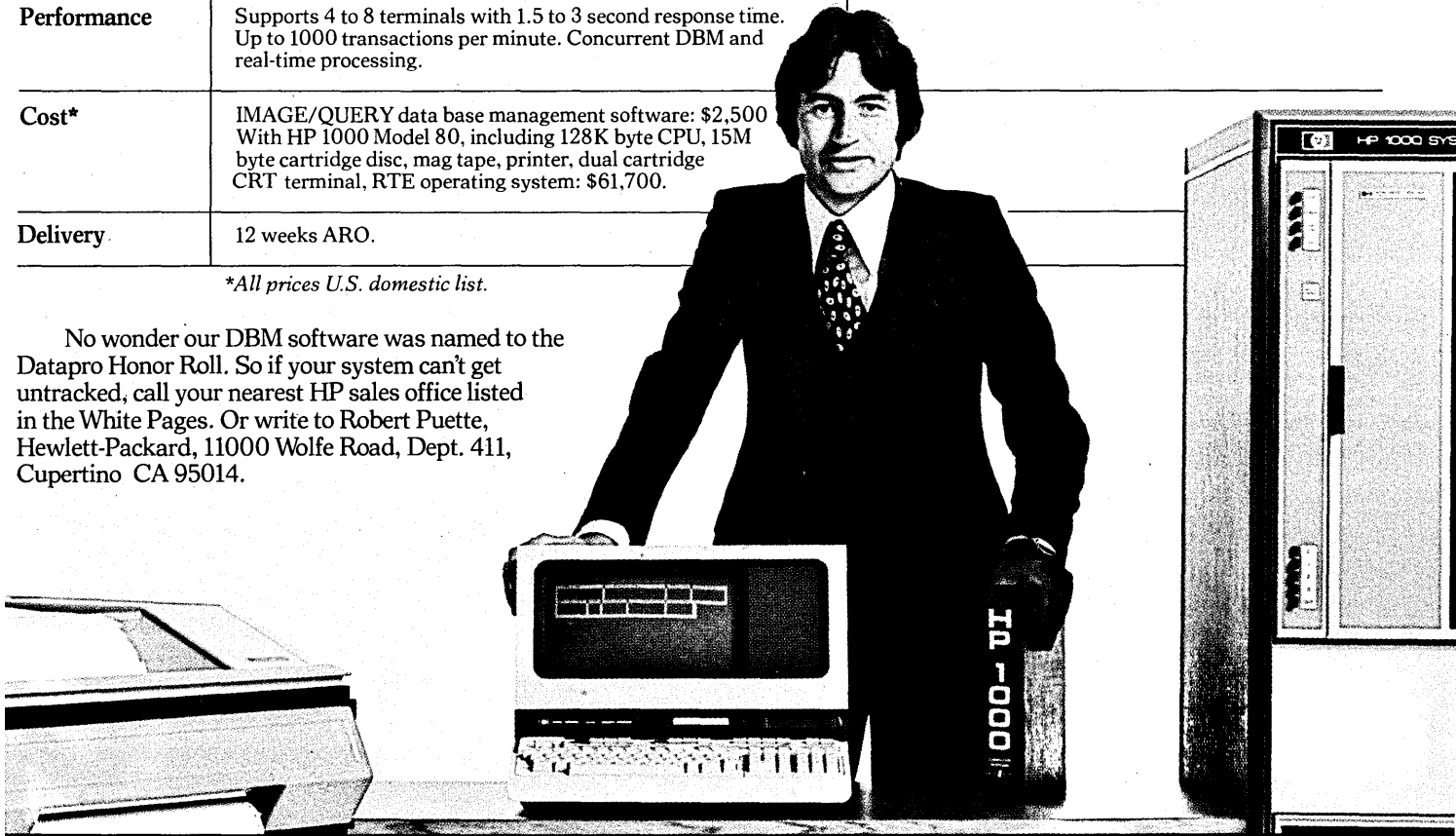

HEWLETT  PACKARD

MANAGEMENT

ryption will be possible within the system, not only at higher speed than their external equivalents, but also with greater effect.

Even in those cases where actual control by the computer system is not absolutely required, the plans for methods and procedures must be integrated with those for the computer system to ensure that the result is both technically and operationally feasible. For instance, if a security violation detected by the system is to be routed to a security officer, the methods and procedures he is to follow must be integrated with system plans so that any special clearance issued is known to the system for future reference (and perhaps to keep an independent audit trail of the actions of the security officer).

This requires that the computer system staff have a voice in choosing and designing the nonautomated methods and procedures as well, to avoid unqualified assumptions about the computer system's performance and cost. The nonautomated procedures will not stand alone; they will be parts of overall strategies working in tandem with other procedures, some of which will be automated. The impetus behind the new procedures is automation, and the necessary background information is known to the computer system staff.

In that case, and many others like it, so-called "technicians" must be given a vastly increased role in decision making. Control over development and use of automated functions must assure that these are compatible with complex modes of system operation, and that their use is scheduled in light of all other system work, to preserve both efficiency and integrity. This control must be exercised by the same individual who manages the computer system, the data processing executive. (Use of the term "executive" here is calculated. It implies commitment to the organization as a whole, and this executive must be just as sympathetic to the needs of the many, varied departments as is any executive.)

Increasing the role of technicians in decision making will not only increase the assurance of technical feasibility of proposed system applications; it also will result in less fragmentation of effort and resources, a higher confidence factor in production schedules, and continuity of individual functions through major system changes.

In support of this expanded data processing responsibility, the systems development and operations staffs must receive much more education, not only in their technical fields, but in other business aspects as well. It is in this new responsibility that the professionalism of data processing personnel will finally be

defined and measured.

Education of computer personnel is essential to prepare them to interpret organization needs for service, for communication of status, and for development of new functions. An argument has raged for a long time over how best to locate the people who run the systems, and it applies to their education as well. Should they be centralized, with all requests for service coming to them? Or should they be decentralized, working for the users? Consistent with the

It is in this new responsibility that the professionalism of dp personnel will finally be defined and measured.

shift of control over automated functions and their use to the dp executive, a third solution offers the best prospect of success: relocate user representatives into the dp group, thus rapidly increasing the knowledge there of the organization's business and giving the users representation close to the dp exec.

The shift of responsibility and authority to the dp staff will cause severe reactions. Great pressure will be put on the top corporate executive to protect the organization from change, to protect people from erosion of their spheres of influence, and particularly to protect his own position. But the executive should remember that past efforts to

avoid these organizational trauma have led to trauma of their own. The difference is that the changes in organization will end, whereas the present types of system failures and their effects will persist and grow infinitely worse if the changes are avoided.

Not all organizations or executives will agree with the radical changes called for, even though it is doubtful that their organizations can survive the competitive pressures from those which do capitalize on the business improvements made possible through the new systems. Government agencies, uninfluenced by competition, may refuse to change even in the face of enormous pressures. But demands for more and better services will affect all organizations, even government agencies, and change will inevitably come to all.

The organizational change required in this first phase of the invasion, as difficult as it is, will be rapidly followed by even more taxing demands. An organization which postpones the Phase 1 changes will find itself almost hopelessly lagging behind as the data processing industry moves into the next generations of systems.

Phase 2 begins to emerge

A picture of the next generation is beginning to emerge in glimpses of distributed processing, firmware and hardware replacement of relatively stable software functions, technology making enormous host cpu's possible, and an increasingly high level of symbolic pro-

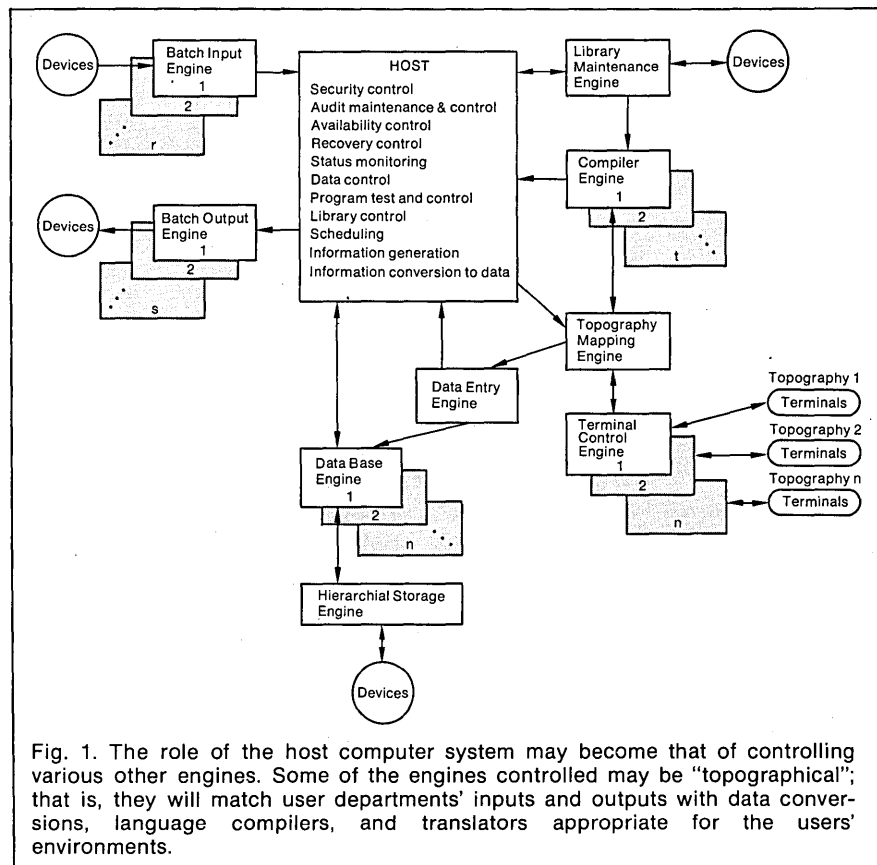

Fig. 1. The role of the host computer system may become that of controlling various other engines. Some of the engines controlled may be "topographical"; that is, they will match user departments' inputs and outputs with data conversions, language compilers, and translators appropriate for the users' environments.

Instrumentation Interfacing: how does your real-time computer measure up?

Feature	Our HP 1000 and 21MX Computers	Your old favorite
Standard Interfaces (IEEE-488, ANSI MC 1. 1)	HP-Interface Bus (HP-IB) simplifies connections to over 200 bus-compatible instruments for stimulus, measurement and display, and reduces installation costs. High-level READ and WRITE calls in FORTRAN and BASIC simplify programming.	
Intelligent Analog and Digital Subsystem	HP's 2240A microprocessor-based analog and digital subsystem off-loads CPU and simplifies programming. Handles complete real-time tasks such as time-scheduled data acquisition, scan synchronization with external events, interrupt waits, waveform sample pacing, temperature drift corrections for high accuracy.	
Real Time Software	Compatible family of memory and disc-based Real Time Executive (RTE) operating systems. Interrupt handling at 100 μ s. Real-time BASIC, ISA FORTRAN with bit-manipulation and real-time extensions.	
Computer Costs*	HP 1000 Model 20 memory-based system from \$21,000. HP 1000 Model 30 disc-based system from \$31,500. (Both include 21MX E-series CPU, 64K bytes memory, 2645A CRT with dual mini-cartridges, RTE software.)	
Interface Costs*	Plug-in measurement and control cards: 32 analog inputs, 32 digital inputs and outputs, \$2,625. 96 channels of analog and digital I/O in μ P-controlled 2240A, \$5,110. HP-IB card, \$600.	
Delivery	8 weeks ARO.	

**All prices shown are U.S. domestic list.*

When you consider the number of instruments we make, it's not surprising that we know how to get the best out of them with our computers. If you'd like to see how well our real-time computers measure up, call you local HP office listed in the White Pages. Or write to Robert Puette, Hewlett-Packard, 11000 Wolfe Road, Dept. 413, Cupertino CA 95014. And save a lot of interface.

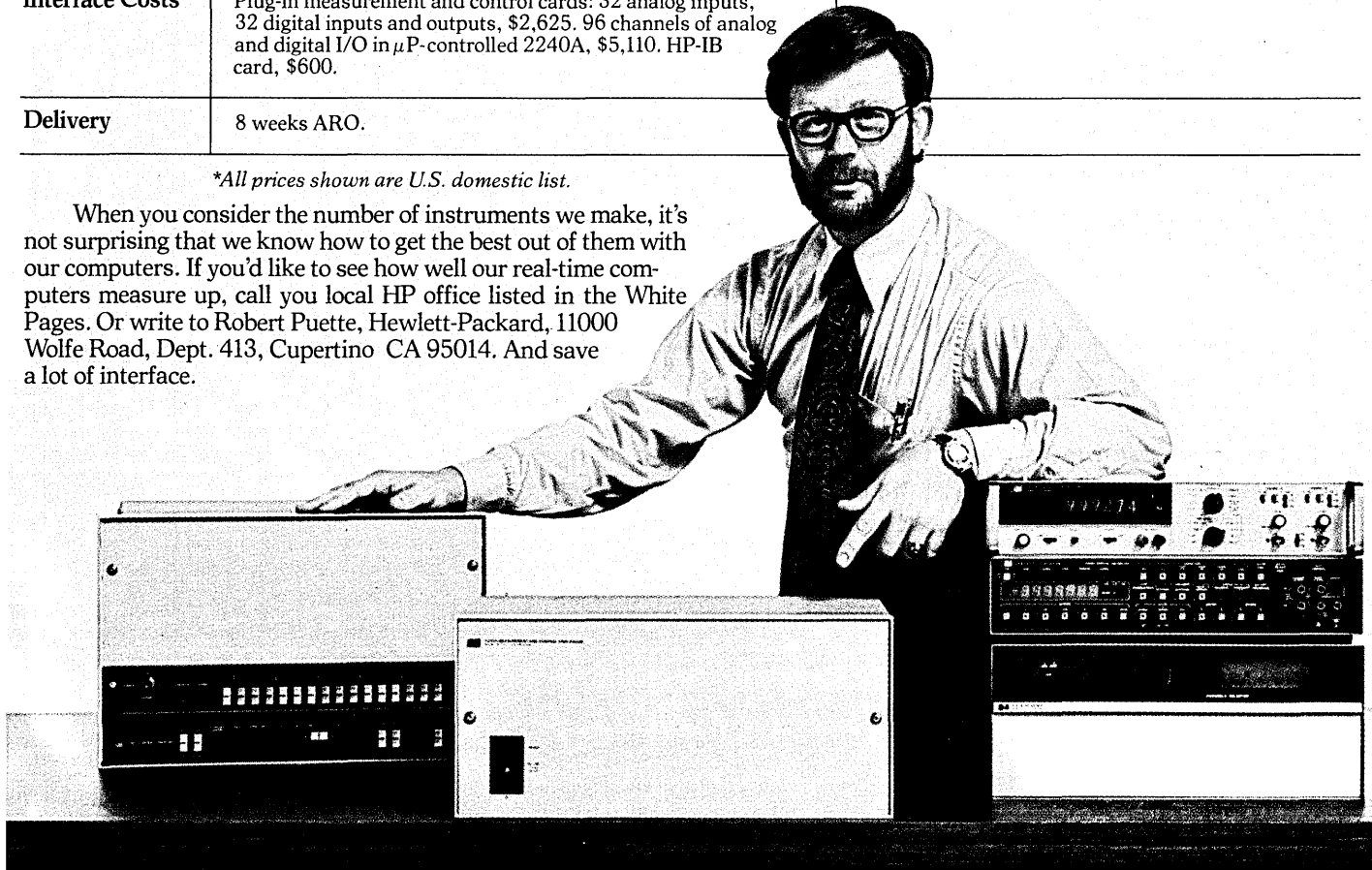

HEWLETT  PACKARD

MANAGEMENT

gramming repertoire for those hosts.

Fig. 1 shows a possible future system structure in this generation. This kind of system will usher in Phase 2 of the invasion of the management area by new computer systems. In this phase, management will be forced to adopt an organizational structure parallel to that of the system, more logical than traditional in nature. Yet management will still preside over the structure, once established, controlling it and assuring that the needs of the system are met.

The system will consist of a host (one or more cpu's) surrounded by engines in which many system functions will be performed totally off-loaded from the host. These engines may be hardwired, or they may be controlled by firmware which is set under control of the host.

Some of these engines will be structural in nature, affecting the organization of the data processing department. The department will have to be organized around the engines, with specially trained personnel working in each functional area. Their procedures and rules will be determined by the rigorous logic in the engines.

The IBM 3800 printer system is a current example of a batch output engine, although still rudimentary compared to what will come. The flexibility of this device, both in font selection and print formatting, combined with its self-monitoring abilities and the communications it carries on with its specially trained operator, has suddenly created a printing environment vastly different from what was possible not long ago. Its speed creates a need for new logistical strategies.

Everything has changed in the printer area, and the changes must exactly meet the requirements of the engine. If this engine is to be used to its full potential, further changes are required in programming and in the user's conceptual understanding of when to use printed output, for what purposes, and how. Whole new fields of application will open up for printed output, and new jobs will be created because of this device (the easiest example to grasp being the creation of new print fonts).

Another example is the data base engine. It will displace the bulk of I/O programming; the orders transmitted by the host will be logical data references. Even the data base engine will deal symbolically with physical data, which in turn will be managed by the hierarchical storage engine. Only at this level, totally provided by the vendor, will device characteristics enter into the issuance of orders for data references. Neither the data base engine nor the hierarchical storage engine will be programmed by the user. The data processing staff will have to adapt to these en-

gines, and perform their human functions accordingly.

Some of the engines will be topographical, meaning they will service end users in a manner consistent with the end users' various environments and disciplines. A topography mapping engine will match user inputs and outputs (through terminals of various specialized types) with appropriate data conversions, language compilers, and translators. There will be topography mapping engines for data entry personnel, on-line programmers, design engineers, nurses, bank tellers, auditors, police, etc. Language translation, program compilation, and data conversion all will go on completely outside the host.

The functions of the host primarily will be control of the system itself, the

The optimization rules followed by the host will be the goals and strategies of the organization as specified by management.

users, and the conversions between data and information based on the topography being served and the needs of the data base engine. These conversions will be the functions of the applications programs.

Notice that most of the functions listed for the host in Fig. 1 are what today is thought of as "overhead." These functions will no longer be considered overhead, but the very essence of what the business needs performed in an automated way. They will be so complex that the full power of the host will be required to perform them.

The combined discipline of the topographical engines and the controls exerted over them by the host will establish which end users may approach the system, when, how, and for what purposes. The system will demand that those users follow prescribed rules deemed suitable for their environments. Management will initially prescribe the rules, with user participation; from then on the system will require that they be followed. The structure and procedures will remain under management's control, but management will have to comply with the structure of the system.

Will Phase 3 be like this?

In Phase 3, the functions of the host will be expanded even more. With very large memories and new memory access logic, the host will be able to optimize the system structure, and the user topography, in order to react to recent inputs describing the outside world. The system will guide the users in their own environments, leading them to provide it with new data and programs (in the general sense).

The user program, for instance, might be a statement of what to do in some area of the business, based on what has been presented by the host. The host, in turn, might have limited the user's choices, based on what it wants optimized. (The optimization rules followed by the host will be the goals and strategies of the organization as specified by management.)

By changing topographies the host will change the structure of the organization, and by guiding the users, the host will change the procedures they are following. The users will then implement nonautomated procedures corresponding to what they have reported to the host. Since their reporting will be the result of guidance by the host, it is fair to say that even nonautomated procedures will be monitored, controlled, and, in some cases, specified by the computer system.

At some point during this third phase, the ability of computer systems, storing the accumulated wisdom of the business, to run organizations according to sets of optimizing rules will be so great that no one person, not even a group of technically competent people, will be able to understand the patterns of procedures and methods being interwoven automatically. At that point, the system will provide the organization structure, set the policies, and direct people in their supporting functions.

The number of managers will be reduced, and their function will at last become the determination of the organization's goals and the strategies to be employed in reaching them—not a bad ending at all. *

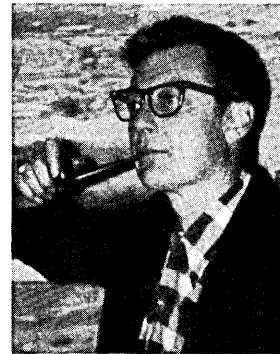

Mr. Steely began his computer career as a programmer trainee with RAND, working on the SAGE system. That was 20 years ago. Now he is an independent consultant in Virginia. In the interim he has been a programmer (SAGE, AN/FSQ-7, Bendix G-15 and G-20, roll-in/roll-out support and RJE for the direct-couple IBM 7040/7094, etc.), a systems analyst (banking data collection, disc remote operating system, etc.), computer salesman (Bendix), educator, and manager. He has worked for RAND, SDC, Bendix, General Dynamics, ITT, IBM, and Communications Corp. of America.

Processor growth: can your small computer make the upgrade?

Product	Our HP 1000 and 21MX Computers	Your old favorite
Computers	<p>21MX computers, with memory capacity of 1.8 million bytes, speeds up to 350 ns, and user microprogramming. All have compatible architecture, instruction sets, I/O and memory.</p> <p><i>K-Series</i> computer on a board: \$974*</p> <p><i>M-Series</i> low-cost computer: \$2,698*</p> <p><i>E-Series</i> high-performance computer: \$3,803*</p> <p>Instructions 70-100% faster than M-Series.</p>	
Systems	<p>HP 1000 includes 21MX-E computer, CRT console with soft keys and dual cartridges, RTE operating system. Fault control memory available to 1.8 million bytes. Easy to upgrade as your needs expand, with full selection of HP manufactured and supported peripherals.</p> <p><i>Model 20.</i> 64K-byte memory-based systems: \$21,000. 500K-byte flexible discs optional.</p> <p><i>Model 30.</i> 64K-byte disc-based system, 15M-byte disc storage: \$36,500. 5M and 50M-byte discs available.</p> <p><i>Model 80.</i> 128K-byte data base management system with 15M-byte disc storage. HP-developed IMAGE DBM software, mag tape and line printer: \$61,700. 50M-byte discs available.</p>	
Software	<p><i>One upward-compatible family of Real Time Executives:</i> RTE manages 1.8 million bytes of main memory. BASIC, FORTRAN, Assembly and Microprogramming languages. Distributed Systems Networks. Measurement and control support.</p>	

*OEM quantity 100. All other prices U.S. domestic list.

If you've been having trouble making the upgrade with your old favorite, it's probably time you got a new one. So call your local HP sales office listed in the White Pages. Or write to Robert Puette, Hewlett-Packard, 11000 Wolfe Road, Dept. 412, Cupertino CA 95014. We don't think anyone should have to live with an incompatible family.



HEWLETT  PACKARD

IT'S THE HARDWARE. That big 5 or 10 Megabyte cartridge disk could be the clincher. Or the bipolar CPU with its popular 8080 instruction set. Maybe it's the 32K bytes of memory, the Keyboard/CRT or the 132 column serial printer. Or maybe it's because they all come together so you don't have to make hardware decisions. **IT'S THE SOFTWARE.** That commercial Enhanced BASIC language makes it so easy to work with. The Disk Operating System with ISAM files gives it large computer file handling capabilities. The Relocatable

Assembler, the Linking Loader, the Editor...they all add up to a highly sophisticated, flexible software suite. All you have to do is add the applications package and it's ready. **IT'S THE PRICE.** If you can handle your own applications software and maintenance, the System 800 which starts at \$14,995 with significant OEM quantity discounts available, is an OEM bargain indeed.

Want to know more? Call or write us today for full details.



What makes System 800 such an OEM bargain?

...it's the hardware!

...it's the software!

...it's the price!

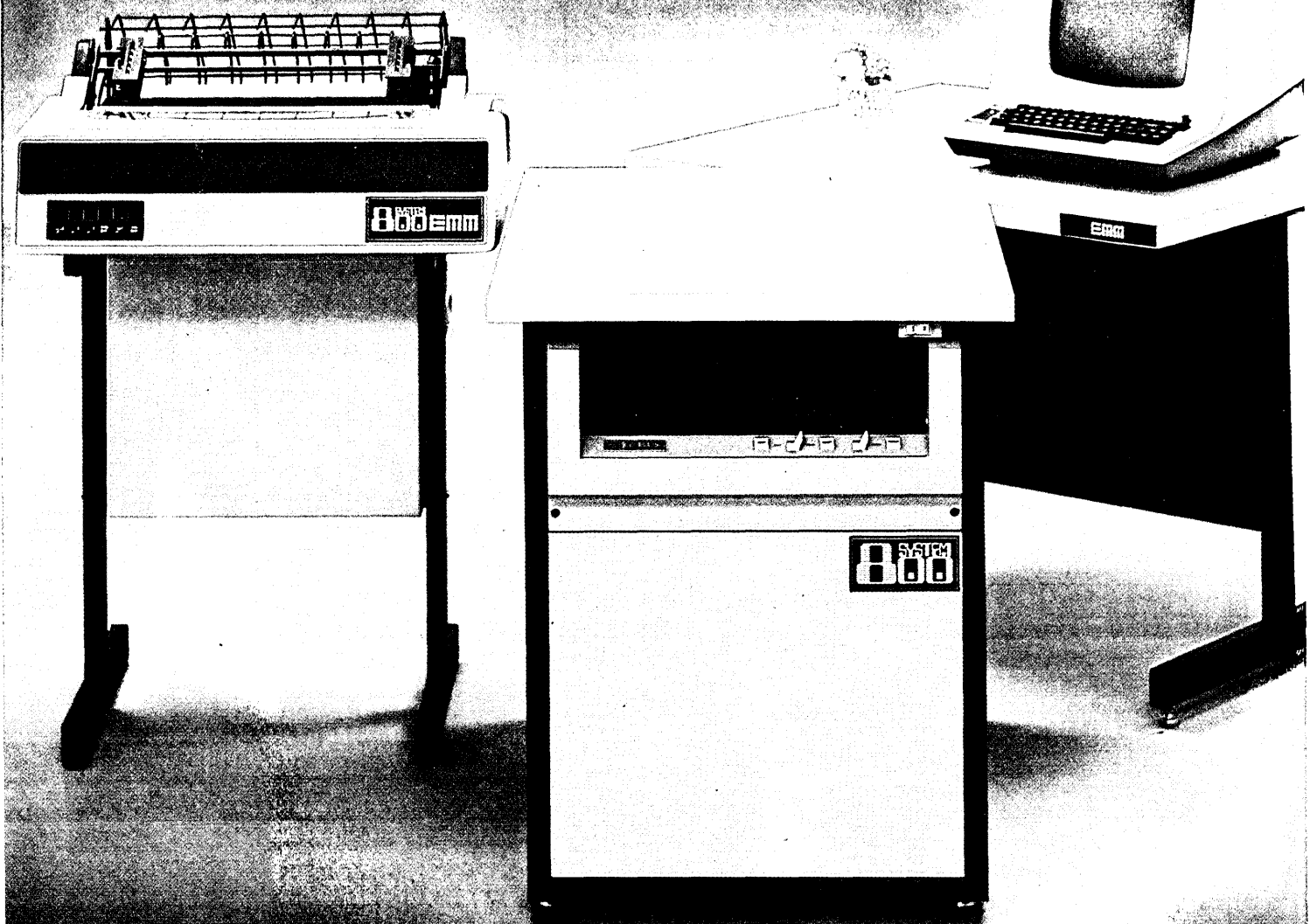

Electronic Memories & Magnetics Corp. 12621 Chadron Ave., Hawthorne, CA 90250. Offices in: San Diego Area (619) 598-0705; New York Area (516) 423-5800; Boston Area (617) 861-9650; London, England Area (01) 751-1213.

Finance

Technology Is Not the Problem

Speakers at high technology conference note that hang-ups of high technology companies are not technology related

"In electronic information handling, as in many other frontier areas, the speed of obtaining the benefits of advanced technology is not set by the technology, but rather by the complexity of the organization problem."

This comment by Dr. Simon Ramo, vice chairman of the board and chairman of the executive committee, TRW, Inc., in the opening talk at a high technology conference held last month in Los Angeles by the Financial Analysts Federation, more or less set the tone for the entire conference. Speaker after speaker noted that the big hang-ups of high technology companies are not technology related.

"It's a question of when the economics match the applications," said Dean Gillette, executive director, systems re-

Home computers will have to compete with things done in the home already.

search, Bell Telephone Laboratories, in talking about advances in bubble memories.

Ryal Poppa, chairman and president of Pertec Computer Corp., said one portion of the home computer market, that for a home utility controller, "is not a now market and won't be much of a market for another five years because of tremendous inertia, antiquated laws and building codes in our country."

Ralph K. Ungermann, executive vice president, Zilog Corp., said home computers will have to compete with things done in the home already just as electronic games have to compete with traditional games.

Regulatory problems

Frank P. Barnes, senior vice president and product group manager, telecommunications products and systems, International Telephone & Telegraph Corp., called Britain's upcoming Viewdata service (March, p. 213) the forerunner of the home information center but noted that regulatory problems hinder development of such a service in the U.S.

David Leeson, president, California Microwave, Inc., talked about electronic mail. He said this would come first in

countries where the post office and telephone operations are together. "Revolutions," said Leeson, "are only possible when you can throw stuff away and in telecommunications this is slow." He said the phone company, when it introduced Touchtone telephones, charged extra for them because they wanted to stave off a demand which would mean throwing away a lot of dial telephones. "We," he said of his company which sells telecommunications products to AT&T, "benefit more from minor changes in AT&T's buying habits than from explosions in new technology."

Paul Visher, vice president and assistant group executive, space and communications group, Hughes Aircraft Co., predicted major changes in the participation of U.S. telecommunications companies in world markets. "We have basically had our hands tied behind our backs in world markets," he said. "All other countries subsidize but AT&T is getting in now"—without a subsidy.

A threat from abroad was seen by Charles E. Sporck, president of National Semiconductor Corp. He warned that the U.S. semiconductor industry will be



DR. SIMON RAMO
"... the organization problem."

destroyed within ten years unless the federal government institutes and enforces free-trade rules for Japanese-made products.

"Successful domination of markets by Japanese companies has weakened or destroyed the corresponding industry in the U.S.," he said. He cited as examples

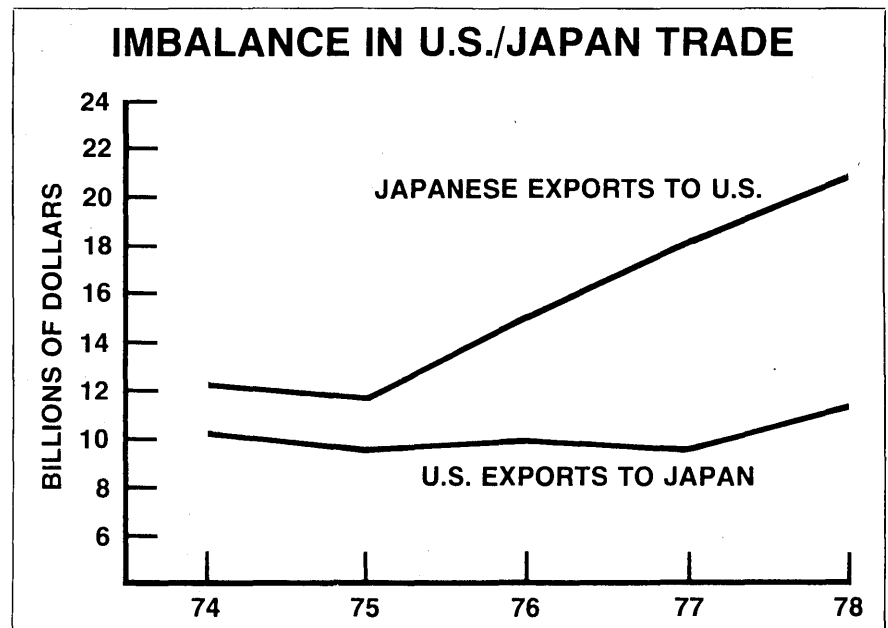

A THREAT FROM JAPAN? Charles E. Sporck of National Semiconductor Corp. warns that the U.S. semiconductor industry will be destroyed within 10 years unless the federal government institutes and enforces free-trade rules for Japanese-made products.

news in perspective

steel, motorcycles, CB radio, hi-fi electronics, tv receivers, sewing machines, calculators, and various passive electronic components. The tactic most often used, he said, is "predatory pricing."

The prime target

Sporck said Japan's prime target today is the data processing industry. "Domination of the semiconductor market in the U.S. is only a part of an overall strategy that intends to gain control of the computer industry in this country." He said Japan's Ministry of International Trade has organized the computer industry into two groups: one that is developing equipment compatible with IBM computers, and another which is devel-

"We benefit more from minor changes in AT&T's buying habits than from explosions in new technology."

oping more advanced non-IBM equipment. "Clearly, IBM and every other computer manufacturer in the U.S. are under attack."

Sporck said the Japanese semiconductor industry enjoys several business advantages denied to the industry in the U.S., including: a 12% import tariff in Japan versus a 6% import tariff in the U.S.; easy access to the U.S. market because of well-developed and non-captive marketing organizations already in existence here, as opposed to difficult access to the Japanese market for U.S. firms; Japanese companies are free to establish small developmental companies in the U.S. for the sole purpose of gaining access to American technology, while it is next to impossible for U.S. firms to do this in Japan; Japan's patent procedures are difficult and restrictive, while patent policies in the U.S. are liberal; in Japan, semiconductor industry business and technological developments are coordinated by the Japanese government to minimize duplication, while no such coordination exists in the U.S.; large subsidies are provided to semiconductor companies for development work consistent with Japanese government policies and profitability of Japanese companies apparently is not necessary as long as their efforts are consistent with government policies, whereas U.S. companies must either be profitable or cease to exist.

Equality of trade rules rather than protectionism is what he advocates, Sporck said. He said his company and the others in the semiconductor industry

in the U.S. are strong proponents of free trade and therefore are not directly asking for an increase in tariffs on Japanese-made semiconductors.

Instead, he said, he recommends a modification of the trade rules that apply to Japan. He suggested a balance of trade agreement in which imports of Japanese-made semiconductor products be made equal to U.S. exports of the same type of product to Japan. "In no case should anything less than equivalency be required."

Sporck also recommended liberalization of the capital gains tax structure in



RYAL POPPA

"... his own computer."

the U.S. to provide incentives for companies to gamble on innovative technologies that would otherwise go untried.

New kind of company

On another note, Pierre Lamond, vice president and technical director of National Semiconductor, predicted the emergence of a new type of company merging semiconductors and systems. "Companies that recognize the evolution will grow."

Both Lamond and Dr. Gordon E Moore, president and chief executive officer of another semiconductor firm, Intel Corp., said their companies are now investing in software development. "It's new to us but necessary," said Lamond, "and we're applying dollars."

Carl Carman, vice president, engineering, Data General Corp., said he sees several semiconductor manufacturers as potential competitors. "I believe we're going to meet the semiconductor firms first in low level products."

Harold O'Kelley, chairman and president of Datapoint Corp., wasn't as worried about the semiconductor companies. "We're in the end-user business. We offer risk leasing and we have an extensive service organization. It's a much bigger nut to crack. They could use their monies better."

And monies are not being spent in

such great quantities for technology as at least two speakers indicated. Moore of Intel said a standard response to any particular set of circumstances in the semiconductor industry is, "lower the prices."

Dramatic reductions

Erich Bloch, vice president and general manager, Systems Product Div., IBM, said "an ever-widening use of computers—in business, scientific and personal applications—can be attributed, in part, to dramatic reductions in the cost of producing the electronic circuits used in them."

Bloch said cost reductions in computer technology were the result of: a better fundamental understanding of the materials used in manufacturing circuits; the development of automated, computer-based design techniques; new and sophisticated manufacturing tools and ad-

"A standard response to any particular set of circumstances in the semiconductor industry is . . . lower the prices."

vances in techniques used to package increasingly dense circuits.

Bloch was talking about big computers like IBM's 3033. He was asked if the demand for such machines surprised IBM. He didn't speak for the company but did say, "It surprised me." He also was asked if IBM had the semiconductor capacity to satisfy memory needs for the big machines on order. His answer: "For the machines we are shipping, we have enough, yes."

O'Kelley of Datapoint said he sees the "electronic office as where the market is going and we intend to participate." He likes the term dispersed data processing as opposed to distributed data processing and that is the route he hopes will get Datapoint into the "office of the future."

Poppa sees small business computer use as the white hope of Pertec but he feels that DDP (whether it be dispersed or distributed) has a heavy overlap with small business systems. "It will be calmly accepted as one industry in the not too distant future."

No talk then

He noted that Pertec, in 1974, launched a campaign to get into the small business computer market "but we didn't talk about it then."

In 1975, he said, "we acquired Computer Machinery Corp. In 1976, we acquired Icon, a manufacturer of microprocessor peripherals, and in 1977 we acquired MITS, producer of the hobbyist computer, Altair, and we've been moving them out of the hobby market as fast as possible. We want to be ready for the

market of the '80s. With the three acquisitions we picked up systems knowledge, extensive software capability, support capability, and a new distribution outlet called stores."

Poppa doesn't want Pertec in the hobby market, which he considers a "now market but very price sensitive," or the home utility controller market, which he feels is hampered by existing laws, or even the home clerical market, although he has a computer of his own for this purpose. "I got mine for a slightly different price than most people would pay." He sees this kind of computer use as being a long way from cost justified,

although he does allow "it has a lot of pizzazz."

Poppa believes, for Pertec at least, that the small business systems market is it. "The market potential is great. The downside risk is small. And there's a unique reason why it's good for PCC. Look at the hardware content. Eighty percent of the cost is peripherals and we have historically been a peripheral manufacturer."

But, he still has his own home computer. He's enjoying it and so, he says, is the rest of his family.

—Edith Myers

World Markets

Why IBM Must Withdraw From India in June

The company was trapped by its past—by a history that to many Indians reeked of near-colonial exploitation

New Delhi—

IBM's November announcement that it would withdraw from India in June came as no surprise to those who had watched the development of the crisis. There were still on-going negotiations through the first half of last year, but in 1976 India had already set up a public corporation with the implicit purpose of taking over IBM's maintenance and support functions—and for over two years India had prohibited IBM imports pending resolution of IBM's status under a 1974 law requiring shared or minority foreign ownership in trading corporations.

Both sides seem to have framed absolute positions. India's 1974 Foreign Exchange Regulation Act (FERA), designed primarily to force British firms out of their lucrative middleman slot in the tea, jute, and fiber export industries, and replace them with corporations which would not repatriate profits, demanded that trading firms surrender majority control to Indian nationals. IBM, fearing a breach in its 100% ownership policy would open it to challenge in far more important markets (e.g., France), refused to bend, and argued that only a wholly integrated, wholly owned network of international subsidiaries could maintain the fabled deficiency, technological prowess (and profits) of Global IBM.

Yet there was room for movement within both positions—at least so far as the letter of the law and a pragmatic appraisal of corporate policy were not hampered by bias, hostility, and distrust.

The FERA legislation had been written with loopholes for just such an exception: the Indian government could legally have exempted a foreign corporation that significantly enriched the econ-

omy and culture, either through technological input or foreign exchange earnings—or more likely and politically feasible, demanded only a fractional dilution which would leave majority foreign ownership. IBM had developed an intriguing proposal which offered India increased foreign exchange earnings through a reorganized Indian corporation and an IBM research center (to be funded with a percentage of IBM-India's post-tax profits) which the company

The room for movement was there, but both sides seemed hobbled in their ability to exploit it.

claimed "effectively simulates the profit retention aspect of equity dilution." In a small but symbolic gesture of concession, IBM also offered to turn over 60% equity in its four antiquated Indian service bureaus to IBM-India employees—the first time [allegedly] IBM has conceded equity in any of its worldwide operations.

Neither could exploit it

The room for movement was there, but both sides seemed hobbled in their ability to exploit it. In India, IBM was trapped by its past, by a history that to many Indians reeked of near-colonial exploitation. It may well have been impossible for the multinational to avoid some equity dilution, given the anti-big business tone of the post-Gandhi government—although IBM's dominance of the Indian dp scene gave them heavy cards to play, had their image been a mite cleaner—but even with Gandhi's more sympathetic Congress Party government,

IBM was being held to account for its past policies.

IBM-India probably was doomed so long as Armonk held to its policy of 100% ownership, but if it was here IBM had thought to bend, the animosities the company itself had seeded would have made accommodations much more difficult than would otherwise be the case.

The stage for confrontation was set by the ever more competitive pressures of the international market, where a host of companies, American and foreign, are only too willing to accept deals at which IBM would balk for a share in India's estimated \$50 million computer import market. More parochial considerations were also important elements in the crisis: the post-colonial defensiveness with which India still views present foreign power; India's proud self-image as a culture above the breakthrough level of technological competence; and the Byzantine political pressures in both the Gandhi and post-Gandhi governments. Yet the stateside questions of how India could risk so much, think it had so little to lose, are intimately tied to the Indian government's surprising refusal to classify IBM as a technology source eligible for special consideration by FERA.

A dumping ground

Since its 1952 entry, IBM has become deeply entrenched in India, with nearly 1,000 systems installed. But IBM had dominated Indian computing with something less than its top-of-the-line equipment. Of those 1,000 IBM systems, there are but two IBM 370s and only six 360s. The rest are virtually all refurbished IBM 1401s, mostly machines that were obsolete in the developed world even before they were rebuilt for India, guaranteed "as is" and priced as new. IBM, the Indians charged, tried to pace Indian dp one generation behind the West so as to use India as a dumping ground for computers discarded elsewhere. The charge, which lies at the heart of India's IBM passion, is disputed by corporate IBM but conceded by many Indian nationals who were IBM-India executives.

"The first computers were imported into India by Esso in 1961—1620s and 1401s," recalled a former IBM staff manager. "That was pretty good; great in fact. Those were then fairly current machines. But when, in 1968 and 1969—with the 360 already four years old—IBM was still pumping 1401s into India. . . . Well, then it's not so great."

Where's the 360?

In 1968, IBM-India gathered its management level staff at the Ashoka Hotel in New Delhi to hear a Watson emissary from the States explain the U.S. antitrust suit against the company. After the presentation, the floor was open for questions, and one rash young manager stood and put the question directly to the home-office man: "Why haven't we in-

news in perspective

roduced the 360s into India? Why . . . ?”

The local general manager was on his feet to interrupt. The questioner “damn near got fired on the spot,” recalled an IBM veteran in attendance, “but the manager said, ‘Now you don’t have to answer such questions from this gentleman. We know what we’re doing. Everything is being done according to our plan!’”

“And sure it was clear what they were doing. They were waiting for the 360s to be returned, to be shipped here and refurbished. That,” said the twenty-year IBMER, sadly, “is when I first started worrying about the company’s long term policy in India.”

The 1966 devaluation of the rupee still remains a bitter memory for many Indian users. The devaluation was mas-

sive—57.5%—and IBM contracts were priced in dollars. Overnight, all customers had to pay 57.5% more in rupees for their machines; in fact, at the same time, IBM chose to hike the support charges. IBM had its worldwide pricing, “but the customers knew these weren’t new machines,” recalled an Indian on the IBM staff at the time. “These were used, returned, and refurbished machines that had already paid for themselves. There was no added dollar value, yet overnight the bills we sent out in dollars were more than 50% higher.”

IBM wouldn’t budge from world pricing, he said—until a couple of years later, “when the dollar began having problems,” the pricing shifted from dollars to rupees.

No reply

Present IBM officials in New Delhi refused to be interviewed, but IBM-India’s regional director, T. B. Finn, is quoted as denying angrily the charge that IBM refused India modern technology. On three occasions, a U.S. Embassy trade official reported, IBM had offered to “bring in the designs for, and manufacture in India, the latest IBM computers: the series/360 in 1962; the series/370 in 1973; and the 370 again in 1976.” According to Finn, said the diplomat, “the government of India had not even afforded IBM the courtesy of a written reply to those proposals.”

It was, apparently, too little too late: To the Indians, in a way the innocent Embassy official had not understood, the 1972 offer of 360 technology was an insult—a proposal whose inauspicious timing would freeze the image of IBM-India to this day.

“IBM proposed to bring in 360s just as

EROSION EXTENDS AROUND THE WORLD

In a world of wildly fluctuating currencies and growing dependence on foreign technology, many developing nations are reaching out to gain control over their economic and industrial fates. The multinational is a logical target, especially IBM, which has the lion’s share of the computer market in most countries of the world.

Nationalization or mandated local ownership of industry is not rampant, but it is growing.

In Indonesia, IBM was allowed to form a new 100% owned subsidiary, but it would be represented by a trading agent that was 100% Indonesian owned. In Nigeria, the Nigerian Enterprises Promotion Decree includes computers and data processing services as industries in which at least 40% of ownership must become Nigerian. A U.S. Commerce Dept. source claimed that IBM’s employees had proposed taking over its operations there, but IBM won’t comment.

Malaysia is another nation with long-term ownership policies, where by 1990 the percentage share of equity holdings in the country by foreigners must decline to 30% from the present 60%. Member nations of the Andean Common Market (ANCOM) in South America—Bolivia, Colombia, Ecuador, Peru, and Venezuela—also have long-term requirements for majority local ownership, in which firms that have been in these countries before the year 1974 must increase local equity participation up to 51% if they wish to take advantage of tariff reductions.

In February, Brazil announced that it had chosen four local companies—all with foreign affiliations—to take over in effect the entire minicomputer and small systems market. This was no small blow to a host of U.S. and European vendors.

The companies Brazil chose were Cobra (Computadores Sistemas Brasileiros S.A.) which has a technology agreement with Sycor, Ann Arbor, Mich.; Sharp Equipamentos, linked to Logabox of France; Electronica Digital S.A., working with Fujitsu; and Lab Electronica, associated with Nixdorf Computers of West Germany. Bids from Burroughs and IBM were rejected because they wouldn’t go along with local ownership requirements.

The Commerce Dept. has issued statistics that might give a clue to the loss of market by U.S. computer vendors there. It claims that by 1980, 7,150 minicomputers will be installed in Brazil, compared with 2,266 installed in 1975. It also says 3,200 small computers, ranging in price from \$30,000 to \$179,000 will be in place in 1980, compared with 1,052 in 1975. Before the Brazilian decision the Commerce Dept. was estimating a market of \$6.6 million in minis in Brazil.

IBM, of course, stands to lose a great deal in Brazil. It had 59% of the small-computer market in mid-1975. It made System/32s in Brazil, but these were to be exported only. IBM says these will have to be phased out because of the Brazilian decree. The *New York Times* in a recent article indicated this will

cost the computer giant \$100 million in exports during a five year period. Burroughs, which according to the Commerce Dept. had 42% of the Brazilian minicomputer market in mid-1975, and 11% of the small-computer market, will be heavily impacted.

Meanwhile in South Africa, U.S. firms can no longer sell computers to military and police agencies. Early this year, the U.S. extended that embargo to include the sale of “machines, parts, and unpublished technical data of U.S. origin” to these agencies.

Hugh Donaghue, a Control Data vice president, said at a recent meeting in Washington of the Computer and Communications Industry Assn., that although U.S. firms respect the embargo on sale of new systems, they are opposed to the most recent edict concerning spare parts, “where we have already legally contracted to provide services and spare parts.” He noted that Siemens, the German supplier which withdrew from the South African market three years ago, “just announced that it would reenter the South African market.”

IBM says it will continue to service tabooed government departments “on a restricted basis” from its overseas plants, although a recent story indicating the giant had shipped parts to South Africa was denied by IBM.

And vendors now are thinking, “with friends like the U.S. government, who needs enemies?”

—Angeline Pantages

the 370 was being introduced to the rest of the world," said Professor M. G. K. Menon, chairman of the Indian Electronics Commission and the most influential ministerial advisor on the IBM case. "It was exactly as the 370 was being introduced to the rest of the world. Exactly. In fact, the 360 proposal was largely based upon old machines being imported and refurbished."

"With the 360 already four years old, IBM was still pumping 1401s into India . . ."

In 1973, the electronics commission used its own authority to stop the leasing of refurbished machines. "We didn't think that that would be the best way to take India forward," explained Menon dryly. "We wanted current technology, modern methods of application." And by the early '70s, the Indian government had decided "that we didn't just want to be a place where you sell computers, market them, and maintain them. We," said Menon, "wanted very much more than that."

Assembly, not technology

Even IBM's proposals on 370 technology were insufficient to satisfy India's ambitions. "That was a disappointment, a real disappointment for me," said Menon. "Again, it would have been just assembly—assembly from the basic components. . . . Now, practically speaking, that is not high technology." For purposes of FERA consideration, he said, "I would call it high technology if IBM set up a semiconductor plant. If, from raw materials, they actually made peripherals. Cutting metal. Not just putting things together and testing them. Something more than assembly! We have plenty of assembly going on in India."

Few targets were more prominent when the reform Desai government was elected with the downfall of Indira Gandhi. Gandhi's Congress Party, so long the ruler of India, was closely identified with big business, corporate favoritism, and corruption. Key officials in the new government—Mohan Dharia, the minister of Commerce, and George Fernandes, Minister of Industry—came into office sworn to purge India of greedy multinationals who had allegedly sucked upon the nation with the connivance of the Gandhi clique. IBM—the Yankee megafirm that always managed to locate its offices in over-priced properties leased from major Indian newspaper publishers, as many Indian journalists noted grimly but privately—was a most prominent target.

No one to stand up

"The net effect of IBM's policies here—some of the holier-than-thou, and much

of the mightier-than-thou—was that when it came down to it, IBM had very few friends in the ministries," said a former IBM-India executive ruefully. Even in the government user population (more than a third of IBM-India's clientele), "there was no one willing to stand up and say don't do it . . . IBM tried harder to integrate itself into tiny Thailand than they ever did in India," he said. "And at least two people who had bad experiences with IBM as important government users were eventually to sit on the FERA board that decided its fate." (In one case, IBM had refused a claimed rebate on a leased machine which had been down for three days. "You can't do that to important government users," recalled the former government manager, "but IBM did it here.")

Trouble with taxes

IBM officials here claim that in the 25 years IBM did business in India, the firm had taken profits of only \$5.5 million on an investment of \$12 million—both figures difficult to take on face value, without some analysis. But the cost of IBM's withdrawal is expected to run at over \$6 million, according to a well-informed IBM source.

There are many businessmen from the front offices of the user group who will sorely miss the reliability and fidelity of IBM support.

Lingering headaches: IBM, having paid \$59 million in Indian taxes, now faces a prolonged legal battle over new Indian tax claims that IBM's inter-company transfer pricing for electromechanical units exported from IBM's small Bombay plant undervalued the products (although "underpriced" import of components at transfer pricing is not challenged). And the company is still trying to collect \$5.5 million owed it for duty-drawback on components imported, assembled in Bombay, then exported.

The overall impact of IBM withdrawal is still very difficult to foresee, but if there are few ardent IBM partisans among the hackers in the user populations, there are many businessmen from the front offices of the user group who will sorely miss the reliability and fidelity of IBM support. Much of the worries about maintenance for IBM systems now focuses on CMC (the Computer Maintenance Corp., Ltd.), the government-owned company that will put its new management, an untried infrastructure, behind most of IBM's present engineering staff (rehired by CMC) to take over IBM support function on June 1. Trying to establish a solvent nonprofit maintenance operation to pick up perhaps 900 computer systems overnight

and provide raw maintenance and basic support at reasonable costs undoubtedly will be a major challenge, but the real test—the real risk taken—lies in India's attempt to redesign the patterns of accountability between user and vendor, interjecting government agencies as powerful arbiters.

There seems to be a dangerous tendency among Indian officials to under-

"I would call it high technology if IBM were to set up a semiconductor plant."

value the accountability that in the past has linked proper sale, full support, and maintenance, to future sales. IBM's policy left the client's salesman with ultimate responsibility for user support, education, and upgrade—and it's a responsive system that works, even if it was only partially implemented in India. The big test for post-IBM Indian computing is whether India's notoriously lethargic bureaucracy can preside over the efficient development of Indian computer users in a manner that approximates a vendor's sales-motivated standards of accountability, sensitivity, and reliability.

The underlying functions of vendor marketing seem woefully undervalued by Indian officials; and the impact of procurement policy decision—spreading Indian computer buys over a wide spectrum of vendors, East European, European, and American, to avoid the sort of dependence the nation had on IBM—may have serious impact in the very service areas which the Indian system removes from direct vendor-user accountability.

Not only IBM

"The history of IBM in India is long and complicated, a story with many nuances to it," declared Prof. Menon, IBM's chief adversary and now virtually godfather to India's new computing scene. "It's a very complicated story looking back, but at this point, on the issue of IBM leaving India, the story is almost completely tied up in our Foreign Exchange Regulations Act. And, as you can see, that is not just being imposed against IBM. Philips is coming down to 40% (equity) from close to 60%. ICL had a 60% manufacturing firm and another 100% company; now both of them are being merged and they're bringing it down to 40%.

"So, it's not an IBM law. Philips is Dutch. ICL is British. We've been doing a fairly objective job. On the other hand, we've just pushed through a proposal for an American company, Burroughs, to go into an equal partnership with Tata (a Parsee Indian firm), for a highly export-oriented manufacturing program for peripherals. . . . I definitely want to scotch

news in perspective

any suggestions of dealings that (IBM's withdrawal) is the result of anti-American sentiment in India! Nothing like!"

Could there have been a deal worked out, Menon was asked. How much leeway could India give IBM?

"What might have been feasible," he said, "is that if IBM could have relaxed the 100% and said we're willing to come down to anywhere below 74% . . . you see, under FERA we have several levels. Above 74 is very difficult, but below 74 is feasible. I mean, if they were willing to say 'OK, we're willing to relax our world policy and be at 74,' that may have

worked. Provided they were willing to give us something that had in it hard evidence of high technology, something involving R&D here, foreign exchange earnings, future potential. I think above 74 would have always been difficult. It would have to have been backed up by really unusual offers. . . . But from 74 it would have been very possible."

—Vin McLellan

(Boston bureau manager Vin McLellan recently returned from India where he interviewed individuals close to the history of IBM's withdrawal from that nation.)

the marriage of word processing and data processing. However, he feels there has been a double standard in applying communications technology to the computer side and to the office side. "It's best to try to lift that."

Tying together

Bisk talked about Electronic Document Distribution (EDD) which he sees as coming of age with the "promise of wide-

There has been a double standard in applying communications technology to the computer side and to the office side.

band satellite transmission and the use of fiber optics." He mentioned the tying together of text editors in a network allowing for remote site revision and being good for "levels of approval."

He foresees more computer controlled networks, including word processing, permitting use of the storage capacity of a cpu to store very large documents.

Word Processing

Meeting of Many Minds

Who takes part in a typical evaluation of word processing?

"Data processing is deciding we really need those people down there," said Bob Rask, manager of industry marketing for IBM's Office Products Div.

The people down there to whom he was referring are those in what is commonly considered word processing. Rask thinks word processing and data processing are coming together. A coparticipant with Rask in an IBM sponsored seminar on word processing, Albert L. Winegar, division director of management services for the IBM division which produces and markets systems in the word processing

"There's always a representative from the data processing department there when we put our proposals on the desk."

category, said, "Our people don't talk only to word processing. We go to data processing."

Rask agreed. "There always is a representative from the data processing department there when we put our proposals on the desk. He is part of the evaluation group." He said a typical evaluation group could consist of: a vice president, administration; manager of word processing; vice president, finance; and vice president, data processing. Who's going to run the show eventually? Rask thinks "an astute individual from that group."

Richard L. Bisk, the IBM division's product marketing operations manager for communications, would add the network manager to the group. He sees an increasing role for communications in



THIS WORD PROCESSING center at the main office of First Federal Savings and Loan Assn. of Broward County, Ft. Lauderdale, Fla., is one of three for the association. Each uses an IBM 6/450 information processor (left rear) combined with mag card typewriters and 6:5 cartridge systems and IBM dictation equipment.

Order entry applications, he said, offer a good opportunity to combine word processing and data processing. In implementing what he and IBM call EDD, Bisk said the first step is application identification, followed by justification, design, and proving the system is operational.

He said timeliness, cost and importance are the factors to be considered in the justification phase. "Network design is a function of volume and placement of communicating word processors. Develop an implementation plan. Should it be cold turkey or phased? Should testing be done when the equipment is in or before? Should there be a pilot phase? Can the system be expanded?"

Bisk said the IBM Office Products Div. in Franklin Lakes, N.J., currently is using nine different networks incorporating communicating word processors. He said three more are on the drawing boards. "We have others using crt's and other non-word processing terminals. We are using our experience."

Three basic networks

IBM propounds three basic networks for EDD. First is a terminal-to-terminal network where two or more locations have a need to exchange information. This can be used for distribution of priority messages or batches of routine correspondence either within an organization or to other organizations. Benefits include: timely information; reduced paper handling; improved pace of information flow; increased efficiency; remote revision capability without rekeying and faster response time.

Typical applications are electronic distribution of: letters; memos; contracts;

Order entry applications offer a good opportunity to combine word processing and data processing.

specifications; plans and forecasts; manuscripts; telephone conversation confirmations; personnel listings and reports; order confirmations; schedules, and project and program reports.

A second type is an IBM Office System 6 controlled network for communications between a central headquarters and distant branches. Generally, such a network would be used for intra-organization communications and would benefit an entire organization rather than just a function or application. Distribution applications are similar to those of a terminal-to-terminal network with the addition of on-line processing and on-line merging of file and text.

The third network type is a computer controlled network using a central computer to store and transmit information to and from remote locations. This network would utilize a centralized host

computer programmed to take on the characteristics of a protected message switching system, storing and transmitting information to and from remote locations.

Coordination required

The company said it offers a central common control for both data and administrative material and requires coordination between the data processing and word processing personnel of the using organization.

Winegar said the fact that the cost of transmitting electronically is coming down "can save a lot of meetings and a lot of traveling." He became involved in what was then called word processing in 1964. "I wasn't so sure it was a good assignment then." He's sure now and he prefers the term information processing. Whatever it's called he believes it's "where data processing was in the late

"Increased interfacing with data processing to further automate some of our word processing functions is an objective for this year."

'50s. It's a question of penetration. The problem is organization and the acceptance of people."

Dave V. Penttinen, vice president, administrative services, for First Federal of Broward, Ft. Lauderdale, Fla., host for the seminar, seemed to agree. He would like to merge word processing, data processing and communications in his savings & loan but faces a problem. "Executives shy away from hitting a keyboard."

First Federal has an OS 6 which it hopes to interface with its mainframe computer via a Varian front-ender it plans to acquire. Penttinen said he works well with the bank's data processing manager who reports to the same boss he does.

First year savings

Broward installed its first word processing system in 1976. "In our first year with word processing, we achieved considerable labor cost savings despite overall association growth of more than 20%," said Penttinen. "Since then, word processing has become an accepted tool throughout the association. Results have included reduced errors and costs, higher quality in production, faster turnaround, and added job satisfaction."

He said extensive studies conducted by a team of in-house researchers led to an analysis of each department's word processing needs. "We learned that in our context of rapid growth, there were different word processing requirements. Some departments are production oriented; others call for customer corre-

spondence, which means more flexibility. Still others need extensive text editing and the ability to cope with technical materials."

The study team's report indicated a need for three word processing centers: one for the loan services department, another for the main office, and a third for the bank's service center building. These were established.

"We expect to keep expanding word processing into new areas," Penttinen said, "including the loan origination dept. and the special services area, which includes the mail room, various new customer service areas as they occur, and branch services. Increased interfacing with data processing to further automate some of our word processing functions is an objective this year."

Cadillac's complaints

Rask told how some other IBM customers are using word processing. Cadillac Motor Car Div., he said, uses an IBM WP 32 to archive complaints. When a customer writes a complaining letter, Cadillac will write back telling him what needs to be done and will also write to his dealer with the same information. If the customer takes no action and subsequently has an accident and sues, Cadillac can defend itself by speedily retrieving all the correspondence. Rask said Cadillac used to handle its consumer response on a big system but "moved down so they can react quicker and it didn't bother the data processing people."

Consumer response, said Rask, has become a big application for word processing with the advent of the vocal con-

The fact that the cost of transmitting electronically is coming down can save a lot of meetings and a lot of traveling.

sumer advocates. Using word processing, when a request or complaint is received, a file is created electronically containing the consumer's name, address, nature of the inquiry, response codes, trouble codes and, if applicable, any refund amount. This information is matched with stored paragraphs to automatically build a response document. The information also can be stored for future processing of records, updating the master file, and future mailings to the customer.

One big user of this kind of application, Rask said, is Betty Crocker Kitchens which receives anywhere from 250,000 to 3 million pieces of mail each day and answers them on a daily basis. And, he said, the Betty Crocker system also cuts refund checks under the firm's "double your money back" guarantee.

—Edith Myers

Service Bureaus

Hardware From the Service Firms

National CSS offering a 'megamini' and others will resell DEC 2020s

Any doubts that the big computer service firms intended to move aggressively into the hardware market were eliminated last month as a number of companies announced plans to remarket DECsystem-2020 computers and National CSS unveiled plans to introduce a 370-compatible megamini called the 3200 series.

Automatic Data Processing, of Clifton, N.J., launched a major program to offer the 2020 to customers as an in-house processor that would be linked to ADP's time-sharing facilities. Tymshare, Inc., of Cupertino, said it aims to move customers from its shared DECsystem there to their own machines without considerable reprogramming and will do this with a 2020 sometime in the late spring. Rapidata, CompuServ and Dataline Systems Ltd. all plan to acquire DECsystem 2020s this spring and summer for the same purpose.

And while these announcements represent a major commitment to hardware sales as an integral part of their time-sharing offerings, the NCSS project is, in scope, the most ambitious undertaking.

In effect NCSS is gambling it can emulate IBM's SBS strategy—combining data communications, hardware, distributed processing, and software all into one

NCSS gambles that it can emulate IBM's strategy for SBS—combine data communications, hardware, and distributed processing in one package.

package—long before the giant computer manufacturer ever gets SBS off the ground.

\$16 million system

Toward this end, NCSS has spent \$16 million developing a system that will compete head-on with the largest DEC, Data General, Hewlett-Packard, Interdata, and Prime offerings, and serve as a 370 replacement. Importantly, also, the company intends to apply sometime this summer to the Federal Communications Commission for permission to compete as a specialized communications carrier providing a national packet-switched network. That network is already operational, and NCSS only needs a green light



WEISSMAN AND MCGUIRE OF NCSS
A 370-compatible megamini
called the 3200 series

from the FCC to put it in business, company president Robert Weissman says.

The introduction of the 3200 and its commitment to the data communications market represent significant steps for NCSS, which in fiscal 1978 (NCSS's fiscal year ends Feb. 28th) has seen revenues jump more than 16% over last year's \$41 million plus figure and pretax profits increase about 34%. To accommodate this growth and its new ventures, the company has moved into new corporate headquarters in Wilton, Conn. Concurrently, its former headquarters in nearby Norwalk have been converted to a base for the firm's newly formed computer division—a group that will be headed up by 34-year-old former IBMer James McGuire, who previously took NCSS's data base management system NOMAD from ground zero to over \$8 million in sales.

Compact controllers

Unlike ADP, which is buying DEC hardware off the shelf then reselling it, NCSS has manufactured its own machine through a subsidiary of U.S. Phillips Trust. This approach is a definite plus in the company's favor, McGuire claims. Specifically, by producing its own 370-compatible megamini, NCSS has, it

claims, improved on the original, designing the controllers to be far more compact than the 370 controllers. "This makes the system less expensive and not nearly as big," says McGuire. "As a result the customer can use it without the computer room environment needed for the 370."

He adds the scaled down megamini is particularly suited for a distributed processing environment, a market NCSS wants to penetrate. "The 3200 could also be used as an extension of a saturated 370, if the 370 owner wants a second machine dedicated to the new, distributed applications for on-line program development," an NCSS marketing paper on the 3200 reads.

Additionally, the 32-bit machine, which sells for about \$200,000 fully configured and is in the 370/135 plus power range, offers multiple language capability, the ability to run all 370 applications, simultaneous time-sharing, RJE and batch capabilities, and virtual memory.

Microcode not a constraint

However, the system's real selling strength is NCSS's existing operational and applications software, the company believes. "With IBM the user has to accept whatever IBM chooses to give him," notes Bob Weissman. "And if IBM decides to change its software or the microencoding embedded in the system, the user has to scramble. But since we produce and maintain our own software, that's not a constraint for us."

Moreover, the lack of constraint may provide NCSS with an edge over some of the PCM's which are vulnerable to IBM's changes. And make no mistake about it, NCSS may be introducing a megamini but its sights are set on a larger target. As Weissman points out, a customer who needs 370/158 power to handle his peak processing requirements once or twice a month, can simply plug into the NCSS network. The 3200 coupled with the packet-switched capability gives a customer the tools he needs to set up his own distributed network, and NCSS's big 370s and Amdahl machines provide him with big system capabilities without the accompanying overhead.

On paper the NCSS strategy makes sense. What will happen in the marketplace is an altogether different question.

—Laton McCartney

A Fresh Start for Wyly Corp.

The name on the door may still read Wyly Corp., but for all intents and purposes the Dallas-based holding company which successfully completed its corporate refinancing last month, might more accurately be called Haeffner & Co.

Though Sam Wyly, the 43-year-old founder of University Computing Co.



SAM WYLY
Only 3%
isn't all that bad

and Wyly Corp., which acts as UCC's holding company, remains as chairman of the board, his once high-flying empire is now under the control of Swiss industrialist Walter Haeffner.

Haeffner, you'll recall, loaned Wyly \$55 million to keep the now defunct

Walter Haeffner now holds 50% of Wyly Corporation.

DATRAN afloat. With the refinancing effort, that debt was exchanged for 5.3 million shares of Wyly stock. That plus the 800,000 shares he already held gives Haeffner—through his Zurich-based investment firm Careal A.G.—50% of the company.

Kason is president

Moreover, John Kason, who reportedly has Haeffner's strong backing and who previously ran UCC's international operations, has been put in as Wyly Corp. president, and he, Haeffner and Haeffner's associate, Werner Schreiber, now comprise three-fifths of the Wyly Corp. board.

Now that the firm's prolonged financial struggle—an experience that former UCC domestic head F. L. "Mike" Harvey, who resigned recently and has gone to Inforex as president and chief operating officer, termed akin to living through

"Chinese water torture"—has been resolved, Wyly Corp.'s prospects look perceptibly brighter.

That, at least, is the assessment of John Kason. To support it, the 55-year-old executive points to his own track record in Europe. From 1972 to 1977—a period when Europe was hit by heavy recession—Kason brought UCC's international sales from \$15 to \$35 million, and its pretax profits from \$1 to \$6 million. In the more stable U.S. market, Kason feels he can do even better.



JOHN KASON
New Wyly president looks at
computer acquisitions soon

Super Computers

Wanted: More Power

No one seems to be working on large scientific computers anymore

Seymour Cray, the designer of superscale computers out of a laboratory in remote Chippewa Falls, Wis., laments that no one seems to be working on the development of large scientific computers anymore. He notes that pioneering efforts in this field ended in the mid-'60s with the Illiac IV from Burroughs, Texas Instruments' ASC and Control Data's Star. "I view these three machines as the last real thrust," he says.

While that does, indeed, seem to be the case, attention was directed to large-scale scientific computation at last month's Comcon 78 in San Francisco, sponsored by the IEEE Computer Society. Rein Turn of TRW Defense and Space Systems Group, said that by the year 1990 it will be feasible to build a uni-processor with a speed of 345 million instructions a second (MIPS). That would

Acquisitions planned

Moreover, Kason says UCC is going to beef up its service operations with new CDC and IBM equipment this year; it will add new software products in its commercial group and take a more aggressive marketing tact in its banking area. It may even make some computer-related acquisitions toward the end of the year, Kason asserts. "I get asked if we're going to sell this or that," he says, referring to Wyly's recent history of unloading various operations, "but we no longer are going to be selling anything. We're building now."

Then there's the \$285 million antitrust suit Wyly Corp. has pending against AT&T—a litigation that contends, in effect, Ma Bell deliberately put DATRAN, Wyly's data communication venture, out of

President John Kason says UCC may even make some computer-related acquisitions toward the end of the year.

business. Wyly now thinks it has a good shot of winning that fight, particularly in light of some recent rulings that have gone against Bell.

As for Wyly himself, the refinancing left the Wyly interests with only 3% of the company. Given the alternative to refinancing—probable bankruptcy—Wyly didn't do all that badly.

—L. M.

be up from the 66 MIPS projected in 1980 and 140 MIPS in 1985.

Turn, who talked in a session chaired by Jack Worlton of the Los Alamos Scientific Laboratory in New Mexico, spoke also of other mainframe architectures that would achieve even greater throughput, such as the single pipeline processor and array processors that have one or more processing elements (PE's). (See panel.)

Microprocessor era

He also spoke of advances yet to come in computer architectures. Noting that the microprocessor is already upon us, he mentioned kilo- and megaprocessor arrays, wherein perhaps 8,000 microprocessors might be used to perform 25 million multiplications a second. In some circles, he reported, the idea of using a

news in perspective

million processors in an array is not considered outrageous. And there are also complex pipeline designs that might use special-purpose processors as building blocks.

Turn (who cautioned that he was not predicting when machines would be built but rather was addressing the time-frame when certain things should be feasible)



SEYMOUR CRAY
Nobody's working on large computers anymore

also mentioned a renewed interest in advanced hybrid computer systems, those combining analog and digital computers, for simulating and controlling physical phenomena or systems. One such lashup, he said, might have the power of six Illiac IV's or eight ASC's or 10 Star 100s or 40 CDC 7600s or, finally, 1,100 PDP-11/70s.

Cray keynoter

But it was Seymour Cray who, as the conference's keynote speaker, had the attention of and fascinated the entire contingent of attendees. Cray, of course, founded Cray Research Inc. in 1972 to continue his development efforts in large scientific machines, a pursuit he formerly enjoyed at Control Data. He said he'd had no intention of leaving CDC, "but I had to do it because Control Data ran out of money, and I thought I'd be better off raising my own money. . . ."

Acknowledging that the cost-effectiveness of small computers is rising, Cray posed and answered the question: What are large computers for?

He spoke of a 10-year, international effort called the global atmosphere research program involving the U.S., European nations, and Russia. It is an attempt to study and model the earth's atmosphere. "Everything we've done to date has been looking at little pieces (of the atmosphere)," he explained, "and with little pieces we can't seem to do the job." What the scientists want to do is see how

those small physical phenomena, interacting with each other, affect atmospheric conditions.

A Cray-1 computer has been installed at the National Center for Atmospheric Research in Boulder, Colo., as well as at the European Center for Medium-Range Weather Forecasting in the U.K. A subsequent order from Russia was squelched by the U.S. government.

Study of turbulence

He described the smoke that curls upward from a tall smokestack and how it breaks apart as it strikes a turbulent eddy in the atmosphere. Within that eddy is

Seymour Cray: There's a need for computing power thousands of times more powerful than anything now available.

THROUGHPUT OF TOMORROW'S PROCESSORS

Year	Single Pipeline (MIPS)	Array Processor	
		1 PE (MIPS)	64 PEs (MIPS)
1980	330	26	1700
1985	715	50	3200
1990	1740	98	6250

Communications

Mail by Computer

Postal Service launches experiment with large businesses

The United States Postal Service is reported to be negotiating with a number of large business firms to establish a computerized "mass mail service" within this country that would enable companies to transmit customer statements and similar correspondence on-line to destination post offices. Delivery would be guaranteed the next day by letter carrier.

Testing of this service likely is to begin next fall, said a USPS spokesman. The goal, he added, is to develop a commercial service which will cost the sender no more per letter than first class mail.

Meanwhile in late March, the House of Representatives was nearing the end of a lengthy debate regarding HR 7700, the Postal Service Act of 1978, which makes a number of changes in USPS operations. One would require the agency to spend substantially more on R&D. Although the House floor debate was mostly about

another and within that, still another. And apparently there is no computer in the world with adequate power to simulate the action within the visible turbulence encountered by that smoke. Thus there's a need for computing power thousands of times more powerful than anything now available, if one is to model the entire earth's atmosphere.

Cray also described something called spatial reconstruction, an effort by surgeons to reconstruct within the computer a section of the human anatomy—in three dimensions, with a 1-millimeter resolution—and to generate those 3-D images 60 times a second. Taking input data from X-ray body scanners, it would make possible "numerical surgery," the performance of exploratory surgery without any risk to the patient. He told of seeing how a heart could be "dissected" to show the blood pumping across a valve, saying, "And that's pretty impressive." But performed in real-time, he added, it would require a processor with a speed of 2,000 MIPS. "It's conceivable that within five or 10 years they'll be able to accomplish their goal," Cray commented.

—Edward K. Yasaki

other features of the bill, it touched on the sensitive issue of competition between the Postal Service and private vendors of on-line message services, and provided some clear-cut guidelines for the agency to follow.

HR 7700, when it left the House Post Office Committee, ordered the agency to spend, by FY '80, "not less than 2%" of its previous year's revenues on R&D, and an equivalent amount, percentage-wise, in subsequent years.

Wants a report

Largely because of objections from the Carter Administration, which is trying to reduce the amount of red ink in the federal budget, this expenditure was reduced somewhat when HR 7700 reached the floor. The new language requires that, starting with FY '82, USPS must spend on R&D 1% of its previous year's operating expenses. Also, by December 31 of 1979,

the Postal Service must complete a study of the "feasibility and desirability of establishing a system for the electronic transmission of mail" and report its recommendations to Congress.

Assuming HR 7700 is enacted, USPS will have to spend approximately \$180 million on R&D by FY '82. The original language would have required an expenditure of more than \$360 million annually, beginning in 1980, according to the House Post Office Committee which held hearings on the legislation. The committee's report said that in FY '78, the agency's R&D budget amounted to \$32 million.

Already at work

Although the House committee said USPS had been "irresponsible" for not investigating the feasibility of distributing mail electronically, the agency has been hard at work for some time on the design of such a system. As a matter of fact, if it hadn't been for the recent resignation of Postmaster General Ben Bailar, the agency probably would already have begun building a test bed at its research headquarters in Rockville, Md., near Washington, to test a prototype of the new system, which is known officially as the "electronic message service system" (EMSS). Bailar's successor, William E. Bolger, is reported to be considering the test bed proposal and

will decide shortly whether or not to approve it.

The goal of EMSS developers is to have a nationwide system in operation no later than 1990, and hopefully by 1986. A limited system, tying together up to 10 post offices, is planned for 1981. Conventional letter mail would feed into this system through high-speed facsimile equipment and be routed to each destination post office via terrestrial or satellite circuits leased from communications

Bill would require USPS to spend \$180 million by FY 1982 on R&D compared with \$32 million in its current budget.

carriers. At the latter point, each message would be converted back to hard copy for delivery by the letter carrier.

Initially, letters would be mailed in the usual way by the postal patron and be converted when they reached his main post office. But on-line input and output via computers, magnetic tape units, keyboard terminals and printers located on the sender's and reviewer's premises, is included in the ultimate network design. The test bed demo, in preparation for this development, will exercise a number of commercially available terminals

which could give EMSS patrons on-line access to the new network. USPS isn't saying much about this aspect of the test, however, because the question of who will supply and maintain the customer terminals—the Postal Service or private vendors—hasn't been settled yet.

The test bed probably will begin operation next year. Much of the equipment is now being fabricated. Fairchild Camera & Instrument is building a sophisticated OCR scanner to convert hard-copy letters to binary form, while Pitney-Bowes has nearly finished construction of the printing and paper-handling equipment. A basic goal of the test bed demo, according to Assistant Postmaster General John Wise, will be to show that the prototype system can routinely be used to process and deliver a letter within a few minutes if it is received in hard copy form, and within a few seconds if it's input to the network in a binary bit stream.

International experiment

Besides domestic mail, EMSS also will handle international correspondence. Late in March the USPS was about to announce an experimental mail service between the U.S. and five European countries. The experiment, being developed in collaboration with Comsat, will interconnect the main post offices in Washington, D.C., and New York City

Proven Mini-Software Designed For Your Business

Pre-Packaged, Off-The-Shelf Programs Covering:

- | | | |
|--|---|------------------------------------|
| <input type="checkbox"/> accounts payable | <input type="checkbox"/> other accounting | <input type="checkbox"/> marketing |
| <input type="checkbox"/> accounts receivable | <input type="checkbox"/> financial analysis | <input type="checkbox"/> education |
| <input type="checkbox"/> general ledger | <input type="checkbox"/> statistical analysis | <input type="checkbox"/> |
| <input type="checkbox"/> payroll | | |

Programs Designed For:

- | | | |
|-------------------------------------|--|-------------------------------------|
| <input type="checkbox"/> BASIC Four | <input type="checkbox"/> PDP 8/11 | <input type="checkbox"/> Four Phase |
| <input type="checkbox"/> Burroughs | <input type="checkbox"/> IBM 3/32/34 | <input type="checkbox"/> |
| <input type="checkbox"/> Datapoint | <input type="checkbox"/> Hewlett Packard | |

Call now or return this ad for complete details to:
Douglas R. Johnson
Resource Software International, Inc.
140 Route 9W
Englewood Cliffs, New Jersey 07632
(201) 947-6104

D

Name _____
Title _____
Company _____
Industry _____
Address _____
City _____ State _____ Zip _____
Telephone _____

Over 14,855,000 packs
and cartridges cleaned

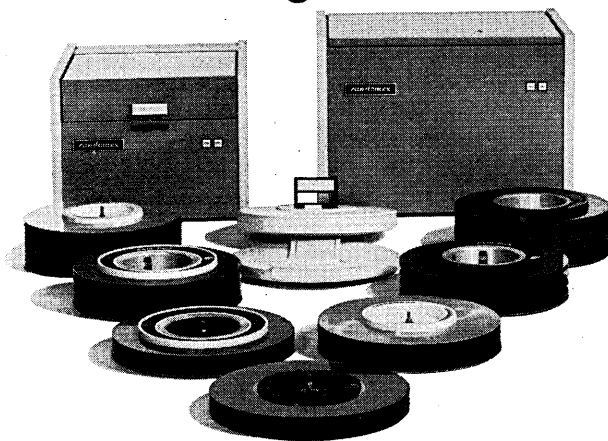

...without damaging a single pack
or cartridge or destroying one bit
of stored information.

randomex inc.

27303 WARRIOR DRIVE
RANCHO PALOS VERDES, CA 90274
(213) 377-9887

Keepers of the computer industry's
data integrity since 1971

DIGITAL, APRIL, 1978.

DIGITAL SPINS THREE NEW DISKS. \$900, \$450, AND \$300 PER MEGABYTE.

The cost of disk capacity just plunged dramatically with the introduction of three new Digital disks.

The first is the new RL01, a 5MB cartridge disk, featuring an embedded track following servomechanism, universal power supply, and extraordinary simplicity—just 5 modules and 11 subassemblies. The RL01 plus controller is the lowest priced disk subsystem available from any mini-computer manufacturer. A typical RL01 subsystem, with a controller and two drives, offers 10MB for under \$9,000... that's only \$900 per MB.

The new RK07 is a mid-range (28MB), high performance cartridge disk drive with features normally found on expensive drives over 100MB. And in a typical subsystem with controller and two drives, can provide 56MB for only \$25,000... \$450 per MB.

And the new RM02 provides 67MB capacity for UNIBUS systems at the lower-than-ever price of \$18,000. Put two of these together with a controller in a typical subsystem and for just \$41,000 you get 134MB...

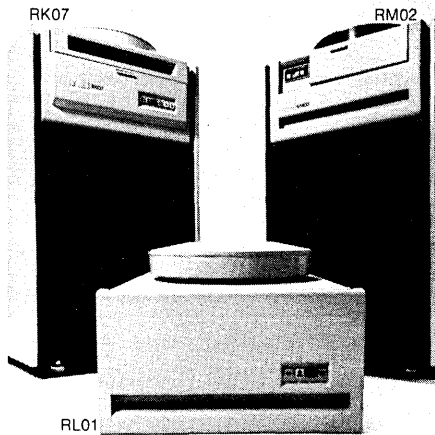

just \$306 per MB.

All the new disks deliver exceptional hardware reliability features including wide design tolerances, broad environmental specs, and advanced cooling systems. And you get remarkable maintainability through sophisticated diagnostic software, modular assembly, easy-access design, and extensive error reporting. To find out all about them, and Digital's commitment to disk leadership, check the box.

SPRING SALE ON MEMORIES.

Digital memory, with Digital quality, Digital reliability, and

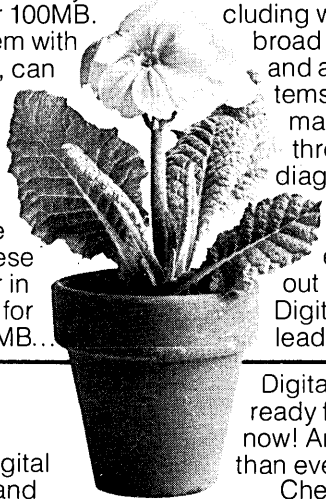

Digital compatibility, is ready for immediate delivery now! And at lower prices than ever before. Check the box.

LET THIS BE A LESSON TO YOU.

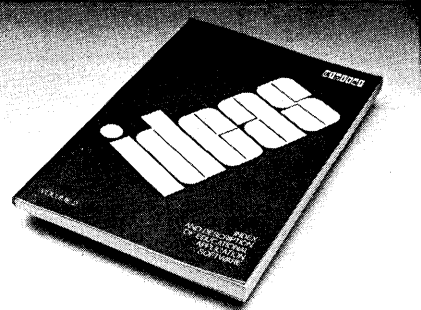

It's the second in a series of Digital catalogs of new applications programs for educators. *IDEAS: VOL. 2* gives teachers and administrators a close-up look at the 270 newest and best software packages available from publishers across the country. Subjects include administration, social science, math, CAI, and games, among many others. For your free copy, check the coupon.

DISTRIBUTED COMPUTING: WHY THE COOKIE DOESN'T CRUMBLE.

From England comes the tastiest application story of the month. A major bakery, with a capacity of 1.25 million cookies per hour, has replaced the batch computing equipment on its factory floor in favor of a distributed computing network, hosted by a PDP-11/40.

Forty-one data entry, video display, and video monitoring units, run by five microprocessor nodes, are connected to the host processor through a Digital DUP-11 synchronous interface. A PDP-11/03 acts as a front-end processor for the host in a star-loop network that monitors and controls the baking and packaging operations.

Projected savings for production monitoring indicate payback on the equipment in 15 months. Ummmm.

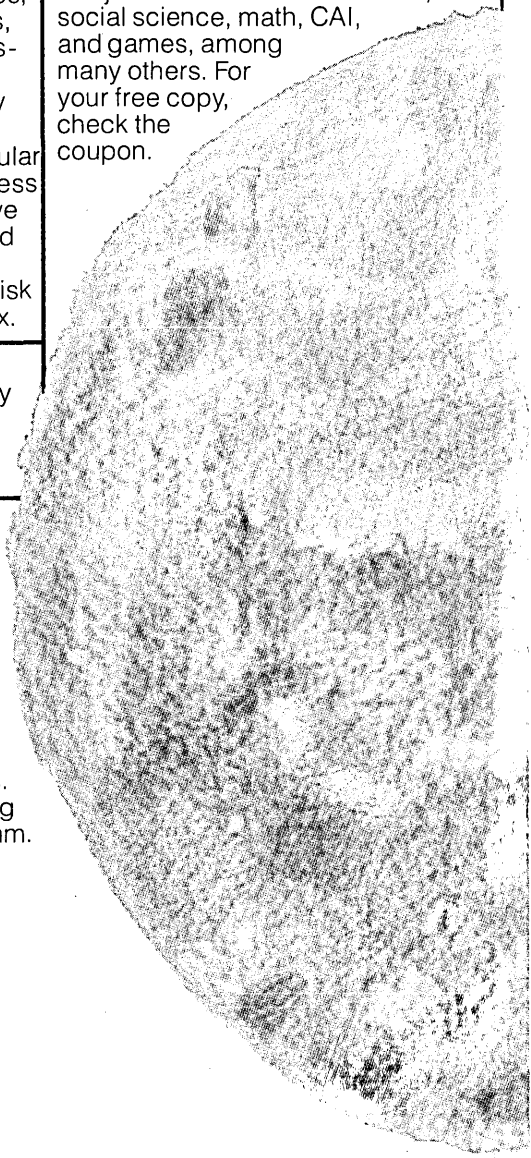

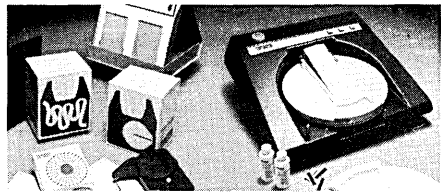

NEED SUPPLIES? CALL US COLLECT. AND CHARGE IT!

Here's a better way to order your disk packs, cartridges, floppies, ribbons, paper, ink, cleaning fluid, tapes, canisters, filters, and even your tables and chairs. It's the new SOS HOTLINE. A supply line with a phone number you can call and place an order up to \$2,000. You can even use your American Express or Master Charge. Delivery in 48 hours. Check the coupon and find out more. Or give it a try. Dial (800) 258-1710. In New Hampshire 884-5718.

PDP 11/34 COMES UP WITH SOME FAST CACHE.

A fast computer just got faster. You can now add 2K bytes of high-speed RAM cache direct map memory to your PDP-11/34, get a hit

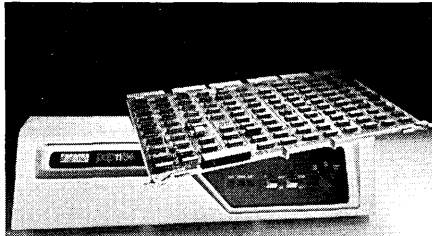

rate of 90%, and get a system that's 60% faster. Deliveries in May. Buy as a system or field upgrade. Check the box.

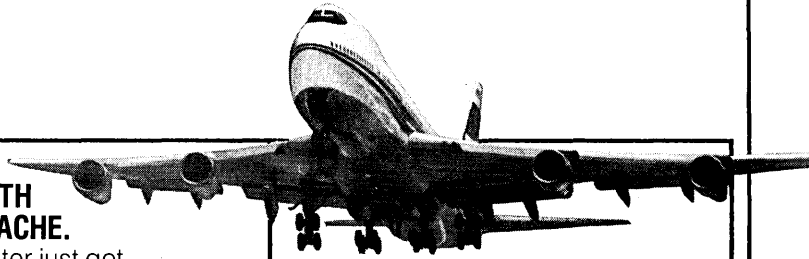

VAX-11/780 FORTRAN "TAKES OFF."

Three major airlines, faced with the need for more pilot simulator time, and more realistic simulators, have contracted for flight simulators built around the new VAX-11/780.

Giant program capacity, 4 billion bytes of virtual memory, unmatched speed, great real-time capability, large word size, and price make the choice of VAX a natural for flight simulators.

In fact, benchmark after benchmark is showing the VAX to be one of the truly great FORTRAN machines, even with its mini price tag. Four times as fast, half the cost seems the most typical benchmark. Check the box and find out why.

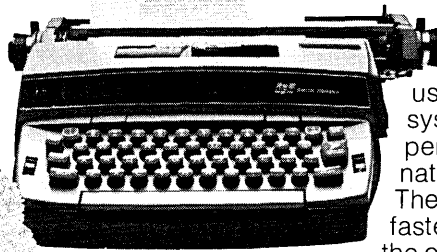

LETTER FROM A WISE MAN.

"I am pleased to inform you that, after consideration of the alternatives presented to us, we have decided to install Digital's VAX-11/780 system. Your product offered an impressive price/performance ratio, when compared to (the alternative), handling an academic computing load. The VAX system appears to be about 4 times faster, while only half the price of (an upgrade to the other system)."

Digital Equipment Corporation, Maynard, MA 01754. European headquarters: 12, av. des Morgines 1213 Petit-Lancy/Geneva. In Canada, Digital Equipment of Canada, Ltd.



(PRICES APPLY IN U.S. ONLY.)

Tell me more about: The 3 new disks Memory Sale D 48
 Digital Supplies Ideas: Vol. 2 11/34 Cache VAX-11/780

Name _____ Title _____

Company _____

Address _____

City _____ State _____ Zip _____

Mail to: Digital Equipment Corporation, 129 Parker St. (PK 3-2/M18), Maynard, MA 01754.

news in perspective

with five unidentified European countries.

Terrestrial circuits leased from domestic suppliers will interconnect the two U.S. stations with Comsat's earth station in West Virginia, and satellite links will carry messages across the Atlantic. For the first nine months, communication will be restricted to test data, after which sample messages, possibly originated within the participating post offices, but maybe including some contributed by prospective users, will be used.

A close observer says, however, a regular commercial service isn't likely "for at least a couple of years" and an on-line end-to-end service through terminals installed on user's premises is "even farther off."

Similarly, this domestic "mass mail service" being developed by USPS with various large companies, also will rely on carrier delivery for some time after it goes into commercial operations. This

Prototype system could deliver hard-copy letters in a few minutes and digital input within seconds.

service will interconnect users to various destination post offices through switched circuits leased from commercial carriers. Store-and-forward capability is planned, along with immediate delivery. Shell Oil Co. is reportedly among the companies involved in the project, together with "several" banking/financial institutions. A USPS spokesman said that a detailed description of the systems may be released in May.

One reason for the reluctance of the Postal Service to discuss its electronic mail plans is that the agency fears private vendors will complain to Congress about "unfair government competition."

Responsible competition

Rep. Charles Whalen Jr. (D-Ohio) brought this matter up during a House floor debate on HR 7700, when he said:

"For the past several years, we have witnessed a sometimes heated debate over the issue of competition in the telecommunications marketplace. I think it is clear now that our public policy has been firmly resolved on the side of responsible competition . . ."

Whalen was particularly concerned about a provision of HR 7700, allowing USPS to charge no more than 60% of the cost of a particular service to the users, and the balance to general overhead. He wondered how this arrangement would "impact" on future competition between public and private EMSS.

Said Rep. James Hanley (D-N.Y.) a co-sponsor of HR 7700: "Our intent is that in no degree will the (USPS) invade an area of private enterprise with respect to electronic communications. We are saying to the agency: Develop your program of research and development to sophisticate the methodology used in the processing of mail . . . take a reading perhaps on electronic communications. But we do not want you to get into a field that is already covered in the private sector."

A little later, Hanley added that his committee doesn't want USPS "to enjoy

competitive advantage over any entity in the private sector. We have spoken out very strongly on this already and I think they understand what we mean."

A House Post Office Committee staff member, when asked for further clarification of these remarks, said USPS essentially was told it can develop an experimental EMSS and investigate the feasibility of offering the service commercially, but it can't actually sign up paying customers in competition with private suppliers. The Postal Service can, however, negotiate with private suppliers to provide such a service on a joint basis, he added.

—Phil Hirsch

(Mr. Hirsch regularly writes for this magazine on communications related affairs.)

Interface '78 Draws 8,000 to Las Vegas

It was showtime for the data communications crowd last month as the Interface '78 conference and exposition put on its flashiest and most successful "show of shows" at the Las Vegas convention center. Starring a glittering array of telecommunications headliners, the four-day conference, held March 6-9, attracted over 8,000—a slightly higher draw than was anticipated by the show's sponsors.

Gambling on a winner, customer-hungry vendors also turned out in force. Even IBM showed up with an off-the-beaten-track booth which charitably included competitive demonstration gear—the most notable and ironic being AT&T's Dataspeed 40/2 communications terminal.

Approximately 180 companies ped-

dled their data communications wares and services, with only minor grumbings from a few over power problems on the exhibit floor. Most exhibitors, however, seemed pleased with the turnout. Boasted one: "We had all our salesmen talking. Bringing any more customers into the booth wouldn't have done us any good."

Session-goers also seemed pleased with the broad-based conference program which included 70 sessions on a wide range of computer-communications topics. Several popular sessions were so heavily attended, with crowds teeming over into the hallways, that the show sponsors decided to run repeats. Some complaints, however, were voiced by several more savvy data communica-



INTERFACE 78: Several popular sessions were so heavily attended that crowds teemed over into the hallways and the show sponsors decided to run repeats.

tions users who griped that some of the sessions were far too elementary. But for the most part, the program was well-received.

Management failures

One group of sessions that seemed to go over well focused on data communications management issues. Speaking at one of these sessions, Ralph E. DeMent, manager of corporate network planning at Digital Equipment Corp., chided management for its lack of nerve in responding to technical change and innovation. He also complained of near-sighted management teams that close their eyes to the consequences and scope of future applications. These management failures, he noted, are especially evident in decision making over the management of microcomputers and the new technology they are spawning, memory and storage, and various transmission technologies such as satellite and fiber optics.

Part of management's "failure of nerve," according to DeMent, is pointed up by their lethargic reaction to rapidly changing technology. Apathetic about using newer technologies, management

Management is chided for its lack of nerve in responding to technical change and innovation.

has not geared up their companies to take advantage of such things as private microwave services or private satellite systems, he claimed.

Getting in a dig at the Bell System, DeMent contended that the communications giant hadn't set a very good example in this area either. AT&T, he argued, could replace all its existing long-haul lines with a \$1 billion satellite investment, saving the company the \$10 billion a year it shells out just to maintain these lines.

Taking even more direct pot shots at Bell, New York-based data communications consultant Harry Newton knocked the "reactive" company for not "taking the initiative and not taking risks" in its service offerings. Addressing a standing-room-only audience at one of the services sessions, Newton, who is president of the Telcom Group, argued that Bell's "one big problem is that it has no powerful vision of where it's going." And the reason for this, he speculated, is the company's very specialized employee training which he claimed rules out "big picture thinking."

Bell Labs' mandate

As an example of this lack of vision, Newton cited the Bell Laboratories alleged mandate to keep the company's business almost exclusively (95%) in voice services. Bell Labs, according to Newton, "sees no future in data commu-

nications, especially in data communications at speeds higher than 9600 bps." Even AT&T's new Bell Data Network (or as it's currently called, the Advanced Communications System) will not go

Future strategies for Bell users: Combine voice and data networks, and use more foreign exchange and private line services.

above the 1600 baud limit "for a long time," he declared.

Newton sees two main components in AT&T's future service strategy. What the

company will be trying to do, he predicted, is "keep competitive rates down while increasing noncompetitive rates." Also as part of this future game plan, the company, he said, will continue to "emulate new services."

Negotiate tariffs

So what should the beleaguered user do? In answer to that question Newton quipped: "Doing business with Bell is like making love to a gorilla." To try and keep this "gorilla" in line, Newton suggested several future strategies for the user: combine voice and data networks, and use more foreign exchange and private line services. He also warned users not to rely on new product rumors from

The best coupler ever made is now better.

The Anderson Jacobson A 242 was probably the most successful acoustic data coupler ever made. Now AJ introduces its successor, the A 242A, the originate mode acoustic data coupler that brings new levels of performance, convenience, and reliability to low speed data transmission.

The A 242A was designed especially for low speed applications—up to 450 baud. Compatible with Bell 103 and 113 type data sets and various AJ modems, the A 242A has a new coupler design that securely locks in the phone handset and improves acoustic performance.

The same engineering advances and features that go into our high speed couplers also enhance the performance of the A 242A. For example, quartz crystal controlled circuitry for accuracy and stability. High receive sensitivity. Outstanding noise and vibration iso-

lation. A user-oriented carrier detector that senses valid data regardless of conditions. In addition, the A 242A includes dual 20mA and RS232 interfaces and switch-selectable full or half duplex operation.

For details on how the A 242A can improve your data communications, get in touch with your nearest AJ sales office. Or write Anderson Jacobson, Inc., 521 Charcot Avenue, San Jose, California 95131, (408) 263-8520. In Canada, Anderson Jacobson Canada Ltd./Ltee. (Available in the U.S. and Canada only.)



The A 242A.

 **ANDERSON
JACOBSON**

news in perspective

Bell and to negotiate heavily on all tariffs.

To keep on top of current automation trends, the conference also featured five sessions on the office of the future. Speaking at the first of these specialized sessions, Howard Anderson, president of the Yankee Group consulting company, gave his prognostications on what may happen in this field.

While there's many potential automated office applications, he noted, there's also a plethora of over-priced hardware on the market. As a result, Anderson maintained that office automation is not cost-effective today but may be in the near future. And that "near future," he argued, will come when the smart users assert themselves over the vendors by coming up with solutions that are not hardware-driven.

—Linda Flato

IBM and AT&T Getting "Edgy," Lecht Claims

It wasn't the happiest of homecomings for the Datacomm 78 conference as it returned to Washington for the second year in a row. Aimed at federal dp and data communications users, the three-day conference, held Feb. 21-23 in Washington's Sheraton Park Hotel, suffered from an unexpectedly low turnout of some 1,700, which disappointed exhibitors who expected a bigger draw.

But despite the low attendance, the conference did manage to score some strong points for its well-organized pro-

gram which featured some 50 workshop/seminar sessions. The most popular session, "Waves of Change," was chaired by Charles P. Lecht, author of a book with the same title and president of Advanced Computer Techniques.

Leading off his "Star Wars" session with the prediction that the giants—IBM and AT&T—are inexorably headed for a big marketplace battle, Lecht went on to explain that this friction between the two companies "should not exist because essentially . . . they're both in exactly the same business." However, he sees this collision as inevitable and believes it "will occur in the mid-'80s after IBM puts up its (Satellite Business Systems) satellite," which he said will catapult the company into the national and international communications business.

IBM's entry into satellite communications, he pointed out, will "blow all the minds of the (Congressional) legislators who had created bills in earlier times that were looking forward through rearview mirrors—none of these bills anticipating internal communications systems which would span continents via satellite technology."

Both getting "edgy"

As the lines continue to blur between dp and communications, Lecht sees both AT&T and IBM getting "edgy." IBM, he said, "is like a Concorde, flying around the U.S. trying to look for a landing place while being shot at by the federal government." Bell on the other hand finds itself faced "with the anomaly that a lot of its technology is easily replaceable."

Explaining this "anomaly" further,

Lecht described AT&T's situation as "technology stumble." The company, according to Lecht, is facing "an enormous write-off—possibly in the magnitude of \$20 to \$30 billion—if modern technology is brought to bear to replace its network of old technology."

And Bell has other worries from IBM. The IBM-Bell battle, he maintained, will start with "skirmishes." These skirmishes, he claimed, will "show Bell producing very high quality intelligent terminal equipment and very powerful and massive cpu's in their own laboratories." While Bell is busy building cpu and terminal muscle, IBM will be setting its sights "on modern technology in communications." This turf swapping, he concluded, "cannot help but test the American system of monopoly and private enterprise."

Project Prelude

Another session speaker, Frederick G. Withington, a consultant with Arthur D. Little, also predicted that AT&T will face some stiff competition from SBS-generated products and services coming out in the 1980s. Clues on exactly what those products and services will be, Withington said, can be uncovered by looking at the Project Prelude experiments. These obvious services, he pointed out, are teleconferencing, wideband high-speed facsimile transmission, and wideband inter-computer communications.

"There seems to be little question," Withington affirmed, "that SBS will try to induce people to take at least the teleconferencing, facsimile and broadband-type of services." This, he contended, will lead to IBM also selling the necessary gear and facilities such as the terminals, conference rooms and facsimile equipment. "It's a near certainty," he claimed, "that IBM will be in the facsimile business, and just about as certain that they will be doing the display and audio equipment to go with teleconferencing."

Another "follow-on" product line, according to Withington, will be audiovisual equipment which uses advanced technologies. The company may also, he predicted, get into inter-plant communications networks by offering fiber optic carrier capabilities to individual companies and buildings. To wrap up his "stabs into the future on the wildest possible note," Withington speculated that by 1990 the mighty mainframer may be making home television sets.

Government regulation

On a more somber note, John Eger, former acting director of the Office of Telecommunications Policy, warned that the biggest threat would not come from the market collision of AT&T and IBM but from excessive government regulation. "The U.S. government," he lamented, "has been killing the goose that lays the golden egg."



DESPITE its small attendance, Datacomm 78 had busy periods in the exhibit area and a promise that it would return in 1979.

For the most air cargo service coast to coast...



Think Big.

The most markets.

When it comes to cargo, no one comes close to United. We fly direct to 110 cities, from Honolulu to New York. And reach 3,800 surrounding communities with fast 'n easy door-to-door delivery. United also provides convenient overseas connections with every domestic and international airline serving the U.S.

The most flights.

We offer you more planes too—362 jets, making over 1,400 flights a day. And every one carries

freight. Including 55 widebodies and 14 all-cargo DC-8F's. So your shipment has plenty of room to fly.

The most people.

United has over 2,000 people ready to help you full-time with your cargo needs. They'll give you consistent cutoff and recovery times. And with A.F.I.S., our advanced computerized tracking system, you'll be in complete control every step of the way. So next time you ship, trust your shipment to the biggest friend around. United.

 **UNITED AIRLINES CARGO**

Think United.

Introducing Bit Pad.

The new,
low-cost digitizer for
small computer systems.

Bit Pad is the newest product from Summagraphics, the leading producer of professional digitizers. It has a small 11-inch active area and a small \$555 price tag. But the list of applications is as big as your imagination.

Better than a joystick or keyboard for entering graphic information, it converts any point on a page, any vector, any distance into its digital equivalents. It's also a menu for data entry. You assign a value, or an instruction to any location on the pad. At the touch of a stylus, it's entered into your system.

Who can use it? Anyone from the educator and the engineer to the hobbyist and the computer games enthusiast. The data structure is byte oriented for easy compatibility with small computers, so you can add a power supply, stand-alone display, cross-hair cursor and many other options.

\$1,000.00 creativity prize. You can also add \$1,000.00 to your bank account as a reward for your inventiveness. Just write an article on an original Bit Pad application and submit it to any national small-computer periodical. If the editors publish it — and the decision is solely theirs — Summagraphics will pay you \$1,000.00. Contact Summagraphics for rules concerning this offer.

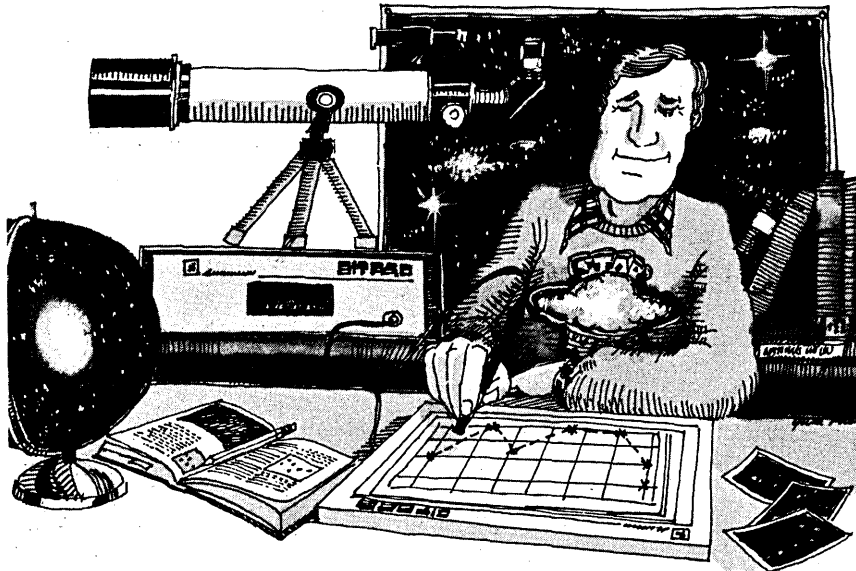

Summagraphics
corporation

35 Brentwood Ave., Box 781, Fairfield, CT 06430
Phone (203) 384-1344. TELEX 96-4348

CIRCLE 153 ON READER CARD

news in perspective

By deceiving the regulatory agencies at the state and federal levels, Bell for the most part has gotten its way. Eger contended, by making "everything look like it's communications." As a result, he quipped, "we're finding this behemoth (AT&T), this 9,000 pound gorilla, crashing through our living rooms saying, 'I'm regulated. I'm a common carrier, and I want to sleep here.'"

But, he argued, "what they are really doing is distorting the free marketplace." Eger's solution is "to free AT&T—to protect the marketplace and not the monopoly." As the "centerpiece" for meaningful reform, the communications law consultant called for a "statutory amendment" to the 1956 consent decree. Such an amendment, he explained, would spell out for the first time exactly what should be a regulated and protected monopoly service and what should be a common carrier service. It would also, he added, create "a new category of enhanced communications services" which Bell along with others could offer on a deregulated basis.

As a result, Eger maintained, AT&T, with appropriate approval, could restructure itself, setting up "unregulated entities to provide communications services shoulder-to-shoulder" with other competitors. This restructuring, he conceded, "would take some internal hassling, but AT&T can do it," he argued. "And the Bell System can do it faster and cheaper for the rate payer, the taxpayer, and the American public."

—L.F.

International

France Election Takes Pressure Off Vendors

France faced a complete nationalization of its computer industry in its general elections last month had the so-called left been the victor.

Early in the month the French Communist Party had proposed the nationalization of CIH-HB (the recently merged Honeywell-Bull and Compagnie Internationale pour l'Informatique), as well as SEMS, Intertechnique, Transac-SINTRA and T-VT. These last four would be a by-product of the nationalization of their majority owners, the large electrical and electronic and engineering groups Thomson-Brandt, CGE, and Marcel Dassault.

As it turned out, France's center-right

alliance retained a comfortable, though shrunken, control of the National Assembly, and thus staved off the left's most serious challenge in 20 years. But the outcome was in doubt right until the election day and generally it was felt the left would win, until the country's voters turned out in record numbers to register their rejection of the left's radical policies.

IBM off the hook

As the communists had planned it, the five computer companies would then have been merged into a single French owned computer company, which would thereby be able to offer a product range as broad and comprehensive as that of IBM France (which not even the Communist Party proposed nationalizing).

Both the combined French computer company's staff and its R&D budget would have been raised 50% above their present levels and the resumption of a French capability in large general purpose mainframes would have been given top development priority.

Although the Communist Party's goals were radical, it was understood that a coalition with the French Socialist Party would not have diluted its efforts to any great extent. Both already had agreed that the CGE, Thomson-Brandt and Marcel Dassault groups should be nationalized which would have resulted in the by-product nationalization of the SEMS and Intertechnique minicomputer manufacturers and the transac-SINTRA and T-VT intelligent terminal manufacturers.

The Socialist Party also was inclined to buy out the 47% minority interest in CII-HB held by Honeywell Information Systems. So the only point remaining at issue between the partners in the left coalition would have been whether the nationalized computer and peripherals manufacturers should remain several or become one. —F.L.

CII-HB Enhancements Aimed at System/34

CII-Honeywell Bull (CII-HB) announced two enhancements for the French developed Series 60, Level 61 which now is marketed only by CII-HB and its European, Middle Eastern, and South American subsidiaries.

The entry level Model 61/40, first announced in December 1975, now can control up to eight local interactive video terminals in addition to the video console, instead of the previous maximum of four terminals. This gives the 61/40 the same expandability as the IBM System/34.

The larger fully compatible Model 61/60-2 (which comprises a 61/40 mainframe and a front-end MTS 7500) remains limited to a maximum of 16 video and/

or teleprinter terminals, but has been endowed with a new operating system (Extended GCOS 61). This gets around Level 61's greatest limitation, a real memory addressing capability limited to a maximum of 16K bytes, by recognizing three distinct types of main memory:

—One or two disc cache memories totaling 16K or 32K bytes, in which a pool of disc file buffers is dynamically controlled by a supervisory algorithm;

—A 16K byte resident file management system comprising reentrant file updating routines,

—A 16K byte general purpose batch processing memory.

Together the three specialized memories can thus total 48K or 64K bytes, the same as on the competing IBM System/34. In addition to this cpu controlled memory, the 61/60-2 console and card I/O processor has its own 8K and the MTS 7500 front end communications processor its own 16K byte memories.

Exchangeable drives

New MSU 0314 exchangeable disc pack drives have also been released for both

Hardware

Three Get 303Xs as Others Wait

Singer Company, which has been hacking away at its dp expenditures for several years, last month became the first recipient of IBM's model 3033 processor a year after IBM announced it.

IBM also announced installation of its first 3032 at the Air Force Data Services Center in Washington, D.C., and of the first 3031 at the Credit Life Insurance Co., Springfield, Ohio. In the announcement, IBM's Data Processing Div. president, Terry R. Lautenbach, noted that IBM experienced "an unprecedented demand" for all three processors and said the company had been able to ship all three processors "at the same time and on schedule." This will be little consolation to the many other customers who must wait in line as IBM scurries to fill its massive backlog, estimated by some at about 12,000 machines. The company has told its customers the unexpected high demand might extend their wait by as long as four years.

In early March IBM president John R. Opel said that demand for the new line has been "phenomenal." As an example, he said before a meeting of New York security analysts that, "the computing capacity of the new processors on order is four times that represented by all of the computers that IBM has ever shipped."

Opel added: "And we've shipped a lot of computers."

Opel also told the analysts that IBM was "pulling out all stops to meet the demand." He said manufacturing facilities were being expanded and many loca-

Level 61 models. Each unit can hold 14.7M, 23M or 46M bytes on an exchangeable 20-surface disc pack. Since either Level 61 model can control up to four disc drives, Level 61's total on-line disc capacity has been raised thereby to 184M bytes maximum.

Other Level 61 enhancements include a new 800 lpm line printer, and interactive transactional processing modules for the IMS 61 Inventory Management System, and the PSC 61 Production Scheduling and Control System.

Side by side with Series 60, Level 61, CII-HB now markets also all the business minis offered in their territories by HIS and HIS Italia. It has released the MOD 400 operating system for Level 6 (called "Mini 6" in CII-HB territories) and offers this for business dp as well as for process control and terminal applications. It has also belatedly announced the entry-level Model 62/20 to the HIS Italia built Series 60 Level 62. —Fred Lamond

tions were working three shifts. "We have people assigned to look for any bottlenecks and find ways to break them," Opel said confirming speculation that the giant computer manufacturer simply had run out of production capacity.

Demand for the new line has been "phenomenal" says IBM president John Opel.

"They haven't had this kind of backlog since the early 1960s, said a former IBMER who remains close to the company and whose firm had ordered ten model 3032 and 3031 machines.

Big budget cuts

Singer Company two years ago said it had cut its dp budget in half (from \$20 million to \$11 million) by reorganizing along distributed processing lines. It did this by throwing out medium and large scale computers, most of them IBM's, and replacing them with smaller System 10s, which Singer once made, and with intelligent terminals, crt's and teleprinters. Two years ago the company had cut its worldwide operations staff to 220 from 600 persons.

The one place the cut didn't affect was its worldwide corporate headquarters at Wayne which serves Singer's three major operating groups and links 57 major company facilities by means of a world-

news in perspective

wide communications network.

Herbert D. Lechner, vice president for systems and administration, said more than 80,000 jobs are being processed every month at Wayne. The company is planning to install a company-wide on-line reporting system next year with support from the 3033.

Col. Phillip J. Wendt, commander of the Air Force Data Services Center, said his 3032 will be used chiefly to prepare and process simulation models for the Air Staff's studies and analysis function. The 3031 at The Credit Life Insurance Co. will be used to meet increased demand for individual customer services which has been growing at a rate of 20% a year. The company's senior vice president, David Halley, said the 3031 will be used to anchor the distributed data processing system that links its headquarters in Ohio with claims offices in Dallas, Los Angeles, Minneapolis, and Syracuse. *

Technology

From Aerospace to Commerce

Error-free high density digital information storage and retrieval is being marketed to business data processing users by the Datatape Div. of the Electronics and Instruments Group of Bell & Howell Co.

It is something of a return to commercial markets for the Pasadena-based group which once, as Consolidated Electrodynamics Corp., was developing a computer aimed at the commercial side of the market. When CEC was acquired by

Development of EDAC was prompted by customer requests for better error rates.

Bell & Howell in the early '50s, the computer effort was spun off as ElectroData Corp., later acquired by Burroughs to get Burroughs into computers. Bell & Howell wanted to keep the Pasadena operations in scientific markets.

But now it's come back to commercial operations as a result of a two year development effort the company said was customer inspired. Its new System 100 high density digital storage and retrieval system operates at 100 megabits per second I/O data rate. The 28 track system packs 90 billion bits of error-free digital information on a 14 in. reel of one inch wide magnetic recording tape.

The major breakthrough, said Bell & Howell's Robert Hawn, was development

of an exclusive error detection and correction technique (EDAC). "We have offered high density storage and retrieval for some time. We've been getting 33K bits per linear inch. With computer people (business) 1600 bpi is considered high density. We could tolerate errors for scientific purposes. Businesses can't."

He called development of EDAC "the bringing of advanced technology out of aerospace to business." He said the high density storage and retrieval will be particularly useful when used in conjunction with high speed communications which 1600 bpi can't handle.

Development of EDAC was prompted by customer requests for better error rates, Hawn said. It was done with a study of error patterns in high density recordings on magnetic tape conducted by Tony Herff of the Datatape Div.

Need for the study, Herff said, was to aid in the design of an error detection and correction technique that would allow for virtually perfect data recording

Networks

Digital vs. IBM

It's emerged as IBM's most aggressive competitor

After Digital Equipment Corp. recently announced two new machines in its DEC-system 20 family, IBM the next day announced dramatic price cuts of 20% for two of its competing mainframes, the 370/138 and 370/148.

The two events may have been pure coincidence, but the IBM announcement can be easily interpreted as a form of backhanded recognition of what the user marketplace has known for many months now—that DEC has emerged as the computer giant's largest and most aggressive competitor.

Moreover, while it was always difficult to know precisely what DEC was trying to do with its equipment—primarily because of its bewildering array of incompatible families and machines—it is evident that the Maynard, Mass.-based computer company is developing a grand plan that is beginning to look coherent to outsiders.

For most of the outside world, DEC was the company that peddled small minicomputers, namely the PDP-8 and the PDP-11 families and, on the high end, there was the large mainframe family, the PDP-10. The twain seldom met.

The interesting phenomenon about Digital Equipment's current product move is that its successor machines to those earlier families are not on the high

and reproduction. The bit error rate study was the first of a three part program. Second part was development and testing of the prototype EDAC hardware. Third part was the finalized design and production units.

Ampex and 3M tapes

The study concerned itself with end-to-end errors for a complete recording system. Tests involved both Ampex 797 and 3M 8390 tapes. Twenty of each were used. Results showed bit error rates for both tapes to be approximately equal to 10^{-7} .

With EDAC, Hawn said, the bit error rate is 1×10^{-10} and better. Using ordinary noncertified instrumentation recording tape, he said, EDAC scans the recorded tracks longitudinally and transversely for variations from a known pattern of odd and even parities, word lengths and word cycles.

With the System 100, Herff said, an entire set of the Encyclopaedia Britannica could fit on 160 ft. of tape. An entire tape could contain everything in the Library of Congress.

—E.M.

and low ends, but both near the middle, being quite equal in size, price, and performance. That means that the VAX 11/780, the minicomputer successor, initially will be extended downward with its

An important development is that everything recently announced is being tied together with Digital Equipment's networking design, DECnet.

hardware models, while the new 2020 offers a way to move up to larger DEC-system 20 and DECsystem 10 machines. Another important development is that everything is being tied together with Digital Equipment's networking design, DECnet.

Wave of the future

"DECnet is a big thing for us and it's going to be even more important as we go along," says Winston R. Hindle, Jr., a DEC vice president and group manager. "We believe it's the wave of the future."

What, actually, is DECnet? The firm says it is the company's "software modules, protocols, hardware, and support services that facilitate construction of

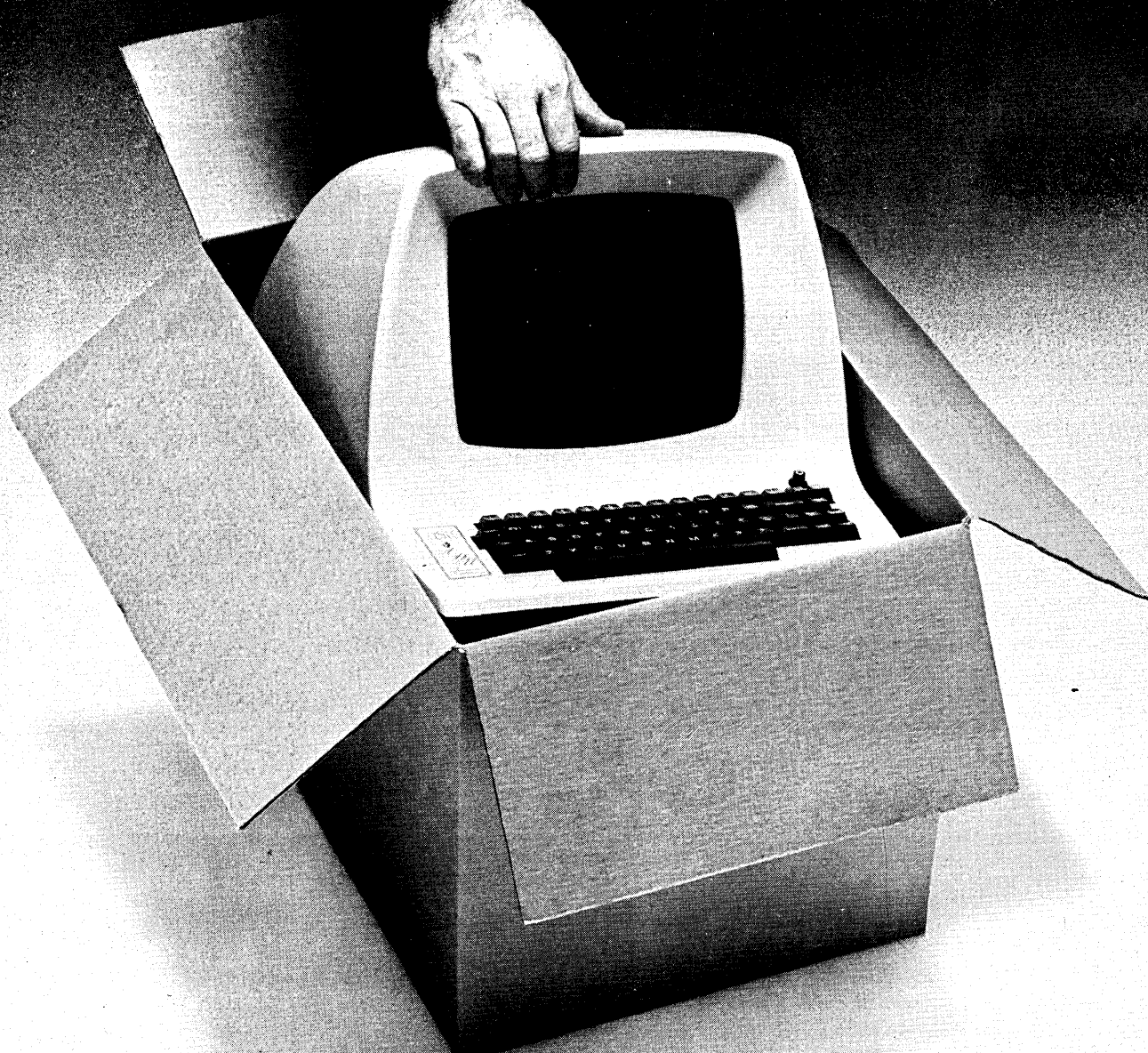

Every 5½ minutes, the world gets a little Dumber.

That's how often we get another Dumb Terminal™ customer for our world famous Dumb Terminal. We've sold over 30,000 of them in three short years.

No wonder.

For just \$895, you get a 12-inch diagonal screen. Full or half duplex operation at 11 selectable data rates.

1920 easy-to-read characters in 24 rows of 80 letters. A typewriter-style keyboard with 59 entry keys. RS232C interface extension port. Direct cursor addressing. Plus options galore.

So when you consider those features and that price, it's easy to see why our Dumb sales have gone bananas.

**DUMB TERMINAL.
SMART BUY.**



LEAR SIEGLER, INC.
ELECTRONIC INSTRUMENTATION DIVISION
DATA PRODUCTS

Lear Siegler, Inc./E.I.D., Data Products, 714 Brookhurst Street, Anaheim, CA 92803; (800) 854-3805. In California (714) 774-1010.

CIRCLE 53 ON READER CARD

news in perspective

distributed computer networks" among DEC's computers. In short, it is the connective tissue that links the entire body of DEC computers from the lowly micro-processor LSI 11 all the way through multimillion dollar DECSYSTEM 10 configurations.

DECnet is the company's answer to IBM's Systems Network Architecture (SNA) which uses a large host computer as network manager. DECnet, though, requires no host computer and its concept supports independent system interconnectability among DEC computers. DECnet's protocol, Digital Data Communications Message Protocol (DDCMP), is message oriented while IBM's protocol, synchronous data link control (SDLC), is bit oriented.

DECnet software products for VAX machines will be available with the first customer shipment of VAX/VMS, and that currently is scheduled for January of 1979. The firm is being more circumspect about the DECSYSTEM 20 DECnet software products, but insiders say the products are under test at customer sites and that first official customer shipments will be in the fall.

In the 20 family, DECnet reportedly



WINSTON R. HINDLE JR.
"DECnet is a big thing for us"

will be a feature of the TOPS-20 virtual memory operating system.

Lots of updating

While the 20 and VAX users will have to wait a few more months for DECnet capability, the firm moved recently to upgrade its DECnet offerings for its flagship machine, the PDP-11. RSTS/E and CTS/500 users have been offered DECnet capability for the first time. However, users with PDP-8's and 10's will have to labor under older DECnet releases that are not fully compatible with the latest DECnet offerings. A DEC spokesman said, however, that the company is working to bring DECnet offerings for those older lines up-to-date later.

The new DECnet software products that have been announced also include DECnet-RT, for PDP-11's using RT-11 real-time operating systems. DECnet upgrades were announced for systems using RSX-11D, RSX-11M, and RSX-11S core only, and for IAS operating systems.

The company said many of the new software products improve "full point-to-point interconnect capability for task-to-task communication, by which programs running on separate network nodes can exchange 8-bit ASCII data, and for file transfer, which allows ASCII sequential files to be copied from one node to another on user command."

On the subject of the two new 20 machines, DEC's Win Hindle was openly

CONVERTING?



Try the experts. DASD Corporation encourages test evaluations of all of our language translators.

RPG/RPG II to COBOL (DOS or OS) will accept all types of RPG and produce **ANS COBOL**. Most translations are 100% error free. Our modular COBOL simplifies maintainability.

SYSTEM/3 COBOL to OS COBOL makes this tedious, redundant conversion completely automatic. We're 97% clean, which frees a lot of man hours for more important tasks.

DOS COBOL to OS COBOL is basically a difference of syntax, but may mean a lot of wasted man hours.

GE MAP to OS COBOL will allow immediate upgrade of your **GE 400** series to full **ANS COBOL**.

360/20 BAL to 360/370 OS ALC is an extremely solid product eliminating a monotonous programming job.

DASD TRANSLATORS SAVE TIME AND MONEY.

Many service options are available: lease, conversion only, conversion and clean compile; full conversion responsibility including testing and JCL.

For a prompt solution to your conversion problems, write or call today.

DASD CORPORATION
National Marketing
1480 Renaissance Drive—Suite 315
Park Ridge, Illinois 60068
312/299-5005



CIRCLE 122 ON READER CARD

EDP AUDITORS ASSOCIATION

6th INTERNATIONAL CONFERENCE

HYATT-REGENCY DEARBORN, MI.

JUNE 19-21, 1978

TOPICS INCLUDE AUDITING APPLICATIONS, ON-LINE SYSTEMS, DATA BASE, EFTS, SECURITY/PRIVACY.

FOR MORE INFORMATION CONTACT:

EDPAA 1978 CONFERENCE

P.O. BOX 61

Sterling Heights, Michigan 48078

Attention: Mr. Charles

PLEASE PRINT

NAME _____

COMPANY _____

ADDRESS _____

CIRCLE 129 ON READER CARD

optimistic about the new machines' future. "We expect the 2020 to do particularly well where we've traditionally done

well—education, time-sharing, and service bureau applications. I also think it's going to do well in the commercial mar-

ket, particularly for someone who wants to grow."

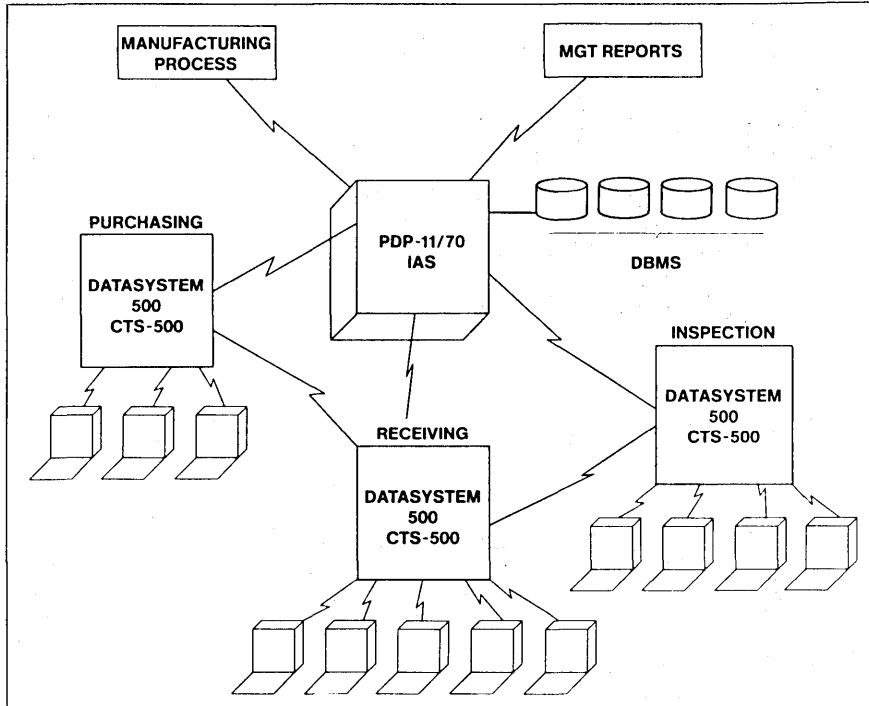

COMMERCIAL NETWORK for manufacturers includes Datasystem 500s, which perform terminal-oriented processing, exchange data among themselves using DECnet/E and update an inventory data base residing on a PDP-11/70 system running IAS and DBMS-11. PDP-11/70 also supports local users for management reporting and program development.

Familiar customers

A similar story is unfolding around the VAX machine. Largely as a result of its FORTRAN capability and the subsequent emphasis on scientific and real-time applications, DEC is finding its customers for the equipment among its traditional minicomputer users in the laboratory, university, and oem markets.

Hindle sees no overlap between the two machines—the VAX 11/780 and the 2020—and he believes the two won't compete with each other. Outside observers, who note the high degree of competitiveness that occasionally surfaces among DEC's various product lines, are not so sure.

Where does IBM's Series/1 fit in this grand scheme? For the moment at least, the Series/1 is out of DEC's picture as far as the VAX is concerned. The Series/1 machines currently compete against DEC's higher-end PDP-11 minicomputers.

But, IBM is readying larger Series/1 machines and DEC can be counted upon to announce new equipment on the downside of VAX. For once, the traditional roles will be reversed—DEC will be going after IBM in the minicomputer marketplace, and IBM will be waiting.

—W. David Gardner

DECwriter II	DECwriter III
\$1,495	\$2,895
DECprinter I	VT52 DECscope
\$2,495	\$1,695
VT55 DECscope	ADM 3A CRT
\$2,695	\$875
TI 745 Portable	ADDS Regent 100
\$1,875	\$1,325
Data Prod. 2230	TECHTRAN 8400
\$7,900	\$1,850

100% EQUITY RENTAL PLAN

DECwriter II \$ 75 mo.	DECwriter III \$145 mo.
DECprinter I 125 mo.	VT52 DECscope 85 mo.
VT55 DECscope 135 mo.	ADM3A CRT 45 mo.
TI 745 Portable 94 mo.	ADDS Regent 100 67 mo.
DATA PROD. 2230 395 mo.	Techtran 8400 93 mo.

FULL OWNERSHIP AFTER 24 MONTHS

RENTAL, 12 MONTH FULL OWNERSHIP AND LEASE PLANS AVAILABLE ON ABOVE AND OTHER EQUIPMENT



TRANSNET CORPORATION
2005 ROUTE 22, UNION, N.J. 07083
201-688-7800

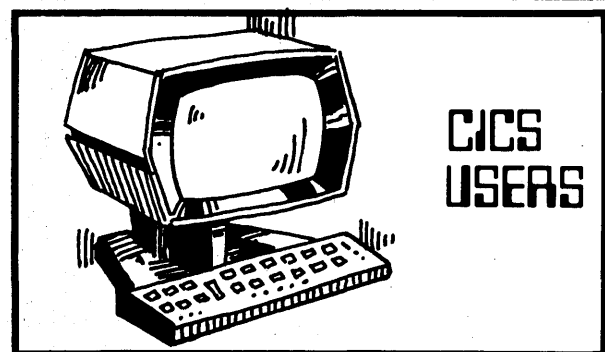

DASD's new utility map generator (MAPGEN) will increase your BMS coding productivity by at least 75%.

MAPGEN is not a new language. It is a system where the completion of a simple specification form will greatly improve accuracy by eliminating unnecessary data, add flexibility and greatly simplify maintenance. All DFHMSD, DFHMDI and DFHMDF macro source statements are program generated.

A hard copy image of each screen is automatically printed at the time the map is defined.

'Map build' features aid in the use of extended features under CICS/VS.

Call or write today

DASD CORPORATION
National Marketing
1480 Renaissance Drive — Suite 315
Park Ridge, Illinois 60068
312/299-5005



Maxell double density floppys. When the data is too important to lose.



If ancient historians had been using Maxell double-density, double-sided floppys instead of stone tablets, our storehouse of data would probably be a lot larger.

Approved by the leading OEM drive manufacturer

That's because our double-density floppys hold more data, hold it more accurately, and hold it longer.

Maxell. Our name should be

music to your ears

Maxell, who makes the world-famous audio tape, makes our EDP products to the highest ISO and IBM diskette specifications. From computer-grade, super-fine magnetic materials. With a special binder that not only improves particle dispersion, but gives a very smooth coating surface.

The result is that our double-density disks, single-density disks,

cassettes and tapes all have one thing in common. They treat every bit of information as if it were irreplaceable.

Dealer inquiries invited

If you'd like to know more about buying Maxell products, contact us.

Maxell Corporation of America,
60 Oxford Drive, Moonachie, NJ
07074. Telephone: (201) 440-8020.
Telex: 134538

maxell[®]

Floppy disks—digital cassettes

CIRCLE 51 ON READER CARD

news in perspective

Reservations

Computer in a Farmhouse

It automates reservations handling for Montreal wholesaler

Working out of a rickety, 100-year-old farmhouse in St. Constant, Quebec, about 16 miles south of Montreal, Serge Lebfèvre sends shivering Montrealers south to warmer climates on package holiday tours. When he decided last November to begin doing it with an HP 3000 computer, it caused no end of problems for Ian Farquharson, the president of a Montreal systems house that designed a turnkey reservations system for Lebfèvre.

First, there wasn't enough space in the house to store a computer. Fire insurance rates on a \$90,000 computer in a wooden building were prohibitive. And, says Farquharson whose company is called InfoBoutique, Ltd., "the floorboards were so uneven, you could get seasick walking across them."

But Lebfèvre's company, Mirabelle Tours, Ltd., managed to install the system in an adjoining barn and between

used a series 1 version of the HP 3000 because of its low price of \$90,000 (compared with previous models priced at \$150,000 and up). But that model is limited to 128K bytes and Farquharson

said his first TOURS customer wanted the system to run about 15 terminals on-line simultaneously. To accommodate the small memory, Jean-Pierre Theoret, the company's vice president, wrote the main reservations program in SPL. His program of more than 3,500 lines of SPL code has only 5K bytes as its largest executable module.

The HP 2640B intelligent terminals use a "block mode" for data entry to make up for response-time delays. They felt that users would be less frustrated with 10 seconds delay after completing a whole form than with a 3 second delay after entering each field. Function keys on the keyboard were programmed to allow fast movement to specific points on

When Mirabelle Tours used a time-sharing service, actual reservations taking was done manually.

last September and this March, the busiest part of the year, had arranged to send some 20,000 Montrealers down to bask in the sun of Acapulco, Florida, and the Caribbean.

A wholesaler

Mirabelle is what is known in the trade as a travel wholesaler of package holidays. It takes reservations from travel agents over the telephone, keeps track of airplane and hotel availability, and provides all the necessary billing and reporting functions. It used to use a Toronto time-sharing service, called Dataline Systems, Ltd., for billing and reporting, but the actual reservations taking was done manually. Farquharson's company designed the system to automate everything, using a Hewlett-Packard 3000 system, with its IMAGE 3000 database software. The programming languages are COBOL and SPL, an Algol-like system language. (A similar system using personal computers is described on page 241.)

The system is called TOURS (The On-line User Reservation System). Farquharson, a 31-year-old British born programmer and system analyst, said he



Mass storage for your DG CPU, under \$7000.*

And that includes the controller.

Our Reflex® Winchester type disc drive will give you up to 63 megabytes of unformatted data storage. With immediate delivery.

Controllers are available from MiniComputer Technology and Xylogics. If you already have an SMD interface, we're compatible.

We'll show you how to put together the whole package for less than \$7000. Right now. Contact one of our local sales offices or the Director of Peripheral Sales, Microdata Corporation, 17481 Red Hill Avenue, P.O. Box 19501, Irvine, CA 92713. Telephone: 714/540-6730. TWX: 910-595-1764.

*Quantity ten price for disc drive and controller.

Sales Offices:

Atlanta: 404/252-9700
Boston: 617/862-1862
Chicago: 312/671-5212
Dallas: 214/387-3073
Los Angeles: 714/533-8035
New York: 516/328-8622
Philadelphia: 215/628-8699
San Francisco: 415/573-7461
Seattle: 206/455-0152
Tampa: 813/872-1557
Washington, DC: 703/620-3995.

Microdata

OEM PERIPHERALS. A SIGNIFICANT DIFFERENCE.

For immediate need circle 134 on reader card.

For information only circle 135 on reader card.

news in perspective

the form. Another key was programmed to re-display automatically the form and the entered data after power failures.

Terminals with 5K

Each terminal was fitted with 5K bytes

of memory to accommodate the peculiar needs of travel wholesalers. Using TOURS, the wholesaler is able to make inquiries through the crt simply by placing a question mark (?) at specific fields on the reservations form. The program recog-

nizes this and displays availability and pricing statistics from the database. Normally, there is a dialog with the travel agent over the telephone and that often necessitates alternating between the reservations form and the displayed statistics. To re-display either of these each time would have caused too long a delay during the conversation.

This problem was solved by storing both the form, with the entered information, and the displayed statistics in the memory of the terminal. The result is that the user quickly can switch from the form to the statistics and vice versa by using keys that read "Next Page" and "Previous Page."

Farquharson's company of six full-time and five part-time employees, has installed two systems so far, but at least six other organizations are studying the system and are expected to place orders during the summer months. Air Canada, the national airline, is another prospect

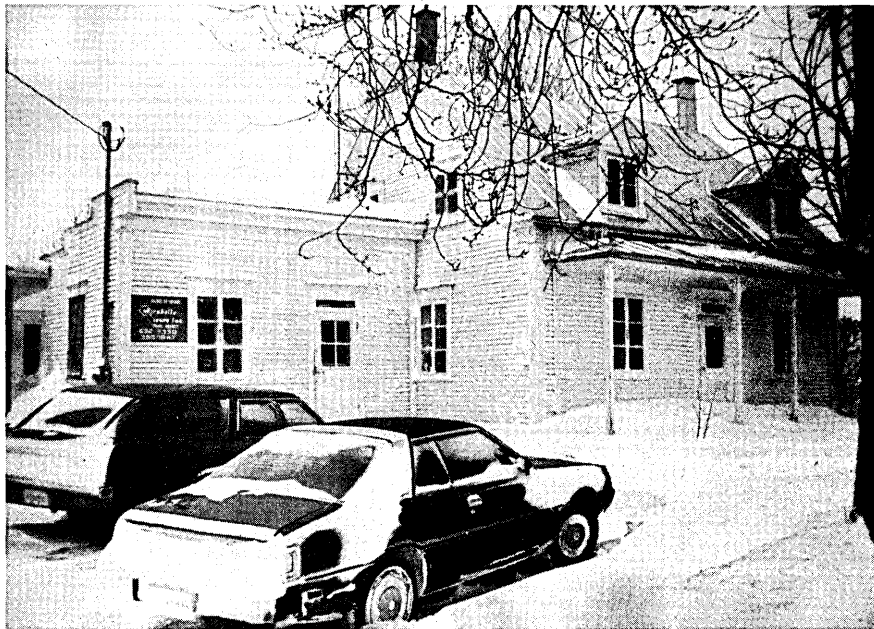

RESERVATIONS PLEASE? Mirabelle's farmhouse and an HP 3000 inside a trailer within a barn.

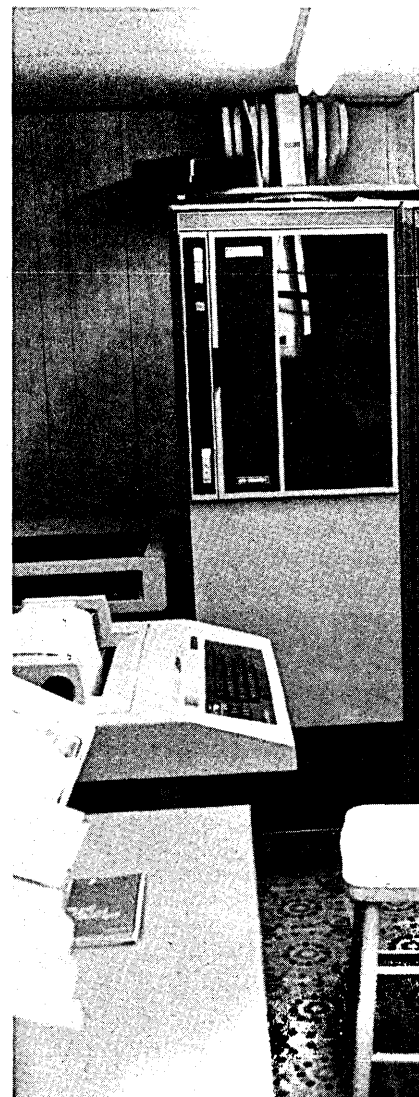

HARVARD BUSINESS SCHOOL announces

Managing the Computer Resource

An Executive Education Program of the Harvard Business School



July 23 -
August 4

The program's emphasis is upon evaluating, managing, and planning the development and growth of the data processing activity.

The orientation of the program is toward management, not technology. Participants will include managers with direct responsibilities for computer-based information systems management; and senior management to whom the computer resource management reports.

Among the topics to be considered are integrating the information systems plan with corporate strategy; data processing personnel selection, organization and evaluation; hardware/software selection decisions; the role of mini-computers and distributed processing; design of cost control and internal controls within the EDP organization; the computer as an instrument of change; centralized versus decentralized operations; and privacy and data banks.

For further information, contact: **Administrative Director, Managing the Computer Resource, Glass Hall, Harvard Business School, Boston, Massachusetts 02163.**

As a matter of policy Harvard University does not discriminate among applicants and participants on the basis of race, religion, sex, national origin, color, or handicap.

and soon the company will begin a marketing program in the eastern U.S. One prospect is a wholesaler operating in several Canadian cities and Farquharson sees such an operation using HP's DS 3000, a distributed network system.

Mirabelle's Serge Lebfèvre, who now uses seven intelligent terminals, foresees using as many as 16 terminals as he begins to set up summer tours to European destinations. He's thinking of plac-

A former mayor of the town now works out of a 100-year-old farmhouse whose lone occupant is his uncle, the janitor.

ing terminals in Ottawa and in Canada's Atlantic provinces (New Brunswick, Nova Scotia, Prince Edward Island, and Newfoundland).

Lebfèvre, 38, used to be the mayor of St. Constant, a farming village of 8,000 on the south bank of the St. Lawrence River. He's a lawyer and a land developer. His family farmed the land until 1965, but then it was subdivided for housing. His uncle is the lone occupant of the farmhouse and also its janitor.

Farquharson said the fire insurance problem was solved by housing the HP 3000 within a trailer within the adjoining barn. But first a complete side of the barn had to be torn down, a skunk nest had to be cleared, and then the side of the barn put up again.

Says Farquharson of the installation: "If this isn't bringing technology to the people, what is?" —T.M.

Software

Cosmic Continues to Struggle On

A clearinghouse for computer programs operated by the Univ. of Georgia under contract from the National Aeronautics and Space Administration still is unable to pay its own way after 11 years in existence. Called *cosmic* (Computer Software Management and Information Center) it provides a way for transferring software from government agencies to outside users and to other government agencies at nominal duplicating costs.

During its fiscal year ended last June 30, the agency spent \$350,000 on operational costs, says Jerry Harrison of the NASA Technology Utilization Office, and who also is the *cosmic* publication program manager. Costs recovered from the sale of programs on a one-time basis, plus leases for NASTRAN (NASA Structural Analysis Program), and the sale of documentation, brought in income of \$270,000. Income from the 1,500 pro-

grams maintained in the *cosmic* library is applied to reducing operating costs of the center, and NASA funds the remainder.

In that year, 158 programs were sold, 20 leases were made, and 2,560 documents were sold at 10 cents a page. Program costs ranged on an average from \$500 to \$1,000. Although a lion's share of the programs came from NASA, and NASA contractors, a small number, about 60, were furnished under a formal agreement with the Dept. of Defense.

Harrison said four or five a year come in from other government agencies that are looking for a way to distribute them. NASA considers *cosmic* a viable national

resource and worth the \$80,000 or so subsidy, says Harrison. "One way to assess the program is to look at the benefits accruing to users as a result of NASA's doing this. We have an active benefits identification program going on at the center to determine on an individual user basis just what the benefits are. Generally we get good feedback."

A study of NASTRAN, beginning in 1971 and projected to 1984, established that the program will return more than \$700 million to the American economy. For instance, Bell Helicopter, Textron, Ft. Worth, uses NASTRAN to analyze loads on all airframes and rotor systems. These analyses have provided a 5% savings in



Mass storage for your Interdata CPU, under \$7000.*

And that includes the controller.

Our Reflex® Winchester type disc drive will give you up to 63 megabytes of unformatted data storage. With immediate delivery.

Controllers are available from MiniComputer Technology. If you already have an SMD interface, we're compatible.

We'll show you how to put together the whole package for less than \$7000. Right now. Contact one of our local sales offices or the Director of Peripheral Sales, Microdata Corporation, 17481 Red Hill Avenue, P.O. Box 19501, Irvine, CA 92713. Telephone: 714/540-6730. TWX: 910-595-1764.

*Quantity ten price for disc drive and controller.

Sales Offices:

Atlanta: 404/252-9700
 Boston: 617/862-1862
 Chicago: 312/671-5212
 Dallas: 214/387-3073
 Los Angeles: 714/533-8035
 New York: 516/328-8622
 Philadelphia: 215/628-8699
 San Francisco: 415/573-7461
 Seattle: 206/455-0152
 Tampa: 813/872-1557
 Washington, DC: 703/620-3995

Microdata

OEM PERIPHERALS. A SIGNIFICANT DIFFERENCE.

For immediate need circle 136 on reader card.

For information only circle 137 on reader card.

news in perspective

airframe structure weight in addition to saving development time. Under previous methods, Bell needed 4,550 man-hours to analyze five load conditions per helicopter; with NASTRAN, only 1,675 man-hours are required for 36 load conditions per helicopter.

Best in existence

NASTRAN, developed at a cost of \$5 million between 1968 and 1970, is probably the best structural analysis program in

existence, owing to its comprehensiveness and versatility, says Harrison. In structural design, it has been used for bridges, railroad cars, automobiles, buildings, and by medical researchers to model a structure of the heart. "NASTRAN's facility at Langley Research Center was spending about \$350,000 annually on maintenance and updating after we acquired the program," he said, "and we simply couldn't afford to do that any longer, so we went to a leasing procedure

You have to be picky when choosing a data communications terminal system. Otherwise, you may just pick up a problem.

That's why Trendata offers a wide selection. From systems for wide flexibility and high production down to a simple reliable machine for limited applications.

When it comes to features, pick them to fit your need—half/full duplex operation, operator switchable ASCII—EBCD—Correspondence code sets, various keyboard legends, variable pitch and line lengths, interchangeable type fonts, switch selectable transmission rates and many more. Then add the options—plot mode, form tractors, additional printer controls, unattended operation along with a range of workstation options.

We also have the pick of the peripherals. Add a flexible disk system, tape

reader/punch, card reader or tape cassette recorder. And with no fuss we supply accessories such as certified diskettes, type elements, ribbons, tape cassettes, etc.

What you don't have to pick is other firms to handle financial arrangements and provide service. We're very finicky about doing those in a very first class manner. Which all leads to the suggestion that before you pick a terminal. . . . pick up the phone and call us.



**Applied Magnetics
Trendata**

610 Palomar Avenue, P.O. Box 5060
Sunnyvale, CA 94086
(408) 732-1790

We like customers who are picky, picky, picky



on that program alone. Most of what we get through leasing is applied to maintenance and updating. The first year the fee for use is \$4,000, and thereafter is \$3,000."

Some software companies with proprietary programs once felt that programs which could not be meticulously maintained by the seller would receive a long, hard look by users, and thus the COSMIC program was not a threat to independents. A spot check of independents indicates that much the same feeling still prevails today.

Typically, though, a user can save almost the whole development cost of a program, which can range from several thousand dollars to \$100,000 or \$200,000. Use of the documentation also can produce savings, though these are harder to identify. "It's hard to say how much you save by determining after reviewing documentation that you don't want to take that route," says Harrison.

Problem of documentation

In a study seven years ago, DATAMATION found disgruntled users howling at the poor quality of documentation. Also in the early days, documentation was free

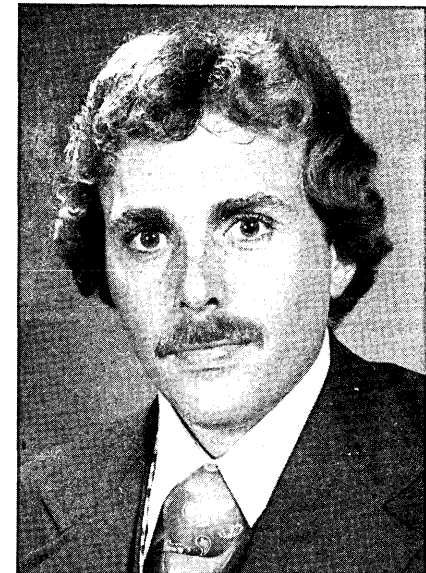

JERRY HARRISON

"Look at the benefits accruing to the users . . ."

and orders for it exceeded sales of programs by a ratio of 50 to 1. That has been reduced now to something like 14 to 1.

"I think the reason people continue to buy more documentation than programs is that this is an effective and economical way of taking a good look at the programs to see if they would be useful. People also buy documentation to see what approach we used for solving a particular problem as a means of suggesting an approach they might take."

In the early days, COSMIC was filling more of a library function, says Harrison, simply sending out what it got in. "We've expanded COSMIC's role and they do a lot

more in terms of evaluation and check-out to make sure the documentation is adequate and complete and is reproducible. The cumulative package acceptance quotient is 45% of the programs submitted."

COSMIC gets high marks on cooperation, responsiveness, and savings, though users still find room for improvement in other areas.

Cut repetitive testing

Jacuzzi Brothers Inc., Little Rock, Ark., greatly reduced repetitive testing by using the "Computer Program for Predicting Turbo Pump Inducer Loading" in developing a large marine jet used to propel everything from small pleasure boats to Navy combat vessels. James E. Ford of that firm says, "I think some better control does need to be made as far as documentation, as well as the computer tapes. But this is a problem with dissemination of computer programs in general, and not just COSMIC's problem."

In its evaluation, COSMIC engineers and scientists must assume that program logic is correct, and they look at documentation from the standpoint of com-



DOCUMENT is prepared by Michael Miller and Lelissa Spratlin to accompany software developed by NASA and disseminated by the Computer Software Management and Information Center (COSMIC).

pleteness for use by others, and rate programs in one of four classes.

Bendix Guidance Systems Div., in Teterboro, N.J., which used three COSMIC programs, says NASTRAN helped them save \$30,000 a year in conducting stress analyses of housings, casings, and gimbal structures. George Sommers of that firm says that time delays have been minimal even when he has asked for considerable documentation.

"They have everything they claim. If I were going to say anything negative, abstracts could be a little better, particularly concerning the principal function. Sometimes you need a little more information than is in the manual, or you can't find

April, 1978

something because it is buried in the manual. So it would be helpful if they had a bit more technical expertise to back them up."

Now are reference centers

At one time NASA had authorized six technology utilization distribution centers to sell the programs in an effort to expand the distribution base. Sales through the outlets were negligible, and this approach has been abandoned, says Harrison. "We found it more effective to have COSMIC as a centralized source for NASA software. We still have those six centers operating and they refer people to COSMIC."

To promote the service, COSMIC is issu-

ing a new catalog this month which will list 300 of its best programs, programs on which it receives the most inquiries. COSMIC also is preparing a new brochure which it will send to everyone on its mailing lists.

Because of the type of work of the developers, many of the programs in the COSMIC inventory are for large scientific and engineering applications that appeal to big companies and universities. It still is trying, as it was seven years ago, to get more programs that have business applications in management systems, personnel records, and financial and inventory control so that COSMIC can be useful to smaller companies.

—Lynn Ridlehuber

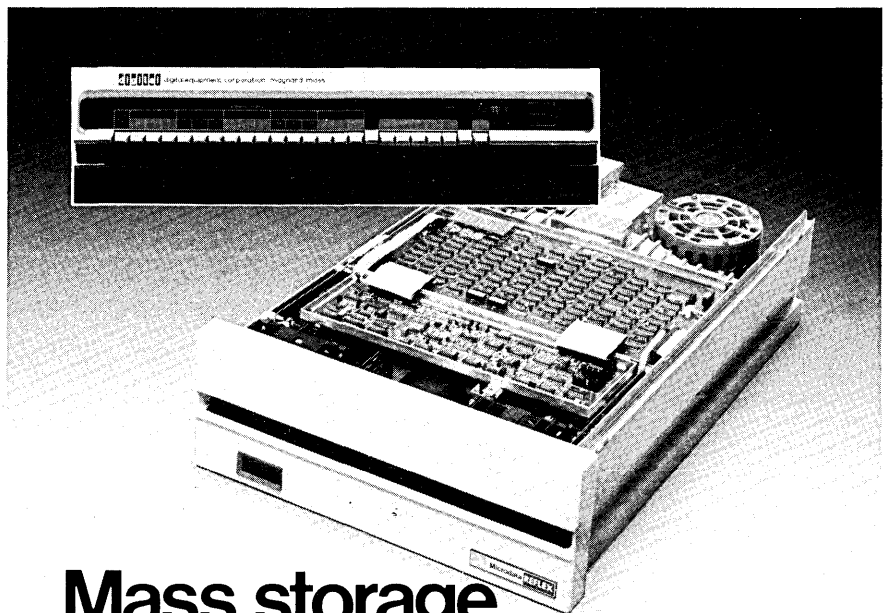

Mass storage for your DEC CPU, under \$8000.*

And that includes the controller.

Our Reflex® Winchester type disc drive will give you up to 63 megabytes of unformatted data storage. With immediate delivery.

Controllers are available from Xylogics and Xebec. If you already have an SMD interface, we're compatible.

We'll show you how to put together the whole package for less than \$8000. Right now. Contact one of our local sales offices or the Director of Peripheral Sales, Microdata Corporation, 17481 Red Hill Avenue, P.O. Box 19501, Irvine, CA 92713. Telephone: 714/540-6730. TWX: 910-595-1764.

*Quantity ten price for disc drive and controller.

Sales Offices:

Atlanta: 404/252-9700
Boston: 617/862-1862
Chicago: 312/671-5212
Dallas: 214/387-3073
Los Angeles: 714/533-8035
New York: 516/328-8622
Philadelphia: 215/628-8699
San Francisco: 415/573-7461
Seattle: 206/455-0152
Tampa: 813/872-1557
Washington, DC: 703/620-3995

Microdata

OEM PERIPHERALS. A SIGNIFICANT DIFFERENCE.

For immediate need circle 138 on reader card.

For information only circle 139 on reader card.

News in Perspective

BENCHMARKS . . .

Honeywell Drops 66/85: Honeywell Inc. said it won't market its big 66/85, introduced with much hoopla early last year (February '77, p. 16). Reason: the current mode logic technology (CML) described by Honeywell at the time of the introduction as the "technology of tomorrow" turned out to be what one company spokesman termed "horribly expensive." The 66/85 was to have been Honeywell's most powerful and expensive computer and part of the firm's Series 60 family. It was billed as being 400% faster than the 66/80, top of the 60 line. Honeywell didn't say how many orders it had received for the big computer but said it has been steering potential customers toward other models since the middle of last year. Among these is the Metropolitan Life Insurance Co. of New York, which ordered the first two systems valued at \$11.1 million.

And Wins Big Contract: Honeywell beat out IBM and Sperry Univac to win a \$6.1 million contract to install its Level 66/80 computer in an Agriculture Dept. data center in New Orleans on a 76 month lease. Earlier Honeywell won out over the same two companies to win an \$8.1 million contract for an Agriculture Kansas City data center. The government estimated that Honeywell discounted its price 72% below list to win the latest contract. This win gives Honeywell its fifth consecutive federal computer award in competitive bids. Besides the Kansas City contract, the company has won a \$38 million Veterans Administration national computer network contract, a \$2 million Customs Service award, and a \$1.1 million Interior Department Bureau of Land Management contract.

Burroughs Settles Suits: An out-of-court settlement has ended suits by four Burroughs shareholders charging the company and its top officers and directors with trading stock on the basis of inside information. The agreement dismisses the suits "with prejudice," meaning the shareholders can't reopen them. Under the settlement involved officials will give up some options on Burroughs stock. Burroughs will pay legal expenses of the plaintiffs and, in the case of one suit, will make cash payments to shareholders who can demonstrate losses on purchases of Burroughs stock in late 1976 or early 1977. The settlement also calls for Burroughs to establish a \$175,000 settlement fund in connection with a class action brought on behalf of shareholders who purchased Burroughs stock between June 1, 1976 and Jan. 31, 1977. The fund will pay out up to \$50,000 in legal fees for the two shareholders who filed the suit. The remaining \$125,000

will be distributed among those Burroughs shareholders who purchased stock during the period and can claim to the satisfaction of a New York State court that they sustained a loss on their investments.

National Champs: A team of four computer science undergraduate students at the Massachusetts Institute of Technology won the 1978 national collegiate FORTRAN programming contest sponsored by the Association for Computing Machinery (ACM) and Upsilon Pi Epsilon, the national computer science honor society. The winning team was put together by Abe Lederman, a sophomore from New York City, who learned of the contest through an ACM publication. His teammates were Larry DeMar, Curt Sanford, and Dan D'Eramo. New York University finished second. Michigan State, last year's champion, was third and Purdue placed fourth.

"Quit Bleeding": Mark Shepherd, Jr., chairman of Texas Instruments, isn't afraid of Japanese competition in semiconductors. He told a group of U.S. executives attending an American Chamber of Commerce breakfast meeting in Tokyo that U.S. semiconductor firms should "quit bleeding and get to work," if they want to beat Japanese competition. He said Japanese semiconductor sales in the U.S. in the next five years are projected at \$400 million, or \$80 million a year. "We do that much ourselves." Shepherd admitted Japanese semiconductor companies are tough competitors and that U.S. firms have "to stay on their toes," particularly in memories where the Japanese have a competitive product.

New Type Microfilm: Stanford Ovshinsky's financially troubled Energy Conversion Devices Inc. has received its first real full-scale production order, a \$7 million order from Minnesota Mining & Manufacturing Co. for a new type of microfilm system. With the system, microfilm or microfiche cards develop instantly when exposed to a flash of light instead of using conventional photographic film that requires exposure and subsequent chemical development. A user can add new pieces of correspondence to a card as it comes in. ECD, founded by Ovshinsky in 1964 to exploit his controversial invention of cheap electronic switching materials, had accumulated a deficit of \$21.9 million by last June 30 after reporting a loss for fiscal 1977 of \$2.7 million on revenue of \$610,000. The new Mirovonic file system ordered by 3M is based on an early Ovshinsky invention, a memory switch in which the application of a low level of energy will cause exposed material to change from opaque to transparent or vice versa. ECD plans to manufacture the

film for the system in its plant in Troy, Mich.

Patent Licensing Agreement: IBM and Comten Inc., St. Paul, Minn., have signed a nonexclusive, worldwide patent licensing agreement primarily covering Comten's patents for computer performance, measurement and evaluation products. Donald J. Herman, Comten president and chairman, said the agreement provides for payment to Comten of \$2,400,000 and a five-year, royalty-free license permitting each company to conduct its present and future business without liability to the other.

Potter Ousted: John T. Potter Sr. was fired from all jobs with Potter Instrument Co., a company he founded in 1942, amid cries from him that Potter directors were acting illegally. Samuel Alexander, vice president of administration and operation, was named president and chief executive of the firm which has been in Chapter XI proceedings since April 1975. No one was named to succeed Potter as chairman. Potter sought a temporary restraining order from Bankruptcy Judge William J. Rudin to prevent the board from instituting its decision. The judge refused to issue the restraining order but agreed to additional hearings on Potter's charges. Potter refused, at the director's meeting, to entertain the motion for his dismissal and claimed its approval was "a complete railroad act."

Shakeout in Tomography: Creative Strategies International, a San Jose, Calif., market research consulting firm, has predicted a major shakeout in the computer tomography market by 1980. The CT scanner, which thrust diagnostic imaging into the medical limelight five years ago, has peaked, said csi, and sales will decline over the next five years. The firm said these declines will be matched by increases in non-U.S. markets but sales will be essentially flat by 1982. csi predicted that six of the 15 computer tomography suppliers will either be out of business or acquired by 1980.

NOTICE

A news story on page 200 of DATAMATION's February issue offered a free copy of a sketch of a sort program to any reader who wrote to a publisher in Amsterdam. Unfortunately, because of a misunderstanding with the publisher, those who wrote were offered instead a subscription to a publication. This misunderstanding has now been corrected. Readers who have written will now receive the promised program sketch—without charge.

THE LEADERS

RAPIFAX

DACOM

INTRODUCE...

RAPICOM

Rapifax, the leader in high speed business facsimile systems and Dacom, the pioneer in data compression technology and leader in specialized facsimile systems for sophisticated commercial and governmental applications, have joined forces in the formation of a new company named RAPICOM, Inc.

RAPICOM. A company with unified marketing and service. A trend-setting engineering and development organization. Total production capabilities. Supplying the most extensive line of advanced high speed facsimile systems available.

RAPICOM. Dynamic. Innovative. Using its expanded technical and marketing resources to fully serve the worldwide communication needs of industry and government. Creating advanced communications systems for the future.

RAPICOM, Inc.

7 Kingsbridge Road • Fairfield, New Jersey 07006
TEL: 201•575-6010 FAX: 201•227-3553

LOOK AHEAD

(Continued from page 18)
to 35% of the company. It now owns about 17%.

ANOTHER DIRECTED VERDICT FOR IBM

Jury duty is considered to be an important underpinning of the American judicial system but for any juror involved in IBM litigation, his duties must appear to be an exercise in futility. The reason?

Federal district court judges have a way of preempting jurors' duties in cases in which IBM is involved. The latest federal judge to block an IBM case from going to a jury for a decision is Judge Roger D. Foley who awarded IBM a directed verdict in litigation instituted by Royal Data, a now defunct Las Vegas computer services firm. Royal Data, once competing with IBM for Las Vegas' credit check business, maintained that IBM employees had spread false rumors about the smaller firm, including a report that Royal Data was connected with the Mafia. In court after the judge and jury heard the Royal Data arguments, IBM claimed that Royal Data hadn't proved its case. Judge Foley agreed and the case didn't go to the jury.

FRED GRUENBERGER ON WHITHER COMPUTING

In June 1987 it will be announced that "all distinctions between micro and minicomputers have disappeared," says the April issue of Popular Computing, a monthly magazine edited by long-time industry observer Fred Gruenberger. Now in its 6th year; the magazine, which says it is the only one in the world devoted to the art of computing, has these other headlines from its annual forecast for the coming decade:

Giant computer embezzlement scheme is revealed, involving government funds (Jan. 1979)...Computer kits disappear, replaced by prepackaged units (Feb. 1979)...Personal computers with power exceeding that of a 7094 now are available for under \$2,000, including peripherals (June 1982).

Number of persons employed full time as "programmers" starts to drop (June 1981)...The job category "programmer" has disappeared (Nov. 1983) ...Superprogrammers now rate \$50K salaries (Dec. 1980).

Cost per line of producing complex software exceeds \$100 (March 1984)...Top speeds of supercomputers reach one nanosecond complete floating add time (July 1985)...More than half of all U.S. computing power is now residing in small dedicated machines (March 1981)...Number of centralized large computers in the U.S. falls below 1,000 (May 1987).

Let's wait and see.

RUMORS AND RAW RANDOM DATA

Hughes Aircraft Co. is about to take the packet plunge. The company, which wants its own private packet switching network, currently is negotiating with Telenet Communications Corp. to set up the system. Sources speculate that Telenet's new thrust in private packet network development is a "hedge" against AT&T's aborning network...Graphnet has been talking with Microwave Associates' Digital Communications unit about building a \$10 million network...The defense mapping agency is planning to upgrade its huge computer complex and will be seeking bids for a hardware contract expected to be valued at more than \$15 million. Among the machines targeted for upgrade are three Univac 1108s that the cartographic engineering agency purchased about eight years ago...Two low priced small discs were being rolled out this month: Shugart Associates's SA4000 drive sells at \$2,550 with 14.5 megabytes of storage. Calcomp's new offering, a 17MB unit, sells for about \$1,300, but in unspecified large quantities. Shughart's quantity price of \$1,500 for 100 units makes it too soon to say who has the bucks per meg advantage.

Take an in-depth look at in-house timesharing:

You know the problems facing the data processing department:

Other departments in your company want faster response, broader capabilities, better service.

And your management wants you to hold down your operating costs.

You're probably looking hard for a solution. A closer look at in-house timesharing could give it to you.

Fast, long-lasting relief

Unlike upgrading a large central computer, expansion to an in-house timesharing system isn't a time-and-money-consuming ordeal.

And unlike buying outside computer time, you're not building in a monthly bill that inevitably keeps building up.

Adding an in-house timesharing capability is a shrewd way to add computer power. Because it won't add significantly to your operating costs; in fact, it can pay for itself by reducing current costs.

Especially if you add the system specifically built for timesharing: our BTI 4000.

A timesharer's timesharer

The BTI 4000 Interactive Timesharing System is made by us:

Basic Timesharing, Inc. We're the computer manufacturer with timeshare experience. Which has helped us produce a computer uniquely right for timesharing.

To help you do more—while helping your company spend less.

Easy to begin, room to grow

You can own your own BTI 4000 for as little as \$35,950. For that you get a ready-to-go system with 10 megabytes of storage and 8 ports—just add terminals.

And start-up won't cause a departmental hang-up. The BTI 4000 can be installed and working for you in one working day.

Expanding to do even more work takes even less work. The

BTI 4000 features modular construction, so system downtime for expansion is minutes, rather than days. You can add disk storage to 400 megabytes; increase user capacity to 32 ports; add peripherals like industry-compatible magnetic tape and a line printer.

Hard working, always working

The BTI 4000 is a true timesharing system. It allows doing any mix of tasks, all at the same time, all completely independent.

It also gives you continuous system availability, because software housekeeping can be performed while users are on-line.

There's also off-hours job-stream processing. So the BTI 4000 can be working for you, even when no one's around.

The BTI 4000 uses BASIC-X, an unusually powerful extension of the BASIC user language, enhanced for business programming.

What's more, the BTI 4000 offers heirarchal account organization and stringent security so that you can maintain total con-

trol over who's using it, and what they can do.

And it does all this without a full-time operator.

Inexpensive help

Used during typical office hours, the operating costs for a BTI 4000, including maintenance, are about \$1 per terminal hour. And should you grow to 24 hour usage, your operating costs shrink to less than 10¢ per terminal hour.

Around-the-clock help

We back our BTI 4000 with any-hour, anywhere, on-line support with dial-up access for problem diagnosis. Yet in a typical installation, our maintenance plan costs less than 1% of the system's purchase price per month.

Look to us

The BTI 4000. The interactive timesharing system that will help your data processing department do more, for less.

For more information, just look to the Basic Timesharing office nearest you.

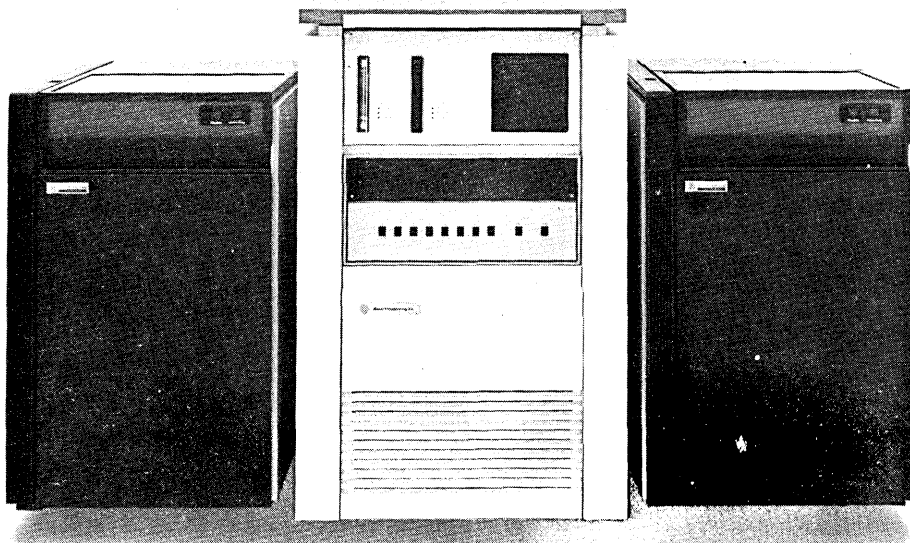

The BTI 4000 Means Business.

Basic Timesharing Inc., 870 W. Maude Ave., Sunnyvale, CA 94086. Sales Offices: East: Cherry Hill, NJ (609) 662-1122; Midwest: Minneapolis, MN (612) 854-1122; Chicago, IL (312) 298-1177; South: Dallas, TX (214) 630-2431; West: Sunnyvale, CA (408) 733-1122; Anaheim, CA (714) 533-7161

hardware

Off-line

It's fitting that a new computer center, operated for the federal Department of Energy (DOE), will use the heat generated by its super computers to heat the building itself. The National Magnetic Fusion Energy Computer Center at the Lawrence Livermore Laboratory will house a CDC 7600, a CDC 6400, and a pair of PDP-11/50s. It also plans to install a Cray-1 next April. A small standby heater will heat the 44,000-square-foot center in emergencies and when the computer center shuts down.

The American National Standards Subcommittee X3B1 (magnetic tape) is currently considering the fate of four standards for mag tape: should the existing standards be reaffirmed, revised, or withdrawn? The subcommittee solicits input from users; if you wish to make your opinions known you can write to J. S. Zajackowski, Chairman, X3B1, Sperry Univac, P.O. Box 500, Blue Bell, PA 19422 and ask for a questionnaire. The subcommittee needs your opinions by May 19.

If your company manufactures computers or business equipment, the U.S. Dept. of Commerce would like to help you get into foreign markets. Primarily interested in helping small to medium size firms, Commerce organizes overseas export promotion events, in which your firm can participate. Between May of this year and July of next, Commerce has organized Trade Center Exhibits in Milan, Tehran, Tokyo, London, and Singapore; just to name a few. More information is available from the Dept. of Commerce, Domestic and International Business Administration, Washington, DC 20230. Or, you can phone Roy Mitchell at (202) 377-2838, or Peter Ryan at (202) 377-2849. Bon voyage.

IBM shaved about 20% off the purchase prices of the 370/148 and 158, bringing them closer in line with the price performance curve set by the 303X...On the same day, March 1, Hewlett-Packard formally announced an across the board \$11,000 price cut on each and every model in its 3000-series.

Cobol Development System

Two-thousand lines of debugged COBOL code per day? This vendor says its turnkey COBOL development systems can help programmers do just that, and, it says, "this capability is demonstrable now!"

The COBOL Program Generator (CPG) system is built around several micro- and minicomputers. The turnkey systems include an ANSI 1974 standard COBOL compiler, development software, and a post processor that converts CPG system COBOL source code into source code for the production machine.

A package called Interactive provides the programmer with three major tools. The first, NEWLIB, helps the programmer describe new files. A data dictionary is created, assigning data names, describing records, field sizes and data types, decimal precision, occurrences, keys, level numbers, security, and other standard requirements. Then BLDPRO generates a COBOL program to build ISAM files described in the data dictionary. The program also includes maintenance functions, with the ability to add, change, delete, renumber, list, search on partial keys, display and accept, change keys, and perform other operations on ISAM files. It also generates screen formats. A third program, RPTWTR, generates COBOL programs that use the data dictionary and data bases built by BLDPRO-produced programs. A report generator, it can gather data from as many as 10 files (based on multiple keys). It provides up to 20 control breaks, ascending or descending sorts, titles and labeling, calculations, and other report requirements.

The CPG system also includes a number of utilities to aid in debugging and program maintenance. An editor eliminates the need for coding sheets and keypunching. The skeleton-driven generators produce structured COBOL programs which can be easily altered and amended.

The CPG software, which is said to run on any interactive system supporting COBOL with the COMPUTE and SORT verbs, and ISAM files, sells for \$17,000. A single-user turnkey system based on a Z-80 microcomputer, 10MB of disc, crt, and printer sells for \$35,000 or leases for \$1,000 per month. A multiuser system, based on General Automation hardware, sells for \$80,000 for a three user system; the same system leases for \$2,400 per month. Other configurations also are available. DAVID R. BLACK & ASSOCIATES, INC., Sewickley, Penn.

FOR DATA CIRCLE 338 ON READER CARD

Voice Data Entry

The Threshold 2000, a minicomputer-based, clustered intelligent terminal controller, can interface as many as 32 of this vendor's voice data entry terminals to IBM mainframes. The controller, which communicates with the cpu via 3270 protocol, connects to terminals with RS232 interfaces. Both voice data entry and conventional terminals can coexist in a Threshold 2000 configuration. Each voice data entry terminal can recognize at least 64 utterances (defined as sounds of 2-seconds or less duration) expandable to 600 utterances. Vocabularies can change from application to application. A Threshold 2000 system, with 3270 communications and one voice entry terminal with a 64 utterance capacity, sells for roughly \$25,000 (of which about 75% goes for the controller). This system can expand to 32 terminals. THRESHOLD TECHNOLOGY INC., Delran, N.J.

FOR DATA CIRCLE 343 ON READER CARD

Computer

DEC added an entry-level mainframe and a new top-of-the-line to its System 20 family. Described as the "world's lowest-priced mainframe," the 36-bit 2020 probably has the least demanding environmental requirements of any comparable machine: it doesn't need air conditioning and it runs off of standard 110 volt wall outlets, drawing about as much electricity as a large hair drier (1,400 watts).

The 2020 offers compatibility with other members of the System 20 fam-



ily. It supports up to 2MB of main memory, and has a virtual memory operating system, TOPS-20, which supports user programs in excess of 1MB. The system offers concurrent interactive time-sharing, multistream batch, and transaction-oriented processing. The basic unit starts with eight asynchronous lines, expandable to 32. It also has

You can't solve today's access control problems
with yesterday's concepts...

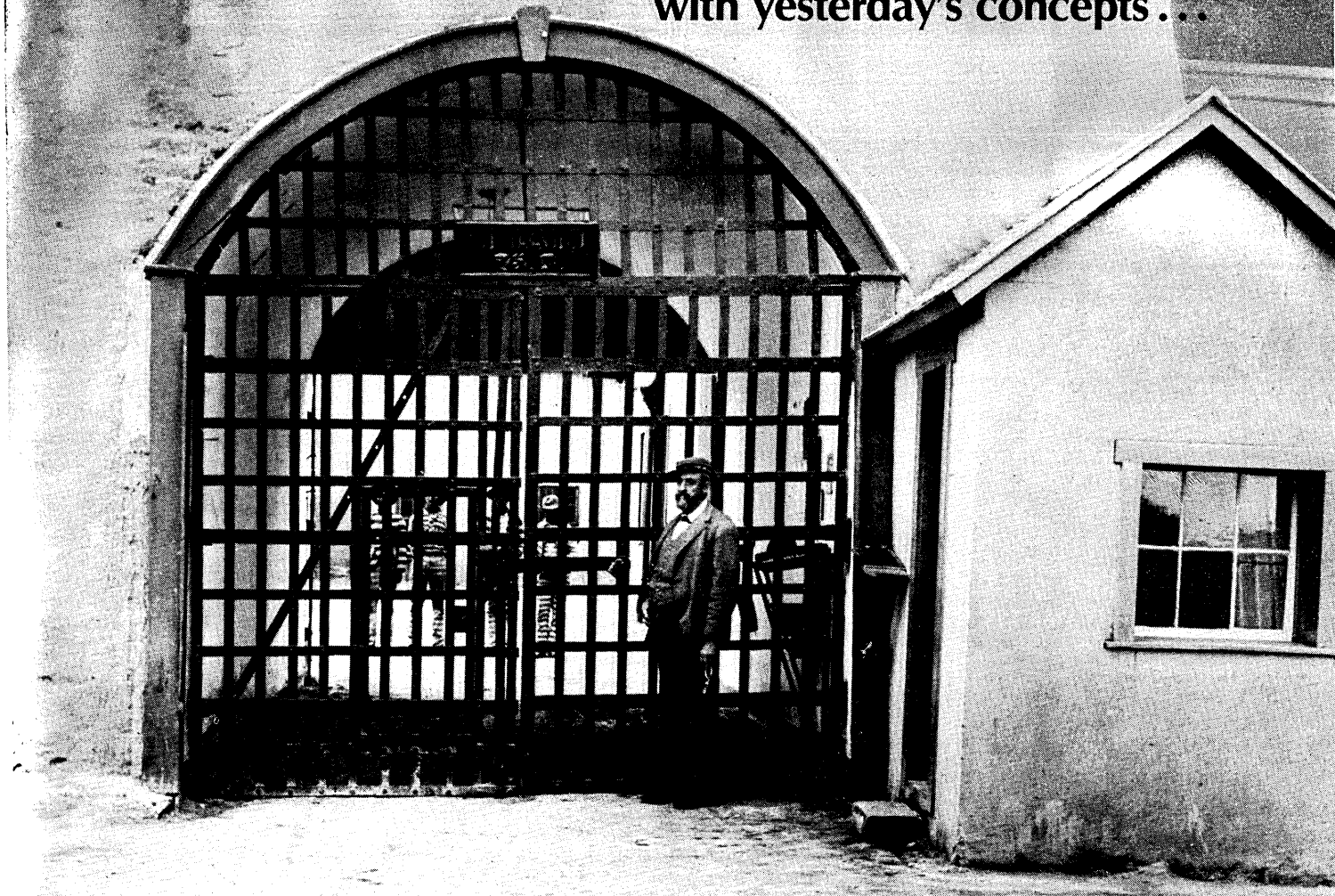

When a valid command card passes within 4 to 6 inches of a concealed sensor, the door is activated immediately. Command cards may double as employee ID cards and can be used to activate the Schlage system while remaining in a pocket or purse.

Consider the hidden alternative — Schlage Electronics Access Control System

Schlage Electronics introduces an access control system that not only eliminates the need for guards and conventional keys, but for card slots or pushbuttons as well. It's the "hidden alternative," the first practical application of electronics technology to control access for business, industry, even residential complexes. Easy to use and install. Regulates and records access by door, time and individual. The Schlage system operates by proximity. A hidden sensor scans a credit card-size command card and transmits signals to a control unit, which regulates access, and to a printer, which records access and attempts. You program the system to suit your needs. Planning and installation is as close as your nearest Schlage Electronics dealer, backed by over 50 years of security service. You can start solving today's access control problems by calling toll-free, (800) 538-1755. In California call (408) 736-8430.

SCHLAGE ELECTRONICS

A Schlage Lock Company
1135 E. Arques Avenue
Sunnyvale, California 94086
(408) 736-8430



CIRCLE 65 ON READER CARD

BUDGET

DOWN

???

DECWRITER

II & III

3-MONTH LEASE

... THEN ...

MONTH -TO- MONTH

1-DAY SHIP

FROM STOCK

AMERICAN TERMINAL LEASING

P.O. BOX 68, BOSTON, MA 02215

617-261-1100

hardware

provision for two synchronous lines. A 67MB disc is included in the minimum system; disc storage capacity can range up to 1.4 billion bytes. The system also has 512 words of cache, and 2K 96-bit words of writable microstore. Software includes COBOL, CODASYL-standard data base management system, FORTRAN IV, APL, CPL (a PL/I subset), and ALGOL. Prices start at \$150,000.

The top-of-the-line 2060 is said to be about ten times as powerful as the 2020. It uses a high-powered version of the KL processor used in other System 20s. Prices start at \$610,000. DIGITAL EQUIPMENT CORP., Maynard, Mass.

FOR DATA CIRCLE 344 ON READER CARD

product spotlight

Microcomputer Disc

A microcomputer disc system, itself controlled by a microprocessor, gives owners of S-100 bus machines 12MB to 48MB of rigid disc storage. A DMA interface version also is offered.

The SIA-2000 uses an 8080 microprocessor with 16KB of RAM and up to 16KB of PROM. The PROM holds code for a controller-resident file management system. Commands to the disc system are in the form of character strings; data references are made by symbolic names assigned by the user. The system recognizes commands for initializing and copying disc platters; creating, opening, and closing files; copying and erasing files; reading, replacing, appending, deleting, and searching of records; accessing records sequentially, randomly, or as ISAM files; and sorting any of the three types of files. The SIA-2000 has error diagnostics and automatic retries in the event of disc error. At power on, the system performs a self-test before becoming ready.

Up to four 12MB drives can be connected to one controller. The drives have one fixed and one removable platter. The system grew out of a custom project built for a French firm several years ago; a similar product has been part of an interactive business system the vendor has marketed since 1975. A single 12MB system sells for \$9,483; the controller alone goes for \$5,783. Deliveries are quoted at 30 days. SYSTEM INTEGRATION ASSOCIATES, Glenmoore, Penn.

FOR DATA CIRCLE 339 ON READER CARD

Tape Maintenance

The 659 Series is a modular mag tape maintenance system. It consists of a tape cleaner and an analyzer; a user can get the cleaner and later add the analyzer. The series has field upgradable electronics, microprocessor function control, programmable analysis, and buffered memory. Cleaning proceeds at 500 ips; analysis runs at 250 ips.

The analyzer can be field upgraded from 1600 bpi to 6250 bpi operation; the vendor says future advances in recording technology will be accommodated by field upgrades. At 6250 bpi

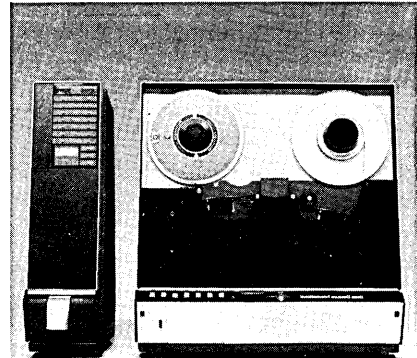

the analyzer uses a resolution block distance for spotting defects which exceeds the specs for GCR block distance. It has a thermal matrix printer for logging errors. A digital threshold level meter allows the user to set non-ANSI standard test thresholds.

The basic vacuum-column cleaner sells for \$5,995. An entry level 800 bpi analyzer starts at \$12,900. DATA DEVICES INTERNATIONAL, INC., Woodland Hills, Calif.

FOR DATA CIRCLE 334 ON READER CARD

Remote Information System

In a move to give its customers more capabilities with little disruption of existing operations, this vendor has come up with the model 85 Attached Application Processor. Designed for use with existing model 76, 78, 82, or Keybatch terminal systems, the model 85 performs application processing of programs written in interactive RPG II and COBOL. Attach the model 85 to one of the vendor's terminal systems and you have the makings of what the vendor chooses to call a Remote Information System. The 85 handles local processing, while the terminal system still does its original job of handling volume data entry and additionally serves as a communications front end to the 85. The two units must be within 25 feet of each other.

The model 85 can be configured with 96KB to 128KB of main memory, 10MB to 100MB of disc, and as many as 15 crts

(Continued on page 218)

You Don't Need A Room Full Of Computers To Use **DISSPLA** Graphics Software...

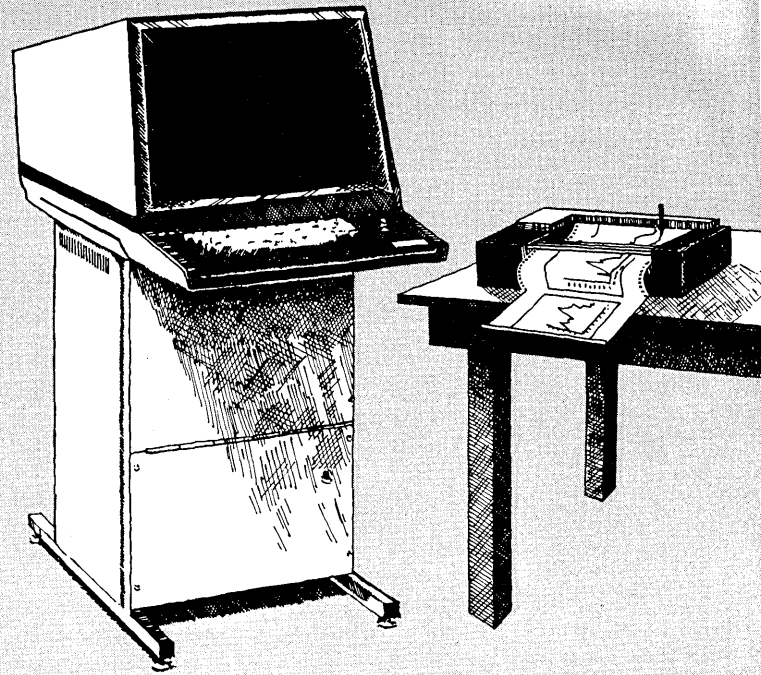
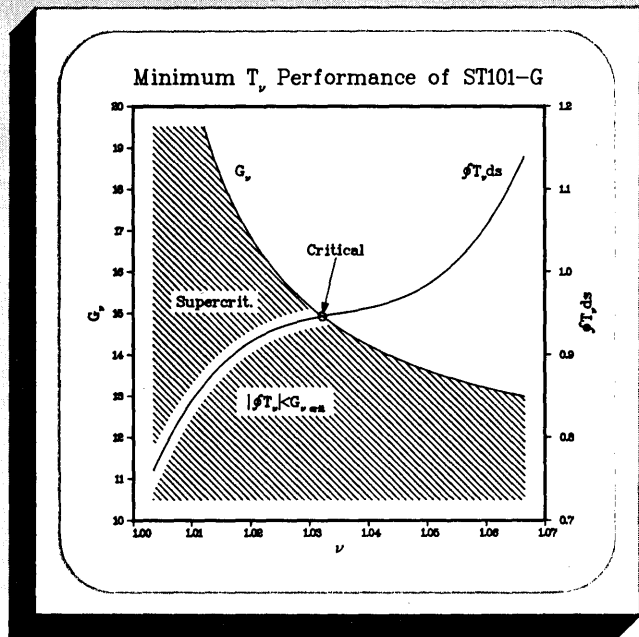

...Just A Service Bureau.

When high powered DISSPLA graphics are added to the software and hardware resources of a service bureau, all you need is the data to be plotted. Whether you have frequent, recurring needs for publication quality graphs, or you just want to produce that one important chart for this afternoon's board meeting, DISSPLA is the vehicle to make this practical.

With minimal initial user investment, service bureaus provide a wide range of utilities. Device independent DISSPLA easily couples your needs and resources to what the service bureau offers.

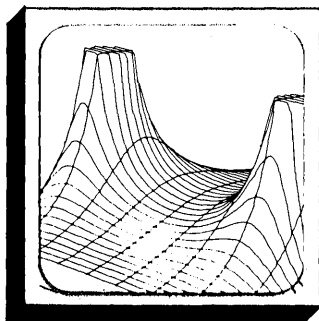

The combination spells convenience, and time and effort savings.

Among the service bureaus offering DISSPLA are: *American Management Systems, Inc. (AMShare), AVCO Computer Services, Babcock & Wilcox Company, Computer*

Sciences Corporation, Infonet Division, Comshare, Inc., Control Data CYBERNET® Services, Information Systems Design, Inc., Interactive Data Corporation, National CSS, Inc., Sun Information Services, Tymshare Inc., and United Computing Systems, Inc.

DISSPLA is easy to use. It was written with the user in mind, using sensible mnemonics, extensive defaults, and intelligible diagnostics. Comprehensive manuals, and a pocket reference, mean the average FORTRAN programmer will produce nice plots in a few hours.

DISSPLA®

Display Integrated Software System and Plotting Language
A proprietary software product of ISSCO

For information call Sunny Harris (714) 452-0170 or (714) 565-8098.
Or write

ISSCO®

Integrated Software Systems Corporation

4186 Sorrento Valley Blvd., Suite G, San Diego, CA 92121 (714) 452-0170

In Europe contact: Repko bv. van Blankenburgstraat 58
The Hague, Holland
Telephone 070-608425



All at once, it's Harris.

Harris now delivers the most cost/performance effective multi-use computer system in the industry.

Our new family of high performance systems—S115, S125 and S135—together with our powerful VULCAN Virtual Memory Operating System supports more than 50 terminals. Simultaneously.

This is a whole new line of medium-scale, multi-use systems with increased reliability and new state-of-the-art technology. You get greater I/O throughput. MOS memory with error correction. Powerful micro processor based CPU. Broad selection of highly reliable peripherals. And all operate with ANSI 74 COBOL, FORTRAN, RPG II, FORGO, SNOBOL, and extended BASIC.

The Harris S100 systems take on many different jobs all at the same time. Multi-stream batch processing. Multiple concurrent RJE's, both host and remote. Multiple interactive time sharing. Real-time processing. And this new generation of high performance computer systems from Harris delivers these all to you, *concurrently*.

If your need is distributed processing, time sharing, data base management, or any type of concurrent multi-use application, *benchmark our new computer system against any other system in the industry.*

Harris Computer Systems, 1200 Gateway Drive, Fort Lauderdale, Florida 33309. Telephone (305) 974-1700. Europe: Harris Intertype, Ltd., 145 Farnham Road, Slough, SL1 4XD, England.

All at once, it's Harris.

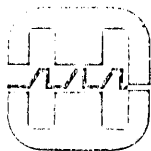

HARRIS
COMMUNICATIONS AND
INFORMATION HANDLING

hardware

(Continued from page 214)

(located within 2,000 feet of the 85). Peripherals include printers and mag tape drives. A multitasking operating system allows concurrent execution of as many as eight independent tasks. A COBOL cross compiler allows down-line loading of applications developed on a central mainframe.

Remote Information Systems communicate using synchronous protocols over point-to-point or multipoint lines.

SDLC is supported, and there is a wide variety of communication emulators, including HASP, 3270, and CDC 200 UT, available.

Four basic system configurations are possible, depending on which terminal system is selected. A minimum system consisting of both a model 85 (96KB, 2 key-stations, 10MB of disc, 125 lpm printer, and software) and a model 76 (with HASP communications at 4800 bps, and a 150 cpm card reader), leases for \$1,377 per month on a 42-month lease, including maintenance; outright purchase is \$52,422. DATA 100 CORP., Minneapolis, Minn.

FOR DATA CIRCLE 342 ON READER CARD

Display Stations

IBM has come up with several new display station terminals for its System/34. The model 5252 dual display station is just that: two 960-character displays, back-to-back. The two displays are independent; an operator at one can perform data entry, while an operator at the other can plug away at some other application, say an accounting routine. Attachment is to the System/34 system unit or 5251 model 2 or model 12 displays.

Two similar models joined the 5251 line. The new 5251 model 2 provides a link to the System/34 via SNA/SDLC; it supports as many as eight additional workstations, including the 5251 model

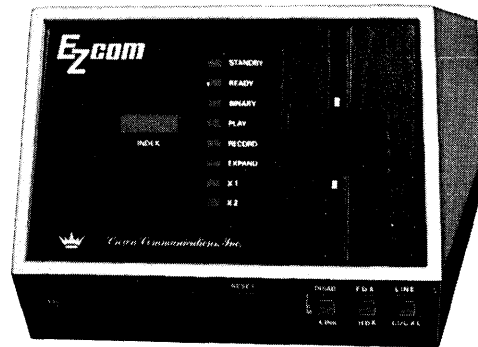

New

EZ Com

Intelligent Data Storage Device very smart about time sharing costs

The new EZ Com can cut the cost of time sharing! EZ Com has a mini-floppy disk storage capacity of 71,680 characters and achieves transmissions speeds from 110 to 9600 baud.

Full compatibility with most terminals and modems. Operator communication with EZ Com's micro-processor provides random access, editing, data retrieval, record length selection, validity checking and other functions.

The EZ Com price makes it easy to own. Contact Joel Stephens, VP Marketing, Crown Communications, Inc., 2750 Northaven, Suite 111, Dallas, TX 75229.

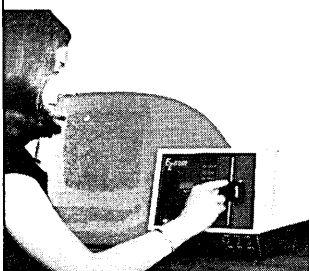

Crown Communications, Inc.
2750 Northaven,
Suite 111 Dallas, TX 75229
Phone (214) 243-6941

Also Crown's CCI-5000 — For those who need a cassette device Crown offers the CCI-5000, with many of the advance advantages of the EZ Com, but in cassette form.

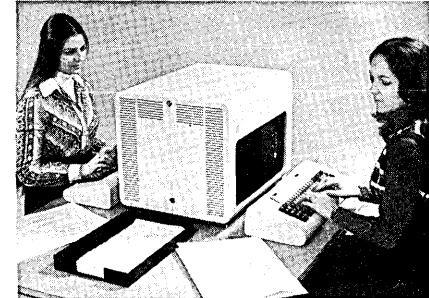

1, announced at the same time. The 5251 model 1 also can attach directly to the System/34 system unit or through a 5251 model 12.

All three of the new stations are supported by the System Support Program, RPG II, and Utilities Program Product. Screen formats created for the new units also can be displayed on the larger 1,920-character screen stations available for the System/34.

The 5252 leases for \$100 per month; it can be purchased for \$3,740. Lease prices for the 5251 models 1 and 2 are \$80 per month and \$135 per month respectively; the purchase prices are \$3,010 and \$4,655. Availability is slated for January of next year. INTERNATIONAL BUSINESS MACHINES CORP., General Systems Div., Atlanta, Georgia.

FOR DATA CIRCLE 349 ON READER CARD

5100 Keypunch Interface

It's not that interfacing a keypunch to a computer is a new idea (the old Bendix G-15D, all 400 some-odd tubes of it, had an 026 interface), it's simply the fact that having a card reader/punch will make the IBM 5100 better suited to small business applications. And, by using an installed 029 or 129, a machine that might otherwise stand idle can perform more productive work. Most of the CCC 1700A Keypunch Interface market will probably come from users who already have a keypunch, and perhaps, still have some card-based applications; new 5100 and 5110 users probably won't want to lay out another \$4,000 for the key-

(Continued on page 223)

ncc pre view

1978 NATIONAL COMPUTER CONFERENCE
ANAHEIM, JUNE 5-8

Record-Setting NCC Planned for Anaheim

The biggest computer show on earth is taking shape as final plans are completed for the 1978 National Computer Conference, June 5-8 in Anaheim.

Conference chairman Stephen W. Miller promises a conference of unparalleled scope and diversity with emphasis on analyses of the latest and most significant frontiers in information processing. And, according to Miller, there is every likelihood that a host of new NCC records will be set in the process... the largest exhibit of computer hardware, software, systems, and services ever held; total conference attendance of up to 40,000 computer specialists, data processing users, managers, educators, students, and government officials; plus a separate Personal Computing Festival which will provide a unique national forum for this fast-growing field.

With the addition of the West Hall at the Anaheim

Convention Center, the NCC '78 exhibit program will approach 1,400 booths, easily surpassing the previous record of 1,146 booths set in Dallas in 1977. More than ever, NCC will be an extraordinary showcase for the latest developments in products and services designed to meet the needs of conference attendees.

The Personal Computing Festival will mark the most comprehensive personal computing event ever held. Included in the Festival, June 6-8 in the Disneyland Hotel Convention Center, will be program sessions, commercial exhibits of consumer computing products and services, plus a contest featuring microprocessor systems and applications.

And this is only part of the picture at NCC '78. A technical and professional program of approximately 100 sessions will cover computer methodology, applications, systems, and societal concerns. Other NCC features include a Professional Development Series of 15 tutorial seminars, and major addresses by leading industry authorities.

NCC '78 brings it all together in a conference that will keep you up-to-date on the latest developments in computing and information processing.

To obtain additional details, or to preregister for NCC '78, return the enclosed coupon.

Exhibits to Set New Mark

Attendees at NCC '78 will have the opportunity to examine virtually every major offering of the computing and information processing industry at the largest single exhibit of computer products and services ever staged. All exhibit space for NCC '78 is sold out, with more than 330 organizations having reserved 1,382 booths...including all 277 booths in the West Hall.

Construction of the new West Hall is believed to represent an unprecedented first, and was authorized by the NCC Board to accommodate those exhibitors who initially were unable to obtain exhibit space for NCC '78. The West Hall is located immediately outside of the west corridor between the North and South Exhibit Halls of the Anaheim Convention Center and will be completely air-conditioned, carpeted, and well-lit. A covered walkway will link this area to the Convention Center. The West Hall will also offer attendees a comfortable, sit-down restaurant featuring the cuisine of four different countries.

More than 4,000 industry representatives will be on hand during the four-day exhibit program to demonstrate their latest products and services, provide technical and commercial data, and to help you find solutions to your information processing needs. The NCC '78 exhibit program offers the year's best opportunity to compare and evaluate competing offerings in essentially all areas including components, data communications equipment, education and training materials, minicomputers, microcomputers, microprocessor systems, mainframes, memory systems, software systems, test equipment, terminals, and other computer peripherals.



Strictly Personal: The Most Comprehensive Personal Computing Event Ever Held

A rewarding personal experience is in store for you June 6-8 at the NCC '78 Personal Computing Festival...the most comprehensive personal computing event ever held. The Festival marks a first for NCC — a major "conference-within-a-conference" with its own program sessions, commercial exhibits, separate registrations, plus a contest featuring microprocessor systems and applications. All Festival activities will take place in the Disneyland Hotel Convention Center, just a few minutes from the Anaheim Convention Center.

Conference registration for NCC '78 includes admission to the Festival. For students, hobbyists, and others not planning to attend NCC, separate one-day and three-day registrations will be available at \$5 and \$9, respectively. There is no minimum age requirement for admission to the Festival.

Now is the time to plan to attend the NCC '78 Personal Computing Festival. The Festival program will include some 30 paper, panel, and tutorial sessions. Talks are expected on such topics as tutorials for computer novices, speech synthesis and recognition, computerized music systems, computer graphics and video art, hardware and software design, personal computers for education, standards, personal computers for the physically handicapped, and small business systems. All papers will be published in a softbound volume, *Festival Digest '78*, which will be available during NCC.

The Festival will feature an extensive display of commercial offerings by organizations serving the personal computing field. According to conference chairman Stephen W. Miller, "The NCC '78 Personal Computing Festival will provide a forum and a marketplace never before equalled in serving this emerging new industry." Approximately 25,000 individuals attended the personal computing exposition at '77 NCC in Dallas — a record which is certain to be broken since Southern California is much more heavily populated with individuals who produce, build, buy, and use personal computers for business needs or for personal enjoyment.

Festival exhibits will provide an overview of the very latest in consumer computing products and services. More than 100 organizations will display systems, components, terminals, software, kits, disc and tape cassettes,



relevant publications, and related hobby items. In addition to 10 x 10 foot booths, which include a standard display package, a limited number of tabletop displays are available.

A Personal Computing Contest will add excitement and challenge to the Festival. The competition will consist of demonstrations and exhibits of a wide range of systems, devices, and applications. Prizes will be awarded for the most outstanding entries in such areas as homebrew DOS, graphics terminals and languages, educational applications, computer games, computerized music systems, and business applications. According to contest chairman Dr. Larry Press of the Southern California Computer Society, the competition will feature displays by individuals and computer clubs. Winning entries will be determined on the basis of innovation, efficiency, usefulness, plus several additional criteria.

To make certain that you keep up-to-date on the year's most exciting personal computing event, or to obtain complete details on participating in the Festival commercial exhibits, just fill out and return the enclosed coupon.

NCC '78 Program Practical, User-Oriented Sessions

Practical applications and effective solutions to data processing problems will be spotlighted in NCC program sessions.

Guidelines being employed by Dr. Leonard Y. Liu, co-chairman of the technical and professional program, include: emphasis throughout the approximately 100 sessions will be on recent developments having practical applications rather than on theoretical concepts; end users will be provided with the opportunity to express their views on key areas involving systems, applications, methodology, and management issues; time will be allotted for presentations based on outstanding papers delivered at recent specialized conferences, symposia, and workshops; and increased attention will be given to developments in other world areas...in this case, Japan.

In addition to sessions covering recent computing developments in Japan, the NCC '78 program will include 25 major topic areas covering computer Applications, Methodology, Systems, and the impact of computers on People and Society.

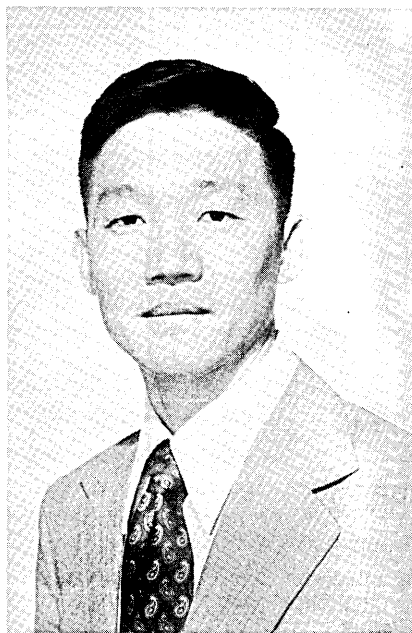

Dr. Leonard Y. Liu

"...stress on practical applications, rather than theoretical concepts..."

"As part of our emphasis on the practical and the useful," Dr. Liu remarks, "it is imperative that we hear more from those who use computer systems." Among many NCC sessions which will stress the role of the user are those on database management systems, computer architecture, and education and careers.

"For example, when we cover computing education," Dr. Liu continues, "rather than just discuss the views of university professors and the latest developments in computer science curricula, we prefer to hear views of the people who hire the graduates, and how they grade the quality of computer education as it relates to their needs."

Applications

Dr. Liu and Dr. Sakti P. Ghosh, co-chairman for the NCC '78 program, plan to cover ten Applications areas, including such topics as special purpose terminals, artificial intelligence, electronic fund transfer systems, simulation, and home and hobby computing. In addition, emphasis will be placed on applications of computers to solve world energy and resource problems...plus analyses of current efforts in office automation.

The use of computers in helping to alleviate energy problems will be covered in some six to eight sessions. Included will be use of decision support systems in planning for transportation, including distribution of petroleum products;



application of large-scale models to predict future patterns in supply and demand for energy products; use of microprocessor technology and microcomputers in conserving energy; plus applications of computers in resource exploration. In addition, four related sessions will center on image processing from remote sensing with special attention to determining existing resources.

Office automation will be scrutinized in five sessions beginning with a review of recent developments followed by an analysis of the impact of minicomputer and microcomputer systems. Included will be a debate on two alternate approaches to office automation — stand-alone systems having their own computing capability versus integrated systems based on timesharing and use of intelligent terminals in remote locations.

Methodology

According to Dr. Liu, computer Methodology will include coverage of performance measurement and evaluation, programming methodology, automatic programming, and analyses of software techniques and tools.

In addition, a number of sessions will provide a detailed look at data processing management and administration at the installation level. Included will be an examination of the role of the data processing manager in long-range planning, scrutiny of data processing costs, analyses of personnel issues and problems involving security and privacy compliance, plus an assessment of the impact of new technology on the DP organization.

Systems

Computer Systems will include coverage of data networks, distributed systems, programming and operating systems, plus special attention to computer architecture, the impact of recent developments on hardware technology, and database management systems. Computer architecture will receive indepth analysis, beginning with a review by leading industry experts of the evolution of architecture—including minis, micros, and mainframes. Other sessions will focus on standardization, the impact of the user on present-day architecture, development of large-scale computer architecture, plus an examination

of special purpose machines developed for the military.

The impact of recent developments on hardware technology will cover what's ahead in computer storage technology, peripheral devices, and power supplies; very large system integration; advances in data communications; and business planning for the marketing of technology. Similar coverage will be given to database management systems beginning with an analysis of the decision to implement large-scale database systems, followed by consideration of a number of critical factors including design, installation, and personnel training.

People and Society

According to Dr. Liu, the conference program will also explore the impact of computers on People and Society through 15 sessions covering communications regulatory policy, legislation and its impact, and computer careers and education. Legislation and its impact will explore both existing legislation and proposals currently on the drawing boards...with emphasis on projected impact on manufacturers, end users, and society as a whole. Specific topics include protection of proprietary interests in software, privacy, personnel issues, computer communications, and computer crime.

Rounding out the NCC '78 conference program will be three special sessions covering recent progress in Japan, featuring participation of leading Japanese experts. Marking an NCC first, these sessions...developed with the cooperation of the Information Processing Society of Japan...will report on the latest developments in computer technology and applications, ranging from advances in semiconductors and computer architecture to multi-terminal banking systems.

In shaping the NCC '78 technical and professional program, Dr. Liu brings to this demanding task a broad and deep understanding of computer technology and applications. He is presently director of systems architecture and standards for IBM in Poughkeepsie, New York, and previously served as manager of the Computer Science Department of the IBM Research Laboratory in San Jose, California, with responsibilities for com-

puter science research including the activities of Departments covering Exploratory Systems, Advanced Application Systems, and Database Systems.

Dr. Liu received a B.S. degree in electrical engineering from National Taiwan University and a Ph.D. in computer sciences from Princeton University. Subsequently, he served on the faculty of the University of Michigan, and in 1969 joined the T.J.Watson Research Center of IBM where he worked on a variety of system projects prior to his move to San Jose.

Professional Development Series

Topics of major importance to computer specialists, users, and managers will be covered in the NCC '78 Professional Development Series. The Series of 15 seminars, under the direction of Gopal Kapur, a leading consultant from Danville, California, will cover a wide range of areas critical to system development, structured methodology, software engineering, database management, and cost-effective computer usage.

Each seminar will consist of a one-day minicourse providing coverage of the latest developments, applications, and trends in a specific area designed to increase professional skills and aid in career development. All seminars will be conducted at The Inn at The Park Hotel. To assure a maximum learning experience, attendance will be limited. The separate nominal fee for each seminar is \$45 and includes complete course material plus access to the four-day exhibit program and the Personal Computing Festival.

Seminars will be conducted by nationally-recognized authorities experienced in presenting such courses. According to Kapur, the seminars will deal both with user-oriented issues as well as subjects of prime interest to computer specialists.

Specific topics include managerial development, security and fraud, managerial opportunities for women, word processing, system capacity planning, database systems, structured methodology, requirement analysis, distributed processing, systems architecture, microcomputers, cryptography, effective computer negotiations, motivating DP professionals, plus a seminar on microprocessor technology stressing hands-on experience.

Call Toll-Free For NCC Travel Data

To assist you in your travel plans, a special toll-free number has been established for the red-carpet NCC Travel Service. By calling 800/556-6882, you're assured of personalized service including the lowest possible airfare — with savings of up to 44 percent in some cases. By acting now, you are guaranteed the best available arrangements whether you intend to fly to California alone, with colleagues, or with your family.

A variety of travel packages are available...depending upon days of the week, departure times, stopovers, and CAB regulations. To get all the facts covering air travel packages from your city, as well as a full explanation of regulations which apply to various discount airfares, just call the special NCC Travel Service toll-free. For example, Super Saver airfares from New York, Philadelphia, Boston, and Washington airports provide savings of up to 44 percent. In addition, special individual air travel programs are available from all major cities to the West Coast with savings of 28 percent — based on regular airfare with a nominal stopover charge of \$15 for each city en route.

Whatever your needs, the NCC Travel Service can work out the best possible arrangements including discount fares for special event groups, seven-day excursions, night coach, and system-wide fares offering unlimited travel.

The NCC Travel Service has been arranged to help you offset the rising cost of transportation and to assist you in meeting personal requirements. There is

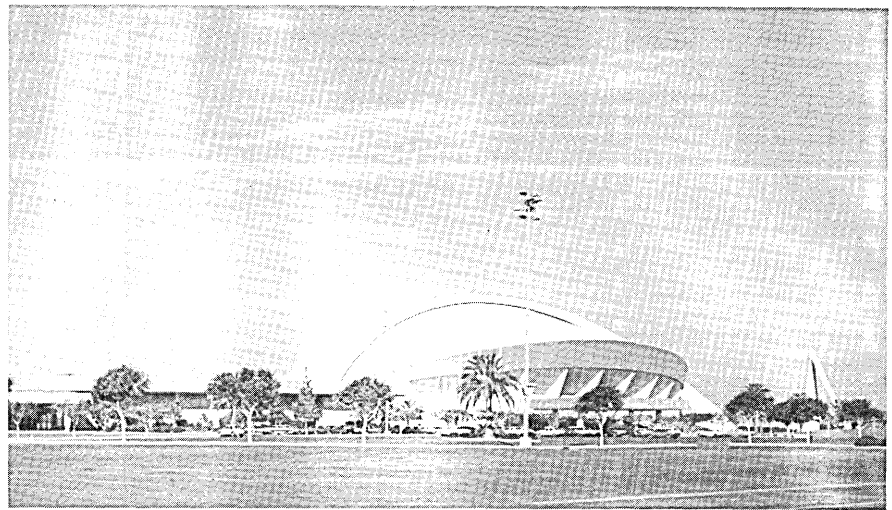

no cancellation fee until tickets are issued, usually about two weeks prior to departure. All major credit cards can be used and payments may be extended over 12 months. Arrangements for direct company billing can also be made.

NCC Travel Service personnel will be on hand at Los Angeles International Airport to help you on your arrival. In addition, a courtesy desk will be maintained in the Convention Center to assist you in handling reservation changes or to arrange for special tours of major attractions in Southern California. To obtain detailed information, call 800/556-6882...or fill out and return the coupon.

NCC '78 Highlights

- The largest exhibit of computer products and services ever held with more than 330 organizations occupying 1,382 booths in the Anaheim

Convention Center.

- Approximately 100 sessions covering 25 technical and professional program areas involving computer Applications, Methodology, Systems, and People and Society.
- A Personal Computing Festival consisting of commercial exhibits, approximately 30 sessions on personal computing topics, and a competition featuring microprocessor systems and applications.
- A Professional Development Series of 15 one-day seminars on topics designed to enhance professional growth and advancement.
- A wide range of special activities... including featured addresses, a conference reception, and Pioneer Day.
- A red-carpet NCC Travel Service offering the best possible travel packages and personalized service.
- Advance NCC registration...providing full-conference registrants with special discounts and other benefits.

Yes, I'm interested in NCC '78 and would appreciate your keeping me informed about the conference program, exhibits, the Personal Computing Festival, and related activities and events.

- Please keep me informed on NCC '78 and send me future issues of **NCC Preview**.
- I wish to preregister for NCC '78. Enclosed is \$60 covering full-conference registration, including program sessions, exhibits, the Personal Computing Festival, and special preregistration benefits.
- My company is interested in exhibiting at the NCC '78 Personal Computing Festival.
- Please send me information on hotel/motel accommodations available through the NCC'78 Housing Bureau.
- I would like to receive additional information about the special NCC '78 Travel Service.

Name _____ Title _____

Company _____ Division _____

Street _____

City _____ State _____ Zip _____

NCC '78...
**New Frontiers in
Information Processing**
c/o AFIPS, 210 Summit Avenue
Montvale, New Jersey 07645
Telephone: 201/391-9810

hardware

(Continued from page 218)

punch, in addition to the \$2,850 for the interface. The interface accepts bit-serial data from the 5100 and converts it to Hollerith for the keypunch. When using a 129 as a card reader, the interface can operate at a continuous rate of 55 cpm. The interface also works with Series 1 minicomputers. COMMUNITY COMPUTER CORP., Philadelphia, Penn.
FOR DATA CIRCLE 351 ON READER CARD

Hobbyist Cassettes

Specifically designed for use with home and hobby computers, these cassettes use media selected to be error free at the recording sensitivities used by popular personal computers. The cassettes are warranted against defects in materials and workmanship. Available in four lengths, the cassettes come four to a package. Packages of 50 feet, 100 feet, 200 feet, and 300 feet cassettes sell for \$2.40, \$2.80, \$3.40, and \$4, respectively. MICROCASSETTE CO., Sunnyvale, Calif.

FOR DATA CIRCLE 350 ON READER CARD

Hobbyist Graphics

A graphics output board for S-100 bus microcomputers operates in either of two modes: digital output or 16-level gray scale. It requires a +8 volt dc power supply and 8KB of RAM. Output conforms to the RS170 video standard. Digital graphic displays have a resolution of 256 points horizontally by 240 points vertically; gray scale resolution is 128 by 120. When not being used for graphics display, the required 8KB of memory is available for other uses. Fully assembled, the board sells for \$235; as a kit it goes for \$195. VECTOR GRAPHIC INC., Westlake Village, Calif.

FOR DATA CIRCLE 353 ON READER CARD

Time-sharing Computer

This vendor's model 350, intermediate in its product line, is a virtual memory time-sharing system which runs user



programs as large as 768KB. Capable of supporting 63 lines, the 350 gives all user's concurrent access to 2MB of virtual memory. Running under the

April, 1978

PRIMOS IV, the 350 executes shared, re-entrant procedures. Programming languages include BASIC/VM (a virtual memory compiler), COBOL, RPG II, and FORTRAN. Data management software is available in the form of MIDAS; communications emulators are offered for 2780, HASP, UT200, and ICL 7020 protocols. Prices start at roughly \$100,000. PRIME COMPUTER, INC., Wellesley Hills, Mass.
FOR DATA CIRCLE 341 ON READER CARD

Security Module

PDP-11 users with need of secure communications or data bases (or both) can make use of the new Data Encryption

Standard (DES) without burdening their processors. The DES1100DSM is a complete encryption/decryption system on one Unibus-compatible circuit board. It enciphers data using the cipher feedback or cipher block chaining encryption mode. The DES algorithm is implemented in a single custom NMOS LSI chip. Encryption and decryption are performed from memory to memory; thus the device can encrypt a message destined for transmission to a remote site, or data going to a mass storage device. Memory accesses are performed on a DMA basis under the control of an M6800 microprocessor. The DES1100DSM sells for \$1,995. MOTOR-

INFONATIONAL RUNS FIRST*

*IN DATAMATION'S 1977 USER RATINGS



CHECK OUR TRACK RECORD . . .

For the most cost-effective, easy-to-operate, integrated accounting systems, call (714) 560-7070 or mail in this coupon.

NAME: _____
TITLE: _____
COMPANY: _____
ADDRESS: _____
CITY: _____
STATE: _____
ZIP: _____ PHONE: _____

I AM INTERESTED IN:

- GENERAL LEDGER
- ACCOUNTS PAYABLE/
PURCHASE ORDER
- ACCOUNTS RECEIVABLE/
SALES ANALYSIS
- FIXED ASSETS

DM 4/78

Choose the winner —

**RUN WITH THE BEST
IN INTEGRATED ACCOUNTING SYSTEMS!
INFONATIONAL**

A Division of United Computing Systems, Inc.

6626 Convooy Court San Diego, CA. 92111 (714) 560-7070



CIRCLE 132 ON READER CARD

hardware

OLA, Government Electronics Div., Scottsdale, Ariz.

FOR DATA CIRCLE 345 ON READER CARD

Distributed Systems

The PTS Mark I and Mark II join this vendor's current offerings in its PTS/1200 line of distributed systems. Mark I, an entry-level system, is designed for smaller offices where an eight-terminal system is sufficient. The Mark I controller cabinet houses a cpu with 64KB or 128KB of memory, as many as five I/O controller boards, and a 10MB front-loading disc subsystem. The vendor offers two types of crts—960 and 1,920 character versions—which can be located as far as 5,000 feet from the controller. Eight devices, in addition to the terminals, can be supported by the Mark I. These include 30 and 120 cps printers, 300 lpm line printers, 800 bpi mag tape, and card readers. The controller also supports 2780, 3780, HASP, and 3270 communications; SDLC is slated for deliveries in the fourth quarter. Software support includes the MACROL language, utilities, and diagnostics. Deliveries are slated for July; a 64KB version of the Mark I controller,

including 10MB of disc, sells for \$23,120, or leases for \$555 on a three-year plan.

The top-of-the-line Mark II controller supports up to 128KB of memory, 12 I/O boards, 24 video terminals, and 20 peripheral devices. It's said to be roughly 25% faster than other PTS controllers. In addition to supporting all the devices available for the Mark I, the

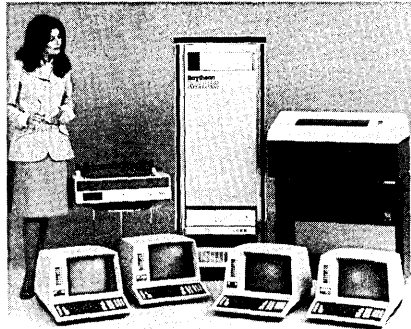

Mark II can have 600 lpm line printers, 1600 bpi tapes, and 80MB discs. Mark II, also slated for July deliveries, sells for \$52,450 with 128KB of memory and an 80MB disc; three-year lease on the same controller is \$1,459 per month. RAYTHEON DATA SYSTEMS, Norwood, Mass.

FOR DATA CIRCLE 340 ON READER CARD

Daisywheel Printer

The PR-DWI printer uses a Diablo daisy-wheel print mechanism. The unit inter-

faces to cpu's through a pair of 25-pin connectors; it comes with detailed instructions for completing the interface to common microcomputer parallel interface boards. An S-100 interface costs an additional \$59. The unit prints bidirectionally at 45 cps. The carriage can be positioned horizontally in steps of 1/120 inch; the platten can step vertically in increments of 1/48 inch. Under program control, the platten can roll forward or backward. Two program packages come with the unit. One supports alphanumeric printing; the other is a printer/plotter package that takes advantage of the 1/120 inch horizontal and 1/48 inch vertical stepping capability of the printer. The software works with popular microprocessor BASIC's, as well as FORTRAN and assembler. The complete hardware/software package sells for \$2,678. ALGORITHMICS INC., Newton Upper Falls, Mass.

FOR DATA CIRCLE 346 ON READER CARD

LSI-11 DMA Interface

Packaged on a dual-height board, this DMA board for DEC's LSI-11 microcomputers can handle extended addresses to 256KB, and it transfers data at rates of up to 400K bytes or words per second. The vendor thinks it's the only DMA board around that will fit the backplane of DEC's recently announced

BUY 35.95
SELL 77.67
FRAN'S

Protect Your Computer Data From Theft

... using the new Federal Data Encryption Standard

Join Ketrion's technical personnel, and industry experts for a 2½ day seminar to review newly developed data encryption technology. Learn state-of-the-art procedures for planning your encryption strategy.

Topic: Computer data security, using commercial cryptographic technology. Includes system solutions and management of cipher keys.

May 8-10—New York City
May 22-24—Washington, DC
June 18-20—Barcelona, Spain
July 24-26—Denver, Colorado

Call or write to:
KETRON, INC.,
Valley Forge Executive Mall, #10
Wayne, PA 19087
Telephone (215) 687-6300 Telex 834394

BUY 45.6
SELL 329.9
FRAN'S
80¢

CIRCLE 157 ON READER CARD

FREE

The New Minicomputer Accessories 1978 CATALOG

48 pages loaded with hundreds of standard (but hard to find) products needed to support your minicomputer installation—Disk Cartridges, Mag Tape, Floppy Disks, Carrying Cases, Binders, I/O Connectors and Cables, Racks and a great deal more.

IMPROVE ORGANIZATION AND EFFICIENCY with ideas found on every page... money and time-saving products and ideas that help you beat the high cost of repetitive tasks and misplaced data.

SAME DAY SHIPMENT of many of our products gets them to you within 24 hours. Last year MCA met a New York customer's need for custom cables with delivery and installation by 7 a.m. the next morning.

Write or call for your free catalog (408) 737-7777. Please advise minicomputer make and model.

Call (408) 737-7777 or write for MCA Catalog.

A FULL, NO-NONSENSE GUARANTEE on all MCA products assures your satisfaction or we'll take it back. And every MCA product is field-proven before we offer it in our catalog. Only by providing products of the highest quality are we able to offer a no-strings guarantee.

MINICOMPUTER ACCESSORIES

130 S. Wolfe Road, P.O. Box 9004, Sunnyvale, CA 94086

CIRCLE 140 ON READER CARD

LSI-11/2, the half-size counterpart to the venerable LSI-11. The vendor sees the board finding use with floppy and hard disc controllers, line printers, and inter-processor communications channels, to name a few. In single quantities, the board sells for \$495, with quantity discounts available. COMPUTER TECHNOLOGY, Oakland, Calif.
FOR DATA CIRCLE 347 ON READER CARD

Hand-held Microfiche Viewer

This hand-held microfiche viewer provides 15X magnification, and viewing by ambient light or its own self-contained light. It has a magnetic back-plate, fluid focusing, a clear ring for additional light and opaque viewing, and a beam splitter to gather light from both external and internal sources. It weighs 8 ounces and will carry a \$49.95 price tag when it goes into production this fall. KEYAN INDUSTRIES, INC., Braintree, Mass.
FOR DATA CIRCLE 354 ON READER CARD

Menu Keyboard

An option for this vendor's 400E crt terminals, this keyboard consists of three 12-key pads. One is for numerics, one for cursor control, and the third contains function keys. Functions are defined in PROM; custom keycaps are

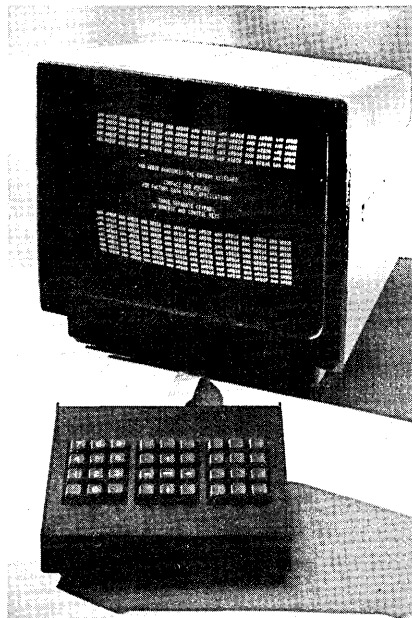

available. The keyboard comes with preprogrammed meanings for each function key (mostly escape codes); custom coding is available for a \$250 setup charge, plus \$70 per unit. In all, 21 keys are available for custom codes. Single unit price for a basic (non-custom) KB400M keyboard is \$1,100. ANN ARBOR TERMINALS, INC., Ann Arbor, Mich.
FOR DATA CIRCLE 337 ON READER CARD

Distributed Processing

Half a dozen enhancements make this vendor's XL40 distributed processing system more flexible and applicable to more applications. Station printers, rated at 60 cps to 120 cps, can now be combined with terminals. The printers are logically associated with terminals through dynamic assignment, and may be located separately from the terminals if warranted by the application. Terminals and printers may now connect to the system over dial-up or leased phone lines. Additionally, display terminal size has been kicked up better than four times from 480 characters to 2,000 characters. Disc capacity has increased from 35MB to 70MB of formatted data. Memory can now be expanded to 512KB, up from a previous maximum of 128KB.

Additional software support has been added in the form of 3270-compatible information retrieval. The system can transparently forward a request for data to a mainframe in the event the local data base doesn't have the desired information.

Installation of the new features is slated for the fourth quarter. A 256KB system, with 35.2MB of disc, eight 480-character displays, a 300 lpm system printer, 360/20 HASP communications, 3270 mode, and a remote subsystem consisting of two 2,000-character dis-

DATAMATION[®] magazine

"1978 MAINFRAME USER SURVEY" AVAILABLE NOW.

This most comprehensive analysis ever of the mainframe systems market has just been published in a 300-page report . . . essential data for industry analysts, planning and marketing executives as well as computer users themselves.

INSTALLATION PLANS OVER THE NEXT TWO YEARS . . .

In this up-to-the-minute report, over 4,300 user sites with nearly \$4 billion worth of systems in use in the U.S., and overseas provide detail answers about their plans to take delivery of 1,470 mainframe systems, valued at \$1.6 billion, plus 50,000 add-on disks, tapes and terminals and 450 million bytes of memory over the next two years.

FIVE SURVEYS IN ONE . . .

This survey takes a penetrating look at the plans of the IBM, Burroughs, Honeywell, Univac and NCR user bases . . . 1978/79 delivery profile for the 3031, 3032 and 3033 . . . all other systems . . . principal peripherals . . . purchase-vs-lease decisions . . . plans to sell used computers . . . buying intentions for plug-compatible CPU's, peripherals and minicomputer . . . network implementation plans . . . operating systems and packaged software usage . . . 1978 EDP budget plans and a "look ahead to 1979".

LARGE CROSS SECTION OF USERS COVERED . . .

The detailed survey questionnaires, completed by 4,300 computer sites, include sites in the U.K., Germany and France as well as the major U.S. mainframe vendor bases. These sites have over 5,200 mainframes installed with a value of \$3.9 billion.

AND THEY PLAN TO BUY MORE . . .

The users at 3,069 sites surveyed indicate they plan during the

next 12-24 months to install more: 1,469 mainframe systems . . . 8,070 disk drives . . . 2,365 tape drives . . . and 39,100 terminals.

VITAL MARKETING GUIDE TO EDP INDUSTRY . . .

This 1978 Mainframe User Survey, published by DATAMATION, is a major study of EDP user buying plans and attitudes. It will be an essential guide for you during the next two-to-three volatile years for the mainframe industry.

ORDER YOUR REPORT NOW . . .

Just complete the coupon and send with payment to: Deborah Dwelley
 DATAMATION Magazine
 35 Mason Street
 Greenwich CT 06830
 (203) 661-5400

_____ One copy, 1978 Mainframe User Survey, \$950.

_____ Additional Survey reports \$200. each.

Name _____

Title _____

Company _____

Street _____

City/State/Zip _____

Telephone _____

MAGNETICALLY SHIELDED DATA PRESERVERS

Protect your Flexible Disks from magnetic degradation, erasure, or physical damage. Cases are designed for storage, shipment and hand carrying. A wide choice of models and capacities also available for Minidisks, Diskettes, Standard Reels, Disk Packs, Standard Cassettes.

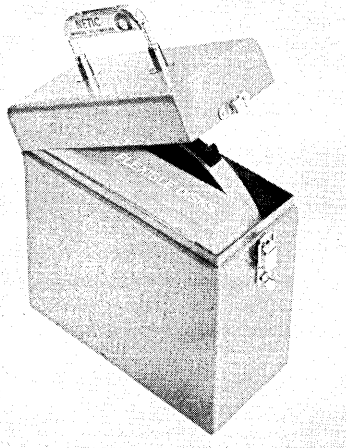

FLOPPY DISK

SEND FOR NEW
TP-5 CATALOG

MAGNETIC SHIELD DIV.



PERFECTION MICA CO.
740 North Thomas Drive
Bensenville, Ill. 60106, USA
Phone 312 / 766-7800
TWX 910-256-4815

CIRCLE 124 ON READER CARD

hardware

plays and two station printers, will lease for \$3,315 per month on a three-year plan, including maintenance and software. The purchase price for this system is \$113,050. CMC Div., PERTEC COMPUTER CORP., Los Angeles, Calif.
FOR DATA CIRCLE 348 ON READER CARD

Modem

In addition to providing 2400 bps communications, these modems can perform diagnostics over the entire communications network. The synchronous modems, compatible with Bell's 201B and 201C data sets, also provide a secondary 110 bps channel used for checking the network. The Diagnostic Controlled Modem (DCM) comes in two versions: master and remote. Test and

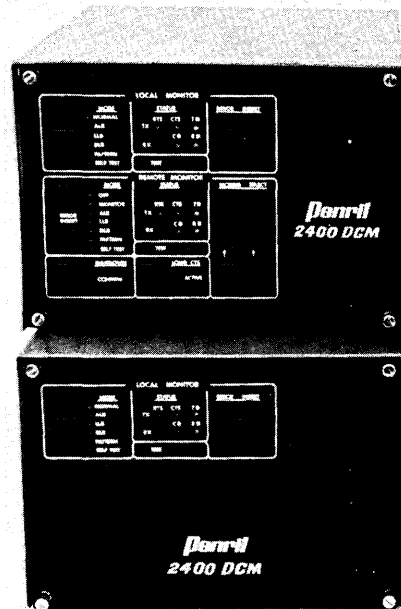

control functions can go on between master and remote sites over the secondary low-speed channel at the same time data communications flow over the main channel. The 2400 DCM series use LSI logic, and include built-in test pattern generators and detectors, and RS232 interfaces. A master site modem sells for \$1,600, a remote site modem for \$1,300. PENRIL CORP., Rockville, Maryland.
FOR DATA CIRCLE 336 ON READER CARD

Microcomputer Core Memory

With a price of \$885 for 16KB, this core memory for Intel 8080s probably won't be a hit with the hobbyist market. But, then, it's not designed for personal computers, it's designed for the SBC 80 line of single-board computers. Dubbed the

When input is inhibited- Output STOPS!

Without INTERTEST, if CICS crashes, your work gets backlogged. Operations wastes efforts routing dumps properly while restarting the system, and programmers search frantically for the error. When testing, it means missed deadlines. CICS crashing can have an enormous impact, even if it happens infrequently.

INTERTEST detects errors, tells you where the bugs are, and lets you solve your problems on-line while CICS continues running. Over 150 satisfied users know this.

If you have CICS or CICS/VS, On-Line Software International, the industry leader in teleprocessing software and services, provides answers to your problems. Write to us, or, for immediate action on INTERTEST, give us a phone call.

TOLL FREE
(800) 631-8374
(201) 423-3200

Software Plaza, Route 208, Hawthorne, N.J. 07506

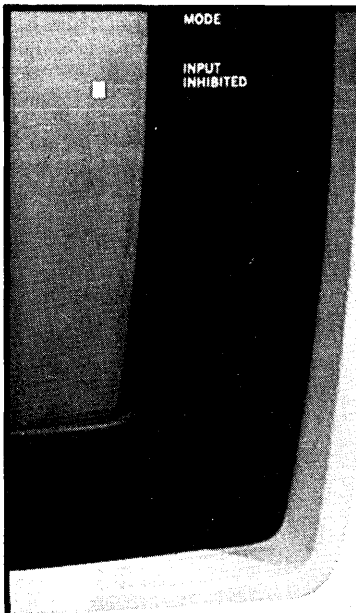

**ON
LINE**
SOFTWARE
INTERNATIONAL

"The link between business and computers"

MCM-8080, the 16KB core memory board provides nonvolatile storage, and accesses data within 325 nsec. Read and write cycle times are 780 nsec, and 1,240 nsec, respectively. The board is pin-compatible with the SBC 016, SBC 046, SBC 416, and MDS 016 memory boards used with Intel's SBC 80/05, 80/10, and 80/20 microcomputers. Switches on the board select 16K contiguous addresses starting at 0000, 4000, 8000, or C000. Oem quantity discounts are offered. AMPLEX CORP., El Segundo, Calif.

FOR DATA CIRCLE 352 ON READER CARD

Modems

Designed for use at a computer site, this vendor's P-113D modems feature auto-answer and compatibility with Bell 103 and 113-type modems. The P-113D is a direct connect modem; it interfaces to the dial phone network through a 97A or 97B jack, and it is said no Data Access Arrangement (DAA) is needed. The half/full duplex modem operates at data rates of up to 300 bps. Eight switches allow users to select options, such as loss-of-carrier disconnect. Front-panel LED's indicate operating status. The P-113D is available as a card for \$250 (single quantity), or as a stand-alone (card, power supply, and cabinet) for \$370. PRENTICE CORP., Palo Alto, Calif.

FOR DATA CIRCLE 335 ON READER CARD



font can print titles at 19 cps in a 44-column format. The unit offers the 128-character ASCII set (96 upper/lower case characters and 32 printable control characters). There are eight matrix fonts in all, including six foreign language character sets. These matrix fonts can be underlined while printing. The unit, known by the picturesque appellation 7245A, also offers 44 built-in programmable instructions to simplify plotting, and escape code sequences to set and clear tabs, select character sets, and per-

form other functions. The desktop unit sells for \$4,600. HEWLETT-PACKARD CO., Palo Alto, Calif.

FOR DATA CIRCLE 356 ON READER CARD



© DATAMATION ®

Smart Card Reader

This vendor has added an Intel 8085-based interface card to its 4000-line of card readers. Changing an EPROM now enables the readers to emulate a variety of communications protocols and interfaces. A currently available EPROM allows emulation of Hewlett-Packard's 7206A optical reader. An IEEE-488 program is expected. A model 4200 one-sided timing mark reader with the microprocessor interface sells for \$2,795; a model 4300, which reads timing marks and standard tab cards goes for \$3,395; a model 4800 which can read data from both sides of a card, goes for \$4,450. The microprocessor card alone has a price tag in the \$1,200 neighborhood. CHATSWORTH DATA CORP., Chatsworth, Calif.

FOR DATA CIRCLE 355 ON READER CARD

Graphic Printer

Vector graphics and printing in a wide variety of fonts make this thermal printer a flexible output tool; its IEEE-488 instrument interface bus compatibility makes it especially attractive in laboratory configurations. It plots at 10 ips, with a resolution of 0.001-inch. It prints 7x9 dot matrix alphanumerics (in four orthogonal directions) at 38 cps; this font allows 88 columns across 8½-inch wide paper. A larger 14x9 matrix

Q1 CORPORATION
the first company to
develop, manufacture and market
microcomputer systems has now introduced
the Q1/Lite, the ultimate office machine
Q1 Corporation • Farmingdale, New York 11735
Telephone: (516) 293-0700 Telex: (510) 224-6144

CIRCLE 147 ON READER CARD ➔

software & services

Updates

FORTH, Inc., developers of a programming language of the same name, installed a turnkey system to control the world's largest infrared telescope at the Univ. of Wyoming's new astronomy observatory atop Jelm Mountain (about 25 miles west of Laramie). The \$100K contract called for installation of a DEC PDP-11/34 system complete with software for driving the telescope and dome, reading and recording data, running a status display, telescope operator's terminal, and observer's graphics terminal. The Manhattan Beach, Calif., firm says using its miniForth language allowed these functions to be implemented in 32K words; the project is said to have taken four man-months.

General Motors is using computerized finite element analysis to predict noise levels in the passenger compartments of its new automobiles. The firm previously used the simulation technique for designing more fuel-efficient cars.

Cullinane Corp., recognized as one of the big guns in the data base management system market, says it has implemented a back-end system linking an IBM 370/158 in Manhattan, Kansas, to a PDP-11/70 in Atlanta. Most data base functions are off-loaded into the PDP-11, which runs the vendor's IDMS-11 data base management system. Data base operations are said to be transparent to 370 users; most of the work is handled by the 11, which is linked to the 370 via Cullinane's Inter-Computer Communications System.

ANSI has set up a committee to look into standards for a text processing language. The committee, known as X3J6, will begin by drafting a "Computer Language for the Processing of Text." The effort began after a study, lead by Robert W. Bemer of Honeywell, found much interest in the area. Charles D. Card of Sperry Univac will chair X3J6; interested parties are invited to join. X3J6 can be reached via the X3 Secretary, c/o CBEMA, 1828 L St., N.W., Washington, DC 20036.

Virtual Networking

Continuing its policy of avoiding small, unsophisticated customers, this vendor's introduction of a Virtual Network capability signifies its commitment to the sophisticated user on the verge of creating a distributed net. And it looks as if they're covering all the bases, offering concurrent use of IBM's SNA/SDLC, X.25, and the major bisync protocols.

As many as 31 of the vendor's SyFA processors can be interconnected by a Virtual Network Controller (VNC), itself one of the vendor's LSI-4/90 minicomputers. Additionally, each of the SyFA's can have synchronous lines running to IBM mainframes. And, Virtual Networks can be interconnected, allowing essentially unlimited expansion.

System software makes interprocessor communications transparent to users at their terminals. An optional parameter in file commands now allows a user to specify which system a file physically resides at; if the parameter is omitted, the system begins searching the user's SyFA, then moves through the network until the file is found (or the entire network searched). System security and file access safeguards exist across system boundaries; subdirectory utilities allow users to create private directories with controlled access.

Each Virtual Network requires a VNC; additionally, each SyFA within the net needs a Distributed Data Base Processor, which provides the interface between the SyFA and the VNC. Virtual Network software is bundled with the necessary hardware. The synchronous communications emulators are existing software products, priced separately. A basic VNC, capable of supporting 15 SyFA's, sells for \$31,500; it's expandable to 31 systems at \$4,000 per four additional systems. Each Distributed Data Base Processor sells for \$7,500. First deliveries are scheduled for the third quarter of this year. COMPUTER AUTOMATION, INC., Commercial Systems Div., Irvine, Calif.

FOR DATA CIRCLE 358 ON READER CARD

Sales Tax Calculation

Written in ANS COBOL, SUTAX can calculate all state, county, and local sales and use taxes. The package also can create audit trails and summary reports. The central part of the package is a subroutine which uses postal zip codes to determine applicable taxes. A user's application program need only supply the purchaser's zip code and the gross

sales amount to the subroutine. The system can handle credits, even if the tax rate has changed in the interim. A monthly update service notifies users of changes in tax rates. On an IBM mainframe, the package occupies about 3KB; the data base takes roughly 1.5MB of disc space. The file structure is ISAM. SUTAX leases for \$96 per month on a one-year plan. AV PRODUCTS, INC., Wakefield, Mass.

FOR DATA CIRCLE 324 ON READER CARD

Reference Retrieval Service

Dialog, an on-line information retrieval service, has added a data base covering *Management Contents*, a periodical containing abstracts of articles of interest to managers. Businessmen, consultants, and librarians can obtain bibliographic references and abstracts of articles published in more than 200 domestic and foreign journals, as well as major business and management conference proceedings. Topics covered by the data base include accounting, human resource development, industrial relations, operations research, production, and public administration. Users can access the data base via terminals connected by phone lines (Tymnet and Telenet access also is available) to the service's computer center in Palo Alto, Calif. An English-like query language and a thesaurus of controlled vocabulary terms allow the user to search and receive a list of references on a given subject. Additionally, a full-text searching capability allows users to search for specific words and phrases in document titles and abstracts. The initial file will contain 33,000 records; roughly 1,500 new documents will be added each month. Searching costs \$55 per connect hour, plus 10¢ for each record printed off-line on the vendor's equipment. LOCKHEED MISSILES & SPACE CO., Palo Alto, Calif.

FOR DATA CIRCLE 326 ON READER CARD

Overseas Fax Service

We're told the Japanese are heavy users of facsimile equipment. With a written language of ideograms, a teleprinter isn't especially practical. Now there's a facsimile service linking Tokyo with New York. The service is expected to expand to other foreign and domestic cities; San Francisco is a likely candidate for inclusion within the next few months.

IMS and TOTAL USERS

YOUR DATA BASE

&

ASI-ST

GO TOGETHER

More IMS and TOTAL installations have chosen the ASI-ST Data Management and Reporting System to implement data base applications than any other product. ASI-ST's dominance in data base environments is easily explained:

- Operates under all IBM 360/370 versions of DOS, DOS/VS, OS and OS/VS.
- Fully supports all TOTAL, IMS and DL/1 features including TOTAL 7 and secondary indexing under IMS/VS.
- Permits creating and updating TOTAL and IMS data bases as well as retrieval.
- Allows concurrent processing of conventional data files with IMS or TOTAL data bases.
- Supported in both batch and on-line environments.

IMS users such as *American Airlines, Dow Chemical, TWA, American Can, The Hartford, Union Carbide;* and TOTAL users like *Combustion Engineering, Northwestern Mutual Life, Anheuser-Busch, Corning Glass Works, Eli Lilly and Holiday Inns* are a few who agree ASI-ST and data base belong together. In addition, ASI-ST provides an unequalled return on investment by maximizing the productivity of both man and machine. Since ASI-ST fully supports conventional data files as well as complex data bases, these benefits are not restricted to IMS and TOTAL users. To obtain more information contact:



The Software Manufacturer

APPLICATIONS SOFTWARE, INC.
Corporate Offices
21515 Hawthorne Boulevard
Torrance, California 90503
(213) 542-4381

Software & Services

The service, dubbed Q-Fax (Q is said to mean urgent or fast in Japanese), is operated by RCA Global Communications and Kokusai Denshin Denwa. Messages can be typed or handwritten on forms supplied by RCA or on almost any 8½ by 11 inch sheet of paper. In New York, RCA will enter the message via a KDD-designed digital fax machine operating at 9600 bps on a full duplex circuit. Total transmission time for a 95-word message is said to be 26 seconds. In Tokyo, KDD's messenger service will deliver messages addressed to any of the city's 23 wards; other addresses will be served by the postal service. Con-



versely, messages addressed to New York will be delivered by messenger in the city, with other addresses served by the postal service or domestic fax service.

The service charges \$10 per page. In comparison, a three minute, direct dial telephone call to Japan costs \$9 (station to station) or \$12 (person to person) during business hours, according to information in New York Telephone Co.'s 1977-78 directory for Manhattan. Obviously, if you can reach your party with a station call, you can save a buck, but we suspect there are enough people who will need fax (for graphics or elusive addressees) to keep Q-Fax busy. RCA GLOBAL COMMUNICATIONS, INC., New York, N.Y.

FOR DATA CIRCLE 323 ON READER CARD

Networking

In April of 1975, this vendor became one of the first to announce a comprehensive methodology for interconnecting its processors in a distributed network. Six months later, delivery slippages and grumblings from inside the product development team indicated unforeseen problems. Three years after announcement, DECnet has about 200 users with a total of roughly 900 operational nodes.

Now the vendor has done some redesign work and announced Phase II DECnet. Phase II shouldn't have any of the earlier problems, considering the once-burned-twice-shy phenomenon and deliveries which began last month.

software spotlight

Microcomputer Cobol

COBOL on a microcomputer? Real COBOL? That's what this microprocessor manufacturer offers for its Z-80. The compiler is said to be an implementation of the ANSI Level I COBOL standard of 1974. One beta-test site tells us that with the exception of the SORT and COMPUTE verbs this compiler can eat programs written for 370/158s.

This COBOL has sequential, indexed, and relative I/O. It's said to be fast, owing much of its speed to the microprocessor's decimal arithmetic and

The new software supports task-to-task communication between programs running on PDP-11s connected by point-to-point communications lines. Programs also may access remote peripherals, except under RSTS/E. Asynchronous or synchronous lines may be used. DECnet doesn't dictate the organization of the network; users can configure star, ring, hierarchical, or random-topology networks to suit their needs.

Phase II software incorporates changes in the Network Service Protocol (NSP), Data Access Protocol (DAP), and Digital Data Communication Message Protocol (DDCMP). DDCMP is said

block move instructions. A special crt interface provides ACCEPT and DISPLAY verbs. Terminals with different operating characteristics are said to be accommodated by changing a few parameters. The beta site we spoke with said they can run 10,000 line programs; they noted the compiler has good segmentation capabilities. And, there's an interactive debugger.

The compiler runs on Z-80 microcomputers with 48KB of memory and floppy disc drives in an RIO operating system environment. The beta site runs a 64KB system. The vendor tells us the compiler has passed the Navy tests for Level I COBOL. The compiler carries a license fee of \$950. ZILOG, Cupertino, Calif.

FOR DATA CIRCLE 320 ON READER CARD

to support future development of compatible DECnet products; the new DAP is said to have better support for the various file systems; NSP extensions handle differences between operating systems, such as buffering techniques, it is said. Phase II DECnet supports the 11-family, from the LSI-11 up to the 32-bit VAX-11/780; Phase II is not directly compatible with earlier releases of DECnet

License fees (per node), including warranty and support services, are \$1,500 for RT-11 and RSX-11S systems, \$2,700 for RSX-11M, RSTS/E, and VAX/VMS systems, and \$3,500 for RSX-11D and IAS systems. The VAX ver-

SMAL/80 BUBBLESORT		STANDARD BUBBLESORT	
SIZE EQU 255	/* max size of ARRAY */;	SIZE: EQU 255	;max size of ARRAY
LOOP:		LOOP1: MVI D,0	;reset "switched" flag for this iteration
D = 0	/* reset "switched" flag for this loop iteration */;	LDA N	
A = M(N);		MOV B,A	;number of list elements
B = A	/* number of list elements */;	LXI H,ARRAY	
HL = ARRAY;		LOOP2: DCR B	
LOOP:		JZ NEXT1	;no more pairs left
IF --B ZERO	/* if no more pairs left */	MOV A,M	;first element of pair
BREAK;		INX H	
A = M(HL);	/* first element of pair */;	CMP H	
++HL;		JP LOOP2	
IF A : M(HL) NEG	/* an interchange */;	MOV C,M	;do an interchange
THEN DO		MOV M,A	
C = M(HL);		DCX H	
M(HL) = A;		MOV M,C	
--HL;		INX H	
M(HL) = C;		MVI D,1	;set the "switched" flag
++HL;		JMP LOOP2	
D = 1	/* set the "switched" flag */;	NEXT1: MOV A,D	
END;		ORA A	
REPEAT:		JNZ LOOP1	
REPEAT WHILE [A = D; A = A OR A] NOT ZERO;		HLT	
N: BYTE SIZE;		N: DB SIZE	
ARRAY: RESERVE SIZE;		ARRAY: DS SIZE	
END PROGRAM;		END	

Language Processor

It's difficult to say exactly what the SMAL/80 language processor (for Intel's 8080 and 8085) really is. On the one hand, it looks similar to a high-level, structured language which might be compiled; on the other hand it bears a striking resemblance to a macro-assembler, with most of its instructions mapping onto single machine-language instructions. SMAL/80 programs can be as efficient as traditional assembly language programs; the programmer has free access to the 8080's registers. A pic-

ture may well be worth 1,000 words; the side-by-side comparison below shows equivalent programs written in SMAL/80 and Intel's assembler. The SMAL/80 language processor runs on 8080, 8085, and Z-80-based microcomputers, and requires 8KB of memory. It's supplied on diskette in either CP/M or Isis format. A translator, which converts Intel assembler into SMAL/80, is included in the purchase price of \$75, as is documentation. CHROMOD ASSOCIATES, New York, N.Y.

FOR DATA CIRCLE 325 ON READER CARD

sion is slated for availability with the first VAX system shipped, all other versions became available last month. DIGITAL EQUIPMENT CORP., Maynard, Mass.

FOR DATA CIRCLE 322 ON READER CARD

Multifunction Executive

An enhanced Multifunction Executive, MFE/IV, coupled with increased hardware support for additional memory, allows users of this vendor's top-of-the-line System IV/90 to concurrently perform data entry, COBOL processing, word processing, and interactive 3270 inquiry to an IBM mainframe. The new executive supports as many as 16 1,920-character video display terminals where users can select, and switch between, any of four major functions. MFE/IV supports DATA IV (data entry), VISION (on-line inquiry and update with transparent access to a mainframe's data base), ForeWord (word processing), and COBOL. As a typical application, the vendor cites a user preparing a proposal in word processing mode; the user might choose to switch to on-line inquiry to check product availability and pricing, then switch back to word processing to finish the proposal. Monthly rental for a System IV/90 with 16 terminals, 288KB of memory, two 67.5MB discs, a 300 lpm printer, and a 9600 bps communications controller is \$3,522 on a 42-month lease. This includes MFE/IV, support software packages, maintenance, systems engineering, and educational services. Deliveries of the new software will begin in the fourth quarter. FOUR-PHASE SYSTEMS, Cupertino, Calif.

FOR DATA CIRCLE 327 ON READER CARD

Data Base Inquiry

Users of the Total data base management system on NCR Century or Criterion systems can now get an interactive query language, IQL. The basics of IQL can be learned in an hour, according to the vendor. Users can make virtually any type of inquiry into the data base at any time; access may be limited through passwords or access codes. The package runs on systems as small as a 96KB Century 101. Two pricing arrangements are offered: a one-time charge of \$15,000, or a monthly license fee of \$572. NCR CORP., Dayton, Ohio.

FOR DATA CIRCLE 328 ON READER CARD

Nova Operating System

The Mass Storage Operating System, MSOS II, will primarily interest oem houses using Data General Novas or Nova-like machines from other sources. Essentially, it's a single-user system, al-



A Program Development System for ECLIPSE and Nova 3.

We developed it. We use it every day. We'll sell it to you. The system supports the text editor and CLI on all your CRT's, runs under RDOS and comes with complete documentation. Give us a call. We'll wrap one up for you. **901-345-3544**

minicomputer division
DATA COMMUNICATIONS CORPORATION
3000 DIRECTORS ROW / MEMPHIS, TENNESSEE 38131

ECLIPSE and NOVA 3 are trademarks of Data General Corporation.

CIRCLE 158 ON READER CARD

SENIOR SOFTWARE ENGINEERS

To review and plan Retail Systems software strategy for Point-of-Sale terminals, communication processors, and general EDP systems. This person will provide consultation to the Retail System family standards and hardware groups. Moreover, he/she will provide intra- and inter-divisional liaison to insure development of interfaces and problem solutions.

A broad understanding of operating systems methodology, application programming techniques, and technology directions will be required as well as sufficient familiarity with hardware design to allow effective assessment of hardware/software interfaces and interactions. A familiarity with high level languages and structural design techniques will be a strong asset.

An appropriate degree and from 2 - 7 years experience will provide the necessary skills.

We invite your response as soon as practical.

NCR

Robert W. Donovan
Engineering & Manufacturing-
Cambridge
NCR Corporation
Cambridge, Ohio 43725
614/439-0291

An Equal Opportunity Employer

Software & Services

though in applications such as data entry it can support multiple terminals, treating each as an I/O device assigned to a single program. The package supports from one to nine mass storage devices, high-speed reader and punch, line printer, and a system console. It will run on Novas with as little as 16K words and one mass storage unit. The resident portion of MSOS takes 350 words; overlays present during command execution take an additional 1,800 words. The basic package includes an editor, relocatable assembler, linker, and extended BASIC (extended precision arithmetic, string functions, formatted output). Options include a macro assembler, cross assemblers for Intel 8080, MOS 6502, and Motorola 6800 microprocessors, and ISAM. The basic purchase price for MSOS II is \$1,000, with each option available for an additional \$200. OEM discounts are offered. RELAY SYSTEMS, INC., Boulder, Colo.

FOR DATA CIRCLE 329 ON READER CARD

Micro Access Method

A microcomputer store owner once commented to us, "Every time someone

begins to develop a business application on a personal computer they find the first step is writing a file access system." With the introduction of KSAM80, an ISAM-like access method for Z-80-based microcomputers with floppy drives, perhaps would-be developers can stop reinventing the wheel and concentrate on programming their applications. Written in a macro-language, KSAM80 can also be generated for 8080-based systems.

Application programs can be written in BASIC; there's talk of writing a FORTRAN interface. Keys, which must be unique, can be any string of up to 255 characters. KSAM80 provides sequential access (starting at any point in the file), random access by partial key, and random access by relative record number. File space is dynamically allocated. Given sufficient buffer space, any number of files may be processed concurrently. The package is said to use buffering techniques which reduce the number of physical disc accesses needed to retrieve a record.

Originally developed under Zilog's Z-80 OS 2.0 operating system, KSAM80 is said to be easily adapted to other environments. The vendor says it runs KSAM80 on a 32KB machine, with the package occupying about 3KB. Object code for the package sells for \$195 to end users. Reportedly, several vendors are interested in acquiring rights to

market KSAM80 on a royalty basis. EFFICIENT MANAGEMENT SYSTEMS CO., Oakland, Calif.

FOR DATA CIRCLE 321 ON READER CARD

Manufacturing System

Manufacturers, particularly those in electronics and other industries with many assemblies and subassemblies in a product line, can use the Summit package to keep track of vital information. The package runs on 32-bit Interdata computers (7/32 or 8/32); an accounting package is included in the price of \$49,500.

Summit provides on-line order entry, editing, processing, and inquiry functions for customer orders, purchase orders, repair orders, and internal sub-assembly manufacturing orders. A bill of materials module is included, and an inventory requirements system helps production scheduling. Inventory control and cost accounting, by individual order, also are supported.

The package interfaces to the vendor's Integrate Business Accounting System (IBAS), which provides accounts receivable and payable, payroll, fixed asset accounting, and general ledger.

Running the multiterminal system (32 users, with optional support for 64) requires a processor with at least 192KB of main memory, at least 20MB of disc, and tape or cartridge disc for system

WITH DOCS USE YOUR 3277 AS A DOS·DOS/VS CONSOLE!

DOCS—Display Operator Console Support—provides the IBM S/360 & S/370 DOS and DOS/VS user with 3277 display unit SYSLOG support. DOCS is simply installed on any DOS or DOS/VS system with no changes required by the user. All 1052, 3210 and 3215 typewriter functions are supported by DOCS with numerous enhancements over a non-DOCS environment. DOCS also enhances DOS/VS operation on S/370, 138, 148, and 158 beyond that provided by the IBM program product. DOCS is quickly and simply installed on any system. All that the user need do is catalog the DOCS distribution tape to his Core Image library, define where the DOCS hard copy file is to be located and execute DOCS. Total installation time required is under 10 minutes. DOCS functions concurrently with EDOS, GRASP, DOS/MVT, DOS/RS, POWER II, ASAP, POWER/VS, and ITEL's DOS/VS executing on a S/360 and will enhance the system operation by providing improved facilities for the use of these packages while DOCS is controlling SYSLOG. DOCS is currently used in over 250 installations world-wide including diverse businesses and US Army bases. DOCS is available from CFS, Inc. as a licensed program product and may be leased monthly, yearly or on a one-time lease arrangement for \$175.00, \$1,890.00 and \$5,670.00 respectively. All three lease plans include free maintenance for as long as DOCS is installed.

SPEED

DOCS provides significant through-put improvement by the very nature of the speed of the 3277 display unit alone. Operators can even pre-answer messages on the console.

MULTIPLE CONSOLES

DOCS allows from 1 to 16 3277 display unit consoles to be used simultaneously as SYSLOG devices.

MULTIPLE OUTSTANDING REPLIES

DOCS permits messages followed by Reads to the typewriter to remain unanswered without tying up the system. All outstanding Reads are shown in high intensity on the display console(s).

REDUCED SUPERVISOR SIZE & OVERHEAD

DOCS does away with any need for the Console Buffering option in DOS or DOS/VS thus providing a savings in the core required by the users' supervisor as well as greatly reducing significant overhead to the entire system. Experience has shown that total through-put improvement with DOCS installed may approach 10% to 20%.

Send requests for DOCS to C F S. License agreements along with detailed information will be sent by return mail. Inquiries may be directed to:

ELIMINATES DEPENDENCY ON TYPEWRITER

DOCS will continue to operate, and allow the entire system to operate, if the 1052, 3210 and 3215 typewriter becomes inoperable. DOCS spools all typewriter data to a hard copy disk file for later printing thus obviating the need for the typewriter to be on-line at all times. Hard copy is asynchronously provided if the 1052, 3210 and 3215 is available. A hard copy listing is also available through a utility program which the user may execute in any problem program partition to list the hard copy file on SYSLST.

NO USER PARTITION REQUIREMENT

DOCS executes in its own pseudo-partition thus allowing the user unrestricted use of the problem program partitions.

MULTIPLE EXTERNAL INTERRUPT KEYS

DOCS provides a separate External Interrupt key for each partition (replacing the use of the MSG command). This is especially convenient for EDOS users. This function is also useful for GRASP users when communicating with a background partition problem program. A unique interrupt key is provided for each DOS/MVT region.



Mr. Richard Goran
C F S, Inc., 1330 Boylston Street, Suite 608
Chestnut Hill, Massachusetts 02167
(617) 566-0222 Telex 94-0285

backup. The Summit package price includes a copy of Interdata's operating system, the manufacturing system software, IBAS, on-site training, installation, and implementation supervision. The package grew out of a custom system that's been up and running for several years. DIVERSIFIED DATA SYSTEMS, INC., Tucson, Ariz.

FOR DATA CIRCLE 357 ON READER CARD

Micro Cross Assembler

Written in ANS FORTRAN IV, this relocatable assembler and linking loader can prepare programs for Intel's 8080 and 8085 microprocessors. The assembler uses Intel mnemonics, and offers conditional assembly, macro expansion, and a cross reference table. Independently assembled programs can be linked into an absolute load module by the linking loader. Assembler output is compatible with the loader used with Intel's MDS systems so the user can use either this vendor's loader or the MDS-resident loader. The cross assembler and linking loader are written for machines with 16-bit or larger word size. Available on several types of machine-readable media, the pair of programs sells for \$1,200, which includes source program and listing, manual, installation notes, and a test program. MICROTEC, Sunnyvale, Calif.

FOR DATA CIRCLE 333 ON READER CARD

Enhanced Support Software

Users of this vendor's model 350 intelligent stand-alone terminal systems can now get an enhanced version of the proprietary TAL II data entry programming language, IBM 3741 communications emulation, disc file continuation support, and a report generator. The new TAL II is said to offer a speed increase in executing arithmetic functions; additionally, it's said to reduce memory requirements, allowing the development of larger programs. IBM 3741 emulation allows the 350 to communicate with IBM 3741, 3747, or mainframe hardware. File continuation support, previously available only to communications programs on the 350, now is supported by TAL II language and utility programs. The report generator is said to closely resemble RPG II. These four enhancements are known as Level F, and will be supplied on three diskette libraries, each priced at \$35. When more than one of the libraries is purchased, the price drops to \$25 each. SYCOR INC., Ann Arbor, Mich.

FOR DATA CIRCLE 330 ON READER CARD

ISAM Replacement

IBM users running DOS or DOS/VS can improve system throughput and reduce disc space usage by using PSAM in place of ISAM, according to the vendor. Throughput improvements of 30% to

50%, and disc space savings in excess of 10% are claimed. Incorporating all ISAM features, the package also has a "multi partition update" capability which allows concurrent retrieval and updating of a file by programs in different partitions. The package maintains file integrity, protecting against record or file damage. PSAM is said to install in 15 minutes; an ISAM-to-PSAM interface allows programs written for ISAM to access PSAM files. The package supports all DASD types and interfaces with all IBM programming languages. It rents for \$350 per month, and a 15-day free trial is provided. UNIVERSAL SOFTWARE INC., Brookfield, Conn.

FOR DATA CIRCLE 331 ON READER CARD

Energy Model

Utility companies, researchers, and students interested in emerging technologies for power generation may be interested in this model of an electrolysis cell for generating hydrogen. Hydrogen-fueled electrical generation is a research topic currently under investigation by independent utilities, institutions, and agencies. The model, while not universally applicable, is said to give a good representation of cell efficiency given cell design and operational parameters. The program should help in the preliminary design of commercial hydrogen production units. Written in



• LEASE • RENT • PURCHASE

... the choice is yours!

A WIDE SELECTION OF PRODUCTS:

- DIABLO 1620, 1641, 1660
- DECWRITERS LA 36, 120, 180
- ADDS CRT's
- TRI DATA FLOPPY DISC
- TELETYPES—TWX/TELEX 32, 33, 35, 43
- ACOUSTIC COUPLERS

SAME DAY SHIPMENT OF SUPPLIES:

- HYTYPE I & II RIBBONS
- HYTYPE PRINT WHEELS
- DECWRITER RIBBONS
- FLOPPY DISKETTES
- CASSETTE TAPES
- QUIET ENCLOSURES

Call our toll free number or drop us a note now for information on our line and your choice of payment plans!





NCE TERMINALS & COMMUNICATIONS, INC.

<p>Regional Office—East 300 Raratin Ctr. Pkwy. Bldg. 806 Edison, NJ 201-225-0872 Toll free # 800-631-5919</p>	<p>Headquarters Office Midwest 1536 Brook Drive Downers Grove IL 60515 312-629-7810 Toll free # 800-323-1780</p>	<p>Regional Office—South 1110 Busch Blvd. Tampa, FL 813-932-2666</p>
--	---	---

Software & Services

FORTRAN IV, the program has been implemented on a Univac 1106 using roughly 9K words. The 210 source statement program is available only as a source listing, with documentation, for \$25. Please cite the clearinghouse identification number, LEW-12740/D, in any correspondence. COMPUTER SOFTWARE MANAGEMENT AND INFORMATION CENTER, University of Georgia, Athens, Georgia.

FOR DATA CIRCLE 332 ON READER CARD

Interactive Packages

Two interactive packages, both capable of helping a user get his output in a useful form, have joined this remote computing service's library of business applications. A graphics package, Plotpac, can produce time plots, bar charts, and scatter diagrams all on the user's time-sharing terminal. Data to be plotted may be entered from the terminal, or it may be the output of another of the vendor's application programs, or the output from a user-written FORTRAN, COBOL, BASIC, or APL program. The user has available commands for formatting, labeling, and placing the graph on the output page. Figure on spending

around \$5 for a plot.

FOR DATA CIRCLE 417 ON READER CARD

If a printed tabular report is more in order, there's IPS Report Writer. A few basic commands entered at the terminal can create a simple report; sophisticated reports are said to take minimal effort. The package includes capabilities for command file processing, virtual field and scroll report processing functions, and "what if" and "look up" commands. A simple report such as a profit and loss statement, is roughly \$7 to \$10. CONTROL DATA CORP., CYBERNET SERVICES, Minneapolis, Minn.

FOR DATA CIRCLE 426 ON READER CARD.

ENGINEERING & MANUFACTURING-DAYTON

NCR's Engineering & Manufacturing Division in Dayton, Ohio, develops and produces financial terminal products. The requirements of the systems business are constantly changing, providing unlimited opportunities for the creative individual.

Opportunities currently exist at all levels (Trainees to Project Leaders) for individuals possessing a background in the following areas:

ELECTRICAL DESIGN ENGINEERS

- Microprocessor Applications
- Digital & Analog Circuits
- Electrical Control Circuitry
- Terminal Peripherals
- Familiarity with Micro-processor Programming Helpful

SOFTWARE EVALUATION ANALYSTS QUALITY ASSURANCE

- Design Analysis
- QA Certification
- Multi-tasking OS concepts
- 8080 Assembly Language
- COBOL Language

PROGRAMMER/SYSTEMS ANALYST SOFTWARE DESIGN

- Microprocessors
- Minicomputers
- Operating Systems
- Distributed Processing Systems
- Systems Constructors & Generators
- Communications Software
- 8080 Assembly Language
- COBOL Language

These positions require a BS in EE, CS or related discipline.

We encourage responses from new graduates.

We invite you to be a part of our future in a rapidly changing and challenging industry. Please submit your resume and salary requirements to:

Mrs. Judith E. Chorazewitz
Engineering & Manufacturing-Dayton
Employment, D-4
NCR Corporation 45479
Dayton, Ohio 45479

An Equal Opportunity Employer

Budgeting and Accounting

A Public Budgeting and Accounting (PBA) package, designed for the System/34, is intended to provide financial control and reporting capabilities to government and school administrators. Functions include budget preparation and tracking, revenue and expenditure accounting, general ledger, and accounts payable. The PBA package is due in November; it has a monthly license fee of \$155. INTERNATIONAL BUSINESS MACHINES CORP., General Systems Div., Atlanta, Ga.

FOR DATA CIRCLE 427 ON READER CARD

*

O perfect little one,
Plated with precious gold,
With graceful curve
And pliant supple form,

Split to vibrate alone,
With subtle independence
That ear is mute to hear,
With tail to entice a strand
To hold a steady breath of flow,

Untarnished, gleaming row on row
waiting to be mated to a tiny tab.
O path of complex codes,
Hidden in a humble box,
Be steadfast in your unseen toil,
To help us earn our daily bread.

—Thomas J. Sullivan

Flowcharting, coding an
N-nested DO loop can
Certainly be an exacting endeavor
Since use of CONTINUES
And documentation
May still not prevent it
From DOing forever.

Designing and programming
IMS systems do
Rarely proceed at a leisurely pace;
In such circumstances
It's sadly predictable—
Competing routines
Lock in deadly embrace.

—Alex Ragen

If you make top-quality data terminals, here are four reasons to use Setchell Carlson CRT display modules in your system.

Reliability:

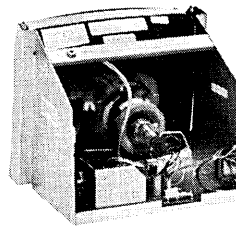

Our data displays are outstanding solid-state designs with critically matched magnetics to optimize the performance levels and dependability demanded by your customers. We use the most advanced engineering and production techniques to assure consistency of performance. No data display is built with more deliberate attention to quality and reliability.

Delivery:

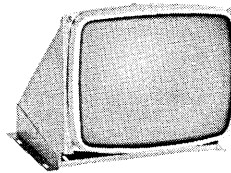

We have been in the display electronics business long enough to know about rush orders. If you need it yesterday — we'll try to get it to you yesterday.

Experience:

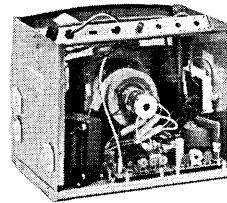

We've built thousands of displays for many of the major manufacturers in the country. Perhaps we already have a unit that would meet your requirements. With slight modifications. It would be less costly than starting from scratch. If you need a new, special package — we'll produce it for you, in the configuration you want, at minimal expense.

Cooperation:

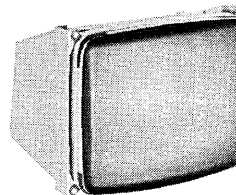

If you're developing a new data terminal, we will be glad to cooperate with your terminal design engineers in reviewing your exact specifications and developing the most economical display possible. And quickly! Whatever you need, we have the experience and talent to design it. And improve it.

But don't take our word. See for yourself by contacting us today.

You'll come up with your own reasons for using Setchell Carlson CRT display modules.

SC ELECTRONICS, INC.
A SUBSIDIARY OF AUDIOTRONICS CORPORATION
530 5th AVE. N.W. NEW BRIGHTON, MN. 55112 (612) 633-3131

The Marketplace...

advertisers' index

SOFTWARE MARKETPLACE

Arkay Computer, Inc.....	236
Boole & Babbage, Inc.	238
Consumer Information.....	238
Cyborg Systems.....	237
DATAMATION	238
Dataware, Inc.....	236
Informatics Inc.	237
Management and Computer Services, Inc.	237
Mathematica Products Group.....	237
Mitchell and Gauthier Associates, Inc.	237
NTIS Computer Products	237
Olympic Systems Inc.	236
Plenum Publishing Corporation	238
System Support Software, Inc.....	238
Technology Transfer Incorporated	236
Universal Computing Systems, Inc.	237

DP MARKETPLACE

American Used Computer Corporation...	238
COMBUR	238
DATAMATION	239
Tone Software Corp.	238

BUY, SELL, LEASE

D.V.I. Co., Inc.	239
-----------------------	-----

JOB MARKETPLACE

E.D.P. Search, Inc.	239
Parker Page Associates, Inc.....	239

SOFTWARE MARKETPLACE

CONVERTING DOS-TO-OS?

THE FOCUS SOFTWARE SYSTEM INCLUDES

COBOL CONVERTER

FOCUS CONVERTS ALL DOS COBOL TO FULL OS ANS COBOL

JCL CONVERTER

FOCUS CONVERTS DQS JCL TO PERFECT OS JCL

DOCUMENTATION

FOCUS PRODUCES COMPLETE OS OPERATIONS DOCUMENTATION

Experienced, Proven, Tested and Implemented.

Full Support, On Site Installation And Briefing Sessions.

WRITE OR CALL TODAY FOR MORE INFORMATION

ARKAY

COMPUTER, INC.
24 Manor House Road
Newton Centre, Mass. 02159
(617) 964-1894

CIRCLE 185 ON READER CARD

CONVERSION SOFTWARE

Proven Software Converters, at a reasonable cost, that automatically convert between 90-100% of the Program Source Lines.

IBM ASSEMBLER-DOS TO OS

ICL 1900 SERIES PLAN TO COBOL

Please indicate interest by checking appropriate box and write or send to —



OLYMPIC SYSTEMS INC.
530 6th AVENUE
PITTSBURGH, PA. 15219 (U.S.)
(412) 391-1538

CIRCLE 197 ON READER CARD

COMPUTER COMMUNICATION

SEMINARS OF EXCELLENCE

SIX DYNAMIC 3-DAY SEMINARS PRESENTED BY THE WORLD'S LEADING AUTHORITIES

- 1. KLEINROCK**
QUEUEING SYSTEMS
JULY 10-12, 1978 • WASHINGTON, D.C.
- 2. ABRAMSON**
SATELLITE DATA COMMUNICATIONS
JULY 17-19, 1978 • WASHINGTON, D.C.
- 3. KLEINROCK-FRANK-ROBERTS**
EXPERTS ON NETWORKS (1-Day Registration Available)
JULY 24-26, 1978 • ATLANTA, GEORGIA
- 4. LUCKY-GREEN**
DATA COMMUNICATION SERVICES AND PROTOCOLS
AUGUST 2-4, 1978 • LOS ANGELES
- 5. DENNING**
PERFORMANCE EVALUATION
AUGUST 14-16, 1978 • BOSTON, MASS.
- 6. KLEINROCK**
COMPUTER NETWORKS
AUGUST 21-23, 1978 • CHICAGO, ILLINOIS

SEMINAR FEE: \$575
DISCOUNTS FOR PREPAYMENT, GROUPS, AND SERIES.

TECHNOLOGY TRANSFER INCORPORATED
P.O. BOX 49785, LOS ANGELES, CALIFORNIA 90049 (213) 478-1331

CIRCLE 204 ON READER CARD

AUTOCODER/SPS to COBOL

Dataware's software translator automatically converts a high percentage of SPS/1400 Autocoder source code to ANS COBOL (DOS or OS).

The Translator converts from:

- IBM 1401
- IBM 1401 SPS
- IBM 1440
- IBM 1410
- IBM 7010

For more information on this translator, please write or call today.

Dataware, Inc.
495 Delaware Street
Tonawanda, New York 14150
(716) 695-1412

CIRCLE 189 ON READER CARD

PL/1 TO COBOL

Dataware's Software Translator automatically converts from IBM PL/1 to ANS COBOL (DOS or OS). The Translator is capable of handling IBM OS or DOS (48 or 60 character set) source programs as input.

For more information on this translator or the others listed below, please write or call today.

- EASYCODER/TRAN to COBOL
- BAL/ALC to COBOL
- AUTOCODER (7070) to COBOL
- COBOL to COBOL

Dataware, Inc.
495 Delaware Street
Tonawanda, New York 14150
(716) 695-1412

CIRCLE 190 ON READER CARD

Dataware Software Translators

RPG to COBOL

Converts RPG and RPG II programs to the industry standard ANS COBOL (DOS or OS). The translator achieves an extremely high percentage of automatic conversion (approaching 100%) of the source code.

RPG to PL/1

Converts RPG and RPG II programs to an optimized PL/1 (DOS or OS). The translator achieves an extremely high percentage of automatic conversion (approaching 100%) of the source code.

For more information on these and our other translators, write or call today.

Dataware, Inc.
495 Delaware Street
Tonawanda, New York 14150
(716) 695-1412

CIRCLE 191 ON READER CARD

You can do your own photocomposition with these tables of various type fonts for computer typesetting

- 1377 Alphanumeric and Graphic Characters
 - COM Devices
 - Digital Plotters
 - Vector Plotters
 - Oriental Characters
 - Katakana
 - Hiragana
 - Kanji
 - Available in BCD and ASCII Character Codes
- Save Time and Money**
Order today—PB-263 925/CPM, \$300. Please specify BCD (odd or even parity) or ASCII option. Outside North American continent prices on request.

For more information on this and other NTIS Computer Products, contact the Computer Products Office at (703) 557-4763 or write to

NTIS
U.S. DEPARTMENT OF COMMERCE
5285 Port Royal Road
Springfield, VA 22161

CIRCLE 196 ON READER CARD

CYBORG PAYROLL SYSTEM

The CYBORG PAYROLL/PERSONNEL SYSTEM handles multiple companies with hundreds of separate earnings and deductions. The expandable data base design allows each user to add, edit and report on as many new fields as required without any reprogramming. CYBORG provides a complete payroll system with all states, city and county taxes and complete audit and accounting reports. CYBORG has automatic check reconciliation, historical reporting, labor reports, including budget to actual comparisons with dollar and variance differences. The CYBORG REPORT LANGUAGE allows for the creation of special reports or output files (card tape or disk) to meet your unique requirements without reprogramming. The system is written entirely in ANS COBOL and will operate efficiently on IBM, Honeywell, Univac and DEC computers.

Cyborg Systems

2 N. Riverside Plaza, Suite 2225
Chicago, Ill. 60606, (312) 454-1865

CIRCLE 187 ON READER CARD

ACSL

The Advanced Continuous Simulation Language is a powerful but easy to use program designed for modelling the behavior of dynamic systems. Applications range from control system analysis to chemical plant models to urban dynamics.

- Interactive or Batch Graphics
- Unlimited Problem Size
- FORTRAN Compatibility
- Sliff Integration

ACSL reduces program development time by factors of two to ten: ACSL is available for CDC 6000/7000, IBM 360/370, UNIVAC 1100 and SEL 32 computers. Access through UCS, CYBERNET and other national networks.

MITCHELL AND GAUTHIER ASSOCIATES, INC.
P.O. Box 685, Concord, Ma. 01742
(617) 369-5115

CIRCLE 195 ON READER CARD

systemacs®

system development methodology

SYSTEMACS is a disciplined methodology for the creation of complete information systems—requirements, analysis, specifications, programming and maintenance. A sequentially logical series of tools, SYSTEMACS enforces standards for all of the participants—user, analyst, programmer and operations. SYSTEMACS controls every phase of the system life cycle comprehensively, concisely, effectively and economically. It provides tools that handle job design, program implementation and quality assurance, which account for over 50 percent of development costs. SYSTEMACS provides the bridge between theory and reality—tried, tested, proven.

Before you make any system decision, talk to the people from macs. Software productivity is our business ... and yours too!

macs
management and computer services, inc.
790 valley forge plaza
valley forge, pa. 19482
215-265-2910

CIRCLE 194 ON READER CARD

the choice of



ADDRESSOGRAPH MULTIGRAPH

ACCOUNTING IV GENERAL LEDGER

Our software products—General Ledger, Accounts Receivable, Accounts Payable and Standard Cost—are the choice of leaders like Addressograph-Multigraph *not by chance, but by design.* For details, call (213) 887-9121

informatics inc.
World's Largest in Software Products
21050 Vanowen St Canoga Pk CA 91304

CIRCLE 192 ON READER CARD

the choice of



National Semiconductor

ACCOUNTING IV® GENERAL LEDGER

Our software products—General Ledger, Accounts Receivable, Accounts Payable, and Standard Cost—are the choice of leaders like National Semiconductor *not by chance, but by design.* For details, call (213) 887-9121.

informatics inc.
World's Largest in Software Products
21050 Vanowen St Canoga Pk CA 91304

CIRCLE 193 ON READER CARD

COBOL

for
DATA GENERAL'S MINI-COMPUTERS
OPERATING WITH RDOS

Sequential, Random, and ISAM disk files.
Up to 32 million bytes per disk file.
Three levels of subscripting.
Full editing capability.
Up to 30 characters in data and paragraph names.
PERFORM statements may be nested to any level.
Conditional statements may be nested to ten levels.
Automatic decimal place alignment.
Automatic sign control.
14 digit numeric accuracy for display data.
48 bit accuracy for binary data.
Assembler subroutines.
5 key stand alone SORT.

Supports moving and fixed head disks, magnetic tape, cassette tape, paper tape, card readers, line printers, and consoles.

UNIVERSAL COMPUTING SYSTEMS, INC.
P.O. Box 3597
Evansville, IN 47734
(812) 423-1841

CIRCLE 200 ON READER CARD

How to get at the heart of the information puzzle



One of the problems facing decision-makers is the glut of data. How to get it, move it around—how to change it into information—can be a real puzzle.

RAMIS provides all the facilities needed for the economical design and operation of information systems in batch, remote job entry and time-sharing environments.

- Complete and automatic data base management technology
- An English-like language for report preparation

- A nonprocedural language for processing and validating transactions
- A data base interface for procedural languages
- An executive to control complex sequences of **RAMIS** routines

RAMIS lets DP professionals build complex systems in one-fifth the time while permitting management staff to tap corporate data bases without putting unnecessary pressure on the DP department.

ramis Mathematica Products Group P.O. Box 2392 Princeton, N.J. 08540 (609) 799-2600

CIRCLE 209 ON READER CARD

"DISKPLAY, IT'S CHEAP AT THREE TIMES THE COST"

Diskplay graphically shows the data set layout of your disk so you know how much space you're actually using.

It shows the unused space in each data set.

It reports defective tracks and the percentage of overflow area being used.

It helps you optimize your present disks and determine when to buy new ones.

And, Diskplay costs only \$495 for DOS or DOS/VS. For a free 21-day trial, call or write us today.

Boole & Babbage, Inc., 510 Oakmead Parkway, Sunnyvale, Ca. 94086. In California: (408) 735-9550. Outside California dial toll free: (800) 538-1872.



CIRCLE 186 ON READER CARD

ПЕРЕВОДЧИКИ!

From Russian to English for Scientific Journals

You can follow the latest Soviet research in your field, and supplement your income, by translating in your home on a free-lance basis. If you have a native command of English, a good knowledge of Russian, and experience or academic training in cybernetics, programming, and computer-related disciplines, you may qualify for our translation program. With our constantly expanding program, we can guarantee you a continuous flow of translations in your specialty.

For additional information contact:

Translations Editor
Plenum Publishing Corporation
227 West 17th Street
New York, N.Y. 10011

CIRCLE 198 ON READER CARD

BURROUGHS USERS

YOU CAN SAVE UP TO 50% ON YOUR PERIPHERAL EQUIPMENT

PRINTERS:

- 1800 1pm (Same source as Burroughs for the 9246-2) \$33,000
- Printer Controllers for 1700 through 6700 and 2800 through 6800 \$4,800
- Graphing Programs

TAPE UNITS:

- 6250 bpi Installed and operating now
- 1600 bpi up to 200 ips
- Uses proven STC Drives and Controllers

MAIN MEMORY: (6700 and 6800 add on)

- Core in 393,216 byte increments
- Comparable to Burroughs planar
- Purchase price \$48,000

SPECIAL PERIPHERALS

- Let us quote putting the peripheral of your choice on a Burroughs Computer

COMBUR

4116 Via Solano, Palos Verdes Estates
California 90274 (213) 378-7002
(604) 273-9940, (301) 299-3038

CIRCLE 202 ON READER CARD

SELL YOUR SOFTWARE IN THE **DATAMATION** MARKETPLACE

CALL GINGER 203-661-5400

CIRCLE 188 ON READER CARD

COMPUTER COMMUNICATION SEMINARS OF EXCELLENCE

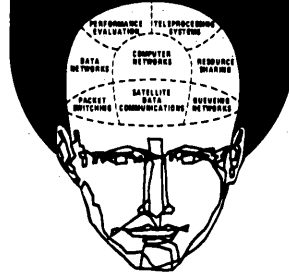

SIX DYNAMIC 3-DAY SEMINARS PRESENTED BY THE WORLD'S LEADING AUTHORITIES

- 1. KLEINROCK**
QUEUEING SYSTEMS
JULY 10-12, 1978 • WASHINGTON, D.C.
- 2. ABRAMSON**
SATELLITE DATA COMMUNICATIONS
JULY 17-19, 1978 • WASHINGTON, D.C.
- 3. KLEINROCK-FRANK-ROBERTS**
EXPERTS ON NETWORKS (11-Day Registration Available)
JULY 24-26, 1978 • ATLANTA, GEORGIA
- 4. LUCKY-GREEN**
DATA COMMUNICATION SERVICES AND PROTOCOLS
AUGUST 2-4, 1978 • LOS ANGELES
- 5. DENNING**
PERFORMANCE EVALUATION
AUGUST 14-16, 1978 • BOSTON, MASS.
- 6. KLEINROCK**
COMPUTER NETWORKS
AUGUST 21-23, 1978 • CHICAGO, ILLINOIS

SEMINAR FEE: \$575
DISCOUNTS FOR PREPAYMENT, GROUPS, AND SERIES.



CIRCLE 210 ON READER CARD

tone 3

IS HIGH PERFORMANCE LOW OVERHEAD

TSO for VS1

CHECK THESE FEATURES

- Edit with full screen capability
- Interactive program execution
- Internal reader job submit
- Operations console support
- Output retrieval with BES support
- Dataset maintenance
- System management
- Catalog management
- Program development
- Standard IBM TSO commands
- Data entry
- Enhanced 3270 usability
- System debugging
- Full ASCII terminal support
- Text editing
- No user swapping
- Performance monitoring support
- No I/OAM
- User command interface
- No VS/2 overhead



Write for Details 11988 TRASK AVE GARDEN GROVE CA 92643 (714) 636-8501

CIRCLE 203 ON READER CARD

#2 IN DEC
WE'RE **#1** IN DELIVERY
BECAUSE WE'RE **#1** IN DELIVERY

DEC LARGE SYSTEMS SPECIALISTS

10 ★ 20 ★ 11/34 ★ 11/45 ★ 11/60 ★ 11/70
CPUs • MEMORY • PERIPHERALS • SYSTEMS

CENTRONICS 101A, 102A, 103
NEW LOWER PRICES START AT \$1250!

8 & 11 OVER 250 DIFFERENT ITEMS IN STOCK

SEND FOR **FREE DEC LIST!**
AMERICAN USED COMPUTER CORPORATION

617-261-1100
P.O. BOX 68, KENMORE STA., BOSTON, MA 02215

CIRCLE 201 ON READER CARD

DATAMATION

VSAM LOAD DLI/IMS VSAM UPDATE INTERNAL SORT — QUIKSORT

- CC** Report Writer • Database Utility
- FO** Intelligent Utility • Mini-language
- OO** Increase Programmer Productivity
- II 62** Reduce Turnaround Time



THE PERFORMANCE EXPANDER

In use by over 400 companies. Four years on "Datapro Honor Roll."

ICP Million Dollar Software Club.

Call Mac or Bob, (513) 435-9514, send your card with this ad, or write for more details.

VSAM RANDOM VSAM SEQNTL ISAM OTHER DATE-BASES DBOMP

SYSTEM SUPPORT SOFTWARE, INC.

5230 Springboro Pike • Dayton, Ohio 45439

CIRCLE 199 ON READER CARD

MINI/MICRO-COMPUTER USERS SPEAK OUT.

The most comprehensive analysis ever of the Mini/Microcomputer market has been compiled by DATAMATION Magazine in a 200-page report that is essential reading for industry analysts, market planners, sales executives as well as users themselves.

This first in a series of annual DATAMATION Mini/Microcomputer survey reports is offered at \$365.

DATAMATION[®]
TECHNICAL PUBLISHING COMPANY

35 Mason St., Greenwich, Conn. 06830
(203) 661-5400

BUY, SELL, LEASE

COMPUTER ROOM FLOORING and AIR CONDITIONING

Sell us your used computer room flooring and air conditioning.

Buy our reconditioned flooring and air conditioning (ED-PAC, LIEBERT, etc.). Completely guaranteed.

D.V.I. CO., INC.
P.O. Box 33
Paoli, PA 19301
(215) 647-4916

CIRCLE 205 ON READER CARD

PROGRAMMERS AND ANALYSTS

If you are a programmer, programmer/analyst or systems analyst and would like the most individualized job search offered in the data processing field today, either on a local or national level, send your resume in confidence to:

E.D.P. SEARCH, INC.
P.O. BOX 331
HARTFORD, CONN. 06101

CIRCLE 206 ON READER CARD

POSITIONS AVAILABLE NATIONWIDE CALL TOLL FREE 800-426-0342

Openings currently exist at all levels. The following is a partial list of those openings.
SYSTEMS PROGRAMMERS TO 35K
DOS/VS, IMS OS-MVS, H6000 & CDC.
PROGRAMMER ANALYSTS TO 24K
Burroughs exp. in mfging., sales & finan.
COBOL PROGRAMMERS TO 22K
2-3 yrs. exp. in any application.
PROJECT LEADERS TO 25K
Prod./Control, Inventory & mfging.
DATA BASE DESIGNER TO 28K
IBM 370/OS environment.
IMS PROGRAMMER/ANALYSTS TO 26K
insurance, mfging. and retail.
SOFTWARE ENGINEERS TO 28K

Call **BILL ISGRIG** or forward resume to:
PARKER PAGE ASSOCIATES
P.O. Box 12308
Seattle, WA 98111
Offices in Washington, D.C., Chicago
Atlanta & Portland, OR.

CIRCLE 207 ON READER CARD

JOB MARKETPLACE

CORPORATE DATA PROCESSING STRATEGIST

A major corporation located in southeastern Wisconsin requires a professional planner to act as key liaison between the Computer and user departments. The prime responsibility will be the identification of potential computer applications and their translation into viable short and long term development plans. This position reports directly to the head of the Computer Department and obviously affords high visibility at the top management level.

The successful candidate must be college degreed, possess significant experience in computer planning (as a user, vendor's representative, or consultant) and exhibit communicative finesse.

If you match this description and are looking for an opportunity to challenge your intellectual capacity and creative analytical skills, send your resume, including salary history, in confidence to:

Datamation Magazine
Box D-M-478
35 Mason Street, Greenwich, CT 06830

"An Equal Opportunity Employer" M/F

If you use computers as models of dynamic systems . . .

you are a simulationist

and

you are invited to join the Society for Computer Simulation and receive our monthly technical journal, *SIMULATION*, every month

The Society for Computer Simulation (SCS) is the *only* society whose central focus is simulation, and *SIMULATION* is the leading monthly journal devoted exclusively to simulation & closely allied computer arts.

If you are working in our field, we think you would find membership in SCS useful in many ways.

In addition to your membership in the Society for Computer Simulation, you'll receive a subscription to *SIMULATION*, the benefits of meeting and interacting with internationally recognized authorities in the field at SCS regional meetings and at national and international conferences cosponsored by SCS, and the knowledge that the information you receive through your membership in SCS will keep you informed in the rapidly advancing art of simulation.

Write for a free sample copy of *SIMULATION* and membership information.

THE SOCIETY FOR COMPUTER SIMULATION

(Simulation Councils, Inc.)

P.O. Box 2228 -D
La Jolla, Calif. 92038



Hardware and Software Engineers

We'll exceed your expectations.

The tremendous acceptance of the LEVEL 6 minicomputer systems exceed even our expectations. And this success has created opportunities that could exceed yours! More responsibility, better advancement, and greater professional growth are waiting for you at Honeywell's Small/Medium Information Systems Division (S/MISD).

We're continuing to expand and are actively seeking outstanding professionals who want more challenging and rewarding careers. Based in our Billerica, Massachusetts facility, you'll be involved in the stimulating activity that the LEVEL 6's success has brought about . . . and contributing in an atmosphere of real accomplishment and pride. If this is what you expect from your career, come to Honeywell S/MISD.

HARDWARE

We have immediate openings for professionals with demonstrated ability in the following areas:

- **Terminals and Communication Definition**
- **Communication/Networking Systems Design**
- **Minicomputer Hardware Systems Engineering**
- **Minicomputer Definition Engineering**
- **Software/Firmware**
- **Circuit Design**
- **Special Products Hardware Development Engineering**

Most of these positions require at least 3 years of experience plus a relevant degree or equivalent.

If you are interested in any of the above opportunities, please forward your resume, including salary history and indicating position or positions of interest, to Jerry Hanyesworth, HONEYWELL, 300 Concord Road, Billerica, MA 01821.

SOFTWARE

These are exceptional opportunities for software professionals with proven expertise to contribute to the

continuing development of the LEVEL 6 minicomputer systems. We're currently seeking talented:

- **Software Systems Engineers** - Translating market requirements into software system definitions including networking and distributed systems.
- **Senior Analyst** - Translating conceptual design objectives into specific implementation requirements or operating systems, communications subsystems, compilers, data management, and transaction processing, and text processing.
- **Analysts and Programmers** - Implementing and testing operating systems, communications subsystems, compilers, data management, and transaction processing techniques. Design and implementation of software test tools and techniques.
- **Software Product Support Analysts** - Provide field support including distributed systems and communications environments.

The above positions require professionals with a solid background including 1-8 years experience, and some require a relevant degree or equivalent.

If you are interested in joining our LEVEL 6 software effort, please forward your resume, including salary history and indicating position or positions desired, to Blanche Hurt, HONEYWELL, 300 Concord Road, Billerica, MA 01821.

**THE
SEARCH
ISON**

An Equal Opportunity Employer M/F

Honeywell

personal computing

by Portia Isaacson, Contributing Editor

and Harold C. Kinne

Distributed Personal Computers

In Dallas, a distributed system consisting of 10 personal computers and an IBM Series 1 minicomputer will soon be on-line helping a wholesale travel agency cope with operating problems brought on, in part, by relaxed government regulations. The tour agency, Adventure Tours, Inc., operates flights from 16 U.S. airports to vacation spots such as the Bahamas, Jamaica, and Acapulco. Adventure accepts bookings from travel agents throughout the U.S.; each booking involves not only date and destination, but can include hotel reservations, meal service, and other options.

Currently, five to eight clerks track bookings by posting them on wall-mounted scheduling boards. When the distributed system comes up, each clerk will have a personal computer for inquiries and entering reservations; the clerks' computers will communicate with the Series 1-managed central data base. Additional personal computers will provide accounting, management information, and printing functions.

As it stands

Adventure's scheduling boards each have 100 slots (representing seats) for paper slips with the seat holder's name and related information. Depending on the scheduled aircraft's capacity, one or more boards may be assigned to each flight. Clerks take telephone reservations from participating travel agents, typing a name slip for insertion into the correct board. Empty slots let all clerks see at a glance how many seats remain available.

The system works well, with only occasional human errors; if a name slip gets inserted into the wrong board a passenger could find himself on the wrong flight to the wrong destination. Careful management checks usually, but not always, find these errors in time.

Until about six months ago the Civil Aeronautics Board (CAB) required submission of passenger manifests 15 days prior to departure. That gave Adventure 15 days for paperwork, and finding and correcting mistakes. Unfortu-

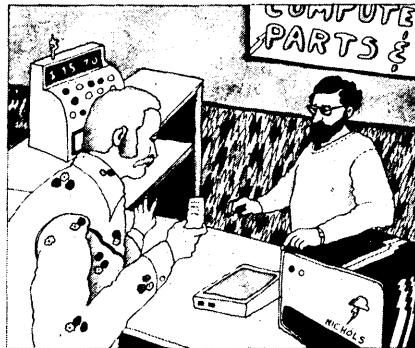

nately, it also meant empty seats remained empty, contributing nothing to the tour's profits.

Then the CAB removed the early

manifest requirement. Now Adventure can sell seats right up to the time of departure and maximize profits. But this leaves little time for paperwork and error checking. Extensive follow up paperwork and record keeping includes the issuing of confirmations and invoices, hotel rooming lists, and alphabetized manifests for the airline.

Business doubled

Currently, Adventure produces manifests five days before departures, making late changes over the telephone. Loss of the 15-day cushion for preparing paperwork, and a rapidly growing business, made it apparent that something had to be done, quickly, for

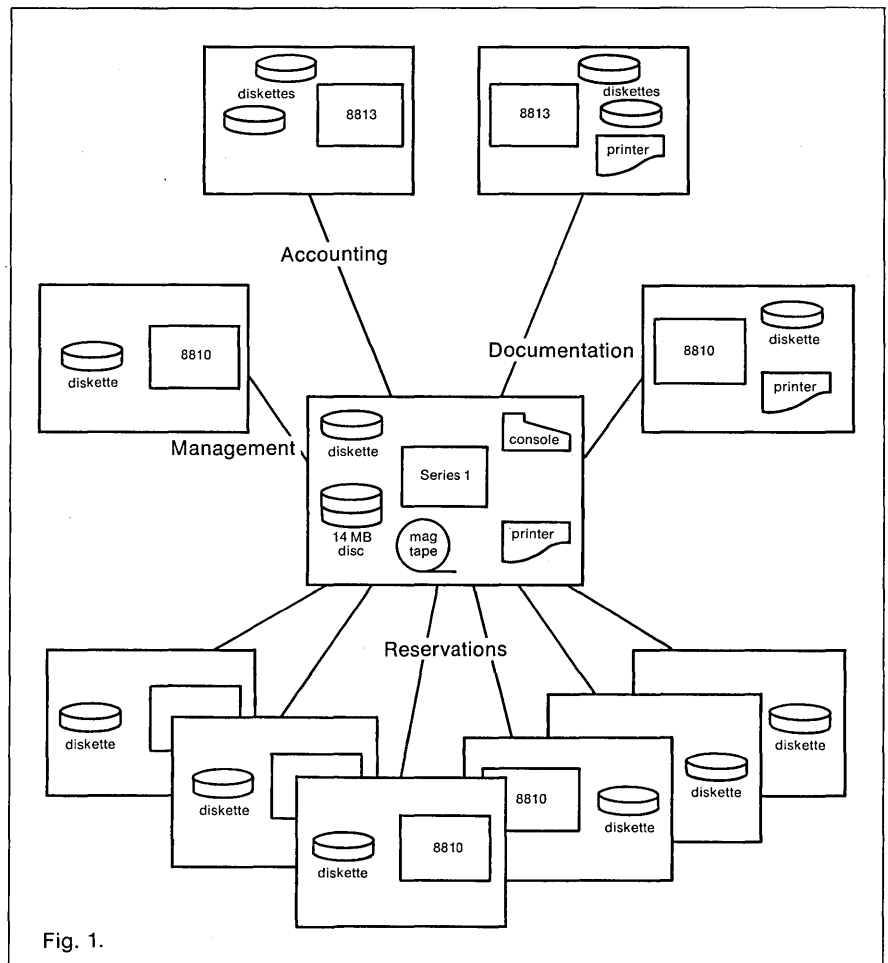

Fig. 1.

Menu

1. PASSWORD SIGN-ON
2. FLIGHT AVAILABILITY
3. NEW RESERVATION BOOKING
4. BLOCK RESERVATION (GROUP SALESPERSON ONLY)
5. CHANGE CONFIRMATION
6. UPDATE WAITING LIST
7. REVIEW OR RE-BOOK CANCELLATION
8. CRUISE RESERVATION

Table 1.

the company to remain profitable and competitive. Business doubled between 1976 and 1977, and looks as if it will double again this year.

The agency may hold more than 20,000 reservations at a given time, and may schedule 25 different flights over any one three-day weekend. And they

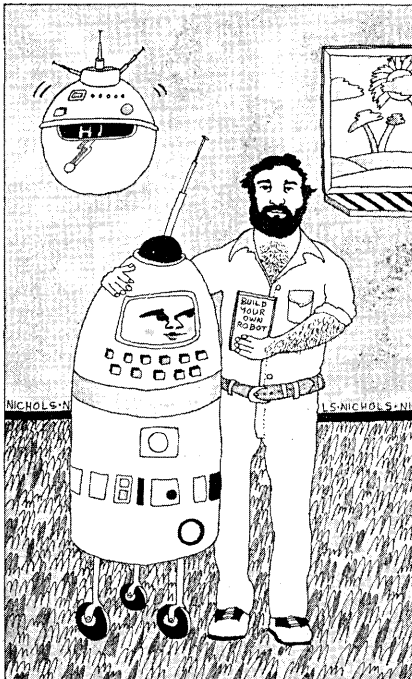

do this with five to eight clerks staffing the telephones and controlling the flight boards.

OTIS coming up

Then the computer entered the picture: Marvin Elder, president of Elder Computing Corp., Richardson, Texas, came up with the concept of OTIS—One-stop-inclusive Tour Information System—using a distributed processing network consisting of 10 personal computers and one minicomputer (Fig. 1). An IBM Series 1 mini controls a data base containing information on all flights and reservations; 10 Polymorphic personal computers interface with it, providing reservation, documentation, accounting, and management

information services. Six Polys, each with its own 90KB mini-floppy drive, act as intelligent terminals to the Series 1 for the individual travel clerks.

Two Polys handle report printing; each runs a Texas Instruments Model 810 printer. Another personal computer does Adventure's accounting, and a fourth supplies on-line information to the agency's general manager. Trend analysis and other statistical reports are available at the general manager's own personal computer.

The system thus includes the 10 Polys, each with 32KB of memory, connected to the Series 1 by a 9600 bps line. All are at the same physical location. The Series 1 has 64KB of memory and is supported by 14MB of hard disc, 0.5MB of floppy disc, a Datum tape drive, a Perkin-Elmer operator console, and an IBM model 5103 printer. A set of microprocessor-controlled rs232 ports interface the Polys to the Series 1. No special hardware was constructed for the OTIS system.

OTIS at work

Upon request, the system will call up current data on seating, options, and flights, displaying the information on a formatted screen at the clerk's location. At power up, the system automatically offers a menu (Table 1) of available services. After signing on with an individual password (to assign responsibility, prevent unauthorized use, and limit access to the data base), the operator can select the desired function. A formatted screen display is then presented, using software written by Elder Computing; a blinking cursor indicates required entries.

Reservation details are forwarded to the Series 1, which updates the data base and prints the required confirmations and invoices. Simultaneous inquiries will be supported; a record-level lockout will preserve the file's integrity while allowing inquiries concurrent with an update. There is no file lock-out involved.

The system will require minimal operator training. It boots itself automatically when the power is turned on,

A PROFILE OF DSS

Data Systems Services is a recently formed organization of General Dynamics providing scientific/engineering and business data processing services to corporate operating divisions. These services are performed at three major regional Data Systems Centers and at numerous nationwide locations.

Because computers and microprocessors are an integral part of many General Dynamics products, we are continually at the leading edge of DP technology. We are involved in projects ranging from Trident submarines, cruise missiles and the new F-16 fighter, to LNG tankers and digital telephone switching systems.

This diversity of challenge, combined with our rapid growth, has created an uncommonly professional and fast-paced organization.

INSTRUCTIONS:

Use the rating scale to indicate your current level of knowledge and write that number in the appropriate spaces to complete your Career Registry Entry form.

RATING SCALE

- 1 Basic Knowledge
- 2 .. Perform Under Direction
- 3 ... Perform Independently
- 4 Teach/Consult

Programmers - Analysts - Software Specialists

General Dynamics Data Systems Services introduces the Career Registry.

We have created this new registration service for DP professionals who are too busy to actively search for important opportunities. It will enable us to notify you of our *immediate openings* in your specialty, and also keep you informed of appropriate *future openings* throughout the year. Qualifications must include a professional degree in Computer Science, Math, Physics, Engineering or Business with a minimum of 2 years experience.

Here's How It Works:

We have listed our principal areas of DP involvement—hardware, software, applications programming and, of course, our widespread geographical locations. All you need to do is to use the scale provided to mark the spaces that best match your qualifications. We, in turn, will notify you of our present and future openings that fit your Career Registry profile.

CAREER REGISTRY ENTRY

Name: _____

Current Position Title: _____

Home Address: _____

City: _____

State: _____ Zip: _____

Home Phone No: _____

Degree: _____ Years Experience: _____

APPLICATIONS AREAS

- ___ Guidance & Control Systems
- ___ Telemetry Data Reduction
- ___ Avionics
- ___ High-Technology Applications
- ___ Micro Processor Applications
- ___ Real-Time/Time-Critical
- ___ CAD/CAM/CMS
- ___ Structural Analysis
- ___ Electronics Design
- ___ Information Management Systems
- ___ Computer Performance Measures
- ___ Data Communications

- ___ Data Base
- ___ Semi-Conductor Technology
- ___ Hybrid Simulations
- ___ Computer Modeling
- ___ Operating Systems
- ___ Computer Design
- ___ Other _____

LANGUAGES

- ___ COBOL
- ___ FORTRAN
- ___ PL/1
- ___ JOVIAL
- ___ MARK IV
- ___ APL
- ___ BASIC
- ___ ACL/BAL
- ___ CSSL
- ___ SIMSCRIPT
- ___ CSMP
- ___ GPSS
- ___ Other _____

SYSTEMS

- ___ IBM 370/168-MP (MVS/JES3)
- ___ CDC CYBER (NOS/BE)
- ___ UNIVAC 1100 (EXEC 8)
- ___ Minicomputer Systems
- ___ Microprocessor Systems
- ___ Military Computers
- ___ Other _____

GEOGRAPHIC PREFERENCE(S) (Simply Check)

- San Diego, California
- Sanford, Florida
- St. Louis, Missouri
- Pomona, California
- Norwich, Connecticut
- Quincy, Massachusetts
- Ft. Worth, Texas
- Quonset Pt., Rhode Island

Please send your completed entry form, together with earnings history, in confidence to: **Mr. M.R. Barlow, Corporate Director, General Dynamics Data Systems Services, Pierre Laclède Center, St. Louis, MO 63105**

GENERAL DYNAMICS

Data Systems Services

U.S. Citizenship required. An equal opportunity employer, M/F.

R

PERSONAL COMPUTING

and pressing the "load" button will display the menu. A few days of on-the-job training and an ability to input data at a keyboard will suffice for the clerk/operator. Data entry routines display screen formats and allow the operator to move forward or backward through the form, skipping entries if desired. When the operator indicates that the input data are correct, the system sends it to the Series 1.

The formatted screen is controlled, in

part, by an assembly language program (for greater speed) which blocks and deblocks individual fields. A text file describes each record type in the main file with a file descriptor record. For each field in the record the descriptor assigns a key name, a type (alphabetic or numeric), and the start and end position in bytes.

Over and above the description of the records, there are a set of supporting routines written in both assembler and BASIC. With this technique, a formatted screen display can contain information from more than one record—a significant increase in capability for the terminal operator as it is no longer necessary

to access different records sequentially. The system presents the requested data on one screen display; the operator need not know from which files it was obtained.

Elder wrote his own operating system for the Series 1 to take advantage of some of the mini's characteristics that are particularly suited to a distributed system. As he says, "The Series 1 operating systems are primarily aimed at multiprogramming . . . this approach is a little different. The Series 1 is not used for applications programming—that is done by the Polymorphics—but as a database controller." OTIS did not require a large, sophisti-

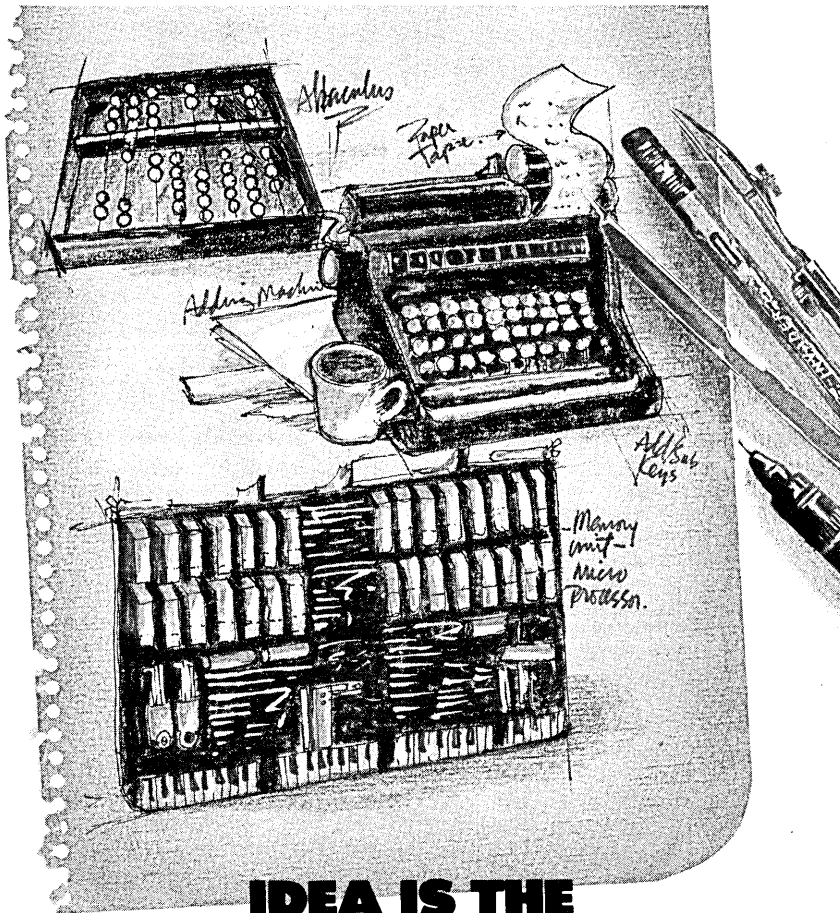

IDEA IS THE FOUNDATION OF INNOVATION.

And innovation is our client's stock in trade. We're LRK Associates and we represent one of the top 10 employers of creative hardware and software design professionals. If your experience matches the areas below, consider initiating a professional

dialogue with us now. We can introduce you to a multitude of long-range projects and programs that will prove not only financially rewarding and professionally stimulating, but will also afford you a tremendous measure of personal pride.

IMMEDIATE OPPORTUNITIES EXIST IN THE AREAS OF:

- Documentation Engineers
- Radar Software Development
- Simulation Design Engineers
- Mini-Computer Software Systems Design and Development
- Command & Decision Software Definition & Design
- Proposals Expertise For Large-Scale Systems
- Command and Control Software Development
- Micro-Processor Software Development
- Hardware/Software Integration
- Software Project Management
- Weapons Software Development
- Data Base Design

In The East:
703-790-8640
LRK Associates
Management Consultants
6845 Elm Street, Rm. 8401
McLean, Virginia 22101

LRK
ASSOCIATES
U.S. Citizenship Required
representing equal employment opportunity M/F/H

In The West:
714-848-8494
LRK Associates
Management Consultants
16371 Beach Boulevard #141, Rm. 8402
Huntington Beach, CA 92647

This new system will provide a small-computer version of decision support systems being used by large-computer based industries.

cated operating system, so Elder took some of the macros existing in various IBM operating systems (disc support, task scheduling, etc.) and sysgenned them together to provide an individualized system.

The OTIS system provides excellent back-up—the Series 1 produces a magnetic tape of transactions as they are received from the Polymorphic terminals. If the system crashes, this tape can be used to recover without returning to the back-up disc produced the preceding night. While the Series 1 is down, each Polymorphic can conduct limited business by retaining reservation requests on its mini-floppy, thus allowing Adventure to continue near-normal business. When the Series 1 comes back on-line, rapid transfer of information from the Polys to the data base can be accomplished.

The system provides impressive growth potential. Elder estimates the starting six operator positions can be increased to about 18 without changing the Series 1 configuration. Adding another 64KB and a second 14MB disc will allow upwards of 30 terminals. The Series 1 itself can handle up to 14 discs and access some 256 devices; the recently announced multiplexor front-end capability should allow OTIS practically unlimited expansion.

Information provided to the general manager is fairly sophisticated. Adventure operates on a rolling time-frame of about six months—meaning some 26 weekly flight schedules are in the system at any one time. The information system can provide analysis of historical data and show relative performance at any time, indicate how closely the current-percentage-filled of future tours corresponds with similar data in the

past, and compare expected final levels against scheduled capacity. This type of information analysis will be very valuable in spotting trends in tourism, changes in performance by individual agents, or changes in types of tour requests from specific geographic areas—data it is essentially impossible to glean from a manual system.

This new system will provide a small-computer version of the decision support systems being used by some large-computer based industries today and should provide an order of magnitude improvement in the individualized information available for decision making support.

"This distributed . . . system will give us almost unlimited flexibility—we can grow with this system for 5 to 10 years with no problem."

Mr. Joe Franken, vice-president and general manager of Adventure Tours, really looks forward to the computerized system. He says, "This distributed data processing system will give us almost unlimited flexibility—we can grow with this system for 5 to 10 years with no problem. We looked at individual computers but they were either too big or too small—this system costs less and does more. The time it will save us in reservations and, of course, with manifests makes it worthwhile to have a computer."

Total cost for the system, including installation, is approximately \$110,000. Monthly maintenance charges will run approximately 1% or \$1,100. The oem will provide maintenance for the Series

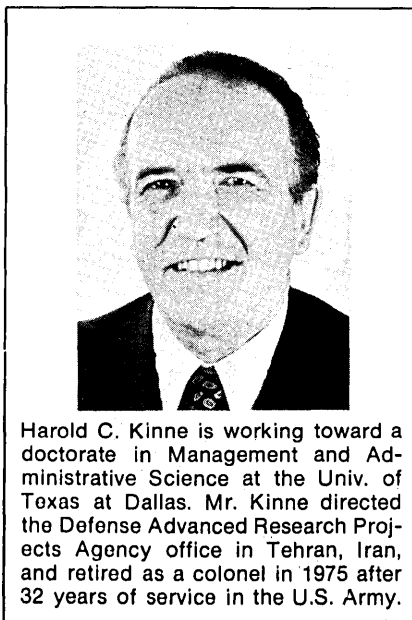

Harold C. Kinne is working toward a doctorate in Management and Administrative Science at the Univ. of Texas at Dallas. Mr. Kinne directed the Defense Advanced Research Projects Agency office in Tehran, Iran, and retired as a colonel in 1975 after 32 years of service in the U.S. Army.

1 and its ancillary equipment including all three printers. The retail computer store which furnished the Polys, COMPU SHOP, provides on-site maintenance for the Polymorphics including provision of spares when needed and some preventive maintenance for the disc drives. Elder estimates the initial cost saving over a single minicomputer capable of supporting the present level of effort at over \$50,000.

Elder sees the future application of a personal computer based system similar to OTIS to the problems of the 3,000 travel agents in this country. A personal computer like the Polymorphic could tie in to PARS—the passenger air-

line reservation system used by commercial airlines to make reservations. Thus the individual travel agent could make his own reservations and receive confirmation without an intermediate airline representative. As a bonus, the personal computer would aid him with routine office functions and could provide statistical analyses of performance.

This is an exciting use of the personal computer, and its application to free the mini for more effective data base management is especially progressive. As the personal machine moves more and more deeply into its business role, we expect to see more such networks. *

San Diego openings in software systems development

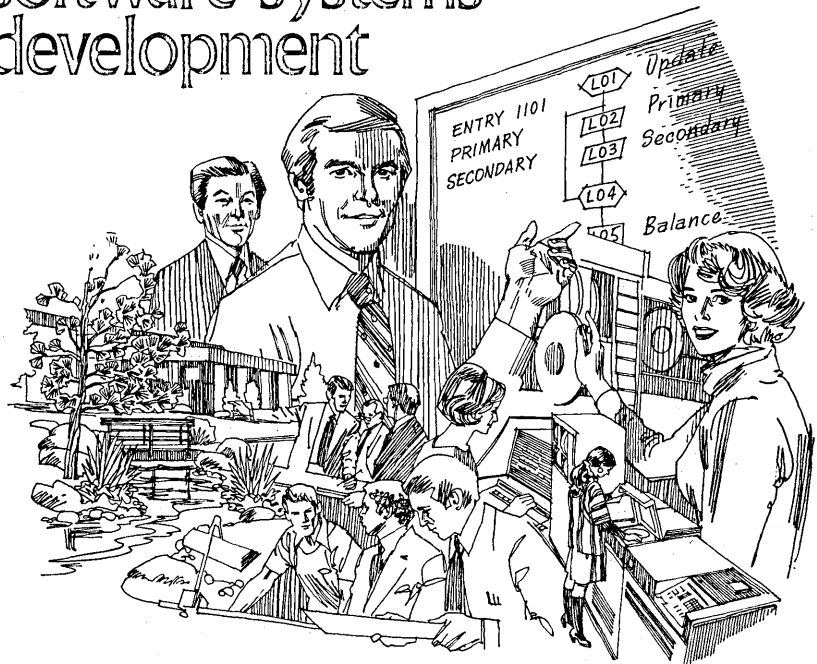

for computer programmers who want to really live 365 days a year

Now you can combine the ideal career opportunity with your favorite lifestyle. We need your help in developing advanced, high-technology EDP systems for customers around the world. We're in a postcard setting one mile from the ocean, only minutes from La Jolla and downtown San Diego and close to everything that this year-round vacation area is famous for. At NCR, you'll enjoy an excellent salary and generous benefits, with periodic merit reviews to ensure your advancement. If one of these new positions describes you, get set to make your last move.

NCR Systems Engineering has opportunities for software professionals in a broad range of disciplines and at all experience levels. Assignments will include development and implementation of EDP systems for specific customers as well as development of total NCR systems. Our current and firm future programs require top people with experience and state-of-the-art knowledge in any of these areas:

- ▣ TELECOMMUNICATIONS SOFTWARE
- ▣ FILE PROCESSING
- ▣ NETWORK DEVELOPMENT
- ▣ LARGE MAINFRAME, MINI AND MICRO PROCESSOR
- ▣ OPERATING SYSTEMS
- ▣ COBOL APPLICATIONS
- ▣ ASSEMBLY LANGUAGE

Please submit your resume with salary history to Thom Harris, Employment Specialist

NCR SYSTEMS ENGINEERING/TORREY PINES

4063 Sorrento Valley Blvd., San Diego, Calif. 92121 □ (714) 452-1020
An Equal Opportunity Employer

Nov. 7-9, 1978
Sheraton-Park Hotel
Washington, D.C.



DATAMATION® Magazine announces its association with Federal Education Programs to present ...

The only Federal Computer Conference that covers all you need to know



If you're in the Federal Government, the Federal Computer Conference is *your* computer conference. It deals with Federal ADP exclusively. And, unlike the usual single-topic ADP seminars or expo's with limited programs, the Federal Computer Conference and Exposition encompasses your *total* information needs.

Structured by Government ADP leaders

The Conference's Program Advisory Group consists of top-level professionals representing every major department and agency user in the Federal ADP community. They know your needs. They have tailored a program that meets them ... a program that provides a *total* learning experience for Federal computer users at every level.

1978 — A critical year

ADP reorganization, software conversion, privacy and security, the emphasis on improving performance and efficiency — issues such as these will make the 1978 Federal Computer Conference especially helpful and meaningful for all Federal ADP users.

Co-sponsored by DATAMATION Magazine

DATAMATION, the leading data processing publication, and Federal Education Programs are Conference sponsors. Their combined expertise and resources assure a Conference of highest quality — a stimulating and professionally rewarding experience. It is your one opportunity to participate in the only major computer conference and exposition tailored exclusively for the Federal ADP community. And, it takes place right in Washington. Easy to get to. Economical. Scheduled for

A total learning experience ... structured by leaders in the Federal ADP community ... devoted exclusively to Federal users ... co-sponsored by DATAMATION Magazine and Federal Education Programs

the fall to fill a major gap in the industry conference calendar.

Bundled Registration

A unique feature for a large conference of this type, and ideal for Government personnel. One fee covers everything — including notebooks containing extensive material on Conference sessions, and luncheons featuring prominent speakers.

"Targeting for Improved ADP Performance"

The Conference theme speaks for its comprehensive coverage. On the agenda:

Professional Enhancement Program —

A one-day introductory program of tutorial seminars on ADP basics, procurement, other broad subjects of interest.

Two-day Main Program — Following the introductory program, two days of in-depth sessions covering topics ranging from key management and policy issues to the latest in products and services.

Federal Services Showcase — Highlighting services available to ADP users from sources *within* the Government.

Major Computer Exposition — Exhibition of diverse products and services featuring the most recent technological advances.

Plus more ... much more ... in the first computer conference and exposition specifically structured to meet your *total* information needs. Plan now to join your colleagues for the 1978 Federal Computer Conference and Exposition at the Sheraton-Park Hotel Nov. 7-9, 1978 — your one opportunity this year, right in Washington, to get it all together! For more information, just fill out the coupon.

Targeting for Improved ADP Performance

Federal Computer Conference and Exposition, P.O. Box 368, Wayland, Mass. 01778

- I'm interested in attending. Please send more information.
- My company may want to exhibit. Please send details.

Name _____ Title _____

Address: _____

_____ Phone _____

Want more from your Remote Computing Service?

See how MMDS can fit your needs.

If you're now a remote computing user, consider Martin Marietta Data Systems' Remote Computing Services (RCS). For a number of reasons.

If you need more computing power, or if you're concerned with what you're not getting from your present RCS supplier, we have a lot to offer.

- ... Economy of use
- ... Unequaled service
- ... State-of-the-art hardware and software
- ... Plus much, much more.

To get the full story on how our RCS can fit your needs, send for our free RCS brochure by filling out the coupon. Or call Dick Nemerson at (301) 321-5744.

Martin Marietta Data Systems
 We  Build & Run Systems

See how MMDS can fit your needs.

Dick Nemerson
 Martin Marietta Data Systems
 300 East Joppa Road
 Baltimore, Maryland 21204

Name _____
 Co. _____
 Title _____
 Address _____
 City _____
 State _____ Zip _____
 Phone _____
 RCS currently using _____

CIRCLE 33 ON READER CARD



Technical Publishing Company
 A Dun & Bradstreet Company

James B. Tafel, Chairman
 John K. Abely, President
 Robert L. Dickson, Exec. Vice President
 Calverd F. Jacobson, Vice President-Finance
 Walter Harrington, Vice President and Controller

Advertising Offices

Eastern District Managers

A. Treat Walker,
 Warren A. Tibbetts: Greenwich, Ct. 06830
 35 Mason St. (203)661-5400

New England District Manager & Vice President

Warren A. Tibbetts: Manchester, N.H. 03104
 112 W. Haven Rd.
 (603) 625-9498

Midwest District Manager

John M. Gleason: Chicago, Ill. 60611
 444 No. Michigan Ave.
 (312) 644-3970

Western District Managers

Alan Balté, Jr.: Los Angeles, Calif. 90035
 1801 S. La Cienega Blvd.
 (213) 559-5111

James E. Filiatrault: Mountain View, CA 94043

2680 Bayshore Frontage Rd.
 Suite 401
 (415) 965-8222

U.K., Scandinavia, Benelux

Intergroup Communications, Inc.
 Wallace K. Ponder, European Director
 Paul D. Dimmock, Regional Manager
 31 Lyncroft Avenue
 Pinner, Middx, HA5 1JU
 England
 Tel: (01) 868 9289
 Cables: PACOM, Pinner

Germany, Austria, Eastern Europe

Fritz Taeuber
 Soltauer Strasse 85
 D-314 Lueneburg
 Germany
 Tel: (0 41 31) 4 38 49

France, Switzerland, Italy, Spain

Gerard Lasfargues
 32 rue Desbordes Valmore
 75016 Paris
 France
 Tel: (1) 288 90 22

Japan

Shigeru Kobayashi
 Japan Advertising Communications, Inc.
 New Ginza Building
 3-13 Ginza 7-chome
 Chuo-ku, Tokyo 104, Japan
 Tel: (03) 571-8748

Technical Publishing Company
 A Dun & Bradstreet Company



Business Magazines
 Consumer Books
 Training Systems

DASH® (DELTA AIRLINES SPECIAL HANDLING) GETS YOUR SMALL PACKAGE THERE IN A BIG HURRY.

Delta handles more over-the-counter shipments of 50 lbs. or less than any other certificated airline. What's more, DASH serves 85 U.S. cities plus San Juan. Any package up to 90 inches, width + length + height, and up to 50 pounds is acceptable. DASH packages accepted at airport ticket counters up to 30 minutes before flight time, up to 60 minutes at cargo terminals. The charge for DASH shipments between any two of Delta's domestic cities is \$30. Rate is \$25 between Dallas/Ft. Worth and Los Angeles or San Diego or San Francisco. There is an extra

charge for pick-up and delivery. For pick-up and delivery, call 800-638-7333, toll free. (In Baltimore, call 269-6393). Special DASH airbill provides speedy documentation. Special DASH bag makes identification easy. DASH shipments are prepaid.

You may pay for your shipment with cash or approved credit or an acceptable major credit card. For full details on rates and shipping information call your nearest Delta air cargo representative.

DELTA IS READY WHEN YOU ARE®



advertisers' index

Able Computer Technology, Inc.	43
Academic Press	250
AFIPS	219-222
American Terminal Leasing	214
Anderson Jacobson, Inc.	144, 193
Applications Software, Inc.	229
Applied Digital Data Systems Inc.	12
Basic Timesharing Inc.	211
Blue Cross of Wisconsin	253
Boeing Computer Services	252
Capex Corporation	72
Centronics Data Computer Corp.	24
CFS, Inc.	232
Cincom Systems, Inc.	111
Compugraphic Corp.	133
Computer Transceiver Systems, Inc.	122
Consolidated Computer International Inc.	115
Control Data Corporation	46, 121
Crown Communications, Inc.	218
Cullinane Corporation	29, 135
DASD Corporation	200, 201
Data Communications Corporation	231
Data General Corporation	16, 116, 117
Data 100 Corporation	136, 137
Datacorp	130
DatagraphiX, Inc.	83
DATAMATION	225
Datapoint Corporation	60
Datum, Peripheral Products Division	Cover 3
Decision Data Computer Corp.	158
Delta Airlines	248
Diablo Systems Division of Xerox Corporation	157
Digi-Log Systems, Inc.	155
Digital Associates Corporation	8
Digital Equipment Corporation	34, 75-80, 104, 190, 191
Digital Pathways Inc.	86
Digital Supplies	82
Diva	126
Documation Incorporated	106, 107
Eastman Kodak Company, Business Systems Markets Division	90
EDPAA 1978 Conference	200
Electronic Memories & Magnetics Corporation	162, 178
Ex-Cell-O Corporation, Remex Division	160, 161
Federal Computer Conference and Exposition	246, 247
Four-Phase Systems	9, 10, 11

Our Service Gets A Perfect Score In Datapro Study

DMS/OS is the data management system
with satisfied users

All our DMS/OS users responding to a recent Datapro study gave our company a perfect 4.0 rating for our vendor technical support. DMS/OS was the only software product in the current Datapro study, with five or more responding users, that scored a perfect 4.0 in vendor technical support. In addition, DMS/OS users rated it at 3.6 in overall satisfaction.

DMS/OS users are satisfied. They are enjoying the benefits of having the most complete data management system available. Let us show you how they are controlling their DASD resources with DMS/OS.

DMS/OS is an established product with an excellent track record for vendor technical support. Just call or write and we will be glad to send a brochure, functional overview, Auerbach and Datapro reports. Find out why DMS/OS is the wave of the future in data management and give us the opportunity to show you, that at Software Module Marketing, service and software come together.

SOFTWARE MODULE MARKETING

Where Service and Software Come Together



Crocker Bank Building/Penthouse • 1007 7th Street • Sacramento, CA 95814 • Telex SMMSAC 377-314 • (916) 441-7234

Are Your DASD's Drowning . . . in a Sea of Data?

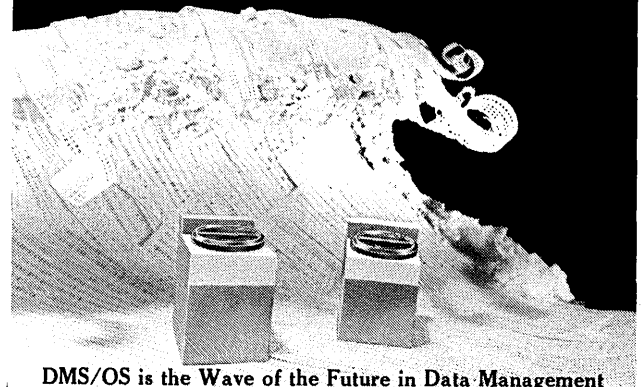

DMS/OS is the Wave of the Future in Data Management

CIRCLE 113 ON READER CARD

THE AUTOMATIC PROGRAMMING INFORMATION CENTRE
STUDIES IN DATA PROCESSING NO. 12

PRINCIPLES OF PROGRAM DESIGN

By M. A. JACKSON

In this volume the author describes and explains a rational method of designing computer programs, adopting a practical, step-by-step approach. The method is particularly—but not solely—suited to programming for data processing and for systems software. Building on the foundations of structured programming, the book shows how to analyse a problem by considering the structures of the input and output data. An important theme of the work is that the design technique applies to systems no less than to programs.

CONTENTS: Introduction. Structures and Components. Basic Design Techniques. Multiple Data Structures. Errors and Invalidity. Backtracking. Structure Clashes. Program Inversion. Complex Inversions. Multi-Threading. Systems and Programs. Optimization. Retrospect. Reading List.

1975, 300 pp., \$22.75/£9.08 ISBN: 0-12-379050-6

PERSPECTIVES ON COMPUTER SCIENCE

From the 10th Anniversary Symposium at the Computer Science Department Carnegie-Mellon University

Edited by ANITA K. JONES

A Volume in the ACM MONOGRAPH Series

CONTENTS: A. Perlis, The Keynote Speech. C. G. Bell, What Have We Learned from the PDP-11? H. Berliner, The Use of Domain-Dependent Descriptions in Tree Searching. R. E. Fikes, Knowledge Representation in Automatic Planning Systems. A. N. Habermann, On the Concurrency of Parallel Processes. R. Iturriaga, A Case Study—Assimilation and Creation of Computer Science Technology in a Developing Country. Z. Manna and A. Shamir, A New Approach to Recursive Programs. A. R. Meyer and M. I. Shamos, Time and Space. A. Newell and G. Robertson, C.mmp: A Progress Report on Synergistic Research. R. Reddy and A. Newell, Multiplicative Speed-up of Systems. H. A. Simon, On the Nature of Understanding. W. A. Wulf, Some Thoughts on the Next Generation of Programming Languages. Excerpts from the Symposium Panel Discussions. Contributed Talks. Demonstrations.

1977, 256 pp., \$19.50/£13.85 ISBN: 0-12-389450-6

DECISION TABLE LANGUAGES AND SYSTEMS

A Volume in the ACM MONOGRAPH Series

By JOHN R. METZNER and BRUCE H. BARNES

This monograph explores the nature and conceptual basis of decision tables in the computer programming context. It shows that decision tables are a viable programming language element by tracing the rich and diverse development of decision table use and supporting research, by showing them theoretically tractable through linguistic analysis and formalization, and by identifying features used to describe and design decision table programming languages and their processing systems.

CONTENTS: Introduction. Semiotics. Programming Language Features. Generalization. Design Implications.

1977, 176 pp., \$14.50/£10.30 ISBN: 0-12-492050-0

A 20% discount on titles in the ACM MONOGRAPH Series is available to members of the ACM. Members should direct their orders to Academic Press, and must include their active membership number.

Send payment with order and save postage plus 50¢ handling charge. Prices are subject to change without notice.

U.S. customers please note: On prepaid orders—payment will be refunded for titles on which shipment is not possible within 120 days.

ACADEMIC PRESS, INC.

A Subsidiary of Harcourt Brace Jovanovich, Publishers

111 FIFTH AVENUE, NEW YORK, N.Y. 10003

24-28 OVAL ROAD, LONDON NW1 7DX

Please send me the following:

___copies, Jackson: *Principles of Program Design*

___copies, Jones: *Perspectives on Computer Science*

___copies, Metzner/Barnes: *Decision Table Language and Systems*

Check enclosed___

Bill me___

NAME_____

ADDRESS_____

CITY/STATE/ZIP_____

Direct all orders to Mr. Paul Negri, Media Dept. Datamtn/4/78

advertisers' index

General Dynamics, Data Systems Services	242, 243
Graphic Controls Corporation	56, 57
Harris Computer Systems	216, 217
Harris Corporation, Communications and Information Handling	253
Harvard Business School	204
Hazeltine Corporation	66
Heath Company	159
Hewlett-Packard	70, 71, 169, 171, 173, 175, 179
Honeywell	35-42, 240
IBM	63, 64, 65
Incoterm Corporation	69
Infonational, Inc.	223
Infonet A Division of Computer Sciences Corporation	112
Inforex	55
Informatics Inc., Software Products	19
Infoton	105
Integrated Software Systems Corporation	215
Intertel	52, 53
Intel Corporation, Data Products Group	2
Kennedy Co.	Cover 2
Ketron Inc.	224
Lawrence Livermore Laboratory	254
Lear Siegler, Inc.	199
The Library of Computer and Information Sciences	145, 146, 147
LRK Associates	244
Magnetic Shield Division, Perfection Mica Company	226
Martin Marietta Data Systems	248
Maxell Corporation of America	202
Memorex	59
Microdata Corporation	203, 205, 207
Mini Computer Accessories	224
Modular Computer Systems Inc.	84, 85
Mohawk Data Sciences	128
National Institutes of Health	254
NCE Terminals & Communications, Inc.	233
NCI, Inc.	134
NCR Corporation	231, 234
NCR Systems Engineering	245
NEC Information Systems, Inc.	49
Nixdorf Computer Corporation	118
Okidata Corporation	4
On Line Software International	226
One-Time Carbon Paper Council	48
Optical Coating Laboratory, Inc.	251

Pansophic Systems of Canada Ltd.	22
Perkin-Elmer Data Systems	31, 33, 88, 89
Pertec Computer Corporation, CMC Division	1
Plessey Microsystems	124, 125
Prentice	127
Printronic, Inc.	58
Q1 Corporation	227
Quest Systems Inc.	254
Qume Corporation	44, 45
Randomex Inc.	189
Rapicom, Inc.	209
RCA Service Company, Data Services	193
Rental Electronics, Inc.	23
Resource Software International, Inc.	189
RSVP Services	254
SC Electronics, Inc.	235
Schlage Electronics	213
The Society For Computer Simulation	239
Software Module Marketing	249
Source EDP	253
Sperry Univac Mini-computer Operations	20, 21
Summagraphics Corporation	196
Sycor	140, 141
Systems Engineering Laboratories	6, 7
Tally Corporation	5
Tandem Computers, Inc.	26, 27
T-Bar Incorporated, Computer Switch Division	30
Technotec	170
Tektronix, Inc., Information Display Group	102, 103, 166, 167
Teletype Corporation	Cover 4
Texas Instruments Incorporated	87
TransNet Corporation	201
Trendata, An Applied Magnetics Company	86
Trivex	28
United Airlines Cargo	195
Universal Data Systems	51
University Computing Company	14, 15
University Microfilms International	68
Varian Graphics	73
Versatec, A Xerox Company	108
Wang Laboratories, Inc.	81
Whitlow Computer Systems, Inc.	13
Wright Line, A Division of Barry Wright Corporation	123
Xerox Computer Services	32

For Glare Reduction

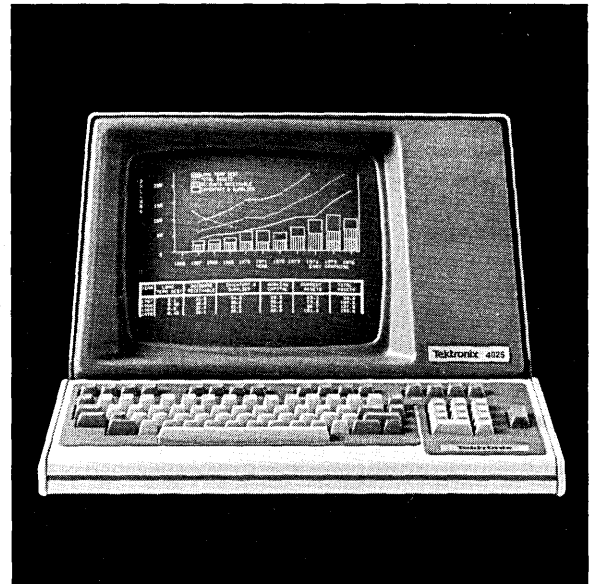

Look to OCLI.

Tektronix did, and found OCLI Contrast Enhancement Products make visual displays easier to view in any ambient light. The key to glare reduction is our HEA® (High Efficiency Antireflection) coating. This efficient, non-diffusing coating reduces reflection from approximately 4.25% to less than 0.35% per surface — a 12:1 reduction.

HEA® coupled with our laminated circular polarizer panels creates "contrast enhancement." That means glare is greatly reduced, contrast dramatically improved.

OCLI Contrast Enhancement Products

- increase the image-to-background contrast ratio
- cut surface reflection
- reduce EMI/RFI and static charges
- use attractive color

We produce them for a variety of systems, including CRT, electro-optical and mechanical displays.

For information and a free copy of our Contrast Enhancement Products Brochure, contact our Technical Products Division, 2789 Giffen Ave., P.O. Box 1599, Santa Rosa, CA 95402. Telephone: 707/545-6440. Teletype: 510-744-2083. In Europe, contact OCLI-Europe, 621 London Rd., High Wycombe, Bucks HP11-1ET, England. Telephone: High Wycombe 36286. Teletype: 83239.

OCLI OPTICAL COATING
LABORATORY, INC.

If you're good, Boeing wants you to work in Seattle and hike and fish and ski and sail and enjoy the Pacific Northwest. Now.

Discover skiing just 90 minutes from work. Hike in abundant forests, catch a salmon, or set sail for scenic islands over the weekend.

You won't find a better opportunity to live in the Northwest than to work for Boeing Computer Services.

BCS provides local and remote computing, custom programming, application packages, training and consulting

services to The Boeing Company and a variety of commercial and government customers.

We're hiring people for the Seattle area right now, so if you're good, we'd like to hear from you.

Mail your résumé to Boeing Computer Services, P.O. Box 3707-JNK, Seattle, WA 98124.

An equal opportunity employer.

The University of _____ is an Equal Opportunity/Affirmative Action Employer.
Offices in Wash. D.C., Chicago, Atlanta, Portland, Or.

WE NEED GOOD PEOPLE

COMPUTER PROFESSIONALS

Boeing Computer Services has immediate openings for experienced people.

We'd like to hear from you now, if you have a background in any of the following areas:

- COMPUTER AIDED DESIGN
- COMPUTER AIDED MANUFACTURING
- COMMUNICATIONS SUBSYSTEMS
- DATA BASE SYSTEMS
- MINI-COMPUTER SYSTEMS
- SCIENTIFIC SOFTWARE
- SYSTEMS/APPLICATIONS PROGRAMMING

BCS

BOEING COMPUTER SERVICES COMPANY
A Division of The Boeing Company

COMPUTER SALES
Career

DATA PROCESSORS
We Present You With Opportunity

THE KEY TO SUCCESS

...lies in having the tools of the trade at hand, and the freedom to use them. You'll find these ingredients for success at Blue Cross of Wisconsin, where highly sophisticated data processing technology and an openness to new ideas combine to form the ideal fulfilling environment sought by data professionals. We're currently seeking goal-oriented, imaginative individuals who are willing to go out on a limb for an innovative concept, with experience in the following areas:

**PROJECT LEADERS
SYSTEMS ANALYSTS
PROGRAMMER ANALYSTS
PROGRAMMERS
DATA BASE ANALYSTS**

with systems, software data, computer or applications programming experience.

We offer an excellent salary, an outstanding benefits program, and the opportunity to extend your knowledge, skills, and creative talents to capacities you never before dreamed possible.

If you're ready to start on the path to success, please send a brief letter or resume to:



Richard Schmidt,
Employment Services Department

Blue Cross

of Wisconsin
401 West Michigan Street
Milwaukee, Wisconsin 53201

Equal opportunity employer m/f

CIRCLE 171 ON READER CARD

CORPORATE MIS MANAGER, MANUFACTURING SYSTEMS FLORIDA LOCATION

Harris, a unified company of decentralized and autonomous divisions, is noted for planning and management that has achieved solid, continuing expansion and profitability. Volume is now approaching the billion dollar level. To meet our growing internal needs, a high level position has been established in the Corporate Management Information operation with excellent growth opportunity. The position will be located in Melbourne, Florida with approximately 30-35% travel required.

Basic responsibilities are in assisting Harris Divisions with implementation of comprehensive Manufacturing Systems. Requires expertise in Engineering-Manufacturing Systems, from support of product development through product shipment. Applicant must understand integration of systems for computer-aided design, configuration control, purchasing, computer-aided manufacturing, manufacturing planning, control, and cost analysis systems. A technical degree is preferred and at least ten years of job related experience.

Please send resume with salary history in confidence to: R.W. Underhill, Harris Corporation, P.O. Box 430, Melbourne, Florida 32901.



HARRIS
COMMUNICATIONS AND
INFORMATION HANDLING

An Equal Opportunity Employer—Male and Female

CIRCLE 174 ON READER CARD

April, 1978

New! 1978 Computer Salary Survey

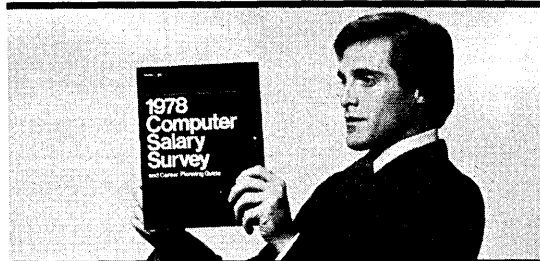

Call for your Free copy today!

Are you making the kind of money you should be making? Inflation and record demand have pushed salaries in the computer field to all time highs. Source Edp's 1978 Computer Salary Survey and Career Planning Guide lets you know whether you're keeping pace.

This comprehensive free report also gives you expert advice on a variety of important career topics such as: when you should consider a job change; what you need to do to break into management; how to make sure you're getting the proper exposure; why timing is so crucial in your long range career development; how you can avoid stagnation — and much more.

The 1978 Computer Salary Survey has been compiled by Source Edp, the largest recruiting firm devoted exclusively to the computer profession in North America. It's must reading if you're concerned about your career. But call now, it could be one of the most important career decisions you've ever made.

For your Free copy, call the Source Edp office nearest you.

East:	Kansas City	Houston
Boston	816/474-3393	713/626-8705
617/482-7613	Minneapolis	New Orleans
Hartford	612/544-3800	504/561-6000
203/522-6590	Northfield IL	West Coast:
New York City	312/446-8395	Encino CA
212/736-7445	Oak Brook IL	213/995-8866
Philadelphia	312/986-0422	Irvine CA
215/665-1717	Rolling Meadows IL	714/833-1730
Stamford CT	312/392-0244	Los Angeles
203/329-8411	Southfield MI	213/386-5500
Union NJ	313/352-6520	Oakland
201/687-8700	St. Louis	415/444-5955
Washington DC	314/862-3800	Palo Alto
703/790-5610	St. Paul	415/328-7155
Wellesley MA	612/771-0544	San Francisco
617/237-3120	South/Southwest:	415/434-2410
Midwest:	Atlanta	Seattle
Chicago	404/325-8370	206/454-6400
312/782-0857	Dallas	Torrance CA
Cleveland	214/387-1600	213/540-7500
216/771-2070	Denver	Canada:
Detroit	303/773-3700	Toronto
313/963-0510	Fort Worth	416/364-2919
	817/338-9300	



If unable to call, write: Source Edp, Department D4
721 Enterprise Drive, Oak Brook, Illinois 60521

(When writing, please be sure to use home address and indicate position title.)

CIRCLE 180 ON READER CARD

253

SYSTEMS ANALYST

San Francisco Bay Area

The Lawrence Livermore Laboratory, an applied science R&D facility operated by the University of California for the U.S. Department of Energy, is located in a rural suburb 45 miles east of San Francisco. Our Supply and Distribution Department has a position for a systems analyst to assist with all facets of the operation involving analysis, design and implementation of manual and data processing systems to improve stock control, inventory procedures, issuance of material, receiving, shipping and warehousing.

Applicant should be familiar with large and mini-computer applications, including devising of models or simulations. Working knowledge of EOQ formula applications desired. Must be capable of working closely with user groups and maintaining liaison between users and data processing programming personnel. Will be expected to prepare proposals and specifications and make presentations to management.

Starting salary commensurate with education, experience and ability. Please send resume, including academic background, salary history and salary requirements to: Sue Porter, Employment Division, LAWRENCE LIVERMORE LABORATORY, P.O. Box 808, Dept. KDA-048, Livermore, CA 94550.

U.S. Citizenship
Required



An Equal
Opportunity
Employer

LAWRENCE LIVERMORE LABORATORY

CIRCLE 175 ON READER CARD

SENIOR SYSTEMS PROGRAMMERS

DECsystem-10 Timesharing

The Division of Computer Research and Technology has career Civil Service positions for senior level systems programmers for the DECsystem-10 timesharing system. Salary ranging from \$18,258 to \$21,883 per annum (GS-11 to GS-12), depending upon educational level and experience.

Duties will consist of maintaining and modifying the monitor and supporting software systems, developing and implementing communications software, as well as advising and instructing the scientific user community in the use of this system. Experience in the DECsystem-10 timesharing system as well as experience in one of the following areas: SAIL, FORTRAN or PL/1, communications, graphics or utility development. A degree in Computer Science, Mathematics, or Physical Science is desirable.

Candidates should call (301) 496-6951 or forward Standard Form 171 to: Miss Stella Nobilio, National Institutes of Health, Public Health Service, 9000 Rockville Pike, Building 12A, Room 3019, Bethesda, Maryland 20014. An Equal Opportunity Employer.

NATIONAL INSTITUTES OF HEALTH

CIRCLE 176 ON READER CARD

Even Webster's Knows About QUEST

QUEST (kwest). v. 1. To make a search; to go on a quest.

QUEST SYSTEMS, INC. n. 1. A corporation founded in 1968. 2. The largest professional recruitment firm in the U.S. functioning solely in the computer sciences; its client companies pay all employment fees, interviewing and relocation expenses. Quest is known for its deep personal commitment to relate to each candidate as an individual with individual goals. 3. Its professional staff averages over 6 years of experience in EDP recruiting (additionally, staff members have direct hands-on experience in programming, systems, hardware sales, etc.) 4. Quest is presently searching for programmers and analysts (commercial, scientific, systems software) for over 3,500 client companies in the U.S. Quest has openings in over 700 U.S. towns and cities. 5. Methodology — see Questsystem.

QUESTSYSTEM (kwest sis'tem). n. 1. Discussing with an individual what he would like to be doing in light of what he has been doing. 2. Analyzing the realities of his objectives as they relate to the current job marketplace. 3. Contacting client companies and other Quest staff personnel to identify positions of possible interest. 4. Introducing the job candidate to his prospective employers by providing complete details to each about the other, ensuring the efficacious use of everyone's time. 5. Arranging interviews. 6. If employment offers are extended, Quest assists in evaluating the responsibilities, compensation and opportunities (and relates those to the initially stated objectives). The Questsystem has been working for thousands of professionals at no expense, whatsoever. Ask your friends of their past dealings with Quest. Then, put the Questsystem to work for you. For additional information on this subject, please inquire directly to Quest Systems, Inc. (All inquiries/resumes received will be responded to immediately and in confidence.)



Call Toll Free
(800) 821-7700, Ext. 114

QUEST SYSTEMS INC.

6400 Goldsboro Road

Washington, D. C. 20034 (301) 229-4200

Baltimore: (301) 788-3500 • Philadelphia: (215) 667-3322

CIRCLE 177 ON READER CARD

PROGRAMMERS AND ANALYSTS

Free Employment Service

Serving Northeast, Southeast and Midwest U.S.

- Scientific and commercial applications
- Software development and systems programming
- Telecommunications
- Control systems
- Computer engineering
- Computer marketing and support

Call or send resume or rough notes of objectives, salary, location restrictions, education and experience (including computers, models, operating systems and languages) to either one of our locations. Or check the reader service card for a free sample resume. We will answer all correspondence from U.S. citizens and permanent residents and will guarantee our best efforts in a professional and ethical manner to all qualified applicants that we think we can help. Our client companies pay all of our fees.

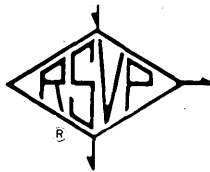

RSVP SERVICES, Dept. M
Suite 700, One Cherry Hill Mall
Cherry Hill, New Jersey 08002
(609) 667-4488

RSVP SERVICES, Dept. M
Suite 300, Dublin Hall
1777 Walton Road
Blue Bell, Penna. 19422
(215) 629-0595

RSVP SERVICES

Employment Agency for Computer Professionals

CIRCLE 179 ON READER CARD

Datum Series/1.

*Magnetic Tape System
Storage Module Disk System
High Speed Line Printer System*



Price/Performance. Reliability.

Datum's Series/1 peripheral systems are designed to complement your IBM Series/1 Model 3 or 5 Computers, providing expanded capabilities.

Datum offers seven or nine track magnetic tape systems, permitting recording densities of 200 bpi NRZ through 1600 bpi phase encoded. Speeds: From 12.5 ips through 125 ips. As many as four transports can be attached to the system.

Datum also offers a family of removable media Storage Module disk systems — 40 megabyte to 300 megabytes.

Software drivers for both tape and disk systems are included, which provide software compatibility with IBM Series/1 operating systems.

Both systems incorporate the new Datum "Universal User's Adapter", a device that allows connection of external devices to the Input-Output bus of IBM Series/1 computers.

Datum provides high speed line printer systems — 300 to 900 lpm (64 characters) — which operate without software modification. (Compatible with IBM's 4973 Line Printer operations). A self test feature on the line printer controller provides the user with a visual performance check of the printer system.

On site installation by DATUM customer engineers is available. Ongoing DATUM maintenance is also available under the DATUM Maintenance Agreement at a fixed monthly charge.

To find out more about how you can increase the effectiveness of your IBM Series/1 computer, contact:

datum inc

**INTERNATIONAL HEADQUARTERS
Peripheral Products Division**

1363 South State College Boulevard
Anaheim, California 92806

Telephone: 714/533-6333 • TWX: 910/592-1289

Telex: 68-5579

REGIONAL OFFICES:

Mid West Sales Office, Des Plaines, Ill., (312) 296-1064

East Coast Sales Office, Mountainside, N.J.,

(201) 654-5590

District Sales Office, San Jose, Ca., (408) 249-5370

EUROPEAN HEADQUARTERS: Datum (Electronics) Ltd., Datum House, 363 Cranford Lane, Harlington, Middlesex, U.K. Phone (01) 897-0456; Telex 935 398 DATUM G. **EUROPEAN REPRESENTATIVES:** Belgium — S.A.I.T., Brussels, Ph. 02/376-2030; Finland — Suma Oy, Helsinki, Ph. 90/644-202; France — Reptec, Paris, Ph. 60/36 856; Italy — C.A.I., Milan, Ph. 02/271-1919; Netherlands — Technitron, B.V., Amsterdam, Ph. 020/458-755; Sweden — Kentele Data, Solna, Ph. 08/830-700; Switzerland — Amera, A.B., Zurich, Ph. 01/571-112; W. Germany — Gevecke, GmbH, Norderstedt, Ph. 040/523-5061 • **OUTSIDE EUROPE:** Please contact International Headquarters.

**THE TELETYPE MODEL 43:
ALL THE TALK YOU'VE HEARD ABOUT IT IS TRUE.**

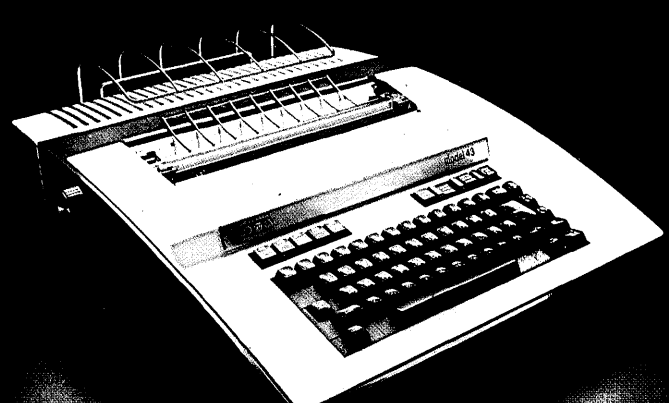

When something as good as the Teletype model 43 teleprinter comes along, it naturally generates a lot of talk. And for a lot of good reasons.

Delivering true 30-character per second throughput, upper and lower case printing in a 132-column format, the model 43 has an exclusive, Teletype-developed 9-wire matrix impact printhead mechanism. This unique feature provides superior service life as well as exceptional print quality, even on multiple copies.

Under the cover, we kept hardware and moving parts to a minimum for maximum reliability. Solid-state circuitry and only five modular components—plus a built-in test capability—mean service is not

only fast, but also simple.

Another convenient cost-saving feature of the model 43 is that it's designed to use 12" wide by 8½" long fanfold paper. Tear off the serrated margins and you've

got a 132-character line on the handy 11" x 8½" paper.

When you add up all the model 43's features, you'll think there's been a mistake when you see the low price. But it's true. Because on a price/performance basis, the model 43 is simply unsurpassed.

The Teletype model 43. After all the good things you've heard about it, no wonder nothing even comes close.



Teletype is a trademark and service mark registered in the United States Patent and Trademark Office.

CIRCLE 3 ON READER CARD