

SPECIAL REPORT: The Plight of the Brazilian User

DATA MATION

FOR MANAGERS OF INFORMATION TECHNOLOGY WORLDWIDE

ADVANCED TECHNOLOGY GROUPS

**Corporations Bet on Teams
With the Right Stuff To Explore
Technology Frontiers**



Also in this Issue:

Users Await Fruitful DEC/Apple Yield

Database Machines: The Least-Cost Route?

Can IBM Revive the RT PC?

Private Networks: The End of an Era?

Sales Force Automation Is More Than Laptops

Unlock The Mysteries Of DB2 Performance.

Dynamic SQL Call Being Executed

```
INSERT INTO TDQM.TABLE821  
(PAGE NO,TOTAL) VALUES (000,1)
```

OMEGAMON



1% DISPLAY DATABASE
(DSND06)

MVS
CICS



IMS
TSO



DFD
DDL
DML
DBD

To manage DB2 performance, you need more than information. You need solutions. OMEGAMON® for DB2 gives you both.

Exception Analysis warns you when key thresholds are exceeded. Before a stray thread turns your system to stone. Then powerful zooming features take you where no one else can. Deep into the passageways of DB2. Right down to the SQL call. And Recommendation Screens translate detailed data into realtime solutions.

Yet what's sophisticated on the inside is made simple on the outside with menus and help screens. OMEGAMON identifies the problem thread so your troubleshooting is as effortless as pressing a PF key.

Proprietary software engineering keeps overhead as low as 1% with minimal space requirements. And OMEGAMON is always available—even when DB2 is locked up.

Candle's always available, too. With round-the-clock customer service, technical education, and a commitment to stay current with IBM. So you won't ever be lost in the passageways of DB2.

To decipher the mystery of DB2 performance, call Terry Forbes today at (800) 541-8513.

!Candle®

Copyright © 1988 Candle Corporation. All rights reserved.

Circle 1 on Reader Card



**“There are no holidays
in a hospital.
Or for its CICS.”**

“At UCLA, our computer center runs 24 hours a day, seven days a week—and practically everything goes through CICS.”

UCLA. An internationally acclaimed medical center where every second is important. Status is everchanging. Everyone needs the latest information. Admissions. Nurses' stations. Labs. Surgery.

That's why UCLA chose The Monitor For CICS™ to manage CICS performance at its computer center. “What initially attracted me to The Monitor was the fact that it made it easy for operators to look at medical application and terminal regions,” remembers **Jerry Johnson, supervising CICS programmer.** “We're running about 450,000 transactions/day and still maintaining half-second response times.”

“I especially like The Cross System Monitor, which runs independent of CICS. It gives us the ability to monitor multiple regions on a single screen. Those graphic displays nicely capture the resource utilization information I need to see during the day. It saves me time—I catch problems before they get big. Best of all, our users get optimum CICS performance.”

The Monitor is the *complete* CICS performance management system that'll help you save the day. Become the hero in your CICS community! For a *free, 30-day trial* of The Monitor For CICS, call us today at **1-800-227-8911** or 1-703-893-9046.

LANDMARK™

**THE
MONITOR**
FOR CICS

MINDS YOUR BUSINESS

Circle 4 on
Reader Card

Landmark Systems Corporation
8000 Towers Crescent Drive, Vienna, Virginia 22180-2700



ORACLE® sets world performance record 265 transactions per second

ORACLE World Records	
MVS	265 tps
UNIX	124 tps
VAX VMS	49 tps

On July 18th, 1988, ORACLE made history by setting performance records in every major computing environment. Using industry standard benchmarks, ORACLE set speed records on IBM compatible mainframes running MVS, DEC VAX minicomputers running VMS, and minicomputers running UNIX.

ORACLE set the world record for performance by running 265 transactions per second (tps) on a 3090-600E class Amdahl* mainframe running the IBM MVS operating system. This breaks the old record of

240 tps set by a cluster of 16 Tandem computers.

ORACLE also set the record for DEC minicomputers by running 49 tps on a VAX 6240 running VMS. This breaks the previous VAX/VMS record of 29 tps set on a VAX 8700 connected to a VAX 8800. ORACLE's results were audited and verified by the Codd and Date Consulting Group. And not only is ORACLE's performance nearly twice as fast as this previous record, but ORACLE's cost per transaction is almost four times better than that of the other system.

ORACLE set a UNIX record of 124 tps on a large mini-computer from Sequent as well. Once again, the results were independently verified by the Codd and Date Consulting Group.

ORACLE has long been recognized as the technology leader in DBMS portability. (ORACLE is still the only DBMS in the world that runs on MVS, VMS and UNIX.) Now ORACLE is the clear technology leader in performance as well. Your DBMS decision just got a little easier. Call us at 800-345-DBMS and sign up for the next seminar in your area.

20 Davis Drive, Belmont, CA 94002
 • World Headquarters (415) 598-8000
 • Calgary (403) 265-2622 • Ottawa (613) 238-2381
 • Quebec (514) 337-0755 • Toronto (416) 596-7750
 • ORACLE Systems Australia 61-2-959-5080
 • ORACLE Europe 44-1-948-6911
 • ORACLE Systems Hong Kong 852-5-266846
 • Amdahl 5890-600E

ORACLE®
 COMPATIBILITY • PORTABILITY • CONNECTABILITY

Call 1-800-345-DBMS, ext. 8205 today.

Comparisons made in this ad to other vendor's results were performed by Oracle based on published results from those vendors. Copyright © 1988 by Oracle. ORACLE is a registered trademark of Oracle Corp. Other companies mentioned own numerous registered trademarks. TRBA

U.S. SEMINARS

AL Birmingham	Oct 11
AR Little Rock	Oct 13
AZ Phoenix	Oct 13, Nov 8, Dec 8
Tucson	Oct 25, Dec 7
CA Costa Mesa	Oct 4, Nov 11, Dec 1
Los Angeles	Oct 18, Nov 15, Dec 13
Oakland	Oct 6
Sacramento	Nov 10
San Diego	Oct 6, Nov 3, Dec 6
San Francisco	Oct 11, Nov 9, Dec 13
San Jose	Oct 26, Nov 17, Dec 15
CO Denver	Oct 27, Dec 20
Colorado Springs	Oct 25
CT Farmington	Oct 4, Dec 7
Stamford	Nov 15
DC Washington (Federal)	Oct 21, Nov 18
FL Ft. Lauderdale	Oct 18
Jacksonville	Oct 19
Tampa	Dec 7
GA Atlanta	Oct 5, Nov 9
IA Des Moines	Nov 10
ID Boise	Oct 5
IL Chicago	Oct 11, Nov 16, Dec 13
Springfield	Nov 9
IN Indianapolis	Oct 13, Nov 17
KS Wichita	Dec 13
KY Louisville	Oct 12
LA New Orleans	Oct 28, Dec 9
Shreveport	Oct 13
MA Boston	Oct 12, Dec 13
Burlington	Nov 18
Springfield	Oct 12
MD Bethesda (Federal)	Dec 2
Bethesda (Commercial)	Dec 7
Baltimore	Oct 19, Dec 15
ME Portland	Oct 5
MI Detroit	Oct 4, Nov 8, Dec 7
Grand Rapids	Oct 12
MN Minneapolis	Oct 19, Nov 10, Dec 13
MO Kansas City	Oct 18, Dec 14
St. Louis	Oct 6, Nov 7, Dec 8
NC Charlotte	Oct 26, Nov 29
Raleigh	Nov 2, Dec 14
Winston-Salem	Oct 5
NE Omaha	Oct 4
NJ Iselin	Oct 13, Nov 17, Dec 15
Princeton	Oct 4, Nov 22, Dec 13
NM Albuquerque	Dec 15
NV Las Vegas	Nov 10
NY Albany	Nov 9
Buffalo	Oct 4
Long Island	Oct 19, Nov 16, Dec 14
New York City	Oct 12, Oct 26, Nov 9, Nov 16, Dec 7, Dec 20
Rochester	Nov 2, Dec 6
OH Cincinnati	Dec 8
Cleveland	Oct 19, Nov 29
Columbus	Dec 6
OK Oklahoma City	Dec 13
Tulsa	Oct 25
OR Portland	Nov 15
PA Harrisburg	Dec 14
Philadelphia	Oct 26, Nov 18
Pittsburgh	Oct 26
Valley Forge	Nov 10, Dec 13
SC Charleston	Oct 5
Columbia	Nov 16
Greenville	Oct 19
TN Memphis	Dec 8
Nashville	Nov 9
TX Austin	Oct 20, Dec 1
Dallas	Oct 4, Nov 15, Dec 8
Ft. Worth	Nov 9
Houston	Oct 6, Nov 10, Dec 7
Midland	Oct 19
San Antonio	Oct 21, Dec 2
UT Salt Lake City	Nov 9, Dec 19
VA Norfolk (Federal)	Oct 4
Richmond	Oct 6, Nov 1
WA Seattle	Oct 20, Dec 13
Spokane	Nov 3
WI Madison	Oct 5, Nov 29
Milwaukee	Oct 12, Nov 5

CANADIAN SEMINARS

To register for Canadian seminars, please call the office nearest you. Calgary 403-265-2622, Ottawa 613-238-2381, Quebec 514-337-0755, Toronto 416-596-7750.

Calgary	Nov 17
Edmonton	Oct 6
Halifax	Oct 13
London	Oct 20, Dec 13
Montreal	Oct 26, Nov 23, Dec 14
Ottawa	Oct 6, Nov 3, Dec 1
Quebec	Oct 5, Nov 2, Dec 7
Saskatoon	Nov 10
Toronto	Oct 11, Nov 8, Dec 6
Vancouver	Nov 10
Victoria	Nov 24
Winnipeg	Oct 20

Attn: National Seminar Coordinator
 Oracle Corporation • 20 Davis Drive
 Belmont, California 94002

My business card or letterhead is attached. Please enroll me in the FREE ORACLE seminar to be held

at: _____

on: _____

DATEMATION

DATAMATION

FOR MANAGERS OF INFORMATION TECHNOLOGY WORLDWIDE

COVER STORY



Advanced Technology Groups 18

BY RALPH EMMETT CARLYLE It's hard to be brave in the face of today's new world of automation, in which not only a company but its suppliers, customers, regulators—the whole external environment—are involved. There's no book of tried-and-true rules for strategic technology management on which to rely. Into the breach come Advanced Technology Groups. Their mission: to understand, evaluate, and influence the development of emerging technologies.

Cover Photography by Walter Wick

DEPARTMENTS

- Letters and Access** 6
- Look Ahead** 13
Favorable terms for AS/400 leasers?
- New Products** 135
Unisys debuts mainframe for OLTP.
- Opinion** 138
On technology watchdogs, IS anxiety, and IS protectionism.
- Career Opportunities** 139
- Information Economics** 140
- Planner** 148
- Company Index** 150
- Buyer's Index** 150

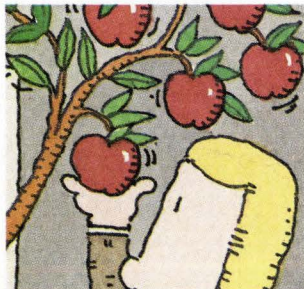

▲75



▲111

SPECIAL REPORT

The Plight of the Brazilian User 30

BY JEFF MOAD The Brazilian government's effort to build a national computer industry has made some progress, but the side effect for users has been equipment shortages and exorbitant prices.

SOFTWARE

CHARGEBACK

Chargeback Systems Come of Age 47

BY JEANNE BUSE As a greater premium is placed on cost control in its shops, the billing of intracompany customers for services received is gaining popularity.

APPLICATIONS

Eight Steps to Applications Engineering 59

BY RAY GOSLIN How can you ensure that your is plan is in step with the firm's larger business plans? This approach involves end users and executives right from the start.

PERFORMANCE

The Push Is On For Data Center Automation 69

BY JEFF MOAD John Houseman may have given the notion of doing things the old-fashioned way some cachet, but users are clamoring for more sophisticated methods at the core of the MIS operation.

SYSTEMS

CONNECTIVITY

Users Await Fruitful DEC/Apple Yield 75

BY BRAD SCHULTZ By and large, users are pleased with the Apple-DEC technical alliance. In fact, many are way ahead of the vendors in forging links between their products.

DATABASES

Database Machines: The Least-Cost Route? 85

BY ED GREGORY Users hold an overwhelmingly favorable attitude toward the cost savings they say they have found with hardware-optimized database solutions.

WORKSTATIONS

Can IBM Revive the RT PC? 95

BY SUSAN KERR Enhancements to IBM's much heralded system are anticipated in 1989, but few would bet the ranch on the RT ever living up to its technical promise.

COMMUNICATIONS

ISDN

Users Colonize ISDN Islands 101

BY BILL MUSGRAVE Ongoing trials show that isdn-like functionality can be obtained with existing technology and the patchwork of "true" ISDN.

NETWORKS

Private Networks: The End of an Era? 111

BY JIM NORTON The advent of managed data networks in Europe may spell a limited future role for the traditional European PTTS.

MANAGEMENT

INTEGRATION

Solving the Systems Puzzle 119

BY CHRISTOPHER KEENE, PETER JESSEL, AND JOHN HAGEL In Part 3 of a series, McKinsey & Co. analysts look at the value of hiring a systems integrator for large-scale project development.

SALES AUTOMATION

It's More Than Just Laptops 127

BY JOE FERREIRA AND MICHAEL E. TREACY Sales force automation, which holds great potential benefit to the corporate bottom line, can be accomplished without alienating sales reps. Here's how.

INTERNATIONAL

Special supplement, not included in all issues. 134-3

Improvement: A Constant Challenge

Form has always followed function at DATAMATION. From its inception in 1957, the magazine has served but one function: to help managers of information technology use software, systems, and communications tools, as well as related services, to their organizations' fullest advantage. However, the form in which DATAMATION's editors have chosen to deliver that benefit has by necessity changed with the times. Whenever readers have indicated they have new or different informational needs, the magazine has responded quickly—increasing its frequency, adding more case histories, broadening its international perspective, etc.

So it should hardly come as a surprise to you to see that with this issue, DATAMATION initiates a redesign aimed at better fulfilling its purpose—helping you. Some changes are more obvious than others—our logo is different, this column is new, opinions are more numerous, articles are more plentiful. But I urge you to pay attention to all of them, especially our Information Economics department, and let us know what you think of our progress. You can use the card opposite this page, call me at (212) 463-6431, fax me at (212) 242-6987, send an MCI mail message to DATAMATION/T. Mead, or write to me at 249 W. 17 St., New York, NY 10011.

The redesign process did not begin at a particular spot or at a particular time. It has been an ongoing pursuit at the magazine during its entire 31 years. Editors have constantly engaged in reader research—qualitative and quantitative—to determine whether DATAMATION delivers the right information in the best possible way to its audience. What has been found in recent years is an increasing tendency among IS executives at user organizations to distinguish DATAMATION as their chief source for in-depth, analytical stories about technologies and the management of them. Given this trend, it only made sense for us to examine whether the design of the magazine was enabling DATAMATION to fulfill its role as best as possible.

The role itself came under intense scrutiny before the redesign was undertaken. In early June, the magazine's editors invested a week of their time to decide DATAMATION's precise editorial mission. They agreed, remarkably, that DATAMATION was right on target with the direction it had embarked on a year earlier: focusing on the five greatest challenges facing its readers:

- Implementing new technologies
- Managing personnel inside and outside the IS organization
- Connecting dissimilar systems
- Protecting existing investments in technology
- Understanding where information technology fits in their core businesses.

Once we determined there was a better way to deliver information to you, the task of actually redesigning DATAMATION fell to six talented individuals. Barrie Stern, James Montalbano, and Bob Lascaro focused on the creative aspects of the redesign, while Hernalee Walker, Gary Hallock, and Harris Salat worried about implementing their efforts on our Atex text processing system. We trust you will be satisfied with their efforts.

Again, please share your thoughts with us.

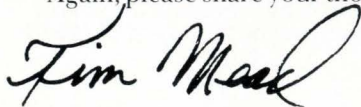

—Tim Mead, Editor-in-Chief



THE REDESIGN TEAM: Lascaro, Hallock, Walker, Montalbano, and Stern.

DATAMATION

Editor-in-Chief Tim Mead

Executive Editor David R. Brousell

Managing Editor Parker Hodges

Senior Editor Linda Runyan

International Editor Paul Tate

Art Director Robert L. Lascaro

Senior Writer Ralph E. Carlyle

Section Editors Theresa Barry, Marsha J. Fisher

Production Editor Hernalee Walker

Production Assistant Suzanne P. White

Copy Chief Steven Korn

Copy Editors Renée Matthews, John Quain

Associate Art Director Anne Cooney

Assistant Art Director Carolee Young

Editorial Assistants Lauren Murphy (London),

Karen J. Scher (New York)

Bureau Managers

Boston Gary McWilliams

Dallas Robert Francis

London Paul Tate

Los Angeles Tom McCusker

San Francisco Jeff Moad

San Jose Susan Kerr

Washington Willie Schatz

Foreign Correspondents

Eastern Europe David Hebditch (London)

France James Etheridge (Paris)

Italy Janette Martin (Milan)

Contributing Editors Joseph Kelly, Fred Lamond, Hesh Wiener

Advisory Board Joseph Ferreira, John Imlay, Angeline Pantages, Russell Pipe, Carl Reynolds

Publishing Director Donald Fagan

Associate Publisher William Segall

Promotion Manager Stacy Aaron

Production Manager Eric Jorgensen

Research Manager Laraine Donisi

Director of Production Robert Elder

Director of Art Department Barrie Stern

Circulation Manager Cheryl Barnett

EDITORIAL OFFICES

Headquarters: 249 W. 17 St., New York, NY 10011, (212) 645-0067; telex 127703; fax (212) 242-6987. **New England:** 199 Wells Ave., Newton, MA 02159, (617) 964-3730; **Washington, D.C.:** 4451 Albemarle St. NW, Washington, DC 20016, (202) 966-7100. **Central:** 9330 LBJ Freeway, Suite 1060, Dallas, TX 75243, (214) 644-3683; **Western:** 12233 W. Olympic, Los Angeles, CA 90064, (213) 826-5818, 582 Market St., Suite 1007, San Francisco, CA 94104, (415) 981-2595; 3031 Tisch Way, Suite 100, San Jose, CA 95128-2593, (408) 243-8838. **International:** 27 Paul St., London EC2A 4JU, England, (44-1) 628-7030; telex 914911; CPO Box 665, Tokyo, Japan, (81-3) 201-2335, fax 2135053.

DATAMATION (ISSN 0011-6963) Magazine is issued twice monthly on the 1st and 15th of every month by The Cahners Publishing Company, A Division of Reed Publishing USA, 275 Washington St., Newton, MA 02158-1630. William M. Platt, Chief Executive Officer; Terrence M. McDermott, President; Frank J. Sibley, Group Vice President; Jerry D. Neth, Vice President/Publishing Operations; J.J. Walsh, Financial Vice President/Magazine Division; Thomas J. Delamaria, Vice President/Production and Manufacturing. Editorial and advertising offices, 249 W. 17th St., New York, NY 10011. Published at Woodstock, IL. Annual subscription rates: U.S. and possessions: \$60; Canada: \$85; Japan, Australia, New Zealand: \$155 air freight; Europe: \$135 air freight, \$250 air mail. All other nations: \$135 surface, \$250 air mail. Reduced rate for U.S. public and school libraries: \$40. Single copy: \$3 in U.S. Sole agent for subscriptions in Japan is Maruzen Co. Ltd., 3-10 Nihonbashi, 2-Chome, Chuo-ku, Tokyo 103, J.; sole agent for all other foreign subscriptions is J.B. Treatsart Ltd., 154 A Greenford Rd., Harrow, Middlesex HA1 3QT, England, (01) 422-8295 or 422-2456. No subscription agency is authorized by us to solicit or take orders for subscriptions. Circulation records are maintained at 44 Cook Street, Denver, CO 80206. Phone (303) 388-4511. Second-class postage paid at Denver, CO 80206 and at additional mailing office. DATAMATION copyright 1988 by Reed Publishing USA; Saul Goldweitz, Chairman; Ronald G. Segel, President and Chief Executive Officer; Robert L. Krakoff, Executive Vice President. All rights reserved. DATAMATION is a registered trademark of Cahners Publishing Co. Reprints of articles are available; contact Frank Pruzina (312) 635-8800. Microfilm copies of DATAMATION may be obtained from University Microfilms, A Xerox Company, 300 N. Zeeb Rd., Ann Arbor, MI 48106. Printed by Graftek Press Inc. All inquiries and requests for change of address should be accompanied by mailing label from latest issue of magazine. Allow two months for change to be made. POSTMASTER: send address changes to DATAMATION, 44 Cook St., Denver, CO 80206.

VMCENTER II Smart Economics.

How Pioneer turns up the volume while turning down costs.

You don't have to be a fanatic about cost control to succeed in the audio business. But it helps.

At Pioneer Electronics, MIS cost savings contribute directly to the company's competitive edge. And MIS officials have taken extraordinary steps to deliver a growing volume of services on a lean budget.

Central to this effort has been the power of VM Software's VMCENTER II.

SAVINGS IN TIME, TAPE, AND DISK SPACE.

Big savings come naturally to VMCENTER II users. In Pioneer's case, the savings have come in three categories: staff time, backup tape, and disk space. Yet they're meeting growing user needs more effectively than ever.

Whether it's adding new users, scheduling off-peak production, or reducing minidisk clutter, VMCENTER II's comprehensive

facilities simplify data center administration while keeping a watchful eye on system usage and costs. No wonder Pioneer regards VMCENTER II as a major systems management asset. And an excellent investment in total data processing performance.

VMCENTER II. *THE* VM SYSTEMS MANAGEMENT TOOL FOR THE FUTURE.

This record is impressive. But it's only the beginning. With its broad capability and proven timesaving features, VMCENTER II is the most important tool you can buy for *all* your VM systems — from 9370 to 3090 to whatever the future may bring.

VMCENTER II. A powerful solution for today. A sound investment for the future. For more information, write or call today:

800-562-7100
703-264-8000

VM Software, Inc.
1800 Alexander Bell Drive
Reston, Virginia 22091

VM
SOFTWARE INC.

1-DTM-8811

The VM Experts

Circle 6 on Reader Card



DOUBLE TROUBLE

Regarding "Fatal Flaws in SQL" by E.F. Codd (Aug. 15, p. 45), I had the dubious pleasure of experiencing the other side of Codd's contention that SQL should suppress duplicate relations. A query to retrieve production counts from the prior 12 months resulted in a return of only 11 counts—most perplexing. As fate would have it, two of the counts were duplicates, so, poof—goodbye duplicate. Now, if I can only figure out an easy way to decide when and which get 'poofed'! There is another answer, of course: include the month abbreviation as a literal in the query, e.g., SELECT 'Jan,' COUNT (PUNITS) FROM . . .

John W. Lonberger
Hiram Walker & Sons Inc.
Fort Smith, Ark.

ANOTHER OPTION

Users of CMS have at least one significant option overlooked in "VM: The Crossroads of Operating Systems" (July 15, p. 79). Key Logic markets a software platform for operating systems that runs CMS with performance equal to or better than VM/SP. Additionally, it provides security and high-performance data sharing with other users running the same hardware, including those running under Unix. CMS is installed directly from the IBM distribution tape without any modifications.

Carl Jones
Vice President, Development
Key Logic
Santa Clara

EMPHASIS ON USERS

Bravo! "Managing Technological Change: The Process Is Key" (Sept. 15, p. 68) is one of the best articles on systems implementation and assimilation I've seen. The approaches to interaction among the users, management, and the technocrats are described well, and the scenarios clearly reinforce the pros and cons of each approach.

I'm particularly impressed because it's so rare to see the emphasis on the users. It seems that few people involved with systems really consider what the user needs to accomplish in terms of the business and how the system will affect people and their responsibilities. It's refreshing to read about a business like XYZ Corp., where users have really assimilated the system and made it part of their work culture. Technology really can promote teamwork and enhance effectiveness, but it doesn't happen automatically.

Training typically focuses on the capabilities of the system—what the computer

can do, how the data must be entered, what reports are produced—to the exclusion of how users' jobs will be affected. We've seen users who've been working with their systems for 10 to 12 months still do the manual steps they always did, then "putting it in the computer." It's difficult to imagine a less productive environment—the system has actually *added* work.

Unfortunately, we find that managers often seriously underrate the impact of changes and the time and effort that users will have to invest to effect it.

Peggy Morgan CMC
President
Management Productivity Group
Cherry Hill, N.J.

DB2-BE-DOO

I read with interest "DB2 Performance Gets Kick . . ." (Sept. 15, p. 19). Our shop has two of the RDBMSs mentioned in your article, those being ADR's Datacom and Teradata's DBC/1012. In your article, you mentioned in passing American Airlines' purchase of a Teradata RDBMS machine.

Although there are not many Teradata users, the popularity of the machines for large shops is quickly growing. Many of us would love to see an article in DATAMATION that authoritatively compares DB2 to Teradata, for, although we've heard a lot of hype from both vendors, each tends to emphasize what their system does best.

Rolf Jaremus, Manager
General Business Systems
Options Exchange
Chicago

ATTITUDE IS KEY

The following anecdote is germane to the discussion of college students' perceptions of IS careers in "How College Students Choose IS Careers" (Sept. 15, p. 40). It illuminates an area of career selection not broached in the article.

"A Mini-Course about Minicomputers to Mini-People" was the name I gave to the talk I was asked to present to my son's sixth-grade elementary school class almost 15 years ago.

As part of the audience analysis in my preparations for this welcome, change-of-pace opportunity, I asked the teacher to provide me with written essay answers from each of the intended class participants to the question: "What is a computer?" To this day, I still have in my archives the grade school kids' handwritten answers. All but one were mesmerized by the technology as depicted in the nuts and bolts of the matter; writing of wires, blinking lights, beeping sounds, consoles, punched cards, paper and magnetic tape,

programming, bits, and bytes. One fellow, the son of a college professor, even used the term "solid-state switched." But the answer that stood out from the rest came from a young lady who perceptively replied, "A computer is a tool to solve the problems of mankind."

In reading the DATAMATION article I thought back on this anecdote, which indicated to me that an individual's selection of IS as a career begins first and foremost as an attitude, perhaps expressed in a simple answer to the question "What is an information system?"

I've since lost touch with Miss Miller, but I can't help speculating about this uncommon young woman. Wherever she is, in whatever she may be doing, she is certain to be outstanding among her peers.

Peter Kushkowsky
Haddam, Conn.

ACCESS

There are several ways to use DATAMATION beyond just reading it. You can call on our experts—the editors who specialize in certain fields are eager to hear of your experiences in and thoughts on how to manage information technology resources. You can contribute articles to the magazine by supplying us with manuscripts for our review. You can learn how competitors and colleagues are using software and systems from our research department, which can provide details of both published and unpublished studies on various aspects of technology usage. And you can always voice your opinion by submitting a letter to the editor—electronically or by post.

EXPERTISE

• **Communications**
Susan Kerr
408/243-8838

• **International**
Paul Tate
011/44-1-628-7030

• **Large-scale systems/
storage**
Jeff Moad
415/981-2595

• **Peripherals**
Tom McCusker
213/826-5818

• **Pcs**
Robert Francis
214/644-3683

• **Sectors**
Linda Runyan
609/683-4051

• **Software**
Ralph Emmett Carlyle
617/888-6312

• **Workstations/
Midrange systems**
Gary McWilliams
617/964-3730

MANUSCRIPTS

Marsha J. Fisher
DATAMATION Magazine
249 W. 17 St.
New York, NY 10011
212/463-6527

LETTERS TO THE EDITOR

Tim Mead
DATAMATION Magazine
249 W. 17 St.
New York, NY 10011
212/463-6431
Fax 212/242-6987
MCI Mail DATAMATION

SUBSCRIPTIONS

In U.S. and Canada:
DATAMATION Magazine
44 Cook St.
Denver, CO 80206
Outside N. America:
27 Paul St.
London EC2PLY
England
011/44-1-628-7030
Fax 011/44-1-628-5984
Telex 914911

Reprints/Permissions:

Frank Pruzina
1350 E. Touhy Ave.
Des Plaines, IL 60018
800/323-4958

Research

Laraine Donisi
DATAMATION Magazine
249 W. 17 St.
New York, NY 10011
212/463-6893

Advertising Sales

Karine Anidjar
249 W. 17 St.
New York, NY 10011
212/463-6526

**We see network
management
from a different
point of view.**

Yours.

See for yourself how NetView™ can help keep your network up, and your costs down.

At IBM, we've helped more companies set up and manage computer networks than anybody else.

We've learned that no two companies have the same needs. And we know how cost efficient and productive your network can be when you manage it yourself.

And that's exactly what IBM NetView lets you do.

NetView solves your missing links.

NetView is IBM's innovative, advanced family of software that lets you control your network.

If there's a weak link or problem in your network, NetView finds it, and enables you to fix it. Sometimes automatically, so no one's even aware there was a problem.

And NetView helps you manage IBM and non-IBM systems, so whether you're designing a new network or improving your present one, your investment is protected.

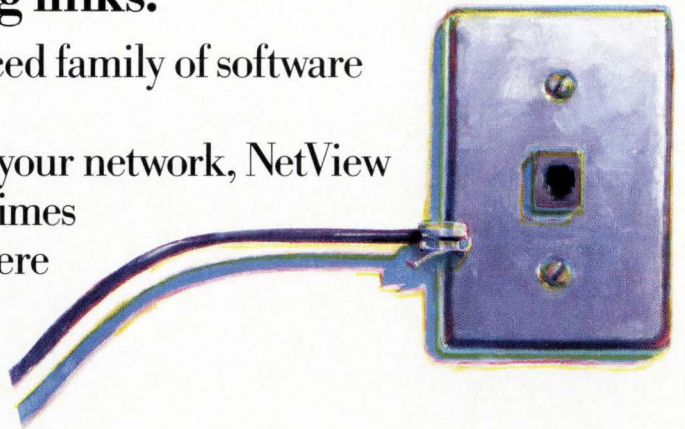

NetView makes your computer the perfect host.

Like any good host, your computer shouldn't keep people waiting.

NetView works to provide more reliable, consistent service to everyone on your network. It automatically handles routine computer and network messages, so your control center operators can concentrate on the really important ones. As a result, your network runs better with fewer processing delays.



NetView works nights and weekends, too.

NetView can run unattended to keep your network and systems working around the clock.

And since NetView never sleeps, you can do business at any time, anywhere in the world.

If you're setting up a network, or trying to make the one you have more productive, we'd like to show you how NetView can help you now. Just call your IBM Representative.

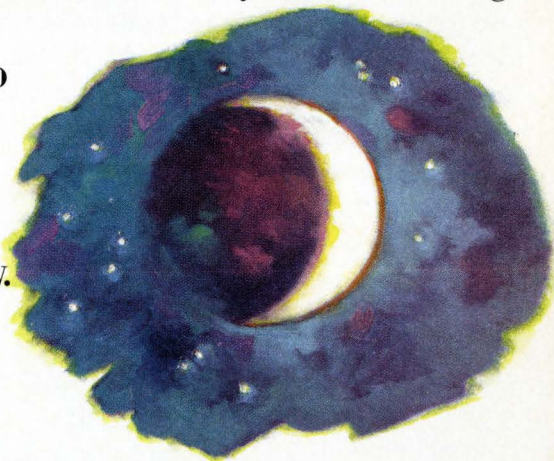

The Bigger Picture

Get the Facts from Your DBMS.

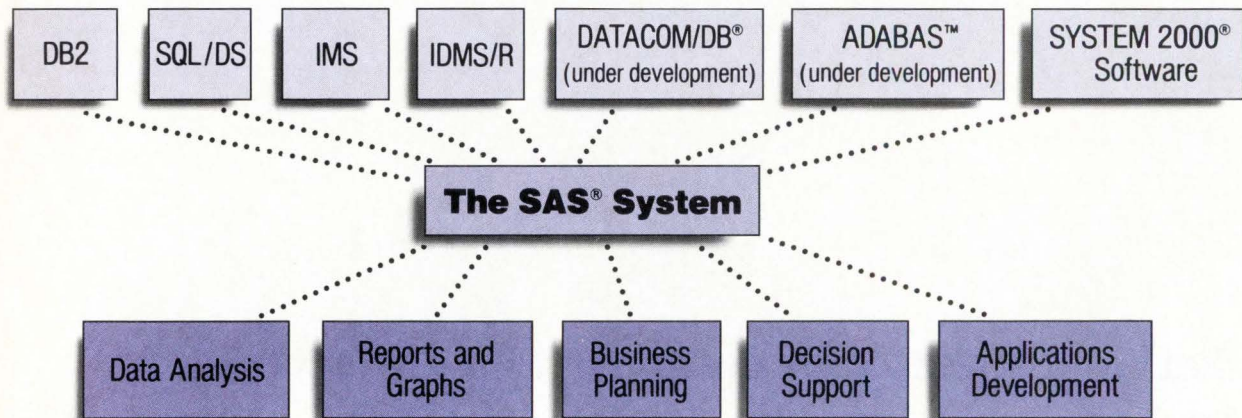

The most powerful applications software has joined forces with the most popular data base management systems. To turn raw data into meaningful facts. To analyze, estimate, optimize, simulate. To produce custom reports and color graphs. Whatever your information need, the SAS System delivers more from the data you store.

Don't Just Store Your Data. Explore Your Data.

The SAS System's ready-to-use tools uncover the real meaning of all those names and numbers. Forecast sales and cash flow. Perform statistical analyses. Build financial and planning models. Create spreadsheets of unlimited size. Schedule projects for best use of time and resources. Produce stacks of personalized letters. Generate calendars, charts, and many other formatted reports. Spot relationships and graph trends with powerful presentation graphics.

Or develop your own applications with the SAS System's efficient fourth-generation language. Customize these applications any way you wish.

If You Know Data Bases. And Even if You Don't.

Menu-driven interfaces link the SAS System with DB2, SQL/DS, IMS, or IDMS/R data bases, and with SYSTEM 2000® Data Management Software. End

users, even those who know nothing about data bases, have immediate access to the data they need. It's as easy as filling in the blanks!

Extract data from your DBMS for use in SAS System applications. Load data from the SAS System directly into your DBMS.

Update values in a data base directly from a SAS System application. All without risk to data security. The SAS System lets you choose which users browse or update specific files.

Get the Facts Today. And Get 30 Days FREE.

Bring the SAS System together with your data base. You'll receive high-quality software—plus training, documentation, and support—all from SAS Institute Inc. We'll even provide a free software trial to get acquainted. For details, call or write today.

```

DB2 INTERFACE:          TABLE NAME: DB2.PERSONNEL
DATA EXTRACTION PANEL  SAS DATA SET: PERS.SUBSET
COMMAND==>

```

FUNC	COLUMN NAME	SAS NAME	FORMAT
*	TABLE - PERSONNEL	***	COLUMNS: 11 * SELECTED: 0 *
F	FIRST NAME	\$10.
F	LAST NAME	\$10.
F	ADDRESS	\$20.
F	CITY	\$20.
F	STATE	\$2.
F	ZIP	\$10.
F	PHONE	\$15.
F	SSN	\$15.
F	RESIDATE	\$4.
F	DEPTCODE	\$7.
F	SUPERVIS	\$10.
F	DIVISION	\$10.
F	TITLE	\$15.

```

----- WHERE CLAUSE -----
city = baltimore_

```



SAS Institute Inc.
SAS Circle Box 8000
Cary, NC 27512-8000
Telephone (919) 467-8000
Fax (919) 469-3737

Get the SAS[®] System.

Ridge Medical Supplies Inc.

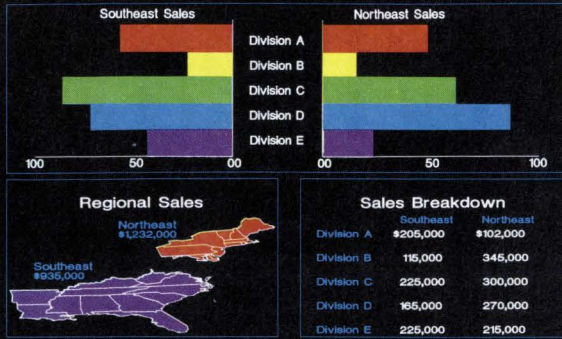

Morgan Cosmetics Inc. P Chart for Perfume Bottle Capacity

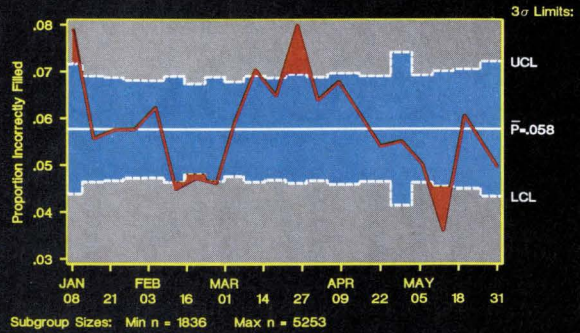

EMS Software International Countries with Products Installed As of January 1, 1987



Quarterly Sales

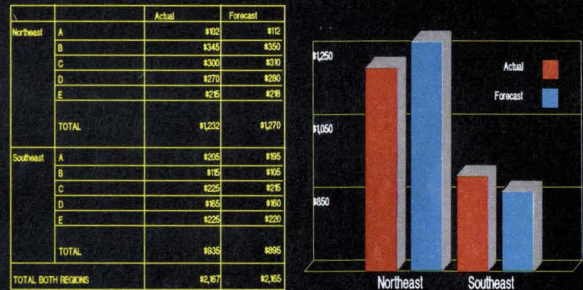

CPU Utilization by Hour

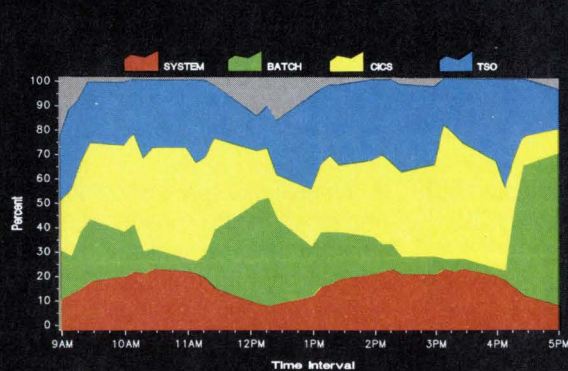

Schedule for Well No. 121-005

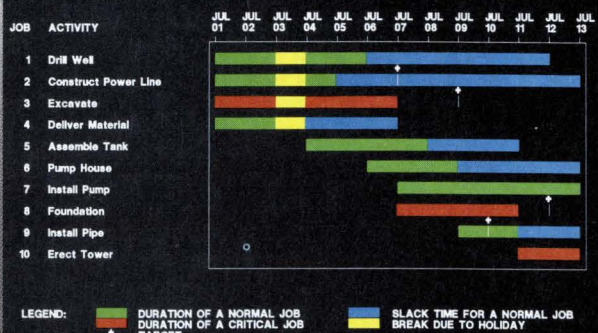

The SAS System runs on IBM Corp.'s 370/30xx/43xx and compatible machines, as well as minicomputers and personal computers.

SAS and SYSTEM 2000 are registered trademarks of SAS Institute Inc., Cary, NC, USA. DB2, SQL/DS, and IMS are products of IBM Corporation, Armonk, NY. IDMS/R is a product of Cullinet Software, Inc., Westwood, MA. DATACOM/DB is a registered trademark of Applied Data Research, Inc. Princeton, NJ. ADABAS is a trademark of Software AG, Reston, VA.

Copyright © 1988 by SAS Institute Inc. Printed in the USA.

Here's an offer only the most analytical minds in America can appreciate.

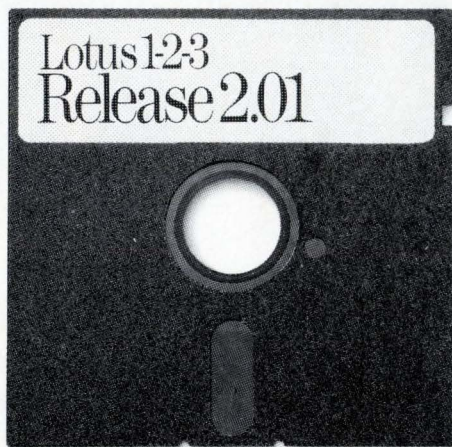

Buy 1.

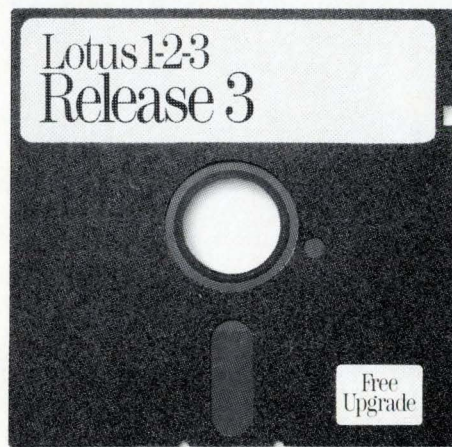

Get 1 free.

After exercising your grey matter with a few hundred "what ifs" every day, it's nice to have a no-brainer to deal with. How's this: for every Lotus® 1-2-3® Release 2.01 you buy on or after September 6, 1988⁽¹⁾, you get a free 1-2-3 Release 3 Upgrade as soon as it's available. (Be sure to save your proof of purchase.)

Easy decision.

After all, 1-2-3 Release 2.01 has recently been rated the top-performing

spreadsheet for an unprecedented fifth straight year by the NSTL.⁽²⁾ In fact, 1-2-3 is the backbone of business, with over 7 million users who depend on it everyday.

Plus, the upcoming 1-2-3 Release 3⁽³⁾ will be the most powerful spreadsheet on the market by far, yet it will offer the familiar 1-2-3 interface and be fully compatible with all your present 1-2-3 data, macros and applications.

The new 1-2-3 will offer an exciting

3-dimensional spreadsheet for better organization and consolidation of data. Plus, improved graphics and powerful database enhancements, including the ability to access external databases, like dBase®, from within your spreadsheet.

See your Lotus Authorized Dealer or Lotus sales rep for details.

Lotus 1-2-3

(1) Upgrade offer valid September 6, 1988 through 90 days after the 1-2-3 Release 3 ship date. (2) National Software Testing Laboratories, Inc. Software Digest Ratings Report, June, 1988. (3) 1-2-3 system requirements will vary from Release 2.01 to Release 3. 1-2-3 Release 3 runs under DOS and OS/2. Hard disk and 640K required. Lotus certified compatible PC with 80286 processor or better recommended. Lotus and 1-2-3 are registered trademarks of Lotus Development Corp. dBase is a registered trademark of Ashton-Tate Corporation.

Wanna Lease an AS/400?

PHILADELPHIA—Users interested in an AS/400 may soon begin to see some pretty good leasing terms. That's because BOC **Bell Atlantic Corp.** has decided to get into the AS/400 business in a big way through its Bell Atlantic Systems Leasing International Inc. subsidiary. BASLI recently acquired Minneapolis-based AS/400 software var Data Three Corp. and has set up 13 offices around the country specializing in AS/400 leases. BASLI, which previously had stayed out of the S/36 and S/38 markets, could put some competitive pressure on IBM Credit Corp.

There Goes Another IS Project

BRUSSELS—Bessel Kok, chief executive of the **Society for Worldwide Interbank Financial Telecommunication** (SWIFT), has given the in-house developers of its next generation service—SWIFT II—an ultimatum after almost two years of delays: unless the multimillion dollar system is performing to spec by the beginning of January, the whole thing will be abandoned. Around 95% of the world's top banks use the global network, and if SWIFT II is scrapped they will have to put up with a limited upgrade of the current Unisys-based system until new plans are formulated.

What's Next?

SAN JOSE—Talk about coincidences, or should we say chummy relationships? **IBM's** recent announcement that it will license Unix applications development tools and end-user interface software from **NeXT Inc.**, the Steve Jobs venture, strangely parallels Big Blue's venture with **Carnegie-Mellon University** that has produced advanced capabilities known as the Andrew Toolkit. To make matters more confusing, Carnegie-Mellon owns 1% of NeXT. However, insiders tell us that the two separate efforts were pursued by different IBM organizations, and word is that the Andrew project holds more long-term technical interest. Nonetheless, talks apparently are under way to see how the two systems may be merged and how IBM can get more bang for its bucks.

Risky Move for DEC

MAYNARD, MASS.—The engineering world is about to get its first look at a RISC/Unix workstation from **Digital Equipment Corp.**, company sources say. The company's annual meeting this week will provide the setting for release of the so-called P-MAX workstation, which incorporates a MIPS Computer Systems Inc. RISC microprocessor. For DEC's engineering users, the new workstation at last unties future price/performance gains from the company's commercial VAX/VMS development efforts. With DEC largely attending to commercial data processing during the past four years, many former VAX-based engineering customers turned to **Sun Microsystems Inc.**, Sunnyvale, Calif., and **Apollo Computer Inc.**, Chelmsford, Mass., for their technical workstations. The workstation is being rushed out to forestall further losses to Sun's SPARC and Apollo's PRISM architectures. VAX/VMS will have its day in the sun in January

when DEC is expected to debut its personal VAX workstation with a VMS version of its DECwindows graphical environment.

Network Profile Set

CUPERTINO, CALIF.—Less than three months after its founding, the **OSI/Network Management Forum** has completed what it calls its technology profile. The eight founders, including Hewlett-Packard, AT&T, and British Telecom, have worked out common network management components fitting within each of the seven layers of the OSI model. The biggest technical chore was settling on types of messages for alarm reports and configuration, according to HPers. By next month, the Forum will make an official request to the international ISO group to work in its suggestions. Given the slow nature of official standards bodies, don't expect the final stamp of approval for some time. Also being worked out is membership expansion. IBM and DEC have expressed interest in joining the forum, but don't hold your breath.

Storage Tape Lives On

LOUISVILLE, COLO.—**Storage Technology Corp.'s** success with its automated tape library for 3480-class tape drives apparently has caught the attention of **IBM**. While IBM has shown little interest in marketing such a device in the past, sources say the company recently began to look seriously at the idea again. Reportedly among the candidates is a library made by an unnamed private West German company. StorageTek expects to have shipped about 300 libraries by the end of this year, close to its original goal and apparently enough to demonstrate that there is a market for tape libraries. Meanwhile, StorageTek recently formed a new marketing unit to sell modified versions of the tape library and its tape transports into the Unisys 1100 and 2200 mainframe market.

The Wait Is Extended

SAN JOSE—Users waiting for **IBM** to announce its long-awaited Application Development Environment repository may have a little longer to wait. Several sources say IBM, which had been hoping to announce the product late this year, has pushed back the big day to early '89. Management changes and a concern with SAA compliance are said to have contributed to the slip.

N.Y. Bank Works On Its Image

BOSTON—One of the highlights at last month's Electronic Imaging '88 conference here was a presentation by Thomas P. Cahill, vice president in the corporate systems department at **Chase Manhattan Bank**. Cahill detailed the explosion of activity in electronic imaging in each of the various departments of the bank and the client-server model it has adopted as a corporate IS strategy. That model, which features mainframe and midrange servers dedicated to specific tasks, closely parallels the model **Digital Equipment Corp.** favors for its own document processing system that is in the works, Cahill says. Chase is pursuing imaging tech-

nology, Cahill says, despite the fact that "We haven't [even] conquered the network problem for regular data processing and when you add image, well, the answers are just not there. We're adding a T1 backbone in Manhattan, but that will barely answer the data processing communications problem."

OSI Plans Revealed

lower three levels of the OSI model, including Token Ring and Ethernet support. The company declines to comment on the availability of the products, but adds that it also will be coming out with an Internet (formerly DDN) product that includes TCP/IP, Ethernet, or X.25 support as a migration tool for its customers.

Unix Not A Hit In Canada

sored by the **Canadian Unix operating system user group** usr/group/can and financed by 35 Canadian organizations, the survey concludes that Unix has far less acceptance in Canada than widely believed, says project director Don Tapscott, a consultant with survey manager **DMR Group Inc.** Among its findings, an overwhelming 80% of Canadian organizations that have Unix systems use the operating system for less than 10% of their total applications work. Notwithstanding the low penetration, the survey estimates a 40% per annum growth rate in Unix installations through 1992, Tapscott says.

IBM Goes Back to School

above everyday business practices, such as deep discounting and price wars, reportedly is marketing its 3090 600 for 20% of the list price. It's not above trading places, either, having recently closed a deal with a major southwestern university for a 3090 400, then offering the state's other major university a 3090 600 for less than what its rival paid for the 3090 400. "This really worries me," says a faculty member at one of the southwestern universities. "I don't know if universities have the wherewithal to withstand the pressure. Once you buy the first machine from a vendor, you're locked into it for the next few generations. It's impossible to get that vendor off the floor. Especially IBM." It could be very tough not to pledge these letters.

NAS Up For Grabs?

Advanced Systems PCM subsidiary now that the \$800 million unit has slipped into the red? According to veteran

MINNEAPOLIS—Network software provider **NCR Comten** says it has some OSI products under development that will offer OSI intermediate systems capability, meaning they will offer the

TORONTO—Unix-based computers account for only 5% of the \$3.2 billion in systems installed last year in Canada, according to a comprehensive survey of 6,000 IS executives here. Spon-

WASHINGTON, D.C.—IBM apparently is hitting universities with a supercomputer rush that would embarrass the most rowdy fraternity on campus. Big Blue, generally thought to be

SANTA CLARA—So what about this speculation that National Semiconductor Corp. will look to unload its **National Ad-**

large systems market watchers, such as Bob Djurdjevic, there are five possible NAS acquirers. That's if you choose to discount the most likely scenario, which is that National will attempt to weather the current downturn and hang onto NAS. Anyway, Djurdjevic says it would make sense for **Amdahl Corp.** to take a look at NAS, if only to consolidate PCM mainframe sources and gain an installed midrange base. Problem there is that NAS supplier Hitachi probably wouldn't look favorably on losing its U.S. systems distribution network to rival Fujitsu, Amdahl's largest shareholder. PCM peripherals vendor **Memorex** is another possibility. The company has been doing well since spinning out from Unisys, and Hitachi might well bless that union. An obvious if unlikely possibility is **Hitachi** itself. Hitachi obviously has a position to protect, but in the past has always shown itself unwilling to enter the U.S. mainframe market on its own. **Comparex**, the Hitachi mainframe distributor in Europe, is another name on the list. Lastly, one of the larger leasing companies might be interested in NAS as a way to diversify. The price tag? Try \$1.5 billion.

One-Stop Shopping For X.25

Data Network Services (MDNS) covering all of Europe by January 1989. How the French, West German, Spanish, and Swedish authorities will reconcile this move and their deals with **Computer Science Corp.'s Infonet** covering MDNS is not yet clear. What is clear is that the European Commission-backed agreement paves the way for a new joint European MDNS company to be set up early next year to run the operation. Major users should benefit from reduced costs and easier network links between European countries.

Unisys Beta Site

ing beta tested at the **State University of New York College at Fredonia**. The DBMS is based on the concepts of semantic data modeling. Daniel O'Connell, assistant professor of computer science at Fredonia, says Unisys's Semantic Information Model System sits on top of its DMS-2 DBMS. Unisys expects to begin marketing the software sometime next year.

Raw Random Data

veiling from startup **Network Computing Devices** of a network display station supporting X Windows. Former Bridge Communications and Ridge Computers founders are at the helm of the Palo Alto venture . . . Fractional T1 services, much hinted at, seem to remain to be off in the future. T1 vendors tell us that **Pacific Bell** had hinted that service would emerge this coming January, but that seems to be delayed. Pac Bell has no comment.

WEST BERLIN—In an unprecedented memorandum of understanding, **22 European telephone authorities** have agreed to try and set up a one-stop shop for X.25-Managed

FREDONIA, N.Y.—Look for a new database management system from **Unisys Corp.** to come to market next year. It's now be-

Look in the upcoming months for **3Com Corp.**, Santa Clara, to finally unveil IBM NetView network management support on its 3Plus Open platform . . .

Late January will mark the un-

Cut Through Applications Backlog Fast With INGRES Relational Database.

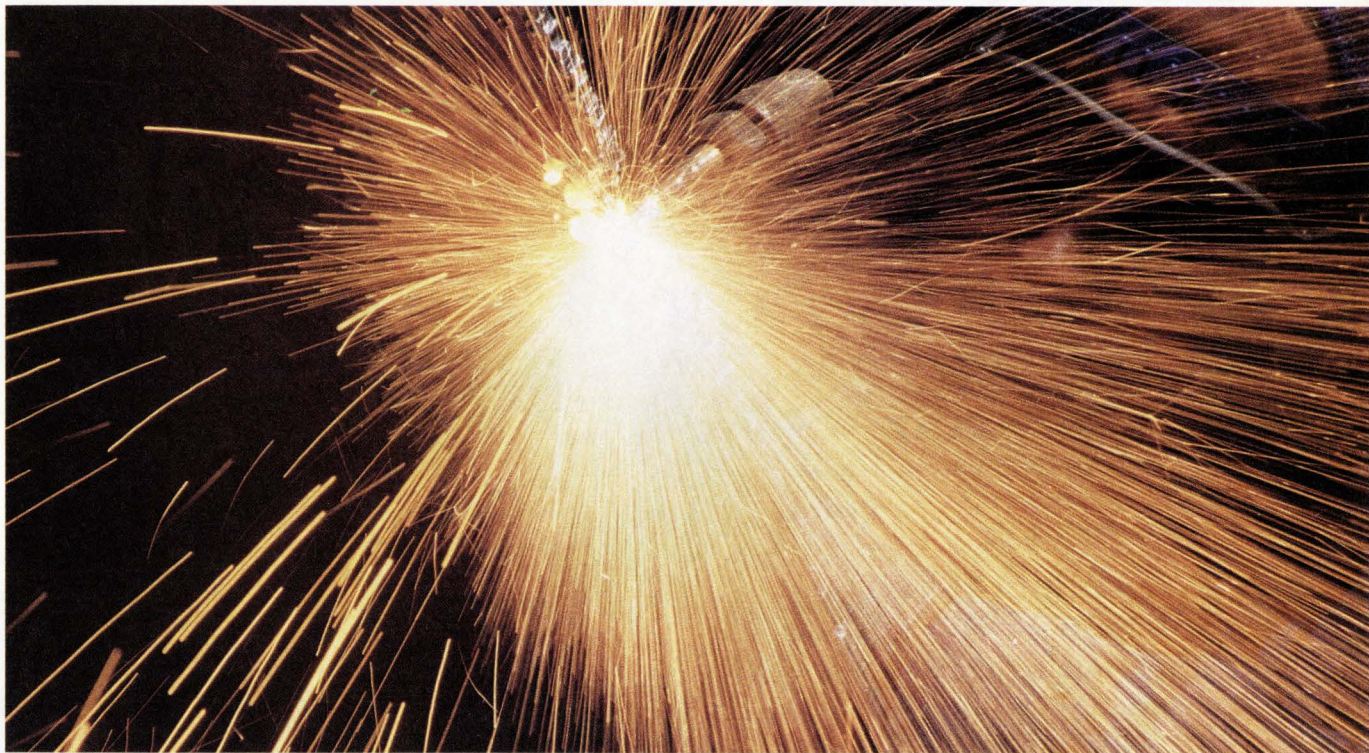

© 1988 Relational Technology Inc.
Printed in U.S.A.

To design, build, and maintain effective business applications, you need the right tools and development options. INGRES combines Tools, Power, and Access to help you cut through development backlogs. In addition, hundreds of ready-to-use INGRES-based business solutions are available.

Tools INGRES offers a robust application development environment providing CASE, 4GL, SQL and visual programming methods. These facilitate complex applications prototyping, deployment, and provides independent end-user query and reporting capabilities. Applications are instantly portable across multiple hardware platforms.

Power INGRES high performance SQL database engine provides OLTP power to support production applications in single or multi-CPU and distributed environments. A unique AI-based query optimizer maximizes processing efficiency.

Access INGRES integrates existing data into your applications through flexible access tools. Gateway access to existing data. Network access to tie your systems together. Distributed technology to integrate islands of information. Access to your data wherever it resides.

Find out how 12,000 installations have cut through their applications backlog fast with INGRES Development Tools.

Call 1-800-4-INGRES

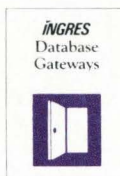
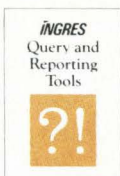

INGRES
RELATIONAL TECHNOLOGY

Corporate Headquarters: 1080 Marina Village Parkway, Alameda, CA 94501, (415) 769-1400
International Headquarters: Anchor House, 15-19 Britten Street, London SW3 3TY; UK, + 44 1 351 7722

Circle 10 on Reader Card

Informix is the #1 d And the only c

To develop your application faster, you need the only 4GL that doesn't rely on COBOL or C to fill in the missing pieces.

INFORMIX-4GL.

A complete COBOL replacement.

Unlike other DBMS products, INFORMIX-4GL is a complete application development language for SQL databases. It's the only 4GL with full screen-building, report-writing and SQL database I/O capabilities designed into a single programming language. Which means it's a real COBOL-replacement-caliber tool. So you'll rarely have to revert to COBOL or C to customize an application.

10 times faster than COBOL.

3 times faster than any other 4GL.

When you leave COBOL and C behind, high productivity kicks in. In fact, with INFORMIX-4GL, you'll be able to deliver even the most complex custom applications at least 10 times

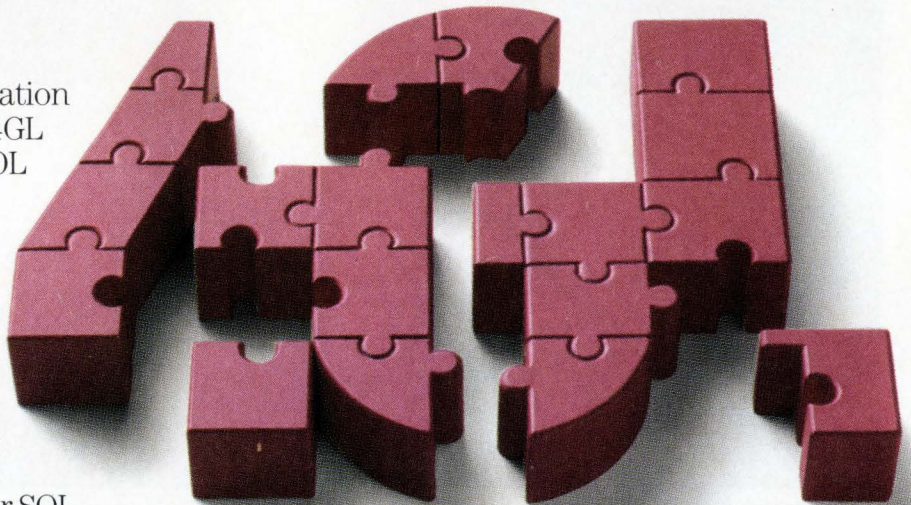

faster than you can with COBOL or C. And 3 times faster than with any other 4GL.

Moreover, application debugging and maintenance are a breeze with our INFORMIX-4GL Interactive Debugger. You can view and debug your 4GL source code while the program runs. Even maintenance time will be reduced drastically.

After all, with the non-procedural syntax there's less code to maintain. And the debugger makes it easy for others to understand and maintain your code.

What's more, our INFORMIX-4GL Rapid Development

*Here's what it takes to make a complete 4GL.
And only Informix has it all.*

- ✓ Complete report-writing screen-building and database I/O language in a single product.
- ✓ Language comprised of non-procedural statements.
- ✓ Language flexibility equal to COBOL or C.
- ✓ Full SQL implementation.
- ✓ Application portability without recompiling*.
- ✓ Complete source code debugger capability.
- ✓ A 10 to 1 increase in developer productivity.

atabase in UNIX. omplete 4GL.

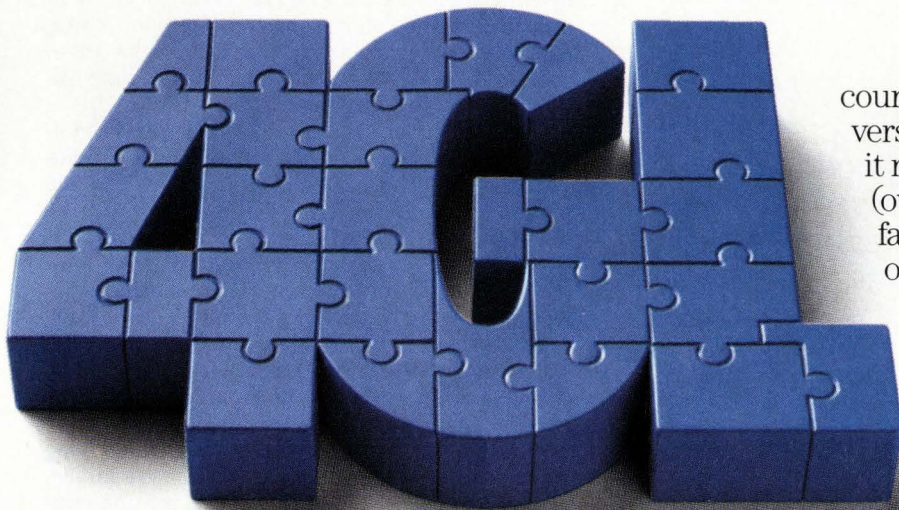

course, most every known version of UNIX. Better yet, it runs on more machines (over 200) from more manufacturers (85) than any other DBMS.

All that and a best-seller, too.

Informix DBMS products for UNIX, including INFORMIX-4GL, outsell their closest competitors

System lets you compile your code in a fraction of the time you'd normally take. And you can port your applications to other operating systems without rewriting or recompiling a single line of 4GL code.*

by a substantial margin. So if you subscribe to the theory that there is safety in numbers, rest assured. With INFORMIX-4GL, the numbers are on your side.

Free booklet,
"How To Choose A 4GL."

For a free copy of our new guide, "How To Choose A 4GL," call or write Informix Software, Inc., 4100 Bohannon Drive, Menlo Park, CA 94025. (415) 322-4100.

And solve the 4GL puzzle. Completely.

INFORMIX-4GL is as flexible as conventional languages, but provides all the power of a 4GL with its non-procedural syntax for handling menus, forms, reports and SQL.

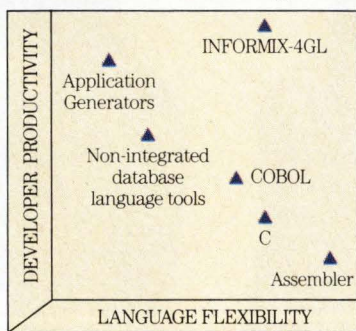

INFORMIX-4GL vs. other application-building tools.

Plus it's more portable.

You can take INFORMIX-4GL just about anywhere—MS-DOS, OS/2, VMS, and, of

INFORMIX

#1 for good reason.

*Obviously, mixed 4GL/C programs or code written to take advantage of specific operating system features may need to be rewritten or recompiled.

Advanced Technology Groups

The growing complexity of IS has created a new corporate entity: the Advanced Technology Group. Its mission is to evaluate and help define how technology is used. But can it remain neutral?

BY RALPH EMMETT CARLYLE

Networking technologies and global markets have conspired to create a new frontier for business. But with this expansion of possibilities has come confusion. Companies are finding that they lack the management know-how to cross this frontier, and so they are dallying behind it. A whole new world of automation that encompasses not only a company but its suppliers, customers, government regulators—the whole external environment—is enticingly close. Yet, companies hold back for lack of precedents, role models, and rules to fall back on. Finance, accounting, manufacturing, sales—all the traditional spheres of a company's operation—have the book of good management principles and guidelines to rely on. The book of strategic information technology management has yet to be written. No knowledge base for such mission-critical automation exists.

As Jeffrey Alperin, assistant vp of corporate technology planning for the giant insurer, Aetna Life & Casualty, tells it, "The enabling technologies and the people charged with assessing their impact—the watchdogs—are so new that no fund of shared experience has yet developed across the industry."

The problems are so complex that no one company, not even IBM, has all the solutions. All must trade what little they do know to learn more. And, as a result, a number of "consensual" models has emerged. Competition, at least in the R&D sphere, is giving way to cooperation. Vendor is now allied with vendor—and, increasingly, with customers—to create a "living lab," a fountain of innovation from which, it is hoped, a stream of network-building tools and mission-criti-

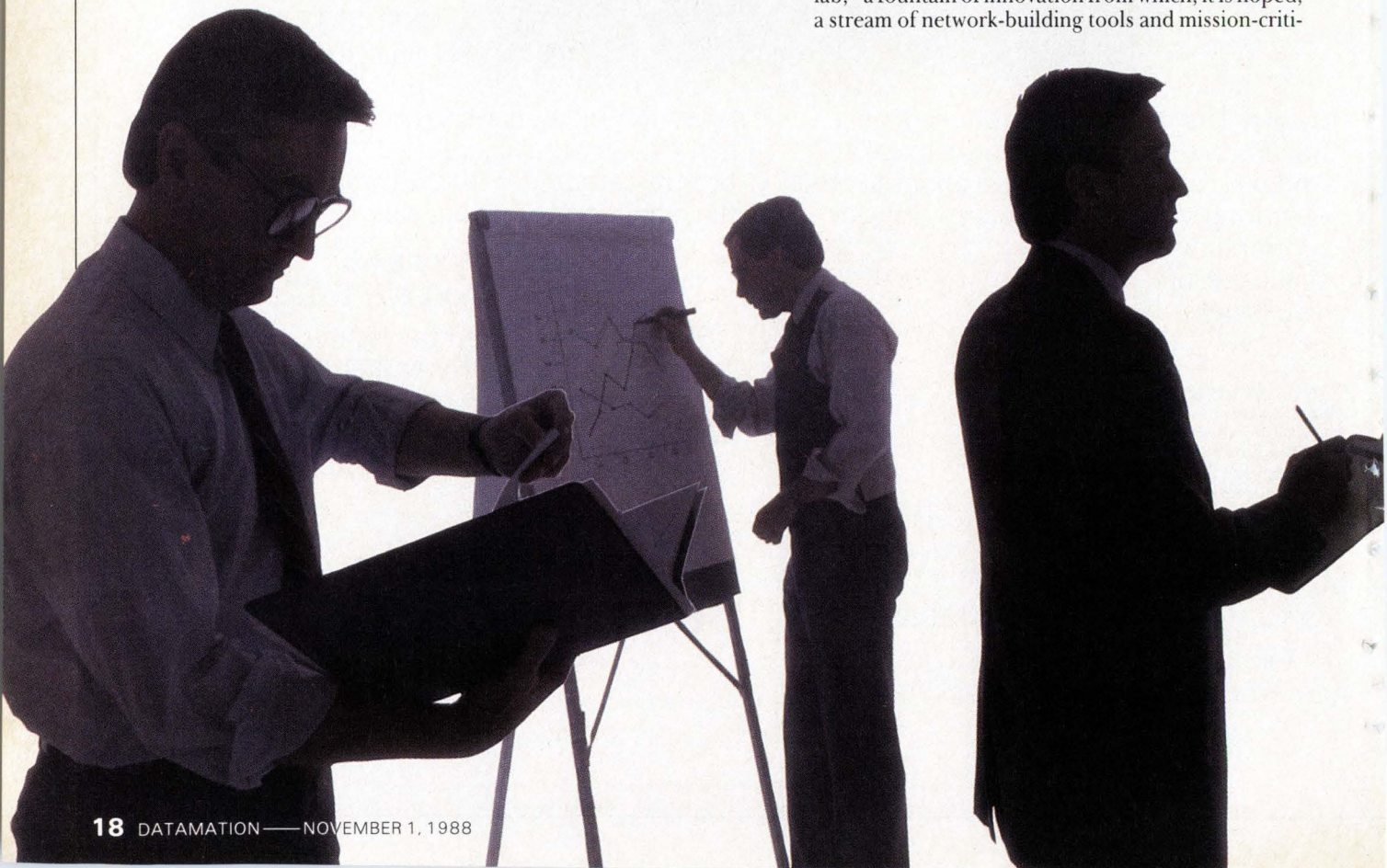

Advanced Technology Groups have sprung up to advise corporations on technology—what they should know about and how to evaluate technology.

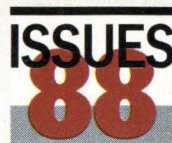

cal applications will flow to break the deadlock.

There is one thing wrong with this scenario, however, or one thing that is lacking. Research shows that many companies lack a formal agency or mechanism for the assessment and transfer of such technology, and for the growth, internally, of their understanding of technology. The exceptions are technology-dependent companies, especially in financial services, which have been forced to surmount the problem. Their solution has been the creation of a new watchdog organization or function. This entity—the Advanced Technology Group (ATG)—is an idea that has caught on amongst vendors and customers alike since the mid-1980s.

What the Watchdog Is Watching

The watchdog's function is to understand new technologies, to evaluate them, and to influence the course of their development—when feasible—and decide when not to redesign the technology to suit the company's needs.

ATGs are a company's technical "reality" test; its quality assurance. They help separate vaporware from visions that can be touched today in the computer room. Its members are trained to sniff out charlatans in the vendor community and give more precise definition to the company's systems requirements. Many technology decisions are now made in decentralized business units. Without ATG input, there is a grave danger that business managers will miss the leading edge technology that can make a difference to their companies. Few IS shops and vendors have the luxury today of being able to mount radical new de-

velopments, and neither side can afford to develop products in a vacuum. The new watchdogs perform a vital service by bringing the two into a synergy that IBM refers to as a "living lab." Some ATGs are skilled enough to design their own chips, and are valued allies of such firms as Intel and Motorola. DATAMATION's research has even found cases of ATGs helping effect mergers between prospective suppliers.

At a time when many new applications are being farmed out to consultant/integrators such as Arthur Andersen and IBM itself or vertically oriented software companies, ATGs are an attempt by leading corporations to return to the driver's seat, to gain more control over their own destinies. These ATGs signal a new aggressiveness among commercial companies, a more proactive involvement in the creation and development of technology. "ATGs say that we've stopped putting all our faith in vendors," says Michael Simmons, executive vp of systems engineering at Bank of America. "We want the expertise in-house to turn inventions into new products on demand. A good vendor is someone that helps us to help ourselves. A teacher makes the best partner."

Aetna's Experience With DEC

The transition to teacher is rarely easy for vendors—even the big names, which tend to remain mired in old ways of thinking, according to Alperin, Aetna's technology watchdog. He remembers the first time Digital Equipment Corp. came to call on him, in fall 1985. Aetna's ATG had just been created. DEC was getting very aggressive in the financial services sector, especially in the true blue IBM bastion of



Photograph by Walter Wick

insurance, and was seeking new ties and alliances.

"It soon became apparent to us that they [DEC] were thinking like an old-style manufacturing company, and we like the product of an information economy," he remembers. "Their attitude was, 'Which of our machines do you want to buy?' Ours was, 'None. We want what's in your heads.'" What Alperin was especially interested in was DEC's expert systems know-

momentum all their own. Apple Computer Inc., through its links to DEC, has now entered into the Aetna equation, though not yet in any formalized way. The insurer has hundreds of Macintosh computers it would like to evolve into intelligent terminals for its VAX environment for such applications as marketing and publishing. Alperin reveals that he wants to expand the Mac's hypercard facility, a textual database

that users can manipulate to create their own views of the data, to encompass hypertext, and, later, hypervoice and hypervideo.

A project is under way to turn the Mac into an in-house teaching tool through a combination of hypertext and CD-ROM disks for the storage of training manuals and documentation.

The pace of such technology transfers is now picking up, with Alperin and his brethren brokering such relationships. We may be witnessing the birth of strategic information technology planning through the emergence of a new phenomenon—what some refer to as the chief technology officer (CTO), though often known by other titles, such as director of advanced technology or vp of strategic (or corporate) planning. Whatever the title, the mission is the same: to run the ATG, broker relationships with technology partners, and introduce the fruits of all this

work in such a way that learning takes place across the organization.

The much-hyped chief information officer (CIO) is usually the CTO's boss. He or she runs the whole IS organization like a business. The CTO, who has more technical depth, scans the technological frontier for know-how that can help cut costs, boost revenues, and increase market share.

The Function Surfaced in a Fordham Survey

Some early evidence of the CTO function came in a 1986 survey of 1,500 ceos from the nation's largest companies by the Fordham Graduate School of Business in New York City. Twenty percent of the corporate leaders reported having a senior-level position with technology assessment as its primary responsibility. There was evidence in the survey that managers at decentralized business units—the new main buyer of information technology—had taken on a part-time technology watchdog role, in addition to their regular duties in sales or manufacturing.

This emerging nucleus—the CTO, ATG, and representatives of the business units—is rapidly becoming the decision-support vehicle for all major technology purchases by the corporation. Within Shearson, Leh-



AETNA'S ALPERIN: There is no fund of shared experience yet.

how. "We asked them to pass to us the total educational process they used to train their knowledge engineers."

DEC was taken aback. Says Alperin, "They were happy to sell us consulting and hardware but balked at such an intimate transfer of knowledge," which, it should be noted, had been procured by DEC at great expense from Carnegie-Mellon University and refined at further

cost within DEC's internal organization. Later, DEC reconsidered, perhaps deciding that the sacrifice was a small price to pay for goodwill in such a quarter, and

select Aetna employees went through a learning experience similar to DEC's own.

Aetna and DEC have since grown very close, and the mini maker has benefited not just from significant VAX sales but from exchanges of insurance-specific knowledge that it can embody in its products.

Alperin and the heads of other ATGs are discovering that, once begun, these mutual exchanges have a

The idea was to create a neutral body. Not mainframe bigots or workstation bigots, but neutral."

JOHNSON OF FMR CORP.

The Fight For Visibility

man & Hutton, such combinations are known as decision-impact groups. DIGs research the market for an emerging technology of interest, create a small pilot, and pass on the fruits of this learning to other interested parties throughout the corporation. The names and faces on the DIGs change all the time. "They're like SWAT teams. They come together, complete the mission, and disband," says one former executive.

The history of warfare affords us an interesting parallel to the DIG, as David P. Norton, partner in the Lexington, Mass.-based management consultancy, Nolan, Norton & Co., explains. At the outset of World War II, new transportation and communications technologies had redefined the nature of battle, opening up new global, as well as regional, theaters of combat, and putting a first-time combination of air, amphibious, and land weapons into action. "A new approach to battle management was required," says Norton, "but such a war had never been fought before and there were no rules to fall back on."

The solution, he says, was the creation of teams of scientists from many disciplines—mathematics, physics, psychology, economics, and so on—who worked together to solve transportation problems. This multidisciplinary approach became known as Operations Research (OR), emerging first in the U.K. around 1940 and later in the U.S.

It's no surprise, then, that 1980s-vintage OR specialists often comprise the core of a new ATG or DIG. One example is Empire Blue Cross/Blue Shield in New York City. Top management was sick of drowning in pulp and asked its ATG to move them to new imaging technologies by the early 1990s. The New York location was handling some 400,000 claims a day, more than half of them on paper.

OR specialists are the unseen hand that guides all the strategic planning decisions of one of the most powerful IS executives in the country, Merrill Lynch's DuWayne Peterson. His team (poached, he says, from RCA) monitor all the big moves of Peterson's ambitious five-year IS recentralization plan and are developing expert systems software for a new network. "We've just started to build the backbone of the network," reveals the man with the \$1 billion-a-year budget and the title of executive vp of operations systems and telecommunications. "This is an accounts processing database crafted from IBM's relational DBMS, DB2." Peterson says he has other ATG specialists looking into CASE, imaging, and advanced telecommunications. All are helping him collapse Merrill Lynch's whole IS operation—described by insiders as decentralized chaos before Peterson showed up nearly two years ago—into two large IBM data centers.

Fidelity's Idea for a Hybrid Organization

But while OR specialists and PhDs (usually in electrical engineering and management sciences) often make up the core of an ATG—and hence of a DIG—the composition of the groups increasingly reflects the consensual models that are emerging across the industry. When Edward C. Johnson III created one of the earliest known ATGs at Fidelity Systems, Boston, he says he had a hybrid in mind: a fusion of experts from business units, communications, and main-

So far, research on ATGs is sparse. The majority of these watchdog groups seems to be in the U.S., though nobody seems to have an accurate fix on how many there are. The London-based Butler Cox Foundation, a research body sponsored by 400 of the world's biggest companies, believes there may be a dozen or so ATGs among its members, but warns that they shouldn't be confused with others involved in technical assessment. "Many IS groups have their own watchdogs; supertechnicians, for example, who are researching the likes of CASE and AI to achieve greater productivity at the data center," says Roger Woolfe, director of resources and research. ATGs have such experts, but ATGs also have wide experience in implementing new systems with end users and working with vendors on R&D.

Some companies claim they don't need an ATG. "We're so high-tech, the whole company is one big ATG," quips Carl Reynolds, vp of communications and dp at Hughes Aircraft and a member of DATAMATION's advisory board.

In those companies that do have them, however, their characters are as different as the cultures that spawned them, although one thing remains constant: be they vendor or customer, they share a reluctance to talk about their work. "It's tantamount to publicly discussing unannounced products, revealing our hand. Why would we do that?" muses one director of advanced technology at a West Coast vendor.

Many are small and must fight for visibility and recognition within their own company. This is even the case at giant concerns, such as Mellon Bank in Pittsburgh. "I've got eight guys [mostly PhDs] who are building a new programmer workbench for me. I'd love a dozen like them—they're hot stuff," remarks the bank's executive vp of MIS, George DiNardo. But, in his more sober moments, DiNardo reminds us that the bank lost \$1 billion last year. "The last thing they want to spend money on is anything labeled research." The bank even cut off its \$100,000 research contribution to nearby Carnegie-Mellon University for the year. "We'll be back again when things perk up," says DiNardo.

Some ATGs are disguised so as to be safe from prying eyes. "Our ATG discretely develops and tests its products in a live store," says Wendy's dp chief, Hari Notowidigdo. "We tried to pick a Wendy's as far from the head office as we could." Notowidigdo adds as a footnote that at least his is "pragmatic R&D."

"We want to work on the cutting edge with top vendors," says Frank Diasparra, vp of technology services for Fidelity Systems, Boston. "Technology is our only lever when we compete with giants, such as Merrill Lynch and Shearson," he says of Fidelity's mutual funds business.

Size is also a trap, according to one leading technology watchdog on Wall Street. "A big, static ATG becomes a target. The expectation level is high," says William L. O'Neill, senior vp of strategic technology planning for Drexel, Burnham and Lambert. O'Neill has headed up ATGs at Merrill Lynch and Shearson in recent years and says small is best. "Do a small pilot well, grow it, and customize," he advises.

Is it Safe?



North Africa...U.S. paratroopers on the way to their next mission. (Credit: International News Photos)

Would You Like to Know a Way to Make Risk-free Decisions About Buying Mainframe Software?

Buy from On-Line Software—the safe buy in mainframe software.

On-Line Software is “the safe buy” because it’s the first and only company to offer you a lifetime guarantee that the money you spend with us today will still be available to meet your changing needs tomorrow.

No more waiting on vendors’ promises for the ultimate solution—take advantage of today’s technology today! IBM® and others may be addressing the “big picture” of tomorrow, but

The Guarantee.

Any time your technical or business needs change and you can no longer use one of our products—or even if you just decide you don't want it anymore—you can simply send it back. We will give you full credit for every dollar of your original license fee toward any other On-Line Software product. All products licensed and maintained under our standard contracts come with this trade-in guarantee.

our software solves your problems today. It's simple. If tomorrow's solutions make today's problems obsolete, send us back our software and trade it in for any other product we offer. And while other vendors develop their solutions, you will be benefiting from the use of ours.

Let's say you migrate from IMS to DB2. Simply trade in our IMS tools for our new DB2 tools. It's as if you could suddenly trade in all your records for compact discs! And, of course, you'll

have our broad array of software products to choose from.

In fact, only two companies—IBM and Computer Associates—offer a wider range of IBM mainframe software than we do; but neither one has our products, nor offers a similar guarantee.

It's like a lifetime trial. Think about it! Any reputable software vendor will offer you a 30-day free trial and a guarantee that the software will perform as expected. But what we are offering you is more. Our guarantee is our promise to you that our software will always be state-of-the-art, and that we'll work so hard to please you that you'll never have a reason to return an On-Line Software product.

So the next time you are evaluating software for your company, ask yourself the question, "Is it safe?" We can't guarantee that technology won't change, but we can guarantee you the purchasing power to change with technology. And we feel safe in making that statement, simply because our software is that good! Just think. If we didn't have complete confidence in our products, would we make this kind of guarantee?

For "the safe buy" in software, call 1-800-642-0177. In Canada, call 201-592-0009.

 **On-Line Software**
INTERNATIONAL

The Safe Buy in Software.

frame groups. "The idea was to create a neutral body. Not mainframe bigots or workstation bigots, but neutral," says Johnson, chairman and ceo of Fidelity's parent, FMR Corp, Boston. Johnson didn't want to create the perception at business units that his ATG was staffed by mad scientists and elite programmers from central IS.

More important still is that ATGs should be neutral

For years IBM has been populating the whole industry with former employees, and conceivably with the IBM psyche. Are all these people an undue influence on ATGs and even DIGs?

The nagging question of who will watch the watchdogs is bound to surface as these groups proliferate. One answer, says a leading technology watchdog, is for DIGs to be structurally separated from the rest of their organization. "They already cut across functional and divisional lines as it is," says William O'Neill, senior vp of strategic technology planning at Drexel Burnham and Lambert.

Should DIGs—even ATGs—be spun off? IBM and other top computer vendors recently created a "neutral" body, the Open Software Foundation for Unix-based software development. Could the same thing happen to watchdogs? Might they even be grouped together by industry? After all, what are a company's information technology strategies worth when it loses key ATG/DIG members to competitors? Might it not be better for an industry to pool its ATGs—yet another consensual model—and leverage off the fruits of such a synergy?

O'Neill believes that ATGs and DIGs have helped precipitate a crisis in our thinking from which prototypes of new networked organizations will be born. They have also

achieved something else, he notes. They represent the first serious attempt to manage technology after three decades of neglect by corporate leaders. "When computer costs went through the roof in the 1960s, top management stepped in," says O'Neill. "They put together what were known as architectural committees to help focus this spending. The DIGs are the '80s version and follow in the wake of a haphazard proliferation of incompatible vendors, languages, standards, and so on."

Technology Management Grows Up

O'Neill feels the DIG represents a coming of age of technology management, an evolution from the prototypical architectural committees. But maybe they are more of a mutation from such established thought. "Strategic IT planning is like a crawling infant that won't come of age until the 21st century," says Aetna's Alperin. "Its birth is maybe the preface to the book of IT management principles we haven't yet distilled from experience. We're just starting to write that book now." Maybe, as we write, ATGs and DIGs will be our technical reality test of quality assurance. And just possibly our insurance against sliding back into technological illiteracy.



EMPIRE BLUE CROSS'S TEAM: Mike Nieberding (c.), Richard Freiberg (l.), and Stephen Landau.

and impartial in their dealings with vendors and consultants. Fidelity's vp of technology services, Frank Diasparra, adds, "If our communications group asks us to research the market for the best T1 multiplexer, they have to be sure that we did exactly that, not that we just went to our pet vendor or favorite consultant for a solution."

We want the expertise to turn inventions into new products on demand. A good vendor is someone that helps us to help ourselves."

SIMMONS OF BANK OF AMERICA

they don't consider anything else, shouldn't these people be seen as purely an extension of IBM's marketing organization?"

Vendors are increasingly recruiting from amongst the ranks of their own customers, or vice versa. Wang's top IS executive was a former customer; Apple's IS chief came from the insurance industry and has since climbed higher up the management tree.

Then there's the pressure on CTOS themselves. "How many of them go into an IBM seminar and come out spouting SAA as the answer to everything?" asks Aetna's Alperin. "If

Just a few
months ago,
computers this powerful
were tracking
planetary movements,
pondering
quantum physics
and building
rockets.



Now they're taking



care of business, too.

Introducing the COMPAQ DESKPRO 386/20e. 20-MHz 386 performance designed to fit the increasingly sophisticated needs of 286 users.

People who work with 386 personal computers used to be called rocket scientists. Now they're also called accountants, engineers, managers and CEO's. Thanks to the new COMPAQ DESKPRO 386/20e.

It delivers 386 power to people whose demanding needs have outgrown the capabilities of their 286 PC's. Better yet, it packs all this power

into a design that fits neatly on your credenza.

Start with speed. Everything in the new COMPAQ

DESKPRO 386/20e is optimized to go faster.

Its 20-MHz Intel 386™ microprocessor with cache memory is surrounded by the exclusive COMPAQ Flexible Advanced Systems (Flex) Architecture. This high-speed combination runs the world's largest library of software 25% faster than non-cache 20-MHz 386-based PC's. And 50% faster than non-cache 16-MHz 386-based PC's.

Its optimized 32-bit design also enables you to take full advantage of powerful 386 software and

multitasking operating systems such as Microsoft® Windows/386, MS® OS/2, XENIX® and UNIX.

You'll find that a long list of high-performance features is built in. One megabyte of memory. Sharp, high-speed VGA graphics. Support for 5¼" and 3½" diskette drives. And standard interfaces to connect a printer, mouse and communications devices.

Of course you have growth potential. Five expansion slots are available: four for a network card, mainframe communications board, modem or other devices, and one high-speed 32-bit slot that allows you to expand memory up to 16 megabytes.

You have options, too. There's room to add two high-speed fixed disk drives, with 110 or 40 megabytes of storage. You can choose a 135- or 40-megabyte tape backup. Or match the number-crunching power of a dedicated engineering workstation by adding a powerful Intel 387™ or Weitek 3167 coprocessor.

With its integrated design and performance, the COMPAQ DESKPRO 386/20e represents the ultimate space vehicle.

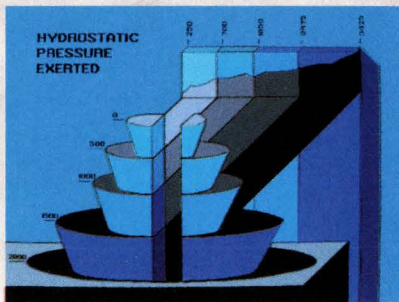

High-speed VGA graphics are built in.

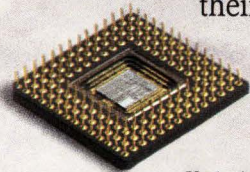

You're in business with a 20-MHz 386 microprocessor.

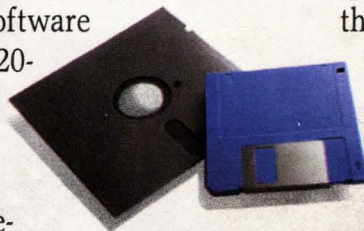

Choose 5¼" and 3½" diskette drives.



Standard interfaces are on board.

COMPAQ

It simply works better.

Compaq makes high performance everybody's business.



Whether you use a personal computer for launching rockets or corporate acquisitions, Compaq delivers the highest-performing solution.

For those who want everything, now, the COMPAQ DESKPRO 386/25 is the most powerful PC available. For growing performance requirements, the new COMPAQ DESKPRO 386/20e is a move into the power structure. And for users considering 286 PC's, the COMPAQ DESKPRO 386s is an affordable route to the fast track.

These PC's are simply the highest-performing in the world. That's one reason PC experts rate COMPAQ highest overall. And why for the past four years COMPAQ has been added by more FORTUNE 1000 corporations than any other brand.

To make this performance part of your business, call 1-800-231-0900, Operator 70. In Canada, 1-800-263-5868, Operator 70. We'll give you the location of your nearest Authorized COMPAQ Computer Dealer and a free brochure.

COMPAQ® is a trademark of Compaq Computer Corporation. Intel® Intel 386 and Intel 387 are trademarks of Intel Corporation. Microsoft®, MS® and XENIX® are trademarks of Microsoft Corporation. MS® Windows/386 and MS® OS/2 are products of Microsoft Corporation. Product names mentioned herein may be trademarks and/or registered trademarks of their respective companies.
*Registered U.S. Patent and Trademark Office. COMPAQ DESKPRO 386/25 graphics ©1988 Accent Software, Inc. ©1988 Compaq Computer Corporation. All rights reserved.

COMPAQ

It simply works better.

TELEX - TELETEX - TELEFAX

for
AS/400

PABX-PS/2 : today

DISOSS

VM/PROFS

MEMO

others

PABX & PS/2

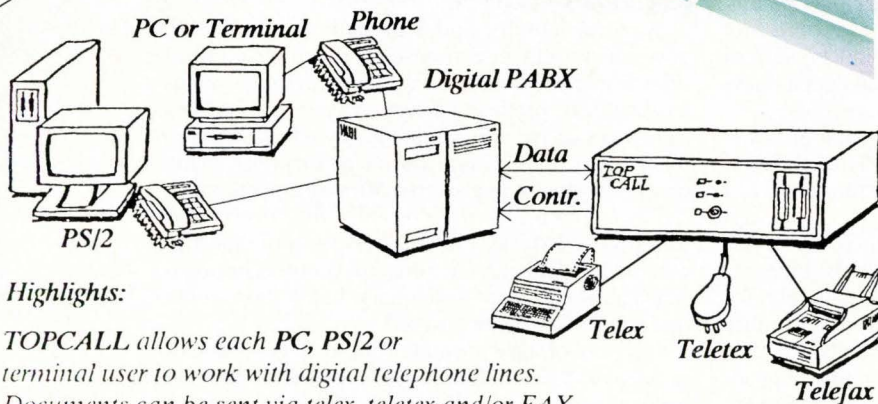

**TOP
CALL**

Highlights:

- TOPCALL allows each PC, PS/2 or terminal user to work with digital telephone lines.
- Documents can be sent via telex, teletex and/or FAX.
- Automatic reception and distribution of messages, mailboxes etc.
- Solutions for Alcatel 5200, IBM 8750, Nixdorf 8818, Hicom, Integral 333

For more information please contact:

Austria: Wien, Tel.: (0222)671643-0, Telex: 135361 tpcal a
Belgium: Charleroi, Tel.: (071)443063, Telex: 51227 acec b
Finland: Helsinki, Tel.: (090)6941700, Telex: 121506 kirja sf
France: Paris, Tel.: 47914702, Telex: incoma 620294f
Germany: München, Tel.: (089)661038, Telex: 522955 tpcal d
Great Britain: London, Tel.: (01)7358082, Telex: 263435 keyehx g
Greece: Glyka Nera, Tel.: (01)6658603, Telex: 222517 depo gr
Italy: Milano, Tel.: (02)2551341, Telex: 352368 ede i
Kuwait: Tel.: 241198, Telex: qumsieh 23736kr
The Netherlands: Tel.: (04180)15925, Telex: 50870 tpcal nl
Oman: Tel.: 562547, Telex: 5729 supplies on
Spain: Barcelona, Tel.: (93)4254722, Telex: 81041 tpcal e
Switzerland: Wädenswil, Tel.: (01)7802373, Telex: 875037 rex ch

TOPCALL International: Mosestiggasse 1, A-1232 Wien, Tel.: (0222)671535-0, Telex: 111388 ede a

Circle 14 on Reader Card

Please see us at EUROCOM - Amsterdam, Delta Hall,
Booth #208. Dec. 6-9.

The Plight of the Brazilian User

IS users in Brazil are caught in a nationalistic catch-22. The government's desire to create a computer industry has made some headway, but users either can't get the equipment they need or what they can get is exorbitantly priced.

BY JEFF MOAD

Christian LaPie has a problem. As information systems director for the Brazilian subsidiary of a major multinational bank, Cr dit Lyonnais of France, LaPie has been given a mandate by his company to develop a new IS architectural plan calling for the integration of all systems under a common database and for the development of major new decision support and risk management systems for upper management.

The problem is that Brazilian informatics laws—which apply to multinationals doing business in Brazil, as well as to Brazilian companies—make it impossible for LaPie's company, Banco Frances e Brasileiro SA, to get the products it needs to revamp its systems. For example, LaPie wants to establish an info center and allow networked pcs and terminals in the bank's 54 branches and its Sao Paulo headquarters to tie into a common database. To make the system work, LaPie says he needs Microsoft's new OS/2 operating system and its communications and multitasking capabilities. Under Brazil's software law, however, OS/2 isn't available in the country, and users can't be sure of when it will be. "OS/2 is critical, but I can't get it," says LaPie. "It's very frustrating doing business here."

For nearly 10 years, the Brazilian computer and software market—easily the largest in South America at over \$3 billion in 1987—has been at the center of a controversial government experiment. In an attempt to build a computer industry from scratch, the Brazilian government has, since the late 1970s, flatly reserved some internal IS markets exclusively for Brazilian vendors, refusing to allow U.S. and other foreign vendors to sell their products in Brazil. The government also has given Brazilian vendors big advantages in other IS markets, discouraged joint ventures, and made life difficult in many ways for foreign IS vendors. The result has been sporadic growth for the Brazilian IS industry as a whole. But along with the growth has come a rising tide of dissatisfaction, not

only from shut-out foreign IS vendors and their governments, but also from Brazilian IS users.

LaPie's experience is illustrative of the problems confronting IS users in Brazil. They have difficulty getting 386-based pcs, pc- and minicomputer-based CIM and CAD software, local area network operating systems, certain classes of laser printers and communications processors, and other products. Those products either fall into the segment of the market reserved by law for Brazilian vendors or are segments in which a Brazilian company is already marketing a product. When that happens, the Brazilian government won't allow a competing foreign product to be imported.

Some products—mainframes, for example—may be imported, but Brazil's protectionist policies still keep the number of foreign vendors low, reducing competition. Imported products also face stiff tariffs and other charges, which often increase the price of products by up to 100%.

In recent months, under pressure from the U.S. government and in response to changing political tides inside the country, the Brazilian government has begun to promise change. A new software law signed this spring offers limited copyright protection for the first time. The government surprised many observers when it approved a Microsoft proposal to sell MS/DOS in Brazil. More recently, the government has approved at least one business venture that suggests a more lenient policy on joint ventures between Brazilian vendors and foreigners. In addition, some trade tariffs have been lowered.

Such moves have prompted the U.S. government to suspend \$105 million in trade sanctions that had been threatened in retaliation for Brazil's protectionist IS import policies. The changes have also attracted the attention of multinational vendors, such as Rockwell, Convex, and others, who want into Brazil, a country with a GNP of over \$250 billion and a large and



The glittering modernity of Brasilia, Brazil's capital city, disguised a system with age-old problems.

growing industrial base, but still with a relatively low rate of IS use.

Hopeful vendors shouldn't start jetting down to Rio or counting their Cruzados just yet. Although Brazil's recent actions seem to have mollified the U.S. Department of Commerce, interviews with computer users, top Brazilian government officials, trade groups, and consultants suggest that, to date, very little has really changed in Brazil. The heralded new software law won't necessarily make it easier for foreign IS vendors to do business in Brazil. In fact, Brazil's protectionist informatics policy, fueled by a strong element of nationalist pride and reinforced by Brazil's pressing financial problems, seems unlikely to change dramatically in the near future, even though there is ample evidence that the policies haven't paid off, even for Brazilian IS vendors.

Besides high price tags, Brazilian-made IS products tend to feature outmoded technology, at least by U.S. and European standards. Brazilian IS vendors, although they enjoy market reserve protection from foreign competitors, face high costs because they are required to use a high percentage of locally produced components. For that reason, Brazilian vendors aren't able to compete on the export market. That keeps their volumes lower than other vendors, and further drives costs and prices up.

The Burden of Old Technology, High Prices

Brazilian IS vendors lag on using new technologies because the government bureaucracy overseeing information technology in Brazil causes delays in getting new products out the door. In addition, the rules discourage long-term technology joint ventures be-

tween Brazilian and foreign vendors. So, Brazilian IS firms either don't have access to foreign technology or, at best, can obtain only onetime technology licensing deals that leave their products outdated in a year or two.

Microtec, a leading Brazilian pc company based in Sao Paulo, is only just now beginning to ship pcs using Intel's 80386 microprocessor. Touma Makdisi Elias, a Syrian-born, U.S.-educated engineer who began the company in 1982, says he waited over seven months to get government approval to import parts to manufacture a 386-based pc. And even then he had to promise to manufacture a discrete version of the system using local components if future volumes are

high. Microtec didn't begin selling an XT-class PC until 1985 or an AT until 1986. IBM shipped the XT in March 1983 and the AT in August 1984. At the current exchange rate, a Microtec AT-class system with a 20MB hard disk lists for over \$3,000, about double the price in the U.S.

"In some ways the market reserve helps us," says Elias.

"But in many ways it hurts us. The bureaucracy gets in the way of our getting the best and cheapest technology in the world, and it keeps us out of the export market." Elias and other vendors have begun pushing for changes in the law that would make exceptions in local content requirements and enable them to compete with South Korea and Taiwan on the export market with for-export-only products.

In the meantime, users continue to pay the price for Brazil's IS trade policies. William Cline, a senior fellow with the Washington, D.C.-based Institute for International Economics, has estimated that, in 1985, users in Brazil paid \$528 million above international

In some ways the market reserve helps us, but in many ways it hurts us. The bureaucracy gets in the way of our getting the best and cheapest technology."

TOUMA MAKDISI ELIAS
PRESIDENT, MICROTEC

prices for Brazilian-made IS products. Based on the growth in Brazilian IS revenues since then, it's estimated that users overpaid by over \$900 million in 1987.

Brazilian government officials say they are studying IS product pricing patterns in Brazil and may take steps to force product prices to decline faster. Such steps could include adjusting domestic content requirements or removing certain key commodity products or components from market reserve protection. But top government officials, such as Luciano Coutinho, secretary general of Brazil's Ministry of Science and Technology, are quick to argue for continuation of Brazil's basic protectionist policy.

"We cannot expect that a sector like informatics in Brazil will be fully prepared to compete in just eight years. We have to give it a larger time span," says Coutinho, the Stanford-educated, Brasilia official who is number two in charge of Brazil's IS policy.

While Brazilian government officials may be content to give the current protectionist policies more time, many users are less patient. The high cost and spotty availability of key technologies means that users must take a slow, piecemeal approach to automation, which puts them at a competitive disadvantage.

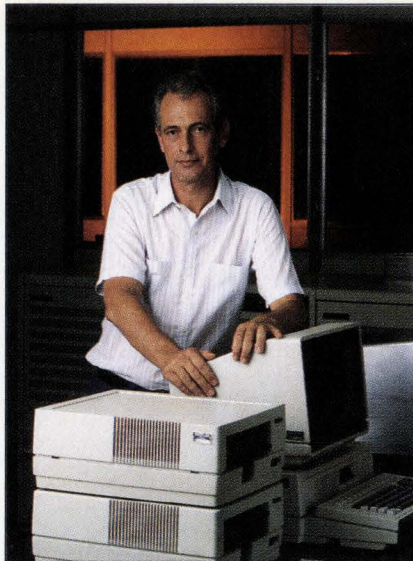

DEDINI'S CHAVES: No date for new VAX.

Dedini SA, a leading Brazilian manufacturer of alcohol and cement plants, located near Sao Paulo, is currently making a major push from a batch environment to an on-line environment, with an emphasis on project management and control manufacturing. "It's something we need to do to become more efficient and to compete for jobs outside of Brazil," says informatics director Mario Ivan Chaves.

Dedini began its current project in 1984, standardizing on Digital Equipment Corp.

VAX 750 hardware sold through a Brazilian distributor under a special 1984 government program designed to bring more advanced minicomputer technology into the country. Now that Dedini is beginning to implement its new system, the company has found that it needs more powerful minicomputers, but the Brazilian distributor has yet to receive government permission to import larger VAX systems. Dedini isn't sure when that will happen, and the company cannot be sure that the American-made Cincom software it uses will continue to be available on DEC hardware under the new Brazilian software law.

Another large Brazilian company with big IS plans is Pao de Acucar SA, the country's largest supermar-

The Exception of Autolatina

While all users in Brazil struggle with the effects of the country's protectionist IS policies, some are in a better position to cope than others.

The Brazilian government's Special Secretariat of Informatics can and does grant exceptions to rules restricting the importation of IS technology. Not surprisingly, SEI seems to grant those exceptions when faced with the needs of a large, multinational user that exports and has the option of taking its operations elsewhere.

One such user is Autolatina, a large truck and car manufacturing joint venture between Ford and Volkswagen in Brazil. Autolatina, which includes Ford and Volkswagen operations in Argentina, manufactures 900,000 cars and trucks annually. Many of those cars and trucks are exported, giving Brazil some much needed balance of trade.

Ford and Volkswagen combined their operations last year to improve sagging profitability. Early this year, Autolatina completed a business plan which, among other things, called for combining IS operations and standardizing on key systems, including accounting, cash flow, CAD/CAM, human resources, purchasing, and, perhaps most important, an on-line engineering information system. The Autolatina Systems Business Plan, published in February, states,

"To maximize the elapsed time and systems development investment required to accomplish these long-term strategies, Autolatina plans to utilize expertise and information systems from the parent companies to the maximum extent possible."

According to Autolatina chief executive for informatics Roberto Gobbi, the company already has gotten SEI approval to import Volkswagen's engineering support system, which will become the standard at Autolatina. The company was able to convince the government that it needed to import such technology rather than trying to assemble it from local components.

"We've always had a good relationship with the government. Our dialogue has been good, partly because we are able to do long-term planning, and it gives us time for thinking and changing," says Gobbi.

A walk through Autolatina's main data center near Sao Paulo shows that the company has plenty of ammunition. One of five data centers, the Sao Paulo site is equipped with IBM 3090 Model 200E and 4381 mainframes. Also in use are Siemens optical character recognition equipment, an IBM laser printer, and a 3725 communications processor—equipment that most other users in Brazil would find it difficult, if not impossible, to get import approval for.

ket and department store chain (annual sales of about \$2 billion). Like many large Brazilian companies, Pao de Acucar had until recently been family owned and managed. A new professional management team was installed last year, however, and with it came a plan to automate the company's in-store operations and order processing. That has meant going from a batch to an on-line environment and equipping stores and headquarters operations with networked pcs tied to IBM mainframes.

Pao de Acucar informatics director Julio Cesar Navas says the company has run into a problem finding the local area network software and bar code reading equipment it needs. Both technologies are covered by Brazil's market reserve policy, which means no foreign vendors can sell LANs or optical character recognition equipment in Brazil. To date, there are not many Brazilian OCR vendors, and users complain that Brazilian LAN software is inadequate, tending to rely on proprietary protocols.

The government already has turned down an application by Novell to sell its LAN software in Brazil, although that hasn't stopped several Brazilian distributors from claiming to represent Novell in Brazil. "There are a lot of adventuresome vendors who don't have real technical knowledge but who survive in Brazil because of the market reserve," complains Navas.

Pao de Acucar and other Brazilian retailers have formed a commercial automation users association to promote their interests. They have had some success in getting the government to approve trial applications using foreign products. But, for the most part, Brazilian users have not yet successfully organized or applied pressure on the government to ease the impact of its policies on IS users. Brazil's largest user organization, known as Sucesu, hosts the annual Informatics Congress and, according to many observers, seems to identify with Brazilian IS vendors as much as it does with users.

Although obviously hurt by their government's policies, many Brazilian users have been reluctant to be openly critical. "As Brazilians, we understand that there may be inconveniences, but we have to support the law," says Pao de Acucar's Navas.

Slowly, some users are beginning to speak out. Recently, even the normally docile Sucesu user group has begun to criticize the government's IS policies. Moreover, some important Brazilian industrialists have questioned the policies. For example, Ozires Silva, former president of Brazil's state-owned aeronautics company, Embraer, has complained in the local press that his company can't get the CAD/CAM equipment it needs to be competitive.

The Expansion of Market Reserve Policies

Brazil's protectionist IS trade policy began to evolve in the late 1970s at a time when the country was still ruled by a military dictatorship. The Brazilian navy first became concerned that the country was falling behind in the IS technology race when it was

forced to go to non-Brazilian vendors for advanced weapons systems. Brazil, which had been hit hard by the oil shock in the mid-'70s, began to formulate a plan to develop IS independence from the rest of the world for both economic and security reasons.

The government formed a high-level Planning Ministry commission to promote the growth of the Brazilian IS industry, and, by 1978, the commission had turned down a proposal by IBM to import its System/32 mini-computer into Brazil. Instead, said the government, five Brazilian companies—including one state-owned firm called Cobra—would sell minicomputers exclusively in Brazil.

IBM, which has done business in Brazil since 1917, continued to sell mainframes in Brazil. The Brazilian government, acting through its Special Secretariat of Informatics (SEI), continued to expand its market reserve policies until they covered the entire low end of the hardware market, effectively prohibiting everything below an IBM 4341. SEI also began to regulate technology licenses, government imports, and the import of IS equipment not affected by market reserve.

In 1984, Brazil replaced its military government with an elected, civilian government and, for the first time, spelled out its protectionist IS policy in what it called the National Informatics Policy law. That law continued the rule of SEI and market reserve at the low end. The law also allowed SEI to turn away foreign IS products that would compete with Brazilian offerings and to put limits on the transfer of technology and capital between Brazilian and foreign IS companies. For example, the law required full control of voting capital in joint ventures and 70% of capital ownership to be in the hands of Brazilian companies, and prohibited restrictions on technology transfers from foreign firms to Brazilian companies or joint ventures.

Critics point out that, by focusing not just on whether equipment is manufactured locally but also on whether Brazilian capital is in control of joint ventures, the Informatics law goes far beyond other import substitution programs undertaken in Brazil and in other developing countries. In Brazil's own successful effort to develop a national automobile manufacturing industry, for example, there were fewer restrictions on foreign capital.

As interpreted today by SEI, Brazil's informatics law means that, except for special cases, foreign vendors of micros and small minicomputers cannot sell those products in Brazil. It also means that foreign products not covered by the blanket low-end market reserve can still be banned if SEI determines that a Brazilian vendor is selling a competing product. So IBM can and does sell 4381 and 3090 mainframes in Brazil, since no national vendors make systems as powerful.

However, SEI says IBM cannot currently market its 3705 or 3725 front-end communications processors in Brazil because two domestic companies—Itautek and CPM Informatica SA—are selling communications processors that will work with IBM mainframes. As a

One user says Brazilians understand that there may be inconveniences, but that they must support the law.

The printers used by
more people can now be
used in more places.

Now you can connect the world's best-selling, best-performing dot matrix printers to your mini, main-frame *and* personal computers.

The connection works this way. An Epson-approved interface board easily installs into an Epson® printer, making it fully compatible with your Systems/3X,

AS/400 or 3270 environment. It's that easy.

The hardest part is deciding which Epson to use. There's the LQ Series—the number one line of letter quality printers in America. Or Epson's legendary FX printers, famous for their unrelenting reliability. Finally, there's the Epson DFX-5000. With a print speed

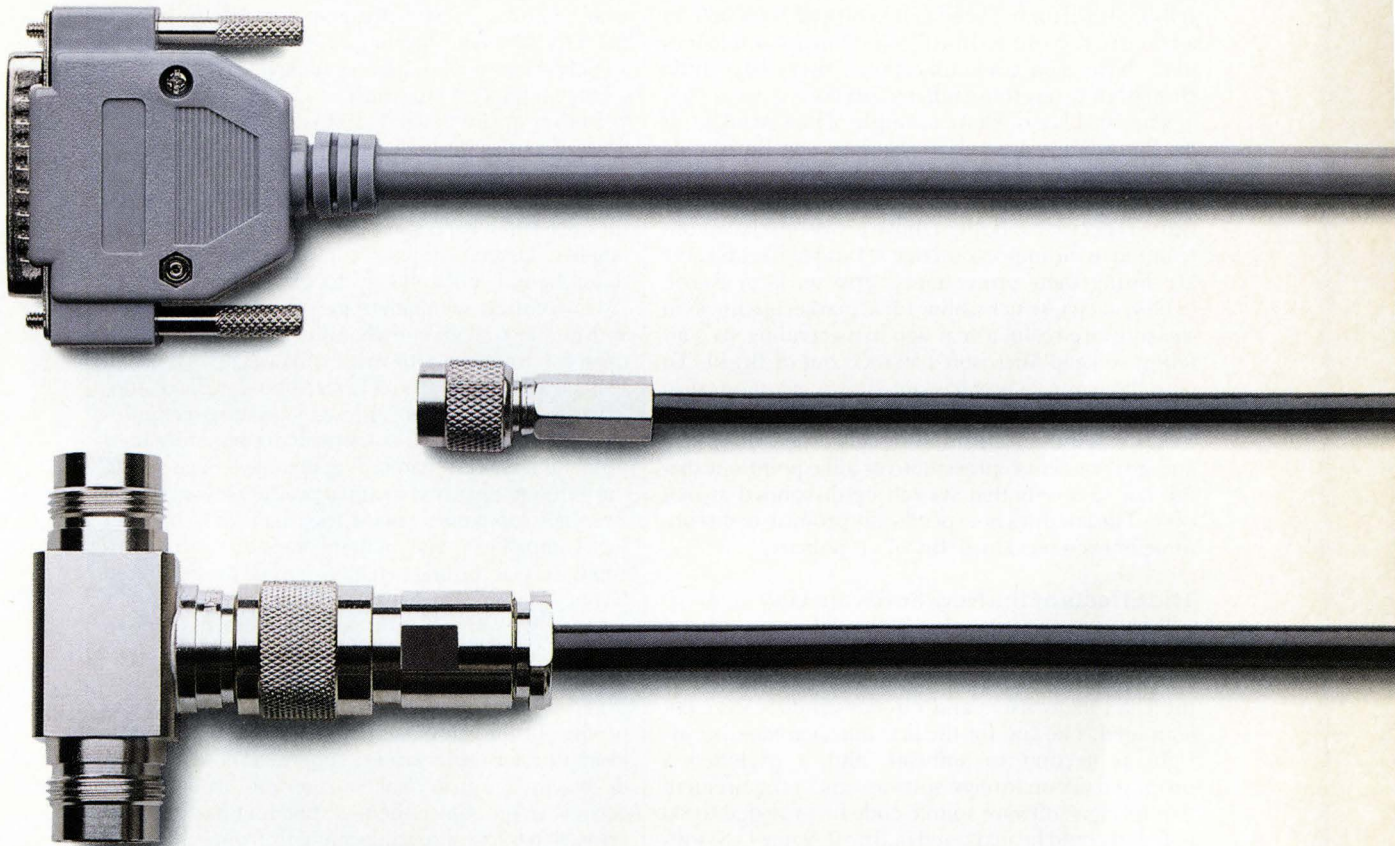

of 533 CPS, this high-volume workhorse is a smart, economical alternative to costly line printers.

In short, when you hook up Epson printers, your users get greater selection, better paper handling and outstanding performance.

Your company gets a tremendous value. And you get all the credit.

Of course, by now you've probably made that connection.

EPSON

**WHEN YOU'VE GOT AN EPSON,
YOU'VE GOT A LOT OF COMPANY.™**

result, communications processors in Brazil are wildly expensive. Users in Brazil say used 3705 processors that would cost \$10,000 in the U.S. command over \$300,000 in Brazil. The processor marketed by CPM is a local version of the NCR Comten processor, and it sells in Brazil for between \$500,000 and \$600,000. In a country the size of Brazil, where many companies must have data communications, users have little choice but to pay those inflated prices.

The 1984 law did have a couple of new wrinkles. It said SEI would continue to regulate IS in Brazil only until 1992. And it created a new government-private sector panel—called CONIN—with the power to overturn SEI decisions. Both of those provisions have contributed to the impression that SEI and market reserve are losing their protectionist grip on IS in Brazil. CONIN, in fact, struck a blow for IS market openness in the software realm a year ago by overruling SEI's attempt to keep Microsoft's MS/DOS out of Brazil. To date, however, CONIN has not shown any interest in going further in challenging SEI.

As far as the 1992 deadline is concerned, observers and government representatives alike point out that the law says only that SEI will be disbanded at that time. The law does not specifically promise to discontinue or even reevaluate Brazil's IS policies.

The Effects of the New Software Law

Brazil's new software law is similarly subject to interpretation. This spring, when the new law passed Brazil's legislature under the threat of retaliation by the U.S., many users and foreign vendors were encouraged. The law, for the first time, extended copyright protection to software and it excluded a proposed tax on foreign software and a requirement that foreign software source code be provided to SEI before it could be marketed in Brazil. Some U.S. software vendors that had stayed away from Brazil because of the lack of copyright protection are reevaluating their position. One is AT&T, which, until now, has not attempted to get approval to license Unix in Brazil.

On second look, however, many foreign vendors, including the software trade association ADAPSO in the U.S., weren't so thrilled with the new Brazilian software law. For one thing, the law offers copyright protection for only 25 years. For another thing, the law still bars foreign software if SEI determines that a "functionally equivalent" Brazilian program exists.

To make matters even more uncertain, the new law says foreign software can be approved only if it runs on computers marketed by foreign companies. So, Brazilian users of Cincom software running on VAX 750 hardware can't be sure that what they're doing will continue to be legal because the hardware is distributed by a Brazilian company. The new law calls for all foreign software, even that sold in Brazil, be recertified by SEI; the certification is only valid for three years. If, in the meantime, a Brazilian company develops a functionally equivalent program, a user of a foreign program could find itself out in the cold.

Foreign software vendors complain they don't know what SEI means by functionally equivalent. They're about to find out; SEI is beginning to rule on a

IS Still an Unknown Quantity to Many

Although some users in Brazil are part of large national or multinational companies with ambitious, sophisticated IS plans built around advanced, on-line applications, relational databases, and modern CASE development technologies, the majority of Brazilian users are still struggling to learn where IS fits into their core businesses. Most Brazilian users spend far less on IS as a percentage of revenues than their counterparts elsewhere.

One reason for that has less to do with the Brazilian government's informatics policies than with the way many older Brazilian companies are owned and organized. Many such firms, even large Brazilian companies, are still owned and operated by their founding families. That means many companies tend to be tradition-bound and unlikely to experiment with IS. "Many of these companies are still in the dark ages, with no MRP systems and a handful of internally developed batch applications written in COBOL," says Alan P. Blau, a partner at Coopers & Lybrand in Sao Paulo.

Partly for that reason and partly because technology is so expensive in Brazil, Brazilian companies tend to spend less on IS than U.S. companies. Even taking the difference in gross national product into account, Brazilian companies spend less than 25% of what U.S. companies spend on minicomputers and microcomputers, according to data compiled by the United Nations. Except for banks and large multinationals operating in Brazil, most users in Brazil seem to spend far less than 1% of annual revenues on IS.

Many family-operated companies are now trying to bring in more professional management. One by-product of that move is often a new focus on IS. For example, at Brazil's largest supermarket chain, Pao de Acucar, a professional manager was brought in as ceo a year ago. Since then, IS spending has been increased to 0.5% of revenue annually from 0.17%.

Brazilian companies trying to modernize still have a long way to go. First, Brazil's protectionist IS import policies raise the cost of IS technology. Second, what remains of the more conservative family management structure is quick to question the payoff from increased IS investments. "It frightens them," says Pao de Acucar informatics director Julio Cesar Navas. "They're always asking us why we need to do this."

series of key certification applications from foreign software vendors. Already, Lotus and Ashton-Tate have applied for certification and have been challenged by Brazilian companies claiming they have programs that are functionally equivalent to 1-2-3 and dBase III.

"The software law represents enormous progress for Brazil, but in many respects it falls short of what many users and foreign vendors wanted," says Sao Paulo attorney Georges Charles Fischer, a specialist on Brazil's computer laws.

Although the U.S. government suspended its trade sanction retaliation after Brazil passed the software law, even Washington wasn't enthusiastic about the law. "Frankly," says U.S. Trade Representative Clayton Yeutter, "we are dubious about whether it is possible to implement the marketing provisions in

**There's one
open system
so open, its
installed base
is growing
faster than
any other.**

UNI

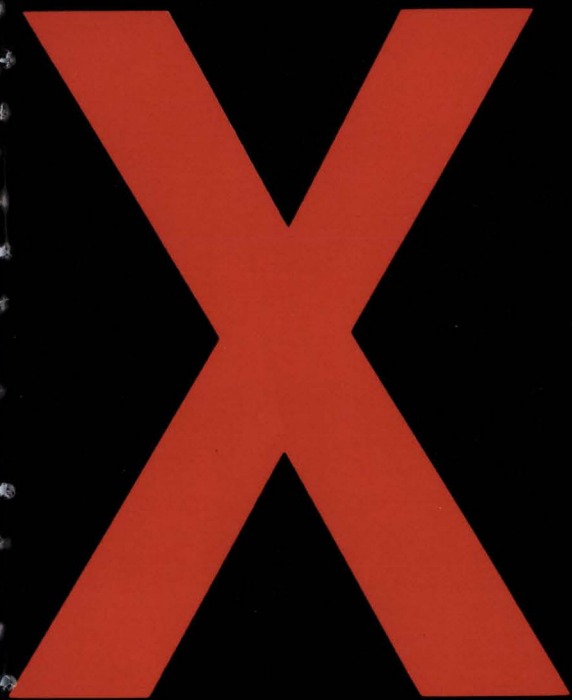
A large, bold, red 'X' symbol is centered on a black background. The 'X' is composed of two thick, intersecting diagonal lines. The background of the entire advertisement is split vertically: the left half is black, and the right half is a solid red color.

And there's
one company
that supports
UNIX[®] O/S best:

upgrades. And nobody supports this vision better than Unisys.

HARDWARE THAT FITS

Unisys offers you one of the broadest, best-fitting and best-supported ranges of UNIX solutions going. 14 models that serve one to 384 users. You can start a departmental system from scratch, integrate a loose collection of PCs, or put your whole organization under the UNIX umbrella once and for all.

SOFTWARE DEVELOPMENT TO BEAT YOUR DEADLINES (AND MAKE A DENT IN YOUR BACKLOG)

While the vision of UNIX applications is global, Unisys also provides 4GLs, like the MAPPER[®]-C, ALLY[®]

and LINC systems, to get new applications up and running faster.

Unisys 4GL applications are self-documenting and easy to modify and maintain. Our common user interfaces easily guide you into office automation and other applications. Plus, our U 6000 series runs the MS-DOS[®] system concurrently so users can keep using their favorite old PC applications.

With our commitment to POSIX and X/OPEN standards, you get a lot of software choices and freedom to communicate with UNIX systems around the world.

SUPPORT YOU CAN LEAN ON

There are some 23,000 Unisys service and support representatives worldwide. Getting one to come in and take care of your system is easy.

And not just your Unisys products—our people are qualified to work on other vendors' products as well.

A VENDOR WHO WANTS YOUR BUSINESS

Look into Unisys. We're a ten-billion-dollar computer company structured around our customers' businesses rather than our own products. From training your people to helping you plan an entire system, Unisys gives you one of the broadest, best-fitting and best-supported ranges of UNIX solutions you'll find anywhere.

Find out just how hard we want to work for you. Call us at 1-800-547-8362, ext. 83. Or call your local Unisys office.

Unisys and UNIX.
The power of².

29 reasons to work with Unisys:

REASONS 1-14:

An extremely broad single-vendor line of UNIX systems including:

U 5000/30

This model is built around the Motorola® 68020 processor at 16.6 MHz. It supports 16 users. Max memory: 8 MB; max storage: 820 MB.

U 5000/35

Motorola 68020 processor at 25 MHz. 32 users. Max memory: 8 MB; max storage: 4.4 GB.

U 5000/50

Motorola 68020 processor at 16.6 MHz. 64 users. Max memory: 16 MB; max storage: 2.3 GB.

U 5000/55

Motorola 68020 processor at 25 MHz. 64 users. Max memory: 16 MB; max storage: 4.8 GB.

U 5000/70

Multiple Motorola 68020 processors at 16.6 MHz. 128 users. Max memory: 36 MB; max storage: 4.2 GB.

U 5000/80

Multiple Motorola 68010 processors at 12.5 MHz. 64 users. Max memory: 16 MB; max storage: 3.8 GB.

U 5000/85

Multiple Motorola 68020 processors at 25 MHz. 80 users. Max memory: 64 MB; max storage: 1.8 GB.

U 5000/90

Multiple Motorola 68020 processors at 12.5 MHz. 128 users. Max memory: 64 MB; max storage: 7.9 GB.

U 5000/95

Multiple Motorola 68020 processors at 25 MHz. 128 users. Max memory: 64 MB; max storage: 8.1 GB. Top of

the U 5000 Series.

U 6000/50

The U 6000 line is built on the Intel® 80386 and runs the UNIX® and MS-DOS® systems concurrently. It handles 32 users. Max memory: 64 MB; max storage: 2.3 GB.

U 7000/40

The U 7000 series is the most powerful UNIX system we make. It was developed with scientific and engineering needs in mind. The U 7000/40 handles 240 users. Max memory: 32 MB; max storage: 16.5 GB.

U 7000/50

The U 7000/50 handles 100 users. Max memory: 32 MB; max storage: 16.5 GB. Single high-performance processor system which can be field upgraded to U 7000/51 and dual-processor U 7000/52 systems.

U 7000/51

Same as the U 7000/50, but with additional cache memory to provide even higher processor performance. U 7000/51 can support up to 240 users.

U 7000/52

Same as the U 7000/51, but with dual processors. U 7000/52 can support up to 384 users.

REASONS 15-18:

Having Unisys in your shop means: 23,000 service and support representatives worldwide to keep your systems up and running—even with third-party equipment.

System planning and implementation by Unisys

people trained in your company's business.

Ongoing training programs and user support.

The security of working with a ten-billion-dollar corporation.

REASONS 19-29:

UNIX O/S-based implementations of powerful software tools and overall software productivity platforms:

- ORACLE™ Relational Data Base.
- UNIFY™ Relational Data Base.
- Unisys MAPPER® 4GL System.
- Unisys LINC 4GL System.
- ALLY 4GL System.
- Unisys OFIS® Ensemble Office Automation System.
- Unisys AI Expert Systems.
- Language compilers: C, COBOL, FORTRAN, Pascal, BASIC, RPG.
- UNIX O/S shell with friendly menu-driven user interface.
- Connections to Unisys, IBM® and other systems, including industry-standard OSI, Ethernet, Public Data Network (PDN) and Defense Data Network (DDN) networking environments.
- Availability of thousands of third-party applications to solve your business needs.

With Unisys, you get one of the broadest UNIX lines in the industry combined with one of the best service and support organizations going.

Unisys and UNIX. The power of 2.

To find out how Unisys can give you a complete UNIX O/S solution, call us at:

1-800-547-8362, ext. 83

MAPPER and OFIS are registered trademarks of Unisys Corporation. Motorola is a registered trademark of Motorola Corporation. UNIX is a registered trademark of AT&T. Oracle is a trademark of Oracle Corporation. Unify is a registered trademark of Unify Corporation. IBM is a registered trademark of International Business Machines Corporation. Intel is a registered trademark of Intel Corporation. MS-DOS is a registered trademark of Microsoft, Inc. ALLY is a registered trademark of Foundation Computer Systems, Inc.

UNISYS

The power of 2

The whole point of the
UNIX operating system
is to create an open
world of software
transportability and
simple hardware

SYs

INCREASE YOUR SALES AND PROFITS...



The powerful, 6.5-lb. Toshiba T1000 is shown above.

With Laptop Computer Systems/Solutions from the HUGH CARVER GROUPSM



"The Portable Productivity People"

Here's how! Our portable *strategic sales information systems* deliver customer, market, product, sales, competitive and demographic information to your field sales and marketing personnel *on demand* by providing a bi-directional link to your internal corporate information systems. The ability to receive and send this vital data gives your people an important competitive edge, making them more *effective* and more *productive*. Applications including order-entry, checking inventory status and stock balancing, promotional and discount scheduling, E-mail and more can be accessed any time, any place it's needed. The results are increased sales and profits for your company.

We specialize in providing turnkey portable computer systems for sales and marketing applications among corporate users. The Hugh Carver Group has installed and supports *thousands* of portable computer systems for companies like General Foods, Cosmair, Warner-Lambert and dozens of other *Fortune 1000* companies. We have years of hands-on experience with computer systems from every major manufacturer as well as *unequaled expertise* in sales and marketing applications.

We create *customized* systems based on an understanding of your needs and expectations using *industry-standard* products (our databases are dBase III[†]-compatible, our networks are Novell[‡]). This unique approach guarantees data and equipment

compatibility with your existing information management systems as well as new technology environments should you decide to upgrade or enhance at some future time.

We provide it all—systems, software, support, training and a level of service *unmatched* in the industry. Fill in and mail the coupon today or call Todd Scofield, Exec. V.P. at (201) 274-3400 for more information on how Hugh Carver Group laptop micro-computer systems can boost productivity for your company too.

Fill-in and mail this coupon today to: Hugh Carver Group, Inc., 7 Deerpark Drive, Suite E, Princeton Corporate Plaza, Monmouth Junction, NJ 08852.

YES! I'd like more information on the Hugh Carver Group and how your portable microcomputer systems can boost productivity for my company. Please...

Send me more information Have a sales rep call me

My interest is: Immediate Within 6 months Keep on file

My company has _____ employees and _____ sales people.

Name _____

Title _____

Company _____

Address _____

City _____ State _____ Zip _____

Phone (_____) _____



HUGH CARVER GROUP, INC.SM

7 Deerpark Drive, Suite E
Princeton Corporate Plaza

Monmouth Junction, NJ 08852
(201) 274-3400



* up to 43% or more (Sales & Marketing Management Magazine survey results, May 1987 issue)

† dBase III is a registered trademark of Ashton-Tate, Incorporated

‡ Novell is a registered trademark of Novell Network Systems, Incorporated

Circle 68 on Reader Card

Brazil's new software law in a fair, nondiscriminatory fashion."

Brazil's IS trade policies have succeeded in at least one respect. SEI figures show that between 1979 and 1985, Brazilian companies increased their share of the Brazilian IS market to just over 50% from 23%. IBM holds the largest part of the remaining share. IS engineering employment has grown steadily—to over 45,000 from 15,000 three years ago.

That still doesn't mean the policies have been a bonanza for most Brazilian vendors. In fact, it's been just the opposite. Market reserve and Brazil's other IS policies have created an umbrella under which hundreds of national IS vendors have emerged. Particularly in the microcomputer market, where vendors must contend with the high cost of Brazilian components and a relatively small market—under 100,000 units per year—many Brazilian companies are struggling to survive.

Recently, one of Brazil's major pc vendors, SID Informatica SA, had to solicit a large government loan to stay in business. Some Brazilian pc vendors have openly accused competitors of resorting to smuggling lower-cost disk drives and other components into the country to boost profitability. According to Sao Paulo-based Arthur Andersen partner Silvio Genesini, "If market reserve and other regulations were dropped today, most Brazilian hardware companies would not survive."

Many Brazilian vendors are advocating that the government again insert itself into the picture, this time to engineer mergers among Brazilian firms in an effort to reduce the cutthroat competition. "Many of us feel the government needs to induce the prices," says Antonio Carlos Rego Gil, president of SID. "We also feel the scope of the government's protection is too broad. It needs to be opened in certain areas."

Overcoming Policy Mistakes

Government officials admit they are looking at speeding consolidation in the Brazilian IS industry, and, they say, they may have made a mistake in applying market reserve policies broadly to the entire low end of the computer hardware market. The result of that, say critics, is that Brazilian companies have spent precious research and development dollars reengineering what in the rest of the world are cheap commodity products, such as rigid disk drives and crts.

Nonetheless, say government officials, by and large Brazil's IS policies have done what they were intended to do—create a domestic computer and software industry. "Ten years ago," says the government's Coutinho, "Brazilian companies had only 2% of the market. Now, they have 50%." And, in some cases, says Coutinho, it hasn't been just a case of Brazilian companies capturing market share only because of favorable laws. Brazilian companies have shown technical creativity, too, he says.

"For example," says Coutinho, "in banking automation, it's a fantastic, Brazilian-conceived solution.

It's something that's very successful, and we believe that Brazil someday can compete in exporting that solution."

Banking automation in Brazil is, in fact, impressive. Banking has been one of the few segments in the Brazilian economy with both the money and the pressing need to automate. Brazil permits banks to operate on a nationwide basis, and many of the country's larger institutions have networks that span its 3.2 million square miles. In addition, Brazilian banks face huge transaction loads, partly due to the country's crushing inflation rate. Brazilians routinely write checks to pay for a cup of coffee or a pack of cigarettes because, in the 48 hours it takes for the check to clear, they come out a few Cruzados ahead. One major Brazilian

bank, Bradesco, estimates that it handles 6 million such transactions a day.

Brazilian banks have poured lots of money into automating tellers and branches, and most of the hardware and software for those jobs has been provided by Brazilian companies. SEI estimates that, in 1987, the financial and banking industries accounted for 41% of the IS purchases in Brazil. Many banks have seen their IS spending grow so fast that they have jumped into the IS business themselves. One large bank, Itau, has formed an IS subsidiary, Itautek, which is a major vendor of microcomputers and other equipment.

Critics answer that there is a lot more to IS in banking than automating tellers. "Itau and Bradesco will spend millions just to automate their tellers, but the technology's still not there to develop integrated, workstation-based systems," says banker LaPie. "It's still just too expensive here."

It should be said that not all users in Brazil face the same problems getting the IS technology they need. Large multinational users that are big exporters, for example, seem to have better luck than others convincing SEI of their need for imported technology. One example is Autolatina, a large automobile and truck manufacturing joint venture between Ford and Volkswagen (see "The Exception of Autolatina").

For now, most Brazilian users and most foreign vendors doing business in Brazil will have to continue dealing with a real world where protectionist policies keep prices high and make a lot of technology unavailable. The political forces that brought reserved IS markets to Brazil may have shifted considerably in the last 10 years. In addition, Brazilians may be facing increasing outside pressure to open up their markets. But, at least for now, the restrictive informatics laws are solidly in place in Brazil.

Explains Ricardo Saur, an industry consultant and an author of the original informatics law, "The argument against us is always that we sell poor-quality products for high prices and that we're very good smugglers. In some ways that's true. But in every country you will historically see a period where local industry has to improve its quality and lower its prices. The question is, are we doing that? We think we are."

We cannot expect a sector like informatics in Brazil to be fully prepared to compete in just eight years."

BRAZILIA'S COUTINHO

TO MAKE YOUR WRITING MORE RIVETING, STOP USING DULL CHARACTERS.

24-wire print quality. 9-wire price.

Ho. Hum. Yawn. That's how people

react when your writing fails to keep them glued to the page. But you'll get readers' attention and keep it, when you write with appealing, fully-developed characters. Like the ones created by our Pinwriter® P2200 printer.

The P2200's 24-wire print head produces crisp, fully-formed characters for a 9-wire price. Which means you get print quality that people will stop and read. At a price that won't stop you.

Of course, stand-out print quality is just one reason the P2200 is outstanding. It sprints through 55 letter quality CPS

or 170 in draft mode. Dresses up memos, letters, etc., with up to 128 type variations. And, like all our Pinwriters, it works with more software packages than any other 24-wire printer.

For more information about the entire Pinwriter Family, call 1-800-343-4418. And discover what a little character development can do for your writing.

For more information about the entire Pinwriter Family, call 1-800-343-4418. And discover what a little character development can do for your writing.



NEC PRINTERS. THEY ONLY STOP WHEN YOU WANT THEM TO.

NEC



SUPRA™ Opens Doors For Best Western.

PROBLEM: How to easily access and update large volumes of corporate information vital for strengthening image and facilitating expansion

CINCOM SOLVED IT: With SUPRA Advanced Relational DBMS and MANTIS, a powerful application development tool

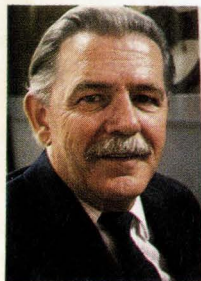

Mr. Robert C. Seate
Manager, Management Information Systems
Best Western International, Inc.

Tracking and managing information for 3,300 hotels in more than 30 countries around the world is enough to give any MIS manager some sleepless nights. But, thanks to the SUPRA™ Advanced Relational DBMS from Cincom®, Best Western's Robert Seate (along with member hoteliers and guests) can rest assured things are running smoothly.

"With SUPRA, we really have the best of both worlds," explains Seate. "We get the advantages of a relational environment and, at the same time, get a system that performs very well in a large volume production environment."

SUPRA's superior performance lets the world's largest hotel chain access and update the marketing data as well as the property and travel publications essential to support and promote each hotel. SUPRA also works in concert with MANTIS®, a flexible application development tool in the CASE ENVIRONMENT™, to drive multiple programs designed to monitor and upgrade quality standards throughout the Best Western organization. "When you increase the value of the chain, people want to become a part of it," Seate explained.

"SUPRA and all the Cincom products work together to help us meet our corporate expansion and quality goals," Seate points out. "It's a set of tools that is very flexible, very easy to use and learn, and very capable of developing and supporting a wide variety of applications."

As for SUPRA's reliability, Seate has no reservations. "Let's put it this way," he says, "we're running our payroll on it. We'd be crazy to do that if we didn't have a high degree of confidence in the system."

If you're looking for a relational data base with IBM and VAX compatibility, high performance and reliability, plus the option of a flexible application development tool, it's time you checked out SUPRA and MANTIS.

Call us today for more product and customer success information, or write our Marketing Service Department, Cincom World Headquarters, 2300 Montana Avenue, Cincinnati, OH 45211.

1-800-543-3010

In Ohio, 513-661-6000

In Canada, 1-800-387-5914

CINCOM

The Better The Solution, The Better The Value.™

Chargeback Systems Come Of Age

The practice of billing intracompany IS customers for the services they use is receiving increased attention from users.

BY JEANNE BUSE

As the era of liberal experimentation and vigorous growth in many IS shops winds down and emphasis shifts to cost control and cutbacks (see "IS Trims Down," Oct. 1, p. 46), both upper management and end users, as IS customers, are increasingly demanding a better grasp of how resources are used and a firmer handle on ways to cut back the associated costs. As a result, there has been a revived interest in chargeback—billing intracompany customers for services received.

A survey of five IS shops, chosen for their geographic and organizational diversity, shows that chargeback technology today can largely satisfy these demands. While their experience with chargeback varies from "seasoned pro" to newcomer, certain practices and conclusions keep appearing in the interviews:

- They all send customers a fixed-rate, usage-based bill and try (with considerable success) to operate as a business within a business.
- All are on their second or third chargeback implementation. The migration from one stage to the next coincides with an evolution in philosophy and occurs when the previous approach is no longer effective.
- The experience of the shops shows that chargeback requires a considerable, long-term resource commitment. It needs maintenance to remain current with business conditions and technology, periodic rate setting, and efforts to sustain user expertise.
- Several shops have found that implementing chargeback is a companywide effort involving customers, IS staff, and the

accounting department.

- The four firms that use third-party, high-end software to do billing (Signal Technologies Inc.'s PACS Plus and Morino Associates' MICS) found that software installation was not the main concern in their implementation.
- Chargeback will effectively involve customers with their IS needs, requests, and costs.
- Chargeback will effectively instill a cost and value consciousness both in services providers and in users.

Government of King County

The "seasoned pro" in the survey is the IS department in the local government of King County, Seattle. When the county's charter was modernized in the 1960s, the IS department was established without direct funding. It had to cover all of its operational expenses from usage charges to customers. In 1974, when budget growth was evoking concern, the county upgraded its IS rate structure and its rate-setting procedures. After the change, budget growth declined, customer satisfaction increased, and IS passed state and county audits.

Today, Clif Burwell, manager of IS, says his chargeback expectations have been

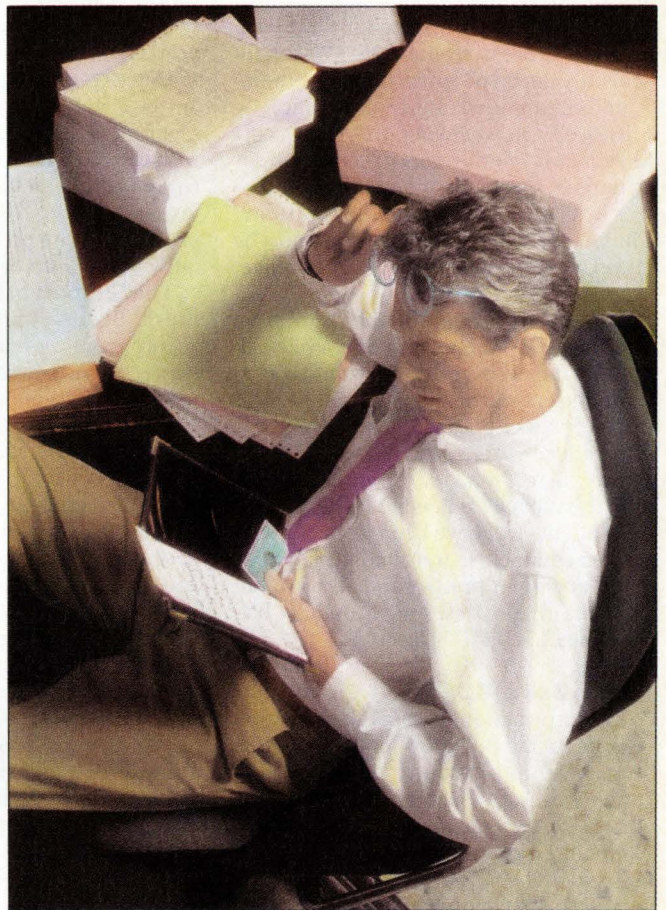

□ AFTER IMPLEMENTING CHARGEBACK SYSTEMS, USERS OFTEN EXPERIENCE SOME STICKER SHOCK.

met. The system provides accountability. "We wanted to identify the true costs associated with data processing at the county," Burwell explains. "We wanted users to be accountable for their costs and to be involved in the budget process."

The system also prevents cross-subsidies—where one user pays for another—which is important when serving non-county customers.

According to Burwell, the system makes IS "more accountable and more responsible for the services we provide. It is easier

to measure our performance because we've got the detail through the chargeback process."

Nevertheless, Burwell still has issues to address. One problem is the complexity of setting rates and customer budgets. It used to take two analysts roughly three months to complete the job.

In 1987, Burwell successfully modernized the process by hiring a consultant who introduced pc spreadsheet technology and streamlined usage forecasting.

Burwell's most vexing problem occurs when a customer's usage exceeds allocated budget. Overruns are not permitted either by law or by the accounting software. Thus, if overruns are billed, funds must be found to cover them; if they are not billed, chargeback is undermined.

The county's usual solution is to make adjustments at the next budget cycle. Although the ideal solution would be to charge users right away, Burwell says his method works because, generally, overruns reduce spare capacity and do not increase current-year IS expenses. By the time the capacity is needed by others, the adjustments will have been made. "Overall," he comments, "our budgets and our actuals come in pretty good. We are not right on in all cases, but, overall, it balances out."

Pacific Bell's ISO

The Information Systems Organization (ISO) at Pacific Bell, now more than three years into production, provides telecom services to California and Nevada. Chargeback was part of a companywide, planned response to divestiture. With the breakup, the heads of all the service organizations—ISO, motor vehicles, reproduction at Pacific Bell—began to consider how they would do business in the future, and chargeback was one option.

Chargeback at ISO dates back to the late 1970s. ISO installed a system that calculated monthly user charges by dividing ISO's bills for the month by the total computing resources used. Each user received the charge proportional to its share of the overall usage. Since users could never predict their share of the overall usage pie or what the total ISO bill for the month would be, the results were unpredictable and users could not be held responsible for budget overruns.

By 1982, ISO was being pressured by upper management to control costs and it was faced with endless requests for service by end users. Dissatisfaction with ISO's billing method was also expressed.

A feasibility study concluded that a fixed-rate, usage-based chargeback sys-

Six Keys to Chargeback Success

With six key elements in place from the beginning, the chances for a smooth chargeback implementation are greatly enhanced. Success in chargeback means that end users are responsible for the costs of their applications and that the IS staff is responsible for the costs of their products and services.

Understanding the Challenge. The primary challenge in realizing the potential benefits of chargeback is organizational, getting both IS and end users to accept new responsibilities, to feel comfortable with them, and, ultimately, to deal effectively with them. The technical aspect of installing chargeback is not the main problem, as the proper software will ease implementation considerably.

The Support of High-level Management. Because widespread organizational change is involved, high-level management support is needed to deal with resistance and to ease the task of assembling and motivating a project team.

A Diverse Project Team. In theory, the project team consists of everyone in the company who will be touched by the new system in their daily jobs, but these people really have limited contact with the system's development. Those whose basic job is to implement the project could be called the nuclear project team. An "extended" project team consists of people with some part-time involvement in varying aspects of the system's development.

The nuclear project team should be chaired by IS and should functionally report to it, since IS should "own" the chargeback system for its products and services. The key IS personnel on the nuclear team should be experienced generalists with both applications and systems programming background. On a nuclear or extended team, there also must be representation from each of the following:

- The end users who ultimately will be responsible for the IS costs, because they need to be convinced that the charges are reasonable, predictable, controllable, and competitive. They may have considerable

input also on how the bills are formatted and the charges presented.

- The applications project managers and staff need to understand how the applications generate charges, how charges can be controlled, how charges to customers are explained, and how the customer's IS budget each year is set or reviewed. They will be important in identifying customers and tying them to usage statistics.

- The IS technical staff needs to understand how their own work and behavior has an impact on the rates, how the rates are set, and how the applications and customers are affected by the rates. They may be involved in the collection, preservation, and forecast of usage statistics, and they will be instrumental in forecasting and controlling IS costs.

- The accounting staff must be committed before the flow of dollars between customers' and IS accounts will be permitted. They also may be involved in identifying and separating IS costs from corporate aggregates and in responsibility accounting.

Drawing on Existing Resources. Chargeback is challenging enough without starting from scratch. It is an established technology with considerable literature available, including articles, books, and government, accounting association, and market research firm publications. There are also consultants and training resources. Use these to reduce development time and costs and to improve the quality of the finished product.

Kickoff Training. Members of the nuclear team should receive the same initial training in chargeback technology. The process initiates team building and provides a common level of technological understanding between members.

Communicating to the Firm. Whether it is called communicating, marketing, or training, the job is still the same. The project team must get the word out to the company, from the project's beginning until long after implementation, when chargeback becomes an integral part of the organization's culture.

tem would make ISO accountable, forecast usage and costs accurately, and provide services within budget. It was also expected to give end users a better picture of their operational costs and to make them accountable for their ISO cost overruns.

The latter recommendation sparked a debate (that continued through 1983 and into 1984), over which groups, at what level, were to be accountable for ISO charges. The solution was to assign responsibility to the group that controlled usage, re-

gardless of level. Chargeback went into production on Jan. 1, 1985.

Has chargeback met its objectives? ISO's director of financial management, Michael Anderson, thinks so. "It has built a more appropriate working relationship between the client and the provider. Instead of us being fully responsible for the whole process, including paying for the freight, it is now a partnership where the client has a much greater interest in what he was receiving for his dollar. [Also] now

we are seeing that as we are pressed for improving financial results in our general company environment, [ISO] is one area the clients look at to try to reduce costs.”

Ronald Cassidy, manager of ISO financial systems, agrees: “Since chargeback has been in, I don’t think people have ever been as aware as they are now of how much it costs to provide services. We have pushed budget accountability quite low . . . so we are very aware, internally, of how much is being spent to develop and operate different projects. We are trying to deliver the best product at the cheapest price.”

What tasks necessary to perfect chargeback followed the initial implementation? One was to develop and maintain a group of “cost pool managers,” each of whom would be responsible for tracking a specific pool of chargeback costs. They set rates and serve as educators and problem solvers. These managers are needed as those originally trained on the system—both end users and ISO staff—are replaced by less experienced personnel.

Another effort was to extend the capabilities of the Chargeback Resource Cen-



KING COUNTY'S BURWELL: IS had to cover all operational expenses.

Photography by Rich Frishman

Only IBM Service can give you this kind of service.

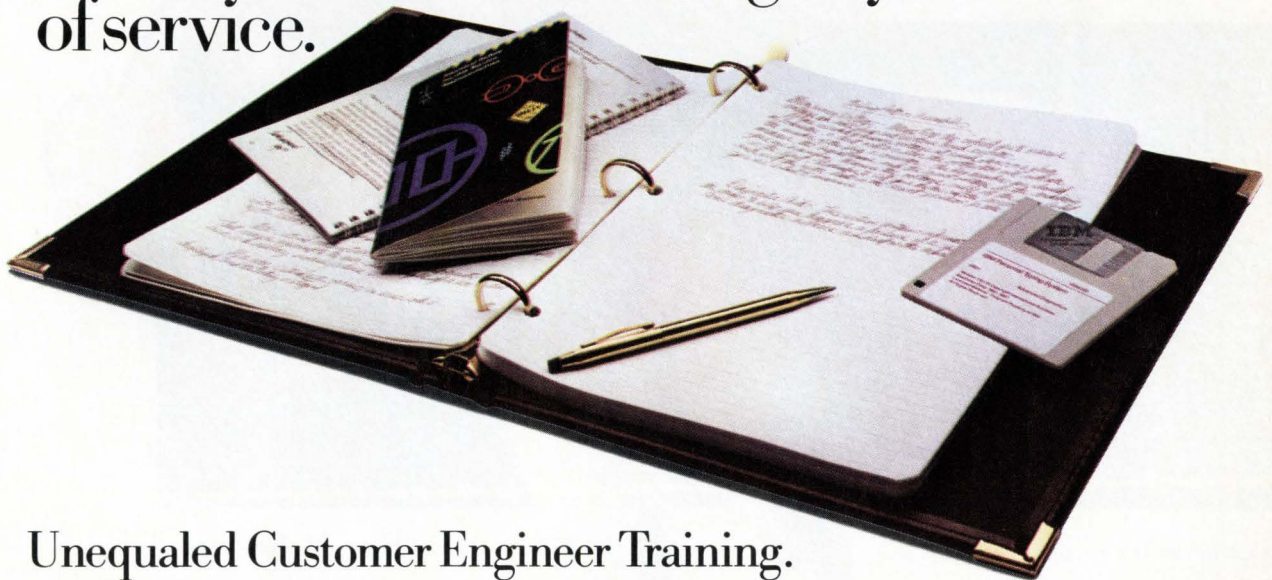

Unequaled Customer Engineer Training.

IBM Service people are the best trained on IBM products. This training starts even before a product is introduced and is continually updated. So, for the best service, come to the people who know your product best.

IBM The Bigger Picture

The Gandalf Hybrid.™ The advanced communications system that unites your computing resources for greater productivity.

The legendary Pegasus.

A classic example of Hybrid power.

A reflection of Gandalf's power of productivity.

We link the best features of your computing resources and deliver them to every desktop. Creating a totally integrated processing and communications system with superior reliability.

Suddenly your computers, local area networks and PCs are completely compatible, and communicating freely. Making more information more

accessible to more people. And giving each department the freedom to choose its own ideal computing resources.

As a result, your productivity soars.

And as your business grows and your computing needs change, the Gandalf Hybrid accepts any new equipment with ease. So with each new addition, the Gandalf Hybrid grows stronger.

More powerful.

Like the legendary Pegasus.



The Gandalf Hybrid, one of a series.

Paul M. Breden

For more information, call Gandalf:

In US: 800-GANDALF

In Canada: 613/723-6500

In UK: 0344/860272

In Europe: 31 20 867611

In Australia: 02-437 5977

In France: 33 1 47 60 0032

© 1988, Gandalf Technologies, Inc.

gandalf

Productivity
Through
Connectivity

Circle 24 on Reader Card

SOFTWARE
CHARGEBACK

ter to allow users to write their own reports in a fourth generation language, rather than requesting only existing, canned reports.

Does Anderson have any words of wisdom for companies considering chargeback? "When you are introducing a significant change, such as this, in the way you are doing business, you have to expect some resistance to change," he says. "Being charged back dollars as opposed to incurring them directly yourself... is threatening to people who aren't as knowledgeable in the state-of-the-art and the techniques of chargeback." Adequate planning and communication, combined with quality training and reference materials, will counteract this problem, Anderson feels.

Northwestern National Life

A third company, Northwestern National Life Insurance Co., which ranks 37th out of more than 1,800 life insurance companies in the U.S., is still breaking in its chargeback system. Its IS department is in Minneapolis.

Northwestern National Life has been

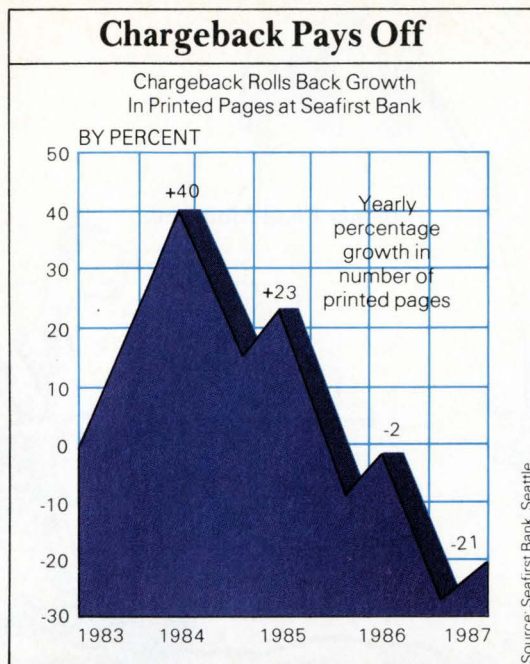

transferring costs to users since shortly after data processing began at the company, and it has had several billing systems. In September 1983, third-party software was replaced by in-house developed programs that allocated costs based on factors provided by the accounting department. As familiarity with this method-

ology increased, expectations of what information it could provide increased as well. Senior management voiced mounting concern over rising IS costs and wanted better control. In response, David Haskin, senior vice president of corporate resources, sponsored a project to tie the consumption of IS resources to expenses.

This required a new chargeback technique and another vendor's package. The implementation began in February 1986 with the project plan. The methodology and services were defined between March and June. The third and fourth quarters, respectively, saw the software installed and in pilot operation. Production began in January 1987.

After implementation, according to James Stubbs, then IS financial controller, users experienced some initial sticker shock. Previously, IS charges were lumped into corporate overhead. The new bills,

Chart by Catherine Francis

Only IBM Service can give you this kind of service.



Fast Access to Parts.

When you need assistance, you need it fast. That's why IBM has mobile vans, Customer Engineers, branch offices and field distribution centers across the country. So wherever you are, whatever you need, we can get you the right parts at the right time.

IBM The Bigger Picture

NO USER SHOULD BE AN ISLAND

If only I had MainLink.

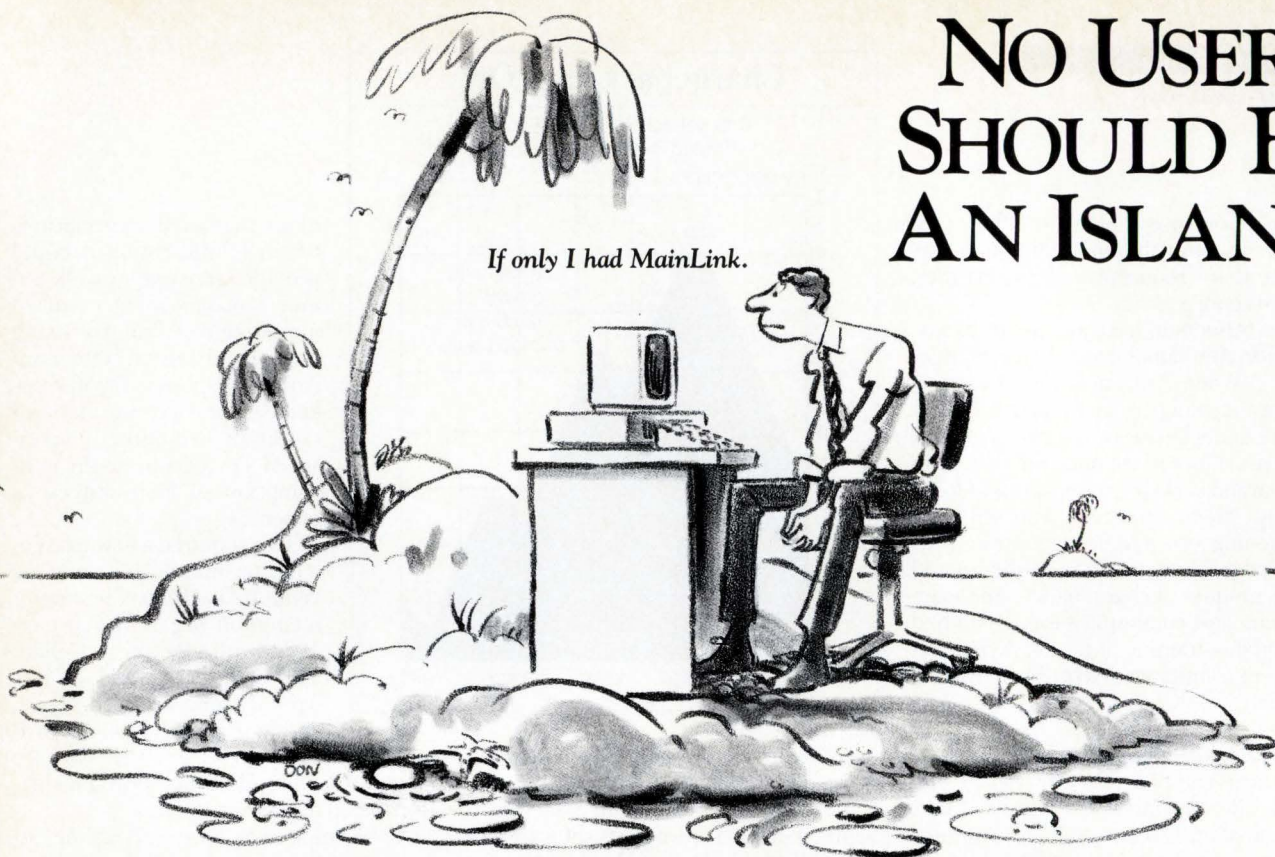

MIS's great recent challenge is to link end users directly to the powerful applications and invaluable databases your organization maintains. You create the opportunity for unprecedented gains in performance. You control and manage that linkage, merging performance and efficiency to achieve true productivity. But there are barriers. Cost is one. Many operations simply can't afford the high price of bridging the gulf between personal computers and the mainframe. Also, the turbulence caused by standards in conflict makes bridge building risky.

IRMA® + IBM® at a fraction of the cost

The MainLink™ terminal emulation system from Quadram has smashed those barriers and made system-wide emulation truly affordable. We've drawn on advanced ASIC chip technology to slash the number of components in the adapter board and give you register-level compatibility with both IRMA and IBM 3270 emulation, at less than half the cost of a comparable IRMA board. MainLink makes it easy to upgrade by starting with economical CUT and then adding software to gain more versatile DFT and Gateway capability as your needs evolve. Even then, you pay a fraction of

what others charge for multiple-session capability.

Now your people can run software designed for either emulation standard. In fact, MainLink II is fully compatible with OS/2 Extended Edition Communications Manager™. Not all leading emulation boards are. It's reassuring to know that with MainLink, no matter which standard prevails, you win.

MainLink by Quadram

Of course, staying power and support are critical for technology that gets this close to your mainframe. That's why working with Quadram is so reassuring. After all, we invented PC enhancement and we continue to enhance performance with value.

High marks from Datapro Research

But don't take our word for it. Ask the hard-nosed evaluators at Datapro.® They liked our dual-standard

performance so much, that they wrote, "MainLink products do what no IBM or IRMA board can do — they offer the user both IBM and IRMA register-level compatibility within one board." Later on they concluded, "... the dual compatibility, reliability, and low pricing make the MainLink products a winning proposition."

Evaluate it now

Send for your evaluation unit now. Choose classic bus or PS/2.* Try it for 30 days right on your system with your software. If you like it, buy it. If not, send it back. Either way, you'll have seen how to build bridges to all those islands. To order your evaluation unit, call Quadram at 404/564-5666.

QUADRAM 
An Intelligent Systems Company
We don't make computers.
We make them better.

One Quad Way, Norcross, GA 30093

Trademarks/owners: Quadram, MainLink/Quadram, IBM, PS/2, OS/2 Extended Edition Communications Manager/International Business Machines Corp. IRMA/Digital Communications Associates, Inc. Datapro/Datapro Research.

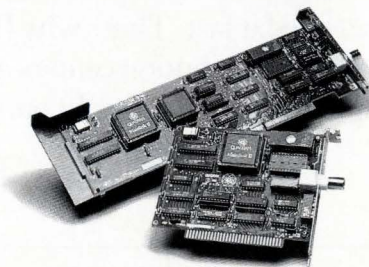

Circle 25 on Reader Card

SOFTWARE CHARGEBACK

while not causing a significant realignment of costs, make IS costs clearly visible. Stubbs, who is now with First Bank Systems, says that this precipitated a rash of questions about how rates were being set and whether the reported charges were correctly applied. However, by the fall of 1987, users were moving away from this line of questioning and beginning to address the real issue—managing the costs.

Scott Coryell, manager of computer management and evaluation, reports that the effects of chargeback can now be seen. User demands have leveled off significantly as their recognition of systems usage and how to do things more effectively has increased. Correspondingly, IS costs have reached a plateau and are no longer growing. Overall, Coryell is satisfied, as he believes chargeback has met its objectives.

What was their key to a successful chargeback project? The team approach, say Stubbs, Coryell, and Gary Booker, MICS administrator. Stubbs advises that "anybody contemplating implementing this has to work with a team. The team is comprised of your technical, your busi-

ness, and your accounting staff."

The other key to success is adequate attention to the impact on the people in your organization. "The actual mechanics of implementing something like this,"

□ WITH AN EMPHASIS ON COST CONTROL, INTEREST IN CHARGEBACK HAS REVIVED.

particularly when you have a good product, says Booker, "is fairly straightforward, fairly easy. It is the organizational aspects that are the toughest to deal with."

"I think the more time you can devote up front to the broader policy decisions, the better success you will have in the implementation," adds Stubbs. "It's not a technical problem, per se, it's the organizational problem."

Halstead Industries

Halstead Industries went into production with its chargeback system in January 1988. The privately owned company is

one of the biggest producers of copper tubing in the world, with its corporate IS headquarters in Zelienople, in western Pennsylvania, near Pittsburgh.

Halstead is the only exclusively non-IBM mainframe company in the sample; it is a six-node, Digital Equipment Corp. VAX/VMS shop with seven corporate sites from California to Connecticut. The sites and nodes are connected by a sophisticated Translan/Ethernet bridge that makes the system appear as though everyone were on one Ethernet cable in one building.

For the last 15 to 20 years, Halstead allocated IS costs to divisions based on total business volume, but that did not provide an accurate picture of how each was using the system. Since the mid-1980s, this has become an issue; as users have grown knowledgeable, they want their costs tied to their use in order to evaluate the benefits received.

Concurrently, another force drove Halstead in the same direction. Halstead IS decided to sell its services as a consultant on the ASK Computer Systems, OMAR, and MAN-MAN packages to outside customers.

Only IBM Service can give you this kind of service.

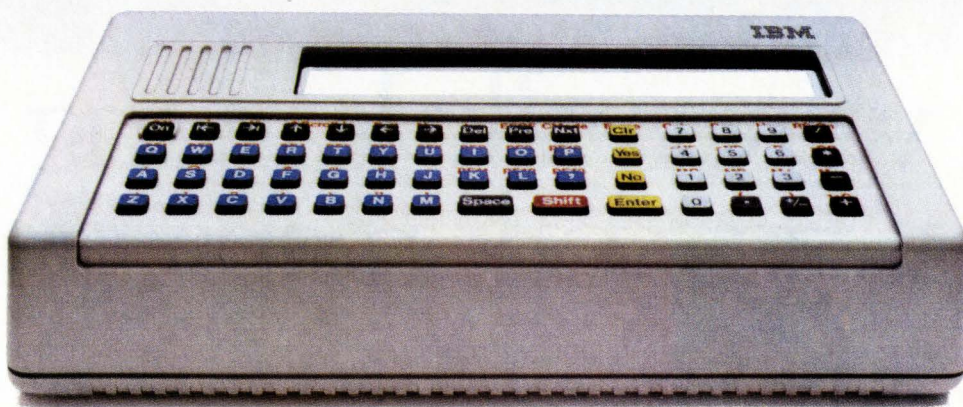

Instant Communication.

IBM Customer Engineers carry a portable communications terminal that gives them vital information before they get to a location. So they arrive better equipped to handle your equipment.

IBM The Bigger Picture



You were really learning about network management.

You tried to juggle too many activities, but you just couldn't manage everything.

It's even tougher today, keeping your users happy while managing a complex network of multi-vendor computing and network control resources.

Real network management involves network configuration, problem detection and correction, bandwidth management, cost

accounting, performance measurement, security, and network forecasting. That's a complex load to pile on your network management staff.

But you don't have to. Our easy-to-operate INF™ system provides all of the above and much more, yet requires no special hardware. It runs *in* your network! Magic? No, just another sensible networking solution from Telematics.

So, learn how to lighten your network management load with the free, premiere issue of *Network Consultant Quarterly*. Contact Telematics International in the U.S. at 1-800-NETWIDE or (305) 772-2117. In the U.K., call (0256) 467385.

TELEMATICS
COMPUTERS FOR COMMUNICATIONS

See us at TCA,
Booth #2406.

Circle 26 on Reader Card

SOFTWARE CHARGEBACK

In 1987, Halstead realized it needed a flat-rate, usage-based chargeback system to serve its own end users and consultancy clients, and it installed a pilot system in the fourth quarter. Production on that system began on Jan. 1, 1988.

The pilot was a success. According to Bernard Lane, corporate manager of IS, "the reception has really been a lot better than I expected. The information being provided is what the divisions are looking for." Overall, the implementation of the pilot system went smoothly, with the software easily installed. It had little organizational impact, however, since users were accustomed to being billed and they had requested an improved chargeback methodology.

The most work was in developing new, standardized IS rates. Rate setting had several steps—deciding what to charge for, identifying the cost components, and determining the actual dollar costs. The last step was the most difficult, particularly when specific IS expenses had to be extracted from a corporate aggregate, and then further subdivided by IS category, as, for example, in allocating processor de-

preciation to one rate and disk depreciation to another.

Rate setting also focuses on the issue of competitiveness. Lane wants to run his shop as a business: "I want to show corporate that we are making a contribution to

□ SETTING SPECIFIC RATES AND CUSTOMER BUDGETS IS A COMPLEX PROCESS.

the bottom line." Lane sees chargeback as "a tool to help me and to help the users. It helps the users monitor their usage, and it helps me monitor my costs. If I start charging too much for machine time . . . I am out of business."

Seafirst Bank

The last company in this series is Seafirst Bank in Seattle, the largest bank in the Pacific Northwest. Seafirst is the newest chargeback player in the survey, having begun chargeback only in 1984 as part of a conversion from Honeywell to IBM systems. All of the other firms had

been routing costs back to customers for many years before implementing their current system. At Seafirst, the first billing software did not handle on-line transactions and was replaced when these costs became significant. The second package was installed during 1986 and went into production on Jan. 1, 1987.

Seafirst differs from the other four organizations in that its users are not held directly accountable for IS costs. The company prepares and delivers flat-rate, usage-based bills, and the associated transfer charges appear on the income statement for each division "below the line." Managers are only appraised on "above the line" expense performance.

Among the several reasons for the practice, explains Timothy Turnpaugh, executive vp, operations group, is that many of the big-ticket items are "death and taxes" variety, nondiscretionary systems that would be run regardless of cost. The proper way to evaluate these, Turnpaugh feels, is not in absolute dollars, but in year-to-year usage trends.

Further, Turnpaugh feels that it would be counterproductive to compare costs of

Only IBM Service can give you this kind of service.



17,000 Customer Engineers.

IBM has over 17,000 highly trained Customer Engineers who provide round-the-clock nationwide coverage. So your business will never have to wait long to get the quality service it needs.

IBM The Bigger Picture

"20 years of
uninterruptible
power from
your LORTEC
3-phase UPS.

"Or your
money back."

Thomas S. O'Neill
President
LORTEC Power Systems, Inc.

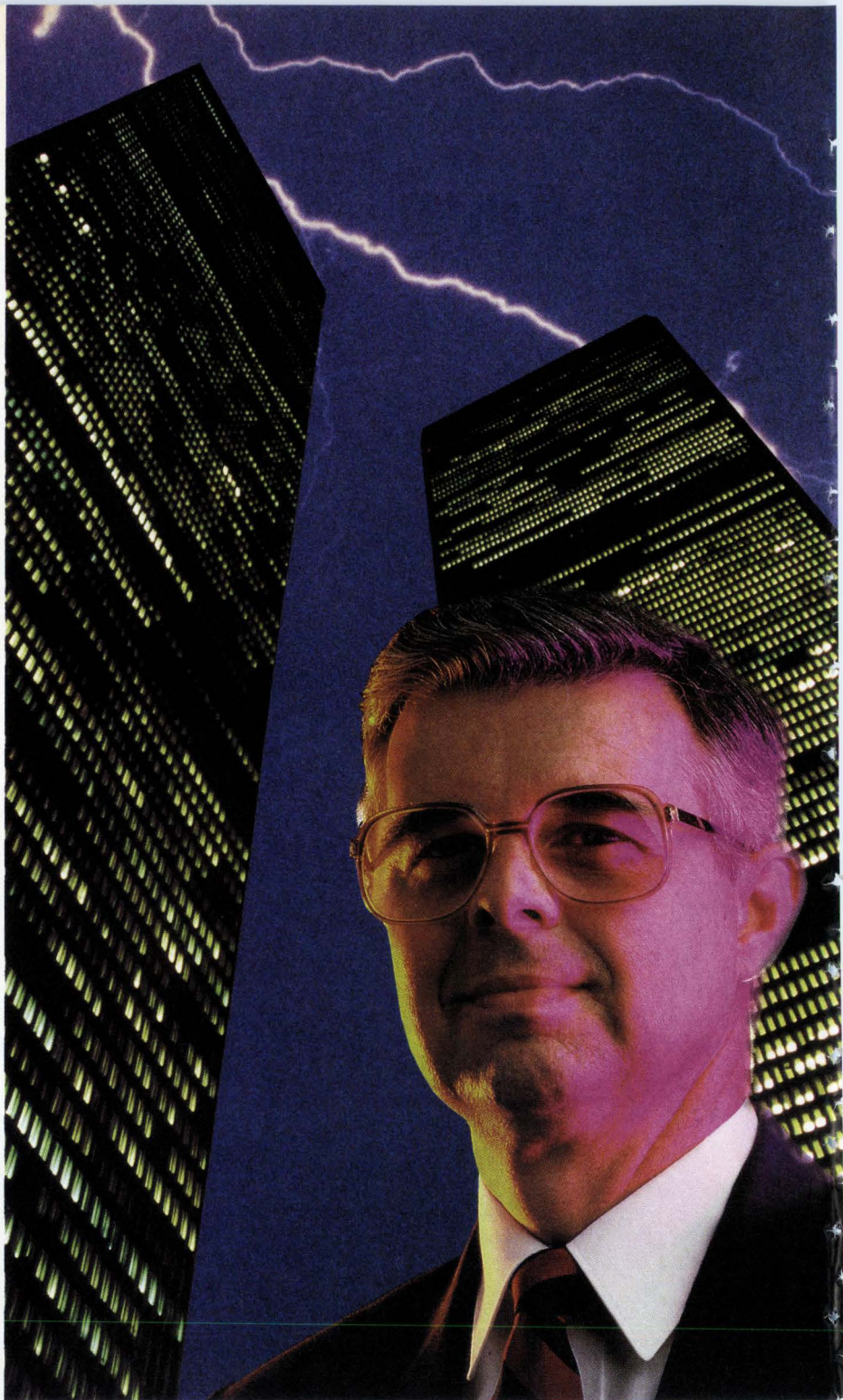

"It's one thing to talk about UPS reliability. It's another thing to back it up with a guarantee. A 20-year guarantee that includes parts availability for 20 years too.

"Well, that's what we've done at LORTEC — if you're not satisfied with the uptime protection of your LORTEC 3-phase system, we'll refund your money.

"We guarantee our system for 20 years, because we build it to last 20 years...with simpler circuitry and fewer electrical components than other UPS's. So there's far less chance of failure.

"Just let us certify the installation and annually inspect your LORTEC 3-phase UPS. Then if you're ever

dissatisfied with its uptime record, send the system back and I'll write you a check.

"That's LORTEC reliability. That's the LORTEC guarantee." *For more information call toll free, 1-800-222-2600, Ext. 265.*

LORTEC UPS
Because your bottom line is staying on line.

145 Keep Court Elyria, Ohio 44035

different, unrelated applications. He is also concerned that economic management, particularly at low organizational levels, might lead to undesirable, "myopic" behavior, such as avoiding electronic mail in order to save the monthly access charge. The real value of a chargeback system for Seafirst comes from reporting usage volumes, which are important in high-level, management-directed cost reduction efforts. An example is its contribution to Seafirst's war on paper. Seafirst recorded a 40% increase in printed pages between 1983 and 1984, which declined to a 21% reduction in pages between 1986 and 1987 (see "Chargeback Pays Off").

Seafirst is keenly interested in cost control because, says Turnpaugh, the businesses that "are going to win or survive in the future are going to have a tremendous grasp of their costs and the metrics associated with those . . . of the quality of their service and the costs associated with that . . . and of the relationship between their cost structure and their quality structure."

Jeanne Buse is a chargeback consultant and trainer with Softwright in Bellevue, Wash.

Looking Back

November 1973

IBM has an avid fan in Acting Attorney General Robert H. Bork, who, ironically, has ultimate responsibility for directing the Justice Dept.'s anti-trust case against IBM. After the case was filed, Bork, an expert in anti-trust law, went on record in *Fortune* magazine on the case. In discussing IBM's then practice of bundling software and hardware, Bork wrote: "Does the selling of computer and software together improperly inhibit the ability of rival computer makers to compete? Of course not . . . it is impossible to see the practice as a means of improperly preventing competition, and with that idea out of the way, the government's suit [against IBM] stands revealed as an attack on outstanding commercial success as such." With such comments on the record, there is some question whether Bork will pursue the IBM case with zeal. (From "Justice Now For IBM?" p. 17.)

November 1978

One retailing executive puts it this way: "I'm not as optimistic today as I was six

months ago about a mass market in home computers." What has happened to dampen all the enthusiasm?

[One] problem is software. Hobbyists are capable of writing their own programs; indeed, they enjoy doing so. But Warren Zorek, electronics department manager for the trendy Bloomingdale's stores, states: "My type of customer is not going to sit down and write his own programs."

. . . Computer Mart's Veit predicts that department stores will sell every unit they carry but envisions "people walking in here with those damned things with the wires dragging out of them and getting mad at me because I won't fix 'em."

". . . Just look at what happened with calculators and digital watches," Ernest said. "Within a couple of years, advanced technology made seemingly sophisticated products obsolete and caused prices to plummet. Since computers are built around the same chip technology, only a fool would predict that the same thing won't happen in this industry." (From "What Santa Won't Bring You," p. 141.)

Only IBM Service can give you this kind of service. Because only IBM has The Bigger Picture.

IBM offers a wide range of exclusive benefits that allow you to keep your equipment up and running. The people, the resources, the commitment and the experience are unequalled. At IBM this is all part of The Bigger Picture. And it's part of the reason nobody can serve you the way IBM Service can.

 The Bigger Picture

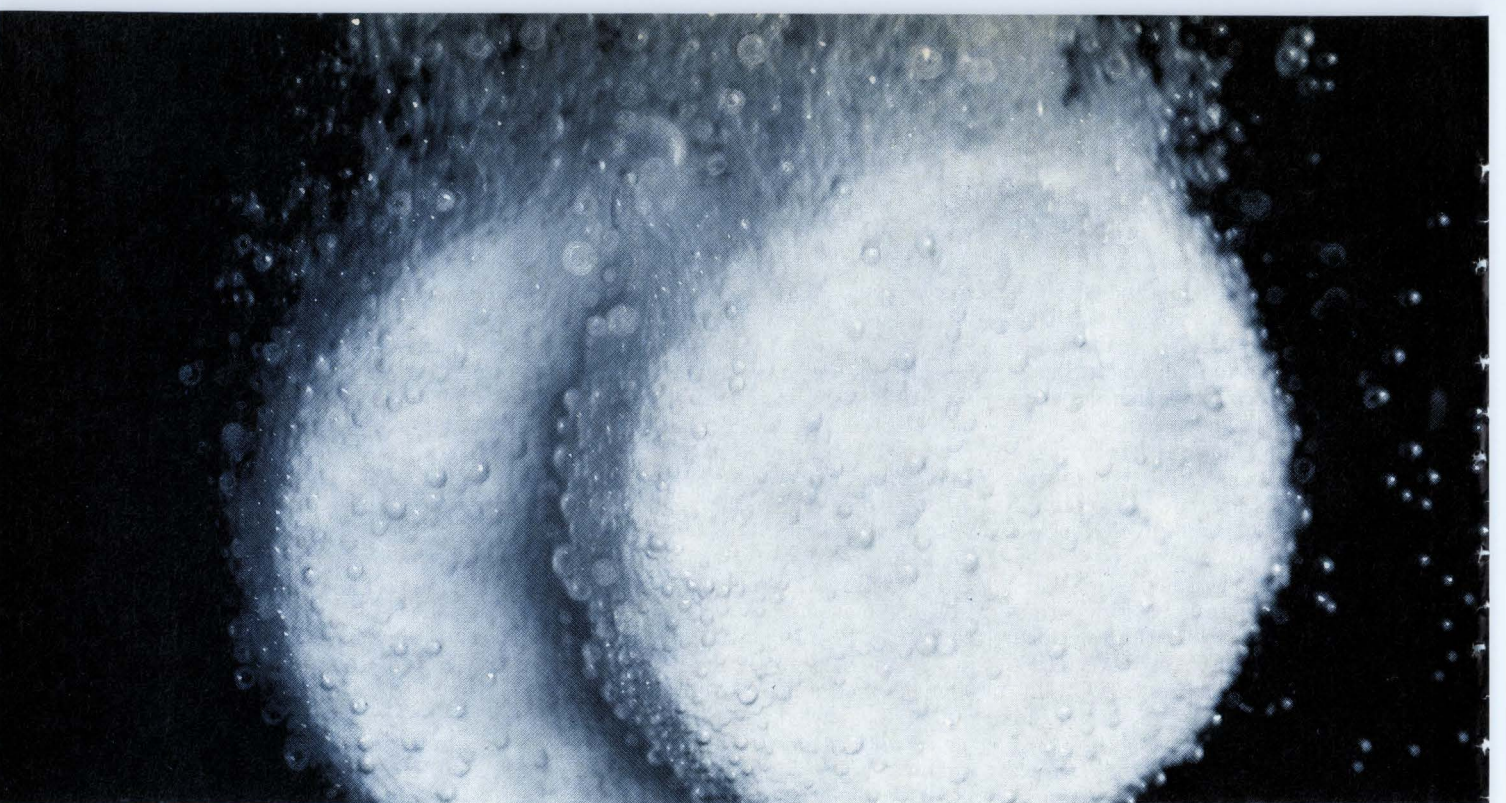

CHOOSING THE WRONG DATA ENTRY SOFTWARE CAN BE UPSETTING TO YOUR SYSTEM.

If you're considering changing your data entry system, you need to make the right decision. Choosing data entry software that's less than perfect can be upsetting to your system. FALCON and PC/FALCON can offer some fast relief.

Quite simply, FALCON is the best data entry software you can buy. In the May 1987 DATAPRO Report on Software, FALCON topped the ratings in overall user satisfaction. DATAPRO said, "If you are in the market for a highly efficient, highly flexible data entry system, you owe it to yourself to look at FALCON!"*

So call (800) 622-9292 and ask for our free FALCON video. Or ask about our free 30-day trial program. Either way, you'll see for yourself that FALCON is strong medicine for data entry headaches.

FALCON runs with MVS/SP/XA and VSE/SP under CICS and stand-alone under VTAM. PC/FALCON runs under MS/DOS.

FALCON and PC/FALCON are proprietary products of Phoenix Software Company, 5933 West Century Boulevard, Suite 1200, Los Angeles, CA 90045.



*Reprinted with permission from "DATAPRO REPORTS ON SOFTWARE: SW45-713UO-201—Systems Enhancements," DATAPRO RESEARCH CORPORATION.

EIGHT STEPS TO APPLICATIONS ENGINEERING

One way to ensure that your IS plan is in sync with your firm's overall business plan is to use an applications engineering approach that involves end users and executives right from the start.

BY RAY GOSLIN

There is no status quo in today's business world. In most cases, a company either moves ahead or it falls behind. To move ahead, a firm must be able to make reliable assessments of its computer applications' strategic impact. Those assessments should be the focus of a company's IS plan, a five-year road map to guide a company into the future.

Assembling a systems scheme of this scope is no trivial task. One way to help streamline and speed the effort is the Applications Engineering approach, which enables a company to take a critical look at its present IS operation and to forecast its future systems needs realistically.

The Applications Engineering technique that I developed 18 months ago while working as an industry consultant with IBM has been implemented by various U.S. companies over the past year. Used as a planning and productivity tool, Applications Engineering can provide the basis for an enterprisewide systems architecture.

On a more fundamental level, the planning process furnishes a company with an evaluation of its current information systems environment while collecting information for the IS plan and prioritizing its applications development activities. Along the way, the Applications Engineering method will help ensure that the finished IS plan complements the company's overall business plan. It will identify the resources needed to support that IS plan and pinpoint the costs and benefits associated with it.

The main advantage to the Applications Engineering method is that it views IS from an end-user perspective. Users, who are involved right from the beginning of the process, forecast their own future requirements. It also enables a company to examine its systems needs and applica-

tions requirements as a whole, rather than looking at them in a fragmented fashion. Applications Engineering, which has some similarities to an applications transfer study and to Business Systems Planning (BSP), actually uses elements from both of these techniques. It takes considerably less time, however, than a full-scale BSP study. Applications Engineering consists of eight steps, each of which has its own objectives.

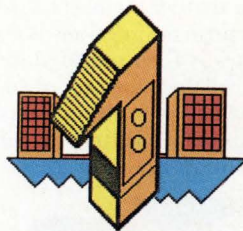

Forming the Project Team

The full-time project team should be made up of a high-level executive, an end-user manager, an IS representative, and a project consultant. Others can be added on a part-time basis if the executive or end-user rep feels they are necessary. The project consultant, who is normally the initiator of the whole effort, recruits the core team members.

The most pivotal person to be selected is the executive. The higher up in the organization the senior manager is, the greater the program's chances for success. Convincing the most appropriate executive to become involved should be a high priority of the project originator.

This executive actually sponsors the effort, and since this person has influence in the company and likely will be the one who approves or disapproves the resulting recommendations, it is crucial that this executive understands and supports the project mission.

That was no problem for Jim Bonk, the

president and ceo of Camelot Enterprises, Canton, Ohio, a videotape and record retailer. Bonk, as the executive sponsor in Camelot's Applications Engineering project, formed a staff team and stayed involved in the process from the beginning to the end. At the end of the effort, the Camelot ceo saw the results he'd hoped for.

"For the first time," Bonk says, "I feel confident that our information systems organization is becoming an integral part of our business."

To get that business orientation, it's essential to have end users involved in the Applications Engineering project. The end-user representative should be a knowledgeable business manager who enjoys the confidence of peers, subordinates, and superiors. The individual should be astute, with a good grasp of company politics as well as procedures and policies.

The IS representative on the project should be one who holds a relatively high rank in the company's information systems hierarchy. The person usually picked for the project is a manager who reports directly to the IS exec. The individual should have a good understanding of state-of-the-art computer and communications techniques and a thorough knowledge of the company's IS environment, as this person will likely play a critical role in evaluating the firm's future systems needs.

All of the team members, including the IS manager, will be picked by the project consultant, usually a respected end user in the company. This person actually guides the project through the various steps to completion. Since the project consultant is the leader, he or she should have the confidence of all the team members, especially the executive sponsor.

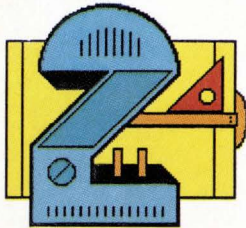

Devising the Project Plan

A half-day meeting with all the team members should be held to plan the project. At the start, the sponsoring executive sets the tone for the project, states the goals of the effort, and then turns the proceedings over to the leader-consultant, who briefly reviews and answers questions about the agenda. The team leader then presents an overview of the project methodology, making sure that all team members understand their roles.

Next, the scope of the endeavor is defined by the team. This will determine exactly what functional areas and which people from those areas need to be included in the project. This is an important issue because the number of people to be interviewed can determine the overall length of the project.

Discussing the project objectives comes next. A list of six or seven key objectives are developed to be used as guidelines for further project activity. Since both the objectives and the scope will be part of the final project report, it's a good idea to document both areas during this planning session.

Finally, the project schedule is set up based upon the number of people to be interviewed. A team will typically interview no more than 10 to 12 people during the course of a project.

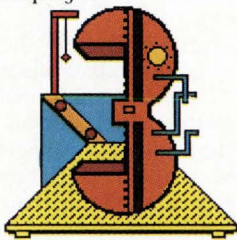

Interviewing Project Participants

During this step, which is the heart of the project, all the required information from the interviews is collected and documented. It is at this time that team members begin to formulate in their own minds what the company's IS needs are. This is when the seeds for future systems and applications development are firmly planted.

The project team working at the planning session should develop a general questionnaire that contains a series of open-ended questions designed to get the

pertinent information. As you might imagine, the more skilled the interviewer, the more valuable the information collected. "Conducting meaningful interviews is the nucleus of the whole Applications Engineering process," says Dennis Murphy, vice president of information systems at Carol Reed, the Portland, Maine, retailer of women's clothing and ski supplies. "If it weren't for our excellent interviews, our results might not have been as dramatic as they were."

All team members participate in the interviews, but one person functions as the primary interviewer, doing most of the questioning and probing for details. The person interviewed talks about his or her area of responsibility, present problems, and future needs. He or she is asked to consider what is needed to perform the job more effectively. Team members take copious notes during the session, which also concentrates on gathering justification data. For example, the person is asked whether having access to certain information will increase sales, decrease costs, or improve customer service.

A standard interview session should take no more than an hour. After it's over, the group discusses what it learned to make sure that all members agree upon what was said in the interview. A transcript of the notes is then prepared for future reference. All the information from the interview, which goes into the final document, helps build an IS plan that jibes with the company's business plan.

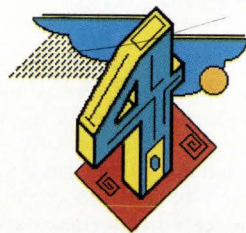

Setting Applications Priorities

After all the interviews have been completed, you need to derive something meaningful from all the information collected. You begin this process by reviewing the separate interview notes and by translating the information into applications nomenclature, where possible. To accomplish this, team members work together, sifting through each individual interview record.

Review the interview notes, extract the application, and then make these results visible on a chart. It is not unusual to identify 30 or 40 separate applications from this process.

Once this list is completed, the next order of business is to prioritize these appli-

cations. The project team determines in advance what the priority designations will be.

An "A" designation means that the application is essential to support long-term business interests; "B" means an application can either save the company significant amounts of money or can be a source for making money; "C" means an application has medium-to-low financial payback to the company; and "D" means the application would be "nice to have." Every application identified must be assigned a priority rating based on the judgment of the project team members.

This prioritization process proved useful for Gander Mountain, Wilmot, Wis., a catalog company that sells hunting, fishing, and camping supplies. This applications-ranking exercise "enabled us to determine the value of a given effort to our company," says Jim Stewart, vp and general manager at Gander Mountain. "We were able to sort through applications relationships and dependencies."



Performing Cost/Benefit Analysis

The purpose of the cost/benefit analysis is to give the executive sponsor and others some idea of applications' benefits to the company.

At a minimum, it should give the executive some feel for where resources should be applied to take advantage of those potential benefits. During this phase, every source of justification information from the interviews is identified. While it may be appropriate to distinguish between hard and soft benefits, many executives prefer that all the advantages be lumped together.

Costs, which are also estimated in the same global context, include prices for hardware, software, communications, and other resources. Personnel costs, where applicable, are also factored into the equation. When estimating software costs, modifications to existing packages are usually considered. A work sheet detailing some areas of potential benefits should be developed for each application. This benefit information eventually will be weighed against the cost figures.

Keep in mind that this exercise is not intended to be precise, but it should provide some direction on where the company



PRINT THICK FORMS WITHOUT GETTING BENT OUT OF SHAPE.

If printing multipart forms gives you multipart hassles, don't lose your cool. Lose the printer. And pick up a Datasouth DS 400 printer instead.

Datasouth specializes in building printers that put in long hours on the toughest jobs, without breaking down. And the DS 400 includes all the details essential to smooth multipart forms operations.

Details such as a straight paper path and a high torque stepper motor. So really fat forms feed straight through without creeping and bunching.

And a high power 18-wire ballistic printhead, backed up by a flat aluminum platen, to print clearly and legibly through six copies.

The DS 400 prints fast, too. Draft text at 400 cps, memo quality at 180 cps, and near letter quality at 120 cps.

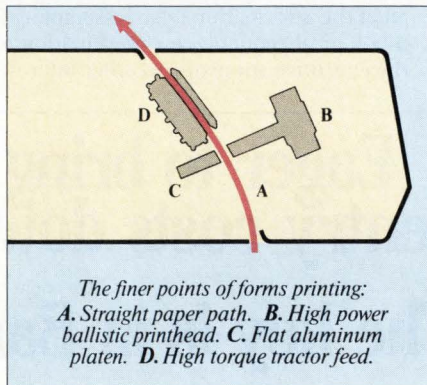

Datasouth has, for over ten years, built printers known for their reliability and industrial strength. That means you can count on the DS 400 to crank out those endless batches. Without a wrinkle.

So stop dealing with your printer's bad form, and start dealing with a Datasouth distributor. For more information, call 800-222-4528 or fill out the coupon below.



Datasouth
AMERICA'S HIGH PERFORMANCE
PRINTER COMPANY

P.O. Box 240947, Charlotte, NC 28224
Tel: (704) 523-8500, Tlx: 6843018 DASO UW
Sales: 1-800-222-4528; Service: 1-800-438-5050
West Coast Office: (415) 940-9828

Circle 29 on Reader Card

Please send me more information on how to get my forms output into shape.



Mail to: Datasouth Computer Corporation
P.O. Box 240947, Charlotte, NC 28224

NAME _____

TITLE _____

COMPANY _____

STREET ADDRESS _____

CITY/STATE/ZIP _____

(_____)

PHONE _____

SOFTWARE

APPLICATIONS

might want to invest IS resources to explore the pinpointed potential. Jim Sage, IS vp at Camelot, endorses the idea of taking a global look at the cost and benefits of an application before doing a more detailed analysis. "I think this approach uncovered some high potential benefit areas that might not have surfaced without it," notes Sage.

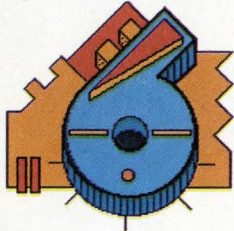

Building the Plan

How and when do these applications fit together into some sort of overall IS plan? The first step is to project the applications identified in the project over a period of three to five years. Normally, the "must have" applications are scheduled as soon as is practical. It is also wise to consider the resources and skills needed to implement these important applications.

One way to project those applications is to make a Ghant chart that reflects all of the applications identified over a period of years. The chart, which can be divided into quarters, includes ongoing applications development activities along with any new material identified by the project. The implementation phase calls for a Key Events chart to describe the activities that must be accomplished to satisfy the implementation plan.

All key events should be documented on this chart to indicate important milestones in the project.

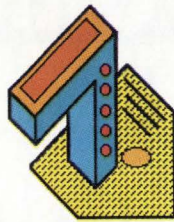

Developing the Presentation

At this point, the project team gathers all of the information it has, assembling it in a logical sequence for presentation to the executive sponsor and other interest-

ed parties. This step more than any other will determine the success of the project. Make sure that the presentation is properly prepared and flawlessly executed.

In preparing that presentation, be certain that all of the project objectives articulated at the initial planning meeting by the executive and the study team have been met. Discuss those objectives with the people in attendance at this session, answer any questions, and be ready to go into the rationale behind those objectives. You should also comment on the interview content. Go through the applications prioritization process and explain the higher priority applications. Be convincing when discussing priorities.

Furthermore, prepare some crisp recommendations to talk about. Discuss the applications list that was developed from interviews. Present the Ghant chart and talk about the benefits and costs associated with each listed application. Be prepared to explain the sequence and the reasons for the order of the applications. Be emphatic but realistic. Make sure the top priority items support the company business plan.

Illustration by Didier Cremeux

Eager to bring your data entry costs down to earth? The key is in Barbados.

Many of your competitors have already discovered that data entry and processing is a far more profitable process in Barbados.

Our work force is skilled and easily trainable, productive and enthusiastic. Our government is business oriented and welcomes any company that wants to dramatically reduce the high cost of data processing.

Our stable political and economic environment is ideal for

your business. You'll enjoy major tax concessions and yet have all the advantages of a fully developed business center.

Barbados has international sea and air ports; and the most advanced telecommunications system in the Caribbean.

Barbados provides the perfect climate for business. But why not discover that for yourself? Write or call us for more information.



BARBADOS INDUSTRIAL DEVELOPMENT CORP.
800 Second Ave., 17th Flr. N.Y., NY 10017. (212) 867-6420.

Yes, I am eager to reduce the cost of data entry.

Name/Title _____
Company Name _____
Address _____
City _____ State _____ Zip _____
Area of Interest _____

D-11/1/88

"This material is prepared by Van Brunt & Co., Advertising Marketing, Inc., 300 East 42nd St., New York, NY, registered with the Dept. of Justice, Washington, D.C. under the Foreign Agents Registration act as an agent of Barbados Industrial Development Corporation, 800 Second Ave., New York, NY. This material is filed with the Dept. of Justice where the required registration is available for public inspection. Registration does not indicate approval of the contents of this material by the United States Government." U.S./Foreign Agents Registration No. 1704.

SEARCH SOFTWARE AMERICA lets you

KEEP UP WITH THE JONESES, JUAREZES, AND THE JAMALS

and all the other names you care to find.

IN THE
NAME MATCHING
BUSINESS
LOST NAMES MEAN
LOST BUSINESS, TIME
AND PRODUCTIVITY.

As computer disk storage has become cheaper, more and more data is kept rather than discarded. Consider the volume of data and names that you have to sift thru. This can be disastrous if retrieval systems are time consuming or inefficient. Whether the names belong to customers, members, offenders or staff, SSA has the software for precise, quick, accurate name-matching whatever the hardware, database, or access method you use!

A MAJOR
BREAKTHROUGH IN THE
DESIGN OF NAME-KEYS
SOLVES THE ERROR
AND VARIATION
PROBLEM.

Our unique algorithm is designed to give fast response to on-line enquiry into databases as large as 50,000,000 records. SSA's rate of accuracy of 98.72% easily outperforms the capabilities of SOUNDIX and PHONETICS.

Whether they are the names of people or companies, despite the high rates of error and variation in names, regardless of their language of origin, our software allows you to achieve optimal performance from your database. SSA can help your business to significantly improve the quality of your searches while reducing the I/O by as much as 95% compared to traditional approaches.

IF CUSTOMERS ARE
YOUR BUSINESS,
YOU MUST BE ABLE
TO USE THEIR
NAMES.

Whether you have called your customer Smith, Smythe, or Smite, Roderiguez or Roderiques, whether you are talking to him or reading signatures, you have to be able to use his name and find his information. It is no longer good enough to rely on social security numbers, account numbers, policy numbers or dates of birth. Good service demands that you can use his or her name despite the phonetic, orthographic and anglicization problems in your data. Search Software America lets you start a new relationship with every name in your database system.

**Quite simply the most intelligent and accurate
name-matching software around.**

(And you can use it for addresses, too.)

Find out more about Search Software America's programs to suit any database, access-method, or hardware. Fill out the coupon today, or call and talk to one of our specialists.

COUPON INFORMATION:

How large are your present files?

- 25,000 to 100,000
- 100,000 to 500,000
- 500,000 to 10 million
- 10 million plus

Industry of your application:

System Use:

- Human Resources and Personnel
- Customer or Prospect Management
- Security or Justice File Searches
- Directories of Members or Users
- File Registries
- Document Retrieval based on names
- Name and Address Merge/Purge
- Other _____

Name _____
Company Name _____
Address _____ City _____ State _____ Zip _____
() _____
Business telephone _____

**Call or mail to our office in
the United States.**

Address: Search Software America
26 Indian Mill Road
Cos Cob, CT 06807

Telephone no.: **203-629-9253**

Telex no.: 5106015757



SearchSoftwareAmerica

**When your
DP execs
recommend
our products,
they've earned
a raise.**

They've offered your company a surefire way to boost its earning power. Here's why:

First, thanks to superior technology, Amdahl mainframes and peripherals (data storage and communications products) run IBM software significantly faster than IBM products do.

So you gain a significantly higher return on your data processing investments.

Second, Amdahl ranks first among all mainframe computer companies in service, technical and software support and ease of use, per an independent survey by the Datapro Research Corporation.

So you gain a level of service and support that ensures dependable performance over time.

Amdahl can improve the bottom line of any company that uses IBM mainframes and peripherals. And more companies are discovering this fact every day.

That's why we're a \$1.5 billion company today, with 7500 employees, plants in North America and Europe and sales/support facilities worldwide.

We have a lot to offer you. Just ask your DP executives.

Amdahl designs, develops and manufactures large-scale, high-performance computer and communications systems and disk storage products for corporations, governments, universities and research foundations throughout the world.

amdahl



Discover *Strategic* Micro Management!

Get the information you need to analyze and plan for the future implementation of end user computing: Buying trends by department, manufacturer, and vendor, statistics on installed base of hardware and software, or annual service and repair costs.

Monitor the costs and performance of your end user support staff: Support staff's average response time, the number of support calls taken, or the annual cost of training and support by product or department.

Show upper management that you are in control of their growing investment in end user computing.

**COMPUTER[®]
ASSOCIATES**

Software superior by design.
200 W. Lowe, Fairfield, IA 52556
(515) 472-6400

Discover The Micro Resource Manager (MRM) and you'll discover why over 500 corporations and government agencies have implemented MRM as their solution to managing end user computing.

MRM is an advanced fourth generation application that has earned the universal praise of micro managers, MIS directors, and software experts worldwide. Over 220 reports and queries allow you to:

- Track hardware, software, or services.
- Analyze budgets, costs, and trends.
- Determine use and distribution patterns.
- Control service and maintenance costs.
- Manage support staff workload.
- ... And much, much more.

Call today for a FREE demo disk.

**The Micro
Resource Manager[™]**

CIRCLE 33 ON READER CARD

Mainframe Interconnection Is Our Line

Our Products Include:

- Blue Cable "New"
- Bus/Tag Testers
- And Much More

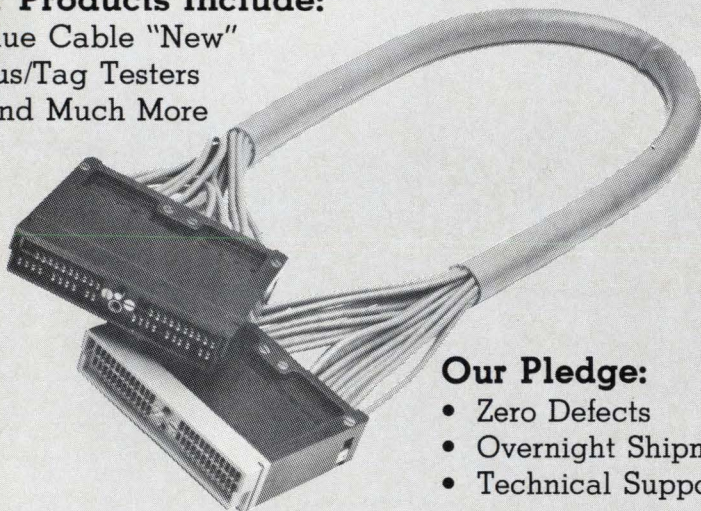

Our Pledge:

- Zero Defects
- Overnight Shipment
- Technical Support

Mainframe I/O Bus/Tag Cable Assemblies

For Pricing And Information Call

REN Electronics Corp.

(A Major OEM Supplier)

755 New Ludlow Road, South Hadley, MA 01075

East of Miss. R. & MN. 413-536-1800 West of Miss. R. 719-275-7595

CIRCLE 34 ON READER CARD

SOFTWARE APPLICATIONS

Get the executive team involved. Ask for their impressions and answer their questions. Allow them to change priorities, but be sure to get a commitment from the executive sponsor to proceed with the plan.

Finally, be certain to leave enough time to talk about the project in general.

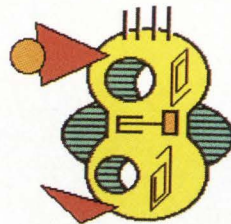

The Project Report

The project team writes a report that summarizes the main points of the project. Normally, each team member develops a different section of the report. This document, which can take many different forms, should include an executive summary, findings, recommendations, and appendices.

The executive summary describes at a fairly high level the current and future needs of the company. The summary should also highlight the applications plan that has been developed and focus on the assigned priorities.

The funding section details the cost justification benefits and cost descriptions and includes all the evidence to support the study findings.

Be sure to spell out the recommendations clearly and concisely. The rationale supporting the recommendations should also be well documented.

The appendices should include a copy of all interview notes and outstanding issues that were encountered during the project. The appendices should also contain a copy of the overhead foils used in the presentation.

If the preceding steps were well done, then the final project report is an academic exercise. Nevertheless, the report can have a lasting effect.

"It's been well over a year since we completed our Applications Engineering effort," reports Camelot's Bonk, "but I still refer to the output document to remind me where we should be focusing our IS resources.

"What we have accomplished based on our Applications Engineering effort is right on target, and I expect similar results in subsequent years," Bonk concludes.

Ray Goslin is a program administrator in the distribution industry segment at IBM in Chicago.

Illustration by Didier Cremeux

The anatomy of a prize Bull.

Bull printers are built to handle everything from tags, labels and bar codes to custom forms.

We know how precious floor space is. At 64" x 30" we occupy far less of it than most high-speed printers.

At speeds of 60 and 90ppm, Bull gives you the capacity to print anywhere from 200,000 to 2,000,000 pages a month.

Fewer moving parts mean fewer tune-ups and repairs. And our straight-through paper path virtually eliminates jamming.

Finally, you don't have to change paper in order to change printers. Bull can handle green bar and a wide variety of other fanfold paper stocks.

Bull's low price makes it the perfect printer for anyone who has outgrown a line printer but isn't ready to pay the high price of a laser.

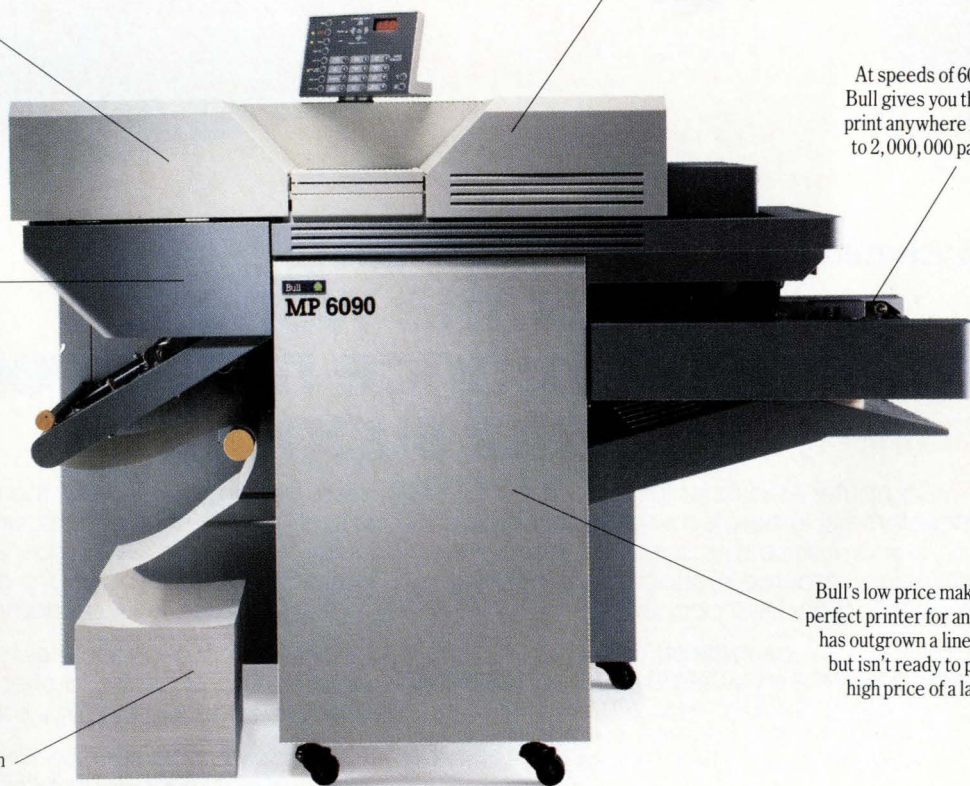

First prize in the printing arena ought to go to the company that solves the toughest customer problem. It's a problem that anyone who needs to print more than fifty pages per minute knows firsthand. Because until now, they had to buy a printer with twice the capacity they really needed. And a price that took years to grow into.

But now there's Bull. A blue-blooded descendant of the \$3 billion worldwide systems supplier, Groupe Bull. Thanks to a new non-impact technology Bull offers blue-ribbon performance for about half the price of a comparable laser printer.

To find out more about how well a Bull runs, call or send for free copies of an independent customer satisfaction report* and detailed data sheet. That way you can see for yourself why we call it a prize Bull.



1-800-541-BULL

Bull
Peripherals

**"Magnetography - A User Study" by Datek Information Services. Bull Peripherals Corporation, 303 Wyman Street, Waltham, MA 02154

Circle 35 on Reader Card

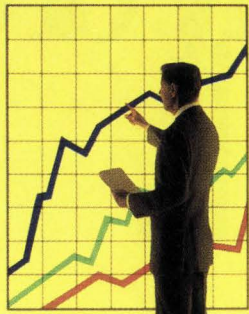

Systems software for MVS data centers:

Enter the world of total performance measurement, total support.

Computer Associates introduces the industry's first integrated solution incorporating performance measurement, capacity planning, resource management, network monitoring and job accounting:

**CA-UNIPACK™/PMA
PERFORMANCE MEASUREMENT AND ACCOUNTING**

Consisting of CA-FASTDASD™, CA-ISS/THREE™, CA-MAZDAMON™, CA-JARS®, CA-JARS®/CICS, CA-JARS®/DSA and CA-JARS®/IDMS or CA-JARS®/IMS.

With **CA-UNIPACK/PMA**, you can fine tune your system, improving its performance and optimizing the utilization of resources. You can reduce costs by accurately forecasting future hardware needs thereby avoiding unnecessary and costly additions or upgrades. You can accurately charge back costs to end

users, allowing you to treat the data center as a profit center. And most importantly, you can easily achieve the CICS response times end users expect, enabling you to consistently maintain service level agreements.

Only Computer Associates has the proven products and expertise to offer this cost-effective, total performance solution.

And only Computer Associates offers **CA-UNISERVICE®/II**, a secure link between your mainframe and CA's Customer Service System 24 hours a day. You get online access to software fixes, interactive problem resolution, plus product tutorials and more!

Call Dana Williams today:
800-645-3003 (Ext.)

© 1988 Computer Associates International, Inc.
711 Stewart Avenue, Garden City, N.Y. 11530-4787

**COMPUTER
ASSOCIATES**
Software superior by design.

- World's leading independent software company.
- Broad range of integrated business and data processing software for mainframe, mid-range and micro computers.
- Worldwide service and support network of more than 100 offices.

Resource & Operations Management • Financial • Banking • Graphics • Spreadsheets • Project Management

The Push Is On For Data Center Automation

A majority of data centers, which are the core of the MIS operation, are still run the old-fashioned way. Users are now pushing for more sophistication.

BY JEFF MOAD

By now, MIS has gotten around to automating just about every aspect of your company—from product design, to the factory floor, to distribution. Try naming an operation that has escaped the push to cut costs and improve quality by automating.

Give up? Well, what about the core of the MIS operation itself, the data center?

While large systems have grown dramatically in power, complexity, and cost in recent years, most data centers are still run the old-fashioned way.

Sounds pretty primitive, doesn't it? Many users are finally beginning to do something about it—they're pushing to automate data centers.

Users such as Alex Polonovich of Guardian Life Insurance hope to enhance systems performance by reducing operator errors, and by cutting data center costs by holding head count flat. Two years ago, Guardian became one of the first users of an automated operations software package called AF/Operator from Candle Corp., Los Angeles.

Like several data center automation products that have hit the market recently, AF/Operator reduces console traffic by automatically handling routine, redundant messages and by restating others in a way that is easier for operators to understand. Guardian has taken AF/Operator several steps further, writing exits that enable the Candle package to interface to basic scheduling software and to track errors automatically.

It's all about to pay off for Guardian, which recently decided to close a New York data center and merge its operations into the Bethlehem, Pa., headquarters' data center. According to Polonovich, the Bethlehem center will be able to handle

the doubled work load with no increase in operations staff, thanks largely to the company's automation efforts.

Costly Operator Errors

Guardian isn't the only large user hoping to solve its data center operations problems through automation. Accord-

yond the operator salaries. A lot of shops are looking at this from a performance and availability standpoint," says CMG president Mel Boksenbaum.

However you look at it, interest in automated data center operations from users that want better data center performance seems to be picking up rapidly. Lynn Eck-

house, president of the Association for Computer Operations Management, says that while only a fraction of data centers currently are automated, there's a lot of interest in it right now. "The number of messages being generated by on-line systems is becoming unmanageable," she says, "and many users are looking [to] a future where all their performance measurement and monitoring systems play together."

Vendors attempting to translate this interest in automated operations into sales include Boole & Babbage with AutoOperator for IMS; Duquesne Systems with AutoMate/MVS; Computer Associates with CA/Opera; and MVS Software with OPS/MVS. Products like OPS/MVS, which issues trouble messages to remote operators via a beeper and allows end users to solve some routine problems, seem well on their way to automating

much of the data center operations.

"By 1993, there won't be a job description for what we [now] call console operators," predicts Jim Woodhill, MVS Software marketing vp.

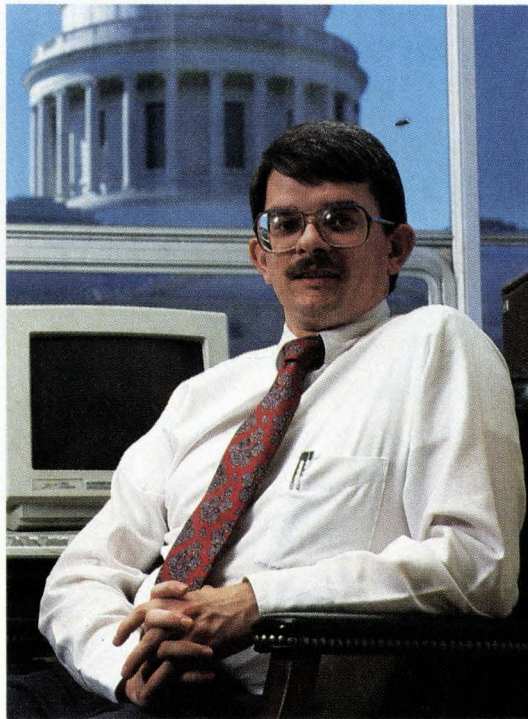

ARKANSAS' WOODS: An auto operator is the first step.

ing to the user-run Computer Measurement Group, over 40% of operations errors come not from today's more reliable operating systems, but from operator errors. "The potential savings go far be-

MIS manager buys M

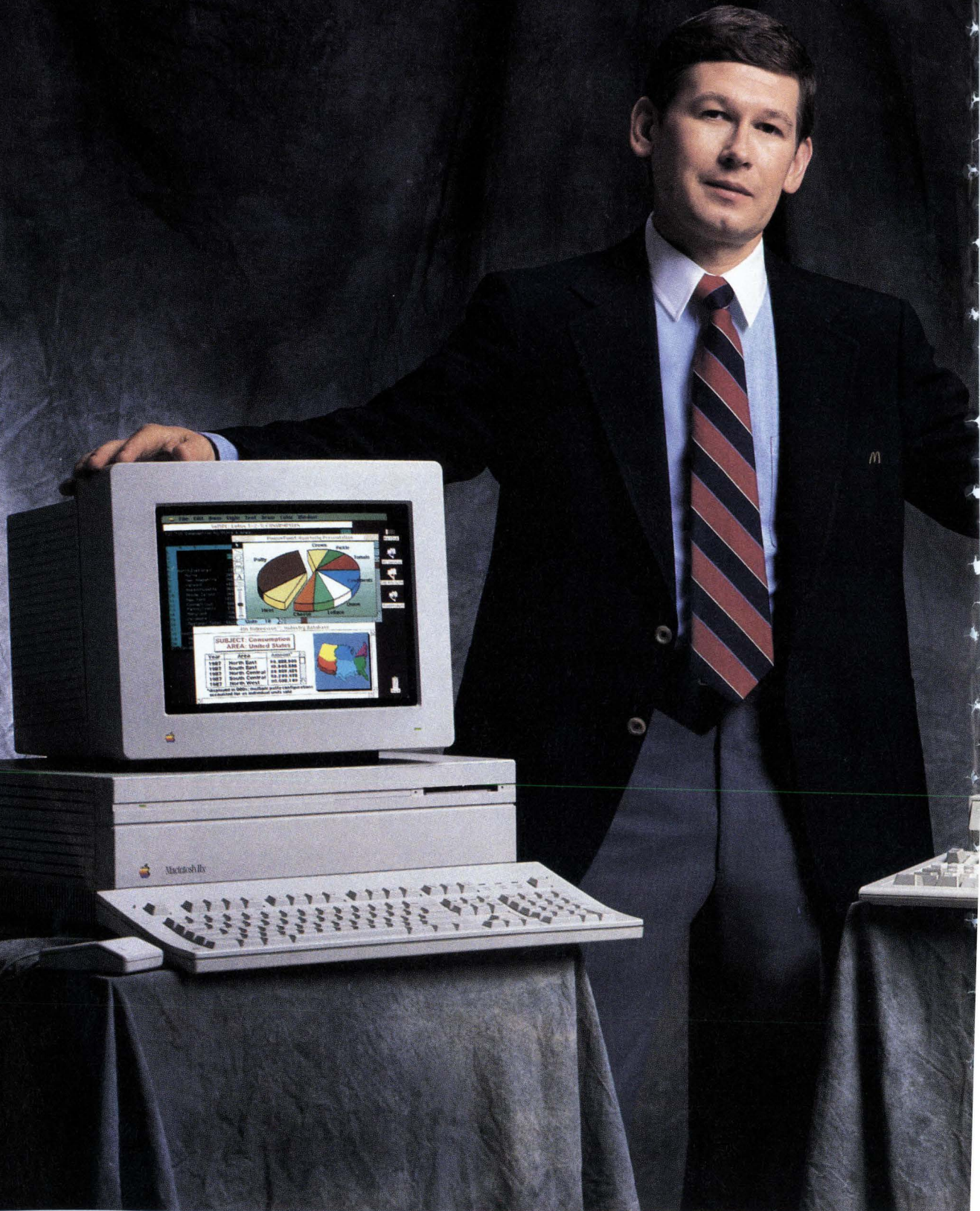

Macintosh keeps PCs.



Although we'd be quite pleased to have you replace every PC you own with Macintosh® computers, the introduction of our machines into a DOS office does not require any such drastic measures.

Because, and we'll say it flat out, Macintosh runs MS-DOS. Macintosh reads MS-DOS. And Macintosh shares data with MS-DOS computers.

How closely a Macintosh works with your PCs depends on what you actually need. Because Macintosh can be configured for almost any degree of compatibility. From easy speaking terms to an intimate working relationship.

If you need to run DOS programs such as 1-2-3 and dBase III, there are several easy ways to do that. One is the AST Mac286 card. Which you simply plug into a slot in the Macintosh II for AT-type performance. Or, if you prefer not even to lift a screwdriver, SoftPC is a software program that lets you run both DOS and Macintosh applications at the same time.

After closer analysis, however, you may find that the kind of compatibility that's really important is the ability to share information effortlessly between computers. Particularly if you have years of accumulated data stored away on PCs.

Here the Macintosh concept of workgroup computing proves itself in practice. In fact, you may find it easier to network Macintosh computers with your PCs than to network PCs by themselves.

Two examples of that are Novell Netware for Macintosh and our own AppleShare® and AppleShare PC file server software. With these systems in place, you can move data back and forth without complications.

And if you don't choose to network, there are other simple ways for Macintosh and PCs to communicate. One is DaynaFile, a Macintosh disk drive system that reads data directly off any of the several DOS disk formats. Another is MacLinkPlus, a cable and software system for sharing data between computers.

But no matter where the information originates, or how it's transferred, once on the Macintosh, this computer's unique power to analyze, enhance, and graphically communicate that information is unmatched.

Which is one reason Macintosh is moving into formerly DOS-exclusive realms in such great numbers.

For a lot more reasons simply call us toll-free at 800-446-3000, ext. 400, for the name of your nearest authorized Apple® reseller.

We'll show you how harmoniously and productively Macintosh can work with any PC work force. Without massive layoffs.



The power to be your best.™

© 1988 Apple Computer, Inc. Apple, the Apple logo, Macintosh and AppleShare are registered trademarks of, and The power to be your best is a trademark of Apple Computer, Inc. MacLink is a registered trademark of, and MacLinkPlus is a trademark of DataViz, Inc. DaynaFile is a trademark of Dayna Communications, Inc. MS-DOS is a registered trademark of Microsoft Corp. 1-2-3 is a registered trademark of Lotus Development Corp. dBase III is a registered trademark of Ashton-Tate Corp. AST Mac286 is a trademark of AST Research, Inc. Netware is a registered trademark of Novell. SoftPC is a registered trademark of Trigenia Solutions. McDonald's and the Golden Arches are registered trademarks of McDonald's Corporation.

Circle 37 on Reader Card

Many users are seeking more than the automation of the console operator function, though. They want data center automation that allows functions to be coordinated. And, more ambitiously, they want a central automation function that also communicates with and acts on information from more complex existing performance monitoring software—programs such as Candle's Omegamon performance management tool or Boole & Babbage's IMF IMS performance tool. "The vendors are just scratching the surface," says Guardian's Polonovich. "We are at the point where we need a system that can bring all the information together and start thinking for itself. A lot of work needs to be done on an AI shell that can make that happen, but it's not there yet."

To get there, many software vendors are rapidly working on interfaces between their automated operations products and performance management tools. "The number one concern for many of our users," says Candle Corp. marketing vp Fred Tremblay, "is when will we have a bidirectional interface between Omegamon and AF/Operator." Candle has promised

such an interface later this month.

Once those interfaces are in place, users and vendors will seek ways to enable automated operations packages to recognize and respond automatically to problem signs the monitoring tools pick up.

One approach being taken by several vendors is to adapt their automation products and performance monitoring tools to IBM's SAA-compliant Rexx high-level procedural language. Using such a language should help vendors and users enforce rules on how the automated systems operations software deals with common problems reported by the performance monitoring software.

Big Blue Joins the Ranks

Recently, IBM announced plans to support Rexx under its NetView network management umbrella and said that it would publish a programming interface between NetView and its Knowledge Tool expert systems product. This move has put IBM among the ranks of vendors pushing automated operations that are enhanced by expert systems.

Some vendors have begun to experi-

ment with adding expert systems compilation techniques to performance monitoring tools. Boole & Babbage, for example, has shipped DASD Advisor to 150 users since February. Such products, however, apply expert systems to performance monitoring on a tool-by-tool basis rather than through a centralized automation facility. Most vendors say they will take that step eventually, but none seems ready to do so just yet.

Meanwhile, users say, there's still plenty of work to be done shaking all the bugs out of the console automation products now coming to market. Users such as Steve Doubleday, an MVS system supervisor at Kaiser Permanente, say that vendors need to think about integrating the console functions they're automating before they begin to add performance monitoring and expert systems to the picture.

Doubleday's Pasadena operation is working with MVS Software to add such integration into its OPS/MVS package. Without it, he says, "We could all be in for a nightmare. We could be seeing all kinds of unintended impacts on performance that we don't want, and we can't afford."

THE INFORMATION FACTORY: The Dream Becomes Reality

INFORMATION

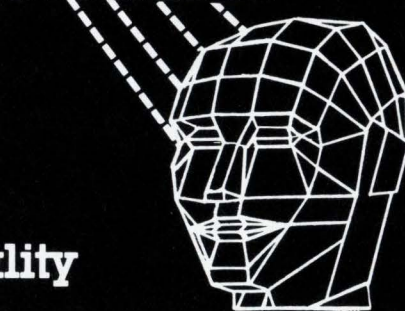

ACTIONS/
DECISIONS

The "Information Factory" is no longer a dream; it is a reality. Implementation details are spelled out in a new book entitled, "THE IRM REVOLUTION: BLUEPRINT FOR THE 21ST CENTURY". This is must reading for those executives and professionals who want to keep abreast of the Information Resource Management (IRM) field. Not only do the authors provide an executive level overview of the concepts and philosophies for IRM, but specific details are provided that can lead you into the information age. It offers pragmatic advice on:

- PROJECT MANAGEMENT
- ENTERPRISE ENGINEERING
- INFORMATION SYSTEMS ENGINEERING
- DATA BASE ENGINEERING
- QUALITY ASSURANCE

The know-how included in this book was developed and proven by thirty years of successful experience. It was not generally available until now due to its proprietary nature. You will see why many successful international corporations have adopted this knowledge.

There are approximately 300 pages in the book, which is priced at \$50.00 (U.S.) per copy. A 20% quantity discount is available for customers ordering ten or more books. To order, simply contact:

m. bryce & associates, inc.
777 Alderman Rd., Palm Harbor, FL 34683

Tel: (813)786-4567 Tlx: 494-6323 (BRY CLWT)
Fax: (813)786-4765

"Software for the Finest Computer-The Mind."

CIRCLE 38 ON READER CARD



bdbf

An Easy Design for Billing and Chargeback

If you're not satisfied with your billing and chargeback system, ask yourself one question: "Is there a complete package that can adapt as my data center expands?"

Yes, there is. It's called BDBF (Billing Database Facility).

Since a billing system needs to be as unique as the data center that uses it, BDBF is designed to be *your* system. It meets your present needs for billing and chargeback, and is designed for flexibility—BDBF changes as your data center changes.

BDBF is a complete, easy-to-use job accounting and chargeback package for MVS and MVS/XA environments. It's powerful in all areas including:

Data Collection

BDBF collects and stores data from multiple sources and lets you add your own.

Billing

BDBF maintains a budget for each user and lets you vary rates by shift, system, etc.

Reporting

BDBF offers many standard reporting functions *and* lets you create custom reports and invoices.

BDBF is easy to install, and since it's written in SAS® it gives you flexibility in analyzing data and producing reports.

For more information about BDBF and how you can bring your billing system up-to-date, contact us today at **(800) 323-2600** or **(412) 323-2600** in Pennsylvania.

Circle 39 on Reader Card



**DUQUESNE
SYSTEMS**

Two Allegheny Center
Pittsburgh, PA 15212

You don't have to wait on tables.

Meet tableBASE™. It will improve programmer productivity and system performance — **often by more than 90%**.

A powerful tool for automating table handling in mainframe applications, tableBASE also effectively manages data in memory, dramatically reducing run-time and I/O. Stop waiting on applications . . . these customers did!

East Midlands Electricity Board (UK)
Cash Management Application, 420,000 transactions

	VSAM	tableBASE	Savings
CPU Time	6.5 min.	3.5 min.	46%
Elapsed Time	2.5 hrs.	5 min.	95%

Security Pacific National Bank
Electronic Funds Transfer system, 660,000 transactions

	VSAM	tableBASE	Savings
CPU Time	14 min.	8 min.	43%
Elapsed Time	7.5 hrs.	28 min.	93%
EXCP'S	895,000	760	99%

Blue Cross and Blue Shield of Ohio
Claims Processing Application, 175,000 transactions

	VSAM	tableBASE	Savings
CPU Time	8 min.	10 sec.	98%
Elapsed Time	30 min.	5 min.	83%

Find out how tableBASE can help you.

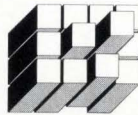

tableBASE

More benchmarks and additional information are available by contacting:
Data Kinetics, 97 Norman Street, Ottawa, Canada K1S 3K5
Tel: (613) 238-6709 FAX: (613) 238-2852

When Monsanto chemist Robert Evans first saw an Apple Macintosh back in 1984, he thought the Mac's graphical user interface was "clever." Still, Evans was reluctant to buy a Mac because all the computing professionals he knew used only command-line interfaces. In fact, that was the only sort of user interface they had ever used.

He recalls "clicking a mouse, pulling down menus, and looking at a cute little display. I kind of worried about my status here." He found, however, that the Mac allowed him to complete tasks faster than would have been possible on IBM PCs, even though the PCs had faster hard disks and shorter system response times.

The productivity advantages of Mac's graphical user interfaces made him "a Macintosh kind of guy," and Evans brought a Macintosh to work in the technology and support division of Monsanto Research, a Monsanto Co. subsidiary devoted to U.S. Department of Energy contracts. Evans' Mac and a small contingent of other Macs have been linked to the vast fleet of Digital Equipment Corp. VAXs and PDP-11s in Monsanto's central computer facility in Dayton, Ohio.

Allen Forster, senior processing engineer at Dow Chemical Co.'s division in Midland, Mich., is another Mac true believer. "I've seen an order of magnitude productivity gain due to the Mac IIs," Forster declares. Macs are superior to MS/DOS pcs as emulators of DEC's VT series terminals, he says, and "the Mac operating system is the best I've ever tried." Forster's division runs process plant design and engineering analysis applications on about 750 Macintoshes. Most of those applications once ran on VAXs under software he remembers as "mediocre at best." Now, improved VAX/Mac integration tools from third-party vendors, as well as from Apple and DEC, are facilitating mainframe/mini-computer-to-pc applications migrations, according to Forster.

Users such as Forster got cheery news in August when the technical alliance between DEC and Apple was announced. For commercial IS organizations that inter-network VAXs with Macintoshes, the announcement holds the promise of new products and better services.

Among other things, the forthcoming offerings would enable users to establish virtual AppleTalk networks and virtual DECnets simultaneously in an internet comprising physical AppleTalk networks and DECnets. They would also support the user interfaces standard for Macs and VAXs, or put a Mac user interface on a VAX or a VAX user interface on a Mac. Using the

Users Await Fruitful DEC/Apple Yield

While users are pleased with Apple and DEC's technology pact, many are way ahead of the vendors' efforts in their own shops.

BY BRAD SCHULTZ

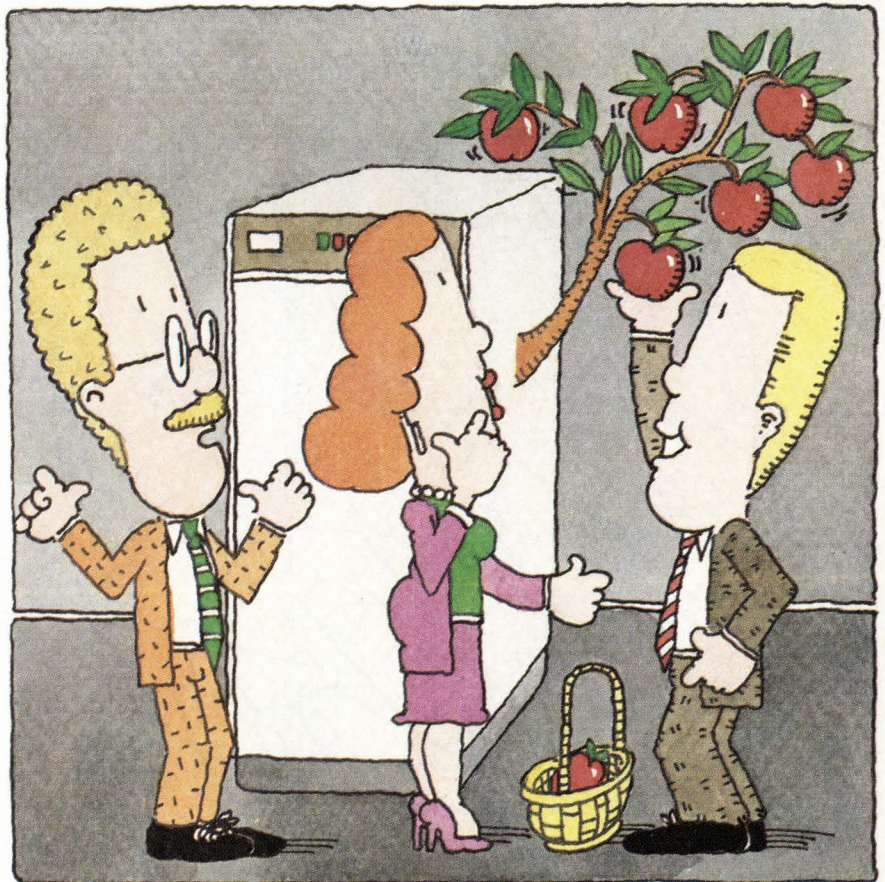

Illustration by Kimble Pendleton Meade

SYSTEMS

CONNECTIVITY

range of available user interfaces, Mac users will be able to exercise the capabilities and resources of linked VAXs, and VAX users will be able to do the same with linked Macs.

Du Pont, Wilmington, Del., plans to implement solutions that emerge from the alliance in addition to its own interim solutions, IS senior consultant Warren Hoffman says. According to Hoffman, Du Pont is one of DEC's largest customers, as well as one of Apple's largest customers. He indicates that his company internetworks thousands of VAXs with thousands of Macs, but declines to give precise totals and configuration details.

The January and August joint announcements by DEC and Apple regarding the alliance "were along the lines of our requirements," says Hoffman. "In fact, Du Pont was among the companies that influenced [DEC] and Apple to work together," he says. Du Pont was driven to seek VAX/Mac integration solutions "by the availability of some very attractive [Mac] software," especially graphics software relevant to Du Pont's technical orientation. Another driving factor, Hoff-

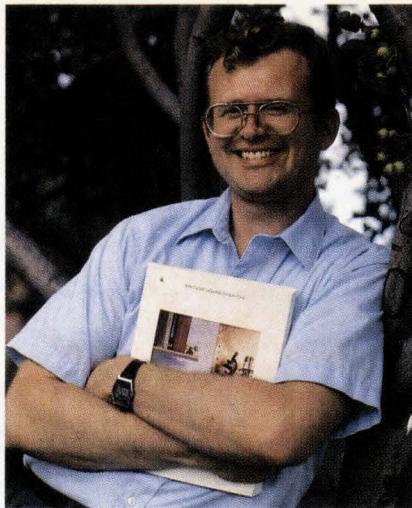

DOW CHEMICAL'S FORSTER: For the user, the DEC-Apple marriage is made in heaven.

man explains, was the software's relatively high ease of use, which trims user learning time requirements.

Competitive, But Cooperative

John Wardley, senior analyst/Macintosh specialist at International Data Corp., Framingham, Mass., says the DEC-Apple relationship represents coinciding interests between two vendors, not a promise to come to each other's rescue or to make each other's welfare a strategic

concern. Despite mutual benefits to be gained by the alliance, Apple and DEC remain mildly competitive. As pcs, Apple Macintoshes theoretically are competitive with DEC's VAXmates. Of much more strain to the DEC-Apple relationship are the options that let Macs emulate VT series terminals, and the options that turn Macs into workstations competitive with DEC's VAXstation series and MicroVAX series workstations. Furthermore, AppleTalk provides LAN solutions that compete against those of DEC.

DEC might use Apple for a while to provide the desktop computing solutions that DEC has failed to market successfully on its own, Wardley speculates, and then dissolve the alliance. In workstations, DEC-Apple competition is sure to increase, he says, and this could strain the relationship to an eventual breaking point.

Dow/Michigan's Forster says, however, that from a user's standpoint, the DEC-Apple arrangement is a marriage made in heaven, and regardless of the outcome of the joint development relationship, users would continue mating Macs to VAXs for years to come. Certainly, users didn't wait

Photograph by Randy Edmond

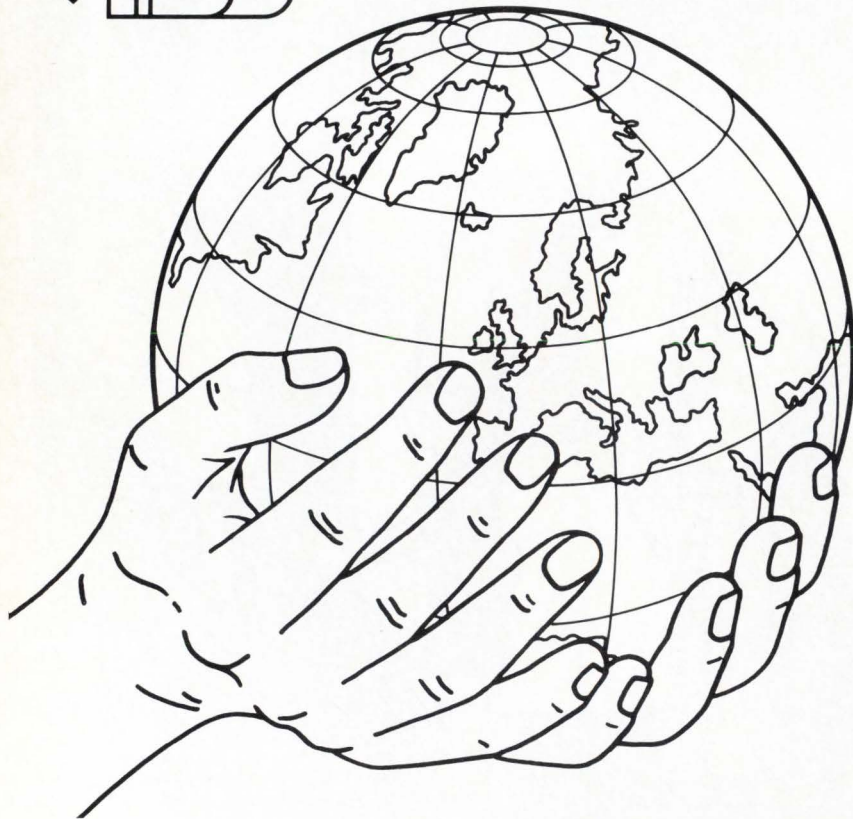

TOTAL EUROPEAN SUPPORT FOR IBM S/3X

Now you can be supported from a local office on an international basis!

International Business Systems (IBS) AB is unique. We are a European Group of software houses totally devoted to the development and distribution of the most advanced systems available for IBM mid-range computers.

Our range of services covers the whole spectrum from configuration and installation to training and full system maintenance. With offices throughout Europe we successfully support projects on a local or multinational basis.

We know that quality and professionalism is important to you. Indeed recent customer satisfaction surveys show a high level of appreciation of the knowledge and ability of our staff to deal professionally with complex, critical situations.

If you want friendly and specialist IBM S/3X advice for any of your European locations, please write or call us, we will be able to put you in contact with your local IBS office.

International Business Systems (IBS) AB

Hemvarnsgatan 8 · Box 3061
172 03 Sundbyberg · Sweden

Telephone: 46-8-98 25 75
Telex: 13334 rpgsto



Offices in Sweden, Finland, Norway, Denmark, Belgium, France, Switzerland, UK and the USA.

CIRCLE 41 ON READER CARD

Apple and DEC Meet OSI

for Apple and DEC to declare their intentions before they began to wed their products. In contrast with Hoffman, some managers in commercial IS organizations that already internetwork VAXs and Macintoshes say that the DEC-Apple technical alliance has yet to make much of a difference in their planning and procurement decisions.

This is true at Arco Oil & Gas Co., Dallas, which began internetworking VAXs with Macintosh IIs last year, before the DEC-Apple alliance was formally launched, according to technology ser-

□ MAC USERS WILL BE ABLE TO EXERCISE THE CAPABILITIES AND RESOURCES OF LINKED VAXS.

vices manager Ed Kelly. Similarly, Alcoa Laboratories, Pittsburgh, began writing its own VAX-Mac network integration software before the alliance and will continue to do so, according to section head Jan R. Kidwell.

Spokesmen for Monsanto and Westinghouse Electric Corp., Baltimore, also confirm that their companies commenced such integrations prior to the alliance. The integrations were built with third-party products such as Technology Concepts Inc.'s CommUnity-Mac, which is a Mac-resident implementation of the Digital Network Architecture for Macs networked under Ethernet with VAXs.

Gary Mauler, a senior engineer in Westinghouse Electric's workstation technology group, questions whether large VAX sites such as his will be inclined to turn many VAXs into servers for Macs and Apple peripherals under AppleTalk, even though tools for doing this are a major objective of the DEC-Apple alliance. Given the richness of DECnet capabilities, it might be better to leave most VAXs in such sites as pure DECnet nodes, with their linked Macs running as VT emulators, than to buy an "AppleTalk for VMS" license for every VAX, he explains.

MS/DOS Still Dominates

Even if these integration-oriented tools accelerate Mac buying at some large VAX sites, it seems likely that, in the commercial sector, MS/DOS pcs will continue to outnumber Macs in most large VAX-hosted networks for years to come. Commercial VAX sites have about three times as many IBM-supplied pcs as they do DEC and Apple pcs combined, according to esti-

Apple Computer Inc. says that AppleTalk capabilities, provided in various Apple products, allow Macintoshes to conform to Digital Equipment Corp.'s Digital Network Architecture (DNA) and to what there is of the International Standards Organization's Open Systems Interconnection (OSI) reference model. DEC's DECnet software products allow DEC hardware to be configured in ways that implement DNA. DEC says DNA eventually will match the OSI model, the higher layers of which are still being defined.

Both DNA and the OSI model have seven layers. The following chart identifies the AppleTalk offerings and important functions of each layer. AppleTalk also supports IBM's Systems Network Architecture and the Transmission Control Protocol/Internet Protocol suite.

LAYER	OSI NAME	DNA NAME	APPLETALK OFFERING*	IMPORTANT FUNCTIONS COMMON TO OSI, DNA
7	Application	User	AppleShare LaserShare	Provides services that support end-user tasks, such as file transfer, remote file access, data communication between applications
6	Presentation	Network Applications	AFP, PostScript	Sets format of files; format, syntax of data
5	Session	Session Control	ASP, PAP, ADSP, Zip Zone Protocol	Delivers packet sequences, character streams; coordinates activity across network zones
4	Transport	End-to-end Communication	ATP, Echo NBP, Zip	Name-to-address mapping; end-to-end reliability
3	Network	Routing	DDP	Routes packets on the basis of address, priority, and link conditions
2	Data Link	Data Link	ALAP, Ethernet	Interfaces computers, peripherals to the transmission medium; sets communication parameters
1	Physical	Physical Link	Twisted pair, coax, fiber optic	Cabling, electrical interface

*Explanation of abbreviations (in alphabetical order): AppleTalk Data Stream Protocol (ADSP), AppleTalk Filing Protocol (AFP), AppleTalk Link Access Protocol (ALAP), AppleTalk Session Protocol (ASP), AppleTalk Transport Protocol (ATP), Datagram Delivery Protocol (DDP), Name Binding Program (NBP), Printer Access Protocol (PAP).

Source: Apple Computer Inc., Digital Equipment Corp.

Digital has it now.

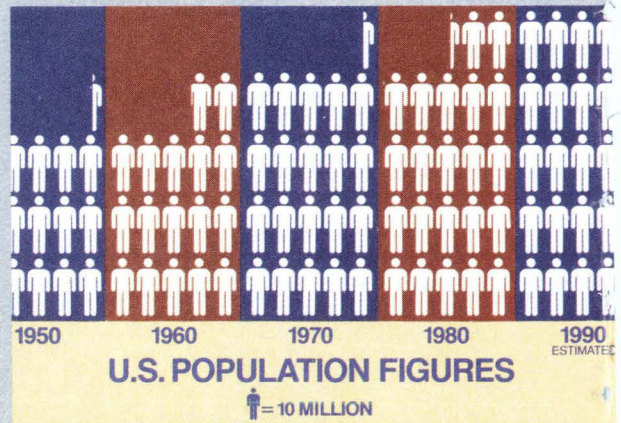

The U.S. Census Bureau has always been at the forefront of data automation technologies, and the 1990 Census will be the largest, most automated in the nation's 200-year history. According to John G. Keane, Director of the Census, "To get on-time, accurate results, we went to a distributed system with Digital computers at each of about 450 data collection sites. This is a whole new way of doing things for us and we looked to Digital for support. They had to train our employees quickly and thoroughly to take full advantage of the new decentralized system. The quality of the training has been outstanding. We expected the initial

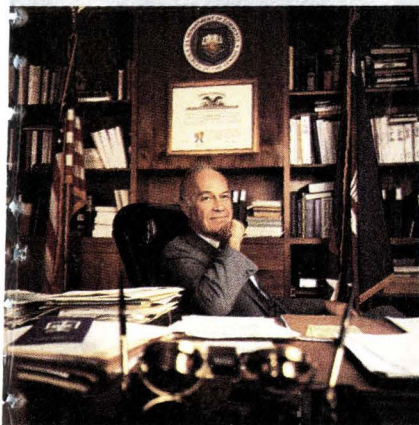

“Training and support that gives us a year’s head start on bringing in the 1990 Census.”

effort at headquarters – from installation of the first systems through employee training – would take a minimum of 18 months. Digital had these systems up and running and our headquarters staff trained and fully productive in only six.”

Dr. Keane concludes, “The success of the Census depends largely on training – how familiar our people are with what they have to do. Our expectations of Digital’s support were very high – but Digital exceeded them.”

To get your Digital advantage now, write to: Digital Equipment Corporation, 200 Baker Ave., West Concord, Massachusetts 01742. Or call your local Digital sales office.

digital[™]

mates by the Computer Intelligence Group, New York. Computer Intelligence estimates that there are about as many Macs at such sites as there are DEC workstations.

At Du Pont, Hoffman says that MS/DOS pcs still outnumber Macs, mainly because most of the company's pc procurements occurred prior to the availability of Apple's Mac II. "We have a very large MS/DOS community, which [cannot afford to] throw out their machines," he says. Most of Du Pont's Mac purchases are being installed as replacements for DEC VT terminals and will be used as pcs that can emulate VTs when and where there is reason to do so.

MS/DOS is so entrenched at some firms that Mac users may feel as though they are engaging in subversive or even unprofessional activity. At Monsanto, most of the IS people who set divisional pc buying standards are "gung ho MS/DOS freaks," according to chemist Evans, who estimates that his division has only about 20 Macintosh IIs, with several more on order, compared with some 400 to 500 IBM and IBM-compatible pcs, running MS/DOS.

The division, which Evans describes as a "technical MIS" organization, is a showcase for Mac-to-VAX and MS/DOS pc-to-VAX communications because its central computer facility runs a vast fleet of DEC VAX and PDP-11s. DEC's only proprietary operating system, VMS, supports all the VAXs, which include 86XX, 83XX, 82XX,

□ **"WE HAVE A LARGE MS/DOS COMMUNITY, WHICH CAN'T THROW OUT THEIR MACHINES."**

11/780, and 11/750 minis, as well as VAXstation 2000 and MicroVAX II workstations. The division has formed VAX-clusters from close couplings of VAX minis and local area networks of VAXstation 2000s.

Although Macintoshes are still a tiny minority of the Monsanto Research division's pc population, Evans argues that the Apple computers are superior to MS/DOS pcs as nodes or adjuncts of DECnets. One reason, he says, is that Macs have su-

perior capabilities for cutting and pasting text and art between a display screen window that shows a task running locally and another window that shows a task running remotely on a VAX under VMS.

There are, however, VAX sites where Macs outnumber MS/DOS pcs. For example, about 600 of roughly 850 installed pcs at Alcoa Labs are Mac IIs, according to Kidwell. This reflects high demand for a graphical user interface—the hallmark feature of all Macs—and scant enthusiasm for DEC's offerings, such as VAXmates, he explains.

DEC's workstation offerings, past and present, are generally perceived as weak. They have never sold well on their own merits in broadly defined markets. The company's only major effort to compete in that market was with an MS/DOS pc called the Rainbow, which failed and was discontinued a few years ago. DEC mainly markets its pcs as elements of big-ticket VAX system integrations.

Apple has its credibility problems, too. One way it can counter skepticism about its ability to grasp commercial IS problems and issues is to point to its own IS organi-

BUY X.25 FROM MICOM.

How can you build a no-compromise X.25 network without sending your communications budget skyward? Call MICOM.

Our newest packet assembler/dis-assembler (PAD) links asynchronous

devices, synchronous devices—or a combination of both—from a single, modular unit. Which can cut your line costs alone in half.

Our latest generation switches make

gateway selections, address translations and best-path routing choices while they traffic more than 500 data packets a second.

An integrated network management

zation. Apple is a Fortune 500 company with challenging and complex IS requirements. Apple's corporate financial applications are concentrated on IBM 3090 mainframes, and the vendor's sales and marketing people around the world interact with an IBM System/38. Computers supporting Apple's R&D include VAXs and Cray Research supercomputers, while Tandem supplies the processors for Apple's factory automation systems.

Peter S. Hirshberg, Apple's manager, host systems, integration, remarks, "We are our own first customer for multivendor integration." VAXs are becoming the backbone of Apple's in-house office automation systems, he says, adding that it was Apple's need to internetwork and interoperate its Macintoshes to VAXs that led to the "AppleTalk for VMS" software platform that is crucial to the DEC-Apple joint development effort. "We really practice what we preach here," says Hirshberg.

Apple must also overcome the strong commercial IS bias against the graphical user interface, as well as play catch-up with IBM and the other companies that got to the commercial IS market first. Even

though Apple shipped pcs years before IBM did, many IS managers regard the Mac II, announced only last year, as the first Apple computer they would consider.

Clear Messages From Apple

Apple made clear its determination to take on IBM on its own turf when it confirmed plans that it would begin shipping an IBM Token Ring network product and

□ DEC MAINLY MARKETS ITS PCS AS ELEMENTS OF BIG-TICKET VAX SYSTEM INTEGRATIONS.

an IBM 3270/5250 terminal emulation board for the Mac II early in 1989. A few weeks later, Apple hired Donald Casey, IBM's chief of communication hardware development, as its chief of data communications research and product marketing. The company clearly has more on its agenda than turning its computers into VAX peripherals.

Nor is DEC simply interested in turning

its computers into Macintosh servers. DEC spokespeople emphasize their company's commitment to addressing the challenges of enterprise computing. A catchphrase of the Corporation for Open Systems (COS), enterprise computing typically requires internetworking (the networking of networks) and interoperability. In that spirit, DEC concentrates on delivering network-oriented solutions.

Various sources, including Apple and DEC, estimate that nearly 40% of VAX sites have Macs. According to Hirshberg, 55% to 60% of the Macs at VAX sites are actually linked to DEC computers, and about 85% of these links are merely emulations of DEC VTS.

Hirshberg says that the DEC-Apple alliance's deliverables, and the anticipation of those deliverables, should put many more Macintoshes in VAX sites, make it standard practice for Macs at VAX sites to be linked with VAXs, and cause the vast majority of these links to conform to the AppleTalk-DECnet integration.

Brad Schultz is a freelance writer based in New York.

OR PAY THE PRICE.



system maintains detailed billing and accounting data on every call. Diagnostics, controls and calling statistics are all presented in plain English.

When it's time to make an investment in

X.25 public data network hardware—or in your own private network—don't take a flyer. We've been a major X.25 supplier since 1982. The experience can save you money.

MICOM[®]

1-800-MICOM U.S.

CIRCLE 43 ON READER CARD

Theirs.



The second most reliable impact printer did this much before it stopped. It wound up in the repair shop after 7,000 hours or ten months of printing.

Ours.

*we never stop
asking*

What if...

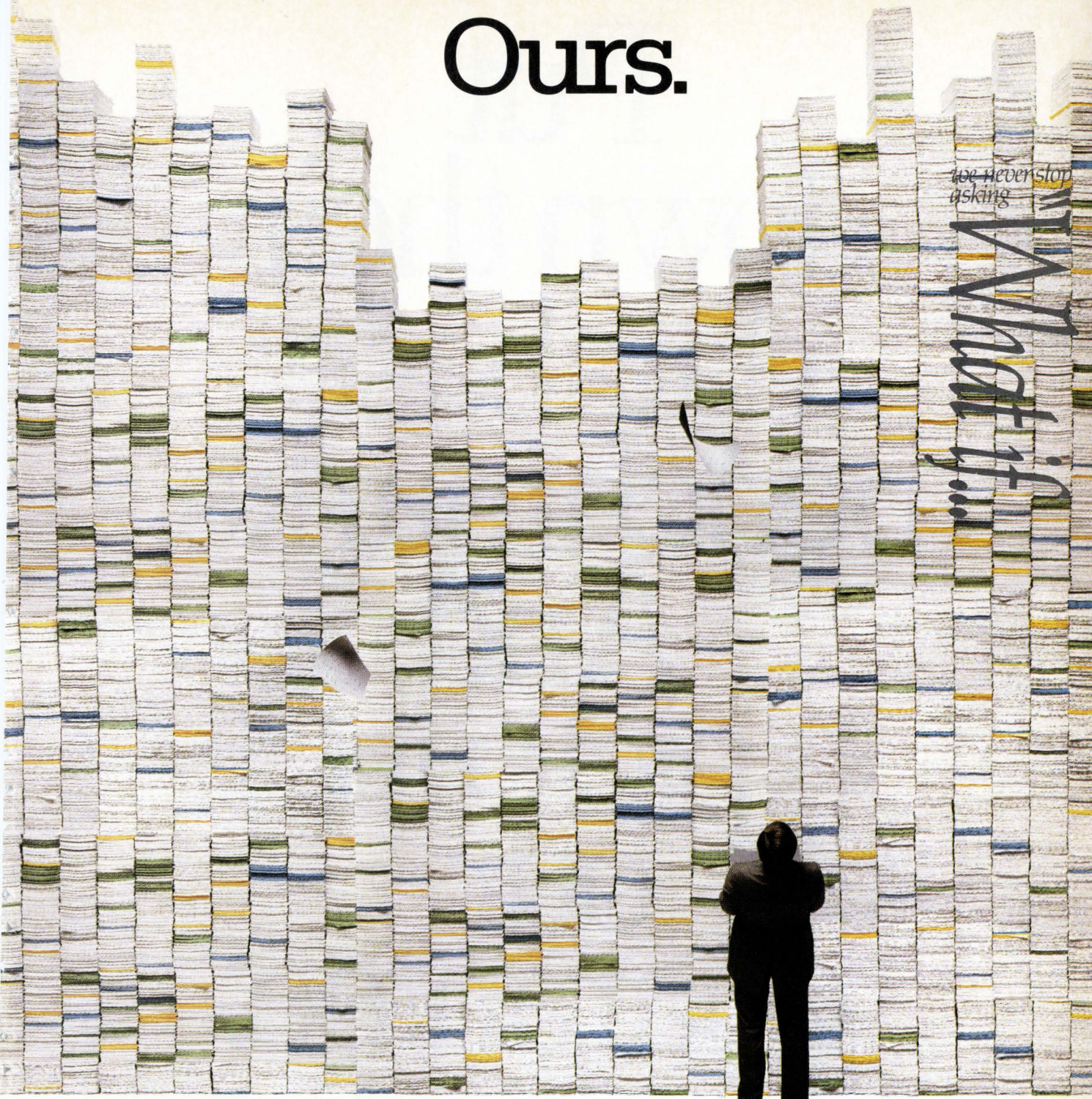

The HP RuggedWriter 480 printer did this much before we stopped counting. After the equivalent of 20,000 hours, it just kept working. And working.

Only HP could have built an impact printer as reliable. Or as fast. At 480 cps for draft and 240 cps for letter quality, you'll be able to turn out everything from letters and spreadsheets to six-part forms, at least 20% faster in letter quality mode than other 24-wire

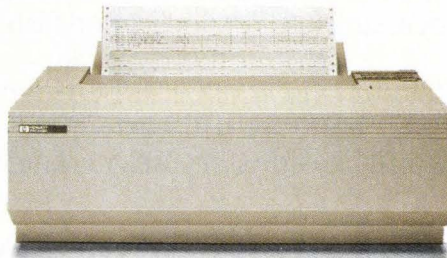

impact printers.

And with its 180 x 360 dot per inch resolution, it's certainly no slouch when it comes to graphics.

It's also compatible with the computer system you already have. IBM PCs. PC-compatibles. And of course, HP.

And compatible with your budget. At a price of just \$1695.

For more information, call 1-800-752-0900, Ext. B287. And you'll see why the competition just doesn't stack up.



**HEWLETT
PACKARD**

Circle 44 on Reader Card

Put
down their
database
benchmarks.
And
pick up
our
guarantee.

We guarantee that INFORMIX-TURBO will run your new UNIX®
on-line transaction processing (OLTP) application faster than any other RDBMS.

Or your money back.

Call today for our INFORMIX-TURBO Guarantee InfoPak,*

1-800-331-1763, ext. 3800.

You'll like our story. We guarantee it.



INFORMIX

#1 for good reason.

*The terms and conditions of our guarantee are contained in our INFORMIX-TURBO Guarantee InfoPak.
Informix is a registered trademark of Informix Software, Inc. UNIX is a registered trademark of AT&T. © 1988 Informix Software Inc.

Database Machines: The Least-Cost Route?

Users interviewed by DATAMATION unanimously declare that hardware-optimized database solutions have saved their IS operations lots of money.

BY ED GREGORY

Relational database machines may never completely supersede host-resident hierarchical or relational databases, but users and analysts say the affordable muscle of these dedicated data servers delivers new power to those who want to make strategic use of information.

"I'd have to have spent 45 times as much as I did to get the same results on a mainframe," says Jeffrey Budd, senior researcher on a long-term pediatric pulmonary study by the Department of Pediatrics at the University of Minnesota Medical School.

Britton Lee Inc., Los Gatos, Calif., and Teradata Inc., Los Angeles, are the two major suppliers of these database machines, the hardware-firmware-software successors to resource-hungry general purpose computer databases. Budd recalls being impressed by a benchmark that showed the Britton Lee would perform three-and-a-half times faster than a Digital Equipment Corp. 11-782 running Relational Technology Inc.'s Ingres. So, after five years of leasing, Budd is spending \$38,000 to purchase Britton Lee's low-end BL300 "shared database machine" for use in a diverse network of personal computers and workstations.

Budd had previously relied on a Data General S-140 minicomputer-based system that required an hour to complete a standard query selecting on two attributes in a database of 40,000 tuples. The Britton Lee dedicated database machine does the task in 35 seconds. He adds that the machine seems especially suited to the health care industry, where seamless information sharing—exchanging clinical records, hospital records, and laboratory

data—is beneficial to all providers.

ANSI Compatibility

Britton Lee machines—like Teradata systems and any software-based relational database that offers portability—work with ANSI-standard SQL tools, including PC/SQL Link, and fourth generation languages, such as Focus. Britton Lee's RISC cpu and Intelligent Database Manager software offload database management functions and storage from the applications system, leaving to the general purpose host or pc-mini-workstation network the tasks of applications processing and communications with end users.

Britton Lee claims 850 installations, compared with fewer than 100 for Teradata, but Teradata's users are far larger and have the power of parallel processing at their fingertips.

Teradata claims the most powerful commercial computer in the world is its DBC/1012 sold to K-Mart Corp. It now has more than 260 parallel cpus providing a cumulative 265MIPS. When it is fully developed, it will use 500 cpus. At its heart is Teradata's Ynet intelligent network linking interface processors, communications processors, and access module processors. It performs many of the tasks associated with multiprocessor management.

Bell Atlantic's information center at Freehold, N.J., is a more typical large



UNIVERSITY OF MINNESOTA'S BUDD: The Britton Lee dedicated database machine seems especially suited to the health care industry.

Teradata user, with 12GB of customer information. Bell Atlantic's system is 10 x 38 x 76: there are 10 processors that link the database machine to a host and other users via Ynet, 38 amps handling requests parceled out by Ynet, and 76 data storage units. The front end is an Amdahl V8 running VM/CMS. Bell Atlantic's marketing users—50 or so in various locations—access the database through Midas, a 4GL interface written in Nomad-2.

Previously, data was dispersed over multiple Honeywell, IBM, and other general computing systems throughout Bell

Atlantic. "The way data is gathered in DASD," reports Tom Kendrick, assistant manager for marketing information systems, "it could take days finding matches and hits for a single report we do on-line with the Teradata."

Carl Ramquist presides over an information center at TransAmerica Inc. in Los Angeles. His 400 users address a Teradata DBC/1012 2 x 14 x 14 through Intellect, the front-end application running on the IBM 3090 Model 400. Ramquist, like many other database machine users, says he faced criticism from other IS pros in his company when he announced his support for a discrete database machine. "Other people in the organization, such as the application programming group, are running DB2 and VSAM," he says, "but I have already proven that I saved \$250,000 by going with the Teradata system for our information center."

Connectivity Is a Factor

While power is often the first criteria, connectivity was a major factor in favor of Britton Lee for Reynolds Electrical & Engineering Co., Las Vegas. "We have a mixed environment: IBM PCs, DEC, HP, Sun, Apollo," says Robert Thompson, branch chief in the IS department for the data center project at REECO and president of the Britton Lee Users Group. "Are they all going to talk to the IBM solution? I don't think so. That is the main advantage of the Britton Lee machine."

A "historical personnel database" for the government that covers more than 30 years of data is maintained by REECO. Thompson says he saved \$200,000 by choosing a database machine over host-resident relational database software. The data originally resided on a CDC 6400 shared with other departments.

Batch processing was the rule for Thompson's project. "We had to get off that Cyber and get something that would give us on-line capabilities. We considered IMS on the System/38, but that could never handle the magnitude of what we wanted to do.

"For what we wanted, the least expensive route was a Britton Lee database machine with a VAX 750 front end," he says. "With a software-based RDBMS, we would have to have gone to a much larger machine, like the VAX 780, and, to get above 25 users, a VAX 785."

Analyst Roxanne Googin, who follows the industry for Needham and Co. in New York, suggests tempering users' enthusiastic responses with the realization that "users tend to defend their position." She quickly adds that the power of relational

databases, and database machines in particular, are fueling the demand for strategic information.

Truth, Justice, and . . .

"It permits you to understand what your business is doing at that moment, giving you better control of costs and response to customers' needs," she says. "I see exponential growth here. It's the American Way: fast food, fast data."

Of the future prospects for the two market leaders, Googin feels that Teradata seems better positioned for the long haul

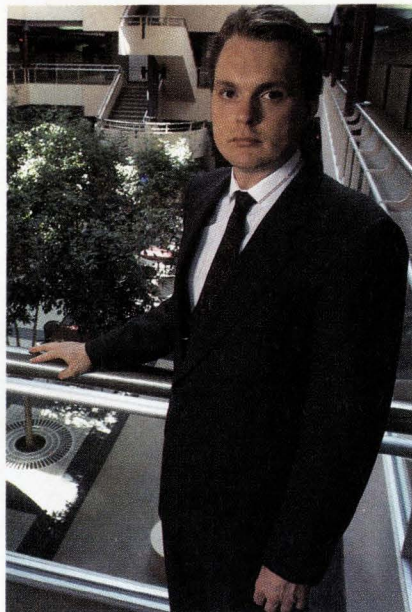

BELL ATLANTIC'S KENDRICK: It would take days to find matches and hits for a single report done on-line with the Teradata.

despite Britton Lee's larger potential market of small- and middle-sized users: "Over time, general purpose systems are going to give Britton Lee a run for its money. But trying to take on Teradata is like going for an elephant with a pea shooter."

Ignoring Small Users?

After new management arrived last October at Britton Lee, top executives spent two months examining the company's strategic business plan. Management cut staff by 20% and emphasized development of the BL8000, a machine capable of extending Britton Lee's limit to 50GB from 16GB and permitting an as-yet-unspecified number of users. "The BL8000 is in beta testing and is on schedule for release early next year," says Jim Candlin, Britton Lee's vp of marketing.

The University of Minnesota's Budd ex-

presses disappointment that Britton Lee seems to be dropping its least expensive system, but Candlin insists that raising the minimum disk drive size to 300MB from 63MB, while adding to the cost of the starter system, does not mean the company is deemphasizing smaller users as it prepares to launch the BL8000.

"What you will see from us is a series of moves through 1989 to place a larger emphasis on the smaller systems," Candlin says. "As the market matures and the understanding of the power of strategic information grows, you are going to see explosive growth in the workstation relational database market." He adds that Britton Lee is backing away from the term "database machine," preferring to call its products "shared database systems."

Candlin says Britton Lee is cooperating in an industry effort to establish more meaningful and verifiable database benchmarks. The company is working with the fledgling Transaction Processing Council to develop new benchmarks, says Candlin, "but it is going to take a year before that gets sorted out."

Teradata's Benchmark Talk

Teradata is less reluctant to talk about performance under existing benchmarks. David Clements, director of marketing for Teradata, says one of the most recent benchmarks on DB2 version 2 had IBM's relational database product reaching about 450 transactions per second running the standard "lost or stolen credit card" benchmark. The test, he says, took place on an IBM 3090 Model 600e dedicated entirely to the task. The same test on a Teradata machine that costs about 40% less produced an operating rate of 1,100tps, Clements says. He does concede that raw transaction processing power loses some of its glory in light of a recent survey by the Gartner Group suggesting that only 5% of the Fortune 1000 companies need a system that can support more than 100tps. Benchmarks for the decision support facilities of a database machine are more difficult to arrive at because they depend on the database and the nuances of the query, Clements says.

Robert J. Anderson, analyst for Sutro & Co. in San Francisco, agrees that Britton Lee is under pressure, but he says the current generation of software-only solutions, although performing better than the early crop, still does not match the database machines when it comes to serving a variety of users and applications with "a single image of data."

The single-image-of-data approach encourages IS managers to consolidate data

AT&T \ā-tē-ənd-tē' \ n **1** : creator of the UNIX[®] Operating System **2** : developer of the foremost UNIX System training program **3** : the source of comprehensive training for the entire computer industry

AT&T defines computer training.

AT&T invented the UNIX Operating System, and no one else can teach you more about it. *But the UNIX System is just part of what AT&T can teach you about computers.* We offer a complete range of training programs, including 135 individual courses in five curriculums:

■ **UNIX System and C Language**—Up-to-date training in System V Release 3, including basic, intermediate, and advanced levels.

■ **Data Communications and Networking**—We'll help you get your computers talking to each other efficiently.

■ **Database Management**—Learn to design and manage a business database.

■ **Business Applications and Personal Computers**—Practical instruction, from word processing to spreadsheets.

■ **AT&T Computers**—We'll teach you to install, maintain, and operate our 3B product line.

You can learn from AT&T at professional training centers

nationwide. Or we'll send our instructors right to you. We even offer low-cost videotape instruction that lets you train at your own pace and convenience.

You'll appreciate the quality of our training. Our AT&T instructors average at least a decade of experience. And classes are small, *just one student per terminal,*

so you'll receive lots of valuable personal attention.

For *definitive* computer training, AT&T is the only right choice. Call or write now for course details.

AT&T COMPUTER TRAINING.

Come right to the source.

1-800-247-1212, ext. 826.

Or send in the coupon below.

© 1988 AT&T

Registrar, AT&T Training, P.O. Box 45038, Jacksonville, FL 32232-9974

YES! I'd like to come right to the source for computer training. Please rush me more information about: Videotape Training in UNIX[®] System, C Language, and Shell Command Language

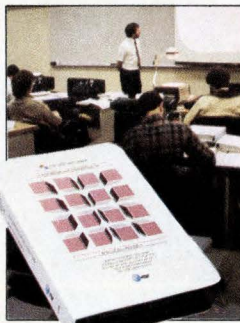

Or course descriptions and schedules for:

- UNIX System and C Language Database Management
 Data Communications and Networking AT&T 3B Computers
 Business Applications and Personal Computers

Name (Please print) _____

Title _____ Phone () _____

Company _____

Address _____

City _____ State _____ Zip _____

DMU10018



AT&T

The right choice.

**MY ANSWER TO LINK'S
IMPOSSIBLY HIGH STANDARDS
OF USER COMFORT.**

VOODOO ERGONOMICS.



James P. Everyother III
CEO, Everyother Terminal Company

"When I heard that Link's new MC₅ terminal meets and exceeds all the tough new ergonomics requirements, even those picky international ones, I saw red.

"I mean, who ever heard of building a terminal better than you have to?"

"They upped their screen refresh

rate to an extra-fast 78Hz, faster than even the strictest regulation calls for. And about 10Hz faster than ours. That eliminates screen flicker even in positive video mode.

"They use overscan to eliminate the black border that can cause user fatigue in positive video mode.

That costs more than the extra-wide bezel we use to cover up the problem,

but they still charge less for their terminal than our overhead will allow us to charge for ours. They're driving me crazy!

"The MC₅ also has a flat screen,

Link's new MC₅ is so advanced, it's almost supernatural.

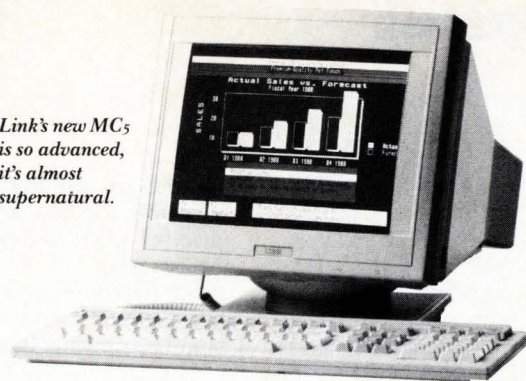

and separate brightness and contrast controls right on the front panel where people can get at them. This terminal has every emulation you could ask for. It can even connect to two different hosts at once.

"And I refuse to mention how low this abomination is priced.

"I've heard Link is working on

If Link's specs get any better, I'll get down on all fours and bark like a dog.

even more cost-effective Multiple Concept terminals. I can hardly wait.

"In fact, I'm on pins and needles.

"Heh."

Link's sticking it to us with these superior product features. It's only fair that I return the favor.

MC ₅ Enhancements
Flat Screen for decreased glare and increased viewing area.
Overscan for full-screen image without distracting black borders.
78Hz refresh rate to eliminate screen flicker.
High-resolution characters.
Separate contrast and brightness controls on front panel.
Advanced surface-mount technology for improved reliability.
Low-power operation.

MC ₅ FEATURES	
Flat screen	7 pages memory
78Hz refresh	512 displayable characters
Full overscan	3 keyboards
Brightness and contrast knobs	2 serial ports
80/132 columns	1 parallel port
24/25/50 data lines	19 emulations
	Virtual terminals

LINK
Technologies, Inc.

THE TERMINALS EVERYOTHER TERMINAL COMPANY HATES.

Link Technologies, Inc., 47339 Warm Springs Blvd., Fremont, CA 94539, 800-448-LINK (In CA 415-651-8000), FAX 415-651-8808.

This space donated in the interest of fairness by Link Technologies, Inc.

Circle 47 on Reader Card

SYSTEMS DATABASES

now dispersed across multiple systems, says Anderson, solving several problems at one time. In addition to low-cost power, Anderson says, "you also return control of the data to a central place, thereby improving the integrity and control issues that have plagued information systems as departments and divisions began creating their own databases."

Something up IBM's Sleeve?

Anderson firmly believes IBM has a hardware-optimized database solution on the drawing board, perhaps even ready to roll, but he suggests IBM is not ready yet to cannibalize its existing mainframe market by unleashing something more powerful. "You won't see IBM come out with a really powerful database machine until there is a need to stop the competitive losses. I don't think that will happen until the database machine market gets well over \$500 million in size," he says.

The analysts say powerful software-only alternatives to a dedicated Britton Lee database system include Oracle, Ingres, Sybase, Pyramid, Sequent, and Informix. Britton Lee counters that the cost

of hardware resources allocated to software-only database packages should be included when evaluating price/performance ratios.

Candlin concedes that Sybase is "an increasingly vigorous competitor" in transaction processing, but adds, "the reason

□ BRITTON LEE CLAIMS 850 INSTALLATIONS, TO LESS THAN 100 FOR TERADATA, BUT TERADATA'S USERS ARE FAR LARGER AND HAVE PARALLEL PROCESSING.

people want to use relational databases is not because it is the best way to do transaction processing, but because they want to do on-line updates at the same time they are doing ad hoc queries."

Anderson agrees that software vendors are closing in on Britton Lee's power to provide cost-effective solutions in the single application area for small- and medi-

um-sized systems, but says that Teradata maintains a firm grasp on its own niche.

Regardless of the outcome of industry efforts to improve benchmarks, the limits clearly are being extended. As end users realize the value of this expanding power, the demand for strategic information systems will force IS professionals to expand their own limits as well.

"Data was used operationally through the 1970s and early 1980s, but now we see a vast growth in the strategic use of information," Teradata's Clements notes.

While relational database machines initially were well received as transaction processing systems, Clements says that "we are finding the greatest use of these large relational databases is answering questions of the executive staff, the marketing staff, the boardroom."

"It's going to be mostly Fortune 500 companies," Needham analyst Googin feels, "but even small guys will be surprised at how much data they have on-line and what they can do with it."

Ed Gregory is a freelance writer based in Nashville.

Statement of Ownership, Management and Circulation

(Required by 39 U.S.C. 3685)

- 1A. Title of Publication: DATAMATION USPS 508-290
- 1B. Publication No. 00116963
2. Date of filing: 10/1/88.
4. Complete mailing address of known office of publication: Cahners Publishing Company, 44 Cook Street, Denver, CO 80206.
5. Complete mailing address of the headquarters of the general business offices of the publishers: Cahners Publishing Company, 249 West 17th Street, New York, NY 10011
6. Full names and complete mailing address of publisher, editor, and managing editor: Publisher: Don Fagan, 249 West 17th Street, New York, NY 10011; Editor: Tim Mead, 249 West 17th Street, New York, NY 10011; Managing Editor: Parker Hodges, 249 West 17th Street, New York, N.Y. 10011
7. OWNER (If owned by a corporation, its name and address must be stated and also immediately thereunder the names and address of stockholders owning or holding 1 percent or more of total amount of stock, if not owned by a corporation, the names and addresses of the individual owners must be given. If owned by a partnership or other unincorporated firm, its name and address, as well as that of each individual must be given. If the publication is published by a nonprofit organization, its name and address must be stated.) Cahners Publishing Company, Division of Reed Publishing USA, 275 Washington Street, Newton, MA 02158-1630
8. Known bondholders, mortgages, and other security holders owning or holding 1 percent or more of total amount of bonds, mortgages or other securities: NONE.
9. N/A.
10. Extent and nature of circulation:

	Average No. Copies Each Issue During Preceding 12 Months	Actual No. Copies Single Issue Published Nearest to Filing Date
A. Total no. copies (Net Press Run)	186,347	187,888
B. Paid circulation		
1. Sales through dealers and carriers, street vendors and counter sales	—	—
2. Mail subscription	179,740	179,016
C. Total paid circulation (Sum of 10B1 and 10B2)	179,740	179,016
D. Free Distribution by mail, carrier or other means samples, complimentary, and other free copies	5,077	7,321
E. Total distribution (Sum of C and D)	184,817	186,337
F. Copies not distributed		
1. Office use, left over, unaccounted, spoiled after printing	1,530	1,551
2. Return from News Agents	—	—
G. Total (Sum of E, F1 and 2—should equal net press run shown in A)	186,347	187,888

(Signature) Robert LaFemina, Mgr. Admin. Svces.

Can IBM Revive The RT PC?

The RISC-based system has attracted few users so far, but Big Blue is expected to add capabilities early next year that could improve its life expectancy.

BY SUSAN KERR

Ever since its debut almost three years ago, IBM's RT system has been a computer in search of users.

Initially, heralded as a system destined to become a standard, the RT has failed to deliver. Instead, it is more notable today for its long list of product firsts for IBM: it's the first standalone system for computer aided manufacturing and engineering, the first product based on RISC technology, and the first significant product supporting Unix. Even with the enhancements that are expected in early 1989, observers still wonder whether the RT will ever live up to its technical promise and find happiness in the IBM product portfolio.

The expanding market acceptance of RISC and Unix should mean a new life for the RT, since IBM has become vocally aggressive with both technologies. This summer, it contacted competitors and warned them of potential infringement of its RISC patents. It has also announced that it will run Unix across a full range of products, including its high-end PS/2 microcomputers, and it is a cofounder of one Unix standards group, the Open Software Foundation.

Moving to Micro Channel

The new systems that IBM is expected to announce in the first half of 1989 should clear up what users term the number one technical constraint on the RT: the 32-bit systems' use of the old 16-bit AT bus. By moving to the 32-bit Micro Channel Architecture, the I/O structure made famous by the PS/2 family, faster I/O and file devices can be attached to the RT. In addition, IBM may introduce a version of the RT

with both built-in RT RISC and 80386 processors. IBM currently offers an AT co-processor option for the RT.

The absence of a 32-bit bus on what is supposed to be a technical workstation is one example of the RT's skittish nature. To date, IBM has appeared hesitant in its marketing and design of the RT. The product has been too underpowered and overpriced to compete on an equal footing with other CAE and CAD/CAM workstations.

No longer. Art Goldberg, IBM's director of business development AIX systems in the personal systems line of business, admits that Big Blue announced the original RT knowing that there were gaps in the product, but he promises that IBM now plans to double the RT's performance at a constant price every 12 to 18 months of its foreseeable future.

Despite these holes, there are a few happy commercial RT users who are assured that IBM should be more aggressive in their markets and is becoming so.

"IBM's just started pushing the RT in this area," says Chris Irwin, technical consultant for WCI, Washington, D.C. His company recently agreed to handle the RT as a member of IBM's Marketing Assistance Program. Irwin's first RT customer will use it as the host for a financial database as well as for word processing. "This is definitely not what you'd consider a standard technical application," he notes.

Another RT commercial user is Jim Robinson, director of marketing administration for the Farm Bureau Insurance Group, the Lansing-based affiliate of the

Michigan Farm Bureau. This agency has roughly 100 field installations with RT systems processing policies and claims as well as performing general office applications.

"I've told IBM that they were missing the boat," says Robinson. "From our vantage point they have a commercial system here."

Despite his generally high regard for the RT and IBM's service, Robinson be-

Big Blue's Technical Blues

IBM trails the pack in technical workstations

Company	Units	1987 Market %
Sun	34,100	29.6
Apollo	24,000	20.8
Digital	24,000	20.8
Hewlett-Packard	17,000	14.7
Silicon Graphics	5,750	5.0
Intergraph	4,060	3.5
IBM	3,400	2.9

lieves the pool of available software needs to be improved. For example, the Farm Bureau has found no good spreadsheet package for the RT, nor any standard offerings for the insurance industry.

AIX to the Rescue?

The push by IBM to get AIX, its version of Unix, on other platforms should help the software shortage. For example, last month AIX became available on high-end PS/2 models. IBM's Goldberg agrees that should help the number of software offerings for the RT. "The PS/2 and the RT are reasonably complementary today and will become more so over time," he says. "Clearly, AIX as a common operating system and the move to a common I/O base in

ISSUE DATE	AD CLOSING DATE	SPECIAL REPORTS	SOFTWARE/SERVICES	SYSTEMS	COMMUNICATIONS	MANAGEMENT
January 1	Dec. 1, '88	IBM				
January 15	Dec. 15, '88	Technology Forecast		RISC	Telecomm. Operations	
February 1	Jan. 2		Transaction Control Systems	OLTP		PCs in IS
February 15	Jan. 16		OS/2 vs. Unix	Security		Product Development
March 1	Feb. 1	DEC		IBM-DEC Connectivity	T-1 Multiplexors	
March 15	Feb. 15		PC-DBMSs	386-Based PCs		Corporate Profile
April 1	Mar. 1	Budget Survey		Weapon Systems	EDI	
April 15	Mar. 15	Connectivity Survey	Expert System Integration	Document Image Processing	Voice Messaging	
May 1	Mar. 31	Companies to Watch	OS/2 on IBM Compatibles			Corporate Profile
May 15	Apr. 14	Large Scale Systems Survey	Operating Systems Evolution			Decentralization
June 1	May 1		Object Oriented Programming (OOPs)	Macintosh in IS	LANs	
June 15	May 15	Application Software Survey		High Performance Computing		Corporate Profile
June 21	May 22	DATAMATION 100				
July 1	June 1	CASE	Non-IBM Operating Systems		Building Corporate Networks	Designing Corporate Computing Architectures
July 15	June 15		On-Line Information Services		Modems	Corporate Profile
August 1	June 30		Graphical User Interfaces	UPS		Multinational IS Operations
August 15	July 14		High-Level Languages	Storage		
September 1	Aug. 1	User Role In Standard Setting		Proprietary Systems		Open Systems Economics
September 15	Aug. 15	Best Computer Science Universities Hall of Fame	DBMSs			
October 1	Sept. 1	Salary Survey			Network Management	Government Computer Research
October 15	Sept. 15	Managing Your Vendor—Part 1		High-End Output Devices		Factory Automation
November 1	Sept. 29	Managing Your Vendor—Part 2	Disaster Avoidance		Electronic Mail	Corporate Profile
November 15	Oct. 13	Mini-Micro Spending Survey	Software Development Standards			Office Automation
November 21	Oct. 20	Industry-by-Industry Spending Survey and Profiles				
December 1	Nov. 1			Electronic Publishing		IS Executives in the 1990s
December 15	Nov. 15	User Group Directory				

DATAMATION

FOR MANAGERS OF INFORMATION TECHNOLOGY WORLDWIDE

INTERNATIONAL	MARKET RESEARCH/ ADVERTISER BENEFITS	TRADE SHOW BONUS DISTRIBUTION	INFORMATION CARD MAILINGS
IBM in Japan	Win a Free Ad: Reader Vote Contest		
IBM in Europe			Closes: Dec. 16, '88
	Cahners Advertising Performance Study		
Offshore Software		Uniform, Feb. 28-Mar. 2, San Francisco	
	Cahners Advertising Performance Study		
1992		Interface, Mar. 13-16, New York	Closes: Feb. 24
	Cahners Advertising Performance Study		
Eastern Bloc Computing	Cahners Advertising Performance Study	Comdex Spring, April 10-13, Chicago	
		NCGA, April 16-20, Philadelphia	
		Connect, April 18-20, Boston	
Far East Operations	Cahners Advertising Performance Study		Closes: Apr. 21
	Market Pulse Study: Large Scale Systems Spending		
Executive Information Systems		PC Expo, June 20-22, New York	
	Cahners Advertising Performance Study		
European 25			Closes: June 23
	Cahners Advertising Performance Study		
ISDN	Cahners Advertising Performance Study		
	Win a Free Ad: Reader Vote Contest		
Japan 10			Closes: Aug. 24
	Cahners Advertising Performance Study		
Worldwide Workstation Trends		Unix Expo, Nov. 1-3, New York	
	Cahners Advertising Performance Study		
Multilingual Software		Comdex Fall, Nov. 13-17, Las Vegas	Closes: Oct. 20
	Market Pulse Study: Minicomputer/ Microcomputer Spending		
	Cahners Advertising Performance Study		
Global IS Strategies for the 1990's			
	Cahners Advertising Performance Study		

Micro Channel... will allow complete transparency at the AIX call level."

The promise that the RT enhancements could be moved to other IBM systems in the future was a big plus for Henry Maxwell, senior staff engineer for Harnischfeger Engineers Inc., a division of materials-handling giant Harnischfeger Industries, Milwaukee. The company used to be more involved with Digital Equipment Corp. systems, but today it uses the RT as part of a system to control forklift operations.

"Our basic intent is not to be in bed with the RT," says Maxwell. "Rather, it is to tell customers they can use what [hardware] they want."

Nonetheless, Maxwell adds that he has been pleasantly surprised by the RT's functionality. IBM has been marketing the RT exclusively as a CAD/CAM box, and in factories it has been pushing the 9370 minicomputer networked with PS/2 systems—both of which miss the mark, he believes. "What's missing in IBM's present factory scenario is the centerpiece: a real-time control computer," he says. "That can be the RT."

Missing the Engineering Market

IBM's been even further off the mark in the technical marketplace. There are no major RT OEMs in the CAE market. While Big Blue clearly defines the RT as an engineering, technical workstation, the system has not done well when compared to its PC and PS/2 brethren and a host of more popular systems from Sun Microsystems and Apollo. San Jose-based market research house Dataquest Inc. estimates that in 1987 IBM shipped 3,500 RTs for technical applications compared with Sun's 32,000 and Apollo's 23,000. An additional 3,500 RTs were shipped for nontechnical applications, such as those found in the financial and banking industries.

"To the best of my knowledge, no one in my area is using the RT," says Nilo Niccolai, manager of Hughes Aircraft Co.'s corporate VLSI support organization, Long Beach, Calif. Instead, the company has settled on Sun and Apollo as workstation platforms. "At one point, I think it was a question of raw power," and the RT's lack thereof, Niccolai says. "Now, people realize it is one of software." None of Hughes's major CAE and CAD software suppliers, such as Mentor Graphics Corp., Beaverton, Oreg., support the RT.

One technical software company that did support the RT has reconsidered its position. BBN Software, Cambridge, Mass., recently decided to halt active marketing of the RT version of its RS/1 engi-

neering data analysis product. "Frankly, the sales performance of the RT has been pretty disappointing," says BBN marketing vp Thomas Kush, who places sales figures for the RT version of RS/1 at "fewer than 100." He reels off a list of reasons the RT has been constrained: "Distribution channels, graphics, software availability, performance of earlier version, pricing. Any one of those a company can overcome, but all five just isn't right."

Big Blue is coming around on some of these issues. First releases of the system were without high-resolution graphics and key networking capability such as Ethernet connectivity. These gaps have been steadily filled in, culminating last

□ THE MAIN CONSTRAINT OF THE RT AS IT NOW EXISTS IS ITS PC AT BUS STRUCTURE.

July in three new models whose main features were faster throughput and greatly needed improved floating point performance.

But there's still more to be done. In the first quarter of 1989, it is anticipated that IBM will continue along the lines it took this summer and introduce new versions with higher throughput and a new bus architecture.

The main constraint of the present RT is its AT bus structure, even though IBM says it runs at speeds up to four times that of a standard AT. Within Harnischfeger, engineers have found that they can do RT disk I/O to the mainframe over a token ring network faster than the RT can perform disk operations internally. Going to a 32-bit bus structure will significantly increase performance, Maxwell says. The most likely scenario calls for IBM to use the same Micro Channel bus used in the PS/2.

Has IBM Held Back the RT?

This is part of the RT's slow and steady improvement. Customers have not flocked to the system yet, but some believe there is still hope. Clare Fleig, systems research director for IBM watchdog International Technology Group, Los Altos, Calif., feels IBM has held back on the RT so as not to interfere with sales of other products. Yet, Fleig says there are indications that the RISC processor central to the RT is finding its way into other mainstream product lines such as the AS/400.

As the RT RISC technology melds into other families, the RT is melding more into IBM's personal computer strategy. One in-

teresting signal of IBM's intentions was the introduction earlier this year of the 6152 academic system, an 80286-based microcomputer with a RISC chip on its motherboard. Goldberg says IBM has no plans to create an RT or RISC coprocessor for other commercial products such as the 9370 or AS/400, but, over time, it has altered its RT PC coprocessor strategy. IBM no longer offers a separate DOS coprocessor board for the RT. Instead, the latest versions of AIX include code that simulates the AT. No similar capability for the OS/2 is yet available.

IBM has wrestled over whether to differentiate its two lines of microcomputers or merge them. "Sure, there's a lot of overlap with the PS/2 and the RT running AIX," says Stephen Hill, director of product marketing for Informix, which gets roughly 2.5% of its business from RT software products. He believes that if IBM were truly to differentiate the two lines, one possible way would be to release a multiprocessor version of the RT system.

A New Song from IBM?

That's been a popular RT rumor for some time, but many are doubtful that IBM would produce a multiprocessor RT offering. IBM clearly has the technical know-how to make a superpowered RISC-based system. If it does so, however, it risks knocking the socks off other IBM systems that boast higher margins for the company. This could explain its rather cautious approach so far with the RT.

Yet, as IBM sees other RISC vendors doing well, it may be changing its tune. The RT architecture still has a lot of growth in it, according to Goldberg. "It clearly could include looking at multiple processor versions of RISC processors," he says. "I don't see any constraints within IBM. We're spending as much on RISC-based products as we are on Intel-based products."

Andrew Allison, editor of *RISC Management*, a Los Altos Hills, Calif.-based newsletter, believes that marketing forces within Big Blue are holding back the technology folks. "Can you imagine what a multiprocessor system would do to IBM's base?" he asks. "Their traditional margins on minis and mainframes just would not be supportable. The RT products that IBM has introduced do not by any means take advantage of their processor."

It's not just performance that IBM needs to work on concerning the RT. If IBM continues to soup up the RT's performance, it still must deal with three years of inertia and a mediocre reputation. That's tough, even for a marketing giant.

"The Data General difference: unparalleled reliability."

Dieter M. Bailly, Vice President, Systems and Data Services, Sitmar Cruises

Data General computers help Sitmar Cruises achieve high customer service standards.

Sitmar Cruises, one of the world's leading cruise lines, prides itself on warm, professional customer service. So its passengers keep coming back again and again.

One important aspect of their service is up-to-the-minute information on tour package availability, cabin assignments, bookings, destination schedules, on-board activities and more.

This requires computers that are up and running continuously.

On shore, since most bookings and cabin assignments are processed immediately by reservation agents, any disruption of system availability can lead to service delays, or the increased costs of hiring supplementary agents. At sea, dependable system performance is vital to keep inventories and passenger billing under control.

Sitmar's need for highly reliable computers, backed by outstanding service and support, is clear. So is their choice of a computer company.

Data General combines a commitment to reliability with innovative service geared to maximizing system availability.

As Dieter Bailly, Vice President of Systems and Data Services, says, "Hardware reliability and effective service response are two critical factors contributing to high computer up time. Data General consistently provides both. Hardware reliability is a must for a cruise line, since the reservation function is real time. And, for our vessels, you can't just call for maintenance in the middle of the ocean."

To find out how Data General can make a difference for you, send the coupon below. Or call 1-800-DATAGEN. In Canada, call 416-823-7830.

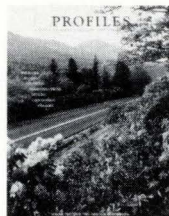

Data General

3400 Computer Drive, Dept. ADV/SIT, Westboro, MA 01580
Please send me the current issue of PROFILES.

Name _____
Company _____
Address _____ Phone _____
City _____ State _____ Zip _____

CALL 1-800-DATAGEN

Circle 50 on Reader Card

We're at your mercy. We want to sell you FOCUS, the number one fourth-generation language for mainframes, minis, and micros. Which means that we have to go the extra mile.

And we will. We'll come to your place, install FOCUS, and create a prototype application that (and here's the trick) runs against your production database.

Or, if you prefer, against FOCUS' own shared relational database manager.

Either way, we'll do it in four hours. At no charge.

What's more, we'll write the entire application in

can, via FOCUS on the second machine, access any major database running there.

In addition, FOCUS offers full portability. An application developed in any environment (see box) will immediately execute in any other. That means, for example, that you can use a PC as a workbench for mainframe application development.

SQL compatibility? However you need it, FOCUS can do it.

There's more.

Developers' Windows let your professional programmers use a windowed interface to create window-driven

TAKE ADVANTAGE OF US.

the FOCUS language—with no exits to COBOL, FORTRAN, or C for the hard parts. FOCUS is such a complete language you can use it to write almost any application—from heavy-duty transaction systems to any type of online inquiry system.

Moreover, FOCUS can directly access every major database system running on every major hardware platform.

We're talking about online access here, not merely batch data extracts. And FOCUS will address multiple databases simultaneously, and do outer joins.

We'll take that a step further. If two computers communicate, a FOCUS user on one

applications quickly and easily. The result is great-looking software with a superior user interface.

TableTalk is the FOCUS point-and-pick windowed interface that lets your end users create their own inquiries, customized reports, or even relatively complex applications—using only the arrow keys and the enter key.

And FOCUS lets you set the security and access levels you want.

Sound too good to be true? It's not. But don't believe this ad. Make us prove it. Just call 1-212-736-4433, Ext. 3700, and ask for details.

And if you give the word, one of our technicians will come out to your place and make it happen. Right before your eyes.

FOCUS environments:

All IBM 370*, PC and PS/2.
VAX/VMS. Wang VS. UNIX V.
Sun/OS and Apollo/Domain.

*With interactive support: TSO, CMS, IMS/DC, MVS/XA, or CICS.



Users Colonize ISDN Islands

Although nationwide end-to-end ISDN connectivity has yet to be realized, users, potential users and suppliers have begun working laying the groundwork for the day when the bridges between islands are built.

BY BILL MUSGRAVE

Nineteen eighty-eight is the year that U.S. users, looking toward a paradise of end-to-end Integrated Services Digital Network (ISDN) service nationwide, began to lay the foundations for that Eden. Users and potential new users apparently have been heartened by continued signs of growth in the technology. New islands of ISDN showed signs of sprouting, as ISDN carriers concentrated on bringing service up in their own regions and detailed prices for ISDN service began to appear.

The inability of carriers to connect multiple networks for end-to-end ISDN service has not posed a problem. As ongoing ISDN trials have proven, ISDN-like functionality can be obtained with existing technology and the patchwork of "true" ISDN.

One such trial, in the San Francisco Bay area, has shown that a patchwork of ISDN can successfully network existing equipment from multiple vendors, including gear that predates ISDN, particularly the RBOCs' sizable installed base of analog switching sites.

The Pacific Bell experiment is running three different switches in three central offices. First on-line was Sunnyvale, Calif., serving Lockheed Missiles and Space with AT&T's flagship 5ESS (Electronic Switching System). Then came several users in San Francisco, where the widely installed analog 1A ESS got Basic Rate Interface (BRI)

support from an NEC Corp. NEAX 61 digital adjunct. Finally, across the Bay in San Ramon, Calif., Northern Telecom's DMS-100 central office switch supports Standard Oil and its Meridian SL-1 private branch exchange (PBX), also from Northern Telecom. For calls that are completed within the same central office, the trial uses out-

band signaling via the D-channel, its internal workings are not important to users. Carrier pigeons or smoke signals could be used if they moved fast enough.

Indeed, there are few foreseeable ISDN applications that cannot be accomplished with existing products in a non-ISDN envi-



of-band signaling as expected with ISDN. For calls originating at one office and terminating at another, however, in-band signaling is used.

Pacific Bell has demonstrated that, as long as the network can deliver ISDN-compliant 64Kbps B-channel traffic and can

ronment. ISDN also makes better use of carriers' facilities in that a single, "integrated" connection to the network eliminates the need for multiple lines for multiple services.

AT&T, MCI, and U.S. Sprint, for instance, already allow customers to assign groups

SIMPLE SOPHISTICATION FOR THE PC WORLD.

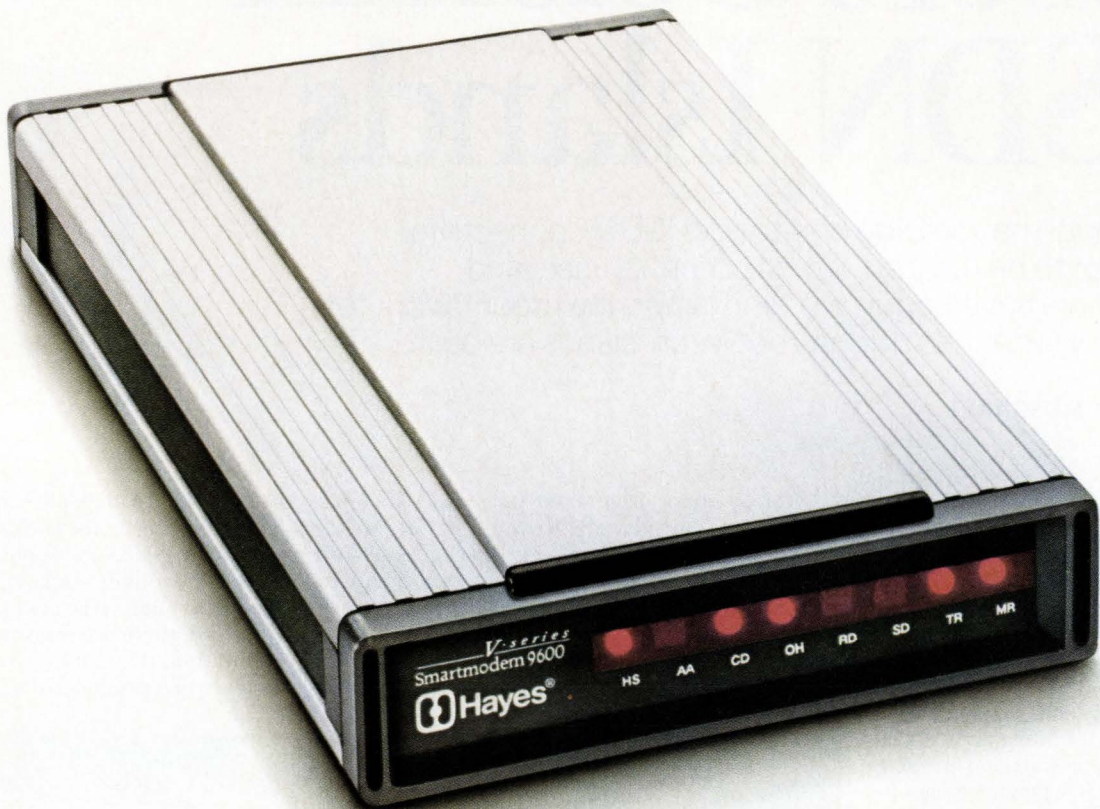

The V-series Smartmodem 9600.

The Hayes V-series™ Smartmodem 9600™ brought a technical sophistication to the high-speed dial-up world that had rarely been seen before.

With error-control for point-to-point communications, it automatically detects errors and then retransmits the data correctly.

With adaptive data compression, it has the capability to double throughput to up to 19,200 bps.

And with Hayes AutoSync, it provides both synchronous and asynchronous communications without the extra expense of a synchronous adapter card.

The Hayes V-series Smartmodem 9600 has a sophistication that not only sets it apart from other PC modems, but above them as well.

SOPHISTICATED SIMPLICITY FOR THE MAINFRAME WORLD.

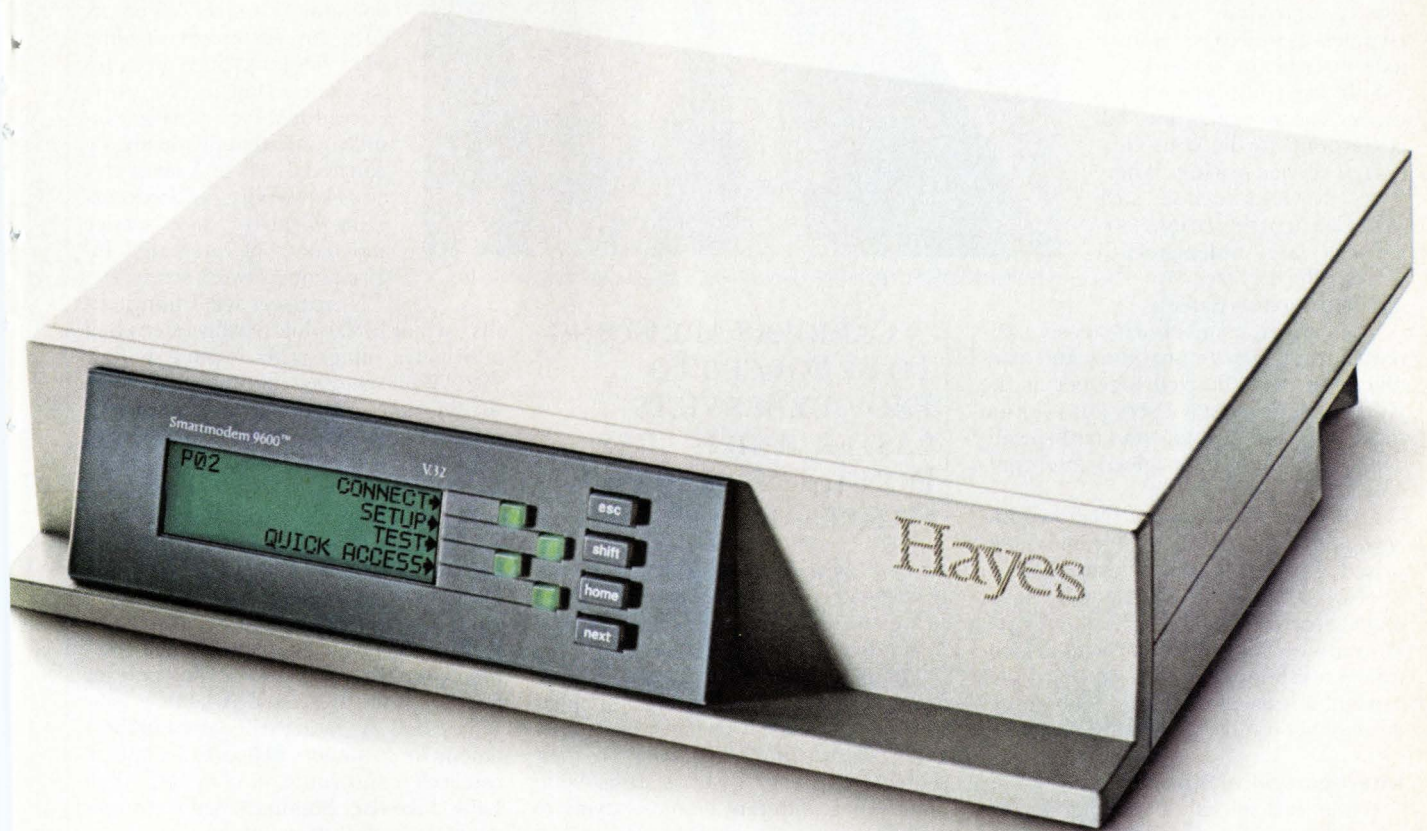

Introducing the Smartmodem 9600 for V.32 communications.

The new Hayes Smartmodem 9600™ brings the simplicity of the PC world to the complex world of wide and local area networks.

For host to host, host to LAN, and data processing centers to remote controllers, the new Hayes V.32 modem gives full-duplex, synchronous and asynchronous communications at 4800 bps and 9600 bps using dial-up or leased-line circuits.

The modem also offers features like automatic leased-line restoration, automatic dial backup and forward error correction to ensure reliable data transmission. An intelligent front panel with an LCD readout puts this array of features at your fingertips. While behind the modem, the Hayes Cable Management System lets you easily install it flush against any wall or cabinet to save space. The Hayes Smartmodem 9600. We're **Hayes**® not just entering the mainframe world, we're improving it.

For your nearest Hayes Advanced Systems Dealer, call 800-635-1225. Hayes Microcomputer Products, Inc., P.O. Box 105203, Atlanta, GA 30348.
© 1988 Hayes Microcomputer Products, Inc.

Circle 52 on Reader Card

of channels within a trunk to access several services, although ISDN is said to improve on this by allowing call-by-call service selection for trunk channels as well as for individual subscriber local loops.

Still, the consolidation of a carrier's service lines does not correspond to the consolidation of service pricing. Where ISDN service has been set, such as in Chicago, the various ISDN services are independently priced offerings (see "An ISDN Tariffed Services Sampler").

The growing number of ISDN users, potential users, service providers, and manufacturers have banded together as the North American ISDN Users (NIU) Forum to identify and develop standard specifications for as-yet-unimagined, interoperable, ISDN applications.

Under the auspices of the National Bureau of Standards, the NIU Forum is comprised of the ISDN Users Workshop, which is chaired by Ed Hodgson, operations manager at Westinghouse Elevator Corp., Morristown, N.J., and the ISDN Implementors Workshop, chaired by Richard Stevenson, advanced technology laboratory director at Southwestern Bell Telephone.

Interoperability Spreads

While the telcos' marketing departments might like to delay the spread of ISDN interoperability to lock in customers in their region, Hodgson sees efforts by groups such as his driving the spread of interoperating ISDN. The carriers, he says, "are going to be forced to provide services faster than their marketing organizations feel they should. If they don't do it, there are others who will."

One application under consideration by the workshops is "home agents." Hodgson explains the idea from his company's perspective: "We have 20 or 30 operators answering telephone calls from people who have problems. The operator enters that into the computer. The operation is staffed 24 hours a day, seven days a week. It is tough to find people to do this.

"With home agents and ISDN," he continues, "we can route the call directly to a person sitting at home with a crt. When he answers the phone, we know what the phone number is of the customer and we can then supply, over the other ISDN line, all the information about that customer. The home agent can enter data interactively into the mainframe; it would appear to them as if they were sitting here. But we don't have to worry about weather,



NIU FORUM'S HODGSON: Users will speed national ISDN's arrival.

□ CARRIERS ARE GOING TO BE FORCED TO PROVIDE SERVICES FASTER, AND IF THEY DON'T, THERE ARE OTHERS WHO WILL.

we don't have to worry about people requirements, because we can use retirees, we can use mothers at home with children, or almost anyone."

Another suggested application is voice and data conferencing, where any number of people from all around the country could discuss the same data on their screens. This use of ISDN is attractive to engineers at different locations trying to evaluate a schematic drawing or data.

More than 200 people showed up for the first Users Workshop meeting in Atlantic City, and Hodgson estimates 300 people attended the group's second meeting, held in mid-September. About 100 of the attendees were users. They approved 36 applications and turned them over to the implementors. Once they finish the specs for them, they will be sent to the Federal Register.

"I've had letters and calls from almost every country in Europe," Hodgson said prior to the gathering. "We're going to have some users from Japan and Hong Kong and, of course, Canada works right with us."

The first sign noticed by users this year that ISDN technology was solidifying came from Ameritech's Illinois Bell. It was the first telephone company to tariff ISDN services, announcing prices for BRI (2B+D) Centrex service in downtown Chicago and nearby Oak Brook. While some potential customers in the area have inquired after primary rate interface (PRI) (23B+D), the carrier hasn't finalized a decision to tariff that access. The month after Ameritech's announcement, AT&T

filed a tariff to bring ISDN PRI services to customers in 18 cities.

Specifically, the Ameritech operating company filed its tariff for customers needing 50 or fewer BRI lines on its Integrated Digital Network. Prices for service at larger installations are individually negotiated. Users of Ameritech's new ISDN service can access existing Centrex voice service and data-only Integrated Information Network services.

Nynex sees itself filing tariffs early in 1989, while Southwestern Bell anticipates filing tariffs in mid- to late 1989. While no other RBOCs have set a tariff filing date, evidence of the technology's expansion to more end users can be seen in the service they are providing on an individual case basis to large customers.

Bell Atlantic and Bell South's Southern Bell provide basic rate and primary rate commercial service on an individual case basis. Since the telephone companies are still riding the learning curve, it isn't surprising to find that many of these "commercial" customers are in the same or related businesses. Bell Atlantic's New Jersey Bell operating company numbers among its customers Bellcore, the RBOCs' research consortium, and AT&T's Bell Labs. Likewise, Southern Bell's customers include AT&T Network Systems, Contel Corp., Prime Computer Inc., and Hayes Microcomputer Products.

Customer Specific Proposals

Southwestern Bell is offering ISDN services under Customer Specific Proposals (CSPs), which are single-customer, single-state price schedules available only to customers ordering more than 400 lines. Southwestern Bell has five CSPs, with the smallest comprising 1,000 terminals at AT&T Technologies in Oklahoma City. That system started up in July. AT&T Network Systems in St. Louis has 2,300 lines on order, with service scheduled to begin this month. Illinois Bell says it will begin providing ISDN BRI service to AT&T Bell Labs in Naperville beginning early next year. The entire installation of 9,500 lines is scheduled for completion during 1989.

U.S. West Communications began providing ISDN services, on an individual case basis, in six cities, in mid-September. At that time, AT&T was announced as its first Colorado ISDN customer. Under a seven-year agreement, U.S. West ultimately will use 1,000 lines to connect AT&T's six Denver metropolitan offices to its integrated

An effective System Architecture should provide an open bridge to communication.

High on the agenda of most companies will be "improving communications". Yet, surprisingly there are still some influential manufacturers of information systems whose very technology impedes communication. The plain fact is that it is not in their interest to allow customers the benefits of free information exchange.

The Olivetti difference.

Olivetti does the opposite. Open System Architecture from Olivetti is a way to pry open closed systems. It is a bridge that by connecting diverse technologies of different manufacturers, permits communication. And accommodates new technology as soon as it is available.

To choose Open System Architecture is to choose freedom. At the foundation of the Olivetti plan are the principles of connectivity and standards. Being able to connect environments defined by different manufacturers facilitates the exchange and integration of information, for an infinite number of tailored applications at all levels of use. Acceptance of standards lets the system evolve and grow naturally, in step with your company.

In short, Open System Architecture from Olivetti fosters not just the coexistence of systems, but their **complete integration**.

The Olivetti solution.

International standards for information network design provide the foundation of Open System Architecture. They manifest themselves in the Olinet family of networking products, which incorporates all ISO/OSI standards for both Local and Wide Area Networking applications. And in Open System Architecture's commitment to the PC world of MS-DOS.

In addition, Olivetti offers a full line of protocols that enables complete connectivity with the environments of the major vendors. And a new, fully integrated line of LSX 3000 minicomputers capable of supporting from two to two hundred linked users.

The industry standard UNIX system is the foundation for the LSX 3000 minicomputer family. These computers support an operating system conforming to the UNIX System V and X/OPEN standards. A world of applications software satisfies the most complex needs. Of course, the computers continue to support MOS, the Olivetti operating system developed for specific market sectors.

Olivetti is represented in all European, Far Eastern and Western countries. For further information about Olivetti systems please contact the Marketing Department of the Olivetti Head Office in your country.

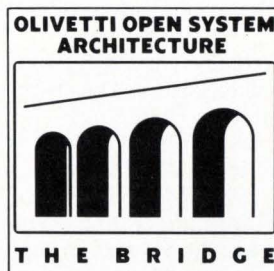

olivetti

voice and data network.

The locations include AT&T's Bell Laboratories in Westminister, the AT&T National Customer Service Center, Technical Marketing Center, and AT&T Network Systems' new Western region headquarters. AT&T says it will employ ISDN for a citywide desk message service, "work at home" applications, and an X.25 connection to a private data network.

A High-Speed Transmission Line

To do this, AT&T will use a high-speed transmission line—primary rate access (23B+D)—for the first time between three AT&T System 85 PBXs and a 5ESS switch in

U.S. West's central office. U.S. West will provide BRI ISDN lines to the 500 employees at the AT&T Network Systems office.

In July, U.S. West began a five-year project to convert nearly 10,000 lines to ISDN for 3M Co. at 23 locations in Minneapolis-St. Paul. In Austin, 3M ordered more than 3,100 ISDN lines from Southwestern Bell; service began in July.

Other local and long distance carriers, such as MCI and U.S. Sprint, are moving to ISDN at paces that should deliver commercial services over the next year or two, but they are not yet ready to disclose pricing structures.

While the local exchange carriers be-

lieve that what users may find in ISDN is a new lure to their Centrex service offerings, others believe it will attract users with multiple locations served by advanced PBXs. With ISDN compliance, PBXs from different vendors could be used as though they were a single telephone network.

"The Savior of Centrex"

By linking sites via ISDN PRI, says Don Mulder, vice president of marketing for Centel Business Systems, Chicago, which markets PBXs and other telecommunications gear, users can have their several switches provide services, such as ring-

An ISDN Tariffed Services Sampler

Ameritech's Integrated Digital Network offers a variety of services, features, and options. Circuit-switched voice service provides access to the company's exchange service. Voice calls outside the customer's business system are subject to those rates. Intercom calls will display the calling number on terminal equipment capable of displaying that information. Conference, transfer, drop, and hold features are standard, as is speed calling from a private six-number list. "Call appearances" tell the network how to make use of the indicator lamps and other status displays on user terminal equipment; 10 user-defined appearances are standard. Circuit-switched data service lets users originate and receive data calls at 56Kbps or 64Kbps. The service can access the carrier's Public Switched Digital Service to reach points outside the business system. Features include intercom dialing, speed calling, and a variety of security restrictions.

Packet switched data service on the D channel (the ISDN out-of-band signaling channel) provides access to the carrier's X.25 packet data network for communications outside the business system. A standard feature, it supports one logical channel and can include intercom calling, throughput class selection and negotiation, and fast select initiation/acceptance. Options include closed user groups, permanent virtual circuits, and additional logical channels. Packet switched data on the 64Kbps B channel additionally offers up to 128 logical channels as standard.

Illinois Bell offers two hypothetical cases of per-line costs of its service on two 50-line systems located in downtown Chicago. For a system offering only circuit-switched voice, the one-time charges, which include the line installation charge, service establishment, system capacity charge, "U" interface, and circuit-switched voice charge, come to \$146.50. The monthly rate for those services is \$16.58. Each line on a system with access to circuit-switched voice, circuit-switched data, and packet switched data on the signaling D channel, has a one-time charge of \$246.50, and a monthly \$29.68 charge. The charges do not include any of the optional interface charges.

According to the tariff filing, systems with 20 or fewer ISDN lines carry a total one-time service establishment charge of \$480 and a monthly charge of \$22.80; 21 to 35 lines are initially \$735, plus \$34.65 per month; 36 to 50 lines bear a onetime charge of \$900 and a monthly fee of \$42.50. Systems larger than 50 lines pay the 36-to-50-line charges, plus \$1,800 up front and \$85 per month for each additional 100 lines.

System capacity charges increase with the number of simultaneous circuit-switched intercom calls allowed from ISDN lines. For one to five intercom transmission paths, there is a single fee of \$200, and a monthly charge of \$30; six to 10 paths cost \$400 up front and \$60 a month; 11 to 15 paths are \$600 and \$90 each month. It costs \$250 to upgrade from one category of service to another and \$550 for each set of 10 lines added over 15. Users that want to install more than 15 paths initially will pay the onetime fee for 11 to 15 paths, plus \$500 and \$75 per month for each additional 10 lines.

The tariff also calls for a onetime charge of \$50 for each BRI interface, with a monthly charge of \$.40 for a four-wire (reference point "T") connection or \$2.35 for a two-wire (reference point "U") connection.

Users of packet switched communications can use customer-specific or common service data facility pooling for communicating to or from non-ISDN locations. With the first, the customer specifies asynchronous access parameters and the modem pool is subject to outbound dialing restrictions specific to the customer. It costs \$10,000, initially, and \$274.15 per month. Common service data facility pooling provides a shared modem pool for 300bps or 1,200bps communications; it costs \$500 once, plus \$25 per month, plus usage charges.

AT&T tariffed two ISDN services—Automatic Number Identification (ANI) and call-by-call service selection. ANI, which AT&T offers under the rubric of Info-2, transmits the 10-digit telephone number of the calling party along with the call. Aimed primarily at telemarketing applications, AT&T offers Info-2 to customers using its Megacom 800 service. AT&T charges \$200 to add or remove Info-2 from an access group; each number delivered costs \$.03.

Call-by-call service selection lets the customer designate any of the 23 B channels in a PRI so these channels can be used with AT&T's circuit-switched services: Megacom 800, Megacom, and Accunet Switched Digital Services. For instance, six B channels could be assigned to outbound Megacom, six more to inbound Megacom 800, and the remaining 11 could be call-by-call selected. By fixing the assignment of some of the B channels, the customer can be assured that an overload of incoming calls doesn't seize them all and block attempts to dial out. AT&T charges \$250 to establish call-by-call service selection, and \$200 for subsequent rearrangement of the group.

SIEMENS

The advantages of choosing a standard.

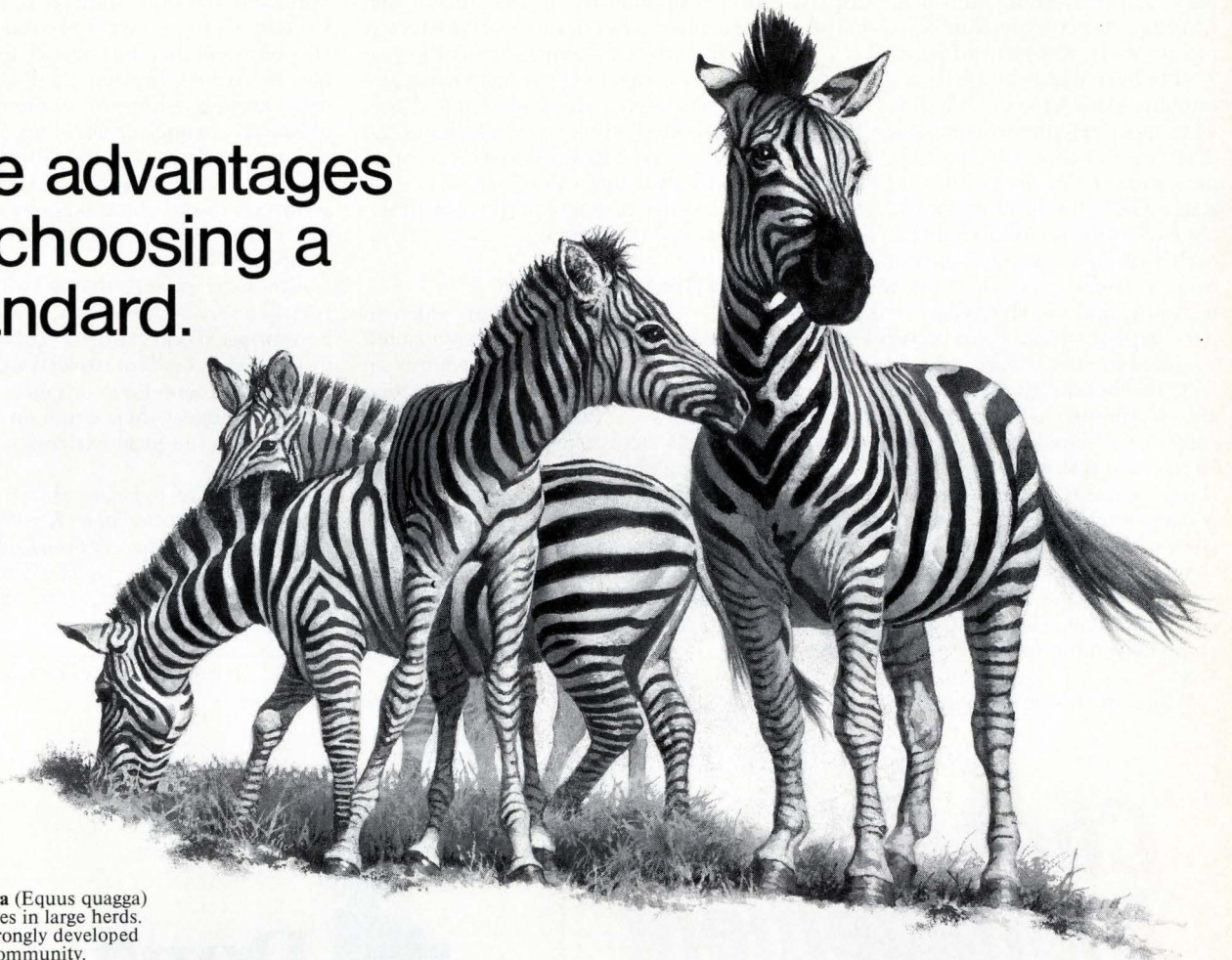

The zebra (*Equus quagga*) usually lives in large herds. It has a strongly developed sense of community.

In many cases, it is external appearances which determine whether you belong together and whether you will hit it off; in short, whether you are part of a particular standard.

This is true not only for the animal kingdom, but also for the reliable interaction of all dp devices in an organisation. One of the fundamental ways of ensuring this is by using reliable standards, and this is why all Siemens PCs operate under MS-DOS and provisions have been made for them to support MS-OS/2. This means that your options are wide open for future applications. The processors used also offer you a time-proven standard: the successful 80286 or 80386 series of microprocessors. Even the user interface for Siemens PCs is based on a tried standard: we have been

delivering MS-Windows as a part of the package for some considerable time.

Yet another guarantee for you is that the Siemens PC family allows you to use 3 1/2" or 5 1/4" floppy disks. The Siemens PC concept means personal computers designed to meet the demands of the future; it is a concept based on decades of experience, not only in the field of data systems, but also in the field of communications engineering.

Reliable intentional standards are only a part of the Siemens PC concept. Each aspect of the concept guarantees flexible communication, reliability into the future and simplicity of operation. It goes without saying that there are also fast, super-quiet printers available for the Siemens PCs.

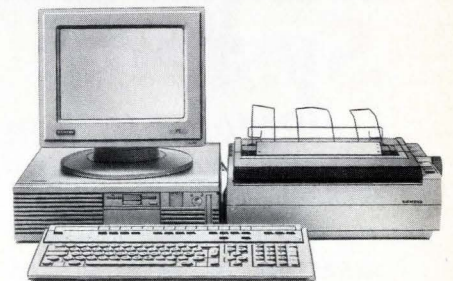

**Get it right from the start.
The Siemens PCs.**

-----Coupon:-----

Siemens AG,
Infoservice 131/Z035
Postfach 23 48, D-8510 Fürth, West-Germany

Please send me information on the following:

- Siemens PCs.
 Siemens printers for PCs.

Name: _____

Company: _____

Full address: _____

COMMUNICATIONS

ISDN

back, call forwarding, and name display (through directory lookup keyed on calling number), across the organization.

"I believe that is how ISDN will be used initially," Mulder says, "but this is at odds with most telephone companies today. They are tariffing the Basic Rate Interface, and very few are tariffing the Primary Rate. They [the local exchange carriers] see ISDN as the savior of Centrex."

Before ISDN can save anything, however, carriers must have the ability to transport and switch 64Kbps clear channels, explains John Todd, network management services marketing director at MCI Communications in Washington, D.C. Common channel signaling, specifically CCITT Signaling System 7, is needed to pass control information, such as call setup requests, across an independent packet switched network that controls carriers' networks.

While MCI has 64Kbps clear channels, says Todd, it plans to implement SS7 by early next year. He adds that the rollout could be completed before the end of this year.

While most long distance carriers and

local telephone companies work to put SS7 in place, AT&T began offering ISDN service directly to customers earlier this year using its common channel signaling system 6 network, which will support SS7. AT&T tariffed PRI access to its facilities and to two ISDN services—Automatic Number Identification and call-by-call service selection—that do not require ISDN in the local carriers' exchanges.

ISDN Controller Needed

AT&T's initial ISDN services are independent of the local telephone companies, but PRI access nevertheless requires an ISDN-compatible controller at the customer's premises. Not surprisingly, AT&T's System 85 PBX is one such choice. When interoperability with local carriers becomes critical, AT&T will cut over to SS7.

AT&T's PRI operates over T1 links between the customer's premises and AT&T's point of presence in any of 18 cities coast to coast. The PRI has an initial fee of \$3,000, and a recurring monthly charge of \$400, in addition to the cost of the T1 link.

Finally, says MCI's Todd, there are

"probably the most difficult of the ISDN structures" to resolve: "the interfaces." He points out that the ISDN PRI, for example, for trunks bearing 23 B-channels, each carrying 64Kbps of user data, and a 64Kbps D-channel for signaling, has three domestic variants. For the 2B+D BRI that provides connection for individual subscribers, MCI and other long distance carriers will have to rely upon local telephone companies, he adds.

Although he asserts that MCI will deliver ISDN-like services before these standards become set, Todd expresses concern that the "equal access" controversy may be played, as more long distance carriers need to connect their common channel signaling to the local exchange carriers' D-channels.

Users interested in joining the NIU Forum Users Workshop can contact Kim Brashears at the National Bureau of Standards, Bldg. 225, Room A224, Gaithersburg, Md. 20899. The forum charges fees only to attend its workshop sessions.

Bill Musgrave is a freelance writer based in California.

Channel Management Systems

for IBM/compatible CPUs.

Reconfigure equipment with the CMS Matrix Switch and obtain local performance from remotely attached control units with the Dynapath Channel Extender. Call for more information.

CMS MATRIX

- full compatibility with IBM channel and channel-connected controllers.
- single matrix crosspoint architecture.
- high density modules save floor space.
- easy operation.
- online expansion and maintenance.

DYNAPATH CHANNEL EXTENDER

- control unit extension up to 5 km.
- 2 totally redundant data paths.
- local response times at extended distances.
- extensive diagnostics.
- no modification of host software.

 **Dynatech Communications**

Dynatech Communications, 991 Annapolis Way, Woodbridge, VA 22191
Telephone 703-550-0011



Send for the latest edition of the free Consumer Information Catalog. The Catalog lists over 200 selected federal publications of consumer interest on subjects like health, nutrition, federal benefits, money management. The Catalog is free and so are many of the booklets. Just send your name and address, no strings attached. Write today:

**Consumer Information Center
Department DF
Pueblo, Colorado 81009**

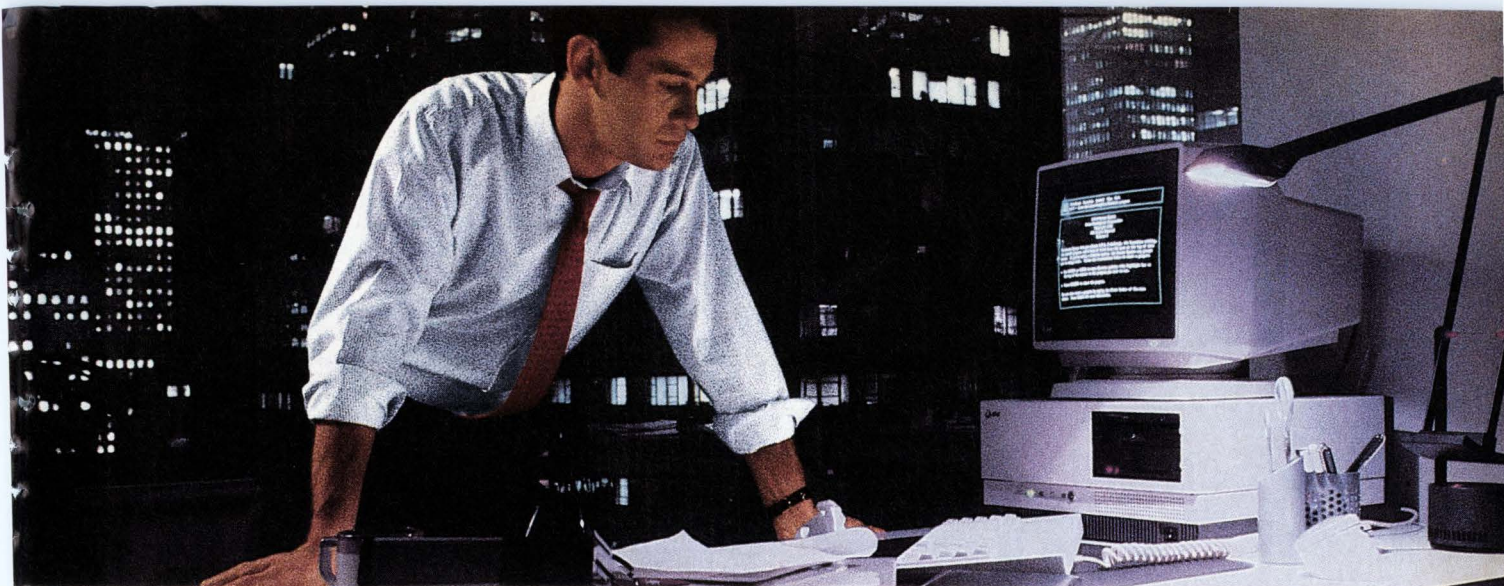

*"Taiwan's down again.
Somehow this is going to be my fault."*

When the overall reliability and transmission quality of your data services are critical to your success, the services you choose for your company can be vitally important.

But it is nice to know you can depend on the AT&T Worldwide Intelligent Network for your communications services between the U.S. and other countries. This network is maintained internationally through the cooperation of PTIs around the world to provide high-performance transmissions.

With subsidiary offices overseas, AT&T offers you reliable customer service. So whether it's facilitating new service installment or keeping existing services operating smoothly and efficiently, you can count on AT&T.

AT&T is also committed to implementing state-of-the-art fiber optic technology along with a wide range of data, voice and video services. These services can enable you to globalize applications with accuracy and timeliness.

Let AT&T tailor services for your business needs and assist in long-range planning. Call your account executive, or the International Response Center at 1 800 448-8600, Ext. 349, and find out how AT&T can meet your needs in the international marketplace.

From equipment to networking, from computers to communications, AT&T is the right choice.



AT&T

The right choice.

Manpower[®] can send you "Lotus^{*}-literate" Temporary office workers. Everywhere!

Over the past two years, more than 100,000 Manpower Temporary office workers have learned the basic functions and applications of Lotus 1-2-3 and have applied them on a wide variety of temporary assignments.

Their training was on IBM PCs located in all 700 Manpower U.S. offices using Skillware[®] — the unique Manpower training diskettes written *by* office workers *for* office workers.

Our exclusive 115-page Lotus 1-2-3 Operator Support Manual is their constant quick-reference companion.



Call us for trained, tested Temporaries to help you with your Lotus 1-2-3 application work or quick-training for your own permanent staff members in Lotus 1-2-3 basics . . . or both!

 **MANPOWER[®]**
TEMPORARY SERVICES

Private Networks: The End of an Era?

The emergence of managed data networks in Europe could undermine many of the traditional reasons why companies set up private networks.

BY JIM NORTON

Europe in the late 1980s holds a unique market opportunity for international data services and their supporting infrastructures, consultants, and systems integration (SI).

In the past, the real demands for coherent, multinational networking in support of vital business requirements have been trapped behind a dam of regulatory monopoly, bureaucracy, and protectionism. The last few years, however, have seen various national governments and the European Commission digging away at the foundations of this order. It will be swept away over the next five years, creating a market ready for change, where most of the products and services required already have been developed.

Added impetus to this movement will come from the need for business reorganization across Europe to exploit the opportunities of the unified market anticipated by 1992.

Such developments, however, raise key questions about the future of the European PTTs and the networking plans of major user corporations. The reregulation of communications across Europe ultimately may weaken the PTTs' voice monopoly and draw users away from the use of purely private networks.

At the core of these questions are the real needs of those user companies that operate across Europe. They require efficient communications support across national boundaries, including the following:

- single points for pan-European fault reporting, moves and changes, new service ordering and help facilities;

- flexible and sophisticated billing and accounting methods that can be attributed to a company's line of business divisions rather than locations;

- single standards for network attachment/terminal equipment, and a single standards and approvals regime;

- harmonized maintenance and support arrangements across Europe, with "local" abilities to integrate and commission new personal and departmental systems;

- clarity and predictability of costs; and

- a choice of service levels matched to business need and cost, from the absolute

reliability demanded in the international financial services community to the less rigorous needs of, say, store-and-forward messaging for manufacturing EDI.

These are the basic requirements, not the only ones. For example, there's also a need for the effective management of proprietary architectures and internetworking.

Firms want networking solutions that are consistent with their installed (usually proprietary) base, yet still open to the attachment of different vendors' equipment. This implies de facto recognition of

the strong presence of IBM, through SNA and earlier protocol sets. It also implies the ability to operate IBM's SNA efficiently over switched, open (X.25) networks and the need to gateway between IBM proprietary and open high-level protocols. It is also important that companies get a manageable total business solution.

The Established Route

Traditionally, companies meet these needs by building an internal communications organization to shield their internal users from the worst excesses of the world outside. Specialized communications staff deal with the multiple PTTs, regulators, and vendors. Private networks are built to create a stable environment and to achieve the desired connectivity. The effect is to establish a miniature multinational communications firm within, say, an oil company or a bank. This route is widely used, because, quite simply, it is the only option.

Private operation has now reached—and indeed exceeded—the limits of the sustainable. Companies are caught in

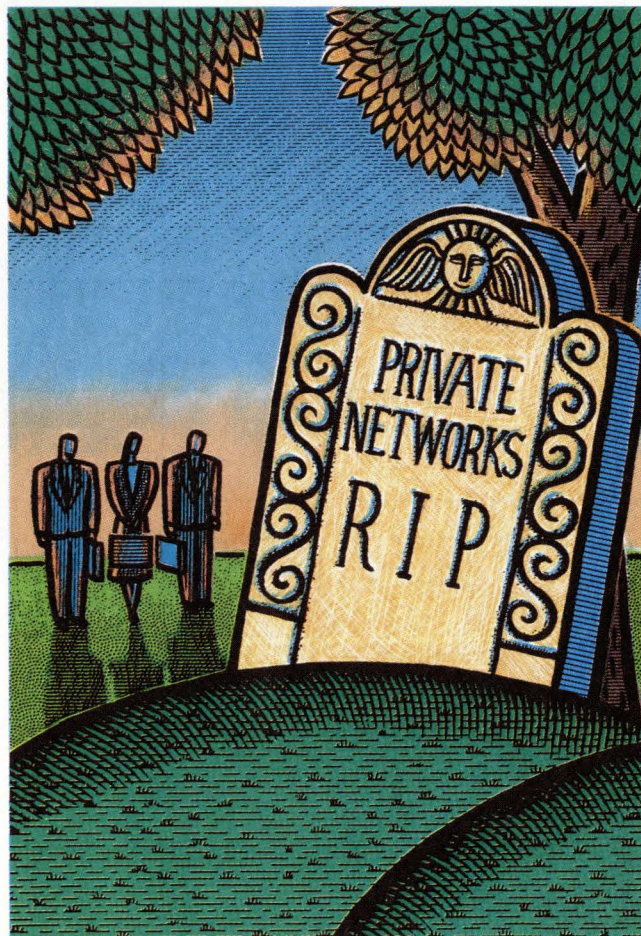

First Half 1989 DATAMATION Editorial Calendar

Issue Date	Ad Closing Date	Special Reports	Software/ Services	Systems	Communications	Management	International
January 1	December 1, '88	IBM					IBM in Japan IBM in Europe
January 15	December 15, '88	Technology Forecast		RISC	Telecomm. Operations		
February 1	January 2		Transaction Control Systems	OLTP		PCs in IS	Offshore Software
February 15	January 16		OS/2 vs. Unix	Security		Product Development	
March 1	February 1	DEC		IBM-DEC Connectivity	T-1 Multiplexors		1992
March 15	February 15		PC-DBMSs	386-Based PCs		Corporate Profile	
April 1	March 1	Budget Survey		Weapon Systems	EDI		Eastern Bloc Computing
April 15	March 15	Connectivity Survey	Expert System Integration	Document Image Processing	Voice Messaging		
May 1	March 31	Companies to Watch	OS/2 on IBM Compatibles			Corporate Profile	Far East Operations
May 15	April 14	Large Scale Systems Survey	Operating Systems Evolution			Decentralization	
June 1	May 1		Object Oriented Programming (OOPs)	Macintosh in IS	LANs		Executive Information Systems
June 15	May 15	Application Software Survey		High Performance Computing		Corporate Profile	
June 21	May 22	DATAMATION 100					

Contact Your Regional DATAMATION Sales Representative for Additional Related Market Research, Advertiser Benefits and Trade Show Bonus Distribution

Twice Each Month
DATAMATION's Career
Opportunities Section
Brings You the
Latest in Current
Job Opportunities in the
MIS Market,
Where you can Reach:

- Software Engineers
- Systems Integrators
- Data Processing Managers
- Programmers/Analysts

a trap between the increasing complexity of (and business dependence on) these networks, and the inability to recruit and retain the necessary skilled and experienced staff. This is particularly ironic since the need to build an internal communications company was an artifact of monopoly and regulation. With the possible exception of banking and financial services, communications is not generally a company's core business.

The Services That Are Offered

The changing regulatory environment is beginning to offer a way out. New services providers, which used to operate at the edge of regulatory tolerance, are emerging. There are three types:

- *Sector network providers*, such as the long established SWIFT and SITA networks in the banking and travel sectors;

□ COMPANIES ARE CAUGHT IN A TRAP BETWEEN NETWORK COMPLEXITY AND THE NEED TO RECRUIT SKILLED STAFF.

- *Managed network providers*, such as General Electric Information Systems Co. (GEISCO), McDonnell Douglas Network Systems Co. (with Tymnet), and Computer Sciences Corp. (with Infonet); and

- *Network integration providers*, such as IBM. Companies in this group tend to have a strong hardware base to protect during the migration of customers from private to shared networks.

All used to be severely limited by regulation in, for example, the sharing of national or international leased circuit capacity. Such restrictions are now being decreased and it is the unanimous, if rather muted, view of the European PTTs that within the next few years they will all face competition in packet switched-style data services.

From these companies—and from new entrants such as the Electronic Data Systems (EDS) subsidiary of General Motors, and various non-European communications companies drawn in by the substantial business opportunity—will come a series of competitive managed network offerings across Europe, and, in some cases, worldwide. Three such consortia are already taking regulatory soundings in Europe to confirm their freedom to operate. It seems likely that their services will emphasize the following:

The Problems for The PTTs

Many observers expect the PTTs to dominate the emerging European market for managed data networking. After all, they hold three cards that normally would guarantee success: control of the national customer bases; network infrastructure in place and in operation; and almost unlimited financial resources.

This view, however, overlooks the major problems and challenges that face the European PTTs. It is not that the PTTs lack an understanding of the marketplace—their national market intelligence is excellent. Nor do they lack the ability to determine the necessary strategy and tactics. What they face are severe limitations in the actions that are available to them from a practical standpoint. Such limitations include the following:

- legislative problems in certain countries in operating a targeted and commissioned account management force;
- lack of mutual trust to develop shared sales and marketing;
- inability to fund new European “overlay” network developments that would conflict with existing national network investments;
- lack of coherence of the existing national X.25 services due to X.75 international gateways blocking key facilities, such as closed user groups and reverse charging;
- cultural difficulties in accepting the need to support proprietary protocols, albeit as a means of migrating the customer base to OSI.

Certain limited joint initiatives have been taken. Most notably, a working party

of the CEPT Commercial Action Committee (CAC) has been meeting for more than 18 months to determine a common approach to Managed Data Network Services (MDNS). Its scope for action appears limited to procedural matters (single point ordering, fault reporting, billing, and so on). While these are important, they do not touch on the key issues of joint account management and improving the basic service by reconciling the incompatible national network architectures.

Joint progress is also bedeviled by uncoordinated individual deals between PTTs and the new services providers, the most dramatic being the development of the relationship between Transpac in France and Computer Sciences Corp., El Segundo, Calif., into an equity deal with other PTTs. France Telecom, the Deutsche Bundespost, Teleinvest in Sweden, and RTT in Belgium have all taken a stake in the worldwide CSC Infonet network; Telefonica in Spain and SIP in Italy are believed to hold options.

It will be difficult to reconcile this kind of external deal with the shared network initiatives being discussed within the CEPT. What's more, the PTTs face significant problems from the divergent views inside the European Commission. One directorate would, in principle, support joint action, while another might well rule it to be anticompetitive.

Overall, the present policies of the PTTs are far from coherent or coordinated. Instead, they seem to lead inevitably to confusion and decline.

- the provision of a consistent, fully featured X.25 service without the limitations currently imposed in PTT services by national X.75 gateways;
- the efficient, multinational support of proprietary protocols, especially 3270 SNA, above the X.25 network. These will probably be backed by new, channel attached, front-end processor developments aimed at removing IBM's dominance of the relatively inefficient 37X5-style front-end operation;
- extensive “one-stop shopping” support, providing single points for ordering, fault reporting, billing, and so on;
- flexible network management, offering the ability to operate hybrid networks (partly private, partly shared) or virtual private networks. New tools will offer better management and control for a company on a shared network than can be found on many existing private networks.

These managed network operators probably will make substantial inroads

into the proprietary private network base, which begs this question: will purely private international (and, eventually, national) networks go into decline? There is little outward sign at present, but there are strong arguments suggesting that will happen, centering around the reasons a private network is set up in the first place: to save money, to achieve connectivity that is not available from any public service, to protect the company's users from the disorder of the outside world, and to provide control of a function vital to the company's commercial and competitive success. None of these reasons will hold in the new environment.

Why Networks Are Set Up

Saving money was certainly historically true in several European countries. A typical example was the U.K., where lack of visibility of the costs of individual elements of PTT service led to private services being tariffed substantially less than the

COMPUTER ASSOCIATES AND TEKTRONIX

LINK MULTIPLE GRAPHICS DATABASES AND DRAW ONE CONCLUSION.

Now you can capture distributed data fast. From factory floor, field office, or corporate boardroom. Then transform it into brilliantly colored charts and graphs that turn data into competitive decisions.

To make it happen, a single clear window, the Tek 4207 color graphics terminal, works with a singularly powerful programmable graphics library, CA-DISSPLA™. The Tek 4207 lets you connect to IBM and

DEC hosts simultaneously. While industry-leading CA-DISSPLA offers device and CPU independence.

So when you team the Tek 4207 with CA-DISSPLA, you create an integrated graphics system for sophisticated visualization and top quality presentation graphics.

Regardless of data source. And regardless of user. Highly flexible, menu-driven access capabilities, built-in graphics generating programs, and full programmability put the power of Tek and Computer Associates into the hands of novices and experienced users alike.

Don't wait to draw the right conclusion about your graphics data needs. Call Tektronix today: **1-800-225-5434**. In Oregon, call 1-235-7202.

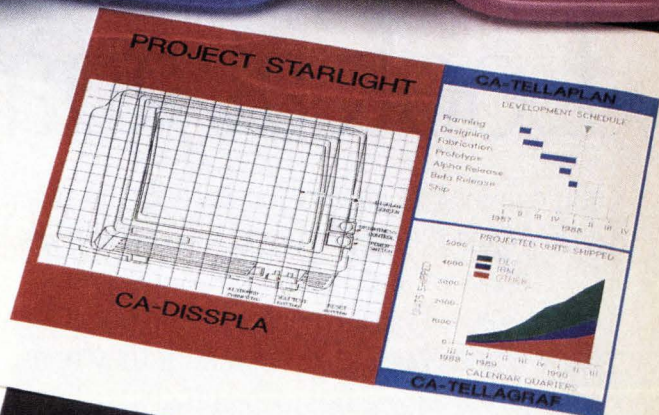
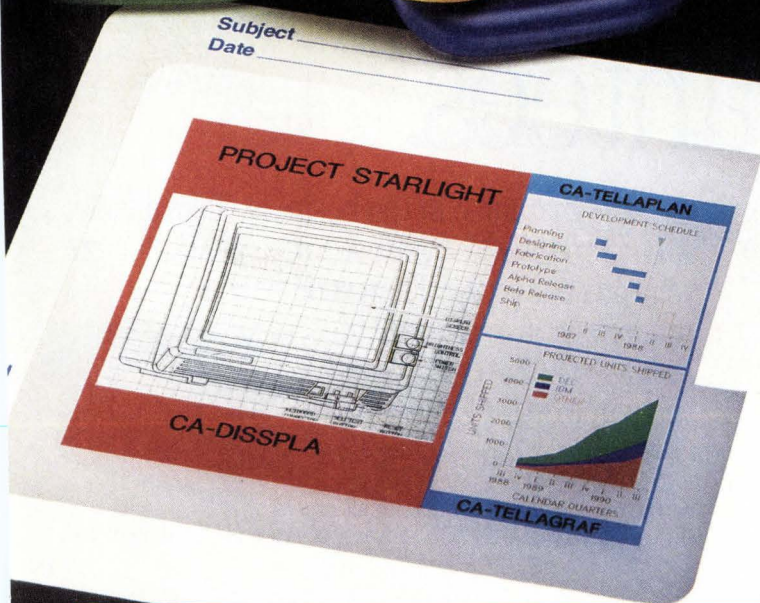

COMPUTER ASSOCIATES

Tektronix

Circle 62 on Reader Card

comparable public service. Inevitably, as reregulation sweeps across Europe, a new breed of regulator will ensure that individual service tariffs are directly related to their costs. This will happen even though most PTTs, (unlike the BT/Mercury Communications duopoly in the U.K.), will not face competition in basic service provision. So, where private circuits were tariffed artificially cheaply compared to the switched network, these tariffs will be progressively rebalanced. Such a process has been visible in the U.K. for the last four years.

The strange case of an individual company being able to buy circuits and switches without the economies of scale of a PTT, being able to meet the costs of integration and operation, and still providing service cheaper than the PTT, will be closed.

The second reason for a private network is achieving connectivity. It is certainly true that extensive international proprietary or split proprietary/OSI networking is still unavailable from the PTTs and is unlikely to become available. However, at least three and perhaps as many as six pan-European managed net-

works will be established over the next five years. They will feature specifically these missing facilities. Support in a shared environment is likely to be both better and less expensive than in a private network.

**□ DEMOLISH
TRADITIONAL REASONS
FOR A NETWORK.**

Third, the private network allowed companies to protect the users, but, again, the key sales thrust of managed data networks will be "one-stop shopping" and the elimination of gratuitous national differences.

Finally, there is the control of networking and its associated business dependencies. What is control exactly? Do companies operating private networks really have this control, or is it merely another myth? Unless a great deal of effort (and expense) has gone into sophisticated network management and monitoring systems, this so-called control is illusory.

Similarly, unless fallback capacity, diversely routed, or contingency attach-

ment to the public networks exist, and skilled staff are available to handle the necessary reconfiguration, mere knowledge of the precise point of failure may be of little comfort. It is at least arguable that shared network or virtual private network operation will offer better "control" than the equivalent private facility. This will be especially true if, as seems likely, the shared network operators offer remote monitoring and administration facilities. These should offer the ability to see what has happened and what the operator is doing about it.

Down—But Not Out

One other related issue here is network security. Security is another very loosely defined concept. Do network managers genuinely believe that private systems linked to public facilities are more secure against eavesdropping, say, than a public or shared network? Adequate technology and engineered systems based on public key cryptographic techniques, for example, exist to offer genuine security where required.

Although these reasons for private

If you think all copiers are the same, Look at guarantees.

You can look at copiers for days but, in many cases, there's no real way to tell them apart.

Here's our suggestion. Look at copier guarantees. That's where you find out if a company stands behind its copiers. If they're as committed as you are to keeping your business running smoothly.

Once you look at guarantees, your job will be easy. Because Harris/3M copiers come with

the best guarantee in the business. Take a look at our Promise. Compare it to the guarantee on your present copier. Then send in the coupon. Or give us a call at 1-800-TLC-COPY. We'll send you a free copy of our 8-page *Consumer Guide to Copiers*.

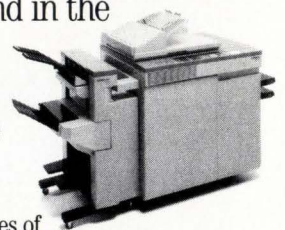

Harris/3M copiers have features for all sizes of offices. That includes the 6070. Seventy copies a minute, guaranteed.

networking may be undermined in the new environment, those nets will not disappear completely. Networks will survive by offering value to their users. The characteristics of the survivors will be that they offer genuine high-level service and competitive edge to their owning company. Those networks that are mere utilities (cost-saving) or infrastructure (connectivity) will gradually disappear. Typically, the networks that will continue will be in industries such as banking and financial services.

The key point is that at least new choices will exist and those choices will continue to grow. Once worldwide managed data networks exist, with a top customer base, can they be denied the ability to support voice as well? In a digital world, how would an arbitrary regulator distinction between voice and data be enforced? All the arguments that managed data networks offer enhanced service beyond basic packet switching also apply to managed voice networks.

By the mid-1990s, we may see worldwide managed networks drawing basic transmission capacity from the PTTs but

providing their own switching and serving the total information (voice, data, image) needs of top customers. It seems a strong possibility.

We are heading into a new era of choice

NEW REGULATORS WILL ENSURE TARIFFS ARE RELATED TO COST.

in networking. For the first time, genuine options will exist for solving corporate network problems via private or shared networks. The shared approach, despite concerns over control, appeals to the senior management of many companies. It allows them to opt out of an increasingly complex managerial and technical problem frequently seen as a diversion from their core business.

This will alter dramatically the role of the telecom manager. At present, in many companies, this is an operational role. A change would be required to match the new challenges forcing telecom managers to manage both internal resources and external dependencies, such as systems inte-

grators and managed network operators. The role also would be able to act as the internal communications champion, showing how networking could improve the bottom line of corporate business units.

While private networks will never disappear entirely, the trends toward reregulation, the growth of managed data networks, the prospects for multimedia network services, and a new role for telecom managers over the next few years may well mark the end of the private networking era. The new era of choice is just around the corner. As the adage goes, this is not the beginning of the end, but the end of the beginning.

Jim Norton is the director of industry studies at U.K. consultancy Butler Cox and Partners in London. He has 18 years' experience in the European communications industry and was formerly head of worldwide business development projects for British Telecom International. A report called The Battle for the European Data Communications Market, which covers some of the issues raised in this article, was published by Butler Cox earlier this year.

e same, don't look at copiers.

The Harris/3M Copier Promise

1. 98% guaranteed up-time or your money back for the time it's down.
2. A free loaner if your copier is out of service for more than 8 hours.
3. An after-hours, toll-free helpline to assist you with minor emergencies.

C. Lance Herrin
C. Lance Herrin
Vice President - Copying Systems Division

Yes, I'd like to know more about Harris/3M copiers and the Harris/3M copier Promise. Please send my free guide.

NAME _____
COMPANY NAME _____
ADDRESS _____
CITY _____ STATE _____ ZIP _____
PHONE # () _____

____ I'd also like information on your full line of fax machines.

Harris/3M P.O. Box 785, Dayton, OH 45401 CN1188H1

HARRIS/3M

Offer is valid for a limited time and other restrictions and limitations apply; see your Harris/3M sales representative for details. ©1988 Harris/3M Document Products, Inc. Harris is a trademark of the Harris Corporation. 3M is a trademark of the 3M Company.

CIRCLE 63 ON READER CARD

Bridge the gap between today's MS-DOS and tomorrow's UNIX with a single computer. Call Hall-Mark for the Unisys 6000/50.

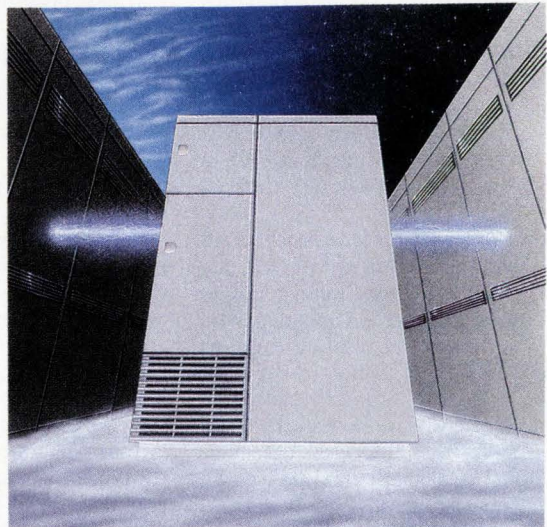

Hall-Mark knows your dilemma — do you recommend MS-DOS equipment because your customers have a large installed base, and heavy software investments? Or, do you introduce them to a UNIX system because it offers a pathway to the future, common user interfaces for important applications.

Hall-Mark recommends both. In a single computer. The Unisys 6000/50 is one of 14 models that serve from 1 to 384 users. The line puts full features, including multi-tasking and multi-users, around the Intel 80386 processor. The Unisys 6000/50 is fast enough for PC power users, and a powerful enough for efficient UNIX operation. Your customers can start with a single computer that runs both operating systems concurrently, then integrate upward, or network in any direction.

No matter which way you go, you'll find someone at a nearby Hall-Mark office to help you get the training, software, communications, sales-support and fast off-the-shelf delivery your business deserves.

You won't have to bridge the gap between MS-DOS and UNIX alone. Not with Hall-Mark and Unisys looking out for your future.



Hall-Mark Electronics Corp. • Dallas, Texas

Delivers the Unisys system that makes sense.

UNISYS

Authorized Distributor

Alabama
Huntsville (205) 837-8700
Arizona
Phoenix (602) 437-1200
California
Bay Area (408) 432-0900
Orange County (714) 669-4100
Sacramento (916) 624-9781
San Diego (619) 268-1201
San Fernando Valley (818) 716-3300
Colorado
Denver (303) 790-1662

Connecticut
Connecticut (203) 271-2844
Florida
Ei. Lauderdale (305) 971-9280
Orlando (407) 830-5855
Tampa Bay (813) 530-4543
Georgia
Atlanta (404) 447-8000
Illinois
Chicago (312) 860-3800
Indiana
Indianapolis (317) 872-8875

Kansas
Kansas City (913) 888-4747
Maryland
Baltimore (301) 988-9800
Massachusetts
Boston (617) 935-9777
Michigan
Detroit (313) 462-1205
Minnesota
Minneapolis (612) 941-2600
Missouri
St. Louis (314) 291-5350

New Jersey
Fairfield (201) 575-4415
New York
Long Island (516) 737-0600
Rochester (716) 244-9290
North Carolina
Raleigh (919) 872-0712
Ohio
Cleveland (216) 349-4632
Southern Ohio (614) 888-3313
Oklahoma
Tulsa (918) 254-6110

Pennsylvania
Philadelphia (215) 355-7300
Texas
Austin (512) 258-8848
Dallas (214) 553-4300
Houston (713) 781-6100
Utah
Salt Lake City (801) 972-1008
Wisconsin
Milwaukee (414) 797-7844

© 1988 Hall-Mark Electronics Corp./400-4103 UNISYS is a registered trademark of AT&T Intel is a trademark of Intel Corp MS-DOS is a trademark of Microsoft Corp

SOLVING THE SYSTEMS PUZZLE

In the third part of a series, McKinsey & Co. looks at systems integrators, a valuable, if underutilized, resource for unique, large-scale project development. Hiring a systems integrator requires cooperation, not abdication of responsibility.

BY CHRISTOPHER KEENE, PETER JESSEL, AND JOHN HAGEL

Have you ever known a corporate MIS manager who slept well at night? There don't seem to be too many of them. If they're not worrying about their users' insatiable demands, they're worrying about the latest conversion or the burgeoning budget. They're worried about the new sprinkler system, the lack of data security, and the new vendor they're trying. They need larger, more complex, and more technically advanced systems. Their core systems are aging. And they haven't got enough resources—not enough people, not enough dollars, and not enough experience. The upshot is that too many things don't get done, and some that do are disasters.

As corporations seek to respond to changing business needs and rebuild their aging systems, more large, onetime, megaprojects are being undertaken. The risks and costs of such projects are too great for corporations not to consider all the options available. Recent fiascos, like the Bank of America MasterNet trust accounting system—which cost \$60 million and was junked—are causing firms to examine an underutilized resource: systems integrators.

Systems integrators have valuable skills to offer today's corporation. The term "systems integrator" has been used to refer to everything from a provider of value-added systems assembly to a vendor of turnkey systems. In this article, the term specifically means a provider of large-

scale development services tailored to meet a firm's total systems needs. This usually entails sourcing the hardware, writing all the applications code, and, perhaps, operating the data centers once the system is finished. The systems integrator typically accepts the responsibility—and

unusual, one-of-a-kind systems, such as the Kennedy Space Center shuttle control system or the Internal Revenue tax return processing system. The government has no MIS department and must depend on outside contractors. Thus, the federal market is huge—\$1.4 billion per year—

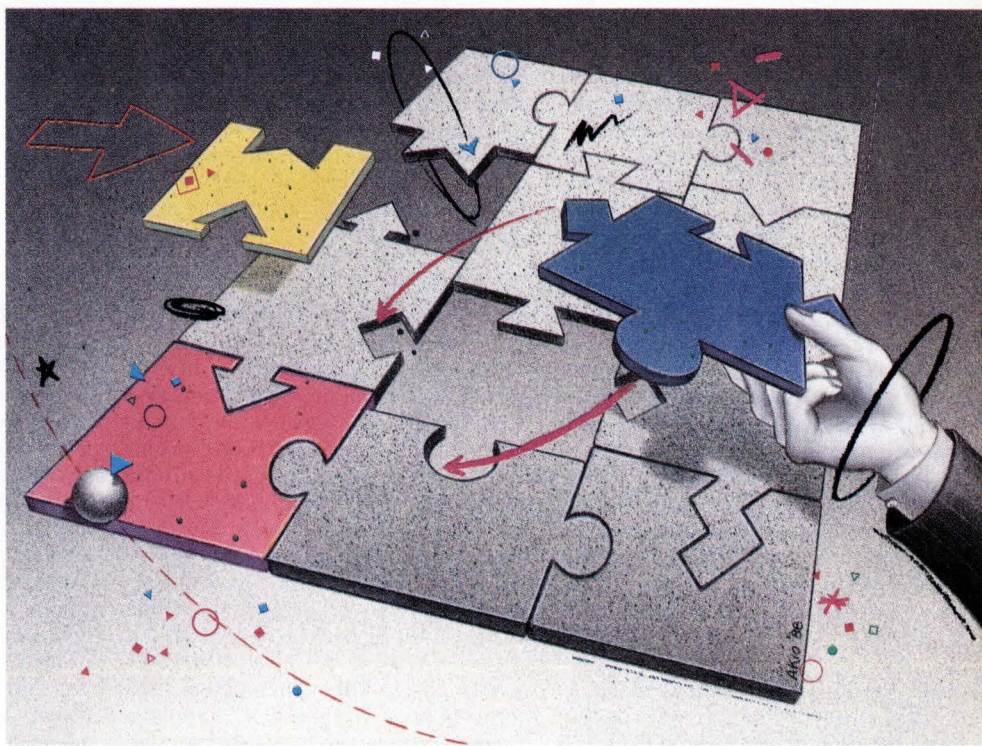

the liability—for delivering a finished, working product.

There are really two distinct systems integration markets: the federal government and the commercial sector. Federal government agencies—civilian and defense—comprise the federal systems market. Federal projects are the highly

and well-organized, with established rules and conventions governing most aspects of the systems procurement process.

The other systems integration market is the commercial one. Commercial systems integration typically involves transaction processing systems, often those that are either brand-new or represent a rearchi-

ecture. This market is worth approximately \$900 million a year and is projected to grow 20% per year over the next five years. Large contracts in this market, such as K-Mart's recent \$143 million deal with EDS for a national point-of-sale network, are no longer rarities.

When To Call a Systems Integrator

By definition, no corporation has experience with once-in-a-career projects (unless it has already been completed). But that is a systems integrator's specialty. Systems integrators are well equipped to tackle formidable development projects, and the larger, more complex, or unusual a project is, the more likely it is that a systems integrator is needed. In general, the strict measure of a project's development cost should not be an overriding factor. In some circumstances, systems integrators actually cost less than internal development because of their experience and specialized knowledge. Even if a systems integrator costs more in out-of-pocket expenditures, those must be balanced against the potential benefits of lower risk, faster delivery, and available capacity.

Managers facing a systems integration task should follow a simple decision tree to determine whether a systems integrator is called for. A project that is small relative to the average project size handled by MIS, and for which resources are readily available, is probably best handled internally. If the project is large but not unique, a turnkey system may be the solution. A large project that does not have a high degree of complexity might best be handled by hiring an experienced project manager to lead an internal team or by farming out only the most resource-intensive parts of the project. But if the project is large and unique, the systems integrator option is worth exploring. And, if the project is significantly complex, a systems integrator most likely can develop the project more cost-effectively and with lower risk. The following are among the valuable assets systems integrators have to offer their customers.

Knowledge of technology. Systems integrators often will have experience with a new technology that the first-time user has no way of obtaining. A good example of this is the expertise provided by IBM for USAA's project to automate and eliminate some 1.6 million paper files, the first large-scale installation of image processing in the insurance industry.

Such experience is of particular importance when something more than off-the-shelf hardware is required. That's why

Procurement Lessons From Uncle Sam

Uncle Sam might not seem a likely teacher, but the commercial world has much to learn from the government's experience in choosing vendors. Users typically have a large say both in the preparation of the specifications and in the selection of the vendor. In fact, government users are not only in the loop, they control the whole process. Unlike the federal world, however, the corporate world has MIS departments, so a more cooperative process is needed. While users should still drive the process, it should be with the advice and consent of MIS.

The federal procurement process is governed by the Office of Management and Budget, which in its Circular A-109 requires users acquiring major systems to adopt a phased acquisition strategy. Federal users must meet the following requirements when proceeding:

Develop explicit criteria for selecting the vendor. Government agencies rate vendors in three categories and pick the highest scorer. The categories are quality of the technical solution; relevant experience of the project management team; and total contract price.

Rating the quality of the technical solution requires the identification of the most important elements of the solution and the ranking of those vendors according to their abilities to supply those elements. The experience of the management team and the evaluated price should be weighted according to their importance in the particular project.

every major hardware vendor is, ipso facto, a systems integrator. Recently, both IBM and Digital Equipment Corp. have declared their commitment to providing systems integration services by forming commercial systems integration divisions. Even companies that don't sell hardware but do have technical skills can get into the act. Several major aerospace firms, such as Martin Marietta, Boeing, and McDonnell Douglas, are making forays into the commercial systems integration market with their internally developed IS skills.

Internal packages that can be tailored to the customer's needs. Although not every situation can be served this way, there is no doubt that some applications systems development can be achieved with packaged components. For example, Washington, D.C.-based AMS is a systems integrator that has met many of its customers' needs with a substantial customization of one of its core financial packages.

Well-developed project management skills. It's not easy to handle a large project effi-

Use the request for proposal (RFP) as a device to generate agreement about the task at hand.

A concise and accurate RFP should be developed for distribution to vendors for bidding. Developing an RFP requires a careful analysis of the projected systems requirements, and all key decision-makers should be involved. Their agreement with the RFP ultimately constitutes their commitment to the project and its specifications. It may be very useful to bring in a systems integrator or a specialized consulting firm to assist in analyzing and writing the RFP. The feds often use one company to do this that is then forbidden to bid on the project itself. The quality of the proposals and the final product will depend considerably on the effort that is put into the RFP.

Solicit multiple proposals to improve the quality of the bids. The RFP should be distributed to several vendors for bidding. There is no other way to ensure the likelihood of a fair price. However, for competitive or other reasons, some corporations may not be willing to sacrifice the time or privacy that this entails. If cost is not a major problem, then one-on-one negotiations may suffice. Even a company with an established relationship with an outside vendor should consider an occasional multiple bid. It helps ensure top-quality service and generally results in lower costs in the long run. The best way to improve service from your current vendor is to purchase something from a competing vendor.

ciently. Because systems integrators do it for a living, they have well-developed internal controls and extensive experience in working with requirement definitions, structured design, and project milestones. They know how to break a big project into manageable pieces and how to approach the issue of bridging. They know a lot about prototyping and are willing to use their knowledge. Possessing strong methodologies can be invaluable, and it prevents expensive, risky, on-the-job training.

Good, professional people. Top systems integrators consider a core of highly experienced project managers to be their greatest asset. Major systems integrators typically assign project managers with more than 15 years of experience to large projects. Their promotions are more likely to have been based on their success in managing people and their decision-making skills than on their technical ability.

Superior project management, however, demands far more than a handful of

Tandy Computers: The broadest selection of PCs in America.



The Tandy[®] 4000 LX

Get the power and performance of Intel's 80386 ...at 20 MHz.

To streamline your heavy business workload, turn to the Tandy 4000 LX. With its 32-bit Intel[®] 80386 microprocessor operating at 20 MHz, the 4000 LX delivers a new level of performance to sophisticated database management and spreadsheet analysis.

Two megabytes of zero wait-state memory make the 4000 LX ready to use with MS[®] OS/2, as well as MS-DOS[®] software. With this much memory standard, the Tandy 4000 LX is also ready to use as the hub of a powerful multiuser office system running SCO[™] XENIX[®] software. And as

a network file server in a 3Com[®] workgroup, the 4000 LX provides 20 MHz performance for exceptionally high-speed data transfer.

The Tandy 4000 LX is highly expandable. Three front-panel device slots and eight expansion slots give power users the flexibility needed in configuring the optimum system.

And for entry-level 386[™] power, we offer the original Tandy 4000. Using an 80386 processor that operates at 16 MHz, the 1MB Tandy 4000 is the perfect low-cost choice for the heavy power user.

The new generation Tandy 4000 LX. From the best-selling family of PC compatibles made in America.

Send me a 1989 RSC-20 computer catalog.

Mail to: Radio Shack, Dept. 89-A-679
300 One Tandy Center, Fort Worth, TX 76102

Name _____

Company _____

Address _____

City _____ State _____

ZIP _____ Phone _____

Tandy Computers: Because there is no better value[™]

Intel/Reg. TM and 386/TM Intel Corp. MS, MS-DOS and XENIX/Reg. TM Microsoft Corp. SCO/TM The Santa Cruz Operation. 3Com/Reg. TM 3Com Corp.

Radio Shack[®]
COMPUTER CENTERS
A DIVISION OF TANDY CORPORATION

Circle 65 on Reader Card

grizzled veterans. Better training programs and greater career opportunities give systems integration vendors a significant advantage in attracting and retaining high-caliber personnel.

Organizational commitment to serve the customer. Reputation counts in this business, and systems integrators must go on to win new jobs from other companies. Therefore, they have a vested interest in serving their customers' needs.

Depth. Even an outstanding corporate MIS department can't produce extra people at the drop of a hat. If reinforcements are needed for a few years during a large development project, what makes more sense? To hire a bunch of inexperienced newcomers off the street, train them, and then fire them two years later? Or to hire a team that's worked together before to augment the regular MIS personnel?

Choosing a Systems Integrator

Once the project scope and need for a systems integrator have been established, the time comes to wrestle with the large choice of vendors. This is not simple: a lot rides on the decision. The customer will have to live with the results—good or bad. A variety of corporate groups will want to get involved in the decision. The best way to select a vendor is to use the structured process employed by the government.

While this structured process goes a long way toward helping select the correct vendor, there is another element that is very important, but somewhat more subjective: trust or "fit." The systems integrator relationship is a close one, like a marriage; you had better make sure that you like working together before setting out on a multiyear voyage.

How do you determine if that fit is there? Get to know your potential systems integration partner. Do a few small jobs together. Sometimes, a vendor specializes in a given industry, so it can speak the same language. This may raise competitive issues, but if it doesn't, then a vendor experienced in your industry might be easier to work with. If the vendor already understands the big picture, some of the work of translating business needs into technical specifications is already done.

Some vendors are better than others at minimizing risk, which is certainly a plus. If the vendor has had experience with similar projects, can use standard instead of custom components, or is able to provide a working prototype, substantial safety may be added. While it is rare in the commercial world for vendors to prototype the solution, this is standard operating procedure in the federal market. For very

Learning Systems Integration The Hard Way

When the U.S. Government Patent Office set out to automate its patent system it got more than it bargained for: some lessons from the school of hard knocks. Four years and \$460 million later, it learned the hard way that bypassing federal procedures did not provide any shortcuts. The project, originally scheduled to be completed in eight months, is still unfinished, and the original \$300 million price tag has ballooned more than 50%.

The original goal was to increase the efficiency of the paper-based system. The Patent Office processes an average of 126,000 patent applications a year. For each patent, examiners have to search through about 1,600 pages out of a total of 27 million paper documents. Combine a little multiplication with the fact that the number of patent applications is steadily growing each year and you can begin to picture the avalanche of paper that threatened to swamp the agency. In 1983, the decision was made to find an external vendor to put all the documents on-line for search and retrieval.

The agency issued a 2,500-page request for proposal outlining the planned system, which was to increase the efficiency of the paper-based system. Despite the complexity of the task, the office obtained a waiver from the Commerce department that exempted it from fulfilling the requirements of Circular A-109, the Office of Management and Budget's directive governing federal procurement of major systems. (The waiver was granted because the Commerce department considered the system to be off-the-shelf and not one-of-a-kind.) Instead, the Patent Office chose a systems integrator based primarily on its own subjective assessment of the proposal and delegated major decision-making power to it.

More than a year after the award, the agency changed the scope of the project. Its objective went from increasing efficiency to improving the quality of the patent search—a far more ambitious goal.

large projects, there is even paid proposal preparation. These live test demos considerably reduce the risk to the customer by forcing the vendor to demonstrate critical elements of the solution before the contract is awarded. For a project that has some major technical risk, it may be worth funding two or three of the vendors through the prototype stage, as General Electric did when it required competing vendors to demonstrate key features of a warehouse-of-the-future system before awarding its \$8 million contract.

The integrator and the Patent Office spent the next 18 months trying to agree on what the new system should look like. During this time, the integrator attempted to develop the necessary software for the system—an impossible task given that the system architecture had yet to be defined. The storage devices with the necessary speed and capacity were not available until three years into the project.

The development's expensive disarray provoked strong criticism from the Government Accounting Office and Congress. The Commerce department took steps to right the project and replaced the project director with Thomas P. Giammo, who had been among the most vocal GAO critics of project. A more cautious approach has been adopted, and overly optimistic technology assessments and schedules have been adjusted to more realistic levels. The text search system is now operational, and the image search is scheduled to be complete next year.

The Patent Office's experience offers many lessons. First and foremost, it should have made sure that there was internal agreement on the basic objectives of the project, which would have prevented the catastrophic act of attempting to switch horses in midstream. The lack of full accord also contributed to an environment in which the systems integrator assumed responsibility that top management should have retained. Further, if the office had not tried to shoot for the moon and had instead established realistic goals from the start, the project would have gotten off the ground sooner. Finally, if the office had not foregone competitive test demonstrations of the proposed solutions and required the integrator to demonstrate key elements of the solution before making the award, it would have understood the limitations of the existing technology and not bet on advancements that didn't materialize on cue. It also would have been able to assess the system's total costs more accurately.

Finally, contract type is an important consideration. Commercial projects generally are performed on a fixed-price basis, though complex or changeable projects may be better on a cost-plus arrangement. This gives the vendor more latitude to modify project scope when necessary.

Once the vendor is selected, ongoing communication between all parties becomes critical. No major corporate project involving a systems integrator can succeed without a three-way partnership.



YOU NEED SOMETHING MORE SOPHISTICATED FOR TODAY'S COMPUTER RESOURCE MANAGEMENT PROBLEMS. YOU NEED PRIME.

Putting out fires—it's part of every MIS/DP Manager's job.

From false alarms in finance to panic in personnel, you just get one problem solved when another one threatens to rage out of control.

But how do you contain your resource management fires—such as data management and access problems, weak communications, and limited applications development?

The PRIME EXL™ Series of multiuser, multitasking supermicrocomputers.

Based on Intel386™ technology, these fully compatible systems, running Prime's implementation of AT&T's UNIX System V.3, are the most efficient tools for managing computer resources within your company.

But not only does the PRIME EXL Series support UNIX®, with optional software packages your users can run their existing DOS™ and PICK® applications as well. You'll also be able to develop custom applications for departmental computing problems now

with the security that they'll work just as well in the future.

Plus, you'll have industry-standard communications capabilities through Ethernet™ over TCP/IP networking software, our PRIME/SNA™ EXL products, and PC-Interface™. This provides the ability to share peripherals and ensures your access to vital information from departments or your corporate mainframe and PCs.

Designed to grow with your company, all PRIME EXL Series systems are fully compatible. There are a variety of configurations you can choose. And, of course, you can count on the worldwide service and support only a Fortune 500 company like Prime can provide.

To find out more about the PRIME EXL Series, simply complete and mail the coupon to the right. Or call 1-800-343-2540. In Canada, call 1-800-268-4700. We'll also send you a free copy of "Integrating the Desktop and Multiuser Operating Environments." It's a straightforward discussion of computer resource management in the UNIX/DOS environment.

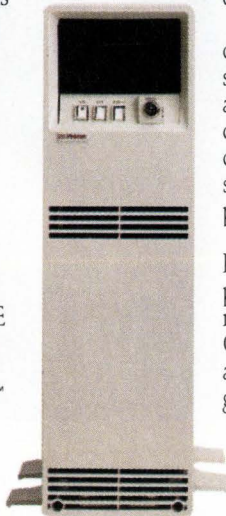

So call today. Because now more than ever, you need the right tools to extinguish your computer resource management fires—and prevent them in the future.

You need Prime.

Putting out fires is a big part of my job, so I'm asking for Prime.

Please send me more information about the PRIME EXL Series, and don't forget my free copy of "Integrating the Desktop and Multiuser Operating Environments."

Please have a Marketing Representative contact me.

Name _____

Title _____

Company _____

Address _____

City _____ State _____ Zip _____

Telephone (_____) _____

Applications Interest _____

Industry Interest _____

Or if you prefer, call **1-800-343-2540**. AD0030024

Mail to: Prime Computer, Inc.
MS 15-60, Prime Park, Natick, MA 01760.



PRIME and the Prime logo are registered trademarks, and PRIME EXL and PRIME/SNA are trademarks of Prime Computer, Inc., Natick, MA. Ethernet is a trademark of the Xerox Corporation. PC-Interface is a trademark of Locus Computing Corp. Intel386 is a trademark of Intel Corporation. UNIX is a registered trademark of AT&T Information Systems, Inc. MS-DOS is a trademark of Microsoft, Corp. And PICK is a registered trademark of Pick Systems.

SEE US AT COMDEX, LAS VEGAS, NOV. 14 - 18, BOOTH #B2.

Circle 66 on Reader Card

MANAGEMENT
INTEGRATION

The Role of the SI Vendor

Technical requirements of customer needing high-speed image retrieval system for forms processing

The systems integrator puts the pieces together

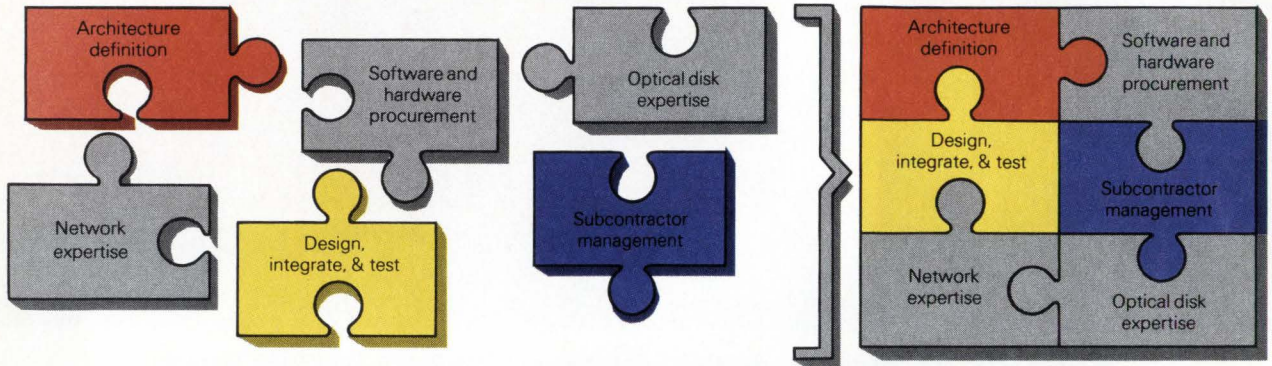

Result: Effective image retrieval system

Source: McKinsey & Co. Inc.

Chart by Paragraphics

NDM AUTOMATES NONSTOP DATA TRANSFER



Keeping up with data transfer requirements can be a high-speed chase in several different directions. Network DataMover is the one vehicle that can take you where you're headed. With automated file transfer and production features that are technology independent.

Network DataMover® is a registered trademark of The Systems Center, Inc., IBM® is a registered trademark of International Business Machines Corp., DEC™ and VMS™ are trademarks of Digital Equipment Corp., Tandem™ is a trademark of Tandem Computers, Inc.

Hiring a systems integrator means cooperation, not abdication of responsibility. Users must take responsibility for leading the business direction and rendering a faithful statement of their requirements. The MIS department has to provide its knowledge of existing systems and make use of its greater familiarity with the users. The systems integrator has to be a good listener and has to play a cooperative, not commanding, role. A systems integrator usually can't know the customer's business as well as the customer, and while it may have experience in the customer's industry and know some things a customer doesn't, every corporate customer of any size has unique market approaches, operational procedures, and plans.

Clients have to be willing to accept outside personnel and work with them, although major systems integrators, such as AMS and Arthur Andersen, routinely staff 50% or more of their project teams from their client organizations. The key step in all these cooperative arrangements is having open channels of communication and

clearly assigned roles. A further critical reason for cooperation is that during any project, MIS is responsible for maintaining existing systems and for learning what it can from the systems integrator. In most cases, the MIS department takes over the task of maintenance once the project is done, which means it must be actively involved during development.

However, the systems integrator cannot be, nor will it ever be, a panacea for poor management of the systems development process. The importance of good project management cannot be overemphasized: it is essential. There is no substitute for top management commitment to the project or for disciplined techniques of good software development. Hiring a systems integrator will never release a company from these vital requirements.

As core systems age, changing the makeup of the overall development climate, learning how to use systems integrators judiciously and effectively is increasingly becoming a skill every corporation will need to possess. Systems

investments should serve a firm's competitive strategy, and any factor that affects sound information systems may make a big difference.

Given the fact that there are a lot more competitors and potential customers than there are systems integrators, forming a strategic alliance with one or more systems integrators may be an excellent idea. In some industries, such as banking or insurance, there are dozens of major competing players. For corporations in these situations, hiring a systems integrator may require a mechanism to protect proprietary information; a strategic alliance that blocks certain work with competitors is one way to do that. Companies with major systems requirements and no existing vendor relationships could find themselves in a bind. Thus, the first player in a given industry that enters into such an alliance may realize a significant advantage.

Christopher Keene, Peter Jessel, and John Hagel are consultants at the New York-based management consulting firm, McKinsey & Co. Inc.

TO ANY ADDRESS ON YOUR BLOCK



NDM also expedites applications like disaster recovery, intercompany data exchange, central software support and lights-out operations. So contact The Systems Center if you'd like to accelerate your data transfer capabilities with NDM. 1-800-292-0104, 214-550-0318



The Network Data Mover Company

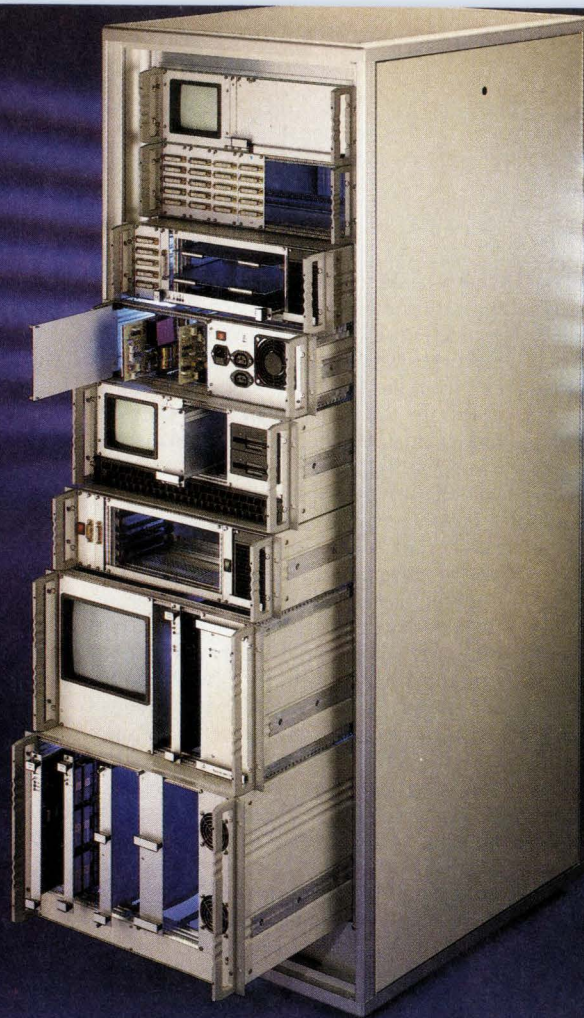

Coming to Wescon!

November 15th to 17th

See this and other enclosure products at

Booth 2033

19" Racks Made by Professionals. For Professionals

For 20 years Knürr AG has been a major supplier in the area of 19" systems.

The programme includes 19" racks, 19" cabinets, 19" consoles, 19" card-frames, 19" chassis, 19" fan units and many more products. The excessive range of accessories enables the economical installation of your electronics.

The latest introduction of the modular system Chasseleon® – a benchcase which is also a full 19" chassis, even on telescopic slides and on chassis runners – increases your possibilities even further.

19" systems by Knürr – a proof of competence. All over the world.



We are closer than you think:

Austria	Grothusen Ges.m.b.H., Tel. 02 22/97 25 29
Australia	Email Ltd., Tel. 03/5 44 82 44
Belgium	Vitronic Belgie NV, Tel. 03/3 25 27 10
Denmark	Otto Ahrens A/S, Tel. 01/71 47 44
Finland	Perel Oy, Tel. 914/2 16 00
France	Knürr S.A.R.L., Tel. 1/43 77 85 85
France (Alsace)	A. Baumann S.A., Tel. 08/8 32 60 26
U.K.	Daturr Ltd., Tel. 02/76 68 12 12
Greece	Nicolaos Asteriadis, Tel. 0 31/27 86 92
India	Elcopak, Tel. 02 12/8 48 46
Israel	Alexander Schneider Ltd., Tel. 03/37 20 89
Italy	Forind Avio Elettronica S.R.L., Tel. 02/2 14 15 11
Japan	Y.H. Supply Co. Ltd., Tel. 4 42/28 51
Netherlands	Vitronic Holding B.V., Tel. 01/62 05 14 40
Norway	Jana Tekniske A/S, Tel. 02/68 53 50
Pakistan	Qaim-Ale-Mohammad Corp., Tel. 7 27 19
Portugal	Sociedade Zickermann S.A.R.L., Tel. 36 90 65
South Africa	Advanced Semiconductor Dev. (PTY) Ltd., Tel. 0 11/8 02 58 20
Spain	S.I.G., Tel. 01/8 88 97 90
Sweden	Garam Elektronik AB, Tel. 08/7 10 03 40
Switzerland	Knürr AG, Tel. 01/8 25 07 07
U.S.A.	Dacobas Inc., Tel. 8 05/5 26 77 33



® **electronica88**

Munich, Nov. 8th to 12th
Hall 12
Booth 12B04

P.O. Box 82 03 69 · Schatzbogen 29 · D-8000 München 82
Tel. 0 89/42 00 40 · Telex 5 29 608-10 knd · Telefax 0 89/42 00 41 18

Circle 16 on Reader Card

Knürr AG



It's More Than Just Laptops

Sales force automation is one of the most high-risk projects IS will ever undertake, but it has the greatest potential benefits to the corporate bottom line. Several steps can prevent alienating sales reps.

BY JOE FERREIRA AND MICHAEL E. TREACY

Many companies seem to be taking a rather simplistic approach to automating their sales forces, judging by the questions they ask: "Would laptops help our salespeople?" or "What systems architecture fits sales systems best?" or "Does our sales force need e-mail?"

These questions, it turns out, are among the last that should be asked. For the sales function to reap the potentially enormous benefits of information technology, IS managers need first to back off their preconceptions about sales systems and then look more closely at the sales force itself for clues on how to automate effectively.

For one thing, why automate the sales force at all? If your answer to this is to reduce the time salespeople spend doing paperwork, try again. Many salespeople do paperwork after hours, and they won't bother learning a system if its only benefit is saving the home office keystrokes and keying errors. Or, if your answer is to allow reps to spend more time with the customers, you should know that many customers want technology to allow them to spend less time with salespeople.

The fact is, sales force automation is a project that requires IS staff to be businesspeople first, and technical experts second.

The need to view all the options from a business perspective is a critical one. A "business perspective" does not imply brand-name shopping for hardware and software from vendors whose financials look strong. It doesn't mean sitting down

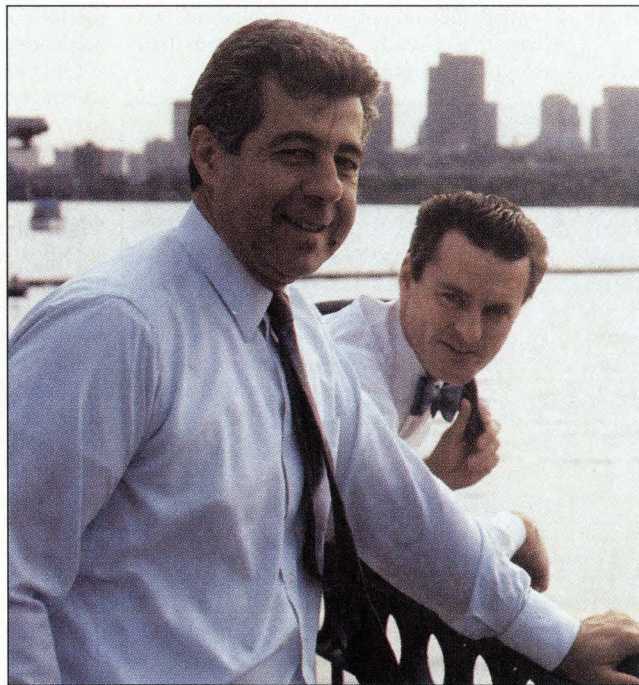

INDEX GROUP'S FERREIRA AND MIT'S TREACY

with the end users for hours to extract detailed systems requirements. Nor does it necessarily mean designing control- or accounting-oriented systems for the sake of saving your company time and money. It means that IS needs to tune into what the

salespeople identify as trouble spots in their work. Sales managers and senior executives should describe the changes they would like made to the role of sales reps; ways to support those desired changes with the appropriate technology should then be explored.

It also means considering changes in tariffs, regulations, foreign competition, new product development, and anything else that might affect the sales environment in your firm. Automating existing sales processes is not enough. At best, it would yield marginal efficiency gains, which would barely cover the cost of implementation.

Sales force automation is one of the most high-risk, high-visibility projects that IS can undertake. To make matters worse, this group of end users is particularly hard to draw in: install a system that brings no obvious benefit to the sales rep, and you may never get a second chance.

If your company is exploring sales force automation, bear in mind that you will be designing a system in the midst of a stormy transition to a new business climate and sales environment. Rather than building a system that just ties things up,

you should take advantage of the new implementation to reassess the company's sales process and to make a few strategic adjustments.

Changes in the business climate over recent years have left many companies' sales functions in need of some pruning and weeding. With the influx of foreign competitors and deregulation, companies face more rivals, while their customer population is no longer expanding quickly. In maturing markets, your company's sales can grow only at the expense of others.

Meanwhile, the pace of technological advances has shortened product life cycles, and the distinction between selling complex products and simple commodity-type products is breaking down. Manufacturers find that selling even \$.29 light bulbs to a store chain requires detailed product comparisons and discount schedules.

More sophisticated and aggressive corporate buyers are reducing the number of suppliers they use and demanding more concessions from them.

Therefore, the demands on individual sales reps are growing heavier: reps must

act as a conduit of marketing information to other departments. Without being able to lengthen the amount of "face time" spent with customers, salespeople must describe an increasingly complex product line, as well as pick up feedback and information on the customers' needs.

Local sales management teams are involved in tasks traditionally left to the central marketing managers: promotions, packaging, even product development. To ride any of these waves, salespeople need access to more information from customers and headquarters—a volume of information manageable only through computers and communications tools.

Coordinated Effort Is Required

Salespeople will need to coordinate their efforts more tightly with product managers and market researchers at the home office, with telemarketing and other support functions, and with field-based sales management. They will need to retrieve and analyze data from headquarters. In addition, salespeople will need effective tools for gathering and transmitting data from the field, such as special database software and file transfer programs. The relevance and integrity of that data must also be considered part of the task of sales force automation.

If your company isn't affected by any of

these trends, then investing in sales force systems may be questionable or pointless.

So, how should IS proceed? Here are five steps that are crucial to success.

To begin, allocate time and money. Some major U.S. corporations spend as much as 20% of their IS budgets on sales and marketing functions. Process manufacturers, chemical, and pharmaceutical firms tend to spend the most.

Effective sales force systems are among the easiest types of systems to cost-justify because their objectives are measurable: increases in leads followed up, increases in customer calls, and increases in sales. Consequently, it may be easier to persuade financial officers to put funds aside for a system that has the potential to boost the bottom line directly. For planning purposes, you can count on about two years from conception to installation; less than that usually signals a system that won't bring significant benefits.

Where IS Is a Priority: 1987 vs. 1990

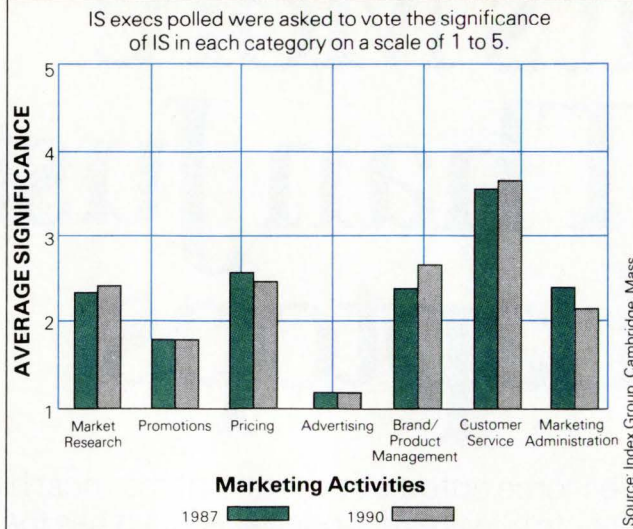

Second, know your business. If the system itself is the dominant focus of the sales and marketing plan, the results will be disappointing, if not disastrous.

Both IS and sales management must view automation as an opportunity to examine and change the company's approach to sales. Which steps in the sales process can best be handled by telephone or by mail, rather than in person? What could be accomplished by downloading information directly to the customer? Are direct sales and telemarketing departments cooperating or competing? How are leads generated and followed up?

Only when such questions are answered can the system begin to take shape. Therefore, the firms that are best at handling business changes, not just at building distinctive systems, will gain the edge.

Viewing Sales as a Matrix

One way to generalize the sales process and make it easier to examine is to view sales in terms of a matrix (see "What Sales Systems Need."). Look at how simple or complex your company's product is—how much information has to be given to the customer before he or she understands the product—and match it against the type of relationship your salespeople will have with their customers. Will the salespeople maintain a simple transaction-type relationship with the customer or a complex partnership in which the salesperson is involved with the customers' own strategies and business plans?

Frito-Lay's direct store-delivery sales force system reflects a simple product and a transaction focus; the corner of the matrix in which efficient ordering is the primary objective of the system. In 1987, the company installed a 10,000-user system to support its sales routes. With a handheld computer, printer, and modem in their vans, the salespeople enter orders and perform accounting functions, such

Four Sizzling Applications

In 1987 and 1988, leading IS managers who are sponsors of Index Alliance's program on sales and marketing identified four hot areas for information systems: sales force automation; telemarketing; computer-supported regional and niche marketing; and intercompany business via EDI and other electronic connections.

Whereas sales force automation places computers and communications devices directly into the hands of salespeople, telemarketing and niche marketing are used in the home office. Telemarketing is arguably the fastest growing element in the mix of marketing activities. Industrial companies as well as consumer product firms are turning to telemarketing to meet marketing communications needs where traditional approaches are no longer effective.

Regional/niche marketing can offset intensified competition in the marketplace by helping define and understand smaller

"clusters" of customers. Companies can use information systems to compile data on customers grouped by location (regional marketing) or by buying preferences (niche marketing). Systems can be used to make swift pricing, promotional, or distribution changes, or to redesign or repackage products in a flexible way.

Electronic data interchange systems are popular with customers and suppliers, and reflect the changing relationship between them. There are many different types of EDI systems, and many different associated risks and benefits. Some EDI systems were installed to keep up with the competition, while others were installed to take the competitive high ground.

These innovative uses of technology all reflect today's tougher markets and the increased load on the sales force. Complex and expensive sales and marketing information systems will grow more commonplace as sophisticated customers and products become the rule.

as invoicing and returns, on-site.

Because the salespeople had to be trained extensively to use the new system, Frito-Lay piggybacked several other changes onto the sales process to leverage the training: changes in route structures, compensation packages, promotions, and customer contact. The result was a marked reduction in nonproductive time (one study showed the new system saved each salesperson at least half an hour per day), as well as reduced inventories and more effective marketing.

The pharmaceutical industry offers the best examples of "simple" products that require a partnership between salespeople and customers. The goal of systems in this corner of the matrix is to facilitate sales calls via customer profiles, account priorities, and call reporting.

Parke-Davis began implementing a system in 1986 for its 800-member prescription drug sales force. In this case, it's not so much that the products are simple as it is that they are well understood by the customers—the physicians who prescribe them. So, the system's database includes information on the physicians themselves, from their educational background to their prescribing habits to the best time to call on them. The system has increased the fruitfulness of customer calls and curbed the sales reps' tendency to call on friendly physicians only.

A few industries offer complex products, but limit themselves to a transaction-type sales effort. In this case, the system exists to support product selection, configuration, and after-sale support. One example is the heating, ventilation, and air conditioning industry, where both Trane and Carrier have developed systems that allow third-party engineers in the sector to access detailed product data to determine which system a building will get while it is still in the design phase. With such sales systems, customer computer use could replace sales force computer use over time.

The sale of complex products via a partnership with the customer may require large databases of product specs for configuration, expert systems, and graphic sales aids that show payment options or customer profitability. Frequently, the products being sold are technical in nature, and the sales rep may need the help of sev-

eral departments to pull a customer's order together.

Anaquest, which manufactures anesthetic drugs, provides its sales force with a variety of applications, including a model of how different anesthetics are dispersed through a patient's body, a model of how

□ RELIABILITY IS CRITICAL, ESPECIALLY IN CASES WHERE THE SYSTEM CAN MAKE OR BREAK SALES.

the company's drugs interact with other medications, and a database of when and under what conditions Anaquest anesthetics have been given to patients. These extensive sales aids mean the sales reps are more conversant with a technical product line than other reps, and ordering and configuration errors decrease.

Your applications may fall into more than one product type matrix cell, but they are likely to stay within one type of orientation toward the customer. In other words, an efficiency-driven ordering system might be used for either simple or complex products, but probably would not be used to foster a close relationship

tem. Just as there is no single report generator that could satisfy all of your senior management's information needs, there is no off-the-shelf system that will do the trick for your sales force.

Most companies are driven by a complex set of sales objectives, which will surface as you go through the matrix. Even then, these objectives may not translate automatically into a systems design. What an IS manager needs is a way to map the company's objectives and sales environment to specific applications, which will in turn dictate systems design.

Sales objectives typically fall into four categories (see "Matching the System and Sales Goals"):

- efficiency, for the sales rep or the corporate office;
- communications, either with customers or between the sales force and headquarters;
- facilitating the sales process, which means helping the sales reps manage their time or improve the sales call itself; and
- improved customer relationships.

Your company may choose one or all of these goals, though perhaps not for implementation all at once. Too many features turn a sales force system into a training nightmare. Push senior managers and sales managers for a list of priorities,

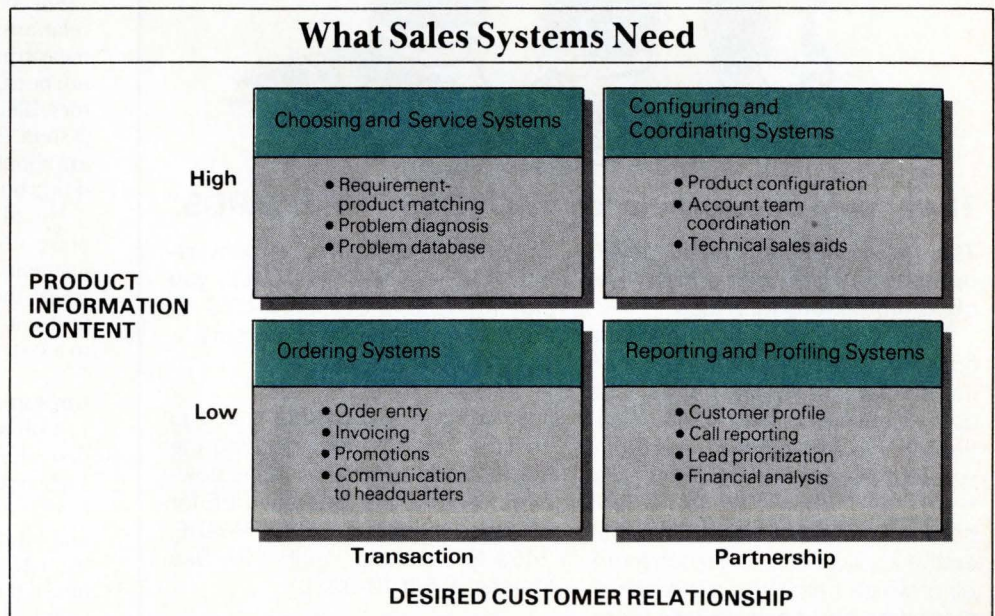

with the buyer, since partnerships are by nature inefficient and labor-intensive.

The third rule for sales force automation is "pick and choose." Avoid thinking of sales force systems as monolithic: in fact, there is no such thing as a generic sys-

and evolve a systems design around those.

One mistake some companies make is to focus heavily on applications that benefit corporate management, such as gathering marketing data, or tracking salespeople's activities and productivity.

Instead, focus on the sales force's own needs, such as account management files, and the users will buy into the system much more readily. It will be easier to add the corporate-oriented applications once users are active on the system.

Another common error is to leave the district sales manager out of the loop dur-

ing the specification and design stages. District sales managers are crucial to the sales function, and they form a key link in the management chain. They can offer valuable input on sales objectives and applications ideas. IS will need them as allies and as liaisons between sales, management, and the project team.

The fourth rule of sales force automation is to plan for changes to the system itself, as it evolves, and for changes to your business processes as a result of systems implementation.

Half-Hearted Effort Will Disappoint

If you put feedback mechanisms in place from the start, then an iterative, evolutionary development for the sales force system need not mean endless disruption. It took 10 years for Frito-Lay to fully develop its sales force system, and while most firms cannot invest that much time, a half-hearted effort will yield disappointing results.

SOME MAJOR U.S. CORPORATIONS SPEND AS MUCH AS 20% OF THEIR IS BUDGETS ON SALES AND MARKETING.

Feedback can take the form of comparing sales results between one sales group running a prototype version of the system and a second, control group without the system. It may be useful also to compare intermediate criteria: calls made, time spent with customers, leads followed, and so on.

For systems with improved customer relationships as the primary objective, measuring these efficiency indicators may not be as useful as measuring "softer" factors. Before and after use of the prototype system, try surveying your customers, asking about sales rep knowledge and ease of doing business with the company.

Use all the information you gather to make adjustments to the system. The adjustments are best handled if you can freeze the design, make changes, then freeze it rather than adding new features to a system perceived to be complete.

Implement in Phases

A phased implementation is ideal. The first phase might be electronic mail for each of the sales reps, plus access for them to corporate databases to retrieve information such as data on product availability, new prices, and so on. The second phase might include applications for account planning, route planning, and/or prospecting. You might wait until the third phase to add programs that require salespeople to send data to corporate headquarters. IS tends to jump to those programs first, reflecting its orientation toward corporate needs.

That tendency in IS leads to the fifth

ARE YOUR PC APPLICATIONS AND YOUR MAINFRAME SPEAKING?

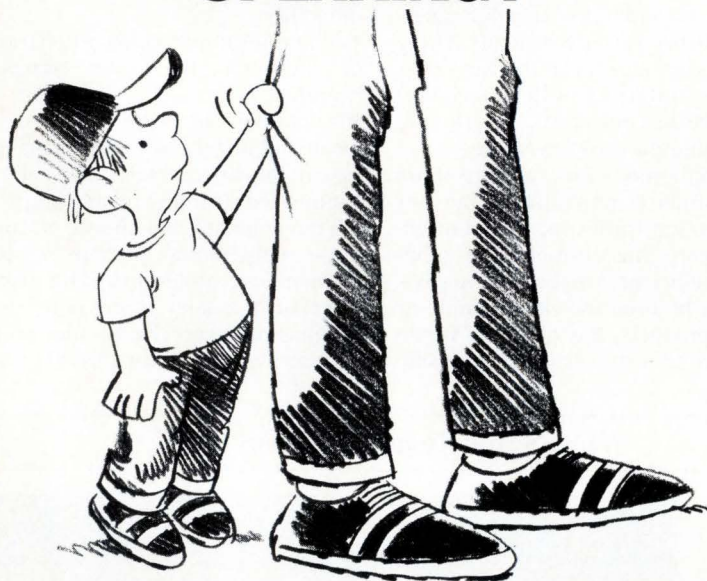

They could be with help from ACROSS-THE-BOARDS.™

This proven Mainframe/PC development tool provides a high level communications interface.

Across-the-Boards is perhaps the only PC-to-Mainframe interface on the market that so fully handles the complex details of data communications. For example, with this product you can access individual records, send information back and forth between programs, construct cooperative applications, and much more. All of which helps you cut development time and costs. What's more, Across-the-Boards adapts to virtually any environment. It provides IBM and compatible PCs with access to the mainframe through all popular coax boards, LAN gateways, bisync,

SDLC and most protocol converters. And with a simple CALL, you can interface to COBOL, BASIC, C, Pascal and Assembler programs.

FREE 30-Day Trial

Just call 1-800-234-9884, and in no time you'll be experiencing the tremendous communications powers of Across-the-Boards FREE for 30 days. Or write us at cfSOFTWARE, 2454 E. Dempster, Suite 201, Des Plaines, IL 60019-9930.

cfSOFTWARE
Mainframe-to-PC connectivity
800-234-9884

CIRCLE 69 ON READER CARD

principle of automating a sales force. Only by setting up the system to fulfill the salespeople's needs first will you obtain their full cooperation. To the salespeople, a new information system means investing many hours getting up to speed on the system and the new procedures that surround it. That investment is unavoidable, but it can be either manageable or overwhelming, depending on how IS sets it up.

If you take a step away every time you add a new step to the sales procedures, the system will feel more like a help to users than a hindrance. It is also important to base the system on the average sales performer so the majority of salespeople can take advantage of it. Otherwise, many salespeople will feel that they have been set up to fail because the system was designed to fit the "fast-trackers."

By the same token, your company may need to find new ways to measure the performance of the salespeople, and perhaps new ways to reward them. For example, a pharmaceutical company trying to en-

courage its sales force to call on other than friendly physicians might tally up calls to new prospects as key to its compensation package. Companies focusing exclusively

□ SALES FORCE AUTOMATION DIRECTS IS TO BE BUSINESSPEOPLE FIRST, AND TECHNICAL EXPERTS SECOND.

on customer relationships might switch from paying strict commissions on completed sales to paying out commissions and incentives for time spent with customers, if the system can track that.

Lastly, plan on lots of support. In a survey of 18 major U.S. corporations last year, Index Alliance found sales force systems to be undersupported. Ten of the respondents called IS support "somewhat inadequate" or "totally inadequate"; only one said support was "completely ade-

quate." Reliability is critical, especially in cases where the system can make or break sales. IS departments in several firms report that they "lost" a sales rep for good because of a single incident in which support was unavailable.

One consumer goods firm maintains a 24-hour support hotline and a stock of replacement computers scattered around the country.

Support also includes providing the data the sales force needs. This would mean revamping some database systems and/or interfaces. Furthermore, initial training for a new system can be a logistical nightmare if the sales force is geographically dispersed. Some firms fly the trainers out to the field, rather than wait for infrequent visits by the sales staff to the headquarters office.

No Shortcuts

As these five steps indicate, sales force systems involve a high degree of risk and demand a high level of commitment. Many companies follow sound principles in automating their sales forces, yet obtain disappointing results because they miss some of the subtleties.

For example, a large pharmaceutical company built a system around corporate needs, not salespeople's needs, because the otherwise competent project leader had no field sales experience. The company made the additional error of moving quickly to a high-commitment pilot program, rather than a lower budget prototype approach, and eventually had to scrap the system and start over.

One consumer packaged goods company made the mistake of putting an ace sales performer in charge of a direct-store delivery system based on handheld terminals. The sales rep isolated himself for most of the design period, based the system on his own experience, and created a monstrosity unworkable system for the less spectacular sales performers.

Unlike most projects, sales force automation has high visibility to both top management and customers, and has a direct impact on revenues. It is important to research the process thoroughly before implementing the transition.

Joe Ferreira, a member of the DATAMATION advisory board, is director of Index Alliance, a service of Cambridge, Mass.-based Index Group Inc., which assists corporations in the effective use of information technology in marketing and sales functions. Michael E. Treacy is assistant professor of the Sloan School of Management at MIT and associate director of Index Alliance.

Matching Systems and Sales Goals

Sales force automation does not profit from a scattershot approach. IS departments report they have more success with a tightly focused effort that singles out just a few sales objectives and customfits the system to those goals. As a rule, these sales objectives fall into four categories: greater efficiency, better communications, an enhanced sales process, and improved customer relationships.

Efficiency applications include order entry, product specification databases, profitability analysis, make vs. buy or lease vs. purchase calculations, call reporting, and expense reporting. Obviously, some of these applications will benefit departments other than sales as well.

Communications applications aim to improve the sales force's communications with its headquarters or field offices. One IS manager observes that the greatest benefit of his company's sales force system was frequent or even daily access to each salesperson. Examples of communications applications are e-mail, computer conferencing/bulletin boards, order tracking, new product or promotion information, competitive intelligence, and product usage or consumption reporting.

Many of these applications involve a substantial flow of information back to headquarters from the field—information

that might be used for control purposes. One caveat: making control a primary objective of the system is unfruitful and can backfire badly. Salespeople tend to be very sensitive to control issues and may leave the system unused or underused if they suspect it is monitoring them.

Facilitating the sales process refers to applications that shape the schedule of the salespeople or applications that are used during sales calls. Examples include lead tracking and analysis, time and territory management, graphic sales aids, quota tracking, product profitability analysis, and sales forecasting.

Applications that directly **improve customer relationships** are few and far between. One might be a database of customer information that includes buying patterns, personal or organizational profiles, and past problems the customer has had with your company or its products. Some of these databases may go as far as to provide a complete list of your company's products and services used by the customer, so that one sales rep knows about products purchased through another rep. Some companies are moving toward providing new product information directly to customers via electronic links, leaving the salesperson free to concentrate on the customer relationship.

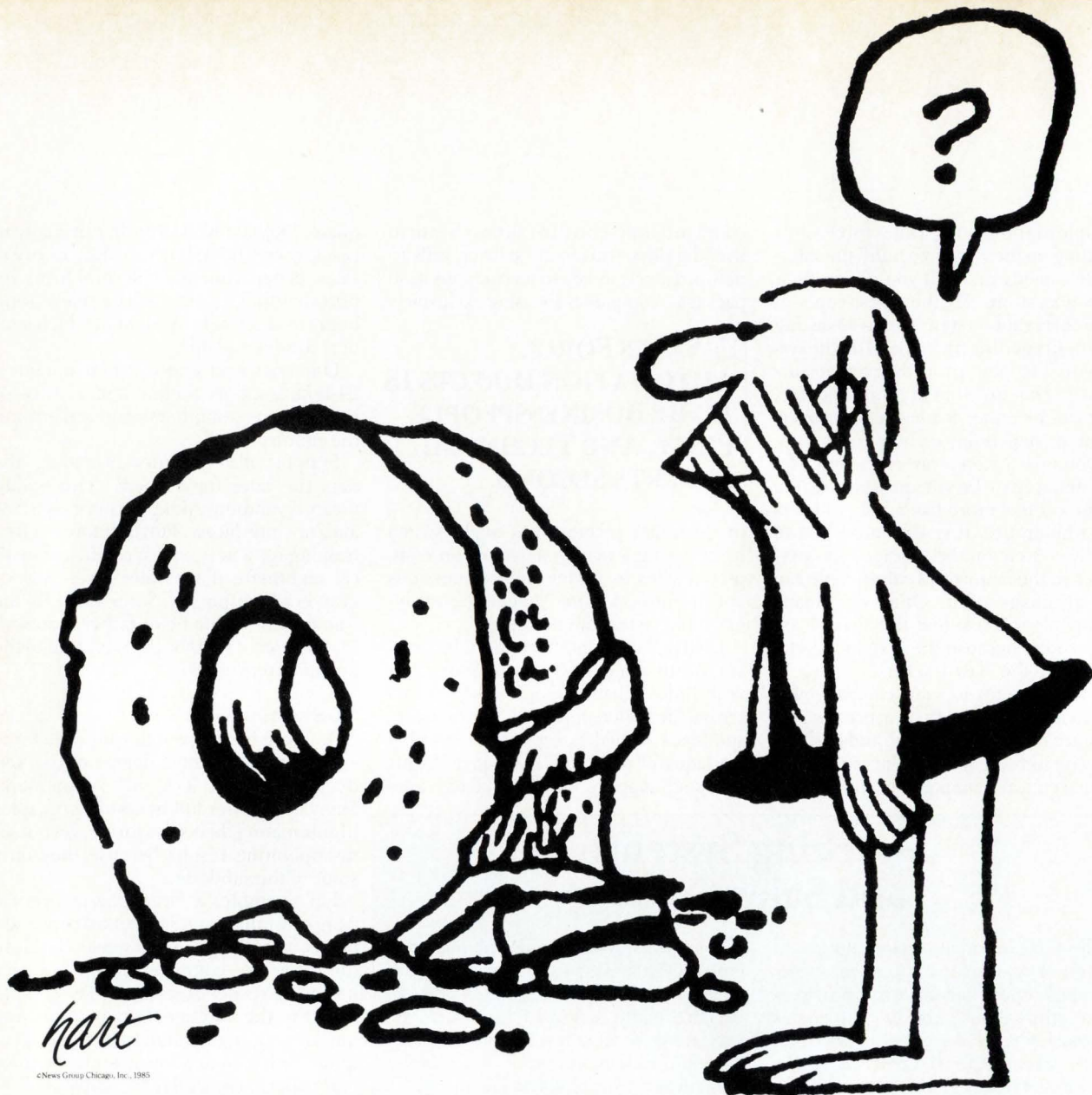

©News Group Chicago, Inc., 1985

WITHOUT ADVERTISING EVEN THE BEST IDEAS TAKE AGES TO CATCH ON.

Every now and then, a new product becomes popular by word of mouth alone. But that process usually takes many months. Sometimes years. By then, the company that makes the new product may be in serious trouble — if they're around at all.

Advertising is the surest way to get an idea to the public. By advertising a new product or service, more people are able to try it more quickly than if it were allowed to "catch on" by itself.

Good ideas become popular right away and bad ideas...well, who needs a square wheel, anyway?

ADVERTISING.
ANOTHER WORD FOR FREEDOM OF CHOICE.

American Association of Advertising Agencies

**DATAMATION
PROVIDES THE
VITAL BACKGROUND
FOR AN ABC 20/20
TV SEGMENT.**



Software Bugs: A Matter of Life and Liability

You read it first in DATAMATION when a major software glitch was linked to the deaths of patients. Once again, the editors of DATAMATION went beyond business as usual to get the full story and its precedent setting legal ramifications for producers of software and hardware.

In addition to keeping MIS professionals informed on the subject, the article also provided important background and a clear mapping of the borderline between technology and the law for the producers of an ABC 20/20 tv segment.

DATAMATION - The Leader in Information Technology Coverage

First Half 1989

DATAMATION Editorial Calendar

Issue Date	Ad Closing Date	Special Reports	Software/ Services	Systems	Communications	Management	International
January 1	December 1, '88	IBM					IBM in Japan IBM in Europe
January 15	December 15, '88	Technology Forecast		RISC	Telecomm. Operations		
February 1	January 2		Transaction Control Systems	OLTP		PCs in IS	Offshore Software
February 15	January 16		OS/2 vs. Unix	Security		Product Development	
March 1	February 1	DEC		IBM-DEC Connectivity	T-1 Multiplexors		1992
March 15	February 15		PC-DBMSs	386-Based PCs		Corporate Profile	
April 1	March 1	Budget Survey		Weapon Systems	EDI		Eastern Bloc Computing
April 15	March 15	Connectivity Survey	Expert System Integration	Document Image Processing	Voice Messaging		
May 1	March 31	Companies to Watch	OS/2 on IBM Compatibles			Corporate Profile	Far East Operations
May 15	April 14	Large Scale Systems Survey	Operating Systems Evolution			Decentralization	
June 1	May 1		Object Oriented Programming (OOPs)	Macintosh in IS	LANs		Executive Information Systems
June 15	May 15	Application Software Survey		High Performance Computing		Corporate Profile	
June 21	May 22	DATAMATION 100					

Contact Your Regional DATAMATION Sales Representative for Additional Related Market Research, Advertiser Benefits and Trade Show Bonus Distribution

BETWEEN DEMONSTRATING A *UNIQUE IDEA* AND DEVELOPING IT *COMMERCIALY...*

YOU MIGHT
BE GLAD
OF *THIS*



3i's Enterprise Cheque
is seed capital in its
simplest form. A single

payment averaging £25,000 for investment in leading-edge technology. If you have a research project which is past the "ideas" stage and ripe for development into a specific product or business, 3i Ventures will provide the money in a fast and efficient manner to get it off the ground.

3i Ventures specialise in investing in businesses with high growth potential, providing both money and management expertise.

For details, please return the coupon or phone Elaine Morgan, 3i Ventures on 01-928 7822.

3i Ventures is part of 3i plc

3i plc is regulated in the conduct of investment business by SIB

Please send me full information on 3i Ventures and Enterprise Cheque scheme.

D 1188

Name _____

University/Research Establishment _____

Address _____

Postcode _____

Telephone no. _____

Post to: 3i Ventures FREEPOST, 91 Waterloo Road, London SE1 2BR.

Or phone 01-928 7822 Ext 2370.



investors in industry

SPOT THE DIFFERENCE



Not difficult! But where were you when the picture was taken?

Not everyone likes fishing, but if you would like more time for living, for playing, then you should know about Mercante. That's the name of a company on the outskirts of Copenhagen which is dedicated to ending office drudgery.

They make the Photon Imager I, a new heavy-duty multi-user/network printer. It prints complex graphics and text at 25 ppm, and it can print three different jobs simultaneously, sort and collate the print-out ready for stapling. Forget about photocopying a single print-out – time's too valuable. Photon Imager I is packed with the latest technology to do your work faster. To make life more enjoyable and leisure time more fun.

If fishing's not your game – how about a round of golf?

MERCANTE

29 MIDTAGER · P.O. BOX 265 · DK-2605 BROENDBY · DENMARK
PHONE + 45 2 96 22 99 · FAX + 45 2 96 06 13 · TELEX 33478 nip dk

Circle 76 on Reader Card

U.K. May Put IS Projects in Private Hands

The British government hopes to save £2.5 billion on an ambitious program aimed at putting more power in the hands of dp chiefs and money in the pockets of service companies. It may displace 15,000 workers.

BY JOHN LAMB

The U.K.'s Department of Social Security, which manages the country's complex benefits schemes, is considering a plan to inject business savvy into the biggest government computer project in Western Europe. That plan involves the novel idea, in Europe anyway, of tying civil servants' pay to performance and putting part of the massive £2 billion (\$3.4 billion) computerization program into the hands of private computer service companies.

Proposals being considered by the U.K. Treasury suggest the department's dp chiefs should be free to sign external facilities management contracts, pay their staff more than civil service rates, use outside development staff, and sell their services inside the Department of Social Security and to other government departments.

"We want to get out from under government constraints," says Alan Healey, deputy director of the department's Operational Strategy Directorate.

The Department of Social Security expects to spend £2 billion (\$3.4 billion) by 1997 on its Operational Strategy, an ambitious computerization program that will put 40,000 terminals on desks in 500 local benefit offices around the U.K. When it is complete, some 30 benefit programs will have been computerized with the help of over 80 mainframes, mainly Series 39 machines from local U.K. supplier ICL.

The systems are expected to deliver savings of £2.5 billion (\$4.3 billion) in running costs, salaries, and reduced fraud. But the Department of Social Security's dp department reckons it could do better—trimming at least 2% from a pres-

ent annual budget of £200 million (\$340 million)—if dp people were given more freedom to make their own decisions. The new systems are expected to cut the number of staff by 15,000 from 70,000.

Healey admits that the Department of Social Security has found it hard to get the right people. "We tend to throw people at problems rather than expertise," he says.

Healey denies that outsiders are needed to keep the strategy on track, though consultants are already used on the project. The next step would open the doors far wider. Three or four giant centers will service the local offices where welfare checks are calculated and paid out. While the bulk of applications would continue to be done in-house, one or two centers could be contracted out.

Computer services companies are already weighing up the prospect of new business. Hoskyns, which runs London's local government dp operation under a £25 million

(\$42.5 million) facilities management contract, reckons that the public sector in the U.K. is second only to financial services in terms of potential business. Health and social services are the jewels in the public sector crown, says Simon Orme, Hoskyns' marketing director. "The Department of Health and Social Services [will be] looking for ways to contain costs in the face of overwhelming demand." That could mean a bonanza for services companies.

The Department of Social Security is already examining changes that might increase the need for centralized services by creating processing "factories" that would replace the 500 local offices. "At the end of this, we expect to have a leaner, fitter department, better able to serve its end users," declares Healey.

John Lamb is a freelance writer in the U.K.

INTERNATIONAL

UNITED KINGDOM: The British government expects big savings by placing a massive computerization program in the hands of private service companies. _____ **3**

WEST GERMANY: The Bundespost moves to protect its revenue bases and to be more responsive to users. _____ **7**

HONG KONG: A study of the prospects for EDI begins. _ **11**

REPORT: Office automation in Japan. _____ **15**

INNOVATION: New parallel computer from AMT; New IBM compatibles from Comparex. _____ **20**

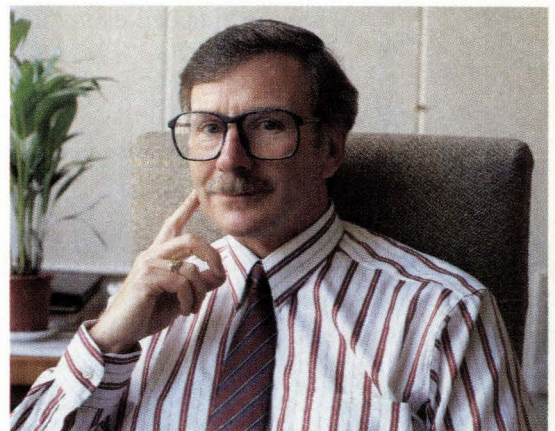

SOCIAL SECURITY'S HEALEY: Finding the right people.

Photograph by Philip Ryan

How Facit B-line m more attractive,

One of the easiest ways to breathe new life into your office is to add a powerful Facit B-line matrix printer to your computer. Not only will it cover all your printout requirements, but the printers are so easy to use that you will really enjoy exploring your new potential.

EASY SWITCHING FROM HIGH PRINT QUALITY TO FAST DRAFT PRINTING

If you still associate matrix printers with dull "computer-style" text, it's time to change your view. The Facit B-line printers feature professional Near Letter Quality printing that will really flatter your word-



The B-line control panel offers instant selection of print quality, font pitch, low-noise printing, etc. Set-up parameters are also controlled from the panel, thereby making the printers very easy to install.

processing. The B3450 even offers Letter Quality which makes printouts virtually indistinguishable from those of daisy-wheel and laser printers. You can also easily customize your texts for special applications by selecting from a wide range of versatile fonts in several pitches.

By flicking a switch on the front panel of the B-line printers, you can quickly change from high quality print to draft quality for lists and other applications when you're in a hurry. And because the Facit B-line printers are designed for high throughput, they maintain their high printspeed even during long printouts.

FLEXIBLE PAPER HANDLING FOR YOUR ADMINISTRATION

The B-line printers permit you to load the paper in several different ways to suit various applications. This facilitates:

- Immediate paper tear-off without losing a single form – great when you use expensive paper
- Parking a continuous form while printing cut-sheets – a real time-saver if you frequently switch paper types
- Accurate feed of thick paper, such as forms and labels

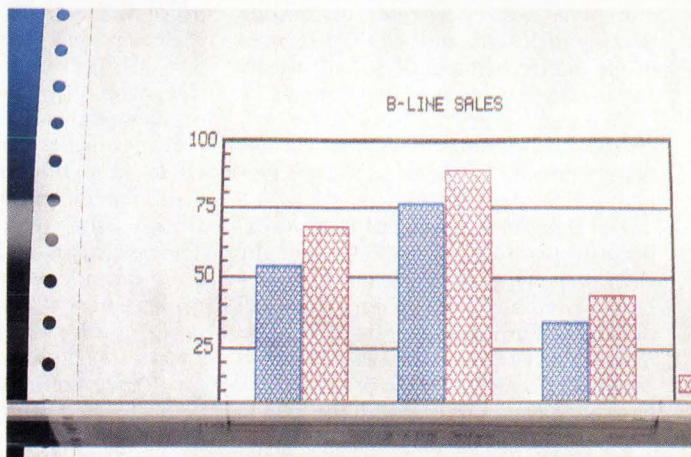
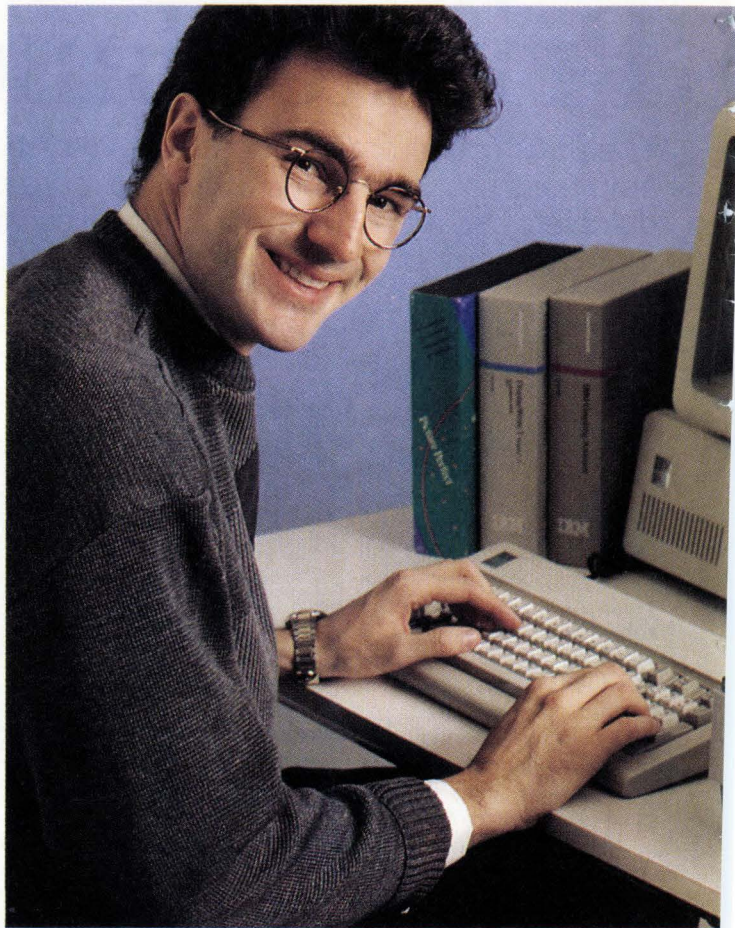

Adding a four-color ribbon gives you seven-color capability for highlighting, labels, business graphics, etc.

You can also equip the printers with an optional single- or double-bin cut-sheet feeder. The double-bin capability is very convenient as it gives you immediate access to two types of paper, such as cut-sheets and envelopes.

makes your printouts efficient and fun.

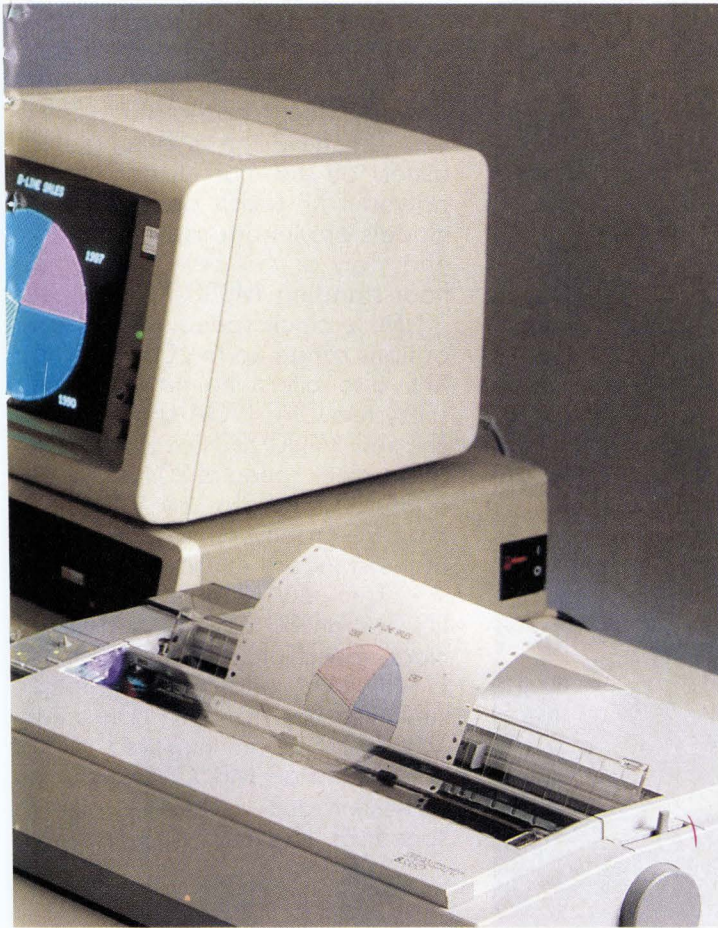

The B-line printers can be used with a wide range of computers ranging from IBM PCs (and compatibles) to large DEC systems.



You can easily customize your printouts with Facit's unique font cards.

9-, 18- AND 24-PIN PERFORMANCE

The Facit B-line includes as many as five printers, each tailored for slightly different applications. The 80-column B3100 and its 136-column counterpart, the B3150, are excellent 9-pin, all-round printers. And the 18-pin B3350 and 24-pin B3450 are especially suitable for wordprocessing. All these printers can be used with a wide range of computers and softwares as they offer parallel and serial interfaces plus several command set emulations as standard.

The Facit B-line also includes the compact B1100, which does not have all the advanced features of its big brothers but is a highly economical alternative for small PC systems and video terminals.

So, if you really want to take advantage of the print-out potential of your computer and software, contact your nearest Facit representative for more information and a demonstration of all printers in the Facit B-line.

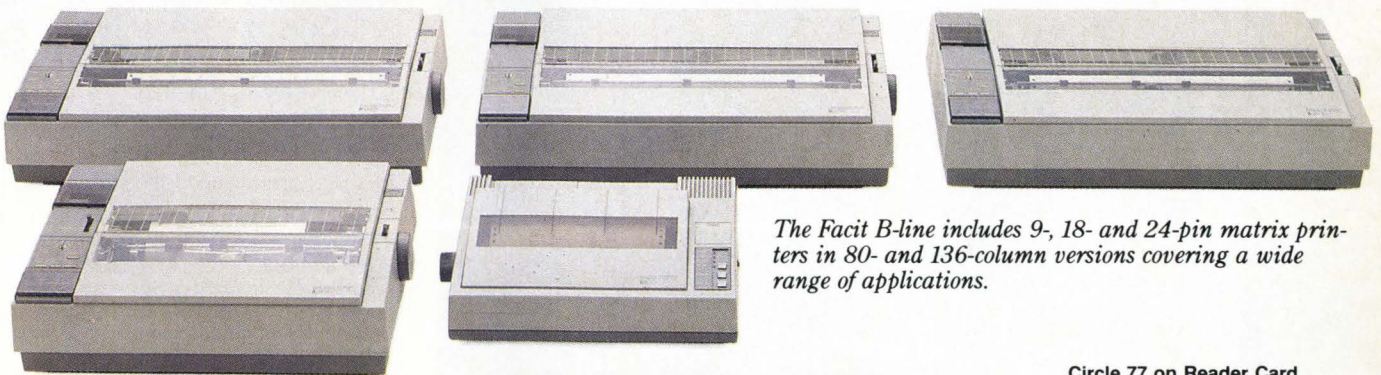

The Facit B-line includes 9-, 18- and 24-pin matrix printers in 80- and 136-column versions covering a wide range of applications.

FACIT

Circle 77 on Reader Card

Facit AB, S-17291 SUNDBYBERG, Sweden. Phone: +468 7643000

AUSTRALIA: Elmeasco Instruments Pty. Ltd., 2-736 28 88. AUSTRIA: Facit GmbH, 0222-613 641. BELGIUM: Facit Office Products NV/S.A., 02-725 20 20. CANADA: Facit Canada Inc., 416-825-2712. CYPRUS: LBM (Lillytos) Ltd 051-646 34. DENMARK: Facit A/S, 02-92 24 00. FINLAND: OY Facit Ab, 90-420 61. FRANCE: Facit S.A., 1-4780 3535. GREAT BRITAIN: Facit Ltd., 0634-83 00 08. GREECE: American Computers & Engineers Hellas S.A., 01-671 97 22. HONGKONG: Gilman Office Machines, 5-893 00 22. ICELAND: Gisli J. Johnsen HF, 1-64 12 22. INDIA: Forbes Forbes Campbell & Co. Ltd., 22-20 48 081. ITALY: Facit S.p.A., 039-63 63 31. JAPAN: Electrolux (Japan) Ltd., 03-479-7570. KOREA: True Trading Co. Ltd., 2-783-3855-7. MALAYSIA: Facit Sdn Bhd, 3-24 24 438. THE NETHERLANDS: Facit B.V., 3480-21784. NEW CALEDONIA: Maison Barrau, 27 37 74. NEW ZEALAND: Northrop Instruments & Systems Ltd., 04-856-658. NORWAY: Facit A/S, 02-38 65 00. PORTUGAL: Regisconta Sarl, 1-56 00 91. SINGAPORE: Far East Office Eqpts Pte Ltd., 66-745 82 88. SPAIN: Facit S.A., 1-733 76 96. SWEDEN: Facit AB, 08-764 30 00. SWITZERLAND: Facit AG, 01-836 75 76. TAIWAN R.O.C.: Dimension, Computer Technology Co., 2-501 55 68. TURKEY: Teknodata Ltd., 1-150 87 47. USA: Facit Inc., (603) 424-8000. WEST GERMANY: Facit GmbH, 0211-528 60.

NEW M380 LINE: NOW MORE THAN EVER THE SPEED AND POWER TO GROW WITH YOU.

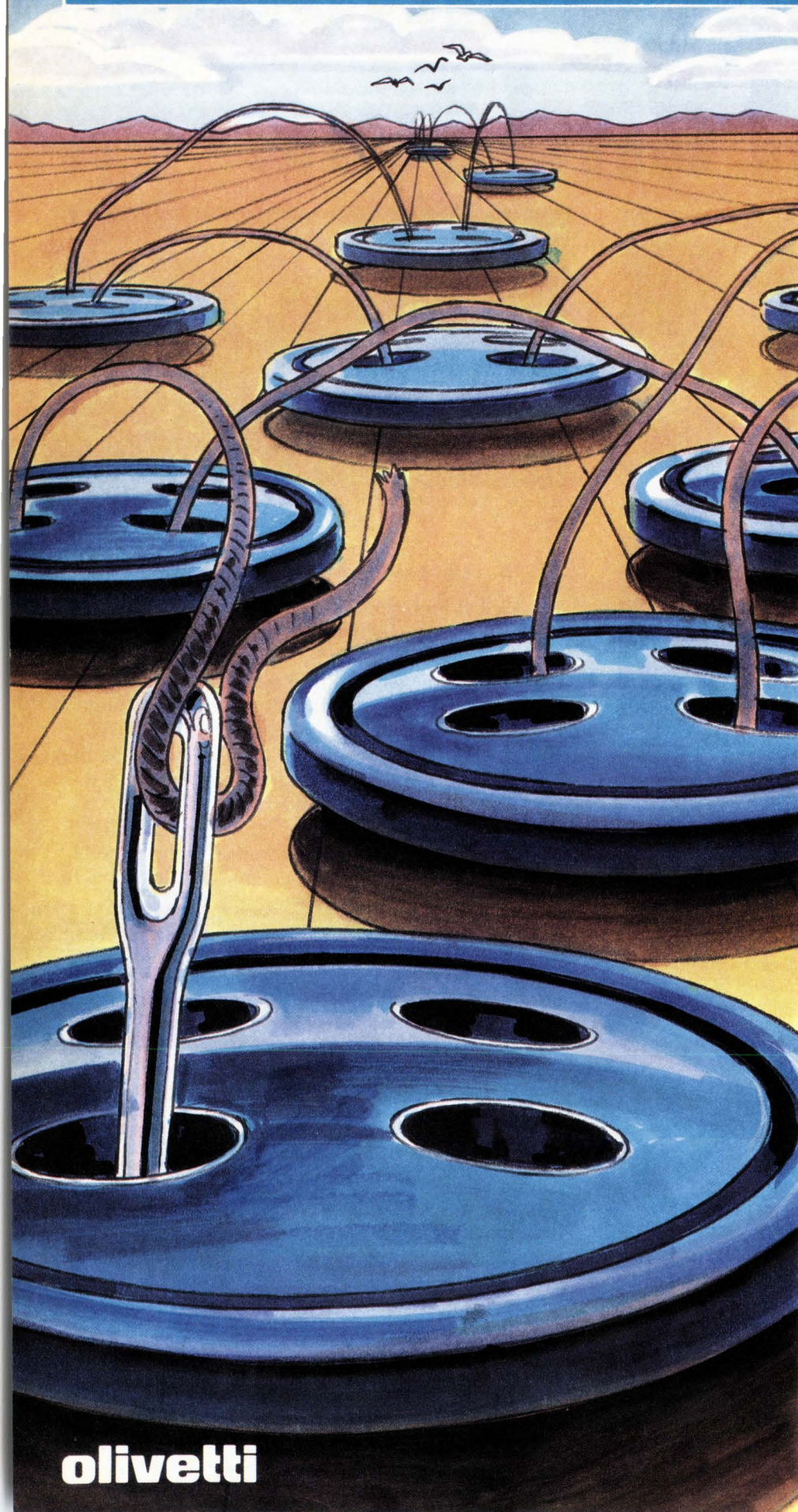

olivetti

To keep you abreast of advances in the important Intel 386™ sector, Olivetti has up-dated its powerful 386™-based M380 line.

The new line is among the fastest on the market, and more powerful XP (extra performance) models are introduced at the top end. Top of the new line is the floor-standing M380/XP5 with a 20 MHz clock speed. Hard disk options range up to 600 MB. The XP5 also offers the new graphic subsystem OVC (VGA-compatible). The new M380/XP3 has 2 MB RAM and a clock speed of 20 MHz, plus a 135 MB hard disk unit. It too has the OVC graphic subsystem as part of the standard configuration.

The new M380/XPI desktop PC has an 80 MB HDU. With a clock speed of 20 MHz, it offers 1 MB RAM and OVC graphic subsystem as standard. The new M380/C has an improved HDU capacity of 63 MB, OVC graphic subsystem and a clock speed of 16 MHz. All

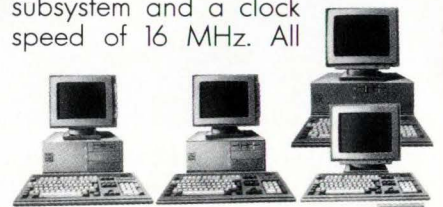

M380 models operate in MS-DOS, XENIX V/386, UNIX V/386 and MS-OS/2 environments.

The new M380 line. Yet another way in which Olivetti is honouring its commitment to bring you the choice of freedom.

386 is a trademark of Intel Corporation. MS-DOS, XENIX/V and MS-OS/2 are registered trademarks of Microsoft Corporation. Unix is a registered trademark of AT&T in the U.S.A. and other countries.

Specifications and conditions subject to change without notice.

OLIVETTI PERSONAL COMPUTERS.

CHOICE OF FREEDOM.

Circle 78 on Reader Card

SIEMENS

Siemens Computers break the MIPS barrier: 100 million instructions per second

Siemens is not just the largest European computer manufacturer; its computers have now entered a new dimension. Heading the 11 new CPUs in three performance classes is the most powerful BS2000 computer ever. It manages over 100 MIPS – million instructions per second.

That makes it ten times as powerful as the largest Siemens computer of just four years ago.

But Siemens wins not just on speed and stamina; we head the field in other disciplines as well:

Our new Hypervisor means that several versions of the BS2000 operating system can be used simultaneously on one and the same computer. Furthermore

the single operating system BS2000 runs on the smallest office computer and the largest mainframe alike. A “virtual data space” of 2 Gigabytes for all CPUs – including the C30 office computer. So even highly complex programs can be run.

The new MS-DOS workstation terminals will not only possess colour graphics capability, but can be upgraded to stand-alone PCs.

And much more besides. You can read about it in the leaflets which we shall be happy to send you without charge. Contact your nearest Siemens office or Siemens Infoservice 133/Z072, PO Box 2348, D-8510 Fürth-Bislohe, Federal Republic of Germany.

Siemens Computers grow to match the task.



100.000.000.

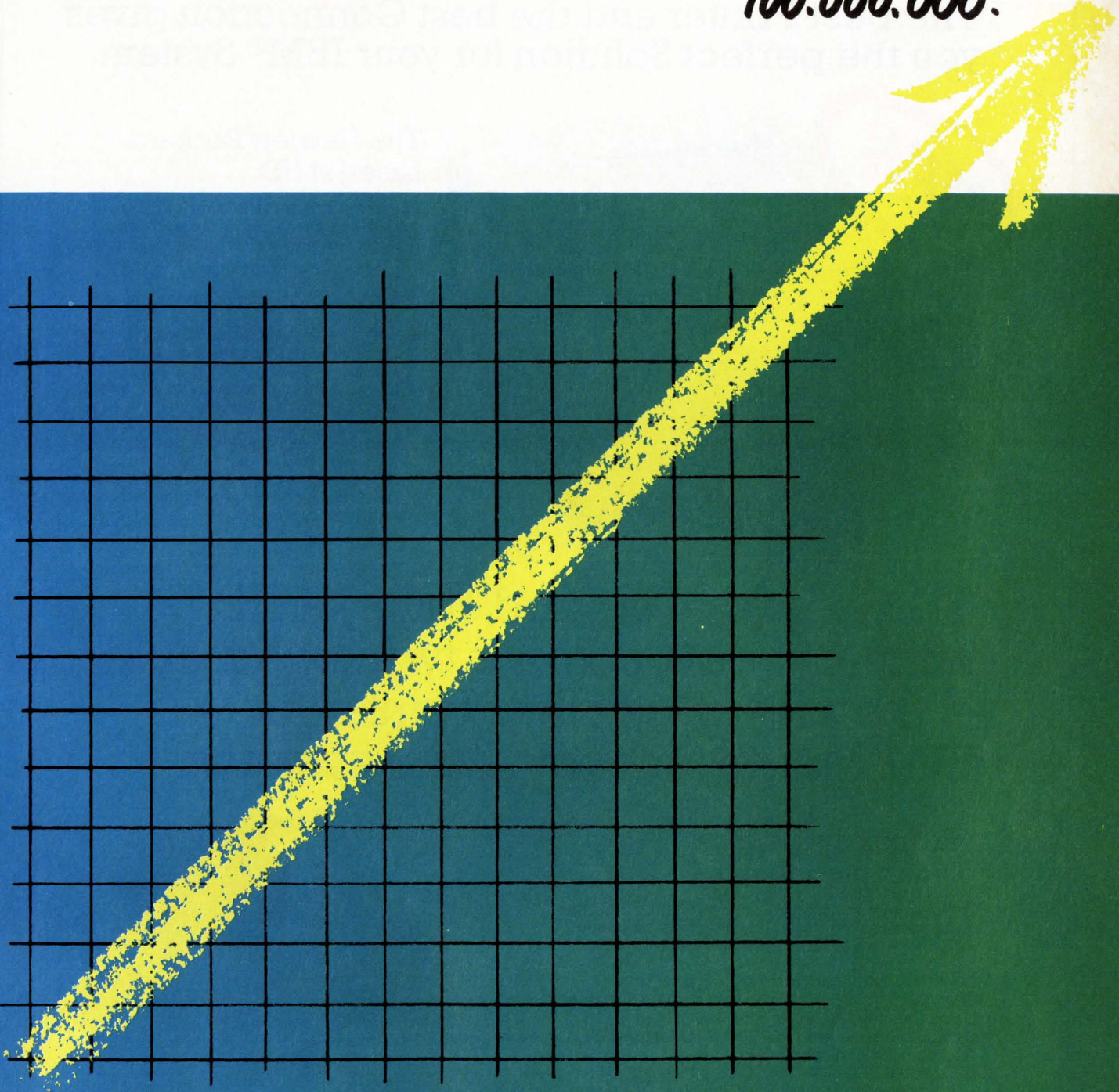

The best Printer and the best Connection gives you the perfect Solution for your IBM® System.



The Hewlett-Packard LaserJet IID

The new advanced HP LaserJet IID gives you all the advantages of the popular LaserJet Series II with additional features such as:

- Single- and two-sided (duplex) page printing.
- Advanced paper handling with two input trays and an additional envelope feeder.
- Increased paper capacity of up to 400 sheets and 50 envelopes.
- 14 internal fonts and a font cartridge with 10 Times Roman and Helvetica fonts are standard with the printer.
- Number of downloaded fonts, macros and form-overlays are only limited by the memory space.

The Hewlett-Packard LaserJet IID with an I-data coax or twinax Module, is the ideal Desk Top Printer for IBM Mainframe and Mini-systems.

Ida coax and twinax plug-in modules.

The plug-in module simply slides into the I/O slot in the rear of the printer, leaving the parallel and serial ports available to print data from your PC.

When you connect the LaserJet printer to your IBM system using the Ida 3270 coax plug-in module, it provides full IBM 3268/3287 and 4214 plug compatibility including all IBM RPQ features. Additional features include:

- Optional IBM 3820 Emulation for Advanced Function Printing (GDDM Graphics, DCF/Script and DW 370).
- APL support.

IBM 3X/AS400 connection with Ida 5219 twinax plug-in module makes the LaserJet fully IBM 3812 plug compatible (in 5219 mode). Additional features include:

- Full support of DisplayWrite/36 and Office/38.
- Automatic Paper Orientation and Computer Output Reduction.

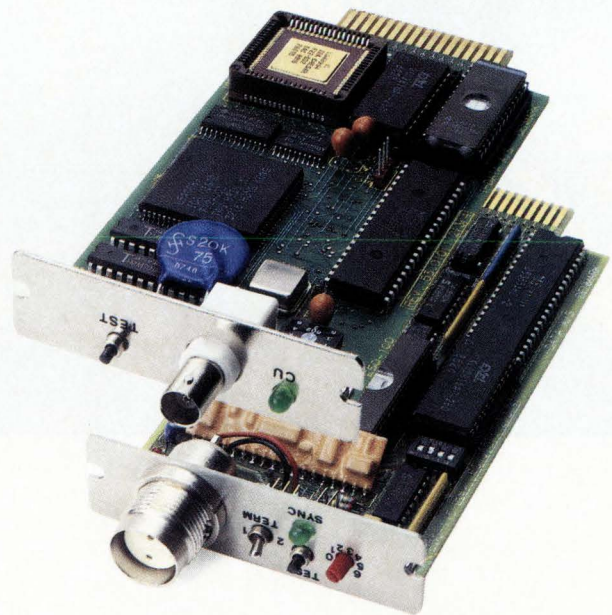

* IBM is a registered trademark of International Business Machines Corporation.

For information on your local dealer call:

Hong Kong Begins EDI Study

Unless the government implements electronic trading solutions, companies fear they will be left behind in Far East race for trade dominance. Users are so concerned they even foot part of the bill.

BY CLAUDIA NALVERN

Starting Nov. 1, a consortium of Hong Kong and Chinese corporations, supported by the Hong Kong government, begins a six-month study to determine the prospects for electronic data interchange (EDI) and how it may protect the territory's much envied trading status in Southeast Asia.

For some local traders, the study long overdue. "If the amount of trade passing through continues at its present level, I don't see how anyone will be able to keep up with it, unless they become more sophisticated," reasons Graham Ross of Deacon & Co., a Hong Kong trader that deals in textiles, hard goods, and toys.

The EDI study will determine whether EDI services are suitable to the territory, what type would be suitable, how they should be run, and how they can be made profitable for investors.

The hope is that the study will come up with some suggestions for relieving the numerous bureaucratic delays that hamper the Hong Kong trading community—a community that produced revenues of \$55 billion in the first six months of this year. The results of the study may also clarify Hong Kong's fears that it is being left behind in the race toward electronic trading systems, which are emerging in other Asian trading centers.

It has taken a year of pressure from the private sector, and an internal review of its own paper processing procedures, to get the Hong Kong government to agree to help fund and participate in the study. Now, at last, the study is under way, with the bulk of the financial backing and corporate clout coming from a consortium called Tradelink Electronic Document Services. Its members are China Resources Holdings, a Beijing-based trading firm; Hong Kong Air Cargo Terminals; two container terminals; the international Swire Group trading company; the Stan-

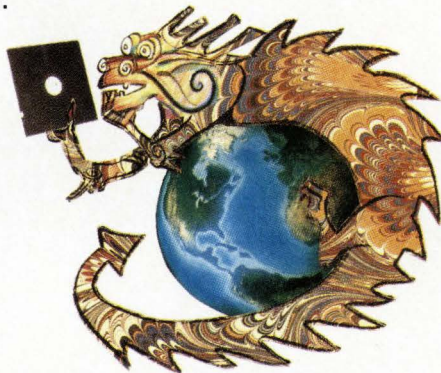

dard Chartered Bank; Maersk (HK) Ltd.; Hongkong and Shanghai Banking Group; and Hong Kong Telecommunications.

Juleta Broomfield, Hongkong Bank's assistant manager of information technology and a full-time member of Tradelink's project management team, is cautious about the study's outcome. "It could be a value-added network or a straightforward store-and-forward system," she says, adding that the study may even recommend that there should be no investment in EDI.

That wouldn't help the problems of bureaucratic delays in Hong Kong. "Often," says Deacon's Ross, "our cargo arrives at its destination before the paper needed to get the goods from the port to the customer has been processed."

Government bureaucracy accounts for a large portion of these delays. A government work force of 800 people handles the 5 million export license applications processed each year. A computer matches redundant information typed from licenses into terminals by local officers, a system that fosters mistakes and delays.

Alan N. Lai, assistant director of Hong Kong's trade department, insists the wait for licenses is two days at most, but traders often complain of 10-day delays. Even Lai has to admit to the long queues for services, and arguments that erupt between messengers and clerks. "What we want to do [with EDI] is cut down the amount of paperwork, staff, and cost," he says.

It would be particularly helpful if the system accommodated the Chinese lan-

guage, since Hong Kong is emerging as a service economy and trading center for China in the run up to its return to Chinese control in 1997. Deals with China now account for 30% of the paper trade declarations generated in Hong Kong—most of which are handled by truck drivers and are written in Chinese.

The EDI network's topography will be relatively easy to design since Hong Kong is geographically small, with one seaport and one airport, and it would be possible to link all trading parties with a single network. This already happens in Singapore, one of Hong Kong's trading rivals, where an EDI service called Tradenet is scheduled to be operational by January. This boosts concern that Hong Kong's service to overseas trading partners may deteriorate if it doesn't keep up.

Overseas links will be a major part of the study, as reliance on international trade has spurred EDI projects throughout the region. Australia leads the way with efforts to link its retail, banking, and transportation communities to the U.S. and Europe, says Burt Meerman, sales manager for trade and transport at General Electric Information Services Company.

Since these countries are not in a position to defy international standards, Hong Kong's Tradelink will most likely follow Edifact standards. Singapore's Tradenet (being implemented by IBM) will also adhere to Edifact, says Dave Swanz, IBM Asia/Pacific's manager for SI.

Tradelink's Broomfield points out, however, that "if major trading partners in the U.S. do not use Edifact, we can not say no to them—we must be open to other systems." Indeed, she says, Hong Kong may eventually need its own equivalent to Europe's Sitpro standards organization.

Claudia Nalvern is a freelance journalist based in Hong Kong.

The new COMPAREX 8/8X Processor-Series

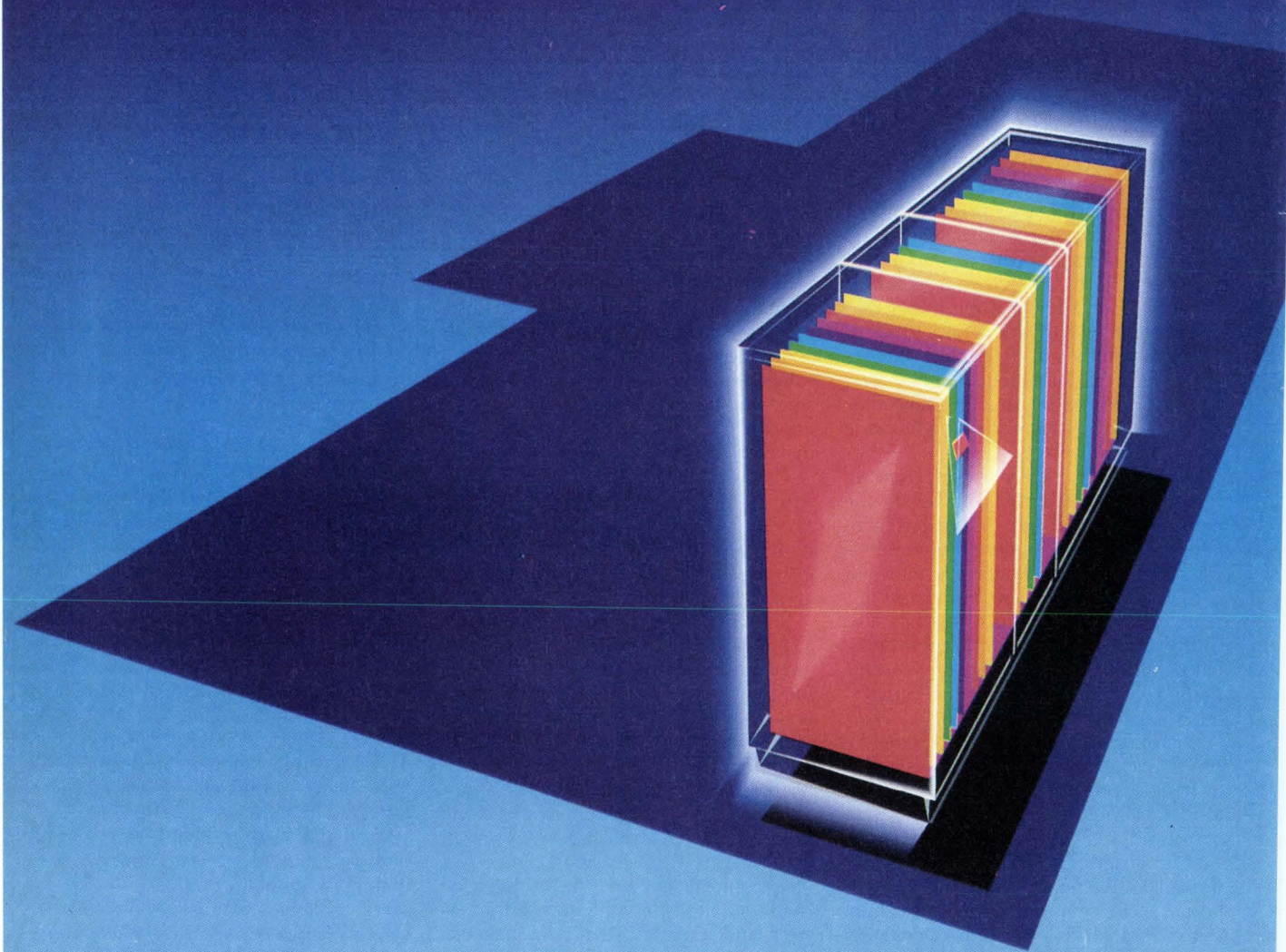

COMPAREX – the newest and largest alternative to IBM in Europe.

The biggest thing about the COMPAREX 8/8X processors: How small and economical they are.

If you're committed to the IBM* world – software, hardware and applications – but your 4381 just can't cope any more then all IBM can offer is an additional 4381 or a leap of faith to a 3090: the devil or the deep Blue sea.

COMPAREX can now offer you a real solution.

The COMPAREX 8/8X family – 4381 size and convenience 3090 performance.

The COMPAREX 8/8X family is ideal for users who need the power and capabilities of the low-end 3090s but don't have the space. Like the 3090s the first three members of the 8/8X family are uniprocessors. But unlike the 3090s they really are small about 1.5 square metres (16 square feet) – roughly the size of a non-executive desk. That's less than a fifth of the space required by a "small" 3090, with similar savings in weight, power consumption and air conditioning.

Power – wherever you look.

The 8/8X processors are powerful enough, but that's not all. Up to 32 channels can be attached to each system, with support for 6 MB/sec transfer to and from selected COMPAREX peripherals. This feature provides channel constraint relief for many users, revitalising on-line operation and re-opening the batch window.

But the real power behind the COMPAREX 8/8X comes from BASF and Siemens, two European giants who have combined to launch COMPAREX a new alternative to IBM.

A commitment to compatibility.

COMPAREX is already the leading compatible alternative to IBM in Europe. With a complete range of hardware products for the medium and large scale user. Our strategy rests solidly on four cornerstones:

- an open-ended commitment to IBM compatibility,
- a product and pricing policy designed specifically to result in improved price/performance for users,
- the development of technically superior products using state-of-the-art-technology wherever appropriate,
- outstanding customer support for COMPAREX and non-COMPAREX hardware and software products, including assumption of overall responsibility for complete installations.

Over 3,000 customers have installed 30,000 COMPAREX products. If you would like to know more about COMPAREX or the 8/8X family please contact us at one of the following:

Great Britain (44) 01-908-3100

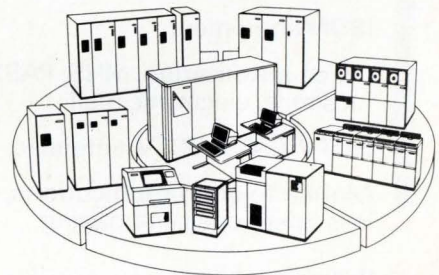

COMPAREX
Informationssysteme GmbH
Gottlieb-Daimler-Straße 10
D-6800 Mannheim
West-Germany

Tel. 06 21/40 09-0

COMPAREX
A BASF and Siemens Company

*IBM is a registered trademark of International Business Machines Corp.

AMSTERDAM: GATEWAY TO EUROPEAN COMMUNICATIONS

EuroComm 88

EXHIBITION

An international exhibition at which a wide range of products, systems, services and applications will be shown:

Networks – PC, WAN, LAN, Packet switching – network components and management systems.

Satellite, digital microwave, cable and fiber optics systems.

ISDN equipment.

Office automation, MHS, PABX, facsimile, electronic mail.

HDTV, CATV, CCTV, antennae.

Mobile telecommunications, cordless telephones and paging.

Participants include: AEG, AT&T, Blaupunkt, Canon, Datapoint, GEC Plessey, Geveke, Hewlett-Packard, Hoskyns Group, McDonnell Douglas, MicroScope, Mitel, NKF Kabel, Nokia-Mobira, Nynex, Philips, RC Computer A/S, Repko, Rohde & Schwarz, SAT, Siemens, STC, Telindus, Unisys and such bodies as the Electronic Engineering Association and the Commission of the European Communities.

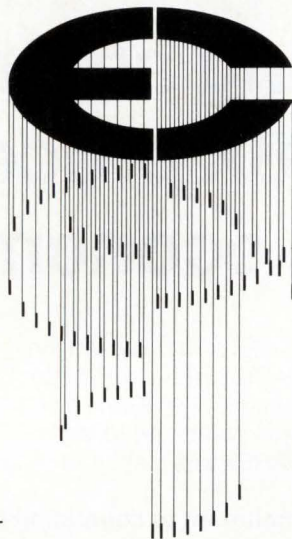

CONGRESS

A top level congress with a programme that comprises:

Tuesday 6th December

Congress and exhibition opening plus presentations by prominent European figures from the (tele-)communications world. Plus five one-day sessions each covering a variety of aspects relevant to the session theme:

Wednesday 7th December

Session 1: Broadband technologies and services.

Session 2: The telecommunication services offering.

Thursday 8th December

Session 3: Telecommunication network developments.

Session 4: The new opportunities in and of telecommunication services.

Friday 9th December

Session 5: The future of telecommunications.

6-9 DECEMBER 1988

Daily 10 a.m. - 5 p.m.

Hollandcomplex
AMSTERDAM **rai**

the official
EuroComm 88
carrier

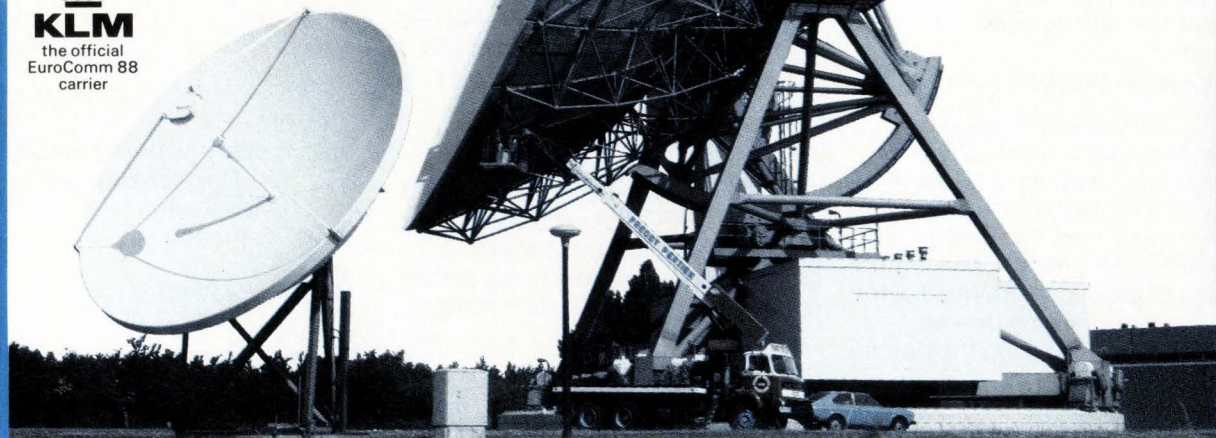

Information: International Exhibition and Congress Centre RAI Amsterdam, Europaplein, 1078 GZ Amsterdam, The Netherlands. Tel.: 31(0)20-5491212, Telex: 16017 raico nl., Telefax: 31(0)20-464469

Automating The Japanese Office

Japanese corporations trail the West in applying new office systems technology. Keyboard-phobic Japanese managers, cultural tradition, and the slow process of establishing standards in desktop systems are limiting OA use.

BY JOHN BOYD

Yoshihisa Akai is an IS manager with a major cultural obstacle to overcome. As the director of the strategic analysis group at Japan Air Lines (JAL) in Tokyo, he has spent the last few years building up a \$3.5 million database system for JAL's executives, including the board of directors and the president. The system provides vital decision-making information to help JAL pilot its way through the competitive dogfights of the international airline business. "It has now become indispensable to use this information in planning strategies," notes Akai.

Despite their active support for this high-tech investment, JAL's senior managers are reluctant to access that vital data themselves. Virtually all the information is still delivered to them in hardcopy form through intermediary staff.

This is not unusual in Japan. Direct management involvement with office automation is still rare in most large Japanese organizations.

"In terms of pure technology, the U.S.

and Japan are about the same, but in applying that technology, the U.S. is more advanced, perhaps as much as five years," comments Shuhei Mitome, an analyst at Arthur D. Little Japan Inc. in Tokyo.

The U.S. got off to a good start in the early 1980s when the growing number of

□ DIRECT INVOLVEMENT BY MANAGEMENT WITH OFFICE AUTOMATION IS STILL RARE IN MOST LARGE JAPANESE COMPANIES.

word processing users and suppliers greeted the pc revolution with open arms. Japan, however, had first to deal with the awesome task of automating *kanji*, the Chinese characters that are used in the complex Japanese writing system, before it could advance.

To be considered literate, a Japanese

must learn at least 2,000 *kanji* characters, many composed of between 10 and 20 strokes. That compares to a maximum of only four strokes in the 26 letters of the Roman alphabet. It is this complexity that has made *kanji* difficult to reproduce on small screens and in business documents.

Progress has been made. Today, Japanese users enter information via a keyboard based on either Roman letters or phonetic syllabaries called *kana*, which the computer then converts into *kanji*. While some complain that input is slow, most Japanese believe the technical problems are a thing of the past.

The result is that the spread of word processors (*waapuro*), which began around 1984, shows no signs of diminishing. Notes Mitome, "While sales of dedicated word processors decline in the U.S., they're continuing to increase here."

Nevertheless, there is still widespread management resistance to using keyboards. With few exceptions, computer input is regarded as the job of a trained



Illustration by Peter Kuper

INTERNATIONAL

JAPAN

OFFICE SYSTEMS

worker, usually one of the so-called office ladies who grace Japanese offices.

"The OA [office automation]-ization of Japan is still mostly an entry operation by women who are trained to input data," says Linda Sherman, project director for the Japan Market Research Bureau Inc. in Tokyo. "In the U.S., a lot of people are making good use of their personal computers through spreadsheets and word processing; they're creating, moving information around in a document until it suits them. In Japan, word processing still means creating a document by hand and having a secretary produce 'pretty print' on a word processor."

What's Wrong with a Quill Pen?

This is less surprising when it's understood that the typewriter was never used as widely in Japan as in the West. Until recently, all documents, except a few pertaining to government and legal matters, were handwritten. This tradition, deeply rooted in an artistic admiration for the handwritten document in Japanese culture, explains the popularity of the facsimile machine, by far the most commonly used business machine in Japan, because it is better suited to customary methods.

"The fax is one of the gadgets of the information society," says Robert Ballon, professor of economics at Tokyo's Sophia

University. "The Japanese may not be using e-mail as much, but given that they practically sleep with a fax on their laps, well, you just add a new button to the fax and you have e-mail. That is only a technical twist."

In an effort to overcome the keyboard phobia among Japanese managers, many companies have tried to simplify the task

□ IN THE UNITED STATES, A LOT OF PEOPLE ARE MAKING GOOD USE OF PERSONAL COMPUTERS; IN JAPAN, WORD PROCESSING STILL MEANS CREATING A DOCUMENT BY HAND.

of inputting *kanji*. At Toshiba in Tokyo, systems personnel have devised plastic keyboard overlays for executive workstations that mark the keys according to function and are tailored to the individual executive's department.

Akai at JAL, meanwhile, hopes to introduce terminals specially tailored for computer-shy management next year so that they can access his database information

directly. "This will cost an additional ¥200 million or ¥300 million. I will also need one or two more staff—and they are particularly hard to get," he says. JAL plans to follow the example set by the Tokyo Electric Power Co., which uses a two-key keyboard and a numeric keypad to select menued items on a screen.

While it may take time to break down the barriers between JAL's management and the keyboard, Akai has noticed that other aspects of traditional Japanese management style have already been affected by the introduction of office systems linked to the information database.

"In the past, management has often been by intuition and *hara* [gut feeling]," Akai says, "but with the introduction of this system, I hope it will change more to management based on actual and accurate information. And I'm beginning to see such a change."

What's more, access to the system has helped staff assess changes faster and better focus their activities. "For instance," he reports, "if we introduce a new fare, we can know the results in a month or so, whereas before it took at least a month longer."

Whereas the sales staff once had the simple goal of "selling more," Akai continues, they are now using the newly available information "to make more profit"

A Network of Laptops At Toshiba's Head Offices

Nao to Yokoyama, like many managers in the internal information and systems division at Toshiba's headquarters in Hammatsucho, Tokyo, uses a J3100 laptop every day for an office application that is still exceedingly uncommon in Japan—e-mail.

"While fax is used much more than e-mail today, the use of e-mail will increase because of its advantages," says Yokoyama. He can check for mail four or five times a day, broadcast messages, and receive a confirmation of receipt.

Yokoyama hooks into the 100Mb optical fiber LAN that runs around the 40-story building. Linked to this are 10Mb coaxial systems that bring distributed data processing to each department. "This network is also connected to other Toshiba offices, plants, and buildings throughout Japan via our group's value-added network," he explains.

This network has been a major success at the Toshiba headquarters. All eight senior managers in the IS division are using e-mail to varying degrees.

One such manager is Kenjiro Hayashi, who has offices in both the telecommunications and planning departments, and so praises the portability of his laptop. Hayashi is presently gathering information in preparation for planning a global communications network for Toshiba.

He demonstrates on his own laptop how he uses Lotus 1-2-3 to list, in any order, overseas branch and sales offices (600 locations

in the U.S. alone) according, for example, to the kind of computers they use, whether they have dedicated or public fax, or just by their address. "I used this to analyze the traffic flow between cities here in Japan to find out where we should use private lease-lines. It can save us a lot of money," says Hayashi.

On an average day, Hayashi spends the first 30 minutes checking his e-mail. "I may have between five and 10 messages and two or three will request a response," he says.

The combination of laptop and network access has made another major difference to the way he does his work—he inputs all of his own data. "Before, I would ask an 'Office Lady' to type for me. Now, I do it all myself and can make new documents from what I've saved on the hard disk. More people know what I'm thinking, and I'm getting more done."

But Hayashi quickly admits that some managers even in his division still fear the keyboard. In the case of Toshiba's senior executives, the company has found a partial answer to keyboard phobia by developing a plastic template that sits over the keyboard and indicates key functions. "By pushing just one or two keys," says Hayashi, "an executive can get important business information at any time."

If senior managers in Japanese corporations are going to be persuaded to use office systems themselves, this kind of combined portability, network access, and user interface may be the answer to many Japanese IS managers' problems.

by concentrating their energies on more lucrative routes.

These glimmers of progress aside, there are still other problems facing IS managers hoping to implement widespread office systems in Japanese corporations. Incompatibility among desktop systems is a particular problem. For example, even though NEC Corp. grabbed over 80% of the 16-bit pc market with its 9800 series (something even IBM in the U.S. never managed to equal), it has not experienced the kind of high-volume corporate purchases typically seen in the U.S. Most larger companies have IBM mainframes or plug-compatibles made by Fujitsu and Hitachi, and obviously look first for pc and terminal compatibility with their big machines.

No Pc Operating System Standard

This failure to reach a common standard in the Japanese pc world extends to operating systems. Although every major manufacturer has decided on Microsoft's MS/DOS for its pc operating system, each has adapted the OS to suit its own ends and peripheral needs. "In personal computers nothing talks to anything yet," says the Japan Market Research Bureau's Sherman. "When you ask the Japanese why, they mostly say it's a matter of pride. Every manufacturer wants to have its own machine."

According to Susumu Furukawa, president of Microsoft Corp.'s Japanese subsidiary, this lack of an industry standard is the reason it took NEC five years to sell 1 million 9800 personal computers. "I worry about the growth rate of pcs in Japan," says Furukawa, who is trying to rally the industry to support a common MS/DOS standard, compatible with the classic IBM PC, called AX (Architecture Extended). "It's only 11% versus more than 30% in the U.S."

Even when the Japanese do get together and eventually agree on a standard, it may be a case of too little, too late. "One of the problems with these group standards is that by the time they put it together, it's old—like MSX," notes Sherman, who sees this slowness to react as the natural outcome of the Japanese tradition of consensus in decision-making, called *nemawashi*.

Without a clear standard, software publishers must spread their resources, which hampers quality. Some observers believe indigenous Japanese business software is not up to the caliber U.S. managers have come to expect.

"Japanese packaged software is not easy to handle," says ADL's Mitome. "Data

□ ANOTHER PROBLEM FACING JAPANESE MANAGERS HOPING TO IMPLEMENT WIDESPREAD OFFICE SYSTEMS IS THAT OF DESKTOP INCOMPATIBILITY.

transfer from one application to another isn't easy or well structured. Other areas [such as] manuals are poor too."

Yet at least packaged software is available for the business pc user. In fact, a number of the popular business packages are simply Japanese versions of best-selling U.S. software from companies such as Lotus, Microsoft, and Ashton-Tate.

When it comes to more powerful busi-

ness systems, *ofucon*, or office computers (IBM System/3X-class machines), firms insist on customized software. "Software for *ofucon* is almost entirely custom-made because the Japanese refuse to adopt business methods, and instead insist on adapting the system to the way they do things manually," says Sherman. "So, software is still unnecessarily expensive, which hampers real proliferation of those systems."

Nevertheless, things are hardly standing still. "The face of the Japanese office has changed dramatically," says Tom Zengage, director of research consultants International Business Information in Tokyo. "When I moved here 10 years ago, it was a different place: paper-filled offices with the odd *kana* typewriter. Now, OA is here to stay."

But Zengage also sees the Japanese lagging behind the U.S. "You can still go through lots of offices where computers are used as decoration. Even at electronics makers, you can find computers unplugged . . . but they are catching up."

One analyst who believes Japan has already caught up is Tetsuo Fukuyama, a partner with Price Waterhouse in Tokyo: "Except in e-mail, where inputting is a problem, we're no longer really behind. If

you have an open office, you don't need many terminals or pcs; you can share them."

Sophia University's Ballon thinks the Japanese may not have caught up in the race to automate the office, but, he asks, "Generally speaking, are we so much better off in the West? That I question, because even in the West we are still quite inept at using all the available numerical data."

Ballon adds a warning for U.S. managers tempted to underestimate the Japanese. "Look at all the work of [quality control] circles here on cost reductions. Certainly, on the production side, this has brought about amazing results. Why shouldn't this same capacity work in the office? To use [the OA gap] as a sign of superiority of the West over Japan would, I think, be a very childish kind of reasoning."

John Boyd is a freelance journalist in Yokohama, Tokyo. He has lived in Japan for 15 years and has written for numerous business and technology publications in Europe, the U.S., and Japan.

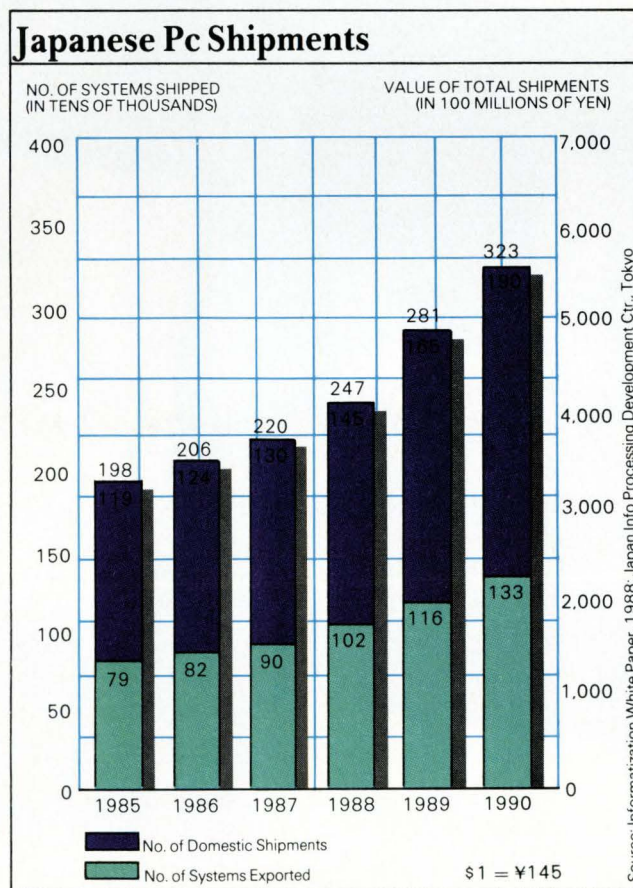

*Best thing
that has happened in the office? Mmmm...*



Alfaskop
*for the European
Generation*



A gift to mankind? Well...

A door opener to a world of new efficiency? Sure!



Alfaskop Networking. For the European Generation.

Something that'll let you in
instead of leaving you out? Correct!

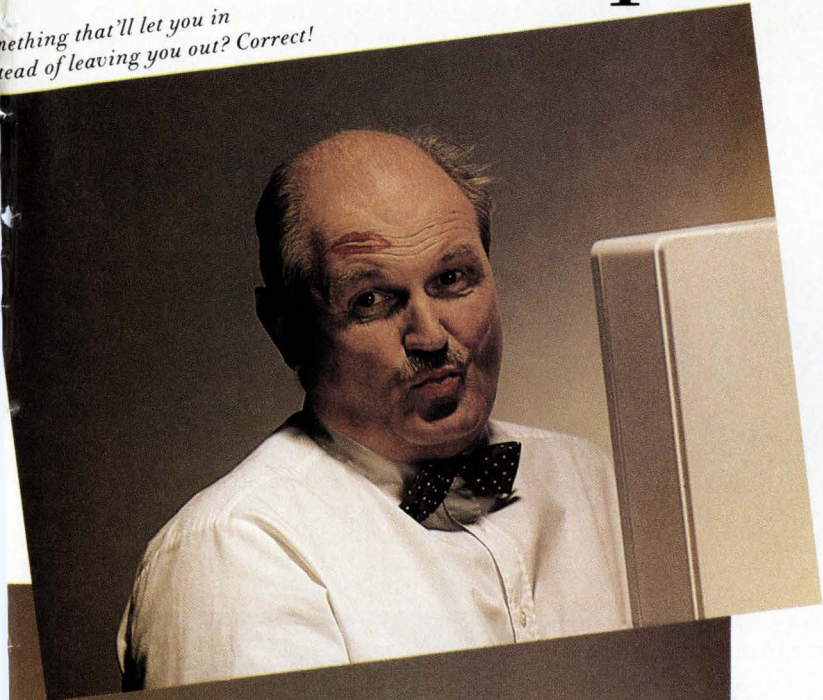

Your company is changing.
The decisionmaking process is decentralized. The pace is mounting. The competition grows.

You must act!
The solution is networking.

More and more people in your company will be able to share essential information. And fast information access and interchange may turn into your company's most competitive weapon.

Use it!

Alfaskop networks.
A European solution made for European needs.

Use it!



NOKIA DATA

Nokia Data is a Scandinavian information technology group specializing in business computers, workstations and networks for the European business community. With more than 600,000 workstations already installed we rank among the biggest suppliers in Europe.

Nokia Data: Denmark (02) 84 33 66 Finland (0) 5671 France (01) 47 80 7117 The Netherlands (03480) 70911 Norway (02) 38 65 00 Spain (91) 457 1111 Sweden (08) 764 20 00 Switzerland (01) 821 59 21 UK (01) 409 27 45 West Germany (0211) 610 90

Circle 83 on Reader Card

Massively Parallel Computer

A new parallel processor from AMT, mainframes from Compaq, and some new Amstrad pcs.

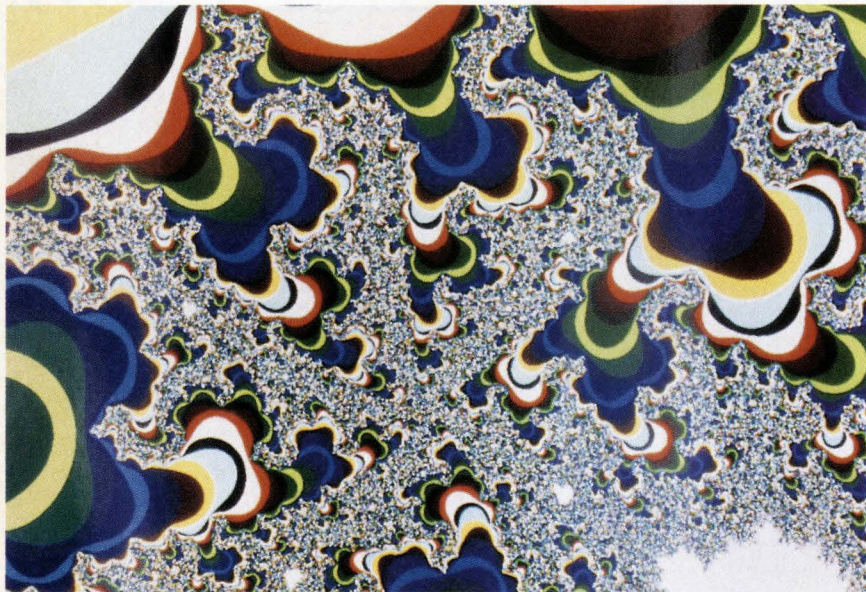

AMT'S DAP 610 parallel computer runs at 40 billion Boolean operations a second.

Parallel computer company Active Memory Technology has introduced a top-end version of its Distributed Array Processor (DAP) machine. It claims that the DAP 610, designed for image processing, simulation, and research applications, has computational power capable of 40 billion Boolean operations per second.

The DAP 610 offers quadruple the power of AMT's earlier massively parallel system, the DAP 510, which was launched a year ago. Perhaps rashly, AMT's chairman, Geoff Manning, also promised to improve the DAP performance by another thousandfold within the next 10 years.

For the time being, the DAP 610 is sufficiently powerful for most of today's specialized applications. The new machine has 4,096 processors, and the 40 billion operations a second translates to character-handling rates of 4 billion characters a second, integer operations of 1,600 million a second, and floating point operations of 200 million a second. The processor-to-memory transfer speed is 4.8GB a second. The high resolution 1024 by 1024 bit-mapped display is refreshed at 60Hz. Memory is expandable from 16MB to 64MB.

It can be attached to a Digital Equipment Corp. VAX or a Sun Microsystems machine and programmed using FORTRAN-Plus development tools running under VMS or Unix. AMT has a software library containing routines for manipulating matrices and vectors, mathematical functions, and some application-specific

packages for image and signal processing.

The DAP 610 computer, with 16MB of memory, costs £250,000 (\$425,000) and is available from ACTIVE MEMORY TECHNOLOGY, Reading, RG6 1AZ, U.K., (44-734) 661111.

Circle 232

IBM-Compatible Mainframes

Europe's largest indigenous IBM-compatible mainframe supplier, Compaq Information Systeme, has brought out new models in its range of Hitachi-built IBM 3090-class machines. The company claims that these offer a 35% price/performance improvement over previous models and that there is now a 25-fold growth path in its 8/XX family of processors.

The new models fall into two ranges: two in the 8/8X range and eight models designated 8/9X.

The new Compaq entry model is called the 8/80, and it offers the lowest entry point to IBM's strategic ESA/370 operating environment with high-speed channels and optical channels. There is also a new 8/87 dyadic processor that compares with the IBM 3090/170S.

The eight 8/9X machines stretch from the 3090/180S class processor, called the 8/90, to the 3090/500S class processor, named the 8/98. All are compatible with Compaq's previous 7/90 family and have been improved by reducing the cycle time, increasing the working storage, and

optimizing the pipelining. All of these new models will be available in the first quarter of 1989. COMPAREX INFORMATION SYSTEME, D-6800 Mannheim 1, West Germany, (49-621) 40090.

Circle 233

Business Pcs

Amstrad, Britain's pc success story and the number one volume pc supplier in Europe last year, is consolidating its position with three new machines, a range of monitors, a modem, and a local area network.

The new pc range is called the PC2000, and the three machines, which come in 24 different configurations, are based on the 8086, 80286, and 80386 processors.

The PC2386 flagship model operates at 20MHz, can support a 80387 coprocessor, has 64KB of cache memory, 4MB of RAM (expandable to 16MB), and comes with MS/DOS 4.0 and Windows 386. A base model with a single drive, 65MB of hard disk storage, and a 12-inch monochrome display costs £2,649 (\$4,500), plus tax.



The PC2286 runs at 12MHz, can support a 80287 coprocessor, has 1MB to 4MB of RAM, an optional 40MB hard disk, and comes with MS/DOS 4.0 and Windows 286. A base model with twin 3½-inch drives costs £999 (\$1,700).

The PC2086 runs at 8MHz, can support a 8087 coprocessor, has 640KB of RAM, an optional 30MB hard disk, and comes with MS/DOS 3.3 and Windows 2.03. A base model with a single 3½-inch drive costs £599 (\$1,000).

Also announced was a three-workstation local area network based on the Corvus Omnet product, a 300bps to 2,400bps modem, and four VGA compatible monitors. The new products will be available by the year's end from AMSTRAD, Brentwood, CM14 4EF, U.K., (44-277) 228888.

Circle 234

SYSTEMS

Unisys Debuts 2200/600 Mainframe for OLTP

Hardware and software improvements increase performance over the 1100/90.

BY ERIC BRAND



The new family provides a growth path for 1100/90, 1100/80, and 2200/400 users.

Unisys's new mainframe line, the 2200/600 series, has twice the performance of the current 1100/90 series, and its new software architecture enables the computers to better—by six times—the industry standard benchmark of 1,000 transactions per second, the company says.

At the time of the Sperry-Burroughs merger, Unisys chairman W. Michael Blumenthal had promised Sperry customers a total renewal of the 1100 family, and the new computers and software are the fulfillment of that promise, says Unisys. The company also claims that the 1100/2200 series provides a compatible growth path from entry level to top-of-the-line machines without requiring software conversion. The 11 models of the 2200/600 represent Unisys's bid for dominance in on-line transaction processing and a direct challenge to IBM's 3090S family.

While the hardware architecture of the 1100/90 series is preserved, the 2200/600 series contains a new instruction processor and main storage complex that implement recent advances in VLSI/ECL technology. The new software architec-

ture, Extended Transaction Processing Architecture, uses what the company calls "close coupling," sharing database access and synchronizing workloads among several host computers. Four four-processor complexes are closely coupled to achieve a peak rate of 6,500tps.

Prices for the 2200/600 series will range between \$1 million and \$8 million; with the Extended Transaction Processing Architecture, however, those figures will range between \$8 million and \$29 million. The single- and dual-processor versions will be available in March 1989; the three- and four-processor models will not be available until June. UNISYS CORP., Blue Bell, Pa. **Circle 216**

HP's New Printer Holds Twice the Paper

Look out, desktop laser jet printer market, here comes Hewlett-Packard with another offering. The HP LaserJet IID, like its sister product, the LaserJet II, prints up to eight pages per minute with 300 by 300

dots-per-inch resolution text and graphics.

The printer provides several new features. At 400 sheets, it has twice the paper capacity, and it has two paper trays. Two-sided printing allows for different binding options: top, for calendar-style binding, and side, for book-style binding. An optional automatic envelope feeder holds up to 50 envelopes. Fourteen of the 24 fonts are internal to the printer and 10 come on the font cartridge, which is included.

The LaserJet IID works with HP Vectras and IBM PCs, and, the company assures, all popular pc software packages. The printer comes with 640KB of memory, and optional 1MB, 2MB, and 4MB memory boards are available. With a one-year warranty, it costs \$4,295. The envelope feeder is priced at \$350. HEWLETT-PACKARD CO., Palo Alto. **Circle 217**

Unix-based, 64-bit Supercomputers and Minisupercomputers

Another bid for a piece of the minisuper/supercomputer action has been made. Astronautics Corp. of America's ZS series of Advanced Computer Systems is designed for general scientific and engineering applications. The ZS-1 and ZS-2 are the first products of a four-year development effort, says the company.

The ZS-1, which already has been installed at the University of Wisconsin in Madison and the Space Remote Sensing Center at the John C. Stennis Space Center, is a Unix-based, 64-bit system. Its highly parallel scalar architecture is coupled with a uniform set of compiler techniques to perform up to 45MIPS/22.5MFLOPS on vectorizable programs, as well as inherently scalar codes. The ZS-1's main memory can range between 32MB and 1.024GB; its I/O subsystem's speed is 180MBps, with one to 32 I/O processors.

The ZS-2, which saw an installation recently at New York University's Courant Institute of Mathematical Sciences, is a dual-cpu implementation as a field upgrade for the ZS-1 similar to the main memory and the I/O processor at a customer's site.

C, FORTRAN, Pascal, and Common Lisp are languages currently released for the ZS. The vendor has slated Ada availability for 1989, along with features for compatibility with IBM MVS and VM and DEC VAX/VMS environments. The ZS-1 is available for purchase. Prices begin at \$295,000. ASTRONAUTICS CORP. OF AMERICA, Madison, Wis. **Circle 218**

SYSTEMS

Removable Winchester Disk Drives

The DM2000G40 and DM2000G100 are small, removable, Winchester disk drives with on-board SCSI controllers, which the maker claims to provide capacity, performance, security, reliability, and portability between different computers. Western Dynex Corp.'s new Datamodules are for IBM PC, XT, AT, PS/2, 80386 computers, and all compatibles. Features include formatted capacities of 40MB (for the DM2000G40) and 100MB (for the DM2000G100), 25msec access times, data rates of more than 10Mbps, self-parking heads, and imperviousness to more than 75g of shock.

The Datamodule is a self-contained,

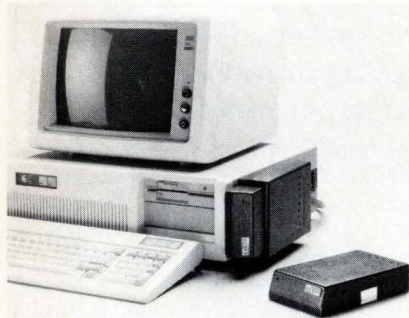

sealed, head/disk assembly that can be removed as a unit and freely exchanged between host computers, according to the company.

A kit, which includes everything necessary to install the product on one computer (including an SCSI adapter card), is oem priced at \$995 for the DM2000G40 and \$1,495 for the DM2000G100. WESTERN DYNEX CORP., Phoenix. **Circle 219**

New Datamedia Micros Work with DEC VAXs

Datamedia Corp. has introduced the NETmate family of network-ready pcs for use with Digital Equipment Corp. VAX computers.

The trio of Intel 80386-based micros, which can immediately hooked in a network, can be configured as clients to VAX-based servers or as workstation peers across a range of pc local area networks. LAN support includes DEC's Personal Computer Systems Architecture, Novell Inc.'s NetWare, NetBios/OSI, 3Com Corp.'s 3+, and Sun Microsystems Inc.'s Network File System.

Priced from \$4,895 to \$6,995, the NETmate family combines IBM PC compatibil-

ity with DEC graphics terminal emulation. Each NETmate supports VGA graphics, from 2MB to 6MB of memory, and AT-compatible and high-speed peripheral buses. In addition, the devices can be configured with either an IBM or DEC VT-style keyboard and up to 80MB of internal disk storage. The NETware family is software compatible with DEC's VT 241/340 display terminals. DATAMEDIA CORP., Nashua, N.H. **Circle 235**

SOFTWARE

An Inexpert System for Programming

Maxem Corp. has announced Cause, programming software for IBM PC and Apple Macintosh users for the creation of business applications without the use of languages or syntax. Comprising a structured database that operates transparently under an intuitive user interface, Cause can be mastered by nontechnical users, as well as by programmers, says Maxem.

Cause programs are built by creating a series of windows to be used in the program; by applying steps—such as "computer," "decision," and "report,"—that define the function to be executed at each point in the program; and by defining data and specifying the use of the data in various steps. The user can trace through the steps at any time, a feature the company says is helpful for guiding less experienced users in structuring their programs. Cause also automatically documents programs as they are being created, says Maxem, and the documentation can be printed with a simple command.

Cause comes in either IBM PC-type 5¼-inch or Macintosh-type 3½-inch disks. Programs developed on one type of computer will run on the other, according to the vendor. The software is designed to make use of color and graphics capabilities, but also may be used with any IBM PC-compatible or Macintosh equipped with 512KB of memory. The price is \$495. MAXEM CORP., Mesa, Ariz. **Circle 220**

DOS Server Upgraded for Higher Speed

Logicraft Inc. is now delivering a faster version of its 386Ware DOS server, which enables a number of concurrent users on a DEC VAX or VAXcluster to run IBM PC software. The new version, called 386Ware Plus, is powered by a 20MHz 80386 microprocessor, along with 70nsec RAM memo-

ry chips. The company says that its benchmarks show the 386Ware plus is 25% faster than its predecessors.

The four-user 386Ware Plus is priced at \$11,995; the eight-user version is \$18,995. LOGICRAFT INC., Nashua, N.H. **Circle 221**

Presentation Graphics System for MVS/TSO Sites

PicSure Plus, version 2.6, is a presentation graphics system for IBM MVS/TSO installation, new from Precision Visuals Inc. The system allows users to create and modify charts without having to learn a programming language, says its creator. Novices and infrequent users can access the system through a set of simple menus; more advanced users can enter commands directly; in-house applications developers and oems can write custom procedures or design special interfaces for their users with a BASIC-like programming language built into the product.

PicSure Plus supports features such as ISPF and dynamic file allocation. When it is selected from the main system-level ISPF panel, a new ISPF panel appears showing current user settings, such as file location and chart output location. In addition, says the vendor, hardcopy devices can be accessed without leaving the chart-building session.

Precision Visuals, which is including documentation with the product, has priced it at \$35,000. PRECISION VISUALS INC., Boulder, Colo. **Circle 222**

COMMUNICATIONS

T1 Resource Management System from Timeplex

The MicroLink/2 Data/Voice Network Exchange is a T1 resource management system from Timeplex Inc. The company is promising that it will expand the T1 marketplace by enabling small organizations to begin building T1 networks with a small initial investment. For example, it says, a point-to-point application that has as few as five analog circuits installed can cost-justify a 56Kbps digital circuit using the MicroLink/2; as the user's requirements increase, the 56Kbps circuit can be upgraded to a T1.

The Link Family modular system allows for various configurations, says Timeplex, and offers combinations of sync, async, and isochronous ports and data links at a range of speeds. Output rates range from 50bps up to 2.048Mbps (the European E-

COMMUNICATIONS

I rate). The Micro/Link/2 can be used as a small, free-standing unit or rack-mounted in the computer room. The price tag on this product reads \$3,500. TIMEPLEX INC., Woodcliff Lake, N.J. **Circle 223**

Transceiver and Repeaters For Ethernet

The Electro-Optic Products division of Siecorm Corp. has announced the RL3000 Ethernet Coax Transceiver, which provides access to Ethernet LANs for transmitting and receiving data, and two Ethernet repeaters.

Fully compatible with IEEE 802.3 and Ethernet version 2.0 specifications, according to Siecorm, the RL3000 provides a signal quality error (or "heartbeat") test function to meet the requirements of specific Ethernet devices. It features LED indicators for "power," "transmit," "receive data," and "collision detection," allowing network and station activity to be monitored. In addition, the RL3000 transceiver is available with "stinger" or N-type connectors for attachment to standard 10Base5 "thick" Ethernet coaxial cable or with BNC-type T-style or vertical connectors for 10Base2 "thin" Ethernet applications.

The RL6000L Ethernet Local Repeater allows for the connection of two Ethernet segments via Ethernet transceiver cables up to 50 meters in length. It features both automatic and manual segmentation functions, which stop data transmission between network segments; this isolates faulty network segments for troubleshooting, says the company. Capable of operating either with or without transceiver Signal Quality Error (SQE) or "heartbeat" signals, the RL6000L also has an extensive array of front-panel diagnostic lights to indicate the presence of Ethernet packets, collisions, or implementation of the segmentation function, according to Siecorm.

The RL7000L is similar to the RL6000L in features, but it provides a means of connecting an Ethernet thin co-ax segment to a thick backbone (via a built-in transceiver with a BNC-type vertical connector) or fiber-optic backbone (via a standard external co-ax or optical transceiver and Attachment Unit Interface cable). Both can be installed as standalone units or rack-mounted.

The RL3000 is available for \$249, the RL6000L costs \$895, and the RL7000L is priced at \$975. SIECORP., Research Triangle Park, N.C. **Circle 224**

BRIEFS

PC-SIG, Sunnyvale, Calif., has **Flu Shot (Plus) to fight computer viruses**. One program on the IBMPC-compatible disk allows the user to write-protect the hard disk before trying new software; the other flags suspicious commands sent to the hard disk. It costs \$10. **Circle 225**

Ring King Visibles Inc., Muscatine, Iowa, has made available a **monitor swivel** to adjust your screen 360 degrees around and 25 degrees up and down. It's priced at \$29.95. **Circle 226**

Accumation Inc., Miami, has a permanent **replacement for IBM PC and AT lithium batteries** (which can last as little as a year). The self-charging Last.Bat system is priced at \$74.95. **Circle 227**

Honeywell Bull Inc., Waltham, Mass., has announced the **ONEimage Image Workstation**, a pc-based system, and the **Local Area Control Subsystem**, a LAN controller for connecting DPS 6 PLUS and DPS 6 systems to Ethernet and OSI local area networks. The workstation is \$10,450; pricing for the subsystem depends on configuration. **Circle 228**

Datapoint Corp., San Antonio, has come out with **DataLAN**, a **pc network system** compatible with MS/DOS, the IBM PC LAN Program, and other MS/NET-compatible network operating systems. It supports Novell record-locking protocols and uses the NetBIOS applications program interface. Versions supporting up to four users, up to eight users, and over eight users are priced at \$595, \$1,195, and \$1,995, respectively. **Circle 229**

Practical Peripherals Inc., Westlake Village, Calif., has introduced the **Mactosh Communications Package**, featuring the company's PM2400 SA external modem, cable, and MicroPhone version 1.1 communications program. Hayes-compatible, and functioning at 300bps, 1,200bps, and 2,400bps, it goes for \$299. **Circle 230**

Compex Inc., Anaheim, Calif., is marketing a four-port **ARCnet LAN controller** for IBM PCs, XTs, and ATs. A-Net, which allows users to build star networks without standalone active hubs, can be purchased for \$395. **Circle 231**

For reprints of articles in this issue, call (312) 635-8800.

For the Best Job Leads in the MIS Market Read DATAMATION's Career Opportunities Section

DATAMATION Brings You the Latest In Qualified MIS Positions

- Software Engineering
- Systems Integration
- Data Processing Management
- Programming/Analysis

Write Your Own Management Book

Advanced Technology Groups, Decision Impact Groups, Chief Technology Officers—the stuff of this issue's cover story—need not be the sole creations of the information elite. The forces that brought about such technology watchdogs exist in small and medium-sized organizations nearly as much as in the financial services supermarkets that already have ATGs, DIGs, and CTOs. Business necessities such as connecting dissimilar systems, developing business unit applications, and linking customers and suppliers know no revenue or asset boundaries.

IS managers and cfo's who think otherwise, and therefore shun strategies and investments to explore new technologies, are kidding themselves. They're placing their organizations at a disadvantage if they continue to think of systems and software outlays as merely another part of capital spending and operations budgets. Why?

Because the efficiencies that properly applied systems and software bring to an operation can immediately affect the bottom line—providing young or struggling companies with the cash flow they require to survive in these competitive times.

Because the organizational changes made possible by today's technologies—notably those enabled by work group computing—can radically improve the design, manufacture, and marketing of products, among other tangibles.

Because the business opportunities created by knowledge of systems and their applications far exceed other avenues of growth—in revenue and profitability.

Because the consequences of ill-informed technology investments can be far-reaching. Naive organizations may find themselves with inferior products, dispirited employees, and disgruntled customers.

Once you agree that there are real benefits from meeting technology challenges head-on, the question becomes one of scale. Large corporations may want to treat their information technology explorations as they would any other major R&D effort—allocating funds and personnel to the same degree that they would to underwrite a product development effort. Medium-sized businesses may want to assign IT research to the functional heads whose departments can most benefit from cost-saving and organization-enhancing systems. Small organizations may just want to badger their suppliers more, exacting

more than just products from their local pc retailers; they should insist on direction, training, and service from their local computer outlets.

“The book of strategic information technology management has yet to be written,” our cover story points out. Don't wait for someone else to write it. Get to work yourself.

—Tim Mead, *Editor-in-Chief*

Slowdown, What Slowdown?

Take a plane. Stand in an IS center in London or Tokyo or Sydney. You'll see what happened to growth in the IS industry. It's alive and well and living abroad.

Europe, hot on the scent of a single market in 1992 after centuries of self-imposed fragmentation; Japan, riding high on its currency wave, the four Pacific dragons breathing down its neck; Australia, fostering newborn technological ambitions; and industrializing countries desperately industrializing—these are the driving forces behind the increased use of IS in the late 1980s.

In sharp contrast, U.S. IS managers seem to be approaching the 1990s not with eager anticipation, but with all the symptoms of an anxiety attack. It needn't be that way. At least, not for long. There are aspects of IS usage in international markets that could break the inertia.

First, emphasize international links—networking the company into new markets. For the IS community, that means starting now to set up effective international nets based on standards. It also means more use of multilingual software, distributed databases, and advanced human interface systems.

Second, take public information technologies seriously. Infrastructures for the next phase, putting IS-based services into the home, are already in place in Europe and Asia. The U.S. risks missing this boat entirely.

Third, and perhaps most important, take a long-term view. This should be a time not only of internal reassessment for IS managers in U.S. corporations, but a time of progressive planning and investment for the future.

Take a leaf from IBM's book. The reason that Michael Armstrong, who is tipped to be John Akers' successor, is now heading up IBM Europe is not so he can enjoy the Riviera sunshine, but so he can learn the ways of the IS world outside the U.S. IS execs can learn much from their colleagues in other countries too. What's the use of

living in a global village if no one goes to school?

—Paul Tate, *International Editor*

Brazil Needs Tools, Not Protectionism

If there is one thing people in developing countries understand, it is new frontiers. This thinking is particularly evident in Brazil, where policymakers have approached information systems much as they would a mighty river that needs to be dammed. By making a concerted effort and a few sacrifices, Brazil's leaders believe the country can build its own industry of IS vendors and become less reliant on foreign sources.

In pursuit of that goal, Brazil, for the last 10 years, has conducted a unique experiment in the form of a protectionist IS import policy. Intended to jump-start Brazil's own industry, it reserves large parts of the IS market exclusively for domestic vendors and restricts IS imports.

The experiment has drawn plenty of fire recently from inside and outside Brazil. Critics, especially those in Washington, D.C., question whether the country's import policies have succeeded in building a viable local IS industry. They also wonder whether such policies are fair to foreign vendors.

Such criticisms are interesting, but they miss the point. The real value of information systems to Brazil will come not from the creation of a few successful Brazilian-owned computer and software companies. The real payoff will come when Brazilian manufacturers, retailers, service companies, and others begin using information systems in creative ways to become more productive and to compete better worldwide—regardless of the source of that technology.

Today, largely because of their government's protective IS import policy, Brazilian users cannot produce goods and services effectively or competitively. Key IS-based products are either too expensive or simply unavailable.

That's not to say that the Brazilian government shouldn't promote its local IS industry and protect Brazilian vendors and users alike from the potentially overwhelming market influence of huge multinational vendors. But Brazilian policymakers must stop looking at information systems technology as an end in itself. They need to start looking at IS primarily as a tool for improving the competitiveness of Brazilian industry.

—Jeff Moad, *San Francisco Bureau Manager*

CTG has the power to take you into tomorrow's technology

A global consulting, systems integration and professional services firm, Computer Task Group has the power to take systems professionals to new technical levels.

With over sixty offices in the U.S., Canada, the United Kingdom, and Europe, CTG works with industry leaders. In fact, 85% of the Fortune 100 companies are our clients. As a result, our three thousand consultants develop solutions in leading edge hardware and software environments.

CTG professionals have hands-on experience in systems integration, expert systems, CASE tools and relational databases. We offer the right people excellent assignments, extensive educational opportunities, highly competitive compensation, comprehensive benefits and a stock purchase plan.

If you're the right person — with a strong background in advanced systems development — join Computer Task Group on the road to tomorrow. Call or send your resume to: **Computer Task Group, Office of Recruitment, 800 Delaware Avenue, Buffalo, NY 14209, 1-800-752-6284.** Equal Opportunity Employer.



a career that touches tomorrow

Supplier Performance Update: Great in '88

Fears at the year's beginning yield to solid gains.

BY MADELINE FRANCHI

Information systems manufacturers are enjoying the fruits of the economic rebound of 1988. Through the first seven months of this year, new orders for IS equipment totaled \$63.6 billion based on revised data from the Commerce department. That's up almost 8% from the same period a year ago. This new order activity is also strengthening factory shipments of information processing equipment, which are up about 10% so far.

U.S. businesses spent an annualized \$40.8 billion for computers and office equipment from April through June of this year. That's a whopping 18% increase compared with the second quarter of 1987 and an increase of 6% from the spending rate in the first quarter of 1988. Investment in commercial communications equipment for information processing reached an annualized \$43.7 billion in the

second quarter, which is up 10% from last year.

Private businesses are not the only buyers. According to the Federal Procurement Data Center, Uncle Sam acquired about \$3.9 billion worth of general purpose automatic data processing equipment, software, supplies, and support in fiscal year 1987. Purchases for fiscal year 1988 may not be as robust due to the budget-cutting process. Fiscal year 1988 first quarter government purchases of IS equipment were estimated to be \$450 million.

The U.S. information systems industry has also been reaping big rewards from the depreciated dollar. The weaker greenback has meant U.S.-made products are less expensive in foreign markets than they used to be.

Through the first half of 1988, U.S. ex-

ports of computers and office machinery swelled to \$11.3 billion, a hike of 30% compared with the same time period last year.

Export growth of U.S. communications equipment is also picking up. Back in 1984, telecommunications exports grew a modest 3.7%, but, by 1987, annual growth had burgeoned to just over 15%. With second quarter 1988 communications equipment exports rising 32% above the second quarter of 1987, it looks like 1988 will be the best year yet. At the same time, import growth of this equipment has slowed dramatically. Increases dwindled to less than 1% in 1987 from 42% annual growth in 1984.

More economic information can be obtained from Cahners Economics Department, 275 Washington St., Newton, MA 02158, (617) 964-3030.

Quarterly Totals

Value of U.S. Information Systems Shipments

BILLIONS \$ SEASONALLY ADJUSTED

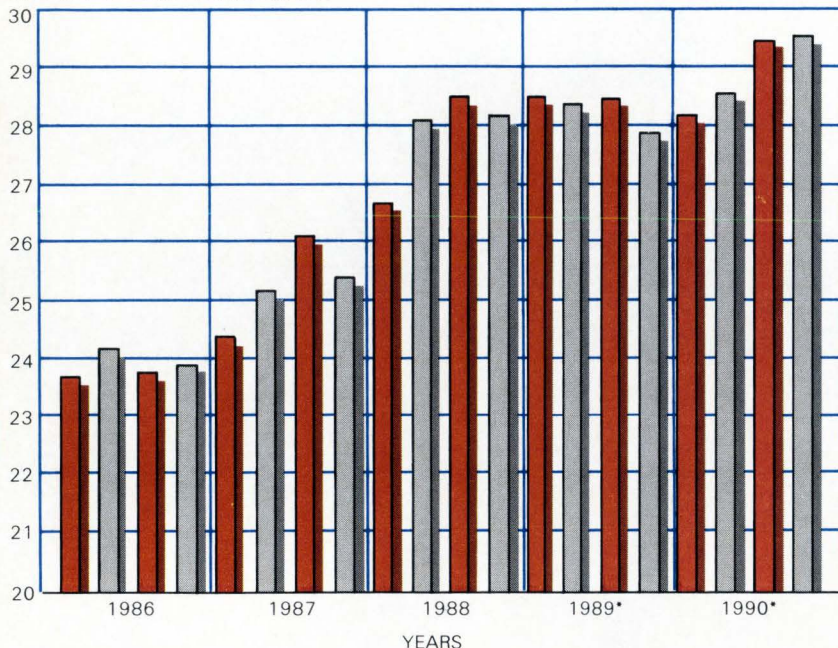

*ESTIMATES

Source: Cahners Economics/Commerce Dept. data series.

Quarterly Totals

Value of Communications Equipment Purchases by U.S.-Based Firms

BILLIONS \$

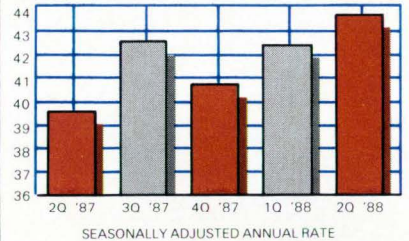

Source: Cahners Economics/Commerce Dept. data series.

Quarterly Totals

Value of Computers & Office Equipment Purchases by U.S.-Based Firms

BILLIONS \$

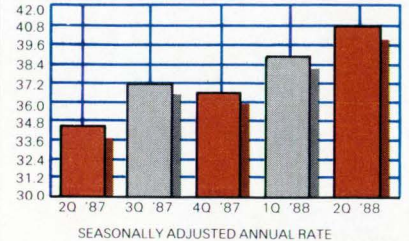

Source: Cahners Economics/Commerce Dept. data series.

ASSOCIATE DIRECTOR

Advanced Computing Facility

The Advanced Computing Facility (ACF) of the Cornell Theory Center is involved in the development of highly parallel processing resources for the scientific community. The Associate Director will be responsible for setting the strategic direction for the ACF communicating with the scientific community regarding software needs and conversion to parallel processing, procuring funding and controlling budget, and providing technical direction to staff.

The successful candidate will possess experience with a variety of parallel systems, including MIMD architectures and transputers; extensive knowledge of UNIX; a demonstrated ability to obtain funding; experience administering advanced computing projects. The minimum of an M.S. in a scientific discipline is required.

Interested candidates should send a resume and letter of interest by November 30, 1988 to: Cynthia Smithbower, Dept. A3701-D, Staffing Services, CORNELL UNIVERSITY, 160 Day Hall, Ithaca, NY 14853.

CORNELL
THEORY
CENTER



Affirmative Action / Equal Opportunity Employer

SOFTWARE SUCCESS

let's
get
together...

Duquesne Systems is a technological leader in IBM system productivity software whose worldwide success has never been more exciting than now. The reason is talent. If your talent matches our opportunities, let's get together. . .

PRODUCT DEVELOPERS/ PROGRAMMERS

- 5+ years experience with BAL
- Strong MVS, VM and/or VTAM experience
- Previous product development experience a plus

PRE-AND POST-SALES TECHNICAL SUPPORT PERSONNEL

- Minimum 3 years experience in MVS or VM environment
- Strong OS/JCL and troubleshooting skills
- BAL or VTAM experience a definite plus

SALES MANAGERS AND ACCOUNT EXECUTIVES

- 5+ years industry experience
- Superior sales achievement record

Other opportunities exist in Technical Training, Contract Administration, Technical Writing, Marketing, and Legal.

We reward success and innovation with a superior compensation and benefits package, plus

high visibility in a progressive environment. To arrange your interview, send resume to: **DUQUESNE SYSTEMS, Department-DM1, Two Allegheny Center, Pittsburgh, PA 15212.** An Equal Opportunity Employer.

talent
to
talent.



DUQUESNE
SYSTEMS

Data Processing Professionals



Can we talk?
ACP/TPF
Programmers

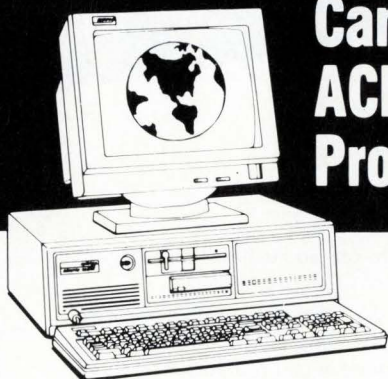

If you are an IBM Assembler or SABRETALK programmer, we can. We can talk about PARS Service (Programmed Airline Reservation System), our dynamic, growth-oriented company. We can talk about how two of the country's most successful airlines merged their computerized reservation systems to form PARS Service...

and how PARS recently joined with GEMINI system of Canada to form the largest multi-hosted CRS system in the world. Then we can talk about how a job with us can take you places, professionally and personally.

PARS SERVICE provides state-of-the-art computerized reservation service to TWA, Northwest, Air Canada and Canadian Airlines. We also develop and improve products for the travel agency industry.

Take off in your career and enjoy worldwide travel privileges on both airlines. We have comprehensive benefits, including:

- Competitive salaries
- Professional/technical training
- Eyewear program
- Hiring bonus
- Non-contributory health insurance
- Relocation expenses

We're situated in the charming City of Fountains — Kansas City — one of the most livable spots in America, ranked 18th in per capita income and 12th in educational achievement.

Curious? Let us tell you more about who PARS Service is, and how we can offer you a world of opportunities. Send your resume to:

Staffing Department
PARS Service Partnership
P.O. Box 20007
Kansas City, MO 64195
1-800-833-PARS

Equal Opportunity Employer



THE INFORMATION SYSTEM
THAT SPANS THE WORLD

Career Opportunities

DATAMATION

1988 Editorial Calendar and Planning Guide

Issue Date	Recruitment Deadline	Editorial Emphasis
Nov. 15	Oct. 26	Mini-Micro Spending
Dec. 1	Nov. 10	Applications Software Spending

National Roberta Renard (201) 228-8602	East Coast Janet O. Penn (201) 228-8610	West Coast Mary Beth West (714) 851-9422
--	---	--

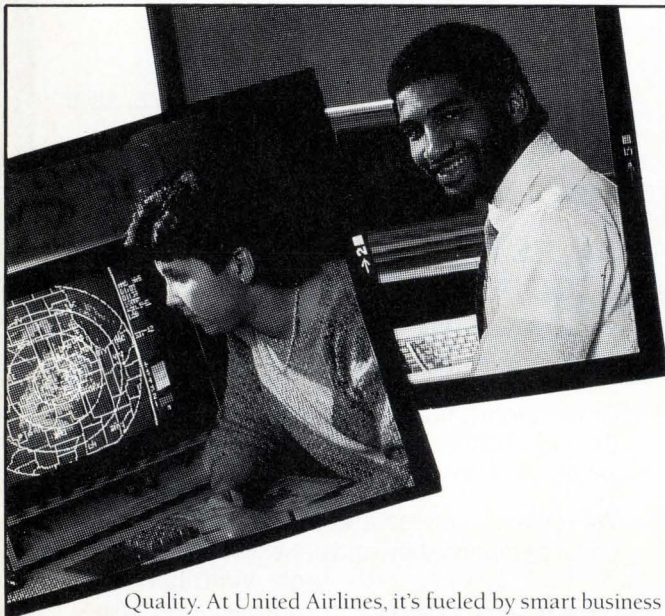

**QUALITY
WINS.
WE'RE
LOOKING
FOR
WINNERS.**

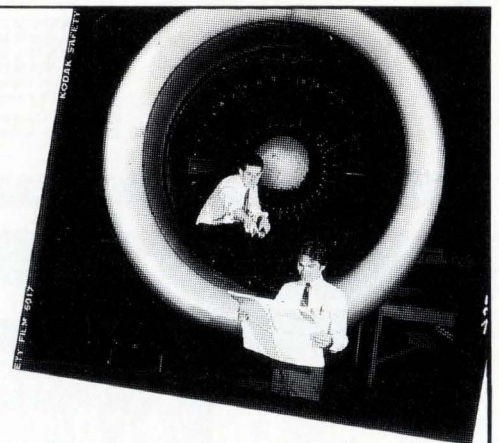

Quality. At United Airlines, it's fueled by smart business systems running on the most advanced technology in the world.

Quality. It's extensive internal training programs. It's well-conceived development projects. It's IBM PS/2 Model 70 Intelligent Workstations running in a sophisticated IDMS Data Base environment. It's VS COBOL II, IDMS ADS/O, FOCUS and SAS.

Quality. Most of all it's you—bringing your skills to major projects in Finance, Human Resource/Payroll, Marketing and Sales. It's fueling our growth. It's right here, right now.

Systems Analysts Consult with users to identify business problems. Prepare cost estimates, resource requirements, develop detailed functional specifications, high level systems design. Requirements include two years systems analysis and project estimating. Prior application programming experience required.

Sr. Programmer Analysts Design, develop and maintain complex programs and subsystems. Consult with user and System Analyst to provide system support. Assist in

planning and estimating projects and maintenance. Requirements include three years of COBOL experience.

Programmer Analysts Will perform a variety of programming assignments involving medium to large scale systems. Responsible for independent problem analysis and program development from design through implementation. Two years COBOL experience and knowledge of structured programming required. CICS/IDMS preferred.

There aren't many opportunities in the world like this. It's all about winning. It's all available at United.

We provide an exceptional compensation program with air travel privileges. Find out more. Send a resume in strictest confidence to: United Airlines, Professional Employment, EXOEJ-D11-173, P.O. Box 66100, Chicago, IL 60666. Equal Opportunity Employer. Principals only.

UNITED
A I R L I N E S

"YOU CAN'T DO THAT"

Build a large scale mainframe computer that will outperform the competition's leading model?

"IMPOSSIBLE!" they said.

But Amdahl did it back in the early 1970s. And today we are a leader in the development, manufacturing, marketing and support of general purpose and scientific computer systems, storage products, communications systems and software.

In less than two decades we have grown from 5 to more than 8,000 "can do" employees around the globe. Our success is a result of teamwork, innovation and commitment to achieve the impossible. If you are ready for challenge, creativity and growth, explore your opportunities with Amdahl in one of the following areas:

Based in Silicon Valley, CA

System Design Engineers

You will work at the core of advanced CPU design, making a substantial contribution to storage and instruction unit development. Additional responsibilities will include logic design and simulation, physical design and engineering support. A logic designer with at least 2 years experience preferably on large systems is needed; familiarity with one or more of the following helpful: pipeline designs, I-unit pipelines, caches, CPU microcode and interlocks.

Staff Design Engineer

Investigating and identifying tools required to affect significant improvement in the productivity of machine failure analysis. Your experience should include 4 to 6 years developing software tools in support of hardware design, bring-up and field support. Experience with PL1 and C helpful.

Assistant Project Manager

You will coordinate between functions, identify issues, negotiate action and generate plans and schedules in support of the development of sophisticated mainframe equipment. Requires at least 2 years experience in the large scale computer industry, ideally in product development or project management. In addition to a relevant technical degree, an MBA will be preferred.

Senior System Design Engineer

Utilize your expertise while you design algorithms, code, test and support microcode for a highly advanced mainframe channel subsystem. You will be a specialist in channel subsystem design and development with 5 years microcoding experience, preferably 370 XA. Hardware experience desirable.

System Design and Senior System Design Engineers

Develop, specify and modify requirements for machine level enhancements and service processor software for advanced large-scale mainframes. *UNIX® and C experience essential for these positions. Senior engineers should have 5 years experience in developing large software systems. Internal knowledge of UNIX and 370 architecture welcome.

Senior System Design Engineer—Programmer

Investigate and identify tools to support development of console software and microcode. Use your technical experience and your critical analysis ability to establish the tools environment in our corporate computer center. Ideally you should have 2 to 4 years experience developing software tools in support of software design. Examples of tools include compilers, microcode assemblers, debugging and software release tools.

Senior Design Engineer—Programmer

Draw on your in-depth experience of advanced design techniques to develop a tool which will translate existing chip and board logic data to conform to existing display and print tools. Two to 4 years experience using Computer Aided Design techniques in software development required, UNIX and C experience helpful.

System Design Engineers—all levels

Putting your ingenuity and investigative skills to work in observing failure trends, you will use field provided data and advanced techniques to draw your conclusions. We will rely on your recommendations to enhance processes and product reliability. You will have 3 to 8 years experience in a design environment which should include mainframe hardware, software and microcode development. System bring-up and field support experience will be welcome.

YOU CAN join in the excitement of creating the computer systems of the future, while enjoying the benefits and competitive salary you would expect from an industry leader.

For immediate consideration, call Deborah Brown at (408) 746-7686 or send your resume to her at Amdahl Corporation, Employment Department 11-3, P.O. Box 3470, M/S 300, Sunnyvale, California 94088-3470. Principals only, please.

Amdahl Corporation is proud to be an equal opportunity employer through affirmative action.

*UNIX® is a registered trademark of AT&T Bell Labs.

YOU CAN AT
amdahl

COMPUTER SECURITY SPECIALISTS

Northrop Aircraft Division in Hawthorne is currently seeking computer security professionals who demand of themselves the highest standards and who understand that safeguarding the next generation of defense technology is of paramount importance.

Using your knowledge of ISM (5220.22-M), DIAM's 50-4&5 and NACISM 5203, you will evaluate, develop and implement computer security specifications based upon customer requirements. You will help guide the technical design of systems including the development, analysis of results and documentation of programming and procedural tests. Requires 10+ years of security experience. An understanding of Tempest requirements and a BS degree a plus.

For immediate consideration, please forward your resume to:
Dawn Roy, NORTHROP AIRCRAFT DIVISION, Manufacturing & General Staffing, Dept. DM/5773, 12540 S. Crenshaw Blvd., Hawthorne, CA 90250.

U.S. CITIZENSHIP REQUIRED. Northrop is an Equal Opportunity Employer M/F/H/V.

NORTHROP

Aircraft Division

MBA/MS in the Management Of Information Systems

The Joseph M. Katz Graduate School of Business offers a unique dual degree program that awards both an MBA and an MS in the Management of Information Systems. The MBA/MS-MOIS degree offers:

- Two terms, 24 credit hours, of advanced MOIS specialty course work.
- A one-term practicum/internship in industry.
- A specially designed, AACSB accredited, 11-month 3-term MBA program that provides excellent preparation for managerial careers.
- State-of-the-art teaching, computing, and information facilities, made possible through major grants from IBM and AT&T.
- An evening program for part-time students.

Write: Director of MS-MOIS Program
272 Mervis Hall
Katz Graduate School of Business
University of Pittsburgh
Pittsburgh, PA 15260
(412) 648-2268



University of Pittsburgh

The Joseph M. Katz

Graduate School of Business

SYSTEMS PROGRAMMER SPECIALISTS

IBM MVS/XA

The Information Resources Management Group at Northrop Electronics Division in Southern California is migrating from an IBM 4381 MVS/SP to an MVS/XA system in preparation for the installation of a more advanced mainframe.

Newly created positions exist for Systems Programmers with MVS/XA system installation/maintenance experience including strong MVS diagnostic skills and SYSGENS, APARS and SMP/E background. Familiarity with IMS and the ability to analyze and evaluate software products and storage devices along with long term planning and facilities utilization experience are highly desired.

BS degree is required, preferably in Computer Science or related Information Science major.

Qualified candidates wishing to enhance their systems programming skills should send resumes/salary history to: *NORTHROP ELECTRONICS DIVISION, Dept. DM/6326, P.O. Box 16, Hawthorne, CA 90251-0016. (Principals Only).*

Northrop is an Equal Opportunity Employer M/F/H/V.

NORTHROP

Electronics Division

Electronics Systems Group

Twice Each Month You Can Reach Qualified MIS Executives In DATAMATION's Career Opportunities Section:

- Software Engineers
- Systems Integrators
- Data Processing Managers
- Programmers/Analysts

For More Information, Call:

Roberta Renard (201) 228-8602
National Recruitment Sales Manager

Janet O. Penn (201) 228-8610
East Coast Recruitment Manager

Mary Beth West (213) 826-5818
West Coast Recruitment Manager

Sr. Software Engineers:

Join the software development team that made our network management system #1, with these comprehensive capabilities:

- Traffic Routing
- Problem Determination
- Network Restoral
- Configuration Management
- Ease of Installation, Operation
- Ease of Expansion (Hardware/Software)
- Performance Management
- Multivendor Compatibility
- Report Generation
- Software Performance
- Overall Performance

Racal-Milgo is an international supplier of digital, analog and fiber optic data communications equipment. In a survey of network management users, the well-respected Datapro Research Corp. concluded: "**Racal-Milgo Communications Management Series received the highest ratings for Overall Performance.**" We're proud of our systems and the people who develop them.

Join our #1 development team working on "next generation" products at our beautiful Ft. Lauderdale headquarters. As a **Sr. Software Engineer**, you'll have opportunities to work with the latest software development tools (including CASE), utilizing your BSCS and 3-5 years of experience that includes *several* of the following: "C", UNIX™, communications protocols, RSX11M, CASE tools, ORACLE™ database, Macro II Assembler, configuration management.

In addition to challenging assignments, supportive management, and opportunities for career growth, you'll appreciate our comprehensive compensation-benefits package, which includes medical/dental/life insurance, 3 weeks of paid vacation your first year, 401K savings plan, 100% paid tuition, and more.

Tell us about your software development specialties.

Send your resume and recent salary history in confidence to: Keith Terrell, Sr. Employment Representative; **Racal-Milgo, Inc.**; P.O. Box 407044 (17812); Ft. Lauderdale, FL 33340-7044.

An EEO/Affirmative Action Employer

ORACLE is a trademark of Oracle Corp.
UNIX is a trademark of Bell Labs.

**Join Racal-Milgo...
thumbs up on the future**

Racal-Milgo®

ENGINEERING

Technical Professionals

Arcata Associates is a fast growing defense company, seeking forward-looking individuals to assist us in building state-of-the-art, high speed data networks and instrumentation systems for the Air Force.

If you seek the challenges and rewards of working in a dynamic company, consider joining the Arcata team in one of the following positions:

PROGRAM MANAGER— Responsible for cost control, scheduling, and oversight of the engineering effort. Must have BS degree and 5+ years' experience managing FFP DOD contracts under MIL-SPECS.

ENGINEERING MANAGER— Lead a large scale systems development project. Must have BS degree, knowledge of computer network technology in a X.25 protocol environment, and 5+ years' experience managing FFP contracts under MIL-SPECS.

SENIOR SOFTWARE ENGINEERING ANALYST— Manage software projects involving computer intelligent controlled instrumentation systems, C³, high speed real-time data control networks, including data switching and control computer systems. Must have a BS degree and 5+ years' technical experience.

SOFTWARE ENGINEERING ANALYST— Design, develop, and supervise the development of a real-time data network for C³ using high speed data switching computers. Must have BS degree and experience in protocol conversions and large scale computer integration.

PRODUCT ASSURANCE MANAGER— Ensure the integrity of engineering design and make technical decisions between performance, production, and support. Must have BS degree and 5+ years' experience in CM, DM, QA, R&M, and ILS under MIL-SPECS.

SUBCONTRACTS/MATERIALS MANAGER— Negotiate, manage, and monitor subcontractors and procure all parts and materials. Must have BS degree, 5+ years' experience managing subcontractors, and a working knowledge of FAR.

Arcata Associates provides an excellent compensation program that includes competitive salaries and a comprehensive benefits package.

For prompt confidential consideration, please call **Tim Wong** at (702) 642-9500 or send your resume to: **Arcata Associates, Inc., Personnel Dept. DM, 4220 Arcata Way, North Las Vegas, NV 89030.** EOE M/F/H.



arcata
associates

For the Best Job Leads in the MIS Market Read DATAMATION's Career Opportunities Section

DATAMATION Brings You the Latest In Qualified MIS Positions

- Software Engineering
- Systems Integration
- Data Processing Management
- Programming/Analysis

For Professional
Growth and
Development

Programmers

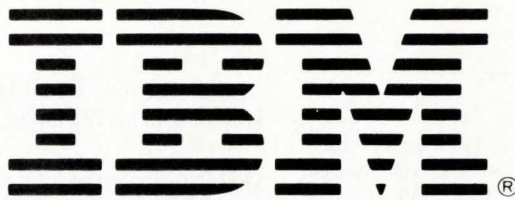

SOFTWARE DEVELOPMENT OPPORTUNITIES

Banking Environment

IBM in Charlotte, North Carolina, has a continuing mission to develop and manufacture superior systems and products for the finance industry. We're actively involved in the use of image technology to provide customer solutions in item processing.

Opportunities now exist for career-oriented professionals with various levels of experience. Currently, we are seeking candidates with ALL THE FOLLOWING CREDENTIALS:

- Minimum of two years installing, modifying, and/or maintaining item processing applications such as Check Processing Control Systems (CPCS) or DOSCHECK.
- Minimum of two years S/370 Assembler programming in MVS/370, MVS/XA, or DOS/VSE environments. Experience with COBOL, VM/CMS, and SCRIPT/GML helpful.
- Experience in application development, including requirements, design, code, unit test, integration test, system test, and project management.

As part of The Bigger Picture of information handling and processing in Charlotte, you'll discover all the advantages offered by the largest city between Atlanta and Washington, D.C. Our broad range of cultural and recreational attractions includes museums, performing arts theatres, a world-class motor speedway and an NBA team—the Charlotte Hornets. Close proximity to our pristine beaches and mountains, and a year-round moderate climate are also ideal for the outdoor person.

Qualified applicants may explore these opportunities further by sending their resume in confidence to: **IBM Corporation, 1001 W. T. Harris Blvd., Dept. 16P/ Bldg. 667-4, Charlotte, NC 28257-3000.**



The Bigger Picture

An equal opportunity employer

PLANNER

NOVEMBER

Comdex Fall '88

Nov. 14-18, Las Vegas. Contact The Interface Group Inc., 300 First Ave., Needham, MA 02194, (617) 449-6600.

Supercomputing '88

Nov. 14-18, Kissimmee, Fla. Contact George Michael, Lawrence Livermore Labs, P.O. Box 808, L-306, Livermore, CA 94550, (415) 422-4239.

Neuro-Nimes '88

Nov. 15-17, Nanterre, France. Contact EC2, 269-287 rue de la Garenne, 92000 Nanterre, France, (33-1) 47-80-70-00, Telefax (33-1) 47-80-66-29.

Records Automation '88

Nov. 16-18, San Diego. Contact the Registrar, 567 Walnut St., Newtonville, MA 02160, (617) 964-3923.

International Conference on 5th Generation Computer Systems '88

Nov. 28-Dec. 2, Tokyo. Contact Hideo

Aiso, Keio Univ., 3-14-1 Hiyoshi Kohoku, Yokohama, 223 Japan, (004) 63-1141.

OSI Product Integration Conference

Nov. 29-Dec. 2, McLean, Va. Contact Bill Horst, Corp. for Open Systems (COS), 1750 Old Meadow Rd., Suite 400, McLean, VA 22102-4306, (703) 883-2730.

Engineering Workstations Conference

Nov. 29-Dec. 2, Los Angeles. Contact Engineering Workstations Conference, P.O. Box 3727, Santa Monica, CA 90403 (213) 450-0500

UNICOM 2 Expo & Conference

Nov. 29-Dec. 1, Dallas. Contact Unicom 2 Convention Office, 333 N. Michigan Ave., Suite 1600, Chicago, IL 60601, (312) 332-2037 or (800) 328-6898.

Cause88

Nov. 29-Dec. 2, Nashville. Contact Cause88, 737 29th St., Boulder, CO 80303, (303) 449-4430.

DECEMBER

AEC Expo

Dec. 7-9, New York. Contact Expoconsul International Inc., 3 Independence Way, Princeton, NJ 08540, (609) 987-9400.

International Conference on Computer Vision

Dec. 12-15, Tarpon Springs, Fla. Contact Ruzena Bajcsy, Computer & Information Science Dept., Univ. of Pennsylvania, 200 S. 33rd St., Philadelphia, PA 19104-6389, (215) 898-6222.

4th Aerospace Computer Security Conference

Dec. 12-16, Orlando, Fla. Contact Marshall Abrams, 1820 Dolly Madison Blvd., McLean, VA 22102, (703) 883-6938.

EDI Systems Conference

Dec. 13-14, Washington, D.C. Contact TDCC/EDIA, 1101 17th St., NW, Suite 712, Washington, DC 20036-4775, (202) 293-5514.

DID YOU KNOW ...

Your Ad in
DATAMATION's Career Opportunities Section
Reaches More Qualified MIS Professionals -
Software Engineers, Systems Integrators,
Data Processing Managers
and Programmers/Analysts
than in any Other Publication?

**Total Reach Now Almost
1,000,000 With Pass-Along Circulation!**

For more information, and to reserve your ad in our next issue call:

Roberta Renard (201) 228-8602
National Recruitment Sales Manager

Janet O. Penn (201) 228-8610
East Coast Recruitment Manager

Mary Beth West (213) 826-5818
West Coast Recruitment Manager

ADVERTISING SALES OFFICES

Publisher
Don Fagan

Associate Publisher
William Segallis

Production Manager
Eric Jorgensen

EASTERN REGION

East

Frances E. Bolger
249 W. 17th St.
New York, NY 10011
(212) 463-6552

Tom Carey
487 Devon Park Dr.
Suite 206
Wayne, PA 19087
(215) 293-1212

Northeast
Edward Rappaport
199 Wells Avenue
Newton, MA 02159
(617) 964-3730

Southeast
Larry Pullman
6520 Powers Ferry Road
Suite 395
Atlanta, GA 30339
(404) 955-6500

Northeast
Kathleen A. Murray
8 Stamford Forum
PO Box 10277
Stamford, CT 06904
(203) 328-2547

Midwest
John Stellwagen
1350 E. Touhy Avenue
Des Plaines, IL 60018
(312) 390-2967

WESTERN REGION

West

Kaye Sharbrough
3031 Tisch Way
Suite 100
San Jose, CA 95128
(408) 243-8838

Janet Engelbrecht
582 Market St.
Room 1007
San Francisco, CA 94104
(415) 981-2594

CAHNERS MAGAZINE DIVISION

William M. Platt
Chief Executive Officer

Terrence M. McDermott
President

Frank Sibley
Group Vice President

Jerry D. Neth
Vice President
Publishing Operations

Tom Dellamaria
VP/Production & Manufacturing

Bob Hubbard
18818 Teller Avenue
Suite 170
Irvine, CA 92715
(714) 851-9422

Texas
Richard W. Sheehan
9330 LBJ Freeway
Suite 1060
Dallas, TX 75243
(214) 644-3683

INTERNATIONAL

Cahners Publishing
Company
27 Paul Street
London, EC2A 4JU, England
Tel: 44 1 628-7030
Telex: 914911 TEC PUB G
Fax: 01-6285984

Managing Director—Europe
Edward Reuteler Jr.
U.K., Benelux
Jan Dawson

Scandinavia
Martin Sutcliffe
France, Italy, Spain
Alasdair Melville

W. Germany, Austria,
Switzerland,
E. Europe
Uwe Kretzschmar

Israel
Roseline Lewin-Wainberg
Cahners Publishing
Company
68 Sokolov St.
Ramat Hasharon 47 235
Israel
Tel.: 03-49 12 69

Japan
Kaoru Hara
Dynaco Int'l Inc.
Suite 1003, Sun-Palace
Shinjuku
8-12-1 Nishishinjuku,
Shinjuku-ku
Tokyo, 160, Japan
Tel: (03) 366-8301
Telex: J2322609
Fax: 03-366-8302

Taiwan
Parson Lee
Acteam International
Marketing Corp.

2 floor, No. 17, Alley 7,
Lane 217, Sec. 3
Chung Hsiao E. Rd.
P.O. Box 18-91
Taipei, Taiwan, ROC
Tel: 886-2-7114833
Telex: 29809 ACTEAM
Fax: 886-2-7415110

Hong Kong
John Byrne & Associates
1613 Hutchison House
10 Harcourt Road
Newline, Central, Hong Kong
Tel: 5-265474
Telex: 61708
Fax: 5-8106781

Singapore
Peter Cheong
Asia Pacific Media House
P.T.E. Ltd.
Newline 100 Beach Road
#24-03 Shaw Tower
Singapore 0718
Tel: 291-5354
Telex: RS50026

DATAMATION CAREER OPPORTUNITIES

Roberta Renard
National Sales Manager
(201) 228-8602

Janet O. Penn
Eastern Sales Manager
(201) 228-8610

Staci Comstock
Production Assistant
(201) 228-8608
103 Eisenhower Parkway
Roseland, NJ 07068

Mary Beth West
Western Sales Manager
12233 W. Olympic Blvd.,
Suite 236
Los Angeles, CA 90064
(213) 826-5818

INFORMATION CARD DECKS PRODUCT/ SERVICES MART

Stacy Aaron
249 W. 17th Street
New York, N.Y. 10011
(212) 463-6551

Cahners Publishing Company
A Division of Reed Publishing USA

Specialized Business Magazines for Building & Construction,
Manufacturing, Foodservice & Lodging, Electronics & Computers,
Interior Design, Printing, Publishing, Industrial Research &
Technology, Health Care, and Entertainment. Specialized
Consumer Magazines: American Baby and Modern Bride.

Marketplace

Smooth Conversion

Changing mainframes,
programming languages or
operating systems? Don't let a
do-it-yourself conversion make
life rough for you. Call the
Smooth Conversion specialists
at CTG/Dataware.

With hundreds of successful
conversions for companies like
yours, we have the tools, the
expertise and the experience
to keep your conversion
on time, on target and
on budget.

For a Smooth Conversion,
call toll-free

1-800-367-2687
CTG/DATAWARE

COMPUTER TASK GROUP INC.
DATAWARE CONVERSION SERVICES

3095 Union Road, Orchard Park, New York 14127-1214
(716) 674-9310 TELEX: 510-100-2155

9-Track Tape Subsystem for the IBM PC/XT/AT



Now you can exchange data files between
your IBM PC and any mainframe or mini-
computer using IBM compatible 1600 or
6250 BPI 9-Track tape. System can also be
used for disk backup. Transfer rate is up
to 4 megabytes per minute on PCs and
compatibles. Subsystems include 7" or 10½"
streaming tape drive, tape coupler card
and DOS compatible software. For more
information, call us today!

QUALSTAR

9621 Irondale Ave., Chatsworth, CA 91311
Telephone: (818) 882-5822

COMPANY INDEX

This index lists vendors, users, user groups, and industrial associations mentioned in DATAMATION this issue, excluding those mentioned only in passing. Page numbers refer to the first page of articles.

A	
Accumation Inc.	135
Aetna Life & Casualty	18
Alcoa	75
Amdahl	13,85
Ameritech	101
Anaquest	127
Apollo Computer Inc.	13,95
Apple	13,18,75
Arco Oil & Gas	75
Astronautics Corp. of America	135
AT&T	101
B	
Bell Atlantic	13,85
Boole & Babbage	69
Britton Lee	85
C	
Camelot Enterprises	59
Candle Corp.	69
Carol Reed	59
Centel Business Systems	101
Chase Manhattan Bank	13
Cincom	30
Comparex	13
Compex Inc.	135
Computer Associates	69
Computer Intelligence	75
Computer Measurement Group	69
Computer Science Corp.	13,111
Control Data Corp.	85
Cray	75
D	
Dallas Semiconductor Corp.	13
Data General	85
Datamedia Corp.	135
Datapoint Corp.	135
Digital Equipment Corp.	13,18,30,75,85,95
Dow Chemicals	75

Drexel, Burnham, Lambert	18
Du Pont	75
Duquesne Systems	69
E	
Electronic Data Systems	111
Empire Blue Cross/Blue Shield	18
Entire Inc.	13
F	
Farm Bureau Insurance Group	95
Fidelity Systems	18
Frito-Lay	127
G	
Gander Mountain	59
Gould Inc.	13
Guardian Life Ins. Co.	69
H	
Halstead Industries	47
Harnischfeger Industries	95
Hewlett-Packard	95,135
Hitachi	13
Honeywell Bull Inc.	135
Hughes Aircraft	18,95
I	
IBM	6,13,30,47,59,69,85,95,111
Illinois Bell	101
Index Alliance	127
Intergraph	95
K	
Kaiser Permanente	69
Key Logic	6
King County, Wash.	47
L	
Logcraft, Inc.	135
M	
Maxem Corp.	135
McDonnell Douglas	111
MCI Communications	101
Mellon Bank	18
Memorex	13
Mentor Graphics	95
Merrill Lynch	18
Microsoft	30
Monsanto Chemicals	75
Morino Associates	47

N	
National Advanced Systems	13
NCR	13,30
Network Computing Devices	13
NeXT Inc.	13
Northern Telecom	101
Northwestern National Life Ins. Co.	47
Novell	30
O	
Open Software Foundation	18
P	
Pacific Bell	13,47,101
Parke Davis	127
PC-SIG	135
Practical Peripherals Inc.	135
Precision Visuals, Inc.	135
R	
Relational Technology	85
Reynolds Electrical and Engineering	85
Ring King Visibles Inc.	135
S	
Seafirst Bank	47
Siecor Corp.	135
Signal Technology	47
Silicon Graphics	95
Sony Corp.	13
Southwestern Bell	101
Storage Technology Corp.	13
Sun Microsystems	13,95
T	
Tandem	75
Teradata	6,85
3Com Corp.	13
Timeplex, Inc.	135
Transamerica	85
U	
Unisys	13,135
University of Minnesota	85
U.S. Patent Office	119
U.S. Sprint	101
U.S. West	101
W	
Western Dynex	135
X	
Xerox Corp.	13

ADVERTISERS INDEX

	Page	Circle
Adobe Systems Inc.	91-94	—
Amdahl	64-65	32
Ameritech***	132-133	70
Apple Computer	70-71	37
AT&T Custom Services	109	59
AT&T Technologies	87	—
Barbados Ind. Dev. Corp.	62	30
Bell Atlantic***	96-97	49
Bell Atlantic**	112-113	61
M. Bryce & Associates	72	38
Bull Peripherals	67	35
Candle Corp.	C2	1
cfSoftware	130	69
Cincom	46	18
Comparex GMBH**	134-12-134-13	81
Compaq Computer Corp.	25-28	—
Computer Assoc.	66	33
Computer Assoc.	68	36
Computer Task Group, Inc.*	149	200
Computer Task Group, Inc.	139	—
Cornell University	141	—
Data General Corp.	99	50
Data Kinetics	74	40
Datasouth	61	29
Digital Equipment Corp.	78-79	—
Duquesne Systems	73	39
Duquesne Systems	141	—
Dynatech Communications	108	57
Epson America	34-35	—
Facit AB**	134-4-134-5	77
Gandalf Technologies, Inc.	50	24
General Datacomm***	105, 107	53, 55
GTE North***	29	13

	Page	Circle
Hall-Mark/Unisys	118	64
Harris/3M Copiers	116-117	63
Hayes Microcomputer	102-103	52
Hewlett-Packard Peripherals	82-83	44
Hugh Carver Group, Inc.	43	68
IBM Corp.	7-9	—
IBM Corp.	49, 51, 53, 55, 57	—
IBS	76	41
I-Data A/S**	134-10	80
Information Builders, Inc.	100	51
Informix Software, Inc.	16-17	—
Informix Software, Inc.	84	—
Interface Systems, Inc.	C3	2
Knurr AG	126	16
Landmark Systems Corp.	1	4
Link Technologies, Inc.	88-89	47
Lortec Power Systems	56	27
Lotus Development Corp.	12	9
MSA	C4	3
Manpower Inc.	110	60
Mercante A/S**	134-2	76
Micom	80-81	43
NEC Peripherals	45	—
Nokia Data Systems	134-18-134-19	83
Olivetti SPA**	105	54
Olivetti SPA**	134-6	78
On-Line Software	22-23	12
Oracle Corp.	2	—
PARS Service Partnership	141	—
Phoenix Software	58	28
Prime Computer, Inc.	123	66

	Page	Circle
Quadram Systems	52	25
Qualstar Corp.*	149	201
RAI/Amsterdam/Eurocom	88**	134-14
88**	134-14	82
Radio Shack	121	65
Relational Technology	15	10
REN Electronics Corp.	66	34
SAS Institute, Inc.	10-11	—
Search Software	63	31
Siemens**	107	56
Siemens AG**	134-8-134-9	79
Systems Center, Inc.	124-125	67
Telematics International	54	26
Tektronix, Inc.	115	62
3i Enterprise Cheque**	134-1	75
Top Call International**	29	14
Unisys Corp.	37-42	—
VM Software, Inc.	5	6
Recruitment Advertising	139, 141-147	—
Amdahl Corp.		
Arcata Assoc.		
IBM Corp.		
Northrup		
Northrup Electronics Group		
Racal-Milgo		
United Airlines		
University of Pittsburgh		
*Marketplace		
**International only		
***Regional Advertiser		