

Matching Magnetic Media With Modern Machines

by Bob Katzive

When Homer, the poet, was writing the Iliad and the Odyssey, he needed a large number of scrolls. Realizing he could get a quantity discount, he put the order out to bid and received the quotes. The higher one was from a well-known reliable supplier, Hyqualities. The other, lower, bid was from a new supplier, Mediocrates. Homer, being blind and not able to tell the difference, selected the lower priced product which is why much of his work has been lost: An early example of valuable data loss due to a poor choice of storage media.



Since that time, data storage media have progressed from reed fibers to sophisticated magnetic films, but the problem of selection remains to haunt the unwary. Some of the major considerations are:

- What makes "good" magnetic media? What can you expect?
- How good does "good" have to be?
- How do you maximize media performance?
- How do you get maximum media life?
- How do you care for magnetic media — and what happens if you don't?

what does magnetic media do?

All magnetic storage media perform the following functions to some degree:

1. Provide a magnetic storage element.
2. Control the location of the magnetic element relative to the read/write head(s).
3. Protect the magnetic element when not in actual head contact.
4. Maintain data integrity over a period of time and under variable environments.

These functions are applicable to cassettes, disks, cartridges and tape and quality/performance judgements can be made between products depending upon how well they perform in these four areas.

The choice of a drive/media subsystem for a given application should not be made without considering quantitative requirements in the area listed above, as well as other system factors such as access time, total storage required and cost.

avoid confusion in specification

Because of the proliferation of media types, there is a tendency to call anything that isn't a reel of ½ inch tape or a magnetic card a "cassette." Even in recent publications, some editors and authors have erred in labeling the diskette, the new 5¼ inch diskette, the ¼ inch diskette, the ¼ inch cartridge, the 0.150 inch cartridge and other products as "cassettes." Such careless nomenclature does no one any good and guarantees a surprise or a delay when placing orders for magnetic media. Fig 1 illustrates commonly used media and their proper names.

the magnetic storage element

Storage capacity is provided by a thin magnetic coating put down upon some supporting structure that is usually a stable, inert, non-magnetic film or a rigid non-magnetic metallic substrate or surface. Both the magnetic coating and the substrate, or base film, must be carefully controlled to provide consistent performance. Because transports/drives are capable of operating over a limited range of adjustments, it is an advantage to employ the most consistent media available, thus minimizing the range of adjustments required.

The actual magnetic performance is controlled by the type of magnetic particle used and the amount of it coated on as the magnetic film. For a given percentage oxide composition, thicker magnetic films will produce more readback output. Most suppliers will specify output referenced to the NBS standard tape. The typical range is +10%, -25% of a specified

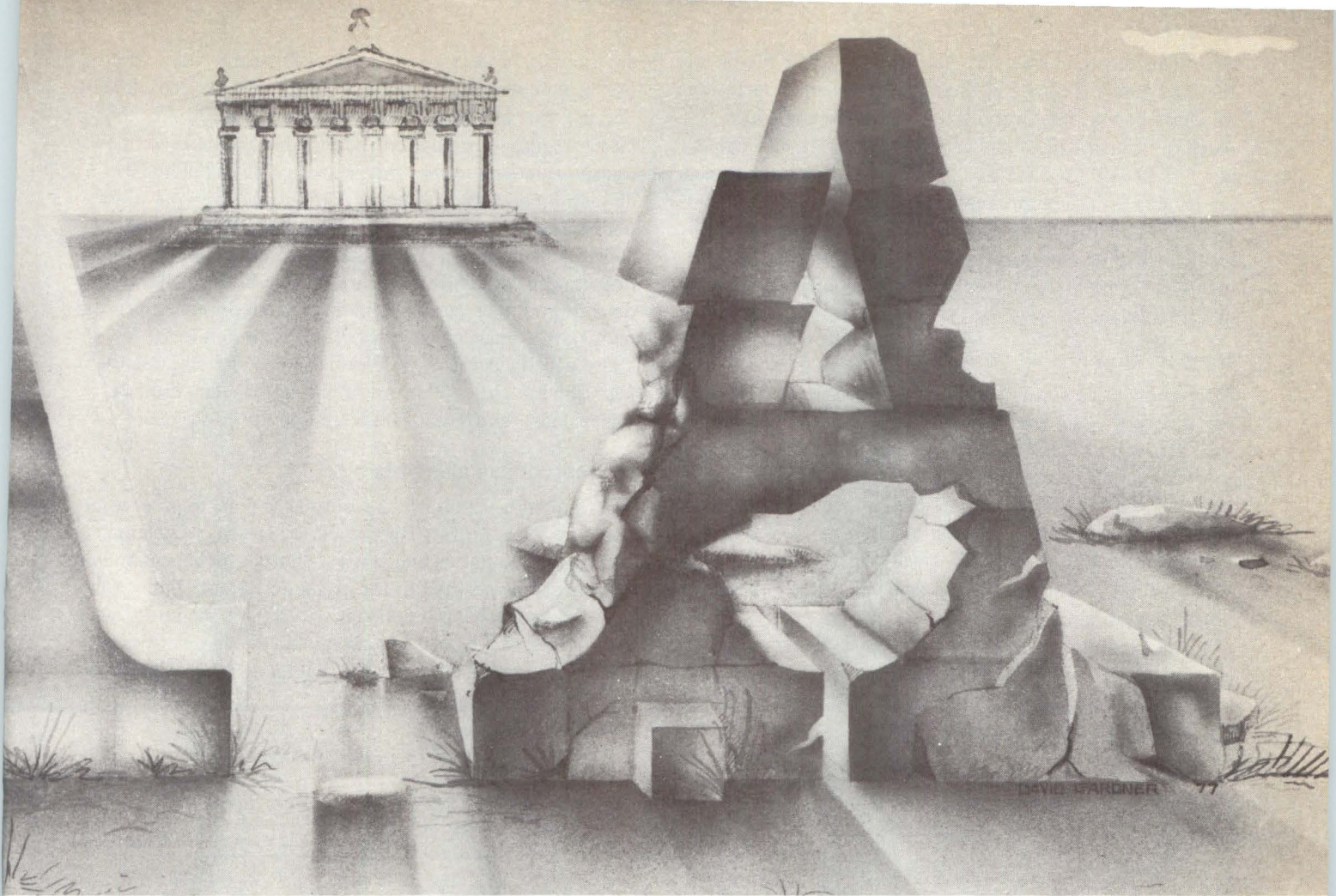

level which is in itself pegged to the NBS standard. For instance, a given tape may be characterized as having an output level of 110%, +10%, - 25%, related to the NBS benchmark. Some suppliers can consistently supply magnetic media with a consistency of $\pm 5\%$ of a given level. This quality is obviously an advantage; since it minimizes the possibility of failures due to component value shifts combining with worst case media tolerances.

The magnetic coating is typically a complex mixture of magnetic particles, polymeric binder for adherence to the base film, carbon particles to provide conductivity to prevent static charge buildup, and lubricants to reduce abrasion and extend media surface and head life. The exact types of substance used and their degree of use are generally closely held secrets among manufacturers; no two magnetic films are precisely the same. There are also batch to batch variations even among magnetic media from the same manufacturer, although the best will not vary more than a few percent in performance regardless of the parameter being measured.

Almost all major media suppliers have the ability to produce non-abrasive media, but simple tests will show vast differences in the following parameters:

- Longevity under actual use
- Adhesion of oxide to base film
- Resistance to solvents
- Transmissivity to visible and infra-red radiation (used to detect "media in place" by drive)
- Electrical conductivity
- Magnetic characteristics

One word of warning: magnetic media designed for audio use generally are inferior in overall oxide coating quality to those designed for digital use in a digital environment. Furthermore, the magnetic and frequency characteristics are notably different. While it is not correct to state that a product designed for audio service will always fail in a digital system, the probability of failures is higher because the design margin is less. Examples: Audio tape typically has poor transmissivity control because audio systems do not use photosensors to detect the presence of the media. Digital media have a more non-linear B-H loop and do not require extended high frequency response for most applications. Similarly, audio tape frequently omits the carbon particles that provide the controlled conductivity necessary to provide a discharge path for static charges built up by high speed tape motion. Of course, there is no chance of confusion with magnetic media other than cassettes; they are not used in both audio and digital applications.

In the case of diskettes, key factors to be evaluated are: amplitude of signal; modulation of constant write amplitude upon readback; grass (random noise); overwrite — (ability to write over previously recorded data); dropouts and drop ins; abrasivity; durability and resolution.

All are significant; some will be more so than others. Resolution is especially important for double density drives. There is no diskette made by any manufacturer which is better in all parameters than any other diskette, though, so your selection must be made on what is important in your given application. It is also worth noting that the results of compara-

tive media tests may be dependent upon the exact design of the drives used, the state of their maintenance, temperature/humidity conditions, airborne contaminants, and which batch of magnetic material happened to be tested. There is much to be said for testing to the point of proving that media are reliable for the purpose intended and stopping there, unless you know that some particular characteristic, if superior, results in a unique performance advantage such as lower maintenance costs that optimizes the trade-off between cost and performance.

the base film

Most media use a plastic base film, usually specified as oriented polyethylene terephthalate. This class of compound includes such products as Mylar™ which is probably the most commonly used film in the U.S., and Celanar™ and Melinex™. However, others are used, especially in products made overseas. The base can be important if the tensile strength varies. While tapes are usually oriented in the direction of tape motion, diskettes generally use a film with equal strength in all directions.

If the base film is not properly handled during manufacture, coating and slitting, the resultant products may have

degraded lifetimes. Proper choice of films and close inspection of incoming film shipments reduce this risk considerably. Because the base film provides much of the control of the magnetic film location relative to the read/write head of a transport, it is important that it be capable of holding its dimensions and strength under conditions of varying stress temperature, and humidity — critical factors as recording densities increase. One of the major factors impeding higher diskette capacity is the tendency of base films to change dimensions under varying humidity. Similarly, the upper temperature range of most base films is limited to 70°C, above which a permanent deformation occurs. Because the base film is a critical element of magnetic media, drive designers must take its capabilities and limits into account.

the mechanical elements

The film sandwich on which recording is done requires some structure to support it. This structure provides protection against contamination and contact damage, and also frequently controls the position of the magnetic surface relative to the head. While mechanical design is critical, it is the most frequently overlooked consideration in media design. For instance, the materials used in the shell of a cassette determine

ANATOMY OF A CASSETTE

To develop the vocabulary necessary to have a dialog with knowledgeable cassette users, the following series of annotated drawings will be helpful.

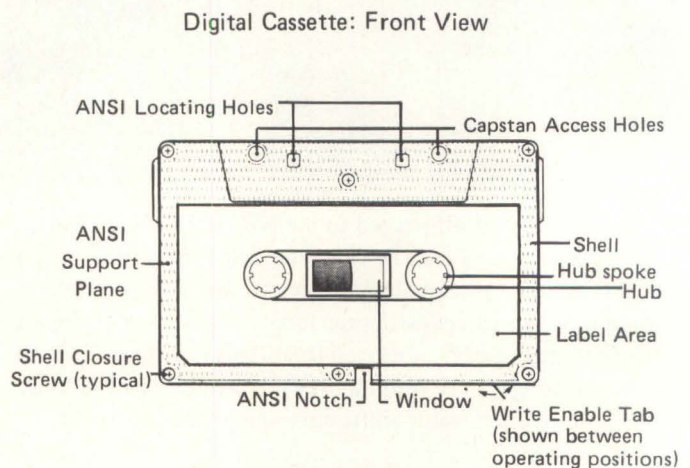
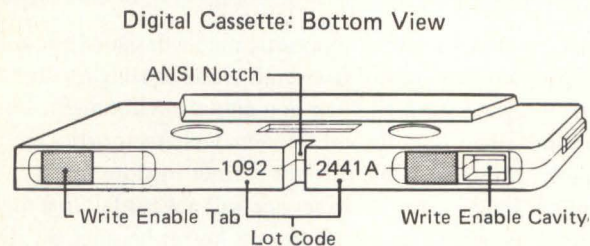

definition of terms

ANSI Locating Holes:	Holes fit over locating pins in drive to position cassette relative to head.
ANSI Notch:	Designates ANSI Standard Digital Cassette. Off center position useful in depicting which side is up.
ANSI Support Plane:	Flat plane along which cassette must be supported with minimum rocking.
Bridge and Tape Guides:	Reinforcement of monolithic bridge provides stability and deformation resistance to critical dimensions in head cavity area.
Capstan Access Holes:	Holes for capstan to fit into on capstan-type drives.
Head Cavity:	Head penetrates into cassette to reach tape in this area.
Hub:	High precision cylindrical surface on which tape pack is wound. Dimensions are critical.
Hub/Leader Lock:	Place where tape and/or leader is attached to hub.
Hub Spoke:	High precision projections mate with drive spindle for minimum whiplash.
Label Area:	Depressed area where label may be placed without rising above ANSI support plane.
Lot Code:	Number identifies lot this cassette is from.
Pressure Pad:	Pushes tape against head to provide good read/write performance. Pad size, material, and pressure are critical performance parameters.
Pressure Pad Spring:	Metal spring applies consistent, non-fatiguing force for pressure pad action.
Roller:	Rotating Delrin tape guide provides smooth tape motion. Must be highly cylindrical to avoid jitter.

GETTING THE MOST FROM YOUR CASSETTES

Digital tape cassettes are designed to provide optimum service and extended life when used in data storage applications. They are precision devices, built to more exacting specification than cassettes used in audio equipment. Reasonable care in handling and storage lengthens the service life of cassettes. These factors are of critical importance.

handling and storage

- Keep the cassette at least three inches from equipment that generates magnetic fields, such as motors, fluorescent lamps, transformers, etc.
- Keep cassette out of direct sunlight; do not allow its temperature to be changed suddenly over large ranges because this can distort tightly wound tape.
- Store the cassette in its box when not in use. Keep it in a dust and lint-free environment.
- Avoid touching the tape surface; fingerprints contain oils that attract dust and other substances that damage tape.
- Remove tape from tape transport only after it has been rewound.
- Avoid dropping the cassette or subjecting it to sharp shocks that may damage the precision bearings. Normal handling

should not cause any difficulties.

- Protect the tape cassette and tape transport from tobacco ash and smoke.
- Never remove the tape from the cassette.
- Examine incoming cassettes for signs of shipping damage. Don't use units suspected of being damaged.
- Neutralize possible mistreatment in shipment by rewinding each tape twice before using it the first time. Wind it all the way forward once, then all the way back. Use a tape transport to do this — do not attempt it manually.
- Store in conditions approximating temperature and humidity conditions in area of use.
- Use pressure sensitive labels with nontransferable adhesive if you are mounting your own labels. Avoid embossed plastic labels; they tend to shed fine particles that can cause contamination.
- Periodic adjustment to the tape transport not only extends tape cassette life, but also helps to keep your entire system working to specification, which will help avoid loss of data. Follow the transport manufacturer's recommendations for periodic preventative maintenance.

Following the simple, common sense suggestions above, will give you the best possible service from your cassette.

Digital Cassette: Opened View

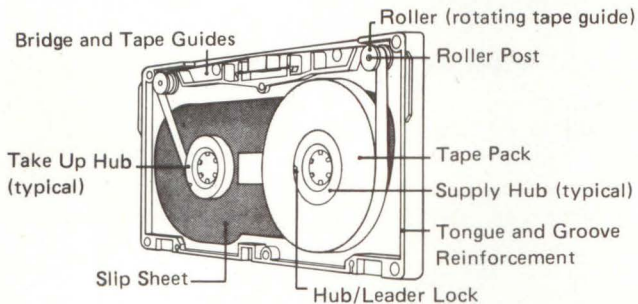

Digital Cassette: Top View
(Tape Removed)

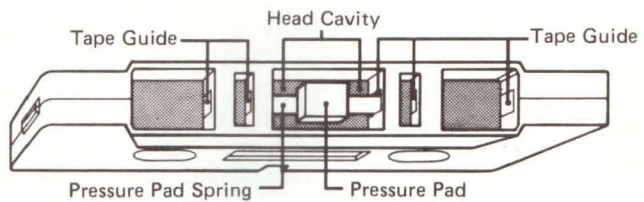

- | | |
|----------------------------------|--|
| Roller Post: | Axis upon which roller turns. Must be exactly perpendicular to avoid skewing the tape or forcing it to one side. |
| Shell: | The outer enclosure of the cassette must be molded precisely to meet ANSI specification. Must withstand abuse; should be rigid to prevent warp and skew. |
| Shell Closure Screws: | Make shell a rigid package, but permit opening of cassette for in-process inspection. |
| Slip Sheet: | Low friction liner reduces tape pack abrasion. |
| Supply Hub: | The hub from which tape is being drawn while the cassette is operating. (Either hub can be the supply hub, depending upon direction of tape travel.) |
| Take Up Hub: | The hub onto which tape is being moved when the cassette is in operation. |
| Tape Guides: | High precision, perpendicular guides control tape path, limit skew. |
| Tape Pack: | Generic term for the rolled up tape on the hub. Pack winding must be tightly controlled to avoid stepping (projecting tape edges subject to abrasion). |
| Tongue and Groove Reinforcement: | Provides extra warp resistance to shells when assembled. Also helps keep dust from infiltrating into cracks. |
| Window: | Provides method of checking tape location; ultrasonic welds keep it firmly attached to shell on all edges to keep dust out. ITC never glues windows in. |
| Write Enable Cavity: | This cavity is exposed to permit entry of cassette drive write enable detection probes. |
| Write Enable Tab: | Tab flips over to permit data written on tape to be protected. When covering the write protect hole, the drive is enabled for writing on the tape. |



Fig 1 Typical mini media L to R — rear: diskette, minidiskette, magnetic cards; front: mini data cassette, data cartridge, data cassettes.

its rigidity, ability to hold tolerances and even its dimensional consistency from unit to unit. In a cassette, this is critical, because the shell influences the tape position. Similarly, the use of ribbed rather than flat slip sheets adds greatly to cassette performance, because it keeps the tape centered and helps minimize skew.

The pressure pad of a cassette, which is usually required to insure good head/tape contact, is the major element in de-

termining system drag. It should be consistent in dimensions, location and spring force to avoid undesirable performance variations. The pad construction utilizing foam or felt mounted on a spring is the most consistent. The rollers must be made to exacting physical dimensions to minimize drag, tape damage, and speed modulation due to dynamic drag variations. Cassette drives using read after write (dual gap) heads generally require a larger pressure pad than those using a single gap head because the tape must be in head contact over a larger area.

The mechanical elements of the ¼ inch cartridge are even more critical than those of a cassette. The ¼ inch cartridge, which is frequently seen as a replacement for inexpensive ½ inch tape drives, is rapidly being developed to tolerances permitting operation of 6400 bpi on suitably designed drives, permitting capacities to 10 megabytes on a single ¼ inch cartridge. Even such simple mechanical features as the notches on the side of a diskette jacket are important; they provide strain relief and help keep the jacket flat.

certified magnetic media

Everybody has certified media, right? Right! And all certified media are the same, right? Wrong! There are three methods of certification in use today, and they produce vastly dif-

ABILITY OF MAGNETIC MEDIA TO WITHSTAND ABUSE

In 1972, the National Bureau of Standards issued a report covering the effects of **Various Hazards on Magnetic Material**. For mini-media users concerned about the effects of environmental hazards, the following material may be helpful.

Effects of Magnetic Fields — Strong fields can alter or destroy data. Keep media at least three inches away from transformers, large motors and other field generating equipment.

Effects of Microwaves — Microwaves have little effect unless the media is in an extremely strong field such as that produced in the inside of a microwave oven. External fields will have no effect; they are too weak.

Effects of Nuclear Radiation — Radiation will not affect the recorded signal per se, but exposure to moderate radiation over a long period might degenerate the plastic. In general, a radiation field strong enough to cause problems with media materials is also a human safety hazard and is unlikely to be encountered.

Airport Metal Detectors — Digital media can be taken through these with no discernible effects. The X-ray machines now in use will not damage magnetic media nor will they alter the data. Most magnetic metal detectors usually will not alter data, but it is wise to avoid taking them through these devices. Have airport security X-ray or hand inspect.

Lightning Strikes — The bolt must hit within 10 feet to cause noticeable damage to the information recorded on the media.

Shock and Vibration — Shock and vibration can cause the tape packs to shift and become stepped. This condition can produce high torque and possible tape jamming until a cassette is rewound (rewinding eliminates the step if the transport is properly designed); rough handling of cassettes is inadvisable for this reason. Data cassettes with ribbed slip

sheets resist the tendency of the pack to become stepped and are less subject to handling damage.

Dust and Fine Particles — Dust and fine particles can cause dropouts if they are embedded in their jackets or boxes or an equivalent dust free medium. Drives should be located in dust free areas and cleaned occasionally with isopropyl alcohol and a swab or some other appropriate cleaning device per manufacturer's instructions.

Temperature and Humidity — A frequent cause of mechanical damage, such as warping or tape stretching, is the storage of media in a hot environment, i.e., a car parked in direct sunlight. The car's internal temperature can exceed 60°C (140°F) for extended periods. You can purchase units rated for such extreme temperature environments. Low humidity can be a problem because electrostatic attraction due to charge built up on moving tape can cause dust and fine particles to adhere to the tape. Backcoated tape suppresses this tendency which is most pronounced at relative humidity lower than 40%. The cassette slip sheet, which is conductive, also helps. Relative humidity exceeding 80% at temperature exceeding 60°C (140°F) may cause tape surfaces to wear unusually rapidly. All tapes are subject to this phenomenon, some more so than others. If you intend to operate any media in a high temperature, over 40°C (104°F), high humidity (over 80%) environment, contact the manufacturer for consultation.

Chemical Solvents — Most volatile solvents can alter the wearing qualities of all commonly used magnetic media. For this reason, don't store media in areas where solvents are used. In most organizations, the only solvents likely to be a problem are those used in spirit duplicators and other liquid process copiers. Storage in the jacket or box will provide nominal protection against transient vapor concentrations.

HOW TO PROTECT YOURSELF FROM DAMAGED DATA

Everyone knows that strange things can happen to data if a computer malfunctions, and there are many checks built into modern systems to detect and correct the results of system malfunctions. Once that data gets stored away on magnetic tape, you can relax and heave a sigh of relief, right? Well, maybe, depending upon the measures you have taken to insure the integrity of your stored data.

But what can go wrong . . . you say. Lots. For instance suppose you are storing data on a cassette that has been around for a while and has been running on a drive that is not in perfect adjustment. That cassette may have a few wrinkles or ripply tape edges that are just waiting for a chance to become dropouts. And, of course, that will happen at the one time you have valuable data to recover and your only copy is on the damaged tape. This, of course, is in complete accordance with Murphy's law, and should surprise no one.

So what can you do about it?

first -- institute a rigorous program of inspection.

- Examine your media handling procedures. Have you been leaving magnetic media around without storing them in their boxes or jackets? Chances are you now have a lot of dust particles on the media. These not only cause dropouts, but can cause excessive head wear if there is a lot of dust. Do you store cassettes on edge to minimize the possibility of pack shifts? Do you store diskettes on edge to minimize jacket warp?

- Examine those cassettes and cartridges. Winding the tape forward slowly, examine the first twenty-four inches or so for wrinkles (deep creases) or rippled tape edges. If you find any, immediately transfer the data on that cassette to a new cassette. Creases and ripples are signs of an impending failure of the tape. Also check to be sure that large pieces of oxide coating are just flaking off the tape edges. This will also eventually cause an error.

- Date the media label when first used. If you have media that has seen very active service and it is more than two years old, you may want to consider replacing it with a newer unit. Not all impending problems show up easily on visual inspection and why take a chance on losing important data? Some of these subtle problems are:

Tape Cinching: Caused by fast stop/starts on drive where winding tension is too low. Can frequently be detected as a gap in the tape pack when looking through the cassette window. (Fig 1)

Tape Pack Shift: Appears as a step in the surface of the tape pack when viewed through the window. Can usually be eliminated by winding to end (on the drive) and then rewinding, but if this condition exists for a long time, edge creasing can result.

Tape Ridges: Caused by scratches or debris on inner layers of tape. These can propagate through a tightly wound tape pack and produce permanent tape deformations — a source of dropouts.

Normal Wear: Under a microscope, well-worn media will show lumps of debris. These lumps are composed of oxide particles deposited over time on the head and then redeposited on the tape as a lump. If large enough, these lumps cause head to tape separations large enough to cause dropouts. This type of wear is typical of all magnetic media.

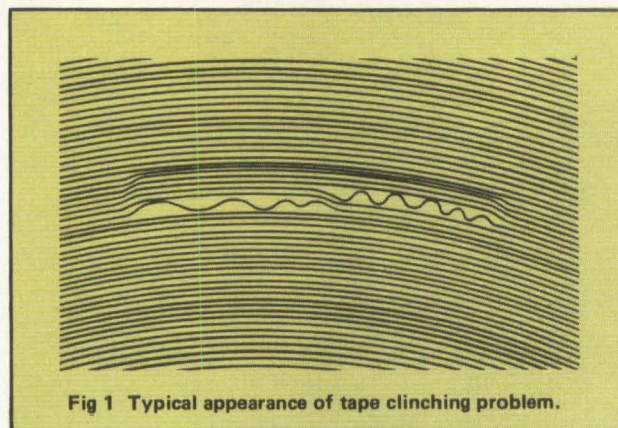

Fig 1 Typical appearance of tape cinching problem.

second -- back up critical data.

- Store critical data on a backup from your working tape on a regularly scheduled basis. This is very inexpensive insurance against all kinds of catastrophes that might damage a system or its storage media. Some organizations maintain as many as three tiers of backup of critical data.

- Make a duplicate of daily tapes or disks if possible.

- Weekly, make a copy of your most recent daily tapes or disks. Update this set on a weekly basis.

- Monthly, make a copy of your most recent weekly tapes or disks. Update this set on a monthly basis.

All of the backups should be stored in a safe place until used the next time. Backups should be rotated yearly so that a fresh set is always in use.

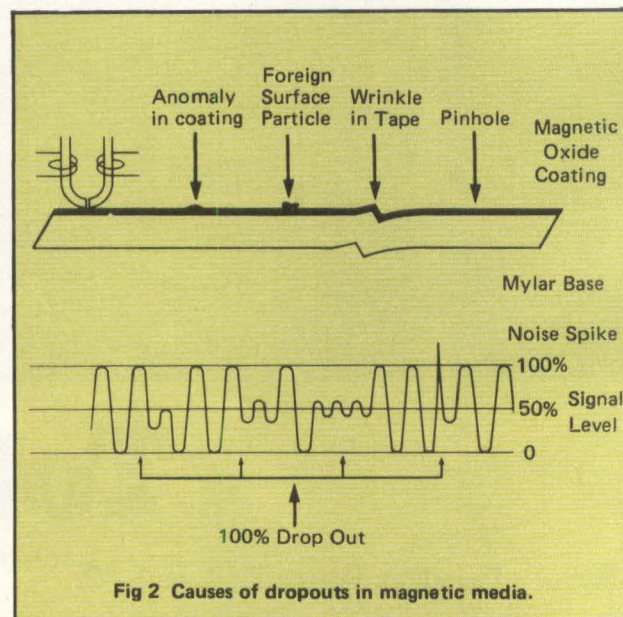
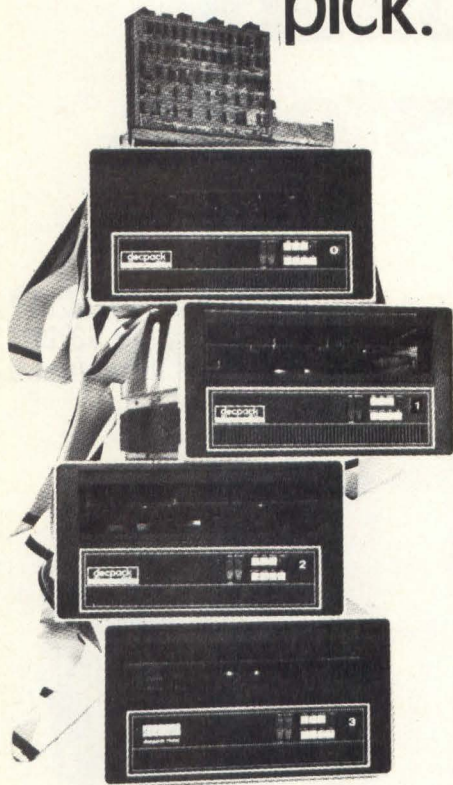

Fig 2 Causes of dropouts in magnetic media.

third -- keep your equipment in good condition.

- Scheduled preventive maintenance is your best insurance against equipment malfunction. If your equipment typically indicates impending failures by goofing up some operations, make up a cassette or disk with those operations on it, and use it once a month to check the system. Otherwise, follow the manufacturer's suggested schedule.

**10 MBytes
...take your
pick.**



DEC
\$26,000
6 Months Delivery
1.56 MHz Transfer
70 ms Positioning

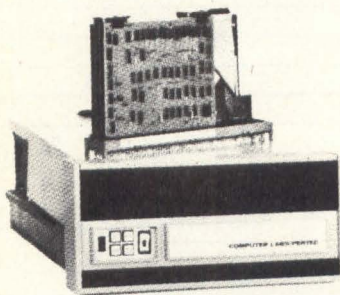

COMPUTER LABS
\$10,700
45 Days Delivery
2.5 MHz Transfer
40 ms Positioning

**COMPUTER
LABS**

The Mini Peripheral People

COMPUTER LABS, INCORPORATED • 505 EDWARDIA DRIVE
• GREENSBORO, N.C. 27409 • TWX 510-922-7954 • (919) 292-6427

Minimizing Drag: Cassette Slip Sheets

Slip Sheets are sheets of low friction material placed in a cassette between the tape pack and the interior sides of the cassette shells. The purpose of slip sheets is to minimize the drag of the tape pack against the side of the shell by interposing a low friction, abrasion resistant surface. A properly designed slip sheet guides the tape as it is wound or unwound, providing a centered, evenly wound tape pack without protruding tape edges that are easily damaged.

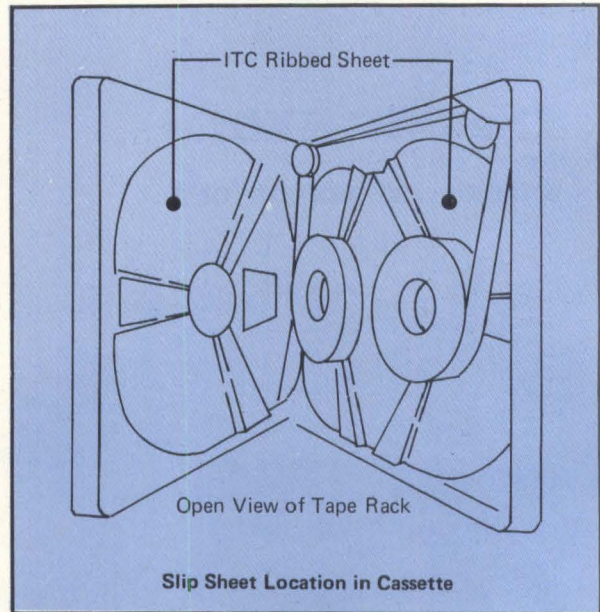

While all digital cassettes have slip sheets, they are far from being the same. Information Terminals Corporation uses two die cut slip sheets in each cassette. Each sheet has six ribs precisely formed into its surface, three radiating from each hub opening. The ribs have a flat surface that bears against the tape pack. Rib height is tightly controlled, producing a flat tape pack that is centered in the cassette. These ribs prevent lateral or transverse rotational pack motions during winding, thus minimizing dynamic skew. The precision of the rib formation provides a more consistent damping during stop-start operations.

High resiliency material is used to form the slip sheet. This provides a cushioning effect against sharp shocks, thus preventing stepped or uneven tape packs, a common cause of excess drag in cassette systems.

Slip sheets are slightly conductive to aid in eliminating static charges that can build up along tape surface. These charges, if present, can cause layers of tape to stick together, increasing drag. Worse, it causes dust particles to be attracted to the tape, which can cause dropouts and accelerated head wear. The conductive slip sheet is an important factor in minimizing these effects. The broad, planar surface of the formed rib is especially effective as a static discharge path.

*Information supplied by Information Terminals Corp.,
323 Soquel Way, Sunnyvale, CA 94086.*

Personal Computing

An exciting, new magazine!

If you don't have your own computer by now, chances are there's one in your immediate future. Personal computers are now being sold at about the price of home stereo systems. Experts project that 1,000,000 personal systems will be up and running by 1980.

PERSONAL COMPUTING will serve as your guide into this exciting new technology. We'll provide you with all the up-to-date information on new computer products, computer stores, and important personal computing events. In addition, each issue contains easy-to-follow, nontechnical articles on computer programming and computer jargon. These articles illustrate how you can use personal computers at home, school, and work.

Get your FREE issue now

Fill out the subscription form below, and we'll send you a complimentary copy. If you don't agree that Personal Computing is everything we say it is, simply write "Cancel" on the invoice and return it to us. If you do want to subscribe, simply pay the bill. In any case, the first issue is on us!

A one year subscription to PERSONAL COMPUTING is just \$8.00.



Please enter my subscription to Personal Computing.

I understand that the first issue is free.

Bill me Enclosed is my check for \$ _____

Bank Americard Master Charge Am Express

Credit Card # _____

Credit Card Expiration Date _____

Name (print) _____

Address _____

City _____

State _____ Zip _____

Note: PERSONAL COMPUTING is a bi-monthly publication. Credit card billing available to U.S. subscribers only. Rates: for 6 issues \$8 in the U.S. Additional postage for Mexico and Canada \$2 surface mail and \$4 airmail; all other foreign \$4 surface mail and \$18 airmail.

PERSONAL COMPUTING

167 Corey Road, Brookline, MA 02146, USA

ferent results in product quality as perceived by the end user.

These methods are:

- Statistical Certification
- Bulk Certification
- Post Assembly Certification

exactly what is certification, anyhow?

Certification is the process of writing a pattern of flux changes on the magnetic media and then reading it back, checking for proper signal amplitude during readback. If the readback signal falls below a certain preset threshold, then a dropout is said to occur. If the cause of the dropout is a defect in the media, the dropout condition will generally exist over a region of the media. Point dropouts are usually caused by damaged media or by a foreign particle that has adhered to the media. Media should be assembled in clean room conditions to minimize the possibility of such contamination.

statistical certification

Statistical Certification is performed by certifying a sample of the media used in a production run. If the media sample is good, all of the lot is presumed good and fit for use. However, there will probably be a significant number of "bad spots" in the lot that will not be detected until the end user encounters them in the form of an error in his system. Statistical Certification is usually performed before the media cartridge is loaded, and some times even before the media is slit. This creates abundant opportunities for the creation of defective product; typically 8 to 10% of the units shipped will have dropouts or other defects.

bulk certification

In bulk certification, the media is usually certified after slitting, but before loading into the end product. All of the media is tested. The disadvantage of this method is that damage occurring during media loading, testing or subsequent manufacturing steps is often undetected until the unfortunate user discovers it the hard way. While superior to Statistical Certification, this method still leaves much to be desired. It is used extensively, though, because it is cheap, but can result in a typical defect rate of 4 to 6% of the units shipped, depending upon the thoroughness of the supplier's quality control effort.

100% post assembly certification

After the product is assembled, it is placed in a specially designed certifier which tests it for dropouts and, in the case of cassettes, other parameters such as tape length, leader length, presence of BOT/EOT holes and the proper hole location. A product passing this type of certification has an extremely high probability of meeting the users performance expectations. Dropouts in shipped products are nil.

Bob Katzive is from Information Terminals Corporation in Sunnyvale, California.