

EDN[®]

Graphing and curve-fitting software	pg 71
Low-drift op amps	pg 99
Battle between EISA and MCA buses	pg 111
Real-time programming series—part 10	pg 157

ELECTRONIC TECHNOLOGY FOR ENGINEERS AND ENGINEERING MANAGERS

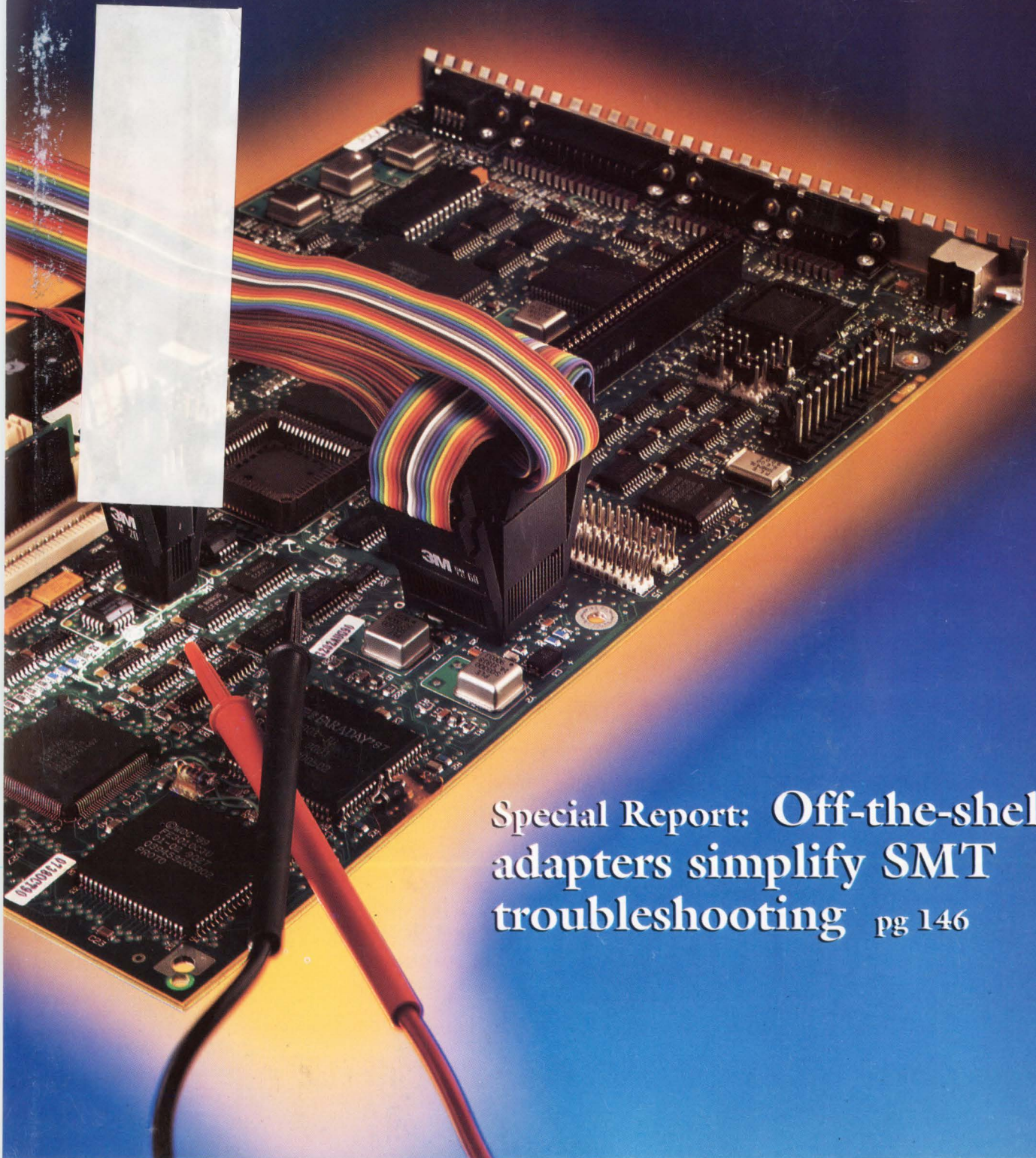

Special Report: Off-the-shelf adapters simplify SMT troubleshooting pg 146

BiCMOS is clearly the way of the future. You can either deny it or wait for it. Or get there first, with Fujitsu Microelectronics, Inc.



It's the name of the game. The guy who gets there first with the fastest, smallest system wins. Those who follow, stay in the game. The rest drop out.

Which is why the smart money is betting on BiCMOS. Combining bipolar speeds with the high-densities and low power of CMOS, it's the technological edge your systems need to stay competitive.

Now meet the leader.

As the leader in both CMOS and bipolar technologies, Fujitsu Microelectronics is uniquely qualified to lead the BiCMOS market. We've already shipped nearly a million units of BiCMOS products. And we've invested over \$500 million in our next generation.

To the rest, follow this.

Our current BiCMOS line has already set quite a pace. You can go standard or ASIC, offering both ECL and TTL interfaces.

Our standard SRAMs deliver maximum access time under 15ns and power dissipation under 1W. While our high-speed BiCMOS ASICs give you over 16,000 gates.

And that's just today. Our next wave of BiCMOS SRAMs will use 0.5 μ technology to deliver sub-10ns access times. While our new sea-of-gates BiCMOS ASICs will offer 180ps typical gate delays and over 160,000 gates.

Get on the phone.

The sooner you design-in Fujitsu BiCMOS, the stronger your new systems will run. Our intensive support can speed your development time every step of the way. Helping you bring a stronger product to market in a much shorter time. And making your systems a very hard act for the competition to follow. To start today, call 1-800-642-7616.

FUJITSU

FUJITSU MICROELECTRONICS, INC.
Integrated Circuits Division
3545 North First Street, San Jose, CA 95134-1804. 1-800-642-7616.

Every step of the way.SM

©1990 Fujitsu Microelectronics, Inc.
Every step of the way is a service mark of Fujitsu Microelectronics, Inc.

**Lead, follow,
or get out
of the way.**

**Presenting
the three rules
of BiCMOS
design.**

ALL ABOARD!

The Engine with Everything You Need
To Get There On Time

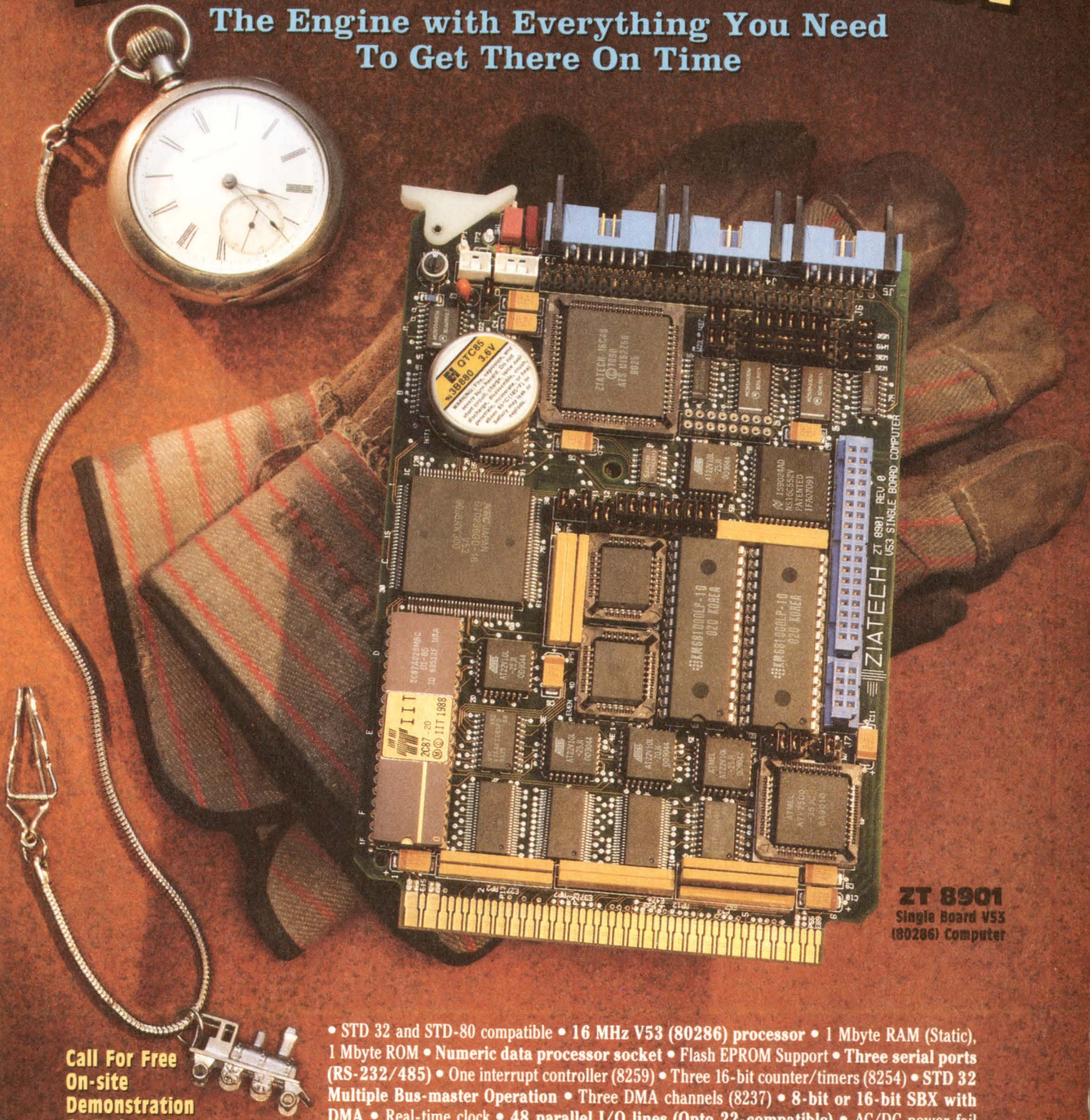

ZT 8901
Single Board V53
(80286) Computer

Call For Free
On-site
Demonstration
Or Technical Data
805-541-0488
FAX: 805-541-5088

- STD 32 and STD-80 compatible
- 16 MHz V53 (80286) processor
- 1 Mbyte RAM (Static), 1 Mbyte ROM
- Numeric data processor socket
- Flash EPROM Support
- Three serial ports (RS-232/485)
- One interrupt controller (8259)
- Three 16-bit counter/timers (8254)
- STD 32 Multiple Bus-master Operation
- Three DMA channels (8237)
- 8-bit or 16-bit SBX with DMA
- Real-time clock
- 48 parallel I/O lines (Opto 22-compatible)
- AC/DC power fail detection
- DOS, VRTX, STD ROM and STD LADDER software support
- Watchdog timer
- 20-year MTBF (175K hours)
- -40° to +85° C Option
- Dynamic 8- and 16-bit bus sizing
- Low power CMOS with sleep mode
- Two-year warranty, and more.

STD 32™

Circle No. 1

ZIATECH
CORPORATION

PC Data Acquisition

Quality • Innovation • Performance

NEW

- RTSI bus for multiboard synchronization
- Software-configurable analog input and gain
- 200 ksamples/sec
- 12-bit resolution
- True self-calibration

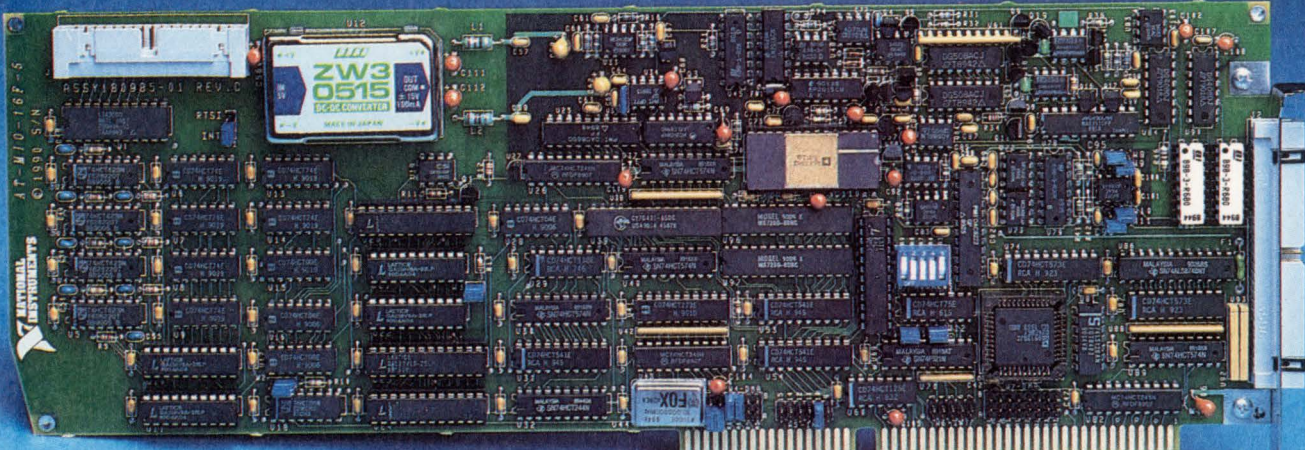

- Dither generator increases effective resolution beyond 12 bits
- Separate analog and digital sections for optimum noise control
- Custom instrument amplifier guarantees 12-bit accuracy at all gains and sampling rates

The National Instruments AT-MIO-16F-5 Sets the New Standard

It takes a serious commitment to quality to deliver data acquisition boards that reliably meet the most demanding specifications. Our new AT-MIO-16F-5 creates a new standard in excellence with several firsts, including a proprietary ultra high-performance instrumentation amplifier, a dither generator for extended resolution, and self-calibration that eliminates the need for external signals required by other "self-calibrating" boards. The quality, innovation, and

performance of our AT-MIO-16F-5 sets the new standard in PC data acquisition. As the table below shows, the rest of our extensive PC product line surpasses industry standards. Each board undergoes a 48-hour burn-in, and passes a thorough system test to guarantee linearity, fast analog input settling, high common-mode rejection, and low noise. At National Instruments, we're serious about data acquisition.

Data Acquisition Board	Computer Bus	Analog Input					Analog Output				Software						
		Channels*	Max Sampling Rate (samples/sec)	Resolution (bits)	Ranges (V)	Gains	Channels	Resolution (bits)	Digital I/O Channels	Counter/Timers	LabWindows	DOS LabDriver	PC LabDriver	Measure	VisionScope	Third Party	
AT-MIO-16F-5	AT	16 SE 8 DI	200,000	12	±5, 0 to 10	0.5, 1, 2, 5, 10, 20, 50, 100	2	12	8	3	✓	✓					Featured Product
AT-MIO-16H-9 AT-MIO-16H-15 AT-MIO-16H-25	AT	16 SE 8 DI	100,000	12	±10, ±5, 0 to 10	1, 2, 4, 8	2	12	8	3	✓	✓	✓	✓	✓	✓	✓
AT-MIO-16L-9 AT-MIO-16L-15 AT-MIO-16L-25	AT	16 SE 8 DI	100,000	12	±10, ±5, 0 to 10	1, 10, 100, 500	2	12	8	3	✓	✓	✓	✓	✓	✓	✓
Lab-PC	XT	8 SE	62,500	12	±5, 0 to 10	1, 2, 5, 10, 20, 50, 100	2	12	24	3	✓	✓	✓	✓			✓
PC-LPM-16	XT	16 SE	50,000	12	±5, 0 to 10 ±2.5, 0 to 5	1	-	-	16†	3	✓	✓	✓	✓			
AT-DIO-32F PC-DIO-96 PC-DIO-24	AT XT XT	- - -	- - -	- - -	- - -	- - -	- - -	- - -	32 96 24	- - -	✓ ✓ ✓	✓ ✓ ✓	✓ ✓ ✓				✓ ✓ ✓
PC-TIO-10	XT	-	-	-	-	-	-	-	16	10	✓	✓	✓				
EISA-A2000	EISA	4 SE SS	1,000,000	12	±5	1	-	-	-	-	✓	✓					✓

* SE - Single-Ended, DI - Differential, SS - Simultaneous Sampling

† 8 Channels In, 8 Channels Out

NATIONAL INSTRUMENTS
The Software Is the Instrument[®]
6504 Bridge Point Parkway
Austin, TX 78730-5039

Circle No. 2

Call for **FREE** Catalog
(512) 794-0100 or (800) 433-3488 (U.S. and Canada)

Nihon National Instruments K.K. (Japan) 03 3788 1921 • National Instruments France 1 4865 3370
National Instruments Italy 02 4830 1892 • National Instruments Switzerland 056 45 58 80
National Instruments United Kingdom 0635 523 545 • National Instruments Germany 089 436 1447

BELL
2000 pts 50 kHz
Sample Rate

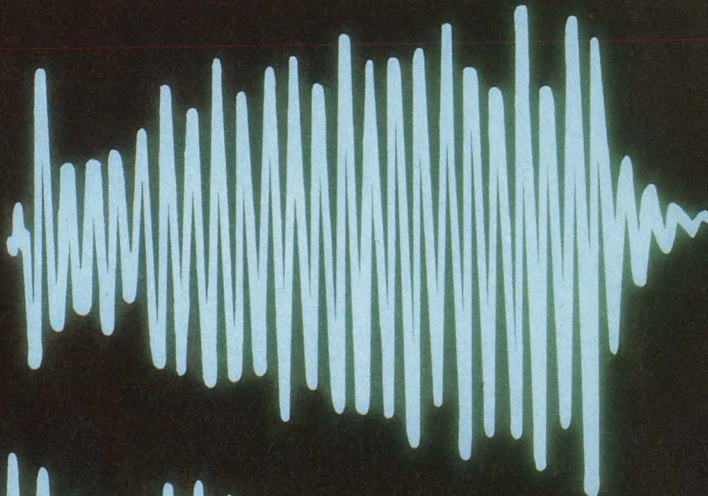

WHISTLE
2000 pts 50 kHz
Sample Rate

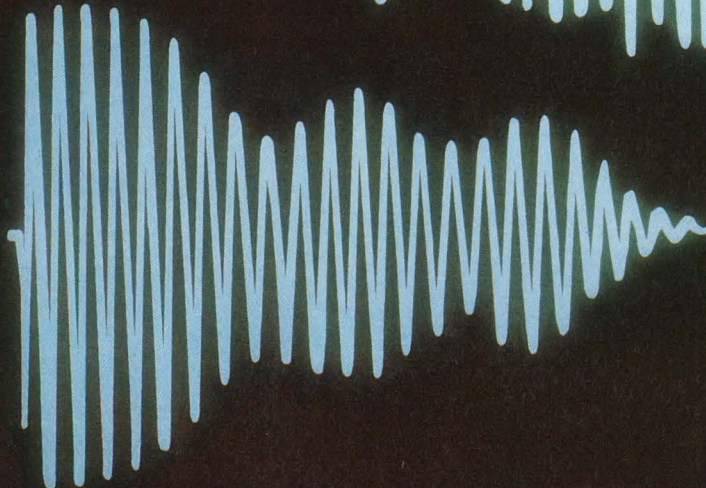

Our new function generator has all the bells and whistles.

In fact, it has any kind of waveform you can imagine. Because the Model 95 combines a high performance function generator with a powerful arbitrary generator.

As a function generator, Model 95 produces remarkably pure square waves, triangles and sines, from 1 mHz to 20 MHz with synthesized accuracy up to 0.001%. It has

the power to output 15 Vp-p into 50Ω, and includes sweep, pulse and modulation modes plus four user-selectable output impedances. There's even an internal trigger generator for trigger, gate and burst.

If you'd rather be arbitrary, Model 95 gives you up to 128k of waveform memory to work with, and a sample rate of 20 MHz. Four different editing

modes help you produce even the most complicated wave shapes quickly and accurately, while analog and digital filters allow you to create the purest output possible.

For information about all the other bells and whistles you'll find on the Model 95, call Wavetek San Diego, Toll Free at **1-800-874-4835** today.

What do you get when you design with our 10 m Ω MOSFET?

NO BIG LOSS.

That's right. Now you can dramatically cut computer system power and voltage losses with the SMP60N03-10L from Siliconix.



of the very high cell density of Siliconix' proprietary SiMOS 2.5 technology and lowering the breakdown voltage of this device for applications that don't require the common 50 V+ rating. The result is 10 m Ω , the industry's lowest $r_{DS(on)}$ available in a TO-220 package. That means increased efficiency because less

This 30 V, 10 m Ω , logic-level power MOSFET will revolutionize your computer designs—from laptops to mainframes and everything in between.

Ideal solution for many applications.

The SMP60N03-10L can be used as a battery backup switch, a load manager, a linear regulator, or a synchronous rectifier. And its lower forward voltage drop and bi-directional current capability make it an ideal replacement for relays and Schottky diodes in all computer applications.

Less heat for more efficiency.

The secret? A unique combination

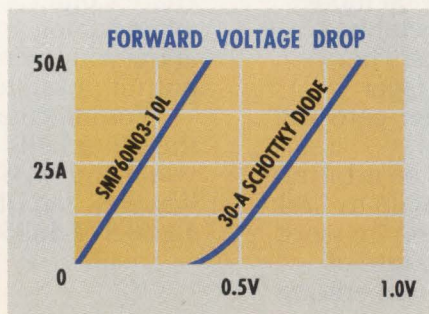

heat is generated in your system. So now you can save the cost and space of heatsinks and sometimes even eliminate the need for a fan.

Improved device and system reliability.

The SMP60N03-10L is avalanche rated and 100% tested to ensure device reliability. And because of its low gate charge fewer external drive components are required. So you'll not only save space and reduce cost, but your system will be more reliable as well.

Available now!

Cut your losses and design more efficiency into your low power systems! Contact your local Siliconix distributor. Or call our toll-free hot line now! 1-800-554-5565, Ext. 956. Ask for our 10 m Ω power MOSFET Design Kit.

Siliconix
incorporated
2201 Laurelwood Road, Santa Clara, CA 95056

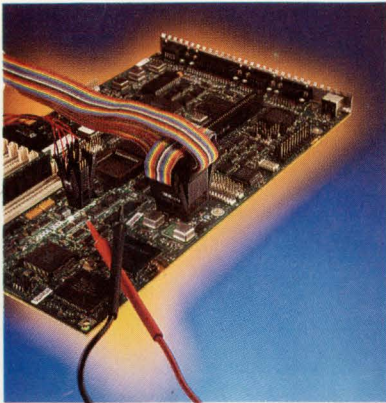

On the cover: Off-the-shelf adapters let you concentrate on the benefits of surface-mount technology. They alleviate the inconveniences of testing and troubleshooting prototypes that contain high-level ICs. See the Special Report on pg 146. (Photo courtesy 3M, Electronics Div)

SPECIAL REPORT

SMT troubleshooting

146

High packing density and high speed are two prime benefits of surface-mount technology (SMT). Yet the very packages that provide these benefits complicate the tasks of prototyping, testing, and troubleshooting surface-mount assemblies.—*Tom Ormond, Senior Editor*

DESIGN FEATURES

Real-time programming—Part 10

157

The major mechanisms for task-to-task interaction that have been described so far (event flags and messages) are all synchronous in that the receiver specifically requests to wait for information to arrive. There is no sense of a private communication targeted to a specific task. Part 10 discusses signals, which are unique in that the sender can impose information on the receiver. For the receiver, the information arrives asynchronously with respect to its current activities.—*David L Ripps, Industrial Programming Inc*

Noninteger division synthesizes multiple clock frequencies

169

Generating multiple clock frequencies from a single reference often requires noninteger division. A basic algorithm provides an alternative to traditional division techniques by giving you some choice of the reference.—*Sid Ghosh, Design Assistance*

TECHNOLOGY UPDATES

Graphing and curve-fitting software: Packages present data so it makes sense

71

This software harnesses the graphics capabilities of your PC or workstation to display and print experimental data in ways that can reveal hidden meanings.—*Dan Strassberg, Associate Editor*

Continued on page 7

EDN[®] (ISSN 0012-7515) is published 48 times a year (biweekly with 2 additional issues a month, except for February, which has 3 additional issues and July and December which have 1 additional issue) by Cahners Publishing Company, A Division of Reed Publishing USA, 275 Washington Street, Newton, MA 02158-1630. Terrence M McDermott, President; Frank Sibley, Senior Vice President/General Manager, Boston Division; Jerry D Neth, Senior Vice President/Publishing Operations; J J Walsh, Senior Vice President/Finance; Thomas J Dellamaria, Senior Vice President/Production and Manufacturing; Ralph Knupp, Vice President/Human Resources. Circulation records are maintained at Cahners Publishing Company, 44 Cook Street, Denver, CO 80206-5800. Telephone: (303) 388-4511. Second-class postage paid at Denver, CO 80206-5800 and additional mailing offices. **POSTMASTER:** Send address corrections to EDN[®], PO Box 173377, Denver, CO 80217-3377. EDN[®] copyright 1991 by Reed Publishing USA; Ronald G Segel, Chairman and Chief Executive Officer; Robert L Krakoff, President and Chief Operating Officer; William M Platt, Senior Vice President. Annual subscription rates for nonqualified people: USA, \$109.95/year; Canada/Mexico, \$135/year; Europe air mail, \$165/year; all other nations, \$165/year for surface mail and \$250/year for air mail. Single copies are available for \$10. Please address all subscription mail to Ellen Porter, 44 Cook Street, Denver, CO 80206-5800.

FLUKE®



PHILIPS



This meter has what you need most: Accuracy and stability that are easy to use.

The Fluke 8840 Series is your best choice in high performance 5½ digit multimeters.

The Fluke 8840A is one of the world's most popular 5½ digit dmm's. For good reason. Basic dc accuracy is 0.005% over one year. And 8840A owners report that typical performance is even better.

The 8840A is also one of the most reliable multimeters in its class, with an MTBF of more than 100,000 hours.

The 8842A offers even more performance. Basic dc accuracy is 0.003% and minimum dcV resolution is 100 nV. And both the warranty and calibration cycle are extended to two years.

The 8840 Series are among the most stable dmm's in their class. That means you can use all 5½ digits of resolution to make meaningful measurements.

And just by looking, you can tell the 8840A and 8842A are easy to use. The vacuum fluorescent display is easy to read from all angles, under all lighting conditions. Plus, true-rms ac and IEEE-488 interface options allow you to buy just the features you need today and to add more later if you need them.

An adjustable tilt-stand for bench use is standard. But rack mounting is quick and simple. Closed case calibration cuts maintenance time. And measurement

speed can be set for 2.5, 20 or 100 readings per second to meet the throughput needs of your application.

So put one of the world's most popular 5½ digit dmm's to work for you today. Call **1-800-44-FLUKE** (1-800-443-5853).

John Fluke Mfg. Co., Inc., P.O. Box 9090, M/S 250, Everett, WA 98206. U.S.: 206-356-5400. CANADA: 416-890-7600. OTHER COUNTRIES: 206-356-5500. © Copyright 1990 John Fluke Mfg. Co., Inc. All rights reserved. Ad No. 00039

FROM THE WORLD LEADER
IN DIGITAL MULTIMETERS.

FLUKE®

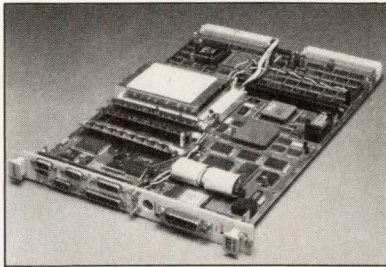

Before selecting a VXI (VME extensions for instrumentation) mainframe, explore the pros and cons of several system configurations (pg 89).

VXI packaging and power issues heat up 89

Some manufacturers have split VXI instruments, locating segments outside the mainframe or in multiple slots, to meet heat dissipation and power demands. Others are using onboard cooling fans, fins, and towers.—*J D Mosley, Regional Editor*

Low-drift op amps: Precision parts demand kid-glove treatment 99

Selecting the best low-drift op amp for your sensitive design is an ordeal in itself. Further trials await when you strive to realize the specified performance goal.—*Brian Kerridge, European Editor*

32-bit buses: Battle between EISA and MCA continues 111

Technical differences between EISA and MCA are beginning to blur. For board designers trying to determine which bus deserves their allegiance, the deciding factor may come down to how easy it will be to sell their product.—*J D Mosley, Regional Editor*

EDITORS' CHOICE

Real-time Unix-like operating system	123
Voice-storage chip	127

PRODUCT UPDATES

VME64 68040-based single-board computer	128
STD Bus DSP board	132
Compact crystal oscillator	134
Real-time multiprocessor series	136

Continued on page 9

EDN magazine now offers Express Request, a convenient way to retrieve product information by phone. See the Reader Service Card in the front for details on how to use this free service.



Cahners Publishing Company, A Division of Reed Publishing USA Specialized Business Magazines for Building & Construction Research Technology Electronics Computing Printing Publishing Health Care Foodservice Packaging Environmental Engineering Manufacturing Entertainment Home Furnishings and Interior Design. Specialized Consumer Magazines for Child Care Boating and Wedding Planning.

DAVE -
NICE DESIGN. I WRITE
DOWN SOME PARTS
THAT'LL MAKE IT A
REALITY. - J
P.S. KEEP YOUR DAY JOB!

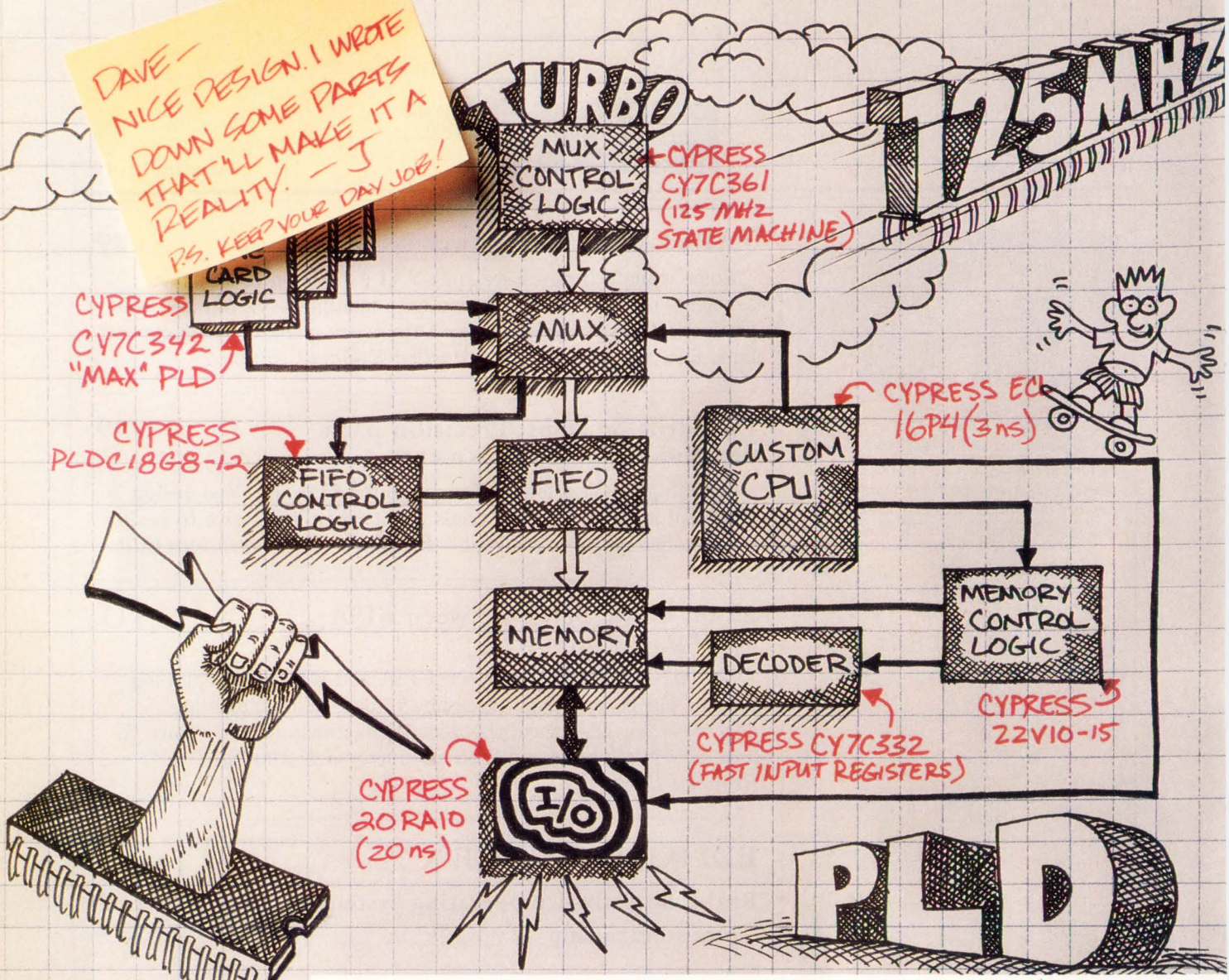

No matter where you're going, or how fast, we have the right PLD.

High Density Family: If you need density up to the level of small gate arrays, coupled with high performance and quick development times, our MAX™ family fills the bill. You get parts that can replace up to 50 TTL parts, or up to 15 PLDs, with performance to 50 MHz. Very flexible, very well supported.

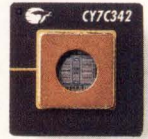

Functionally Specialized Family: We've created new architectures tailored to key functions, to give you maximum performance. For example, for state machine functions, our CY7C361 employs an innovative 'split-plane' architecture to cut feedback loop delay and enable 125 MHz performance.



Standard Enhanced Family: If you like the 'classics' but want state-of-the-art performance, you'll find plenty of solutions in our Standard Enhanced Family. Consider our CMOS 18G8 Universal PAL at 12 ns. Or our CMOS 22V10 at 15 ns. Or our 20RA10 at 20 ns. Our ECL 16P4 (10E302) at 3 ns. To name a very fast few.



Call for your free Data Book. Hotline: 1-800-952-6300.* Ask for Dept. C4J.



*1-800-387-7599 In Canada. (312)-672-2220 In Europe.
©1990 Cypress Semiconductor, 3901 North First Street, San Jose, CA 95134. Phone: (408)943-2666, Telex 821032 CYPRESS SNUJ, TWX 910-997-0753. Trademarks: MAX - Altera Corporation.



CYPRESS SEMICONDUCTOR

VP/Publisher
Peter D Coley

Associate Publisher
Mark Holdreith

VP/Editor/Editorial Director
Jonathan Titus

Managing Editor
Joan Morrow Lynch

Assistant Managing Editor
Christine McElvenny

Special Projects
Gary Legg

Home Office Editorial Staff
275 Washington St, Newton, MA 02158
(617) 964-3030

Tom Ormond, *Senior Editor*
Charles Small, *Senior Editor*
Jay Fraser, *Associate Editor*
John A Gallant, *Associate Editor*
Michael C Markowitz, *Associate Editor*
Dave Pryce, *Associate Editor*
Carl Quesnel, *Associate Editor*
Susan Rose, *Associate Editor*
Julie Anne Schofield, *Associate Editor*
Dan Strassberg, *Associate Editor*
Chris Terry, *Associate Editor*
Helen McElwee, *Senior Copy Editor*
James P Leonard, *Copy Editor*
Gabriella A Fodor, *Production Editor*
Brian J Tobey, *Production Editor*

Editorial Field Offices

Steven H Leibson, *Senior Regional Editor*
Boulder, CO: (303) 494-2233

Doug Conner, *Regional Editor*
Atascadero, CA: (805) 461-9669

J D Mosley, *Regional Editor*
Arlington, TX: (817) 465-4961

Richard A Quinnell, *Regional Editor*
Aptos, CA: (408) 685-8028

Anne Watson Swager, *Regional Editor*
Wynnewood, PA: (215) 645-0544

Maury Wright, *Regional Editor*
San Diego, CA: (619) 748-6785

Brian Kerridge, *European Editor*
(508) 28435
22 Mill Rd, Loddon
Norwich, NR14 6DR, UK

Contributing Editors
Robert Pease, Don Powers,
David Shear, Bill Travis

Editorial Coordinator
Kathy Leonard

Editorial Services
Helen Benedict

Art Staff
Ken Racicot, *Senior Art Director*
Chinsoo Chung, *Associate Art Director*
Cathy Madigan, *Staff Artist*
Sharon O'Brien, *Staff Artist*

Production/Manufacturing Staff
Andrew A Jantz, *Production Supervisor*
Sandy Wucinich, *Production Manager*
Melissa Carman, *Production Assistant*
Diane Malone, *Composition*

Director of Art Department
Robert L Fernandez
Norman Graf, *Associate*

VP/Production/Manufacturing
Wayne Hultzky

Director of Production/Manufacturing
John R Sanders

Business Director
Deborah Virtue

Marketing Communications
Anne Foley, *Promotion Manager*
Pam Winch, *Promotion Assistant*

DESIGN IDEAS

Power booster operates efficiently	183
A/D board hooks to IBM PC printer port	184
Filter antialiases and sinc compensates	186
Feedback and amplification	188

EDITORIAL 65

Let's be sure we don't discard too much of our technical history.

NEW PRODUCTS

Computers & Peripherals	192
Components & Power Supplies	198
Integrated Circuits	208
Test & Measurement Instruments	212
CAE & Software Development Tools	222

PROFESSIONAL ISSUES

Will you be the victim of age discrimination?	247
---	-----

The answer is probably yes. Here's what you can do about it.
—Jay Fraser, *Associate Editor*

DEPARTMENTS

News Breaks	23
Signals & Noise	45
Calendar	56
Leadtime Index	141
Literature	230
Career Opportunities	254
EDN's International Advertisers Index	259



Give your PC designs all the bells and whistles.

It's easy with Motorola peripheral chips.

The simplest and most cost-effective way to give your new PC design all the latest bells and whistles is with Motorola PC Chip Set products. Our new peripheral chips make light work of state-of-the-art PC development.

The single-chip Floppy Disk Controller.

There's only one true single-chip Floppy Disk Controller (FDC) available today and it's from Motorola. The MCS3201 is an IBM PC/XT/AT[®] floppy disk formatter and controller that offers on-chip address decoding. The design requires only one external 24 MHz crystal. This FDC offers four different densities, 360K, 720K, 1.2M and 1.44M, and data transfer rates of 250, 300 and 500 kb/s.

Industry standard Multi-Function I/O Controllers.

Three new multi-function I/O controllers offer highly integrated solutions for all IBM PC/XT/AT systems. The MCCC16C462 is the industry's only "452" standard with an on-board crystal driven clock reference. This dual serial and single parallel port controller combines a 452 pinout with all the space and money savings of its own crystal oscillator. Motorola also makes two other controllers for use with a TTL clock reference—the single serial, single parallel MCCC16C451 and the dual serial, single parallel MCCC16C452.

New additions to the first family of EIA-232.

Two new families expand Motorola's industry-standard EIA-232 product lines—the MC145406/07 for notebook applications and the MC145403/4/5/8 for desktop applications.

A Real-Time Clock with real-time improvements.

The MCCC146818B Parallel Real-Time Clock (RTC) is a generous improvement of the world standard 18A. We've doubled to user-available RAM to 114 bytes and dramatically reduced the standby current draw. Then, to make your design chores a snap, we've created a module that includes a battery and crystal to keep time, save money and save space to boot.

The MCCC1850 Serial Real-Time Clock is the first Motorola RTC designed for workstations, UNIX/DOS based machines with power

supply auto-restart and 64 bytes of CMOS static RAM. To the workstation designer, the 1850 means flexibility and reliability.

Take it from here.

Motorola PC chips combine technology and innovation to make your PC designs the very best they can be. We've put together an information pack that's yours for the asking; it includes complete technical information on all of Motorola's peripheral devices for IBM PC/XT/AT machines. If you'd like one, simply complete and return the coupon below, write to us on your company letterhead at P.O. Box 20912, Phoenix, AZ 85036, or contact your local Motorola Sales office.

PC/XT and PC/AT are registered trademarks of IBM Corp. MCS is a trademark of Motorola Inc. The PC Chips logo is a trademark of Motorola Inc.



MOTOROLA

To: Motorola Semiconductor Products, Inc., P.O. Box 20912, Phoenix, AZ 85036

Please send me the PC Peripheral Chips information pack.

Name _____ EDN021891

Title _____

Company _____

Address _____

City _____

State _____ Zip _____

Call me (_____) _____



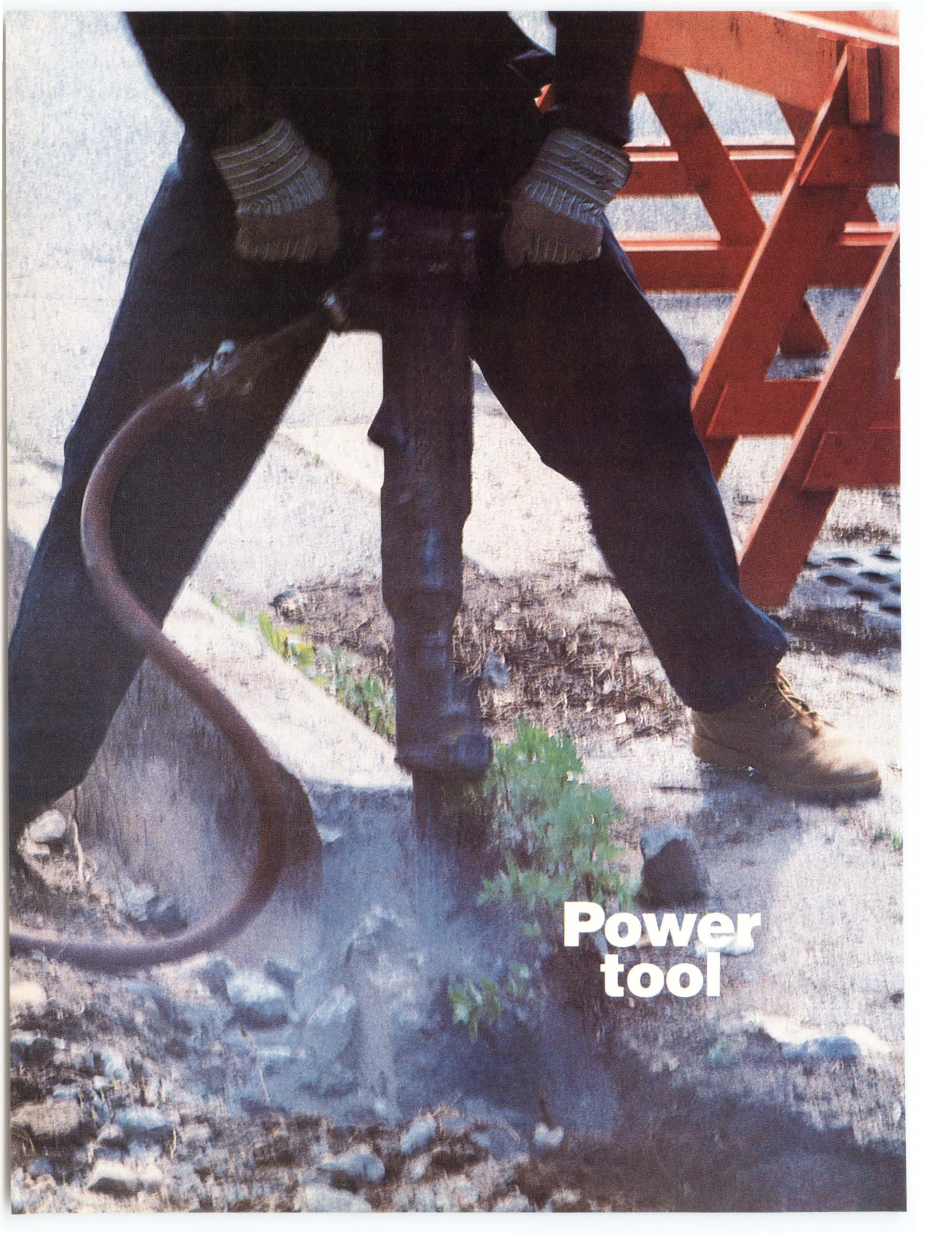

**Power
tool**

KEPCO ac-dc dc-dc SWITCHING POWER SUPPLIES

Field-proven in a broad spectrum of applications and certified by the world's safety agencies, here are versatile, rugged power tools for your design needs. Choose voltages up to 48V dc; power up to 1500W; ac or dc input. Features include active soft-start, remote voltage control, overvoltage protection, current limiting and built-in EMI filtering. The 600W and 1500W models provide for current-share paralleling. Kepco's switchers are also available in low-cost open frame and pc-card styles for OEM applications. Please request our catalog.

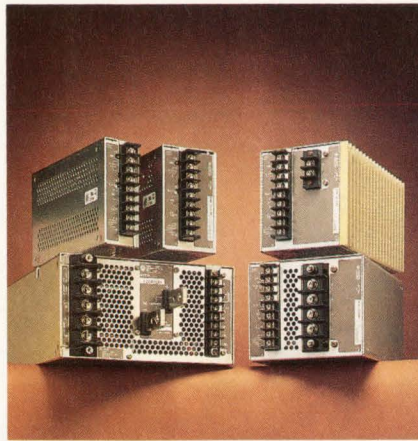

ac to dc power single output 50W, 100W, 175W, 300W, 1500W

- 3V-48V dc output
- jumper selectable inputs:
85-132 or 170-264V ac,
240-370V dc
- fully enclosed
- UL/CSA/TÜV
- Tested to MIL STD 810D
- FCC Class A EMI filtering

Kepco Group RAX Power Supplies



ac to dc power single output 600W

- 2V-48V dc output
- jumper selectable inputs:
85-132 or 170-264V ac, 240-370V dc
- fully enclosed
- UL/CSA
- Tested to MIL STD 810D

Kepco Group RBX Power Supplies

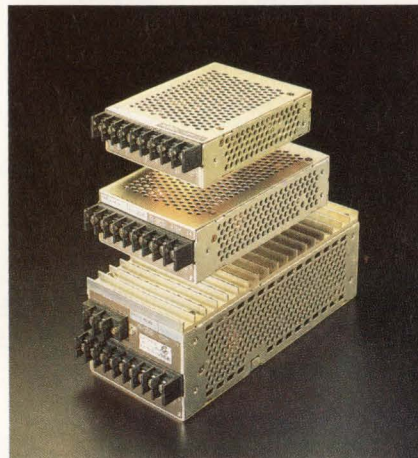

dc to dc power single output 30W, 60W, 150W

- 5V-48V dc output
- 24 and 48V input
(60V available on some models)
- fully enclosed
- UL/CSA
- MIL STD 461B EMI filtering
- Tested to MIL STD 810D

Kepco Group ERD Power Supplies

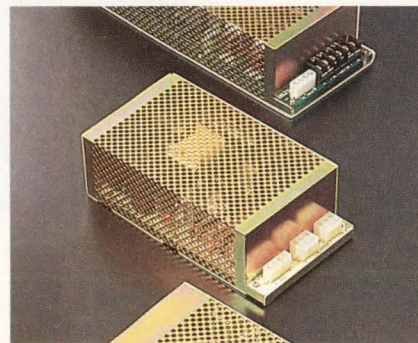

ac to dc power single output 30W, 60W, 120W, 240W

- 5V-24V dc output
- jumper selectable inputs:
85-132 or 170-264V ac, 240-370V dc
- P-C card, L-chassis, optional enclosure
- UL/CSA/TÜV
- FCC Class B EMI filtering

Kepco Group ERX Power Supplies

Power tools

SEE OUR PAGES
IN VOLUME D

eem⁹⁰₉₁

For your free copy of Kepco's new 56-page catalog,
"Kepco Switching Power Supplies for the '90s" (#146-1692),
call/fax/write Dept. LWT-12, Kepco, Inc., 131-38 Sanford Avenue, Flushing, NY 11352 USA
Tel: (718) 461-7000 • Fax: (718) 767-1102 • Easylink (TWX): 710-582-2631





THE MULTIPLE CHOICE ANSWER FOR SMD

BOURNS

New! New! New! 4mm Sealed Multiturn

The only way to get multiturn trimming precision in a 4mm surface mount potentiometer is with the new Bourns Trimpot® Model 3224 11-turn sealed trimmer. Dynamite specs. Rugged construction.

- Size 4.6mmL x 4.8mmW x 3.7mmH
- Contact Resistance Variation 1% max.
- Resistance Range 10 ohms-2 megohms, ±10%
- Temperature Coefficient ±100ppm/°C
- Rotational Life 200 cycles

CIRCLE 171 CALL ME
CIRCLE 172 SEND LITERATURE



Popular 1/4-Inch Sealed Multiturn

Available in either horizontal or vertical adjust styles, the Model 3269 offers multiturn precision trimming flexibility with excellent performance characteristics.

- Size 6.35mmSq x 4.45mmH
- Contact Resistance Variation 3% max.
- Resistance Range 10 ohms-1 megohm, ±10%
- Temperature Coefficient ±100ppm/°C
- Rotational Life 200 cycles

CIRCLE 169 CALL ME
CIRCLE 170 SEND LITERATURE



3mm Open-Frame Single-Turn

The Model 3363 is the industry's smallest 3mm design meeting both EIA and EIAJ footprint standards. With a film-coated resistor, it can be either wave or reflow soldered.

- Size 3.6mmL x 3.0mmW x 1.3mmH
- Contact Resistance Variation 5% max.
- Resistance Range 100 ohms-1 megohm, ±25%
- Temperature Coefficient ±250ppm/°C
- Rotational Life 20 cycles

CIRCLE 173 CALL ME
CIRCLE 174 SEND LITERATURE

TRIMMERS



4mm Open-Frame Single-Turn



With a cost-effective chip style design, the Model 3304 features a cross-slot rotor that is ideal for automatic assembly and adjustment techniques.

Size 4.8mmL x 3.8mmW x 2.4mmH
 Contact Resistance Variation . . . 5% max.
 Resistance Range 10 ohms-2 megohms, $\pm 25\%$
 Temperature Coefficient . . . $\pm 200\text{ppm}/^\circ\text{C}$
 Rotational Life 20 cycles

CIRCLE 175 CALL ME
CIRCLE 176 SEND LITERATURE

Surface Mount Trimmer Design Kit

Get samples fast for prototyping with the surface mount trimmer design kit. Over 200 trimmers in popular sizes, styles and resistance values.

- 3mm single-turn
- 4mm sealed single-turn
- 4mm single-turn chip style
- 1/4-in. sealed multiturn

CIRCLE 177 CALL ME
CIRCLE 178 SEND LITERATURE

4mm Sealed Single-Turn

The rugged Model 3314 trimmer is ideal for reliable performance in harsh environments. Top and side adjust styles provide excellent compatibility with pick-and-place assembly techniques.

Size 4.5mmSq x 2.55mmH
 Contact Resistance Variation . . . 1% max.
 Resistance Range 10 ohms-2 megohms, $\pm 20\%$
 Temperature Coefficient $\pm 100\text{ppm}/^\circ\text{C}$
 Rotational Life 100 cycles

CIRCLE 179 CALL ME
CIRCLE 180 SEND LITERATURE

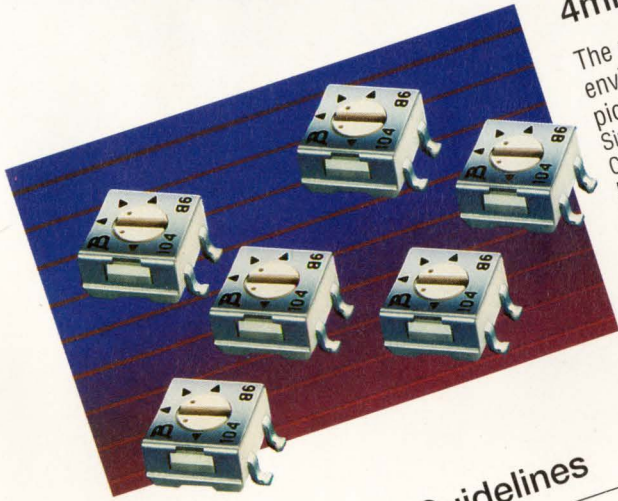

Trimmer Processability Guidelines

Model	Packaging	Sealed/Open	
		Sealed	Open
3224	7 In. Reel	Sealed	Wave & Reflow
3269	Tube & 13 In. Reel	Sealed	Reflow Only
3304	7 In. Reel & 13 In. Reel	Open	Reflow Only
3314	7 In. Reel & 13 In. Reel	Sealed	Wave & Reflow
3363	7 In. Reel	Open	Wave & Reflow

CALL 1-800-22BOURNS

For a FREE BROCHURE and the telephone number of your nearest sales office providing technical assistance.

Bourns, Inc., 1200 Columbia Avenue, Riverside, California 92507-2114; (714) 781-5500; European Headquarters: Zugerstrasse 74, 6340 Baar, Switzerland: 042-333333; Benelux: 070-3874400; France: 01-40033604; Germany: 0711-22930; Ireland: 021-357001; United Kingdom: 0276-692392; Asia Pacific Headquarters: 510 Thomson Road, Unit 09-01A SLF Building, Singapore 1130; (65) 353 4118; Hong Kong: (852) 50072171; Korea: (882) 2-556-3619; Japan Headquarters: Nichibeit Time 24 Building, 35 Tanau-Cho, Shinjuku-Ku, Tokyo, 162, Japan: (81) 3-260-1411



COPYRIGHT © 1991, BOURNS, INC. 1/91

S A M S U N G

NOW

**A MILLION TRANSISTORS ON A
UNTIL YOU CONTEMPLATE AN**

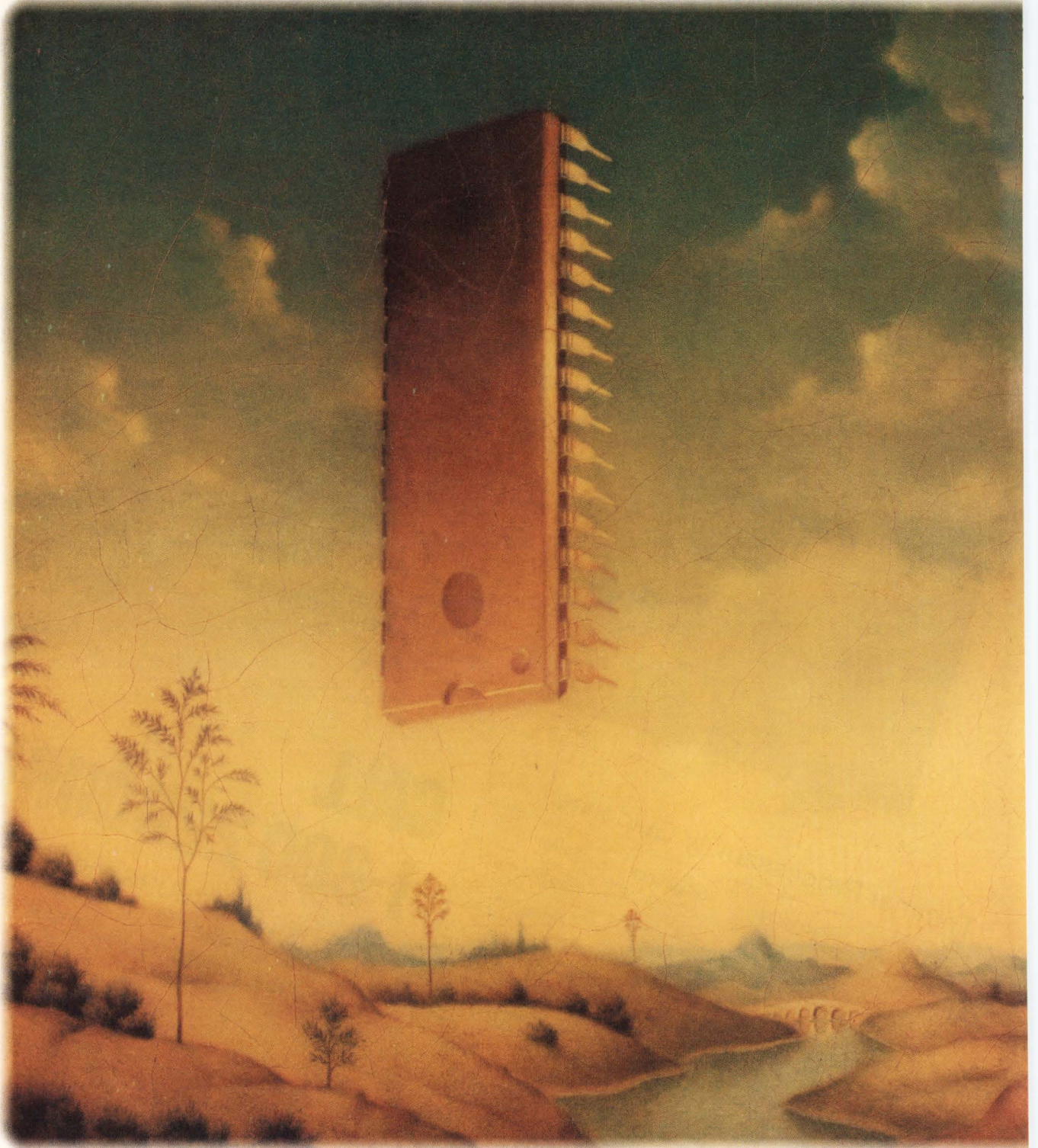

MICROPROCESSOR IS IMPRESSIVE, SRAM WITH SIX TIMES AS MANY.

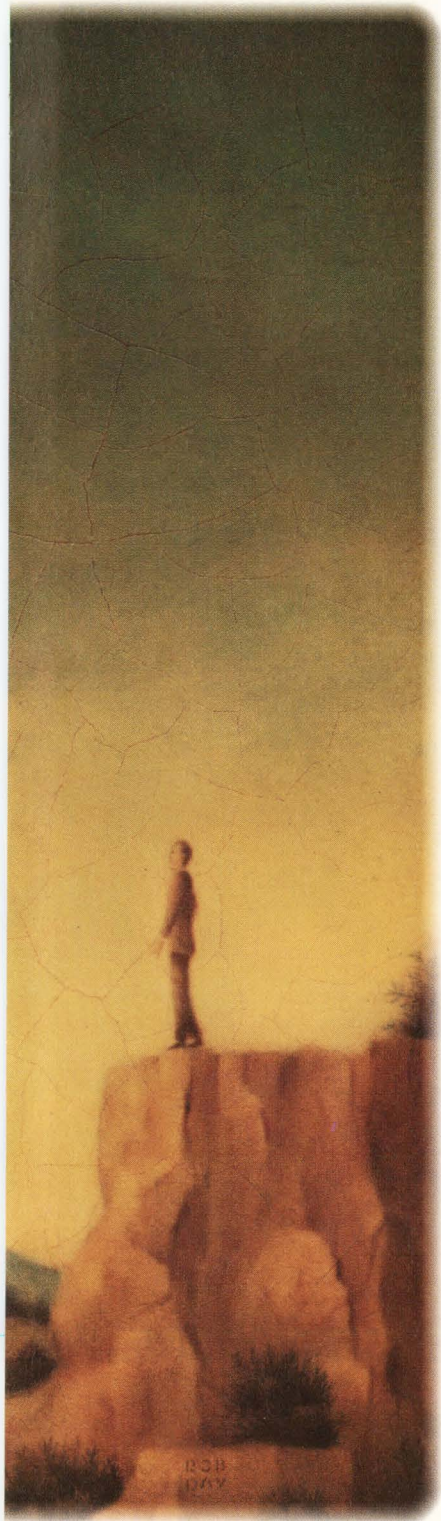

The recently introduced Samsung 1-meg SRAMs have a transistor count of 6.6 million.

In a day and age when makers of advanced microprocessors take understandable pride in the 1 million transistors on their chips, we think it's forgivable for us to be proud of the vastly greater number on these SRAMs.

They're among the most difficult of all semiconductors to produce, and only a few manufacturers can make them.

We offer the 1-meg slow SRAM in several speeds, several power ratings, and several package types. We're currently developing the part in the revolutionary TSOP packaging.

All those things—plus forthcoming high-density fast and ultra-fast SRAMs, plus additional slow parts for main store and buffer applications—give you an

idea of Samsung's commitment to this demanding technology.

Besides the 1-meg slow SRAM, in the main-store and buffer areas we'll sample next year a 1-meg fast static RAM family, and go into production with a 1-meg pseudo-SRAM.

THE SAMSUNG 1-MEG SRAM

Speeds: 70°, 85, 100, 120 ns.

Package types: TSOP°, DIP, SOIC.

Power ratings: Low-low°, low, standard.

Organization: 128K x 8.

For information on the 1-meg SRAM or our 1-meg pseudo-static, write today to SRAM Marketing, Samsung Semiconductor, 3725 No. First St., San Jose, CA 95134. Or call 1-800-669-5400, or 408-954-7229.

After all, the best way to contemplate the 6.6 million transistors on the part, is to get your hands on one.



° Available 1991. © Samsung Semiconductor, Inc., 1990.

CIRCLE NO. 5

Signetics. Delivering world-class

ABT245/MB2245

$T_{PD} = 4.5ns$

$I_{OL} = 64mA$

$I_{OZ} = 50\mu A$

© 1990 NAPC

Philips Components

BiCMOS when you need it—now.

ABT, THE FASTEST, LOWEST POWER BUS INTERFACE LOGIC, IS SHIPPING TODAY.

To meet today's design demands, you need bus interface logic with the highest possible speeds and the lowest possible power dissipation. You also need a full 64mA of drive and low switching noise.

That's exactly what you get from our ABT family. The family of advanced BiCMOS bus interface logic products that are shipping today.

Our ABT products are the world's fastest TTL-compatible bus interface logic available. Each provides the low power dissipation and low noise of our QUBiC advanced BiCMOS. You also get simultaneous switching of all the 64mA outputs and standby power of essentially zero. Plus, we offer a commercial temperature range of -40°C to $+85^{\circ}\text{C}$.

Best of all, we're currently delivering over 15 ABT products. With more products being released every day. We're also pioneering Extended Data Sheets, which give you *all* the specifications you need.

And, for your applications demanding minimum board space, we're now offering the world's first multiple-byte BiCMOS interface products, our 16- to 20-bit-wide MB2000 MULTIBYTE™ family.

For more information, or for our Advanced BiCMOS Bus Interface Logic Products Brochure, contact us today: 800-227-1817, ext. 724D.

MULTIBYTE is a trademark of NAPC.

Signetics

EXTENDING THE DIMENSIONS OF PERFORMANCE



SIEMENS

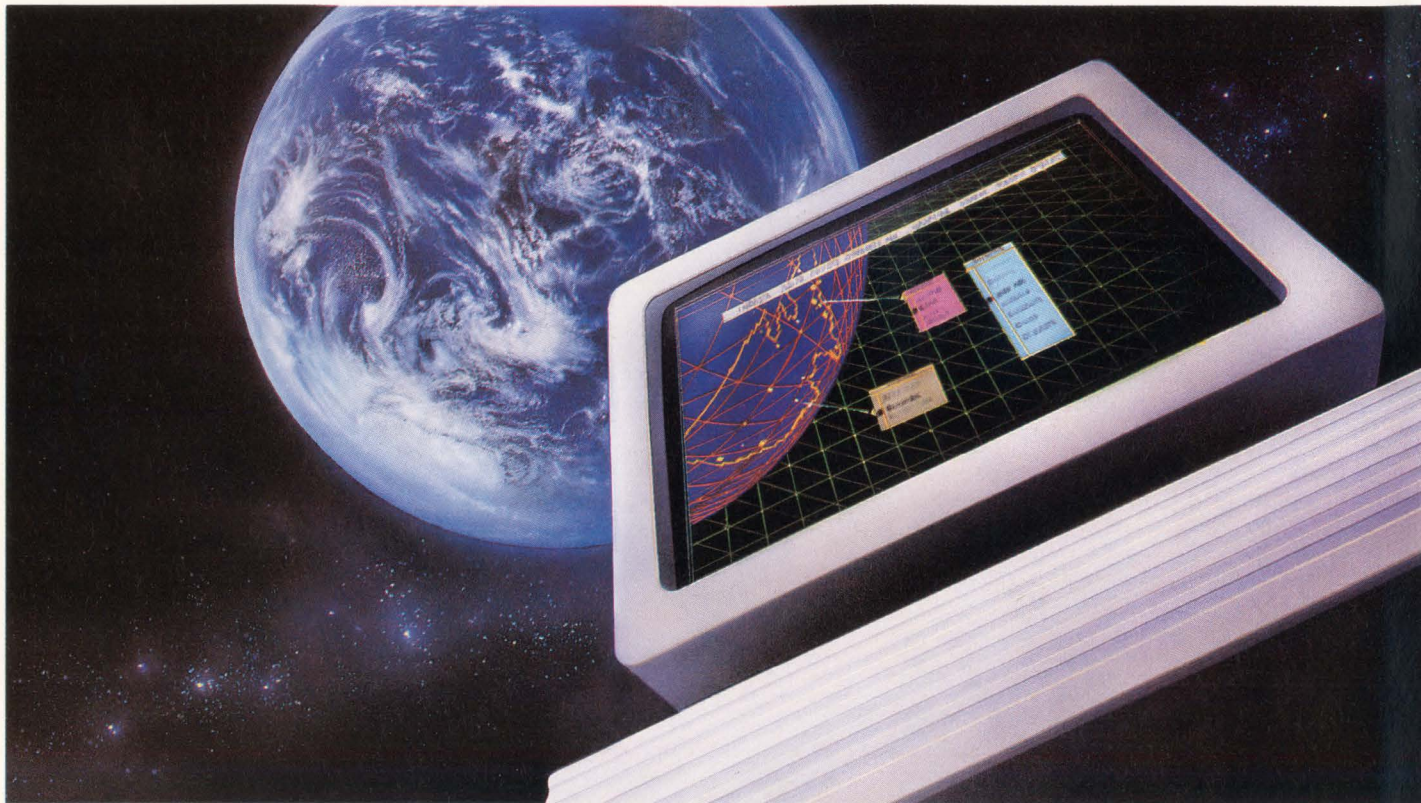

Universal Intelligence.

Siemens is a worldwide supplier of systems solutions for the workstation and embedded control markets.

Siemens is continuing to demonstrate the innovation which has made us the universal choice in advanced IC technology.

Siemens offers industry-standard MIPS 32-bit RISC microprocessors, which are ideal for workstations, file servers and multiprocessor systems, as well as high-performance embedded applications. Of the five certified CMOS MIPS semiconductor suppliers, we're the sole European source, to offer you solutions worldwide.

We're also the only European DRAM

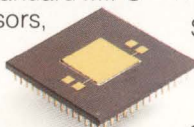

High-performance RISC 32-bit microprocessors.



Reliable 1-Mb and 4-Mb DRAMs.

manufacturer, providing high-quality 1-Mb and 4-Mb DRAMs. In fact, we're one of the world's leading suppliers, with DRAMs available worldwide, in volumes which have doubled since 1989. And we are continuing to advance this technology with our 16-Mb and 64-Mb DRAM programs.

Siemens CMOS ASIC technology features both Sea-of-Gates and standard-cell product families.

Our 1.5, 1.0 and sub-micron technologies are compatible with Toshiba even at the GDS2 database level, for true alternate sourcing worldwide. And they come with European content and U.S. design support, as well as

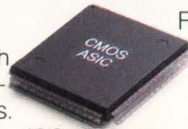

ASIC solutions in both Sea-of-Gates and standard-cell.

the best service in the industry.

Plus, we offer the most comprehensive communication IC family in the world, to support the networking requirements of high-performance workstations.

If you're manufacturing or marketing worldwide, find out what makes our embedded control and workstation systems solutions the universal favorites.

For details, call **(800) 456-9229**, or write:

Siemens Components, Inc.
2191 Laurelwood Road
Santa Clara, CA 95054-1514

Ask for literature package M20A 001.

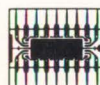

**Siemens
World Wise, Market Smart.**

NEWS BREAKS

EDITED BY SUSAN ROSE

VMEBUS 68040-BASED BOARDS INTRODUCED AT BUSCON WEST

Several board vendors introduced VMEbus products based on the 68040 μ P at Buscon West in Santa Clara, CA, Jan 29 to 31. Force Computers and Radstone Technology introduced 68040-based boards with 32-bit VMEbus implementations. Radstone's Model 68-42 includes a 68020 auxiliary processor that controls onboard I/O such as SCSI, Ethernet, and RS-232C. The board also includes as much as 2M bytes of dual-ported zero-wait-state static RAM. The 68-42 can accommodate 40-MHz μ Ps. A 25-MHz base configuration costs \$6495. Base configurations of the Force CPU-40 with no dynamic RAM start at \$3990. The board can hold as much as 16M bytes of dynamic RAM, and it includes the company's Eagle 32-bit daughter-board interface. Synergy Microsystems introduced a VME64 68040-based board, the SV430 (for additional information, see page 128). Force Computers, Campbell, CA, (408) 370-6300, FAX (408) 374-1146. Radstone Technology, Montvale, NJ, (201) 391-2700, FAX (201) 391-2899. Synergy Microsystems, Encinitas, CA, (619) 753-2191, FAX (619) 753-0903. —Maury Wright

OCTAL, 8-BIT DACs REPLACE EIGHT POTENTIOMETERS

You can replace as many as eight potentiometers with each DAC-8840 and DAC-8841 octal, 8-bit, multiplying DAC from Analog Devices. Serial commands set each converter's gain, and the devices handle analog signals from dc to 1 MHz. The DAC-8840 runs on $\pm 5V$ and has 4-quadrant multiplication. The DAC-8841 runs on 5V and performs 2-quadrant multiplication. The ICs cost \$9.95 (100). Analog Devices, Norwood, MA, (617) 329-4700, FAX (617) 326-8703, TLX 924491. —Steven H Leibson

CAE TOOL OPENS WINDOWS ON PLD DESIGN

Altera Corp's Max + Plus II PLD design tool runs under Microsoft Windows 3.0. The Windows-based version of the company's Max PLD family, like the DOS version, has hierarchical schematic capture, hardware-description-language logic entry, logic synthesis, and timing simulation. The tool also handles the company's EP Classic and 7000 series PLDs and multipart partitioning and waveform-logic-entry capabilities. It also has an integrated EDIF interface to other CAE tools.

The tool allows multiple windows on the same file, letting you simultaneously view your entire design and zoom in on a small section. You can also rapidly switch between design entry, compilation, and timing simulation. The memory management provided by Windows 3.0 lets the new version handle larger designs and simulate faster than the DOS version. The tool also has a degree of hardware independence—the Windows graphics interface handles the need for drivers for your graphics card. The design tool costs \$9995 and will be available in April. Altera Corp, San Jose, CA, (408) 984-2800, FAX (408) 954-0348. —Richard A Quinnell

RF SIMULATOR PARTITIONS LINEAR AND NONLINEAR CIRCUITS

A harmonic-balance algorithm within jOmega from EEsof lets you simulate and optimize RF circuits operating at 30 to 3000 MHz. The algorithm allocates and manipulates your design between the software's linear and nonlinear simulators. The \$24,500 package also includes a schematic editor; a statistical-analysis capability that lets you balance performance, cost, and yield constraints; and 50 RF package-

NEWS BREAKS

level circuit and standard bipolar junction transistor models. A \$5000 optional floor planner enhances your everyday pc-board software by working with the simulator to help you account for layout effects during simulation. EEsof, Westlake Village, CA, (818) 991-7530, FAX (818) 991-7109.—Michael C Markowitz

DRIVER-TRANSLATOR HAS 3.5-NSEC PROPAGATION DELAY

The 10G014 driver-translator from Gigabit Logic accepts four pairs of ECL inputs and multiplexes them to four differential TTL outputs. The propagation time is typically 3.5 nsec. The primary application for the chip is a dynamic RAM and static RAM driver for memories requiring multiplexed row and column addresses. The open-drain TTL outputs have 90-mA drive capability for large bused-memory architectures with high capacitive loads. The chip requires $\pm 5V$ supplies and dissipates 500 mW typically. For compatibility with other ECL products, the negative supply also operates off -4.5 or $-5.2V$. The \$13.90 (10,000) chip is available in a 44-pin plastic leaded chip carrier or a 40-pin leaded or leadless ceramic chip carrier. Gigabit Logic, Newbury Park, CA, (805) 498-9664, FAX (805) 499-2751.—Doug Conner

36-BIT-WIDE FIFO MEMORY CLOCKS AT 40 MHz

The LH5420 FIFO memory from Sharp provides two banks of 256×36 -bit memory for bidirectional operation. The highest speed device clocks at 40 MHz and features a 15-nsec access time. You can also use the device as a data funnel because one of its two I/O ports will operate as a 9- or 18-bit port in addition to the full word width. Each I/O port has full, half-full, empty, and programmable almost-full and almost-empty flags. A bypass mode and two mailbox registers allow you to pass commands and status information through the device without sending them through the FIFO-memory section. Sample pricing is \$130. Sharp Electronics Corp, Mahwah, NJ, (201) 529-8757, TLX 426903.—Steven H Leibson

CONFORMANCE SOFTWARE TESTS AT THE RIGHT PRICE

With a piece of software, you can test math coprocessors for 80386-based personal computers against the IEEE-754-1990 standard test suite for 80-bit computer arithmetic. Coprocessors that fail to meet the specification cause insidious errors because the computer does not give any indication that the data it is generating are incorrect. The coprocessor conformance software that catches these errors was developed at the University of California, Berkeley. Cyrix Corp is distributing it free of charge (limit one per customer). Ask for the IEEE test suite. Cyrix Corp, Richardson, TX, (214) 234-8387, FAX (214) 234-8397.—Michael C Markowitz

VXIBUS DIGITAL WORD GENERATOR OPERATES AT 50 MHz

The IT4620 digital word generator from Interface Technology provides 16 channels when operating at 50 MHz or 32 channels when operating at 25 MHz. If you need more channels you can add IT46E20 expansion cards, each providing an additional 32 channels at 50 MHz or 64 channels at 25 MHz. Memory depth is 16k words for 50-MHz operation or 8k words for 25-MHz operation. You can generate complex patterns with these word generators by organizing the data in nested-loop sequences. A timing-simulator mode lets you independently control the time duration of each word. The IT4620 costs \$4950, and the IT46E20 costs \$1950. Orders will be accepted in March; initial deliveries take eight weeks. Interface Technology, Glendora, CA, (818) 914-2741, FAX (818) 335-8346.—Doug Conner

Thanks to us the government knows this is not an enemy sub.

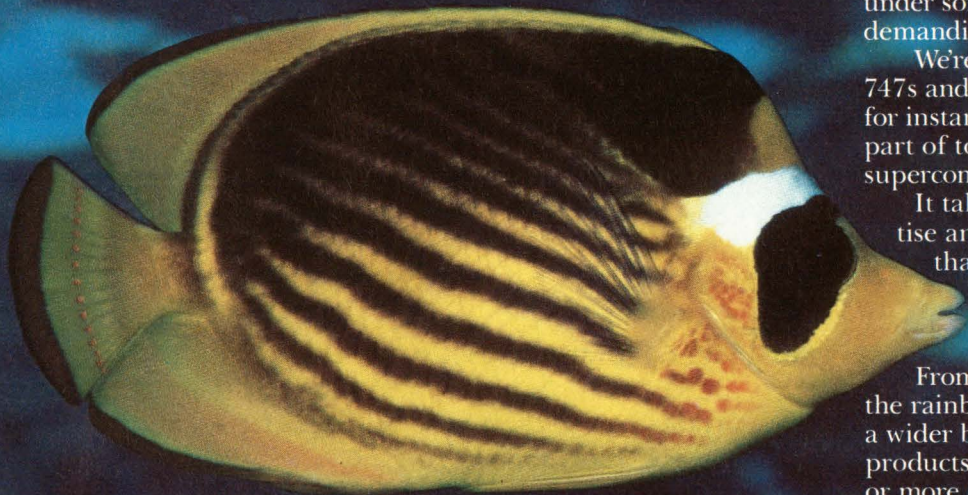

Here in the lonely depths off America's coast, sophisticated listening devices assure our defense forces a passing butterfly fish is not an enemy intruder.

On board each device are ITT Cannon microminiature connectors.

In fact, you'll find Cannon microminiature connectors performing in some of the nation's most critical projects, under some of the world's most demanding conditions.

We're in pacemakers, 747s and Minuteman missiles, for instance. And we're part of today's advanced supercomputers.

It takes the design expertise and innovative solutions that ITT Cannon offers to meet these types of challenges. And yours.

From under the sea to over the rainbow, no one provides a wider breadth of connector products at competitive prices or more engineering know-how. Maybe that's why we've been the leading force in microminiature technology for over 25 years running.

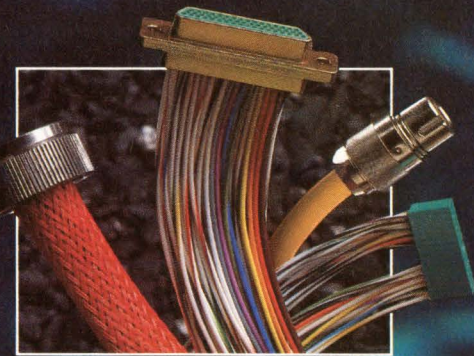

So why fish around for a connector company when you can enjoy the depth and strength of the leader: ITT Cannon.

For application assistance or to request our new brochure, call us at (714) 557-4700 today. Or write ITT Cannon, 666 E. Dyer Rd., P.O. Box 929, Santa Ana, CA 92702-0929 FAX: (714) 754-2142.

ITT Cannon
AN ITT EMC WORLDWIDE COMPANY
Discover our strengths.

CIRCLE NO. 7

NEWS BREAKS

VOLTAGE REGULATOR HAS 1V DROPOUT VOLTAGE, AND MORE

The LT1185 from Linear Technology Corp is a low-dropout and negative voltage regulator with a user-adjustable current limit. The regulator has a guaranteed dropout voltage of 1V at 3A. At lower currents, the dropout voltage is lower. Most older 3A regulators feature a fixed 5A current limit. This current level permits overloads, which can potentially damage the input components, such as transformers and diodes. Being able to set the current limit precisely at a value just above the normal operating range reduces stress and eases design requirements of the input power circuitry that goes with the regulator. If you don't set a limit, the device's internal limit sets it for you. The output voltage range of the regulator is -2.5 to -25 V. If the input voltage is floating and you ground its output, the device operates as a positive voltage regulator. The device comes in a 5-lead TO-3 metal can that operates over -55 to 150°C , and in a 5-lead TO-220 package that operates over 0 to 125°C . The TO-220 molded plastic package costs \$3.70 (100). Linear Technology Corp, Milpitas, CA, (408) 432-1900, FAX (408) 434-0507.—Anne Watson Swager

TEST GENERATOR MODULES AND RF PRODUCTS FOR VXIBUS

Racal-Dana's VXIbus products include digital test modules, RF prototyping modules, and RF enclosures. The Model 6451 digital test module supports 48 bidirectional TTL-level channels at 20 MHz. You can synchronize multiple modules for a total of 576 channels. You can also configure the channels as 48 separate stimulus channels and 48 response channels. Channel-to-channel skew is ± 5 nsec within a module and ± 7.5 nsec across multiple modules. The C-size module is \$14,995; delivery is 16 weeks.

For RF applications, the company manufactures the 1261E VXIbus chassis. The double-skin chassis provides typical shielding effectiveness of 100 dB. To reduce noise sources further, the chassis uses low-noise and low-ripple linear supplies. The chassis costs \$11,995 and has a 16-week delivery. Also for RF applications is the Model 7065 prototyping module. The module includes message-based VXIbus interface circuitry, provides efficient heat dissipation, and maintains an EMI-shielded environment for the prototyping area. The chassis are available in single- and double-width C-size modules and prices start at \$2495. Delivery is 16 weeks. Racal-Dana, Irvine, CA, (800) 722-3262, FAX (714) 859-2505.—Doug Conner

CONTROL IEEE-488 DEVICES WITH C++

The addition of Turbo C++ routines to the module library of the \$495 HP 82335A IEEE-488 interface card expands the number of programming languages supported by the product to 12. Other language modules support Basic, Pascal, and C compilers and interpreters from several vendors. The card also includes printer and plotter drivers for serial- and parallel-interface peripherals. Hewlett-Packard Co, Palo Alto, CA, phone or FAX the local office.—Steven H Leibson

CONTRACT TEST ON A BUDGET

Integrated Measurement Systems has formed an engineering group to design custom test systems for low-volume-production test applications. The engineering group will focus on testing complex ICs and pc boards. These systems will cost much less than production test equipment. The group will specialize in applications that have stringent mixed analog-digital test requirements, including automotive, medical,



Chips, lead frames, carriers and molding compound can't lift you out of the crowd.

Dale® is the partner you need to convert surface mounting from concept to reality. We can save you time by providing a wide range of functions from one proven source.

This includes the industry's most versatile choice of surface mounted thick and thin film chip resistors and resistor networks. Plus wirewound resistors, chip potentiometers, thermistors, inductors, transformers and oscillators.

Partnering with Dale gives you broad compatibility with automatic placement equipment and standard soldering methods, plus ship-to-

Dale® Can.

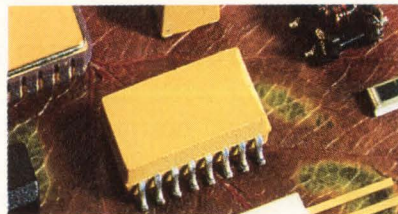

stock capability assured by strong emphasis on statistical process control.

For complete information, call:
Thick Film Resistor Networks,
Thermistors: 915-592-3253; **Thin**

Film Networks, Thick/Thin Film
Chips: 402-371-0080; **Wirewound**
Resistors: 402-563-6506; **Chip**
Potentiometers, Oscillators:
602-967-7874; **Inductors,**
Transformers: 605-665-9301.

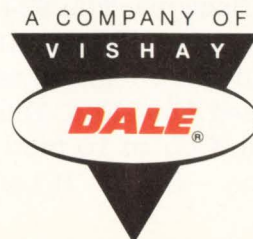

NEWS BREAKS

and telecommunications. It will provide design and test engineers with a range of services, including turnkey product development for a variety of test applications, third-party hardware/software integration services, and test consulting. Through a strategic-partnership program, the company can team up with leading test equipment manufacturers to develop fully integrated, off-the-shelf test stations. Integrated Measurement Systems Inc, Beaverton, OR, (503) 626-7117, FAX (503) 644-6969.—Anne Watson Swager

NEW DIVISION PROVIDES BOARD DESIGN AND MANUFACTURING

A new division of S-MOS Systems offers board-level design, manufacturing, test, and assembly. The company will produce custom boards and modules for laptop, portable, and notebook computers, and small communication products such as cellular phones and pagers. The company is the only US vendor that can offer surface mounting and pin-through holes in conjunction with chip-on-board, tape-automated bonding (TAB) and chip-on flex capabilities. Multilayer boards can have eight layers. You can incorporate ICs having 0.5-mm-pin pitch on a board which allows three traces between pins. The facility is also developing the capability to handle ICs with 0.25- to 0.30-mm-pin pitch, allowing three to four traces between pins.

TAB packages can accommodate 256-pin dies and will be able to handle 500-pin dies in the near future. In addition, the boards can accommodate 0.5-mm-pin pitch quad flatpacks with 256 pins. The company will accept volumes as low as 5000 units/year for large, complex designs and as many as 500,000 units/year for less integrated designs. S-MOS, Raleigh, NC, (919) 878-1120, FAX (919) 878-1125.

—John Gallant

5½-DIGIT ADC HAS 10-μV RESOLUTION

Harris Semiconductor's HI-7159 5½ digit ADC integrates ADCs with 10 μV—1 count in 200,000—resolution. The converter's dual-slope architecture provides this resolution with no other critical external components. The device uses ratiometric measurements for its 5½-digit precision, and autozeroing to eliminate zero drift over temperature. The converter's linearity has a maximum of ±3 counts and is typically ±1 count. The conversion rate for 5½-digit resolution is 15 conversions/sec. Speed increases to 60 conversions/sec when you switch the device to a 4½-digit, uncompensated mode. The converter has three interface options—two serial and one parallel. You can program the serial modes for one of four common baud rates. Samples of 28-pin DIPs are available now. Production quantities will be available by the end of March for \$20 (100). Harris Semiconductor, Melbourne, FL, (800) 442-7747, FAX (407) 724-3111.—Anne Watson Swager

DSO AND FREQUENCY COUNTER JOIN VXIBUS FAMILY

Instrument-system designers working with the VXIbus can add two more choices to their rosters: the HP E1420A universal counter and the HP E1426A digitizing oscilloscope. The \$3450 counter provides two 200-MHz input channels and can take more than 40 measurements/sec. The \$6960 digitizing oscilloscope has four 500-MHz input channels, takes 8-bit measurements at 20M samples/sec, and occupies two C-sized bus slots. You can use a measurement-averaging feature to boost the scope's resolution to 10 bits. Hewlett-Packard Co, Palo Alto, CA, phone or FAX the local office.—Steven H Leibson

Actual size

Actual output

20 WATTS

Now AC to DC

Actually meets

- MIL-STD-2000
- MIL-STD-810C
- MIL-S-901C
- MIL-STD-461C
- MIL-STD-704D
- NAVMAT GUIDELINES

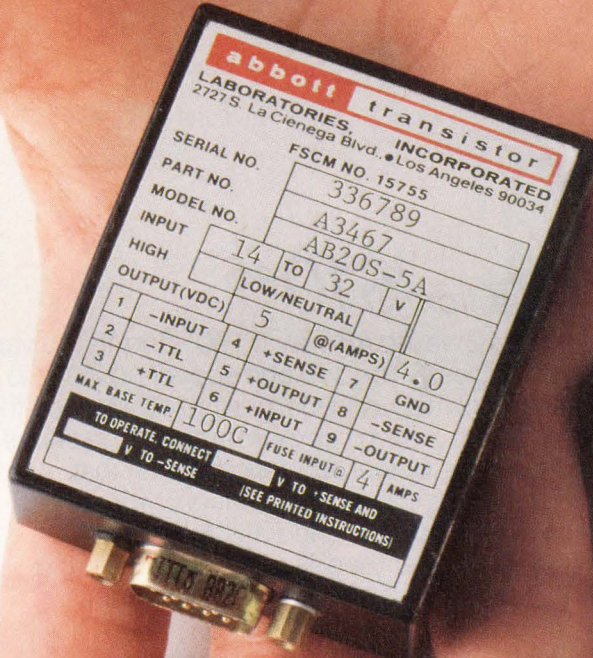

Mil/Pac™ high-density military power supplies.

Now you can order Abbott's full mil-qualified compact power supplies in both DC and AC input models.

Mil/Pacs come in 20W, 35W and 50W configurations, with single (5, 12, 15, 24, or 28V) or dual (±12V; ±15V) outputs.

DC-to-DC models accept input from 14V to 32V. AC-to-DC models accept 103.4 to 126.5V rms, 47-440 Hz single phase.

All Mil/Pacs operate at temperature extremes from

-55°C to +100°C. All are designed with a field-proven topology that has been verified by rigorous environmental stress screening.

Mil/Pacs are available with or without MIL-STD-2000. Either way, the specs are worth reading. Just write us at 2727 South La Cienega Bl., Los Angeles, CA 90034. Or call (213) 936-8185.

abbott
WHEN RELIABILITY IS IMPERATIVE.™

THE WORLD'S LARGEST SELECTION OF **POWER SPLITTERS/ COMBINERS**

2 KHz to 8 GHz from **\$10⁴⁵**

With over 300 models, from 2-way to 48-way, 0°, 90° and 180°, a variety of pin and connector packages, 50 and 75 ohm, covering 2KHz to 8000MHz, Mini-Circuits offers the world's largest selection of off-the-shelf power splitter/combiners. So why compromise your systems design when you can select the power splitter/combiner that closely matches your specific package and frequency band requirements at lowest cost and with immediate delivery.

And we will handle your "special" needs, such as wider bandwidth, higher isolation, intermixed connectors, etc. courteously with rapid turnaround time.

Of course, all units come with our one-year guarantee.

For detailed specs and performance data, refer to the *MicroWaves Product Directory*, *EEM* or *Mini-Circuits RF/IF Signal Processing Handbook, Vol. II*. Or contact us for our free 68-page *RF/IF Signal Processing Guide*.

finding new ways ...
setting higher standards

Mini-Circuits

A Division of Scientific Components Corporation
P.O. Box 350166, Brooklyn, New York 11235-0003 (718) 934-4500
Fax (718) 332-4661 Domestic and International Telexes: 6852844 or 620156
WE ACCEPT AMERICAN EXPRESS

CIRCLE NO. 10

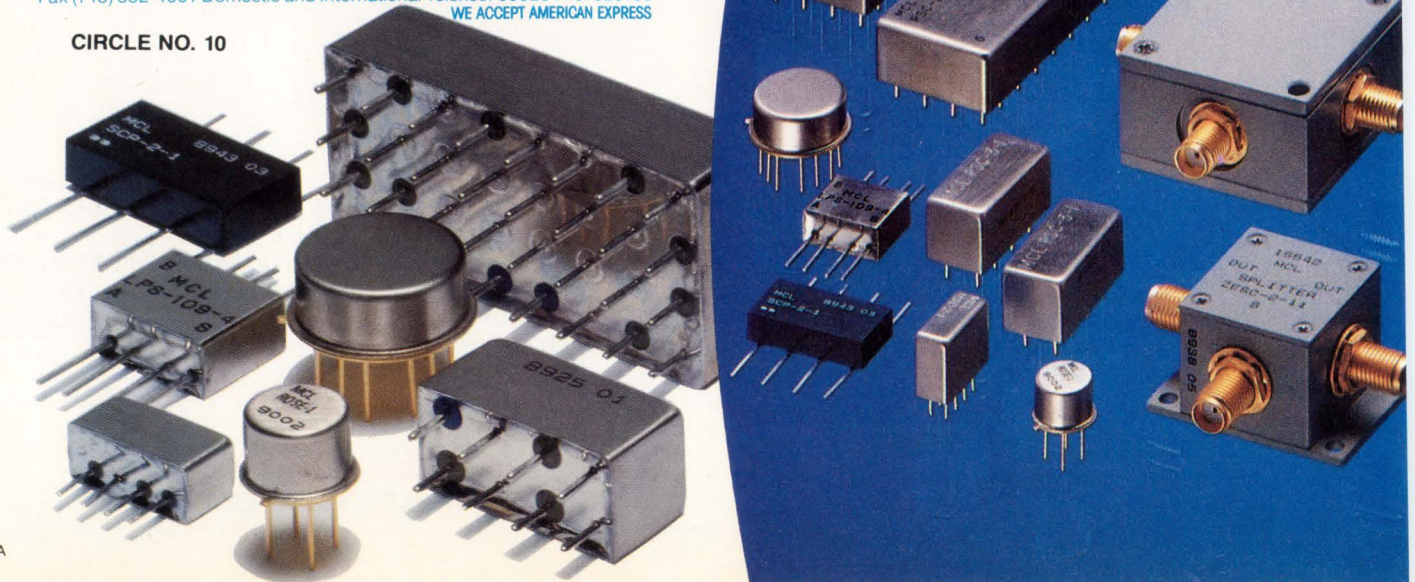

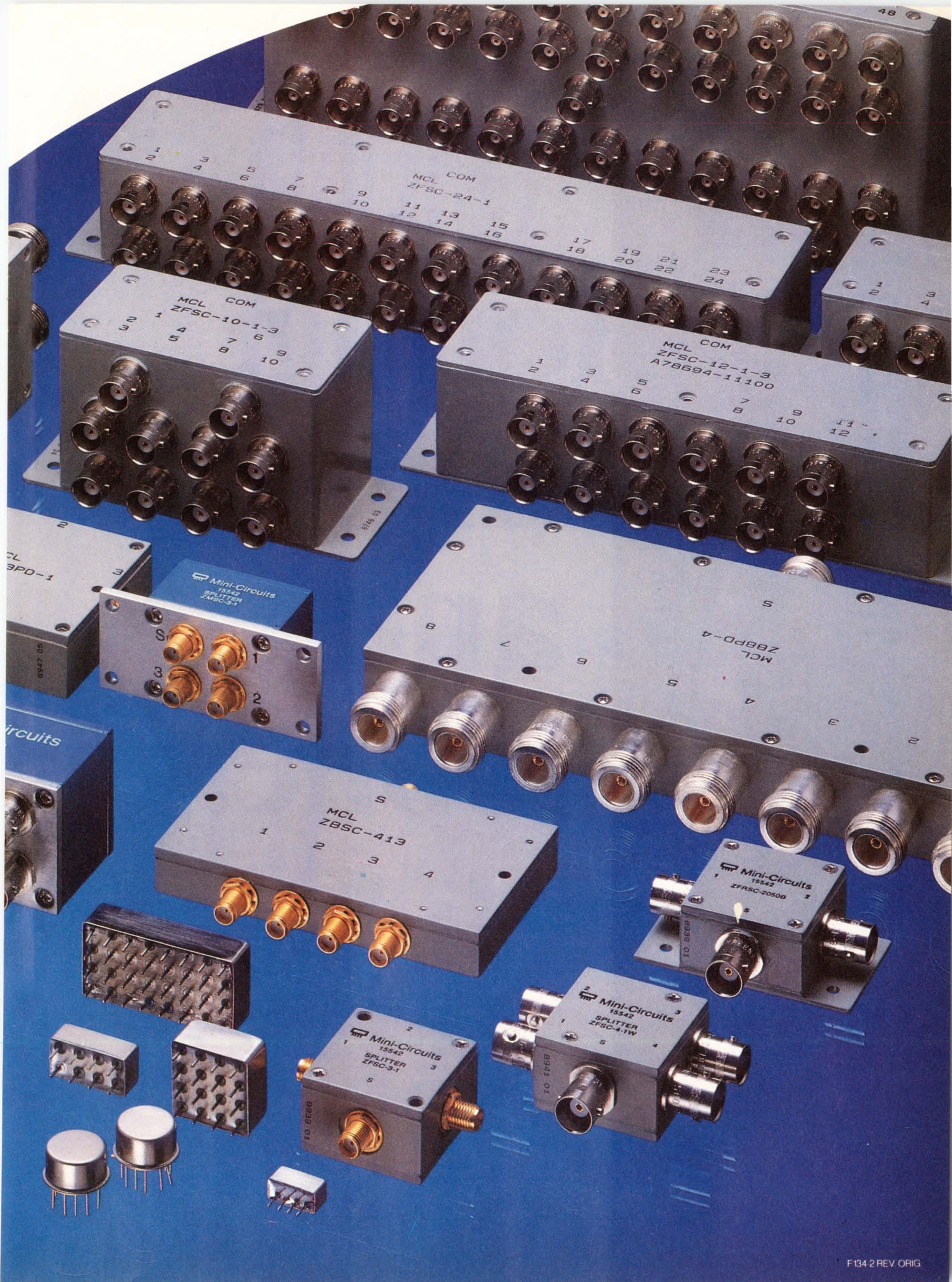

MCL COM
ZFSC-24-1

MCL COM
ZFSC-10-1-3

MCL COM
ZFSC-12-1-3
A78694-11100

MCL
ZB8PD-4

MCL
ZBSC-413

Mini-Circuits
15542
ZFSC-2050B

Mini-Circuits
15542
SPLITTER
ZFSC-4-1W

Mini-Circuits
15542
SPLITTER
ZFSC-3-1

**Young,
single,
and
mobile.**

Our new line of integrated telecommunication devices put more power-lean performance on a single, highly portable chip.

There's no doubt about it; the telecommunications market is on the move. And today's equipment is smaller, lighter, and more powerful than ever before.

But what about the next generation?

That's where Fujitsu Microelectronics steps in. Because our new family of integrated high-speed prescalers, low-power PLLs, and VCOs can fit even more advanced technology into even smaller spaces.

We put all the pieces together.

Our new MB1500 family of BiCMOS prescaler/PLL synthesizers offers the world's lowest power, highest operating frequency, single-chip device available today—capable of operating frequencies up to 2.5 GHz. Or choose the MB551, the industry's first single-chip prescaler with VCO. In addition, Fujitsu offers

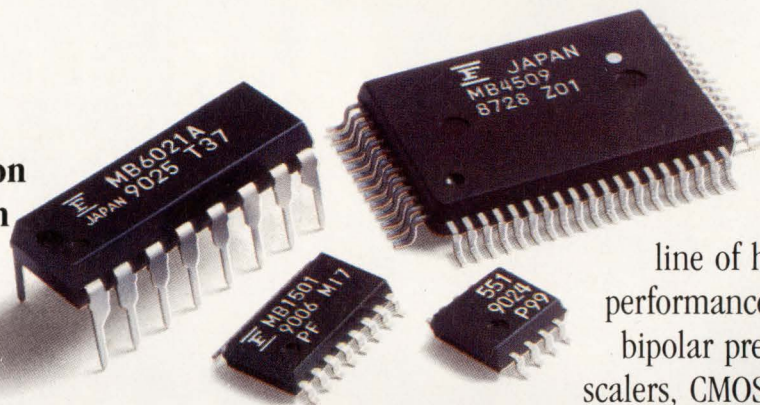

a full line of high performance bipolar pre-scalers, CMOS

PLLs, cellular mobile radio ICs, filters, CODECs, and CMOS telephone ICs to meet your needs.

Pick up an application.

It all adds up. Fujitsu's single-chip solutions are the superior choice for most of your telecommunications applications including cellular and mobile phones and radios, telemetry and test equipment, and security systems. And best of all, Fujitsu will work with you every step of the way to maximize the power and efficiency of your designs.

Now, pick up the phone.

When it comes to telecommunications, you *can* have it all. Just choose the new generation of single, integrated, and mobile devices from Fujitsu. For more information, call us from your car or office at 1-800-642-7616.



FUJITSU MICROELECTRONICS, INC.

Integrated Circuits Division

3545 North First Street, San Jose, CA 95134-1804. 1-800/642-7616.

Every step of the way.SM

© 1990, Fujitsu Microelectronics, Inc.
Every step of the way is a service mark of Fujitsu Microelectronics, Inc.

Does it meet Six Sigma

Can it do true

mixed-mode

testing?

What tools have been developed?

Before the A500 started testing Motorola's mixed-



"Motorola has adopted a Six Sigma initiative which focuses attention on approaching zero-defect performance in everything we do, including our test systems. Our purchase of

IMAGE is a trademark of Teradyne, Inc.

the Teradyne A500 test system supports our Six Sigma initiative and our competitive leadership challenge."

Director of Marketing

Motorola knows you can't have a Six Sigma process unless you can test to Six Sigma standards. That's why Motorola's MOS Digital-Analog Integrated Circuits Division chose the Teradyne A500 Analog VLSI Test System. Because, in addition to proving the A500 could handle the

Motorola and (AA) are registered trademarks of Motorola, Inc.

complex technical requirements of Motorola's advanced ISDN interfaces, we also demonstrated that we could perform to Motorola's stringent quality levels.

"Can it do scan testing? Digitize high-frequency waveforms? Do true mixed-mode testing? Does it have a flexible architecture? Can you give us the support for a Six Sigma process? Applications expertise? Complete documentation? The right tools? In each case, Teradyne answered yes."

Manager, Advanced Test Technology

standards?



CAN IT DIGITIZE HIGH-FREQUENCY WAVEFORM

can it do scan testing?

signal technology, Teradyne had to pass a few tests.

With the A500, Motorola had the ability to digitize waveforms at 20 MHz, plus the high pin count necessary to guarantee that their ISDN U-Interface worked the way it was supposed to.

Best of all, the A500's full tester simulation and powerful IMAGE™ software provided the design flexibility and rapid debugging Motorola needed to deliver defect-free parts on time.

"The A500 gave us the resources we needed, in one place, to be able to have a functioning test program very quickly – at least two to three times faster than any other test system. This type of support is just what we need to get our complex circuits, such as the U-Interface transceiver, to the marketplace ahead of the competition."

Operations Manager

To Motorola, delivering Six Sigma quality is not just a promise. It's a way of doing business. And it's a test that must be passed by suppliers as well.

To see how our A500 family of test systems can help you deliver quality, call Beth Sulak at (617) 482-2700, ext. 2746.

Or call your nearest Teradyne sales office, or write: Teradyne, Inc., 321 Harrison Ave., Boston, MA 02118.

TERADYNE

Our new ML2261 8-bit A/D converter takes speed and accuracy to an entirely new level: 670ns.

Latch onto Micro Linear's new ML2261. Without question, the fastest, most accurate microprocessor-compatible 8-bit A/D converter on the market. With performance features that'll leave most microprocessors in a no-wait state.

By utilizing half-flash techniques, the ML2261 achieves A/D conversion times of 670ns over temperature and V_{CC} . It quickly converts an analog 0V to 5V sine wave at 500 kHz to its digital representation with 48 dB signal-to-noise ratio. Digital error correction is used to achieve a total unadjusted error of better than $\pm 1/4$ LSB. (Total unadjusted error includes the sum of linearity, zero scale and full scale errors).

It's also easier to use, because the ML2261's differential architecture provides superior power supply rejection. The analog input is 0V to 5V with a 5V power supply. And because

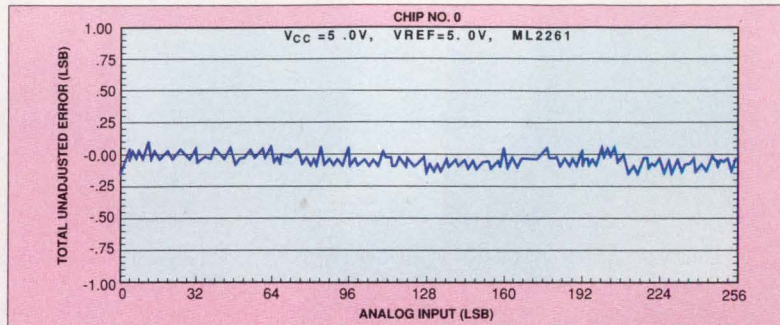

Built-in digital error correction delivers true 8-bit accuracy, with typical unadjusted error of less than $\pm 1/4$ LSB.

inputs can withstand at least 25 mA, you can achieve better latch-up immunity on analog inputs. The digital interface is also designed to keep up with the fastest microprocessors and appears as a memory location or I/O port to the microprocessor. In addition, no external clock is required and power dissipation is a mere 75 mW. All parameters are guaranteed over the supply tolerance and temperature range.

Combined, the ML2261 gives you the fastest, most accu-

rate, easiest to use 8-bit converter for a wide range of applications including disk drives, medical instrumentation and signal processing. With a price/performance ratio that's significantly lower than comparable converters.

Devices are now available in standard 20-pin DIP or surface-mount PCC packages, with 100-unit prices beginning under \$9.00.

For more information.

To find out more about how you can quickly convert your new product design to the ML2261, just call (408) 433-5200. Or write to: Micro Linear, Dept. TFA, 2092 Concourse Drive, San Jose, CA 95131. We'll send you all the specs. In a flash.

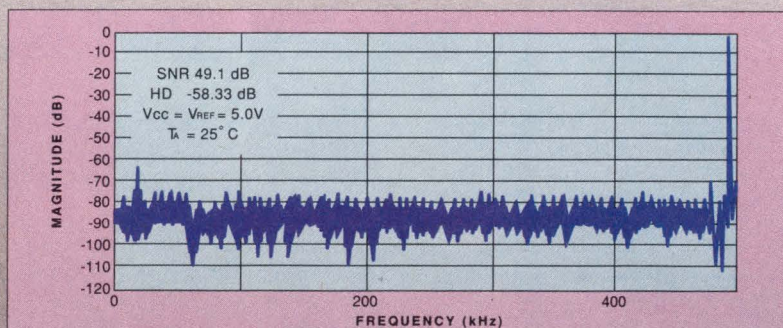

The ML2261 maintains ideal signal-to-noise ratios independent of increasing analog input frequencies to 500kHz.

 **Micro Linear**

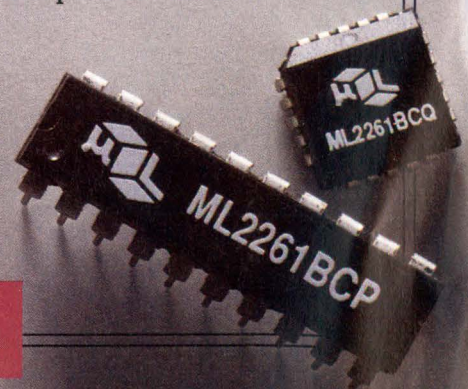

SIGNALS & NOISE

How to obtain better performance

In Mark Stitt's article, "Boost instrument-amp CMR with common-mode-driven supplies" (EDN, October 25, 1990, pg 183), he illustrates the improvement possible by means of proper analog design, using composite amplifiers vs the limited specifications of modules.

Although Mark mentions the requirement that IC₄-IC₇ in Fig 2 have high speed to achieve the best results, capacitors C₁-C₂ cause a roll-off in the response of the $\pm 5V$ supply at 300 Hz. This action is also evident in Fig 4, where the CMR of the enhanced version is relatively flat at lower frequencies, has dropped -3 dB at 300 Hz, and begins rolling off at an initial -20 dB per decade. It would appear that even better performance could be obtained if the bandwidth of IC₆ and IC₇ were increased so as not to limit the bandwidth of IC₄ and IC₅.

Richard L Panosh

President

Vista Medical and Electronic Engineering

Lisle, IL

(The author's reply: In reply to Richard Panosh's letter, it is perhaps an unfortunate coincidence that the CMR of the boosted IA begins to roll off at about the same frequency that would be predicted by the RC time constant of C₁, R₇ and C₂, R₆ in the feedback of subregulator amplifiers, IC₆ and IC₇. Actually, the subregulator amplifiers are operating as unit-gain followers with feedback resistors to establish a $\pm 5V$ offset. The 0.01- μF capacitors, C₁ and C₂ in parallel with the 50 k Ω feedback resistors, are an arbitrary but adequate value to prevent gain peaking. Without C₁ and C₂, the feedback resistors would react with op-amp input capacitance and current-source output capacitance, causing excessive gain peaking. If anything, a larger value capacitor would improve high-frequency performance.

frequency performance. The serious overdesigner might even be tempted to parallel the 0.01- μF ceramic capacitor with a 1- μF tantalum capacitor. Care must be exercised, however, to avoid excessive stray capacitance.

Richard is correct—faster is better for IC₆ and IC₇.)

Is garbage collection on Ada possible?

As an enthusiastic user of Ada and a consultant on Ada's use in real-time environments, I read Ben Brosgol's article on real-time Ada with great interest. Although Ada typically has a longer learning curve than more traditional approaches to real-time design, the use of Ada can pay off handsomely in more functional and reliable systems—especially in systems with a large amount of software.

I'm concerned, however, that Ben continues to perpetuate a view that was proven wrong 14 years ago. He contends (EDN, October 1, 1990, pg 107) that "automatic reclamation schemes suffer from unbounded execution times, which could cause your program to miss a critical deadline." I wrote a paper entitled "List Processing in Real Time on a Serial Computer" (Communications of the Association of Computing Machinery, April, 1978), which shows that it's possible to perform automatic garbage collection (reclamation) in such a way that the amount of time to allocate an object can be bounded by a time linearly proportional to the object's size, and that the constant of proportionality can be quite small. Because this scheme performs all of its work during allocation time, no additional time is required to reclaim storage outside of these allocation calls. Because the object must be initialized, and this initialization takes time at least proportional to the object's size, there's not much room for improvement in this algorithm.

This real-time garbage collector algorithm has received extensive testing as a result of its use in at least three commercial Lisp Machine products. Some file servers based on Lisp Machine technology have run 24 hours a day for months and years without garbage collection delays. Others have proposed substantial extensions to my work, including "generational garbage collection," which is currently the state of the art in garbage collection for Lisp, Smalltalk, and a number of other languages. Although not strictly real time, generational garbage collection is mostly incremental and is particularly well-suited to applications involving user interactions.

Garbage collection has therefore received a bad rap from those in the real-time and Ada communities. This obsolete view has severely hampered the widespread use of newer, highly productive software techniques, including object-oriented programming.

Henry G Baker, PhD

*Nimble Computer Corp
Encino, CA*

(The author's reply: I want to thank Henry Baker for calling attention to his algorithm for real-time garbage collection, because its bounded-time performance and its avoidance of heap fragmentation offer attractive benefits. His letter raises interesting questions: Can automatic garbage collection be implemented for Ada, and if so, would this be practical in real-time applications?

The answer to the first question is "Yes." Ada's strong typing enables the runtime executive to know the type, and thus the structure of each data object—an essential requirement for a garbage collector. Although compile implementors would need to consider interactions with tasking and exception handling, experience with previous languages such as Algol 68 has shown

PICO POWER INDUCTORS

**PLUG-IN
SURFACE MOUNT
AXIAL INDUCTORS
TOROIDAL
INSULATED LEADS**

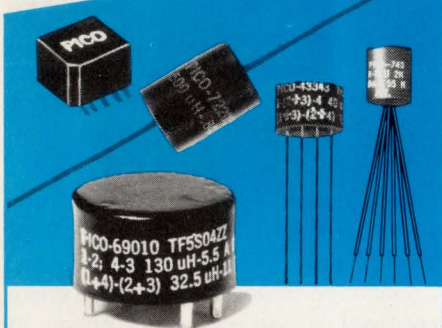

PICO's Ultra-Miniature Power Inductors are ideal for Noise, Spike and Power Filtering Applications in Power Supplies, DC-DC Converters and Switching Regulators.

- QPL standards available MIL-T-27/356
- Temperature range -55°C to $+130^{\circ}\text{C}$
- All units are magnetically shielded
- All units meet the requirements of MIL-T-27 (TF5S04ZZ)
- Minimum possible size
- Split windings
- Inductance values to 20mH with DC currents to 23 amps

PICO manufactures complete lines of Transformers, Inductors, DC-DC Converters and AC-DC Power Supplies

Delivery—
stock to
one week

SEE EEM,
THOMAS REGISTER
OR SEND DIRECT FOR
FREE PICO CATALOG

**PICO
Electronics, Inc.**
453 N. MacQuesten Pkwy. Mt. Vernon, N.Y. 10552

Call Toll Free **800-431-1064**
IN NEW YORK CALL **914-699-5514**

SIGNALS & NOISE

the feasibility of garbage collection for languages with rich runtime semantics.

The question, then, is not whether it's possible to implement garbage collection in an Ada runtime system, but whether such implementation will be applicable to real-time systems. Two principal issues arise, however:

1. *How appropriate is the technique in programs where C-like or low-level features (address arithmetic, unchecked conversions, "hidden" pointers, representation clauses) are used? Real-time programs tend to require such features, but using them can render garbage collection unsafe or make it so conservative in its reclamation that its purpose is defeated.*

2. *What is the data space overhead? Henry's article in the CACM implies a doubling of the heap space requirements, in the absence of data compaction techniques that have a side effect of increasing execution time. In some environments this increase in space requirements may be tolerable, but in applications with tight storage constraints the overhead may be unacceptable.*

In summary, although it was perhaps an oversimplification to state that "automatic reclamation schemes suffer from unbounded execution times," the applicability of garbage-collection strategies to real-time Ada programs remains an area where further work is needed. Meanwhile, programmers can reclaim storage via the various techniques described in the article—for example, explicit deallocation.)

Maintaining privacy of phone number

Joseph Gili (EDN, November 8, 1990) concisely sums up privacy rights in telephony as: (1) The right of one called to know who is calling; and (2) the right of a caller to keep his or her number private. He offers a good plan to protect both rights.

Another plan is: (1) Allow a caller to block transmission of his or her number to the one called; and (2) allow the one called to block incoming calls with the caller's number attached. With this plan, calls go through when both parties agree on the terms and are blocked when both parties don't agree. Simple, and elegant.

Quite frankly, I don't want anyone, friend or foe, to be able to access my number unless I can also access his or hers.

Wesley Mansfield
President
Tennsoft Inc
Dunlap, TN

Speaking Polish not an open door to closing deals

In his editorial (EDN, August 2, 1990, pg 47), Gary Legg is absolutely right in saying that "facts don't always tell the truth" when making comparisons about Poland.

As a Pole raised and educated in the US, returning to Poland twice this year has been eye opening. The quality of life is better in Poland today than it was 14 years ago when I worked there temporarily. Opportunities are enormous and widespread, yet enterprises are waiting to be rescued by Western businesses. The lifestyle, although cramped in many ways, is refreshing. As an international procurement and marketing manager, I find Poland an easily misunderstood quagmire.

I am working with Polish individuals and private, institutional, and public organizations of all sizes. A concerted effort has been made in the development of business within the electronics arena both in hardware and software. Making comparisons is fraught not only with the hazards of misconception but is usually misleading and downright erroneous. As an example, Gary cites simple wage rates and gives three examples of \$75, \$100,

VGA

Get On Board.

Introducing VGA that fits your motherboard and your budget.

To put VGA graphics on your motherboard, you need a cost-efficient, highly integrated, powerful solution that uses minimal board space. You need the new CL-GD5320 Enhanced VGA-Compatible Graphics Chip from Cirrus Logic.

Use it to incorporate full 16-bit or 8-bit VGA into low-cost personal computers. You only need two industry standard 256K x 4 DRAMs and as few as five other ICs. Whatever memory speed you select — 80ns, 100ns, or 120ns — you'll get a complete VGA display system with greater performance than systems using a more expensive solution with 64K x 4 DRAMs.

You don't sacrifice features. You get 16-bit and 8-bit support for the VGA graphics standard, and full, register-level backwards compatibility. For maximum performance, it has an 8/16-bit CPU interface, independent video and DRAM clocks,

internal FIFOs, and page mode DRAM access. And it will interface to both analog (PS/2 and multi-sync) and TTL monitors.

You can also pick a ready-to-use solution that's right for you. Anything from a chip with full BIOS, drivers, utilities, user's manual, and documentation — to a complete manufacturing kit including everything you need to quickly move into high-volume production.

Make your PC more competitive and save time, space, and money. Call Cirrus Logic today.

Get on board. Call today for more information on our motherboard VGA solutions. Call 1-800-952-6300. Ask for dept. LM22.

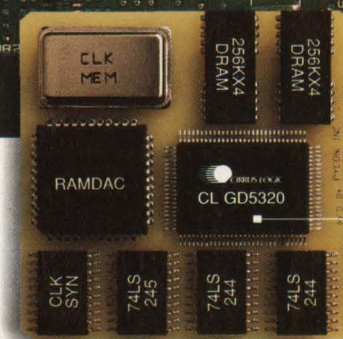

This full 16-bit CL-GD5320 lets you implement 16-bit or 8-bit VGA capabilities on your motherboard with as few as 5 other chips and two 256K x 4 DRAMs. Get a complete solution that saves time, space, power, and expense. You still get all the speed, features and flexibility you're looking for.



C L O S I N G T H E G A P

©1990 Cirrus Logic, Inc., 3100 West Warren Avenue, Fremont, CA 94538 (415) 623-8300; Japan: 462-76-0601; Singapore: 65-3532122; Taiwan: 2-718-4533/4534; West Germany: 81-52-2030/6203
Cirrus Logic, and the Cirrus Logic logo are trademarks of Cirrus Logic, Inc. All other trademarks are registered to their respective companies.

Surface Mountain

Sprague-Goodman offers a wide range of Surftrim® trimmer capacitors and Surfcoil® chip inductors for surface mount applications.

For high quality, sensible prices and ready availability, phone (516) 746-1385 today.



134 Fulton Avenue
Garden City Park, NY 11040-5395
TEL: 516-746-1385 • TELEX: 14-4533
TWX: 510-600-2415 • FAX: 516-746-1396



CIRCLE NO. 30

Twice as Precise as Electrochemical Etching BALCO Microformed™ Parts

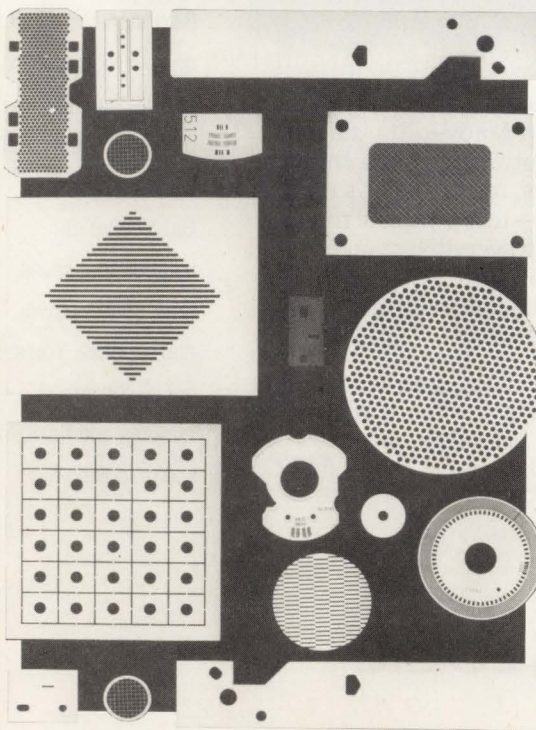

For encoder discs, masks, optical slits, aperture plates, ink-jet nozzles, reticles, laser electrodes and more, BALCO Microformed parts offer over two times the precision of electrochemical etching.

The Microformed process uses electrochemical plating on a mathematically calculated, photographically generated pattern. Holes and slots are routinely as small as 2 microns \pm 1 micron. Complex designs with sharp, burr-free edge definition are typical. Parts can be absolutely flat or three-dimensional. And low-cost, Microformed tooling is ideal for small or large production runs.

Let us design a Microformed part with you.

Call 203/481-4277

DELKER
CORPORATION

P.O. Box 427 • Branford, CT 06405 • 203/481-4277 • FAX: 203/488-6902

1"

CIRCLE NO. 31

SIGNALS & NOISE

and \$125 a month; in fact, the American businessman should be prepared to pay upwards of \$400 a month. Still inexpensive, but a big difference.

Even more important is the need for expertise on doing business with Polish individuals and companies. I have worked with the Japanese for 15 years and consider it much more difficult to deal with Poles, even though I'm a "near native" speaker of the Polish language. Determining who knows what and how to get something accomplished in Poland is an immense problem.

Having said all that, and with more to say about the problems of doing business in Poland, I remain very optimistic. I was involved in Japan and Taiwan in the mid 1970's and agree that Poland has more to offer in the 1990's than was available in Asia only 15 years ago.

*Chris J Gniewosz
Chrisco Trading
Portland, OR*

IT'S EASY TO HAVE YOUR SAY

EDN's Signals & Noise column provides a forum for readers to express their opinions on issues raised in the magazine's articles or on any topic that affects the engineering industry. You can use one of several easy ways to reach us. First, there's always the mail. Send your letters to Signals & Noise Editor, EDN Magazine, 275 Washington St, Newton, MA 02158. Or, send us a message via MCI mail at EDNBOS. Finally, EDN's bulletin-board system is ready for use—and it's free (except for the phone call). You can reach us at (617) 558-4241 and leave a letter in the EDITORS Special Interest Group. You'll need a 2400-bps or less modem and a communications program that is set for eight data bits, no parity, and one stop bit, or 2400, 8N1 in shorthand.

EDN

Sprague®

SMT
STANDARDS.



8008P1290

Sprague tantalums set surface mount standards.

Sprague Type 195D and 293D solid tantalum chips meet the new EIA standards for surface mount capacitors. Both types are supplied taped and reeled per EIA 481A. Standard ratings: 0.10 to 100 μ F, 4 to 50 WVDC.

Conformal-coated Type 195D TANTAMOUNT® capacitors meet EIA IS-29 for Extended Capacitance Range devices. These units

feature gold or solder plated terminals and the highest capacitance in the smallest packages available in the industry.

Rugged, fully molded Type 293D TANTAMOUNT® capacitors conform to EIA IS-28 for Standard Capacitance Range devices. These "machine-friendly" tantalum chips are compatible with all automatic placement equipment.

Write for "Quick Guide", ASP-642B, to Marketing Communications, Sprague Electric Company, P.O. Box 9102, Mansfield, MA 02048-9102. Or call 1-800-SPR-0800.

 **SPRAGUE®**

WHY THE FIRST 040 VME MIGHT AS WELL BE THE LAST.

Memory modules available in 4 and 16 MB DRAM or SRAM.

DRAM memory module supports burst fill mode for 50 Mbyte/sec memory bandwidth.

On board DMA-based architecture provides maximum performance and parallel real-time operation.

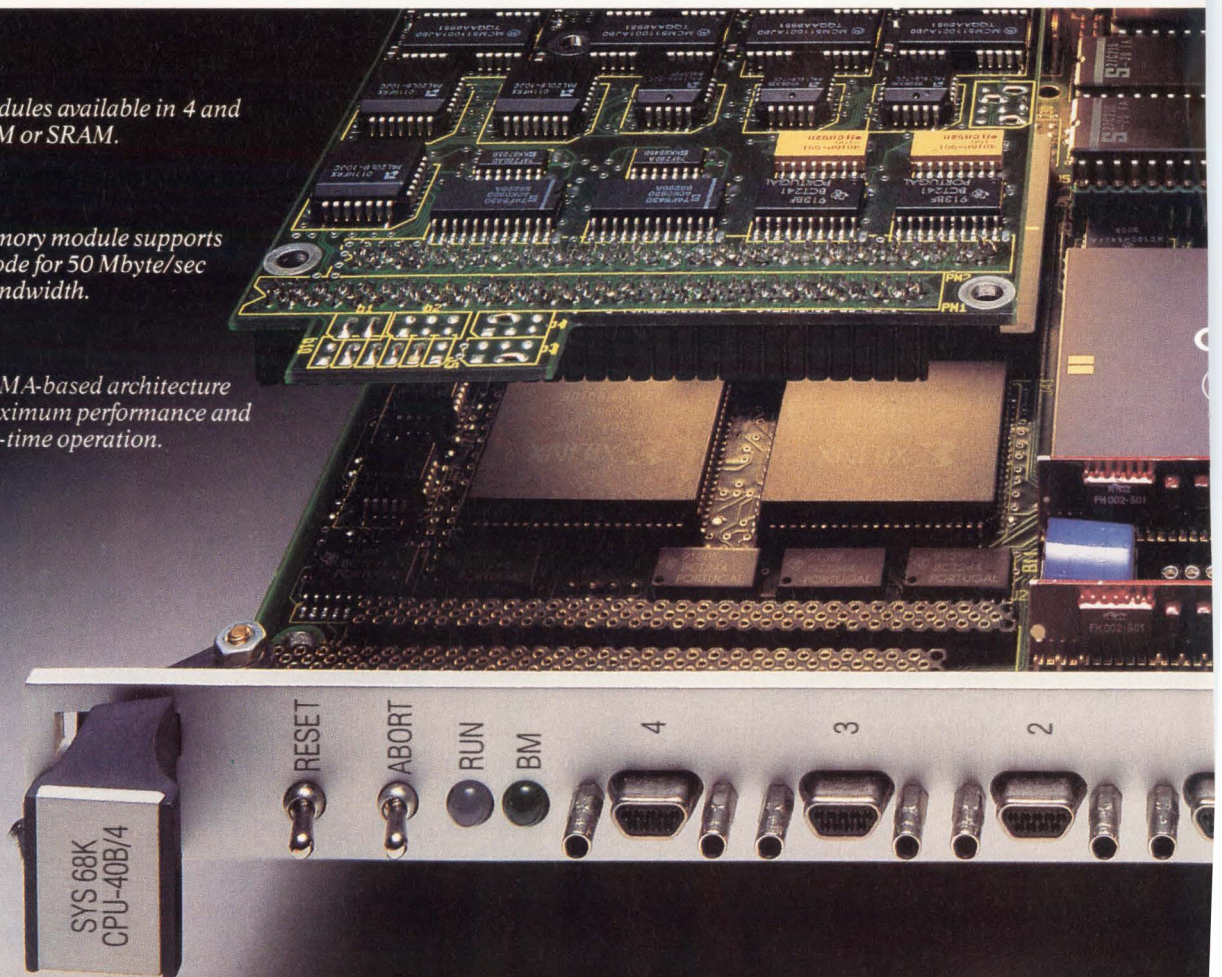



Second, setting else can sustained at 25 MHz*. And DMA transfers at a screaming 50 Mbytes per second sustained (3 microseconds on the VMEbus).

So it might just be the last 040 board you'll ever need.

That's because we've fully optimized the on-board architecture. Thanks to our 281-pin gate array, DMA operations can be handled between on-board RAM, the VMEbus and on-board I/O devices. Or through our FLXi interface to other I/O drivers.

All of which means the CPU is free over 75% of the time to run your application.

First, we're delivering 040 VME single board computers today. In quantity. So you can get started while the rest of the world waits for a delivery date from other suppliers.

our new CPU-40 board is performance standards nobody touch. Like 30,000 dhrystones

Developing new applications is also a snap. Choose from the broadest range of third-party software in the business, including VMEPROM™, pSOS+™, VRTX32™, OS-9™, VxWorks™, UNIFLEX™, MTOS™ and UNIX® 5.4.

Of course, we provide comprehensive support with the industry's best-rated documentation,** complete systems integration support and technical assistance.

CPU-40 PERFORMANCE CHARACTERISTICS

Data from	CPU	CPU	CPU	CPU	VMEbus	SCSI*	Floppy Disk*	Ethernet*	Shared RAM*	VMEbus*
Transfer to	Shared RAM	EPROM	Serial I/O Timers	SCSI, Ethernet Controller, Floppy Disk	Shared RAM	Shared RAM	Buffer RAM	Dual-port RAM	VMEbus	VMEbus
Transfer Speed	53.7 MB/sec	16 MB/sec	2 MB/sec	2 MB/sec	5 MB/sec	4 MB/sec	500 KBit/sec	10 MB/sec	15 MB/sec	15 MB/sec
Local 68040 CPU Operation	100%	100%	100%	100%	70%	80%	100%	100%	75%	100%

*DMA x FPS

So be the first in your company to turn 040. Call 1-800-BEST-VME, ext. 40, for more information or fax a request to (408) 374-1146 for an immediate response. It'll be to your lasting advantage.



VME at its best.

FORCE Computers, Inc. 3165 Winchester Blvd. Campbell, CA 95008-6557
 *Actual dhrystone results may vary depending on compiler used. **Computer Design News, March 12, 1990. All brands or products are trademarks of their respective holders. © 1991 FORCE Computers, Inc.

CIRCLE NO. 15

Modular Eagle I/O subsystems provide high flexibility for a variety of applications.

FLXi interface supports high-performance I/O via Eagle modules.

FGA-002 gate array provides message broadcast interrupt management. A 32-bit DMA controller that supports local shared memory, VMEbus and I/O data transfers.

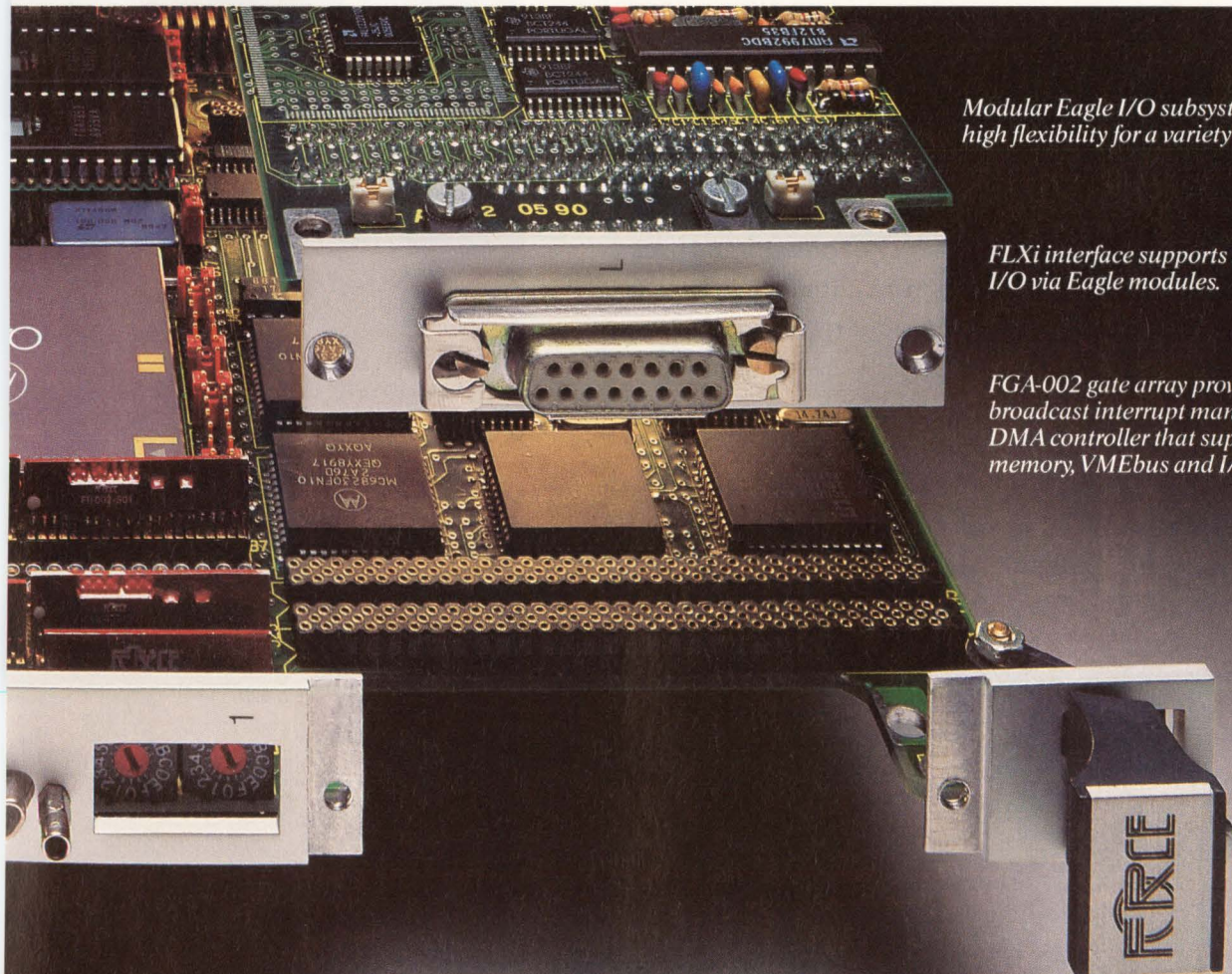

Your Formula for

Introducing nX: Oki's performance-packed family of MCUs

The Oki nX equation for next-generation microcontrollers quickly adds up to a lot of pluses.

Take our 65000 Series, for example. With a 400-ns cycle time at 10 MHz, these speed-enhanced 8-bit MCUs boost performance up to 40% over current 80C51-based devices. Add a variety of on-chip features — A/Ds, I/O lines, PWMs, counters, timers, up to 16K bytes ROM and 384 bytes RAM — and you'll see how nX equals a tremendous range of cost-effective 8-bit solutions.

Then there's our 66000 Series of 8/16-bit MCUs, providing a migration path between current 8-bit and new 16-bit devices. And offering even higher levels of integration and memory. Pluses include 8-bit

external data bus with 16-bit internal address, up to 68 I/O lines, a 400-ns cycle time at 10 MHz, and up to 32K bytes ROM and 1K byte RAM.

For blazing speed and full 16-bit implementation, explore the high-performance features of our 67000 Series: 200-ns cycle time at 10 MHz, 56 I/O lines, three 16-bit and two 8-bit timers, and more.

But the addition doesn't stop here. Figure in one-time programmable (OTP) versions. A variety of pinouts and packages. And comprehensive development tools — assemblers, compilers, and translators.

Plus there's one last number to consider in the nX formula: **1-800-OKI-11NX**. Call now and let us bring you up to speed on the nX generation of faster MCUs — from Oki.

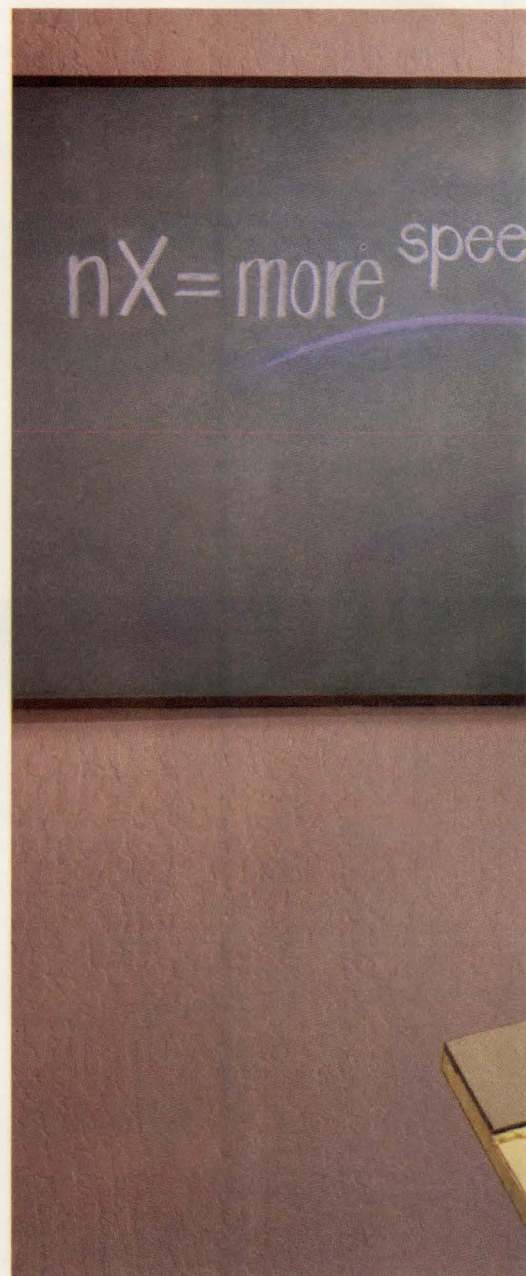

Transforming technology into customer solutions

Faster MCUs



Oki nX Product Family

Part #	Features	ROM	RAM	Package
65511	32 I/Os, 2x8-bit timers, watchdog timer, serial I/O	4KB	128B	40-DIP 44-PLCC/QFP
65512/ 65P512	32 I/Os, 3x8-bit timers, 1x16-bit timers, serial I/O	8KB	128B	40-DIP 44-PLCC/QFP
65513/ 65P513	Same as 65512 with 24 additional I/Os	8KB	128B	64-SDIP/QFP 68-PLCC
65524/ 65P524	Same as 65512 with 2x8-bit PWM, 8-bit A/D, additional ROM/RAM	16KB	384B	64-SDIP/QFP 68-PLCC
66201/ 66P201	• 48 I/Os • 10-bit A/D	16KB	512B	64-SDIP/QFP 68-PLCC
66207/ 66P207	• 4x16-bit timers • 2x16-bit PWM	16KB	512B	64-SDIP/QFP 68-PLCC
66301/ 66P301	• Serial interface • Transition detector	32KB	1KB	64-SDIP/QFP 68-PLCC
66417/ 66P417	68 I/Os, 10-bit A/D, 3x16-bit timers, 4x16-bit PWM, serial interface	32KB	1KB	80-QFP
67620/ 67P620	56 I/Os, 3x16-bit timers, 2x8 bit timers, serial interface	16KB	512B	64-SDIP/QFP 68-PLCC



OKI
Semiconductor

CA Irvine 714/752-1843, Tarzana 818/774-9091, San Jose 408/244-9666 FL Boca Raton 407/394-6099
 GA Norcross 404/448-7111 IL Rolling Meadows 708/870-1400 MA Stoneham 617/279-0293 MI Livonia 313/464-7200
 NC Morrisville 919/469-2395 NY Poughkeepsie 914/473-8044 PA Horsham 215/674-9511 TX Richardson 214/690-6868

Goes great

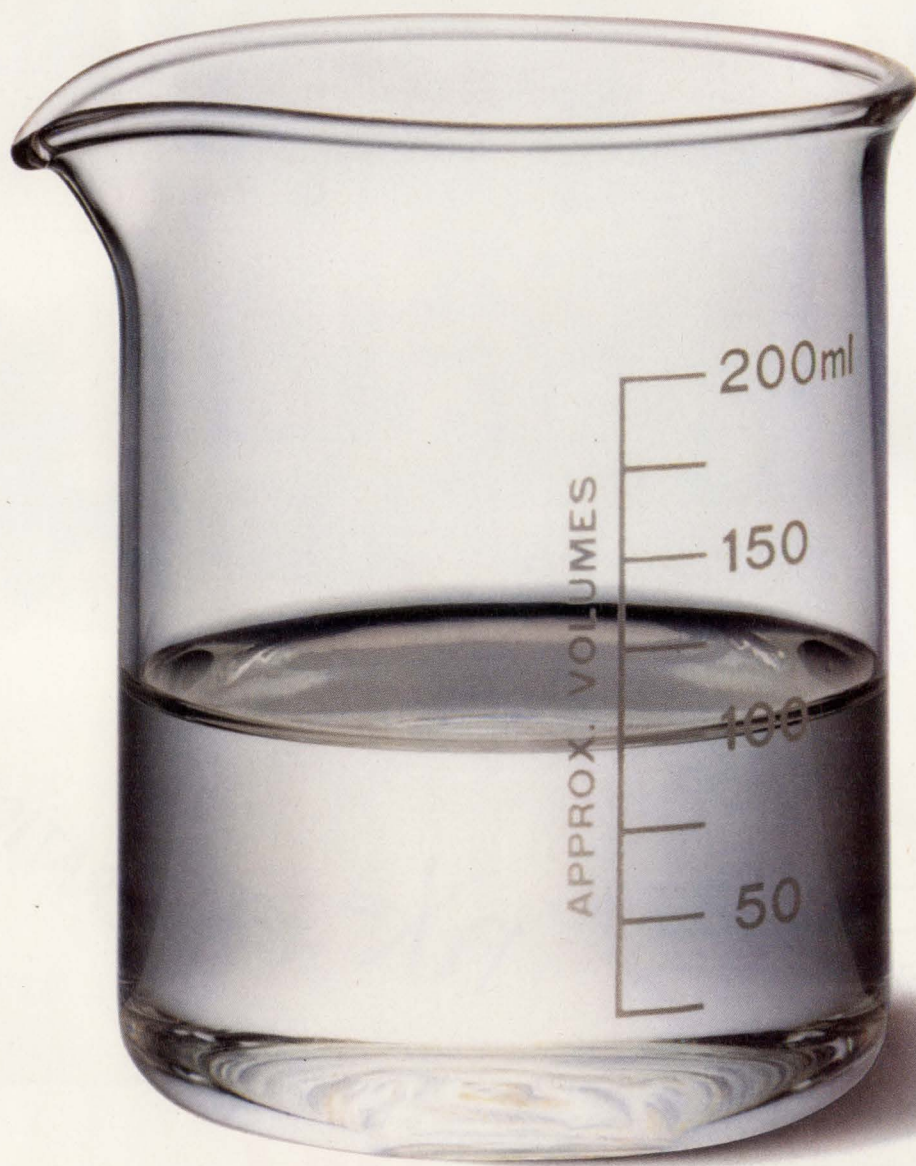

*Trademark of The Dow Chemical Company

EDN February 18, 1991

with chips.

If you've been following the developments in high-density multichip modules, you know the great promise that lies there.

If you've been *leading* the developments, however, you know the great problem that lies there.

Namely, the search for a polymer dielectric that can make multichip modules truly practical.

For which reason we are pleased to introduce you to new bisbenzocyclobutenes (BCBs) from Dow.

BCBs offer big advantages over the polyimides you may have been experimenting with. To start, they simply perform better—by about 50%. And in the process, they simplify manufacturing and lower your overall costs.

CHIPS WITHOUT RIDGES.

Where does BCB's advantage come from?

For one thing, from its extremely low dielectric constant. In general, you can get away with layers 25% thinner than you'd need with polyimides. This means higher density and, therefore, higher performance.

You also get much better leveling than with polyimides. BCB planarizes more than 90%, compared with the 30% or less typical of polyimides. This nearly ridgeless surface reduces crosstalk and improves etching as well.

And BCB can take the heat, literally. It shows great thermal stability at curing temperatures. This, together with its naturally low modulus, gives you a

finished module created with less stress than one made with most polyimides.

NO MORE SOGGY CHIPS.

Water, a byproduct of the polyimide curing process, is the enemy of the multichip module. It complicates

manufacturing and robs polymers of their dielectric appeal.

BCB, on the other hand, produces no water. So there's no need for additional drying during manufacture. And since it vigilantly resists moisture (absorbing just 0.25% of its weight after 24 hours at 100°C), the dielectric properties you design in, stay in.

BCB also offers excellent adhesion to aluminum, copper, silicon dioxide—and to itself.

So there's no need for the metal tie layers other dielectric materials require.

YOUR CHIPS, OUR DIP.

All in all, this means you can manufacture high-density modules faster, with fewer rejects and, therefore, less expensively with BCB. And wind up with modules that perform far better than they would with polyimides.

If BCB sounds good in theory, we invite you to learn from the experience of those who have put it into practice—including one manufacturer who has successfully gone into full commercial production.

If you'd like more information, call us today at 1-800-441-4DOW.

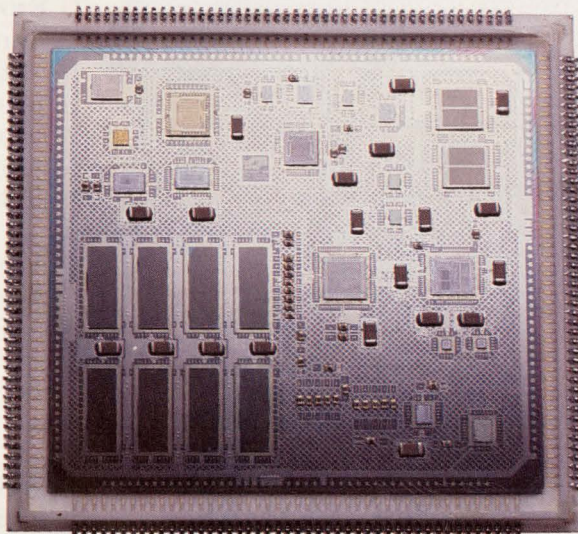

The motherboard of a microcomputer, on a multichip module made with BCB from Dow—actual size.

See us at Nepcon Booth #1110



Dow Plastics

We don't succeed unless you do.

World Class Ferrite Core Manufacturers. At Your Fingertips.

To get the best in ferrite quality and service, you have to know the right buttons to push. 1-800-345-4082. That's your direct line to DEXTER, your One Stop Shopping Center for your every ferrite need. From world class manufacturers such as SIEMENS, MAGNETICS, FAIR-RITE, HITACHI, MMG/KRYSTINEL. From standard stock items, ready for 24-hour delivery, to the most intricate custom designs utilizing DEXTER's extensive value-added services, like precision fabrication, E-core and pot-core gapping and testing, and more.

Call Toll Free 1-800-345-4082 for Free Catalog and Nearest DEXTER Location.

ATLANTA • BOSTON • CHICAGO • DALLAS • LOS ANGELES • MINNEAPOLIS/ST. PAUL • NEW YORK • SAN FRANCISCO • TOLEDO/DETROIT • ENGLAND • WEST GERMANY

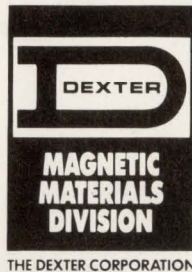

CIRCLE NO. 32

- Crystals
- Crystal Oscillators
- Crystal Filters
- Ceramic Resonators

RALTRON

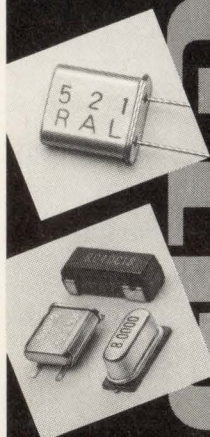

WHEN IT COMES TO HIGH ACCURACY CRYSTAL UNITS, ONLY RALTRON HAS IT ALL.

RALTRON manufactures one of the industry's most complete lines of high quality crystal units. Call us for all your crystal needs from micro-processor to AT strip to tuning fork to high accuracy. Or call us for our 28 page catalogue.

HIGH ACCURACY CRYSTAL UNITS

- Frequency Range: 1.0 MHz-360 MHz
- Mode of Oscillation: Fundamental to 9th O.T.
- Frequency Tolerance: @ 25°C: ± 2.5 ppm to ± 100 ppm
- Frequency Stability: ± 3 ppm (-10°C to +60°C) to ± 50 ppm (-55°C to +105°C)

SURFACE MOUNT CRYSTAL UNITS HC-45/U SMD, TT SMD, HC-49S SMD

- Frequency Range: 3.5 MHz-360 MHz
- Mode of Oscillation: Fundamental to 9th O.T.
- Frequency Tolerance: @ 25°C: ± 2.5 ppm to ± 100 ppm
- Frequency Stability: ± 3 ppm (-10°C to +60°C) to ± 100 ppm (-10°C to +70°C)

The Products. The Prices. The People. Only RALTRON has it all.

RALTRON ELECTRONICS CORP.

2315 NW 107th Avenue, Miami, Florida 33172
FAX (305) 594-3973 TELEX 441588 RALSENU
(305) 593-6033

CIRCLE NO. 33

CALENDAR

International Conference on Artificial Intelligence, Miami Beach, FL. CAIA '91, IEEE Computer Society, 1730 Massachusetts Ave NW, Washington, DC 20036. (202) 371-1013. February 24 to 28.

NEPCON West '91, National Electronic Packaging and Production Conference, Anaheim, CA. Cahners Exposition Group, 1350 E Touhy Ave, Des Plaines, IL 60018. (708) 299-9311. FAX (708) 635-1571. February 24 to 28.

European Design Automation Conference, Amsterdam, The Netherlands. Professor Jochen Jess, Eindhoven University Technology, Box 513, 5600 MB Eindhoven, The Netherlands. (Phone) 31-40-47-3353. February 25 to 28.

Applications of UNIX Utilities (short course), Seattle, WA. Specialized Systems Consultants Inc (SSC), Box 55549, Seattle, WA 98155. (206) 527-3385. FAX (206) 527-2806. February 26.

Problem Solving with the Power-scope (short course), Foster City, CA. Basic Measuring Instruments, 335 Lakeside Dr, Foster City, CA 94404. (415) 570-5355. FAX (415) 574-2176. March 4 to 5.

Converting, Expanding, & Upgrading IBM & PS/2 (short course), Boston, MA. Center for Advanced Professional Development, 1820 E Garry St, Suite 110, Santa Ana, CA 92705. (714) 261-0240. March 4 to 5.

Capacitor and Resistor Technology Symposium, Las Vegas, NV. CARTS Office, 904 Bob Wallace Ave, Suite 117, Huntsville, AL 35801. (205) 536-1304. FAX (205) 539-8477. March 4 to 7.

SEMICON/Europa, Zurich, Switzerland. SEMI, 805 E Middlefield Rd, Mountain View, CA 94043.

MEGA MEMORY.

SONY HIGH-DENSITY SRAMS				
MODEL	CONFIG.	SPEED (ns)	PACKAGING	DATA RETENTION
CXK581000P*	128K x 8	100/120	DIP 600 mil	L, LL
CXK581000M*	128K x 8	100/120	SOP 525 mil	L, LL
CXK581100TM*	128K x 8	100/120	TSOP	L, LL
CXK581100YM*	128K x 8	100/120	TSOP (reverse)	L, LL
CXK581001P	128K x 8	70/85	DIP 600 mil	L
CXK581001M	128K x 8	70/85	SOP 525 mil	L
CXK581020SP	128K x 8	35/45/55	SDIP 400 mil	
CXK581020J	128K x 8	35/45/55	SOJ 400 mil	
*Extended temperature range available.			L = Low power.	
			LL = Low, low power.	

MEGA COMMITMENT.



As you can see, Sony's more committed than ever to meeting your high-density SRAM needs.

Just consider the enhancements we've made in a few short months: TSOP and TSOP-reverse packaging. Low data retention current. And extended temperature range.

All based on our unique 0.8-micron CMOS technology, and available in 32-pin DIP and surface-mount plastic packages.

Then consider our ever-increasing production capabilities. We've just added yet another SRAM facility in Japan. And acquired a large AMD facility in San Antonio, Texas.

So you can really count on us in a crunch. Need more proof we're serious about your each and every SRAM need?

Call us. We've got more breakthroughs on the way. Well over 100 SRAM products spanning the performance spectrum. And the desire to meet—or exceed—your toughest performance spec.

Sony high-density SRAMS are shipping now, complete with competitive pricing. So call (714) 229-4190 today. Or write Sony Corporation Of America, Component Products Company, 10833 Valley View St., Cypress, CA 90630, Attention: Semiconductor sales. FAX (714) 229-4285.

SONY®

It takes a huge setup to test ISDN terminal equipment ...

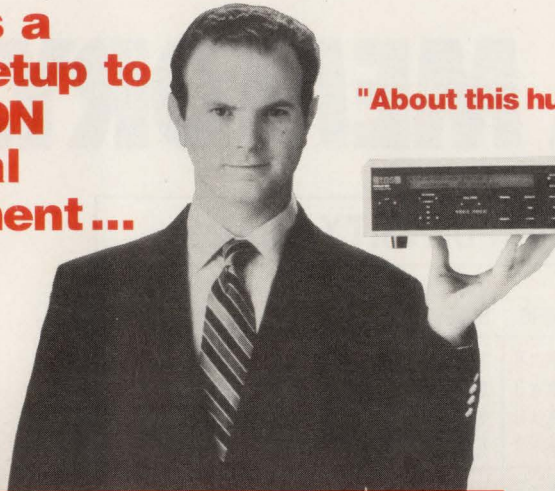

"About this huge."

TAS Apollo 802 ISDN Emulator puts an ISDN network in the palm of your hand.

- Drastically reduces the cost and complexity of ISDN terminal equipment test setups
- More economical and more thorough than testing with "real" ISDN lines
- Tests analog and digital functions of ISDN terminal equipment
- Saves you money by interfacing your non-ISDN test equipment (scopes, signal generators, data analyzers) to your ISDN terminal equipment
- Makes ISDN training and demonstrations a snap!



**Apollo 802:
Huge Capability in a
Small Package**

34 Industrial Way East, Eatontown, NJ 07724-9917 • Phone (908) 544-8700 • FAX (908) 544-8347

CIRCLE NO. 34

IEEE-488

You can control any IEEE-488 (HP-IB, GP-IB) device with our cards, cables and software for the PC/AT/386, EISA, Micro Channel and Macintosh II. You get fast hardware and software support for all the popular languages, plus a software library of time saving utilities. Instrument control has never been easier.

FREE
Informative Catalog **800-234-4232**
Applications help **(617) 273-1818**

cec Capital Equipment Corp.
Burlington, MA. 01803

Micro Channel is a trademark of IBM

CIRCLE NO. 35

CALENDAR

(415) 940-6961. In Europe, (071) 379-3434. FAX (071) 497-8728. March 5 to 7.

SQL (Structured Query Language): A Hands-On Workshop, Seattle, WA. Learning Tree International, Box 45028, Los Angeles, CA 90045. (800) 421-8166; in Canada, (800) 267-1824; in CA, (213) 417-9700. March 12 to 15.

Advanced Research in VLSI Conference, University of California, Santa Cruz, CA. Kevin Karplus or Jean McKnight, Computer Engineering, UCSC, Santa Cruz, CA 95064. (408) 459-2303. March 25 to 27.

National Telesystems Conference, Atlanta, GA. IEEE's Aerospace and Electronic Systems Section, Scott Wood, Scientific-Atlanta, 4388 Shackleford Rd, Norcross, GA 30093. (404) 925-6377. March 26 to 27.

VHDL Conference, Cincinnati, OH. VHDL User Group, Randy Harr, 3145 Geary Blvd, Suite 123, San Francisco, CA 94118. (408) 984-5952. FAX (408) 984-6723. April 8 to 10.

National Electronic Manufacturing and Design Expo, Chicago, IL. Amy Riemer, Cahners Exposition Group, Box 3833, Stamford, CT 06905. (203) 352-8292. April 8 to 11.

1991 International Reliability Physics Symposium, Las Vegas, NV. IEEE IRPS, SAR Associates, Box 308, Westmoreland, NY 13490. (315) 339-3971. FAX (315) 336-9134. April 8 to 11.

Electro/International, New York, NY. Electronic Conventions Management, Electro/International, 8110 Airport Blvd, Los Angeles, CA 90045. (800) 877-2668. FAX (213) 641-5117. April 16 to 18.

PSSST...

Even though they're Power Factor Corrected, the power supplies you're now using could ban your products from Europe after 1992. They might keep you from doing business domestically, too.

Your PFC supplies might not meet IEC 555-2 because they have too much current circulating in third and fifth order line current harmonics.

Pioneer supplies have less than 5% total harmonic current content. They feature built-in $>.99$ active Power Factor Correction, meet proposed IEC 555-2,

all applicable international safety and EMC standards, and are available from 250 to 2000 watts, in single or multiple outputs. Delivery for most models in OEM quantities is 60-90 days.

P.S. — We apologize for not having brought you this information earlier. But the word is out. We've been shipping our PFC supplies worldwide for more than two years. So call us now at 800-233-1745, or 800-848-1745 in California.

Pioneer Magnetics

FILTERS



dc to 3GHz from \$1145

lowpass, highpass, bandpass, narrowband IF

- less than 1dB insertion loss • greater than 40dB stopband rejection
- 5-section, 30dB/octave rolloff • VSWR less than 1.7 (typ) • meets MIL-STD-202 tests
- rugged hermetically-sealed pin models • BNC, Type N; SMA available
- surface-mount • over 100 off-the-shelf models • immediate delivery



low pass dc to 1200MHz

MODEL NO.	PASSBAND, MHz (loss <1dB)		fco, MHz (loss 3db)	STOP BAND, MHz (loss >20dB) (loss >40dB)			VSWR		PRICE \$ Qty. (1-9)
	Min.	Max.		Max.	Max.	Min.	pass-band typ.	stop-band typ.	
PLP-10.7	DC-11		14	19	24	200	1.7	18	11.45
PLP-21.4	DC-22		24.5	32	41	200	1.7	18	11.45
PLP-30	DC-32		35	47	61	200	1.7	18	11.45
PLP-50	DC-48		55	70	90	200	1.7	18	11.45
PLP-70	DC-60		67	90	117	300	1.7	18	11.45
PLP-100	DC-98		108	146	189	400	1.7	18	11.45
PLP-150	DC-140		155	210	300	600	1.7	18	11.45
PLP-200	DC-190		210	290	390	800	1.7	18	11.45
PLP-250	DC-225		250	320	400	1200	1.7	18	11.45
PLP-300	DC-270		297	410	550	1200	1.7	18	11.45
PLP-450	DC-400		440	580	750	1800	1.7	18	11.45
PLP-550	DC-520		570	750	920	2000	1.7	18	11.45
PLP-600	DC-580		640	840	1120	2000	1.7	18	11.45
PLP-750	DC-700		770	1000	1300	2000	1.7	18	11.45
PLP-800	DC-720		800	1080	1400	2000	1.7	18	11.45
PLP-850	DC-780		850	1100	1400	2000	1.7	18	11.45
PLP-1000	DC-900		990	1340	1750	2000	1.7	18	11.45
PLP-1200	DC-1000		1200	1620	2100	2500	1.7	18	11.45

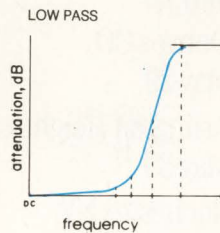

high pass dc to 2500MHz

MODEL NO.	PASSBAND, MHz (loss <1dB)		fco, MHz (loss 3db)	STOP BAND, MHz (loss >20dB) (loss >40dB)		VSWR		PRICE \$ Qty. (1-9)
	Min.	Max.		Min.	Max.	pass-band typ.	stop-band typ.	
PHP-50	41	200	37	26	20	1.5	17	14.95
PHP-100	90	400	82	55	40	1.5	17	14.95
PHP-150	133	600	120	95	70	1.8	17	14.95
PHP-175	160	800	140	105	70	1.5	17	14.95
PHP-200	185	800	164	116	90	1.6	17	14.95
PHP-250	225	1200	205	150	100	1.3	17	14.95
PHP-300	290	1200	245	190	145	1.7	17	14.95
PHP-400	395	1600	360	290	210	1.7	17	14.95
PHP-500	500	1600	454	365	280	1.9	17	14.95
PHP-600	600	1600	545	440	350	2.0	17	14.95
PHP-700	700	1800	640	520	400	1.6	17	14.95
PHP-800	780	2000	710	570	445	2.1	17	14.95
PHP-900	910	2100	820	660	520	1.8	17	14.95
PHP-1000	1000	2200	900	720	550	1.9	17	14.95

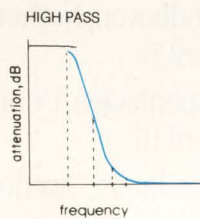

bandpass 20 to 70MHz

MODEL NO.	CENTER FREQ. MHz F0	PASS BAND, MHz (loss <1dB)			STOP BAND, MHz (loss > 10 dB) (loss > 20 dB)				VSWR 1.3:1 typ. total band MHz	PRICE \$ Qty. (1-9)
		Max. F1	Min. F2	Min. F3	Max. F4	Min. F5	Max. F6			
PIF-21.4	21.4	18	25	4.9	85	1.3	150	DC-220	14.95	
PIF-30	30	25	35	7	120	1.9	210	DC-330	14.95	
PIF-40	42	35	49	10	168	2.6	300	DC-400	14.95	
PIF-50	50	41	58	11.5	200	3.1	350	DC-440	14.95	
PIF-60	60	50	70	14	240	3.8	400	DC-500	14.95	
PIF-70	70	58	82	16	280	4.4	490	DC-550	14.95	

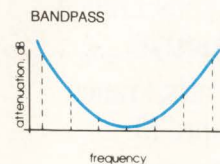

narrowband IF

MODEL NO.	CENTER FREQ. MHz F0	PASS BAND, MHz I.L. 1.5dB max.		STOP BAND, MHz I.L. >20dB		STOP BAND, MHz I.L. >35dB		PASS-BAND VSWR Max.	PRICE \$ Qty. (1-9)
		F1-F2	F3	F4	F5	F6-F9			
PBP-10.7	10.7	9.5-11.5	7.5	15	0.6	50-1000	1.7	18.95	
PBP-21.4	21.4	19.2-23.6	15.5	29	3.0	80-1000	1.7	18.95	
PBP-30	30.0	27.0-33.0	22	40	3.2	99-1000	1.7	18.95	
PBP-60	60.0	55.0-67.0	44	79	4.6	190-1000	1.7	18.95	
PBP-70	70.0	63.0-77.0	51	94	6	193-1000	1.7	18.95	

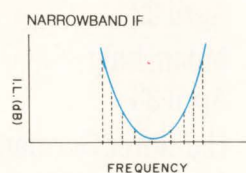

Mini-Circuits

CIRCLE NO. 19

Here's where the barricades start to come down in the mixed signal revolution.

North American Locations & Dates

Cedar Rapids, IA	March 18	Los Angeles, CA	April 10
Cleveland, OH	March 19	Woodland Hills, CA	April 11
Pittsburgh, PA	March 20	San Diego, CA	April 12
Atlanta, GA	March 25	McLean, VA	May 6
Clearwater, FL	March 26	Baltimore, MD	May 7
Orlando, FL	March 27	Cherry Hill, NJ	May 8
Huntsville, AL	March 28	Fort Washington, PA	May 9
Waltham, MA	April 1	Raleigh, NC	May 10
Saddlebrook, NJ	April 2	Toronto, Canada	May 13
Westchester, NY	April 3	Santa Clara, CA	May 14
Smithtown, NY	April 4	Pleasanton, CA	May 15
Cromwell, CT	April 5	Bellevue, WA	May 16
Santa Clara, CA	April 8	Beaverton, OR	May 17
Costa Mesa, CA	April 9	Woburn, MA	May 20
		Montreal, Canada	May 21
		Bloomington, MN	May 22

Houston, TX
May 23

Dallas, TX
May 24

Phoenix, AZ
May 28

Denver, CO
May 29

Arlington Heights, IL
May 30

Rochester, NY
May 31

International Locations & Dates

Eindhoven, Netherlands
April 15

Copenhagen, Denmark
April 16

Stockholm, Sweden
April 17

Lyons, France
April 18

Paris, France
April 19

Rome, Italy
April 22

Milan, Italy
April 23

Hannover, Germany
April 24

Frankfurt, Germany
April 25

Munich, Germany
April 26

Birmingham, England
April 29

London, England
April 30

Vienna, Austria
May 2

Zurich, Switzerland
May 3

Seoul, Korea
June 3

Seoul, Korea
June 4

Taipei, Taiwan
June 5

Taipei, Taiwan
June 6

Hong Kong
June 7

Tokyo, Japan
June 10

Tokyo, Japan
June 11

Osaka, Japan
June 12

Osaka, Japan
June 13

Nagoya, Japan
June 14

Not too long ago, digital designers didn't need to know about analog. And the analog guys didn't need to worry about digital.

But with the revolution that's happening in mixed signal technology, that's far from true anymore.

You see, mixed signal technology is the only way to break down the barriers to higher levels of system integration, better performance, and faster time to market. And it accomplishes these difficult tasks by combining both signals on a single chip.

As the leader in mixed signal technology, Analog Devices has the most experience in assisting both analog and digital designers in applying it to their systems.

Which is why every designer from both camps should attend our Mixed Signal Design Seminar.

For example, in this comprehensive full-day seminar we'll cover such things as digital signal processing, interfacing converters to DSP, analog signal conditioning, digital and analog filtering, sigma delta converters, sampled data systems, and practical techniques for building a better board.

In short, you'll leave this seminar with a better idea of how to put mixed signal technology to work for you in a broader range of applications. And you'll leave with a design handbook, the industry's largest SPICE macromodel library, and more.

Admission is just \$20, and includes all materials and lunch, but you must pre-register.

The mixed signal revolution has started, so make sure nothing stops you from attending this seminar. To reserve your space, return the coupon. For more information or to charge your ticket, call (617) 937-1430 or (800) 262-5643.



The Mixed Signal Design Seminar from Analog Devices.

____ Yes, I want to be part of the revolution. So don't start the Mixed Signal Design Seminar without me.

Name _____

Title _____

Company _____

Address _____

City _____ State _____ Zip _____

I'd like to attend in the following City: _____ Date: _____

Please include a check for \$20 payable to: Analog Devices

Return to: Analog Devices, Mixed Signal Design Seminar, 181 Ballardvale St., Wilmington, MA 01887.

For more information, or to charge your ticket, call (617) 937-1430 or (800) 262-5643.



OUR FEET MATCH YOUR PADS

If you're looking for a chip carrier socket with a small footprint, you can stop looking! Samtec sockets can be surface mounted on the same PCB pads that are used to mount PLCC's. Precision stampings, high temperature plastics, and unique contact and body designs now allow you to take full advantage of the small size of Plastic Leaded Chip Carriers.

Samtec sockets are available with 28, 32, 44, 52, 68 and 84 leads.

Call your Samtec distributor or

1-800-SAMTEC-9

Until 7pm EST

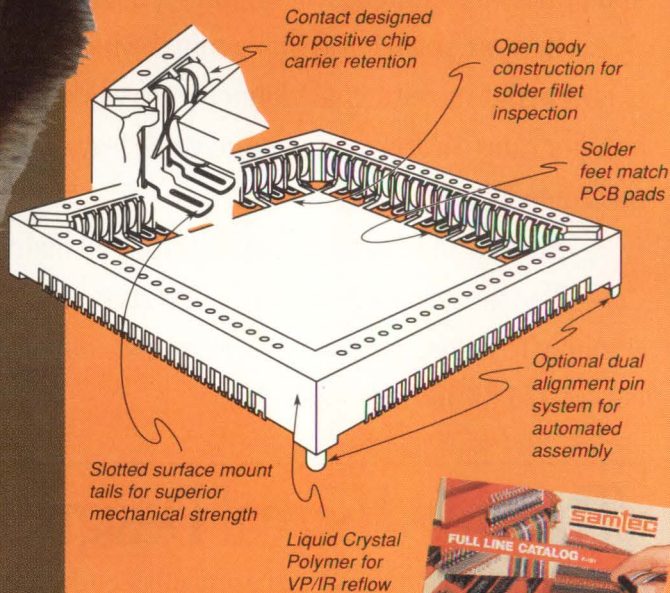

Just released! Samtec's new full line catalog F-191. Get yours today.



samtec



IS SUDDEN SERVICE

New Albany, Indiana USA • Sacramento, California USA • Cumbernauld, Scotland UK • Singapore

SAMTEC, INC. • P.O. Box 1147 • New Albany, IN 47151-1147 USA • Phone 812-944-6733 • Fax 812-948-5047 • TWX 810-540-4095 • Telex 333-918

EDITORIAL

Save that technojunk!



Recently I looked through a local want-ad publication and was surprised at the old electronic and computer equipment that people are selling. Much of that equipment is obsolete and of little use, but some of it represents milestones in our technical past. It's sad to see it selling so cheaply and viewed as having so little value. I'm not talking about Nintendo games and citizen-band radios. At least in this part of the US, sellers offer older minicomputers, μ P development systems, and test equipment.

It's easy to get caught up in the push for newer and better equipment and to declare older equipment obsolete. Most of the electronic companies I've dealt with have a shelf of such older equipment. The engineers can't decide whether to keep it for parts or to scrap it. Often when someone needs a power supply, a μ P board, a display, or other component, they'll remove it from the old gear they have at hand. Slowly, more and more components are stripped out of the old equipment, leaving skeletons that end up in a dumpster. All too often we're destroying the history of electronics, perhaps because that "old" equipment is still too new to be viewed as historic. I don't know of anyone who would strip a hand-made brass microscope from the 1880s to get a brass tube, or anyone who would tear an old coil out of an antique Atwater-Kent radio. Unfortunately, that's what many of us are doing with our old electronic equipment.

Several years ago, a fellow I knew uncovered some old Philbrick operational amplifiers in his lab. To his dismay, he found they used vacuum tubes and high voltages, so they were of no use to him. These unused devices in brand-new boxes went into the trash. I salvaged all of them, saved a couple and gave others to friends who appreciated their historical significance. By casually throwing out old equipment and components, we start losing the artifacts of electrical and electronics history—I'm sure that many younger engineers think the 741 IC was the first op amp. Old devices, like the Philbrick op amps, are just the things that put today's technologies in perspective and relate them to past developments.

The Computer Museum in Boston and the Smithsonian Institution in Washington, DC have displays that provide a history of computers and information systems. They provide homes for some older equipment and a starting place for electronic history. But we need a broader display of electronic technology, its roots, its development, and the devices and products that embody the technology. Without such a repository for information and devices, we'll lose an appreciation for early developments, and we won't have a place where people can see what engineers have devised over the years. Although museums are slowly beginning to offer such exhibits, we may still be too close to the early days of electronics to provoke interest in a museum of electronic technology. So, in the meantime, take a look in your bin of old equipment. You may have some antiques that are worth preserving—even if they never reach a museum. You've got an Intel 8008 development system with a 1702A PROM programmer? Well, dust it off and keep the scroungers from snatching its toggle switches. Someday you'll be able to point to it and brag, "I remember the days when...." History and the artifacts that go with it are important, for without them, history becomes rumor.



Jesse H. Neal
Editorial Achievement Awards
1987, 1981 (2), 1978 (2),
1977, 1976, 1975
American Society of
Business Press Editors Award
1988, 1983, 1981

Jon Titus
Editor

BEFORE YOU CHOOSE P BETTER CHECK

Things aren't always what they seem.

Some people would have you believe FPGAs are faster and denser than MAX™ EPLDs.

Funny how they never mention *in-system* performance, though. When they talk about speed, they quote 100MHz flip-flop toggle rates. When they talk about density, they recite raw gate counts.

Which could make your high-performance design highly disappointing.

But if you want to do more than just spin your wheels, consider MAX.

It's the first family of programmable logic

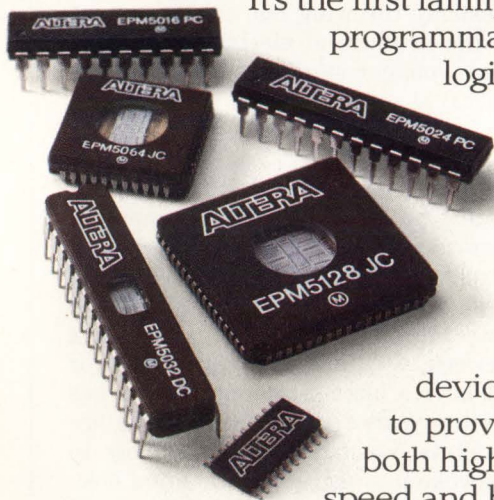

devices to provide both high speed and high

logic density where it counts. At the system level.

Which means MAX can handle just about all your logic needs. In fact, a single 64-macrocell EPM5064

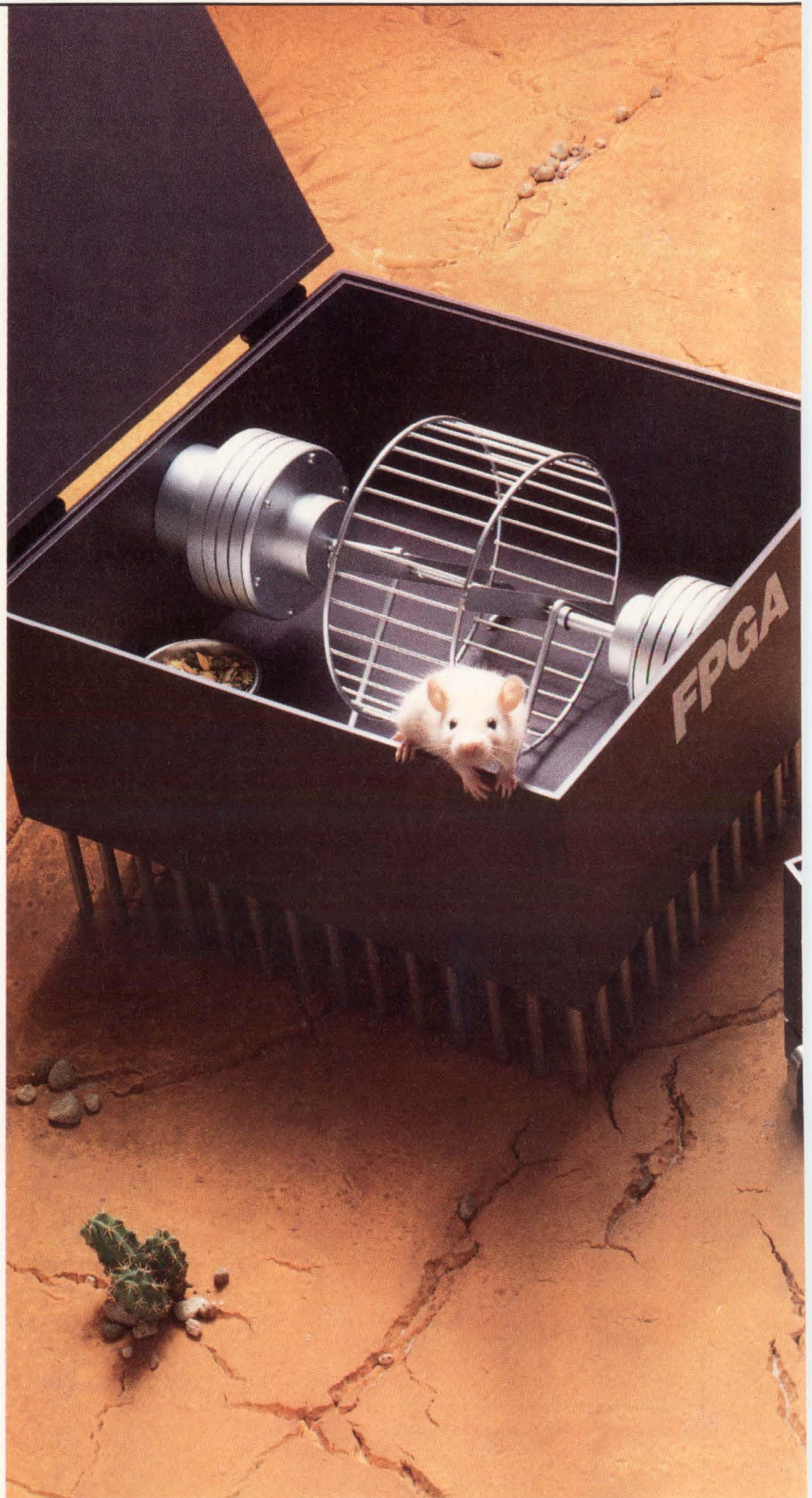

ROGRAMMABLE LOGIC, UNDER THE HOOD.

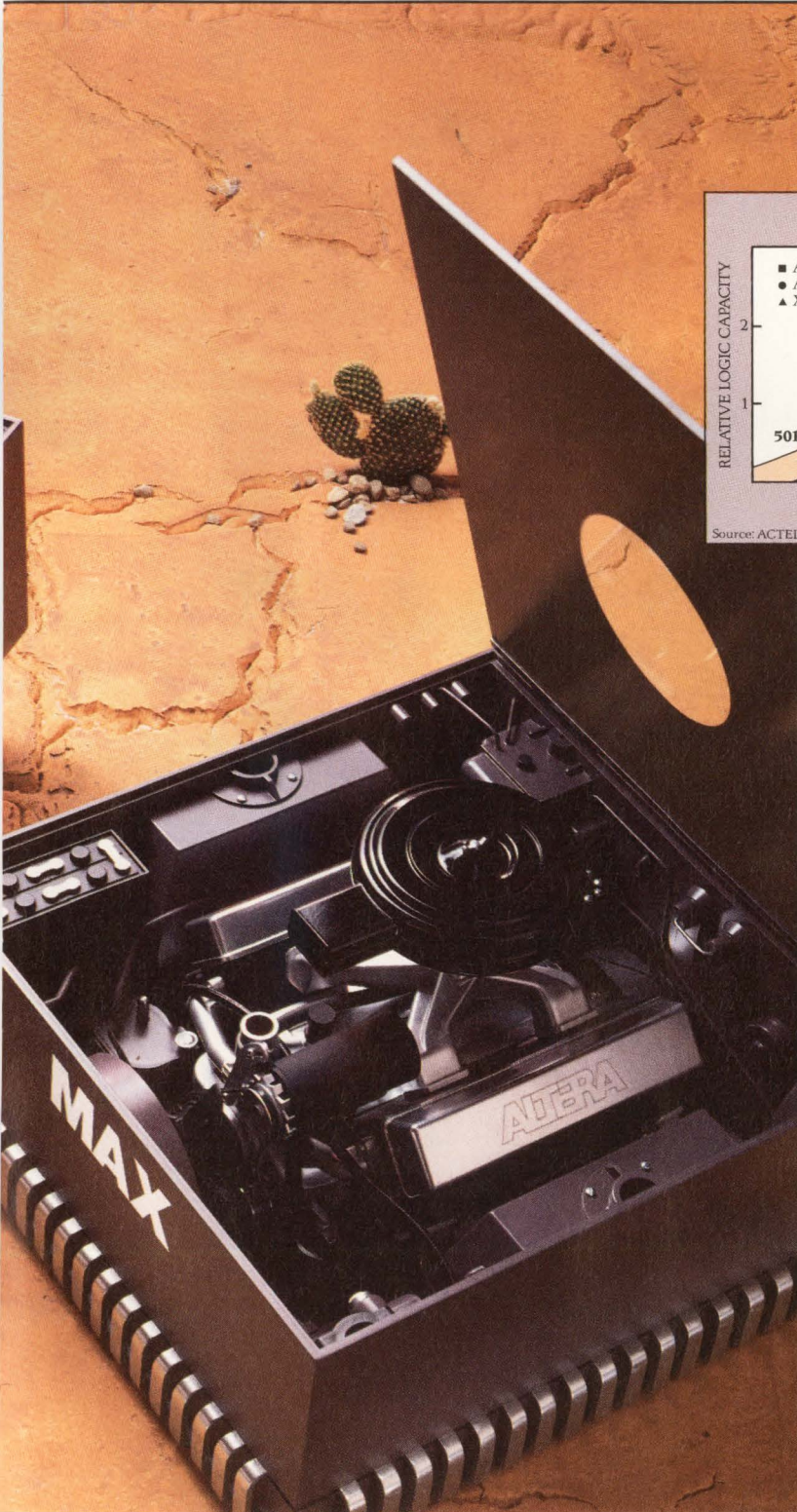

can integrate anything from simple system glue logic right up to complex graphics coprocessors and LAN and memory controllers.

Or take the 68-pin MAX EPM5128. It's up to 50% faster and 100% denser

than comparable FPGAs, thanks to its high-performance architecture and superior logic routability. But don't take our word for it—just take a look at the competition's benchmarks.

Best of all, MAX gives you this unbeatable performance in record time. With powerful, easy-to-use MAX+PLUS™ software, design compile times are measured in minutes. Not hours or days.

So if you're looking to redefine system performance, talk to the folks who invented the EPLD. Call Altera today at (408) 984-2800.

We'll make sure you've got plenty of horses under the hood.

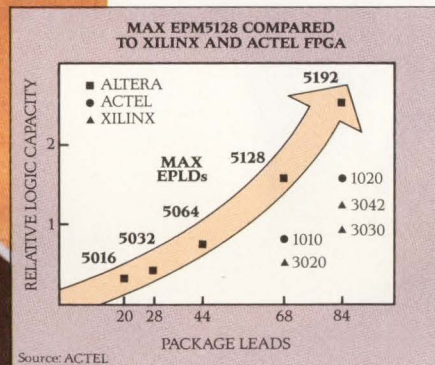

ALTERA

2610 Orchard Pkwy., San Jose, CA 95134-2020
Tel. (408) 984-2800 Fax. (408) 248-6924

MAX and MAX+PLUS are trademarks of Altera Corporation. © 1990, Altera Corporation.

Recently, our customers have a few choice words for us.

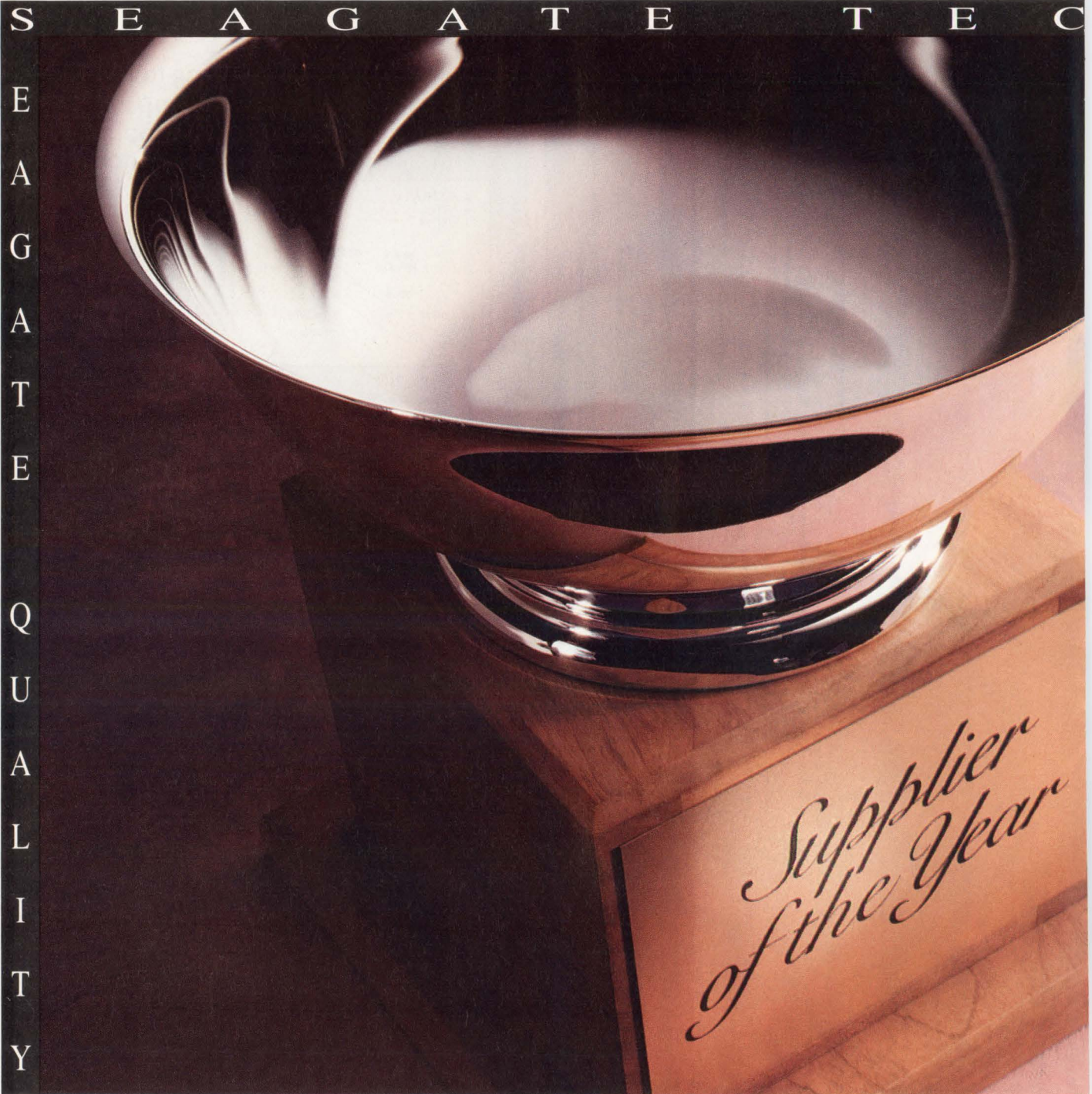

Seagate and the Seagate logo are registered trademarks of Seagate Technology, Inc. ICL, Olivetti and AT&T are registered trademarks of their respective companies.
© 1990 Seagate Technology, Inc.

had

For years Seagate has been best-known as the volume producer of disc storage products. But our reputation as solely a manufacturing

powerhouse is beginning to change.

In the past several months Seagate has received three Disc Drive Supplier of the Year awards from some of our valued OEM customers. In every case, the commendations have been earned not just for supplying quality products, but for providing superior customer service.

ICL, Britain's leading information technology company, honored us with their Vendor Award Citation for being responsive to their flexibility of delivery and cost of ownership requirements. In addition, our Wren drives exceeded their stringent reliability and "plug-and-play" criteria.

Olivetti, the Italian computer company, awarded us their Quality Award for Customer Satisfaction for the same reasons. By meeting Just-in-Time delivery schedules, listening to the customer, exchanging data from the field and providing training and support, we have helped Olivetti provide superior products and service to their customers.

Most recently, AT&T's Oklahoma City Works presented Seagate with its 1990 "Partner in Excellence" award during their Quality Month observance. Once again, Seagate was selected for its ability to meet AT&T's high standards of quality, delivery, service, cost and technical support.

So while Seagate is still the first name in disc drives, we're making quite a name for ourselves in quality and customer service, as well. To learn more about the benefits of a partnership with Seagate, call us at 800-468-DISC, or 408-438-6550.

And to our customers, we offer a couple of choice words of our own: Thank you.

H N O L O G Y

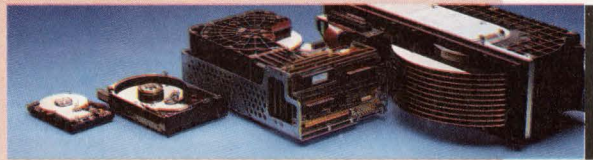

 **Seagate**

The first name in disc drives

The universe is expanding.

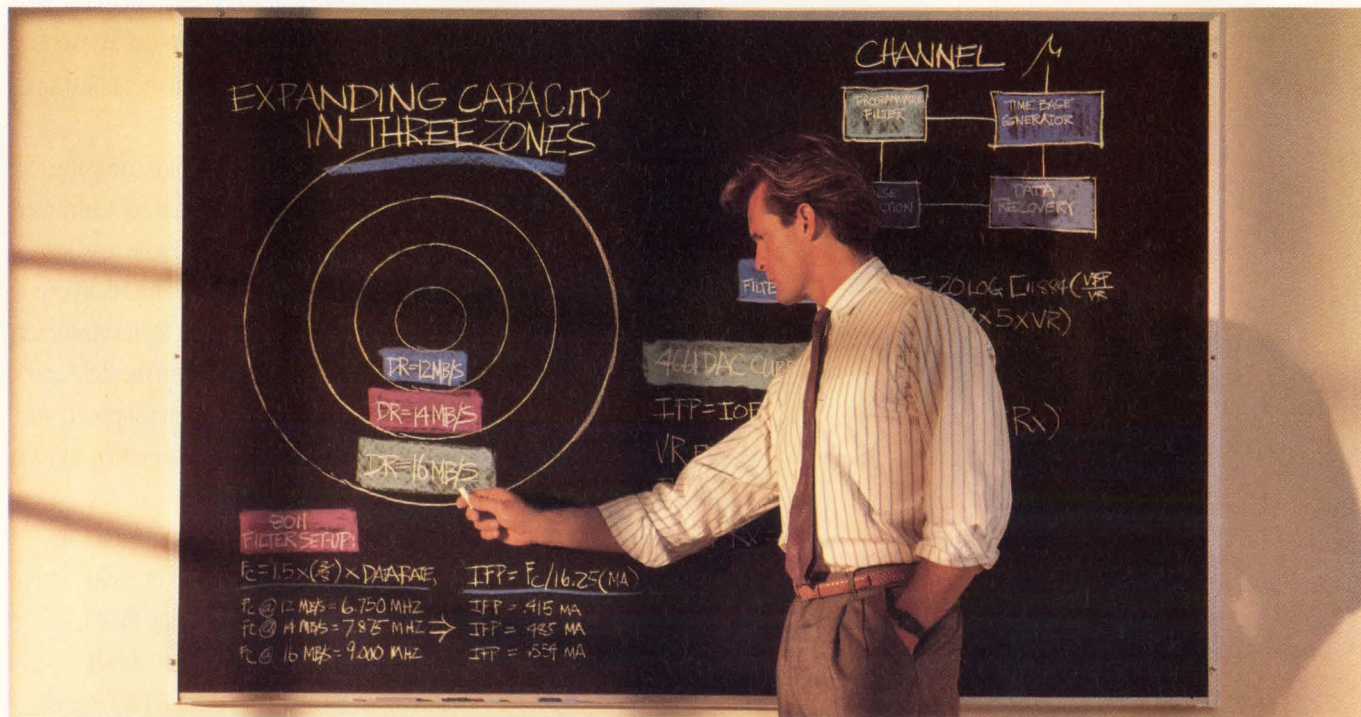

Constant Density Recording

Strap yourselves in. Get ready for warp speed. Our new approach to constant density recording has just given disk drive design a considerable boost in storage capacity.

Even better, we've enhanced performance while significantly reducing board space requirements.

Key to our unique "building-block" thinking is an integrated time base generator and a breakthrough programmable active filter. The latter—the 32F8011—is a

revolution in itself, one that lets you program channel bandwidth from 5-13 MHz. Continuously.

A real space saver is the 32D4661 Time Base Generator. It has integrated the functions of 4-5 previously needed external components and comes in one neat 24-pin package.

Add this capability to your read/write channel design and you've got your higher capacity mixed-signal IC solution in place.

Fully designed and compatible. And more appreciative of your bottom line.

To expand the capacity of your next disk drive design, contact your nearest Silicon Systems representative. Or call us for literature package SPD-3.

Silicon Systems, Inc.

14351 Myford Road, Tustin, CA 92680
Ph 1-800-624-8999, ext. 151 Fax (714) 669-8814
European Hdq. U.K. Ph (44) 79-881-2331
Fax (44) 79-881-2117

silicon systems[®]

Circle 52 for Product Info

Circle 53 for Career Info

GRAPHING AND CURVE-FITTING SOFTWARE

Packages present data so it makes sense



This software harnesses the graphics capabilities of your PC or workstation to display and print experimental data in ways that can reveal hidden meanings.

Dan Strassberg,
Associate Editor

Like the ancient mariner surrounded by water with not a drop to drink, engineers often feel cast adrift in a sea of experimental data with not a point that makes sense. When such a situation leaves you feeling lost, a personal computer or workstation equipped with graphing software and a plotter or graphics-capable printer can act as your compass, your rudder, and your engine. By helping you make sense of the data you've gathered, these tools can empower you to set a true course toward solving your problem.

Graphs, 3-D displays, and contour plots are only the beginning of a long list of visualization aids that can show you relationships among variables that columns of figures never can. (In a family of contour plots, each contour line shows the combinations of a pair of variables for which a third variable achieves a specified value.)

Many of the software packages listed in Table 1 perform such functions as automatic curve fitting, in which the software finds an equation that closely matches a set of experimental data points. Different equations can describe different regions of the data. Some packages, such as The Math Works's Spline Toolbox, perform "spline" fits. The software selects regional boundaries so

that curves connect to one another without discontinuities. Often, the software will let you try different forms of equations, so you can see how closely you can get the curves to fit the data.

Animation is beginning to play a role in data interpretation. Personal computers, long a mainstay in data acquisition, are gaining in speed and power and in their ability to display pictures. Workstations, which are even more powerful than PCs, are finding increasing use in experiment control. Experimenters' use of this fast, powerful hardware is encouraging software designers to find new ways of processing experimental data to make it more meaningful. One result is a class of products called visualization packages, some of which produce animated high-resolution displays.

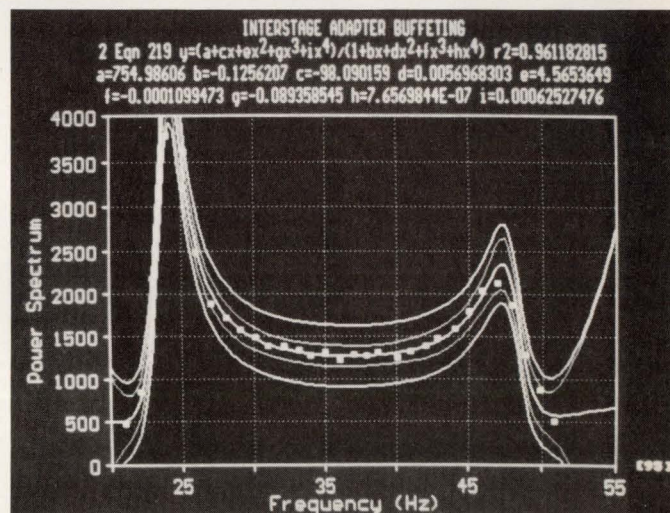

Color-plotting families of curves in two dimensions on a single set of axes is a capability of many graphing packages, such as Jandel's Tablecurve. The middle curve results from discrete experimental data points. The software fitted a smooth curve to the data. The curve consists of several segments; a different equation describes each segment.

TECHNOLOGY UPDATE

Graphing and curve-fitting software

Temperature testing an automobile engine shows how you could use a visualization package. Thermocouples buried at many points in the engine block record temperatures. Data-acquisition software gathers the thermal data and puts it in a file on disk. Visualization software

can present a 3-D picture of the engine block. It can read the file of temperature data and, through color or shading, depict isothermal (equal-temperature) surfaces within the block. These surfaces move as a function of engine speed, load, and time. Sequences of images pre-

sented in rapid succession show this movement. With such animated displays, experimental results take on an instant meaning that tables of readings and even 2-D plots cannot convey.

Visualization packages that can produce animated displays are not

Table 1—Representative graphing, curve-fitting, and visualization software packages

Vendor	Package	Computer system ¹	US list price	Key features, comments
Advanced Graphics Software	Slidewrite Plus V4.0	IBM PC	\$445	Includes four custom scientific figure libraries.
Advanced Micro Solutions	Segs V2.0	IBM PC	\$50 to \$200	2-D plots. Reads ASCII and 1-2-3 files.
Amtec Engineering	Tecplot V4.0	IBM PC/AT	\$649	Reads ASCII files. Displays multiple 2- and 3-D plots. Makes contour plots.
		Workstations	\$1695	
BBN Software Products	RS/1 V4.2	IBM PC/AT (math coprocessor helpful)	\$2000	Scatter plots, histograms, bar charts, X-Y and 3-D graphs. Data analysis, statistics, and curve fitting.
Binary Engineering	Tech*Graph*Pad V4.0	IBM PC, workstations	\$395	Reads ASCII and 1-2-3 files. Makes eight plot types. Smooths data. Fits curves.
BV Engineering	Grafmaker V1.0	IBM PC	\$195	Reads ASCII files. Mixes graph types. Axes can be log or linear.
Caren Co	Mathgraph 11/90	IBM PC	\$695	Reads ASCII files. Cracks unknown binary files. Makes 2- and 3-D plots, contour and surface plots. Smooths data. Fits curves.
		DEC 3100, 5000, VAX	\$1400	
		Cray	\$10,000	
Damaskos	Di-Graph V1.03	IBM PC	\$144.95, \$194.95 (with source code)	Makes 2- and 3-D plots, contour and polar plots, and Smith charts. Graphs algebraic and trig functions. Source code is in Quickbasic.
DSP Development	Dadisp	IBM PC, workstations	\$895 to \$6995	Post-acquisition data manipulation and display.
Dynacomp	PC Graphics	IBM PC	\$49.95	3-D module, \$19.95. Specializes in function graphing.
Golden Software	Grapher V1.79	IBM PC	\$199	Makes 2-D plots. Reads ASCII files.
	Surfer V4.15	IBM PC	\$499	Makes 3-D and contour plots. Reads ASCII and 1-2-3 files.
Heartland Software	Ugraph V3.00	IBM PC	\$395	Handles many file formats. Makes 2- and 3-D plots.
Island Products	Nfit V1.1	IBM PC	\$89.50	General-purpose nonlinear curve fitting.
Jandel Scientific	Sigmaplot V4.0	IBM PC	\$495	Eight plot types. Smoothing curve fitting, regression, statistics. Imports ASCII, DIF, and 1-2-3 files.
	Tablecurve V2.11	IBM PC	\$395	Automated curve fitting. Graphing. Reads binary, dBase, ASCII, and 1-2-3 files.
	Peakfit V2.0	IBM PC	\$595	Separates and analyzes multiple peaks in data.
The Math Works	Spline Toolbox	IBM PC with math processor, workstations	\$295	Requires Matlab (from \$695, depending on computer). Fits curves to data using piecewise polynomials. Lets you build splines.
Micromath Scientific Software	Graph V2.02	IBM PC	\$149	Scientific plotting, data transformation. Reads ASCII files. Simple curve fitting.
	Minsq V3.12	IBM PC	\$249	Nonlinear curve fitting. Model development.

Notes: 1. As used here, the term IBM PC refers to personal computers based on any member of the 80x86 family of processors. These PCs are compatible with the original IBM PC. Software runs under MS-DOS. IBM PC/AT refers to computers based on 80286, i386 and i486 processors and that are compatible with the original IBM PC/AT. A listing of OS/2 indicates that the software runs under that operating system; obviously the computer must support OS/2.
2. Price is for single floating license. Academic discount lowers price. Licenses that permit multiple users on a network also lower the price per user.

TECHNOLOGY UPDATE

yet numerous. **Table 1** lists just three—from Precision Visuals, Research Systems, and Spyglass. Of the three vendors, the first two offer packages that run only on workstations. Spyglass's packages run on Apple Computer's Macintosh II family. By mid year, you can expect

a visualization package for PCs based on 386 and i486 μ Ps.

For many of the experiments electrical engineers perform, visualization packages provide more than enough power. In fact, you may be able to get by with the graphing capabilities of a spread-

sheet program. As **Ref 1** points out, though, most spreadsheets are tailored to business applications. They excel at producing bar and pie charts, but most can't create surface or contour plots. Few spreadsheets can show the limits of a range of data obtained from re-

Vendor	Package	Computer system ¹	US list price	Key features, comments
Mihalisin Associates	Temple-Graph V2.4	Sun workstations	\$1290 ²	Graphing and data analysis. Templego, which does graphing only, costs \$500.
Precision Visuals	PV-Wave (point-and-click version)	Sun workstations	\$2500	2- and 3-D visualization and data analysis. Animated displays. Can read files in many formats without advance information about the format.
Prescience	Theorist V1.1	Macintosh (all types)	\$399.95	Reads tab-and return-delimited ASCII files and anything from the clipboard.
Research Systems	IDL V2.0.11	Five vendors' workstations	\$2200 to \$9000	Generalized data reduction, analysis, visualization, and image processing. Reads binary and formatted data.
Scientific Programming Enterprises	Plot-It	IBM PC/AT	\$195	2- and 3-D graphs (60 types). Linear and nonlinear regression analysis.
		OS/2	\$295	
Signal Technology	NI!Power Base V1.0	DEC and Sun workstations	\$6000	Graphing and analysis. Reads ASCII and binary files and files from the vendor's ILS package.
Speakeasy Computing	Graph-easy V Zeta	IBM PS/2, RT, and RISC; DEC and Sun workstations	\$2000 to \$5000	Graphics component of numerical solution package called Speakeasy.
Spiral Software	Easyplot V II	IBM PC	\$349	2- and 3-D plotting and data analysis. Zoom and scroll.
Spyglass	Spyglass Transform	Macintosh II	\$395	Data visualization. Reads ASCII files. Creates color, interpolated, and polar images and line graphs.
	Spyglass View	Macintosh II	\$395	Usable as companion to Spyglass Transform. Creates surface and contour plots and cross sections.
Statsoft	CSS: Graphics	IBM PC OS/2	\$495	2-, 3-, and 4-D graphing; data analysis. Vendor has a statistical package (CSS/3, \$595). CSS: Statistica combines the two (\$795).
Synergy Software	Kaleido-Graph V2.1	Macintosh	\$249	16 plot types. High-speed curve fitting.
Systat	Systat V5.0	IBM PC	\$895	Includes all functions of Sygraph, a stand-alone graphing package: contour plots, nonlinear scatter-plot smoothing, and dimensional maps.
	Mac Systat V5.0	Macintosh		
Triakis	Dan V1.2	Sun SPARCstations	\$395	Inputs and outputs in several file formats. Manipulates data tables in memory. Makes X-Y plots.
	Dan V2.0	Next		
TriMetrix	Axum V1.02	IBM PC	\$495	Imports ASCII, 1-2-3, and dBase files. Creates 2- and 3-D plots, contour plots, and Smith charts.
Wavemetrics	Igor V1.24	Macintosh (all types)	\$295	2-D graphing, curve fitting, data analysis. Macro language lets you automate functions such as peak analysis without additional software. Imports ASCII files (space, comma, and tab delimited); Excel and binary files.
3-D Visions	Graftool V3.3	IBM PC	\$495	2- and 3-D graphing and data analysis. Reads ASCII, DIF and 1-2-3 (WKS and WK1) files.

TECHNOLOGY UPDATE

Graphing and curve-fitting software

peated trials of an experiment while plotting a single curve through the scattered points. Usually, curve fitting with a spreadsheet program involves entering equations and making repeated trials. You may not think of this exercise as programming, but it really is.

So, if you're serious about using a computer to produce plots and graphs of experimental data, you'll want one or more packages that perform the same functions as the graphing, curve-fitting, and visualization software packages in **Table 1**. Despite its length, the **table** probably omits more packages with graphing and plotting capabilities than it includes. For example, many data-acquisition packages contain graphing and plotting routines, some of which are quite advanced. Such software isn't included, nor are libraries of graphing and plotting routines that you can call from your own high-level-language programs.

Selection requires savvy

With such an array of choices, how do you select one package (or a small number of packages) well suited to your needs? The flippant answer, of course, is "very carefully." **Table 1** and the list of vendors in the **box**, "For more information . . ." are, at best, just starting points for your search. A few of the factors you should consider and questions you should ask are

Are you going to use the software daily or only occasionally? User interfaces with pull-down menus can make occasional use of a package pleasant but may make frequent use exasperating. For this reason, some packages with pull-down menus have a "hidden" command-driven interface to speed operation for experienced users. If you do not use a mouse or pointing device, is the operation of

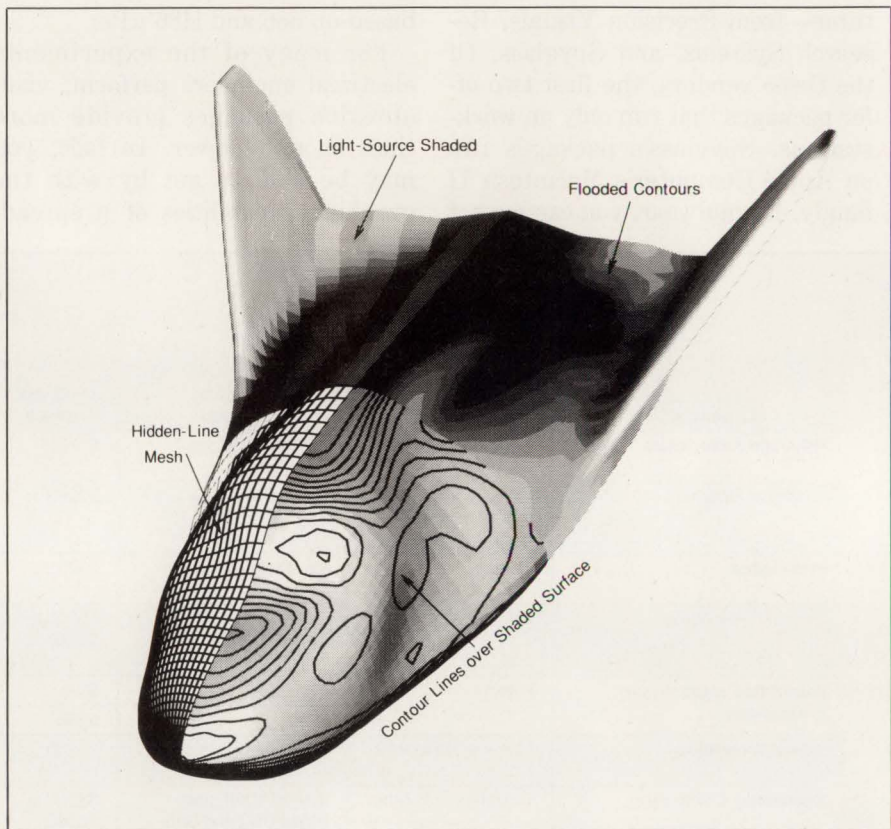

Three-dimensional displays take many forms, several of which appear in this illustration created with Amtec's Tecplot. Shown are a surface described by a mesh, shaded surfaces with and without contour lines, and a surface with flooded contours.

the software acceptable without one?

Create a list of the functions you want a package to perform. If possible, obtain a functional, interactive demonstration version of the software and spend enough time with it to assure yourself that it satisfies you in its performance of the functions you desire. Make sure the software operates fast enough on the computer you will actually use.

Will the program read data from files in a format your data-acquisition software can produce? For example, most packages claim to read ASCII files, but ASCII is hardly a complete specification for a file containing a data table. What characters does the software accept as delimiters between entries—commas, carriage

returns, tab characters? If you are plotting several dependent (Y) variables versus a single independent (X) variable, must the table repeat the X values for each set of Y values? If your X values are not always equally spaced, make sure the software still accepts them.

Many packages read spreadsheet files in Lotus WKS or WK1 formats. A few packages claim to "crack" unknown ASCII and binary file formats. If you need this capability, test it by asking the software to read a file of the type you want it to accept.

How large are the data sets the program can handle? If your data consists of more points than the program can read into memory at one time, you can prob-

Text continued on pg 76

TECHNOLOGY UPDATE

For more information . . .

For more information on the graphing, curve-fitting, and visualization software packages discussed in this article, circle the appropriate numbers on the Information Retrieval Service card or use EDN's Express Request service. When you contact any of the following manufacturers directly, please let them know you read about their products in EDN.

You can download a machine-readable version of this list from the EDN computer bulletin-board system (BBS). The downloadable list includes a larger number of companies than appear here. Some of the additional firms' products did not fit within the product category as defined in this article. Other companies failed to respond to our request for information. You can reach the EDN BBS at (617) 558-4241 (300, 1200, 2400, 8,N,1, 24 hours, 7 days). Look for file #TU260 in the /freeware SIG.

Advanced Graphics Software Inc
333 W Maude Ave
Suite 105
Sunnyvale, CA 94086
(408) 749-8620
FAX (408) 749-0511
Circle No. 700

Advanced Micro Solutions Inc
3817 Windover Dr
Edmond, OK 73013
(405) 340-0697
FAX (405) 749-0594
Circle No. 701

Amtec Engineering Inc
Box 3633
Bellevue, WA 98009
(206) 827-3304
FAX (206) 827-3989
Circle No. 702

BBN Software Products Corp
10 Fawcett St
Cambridge, MA 02138
(617) 873-6000
FAX (617) 873-3315
Circle No. 703

Binary Engineering Inc
400 Fifth Ave
Waltham, MA 02154
(617) 890-1812
FAX (617) 890-1340
Circle No. 704

BV Engineering
2023 Chicago Ave
Suite B-13
Riverside, CA 92057
(714) 781-0252
FAX (714) 781-0626
Circle No. 705

Caren Co
12137 Midway Dr
Tracy, CA 92507
(209) 835-0295
Circle No. 706

Damaskos Inc
Box 469
Concordville, PA 19331
(215) 358-0200
FAX (215) 558-1019
Circle No. 707

DSP Development Corp
1 Kendall Sq
Cambridge, MA 02139
(617) 577-1133
FAX (617) 577-8211
Circle No. 708

Dynacomp Inc
178 Philips Rd
Webster, NY 14580
(716) 265-4040
Circle No. 709

Golden Software Inc
Box 281
Golden, CO 80401
(800) 333-1021;
in CO, (303) 279-1021
FAX (303) 279-0909
Circle No. 710

Heartland Software Inc
234 S Franklin
Ames, IA 50010
(515) 292-8216
FAX (515) 292-8216
Circle No. 711

Island Products
Box 253, Station 1
Galveston, TX 77550
(800) 342-4681;
in TX, (409) 761-2463
FAX (409) 761-6424
Circle No. 712

Jandel Scientific
65 Koch Rd
Corte Madera, CA 94925
(800) 874-1888;
in CA, (415) 924-8640
FAX (415) 924-2850
Circle No. 713

The Math Works Inc
21 Eliot St
South Natick, MA 01760
(508) 653-1415
FAX (508) 653-2997
Circle No. 714

Micromath Scientific Software
2034 E Fort Union Blvd
Salt Lake City, UT 84121
(801) 943-0290
FAX (801) 943-0299
Circle No. 715

Mihalisin Associates
600 Honey Run Rd
Ambler, PA 19002
(215) 646-3814
FAX (215) 643-4896
Circle No. 716

Precision Visuals Inc
6260 Lookout Rd
Boulder, CO 80301
(303) 530-9000
FAX (303) 530-9329
Circle No. 717

Prescience Corp
814 Castro St, Suite 106
San Francisco, CA 94114
(415) 543-2252
FAX (415) 882-0530
Circle No. 718

Research Systems Inc
777 29th St, Suite 302
Boulder, CO 80303
(303) 786-9900
FAX (303) 786-9909
Circle No. 719

Scientific Programming Enterprises
Box 669
Haslett, MI 48840
(517) 339-9859
FAX (517) 339-4376
Circle No. 720

Signal Technology Inc
Box 1950
Goleta, CA 93116
(805) 968-3000
FAX (805) 967-0871
Circle No. 721

Speakeasy Computing Corp
224 S Michigan Ave
Chicago, IL 60604
(312) 427-2400
FAX (312) 427-4777
Circle No. 722

Spiral Software
6 Perry St, Suite 2
Brookline, MA 02146
(617) 739-1511
FAX (617) 739-4836
Circle No. 723

Spyglass Inc
701 Devonshire Dr, C-17
Champaign, IL 61820
(217) 355-1665
FAX (217) 398-0413
Circle No. 724

Statsoft Inc
2325 E 13th St
Tulsa, OK 74104
(918) 583-4149
FAX (918) 583-4376
Circle No. 725

Synergy Software
2457 Perkiomen Ave
Reading, PA 19606
(800) 876-8736;
in PA, (215) 779-0522
FAX (215) 370-0548
Circle No. 726

Systat Inc
1800 Sherman Ave
Evanston, IL 60201
(708) 864-5670
FAX (708) 492-3567
Circle No. 727

Triakis Inc
560 Bryce Ave
Los Alamos, NM 87544
(505) 672-3180
FAX (505) 662-2775
Circle No. 728

Trimetrix Inc
444 NE Ravenna Blvd
Suite 210
Seattle, WA 98115
(206) 527-1801
FAX (206) 522-9159
Circle No. 729

Wavemetrics
Box 2088
Lake Oswego, OR 97035
(503) 620-3001
FAX (503) 620-6754
Circle No. 730

3-D Visions Inc
412 S Pacific Coast Hwy
Redondo Beach, CA 90277
(213) 540-8818
FAX (213) 540-3492
Circle No. 731

VOTE . . .

Please also use the Information Retrieval Service card to rate this article (circle one):

High Interest 518

Medium Interest 519

Low Interest 520

TECHNOLOGY UPDATE

Graphing and curve-fitting software

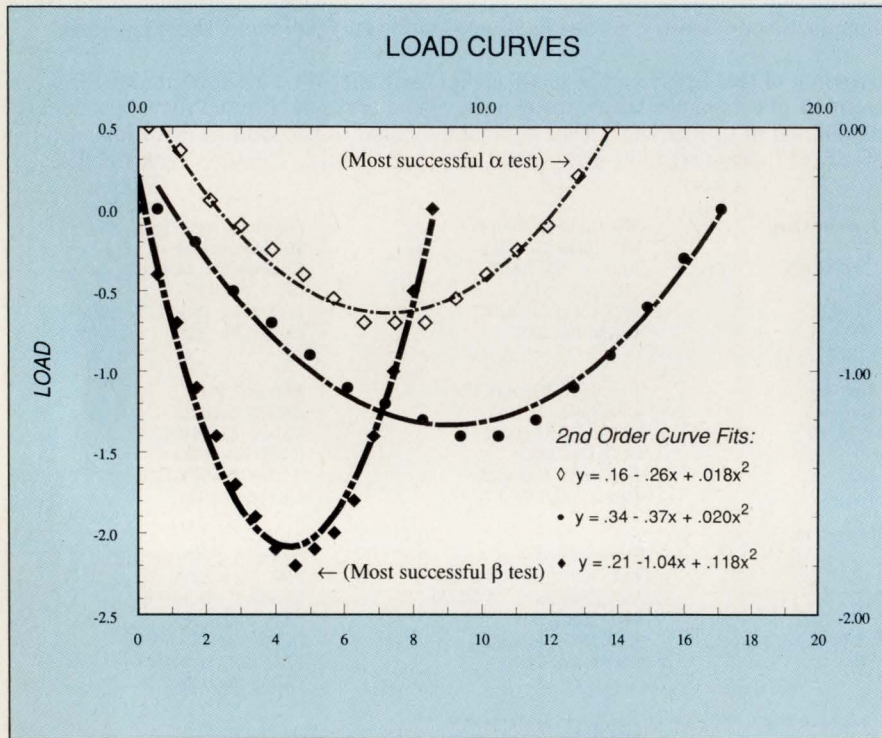

Fitting curves to data is a useful way of perceiving relationships among variables. Next to these curves, which were created with Binary Engineering's Tech*Graph*Pad, are the equations the software created to fit the experimental data.

ably break up the files into smaller ones. But doing so may require a lot of work, and the graphic output may not be acceptable. Some programs will read in every Nth set of Y values or every Nth set of X values within a limited range of X values, where you can specify N and the boundaries of the X range. Such capabilities can be quite useful.

Does the software support your printer or plotter? Most packages support large numbers of output devices, sometimes hundreds. Nevertheless, neglecting to check whether compatibility exists with your hard-copy device can result in unpleasant—and potentially costly—surprises.

Similar caveats apply to checking for compatibility with your video-display hardware. You should make sure that packages that support the IBM VGA standard specifically support your brand of VGA

card at the resolution you hope to use. At resolutions greater than 640×480 pixels, little compatibility exists among supposedly equivalent VGA cards. If your graphics package supports resolutions such as 800×600 or 1024×768 pixels, you may have to rely on your VGA board vendor for video-driver software. Drivers for any but the most widely used packages are often difficult or impossible to obtain.

Will the software save its graphical output to a file on disk? If so, what graphics file formats does it let you use? Once you've saved a file, can you produce the graphics on a printer or plotter without using the graphics package? With an appropriate hard-copy device, you can do so with files of certain standard types, such as Postscript and HPGL (Hewlett-Packard Graphics Language). Such a capability can be important if you

plan to use the software on your PC at home but will be printing out your plots on a laser printer at work.

In addition to becoming an invaluable tool in your work, graphing, plotting, curve-fitting, and visualization software can also be a lot of fun to work with. One problem with selecting a technical graphics package, however, is the sheer number of products and their varied range of capabilities. Therefore, doing an intelligent job of selecting a package requires you to be clear about your needs. In addition, evaluating products will probably take more of your time than you'd like. If you take the trouble, though, your efforts will almost certainly be richly rewarded with time saved in interpreting data and good-looking reports and presentations.

EDN

References

1. Stinson, Craig, "Who needs a graphics package anyway?" *PC Magazine*, December 11, 1990, pg 249.
2. Titus, Jon, "Draw your graphs on printers and plotters," *EDN*, April 13, 1989, pg 53.

Article Interest Quotient
(Circle One)

High 518 Medium 519 Low 520

WHAT'S NEXT

EDN's March 1, 1991, edition is our annual communications technology special issue. Leading off the coverage is associate editor Mike Markowitz's cover story on recent ISDN developments. Two other staff-written stories will look at CAE tools for transmission-line problems and transmitter and receiver modules for fiber-optic communications.

CENTENNIAL
100
1891-1991

From Lights To
Products That
Enlighten...
Our Century-
Long Spirit Of
Innovation
Lives On.



Philips Components



PHILIPS

The first Philips carbon-filament lamp still burns symbolically today, inspiring us in the fundamental research that leads to better products.



What a century! It started in 1891 with a young Dutch engineer deciding to produce incandescent lamps. Gerard Philips couldn't have dreamed that his tiny factory staffed with 10 would grow into a giant—the 22nd largest industrial corporation in the world.

He believed in the power of research. In 1908, he created a chemistry laboratory to help solve production issues with all types of lamps. Then six years later, he helped establish the Philips Physics Laboratory, which still today provides a broad range of research.

When suppliers proved unreliable during World War I, Philips opened its own plants to produce glass, hydrogen gas and cardboard. While others responded to the Depression by cutting back on research, Philips moved ahead with breakthroughs in gas-discharge lamps, X-ray equipment, gramophones, car radios, telecommunications equipment, welding rods and electric shavers.

Even vast destruction during World War II couldn't stop the momentum. Factories were rebuilt and production again reached pre-war levels by 1946.

After the war, science and technology made great advancements. Philips R&D laboratories contributed significantly with the invention of new magnetic materials that were used on a large scale. The knowledge obtained from this research formed the basis of later work on transistors, integrated circuits and charged coupled devices.

In recent years, Philips' work on lasers and microelectronics has achieved great advances in processing, storage and transmission of images, sound and data. Among the developments are the compact disc, LaserVision optical disc and new optical telecommunications systems.

Today in North America, Philips Components Discrete Products Division supplies the marketplace with thousands of quality electronic products. Passive components such as resistors, capacitors and trimmers. Discrete semiconductors including power, surface mount, MOSFET and small signal devices. Ferrite cores, beads, chokes, recording heads and other specialty products. And professional components such as camera tubes, photomultipliers and image intensifiers.

Our century-long spirit of innovation continues. Use the attached reply card to learn more about our products.

On front: Gerard Philips testing carbon filaments for lamps in 1890.

Microwave Transistor Offers Highest Output Power.

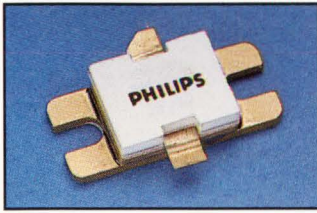

Philips' new PXB16050U microwave CW transistor provides the highest available output yet. Ideal for use in satellite links in INMARSAT and similar systems, the new transistor features input and output prematching circuits that simplify external circuit design and more evenly distribute power over its total active area. The result: no hot spots.

With its NPN silicon planar epitaxial design, the PXB16050U is geared for peak performance in common-base Class C narrow band amplifiers. Use it for voice and data communications on ships, aircraft and ground-based systems.

It provides 50W continuous wave power at 1.6GHz while operating from a 28V supply. Typical power gain is 9.5dB. Collector efficiency is as high as 52% with a low thermal resistance of 1.5K/W.

Gold metallization helps assure stability and extend device life, while use of diffused emitter ballasting resistors improve ruggedness and ensure excellent current sharing. Spec sheets available; delivery is 10 weeks ARO.

PPR5000 Film Resistors: Uncommon Stability, Power Handling.

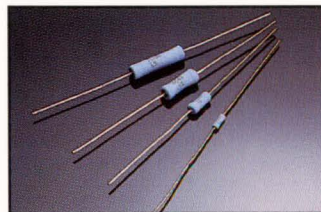

Now you can specify a precision power film resistor with the stability and power handling ability you thought only wirewounds offered.

Replace your precision wirewound resistors with the new PPR5000 Series film resistors from Philips.

These resistors achieve the typically low inductance and reliability of metal film resistors

and the power handling and stability of wirewounds—while maintaining comparably smaller size.

In power handling, the new series ranges from 1, 2, 3 and 5 watts at 25 °C with temperature coefficients to ± 20 PPM. Tolerance levels are $\pm .05\%$ to $\pm 1\%$ and maximum voltage ranges from 160 V at 1 watt to 500 V at 5 watts.

Ask for the PPR5000 resistors in bulk or on tape and reel. Delivery is 6 to 14 weeks.

Surface Mount Film Capacitors Keep Cost And Size Small.

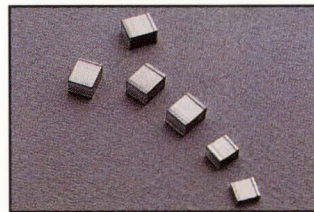

Thinking of ways to do away with encapsulation and shrink dimensions even more? Philips' new surface mount metallized film capacitors are what you need.

Made of high-temperature resistance dielectric polyphenylene sulphide (PPS) film in stacked construction, they're among the smallest capacitors on the market today. Three case sizes are available.

These new film capacitors feature solder-coated copper end-terminals to improve their solderability. They're ideal for all soldering processes—including wave soldering. Among other features: stability with temperature, voltage and frequency, high insulation resistance, low tan ESL/ESR, an open-circuit failure mode and high reliability.

Rated voltage is 25V DC with capacitance tolerances of ± 5 and $\pm 10\%$. Capacitors are available in blister tape on reel or in bulk.

First Schottky Rectifier In SOT-223 SMD® Package.

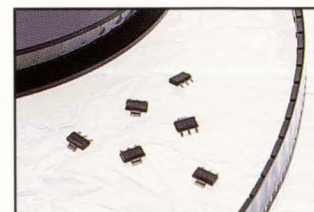

Philips has introduced the world's first Schottky power rectifiers in an industry-standard SOT-223 surface mount package.

PBYR235CT, PBYR240CT

and **PBYR245CT** feature a center-tapped pair of Schottky diodes. Each is capable of delivering an average output current of 1A and is perfectly matched through single monolithic substrate fabrication.

To assure highly efficient operation, the new rectifiers' forward voltage drop is less than 0.45V at a current of 1A. Leakage current at the diodes' maximum continuous reverse voltage is less than 100 μ A.

Key features of the Schottky series include small size—just 6.5 x 3.5 x 1.8mm—a 2A current rating and surface mount capability.

The series offers reverse voltage ratings of 35, 40 and 45 volts that make it especially suited for low-voltage switch mode power supply applications such as 5V/2A units.

They're available on standard 12mm tape for SMD pick and place equipment. Samples and data sheets available. Production quantities delivered from 6 to 8 weeks ARO.

SOT-223 SMD® Package: Another Design First.

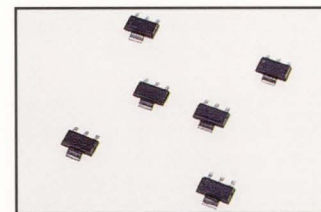

Few things have advanced medium-power surface mount design flexibility as much as Philips' introduction of its SOT-223 package.

A one-watt discrete semiconductor package when mounted on FR4 PCB, the SOT-223 allows you to achieve higher power dissipations and maximize board space without relying on conventional through-hole components. The new package dissipates 1 to 2 watts, and board mounting is possible with either reflow or wave soldering.

The SOT-223 is designed with flexibility of application in mind. The package can accommodate bipolar transistors, small signal MOSFETs, Schottky diodes, rectifier diodes, power MOSFETs, wide band/RF transistors, triacs and thyristors.

The surface mount package is especially suited to all applications where circuit board space is severely limited and power

dissipations approaching 1W are required.

Flanged Varistors Improve Solderability.

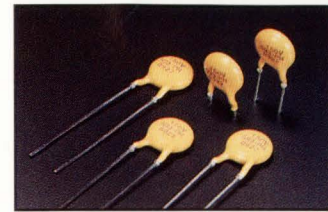

An exclusive flanged design is key to the improved solderability of a new series of Philips zinc oxide disc varistors.

The new design also makes component insertion easier.

Available in 5mm and 7mm diameters, the new flanged varistors further expand Philips' line of straight-lead and kinked-lead devices.

By defining the mounting height of the varistor, the flanged lead minimizes stress on the component from automatic insertion equipment. The flange also improves solderability by allowing flux to escape through the PCB holes during soldering.

The new varistors offer maximum AC voltage ratings from 14V to 460V; maximum DC voltages from 18V to 615V. With maximum nonrepetitive transient current ratings from 100A to 1200A, and transient response times of less than 20 nsec.

Use them to suppress voltage transients in telecommunications, data processing, consumer and automotive electronics applications. They're available in bulk or tape and reel. Delivery 6-12 weeks.

Plumbicon® Camera Tube Geared To Medical, Industrial Use.



Medical X-ray imaging, military and industrial vision systems will get a boost from the new very high resolution Plumbicon camera tube.

High spatial resolution, improved contrast resolution and enhanced S/N are among the advantages of Philips' Type 88XQ tube.

Electrostatic deflection reduces both the tube's length and overall "in-coil" diameters, making it an ideal fit for compact cameras. Its conical shape helps reduce operation scanning voltage. And because of the electrostatic deflection, corner and center resolution are better than that offered by magnetic deflection tubes.

The 88XQ is especially suited for medical imaging. It offers the highest modulation depth of all lead oxide tubes, resolving more than 2500 TV lines in the center and more than 1600 in the corner. Short response time is another advantage. And the camera tube's lag is tunable, a major design benefit for such dynamic applications as cardiac study.

Other 88XQ features: a low output capacitance (LOC) window, and a diode gun capable of handling 4 μ A of peak signal with minimal loss of resolution and deterioration of lag characteristics.

Flat E-Cores Reduce Height In Transformers.

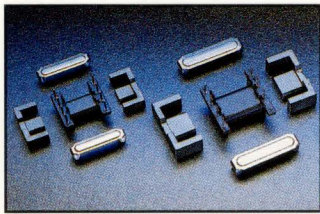

Making use of low-loss 3F3 material, Philips is introducing a series of flat E-cores designed to cut the height of transformers in DC/DC power modules.

The EFD (Economic Flat Design) cores come in four types:

- 15/8/5 for board areas 15 x 15mm and 500kHz operation
- 20/10/7 for board areas 20 x 20mm and 300kHz operation
- 25/13/9 for board areas 25 x 25mm and 100kHz operation
- 30/15/9 for board areas 30 x 30mm and 100kHz operation

All the new flat cores can be operated at up to 1MHz and can be used in transformers with

power throughput densities as high as 20W/cm. That's possible because of the cores' high-frequency ferrite materials and computer-aided design.

EFD cores come with matching bobbins and clips suitable for automated production lines. Sample cores — with bobbins and clips — are now available from Philips.

SMD® Tantalum Chips Offer Extended Capacitance.



Philips is introducing a new line of conformally coated tantalum chip capacitors for use in high-reliability and medical applications.

The 49EC Series capacitors offer high capacitance density with low ESR values at 100 kHz and low DC leakage current. They're designed for operation from -55 °C to +85 °C with rated DC voltage applied. At 67% of rated voltage, the temperature range can be extended to +125 °C.

The new capacitors, though non-military, are pad-compatible and interchangeable with established MIL-C-55365/4 CWR06 conformally coated and CWR09 molded tantalum chips.

Depending on the voltage rating, 49EC chips offer two to three times the capacitance values of CWR06 and CWR09 products in the same case size. Rated DC voltages of 4, 6, 10, 15, 20, 25 and 35 volts are available in each of eight case sizes. These sizes are identical to those of CWR06 devices. Gold-plated or hot solder-dipped terminals are available. Standard capacitance tolerances include $\pm 20\%$, $\pm 10\%$ and $\pm 5\%$. Delivery is 12 to 14 weeks ARO.

Sales Offices and Manufacturer Representatives

AL	Huntsville, Over & Over, Inc.	(205) 837-7105
AZ	Tempe, Philips Components	(602) 820-2225
CA	Anaheim, Philips Components	(714) 441-0385
CA	Folsom, Webster Associates	(916) 989-0843
CA	Mission Hills, Philips Components	(818) 891-6299
CA	San Diego, Philips Components	(619) 453-0332
CA	Sunnyvale, Philips Components	(408) 991-2110
CO	Englewood, Philips Components	(303) 779-9696
FL	Altamonte Springs, Philips Components	(407) 339-5073
FL	Ft. Lauderdale, Philips Components	(305) 485-0115
GA	Norcross, Over & Over, Inc.	(404) 449-6205
GA	Roswell, Philips Components	(404) 992-0150
IA	Cedar Rapids, Lorenz Sales, Inc.	(319) 377-4666
IL	Bannockburn, GMR Sales, Inc.	(708) 295-8440
IL	Rolling Meadows, Philips Components	(708) 670-9494
IN	Fort Wayne, Corrao Marsh, Inc.	(219) 482-2725
IN	Greenfield, Corrao Marsh, Inc.	(317) 462-4446
IN	Kokomo, Philips Components	(317) 456-1615
KS	Overland Park, Lorenz Sales, Inc.	(913) 469-1312
KS	Wichita, Lorenz Sales, Inc.	(316) 721-0500
MA	Woburn, Philips Components	(617) 932-4748
MD	Columbia, Delta III Associates	(301) 730-4700
MI	Farmington Hills, Philips Components	(313) 553-6010
MN	Minneapolis, Electric Components Sales, Inc.	(612) 933-2594
MO	St. Louis, Lorenz Sales, Inc.	(314) 997-4558
NC	Charlotte, Over & Over, Inc.	(704) 542-9111
NC	Raleigh, Philips Components	(919) 782-3334
NC	Raleigh, Over & Over, Inc.	(919) 876-7338
NE	Lincoln, Lorenz Sales, Inc.	(402) 475-4660
NJ	Englewood Cliffs, Ed Glass Associates	(201) 592-0200
NJ	Parsippany, Philips Components	(201) 455-1507
NY	Binghamton, Empire Tech. Assoc., Inc.	(607) 772-0651
NY	Skaneateles, Empire Tech. Assoc., Inc.	(315) 685-5703
NY	East Rochester, Empire Tech Assoc., Inc.	(716) 381-8500
NY	Port Ewen, Empire Tech Assoc., Inc.	(914) 331-5553
OH	Dayton, Philips Components	(513) 436-0066
OH	Wickliffe, Philips Components	(216) 731-7721
OR	Beaverton, Eclipse Market Group	(503) 642-1661
PA	Willow Grove, Philips Components	(215) 659-6096
PR	Caparra Heights, M. Anderson Co., Inc.	(809) 783-6544
TX	Richardson, Philips Components	(214) 231-8274
TX	Austin, Philips Components	(512) 331-8828
TX	Houston, Philips Components	(713) 272-8086
WA	Redmond, Eclipse Market Group	(206) 885-6991
WA	Spokane, Eclipse Market Group	(509) 922-3972
WI	Milwaukee, Philips Components	(414) 228-4244
Canada	Scarborough, Ontario, Philips Components	(416) 292-5161
Mexico	CD, Juarez, Chihuahua, Philips Components	011 + 52 + 16 + 186701/02
Mexico	Guadalajara, Jalisco, Philips Components	011 + 52 + 36 + 522770/72
Mexico	Mexico City, Philips Components	011 + 52 + 55 + 333858/59

1-800-447-3762

Philips Components



PHILIPS

1pA MUX LEAKAGE CURRENT! 150V_{p-p} FAULT PROTECTION!

MUXs Offer 1000X Less Leakage Than DG508/509

Maxim's MAX328/329 CMOS multiplexers feature the industry's lowest on and off leakages, <1pA, providing system accuracy up to 16 bits over temperature. Low input leakages allow use of high-value resistors (43k Ω) in series with channel inputs. These resistors can withstand over 110V AC faults indefinitely while maintaining <40nV offset error voltages.

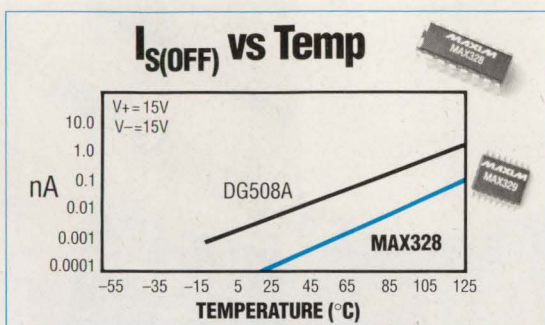

The MAX328/329 have <1pA leakage at 25°C — 1000X lower than the DG508/509.

- Single-Ended, 1-of-8 Device (MAX328)
Differential, 2-of-8 Device (MAX329)
- 1pC Charge Injection
- 1.9mW Power Consumption
- Single-Supply (+10V to +30V), or Dual-Supply ($\pm 5V$ to $\pm 18V$) Operation
- Analog-Signal Range Includes Rails
- Plug-in Upgrade of DG508/509 for only \$4.70 (1000-up)

Fault Protection: MAX378 -150V, DG508 -0V!

The MAX378/379 provide $\pm 75V$ of fault protection with supplies off, and $\pm 60V$ with supplies on — the highest in the industry! Unlike other fault-protected multiplexers, both input and output pins are current limited to only nanoamps under overvoltage conditions. This protects sensors, signal sources, ADCs, or other valuable circuitry from destruction.

- 8-Channel, Single-Ended, 1-of-8 Device (MAX378)
4-Channel, Differential, 2-of-8 Device (MAX379)
- $\pm 75V$ of Protection with Supplies Off
 $\pm 60V$ of Protection with Supplies On
- Only Nanoamperes of Input Current Under All Fault Conditions
- Dual-Supply Operation ($\pm 4.5V$ to $\pm 18V$)
- Latchup-proof Construction
- Plug-in Upgrade of DG508/509 for only \$11.30 (1000-up)*

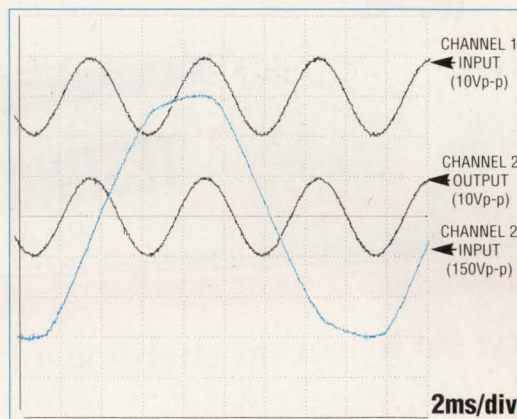

To demonstrate the ruggedness of MAX378, CH2 is overdriven with a 150V_{p-p} AC signal. This channel survives, and the adjacent on channel (CH1) is unaffected during this abuse.

Call your Maxim representative or distributor today for applications information, datasheets and samples. Or, write Maxim Integrated Products, 120 San Gabriel Drive, Sunnyvale, CA 94086, (408) 737-7600, FAX (408) 737-7194.

* FOB, U.S.A.

MAXIM

Distributed by Arrow, Bell/Graham, Hall-Mark, Nu Horizons, Pioneer, and Wyle. Authorized Maxim Representatives: Alabama, (205) 830-0498; Arizona, (602) 730-8093; California, (408) 248-5300, (619) 278-8021, (714) 261-2123, (818) 704-1655; Colorado, (303) 799-3435; Connecticut, (203) 384-1112; Delaware, (609) 778-5353; Florida, (305) 426-4601, (407) 682-4800; Georgia, (404) 447-6124; Idaho, (503) 292-8840; Illinois, (708) 358-6622; Indiana, (317) 844-8462; Iowa, (319) 393-2232; Kansas, (816) 436-6445; Louisiana, (214) 238-7500; Maryland, (301) 644-5700; Massachusetts, (617) 329-3454; Michigan, (313) 583-1500; Minnesota, (612) 944-8545; Mississippi, (205) 830-0498; Missouri, (314) 839-0033, (816) 436-6445; Montana, (503) 292-8840; Nebraska, (816) 436-6445; Nevada, (408) 248-5300; New Hampshire, (617) 329-3454; New Jersey, (201) 428-0600, (609) 778-5353; New Mexico, (602) 730-8093; New York, (201) 428-0600, (607) 754-2171; N. Carolina, (919) 851-0010; Ohio, (216) 659-9224, (513) 278-0714, (614) 895-1447; Oklahoma, (214) 238-7500; Oregon, (503) 292-8840; E. Pennsylvania, (609) 778-5353; W. Pennsylvania, (614) 895-1447; S. Carolina, (919) 851-0010; Tennessee, (404) 447-6124; Texas, (214) 238-7500, (512) 835-5822, (713) 789-2426; Utah, (801) 561-5099; Virginia, (301) 644-5700; Washington, (206) 823-9535; W. Virginia, (513) 278-0714; Wisconsin, (414) 792-0920; Canada, (416) 238-0366, (613) 225-5161, (604) 276-8735, (514) 337-7540.

Maxim is a registered trademark of Maxim Integrated Products. © 1991 Maxim Integrated Products.

IN THE ERA OF MegaChip™ TECHNOLOGIES

A lot has been said about company is doing a lot about



testability, but only one it. Texas Instruments.

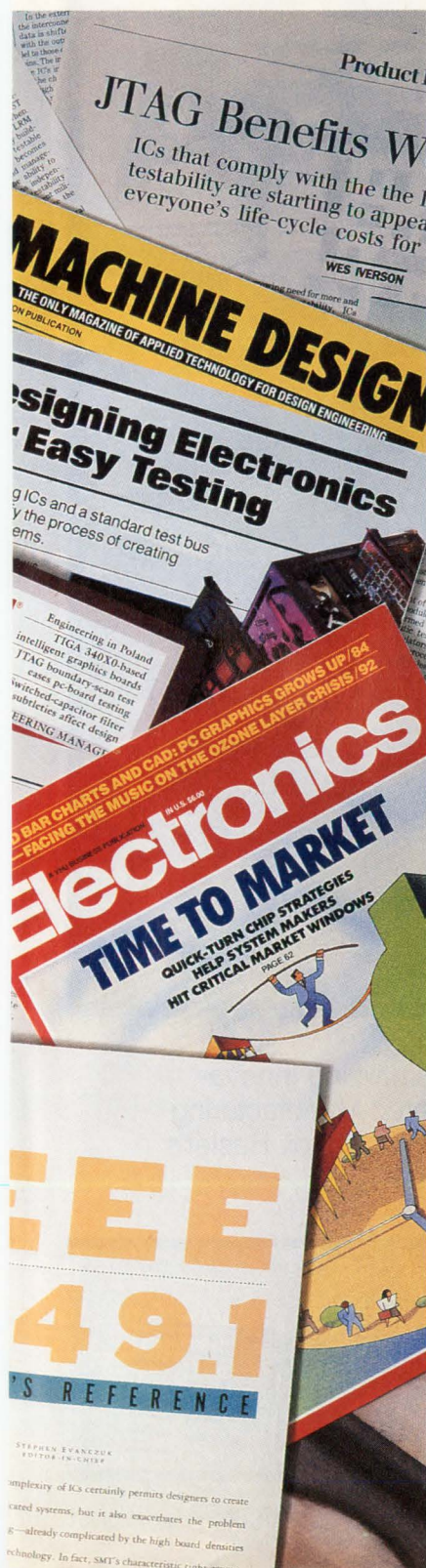

You've seen the headlines and read the stories. Design-for-test (DFT) is a challenge but one that's now easier to live with. The reason: Texas Instruments is the first to develop products for implementing the JTAG/IEEE 1149.1 testability standard quickly and effectively.

To market faster at lower cost

By implementing testability into your system from the outset, you can create one that uses high-performance circuits and is readily manufacturable, one that is lower in total cost and on the market faster. You can expect:

- Test integration — from silicon to system — that reduces debug and test time
- Reduced test software development time — generating test vectors is greatly simplified
- Reduced capital investment in test equipment
- Increased system fault coverage and reliability

SCOPE, our broad-based solution

To simplify and speed your design task, TI has developed its SCOPE™ (System Controllability/Observability Partitioning Environment) family. It is a coordinated, broad-choice set of commercial and military products compatible with the IEEE 1149.1 standard.

Included are bus-interface devices, standard cells, gate arrays, and digital signal processors, as well as our ASSET™ (Advanced Support System for Emulation and Test) diagnostics software.

On the way are diary memories, a series of IEEE 1149.1 stand-alone

controllers, and microprocessors with boundary-scan and built-in self-test features.

We are in for the long haul

As a member of the Joint Test Action Group (JTAG), we contributed to the formulation of the IEEE 1149.1 standard and wholeheartedly support it. We are committed to growing our SCOPE family of products so that designing to the IEEE 1149.1 standard will be like second nature.

Your future competitiveness depends upon an engineering methodology where design teams bear the burden of testability, manufacturability, and reliability. The demands of concurrent engineering will be met in part by the extended capabilities accessed via the IEEE standard — from embedded system information that allows realtime availability of data throughout the design cycle to emulation and realtime system analyses capabilities built right into the silicon.

Get our floppy free, and learn more

Call 1-800-336-5236, ext. 3909, and we'll send you our unique floppy disk presentation. Just pop it into any MS-DOS™-compatible PC to find out more about DFT and TI's SCOPE testability family. What's more, the disk features a formula that allows you to calculate the cost-effectiveness of implementing testability in your system.

You will continue to read headlines about DFT. We intend to make many of them.

™ MegaChip, SCOPE, and ASSET are trademarks of Texas Instruments Incorporated.
MS-DOS is a trademark of Microsoft Corporation.
© 1990 TI

08-0205

**TEXAS
INSTRUMENTS**

BASLER CUSTOM TRANSFORMERS FOR YOUR SPECIFIC NEEDS



Basler Electric is a diversified world-wide supplier of custom magnetic components. Ranging from 5VA to 2000KVA, these products meet

agency requirements utilizing Innovative Designs, Automated Manufacturing and Statistical Process Control. Basler's expertise can help you!

B **Basler Electric**
MAGNETIC PRODUCT GROUP

Box 269, Route 143, Highland, IL 62249
Telephone: 618-654-2341
Fax: 618-654-2351

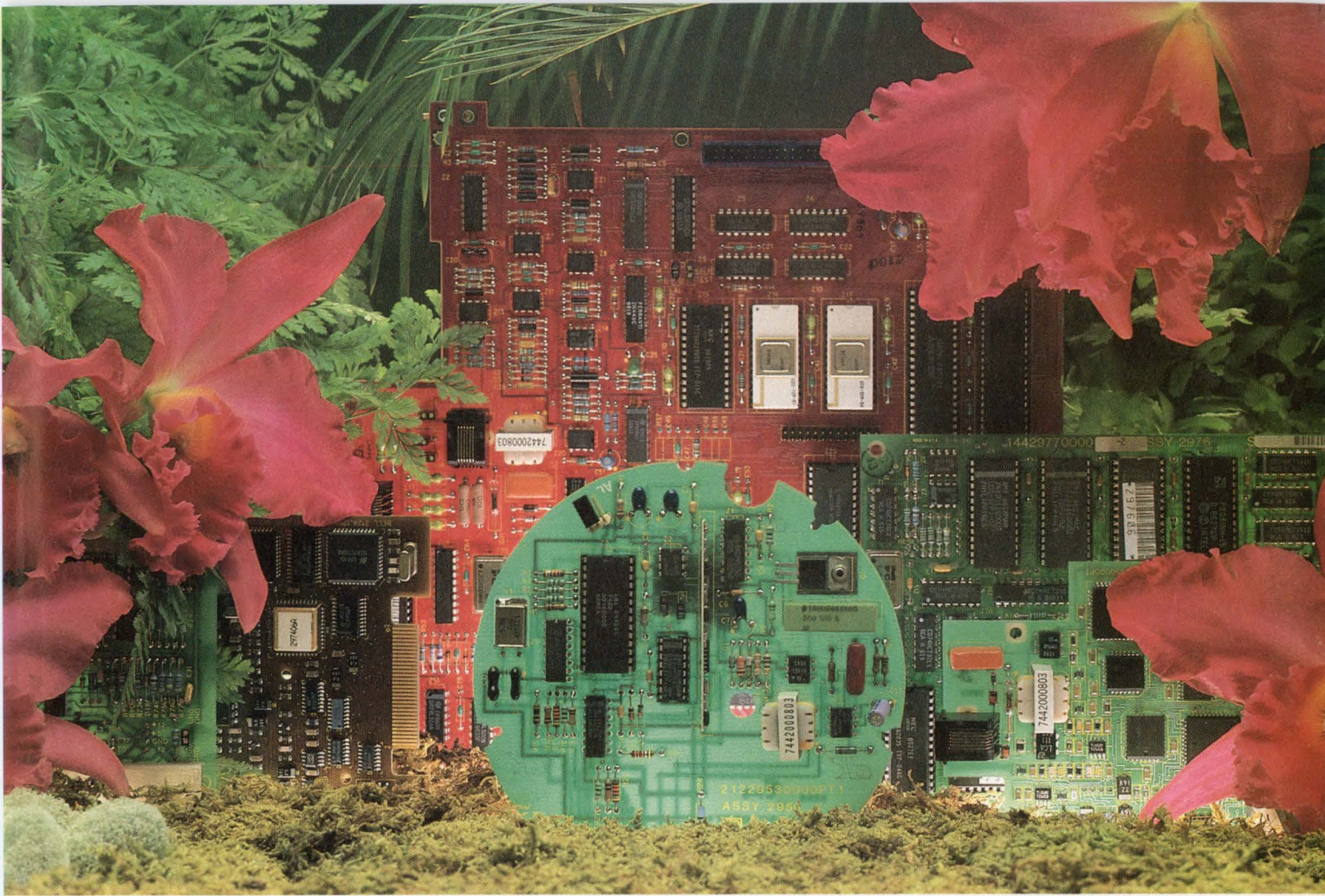

Exotic Customs at UDS

The special requirements of data communications OEMs have resulted in some pretty exotic custom modem cards from UDS.

Funny form factors are routine fare for our custom designers. Nooks, crannies and odd card configurations are no problem, given sufficient square inches of real estate. UDS engineers have even designed a complete 2400 bps modem that's the size of a credit card.

Non-standard modem functions are another specialty of the house. For example, UDS engineers have already designed and delivered a hand-held RF modem operating at 9600 bps!

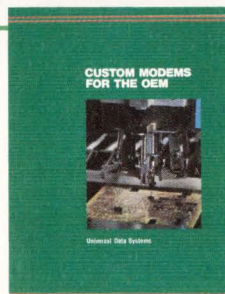

For a generous sampling of UDS' custom design capabilities, ask for the new, free OEM modem brochure.

UDS has successfully handled more than 3,000 custom OEM modem design assignments — and we can handle yours. To begin an exotic custom, contact UDS, 5000 Bradford Drive, Huntsville, AL 35805-1993. Phone 205/430-8000; FAX: 205/430-8926.





Fasten Your Seat Belt... Token Ring Accelerates to 16 Mbps.

Two New SBE 16 Mbps Controllers Bring High-Speed Token Ring to VMEbus/Multibus Systems.

One advantage of Token Ring is that it provides an efficient, high-performance interconnect with IBM mainframes. In a multinodal LAN environment, Token Ring provides *four times the throughput of Ethernet.*

SBE delivers high-performance Token Ring with two new intelligent 16 Mbps communications controllers that interface VMEbus/Multibus Systems with Token Ring LANs.

SBE's Token Ring Controllers include these features:

- Software-selectable interface for 4 or 16 Mbps.
- High-speed, on-board 32-bit 68020/68030 25MHz processors.
- 1 MB or 4 MB of DRAM.
- Support for IEEE 802.5 standards.

Turn to SBE and discover the difference these new 16 Mbps VMEbus/Multibus Controllers can make in your LAN application.

For fast action, call: 1-800-347-COMM.

SBE, Inc., 2400 Bisso Lane, Concord, CA 94520

SBE
Communications &
Real-time Solutions

VXI packaging and power issues heat up

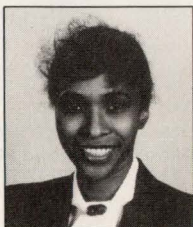

Some manufacturers have split VXI instruments, locating segments outside the mainframe or in multiple slots, to meet heat dissipation and power demands. Others are using onboard cooling fans, fins, and towers.

J D Mosley,
Regional Editor

Many test engineers incorrectly assume that all VXI (VME extensions for instrumentation) mainframes are created equal. However, VXI enclosures and power ratings vary, and they are among the most important factors that designers of VXIbus test-and-measurement systems should investigate. The high performance that engineers demand from VXI instruments can translate into high power consumption, which in turn results in high heat dissipation. If you let such heat build up within the enclosure, you can jeopardize the integrity of your components' measurements.

Unfortunately, many manufacturers fail to publish specs for cooling capacity. So, when shopping for a mainframe, you should find out each box's cooling capacity per slot and identify which slot presents the worst case. You must also verify whether the manufacturer's per-slot power ratings are based on continuous or intermittent operation. Specs based on 30-sec operation cycles may not provide an adequate safety margin if the VXI module you plan to use functions continuously for longer periods of time.

Even if you don't have your mainframe loaded with modules, heat can produce problems if the air blown into the enclosure merely swirls

through the empty slots, following the path of least resistance. Hewlett Packard combats this problem in its C-size E1400B mainframe by using a pressurized air-channel cooling system. This system forces air through each module, even when any or all of the enclosure's faceplates are open.

Other enclosure manufacturers equip their mainframes with *smart fans* that incorporate thermal resistors. These heat-sensitive resistors permit a fan to slow down or speed up in response to the temperature within the enclosure. However, a blocked vent can restrict airflow so severely that even the smartest fan wouldn't be able to dissipate sufficient heat to protect your instruments.

Augat solves the blocked-vent dilemma by equipping its enclosures with airflow sensors connected to audible

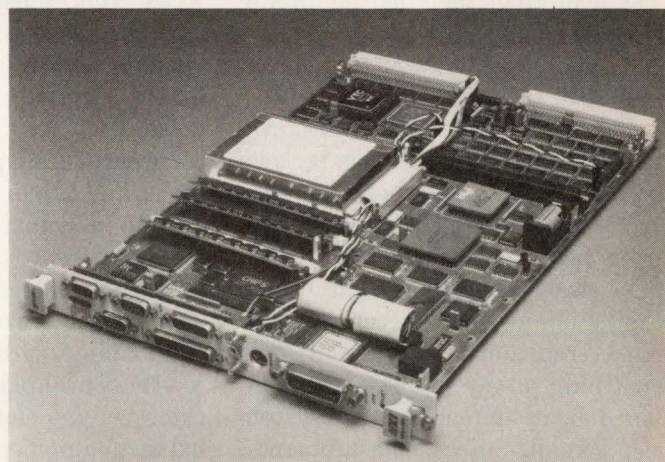

As manufacturers pack more components and functionality into a single VXI module, heat and power considerations escalate. National Instruments used SMT components, custom ASICs, and advanced packaging technology to produce the VXIpc-386/1, the industry's first single-slot PC/AT-compatible embedded VXI controller.

TECHNOLOGY UPDATE

VXIbus power and packaging

alarms. Besides alerting you to the problem of a blocked vent, the alarm also notifies you when to change air filters. Similarly, Augat enclosures monitor all seven power-supply outlets and provide visual and audible alarms that warn you of both intermittent glitches and terminal power failures.

In contrast, Racal-Dana markets a VXI module that cools itself. The company sells a 250-MHz time-interval analyzer that contains a number of high-performance custom ASICs. Instead of relying upon whatever air flow might be available in an enclosure, this module includes fans to ensure adequate ventilation. So, the board should perform to spec no matter how your mainframe controls cooling.

Not all methods of achieving maximum heat dissipation have met with acceptance. Tom Curfman, product marketing manager for ICS Electronics, noted that his company used to offer an enclosure with steel shields for optimum cooling capability. Customers objected so strongly to the weight of the box that ICS now only produces enclosures with aluminum shields. Unfortunately, these lightweight boxes dissipate less heat than their heftier predecessors.

Separate the hot from the cold

In traditional rack-and-stack systems, each instrument has its own power supply, and these supplies can generate a lot of heat. Aside from heat, switching power supplies also generate oscillations on the dc power line. Therefore, since most traditional instruments use switching power supplies, the combined heat and noise in a system can actually affect measurements. VXI systems attempt to avoid the heat and noise of a traditional configuration.

If your VXI system comprises only simple measurement instru-

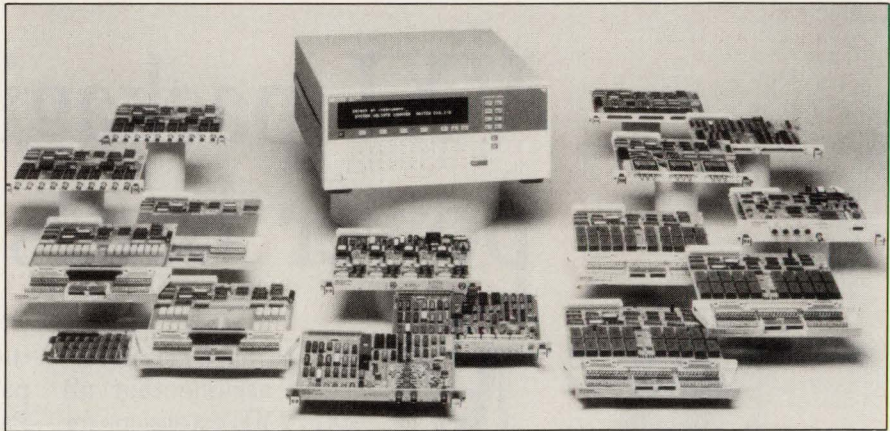

Billed as an entry-level alternative to the more popular C-size modules, Hewlett-Packard's 75000 B-size series of VXIbus products offers low-cost computer-aided test and measurement.

ments, they shouldn't create significant heat and noise problems. Unlike traditional rack-and-stack test systems, all the instruments in your VXIbus system will share a common enclosure and power supply. But, if your applications require you to use test equipment that consumes a lot of power, you shouldn't plan to locate that equipment inside the VXI enclosure. Instead, you should use Slot 0, or a VXIbus extender, and a separate backplane. High power consumption often produces high heat and noise, so you should segregate high-power devices from sensitive instruments. You may have to sacrifice the convenience of using a single enclosure for the security of avoiding heat and noise.

Intepro, a company that manufactures a VXIbus power-supply test system, eliminates noise and heat constraints by splitting their test instrument into two segments. A C-size, message-based, power-system commander card plugs into your VXIbus backplane and communicates via any slot 0 with the external test equipment. The commander card contains all the firmware needed to control the rack-mounted test equipment. That way, not only is the heat- and noise-generating equipment isolated from the VXI

mainframe, but Intepro customers also can upgrade to a VXI interface without abandoning their existing hardware.

The key to successfully splitting such instruments lies in the way the two halves communicate with each other. As noted by Michael O'Connor, president of Intepro, you will achieve maximum system performance if you are careful not to create a hybrid architecture. Such a hybrid would occur if you mixed internal VXIbus and external IEEE bus operations. Although both buses appear to be well-matched according to their data transfer rates, the IEEE-488 transfer performance slows dramatically when your system frequently accesses one or more discrete addresses, as is the case in most test and measurement applications.

Larry Desjardin, HP's VXI program manager, maintains that splitting up an instrument into multiple slots inevitably reduces that instrument's performance. At the present time, that drop in performance makes VXI less suitable than other platforms for highly sensitive RF and microwave measurements. However, Desjardin theorizes that future technological advances may minimize this performance loss and allow the VXIbus to adequately ad-

TECHNOLOGY UPDATE

Table 1—Representative VXibus system components

Manufacturer	Model	Form factor	Description	Price	Features
BICC-Vero	Backplanes	C, D	Backplanes	\$600 to \$2500	10-layer striplining construction; 5- to 13-slot versions
Colorado Data	73A-021	C	13-slot mainframe	\$6000	Includes power supply for maximum of 45W/slot; Block-mode high-speed data transfers
	73A-IBX	C	IEEE-488 VXibus system	\$8000	Access to individual VXibus registers; Interface to IEEE-488 instruments via IEEE-488 bus
	73A-PCX	C	PC-compatible instrument system	\$8500	Includes interface to PC-compatible computers via IEEE-488 bus
	73A-PRT	C	Prototyping system	\$10,000	Mainframe with Slot 0 prototype modules; Message-based VXI interface
Elgar	VXP1000	C, D	Power supply controller card	\$2495	Controls 4 power sources with as many as 16 dc channels and three phases of ac power
Elma	System 12	A, B, C, D	Backplanes & chassis	\$4000 to \$5500	Modular systems available from stock with power supplies ranging from 100W to 2000W
	69-A12VXIB	B	Backplane	\$995	12-slot B-size backplane; 12-layer strip line construction; Separate TTL and ECL signal layers
	69-A13VXID	D	Backplane	\$2395	13-slot D-size backplane; 12-layer strip line construction; Separate TTL and ECL signal layers
Hewlett-Packard	E1400B	C	13-slot mainframe	\$6275	Jumperless backplane; Power supply; Pressurized air-channel cooling
	E1300A	B	7-slot mainframe	\$2300	Built-in Slot 0 & Resource Manager; HP-IB and RS-232 interfaces; 80W power supply
	E1301A	B	7-slot mainframe	\$2800	Similar to E1300A; Includes front panel & 2-line display
ICS Electronics	VXI-KIT 113-991	C	Shielded enclosure	\$250	Single-wide; Includes front panel, RFI gasket, and side shields
	VXI-KIT 113-992	C	Shielded enclosure	\$300	Double-wide; Includes front panel, RFI gasket, and side shields
Mac Panel	Series 120	A, B, C	Subrack assemblies	\$2000 to \$5000	Custom-configured mainframe rack assemblies and associated hardware
Mupac	GB12	B	Backplane	\$895	Split ground-plane reduces ground loops
	213 Series	C	Wire-wrap board	\$1395	Schottky design aids current distribution and capacitance
National Instruments	VXI-AT2000	C	MXI Interface kit for PC/AT	\$3800	Lets a PC/AT function as a VXI commander and Resource Manager; Includes Labwindows
	VXI-MXI	C	VXibus mainframe extender to MXibus	\$1995	Transparent 1-slot extension for VXibus
	VXI-1000	C	5-slot mainframe	\$3600	250W power supply; Carrying handle; Short-circuit protection; Rack mountable
Racal-Dana	1261	C	13-slot mainframe	\$6450	12-layer backplane; Power supply; Cooling fans; Recessed cable tray
	1261E	C	RF chassis	\$11,995	Double-skin construction attenuates external radiation; Shielded door for RFI sealing
	1262	C	13-slot mainframe	\$9875	Similar to 1261, with hinged receiver mechanism and interconnect assembly
Radisys	VXI-B1	B	Portable 12-slot chassis	\$9995	Includes embedded 80386SX-based computer and Slot 0 controller
	VXI-B2	B	Portable 12-slot chassis	\$12,285	Includes embedded 25-MHz 80386-based computer and Slot 0 controller
Tektronix	VXI1500	D	13-slot mainframe	\$9995	Includes power and cooling for maximum of 100W/slot
	VXI1505	D	6-slot mainframe	\$7150	Includes power and cooling for maximum of 100W/slot
	VXI1400	C	13-slot mainframe	\$7000	Includes power and cooling for maximum of 50W/slot
	VXI1405	C	5-slot mainframe	\$3795	250W power supply; Carrying handle; Short-circuit protection; Rack mountable
Tracewell	System 23	C, D	13-slot mainframe	\$5510, \$6595	Mainframe comes with a 1000W power supply
	System 24	C	5-slot development system	\$2445	Mainframe includes a 700W power supply
	System 90	C, D	13-slot mainframe	\$6360, \$7115	Microprocessor-controlled, monitors power supply voltages and airflow, visual and audible alarms

TECHNOLOGY UPDATE

VXibus power and packaging

dress a full range of high- and low-frequency applications.

If you wish to sidestep the "split instrument" dilemma, consider using a VXibus extender. The most popular is the MXibus (multisystem Extensions interface bus), which lets you connect multiple VXI mainframes, stand-alone instruments, and IBM PC-compatible computers without the kind of performance degradation you'd experience in a VXI/IEEE-488 hybrid.

The MXibus (pronounced MIX-ee bus) is a VXibus enhancement that lets you daisy-chain and multidrop mainframes full of card-bound VXI instruments, as well as full-size physical instruments and PCs. It provides a 32-bit multimaster, frame-to-frame interface that lets a single VXibus resource manager configure and control as many

as 256 devices in a parallel-bus architecture.

Developed by National Instruments, MXibus lets you tightly couple a VXibus to computers and instruments that will never physically fit on a VXI module. MXibus provides word-serial drivers and utilities that let the VXI resource manager identify all the devices in a system, manage self-testing, configure the A24 and A32 address maps, establish the initial system hierarchy for multimaster arbitration, and initialize normal system operation. MXibus also defines a method for extending TTL triggers, VME interrupts, CLK10, and SYSFAIL across multiple frames.

Because MXibus doesn't specify what you can attach to it, it is more of a general-purpose bus than the instrument-specific IEEE-488.

Thus, you can tap the data flow from high-speed input devices such as optical scanners without facing the bottleneck posed by protocol-laden links.

In addition, although embedded PCs-on-a-board are currently available for the VXibus, you may find the combination of your own PC and a \$995 AT-MXI board from National Instruments to be a more cost-effective and versatile option for control and programming. And if you think that an embedded PC would, by definition, provide higher performance because it's located on the VXI backplane, remember that such functionality as memory caching and math coprocessing can actually make your external PC faster than its bare-bones, internal cousin.

A VXI Consortium technical subcommittee is currently using the

Inquire about
price reductions
on DTI's
Single Board Computers.



STILL...MORE

About The DTI 25/33MHz '486'

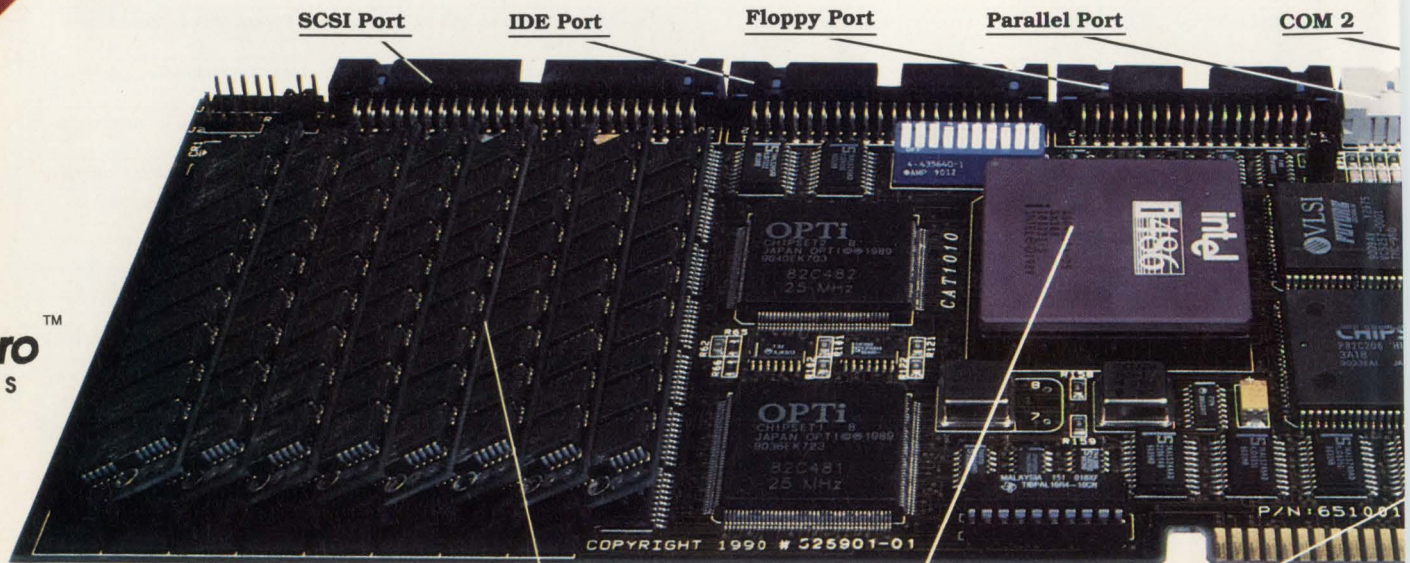

Slotpro™
SERIES

Product names are trademarks or registered trademarks of their respective companies.
386 & 486 are trademarks of Intel Corp.
SLOTpro is a trademark of Diversified Technology

Up to 32M
RAM On-board

High Performance Intel
80486 33MHz

Industry Standard
Custom BIOS

TECHNOLOGY UPDATE

MXIbus as the basis for mainframe-extension standardization.

Determining the size of the boards you will use in your VXI system requires more than mere space considerations. A- and B-size modules have dimensions identical to their VMEbus counterparts—3.9×6.3 in. and 9.2×6.3 in., respectively, with 0.8-in. slot spacing. C-size modules measure 9.2×13.4 in. and D-size is 14.4×13.4 in., both with 1.2-in. slot spacing. Fig 1 displays the relative size of the four form-factors and the signals available to the modules via the three defined VXIbus connectors.

A-size modules are scarce, mainly because of their limited board size and limited data-transfer capacity. D-size boards are the only boards that can access VXI's P3 connector, with its additional 24-pin local bus,

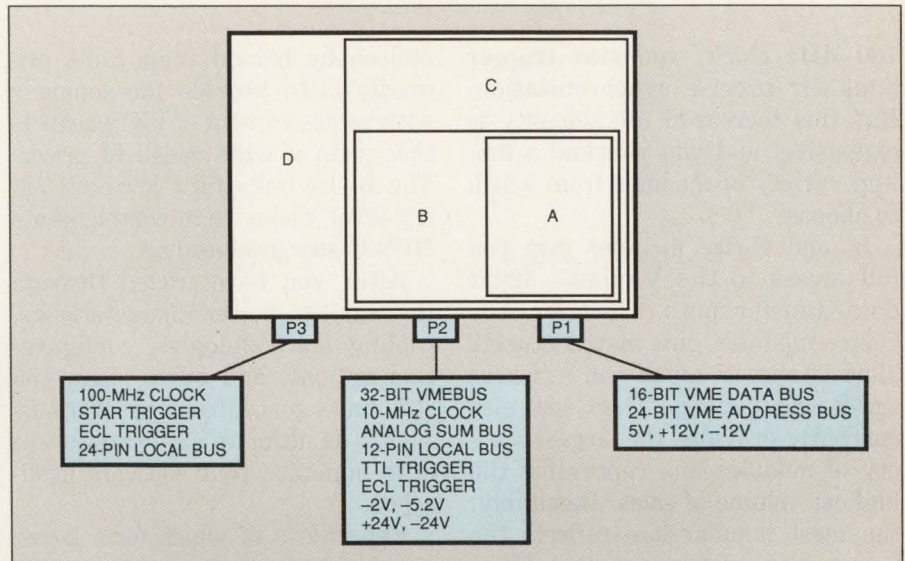
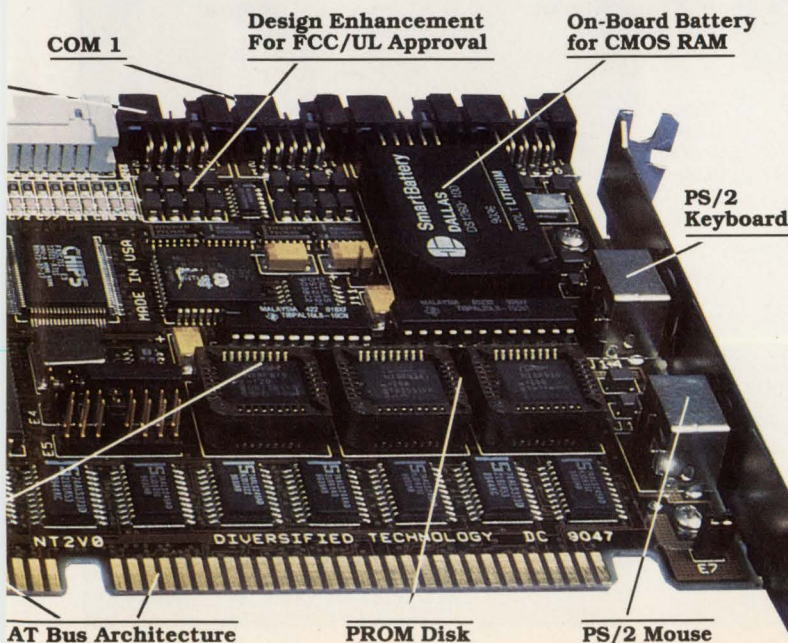

Fig 1—The VXIbus specifies three 96-pin DIN connectors. In addition to three power pins and some interrupt buses, P1 includes a data-transfer bus that offers 24 address bits and 16 data bits. P2 expands the data-transfer bus to 32 bits and includes greater resources such as four additional power-supply voltages, a local bus, the module-identification bus, a current-summing bus, TTL and ECL trigger buses, and a 10-MHz clock. The D-size P3 connector offers 24 more local-bus lines, a 100-MHz clock, and more trigger lines.

REAL FACTS!

Single Board Computer



COMPARE FUNCTION	DTI CAT1010 486	Competitor 1 486	Competitor 2 486
25, 33MHz CPU- Shipping Now!	✓		25MHz Only 7-8 Wks Del.
Up to 32M RAM Onboard	✓		
Noise Reduction Circuitry For FCC Class B	✓		
PS/2 Mouse Support	✓		
PS/2 Keyboard Support	✓		
On-Board Battery Real Time Clock	✓		✓
Bi-directional PS/2 Printer Port	✓		
2 Serial Ports - Up to 115K Baud	✓		
Future Domain SCSI	✓		
IDE Interface	✓		
Floppy Interface	✓		
Up to 512Kb User PROM Disk	✓		
Double Sided Surface Mount Technology	✓		
Manufactured In-House(U.S.A.)	✓		
Landmark V1.14 Speed at 25MHz	114.1		84
Landmark V1.14 Speed at 33MHz	150.9		

NOT AVAILABLE

Call us toll free for orders and information.

1-800-443-2667

Diversified Technology

An Ergon Co.

U.S.A. - (601) 856-4121 Fax (601) 856-2888
 Outside U.S.A. - (201) 891-8718 Fax (201) 891-9629

TECHNOLOGY UPDATE

VXIbus power and packaging

100-MHz clock, and star trigger lines for precise synchronization. But this increased functionality is expensive, and you will find a limited variety of modules from which to choose.

B- and C-size modules give you full access to the VXIbus's 32-bit data-transfer path. However, the C-size modules give manufacturers almost twice as much real estate as the B-size modules. The C-size also currently provides the largest variety of modules and represents the highest volume of sales. Inevitably, the most popular size reflects the best price/performance ratio. However, if you face a limited budget or severe size constraints, you'll find HP promoting a comparable variety of B-size VXIbus products.

HP is fairly unique in touting B-size configurations. The marketing

philosophy behind these units primarily is to provide the company with an assortment of VXI products that span a wide range of prices. The B-size units fill a low-cost, entry-level niche that complements HP's C-size product line.

After you have waded through the various power characteristics, cooling methodologies, configuration options, and board sizes, you still have to confront software issues. The ultimate hardware caveat is to minimize your software headaches.

Regardless of which form factor you decide to adopt, make sure the modules have a SCPI-compatible command-set interface. SCPI (Standard Commands for Programmable Instrumentation) provides a common command set that simplifies software development and maintenance,

thereby reducing your overall system costs. Standardizing on SCPI (pronounced skippy) also provides you with a simple migration path to higher performance instruments that may become available in the future.

EDN

References

1. Bodie, Fred, *VXIbus Newsletter*, Vol 2, No 3, August 1990.
2. Kerridge, Brian, "Small products add big spark to test field," *EDN*, November 22, 1990, pg 43.

Article Interest Quotient (Circle One)

High 512 Medium 513 Low 514

For more information . . .

For more information on the VXIbus products discussed in this article, circle the appropriate numbers on the Information Retrieval Service card or use EDN's Express Request service. When you contact any of the following manufacturers directly, please let them know you saw their products in EDN.

Augat Inc

452 John Dietsch Blvd
Attleboro Falls, MA 02763
(508) 699-9800
Circle No. 667

Elma Electronic Inc

41440 Christy St
Fremont, CA 94538
(415) 656-3400
FAX (415) 656-3783
Circle No. 671

Mac Panel Co

551 W Fairfield Rd
High Point, NC 27264
(919) 861-3100
Circle No. 675

Radisys Corp

19545 NW Von Neumann Dr
Beaverton, OR 97006
(800) 950-0044
FAX (503) 690-1228
Circle No. 679

Bicc-Vero Electronics Inc

1000 Sherman Ave
Hamden, CT 06514
(203) 288-8001
FAX (203) 287-0062
Circle No. 668

Hewlett-Packard Co

Box 301
Loveland, CO 80539
(800) 752-0900
Circle No. 672

Mupac Corp

10 Mupac Dr
Brockton, MA 02401
(508) 588-6110
FAX (508) 588-0498
Circle No. 676

Tektronix

Box 4600
Beaverton, OR 97076
(800) 835-4894
Circle No. 680

Colorado Data Systems Inc

3301 W Hampden Ave, Unit C
Englewood, CO 80110
(303) 762-1640
FAX (303) 781-0253
Circle No. 669

ICS Electronics Inc

744 S Hillview Dr
Milpitas, CA 95035
(408) 263-5500
FAX (408) 263-5896
Circle No. 673

National Instruments Corp

6504 Bridge Point Pkwy
Austin, TX 78730-5039
(512) 794-0100
FAX (512) 794-8411
Circle No. 677

Tracewell Enclosures Inc

567 Enterprise Dr
Columbus, OH 43081
(614) 846-6175
FAX (614) 846-4450
Circle No. 681

Elgar

9250 Brown Deer Rd
San Diego, CA 92120
(619) 450-0085
FAX (619) 458-0267
Circle No. 670

Intepro Systems Inc

6 Fortune Dr
Billerica, MA 01821
(508) 663-7555
FAX (508) 663-7558
Circle No. 674

Racal-Dana Instruments Inc

4 Goodyear St
Irvine, CA 92718
(714) 859-8999
FAX (714) 859-2505
Circle No. 678

Virginia Panel Corp

1400 New Hope Rd
Waynesboro, VA 22980
(703) 949-8376
FAX (703) 942-2856
Circle No. 682

Should you use power factor correction in your 400W-2,500W power supplies?

Phone for this free report.

Now it's easy for you to evaluate the benefits of power factor correction. Phone to reserve your copy of this exclusive report and discover:

- ✓ The systems most prone to low power factor, with a graphical example of how the problem occurs.
- ✓ How to quickly determine whether power factor correction is appropriate for your applications.
- ✓ How to get 30% more power out of any standard wall socket—and meet UL's spec requiring that equipment plugged into a 15A outlet draw no more than 12A.
- ✓ The most cost-effective way to eliminate potential safety hazards from harmonic distortion.

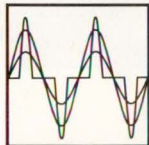

With power factor correction, the input current is virtually sinusoidal.

- ✓ An update on the IEC 555.2 harmonic distortion spec.
- ✓ The critical advantages of an active over a passive power factor correction scheme.
- ✓ Special benefits of power factor correction for companies that operate sensitive equipment on an A/C line.
- ✓ Tips on selecting converter topology to ensure maximum efficiency and reliability in a power factor corrected supply.
- ✓ How to use the same supply anywhere in the world without modification.
- ✓ How to use power factor correction as a marketing tool for your products.

How to instantly become an expert on power factor correction.

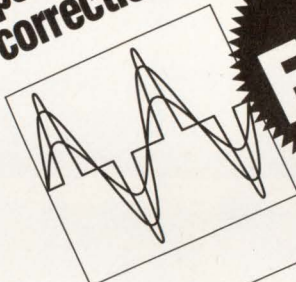

FREE

MTBF exceeds 200,000 hours.*

Power Components' power factor corrected supplies have a MTBF of more than 200,000 hours (using Mil-217E standards).

A statistical process control system with 20 measurement points ensures consistent quality. Our QA system follows Mil-I-45208 and ESD standards.

For exceptional reliability, a half-bridge power converter is used to reduce the transformer's operating temperature and minimize thermal stress.

Power supplies are inspected and tested repeatedly. Each supply is burned-in at 50°C at full load while being cycled "on" and "off." You get a printout of final test results with each supply.

Get power factor corrected supplies for about the same price as many standard supplies.

Power Components uses a modular, conservative design approach. You don't pay extra for features you don't need.

And since manufacturing takes place in our low-cost facility in Mexicali, Mexico, a major savings is passed on to you.

The result? Power factor corrected supplies from Power Components—with exactly the features you need—cost about the same as many standard supplies from other makers.

For your free report or more information, phone:

1-800-828-7289

Extension 101

*Single output supply. (All other Power Components' supplies contain a minimum MTBF of 160,000 hours.)

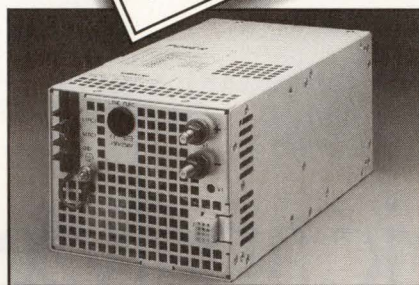

Power Components makes 250W-2,500W switching power supplies with and without power factor correction.

Specialists in power factor correction.

We're Power Components, makers of high performance switching power supplies in the 250W-2,500W range—and a leader in power factor correction. We were among the first to produce a 1,000W power supply with .998 power factor.

Power factor corrected supplies from Power Components meet UL, CSA, VDE and FCC standards, and IEC 555.2 harmonic requirements.

The Power Factor Correction Specialists

POWER COMPONENTS

Subsidiary of Vanguard Electronics Co., Inc.

1480 West 178th Street, Gardena, CA 90248 213-323-8120 (fax) 213-329-8427

FLUKE®

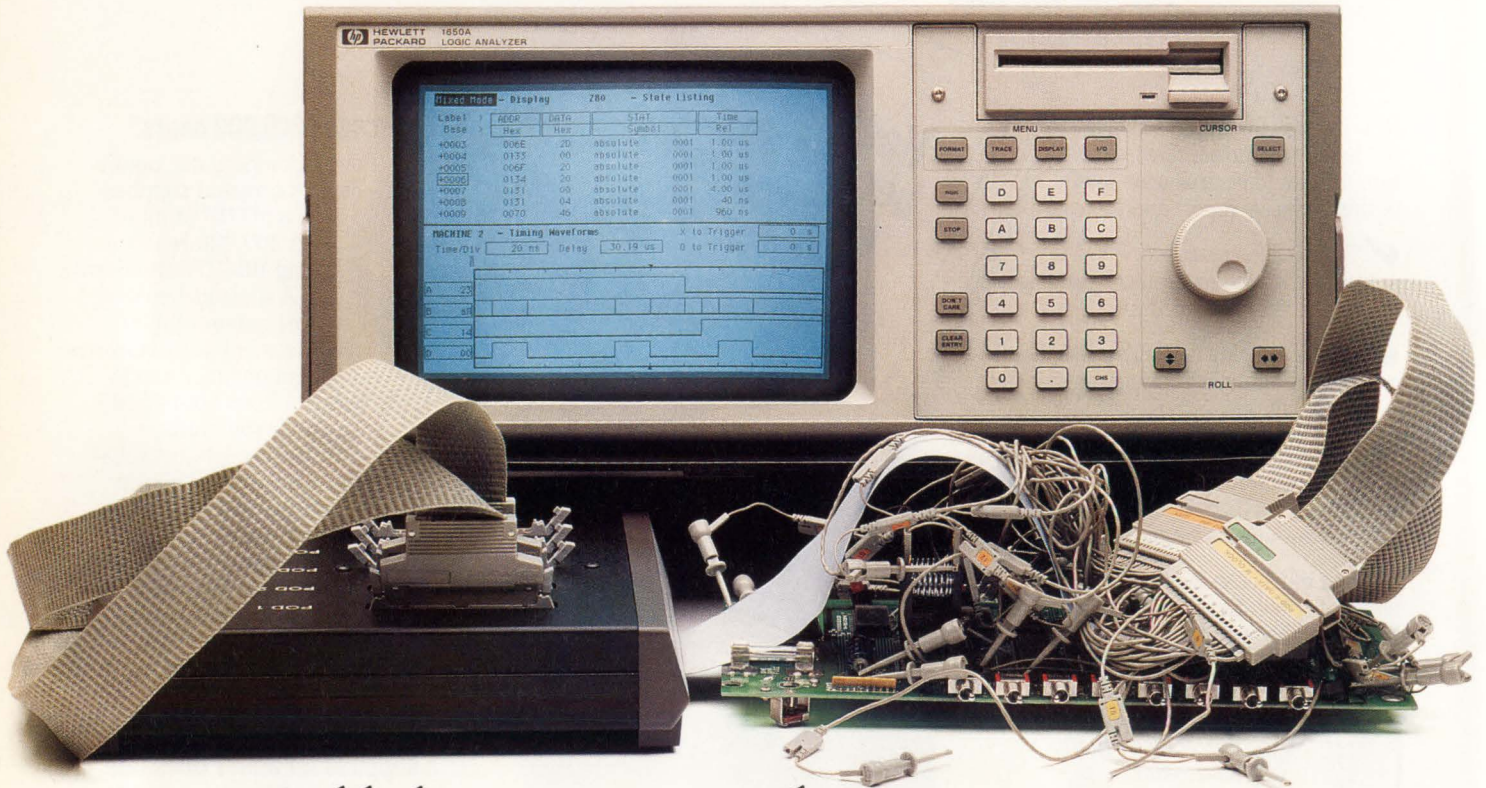

All logic analyzers give you integrated state and timing, sooner or later.

Why not now?
Introducing the new Philips PM 3580 family of logic analyzers from Fluke: the first instrument architecture to give you state and timing together on each channel—with a single probe.

Connect the probe to your board for state and you're automatically hooked up for timing. Or vice versa.

This means no more dual probing—a pain anytime and the source of loading problems—and no reconfiguration between state and timing. Which makes

A basic comparison: Record all state and timing data on an 8-bit microprocessor with multiplexed bus, 8-bits for address, 3 control signals and a clock	HP 1654B	Tek PRISM/MPM	Philips PM 3580/30
Probing:			
Channels used	48 ¹	48 ²	20
One connection	No	No	Yes
Setups	Two	Two+	One
Interfaces to learn	Two	Two+	One
Integrated state & timing triggering	No, only one arming condition	No, only indirect 4-bit Teklink	Yes, 8 levels
State & timing data per pin	No	No	Yes
Price	\$6700	\$8600	\$4250
<small>Footnotes:</small>	<small>1) 8 channels lost to de-multiplexing 2) De-multiplexing requires double probing and only nine high-speed channels on basic unit</small>		

these analyzers simple to learn and use.

Plus, the pop-up menus and keyboard shortcuts guide you quickly through setup and data analysis. No matter if you use it every day or once a year.

What's more, capturing an elusive bug has never been easier with eight unrestricted trigger levels that let you select from state and



PHILIPS

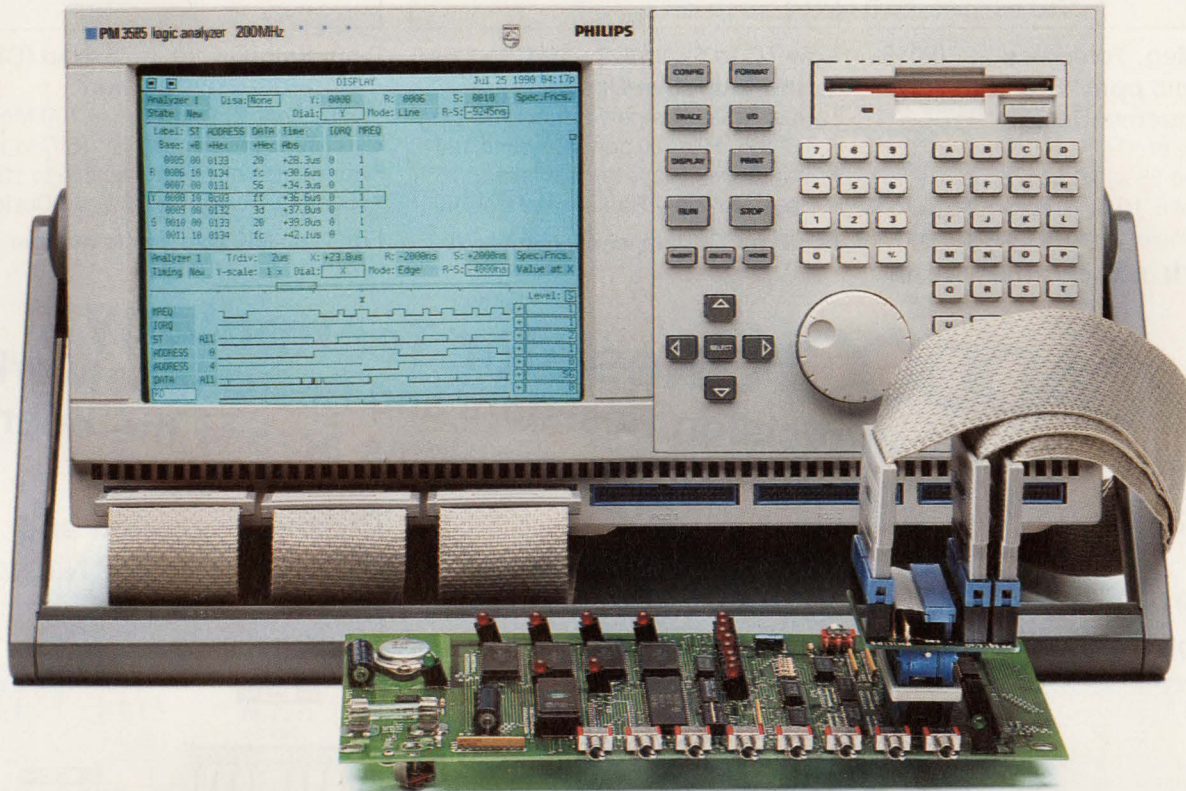

Why not sooner?

timing trigger conditions on each level.

But being simple doesn't mean simplistic. Basic performance of the PM 3580 family ranges from 32 to 96 channels, each with 50 MHz state and up to 200 MHz timing, plus 3 nanosecond glitch capture and 2K of memory per channel. For 8-, 16- and 32-bit processors.

And you get all this for nearly half the cost of comparable analyzers.

We'd like to send you a video. Or show you how to make state and timing measurements at your workplace—

in 30 minutes or less.

We'll even bring the stopwatch so you can time us. And you can keep it to time the competition.



So call us today at **1-800-44-FLUKE**.
Ask for extension **720**.
Because sooner is better.

John Fluke Mfg. Co., Inc., P.O. Box 9090, M/S 250C, Everett, WA 98206-9090, U.S. (206) 356-5400. Canada (416) 890-7600. Other countries: (206) 356-5500. © 1990. All rights reserved. Ad No. 00001.

FAST ANSWERS.

FLUKE®

Type TN Lab Grade New
Low TC Precision Resistors

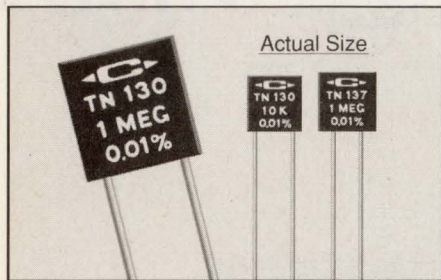

- 1 K to 1 Meg, Tolerance to $\pm 0.01\%$
 Low TC to 5 ppm/ $^{\circ}\text{C}$, 0 $^{\circ}\text{C}$ to 70 $^{\circ}\text{C}$
- Non-Inductive Design
 - Tolerance of $\pm 0.01\%$, $\pm 0.025\%$, $\pm 0.05\%$, $\pm 0.1\%$, $\pm 0.25\%$, $\pm 0.50\%$ or $\pm 1\%$
 - Low TC of 5, 10 or 20 ppm/ $^{\circ}\text{C}$, 0 to 70 $^{\circ}\text{C}$
 - Space Efficient Radial-Lead Design
- For Type TN data, circle number 101

Type TK Low TC Precision
Radial-Lead Film Resistors

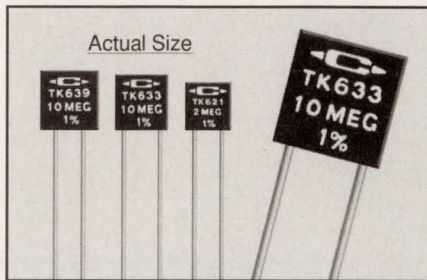

- Low TC to 5 ppm/ $^{\circ}\text{C}$, -55 $^{\circ}\text{C}$ to 125 $^{\circ}\text{C}$
- Non-Inductive Design
 - Resistance Range 1 Kohm to 10 Meg
 - TC of 5, 10 or 20 ppm/ $^{\circ}\text{C}$, -55 to 125 $^{\circ}\text{C}$
 - Tolerance of $\pm 1\%$ (available to $\pm 0.05\%$)
 - Space Efficient Radial-Lead Design
- For Type TK data, circle number 102

Type MK Precision Power
Radial-Lead Film Resistors

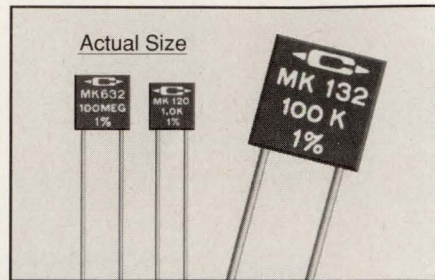

- 0.50 Watt (CK05), 0.75 Watt (CK06)
- Non-Inductive Design
 - Resistance Range 1 Ω to 100 Meg
 - TC as low as 50 ppm/ $^{\circ}\text{C}$, -15 $^{\circ}\text{C}$ to 105 $^{\circ}\text{C}$
 - Tolerance of $\pm 1\%$ (available to $\pm 0.1\%$)
 - Space Efficient Radial-Lead Design
- For Type MK data, circle number 103

CADDOCK[®] Resistor Technology

Precision and Ultra Precision Resistors and Resistor Networks
 with a 25 year record for solving problems across the board!

Type T912 and Type T914
Precision Resistor Networks

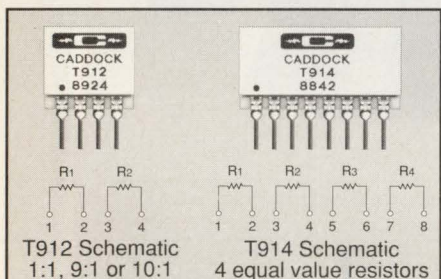

- Ultra Precise Ratios to 0.01%**
- 14 Standard Resistance Values from 1 Kohm to 1 Meg (Custom to 2 Meg)
 - Ratio Tolerance from 0.01% to 0.1%
 - Ratio TC of 2, 5 or 10 ppm/ $^{\circ}\text{C}$, 0 to 70 $^{\circ}\text{C}$
 - Custom ratios available, 1:1 to 250:1
- For Type T912/T914 data, circle 104

Type 1776 Precision
Decade Voltage Dividers

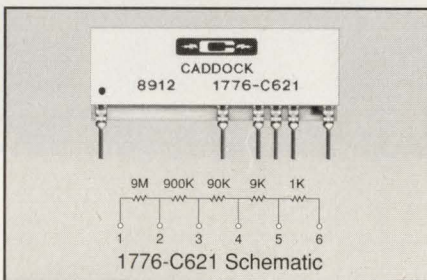

- Voltage Division 10:1 to 10,000:1**
- Ratio Tolerance 0.02%, 0.05%, 0.1%, 0.25% or 0.5%
 - Ratio TC of 5, 10, 25 or 50 ppm/ $^{\circ}\text{C}$, from 0 $^{\circ}\text{C}$ to 70 $^{\circ}\text{C}$
 - Select from 39 Different Models
 - Voltage Rating to 1,200 Volts
- For Type 1776 data, circle number 105

Custom Precision and
Ultra-Precision SIP Networks

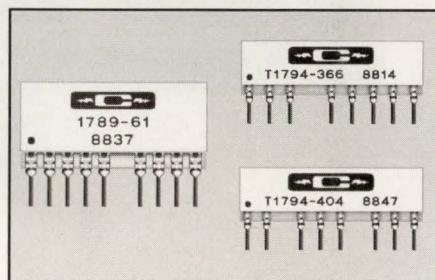

- Ratio Tolerance to 0.01%**
- Resistance Range 0.5 ohm to 50 Meg
 - Abs. Tolerance from $\pm 0.025\%$ to $\pm 1\%$
 - Ratio Tolerance from 0.01% to 1%
 - Abs. TC of 15 ppm, 25 ppm, 50 ppm or 80 ppm/ $^{\circ}\text{C}$, from 0 $^{\circ}\text{C}$ to 70 $^{\circ}\text{C}$
 - Ratio TC of 5 ppm, 10 ppm, 25 ppm or 50 ppm/ $^{\circ}\text{C}$, from 0 $^{\circ}\text{C}$ to 70 $^{\circ}\text{C}$
- For Custom data, circle number 106

More high performance resistor products from

CADDOCK
 ELECTRONICS, INCORPORATED

These products are manufactured with Caddock's exclusive Micronox[®] or Tetrinox[®] Resistance Film Technologies. For your copy of the Caddock General Catalog call or write:

Applications Engineering
 Caddock Electronics, Inc.
 1717 Chicago Avenue
 Riverside, California 92507
(714) 788-1700

The Caddock General Catalog includes specifications on over 200 models of high performance resistor products.

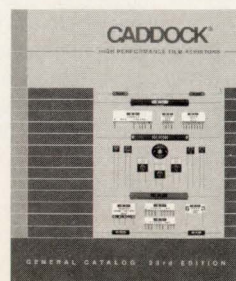

LOW-DRIFT OP AMPS

Precision parts demand kid-glove treatment

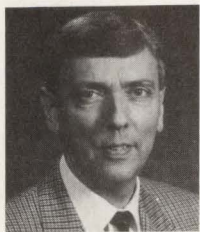

Selecting the best low-drift op amp for your sensitive design is an ordeal in itself. Further trials await when you strive to realize the specified performance goal.

*Brian Kerridge,
European Editor*

Achieving input offset voltage temperature coefficients (V_{io} TC) of less than $1 \mu\text{V}/^\circ\text{C}$ in op amps is now commonplace. But, for precision circuits, this specification and other low-drift effects can still dog your design. Depending upon the application, V_{io} , V_{io} noise, and input bias current (I_B) all can prove troublesome. If you demand speed or low power consumption, then expect to trade off low-drift performance.

The problem op amp designers face is how to balance these key spec areas. It's possible to maximize any one parameter at the expense of others, and the designer's dilemma is choosing which parameter to maximize and by how much. The net result is a mishmash of devices, all justifiably claiming low drift. If you're designing temperature- or strain-gauge amplifiers, DMM front ends, log amps, low-noise audio circuits, low-frequency active filters, and reference buffers, you'll need time to sift out the optimal part for your application. Compound the list with dual and quad versions; mix in metal, ceramic, and plastic packages; and you could end up poring over data sheets for hours.

Although designers do an excellent job of minimizing drift within the op-amp package, effects of thermal EMF, current

leakage, and extraneous noises persist. Simply thrusting a low-drift op amp into a socket or casually soldering it to an open pc board will ruin your overall design. Unless you consider the choice of materials and component layout along the op amp's signal path, external error sources will spoil its low-drift capability.

Table 1 shows just a small selection of the available low-drift op amps. Take care when comparing these parts—the table displays the breadth of what's available, rather than a collection of equivalent parts. Hence, the price column shows disproportionate differences.

Some vendors offer their best specs only in more expensive ceramic or metal packages. Lower-cost plastic packages are not preferred for low-drift designs. Ceramic and metal packages have hermetic seals and lower thermal resistance. Observe also, in **Table 1**, that although

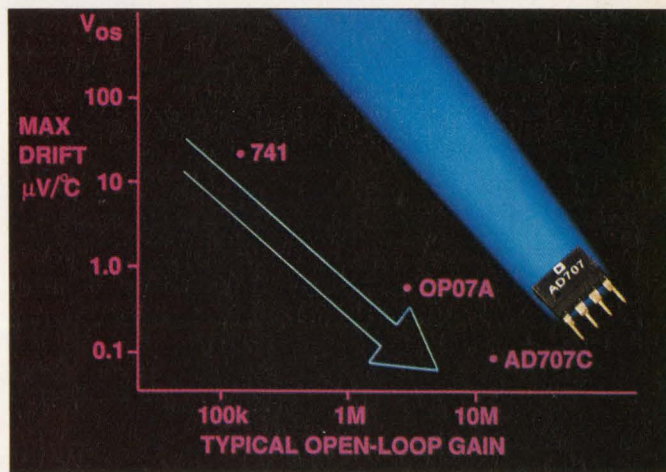

Analog Devices' bipolar AD707C performs far better than the ancient 741 and the long-standing low-drift champion OP07A. It's expensive at \$16, but with a V_{io} TC max of $0.1 \mu\text{V}/^\circ\text{C}$ and an open-loop voltage gain of 138 dB min, the AD707C offers CMOS chopper drift performance without the noise penalty.

TECHNOLOGY UPDATE

Low-drift op amps

all noise specs appear for 0.1 to 10 Hz bandwidth, some manufacturers give only typical noise specs, notably for chopper input parts. In a design, you need to know the p-p noise, and that may be double the typical value supplied.

Making the choice for input

One of the key decisions you'll make in selecting a low-drift op amp will be between conventional bipolar or chopper input stages. Chopper input amps offer outstanding V_{io} low-drift performance over time and a range of temperatures. Using CMOS technology, the I_B and power-consumption specifications are also attractive. Additionally, some parts operate on $\pm 15V$ supplies, overcoming the earlier $\pm 7.5V$ limitation. But you pay the penalty of increased noise when you use choppers. Although improvements over the original 7650 chopper from Intersil are appreciable, bipolars still score higher in this one area.

At Precision Monolithics, Art Kapoor, product marketing manager, agrees: choppers have improved, but the best overall compromise of low-drift parameters comes from a bipolar design. The company's OP177E is an example of what is achievable. This part has a noise specification of $0.15 \mu V$ rms max for 1 to 100 Hz, and a V_{io} TC of $0.1 \mu V/^\circ C$ max.

Linear Technology's Bob Dobkin, vice president of engineering, has a hard time believing that anyone has achieved a V_{io} TC of $0.1 \mu V/^\circ C$ from a bipolar op amp. In his view, you can measure performance at this level five times and get five different answers. He maintains that 0.2 to $0.3 \mu V/^\circ C$ is a more reasonable expectation. Linear Technology is the only company that offers bipolar and chopper low-drift op amps. Dobkin defends chopper

op amps' noise performance but agrees they have shortcomings for designs handling ac signals, heavy loads, or requiring low wideband noise. Linear Technology publishes a useful guide to help you select chopper vs bipolar op amps (Ref 1).

Texas Instruments squeezes a neat combination of low-drift parameters from a nonchopping CMOS op amp with its TLC2201B. However, for a precision amp, it's a bit short on open-loop gain—at just 100 dB with a 10-k Ω load. Its common-mode and supply-voltage rejection ratio at 90 dB also requires attention.

Harris' 5221 shows a rare combination of low-drift parameters and speed. The amp slews at $25V/\mu sec$, but the penalty is power consumption, with a max supply current requirement of 11 mA.

All op amps shown in Table 1 are

single-amplifier devices. In most cases, vendors offer dual and quad versions in a single package. For bipolar types, packaging multiple devices compromises drift specifications. You must consider the possibility of thermal crosstalk from one amplifier to another and accept the absence of nulling pins for finely adjusting input-offset voltage. Even where nulling pins exist, you need to take care not to use this facility to force large offsets into the op amp's input stage. If you attempt this in order to cancel a zero error from an earlier section of your design, you will simply degrade the V_{io} TC of the op amp. Typically, every 300 μV of offset you impose results in a $1 \mu V/^\circ C$ TC.

When you've decided which op amp is best for your design, preserving that performance in practice is the next obstacle. The great-

For more information . . .

For more information on the low-drift op amps discussed in this article, circle the appropriate numbers on the Information Retrieval Service card or use EDN's Express Request service. When you contact any of the following manufacturers directly, please let them know you saw their products in EDN.

Analog Devices Inc
1 Technology Way
Norwood, MA 02062
(617) 329-4700
FAX (617) 326-8703
Circle No. 659

Harris Semiconductor
Box 883
Melbourne, FL 32902
(800) 442-7747
Circle No. 660

Linear Technology Corp
1630 McCarthy Blvd
Milpitas, CA 95035
(800) 637-5545
FAX (408) 434-0507
Circle No. 661

Maxim Integrated Products
120 San Gabriel Dr
Sunnyvale, CA 94086
(408) 737-7600
FAX (408) 737-7194
Circle No. 662

National Semiconductor Corp
2900 Semiconductor Dr
Santa Clara, CA 95052
(800) 727-9959
FAX (408) 721-4148
Circle No. 663

Precision Monolithics Inc
Box 58020
Santa Clara, CA 95052
(408) 727-9222
FAX (408) 727-1550
Circle No. 664

VOTE . . .

Please also use the Information Retrieval Service card to rate this article (circle one):

High Interest 485
Medium Interest 486
Low Interest 487

Teledyne Components
1300 Terra Bella Ave
Mountain View, CA 94039
(415) 968-9241
FAX (415) 967-1590
Circle No. 665

Texas Instruments Inc
Box 809066
Dallas, Tx 75380
(214) 995-6611
Circle No. 666

TECHNOLOGY UPDATE

Table 1—Representative low drift op amps

Vendor	Model	Input type	Input offset-voltage vs temperature ($\mu\text{V}/^\circ\text{C}$)	Input offset-voltage vs time ($\mu\text{V}/\text{month}$)	Input voltage-noise 0.1 to 10 Hz ($\mu\text{V p-p}$)	Input offset-voltage (μV)	Input bias-current	Package	Comments	Price (100s)
Analog Devices	AD707C	Bipolar	0.1	0.2 typ	0.35	15	1.0 nA	TO-99, 8-pin ceramic DIP		\$16.00
	AD829A	Bipolar	0.3 typ	NS	0.05 typ	500	7 μA	8-pin ceramic DIP	Bandwidth 120 MHz ($A_V = -1$), slew-rate 230 $\text{V}/\mu\text{sec}$	\$4.25
Harris	HA-5147A	Bipolar	0.6	NS	0.18	25	40 nA	TO-99, 8-pin ceramic DIP	Gain bandwidth product 120 MHz ($A_V > 10$), slew-rate 35 $\text{V}/\mu\text{sec}$ typ	\$8.78
	HA-5221	Bipolar	0.5 typ	NS	0.25 typ	750	100 nA	TO-99, 8-pin ceramic DIP	Gain bandwidth product 35 MHz ($A_V = 1$), slew-rate 25 $\text{V}/\mu\text{sec}$ typ	\$6.68
Linear Technology	LT1037A	Bipolar	0.6	1.0	0.13	25	35 nA	TO-5, 8-pin ceramic & plastic DIP	Open-loop voltage gain 126 dB min with 600 Ω load, slew-rate 11 $\text{V}/\mu\text{sec}$	\$5.00
	LT1097C	Bipolar	1.0	0.3 typ	0.5 typ	50	250 pA	8-pin plastic DIP	Supply current 0.56 mA max	\$1.05
	LTC1150C	Chopper	0.05	0.05/ $\sqrt{\text{month}}$ typ	1.8 typ	5	50 pA	TO-5, 8 & 14-pin ceramic & plastic DIP, 8-pin SO	Supply voltage ± 2.5 to $\pm 18\text{V}$, supply current adjustable 0.2 to 0.8 mA	\$3.85
Maxim	MAX480C	Bipolar	1.5	NS	3.0 typ	70	3 nA	8-pin plastic DIP, 8-pin SO	Supply voltage $\pm 0.8\text{V}$ to $\pm 18\text{V}$, supply current 20 μA max at 15V	\$3.95
	MAX422E	Chopper	0.05	0.1/ $\sqrt{\text{month}}$ typ	1.2 typ	5	30 pA	8-pin plastic DIP	Supply voltage $\pm 2.5\text{V}$ to $\pm 16.5\text{V}$	\$3.77
	MAX425C	CMOS	0.05	NS	0.25	5.0	200 pA	8 & 16-pin ceramic & plastic DIP, and SO	Programmable zeroing facility, eg: auto-zero cycles at 1-minute intervals	\$9.50
National Semiconductor	LM607C	Bipolar	0.3	0.2 typ	0.5	40	4.0 nA	TO-99, 8-pin ceramic & plastic DIP		\$1.26
	LM627A	Bipolar	0.6	0.2	0.18	50	20 nA	TO-99, 8-pin ceramic & plastic DIP		\$4.53
Precision Monolithics	OP-07A	Bipolar	0.6	1.0	0.6	25	2.0 nA	TO-99, 8-pin ceramic DIP	Former industry standard	\$16.50
	OP-21E	Bipolar	1.0	NS	NS	100	100 nA	TO-99, 8-pin ceramic DIP	Supply voltage ± 2.5 to $\pm 15\text{V}$, supply current 300 μA max	\$3.25
	OP-50E	Bipolar	0.3	NS	0.12 typ	25	5.0 nA	14-pin ceramic DIP	Output current $\pm 50\text{ mA}$	\$8.10
	OP-177E	Bipolar	0.1	0.2 typ	0.6	10	1.5 nA	8-pin ceramic DIP		\$14.95
Teledyne Components	TSC911A	Chopper	0.15	NS	11 typ	15	70 pA	8-pin ceramic & plastic DIP, and SO	External capacitors not required	\$2.14
	TSC9420E	Chopper	0.1	0.1/ $\sqrt{\text{month}}$ typ	1.1 typ	5	30 pA	8 & 14-pin plastic and ceramic DIP	Supply voltage $\pm 15\text{V}$	\$3.89
Texas Instruments	TLC2654A	Chopper	0.05	0.02	1.5 typ	10	50 pA typ	8 & 14-pin ceramic & plastic DIP, and SO		\$3.01
	TLE2027A	Bipolar	1.0	1.0	0.13	25	35 nA	8-pin ceramic & plastic DIP, and SO		\$5.26
	TLC2201B	CMOS	0.5 typ	0.005	0.7 typ	200	1 pA typ	8-pin ceramic & plastic DIP, and SO	Supply voltage $\pm 8\text{V}$; common-mode & supply-voltage rejection ratio 90 dB min	\$8.20

Notes: Maximum specifications at 25°C shown unless otherwise stated
 NS=not specified
 SO=small outline
 A_V =open-loop voltage gain
 Prices shown in order of availability, plastic, ceramic, or metal

TECHNOLOGY UPDATE

Low-drift op amps

est threat to low-drift performance comes from the presence of thermal EMFs external to your op amp. These irritating sources of voltage occur wherever a junction of differ-

ing metals produces a temperature gradient. A typical thermocouple intended for use as a temperature sensor develops around 10 to 50 $\mu\text{V}/^\circ\text{C}$, depending on the type. When

you compare that TC with an op amp's normal V_{io} TC of under 0.5 $\mu\text{V}/^\circ\text{C}$, it's no surprise that stray EMFs in a signal path can ruin a design. A series of junctions exists

Digital bits invade analog part

Maxim offers an alternative to bipolars and choppers with a commutating autozero CMOS op amp. The recently announced MAX425 and MAX426 apply internal switching to null the input characteristics of CMOS amps in a similar fashion to choppers.

Whereas choppers attempt to optimize all input drift errors, including 1/f noise, with one internal nulling loop, Maxim's design employs two independent and programmable on-chip nulling schemes. First is an autozero loop, and second is a commutating input switch. Fig A shows the essential parts of the design.

The autozero loop operates by shorting the input switch and nulling the first and second stages of the op amp. The loop operates until the voltage at the comparator equals the level immediately prior to commencement of the autozero cycle. Digital memory in the control logic stores the correction factor and maintains the null by controlling the analog input stages via DACs. One cycle of this autozero loop typically reduces an inherent 50 μV V_{io} to 0.5 μV . You can program the autozero loop to operate on command, or automatically once per minute. While the autozero loop is in action, the op amp's

third stage operates as a sample-and-hold circuit and maintains the op amp's output at a constant voltage. The down side of this technique is the 50 msec it takes for one cycle of autozero, even on the faster MAX426. The merit is that if your design enjoys a stable environment, you may need only one cycle of autozero every few hours or days.

The commutating input switch runs at a default frequency of 300 Hz, although external frequency control is possible. When the switch operates, the op amp's V_{io} alternately adds to and subtracts from your real input signal. The resultant input is the real signal, amplitude modulated at 300 Hz by V_{io} and 1/f noise. Later averaging yields only the real input signal.

You can decide when either, neither, or both nulling schemes suit your application. In practice, the commutating switch operation is almost always beneficial, otherwise 1/f noise remains in the signal path. The autozero operation is optional, but normally necessary at least once following power-up. It removes a chunk of V_{io} , and minimizes the amplitude modulation at the commutating switch.

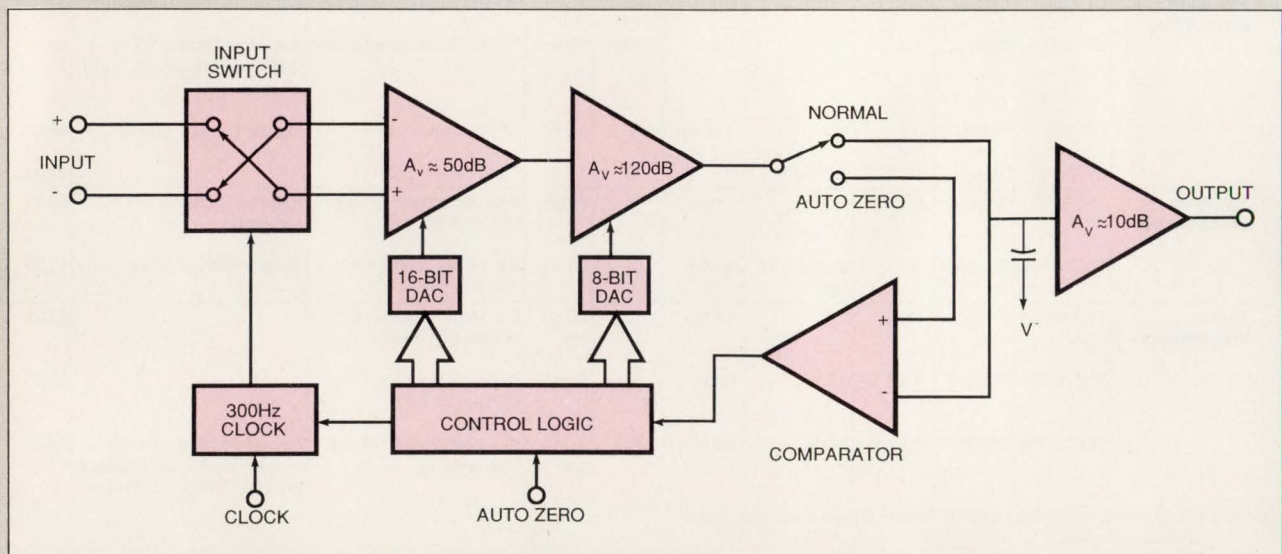

Fig A—The MAX425 or MAX426 from Maxim enables you to vary low-drift input specs, using a programmable commutating input switch and digital autozero loop.



The programmable display system:

The computer interface with the pushbutton feel.

Vivisun Series 2000, now the leading programmable display pushbutton system, interfaces the operator with the host computer. The user-friendly LED dot-matrix displays can display any graphics or alpha-numerics and are available in green, red or amber. They can efficiently guide the operator through any complex sequence with no errors and no wasted time.

They also simplify operator training as well as control panel design. One Vivisun Series 2000

programmable display system can do the work of 50 or more dedicated switches. In short, Vivisun Series 2000 gives the design engineer more control over the design.

Contact us today.



AEROSPACE OPTICS INC.

3201 Sandy Lane, Fort Worth, Texas 76112
(817) 451-1141 • Telex 75-8461 • Fax (817) 654-3405

*Vivisun Series 2000
programmable displays. The intelligent
communications system.*

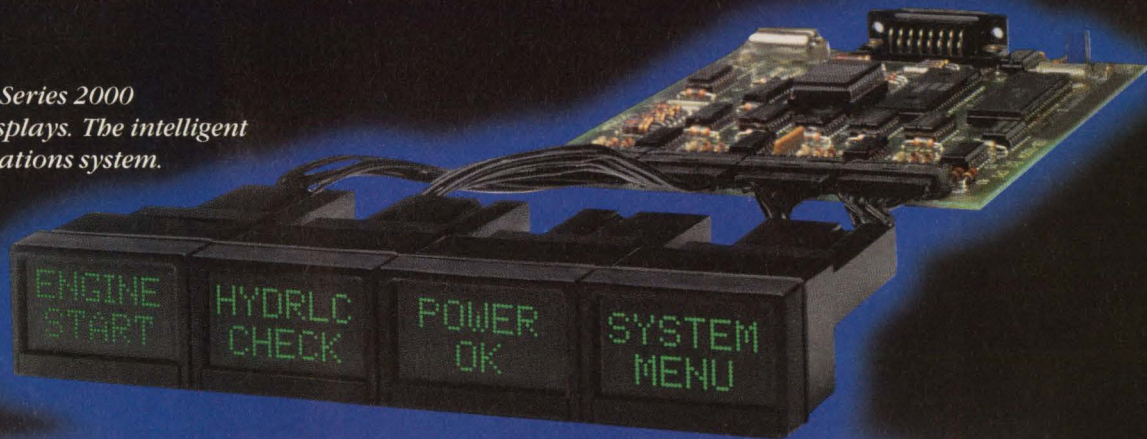

SERIES

VIVISUN 2000™

TECHNOLOGY UPDATE

Low-drift op amps

all along a signal path from the op amp to the primary input signal. These junctions include every solder-joint, pin-to-socket and component-to-lead connection, relay contact, and any plug-in or screw termination. For example, the front-end dc amplifier circuitry of every bench DMM includes this series of parts.

Tot up the thermocouples

As a first objective in limiting thermal EMF effects, minimize the number of junctions and thermal gradients along the signal tracks. Balancing the number of junctions in series with the inverting and non-inverting inputs of the op amp is another method. In some cases, this will mean designing in a few phantom components that have no use

other than producing minute balancing EMFs in the signal path.

Op-amp designers achieve a high level of thermal balance within packages by maintaining a strictly symmetrical geometry on the die. Following this practice with your pc-board layout yields similar benefits. In most cases, in-series components conveniently develop opposing polarity EMFs at each end junction. But the orientation of the component is important in encouraging the EMF magnitude at each end to equate. Mount the part so that, wherever possible, heat generated within and around the part spreads uniformly throughout its body.

Junctions of different metals in the signal path are generally unavoidable. Most plastic-package op amps use Kovar, a copper alloy, for

the lead-frame material. PMI warns you to expect $2 \mu\text{V}/^\circ\text{C}$ from the Kovar-to-copper thermocouple where the op amp's lead connects to your pc-board track. Some lead frames use nickel alloy, and the corresponding TC is $18 \mu\text{V}/^\circ\text{C}$. Maxim helps you counter these effects by using a copper lead frame on its range of low-drift op amps.

Relay contacts are other notorious offenders, being housed in the comfort of warm energizing coils. Connecting two pairs of contacts in series and back to back is a useful technique for partially canceling EMF. Ideally, don't put relays in the signal path. If there's no other way, consider a latching relay.

If you mistrust Seebeck and his law of intermediate metals, then the composition of the solder you

Visit the Modulation Domain and get

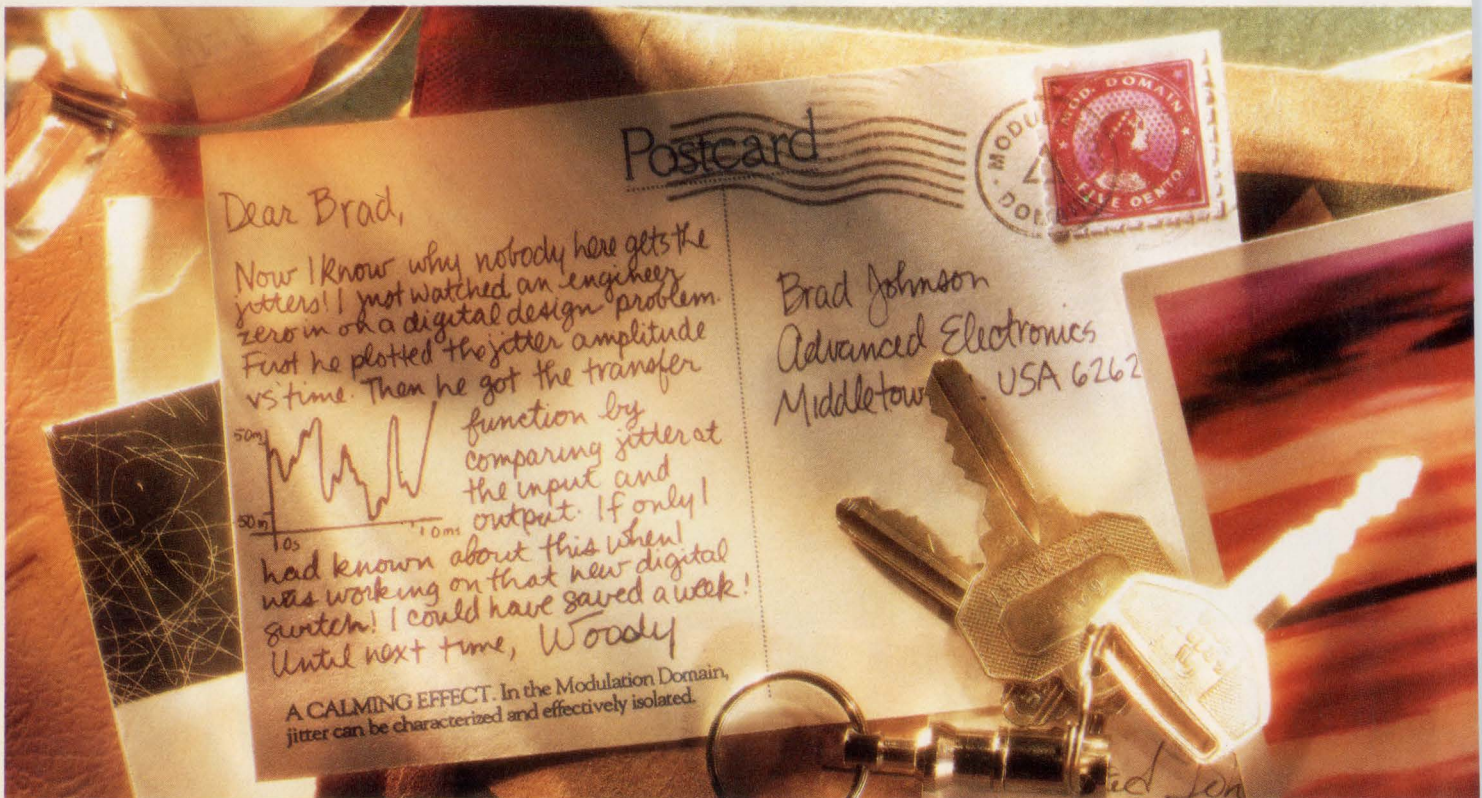

TECHNOLOGY UPDATE

use is worthy of closer scrutiny. In most cases, the thermal gradient across a solder joint should be so low as to push any thermal EMF into the noise floor of your design. If you doubt this opinion, then follow advice from UK-based Multi-core Solders Ltd and use a low-thermal solder. According to Multi-core, changing from regular solder—60% tin and 40% lead—to a 70% tin and 30% cadmium solder limits thermal EMFs to $0.3 \mu\text{V}/^\circ\text{C}$ —10% of the original value.

Whatever else you do to reduce thermal EMFs, eliminating temperature transients from the region of input circuitry is bound to yield dividends. Make sure your op amp doesn't drive heavy loads; in practice, just 7 mW dissipation in the op amp's output stages produces

1°C rise on the chip. Finally, surrounding the sensitive circuitry with draft screens gives any remaining thermal EMFs a chance to stabilize.

Tracing the rainbow's end

If you find yourself reduced to attempting to locate and measure invading thermal EMFs, then you may want to give up. This activity normally proves unrewarding and extremely time-consuming. Bear in mind each time you approach a junction with a measuring probe, you immediately alter the resident thermal EMF. Even if you manage to make a sensible measurement, you'll have to pretend that there are no additional EMFs at your probe tips. If you are going to exclude probes by soldering your

measurement leads directly to the circuit, then do this just before coffee break, or, better still, before an extended luncheon. Once a hot iron has been anywhere near input tracks, thermal equilibrium takes at least 15 minutes to return. If, after all this rigmarole, you're still determined to have a go, then try using a simple analog readout microvoltmeter to make the measurements. The battery-powered Keithley 155 with a $\pm 1\text{-}\mu\text{V}$ bottom scale is one of these.

Other evils threaten your low-drift design, especially if the signal's source resistance is high (for example, greater than 100 k Ω). In an instrumentation amplifier, or the front-end of a DMM, input current must be below 50 pA. A chopper op amp looks ideal, but the problem

a fix on jitter.



Until now, when you looked at jitter on an oscilloscope, all you could see was fuzz. And the only way to find the source was by trial and error. In the Modulation Domain, you can actually display jitter as a function of time. That way, you know exactly how much there is and when it occurs, so it's easier to tell where it comes from. You can even examine the jitter spectrum and quantify the jitter gain (transfer function). All in a matter of minutes.

Jitter analysis is just one way the Modulation Domain can help make you a better designer. To see more, call Hewlett-Packard at **1-800-752-0900***. Ask for **Ext. 1830**, and we'll send you the *Visitor's Guide to the Modulation Domain* on floppy disk with complete descriptions of major landmarks and points of interest.

There is a better way.



*In Canada, call 1-800-387-3867, Dept. 417.

Any similarity to existing persons or companies is purely coincidental.

© 1990, Hewlett-Packard Co. TMSCD055A/EDN

Low-drift op amps

is to ensure that the op amp's input bias current flows from the signal input, and not from an undefined source elsewhere in the circuit.

Normally, one of the 15V power rails sits adjacent to the op amp's input pads. Any leakage inside, or across the surface of the pc board from the power rail to the high-impedance signal path, appears as voltage offset in series with the input signal. Dirty boards, or solder flux, encourage surface leakage. Even meticulously clean boards leak several hundred picoamperes, especially in damp conditions. The common answer is to surround pads for the sensitive input pins, top and bottom side, by an additional guard track on the pc board. To be effective, this guard must connect to a low impedance point that matches the voltage at the op amp's input pins. The guard rings divert stray leakage from the op amp's input. If a conformal layer of solder resist coats the pc board, then arranging to expose the guard track to air minimizes the chance of contaminants bridging the guard, especially in conditions of high humidity. Ideally, all component pads along the signal paths require guarding in this way. Alternatively, you can make all connections along the signal path off the pc board's surface by, for example, using high insulation standoffs.

EDN

Reference

1. Linear Technology, George Erdi, "Design Notes, Number 42. Chopper vs Bipolar Op Amps—An Unbiased Comparison."

Article Interest Quotient
(Circle One)

High 485 Medium 486 Low 487

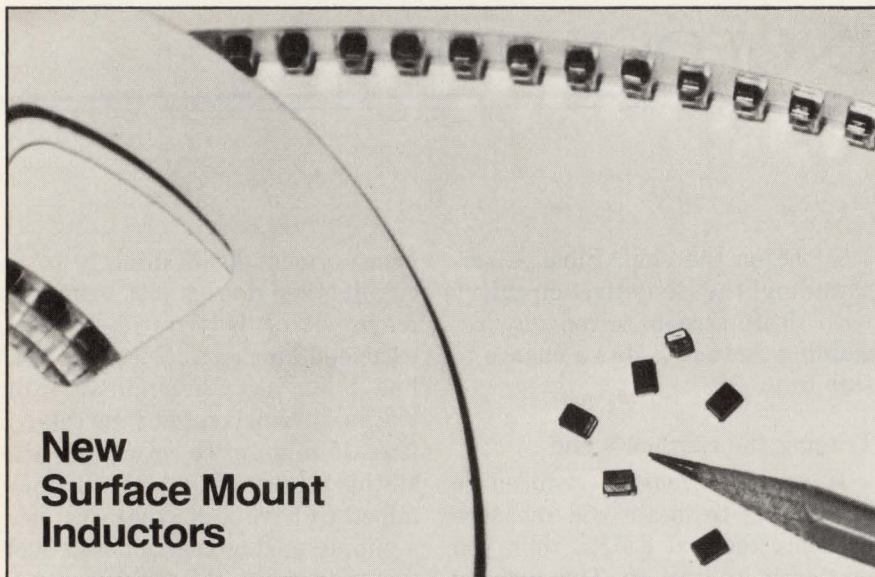

New Surface Mount Inductors

Surface mount .22uH inductors from reel packaging: .1 uH through 1000 uH in 46 values available.

- Internally welded connections
- Precise dimensions permit automatic insertion.
- Excellent flow soldering terminal strength
- Solderability per MIL STD 202 Method 208
- Operating temperature range: -20°C to +85°C
- Shock and pressure resistant
- Positive value identification with laser marking
- Epoxy resin encapsulation... Ferrite core ... Tinned copper terminals

Catalog on request.



J.W. Miller Division
BELL INDUSTRIES

306 E. Alondra Blvd. ■ Gardena, CA 90247 ■ (213) 537-5200 ■ FAX (213) 631-4217
Since 1924, leading manufacturer of standard and custom inductors.

CIRCLE NO. 37

New Dimensions for On-Board Power



HR150 DC-DC Converters

- Up to 20 W output and 82% efficiency
- 18 to 36 or 10 to 16 Vdc input
- 1, 2 or 3 outputs at +5, ±12, or ±15 Vdc
- Regulation: line = 0.1%; load = 0.2%
- Stock, from \$128 (qty. 100)

DIP DC-DC Converters

- Up to 1.5 W output and 82% efficiency
- 3 to 7, 9 to 15, or 16 to 32 Vdc input
- 1 or 2 outputs at +5, ±12, or ±15 Vdc
- Regulated, unregulated, or mixed
- Stock, from \$51 (qty. 100)

Save board area! Interpoint's low-profile industrial DC-DC converters use as little as **1/3 the area** of the power supplies you're using now. Over 90 models rated at 1 to 30 watts.

interpoint

Call to order: **800-822-8782**

10301 Willows Rd., Redmond, WA 98073-9705

CIRCLE NO. 38

All the features of HP BASIC, and more. For less.

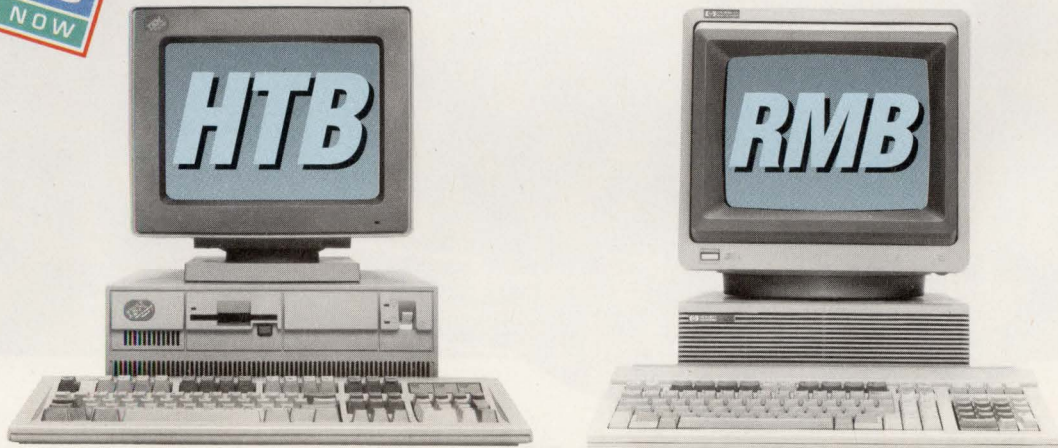

HTBasic	BASIC FEATURES:	HP BASIC
YES	IEEE-488 GPIB (HP-IB), RS-232 Instrument Control	YES
YES	Integrated Environment: Mouse, Editor, Debugger, Calculator	YES
YES	Supports 16 Megabytes of Memory (breaks DOS 640K barrier)	YES
YES	Engineering Math: Matrix Math, Complex Numbers	YES
YES	High Level Graphics: Screen, Plotter, Printer	YES
YES	Structured Programming with Independent Subprograms	YES
YES	Runs on Industry Standard Personal Computers	NO*
YES	Industry Standard Graphic Printer Support: Epson, IBM, lasers, etc.	NO
YES	Industry Standard Network Support: Novell, IBM, Microsoft, NFS, etc.	NO
YES	Industry Standard IEEE-488 Support: National Instruments, IOtech, etc.	NO
YES	Exchange data files with Industry Standard PC applications	NO*
YES	No-charge Telephone Technical Support	NO
YES	Instant on-line HELP system	NO

A Costly Situation. Every engineer needs the power and features of a "Rocky Mountain" BASIC workstation, but not everyone can have one. They simply cost too much. Fewer workstations, less productivity. **The Best Way.** TransEra HTBasic software provides the *only* way for serious technical computer users to turn their PC into a workstation without having to add costly hardware. Powerful workstations for everyone means greater productivity. **Extraordinary Versatility.** In addition, TransEra HTBasic works with the Industry Standard Personal Computer hardware, software, and networks. It even allows you to easily exchange data between your favorite DOS programs and the files you create in the BASIC workstation environment. All at a fraction of the cost of other solutions.

More compatibility. More versatility. More possibilities.
Less expense. Less hassle.

To find out more, call 1-801-224-6550.

TransEra
Engineering Excellence for 15 Years™

CIRCLE NO. 92

* Without the addition of a costly 68000 co-processor. © Copyright 1990 TransEra Corporation. All rights reserved. HP, HP BASIC, and HP/IB are registered trademarks of Hewlett-Packard Co.

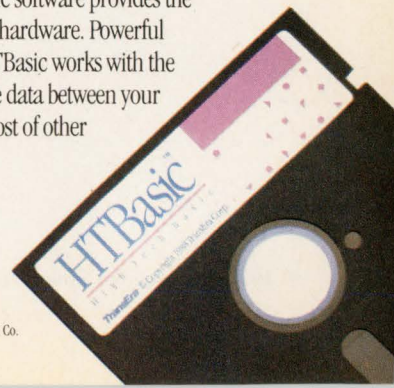

The Encapsulant Problem Solvers.

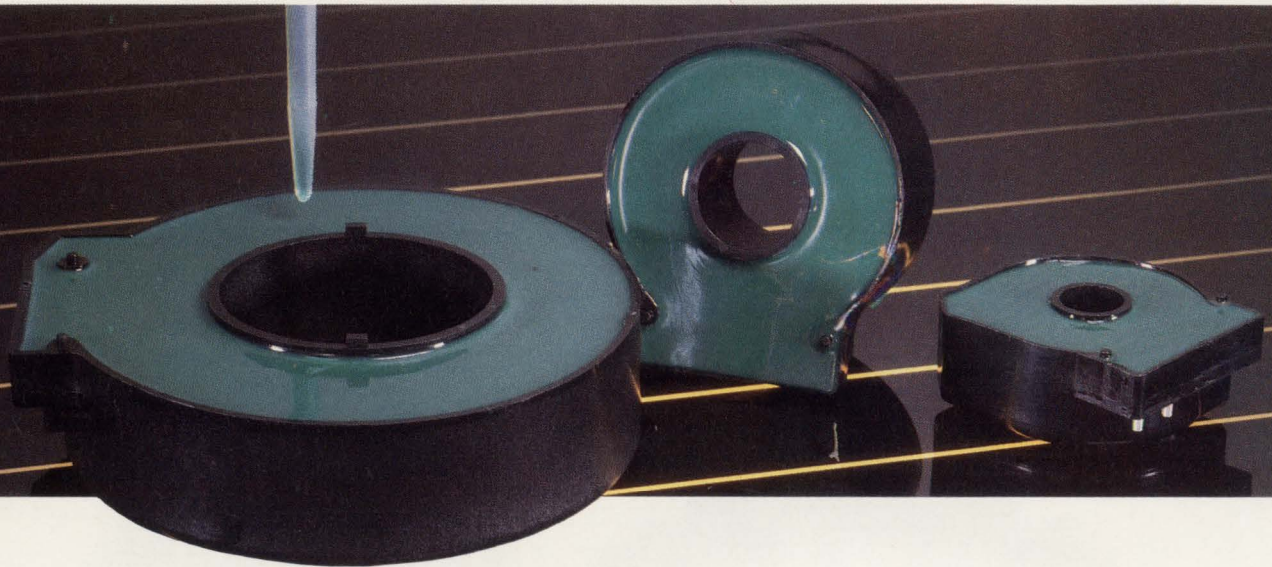

**With over 2,700 products, we've
got one for you.**

A case in point:

When an OEM manufacturer of power distribution systems needed a specialized encapsulant for toroidal coils, they called Emerson & Cuming. Their requirements specified an epoxy-based, single-component product which could eliminate meter/mix/dispense equipment, yet cure at a low temperature and possess exceptional thermal shock characteristics. The solution—one of our STYCAST® series encapsulants.

Emerson & Cuming offers thousands of standard products and the ability to customize for your specific application. We have the encapsulant, adhesive or coating you need to write your own success story.

To get a free selector guide or product sample for evaluation, give us a call.

1-800-832-4929.

Encapsulants • Adhesives • Coatings

**EMERSON
& CUMING™**
a GRACE company

Making today's products better.
Making tomorrow's products possible.

Here's 32 New Channels of Fast Analog Action

The new VMIVME-4132 delivers 32 high quality analog output channels programmable with on-board jumpers for a variety of voltage range operations.

All outputs have a 12-bit resolution and can source or sink 10 mA at ± 10 V. For off-line testing, the analog outputs can be disconnected from the load. The Analog Output Board is a standard double height printed circuit board which is compatible with the VMEbus specification (Rev. C.1)

Built-in-Test multiplexer logic provides the user with the capability to test all of the active components on the board, including the output switches. This test scheme utilizes the on-board Analog-to-Digital Converter (ADC) multiplexers.

4132 Features and Applications include: 2 Year Warranty • 24 Hour Customer Service Hotline • 32 Analog Output Channels • 12-bit Digital-to-Analog Converter • 32 S&H Outputs • 10 mA Outputs • Output Short Circuit and Transient Protected • Program Controlled On-Line and Off-Line Operating Modes • Unipolar (0 to 10 V, 0 to +5 V) or Bipolar (± 2.5 V, ± 5 V, and ± 10 V) • Program Selectable Scan Rates Provide Improved Response for Complex Output Functions • Built-in-Test On-Board - tests 100% of Active Components, Effective in both On-line and Off-line Modes with On-board Self-Test Multiplexer and Analog-to-Digital Converter



Now Available for Immediate Shipment and Backed by a 100% Satisfaction Guarantee. Call Our TOLL-FREE Hotline Today!

- On-Board + 15 V DC-to-DC Conversion
- Front Panel Self-Test LED • Semiconductor Output Switches (0.1 Ω Output Impedance)

VMIC's 2 Year Warranty and 24 Hour Customer Service Hotline combined with superior VMEbus product quality and performance make us the program to tune into. Call TOLL-FREE and see the 32 Hit Channels you've been missing...

1-800-322-3616

VMIC ^{VME} 

VME MICROSYSTEMS INTERNATIONAL CORPORATION

**12090 South Memorial Parkway
Huntsville, Alabama 35803-3308
(205)880-0444 FAX(205)882-0859**



The Standard for Circuit Simulation

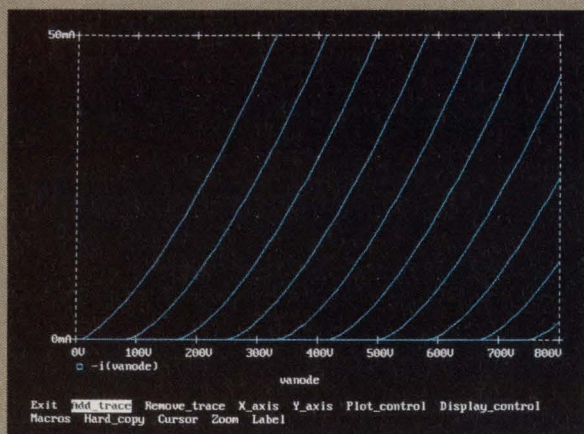

I-V curves of a triode vacuum tube

Analog Behavioral Modeling

The Analog Behavioral Modeling option for the PSpice Circuit Analysis package allows you to describe analog components, or entire circuit blocks, using a formula or look-up table. Linear blocks may be described using either a Laplace transform or a frequency response table. Once defined, you can use these blocks in all PSpice analyses, including DC, AC, and transient.

Modeling entire blocks of circuitry is a powerful aid in designing a system from the top down. You can describe a functional block by its behavior without worrying about how that function will be implemented. Later on in the design process, you can replace the block with the actual circuitry.

Another application is the modeling of electronic components which are not built into PSpice. The photo shows an example of simulating the DC characteristics of a 3/2-power-law device.

Since its introduction over six years ago, MicroSim's PSpice has sold more copies than all other SPICE-based programs combined. PSpice provides broad capabilities, accurate results, diverse options, and availability across a wide range of computer platforms. PSpice includes an extensive device library of 3,000+ analog parts and 1,300+ digital parts, at no extra charge.

Besides Analog Behavioral Modeling, PSpice provides the following options:

Digital Simulation: simulation of mixed analog/digital circuits with feedback between the analog and digital sections.

Monte Carlo Analysis: calculates the variations in a circuit's performance allowing for component tolerances. This option performs statistical analyses: Monte Carlo, Sensitivity, and Worst Case.

Probe: acts as a "software oscilloscope" to provide an interactive viewing and processing environment for simulation results (see photo).

Parts: is a parameter extraction program allowing the extraction of device model parameters from data sheet information.

PSpice is available on the PC (running DOS, Protected Mode DOS, or OS/2), Macintosh II, Sun 3, Sun 4, and SPARCstation, DECstation 2100, 3100, and 5000, and the VAX/VMS families.

In addition to the Circuit Analysis package, the PSpice family of products also contains the Circuit Synthesis package, which consists of our two filter synthesis products: Advanced Filter Designer and Standard Filter Designer. Filter Designer is an interactive design aid for synthesizing and analyzing active filters. Features include:

- Analysis of low pass, high pass, band pass, and band reject filter types.
- Synthesis of all available filter types using Butterworth, Chebyshev, Inverse Chebyshev, and Elliptic (Cauer) functions.
- Capability to synthesize arbitrary transfer functions and delay equalization filters (only available in Advanced Filter Designer).

Each copy of our Circuit Analysis and Circuit Synthesis programs comes with MicroSim's extensive product support. Our technical staff has over 150 years of combined experience in CAD/CAE, and our software is supported by the engineers who wrote it.

For further information about the PSpice family of products, call us at (714) 770-3022 or toll free at (800) 245-3022. Find out for yourself why PSpice has become the standard for circuit simulation.

20 Fairbanks • Irvine, CA 92718 USA • FAX (714) 455-0554

32-BIT BUSES

Battle between EISA and MCA continues

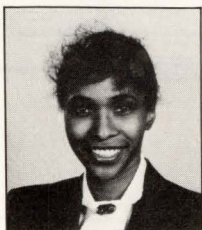

Technical differences between EISA and MCA are beginning to blur. For board designers trying to determine which bus deserves their allegiance, the deciding factor may come down to how easy it will be to sell their product.

J D Mosley,
Regional Editor

As the smoke clears in the battle to establish 32-bit bus supremacy in the IBM PC arena, neither IBM's Micro Channel Architecture (MCA) nor the Extended Industry Standard Architecture (EISA) appear to provide board designers with any overwhelming arguments for pledging fidelity to either bus. The differences between the buses certainly are real, but the final evaluation reveals that the pros and cons offered by each bus give neither a discernibly superior technology.

Both architectures are suitable for combating the existing bandwidth bottleneck presented by the Industry Standard Architecture (ISA) found in IBM PC/AT and compatible computers. The 16-bit ISA bus limits data transfer to a maximum of 8M bytes/sec. EISA, the extended version of ISA, expands that to a 33M byte/sec data-transfer rate under DMA control. MCA presently has a maximum bus-transfer-rate of 20M bytes/sec, but IBM can double that rate to 40M bytes/sec and has described future MCA modes that will permit data transfers of 80M and 160M bytes/sec.

Although at first glance MCA seems to offer data-transfer performance-potential that is superior to EISA, Richard Archuleta, Director of Advanced System Development for Hewlett-Packard, says the difference is minimal.

The speed differential between the two buses exists because MCA uses a 10-MHz clock while EISA—for the sake of backward compatibility with ISA—uses an 8.33-MHz clock.

Currently available MCA-computers use an asynchronous 2-clock, 200-nsec address and data-transfer cycle that result in a 20M-byte/sec transfer rate. In contrast, the EISA spec has a 1-clock cycle that yields a maximum burst-mode data-transfer rate of 33 MHz, although

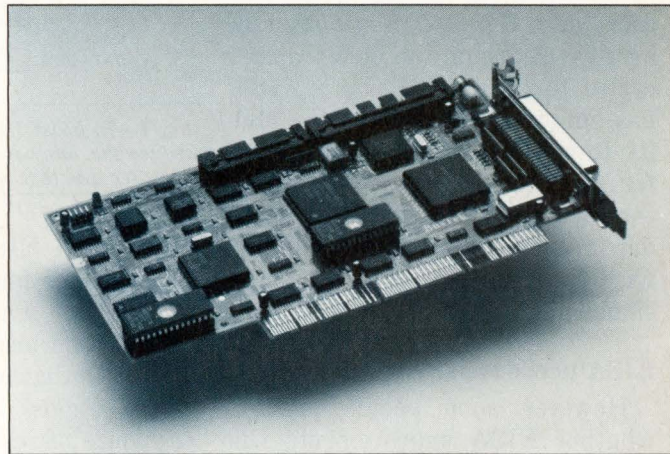

You don't have to use a standard chip set to implement EISA or MCA. Bustek Corp's BT-742A has a proprietary bus master ASIC for DMA and a SCSI-controller ASIC that reduces protocol overhead.

normally the EISA bus also uses a 2-clock cycle that moves data at 16.6M bytes/sec.

The MCA performance upgrades announced in IBM's September 26, 1989 *Micro Channel Architecture Update* involve significant changes in the bus's components. IBM will execute the next-generation 40M-byte/sec transfer rate by reducing the number of necessary clock cycles with a streaming data-

TECHNOLOGY UPDATE

32-Bit Buses

transfer. The address and first data-transfer will occupy a normal 200-nsec period, but subsequent data-transfers will happen in 100-nsec intervals, thereby making the transfer speed of the EISA and MCA buses roughly equivalent. Fig 1 illustrates the anticipated improvements in MCA data-transfer.

To move data along at 80M and 160M bytes/sec by transferring 64 bits of data simultaneously, Archuleta says that IBM will have to abandon the TTL logic currently found in IBM PCs and switch over to the ECL family, which is much faster. However, he says, the high price of the technology is not practical for any IBM PC currently costing less than \$20,000.

For 80M-byte/sec data transfers, IBM plans to multiplex MCA's 32-bit address bus so that it can also carry data. The 160M-byte/sec rate involves reducing the data-transfer cycles to 50 nsec. However, IBM has not yet demonstrated the ability to accomplish such rapid transfer rates. Archuleta is confident that when IBM can deliver these data-transfer rates, EISA will likewise improve its rates by using similar methods and components.

EISA needs noise control

However, some people question whether EISA improvements will be so easily accomplished, citing the bus's inherent technological handicap of backward compatibility with ISA. Audrey Harvey, Engineering Manager for the Data Acquisition Division of National Instruments Corp, is concerned that at data-transfer rates exceeding 33 MHz, the EISA bus could produce unacceptably high levels of noise because of the relatively unsophisticated grounding scheme incorporated into the bus's ISA component.

Archuleta refutes that concern by noting the availability of currently

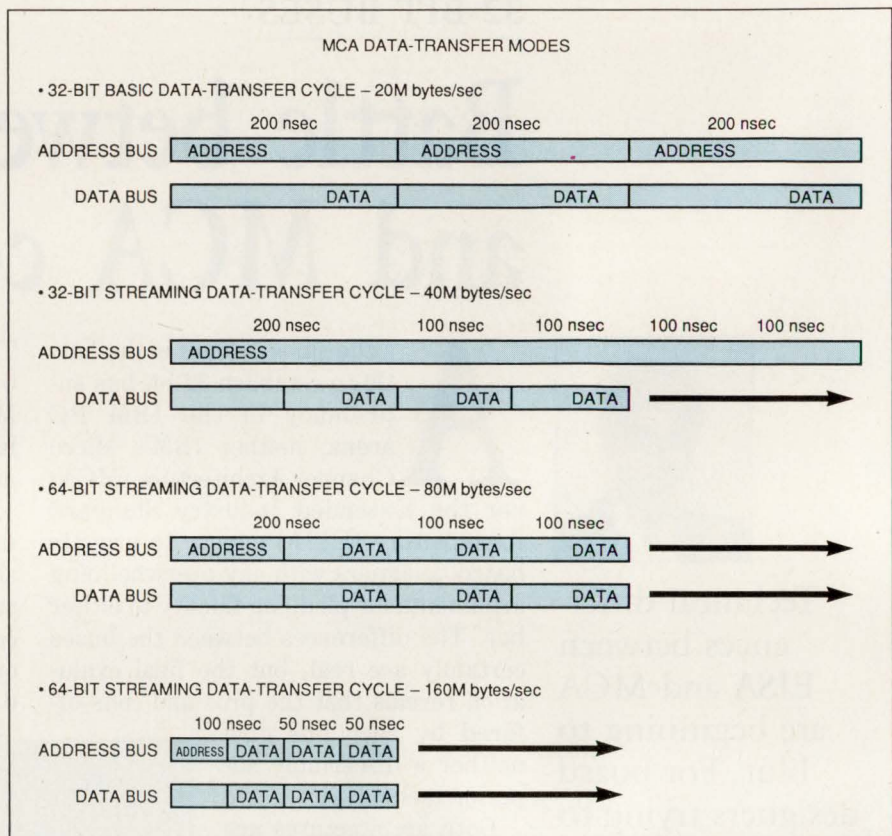

Fig 1—To boost MCA's data-transfer rate from its current 20M bytes/sec, IBM plans to reduce the number of necessary clock cycles by using streaming data transfers for 40M bytes/sec and then multiplex the address bus for an effective 80M bytes/sec.

unspecified EISA pins for future performance improvements and insisting that when the demand for more speed arises, the technology will meet that need.

Yet, amidst all this conjecture, the voice of reason points out that the real stumbling block to improved computational performance is not hardware constraints. Rather, it is the lack of proficient software.

Harvey is quick to note that DOS extensions are becoming de rigueur as software capabilities continue to exceed the restrictive boundary imposed by DOS's 640k-byte memory limit. The user expects to access much larger data buffers in an extended DOS environment, potentially causing interrupt latencies to increase to more than 100 μ sec.

This increase in interrupt latency occurs because many DOS system functions operate in real mode, and interrupts often require a mode switch. As a result, the 32-bit DMA control offered by EISA and MCA permits faster data-transfer throughput without an increased requirement for interrupt service.

However, Pete MacCormack, Texas Instruments' EISA Program Manager, notes that neither EISA nor MCA are "here" today: No software is available to fully exploit either bus's 32-bit capabilities. Furthermore, he says the bus advocates must prove their products are marketable—mere jousting with technical specs will not ensure either bus's longevity.

The "openness," or general availability, of each specification will

TECHNOLOGY UPDATE

How MCA and EISA compare

Appreciating advancements in technology is often a simple matter of perspective. I remember sitting before my CP/M-based Osborne 1 computer in 1982, staring in amazement at an ad for a 5M-byte hard-disk drive, and wondering why in the world would anyone want to shove that much (presumably valuable) data onto one (presumably fallible) storage device. Less than a decade later I'm chomping at the bit for a 200M-byte drive and wishing I could afford one with even greater storage capacity.

The same sort of performance scenario unfolded when ISA evolved from the 8-bit IBM PC/XT bus to the IBM PC/AT's longer 16-bit slot. Although 8-bit expansion boards still remain popular for such simple functions as modem communication or serial and parallel data I/O, a vast number of 16-bit cards currently provide the necessary high-performance data transfers required for complex

graphics, number crunching, and LAN functions.

In 1987, IBM introduced a bus for its PS/2 line of computers—the Micro Channel Architecture, which promised workstation performance for desktop computers by specifying a 32-bit-wide data-transfer path, bus mastering, automatic system configuration, and 20M-byte/sec throughput. However, this architecture is completely incompatible with IBM's PC line of computers. And IBM PC users who make the MCA upgrade must abandon their existing investment in plug-in boards and software.

In response, a consortium of companies led by Compaq Computer Corp proposed EISA, an alternate 32-bit architecture that extended—rather than replaced—the 16-bit IBM PC/AT bus. Use the following table to compare and contrast the benefits offered by these two competing bus specifications.

MCA benefits

- Proposed technical advancements can provide data-transfer rates reaching 160M bytes/sec. MCA's current transfer rate is 20M bytes/sec.
- Completely redesigned pinouts in MCA connectors provide a ground for every four signals to minimize signal crosstalk.
- MCA has a 10-MHz bus clock.
- Micro Channel uses asynchronous transfer timing, thus simplifying timing considerations.
- MCA uses a distributed and prioritized arbitration scheme that operates in a serial fashion. Bus Master priority is dictated by the system, or you can optionally implement an "equal and fair" priority procedure.
- DMA transfers occur in a serial fetch-and-deposit manner.
- MCA plug-in-board configuration is strictly a programmable function with critical setup parameters stored on board in battery-backed RAM. IBM assigns unique ID numbers to each board manufacturer's plug-in card, thus permitting the system to correctly identify any board, regardless of its slot location.
- MCA's spec provides for options like video functions and sound or music.
- Within MCA, the CPU cannot even access its own memory when another device controls the bus. However, MCA's prioritized bus arbitration scheme provides CPU control.
- MCA implements a level-sensitive interrupt line that prevents the computer system from crashing, as can happen when edge-triggered peripherals or devices get hung up as a result of noise on the interrupt line, creating spurious signals.
- MCA expansion cards contain 36 in.² of board space, 58 or 89 pins, and 1.6A per slot. However, these cards exhibit superior EMI characteristics due to their numerous power and ground planes.
- MCA is proprietary—IBM controls documentation, improvements, and enhancements centrally.

EISA benefits

- Current maximum data-transfer rate of 33M bytes/sec.
- EISA's connector pinout intersperses grounding between the existing ISA pins to maintain and improve upon backward compatibility.
- EISA's 8.33 MHz clock maintains backward compatibility with ISA.
- EISA employs synchronous transfer timing to maintain backward compatibility with ISA.
- EISA uses a centralized arbitration scheme that operates in a parallel fashion with a time-sliced, "equal and fair" priority procedure.
- DMA transfers occur in a parallel flyby manner.
- You can either configure EISA plug-in boards using physical jumper switches, or program them using software configuration files supplied by the board manufacturers. Each EISA expansion slot has an assigned address so that you can use multiple identical boards without I/O conflicts. Every EISA board manufacturer has a special 3-character code used as a prefix to create a unique identification code for each board.
- EISA has undesignated pins that can accommodate additional features in the future, as needed.
- EISA utilizes cache memory in such a way that the CPU can continue to work, even when another device controls the bus.
- EISA lets you program each interrupt individually for either edge- or level-sensitivity, which maintains compatibility with ISA's edge-triggered interrupts. But you must be careful not to mix devices using different interrupt schemes on the same channel.
- EISA boards are 58 in.² and provide 4.5A per slot.
- EISA is an open spec. Improvements and enhancements are contingent upon agreement by the EISA consortium. Anyone can obtain documentation describing every aspect of this architecture.

TECHNOLOGY UPDATE

32-Bit Buses

have an impact on its broad acceptance among designers. Until the EISA spec was finalized, interested designers had to pay \$2500 and sign a nondisclosure agreement before taking a peek at the proposed specification. Today, however, you can contact BCPR Services at (202) 371-5921 and pay \$125 for a copy of the spec, or \$450 for the spec, one year of updates, and access to the EISA Forum electronic bulletin board.

IBM provides copies of portions of the MCA spec free of charge. Anyone can obtain aspects of the spec not covered by IBM patents by calling the Software Publications Hotline at (800) 327-5711. You can also obtain a complete list of IBM PS/2 hardware publications by calling the Technical Directory at (800) 426-7282.

According to IBM's Mike Ryder, if you want to build computers for the MCA, you have to license the technology from IBM and pay a royalty fee of 2% for each mother board you sell. However, plug-in boards for the MCA are not constrained by any of IBM's patents, so manufacturers pay nothing to be added to IBM's list of preferred developers, thereby gaining access to the spec and any subsequent updates.

Chip sets simplify designs

From a plug-in board-designer's point of view, both EISA and MCA provide straightforward development paths because of the availability of chip sets for intelligent bus control, buffering, and DMA. Intel, the first chip manufacturer to introduce chips for EISA and MCA, also

provides chip sets for these specs.

Intel's 82350 EISA chip set comes in a \$90 (1000) 25-MHz and a \$109 (1000) 33-MHz version, each of which includes the company's 82357 integrated system peripheral and 82358 EISA bus controller. You can also purchase an optional \$16 (1000) 82352 EISA bus buffer that replaces 17 TTL glue-logic chips to further simplify your circuit.

Early this year Intel will announce a version of the 82350 EISA chip set that will reduce the number of chips necessary to manufacture a mother board from 90 to 100 chips down to about 40 chips. The chip set will not only lower the overall cost of producing a mother board, but will shrink the size of the board to a "baby AT" form factor.

Intel's \$32.50 (1000) 82355 EISA

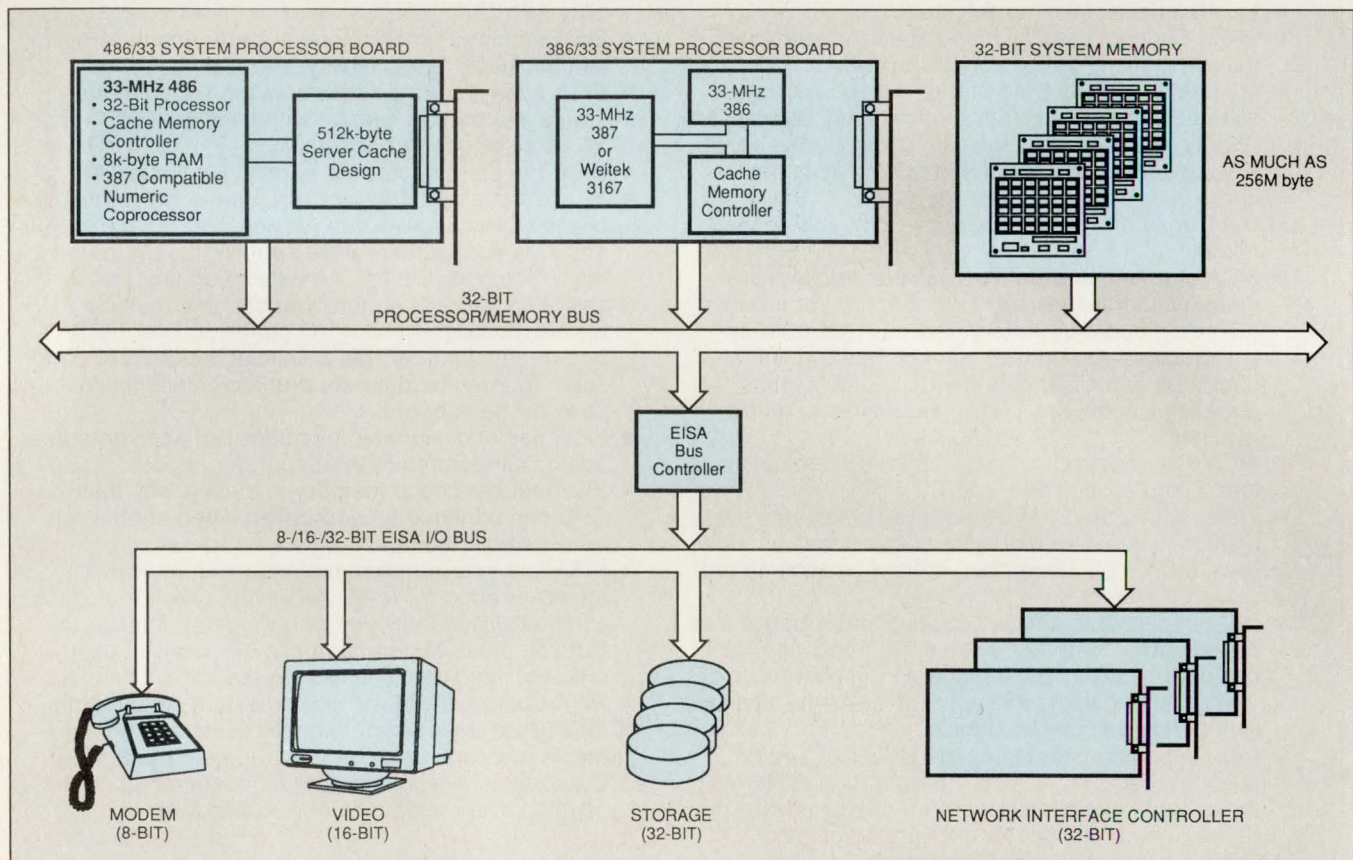

Complementing the EISA bus with a 32-bit processor/memory bus called the Flex/MP, Compaq's Systempro Model 486/840 has two system processors that simultaneously operate from their memory caches.

TOKIN EMC SHUTOUT.

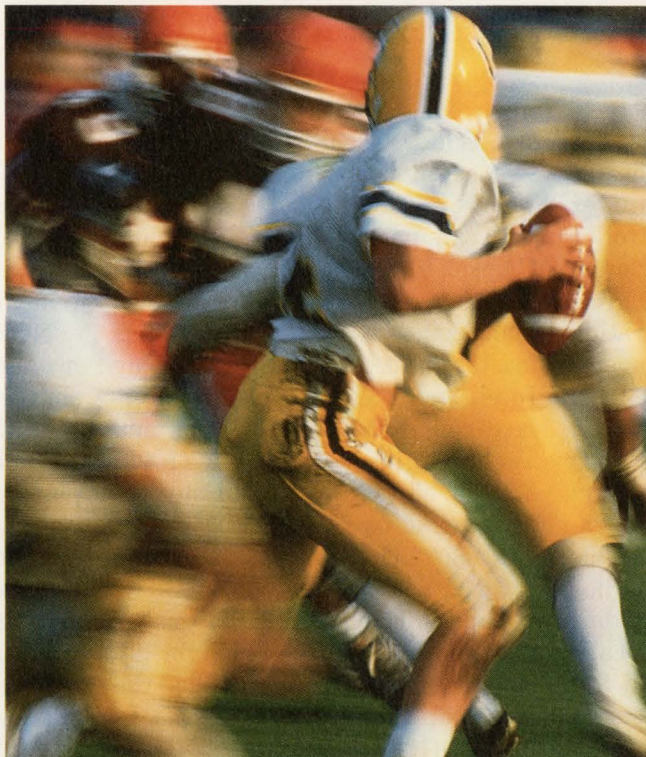

When you're head to head against a tough opponent, you need optimum protection. And when the opponent is electromagnetic interference, you need the finest EMC lineup available—a defence that handles both power lines and data lines in

a way that keeps you in the lead throughout the season.

Tokin fields only the best EMC components, an all-star

team comprising high-frequency magnetic materials and Tokin's exhaustive background in EMC technology.

Check out Tokin's power and data line devices, then get on the winning team... today.

Power Line Filters	SN Coils	SN Coils with Terminal Base	SC Coils	SC Coils with Terminal Base	SC Coils for High Frequencies
	SU Coils	SU Coils for High Frequencies	SE Coils	SE Coils Low Leakage Magnetic Flux Types	SS Coils
Data Line Filters	DC Line Filters (Type SH)	S-DIP Filters	EMC Chip Filters (M-600 Series)	EMI Cores (ESD-QR Series)	EMI Cores (ESD-FPD Series)
	EMC Chip Filters (M-700 Series)	Bead Inductors	Feed through Capacitor Filters (EG Series)	SB Coils (SBT-W Series)	SN Coils (SN-S3M Series)
					EMI Connectors

N: Normal mode C: Common-mode



Tokin Corporation

Hazama Bldg., 5-8, Kita-Aoyama 2-chome, Minato-ku, Tokyo 107, Japan
Phone: 03-402-6166 Fax: 03-497-9756

Tokin America Inc.

155 Nicholson Lane, San Jose, California 95134, U.S.A.
Phone: 408-432-8020 Fax: 408-434-0375

Chicago Branch
9935 Capitol Drive, Wheeling, Illinois 60090, U.S.A.
Phone: 708-215-8802 Fax: 708-215-8804

Tokin Electronics (HK) Ltd.

Room 806 Austin Tower, 22-26A Austin Avenue, Tsimshatsui, Kowloon, Hong Kong
Phone: 367-9157 Fax: 739-5950

Taiwan Liaison Office

3F-4, No. 57 Fu Shing N. Road, Taipei, Taiwan
Phone: (02) 7728852 Fax: (02) 7114260

Singapore Branch

140 Cecil Street, No. 13-01 PIL Bldg., Singapore
Phone: 2237076 Fax: 2236093

Tokin Europe GmbH

Knorrstr. 142, 8000 München 45, Germany
Phone: 089-311 10 66 Fax: 089-311 35 84

You can reach our agents by phone: Denmark (03) 63 3830; France (1) 45-34-7535; Italy (0331) 67-8058; Spain 729-1155; Switzerland (01) 830-3161

TECHNOLOGY UPDATE

32-Bit Buses

bus master interface controller for designing plug-in boards integrates the EISA, CPU, and transfer buffer interfaces. The controller automatically administers such EISA bus master protocol as cycle timing and execution, arbitration and pre-emption, and byte alignment.

For MCA mother boards, Intel sells a chip set manufactured by IBM. The set includes two local I/O channel-support chips (82303 and 82304), a DMA controller and central arbiter (82307), an MCA bus controller (82308), an address bus controller (82309), and a floppy-disk controller (82077AA). Intel calls this set the 82311 and sells a \$71 (1000) 16-MHz 80386SX version, an \$89.50 (1000) version for the 20-MHz 80386, and a \$133 (1000) 25-MHz set for 80386 and 80486 CPUs.

Chips and Technologies makes its own MCA mother-board chip sets. The Chips/280 is suitable for use with 80386 CPUs that operate as fast as 33 MHz. The \$173 (1000) chip

set includes BIOS, VGA graphics, two serial ports, and one parallel I/O. For 80386SX and 80286 CPUs, you can purchase the \$94 (1000) Chips/250 chip set.

For plug-in boards, IBM also makes the \$45 (1000) 82325 bus master interface, which is sold by Intel, and a \$21 (1000) slave interface called the 82326. Chips and Technologies sells a \$40 (1000) 82C614 Microchips bus master interface and two \$20 (1000) slave interfaces: the 82C611 and the 82C612, with DMA.

Capital Equipment Corp makes its own MCA interface chip for designing expansion boards called the One Chip Plus (88C01), which sells for \$34 (100) or \$27.50 (1000). The company also offers development packages for I/O and memory card designers that include the 88C01, design-utility software, an application guide, a recommended IBM PC layout, design guidelines, and a CAD library. Pricing ranges from

\$495 for a basic I/O package (03000-50100) to \$995 for a combined I/O and memory package (030000-50300) that includes background or foreground control for data acquisition and other I/O functions.

NCR offers a \$36.25 (1000) bus mastering host-interface controller-chip, called the 86C05 Micro Channel/EISA/AT/Nubus. Plug-in board designers can use this chip to support multiple architectures without redesigning the host-interface logic, an effort that NCR officials estimate as 75% of the total hardware and firmware application-development task. The chip facilitates 20M-byte/sec data-transfer rates and includes a 32-word x 32-bit FIFO-buffer for 8-, 16-, or 32-bit transfers to host memory. The board also contains a programmable 8- or 16-bit DMA interface.

Although such chip sets can speed board development, some companies elect to develop their own proprietary circuits to inter-

For more information . . .

For more information on the MCA and EISA products discussed in this article, circle the appropriate numbers on the Information Retrieval Service card or use EDN's Express Request service. When you contact any of the following manufacturers directly, please let them know you read about their products in EDN.

Advanced Logic Research Inc
9401 Jeronimo
Irvine, CA 92718
(800) 444-4257;
in CA, (714) 581-6770
Circle No. 804

Bustek Corp
2255G Martin Ave
Santa Clara, CA 95050
(408) 492-9090
FAX (408) 492-1542
Circle No. 805

Capital Equipment Corp
99 S Bedford St
Suite 107
Burlington, MA 01803
(800) 234-4232;
in MA, (617) 273-1818
Circle No. 806

Chips and Technologies Inc
3050 Zanker Rd
San Jose, CA 95134
(408) 434-0600
Circle No. 807

Compaq Computer Corp
Box 692000
Houston, TX 77269
(800) 231-0900
Circle No. 808

Data Technology
500 Yosemite Dr
Milpitas, CA 95035
(408) 262-7700
FAX (408) 942-4052
Circle No. 809

VOTE . . .

Please also use the Information Retrieval Service card to rate this article (circle one):

High Interest 515 Medium Interest 516 Low Interest 517

Hewlett-Packard Co
19310 Pruneridge Ave
Cupertino, CA 95014
(800) 752-0900
Circle No. 810

IBM Corp
1133 Westchester Ave
White Plains, NY 10604
(800) 426-2468
Circle No. 811

Intel Corp
3065 Bowers Ave
Santa Clara, CA 95051
(408) 987-8080
Circle No. 812

National Instruments Inc
6504 Bridge Point Pkwy
Austin, TX 78730
(800) 433-3488;
in TX, (512) 794-0100
FAX (512) 794-8411
Circle No. 813

NCR Corp
Logic Products Marketing
Dayton, OH 45479
(800) 525-2252
Circle No. 814

GOODBYE WORKSTATION

HELLO PADS-PCB

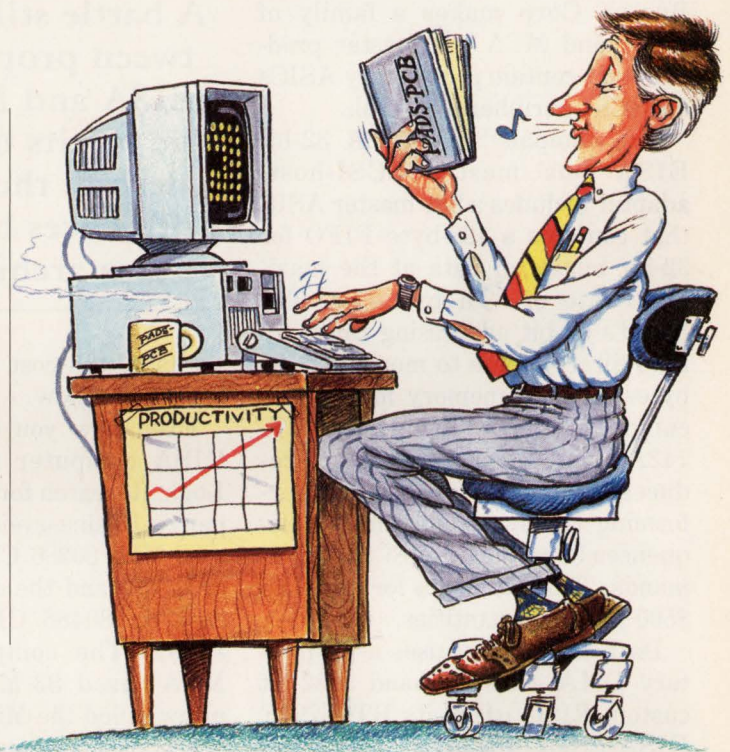

It's time to say goodbye

to expensive engineering workstation based CAD systems. Why should management tie up \$100,000.00 or more in a workstation when the same (and often better) performance is obtained with PADS-PCB, a PC based CAD system?

PADS-PCB is a high performance printed circuit board design software that offers a degree of functionality a designer could expect only from an expensive engineering workstation, including Logic Simulation, Circuit Analysis, and Thermal Analysis.

Powerful auto/interactive features are a part of what makes PADS-PCB the best selling CAD system on the market today!

- 1 mil database-32"x32" board size-30 layers
- Large circuit capabilities: In excess of 400 equivalent 14 pin IC's
- Automatic and interactive component placement aids
- Automatic and interactive track routing
- Automatic design rule checking
- Superior Surface Mounted Device capability
- Fine line design
- Superb analog design capability
- Inputs from Futurenet, Orcad, Schema, PADS-LOGIC and others
- 100% routing with PADS-SuperRouter, the accepted standard for rip-up and reroute autorouting

- New! PADS-Push N' Shove Auto-Interactive Push N' Shove Router. Great for analog and critical circuitry.

CAD Software asks you to try its Evaluation Package, at no charge, so you can judge for yourself how PADS-PCB can be the solution to your design problems. Ask about our Leasing Program. Call our Sales Hotline today at **(800) 255-7814;** in Massachusetts, **(508) 486-8929.**



119 Russell Street
Suite #6
Littleton, MA 01460

CAD
Software, Inc.

CIRCLE NO. 96

32-Bit Buses

face with the bus. For example, Bustek Corp makes a family of EISA and MCA bus master products that contain proprietary ASICs for SCSI peripheral control.

The company's BT-742A 32-bit EISA bus master SCSI-host-adaptor includes a bus master ASIC that contains a 128-byte FIFO for 32-bit bursts of data at the maximum rate of 33M bytes/sec. The board's 32-bit addressing range allows direct access to more than 4G bytes of main memory in the host computer. In addition, the BT-742A's SCSI-controller ASIC reduces protocol overhead by performing common algorithms or sequences in response to SCSI-2 commands. The board sells for less than \$500 in OEM quantities.

Data Technology uses a proprietary DMA controller and a 32-bit custom RISC μ P in its DTC6290E EISA/ESDI disk-drive controller board. The board controls as many as four 15M-bps ESDI drives and as many as three floppy-disk drives. Performing most hard-disk access operations in less than 0.5 msec, this \$895 bus master can also transfer data without using the host CPU.

It's a matter of volume

The infrastructure that will pave the way for your next 32-bit bus design is currently in place. However, which spec will emerge as the architecture of choice remains an unanswered question. Based on the volume of interest designers have shown, MacCormack predicts that EISA will be the dominant 32-bit architecture by 1992. Accordingly, Texas Instruments expects to introduce an EISA chip set this year, believing that demand for the chips will be sufficient to reduce the price enough to effectively compete with ISA. And as the price of the chip

A battle still rages between proponents of EISA and MCA over the merits of each bus despite the minimal differences between the two architectures.

set falls, the cost of complete systems will follow.

Even now you can purchase an EISA computer from Advanced Logic Research for \$1995. The company's Businessveisa model 101 has a 33-MHz 80386 CPU and 1M byte of RAM, and the company offers a 25-MHz 80486 CPU upgrade for \$1995. The company makes an MCA-based 33-MHz 80386 computer called the Microflex 3300 that has a base price of \$5795, but includes 2M bytes of RAM, a 70M-byte hard-disk drive, a 1.44M-byte 3½-in. floppy-disk drive, a parallel port, a mouse port, and a serial port.

IBM has announced the \$16,695 Model 90 and \$17,745 Model 95 PS/2 computers that use the MCA's 20M-byte/sec data-transfer rate. However, they boost system performance with a 33-MHz 80486 CPU nestled in an extendible processor "complex" that resides on a plug-in board, rather than on the motherboard. Therefore, you can upgrade the CPU to accommodate advances in future technologies. These computers also include a video bus master—the XGA Display Adapter/A, which is compatible with the existing 640×480 VGA video standard, but boosts screen resolution to 1024×768 in 256 colors.

There will always be a few individuals who insist that the EISA

vs MCA debate is much ado about nothing—that IBM PC performance in excess of 40M bytes/sec will create more noise and data integrity problems than it could possibly resolve. Yet, enterprising designers have met and overcome every technical obstacle presented during the evolution of personal computing, and will presumably continue to do so.

Both EISA and MCA offer a logical 32-bit path, and neither seems to have a significant technological edge. Ultimately, MCA board manufacturers will find their fortunes inexorably tied to IBM's marketing clout, while EISA will most likely give board designers a more diverse, but also more cost-conscious, market. **EDN**

References

1. Gallant, John, "A program guide for EISA vs MCA," *EDN*, September 28, 1989, pg 75.
2. Glass, L Brett, "Inside EISA," *Byte*, November 1989, pg 417.
3. Harvey, Audrey F, "EISA and Micro Channel Battle in the OEM Ring," *The OEM Integrator*, Spring 1990, pg 67.
4. Kumar, Amaresh, "Understand EISA Bus-Cycle Translations," *Electronic Design*, October 11, 1990, pg 81.
5. Mosley, J D, "MCA and EISA square off," *EDN*, April 12, 1990, pg 61.
6. Newcom, Kerry, "The Micro Channel versus the AT Bus," *Byte IBM Special Edition*, Fall 1988, pg 91.
7. Pinto, James J, "EISA vs MCA," *I&CS*, October 1989, pg 47.
8. Rosch, Winn L, "Cashing in on the Micro Channel," *PC Magazine*, October 30, 1990, pg 101.
9. Smith, Bud E and William L Rinko-Gay, "EISA vs MCA," *Personal Workstation*, February 1990, pg 60.

Article Interest Quotient (Circle One)

High 515 Medium 516 Low 517

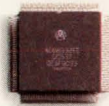

68332
Available
Mar. 1990



HP emulator
available
Dec. 1989
*(Got a little ahead
of ourselves.)*

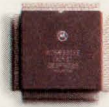

68331
Available
Sept. 1990



HP emulator
available
Nov. 1990



68302
Available
Oct. 1989



HP emulator
available
Aug. 1990
*(We didn't start until
Feb. 1990, but we finished
it in 6 months.)*



68040
Available
Q4 1990



HP emulator
available
Q1 1991

Coincidence? We don't think so.

Nobody supports the Motorola line of microprocessors better than the Hewlett-Packard 64700 Series of emulators.

You see, HP has agreements with key chip manufacturers. Like Motorola. So while they're working on the next hottest chip design, we're simultaneously developing an emulator.

Our relationship with Motorola has allowed us to provide emulators this quickly for the new 68302, 68331 and 68332 processors.

As well as for the upcoming 68040. And, of course, we've always had broad support for the 68000, 68010, 68020 and 68030.

HP emulators also provide a complete solution. Logic and performance analysis tools and code coverage are all in the same box. They come with C cross compilers, simulators/debuggers and branch validators.

Even better, HP emulators work in real time without halting your target system. Which means you'll ensure a thorough analysis

of your design by executing it at full speed. Not by second-guessing.

All of this is accompanied by HP's renowned service and support. So call **1-800-752-0900, Ext. 1904** for a free demo disk or videotape. They'll demonstrate all the benefits of using an HP emulator. And by the way, if we answer your call quickly, it's no coincidence.



**HEWLETT
PACKARD**

FLUKE®

YOUR COMPLETE GUIDE TO PC-BASED INSTRUMENTATION SYSTEMS

FLUKE

DIGITAL STORAGE OSCILLOSCOPES

N Lozem spium ditor all amet, conser...
R Lozem spium ditor all amet, conser...
T Lozem spium ditor all amet, conser...
G spium ditor all amet, conser...

TERS

Model	Bandwidth	Storage	Resolution	Trigger	Serial	Price
DSO100	100 MHz	100,000	8-bit	Edge	Yes	\$1,200
DSO200	200 MHz	200,000	8-bit	Edge	Yes	\$1,800
DSO300	300 MHz	300,000	8-bit	Edge	Yes	\$2,400
DSO400	400 MHz	400,000	8-bit	Edge	Yes	\$3,000
DSO500	500 MHz	500,000	8-bit	Edge	Yes	\$3,600
DSO600	600 MHz	600,000	8-bit	Edge	Yes	\$4,200
DSO700	700 MHz	700,000	8-bit	Edge	Yes	\$4,800
DSO800	800 MHz	800,000	8-bit	Edge	Yes	\$5,400
DSO900	900 MHz	900,000	8-bit	Edge	Yes	\$6,000

N Lozem spium ditor all amet, conser...
L Lozem spium ditor all amet, conser...

SWITCHING SYSTEMS

S Lozem spium ditor all amet, conser...
A Lozem spium ditor all amet, conser...
M Lozem spium ditor all amet, conser...

If this free catalog doesn't grab you,

Call for our free catalog, or else. Or else you won't be able to quickly find everything you need to build affordable, yet superb PC-based test systems. Such as signal sources, DSOs and data acquisition tools.

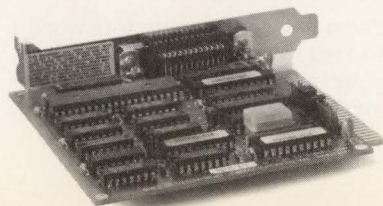

Nor will you be able to take advantage of our other free offer: Buy a power supply or switching system, plus any GPIB instrument and get a \$695 PC GPIB interface card.

But to get your free card, you'll



PHILIPS

PROGRAMMABLE POWER SUPPLIES

Programmable power supplies are essential for testing and measuring electronic equipment. They provide a stable, accurate, and programmable source of power for a wide range of applications. The 6800 series offers a variety of models to meet your needs.

Model	Output Voltage	Output Current	Power
6800-100	0-100V	10A	1000W
6800-200	0-200V	5A	1000W
6800-300	0-300V	3A	900W
6800-400	0-400V	2A	800W
6800-500	0-500V	1.5A	750W
6800-600	0-600V	1A	600W
6800-700	0-700V	0.7A	490W
6800-800	0-800V	0.5A	400W
6800-900	0-900V	0.3A	270W

GPIB SYSTEMS SOFTWARE

Remote control and data transfer are made easy with the GPIB Systems Software. This software allows you to communicate with your test equipment from a personal computer. It provides a powerful and flexible environment for test automation.

SIGNAL SOURCES

Test your equipment with precision and accuracy using our signal sources. These devices provide a wide range of waveforms and frequencies for testing and measurement. The 6800 series offers a variety of models to meet your needs.

Model	Frequency Range	Output Power
6800-100	100kHz - 10MHz	10W
6800-200	100kHz - 10MHz	5W
6800-300	100kHz - 10MHz	3W
6800-400	100kHz - 10MHz	2W
6800-500	100kHz - 10MHz	1.5W
6800-600	100kHz - 10MHz	1W
6800-700	100kHz - 10MHz	0.7W
6800-800	100kHz - 10MHz	0.5W
6800-900	100kHz - 10MHz	0.3W

COUNTERS AND TIMER/COUNTERS

Counters and timer/counters are essential for testing and measuring electronic equipment. They provide accurate and precise measurements of time and frequency. The 6800 series offers a variety of models to meet your needs.

Model	Counting Rate	Resolution
6800-100	100MHz	1ns
6800-200	200MHz	0.5ns
6800-300	300MHz	0.3ns
6800-400	400MHz	0.2ns
6800-500	500MHz	0.1ns
6800-600	600MHz	0.05ns
6800-700	700MHz	0.03ns
6800-800	800MHz	0.02ns
6800-900	900MHz	0.01ns

maybe our other freebie will.

want to see our catalog first*
This offer ends July 30, 1991. Limit one card per customer.
For a catalog and details, call 1-800-44-FLUKE. Ask for extension 701. The call is free (what else).

*If you have our catalog already, great - feel free to go straight to the phone and order.
John Fluke Mfg. Co., Inc., P.O. Box 9090, M/S 250C, Everett, WA 98206-9090. U.S. (206) 356-5400. Canada (416) 890-7600. Other countries: (206) 356-5500.
© 1990. All rights reserved. Ad No. 00044.

FAST ANSWERS.

FLUKE
CIRCLE NO. 98

Everything You Ever Wanted In UNIX. And Less. \$99.95*

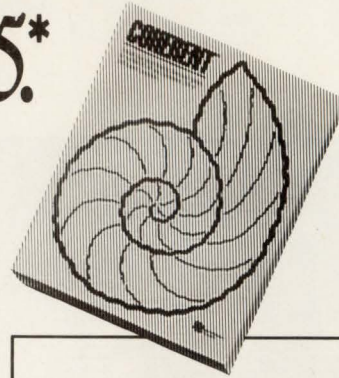

OK. We know it's hard to believe. So just consider this. Coherent™ is a virtual clone of UNIX. But it was developed independently by Mark Williams Company. Which means we don't pay hundreds of dollars per copy in licensing fees.

What's more, Coherent embodies the original tenet of UNIX: small is beautiful. This simple fact leads to a whole host of both cost and performance advantages for Coherent. So read on, because there's a lot more to Coherent than its price.

SMALLER, FASTER... BETTER.

Everybody appreciates a good deal. But what is it that makes small so great?

For one thing, Coherent gives you UNIX capabilities on a machine you can actually afford. Requiring only 10 megabytes of disk space, Coherent can reside with DOS. So you can keep all your DOS applications and move up to Coherent. You can also have it running faster, learn it faster and get faster overall performance. All because Coherent is small. Sounds beautiful, doesn't it?

But small wouldn't be so great if it didn't do the job it was meant to do.

LESS IS MORE!	Coherent For the IBM-PC/AT and compatible 286 or 386 based machines.	Santa Cruz Operation's XENIX 286, Version 2.3.2
No. of Manuals	1	8
No. of Disks	4	21
Kernel Size	64K	198K
Install Time	20-30 min.	3-4 hours
Suggested Disk Space	10 meg	30 meg
Min. Memory Required	640K	1-2 meg
Performance*	38.7 sec	100.3 sec
Price	\$99.95	\$1495.00

*Byte Exec benchmark, 1000 iterations on 20 MHZ 386. Hardware requirements: 1.2 meg 5¼" or 1.4 meg 3½" floppy, and hard disk. Does not run on Microchannel machines.

EVERYTHING UNIX WAS MEANT TO DO.

Like the original UNIX, Coherent is a powerful multi-user, multi-tasking development system. With a complete UNIX-compatible kernel which makes a vast world of UNIX software available including over a gigabyte of public domain software.

Coherent also comes with Lex and Yacc, a complete C compiler and a full set of nearly 200 UNIX commands including text processing, program development, administrative and maintenance commands plus UUCP.

CRITICS AGREE: IT'S AN INCREDIBLE VALUE!

"Mark Williams Co. seems to have mastered the art of illusion; Coherent comes so fully qualified as a UNIX clone, you find yourself thinking 'I can't believe it's not UNIX.'"

—Sean Fulton, UNIX Today!, November 26, 1990

"...(Coherent) may be the best thing that has happened to UNIX yet."

—William Zachmann, PC Week, November 5, 1990

"If you want to come as close as you can to real UNIX for a low price, COHERENT can't be beat."

—Warren Keuffel, Computer Language Magazine, November 1990

"If you want a UNIX-like development and learning system for less than \$100...I don't see how you can go wrong with Coherent."

—David Fiedler, BYTE Magazine, November 1990

EXPERIENCE, SUPPORT AND A 60-DAY MONEY BACK GUARANTEE.

Wondering how something as good as Coherent could come from

NEW COHERENT RELEASE 3.1 NOW WITH...

- elvis: vi editor clone
- SCSI (Adaptec AHA 154x series and more on the way.) and ESDI support
- UUCP Bulletin Board System
- RAM disk support
- And much, much more!

OVER 10,000 SATISFIED USERS!

nowhere? Well it didn't. It came from Mark Williams Company, people who've developed C compilers for DEC, Intel, Wang and thousands of professional programmers.

We make all this experience available to users through complete technical support via telephone. And from the original system developers, too!

Yes, we know \$99.95 may still be hard to believe. But we've made it fool-proof to find out for yourself. With a 60-day money-back no-hassles guarantee.

You have to be more than just a little curious about Coherent by now. So why not just do it? Pick up that phone and order today.

You'll be on your way to having everything you ever wanted in UNIX. And for a lot less than you ever expected.

1-800-MARK WMS

(1-800-627-5967 or 1-708-291-6700)

FAX: 1-708-291-6750

60-DAY MONEY BACK GUARANTEE!



Mark Williams Company

60 Revere Drive
Northbrook, IL 60062

*Plus shipping and handling. Coherent is a trademark of Mark Williams Company. UNIX is a trademark of AT&T. XENIX is a trademark of Microsoft.

Real-time Unix-like operating system implements Posix 1003.4 extensions

Version 2.0 of the Unix-compatible Lynxos real-time operating system implements the complete set of real-time extensions specified in IEEE Posix 1003.4 (also called Posix.4). The Posix.4 standard makes possible real-time applications that can run on systems and processors from multiple vendors. Lynxos 2.0 also offers compatibility with threads, a form of lightweight tasks defined by Posix.4a.

Lynxos 2.0 provides the following features defined in Posix.4 extensions:

- Binary semaphores
- Process memory locking
- Shared memory
- Priority scheduling
- Asynchronous event notification
- High-resolution timers
- Interprocess communication
- Asynchronous I/O
- Synchronized I/O
- Contiguous real-time files.

The priority-scheduling facility provides several priority-driven scheduling policies including first in/first out. The timers in Lynxos go far beyond Unix timers and have nsec resolution for both absolute- and relative-timing operations.

Posix.4a defines the use of threads as a more efficient way to set up multiple concurrent execution paths within a task than the use of processes. Multiple threads within a process share address space and require less context information than a process. Thus, an operating system requires less CPU and memory resources to start, stop, or switch between threads. Lynxos

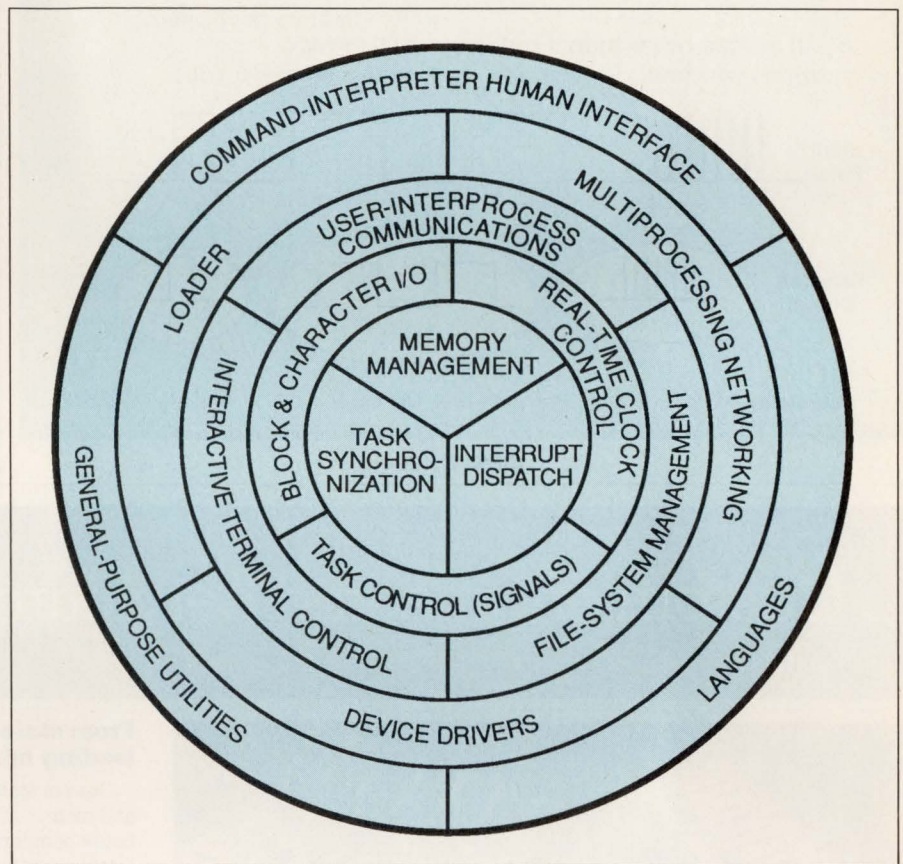

Fig 1—The task-control and scheduling capability built into Lynxos 2.0 allows the real-time operating system to respond quickly to external events; yet the software maintains binary compatibility with System V Unix.

2.0 fully supports the Posix.4a threads concept and the thread model implied by Ada tasking.

Although compatible with Unix and Posix.4, Lynxos is a real-time operating system developed with no Unix System Laboratories (AT&T) code. **Figure 1** depicts the structure of Lynxos. The operating system can respond to an external event in <math><450 \mu\text{sec}</math>, worst case, when running on a 20-MHz 80386-based system. The specified worst-

case response time includes interrupt disable, dispatch, interrupt routine execution, pre-emption disable, scheduling, context switch, and return system call. The company also guarantees the specification on systems with disk drives and networks.

You can also place Lynxos in ROM for embedded applications, yet the operating system supports demand-paged virtual memory and offers compatibility with Unix Sys-

PPD-56 Series PROGRAMMABLE PULSE DISCRIMINATOR



**data
delay
devices, inc.**



Unit Can Be Programmed To Digitally Discriminate:

- All pulses below a certain pulse-width.
- or
- All pulses above a certain pulse-width.
- or
- All pulses other than a pulse-width window.

Specifications:

- Microprocessor compatible
- Input signal: Schottky TTL
- Output load: TTL Schottky loads
- No. bits: 6
- Pulse width increment: 0.5 NS to 10 NS
- Operating temperature: 0° to 70°C (-55°C to +125°C on request)
- Temperature coefficient: 100 PPM/°C
- Power supply: 5 Vdc

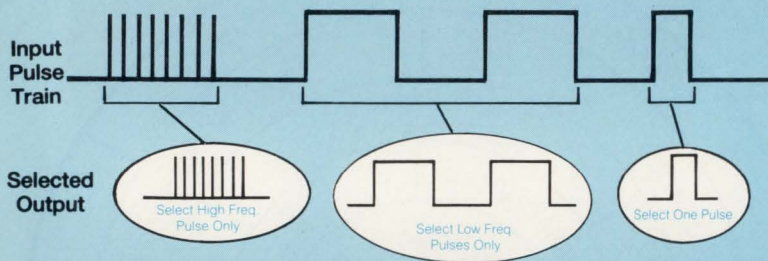

Data Delay Devices • 3 Mt. Prospect Ave., Clifton, N.J. 07013 • (201) 773-2299

CIRCLE NO. 41

EDN EDITORS' CHOICE

tem V interprocess communications facilities. The operating system also offers binary compatibility with shrink-wrapped application software for Unix such as Wordperfect.

You can buy Lynxos for a number of popular μ P families including the Intel 860, 80386, and 80486; the Motorola 680X0 and 88000; and the Mips R3000 and R6000. A version for IBM PC/AT compatibles costs \$1495. You can also buy a number of options such as X-window support, the Motif graphical user interface, and TCP/IP network support. An IBM PC-compatible development kit for ROM-based systems costs \$2995.—**Maury Wright**

*Lynx Real-Time Systems Inc,
16780 Lark Ave, Los Gatos, CA
95050. Phone (408) 354-7770.
FAX (408) 354-7085.*

Circle No. 736

Custom engineered beryllium copper parts.

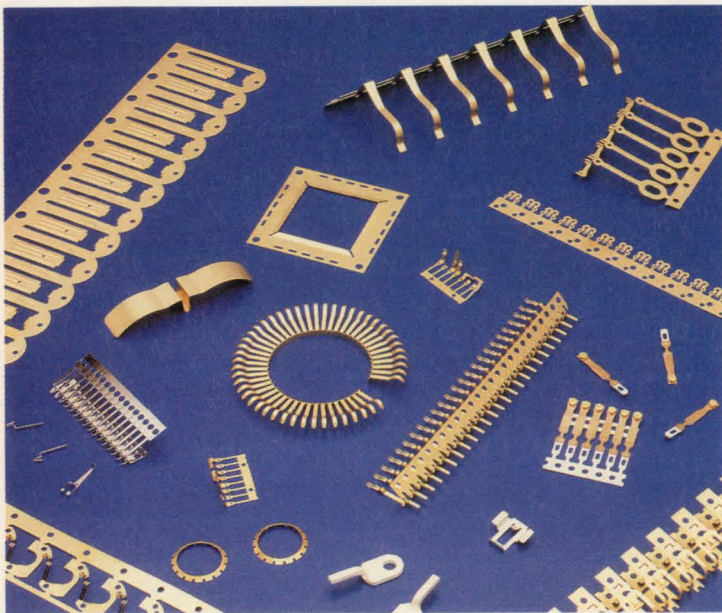

From state-of-the-art design to the industry's leading fabricating technology.

Custom stampings, springs, contacts, gaskets, assemblies and more... if it's made from beryllium copper, there isn't a better company to help design and make it for you than Instrument Specialties.

During initial design, we're the only manufacturer in the industry to offer state-of-the-art FEA (Finite Element Analysis) to test your design parameters *before* production. Add to that CAD for design flexibility, and photoetching for economical prototype development... all leading to complete, TQA-backed manufacturing capabilities that include wire EDM, CAM, optical gauging video inspection, high speed punch pressing, proprietary heat treating, plating, special packaging, and more.

Whatever your custom requirements, call us for custom solutions.

Instrument Specialties

Headquarters

Delaware Water Gap, PA 18327-0136
TEL: 717-424-8510 FAX: 717-424-6213

Western Division—Placentia, CA

TEL: 714-579-7100 FAX: 714-579-7105

European Division—Liege, Belgium

TEL: 011-32-41-63-3021 FAX: 011-32-41-46-4862



The World of Beryllium Copper

Latin America, Middle East, except Israel: Beekman Laboratories, Inc., 914-472-6600; **Portugal:** Componenta Lda. 351-1-3621283; **Sweden:** LTG Marketing AB, 46-8-7039380; **Finland:** Euroshield OY, 358-38-50631; **Norway:** Feiring, 47-2-649070; **France:** Phytroic, 33-1-69-03-21-06; **UK:** Ramp Electronics, 44-703-260161; **Canada:** A.C.Simmonds & Sons, Ltd., 416-839-8041; **Switzerland, Austria, Liechtenstein:** KAB AG, 41-1-7342000; **Italy:** Sirces SRL, 39-2-57404962; **Israel:** Grand Central, Tech., 972-52-547520; **Germany:** Microscan GMBH, 49-89-964841; **Denmark:** SC Metric A/S, 45-42-804200; **Belgium, Luxembourg:** ACAL 32-2-720-5983; **Netherlands:** ACAL, 31-40-816565, Bodamer BVBA 32-2-452-3990; **South Africa:** Connecta C.C., 27-11-4632240; **Spain:** Amritron Pasivos, 34-1-5420906; 34-3-4907494; **Turkey, Greece:** Oakdale Industrial Electronics Corp. 516-737-8013.

CIRCLE NO. 42



With this Ethernet chip set, your competitors will swear you took a shortcut.

The shortest route to market begins with our three-chip set — the EtherStar™ controller, encoder/decoder, and transceiver — from Fujitsu's Advanced Products Division.

We've engineered this Ethernet set to offer you unparalleled ease of design. With our expert design support and optional manufacturing kit, you have everything you need to get new products out in record time.

EtherStar's unique buffer manager automatically controls buffer memory access and allocation, making application software easier to develop. And EtherStar handles many functions usually performed by the software driver in hardware — boosting system performance. No wonder official *Novell certification tests performed by independent consultants show that products based on our chip set have higher data-transfer rates.

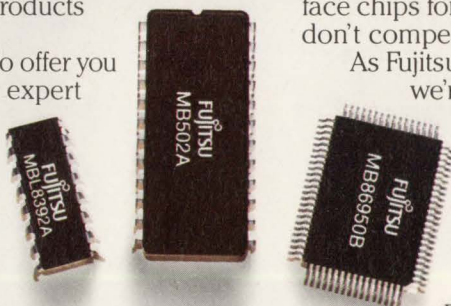

Unlike some of our competitors, we can supply you with complete system solutions, including interface chips for standard bus architectures. And we don't compete with you by selling boards.

As Fujitsu's American arm, we're in close touch with your marketplace and what you need to excel there. So call us at

1-800-866-8608. Learn about the family of high-performance Ethernet solutions from Fujitsu's Advanced Products Division.

And take the shortest, smartest pathway to Ethernet success.



FUJITSU

Delivering the Creative Advantage.

*Novell certification applies to the EtherStar LAN adapter which incorporates the Fujitsu chip set.

FUJITSU MICROELECTRONICS, INC., Advanced Products Division, 50 Rio Robles, San Jose, CA 95134-1806. EtherStar is a trademark of Fujitsu Microelectronics, Inc. © 1990 Fujitsu Microelectronics, Inc.

Take the risk out of V.32 and V.32 bis speeds

Reaching for the upper limits of modem performance needn't mean taking chances with the results. Rockwell International's RC9696 family gives you the confidence of proven turnkey solutions, the highest installed base in its class, a 5-year warranty and compatibility with V.32 or V.32 bis protocols, as well as with other Rockwell products.

For a basic modem with exceptional throughput, select the V.32/V.32 bis RC9696/14 for its 14.4 kbps speed and Group 3 fax compatibility. Or use the V.32 RC9696AC for 9600 bps speed, Group 3 fax, and extensive features such as V.42 and V.42 bis error correction and data compression.

For a low-risk introduction to Rockwell's speedy RC9696 products, contact Rockwell Communication Systems at P.O. Box C, M.C. 501-300, Newport Beach, CA 92658-8902; (800) 854-8099; in California: (800) 422-4230.

RC9696/14

- Complete V.32 and V.32 bis compatibility
- Highest installed base
- First worldwide product compatible with Group 3 14.4 fax (V.17)* and V.32 bis
- 14.4 kbps transmission speed, with 12.0 kbps fallback
- Extensive diagnostic capabilities
- Complies with all international standards, including V.22 bis, V.21 and V.23

RC9696AC

- V.32 compatibility
- AT command set
- Group 3 14.4 fax (V.17)*
- V.42 and MNP® 4 error correction protocols
- V.42 bis and MNP® 5 data compression
- Device set includes controller and protocol conversion chip
- Extensive compatibility with other Rockwell products

*V.17 approval is anticipated in 1991.
MNP is a registered trademark of Microcom, Inc.



**Rockwell
International**

...where science gets down to business

CIRCLE NO. 100

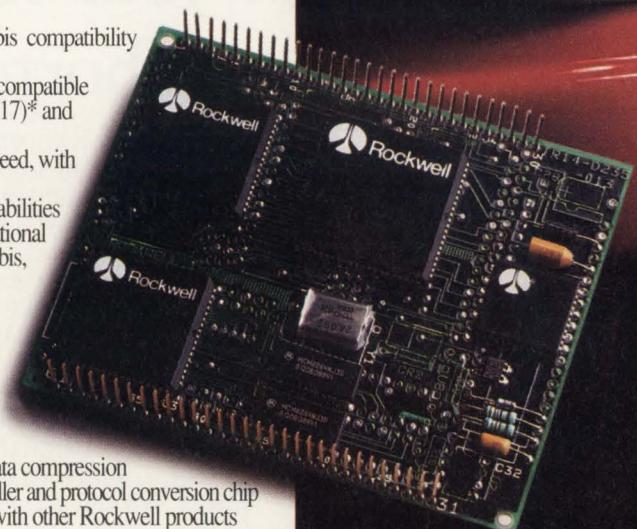

Voice-storage chip supplies nonvolatile analog memory

Today, voice-storage devices have become standard products. They're fairly easy to use and many manufacturers offer them, but the technology is basically the same—digitize a signal, store it, and play it back. Now, however, a small start-up company offers a voice-storage chip that requires neither an A/D nor a D/A converter. Instead, the ISD-1016 chip relies on analog memory.

Charge-coupled devices have supplied analog memory for years, but their ability to save information depends upon a constant source of power. However, this chip relies on nonvolatile memory cells that use a proprietary CMOS/EEPROM technology to store charges in a RAM arrangement. Thus, the chip requires no backup power supply to maintain its analog information—the chip draws 10 μ A of standby current only because it contains other circuitry.

The device operates from a 5V power supply, and it requires few external passive components—resistors and capacitors that control filtering and automatic gain-control characteristics. Distortion is about 2%. The chip requires no external crystal or clock signal.

Applications are typical for voice-output products: phone-answering equipment, portable telephones, pagers, emergency equipment, and alarms. Because the chip's price is \$16 (1000), it should start to appear in such applications fairly soon. The chip can deal with all types of analog information, not just speech or

music. For example, it can store test waveforms, sample analog signals, store correlation data, and hold filter coefficients. The company's CMOS/EEPROM technology may also find a use in neural-network chips in which the weighting values for individual neurons are stored analog values rather than binary (digital) values.

The chip stores as many as 16 sec of speech, and you can cascade as many of the chips as you need to extend a message's length. Because the chip uses a RAM structure, you can access portions of a message or divide the 16-sec interval into subintervals and several shorter messages. To record a message, a microphone connects directly to the chip. The chip's output also drives a small speaker directly, although you might use a small external audio-amplifier IC in some applications. You can order the voice-storage chip in a 28-pin DIP or in a 28-pin plastic leadless chip carrier.—*Jon Titus*

Information Storage Devices Inc., 2332B Walsh Ave, Bldg G, Santa Clara, CA 95051. Phone (408) 562-9550. FAX (408) 562-9559.

Circle No. 733

Lowest Profile
0.5" ht.,
up to 55 Watts



PICO AC-DC Power Supplies

- **Input Voltage 90 to 130 VAC (47/440Hz)**
- **Single, Dual, Triple Outputs**
- **1200V Rms Isolation**
- **Low Isolation Capacity Available**
- **Continuous Short Circuit Protection**
- **High Efficiency**
- **Fully Regulated Voltage Outputs**
- **Operating Temperature -25°C. to +70°C. with No Heat Sink or Electrical Derating Required**
- **Expanded Operating Temperature Available (-55°C. to +85°C. ambient)**
- **Optional Environmental Screening Available**

PICO manufactures complete lines of Transformers, Inductors, DC-DC Converters and AC-DC Power Supplies

Delivery—
stock to
one week

SEE EEM,
THOMAS REGISTER
OR SEND DIRECT FOR
FREE PICO CATALOG

PICO
Electronics, Inc.

453 N. MacQuesten Pkwy. Mt. Vernon, N.Y. 10552

Call Toll Free **800-431-1064**

IN NEW YORK CALL **914-699-5514**

VME64 68040-based single-board computer supports 32M bytes of dynamic RAM

The SV430 CPU board's compliance with the VME64 bus spec and a 68040 host μ P make this board well suited for high-performance Unix or real-time system applications. The board accommodates as much as 32M bytes of interleaved dynamic RAM. Also, its 68030 μ P acts as an auxiliary processor that controls communication, disk, and other I/O operations.

The 68040 μ P provides the SV430 board with 19 to 25 MIPS of power, depending on your choice of 25- or 33-MHz ICs. The processor includes dual 4k-byte instruction and data caches, a 68882-compatible floating-point unit, and an integrated memory-management unit. After more than a year's delay, Motorola has just begun to ship the chips in volume.

The CPU board can perform

VMEbus block transfers as fast as 66M bytes/sec using the 64-bit wide data path described in the new revision D VMEbus spec (commonly called VME64). But the board maintains compatibility with standard 32-, 16-, and 8-bit VMEbus boards, and supports 33M-byte/sec block transfers at 32 bits. The board performs 10M-byte/sec VMEbus transfers during standard shared-

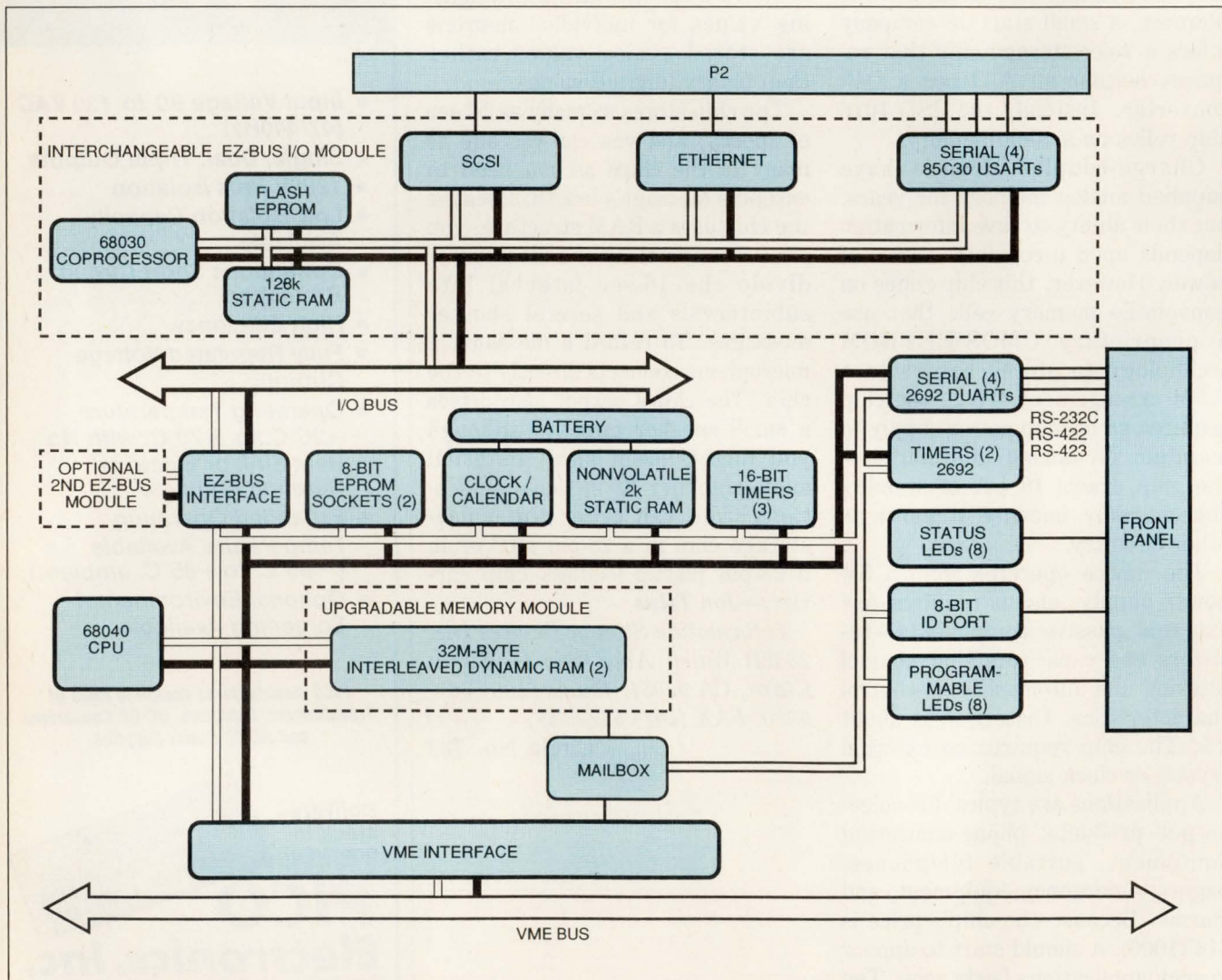
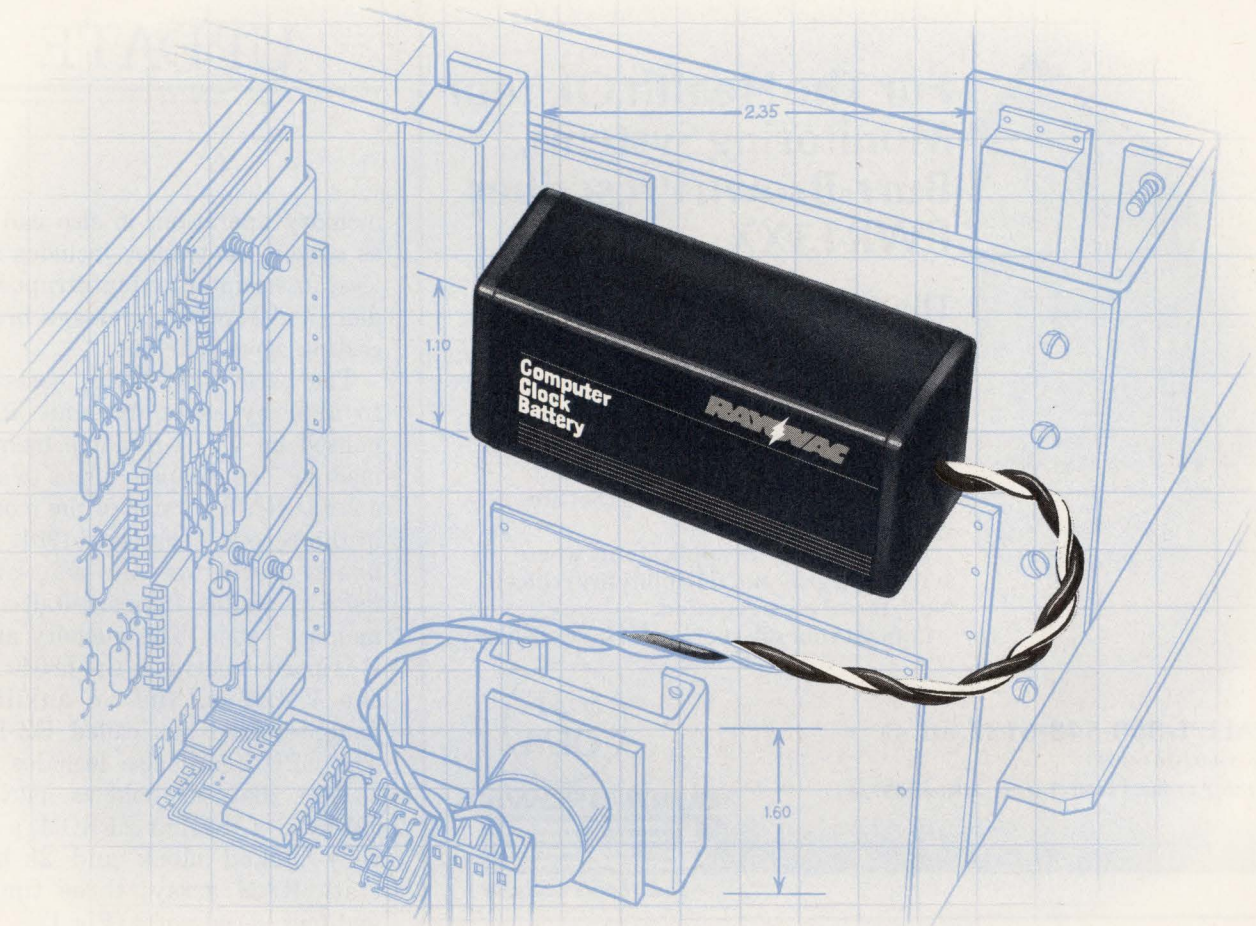

Fig 1—The 68040 μ P and memory, combined with the 68030-based EZ-Bus I/O modules, make the SV430 a true single-board computer. This computer allows eight users to run Unix via serial ports.



WHY MORE COMPANIES ARE PLUGGING US INTO THEIR DESIGNS.

Today the Rayovac 844 computer clock battery is specified by 23 system architects worldwide. Its proven reliability safeguards the configuration file memory in 286/386/486 personal computer products, especially in power-down situations.

Maintaining voltage is just one way the Rayovac 844 delivers superior reliability. It also offers long life, a 3-5 year span, plus safety no

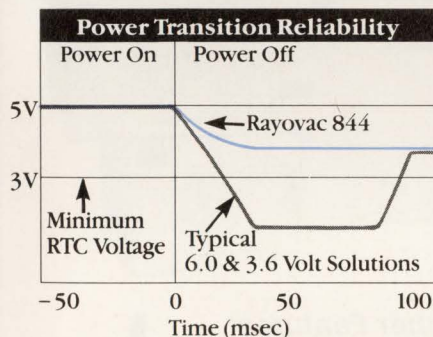

The 844 ensures IC voltage above the critical 3.0V level maintaining clock stability and configuration file memory.

lithium battery can match.

The 844 is compatible with industry standard chip

sets: Chips & Technology; VLSI Technology; Western Digital; Zymos and Intel. And it's made in the U.S.A., with on-time delivery available around the world.

So plug added reliability and service into your design. Specify a Rayovac 844. Call Rayovac's Technical Sales & Marketing Department for complete information and battery specifications at 608-275-4694.

RAYOVAC®

UPDATE

For The Health Of Your Monitoring Systems, Burr-Brown Prescribes PWR13XX.

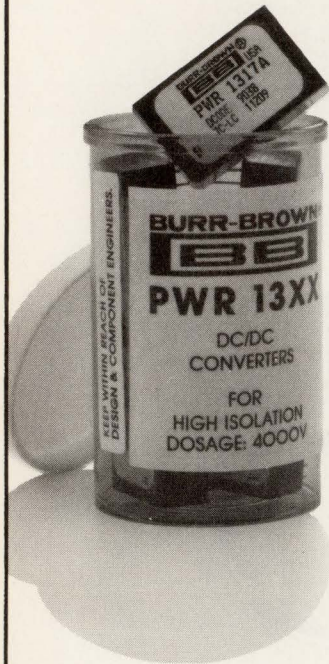

The DIP DC/DC Converter For Ultra High Isolation: 4000V.

Medical grade isolation is yours with a dose of 1.5 watts of unregulated output power from the PWR13XX. Its dual-in-line package uses only 1 inch² of PC Board space and comes in low prices that are easy to swallow.

Use as needed for applications where system integrity and reliability are critical. No external parts required.

Contact your salesperson for quick delivery.

\$ 21
OEM



CALL 1-800-548-6132 ext. 43

Fax 1-602-741-3895

Write P.O. Box 11400 - Tucson, Arizona 85734

CIRCLE NO. 44

memory operation; it also can act as system controller, includes a 7-level interrupter and interrupt handler, and supports message broadcasting across the bus.

The basic CPU board hosts 2M to 32M bytes of dynamic RAM housed on an upgradable memory module. The company plans to offer a static-RAM version of the module in the second quarter of 1991. The board performs one-wait-state memory writes and zero-wait-state memory reads. The memory array is triported between the 68040 μ P, the VMEbus, and an auxiliary daughter-card bus called EZ-Bus. The CPU board also includes two sockets that can hold as much as 1M-byte of ROM or EPROM, a battery-backed clock and 2k-byte static-RAM array, three timers, and four serial ports (**Fig 1**).

The standard configuration's single EZ-Bus daughter card handles I/O operations. A 68030 μ P, operating as an auxiliary processor to the 68040, controls the I/O operations. The EZ-Bus module includes a SCSI bus, an Ethernet network connection, and four serial ports, all of which are connected to the VMEbus P2 connector. The module also includes buffer memory and 128k bytes of flash EPROM. You can also add a second EZ-Bus module; the company offers a number of daughter cards, such as cards for Arcnet networks or ESDI disk drives.

You can buy Unix System V release 4.3 for the board or choose from a number of real-time operating systems such as Ready Systems' VRTX, Microware's OS-9, and Wind River's Vxworks. The SV430, with a 25-MHz 68040, costs \$4605.—**Maury Wright**

Synergy Microsystems Inc, 179 Calle Magdalena, Encinitas, CA 92024. Phone (619) 753-2191. FAX (619) 753-0903.

Circle No. 737

ENVIRONMENTAL CHAMBERS

Chamber Features:

- Local Programming
- IEEE-488
- RS232/RS422
- Auto Ramping
- PID Control
- Auxiliary I/O
- Battery Back-up
- Up to 3 cu. ft. Workspace
- Customization and Racking

2 Year Warranty
30 Day Free Trial
Purchase, Lease or Rent

Call us for:

- Environmental Chambers
- Retrofit Controls
- Process Controllers
- Custom Work

Tel. 305 587 5577
Fax. 305 587 0450

Sun Electronic Systems, Inc., 1601 N.W. 38th. Avenue, Fort Lauderdale, FL 33311

CIRCLE NO. 45

TAKE SOLDER PASTE AND DIPPING OUT OF CIRCUITS ASSEMBLY

...and improve product reliability

NAS solder and flux bearing edge clips are applied with a method that is simple, quick and exceptionally consistent. Solder paste, solder and flux dipping, and board clean-up — all steps in the circuits assembly process that yield high rates of rejects — are eliminated.

Preforms on edge clip terminals contain precisely the right amounts of the proper solder and flux for each application, and the exclusive NAS "Claw" grip holds each preform. This unique grip design provides direct contact between solder and conductor pads, a beneficial

wiping action as clips are attached

and positive control of solder flow. A single reflow operation for top and bottom preforms — using any method that raises temperatures to reflow levels — produces perfect solder joints every time.

When you use NAS solder and flux bearing edge clips, expensive rework becomes virtually a thing of the past.

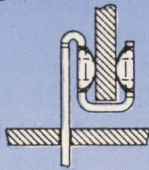

The simple, efficient method of applying NAS solder and flux bearing edge clips:

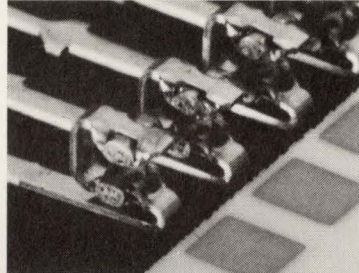

Direct contact between solder preforms and conductor pads produces a beneficial wiping action as clips are attached, either manually or with a lead attachment machine.

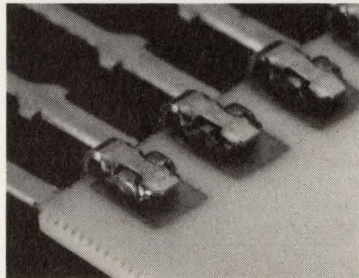

Interference fit holds clips firmly in position for reflow. Top and bottom preforms are reflowed in one operation using any method that raises temperatures to reflow levels.

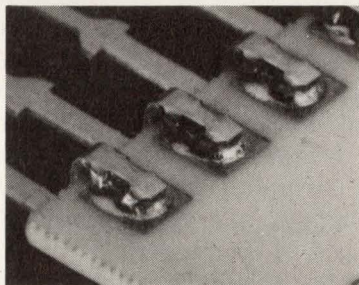

Precise amounts of the right solder and the shape of the "Claw" grip provide control of solder flow without a solder stop. This assures perfect mechanical and electrical bonding without wicking or bridging.

Unretouched Macro Photography

Most or all of the costly inspection procedures necessary with other methods can also be eliminated. The overall result is a far less costly circuits assembly process, and more reliable, better performing products.

NAS offers a large selection of edge clips, including .100, .075 and .050 centerlines for both through-hole and surface mounting of SIP, DIP, Quad and Multi-chip devices. Our surface mount clips are the most effective solution to the problem of thermal mismatch, and are available in a variety of types. Ask about our Compliant "J" surface mount designs with .025 and 1mm centerlines.

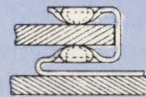
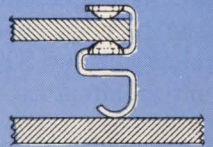

In addition to a complete line of edge clips, NAS offers economical semi-automatic SIP, DIP and Quad lead attachment machines, and bench-top and in-line reflow machines, all of which further enhance assembly efficiency and reliability.

For complete information about any of our products, please contact:

**NAS Electronics, 381 Park St.,
Hackensack, NJ 07602.
Phone (201) 343-3156.
FAX (201) 343-4883.**

NAS
ELECTRONICS

**100%
solderability
with the
"CLAW"
...our exclusive
grip design**

CIRCLE NO. 108

NAS-TEKA Electronics GmbH
Carl-Zeiss-Strasse 14/1
D-7100 Heilbronn, Germany
PHONE: 07066/7056
FAX: 07066/4108

In Europe
Nasbrit Ltd.
Nobel Road
Wester Gourdie Industrial Estate
Dundee, Scotland DD2 4UX
PHONE: Dundee 0382-622222
FAX: 03826/22217

ELMITECH
31 Chemin De Montjean
Sentiers 505
F-94266, Fresnes, Cedex,
France
PHONE: (1)46684433
FAX: (1)46684345

an
Interplex
Technology
company

STD Bus DSP board delivers 25M flops and 3.5M-byte/sec data transfer

The MCM-DSP32C single-board processor can handle computation-intensive embedded applications at the high speed of a DSP chip. It plugs into an STD Bus, and its 32-bit architecture operates at a clock frequency of 50 MHz. This board can execute a 1024-point FFT in 3.3 msec, multiply two 4×4 matrices in 6.16 μ sec, and compute the response of a complex adaptive FIR filter in real time at 80 nsec/tap.

The board contains AT&T's fastest floating-point processor, the 25M-flops DSP32C. Featuring four 40-bit accumulators, 22 general-purpose registers, and 6k bytes of internal RAM, the CMOS device is also compatible with IEEE's STD 754 floating-point format.

One of the chip's most attractive attributes, however, is its instruction set—all instructions execute in a single cycle. Conditional branching and conditional ALU operations simplify your programming task and permit efficient, compact coding. A data-stationary-coding feature enables parallel operation of arithmetic and logic functions and provides automatic pipeline control.

This DSP board provides a data-transfer rate of 3.5M bytes/sec due in part to its I/O-mapped interface, which transfers data to the STD Bus three times faster than a memory-mapped alternative could. The interface automatically senses and selects 8- or 16-bit data transfers, or you can slave the I/O so that onboard functions occur independently of the host STD Bus CPU. When you operate the board in this way, the DSP chip continues calculating even during the data-transfer process.

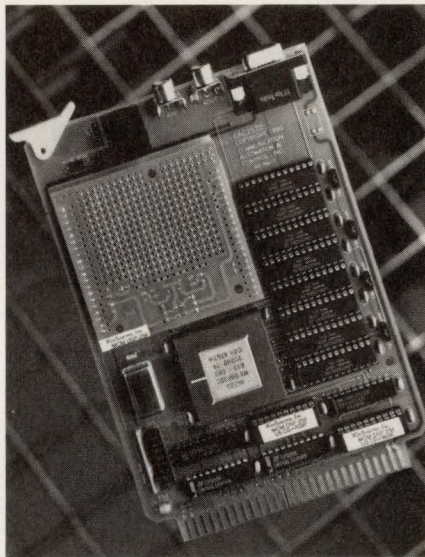

Based on AT&T's 50-MHz DSP32C processor, the MCM-DSP32C single-board DSP chip accelerates your computation-intensive applications by operating independently of the host system's CPU.

Using its ability to address 32 bits of memory at 4 times/cycle, the AT&T chip minimizes your code's execution speed by reducing memory-access bottlenecks. A byte-addressable address space provides storage for 8- and 16-bit data. The board interfaces to external devices and daughter boards via its serial and parallel ports. For optimal throughput, the chip performs 8-, 16-, and 24-bit integer conversions. And for telecommunications or speech applications, you can rely on this device to do μ -Law and A-Law conversion.

You can purchase a \$395 source-level debugger called the D3EMU. Featuring a windowed user interface, this debugger lets you display and modify memory contents by scrolling or paging through your code. Windows display both the

D3EMU's high-level, C-like language source code and the corresponding assembly-language instructions. You also receive a runtime function library, as well as a set of utilities and sample programs such as a hex converter and a voice-recording demonstration.

A \$495 software-support library, dubbed the WEDSP32C-SL, has an assembler, a link editor, a simulator, and other utilities. You can also buy a \$1495 optimizing C-language compiler and a \$95 library of application routines called the WEDSP32C-AL.

The MCM-DSP32C DSP board with a maximum of 256k bytes of zero-wait-state RAM costs \$1795. With 64k bytes of RAM, the board sells for \$1495. An onboard adapter lets you plug in a daughter board, such as the \$295 DBCS5339. The daughter board contains 16-bit, dual-channel, 48-kHz delta-sigma A/D and antialiasing filters for spectral-analysis and filtering applications.

Other daughter boards include the \$195 DBT7525, which provides an 8-kHz, 16-bit, single-channel, pulse-code-modulating Codec for use in telecommunications applications. A \$145 DBserial board offers an interface to the DSP32C's serial I/O channel. And a \$95 DBproto board lets you design special-purpose interface electronics.

—J D Mosley

WinSystems Inc, Box 121361, Arlington, TX 76012. Phone (817) 274-7553. FAX (817) 548-1358.

Circle No. 735

American Takes A New Approach To Tokyo.



Beginning March 2, American Airlines brings you Japan in a new way. With convenient nonstop service from San Jose/Silicon Valley to Tokyo. That's in addition to our current nonstop from Dallas/Fort Worth.

You'll fly in our new MD-11 LuxuryLiner, specially designed for comfortable long-range travel. And you'll enjoy our International Flagship Service[®] with everything from roomy leather and sheepskin seats in First and Business Class to award-winning food and wine, including a choice of authentic Japanese entrees. And of course, members of our AAdvantage[®] travel awards program will earn valuable mileage credit.

Only American brings you Tokyo like this. So call your Travel Agent or American Airlines at 1-800-624-6262. And experience the American approach to Japan.

American Airlines[®]
Something special to Japan.

Schedules subject to change. AAdvantage[®] is a registered trademark of American Airlines, Inc. American Airlines reserves the right to change AAdvantage program rules, regulations, travel awards and special offers without notice, and to end the AAdvantage program with six months notice.

PRODUCT UPDATE

Compact crystal oscillator features 2×10^{-7} stability

The Model TF-65010-B crystal oscillator is available with a TTL-compatible, square-wave output anywhere in the frequency range of 1 to 20 MHz. Housed in a package measuring $1.38 \times 1.06 \times 1$ in., the unit utilizes oven-like compensation techniques to achieve a temperature stability of 0.2 ppm over a -20 to $+70^{\circ}\text{C}$ operating range. In addition, it reaches this stability level in 2 minutes, drawing 3W, which is far less power consumption than the typical oven-controlled oscillator would require. Thus, the oscillator opens up a number of high-stability applications that you would have previously avoided due to cost.

Because the unit does not employ classical oven control for compensation, it reacts to temperature variations in real time, and it has no hysteresis characteristics. Phase noise at 10 kHz is specified at -140 dBc. Because you can adjust the output frequency over a maximum range of ± 6 ppm, you can compensate for more than 10 years of aging. The oscillator operates with supply voltages of 5 and 12V.

In a classical oven-controlled crystal oscillator, a resistance wire heater controls the temperature of an oven that houses the crystal and associated electronics. The combined thermal mass of the oven and the crystal retards crystal heating, and it can take as long as 10 minutes to stabilize the oven-controlled crystal oscillator. The oscillator's design allows it to heat the crystal directly and position the temperature sensor inside the crystal case and in contact with the crystal. This scheme provides an accurate and



A ± 0.2 ppm temperature stability is a key feature of the TF-65010-B crystal oscillator. The device achieves this stability performance without the use of oven control techniques. As a result, warm-up time measures 2 minutes, and power consumption is 3W.

real measurement of crystal temperature and significantly shortens warm-up time.

Because the resistance heating element acts directly on the unit's AT-cut crystal, the unit has no power requirement for oven heating. Thus, this direct-heating scheme reduces oscillator size and power consumption. The TF-65010 costs \$65 (10,000); allow 8 to 12 weeks ARO for delivery.

—Tom Ormond

Raltron Electronic Corp, 2315 NW 107th Ave, Miami, FL 33182. Phone (305) 593-6033. FAX (305) 594-3973.

Circle No. 732



Call Your Authorized Maxtor Distributors

A.D.P.I.
1-800-275-2374
301-258-2744

Anthem Electronics
408-452-2287

Arrow Commercial Systems Group
1-800-323-4373

Arrow/Klerulff
1-800-777-2776

Avnet Computer
1-800-422-7070

B.S.M./Business Solutions in Micro
1-800-888-3475
214-699-8300

Cal Abco
818-704-9100
800-669-2226

Compac Micro Electronics
1-800-426-6722
415-656-2244

Computer Brokers of Canada (C.B.C.)
416-660-1616
604-273-1155

CPC
714-757-0505
800-582-0505

Data Storage Marketing (D.S.M.)
1-800-543-6098
303-442-4747

Firstop Computer
1-800-832-4322

Future Electronics
514-694-7710

Intellect
011-525-255-5325

JACO
214-733-4300

Marshall Industries
1-800-522-0084

Microwave Distributors
1-800-777-2589
503-646-4492

Mini Micro
408-456-4500
1-800-628-3656

Pioneer Standard Electronics
1-800-874-6633

Pioneer Technologies
1-800-227-1693

S.E.D.
1-800-444-8962
404-491-8962

Tech Data
1-800-237-8931
813-539-7429

Technology Factory
1-800-848-2073
1-800-227-4712

Technology Marketing Group
1-800-688-7000
612-942-7000

U.S. Computer
305-477-2288

Wyle Laboratories
1-800-289-9953

The Right Specs. Right Now.

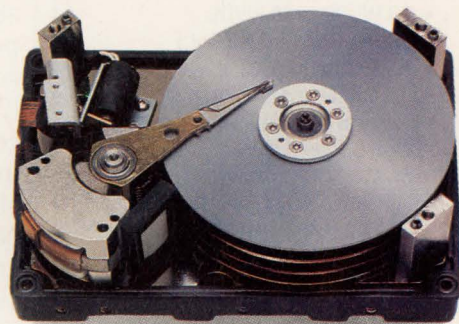

Maxtor LXT-340

See for yourself. The Maxtor 340MB (formatted) 3.5-inch LXT-340 drive, a field-proven design, is available for shipment right now, in volume.

Proven design delivers unbeatable performance including a sequential data transfer rate that is 20% faster than the comparable 331MB Seagate ST1400.

Essential components are common in *all* drives within the LXT family. This commonality provides easy migration upwards or downwards making future qualifications for other family members happen quickly and efficiently.

Call and ask about our LXT family of high-performance, 3.5-inch AT and SCSI drives with capacities from 213MB to 535MB. Because right now can't be soon enough. **Call your nearest Authorized Maxtor Distributor.**

3.5 Inch Disk Drive Comparison Criteria	Maxtor LXT	Seagate ST14xx
Shipping 300MB Class in Volume	Yes	No
Full Range of Capacities from 213MB to 535MB	Yes	No
Commonality in Family for Components and Manufacturing	Yes	No

We Drive Harder.

Maxtor[®]

© 1991 Maxtor Corporation
LXT is a trademark of Maxtor Corp.



IC[®] RSS

**Lo-Profile
Sub-Subminiature
Electrolytics Capacitors**

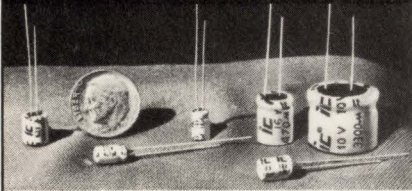

**Proven Reliability
... 100% Burn-In Tested**

- 0.1 Mfd. to 3,300 Mfd.
- 6.3 WVDC to 50 WVDC
- ±20% Std. (±10% Opt.)
- -40°C to +85°C
- ≤ .006CV or 1µA Min.
- Epoxy or Solvent Tolerant seals (Opt.)
- Tape & Reel Available

IC[®] TECH TIPS

Type RSS is perfect for low profile replacement applications and new designs requiring small size, low leakage, rugged performance and low cost. The Sub-Subminiature space saving design is perfect for small hand-held devices, low profile PC boards, probes, sensors and miniature devices. Utilizing the latest technology high gain, etched capacitor foil, type RSS is perfect for applications that need higher than tantalum ripple current and surge voltage parameters. Perfect for new designs and retrofits for timing circuit applications, low noise, bypass and coupling modes. IC's type RSS capacitors provide ideal frequency response for telecommunications circuitry and offer outstanding stability over time. The typical useful operating life at room temperature can easily exceed 10 years. Available on tape or reel for use on the latest automatic insertion equipment. Optional features: epoxy or solvent tolerant end seals for use with different cleaning systems. Modern manufacturing techniques keep RSS at ultra-affordable prices and maintain long life performance at highest quality levels.

©1990 ILLINOIS CAPACITOR, INC.

**The Source for Quality,
Performance and Delivery.**

IC[®] ILLINOIS CAPACITOR, INC.

3757 West Touhy Avenue
Lincolnwood, Illinois 60645
(708) 675-1760
Fax (708) 673-2850

PRODUCT UPDATE

Real-time multiprocessor series occupies one board set

Series 7000 computers perform real-time multiprocessing without using multiple CPU board sets. Instead, the 2-board set that composes the computers' CPU can accept one, two, or three 68040 μ Ps (25- or 33-MHz versions). The two computers that make up the set run under the company's real-time version of the Unix operating system. Nonintrusive bus-snooping circuitry maintains coherency between the μ Ps' internal cache memories.

According to the manufacturer, the computers can accept raw data from VMEbus I/O boards across several channels, at aggregate rates as high as 50M bytes/sec. The computers' I/O channels hew to the VME32 standard and the proposed VME64 standard for 32 and 64 bitblts, respectively. The VME32 transfers run at rates as high as 30M bytes/sec, and the VME64 transfers run at 37M bytes/sec.

An internal 48-bit clock having a 480-nsec period paces the computers' activity. In addition, the computers have three 32-bit interrupt timers that can measure intervals between pairs of external events or can count occurrences of external events. A 20-bit interrupt timer triggers pattern-based scheduling events, and a 32-bit square-wave generator provides a synchronizing signal for peripheral systems.

The computers can access from 8 to 112M bytes of parity memory. The memory can include as much as 5123k bytes of UV EPROM. Having this much EPROM may seem like overkill until you consider how long reloading a 5M-byte Unix system from disk would take. Hav-

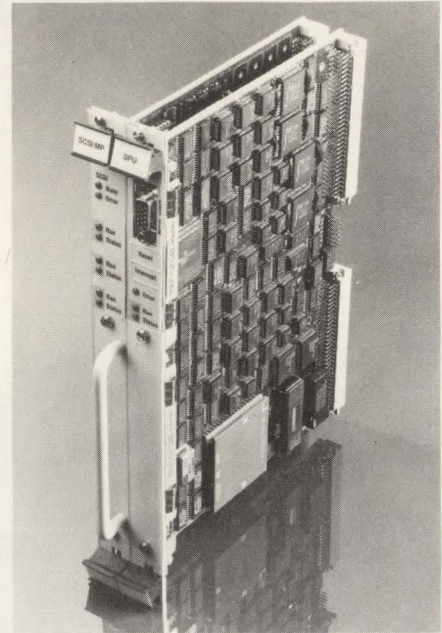

A 2-board VMEbus computer performs real-time multiprocessing with one, two, or three onboard 68040 μ Ps.

ing the operating system in ROM speeds recovery from outages. A 5M-byte/sec SCSI port accesses off-line storage. A 24M-byte/sec pk IPI-2 disk system is optional.

Packaged on 6U VMEbus boards, the CPU set fits into 5- or 21-slot enclosures. A 5-slot chassis with one μ P and an 8M-byte memory costs \$14,500. A 21-slot chassis with one μ P and an 8M-byte memory costs \$27,995. Additional μ Ps cost \$3000. The company plans to sell the CPU board set but has not yet fixed a price for it.

—Charles H Small

Concurrent Computer Corp, 106 Apple St, Tinton Falls, NJ 07724. Phone (800) 631-2154 (US and Canada); in NJ, (201) 758-7000.

Circle No. 734

At last, an entirely new approach to clock speed

Get five times faster throughput from NEC K-Series™ microcomputers.

As a developer of real-time control systems, you know that designing in a faster CPU is not enough. You also need intelligent I/O management for the best possible system throughput.

NEC's K-Series™ microcomputers are perfect for real-time control designs requiring multi-tasking, such as automotive control, ISDN and computer peripheral controllers.

Peripheral Management Unit™

The K-Series' unique architecture includes a revolutionary Peripheral Management Unit™ macro service for nonstop instruction execution while processing up to 16 I/O requests at the same time. By designing in the K-Series microcomputer, you can improve your system throughput by as much as 5X.

The K-Series 8-bit and 16-bit microcomputers give you a real-time output port; an advanced counter/timer system; a high-speed, high-resolution A/D converter; and many other on-chip intelligent peripherals.

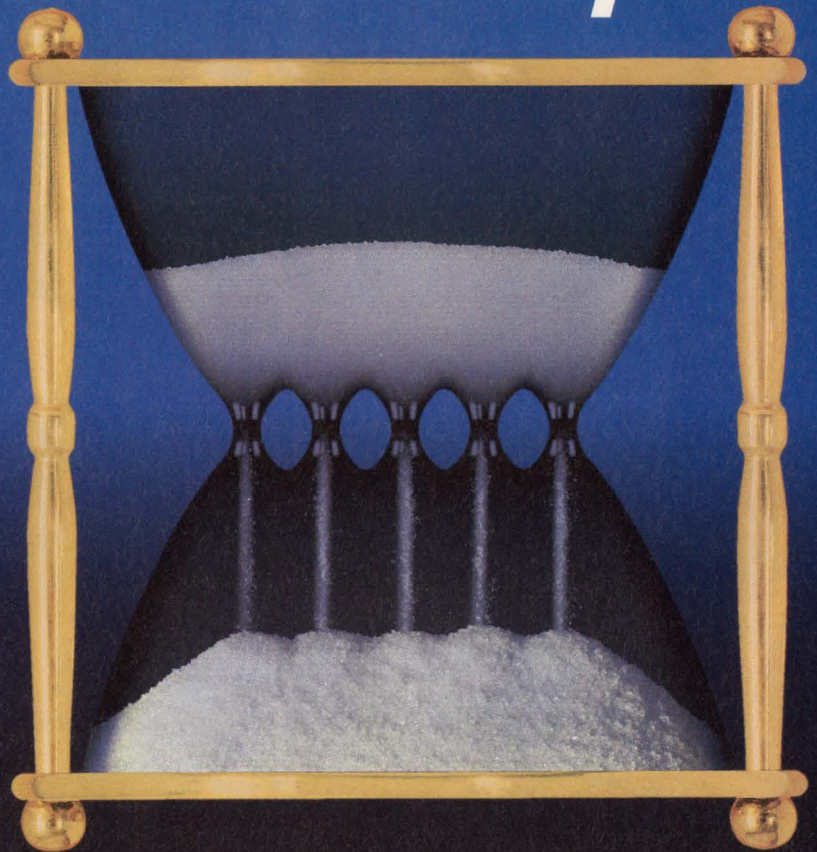

Not since the invention of the hourglass has anyone come up with a more ingenious way to speed up silicon.

The K-Series provides you a worry-free upgrade path from the 8-bit K2 microcontroller family to the 16-bit K3 devices. And your future designs will exploit the power of the lightning-fast 125-ns K6, with real-time operating system in

microcode, and complete K3 software compatibility.

To learn more about the K-Series microcomputers with up to 1K bytes of on-board RAM, 32K bytes of ROM/EPROM, and Peripheral Management Unit coprocessing power, call now.

For fast answers, call us at:

Australia Tel:03-267-6355. Telex:38343.
 France Tel:1-3067-5800. Telex:699499.
 Germany Tel:0211-650302. Telex:8589960.
 Hong Kong Tel:755-9008. Telex:54561.
 Ireland Tel:1-6794200. Telex:90847.
 Italy Tel:02-6709108. Telex:315355.
 Korea Tel:02-551-0450. Fax:02-551-0451.
 The Netherlands Tel:040-445-845. Telex:51923.
 Singapore Tel:4819881. Telex:39726.
 Spain Tel:1-419-4150. Telex:41316.
 Sweden Tel:08-753-6020. Telex:13839.
 Taiwan Tel:02-719-2377. Telex:22372.
 UK Tel:0908-691133. Telex:826791.
 USA Tel:1-800-632-3531. Fax:1-800-729-9288.

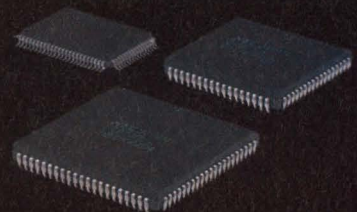
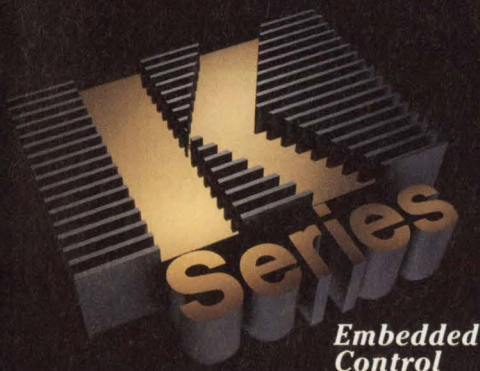

NEC

The CAMbridge Crossover

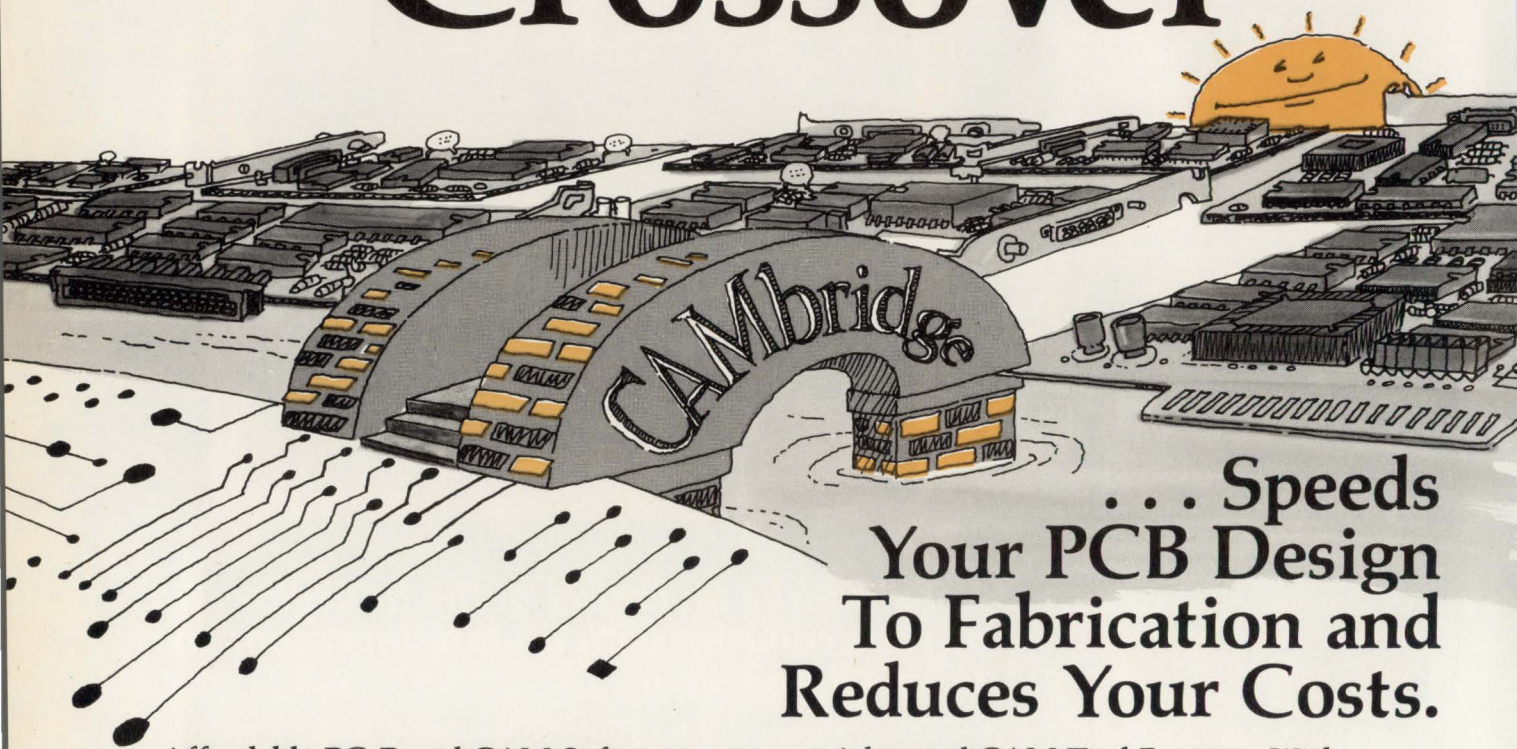

... Speeds
Your PCB Design
To Fabrication and
Reduces Your Costs.

Affordable PC-Based CAM Software That Bridges The Gap Between PCB Design and Fabrication

CAM-bridge™ provides the PCB designer, service bureau and fabrication house a complete set of high performance CAM tools designed to eliminate user fatigue, omit time-consuming replots, allow prototype without photoplotting, uncover design and house-keeping errors, and insures successful preparation of artwork to meet manufacturing requirements.

An Ideal Companion For Your CAD System

PADS-PCB™, PADS 2000™, ORCAD/PCB II™, RACAL REDAC™, FUTURENET™, CALAY™, PCAD™, PROTEL™, TANGO™, MENTOR™, VALID™, COMPUTERVISION™, CADNETIX™, SCICARDS™, EEDESIGNER™ and more...

Advanced CAM Tool Features With Workstation Performance

- Editor/Viewer/Design Builder/Import of aperture lists
- Quick check plots on LaserJET, BubbleJET, InkJET and Dot Matrix printers
- Full panelization with automatic thieving, venting, film mounting, step & repeat, polygon fill, and more...
- Extremely FAST Design Rule Checking
- NC drill output
- Format conversion for GERBER, HPGL, DMPL, DXF, EXCELLON, POSTSCRIPT and more...

FREE DEMO DISK CALL:

Inside MA: 617-621-7101

Outside MA: 800-825-7051

ALS DESIGN

USA HQ
One Kendall Square, #2200
Cambridge, MA 02139



EUROPE HQ
38 Rue Fessart, 92100 Boulogne, FR
Phone: (33) 1-46 04 30 47

PURE SPECTRUM ANALYSIS

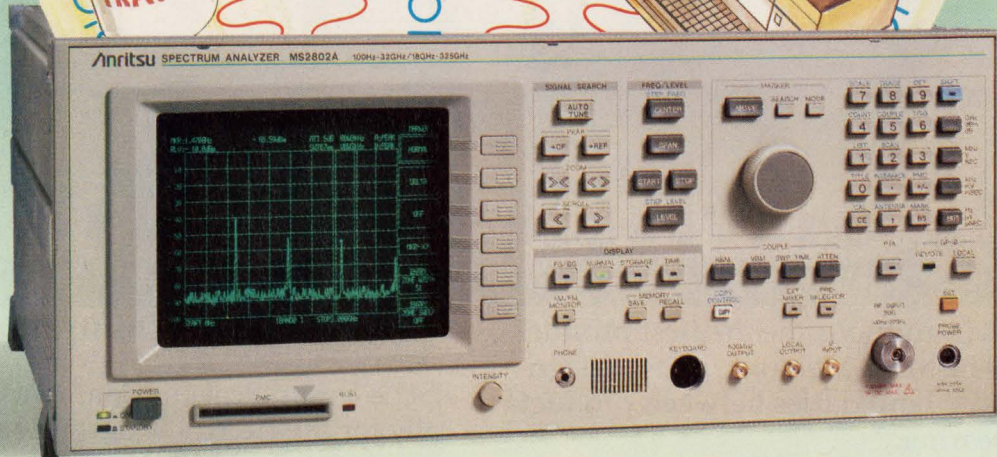
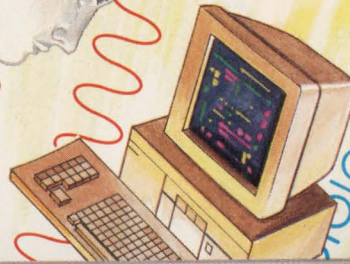

Plus A Whole Lot More From 100 Hz to 32 GHz



Two GPIB Buses, One For Host Computer Control, One For PTA Control



High Purity And Signal Stability Provide 1 Hz Synthesizer Resolution To 32 GHz



Printer/Plotter Support For GPIB And Video Output



An Internal Counter Provides 1 Hz Resolution To 32 GHz



A Multitude Of Features At A Reasonable Price



Average Noise Floor is < -115 dBm At 24.5 GHz



Built-In Intelligence For Extended Memory



An Internal Computer Provides Custom Software Without An External Controller



Multiple Traces And Trace Storage For Easy Manipulation



Waveforms Can Be Viewed In The Time And Frequency Domain Simultaneously

For literature, application assistance or a demo on the MS2802A Spectrum Analyzer, contact ...
 Anritsu America, Inc., 15 Thornton Road, Oakland, NJ 07436-3185.
 Call 800-255-7234 or (in NJ) 201-337-1111. FAX 201-337-1033.

Anritsu

OrCAD presents Release IV

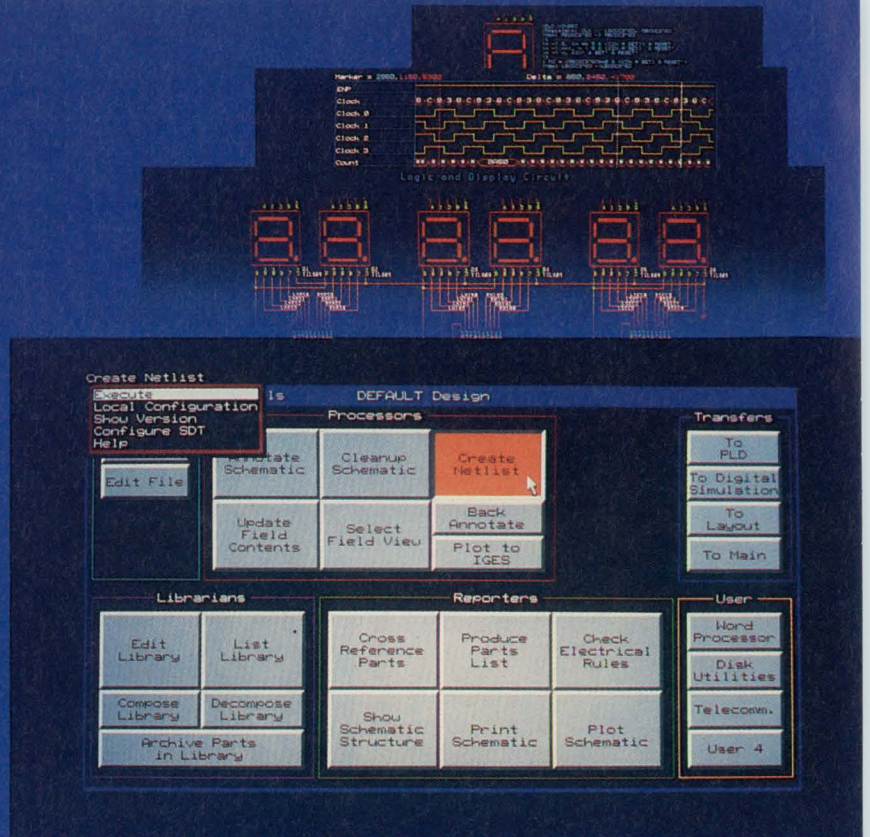

The limits are gone

OrCAD has introduced the greatest product upgrade in its history. Memory limits, design restrictions, even boundaries between products are all disappearing.

For years, OrCAD's competitors have been playing a game of catch-up. With the introduction of Release IV, the race is over. No one will match our price/performance ratio on these features:

- Schematic Parts Library has been increased to over 20,000 unique library parts
- Digital Simulation process has been speeded up by an order of magnitude
- Printed Circuit Board Layout package offers autoplacement and autorouting at no extra charge
- Expanded memory capabilities

Best of all, OrCAD introduces ESP

ESP is a graphical environment designed specifically for the electronic designer. Software tools appropriate for different stages in the design process are now linked together to form a seamless flow of information. This easy-to-use framework relieves the designer of time consuming tasks and the inconvenience of moving from one tool set to another. You can now spend more time productively designing.

For more information . . .

You need to know more about Release IV and all of the benefits OrCAD has to offer. Call the telephone number below and we'll send you a free demonstration disk.

OrCAD 

More designs from more designers

For more information, call (503) 690-9881

or write to OrCAD Sales Department, 3175 N.W. Alcock Drive, Hillsboro, Oregon, 97124

LEADTIME INDEX

Percentage of respondents

ITEM	Percentage of respondents						Average (weeks)	
	Off the shelf	1-5 weeks	6-10 weeks	11-20 weeks	21-30 weeks	Over 30 weeks	Last month's average (weeks)	Average (weeks)
TRANSFORMERS								
Toroidal	0	62	13	25	0	0	6.7	7.3
Pot-Core	0	50	25	25	0	0	7.3	8.8
Laminate (power)	0	83	17	0	0	0	3.8	7.1
CONNECTORS								
Military panel	0	14	57	29	0	0	9.4	9.1
Flat/Cable	15	46	31	8	0	0	5.0	3.9
Multi-pin circular	0	78	22	0	0	0	4.0	9.0
PC (2-piece)	20	50	30	0	0	0	3.8	6.0
RF/Coaxial	11	56	33	0	0	0	4.3	4.1
Socket	42	50	8	0	0	0	2.1	4.3
Terminal blocks	33	50	17	0	0	0	2.8	4.3
Edge card	42	25	25	8	0	0	3.9	3.6
D-Subminiature	18	36	36	10	0	0	5.5	4.8
Rack & panel	14	57	29	0	0	0	4.0	5.0
Power	0	62	38	0	0	0	4.8	7.6
PRINTED CIRCUIT BOARDS								
Single sided	8	58	34	0	0	0	4.4	3.8
Double sided	0	60	33	7	0	0	5.5	4.7
Multi-layer	0	43	50	7	0	0	6.3	6.0
Prototype	9	73	18	0	0	0	3.6	3.6
RESISTORS								
Carbon film	44	39	17	0	0	0	2.5	2.7
Carbon composition	46	31	8	15	0	0	3.8	4.7
Metal film	40	60	0	0	0	0	1.7	4.3
Metal oxide	25	50	17	8	0	0	4.0	3.4
Wirewound	31	38	16	15	0	0	4.7	5.1
Potentiometers	27	40	20	13	0	0	4.8	5.2
Networks	43	21	15	21	0	0	5.0	4.6
FUSES								
Switches	78	11	0	11	0	0	2.0	1.8
SWITCHES								
Pushbutton	42	25	25	8	0	0	3.9	5.2
Rotary	43	14	43	0	0	0	3.8	4.7
Rocker	33	34	33	0	0	0	3.6	4.5
Thumbwheel	38	13	49	0	0	0	4.3	7.0
Snap action	50	25	25	0	0	0	2.7	4.9
Momentary	25	50	25	0	0	0	3.4	4.9
Dual-in-line	44	23	33	0	0	0	3.3	5.3
WIRE AND CABLE								
Coaxial	31	46	23	0	0	0	3.2	2.2
Flat ribbon	45	55	0	0	0	0	1.6	3.0
Multiconductor	38	38	24	0	0	0	3.0	2.9
Hookup	47	53	0	0	0	0	1.5	1.6
Wirewrap	36	45	19	0	0	0	2.8	3.1
Power cords	18	55	27	0	0	0	3.8	4.7
POWER SUPPLIES								
Switcher	9	45	27	19	0	0	6.4	9.2
Linear	20	50	20	10	0	0	4.6	7.9
CIRCUIT BREAKERS								
Heat sinks	33	33	12	22	0	0	5.3	6.2
BATTERIES								
Lithium coin cells	42	58	0	0	0	0	1.7	3.2
9V alkaline	60	40	0	0	0	0	1.1	4.9
Real-time clock back-up	29	71	0	0	0	0	2.1	3.7
RELAYS								
General purpose	17	50	25	8	0	0	4.7	4.8
PC board	21	36	36	7	0	0	5.0	4.5

ITEM	Percentage of respondents						Average (weeks)	
	Off the shelf	1-5 weeks	6-10 weeks	11-20 weeks	21-30 weeks	Over 30 weeks	Last month's average (weeks)	Average (weeks)
Dry reed	38	25	37	0	0	0	3.7	6.0
Mercury	29	29	42	0	0	0	4.2	5.0
Solid state	22	34	44	0	0	0	4.5	7.5
DISCRETE SEMICONDUCTORS								
Diode	22	50	6	22	0	0	5.3	3.1
Zener	22	39	17	22	0	0	5.9	4.4
Thyristor	21	36	22	21	0	0	6.0	3.1
Small signal transistor	27	40	13	20	0	0	5.3	5.6
MOSFET	27	33	20	20	0	0	5.6	5.4
Power, bipolar	29	36	14	21	0	0	5.4	6.4
INTEGRATED CIRCUITS, DIGITAL								
Advanced CMOS	17	17	41	25	0	0	7.6	4.1
CMOS	33	22	33	12	0	0	5.1	3.5
TTL	33	27	27	13	0	0	4.9	2.8
LS	50	13	18	19	0	0	4.7	2.7
INTEGRATED CIRCUITS, LINEAR								
Communication/Circuit	7	43	43	7	0	0	5.8	4.7
OP amplifier	27	27	39	7	0	0	5.0	3.9
Voltage regulator	31	15	46	8	0	0	5.3	3.9
MEMORY CIRCUITS								
DRAM 16K	0	66	17	17	0	0	5.9	3.6
DRAM 64K	14	57	15	14	0	0	5.0	3.6
DRAM 256K	22	56	22	0	0	0	3.4	4.4
DRAM 1M-bit	25	37	38	0	0	0	4.1	3.4
SRAM 4K x 4	0	33	50	17	0	0	7.6	4.9
SRAM 8K x 8	11	33	56	0	0	0	5.4	4.7
SRAM 2K x 8	14	29	43	14	0	0	6.4	4.1
ROM/PROM	0	50	33	17	0	0	6.7	4.7
EPROM 64K	0	42	50	8	0	0	6.4	4.7
EPROM 256K	8	33	50	9	0	0	6.3	4.2
EPROM 1M-bit	13	13	61	13	0	0	7.2	4.9
EEPROM 16K	0	38	49	13	0	0	7.0	5.9
EEPROM 64K	0	44	44	12	0	0	6.6	5.4
DISPLAYS								
Panel meters	33	34	33	0	0	0	3.6	4.3
Fluorescent	25	0	25	50	0	0	9.7	8.4
CRT 12-in. monochrome	25	0	25	50	0	0	9.7	7.6
LED	15	23	46	16	0	0	6.8	4.5
Liquid crystal	9	36	36	10	9	0	7.8	6.3
MICROPROCESSOR ICs								
8-bit	15	38	23	15	9	0	7.5	3.3
16-bit	15	46	39	0	0	0	4.4	4.3
32-bit	18	36	19	27	0	0	6.7	5.4
FUNCTION PACKAGES								
Amplifier	14	57	29	0	0	0	4.0	6.5
Converter, analog to digital	22	44	34	0	0	0	4.0	6.5
Converter, digital to analog	22	44	34	0	0	0	4.0	5.4
LINE FILTERS								
Capacitors	14	43	43	0	0	0	4.7	7.2
CAPACITORS								
Ceramic monolithic	46	31	15	8	0	0	3.3	2.5
Ceramic disc	42	41	17	0	0	0	2.5	3.3
Film	45	27	18	10	0	0	3.7	4.5
Aluminum electrolytic	25	38	31	6	0	0	4.5	3.4
Tantalum	24	18	58	0	0	0	5.1	4.0
INDUCTORS								
	27	27	27	19	0	0	5.9	5.4

Source: Electronics Purchasing Magazine's survey of buyers.

REMEMBER WHEN SQUARE WAVES WERE SQUARE?

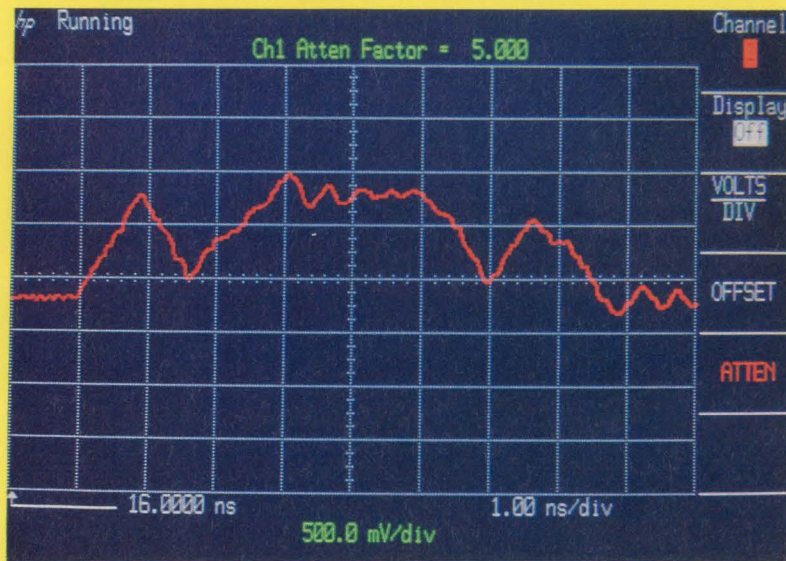

Typical Digital Waveform, circa 1990
Clock rate > 100 MHz
Rise/Fall Time < 0.5 nsec.
Equivalent microwave signal > 1GHz

THAT WAS THEN. THIS IS NOW.

If you're designing today's high speed digital ICs, circuits or systems, you're probably looking at clocks of 100 MHz or faster, with signal components exceeding 1GHz. At these speeds, digital signals assume the characteristics and problems of microwaves.

Welcome to the future.

At Cascade Microtech we offer high speed T&M solutions based on measurement technologies bred and proven in microwaves, and now available for today's digital world.

Our high frequency microprobing equipment and computer-aided test software will let you accurately characterize circuits, devices, packages, and even boards. *At their full operating speeds.* So you can quickly eliminate timing skew, degraded signal edges, ground bounce, and other high speed problems.

Free Booklet

To introduce you to high frequency microprobing, and help you create products that perform better and more reliably, we've prepared a comprehensive booklet, "*High Speed Digital Microprobing: Principles and Applications.*"

For your free copy, use the reader service card, write, or call Jerry Schappacher at **(503) 626-8245.**

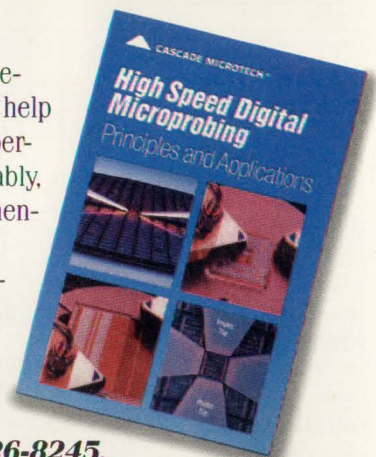

 **CASCADE MICROTCH®**

14255 SW Brigadoon Ct.
Beaverton, Oregon 97005

WORLD CLASS ENGINEERING SOLUTIONS

That's what you'll find at Electro/International, the East Coast's only global electronics conference and exhibition for the entire engineering team with:

Over 700 exhibits of problem-solving products

38 professional/technical sessions and six tutorials organized in eight tracks: ■ Global Business ■ Computers, Software and Digital Systems ■ Medical ■ Communications ■ Manufacturing and Testing ■ IC Technology ■ Career ■ General Interest

Half-day short courses offering intensive learning opportunities

■ Keynote speech by Congressman Don Ritter ■ Purchasing conference ■ Blue ribbon panel exploring vital issues in technology, business and the profession ■ Newest developments in EDA tools in the Automated Design Center

Don't miss this outstanding educational opportunity with real bottom line returns for you and your company. Fax or write today for more information and plan now to attend.

April 16-18, 1991
Jacob Javits Convention Center
New York, N.Y.



Send me more information about Electro/International. I am interested in information about:

exhibits technical/professional sessions short courses special events

Name _____ Address _____

Title _____ City _____ State _____ Zip _____

Company _____

EDN021891

Fax: 213/641-5117 • Mail to: Electro/International Preview • 8110 Airport Blvd. • Los Angeles, CA 90045

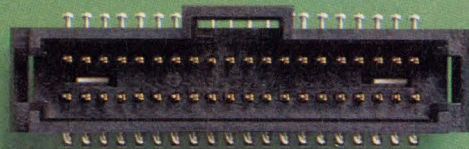

Think small. Think surface.

Our latest high-density surface-mount connectors offer a special design advantage — they bring you all the flexibility of the AMPMODU System 50 connector family.

System 50 SMT receptacles and headers intermate with our complete .050" x .100" system, including cable-to-board types that expand your design thinking to include flat flex cable, .050" center flex etched circuitry, and .025" center ribbon cable.

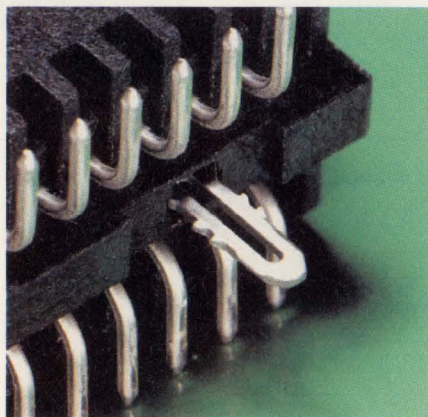

Unique hold-down design requires only simple board support during placement. Design, materials are process-compatible.

Surface-mount versions are available in vertical, double-row versions, fully shrouded, in select sizes from 8 through 100 positions. Our compact design uses the same reliable System 50 interface, with dual-beam phosphor bronze receptacles plated gold-over-nickel on the mating end, tin-lead on the tail.

Dimensioning, tolerances, and positioning datums are engineered for robotic placement. A simple, low insertion

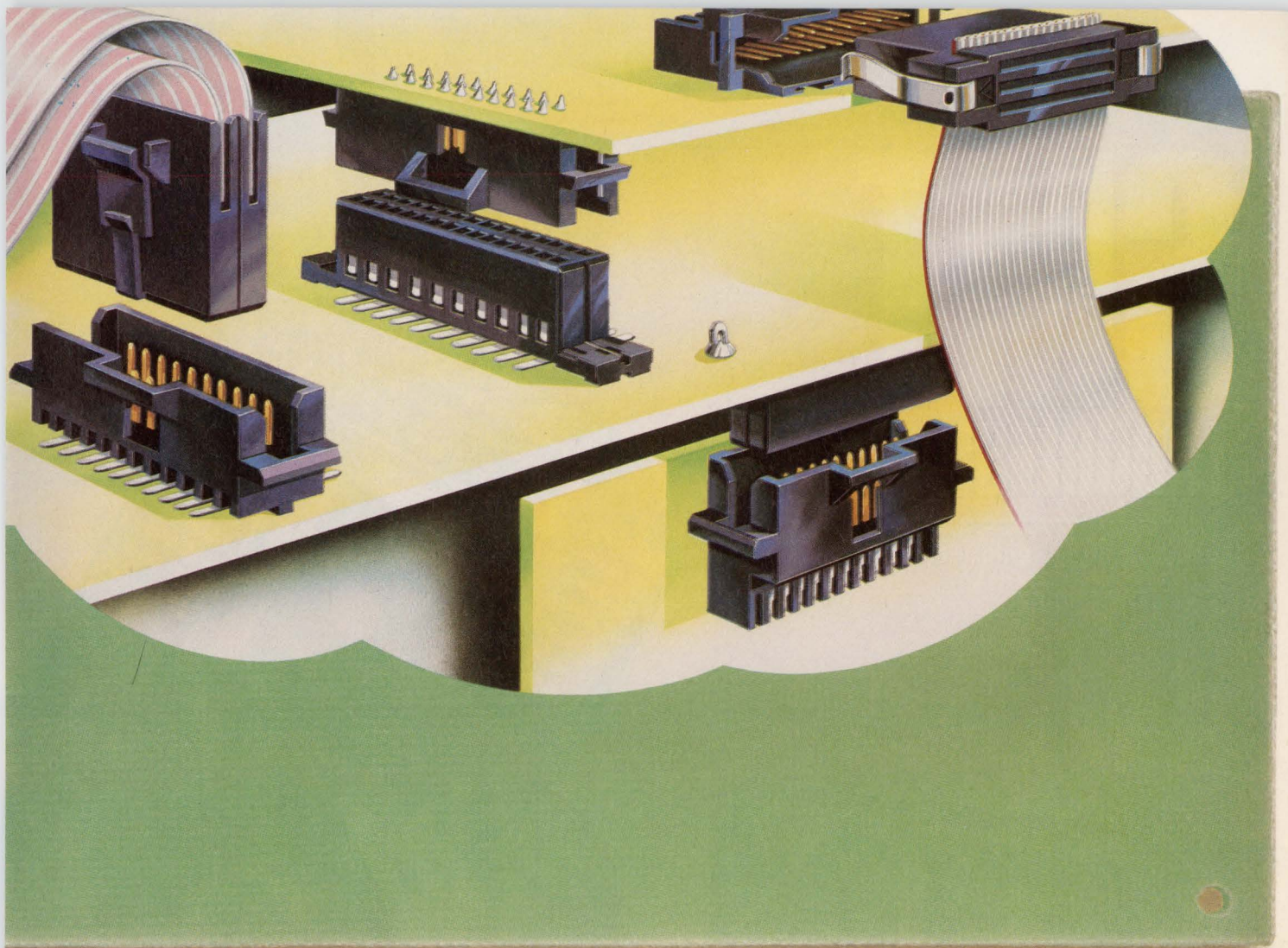

Think system.

force hold-down secures the connector during processing and provides long-term strain relief. 94V-0 housings are compatible with reflow soldering.

Intermate with the AMPMODU System 50 family for board-to-board stacking and mother/daughter configurations, and mass-termination cable-to-board interface.

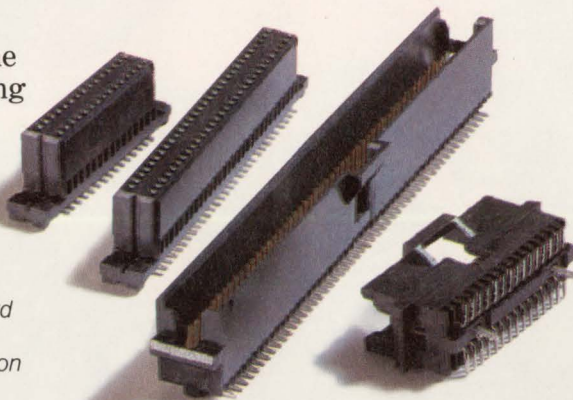

Call the AMP Product Information Center at 1-800-522-6752 for more information on AMPMODU System 50 surface-mount connectors, and the System 50 family. AMP Incorporated, Harrisburg, PA 17105-3608.

AMP and AMPMODU are trademarks of AMP Incorporated.

THIS IS AMP TODAY.

AMP

SMT

TROUBLESHOOTING

Tom Ormond, Senior Editor

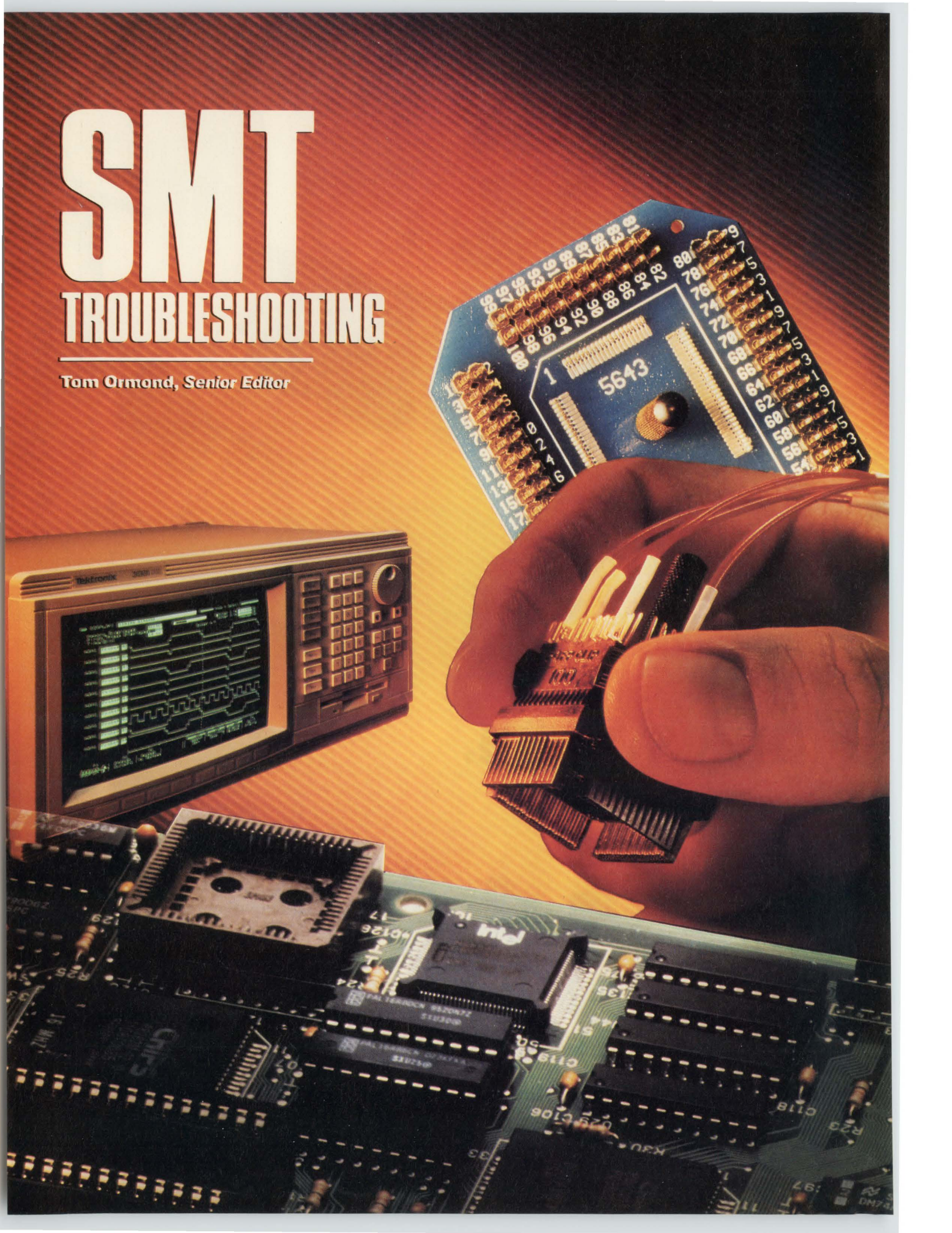

While today's IC packages can significantly reduce the size of electronic subassemblies, these same packages can be a problem when it comes to prototyping new designs and testing and troubleshooting completed assemblies. Increasing pin counts and finer lead pitches create a real challenge when it comes to probing a package terminal.

Wire wrapping has long been the primary technique used to fabricate prototypes of new circuit designs. Several breadboarding panels and IC sockets allow designers to easily fabricate a circuit prototype. In the surface-mount world, most high-level ICs are housed

High packing density and high speed are two prime benefits of surface-mount technology (SMT). Yet the very packages that provide these benefits complicate the tasks of prototyping, testing, and troubleshooting surface-mount assemblies.

in one of three packages—LCC (leadless chip carrier), PLCC (plastic leaded chip carrier), or PQFP (plastic quad flatpack) (see box, "Sorting out some acronyms"). Unfortunately, few products allow designers to readily interface these packages to wire-wrap posts for prototyping. Most of the breadboarding panels are designed for through-hole components and typically have 0.100-in. pin spacings. Pin spacings on the PLCC and LCC packages are typically 0.050 in., whereas spacings for PQFP packages are only 0.025 in.

A second problem occurs during the troubleshooting and testing operations when you try to use test equipment probes at the chip pins. PLCC, LCC, and PQFP package pin counts can exceed 100. Locating a particular pin number on a package with so many leads, and then trying to hold the probe in place on the edge of a lead with center-to-center spacing as low as 0.025 in., proves to be a frustrating, and possibly dangerous, operation.

You could get around these problems by having a technician spend two to six hours hand-fabricating an adapter to convert a chip-carrier socket for wire wrapping. However, you would still have the problem of trying to locate a particular pin for test-probe attachment.

Fortunately, there is a more productive solution to

A μ P test clip lets you take SMT troubleshooting into your own hands. (Photo courtesy ITT Pomona Electronics)

the prototyping/troubleshooting problem—off-the-shelf adapters. Several vendors offer such products, and all are designed to ease the tasks of either prototyping new designs or troubleshooting production surface-mount assemblies. Antona, McKenzie Technology, Ironwood Electronics, and Global Specialties all offer prototyping adapters.

Easing the prototyping process

Antona offers several adapters designed to ease the prototyping tasks for a variety of surface-mount packages. The Model ANC-8068 adapter, for example, allows designers to readily wire-wrap prototypes of equipment that employs 68-pin PLCC or LCC type packages. The adapter, which is available with either 3-level wire-wrap pins or gold-plated machined pins, can accommodate PLD or erasable type devices that are installed and removed frequently during the system design cycle.

Occupying just less than 6 in.² of board space, the ANC-8068 adapter features labeled test points for each of the 68 pins. The labeling makes it much easier for test personnel to attach oscilloscope or logic-analyzer probes properly. Adapter termination pins are on a 0.3-in. centered-row spacing, so the unit is compatible with a variety of off-the-shelf prototyping panels.

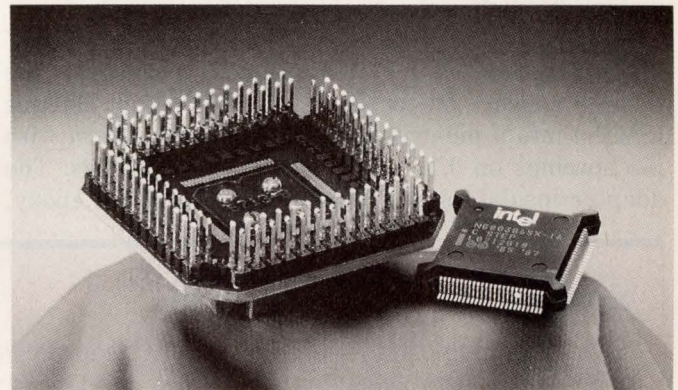

Designed specifically for the Intel 386SX, this test clip from Emulation Technology lets you test a chip that's already on board or bypass that chip with a known-good chip to test out the remainder of the board circuitry.

Adapter documentation includes a user's manual, which contains an adhesive-backed pin-numbering sheet. This sheet can serve as a guide during the wire-wrapping process of the prototype. The documentation also includes a template of the adapter, which designers can use as a signal-to-pin designation map. The ANC-8068 is available from stock and costs \$135.

Handling higher pin-count devices

Antona also addresses the needs of designers working with PQFP-packaged devices. Their model ANC-9260 provides a simple means of wire-wrapping 160-pin PQFP devices. The clam-shell-type adapter is rated

for 25,000 insertion/removal cycles. The unit occupies just over 8 in.² of board space and includes test pins for each of the 160 pins that are designed to accommodate test probes.

The terminations on the ANC-9260 are spaced on 0.1-in. centers to minimize board real-estate needs and

Increasing pin counts and finer lead pitches create a real challenge when it comes to probing an IC package terminal.

noise problems. These adapters are also available with either 3-level wire-wrapped pins or gold-plated machined pins. The ANC-9260 includes the same amount of documentation as the 8068 and is priced at \$249. The company also offers adapters that accommodate devices housed in 84- and 100-pin PQFP packages.

McKenzie Technology's ADP Series device carriers are translator boards that have surface-mount pads on one side and through-hole pins on the other. The carriers allow a prototyper to install surface-mount packages into a wire-wrappable breadboard. You can also plug the carriers into another through-hole socket, making it much easier to change defective ICs.

The ADP carriers are available for both JEDEC standard PLCC and PQFP gull-wing packages. The devices convert 68- or 84-pin surface-mount devices (SMDs) into a pin-grid-array (PGA) grid pattern with pin spacings on 0.1-in. center-to-center spacings. The adapter insulators are copper-clad, FR4 glass epoxy,

and contacts are tin-lead-plated phosphor bronze. Prices are \$11.55 and \$13.29 for a 68-pin PLCC and a 132-pin PQFP adapter, respectively.

In addition to a number of PLCC package adapters, Ironwood Electronics also offers prototyping adapters for both JEDEC and EIAJ PQFP packages. The JEDEC units range from 84 to 164 pins. All of the units are designed to have the smallest possible footprints. The units employ gold-plated pins and are available with either solder-tail or wire-wrappable terminations. Prices range from \$145 to \$200.

For the EIAJ packages, Ironwood offers both socketed and soldered versions. In the latter units, the IC is soldered directly to the adapter and connections are routed to wire-wrappable panel interconnects. The soldered versions have a low profile and are available in sizes that accommodate packages with 60 to 208 pins. These adapters also feature gold-plated pins and are available with either solder-tail or wire-wrappable pins. Prices range from \$45 to \$156.

Who needs to wire-wrap?

The Surfboard prototyping system from Global Specialties provides a simple and nondestructive vehicle for breadboarding circuitry that employs surface-mount chip-carrier packages. For the designer, the system eliminates the need to fabricate circuitry with permanent connections for testing, evaluating, and troubleshooting—a time-consuming and expensive process.

Each Surfboard consists of a chip-carrier socket mounted on a pc board containing two solderless breadboarding strips. Traces on the pc board connect the socket to the strips. Numbers on the pc board identify each pin location on the chip-carrier socket, making it

Sorting out some acronyms

The following glossary defines some of the more widely encountered surface-mount acronyms and specialized terms.

Chip carrier—a rectangular or square package that has I/O connections on all four sides of the package. On leadless versions, the I/O connections consist of metallized terminations. On leaded versions, I/O connections are attached to the side of the package.

EIAJ—Japanese equivalent of the Joint Electronic Device Engineering Council.

JEDEC—Joint Electronic Device

Engineering Council. This group has developed two basic package styles for chip-carrier packages. One has a 0.050-in. pin spacing, and the second has a 0.040-in. pin spacing.

LCC—Leadless chip carrier. This is a chip package whose input and output pads sit right on the perimeter of the package. LCCs come in several versions.

PLCC—Plastic leaded chip carrier. This package can have from 18 to 100 pins. These devices are available with either J or gull-wing type leads.

PQFP—Plastic quad flatpack.

This is the JEDEC-approved package for chips with 44 to 256 terminals. JEDEC PQFP carriers typically utilize a 0.025-in. pin spacing, and EIAJ units utilize either a 0.0256- or 0.0316-in. pin spacing.

Quad pack—term used by some manufacturers to designate a PLCC package.

SOIC—Small-outline integrated circuit.—This carrier occupies an area about 30 to 50% less than an equivalent DIP. Typically, the SOIC package employs gull-wing leads spaced on 0.050-in. centers.

easy to identify which pin you're wiring. To make any design modifications, you simply move the wire in question from one location on the breadboarding strip to another.

The Surfboard line consists of five models that accommodate chip carriers with 20, 28, 44, 68, and 84 pins. All units accept JEDEC Type A devices and come with a lifetime warranty. Prices range from \$34.95 to \$49.95.

All of the adapters discussed up to this point are primarily designed for one-of-a-kind prototype service. You could, of course, use the devices for interim short runs of wire-wrap cards in end-user equipment. However, 3M, Pomona, Emulation Technology, and Ironwood all offer products that are designed primarily for troubleshooting and testing finalized-production circuit boards.

3M's line of test accessories includes two families of test clips designed for surface-mount assemblies:

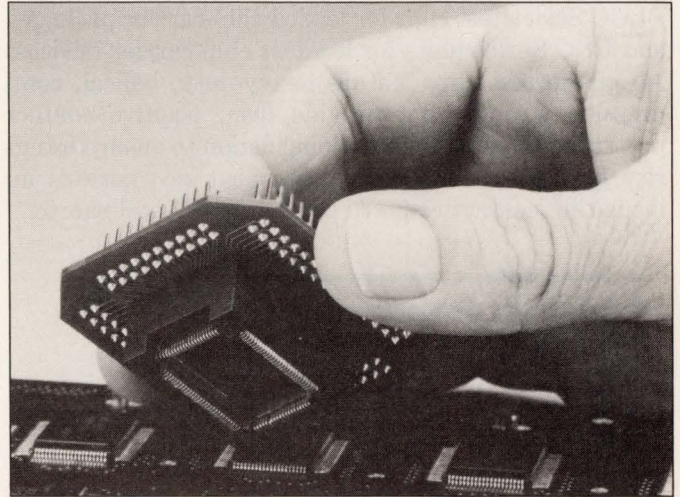

Designed for PQFP packages, ITT Pomona's 5640 Series test clips feature a press-on design to fit directly over the surface-mounted ICs. Contact with the IC's gull-wing leads is via specially configured gold-plated beryllium copper pins.

Getting the whole picture

In today's electronics world, the design goal seems to be smaller and faster circuitry. Surface-mount technology, fine-pitch geometries, and large-scale integration are all attempts to pack more electronic functionality into less space. However, higher performance often translates into greater heat generation and smaller surface areas equate to less heat dissipation. This results in higher internal operating temperatures—a situation that can decrease system reliability.

Reliability problems are often compounded because today's electronic products are being used more and more in hostile environments. Today, many electronic system designs require users to customize them by selecting from an endless combination of add-on boards from a number of vendors. As a result, product design must frequently allow for a range of uncontrollable and unforeseeable environmental and intrinsic heat sources.

This heightened concern for reliability has increased the importance of thermal analysis in prod-

uct design and development. Using sophisticated infrared scanning techniques to create thermal pictures or temperature maps (thermograms), the thermal imaging system is the thermal-analysis tool of choice. Although different systems vary in their resolution and scanning speeds, all can generate a complete thermogram of an operating circuit board in less than a minute. Displayed graphically, the data is easy to interpret quickly. Using these capabilities assures the design engineer that the final design will contain no hidden thermal flaws.

The Compix 6000 thermal imaging system from Compix Inc is an economical tool for analyzing the thermal characteristics of components, pc boards, and assemblies. The 2-part system (camera and controller) allows you to examine components and boards during verification, isolate potential thermal problems, and take corrective action. The 6000's high-resolution CRT display (greater than 47,000 pixels) offers a choice of six palettes in color

or gray scale. The system will provide both isothermal (color band) temperature mapping and point-by-point temperature measurement with a cursor. The system measures temperatures ranging from 17 to 150°C and records variations as low as 0.2°C. Focus adjustments allow the system to accommodate circuit-board sizes from 3×4 in. to 36×36 in. Close-up adjustments show circuit details as small as 0.015 in.

By utilizing COM6 software with the 6000 system, you can leverage the power of a PC to store, retrieve, and compare images, zoom and pan on-screen, and convert temperature measurements from Fahrenheit to Celsius to milliwatts. COM6 features a menu-driven interface. The software also allows you to remotely control the 6000 system from the PC. A complete system (which includes a folding camera stand, COM6 software, and documentation for the 6000 and the software) costs \$18,500.

SMT troubleshooting

PLCC Series test clips for leaded chip-carrier packages and LCC Series units for leadless chip-carrier devices. All of the test clips feature heavy-duty, helical, compression springs that provide firm, positive contact pressure, and a patented wiping action to ensure integrity in testing. The clip design also incorporates an insulating contact comb to prevent accidental shorts.

Displayed graphically, the data obtained from a thermal-analysis system is interpreted easily.

Both lines of clips include units that accommodate 20-, 28-, 44-, and 68-pin chip-carrier packages with 0.050-in. center-to-center pin spacings. All four sides of the test clips open simultaneously to provide a 1-step attachment to the device under test. All probe access points are visible, providing fast and safe individual lead testing.

PLCC and LCC Series test clips handle high-density, surface-mount assemblies, readily testing ICs with as little as 0.200-in. row-to-row spacing between adjacent devices. The clip contacts are staggered in a 0.1-in. center-to-center pattern. This design facilitates probe attachment and helps prevent the accidental shorting of adjacent probes. These 0.25-in.-square contact pins readily accept single-row female socket connectors. The clips are available with alloy 764 or gold-plated leads and cost \$15.95 to \$39.95 for both lines.

ITT Pomona's 5640 Series test clips consists of three

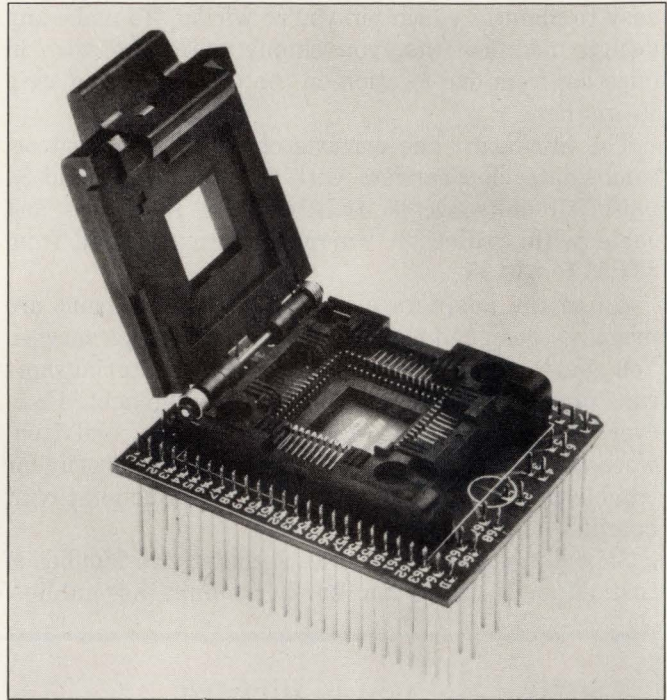

Available with 3-level wire-wrap pins, Antona's ANC-8068 adapters offer an efficient way to prototype equipment that employs 68-pin PLCC or LCC packages.

models that break out the high-density lead patterns of gull-wing type PQFP devices. Models 5643, 5644, and 5645 provide a readily accessible troubleshooting pattern for 100-, 120-, and 160-pin packages, respectively. The devices eliminate the need for handwiring test sockets and ease the task of accessing otherwise impossible-to-test device leads.

Manufacturers of SMT adapters

For more information on prototyping and troubleshooting devices such as those described in this article, circle the appropriate numbers on the Information Retrieval Service card or use EDN's Express Request service. When you contact any of the following manufacturers directly, please let them know you saw their products in EDN.

Antona Corp
1643½ Westwood Blvd
West Los Angeles, CA 90024
(213) 473-8995
FAX (213) 473-7112
Circle No. 650

Emulation Technology
2344 Walsh Ave
Bldg F
Santa Clara, CA 95051
(408) 982-0660
FAX (408) 982-0664
Circle No. 653

Ironwood Electronics Inc
Box 21151
St Paul, MN 55121
(612) 431-7025
FAX (612) 432-8616
Circle No. 655

McKenzie Technology
44370 Old Warm Springs Blvd
Fremont, CA 94538
(415) 651-2700
FAX (415) 651-1020
Circle No. 657

Compix Inc
16195 SW 72nd Ave
Tigard, OR 97224
(503) 639-8496
FAX (503) 639-1934
Circle No. 651

Global Specialties
Box 1942
New Haven, CT 06509
(203) 624-3103
FAX (710) 465-1227
Circle No. 654

ITT Pomona Electronics
Box 2767
Pomona, CA 91769
(714) 623-3463
FAX (714) 629-3317
Circle No. 656

3M Co
Electronic Products Div
Box 2963
Austin, TX 78769
(512) 984-5734
Circle No. 658

EDI Corp
Box 366
Patterson, CA 95363
(209) 892-3270
FAX (209) 892-3610
Circle No. 652

VOTE...

Please also use the Information Retrieval Service card to rate this article (circle one)

High Interest 470 Medium Interest 471 Low Interest 472

Vertical Mount Fixed Resistors

Series RSS Vertical Mount Metal Oxide Fixed Resistors feature self-standing, snap-in terminals, and they exhibit an excellent high frequency response and low inductance, making them suitable for PC board mounting in power supplies, switching regulators, monitors, printers, and color TVs.

Model RSS3FB is rated at 3W with a resistance range of 1Ω to $100K\Omega$. Model RSS5FB is rated at 5W with a resistance range of 1Ω to $2.4K\Omega$. Both are available in 15mm and 25mm heights. Free samples are available, contact Noble at 708/364-6038.

CIRCLE NO. 163



2-, 4-Bit and 5-Bit Rotary Encoders

Noble SDB161 2-, 4- and 5-bit encoders are compact (21mm ϕ) with a low profile (under 10mm height). Built with a sturdy diecast and steel construction, these encoders offer long life and reliability.

SDB161 encoders are for relative (2-bit) and absolute (4-bit, 5-bit) reference applications. 2-bit switches offer 36 detented positions; 4-bit switches offer 12 or 16 detented positions; 5-bit switches offer 24 or 32 detented positions. All encoders feature continuous rotation. The 2-bit is available in gray code; the 4- and 5-bit versions offer either binary or gray code. Custom designs can be accommodated. For free samples, contact Noble at 708/364-6038.

CIRCLE NO. 164

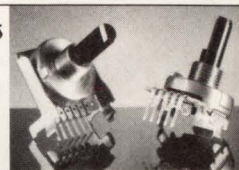

BIG IDEA

(If you didn't see the 3mm trimmer potentiometer, look again!)

When it comes to quality execution of electronic componentry, Noble crosses all the Ts and dots every I.

Our surface mount trimmer potentiometer (TMC3K) continues our commitment to space saving design, bringing state-of-the-art performance to a new dimension:

3.0mm x 3.65mm x 1.5mm

Easily adjusted, TMC3K incorporates a metal glaze element for outstanding stability; it is designed for reflow soldering, can be adhesive-mounted to circuit boards, and is available on 8mm tape for automated

assembly. Operating temperature range is -30°C to $+125^{\circ}\text{C}$.

The Noble 3mm potentiometer is perfect for hand held equipment, disk drives, bar code devices, and other consumer and business electronic products. For a free sample and more information on why it makes sense for you, call or write Noble today.

 **NOBLE**

5450 Meadowbrook Industrial Court
Rolling Meadows, IL 60008
Phone: (708) 364-6038 FAX: (708) 364-6045

4mm Surface Mount Trimmers

TMC4K "chip" trimmers feature a ceramic substrate, a metal glaze element, and an insulated knob for easy adjustment. The TMC4K can withstand operating temperatures of -30°C to $+125^{\circ}\text{C}$ and is rated at 0.2 watts of power at 20V. Its standard resistance range is 200Ω to $1M\Omega$. Outside dimensions are 3.8mm wide x 4.5mm long (2.1mm height).

Available on tape and reel. Can be held to a circuit board by an adhesive for reflow soldering. Call Noble at 708/364-6038 for a free sample.

CIRCLE NO. 165



Slide Potentiometers

The VJ Series High and Low Profile Slide Potentiometers are lightweight, durable, and provide smooth operation. They function as volume, balance, brightness/contrast, temperature, lighting and graphic equalizer controls.

The Low Profile Series (with single or dual elements) features a slide travel of 15, 20, 30, 45, or 60mm. The High Profile Series is available in 30, 45, 60, 80 or 100mm travel.

Custom designs can be accommodated. Contact Noble at 708/364-6038 for a free sample.

CIRCLE NO. 166

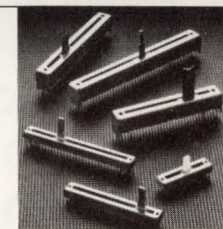

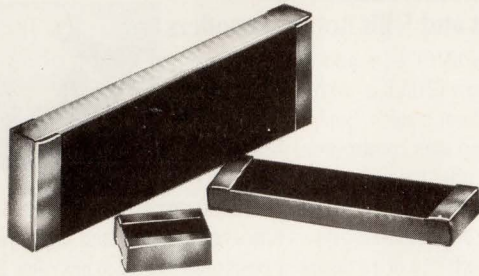

You won't find a more reliable MIL-R-55342 chip resistor.

These thick film and thin film chip resistors are designed for hybrid microelectronic circuits and surface mount applications which demand high reliability. All parts are MIL-R-55342-qualified with life failure rates to 0.001% per 1,000 hours. State of the Art is the only thick film S-level manufacturer. In the world. Our thin film resistors are qualified to R level. Available in a full range of sizes and values, and with a wide selection of terminations. Tolerances to 0.1%; TCRs to ± 25 ppm (Characteristic E). Anti-static waffle packs or tape and reel. For more information and free catalog, call or write:

1-800-458-3401

State of the Art, Inc.
2470 Fox Hill Road, State College, PA 16803-1797
TEL. 814-355-8004 • FAX 814-355-2714

CIRCLE NO. 47

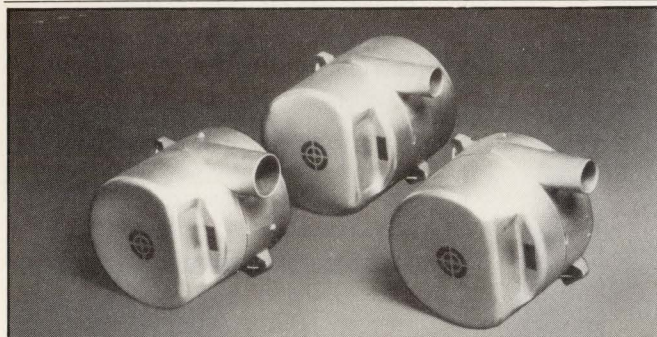

Compact motorized blowers provide high vacuum and pressure

Windjammer® centrifugal blowers, only 5.7" in diameter provide performance from 50" H₂O vacuum at 0 flow to 110 CFM at 0" H₂O. Designed for business machines, medical equipment and materials handling systems. Drive options include brushless DC motors with or without an integral controller, featuring manual or remote speed control. AMETEK, Lamb Electric Division, 627 Lake Street, Kent, OH 44240. Tel: 216-673-3451. Fax: 216-673-8994. In Europe, Friedrichstrasse 24, 6200 Wiesbaden, Germany. Tel: 6121-370031. Fax: 6121-370033.

AMETEK
LAMB ELECTRIC DIVISION

CIRCLE NO. 48

SMT troubleshooting

Each test clip features a press-on design, which allows the unit to fit directly over the surface-mounted ICs. A built-in pin locator identifies pin 1 on the device under test to eliminate any chance of alignment error. The test clip makes contact with the PQFP's gull-wing leads via specially configured, gold-plated, beryllium copper pins. The clips have a black, molded liquid-crystal polymer housing covering multiple rows of 0.025-in.-square gold-plated, phosphor bronze pins. These pins are positioned on a 0.100-in. grid to accommodate commercially available headers. Model 5643, 5644, and 5645 test clips are priced at \$317, \$353, and \$425, respectively.

Satisfying specific needs

Emulation Technology offers a line of prototyping/troubleshooting adapters that will accommodate LCC, PLCC, and PQFP (both EIAJ and JEDEC type) device packages with pin counts ranging from 20 to 160. One PQFP adapter is the 386SX test clip, designed specifically to facilitate testing of the 386SX chip from Intel—a device that is housed in a PQFP package with 100 pins spaced on 0.025-in. centers. The unit consists of a small pc board, which fits into the palm of your hand. A clip on the bottom of the unit's board covers the 386SX chip already soldered onto the pc board you're testing. A set of pins are located around the perimeter of the top of the unit's pc board. These pins are spaced on 0.1-in. centers—a spacing that makes it easy to attach test leads.

The 386SX test clip allows you to bypass the chip already soldered to the circuit board under test. The clip lets you disable the soldered chip and replace it with a chip that you plug into the test clip. The test clip also lets you use an emulator to imitate the chip already soldered onto the circuit board. In essence, the 386SX lets you simply test the chip already soldered onto the circuit board, disable that chip and test the circuit board, or test the board using an emulator in place of the chip under test. The test clip costs \$875.

The Loclip from Ironwood Electronics is a specialty low-profile interconnect device for probing or interconnecting SMD packages. The units will accommodate 20-, 28-, 32-, 44-, 52-, 68-, and 84-pin PLCCs as well as 32-pin SOICs. You can clip the Loclip device onto the surface-mounted PLCC package. Because the mounted height of the Loclip ranges to as low as 0.450 in., you can then reinsert the board into a backplane mounted in a card cage. Prices range from \$56 to \$85.

EDN

Article Interest Quotient (Circle One)
High 470 Medium 471 Low 472

**We developed
LONWORKS technology,
a better way to add control and
communications capabilities
to your products
quickly and inexpensively.**

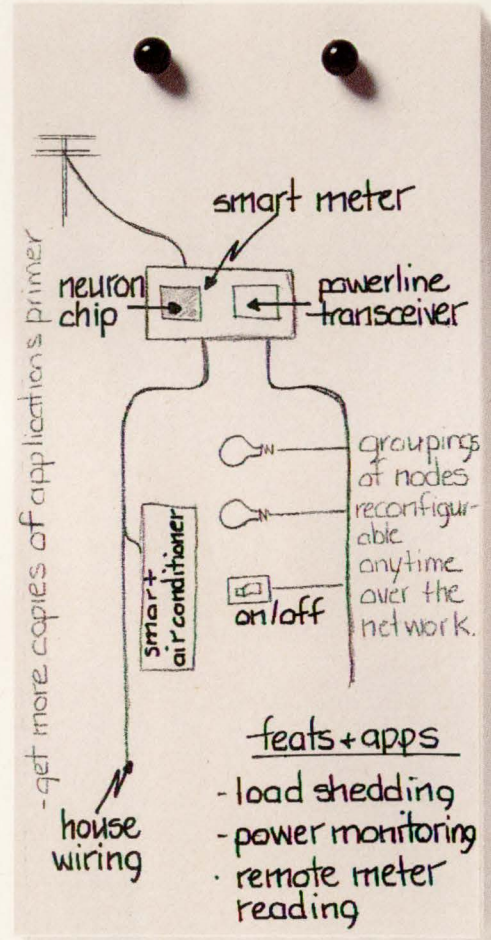
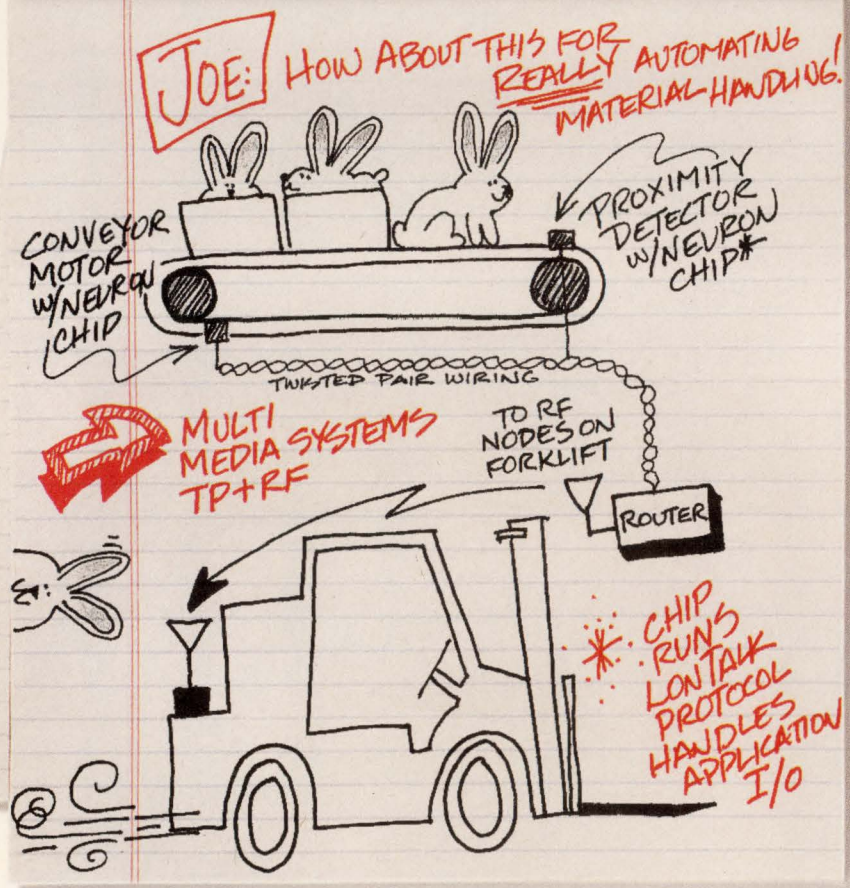
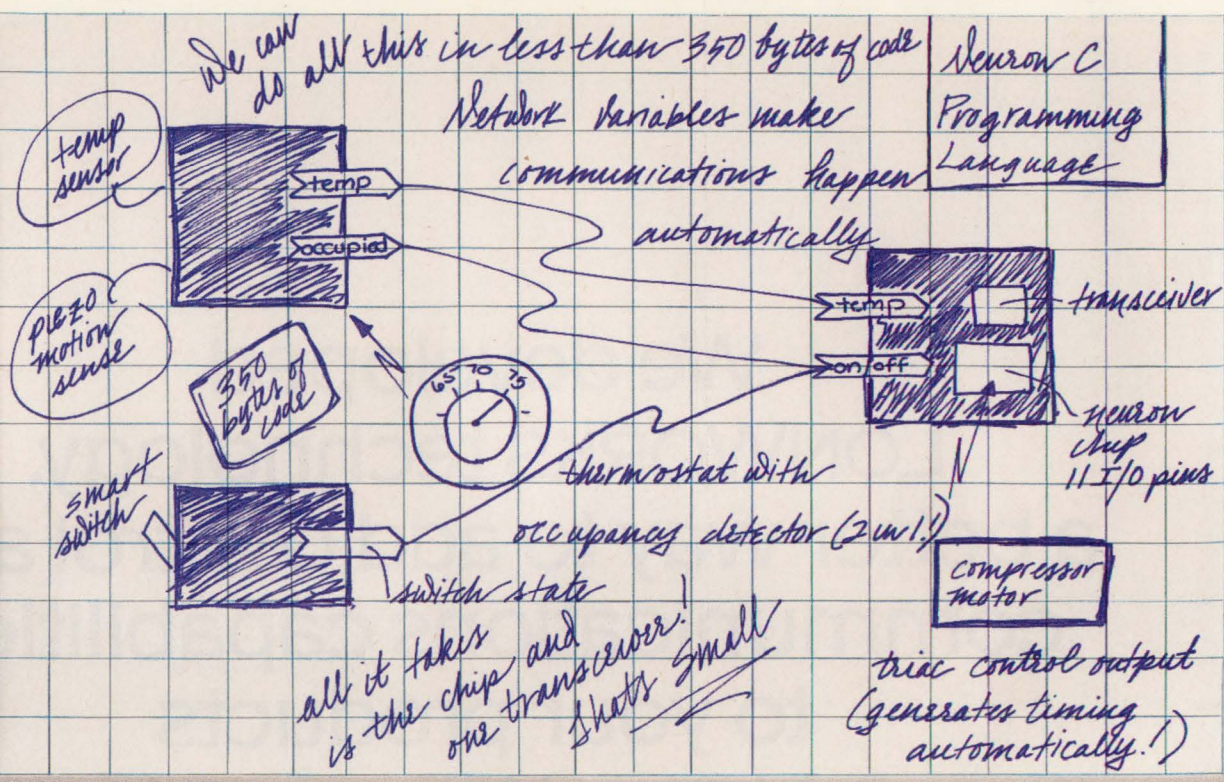

© 1991 Echelon Corporation. LONWORKS, LONBUILDER and LONTALK are trademarks, and ECHELON, LON, and NEURON are registered trademarks of Echelon Corporation. Other names may be trademarks of their respective companies. Some of the LONWORKS tools are subject to certain Terms and Conditions. For a complete explanation of these Terms and Conditions, please call 1-800-258-4LON.

ECHELON SEMINAR

- WE CAN DO ALL THESE WITH 1 WIRING HARNESS
- PRIORITY FEATURE OF LONTALK PROTOCOL GUARANTEES RESPONSE TIME FOR CRITICAL FUNCTIONS
- NEW APPLICATIONS? RF TO AUTOMATIC TOLL SENSOR?

○ CHIPS

- 3 CPUs
- RAM, EPROM (ROM)
- COMM & I/O

MULTIPLE SOURCES



TOSHIBA

14mm

MOTOROLA
TOSHIBA

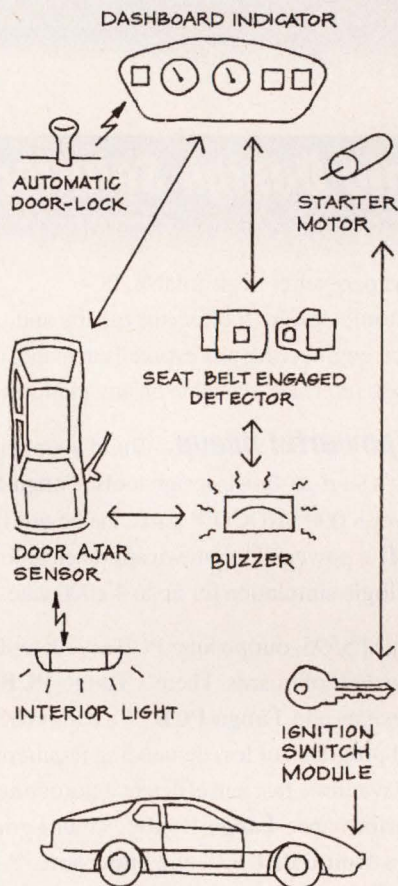

LONWORKS SEMINARS

ARIZONA	Phoenix	June 25
CALIFORNIA	Irvine	May 2
	Los Angeles	March 13
	San Diego	March 12
	Santa Clara	March 14
COLORADO	Denver	June 26
CONNECTICUT	Stamford	June 18
FLORIDA	Ft. Lauderdale	April 9
	Orlando	April 10
GEORGIA	Atlanta	April 11
INDIANA	Indianapolis	June 5
ILLINOIS	Chicago	March 21
KANSAS	Kansas City	March 28
MARYLAND	Baltimore	April 26
MASSACHUSETTS	Boston	April 3
MICHIGAN	Detroit	March 28
MINNESOTA	Minneapolis	March 19
MISSOURI	St. Louis	June 6
NEW HAMPSHIRE	Manchester	May 7
NEW JERSEY	Fairfield	June 12
NEW YORK	Albany	June 19
	Long Island	April 4
	Rochester	June 11
	Tarrytown	May 9
OHIO	Cleveland	March 27
	Dayton	June 4
OREGON	Portland	April 16
PENNSYLVANIA	Philadelphia	May 8
	Pittsburgh	June 20
TEXAS	Dallas/Ft. Worth	May 1
	Houston	April 30
VIRGINIA	Tysons Corner	June 13
WASHINGTON	Seattle	April 17
WISCONSIN	Milwaukee	March 20
UTAH	Salt Lake City	June 27
CANADA	Montreal	April 24
	Ottawa	April 23
	Toronto	April 25
	Vancouver	April 18
EUROPE	Düsseldorf	May 20
	London	May 16
	Milan	May 28
	Munich	May 21
	Paris	May 30
	Stockholm	May 14
	Zurich	May 23
JAPAN	Osaka	(TBA)
	Tokyo	(TBA)

1-800-258-4LON

For Reservations and Information

What You Do With It Is Your Business.

Spend a day in one of our free LONWORKS™ seminars and we'll change the way you develop products forever.

You'll learn about the technology that uses the latest computer, semiconductor and networking advances to add control and communication capabilities to your products.

You'll see the heart of LONWORKS, the NEURON® CHIP that's small enough to fit into any product. Smart enough to control and respond to other devices. Flexible enough to communicate over standard media. Inexpensive enough that everyone can afford it.

You'll discover how easy it is to program and link NEURON CHIPS into virtually invisible networks of intelligent devices.

How our powerful LONTALK™ protocol lets you use electrical powerlines, twisted pair, radio waves, and other common media as communication paths.

How our LONBUILDER™ Developer's Workbench helps you design LONWORKS networks into your products to make them work "smarter." How to connect your LONWORKS-based products into smart systems. And how to connect those systems into interoperating LONWORKS environments as large as a building, a home or a factory. All in far less time and for much less money than it takes to develop your own protocols and tools.

LONWORKS technology is something every designer in every industry can use. A day at a LONWORKS seminar will give you the information and inspiration to make your products sense, control, communicate and cooperate better than ever.

So find the seminar nearest you. Call 1-800-258-4LON for your reservation. And learn all about the new technology that will help you improve your products. And your business.



Echelon Corporation • 4015 Miranda Avenue • Palo Alto, CA 94304 • Telephone (415) 855-7400 • FAX (415) 856-6153

Echelon Europe Ltd. • 105 Heath Street • London NW3 6SS England • Telephone (071) 431-1600 • FAX (071) 794-0532 • International Telephone +44 71 431-1600 • International FAX +44 71 794-0532

Ask us about our new releases
with many added features.

The Complete Electronic Design Solution.

Tango

For complete specs
and FREE evaluation
packages, call
800 433-7801



Tango is the pacesetter in affordable, PC-based electronic design. It offers the quality and performance engineering professionals demand, and the easiest-to-use interface available on any platform, at any price.

Tango's powerful lineup. Build your personal CAE/CAD workstation with Tango's start-to-finish design tools. **Tango-Schematic**,™ just \$495, includes over 8,000 SEDCO™ parts, the largest library on the PC. Experience **Tango-PLD**'s powerful top-down approach to logic design for only \$495. Add interactive logic simulation for up to 40,000 gates with **Susie**.™

Starting at just \$595, our popular PCB layout tools have designed *tens of thousands* of boards. There's **Tango-PCB PLUS**,™ for complex designs and **Tango-PCB**,™ a comprehensive, yet economical program for less demanding requirements. Tango designers have three fast and efficient autorouting options: the high-performance **Tango-Route**,™ multi-grid, multi-layer **Tango-Route PLUS**,™ and **Superoute**,™ the industry-leading rip-up and re-try, 100% completion autorouter. Finally, there's the **SMT Plus Library**,™ supplying proven land patterns for sophisticated SMT designs.

Tango extras at no extra charge.

Your investment in Tango software includes clear, concise documentation; responsive technical support, free by phone or fax; first year of updates free, with affordable annual renewals; our 24-hour Tango BBS; directories of service bureaus and design consultants; a quarterly newsletter; and our money-back guarantee. Give us a call to discuss your design requirements. You'll find our customer service is as friendly as our software.

CIRCLE NO. 123

Tango™

Helping good ideas become great products.

ACCEL Technologies, Inc.
6825 Flanders Drive • San Diego, CA 92121
619/554-1000 • Fax 619/554-1019

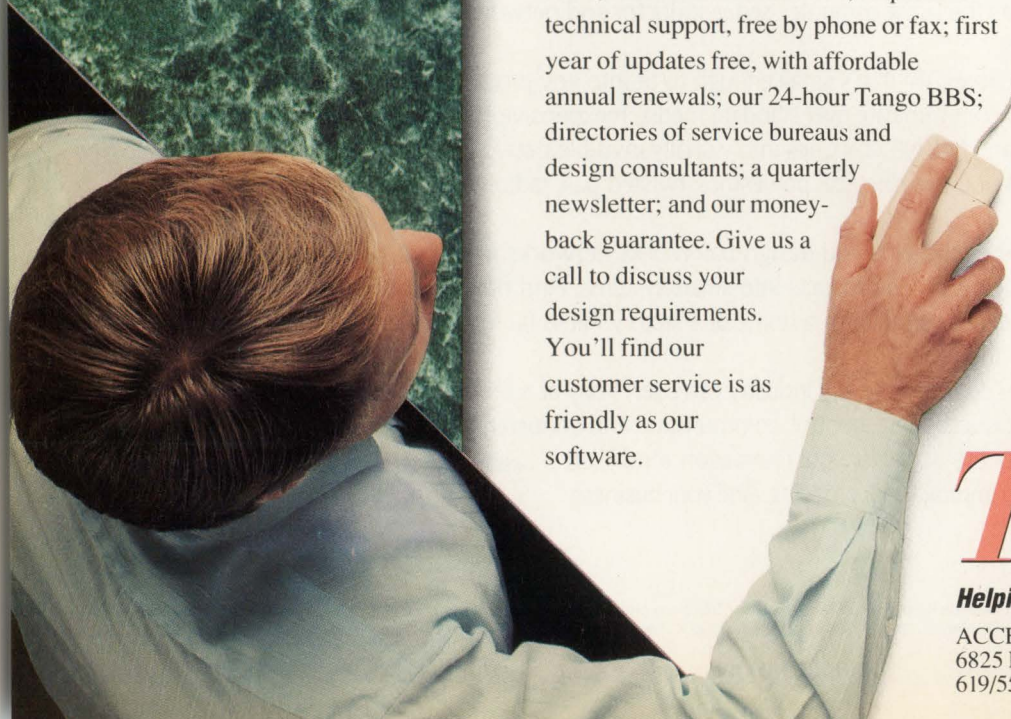
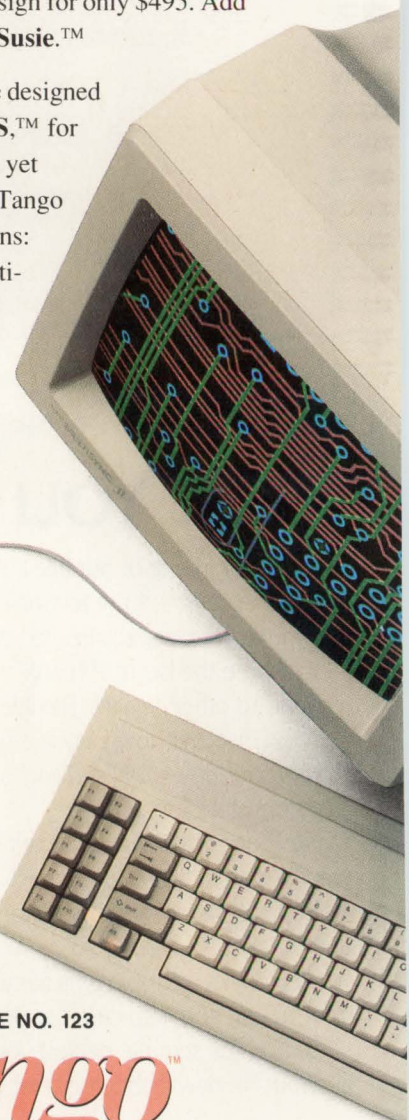
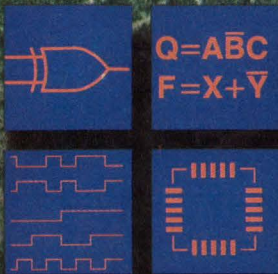

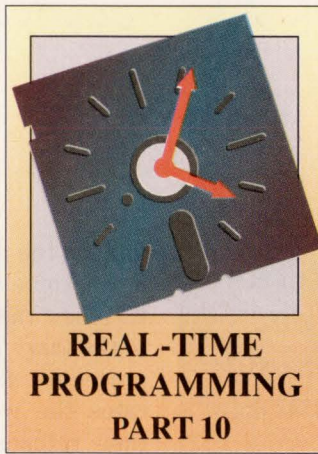

Task coordination and communication via signals

The major mechanisms for task-to-task interaction that have been described so far (event flags, messages, semaphores, and controlled shared variables) all use public objects that are accessible to all tasks. There is no sense of a private communication targeted to a specific task. Part 10 discusses signals, which fill this gap by permitting one task to send information to a designated recipient.

David L Ripps, *Industrial Programming Inc*

A signal is a software interrupt that may be handled at the task level. There are four modes of use:

- intratask coordination—A task may elect to have a signal sent to itself as the completion indicator for a requested service (coordination modes **CSIGN**).
- intertask coordination/communication—A task can send a signal to another task, or to a group of tasks, as a means of coordination or communication.
- error recovery—The OS automatically sends Sig-

From the book, *An Implementation Guide to Real-time Programming*, by David L Ripps, ©1989. Excerpted by permission of Prentice-Hall Inc, Englewood Cliffs, NJ.

- nal 26 to a task when the task generates an error exception, such as an arithmetic overflow. For many processors, error exceptions are also caused by a reference to a nonexistent address and an attempt to execute an unimplemented instruction.
- debugging—A signal is sent after the execution of a breakpoint, which is often implemented as an illegal instruction or a software interrupt instruction. A different signal is sent after the execution of any instruction for which tracing or single-step operation has been enabled. Normally, these signals invoke the Debugger.

This part of the series concentrates on the coordination and communication aspects of signals.

MTOS-UX has 32 signals in total, but only 0 to 15 and 31 are available for task-to-task interaction. (The remaining 15 signals are reserved for error recovery and debugging.)

Signals differ from other coordination mechanisms in two ways. First, signal communication can be synchronous or asynchronous. In synchronous communication, the receiver chooses to ask for information. Waiting for an event flag or a message is synchronous. Signal communication can also be synchronous when the receiver issues a pause-until-signal-arrives request.

Unlike most task-to-task interaction facilities, which use public objects accessible to all tasks, signals permit private communication to specific tasks.

However, signal communication can also be asynchronous. The sender transmits a signal to the receiver, thereby imposing the information on the recipient. As far as the receiver is concerned, the information arrives spontaneously and is not necessarily related to whatever ongoing activity the receiver happens to be doing. Thus, signals are the task-level analog of an external interrupt.

The second difference is that each task can decide how it will respond to each separate signal. The choices are: (1) ignore the signal, (2) perform a specified task-level procedure, (3) be blocked until continued by the Debugger, or (4) be forced to terminate. Signal 31 (the "kill" signal) is usually reserved for the forced termination. The response to intertask signals is commonly to perform a task-selected procedure (choice 2).

The signal mechanism is inherent within the operating system. Signal facilities may neither be created nor destroyed. All a task can do is change its response to a given signal.

Signaling as an end-of-service indicator

Previous sections have discussed two ways in which a task can determine that a requested service is completed:

- It can wait so that the request function does not return until the service is completed (mode **WAIFIN**).
- It can continue immediately and have a specified local event flag set upon completion of the service (mode **CLEFn**).

There is also a third mode, **CTUNOC**, in which the task continues without any coordination.

The fourth possibility is to have the task continue, with a signal in the range 0 to 15 sent when the service is completed. This mode is specified by the literals **CSIG0** to **CSIG15** in the coordination field of the service. The following word diagram illustrates how the signaling mechanism can be put to advantage:

1. Allocate a work area from a pool; save the address.
2. Build a message in the work area.
3. Set the response to, say, Signal 3 to be procedure *done3* ().

4. Send the message with **CSIG3** as coordination mode.
5. Continue with other work.
6. When the message is transferred, Signal 3 is sent to the task. The ongoing other work is interrupted and procedure *done3* is performed. The procedure deallocates the work area whose address was saved and then returns. This automatically resumes the interrupted other work.

Thus, the benefit of signal coordination is that it permits some task-level operations to be performed upon the completion of a service, without having to wait directly for that completion.

Set response to signal

When a task is first created, the default response is to ignore Signals 0 to 15 and terminate for Signal 31. (If the optional Debugger task has been installed, then the default for the error signals, 15 to 30, is to become blocked and start the Debugger to unblock it. If the Debugger is not present, the default is to print an error message on the System Console via the Error Logger task, if present, and then terminate the errant task.)

The function *setsig* resets the response to a prescribed list of signals. The C definition of the function is

```
int setsig (sigmsk,resp)
long int sigmsk;
int (*resp) 0;
```

The signals of interest are selected by *sigmsk*, using one bit per signal, left to right. A value of 0x80000000 selects only Signal 0. The literals **SIG0** to **SIG31** may be combined to select the appropriate bit or bits. **SIGALL** means all signals.

The desired response is indicated by *resp*. Four literals are recognized: **SIGIGN** (ignore), **SIGBLK** (become blocked if the Debugger is present; terminate if not), **SIGTRM** (terminate), and **SIGDFL** (reinstate the default). Any other value is assumed to be the address of a function to be executed upon receipt of the signal.

NOERR is returned for a successful call of *setsig*. **BADPRM** indicates that the change was rejected because the function was not executable (for example, started on an odd address for the 680xx family).

Some examples of the call are to reset the response of all signals to the default,

```
setsig (SIGALL,SIGDFL);
```

to set the response to Signal 3 to procedure *done3*,

```
int done3(); /* define done3 as a procedure */
setsig (SIG3,done3);
```

and to set the response to Signals 1, 2, and 5 to ignore the signal.

```
setsig (SIG1+SIG2+SIG5,SIGIGN);
```

Signal response procedure

The structure of a signal response procedure is identical to that of a task: It is a procedure having a single argument. The argument is the address of a structure that is built by the OS when the signal is sent. The structure contains the signal number, plus the context of the task at the point of interruption. While the latter may not be of interest for communication and coordination signals, it is vital for error signals.

The signal response procedure executes at the task level and can issue any OS requests that the task could. The procedure acts completely as though it had been called by the task. It inherits the priority of the interrupted task and any task-level objects that the task had at that point. It can access any static data that the interrupted task could, but cannot see any local data. (This is generally true of a called procedure in C.) Correspondingly, any changes the procedure makes to the priority, task-level objects, or static data are the same as though the interrupt task itself had made them.

Normally, the procedure returns by reaching the last curly bracket of its code. In that case, the task continues from the point of interruption. Nevertheless, the procedure is free to terminate the task itself by issuing *exit* or *trmrst*.

Because the procedure acts as an extension of the task, the procedure may not execute immediately upon the arrival of the signal. For example, if the target task is blocked waiting for a previous service to be completed, the signal processing is postponed until the task becomes Active. Furthermore, while a task is executing a procedure invoked by a communication or coordination signal, the OS will not pre-empt that processing to handle another signal of the same type. The OS records any pending signals for a task and then processes them as soon as it is appropriate to do so.

Task-to-task communication via signals

One task can send a signal to another task, thus invoking whatever response the receiver currently has in force. The request specifies both the receiving task and the signal number.

```
sndsig (tskRid,15L); /* send signal 15 to task R */
```

Normally, the first argument is the identifier of the target task. (It is not an error for a task to send a

signal to itself.) For the special value 0, the signal is sent to all other application tasks in the system. This might be used to terminate all tasks prior to shutting down the computer.

```
sndsig (0L,31L);
```

One advantage of the signal for task-to-task communication is that the receiver can be interrupted to perform some signal-specific activity via a response procedure and then return to continue the interrupted "main" line of execution. This can be illustrated with a task (**HU**) that handles unusual conditions detected by a pair of scanning tasks (**SD** and **SM**). The individual scanning tasks have neither the time to evaluate the unusual conditions they find nor the overall information to take proper action. Thus, when a scanning task detects something that needs closer scrutiny, it sends a signal to **HU**.

For **SD**, the "somethings" are discrete events that

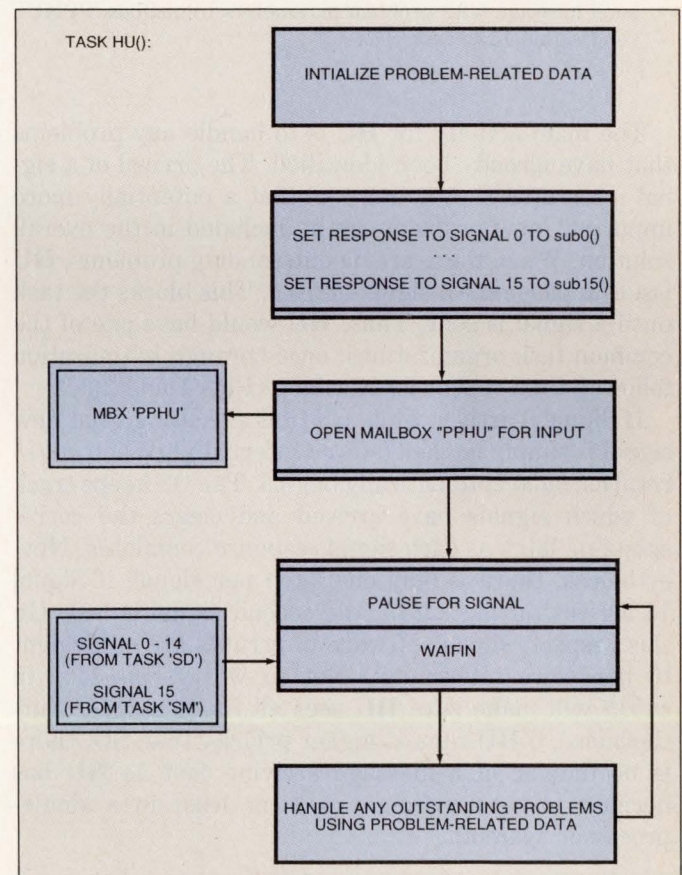

Fig 1—In a typical application of intertask communication via signals, one task handles unusual conditions detected by other tasks. In this example, problem-handling task HU receives signals from scanning tasks SD and SM.

Each task can decide how it will respond to each separate signal: ignore it, perform a specified procedure, be blocked temporarily, or be forced to terminate.

can be represented by integers 0 to 14. Thus, **SD** just sends the corresponding signal

if problem "i" is suspected then send signal "i" to task HU;

The problems detected by **SM** are more complex so that further information must accompany the signal. **SM** transmits the auxiliary data in a mailbox message.

```
if problem is suspected then
{
  send message with problem parameters to mailbox 'PPHU';
  send signal 15 to task HU;
}
```

The main activity for **HU** is to handle any problems that have already been identified. The arrival of a signal interrupts that activity so that a potentially more important new problem can be included in the overall solution. When there are no outstanding problems, **HU** issues a pause-until-signal-arrives. This blocks the task until a signal is sent. Thus, **HU** would have one of the common task organizations: once-through initialization followed by a repeat-forever loop (Figs 1 and 2).

If Signal 0 arrives while *sub15* is executing, that new signal is simply latched (stored internally). When *sub15* returns, *sub0* automatically begins. The OS keeps track of which signals have arrived and clears the corresponding latch as each signal response completes. Nevertheless, there is only one latch per signal; if Signal 15 arrives during *sub15*, the second signal is lost. (In this respect, signal software interrupts are equivalent to hardware interrupts.) Not to worry, the loop in *sub15* will make sure **HU** sees all its messages. Furthermore, if **HU** runs at higher priority than **SD**, there is no danger of a message arriving just as **HU** has decided to return from *sub15* (at least in a single-processor system).

Task-to-task coordination via signals

Simple intertask coordination can be achieved by having one task (**TskT**) pause for a signal that is sent by another task (**TskC**) when **TskC** wants **TskT** to

continue. This is closely related to the coordination pairs pause/cancel-pause and wait-for-local-event-flag/set-local-event-flag.

The pause-for-signal request specifies a maximum wait time. The time can be a specific interval

```
pausig (100+MS);
```

or can be "forever."

```
pausig (NOEND);
```

The first signal to arrive cancels the pause to continue the task, even if the response is to ignore the signal. Normally, *pausig* returns the signal number (0 to 31). However, if a signal does not arrive within the given interval, *pausig* returns with a value of **TIMOUT**. An invalid time interval is indicated by the value **BADPRM**.

Sending a signal after a given interval

A task can have a specified signal sent to itself after a given interval.

```
sgisig (3L,2+MIN);
```

The signal to be sent is specified by the first argument. Proper values are 0 to 15 and 31. The interval is given in the usual way.

Often, the response to a signal sent by *sgisig* is the execution of an asynchronous procedure. In this way,

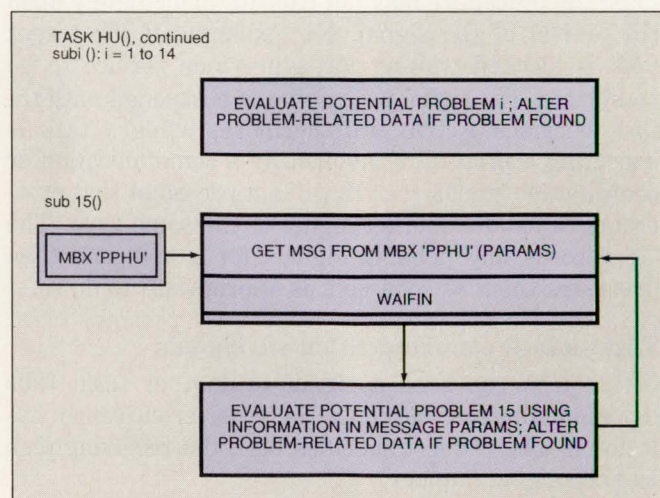
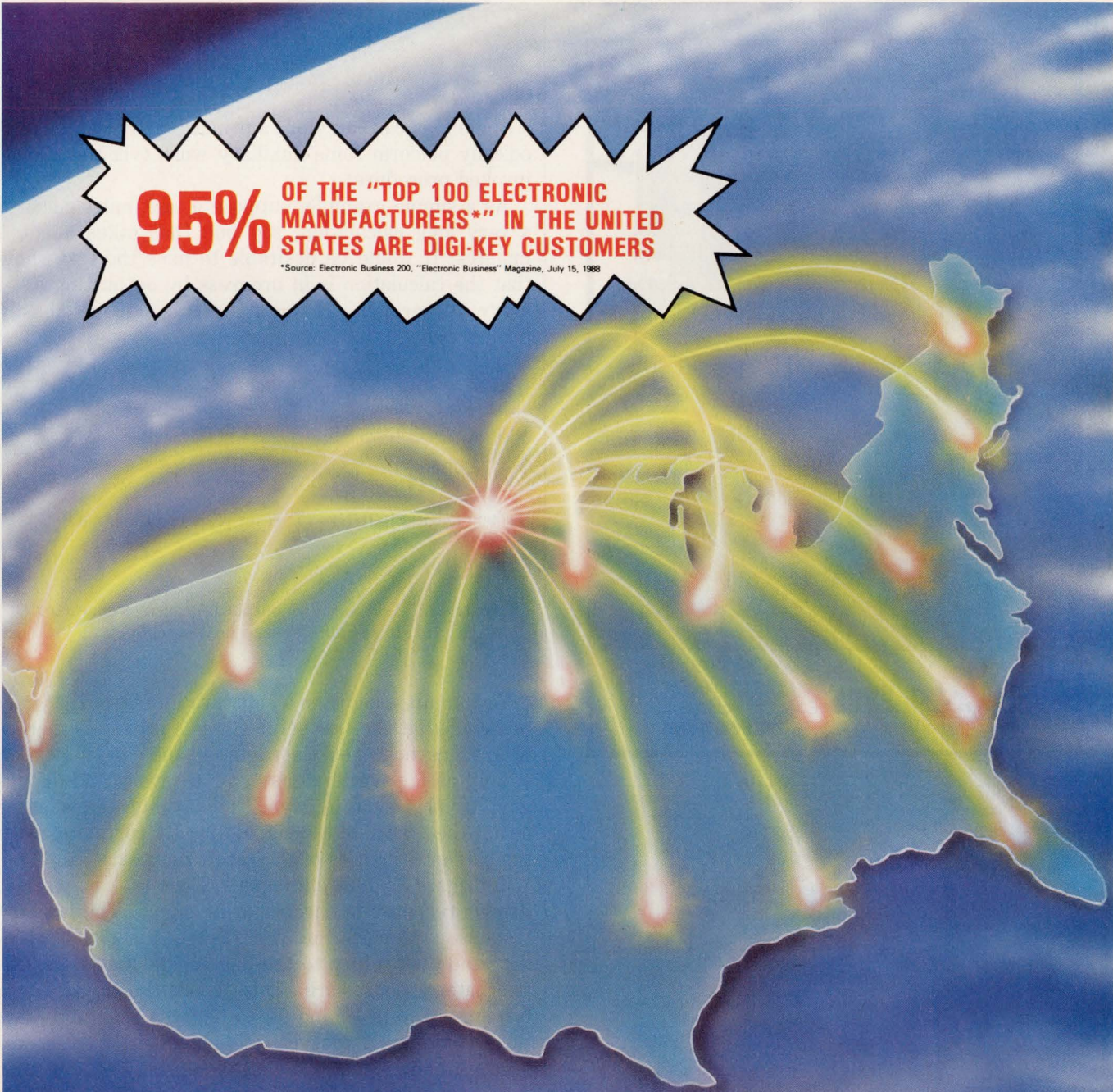

Fig 2—The problem-handling response of task HU depends on which signals the task receives. Signals 0 through 14 represent simple events that can be represented by integer numbers. The event represented by signal 15 is more complex, requiring further information to be sent to task HU via a mailbox.



95% OF THE "TOP 100 ELECTRONIC MANUFACTURERS*" IN THE UNITED STATES ARE DIGI-KEY CUSTOMERS

*Source: Electronic Business 200, "Electronic Business" Magazine, July 15, 1988

It's no accident that 95% of the "Top 100 Electronic Manufacturers" in the United States are Digi-Key customers. The numbers tell the Digi-Key story. Let the Digi-Key numbers work for you today.

95% OF THE ITEMS IN DIGI-KEY'S CATALOG ARE AVAILABLE FOR "OFF-THE-SHELF" DELIVERY — AND THE OTHER 5% ARE ON THE WAY!!

99% OF ORDERS ARE SHIPPED TO DIGI-KEY CUSTOMERS WITHIN 24 HOURS!!

100% COMMITMENT TO CUSTOMER SATISFACTION!!

Call today for your free catalog

Digi-Key
CORPORATION

701 Brooks Ave. South
Thief River Falls, MN 56701
Toll Free: 1-800-344-4539
Fax: 218-681-3380

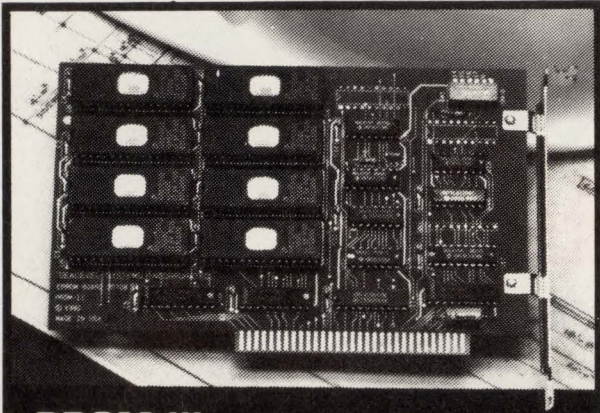

PROM-III

- PUT DOS AND APPLICATION IN EPROM
- ALLOWS DISKLESS OPERATION
- UP TO 1 MBYTE ROM-DRIVE WITH 16K FOOTPRINT
- PROMKIT SOFTWARE BY ANNABOOKS
- FLASH EPROM SUPPORTED
- BATTERY RAM MODULES SUPPORTED
- DELIVERY FROM STOCK



SEALEVEL SYSTEMS INC.
PO BOX 1808
EASLEY, SC 29641
(803) 855-1581

CIRCLE NO. 56

Measure...

Displacement Proximity Level

With ALPHASENSORS' Microwave
Sensor Technology

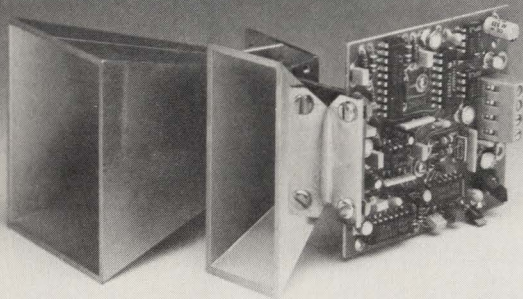

Microwave Sensors Offer:

- Non Contact Measurements
- Superior Performance in Harsh Environments
- Velocity, Presence and Motion Sensing Capability
- Low Cost/High Performance

Put our ALPHASENSORS' microwave technology to the test—order our MSM 10200 Motion Sensor Evaluation Kit—\$195, delivered from stock. For more information, call or write:

AM Sensors, Inc.
26 Keewaydin Dr. - Unit B, Salem, NH 03079
Tel: (603) 898-1543 Fax: (603) 898-1638
(Yes! We've moved and changed our name!)

CIRCLE NO. 57

a single task can carry out a primary activity and periodically perform some auxiliary work (via the signal-invoked procedure).

As a simple example, suppose a task must perform a very long calculation, say one that takes about 5 minutes. It would be desirable to have the task show that the calculation is in progress by outputting a '>' every 10 seconds. This can be accomplished easily through *sgisig*.

```
int showp ();          /* define showp as a procedure */
setsig (SIG0,showp);  /* set response to signal 0 */
sgisig (0L,10+SEC);   /* send first signal 0 */

do long calculation

setsig (SIG0,SIGIGN); /* reset response to signal 0 */
...
showp ()
{
  putchar ('>');      /* output in-progress character */
  sgisig (0L,10+SEC); /* send next signal 0 */
}
```

To sum up, a signal is a software interrupt that may be handled at the task level. Signals provide a mechanism for asynchronous coordination and communication as well as for synchronous error recovery and debugging. (Synchronous or asynchronous indicates whether or not the arrival of the signal directly correlates with the current activities of the receiving task.)

There are 32 different signals. Each task may select its own response to each separate signal. The primary response is to perform a preselected, task-level procedure and then return to the ongoing task activity. Alternate responses are: (1) to ignore the signal, (2) to terminate the task, and (3) to halt the task and start the Debugger. A task can determine its current response to any signal and can dynamically change that response.

The OS automatically sends a corresponding signal when it detects a task error, such as an arithmetic fault or a bad parameter within a service call. A task may elect to have the OS send a signal when a requested service is completed or a given time interval has elapsed. A task can also send a selected signal to one given task, to a group of tasks, or to all of the application tasks. Finally, a task can pause until a signal arrives from any of the aforementioned sources.

The next installment, Part 11, will conclude this series with a wrap-up of the task coordination discussion.

EDN

Article Interest Quotient (Circle One)
High 482 Medium 483 Low 484

Our quad high-side driver is the perfect switch for your intelligent environment.

Offering four independent 1A switches.

The LMD18400, the industry's first and only quad high-side switch, truly has a mind of its own.

Our intelligent solution has four independent power switches, each with a separate ON/OFF control. They're capable of driving 1A continuous and 3A peak loads. Together, they have a rating of 6A peak.

Our quad design achieves a higher level of integration and saves you a valuable chunk of real estate.

What's more, it drives every possible load: resistive, capacitive, and inductive. Making it the ideal design for automotive and far-reaching industrial applications.

Communicating with 11 diagnostic checks.

With a built-in serial interface, the LMD18400 provides extensive diagnostic data to a μC or μP , including switch status readback, output-load fault conditions, and thermal and overvoltage shut-down status.

Which results in bidirectional, real-time communications that can prevent blowouts, minimize downtime, and maximize your system performance.

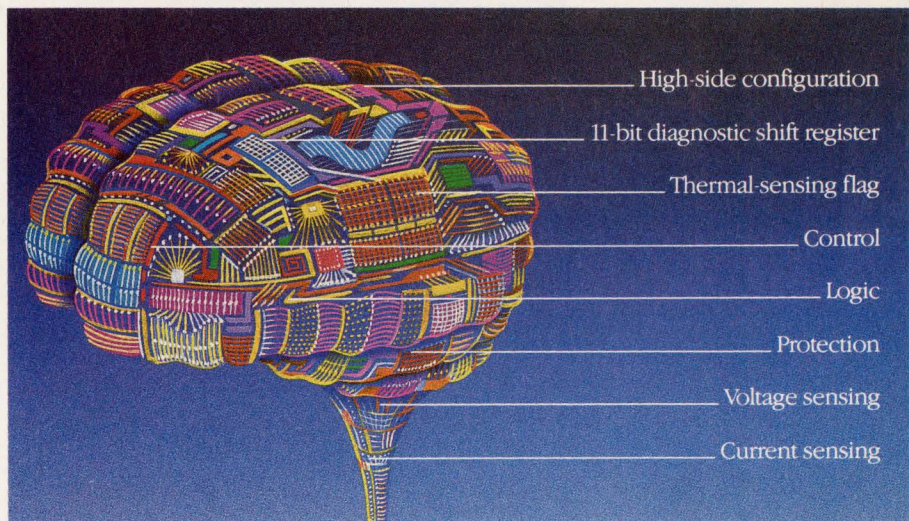

Providing unparalleled protection.

By integrating CMOS, DMOS, and bipolar on the same chip, we're able to deliver an optimized, mixed analog + digital technology for power, control, and protection.

action. And should the temperature reach 170° , the device automatically shuts down. A critical feature that can make your design less susceptible to damage.

It also means voltage and current sensors, which prevent burnout with an instantaneous power limit of 15W. And due to its high-side configuration, an accidental short wouldn't ground the battery.

Make the intelligent switch.

For your LMD18400 design kit, call or write us today.

And get an inside look at the brains behind the brawn.

1-800-NAT-SEMI, Ext. 107
National Semiconductor Corp.
P.O. Box 7643
Mt. Prospect, IL 60056-7643

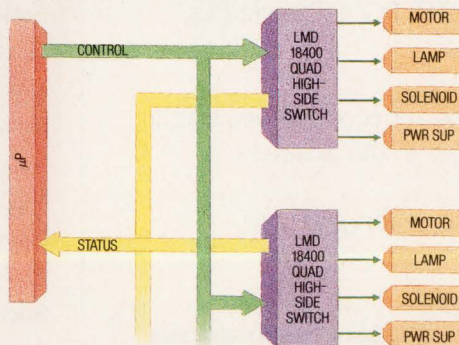

Parallel operation of LMD18400s

Fail-safe protection. Which means a two-stage thermal warning system that sends a distress flag to the host system at 145° , giving you ample time to take corrective

See our
specs in

CAPS

Where can you
find specs on
ICs from every
semiconductor
advertiser in
this magazine?

... **in CAPS!**

Just over a year ago, we introduced CAPS™ – the PC-based system that revolutionized the integrated circuit search and selection process. Engineers loved it!

Today, CAPS gives you vital information on more than 500,000 parts from over 425 manufacturers worldwide. Plus, you get hundreds of thousands of digitally-stored images of complete manufacturers' datasheets. All delivered on CD-ROM discs and updated every month!

To make it easy, CAPS includes everything you need and runs on standard hardware like IBM® PC/AT™-style PCs, PC networks, and Sun-3™ workstations.

So, if you're looking for ICs and semiconductors, take a look at CAPS. We've got the best names in the business.

*Find out more! For a free brochure,
call 800-245-6696 today!*

C A H N E R S

CAPSTM

Computer Aided
Product Selection

Cahners Technical Information Service
275 Washington Street
Newton, MA 02158-1630
Telephone: 617-558-4960
Facsimile: 617-630-2168
Telex: 940573
800-245-6696

Look for ads from these IC and
semiconductor manufacturers
in this issue:

Analogic Corporation	225
Cirrus Logic Inc.	47
Cypress Semiconductor	8
Datel Inc.	257
Fujitsu Microelectronics	C2
International Rectifier	C3
Lattice Semiconductor	187
Linear Technology	181-182, 250
Mitsubishi Electronics America	217-219
Motorola/Semiconductor Prod.	10-11
National Semiconductor	165
NEC	137, 207, 227
OKI Semiconductor Group	52-53, 215
Philips-Discreet Component Div.	77-82
Rockwell International	126
Samsung Semiconductor	16-17
Siemens AG	C2
Siemens Components	22
Signetics Corporation	18-21, 37-44
Silicon Systems	70
Texas Instruments	84-85

CAPS is a trademark of Reed Publishing (USA) Inc. IBM is a registered trademark and AT is a trademark of International Business Machines Corporation. Sun-3 is a trademark of Sun Microsystems, Inc.

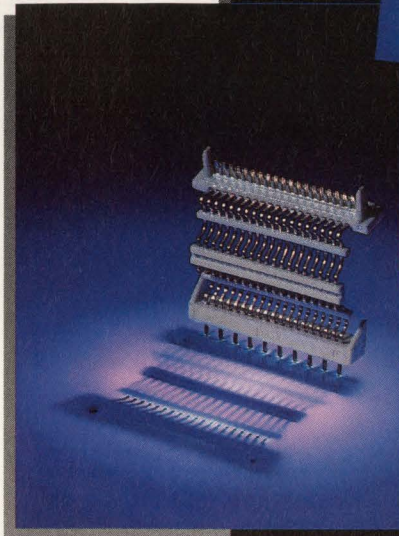
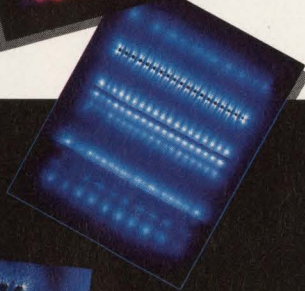

United States Europe Japan Korea Singapore



GREATER WORLD CLASS POWER FROM OUR NEW GLOBAL CONNECTIONS

The recent alliance of Elco and AVX with Kyocera forms a solid business relationship that gives us even stronger connections to today's exciting world of technology.

These connections strengthen our own high quality standards and link us to new sources of innovation throughout the world.

Together we combine our talents, energies, and experience to provide you with an ever-expanding line of advanced connector products of unsurpassed value. These new connections also contribute to a fresh spirit of efficient service and delivery and

assure you of timely response to your ever-evolving needs.

From a new source of energy emerges a powerful new Elco.



Elco Corporation

A Kyocera Group Company

World Class Connections

Copyright 1990, Elco Corporation.
All rights reserved.

PCXI: THE ONLY MODULAR INDUSTRIAL PC.

PCXI changes the rules for industrial PCs.

For the first time, all PC functions are modular, interchangeable and upgradeable.

CPU modules are interchangeable (8088/286/386/486). Power modules are interchangeable (switching, linear, UPS, battery).

Graphics, disk, memory and modem modules are interchangeable.

And because PCXI is completely backward compatible, all the PC instrumentation, data acquisition and control boards in the marketplace are modular, interchangeable and upgradeable,

No longer are you tied to a single manufacturer. Instead, you can specify the right solution — with no compromise.

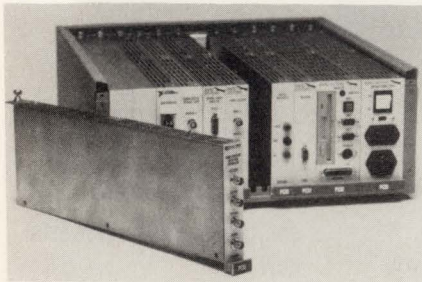

PCXI modules universally accept all PC cards. Instead of one source, you have your choice of the entire marketplace.

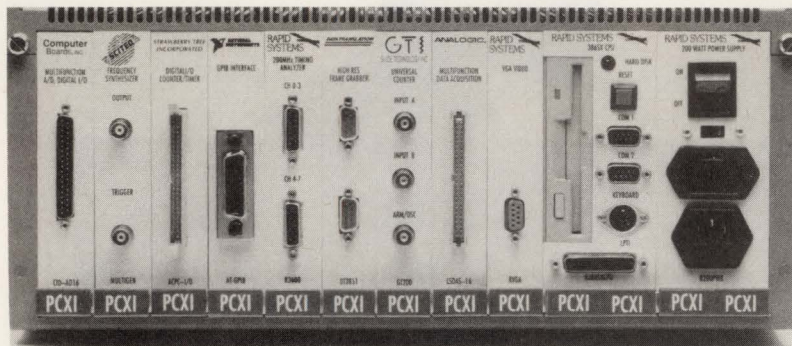

PCXI is available in portable, tabletop or rackmount versions, up to 13 slots. The rack width version shown here includes a 386 CPU, 200 watt power supply, VGA video, 40 meg hard drive, 1.4 meg floppy drive, plus eight slots for function modules.

A PC without the problems of PCs.

No longer is the PC a questionable environment for your product.

PCXI shielded modules solve the previous noise and emission problems of the PC environment — and offer protection for handling. Power and ground are specified and verifiable. Air flow and cooling are specified and verifiable. Termination problems are solved.

No longer must the PC be disassembled for the smallest change: PCXI modules easily slide in and out. No more awkward cabling from the rear of the PC: all connectors are on the front panel in standard configurations.

Finally, no longer is the future of the PC bus a question: PCXI Consortium manufacturers are committed to the continued development of PCXI as a multivendor standard.

We're 100% dedicated to finding a PCXI solution for your requirements.

Whether you're looking at one system or hundreds, Rapid Systems offers PCXI engineering services and OEM developer programs. We'll completely assemble a PCXI system for you,

assist as needed, or custom design a PCXI enclosure.

Plus, we maintain the industry's only data base of all engineering, industrial and scientific PC products in the marketplace and can assist you in finding the right system solution: both hardware and software.

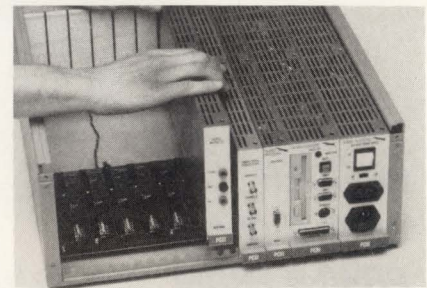

PCXI modules plug interchangeably into any function slot in the passive backplane, so you can conveniently reconfigure to the requirements of the job.

If you'd like the complete story on PCXI, call today: (206) 547-8311

RAPID SYSTEMS

Rapid Systems, Inc. 433 N. 34th Street, Seattle, WA 98103
(206) 547-8311, Telex 265017 UR, FAX 206-548-0322



Noninteger division synthesizes multiple clock frequencies

Generating multiple clock frequencies from a single reference often requires noninteger division. A basic algorithm provides an alternative to traditional division techniques by giving you some choice of the reference.

Sid Ghosh, *Design Assistance*

Designing frequency dividers that have noninteger division ratios is a problem that has long plagued the digital designer. The problem is particularly vexing when you must generate multiple clock frequencies synchronized to a single reference. One of the traditional methods for generating fractional division ratios is to use a frequency synthesizer that has a divide-by-M counter on the input to a phase-lock loop and a divide-by-N counter in the feedback path. Because the frequency synthesizer uses the ratio of N/M as the division ratio, however, this method loses accuracy when the synthesizer must generate a clock frequency that requires a non-rational divisor.

Another traditional method uses a very high frequency reference, which has a period equal to the least common multiple of all the desired clock periods. You then obtain the desired clock frequency using a counter that divides the reference by an integer. Often, however, this method requires a reference that is so high

in frequency that it becomes difficult, if not impossible, to generate.

A typical application that requires a large number of clock frequencies synchronized to a single reference is the generation of fractional T1 clocks for private T1 networks. In these "customer-premise-equipment" applications the fractional T1-clock rates can be any frequency in the range of $N \times 64$ kHz (where $N = 1$ to 24) or 56 kHz. You must synchronize these clock rates to the 1544-kHz T1 transmission rate. A variation on the integer divider method lets you synthesize the fractional T1-clock rates using noninteger division. The noninteger divider gives you some flexibility in selecting the reference frequency and enables you to use standard fast-logic families.

As with all synthesis methods, the noninteger division technique produces a clock frequency that has phase jitter. You must evaluate the jitter to determine if the technique is applicable to your needs. A couple of examples illustrate the technique and the resultant p-p phase jitter. The examples use a reference frequency, called HICLK, which is a multiple of the 1544-kHz T1 transmission rate.

$$\text{HICLK} = 24 \times 1544 \text{ kHz} = 37.056 \text{ MHz}$$

The technique always generates a clock frequency, CLK', which is twice the desired frequency ($\text{CLK}' = 2 \times \text{CLK}$) so you can use a divide-by-2 counter to obtain the desired frequency having a precise 50%

The noninteger divider gives you more flexibility in selecting the reference frequency.

duty cycle. The first example synthesizes a 128-kHz clock frequency. In this example, the division ratio is

$$DIV = HICLK/CLK' = 24 \times 1544/256 = 144.75.$$

The technique employs an algorithm that produces a division ratio (DIV) that is a positive real number. The division ratio is given by

$$DIV = (A \times d + B \times (d + 1))/(A + B),$$

where A and B are integers that are prime numbers and d is the integer value of the division ratio,

$$d = INT(DIV).$$

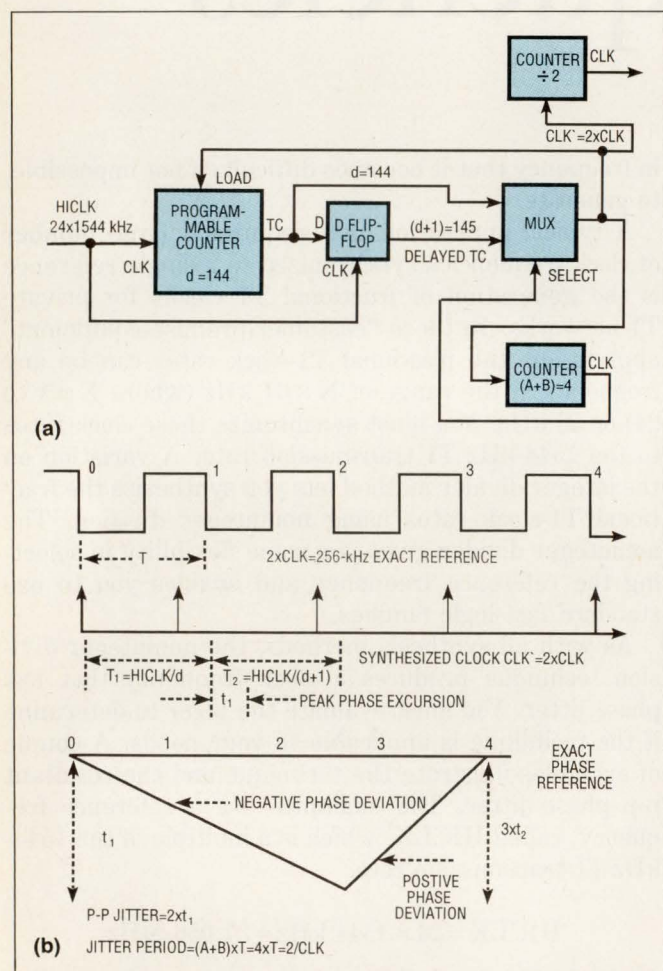

Fig 1—The block diagram shows an implementation to synthesize a 128-kHz clock (a). You can analyze the jitter on the CLK' signal by comparing the time to divide the HICLK by d or d+1 with the period of an exact 256-kHz reference (b).

You must determine the values for A and B before you can apply the division algorithm. The method for computing A and B will be shown later in the text, but for this example let A = 1 and B = 3. Therefore,

$$DIV = (144 + 3 \times 145)/4.$$

This expression indicates that you can obtain CLK' by dividing the HICLK reference frequency once by 144 and then thrice by 145. Then repeat the cycle after the four indicated divisions. **Fig 1a** shows a block diagram of a possible implementation. A digital multiplexer selects either the terminal count (TC) from a programmable counter that divides the HICLK by d = 144 or a delayed TC from a D flip-flop that delays TC by one HICLK period. The delayed TC is a signal representing a division by d + 1 = 145.

Each output from the multiplexer loads a count number into the programmable counter and clocks a divide-by-4 (A + B) counter to control the multiplexer's selection. The control causes the multiplexer to select one TC signal and three-delayed TC signals before repeating the cycle. Another counter divides the output frequency of the multiplexer (CLK') by 2 to generate the desired clock frequency (CLK) having a 50% duty cycle.

Fig 1b illustrates the jitter on the synthesized CLK' period. The diagram compares the edge transitions of the synthesized 256-kHz clock with the edge transitions of an exact 256-kHz reference. You calculate the peak phase jitter using the following relationships:

T = period of the exact reference,

$$T = 1/(256 \times 10^3) = 3.906 \mu\text{sec},$$

$$T_d = d \times (\text{HICLK period}),$$

$$T_d = 144 \times (1/(24 \times 1544 \times 10^3)) = 3.886 \mu\text{sec},$$

$$T_{d+1} = (d + 1) \times (\text{HICLK period}),$$

$$T_{d+1} = 145 \times (1/(24 \times 1544 \times 10^3)) = 3.912 \mu\text{sec},$$

$$t_1 = T - T_d = 20.2 \text{ nsec}, \text{ and}$$

$$t_2 = T_{d+1} - T = 6.75 \text{ nsec}.$$

The synthesized CLK' period lags behind the period of an exact 256 kHz clock by t₁ = 20.2 nsec when the division ratio is 144 and leads the period of an exact

256-kHz clock by $t_2 = 6.75$ nsec when the division ratio is 145. Because 3×6.75 nsec = 20.2 nsec, the phase of the synthesized CLK' coincides with the phase of an exact 256-kHz clock at the start of each cycle. But within the cycle the p-p jitter is $2 \times 20.2 = 40.4$ nsec because the phase deviation can be either positive or negative. The jitter frequency is $256/4 = 64$ kHz ($CLK'/(A+B)$).

A second example synthesizes a 256-kHz clock from the HICLK. The CLK' frequency in this case is 512 kHz. Therefore,

$$DIV = 24 \times 1544 / 512 = 72.375, \text{ and}$$

$$d = \text{INT}(DIV) = 72.$$

Let $A = 5$ and $B = 3$ then

$$DIV = (5 \times 72 + 3 \times 73) / 8.$$

Fig 2a shows a block diagram of the implementation. In this example, the multiplexer selects either five

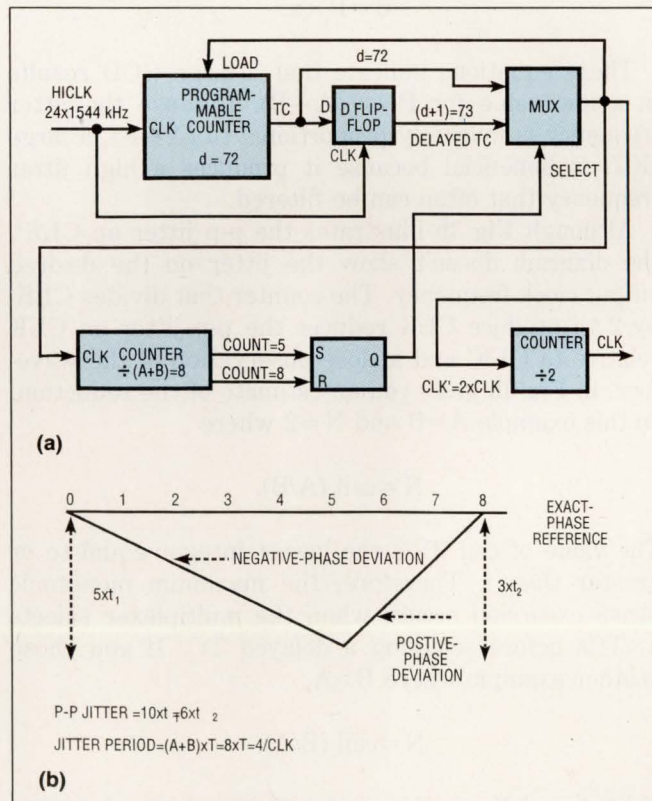

Fig 2—This implementation (a) is one possible way to synthesize a 256-kHz clock. This implementation, however, results in a large p-p jitter (b) on the CLK' signal.

Tics from a programmable counter that divide the HICLK by 72, or three delayed TCs from the D flip-flop that divide the HICLK by 73. The output of the multiplexer clocks a divide-by-8 ($A+B$) counter that decodes the fifth and the eighth count to control the multiplexer. A set-reset flip-flop uses the signals from the divide-by-8 counter to control the multiplexer. As in the first example, each output from the multiplexer loads the programmable counter with a count number and a counter divides the CLK' frequency by 2 to generate the 256-kHz clock with a 50% duty cycle.

In this example, t_1 and t_2 calculate to be 10.1 nsec and 16.9 nsec, respectively. Fig 2b shows that the p-p jitter is approximately 100 nsec ($10 \times t_1$). You can reduce the phase jitter by modifying the control to the multiplexer. For example, the control circuitry could alternate the selection of the TCs and the delayed TCs for the first six counts of the cycle followed by the selection of 2 TCs. This modification, or a similar selection scheme, maintains the same division ratios for the cycle but reduces the p-p jitter on the CLK' frequency.

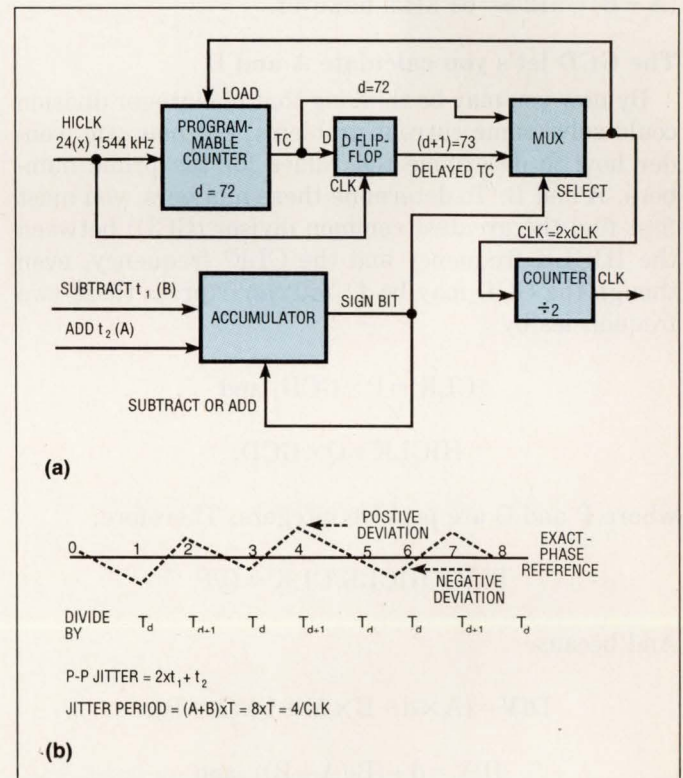

Fig 3—The block diagram shows a modification that alters the selection of the terminal counts and the delayed terminal counts to synthesize the 256-kHz clock (a). The modification produces less jitter (b) than the implementation shown in Fig 2a.

You must evaluate the synthesized clock jitter to determine whether noninteger division is applicable to your needs.

The block diagram shown in **Fig 3a** implements this modification. The concept uses an accumulator, which accumulates the values for t_1 and t_2 , to control the multiplexer. When the sign bit from the accumulator is positive, the multiplexer selects TC and the accumulator subtracts the value of t_1 from its contents. Similarly, when the sign bit is negative, the multiplexer selects delayed TC, and the accumulator adds t_2 to its contents. The accumulator's contents is initially 0, and the contents return to 0 after $A + B$ divisions.

The noninteger division algorithm guarantees that the accumulator's content will converge to 0 after starting from any initial condition and that there will never be an overflow condition. In addition, because t_1 and t_2 are real numbers, you can replace their values with the integers for B and A , which are proportional to t_1 and t_2 , respectively. **Table 1** tabulates the sequence of events for a cycle to synthesize the 256-kHz clock. Comparing **Fig 2b** with **Fig 3b** shows that the modification reduces the p-p jitter from 100 nsec to 36 nsec. The jitter frequency for both cases is $CLK' / (A + B) = 512/8 = 64$ kHz, however.

The GCD let's you calculate A and B

By now you may be thinking that noninteger division could solve some current problems, but now you wonder how to determine the values for the prime numbers, A and B . To determine these numbers, you must first find the greatest common divisor (GCD) between the HICLK frequency and the CLK' frequency, even though the GCD may be 1. You can express these two frequencies by

$$CLK' = P \times GCD, \text{ and}$$

$$HICLK = Q \times GCD,$$

where P and Q are positive integers. Therefore,

$$DIV = HICLK/CLK' = Q/P.$$

And because

$$DIV = (A \times d + B \times (d + 1)) / (A + B),$$

$$DIV = d + (B / (A + B)), \text{ and}$$

$$DIV = d + x,$$

where x is a positive number equal to or greater than

Table 1—Sequence of accumulator contents

Sign bit	t_1 and t_2 accumulator contents (n sec)	A and B accumulator contents
+	0	0
-	-10.1	-3
+	+6.8	+2
-	-3.3	-1
+	+13.6	+4
+	+3.4	+1
-	-6.7	-2
+	+10.2	+3
+	0	0

0 and less than 1, you can use a small amount of algebra on these equations, yielding

$$A + B = P,$$

$$A = P \times (1 - x), \text{ and}$$

$$B = P \times x.$$

These equations indicate that a large GCD results in a low value for P or $(A + B)$. Because the jitter frequency is inversely proportional to $(A + B)$, a large GCD is beneficial because it produces a high jitter frequency that often can be filtered.

Although **Fig 3b** illustrates the p-p jitter on CLK', the diagram doesn't show the jitter on the desired output clock frequency. The counter that divides CLK' by 2 to produce CLK reduces the p-p jitter on CLK relative to CLK' and a close observation of the waveform in **Fig 3b** gives you an estimate of the reduction. In this example $A > B$ and $N = 2$ where

$$N = \text{ceil}(A/B).$$

The value of $\text{ceil}(f)$ is the lowest integer equal to or greater than f . Therefore, the maximum monotonic phase excursion occurs when the multiplexer selects $2 \times$ TCs before selecting a delayed TC. If you chose another example where $B > A$,

$$N = \text{ceil}(B/A).$$

If $B > A$ and $N = 2$, the maximum monotonic phase excursion occurs when the multiplexer selects $2 \times$ delayed TCs before selecting a TC.

In general, when $A > B$ and N is even, there is a

“If You Just Want To Compete, You Can Use Any Solder Mask System. If You Want To Win, You Need VALU.™”

Robert Herring, Jr.
Vice President Manufacturing
HERCO Technology Corp.

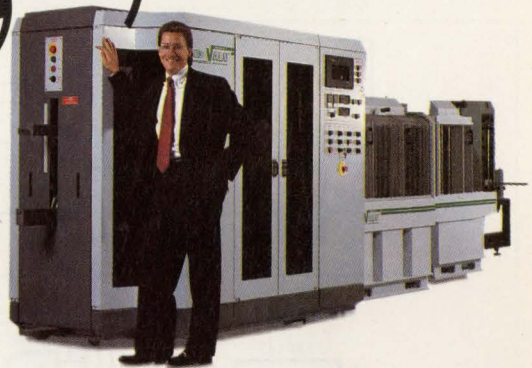

When HERCO Corporation wanted a system that would give their customers the cost-effectiveness of liquid solder masks and the design freedom of dry film, they chose the DuPont VALU™ System – the only wet/dry solder mask system available today.

The VALU system is helping HERCO meet the demand for sophisticated surface mount circuitry designs, because it allows wide latitude encapsulation of fine line circuitry, regardless of orientation and circuit heights. And it creates a thin, uniform coating that is clean and free of skips, voids and pinholes – all in a single pass. This means better PWBS for their customers.

And greater first-pass yields for HERCO.

The low viscosity liquid flows easily to fill spaces between circuitry, and the thin dry film capping layer gives assured coverage over the copper. Also, because of the dry film component, VALU can tent via holes to achieve 30 to 50% better real estate utilization.

So, if you're looking for a solder mask system that's a step beyond dry film or liquid systems alone, choose the one that's helping HERCO become an industry leader. The DuPont VALU System.

For a free brochure and to arrange for a free trial coating of VALU on your PWBS, call **1-800-237-4357** today.

DuPont Electronics
Share the power of our resources.



The technique always synthesizes a clock that runs at twice the desired clock frequency, which you divide by 2 to obtain the desired clock having a 50% duty cycle.

maximum of $N \times TCs$ that produce a peak time lag of $N \times t_1$ sec from a theoretical exact period before one, and only one, delayed TC occurs. When N is odd, the peak time lag is $N - 1 \times t_1$ from the theoretical exact period. In addition, because a period of the CLK signal is twice the period of the CLK' signal, 1 period of the CLK signal, which contains a time lead of t_2 due to the delayed TC period, always includes a time lag of t_1 due to the TC period either preceding or following the transition that causes the time lead. Therefore, the peak time lead of the CLK period relative to a theoretical exact period is $t_2 - t_1$. To summarize,

If $N = \text{even}$, the p-p jitter = $N \times t_1 + (t_2 - t_1)$,

where p-p jitter = $(N - 1) \times t_1 + t_2$.

If $N = \text{odd}$, the p-p jitter = $(N - 1) \times t_1 + (t_2 - t_1)$,

where p-p jitter = $(N - 2) \times t_1 + t_2$.

For those situations where $B > A$ and $N = \text{ceil}(B/A)$, you then swap t_1 and t_2 . Because the p-p jitter of the CLK' signal is always $N \times t_1 + t_2$, the divide-by-2 counter reduces the p-p jitter, but the reduction is most pronounced when N is a small number. Also, the jitter frequency on the CLK signal is the same as the jitter frequency on the CLK' signal. You calculate the percentage of p-p output jitter by

$$\% \text{ p-p jitter} = \text{p-p jitter} \times (\text{CLK frequency in Hz}) \times 100.$$

Fig 4 shows a circuit that synthesizes all of the fractional T1 clocks used in private networks. The circuit employs a 9-stage programmable counter, comprising a JK flip-flop (IC_{1A}) and 2 binary counters (IC₂ and IC₃), which divide the HICLK frequency. The 9-stage counter requires a programmable number for each fractional T1 clock given by

$$\text{PRE-LOAD} = 511 - d.$$

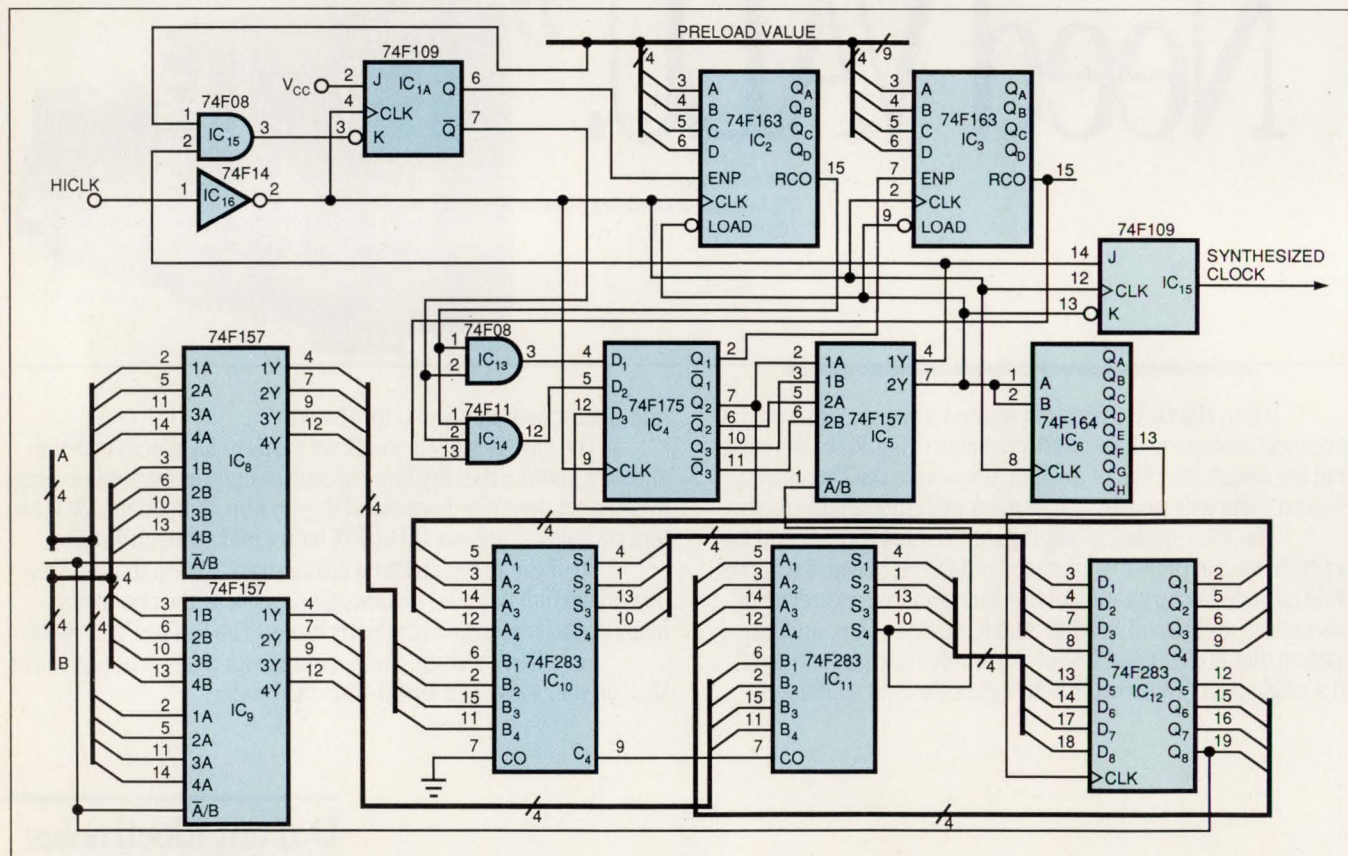
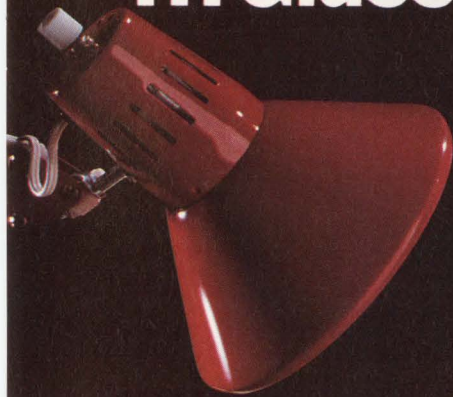

Fig 4—The circuitry synthesizes all of the fractional T1 clock frequencies. A μP or a PROM must interface to the circuit to supply the PRE-LOAD value, the A value, and the B value for each synthesized clock.

What do you mean, you can't offer me a 60 KV, 100 W standard supply in a 3-1/2 inch rack ... Glassman can!



That's right. Only Glassman's EH Series of 100 W off-the-shelf supplies offers a full family rated from 0-1 KV up to 0-60 KV in a 13 pound, 3-1/2 inch rack-mounted package. All feature individual voltage and current controls and meters. All are provided with remote control facilities, including voltage and current programming, output voltage and current monitors, high voltage TTL-compatible enable/disable, and safety interlock terminals.

Unique to all standard Glassman HV supplies, including the EH Series, is air insulation of all high

voltage components. Air insulation provides field-proven reliability, easy access for service, and a sharp reduction in weight.

Write or call for more information on Glassman's complete line of HV power supplies.



Glassman High Voltage, Inc.

Route 22 (East),
Salem Industrial Park,
P.O. Box 551,
Whitehouse Station, NJ 08889
Telephone (201) 534-9007,
TWX 710-480-2839.
FAX: (201) 534-5672

GLASSMAN HIGH VOLTAGE INC.

CIRCLE NO. 129



You can reduce the p-p phase jitter by altering the sequence that the multiplexer selects either the terminal count or the delayed terminal count.

Table 2—Fractional T1 clock parameters

Clk (kHz)	DIV	d	Pre-load value	GCD	P	A	B	p-p Jitter ns	% Jitter
56	330.86	330	181	16	7	1	6	42.41	0.24
64	289.50	289	222	64	2	1	1	0.00	0.00
128	144.75	144	367	64	4	1	3	26.99	0.35
192	96.50	96	415	192	2	1	1	0.00	0.00
256	72.38	72	439	64	8	5	3	26.99	0.69
320	57.90	57	454	64	10	1	9	43.18	1.38
384	48.25	48	463	192	4	3	1	26.99	1.04
448	41.36	41	470	64	14	9	5	26.99	1.21
512	36.19	36	475	64	16	13	3	37.11	1.90
576	32.17	32	479	192	6	5	1	35.98	2.07
640	28.95	28	483	64	20	1	19	48.58	3.11
704	26.32	26	485	64	22	15	7	26.99	1.90
768	24.13	24	487	192	8	7	1	40.48	3.11
832	22.27	22	489	64	26	19	7	26.99	2.25
896	20.68	20	491	64	28	9	19	26.99	2.42
960	19.30	19	492	192	10	7	3	26.99	2.59
1024	18.09	18	493	64	32	29	3	47.23	4.84
1088	17.03	17	494	64	34	33	1	50.80	5.53
1152	16.08	16	495	192	12	11	1	44.98	5.18
1216	15.24	15	496	64	38	29	9	39.77	4.84
1280	14.48	14	497	64	40	21	19	26.99	3.45
1344	13.79	13	498	192	14	3	11	38.55	5.18
1408	13.16	13	498	64	44	37	7	44.16	6.22
1472	12.59	12	499	64	46	19	27	26.99	3.97
1536	12.06	12	499	192	16	15	1	47.23	7.25

Note: HICLK = 24 × 1544 kHz

The gates at IC₁₃ and IC₁₄ select either the TC, to divide the HICLK by d, or the delayed TC to divide the HICLK by d + 1. The D flip-flops at IC₄ synchronize the TC and the delayed TC to the HICLK. The multiplexer at IC₅ selects one of the synchronized signals from the divider. The selection depends on the MSB from an accumulator, comprising the 2 parallel adders at IC₁₀ and IC₁₁ along with the 8-bit latch at IC₁₂.

By entering the value for A as an input to the selector at IC₈ and the 2's complement value for B as an input to the selector at IC₉, the parallel adders can either add A or subtract B from the accumulator contents. The output of the latch at IC₁₁ selects either IC₈ or IC₉. In addition, each output from the multiplexer loads the PRE-LOAD value into the 9-stage programmable counter and the J-K flip-flop at IC_{1B} divides the multiplexer output by 2 to generate the fractional T1 clock. The HICLK signal also clocks the counter at IC₆ to delay the multiplexer's output by 8 HICLK periods before the latch at IC₁₁ produces the control signal for IC₈ and IC₉.

The circuit must interface with either a μP or a PROM to provide the PRE-LOAD values for the 9-stage programmable counter, the value for A, and the 2's complement value for B. These values are different

for each synthesized clock. Table 2 tabulates these values and the other parameters necessary for synthesizing all of the fractional T1 clock frequencies. Although the HICLK equals 24 × 1544 kHz to generate the tabulated clock frequencies, you could use another HICLK frequency, such as HICLK = 32 × 1544 Hz, to improve the jitter performance.

EDN

Author's biography

Sid Ghosh is a telecommunications consultant and has been president of Design Assistance in Crescent City, CA for two years. He has experience in the design of digital cross-connectors, digital loop carriers, multiplexers (T1, Sonet products, and Fiber), and channel banks. He is a senior member of the IEEE and holds BS degrees from Calcutta University and London University. In his spare time he enjoys jogging and hiking.

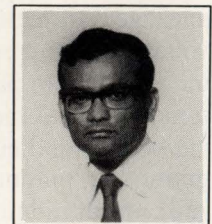

Article Interest Quotient (Circle One)
High 497 Medium 498 Low 499

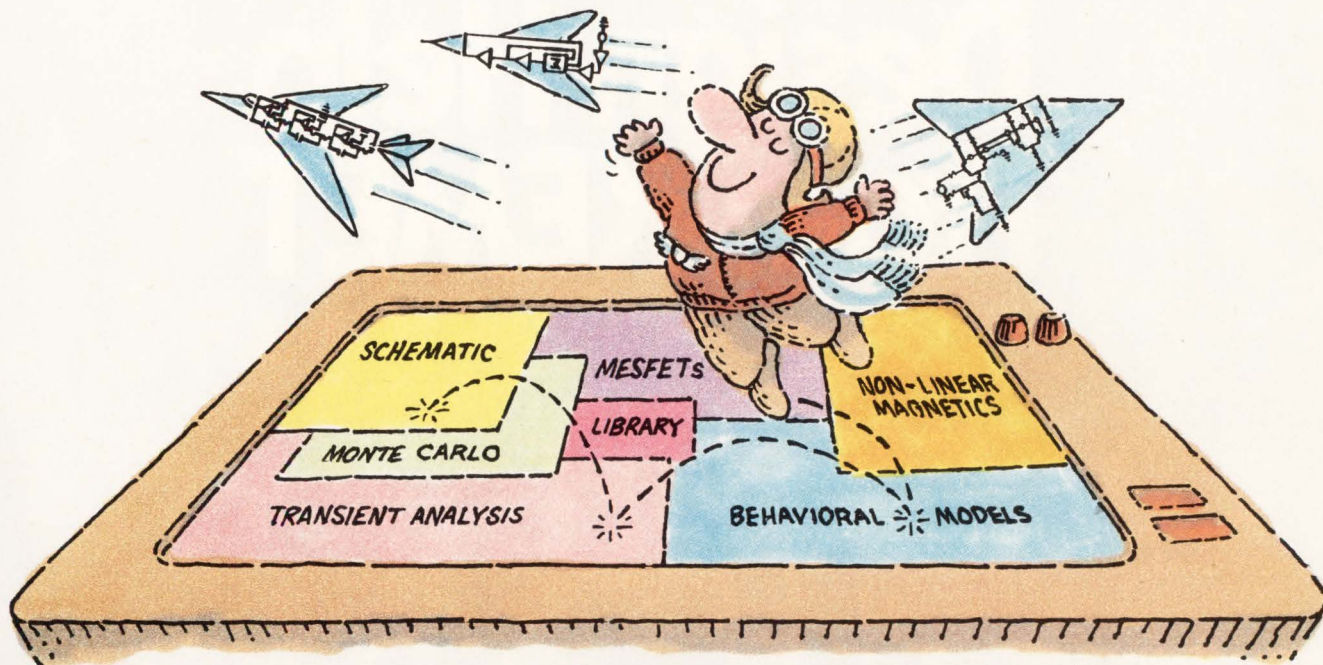

THE NEW MICRO-CAP III.™ SO YOU CAN TEST-FLY EVEN MORE MODELS.

It wasn't easy. But we did it. Made the long-time best-selling IBM® PC-based interactive CAE tool even better.

Take modeling power. We've significantly expanded math expression capabilities to permit comprehensive analog behavioral modeling. And, beyond Gummel Poon BJT and Level 3 MOS, you're now ready for nonlinear magnetics modeling. Even MESFET modeling.

Analysis and simulation is faster, too. Because the program's now in "C" and assembly language. That also means more capacity—for simulating even larger circuits.

As always, count on fast circuit creation, thanks to window-based operation and a schematic editor. Rapid, right-from-schematics analysis—AC, DC, Fourier and transient—via SPICE-like routines. The ability to combine digital/analog circuit simulations using integrated switch

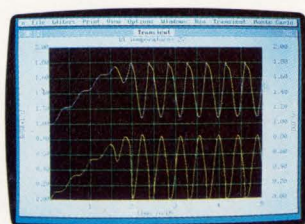

Transient analysis

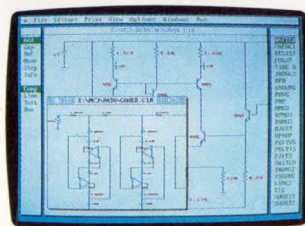

Schematic editor

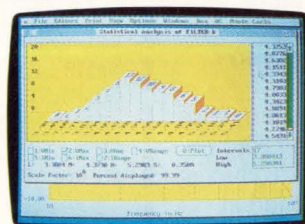

Monte Carlo analysis

models and parameterized macros. And stepped component values that streamline multiple-plot generation.

And don't forget MICRO-CAP III's extended routine list—from impedance, Nyquist diagrams and BH plots to Monte Carlo for statistical analysis of production yield. The algebraic formula parsers for plotting virtually any function. The support for Hercules, CGA, MCGA, EGA and VGA displays. Output for plotters and laser printers.

Cost? Still only \$1495. Evaluation versions still only \$150. Brochure and demo disk still free for the asking. Call or write for yours today. And see how easily you can get ideas up and flying.

spectrum

1021 S. Wolfe Road
Sunnyvale, CA 94086
(408) 738-4387

Design Help From KEMET



Solid Tantalum



Multilayer Ceramic



Precision Film

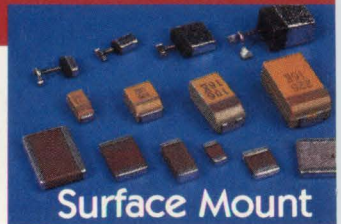

Surface Mount

From constant product testing and analysis to a steady offering of engineering bulletins and applications assistance, KEMET's know-how is working for you!

Before we could offer you a fully tested more crack-resistant ceramic chip dielectric, we spent years in the lab, using new analysis tools, trying new processes, modifying basic materials.

We provide a whole series of bulletins dealing with surface mount caps: reflow and wave soldering techniques, repair, mounting pad considerations. Producing high-performance components is just half our job at KEMET. Giving you the industry's best technical support is the other half. And always KEMET makes it easy to buy, worldwide.

CIRCLE NO. 135

Tell Me More, KEMET...

- Send me your general catalog.
- Have a sales representative call me.

I'm interested in:

- Ceramics
- Tantalums
- Mil-Spec
- Surface Mount
- Customs
- Film

NAME _____
 COMPANY _____
 ADDRESS _____
 CITY _____ STATE _____ ZIP _____
 PHONE _____

P.O. Box 5928
 Greenville, SC 29606
 803/963-6348

KEMET[®]
 Electronics Corporation

Single Signal Interconnects

- Offer high performance and economy
- Impedance controlled

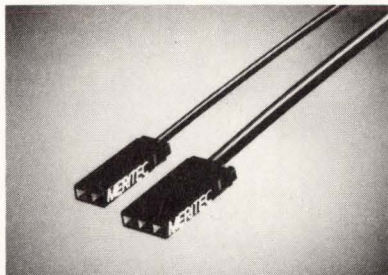

Meritec's economical 1x2 and 1x3 Single Signal Interconnects (SSITM) are engineered to match application requirements for controlled impedance and propagation rate while minimizing crosstalk. The assemblies mate with .025" square or round pins and are side-to-side and end-to-end stackable on a .100" x .100" grid. A spring latch connects the termination to the housing or to Meritec's Single Signal Carrier Systems (SSCTM), which allow grouped interfacing with single, dual or triple row headers.

Mark No. 40 on Inquiry Card

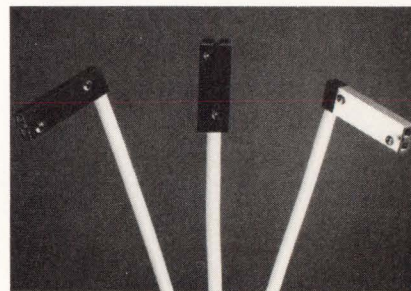
**Low crosstalk Shielded Performance Interconnects**

- EMI/RFI shielded
- Impedance controlled

Shielded Performance Interconnects (SPITM) from Meritec are EMI/RFI shielded and impedance controlled to the PC board. The assemblies are available in axial or right angle configurations with nickel plated or epoxy coated metal housings. Boxed contacts with thermo resistant welding to the conductors assure electrical continuity. SPI interconnects mate with standard .025" square or round pins and are side-to-side and end-to-end stackable on a .100" x .100" grid. Also available in a bonded format for multi socket systems.

Mark No. 40 on Inquiry Card

High-Performance Interconnects That Terminate High Cost.

Meritec has terminated the high cost of high performance interconnects for fast logic applications. We produce a full line of cable assemblies for applications in the 3ns to sub nanosecond range—engineered to match your requirements for controlled impedance and propagation rate while minimizing crosstalk. We deliver assemblies of unparalleled quality. On time. At a very reasonable price.

Our complete line includes Single Signal Interconnects (SSI™), Shielded Performance Interconnects (SPI™) and Multi Signal Interconnects (MSI™), terminated to a diversity of controlled impedance cables, including coax, twin coax, FEP, PTFE and our Flatex™ textile cable.

Call Meritec today at 216-354-3148 for more information and a free copy of our capabilities brochure.

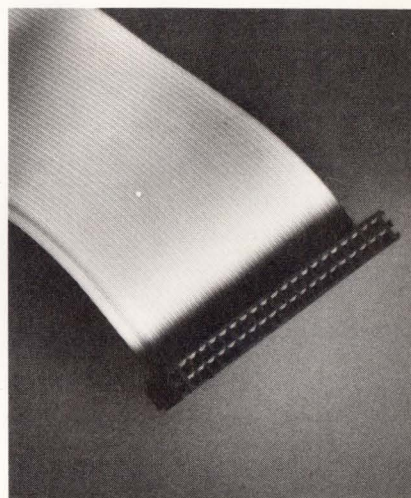
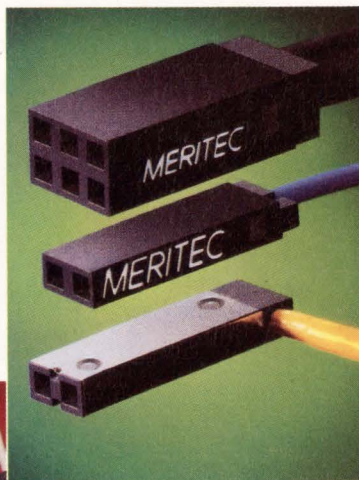
**Multi Signal Interconnects terminated to FEP or PTFE cable**

- High strength molded terminations
- Controlled impedance

Precision, high strength molded terminations on Meritec's Multi Signal Interconnects (MSITM) assure high reliability in critical applications. The assemblies offer controlled impedance and low crosstalk. Standard impedances are available from 50 to 95 Ω. EMI/RFI shielding is optional. The connectors are compatible with latch and eject headers and are available in high or low profile configurations. The high profile configuration is available with pull tabs.

Mark No. 40 on Inquiry Card

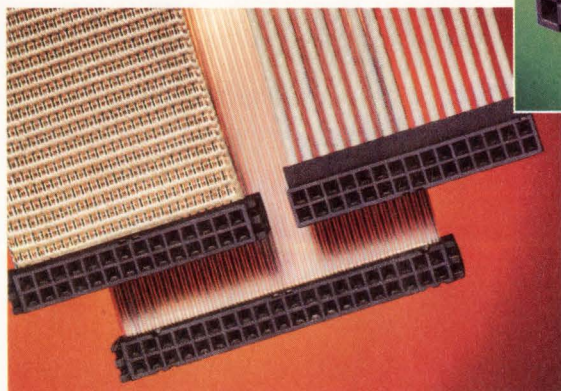

Where quality assures performance

1359 West Jackson Street
P.O. Box 8003
Painesville, Ohio 44077
216-354-3148
FAX: 216-354-0509

Emulation power without compromise



EZ-Pro™ 1.5 price performance leader for 8-bit in-circuit emulation.

Power in selection—System support for more processors than any other manufacturer in the world. Power in product range to match your needs—from economical basic configurations to fully featured systems.

Power in performance—Completely integrated capabilities include options such as versatile trace, performance analysis, EPROM programming, C source level debugging, over 100 personality modules with a common universal platform for different processors, C cross compilers, cross assemblers and more.

Power without compromise—All invented here. Supported here. And available to rent or purchase now.



EZ-Pro 2.1 industry workhorse for 16-bit and 8-bit designs.

Free Demo Disk!

See how easily you can use these sophisticated development tools. Our marketing department will ship your demo disk today. Please Call:

(714) 731-1661

 **american
automation**

Headquarters: 2651 Dow Avenue, Tustin, California 92680-7207
Telephone (714) 731-1661. **European Headquarters:** UK Oxford 993 778991. **Distributors:** Australia 3-5601011, Belgium 2-4681400, France 1-69308050, India 418387, Indonesia 22-71880, Italy 2-50722282, Korea 2-7849942, Spain 1-7291155, Switzerland 1-4354111, Taiwan 2-7368150, West Germany 89-6127087.

A Simple Ultra-Low Dropout Regulator

Jim Williams

Switching regulator post regulators, battery powered apparatus, and other applications frequently require low drop-out linear regulators. Often, battery life is significantly affected by the regulator's dropout performance. Figure 1's simple circuit offers lower dropout voltage than any monolithic regulator. Dropout is below 50mV at 1A, increasing to only 450mV at 5A. Line and load regulation are within 5mV, and initial output accuracy is inside 1%. Additionally, the regulator is fully short circuit protected, and has a no load quiescent current of 600 μ A.

Circuit operation is straightforward. The 3-pin LT1123 regulator (TO-92 package) servo controls Q1's base to maintain its feedback pin (FB) at 5V. The 10 μ F output capacitor provides frequency compensation. If the circuit is located more than six inches from the input

source the optional 10 μ F capacitor should bypass the input. The optional 20 Ω resistor limits LT1123 power dissipation and is selected based upon the maximum expected input voltage (see Figure 2).

Normally, configurations of this type offer unpredictable short circuit protection. Here, the MJE1123 transistor shown has been specially designed for use with the LT1123. Because of this, beta based current limiting is practical. Excessive output current causes the LT1123 to pull down harder on Q1 until beta limiting occurs. Under these conditions the controlled pull down current combines with Q1's beta and safe operating area characteristics to provide reliable short circuit limiting. Figure 3 details current limit characteristics for 30 randomly selected transistors.

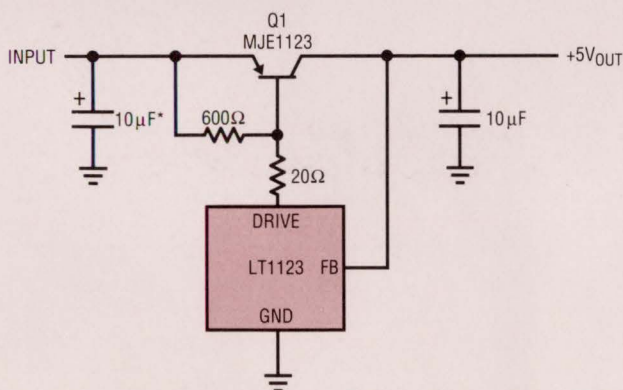

* = OPTIONAL (SEE TEXT)
MJE1123 = MOTOROLA

DN44 • TA01

Figure 1. The Ultra-Low Dropout Regulator. LT1123 Combines with Specially Designed Transistor for Lowest Dropout and Short Circuit Protection.

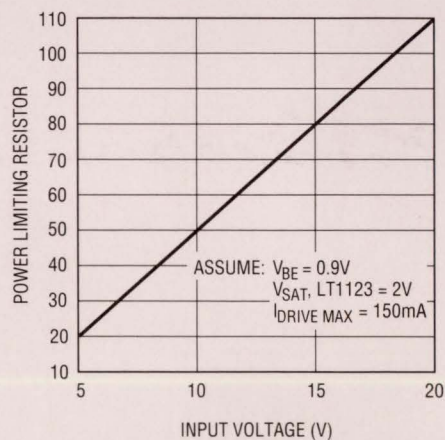

DN44 • TA04

Figure 2. LT1123 Power Dissipation Limiting Resistor Value vs Input Voltage

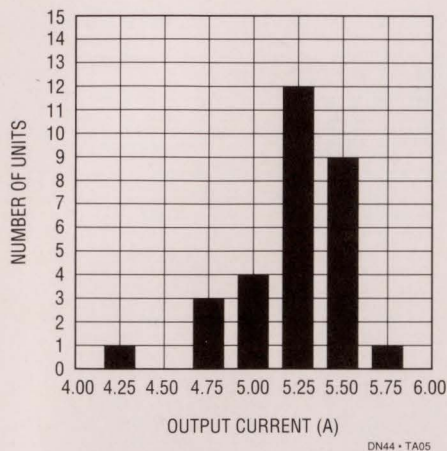

Figure 3. Short Circuit Current for 30 Randomly Selected MJE1123 Transistors at $V_{IN} = 7V$

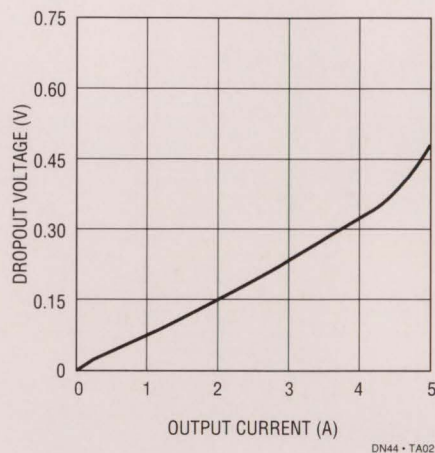

Figure 4. Dropout Voltage vs Output Current

Figure 4 shows dropout characteristics. Even at 5A, dropout is about 450mV, decreasing to only 50mV at 1A. Monolithic regulators cannot approach these figures, primarily because monolithic power transistors do not offer Q1's combination of high beta and excellent saturation. For comparison, Figure 5 compares the circuit's performance against some popular monolithic regulators. Dropout is ten times better than 138 types, and significantly better than the other types shown. Because of Q1's high beta, base drive loss is only 1%-2% of output current, even at full 5A output. This maintains high efficiency under the low $V_{IN} - V_{OUT}$ conditions the circuit will typically operate at. As an exercise, the MJE1123 was replaced with a 2N4276, a Germanium device. This combination provided even lower dropout performance, although current limit characteristics cannot be guaranteed.

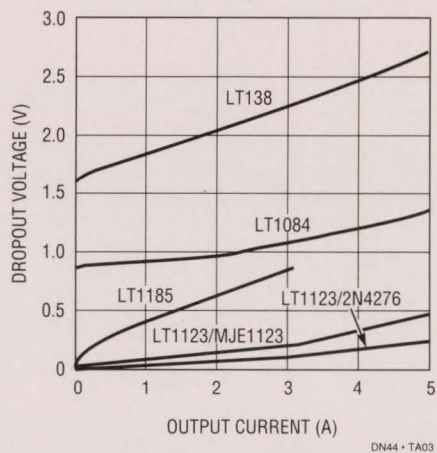

Figure 5. Dropout Voltage vs Output Current for Various Regulators

For literature on our Low Dropout Regulators, call (800) 637-5545. For applications help, call (408) 432-1900, Ext. 456

DESIGN IDEAS

EDITED BY CHARLES H SMALL

Power booster operates efficiently

A Simopoulos
Conversion Devices Inc, Brockton, MA

The power booster in **Fig 1** functions as either a high-efficiency "power multiplexer" or, if you supply an external signal-source, as a high-power linear amplifier.

If you want to drive a load with a high-power square wave, the circuit simply draws power from two external power sources, V_1 and V_2 , alternately. In this mode, the circuit's power-handling devices function as switches, dissipating minimal power. The RC time constant of the integrator, IC_1 , determines the circuit's oscillation period. The integrator's triangle-wave output drives a simple triangle-to-square-wave converter.

If you supply an external drive waveform, the circuit

functions as a linear amplifier, and, consequently, inherently dissipates a varying portion of that power. The power amplifier is stable for gains ≥ 15 .

Diodes D_1 and D_2 limit the FET's gate-voltage swing to less than 15V. D_3 is a dual Schottky diode that protects the FETs from short circuits between the two supplies, V_1 and V_2 , through an FET's parasitic diode. With D_3 in place, you can choose either power channel for the higher voltage input.

To drive the FETs, Q_5 and Q_6 , at switching frequencies greater than 1 kHz, you will have to employ gate drivers for them. (EDN BBS /DL_SIG #922) **EDN**

To Vote For This Design, Circle No. 746

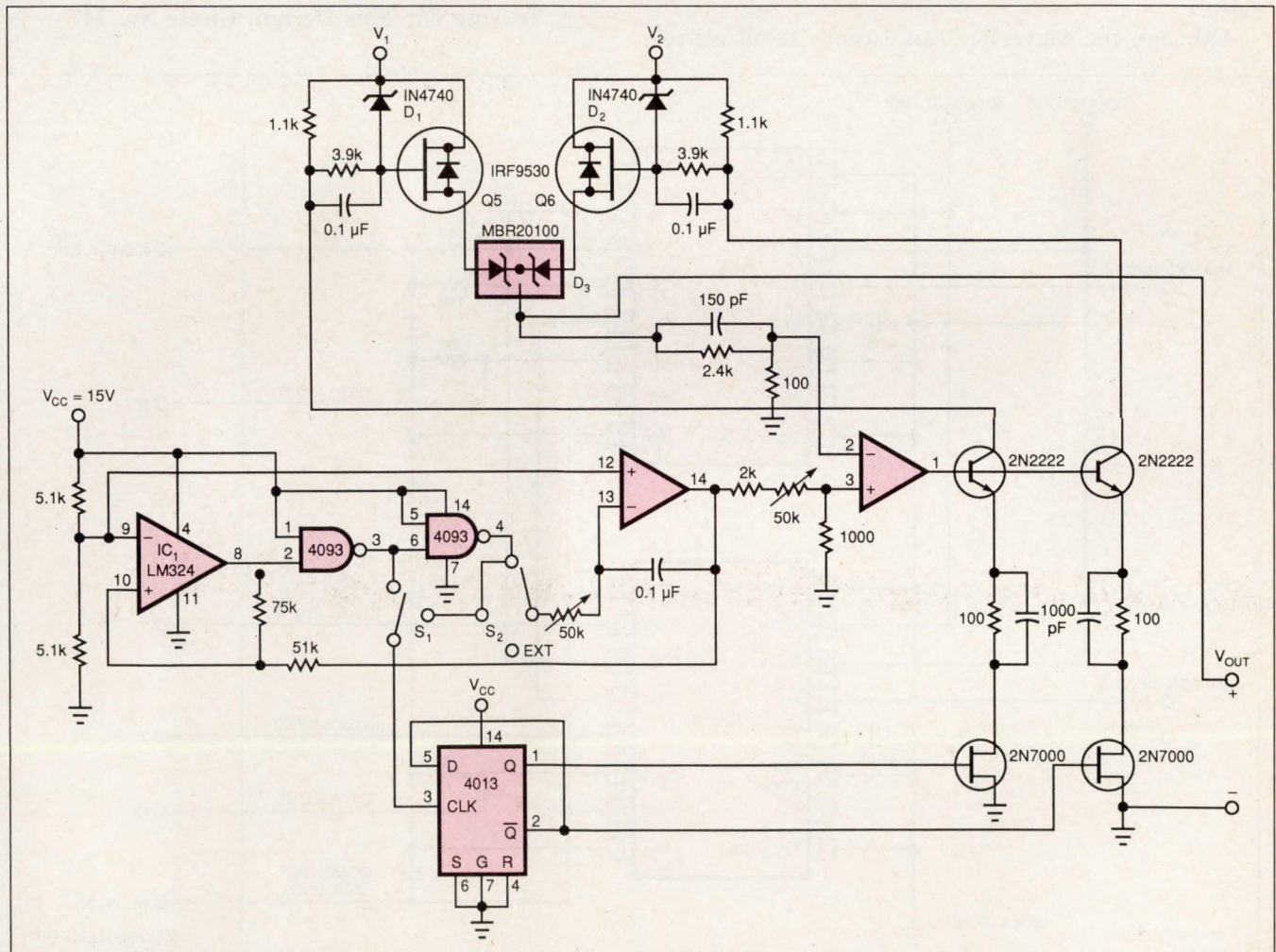

Fig 1—This power booster works as either a switch-mode power multiplexer or a linear amplifier.

A/D board hooks to IBM PC printer port

Bob Underwood
 Maxim Integrated Products, Sunnyvale, CA and
 Mark Underwood
 Cupertino, CA

An IBM PC can operate the two 12-bit A/D converters in Fig 1 via its printer port. The converters' serial outputs use only two of the printer port's eight data lines (DATA A OUT, DATA B OUT). Because the IBM PC's printer port supplies no power, interface software running on the PC programs the six unused data lines high. Busing these data lines provides power for the digital portion of the A/D converters. (The converters have internal optoisolators. Consequently, you must provide isolated supplies for their analog sides.)

Although the converters can execute 12-bit conver-

sions in 6 μ sec, the slow software-driven approach used in this Design Idea stretches conversion periods out to about 100 μ sec (depending on your PC's clock speed).

The circuit takes advantage of the converters' optoisolator inputs to put their clock and start inputs in series. Therefore, the converters operate synchronously.

The accompanying software starts the conversions, issues clock pulses, reads the data bits as they become available, and stores them in memory. The listing is too long to reproduce here; you can obtain it from the EDN BBS (617-558-4241, 2400, 8, N, 1).

(EDN BBS /DL SIG #924)

EDN

To Vote For This Design, Circle No. 747

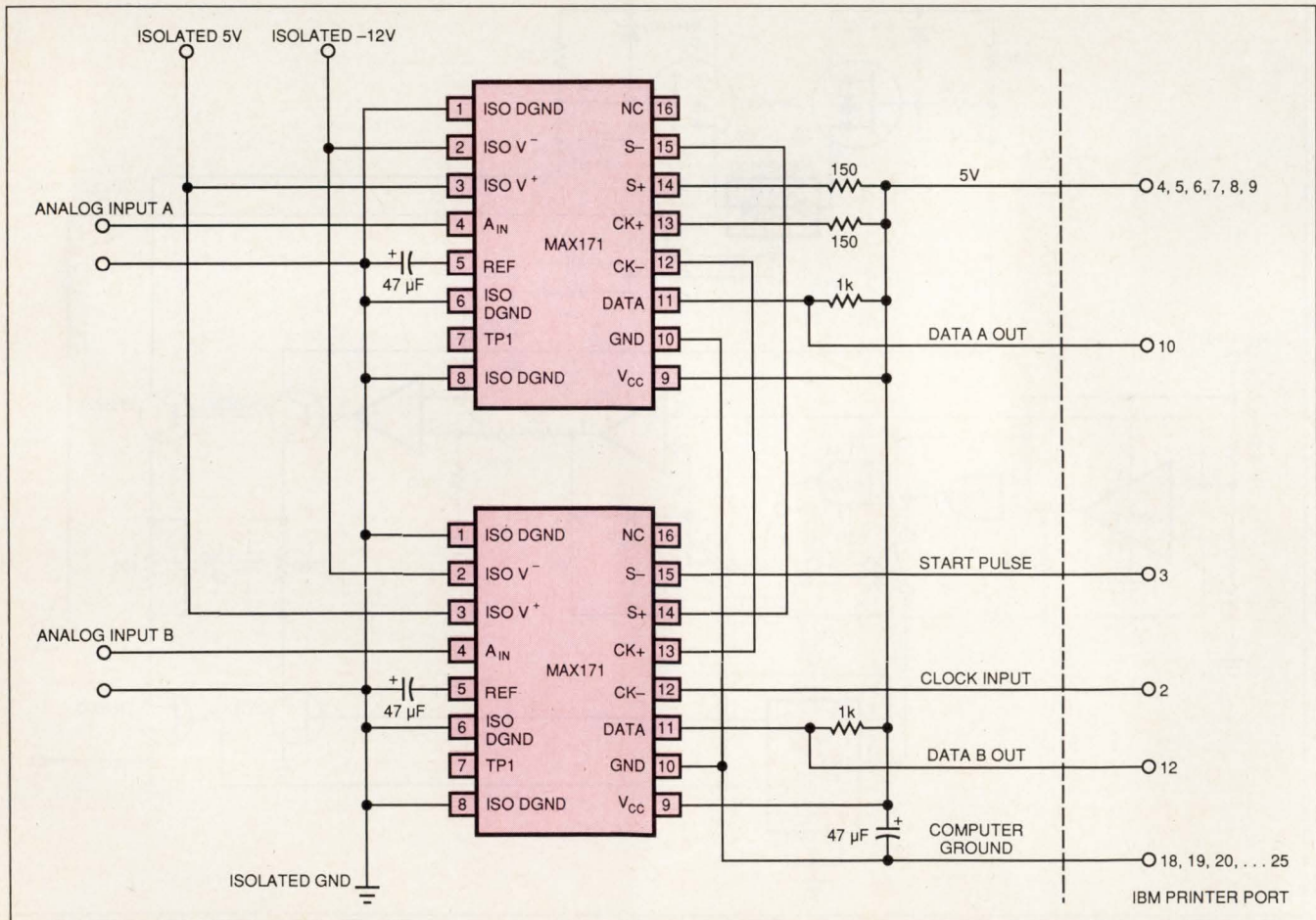
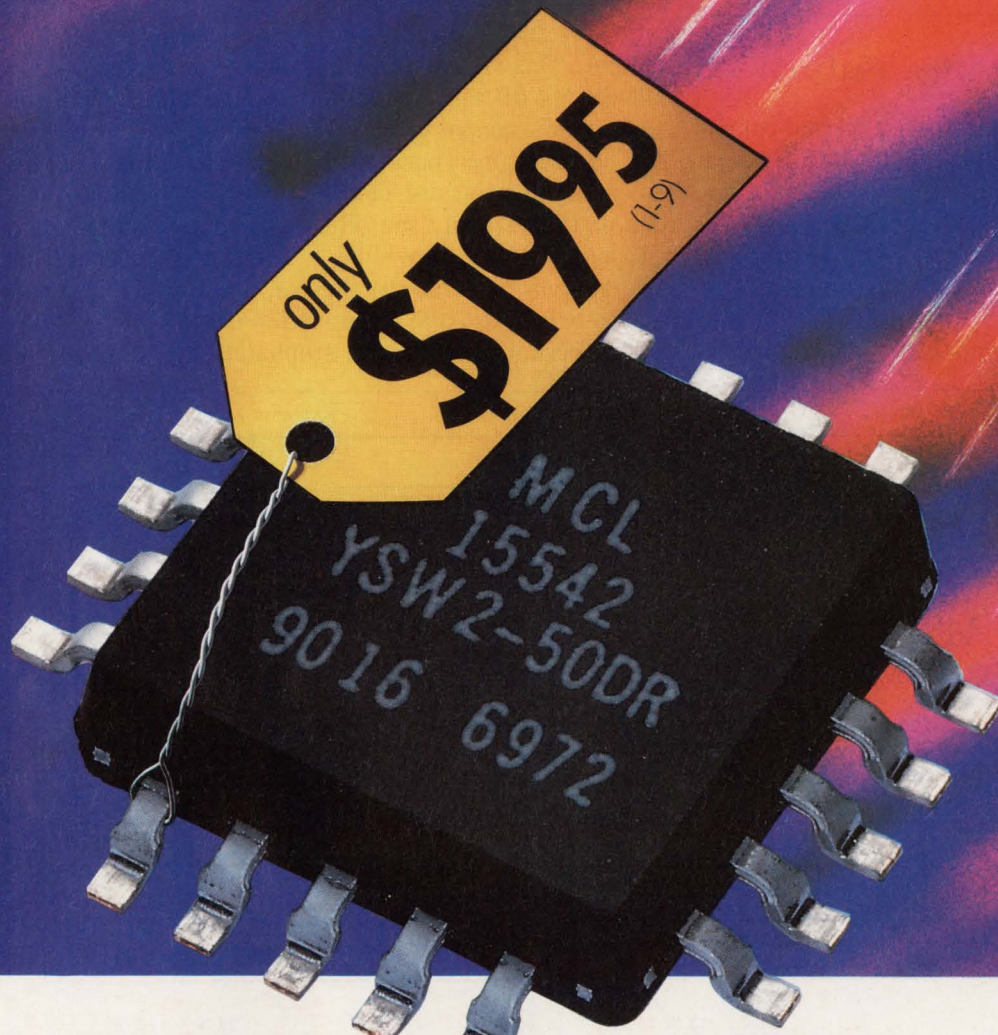

Fig 1—This IBM PC A/D converter board derives computer-interface power from unused printer-port data lines.

incredible!



SPDT switch dc to 5GHz with built-in driver

Truly incredible... a superfast 3nsec GaAs SPDT reflective switch with a built-in driver for only \$19.95. So why bother designing and building a driver interface to further complicate your subsystem and take added space when you can specify Mini-Circuits' YSW-2-50DR?

Check the outstanding performance specs of the rugged device, housed in a tiny plastic case, over a -55° to $+85^{\circ}$ C span. Unit-to-unit repeatability for insertion loss is 3-sigma guaranteed, which means less than 15 of a 10,000-unit production run will come close to the spec limit. Available for immediate delivery in tape-and-reel format for automatic placement equipment.

SPECIFICATIONS YSW-2-50DR

	dc- 500MHz	500- 2000MHz	2000- 5000MHz
Insertion loss, typ (dB)	0.9	1.3	1.4
Isolation, typ(dB)*	50	40	28
1dB compression, typ (dBm @ in port)	20	20	24
RF input, max dBm (no damage)	22	22	26
VSWR (on), typ	_____	1.4	_____
Video breakthrough to RF, typ (mV p-p)	_____	30	_____
Rise/Fall time, typ (nsec)	_____	3.0	_____

*typ isolation at 5MHz is 80dB and decreases 5dB/octave from 5-1000 MHz

finding new ways ...
setting higher standards



Mini-Circuits

WE ACCEPT AMERICAN EXPRESS

P.O. Box 350166, Brooklyn, New York 11235-0003 (718) 934-4500 Fax (718) 332-4661 Telexes: 6852844 or 620156

Filter antialiases and sinc compensates

Gary Sellani
Maxim Integrated Products, Sunnyvale, CA

Two dual-biquad filter chips and some external components (Fig 1) form a multipurpose filter for reconstructing D/A converter signals. Connected to a converter's output, the filter provides antialiasing, reduces the D/A converter's quantization noise, and compensates for $\sin(\pi x)/(\pi x)$ —the "sinc" function—attenuation.

The sinc-function attenuation stems from the nature

of the rectangular pulses that compose the converter's output. This attenuation reduces the output signal by almost -4 dB at frequencies corresponding to half the converter's sample rate.

The circuit incorporates an inverse-sinc function that operates to one-third of the converter's sample rate. Beyond one-third, the filter's response shifts to a stopband filter's, providing -70 -dB attenuation. This attenuation conforms to the converter's inherent signal-to-noise ratio and quantization error.

To prevent aliasing, the stopband edge must be no

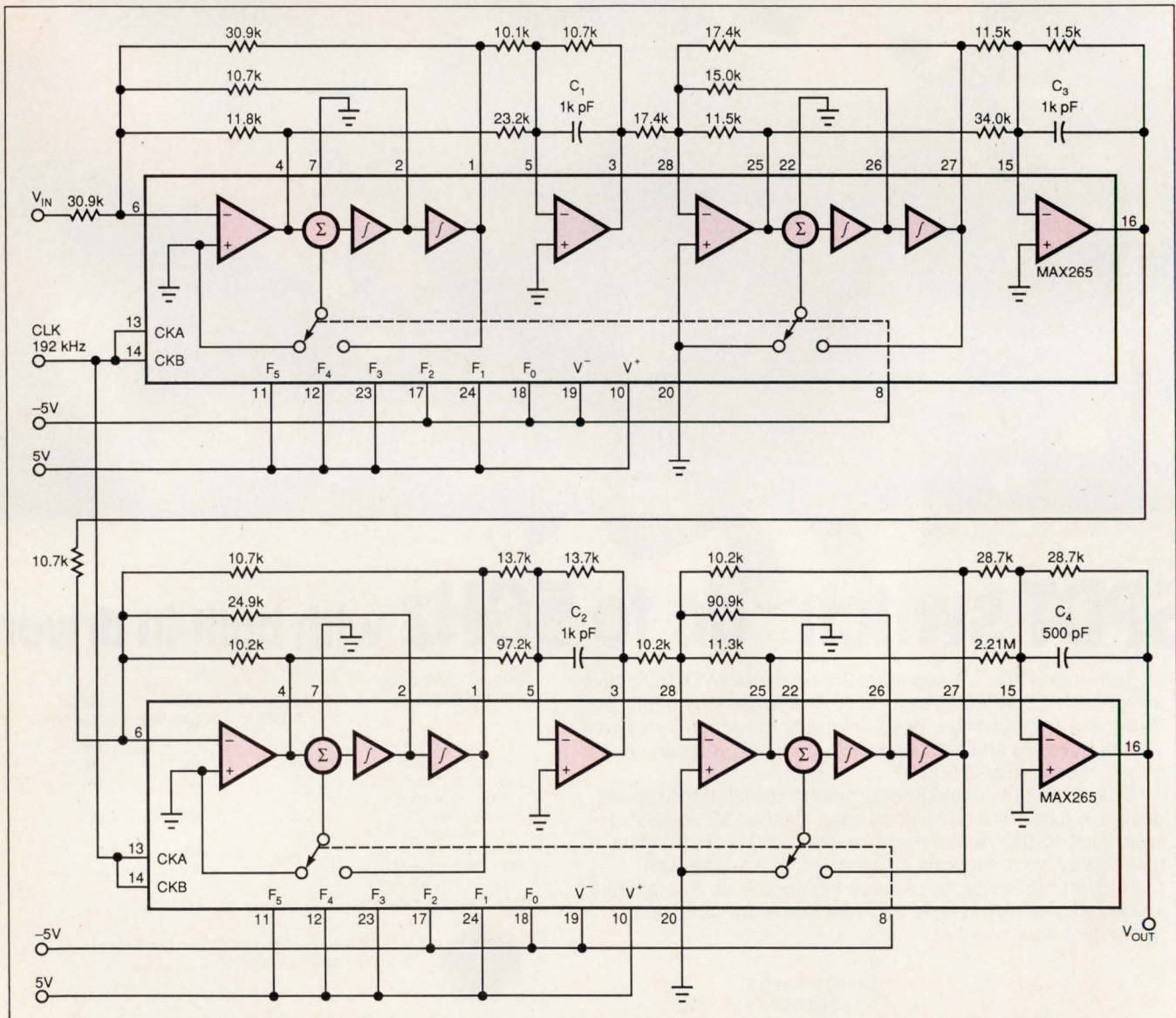

Fig 1—This circuit not only filters out high-frequency aliases and quantization noise, it provides sinc-function compensation.

MORE IS MORE. LESS IS MORE.



To many of you, our 15ns GAL22V10 is almost perfect. Which is why we designed the 28-pin **GAL26CV12** and 20-pin **GAL18V10**. These new GAL[®] devices repackage the familiar GAL22V10 architecture to give you the flexibility your design requires. So more and less, the GAL26CV12 and GAL18V10 make perfect sense.

All three devices offer 15ns T_{pd} using our electrically erasable E²CMOS[®] technology, the fastest CMOS PLD technology anywhere. Erasability allows us to 100% test each and every GAL device, so you realize perfect programming yields, less board rework, and fewer system failures. And you can program them again and again and again...

The new GAL26CV12 and GAL18V10 from Lattice. Proof that once again, our logic makes perfect sense. For **FREE** device samples and a databook, call **1-800-FASTGAL**. Ask for Dept. 202.



5555 Northeast Moore Court • Hillsboro, Oregon 97124

Inventors of the E²CMOS PLD[™]

Copyright © 1990, Lattice Semiconductor Corporation. GAL AND E²CMOS are registered trademarks of Lattice Semiconductor Corporation.

DESIGN IDEAS

higher than the Nyquist frequency ($f_s/2$). To achieve 70-dB stopband rejection with this eighth-order filter requires a transition ratio ($f_{\text{STOPBAND}}/f_{\text{PASSBAND}}$) of 1.5, which sets the passband's upper limit at $f_s/3$.

To ensure maximum dynamic range, the four filter sections exhibit increasing Q from input to output. The pole-zero pairs of each section also exhibit increasing frequency, minimizing the different component values required.

Note the feedback capacitors C_1 through C_4 across each filter chip's output op amps. These capacitors have two purposes: they improve the quality of transmission zeros, and they form 1-pole lowpass filters that help to smooth out the discrete-level steps which the filters'

switched-capacitor action introduces. These 1-pole filters have little effect on the passband's shape because their high corner frequencies introduce only 0.1 dB of loss at 1 kHz.

Note also that you can apply a simple divide-by-64 circuit to the 192-kHz clock frequency to set the necessary $3 \times$ ratio between the converter's sample rate and the filter's 1-kHz corner frequency. The V^+ , V^- , and the F_0 through F_5 connections program each filter chip for an f_{CLK}/f_0 ratio of 191.64.

(EDN BBS /DI_SIG #921)

EDN

To Vote For This Design, Circle No. 748

FEEDBACK AND AMPLIFICATION

Numerous improvements suggested

I would like to suggest improvements for three of the Design Ideas presented in the October 1, 1990, issue of EDN.

First, for Francesco Ruggiero's "Scrambler disguises voice signals" on pg 127, note that the EP pin of the top 74HC161 is floating—a dangerous practice. And because the 74HC161 generates its CO (carry-out) asynchronously, runt pulses at its CO pin, arising from differences in propagation time, can cause problems

for unlocked logic. I suggest readers first tie the EP pin to 5V. Then cut the CO connection to pin 3 of the 74HC74 flip-flop, and instead connect pin 11 of the top 74HC161 to the flip-flop.

Next, for Tarlton Fleming's "S/H circuit multiplexes op amp" on pg 128, I see problems with the drawing of the left-hand switch. R_1 should be inside the feedback loop for op amp stability; leakage and capacitance are less on the switched pin of the CMOS switch than

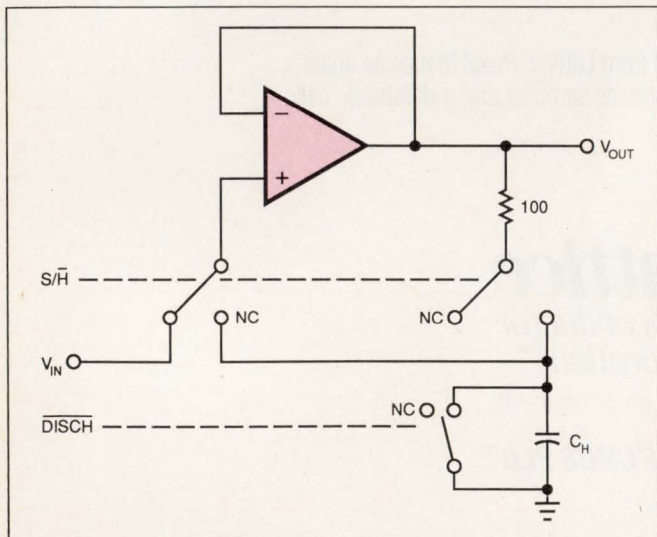

Fig 1—Revising the topology of an S/H circuit improves its performance.

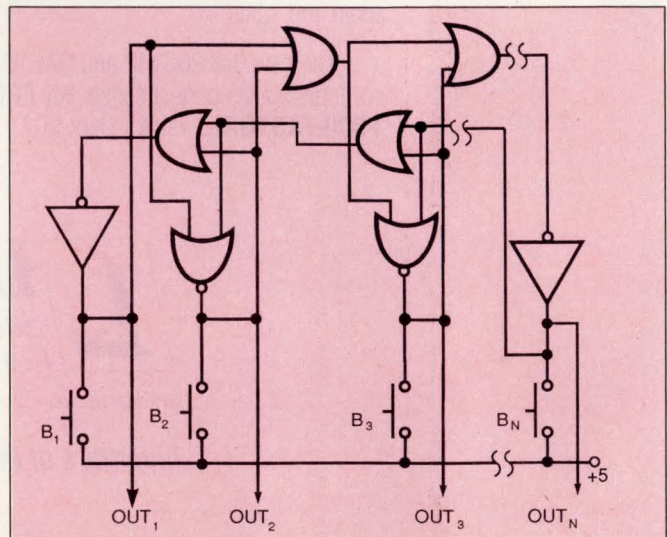
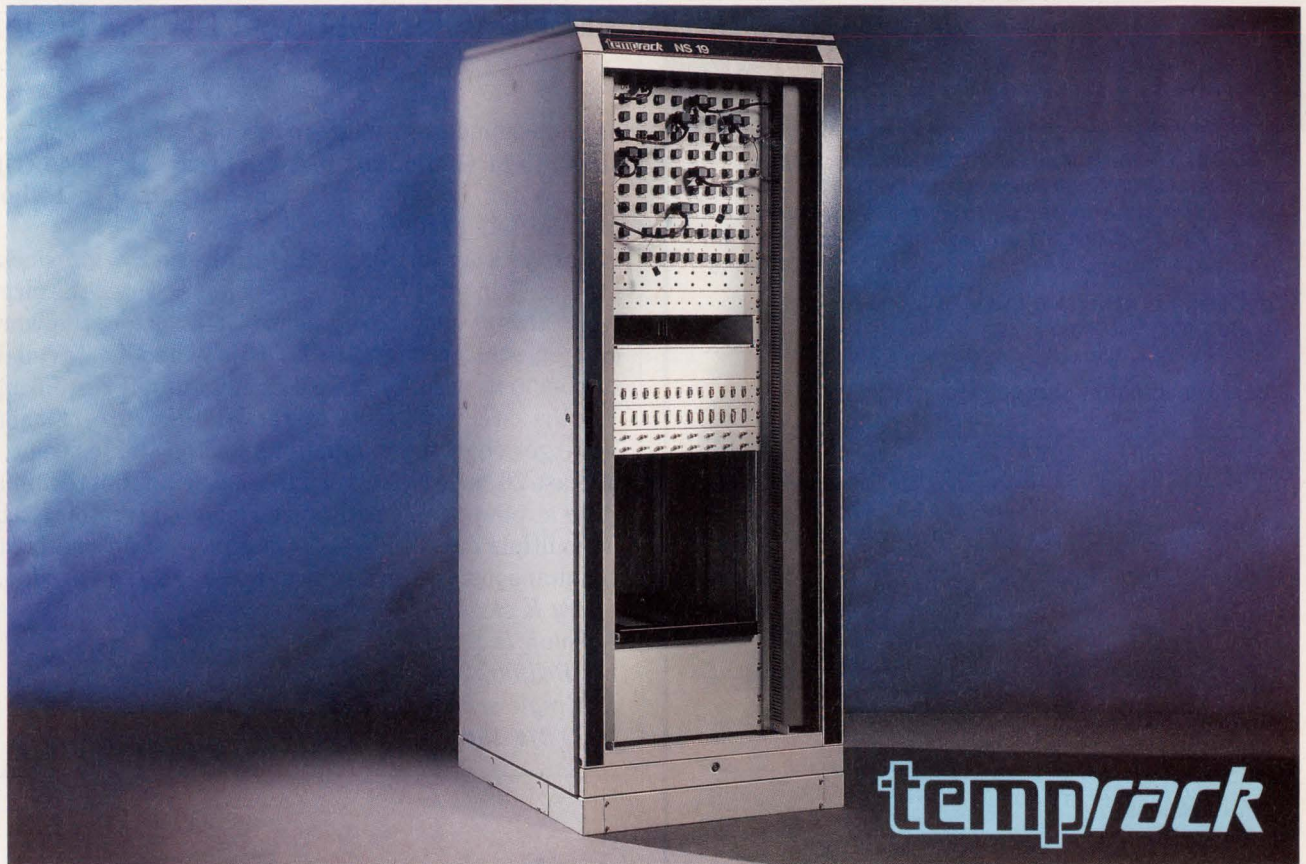

Fig 2—Stiffer drive current and multiple-keypress lockout enhances the performance of an interlocked switch circuit.

THE NETWORK SOLUTION.



temprack

Speed is of the essence when installing networks. The many practical ideas incorporated in Temprack are timesavers for your network project – both at the planning stage and during on-site assembly.

- 1.) Model: Temprack NS 19
41 U*, Width 800, Depth 800.
Order No. 1.113.816.3
- 2.) 19" distribution patch panel IBM for 32 connectors with mounting-kit
Order No. 1.113.763.3
- 3.) 19" fixed shelf, 2U*
Order No. 1.113.737.3
- 4.) Jumpering bracket for cable feed
Order No. 1.113.749.7/pair

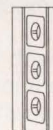
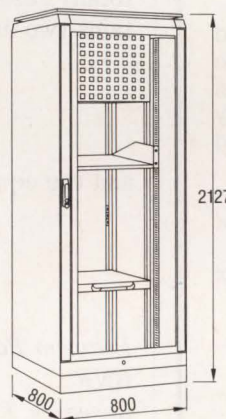

Fixed and withdrawable shelves with perforations for equipment up to a width of 735 mm. Fixed 2 U chassis trays for use in 19" enclosures and swing frames accommodate units up to a depth of 380 mm.

Will accept 19" distribution patch panels for all types of connector. (IBM, BNC, optical waveguides, etc.).

The cable trunking is ideal for the professional installation of mains power supply and telecommunication cabling etc.

 excellent quality world-wide	® KNÜRR – MECHANIK FÜR DIE ELEKTRONIK AG
	Schatzbogen 29 D-8000 München 82 Telefon (089) 4 20 04-0 Telex 5 29 608-10 Telefax (089) 4 20 04-118

bfr	FF	£	nkr	sfr	US \$	DM
1.) 44 236,50	7609,00	763,00	9047,00	1917,00	1662,00	1915,00
2.) 2788,20	480,00	41,90	571,00	121,00	105,00	135,80
3.) 1663,20	285,00	14,70	338,00	72,00	62,00	72,00
4.) 351,10	60,00	5,70	72,00	15,00	13,00	15,20
Knürr NV Tel. 03-326.02.99 Fax 03-325.55.43	Knürr s.a.r.l. Tel. (1) 43 77 85 85 Fax (1) 43 39 02 10	Knürr (UK) Ltd. Tel. 04 80-49 61 25 Fax 04 80-49 63 73	Knürr Norge A/S Tel. 02-65.02.20 Fax 02-65.32.30	Knürr AG Tel. 01-82 50 707 Fax 01-82 50 803	Knürr USA Inc. Tel. (805) 526-7733 Fax (805) 584-8371	Knürr AG Tel. (089) 4 20 04-0 Fax (089) 4 20 04-118

(* U = 1 3/4" = 44.45 mm)

Delivery ex stock. Prices ex works, excluding packing, exclusive VAT.

DESIGN IDEAS

Design Entry Blank

\$100 Cash Award for all entries selected by editors. An additional \$100 Cash Award for the winning design of each issue, determined by vote of readers. Additional \$1500 Cash Award for annual Grand Prize Design, selected among biweekly winners by vote of editors.

To: Design Ideas Editor, EDN Magazine
Cahners Publishing Co
275 Washington St, Newton, MA 02158

I hereby submit my Design Ideas entry.

Name _____

Title _____ Phone _____

Company _____

Division (if any) _____

Street _____

City _____ State _____

Country _____ Zip _____

Design Title _____

Home Address _____

Social Security Number _____

(Must accompany all Design Ideas submitted by US authors)

Entry blank must accompany all entries. Design entered must be submitted exclusively to EDN, must not be patented, and must have no patent pending. Design must be original with author(s), must not have been previously published (limited-distribution house organs excepted), and must have been constructed and tested.

Exclusive publishing rights remain with Cahners Publishing Co unless entry is returned to author or editor gives written permission for publication elsewhere.

In submitting my entry, I agree to abide by the rules of the Design Ideas Program.

Signed _____

Date _____

Your vote determines this issue's winner. All designs published win \$100 cash. All issue winners receive an additional \$100 and become eligible for the annual \$1500 Grand Prize. **Vote now**, by circling the appropriate number on the reader inquiry card.

FEEDBACK AND AMPLIFICATION

on the common pin. Also, parts cost drops from \$3.50 (1000) to \$1 (100) if you use a generic 74HC5043 triple dpst switch rather than a quad switch. **Fig 1** shows my suggested redesign.

Lastly, Tian Jin Qin's "Inverters mimic interlocked switches" on pg 132 also has problems. First, the circuit won't always switch. If you use CMOS logic, the worst-case current through B_1 , C, R_3 , S, and D_{1B} available to a switch, assuming a $5V \pm 10\%$ supply, is 5.5 mA. For the circuit to work correctly, this current should be larger than the maximum inverter sink current, or at least 20 mA. Next, the circuit has an indeterminate state at power-on. Lastly, you could inadvertently turn on multiple outputs by pressing more than one button simultaneously. **Fig 2** shows my suggested revision.

*Larry K Baxter, VP Engineering
Echolab Inc
175 Bedford Rd
Burlington, MA 01803
(617) 273-1512*

Author corrects equations

The Design Idea I contributed, "Passive network is totally resistive" (EDN, August 2, 1990, pg 135), contains two errors. The equation for L should be

$$L = \frac{R}{\omega_0} = \frac{R}{2\pi F_0}$$

and the equation for C should be

$$C = \frac{1}{\omega_0 R} = \frac{1}{2\pi F_0 R}$$

*Prayson Pate
BNR
Research Triangle Park, NC*

EDN's bulletin board is on line

Call EDN's free bulletin board service (BBS) at (617) 558-4241 (2400,N,E,1) and select /DI_SIG to get additional information or to comment on these Design Ideas.

X-ray: ANSLEY® 50-pin "D" Connector with patented spread pitch design.

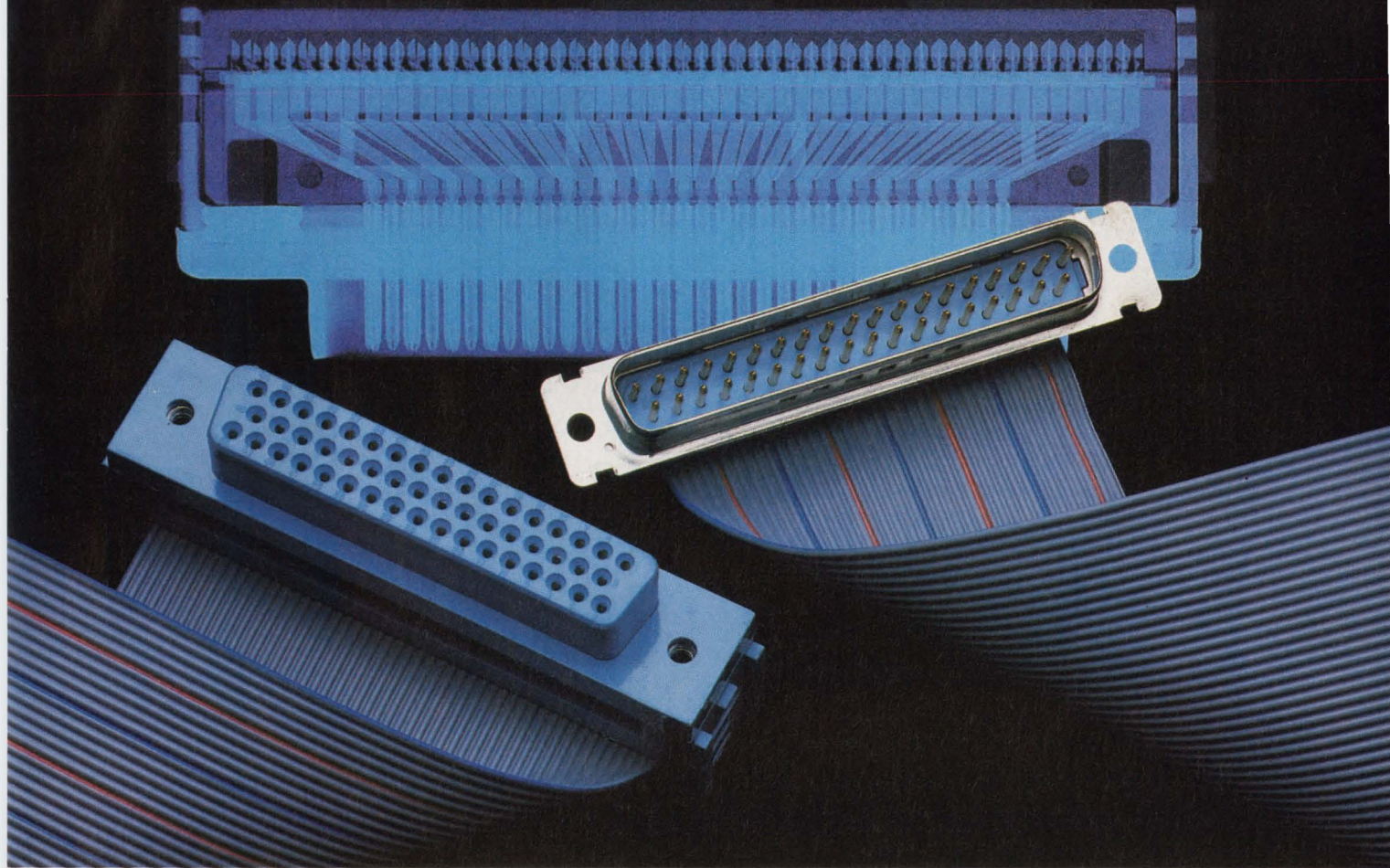

A revealing look at the broadest line of IDC connectors available.

We show an X-ray of one of our IDC connectors to emphasize that it's what's beneath the surface that makes the difference in IDC connector performance. To make your best choice among IDC connector systems, take a close look at our line.

The broadest line in the industry.

- "D" connectors, headers, female sockets, ribbon, card edge, male, DIP plug, plus a full line of flat and round-to-flat cables.

A real system with real system benefits.

- Cable, connectors and tooling (hand or automatic) are designed and built to work as a system — this is your assurance of reliability.

Designed for performance, built for productivity.

- We extrude our cable to maintain precise conductor to conductor spacing.
- Our beryllium copper contacts assure long-term stress retention in the critical crimp zone — preventing relaxation and the potential for intermittence.

- ANSLEY® pioneered the **one-piece connector** design. It's still the standard of the industry.
- Self-aligning **cable guides** in the connector assure positive termination every time — the key to high-yield, low-scrap production.

The company behind the product.

A close look at our company will reveal our strong financial position, our commitment to the future, and our ability to support you worldwide. Write for our Annual Report — it's like an X-ray of our company.

To take a close look at our complete ANSLEY® IDC Connector line, and for the location of our nearest stocking distributor, call

1-800-344-4744.

Thomas & Betts Corporation, Electronics Division,
1001 Frontier Road, Bridgewater, NJ 08807 201-685-1600

Thomas & Betts

Thomas & Betts facilities in **Australia:** Wyong North N.S.W., 43 53 2300; **Canada:** Ontario, 416-568-9765; **France:** Rungis Cedex, 1-46 87 23 85; **Hong Kong:** Kowloon, (852) 3-7391286; **Italy:** Milan, 02-61 20 451; **Japan:** Tokyo, 3 791 6411; **Mexico:** Naucalpan, 905 393 85 10; **Singapore:** 747 0244; **Spain:** Barcelona, 03-3 00 22 52; **Sweden:** Upplands Vasby, 07 60-8 81 10; **Taiwan:** Taipei, 2 713 0509; **United Kingdom:** Dunstable 0582-608101; **West Germany:** Egelsbach, 0 61 03-40-40.

NEW PRODUCTS

COMPUTERS & PERIPHERALS

STD Bus DSP Board

- Utilizes 50-MHz DSP32C CMOS chip
- Executes 1024 complex FFT in 3.3 msec

The MCM-DSP32C STD Bus board features a 50-MHz AT&T DSP32C CMOS digital signal-processing chip. The chip can deliver 25M flops, and it has four 40-bit accumulators, 22 general-purpose registers, and 6k bytes of internal RAM. The board comes with either 64k bytes or 256k bytes of zero-wait-state RAM with a 32-bit data path. Some benchmarks include executing a 1024-point complex FFT in 3.3 msec, multiplying a 4×4 matrix in 6.16 μ sec, and calculating a complex adaptive FIR filter, having 80 nsec/tap. The board processes digital signals independent of the host, and the host can transfer data to and from the board

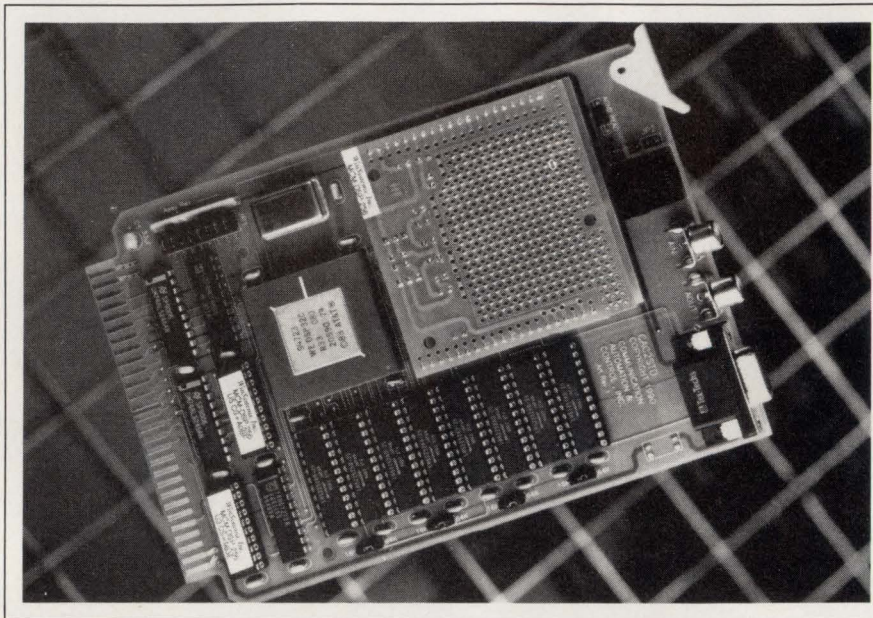

at 3.5M bytes/sec, using programmed I/O data transfers. A daughter-board connector accepts modules with serial ports, a Codec,

or a 16-bit A/D converter. \$1495.

WinSystems Inc, Box 121361, Arlington, TX 76012. Phone (817) 274-7553.

Circle No. 364

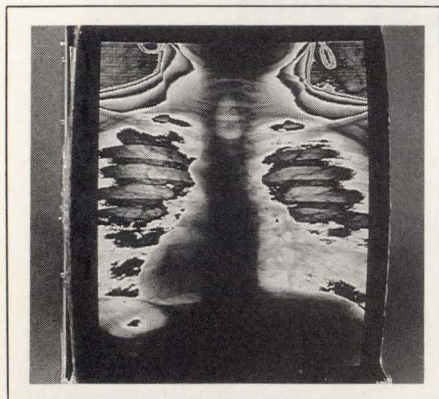

19-In. Gray-Scale Display

- Provides 1536×2048 pixels for medical images
- Has 200-MHz video bandwidth

The GMA212 19-in. gray-scale display, which is designed for medical imaging, has 1536×2048 pixels. The monochrome display's use of a P45 phosphor and a 31% transmission filter provides an ideal combination for soft-copy diagnostics on x-ray images. Other features include a 200-MHz video bandwidth,

brightness and contrast controls, and enough dynamic range to display 256 shades of gray. The display uses a high-frequency switching power supply. It has a digitally correcting focus and astigmatism device, which displays well-focused images in the corners. The display weighs 55 lbs and measures $19.625 \times 14.0 \times 19.8$ in. \$7000.

Tektronix Display Products, Box 500, M/S 46-943, Beaverton, OR 97077. Phone (800) 835-9433, ext 2002; in OR, (503) 627-5000. FAX (503) 627-1070. TLX 192825.

Circle No. 365

Ethernet Transceiver

- Interconnects coaxial and unshielded twisted-pair LANs
- Conforms with the IEEE-802.3 10Base-T standard

The G/Ethertwist transceiver for Ethernet networks can interconnect coaxial and unshielded twisted-

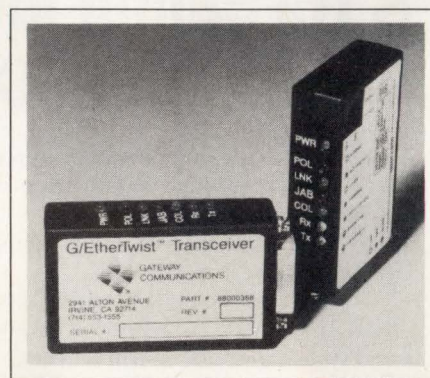

pair (UTP) networks. The transceiver, which complies with the IEEE-802.3 10Base-T Ethernet standard, allows adapters, fan-outs, and repeaters to operate using UTP wires. The unit's RJ-45 jack provides an interface for the UTP-wired section and a male attachment-unit-interface connector to interface with the coaxial section. The transceiver transmits and receives data, detects data collisions on the network, and performs heart-beat or signal-quality error tests. Seven

TO-5 RELAY TECHNOLOGY

The Surface Mount Centigr[®]

- Leads formed for direct surface mounting
- High performance military relay
- RF switching through 1 GHz

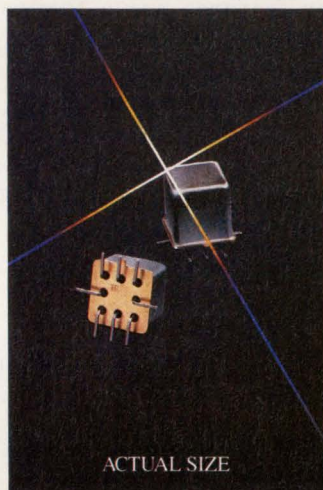

There's only one new thing about the newest Centigr[®] relay. It has leads formed for direct PC board surface mount "onsertion."

Everything else is the same. The same 100% all welded construction and rugged uniframe design. Operating power as low as 200mW. High force/mass ratios for increased resistance to shock and vibration.

Electrical characteristics are the same, too. Precious metal

contact material with gold plating assures switching capabilities from dry circuit to 1 amp. Low intercontact capacitance and contact circuit losses make it an excellent choice for RF switching at frequencies through 1 GHz.

In other words, Teledyne Relays has done it again. We've taken a popular, reliable product based on proven TO-5 technology, and adapted it to the latest produc-

tion techniques without affecting its performance. And it's that performance, after all, that has won Centigr[®] its place in your hearts and designs.

The Surface Mount Centigr[®]. It's available in both general purpose and sensitive versions. Call or write today for complete information.

 **TELEDYNE RELAYS**
Innovations In Switching Technology

Teledyne Relays, 12525 Daphne Avenue, Hawthorne, California 90250 • 213-777-0077, FAX: 213-779-9161.

European Headquarters: W. Germany: Abraham Lincoln Strasse 38-42, 6200 Wiesbaden • Belgium: 181 Chaussee de la Hulpe, 1170 Brussels • U.K.: The Harlequin Centre, Southall Lane, Southall, Middlesex, UB2 5NH • Japan: Taikoh No. 3 Building, 2-10-7 Shibuya, Shibuya-Ku, Tokyo 150 • France: 85-87 Rue Anatole-France, 92300 Levallois-Perret.

LEDs indicate power, polarity, link, transmit, receive, jabber, and collision. The unit measures 1.6 × 0.7 × 2.7 in. and weighs 2 oz. \$150.

Gateway Communications Inc., 2941 Alton Ave, Irvine, CA 92714. Phone (800) 367-6555; in CA, (714) 553-1555. FAX (714) 553-1616.

Circle No. 366

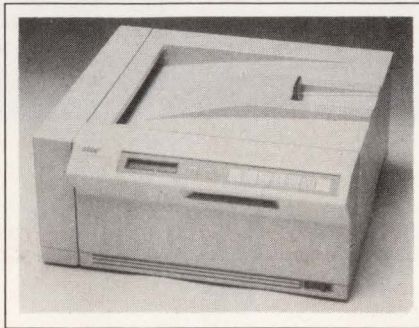

Laser Printer

- Uses an i960 μ P to print at 4 pgs/minute
- Has 1M byte of RAM and 14 internal fonts

The Star Laserprinter 4 uses Intel's i960 RISC μ P. Its 1M byte of RAM ensures a maximum print speed of 4 pgs/minute when printing a full page of graphics at 300 dpi. You can expand the memory in 1M, 2M, or 4M increments to store downloaded fonts. The unit is software and hardware compatible with HP's

Laserjet IIP; its 14 internal fonts are virtually identical to the Laserjet II Series fonts. In addition, the printer accepts LaserJet II Series font cartridges, toner cartridges, and a lower-level paper cassette. Other features are a Centronics parallel port and an RS-232C port. \$1395.

Star Micronics America Inc., 420 Lexington Ave, Suite 2702, New York, NY 10170. Phone (800) 447-4700; in NY, (212) 986-6770. FAX (212) 286-9063. **Circle No. 367**

Development Board

- Connects to a PC compatible for 80C51 μ Cs
- Has an 80C552 μ C and a monitor program in 32k-byte EPROM

The DB-51 development board has sockets that accept any member of the 80C51 family of microcontrollers. An 80C552 microcontroller runs a monitor program in a 32k-byte EPROM, a programmed 87C751 microcontroller, 32k bytes of RAM, and a 1¼ × 7¼-in. prototyping area that gives you access to all of the microcontroller's signals. The board connects to an IBM PC or compatible running MS-DOS via an RS-232C link. The host must have a minimum of 512k bytes of RAM and a hard- or floppy-disk drive. Software for the host includes a symbolic debugger, an on-line assembler and disassembler, and upload and download utilities. You can write programs in assem-

All you need to know about 5.25" Winchester disk drives, inside

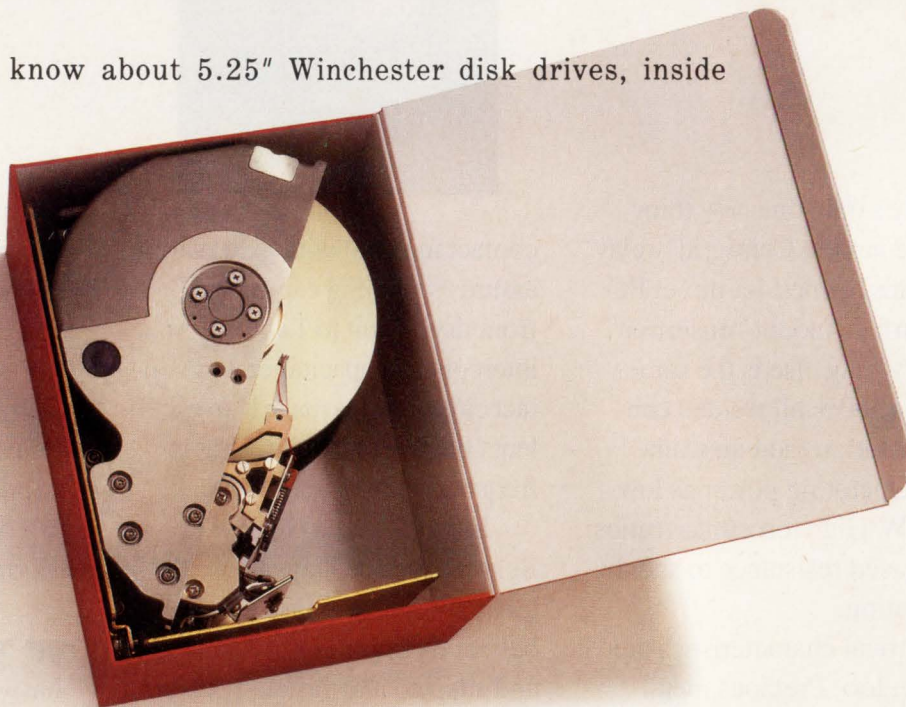

14ms Avg. seek

Variable sector sizes

1.6GB Capacity

SCSI-2 Interface

5MB/Second transfer rate



Computers and Communications

It's nice to know that NEC disk drives have the most advanced technical features. And it's reassuring that they're consistently available, and with a DOA rate of less than 1%, and up to 100,000 hours MTBF rate that they're reliable.

bly code or in C language or PLM, and you can display the contents of all the registers on the screen. Board for the 80C552 and software, \$320.

Signetics Co., Box 3409, Sunnyvale, CA 94088. Phone (408) 991-3445. **Circle No. 368**

Short-Range Modems

- *Have built-in surge protection for RS-232C links*
- *Operate over two twisted-pair lines*

Two asynchronous short-range modems are available with built-in surge protection. They use silicon avalanche diodes to protect internal circuits and external equipment. The Model 1009S can communicate at a distance of 17 miles and at data rates as fast as 19.2k bps. It receives its power by detecting the data. The unit measures 2.5×

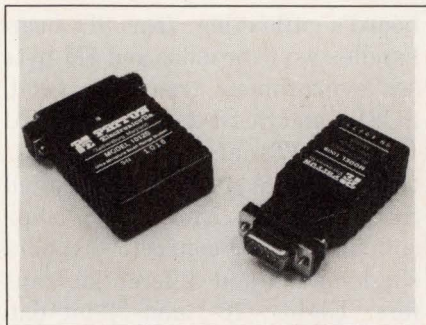

0.75 in. and has a DB-9 connector. The Model 1012S has transformer isolation for protection against signal disruptions. It operates in asynchronous networks having as many as 10 terminal drops. The 1012S also receives its power by detecting the data; it operates at a distance of 6 miles and at data rates as fast as 19.2k bps. Measuring 2.66×0.73 in., the 1012S has a DB-25 connector. Both models operate over two twisted-pair wires and handle peak surges of 600W/wire.

Model 1009S, \$75; Model 1012S, \$120.

Patton Electronics Co., 7958 Cessna Ave, Gaithersburg, MD 20879. Phone (301) 975-1000. FAX (301) 869-9293. **Circle No. 369**

VMEbus SCSI-2 Adapter

- *Transfers data to SCSI-1 and SCSI-2 disk drives*
- *Handles 32-bit VMEbus transfer rates at 30M bytes/sec*

The RF3560, the latest member of the Rimfire family of intelligent SCSI host adapters, supports the SCSI-2 mandatory commands, command sets, and command queuing. It runs directly from a host operating-system's I/O command queue and controls data transfers independently. Tasks such as transferring SCSI messages, peripheral status, and error recovery between the host and as many as SCSI-2 peripherals take place during the

and out.

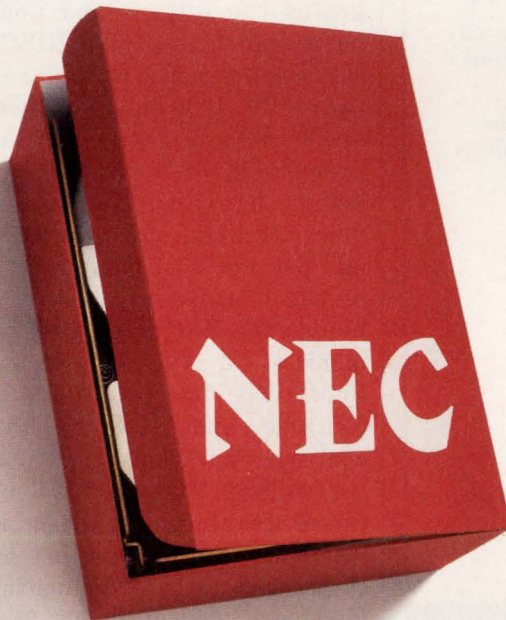

But all you really need to know is that they're made by NEC, a 24-billion-dollar company, and the fourth largest manufacturer of disk drives in the world. For more information, call 1-800-NEC-INFO.

NEC

TIMING DIAGRAMS

- ✓ Hard to Draw
- ✓ Tough to Modify
- ✓ Painful to Analyze
- ✓ Required for Reliable Designs

Relax,
now there's

TIMING DESIGNER™

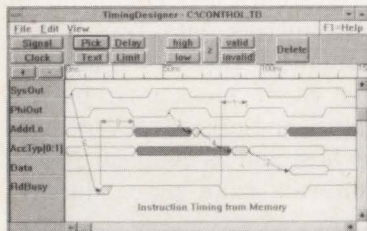

The Timing Diagram Drawing and Analysis Software that ...

- Lets you create and modify timing diagrams in minutes instead of hours.
- Automatically performs worst case timing analysis.
- Instantly highlights timing violations.
- Generates standardized timing documentation.

TimingDesigner™ will help you develop better designs more quickly!

Pick up the phone now and call for more information.

206 • 869-4227



CHRONOLOGY

2849 152nd Ave. NE / Redmond, WA 98052
FAX: (206) 869-4229

CIRCLE NO. 59

COMPUTERS & PERIPHERALS

board's offloading. The 6U board handles asynchronous and 5M-byte/sec synchronous transfer rates to SCSI-1 and SCSI-2 disk drives, CD-ROMs, DATs, and helical scan-tape transports. A face-plate mounted, SCSI-2, 50-pin ribbon or a 50-pin subminiature D connector supports single-ended and differential transfers. Eight-, 16-, and 32-bit data transfers on the VMEbus occur at rates as fast as 30M bytes/sec. \$1495.

Ciprico Inc, 2955 Xenium Ln, Plymouth, MN 55441. Phone (612) 559-2034. **Circle No. 370**

VMEbus Single-Board Computer

- Utilizes a RISC CPU based on MIPS chip set
- Contains a SCSI and an Ethernet controller

The Pacerunner/3400 is a VMEbus single-board computer (SBC) in a 6U form factor. It uses either a 25- or 33-MHz version of the company's PR3400A CPU. The CPU integrates the integer and floating-point unit of the MIPS RISC chip set. The board also utilizes the company's PR3100 chip. Some features are an 8-word write buffer, a programmable 32-word read buffer, and parity logic. The board provides 64k bytes of instruction cache and 64k bytes of data cache, both of which are expandable to 256k bytes. The SBC's 4M bytes of dynamic RAM is expandable to 16M bytes. The board's 53C700 SCSI controller and a 79C900 Ethernet controller both have on-chip DMA controllers. Two RS-232C ports, three 16-bit counter/timers, a watchdog timer with a time of day clock, and 50 bytes of nonvolatile RAM are also available. 25-MHz version, \$9995; 33-MHz version, \$10,995.

Performance Semiconductor Corp, 610 E Weddell Dr, Sunnyvale, CA 94089. Phone (408) 734-8200, ext 384. **Circle No. 371**



THIS DECADE, MAKE A COMMITMENT TO USE ONLY THE BEST.

FOR TEN YEARS INTROL HAS BEEN CREATING THE WORLD'S BEST HIGH-POWERED TOOLS FOR EMBEDDED SYSTEMS PROGRAMMERS.

OUR C COMPILERS, MODULA-2 COMPILERS, SOURCE LEVEL DEBUGGERS, AND MACRO ASSEMBLERS ARE IN USE BY MAJOR CORPORATIONS AND SAVVY INDEPENDANT CONSULTANTS FROM SAN FRANCISCO TO SINGAPORE.

ALL OUR PRODUCTS ARE FULLY COVERED BY COURTEOUS AND HIGHLY EFFICIENT TECHNICAL SUPPORT TO ASSIST YOU WITH ANY PROBLEMS YOU MAY ENCOUNTER.

SO, THIS DECADE, MAKE A COMMITMENT - TO INTROL.

6801, 6301, 68HC11, 6809, 68000/
10,68020/30/40,68332,32000
MSDOS, MAC-MPW, VAX VMS/ULTRIX, DECSTATION, IBM
RS6000, SUN3, SUN4, APOLLO, 386 UNIX SYSTEM V

INTROL CORPORATION • 9220 WEST HOWARD AVENUE
MILWAUKEE, WI 53228

TEL 414.327.7171, FAX 414.327.7734



INTROL
CORPORATION

CIRCLE NO. 60

EDN February 18, 1991

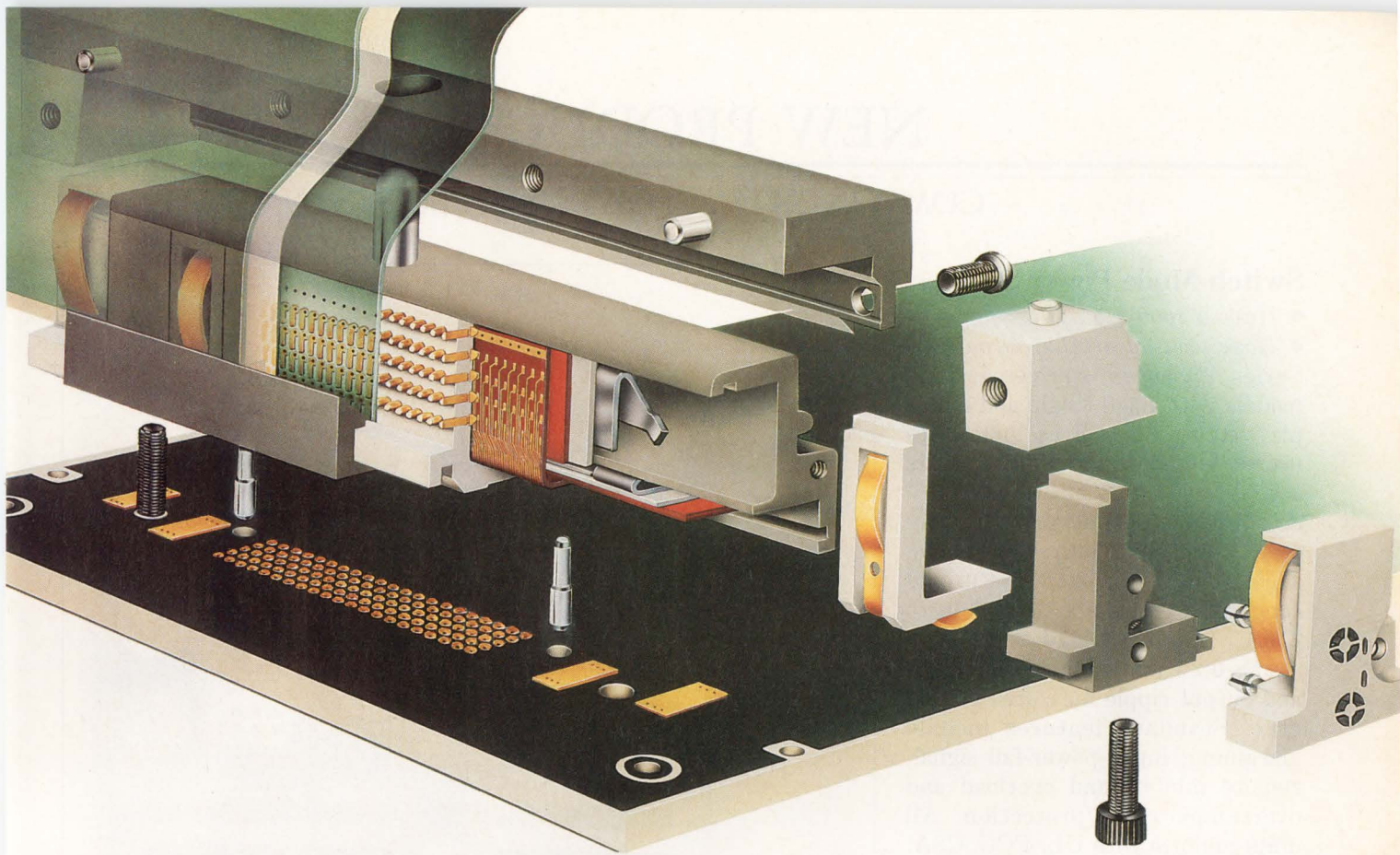

Out of sight performance!

Introducing the next generation interconnect, EII: transparent to high frequency signals, therefore eliminating connector induced signal distortion. Until now, the limiting factor for signal integrity in high speed electronic circuits has been the connector. The source may be matched to the load, but an impedance mismatch at the connector degrades performance. Signal integrity

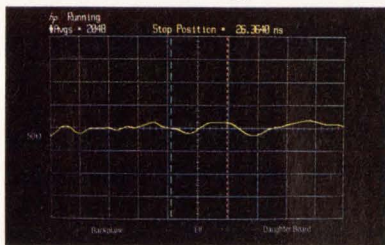

EII achieves matched impedance of the connector to the backplane and daughter card.

through EII is maintained because reflection, crosstalk, attenuation, signal skew, and rise-time degradation are reduced to absolute minimums. This unprecedented performance is made possible by a unique flexible microstrip transmission line structure with a continuous ground-plane as the major signal path through EII. Augat, the company known for quality and innovation, is

now setting a new standard of performance – EII. Outta' sight!

AUGAT® *Quality and Innovation*

Augat Inc., Interconnection Products Division

33 Perry Ave., P.O. Box 779,
Attleboro, MA 02703
(508) 222-2202
FAX: (508) 222-0693



NEW PRODUCTS

COMPONENTS & POWER SUPPLIES

Switch-Mode Power Sources

- Have a 1000W output
- Have user-adjustable outputs

Series 28 power sources include models with fixed single and multiple outputs as well as units with user-adjustable outputs. The units accept inputs of 120/240V ac or 48V dc. Multiple-output versions provide three or four outputs including a 5V/120A main output. Outputs range from 2 to 56V dc and 10 to 250A. Line and load regulation equals 0.2% and 0.8%, respectively, and output ripple measures 1% p-p max. Standard features include margining, input power-fail signal, remote inhibit, and overload and overtemperature protection. All units conform with UL, FCC, CSA, and VDE safety and EMI requirements. Standard options include output power-good signal and automatic current-sharing capability. Single-output models, \$661 to \$795; multiple-output versions, \$717 to \$1034.

Qualidyne Systems Inc., 3055 Del Sol Blvd, San Diego, CA 92154. Phone (619) 575-1100. FAX (619) 429-1011. TLX 709029.

Circle No. 383

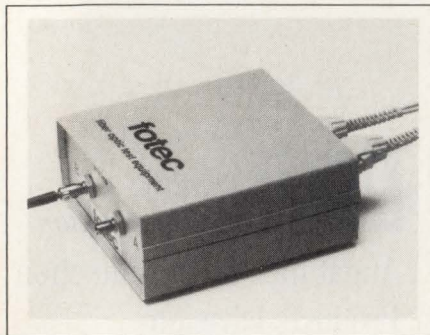
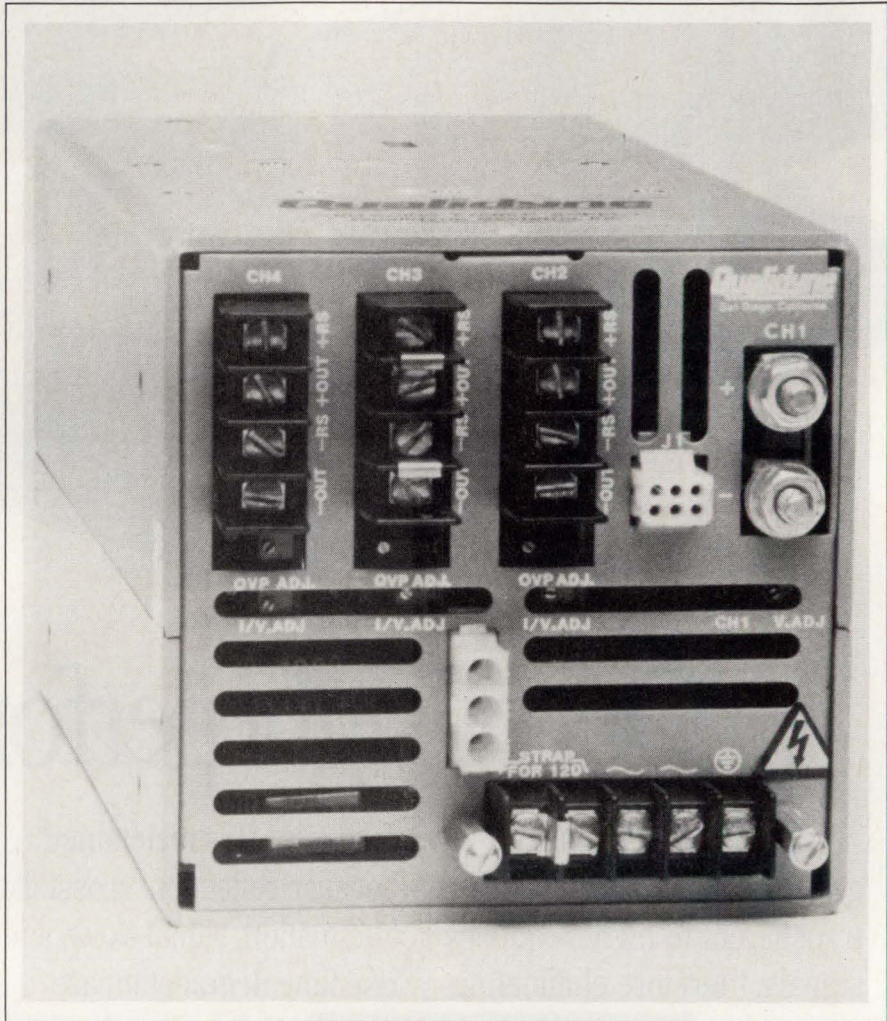

Optical Tap

- Tests operational networks
- Introduces 1.5-dB loss

The A 175-FDDI Fototap optical tap plugs into FDDI networks and diverts a small amount of optical power to test equipment. The unit

allows you to perform tests during network operation. The device looks like a bypassed station to an FDDI network. It introduces 1.5-dB link loss and provides a calibrated optical output, which is approximately 10 dB down from the actual FDDI ring level. You can then use this optical signal with appropriate test equipment to measure link power or convert the tap output to electrical signals for use with oscilloscopes or logic analyzers. \$950.

Fotec Inc., Box 246, Boston, MA 02129. Phone (800) 537-8254; in MA, (617) 241-7810. FAX (617) 241-8616. TLX 501372. Circle No. 384

VXibus Backplane

- Features a 100-MHz clock line
- Includes separate TTL and ECL signal lines

These D-sized backplanes are designed to revision 1.3 of the VXibus specification. Developed for use with P1, P2, and P3, 96-pin press-fit connectors, the backplanes feature a 100-MHz clock line and synchronized signal lines for high speed applications. Four parallel ECL trigger lines provide inter module triggering at rates in excess of 100-MHz, and the ECL star lines offer precision timing. Separate TTL and ECL signal layers ensure controlled impedance for each logic family and

Introducing an all-Tek communications test system featuring bit error rate testing and waveshape analysis. FDDI and SONET test capability. Margin and mask testing. Plus direct jitter, noise and eye diagram measurements like you've never seen before.

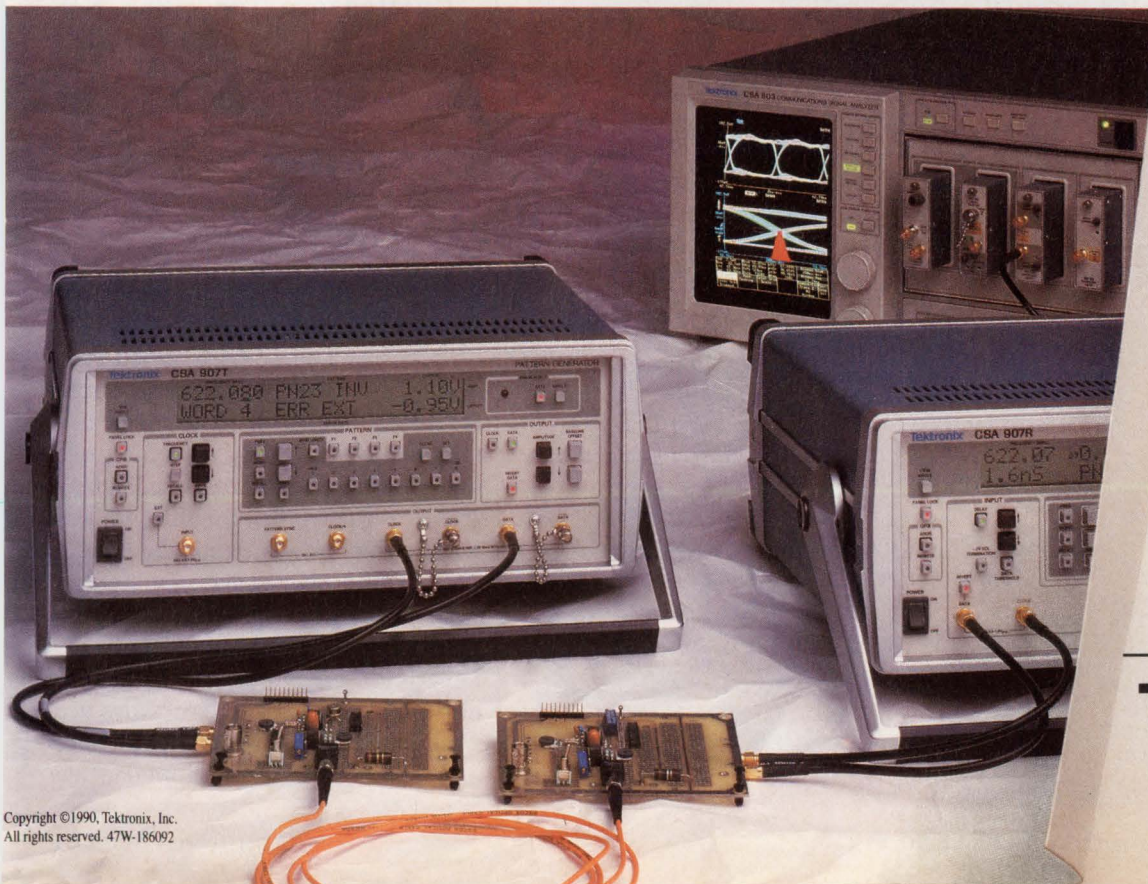

See what's behind the big talk!

Call 1-800-426-2200 ext. 300 to qualify for our free videotape introduction to Tek's breakthrough CSA family.

Tektronix
COMMITTED TO EXCELLENCE

CIRCLE NO. 137

keep propagation delays within critical timing parameters. The backplanes feature a 12-layer strip-line construction. Four ground and four power layers make up the distribution system for -5.2 , -2 , 5 , ± 12 , and $\pm 24V$. Available in 5- and 13-slot versions, the units utilize 24 local bus lines for communication

between adjacent modules. The units also feature protection that meets the SUMBUS revision. 13-slot model, from \$2415; 5-slot version, \$1015.

Augat Inc, Box 779, Attleboro, MA 02703. Phone (508) 222-2202. FAX (508) 222-0693.

Circle No. 385

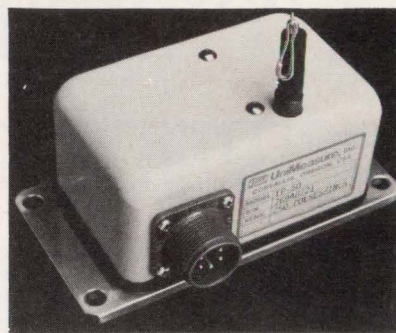

Position Transducer

- Available in metric versions
- Has a TTL-compatible output

The EP Series of digital linear position transducers consists of four English versions and four metric models. Maximum measurement capability ranges from 10 to 500 in. All models have $\pm 0.05\%$ accuracy, and resolutions range to 0.002 in. The transducers operate from a 5V dc input and provide a 2-channel, TTL-compatible output signal with phase quadrature. A differential output is available as an option. The transducers are housed in an aluminum case and have an operating range of 0 to 70°C. From \$495.

UniMeasure Inc, 7055 NW Grandview Dr, Corvallis, OR 97330. Phone (503) 757-3158. FAX (503) 757-0858. Circle No. 386

Neon Indicators

- Are UL listed
- Rated for 105°C

The $\frac{5}{16}$ -in. diameter neon indicators in the 2100 Series operate from 110 or 220V. UL and CSA listed, the 48 models are divided into three families. Model 2110 devices are supplied with raised nylon bezels and lenses; Model 2120 indicators feature flush, low-profile lenses with nylon bezels, and the Model 2150 group has stove-pipe lenses with chrome bezels. All units incorporate nylon housing and polycarbonate lenses and are rated for operation at 105°C. The indicators are available in a range of lens colors and come with prestripped wire

HIGH BETA DARLINGTON LOW COST DESIGN

- 15-20% More Rugged Than Std. Darlington

- New R&D Processing Techniques Advance Bipolar Technology

- Best Cost Performance Trade-Off

- 600A/1200V

- Fits Existing Design Layout

- Reduce Drive Power By 90%

- (BETA) Performance Increased HFE By 10 Times

- Best SOA

- Faster Switching

A continuing investment for the advanced products of tomorrow.

Call **THE POWER LINE** at 1-800-451-1415.

POWEREX

Joint Venture Corporation of Westinghouse, General Electric, and Mitsubishi Electric
Hillis Street, Youngwood, PA 15697
FAX 412-925-4393

End the connector compromise...

1. LIF RACK & PANEL CONNECTORS

2. MULTIPIN WITH 8-200 AMP CONTACTS

3. MIL-C-28748A RELIABILITY

...in electronic power supplies

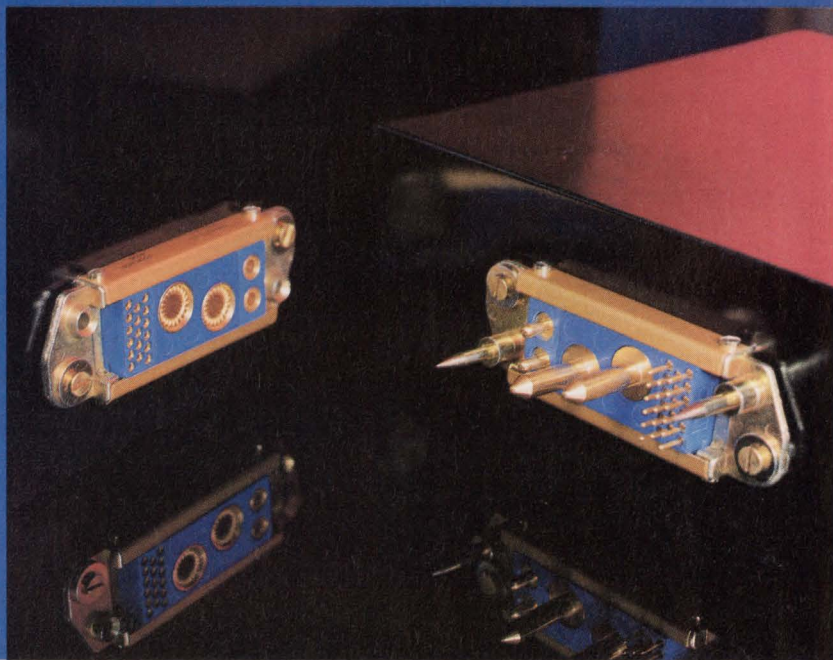

Only Hypertronics ends the compromise in power supply connectors for backplane subassemblies—in military, computer and other electronic systems—by combining Low Insertion Force (LIF) power, signal and MIL spec reliability in a single rack & panel connector.

Our modular design gangs power contacts, rated from 15 to 200 amps, with low-insertion-force signal contacts. Combine these design alternatives with high current/small size performance of the Hypertac® contact—for unique cost and space efficiency.

And now our L Series connectors have been proven to MIL-C-28748A performance standards.

Now you can have it all...in rack & panel

connectors for power and signal applications ranging from power supply to portable disc drives. End the connector compromise by calling 1-800-225-9228, toll free.

HYPERTAC®:
Inserting pin into hyperboloid sleeve.

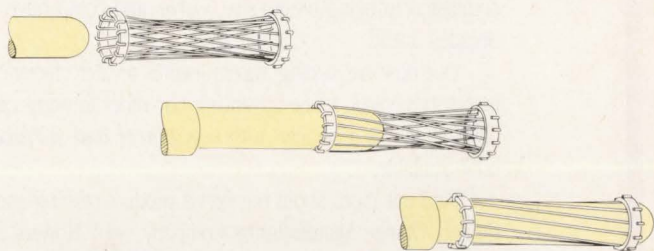

HYPERTRONICS CORPORATION

"New Horizons in Connectors"

16 Brent Drive, Hudson, MA 01749 (508) 568-0451 FAX (508) 568-0680

CIRCLE NO. 138

leads or tinned, male quick-connect terminals. Standard variations include a choice of lenses, leads, terminations, and body finishes. From \$0.45 (OEM qty).

Industrial Devices Inc, 260 Railroad Ave, Hackensack, NJ 07601. Phone (201) 489-8989. FAX (201) 489-6911. **Circle No. 387**

Surface-Mount Keyswitches

- Available with or without actuators
- Have a sealed design

KSC keyswitches are available with or without actuators. The units come with a choice of operating force—160, 300, or 500g. The switches are offered with either sil-

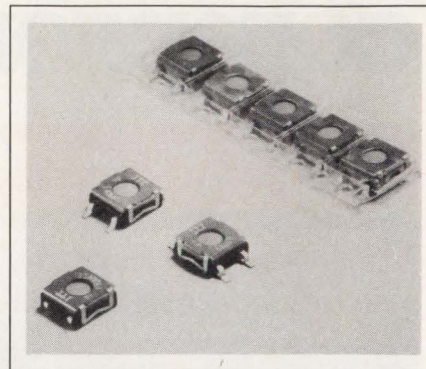

ver or gold contacts and a choice of either J-lead or gull-wing terminations. The units are totally sealed and will accommodate double-wave, infrared, and vapor-phase soldering techniques. To accommodate pick-and-place machines, the switches are supplied in thermoformed tape on reels of 500 pieces. \$0.25 to \$0.50. Delivery, stock to eight weeks ARO.

ITT Schadow Inc, 8081 Wallace Rd, Eden Prairie, MN 55344. Phone (612) 934-4400. TLX 290556. **Circle No. 388**

HOW TO PURCHASE PEACE OF MIND

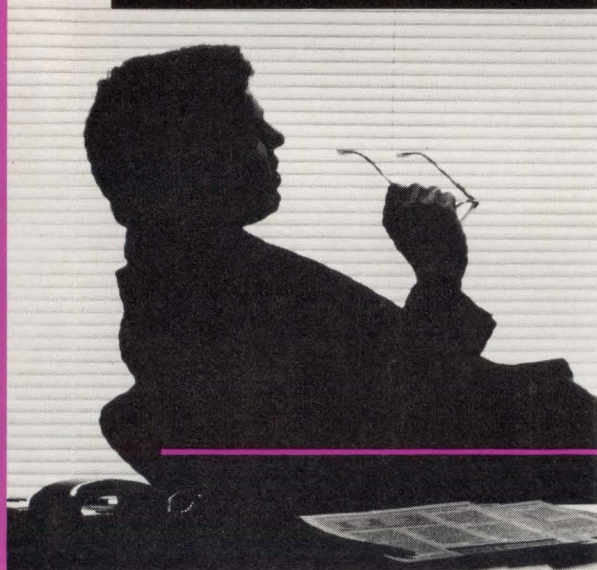

At Ohmite, we know that your requirements extend well beyond the need for a functional product.

Total reliability. On-time delivery. Availability. Quality. State-of-the-art manufacturing. Responsiveness. These are the elements of success you purchase whenever you specify Ohmite wirewound resistors and electronic components.

Since 1925, we've been a supplier you can rely on totally. We're committed to being progressive, viable, and competitive for many decades ahead.

Our new bar coding system assures greater efficiency and improved inventory control, while advancing our order tracking capability. Product development is a priority, with new **power and surface mount resistors** now available.

Find out more about our broad product offering and reliable service. Contact Ohmite Manufacturing Company, 3601 Howard Street, Skokie, IL 60076. Fax: 708-675-1505. Telephone: **708-675-2600**.



A Tradition of Reliability

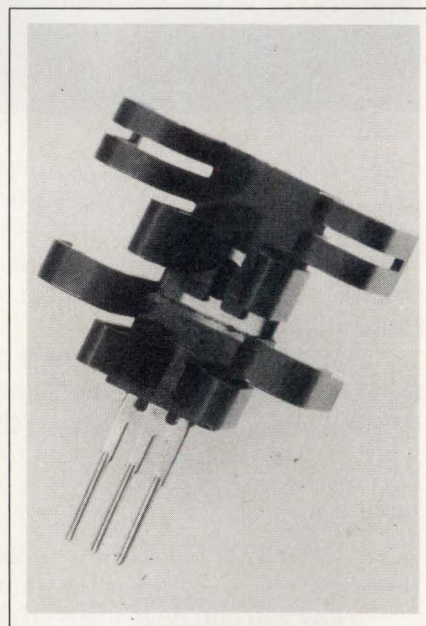

TO-220 Heat Sinks

- Have a spring retainer
 - Mount vertically or horizontally
- The Spider heat sinks have an integral spring retainer that holds the TO-220 semiconductor package

Two state-of-the-art FIFOs from Sharp to solve your toughest data flow challenges.

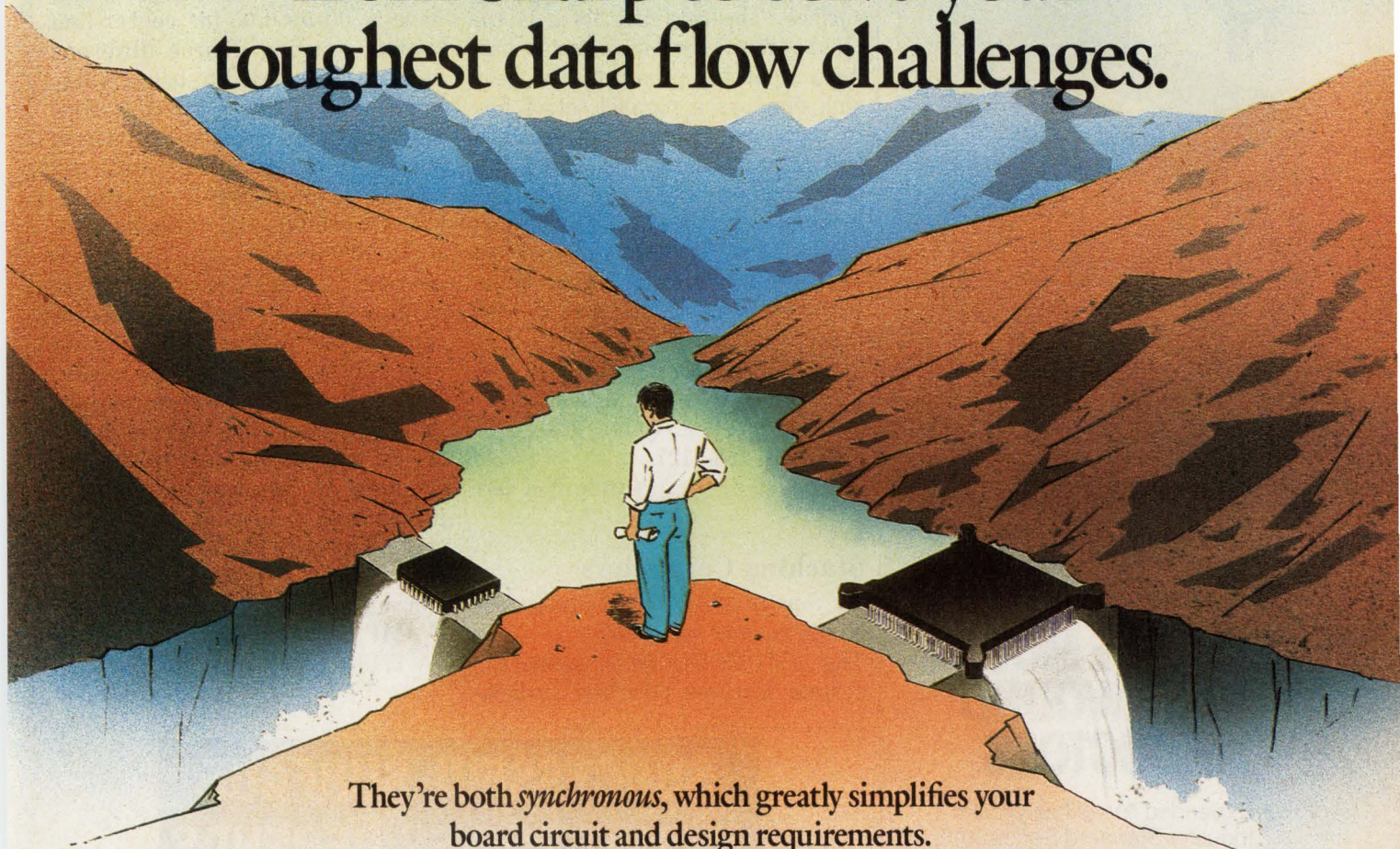

They're both *synchronous*, which greatly simplifies your board circuit and design requirements.

Their proprietary *look-ahead access architecture* delivers speedier access and cycle times while reducing power consumption.

Introducing: The LH5492 4K x 9 Clocked FIFO.

Sharp's new LH5492 is a dual-port clocked FIFO, with a 4K x 9 configuration. The clocked interface is a significant enhancement in FIFO design over previous asynchronous parts. The clocked enables on the LH5492 eliminate the requirement to shape waveforms, resulting in simpler design tasks, and lower parts count.

Its high-speed clocked interface can be used directly with the typical 40%/60% duty cycle system clock. And a separate \overline{OE} control signal provides independent control over output buffers.

The second enable pin on each part can be directly tied to logic to simplify external logic requirements.

The LH5492 4K x 9 clocked FIFO comes in a 32-pin PLCC. It is available with access times of 20 ns, 25 ns and 35 ns, and cycle times of 25 ns, 35 ns and 50 ns, respectively.

Introducing: The LH5420 256 x 36 x 2 Bidirectional FIFO.

Sharp's new LH5420 is actually two 256 x 36-bit FIFOs in one. Operating in parallel but opposite directions to provide bidirectional data buffering that would normally require multiple independent devices.

Its 36-bit word width is an industry first. And ideal for interfacing with new generation higher-speed 32/36-bit and 64/72-bit microprocessors and buses. Moreover, a choice of 9, 18, or 36-bit word widths on Port B means efficient word width matching.

Programmable Almost Empty and Almost Full status flags on each port—in addition to Full, Half Full and Empty flags—allow you to either leave the flags set at their initialized setting of 8, or program them over the entire FIFO depth.

The LH5420 comes in a 132-pin plastic QFP package. It is available with access times of 15 ns, 20 ns and 25 ns, and cycle times of 25 ns, 30 ns and 35 ns, respectively.

SHARP.

By Design.

Sharp Electronics Corporation

COMPONENTS & POWER SUPPLIES

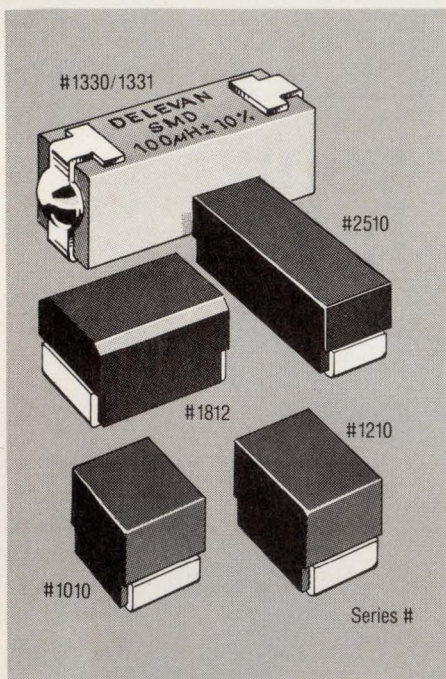

THE MOST COMPLETE OFFERING OF SURFACE MOUNT WIRE-WOUND INDUCTORS

- Expanded line of low-profile Industry Standard Series 1010, 1210 & 1812 inductors
- Series 1330/1331 and 2510 are direct physical and electrical replacements for standard shielded and unshielded axial leaded inductors
- Inductance values from 0.22 μ H to 1000 μ H - shielded units to 560 μ H
- Exclusive terminations offers proven reliability with any soldering method
- Our SM Inductor designs are covered by U.S. Patent numbers 4,914,804, 4,801,912 and 4,934,048
- Designs available in 1%, 2%, 3%, and 5% tolerances
- Complete lot traceability with each unit



270 Quaker Road, East Aurora, NY 14052-0449
(716) 652-3600 FAX (716) 652-4814

MADE IN AMERICA BY AMERICAN CRAFTSMEN
TO AMERICAN STANDARDS OF EXCELLENCE

CIRCLE NO. 63

firmly to the heat-sink mounting surface. The retaining force is applied at four locations to ensure uniform mounting pressure. The heat sink employs a parallel set of fins to maximize thermal performance and minimize board-space and volume requirements. The units are available with or without solderable tinned tabs for either vertical or horizontal mounting. Heat sinks without tabs, \$0.24; heat sinks with tabs, \$0.33 (1000).

Aavid Engineering Inc, Box 400, Laconia, NH 03247. Phone (603) 528-3400. FAX (603) 528-1478. TWX 510-298-1127.

Circle No. 389

Stacking Connectors

- Come in 10- to 100-position sizes
 - Are surface mountable
- The AMPMODU 50/50 connector system features polarized surface-

mount headers and receptacles that have a 0.05 × 0.05-in. center-line contact spacing. Three different headers allow board-to-board stacking heights of 0.25, 0.32, or 0.39 in. Nonprotrusive metallic hold-downs allow you to mount the connectors on both sides of 0.062-in. pc boards. The connectors are available with 10 to 100 positions—in 10-position increments. Receptacles feature beryllium copper, redundant-beam contacts; the headers use 0.018-in.-diameter phosphor bronze posts. Both headers and receptacles are duplex plated to increase reliability on the mating end and to ease the soldering process on the tails. Built-in standoffs on both headers and receptacles ease board-cleaning operations. \$0.07 to \$0.09/mated line. Delivery, stock to 10 weeks ARO.

AMP Inc, Box 3608, Harrisburg, PA 17105. Phone (800) 522-6752.

Circle No. 390

SUCCESSFUL SURFACE MOUNT POWER DEPENDS ON THERMAL CLAD®

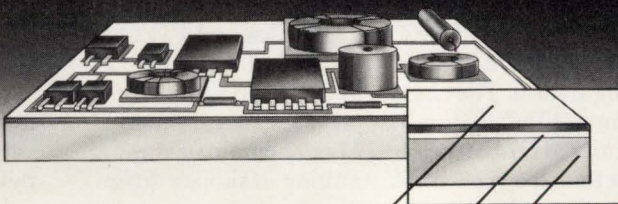

Etched Copper Circuit Layer
Insulation Layer
Metal Base Layer

HERE'S WHY:

- THERMAL CLAD is more thermally effective than FR4, PCB material. Devices will dissipate up to four times more power. (TR 1 °C/Watt)
 - THERMAL CLAD metal base plate is tougher than ceramic. No breakage and larger panel sizes.
 - THERMAL CLAD increases your design flexibility.
- Call Bergquist today with your custom application for THERMAL CLAD! Toll Free: 800-347-4572

BERGQUIST

5300 Edina Industrial Blvd., Minneapolis, MN 55435
Tel: (612) 835-2322 • Fax: (612) 835-4156

CIRCLE NO. 64

Get on board NEC's 3-MIPS V53

On-board peripherals, that is

Our V53 microprocessor has some very important passengers, right on the chip. Like a 71071- and 8237-compatible 4-channel DMA controller that delivers eight megabytes per second data throughput. And three 8254-compatible timer/counters, a 16-bit refresh counter, an 8259-compatible interrupt controller, and 8251-compatible serial I/O port. All on-board, and all software compatible with industry standard devices.

Wicked fast

But if you think the weight of all this on-board cargo slows anything down, think again. Our 16 MHz microprocessor screams along at a minimum instruction execution speed of 125 nanoseconds and can

address up to 16 megabytes of memory. And on-board hardware allows memory implementation of a LIM 4.0 specification. Of course, the V53 is instruction-set-compatible with the entire V-series family of microprocessors and can serve as your embedded DOS engine. Don't settle for less than *both* thrilling speed and on-chip peripherals.

Smooth ride

And since you want a ride that's smooth as well as a fast, we offer you the development tools you need. And whether you choose the 132-pin PGA or 120-pin QFP, you'll save time, money and board space when

you specify NEC's V53 16-bit microprocessor, with on-board peripherals.

Free Data Book

For your free copy of NEC's 16-bit V-Series Microprocessor Data Book, call 1-800-632-3531. Ask for Info Pack #100.

NEC Electronics Inc.
401 Ellis St.
P.O. Box 7241
Mountain View, CA 94039-7241
1-800-632-3531/1-415-965-6158

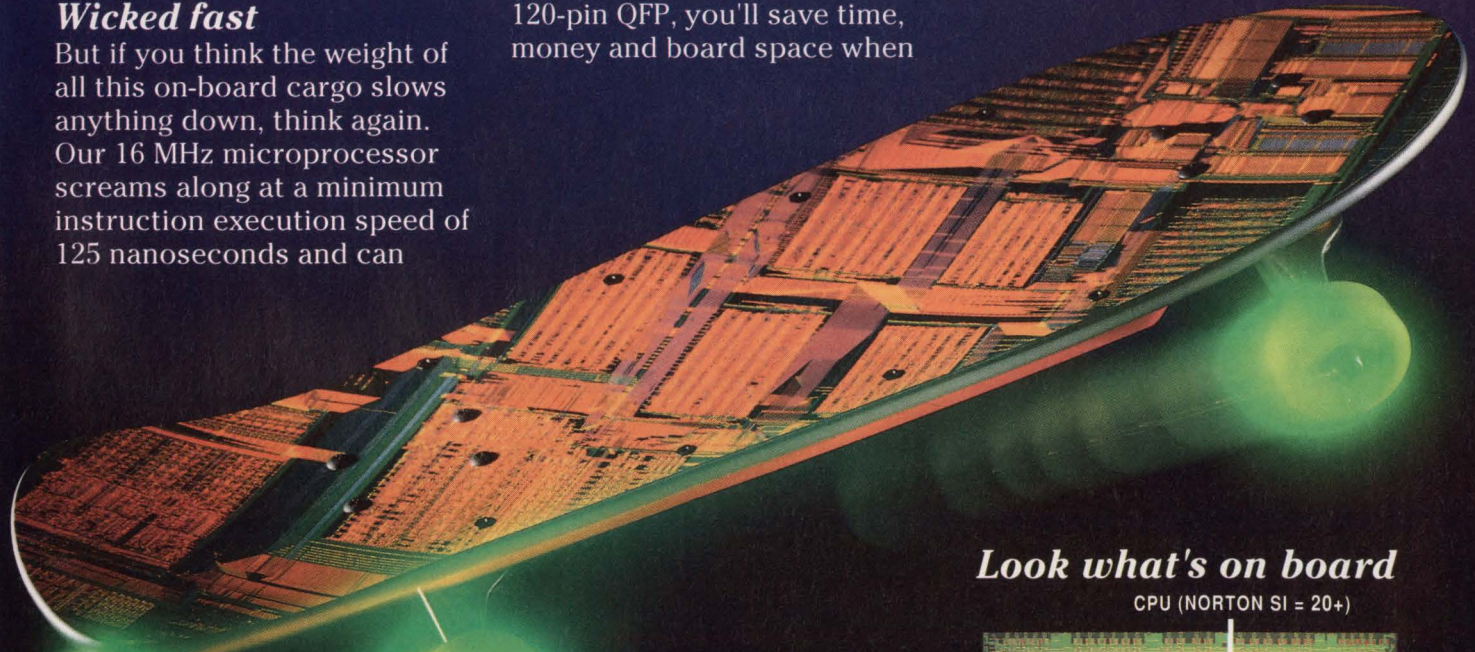

Look what's on board

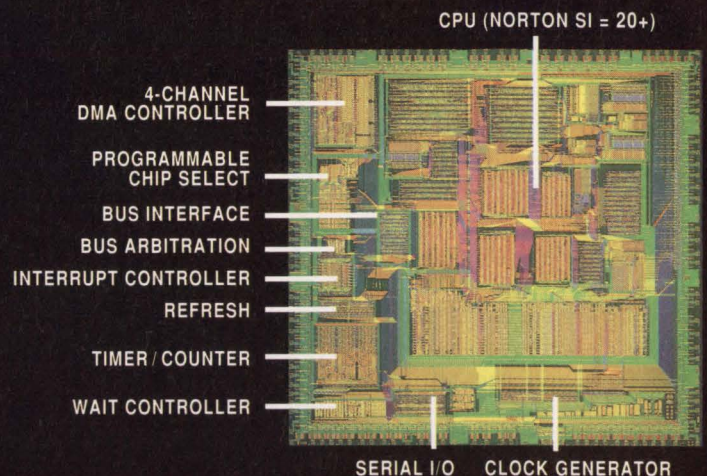

Free Data Book
Call 1-800-632-3531
FAX 1-800-729-9288

NEC

NEW PRODUCTS

INTEGRATED CIRCUITS

Precision 5V Reference

- Less than 2-ppm/°C drift
- Needs no heated substrate

Intended to reduce power requirements in 12- to 16-bit conversion applications, the LT1027 precision reference achieves high accuracy without need of a power-consuming heated substrate. Available in four grades of tolerance and drift, the highest grade LT1027A is pin compatible with the industry standard LT1021-5 and REF-02. Factory trimmed to an output voltage of $5.000\text{V} \pm 1\text{ mV}$ at 25°C , the A-grade device exhibits less than 2-ppm/°C drift. The lowest grade LT1027D has a $\pm 5\text{-mV}$ output tolerance and 7.5-ppm/°C drift. The references settle within $\pm 0.01\%$ of final value in 2 μsec with no external load or when sourcing current. The output can sink or source currents as high as 10 mA. The low-

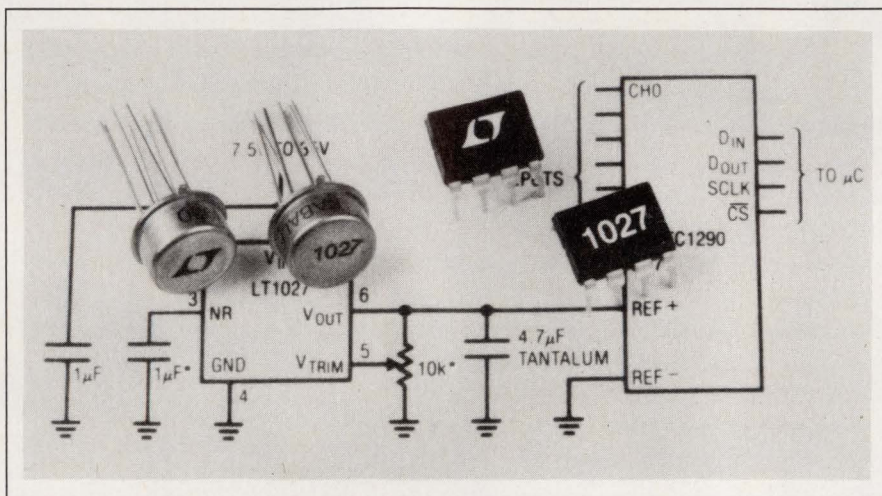

noise references have a noise reduction pin for use with a low-leakage external capacitor; using the pin reduces wideband noise from 2 to 1.2 μV over the 10-Hz to 1-kHz range. The devices also have a trim pin for adjusting the output voltage over a $\pm 30\text{-mV}$ range. All grades of the

LT1027 are available in 8-pin, TO-39 metal cans. The B, C, and D grades also come in an 8-pin plastic DIP. \$5.50 to \$14.10 (100).

Linear Technology Corp., 1630 McCarthy Blvd, Milpitas, CA 95035. Phone (408) 432-1900. FAX (408) 434-0507. **Circle No. 391**

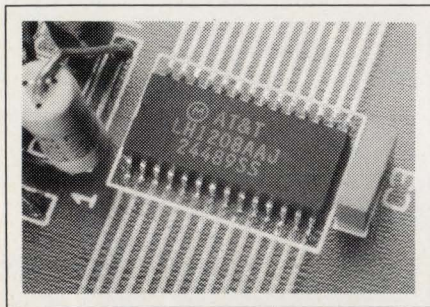

PBX Switch-Set IC

- Performs break and access functions
- Contains five high-voltage switches

The LH1208 PBX switch-set IC replaces several PBX components. The device performs the break and access functions between the PBX line feed and the telephone loop. These functions cause the telephone to ring or the message-waiting lamp to light. The switch set's monolithic single-chip construction eliminates the problems normally associated with mechanical contacts. The

chip's analog and digital circuitry includes five high-voltage switches, ring-trip/off-hook circuits, zero-crossing switching, and an auxiliary latch. The LH1208 comes in a 28-pin SO package and a plastic leaded chip carrier. \$7.80 (100).

AT&T Microelectronics, Dept 52AL300240, 555 Union Blvd, Allentown, PA 18103. Phone (800) 372-2447; in Canada, (800) 553-2448.

Circle No. 392

8-Bit Video DACs

- Feature 40-MHz sampling
- Can drive a 75Ω cable

Designed for high-speed conversion applications such as RGB graphics and high-resolution video, the MC10322 and MC10324 8-bit D/A converters can sample at rates as high as 40 MHz. Functionally identical, the MC10322 has TTL-compatible inputs, and the MC10324 has ECL-compatible inputs. The

devices' input registers eliminate the need for external latches, unless the transparent mode is selected. Video controls (Force High, Blank, Bright, and Sync) permit an easy interface to standard video systems. The DACs have conversion (clock) inputs that can be either differential or single ended. The DACs also provide complementary outputs for use with custom displays or special effects. The devices come in 24-pin DIPs and cost \$4.36 (250).

Motorola Inc, EL340, 2100 E Elliot Rd, Tempe, AZ 85284. Phone (602) 897-3615. **Circle No. 393**

Floating-Point Processors

- Run at a 50-MHz clock rate
- Deliver 100M-flops performance

Targeted at the workstation and massively parallel computer markets, the W4164 and W4364 floating-point processors can deliver a 100M-flops performance and run at



We're Revolutionizing Surface Mount Technology, In Our Own Small Way.

Higher mounting densities through miniaturization—that's the goal of today's component manufacturers.

At TDK, we've led the way in developing surface mount chips that greatly reduce the number of devices per board.

But miniaturization has its limits.

Even the most advanced automated mounting equipment, such as TDK's AVIMOUNT® line, cannot reliably mount SMDs smaller than 1.0 x 0.5mm.

To overcome this problem, we've focused on pattern design technology and advanced sintering techniques to produce composite multilayer chip components such as LC filters, capacitor networks, and chip transformers.

These multilayer components provide greater reliability and lower assembly costs that will impact on your business in no small way.

Call or write us today for your free SMT catalog.

 **TDK**®
TDK Corporation Of America

HEAD OFFICE 1600 Feehanville Drive, Mt. Prospect, IL 60056 USA PHONE: (708) 803-6100 CHICAGO REGIONAL OFFICE Phone: (708) 803-6100 INDIANAPOLIS REGIONAL OFFICE Phone: (317) 872-0370 NEW YORK REGIONAL OFFICE Phone: (516) 625-0100 LOS ANGELES REGIONAL OFFICE Phone: (213) 539-6631 DETROIT DISTRICT OFFICE Phone: (313) 462-1210 NEW JERSEY DISTRICT OFFICE Phone: (201) 736-0023 BOSTON DISTRICT OFFICE Phone: (508) 624-4262 HUNTSVILLE DISTRICT OFFICE Phone: (205) 464-0222 GREENSBORO DISTRICT OFFICE Phone: (919) 292-0012 DALLAS DISTRICT OFFICE Phone: (214) 506-9800 SAN FRANCISCO DISTRICT OFFICE Phone: (408) 437-9585 TDK CORPORATION, TOKYO, JAPAN.

CIRCLE NO. 141

Bigger.

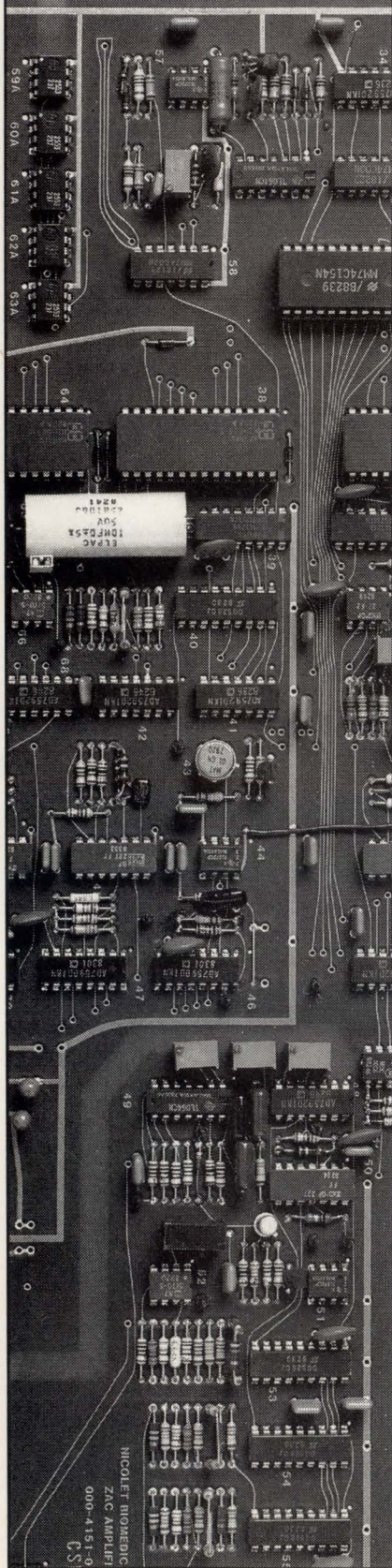

CIRCLE NO. 65

INTEGRATED CIRCUITS

a clock rate of 50 MHz. The processors reduce board space by integrating several functions on a single chip, including a register file, a multiplier/divider unit, and an ALU. The register file eliminates the need for off-chip devices, and the independently controlled ALU and multiplier/divider unit enable the processors to perform two independent numeric operations simultaneously. The W4164 has an 8-port register file and a single 64-bit I/O port. The W4364 has a 9-port register file and three 64-bit I/O ports, which optimize the device for vector applications. The W4164 will be available in the second quarter of 1991, and the W4364 will be available in the fourth quarter of 1991. W4164, \$575; W4364, \$625 (1000).

Weitek Corp, 1060 Arques Ave, Sunnyvale, CA 94086. Phone (408) 738-8400.

Circle No. 394

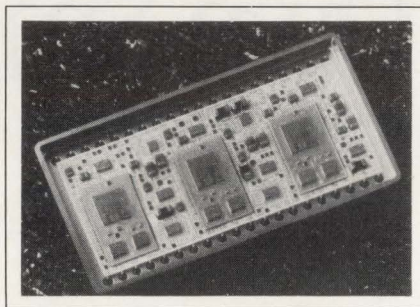

3-Channel, 16-Bit R/D Converter

- *Type-II servo-loop tracking*
- *Operates from a 5V supply*

The HRD1346 16-bit resolver-to-digital (R/D) converter contains three independent channels. Each channel is a Type-II tracking converter with zero velocity-lag error. The converter has an accuracy of 1.3 arc-minutes, which is maintained with signal-to-reference phase shifts to $\pm 45^\circ$. Special anti-lock-up circuits ensure that the converter does not lock into an angle 180° from the true angle, when a step function of 180° is applied. A transparent latch, configured as two independently enabled 8-bit

bytes, eases the transfer of data. The R/D converter, which is fully compatible with 8- and 16-bit microprocessors, operates from a single 5V supply and consumes 30 mA of current. HRD1346 in a 40-pin hybrid package, \$1345. Delivery, 12 to 16 weeks ARO.

Natel Engineering Co Inc, 4550 Runway St, Simi Valley, CA 93063. Phone (805) 581-3950. FAX (805) 584-4357.

Circle No. 395

Ethernet Transceiver

- *For use with 10Base-T LANs*
- *Low-power operation*

Designed for use with 10Base-T twisted-pair LAN media, the 92C03 Ethernet transceiver has all key analog and digital functions on chip and supports both embedded and external media-attachment-unit applications. The low-power device draws an idle current of less than 35 mA, compared with competitive types that draw as much as 350 mA. The chip also features a nonoperating mode that disables the internal clock and reduces current drain to $<250 \mu\text{A}$. This mode is useful for conserving power in laptop-computer and other power-sensitive applications. In addition to meeting the 10Base-T standard, the transceiver also supports pre-10Base-T designs by allowing for the disabling of the link test and the signal-quality-error test. The transceiver is available in 28-pin DIPs or plastic leaded chip carriers. DIP version, \$9.75 (1000).

NCR Corp, 1700 S Patterson Blvd, Dayton, OH 45479. Phone (800) 334-5454; in OH, (513) 445-5000.

Circle No. 396

Dual-Port Static RAMs

- *Have 25-nsec access times*
- *Organized as $1k \times 8$ and $2k \times 8$ bits*

Featuring access times of 25 nsec, an 8-member family of dual-port static RAMs (SRAMs) can work

INTEGRATED CIRCUITS

with processors running as fast as 40 MHz. Available in basic organizations of $1k \times 8$ bits and $2k \times 8$ bits, the CY7CXXX devices come in both master and slave configurations and in a choice of either 48- or 52-pin packages. Dual-port SRAMs that allow two processors to share a common memory provide two sets of address, data, and control signals; one for the "left" port and one for the "right" port. Usually, 8-bit applications require one master. You can use slave devices to expand word width. Because of pin limitations at the $2k \times 8$ -bit level, interrupt outputs are not available in the 48-pin DIP. In the 52-pin LCC and plastic leaded chip carriers, interrupt outputs are available from both master and slave devices. CY7C141 $1k \times 8$ -bit slave, \$32.20; CY7C136 $2k \times 8$ -bit master, \$47.20.

Cypress Semiconductor, 3901 N First St, San Jose, CA 95134. Phone (408) 943-2600.

Circle No. 397

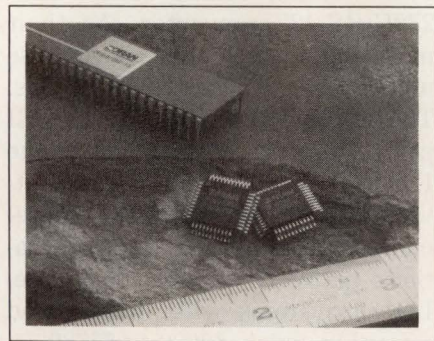

Image-Compression IC

- Performs discrete cosine transforms
- Operates bidirectionally

Designed for image-compression applications, the ZR36020 processor performs 2-D forward and inverse discrete cosine transforms (DCTs). By cascading the device with an image coder/decoder, the user can realize a JPEG-compliant image-compression system. Bidirectional operation facilitates dynamic compression and decompression switching. The processor performs

an 8×8 DCT every 4.2 μ sec (15-MHz data rate) and supports four different data formats. Power consumption is <625 mW, and a low-power standby mode reduces this figure to 10 mW. The DCT processor is available in a 44-pin quad flat-pack or a 48-pin ceramic DIP. \$79 (100).

Zoran, 1705 Wyatt Dr, Santa Clara, CA 95054. Phone (408) 986-1314. FAX (408) 986-1240.

Circle No. 398

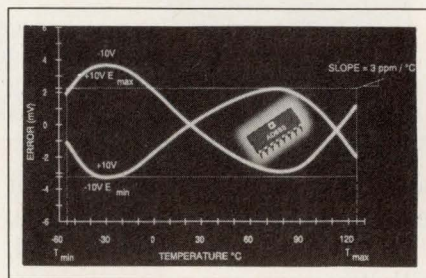

Precision $\pm 10V$ Reference

- Initial error is <2 mV
- Drift is <1.5 -ppm/ $^{\circ}C$

According to the company, the AD688 is the industry's first monolithic $\pm 10V$ reference. The device features a maximum initial error of 2.0 mV, a maximum tracking error of 1.5 mV, and a maximum temperature drift of 1.5-ppm/ $^{\circ}C$. Designed for use in such applications as 12- to 16-bit data-acquisition systems, the reference offers 12-bit accuracy without any user adjustments. For greater levels of precision, you can use the gain and balance-adjust pins to calibrate the reference. In addition, Kelvin force-and sense-connections correct for the effects of voltage drops in circuit wires. Noise from the buffered voltage outputs is typically 0.6 μ V pk-pk with a spectral density of 140 nV/ \sqrt{Hz} . The AD688, in a 16-pin ceramic DIP, comes in three accuracy and temperature grades. From \$12.75 (100).

Analog Devices, 181 Ballardvale St, Wilmington, MA 01887. Phone (617) 937-1428. Circle No. 399

Better.

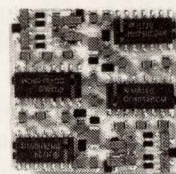

BETTER BECAUSE IT'S SMALLER.

Space is the first thing you save at PHM. You can expect a 1:10 reduction in size with our hybrids, 1:4 with surface-mount boards.

BETTER BECAUSE IT'S FASTER.

You also save time. Send us your design parameters and you'll get a prototype in 4 to 6 weeks (sooner if you need a miracle).

BETTER BECAUSE IT'S CHEAPER.

Time is money — see above. A PHM prototype typically is less than \$3,000.

BETTER BECAUSE IT'S BETTER.

Our products deliver exceptional performance and reliability. That's because we use only the latest techniques in design and manufacturing.

BETTER GIVE US A CALL.

See why companies like Tektronix, Motorola, RCA and Hewlett Packard come to us with their biggest problems. Call 1-800-622-5574 for a free quote or literature package.

10575 SW Cascade Blvd. Portland, OR 97223
(503) 684-5657 FAX (503) 620-8051



We do small miracles.

Copyright © 1990 Pacific Hybrid Microelectronics

CIRCLE NO. 66

NEW PRODUCTS

TEST & MEASUREMENT INSTRUMENTS

Digital Logic-Analyzer Probe

- Includes bus simulation and logic analysis
- Accepts pods for specific 8-, 16-, and 32-bit μ Ps

When equipped with appropriate pods and probes, the Model 5100 instrument performs bus simulation through 152 programmable I/O lines; operates as a 9-channel, 100-MHz logic timing analyzer; and aids in troubleshooting specific 8-, 16-, and 32-bit μ Ps. Among the processors supported are the 68020 and the i386. Among the buses supported are the VMEbus, Multibus, IBM PC/AT bus, and SCSI bus. In addition to logic analysis, the logic-analyzer probe supports signature analysis and measures frequency

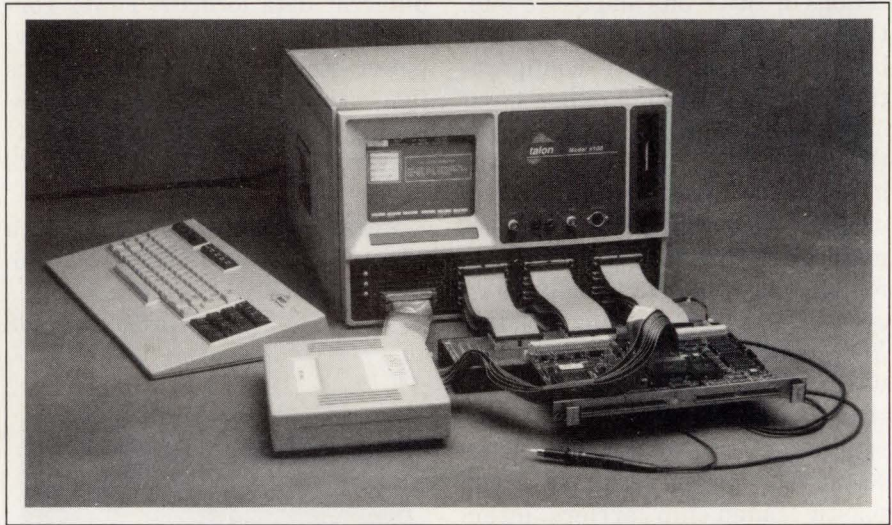

and other analog quantities. Unit equipped with logic analyzer probe, 152 I/O lines, and 32-bit μ P pod, \$21,195.

Talon Instruments, 150 E Arrow Hwy, San Dimas, CA 91773. Phone (714) 599-0690. FAX (714) 599-6529.
Circle No. 372

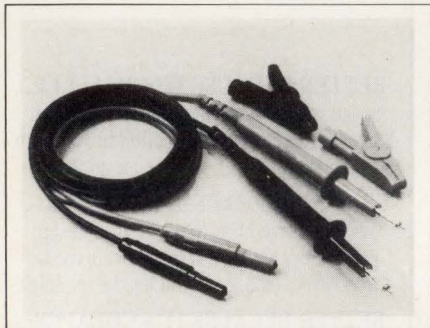

Multimeter Test Leads

- Let you plug alligator clips onto banana-plug tips
- Accommodate many types of accessory tips

The TL1000 silicone-rubber multimeter lead set includes right-angle or straight-shielded banana plugs and fully insulated alligator clips, with hard-plastic insulators. You can adapt the lead set to particular uses by pushing accessories onto banana plugs at the lead ends farthest from the meter. Such accessories include push-on hooks and spade lugs. Other accessories include adapters for meters with recessed male inputs and extended

sleeves to link cables for greater length. You can use the 1.2m lead set for measuring voltages as high as 1 kV and currents as high as 10A. The straight plugs have spring-loaded, retractable safety sleeves; the right-angle plugs have fixed rubber sleeves. \$14.

Test Probes Inc, 9178 Brown Deer Rd, San Diego, CA 92121. Phone (800) 368-5719.

Circle No. 373

Data-Acquisition Units For Next Workstations

- For analog and digital I/O
- Driver software links to Objective-C

The ADC488/16 16-bit A/D converter has 16 single-ended or 8 differential inputs and 100k-sample/sec throughput. The ADC488/8S ADC has eight differential inputs, each with its own S/H amplifier. The DAC is available with two or four channels. All DAC outputs are ohmically isolated from each other and from chassis ground. The Digi-

tal/488 is an 80-bit digital I/O interface. The Serial488/4 is a 4-channel bidirectional IEEE-488 to RS-232C/RS-422 converter. As their model numbers imply, all of these units connect to the IEEE-488 bus. The SCSI488/N interfaces the SCSI port of a Next workstation to the IEEE-488 bus. Driver488/N is software that lets you control the aforementioned units from the workstation's native Objective-C language. I/O subsystems with drivers and several modules, \$2990 to \$5780.

IOtech Inc, 25971 Cannon Rd, Cleveland, OH 44146. Phone (216) 439-4091. FAX (216) 439-4093.

Circle No. 374

Workstation-Based Test-Development Software

- Lets you develop test programs by connecting icons
- You can define your own icons via C-language routines

Real-time Integrator is software for the vendor's Unix and RISC-based workstations; it allows you to de-

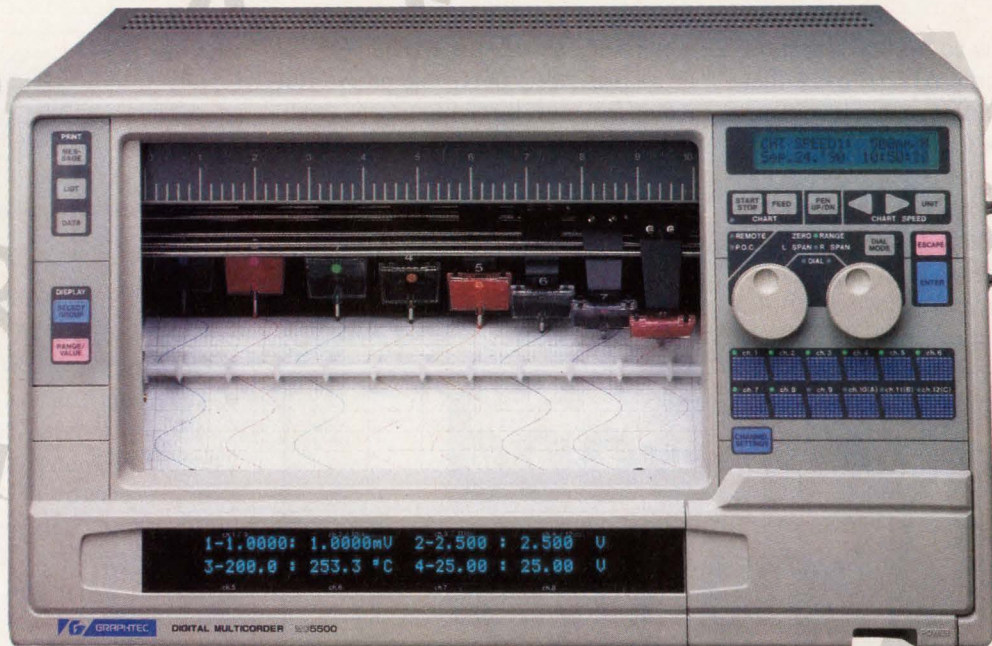

THE WORLD'S SMARTEST 12-CHANNEL PEN RECORDER

More intelligent functions, and more channels—two key points that make the new Graphtec MC5500 Digital Multicorder a truly powerful package.

MORE INTELLIGENT FUNCTIONS—A smart machine means better efficiency. The MC5500 has a bright digital display that shows measured values and span, a 32 Kword memory card as standard equipment (256 Kword optional), and 5 different printed logging and report modes. You also get Auto Bias recording, Partial Enlargement/

Reduction, Zone recording, remotely adjustable chart speed and a GPIB interface for control by the host computer.

MORE CHANNELS—If you need to record more than 8 channels of data, the choice is simple. You can either double up on hardware, bulk, and complexity, or simply buy the compact 12-channel version of the MC5500.

For more information on this truly SMART pen recorder, call, write or fax us today.



WESTERN GRAPHTEC, INC.

11 Vanderbilt, Irvine, CA 92718 • (714) 770-6010
(800) 624-8396 inside CA (800) 854-8385 outside CA
FAX: (714) 855-0895

velop programs to control and monitor test instruments and to reduce, display, and analyze their output. The package's icon-based graphical interface lets you create programs by interconnecting icons on the screen; no traditional programming is needed. The package supports instruments that interface with the

workstations via an IEEE-488 bus or an RS-232C port. You can define icons for new instruments by writing routines in C. Development kit, \$2700; runtime license, \$600.

Digital Equipment Corp, 146 Main St, Maynard, MA 01754. Phone (800) 344-4825; in MA, (508) 493-5111. **Circle No. 375**

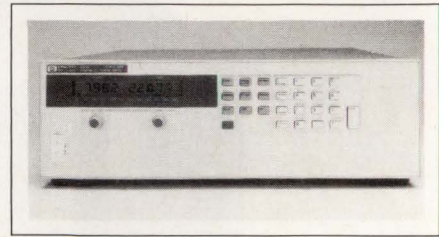

IEEE-488-Controlled Power Supplies

- Occupy 5¼ in. in EIA racks
- 8V version produces noise of 7 mV p-p in a 20-MHz bandwidth

The HP 6671A and 6674A power supplies occupy 5¼ in. of mounting height in a 19-in.-wide EIA equipment rack. The IEEE-488-programmable 8V and 60V units produce 1.96 and 2.1 kW of output power, respectively. The 8V unit produces 7 mV p-p in a 20-MHz bandwidth. A 5-pole common-mode current filter helps to lower the normal-mode noise, and the 8V unit offers common-mode noise of 5 mA p-p. The vendor claims that this current is from 1 to 10% of that produced by other switching supplies. The units respond to the SCPI syntax. HP 6671A 8V unit, \$4450; HP 6674A 60V unit, \$4300.

Hewlett-Packard Co, 19310 Pruneridge Ave, Cupertino, CA 95014. Phone (800) 752-0900.

Circle No. 376

AC-Power-Quality Analyzer

- Features DSO, rms voltmeter, and clamp-on ammeter
- Monitors harmonic distortion and power disturbances

The Model 658 Power-Quality Analyzer electrical troubleshooting tool incorporates features of a digital storage oscilloscope, a true-rms clamp-on ammeter, a true-rms voltmeter, a harmonic-distortion analyzer, and a power-disturbance monitor. The 24-lb, 4-channel unit includes a 5-in. flat-panel display, a 3½-in. floppy-disk drive, and a graphics printer. You can view any voltage or current waveform and also see its peak and rms values up-

Turn Good Ideas Into Good Articles

With EDN's FREE Writer's Guide!

Would you like to get paid for sharing your clever engineering ideas and methods with your professional colleagues? If so, then send for EDN's new FREE writer's guide and learn how.

You don't need the skills and experience of a professional writer. And you don't need to know publishing jargon. All you *do* need are a little perseverance, your engineering skills, and the ability to communicate your ideas clearly.

Our new writer's guide takes the mystery and intimidation out of writing for a publication. It shows you how to write for EDN using skills you already have. Plus, it takes you step-by-step through the editorial procedures necessary to turn your ideas into polished, professional articles.

Get your **FREE** copy of EDN's writer's guide by circling number 800 on the Information Retrieval Service Card or by calling (617) 964-3030.

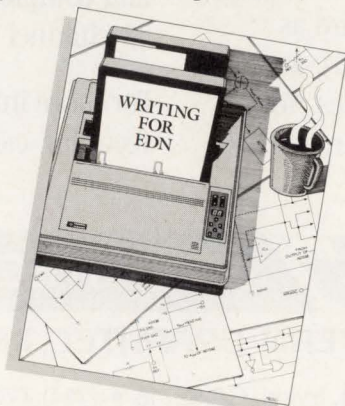

For Automotive Chips that Talk, Talk to Oki.

RealVoice™ Synthesizers offer Quality and Affordability

If you think speech synthesizers sound toy-like and are too complex and costly, try Oki's RealVoice family of easy-to-use, *affordable* synthesizers — and listen to the difference.

Once you've heard the realistic sound, you'll see why they're ideal for car security systems, cellular phones, safety monitors, and more.

Our on-chip filter and D/A reduce design time and IC count, while increasing system reliability. Plus we offer a range of devices, demo boards, and a low-cost development system with PC-based boards and software.

For samples of quality that speaks for itself, call OKI today
1-800-OKI-6388.

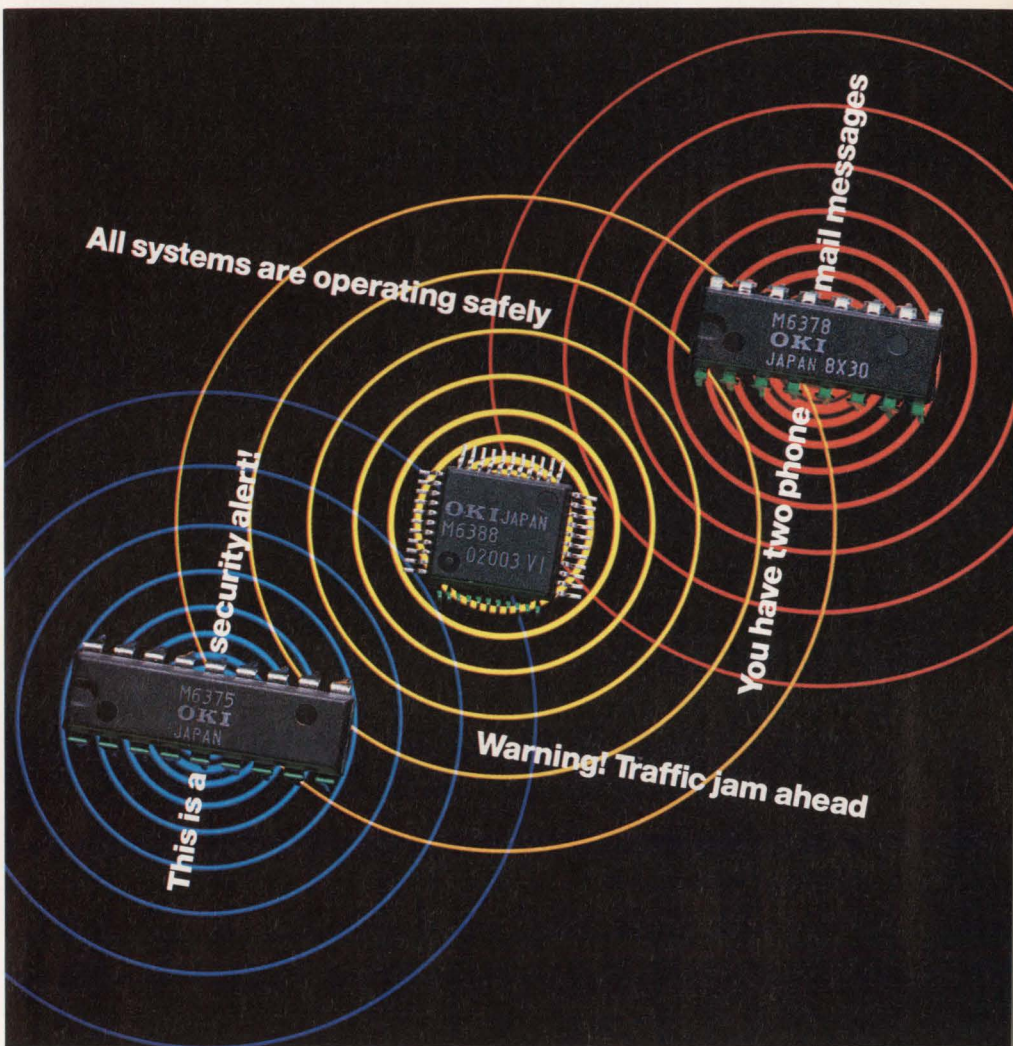

Oki's RealVoice™ Speech Synthesis Family

Part #	Description
MSM6295	4-channel speech synthesizer
MSM6322	Pitch control IC
MSM6372	Speech synthesizer with 128K ROM, 5 secs
MSM6373	Speech synthesizer with 256K ROM, 10 secs
MSM6374	Speech synthesizer with 512K ROM, 20 secs
MSM6375	Speech synthesizer with 1M ROM, 40 secs
MSM6376	Evaluation chip for MSM6372/73/74/75
MSM6378	Speech synthesizer with 256K OTP ROM
MSM6388	Solid-state recorder/1M serial register I/F



OKI
Semiconductor

Transforming technology into customer solutions

785 North Mary Avenue
Sunnyvale, CA 94086-2909

RealVoice is a trademark of Oki Semiconductor.

dated continuously in numeric form. You can also zoom in on waveform details. A monitor mode stores digitized records of disturbances in non-volatile memory for later analysis. Approximately \$13,000.

Dranetz Technologies Inc., Box 4019, Edison, NJ 08818. Phone (201) 287-3680. **Circle No. 377**

Switching Modules For Analog And Digital Signals

- Accommodate low-level and high-frequency signals
- High-speed unit has 32k-word memory

The System 23 family of modules plug together to form switching subsystems that route analog and

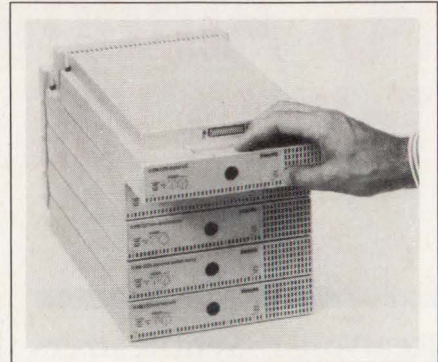

digital signals to and from test instruments. Each switching subsystem must include a master module that provides an interface to the IEEE-488 bus and can furnish power to 15 modules. The family has modules of seven types, including matrix switches, high-frequency switches, and switches with low thermal offsets. A 32-channel digital I/O module has a 32k-word buffer and can handle I/O operations at 2 MHz. Programming conforms to the SCPI syntax. Modules, \$850 to \$1650.

John Fluke Mfg Co Inc., Box 9090, Everett, WA 98206. Phone (800) 443-5853; in WA, (206) 347-6100. **Circle No. 378**

Philips Test and Measurement, Bldg TQIII-4, 5600 MD, Eindhoven, The Netherlands. Phone local office. **Circle No. 379**

2-MHz Sweep/Function Generator

- Produces sine, square, triangular, and TTL waveforms
- Lets you vary sweep width to 100:1

The FG-2000 2-MHz sweep/function generator produces five waveforms—sine, square, and triangular waves; ramps; and a TTL-compatible pulse train. The generator can operate as a frequency-modulated source or as a voltage-controlled generator using its internally synthesized ramp as the modulating source. The output is 10V p-p into 50Ω or 20V p-p into an open circuit. A switchable ×20 attenuator, vari-

OTTO Precision Switches



ACTUAL SIZE!

A Snap-Action Basic Switch so small yet delivers **1,000,000 cycles!**

And, would you expect a big 2 ampere switching capability in such a small package? That's twice the others! Our new B1 series basic switch also handles low level logic signals as well. Thanks to our patented switch design, you can expect 1,000,000 mechanical cycles; 25,000 electrical cycle life! Truly a precision switch, the B1 has a

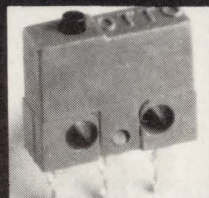

Three times actual size!

Movement Differential typically less than .002"; Operating Position tolerance of .015" max. Molded-in and sealed terminals. Industrial and military grades. Ask about our full service value added capability, too. We will take your requirements from concept, through prototype, and on to your complete end product's assembly.



OTTO

CONTROLS

Call or Fax for our new 44 page Catalog today.

2 E. Main St. • Carpentersville, IL 60110 • Tel: 708/428-7171 • Fax: 708/428-1956

CIRCLE NO. 68

Another FLASH Of Brilliance From Mitsubishi.

From the people who brought you ZIP packaging and the first TSOPs, another great idea – Flash EEPROMs from Mitsubishi.

Lower the cost of your system upgrades with Flash EEPROMs' on-board reprogramming. In workstations, office automation equipment and telecommunications systems, our 10K erase/write

cycles ensure the reliability of your product.

Mitsubishi Flash EEPROMs are available in 1 Mb, 128K x 8 DIP packages, as fast as 100ns. Flash will also be available in 64K x 16, and higher densities. Watch for TSOP (Thin-Small-Outline-Package), SOP and PLCC versions in the future. Here's another brilliant idea:

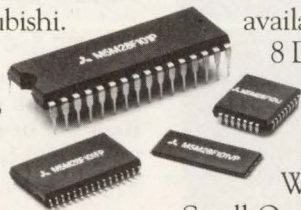

VISION
ACTION
REALITY

SM call us now at
1-800-624-8999,
ext. 178D and set
your vision into
action with Mitsubishi Flash
EEPROMs. They can make your
new design a reality.

 **MITSUBISHI**
ELECTRONIC DEVICE GROUP

able dc offset, and adjustable symmetry enhance the unit's flexibility. \$349.

Ztest Electronics Inc, 290 Larkin St, Buffalo, NY 14220. Phone (416) 238-3543. FAX (416) 238-1377. **Circle No. 380**

VMEbus Data-Acquisition Module

- Includes 12-bit 1- μ sec or 14-bit 2- μ sec ADC
- Has four input channels and plug-in ADC section

The DVME-614 VMEbus data-acquisition module accepts very fast, accurate plug-in ADCs. The 4-channel unit accommodates a 12-bit ADC that makes a conversion in 1 μ sec or a 14-bit ADC that converts in 2 μ sec. The board contains a 4096-word FIFO buffer that permits nonstop acquisition during transfers of data blocks to the

CPU's memory. In addition to transfers via the VMEbus, the board can send data from the buffer through its parallel port at 4M bps. You can trigger the ADC with analog or digital signals. The board includes counter/timers to divide a trigger signal's frequency. It also contains a comparator and threshold DAC for analog triggering. 12-bit, 1k-word buffer, \$2395; 14-bit model, \$2590.

Datel Inc, 11 Cabot Blvd, Mansfield, MA 02048. Phone (508) 339-3000. **Circle No. 381**

200k-Sample/Sec, 16-Channel ADC Board

- Simultaneously samples all channels
- Includes four DACs and 24 digital I/O lines

The PC-30DS data-acquisition boards plug into the IBM PC/AT

bus. They include a 12-bit ADC that can take 200k samples/sec. The ADC is preceded by one to four multiplexed S/H circuits, each having four channels. These circuits can simultaneously sample all of the analog inputs. Also on the board are 24 digital I/O channels, two 12-bit DACs, and two 8-bit DACs. The board includes channel-list hardware that lets you scan channels in customized sequences. Once you've specified a scan, you can start it with a terse command. A block-scan mode and dual-channel DMA let you store long, gap-free data sequences in the computer's memory. The vendor supplies high-level-language drivers with source code. PD-30DS 16-channel unit, \$1495; PD-30DS/4 4-channel unit, \$1295.

United Electronic Industries, 10 Dexter Ave, Watertown, MA 02172. Phone (617) 924-1155. FAX (617) 924-1441. **Circle No. 382**

**HIGH FIN DENSITY HEAT SINKS
REDUCE SIZE and COST**

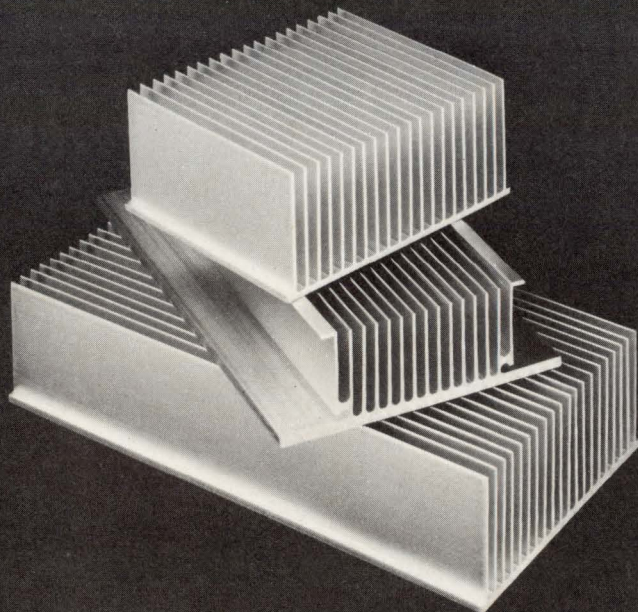

Achieve maximum heat transfer efficiency with EG&G Wakefield Engineering High Fin Density heat sinks for power-generating components. Our 510, 511, and 512 Series standard heat sinks yield the same thermal performance as other heat sinks needing nearly twice as much space.

Designed for cooling isolated power modules, amplifiers, and other power-generating components, these heat sinks are manufactured with a unique process which we developed to maximize the surface area available — to yield 130 sq in. of cooling surface per linear inch of extrusion!

Available Now

Standard heat sinks in three different profiles and several lengths are available now from stock.

Lower Cost

Because of the substantial material savings with these unique designs, our High Fin Density heat sinks save on weight and cost per unit volume. The weight savings is approximately 60%!

Call our Sales Department today for the name of our stocking distributor nearest you, at (617) 245-5900.

EG&G WAKEFIELD ENGINEERING

60 AUDUBON ROAD, WAKEFIELD, MA 01880

TEL: (617) 245-5900 • FAX: (617) 246-0874

Western U.S. Sales Office • 3777 RUFFIN ROAD, SAN DIEGO, CA 92133

TEL: (619) 279-2253 • FAX: (619) 576-9286

FOR RUGGED, RELIABLE POWER... **LOOK TO**

B Basler Electric

THE INNOVATORS IN SWITCHING POWER SUPPLIES

Summit Power Supplies offer a wide range of output configurations, a maximum of standard features, and are tailorable to special requirements. Custom packaging available.



JX400 WATTS
(10" x 5" x 2.5")

- High Package Density
- UL/CSA/IEC/VDE/TUV Approvals
- 115/230 Auto Select Inputs
- Three to Five Outputs
- Adjustable Auxiliary Outputs
- Parallel Operation
- FCC/VDE/EMI Filters
- Fan Options
- Meets Mil-style Shock/Vibration Specs

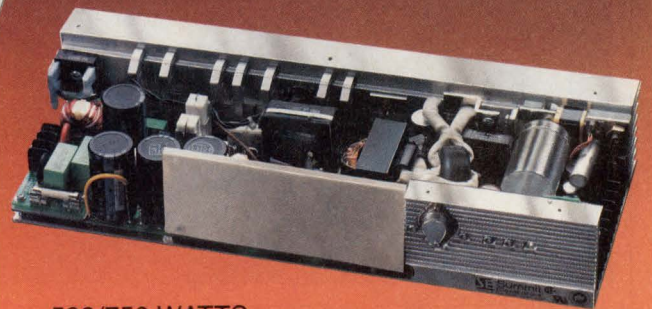

500/750 WATTS

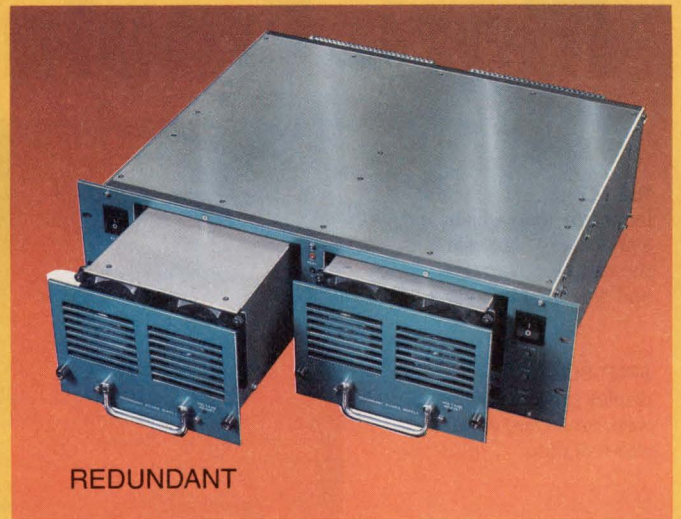

REDUNDANT

CALL TOLL FREE

1-800-645-2074

FOR INFORMATION ON

Summit® POWER SUPPLIES FROM
BASLER'S ELECTRONIC PRODUCT GROUP

B Basler Electric

Box 269, Route 143 • Highland, IL 62249 • 618-654-2341 • Fax: 618-654-2351

VALUE ADDED!!

Enclosures, harnesses, auxiliary assemblies to customer specs.

NEW PRODUCTS

CAE & SOFTWARE DEVELOPMENT TOOLS



PC-Hosted Cross-Development Tools for OS-9

- Allow you to develop and debug applications in C on a PC
- Let you download your programs to 680X0-based system for OS-9

PCBridge lets you develop and debug real-time applications in C on an IBM PC or compatible. You can cross-compile the programs, download them via a serial link to a remote 680X0-based system that runs the OS-9 operating system, and link your application modules to existing libraries and drivers. PCBridge comes with a C cross-compiler, an assembler, a linker, a state debugger, an OS-9 memory-module loader, and other development aids. If you're designing the entire OS-9 target system, you can use the

More Emulation For Less!

HIGH-LEVEL
language source lines and symbols are shown in both the disassembled trace and breakpoint displays.

SPLIT-SCREEN
display provides multiple work areas and different views of data.

BREAKPOINT
shows register contents and allows modification; registers are highlighted as they change.

```

D TIME      200E 00 (write)
E           200F 00 (write)
L0053_M2   count = 0; /* zero out the initial count */
F L0053_M2 F02C 5F          CLRB
11         F02D 4F          CLRA
13         F02E FD2010      STD COUNT
16 COUNT   2010 00 (write)
17         2011 00 (write)
L0054_M2   bits = 0x00; /* set
18 L0054_M2 F031 CC0000
Command>

L0052_M2   time = 0x000; /* set
PC=       MAIN          F026 CC0000
Command> Breakpoint set at L0053_M
A=00 B=00 X=C258 Y=BA00 SP=0
L0053_M2   count = 0; /* zer
PC=       L0053_M2      F02C 5F
Command> Breakpoint set at L0054_M

A=00 B=00 X=0017 Y=BA00 SP=0
L0054_M2   bits = 0x00; /* set
PC=       L0054_M2      F031 CC0000
Command>

Orion Help Memory Files Analyzer Debug Epron Special Configuration
    
```

ANALYZER TRACE
triggering shows realtime instruction execution enabling you to debug by symptom.

DEBUG POPUP
gives immediate access to breakpoints, single-steps and all debug functions.

POPUP MENUS
make the 8620 the easiest development system to learn and use.

Go ahead and compare the 8620. For 8- and 16-bit processors, there's nothing else like it. The feature-rich 8620 gets your product to market faster and costs less. Call for a demonstration and free demo disk. Orion Instruments, Inc. 180 Independence Drive, Menlo Park, CA 94025. FAX (415) 327-9881.

ORION
INSTRUMENTS

Computer Integrated
Instrumentation Since 1980

CALL TODAY 800-729-7700

FREE
Demo Disk!



A black and white photograph of a hand holding a PAL chip that is on fire. The hand is positioned at the top of the frame, and the chip is held between the fingers. A bright orange and yellow flame is visible at the bottom of the chip. The background is dark and smoky. The text is overlaid on the image.

A few words of advice from high-performance μ PLDs.

Chill out, PAL.

Many designers have hot, high-performance designs. Literally.

Fortunately, Intel has a simple way to reduce system heat and still get incredible performance. The μ PLD Family of programmable logic devices.

Take, for example, the 85C220 and 85C224. They operate at 80MHz (100 MHz internally) with only a 10ns total propagation delay.

And since μ PLDs are manufactured using Intel's CHMOS* technology, they require just 1/4 the power of their pin-compatible bipolar PAL* alternatives. Which means they can lower

system heat by 35 percent and help reduce board-level failures, too. So they're certain to give your high-performance system a boost. And send chills up the spine of your motherboard.

Learn more about Intel μ PLDs and receive a μ PLD/PAL heat comparison. Call (800) 548-4725 and ask for Literature Packet #IA28.

Otherwise, you could take some heat over your system design.

The Intel logo, consisting of the word "intel" in a lowercase, sans-serif font with a registered trademark symbol (®) to the upper right of the letter "l".

intel®

© 1990 Intel Corporation. *CHMOS is a patented process of Intel Corporation. PAL is a trademark of AMD.

CIRCLE NO. 146

Portpak tool set, which includes sample source code for I/O device descriptors and device drivers, as well as for boot ROMs. Portpak's Make utility helps you keep track of the proper versions of each module. \$1400.

Microware Systems Corp, 1900 NW 114th St, Des Moines, IA 50325. Phone (515) 224-1929. FAX (515) 224-1352. **Circle No. 351**

Software Development System

- Target CPU may be any 8- or 16-bit μP from Intel or Motorola
- Host system may be IBM PC/AT or compatible

Ez-pro development systems consist of an IBM PC/AT or compatible for software development, C cross-compilers and cross-assemblers for most Intel and Motorola 8- and 16-bit μP s and microcontrollers, and

an in-circuit emulator (ICE) configured for the target CPU. The C cross-compilers conform to the draft ANSI standard and will be revised to comply with the final standard. The C cross-compilers produce assembly-language for the target CPU, and a cross-assembler and linker generate the executable code for downloading to the ICE via a 56k-bps serial link. The Emulation Executive is a source-level debugger that runs on the host computer and controls execution of the program under test by means of the ICE. A deep-trace hardware option allows you to capture all address-bus and data-bus information during execution and to set hardware breakpoints on external probe data or on complex sequences of events. A variety of utility programs is available. You can also rent complete development stations for a specific target CPU. Emulator, de-

pending on the target CPU, from \$1995; cross-assemblers with linker, \$595; C cross-compilers (with cross-assembler and linker), \$895.

American Automation, 2651 Dow Ave, Tustin, CA 92680. Phone (714) 731-1661. FAX (714) 731-6344.

Circle No. 352

Neural-Network Development Tool

- Explains how the neural network arrived at a decision
- Interprets back-propagation networks

Neuralworks Professional II/Plus is a design tool that allows you to develop neural networks for a variety of host computers. To facilitate development of embedded systems, the Flashcode feature can interpret back-propagation networks and their variations created by Neuralworks; and, from them it generates

Power distribution. Made simple.



Why settle for this ...

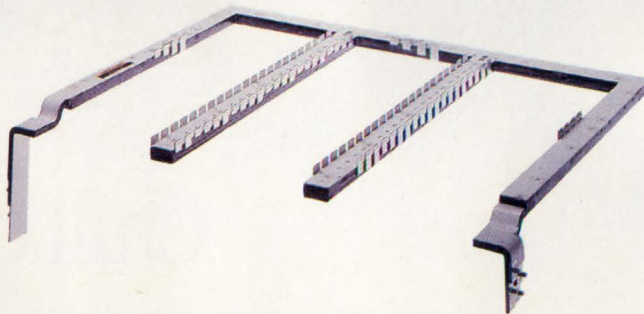

... when you can have this?

See Us at NEPCON '91 Booth #2234

You already know how complex a power distribution network can get. Wires, terminals, shrink tubing and cable ties, just to start things off. Then there's the fixturing, testing, crosstalk and ringing. Top it all off with dents in the budget, quality certification headaches and a ferocious appetite for enclosure real estate.

The Bus Bar Division of Methode

Electronics can custom design solutions to your power distribution problems. From bus systems that mount on circuit boards and backplanes to sophisticated laminated or powder coated bars, Methode's bus bars provide reliability and economy.

If high current densities, low noise, designed-in capacitance and accurate termination locations are what you

need, talk to us.

We'll make power distribution simple.

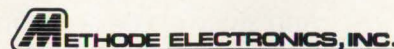

Bus Bar Division
4001 Industrial Avenue
Rolling Meadows, IL 60008
708/577-9545 • Fax: 708/577-9689

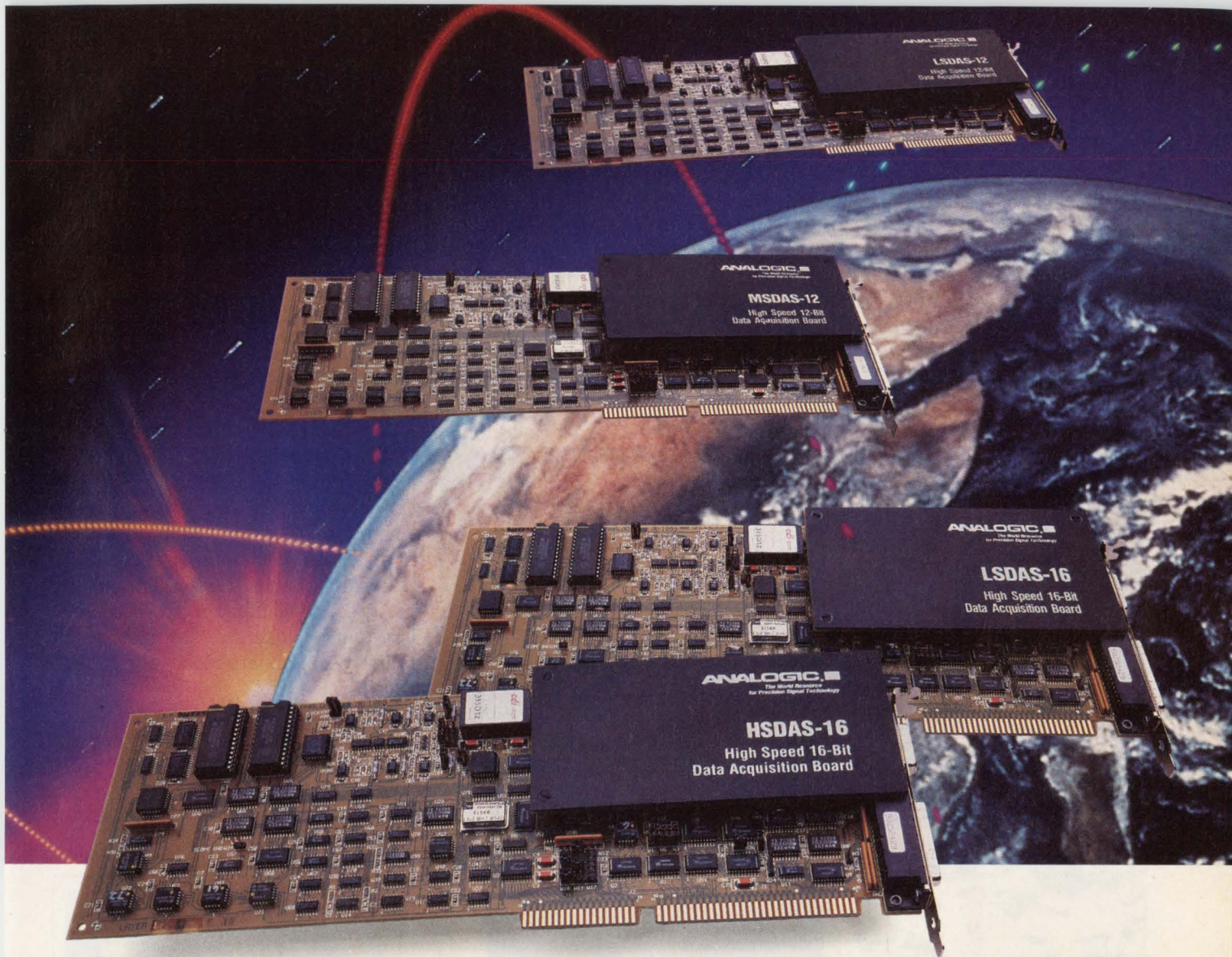

Analogic's DAS Family Outclasses the Competition

	Resolution	Throughput	Price*
HSDAS-16	16 Bits	200 kHz	\$1695
LSDAS-16	16 Bits	50 kHz	\$1395
HSDAS-12	12 Bits	400 kHz	\$2295
MSDAS-12	12 Bits	200 kHz	\$1495
LSDAS-12	12 Bits	100 kHz	\$1195

*Single unit price. Quantity discounts available.

For Applications Assistance, Call: David Wilson, Analogic Corporation, (800) 446-8936. For Sales Assistance, Call: Digital Distributors (800) 227-0349; In South Central USA: Norcom, Inc. (214) 386-4888; In Northeast USA: Trilogic (508) 658-3800

Analogic's DAS family outclasses the competition in resolution, throughput, and price! The DAS family features auto-calibration to eliminate DC errors, precision 12-bit and 16-bit analog-to-digital converters, and sampling rates from 50 kHz to 400 kHz.

Only Analogic provides the shielding necessary for less than 1 LSB of noise *in the PC*. The software-programmable multifunction boards include dual-deglitched DACs, a multi-channel counter/timer, a 16-bit digital input/output port and a 16-channel single-ended or 8-channel differential analog input multiplexer.

The DAS family includes:

- High-speed DMA for fast data acquisition
- Simultaneous sampling of up to four analog inputs
- Deglitched DACs for quiet, low-distortion analog output waveforms
- 32K points of DAC RAM for waveform generation
- Expansion multiplexers for up to 256 inputs
- Application software from HEM, DADiSP, and LABTECH

Our guaranteed analog performance, digital flexibility, and software support are backed up by over twenty years of recognized leadership in precision data acquisition technology.

ANALOGIC

The World Resource
for Precision Signal Technology

C source code. After compiling this source code, you can embed the resulting stand-alone program into application programs or DSP boards. The Explainnet feature lets the network explain how it arrived at a particular decision and which input has the greatest effect. The program also allows you to create

neural networks for embedding into Digital Neural Network Architecture ICs from Neural Semiconductor (San Diego, CA). Other enhancements to this version of Neuralworks include a back-propagation builder that lets you create more than 8000 variations of back-propagation networks from a single

menu; 40 new commands that help you to create special configurations; and seven new network types. The new types are Kohonen self-organizing map, learning vector quantization I and II, extended learning vector quantization, delta bar delta, extended delta bar delta, and directed random search, all of which can improve the performance of certain types of applications. Neuralworks Professional II/plus, for IBM PC/ATs under DOS or OS/2, and Macintosh SE and II computers running MAC OS, \$1895; for Sun workstations running Unix and for the Meiko and Alacron Transputer boards, \$3995; for the IBM RS-6000 running Unix, and for i860-based coprocessor boards from Myriad Solutions, \$4995.

Neuralware Inc, Penn Center W, Bldg IV, Suite 227, Pittsburgh, PA 15276. Phone (412) 787-8222. FAX (412) 787-8220.

Circle No. 353

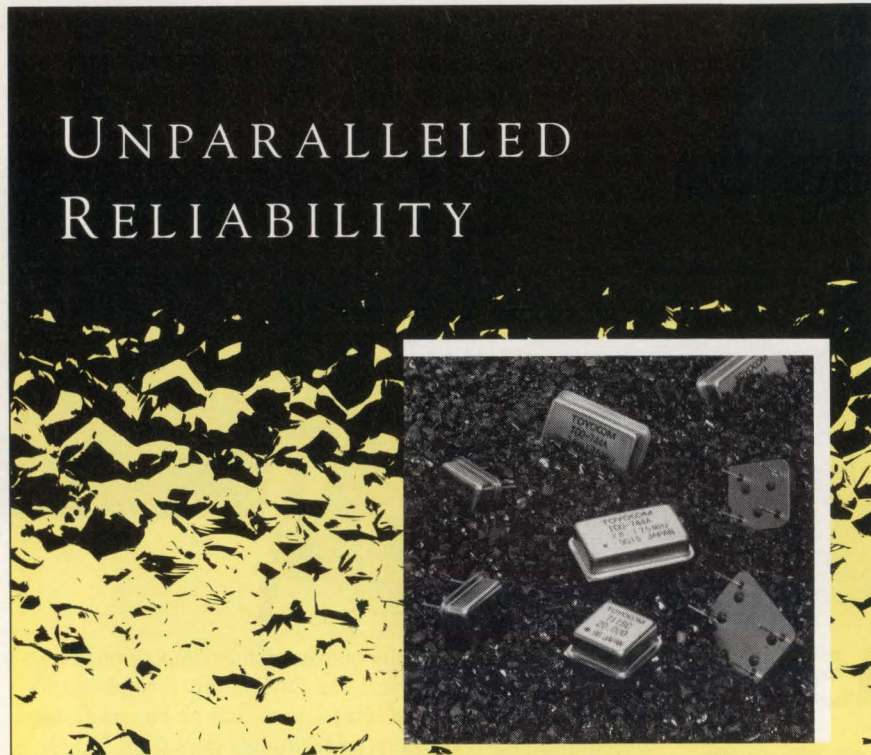

From the first discussion about your specs, through prototype design, testing, fine tuning and full-scale production, Toyocom is devoted to developing a completely reliable solution for your computer application - one that delivers maximum performance at a minimal price.

Our crystal clock oscillators offer performance you would typically associate with customization, at standard prices. Our TCO-700 series performs to the most exacting specs:

- TTL output levels to 100 MHz.
- CMOS output levels to 70 MHz.
- Full (14-pin) and half-size (8-pin) models.
- Tri-state output feature.

Let us develop a reliable solution for your computer applications. Contact TOYOCOM, 617 E. Golf Road, Arlington Heights, IL 60005.

Phone Toll-Free today 1-800-TOYOCOM.

TOYOCOM

T I M I N G I S E V E R Y T H I N G

CIRCLE NO. 72

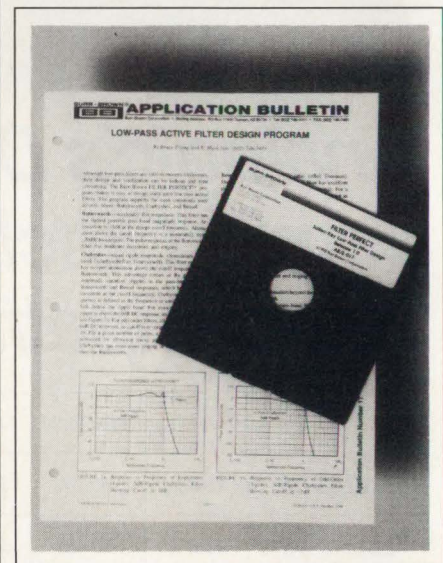

Design Tool For Active Lowpass Filters

- Selects standard capacitor values
- Specifies exact resistor values or nearest 1% value

Filter Perfect is a free software package that runs on IBM PCs and compatibles and helps you design active lowpass filters. The menu-

Uncanny capacitance.

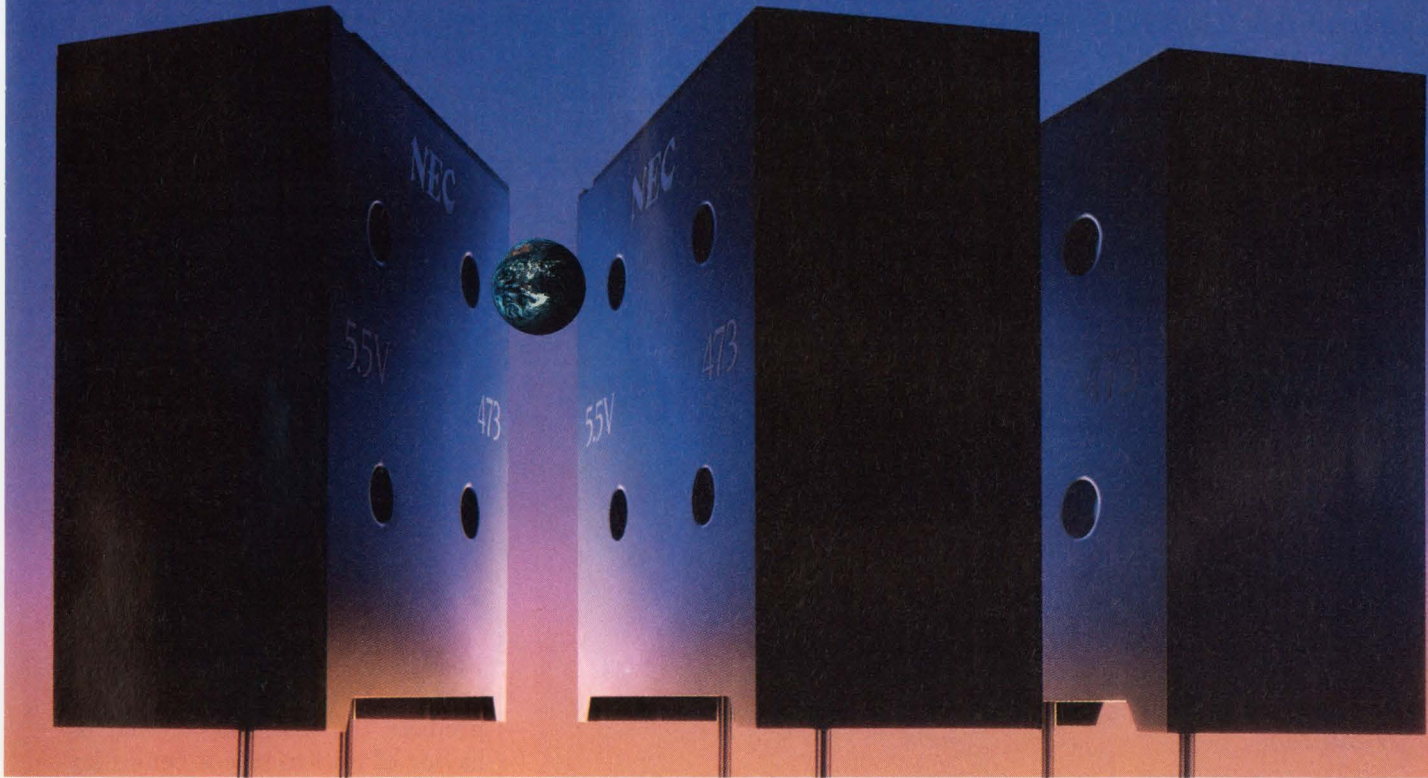

NEC Supercaps offer out-of-this-world performance.

Creating large capacitance in small cases has been an NEC specialty for decades. The three new Supercaps in our FM series are an extraordinary example.

To equal the 0.169F capacitance that NEC has crammed into these electric double-layer capacitors, Mother Nature would require 238 spheres the size of planet earth.

Supercaps are the ideal replacement for backup batteries. They feature fast charging, semipermanent

life and excellent safety factors.

Supercaps come in eight series. They cover a wide range of backup needs from CMOS RAMs and microcomputers to large-current



applications. For more information, contact NEC today.

Series	Application	Capacitance (F)	Feature
FYD	RAM/microcomputer backup	0.022 - 2.2	Space saving
FYH		0.022 - 1.0	Low profile
FYL		0.01 - 0.047	Extra low profile
FM		0.022 - 0.1	Auto insertion/soldering
FR		0.022 - 1.0	Wide operating temperature (-40°C to +85°C)
FS	Medium backup current	0.022 - 1.0	
FA	Large backup current	0.047 - 1.0	5.5V
FE		0.022 - 0.47	11.0V
		0.047 - 1.5	Low ESR

For fast answers, call us at:

USA Tel: 1-800-632-3531. Fax: 1-800-729-9288. Germany Tel: 0211-650302. Telex: 8589960. The Netherlands Tel: 040-445-845. Telex: 51923.
 Sweden Tel: 08-753-6020. Telex: 13839. France Tel: 1-3067-5800. Telex: 699499. Spain Tel: 1-419-4150. Telex: 41316. Italy Tel: 02-6709108. Telex: 315355.
 UK Tel: 0908-691133. Telex: 826791. Ireland Tel: 1-6794200. Telex: 90847. Hong Kong Tel: 755-9008. Telex: 54561. Taiwan Tel: 02-719-2377. Telex: 22372.
 Korea Tel: 02-551-0450. Fax: 02-551-0451. Singapore Tel: 4819881. Telex: 39726. Australia Tel: 03-267-6355. Telex: 38343.

driven program lets you select Butterworth, Chebyshev, and Bessel filters, guides you in choosing the number of poles, and calculates capacitor and resistor values. Even-ordered filters consist of cascaded sections of Sallen-Key complex pole-pairs. The program selects standard capacitor values and then

calculates exact resistor values for the filter you have selected. If you select the 1% option, the program selects the closest 1% value for one resistor in each pole-pair; then it recalculates the exact value for the second resistor (using the 1% value for the first resistor as an exact value) before selecting the closest

1% value for the second resistor. This procedure produces the most accurate design you can implement with 1% resistors. The 5¼-in. disk comes with an application note (AB-017) that describes how the program works, gives further guidance on the design of lowpass filters, and shows the measured results of some actual filters designed with the aid of the program. You can obtain the package at no charge from your nearest Burr-Brown sales office.

Burr-Brown Corp., Box 11400, Tucson, AZ 85734. Phone (602) 746-1111. FAX (602) 889-1510.

Circle No. 354

Programmable Linear Phase Filters for A/D Prefiltering Applications

848DOW Series Combines Constant Delay of a Bessel Filter With The Sharp Attenuation of a Butterworth Filter.

Features:

- 8 pole, 6 zero linear phase lowpass filters
- Digitally programmable corner frequency
- 8 bit (256:1) tuning ratio
- Internally latched control lines to store frequency selection data
- Linear phase response to minimize phase distortion
- Sharp roll-off for anti-aliasing
- Plug in, ready to use, fully finished, filter module
- Five frequency ranges to 51.2kHz

Other Filter Products available:

- Elliptic • Programmable • Fixed Frequency
- Instrumentation • Custom Designs

For more information, please call us at **508-374-0761**

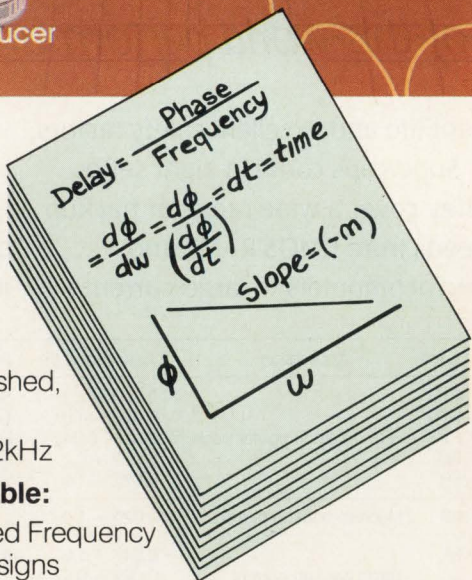
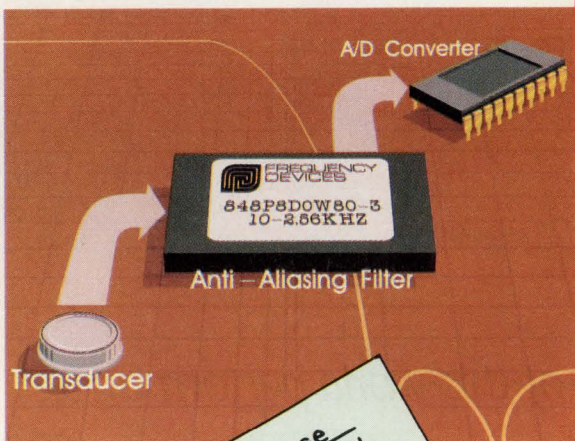

FREQUENCY DEVICES

25 Locust Street
Haverhill, MA 01830
(508) 374-0761

Simulator Predicts Transmission-Line Behavior

- Lets you design critical traces before layout begins
- Handles buried microstrip and asymmetric stripline

Linesim is a program that runs on an IBM PC/AT or compatible and predicts the transmission-line behavior of critical traces before layout begins. You specify the circuit elements (drivers, receivers, transmission lines, resistors, and capacitors) by clicking on library models with a mouse; the simulation appears in the form of an oscilloscope display. The program is completely interactive; to resimulate after a parameter change, you merely modify the schematic and replot. Thus, you can quickly determine the proper strategies and component values for line terminations. The program comes with an extensive model library that includes devices in the 74FCT, 74BCT, 74AC, 74HC, 74F, 74AS, 74ALS, and 74LS logic families, as well as programmable logic devices. \$595.

Hyperlynx, Box 3578, Redmond, WA 98073. Phone (206) 869-2320. FAX (206) 881-1008.

Circle No. 355

Introducing The New CADSTAR...

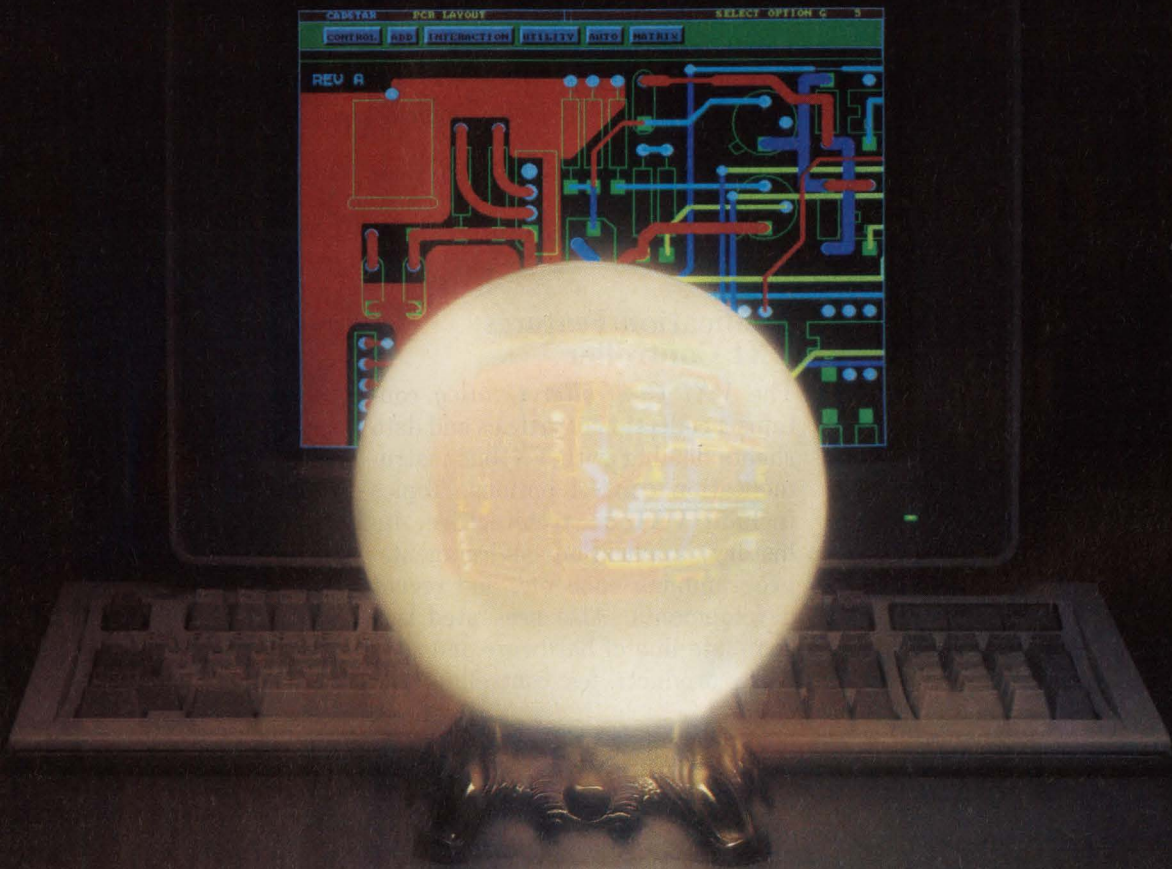

IT ALMOST READS YOUR MIND.

CADSTAR's revolutionary new user interface almost reads your mind, anticipating your next move and intelligently defaulting to the most likely action. For example, if you pick a part, CADSTAR lets you move it without selecting an action from a menu. If you pick a connection, you can manually route it instantly.

CADSTAR's new Motif style graphical interface has clear, logical menus integrated across all functions. The best part is, you'll rarely need to use those menus! Imagine software so smart, it knows what you want to do next. CADSTAR is easy to learn, and it drastically reduces keystrokes, saving you hours.

The Power Remains

CADSTAR remains the most powerful design software you can

run on a PC. Unique features like comprehensive, automatic/interactive routines for placement, gate and pin swapping, and routing give you remarkable design flexibility. Racal-Redac continues to enhance the design technology used by thousands of engineers worldwide. CADSTAR includes:

- Integrated Schematic Capture, PCB Layout, Autorouting, Manufacturing Outputs
- 5,000 part library
- Double sided SMDs
- Curved tracks & copper, teardrop pads
- Copper maximization
- Blind & buried vias
- Toll Free hotline support

CADSTAR works with Racal-Redac's 386 Advanced Router, the

most powerful PC based router available. It features 32 bit, gridless, shove aside, rip up and retry technology for 100% routing completion.

Is There A CADSTAR In Your Future?

Call or write for your free CADSTAR demo disk and brochure. See for yourself how powerful, and easy to use, new CADSTAR really is. Call (508) 692-4900.

CADSTAR™

RACAL-REDAC

Racal-Redac, Inc.
238 Littleton Road
Westford, MA 01886-9984, USA
Phone: (508) 692-4900
Fax: (508) 692-4725

LITERATURE

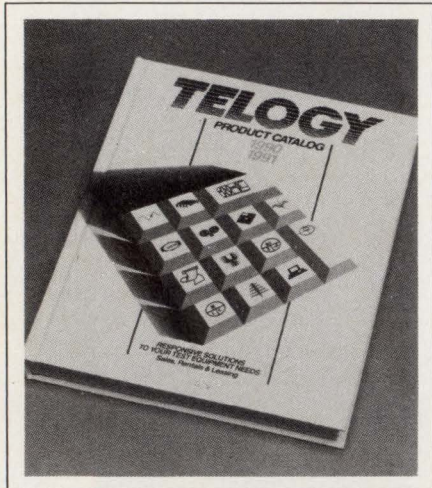

Guide Provides Listing Of Test Equipment

This 300-pg catalog is actually a reference guide, describing 3000 electronic test instruments, which are available for rental, lease, or purchase. You can easily find the 24 product categories; they are marked with individual icons. A

helpful feature is the book's index arranged by product type, manufacturer name, and model number. An additional equipment-substitution index suggests alternative product selections. The publication provides photographs of the most popular instruments.

Telogy, 150 Shoreline Dr, Redwood City, CA 94065.

Circle No. 356

Publication Features VXI Controller

The *VXI Controller Catalog* contains a collection of articles and data sheets dealing with VXIbus instrumentation control options. Topics include VXIbus architecture, its history, application environments, programming concepts, and recent developments. Also presented is a complete line of hardware and software products for controlling the

VXIbus systems, such as an external IEEE-488 controller, an external computer with an MXIbus interface, or an embedded PC controller.

National Instruments, 6504 Bridge Point Pkwy, Austin, TX 78730.

Circle No. 357

Booklet Features Switching Power Supplies

This 4-color catalog describes a full line of switching power supplies. The 20-pg publication includes switching mode regulators, dc/dc converters, off-line switch power supplies, and electronic load devices with ratings of 1 to 720W output. Also discussed are selection tables, device descriptions, features and benefits, block diagrams, and specification charts.

Melcher Inc, 200 Butterfield Dr, Ashland, MA 01721.

Circle No. 358

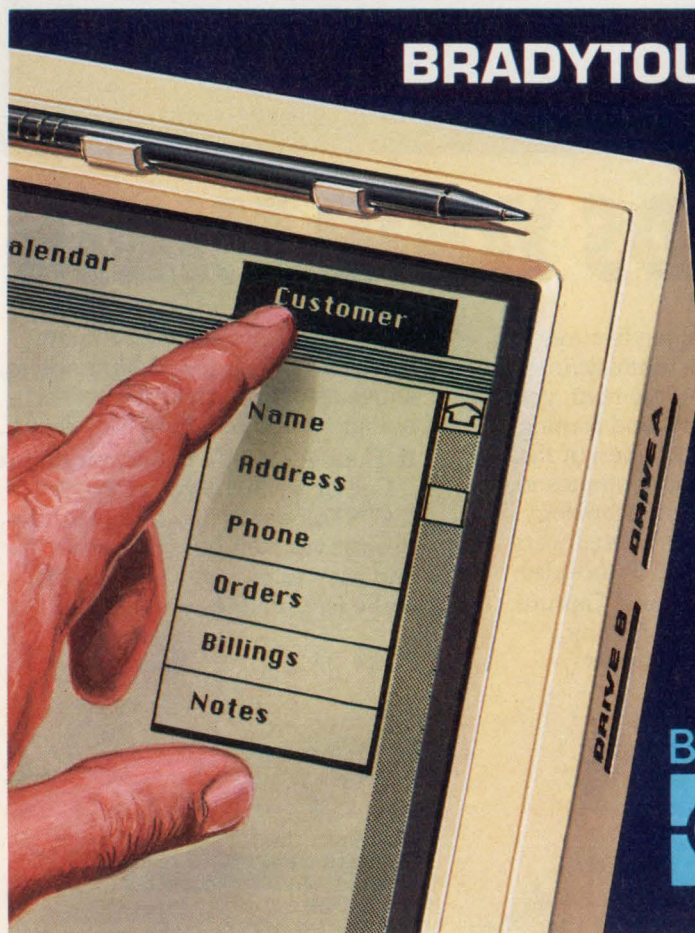

BRADYTOUCH™ TRANSPARENT TOUCH SCREENS

Put technology at your fingertips with a BRADYTOUCH™ Transparent Touch Screen. Available in matrix or analog designs, BRADYTOUCH™ Screens are the ideal, affordable solution to your touch screen needs.

Best Transparency in its Class

BRADYTOUCH™ Screens transmit light better than any other membrane screens. A unique "total surface" optical-adhesive design reduces transmission losses, resulting in improved clarity.

Reliable

BRADYTOUCH™ Screens are made of durable, yet lightweight plastics. Abrasion-resistant, non-glare finishes are available for particularly demanding applications.

Let us help you with your touch screen needs. Call or write today.



W. H. BRADY CO. THIN FILM PRODUCTS

8225 W. Parkland Ct. • P.O. Box 571
Milwaukee, Wisconsin 53201
Phone: 414-355-8300 • Fax: 414-354-0453

© Copyright 1990 W. H. Brady Co. All rights reserved.

CIRCLE NO. 74



Development Puzzles Solved by Pentica

(Part One of a Design Dictionary)

Trace Buffer n. Digital memory part of in-circuit emulator. Used to store a sequence of microprocessor addresses, data and status for post execution analysis.

The Puzzle: You have developed a complex real time system with interrupt driven multi-tasking software. Each of the software tasks has been debugged. No problems show up under simulation. The hardware designer, insisting his part works great, has gone on vacation. However, the complete system crashes after anything between 10 minutes and 3 hours.

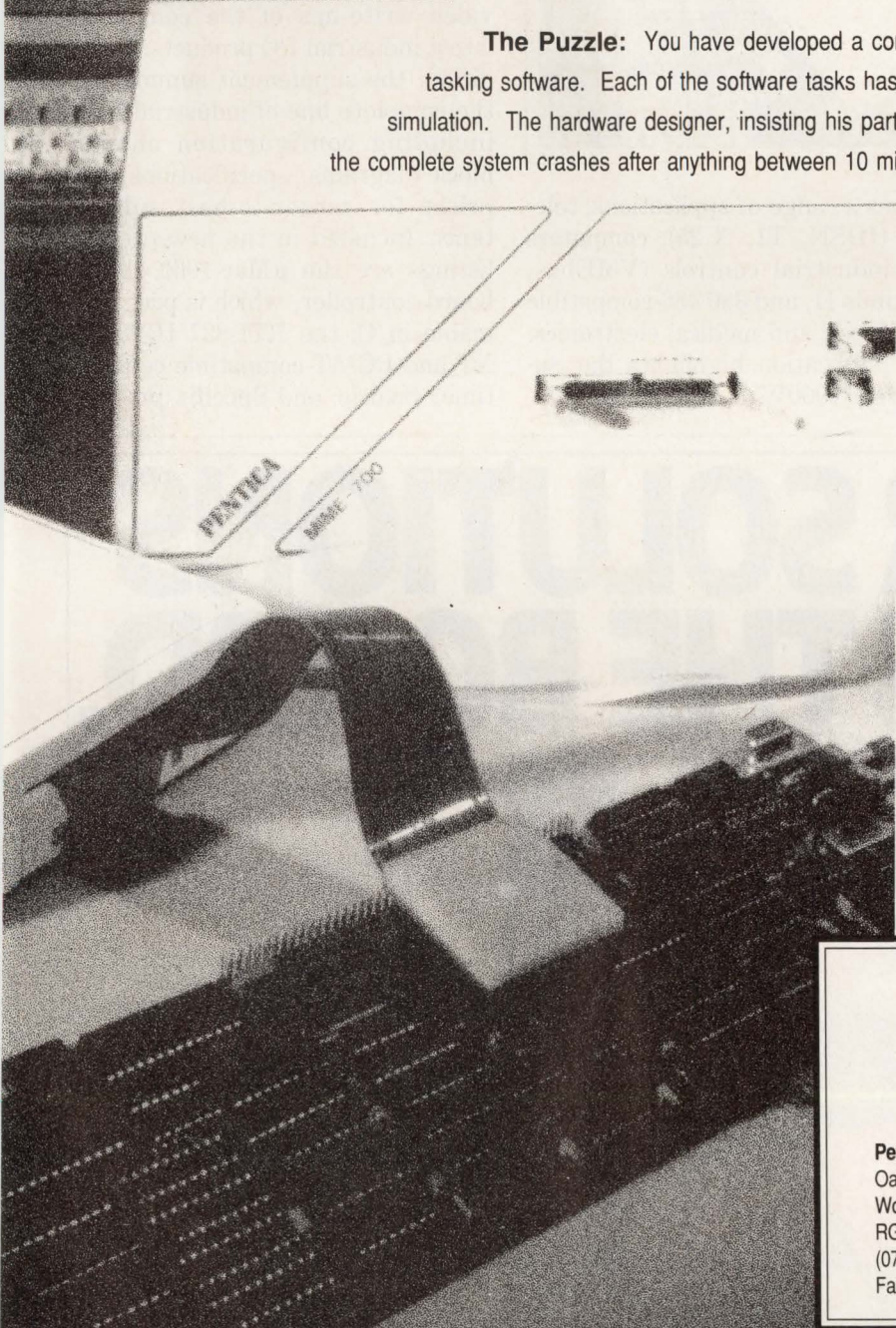

The Solution: Use an ICE with a trace buffer large enough to capture the events which lead to the crash. Complex and sequential triggering of the trace may be required to stop tracing events which occur after the crash--an 8k word trace buffer could overflow in under 2ms. Pre-filtering of trace cycles can be used to extend the capture time. The ability to re-trigger the trace allows critical areas to be traced and then disregarded if the crash does not happen. Comprehensive search facilities are needed to analyse large amounts of data.

Pentica's MIME-700 in-circuit emulator offers these features and more, while Pentica prides itself on its superior technical service and support. Write or phone and let's start solving your next development puzzle!

PENTICA IN-CIRCUIT EMULATORS

We love to solve puzzles!

Pentica Systems, Ltd
Oaklands Park
Wokingham, Berkshire
RG11 2FE
(0734) 792101
Fax: (0734) 774081

Pentica Systems, Inc.
One Kendall Square
Building 200
Cambridge, MA 02139
(617) 577-1101
Fax: (617) 494-9162

Measuring-Equipment Catalog

This 572-pg catalog details automatic test equipment/process controllers, signal generators, radio test sets, spectrum and network analyzers, and logic test equipment/recorders. The publication is divided into 13 sections. A choice of peripheral measurement devices appears in the appendix.

Rohde & Schwarz, 8000 Munchen 80, Muhldorfstr 15, Germany. **Circle No. 359**

Booklet Features Switching Power Supplies

The 1991 switching power-supply catalog discusses more than 100 standard switching power supplies. The publication also notes that the vendor produces modified, repackaged, and custom switching power supplies. The 32-pg booklet de-

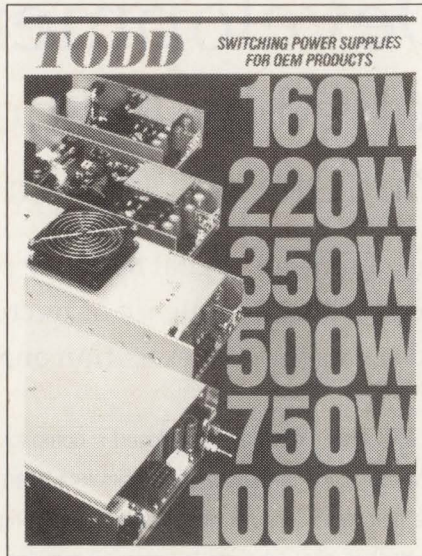

scribes a range of applications: telecom (ISDN, T1, X.25); computers and industrial controls (VMEbus, Multibus II, and 386/486-compatible machines); and medical electronics. The publication highlights the Supermax 1000W series power sup-

plies, a switcher designed from the ground up with power-factor correction.

Todd Products Corp, 50 Emjay Blvd, Brentwood, NY 11717.

Circle No. 360

I/O Products Catalog Supplement

The 1990 *Data Acquisition and Control Catalog Supplement* provides write-ups of the company's latest industrial I/O products. In addition, the supplement summarizes the complete line of industrial I/Os, including configuration charts, block diagrams, specifications, and prices for sensor-to-host subsystems. Included in the new-product listings are the μ Mac-1060 single-board controller, which is programmable in C; the RTI-827 IBM PC/XT and PC/AT-compatible counter/timer boards; and Specifix process-

BETTER SOLUTIONS ACROSS THE BOARD.

C&K Surface Mounted Switches are sealed to prevent process contamination and can withstand today's high soldering temperatures and pressure wash cleaning methods. We audit every production lot for seal integrity. Tin-lead terminal plating standard. Dispensing tube as well as tape and reel packaging available. Choose toggle, pushbutton,

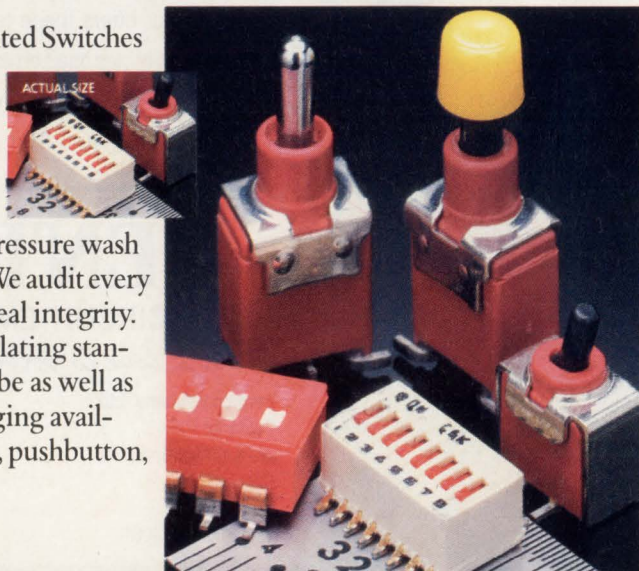

slide, or DIP configurations, including ultra-mini. Send for free samples and our latest catalog. Call (800) 635-5936. Or Fax (617) 527-3062.



The Primary Source Worldwide...

C&K Components, Inc.
15 Riverdale Avenue
Newton, MA 02158-1082



Introducing Zilog's Smart Access Controller... Z180 intelligence and SCC communications together in one package.

The Z80181™ SAC™ Controller is the Smart Access Controller™ that combines two powerful standards. You get Zilog's industry standard SCC™ controller for datacom connectivity together with the popular Z180 CMOS controller. And all that utility comes with the user-friendly Z80® code CPU compatible software.

High integration. High performance. Smart communicator.

The Superintegration™ SAC Controller packs the popular high performance Z180 architecture into a new cell suitable for many datacom and peripheral control applications. You get the SCC single-channel communication cell with two additional UARTS, a 4 x 8-bit counter timer (CTC) and onboard 16-bit I/O. The SAC Controller runs at 10 MHz and drives fast serial communications at 2.5 Mbits/sec. With the reduced 3 cycles per instruction, the SAC Controller gives you Z80 code performance 25% faster. That makes the SAC Controller the highest performance, low power embedded controller around.

The best cost/performance of any embedded controller out there.

Whatever your application — data communications, modems, FAXs, printers, terminals, industrial controls — the SAC Controller combination gives you the best cost/performance ratio. Everything you need for your system is on the chip. The SAC Controller brings you all the advantages of Zilog's Superintegration technology. Off-the-shelf and backed by our solid reputation for quality and reliability.

To find out more about the SAC Controller, or any of Zilog's rapidly growing family of Superintegration products, contact your local Zilog sales office or your authorized distributor today. Zilog, Inc., 210 Hacienda Ave., Campbell, CA 95008, (408) 370-8000.

Don't throw away your old software.

The Z80 family continues to be the most popular group of intelligent peripheral controllers on the market. With good reason. It's a tribute to our Superintegration™ technology and the performance of the controllers themselves. And since each new product in the family, like the SAC™ is based on the same Z80/180 code you'll be able to migrate your existing software easily and effectively. We don't have to tell you how important that is. Here's a list of the fast-growing family of Z80-based intelligent peripheral controllers. It's a list that's not likely to stop expanding any time soon... stay tuned.

	System				Serial		Timers		Parallel	
	CPU	OS	MCU	RAM	UART	UART	CTC	CT	PIA	PIO
Z84C01	✓	✓							✓	✓
Z84C50	✓	✓							✓	✓
Z84C90			✓						✓	✓
Z80180	✓	✓	✓	✓		✓			✓	✓
Z80280	✓	✓	✓	✓		✓			✓	✓
Z84013/C13	✓	✓	✓	✓					✓	✓
Z84015/C15	✓	✓	✓	✓					✓	✓
Z84011/C11	✓	✓	✓	✓		✓	✓	✓	✓	✓
Z80181	✓	✓	✓	✓		✓	✓	✓	✓	✓

Right product. Right price. Right away.



ZILOG SALES OFFICES: CA (408) 370-8120, (714) 838-7800, (818) 707-2160, CO (303) 494-2905, FL (813) 585-2533, GA (404) 448-9370, IL (312) 517-8080, NH (603) 888-8590, MN (612) 831-7611, NJ (201) 382-5700, OH (216) 447-1480, PA (215) 653-0230, TX (214) 987-9987, WA (206) 523-3591, CANADA Toronto (416) 673-0634, UNITED KINGDOM Maidenhead (44) (628) 39200, W. GERMANY Munich (49) (89) 672045, JAPAN Tokyo (81) (3) 587-0528, HONG KONG Kowloon (852) (3) 723-8979, KOREA (82) (2) 552-5401, TAIWAN (886) (2) 741-3125, SINGAPORE 65-235 7155, DISTRIBUTORS: U.S. Anthem Electronics, Hall-Mark Electronics, JAN Devices, Inc., Schwebel Electronics, Vargas Electronics, Western Microtechnology, CANADA Future Electronics, SEMAD, LATIN AMERICA Argentina - Tel. (1) 46-2211, Brazil - Digibyte (011) 581-1945, Semiconductores Profesionales (5) 536-1312.

control software and DOS drivers. A 9-section selection and configuration guide helps you determine the optimal configuration for specific applications. Product sections cover computer plug-in I/O boards; distributed I/O subsystems; modular signal conditions; analog signal-conditioning panels; digital subsys-

tems, and software. Following these product sections are the product reference, listing each product's description and price, and an index, directing you to more detailed information in the main catalog.

Analog Devices, Literature Center, 70 Shawmut Rd, Canton, MA 02021. **Circle No. 361**

Comprehensive Listing Of STD Buses

The 480-pg STD Bus Technical Databook describes STD Bus and CMOS STD Bus products. The 10 tabbed sections make it easy to find the product you are looking for. The publication highlights the full STD Bus 8-bit and 16-bit Specification and STD Bus Practice and discusses more than 200 STD Bus devices for embedded and DOS-compatible systems. You will find technical specifications, photographs, and dimensional drawings for the full line of non-DOS single-board computers. Other products include 8088, 80286, and 80386 CPUs; memory; Ethernet and Arnet networks; industrial I/O devices; card cages with power supplies; video controllers; and software for use in harsh industrial environments. The book features a section on the vendor's STD-AT, a true 80286 and 80386SX-based industrial computer that's compatible with the IBM PC/AT and PC/XT. An STD Bus Product Second Source/Cross Reference of more than 100 of the vendor's cards is included for such STD Bus manufacturers as Analog Devices, Prolog, Datricon, Data Translation, and Mostek.

WinSystems Inc, Box 121361, Arlington, TX 76012.

Circle No. 362

EXPERIENCE A WORLD ACCLAIMED PLD PROGRAMMER for the 90's.

THE ONLY MULTIPROGRAMMER® THAT CAN WEAR EVERY HAT.

BYTEK's Model 135H is a GANG/SET or Universal PLD MULTIPROGRAMMER® All-In-One Site. Performs well in both Production or Development environments. Purchase only the technology support you need today and expand support as required through simple micro disk device library updates.

Programming algorithms are approved by major semiconductor manufacturers. Plus, BYTEK's after-sale support is guaranteed with **over 10 years** as the world's leader in **Low-Cost, High Performance** programming equipment.

- ✓ Supports virtually all Memory Devices and PLDs.
- ✓ 25-key Integrated Keyboard & 40 Character LCD.
- ✓ RS232 & Parallel I/O Port for High Speed Data Transfer.
- ✓ Extensive SET Programming capabilities in either Standalone or Computer Remote operations including Set of Sets.
- ✓ Automatically **Serializes** up to 16 devices at one time.
- ✓ **FREE** Warranty plus **FREE** Device Library Updates for one year.

Also available: EZ-WRITER™ low-cost portable Engineering Programmers, MULTITRAK™-4000 high volume Production Programmers, & UNITRAK™ Universal PLD Programmers.

Order Today on a 15 Day Money-Back Guarantee:

1-800-523-1565

Prices from
\$995^{00*}



Made in the USA.

BYTEK
Corporation

543 NorthWest 77th Street, Boca Raton, FL 33487
(407)994-3520 * FAX: (407)994-3615 * TELEX: 4998369BYTEK

* U.S. list price only

CIRCLE NO. 76

App Note Explains Emulation System

This application brief examines the vendor's installation and utilization of the RPM Emulation System; its title is *Rockwell NTSD: ASIC Design Productivity Improvements*. The focus is on ASIC hardware emulation. "Sneakernet," an excerpted version of this study, is also available.

Quickturn Systems Inc, 325 E Middlefield Rd, Mountain View, CA 94043.

Circle No. 363

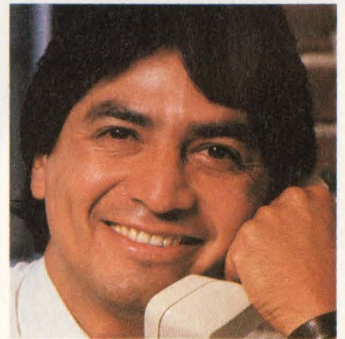
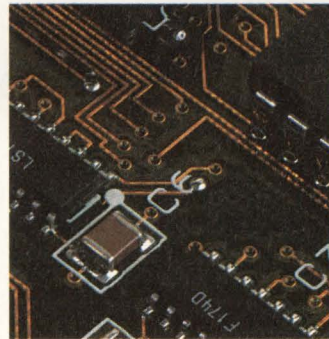
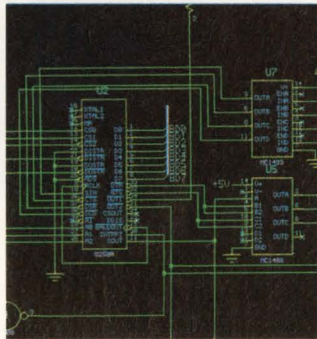
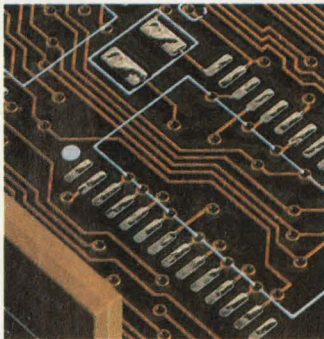
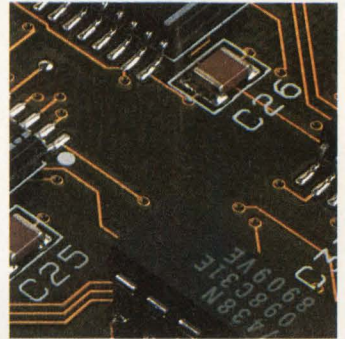
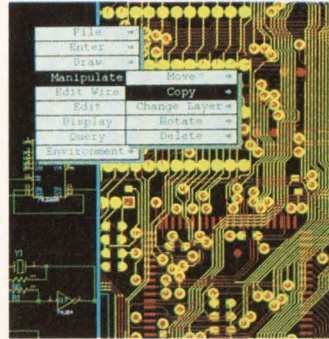
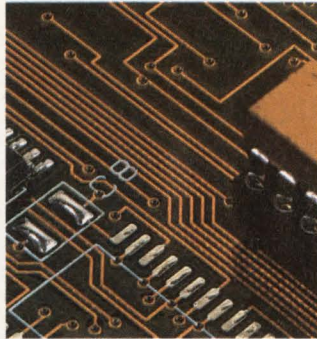
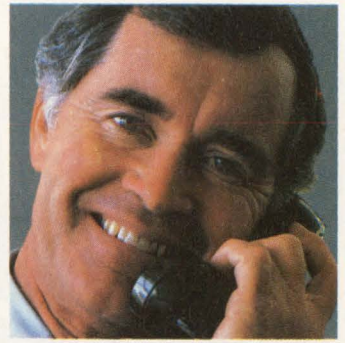
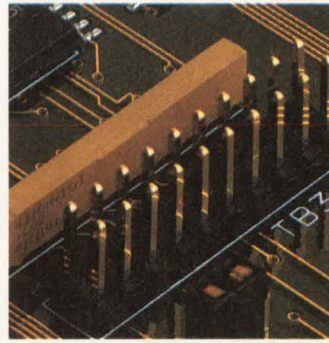
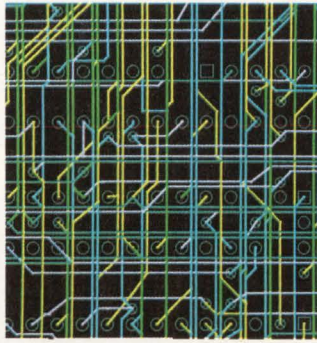
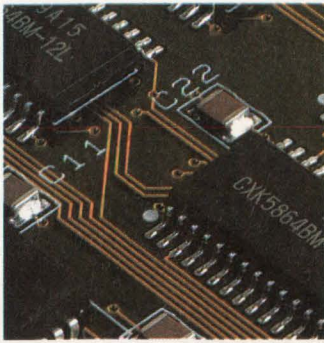

PREMIER PCB

World class UNIX productivity.

Around the world, productivity is the driving force in PCB CAD design.

World class UNIX® productivity for technical workstations is exactly what you get with PREMIER PCB™. Together with the proven quality that has made P-CAD the worldwide leader in PCB design.

PREMIER PCB gives you the power, flexibility and speed you need to get your next product to market faster. And with a high-level user interface and end-to-end integration that lets you complete and verify your designs with more efficiency – in a lot less time.

Worldwide networks mean a mix of platforms, as well as shared databases and libraries. That's why P-CAD supports the transfer of database files and libraries between DOS and UNIX-based systems. And with network licensing, PREMIER PCB is equally productive in workstation or server environments.

P-CAD enhances your productivity with worldwide training and support. You'll get fast answers from our global network of Value-Added Resellers, as well as our Technical Support Center and hotline with a 24-hour electronic bulletin board.

Find out how you can boost your productivity with PREMIER PCB on a Sun® SPARCstation™ or IBM® RISC System/6000™. Call P-CAD today for your nearest reseller. We'll send you a FREE copy of our new applications booklet, "PCB CAD Proven Solutions." Call toll-free: 800-523-5207. (In CA: 800-628-8748)



p-cad[®]
PRODUCTS FROM CADAM, AN IBM COMPANY

P-CAD and CADAM are registered trademarks and PREMIER PCB is a trademark of CADAM INC. IBM is a registered trademark and RISC System/6000 is a trademark of International Business Machines Corp. Sun is a registered trademark and SPARCstation is a trademark of Sun Microsystems, Inc. UNIX is a registered trademark of AT&T. P-CAD, 1290 Parkmoor Ave., San Jose, CA 95126, (408) 971-1300, FAX (408) 279-3752. ©1991 CADAM INC.

You're giving our Specialty Films good reviews!



FR-LEXAN
 This stuff is great for flame resistance and dielectric strength.
 Bill

Great insulation material VALOX
 Also - much less expensive!
 Sid

Go with Ultem - We'll save \$ without compromising high temp resistance. Good for diecutting too!!
 BJ

The GE Specialty Films stocked by TEKRA are proving to be tougher, stronger, and more cost effective than the competition in hundreds of demanding applications.

Specify ULTEM® flame-retardant polyetherimide film for flexible circuits, high voltage insulation, and high temperature wave soldering tapes. Save as much as 50% over Kapton®, without compromising high-temperature resistance, dielectric strength, or UL94 V-O requirements.

Choose VALOX® to outperform polyester films for excellent dielectric strength, fabricating and

flame retardancy. This makes VALOX an exceptional material for internal insulation and is priced less than many films in its class. Then use TEKRA to laminate VALOX for an EMI/RFI shield.

Or consider FR-LEXAN polycarbonate films for superior dielectric strength and flame retardancy with superb puncture resistance.

Now consider TEKRA, the best choice to meet your requirements for any of these GE specialty films. TEKRA's inventories are unmatched; every conceivable texture, width, gauge and color made is in stock in quantity. Combine this with our expert technical services and converting capabili-

ties, and regardless of the film you choose, there's only one choice: TEKRA.

Call today. 1-800-448-3572

ULTEM, VALOX, and FR-LEXAN are trademarks of GE Company. Kapton is a trademark of El DuPont de Nemours

TEKRA CORPORATION
 16700 West Lincoln Avenue
 New Berlin, WI 53151
 Phone (414) 784-5533
 (800) 448-3572

Branch Offices:
 Boston Area
 Los Angeles Area

 **TEKRA**
 innovation
 in film technology

CIRCLE NO. 154

EDN PRODUCT MART

This advertising is for new and current products.

Please circle Reader Service number
for additional information from manufacturers.

Imagine if
YOUR
product
could
talk!

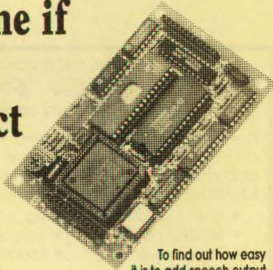

To find out how easy
it is to add speech output
to your own products, call for
your free V8600 data book today!

- Converts plain ASCII text into high quality speech
- Requires only a single 5V supply and speaker
- Use in computers, voice-mail, warning systems, etc.
- Built in μ P, serial and printer interfaces
- Less than \$100 in OEM quantities
- Customization services available

RC SYSTEMS INCORPORATED USA/Canada - Phone/Fax: (206) 672-6909
UK/Ireland - 081 539 0285 Fax: 081 558 8110

CIRCLE NO. 325

68HC11

PC-based emulator for 68HC11

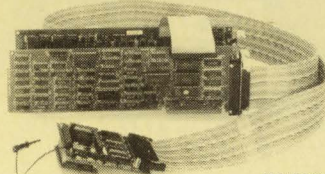

SEE EEM 90/91
Pages D 1320-1323

- PC plug-in or RS-232 box.
- Pull-down menus with full window support, combined with command-driven User Interface.
- Up to 16 MHz real time emulation.
- No intrusions to the 68HC11's resources.
- 48 bit wide 16K deep trace. All functions usable without disturbing emulation. Time stamping. Two level trigger.
- Symbolic and C Source Level Debugging, including in-line assembler and disassembler.
- Supports A, E, D and F parts.

Prices: 64K Emulator and pod \$2590; 4K Trace \$1995*
CALL OR WRITE FOR FREE DEMO DISK!

NOHAU CORPORATION 51 E. Campbell Avenue
Campbell, CA 95308
FAX (408) 373-7869
CORPORATION (408) 866-1820

*US only

CIRCLE NO. 326

PLD Design Software

Get Started with CUPL™ for only
\$149.95

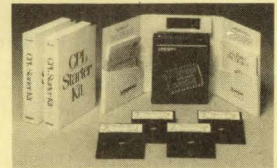

Now you can have a PLD Starter Kit that gives you all the horsepower that the CUPL PLD compiler offers, at a fraction of the cost. For more information, call 1-800-331-7766 or 305-974-0967.

LOGICAL
DEVICES, INC.

CIRCLE NO. 327

VOLTAGE SELECTABLE INTERNATIONAL SYSTEM

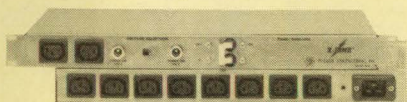

Z-LINE TPC 884

The TPC, a voltage-selectable power distribution and control system, can have either 120 or 240 volt input and output. Designed with IEC-, UL-, CSA- and VDE- approved components, operating up to 16 amps in Europe and 20 amps in North America. Size: 19.0" x 1.75" x 7.0". EMI/RFI filtering, spike/surge suppression and overload circuit breaker protection are standard. Remote on/off is optional.

Pulizzi Engineering, Inc.
3260 S. Susan St.,
Santa Ana, CA 92714
714/540-4229 FAX: 714/641-9062

CIRCLE NO. 328

THERMO-PROBE

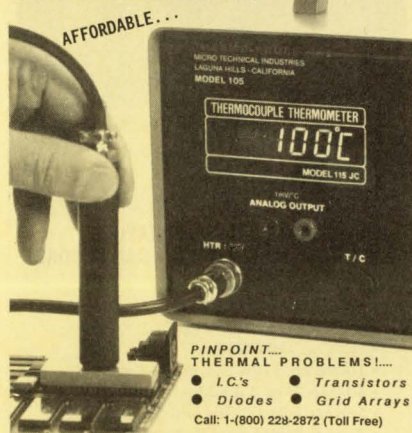

PINPOINT...
THERMAL PROBLEMS!...

- I.C.'s
- Transistors
- Diodes
- Grid Arrays

Call: 1-(800) 228-2872 (Toll Free)

MICRO-TECHNICAL INDUSTRIES
23132 La Cadena Dr. - Bldg. E
Laguna Hills, CA 92653
Tel: (714) 855-4326 / Fax: (714) 855-9545

CIRCLE NO. 329

DC-DC CONVERTER

- * 5W-60W, SINGLE, DUAL, TRIPLE OUTPUT
- * Input Range: 9 to 18V, 18 to 36V, 36 to 72V
- * Output Range: $\pm 5V$, $\pm 12V$, $\pm 15V$, $\pm 24V$
- * Input Pi Filter, EMI/RFI Shielding
- * Special and Custom Design

OEM ASSEMBLY SERVICE

Galaxy is your answer. We have over 5 years' experience with Telephone and PBX systems, switching power supplies, and computer boards; and use the latest state-of-the-art SMT equipment. We handle every aspect of PC board manufacturing — from layout to lamination, from etching to assembly & testing. Inquiries are welcome all the time!

GALAXY MICROCRAFT SYSTEMS CO., LTD.

7FL., NO. 25, LANE 23, RUI-AN ST., TAIPEI,
TAIWAN, R.O.C. P.O. BOX 24-543 TAIPEI
TEL: 886-2-7051622 FAX: 886-2-7016600

CIRCLE NO. 330

To advertise in Product Mart, call Joanne Dorian, 212/463-6415

Small But Mighty

High Level Language and Math Library
On a Tiny I/O-Rich Microcontroller

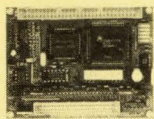

- 44 I/O Lines
- Floating Point Math
- Multitasking 68HC11
- 64K ROM, 128K RAM
- Resident Debugger

All the software you need for data acquisition, control, and instrumentation: high level FORTH language, assembler, debugging tools, multitasker, and extensive matrix math library including FFT and equation solution — all on the board.

Low power I/O-rich hardware: 8 A/D, 24 digital and 8 timer-controlled I/O lines, 2 serial links, 128K battery-backed RAM, only 300 mW, 3"X4".

The QED Board: OEM versions from \$495 (100s).

Mosaic Industries Inc. 415/790-1255
5437 Central Ave. Suite 1, Newark, CA 94560

CIRCLE NO. 331

ADVANTECH



PC-Based Universal Device Programmer

PC-UPROG \$895

- Programs most PLDs and memories up to 40 pins
- Menu driven device selection by P/N and manufacturer
- Full screen editor for fuse maps and memory buffers
- JEDEC standard vector test functions
- New devices can be easily added by yourself
- Self test and diagnosis for high programming yield
- One year warranty and free device update

408-293-6786

1310 Tully Rd., #115, San Jose, CA 95122 FAX 408-293-4697

CIRCLE NO. 332

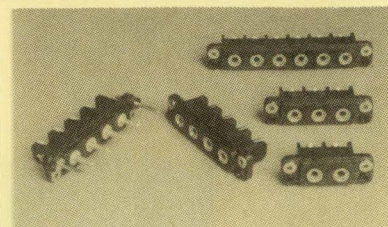

200 AMPERE MULTIPIN LIF RACK & PANEL CONNECTOR

LSH Series Connectors provide one to six 200 amp contacts in a rugged, Ryton® float mountable assembly. The 200 amp continuous per contact rating in a low weight compact assembly make it ideal for power disconnects on electric vehicles, aircraft and other mobile vehicles.

HYPERTRONICS CORPORATION

16 Brent Drive, Hudson, MA 01749

800-225-9228

(in Mass & Canada 508-568-0451)

FAX: 508-568-0680

CIRCLE NO. 333

RELIABILITY AND MAINTAINABILITY PREDICTION AND FMECA ANALYSIS SOFTWARE

Hundreds have used this leading computer-aided engineering software since 1982.

Powertronic Systems offers software to predict Reliability and Maintainability and for Failure Modes Effects and Criticality Analysis. Hundreds of users have selected from PSI's large, versatile and integrated software family for military and industrial equipment and for both electrical and mechanical systems. And, data inputs to these programs may be interactive or batch mode from other CAE or database programs.

Programs implement MIL-STD-1629; MIL-HDBK-217 including E Notice 1; and MIL-HDBK-472.

PSI

Powertronic Systems, Inc.

P.O. Box 29109 New Orleans 70189
(504) 254-0383 FAX (504) 254-0393

CIRCLE NO. 334

RELIABILITY PREDICTION SOFTWARE

ARE YOUR PRODUCTS RELIABLE?

The RelCalc 2 Software Package predicts the reliability of your system using the part stress procedure of MIL-HDBK-217E, and runs on the IBM PC and full compatibles. Say goodbye to tedious, time consuming, and error prone manual methods! RelCalc 2 is very easy to use, and features menu windows, library functions, global editing for what-if? trials, and clear report formats. Try our Demo Package for \$25.

T-CUBED SYSTEMS, 31220 La Baya Drive #110, Westlake Village, CA 91362. (818) 991-0057 • FAX: (818) 991-1281

CIRCLE NO. 335

Elegant, concise, fast & standardized

FLOATING POINT

libraries for embedded applications

Based on the IEEE 754 standard, FPAC (32 bit) and DPAC (64 bit) libraries are mature, well documented, and fully tested. The libraries are fully ROMable and include the following:

- Basic Operations
- Square Root
- Trigonometric
- ASCII Conversion
- Integer Conversion
- Logarithmic

U S Software supports most Intel, Motorola, Zilog and Hitachi micros, including 80X86, 80386, 680X0, 80960, 8051, 8096, 68HC11, Z80, 6809 and 6301.

For additional information, please contact:



U S SOFTWARE

United States Software Corporation

14215 NW Science Park Drive

Portland, Oregon 97229

800-356-7097

503-641-8446

503-644-2413 (FAX)

CIRCLE NO. 336

Create a DISKLESS PC

IT'S EASY..IT'S SIMPLE.....
THERE'S Nothing to it!!!

PROMDISK™ III

IBM PC DISK EMULATOR CARD

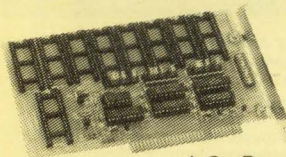

- * On-Board BIOS ROM
- * IBM PC/XT/AT Compatible
- * Mix EPROMs, EEROMs, SRAMs
- * Emulates up to 1.024Mbyte Drive
- * Occupies 32K PC address space
- * Supports popular Byte-Wide chips
- * Includes PROMDISK™ III Software

For Information Call or Write:
MICRO COMPUTER SPECIALISTS, INC.
810-208 Los Vallecitos
San Marcos, CA 92069
(619) 744-8087

CIRCLE NO. 337

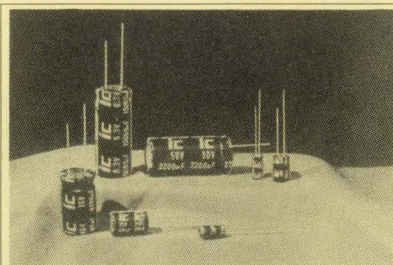

TYPE RMR +105°C SUBMINIATURE ALUMINUM ELECTROLYTIC CAPACITORS

- 100% Burn-In Tested
- 0.47 Mfd. to 15,000 Mfd.
- 6.3 WVDC to 450 WVDC
- -40°C to +105°C Min.
- Tolerance: ±20% Std. (±10% Opt.)
- ≤0.002CV or 2 µA Min.
- Solvent Tolerant End Seal (≤250 WVDC)
- Tape & Reel/Ammo Pack Avail.



ILLINOIS CAPACITOR, INC.

3757 West Touhy Avenue,
Lincolnwood, IL 60645
(708) 675-1760 FAX (708) 673-2850

CIRCLE NO. 338

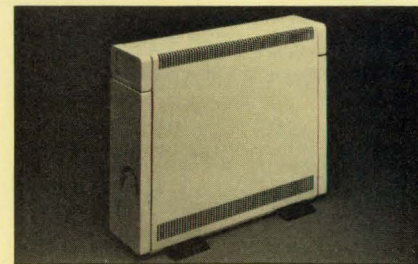

Techtower™

Deskside Computer Cabinet

- Top and sides lift off for easy access
- Clean, attractive styling
- Fits next to or under a desk
- Components can be mounted vertically or horizontally
- Fits all standard dimension chassis
- Shielded designs available



General Devices Company, Inc.

General Devices Company, Inc., P.O. Box 39100,
1410 S. Post Rd., Indianapolis, IN 46239, (317) 897-7009,
Telex: 27-2169 (GENDEVI CO IND), FAX: 317-898-2917

CIRCLE NO. 339

To advertise in Product Mart, call Joanne Dorian, 212/463-6415

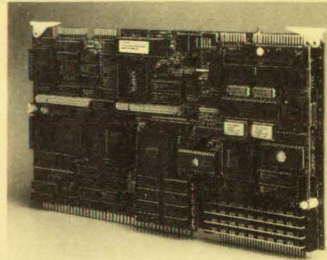

PC/AT™ COMPATIBILITY ON MULTIBUS

In 1989 our MAT286™ SBC brought PC-DOS to Multibus I. Since then no competitor has come close in terms of features, price, or technical support. We've added capabilities, such as 8 megabytes of onboard EPROM capacity, MATxSSD Solid-State Disk software, EMS 4.0, and low power CMOS components. Now we are announcing our new MATxSYSIO2 daughter-card with 16-bit VGA and LCD flat-panel interfaces, 1-1 interleave MF/M/LL ST506 hard-disk/floppy disk controller, and a PC/AT Bus short-card adaptor. And, yes, we are working on MAT386, the 386-based Multibus AT that will be compatible with the 286-based standard, MAT286.

Phone (408) 253-0250 for more information.

Single Board Solutions, Inc.

20045 Stevens Creek Blvd, Cupertino, CA 95014
PC/AT™ IBM

CIRCLE NO. 340

DEVELOPERS' TOOLS

The Total Solution Programmer
The best-selling Programmer since 1985
Appreciated by over 50,000 users worldwide

TUP-300
Universal Programmer
& Tester (PC based)
from \$ 595.-

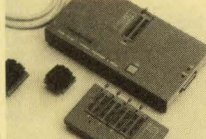

■ 40-Pin ZIF socket can be expanded up to 68 Pin for 8 to 68 Pins DIP or PLCC chips.

■ Programs 20 to 68 Pin PLD (PAL, CPAL, IFL, GAL, PEEL, EPLD, EEPLD), EPROM (up to 16 Mbit), EEPROM, Serial PROM, Special PROM, Bipolar PROM & MPU (8741/42/48/49, 8051/51FA, FB, FC/521/541/252/751/752/552/451, 8796/97, 68705, 286E11/21, TMS7742, TMS77C82, 8795A, ...)

■ Tests TTL (74/54), CMOS (40/45), SRAM, DRAM, SIP DRAM and SIM DRAM.

■ Full screen edit, HEX to OBJ, 2-way or 4-way Binary File Splitter and Shuffler, 6 MPU Dis-assemblers.

■ 34 various adapters (4 sockets, ROM-RAM, PLCC, ...) from \$95.-

■ Other high quality programmer cards at low cost available from \$119.-

UV Eraser (UV-32) for 32 pcs at \$95.-

Call us today for complete product line

■ 1 year warranty, 30 days money back guarantee

■ 1 year free software updates and Customer Support

TRIBAL MICROSYSTEMS

Tel: (415)623-8859 Fax: (415)623-9925

44388 S. Grimmer Blvd, Fremont CA 94538

CIRCLE NO. 341

DEVELOPERS' TOOLS

TPT-100 \$145.-
POCKET IC TESTER

• Tests TTL (74/54), CMOS (40/45) and DRAM
• 9V battery operated
• LCD display
• Search unknown IC

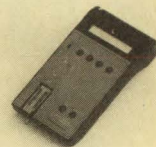

TRE-200 \$295.-
8/16 BIT
ROM/RAM EMULATOR
(PC based)

• 8 or 16 Bit
• ROM: 2764, 128, 256, 512
• RAM: 6264, 62256
• Fast down/up load
• Screen edit
• Dis-assembler for 6 MPUs

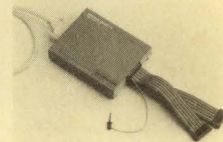

TLK-PLD PLD Learn Kit \$85.- TLK-GAL GAL Learn Kit \$85.-
TLK-PEEL PEEL Learn Kit \$85.- TLK-8051 8051 Learn Kit \$85.-

• Enable beginners to design their own PLD/PEEL/GAL/MPU within a short period of time.

• Design & Experiments manuals and Experiment PCB Kit

Call us today for complete product line

■ 1-year warranty 30 days money back guarantee

TRIBAL MICROSYSTEMS

Tel: (415)623-8859 Fax: (415)623-9925
44388 S. Grimmer Blvd, Fremont CA 94538

CIRCLE NO. 342



Design, Program, Test

TURPRO-1 Universal Pin Driven I.C. Programmer
Current and Future Devices Supported

- PALs, GALs, PEELs, PLDs, FPGAs, E/EPROMs, PROMs, MPUs, etc.
- 8-40 Pins DIP and 20-188 Pins PLCC Packages.
- PC Remote Control via RS232C or Parallel Port.
- I.C. MFR. Approved • Self-Contained Power Supply + 2 CPUs.

=== Only \$1,450 for ===

State-of-the-Art Performance

SYSTEM GENERAL Tel: 408-263-6667
Fax: 408-262-9220

CIRCLE NO. 343

LOW PROFILE MODEM DAA

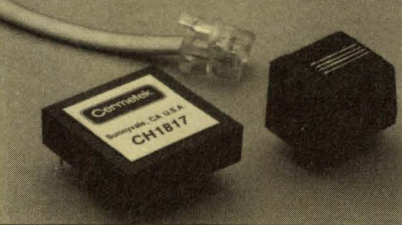

CH1817

- Less than 0.3" high x 1.0" x 1.0"
- FCC Part 68 and DOC Approvable
- UL 1459 Approvable
- Compatible with all modem chip sets including V.32

Your Source for Modem Components:



Tel: 408-752-5000
Fax: 408-752-5004

Cermetek Microelectronics, Inc.
1308 Borregas Ave. • Sunnyvale, CA 94089

CIRCLE NO. 344

END WARPAGE WITH BOARD STIFFENERS

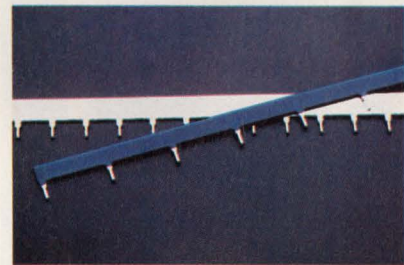

- Rigidize board during, after assembly
 - Prevent vibration and shock damage
 - One-step installation requires no hardware
 - Use as ground or carry up to 64 amps
- Send for Rogers Board Stiffeners
Application Bulletin.
Rogers Corp., 2400 S. Roosevelt St.
Tempe, AZ 85282 602/967-0624

CIRCLE NO. 345

A 3"x 5" Single Board Computer with FREE C Source Utilities!

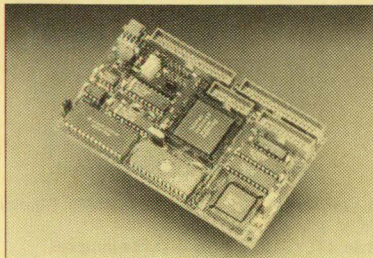

30-Day Money-Back Guarantee!

- 8051 type architecture
- Siemens 80C535
- 40 digital I/O lines
- 2 RS232 ports and 1 RS485 port
- 8-Bit A/D converter with 8 multiplexed inputs
- Power supervisory circuits
- 8KB or 32KB RAM / 32KB or 64KB EPROM
- 5x4 keypad encoder
- On board +5V regulation
- Optional real time clock
- Over 40 FREE C source utilities

TRI-L DATA SYSTEMS
94-871 Farrington Hwy, 2nd Fl.
Waipahu, HI, USA 96797-3146
Phone: (808) 671-5133
FAX: (808) 671-8543
Toll Free: 1-800-245-8745

CIRCLE NO. 346

At Last a Truly Industrial 386 AT System for the OEM

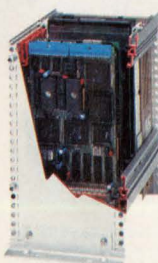

16 or 20 MHz 80386 SX CPU with 80387 Arithmetic Unit
1.24 or 8 Mbytes of on-board RAM. Full support for LIM EMS and BIOS Shadowing
Onboard support for COM1, COM2, LPT, keyboard, clock, floppy and hard disk

Two boards make a complete 386 computer with your choice of EGA or VGA display
Extremely rugged 100 x 160 mm Eurocard construction, with pin-in-socket bus connector
Fully expandable with over 200 G-64/G-96 bus I/O functions including: parallel and serial I/O, networking, MIL 15553, motion control and vision

For more information please call

USA (800) 4-GESPAC or (602) 962-5559
EUROPE (FRANCE) (33) 94-30-34-34
International (Switzerland) (41-22) 794-3400



CIRCLE NO. 347

SERIES PI

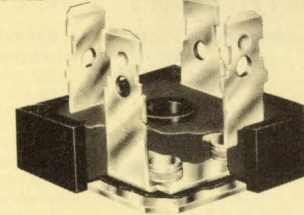

40 A RECTIFIERS

Integral heat sink
Quick connect or wire leads
400 A surge
Standard, fast, and ultrafast
UL Recognized

American manufacturer of rectifiers since 1951.
Buy from the specialist.

edi® electronic devices
AN AMERICAN ELECTRONIC COMPONENTS COMPANY
21 GRAY OAKS AVE • YONKERS, NY 10710
TEL: 800-678-0828 • FAX: 914-965-5531

CIRCLE NO. 348

To advertise in Product Mart, call Joanne Dorian, 212/463-6415

40-PIN E/EPROM PROGRAMMER

Lifetime S/W via BBS

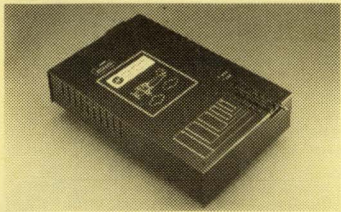

PILOT-144: Powerful PC-driven 40-pin programmer supports E/EPROMs up to 40-pins. Standard parallel port interface means fast thru-put and no need to install high voltage cards inside your PC. Built-in power supply. Upgradable to support 875x and 874x micros. \$795. SATISFACTION GUARANTEED.

408-243-7000, 800-627-2456, Fax 408-736-2503



ADVIN SYSTEMS INC.
1050-L E. Duane Ave., Sunnyvale, CA 94086

CIRCLE NO. 349

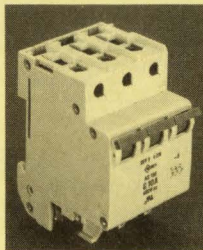

AS 168 Energy Limiting Circuit Breaker

- Superior Short Circuit Protection
- Selective Disconnection - No nuisance shutdown
- Easy Installation with Quick Connect Terminals, screw terminals, or DIN Rail Mounting
- Worldwide Approvals, VDE, UL, & CSA
- Single, Double, Triple, and four pole versions
- Current Ratings - 0.5 to 50 Amp
- AC rating to 480 and DC rating 120 Volts per pole
- Available with Switched Neutral, Auxiliary and Signal contacts
- Stock available in Connecticut

Contact: **Inmark Corporation**, 4 Byington Place
Norwalk, CT 06850 Telephone: 203-866-8474
Fax: 203-866-0918

CIRCLE NO. 350

Instant Microcontroller

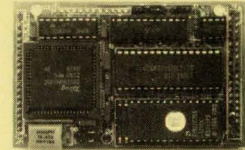

Instant C Programming

Don't use a microprocessor, use a **SmartBlock™** microcontroller module to build your custom controller. Our low cost Dynamic C™ makes programming a snap. 3.5 x 2.5 inch module includes microprocessor, memory, time/date clock, eeprom, watchdog, serial ports and more. As low as \$59. The efficiency of a custom design without the headaches.

Z-World Engineering

1340 E. Covell Blvd., Davis, CA 95616

Tel: (916) 753-3722

Fax: (916) 753-5141

CIRCLE NO. 751

48 CHANNEL 25 MHz LOGIC ANALYZER

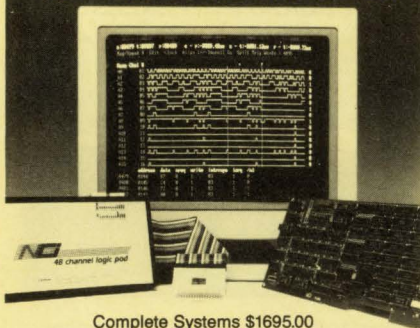

Complete Systems \$1695.00

*New windows 3.0 compatible software.

- 48 Chnrls @25MHz x 4K word deep
- 16 Trigger words/16 level Trigger Sequence
- Storage and recall of traces/setups to disk
- Disassemblers available for: 68000, 8088, 8086, 6801, 6811, Z80, 8085, 6502, 6809, 6303, 8031

NCI □ 6438 UNIVERSITY DRIVE,
HUNTSVILLE, AL 35806

Tel (205) 837-6667 Fax (205) 837-5221

CIRCLE NO. 752

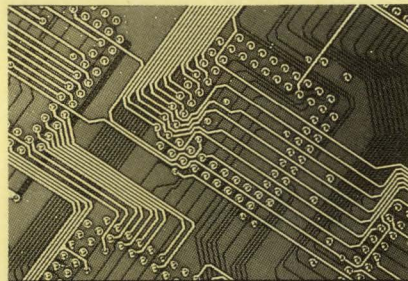

Your reliable & economic source for printed circuit boards.

We offer a wide range of double-sided & multilayer PCBs with high reliability fast service, top quality and competitive price. We can help you become more effective & profitable through the next decade. Don't hesitate! Contact us now!

SALES AGENTS WANTED.



GLOBAL PMX CO., LTD.

12TH FL. NO. 689, CHUNG SHAN N. RD.
SEC. 5, TAIPEI, TAIWAN, R.O.C.
TEL: 886-2-8356244 FAX: 886-2-8356254

CIRCLE NO. 753

Consistency is key

to the power of EDN Product Mart

CIRCLE NO. 754

Protel Easytrax 2™

Outstanding value in Printed Circuit Board/CAD for your Macintosh and PC

Protel Easytrax 2 is a new, low-cost design package for PC and Macintosh users that includes everything required to produce professional quality Printed Circuit Board artwork.

Our easy-to-learn menu-driven design system breaks the 'expert barrier' - you'll be designing in minutes, not hours. Our comprehensive tutorials guide you through the program's extensive features that take the tedium out of board layout.

- Comprehensive library of Through-hole devices
- Gerber photoplotting and N/C drill tapes
- On-the-fly library components creation
- Intelligent Pad to Pad autorouting
- Switchable Metric/Imperial grid
- Auto-panning
- PostScript™ printing
- Powerful user-definable Macros
- Independent print/plot program
- Multi-layer boards of up to 32 X 32 inches.

At Protel, we offer free technical support, 24-hour BBS, and 30-day money back guarantee. Prices start at

Free Evaluation Package
Toll Free: 800-544-4186

\$450

Protel Technology, Inc.
50 Airport Parkway, San Jose, CA 95110
Tel: 408-437-7771 Fax: 408-437-4913



CIRCLE NO. 755

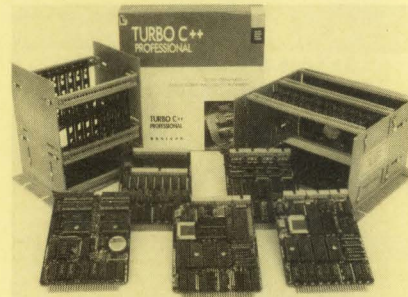

TURBO-STD-BUS

R.L.C.'s large selection of 8 and 16-Bit STD Bus Single Board Computers offer an Intel 80C186/188 CPU and 80C187/8087 Numeric Co-Processor at true bus speeds up to 16 MHz. On-board functions include MEMORY, SERIAL PORTS, REAL TIME CLOCK, TIMERS, DMA, INTERRUPT CONTROLLER, and BATTERY BACK-UP, WATCH-DOG TIMER and much more. R.L.C. also offers 16-Bit support cards, card cages and complete software support using the award winning TURBO-DEBUGGER. For more information and technical assistance please call Robert Coomer.

R.L.C. Enterprises
(805) 466-9717

4800 Templeton Road Atascadero, CA 93422

CIRCLE NO. 756

UNIPRO

40-Pin Universal Device Programmer

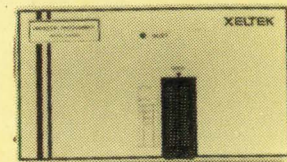

- Programs PLD, E(E)PROM (upto 4MB), Bipolar PROM & Microcontroller
- Tests TTL/CMOS logic & D/S memory
- Reliable and fast programming with Normal, Intelligent, Interactive, Quick pulse algorithms
- Accepts JEDEC, INTEL extended HEX, Motorola S, Tektronix HEX, Binary formats
- Manages 8, 16, and 32-bit word split
- Supports most compilers in JEDEC format
- S/W controlled 40-pin universal programmer
- Interfaces w/ IBM PC/XT/AT/386 or compatibles
- High speed parallel interface card to PC

XELTEK

764 San Aleso Ave.
Sunnyvale, CA 94086
TEL (408) 745-7974
FAX (408) 745-1401

CIRCLE NO. 757

To advertise in Product Mart, call Joanne Dorian, 212/463-6415

NEW ELF METER

F.W. Bell, the world's leading maker of gaussmeters, is introducing a new hand-held ELF Meter. The Model 4060 ELF Meter provides for easy readings of extremely low frequency magnetic fields, such as those generated by power lines, TV's, computer monitors, electric blankets and other home appliances and electrical devices. Models are available for reading fields generated by 50 Hz or 60 Hz applications. The Model 4060 ELF Meter has two ranges, Milligauss (low) and Gauss (high) with 1 mG resolution. The meter is presented at a very low cost.



F.W. BELL, INC.

6120 Hanging Moss Rd., Orlando, FL 32807
Phone: 407-678-6900

CIRCLE NO. 758

**X.25 SDLC
QLLC HDLC
ADCCP PAD**

- C source code
- ROM-able
- Full porting provided
- No OS required



GCOM, Inc.
1776 E. Washington
Urbana, IL 61801
(217) 337-4471

Specialists in Computer Communications
FAX 217-337-4470

CIRCLE NO. 759

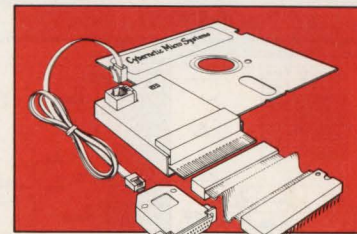

8051 Emulator - \$1250

d²ICE is a low cost, Full Speed, real time 8051 Emulator. Powerful user interface for Hi-level multi-window source code debugging. Uses IBM-PC COM1/2. No Slots! Portable, fits in shirt pocket. Assembler and test bed included.



Cybernetic Micro Systems

PO Box 3000 • San Gregorio CA 94074
Ph: (415) 726-3000 • Fax: (415) 726-3003

CIRCLE NO. 760



901 video test generator

- Ideal for production and servicing video displays
- Preprogrammed formats include: CGA, EGA, VGA, 8414A, Mac and all standard HDTV Formats, etc.
- Over 50 test images included for making size, linearity, focus and color adjustments
- Easy to use—free video tape available



Ask for Free Video Tape

2111 Big Timber Road, Elgin, IL 60123 U.S.A.
(708) 888-0450 • FAX (708) 888-2802

CIRCLE NO. 761

NEW! **iceMASTER**
8051 68HC11

Your Window to Emulation Productivity

- Easy to learn & use
- Windowed interface—user configurable
- FAST! Download—< 3 sec. typ. at 115KB
- Source Level debug

- A 4K frame trace buffer with advanced searching capabilities.
- Hyperlinked On-line help guides you through the emulation process.
- Best Performance Analyzer in the industry.
- iceMASTER connects easily to your PC, requires no disassembly, or expansion slots. Works on any PC (DOS or OS/2), MicroChannel or EISA. Even laptops!
- Supports more than 50 different 8051 family derivatives. M68HC11 support will be available early in 1991.
- Try iceMASTER risk free! Satisfaction Guaranteed or return for a full refund!*
- RENTALS AVAILABLE! Ideal for consultants and researchers!
- Call today for free demo disk and ask about a free 8051 Macro Assembler! (800)638-2423



MetaLink Corporation P.O. Box 1329 Chandler, AZ 85244-1329
(602) 926-0797 FAX (602)926-1198 TELEX 499805MMLNK

FREE ASSEMBLER

CIRCLE NO. 762

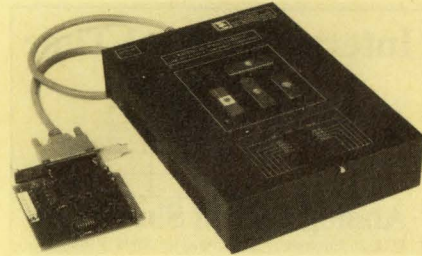

PC BASED UNIVERSAL DEVICE PROGRAMMER \$695/895

- Programs EE/EPROMs, PALs, GALs, EPLDs, MICROs, BIPOLARS, PEELs.
- Software driven pin drivers. D/A generated programming voltages (8 bit DACs used to generate voltages from 5-25V with 0.1V resolution for all 40 pins)
- Upgradable for virtually any future programmable devices up to 40 pins.
- Self subsistent operation. No additional modules or plug-in adapters required.
- Includes user friendly MEMORY BUFFER FULL SCREEN EDITOR.
- Commands include: Fill, Move, Insert, Delete, Search, ASCII or HEX entry.
- Friendly Menu Driven interface. Device selection by P/N and manufacturer.
- Supports 816/32 bit data word formats.
- Programming algorithm: Normal, Intelligent I&H, Quick Pulse Programming.
- Verily operation performed at normal & worst case operating voltage.
- Functional test: JEDEC standard functional testing for logic devices.
- TTL Logic functional test for 74xx/54xx series devices.
- File formats accepted: JEDEC (ball), JEDEC (kernel), Straight Hex, MOS Technology, Motorola Hex, Intel Hex, Tektronix Hex.
- Customer support via voice line, fax & dedicated BBS. Full 1 year warranty.
- Base price: \$695 includes Interface card, cable, Memory/Micro/Bipolar library and 1 year free updates. \$895 with additional Logic Device Library.
- Library updates can be received via floppy or Customer Support BBS.

MC / VISA / AMEX

Call today for datasheets!



B&C MICROSYSTEMS, Inc.
750 N. Pasadena Ave., Sunnyvale, CA 94086 USA
TEL: (408) 730-5511 FAX: (408) 730-5521

CIRCLE NO. 763

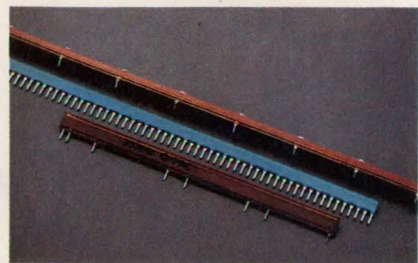

SAVE SPACE WITH Q/PAC® COMPONENTS

- Provide built-in capacitance
- Eliminate decoupling capacitance
- Gain 4-layer board quietness with 2-layer economy
- Vertical or horizontal mounting

Send for Rogers Q/PAC® Application Bulletin.

Rogers Corp., 2400 S. Roosevelt St.
Tempe, AZ 85282 602/967-0624
CIRCLE NO. 764

UNIVERSAL PROGRAMMER

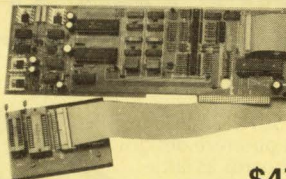

\$475

PAL EPROM
GAL 8748/49
PROM 87C51...
EEPROM EXOTIC'S

5ns PALS

4 Meg EPROMs

Parts added at your request.

FREE software updates on BBS.
Powerful menu driven software.

Call - (201) 994-6669

Link Computer Graphics, Inc.

4 Sparrow Dr., Livingston, NJ 07039 FAX: 994-0730

CIRCLE NO. 765

LATTICE - MMI - INTEL - TI
AMD - DALLAS - ALTERA

CATALYST - XICOR
WSI - ICT - and MORE

ROM-IT

EPROM EMULATION SYSTEM



NEW 4-MEGABIT VERSION

- Emulates up to 8 4-Megabit EPROMs with one control card.
- Downloads 2-Megabit programs in less than 23 seconds.
- Allows you to examine and modify individual bytes or blocks.
- Accepts Intel Hex, Motorola S-Record and Binary files.
- Software available for IBM PC and compatibles and Macintosh systems.
- Base 27256 EPROM System \$395.00 Other configurations available.

ORDER TODAY—IT'S EASY
CALL OR FAX FOR MORE INFORMATION



Incredible Technologies, Inc.
(708) 437-2433
(708) 437-2473 Fax

VISA now accepted.

CIRCLE NO. 766

To advertise in Product Mart, call Joanne Dorian, 212/463-6415

SPICE SOFTWARE

CAE TOOLS FOR THE PC

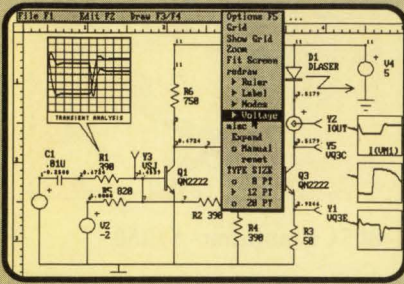

From Schematic Entry, through SPICE Simulation, to Graphical Post Processing, only \$790

- ISPCICE - Full Featured SPICE Circuit Simulation
- SPICENET - Graphical Schematic Entry for SPICE
- INTUSCOPE - Waveform Display and Plotting
- PRESPIICE - Model Libraries, Monte Carlo analysis
- SPICEMOD - SPICE Model generation from data sheets



P.O. Box 710 San Pedro, CA 90733-0710
Tele (213) 833-0710
FAX (213) 833-9658

CIRCLE NO. 767

PROTOTYPING ADAPTORS

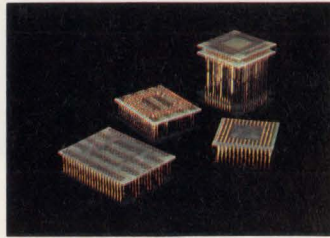

BY THE HUNDREDS

Our line of prototyping adaptors for VLSI devices including PGA, PLCC, LCC, ZIP, DIP and Quad Flat PAK is the most extensive available in the industry. These devices allow easy prototyping of these difficult to handle devices. Pins and sockets used are gold plated and of the highest quality. Parts are available in solder tail or with 3 level wirewrap pins. All types of wirewrap panels are covered. Ask about our custom design services for unique solutions in packaging.

IRONWOOD ELECTRONICS

P.O. BOX 21151, ST. PAUL, MN 55121
(612) 431-7025; FAX (612) 432-8616



CIRCLE NO. 768

PLCC LoClip - PLCC Probe

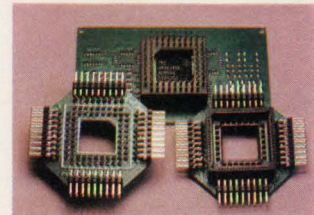

NEW PRODUCT

The PLCC-LoClipXX line from Ironwood is a new product line allowing probing of surface mount PLCC's at a fraction of size of other clips. The U and L ver. have right angle leads (cable connect or probing). Device heights of 0.75", 0.57", and 0.45" for S, U, and L boards respectively enable probing of boards in backpanels. Interdevice spacing of 0.10" allowed. PLCC's from 24 to 84 pins supported. Kits of 10 with different sizes/carrying case available at substantial discount.

IRONWOOD ELECTRONICS

P.O. BOX 21151, ST. PAUL, MN 55121
(612) 431-7025

CIRCLE NO. 769

Interactive/Real-Time

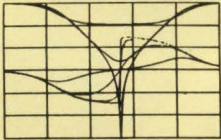

Analog Circuit Simulation

ECA-2 Electronic Circuit Analysis offers: • AC, DC, Transient, Fourier, and Temperature Analysis with Nominal, MonteCarlo and/or Worst-Case component values • Interactive or batch modes • Full nonlinear simulation • Sine, Pulse, PWL, SFFM, and Exponential generators • IBM PC/Mac • Multiple plots • On-line real time graphics - 2 to 50 times faster than SPICE • Over 500 nodes • Advanced component parameters • Component optimization sweeping • Full editing, built-in or external • New detailed 424 page manual

Call for FREE DEMO!



CIRCLE NO. 770



CROSS-32 V2.0 META ASSEMBLER

- Table based absolute macro cross-assembler using the manufacturer's assembly mnemonics.
- Includes manual and MS-DOS assembler disk with tables for ALL of the following processors:

1802	64180	6801	8048	TMS320	Z8
37700	6502	6805	8051	TMS340	Z80
50740	65816	6809	8085	TMS370	Z180
7500	COP400	6811	8086	TMS7000	Z280
SUPER8	COP800	68000	8096	TMS9900	MORE...
- Users can create tables for other processors or ask us, we have many more!
- Generates listing, symbol table and binary, Intel, and Motorola hexcode.
- Free worldwide airmail shipping & handling.

US\$199.00 CDN\$239.00



UNIVERSAL CROSS-ASSEMBLERS
P.O. Box 6158
Saint John, N.B.,
E2L 4R6 Canada
Voice/Fax: (506)847-0681



CIRCLE NO. 771

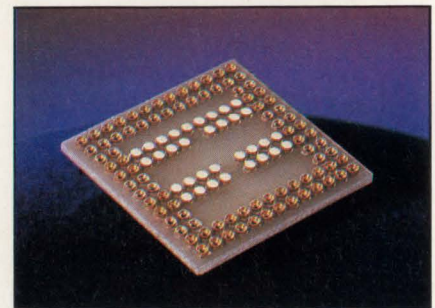

Over 300 Prototyping Adaptors

- Adapt-A-Boards™ make it easy to adapt standard or high-density prototyping boards to a variety of packages.
- For all package types: LCC, PLCC, PGA, PQFP, SDIP (shrink DIP devices), SOIC and more!
- Bottom configurations adapt to wire wraps or solder tail pins. Boards conform to Mil-C-45204.
- Quick turnaround on custom engineering services, if needed. For a free catalog, contact:

Emulation Technology, Inc.
2344 Walsh Ave. Santa Clara, CA 95051
Phone: 408-982-0660 FAX: 408-982-0664



CIRCLE NO. 772



Multi-Tasking EXECS

US Software offers hi-performance software tools for embedded applications.

Get the full details by calling:

800-356-7097
503-641-8446
503-644-2413 (FAX)



U S SOFTWARE

United States Software Corporation
14215 NW Science Park Drive
Portland, Oregon 97229

CIRCLE NO. 773

FREE FOR ALL

Free for all who call Omaton - a PC board layout demo disk! Try SCHEMA PCB for FREE and optimize designs for boards as large as 32" x 32", 30 layers, right on your PC. Call Omaton for your FREE demo disk today!



1-800-553-9119

CIRCLE NO. 774



'488 CONTROL FOR YOUR MACINTOSH II

- Control any instrument in minutes.
- Supports BASIC, Pascal, C and Hypertalk.
- HyperCard utilities included.
- Software library. Risk free guarantee.



Capital Equipment Corp.
Burlington, MA. 01803

Informative catalog 800-234-4232
Applications help (617) 273-1818

CIRCLE NO. 775

To advertise in Product Mart, call Joanne Dorian, 212/463-6415

Now Networkable!

Facts about
500,000
ICs and Semiconductors
at Your Fingertips

Cahners CAPS is the newest component search and selection tool for electronic design engineers:

- PC-driven, CD-ROM-based
- Includes unabridged manufacturers' datasheets
- Represents more than 450 manufacturers worldwide

Call toll-free: 1-800-245-6696

CAHNNERS

CAPS
Computer Aided
Product Selection

275 Washington Street
Newton, MA 02158-1630
Telephone: 617-558-4960
Facsimile: 617-630-2168
Telex: 940573

CIRCLE NO. 776

LOW COST
Data Acquisition
Cards for
PC/XT/AT



12 Bit A/D & D/A [PCL711S] \$295

- A/D converter: 8 single-ended channels; Uses AD574 device; Conversion time is less than 25 μ sec; Input range: $\pm 5V$; Software Trigger Mode only.
- D/A converter: 1 channel; 12 bit resolution; 0 to $\pm 5.10V$ Output Range.
- Digital I/O: 16 In/Out (TTL compatible); External Wiring Terminal Board incl.
- Utility Routines and Demo/Sample Programs for BASIC and Quick-BASIC.

12 Bit A/D & D/A [PCL812] \$395

- A/D converter: 16 single ended inputs; Uses AD574; Conversion time less than 25 μ sec; Built-in programmable power; Input Ranges: $\pm 10V$, $\pm 5V$, $\pm 1V$.
- D/A converter: 2 channels; 12 bit resolution; Output Range 0-5V.
- Digital I/O: 16 In/Out (TTL compatible); Programmable Counter/Timer (8254).
- DMA and interrupt capability; Utility software and sample program in BASIC.

Fast 12 Bit A/D/A [PCL718] \$795

- A/D converter: 16 single ended or 8 differential channels; 12 bits resolution; Programmable scan rate; Built-in Interrupt and DMA control circuitry. Conversion speed 60,000 samples/sec (standard), 100,000 samples/sec (optional).
- Input Ranges: Bipolar: $\pm 10V$, $\pm 5V$, $\pm 2.5V$, $\pm 1V$, $\pm 0.5V$; Unipolar: 0-5.2, 1V.
- D/A converter: 2 channels; Resolution: 12 bits; Settling time: 5 μ sec; $\pm 5V$.
- Digital I/O: 16 In/Out (TTL compatible); Programmable Counter/Timer (8254).
- Software: Utility software for BASIC & QuickBASIC included. Sample prgm. Supported by LabDAS, ASSYST, LABTECH, Uniscope.

6 Channel 12 bit D/A [PCL726] \$495

- Output Ranges: 0 to $\pm 5V$, 0 to $\pm 10V$, $\pm 5V$, $\pm 10V$, or sink 4-20mA.
- Settling time: 70 μ s. Linearity: $\pm 1/2$ bit. Voltage output drive capacity: $\pm 5mA$.
- Digital I/O: 16 digital input and 16 digital outputs (TTL compatible).
- MC/VISA/AMEX Call today for datasheets!



B&C MICROSYSTEMS INC.
750 N. Pastoria Ave, Sunnyvale, CA 94086 USA
TEL: (408)730-5511 FAX: (408)730-5521

CIRCLE NO. 777

LEMO'S NEW CIRCULAR CONNECTOR CATALOG

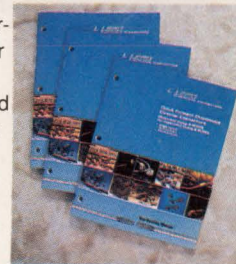

LEMO's new circular connector catalog highlights expanded shell and insert designs. Insert configurations are available in single, multi or mixed designs including signal, coaxial, triaxial, high voltage, fiber optic and fluidic/pneumatic. Shell styles are available in standard chrome plated brass, anodized aluminum or stainless steel.

LEMO USA INC

P.O. Box 11488, Santa Rosa, CA 95406
Phone (800) 444-LEMO, Fax 707/578-0869

CIRCLE NO. 778

**Combine Your
Product Mart Ads**

In EDN's Magazine
and
News Editions for
higher impact and a
lower rate.

CIRCLE NO. 779

**C for the 8051
Compare:**

Benchmark Results—Sample program:
Eratosthenes Sieve Program from BYTE (1/83),
expanded with I/O and interrupt handling.

	FRANKLIN SOFTWARE C-51 v2.1	MCC51 v1.2	Archimedes ICC51 v2.20A
Linkage time	6 sec	9	29
Execution time	0.88 sec	9.00	11.45
Total code size	1726 bytes	3798	5318
Compilation time	17 sec	18	12
Sieve module size	541 bytes	1021	736

Call now for your free DEMO disk.

FRANKLIN
SOFTWARE, INC.

888 Saratoga Ave. #2 • San Jose, CA 95129
(408) 296-8051 • FAX (408) 296-8061

CIRCLE NO. 780

**There is a Difference!
Lifetime Free Updates**

CP-1128
\$1295

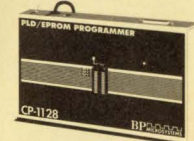

A programmer is not just another programmer. That is why BP Microsystems is committed to bringing our customers the highest quality programmers at an affordable price. This commitment is evident in our CP-1128 Combination PROM/EPROM/PLD Programmer supporting over 1800 devices up to 28-pins. Call today!

BP MICROSYSTEMS

1-800-225-2102
713/461-9430

CIRCLE NO. 781



**Schematic
Capture
for the
Macintosh**

DESIGNWORKS

Schematic features Menu-driven, mouse-controlled operations • cut/copy/paste between circuits • right-angle rubber-banding. **Digital simulation** 13-state, event-driven simulation • logic analyzer-style timing window • PLD support. **Libraries** Fully-simulated 7400, 4000, 10K series, PLDs, PROMs and RAMs, non-simulated analog and discrete components • User-definable, simulated custom symbols. **Interfaces** Formats for Douglas CAD/CAM, Cadnetix, Calay, Orcad, Tango, Racal Redac, Spice. • user-definable printers, dot-matrix printers, HP, Houston, Roland pen plotters. **Requirements** Macintosh Plus, SE, II, IIfx, or IIfx.

CALL (604) 669-6343 FOR YOUR
FREE DEMO DISK TODAY.

CAPILANO COMPUTING SYSTEMS LTD.

CIRCLE NO. 782

WORLD'S SMALLEST
SMT QUARTZ CRYSTALS and CLOCK OSCILLATORS
212-505-4179

- 10kHz-32MHz
- ceramic & metal packages
- hermetically-sealed
- hi-temp mounting
- tape & reel thru-hole versions
- shock resistant

MC MICRO CRYSTAL
35 East 21st Street
New York, N.Y.

FREE CATALOG

CIRCLE NO. 783

Telecom Solutions from Teltone

**Central Office Grade
DTMF Transceivers**

Complete, single-chip DTMF transmitter/receivers with call progress detection, automatic tone burst mode, and adjustable guard time.



For paging systems, fax machines, interconnect dialers, PBX systems, computer systems, etc. CMOS, 5-volt power supply, 20-pin DIP.

- M-8880 features 6500/6800 microprocessor interface.
- M-8888 features 8051, 8086/88 microprocessor interface.

1-800-426-3926

Or: 206-487-1515 Fax: 206-487-2288

TELSTONE

INNOVATING SOLUTIONS
In Telecom Interface Components

Teltone Corporation, 22121-20th Avenue SE, Bothell, WA 98021

CIRCLE NO. 784

To advertise in Product Mart, call Joanne Dorian, 212/463-6415

LINEAR SEMINAR FOR DESIGNERS BY DESIGNERS. (New Product Workshop)

100 MHz Op Amp

0.1 Distortion
Low Pass Filter

Free Application
Handbook
Free Databook

Free Lunch
Free Samples

88% Efficiency
Switchers

Plan to attend this one day seminar given by Linear's top designers.

If you design analog circuits or sub-systems, this is one seminar you don't want to miss. It's presented by Linear Technology's senior design engineers. The emphasis is on "real world" applications and the typical challenges facing today's design engineer. Each application presented has been breadboarded at Linear Technology. And because our top engineers are also giving this seminar, they're intimately familiar with the ICs and their applications.

Topics To Be Covered Include:

Operational and Instrumentation Amplifier Applications

- High speed op amps with slew rates ≥ 250 volts/ μ sec.
- Single supply micropower devices
- Selection techniques to minimize noise

Power Supply Design

- High efficiency ($\geq 90\%$) switching regulators
- Transformer and inductor design/selection
- Micropower switchers
- Single cell converters

Filter Applications and Design

- New family of high performance, low noise, switched capacitor filters.
- Filter design software ("FilterCAD")

PHASE II

Seminar Number	Seminar Location	Date
12	Santa Clara	1/29
13	San Diego	2/6
14	Los Angeles/Woodland Hills	2/7
15	Baltimore	2/26
16	Orlando	2/27
17	Irvine/Garden Grove	2/27
18	St. Petersburg (FL)	2/28
19	Portland	3/19
20	Dayton	3/19
21	Detroit	3/20
22	St. Louis	3/21
23	Santa Rosa	3/21

We'll be adding additional seminar locations. Watch for them.



TOUGH PRODUCTS
FOR TOUGH APPLICATIONS.

Data Converters

- New A-D converters with serial protocol
- Simplified microprocessor interfacing

Low Power Interface Circuits

- Both RS232 and RS485 transceivers
- Design and application notes for: Driving long lines • Capacitive loading • Power down and power up

New Products

- Preview of new 1991 products

And these are just a few highlights from the topics to be covered. You'll also receive: Lunch • 1500 page Databook • 1000 page Application Handbook • NOISE Disk • SPICE Disk • FilterCAD Software and Filter Handbook • Product samples

Plan to attend now. You'll learn "tricks of the trade" from our Seminar Presentation Teams headed by industry experts including:

Bob Dobkin Carl Nelson
Jim Williams George Erdi
Nello Sevastopoulos

Cost is \$30.00 and you can register now by calling **800-637-5545**. VISA and MasterCard accepted. Or send your check to Linear Technology Corporation, 1630 McCarthy Blvd., Milpitas, CA 95035.

Will you be the victim of age discrimination?

The answer is probably yes. Here's what you can do about it.

Jay Fraser,
Associate Editor

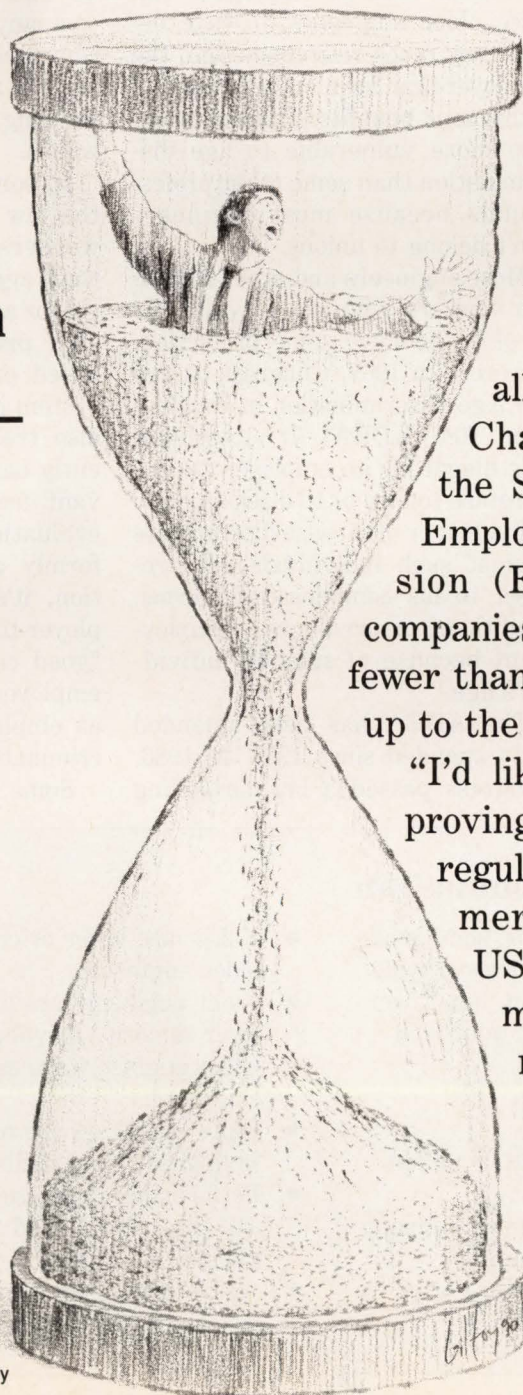

Illustration by Bruce Gilfof

If you stay in the engineering profession after age 40, chances are that you will encounter age discrimination.

“Discrimination occurs on all levels of employment,” says Charles Carattini, director of the San Jose office of the Equal Employment Opportunity Commission (EEOC), “and it occurs in companies that are small—those with fewer than 100 employees—all the way up to the giants.”

“I’d like to believe things are improving due to the new laws and regulations,” says Richard Plummer, Chairman of the IEEE-USA Anti-Discrimination Committee, “but in the past the majority of engineers faced age discrimination at some time in their careers.”

Determining how many serious incidents of age discrimination occur each year is difficult. The federal

government doesn't keep separate statistics on age-discrimination complaints. They're included in a single category along with complaints about racial, gender, and religious discrimination. Exact figures are also hard to come by because many age-discrimination cases are quietly settled out of court. However, the EEOC and state agencies receive about 25,000 complaints about all types of discrimination every year.

"I can tell you in the last five years or so, throughout the whole country there has been an increase in age-discrimination charges filed with the commissions," says Caratini. "I think it has to do with people living longer, being more active, and not seeing themselves at age 60 the way they used to."

Engineers face special problems

In some professions, such as medicine and law, age is equated with knowledge and experience. Older doctors and lawyers are sought after for their expertise. In engineering, employers all too often consider older engineers less valuable than their younger counterparts. Engineers fresh out of school supposedly bring with them a knowledge of the latest technologies and an energy that older engineers just can't match.

"Cases are settled out of court only about 33% of the time."

Another reason older engineers are often targets of age discrimination is purely financial. Younger engineers will sometimes accept jobs for low salaries just to get some experience. And if employers can force older engineers to leave before they reach retirement age, the employers can save on pensions and retirement benefits. Engineers are also more vulnerable to age discrimination than some other professionals because most engineers don't belong to unions.

Most engineers and other American workers who are 40 years old or older do have some protection, however. In 1967, Congress passed the Age Discrimination in Employment Act (ADEA). It states that it is illegal for an employer "to fail or refuse to hire or to discharge any individual or otherwise discriminate against such individuals with respect to his compensation, terms, conditions, or privileges of employment because of such an individual's age."

The ADEA has been amended and expanded since 1967. In 1986, Congress passed a law forbidding

mandatory retirement and requiring employers to continue to pay into health-insurance and pension plans for workers who stay on after age 65. Last October, Congress passed the Older Workers Benefit Protection Act, which bars employers from cutting off extended benefits such as disability payments.

Not everyone comes under the protection of the ADEA, however. To qualify, you must work for a company in an industry that affects commerce, and the company must employ at least 20 people for every working day in each of 20 or more weeks.

In some circumstances, however, the law allows employers to treat workers differently according to their age. For example, it's not illegal for a company to establish a pension program or a benefit plan based on seniority as long as the system is equitable. Companies can also treat their employees differently based on reasonable and relevant factors such as performance evaluations that are applied uniformly and consistently. In addition, it's not unlawful for an employer to discharge an employee for "good cause." Of course, what an employer may consider good cause, an employee may consider age discrimination.

Some large judgments have been

Warning signs of age discrimination

Age discrimination can take many forms, some more subtle than others. Don't assume that every layoff or reassignment involves discrimination, but if you notice a recurring pattern of incidents, your company may be violating the law.

Here are some signs to watch for:

- Older engineers are often induced or forced into early retirement.
- Older engineers are laid off while the company continues to hire younger engineers.
- Lack-of-work notices are issued more often to older engineers than to younger ones.
- Raises are lower or come less frequently for older engineers.
- Older engineers are often demoted or have their seniority privileges taken away.
- Older engineers are assigned tasks below their skill level.
- Older engineers are not given opportunities to upgrade their skills.
- Performance appraisals are highly subjective and the criteria used for them are not explained.
- Age is stated—or implied—as a reason for demotion or termination.



ARIES®

a "small advantage" . . .

We can move fast to solve your problems. . . *"We're small enough to listen. . . big enough to produce."* Your requirements get immediate attention. We don't go through a lot of red tape to get a job done. Our solutions are fast. That's where we have a "small advantage" over the big industry leaders. "We" can get a job done before "they" finish the paper work. We prove how our "small advantage" works to more customers every day.

Here's proof!

ADAPTORS

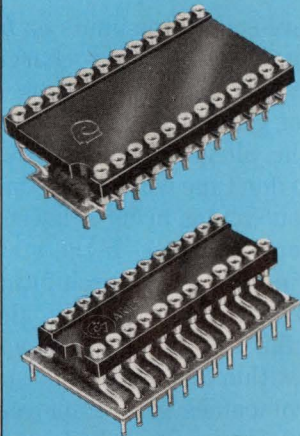

We can change your footprint faster than you can tie your shoes!

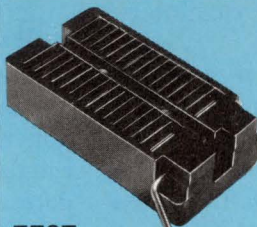

TEST SOCKETS



We can make fast modifications to our standard product. Put us to the "test".

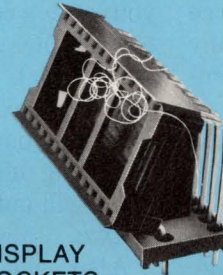
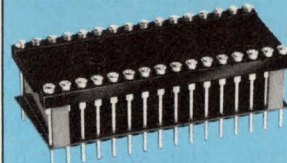

DISPLAY SOCKETS

When it comes to sockets, Aries knows all the "angles" . . . and we have "elevated" sockets to a new plateau!

PROGRAMMERS

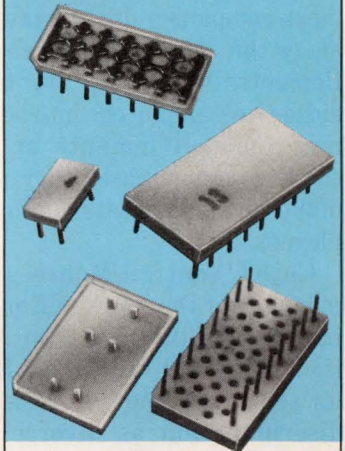

Miniaturization and Multi-Function - Programmable devices to suit your design requirements.

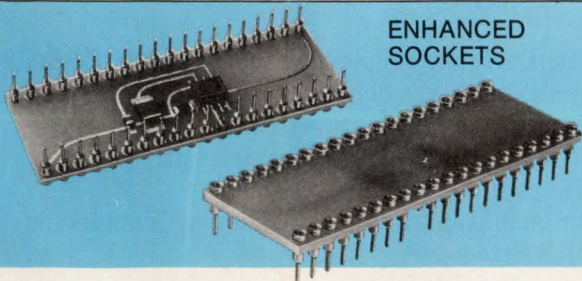

ENHANCED SOCKETS

Wasted space is put to work using surface mount technology!

*Small enough to listen. . .
big enough to produce.*



ARIES®
ELECTRONICS, INC.

P.O. Box 130, Frenchtown, NJ 08825
Phone 1-908-996-6841 Telex 6974615 FAX 908-996-3891

Professional Issues

won under the ADEA. In 1987, a court ordered Pan American Airlines to pay \$17.2 million to 100 of its former pilots who had been forced to retire when they reached age 60. And in 1988, Westinghouse agreed to pay a record \$35 million to a group of its former employees. The employees had sued the company because when they retired they had to choose between pensions and severance pay. Younger workers who left Westinghouse received both.

The IEEE-USA Anti-Discrimination Committee investigates age-discrimination complaints from engineers and advises them on how to deal with their companies. "It's much better if the complaint can be resolved amicably out of court," says Plummer. "The problem is most companies don't want to give away the store in out-of-court settlements. What they try to do is either talk employees into accepting marginal settlements or coerce them. In some cases they actually make veiled threats against employees."

Cathy Ventrell-Monsees is the manager of the Worker Equity Department of the American Association of Retired People (AARP) and its senior attorney. "I look at age discrimination as divorce in the workplace," she says, "and it can be just as dirty as a divorce proceeding."

If you feel you have been the victim of age discrimination and are

"Age discrimination is divorce in the workplace, and it can be just as dirty as a divorce proceeding."

considering filing a complaint, you should gather your evidence carefully. Your first step should be to begin keeping a journal or diary. "Start recording events that transpire—any statements that are made, any actions taken by the company," says Plummer. "Jot down all statements made by management regarding [your] employment or performance." Hearings and trials can drag on for months or even years. Don't depend on your memory. Keep careful records.

Make sure you have copies of your performance evaluations and any awards or letters of commendation you may have received. Once you leave a company, getting access to your files may be difficult. If you go to trial, the defense attorney may cross-examine you and call into question your record at work. Proof of a long history of solid achievement will outweigh a small mistake or two.

Also, ask your manager for a clear statement of company policies with regard to age. For example, ask for the criteria the company uses to decide who goes first in case of a layoff and who is included in training programs.

Talk to people in other areas of the company. Find out if they're facing the same problems you are and if older workers have been treated differently than younger workers in their departments. See if a pattern of discrimination emerges. If other engineers in your firm believe they have been discriminated against, you may want to join together and file a class-action lawsuit.

When you feel certain you can prove you have been the victim of age discrimination, make a complaint to the EEOC. It will investigate your complaint and, if it determines that your former employer has violated the law, take legal action for you.

Inflexible time limits

There are strict time limits on filing an age-discrimination charge. You must file within 180 days of the date of your termination or the date of the alleged discriminatory act. If you don't file within that time period, you cannot bring a lawsuit against your company. If the state you live in has a law prohibiting age discrimination and you also want to file a state charge, you must file within 300 days.

Some companies give employees notice that they will be laid off in two or three months. The time limit for filing a charge begins on the day you receive that notice, *not* on the day you eventually leave the company. Some companies lay people

Know your rights

If you think you have been discriminated against because of your age, make sure you know your rights. The IEEE publishes a booklet entitled "Age Discrimination in Employment: What Are Your Rights and Protections?" It's free upon request to both members and nonmembers. Write or phone: IEEE-USA Anti-Discrimination Committee
1828 L Street NW, Suite 1202
Washington, DC 20036
(202) 785-0017

The US Equal Employment Opportunity Commission also publishes booklets that explain your rights and how to pursue legal action. You can visit one of its 50 local offices around the country, or write or phone its headquarters:
US Equal Employment Opportunity Commission
2401 E Street NW
Washington, DC 20507
(800) 872-3362



The Bettman Archive, Inc.

It takes experience to handle both limpness *and* flexibility.

Small, lightweight, flexible--these are the requirements we meet often. But "*limp as a noodle?*" An appetizing challenge.

Texas Instruments came to us for a complete interconnect system for a gyroscope controlled guidance system. Application-engineered to extremely demanding weight and space requirements, this dynamic system also must endure constant flexing.

At Precision Interconnect, we're working every day to meet requirements like these. We manufacture microminiature cables with conductors as small as 42 AWG and terminate them to our standard line of Micro-D and linear strip connectors with .050" (1.27mm) centerline spacing. Custom and nano strip connectors with .025" (.64mm) spacing can also be assembled.

Our expertise, increasing with each unique problem we solve, ensures that all critical components of your interconnect system are designed in, built in, and tested. We begin by discussing your specific interconnect system problems.

Maybe over lunch?

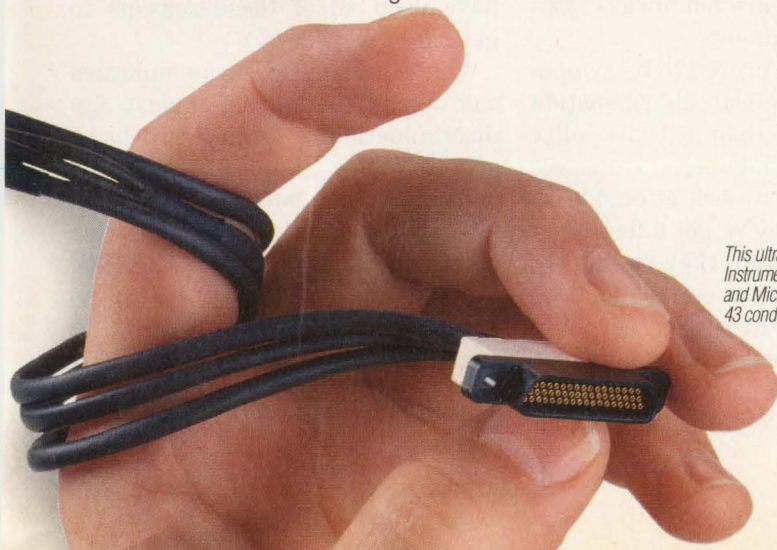

This ultra flexible harness for Texas Instruments terminates Nano Strip and Micro-D connectors to 43 conductors, 32 to 40 AWG.



**PRECISION
INTERCONNECT**

16640 S.W. 72nd Avenue
Portland, OR 97224
(503)620-9400

Offices in San Francisco, Dallas,
Wilmington, Düsseldorf and Tokyo.

CIRCLE NO. 158

off but tell them there's a good chance they will be recalled soon. Don't let the time limit expire while you're waiting to be recalled. File as soon as you're laid off.

Once you have filed a complaint against your company, it may choose to settle with you out of court. "There's a procedure within the EEOC to deal with these cases through settlement agreements, and we use that procedure when the respondent companies or agencies wish to settle," says Carattini. "We require that [the employees] get full relief under the law, but cases are settled out of court only about 33% of the time."

If your company doesn't wish to settle, you may be in for a rough time even before you get to court. It's illegal for a firm to retaliate against a person who files a charge of age discrimination, participates in an investigation, or opposes an unlawful practice. However, that doesn't stop some companies from harassing people or trying to scare them into dropping the charge.

"They'll say they're going to prove that the charge was unjustified, that it was a frivolous lawsuit," says Plummer. "In that case, they can force the plaintiffs to pay the court costs. And any large company can generate hundreds of thousands of dollars of court costs in any given case."

"In litigation, it's not uncommon for a big company to try to paper the other side to death, filing lots of motions and taking depositions of the employee that lasts for days and days—sort of an interrogation under the lights," says Ventrell-Monsees.

Engineers who filed lawsuits against their former employers have had their pension checks stopped or their health-care benefits suspended. Any retirement perks you have earned can also disappear.

The EEOC may investigate your complaint and decide not to take le-

"In the last five years there has been an increase in age-discrimination charges filed."

gal action. If that happens, it will issue you a "right-to-sue" letter, which means it's up to you to pursue the case on your own.

Bringing a private lawsuit

You might be better off hiring your own lawyer and bringing a civil lawsuit against your company. First of all, the EEOC has only a few hundred investigators nationwide. It may take a year or more for the EEOC to complete an investigation. Second, the EEOC receives thousands of complaints each year, but very few of them ever end up as court cases. For example, in 1986 the EEOC initiated just 118 lawsuits.

A third reason for pursuing a case on your own is that with an EEOC lawsuit, the amount of money you can recover is limited to your loss of earnings or benefits. If you win a private lawsuit, you can also collect punitive damages and damages for pain and suffering. In addition, if you can prove that there was willful discrimination against you, the court can triple the award.

Two of the drawbacks of going ahead with your own lawsuit are that hiring a lawyer may be expensive and juries are not always sympathetic to engineers.

"Juries have proved to be sympathetic in blue-collar discrimination cases, more so than in white-collar cases," says Plummer. "I suspect that many jurors look at engineers and think, 'They've got a degree in engineering and they're highly paid, and they've earned all this money all their lives. They certainly should have saved enough to get along without a job for a while, and in all probability they'll be able

to obtain another high-paying job. Why should I give them a big bundle?'"

Be sure your case is sound and you're ready for a long haul before you plunge in. "You're going to have to find a lawyer who will give you an accurate and open assessment of how things stand," says Ventrell-Monsees. "You have to make an emotional commitment to proceed with the litigation. It's going to take up a lot of energy. You're making a commitment that will consume your life for a while."

Preventive measures

You and your company don't have to end up in court. You can take some measures to protect yourself from age discrimination.

Make sure you take part in your company's training programs. Firms sometimes cite an engineer's lack of knowledge of current technology as a reason for termination. You should also take outside courses to keep your knowledge up-to-date and your skills sharp.

Ask your manager for more challenging projects or volunteer for extra assignments. It's widely believed that older workers aren't as productive as younger ones. Continually doing the same type of work and never stretching yourself will only reinforce that myth.

Don't make obvious mistakes such as constantly arriving at work late, taking extended lunch hours, or missing deadlines. Companies have used all of these reasons to get rid of workers.

Ventrell-Monsees says employees can defend themselves against age discrimination by taking two basic steps: "They should know their rights and not be afraid to speak up about what they see as unfair treatment." **EDN**

Article Interest Quotient
(Circle One)

High 506 Medium 507 Low 508

Sampling A/Ds

There's only one complete source.

No matter what your requirement, you will find the answer in DATEL's broad line of Sampling Analog-to-Digital Converters.

Fast becoming the industry standard

Characterized through Nyquist operation, these converters offer superior Signal-to-Noise ratios and harmonic distortion specifications.

Bottom line, compare these converters with any competitive units, and you'll see there is no reason to look anywhere else.

Model	Bits	Throughput (MHz)	Linearity (LSB)	Power (Watts)	Case
ADS-111	12	0.500	±1/2	1.3	24-PIN
ADS-193	12	1.0	±1/2	1.3	40-PIN
ADS-112	12	1.0	±1/2	1.3	24-PIN
ADS-117	12	2.0	±3/4	1.4	24-PIN
ADS-132	12	2.0	±1/2	2.9	32-PIN
ADS-118	12	5.0	±3/4	2.3	24-PIN
ADS-131	12	5.0	±3/4	3.8	40-PIN
ADS-130	12	10.0	±3/4	4.0	40-PIN
ADS-924	14	0.300	±1	1.3	24-PIN
ADS-928	14	0.500	±1/2	2.9	32-PIN
ADS-941	14	1.0	±3/4	3.1	32-PIN
ADS-942	14	2.0	±3/4	3.2	32-PIN
ADS-976	16	0.200	±2	0.9	32-PIN
ADS-930	16	0.500	±1 1/2	1.8	40-PIN

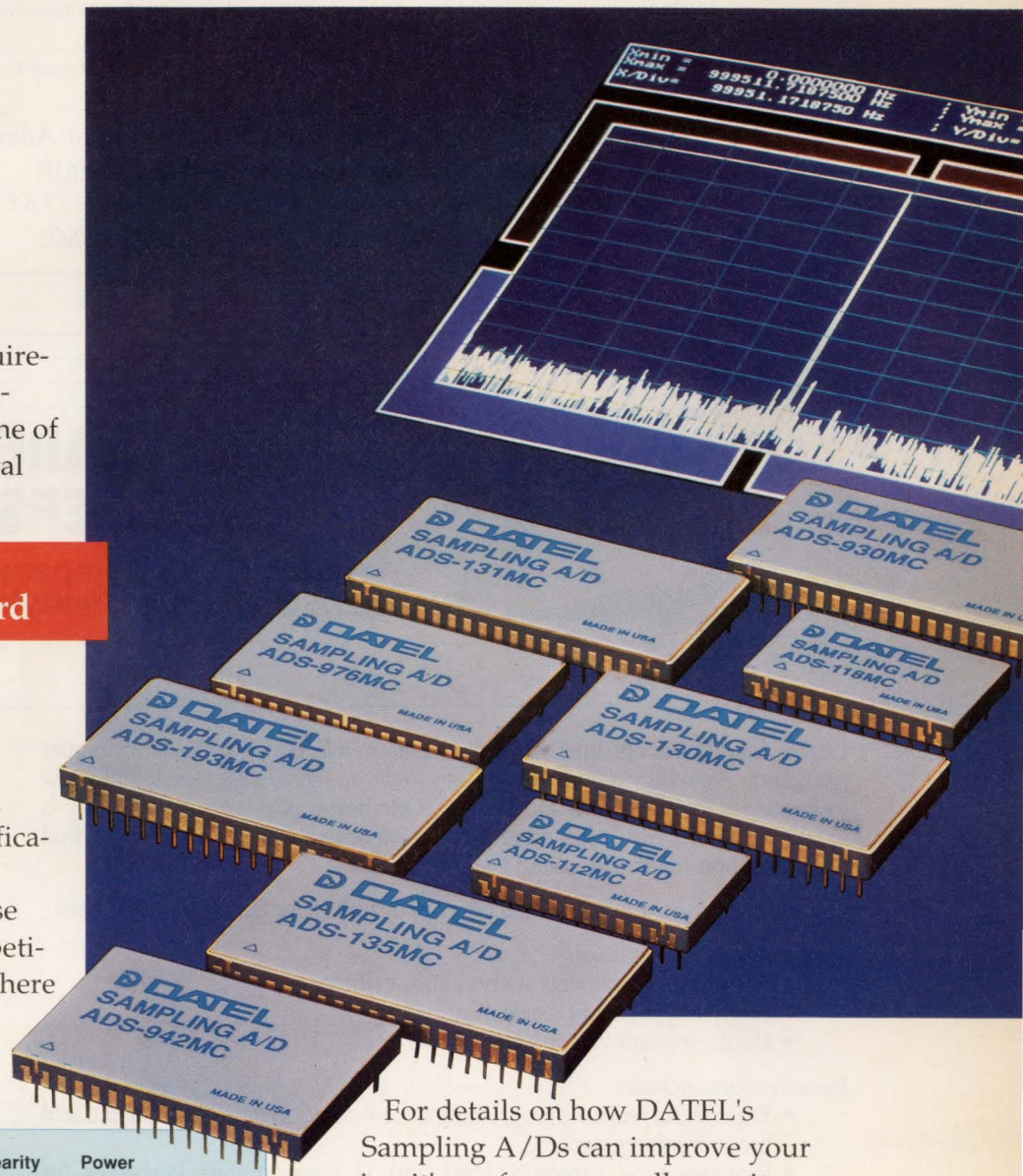

For details on how DATEL's Sampling A/Ds can improve your circuit's performance call or write DATEL, Inc., 11 Cabot Boulevard, Mansfield, MA 02048.

Let DATEL convert you.
Call now 800-233-2765

DATEL

INNOVATION AND EXCELLENCE IN PRECISION DATA ACQUISITION
DATEL, Inc., 11 Cabot Boulevard, Mansfield, MA 02048 (508) 339-3000

CAREER OPPORTUNITIES

1991 Recruitment Editorial Calendar

Issue	Issue Date	Ad Deadline	Editorial Emphasis
Magazine Edition	Mar. 14	Feb. 21	Software Tools, Computer Architectures, Materials Technology, ICs & Semiconductors/Instrumentation Circuits
Magazine Edition	Mar. 14	Feb. 21	Software Engineering Special Issue, (To be polybagged with the March 14th Magazine Edition issue)
News Edition	Mar. 21	Mar. 1	CAE, Computer Buses**, Regional Profile: Alabama, Georgia, N. Carolina**

Call today for information on Recruitment Advertising:

East Coast: Janet O. Penn (201) 228-8610

West Coast: Nancy Olbers (603) 436-7565

National: Roberta Renard (201) 228-8602

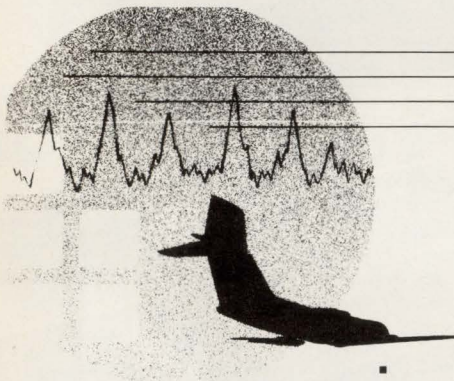

SOFTWARE ENGINEERS

World Class Company
Southern California Lifestyle

Litton Aero Products, internationally recognized as the world leader in inertial navigation systems, is expanding into new markets and developing new technologies for the 1990s and beyond. Our beautifully landscaped facility is located in Moorpark — just 45 minutes north of Los Angeles where you'll find affordable housing and Southern California climate.

Our continued growth has created new opportunities for **Software Engineers**.

You will be responsible for:

- Software requirements analysis and verification.
- Program design and mechanization.
- Hardware/software integration and test.

Requirements include:

- Expertise in real time programming for avionics systems, utilizing modern programming practices.
- Proficiency in assembly level and C programming languages for embedded microprocessors.
- Knowledge of navigation systems, Kalman filters, strapdown inertial systems, motion simulators, control system analysis.
- BS/EE math or CS.

In return for your expertise, we offer an atmosphere filled with challenge and support along with a highly attractive salary and benefits package.

For immediate consideration, please send your resume with salary history to: **Litton Aero Product, Dept. DA, 6101 Condor Dr., Moorpark, CA 93021-2699. FAX (805) 378-2207. Or call: (805) 378-2092.**

Equal Opportunity Employer

Litton

Aero Products

If You're
Looking
For a Job,
You've
Come to
The Right
Place.

EDN CAREER
OPPORTUNITIES

EDN

Cabletron Systems, Inc., a multi-national NYSE member company, with corporate headquarters in Rochester, New Hampshire, offers one of the broadest portfolios of networking hardware/software products currently available. We have recently been ranked number 2 "Best Small Company in America" by *Forbes* magazine, and are among the top 10 U.S. companies in LAN (Local Area Network) market share.

Our ultra-modern facilities are located in southern New Hampshire, minutes away from great skiing in the mountains, and the beautiful beaches of New England's seashores.

When it comes to Opportunities in Engineering . . . We've Got The Solution!

UNIX Platform

Network Architecture (Network Management) — Chief designer/architect of customized management modules to meet customer specifications. Demonstrated technical expertise using UNIX™ and C/C++ in complex integrations of network management software/hardware.

Senior Software Engineer (Network Protocols) — Integrate NEW protocols into Cabletron's network management UNIX-based products.

Product Coordinator — Coordinate/manage/track issues from product inception through release cycle. Technical experience in product/project coordination in software engineering environment. Knowledge of network management/LAN network hardware components a plus.

Software Engineers (Mid-Level to Senior) — Provide network gateway development/network applications management. Strong background in UNIX/C or C++ development/network communications a plus. Some positions require specific experience porting existing software products written in C/C++ from one UNIX vendor platform to another.

Software Engineers (Maintenance Group) — Demonstrated ability to effectively fix software problems for state-of-the-art released products. Current platform is SUN/UNIX/X-Windows. C/C++ in UNIX required. Several years' experience in software support role or comparable is desired. Graphic interfaces knowledge a plus.

Technical Support

Systems Engineer — Provide post-sales support of a network management product. Minimum of 2-3 years' network experience combined with good understanding of UNIX operating systems and various hardware platforms. Programming experience utilizing C++ and relational database architecture a plus. Approximately 20%-40% travel.

Applications Engineer — Support/train customers through the presentation/installation/configuration of a network management product. Minimum of 2-3 years' network experience combined with UNIX operation background. Previous network administration experience a plus. Approximately 40%-50% travel.

Embedded Communications

Firmware Engineers (Senior) — 5+ years' experience with networking protocols/real-time embedded software/multitasking/low level drivers as well as background in RISC processors and hardware design. Fluent in C/C++. BSEE required/MSEE preferred.

Software Engineers (Mid-Level to Senior) — Familiar with multi-protocol architecture/LAN/WAN technologies and embedded systems. Experience with transport layer and below with one or more of the following essential: TCP/IP, X.25, DECnet, Appletalk, SNMP, ISO.—MS-DOS Windows

MS-DOS/Windows

Windows Software Engineers (Senior to Principal) — Windows-based network management projects. Fluent in C. Knowledge of C++ a plus. 1-2 years' experience with "Microsoft Windows" required. Background in network management/data communications/graphics/or database design highly desired.

Quality Assurance

QA Engineers and Testers — Testing state-of-the-art network management firmware/software products. Background in software systems and integration testing methods, preferably in a networking environment. QA Testers require AS degree or equivalent. QA Engineers require knowledge of C/C++.

For more information, call Joe Tringali at (603) 335-4316, or fax your resume to his attention at (603) 332-8007, or send a resume to Cabletron Systems, Inc., Dept. EDN218, P.O. Box 5005, Rochester, NH 03867. We are an equal opportunity employer. These are not agency fee-paid positions.

UNIX is a registered trademark of AT&T Bell Laboratories



Find out more about the opportunities available at Cabletron Systems. With a PC and modem, dial (508) 263-3857, hit return twice and enter CABNET when prompted for a password.

CABLETRON SYSTEMS Inc.

The Complete Networking Solution

QMS is a leader in the rapidly expanding nonimpact printer systems market and is a major producer of intelligent enhancement products for impact printers. The company offers the broadest selection of intelligent laser and color thermal transfer printers available for use in electronic publishing, office automation, advanced imaging and automatic identification applications. We sell print systems in 34 countries and have wholly owned subsidiaries in Canada and Europe.

At our Sunbelt headquarters located in Mobile, Alabama, we develop and manufacture print systems employing leading edge technology while enjoying the benefits of nearby beaches and abundant outdoor recreational activities. We enjoy a favorable buyers market for housing and are free from the hassles of long commutes on congested highways.

We are seeking qualified candidates for the following positions. Technical positions require a BS degree in appropriate disciplines with an MS degree preferred.

SOFTWARE ENGINEER

Expertise in one or more of the following areas: C assembly language, architectural design of real time embedded systems, communication networks, systems interfaces, operating systems (DOS, OS/2, UNIX, VMS), PostScript, graphics algorithms, compiler design and formal language theory.

TEST SUPPORT ENGINEER

Responsibilities will include maintaining and upgrading functional test equipment and fixtures; resolution of test problems; failure analysis, and quality/yield improvement.

Ideal candidate must possess a BS in Electrical or Electronic Engineering with a minimum of 3 years experience in test engineering utilizing programmable test equipment. Knowledge of functional and in-circuit test as well as digital circuitry troubleshooting are essential.

TEST ENGINEER

Ideal candidate will possess a BSEE with 2-6 years experience in test design. Knowledge of Fairchild, in-circuit summation functional, or programming in C or PASCAL required. Individual will develop test hardware and software to support production testing of micro-processor based circuit board assemblies.

TECHNICAL RECRUITER

Successful candidate will establish and conduct college relation programs, interview, recruit and transfer all advertising activity necessary to fulfill manpower required primarily in the skilled and professional areas. Responsibilities also include administering other human resources functions and duties as required.

Qualified candidate must possess a BS degree, MBA is desired. A minimum of 2 years progressive experience in technical recruiting is required. Strong communication skills, a high personal standard and strong conviction are a must.

QMS offers an excellent salary and benefits package. Please rush your confidential resume to: **Ted Labay, Dept. EDN2/18, QMS, Inc., One Magnum Pass, Mobile, AL 36618.** An Equal Opportunity Employer.



CONTRACT CMOS VLSI DESIGN ENGINEERS (Austin, Texas)

A leading high-tech company is seeking Design Engineers experienced in CMOS circuits, schematic capture and layout verification.

- Six month assignments
- Outstanding compensation

To apply, forward your resume to:

**Cahners Publishing
103 Eisenhower Parkway
Dept. JOP-0218
Roseland, NJ 07068**

An Equal Opportunity Employer.

The best jobs aren't classified.

**They're in EDN's Magazine
and News Editions. And EDN
is the best place to find
news of the best job openings.**

Who do you think you are?

Are you an ASIC engineer? Or are you a RISC microprocessor person? How about digital signal processing (DSP) chips? At most places, you know exactly who you are in relation to these areas. Because most places only develop a single technology. Not at LSI Logic. Here, we're breaking down the boundaries between technologies. Because we don't just develop ASICs. We're also heavily involved in RISC microprocessors. And our family of DSP chips continues to grow. No one else does all three.

What this means for you is the chance to break some boundaries of your own. Here, you can confer with colleagues in other disciplines, in Silicon Valley and around the world. And contribute to a wide variety of projects. It's time to see yourself in a whole new light. At LSI Logic.

MICROPROCESSORS

MIPS Applications Manager
Design Engineers

- RISC
- Systems
- SPARC

Field Applications Engineers
Business Program Manager
Technical Program Manager
Product Marketing Engineer

(Please refer to Job #EDN/BK06)

ASIC

Applications Engineers
CAE Design Engineer
CMOS Design Engineer
Senior Software Engineer
Mask Designers
CAD Software Engineers
Design Engineering Technician

(Please refer to Job #EDN/BK06)

RESEARCH & DEVELOPMENT

R&D Device Modeling Manager
Process Development Engineers
Device Modeling Engineers
CAD Manager
CAD Specialist
Systems Analyst

(Please refer to Job #EDN/RD06)

OPERATIONS

Test Development Engineers
Product Engineer
Failure Analysis Engineer

(Please refer to Job #EDN/RD06)

DSP

Product Line Manager
Applications Engineer

(Please refer to Job #EDN/BK06)

FAX YOUR RESUME TODAY!

408-433-6825

or E-MAIL YOUR RESUME TO

resume @lsil.com

**INDICATING APPROPRIATE
JOB NUMBER**



If you have a PC and a modem, find out more about LSI Logic and other opportunities we have available. Just dial (508) 263-3857, hit return twice, and enter LSI when prompted for a password.

By identifying the most favorable benefits and investment programs, we're able to provide a well-rounded employment package that includes medical/dental/life insurance, vision care, a 401(k) plan, stock purchase plan, and tuition reimbursement. If unable to fax, please mail your resume, indicating appropriate Job Number, to Professional Staffing, LSI Logic Corporation, 1551 McCarthy Blvd., Milpitas, CA 95035. An equal opportunity employer. Principals only, please.

IGNORE THE BOUNDARIES

LSI LOGIC

We won't just sell you a display—we'll make sure you buy the one that's right for you.



We're here to help you. IEE offers a wide variety of display technologies in an extensive assortment of sizes and formats. But that's not all. We also can provide you with all the technical support and expertise that you'll need to select and use the right display for your application.

Choose from vacuum fluorescent, dc plasma, or liquid crystal flat panel displays.

To get you started, we'd like to send you a free copy of our product selector, titled *Selecting Alphanumeric Display Modules*. This informative, easy-to-understand guide contains the valuable information you'll want before buying an alphanumeric display.

Just call or write today and let the display experts show you how you can become a display expert too.



INDUSTRIAL ELECTRONIC ENGINEERS, INC.
Industrial Products Division
7740 Lemona Ave., Van Nuys, CA 91409-9234
Tel.: (818) 787-0311, Ext. 418 • Telex: 4720273 IEEINT
FAX: (818) 901-9046 (G2/G3)

Immediate, Circle 50

Reference, Circle 51

EDN February 18, 1991

EDN's INTERNATIONAL ADVERTISERS INDEX

Abbot Electric	29	IEE	258	Raltron	56
ACCEL Technologies Inc	156	Illinois Capacitor	136, 240	Rapid Systems	169
Advin Systems Inc	242	Incredible Tech	243	Rayovac	129
Aerospace Optics	103	Inmark	242	RC Systems	239
Alpha Industries	162	Instrument Specialties Co Inc	124	Rockwell International	126
ALS Design Corp	143	Intel	223	Rogers Corp	241, 243
Altera Corp	66-67	International Rectifier	C3		
American Advantech	240	Interpoint	106	Samsung Semiconductor	16-17
American Airlines	133	Intrrol Corp	196	Samtec Inc	64
American Automation	180	Intusoft	244	SBE	88
Ametek	152	Ironwood Electronics Inc	244	Sea Level Systems	162
AMP	144-145	ITT Cannon	25	Seagate Technology	68-69
Analog Devices Inc	62-63			Sharp Electronics	205
Analog Micro Systems	130	John Fluke Manufacturing Co Inc	6, 96-97, 120-121	Siemens*	22, 214
Analogic Corp	225			Siemens AG**	C2
Anritsu America	139	J W Miller Bell Industries	106	Signetics Corp	18-21, 37-44
Aries Electronics Inc	249			Silicon Systems	70
Augat	197	Kemet Electronics	178	Siliconix Inc	4
		Kepeco Inc	12-13	Single Board Solutions	241
Basler Electric	86, 221	Knuerr AG	189	Sony	57
B&C Microsystems	243, 245			Sorensen Co	98A-L
Berquist Co	206	Lattice Semiconductor Corp	187	Spectrum Software	177
Bourns	14-15	Lemo USA Inc	245	Sprague Electric Co	49
BP Microsystems	245	Linear Technology Corp	181-182, 246	Sprague Goodman	48
BYTEK Corp	234	Link Computer Graphics Inc	243	State of the Art Inc	152
		Logical Devices Inc	239	Sun Electronic Systems Inc	130
CAD Software Inc	117			System General	241
Caddock Electronics Inc	98	Mark Williams	122		
Cahners CAPS	166, 245	Maxim Integrated Products	83	Tatum Labs	244
Capilano Computer Systems Inc	245	Maxtor	134-135	T-Cubed Systems Inc	240
Capital Equipment Corp	58, 244	MCSI	240	TDK Corp of America	209
Cascade Microtechnologies	142	Meritec	179	Tek	199-201
Cermetek	241	MetaLink Corp	243	Tekra	238
Chronology	196	Methode Electronics Inc	224	Telecom Analysis Systems	58
CirrusLogic	47	Micro Crystal	245	Teledyne Relays	193
C & K Components Inc	232	Micro Linear	36	Teltone Corp	245
Cybernetic Micro Systems	243	Micro Technical Ind	239	Teradyne	34-35
Cypress Semiconductor	8	MicroSim Corp	110	Texas Instruments Inc	84-85
		Mini-Circuits Laboratories	30-31, 60-61, 185, 260	Thomas and Betts Corp	191
Dale Electronics Inc	27			Tokin Corp	237
Data Delay Devices	124	Mitsubishi	217-219	Toyocom	226
Data I/O Corp	C4	Mosiac Industries Inc	240	Transera	107
Datel	257	Motorola	10-11	Tribal Microsystems	241
Delevan Div API	206			Tri-L Data Systems Inc	241
Delker	48	NAS Electronics	131		
Dexter Magnetics	56	National Instruments	2	Universal Cross Assemblers	244
DigiKey	161	National Semiconductor Corp	163-165	Universal Data Systems	87
Diversified Technology	92-93	NCI	242	US Software	240, 244
Dow Chemical USA	54-55	NEC Corp	137, 194-195, 207, 227		
Du Pont Co	173	Noble	137	VME Microsystems	109
		Nohau Corp	239		
Echelon	153-155	Ohmite Mfg Co	204	Wavetek	3
ECM	138	OKI Semiconductor*	52-53, 215	W H Brady	230
EG&G Wakefield Engineering Inc	220	Omation Inc	244	WR Grace	108
Elco Corp	167	OrCAD Systems Corp	140		
Electronic Devices	241	Orion Instruments	222	Xeltek	242
Emulation Technology Inc	244	Otto Controls	216		
				Ziatech Corp	1
Force Computers Inc	50-51	Pacific Hybrid Microelectronics	210, 211	Zilog Inc	233
Franklin Software Inc	245	P-Cad	235-237	Z-World	242
Frequency Devices	228	Pentica Systems	231		
Fujitsu APD	125	Philips Discrete Products Div*	77-82		
Fujitsu Microelectronics Inc*	32-33, C2	Pico	46, 127		
F W Bell Inc	243	Pioneer	59		
		Power Components	95		
Galaxy Microcraft Systems	239	Powerex Inc	202		
GCOM Inc	243	Powertronic	240		
General Devices	240	Precision Interconnect	251		
Gespac Inc	241	Protel Tech Inc	242		
Glassman High Voltage Inc	175	Pulizzi Engineering	239		
Global PMX Co Ltd	242				
Graphtec Corp	213	Quantum Data Corp	243		
		Racal-Redac	229		
Hewlett-Packard Co	104-105, 119				
Hypertronics Corp	203, 240				

Recruitment Advertising 254-257

Cabletron Systems
Litton Aero Products

*Advertiser in US edition
**Advertiser in International edition

This index is provided as an additional service. The publisher does not assume any liability for errors or omissions.

rugged plug-in amplifiers



0.5 to 1000 MHz from \$13⁹⁵ (10 to 24 qty)

Tough enough to meet full MIL-specs, capable of operating over a wide -55° to $+100^{\circ}\text{C}$ temperature range, in a rugged package... that's Mini-Circuits' new MAN-amplifier series. The MAN-amplifier's tiny package (only 0.4 by 0.8 by 0.25 in.) requires about the same pc board area as a TO-8 and can take tougher punishment with leads that won't break off. Models are unconditionally stable and available covering frequency ranges 0.5 to 1000MHz, NF as low as 2.8dB, and power output as high as +15dBm. Prices start at only \$13.95, including screening, thermal shock -55°C to $+100^{\circ}\text{C}$, fine and gross leak, and burn-in for 96 hours at 100°C under normal operating voltage and current.

Internally the MAN amplifiers consist of two stages, including coupling capacitors. A designer's delight, with all components self-contained. Just connect to a dc supply voltage and you are ready to go.

The new MAN-amplifiers series...
another Mini-Circuits' price/performance breakthrough.

MODEL	FREQ. RANGE (MHz)	GAIN dB		MAX. OUT/PWR†	NF dB	DC PWR 12V,	PRICE \$ ea.
	f_L to f_U	min	flatness††	dBm	(typ)	mA	(10-24)
MAN-1	0.5-500	28	1.0	8	4.5	60	13.95
MAN-2	0.5-1000	19	1.5	7	6.0	85	15.95
MAN-1LN	0.5-500	28	1.0	8	2.8	60	15.95
◇MAN-1HLN	10-500	10	0.8	15	3.7	70	15.95
*MAN-1AD	5-500	16	0.5	6	7.2	85	24.95

††Midband $10f_L$ to $f_U/2$, $\pm 0.5\text{dB}$ †dB Gain Compression ◇Case Height 0.3 In.

Max input power (no damage) +15dBm; VSWR in/out 1.8:1 max.

*Active Directivity (difference between reverse and forward gain) 30 dB typ.

finding new ways...
setting higher standards

Mini-Circuits

A Division of Scientific Components Corporation
P.O. Box 350166, Brooklyn, New York 11235-0003 (718) 934-4500
Fax (718) 332-4661 Domestic and International Telexes: 6852844 or 620156

CIRCLE NO. 160

C118 REV. E

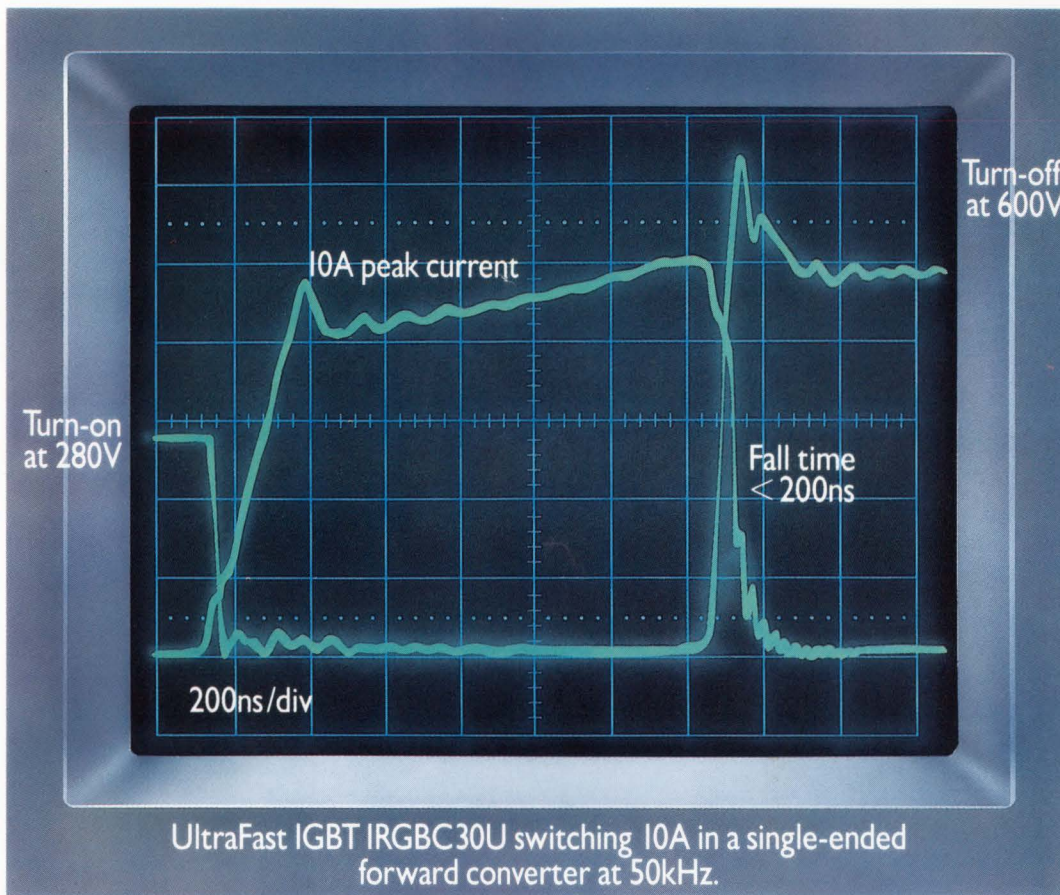

IGBTs Without A Trace of Competition.

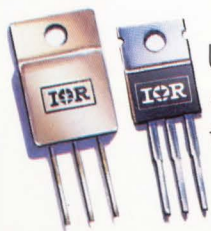

IR announces Ultra Fast IGBTs: our 600V power transistors that switch faster and run cooler than any you've ever used. Forget about bipolar. Put these

breakthrough devices in your high-voltage, high-current, medium-frequency applications and get performance unparalleled for the price.

Which should come as no surprise. IR IGBTs build on the same proprietary technology that made IR's HEXFETs® world leaders.

Call 1 (213) 640-6534 and ask about Standard, Fast or Ultra-Fast IGBTs, optimized for your operating frequency. And available from 10A to 70A, in commercial or hi-rel packages.

We'll be happy to arrange a screening.

IR International Rectifier

WORLD HEADQUARTERS: 233 KANSAS ST., EL SEGUNDO, CA 90245, U.S.A. (213) 772-2000. TWX 910 348-6291, TELEX 472-0403. EUROPEAN HEADQUARTERS: HURST GREEN, OXTEY, SURREY RH8 9BB, ENGLAND TELEPHONE (0883) 713215, TELEX 95219

CIRCLE NO. 161

NEW
Programming
2900 System

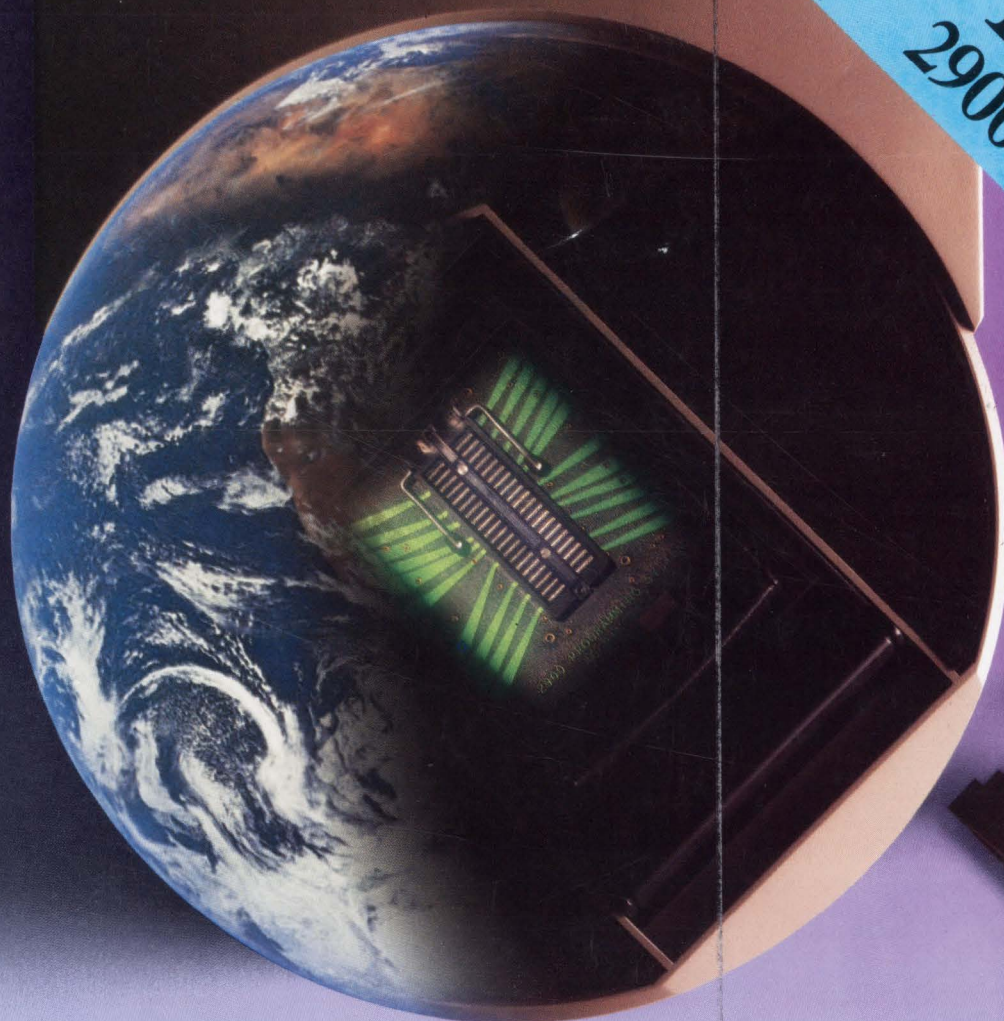

Out-of-this-world performance at a down-to-earth price.

The new 2900 Programming System brings the cost of high-performance programming down to earth. Buy only the device libraries you need today and expand capability when you need it with simple software updates.

The 2900 supports virtually every programmable logic and memory

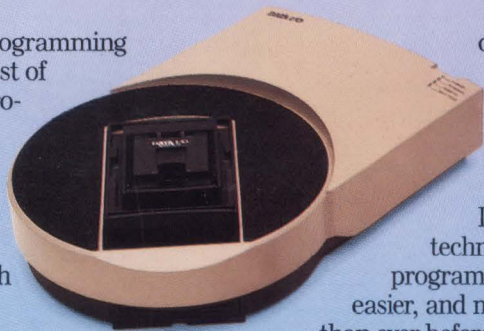

device on the market— even surface-mount packages.

Its innovative technology makes programming faster, easier, and more affordable than ever before. And with

Data I/O®'s industry-standard design and testing software, you can create a

complete PLD development solution.

For more than 15 years, Data I/O has set the standard in device programming. Call today to learn how the 2900 is setting a new standard for both price and performance.

Call today for a **FREE** tutorial.



1-800-247-5700

Data I/O Corporation 10525 Willows Road N.E., P.O. Box 97046, Redmond, WA 98073-9746, U.S.A. (206) 881-6444/1-800-247-5700
Data I/O Canada 6725 Airport Road, Suite 302, Mississauga, Ontario L4V 1V2 (416) 678-0761
Data I/O Europe World Trade Center, Strawinskylaan 633, 1077 XX Amsterdam, The Netherlands + 31 (0)20-6622866/Telex 16616 DATIO NL
Data I/O Instructomatic Electronic Systems Vertriebs GmbH Lochhamer Schlag 5A, 80332 Graefelfing, W. Germany, 089-85-85-80
Data I/O Japan Sumitomosaimi Higashishinbashi Bldg., 8F, 2-1-7, Higashi-Shinbashi, Minato-Ku, Tokyo 105, Japan (03) 432-6991/Telex 2522885 DATAIO J

©1990 Data I/O Corporation

CIRCLE NO. 162

DATA I/O
Corporation