

EDNI[®]

Cache coherency	pg 41
Contact-enhancing chemicals	pg 59
Create signals with direct digital synthesis	pg 95
PC math software and calculator review	pg 115

ELECTRONIC TECHNOLOGY FOR ENGINEERS AND ENGINEERING MANAGERS



Special Report:
**Instrumentation amps extract
elusive signals in common-mode noise**
pg 82

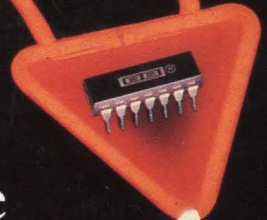

BiCMOS is clearly the way of the future. You can either deny it or wait for it. Or get there first, with Fujitsu Microelectronics, Inc.



BiCMOS

It's the name of the game. The guy who gets there first with the fastest, smallest system wins. Those who follow, stay in the game. The rest drop out.

Which is why the smart money is betting on BiCMOS. Combining bipolar speeds with the high-densities and low power of CMOS, it's the technological edge your systems need to stay competitive.

Now meet the leader.

As the leader in both CMOS and bipolar technologies, Fujitsu Microelectronics is uniquely qualified to lead the BiCMOS market. We've already shipped nearly a million units of BiCMOS products. And we've invested over \$500 million in our next generation.

To the rest, follow this.

Our current BiCMOS line has already set quite a pace. You can go standard or ASIC, offering both ECL and TTL interfaces.

Our standard SRAMs deliver maximum access time under 15ns and power dissipation under 1W. While our high-speed BiCMOS ASICs give you over 16,000 gates.

And that's just today. Our next wave of BiCMOS SRAMs will use 0.5 μ technology to deliver sub-10ns access times. While our new sea-of-gates BiCMOS ASICs will offer 180ps typical gate delays and over 160,000 gates.

Get on the phone.

The sooner you design-in Fujitsu BiCMOS, the stronger your new systems will run. Our intensive support can speed your development time every step of the way. Helping you bring a stronger product to market in a much shorter time. And making your systems a very hard act for the competition to follow. To start today, call 1-800-642-7616.

FUJITSU

FUJITSU MICROELECTRONICS, INC.

Integrated Circuits Division

3545 North First Street, San Jose, CA 95134-1804. 1-800-642-7616.

Every step of the way.SM

© 1990 Fujitsu Microelectronics, Inc.
Every step of the way is a service mark of Fujitsu Microelectronics, Inc.

**Presenting
the three rules
of BiCMOS
design.**

**Lead, follow,
or get out
of the way.**

It's Everything a PC Isn't.

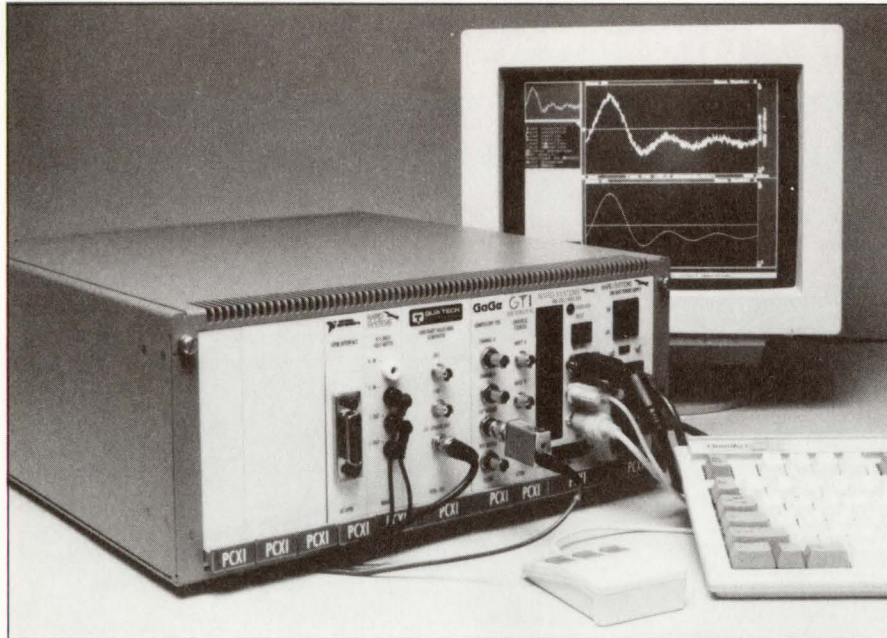

ALL THE BENEFITS OF A PC, NONE OF THE HASSLES.

We've changed the rules for industrial PCs.

PCXI is a modular, interchangeable, multi-vendor PC bus system. Noise, emissions, power, ground, airflow and cooling are specified and verifiable. All PC functions, from CPU (286/386/486) to power supplies, are enclosed in metal shielded modules. Connectors are on the front panel.

It's what industrial PCs always should have been.

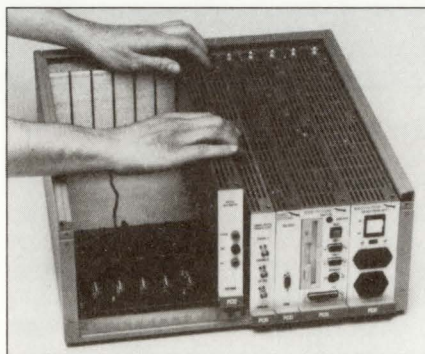

PCXI modules plug interchangeably into slots in the ISA passive backplane. All PC boards are universally accommodated.

PCXI IS ALSO EISA: 32 BITS AND BUS MASTERED.

The PCXI EISA system offers full PCXI modularity combined with the power and speed of 32-bit EISA capability: true multi-processing; 33 megabytes/second data transfer for bus masters and DMA; automatic configuration of system and modules.

It's the first ever EISA PC designed from the ground up for industry.

ALMOST VXI FOR MUCH LESS.

If you have a true VXI application, we'd never suggest PCXI.

But for all those thousand and one other jobs, well, PCXI is a lot like VXI. VXI is modular and upgradeable, so is PCXI. They primarily use a 286/386 CPU, so do we (except we can also offer you a 486). VXI has quite a few instrumentation and function modules from manufacturers, so does PCXI (except there are thousands of modules, off-the-shelf, from hundreds of manufacturers). We even look alike.

The only difference is that we cost so much less.

PCXI

(206) 547-8311

WE'VE GOT THE PCXI SYSTEM FOR YOUR APPLICATION.

INDUSTRIAL COMPUTERS

ISA Chassis: Tabletop,
Rackmount & Portable
286/386/486 CPUs
Hard/Floppy Drives
Graphics
Expansion Chassis
Monitors/Keyboards/Mice
PC Peripherals

EISA INDUSTRIAL COMPUTERS

EISA Chassis: Tabletop &
Rackmount
EISA 386 CPU
EISA Function Modules

FUNCTION MODULES

Analog Input Modules
Analog Output Modules
Digitizer Modules
Analog Filter Modules
Logic Analyzer Modules
Multiplexer Modules
Relay I/O Modules

Time Modules
Transducer Modules
Counter/Timer Modules
Data Logger Modules
Multifunction A/D, D/A, DIO Modules
Digital Scope Modules
FFT Spectrum Analyzer Modules
GPIB/IEEE 488 Interface Modules
Programmable Power Supply Modules
Signal Source Modules
1553/ARINC 429 Modules
Stepper Motor Control Modules
Prototype Modules
Bus Analyzer Modules

Communication Modules
RS422/485 Interface Modules
Industrial Modules
Digital Signal Processing Modules
Digital Multimeter Modules
Digital I/O Modules
Matrix Switch Modules
Memory Modules
Fiber Optics Interface Modules
Image Processing Modules
Digital Panel Meter Modules
UPS Power Modules
Voice Modules

RAPID SYSTEMS

433 North 34th Street, Seattle, WA 98103 • (206) 547-8311 • FAX: 206-548-0322

Circle No. 1



PC Data Acquisition

Quality • Innovation • Performance

NEW

- RTSI bus for multiboard synchronization
- Software-configurable analog input and gain
- 200 ksamples/sec
- 12-bit resolution
- True self-calibration

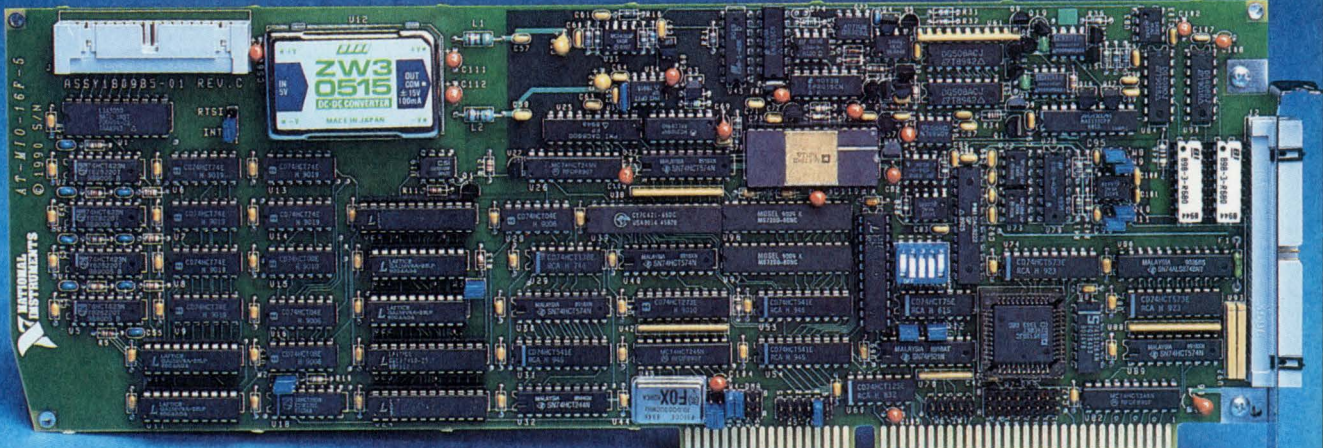

- Dither generator increases effective resolution beyond 12 bits
- Separate analog and digital sections for optimum noise control
- Custom instrument amplifier guarantees 12-bit accuracy at all gains and sampling rates

The National Instruments AT-MIO-16F-5 Sets the New Standard

It takes a serious commitment to quality to deliver data acquisition boards that reliably meet the most demanding specifications. Our new AT-MIO-16F-5 creates a new standard in excellence with several firsts, including a proprietary ultra high-performance instrumentation amplifier, a dither generator for extended resolution, and self-calibration that eliminates the need for external signals required by other "self-calibrating" boards. The quality, innovation, and

performance of our AT-MIO-16F-5 sets the new standard in PC data acquisition. As the table below shows, the rest of our extensive PC product line surpasses industry standards. Each board undergoes a 48-hour burn-in, and passes a thorough system test to guarantee linearity, fast analog input settling, high common-mode rejection, and low noise. At National Instruments, we're serious about data acquisition.

Data Acquisition Board	Computer Bus	Channels*	Analog Input				Analog Output				Software						
			Max Sampling Rate (samples/sec)	Resolution (bits)	Ranges (V)	Gains	Channels	Resolution (bits)	Digital I/O Channels	Counter/Timers	LabWindows	DOS LabDriver	PC LabDriver	Measure	VisiScope	Third Party	
AT-MIO-16F-5	AT	16 SE 8 DI	200,000	12	±5, 0 to 10	0.5, 1, 2, 5, 10, 20, 50, 100	2	12	8	3	✓	✓					
AT-MIO-16H-9	AT	16 SE	100,000	12	±10, ±5, 0 to 10	1, 2, 4, 8	2	12	8	3	✓	✓					✓
AT-MIO-16H-15	AT	16 SE	100,000	12	±10, ±5, 0 to 10	1, 10, 100, 500	2	12	8	3	✓	✓					✓
AT-MIO-16H-25	AT	8 DI	100,000	12	±10, ±5, 0 to 10	1, 10, 100, 500	2	12	8	3	✓	✓					✓
AT-MIO-16L-9	AT	16 SE	100,000	12	±10, ±5, 0 to 10	1, 10, 100, 500	2	12	8	3	✓	✓					✓
AT-MIO-16L-15	AT	16 SE	100,000	12	±10, ±5, 0 to 10	1, 10, 100, 500	2	12	8	3	✓	✓					✓
AT-MIO-16L-25	AT	8 DI	100,000	12	±10, ±5, 0 to 10	1, 10, 100, 500	2	12	8	3	✓	✓					✓
Lab-PC	XT	8 SE	62,500	12	±5, 0 to 10	1, 2, 5, 10, 20, 50, 100	2	12	24	3	✓	✓	✓	✓			✓
PC-LPM-16	XT	16 SE	50,000	12	±5, 0 to 10 ±2.5, 0 to 5	1	-	-	16†	3	✓	✓	✓				✓
AT-DIO-32F	AT	-	-	-	-	-	-	-	32	-	✓	✓					✓
PC-DIO-96	XT	-	-	-	-	-	-	-	96	-	✓	✓	✓				✓
PC-DIO-24	XT	-	-	-	-	-	-	-	24	-	✓	✓	✓				✓
PC-TIO-10	XT	-	-	-	-	-	-	-	16	10	✓	✓	✓				
EISA-A2000	EISA	4 SE SS	1,000,000	12	±5	1	-	-	-	-	✓	✓					✓



* SE - Single-Ended, DI - Differential, SS - Simultaneous Sampling † 8 Channels In, 8 Channels Out



Call for **FREE** Catalog
(512) 794-0100 or (800) 433-3488 (U.S. and Canada)

Nihon National Instruments K.K. (Japan) 03 3788 1921 • National Instruments France 1 4865 3370
National Instruments Italy 02 4830 1892 • National Instruments Switzerland 056 45 58 80
National Instruments United Kingdom 0635 523 545 • National Instruments Germany 089 436 1447

Circle No. 2

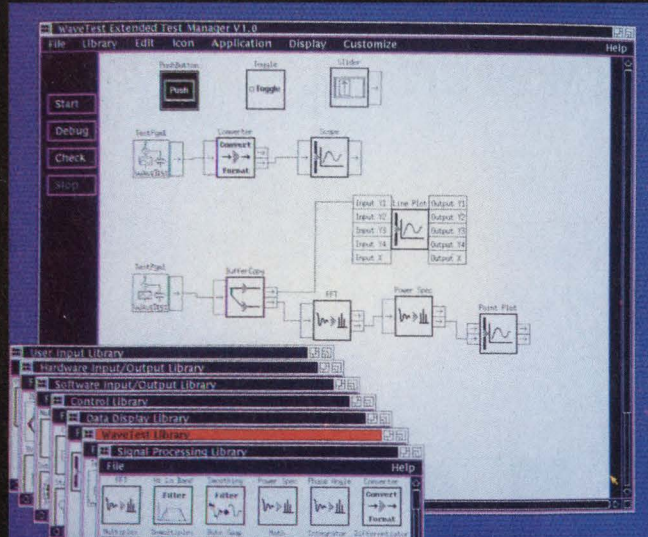

Just select and move icons to build a complete ATE test and data management program.

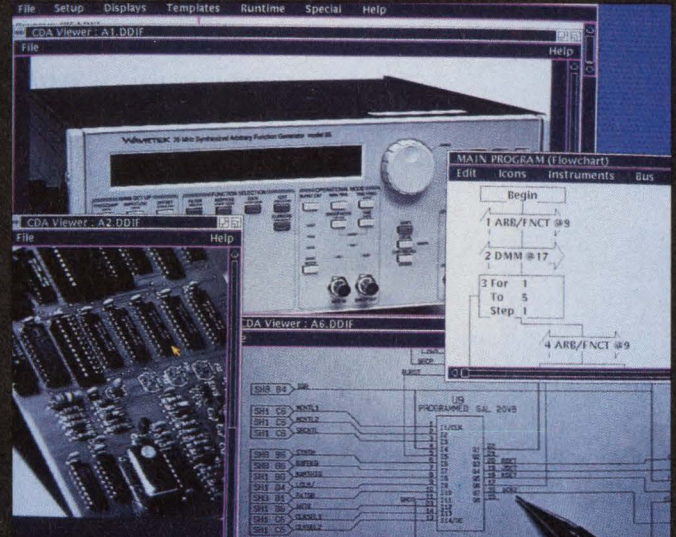

Exciting graphic possibilities include visual operator prompts for repair or calibration.

Create test programs, run them, analyze data, then go to lunch. That's WaveTest® on a DEC system.



WaveTest XTM (Extended Test Manager) is the software solution test designers have dreamed about, when they had time to sleep. It combines the fun and efficiency of iconic test generation with the power of VMS and ULTRIX workstation environments. You can collect, analyze and distribute test data with the flick of a mouse.

WaveTest XTM provides graphics, plotting, FFT's, power spectral density analysis, statistical analysis and much more. It also links seamlessly with thousands of third party software application packages.

WaveTest XTM operates in the industry standard X-Windows environment. If you've worked in DOS Windows, you'll be in familiar territory.

To create your specific automated testing and reporting program, just drag

and connect icons from our Libraries. The icons represent subroutines which can control instruments or systems, run tests, or access network resources and data management tools. WaveTest XTM automatically ties it all together, even generates the test documentation.

For more information about WaveTest XTM on Digital workstations, call Wavetek San Diego, Toll Free, today at **1-800-874-4835**.

WaveTest and XTM are trademarks of Wavetek Corporation. DEC, VMS and ULTRIX are trademarks of Digital Equipment Corporation. X-Windows is a trademark of Massachusetts Institute of Technology. Windows is a trademark of Microsoft Corp.

© 1990 Wavetek Corporation

Circle 11 for Literature

Circle 12 for Demonstration

WAVETEK®

What do you get when you
design with our 10 mΩ MOSFET?

NO BIG LOSS.

**That's right.
Now you can
dramatically
cut computer
system power
and voltage
losses with the
SMP60N03-10L
from Siliconix.**

This 30 V, 10 mΩ, logic-level power MOSFET will revolutionize your computer designs—from laptops to mainframes and everything in between.

Ideal solution for many applications.

The SMP60N03-10L can be used as a battery backup switch, a load manager, a linear regulator, or a synchronous rectifier. And its lower forward voltage drop and bi-directional current capability make it an ideal replacement for relays and Schottky diodes in all computer applications.

**Less heat
for more
efficiency.**
The secret?
A unique
combination

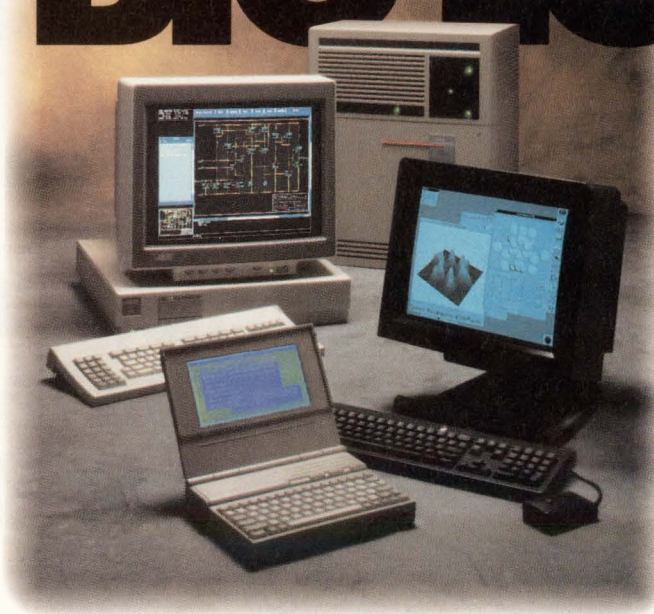
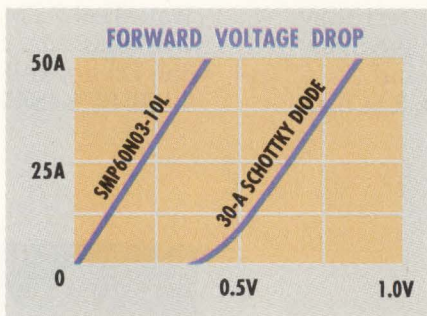

of the very high cell density of Siliconix' proprietary SiMOS 2.5 technology and lowering the breakdown voltage of this device for applications that don't require the common 50 V+ rating. The result is 10 mΩ, the industry's lowest $r_{DS(on)}$ available in a TO-220 package. That means increased efficiency because less

heat is generated in your system. So now you can save the cost and space of heatsinks and sometimes even eliminate the need for a fan.

Improved device and system reliability.

The SMP60N03-10L is avalanche rated and 100% tested to ensure device reliability. And because of its low gate charge fewer external drive components are required. So you'll not only save space and reduce cost, but your system will be more reliable as well.

Available now!

Cut your losses and design more efficiency into your low power systems! Contact your local Siliconix distributor. Or call our toll-free hot line now! 1-800-554-5565, Ext. 956. Ask for our 10 mΩ power MOSFET Design Kit.

 **Siliconix**
incorporated
2201 Laurelwood Road, Santa Clara, CA 95056

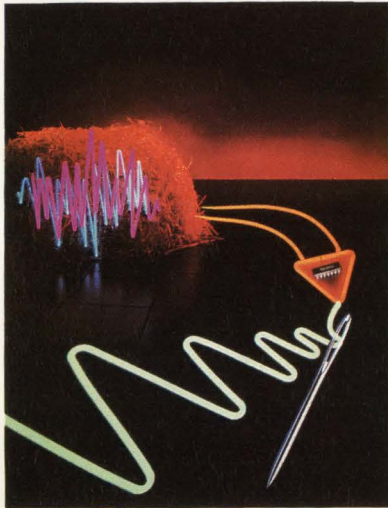

On the cover: If your amplifier has too much inherent noise, your signal can get lost and become indiscernible. Today's monolithic instrumentation amplifiers, however, offer an economical and accurate alternative to identifying even weak signals. See our Special Report beginning on pg 82. (Photo courtesy Burr-Brown Corp)

SPECIAL REPORT

Monolithic instrumentation amplifiers 82

As they become cheaper and more versatile, monolithic instrumentation amplifiers are growing more attractive for high-accuracy circuit applications. The days of discrete designs' dominance may be numbered.—*Doug Conner, Regional Editor*

DESIGN FEATURES

Create signals having optimum resolution, response, and noise 95

Simultaneously achieving fine frequency resolution, fast switching speed, and low phase noise is the hallmark of the signal-generation technique known as direct digital synthesis.—*Earl McCune Jr, Digital RF Solutions Corp*

EDN Product Review: Choose PC software or scientific calculators to tame tough math 115

For less than \$400 you can get a top-of-the-line scientific calculator or an IBM PC software package that will solve a wide range of your engineering math problems. The calculators are more portable; the programs are more powerful. All have a lot of capability.—*Richard E Douglass, Consultant*

TECHNOLOGY UPDATES

Cache-coherency protocols: Protocols keep data consistent 41

Maintaining data consistency in numerous cache RAMs operating on a shared-memory bus can give a system designer a headache. Some well-defined cache-coherency protocols can keep these headaches from becoming migraines.—*John Gallant, Associate Editor*

Continued on page 7

EDN[®] (ISSN 0012-7515, GST Reg. #123397457) is published 48 times a year (biweekly with 2 additional issues a month, except for February, which has 3 additional issues and July and December which have 1 additional issue) by Cahners Publishing Company, A Division of Reed Publishing USA, 275 Washington Street, Newton, MA 02158-1630. Terrence M McDermott, President; Frank Sibley, Executive Vice President; Jerry D Neth, Senior Vice President/Publishing Operations; J J Walsh, Senior Vice President/Finance; Thomas J Dellamaria, Senior Vice President/Production and Manufacturing; Ralph Knupp, Vice President/Human Resources. EDN[®] is a registered trademark of Reed Properties Inc., used under license. Circulation records are maintained at Cahners Publishing Company, 44 Cook Street, Denver, CO 80206-5800. Telephone: (303) 388-4511. Second-class postage paid at Denver, CO 80206-5800 and additional mailing offices. **POSTMASTER:** Send address corrections to EDN[®], PO Box 173377, Denver, CO 80217-3377. EDN[®] copyright 1991 by Reed Publishing USA; Ronald G Segel, Chairman and Chief Executive Officer; Robert L Krakoff, President and Chief Operating Officer; William M Platt, Senior Vice President. Annual subscription rates for nonqualified people: USA, \$109.95/year; Canada/Mexico, \$135/year; Europe air mail, \$165/year; all other nations, \$165/year for surface mail and \$250/year for air mail. Single copies are available for \$10. Please address all subscription mail to Ellen Porter, 44 Cook Street, Denver, CO 80206-5800.

THE SPARC OF A NEW GENERATION.



A new generation of performance.

The new SPARCstation™ 2 from Sun Microsystems delivers almost twice the CPU performance of previous generations – the highest performance in its class.



Integer Unit



Floating Point Unit



Cache Controller and Memory Management Unit



Cache Storage Units



The complete SPARC chipset, designed by our ROSS Technology subsidiary, is now available for high-volume applications.

The reason for this blazing speed: The highest-performance CMOS SPARC® available. The CY7C601, 32-bit SPARC microprocessor and CY7C157 16K x 16 Cache Storage Units from Cypress Semiconductor. Cypress 0.8 micron CMOS gives the CY7C601 SPARC RISC microprocessor 40 MHz clock rates and a sustained throughput of 29 MIPS.

Next generation compatibility.

Because they're SPARC chips, they're completely compatible with over 2100 SPARCware™ products. They offer true scalability into a wide spectrum of applications. And a growth path for future high-performance products.

Get this level of performance, potential, and compatibility for your next-generation products.

The Cypress SPARC.

For the whole story on RISC, call the Cypress Hotline at 1-800-952-6300.* Ask for dept. C4M.

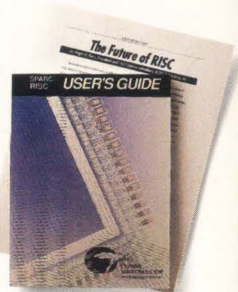

*1(800)387-7599 in Canada. (32)2 672-2220 in Europe. ©1990 Cypress Semiconductor, 3901 North First Street, San Jose, CA 95134. Phone: (408) 943-2600, Telex: 821032 CYPRESS SNJ UD, TWX: 910-997-0753. SPARC is a registered trademark of SPARC International, Inc. SPARCstation and SPARCware are trademarks of SPARC International, Inc., licenced exclusively to Sun Microsystems, Inc. Products bearing the SPARC trademark are based on an architecture developed by Sun Microsystems, Inc.



CYPRESS SEMICONDUCTOR

VP/Publisher
Peter D Coley

Associate Publisher
Mark Holdreith

VP/Editor/Editorial Director
Jonathan Titus

Managing Editor
Joan Morrow Lynch

Assistant Managing Editor
Christine McElvenny

Special Projects
Gary Legg

Home Office Editorial Staff
275 Washington St, Newton, MA 02158
(617) 964-3030

Tom Ormond, *Senior Editor*
Charles Small, *Senior Editor*
Jay Fraser, *Associate Editor*
John A Gallant, *Associate Editor*
Michael C Markowitz, *Associate Editor*
Dave Pryce, *Associate Editor*
Carl Quesnel, *Associate Editor*
Susan Rose, *Associate Editor*
Julie Anne Schofield, *Associate Editor*
Dan Strassberg, *Associate Editor*
Chris Terry, *Associate Editor*
Helen McElwee, *Senior Copy Editor*
James P Leonard, *Copy Editor*
Gabriella A Fodor, *Production Editor*
Brian J Tobey, *Production Editor*

Editorial Field Offices

Steven H Leibson, *Senior Regional Editor*
Boulder, CO: (303) 494-2233

Doug Conner, *Regional Editor*
Atascadero, CA: (805) 461-9669

J D Mosley, *Regional Editor*
Arlington, TX: (817) 465-4961

Richard A Quinell, *Regional Editor*
Aptos, CA: (408) 685-8028

Anne Watson Swager, *Regional Editor*
Wynnewood, PA: (215) 645-0544

Maury Wright, *Regional Editor*
San Diego, CA: (619) 748-6785

Brian Kerridge, *European Editor*
(508) 28435
22 Mill Rd, Loddon
Norwich, NR14 6DR, UK

Contributing Editors
Robert Pease, Don Powers,
David Shear, Bill Travis

Editorial Coordinator
Kathy Leonard

Editorial Services
Helen Benedict

Art Staff
Ken Racicot, *Senior Art Director*
Chinsoo Chung, *Associate Art Director*
Cathy Madigan, *Staff Artist*
Sharon O'Brien, *Staff Artist*

Production/Manufacturing Staff
Andrew A Jantz, *Production Supervisor*
Sandy Wucinich, *Production Manager*
Melissa Carman, *Production Assistant*
Diane Malone, *Composition*

Director of Art Department
Robert L Fernandez
Norman Graf, *Associate*

VP/Production/Manufacturing
Wayne Hulitzky

Director of Production/Manufacturing
John R Sanders

Business Director
Deborah Virtue

Marketing Communications
Anne Foley, *Promotion Manager*
Pam Winch, *Promotion Assistant*

Contact-enhancing chemicals: Fluids vanquish intermittent contacts 59

Chemicals that improve connector performance may sound more like patent medicines than serious products, but you can obtain remarkable improvements in reliability and performance with a few strategic drops.—*Steven H Leibson, Senior Regional Editor*

EDITORS' CHOICE

Low-drift op amps 73

PRODUCT UPDATES

Repeater interface controller 74
CAE simulator package 76

DESIGN IDEAS

One coax cable carries video and power 137
 μ P controls negative-voltage converter 140

EDITORIAL 35

Weapon systems furnish some design and test lessons that Congress—and engineers—should keep in mind.

NEW PRODUCTS

Test & Measurement Instruments 144
Computers & Peripherals 148
CAE & Software Development Tools 156
Components & Power Supplies 162
Integrated Circuits 168

DEPARTMENTS

News Breaks 15
Signals & Noise 26
Career Opportunities 182
EDN's International Advertisers Index 187

Cahners Publishing Company, A Division of Reed Publishing USA Specialized Business Magazines for Building & Construction Research Technology Electronics Computing Printing Publishing Health Care Foodservice Packaging Environmental Engineering Manufacturing Entertainment Home Furnishings and Interior Design. Specialized Consumer Magazines for Child Care Boating and Wedding Planning.

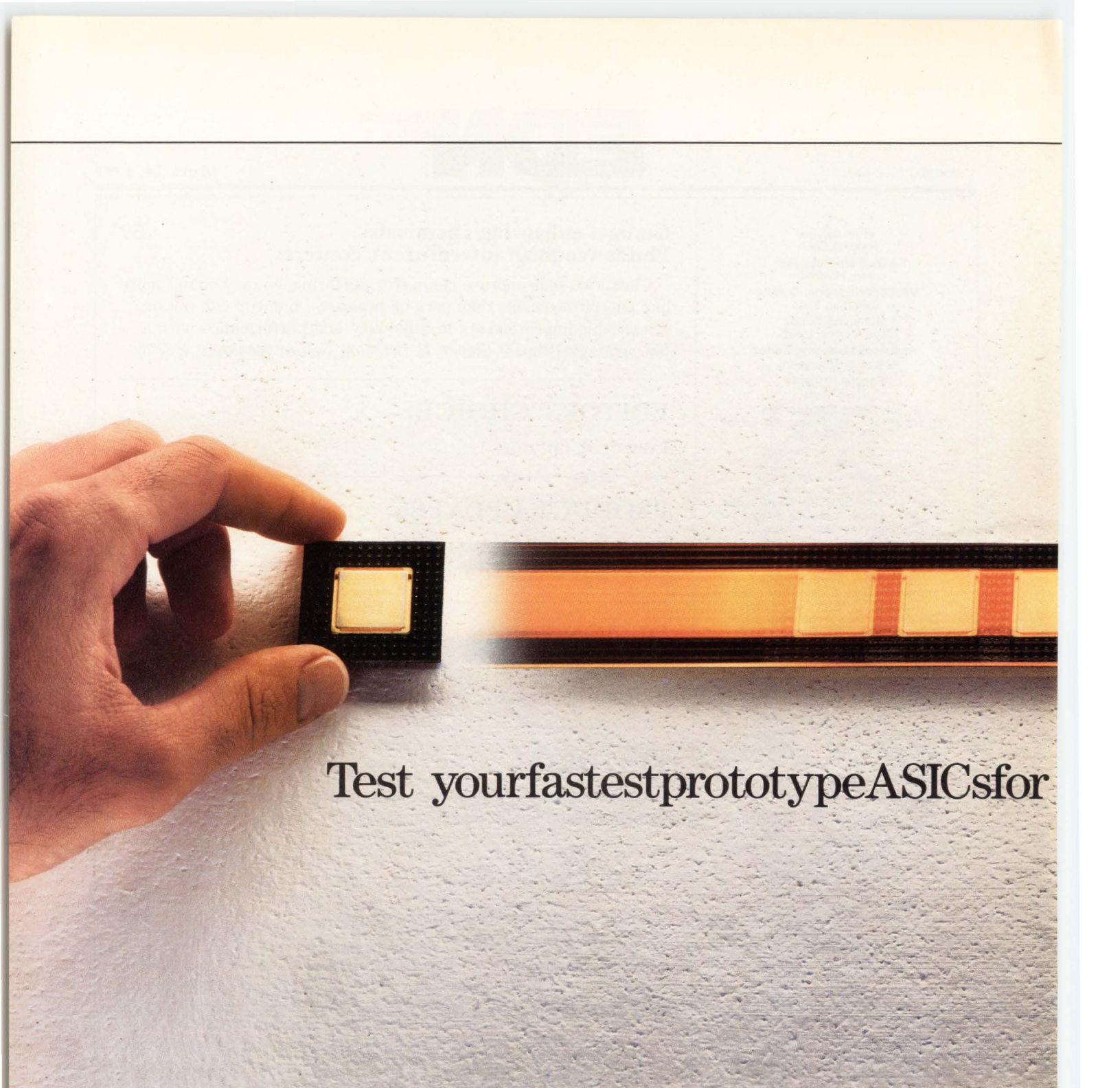

Test your fastest prototype ASICs for

Finally, a 400 MHz IC Evaluation System.

Before you send those fast ASIC designs off to production, make sure they'll handle the stress of real-world operating conditions.

Now, that's possible—even for GaAs, ECL, and BiCMOS devices—with the new 400 MHz, HP 82000 IC Evaluation System.

It's a testing breakthrough . . .



a 400 MHz vector rate on all channels and up to 512 pin capacity. Finally, you can verify and characterize complex prototype ASICs to their limits. Which means you'll send fast ICs to production with the confidence that they won't return for time-consuming and expensive redesign.

You can even go a step further. Its high-throughput software lets you efficiently test small

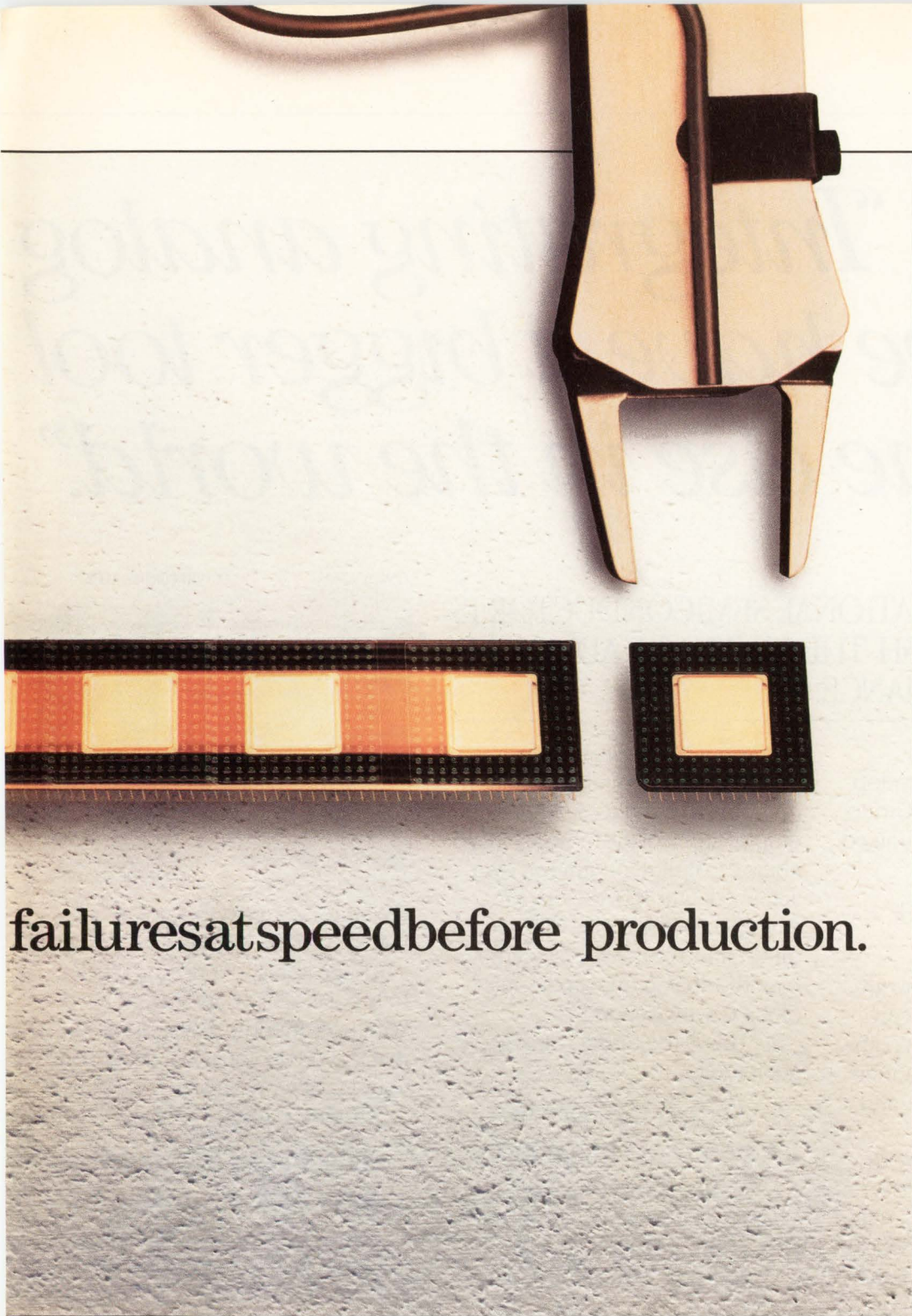

failures at speed before production.

batch production runs, too.

And because all the systems in the HP 82000 family are modular, you can expand from 50, 100, or 200 MHz to 400 MHz as your needs change. This protects your original investment.

So call **1-800-752-0900*** today. Ask for **Ext. 1615** and we'll send the details on giving those fast ASICs a real-world test. Before you pass them on to production.

There is a better way.



*In Canada, call 1-800-387-3867, Dept. 413

“Integrating analog But we have a bigger tool anyone else in the world.”

HOW NATIONAL SEMICONDUCTOR IS HELPING YOU PUSH THE LIMITS OF ADVANCED SYSTEMS PERFORMANCE.

Tom Redfern, National's Director of New Product Development, Interface/Peripherals Group, talks about the challenges of mixed analog+ digital technology.

Making Futurebus+ a reality.

“Traditional bus protocols are starting to hit the wall. They can't accommodate the wide data paths and high transfer rates demanded of the next generation of 32- and 64-bit microprocessors.

“That's why we've been an active participant on the IEEE's Futurebus+ committee since its founding in 1979. And that's why we invented the Backplane Transceiver Logic (BTL) that makes

Futurebus+ a reality today.

“Our first Futurebus+ chipset contains five devices, and they employ some of the most advanced analog+ digital integration ever achieved. Our BTL drivers, for example, let the digital CPU send information to the digital memory over the analog bus at peak rates of 2-3 Gbytes/second!

“This is the future— and we've got it today.”

Setting the pace in system-level integration.

“Another great example is CLASIC, our powerful Custom Linear ASIC family.

“To reach system-on-chip performance, you've got to integrate analog and digital functions onto the same substrate.

“Well, CLASIC does that.

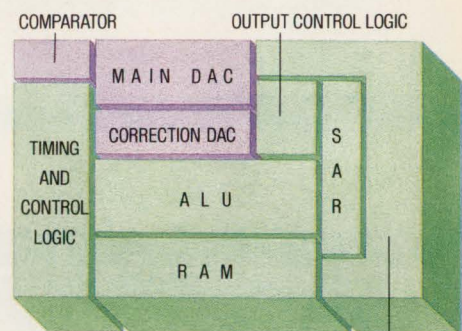

ADC1251
DIGITAL ANALOG
DIGITAL OUTPUT DATA LATCH AND BUFFERS

Op amps, comparators, references, DACs, VCOs, PLLs, plus digital cells — a huge library of building blocks. In bipolar, CMOS, and BiCMOS. With user-friendly design tools that let you do your own design on your PC or workstation.

“It's that simple.”

Reaching a new level of ADC accuracy.

“Our new ADC1251 takes a quantum leap in integration. It's powered by a sophisticated digital controller and is totally self-calibrating, so it will maintain linearity over time, temperature, and supply voltage.

“You get 12-bit-plus-sign resolution with a 8.0µs conversion



*and VLSI digital isn't easy.
box for doing that job than*

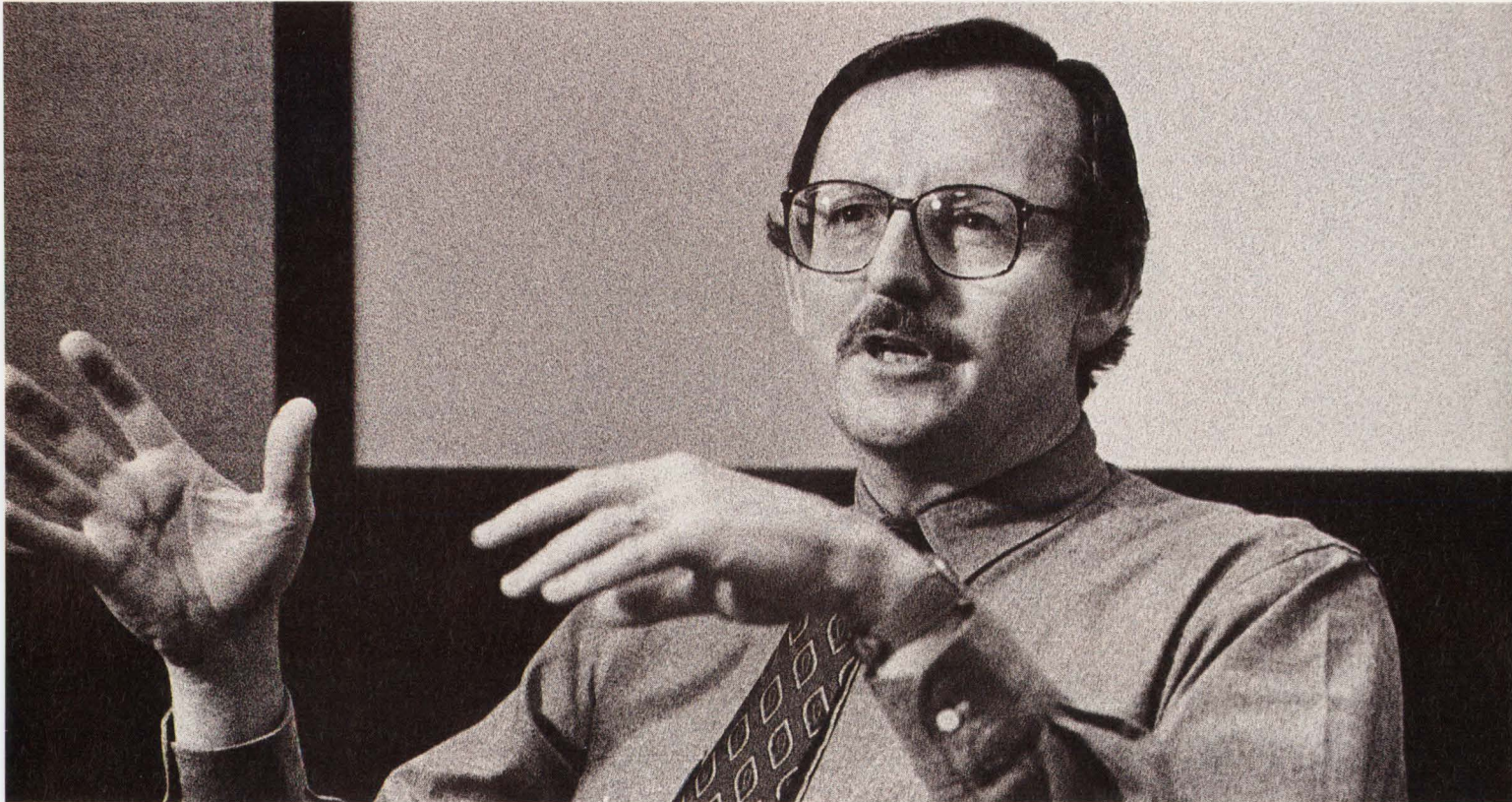

time and a $\pm 1/2$ LSB non-linearity accuracy while dissipating 113mW max at $\pm 5V$.

"Try to find that in any other ADC. You can't."

Pushing the limits of analog + digital integration.

"To achieve these levels of integration, you need powerful tools in the hands of experienced designers.

"We've got them. A full range of process technologies, including fourth-generation bipolar ECL and

BiCMOS, which give us 0.8μ lithographies with bipolar F_{Ts} of 15GHz and 50ps gate delays.

"We also have some of the most advanced design tools in the industry, developed through our strategic alliance with Cadence.

"And we have seasoned analog and digital designers who know the art of putting those tools to work in advanced analog+ digital designs.

"This is the leading edge— and we're leading it."

Putting it all to work for you.

"The only way to make the systems-performance breakthroughs and the systems-cost breakthroughs demanded by next-generation products is to integrate analog+ digital. We're doing it all, right now. So if I were a designer, I'd call us. Soon."

1-800-NAT-SEMI, Ext. 117



© 1991 National Semiconductor Corporation
CLASIC is a trademark of National Semiconductor Corporation.



INTRODUCING THE BEST DISK DRIVES

The newest generation of disk drives from Conner. Lighter. Cooler. Smarter. Faster. With more capacity than ever before. Precisely what high-performance dreams are made of.

And, for the fourth consecutive year, Conner is delivering a generation ahead of the competition. Helping major OEMs get new systems to market faster than they ever dreamed possible.

Sell. Design. Build.

Before we design or build a product, our engineers work closely with the most respected experts in the industry—our customers. By asking the right questions, we identify specific needs. Sooner. And fill those needs with the right products. Faster.

So it's no surprise that more of the world's leading OEMs work with Conner.



Summit 510MB

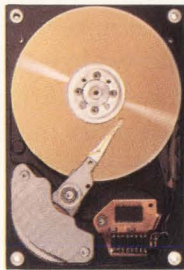

Hopi 80MB

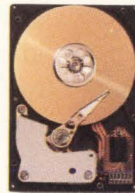

Pancho 30, 40, 60 MB

World Headquarters: 3081 Zanker Road, San Jose, CA 95134 Telephone: (408) 456-4500 FAX: (408) 456-4501 Sales Offices: Asia—Singapore: (65) 2961992 • Taipei: (886) 2-718-9193 • Tokyo: (81) 3-485-8901 • Seoul: (82) 2-551-2777 Europe—© 1991 Conner Peripherals, Inc.

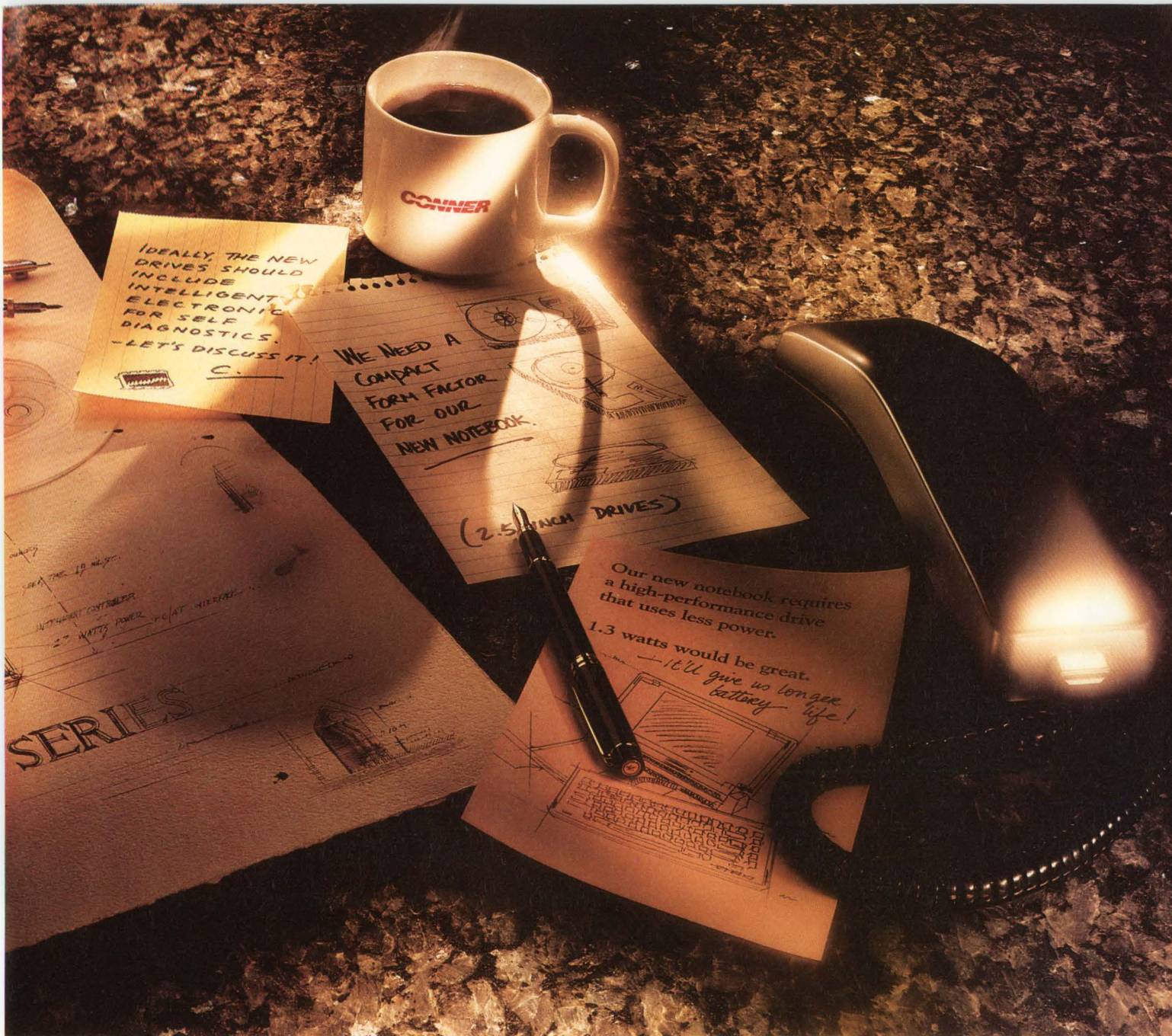

OUR CUSTOMERS COULD DREAM UP.

Because we consistently design the exact disk drives our customers need. Then build those drives — in volume.

Keeping You A Generation Ahead.

The results of this unique sell-design-build strategy have been remarkable. Using proven technologies, our high-performance 3.5-inch and 2.5-inch disk drives continuously set the standards. For all major segments of the market.

The fact is, Conner delivers disk drives for today's powerful systems. From high-end workstations

and file servers to desktop, laptop and notebook PCs.

And Conner has sales offices and manufacturing facilities in Europe, Asia and America. Keeping us close to our customers around the globe.

So call Conner today. And we'll work together to turn your dreams into realities.

CONNER

DELIVERING A GENERATION AHEAD.

London: (44) 249-444-049 • Munich: (49) 89-129-8061 • Paris: (33) 1-47-47-4108 • Ivrea: (39) 125-631715 • U.S.—Boston: (508) 660-1088 • Dallas: (214) 680-2913 • Los Angeles: (714) 455-2777 • Minneapolis: (612) 449-5186 • San Jose: (408) 456-4500.
Authorized U.S. Distributors: Anthem Electronics, Avnet Computer, CAL-ABCO

SIEMENS

0.005%/°C

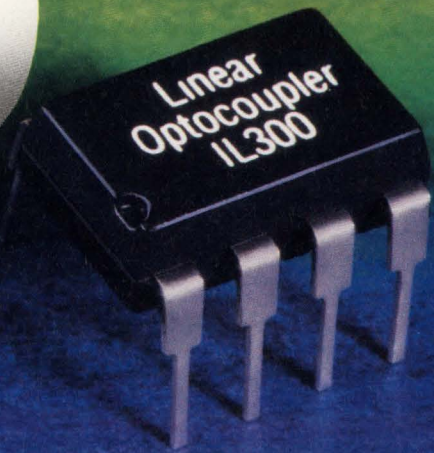

Gain Without Pain.

New linear optocoupler— Rx for stability.

The phrase "linear optocoupler" has always been a contradiction in terms.

Until now.

Siemens new IL300 optocoupler uses a unique, optical feedback loop to neutralize gain and offset drift caused by

temperature and LED degradation.

The results will change the way you

think about optocouplers: DC gain stability of $\pm 0.005\%/^{\circ}\text{C}$, $\pm 0.01\%$ servo linearity, a wide ($>200\text{kHz}$) bandwidth, power consumption

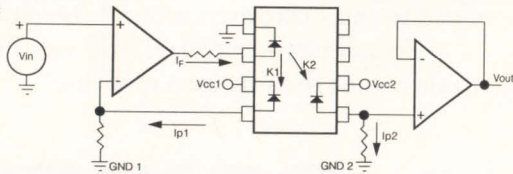

under 15mw, and 7500 VAC Withstand Test Voltage.

The IL300's stable operational characteristics are achieved by controlling the AlGaAs IRLED output flux with an optical feedback circuit. The servo PIN photodiode captures a percentage of the flux and generates a signal that can be used to control the LED drive

current. This compensates for the LED's inherent non-linear, time, and temperature characteristics.

The IL300's stability and excellent isolation characteristics make it ideal for power supply regulation, medical sensor isolation, audio signal inter-

facing, digital telephone isolation, and many other applications.

It gives engineers a flexible, cost and power efficient component for applications in which optocouplers were never practical before.

For complete information on our new linear optocoupler, including application tips, call 408-725-3543.

Siemens Components, Inc.
Optoelectronics Division
19000 Homestead Road
Cupertino, CA 95014-1799

The IL300 linear optocoupler. Gain without pain.

Distributors: Advent Electronics, Inc., Hall-Mark, Insight Electronics, Marshall, Summit, Western Microtechnology.

Siemens
Practical Solutions By Design.

NEWS BREAKS

EDITED BY SUSAN ROSE

SOLID-STATE STORAGE DEVICE REPLACES DISK DRIVES

Winsystems' \$325 MCM-RSSD IC memory-card drive can replace a floppy-disk drive in STD Bus applications. It replaces conventional rotating-disk memories in harsh environments where computers are subject to extreme temperatures, magnetic fields, vibration, dirt, and fumes. The drive uses ESD-resistant RAM data cartridges that store as much as 2M bytes of data. The drive has an operating temperature range of 0 to 65°C and comes with a card ejector, vibration-resistant front-panel latch, and a front-panel status display. The host STD Bus microcomputer identifies the drive as an I/O-mapped card. A bootable BIOS extension for this unit costs \$50. The CMOS version of the drive, the LPM-RSSD, is \$335. Winsystems Inc, Arlington, TX, (817) 274-7553, FAX (817) 548-1358.—J D Mosley

S/H-AMPLIFIER ARCHITECTURE OPTIMIZES DYNAMIC SPECS

The AD9100 S/H amplifier from Analog Devices integrates a closed-loop input amplifier with a switching network that reduces distortion but maintains the slew rate of traditional open-loop S/H-amplifier designs. The acquisition time to a 2V step is typically 16 nsec to 0.01% accuracy, which translates to 12-bit accuracy at clock rates of 30M samples/sec. The amplifier's hold-mode distortion is guaranteed to be less than -81 dB (full scale) for frequencies as high as 12 MHz and -74 dB for frequencies as high as 20 MHz. The amplifier can drive capacitive loads as high as 100 pF, making it a good match for 8- and 10-bit flash converters that operate as high as 60M samples/sec.

The amplifier requires $\pm 5V$ supplies. It has an internal hold capacitor and internal decoupling capacitors. The differential ECL encode clock reduces jitter to less than 1 psec, and the device internally clamps the analog input to prevent damage from voltage transients. The amplifier's spectral noise density is $3.3 \text{ nV}/\sqrt{\text{Hz}}$, and feedthrough rejection is 83 dB at 20 MHz. The device is available in a 20-pin ceramic DIP specified for commercial, industrial, or military temperature ranges. The commercial temperature version costs \$79 (100). Analog Devices Inc, Greensboro, NC, (919) 668-9511, FAX (919) 668-0101.—Anne Watson Swager

HANDHELD TESTERS SPOT LAN CABLE PROBLEMS

Cabling problems crash networks. The HP J2181A, HP J2177A, and HP J2187A handheld testers from Hewlett-Packard can help you find such problems quickly. Two of the testers incorporate time-domain reflectometers that isolate and identify faults in LAN cables: The \$1495 HP J2181A cable scanner locates faults in coaxial and simple twisted-pair cables, and the \$2495 HP J2177A pair scanner performs the same task for more complex twisted-pair systems. The \$995 HP J2187A quick scanner performs LAN diagnostic tests. All three testers incorporate 2-line LCD displays for presenting setup and diagnostic messages. Hewlett-Packard Co, Palo Alto, CA, phone or fax the local office.—Steven H Leibson

MICROCONTROLLER HOUSES EPROM, EEPROM, AND ADC

The single-chip ST90E40 8-bit CMOS microcontroller from SGS-Thomson combines 16k bytes of EPROM for program storage with 512 bytes of EEPROM and 256 bytes of RAM mapped into data space. Also on chip are an 8-bit ADC, eight channels,

NEWS BREAKS

sample-and-hold. The chip also has a conversion time of 11 μ sec. The chip has two 16-bit programmable timers and a 375k-baud serial communications interface. Seven 8-bit I/O ports carry the address and data bus, status and timing signals, analog inputs, interrupts, and serial or parallel data. The 12-MHz ST9-series core processor has a 128k-byte address range, 256-byte register file, and DMA control. The ST90E40 in a 68-pin ceramic leaded chip-carrier package is \$50 (1000). The 1-time-programmable ST90T40 in a plastic leaded chip carrier, expected by the third quarter of 1991, will cost \$20 (10,000). The ST9040 with 16k bytes of maskable ROM in place of EPROM, due at the end 1991, will cost \$8 (100,000). SGS-Thomson Microelectronics, Agrate, Italy, (39) 60351, FAX (39) 6035700.—Brian Kerridge

PERIPHERAL IC MAKES μ P CRASH PROOF

The Micro Softener IC from Dallas Semiconductor lets an assortment of μ Ps resume operation after a power outage by retaining calibration, program, and data information. The chip acts as a power monitor, a watchdog timer, a nonvolatile controller, an address decoder, a bootstrap ROM, and dual-port register file. It has its own uninterruptable lithium-battery power supply. The chip lets you make software updates or changes via an on-chip serial port for the 6303, 68HC11, 80C196, and the 8086-compatible V40 μ Ps, thus eliminating any need to open the system to access the IC. The chip's on-chip bootstrap loader automatically initializes the μ P with application code you can download from any IBM PC. Therefore, you don't need to add a boot EPROM to your circuit. The chip also provides additional I/O capabilities for sensors and pushbuttons with its 32 parallel-port pins. Prices for the chip range from \$7 to \$9.20 (1000), depending upon the μ P. Dallas Semiconductor, Dallas, TX, (214) 450-0448, FAX (214) 450-0470.—J D Mosley

ADA COMPILER TRIPLES PREDECESSORS' SPEED

The latest version of the Ada Software Development Environment for 80486-based IBM PCs running DOS creates code that runs three times faster than that of its predecessor. The \$4995 package includes an optimizing compiler and runtime executive, binder, multiple libraries, symbolic source-level debugger, program viewer, cross-reference generator, a make utility, source-code reformatter, and a math package. The package operates the Intel 80486 μ P in its 32-bit mode, which circumvents the operating system's 640k-byte RAM limits and the constraints of segmented architecture imposed by the μ P's antecedents. The package requires 4M bytes of extended memory. Alsys Inc, Burlington, MA, (617) 270-0030, FAX (617) 270-6882.

—Steven H Leibson

DIFFERENTIAL INPUTS QUIET CONVERSION

The TLC1225 from Texas Instruments uses differential inputs to reduce system errors created by common-mode noise. For single 5V supply operation, the input common-mode voltage range is 0 to 5V. The converter suits industrial control and data communications and is compatible with most μ Ps and DSPs. The device features a 12- μ sec conversion period. The device's self-calibration eliminates factory laser trimming and offset adjustments in the field. You initiate calibration, which takes 300 clock cycles to complete, by issuing a command word to the data bus. The TLC is available in a plastic DIP characterized over a temperature range of -40 to $+85^{\circ}\text{C}$ and costs \$16.74 (1000). The TLC1125, an 11-bit linear device similar in all other respects to the TLC1225, costs \$11.17 (1000). Texas Instruments Inc, Dallas, TX, (800) 336-5236, FAX (214) 995-4360.—Anne Watson Swager



The Standard for Circuit Simulation Switch-Mode Power Supply Design

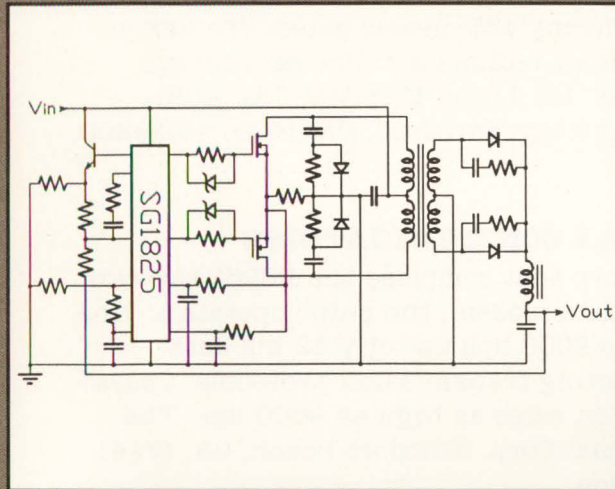

Current mode power supply schematic.

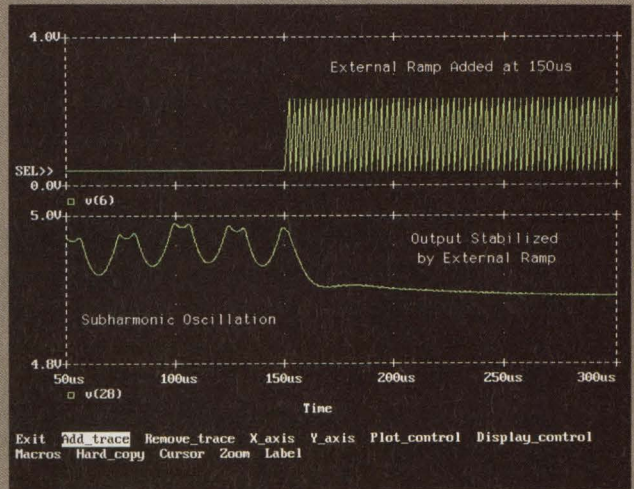

Power supply simulated using mixed analog/digital simulation. Plot shows subharmonic oscillation being suppressed by external ramp.

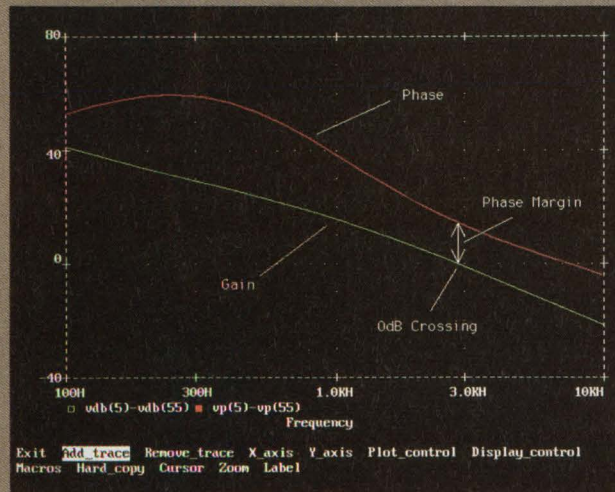

Simulation using the Vorperian switch model to examine the stability of a power supply.

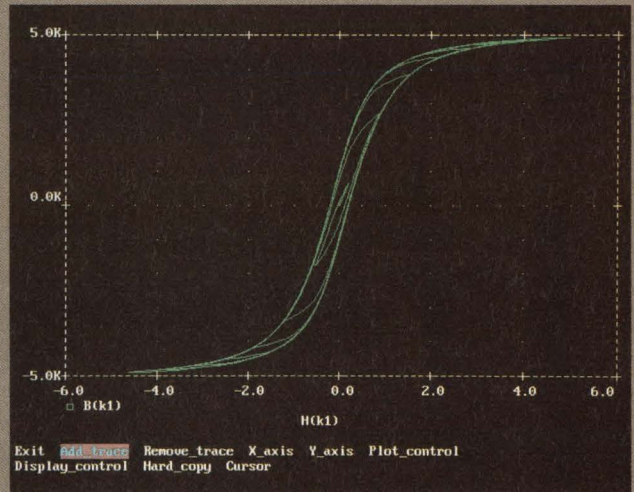

Hysteresis curve of transformer.

A cycle by cycle simulation of switch-mode power supplies is recognized as a difficult simulation task for SPICE-based simulators, which must cope with timings that can span 4 orders of magnitude. This problem invariably results in very long simulation times, but is improved considerably by MicroSim's approach of building the controller macromodel chips so that a significant section is simulated in the digital domain. PSpice's behavioral modeling and mixed analog/digital simulation capability makes this possible.

PSpice is available on the IBM-PC (running DOS or OS/2); Macintosh II; Sun 3, Sun 4, and SPARCstation; DECstation 2100, 3100, and 5000; and the VAX/VMS families. In addition to the PWM macromodels, the PSpice library contains over 3,500 analog and 1,500 digital parts which can be used in a variety of applications. Our technical staff has over 150 years of combined experience in CAD/CAE, and our software is supported by the engineers who wrote it.

For further information about the PSpice family of products, call us at (714) 770-3022, or toll free at (800) 245-3022. Find out for yourself why PSpice has become the standard for circuit simulation.

20 Fairbanks • Irvine, CA 92718 USA • FAX (714) 455-0554

NEWS BREAKS

GATE ARRAY INCLUDES BUILT-IN TEST NETWORK

LSI Logic's LFT150XXX series family of gate arrays uses the built-in test technology developed by Crosscheck Technology Inc. The technology allows you to read every node in your completed design, thus simplifying test vector creation.

The family has four initial members, offering between 270 and 410 I/O lines. Their sizes range from 86k to 190k available gates, offering 43% usable gates. The arrays use the company's 1 μ m HCMOS LCA100K gate-array technology. The gate arrays start at \$120 (10,000) for 160-pin quad flatpacks. LSI Logic, Milpitas, CA, (408) 433-4554, FAX (408) 433-7241. Crosscheck Technology, San Jose, CA, (408) 432-9200, FAX (408) 452-0734.—Richard A Quinnell

TWO-CHIP-MODEM IC SUPPORTS DATA, FAX COMMUNICATIONS

The two chips from Rockwell International Corp that comprise the RC9624AC can create an integrated data and fax modem. As a data modem, the chips operate at line speeds to 2400 bps and will deliver data rates to 9600 bps using V.42 bis data compression. The chips also execute error-correcting transmission protocols. Operating as a fax modem, the chips attain transmission rates as high as 9600 bps. The chip set costs \$35 (10,000). Rockwell International Corp, Newport Beach, CA, (714) 833-4600, FAX (714) 833-4078.—Steven H Leibson

A/D CONVERTERS COME IN A NEW PACKAGE

Burr-Brown Corp's ADC574A and ADC774 A/D converters now come in 28-lead plastic leaded chip-carrier packages. The successive-approximation converters include a 10V reference, an internal clock, TTL-compatible 3-state output buffers, and a microprocessor interface. The converters have either 8- or 12-bit resolution, depending on external programming. The ADC574A converts 12 bits in 25 μ sec max and 8 bits in 17 μ sec. The ADC774's 12-bit conversion takes a maximum of 8.5 μ sec and its 8-bit conversion takes 5.3 μ sec. Both devices have a 150-nsec bus-access time. Missing codes are not guaranteed for either device over their 0 to 75°C specified temperature range. Versions of the ADC574 with ± 1 -LSB and $\pm 1/2$ -LSB linearity cost \$19.20 and \$25.20 (OEM qty), respectively. The two linearity versions of the ADC774 cost \$25.20 and \$52.30, respectively. Burr-Brown Corp, Tucson, AZ, (800) 548-6132, FAX (602) 889-1510.—Anne Watson Swager

PACKET OF PAPERS DESCRIBES THE VXIBUS

You'll find a broad range of VXibus topics covered in a packet of papers compiled by Hewlett-Packard and offered at no charge. Topics include an overview of the VXibus, hints on applying the architecture, information on designing VXibus instruments, and configuration hints. Hewlett-Packard Co, Palo Alto, CA, phone or fax your local office.—Steven H Leibson

REAL-TIME OPERATING SYSTEM FOR FIXED-POINT DSPs

Ready Systems's VRTX32/56000 real-time operating system works with Motorola's 56000 family of 24-bit fixed-point DSPs. The operating system provides synchronization mechanisms, priority-based scheduling, and intertask communication. Development licenses start at \$6000. Production licenses start at \$235 (100). Ready Systems, Sunnyvale, CA, (800) 228-1249, FAX (408) 736-3400.—Doug Conner

REDUNDANCY REDUNDANCY REDUNDANCY

Dale's Three Sourcing Locations Protect RNC "S" Level Deliveries. Stock to Six Weeks on Most Values.

RNC redundancy — from Dale®. Now more than ever, it means guaranteed delivery for "S" level orders from three qualified locations. One call lets you lock-in requirements for:

- 10 ohms to 7.5 megohms.
- Special testing at all locations.

Call today. Get instant access to our extensive RNC "S" level capacities, plus reliable, precisely-timed delivery. Discover how our decision to maintain a multi-source supply system for many components — particularly MIL-R-55182 — protects you with redundancy insurance over an increased value range. Contact your Dale Representative or Distributor, or phone our RNC sourcing headquarters.

MIL-R-55182 Range "S" Level	
Style	Value Range
RNC50	10 - 796K Ω
RNC55	10 - 2.0M Ω
RNC60	10 - 2.49M Ω
*RNC65	10 - 4.99M Ω
*RNC70	10 - 7.5M Ω

* Available in RNR and RNN as described in Table I of MIL-R-55182 for values above 1M Ω for RNC65 size and above 70K Ω for RNC70 size.

Norfolk Division, 2300 Riverside Blvd.
Norfolk, NE 68701-2242 • Phone (402) 371-0080 • FAX (402) 644-4206



FILTERS



dc to 3GHz from \$1145

lowpass, highpass, bandpass, narrowband IF

- less than 1dB insertion loss • greater than 40dB stopband rejection
- 5-section, 30dB/octave rolloff • VSWR less than 1.7 (typ) • meets MIL-STD-202 tests
- rugged hermetically-sealed pin models • BNC, Type N; SMA available
- surface-mount • over 100 off-the-shelf models • immediate delivery

low pass dc to 1200MHz

MODEL NO.	PASSBAND, MHz (loss <1dB)		fco, MHz (loss 3db)	STOP BAND, MHz (loss>20dB) (loss>40dB)			VSWR		PRICE \$ Qty. (1-9)
	Min.	Max.		Min.	Max.	Max.	pass-band typ.	stop-band typ.	
PLP-10.7	DC-11		14	19	24	200	1.7	18	11.45
PLP-21.4	DC-22		24.5	32	41	200	1.7	18	11.45
PLP-30	DC-32		35	47	61	200	1.7	18	11.45
PLP-50	DC-48		55	70	90	200	1.7	18	11.45
PLP-70	DC-60		67	90	117	300	1.7	18	11.45
PLP-100	DC-98		108	146	189	400	1.7	18	11.45
PLP-150	DC-140		155	210	300	600	1.7	18	11.45
PLP-200	DC-190		210	290	390	800	1.7	18	11.45
PLP-250	DC-225		250	320	400	1200	1.7	18	11.45
PLP-300	DC-270		297	410	550	1200	1.7	18	11.45
PLP-450	DC-400		440	580	750	1800	1.7	18	11.45
PLP-550	DC-520		570	750	920	2000	1.7	18	11.45
PLP-600	DC-580		640	840	1120	2000	1.7	18	11.45
PLP-750	DC-700		770	1000	1300	2000	1.7	18	11.45
PLP-800	DC-720		800	1080	1400	2000	1.7	18	11.45
PLP-850	DC-780		850	1100	1400	2000	1.7	18	11.45
PLP-1000	DC-900		990	1340	1750	2000	1.7	18	11.45
PLP-1200	DC-1000		1200	1620	2100	2500	1.7	18	11.45

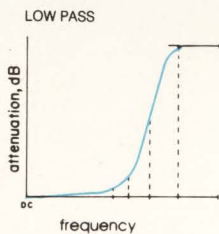

high pass dc to 2500MHz

MODEL NO.	PASSBAND, MHz (loss <1dB)		fco, MHz (loss 3db)	STOP BAND, MHz (loss>20dB) (loss>40dB)		VSWR		PRICE \$ Qty. (1-9)
	Min.	Max.		Min.	Max.	pass-band typ.	stop-band typ.	
PHP-50	41	200	37	26	20	1.5	17	14.95
PHP-100	90	400	82	55	40	1.5	17	14.95
PHP-150	133	600	120	95	70	1.8	17	14.95
PHP-175	160	800	140	105	70	1.5	17	14.95
PHP-200	185	800	164	116	90	1.6	17	14.95
PHP-250	225	1200	205	150	100	1.3	17	14.95
PHP-300	290	1200	245	190	145	1.7	17	14.95
PHP-400	395	1600	360	290	210	1.7	17	14.95
PHP-500	500	1600	454	365	280	1.9	17	14.95
PHP-600	600	1600	545	440	350	2.0	17	14.95
PHP-700	700	1800	640	520	400	1.6	17	14.95
PHP-800	780	2000	710	570	445	2.1	17	14.95
PHP-900	910	2100	820	660	520	1.8	17	14.95
PHP-1000	1000	2200	900	720	550	1.9	17	14.95

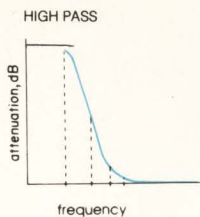

bandpass 20 to 70MHz

MODEL NO.	CENTER FREQ. MHz F0	PASS BAND, MHz (loss <1dB)		STOP BAND, MHz (loss > 10 dB) (loss > 20 dB)				VSWR 1.3:1 typ. total band MHz	PRICE \$ Qty. (1-9)
		Max. F1	Min. F2	Min. F3	Max. F4	Min. F5	Max. F6		
PIF-21.4	21.4	18	25	4.9	85	1.3	150	DC-220	14.95
PIF-30	30	25	35	7	120	1.9	210	DC-330	14.95
PIF-40	42	35	49	10	168	2.6	300	DC-400	14.95
PIF-50	50	41	58	11.5	200	3.1	350	DC-440	14.95
PIF-60	60	50	70	14	240	3.8	400	DC-500	14.95
PIF-70	70	58	82	16	280	4.4	490	DC-550	14.95

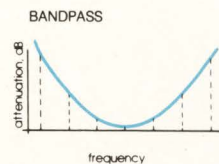

narrowband IF

MODEL NO.	CENTER FREQ. MHz F0	PASS BAND, MHz I.L. 1.5dB max. F1-F2	STOP BAND, MHz I.L. > 20dB		STOP BAND, MHz I.L. > 35dB		PASS-BAND VSWR Max.	PRICE \$ Qty. (1-9)
			F5	F6	F7	F8-F9		
PBP-10.7	10.7	9.5-11.5	7.5	15	0.6	50-1000	1.7	18.95
PBP-21.4	21.4	19.2-23.6	15.5	29	3.0	80-1000	1.7	18.95
PBP-30	30.0	27.0-33.0	22	40	3.2	99-1000	1.7	18.95
PBP-60	60.0	55.0-67.0	44	79	4.6	190-1000	1.7	18.95
PBP-70	70.0	63.0-77.0	51	94	6	193-1000	1.7	18.95

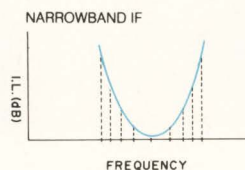

Mini-Circuits

CIRCLE NO. 97

P.O. BOX 350166, Brooklyn, New York 11235-0003 (718) 934-4500 FAX (718) 332-4661 TELEX 6852844 or 620156 WE ACCEPT AMERICAN EXPRESS

F132-2 REV. ORIG.

Outside, all disc drives look t It's really what's inside that co



S
E
A
G
A
T
E
T
E
C

E
A
G
A
T
E

Q
U
A
L
I
T
Y

Zone Bit Recording, ZBR, Seagate and the Seagate logo are registered trademarks of Seagate Technology, Inc.
© 1990 Seagate Technology, Inc.

he same. units.

Apart from our nameplate, a Seagate disc drive looks much like any other when viewed from the outside. But it's the tangible and intangible elements we put inside that make a Seagate drive really shine.

If you could see inside you'd find the best components available. Many of them—such

as discs, motors, semiconductors and thin-film heads—we design and build ourselves, allowing us to control their quality, cost and availability. Most of what we don't manufacture is obtained from a select group of vendors who must meet our strict Supplier Certification Program criteria. This guarantees consistently high quality and continual conformance to our customers' requirements.

Technology is another key Seagate ingredient. As the holder of over 200 disc drive patents, we constantly develop state-of-the-art technologies to enhance the value of our products to our customers. For example, Zone Bit Recording™ increases the amount of information that can be stored on a disc. But besides increasing the drive's capacity and throughput, ZBR™ technology can reduce the required number of heads and discs, thereby reducing costs, increasing performance and making the drive significantly more reliable.

The third major factor that sets Seagate drives apart is our commitment. You see it in the inspired dedication of our employees: like our engineers, who apply the latest technology advances to our current models. In our assemblers and technicians, who are committed to producing defect-free products. And in our sales, customer service and technical support groups, who continually go the extra mile to ensure complete customer satisfaction.

But most of all, Seagate drives are built upon experience: the market insight and technical knowhow that can only come from selling more than 25 million drives since the industry's inception. It's the kind of experience you won't find at any other disc drive company.

To be sure you're getting Seagate quality and technology inside where it counts, make sure there's a Seagate nameplate on the outside. For more information, contact Seagate at 800-468-DISC, or 408-438-6550.

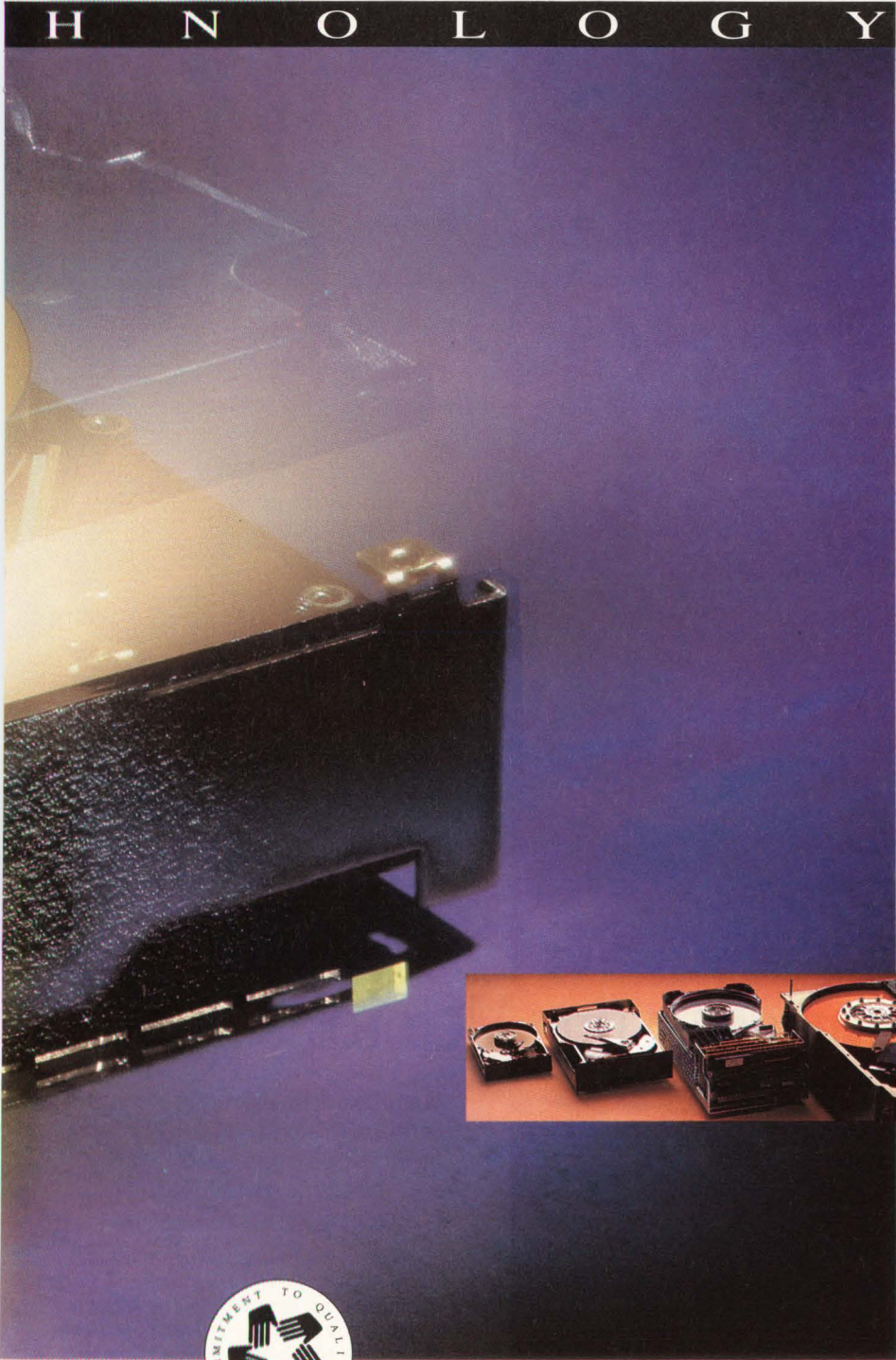

 **Seagate**

The first name in disc drives

Does it meet Six Sigma

Can it do true

mixed-mode

testing?

What tools have been developed?

Before the A500 started testing Motorola's mixed-



"Motorola has adopted a Six Sigma initiative which focuses attention on approaching zero-defect performance in everything we do, including our test systems. Our purchase of

the Teradyne A500 test system supports our Six Sigma initiative and our competitive leadership challenge."

Director of Marketing

Motorola knows you can't have a Six Sigma process unless you can test to Six Sigma standards. That's why Motorola's MOS Digital-Analog Integrated Circuits Division chose the Teradyne A500 Analog VLSI Test System. Because, in addition to proving the A500 could handle the

complex technical requirements of Motorola's advanced ISDN interfaces, we also demonstrated that we could perform to Motorola's stringent quality levels.

"Can it do scan testing? Digitize high-frequency waveforms? Do true mixed-mode testing? Does it have a flexible architecture? Can you give us the support for a Six Sigma process? Applications expertise? Complete documentation? The right tools? In each case, Teradyne answered yes."

Manager, Advanced Test Technology

IMAGE is a trademark of Teradyne, Inc.

Motorola and  are registered trademarks of Motorola, Inc.

It have a high pin count

standards?

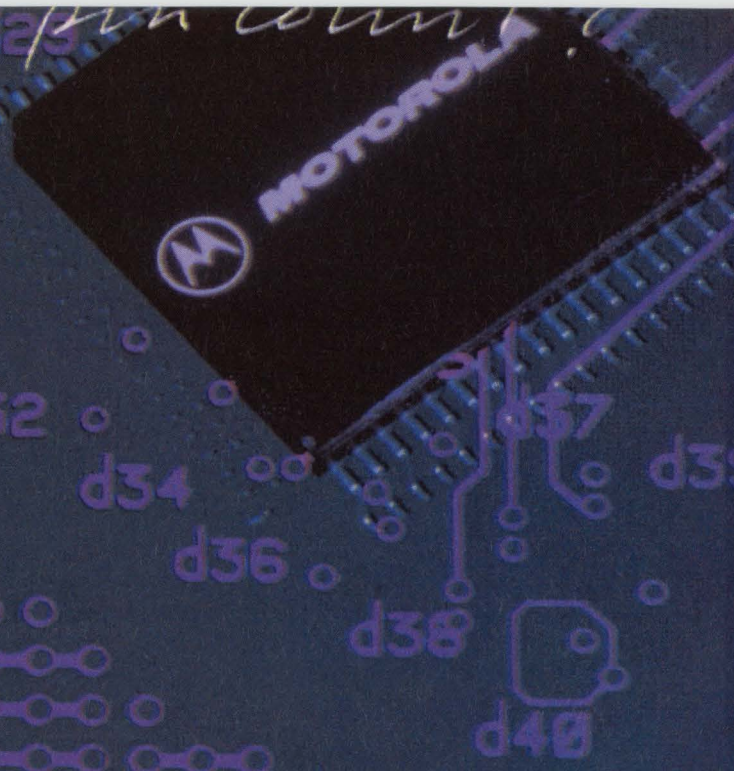

CAN IT DIGITIZE HIGH-FREQUENCY WAVEFORM

Can it do scan testing?

signal technology, Teradyne had to pass a few tests.

With the A500, Motorola had the ability to digitize waveforms at 20 MHz, plus the high pin count necessary to guarantee that their ISDN U-Interface worked the way it was supposed to.

Best of all, the A500's full tester simulation and powerful IMAGE™ software provided the design flexibility and rapid debugging Motorola needed to deliver defect-free parts on time.

"The A500 gave us the resources we needed, in one place, to be able to have a functioning test program very quickly – at least two to three times faster than any other test system. This type of support is just what we need to get our complex circuits, such as the U-Interface transceiver, to the marketplace ahead of the competition."

Operations Manager

To Motorola, delivering Six Sigma quality is not just a promise. It's a way of doing business. And it's a test that must be passed by suppliers as well.

To see how our A500 family of test systems can help you deliver quality, call Beth Sulak at (617) 482-2700, ext. 2746.

Or call your nearest Teradyne sales office, or write: Teradyne, Inc., 321 Harrison Ave., Boston, MA 02118.

TERADYNE

LCD Proto Kit

Everything you need to start your LCD application ... create complex screens in just a few hours!



240 x 64 pixel Supertwist LCD mounts directly onto CYB003 prototyping board.

Kit provides serial interface to IBM PC for quick prototyping. Board also supports displays up to 240 x 128 pixels.

Interface to 6 soft keys or 4 x 4 key matrix.

Dial 0-25k ohms for LCD contrast.

Wirewrap area for custom circuitry or back-light.

* The CY325 LCD Windows Controller provides parallel or serial high-level control of instrument-size LCDs. Up to 256 built-in windows support window-relative text, bargraphs, waveforms, and plots. Text and graphics are maintained in separate planes, facilitating special effects. Complete User Manual included.

RJ 11 serial jack for Rx/D, Tx/D, CTS, and GND, plus 2 spares.

5 Pin Power DIN. Alternate Power Connector.

Add your own 8051 CPU for stand alone operation.

Kit also includes:

Power supply provides +5v and Gnd for board, -12v for LCD, and +12v spare.

Sample routines in 8051 Assembler and QuickBasic.

LCD Paint™ for creating your own graphics images.

4-wire RJ11 style cable with DB25F connector for your IBM PC.

Demo routines preprogrammed into 8751 for immediate gratification.

\$495 - Kit
Popular LCD Starter Kit.



(\$595 pre-assembled & tested)

*The CY325 40-pin CMOS LCD Controller IC is available from stock @ \$75/singles, \$20/1000s (Surface mount also avail in qty.)

CyberneticMicroSystems

Box 3000 • San Gregorio CA 94074
Tel: 415-726-3000 • Fax: 415-726-3003

SIGNALS & NOISE

Reader swears by the Mac

Gosh, isn't it wonderful that Jon Titus has joined the 1990s (EDN, October 11, 1990, pg 49)? He has discovered that people want to be able to use a computer, not hack with it. He's all blown away to find that the PC community, with the introduction of the painfully slow Windows 3.0, is almost to the stage where Macintosh was in 1984.

One very worthwhile thing to come from the introduction of Windows 3.0 is that it has forced Apple to introduce lower-cost versions of the Mac. Note, though, that the lowest priced Mac has all the operating features of a PC with Windows, without the extra cost of a monitor, VGA card, and mouse. All these are included in the Mac price. I started using DOS-based machines and cursed the awkward interface. Then I found the Mac and have never looked back. Go for the real thing.

*J Thomas Baylor, PE
San Diego, CA*

(Ed Note: I would have been more impressed if Apple had made a commitment to an open bus and had encouraged more engineering and scientific applications.)

Engineers' salaries should be "professional"

There has been a lot of talk about engineers' salaries. I've always thought of an engineer as a professional that society puts in the same class as lawyers and doctors. Society believes that professionals (lawyers, doctors, and engineers) are paid the most, but this is not the case.

Perhaps the engineering profession has been stepped on through ignorance. Engineers' salaries cannot even approach lawyers' and doctors' salaries. Even some grade-school teachers with 5 years' experience are making more money than an average engineer with 5 years'

experience (and engineers have to work all year long).

You'd think that the hard work that engineers do in obtaining their education and keeping up with the pace of technology would be rewarded with a generous salary. The people who design a product (and who are essentially responsible for it) should be paid the most, not a salesman who goofed off through the college years (and landed his job because of his personality).

Salesmen, in fact, can generally set their own hours and adjust their schedules as they see fit, yet they still earn a higher dollar amount through commissions and sales than the average engineer. Shouldn't the engineer who designed the features of the product get a part of this commission? Actors and singers get royalties from their work for years after—why shouldn't engineers?

I think it's time to think of the importance of attracting good engineers by rewarding them with more than just a pat on the head for a job well done.

*Name withheld by request
Aiken, SC*

TMW also sponsors "Test Engineer" award

In Dan Strassberg's editorial "Support your local test engineer" (EDN, January 21, 1991, pg 57), he inadvertently overlooked Test & Measurement World's (TMW's) role as an ongoing co-sponsor of the Test Engineer of the Year award, along with John Fluke Mfg Co Inc. EDN, which is a sister publication of TMW magazine, apologizes for the oversight.

Reader catches errors and omissions

I'd like to bring to your notice some mistakes in illustrations for the article, "AC-driven bridge circuits suit specific applications" (EDN, November 8, 1990, pg 235). In Fig Ab,

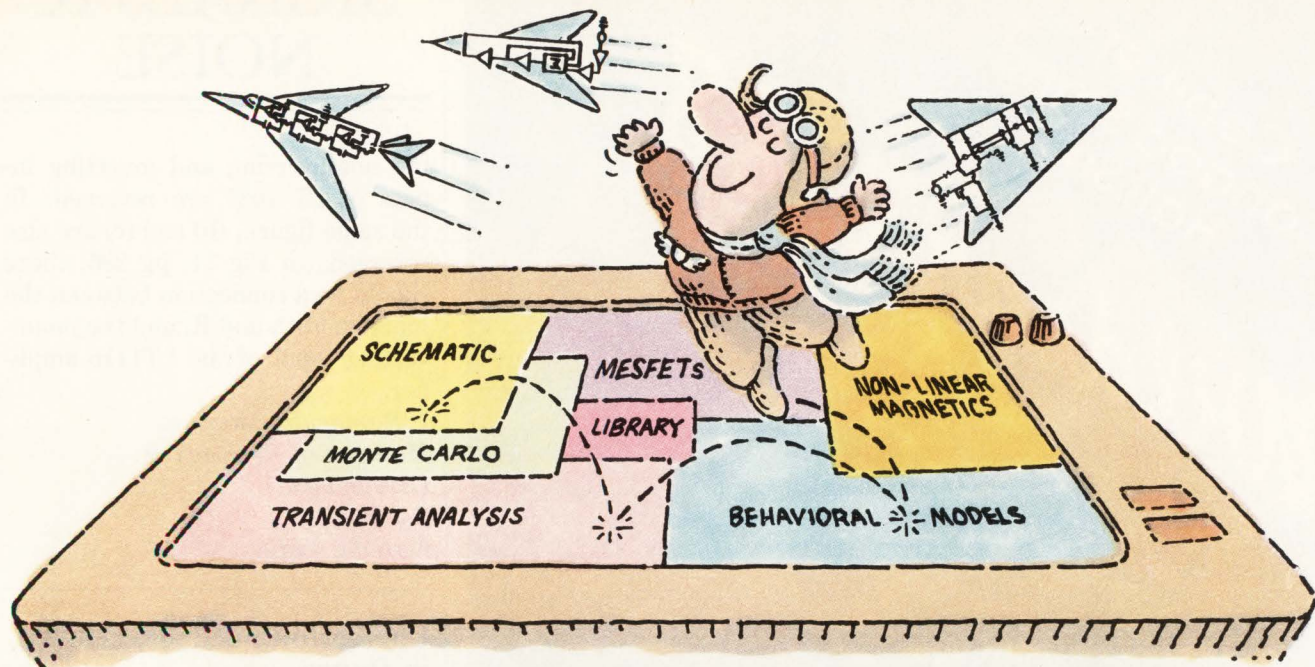

THE NEW MICRO-CAP III.TM SO YOU CAN TEST-FLY EVEN MORE MODELS.

It wasn't easy. But we did it. Made the long-time best-selling IBM® PC-based interactive CAE tool even better.

Take modeling power. We've significantly expanded math expression capabilities to permit comprehensive analog behavioral modeling. And, beyond Gummel Poon BJT and Level 3 MOS, you're now ready for nonlinear magnetics modeling. Even MESFET modeling.

Analysis and simulation is faster, too. Because the program's now in "C" and assembly language. That also means more capacity — for simulating even larger circuits.

As always, count on fast circuit creation, thanks to window-based operation and a schematic editor. Rapid, right-from-schematics analysis — AC, DC, fourier and transient — via SPICE-like routines. The ability to combine digital/analog circuit simulations using integrated switch

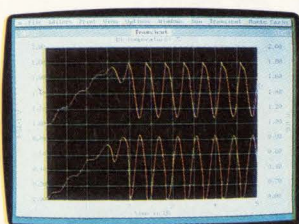

Transient analysis

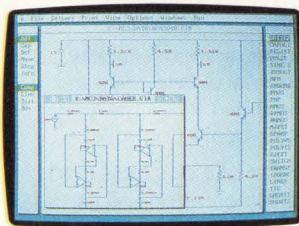

Schematic editor

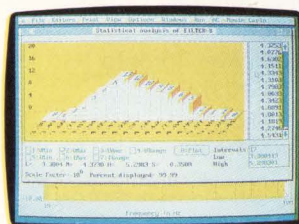

Monte Carlo analysis

models and parameterized macros. And stepped component values that streamline multiple-plot generation.

And don't forget MICRO-CAP III's extended routine list — from impedance, Nyquist diagrams and BH plots to Monte Carlo for statistical analysis of production yield. The algebraic formula parsers for plotting virtually any function. The support for Hercules, CGA, MCGA, EGA and VGA displays. Output for plotters and laser printers.

Cost? Still only \$1495. Evaluation versions still only \$150. Brochure and demo disk still free for the asking. Call or write for yours today. And see how easily you can get ideas up and flying.

spectrum

1021 S. Wolfe Road
Sunnyvale, CA 94086
(408) 738-4387

SIGNALS & NOISE

the noninverting and inverting inputs of LT 1037 are reversed. In the same figure, (b) and (c) are also reversed. In Fig 11, pg 236, there should be a connection between the junction of C_1 and R_1 and the noninverting input of the LT1115 amplifier.

*V Ramasubramaniam
Manager of Research &
Development
Systronics
Naroda, India*

Correction needed in figure

I generally don't write about things in magazines, but just can't help pointing out an error in Fig A (EDN, November 8, 1990, pg 235). The pentode vacuum tubes are actually shown in (c), not (b), as indicated. Maybe it was the use of the tube symbol that caught my eye.

*Robert A Judd
Design Engineer
Watlow Controls
Winona, MN*

IT'S EASY TO HAVE YOUR SAY

EDN's Signals & Noise column provides a forum for readers to express their opinions on issues raised in the magazine's articles or on any topic that affects the engineering industry. You can use one of several easy ways to reach us. First, there's always the mail. Send your letters to Signals & Noise Editor, EDN Magazine, 275 Washington St, Newton, MA 02158. Or, send us a message via MCI mail at EDNBOS. Finally, EDN's bulletin-board system is ready for use—and it's free (except for the phone call). You can reach us at (617) 558-4241 and leave a letter in the EDITORS Special Interest Group. You'll need a 2400-bps or less modem and a communications program that is set for eight data bits, no parity, and one stop bit, or 1200/2400, 8N1 in shorthand.

EDN

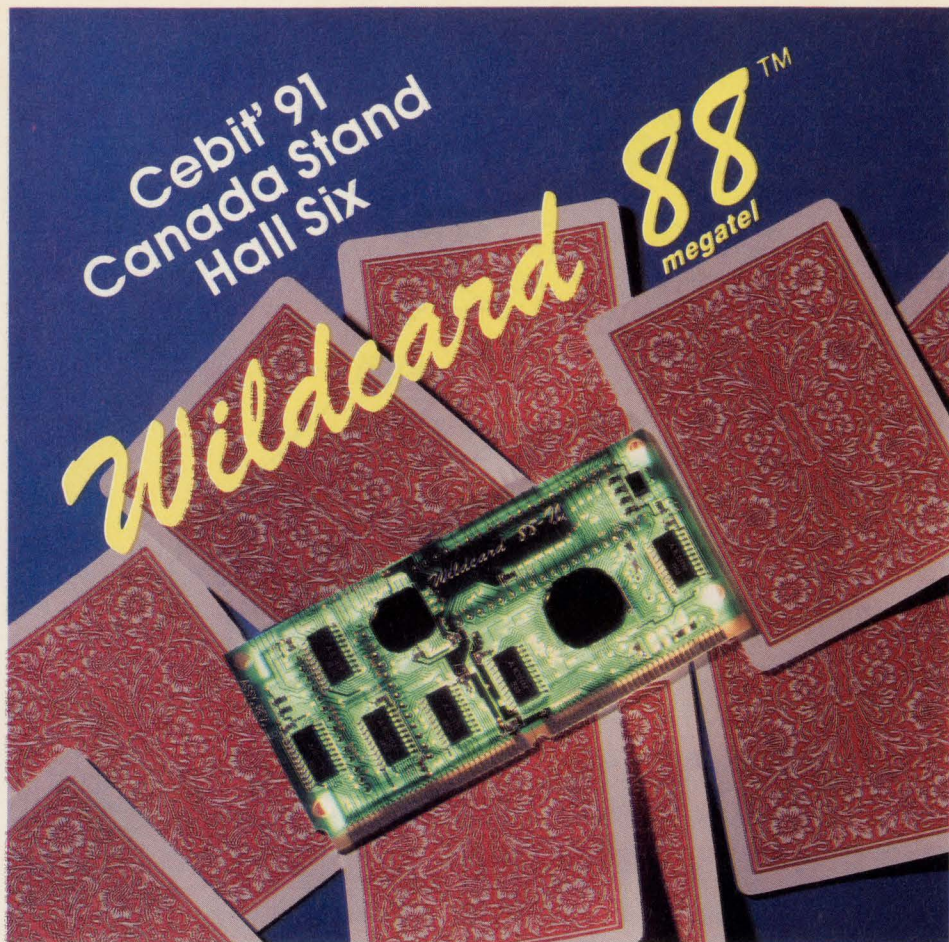

Count yourself in with the Wildcard 88™

- Supports XT Turbo mode CPU clock speeds of 4.77, 7.15 and 9.54 MHz
 - 10 MHz CPU clock frequency
 - Supports up to 32K Bytes of onboard BIOS EPROM
 - Small 2" x 4" form factor
 - Bios available for easy integration
 - Onboard DRAM controller for easy system design
 - Onboard bus controller supports XT I/O channel
 - Supports 8087 co-processor operation (with socket) for high speed numeric data processing
 - Reduces XT parts count by 75%
 - Supports up to 640K of system DRAM
 - Onboard sound generator supports speaker control
 - Improves total system reliability
 - Reduces overall system costs and factory overhead
 - Onboard Keyboard Controller card the size of a business card.
- For more information call us today.

Megatel Computer Corporation

125 Wendell Ave., Toronto,
Ontario M9N 3K9
(416) 245-3324
FAX (416) 245-6505

Wildcard 88™ is a trademark of Megatel Computer Corp.
IBM PC, XT are registered trademarks of IBM Corp.

Megatel is expanding the Wildcard family to offer you more development flexibility.

The Wildcard family offers the lowest cost, smallest footprint solution for your XT class system. It integrates all functions of the IBM PC, XT® motherboard minus DRAM and DRAM drivers. All on a circuit

—megatel—

Our Versatec plotters are years ahead of the competition.

They always have been.

And now our plotters offer another unmatched feature: the Xerox Total Satisfaction Guarantee. It guarantees your complete satisfaction for three years — three times longer than any other manufacturer. And only you decide when you're satisfied.

That's how confident we are about our entire line of plotters, including Turbo CADmate™, our affordable, high performance wide-format electrostatic plotter; the 8900 Series high performance electrostatic color plotter featuring unattended operation; and the 8836 II Laser, the industry's most popular wide-format plain paper plotter.

All Versatec plotters are covered by this exclusive guarantee. There are no catches. No fine print.

Here it is in plain English:

"If you are not satisfied with your Xerox equipment, at your request, Xerox will replace it without charge to you with an identical model or a machine with comparable features and capabilities.

"This Xerox Total Satisfaction Guarantee applies to Xerox equipment acquired by you from Xerox and continuously maintained by Xerox or its authorized representatives under our Manufacturer's Warranty or a Service Contract."

Now that's simply the best warranty you can get. No ifs, ands or buts about it. After all, you'd expect nothing less from Xerox Engineering Systems. The world's largest supplier of engineering copiers, Versatec printers and plotters.

So, for more information, call us at 800-538-6477.

In California, 800-341-6060. Or go ahead and buy your Versatec plotter today. You'll still have a few years to think it over.

Xerox Engineering Systems

2710 Walsh Ave., Santa Clara, CA 95051
Xerox is a trademark of Xerox Corporation. Versatec and Turbo CADmate are trademarks of Versatec, Inc.

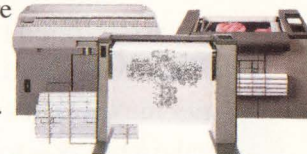

CIRCLE NO. 93

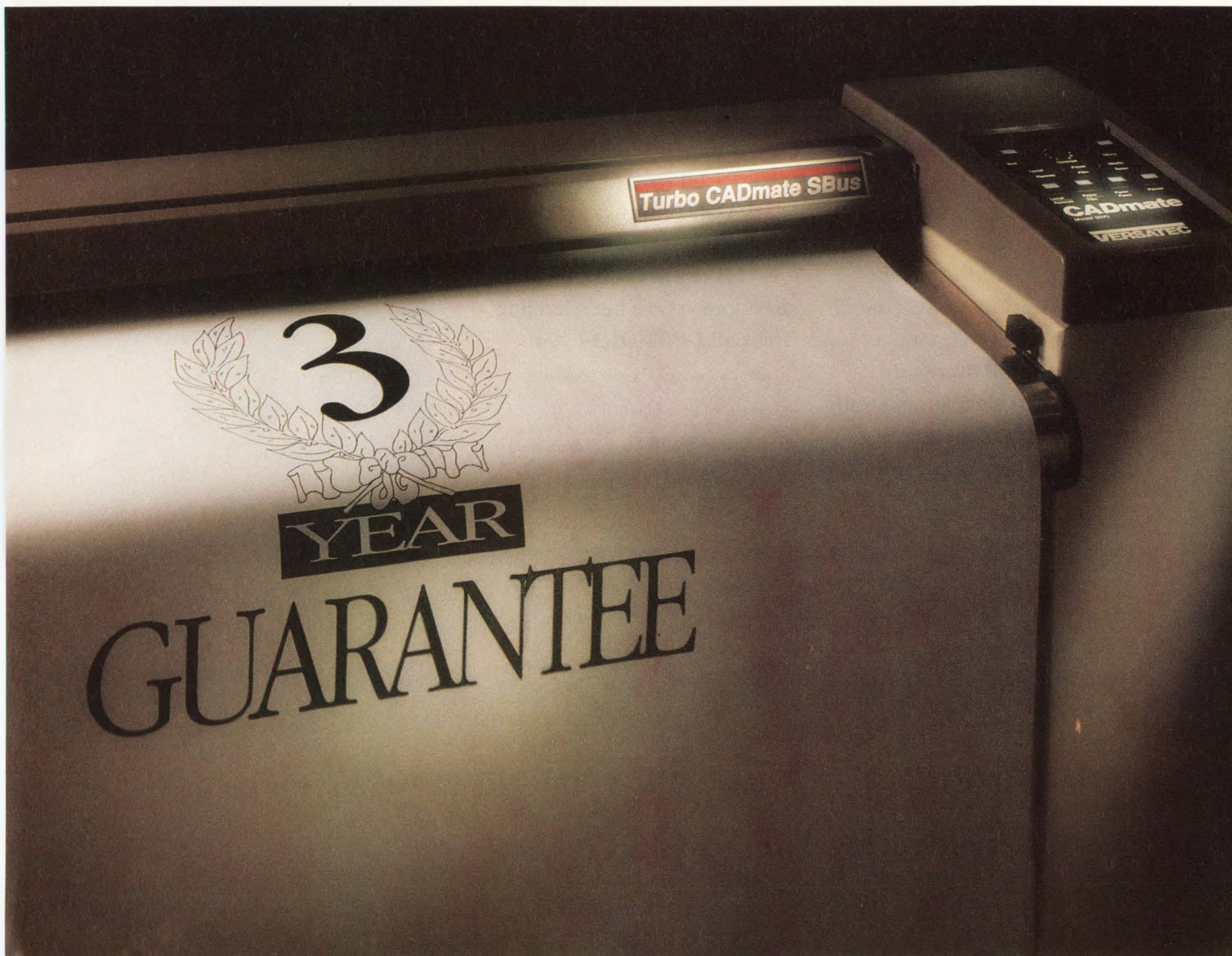

Boxed In by Proprietary

Break Out with Oki

If you're trapped trying to design ASICs with vendor-specific tools, it's time to make a break—for Oki.

Because at Oki, we take a "customer-friendly" approach to ASIC design by supporting the range of industry-standard tools you're used to working with.

Verilog, for example, is our in-house simulator, providing high-quality customer-to-Oki and Oki-to-customer design interface. So you enjoy shorter design and verification cycles and the assurance that your design will work.

Is your ASIC design platform workstation- or PC-based? No matter. With Oki, you get across-the-board hardware, software, and operating system support for DAZIX, Mentor, Valid, Viewlogic, and others.

Just choose the environment you're familiar with, and start designing. There's no relearning effort required.

If you're ready to escape the limitations of vendor-favored tools, Oki is ready to set you free—with complete design support: 24-hour, fully-equipped, state-of-the-art design centers. Customer-compatible tools. A true 0.8 μ m drawn family of SOGs for next-generation products. Industry-standard JEDEC metric packages. Data books, design guides, and more.

Make a break for the design freedom you've been longing for. Call **1-800-OKI-6994**.

Apollo, Cadence, DAZIX, DEC, Digital, DNIX, DOMAIN, GED, HP, IDEA, LOGICLAN, Mentor Graphics, PC-DOS, RapidSIM, Sun, Sun OS, Synopsys, ULTRIX, Valid, ValidSIM, Verilog, Viewlogic, and Workview are trademarks of others.



Transforming technology into customer solutions.

ASIC Tools?

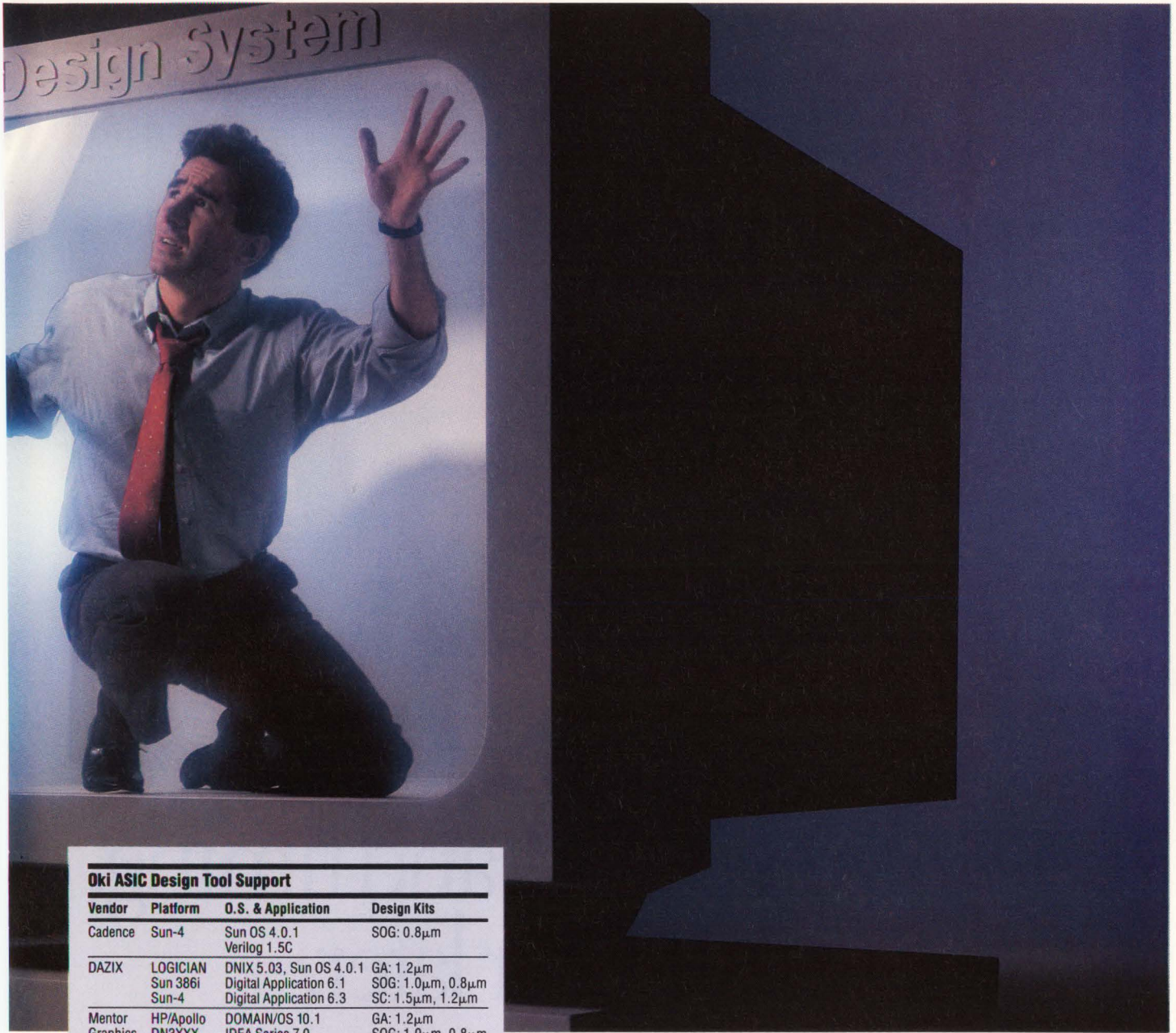

Oki ASIC Design Tool Support

Vendor	Platform	O.S. & Application	Design Kits
Cadence	Sun-4	Sun OS 4.0.1 Verilog 1.5C	SOG: 0.8 μ m
DAZIX	LOGICIAN Sun 386i Sun-4	DNIX 5.03, Sun OS 4.0.1 Digital Application 6.1 Digital Application 6.3	GA: 1.2 μ m SOG: 1.0 μ m, 0.8 μ m SC: 1.5 μ m, 1.2 μ m
Mentor Graphics	HP/Apollo DN3XXX DN4XXX	DOMAIN/OS 10.1 IDEA Series 7.0	GA: 1.2 μ m SOG: 1.0 μ m, 0.8 μ m SC: 1.5 μ m, 1.2 μ m
Synopsys	Sun-4	Sun OS 4.03 *Interface to Mentor, Valid, Viewlogic	SOG: 1.0 μ m, 0.8 μ m
Valid	Sun-4 Sun-3	Sun OS 4.0.1 GED, ValidSIM, RapidSIM	GA: 1.2 μ m SOG: 1.0 μ m, 0.8 μ m SC: 1.5 μ m, 1.2 μ m
	DEC Station 3100	ULTRIX ValidSIM GED	GA: 1.2 μ m SOG: 1.0 μ m, 0.8 μ m SC: 1.5 μ m, 1.2 μ m
Viewlogic	Sun-4	Sun OS 4.0.3 Workview 4.0	GA: 1.2 μ m SOG: 1.0 μ m, 0.8 μ m SC: 1.2 μ m
	PC386	DOS 3.3 Workview 4.0	GA: 1.2 μ m SOG: 1.0 μ m, 0.8 μ m SC: 1.2 μ m



OKI
Semiconductor

785 North Mary Avenue
Sunnyvale, CA 94086-2909

FLUKE®



All logic analyzers give you integrated state and timing, sooner or later.

Why not now?
Introducing the new Philips PM 3580 family of logic analyzers from Fluke: the first instrument architecture to give you state and timing together on each channel—with a single probe.

Connect the probe to your board for state and you're automatically hooked up for timing. Or vice versa.

This means no more dual probing—a pain anytime and the source of loading problems—and no reconfiguration between state and timing. Which makes

A basic comparison. Record all state and timing data on an 8-bit microprocessor with multiplexed bus, 8-bits for address, 3 control signals and a clock.	HP 1654B	Tek PRISM/MPM	Philips PM 3580/30
Probing:			
Channels used	48 ¹	48 ²	20
One connection	No	No	Yes
Setups	Two	Two+	One
Interfaces to learn	Two	Two+	One
Integrated state & timing triggering	No, only one arming condition	No, only indirect 4-bit Teklink	Yes, 8 levels
State & timing data per pin	No	No	Yes
Price	\$6700	\$8600	\$4250
<small>Footnotes:</small>	1) 8 channels lost to de-multiplexing 2) De-multiplexing requires double probing and only nine high-speed channels on basic unit		

these analyzers simple to learn and use.

Plus, the pop-up menus and keyboard shortcuts guide you quickly through setup and data analysis. No matter if you use it every day or once a year.

What's more, capturing an elusive bug has never been easier with eight unrestricted trigger levels that let you select from state and



PHILIPS

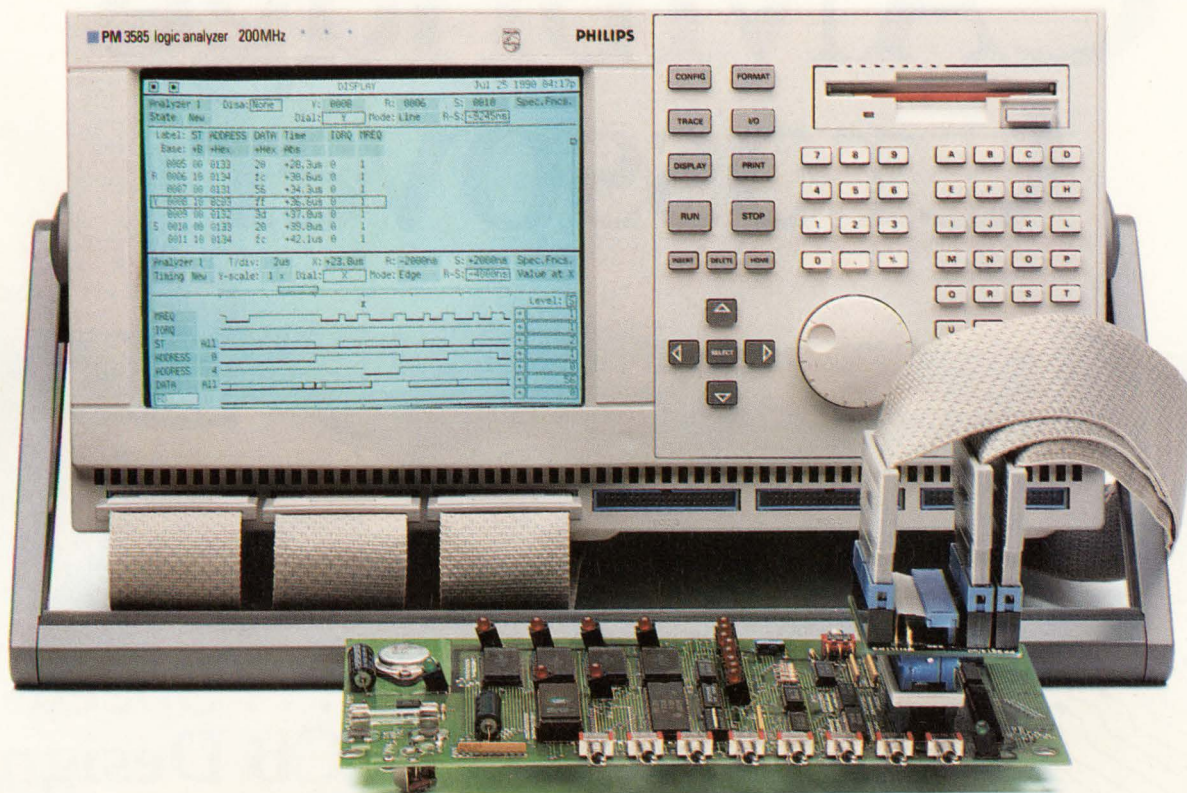

Why not sooner?

timing trigger conditions on each level.

But being simple doesn't mean simplistic. Basic performance of the PM 3580 family ranges from 32 to 96 channels, each with 50 MHz state and up to 200 MHz timing, plus 3 nanosecond glitch capture and 2K of memory per channel. For 8-, 16- and 32-bit processors.

And you get all this for nearly half the cost of comparable analyzers.

We'd like to send you a video. Or show you how to make state and timing measurements at your workplace—

in 30 minutes or less.

We'll even bring the stopwatch so you can time us. And you can keep it to time the competition.

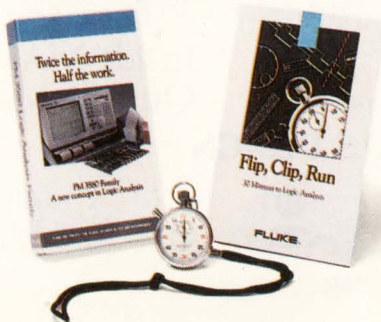

So call us today at **1-800-44-FLUKE**.
Ask for extension **720**.

Because sooner is better.

John Fluke Mfg. Co., Inc., P.O. Box 9090, M/S 250C, Everett, WA 98206-9090, U.S. (206) 356-5400. Canada (416) 890-7600. Other countries: (206) 356-5500. © 1990. All rights reserved. Ad No. 00001.

FAST ANSWERS.

FLUKE®

The CAMbridge Crossover

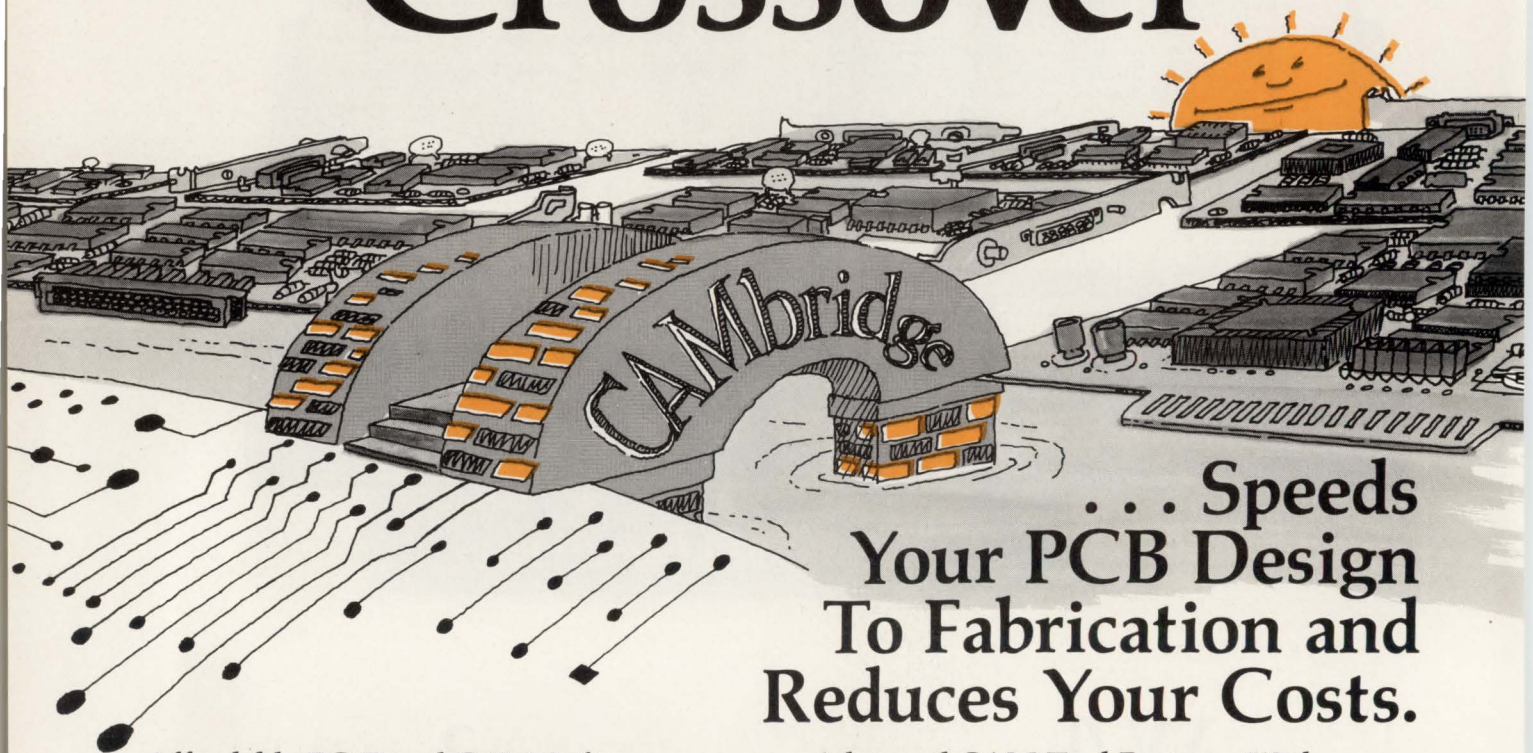

... Speeds
Your PCB Design
To Fabrication and
Reduces Your Costs.

Affordable PC-Based CAM Software That Bridges The Gap Between PCB Design and Fabrication

CAM-bridge™ provides the PCB designer, service bureau and fabrication house a complete set of high performance CAM tools designed to eliminate user fatigue, omit time-consuming replots, allow prototype without photoplotting, uncover design and house-keeping errors, and insures successful preparation of artwork to meet manufacturing requirements.

An Ideal Companion For Your CAD System

PADS-PCB™, PADS 2000™, ORCAD/PCB II™, RACAL REDAC™, FUTURENET™, CALAY™, PCAD™, PROTEL™, TANGO™, MENTOR™, VALID™, COMPUTERVISION™, CADNETIX™, SCICARDS™, EEDESIGNER™ and more...

Advanced CAM Tool Features With Workstation Performance

- Editor/Viewer/Design Builder/Import of aperture lists
- Quick check plots on LaserJET, BubbleJET, InkJET and Dot Matrix printers
- Full panelization with automatic thieving, venting, film mounting, step & repeat, polygon fill, and more...
- Extremely FAST Design Rule Checking
- NC drill output
- Format conversion for GERBER, HPGL, DMPL, DXF, EXCELLON, POSTSCRIPT and more...

FREE DEMO DISK CALL:

Inside MA: 617-621-7101

Outside MA: 800-825-7051

ALS DESIGN

USA HQ
One Kendall Square, #2200
Cambridge, MA 02139



CIRCLE NO. 76

EUROPE HQ
38 Rue Fessart, 92100 Boulogne, FR
Phone: (33) 1-46 04 30 47

EDITORIAL

Smart weapons, smart lessons



As a member of the electronics industry, I'm particularly pleased that intelligent weapons such as the Tomahawk cruise missile, Patriot air-defense missile, and laser-guided bombs worked well at the start of the UN-coalition war against Iraq. For years, many of these smart weapons have been under scrutiny in the US Congress and the Pentagon. Unfortunately, few legislators have an engineer's perspective on thorough design or test. Congress should be on the lookout for weapons that are poorly designed and tested. Following, I've listed a few guidelines that might help. There are some lessons for all of us here:

1. Test your product under realistic and uncontrived conditions. Have disinterested people test it. Several extremely complex military weapons such as the Aegis cruisers have yet to be tested under realistically simulated battle conditions. Testing some systems involves "practice tests" that let the testers predict a system's expected performance. These test simulations are bogus, yet this testing mentality often prevails in the military. *Engineers never say, "Hey, if it works in this lab, it will work anywhere. After all, they're not going to give one of these to just any maintenance jockey."*

2. Adapt off-the-shelf products with care. They're not necessarily adaptable to all designs. When the US Army designed the Sgt York division air-defense (DIVAD) system several years ago, it specified many off-the-shelf electronic systems. Despite the fact that some of the off-the-shelf radar equipment was originally used in aircraft, it was thought that using it in the DIVAD system would save money and avoid the time needed for a new design. Unfortunately, the off-the-shelf equipment wasn't suitable for the tasks at hand. *An engineering manager would never say, "It took a lot of money to design the custom-built power supply in our El-Cheapo clone computers, so it'll work in our new line of medical instruments, too."*

3. Don't try to duplicate your competitors' successes. The DIVAD system essentially mimicked the Soviet Union's older ZSU-23/4 air-defense system which was effective years ago in Middle East combat. Times change and so do aircraft characteristics. However, as the US military designed the DIVAD system, it could never keep up with advancing aircraft maneuverability, thus defeating the system. Luckily it was canceled. *Engineers are too smart to be taken in by, "This idea will make your company into the next Apple Computer..."*

4. Put money in your budget to give your managers and sales people realistic training. Many weapons are so expensive that the troops that control them almost never have the opportunity to test fire them—even under controlled conditions. One Army outfit I knew of sponsored an annual competition to see which *one* gunner got to fire an antitank missile. *An engineering-group leader would never say, "Ok, ok, we'll send one engineer for an afternoon course on the new 250-MHz logic analyzer, then at lunch she can tell the rest of you how to use it."*

5. Don't needlessly endanger the people who use your product. Few of us would consider putting a 1000V power-supply contact on the front panel of a tester or exposing people to other avoidable hazards. I pity the troops who fire the US's TOW antitank missiles. The soldiers must remain exposed from the time they sight the missile on a target until the missile reaches its target. The blast from launching a TOW missile is a glaring target for enemy gunners. Our NATO allies have a more effective antitank system that protects the gunners. After all, if they miss their targets, they should be alive to try again. *As engineers, we've never heard, "No one would ever be stupid enough to put a screwdriver in . . . ZAP."*



Jesse H Neal
Editorial Achievement Awards
1987, 1981 (2), 1978 (2),
1977, 1976, 1975
American Society of
Business Press Editors Award
1988, 1983, 1981

Jon Titus
Editor

Send me your comments via FAX at (617) 558-4470, or on the EDN Bulletin Board System at (617) 558-4241 300/1200/2400,8,N,1.

THE WORLD'S LARGEST SELECTION OF **POWER SPLITTERS/ COMBINERS**

2 KHz to 8 GHz from **\$10⁴⁵**

With over 300 models, from 2-way to 48-way, 0°, 90° and 180°, a variety of pin and connector packages, 50 and 75 ohm, covering 2KHz to 8000MHz, Mini-Circuits offers the world's largest selection of off-the-shelf power splitter/combiners. So why compromise your systems design when you can select the power splitter/combiner that closely matches your specific package and frequency band requirements at lowest cost and with immediate delivery.

And we will handle your "special" needs, such as wider bandwidth, higher isolation, intermixed connectors, etc. courteously with rapid turnaround time.

Of course, all units come with our one-year guarantee.

For detailed specs and performance data, refer to the *MicroWaves Product Directory*, *EEM* or *Mini-Circuits RF/IF Signal Processing Handbook*, Vol. II. Or contact us for our free 68-page *RF/IF Signal Processing Guide*.

finding new ways ...
setting higher standards

Mini-Circuits

A Division of Scientific Components Corporation
P.O. Box 350166, Brooklyn, New York 11235-0003 (718) 934-4500
Fax (718) 332-4661 Domestic and International Telexes: 6852844 or 620156
WE ACCEPT AMERICAN EXPRESS

CIRCLE NO. 96

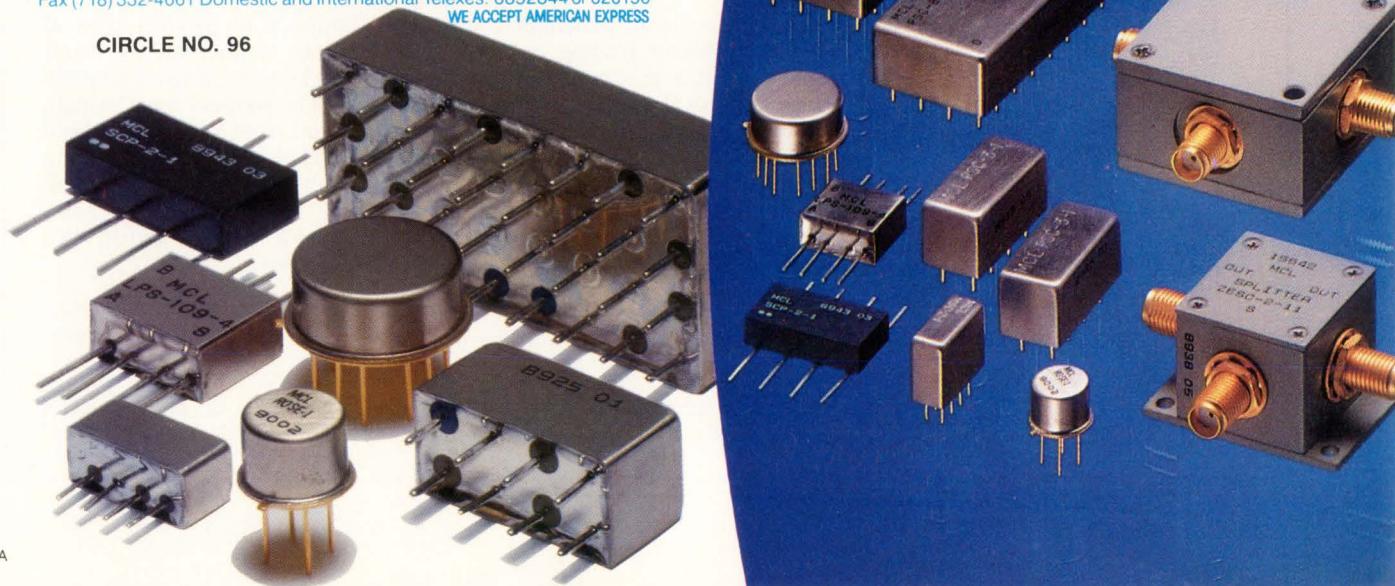

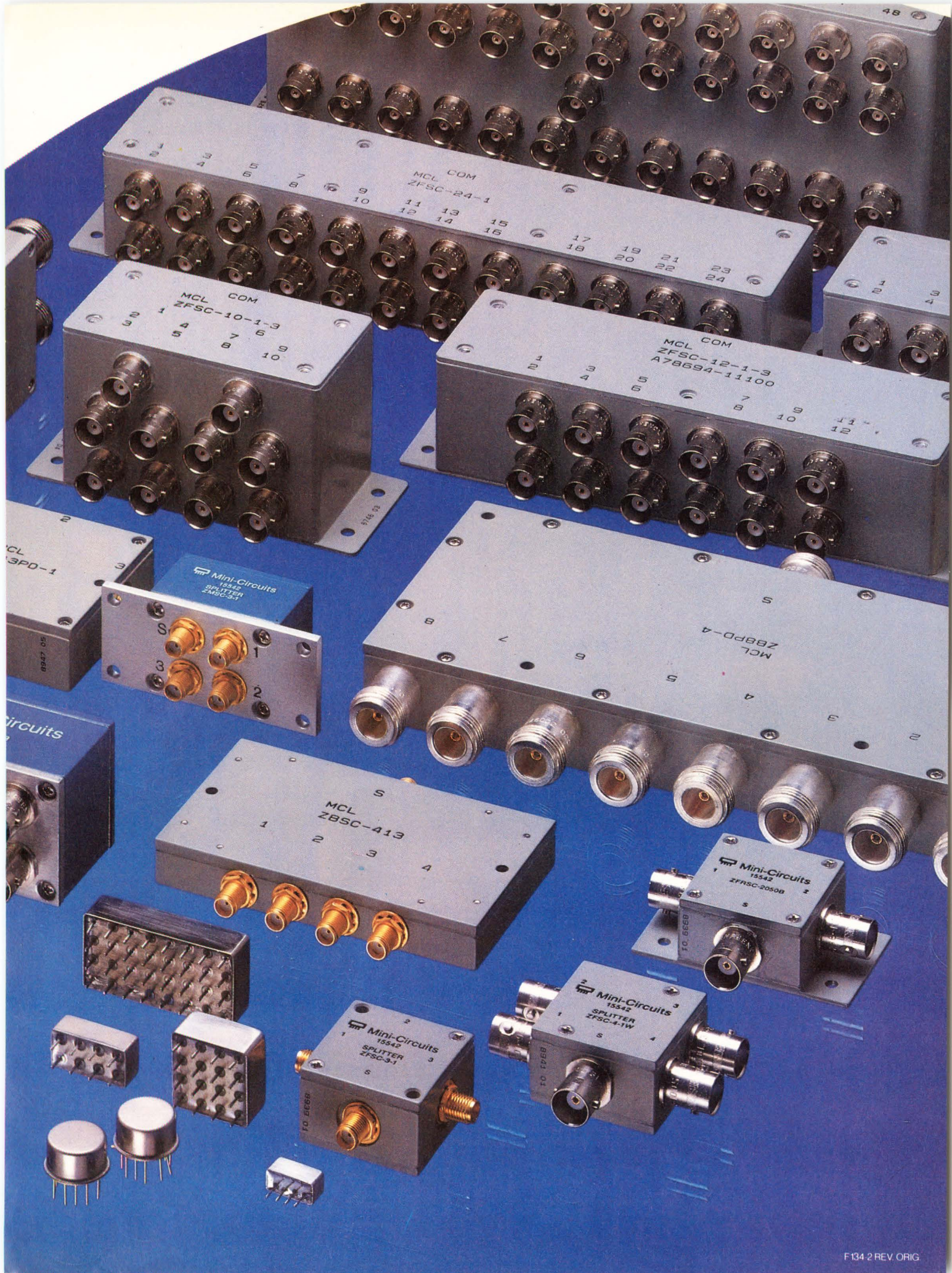



Brought to you by Motorola.

CMOS Application-Specific Standard ICs bring your ideas to life.

Are you designing advanced electronics products with a handicap? You are if you don't know all about the new Application-Specific Standard ICs from Motorola. We've added 19 new products to our already vast portfolio and we've made them easy to find—by putting them all into our new data book, along with a host of application notes and design information.

10-bit A-to-D Converters.

There's three new 10-bit A-to-D Converters which offer five to eleven channels of input with on-board S/H. These are SAR-type converters with a serial interface that permits a 8, 10 or 16-bit data transfers, making them completely SPI compatible. Reference voltages down to 2.5 volts are accommodated.

New LED Display Driver.

Motorola's newest LED Display Driver is configurable to drive individual lamps, seven-segment displays or a combination of both. Each of these cascable ICs drives five digits plus decimals. They also offer a serial interface and a variable current source to easily vary the display's brightness.

Advanced Video Circuits.

New additions to our video circuits portfolio include an Enhanced Comb Filter and Video Op Amps for video signal processing in TVs and VCRs. Our Comb Filter minimizes common comb-filter problems such as dot crawl and cross color.

As a companion to our filter, Motorola has introduced Dual Video Amplifiers. These video op amps have a

guaranteed bandwidth of 10 MHz, are capable of directly driving 150 Ohm loads and have a gain of 10 dB at 5 MHz.

Dual PLLs for cordless telephones.

Motorola Dual Phase-Locked Loop frequency synthesizers designed for cordless telephones have a maximum frequency of 60 MHz with a supply range of three to five volts. They synthesize up to 15 channel pairs.

Motorola also has a new general purpose dual PLL that's designed to interface with both VHF and UHF dual modulus prescalers.

Single-chip VHF PLL Frequency Synthesizer.

Our newest PLL device takes full advantage of the latest high performance CMOS technology to achieve frequencies of 160 to 180 MHz. It has a SPI-compatible serial interface, fully-programmable reference and VCO counters. It also touts two unique, patented features: one that allows unused outputs to be shut off to limit EMI and a jam load feature that minimizes lock times.

Remote Control at your fingertips.

Built for secure remote control, our encoder/decoder pairs allow your choice of up to 13 address bits and 4 data bits or 17 address lines to allow up to 131,072 different codes. For extra security, there's even an output which signals that incorrect codes have been received.

Select the ones that are right for you.

All of these new products, along with our complete application-specific standard portfolio, are discussed in detail in our newly-revised data book (DL 130). There's also thirteen application notes offering design tips and assistance. But best of all, the book is free. To get your copy, just complete and return the coupon below or write to Motorola on your company letterhead.



MOTOROLA

To: Motorola Semiconductor Products, Inc., P.O. Box 20912, Phoenix, AZ 85036
Please send me my copy of the *Motorola CMOS Application-Specific Standard ICs Databook*.

478EDN031491



Name _____
Title _____
Company _____
Address _____
City _____
State _____ Zip _____
Call me (_____) _____



The secret to better Ethernet is NICE. And simple.

Introducing NICE™. The new MB86960 Network Interface Controller with Encoder/Decoder from the Advanced Products Division of Fujitsu Microelectronics.

With the unveiling of NICE, Ethernet LAN technology reaches a new level of integration.

Now LAN system designers can have an Ethernet controller, buffer management unit and 10 Mbit per second Manchester encoder/decoder on a single chip. So you can now develop high-performance LAN boards more cost effectively than ever before.

For instance, design adapter cards for high-performance buses using just two Ethernet chips instead of the usual three. Simply combine NICE with our new MB86962 10BASE-T transceiver, the most advanced solution for twisted-pair needs. Or choose our MBL8392A if you need a coax interface.

And used with our MB86953 PC Bus Interface Unit, NICE can further reduce costs and complexity when developing



PC XT/AT® adapter cards. Replacing the need for up to ten separate parts.

All in all, NICE has some impressive features to enhance your LAN's entire performance. Such as a data bus transfer rate of 20 Mbytes per second. A low-power standby mode. And bus compatibility for most standard microprocessors.

But what's really nice is our understanding of the marketplace. As Fujitsu's American arm, we know what it takes to get you there a lot faster. With greater cost effectiveness.

So now that the secret is out, call us at 1-800-866-8608. And discover NICE. The world's most advanced, highly-integrated Ethernet solution.

FUJITSU

Delivering the Creative Advantage.

NICE is a trademark of Fujitsu Microelectronics, Inc. XT and AT are trademarks or registered trademarks of IBM Corp. © 1991 Fujitsu Microelectronics, Inc. FUJITSU MICROELECTRONICS, INC., Advanced Products Division. 77 Rio Robles, San Jose, CA 95134-1807.

CACHE-COHERENCY PROTOCOLS

Protocols keep data consistent



Maintaining data consistency in numerous cache RAMs operating on a shared-memory bus can give a system designer a headache. Some well-defined cache-coherency protocols can keep these headaches from becoming migraines.

*John Gallant,
Associate Editor*

Interconnecting multiple processors on a shared-memory bus poses the problem of cache coherency. Because any self-respecting processor has its own cache memory these days, the designer must ensure that multiple caches and the global memory residing on the same bus have a common perception of the data at a particular memory location. This issue has spawned a variety of hardware-based schemes to maintain consistent data when more than one processor requires access to the same database. These schemes include the write-through, MOESI, MESI, and central-directory cache-coherency protocols.

IBM introduced the cache memory in the 3070 mainframe computer in 1973. A cache is much smaller and faster than main memory and temporarily holds replicas of certain main-memory addresses. Caches are essentially a com-

promise way of obtaining an inexpensive zero-wait-state memory when the main memory is slower than the CPU. Since 1973, μ P design has concentrated on attaining faster operating speeds; dynamic-RAM design has concentrated primarily on achieving higher densities.

Because the speed gap between the μ P and main memory continues to widen, a local cache RAM has become practically a necessity in high-performance systems. In fact, many highly integrated μ Ps, such as Motorola's 68030 and 68040 and Intel's 80486 and i860, incorporate a cache controller and a cache RAM on chip.

A cache miss causes problems

Fig 1 shows a typical multiprocessor system that is tightly coupled to a shared global memory via a high-speed bus. Most of the time, each CPU operates on the data in its local cache. How-

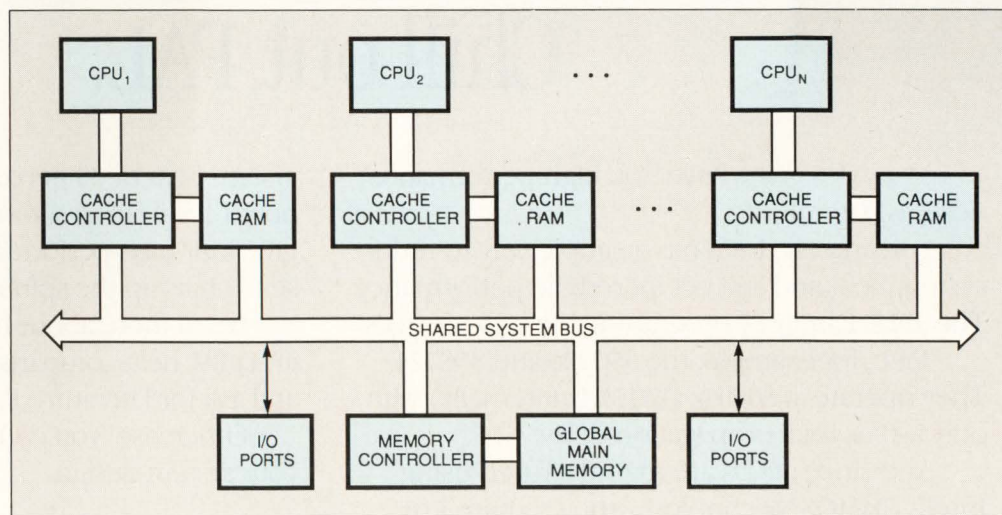
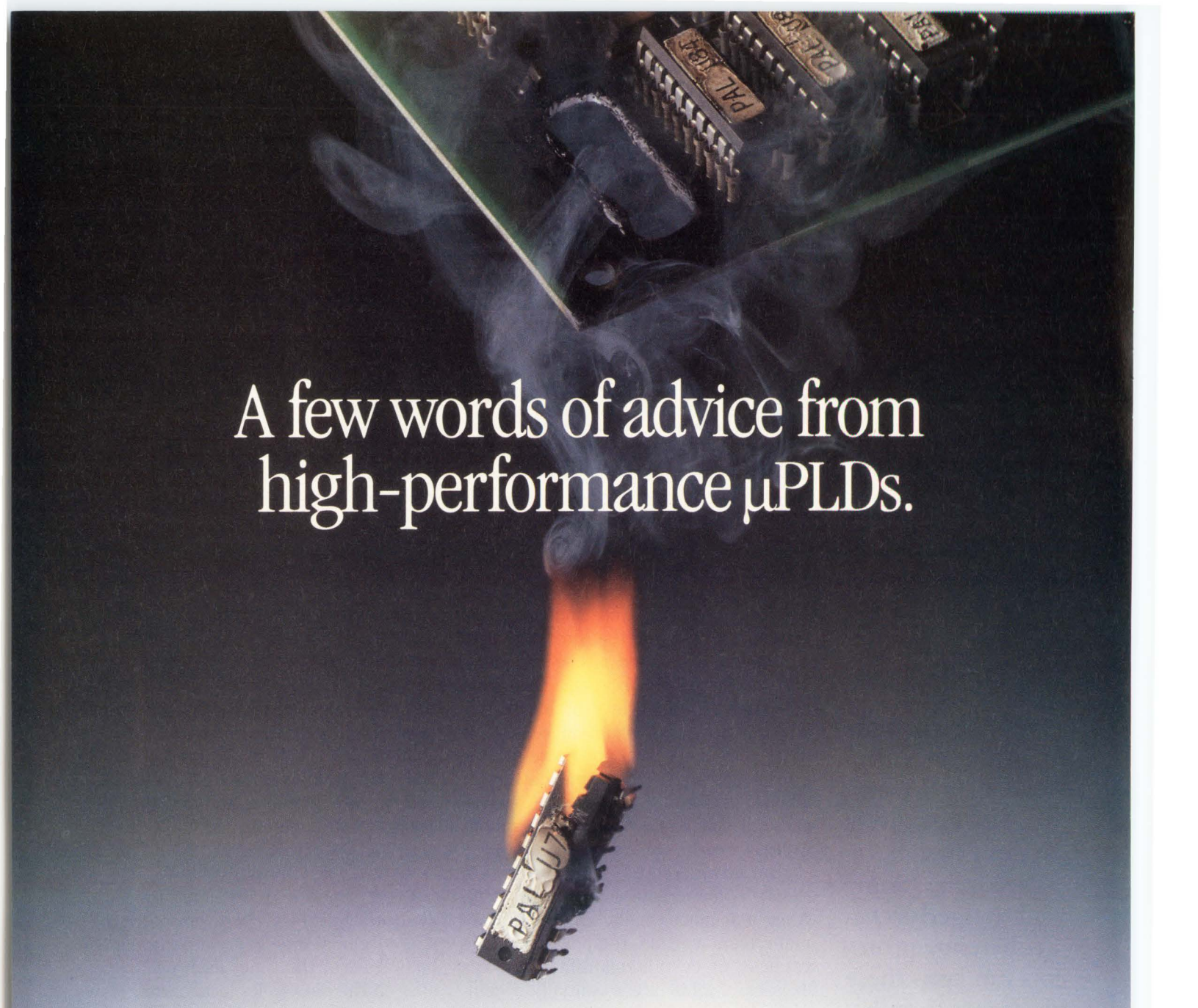

Fig 1—A tightly coupled multiprocessor connects n CPUs and their local cache RAMs to the global main memory via a wide-bandwidth system bus.



A few words of advice from high-performance μ PLDs.

Chill out, PAL.

Many designers have hot, high-performance designs. Literally.

Fortunately, Intel has a simple way to reduce system heat and still get incredible performance. The μ PLD Family of programmable logic devices.

Take, for example, the 85C220 and 85C224. They operate at 80MHz (100 MHz internally) with only a 10ns total propagation delay.

And since μ PLDs are manufactured using Intel's CHMOS* technology, they require just 1/4 the power of their pin-compatible bipolar PAL* alternatives. Which means they can lower

system heat by 35 percent and help reduce board-level failures, too. So they're certain to give your high-performance system a boost. And send chills up the spine of your motherboard.

Learn more about Intel μ PLDs and receive a μ PLD/PAL heat comparison. Call (800) 548-4725 and ask for Literature Packet #1A28.

Otherwise, you could take some heat over your system design.



TECHNOLOGY UPDATE

Cache-coherency protocols

ever, when a CPU attempts a read or a write to an address that isn't in its local cache—an occurrence called a cache miss—the CPU's arbitration logic must arbitrate for control of the bus so the cache RAM can access the data from the main memory.

A problem arises when several copies of the data at that address exist in the local caches of different CPUs at the same time. Because any CPU can modify the data in its local cache RAM, the main memory may not contain the most up-to-date copy of the data. A trivial method of ensuring that the requesting CPU obtains the most-recent data is to have sections of memory that more than one CPU share reside in main memory only—not in any of the local caches. Although implementing this method is simple, system designers generally don't employ the method because it results in inefficient multiprocessing.

A write-through cache-coherency protocol is also relatively simple to implement but can be effective when only a few medium-perform-

ance CPUs, such as 68010 or 80286 μ Ps, are on a wide-bandwidth bus. Note that in this article, a policy refers to the method a cache controller employs to update main memory whenever the CPU modifies data in the local cache RAM. A protocol refers to a procedure a system uses to maintain consistent data in the caches and the main memory. Note also that there are both a write-through policy and a write-through protocol.

The write-through protocol requires that the cache controller assign a 1-bit attribute to each line in its local cache RAM. A line is a block of data having contiguous addresses; the attribute identifies whether the line is valid or invalid. If a line is valid, a CPU can read or write to that line; if a line is invalid, the CPU must access the main memory.

In the write-through policy, which works in conjunction with the write-through protocol, the cache controller transfers a line to its local cache RAM from main memory whenever a cache miss occurs on a

read operation. A cache controller updates its local cache on a valid cache hit and the main memory every time a CPU issues a write command. The memory controller queues the write requests, which lets the CPU continue without waiting for the end of the write cycle.

For the write-through protocol to work, each cache controller must monitor the address bus whenever a CPU writes to main memory. If the cache controller determines that the write address corresponds to an address in its local cache RAM, the controller must invalidate the line containing that address. Thus, only the cache RAM containing a line with a valid attribute and the main memory contain up-to-date copies of the data. A cache with an invalid line must access main memory to obtain a valid copy of the data.

Because the write-through policy generates lots of bus traffic, a system bus using the write-through protocol can easily become saturated when multiple high-performance μ Ps share a memory bus with-

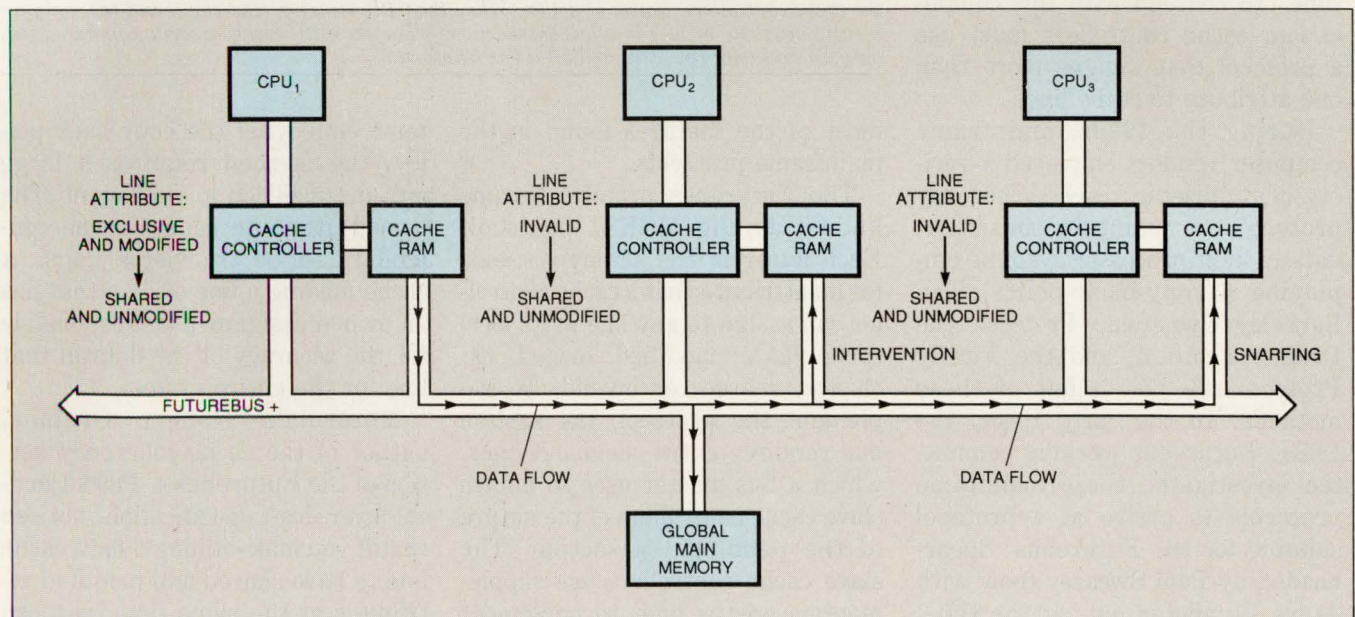

Fig 2—The Futurebus+ MESI protocols minimize system bus traffic. Here, CPU₂ issues a read to an invalid line in its local cache. Because CPU₁'s local cache has an exclusive and modified copy of the line, CPU₁ intervenes in the transaction. At the same time, CPU₃'s cache snarfs the data to obtain a shared and unmodified copy of the line.

TECHNOLOGY UPDATE

Cache-coherency protocols

out sufficient bandwidth. In fact, the 40M-byte/sec VMEbus, which can implement the write-through protocol using its location monitor, saturates when just two 68030s having 64k-byte second-level local cache RAMs have common access to the bus's main memory, according to Motorola's Robert Greiner.

Cache controllers that implement a copy-back policy can significantly reduce bus traffic in a multiprocessor system. In the copy-back policy (also known as the write-back policy), a CPU writes only to its local cache RAM and not to the main memory, unless the cache is full. The controller flags the modified data in the cache RAM as dirty. The controller updates the main memory when it replaces a line in the cache RAM because of a read miss.

Although the copy-back policy reduces bus traffic, it complicates the cache-coherency issue. Because any CPU can write data into its local cache RAM without informing the system, many modified copies of the data can exist at any particular time. To contend with this complication, cache controllers must use a protocol that assigns more than one attribute to cache lines.

During the 1970s, mainframe computer vendors employed a variety of proprietary cache-coherency protocols to maintain consistent data in multiprocessor systems employing a copy-back policy. The Berkeley Ownership Protocol, the Dragon Protocol, and the Firefly Protocol are just a few of these methods. In the early 1980s, the IEEE Futurebus working committee investigated these mainframe protocols to arrive at a protocol suitable for the Futurebus. Spearheaded by Paul Sweazey (now with Apple Computer but, at the time, with National Semiconductor), the committee defined an open cache-coherency protocol that contains

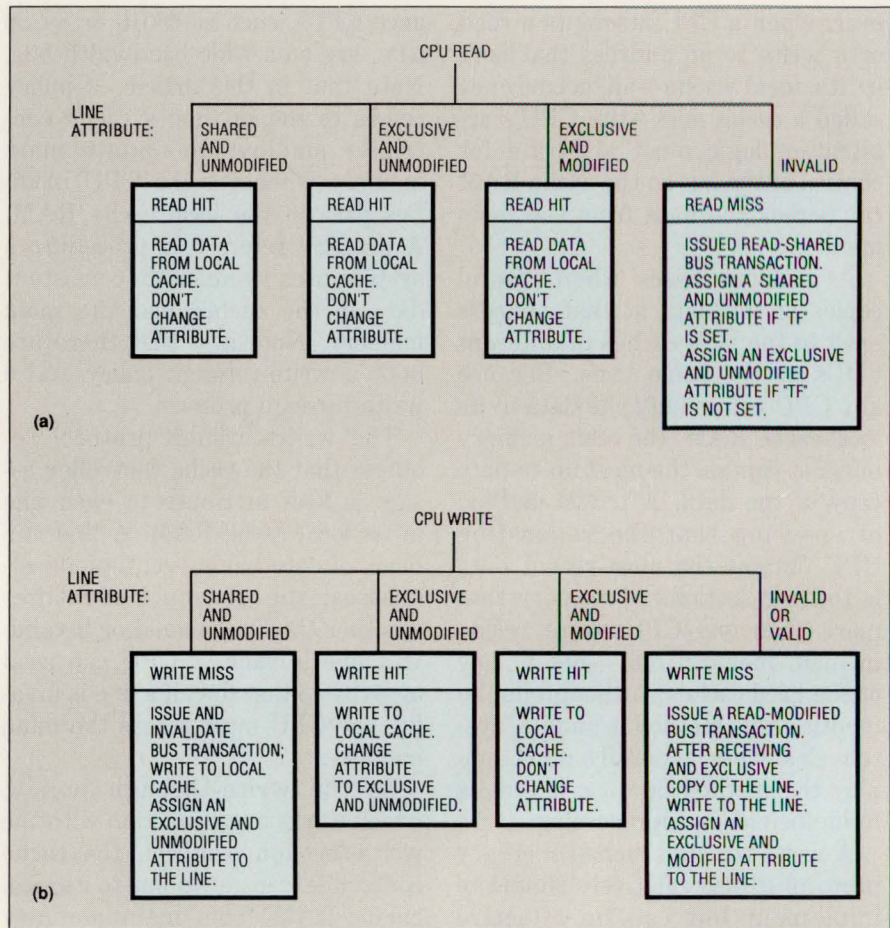

Fig 3—In the Futurebus+ implementation of the MESI protocol, line attributes determine the cache controllers' course of action. When the CPU issues a read command (a), only an invalid attribute results in a bus transaction. When the CPU issues a write command (b), only an exclusive line can prohibit a bus transaction.

most of the features found in the mainframe protocols.

The Futurebus protocol became known as the MOESI protocol. Each letter in the acronym stands for an attribute that a cache controller can assign to any line in its local cache RAM: modified, owned, exclusive, shared, or invalid. To implement the protocol, the system bus requires extra command lines, which a bus master uses to inform slave cache controllers of the nature of the pending transaction. The slave cache controllers use supplementary status lines to implement the protocol.

Although the MOESI protocol guarantees data consistency in sys-

tems employing the copy-back policy, the method requires a large amount of silicon to implement. The owned attribute causes cache controllers to be transistor hogs. A cache holding a line of data that has an owned assignment is responsible for the accuracy of the data in that line for the entire system.

Motorola's Robert Greiner, author of the cache-coherency section of the Futurebus+ P896.1 logical-layer draft specification, noticed that if you make it illegal for a cache line to have shared and modified attributes at the same time, you can eliminate the owned attribute from the MOESI protocol. The shared attribute indicates that another cache

TECHNOLOGY UPDATE

Cache-coherency protocols

on the bus shares a copy of the line; the modified attribute indicates that the cache line supersedes the copy in main memory because the local CPU has written data to the line.

Essentially, a slight change to the MOESI protocol makes a line having a shared attribute valid only when the line is unmodified. This modification results in the MESI protocol, which the current Futurebus+ specification employs and which requires considerably less silicon to implement than does the MOESI protocol.

The MESI protocol is gaining popularity among many shared-memory system designers. The protocol is employed in Corollary's (Irvine, CA) 486/smp and Sequent's (Beaverton, OR) Symmetry series of shared-memory bus computers. The IEEE Nubus working group has submitted a draft specification for sponsor ballot that supports the MESI protocol. The revised Nubus standard, known as Nubus90, defines three new command lines and a status line to realize the protocol. The Nubus MESI protocol supports cache line sizes of 4, 8, 16, 32, and 64 bytes.

Although many ways to implement the MESI protocol exist, exploring the Futurebus+ implementation is possible because Futurebus+ is an open architecture. Each cache controller on the bus assigns a 2-bit attribute to each line in its local cache RAM. The attribute indicates whether the line is valid or invalid, shared and unmodified, exclusive and unmodified, or exclusive and modified. An exclusive attribute means that no other cache RAM has a copy of the line; a shared attribute means that another cache RAM has a copy of the line. The local CPU can read a valid line privately. A modified line must always be exclusive, and an exclusive line is always valid.

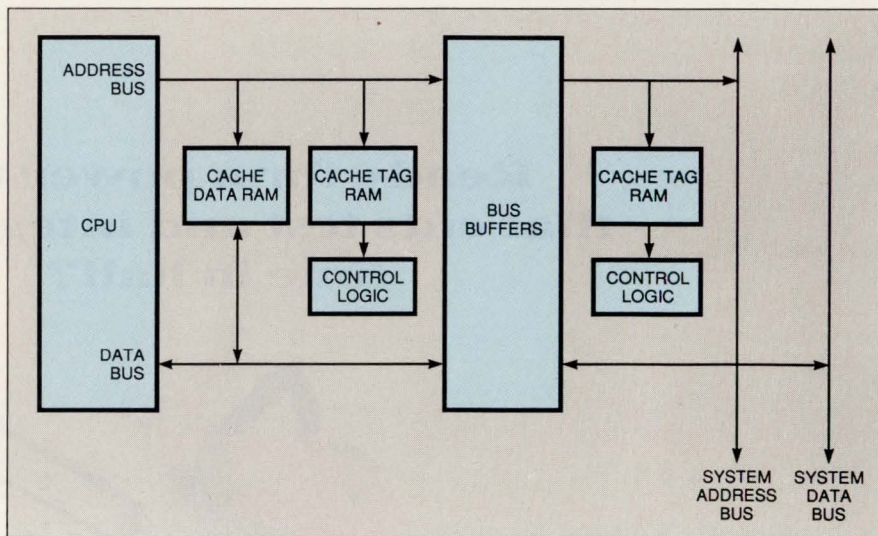

Fig 4—Dual cache-tag RAMs simplify snooping. One of the RAMs can snoop the address lines from the CPU, while the other snoops the bus address lines.

Futurebus+ defines eight bus transactions to transfer data over the bus. The bus master activates four bus command lines to let the other cache controllers, or slaves, know which of the eight possible transactions is about to occur. The master informs the other bus modules of the affected memory address by activating the bus address lines. Each of the cache controllers contains snoop logic, which monitors the bus address lines to determine whether its local cache RAM contains a copy of the data that is at that memory address. In response to the information from the master, the snooping cache controller activates two status lines, the transaction-flag (TF) line and the intervention (IV) line, which determine the action of the master and the slaves during the transaction.

A slave's snoop controller activates the wire-ORed TF status line when its local cache has a shared copy of the data. A slave's snoop controller activates the IV status line when the slave wishes to intervene in a transaction. A slave must intervene in a transaction if the master is attempting a read from the shared memory, and the slave

has an exclusive and modified copy of the data. This intervention lets the bus transfer a valid line from one cache to another.

Snoop before snarfing

Futurebus+ permits any cache controller or the memory controller to capture a copy of a line when other modules on the bus are exchanging that line during a transaction. The controller captures the data—an action called snarfing—by converting the transaction to a broadcast operation. Snarfing conserves bus traffic by preventing the controller from initiating a redundant bus transaction to get the same data. When a cache controller snarfs a line, it assigns a shared and unmodified attribute to that line in its local cache RAM, as **Fig 2** shows. Note that after any bus transaction, the local cache controller must reassign attributes to the affected line.

You can implement the MESI protocol using only four of the eight Futurebus+ transactions: read shared, read modified, invalidate, and copy back. When a CPU issues a read to an address in a line that has a shared and unmodified, exclu-

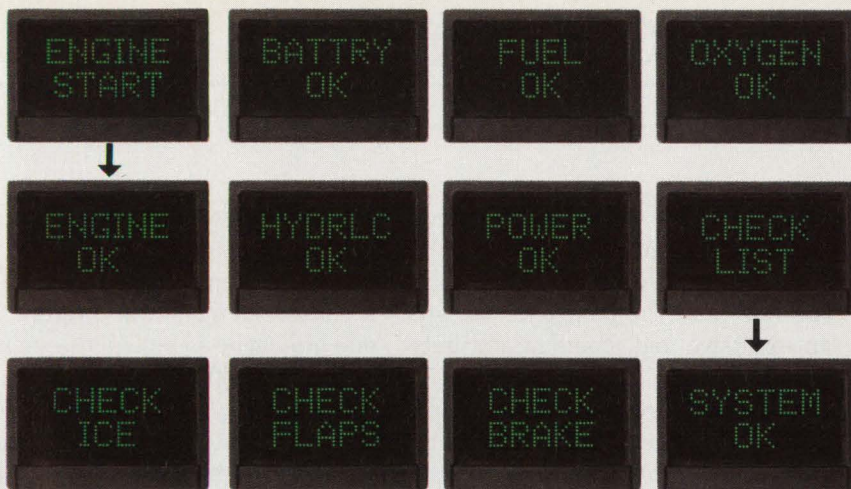

AN APPLICATIONS EXAMPLE.

While the following example is for aircraft, it could apply to any air, land, sea or space system.

SEQUENCE ONE: The four-pushbutton display reads "ENGINE START," "BATTERY OK," "FUEL OK," "OXYGEN OK." The operator selects "ENGINE START."

SEQUENCE TWO: The four-pushbutton display now changes to read "ENGINE OK," "HYDRLOC OK," "POWER OK," "CHECK LIST." The operator selects "CHECK LIST."

SEQUENCE THREE: The four-pushbutton display now reads "CHECK ICE," "CHECK FLAPS," "CHECK BRAKE," "SYSTEM OK." In this manner, the designer can program in as many sequences as required.

Design flexibility: The programmable display system.

Vivisun Series 2000, now the leading programmable display pushbutton system, interfaces the operator with the host computer. The user-friendly LED dot-matrix displays can display any graphics or alpha-numerics and are available in green, red or amber. They can efficiently guide the operator through any complex sequence with no errors and no wasted time.

They also simplify operator training as well as control panel design. One Vivisun Series 2000

programmable display system can do the work of 50 or more dedicated switches. In short, Vivisun Series 2000 gives the design engineer more control over the design.

Contact us today.



AEROSPACE OPTICS INC.

3201 Sandy Lane, Fort Worth, Texas 76112
(817) 451-1141 • Telex 75-8461 • Fax (817) 654-3405

CIRCLE NO. 39

*Vivisun Series 2000
programmable displays. The intelligent
communications system.*



SERIES

VIVISUN 2000™

TECHNOLOGY UPDATE

Cache-coherency protocols

sive and unmodified, or exclusive and modified cache attribute, the operation is a read hit, and no bus transaction is necessary (**Fig 3a**).

However, if the line has an invalid attribute, the operation is a read miss, and the CPU arbitrates for the bus to issue a read-shared transaction. If a second controller sets the TF status line, the CPU's controller assigns a shared and unmodified attribute to the cache line after its local cache RAM receives a copy of the data from the bus. If the TF status line isn't set, the cache controller assigns an exclusive unmodified attribute to the line.

When a CPU issues a write command to an address in a line that has an exclusive attribute, the operation is a write hit, and no bus transaction is necessary (**Fig 3b**). If the line isn't exclusive, the operation is a write miss—even if the line is valid. If the CPU's cache RAM has a copy of the data in a shared and unmodified line, the local cache controller writes to the cache RAM and assigns an exclusive and modified attribute to the line. The controller must then issue an invalidate bus transaction. When the other cache controllers detect the invalidate bus transaction, they must assign an invalid attribute to their copies of the line.

If a write miss occurs and the local cache RAM doesn't contain a copy of the data in a shared and unmodified line, the CPU's controller issues a read-modified transaction. The read-modified transaction lets the requesting cache controller obtain an exclusive copy of the line in order to modify it. The controller's cache RAM can obtain the line from either an intervening cache controller's cache RAM or the main memory. Other cache controllers must invalidate shared copies of the

line. Once the requesting controller's cache RAM receives the exclusive line, the local CPU writes to the line, and the controller assigns an exclusive and modified attribute to it.

The MESI protocol allows a cache controller to use a transaction to allocate empty space in its cache RAM to service cache misses. The controller can flush a line in its

You can't currently buy any silicon that implements the MESI protocol.

cache RAM that is not exclusive and modified. If the line is exclusive and modified, the cache controller must transfer it to main memory before the location can be reused.

A cache controller also uses a bus transaction when data must be restored in main memory. **Ref 2** contains a more detailed description of all the Futurebus+ transactions as well as some concrete examples of the MESI protocol in action.

Although the MESI protocol is gaining adherents as the cache-coherency protocol for shared-memory bus systems, you can't currently buy any silicon that implements the technique. However, a number of chip vendors are actively developing chip sets for this purpose. Texas Instruments (Dallas, TX) is developing a chip set that will implement the Futurebus+ version of the MESI protocol, and S-MOS (San Jose, CA) is developing silicon that will integrate the cache-controller and memory-controller functions on a single chip.

Because on-chip cache controllers in today's highly integrated μ Ps only execute a write-through pol-

icy, designers place a second cache between the system bus and the CPU when employing these μ Ps in a shared-memory bus system. The on-chip cache is called the primary cache; the off-chip cache is called the secondary cache. The secondary cache translates the primary cache's write-through policy to a copy-back policy to use the MESI protocols on the system bus.

Systems employing this hierarchical caching scheme often incorporate a rule called the principle of inclusion. The principle of inclusion always requires the secondary cache RAM to have a superset of the data in the primary cache RAM. You implement the principle

of inclusion using two basic precepts:

1. Any data the cache controller writes into the primary cache RAM, it must also write into the secondary cache RAM.
2. Any data the cache controller removes from the secondary cache RAM it must also force out of the primary cache RAM.

The principle of inclusion lets the secondary cache screen invalidation transactions on the system bus and thereby limit the number of invalidation transactions sent to the primary cache controller. Because the CPU must stop during an invalidation cycle, this screening reduces the number of unnecessary CPU wait states.

Two tags are better than one

Snooping cache controllers, such as those that implement the MESI protocol, often use dual cache-tag RAMs for each CPU to determine whether a memory location resides in the local cache (**Fig 4**). The cache-tag RAM contains the upper address bits, or tags, for each stored location as well as a com-



For Most People, It Was Just Another Warm September Day.

For design engineers, it was the day mixed analog/digital design came of age.

The event was the mixed-signal design demonstration at the IEEE Bipolar Circuits and Technology Meeting (BCTM). The goal was to give credence to mixed-signal simulation and to benchmark companies in the marketplace. The results were conclusive.

Viewlogic came up with the right answer first.

But more to the point, what we did at BCTM in September, we can do for you now. We're the only company with a proven technology and a three year track record of success. The only one that integrates design capture, simulation and analysis.

But that's just the beginning.

Performance and Flexibility available nowhere else.

With VIEWsim/SD, you'll get the choices you need. You'll be able to mix behavioral models with gates and SPICE primitives. Choose from leading analog simulators like PSPICE and HSPICE. Include physical hardware models for devices when software models are not available. Use the most popu-

lar platforms from SUN, DEC and IBM. Our white paper "Mixed-Signal Simulation Benchmark Report" proves the point. **Call us at 1-800-422-4660, Ext. 102.** You'll like the climate we're creating for mixed-signal design.

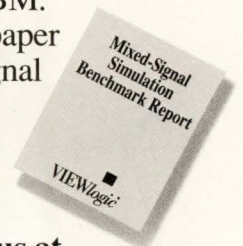

Full Hierarchical Design

Automatic Design Partitioning

Mixed-Signal Simulation With Behavioral, Device, Hardware Models

Integrated Mixed Signal Analysis

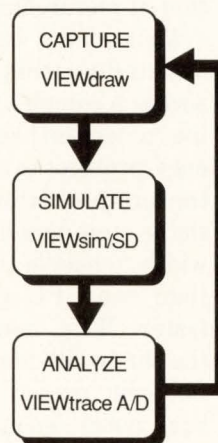

VIEWlogic[®]
The CAE Company

Viewlogic Systems, Inc.
293 Boston Post Road West
Marlboro, MA 01752
508-480-0881
508-480-0882 FAX

PSPICE and HSPICE are trademarks of their respective companies.

Sprague-Goodman

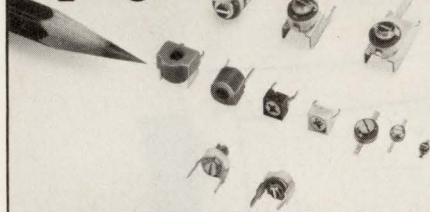

Ceramic Dielectric Trimmer Capacitors

Rugged 5 & 7 mm types

Operating temp: -55° to +125°C
Cap ranges: 1.3-2.0 pF to 12-160 pF

Miniature types suitable for hybrids

Operating temp: -25° to +85°C
3 series: 2.0 x 1.2 mm; 3.0 x 1.5 mm;
5.0 x 2.0 mm
Cap ranges: 2.5-10 pF to 5.5-40 pF

Microwave types

Operating temp: -55° to 85°C
Cap ranges: 0.5-2.0 pF; 1-4.0 pF; 2.0-10 pF
Q > 500 at 100 MHz

Plastic encased 4 x 4.5 mm and 5 mm types

Designed for volume applications
Surface mount and printed-thru-hole models
Cap ranges: 1.7-3.0 pF to 10-50 pF

Phone, fax or write today for
Engineering Bulletin SG-305B.



134 Fulton Ave., Garden City Park, NY 11040
Phone: 516-746-1385 • Fax: 516-746-1396

CIRCLE NO. 15

Sprague-Goodman

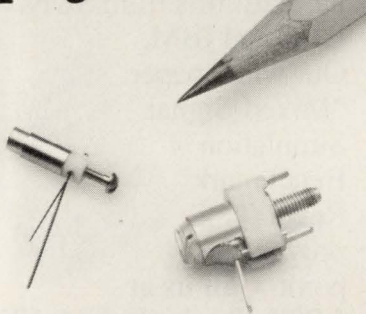

Multiturn Plastic Trimmer Capacitors

- Cap ranges: 0.25-1.5 pF;
2.0-10 pF
- Multiturn resolution at low cost
- Q typically > 2000 to VHF
- Temp coefficient of capacitance:
-50 ± 50 ppm/°C;
0 ± 200 ppm/°C
- Operating temp: -55° to 125°C;
-40° to 100°C

Phone, fax or write today for
Engineering Bulletin SG-401B.



134 Fulton Ave., Garden City Park, NY 11040
Phone: 516-746-1385 • Fax: 516-746-1396

CIRCLE NO. 16

TECHNOLOGY UPDATE

Cache-coherency protocols

parator that matches the upper address bits of a pending transaction to signal a cache hit. A single cache-tag RAM would require a multiplexer to switch between tags generated by the CPU and tags on the system bus. By employing dual cache-tag RAMs—one that snoops the tags from the local CPU and one that snoops the tags on the system bus—matching tags is faster.

Although snooping bus schemes such as the MESI protocol are popular in shared-memory bus systems, they aren't the only way to maintain cache coherency. For example, in a central-directory technique, the memory controller maintains tables that contain critical information on the status of each cache in the system.

Chips and Technologies Inc (San Jose, CA) employs this technique in the M/PAX chip set, which can maintain data consistency for as many as six cache RAMs. A central data-coherency unit invalidates lines that contain shared data when a cache controller requests exclusive ownership of a line. The unit also transfers ownership of a line when another cache controller requests an exclusive copy. Because the central-directory technique doesn't require snooping or cross-interrogation between cache controllers, it simplifies the implementation of hierarchical bus structures.

Maintaining cache coherency on a shared-memory system bus of any sort is a complex issue. Implementing a write-through cache-coherency protocol is relatively easy, but the protocol is only effective when the system bus has sufficient bandwidth to handle the traffic that more than one CPU generates. Today's faster CPUs, however, are pushing the bandwidth limits of system buses. Snooping protocols based on a copy-back policy, such as the MESI pro-

col, are gaining adherents to preserve available bandwidth.

Hierarchical bus structures that have caches on more than one bus present further difficulties. Because a central-directory protocol eliminates cross interrogation between caches, it can simplify matters. However, directory-based schemes require lots of silicon to maintain status tables for every cache in the system. Perhaps a combination of a snooping protocol and a directory protocol is a compromise solution for hierarchical bus structures.

Some board vendors circumvent the problem of cache coherency by creating a cluster of multiprocessing CPUs on a single bus module. The module usually contains two to four CPUs, each operating from its own local cache, and a large portion of main memory. A cache-coherency protocol is only necessary for the cluster, so the module can communicate with the system bus via a dual-port RAM. **EDN**

Acknowledgments

Although the author takes responsibility for the accuracy of this article, he is grateful to Motorola's Robert Greiner, Intel's John Hyde, and Integrated Device Technology's Jim Handy for their helpful comments and suggestions in its preparation.

References

1. DeCegama, Angel L, *Parallel Processing Architectures and VLSI Hardware*, Volume 1, Prentice Hall, Englewood Cliffs, NJ, 1989.
2. P896 Working Group, "Future-bus + Logical Layer Specifications P896.1R," IEEE Computer Society Press, Los Alamitos, CA, February 14, 1990.

Article Interest Quotient
(Circle One)

High 512 Medium 513 Low 514

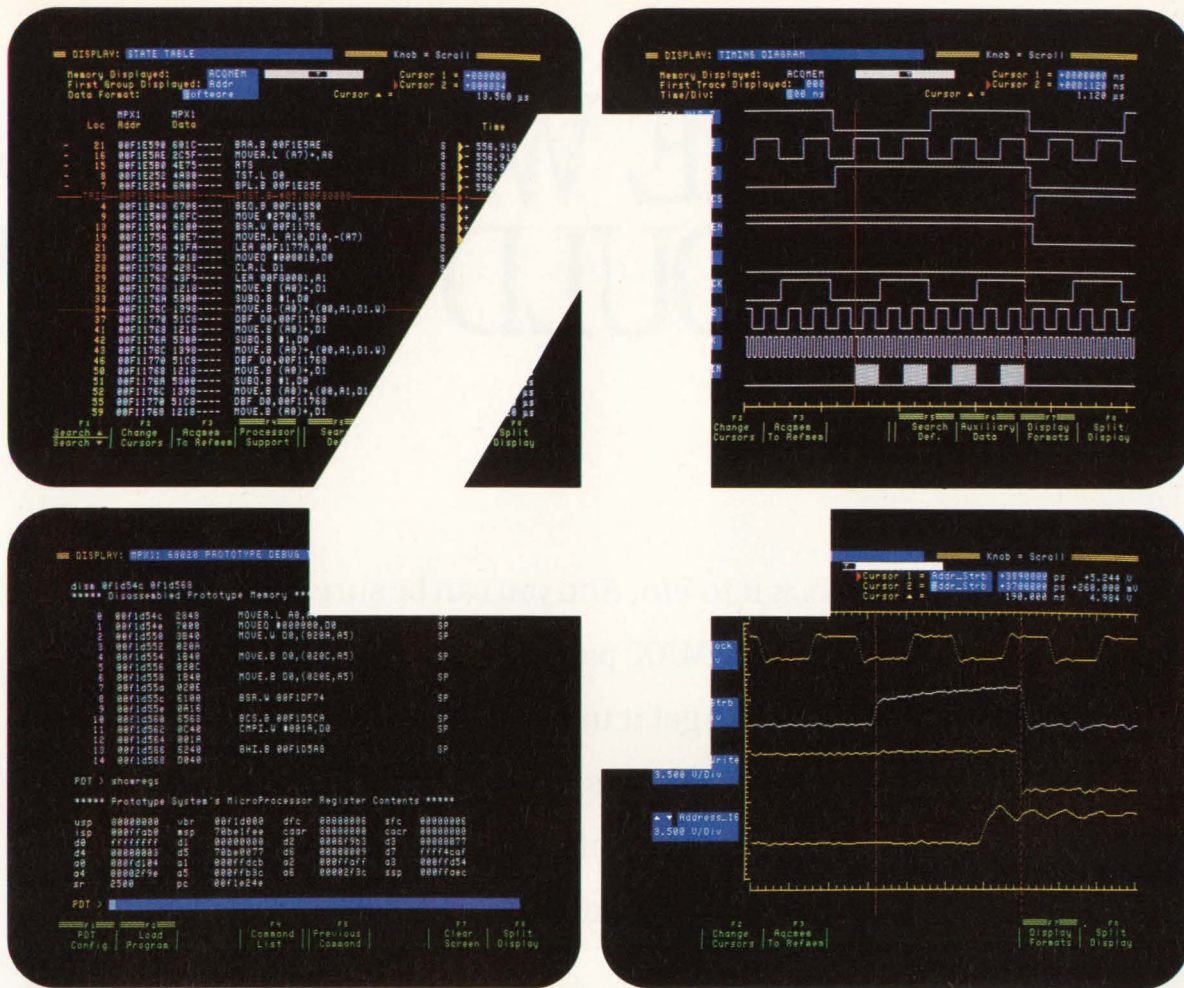

Prism. Four instruments in one logic analyzer. For faster, time-correlated results.

State analyzer. Timing analyzer. Emulator. DSO. Getting the complete picture is easier than you think.

The 4-in-1 Prism 3000 Series is unlike any other logic analyzer. From one keyboard and display, it can do the work of multiple instruments. It can time-correlate data acquired by one Prism module to data acquired by all other modules, via revealing split-screen displays.

Combine the triggering and channel resources of a logic analyzer with emulator-like ability to change registers, patch memory, and step through your code. View both signal timing and signal integrity at the same time with the integrated DSO.

For twice the power and convenience afforded by separate instruments, at half the cost, contact your Tek sales engineer. Or call 1-800-426-2200 for the complete multipurpose Prism story.



Tektronix
COMMITTED TO EXCELLENCE

Rental units available from your local rental company.
Copyright © 1990, Tektronix, Inc. All rights reserved. PRZ-100

IMAGINE WHAT A CMO COULD DO TO YO

Now you can really stick it to 'em. And you can be sure they'll get the point. Because our two new MAX® parts will make your next design



unbeatable. And get it to market faster.

Introducing Altera's 100-pin EPM5130 and 7500-gate EPM5192. Both packed with I/O and logic unheard of in a CMOS EPLD.

In fact, they're your best programmable alternative to gate arrays yet. Because

MAX delivers high logic density and superior 50 MHz *in-system* speed. All thanks to our innovative MAX architecture.

Even design is faster. That's because our new MAX+PLUS® II software takes full advantage of the enhanced memory management and multi-tasking capabilities of Windows™ 3.0.

MAX+PLUS II can also automatically partition large logic designs into a set of EPLDs. In minutes. So you can deliver your finished design while



S EPLD WITH 100 PINS UR COMPETITION.

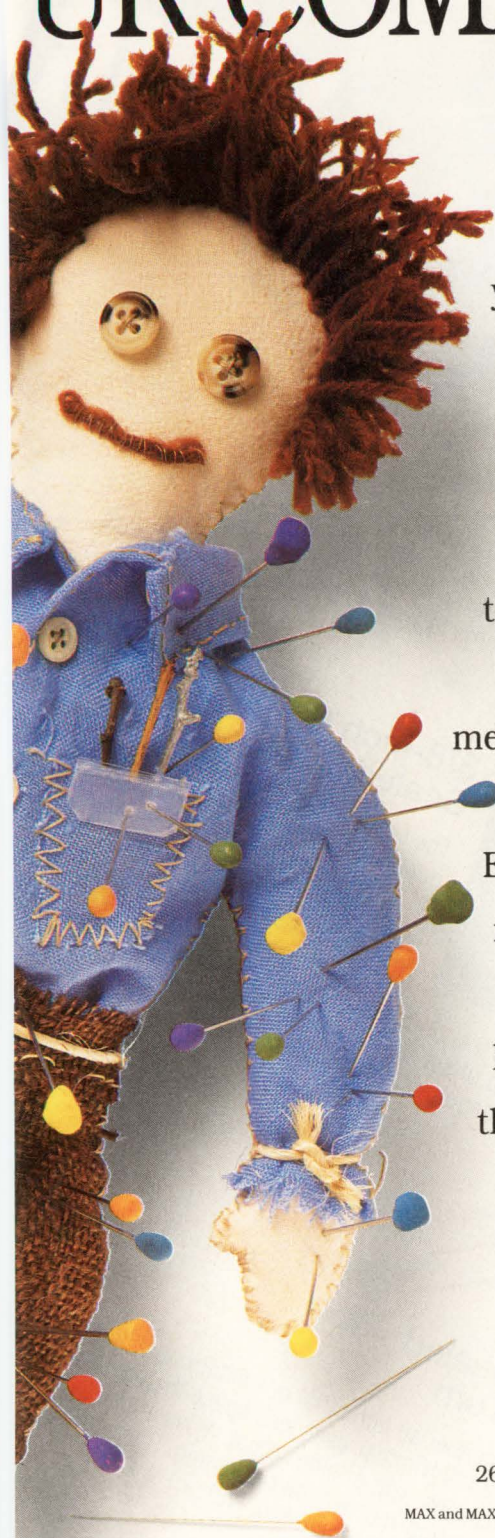

your competition's stuck manually partitioning his schematics.

You can even choose from a wide variety of erasable windowed and OTP packages. Including pin grid array, quad flat pack and PLCC package options. Which makes them perfect for full production or gate array prototyping.

Of course, the EPM5130 and EPM5192 are just two members of the modular MAX family. Devices range from 20 to 100 pins, 16 to 192 macrocells. In fact, there's an EPLD for every logic design task. Because we make the industry's broadest line of CMOS PLDs.

So if you're looking for devices with high density, high I/O and high speed, talk to the people who invented the EPLD. Call Altera today at (408) 984-2800.

We'll help you keep your competition pinned down.

ALTERA

2610 Orchard Pkwy. San Jose, CA 95134-2020/(408) 984-2800/Fax: (408) 248-6924

MAX and MAX + PLUS are registered trademarks of Altera Corporation. Windows is a trademark of Microsoft Corporation. © 1991, Altera Corporation.

BOURNS

THE PERFECT CHOICE FOR ALL YOUR

1/4-Inch Square Sealed Single-Turn

The ideal trimmer for almost any application, the 1/4-inch square Model 3362 features a value-engineered design that's compatible with automatic assembly and adjustment equipment. Its cermet resistance element and multiwire wiper ensure excellent performance with a low 1% CRV. Resistance range is 20 ohms to 2 megohms. Great performance. Low price. Best value.

3/8-Inch Square Sealed Single-Turn

The Model 3386 is the industry's most popular single-turn trimmer. Select from 12 different terminal styles in top or side adjust configurations. It's sealed to withstand wave soldering and available in tape-and-reel packaging. Options include a knob for finger adjust and high voltage and opamp offset styles. Resistance range is 10 ohms to 2 megohms, with a 1% CRV.

1/4-Inch Square Multiturn

As the industry's smallest multiturn through-hole trimmer, the Model 3266 features a double chevron shaft seal and standoffs that allow PC board washing. Choose from either industrial or military qualified styles. Standard resistance range is 10 ohms to 1 megohm, with a 3% CRV.

1/4-Inch Round Sealed Single-Turn

Available as either an industrial or military qualified device, the Model 3329 trimmer uses less space than equivalent square packages. Top or side adjust styles are available in either tape-and-reel or tube packaging. Resistance range is 10 ohms to 1 megohm, with a 1% CRV.

TRIMMER NEEDS

3/4-Inch Rectangular Multiturn



With a low printed circuit board profile of only 1/4-inch high, the Model 3006 is ideal for panel mount applications where board space is a concern. A transparent housing also can be specified for visual setting without hook-up and instrumentation. Resistance range is 10 ohms to 5 megohms, with a 1% contact resistance variation and $\pm 100\text{ppm}/^\circ\text{C}$ temperature coefficient.



5/16-Inch Round Sealed Four-Turn

The Model 3339 features a unique planetary drive offering the precise wiper setting of a multiturn device in a single-turn package. Choose from top or side adjust styles. Resistance range for this cermet trimmer is 10 ohms to 1 megohm, with a contact resistance variation of 3% and a temperature coefficient of $\pm 100\text{ppm}/^\circ\text{C}$.

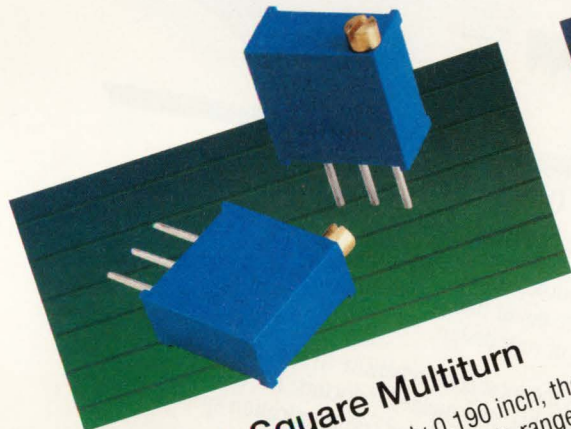

3/8-Inch Square Multiturn

With a thin body profile of only 0.190 inch, the Model 3296 trimmer is ideal for a wide range of applications where precise adjustment is important. Available in tape-and-reel packaging, the Model 3296 comes in five pin styles and either top or side adjust styles. Standard resistance range is 10 ohms to 5 megohms, with a 3% CRV.

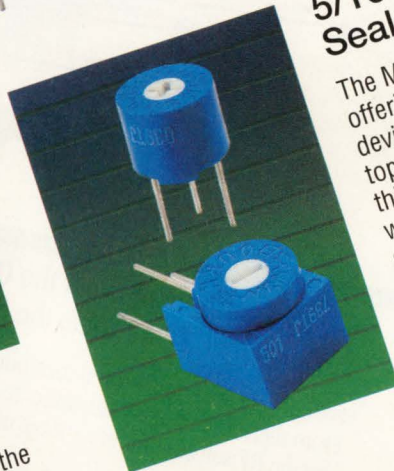

BOURNS TRIMPOT

Bourns, Inc., 1200 Columbia Avenue, Riverside,
California 92507-2114; European Headquarters:
Zugerstrasse 74, 6340 Baar, Switzerland: 042-333333;
Asia Pacific Headquarters: 510 Thomson Road, Unit
09-01A SLF Building, Singapore 1130; (65) 353 4118

FREE SAMPLE OFFER* CALL BOURNS 714-781-5500

Call Bourns and tell us about your application. Qualify for your free sample and data sheet from participating distributors.

ADVACOM
ALMAC

BELL
BRILL
EAC

ELECTRONIC SUPPLY
ELECTRO SONIC
GRS ELECTRONICS
GERBER
HALL-MARK

HAMILTON/AVNET
HAMMOND
HARPER/SID
HARRISON
HUGHES PETERS
ITT MULTICOMPONENTS
MARSH
MARSHALL

MAST
MIDAN
OHM
PIONEER STANDARD
RS ELECTRONICS
RESCO
ROME
SUMMIT
TTI

*Limited offer. Restrictions apply.
COPYRIGHT © 1991, BOURNS, INC. 2/91

The Undercover Story On RF Performance.

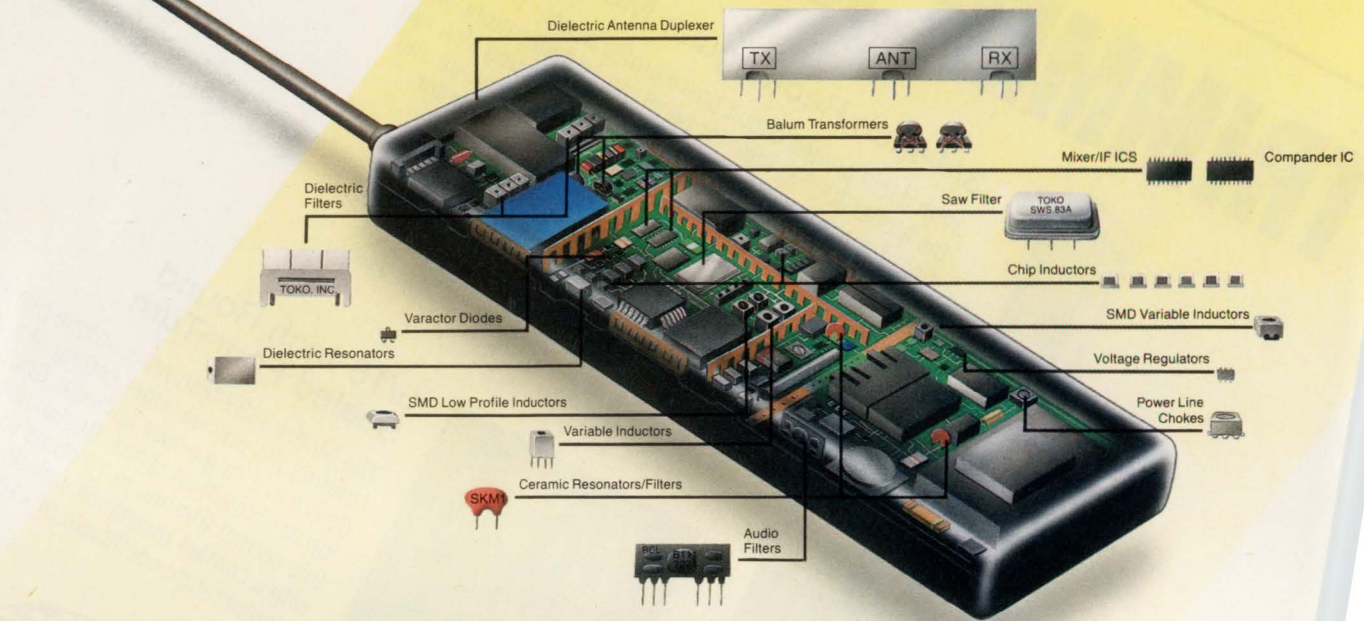

For RF Components with the Quality and Performance Difference, the Name to Know Is Toko.

Look inside leading personal communications products, and you'll find more of Toko. From dielectric antenna duplexers to power line chokes, Toko can offer an application-specific RF solution for every stage of your design.

Our selection of RF components is the most comprehensive in the industry and includes: surface mount, fixed, variable, and molded inductors; LC, SAW, ceramic, helical and dielectric filters; Balun transformers; and communication-specific ICs.

All are designed to work together and feature low loss for exceptional performance. Tuneable or fixed construction magnetics, ceramics, hybrids, and ICs...all are available from one source: Toko.

Toko is also the world's largest manufacturer of coils and filters and one of the most vertically integrated. Our quality and reliability are unequalled; an enviable industry-low failure rate has resulted in numerous top supplier preferred classifications.

Whatever your RF/IF application—personal communications, satellite communications, computer, automotive convenience systems, or video—the name to know is Toko.

Discover the quality and performance difference Toko products can make in your RF/IF application. For more information, write Toko today, attention: RF/IF Engineering, or call the Toko location nearest you: Midwest, (708) 297-0070; East, (203) 748-6871; Southeast, (205) 772-8904; West, (408) 432-8281.

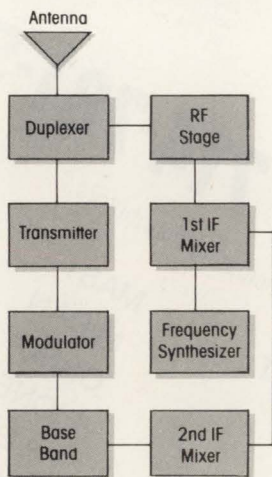

TOKO
TOKO AMERICA, INC.

1250 Feehanville Drive, Mt. Prospect, IL 60056

*Your strategic partner...
for all the right reasons.*

CIRCLE NO. 46

EDN March 14, 1991

CONTACT-ENHANCING CHEMICALS

Fluids vanquish intermittent contacts

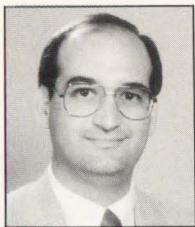

Chemicals that improve connector performance may sound more like patent medicines than serious products, but you can obtain remarkable improvements in reliability and performance with a few strategic drops.

Steven H Leibson,
Senior Regional Editor

Despite their best efforts, socket and connector vendors cannot deliver faultless parts. Airborne contaminants, corrosive environments, and a naturally oxidizing planetary atmosphere all conspire to degrade a connection's performance. As the quality of other electronic components continues to improve, the relative unreliability of a product's sockets and connectors emerges as a major cause of product failure. Fortunately, chemical solutions exist for these problems. If you have no experience with such products, you may consider them to be more like snake oil than a remedy for product failures, but many engineers think these chemicals are a godsend.

The shiny finish of a quality connector's contacts looks as though it should work well without help. Despite appearances, however, the contacts of even the best sockets and connectors aren't smooth. Their metallic surfaces have microscopic peaks and valleys. When two parts of a mating connector meet, they actually touch through myriad contact points. A sufficient number of these contacts makes a good electrical connection. However, dirt and corrosion reduce the number of contact points and restrict the flow of current across the joint.

Oxygen in the atmosphere corrodes contact surfaces that lack gold plating. (Because gold is a noble metal, it doesn't readily react with other substances.) Connector vendors may use gold plating to boost a contact's performance, but the corrosive gases found in many industrial environments can degrade even gold-plated contacts. Plated gold is porous, so contaminants can pass through the gold to attack the metal underneath the plating. Over several months, a sufficiently corrosive environment can strip the gold plating from a connector.

When mated together with a high normal force, tin-plated contacts can form gas-tight connections that exclude oxidation and corrosion. Like a gold-plated



An electric field activates the conductive properties of D W Electrochemicals' Stabilant 22, a liquid polymer that improves electrical connections. (Photography by Steven H Leibson)

Wow. That's what everybody says when they see the new Mark 12 Data Management System from the leader in thermal array-based recording, Western Graphtec. The best features of paper-based recorders and computer-based data acquisition systems.

Up to 32 channels, each with a real-time 20 kHz bandwidth. A built-in video monitor so you don't even need to run the chart until you need to, with a standard video output for driving your external monitors.

And that's just the beginning. Plug a hard drive directly into the Mark 12's SCSI port and stream data to it *in real-time*.

Tired of the same old charts and grids? *Design your own*, with virtually any mix of channel sizes and custom grids. Perfect for in-house reports and publications. *That's power.*

Save all your set-ups to the credit-card size *Personal RAM Card* that plugs into the front panel. Never do the same set-up twice again. *That's smart.*

Stack multiple records in the 2 mega-sample *battery backed-up* memory. Ready to review it? Turn the handy jog wheel and watch as your data scrolls across the video display. Print out only what you need. *That's data management.*

We even created our own printhead—a single 15" array which eliminates the *data gap* suffered by 2-headed recorders. Completely designed and built right here in the USA with a two year warranty on everything. *That's Western Graphtec.*

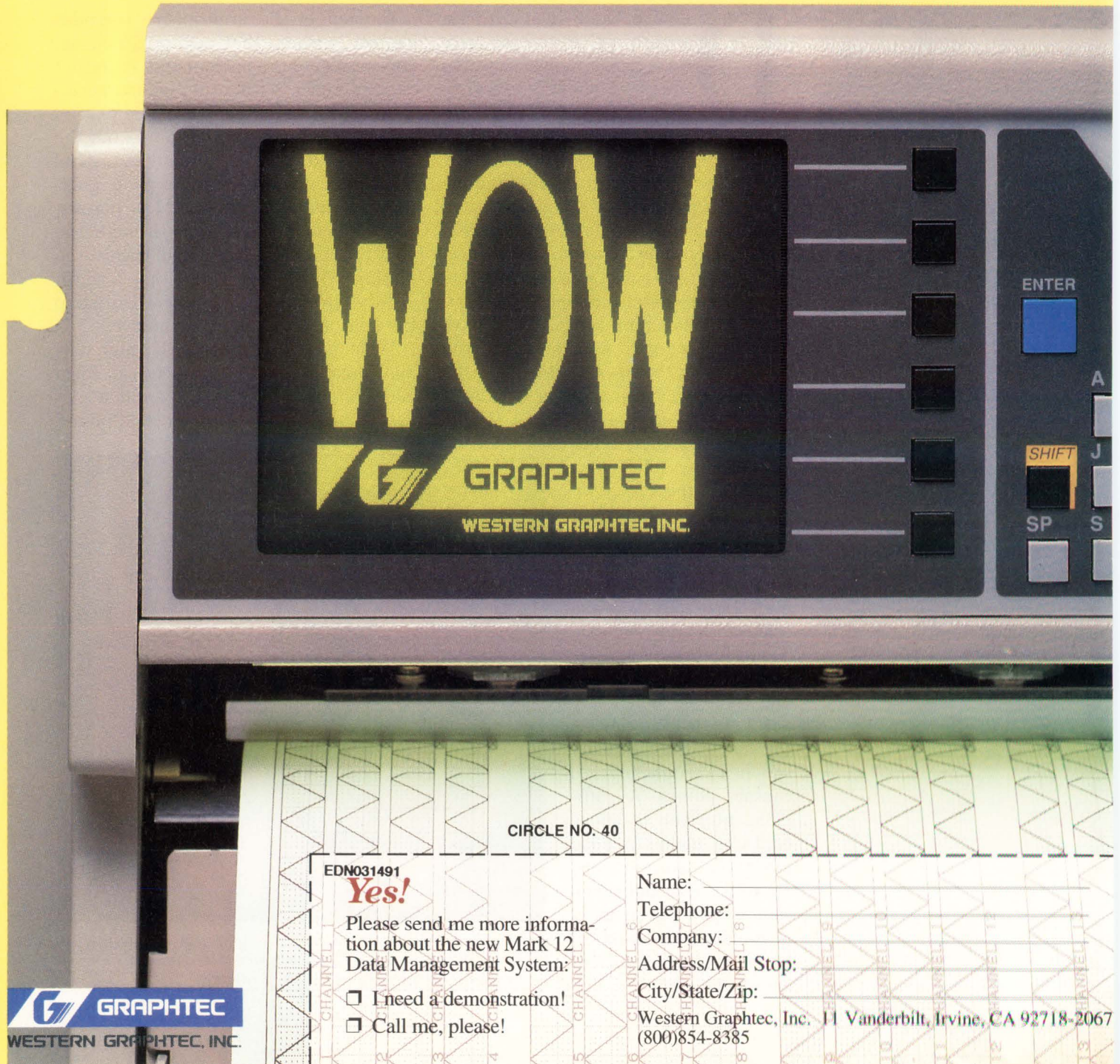

CIRCLE NO. 40

EDN031491

Yes!

Please send me more information about the new Mark 12 Data Management System:

- I need a demonstration!
- Call me, please!

Name: _____
Telephone: _____
Company: _____
Address/Mail Stop: _____
City/State/Zip: _____

Western Graphtec, Inc. 11 Vanderbilt, Irvine, CA 92718-2067
(800)854-8385

 **GRAPHTEC**
WESTERN GRAPHTEC, INC.

TECHNOLOGY UPDATE

Contact-enhancing chemicals

connection, a gas-tight joint reduces the problems caused by oxidation, corrosion, and contaminants. However, mechanical vibrations and expansion and contraction from thermal cycling can cause even gas-tight connections to make and break. Each time a connection breaks, oxidation and corrosion take place at the newly exposed contact site. The process is called fretting corrosion (Ref 1).

Fretting corrosion can cause intermittent failures—one of the worst problems to find and solve. These intermittent failures will often disappear, temporarily, if you unplug and then reconnect the failing contacts. A formerly gas-tight connection can open permanently when a layer of insulating film composed of corrosion products builds in a contact joint. Even if the connection doesn't open, its resistance can increase from milliohms to ohms over long time periods as more and more contact points open.

Insulating films in contact junctions form Schottky diodes that distort low-level signals while conducting larger signals. Analog circuits that depend on such a connection may completely fail because of the resistance increase and distortion. Even digital signals can experience significant degradation in rise and fall times.

You can fight oxidation and corrosion. A lubricant applied to mating connectors will seal that connection and prevent airborne contaminants and reactive gases from reaching the contact area. Mineral oil mixed with microcrystalline wax appears to be an adequate contact lubricant for new, uncontaminated surfaces (Ref 2).

If you're fresh out of microcrystalline wax, or if you're treating sockets and connectors that have been in service for a while, you may want to use a prepared product to

For more information . . .

For more information on the contact-enhancing chemicals discussed in this article, circle the appropriate numbers on the Information Retrieval Service card or use EDN's Express Request service. When you contact any of the following manufacturers directly, please let them know you saw their products in EDN.

Caig Laboratories Inc
Box J
Escondido, CA 92025
(619) 743-7143
FAX (619) 743-2460
Circle No. 700

D W Electrochemicals Ltd
9005 Leslie St, Unit 106
Richmond Hill
Ontario L4B 1G7
Canada
(416) 889-1522
Circle No. 701

VOTE . . .

Please also use the Information Retrieval Service card to rate this article (circle one):

High Interest 470
Medium Interest 471
Low Interest 472

strip off the existing contamination and provide a barrier to corrosion. If so, consider the Cramolin family of chemicals from Caig Laboratories.

Caig makes two types of Cramolin: red and blue. Red Cramolin cleans contacts by dissolving corrosion. After using the red variant, you wipe away the residue and use the blue Cramolin to protect the cleaned contacts. Two-ounce bottles of red and blue Cramolin liquid cost \$15.75 and \$16.25, respectively; 6-oz spray cans of red and blue Cramolin cost \$8.95 and \$9.25, respectively. Caig also sells several forms of Cramolin paste for contacts that carry currents of hundreds or thousands of amperes. The company will soon introduce Cramolin Gold for protecting gold-plated contacts.

Ben Poehland detailed seven years of experience with Cramolin products in one of his columns, "The 8-Bit Alchemist," which appears in *Current Notes*, a magazine for Atari computer users (Ref 3). Poehland described using the chemicals on cable connectors, plugs, jacks, sockets, and particularly on dirty switches. He used red Cramolin to quiet a switch that was injecting noise into a video display after a few week's use. A misbehaving disk-drive selector switch responded similarly.

Poehland also explained how he

mixes preparations based on Cramolin products; he doesn't use them straight. He mixes each 2-dram bottle with sufficient trichloroethane to make three ounces of solution. He blends the mixtures in travel-sized, glass mouthwash bottles after carefully relabeling the bottles. Poehland states that thinner Cramolin films work better.

Fill in the gaps

Cleaners and lubricants such as Cramolin enable connectors to perform as designed. However, these chemicals do not conduct electricity; they rely on the connector's contact points to carry current. Stabilant 22 from D W Electrochemicals is a concentrated liquid polymer that fills gaps between mated contacts and conducts current under an applied electric field. Consequently, the company claims that the substance enhances a contact's conductivity. A 15-ml bottle of Stabilant 22 costs \$102.

D W Electrochemicals also sells a dilute version of the product, Stabilant 22a, which consists of 4 parts isopropyl alcohol and 1 part Stabilant 22. This thinner mixture easily flows into small spaces, such as between an IC's pins and its socket contacts. Thus, you can apply Stabilant 22a to connections without separating the contacts, and capil-

TECHNOLOGY UPDATE

Contact-enhancing chemicals

lary action will transport the fluid into the gaps. A 15-ml bottle of Stabilant 22a costs \$36. You can get Stabilant 22 in an 8:1 dilution from Sumiko (Berkeley, CA, (415) 843-4500), an importer of high-end audio equipment. Sumiko calls its mixture Tweek. A 7-ml bottle of Tweek costs \$18.

Like Cramolin, Stabilant 22 has its advocates. Bill Loughman, a programmer at Children's Hospital in Oakland, CA, rejuvenated an ailing, 15-year-old Processor Technology Sol computer using the product. (Processor Technology met its demise years ago, but its computers continue to work.) Loughman added a 5M-byte hard-disk drive to his computer, and the drive had become less reliable over the years. However, Loughman felt he had invested too much of his time and money in the old CP/M machine to retire it.

Hard-disk errors and system crashes occurred with increasing and irritating frequency. Loughman tried replacing cables and connectors but accomplished nothing. Finally, he bought a bottle of Stabilant 22a from Personal Computing Tools (Los Gatos, CA, (800) 767-6728) and treated every connector and IC socket in the system. The computer, which had been failing almost hourly, worked for months without a problem. By coating its edge connector with the liquid, Loughman also refurbished a Sol plug-in personality card that had never worked right.

Personal Computing Tools, a catalog sales outfit, sells a 50-ml bottle of Stabilant 22a for \$76. The company's president, Leon Hamner, says that he has heard several success stories like Loughman's. He has also learned of similar successes at computer manufacturers who prefer to keep their use of the liquid quiet. Hamner says he knows the

chemical must be a good product because he has sold approximately 500 bottles and has had less than 2% returned. He says that return rate is very low for products sold through a catalog.

Quantitative evidence

The lack of meaningful performance specifications for these chemicals leaves you with little useful information about their effectiveness except for qualitative anecdotal evidence. However, D W Electrochemicals has performed some ex-

low-level signals and created the distortion.

After aging these connectors on an electronics-manufacturing-shop floor for 31 days unmated, and then 31 more days mated, the edge-connector contacts introduced more than twice the harmonic distortion than they did when new. Applying Stabilant 22 dropped the distortion well below the when-new levels. After this test, another 62 days of aging produced no distortion increases.

In a second experiment, the com-

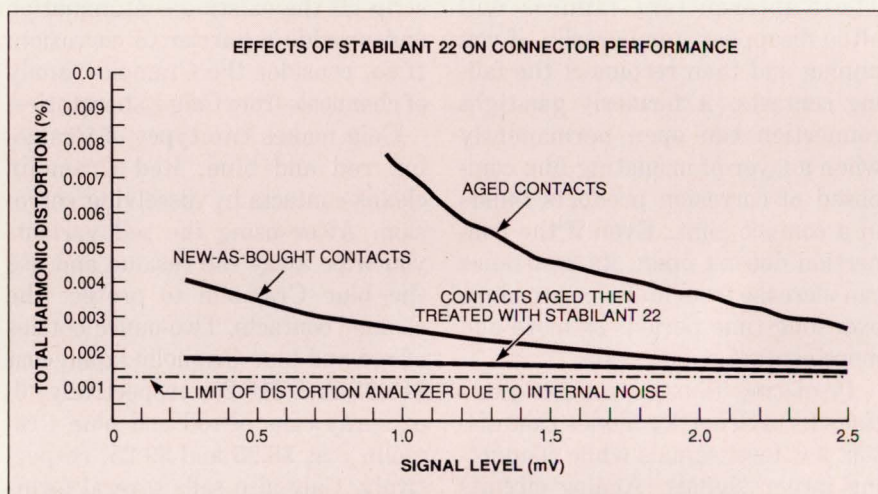

Fig 1—Aging in the relatively benign atmosphere of an electronics-manufacturing-shop floor more than doubled the distortion introduced by a series circuit of 100 edge-connector contacts. Subsequently coating the connectors with Stabilant 22 dropped the distortion below its original value.

periments that produced quantitative information (Refs 4 and 5). In one experiment, the company used a distortion analyzer and a spectrum analyzer to measure the performance of 10 sets of 100 gold-plated edge-connector fingers wired in series.

As you can see from the graph in Fig 1, the total harmonic distortion generated by the new (at least newly acquired) contacts rose to about 0.004% at low signal levels. The company hypothesizes that thin oxidation films on the contacts created Schottky diodes that rectified

pany treated an old and unreliable S-100 Bus memory board. After measuring the rise times of control signals at 10 of the memory chips' pins, the company applied Stabilant 22 to the board's ICs and sockets. The chemical improved the rise times of the observed signals by an average of 40% and produced a 70% improvement in one instance. Further, the formerly unreliable board worked dependably. The company theorizes that the IC socket's contacts had been exhibiting high contact resistance caused by oxidation.

Because MOS memory chips have

We're giving away our management secrets.



More project managers are using Microsoft® Project for Windows™ than any other package.

Probably because Microsoft Project for Windows wouldn't be any different if you'd planned it yourself.

Work with data easily. Create customized filters, tables, even output.

Manipulate PERT and Gantt charts by clicking and dragging.

See for yourself. Just give us a call at (800) 541-1261, Dept. P97, and we'll send you a free working model.

Microsoft®
Making it all make sense®

Offer good until June 30, 1991 or while supplies last. The first working model is free; additional models are \$9.95 plus applicable sales tax. Offer good only in the 50 United States. In the U.S., call (800) 541-1261, Dept. P97. For information only. In Canada, call (416) 568-3503; outside the U.S. and Canada, call (206) 936-8661. © 1991 Microsoft Corporation. All rights reserved. Microsoft and the Microsoft logo are registered trademarks and Windows and Making it all make sense are trademarks of Microsoft Corporation.

TECHNOLOGY UPDATE

Contact-enhancing chemicals

high-impedance inputs, the memory ICs on the S-100 Bus board could continue to operate even if the junction impedances between the ICs' pins and the socket contacts were several ohms. A high contact resistance between the socket contacts and the IC pins combined with the ICs' input capacitance could degrade signal rise times and induce failures. Reducing that contact resistance thus improved the rise times.

Even with these stories of miraculous cures, you should be skeptical. Don't let this anecdotal evidence convince you that contact-enhancing chemicals are a cure for all your electrical problems. You cannot remedy fundamental design problems such as timing violations or noisy circuits through the pro-

miscuous use of a spray can or a goop-laden brush. However, the evidence does indicate that these products can conquer oxidation, corrosion, dirt, and intermittent contacts. Because the chemicals are inexpensive, you can afford to evaluate the vendors' claims yourself without incurring much risk. The possibility that you might greatly reduce field failures warrants such investigation. **EDN**

References

1. Whitley, James H, *Investigation of Fretting Corrosion Phenomena in Electric Contacts*, Application note P-180-76, Amp Inc, Harrisburg, PA, 1976.
2. Abbott, W H and J H Whitley, *The Lubrication and Environmental Protection of Alternatives to Gold for Electronic Connectors*, Application note P-

230-80, Amp Inc, Harrisburg, PA, 1980.

3. Poehland, Ben, "The 8-Bit Alchemist: The Magic Juice!," *Current Notes*, October 1990, pg 24.

4. *Effects of Stabilant 22 on Harmonic Distortion in Connectors*, Technical Note Number 24, Revision 3, D W Electrochemicals Ltd, Ontario, Canada, 1987.

5. *Effects of Stabilant 22 on Signal Rise Time in IC Sockets*, Technical Note Number 39, Revision 3, D W Electrochemicals Ltd, Ontario, Canada, 1987.

6. Leibson, Steven H, "IC-socket innovations keep pace with improvements in packaging technologies," *EDN*, September 19, 1985, pg 61.

Article Interest Quotient (Circle One)

High 470 Medium 471 Low 472

DELTEM™ PLASTIC HEAT SINKS for PQFPs and PLCCs

DELTEM™ D10650-40 Pin Fin
Heat Sink for 44 to 68-Icd PLCCs,
100 to 132-Icd PQFPs

DELTEM™ D10100-28 Radial Fin
Heat Sink for 68 to 84-Icd PLCCs,
100 to 164-Icd PQFPs

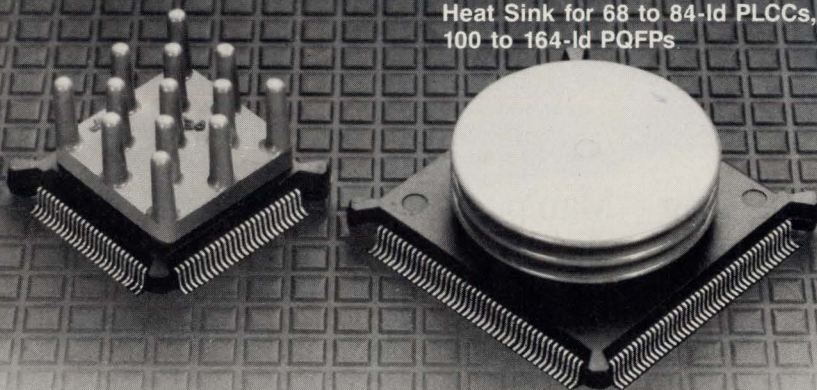

 **EG&G WAKEFIELD ENGINEERING**
60 AUDUBON ROAD, WAKEFIELD, MA 01880
TEL: (617) 245-5900 • TWX: 710-348-6713 • FAX: (617) 246-0874

EG&G Wakefield Engineering DELTEM™ (Patent pending) plastic heat sinks offer low-cost solutions for excessive junction temperatures in microprocessors, ASICs, and cache memory devices. DELTEM™ heat sinks for PQFPs and PLCCs are manufactured from a thermally enhanced polymer specially compounded by EG&G Wakefield Engineering to solve unique heat dissipation problems of plastic IC packages.

Reduced TCE Mismatch

Improved material compatibility to reduce case-to-sink Thermal Coefficient of Expansion (TCE) mismatch. Our new DELTEM™ material aligns the expansion characteristics of the IC package and heat sink to virtually eliminate excessive bond line stress.

Near-Equal Thermal Performance

At low airflows (0-200LFM) typical of microprocessor and logic applications, DELTEM™ heat sinks provide near-equal thermal performance when tested versus aluminum heat sinks of similar size.

Less Mass, Lower Weight, Low Cost

Less mass and 40% lower weight reduce the risk of stress-induced solder joint fatigue for gullwing packages. Low unit cost for our DELTEM™ heat sinks provides improved thermal performance for cost-effective PQFP and PLCC packages.

Call our Application Engineering Department today at 617/245-5900 for DELTEM™ plastic heat sinks for PQFPs and PLCCs.

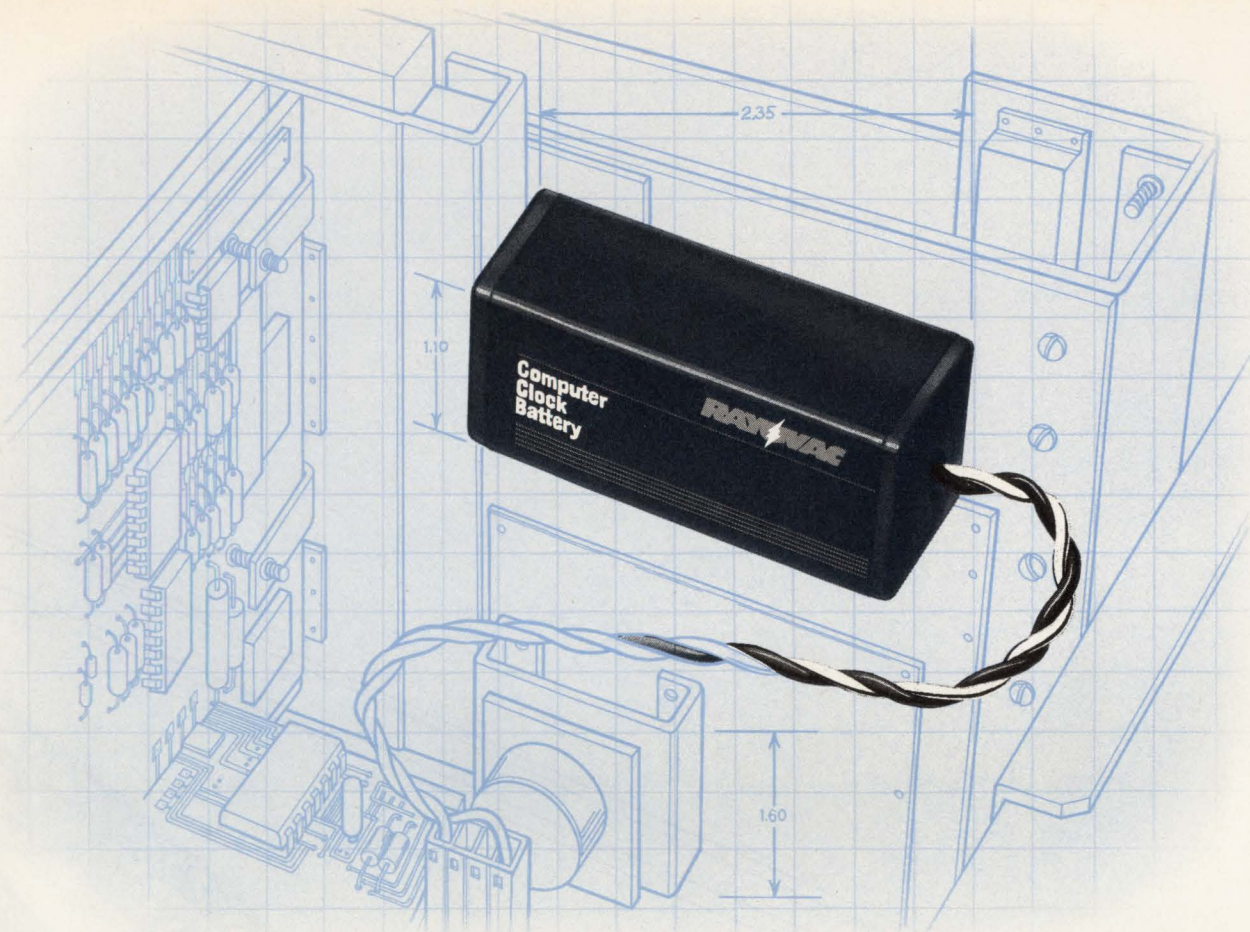

WHY MORE COMPANIES ARE PLUGGING US INTO THEIR DESIGNS.

Today the Rayovac 844 computer clock battery is specified by 23 system architects worldwide. Its proven reliability safeguards the configuration file memory in 286/386/486 personal computer products, especially in power-down situations.

Maintaining voltage is just one way the Rayovac 844 delivers superior reliability. It also offers long life, a 3-5 year span, plus safety no

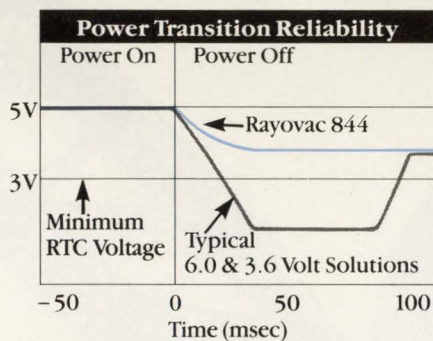

The 844 ensures IC voltage above the critical 3.0V level maintaining clock stability and configuration file memory.

lithium battery can match. The 844 is compatible with industry standard chip

sets: Chips & Technology; VLSI Technology; Western Digital; Zymos and Intel. And it's made in the U.S.A., with on-time delivery available around the world.

So plug added reliability and service into your design. Specify a Rayovac 844. Call Rayovac's Technical Sales & Marketing Department for complete information and battery specifications at 608-275-4694.

RAYOVAC®

The power of innovation

© 1990 Rayovac Corporation



Introducing The Erector Set for Embedded Control Applications

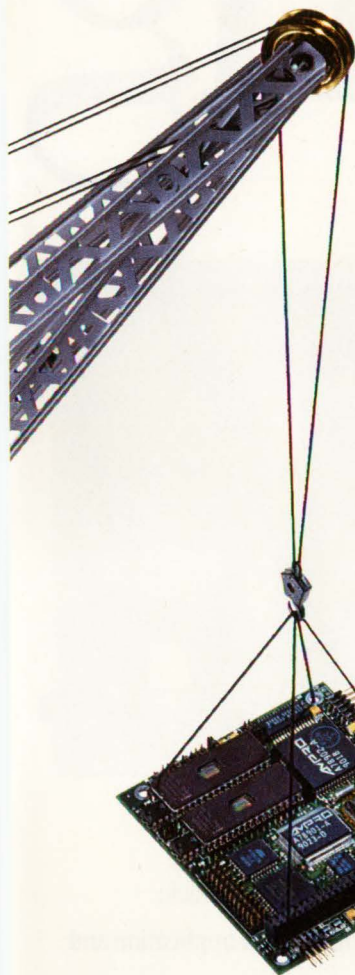

Remember the challenge of constructing "engineering marvels" with your Erector® set? That red metal box held a complete set of interlocking pieces — all that was needed to assemble just about anything. Your imagination was the only limitation.

That's the idea behind Ampro's new way for OEMs to build embedded control applications. Put your application together, simply and quickly, using Ampro Embedded System Modules

Our CoreModule™ family packs ready-made full PC- or AT-compatible intelligence into 3.6" x 3.8" x 0.6". Just plug one into your circuit board — like plugging in a chip — to easily interface to your own logic. They operate over 0 to 70°C, and include a CMOS CPU, RAM, extended BIOS, Solid State Disk, serial and parallel I/O ports, keyboard and speaker interfaces, and a real-time clock.

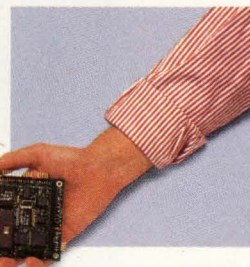

Stack a CoreModule unit together with one or more of our expansion MiniModule™ peripherals (no backplanes or card cages needed). MiniModule products, also 3.6" x 3.8", can be used to add display controllers, more Solid State Disk capacity, network controllers, modem and facsimile features, additional I/O, and much more.

You'll get your product to market faster, with less risk, and at lower cost, because the CoreModule family is based on the most economical industry standard architecture. Now you can focus on the more challenging part of your system — the application itself.

Ultrasound monitors, point-of-sale terminals, robotics, network controllers — no matter what kind of "engineering marvel" you're building, you should be using Ampro's "Erector set" for your embedded control application.

Call **1-800-966-5200**. Get the Information Kit on CoreModule and MiniModule products today.



Pioneering Solutions for Embedded Control

Making

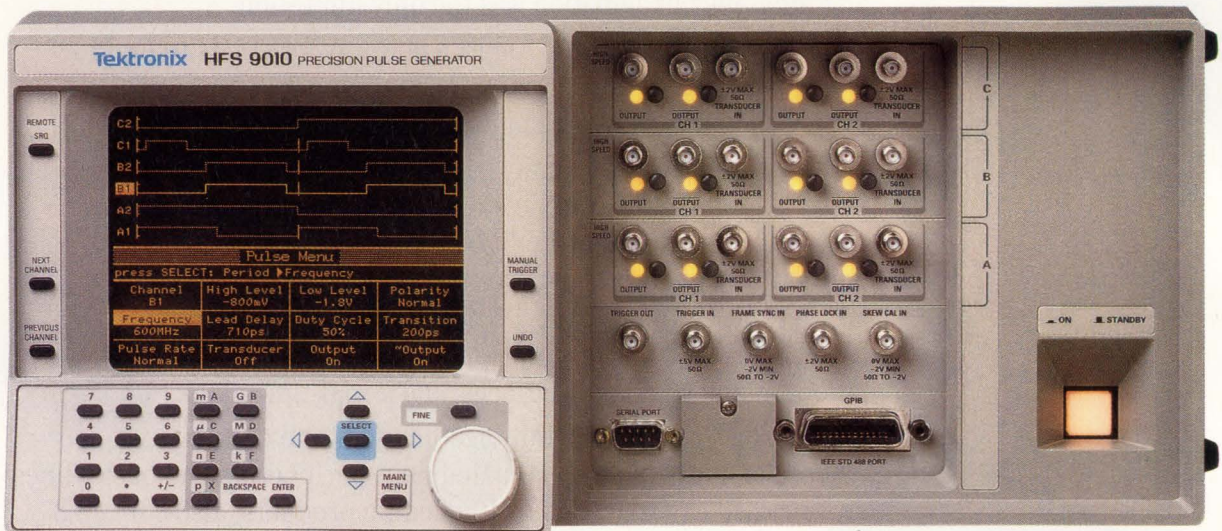

You're looking at the biggest news in signal sources in years: two new families of pulse generators from Tektronix.

You can already see one reason why Tek's new pulse generators are stirring up so much interest: their what-you-see-is-what-you-get user interface vastly simplifies your life.

Now you can stop piecing the big picture together from one-line LEDs, blinking error lights and trial-and-error iteration. Tek's new scope-like display lets you set up and modify a whole set of parameters at once, with a true representation of your pulses

and instant, visual feedback.

You name your application and logic technology: Tek has a signal source to match. For the first time, you can choose channel capacities from one to six channels, or rep rates from 50 MHz to a remarkable 600 MHz. Choose tools designed for logic, fast logic, or *mixed* technologies. Vary transition times from 200 ps to 10 ms. Test complex timing relationships with ease.

Add to all this our popular pulse generator plug-ins from Tek TM500/

Waves.

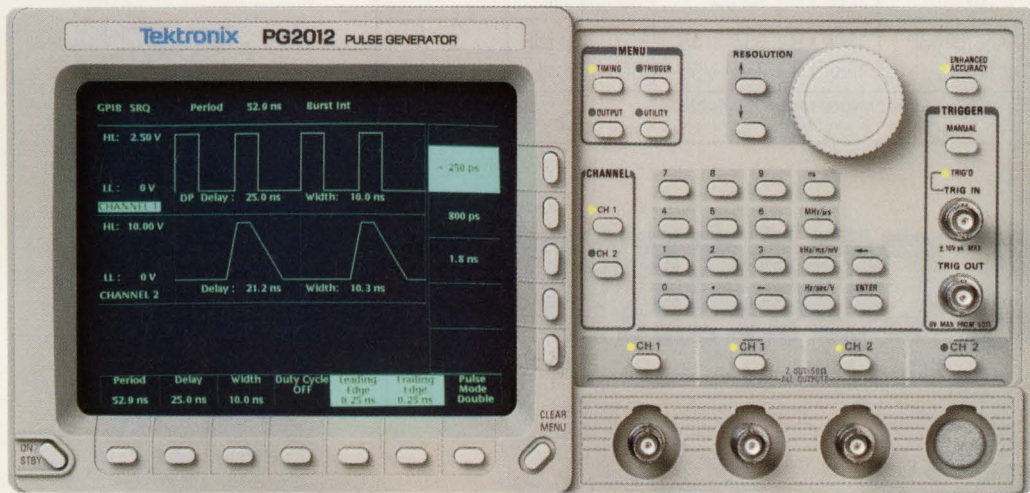

5000 modular instrumentation, and you can see why we're making waves!

Easier to use, more precise and more expandable, Tek's new pulse generators are doing for signal sources what DSOs have done for measurements.

Contact your Tek sales office for a demonstration, or call for more information.

1-800-426-2200

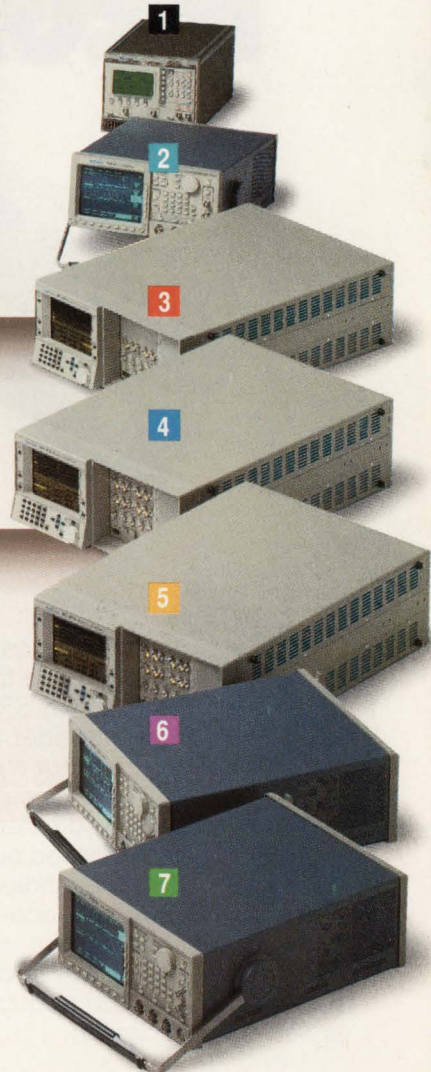
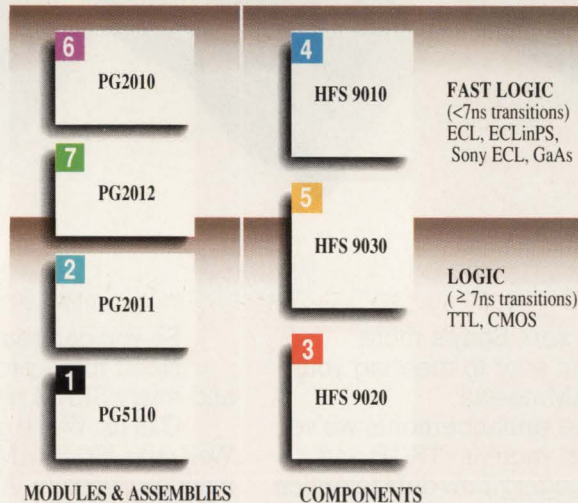

One company measures up.

Tektronix
COMMITTED TO EXCELLENCE

MEGA MEMORY.

SONY HIGH-DENSITY SRAMS				
MODEL	CONFIG.	SPEED (ns)	PACKAGING	DATA
				RETENTION
CXK581000P*	128K x 8	100/120	DIP 600 mil	L, LL
CXK581000M*	128K x 8	100/120	SOP 525 mil	L, LL
CXK581100TM*	128K x 8	100/120	TSOP	L, LL
CXK581100YM*	128K x 8	100/120	TSOP (reverse)	L, LL
CXK581001P	128K x 8	70/85	DIP 600 mil	L
CXK581001M	128K x 8	70/85	SOP 525 mil	L
CXK581020SP	128K x 8	35/45/55	SDIP 400 mil	
CXK581020J	128K x 8	35/45/55	SOJ 400 mil	

*Extended temperature range available. L = Low power.
LL = Low, low power.

MEGA COMMITMENT.



As you can see, Sony's more committed than ever to meeting your high-density SRAM needs.

Just consider the enhancements we've made in a few short months: TSOP and TSOP-reverse packaging. Low data retention current. And extended temperature range.

All based on our unique 0.8-micron CMOS technology, and available in 32-pin DIP and surface-mount plastic packages.

Then consider our ever-increasing production capabilities. We've just added yet another SRAM facility in Japan. And acquired a large AMD facility in San Antonio, Texas.

So you can really count on us in a crunch. Need more proof we're serious about your each and every SRAM need?

Call us. We've got more breakthroughs on the way. Well over 100 SRAM products spanning the performance spectrum. And the desire to meet—or exceed—your toughest performance spec.

Sony high-density SRAMS are shipping now, complete with competitive pricing. So call (714) 229-4190 today. Or write Sony Corporation Of America, Component Products Company, 10833 Valley View St., Cypress, CA 90630, Attention: Semiconductor sales. FAX (714) 229-4285.

SONY®

Low-drift op amps incorporate switching input stage and DAC-controlled autozero loop

Max425 and Max426 CMOS op amps (\$9.50 (100) in 8-pin plastic DIPs) employ a novel internal architecture that allows them to equal or surpass the low-drift performance characteristics of bipolar and chopper-input alternatives. The maximum specifications for input-offset voltage are V_{io} of $5 \mu\text{V}$, V_{io} TC of $0.05 \mu\text{V}/^\circ\text{C}$, and input bias current (I_B) of 200 pA . V_{io} noise in a 0.1-to-10-Hz bandwidth is typically $0.25 \mu\text{V}$ p-p, which represents a fivefold improvement on similar specs for the best choppers.

Both amps have 140-dB min open-loop voltage gain and common-mode and power-supply rejection ratios of 120 dB min. Internal compensation yields gain-bandwidth products of 350 kHz and 15 MHz, for the Max425 and Max426, respectively. The amps consist of three amplifier stages under control of on-chip logic circuitry. The essential parts appear in the block diagram of Fig 1.

The op amps achieve low-drift performance by using two independent and programmable on-chip nulling techniques. The first is an autozero loop, and the second is a commutating input stage.

The autozero loop operates by shorting the input switch and nulling the first two stages of the op amp. The loop operates until the voltage at the comparator equals the level immediately prior to commencement of the autozero cycle. Digital memory in the control logic stores the correction factor and maintains the null via DACs. One cycle of this autozero loop typically reduces a $50\text{-}\mu\text{V}$ V_{io} to $0.5 \mu\text{V}$.

You can program the autozero

loop to operate either on command or automatically once every minute. While the autozero loop is in action, the op amps' output stage operates as a S/H circuit and maintains output at a constant voltage. The downside of this technique is the 50 msec it takes for one cycle of autozero operation to execute, even on the faster Max426.

The input stage commutates at a default frequency of 300 Hz, although external frequency control is possible. When the switches operate, the op amps' V_{io} and 1/f noise alternately add to and subtract from the external signal source. The effective input is the signal source, amplitude modulated at 300 Hz by the op amps' input offset and noise. A similar waveshape appears at the op amps' output, with an average value of the signal source multiplied by the closed-loop gain.

You have a choice of programming both, either, or neither nulling method for operation. There are performance tradeoffs, however.

Without programming the commutating switch, no cancellation of 1/f noise results. In addition, without an occasional cycle of autozero-loop operation, the op amps' output signal may contain an increasing level of 300-Hz ripple.

Basic applications include use of the op amps as thermocouple-sensor and strain-gauge-bridge amplifiers. Judicious programming of the nulling techniques, however, allows you to use the amplifiers for other applications. For example, with the commutating switch off, I_B max reduces to 10 pA , opening up possible use in high-impedance circuits. In data-acquisition systems where continuous or burst readings demand minimal interruption, you can hold off operation of the autozero loop until a convenient time slot is available.—**Brian Kerridge**

Maxim Integrated Products, 120 San Gabriel Dr, Sunnyvale, CA 94086. Phone (408) 737-7600. FAX (408) 737-7194.

Circle No. 732

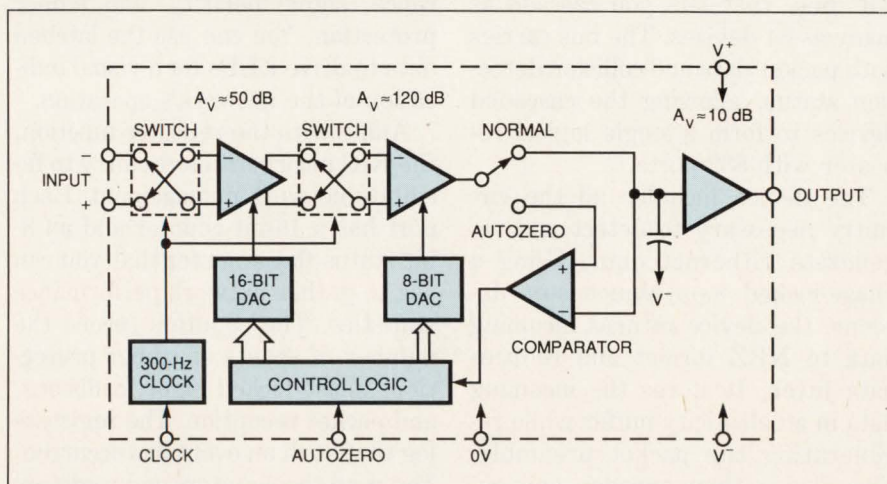

Fig 1—Two independent on-chip nulling techniques in Max425 and Max426 op amps allow you to tailor low-drift performance to a variety of applications.

Repeater IC offers 12 10Base-T ports with network management capability

The DP83950 repeater interface controller (RIC) simplifies the design of managed Ethernet hubs by combining, in a single IC, both repeater circuits and logic for gathering network-management data. The IC contains transceivers, PLL-based Manchester encoding and decoding circuits, and an elasticity buffer for receiving and regenerating data packets. It also contains a variety of event counters, status registers, and interface circuits for handling the network data.

The RIC has 13 Ethernet ports. One port contains an attachment unit interface (AUI) for connecting to AUI-compatible transceiver boxes and cable. The remaining 12 ports contain on-chip 10Base-T transceivers, allowing you to connect the port to twisted-pair wiring with an additional 74ALSXXX driver and a transformer filter. Or, you can bypass the on-chip transceivers and use external transceivers for connection to other media.

You are not limited to 13 ports in your hub, however. The RIC offers a set of signals, called the inter-RIC bus, that lets you cascade as many as 64 devices. The bus carries both packet data and collision detection status, allowing the cascaded devices to form a single logical repeater with 832 ports.

The device includes all the circuitry necessary to detect and regenerate Ethernet data. Using a phase-locked loop Manchester decoder, the device returns incoming data to NRZ format and reduces data jitter. It stores the incoming data in an elasticity buffer while regenerating the packet preamble. The device then encodes and retransmits the stored data.

You control the RIC's operation

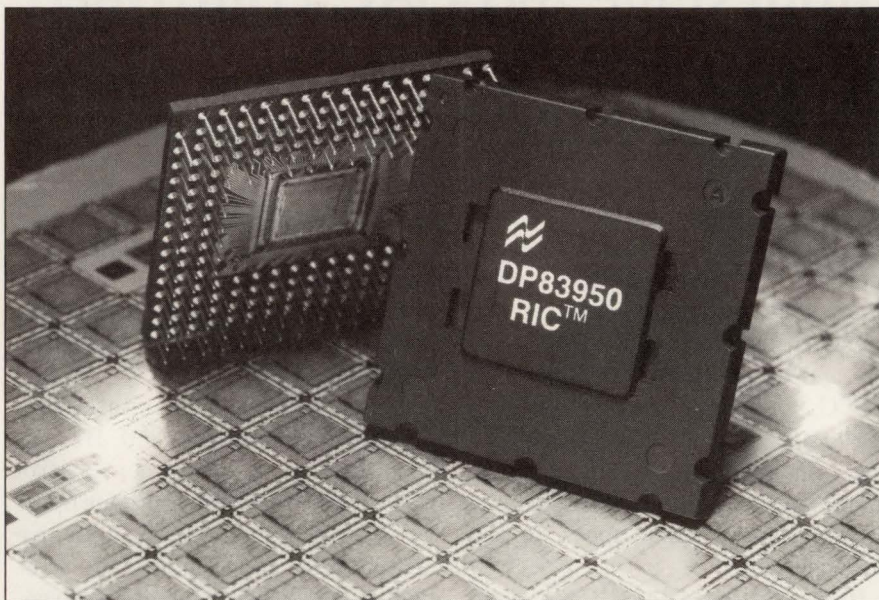

Combining both repeater and network-management functions, the DP83950 helps you build managed and nonmanaged IEEE-802.3 Ethernet hubs.

via an 8-bit microprocessor interface port that serves a dual purpose. In addition to interacting with the host processor, the port can address and drive status display latches. These latches provide 5 bits of information on each port, including link integrity, collision occurrence, signal polarity, and jabber protection. You can use the latched data to drive LEDs for a visual indication of the network's operation.

Along with the repeater function, the RIC incorporates circuitry to facilitate network management. Each port has a 16-bit counter and an 8-bit status-flag register that you can use to gather network performance statistics. The counters record the number of events of jabber protection, phase-locked error, collisions, and packet reception. The registers log that such an event has occurred. You read the counters and registers through the RIC's microprocessor interface.

The RIC also facilitates network management by creating a hub-management status packet. The device can duplicate and transfer an incoming packet to another port and to an Ethernet controller connected to the hub-management interface. The device then appends 7 bytes of status information to the packet sent to the controller. The status information includes the receiving port's address, the timing of any collisions, the time between packets, and the event counter status flags, allowing the controller to analyze the network's performance on a per-packet basis.

The RIC is a 5V CMOS device housed in a 160-pin plastic pin-grid array package. It is available in sample quantities and costs \$145 (100).—**Richard A Quinnell**

National Semiconductor, Box 58090, Santa Clara, CA 95052. Phone (408) 721-7020 or local office.

Circle No. 731



Introducing Zilog's Smart Access Controller... Z180 intelligence and SCC communications together in one package.

Don't throw away your old software.

The Z80 family continues to be the most popular group of intelligent peripheral controllers on the market. With good reason. It's a tribute to our Superintegration™ technology and the performance of the controllers themselves. And since each new product in the family, like the SAC™, is based on the same Z80/180 code you'll be able to migrate your existing software easily and effectively. We don't have to tell you how important that is. Here's a list of the fast-growing family of Z80-based intelligent peripheral controllers. It's a list that's not likely to stop expanding any time soon... stay tuned.

	System					Serial		Timers		Parallel		
	C P U	O S C	M M U	R A M	D M A	U S A R T	U A R T	C / S	C T C	C / T	P I A	P I O
Z84C01	✓	✓									✓	✓
Z84C50	✓	✓					✓				✓	✓
Z84C90			✓								✓	✓
Z80180	✓	✓	✓	✓	✓		✓	✓			✓	✓
Z80280	✓	✓	✓	✓	✓		✓	✓			✓	✓
Z84013/C13	✓	✓					✓	✓			✓	✓
Z84015/C15	✓	✓					✓	✓			✓	✓
Z84011/C11	✓	✓					✓	✓			✓	✓
Z80181	✓	✓					✓	✓			✓	✓

The Z80181™ SAC™ Controller is the Smart Access Controller™ that combines two powerful standards. You get Zilog's industry standard SCC™ controller for datacom connectivity together with the popular Z180 CMOS controller. And all that utility comes with the user-friendly Z80* code CPU compatible software.

High integration. High performance. Smart communicator.

The Superintegration™ SAC Controller packs the popular high performance Z180 architecture into a new cell suitable for many datacom and peripheral control applications. You get the SCC single-channel communication cell with two additional UARTS, a 4 x 8-bit counter timer (CTC) and onboard 16-bit I/O. The SAC Controller runs at 10 MHz and drives fast serial communications at 2.5 Mbits/sec. With the reduced 3 cycles per instruction, the SAC Controller gives you Z80 code performance 25% faster. That makes the SAC Controller the highest performance, low power embedded controller around.

The best cost/performance of any embedded controller out there.

Whatever your application — data communications, modems, FAXS, printers, terminals, industrial controls — the SAC Controller combination gives you the best cost/performance ratio. Everything you need for your system is on the chip. The SAC Controller brings you all the advantages of Zilog's Superintegration technology. Off-the-shelf and backed by our solid reputation for quality and reliability.

To find out more about the SAC Controller, or any of Zilog's rapidly growing family of Superintegration products, contact your local Zilog sales office or your authorized distributor today. Zilog, Inc., 210 Hacienda Ave., Campbell, CA 95008, (408) 370-8000.

Right product. Right price. Right away.



ZILOG SALES OFFICES: CA (408) 370-8120, (714) 838-7800, (818) 707-2160, CO (303) 494-2905, FL (813) 585-2533, GA (404) 448-9370, IL (312) 517-8080, NH (603) 888-8590, MN (612) 831-7611, NJ (201) 382-5700, OH (216) 447-1480, PA (215) 653-0230, TX (214) 987-9987, WA (206) 523-3591, CANADA Toronto (416) 673-0634, UNITED KINGDOM Maidenhead (44) (628) 39200, W. GERMANY Munich (49) (89) 672045, JAPAN Tokyo (81) (3) 587-0528, HONG KONG Kowloon (852) (3) 723-8979, KOREA (82) (2) 552-5401, TAIWAN (886) (2) 741-3125, SINGAPORE 65-235 7155, DISTRIBUTORS: U.S. Anthem Electronics, Hall-Mark Electronics, JAN Devices, Inc., Schwebel Electronics, Vargas Electronics, Western Microtechnology, CANADA Future Electronics, SEMAD, LATIN AMERICA Argentina - Vel. (1) 46-2211, Brazil - Digibyte (011) 581-1945, Semiconductores Profesionales (5) 536-1312.

Simulator analyzes and optimizes high-frequency circuits

A CAE package called jOmega simulates circuits operating at 30 to 3000 MHz. A harmonic-balance simulator that partitions the design into linear and nonlinear portions facilitates such high circuit-speed analysis. For the nonlinear section, the simulator represents currents and voltages by harmonic-series time-domain waveforms. The simulator uses the FFT to convert the waveforms to the frequency domain. Frequency-domain equations allow the simulator to determine the boundary conditions and iterative analysis provides the internal circuit analysis.

The simulator's ability to optimize both linear and nonlinear circuits and to use lossy and dispersive transmission-line RF circuit models are among the advantages of harmonic balance over such classical simulation algorithms as Spice.

The package's statistical-analysis capability provides two optimization routines. The first allows you to simulate and tune your circuit to meet tight performance specifications. Nonlinear tuning offers the ability to gain insight into your circuit's operation via circuit tradeoffs. This tuning capability can assist you in securing optimum conditions for amplifier output, mixer conversion loss, and oscillator-output spectral purity. The other routine performs yield optimization, letting you trade off component cost, reliability, and performance.

In addition, jOmega features a schematic editor and a library of approximately 50 RF, package-level circuit models and standard BJT (bipolar junction transistor) models

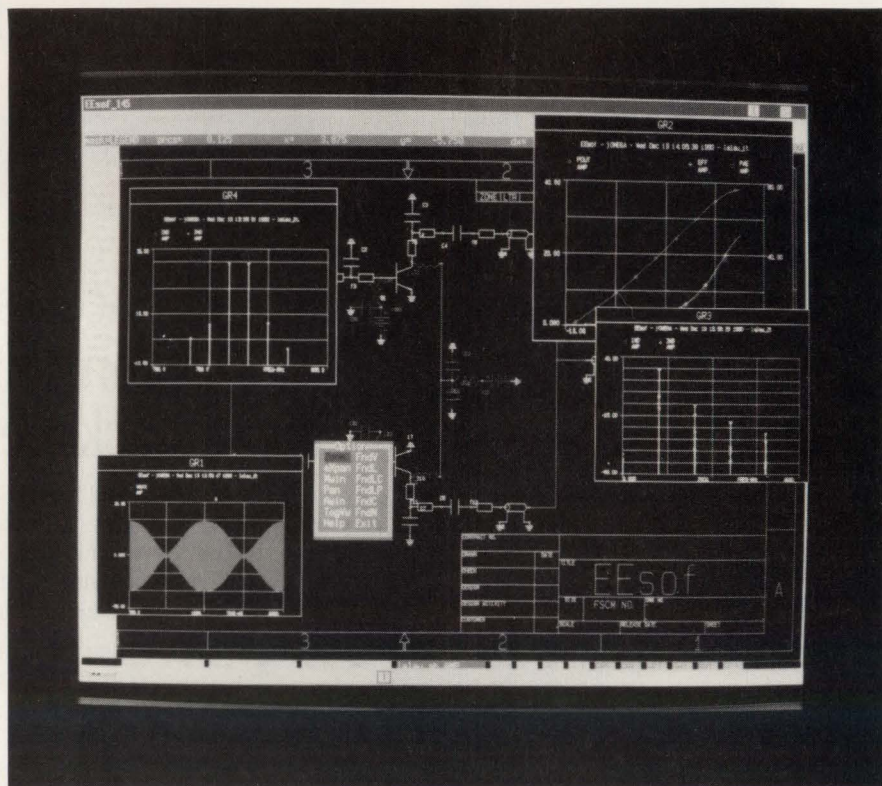

A harmonic-balance algorithm in jOmega analyzes and optimizes operating characteristics such as power saturation, power-added efficiency, and intermodulation distortion.

that you can customize. File management and documentation tools are also part of the tool set.

An option to the software adds floor planning and the ability to mix physical layout and electrical simulation. Using the floor planner, you can verify that all components will fit on your board. With this feature, you can predict and fix proximity and parasitics problems before you draft a layout of the board.

The jOmega floor-planning tools augment—rather than replace—more powerful board-layout tools. The package's software communicates with other layout software via

Gerber, IGES (Initial Graphics Exchange Specification), and neutral mask output file standards.

The software runs on IBM PCs under OS/2 and on Sun, HP/Apollo, and IBM workstations. Available in the second quarter of 1991, the software costs \$24,500; the final price depends on the system, configurations, and options you choose. The floor planner costs \$5000.

—Michael C Markowitz

EEsof Inc, 5601 Lindero Canyon Rd, Westlake Village, CA 91362. Phone (818) 991-7530. FAX (818) 991-7109. TLX 384809.

Circle No. 730

The only 16-bit, 500 kSPS SADC with guaranteed dynamic performance.

For the competition, that's not a pretty picture.

If you're working in spectral imaging applications, our new AD1382 presents a very pretty picture indeed. Because it's the first 16-bit, 500 kSPS single-package sampling A/D converter to offer guaranteed ac performance.

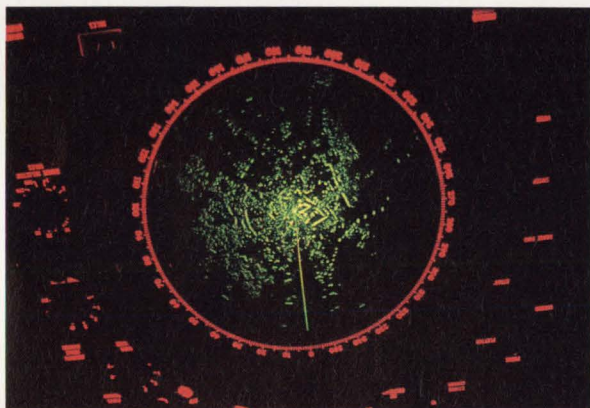

The use of the AD1382 is soaring in radar applications, thanks to its higher level of integration and guaranteed dynamic performance.



With its wide dynamic range and low noise, the AD1382 has a great image with people working in magnetic resonance imaging applications.

The AD1382 delivers guaranteed 100% production tested SNR, THD and peak distortion performance at three input frequencies and over two input ranges – testing that gives you the confidence to design for the best possible noise performance in your system.

You can also feel confident about the cost-effectiveness of the AD1382. It offers a higher level of integration with on-board track/hold and reference.

And since it's a single package, it's easier to design in and uses less

board space than more expensive modular or multipackage solutions.

For a better picture of what the AD1382 can do for you, contact Analog Devices at 1-800-262-5643. Or write to Analog Devices, P.O. Box 9106, Norwood, MA 02062-9106.

AD1382

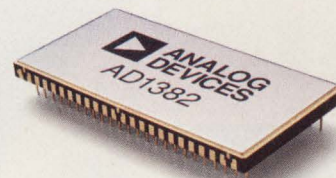

A 16-bit 500 kSPS SADC, the AD1382 provides excellent dynamic and static performance in a dual inline ceramic package.

Guaranteed (@25°C, ± 5 V input range):

SNR

- 5 kHz 90 dB min
- 100 kHz 90 dB min
- 200 kHz 88 dB min

THD & Peak Distortion

- 5 kHz – 90 dB min
- 100 kHz – 88 dB min
- 200 kHz – 74 dB min

DC specifications include:

0.0015% FSR INL, 0.0006% FSR DNL and NMC guaranteed to 16-bits

Other features include:

Zero offset autocalibration
 ± 5 V, ± 10 V Bipolar input range

An evaluation board for the AD1382 is available.



*Putting high-performance power distribution
on the fast track.*

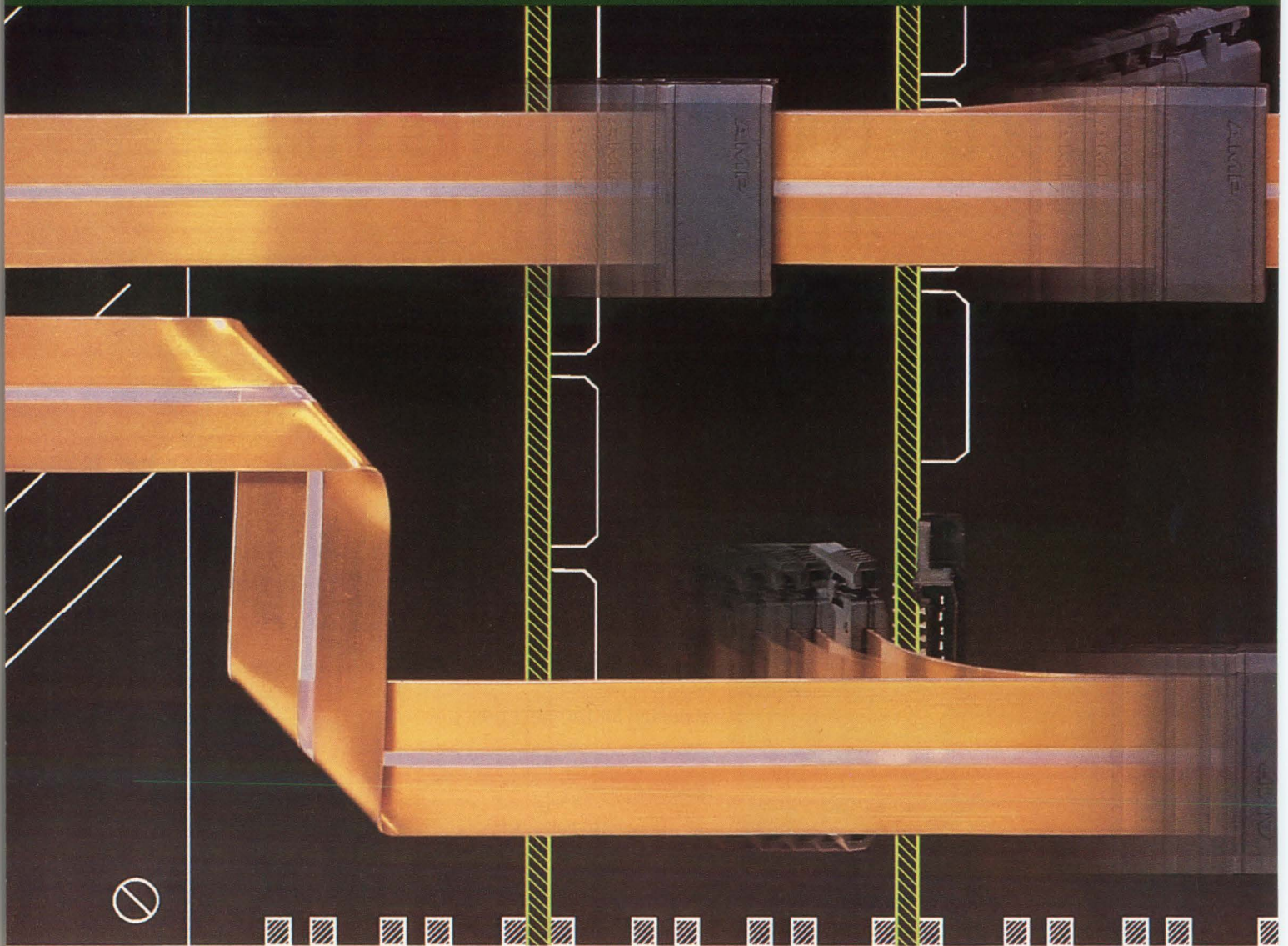

THIS IS AMP TODAY.

Designers of today's high-performance power distribution systems (PDSs) need a practical way to take advantage of the compact size, thermal efficiency, and low inductance of insulated flat copper power cable.

Our newest invention not only makes flat conductors practical, it adds powerful new options to the way you can design your 'flat power' PDS.

AMPOWER Wave Crimp

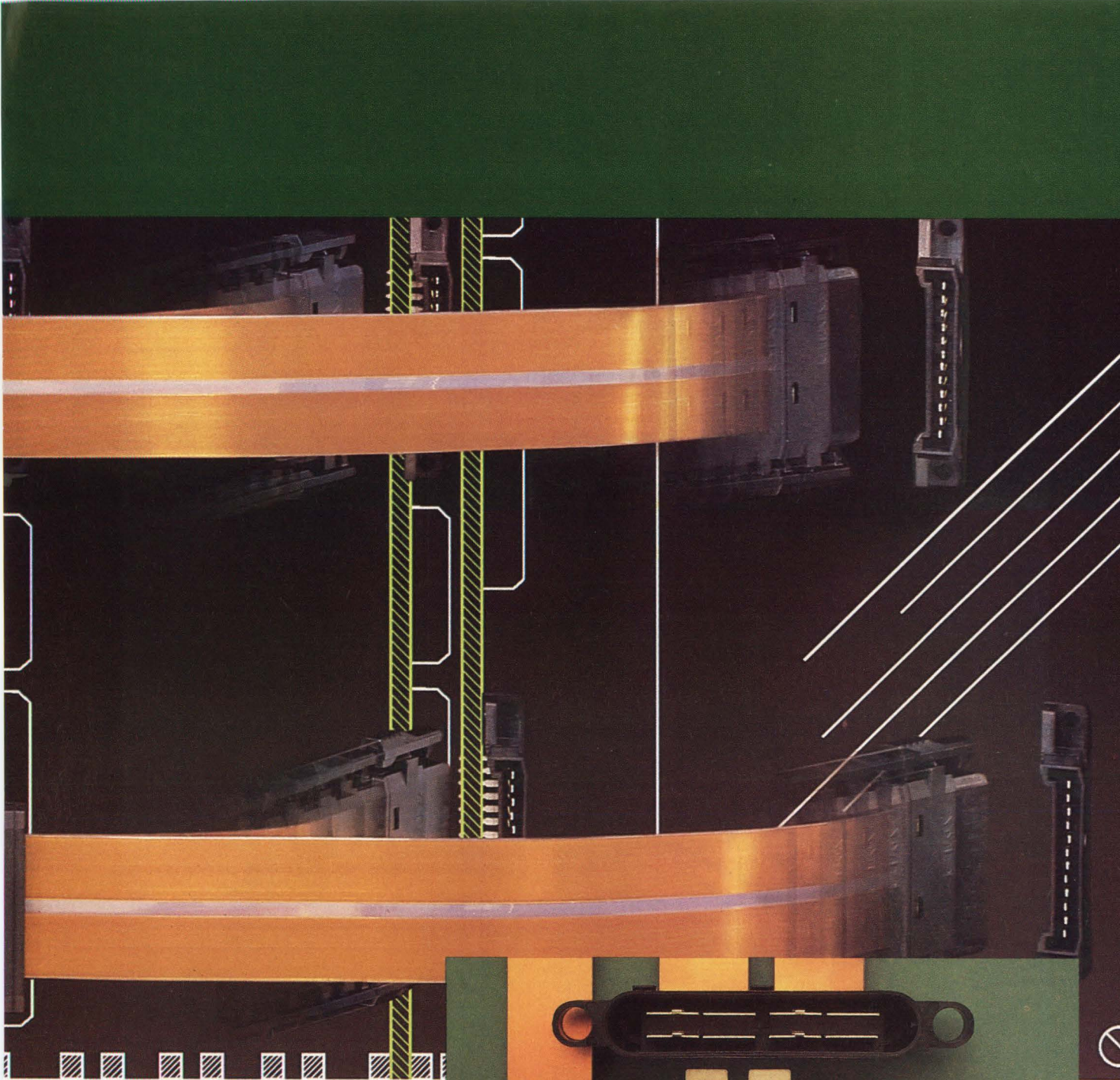

Assemblies let you specify direct taps on flat cable wherever you'd like, for efficient branching. And they give you a true modular approach to power—with separable printed circuit board connectors and sequenced Blind Mate drawer connectors—for fast assembly, and easy service and upgrade.

The exclusive crimp termination contacts an area 50% greater in cross section than the conductor itself. Result: no thermal penalties,

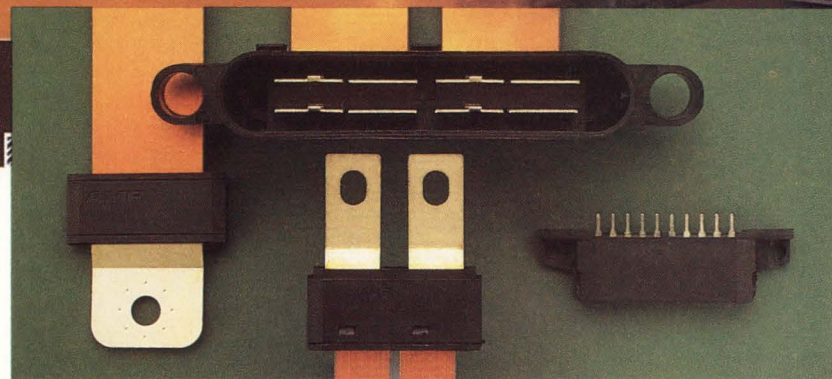

Flat conductor PDS made practical.

no current restrictions, no compromise in the inherent low-noise properties of flat conductors. Electrical characteristics are consistently predictable.

To realize all the new opportu-

nity in flat power right now, call 1-800-522-6752 (fax 717-561-6110) and ask about AMPower Wave Crimp Assemblies. In Canada call 416-475-6222. AMP Incorporated, Harrisburg, PA 17105-3608.

From Outer Space to Your Place,

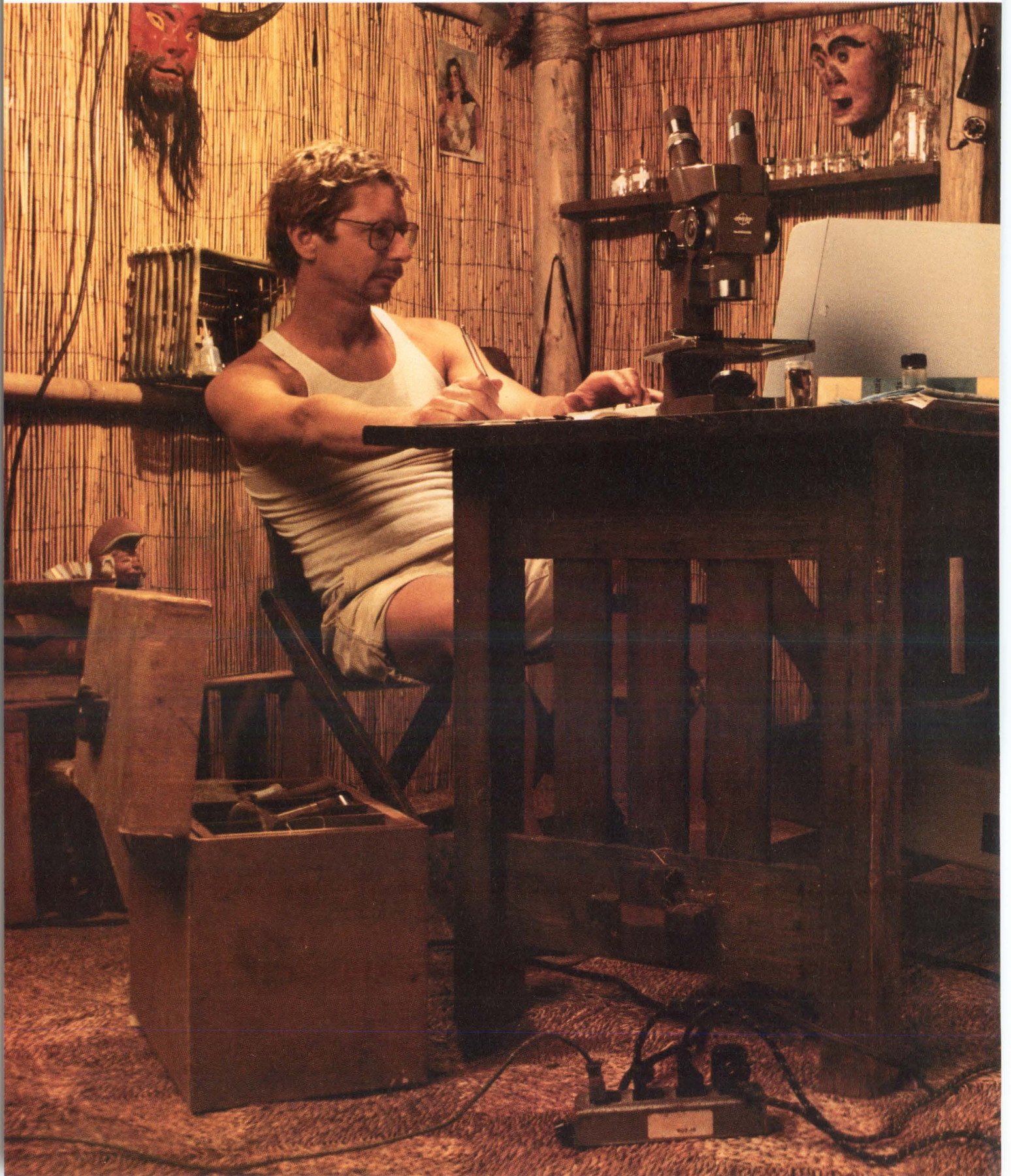

We're Your Best Defense.



By putting our military experience to work in high-volume, low-cost applications, we're giving new meaning to the term *National Defense*. Our Power Supply Supervisory Chips are a good example.



These Raytheon Linear Arrays (*RLAs*) act as a computer's early warning system. They monitor internal voltage levels to 0.3% accuracy—and signal a shut down before power surges can fry the system.

It's "Defense Technology" with a peaceful purpose. And it's helping take computers into places they've never been.

Our *RLAs* have business benefits, too. If you can't decide between a custom or semicustom device, don't. Our *Win-Win* program lets you get to market quickly with a semicustom array, then shift to full custom as sales increase.

Win-Win is fast, flexible, and makes good business sense because it eliminates the risk of getting into a full custom array before you're really ready.

Raytheon is committed to analog technology. From our design kits and engineering support to our fab and plastic assembly facility. We have the experience it takes to help you develop creative, cost effective solutions.

Find out how. Call 1-800-722-7074 for our new analog brochure.

Raytheon Company, Semiconductor Division.
350 Ellis St. Mountain View, CA 94039.

CIRCLE NO. 72

Raytheon

Where quality starts with fundamentals

Monolithic instrumentation amplifiers

Although you can design your own instrumentation amplifier from an op amp and four resistors, you'll find it difficult to maintain accuracy for resolution beyond 12 bits. Monolithic instrumentation amplifiers offer a high-performance alternative.

An instrumentation amplifier differs from an ordinary op amp in that it is a committed differential-input gain block with a fixed or easily set gain. Instrumentation amplifiers accept a differential input signal, multiply it by a gain, and output a single-ended signal referenced to a local analog ground. Because input signals are often of low amplitude, many instrumentation amplifiers let you amplify the signal by gains of 1000 or more.

The differential input signal to an instrumentation amplifier may have an amplitude of only a few millivolts riding on top of a common-mode signal of several volts. For cases where common-mode voltages are large, a high common-mode rejection ratio (CMRR), defined as the ratio of differential gain to common-mode gain, is important. The high CMRR keeps the common-mode voltage fluctuations from

causing errors in the output.

The low-frequency CMRR for monolithic instrumentation amplifiers typically ranges from around 75 dB for a gain of 1 to 120 dB for a gain of 1000 (Table 1). The CMRR depends on frequency, diminishing as the frequency increases. Instrumentation-amplifier data sheets provide graphs showing the degradation of CMRR with increasing frequency.

Some other traits common to instrumentation amplifiers are a matched high-input impedance and a low input-bias current. A low input-bias current is important when signal sources have a high output impedance or when you're coupling the input through a large series resistance. You may need to include large series resistors on the inputs of an instrumentation amplifier for overvoltage protection or as part of a low-pass RC filter.

You needn't purchase a ready-made instrumentation amplifier. You can construct your own inexpensive device as shown in Fig 1. This configura-

As they become cheaper and more versatile, monolithic instrumentation amplifiers are growing more attractive for high-accuracy circuit applications. The days of discrete designs' dominance may be numbered.

Doug Conner,
Regional Editor

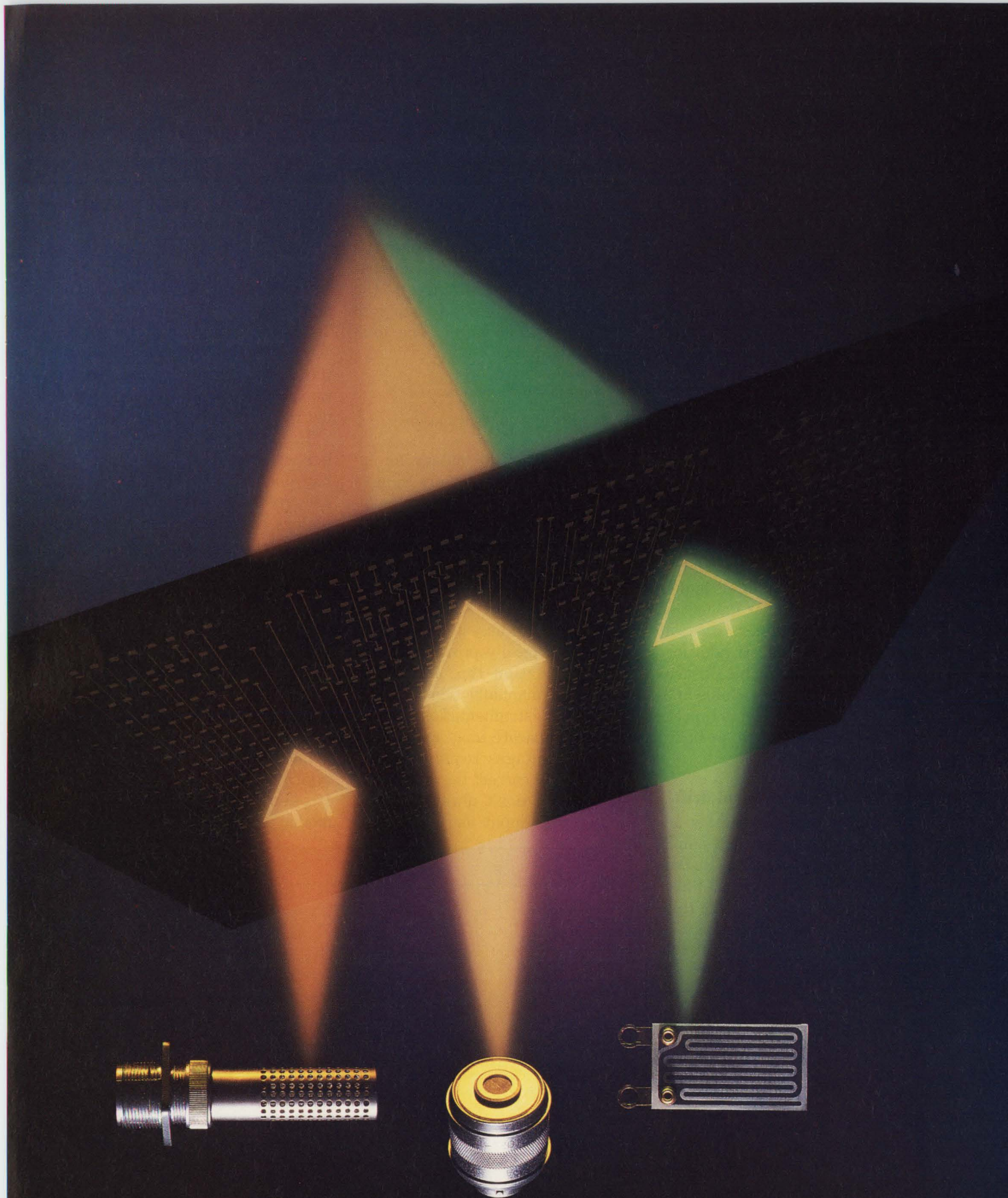

Lower cost, enhanced designs, and improved performance are earning monolithic instrumentation amplifiers a place in more applications. (Photo courtesy Linear Technology)

Instrumentation amplifiers often have separate input and output offset-voltage specifications.

tion is the simplest form of differential amplifier—adequate for 8-bit resolution applications. It offers neither matched nor high input impedance. Linearity, drift, and CMRR specifications will depend on the components used.

You can also construct 2- and 3-amplifier devices for better performance; however, you may not be able to justify using them. As you add amplifiers, the component cost and pc-board space begin to add up to the point where a monolithic instrumentation amplifier would be more economical and offer higher performance. Pricing for monolithic instrumentation amplifiers starts at approximately \$5 (100). In addition, more-compact monolithic instrumentation amplifiers, available in 8-pin DIPs and surface-mount packages, consume even less pc-board space.

Monolithic designs control drift

Monolithic designs offer other advantages over do-it-yourself amplifiers. Because monolithic instrumentation amplifiers keep all internal resistors close to the same temperature, drift specifications are typically quite good. Although off-chip matched-resistor networks can also provide stable resistance ratios, thermocouple effects between the resistor network and the op amp can cause specifications to drift with temperature changes.

Instrumentation amplifiers usually amplify low-level signals, where the range of the differential input may be only tens of millivolts. When dealing with these low-level signals, voltage offsets caused by the instrumentation amplifier are critical. Unlike operational amplifiers, whose data sheets typically specify voltage offsets as an input

offset voltage, instrumentation amplifiers often have two specifications for offset voltages: one for input offset voltage and one for output offset voltage.

The reason for separating the voltage offset specification is that the input and output stages of the amplifier contribute separately to the total voltage offset. The total offset voltage is

$$V_{\text{OFFSET}} = V_{\text{INPUT OFFSET}} \times \text{Gain} + V_{\text{OUTPUT OFFSET}}$$

The total dc offset voltage for instrumentation amplifiers ranges typically from 10 μV to a few millivolts. You can trim amplifiers with high dc offset voltages for high-accuracy dc applications if the offset is stable enough over time and temperature.

Instrumentation-amplifier manufacturers typically provide application information that includes a method of manually trimming the dc offset. Instrumentation amplifiers with separate input and output dc offset voltages require two adjustments to correct the offset completely. You don't always need to correct both input and output off-

sets. For high-gain values, the input offset voltage dominates the error term, so you can usually obtain acceptable results by correcting only the input offset.

Another approach manufacturers offer is an auto-zeroing method which lets you periodically measure and correct the output of the instrumentation amplifier. Auto-zeroing typically involves shorting the two inputs of the instrumentation amplifier and adjusting the output to zero in software or hardware.

The easiest way to get an amplifier with low dc offset voltage is to buy one. Linear Technology broke new ground in instrumentation amplifiers by offering the first chopper-stabilized instrumentation amplifier, the LTC 1100, with a 10 μV total offset.

Gain considerations

DC offset isn't the only issue to consider when evaluating the dc accuracy of an instrumentation amplifier; gain accuracy is also important. The nominal gain error on monolithic instrumentation amplifiers typically ranges between 0.01% and 1%, depending on both the amplifier model and the gain you select. If

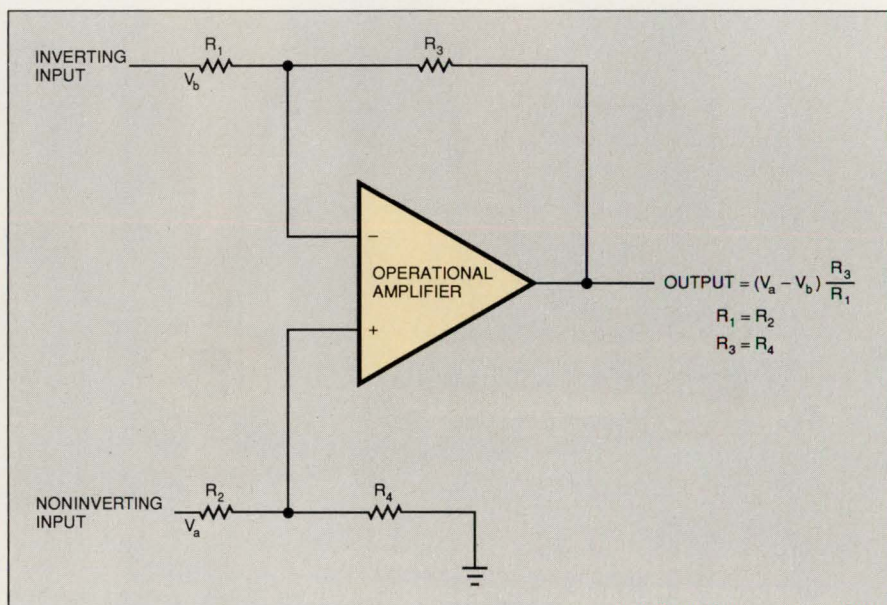

Fig 1—An op amp and four resistors make a differential amplifier of limited capability. This low-cost circuit is normally adequate for 8-bit applications.

the nominal-gain-error contribution is too large, you can trim the gain for higher accuracy.

Other sources of gain error are difficult or impossible to trim. The gain nonlinearity error can range from almost nothing (0.0007%) to 0.1%. Gain drift accompanying temperature changes can add errors ranging from 4 ppm/°C to 100 ppm/°C. An error of 100 ppm/°C may not sound like much, but if your amplifier must operate over a relatively large temperature range, such as 70°C, you're looking at a potential 0.7% error.

You should watch for potential drift problems, but the selection of gains available, and how you select them, may be just as important. You can use three common methods

to set the gain of instrumentation amplifiers: adding resistors, selecting with pins, and selecting with software.

Programming gains with resistors gives you the most flexibility, typically allowing you to select gains from 1 to 10,000. Using one or two resistors having the right values, you can set any desired gain value. Of course, the resistors must be precision resistors with low drift characteristics. However precise initially, resistor-programmed gains carry the potential disadvantage of increased drift with temperature changes.

Instrumentation amplifiers that let you use pin- or software-programmable gains fully specify the drift in their product data sheets.

Gains available on these products are usually limited to powers of 10 or powers of 2. Pin-programmable instrumentation amplifiers require you to connect the appropriate signals and pins to select the gain. Software-programmable instrumentation amplifiers let you select among the possible gains by applying a digital word to the inputs.

The advantage of pin- and software-programmable instrumentation amplifiers is that no precision resistor is needed to program the gain. The disadvantage is in limiting you to the built-in gains.

Adjust gain with fixed-gain amps

If you want a gain that isn't available on a pin- or software-programmable instrumentation amplifier,

Table 1—Representative monolithic instrumentation amplifiers

Manufacturer	Product	Gain	Gain select method	Gain error (% max at 25°C) ¹	DC input offset (±μV max at 25°C) ¹	DC output offset (±μV max at 25°C) ¹	Input bias current (nA max at 25°C) ¹	Unit price ² (100)	Notes
Analog Devices	AD365	1, 10, 100, 500	Digital	0.05 to 0.1	200	5000	50	\$65.10	Includes track-and-hold. Gains from 1 to 160 are possible; single supply. THD + Noise < 0.01% for gain = 100, from 20 Hz to 20 kHz; 850 pV√Hz Noise.
	AD522	1 to 10,000	Resistor	0.05 to 1.0	200 to 400	0	25	\$37.80	
	AD524	1, 10, 100, 1000	Pin	0.02 to 2.0	50 to 250	2000 to 5000	15 to 50	\$9.90	
	AD526	1, 2, 4, 8, 16	Digital	0.01 to 0.15	250 to 700	0	0.15	\$8.25	
	AD624	1, 100, 200, 500, 1000	Pin	0.02 to 1.0	25 to 200	2000 to 5000	15 to 50	\$11.90	
	AD625	1 to 10,000	Resistor	0.02 to 0.05	25 to 200	2000 to 5000	15 to 50	\$9.50	
	AD626	20	Fixed	0.2	NA	NA	NA	\$3.00	
	AMP-01	0.1 to 10,000	Resistor	0.6 to 0.8	50 to 100	3000 to 6000	4 to 6	\$9.90	
	AMP-02	1 to 10,000	Resistor	0.02 to 0.7	100 to 200	4000 to 8000	10 to 20	\$4.75	
	AMP-05	0.1 to 2,000	Resistor	0.5 to 1.0	1000 to 2000	15,000 to 25,000	0.05 to 0.1	\$9.90	
SSM-2017	1 to 1000	Resistor	0.13 to 3.5 typ	220 typ	47 typ	6700 typ	\$1.80		
Burr-Brown	PGA202	1, 10, 100, 1000	Digital	0.15 to 1.0	500 to 1000	5000 to 20,000	0.050	\$6.95	THD + Noise ≤ 0.0009% for gain = 1000, at 1 kHz.
	PGA203	1, 2, 4, 8	Digital	0.15 to 0.25	500 to 1000	5000 to 20,000	0.050	\$6.95	
	INA102	1, 10, 100, 1000	Pin	0.05 to 0.9	100 to 500	200 to 300	30 to 50	\$5.65	
	INA103	1, 100	Pin	0.01 to 0.25	50 to 100	2000 to 5000	8000 to 12,000	\$6.90	
	INA120	1, 10, 100, 1000	Pin	0.05 to 1.0	25 to 200	600 to 2000	20 to 50	\$5.90	
Linear Technology	LTC1100	10, 100	Pin	0.04 to 0.075	10	0	0.05	\$6.45	Chopper stabilized; single supply. Single supply.
	LTC1101	10, 100	Pin	0.04 to 0.06	160 to 220	0	8 to 10	\$4.95	
	LTC1102	10, 100	Pin	0.05 to 0.07	600 to 900	0	0.04 to 0.06	\$4.95	
National Semiconductor	LM363	10, 100, 1000	Pin	0.5	100 to 2000	0	10	\$8.35	

Notes: NA = Specification not available at press time.
 1. Range of maximum values is for different versions and gain settings.
 2. Amount is for lowest priced version.

Even for low-frequency signals, you may have bandwidth concerns if you are multiplexing signals.

you essentially have three choices. First, you can use a resistor-programmable instrumentation amplifier. Also, some pin- and software-programmable instrumentation amplifiers let you use resistors for setting nonstandard gains.

Second, you can add a conventional op-amp gain stage after the instrumentation amplifier. Because the output of the instrumentation amplifier provides a signal with low impedance that is referenced to ground (single-ended), setting the gain with an op amp is relatively easy. But the additional gain stage provides another source of gain error and drift. If you need to trim the circuit to correct gain error, then you can trim both the instrumentation amplifier's contribution and that of the op-amp gain stage with one adjustment.

In this case, the gain drift with temperature will remain an important consideration unless you'll be using the circuit for a relatively narrow temperature range. Adding periodic automatic gain calibration to the circuit, similar to auto-zeroing for offset, would also eliminate this concern.

The third choice is to perform final gain scaling in software. For certain applications, you'll often convert the analog output to a digital word and send it to a computer. Initial scaling usually is necessary only to set the correct order of magnitude for the signal. This adjustment is sufficient to satisfy electrical considerations such as the acceptable voltage range for the A/D converter. Once the analog signal is converted to digital, you can perform the final scaling in software.

If you need an instrumentation amplifier for a high-accuracy appli-

cation, you need an accurate output voltage at the load, not just on the output pin of the amplifier. Instrumentation amplifiers typically have an output-drive-current capability of several milliamperes. However, when dealing with high-accuracy circuits, you sometimes need to deliver an accurate voltage to a node through some resistive series connection.

Even a 0.1Ω series resistance will cause a $100\text{-}\mu\text{V}$ offset when you drive 1 mA through it. To avoid this offset, some instrumentation amplifiers provide an output sense line in addition to the output force line. The sense line feeds back the output voltage measured at the load, allowing the amplifier to compensate for any voltage drop between the amplifier and the load. If you keep the instrumentation amplifier and associated circuitry close together, you can probably avoid both voltage drops because of series resistance and the need for a sense line. But if you can't keep the amp and circuitry close, a sense line can save components and reduce offset when the voltage drops are unavoidable.

Another feature showing up on instrumentation amplifiers is single-

supply operation. Although you can use a single supply plus ground to power any instrumentation amplifier, the qualities that define useful single-supply operation are usually operation at 5V or less and the ability of the inputs and output to swing very close to the supply and ground.

At least three instrumentation amplifiers—the LTC1100 and LTC1101 from Linear Technology and the AD626 from Analog Devices—now offer single-supply operation. The LTC1101 operates down to ground with the lowest supply current requirement of any instrumentation amplifier— $120\text{ }\mu\text{V}$. The AD626 has a midscale offset feature that allows it to accept bipolar signals with a single supply. Input signals can exceed the range of the supply rails.

The amplifiers discussed so far have been instrumentation amplifiers for dc applications. Yet these amplifiers often end up in applications where the frequencies are between dc and 10 Hz . For these low-frequency applications, dc performance is of primary importance, but ac performance may also require attention.

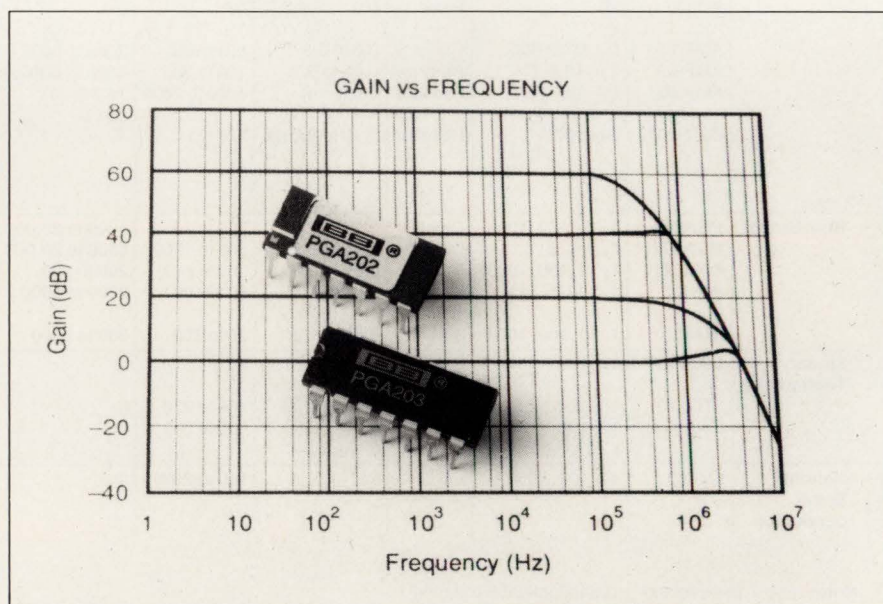

Select among gains of 1, 10, 100, and 1000 with a 2-bit digital word on Burr-Brown's PGA202. The PGA203 provides gains of 1, 2, 4, and 8.

Though your application may use only signals below 10 Hz, if you will be multiplexing different signals through an instrumentation amplifier, you may need a higher-bandwidth amplifier. Each time you switch the multiplexer to a different signal, you need to wait for the instrumentation amplifier's output to settle before you can take a reading. You must make sure the settling time of the amplifier is compatible with the time you'll spend on each signal. Higher-bandwidth amplifiers often have the faster settling time you'll need.

Instrumentation amplifiers are also useful in audio and other applications where frequencies of interest are above 10 Hz. In these higher-frequency cases, the ac performance becomes critical, and the dc performance often becomes secondary.

For audio applications, you may want to consider instrumentation amplifiers designed specifically for audio frequencies. You'll find these amplifiers characterized for specs important to audio, such as total

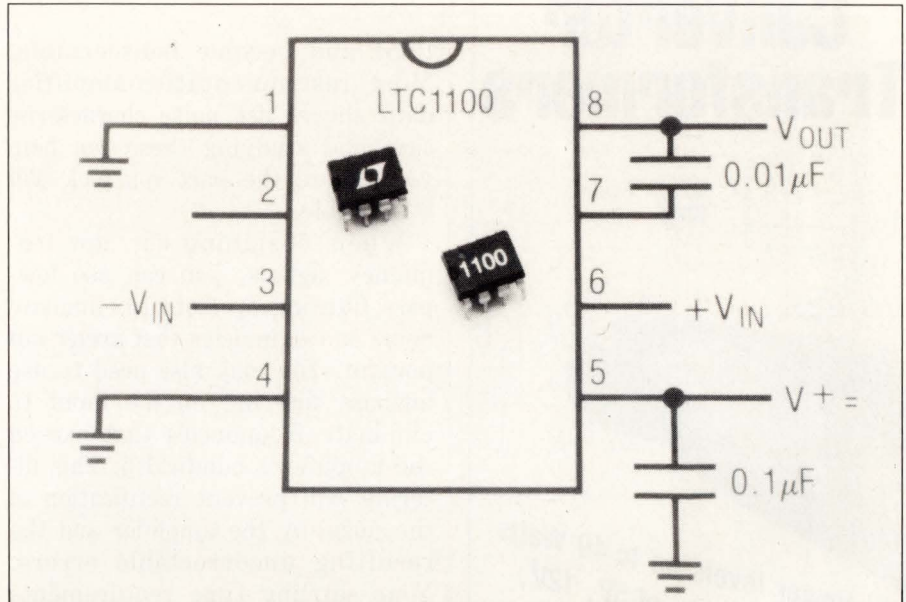

A maximum total offset of 10 μV makes the chopper-stabilized LTC1100 from Linear Technology a good candidate for high-accuracy applications. The 8-pin DIP version has a fixed gain of 100. The 16-pin surface-mount version offers gains of 10 and 100.

harmonic distortion (THD). For example, Burr-Brown's INA103 has a typical THD plus noise of 0.0009% at 1 kHz and a gain of 100. PMI's (a division of Analog Devices) SSM2017 has a THD of less than 0.01% for audio frequencies

while operating at a gain of 1000.

If you're amplifying low-amplitude signals such as soft musical passages, you'll often be concerned with the amplifier's noise. If the amplifier has too much inherent noise, your signal can sink into the noise

Put guards to work on sensitive signals

When working with low-frequency signals, you may elect to use a grounded shield around the input lines to reduce the noise pickup. The grounded shield causes a significant capacitive coupling of the signal-to-ground and low-pass signal filtering, especially if the signal source has a high output impedance. To reduce the signal's capacitance to ground, a guard driver can buffer the input signal to drive the shield (Fig A). Although the guard does nothing to reduce the capacitance to the shield, the signal and shield swing together, eliminating the voltage changes across the capacitance.

Note that the guard need not be the same voltage as the signal as long as the offset remains constant. The guard drivers provided on some instrumentation amplifiers are a diode drop away from the signal voltage.

Guards can provide another benefit, particularly on the surface of a pc board, by reducing leakage currents. A pc board that has become dirty provides

leakage paths between nearby signals. If you surround the input signals to the instrumentation amplifier by a guard line at the same voltage as the inputs, all leakage will be between the guard and surrounding signals, having no effect on the input signal.

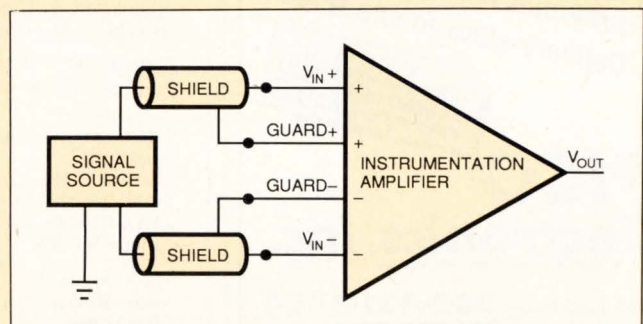
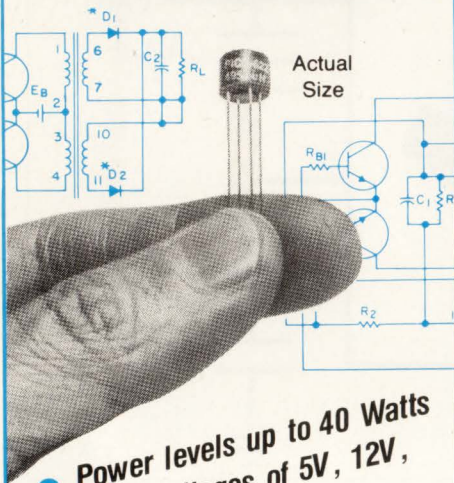

Fig A—Guard drivers available on some instrumentation amplifiers let you shield the inputs from noise yet avoid paying a penalty on input bandwidth due to capacitive coupling with ground.

ULTRA-MINIATURE

DC-DC Converter Transformers



- Power levels up to 40 Watts
- Input voltages of 5V, 12V, 24V and 48V
- Standard output voltages up to 300V (special voltages can be supplied)
- Can be used as self-saturating or linear switching applications
- Operation over ambient temperature range from -55°C to +105°C
- All units meet MIL-T-27 (TF5S40ZZ)
- Secondary can be connected for full-wave or dual bridge
- All units are magnetically shielded
- Schematics and parts list provided with transformers
- Delivery-stock to one week

SEE EEM,
THOMAS REGISTER
OR SEND DIRECT FOR
FREE PICO CATALOG

PICO
Electronics, Inc.
453 N. MacQuesten Pkwy. Mt. Vernon, N.Y. 10552

Call Toll Free **800-431-1064**
IN NEW YORK CALL **914-699-5514**

Send for PICO's new catalog featuring
Ultra Miniature Transformers/Inductors/
DC-DC Converters

CIRCLE NO. 18

Monolithic instrumentation amplifiers

floor and become indiscernible. Most instrumentation-amplifier data sheets list noise characteristics, and studying these can help you ensure the part you pick will be suitable.

When designing for low-frequency signals, you can use low-pass filtering up front to eliminate noise at frequencies that aren't important. You may also need to use lowpass filtering on the input to eliminate frequencies that exceed the amplifier's bandwidth. This filtering will prevent rectification of the noise by the amplifier and the resulting uncorrectable errors. Your settling time requirements will often dictate how low you can make the pass frequency.

Instrumentation amplifiers find use in amplifying differential signals, especially when common-mode voltages are present or you need to change the reference ground voltage to another ground. For instrumentation amplifiers, the grounds typically need to be within 10 to 30V of each other. When you need to change ground references, where potential differences are greater, you can use isolation amplifiers. Isolation amplifiers are hybrid circuits and more expensive than

instrumentation amplifiers. However, they can operate with potential differences of hundreds or even thousands of volts.

Although instrumentation amplifier prices are just beginning to drop below the \$5 level, the devices are still too expensive for many applications where they would otherwise be ideal. For example, when measuring current through a resistor, an instrumentation amplifier provides a simple way to obtain a voltage proportional to current, even when neither end of the resistor is at ground potential.

You can expect to see performance improvements in the future. Meanwhile, prices should continue to drop on new instrumentation amplifiers, so you'll be able to use them for all the applications where you need a differential input gain device. For high-performance applications, you can expect to see offsets improve, so you won't always need to trim them. **EDN**

Article Interest Quotient
(Circle One)
High 518 Medium 519 Low 520

Manufacturers of monolithic instrumentation amplifiers

For more information on monolithic instrumentation amplifiers such as those described in this article, circle the appropriate numbers on the Information Retrieval Service card or use EDN's Express Request service. When you contact any of the following manufacturers directly, please let them know you saw their products in EDN.

Analog Devices Inc
Box 9106
Norwood, MA 02062
(617) 329-4700
FAX (710) 394-6577
Circle No. 658

Linear Technology Corp
1630 McCarthy Blvd
Milpitas, CA 95035
(408) 434-0507
FAX (408) 434-0507
Circle No. 660

National Semiconductor
Box 58090
Santa Clara, CA 95052
(408) 721-5000
FAX (910) 339-9420
Circle No. 661

Burr-Brown Corp
Box 11400
Tucson, AZ 85734
(602) 746-1111
FAX (602) 741-3895
Circle No. 659

High Performance Power at Low Cost

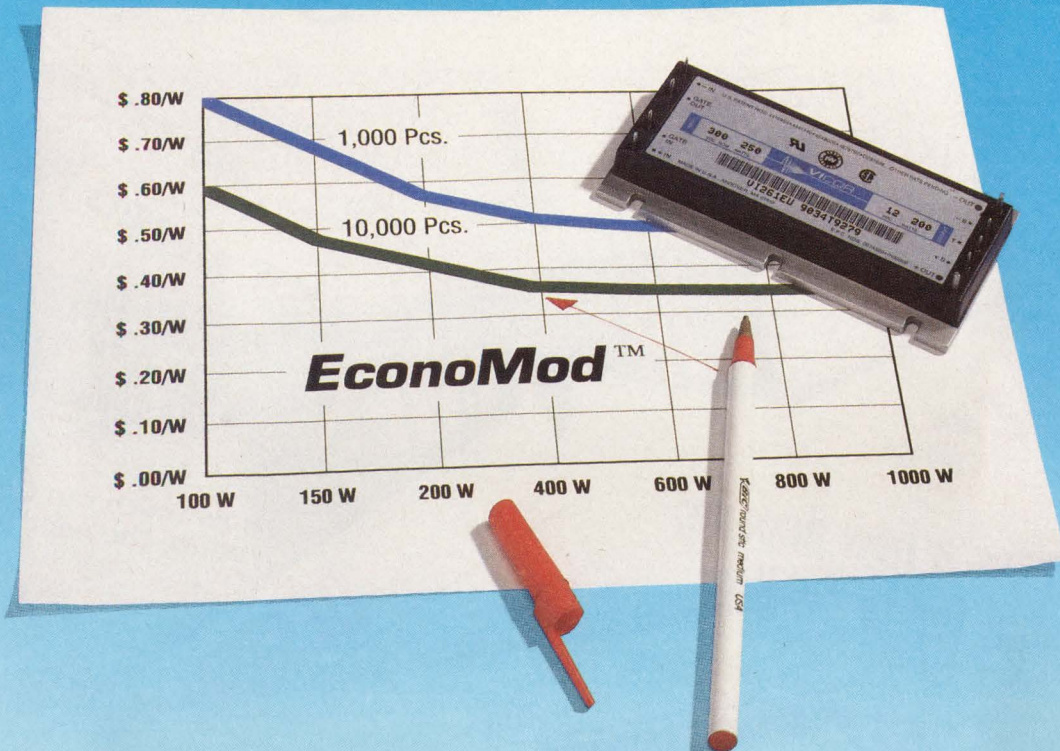

If you thought component-level power was too expensive for your high volume, cost sensitive applications . . . we've got good news. Vicor's new EconoMod™ family of component-level power converters offers the size and performance advantages of Vicor's megahertz power technology at prices as low as 33¢ per Watt in OEM quantities. Available in over 180 popular combinations of input voltage, output voltage and output power, and sharing Vicor's "industry standard" encapsulated package, every EconoMod and

compatible Power Booster™ features the high power density, high efficiency, "instant expandability" and component-level flexibility that make traditional power supplies obsolete. From 50 Watts to kiloWatts . . . EconoMod brings the benefits of contemporary power solutions to cost sensitive applications.



23 Frontage Road, Andover, MA 01810
Tel.: 800-735-6200, 508-470-2900 • Fax: 508-475-6715
Vicor GmbH, Tel.: 49-8031-42083 • Fax: 49-8031-45736

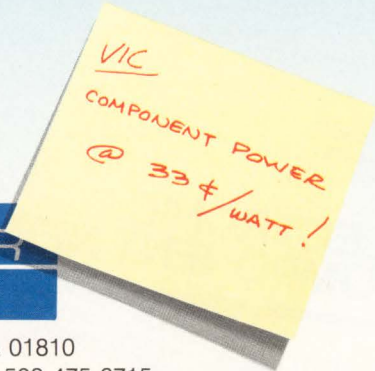

Component Solutions For Your Power System

IN THE ERA OF MegaChip™ TECHNOLOGIES

A lot has been said about company is doing a lot about



testability, but only one it. Texas Instruments.



You've seen the headlines and read the stories. Design-for-test (DFT) is a challenge but one that's now easier to live with. The reason: Texas Instruments is the first to develop products for implementing the JTAG/IEEE 1149.1 testability standard quickly and effectively.

To market faster at lower cost
By implementing testability into your system from the outset, you can create one that uses high-performance circuits and is readily manufacturable, one that is lower in total cost and on the market faster. You can expect:

- Test integration — from silicon to system — that reduces debug and test time
- Reduced test software development time — generating test vectors is greatly simplified
- Reduced capital investment in test equipment
- Increased system fault coverage and reliability

SCOPE, our broad-based solution

To simplify and speed your design task, TI has developed its SCOPE™ (System Controllability/Observability Partitioning Environment) family. It is a coordinated, broad-choice set of commercial and military products compatible with the IEEE 1149.1 standard.

Included are bus-interface devices, standard cells, gate arrays, and digital signal processors, as well as our ASSET™ (Advanced Support System for Emulation and Test) diagnostics software.

On the way are diary memories, a series of IEEE 1149.1 stand-alone

controllers, and microprocessors with boundary-scan and built-in self-test features.

We are in for the long haul

As a member of the Joint Test Action Group (JTAG), we contributed to the formulation of the IEEE 1149.1 standard and wholeheartedly support it. We are committed to growing our SCOPE family of products so that designing to the IEEE 1149.1 standard will be like second nature.

Your future competitiveness depends upon an engineering methodology where design teams bear the burden of testability, manufacturability, and reliability. The demands of concurrent engineering will be met in part by the extended capabilities accessed via the IEEE standard — from embedded system information that allows realtime availability of data throughout the design cycle to emulation and realtime system analyses capabilities built right into the silicon.

Get our floppy free, and learn more

Call 1-800-336-5236, ext. 3909, and we'll send you our unique floppy disk presentation. Just pop it into any MS-DOS™-compatible PC to find out more about DFT and TI's SCOPE testability family. What's more, the disk features a formula that allows you to calculate the cost-effectiveness of implementing testability in your system.

You will continue to read headlines about DFT. We intend to make many of them.

™ MegaChip, SCOPE, and ASSET are trademarks of Texas Instruments Incorporated.
MS-DOS is a trademark of Microsoft Corporation.
© 1990 TI 08-0205



**TEXAS
INSTRUMENTS**

Multi Roles. One actor, many faces...

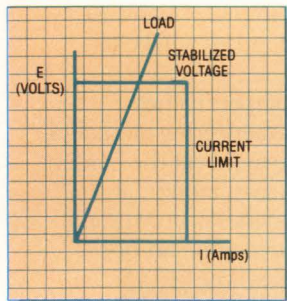

One power supply, many applications.

KEPCO'S SERIES ATE VOLTAGE STABILIZERS HAVE MANY ROLES...



....SUPPLY
STABILIZED VOLTAGE
0.001% voltage stabilizer

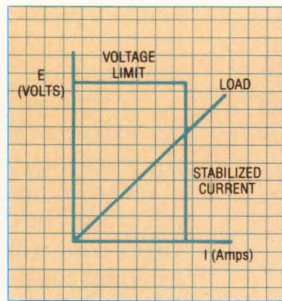

AND CURRENT.
0.005% current stabilizer

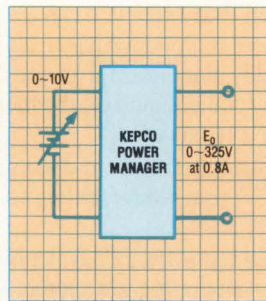

THEY'RE PROGRAMMABLE
IN VOLTAGE MODE.
A voltage stabilizer controlled
by a 0-10V d-c signal

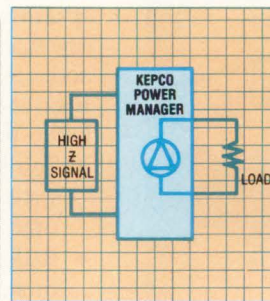

THEY'RE PROGRAMMABLE
IN CURRENT MODE.
A current stabilizer controlled
by a high impedance source

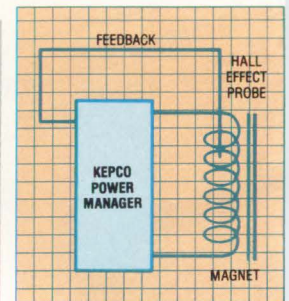

THEY'LL ACCEPT
FEEDBACK.
A magnetic field stabilizer
controlled by a Hall-effect sensor



Model ATE 325-0.8M



The actor/model is *Jan Leighton*, whose face has been photographed as everyone from Patton to MacArthur to Lincoln. One face, many roles. More than 3,372 historical notables according to his fact sheet!

The power supply is Kepco's ATE. While it cannot claim quite so many roles as Jan Leighton, its flexibility will delight you. ATE power supplies are comfortable in roles as voltage sources, current stabilizers, power amplifiers, GPIB listeners and MATE-verified talker-listeners.

ATE are comfortable on your bench, in your systems or installed in your test rack... you can control them with analog signals or digital. You can use their integral uncommitted op amps to scale, sum, integrate or multiply a variety of signal stimuli in servo roles. A versatile piece of test equipment indeed.

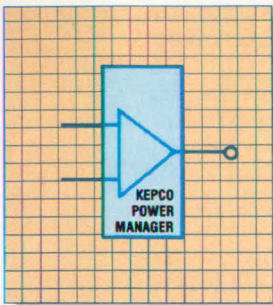
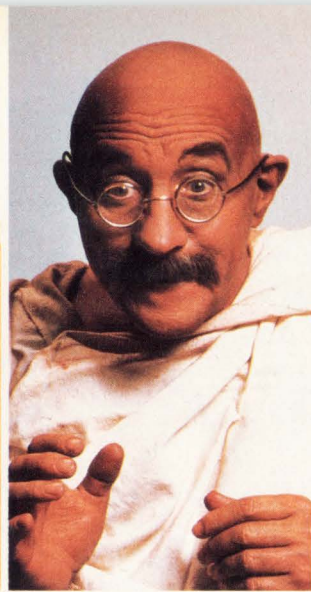

THEY'LL FUNCTION AS AN AMPLIFIER...
A self-powered oversized op-amp

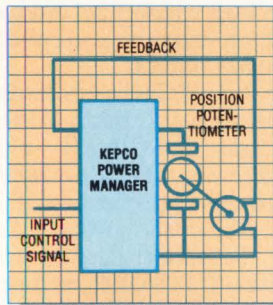

OR CONTROL A MACHINE.
A servo amplifier to drive a positioning motor

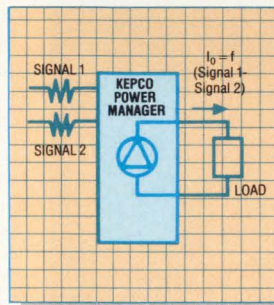

ATE CAN SUM INPUT CONTROL SIGNALS
A current stabilizer controlled by the difference between two signals

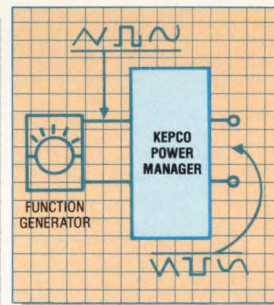

...BE DRIVEN BY AN ANALOG FUNCTION
A voltage stabilizer controlled by a signal generator

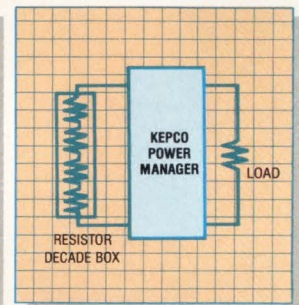

OR INTERFACE TO THE DIGITAL WORLD
A voltage stabilizer controlled by a passive resistance decade box

ATE are made in 5 power ranges, 50 to 1000W (voltage ranges 0-6V to 0-325V) to afford:

- High stability (less than 0.0005% source effect, 0.001% load effect).
- Very low ripple and noise (0.1mV rms, 1mV pp).

- Rapid recovery (<50µsec).
- Most important... ATE's linear design supports a fast-programming mode which — for your control signals — allows a wide bandwidth response ... 16KHz in our 0-6V, 100 Ampere model, allowing

roles ordinary power supplies cannot imagine.

- Fast Recovery current stabilizer
- Wide band power amplifier
- Rapid response to sequenced programs



Like Jan Leighton, Kepco's 41 different ATE models are capable of many roles, limited mainly by your imagination. We'd like to tell you more. ATE's unique user port allows you access to the principal control points. A simple 3-step procedure allows you to configure your ATE for whatever role you require.

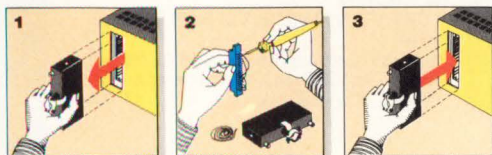

CIRCLE NO. 60

By appropriate wiring of the mating plug, your ATE easily assumes a variety of roles: voltage/current controller, resistance programmed, voltage programmed, digitally programmed, power amplifier, servo amplifier, integrator.



146-1716

146-1704

146-1739

SEE OUR PAGES IN VOLUME D **eem**₉₁

Call/fax/write to Dept. LLT-12 for any of our three catalogs.

Kepco, Inc., 131-38 Sanford Avenue, Flushing, NY 11352 USA (718) 461-7000 • FAX (718) 767-1102 • Easylink (TWX): 710-582-2631

KEPCO EUROPE, LTD., London, England: Salamander Quay West, Park Lane, Harefield, Middlesex UB9 6NZ • Tel: +44 895 825046 • Fax: +44 895 825045

BRITISH ISLES: PPM Instr. Ltd. • Tel: (0483) 301333 • Fax: (0483) 300862 GERMANY: Compumess Elektronik GMBH • Tel: (089) 32 00 95 56 • Fax: (089) 32 00 95 25

FRANCE: M.B. Electronique • Tel: (1) 39 56 81 31 • Fax: (1) 39 56 53 44 ITALY: Sistrel, S.p.A. • Tel: (02) 618 1893 • Fax: (02) 618 2440

Integrating datafax modems with full G3 capability takes a world of experience.

The fast-growing worldwide base of 15 million fax machines is an audience you can't ignore. And nearly 75% use Rockwell International modems. So you know who you can count on for true compatibility in a whole family of integrated datafax solutions—at remarkably reasonable prices. Rockwell technology and worldwide support from software vendors make your project easier to design and faster to market.

Rockwell's TrueFAX™ modem family offers a clear migration path for present and future applications. Including the RC224ATF—a low-power, fully integrated single device with Group 3 fax send/receive capabilities based on industry-standard ANSI/EIA-578 Service Class 1 AT commands.

For open-architecture solutions, choose Rockwell's RC9624DP data pump or RC9624AC integrated device set. Both support major international protocols for data and send/receive fax; the RC9624AC also offers a fully featured datafax AT command set, plus V.42/V.42 bis.

Low power consumption, low cost and small size. They're all yours with the versatile Rockwell family of datafax modems. For details, contact Rockwell Communication Systems at P.O. Box C, M.C. 501-300, Newport Beach, CA 92658-8902; (800) 854-8099; in California: (800) 422-4230; Fax—(714) 833-4078 or (714) 833-4391.

RC224ATF

- CCITT V.22, V.22 bis, Bell 212A and 103 operating modes
- EIA TR30.2.2/88 AT commands
- V.29, V.27 ter, and V.21 Channel 2 G3 send/receive fax modes
- ANSI/EIA-578 Service Class 1 fax commands
- 2-device version available (external memory bus)

RC9624DP

- CCITT V.21, V.22, V.22 bis, V.23, Bell 212A and 103 modes
- Supports V.42 error correction protocol (HDLC framing)
- V.29, V.27 ter, V.21 Channel 2 G3 send/receive fax modes
- Single CMOS VLSI device



...where science gets down to business

CIRCLE NO. 61

TrueFAX™

Create signals having optimum resolution, response, and noise

Simultaneously achieving fine frequency resolution, fast switching speed, and low phase noise is the hallmark of the signal-generation technique known as direct digital synthesis.

Earl McCune Jr, *Digital RF Solutions Corp*

Direct digital synthesis (DDS), also known as direct digital frequency synthesis (DDFS), is a newcomer to the toolbox of engineers who develop hardware for generating signals and waveforms. Because of component tolerances, value variations with time, and manufacturing inconsistencies, traditional analog techniques can only approximate a desired signal. In contrast, DDS calculates the signal directly.

DDS is known as a numeric—rather than a digital—technique. Two concerns account for this categorization: one technical, the other more marketing oriented. The technical reason stems from the direct calculations; the signal is actually generated by manipulating numbers. Although “digital” can have the same meaning as “numeric,” digital can also refer to signals having (usually) two fixed amplitude levels. DDS does use techniques that are digital in both senses, but the two most important aspects of DDS are the numeric means it uses to represent quantities and the inherent precision that results from its use of numbers.

The marketing-oriented reason for calling DDS a numeric technique relates to the constraints imposed by traditional analog design. To maintain waveform inaccuracies of 0.1% or less (60-dB dynamic range),

designers have avoided digital circuits. Such circuits have a reputation for generating noise currents that degrade signal purity in sensitive analog circuits nearby. With DDS, the digital circuits actually generate the analog signals. Using “numeric” rather than “digital” as the descriptor helps to dissociate DDS from digital circuits’ unsavory reputation.

You can view DDS as an extension of digital signal processing (DSP) in accordance with the ideas presented in **Fig 1**. DSP has been around for many years. It is often used for filtering signals after an analog-to-digital conversion. DSP is also used to transform such digitized signals. For example, DSP techniques such as the FFT can transform a time-domain signal into an equivalent frequency-domain signal. These uses are

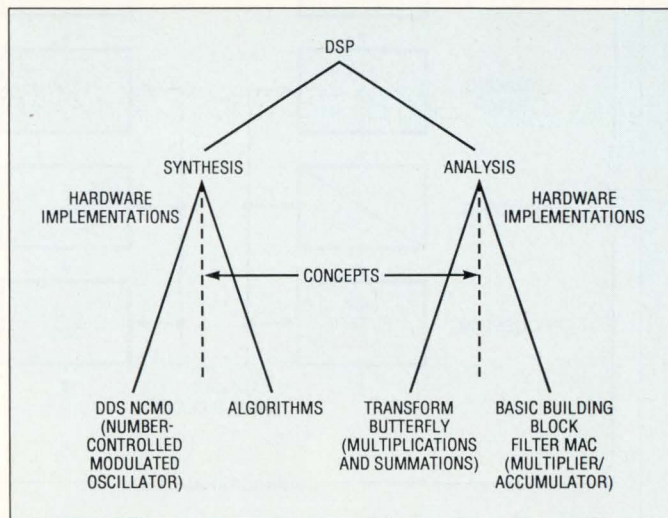

Fig 1—You can view DDS as closely parallel to DSP. Both subject areas have sets of mathematical and hardware tools whose functions are intimately related.

What is really important about DDS is the numeric means it uses to represent quantities and the inherent precision that results from its use of numbers.

analytical; they take an existing signal and change it.

Signal synthesis doesn't begin with an existing signal. DDS takes a small set of parameters (numbers) that describe the desired signal and generates a number sequence that represents the signal. This number sequence usually undergoes a digital-to-analog conversion to finally produce an analog signal. (See box, "The sampling theorem backwards.")

A major motivation for the development of DDS is achieving high accuracy at moderate cost. Calculators selling for \$9.95 are accurate to 12 digits, whereas analog systems must incur large costs to maintain 0.1% accuracy—equivalent to three digits. By maximizing the use of digital techniques, DDS generates accurate analog signals inexpensively.

There are several ways to implement DDS. Where generating high frequencies is unnecessary—for example, in the voice band—you can implement DDS with

general-purpose microprocessors. Low- and medium-speed phone-line modems have been built this way for years. As the required signal frequency increases above the audio range, the computing overhead for signal generation increases proportionally. Somewhere in the low RF (radio-frequency) range, the computing requirements become prohibitive even for modern, high-speed general-purpose μ Ps. At these higher signal frequencies, you should consider implementing DDS with dedicated hardware.

Dedicated DDS devices are optimized for signal synthesis. Their inputs are the signal parameters; their output is the desired signal. The control processor only needs to keep up with the signal parameters, not with the complete signal. The DDS device acts as a peripheral, freeing the main processor for other tasks.

Fig 2 shows the basic block diagram of a direct digital synthesizer. The DDS has three main blocks: the digi-

The sampling theorem backwards

Direct Digital Synthesis (DDS) obviously belongs to the synthesis side of Digital Signal Process-

ing (DSP). There is no signal to be sampled or processed; rather, there is a sampled signal to be

used. In this respect, DDS operates the sampling theorem in the reverse of the usual direction.

The left side of Fig A shows the sampling process as you would conventionally apply it in DSP. You must first band-limit the input signal with an anti-aliasing filter, after which the signal is sampled and digitized. The digitizer provides a number sequence that can be further processed to identify characteristic parameters.

With DDS, the characteristic parameters exist first. The number sequence is generated from these parameters and then converted into an analog waveform. The alias signals characteristic of a sampled signal are then removed with a band-limiting filter. The math is the same; the order of performing the operations is different.

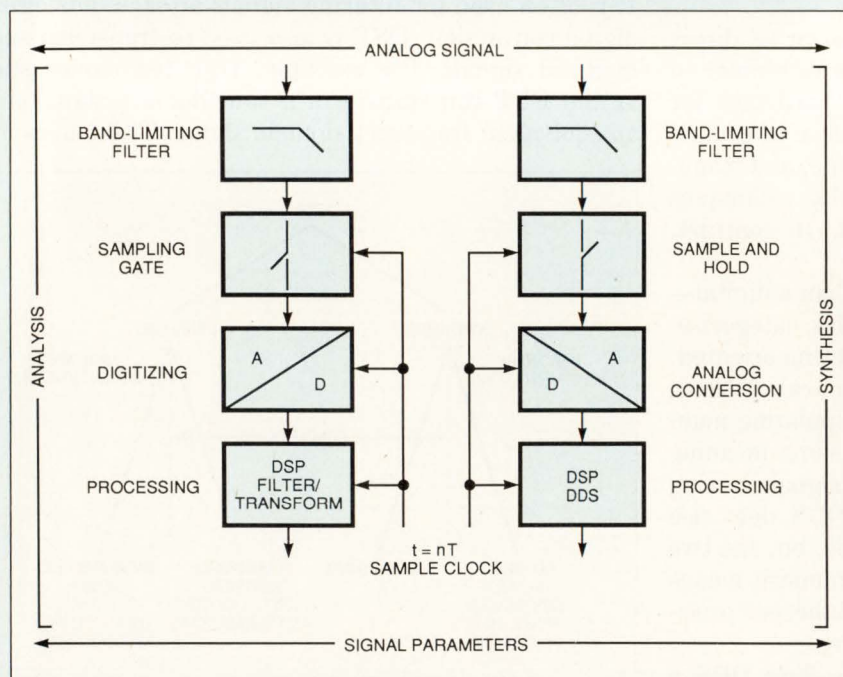

Fig A—Waveform analysis using DSP and waveform synthesis using DDS involve similar operations. But DSP and DDS reverse the order of the operations.

tal accumulator, a waveform map, and the digital-to-analog converter. The input parameters are the signal frequency, represented by a number, and the timebase clock. The whole assembly is often called a number-controlled oscillator (NCO).

The objective of the NCO is to produce a signal $s(t)$ according to the basic signal equation

$$s(t) = A \cos(2\pi \cdot f \cdot t). \quad (1)$$

To the NCO, f is the signal-frequency-number input parameter, and t is the time reference provided by the clock. The waveform map provides the sinusoidal cosine waveform and the digital-to-analog conversion sets the output-signal amplitude, A .

The argument of the cosine is the signal phase, which, for a fixed output frequency, must be a linear ramp. The digital accumulator generates this ramp. At every cycle of the clock, a phase increment corresponding to the desired output frequency is added to the existing phase value. At a particular output frequency, this increment will be fixed, and its repeated accumulation results in the desired ramp.

The accumulator is not a counter. The step size of a counter is fixed, usually at unity. For the digital accumulator, the step size corresponds to the signal-frequency number, f . This distinction will become important shortly in deriving the DDS tuning relationship.

Waveform map

If an NCO's output waveform is fixed as a cosine, a fixed ROM can implement the waveform map. Addresses in the ROM will represent the phase position within the output-signal cycle, and the data stored at each address will be the corresponding cosine amplitude.

Note that the waveform mapping is general. Maps can be made for disk read/write-head waveforms, non-linear-phase signals, and even noise waveforms. A particularly special case is the operation of two waveform maps in parallel, one with a cosine and the other with a sine waveform. This technique provides absolute quadrature signals, which are required by many signal-processing and DSP applications.

The waveform map must operate at the full clock speed. Because the map follows the digital accumulator, each clock pulse provides different information to the map, and the map must settle completely within each clock period. If it doesn't do so, it will incorrectly

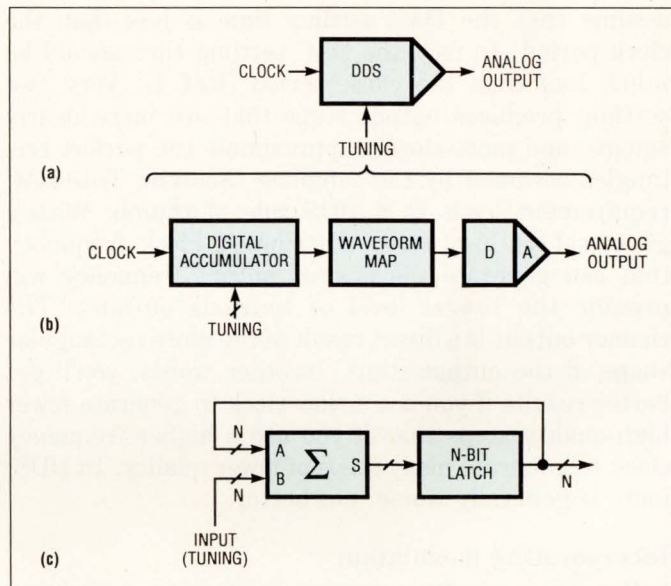

Fig 2—You can think of a DDS as a single block (a) with digital and tuning inputs and an analog output. The more complex representation (b) more closely approximates the real nature of the DDS, and the 2-block representation of the digital accumulator in c suggests that the accumulator is more than a simple counter.

convert the phase information from the digital accumulator to the corresponding amplitude value. For example, a 10-MHz clock requires the waveform map to have a cycle time of less than 100 nsec.

The analog-conversion block takes the amplitude number sequence from the waveform map and converts it into a single analog signal. Today, a single-chip DAC usually performs this operation. Because the amplitude number sequence represents the actual, real-time samples that an accurate ADC would have generated from the desired signal, had the signal existed, the DAC output signal is the (re)constructed waveform of the desired signal.

In general, DAC devices are not designed for use in DDS (Ref 1). High-quality DDS output signals demand that the DAC not only have good static linearity, but also that its dynamic characteristics (slewing and settling) be well matched and controlled. A common fix for a DAC with unsatisfactory dynamic characteristics is to follow it with a sample-and-hold (S/H) circuit. Doing so replaces the DAC's dynamic characteristics with those of the S/H circuit, which are generally better. As the DAC manufacturers improve their products to meet the needs of high-quality DDS outputs, the use of S/H circuits in DDS will diminish.

Discussions of DACs in DDS applications generally

DDS takes a small set of parameters (numbers) that describe the desired signal and generates a number sequence that represents the signal.

assume that the DAC settling time is less than the clock period. In fact, the DAC settling time should be *much* less than the clock period (Ref 1). Very fast settling produces output steps that are more nearly square, and more closely approximate the perfect rectangles assumed by the sampling theorem. This DAC requirement leads to a DDS rule of thumb: With a given set of hardware, the slowest clock frequency that can generate the desired output frequency will provide the lowest level of spurious outputs. The cleaner output is a direct result of the more rectangular shape of the output steps. In other words, you'll get better results if you use a slow clock to generate fewer high-quality steps than if you use a higher frequency clock to generate many steps of lower quality. In DDS, more is generally worse, not better.

Incorporating modulation

For communications purposes, pure sine waves are essentially useless. To pass information along, you must modulate the sine wave in some way. A sine wave has three characteristics capable of modulation: amplitude, frequency, and phase. Including them in the general signal, Eq 1 gives the general communications signal:

$$s(t) = A(t)\cos(2\pi \cdot (f + f_m(t))t + p(t)).$$

$A(t)$ represents amplitude modulation (AM), $f_m(t)$ represents frequency modulation (FM), and $p(t)$ represents phase modulation (PM). A DDS device that includes modulation capabilities is called a modulated NCO, an NCMO for number-controlled modulated oscillator, or an MNCO for modulated, number-controlled oscillator.

Interest in using continuous-phase signals to conserve output bandwidth is growing. A signal that does not have phase continuity will be discontinuous at its first derivative. Rapid changes in a waveform produce high-frequency sidebands, and a signal whose first derivative is discontinuous can have high-frequency sidebands that contain significant energy. The more of the signal's high-order derivatives that are continuous, the smaller the waveform's high-frequency content will be.

DDS is inherently a continuous-phase technique; its output-waveform calculation always proceeds from the present point, whether or not any parameter changes. Therefore, DDS completely eliminates switching transients, overshoot, and undershoot. By definition, phase modulation can produce phase discontinuities, but a

modulated NCO can only approximate them. The modulated NCO approximates phase discontinuities by performing a large number of small phase steps in quick succession. Ideally, one of these steps should occur in every DDS clock cycle. You can purchase devices and hardware that phase-modulate at this rate (Refs 2, 3, and 4).

Developing DDS designs

Frequency resolution is one of the primary issues of any synthesized-signal design. For DDS, you find the output frequency f_o from the relationship

$$f_o = (f_{\text{clk}}/K) \cdot M \text{ Hz}, \quad (2)$$

where f_{clk} is the applied clock frequency, in Hz, M is the tuning number applied to the DDS, and K is the operating modulus of the DDS digital accumulator.

The clock frequency sets the DDS's sampling rate, which is the rate at which the DDS updates the signal-amplitude samples. In almost all cases, the sampling rate is equal to the frequency of the applied clock. The design of the DDS device determines the operating modulus, K , which equals the number of states that the accumulator can take on. Since most devices use binary circuits, K is usually a power of two such as 2^{24} or 2^{32} . When DDS devices use decimal circuits, K is a power of ten such as 10^6 or 10^8 . A new technique called variable resolution (VR) lets you set K to any number between 1 and the digital accumulator's maximum intrinsic number of states.

The tuning number, M , is an integer between zero and $K/2$. The upper bound is called the Nyquist limit, a requirement from the sampling theorem to guarantee a unique output frequency. When $M=0$, Eq 2 shows that the output frequency will also go to zero. Therefore DDS designs include dc within their tuning bandwidth. The frequency resolution of the DDS is the derivative of Eq 2 with respect to M . This calculation gives the DDS resolution (f_{res}) as

$$f_{\text{res}} = f_{\text{clk}}/K. \quad (3)$$

The frequency resolution is identical to the output frequency when $M=1$. Because M must be an integer, all output frequencies will be harmonics of the resolution given in Eq 3. For this reason, this resolution is occasionally called the DDS quantization frequency.

DDS frequency resolutions can be very small. As an example, consider a 24-bit binary DDS device oper-

ating with a 10-MHz clock. The 24-bit accumulator sets K to 16,777,216 and yields a frequency resolution of $10,000,000/16,777,216 = 0.59$ Hz. Ease of achieving fine frequency resolution is a fundamental characteristic of the DDS. More bits give even finer steps.

Several applications require an exact frequency resolution, and have a single, high-precision reference frequency for the DDS clock. For these designs, a simple algebraic shift of **Eq 3** would be useful:

$$K = f_{\text{clk}}/f_{\text{res}} \quad (4)$$

Such an approach would set the DDS modulus and the desired resolution exactly. The Variable Resolution (VR) technique accomplishes these objectives. If a design requires precise resolution, such as 2.85714 Hz or 0.100000 Hz, it must either supply a special clock frequency to the DDS according to

$$f_{\text{clk}} = K \cdot f_{\text{res}}$$

or use VR technology, according to **Eq 4**.

Synthesizer output bandwidth

As mentioned before, there is a maximum output frequency at which the tuning relationship of **Eq 2** holds. This frequency (the Nyquist frequency) is equal to one half of the applied clock frequency. As with most real designs, the practical upper limit is lower than the theoretical limit. For DDS, the practical upper limit lies around 40 to 45% of the clock frequency. This limitation holds not only for the tuned output frequency, but also includes the sum of any and all modulation sidebands above the carrier.

Output settling-time performance

The first D in DDS stands for direct, which means DDS designs do not use feedback to ensure output-frequency accuracy. This approach differs from the PLL approach, which depends on feedback to achieve output-frequency accuracy. The PLL must stabilize its feedback loop to effect any frequency change. Hence, changing the frequency of a PLL takes longer than the reciprocal of the PLL's bandwidth.

As soon as you change the applied-frequency number, M , a DDS starts using the new M value in its calculations. The DDS' pipeline depth (number of calculation stages) establishes the time required for the output signal to reflect this frequency change. If, for example, a DDS has a 10-MHz clock and 32 stages, it

will require 3.2 microseconds. More efficient designs, using fewer stages, switch proportionally faster: With the same clock, a 6-stage DDS will settle in 600 nanoseconds. Hardware is readily available with 5 stages of registers from the applied tuning number to the DAC output. With a 10-MHz clock, such a design exhibits the same frequency agility (settling time) as a 32-stage design operating at 64 MHz.

Dealing with output alias signals

Because it is a sampled system, a DDS has a multiple-signal output spectrum. In addition to the desired output signal at f_o , there are output signals at each harmonic of the clock plus f_o . The output spectrum is therefore f_o , $f_{\text{clk}} + f_o$, $2 \cdot f_{\text{clk}} + f_o$, $3 \cdot f_{\text{clk}} + f_o$, etc. The additional signals, often referred to as alias signals, are mixing products of the output signal with the clock and all of its harmonics. These signals must be removed by lowpass filtering to leave only the desired f_o signal. This filtering is the reverse of the antialias filtering used ahead of ADCs.

To make the output filter realizable, the upper output frequency is nominally 40% of the clock frequency. As the upper output frequency approaches the Nyquist frequency from below, the alias frequency at $f_{\text{clk}} - f_o$ approaches the Nyquist frequency from above. The closer the upper output and alias frequencies get to each other, the more complex the output lowpass filter must become. If you try to make the output frequency exceed 40% of the clock frequency, the output filter quickly becomes impractical. For example, achieving 60 dB of alias rejection when the output frequency is 42% of the clock requires a Chebyshev lowpass filter with more than 20 sections. Realizing any analog filter of seven sections or more requires special care, but producing a filter with 20 sections is almost impossible.

At the output of the lowpass filter, analog signal (re)construction is complete. The signal can then be used directly, or additionally processed by such conventional analog techniques as amplification, mixing, limiting, and multiplication.

Determining output-signal quality

The cosine is a transcendental function, which the waveform map cannot quantize precisely. The quantization errors that inevitably exist produce signals in addition to the main signal and the alias terms. These nonharmonic extra signals are called DDS spurs. In a good DDS design, these spurs will be relatively low in amplitude—at least 60 dB below the main output.

There are three main blocks: the digital accumulator, a waveform map, and the digital-to-analog conversion.

In the best DDS designs, the spurs are 70 to 80 dB below the main output. If required, under some conditions, you can reduce the spurs even further.

When you tune the main signal, the DDS spurs generally move around much faster than the main signal does. You can predict the location of the spurs by modifying a technique used in analog systems with mixers (Refs 5 and 6). Near output frequencies that are integral submultiples of the clock ($1/3$, $1/4$, $1/10$, etc.), the spurs all "gather around" the main output. At exact integral submultiples of the clock, the spurs all cross over the main output. You can quickly check a DDS design's degree of spur generation by tuning the DDS to near the $1/3$ - and $1/4$ -clock-frequency crossovers. You can then directly evaluate the output spectrum quality from plots similar to those of Fig 3.

Construction hints for success

A DDS, by nature, uses digital circuits to perform analog functions. The absence of noise generation is essential for a successful design. High-frequency construction techniques are necessary. Clock frequencies are typically 10 to 50 MHz. On a standard pc board made from G-10 or FR-4 laminates, the shortest wavelength is about 270 cm. Transmission-line effects are not important here, because a typical DDS design covers 10 to 20 cm—under $1/10$ of a wavelength.

Loop currents are another matter. The DDS's digital circuits have edge speeds of less than 10 nsec. The currents these circuits produce have significant energy at 500 MHz or more. The signal current must flow from

the driving IC's dc supply pin, through its output transistor(s), to the receiving IC's input pin, and back to the supply through the ground. Fig 4 shows this current path.

Any signal transfer from one IC to another has three loop currents. The driving IC draws current from its supply pin to turn on an output-pin driver. Some of this current flows into the interconnection as signal current. The rest flows out the driving IC's ground pin to return to the supply.

The signal current flows to the receiving IC and draws a matching current from the IC as required to conserve charge. (Basic physics strikes again!) This return signal current flows from the receiving IC's ground pin, underneath the signal trace (if there is a ground plane there), and back to the driving IC to return to the supply.

A third loop current results from the effects of the signal on the receiving IC. The receiving IC will draw current from its own supply pin in response to the stimulus. This current will flow out of the IC's ground pin and will return to the power supply.

Good low-noise construction will guarantee that all of these currents flow in the smallest possible area. Radiation and other interference increases in direct proportion to the area enclosed by the conductors carrying these currents. Also, if more than one current flows in a conductor, the currents can interact. Careful layout of the pc board is essential to minimize signal-loop sizes and impedances common to several loops.

Current loops around each IC are a slightly different

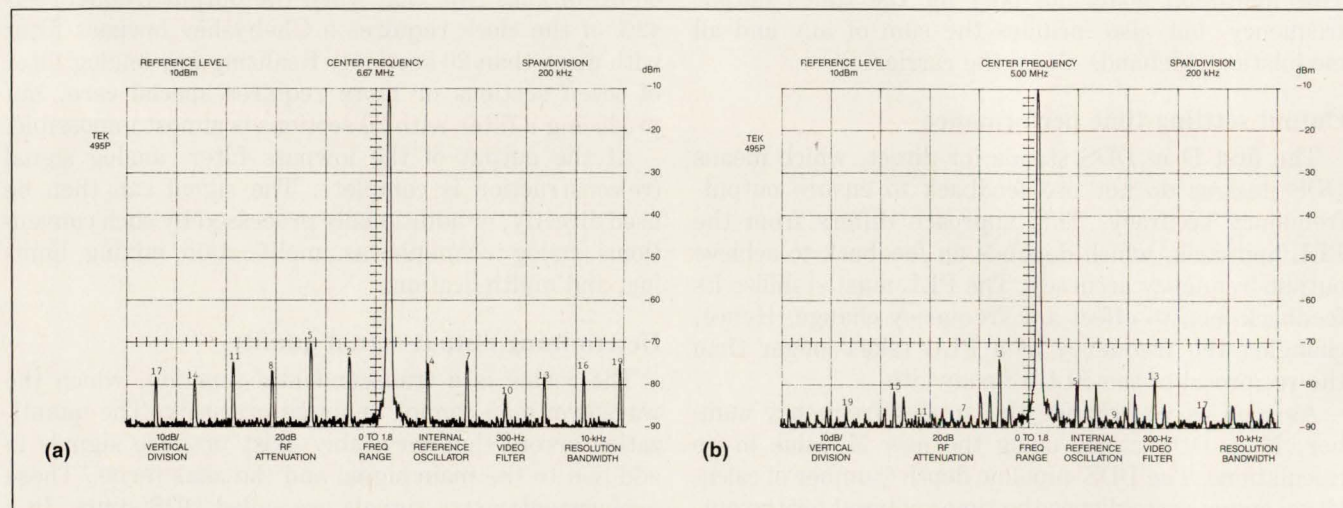

Fig 3—You can quickly check a DDS design's degree of spur generation by tuning the DDS to near the $1/3$ - (a) and $1/4$ -clock-frequency (b) crossovers. Spectral plots such as these then readily reveal the spurs.

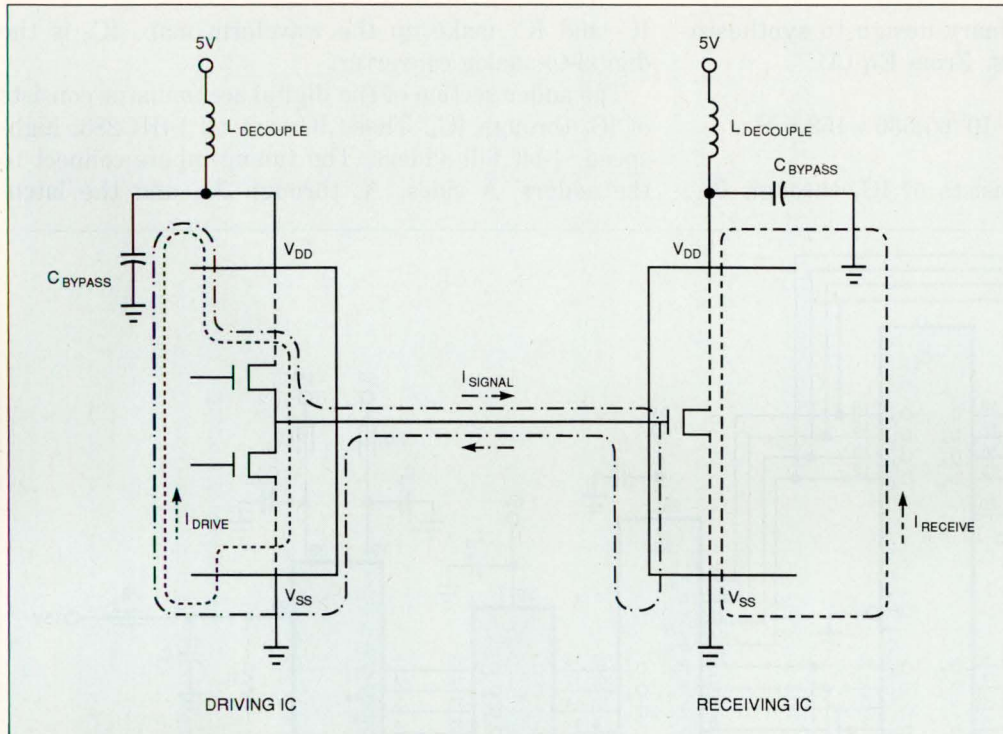

Fig 4—When one IC sends a signal to another, the currents that flow create electromagnetic fields. Understanding the current paths in signal leads and ground planes helps you to minimize the spurious signals generated by the changing fields.

matter. The bias component of the switching currents should never flow far from the IC—this is the idea behind the use of bypass capacitors. If the impedance of the bypass capacitor is lower than that of the power supply as seen by the IC power pin, the switching current will come from and return to the bypass capacitor (hence the name). Between switching transients, the bypass capacitor will recharge from the higher impedance supply. If there is no bypass capacitor, the IC will be forced to draw power from the power supply during the transient. Because power supplies are rarely right next to their loads, the loop-current path will enclose a large area. Radiation and interference will be severe.

Multilayer PC boards and surface-mounted components are a significant help in controlling these currents. A ground-plane layer immediately below the signal traces minimizes the signal-current path length. Surface-mounted bypass capacitors have lower lead inductances than do through-hole-mounted capacitors. Mounting these devices on the back of a pc board further reduces the length of the current path. Nevertheless, these modern components and construction techniques are mixed blessings. Besides costing more, they can cause problems with power distribution.

A bypass capacitor will work when its impedance,

as seen by the IC's power pin, is lower than that of the power supply. By design, a power plane, like a ground plane, has a very low impedance. For the bypassing to control the transient loop current, there must be some impedance between the point where the IC draws current from the power plane and the junction of the IC's power pin and the bypass capacitor. This impedance can take the form of a ferrite bead or, if the dc current is low enough, a smaller chip inductor. A 470-nH inductance is a good value for this application. Without the series inductance, the bypassing is ineffective; the ICs draw energy directly from the low-impedance power and ground planes in a manner that makes control essentially impossible.

Fig 5 shows a simple DDS design using standard components. This synthesizer, which is useful as a general-purpose signal generator covering the audio and low-RF ranges, has the following specifications:

Output Frequency Range	0 to 4 MHz
Frequency Resolution	152.6 Hz
Spurious Signal Suppression	50 dB below carrier
Frequency Switching Time	<500 nsec

A 10-MHz crystal-reference frequency drives this sample design.

With a given set of hardware, the slowest clock frequency that can generate the desired output frequency will provide the lowest level of spurious outputs.

The DDS uses a 16-bit binary design to synthesize the required frequency steps. From Eq (3)

$$f_{res} = f_{clk}/K = 10 \text{ MHz}/2^{16} = 10^7/65,536 = 152.6 \text{ Hz.}$$

The digital accumulator consists of IC₁ through IC₆.

IC₇ and IC₈ make up the waveform map. IC₉ is the digital-to-analog converter.

The adder section of the digital accumulator consists of IC₁ through IC₄. These ICs are all 74HC283, high-speed, 4-bit full adders. The tuning inputs connect to the adders' A sides, A₀ through A₃, and the latch-

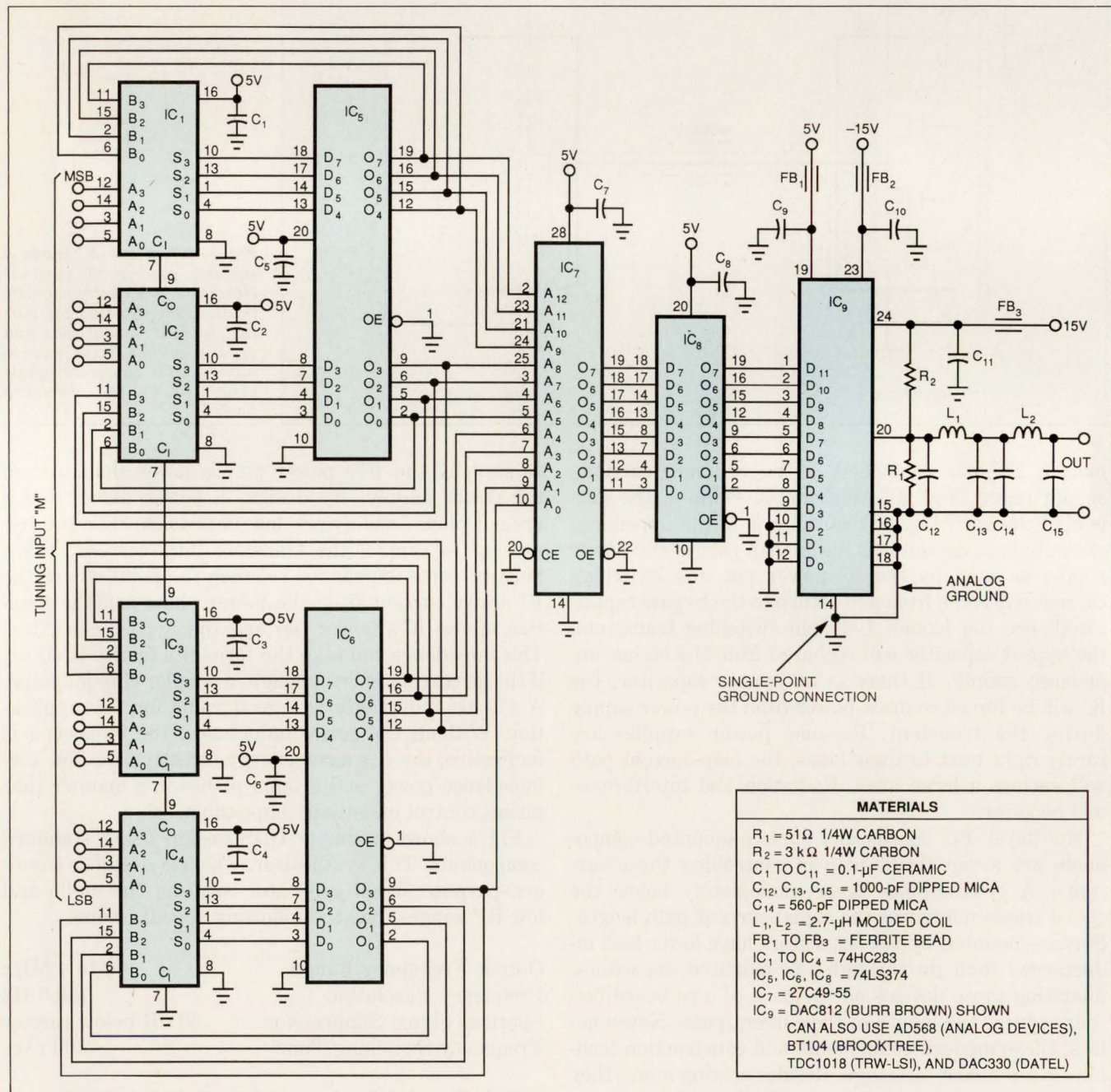
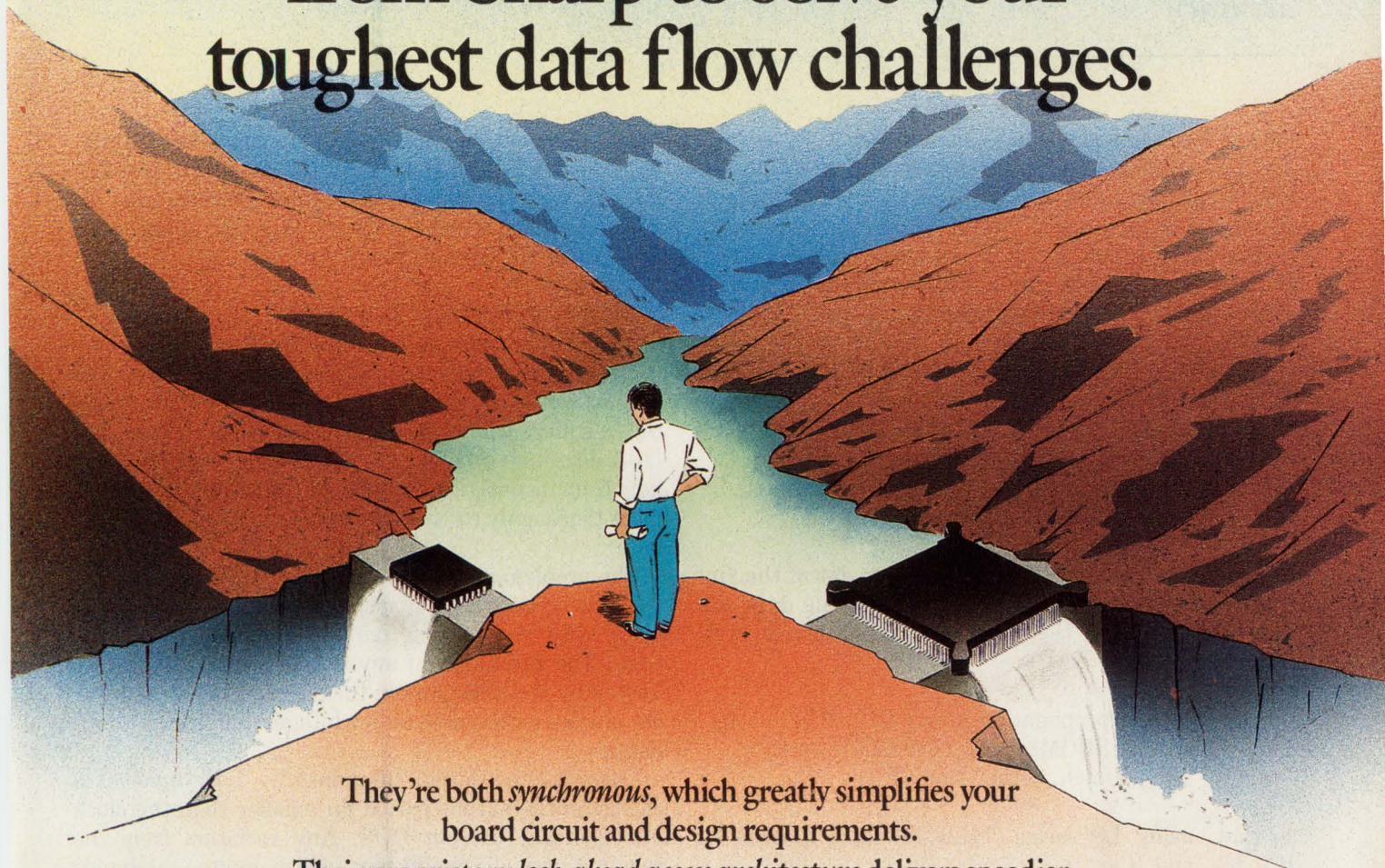

Fig 5—This 0- to 4-MHz DDS uses nine readily available ICs. All of the other components are passive.

Two state-of-the-art FIFOs from Sharp to solve your toughest data flow challenges.



They're both *synchronous*, which greatly simplifies your board circuit and design requirements.

Their proprietary *look-ahead access architecture* delivers speedier access and cycle times while reducing power consumption.

Introducing: The LH5492 4K x 9 Clocked FIFO.

Sharp's new LH5492 is a dual-port clocked FIFO, with a 4K x 9 configuration. The clocked interface is a significant enhancement in FIFO design over previous asynchronous parts. The clocked enables on the LH5492 eliminate the requirement to shape waveforms, resulting in simpler design tasks, and lower parts count.

Its high-speed clocked interface can be used directly with the typical 40%/60% duty cycle system clock. And a separate \overline{OE} control signal provides independent control over output buffers.

The second enable pin on each part can be directly tied to the flags to simplify external logic requirements.

The LH5492 4K x 9 clocked FIFO comes in a 32-pin PLCC. It is available with access times of 20 ns, 25 ns and 35 ns, and cycle times of 25 ns, 35 ns and 50 ns, respectively.

Introducing: The LH5420 256 x 36 x 2 Bidirectional FIFO.

Sharp's new LH5420 is actually two 256 x 36-bit FIFOs in one. Operating in parallel but opposite directions to provide bidirectional data buffering that would normally require multiple independent devices.

Its 36-bit word width is an industry first. And ideal for interfacing with new generation higher-speed 32/36-bit and 64/72-bit microprocessors and buses. Moreover, a choice of 9, 18, or 36-bit word widths on Port B means efficient word width matching.

Programmable Almost Empty and Almost Full status flags on each port—in addition to Full, Half Full and Empty flags—allow you to either leave the flags set at their initialized setting of 8, or program them over the entire FIFO depth.

The LH5420 comes in a 132-pin plastic QFP package. It is available with access times of 15 ns, 20 ns and 25 ns, and cycle times of 25 ns, 30 ns and 35 ns, respectively.

SHARP
By Design.

Sharp Electronics Corporation

DDS designs do not use feedback to ensure output-frequency accuracy. A PLL depends on feedback to achieve output-frequency accuracy.

output feedback connects to their B sides, B₀ through B₃. This arrangement is arbitrary, but it is easy to remember. To configure the four devices as a single 16-bit adder, the carry output of one stage connects to the carry input of the next-higher stage. Latches IC₅ and IC₆ complete the digital accumulator. The adder outputs drive the latch inputs: IC₁ and IC₂ drive IC₅; IC₃ and IC₄ drive IC₆.

The waveform map consists of PROM IC₇ and latch IC₈. The PROM contains 8k (2¹³) bytes, so there are 13 address bits. The PROM contains a full sine wave calculated from

$$\text{data} = 127 \cdot (\sin(2\pi \cdot \text{address}/8192) + 1),$$

where $0 < \text{address} < 8191$, and the argument of the sine function is in radians. Latch IC₈ retimes the data output. You can find the required PROM-device cycle time from

$$\begin{aligned} \text{clock_period} = & \text{propagation_delay (IC}_5, \text{IC}_6) \dots t_{pd} \\ & + \text{PROM_cycle_time (IC}_7) \dots t_{cy} \\ & + \text{latch_setup_time (IC}_8) \dots t_{su}, \end{aligned}$$

so that, using LS series (74LS374) latch devices for IC₅, IC₆, and IC₈,

$$\begin{aligned} t_{cy} < & T_C - t_{pd} - t_{su} \\ < & 100 - 25 - 20 \text{ nsec} \\ < & 55 \text{ nsec.} \end{aligned}$$

Faster latch devices will allow correspondingly longer PROM cycle times. For this example, a PROM device of type 27C49 through 27C55, or a similar part, permits 10-MHz operation.

IC₉ performs digital-to-analog conversion. Several devices meet the requirements of this function; the Burr-Brown DAC812 is shown. This device settles to 12-bit accuracy in less than 50 nsec, about half of the clock period. R₁ converts the 0- to 10-mA DAC output current to a voltage and also sets the output impedance of the DAC. A resistance of 50Ω matches the conventional line impedance of RF circuitry. Resistor R₂ injects a 5-mA current into the DAC output node to center the DAC output range around zero.

The 5-section LC, lowpass filter removes the output-signal alias terms. The component values produce a Chebyshev filter with 0.1 dB of passband ripple and a cutoff frequency of 4 MHz in a 50Ω system.

Thus, designing the filter completes the synthesizer's

design. The output signal power is nominally 0.5 mW, which is 5 dB less than 1 mW (-5 dBm). The frequency-switching time is two clock periods, that is, 200 nsec. The measured spurious-signal suppression is -52 dBc (52 dB less than carrier level).

Square-wave time-base generator

Many applications do not require sine waves. In timing applications, square waves are all you need. Because DDS is a digital technique, you would expect that a square-wave output would be natural. Alas, the DDS does not produce a square wave without some help from its designer. The reasoning, which is covered more thoroughly elsewhere (Ref 7), is only summarized here.

The problem stems from the fact that a DDS design is a synchronous digital system. Its state will change, along with any output, only in response to a clock edge. The resolution of any output cycle is therefore limited by the clock period: the duration of any individual output cycle must be an integer number of clock periods.

Changing the output frequency by 1 Hz involves a change in the output period far smaller than the clock period of any current DDS. Any variation from the required period is modulation, which creates sidebands and spurs. Because the time quantization is too coarse to achieve the necessary signal quality, interpolation is necessary. The DDS output lowpass filter (LPF) performs the interpolation. Because the LPF is built from fixed components, it qualifies as an LTI (linear, time-invariant) network—a concept from early circuit-analysis classes. LTI networks have a “natural frequency” which is sinusoidal; you obtain the highest quality output signals by driving the filter with sinusoidal signals. This purpose underlies the cosine waveform map and the DAC. To effectively filter the phase information, you must make the LPF as “happy” as possible. The LPF will then perform the required time interpolation and yield a clean signal. But it is a sine wave. To make it square, you must employ amplitude limiting, usually with a comparator of some sort.

Fig 6 shows a wideband clock generator built with DDS. Note that this design creates a square wave by limiting a sine wave's amplitude. From a 50-MHz clock, this generator will provide a direct square-wave output from dc to the limit of the LPF, probably around 20 MHz.

At low output frequencies, the jitter on the DDS square-wave output is less objectionable than it is at

DESIGN WITH ANALOG WORKBENCH II AND YOU WON'T HAVE TO MANUFACTURE EXCUSES.



2820 Orchard Parkway, San Jose, CA 95134 *ASIC Technology & News: Focus Report, August, 1990.

© 1990 Valid Logic Systems, Inc.

Go ahead, explain it.

Tell them how small variations in component tolerances, process parameters and operating temperatures can cause an analog design to fail in manufacturing. Or worse yet, in the field. Even though it worked in the lab or in SPICE.

That's a problem Valid can help you avoid. As the leading supplier of analog EDA systems, we understand how downstream factors can sabotage your analog circuits.

That's why our Analog Workbench II provides the most complete selection of in-process analysis tools. So you can dramatically improve the quality, reliability and manufacturability of your analog ASICs or boards.

Choose from sophisticated tools like parametric, worst case and sensitivity analysis to identify critical design dependencies. Advanced statistical analysis to predict and optimize manufacturing yields. And Smoke Alarm™ stress analysis to ensure that com-

ponents stay within safe operating limits.

All analyses support DC as well as AC and transient measurements. And with Valid's unique Distributed Network Processing option, you can automatically partition compute-intensive runs across a network of workstations. Providing desktop performance of 100 MIPS or more, to give you more time to refine your design.

Analog Workbench II delivers all this capability in an integrated, easy-to-use environment that *ASIC Technology & News* calls "a designer's dream."* With system-level function blocks for top-down design. The world's largest analog component libraries. And tight integration with IC or PCB physical design tools.

It's all part of Valid's Process Integration Architecture, the industry's most practical and comprehensive approach to concurrent engineering.

For more information, call 1-800-48-VALID today. We'll take the excuses out of your next analog design.

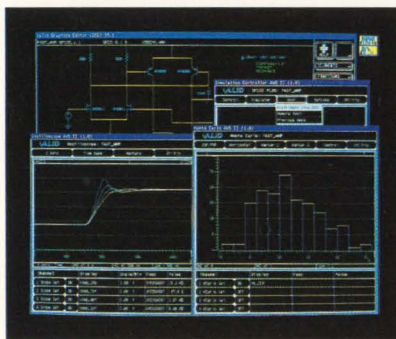

Valid's in-process analysis lets you catch downstream errors before they occur.

VALID

Tough Issues, Valid Answers.

If you try to make the output frequency exceed 40% of the clock frequency, the output filter quickly becomes impractical.

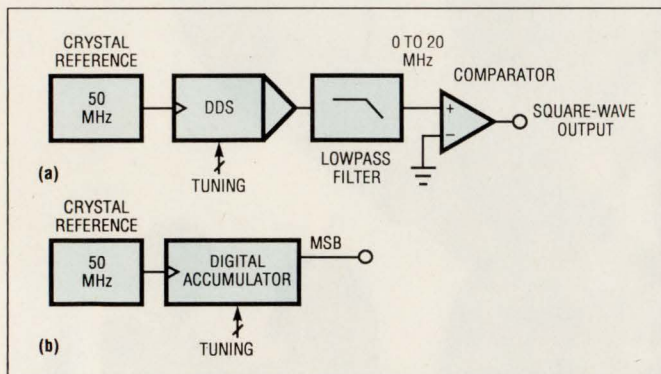

Fig 6—To obtain a high-quality square wave over a broad range of frequencies, you must have the DDS generate a sine wave. Then you must filter out the harmonics and limit the sine wave's amplitude, as in **a**. But if you are interested only in low-frequency square waves and you can tolerate moderate jitter, the DDS's digital accumulator alone may suffice, (**b**).

high frequencies. If you need only a low-frequency output, you need not generate a sine wave and limit its amplitude to produce a square wave. **Fig 6b** shows an implementation that dispenses with sine-wave generation and amplitude limiting. With a strict limitation on its bandwidth, the direct output exhibits tolerable jitter, according to:

$$f_{\text{max, direct square wave}} = f_{\text{clk}} \cdot \% \text{ jitter} / 2.$$

This example uses a 50-MHz clock. Square waves with 0.1% jitter are directly obtainable from dc to 25 kHz. If you increase the jitter tolerance to 1%, the output bandwidth can increase to 250 kHz. Though it is not

very efficient as square-wave generators go, this DDS design would be small and exceedingly stable.

Arbitrary output waveforms are possible, as mentioned earlier, by changing the information in the waveform map. **Fig 7** shows two common ways to change this information; real-time map changes are possible. Through the use of a dual-port RAM, a computer can insert changes to the waveform as the DDS operates. A generator with such an architecture can produce high-quality speech and is suited to any application that requires a large number of waveforms.

If the number of different waveform types is relatively small, a single PROM can hold them all. An external processor can select the desired waveform with the upper address bits. A typical application of this type is in testing of disk-drive read circuits. The PROM holds proper waveforms for positive and negative flux transitions as well as several types of problem waveforms for each transition direction. The processor can supply the circuit under test with normal waveforms, occasionally insert a particular error, and then return to normal operation. Digital buses and communications links are testable in a similar way.

Direct Digital Synthesis is a real technology, well beyond the experimental stage. DDS devices and subassemblies are available today from several manufacturers. Because DDS does not rely on feedback, it can simultaneously realize small frequency steps, fast frequency switching, and low phase noise. Careful construction techniques have solved the spurious-signal problem that has traditionally limited DDS applications in communications systems. Hence, the doors are open

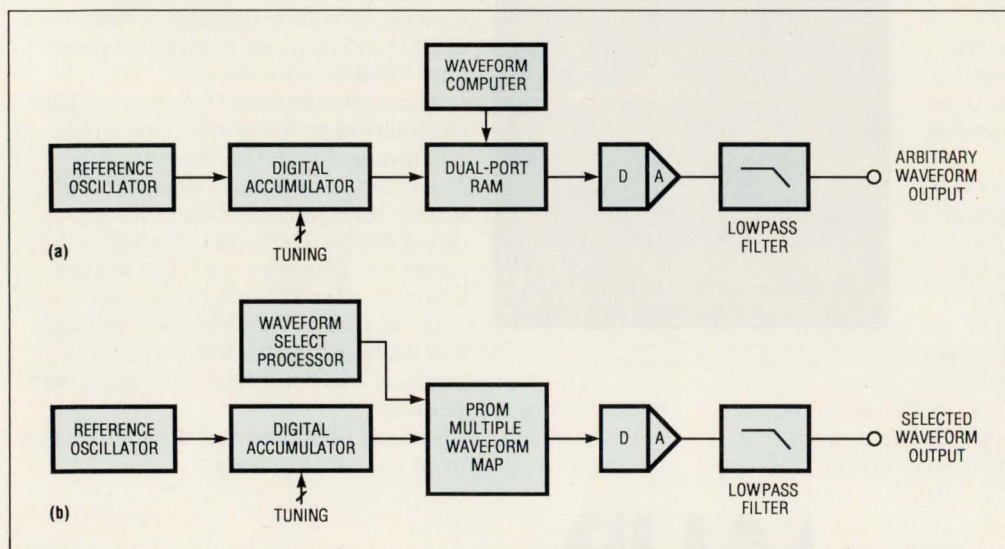
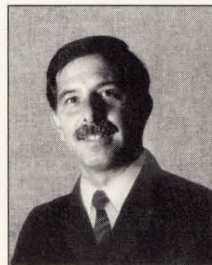
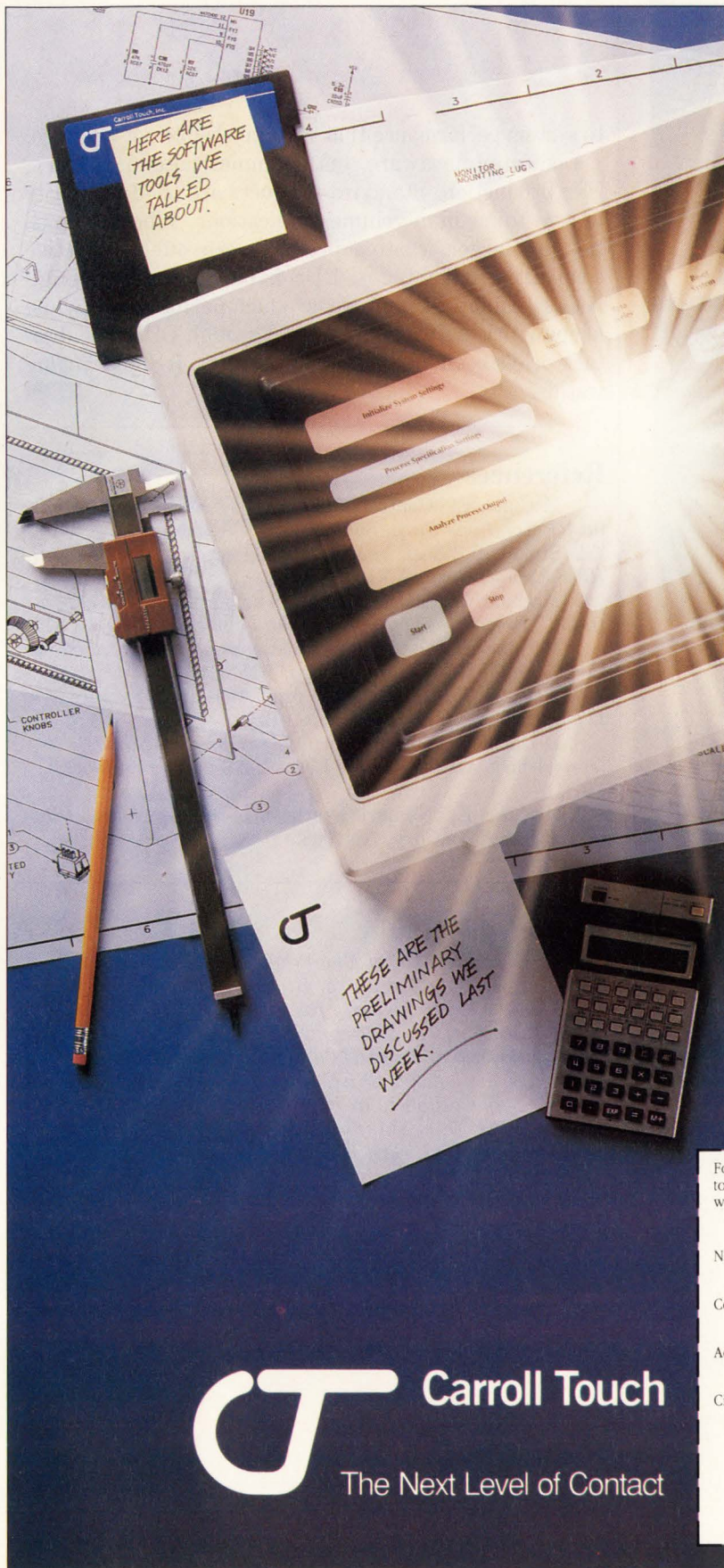

Fig 7—Obtaining arbitrary waveforms from a DDS can involve using a dual-ported memory and feeding it new waveform maps on the fly, (**a**). For less demanding applications, a ROM can store several waveform maps, (**b**), and the MSBs of the ROM address can determine which waveform the DDS produces.

"WE'VE HAD GREAT SUCCESS WITH CARROLL TOUCH. WHY CHANGE IF IT'S WORKING?"



John Santacroce
*Mechanical Engineering
 & Project Manager*
 Hewlett-Packard Company

"As a diverse international corporation, Hewlett-Packard manufactures everything from computers, measurement and computation equipment, medical equipment, analytical equipment and more. We're known for our high level of test and measurement systems capabilities.

"We recently developed a touch-based automotive test system for a customer and there was no debate over using Carroll Touch in designing this. Our past experience with them has been very successful.

"From my point of view, Carroll Touch has provided good, reliable touch frame assemblies. They also bring a high level of engineering expertise to our team, especially in the materials selection area.

"Carroll Touch people really approach our projects as a team project."

"Working with Carroll Touch people is great because everybody is part of the team – which helps us create a very successful product. Their willingness to go that extra step makes our job much easier.

"In developing a recent functional spec for a touch frame, Carroll Touch engineers worked closely with us in making sure that the assemblies would survive electrostatic discharge.

"We held design reviews of the various approaches and all of our recommendations were considered very sincerely by Carroll Touch. Comments were intelligently relayed back to us and everything we asked for was delivered in the specified time."

For more information on how Carroll Touch can help you create success with your touch technology applications, call 512/244-3500, or simply mail your business card with this coupon to Carroll Touch, P.O. Box 1309, Round Rock, Texas 78680.

Name _____ Title _____

Company Name _____

Address _____

City _____ State _____ Zip _____

Carroll Touch
 The Next Level of Contact

Carroll Touch
 The Next Level of Contact
 EDN031491

© 1990 Carroll Touch



Surface Mounted Miniature Fuse for 125 V

Wickmann - worldwide known as Supplier of high quality circuit protection devices - now offers a surface mounted miniature fuse (SMD) with the dimensions 7,3 x 4,3 x 3,0 mm³. The use of most modern technologies produced superior properties such as: ● (very) quick-acting-time-current characteristic ● high load- and pulse stability ● defined and long-term stable performance ● efficient automatic mounting by blister taping according to IEC 286-3. The listing by Underwriters Laboratories for 125 V opens a wide range of applications for this component.

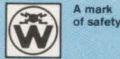

Wickmann-Werke GmbH

Postbox 2520 · D-5810 Witten 6 · Tel. 023 02 / 66 20 · Fax 023 02 / 66 22 19

CIRCLE NO. 19

Measure...

Displacement Proximity Level

With ALPHASENSORS' Microwave Sensor Technology

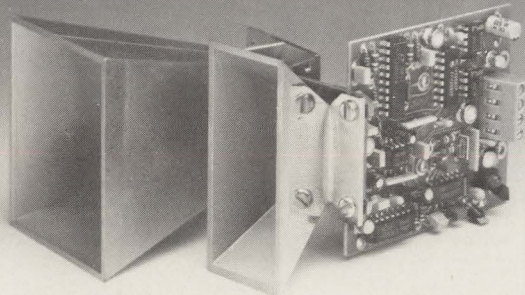

Microwave Sensors Offer:

- Non Contact Measurements
- Superior Performance in Harsh Environments
- Velocity, Presence and Motion Sensing Capability
- Low Cost/High Performance

Put our ALPHASENSORS' microwave technology to the test—order our MSM 10200 Motion Sensor Evaluation Kit—\$195, delivered from stock. For more information, call or write:

AM Sensors, Inc.
26 Keewaydin Dr. - Unit B, Salem, NH 03079
Tel: (603) 898-1543 Fax: (603) 898-1638
(Yes! We've moved and changed our name!)

CIRCLE NO. 20

to system performance that was impossible not long ago.

Dedicated hardware, both commercial and military, is in production. Standard products are used primarily in low- to medium-volume applications. Where quantities are larger, custom products can offer attractive competitive advantages. DDS is moving into the engineer's toolbox to improve product performance while keeping pricing within reason. Through DDS, the digital world's economy is moving into the RF and analog worlds.

EDN

References

1. McCune, E, "Control of spurious signals in DDS," *Digital RF Solutions Corp*, Santa Clara, CA, AN1004.
2. Stokes, P, "Basic 'analog' NCMO applications," *Digital RF Solutions Corp*, AN1003.
3. McCune, E, "Data modulation using direct digital synthesis," *Proceedings of the RF technology expo*, 1990, pg 413.
4. McCune, E, "Data communications and numeric modulation," *Digital RF Solutions Corp*, AN4001.
5. McCune, E, "Quantitative prediction of DDS spurs," *Digital RF Solutions Corp*, AN1012.
6. Digital RF Solutions Corp, "Spur predictor disk," (spreadsheet worksheets for Lotus 1-2-3 and Framework II/III).
7. McCune, E, "Numeric synthesis of square waves," *Digital RF Solutions Corp*, AN1008.

Author's biography

Earl McCune Jr is VP of Engineering at Digital RF Solutions Corp. He has been with the firm for nearly five years and has developed module- and board-level synthesizers using DDS and other techniques. He holds a BSEE from the University of California at Berkeley and an MSEE from Stanford University (Stanford, CA). Earl is a member of IEEE. His leisure activities include hiking, bicycling, and working with model aircraft.



Article Interest Quotient (Circle One)
High 497 Medium 498 Low 499

**We developed
LONWORKS technology,
a better way to add control and
communications capabilities
to your products
quickly and inexpensively.**

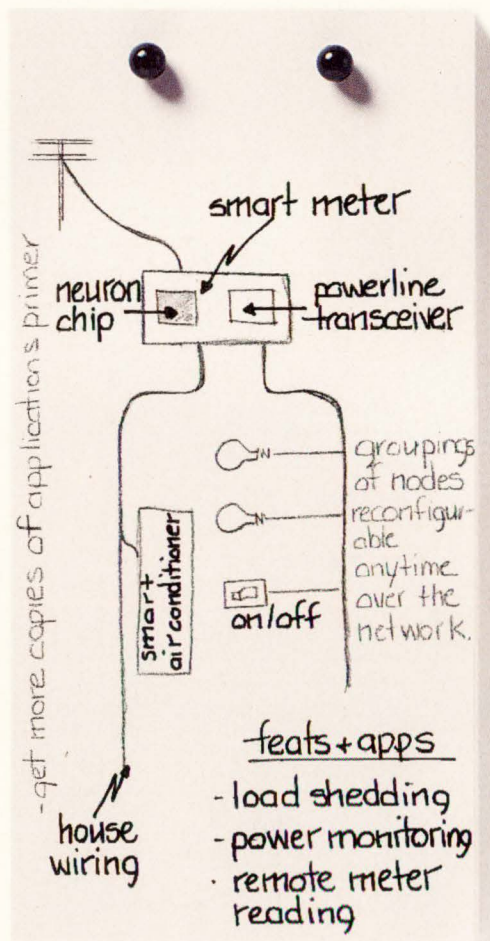
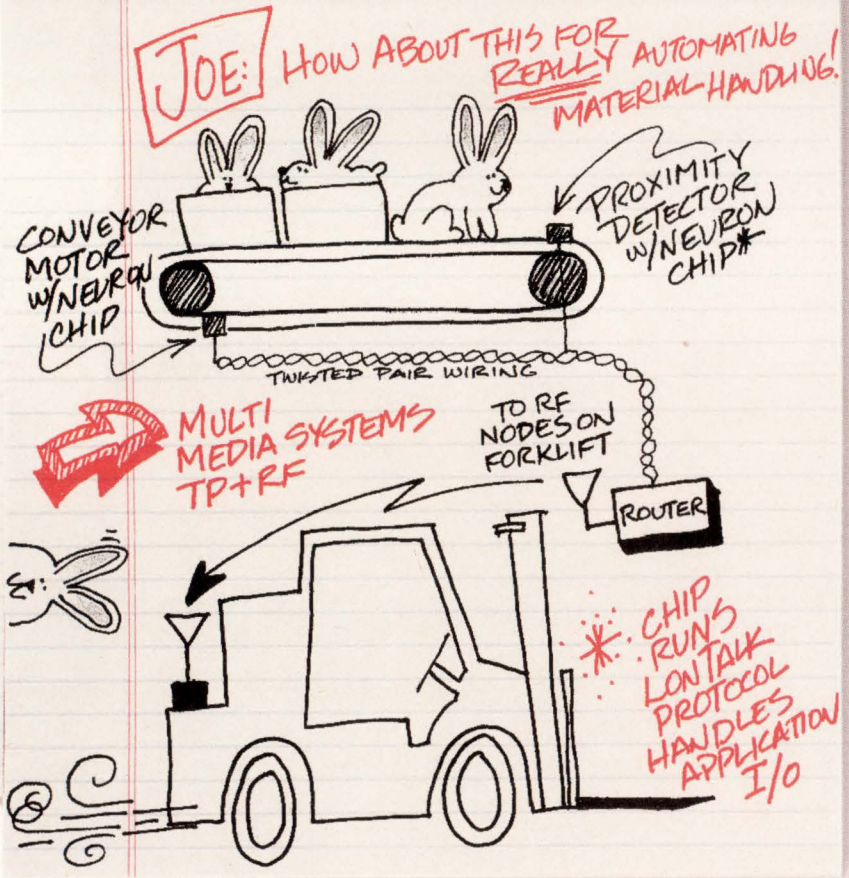
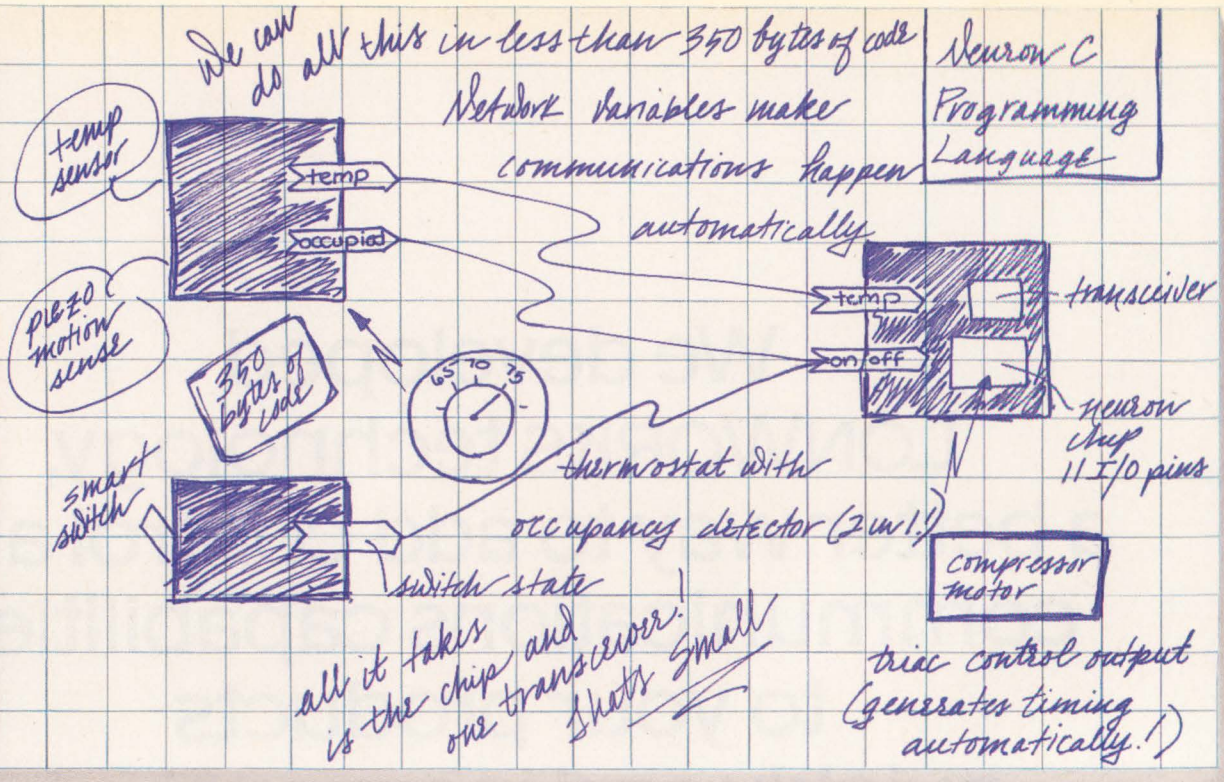

© 1991 Echelon Corporation. LONWORKS, LONBUILDER and LONTALK are trademarks, and ECHELON, LON, and NEURON are registered trademarks of Echelon Corporation. Other names may be trademarks of their respective companies. Some of the LONWORKS tools are subject to certain Terms and Conditions. For a complete explanation of these Terms and Conditions, please call 1-800-258-4LON.

ECHELON SEMINAR

- o WE CAN DO ALL THESE WITH 1 WIRING HARNESS
- o PRIORITY FEATURE OF LONTALK PROTOCOL GUARANTEES RESPONSE TIME FOR CRITICAL FUNCTIONS
- o NEW APPLICATIONS? RF TO AUTOMATIC TOLL SENSOR?

o CHIPS

- 3 CPUs
- RAM, EPROM (ROM)
- COMM & I/O

MULTIPLE SOURCES



TOSHIBA

14mm

MOTOROLA
TOSHIBA

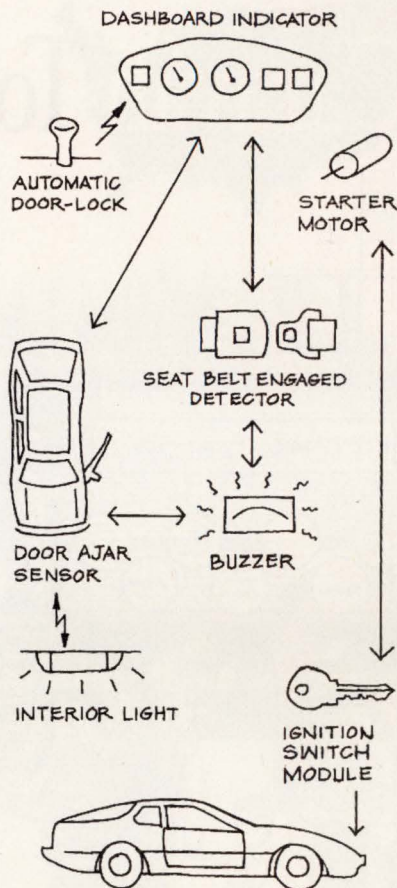

LONWORKS SEMINARS

ARIZONA	Phoenix	June 25
CALIFORNIA	Irvine	May 2
	Los Angeles	March 13
	San Diego	March 12
COLORADO	Santa Clara	March 14
	Denver	March 26
CONNECTICUT	Stamford	June 18
FLORIDA	Ft. Lauderdale	April 9
	Orlando	April 10
GEORGIA	Atlanta	April 11
INDIANA	Indianapolis	June 5
ILLINOIS	Chicago	March 21
KANSAS	Kansas City	March 26
MARYLAND	Baltimore	April 2
MASSACHUSETTS	Boston	April 3
MICHIGAN	Detroit	March 28
MINNESOTA	Minneapolis	March 19
MISSOURI	St. Louis	June 6
NEW HAMPSHIRE	Manchester	May 7
NEW JERSEY	Fairfield	June 12
NEW YORK	Albany	June 19
	Long Island	April 4
OHIO	Rochester	June 11
	Tarrytown	May 9
	Cleveland	March 27
OREGON	Dayton	June 4
	Portland	April 16
PENNSYLVANIA	Philadelphia	May 8
	Pittsburgh	June 20
TEXAS	Dallas/Ft. Worth	May 1
	Houston	April 30
VIRGINIA	Tysons Corner	June 13
WASHINGTON	Seattle	April 17
WISCONSIN	Milwaukee	March 20
UTAH	Salt Lake City	June 27
CANADA	Montreal	April 24
	Ottawa	April 23
EUROPE	Toronto	April 25
	Vancouver	April 18
	Düsseldorf	May 20
JAPAN	London	May 16
	Milan	May 28
	Munich	May 21
	Paris	May 30
	Stockholm	May 14
Zurich	Zurich	May 23
	Osaka	(TBA)
Tokyo	(TBA)	

1-800-258-4LON

For Reservations and Information

What You Do With It Is Your Business.

Spend a day in one of our free LONWORKS™ seminars and we'll change the way you develop products forever.

You'll learn about the technology that uses the latest computer, semiconductor and networking advances to add control and communication capabilities to your products.

You'll see the heart of LONWORKS, the NEURON® CHIP that's small enough to fit into any product. Smart enough to control and respond to other devices. Flexible enough to communicate over standard media. Inexpensive enough that everyone can afford it.

You'll discover how easy it is to program and link NEURON CHIPS into virtually invisible networks of intelligent devices.

How our powerful LONTALK™ protocol lets you use electrical powerlines, twisted pair, radio waves, and other common media as communication paths.

How our LONBUILDER™ Developer's Workbench helps you design LONWORKS networks into your products to make them work "smarter." How to connect your LONWORKS-based products into smart systems. And how to connect those systems into interoperating LONWORKS environments as large as a building, a home or a factory. All in far less time and for much less money than it takes to develop your own protocols and tools.

LONWORKS technology is something every designer in every industry can use. A day at a LONWORKS seminar will give you the information and inspiration to make your products sense, control, communicate and cooperate better than ever.

So find the seminar nearest you. Call 1-800-258-4LON for your reservation. And learn all about the new technology that will help you improve your products. And your business.



Echelon Corporation • 4015 Miranda Avenue • Palo Alto, CA 94304 • Telephone (415) 855-7400 • FAX (415) 856-6153

Echelon Europe Ltd. • 105 Heath Street • London NW3 6SS England • Telephone (071) 431-1600 • FAX (071) 794-0532 • International Telephone +44 71 431-1600 • International FAX +44 71 794-0532

The 1991 EDN Caravan Tour

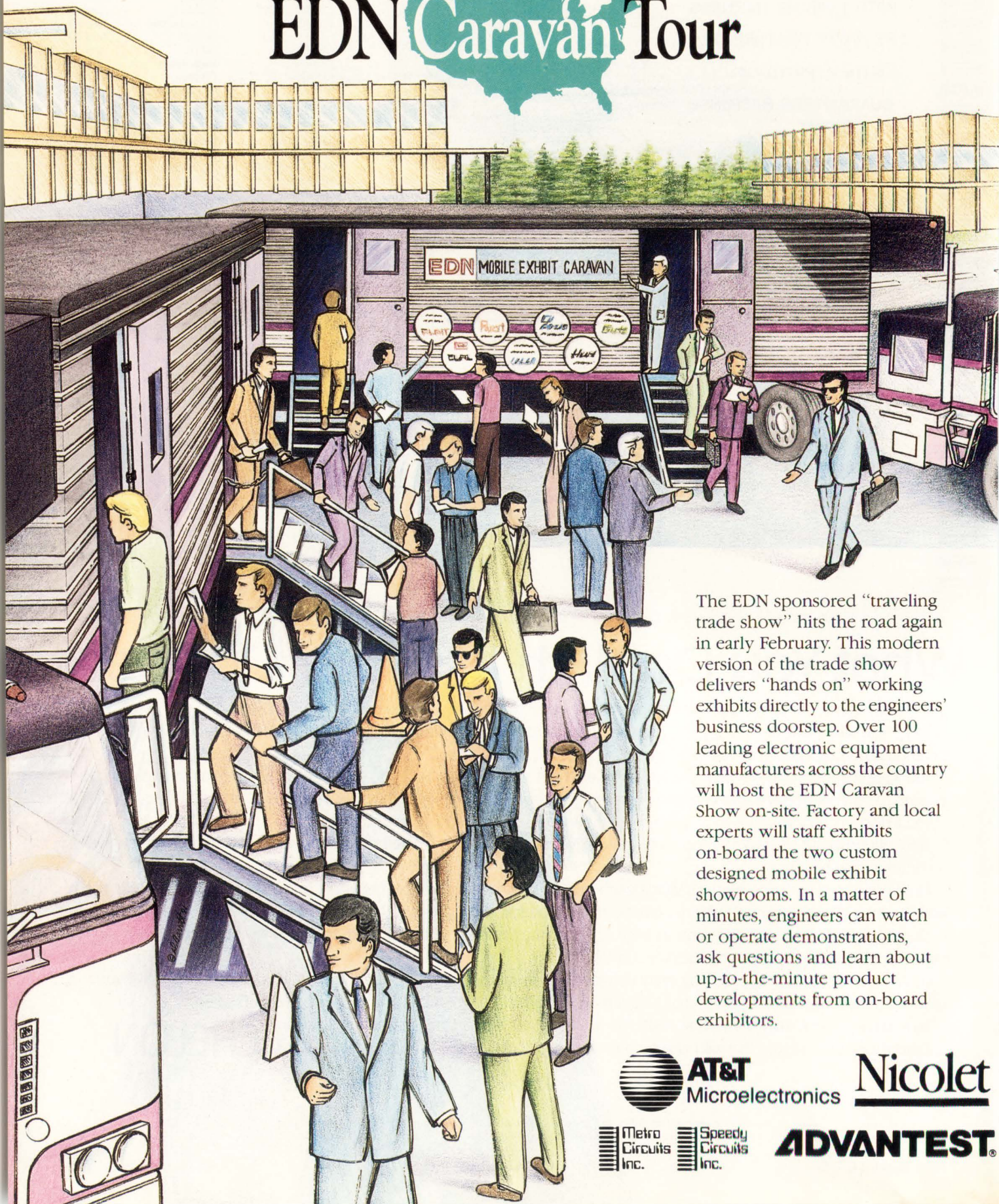

The EDN sponsored "traveling trade show" hits the road again in early February. This modern version of the trade show delivers "hands on" working exhibits directly to the engineers' business doorstep. Over 100 leading electronic equipment manufacturers across the country will host the EDN Caravan Show on-site. Factory and local experts will staff exhibits on-board the two custom designed mobile exhibit showrooms. In a matter of minutes, engineers can watch or operate demonstrations, ask questions and learn about up-to-the-minute product developments from on-board exhibitors.



EDN CARAVAN ELECTRONIC SHOW TOURS

Bringing New Products and Ideas to Your Business Doorstep

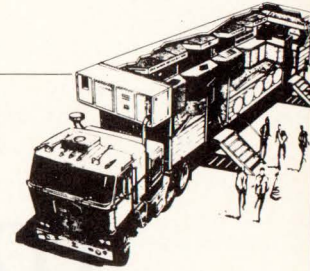

DATE	TIME	SITE
4/1 Monday	9:00-12:00 AM	SANDIA NATIONAL LABORATORIES Kirkland Air Force Base, Albuquerque, NM
4/1 Monday	1:30-4:00 PM	HONEYWELL INC., Defense Avionics 9201 San Mateo Blvd. N.E., Albuquerque, NM
4/2 Tuesday	9:00-12:00 AM	LOS ALAMOS NATIONAL LABORATORIES Albuquerque, NM
4/3 Wednesday	9:00-11:30 AM	DIGITAL EQUIPMENT CORPORATION 301 Rockrimmon Blvd., So., Colorado Springs, CO
4/3 Wednesday	2:00-3:30 PM	METRUM INFORMATION SYSTEMS 4800 East Dry Creek Road, Littleton, CO
4/4 Thursday	9:00-11:30 AM	AT&T BELL LABORATORIES 11900 N. Pecos St., Denver, CO
4/4 Thursday	1:30-4:00 PM	BALL CORPORATION 1950 33rd St., Boulder Ind. Park, Boulder, CO
4/5 Friday	8:00-4:00 AM-PM	MARTIN MARIETTA ASTRONAUTICS (three sites) 12250 So. Highway 75, Denver, CO
4/8 Monday	9:00-11:00 AM	BEECH AIRCRAFT CORPORATION 9709 E. Central, Wichita, KS
4/9 Tuesday	9:00-11:30 AM	SEAGATE TECHNOLOGY 10323 W. Reno Avenue, Oklahoma City, OK
4/10 Wednesday	9:00-12:00 AM	GENERAL DYNAMICS CORPORATION Spur 341 (N. G.D. Blvd.), Forth Worth, TX
4/10 Thursday	1:30-3:30 AM	TEXAS INSTRUMENTS, INC. Forest Lane, Dallas, TX
4/11 Thursday	9:00-11:30 AM	ROCKWELL INTERNATIONAL Shiloh & Renner Rd., Richardson, TX
4/11 Thursday	1:00-3:30 PM	ROCKWELL INTERNATIONAL 1225 N. Alma Road, Richardson, TX
4/12 Friday	8:30-11:00 AM	E-SYSTEMS INC. 1570 Farm Road, Greenville, TX
4/12 Friday	12:30-3:30 PM	E-SYSTEMS INC. 1200 Jupiter Road, Garland, TX
4/15 Monday	9:00-12:00 AM	COMPAQ COMPUTER CORPORATION 20555 FM 149, Houston, TX
4/15 Monday	1:30-3:30 PM	COMPAQ COMPUTER CORPORATION 20555 FM 149, Houston, TX
4/16 Tuesday	9:00-11:30 AM	IBM CORPORATION 11400 Burnet Road, Austin, TX
4/16 Tuesday	1:00-3:00 PM	TEXAS INSTRUMENTS, INC. 12501 Research Blvd., Austin, TX
4/17 Wednesday	9:00-11:30 AM	DELL COMPUTER CORPORATION 9505 Arboretum Blvd., Austin, TX
4/17 Wednesday	1:00-3:00 PM	TRACOR, INC. 6500 Tracor Lane, Austin, TX
4/18 Thursday	9:00-11:00 AM	ELECTROSPACE SYSTEMS INC. 1301 E. Collins Road, Richardson, TX
4/18 Thursday	12:00-1:30 PM	CONVEX COMPUTER CORPORATION 701 N. Plano Road, Richardson, TX
4/18 Thursday	2:30-4:00 PM	DSC COMMUNICATIONS 1000 Coit Road, Plano, TX

DATE	TIME	SITE
4/19 Friday	9:00-11:30 AM	TEXAS INSTRUMENTS, INC. 2501 W. University, McKinney, TX
4/19 Friday	1:00-3:00 PM	TEXAS INSTRUMENTS, INC. 6500 Chase Oaks Blvd., Plano, TX
4/22 Monday	9:00-11:30 AM	BENDIX KING CORP. 400 N. Rogers Road, Olathe, KS
4/22 Monday	12:30-2:30 PM	ALLIED SIGNAL AEROSPACE 2000 E. 95th Street, Kansas City, MO
4/23 Tuesday	8:30-11:00 AM	EMERSON ELECTRONICS & SPACE 201 Evans Lane, St. Louis, MO
4/23 Tuesday	11:30-1:00 AM-PM	EMERSON ELECTRONICS & SPACE 8100 W. Florissant Ave., St. Louis, MO
4/23 Tuesday	2:15-4:30 PM	McDONNELL DOUGLAS ELECTRONIC SYSTEMS COMPANY St. Charles, MO
4/24 Wednesday	9:00-12:00 AM	AT&T BELL LABORATORIES (Indian Hill Main) 2000 N. Naperville Road, Naperville, IL
4/24 Wednesday	1:30-4:00 PM	AT&T BELL LABORATORIES (Court Building) Naperville-Wheaton Road, Naperville, IL
4/25 Thursday	9:00-11:30 AM	NORTHROP CORPORATION, Defense Systems 600 Hicks Road, Rolling Meadows, IL
4/25 Thursday	12:30-3:00 PM	MOTOROLA, INC., Cellular Group 1501 W. Shure Drive, Arlington Heights, IL
4/26 Friday	8:30-11:00 AM	ZENITH ELECTRONIC SYSTEMS 1000 Milwaukee Avenue, Glenview, IL
4/26 Friday	12:30-2:30 PM	MOTOROLA, INC., Automotive & Industrial Elex. 4000 Commercial Avenue, Northbrook, IL
4/29 Monday	9:00-11:30 AM	ROCKWELL INTL. Commercial Avionics 400 Collins Road N.E., Cedar Rapids, IA
4/29 Monday	12:00-1:30 PM	ROCKWELL INTL. Collins Defense Communications 855 35th Street N.E., Cedar Rapids, IA
4/29 Monday	2:15-3:30 PM	ROCKWELL INTL. Collins Defense Communications Collins Road — Bldg. 153, Cedar Rapids, IA
4/30 Tuesday	9:00-11:30 AM	IBM CORPORATION Highway 52 So. & NW 37th St., Rochester, MN
4/30 Tuesday	2:00-4:45 PM	ROSEMOUNT, INC. 12001 Technology Drive, Eden Prairie, MN
5/1 Wednesday	9:00-11:00 AM	ROSEMOUNT, INC. 200 Market Boulevard, Chanhassen, MN
5/1 Wednesday	1:30-4:00 PM	HONEYWELL INC., Commercial Flight Systems 840 Evergreen Blvd., Coon Rapids, MN
5/2 Thursday	:00-11:30 AM	UNISYS CORPORATION 2276 Highcrest Street, Roseville, MN
5/2 Thursday	12:30-3:30 PM	3M COMPANY 3M Center, Saint Paul, MN
5/3 Friday	9:00-11:30 AM	GENERAL ELECTRIC CO., Medical Systems 3000 N. Grandview Blvd., Waukesha, WI
5/3 Friday	12:30-2:30 PM	ALLEN-BRADLEY COMPANY 1201 So. 2nd Street, Milwaukee, WI

B Basler Electric

Tektronix
WAVETEK



BUSSMANN

EAGLE **EP** **PICHER**

CAHNERS
CAPS
Computer Aided
Product Selection

APEX
µtech

MITSUBISHI
ELECTRONICS

CIRCLE NO. 49

DATA I/O
Corporation

LeCroy
Innovators in Instrumentation

For the fastest SRAMs, come to the record holder.



NEC offers the fastest CMOS SRAMs on the market today: 64K/12ns, 256K/15ns, and 1M/20ns.

That's fast enough to eliminate wait states in most applications, including mainframes, minis, workstations and mass storage. Our 256K family includes a device with a parity check function.

All our SRAMs are fabricated with NEC's leading-edge 0.8 μ m CMOS technology. And we're already developing 4M fast SRAMs

with 0.55 μ m technology.

If you're working on a speed-intensive system, we've got some

very quick solutions. For more information on the fastest SRAMs, contact NEC today.

Capacity	Part Number	Organization	Access Time (ns)	Package
64K	μ PD4361B	64K x 1	12/15/20	DIP/SOJ
	4362B	16K x 4	12/15/20	DIP/SOJ
	4363B	16K x 4 OE	12/15/20	DIP/SOJ
	4368	8K x 8	15/20	DIP/SOJ
	4369	8K x 9	15/20	DIP/SOJ
256K	43251B	256K x 1	15/20/25	DIP/SOJ
	43254B	64K x 4	15/20/25	DIP/SOJ
	43253B	64K x 4 OE	15/20/25	DIP/SOJ
	43258A	32K x 8	15/20/25	DIP/SOJ
	43250A	32K x 8 (with parity check)	15/20/25	DIP/SOJ
288K	43259A	32K x 9	15/20/25	DIP/SOJ
1M	431001	1M x 1	20/25/35	SOJ
	431004	256K x 4	20/25/35	SOJ

For fast answers, call us at:

USA Tel:1-800-632-3531. Fax:1-800-729-9288. Germany Tel:0211-650302. Telex:8589960. The Netherlands Tel:040-445-845. Telex:51923.
Sweden Tel:08-753-6020. Telex:13839. France Tel:1-3067-5800. Telex:699499. Spain Tel:1-419-4150. Telex:41316. Italy Tel:02-6709108. Telex:315355.
UK Tel:0908-691133. Telex:826791. Ireland Tel:01-6794200. Fax:01-6794081. Hong Kong Tel:755-9008. Telex:54561. Taiwan Tel:02-719-2377. Telex:22372.
Korea Tel:02-551-0450. Fax:02-551-0451. Singapore Tel:253-8311. Fax:250-3583. Australia Tel:03-267-6355. Telex:38343.



Choose PC software or scientific calculators to tame tough math

For less than \$400 you can get a top-of-the-line scientific calculator or an IBM PC software package that will solve a wide range of your engineering math problems. The calculators are more portable; the programs are more powerful. All have a lot of capability.

Richard E Douglass, *Consultant*

For engineering computations from basic trig to matrix math and more, you can turn to a variety of software packages and engineering/scientific calculators for assistance. I recently compared some typical computational tools—four software programs and four calculators—that provide many of the features an electronics engineer might want. The calculators and software aren't direct competitors, but they illustrate the capabilities that are now available for a modest amount of money. All of the tools reviewed have a list price of less than \$400.

The four calculators I chose are the Hewlett-Packard HP 48SX, the Texas Instruments TI-81, the Sharp PC-E500, and the Casio fx-8000G. All are their manufacturers' top-of-the-line models. The Sharp and the

HP are actually small computers, but I call them calculators to emphasize their portability.

The software packages I chose are SoftWarehouse's Derive (Release 1.58), Universal Technical Systems Inc's TK Solver Plus (Release 1.1), MathSoft Inc's MathCad 2.5, and Borland International's Eureka 1.0. All the programs run on IBM and compatible PCs under MS-DOS. Selection criteria for this review included a less-than-\$400 list price; other packages are available that are more expensive and perhaps more capable.

(Ed note: After this review was prepared, SoftWarehouse released a new version of Derive. Derive 2.0 has expanded and extended capabilities for programming, equation solving, matrix operations, calculus, numerical methods, plotting, and user interfaces. The program's documentation was substantially improved. We regret that this review could not cover these recent additions.)

It is still generally true that calculators are more portable than computers and better suited for immediate calculations that might be required in meetings or while traveling. Computers generally provide more computational power than calculators. Nevertheless, the gap between calculators and computers becomes smaller every year; therefore, I've attempted to evaluate calculators and software packages on the same features; those useful to a working engineer.

The types of features covered in the comparison ta-

Calculators are more portable, but computers provide more options. The differences become smaller every year.

bles (Tables 1 through 19) indicate the range of capabilities of these tools. These features include

- scientific calculator functions
- data storage and recall
- user-defined functions
- complex mathematics
- vector mathematics
- matrix mathematics
- statistical calculations
- numerical solution of equations
- symbolic algebra and calculus
- reference formulas and constants
- unit conversions
- graphics and graphical analysis
- programming features
- text entry and edit
- clock functions
- printer interface
- mass-storage interface
- computer interface.

“Report Card” shows grades

Table 1 lists a very brief summary of the tools, including price information and grades (from A to F, as in school) for overall capabilities and ease of use. The grades summarize my opinions about the quality of the tools. Therefore, there is, of course, a degree of subjectivity involved.

A very important factor in ease of use is the “intuitiveness” of the command structure. You can use some of the tools, at least for simple tasks, without reading the documentation. Others are difficult to use even after studying the manuals.

Other ease-of-use factors are the number of key-strokes required to accomplish a given job and the availability of on-line help. Finally, and probably most important to ease of use, is the quality of the documentation package.

As I began reading the calculators’ and programs’ documentation, I was surprised at how difficult it was to determine which tools have which features. In many cases, I found myself experimenting with a tool just to determine if a particular feature was available. So I apologize if I’ve failed to list some products’ features, but if a feature isn’t listed in a tool’s documentation index, then the tool’s manufacturer must share the blame with me.

Several factors contribute to the ease or difficulty in using these tools’ documentation (Table 2). Two inseparable ones are the completeness of the description

of operations and the completeness of the index. A tutorial section that groups operations by function is helpful, as is a reference section that lists operations in alphabetical order.

The Casio calculator’s documentation doesn’t contain an index. I am immediately turned off by a manual without an index, no matter how complete the table of contents is. On calculators as powerful and complex as those reviewed here, each key typically serves multiple functions. It is important that the documentation make these functions clear.

Table 3 summarizes the tools’ most basic features. All of the tools can perform the functions of a simple scientific calculator. All the tools use algebraic data entry, except the HP calculator, which uses Reverse Polish (except for symbolic equations). (As an aside, I prefer Reverse Polish, but I find algebraic entry much more acceptable on a multiline screen.)

The number of memory cells addressable by calculator commands of the type STO A (to store a value in memory register A) varies among the tools. The Sharp calculator provides substantial additional memory that certain functions can address. The HP calculator and the four software packages assign variable names to values (for example, NUM=4). The number of storage locations is limited by total available memory. I found the HP method quite clumsy (it required too many key strokes) compared to the others.

I had difficulty determining the arithmetic precision used by most of the tools for internal computations; the table entries are my best guesses after gleaning the documentation.

Menus or marked keys

Intrinsic functions (Table 4) are those frequently provided by special function keys on a scientific calculator, or are otherwise built into the tool. The TI and HP calculators provide math menus, as opposed to special function keys, for some functions. Math menus require a few more key strokes and are, therefore, a little less convenient to use. The computer programs typically access these functions by direct commands, such as $Y = \sin(30)$, followed by a SOLVE or PRINT Y command.

The ability to define and analyze functions is one of the most important capabilities of these tools, second only to the basic calculation functions. All the tools let you define functions of one or more independent variables for subsequent graphing, numerical evaluation, and analysis. The tools differ in the types of mathemati-

Math tools in summary

The four calculators and the four PC software packages that I examined are all capable tools for solving engineering math problems. There are substantial differences among the tools, however, so your own needs will determine which one is best for you.

The Casio fx-8000G is a compact and fairly conventional programmable scientific calculator that is augmented by function-definition and graphing features. Access to its scientific functions is via function keys (as opposed to a menu), so access is fast, but the keyboard is crowded and hard to read. The Casio's text editing and storage features are handy for phone lists.

The TI-81, like the Casio, is compact, fairly conventional, and has function-definition and graphing features. Its graphical analysis capabilities are somewhat more powerful than the Casio's. Because you access some of its scientific functions via a menu, the TI has a less cluttered keyboard, but requires more keystrokes. It has no text editing and storage capabilities. I found the TI the easiest of the calculators to learn and use.

The Sharp PC-E500 is a little less compact than the Casio and TI calculators, but substantially more powerful. It is really a combination of a scientific calculator and a Basic-language computer. As a calculator, it was almost as

easy to use as the TI. With its QWERTY keyboard and built-in Basic, it was far and away the easiest for me to learn to program. Its special function-definition mode was easy to learn and use. Unfortunately, its graphics-analysis mode was the least powerful of the calculators.

The HP 48SX is the most powerful of the four calculators. It has an amazing number of features. However, the limited space for control keys means that each key must serve three or four functions, and the command structure was not very "intuitive." I found it very difficult to learn and use.

The four computer programs all have better equation-solving capabilities than any of the calculators. Eureka is the least expensive and least powerful, but I found it easiest to use. If you don't need this kind of tool very often, the ease-of-use factor becomes very important. I plan to keep Eureka around as the first tool to try for solving equations.

Because of the flexibility of its command structure (or programming language), TK Solver Plus is in some sense the most powerful of the programs. I found it the most difficult to use, however. It would probably be most useful with an applications library.

Although MathCad has equation-solving capabilities, its strong point is its enhanced func-

tion-definition, analysis, and graphing capabilities. Once you get used to the mathematical editor (which took me some time), you can define, evaluate, and plot complicated functions (including complex variables, vectors, derivatives, and integrals) very quickly. The program's supplier advertises it as a mathematical scratchpad; I found it serves very well in that capacity.

Derive is a strange beast, but it can be very useful. Even though I've used the program a number of times over the last year or so, I still find it hard to use. Nevertheless, if I have a substantial amount of algebra (or an algebraically complex series expansion or derivative) to do, the first thing I do is unlimber Derive. If I can get Derive to solve the problem (or pieces of the problem), I usually feel the time spent struggling with the program has been worthwhile. If Derive can solve the problem at all, it gives a correct answer; if I solve the problem by hand, I usually have to do it several times to ensure I haven't made a careless mistake. Also, Derive will save its answers in a text file that I can import directly into my Fortran programs. I also use Derive's extended numerical accuracy to obtain results that I can compare with those from my programs.

cal operations you can include in a function and the types of analyses you can perform. **Table 5** indicates features available for user-defined functions containing only simple variables; **Tables 7, 8, 9, and 17** cover complex variables, vectors, matrices, and graphical analysis features.

All of the programs and calculators provide some capability for solving user-defined equations, but the capabilities vary widely. At a minimum, you can determine the roots of a user-defined function by graphical means. The more capable tools will solve a set of nonlinear equations, subject to constraints (including inequalities), by sophisticated numerical-analysis tech-

niques. **Table 6** lists the capabilities. I didn't have time to experiment with equation solving as much as I would have liked, so the entries in the table are based largely on documentation.

The capabilities for performing complex-number, vector, and matrix operations also vary widely among the tools. Some of the tools offer no such capabilities; others treat complex values, vectors, and matrices in virtually the same way as real numbers and functions. The best complex-math features (**Table 7**) come with the HP calculator and with the Eureka, MathCad, and Derive programs.

As indicated in **Table 8**, the HP calculator, MathCad,

Two of the tools—the Derive software package and the HP 48SX calculator, perform symbolic mathematical operations.

and Derive have the best vector-math features. I found using the vector-analysis features of the HP a little tedious, primarily because of the small, cluttered keyboard. I've owned versions of MathCad and Derive for some time and have found them both useful and easy to use in solving vector math problems.

None of the tools I reviewed provide the complete set of matrix-analysis features that you find in special-purpose matrix-analysis software for IBM-compatible (and other) computers. Nevertheless, some of them offer capabilities that are sufficient for most needs (**Table 9**). The Sharp and HP calculators and the MathCad and Derive programs are the strongest in this area. TK Solver has good capabilities, but in my opinion is less convenient to use.

My observation about statistical-analysis features is the same as for matrix-analysis features: None of the tools provide the complete set of statistical-analysis features offered by special-purpose statistical-analysis software. All the tools except Eureka provide some capability for statistical operations on tabulated data; some offer capabilities that are sufficient for most needs (**Table 10**). Once again, the Sharp and HP calculators and the MathCad and Derive software packages are the strongest in this area; TK Solver has good capabilities, but is less convenient to use. The Sharp and HP calculators and the TK Solver library provide programs for computing the most common probability functions (**Table 11**).

Symbolic algebra and calculus

Derive and the HP 48SX perform symbolic mathematical operations. (See **Table 12** for symbolic algebra features and **Table 13** for symbolic calculus.) For example, given the equation

$$a*x^2+b*x+c=0,$$

the tools will provide the solution

$$x=[-b \pm \sqrt{(b^2-4*a*c)}]/(2*a).$$

Derive is somewhat more powerful than the HP calculator. I found the HP's symbolic capabilities more useful for reference to math formulas (common integrals, series expansions, and so forth) than for solving symbolic equations.

I have owned Derive (and its predecessor, MuMath) for several years, and I have found it helpful in several applications. Generally, I've used it for such tasks as

simplifying algebraic expressions and expanding expressions in Taylor's series. There are more powerful symbolic-math programs than Derive, but not in the same price range.

Several of the tools provide reference formulas, tables of mathematical constants, and tables of physical constants. (See **Table 14** for details.) The volume of reference data in the Sharp calculator particularly impressed me; for the HP calculator, an optional HP Solve Equation card—which was included in the unit I reviewed—offers capabilities similar to the Sharp's.

As shown in **Table 15**, some of the tools can convert among different sets of units (for example, inches and centimeters) and will test dimensional consistency of variables used in arithmetic calculations. (In other words, they won't let you add apples to oranges.) The units-checking feature is handy, but I find it a little tedious to enter units with variables in equations, so I probably would make little use of it.

Graphics and graphical analysis

Graphing user-defined functions is possible with all the programs and calculators. I found this capability one of the tools' most useful features (**Table 16**). With a suitable output device, some of the tools can produce report-quality graphs.

Some of the tools can also be used to analyze graphical displays of user-defined functions (**Table 17**). At a minimum, you can use a cursor to move cross-hairs on a display and get a read-out of cursor position. Some of the tools offer greater analysis capabilities, such as numerical integration of the area between two plotted curves.

One of the main purposes of these computational tools is to eliminate the need for programming. Nevertheless, there are at least two reasons for including some programming features: batch processing of operations (putting the operations in a queue for later execution) and the need to perform computations that the tools don't provide directly. Programming capabilities of the tools vary widely (**Table 18**).

The Casio and TI calculators use a keystroke-entry type of programming language similar to that found in most earlier generations of scientific calculators. The Sharp has a modified version of the interpreter Basic used in most personal computers. The HP language is different from anything I have ever seen; it is a mix of keystroke-entry commands, high-level-language constructs (for example, *if-then-else-end*), and stack-object manipulation commands. I found the HP difficult to

For more information . . .

For more information about the calculators and software packages reviewed in this article, circle the appropriate numbers on the Information Retrieval Service Card or use EDN's Express Request Service. When you contact any of the following companies directly, please let them know you saw their products in EDN.

Borland International
1800 Green Hills Rd
Scotts Valley, CA 95066
(408) 438-8400
Circle No. 650

Casio Inc
570 Mt Pleasant Ave
Dover, NJ 07801
(201) 361-5400
Circle No. 651

Hewlett-Packard
Inquiries Manager
1000 NE Circle Blvd
Corvallis, OR 97330
Phone local office.
Circle No. 652

Mathsoft Inc
201 Broadway
Cambridge, MA 02139
(800) 628-4223; in MA,
(617) 577-1017
FAX (617) 577-8829
Circle No. 653

Sharp Electronics Corp
Sharp Plaza
Box 650
Mahwah, NJ 07430
(800) 237-4277
Circle No. 654

VOTE . . .

Please also use the Information Retrieval Service card to rate this article (circle one)

High Interest 491 Medium Interest 492 Low Interest 493

Soft Warehouse Inc
3615 Harding Ave, Suite 505
Honolulu, HI 96816
(808) 734-5801
FAX (808) 735-1105
Circle No. 655

Texas Instruments
Consumer Relations
Box 53
Lubbock, TX 79408
(806) 747-1882
FAX (806) 741-2146
Circle No. 656

Universal Technical Systems
1220 Rock St
Rockford, IL 61101
(815) 963-2220
FAX (815) 963-8884
Circle No. 657

program, the Sharp quick and easy (since I already knew Basic), and the Casio and TI fairly easy, but tedious.

With the software packages, you enter equations much as you would write them on a sheet of paper. Eureka, TK Solver, and MathCad allow sort of a free-form entry—you use the program's built-in editor to steer a cursor around the screen and make changes to equations much as you would with your favorite text editor. Derive's entry and editing capabilities are much more limited and difficult to use. You enter each equation or expression on a numbered line; once entered, the line is not easy to edit.

Eureka, TK Solver, and Derive can import text and equations from ASCII disk files. The equations are of a form typically used by high-level languages—for example, $f(x) = x^2 + \sin(x)$. With MathCad, you have to use the program's editor to create program statements and equations appear in a true math format. You can save the statements in disk files for later recall and editing, but you can't use an ASCII editor on them.

TK Solver is the only one of the computer programs with a programming language that has full provisions for subroutines with local variables, IF-THEN-ELSE constructs, DO loops, and so forth. Although this language gives TK Solver a great deal of power, I found it hard to harness that power because of the way the software partitions various kinds of program specifications into sheets and sub sheets. These include

- a rules sheet for specifying the main equations defining your problem,
- a variables sheet for specifying such things as the type and status (input, output, guess, list variable) of variables in the equations,
- variables sub sheets (to specify units), and more.

Even though TK provides some help in negotiating the sheets, I found programming the sheets and ma-

neuvering among them tedious. On the positive side, the sheet approach does force you to use a modular program structure, declare variables, and do other things that constitute good programming practice.

Hardware interfaces and options

Most of the calculators provide interfaces to personal computers, hard-copy devices, and mass storage (Table 19), although these interfaces are usually extra-cost options. The software packages, of course, use your computer's hardware facilities.

The HP and Sharp calculators have built-in serial ports, although the Sharp's connector is nonstandard. The Casio has an optional Centronics port. The HP, Sharp, and Casio calculators connect to optional printer/plotters. Add-in memory modules are available for the HP and the Sharp. Application software libraries come with the TK Solver, MathCad, and Derive software packages and optional libraries are also available. The HP calculator, as mentioned earlier, has optional application libraries on plug-in cards.

While computational speed is probably not the most important factor in determining the utility of these tools, it can nevertheless be important. To provide some information about relative speed, I devised a test computation that all the tools could handle. The computer I used for the tests is an Everex Step 25 with a 25-MHz 80386 CPU and an 80387 numeric coprocessor. For other computers with numeric coprocessors, speed results should scale roughly with clock speed.

The computation I used for the speed test is a summation of a geometric series for which there is also an analytical solution. The series is

$$S = \sum_{n=0}^N x^n,$$

None of the tools provide the complete set of matrix-analysis features that you find in special-purpose matrix-analysis software.

which can be summed analytically to give

$$\frac{1-x^{N+1}}{1-x}$$

Timing the calculations with a stop watch, I used each tool to evaluate the sum for $x=0.99$ and $N=500$. All the tools gave the correct answer (99.34295221788) to the number of significant figures that they could display. The elapsed times were

Casio fx-8000G	13.1 sec
TI-81	13.0 sec
Sharp PC-E500 (single precision)	6.5 sec
Sharp PC-E500 (double precision)	9.0 sec
HP 48SX	41.6 sec
Eureka	0.4 sec
TK Solver Plus	0.2 sec
MathCad	0.5 sec
Derive	0.1 sec

I was surprised at how long the HP took to perform

the calculation. It may well be that the code I wrote was not the most efficient method for this calculator.

Overall, I am impressed with all the tools; I believe they all provide a lot of power for not much money. There are substantial differences among them, however, and the information provided here should help you evaluate the tools for your own needs. **EDN**

Author's biography

Richard E Douglass is an independent consultant specializing in analytical tools for sonar systems design. He has a PhD in mechanical engineering from the University of Texas and is a member of the Acoustical Society of America.

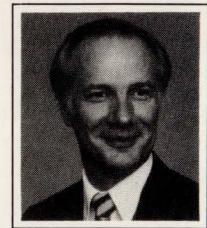

Article Interest Quotient (Circle One)
High 491 Medium 492 Low 493

Table 1—"Report card"

	Casio fx-8000G	TI-81	Sharp PC-E500	HP 48 SX	Eureka	TK Solver Plus	MathCAD	Derive
List price	\$120	\$110	\$229	\$350	\$167	\$395	\$349	\$200
Ease-of-use grade (A-F)	C	A	A	D	B	C	B	D
Capability (A-F)	C	C	B	A	C	A	A	A

Table 2—Documentation

	Casio fx-8000G	TI-81	Sharp PC-E500	HP 48 SX	Eureka	TK Solver Plus	MathCAD	Derive
On-line help	No	No	No	No	Yes	Yes	Yes	Yes ¹
Table of contents	Yes	Yes	Yes	Yes	Yes	Yes	Yes	Yes
Index (grade A-F)	No	C	C	B	C	C	B	D
Organization (grade A-F)	C	C	B	B	C	B	D	C
Tutorial section (commands grouped by function)	Yes	Yes	Yes	Yes	Yes	Yes	Yes	Yes
Alphabetical command reference section	Yes	Yes	Yes	Yes	Yes	Yes	Yes	No
Examples (grade A-F)	C	B	B	C	D ²	B ³	B	D
Clarity of explanatory text (grade A-F)	C	B	B	C	C	B	B	D

- Notes: 1. On-line help often refers only to a page in the user's manual.
2. Examples and command descriptions are in separate sections.
3. No examples for the library routines, which supply a large part of the software's power, are provided.

Table 3—Basic operations and data

	Casio fx-8000G	TI-81	Sharp PC-E500	HP 48 SX	Eureka	TK Solver Plus	MathCAD	Derive
Algebraic (A) or Reverse Polish (RP) data entry	A	A	A	RP ¹	A	A	A	A
Number of memory cells for basic storage	26 ²	27 ³	26 ³	NA	NA	NA	NA	NA
Number of screen text lines	8×16	8×16	4×40	4×20	25×80	25×80	25×80	25×80
Significant figures for calculations	13	13	10 ⁴	15 ⁵	13 ⁵	15 ⁵	15 ⁵	∞ ⁶
Fixed number of decimal places displayed	Yes	Yes	Yes	Yes	Yes	Yes	Yes	Yes
Scientific notation	Yes	Yes	Yes	Yes	Yes	Yes	Yes	Yes
Engineering notation	Yes	Yes	Yes	Yes	No	Yes	No	No

Notes: NA = Not applicable because partition of memory between data and program instructions is under system control.

1. Uses algebraic notation for symbolic equations.
2. Memory can be repartitioned for more data and less program storage.
3. Additional variable memory for Basic programs and special operations, such as matrix analysis, available.
4. 20 significant figures in double-precision mode are available for most operations. In both single and double precision, some internal calculations use greater significance (for example, 12 significant figures for single precision, 24 for double).
5. Number of significant figures is not clear from documentation.
6. The user specifies the significance of numeric data. Significance apparently is limited only by available memory.

Table 4—Intrinsic built-in functions

	Casio fx-8000G	TI-81	Sharp PC-E500	HP 48 SX	Eureka	TK Solver Plus	MathCAD	Derive
+ , - , * , ÷	Yes	Yes	Yes	Yes	Yes	Yes	Yes	Yes
π , e^x , $\ln(x)$	Yes	Yes	Yes	Yes	Yes	Yes	Yes	Yes
10^x , \log_{10}	Yes	Yes	Yes	Yes	Yes	Yes	Yes	Yes
y^x	Yes	Yes	Yes	Yes	Yes	Yes	Yes	Yes
Sin, Cos, Tan	Yes	Yes	Yes	Yes	Yes	Yes	Yes	Yes
\sin^{-1} , \cos^{-1} , \tan^{-1}	Yes	Yes	Yes	Yes	\tan^{-1} only	Yes	Yes	Yes
Deg (D), Rad (R), Grad (G) angle modes	D, R, G	D, R	D, R, G	D, R, G	R	D, R	R	R
Sinh, Cosh, Tanh	Yes	Yes ¹	Yes	Yes ¹	Yes	Yes	Yes	Yes
\sinh^{-1} , \cosh^{-1} , \tanh^{-1}	Yes	Yes ¹	Yes	Yes ¹	No	Yes	Yes	Yes
n!	Yes	Yes ¹	Yes	Yes ¹	Yes	Yes ²	Yes	Yes
$\Gamma(x)$	No	No	Yes ¹	No	No	Yes ²	Yes	Yes
Bessel functions	No	No	No	No	No	Yes ²	Yes	Yes ²
Financial functions (present value, etc.)	No	No	No	No	Yes	Yes ²	No	Yes
Decimal < - > hours.minutes.seconds	Yes	No	Yes	Yes ¹	No	No	No	No
Absolute value of x	Yes	Yes	Yes ³	Yes ¹	Yes	Yes	Yes	Yes
Integer part (next smaller, larger)	Yes	Yes ¹	Yes ³	Yes ¹	Yes	Yes	Yes	No
Fractional part of x	Yes	Yes ¹	No	Yes ¹	Yes	No	No	No
Mantissa, exponent of x	No	No	No	Yes	No	No	No	No
Round x to n significant figures	No	Yes	No	Yes ¹	No	Yes	Yes	No
Truncate x to n significant figures	No	No	No	Yes	No	No	No	No
Sign of x	No	No	Yes ³	Yes ¹	Yes	Yes	No	Yes
Remainder (Modulo x with respect to y)	No	No	No	Yes ¹	No	Yes	Yes	No
Minimum, maximum of {x, y, ...}	No	No	No	Yes ¹	No	Yes	Yes	Yes
Set value according to test (eg, Value=x>y)	No	Yes ¹	Yes ³	Yes ¹	No	Yes	Yes	No
Prime factors of number	No	No	Yes ⁴	No	No	Yes ²	No	Yes
Greatest and least common multiples of number	No	No	Yes ⁴	No	No	Yes ²	No	No
Logic operations (eg, AND, OR, XOR)	Yes	No	Yes ³	Yes ¹	No	Yes ²	No	No

- Notes: 1. Function available via math menu, not function key.
 2. Function is in library that comes with the software.
 3. Available in Basic's immediate mode. Not available on function keys.
 4. Function is in built-in program library.

Table 5—Evaluation and analysis of user-defined functions

	Casio fx-8000G	TI-81	Sharp PC-E500	HP 48 SX	Eureka	TK Solver Plus	MathCAD	Derive
Simple define/edit mode	Yes ¹	Yes ²	Yes	Yes ³	Yes	Yes	Yes ³	Yes
Nesting of user functions	No	No	Yes	Yes	Yes	Yes	Yes	Yes
Numerical evaluation of function	Yes ⁴	Yes ⁴	Yes	Yes	Yes	Yes	Yes	Yes
Roots of function by search methods	Yes ⁴	Yes ⁴	Yes ⁵	Yes ⁵	Yes	Yes	Yes	Yes
Roots of polynomials (all complex roots)	No	No	Yes ⁶	Yes ⁷	Yes	Yes ⁸	No	Yes
Numerical differentiation of function	No	Yes	No	No	Yes	Yes ⁸	Yes	Yes
Numerical integration of function	No	No	Yes ⁹	Yes	Yes	Yes ⁸	Yes	Yes
Numerical integration of differential equation	No	No	No	No	Yes	Yes ⁸	No	No
Max/min of function	No	No	No	No	Yes	Yes ⁸	No	No
Fourier transform of function	No	No	No	No	No	Yes ⁸	No	Yes ¹⁰
Sums, series definition of function	No	No	No	Yes	Yes	Yes	Yes	Yes
Product-form definition of function	No	No	No	No	No	No	Yes	Yes
Continued-fraction definition of function	No	No	No	No	No	No	No	No

- Notes:**
1. Function definition is by entry of an algebraic keystroke sequence, such as those used for calculator math operations. Subsequent functions can be superimposed on plot, but only last function remains in memory.
 2. Function definition is by entry of an algebraic keystroke sequence, such as those used for calculator math operations. You can enter as many as four functions and superimpose their plots.
 3. Equation editor displays equations in true mathematical format.
 4. Evaluating functions and locating roots involves manually moving cursor and reading ordinate value.
 5. Numerical root-search methods are in built-in program libraries.
 6. Built-in cubic-polynomial solver.
 7. Built-in quadratic-polynomial solver.
 8. Function is in library that comes with the software.
 9. Numerical-integration procedure is in a built-in program library.
 10. Fourier-transform procedure is in a library that comes with the software.

Table 6—Numerical solution of simultaneous equations

	Casio fx-8000G	TI-81	Sharp PC-E500	HP 48 SX	Eureka	TK Solver Plus	MathCAD	Derive
Sets of linear equations	No	Yes ¹	Yes	Yes	Yes	Yes	Yes	Yes
Sets of nonlinear equations	No	No	No	No ²	Yes	Yes	Yes	No
Optimization (maximize function with constraints)	No	No	No	No	Yes	Yes ³	Yes ⁴	No

- Notes:**
1. Linear-equation solver requires user interaction to apply matrix row operations.
 2. Multiple-equation solutions available, but you must sequence the equations so that the first equation has only 1 unknown, the second has only 2 unknowns (including the unknown in the first equation), and so on.
 3. Function is in library that comes with the software.
 4. Built-in procedure for minimizing error subject to constraint equations.

Table 7—Complex mathematics

	Casio fx-8000G	TI-81	Sharp PC-E500	HP 48 SX	Eureka	TK Solver Plus	MathCAD	Derive
+ , - , * , ÷	No	No	Yes ¹	Yes	Yes	Yes ²	Yes	Yes
y^x	No	No	No	Yes	Yes	Yes ³	Yes	Yes
Sin, Cos, Tan	No	No	No	Yes	Yes	Yes ⁴	Yes	Yes
\sin^{-1} , \cos^{-1} , \tan^{-1}	No	No	No	Yes	Tan ⁻¹ only	Yes ⁴	Yes	Yes
e^x , ln(x)	No	No	No	Yes	Yes	Yes ⁴	Yes	Yes
Absolute value	No	No	Yes ¹	Yes	Yes	No	Yes	Yes
Argument (phase)	No	No	Yes ¹	Yes	Yes	No	Yes	Yes
Conjugate	No	No	No	Yes	No	Yes ²	Yes	Yes
Real part, imaginary part extraction	No	No	No	Yes	Yes	Yes ²	Yes	Yes
Combine real x, y into $x + i*y$	No	No	No	Yes	Yes	Yes ²	Yes	Yes

- Notes:**
1. Built-in program for elementary complex operations.
 2. Requires complex values to be in the form (a, b). Mixing real and complex numbers in arithmetic operations not allowed.
 3. Built-in function for raising a complex value to a real power.
 4. Function is in library that comes with the software.

**“CERTAINLY, OUR
DMMs GIVE YOU ACCURATE
READINGS. THAT’S A GIVEN.
BUT THERE’S MORE TO
THEM THAN MEETS THE EYE.
DROP ME A NOTE AND
I’LL SHOW YOU.”**

Joseph F. Keithley, Chairman

Joseph F. Keithley

SEE FOR YOURSELF.

From the outside they may look like your standard digital multimeters. They're not. Keithley doesn't make standard instruments. Quality — that's what we're known for. And that's a given with these DMMs.

They're designed, engineered, built to give you more features, more value. And as a result, more performance benefits at less cost than other DMMs.

Put them on your bench or in an automated test system. They'll give you 100pA and 100nV sensitivity. Reading rates up to one million per second. Memory

to store readings. And even the portable units have automatic calibration over the IEEE bus.

And anytime you want assistance, make one phone call and you'll get the answers you need from our Applications Department. This dedicated staff of engineers has the experience to help you with equipment selection and test system design.

Drop us a note at 28775 Aurora Road, Cleveland, Ohio 44139. Or call 1-800-552-1115, Ext. 394, for all the facts. You'll see what you've been missing.



KEITHLEY INSTRUMENTS

Table 8—Vector mathematics

	Casio fx-8000G	TI-81	Sharp PC-E500	HP 48 SX	Eureka	TK Solver Plus	MathCAD	Derive
Cylindrical coordinate mode (2D, 3D)	No	No	No	Yes	No	No	No	No
Spherical coordinate mode (for 3D)	No	No	No	Yes	No	No	No	No
Conversion between modes	No	No	No	Yes	No	No	No	No
Assemble, extract components	No	No	No	Yes	No	Yes ¹	Yes	Yes
Complex elements	No	No	No	Yes	No	No	Yes	Yes
Add, subtract	No	No	No	Yes	No	Yes ¹	Yes	Yes
Multiply by constant	No	No	No	Yes	No	Yes ¹	Yes	Yes
Dot product	No	No	No	Yes	No	Yes ¹	Yes	Yes
Cross product	No	No	No	Yes	No	No	Yes	Yes
Magnitude	No	No	No	Yes	No	No	Yes	No

Note: 1. Treats vectors as special "lists" and provides list operations equivalent to these vector operations.

Table 9—Matrix mathematics

	Casio fx-8000G	TI-81	Sharp PC-E500	HP 48 SX	Eureka	TK Solver Plus	MathCAD	Derive
Convenient data entry/edit	No	Yes ¹	Yes ²	Yes ³	No	Yes ⁴	Yes	Yes
Identity matrix generation	No	No	No	Yes	No	No	Yes	Yes
Other special form matrix generation	No	No	No	Yes ⁵	No	Yes ⁴	Yes ⁶	Yes ⁷
Complex elements	No	No	No	Yes	No	No	Yes	Yes
Add, subtract	No	Yes	Yes	Yes	No	Yes	Yes	Yes
Transpose	No	Yes	Yes	Yes	No	Yes ⁸	Yes	Yes
Multiply	No	Yes	Yes	Yes	No	Yes ⁸	Yes	Yes
Determinant	No	Yes	Yes	Yes	No	Yes ⁸	Yes	Yes
Trace	No	No	No	No	No	No	Yes	Yes
Maximum, minimum element	No	No	No	Yes ⁹	No	No	Yes	No
Sort elements	No	No	No	No	No	No	Yes	No
Absolute value (Euclidean norm)	No	No	No	No	No	No	Yes	No
Row, column norms	No	No	No	Yes	No	No	No	No
Inverse	No	Yes	Yes	Yes	No	Yes	Yes	Yes
Eigenvalues	No	No	No	No	No	Yes ⁸	No	Yes
Eigenvectors	No	No	No	No	No	Yes ⁸	No	No

- Notes: 1. Handles as many as three 6x6 matrices.
 2. Handles as many as 29 matrices. Maximum size, with sufficient memory installed, is 256x256.
 3. Special editor for matrix data entry provided.
 4. Treats matrices as special "lists" and provides list operations equivalent to these matrix operations.
 5. Can generate a matrix with elements all the same value.
 6. Can define elements using its list-creation ("range variable").
 7. Can define elements as functions of indices.
 8. Function is in library that comes with the software.
 9. Provided as statistical function.

Table 10—Statistical calculations and data analysis

	Casio fx-8000G	TI-81	Sharp PC-E500	HP 48 SX	Eureka	TK Solver Plus	MathCAD	Derive
Convenient data entry/edit	No ¹	Yes ²	Yes ³	Yes ⁴	No	Yes ⁵	Yes ⁶	Yes ⁷
Total of values	Yes	Yes	Yes	Yes	No	Yes ⁸	No	No
Maximum, minimum	No	No	No	Yes	No	Yes ⁸	Yes	No
Mean, variance, standard deviation	Yes	Yes	Yes	Yes	No	Yes ⁸	Yes	Yes
Covariance and/or correlation (paired tables)	Yes	Yes	Yes	Yes	No	Yes ⁸	Yes	No
Linear regression	Yes	Yes	Yes	Yes	No	Yes ⁸	Yes	Yes ⁹

- Notes: 1. Statistical analysis uses special data-entry mode with limited editing. After running an analysis, you cannot edit data and repeat analysis.
 2. Has data-table editor that allows editing data between analyses.
 3. You can use Basic to create statistical data. Basic data and statistical-analysis data reside in same area.
 4. Enter and edit data in a special statistics mode or in the matrix editor mode.
 5. You use a list sheet to enter statistical data.
 6. Treats statistical data as vector elements.
 7. Statistical functions operate only on vector and matrix elements.
 8. Function is in library that comes with the software.
 9. Generalized function-fit capability for regression provided.
 10. Other types of regression are only possible indirectly (for example, by taking log of independent variable).
 11. Plots histogram data but does not provide tabular output.

The Magic Module™—DC/DC Converter... the ultimate in proven performance, power capability, size and features...

When designing a DC/DC converter into your system, you want the assurance that a surprise is not going to pop up. With Electronic Measurements' EMQ Series of Magic Modules, you have the assurance of dependable performance, since the design incorporates proven fixed frequency, forward converter technology with current mode control and a nominal frequency of 250 kHz. Another good reason to choose the Magic Module is size. The EMQ Series also offers the highest power rating for any self-contained 5-V output, high density, board mounted unit available.

For example, the EMQ48-05-40, rated at 200 W, occupies a footprint of only 2.4" x 4.6" with a 0.625" profile, and a nominal input of 48 VDC.

For a pleasant surprise, check these MAGIC MODULES features:

- More watts per cubic inch than any other 40 Amp. converter
- Forward converter topology for proven reliability

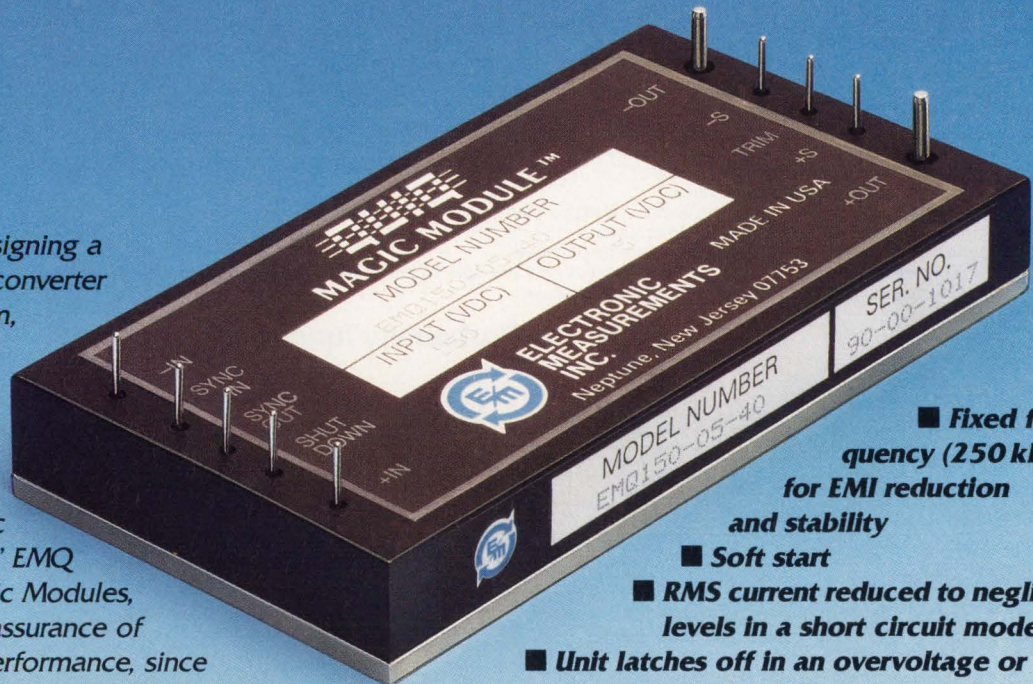

- Fixed frequency (250 kHz) for EMI reduction and stability
- Soft start
- RMS current reduced to negligible levels in a short circuit mode
- Unit latches off in an overvoltage or over temperature condition
- Operates in the N + 1 Mode for system redundancy
- Standard units include outputs from 5 to 48 VDC, inputs from 10 to 300 VDC, 50 to 200 watts power out
- Thermal characteristics allow for PC board mount with only natural convection up to 50 watts

Best of all, you have the assurance that THE MAGIC MODULE comes from Electronic Measurements, a company with over 40 years of power conversion experience.

THE MAGIC MODULE brochure is yours for the asking. If you need information immediately, call TOLL FREE 1-800-631-4298 (In NJ, HI, AL and Canada 908-922-9300).



A PRODUCT OF

ELECTRONIC MEASUREMENTS INC.

405 Essex Road, Neptune, NJ 07753 • CALL TOLL FREE 800-631-4298 • Fax: 908-922-9334
(In NJ, Alaska, Hawaii & Canada Call: 908-922-9300)

CIRCLE NO. 52

Table 10—Statistical calculations and data analysis (continued)

	Casio fx-8000G	TI-81	Sharp PC-E500	HP 48 SX	Eureka	TK Solver Plus	MathCAD	Derive
Other types of regression (eg, Log fit)	No	Yes	No ¹⁰	Yes	No	Yes ⁸	No	Yes ⁹
Linear interpolation on data table	No	No	No	No	No	Yes	Yes	No
Higher-order interpolation on data table	No	Yes	No	No	No	Yes	Yes	No
Sort data	No	Yes	Yes ¹⁰	No	No	Yes ⁸	Yes	No
Histogram (density function)	Yes ¹¹	Yes ¹¹	No	Yes	No	Yes ⁸	Yes	Yes
Generate uniform distribution random numbers	Yes	Yes	Yes	Yes	No	Yes ⁸	Yes	No
Generate normal distribution random numbers	No	No	No	No	No	Yes ⁸	No	No

- Notes:** 1. Statistical analysis uses special data-entry mode with limited editing. After running an analysis, you cannot edit data and repeat analysis.
 2. Has data-table editor that allows editing data between analyses.
 3. You can use Basic to create statistical data. Basic data and statistical-analysis data reside in same area.
 4. Enter and edit data in a special statistics mode or in the matrix editor mode.
 5. You use a list sheet to enter statistical data.
 6. Treats statistical data as vector elements.
 7. Statistical functions operate only on vector and matrix elements.
 8. Function is in library that comes with the software.
 9. Generalized function-fit capability for regression provided.
 10. Other types of regression are only possible indirectly (for example, by taking log of independent variable).
 11. Plots histogram data but does not provide tabular output.

Table 11—Probability functions

	Casio fx-8000G	TI-81	Sharp PC-E500	HP 48 SX	Eureka	TK Solver Plus	MathCAD	Derive
Binomial coefficient	No	No	No	No	No	Yes ¹	No	No
Number of permutations, combinations	No	Yes ²	Yes ³	Yes ²	No	Yes ¹	No	No
Calculate normal (Gauss) probability	No	No	Yes ⁴	Yes	Yes	Yes ¹	Yes	Yes
Calculate Chi-square probability	No	No	Yes ⁴	Yes	No	Yes ¹	No	No
Calculate T probability	No	No	Yes ⁴	Yes	No	Yes ¹	No	No
Calculate F probability	No	No	Yes ⁴	Yes	No	Yes ¹	No	No

- Notes:** 1. Function is in library that comes with the software.
 2. Function available via math menu, not function key.
 3. Available as intrinsic function in calculator Basic mode.
 4. Built-in programs for these functions provided.

Table 12—Symbolic algebra

	Casio fx-8000G	TI-81	Sharp PC-E500	HP 48 SX	Eureka	TK Solver Plus	MathCAD	Derive
Solve for variable in equation	No	No	No	Yes ¹	No	No	No	Yes ²
Collect like terms in expression	No	No	No	Yes	No	No	No	Yes
Expand products and powers in expression	No	No	No	Yes	No	No	No	Yes
Factor polynomial	No	No	No	Yes ³	No	No	No	Yes ⁴
Cancel common factors in ratio of polynomials	No	No	No	No	No	No	No	Yes
Manual rearrangement of elements of expression	No	No	No	Yes	No	No	No	Yes
Substitute expressions for variables	No	No	No	No	No	No	No	Yes
User-defined transformations	No	No	No	No	No	No	No	Yes
Vectors, matrices	No	No	No	No	No	No	No	Yes

- Notes:** 1. Can isolate or solve for a variable in an equation if the variable appears only once and if the equation is sufficiently simple.
 2. Can isolate, or solve for, a variable in an equation if the equation is sufficiently simple.
 3. Can only factor quadratics.
 4. Can factor a polynomial of arbitrary degree if the equation is sufficiently simple.

Table 13—Symbolic calculus

	Casio fx-8000G	TI-81	Sharp PC-E500	HP 48 SX	Eureka	TK Solver Plus	MathCAD	Derive
Differentiation of user-defined function	No	No	No	Yes ¹	No	No	No	Yes ¹
Integration of user-defined function	No	No	No	Yes ¹	No	No	No	Yes ¹
Taylor series for user-defined function	No	No	No	Yes ^{1,2}	No	No	No	Yes ¹
Vector calculus	No	No	No	No	No	No	No	Yes ³

- Notes:** 1. Operation possible if the function is sufficiently simple.
 2. Maclaurin series expansion (about the origin) in the expansion variable provided.
 3. Can form gradient, divergence, and Laplacian vector operators.

Power Surges...

10V/cm
Actual Photo

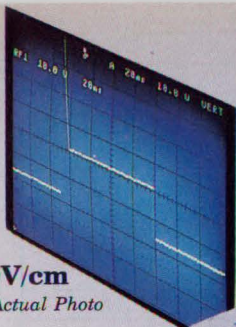

VI-IAM™

Input Attenuator/Filter Module
2.28"L x 2.4"W x 0.5"H



VI-200

DC-DC Converters
4.6"L x 2.4"W x 0.5"H



1V/cm
Actual Photo

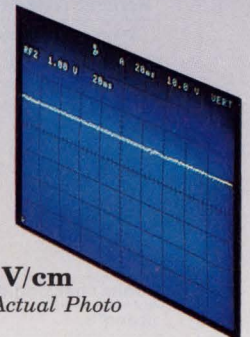

...Are Not Transient Events!

If your system prime power comes from a DC source, you know how troublesome...or even catastrophic...unpredictable overvoltage events can be. Load dumps, lightning strikes or cleared fuses result in voltage surges and high voltage transients which can exceed the voltage ratings of your power system and cause interruptions in system operation or outright system failure. How can you ensure safe, uninterrupted operation of critical equipment in the face of input source transients and surges?

Vicor Has The Solution...

Our new family of **Input Attenuator Modules (VI-IAM)** provides maximum protection against source transients and surges while occupying a minimum amount of valuable board space. If your prime power source is 24, 48 or 300 Volts...your output voltages are between 2 and 95 Volts...and your system has to comply with the rigorous surge and transient requirements imposed by Bellcore, British Telecom or IEC specifications, then combining a VI-IAM with standard Vicor VI-200 converters is your solution for providing up to 400 Watts of protected system power. Need more power? VI-IAM lets you expand to 800 Watts. And IAM's small size and high efficiency—greater than 96%—perfectly complement the efficiency, density and reliability advantages of Vicor's component-level power converters.

EMI/RFI

VI-IAM and VI-200's are a winning combination that won't talk back in your most demanding Telecommunications or Industrial applications...IAM's built-in filter meets Bellcore, British Telecom and FCC/VDE specifications for EMI/RFI.

VI-IAMs Are Designed For Use With The Following Products:

VI-200 Series DC-DC Converters and Power Boosters™



- Up to 50 Watts/cubic inch
- Inputs 10 to 400 VDC
- Outputs 2 to 95 VDC
- 50 to 200 Watts
- UL, CSA, TÜV, VDE

VI-J00 MiniMod™ Series DC-DC Converters

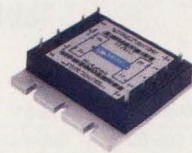

- Up to 50 Watts/cubic inch
- Inputs 10 to 400 VDC
- Outputs 2 to 95 VDC
- 25 to 100 Watts
- UL, CSA, TÜV (IEC 950)

Vicor Corporation 23 Frontage Road, Andover, MA 01810
Tel: 800-735-6200 • Tel: 508-470-2900 • Fax: 508-475-6715
Vicor GmbH Tel: 49-8031-42083 • Fax: 49-8031-45736

Component Solutions For Your Power System



Table 14—Reference formulas and constants

	Casio fx-8000G	TI-81	Sharp PC-E500	HP 48 SX	Eureka	TK Solver Plus	MathCAD	Derive
Physical constants	No	No	Yes	No ¹	No	No	No	Yes ²
Algebraic identities (factorization, etc)	No	No	Yes	No ³	No	No	No	No ³
Trigonometric identities	No	No	Yes	No ³	No	No	No	No ³
Table of integrals	No	No	Yes	No ³	No	No	No	No ³
Table of Laplace transforms	No	No	Yes	No	No	No	No	No
Electrical formulas (Ohm's Law, etc)	No	No	Yes	No ¹	No	No	No	No
Electric and magnetic field formulas	No	No	Yes	No ¹	No	No	No	No
Equations of motion	No	No	Yes	No ¹	No	No	No	No
Hydrodynamics formulas	No	No	Yes	No ¹	No	No	No	No
Thermodynamic formulas	No	No	Yes	No ¹	No	No	No	No
Elasticity formulas	No	No	Yes	No ¹	No	No	No	No
Periodic table of elements	No	No	Yes	No ¹	No	No	No	No
Chemistry formulas	No	No	Yes	No ¹	No	No	No	No

Notes: 1. Available on optional library card.
 2. Available in library that comes with the software.
 3. Not provided in tabular form, but resident in symbolic-manipulation rules.

Table 15—Units conversion

	Casio fx-8000G	TI-81	Sharp PC-E500	HP 48 SX	Eureka	TK Solver Plus	MathCAD	Derive
Units checking/tracking in computations	No	No	No	Yes	No	Yes ¹	Yes ¹	No
Length	No	No	Yes	Yes	No	No	No	Yes ²
Area	No	No	Yes	Yes	No	No	No	Yes ²
Volume	No	No	Yes	Yes	No	No	No	Yes ²
Angle	No	No	No	Yes	No	No	No	Yes ²
Time	No	No	No	Yes	No	No	No	Yes ²
Speed	No	No	Yes ³	Yes	No	No	No	No
Acceleration	No	No	No	No	No	No	No	No
Mass	No	No	Yes	Yes	No	No	No	No
Force	No	No	Yes ³	Yes	No	No	No	Yes ²
Energy	No	No	Yes	Yes	No	No	No	Yes ²
Power	No	No	No	Yes	No	No	No	Yes ²
Pressure	No	No	No	Yes	No	No	No	No
Electric charge	No	No	No	Yes	No	No	No	Yes ²
Temperature	No	No	No	Yes	No	No	No	No
Light	No	No	No	Yes	No	No	No	No
Prefixes (micro, etc)	No	No	No	Yes	No	No	No	Yes ²

Notes: 1. Allows user-defined conversions.
 2. Available in library that comes with the software.
 3. Provides some of these conversions.

Table 16—Graphics

	Casio fx-8000G	TI-81	Sharp PC-E500	HP 48 SX	Eureka	TK Solver Plus	MathCAD	Derive
Display resolution (pixels)	95x63	96x64	240x32 ¹	130x55	EGA ²	VGA	VGA	VGA
Plot tabulated data	Yes	Yes	Yes	Yes	Yes	Yes	Yes	Yes
Auto plotting (scaling, sampling)	Yes	Yes	Yes	Yes	Yes	No ³	Yes	Yes
X, Y plots	Yes	Yes	Yes	Yes	Yes	Yes	Yes	Yes
Log, log-log	No	No	No	No	No	Yes	Yes	No
Parametric X, Y	No	Yes	No	Yes	No	Yes	Yes	Yes
Conic (two branches)	No	No	No	Yes	No	No	No	No

Notes: 1. Uses only 140 of the 240 pixels across in its built-in graphics program.
 2. Default display is text mode. Selecting the zoom feature switches to one of your computer's graphics modes, presumably the highest resolution available. On the author's computer, however, Eureka selected the EGA mode, even though VGA was available.
 3. Makes you set up a data table to plot a function.
 4. Available in library that comes with the software.
 5. Plots surfaces, but without hidden lines.
 6. Lets you annotate plots by placing text in regions near graphics.

Our Concept

Permanent pursuit of perfection

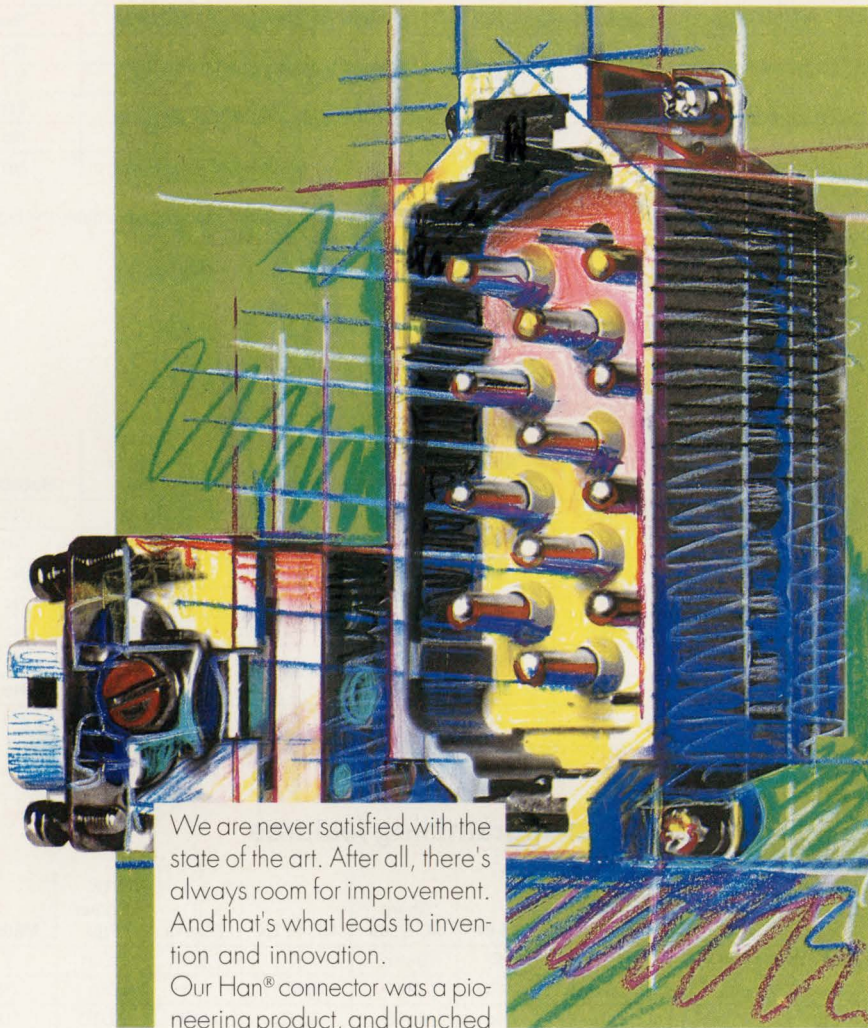

We are never satisfied with the state of the art. After all, there's always room for improvement. And that's what leads to invention and innovation.

Our Han® connector was a pioneering product, and launched a whole series of innovative products. But we're not resting on our laurels. We're constantly in pursuit of improvement and perfection. For us, the state of the art is nothing more than the base for new optimal problem-solving. The only chance for the future and our customers worldwide.

For even better connections:

World headquarters:
HARTING ELEKTRONIK GmbH
P.O.Box 1140 · D-4992 Espelkamp · Germany
Phone (0 57 72) 47-0 · Fax (0 57 72) 47-461
Telex 9 72 310-11 he d

HARTING Subsidiary Companies:

Austria/Vienna
Tel. 02 22/68 68 18
Belgium/Brussels - Zellik
Tel. 02-466.01.90
France/Paris
Tel. (1) 486 323 89
Great Britain/Northampton
Tel. (06 04) 76 66 86
Hongkong
Tel. 08 52-422 18 09
Italy/Milano - Vimodrone
Tel. (2) 27 40 03 00
Japan/Yokohama
Tel. 045-931.57 15
Netherlands/Breda - Etten Leur
Tel. 01608-354 00
Norway/Oslo
Tel. 02-6475 90
Spain/Barcelona
Tel. (3) 323 20 22
Sweden/Stockholm - Spånga
Tel. (08) 7 61 79 80
Switzerland/Zürich - Scherzenbach
Tel. 01-8 25 51 51
USA/Chicago - Hoffman Estates
Tel. (708) 519-77 00

Agencies:
Denmark, Finland, South Africa

Representatives:
PRC/Shanghai, ROC/Taipei,
ROK/Seoul, Singapore



Table 16—Graphics (continued)

	Casio fx-8000G	TI-81	Sharp PC-E500	HP 48 SX	Eureka	TK Solver Plus	MathCAD	Derive
Polar plots	No	Yes	No	Yes	No	No	No	Yes
Contour plots	No	No	No	No	No	Yes ⁴	No	No
3-D (surface) plots	No	No	No	No	No	Yes ^{4,5}	Yes	Yes
Bar charts	Yes	Yes	No	Yes	No	Yes	No	Yes
Pie charts	No	No	No	No	No	Yes	No	No
Error bars	No	No	No	No	No	No	Yes	No
Multiple curves/plot	Yes	Yes	No	Yes	No	Yes	Yes	Yes
Multiple line types	No	No	No	No	No	No	No	No
Axis labels	No	No	No	Yes	No	Yes	No	No
Text/titles	No	No	No	No	No	Yes	Yes ⁶	No
Drawing capability (lines, curves)	Yes	Yes	No	Yes	No	No	No	No
Zoom capability	Yes	Yes	No	Yes	No	No	No	Yes

- Notes:** 1. Uses only 140 of the 240 pixels across in its built-in graphics program.
 2. Default display is text mode. Selecting the zoom feature switches to one of your computer's graphics modes, presumably the highest resolution available. On the author's computer, however, Eureka selected the EGA mode, even though VGA was available.
 3. Makes you set up a data table to plot a function.
 4. Available in library that comes with the software.
 5. Plots surfaces, but without hidden lines.
 6. Lets you annotate plots by placing text in regions near graphics.

Table 17—Graphical analysis

	Casio fx-8000G	TI-81	Sharp PC-E500	HP 48 SX	Eureka	TK Solver Plus	MathCAD	Derive
Cursor readout	Yes ¹	Yes	No	Yes	No	No	No	Yes
Trace function	Yes	Yes	No	No	No	No	No	No
Evaluate plotted function at cursor	Yes	Yes	No	Yes	No	No	No	No
Root location (automated search)	No	No	No	Yes	No	No	No	No
Slope calculation	No	No	No	Yes	No	No	No	No
Area calculation	No	No	No	Yes	No	No	No	No
Extremum calculation	No	No	No	Yes	No	No	No	No
Plot derivative	No	No	No	Yes	No	No	No	No

- Note:** 1. Does not allow concurrent control of horizontal and vertical cursor position. You use arrow keys for horizontal and vertical control, but you must hit a key to toggle between the two.

Table 18—Programming features

	Casio fx-8000G	TI-81	Sharp PC-E500	HP 48 SX	Eureka	TK Solver Plus	MathCAD	Derive
Type of programming (keystroke (K) equation (EQ))	K ¹	K ¹	Basic	K ²	EQ ³	EQ ³	EQ ³	EQ ³
Memory available	1446 ⁴	2400	28K ⁵	28K ⁵	NA	NA	NA	NA
Data, program instruction partition	Yes ⁵	No	AUTO	AUTO	AUTO	AUTO	AUTO	AUTO
Directories	No	No	No	Yes	Yes	Yes	Yes	Yes
Editor for command entry	Yes	Yes	Yes	Yes	Yes ⁷	Yes ⁷	Yes ⁸	Yes ⁷
Subroutines	Yes	Yes	Yes	Yes	Yes	Yes	No	No
Functions	No	No	Yes	Yes	No	Yes	Yes	Yes

- Notes:** NA = Not applicable.
 1. Programming language is calculator-keystroke queue type.
 2. Language is a combination of calculator-keystroke commands and high-level-language commands.
 3. Equation-statement types of commands.
 4. 1446 "steps" provided. A keystroke command uses either one or two steps.
 5. Additional memory is available at extra cost.
 6. Lets you partition 206 "steps" of memory between program and data. One data cell is equivalent to 8 program steps.
 7. You can create command sequences with built-in editor, or import sequences created with another editor. Expression of equations is in a high-level-language notation similar to Basic.
 8. You can only create and edit command sequences using the built-in editor, which displays equations in mathematical notation rather than a high-level-language notation.
 9. Provides only a conditional jump past the next statement line.
 10. Has a primitive 1-line IF test for function definition. For example, $f(x)=IF(x>0, 1, -1)$ indicates that $f(x)$ is 1 for x greater than 0 and -1 for x less than or equal to 0.
 11. "Range variables" provide most of the computational power of Do loops.
 12. Data files are treated as "objects."
 13. Accesses data tables using its peculiar list-function save and load.

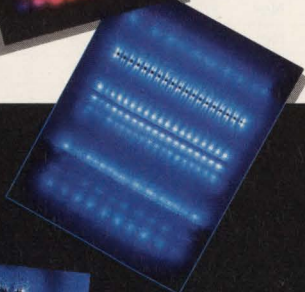

United States Europe Japan Korea Singapore

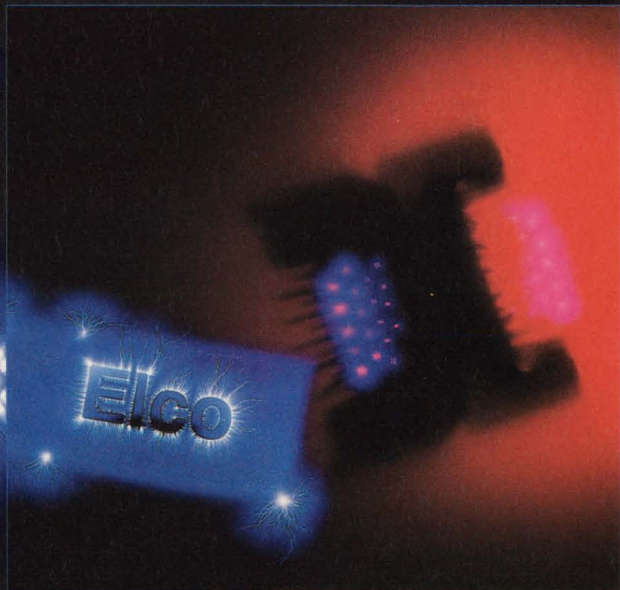

***GREATER
WORLD CLASS
POWER FROM
OUR NEW
GLOBAL
CONNECTIONS***

The recent alliance of Elco and AVX with Kyocera forms a solid business relationship that gives us even stronger connections to today's exciting world of technology.

These connections strengthen our own high quality standards and link us to new sources of innovation throughout the world.

Together we combine our talents, energies, and experience to provide you with an ever-expanding line of advanced connector products of unsurpassed value. These new connections also contribute to a fresh spirit of efficient service and delivery and

assure you of timely response to your ever-evolving needs.

From a new source of energy emerges a powerful new Elco.



World Class Connections

Copyright 1990, Elco Corporation.
All rights reserved.

Table 18—Programming features (continued)

	Casio fx-8000G	TI-81	Sharp PC-E500	HP 48 SX	Eureka	TK Solver Plus	MathCAD	Derive
Local variables in subroutines/functions	No	No	No	Yes	No	Yes	No	No
String variables	No	No	Yes	Yes	No	No	No	No
Logical variables	No	No	No	Yes	No	Yes	No	No
If-then-else branching	No ⁹	No ⁹	Yes	Yes	No	Yes	Yes ¹⁰	No
Do loops	No	No	Yes	Yes	No	Yes	Yes ¹¹	No
Formatted print of computed data	No	Yes	Yes	Yes	No	Yes	Yes	No
Prompt and wait for user input	Yes	Yes	Yes	Yes	No	No	No	No
Test keyboard and proceed if no entry	No	No	Yes	Yes	No	No	No	No
Graphics commands	Yes	Yes	Yes	Yes	No	No	Yes	No
Device control (eg, printer port)	No	No	Yes	No	No	No	No	No
Time/date functions	No	No	No	Yes	No	No	No	No
Error trapping	No	No	Yes	Yes	No	No	No	No
Single-step debugging capability	No	No	Yes	Yes	No	No	No	No
Set breakpoint debugging capability	No	Yes	Yes	Yes	No	Yes	No	No
Examine variables debugging capability	No	No	Yes	Yes	No	Yes	No	No
Data file access	No	No	Yes	Yes ¹²	No	Yes ¹³	Yes	No

Notes: NA = Not applicable.

1. Programming language is calculator-keystroke queue type.
2. Language is a combination of calculator-keystroke commands and high-level-language commands.
3. Equation-statement types of commands.
4. 1446 "steps" provided. A keystroke command uses either one or two steps.
5. Additional memory is available at extra cost.
6. Lets you partition 206 "steps" of memory between program and data. One data cell is equivalent to 8 program steps.
7. You can create command sequences with built-in editor, or import sequences created with another editor. Expression of equations is in a high-level-language notation similar to Basic.
8. You can only create and edit command sequences using the built-in editor, which displays equations in mathematical notation rather than a high-level-language notation.
9. Provides only a conditional jump past the next statement line.
10. Has a primitive 1-line IF test for function definition. For example, $f(x)=IF(x>0, 1, -1)$ indicates that $f(x)$ is 1 for x greater than 0 and -1 for x less than or equal to 0.
11. "Range variables" provide most of the computational power of Do loops.
12. Data files are treated as "objects."
13. Accesses data tables using its peculiar list-function save and load.

Table 19—Hardware interfaces and options

	Casio fx-8000G	TI-81	Sharp PC-E500	HP 48 SX	Eureka	TK Solver Plus	MathCAD	Derive
Computer interface	No	No	Yes	Yes	NA	NA	NA	NA
Printer/plotter interface	Yes	No	Yes	Yes	Yes	Yes	Yes	Yes
Mass storage interface	Yes	No	Yes	Yes	NA	NA	NA	NA
Memory	No	No	Yes	Yes	NA	NA	NA	NA
Libraries	No	No	No	Yes	No	Yes	Yes	Yes

Note: NA = Not applicable.

Our quad high-side driver is the perfect switch for your intelligent environment.

Offering four independent 1A switches.

The LMD18400, the industry's first and only quad high-side switch, truly has a mind of its own.

Our intelligent solution has four independent power switches, each with a separate ON/OFF control. They're capable of driving 1A continuous and 3A peak loads. Together, they have a rating of 6A peak.

Our quad design achieves a higher level of integration and saves you a valuable chunk of real estate.

What's more, it drives every possible load: resistive, capacitive, and inductive. Making it the ideal design for automotive and far-reaching industrial applications.

Communicating with 11 diagnostic checks.

With a built-in serial interface, the LMD18400 provides extensive diagnostic data to a μ C or μ P, including switch status readback, output-load fault conditions, and thermal and overvoltage shut-down status.

Which results in bidirectional, real-time communications that can prevent blowouts, minimize downtime, and maximize your system performance.

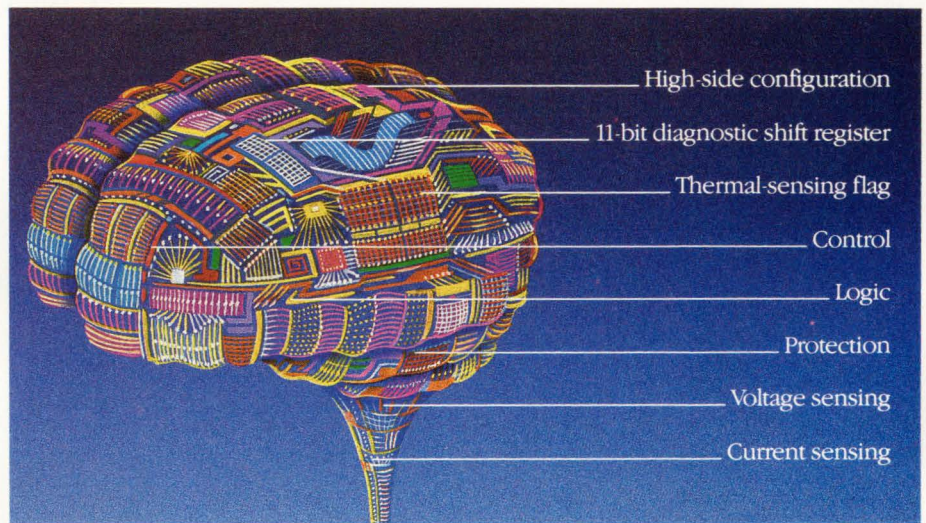

Providing unparalleled protection.

By integrating CMOS, DMOS, and bipolar on the same chip, we're able to deliver an optimized, mixed analog + digital technology for power, control, *and* protection.

action. And should the temperature reach 170°, the device automatically shuts down. A critical feature that can make your design less susceptible to damage.

It also means voltage and current sensors, which prevent burnout with an instantaneous power limit of 15W. And due to its high-side configuration, an accidental short wouldn't ground the battery.

Make the intelligent switch.

For your LMD18400 design kit, call or write us today.

And get an inside look at the brains behind the brawn.

1-800-NAT-SEMI, Ext. 107
National Semiconductor Corp.
P.O. Box 7643
Mt. Prospect, IL 60056-7643

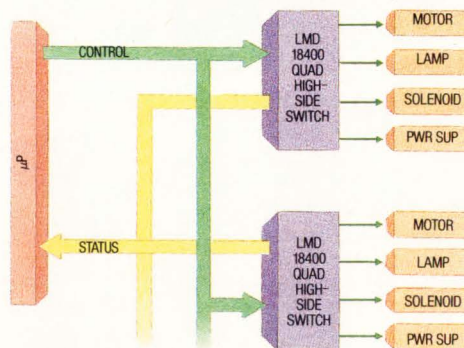

Parallel operation of LMD18400s

Fail-safe protection. Which means a two-stage thermal warning system that sends a distress flag to the host system at 145°, giving you ample time to take corrective

"C" Better.

C cross compilers and assemblers for over 100 processors.

C Cross Compilers feature:

- ANSI standard support
- Extensive optimization
- Cross processor portability
- Inline assembly source
- ROMable code
- IBM PC host

Cross Assemblers & Linkers feature:

- Motorola/Intel compatible
- Flexible assembly directives
- User-defined macros
- Linker relocation control
- Boundary checking

Your growing development needs can be completed by our comprehensive family of development tools. American Automation extends productivity with in-circuit emulators, which feature C-source level debugging, versatile trace capability, performance analysis, PROM programming capability and more—all under our expertise and support.

Free demo disk!

See how this feature-rich development environment can benefit you. Call us for your choice of C-Compiler demonstration diskette:

(714) 731-1661



**american
automation**

Headquarters: 2651 Dow Avenue, Tustin, California 92680-7207, Telephone (714) 731-1661.
European Headquarters: UK Oxford 0993-778991. **Distributors:** Australia 35-601011, Belgium 02-468-1400, France 1-69308050, India 44-417423, Indonesia 02-271-880, Italy 2-50721, Korea 02-784-9942, Spain 1-729-1155, Switzerland 1-435-4111, Taiwan 02-7061271, West Germany/Netherlands/Austria 089-6127087.

EZ-Pro is a trademark of American Automation.



DESIGN NOTES

Number 45 in a series from Linear Technology Corporation

March, 1991

Signal Conditioning for Platinum Temperature Transducers

Jim Williams

High accuracy, stability, and wide operating range make platinum RTDs (resistance temperature detectors) popular temperature transducers. Signal conditioning these devices requires care to utilize their desirable characteristics. Figure 1's bridge based circuit is highly accurate and features a ground referred RTD. The ground connection is often desirable for noise rejection. The bridge's RTD leg is driven by a current source while the opposing bridge branch is voltage biased. The current drive allows the voltage across the RTD to vary directly with its temperature induced resistance shift. The difference between this potential and that of the opposing bridge leg forms the bridge's output.

A1A and instrumentation amplifier A2 form a voltage controlled current source. A1A, biased by the LT1009

reference, drives current through the 88.7Ω resistor and the RTD. A2, sensing differentially across the 88.7Ω resistor, closes a loop back to A1A. The $2k-0.1\mu F$ combination sets amplifier rolloff, and the configuration is stable. Because A1A's loop forces a fixed voltage across the 88.7Ω resistor, the current through R_p is constant. A1's operating point is primarily fixed by the 2.5V LT1009 voltage reference.

The RTD's constant current forces the voltage across it to vary with its resistance, which has a nearly linear positive temperature coefficient. The non-linearity could cause several degrees of error over the circuit's $0^\circ C-400^\circ C$ operating range. The bridge's output is fed to instrumentation amplifier A3, which provides differential gain while simultaneously supplying non-linearity

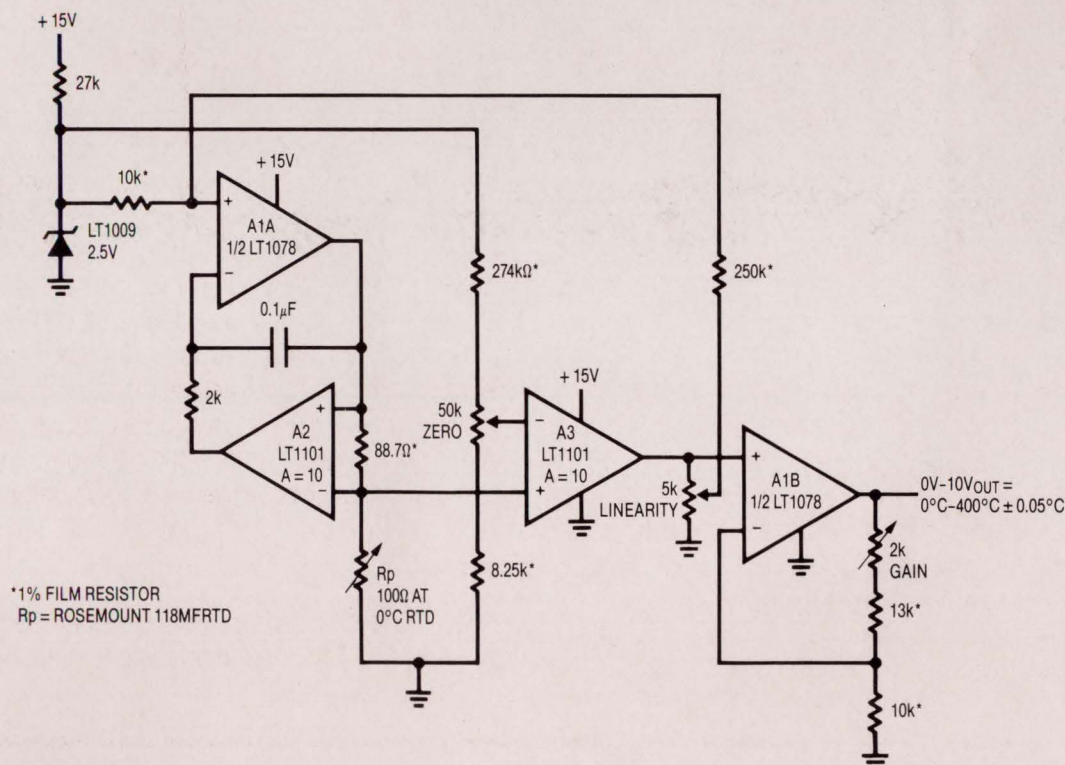

Figure 1. Linearized Platinum RTD Bridge. Feedback to Bridge from A3 Linearizes the Circuit.

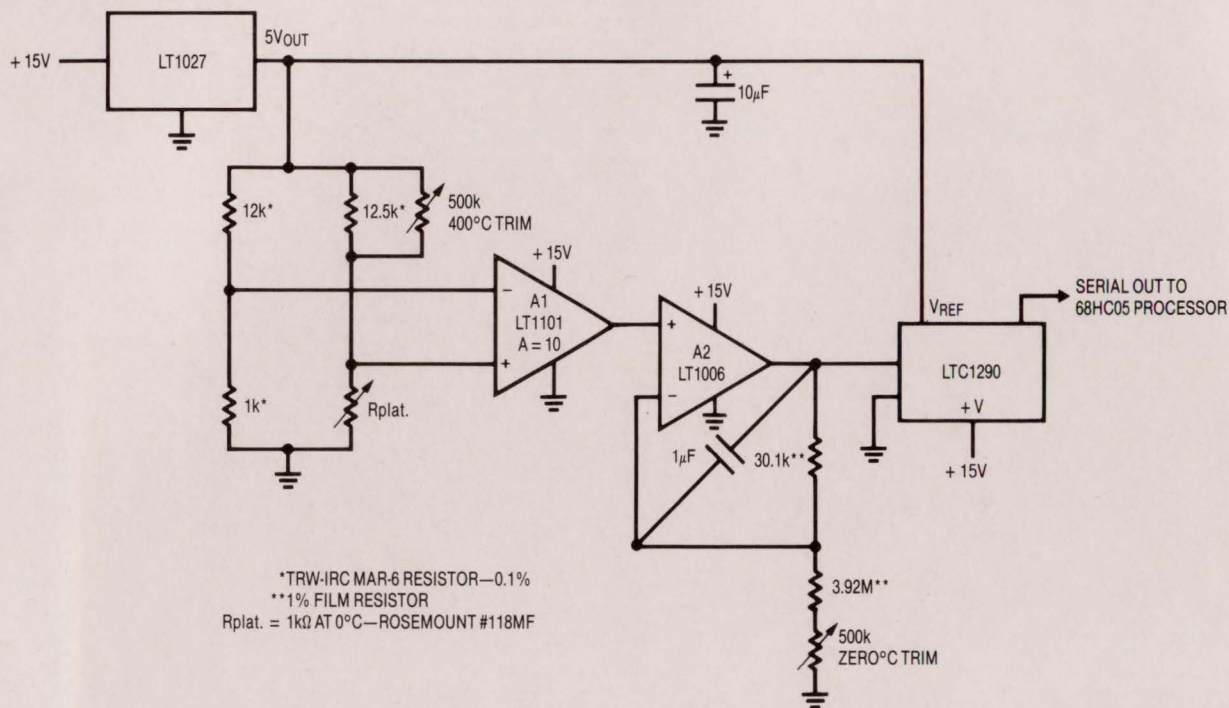

Figure 2. Digitally Linearized Platinum RTD Signal Conditioner

correction. The correction is implemented by feeding a portion of A3's output back to A1's input via the 10k-250k divider. This causes the current supplied to Rp to slightly shift with its operating point, compensating sensor non-linearity to within $\pm 0.05^\circ\text{C}$. A1B, providing additional scaled gain, furnishes the circuit output.

To calibrate this circuit, substitute a precision decade box (e.g., General Radio 1432k) for Rp. Set the box to the 0°C value (100.00Ω) and adjust the zero trim for a 0.00V output. Next, set the decade box for a 140°C output (154.26Ω) and adjust the gain trim for a 3.500V output reading. Finally, set the box to 249.0Ω (400.00°C) and trim the linearity adjustment for a 10.000V output. Repeat this sequence until all three points are fixed. Total error over the entire range will be within $\pm 0.05^\circ\text{C}$. The resistance values given are for a nominal 100.00Ω (0°C) sensor. Sensors deviating from this nominal value can be used by factoring in the deviation from 100.00Ω . This deviation, which is manufacturer specified for each individual sensor, is an offset term due to winding tolerances during fabrication of the RTD. The gain slope of the platinum is primarily fixed by the purity of the material and has a very small error term.

The previous example relies on analog techniques to achieve a precise, linear output from the platinum RTD bridge. Figure 2 uses digital corrections to obtain similar results. A processor is used to correct residual RTD non-linearities. The bridges inherent non-linear output is also accommodated by the processor.

The LT1027 drives the bridge with 5V. The bridge differential output is extracted by instrumentation amplifier A1. A1's output, via gain scaling stage A2, is fed to the LTC1290 12-bit A-D. The LTC1290's raw output codes reflect the bridges non-linear output versus temperature. The processor corrects the A-D output and presents linearized, calibrated data out. RTD and resistor tolerances mandate zero and full scale trims, but no linearity correction is necessary. A2's analog output is available for feedback control applications. The complete software code for the 68HC05 processor, developed by Guy M. Hoover, appears in Application Note 43.

For literature on our Amplifiers and Data Converters, call (800) 637-5545. For applications help, call (408) 432-1900, Ext. 456

DESIGN IDEAS

EDITED BY ANNE WATSON SWAGER

One coax cable carries video and power

Jeff Kirsten and Charlie Allen
Maxim Integrated Products, Sunnyvale, CA

In Fig 1's video system, a single coaxial cable carries eight video channels, and returns the selected signal. The system can choose one of several remote surveillance-camera signals, for example, and can display the picture on a monitor near the interface box.

The interface box (Fig 2) encodes a desired channel with three bits via the switch settings of S_1 through S_3 . You can modify the circuit to read an applied digital

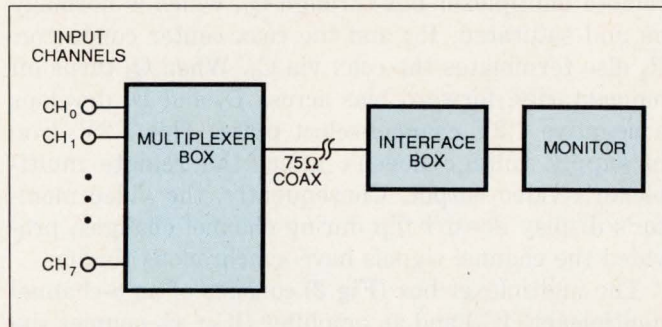

Fig 1—This 1-cable system carries composite video (NTSC, PAL, or SECAM), power, and channel-select signals.

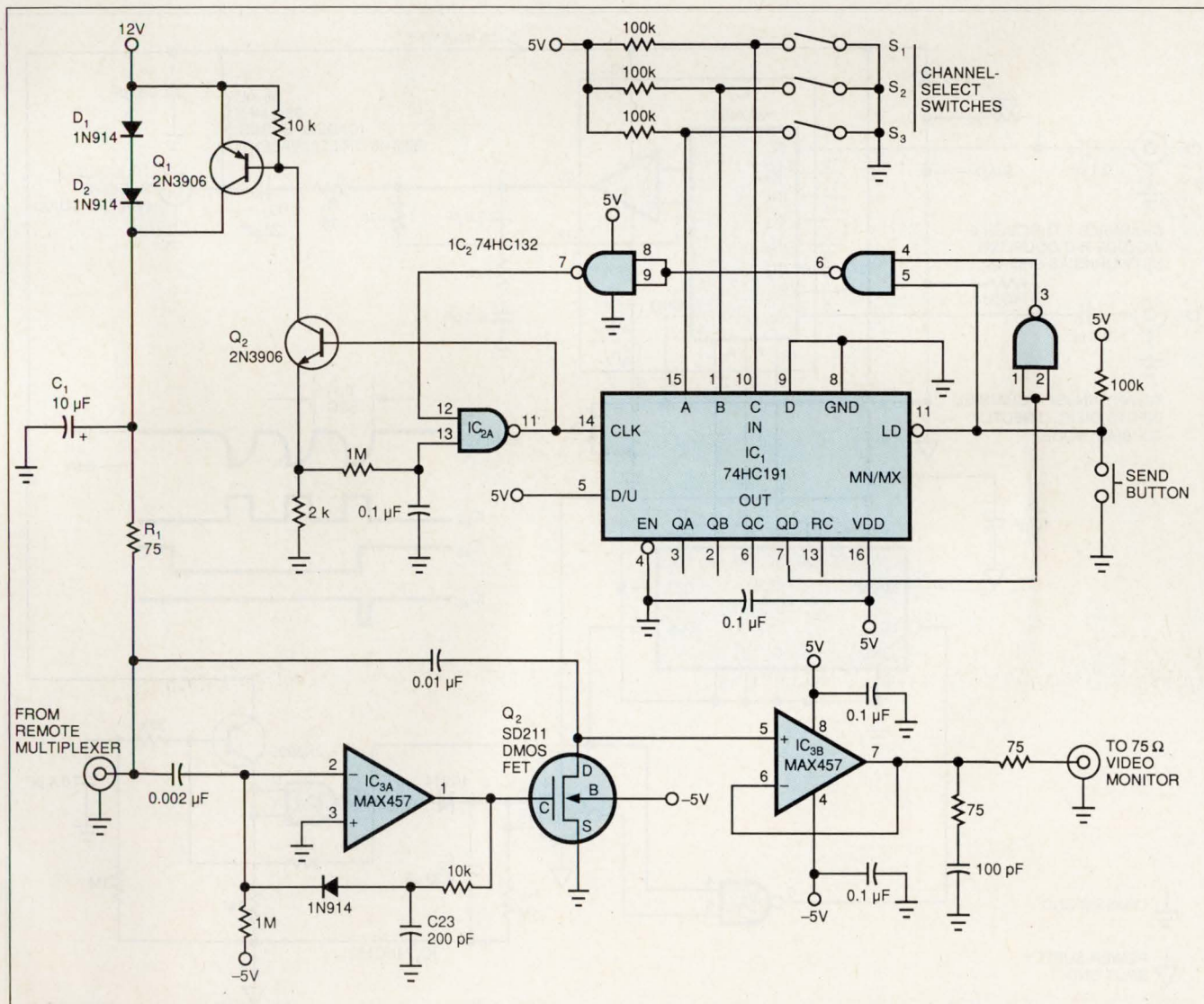

Fig 2—The interface end of Fig 1's circuit delivers 10V down the cable, pulses the supply voltage to transmit channel-change commands, and buffers the received video signal.

DESIGN IDEAS

input. Momentary depression of the send button triggers down-counter IC₁ and gate oscillator IC_{2A}, which respond by initiating a channel-selection burst.

Supply current flows from the interface box to the remote multiplexer box through Q₁, which is normally on and saturated; R₁; and the coax center conductor. R₁ also terminates the coax via C₁. When Q₁ turns off momentarily, forward bias across D₁ and D₂ develops a negative 1.2V channel-select pulse. This 1.2V drop in supply voltage doesn't affect the remote multiplexer's video output. Consequently, the video monitor's display doesn't flip during channel changes, provided the channel signals have synchronous timing.

The multiplexer box (Fig 3) consists of an 8-channel multiplexer (IC₁) and an amplifier (IC₂). C₁ couples the multiplexer's baseband video output to the cable, and L₁ decouples the video from dc power arriving on the

same line. The power, approximately 30 mA at 10V, drives all circuitry in the multiplexer box.

Channel-select input signals generated at the interface box—1 pulse for channel 0, 8 pulses for channel 7—pulse the circuit in Fig 3's 10V supply to 8.8V and back at a 10-Hz rate. Q₁ and its associated components convert these pulses to 5V-logic levels that clock the 4-bit counter, IC₂. The counter in turn selects the desired multiplexer channel. The first pulse of a burst selects channel 0. Subsequent pulses that arrive before discharge of the timeout network R₂ and C₂ each advance IC₂ by one count. Thus, channel 0 appears almost instantly, and channel 7, when selected, appears near the end of a 0.8-sec burst.

The short time constant associated with coupling video to the cable—C₁ and R₁ in the multiplexer box in Fig 3, R₁ in the interface box in Fig 2—enables you

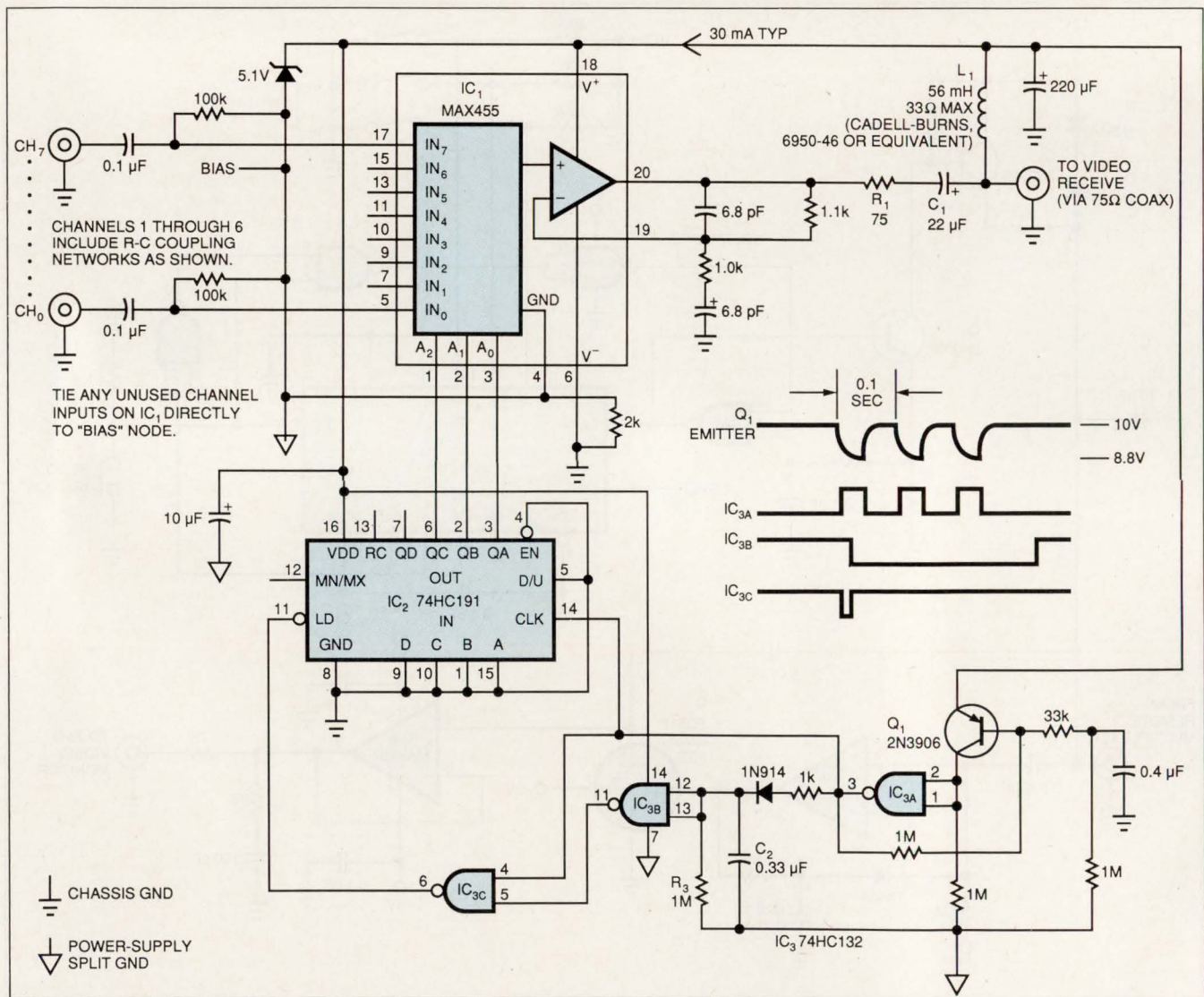
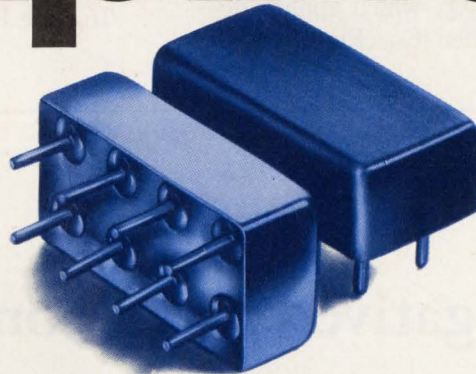

Fig 3—The multiplexer circuit in Fig 1 receives power and control signals over the coaxial cable while driving the cable with the currently selected video signal.

rugged plug-in amplifiers



0.5 to 1000 MHz from \$13⁹⁵ (10 to 24 qty)

Tough enough to meet full MIL-specs, capable of operating over a wide -55°C to $+100^{\circ}\text{C}$ temperature range, in a rugged package... that's Mini-Circuits' new MAN-amplifier series.

The MAN-amplifier's tiny package (only 0.4 by 0.8 by 0.25 in.) requires about the same pc board area as a TO-8 and can take tougher punishment with leads that won't break off. Models are unconditionally stable and available covering frequency ranges 0.5 to 1000MHz, NF as low as 2.8dB, and power output as high as +15dBm.

Prices start at only \$13.95, including screening, thermal shock -55°C to $+100^{\circ}\text{C}$, fine and gross leak, and burn-in for 96 hours at 100°C under normal operating voltage and current.

Internally the MAN amplifiers consist of two stages, including coupling capacitors. A designer's delight, with all components self-contained. Just connect to a dc supply voltage and you are ready to go.

The new MAN-amplifiers series...
another Mini-Circuits' price/performance breakthrough.

MODEL	FREQ. RANGE (MHz)	GAIN dB		MAX. OUT/PWR†	NF dB	DC PWR 12V,	PRICE \$ ea.
	f_L to f_U	min	flatness††	dBm	(typ)	mA	(10-24)
MAN-1	0.5-500	28	1.0	8	4.5	60	13.95
MAN-2	0.5-1000	19	1.5	7	6.0	85	15.95
MAN-1LN	0.5-500	28	1.0	8	2.8	60	15.95
◇MAN-1HLN	10-500	10	0.8	15	3.7	70	15.95
*MAN-1AD	5.500	16	0.5	6	7.2	85	24.95

††Midband $10f_L$ to $f_{U/2}$, $\pm 0.5\text{dB}$ †dB Gain Compression ◇Case Height 0.3 In.

Max input power (no damage) +15dBm; VSWR in/out 1.8:1 max.

*Active Directivity (difference between reverse and forward gain) 30 dB typ.

finding new ways...
setting higher standards

Mini-Circuits

A Division of Scientific Components Corporation
P.O. Box 350166, Brooklyn, New York 11235-0003 (718) 934-4500
Fax (718) 332-4661 Domestic and International Telexes: 6852844 or 620156

DESIGN IDEAS

to select any channel in less than one second. But it also allows the composite video's synch-pulse baseline to shift with picture content. To counter this shift and its effect on the monitor's video synchronization, peak detector IC_{3A} drives DMOS FET Q₂, which applies dc restoration ahead of the video buffer IC_{3B} (Fig 2). Dur-

ing each negative sync pulse, Q₂ turns on just long enough to clamp the pulse tip at 0V. (EDN BBS /DI_SIG #938) **EDN**

To Vote For This Design, Circle No. 748

μP controls negative-voltage converter

Dan Kuechle
Network Systems Corp, Minneapolis, MN

The dc/dc converter in Fig 1 produces a variable negative voltage using no coil or transformer. The circuit was designed to drive the contrast pin on an LCD display in a system without a negative supply. The LCD display needs a few microamps of negative voltage and has to be user-adjustable.

A 74F374 octal 3-state flip-flop register generates a

square wave that the circuit ac-couples to the rectifier diodes and to the load. By controlling the number of zeros written into the flip-flop, the processor can control how many flip-flops are actively driving the load, and thus, how high the output voltage will be. The figure includes a table of approximate input words and output voltages. (EDN BBS /DI_SIG #939) **EDN**

To Vote For This Design, Circle No. 749

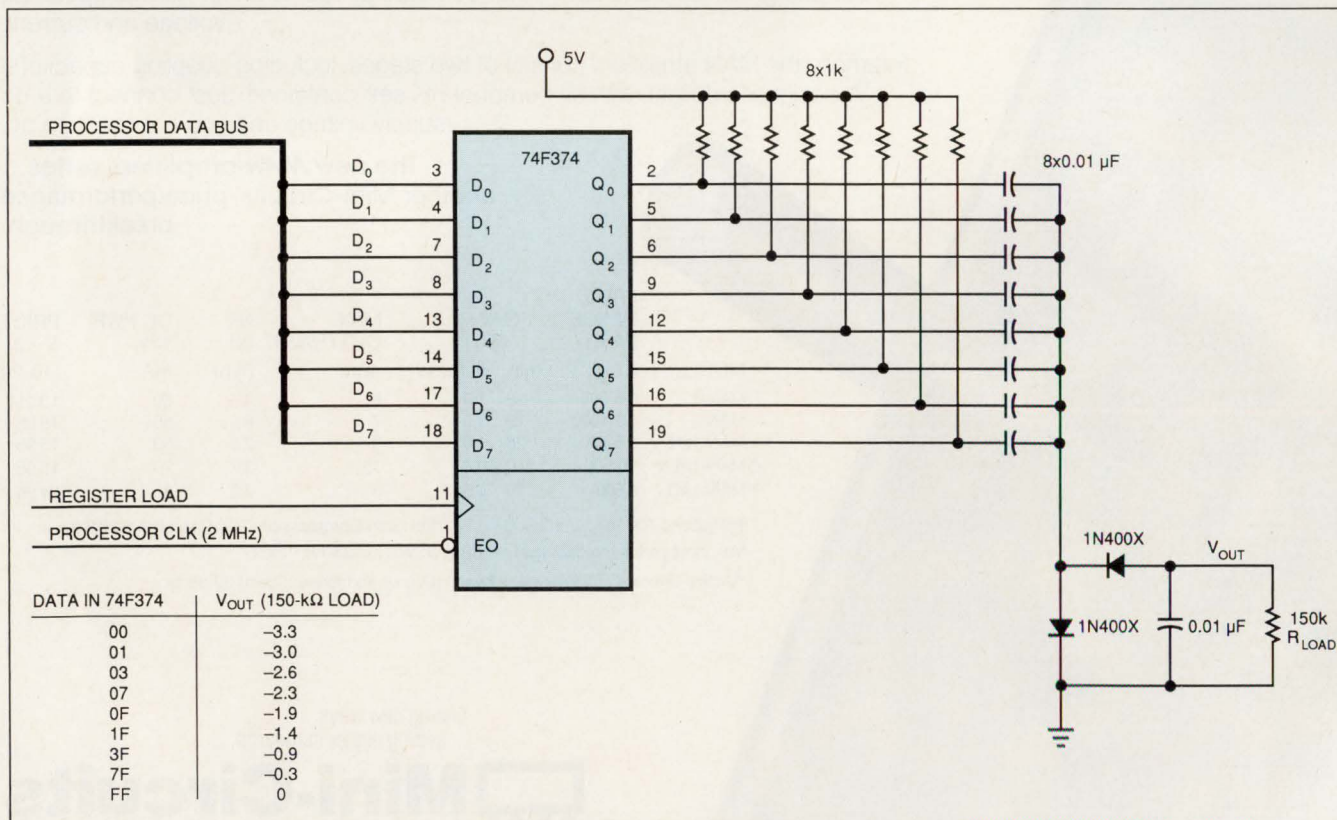
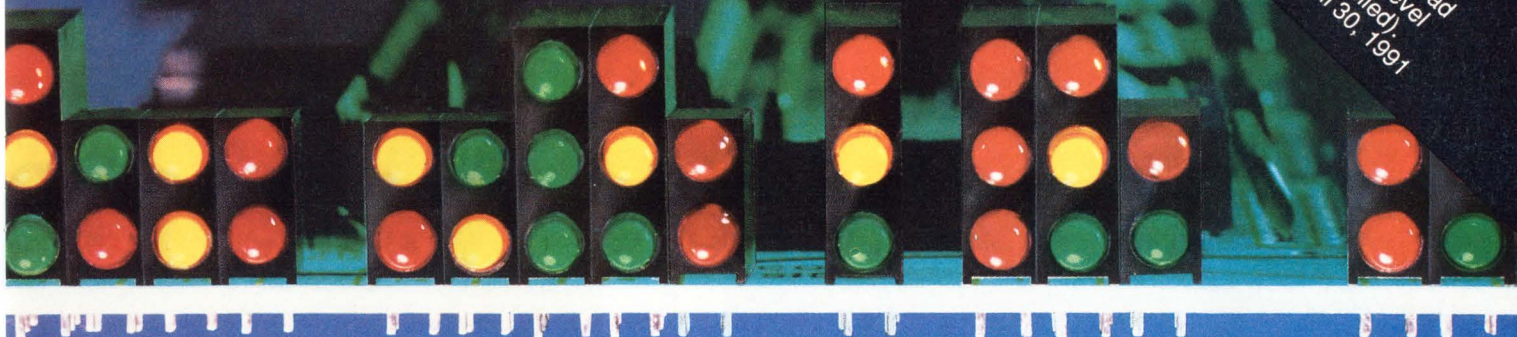

Fig 1—The processor's data bus controls the state of eight flip-flops that ultimately control the level of this negative voltage converter's V_{OUT}.

FREE SAMPLES
write or fax on your letterhead
today. Specify bi- or tri-level
(red only will be supplied).
This offer will end April 30, 1991



MANHATTAN CBISM "SKYSCRAPERS" LOWER THE PRICE OF REAL ESTATE.

Dialight LED bi- and tri-level CBI (Circuit Board Indicator) skyscrapers save valuable real estate. Ideally suited as logic status, circuit board and polarity indicators as well as panel illuminators, the Manhattan Series can satisfy your most demanding design requirements. Offered in two sizes—T-1 (3 mm) and T1¼ (5 mm bi-level only) in a wide variety of LEDs (diffused, non-diffused, super-bright, super-efficient, integral resistor), they can be ordered in standard and custom combinations of red, yellow and green. Operating temperatures range from -55° to +100°C. Manhattan CBIs have specially designed standoffs to facilitate board cleaning and washing. The housing materials meet UL94V-O flammability rating.

Because we pay strict attention to lead tolerance and alignment specs of automatic insertion equipment, Dialight's packaging has become the standard by which others are measured. The Manhattan CBI Series is available from stock through our wide network of distributors.

For more information contact: Dialight Corporation, 1913 Atlantic Avenue, Manasquan, New Jersey, 08736; Tel.: (908) 528-8932; Fax: (908) 223-8788.

DIALIGHT

Looking We m



for lower NRE? make it Tiny.

Here's How To Develop Analog/Digital ASICs In Less Time, For Less Money.

Now, for an absolutely tiny price, you can partition complex mixed mode ASICs and separately design and verify the critical segments through fabrication. Cost of fab will no longer stop you from a divide and conquer methodology. Use Tiny Chips and go a step at a time. Tiny Chips, available on Foresight multi-project wafer runs, reduce NRE costs and help you move confidently from prototypes into production.

Twelve packaged parts are available at a cost of just \$1,500. And Foresight runs are regularly scheduled, so development can be pipelined; some segments can be in design, some in fab, while others in test and debug... all at the same time.

Foresight runs support larger die sizes for characterization of completed designs prior to production.

As you might expect from the only foundry to guarantee quick turnaround, Tiny Chips are available in a mere 20-25 working days from CMOS runs supporting:



1.2, 1.5 and 2.0 micron feature sizes

2.0 micron buried channel CCDs

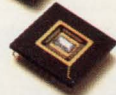

a 40 pin Tiny Chip pad frame supplied by Orbit

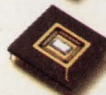

the DoD 2/1.2 micron CMOSN standard cell library with RAM and ROM generators

Getting started is easy as getting design rules and process information in our newly published Foresight User Manual.

If you are trying to build complex ASICs, without building up time and cost, Orbit's new Tiny Chip service may be the biggest news yet. To get more information in a hurry, contact Technical Marketing, Orbit Semiconductor, 1230 Bordeaux Drive, Sunnyvale, CA. Or call (408) 744-1800 or (800) 331-4617. In CA (800) 647-0222. FAX (408) 747-1263.

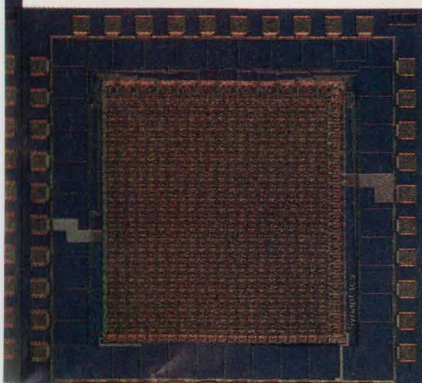

What others promise, we guarantee.

NEW PRODUCTS

TEST & MEASUREMENT INSTRUMENTS

Portable 500-Hz Oscillographic Recorder

- Can have two or four channels
- Accepts plug-in signal conditioners

The Easygraf is a 22-lb portable oscillographic recorder with 500-Hz frequency response. It accepts plug-in signal conditioners and uses fixed thermal elements to print one, two, or four analog traces; the chart grid; event markers; and alphanumeric annotation on 4-in.-wide, fan-folded paper. Resolution is 200 dpi. The analog traces can appear superimposed or side by side. The recorder samples each channel 5000 times/sec. Chart speed is variable from 0.01 to 100 mm/sec. The basic unit accommodates two plug-in signal conditioners from a new family called the 6600 series. Four-channel operation requires a companion case to hold the third and fourth

conditioners. \$3995; signal conditioners from \$315.

Gould Inc., 8333 Rockside Rd, Valley View, OH 44125. Phone (216) 328-7264. FAX (216) 328-7400.

Circle No. 351

Factory Data-Collection Terminal

- You can connect 160 terminals on an RS-485 loop
- Includes 64k bytes of nonvolatile memory

The MEC-51 preprogrammed factory-data terminal automatically collects and processes data from production machinery; receives information that machine operators enter on its sealed hexadecimal keypad; displays data on an 8-digit LED display; and transmits data on a 2-wire RS-485 loop. As many as 160 terminals connect on a single

2-wire loop. The unit's inputs are optically isolated. The μ P that controls the terminal has 64k bytes of nonvolatile RAM. Lotus Development Corp's 1-2-3/@Factory software helps you create reports from the data collected by the terminal. \$895.

Manufacturing Technology, 578 Post Rd E, Suite 621, Westport, CT 06880. Phone (203) 454-8730.

Circle No. 352

RS-232C Tester

- Performs eight functions
- Weighs 2.6 lb; uses three 9V batteries

The DataTool 5500 is a 2.6-lb unit that receives power from three 9V batteries. It performs the following functions on RS-232C signals: data monitoring, bit error-rate testing, data trapping, device exercising,

This is the most significant

It's Aurora™ phosphor. Developed by Loctite Luminescent Systems, this remarkable product is setting a standard far above the performance levels of all other illuminative phosphors.

Electroluminescent (EL) technology, in its search for brighter and longer-lived lamps, has been dependent on a limited choice of phosphors. To overcome this restriction and produce the industry's most efficient EL lamps, we initiated an intensive research program to develop a phosphor dramatically better than any in existence. The result was Aurora.

With this new phosphor, we are making a new generation of ELs - the Aurora™ lamp line, with longer life and higher sustainable brightness than any ELs on the world market. Our green and white Aurora lamps outperform any competitive light



**LOCTITE
LUMINESCENT
SYSTEMS INC.**

SETTING THE STANDARD
A SUBSIDIARY OF LOCTITE CORPORATION

ETNA ROAD, LEBANON, NH 03766
PHONE (603) 448-3444
FAX (603) 448-3452 TWX 710-366-0607



and device simulation. It also operates as a breakout box, a pulse-level voltmeter, and a cable tester; it detects power dropouts during error-rate tests. The unit configures itself automatically to match the charac-

teristics of the monitored data stream. You can download test setups and error messages to the tester; it stores this information in nonvolatile memory. It simultaneously analyzes the received and transmitted data streams and prints test data during tests. \$1295.

Datacom Technologies Inc., 11001 31st Pl W, Everett, WA 98024. Phone (206) 355-0590. FAX (206) 353-9252. **Circle No. 353**

Multichannel Filter/Amplifier

- Can have 64 channels
- Plug-ins let you program their gain and filter response

The 9064 is a multichannel filter/amplifier. You can mount the 7-in.-high chassis in an EIA rack. The chassis, which accepts 16 plug-in cards, includes a power supply, a

fan, a digital controller with battery-backed memory, a common bus for monitoring individual channels, and RS-232C and IEEE-488 ports. Plug-in cards contain two or four channels. The channels can be filters with fixed or programmable response and amplifiers with fixed or programmable gain. Lowpass filters can have 8-pole, Bessel, Butterworth, elliptic, or constant-delay response. Highpass filters can have 8-pole elliptic or Butterworth response. Programmable and fixed corner frequencies range from 1 Hz to 51.2 kHz $\pm 2\%$. Unit-to-unit amplitude response tracks to ± 0.05 dB; phase to 0.5° . Chassis, \$4000; cards from \$400. Delivery, six to eight weeks ARO.

Frequency Devices Inc., 25 Locust St, Haverhill, MA 01832. Phone (508) 374-0761. FAX (508) 521-1839. **Circle No. 354**

illumination breakthrough in decades.

source for LCD backlighting, panel illumination, membrane switch and graphics backlighting, to name a few applications.

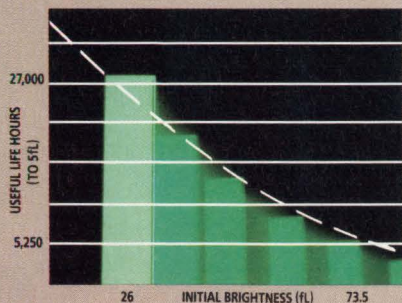

Only Aurora ELs offer this extensive life-to-brightness range. Now you can have lamps customized to your life/brightness requirements. This wide range includes lamps with initial brightness of 25fL and typical useful life in excess of 27,000 hours, to lamps with initial brightness exceeding 70fL and with typical life of 5,250 hours.

Greater design flexibility and cost-efficiency.

Aurora's spectacular life/brightness advantages, as shown in the chart, offer the designer more opportunities than ever before. Combining these benefits with our advanced fabrication techniques, we can produce solid-state, flexible Aurora lamps in almost any size and shape, even complex forms with multiple holes and cutouts. With no glass bulbs or fragile filaments to break, lamp maintenance is minimal with few, if any, replacement costs. And able to withstand shock and vibration as well as temperature and humidity extremes without catastrophic failure, lamp life is phenomenal. In fact, with three times the life of any other EL, Aurora lamps can be expected to last the life of the products in which they are used.

Get the most from the Aurora breakthrough with our performance matched EL systems.

By creating perfectly matched combinations of LLS dc-to-ac inverters and Aurora lamps, our engineers can design an EL system to precisely meet your lighting requirements. With our broad product range, and over 20 years of EL experience, we welcome your questions, especially challenging ones concerning unique applications. Call or Fax the LLS Marketing Department.

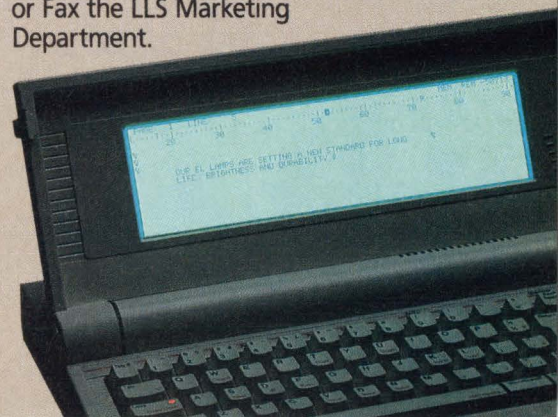

If You're Looking Turnaround, Head

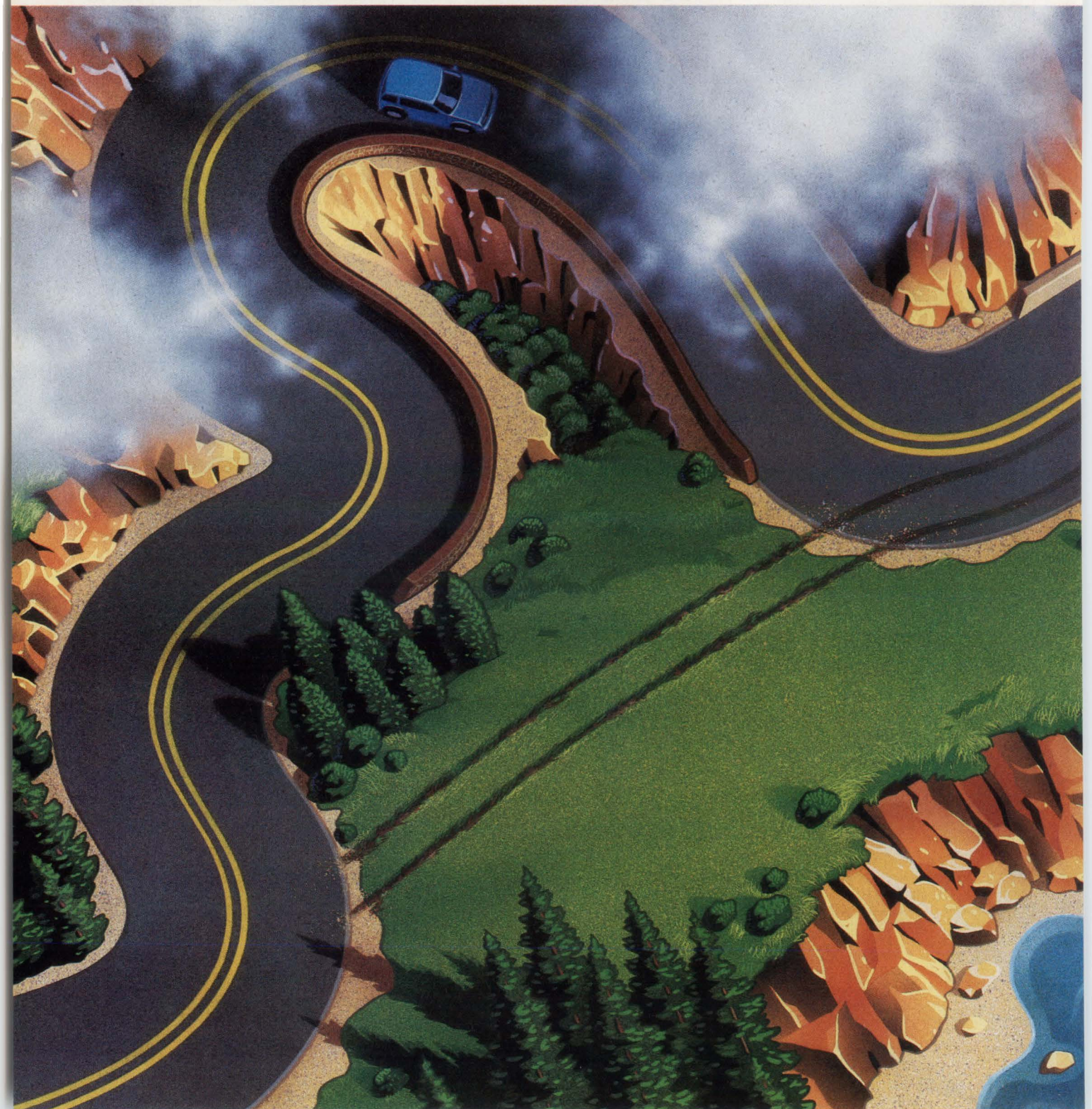

For Fast Gate Array Straight For Toshiba.



Engineering samples in just 8 working days: How's that for a time-saving shortcut? Now you can tap into Toshiba's advanced CMOS process and enormous ASIC manufacturing capacity and also get one of the most aggressive turnaround times in the business.

We've geared up our Sunnyvale, CA fab facility to provide accelerated response for both engineering samples and production volumes of high performance gate arrays.

Give us 8 working days and we'll support your aggressive development schedules for up to 68,000 raw gates in high speed, 1.0 micron gate array. Or we will make larger designs of up to 172,000 raw gates in 15 working days.

We can get your project off to a rolling start with the Toshiba Design Environment. It covers the full CAD spectrum and is compatible with the major EWS including AIDA, Cadence,

Dazix, HILO, HP, IKOS, Mentor, Synopsys, VALID, Verilog and Viewlogic.*

No one knows more than Toshiba when it comes to high volume production of high performance ICs. That's why it makes sense to head for our gate array expressway.

There's no faster route to success.

For technical literature, call 1-800-888-0848, ext. 517

The Toshiba Design Environment supports the major EWS.

Sales Offices: Deerfield, IL 708-945-1500; Burlington, MA 617-272-4352; Sunnyvale, CA 408-737-9844; Tustin, CA 714-259-0368; Richardson, TX 214-480-0470; Norcross, GA 404-368-0203; Portland, OR 503-629-0818

Now supporting Synopsys, Verilog, SCAN and "JTAG"

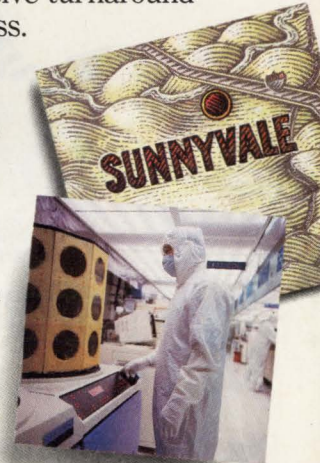

Local fab line speeds prototyping and supports production volumes, too.

In Touch with Tomorrow
TOSHIBA

TOSHIBA AMERICA ELECTRONIC COMPONENTS, INC.

*AIDA, Cadence, Dazix, HILO, HP, IKOS, Mentor, Synopsys, VALID, Verilog and Viewlogic may be registered trademarks by others.
© 1990 Toshiba America Electronic Components, Inc. MAS-90-035

NEW PRODUCTS

COMPUTERS & PERIPHERALS

Optical Character Reader

- Recognizes typeset fonts and bar codes
- Reads text from typewriters and dot-matrix printers

The Datasweep 2 handheld optical character reader reads font sizes having from 6 to 20 points. It con-

tains a database of common office fonts and special fonts such as OCR-A, OCR-B, and E13B. An option lets the unit read bar codes. The reader operates with IBM PCs or 100% compatible computers, running DOS 3.0 or higher and having a minimum of 256k bytes of mem-

ory. The software requires approximately 35k bytes of memory. The unit requires a full-sized expansion slot and can read from 25 to 30 cps. It can read data that is underlined or located within boxes with an accuracy >99.9%. Print quality the unit reads ranges from typewriter or laser-printer quality to dot-matrix draft mode. An RS-232C port is part of the unit. \$1795.

Soricon Corp, 4725 Walnut St, Boulder, CO 80306. Phone (303) 440-2800. FAX (303) 442-2438.

Circle No. 367



SURVIVAL OF THE FASTEST

Cheetah makes your AT fit for the DSP jungle

At 49.5 MFLOPS (285 MOPS, total), Atlanta Signal Processors' Cheetah™ is one of the fastest cats around. The new DSP add-in board is based on Motorola's DSP96002 – the first floating point digital signal processor to use IEEE 754 Standard SP (32-bit) and SEP (44-bit) arithmetic.

In addition to the DSP96002, the Cheetah board houses two Motorola DSP56001 fixed point processors and up to two Mbytes of zero-wait state static RAM. A large family of special-purpose daughter boards is available to take advantage of Cheetah's flexible I/O and memory architecture.

The ASPI board is a versatile tool for developing DSP96002-based systems, including speech coding, color video, stereo sound, three-dimensional graphics and other multimedia applications.

Among the more useful daughter boards are an A/D-D/A data acquisition system, 64-Mbyte memory expansion board and a multi-processor interface.

And you don't need to be a fat cat to own a fast cat. Cheetah can turn your AT into a supercomputer for a very modest investment. For detailed specifications and prices, contact

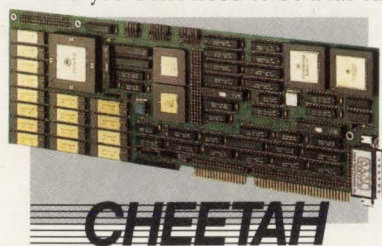

CHEETAH



WORLD LEADERS IN DSP DESIGN TOOLS

770 Spring Street • Atlanta, GA 30308 USA • 404/892-7265 • FAX: 404/892-2512

CIRCLE NO. 22

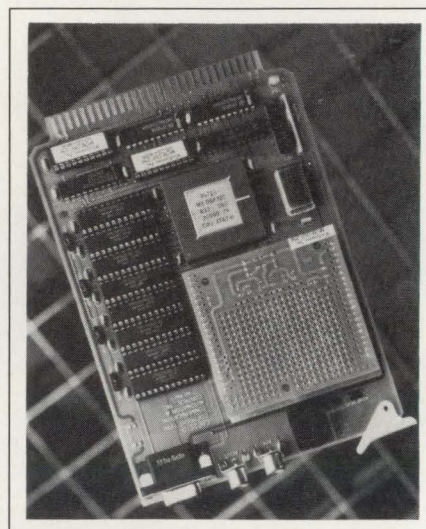

DSP Board

- Uses 50-MHz DSP32C chip for the STD bus
- Comes with either 64k or 256k bytes of zero-wait-state RAM

The MCM-DSP32C DSP board for the STD bus features a 50-MHz AT&T DSP32C DSP chip that delivers 25M flops. It contains either 64k or 256k bytes of zero-wait-state RAM that has a 32-bit-wide data path. Benchmarks include executing a 1024-point complex FFT in 3.3 msec; multiplying a 4x4 matrix in 6.16 µsec; and calculating a complex adaptive FIR filter having 80 nsec/tap. The host can transfer data to the board as fast as 3.5M bytes/sec using programmed I/O transfers. Data transfer is independent of the

OrCAD presents Release IV

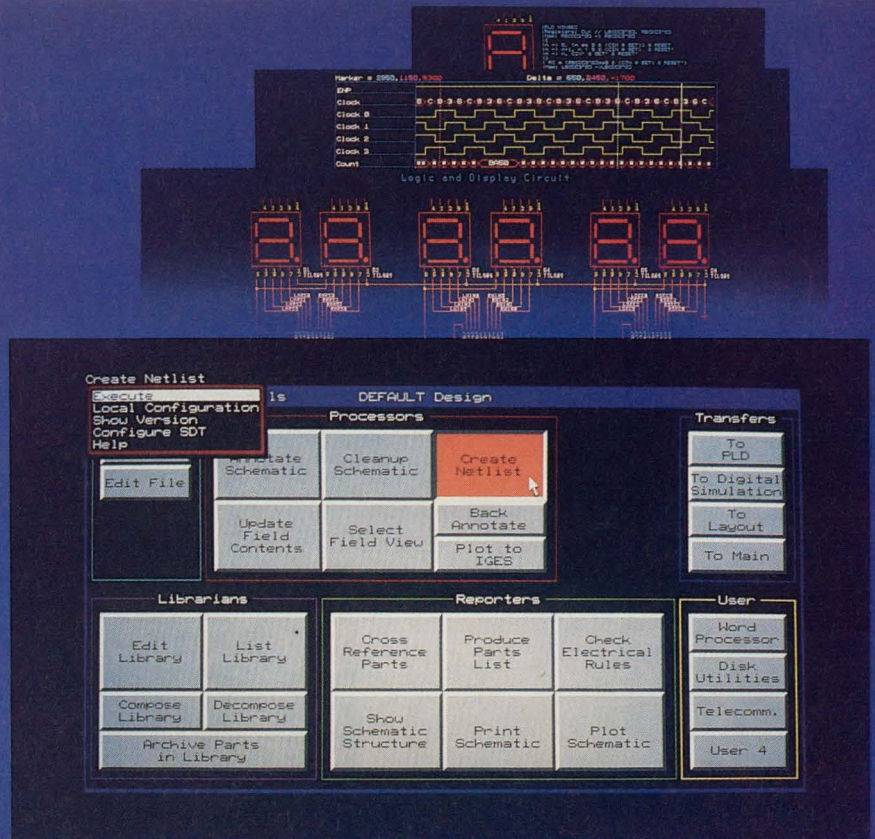

The limits are gone

OrCAD has introduced the greatest product upgrade in its history. Memory limits, design restrictions, even boundaries between products are all disappearing.

For years, OrCAD's competitors have been playing a game of catch-up. With the introduction of Release IV, the race is over. No one will match our price/performance ratio on these features:

- Schematic Parts Library has been increased to over 20,000 unique library parts
- Digital Simulation process has been speeded up by an order of magnitude
- Printed Circuit Board Layout package offers autoplacement and autorouting at no extra charge
- Expanded memory capabilities

Best of all, OrCAD introduces ESP

ESP is a graphical environment designed specifically for the electronic designer. Software tools appropriate for different stages in the design process are now linked together to form a seamless flow of information. This easy-to-use framework relieves the designer of time consuming tasks and the inconvenience of moving from one tool set to another. You can now spend more time productively designing.

For more information . . .

You need to know more about Release IV and all of the benefits OrCAD has to offer. Call the telephone number below and we'll send you a free demonstration disk.

OrCAD 

More designs from more designers

For more information, call (503) 690-9881

or write to OrCAD Sales Department, 3175 N.W. Alcock Drive, Hillsboro, Oregon, 97124

IEEE-488

You can control any IEEE-488 (HP-IB, GP-IB) device with our cards, cables and software for the PC/AT/386, EISA, Micro Channel and Macintosh II. You get fast hardware and software support for all the popular languages, plus a software library of time saving utilities. Instrument control has never been easier.

FREE Informative Catalog **800-234-4232**
Applications help (617) 273-1818

cec Capital Equipment Corp.
Burlington, MA. 01803

Micro Channel is a trademark of IBM

CIRCLE NO. 23

COMPUTERS & PERIPHERALS

DSP's execution of a program. The DSP board can perform 8- or 16-bit data transfers on the STD bus. You have the option of adding a daughter board to provide serial I/O, a Codec, a 16-bit ADC, or prototyping space. \$1495.

Winsystems Inc, 715 Stadium Dr, Suite 100, Arlington, TX 76011. Phone (817) 274-7553. FAX (817) 548-1358. **Circle No. 368**

Multibus II Adapter

- Drives 32-bit devices using the HSD protocol
- Has data-transfer rate >3.5M bytes/sec

The MBHSD adapter board for the Multibus II provides a bidirectional link to a 32-bit external device using the Gould/Encore HSD protocol. It can also connect the Multibus II system to a Gould/Encore HSD board or another MBHSD. The data-transfer rate is >3.5M bytes/sec. During data transfers, the board can reformat the words by byte swapping, word swapping, or word and byte swapping. The 6U board supports data transfers via the LBX bus or PSB interface. All features are software selectable. Board, documentation, and 20-ft ribbon cables, \$4750.

Applied Data Sciences Inc, Box 814209, Dallas, TX 75381. Phone (214) 243-0113. FAX (214) 243-0217.

Circle No. 369

TableCurve™

One step fits 221 equations to your X-Y data. Automatically. In less than 7 seconds.*

With TableCurve™ finding the best formula to fit your data couldn't be simpler...or faster.

- **Flexible Data Input** – input from Lotus™, dBase™, ASCII and many other file formats, or manually from the keyboard.
- **Data Manipulation** – smooth data, weight data, or apply standard math calculations.
- **Curve Fitting** – 221 candidate equations including Gaussian, log-normal, sigmoidal, sine, and user-defined—ranked by best fit and interactively displayed.



- **Speed*** – an 8MHz PC AT, with math coprocessor, will process 221 equations (50 data points) in 6.8 seconds. More powerful systems are much faster.
- **Output** – supports most dot-matrix and LaserJet™ printers. Output directly to SigmaPlot 4.0™, Lotus, ASCII, and other formats.
- **Quality Interface** – pull down menus, mouse support and more.

To find out more about TableCurve or other scientific and engineering software from Jandel, just give us a call.

Free brochure **800-874-1888**
Outside U.S. **415-924-8640**

FAX: 415-924-2850

In Europe: Schimmelbuschstr. 25, D-4006 Erkrath 2, W.-Germany
Ph: 0 2104 / 3 60 98 • FAX: 0 2104 / 3 31 10

Jandel "Microcomputer Tools for the Scientist"
SCIENTIFIC

■ 65 Koch Road ■ Corte Madera, CA 94925

CIRCLE NO. 24

Memory Cards

- Available in full- and half-card formats
- Feature EEPROM or EPROM to transport data

The Courier, a line of portable memory cards, features a selection of read/write EEPROM and one-time-programmable EPROM memories. The densities range from 256k to 1024k bits. Operating as in-circuit memory, the cards provide random access to data as fast as 300

SOLID STATE RELAY

Our FB Series military solid-state relay features high speed and low off-state leakage.



Here's what you get:

- Availability to pending DESC drawing 89116 with screening to "W" and "Y" levels of MIL-R-28750.
- High-voltage output
- Very-low leakage current (200 nA)
- DC or bi-directional power FET output (see wiring diagrams)
- Ideal for ATE applications
- Optical isolation
- Fast switching speed
- Adjustable turn-on times
- Low profile 6-pin mini-DIP
- Cost efficiency

Review the electrical characteristics below and call us for immediate application assistance.*

INPUT ELECTRICAL CHARACTERISTICS (-55° to +105° unless otherwise noted)				
	Min	Max	Units	
Continuous Input Current (I_{IN})	10	50	mA_{DC}	
Input Current (Guaranteed On)	10		mA_{DC}	
Input Current (Guaranteed Off)		100	μA_{DC}	
Input Voltage Drop at (I_{IN}) = 25mA		3.25	V_{DC}	
OUTPUT ELECTRICAL CHARACTERISTICS (-55° to +105° unless otherwise noted)				
Part Number	FB00CD	FB00FC	FB00KB	Units
Bidirectional Load Current (I_{LOAD})	± 1.0	± 0.50	± 0.25	$\text{A}_{DC/APK}$
DC Load Current (I_{LOAD})	2.0	1.0	0.5	A_{DC}
Bidirectional Load Voltage (V_{LOAD})	± 80	± 180	± 350	V_{DC}/V_{PK}
DC Load Voltage (V_{LOAD})	80	180	350	V_{DC}
ON-Resistance (R_{ON}) at (I_{LOAD}) max.	0.72	1.8	12.9	Ohms
Turn-On Time (T_{ON})	800	800	500	μs
Turn-Off Time (T_{OFF})	300	600	500	μs

- Notes: 1. A series resistor is required to limit continuous input current to 50mA (peak current can be higher).
 2. Rated input current is 25mA for all tests.
 3. Loads may be connected to any output terminal.
 4. ON resistance shown is for the bidirectional configuration. The DC ON resistance is 1/4 of these values.

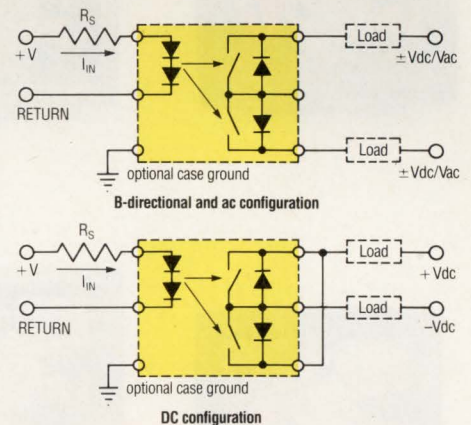

"CREATING THE STANDARD OF THE FUTURE"

TELEDYNE SOLID STATE
A Division of Teledyne Relays

*For immediate application assistance call 1-800-284-7007 or FAX us at 213-779-9161.

Teledyne Solid State, 12525 Daphne Avenue, Hawthorne, California 90250.

If you can see it, we can print it.



No matter what application you're using, no matter what monitor you're viewing it on, the CH5500 video color printer can produce a hard copy. It supports over 350 video sources—more than any other printer.

Moreover, since the CH5500 doesn't use software, it captures your image fast—so you can get back to work. And it offers outstanding 300 dpi quality in both A and B sizes.

To find out more, give us a call at 1-800-873-4561, Dept. SI-C4.

After all, we pioneered video color printing. And we still do it best. Anybody can see that.

SII 
Seiko Instruments

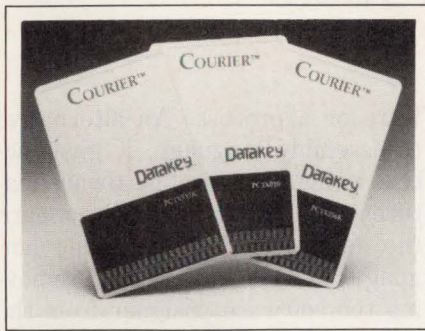

nsec. The cards are well suited for use in compact systems where they serve as an alternative to disk or tape drives. Both full- and half-card formats are available. The cards attach to the host system via a 38-pin connector. The contacts are gold plated and have a rating of 10,000 insertion-removal cycles. The non-volatile memories retain data for a minimum of 10 years; they require a 5V supply. Three EPROM cards have the following data formats: 32k x 8 bits, 64k x 8 bits, and 128k x 8 bits. An EEPROM card has a 32k x 8-bit format. \$18 to \$130.

Datakey Inc, 407 W Travelers Trail, Burnsville, MN 55337. Phone (612) 890-6850. **Circle No. 370**

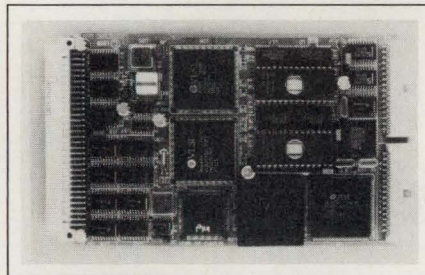

Single-Board Computer

- Uses an 80386-SX for the G-64/96 bus
- IBM PC/AT compatible

The GESMPU-38 single-board computer for the G-64/96 bus comes on a 100 x 160-mm Eurocard. It uses an 80386-SX μ P and 80387-SX coprocessor, running at either 16 or 20 MHz. The board is IBM PC/AT compatible and comes with 1M, 2M, 4M, or 8M bytes of dynamic RAM arranged in one, two, or four banks. The board has hardware support for

the LIM EMS 4.0 extended memory standard as well as ROMBIOS and VideoBIOS. Other features include a page-address register, a timer, an interrupt controller, port B logic, a real-time clock/calendar with 114 bytes of battery-backed CMOS RAM, a DMA controller, and a PC/AT-compatible keyboard

controller. Two serial ports, a bi-directional parallel-printer port (LPT1), a 37C65B floppy-disk controller, and an IDE hard-disk port also come with the board. \$2195 with 1M byte of RAM.

Gespac Inc, 50 W Hoover Ave, Mesa, AZ 85210. Phone (602) 962-5559. **Circle No. 371**

Programmable Anti-Alias Filters for Critical A/D Prefiltering

848P8E Series are Elliptic lowpass filters providing extremely sharp roll-off for A/D prefiltering.

Features:

- 8 pole, 6 zero elliptic lowpass filters
- Digitally programmable corner frequency
- Shape factor of 1.77 at 80db
- 8 bit (256:1) tuning ratio
- Internally latched control lines to store frequency selection data
- Ideal for single or multi-channel applications
- Plug in, ready to use, fully finished filter modules
- Five frequency ranges to 51.2kHz

Other Filter Products Available:

- Linear phase • Programmable
- Fixed frequency • Instrumentation
- Custom designs

For more information about how Frequency Devices can meet your most critical filtering requirements, call our applications engineers at **(508) 374-0761**.

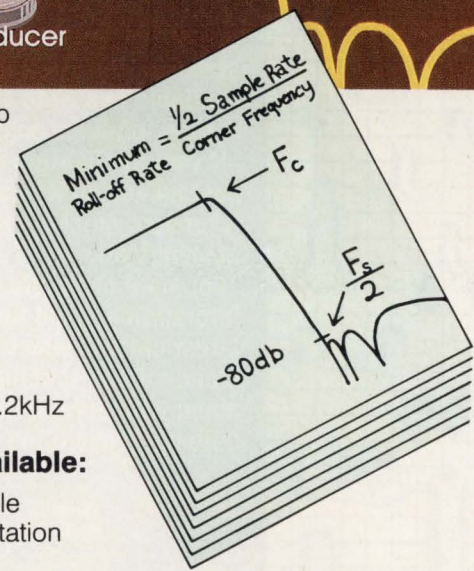
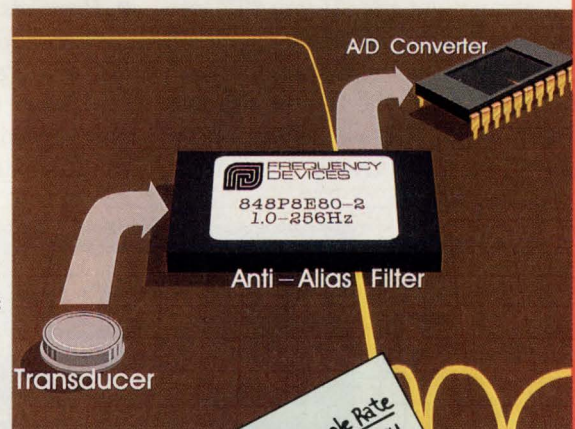

FREQUENCY DEVICES™

25 Locust Street
Haverhill, MA 01830
(508) 374-0761

NEW PRODUCTS

CAE & SOFTWARE DEVELOPMENT TOOLS

CAE Routing Tool

- Automatic and interactive routing
- Postscript and HP Laserjet outputs

Version 2.0 of Pads-2000 includes many features that, according to the manufacturer, are superior to those in more expensive workstation-based CAE systems. A major enhancement is T-Routing, the ability to route from any track within a net to any other pin, via, or track segment within the same net. You can start from or tie into a track using a "T" without having to finish at a component pin. If you "T" into another track and your operation results in an excessive track length on your board, the T-Routing feature automatically cleans up and removes the excess track. The feature

also works in interactive mode. The tool allows micro vias in addition to existing through vias and blind/buried vias. Text and graphics symbols can rotate 360° in 0.1° increments. \$5995.

CAD Software Inc., 119 Russell St, Suite 6, Littleton, MA 01460. Phone (508) 486-9521. FAX (508) 486-8217. **Circle No. 372**

Software Tool For Machine-Level Coding

- An alternative to using an assembler
- Prompts for inputs and checks for syntax errors

M-Code Personal, a software tool that runs on PCs, lets engineers, technicians, and scientists who write small programs control hard-

ware or a process. An alternative to assembly language, it gives access to machine-level hardware features and doesn't force you to learn the details of a programming language. In fact, rather than removing the software designer from the hardware as languages try to do, M-Code takes you to the hardware and helps automate coding for it. Interactive prompts and syntax checking help you create code; no edit/assemble/link sequence is necessary. You simply create your code, save it to disk, rename it as a COM file, and run it. As an alternative, you can develop code for PROM-based remote target systems. The tool allows programs as large as 64k bytes and comes with a small library of routines. An optional source-code package includes



EYELETS

At Stimpson, we maintain the industry's largest line of standard and specialty eyelets, available in a wide variety of metals, platings and finishes. If your application requires a custom design we can produce it for you, quickly and economically. For more complete design information, send today for our latest catalog which illustrates standard and specialty eyelets along with our full line of automatic eyeleting machines.



900 SYLVAN AVE., BAYPORT, NY 11705-1097
(516) 472-2000 • FAX (516) 472-2425 • TX-ITT-497-2370



Quality Sockets and Plugs

Standard, Customized and New Designs



Prototype through Production

CONNECTOR CORPORATION

6025 N. Keystone Ave. • Chicago, IL 60646-5290
Phone: 312/539-3108 • TWX 910-221-6059 • FAX: 312/539-3825

WE'LL GIVE YOU THE WORLD

... Of Electronic Design

You asked for an integrated set of CAE/CAD design tools which could deliver every aspect of your engineering design needs—at an affordable price. CAD Software offers the highest performing design system for your PC. Schematic capture, logic simulation, printed circuit board design, auto-routing, thermal analysis, and computer aided manufacturing are all within the PADS Design system.

Your design begins with **PADS-Logic**, the only PC-based schematic capture system which has a true multi-sheet database for quick and accurate design capture and data transfer to your PCB design. **PADS-Logic** has a large circuit capacity of over 1,000 equivalent IC's per design, a Hierarchical design ability with an unlimited number of levels, superb analog design capability, forward and backward annotation, a Part Editor and Graphical Library browsing.

PADS-PCB sets the standard for affordable high performance PCB design. A one mil database, 30 layers, automatic design rules checking, SMD ability, excellent interactive routing, and a set of ECO routines which ensure fast accurate changes, are just some of the features which have made **PADS-PCB** the #1 selling PC based PCB design system.

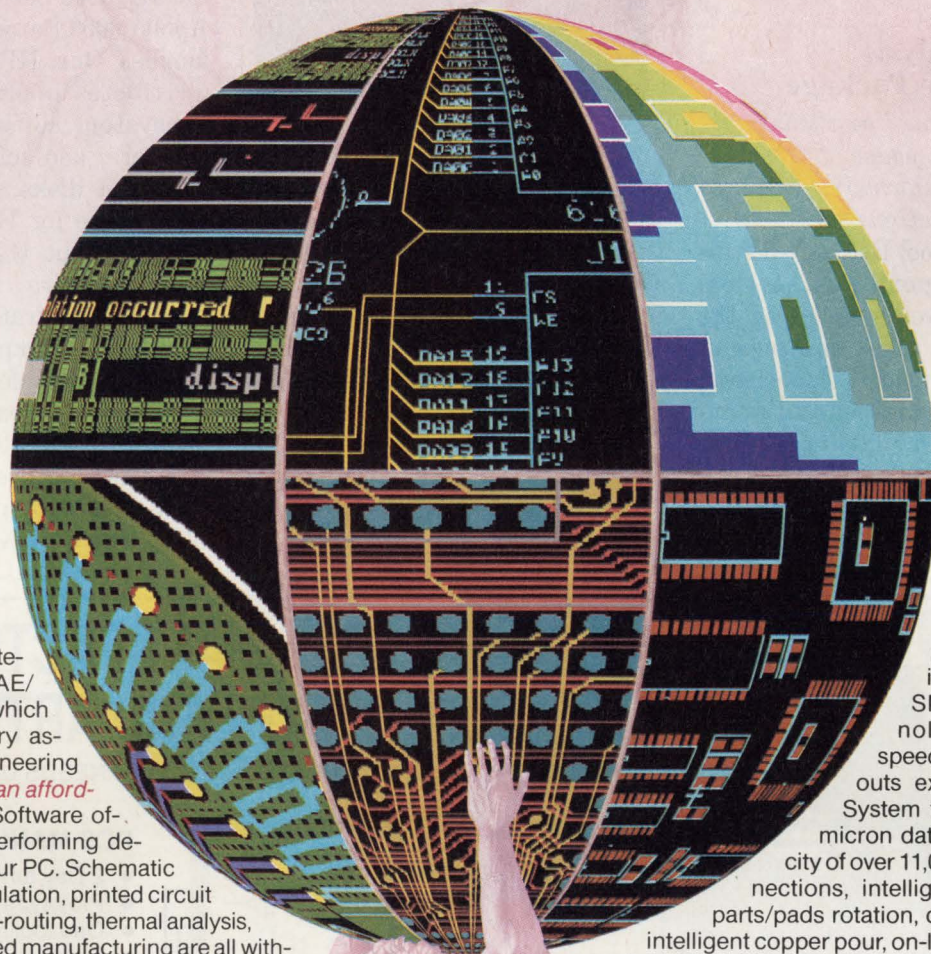

PADS-2000, the star that outshines any other PC-Based PCB design system, can handle even the most complex designs, including double sided SMD's, mixed technology boards, high speed designs, and layouts exceeding 2000 IC's. System features include a 1 micron database, design capacity of over 11,000 parts/32,000 connections, intelligent T-Routing, 0.1° parts/pads rotation, curved trace routing, intelligent copper pour, on-line and batch design rules checking, digital, analog and high speed/critical circuit auto-routers are included in **PADS-2000**.

Our extensive line of auto-routers work around the clock so you don't have to. The **PADS-SuperRouter** rips-up and reroutes the connections to 100% completion. **PADS-Push n' Shove** interactive auto-router is superb for analog and critical circuitry.

Call CAD Software today for your local Authorized Reseller, or for a no-cost Evaluation Package, and experience the world of electronic engineering design:

CAD
Software, Inc.

(800) 255-7814, Inside MA, (508) 486-8929

119 Russell Street, Littleton, MA 01460

routines for keyboard, display, and ASCII conversion. M-Code Personal, \$99.95; source-code package, \$29.95.

DOSystems Inc, Box 4601, Carmel, CA 93921. Phone (408) 625-9016. **Circle No. 373**

Thermal-Analysis Power-Supply Package

- Performs thermal analysis during design phase
- Used for transformers, capacitors, and resistors

CAE software tool Betasoft-R runs on a PC and performs thermal analyses of power supplies in the design stage. It takes into account various transformers, capacitors, and resistors in addition to the microelectronics of a supply. The power supply can be at any elevation, under natural or forced-air cooling, and with various heat sinks

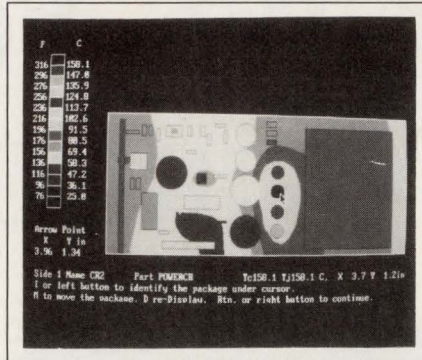

or heat-spread planes attached. The software can model 3-D flow and thermal fields and can interface with CAE products from Mentor, Valid, P-CAD, AutoCAD, OrCAD, RPP, and Relx. The tool runs on DOS-based PCs that have 640k bytes of memory and an EGA display. \$1995.

Dynamic Soft Analysis Inc, 213 Guyasuta Rd, Pittsburgh, PA 15215. Phone (412) 781-3016. FAX (412) 781-3098. **Circle No. 374**

Software On CD-ROM

- Replaces magnetic tape and printed documentation
- Allows keyword search of documentation

Two types of software are now available on CD-ROM for users of the HP 9000 Series 300 and the HP Apollo 9000 Series 400 workstation families. One, HP Laser-release/UX distributes operating-system and subsystem software, application software, and software updates on CD-ROM disks. The other, Software Store for HP, contains information about third-party applications software, including promotions, demonstrations, on-line documentation, company information, and ordering information. Updates to HP Laser-release/UX go to users monthly on CD-ROM disks; updates to Software Store for HP are quarterly. Software provided with HP Laser-release/UX includes the HP-

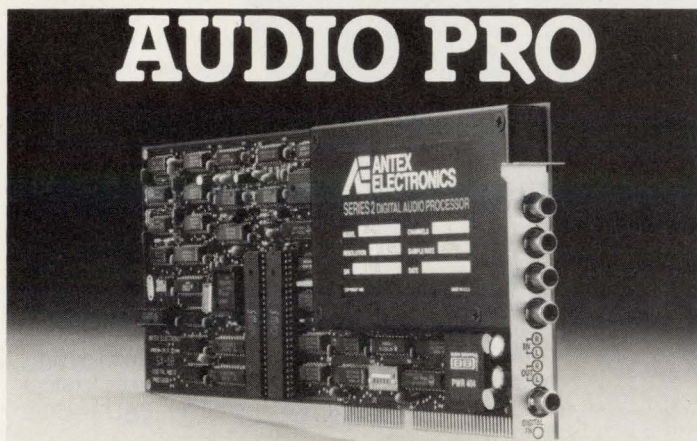

AUDIO PRO

Introducing... CD quality, stereo high fidelity, digital audio you record and playback on your PC-AT/286/386/Model 30 or compatible.

Featuring... real time direct to disk data transfer... 16-bit resolution... 20Hz to 20kHz audio response... 0.005% THD... 6.25 to 50kHz programmable sample rate... 92dB dynamic range... 90db s/n... digital input... 4 to 1 ADPCM compression.

Use for digital audio recording, editing, mastering and transmission in broadcasting, entertainment systems, film production, audio/visual presentations and interactive CDI/DVI systems.

If you're an audiophile with microcomputer resources call 1-800-338-4231 (ex. CA.) for details on our Audio Pro... the Series 2/Model SX-10.

ANTEX ELECTRONICS
16100 S. Figueroa St. • Gardena, CA 90248 • Tel (213) 532-3092 • FAX (213) 532-8509

PCB MANUFACTURING DESIGN AND ARTWORK!

ALL YOUR CIRCUIT BOARD NEEDS UNDER ONE ROOF

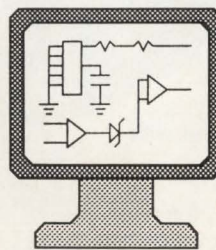

PCB MANUFACTURING

- 2 Day turn on multi-layers
- Prototype and production
- One tooling charge for both
- Turn-key assembled boards

PCB DESIGN

- Backplanes
- Impedance control
- Analog and ECL
- Surface mount

TECHNICAL ASSISTANCE

- PCB design tips
- Mfg cost cutting tips
- Testing guidelines
- We accept gerber data via modem (714) 970-5015

CALL FOR A QUOTE!

A MANUFACTURING, PCB DESIGN AND SUPPORT CENTER



**MURRIETTA
CIRCUITS**

4761 E. HUNTER AVE. ANAHEIM, CA. 92807
TEL: (714) 970-2430 FAX: (714) 970-2406

Series PK High Voltage Power Supplies Check Out Best!



- 4 and 8 kW models from 3 to 500 kV
- 4 kW (to 75 kV), 10.5" high and <70 lbs.
- 12 and 15 kW models available
- Low stored energy
- Air insulated for light weight, enhanced serviceability
- Regulation better than 0.1%
- Ripple better than 0.1%
- Efficiency better than 85%
- Fixed switching frequency due to pulse width modulated design

- Full range of Remote and Local controls
- 3-1/2 digit LCD displays for output voltage and current
- 10-segment bar graph output trend indicators
- Full "control" status annunciators
- Operates in either voltage or current regulated mode
- Current trip feature standard... customer selectable
- Intelligent, latching safety interlocks

- "External trip" input, customer-defined use
- Full protection for overloads, short circuit, and arcing conditions
- 3-year standard warranty
- Local factory sales and service on three continents!

Ask for our new Series PK brochure with full information. Or, better yet, give us a call with your next high voltage application. We'll provide responsive, knowledgeable assistance. And we'll deliver, on time, with superior performance, value, and reliability.

Glassman... The innovators in high voltage technology

GLASSMAN HIGH VOLTAGE INC.



GLASSMAN U.S.A.

Glassman High Voltage, Inc.
P.O. Box 551
Route 22 East
Salem Industrial Park
Whitehouse Station, NJ 08889
U.S.A.
Telephone: (908) 534-9007
TWX: 710 480-2839
FAX: (908) 534-5672

GLASSMAN EUROPE

Glassman Europe Limited
Studio 4
Intec 2
Wade Road
Basingstoke
Hampshire RG240NE
England
Telephone: (0256) 810808
FAX: (0256) 810815

GLASSMAN JAPAN

Glassman Japan High Voltage Limited
Taira Building
1-17, Taira 1-chome
Miyamae-ku, Kawasaki 216
Japan
Telephone: (044) 877-4546
FAX: (044) 877-3395

World Class Ferrite Core Manufacturers. At Your Fingertips.

To get the best in ferrite quality and service, you have to know the right buttons to push. 1-800-345-4082. That's your direct line to DEXTER, your One Stop Shopping Center for your every ferrite need. From world class manufacturers such as SIEMENS, MAGNETICS, FAIR-RITE, HITACHI, MMG/KRYSTINEL. From standard stock items, ready for 24-hour delivery, to the most intricate custom designs utilizing DEXTER's extensive value-added services, like precision fabrication, E-core and pot-core gapping and testing, and more.

Call Toll Free 1-800-345-4082 for Free Catalog and Nearest DEXTER Location.

ATLANTA • BOSTON • CHICAGO • DALLAS • LOS ANGELES • MINNEAPOLIS/ST. PAUL • NEW YORK • SAN FRANCISCO • TOLEDO/DETROIT • ENGLAND • WEST GERMANY



THE DEXTER CORPORATION

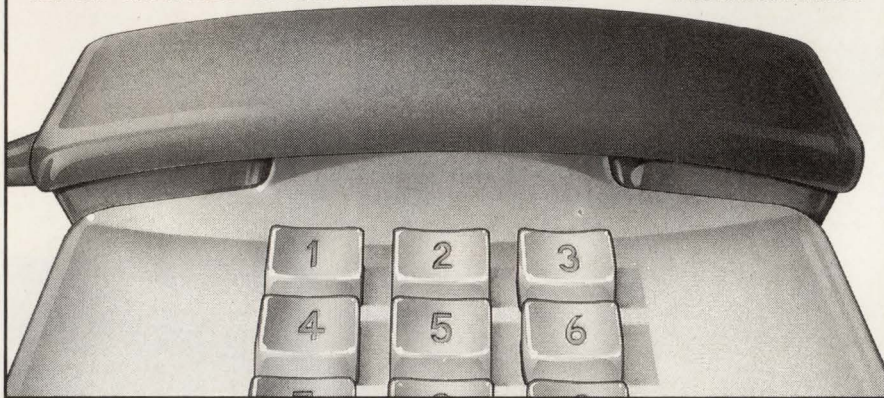

CIRCLE NO. 30

CAE & SOFTWARE

UX 8.0 operating system, select HP application software, the OSF/Motif graphical user interface, and subsystem modules that include compilers, network software, and graphics software. A full-text-retrieval software package based on OSF/Motif allows users to search the software's documentation for keywords. With Software Store for HP, users can choose a point-and-click procedure to review a variety of applications software. A printed buyers' guide also comes with each CD-ROM disk. The supplier also sells CD-ROM hardware for all of its systems running HP-UX. HP Laser-release/UX, from \$495; Software Store for HP is free.

Hewlett-Packard Co., 19310 Pruneridge Ave, Cupertino, CA 95014. Phone (800) 752-0900.

Circle No. 375

Line- And Bus-Design Software

- For high-bit-rate data transmission on strip lines
- Calculates transmission-line matrices

K G Line Design, a CAE program, performs design calculations for low-crosstalk, high-bit-rate data transmission on multiwire lines and buses. The program calculates the impedance-matching (no crosstalk, no reflection) network elements from the line's geometry; it also calculates the crosstalk due to mismatch for any termination network as well as the crosstalk that develops as a pulse propagates along the line. It can also calculate the gains for an unscrambler-decoder (to "undo" the crosstalk) if it appears to be the best solution. The software runs on IBM PCs and compatible computers. Regular 45-wire version, \$475; demo 3-wire version, \$5.

Kenneth D Granzow Consultant, 1079 Haverhill Pl, Colorado Springs, CO 80919. Phone (719) 528-6784. Circle No. 376

- Crystals
- Crystal Oscillators
- Crystal Filters
- Ceramic Resonators

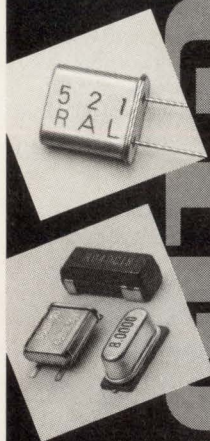

WHEN IT COMES TO HIGH ACCURACY CRYSTAL UNITS, ONLY RALTRON HAS IT ALL.

RALTRON manufactures one of the industry's most complete lines of high quality crystal units. Call us for all your crystal needs from micro-processor to AT strip to tuning fork to high accuracy. Or call us for our 28 page catalogue.

HIGH ACCURACY CRYSTAL UNITS

- Frequency Range: 1.0 MHz-360 MHz
- Mode of Oscillation: Fundamental to 9th O.T.
- Frequency Tolerance: @ 25°C: ±2.5 ppm to ±100 ppm
- Frequency Stability: ±3 ppm (-10°C to +60°C) to ±50 ppm (-55°C to +105°C)

SURFACE MOUNT CRYSTAL UNITS HC-45/U SMD, TT SMD, HC-49S SMD

- Frequency Range: 3.5 MHz-360 MHz
- Mode of Oscillation: Fundamental to 9th O.T.
- Frequency Tolerance: @ 25°C: ±2.5 ppm to ±100 ppm
- Frequency Stability: ±3 ppm (-10°C to +60°C) to ±100 ppm (-10°C to +70°C)

The Products. The Prices. The People. Only RALTRON has it all.

RALTRON ELECTRONICS CORP.

2315 NW 107th Avenue, Miami, Florida 33172
FAX (305) 594-3973 TELEX 441588 RALSENUJ
(305) 593-6033

CIRCLE NO. 31

Here's where the barricades start to come down in the mixed signal revolution.

North American Locations & Dates

Cedar Rapids, IA March 18	Saddlebrook, NJ April 2	Woodland Hills, CA April 11	Toronto, Canada May 13	Bloomington, MN May 22
Cleveland, OH March 19	Westchester, NY April 3	San Diego, CA April 12	Santa Clara, CA May 14	Houston, TX May 23
Pittsburgh, PA March 20	Smithtown, NY April 4	McLean, VA May 6	Pleasanton, CA May 15	Dallas, TX May 24
Atlanta, GA March 25	Cromwell, CT April 5	Baltimore, MD May 7	Bellevue, WA May 16	Phoenix, AZ May 28
Clearwater, FL March 26	Santa Clara, CA April 8	Cherry Hill, NJ May 8	Beaverton, OR May 17	Denver, CO May 29
Orlando, FL March 27	Costa Mesa, CA April 9	Fort Washington, PA May 9	Woburn, MA May 20	Arlington Heights, IL May 30
Huntsville, AL March 28	Los Angeles, CA April 10	Raleigh, NC May 10	Montreal, Canada May 21	Rochester, NY May 31
Waltham, MA April 1				

Also at 24 locations in Europe and the Far East.



With the revolution in mixed signal technology, digital designers now need to know about analog. And the analog guys can no longer turn their backs on digital.

Mixed signal technology is the only way to smash the barriers to higher levels of system integration, better performance, and faster time to market. And it accomplishes these difficult tasks by combining both signals on a single chip.

Which is why designers from both camps should attend our Mixed Signal Design Seminar. A comprehensive full-day tutorial that covers everything from digital signal processing and sampled data systems to sigma delta converters, techniques for building a better board, and much more.

The mixed signal revolution has started, so make sure nothing stops you from attending this seminar. To reserve your space, return the coupon. For more information or to charge your

ticket, call (617) 937-1430 or (800) 262-5643.



The Mixed Signal Design Seminar from Analog Devices.

I want to be part of the revolution, so don't start the Mixed Signal Design Seminar without me.

Name _____

Title _____

Company _____

Address _____

City _____ State _____ Zip _____

I'd like to attend in the following City: _____ Date: _____

Please include a check for \$20 payable to: Analog Devices. Return to: Analog Devices, Mixed Signal Design Seminar, 181 Ballardvale St., Wilmington, MA 01887.

EDN031491

For more information, or to charge your ticket, call (617) 937-1430 or (800) 262-5643.

NEW PRODUCTS

COMPONENTS & POWER SUPPLIES

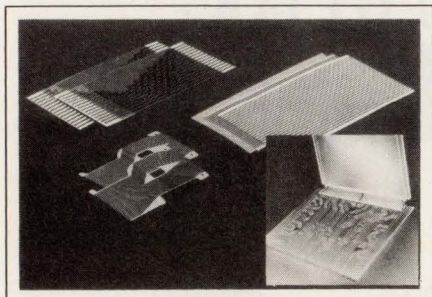

Flexible Connectors

- Available with carbon or carbon-silver traces
- Designed for pc-board applications

J-Type flexible connectors are designed for board-to-LCD or board-to-board applications. The line consists of units with carbon (JC Type) or carbon-silver (JS Type) traces screened to a polyester substrate. An anisotropic conductive thermoplastic is then applied over either the bonding-interface surface or the entire surface. The polyester material is typically 0.025 mm thick, but other thicknesses are available. JS-Type devices have a trace pitch as small as 0.3 mm using 0.15-mm trace widths. JC units have a minimum pitch of 0.5 mm and use trace widths of 0.25 mm. JC connector measuring 30×49 mm with 27 traces on 1-mm centers, \$0.10 (1000).

Shin-Etsu Polymer America, 34135 7th St, Union City, CA 94587. Phone (415) 475-9000. FAX (415) 475-0613. **Circle No. 361**

Optical Encoder

- Housed in a 2-in.-diameter package
- Has a fully sealed design

The H20 rugged industrial optical encoder is housed in a 2-in.-diameter package. It features an 80-lb load bearing, and an aluminum housing that is fully sealed against oil and water splash. An unbreakable code disk provides as many as

600 cycles/turn (2400 counts/turn) on two quadrature channels. Zero index is also available. The unit operates from a supply of 5 to 24V and employs a single LED source. Hollow- and through-shaft versions are also available. Additional options include tethered mounting arrangements, sealed cable or environmental connectors, and a variety of mounting configurations. \$100 (OEM qty).

BEI Motion Systems Co, Industrial Encoder Div, 7230 Hollister Ave, Goleta, CA 93117. Phone (800) 350-2727; in CA, (805) 968-0782. FAX (805) 968-3154.

Circle No. 362

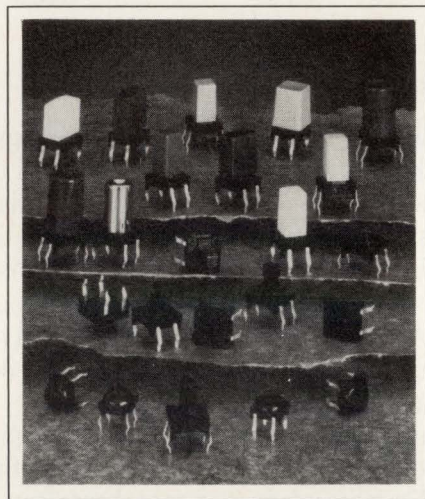

Miniature Keyswitches

- Designed for logic-level switching applications
- Measure only 7 mm square

CDS710 and CDS720 Series miniature keyswitches measure only 9 and 7 mm square, respectively. Both lines are designed for analog or digital logic-level switching and are TTL and MOS compatible. The snap-dome construction provides a positive tactile feedback and an audible response. The switches will handle loads of 1 to 20V dc. Terminations on the 710 are designed for pc-board mounting on a 0.1-in. grid.

Switch housing material is polycarbonate, and the contact/dome spring is made of silver-plated phosphor bronze. Terminals are brass plated to enhance solderability. All units meet IEC 68, UL 94V-0, UN-D 1119, and UN-L 1152 test standards. CDS710, \$0.219; CDS720, \$0.145 (10,000).

CRL Components Inc, Highway 20 West, Fort Dodge, IA 50501. Phone (515) 573-1300. FAX (515) 573-1342. **Circle No. 363**

DC/DC Converters

- Feature a wide input range
- Develop a 30W output

SIW dc/dc converters accept inputs of 9 to 36V and 20 to 72V and develop single, dual, or triple outputs of 5 to 48V in 15 or 30W versions. Standard converter features include an LC-network input filter, 6-sided shielding, overtemperature shutdown, protection against input voltage surges, short-circuit protection via current limiting, and intrinsic reverse-polarity protection. Typical converter efficiency measures 85%. The units are housed in a 3×2.56×0.84-in. case which features an industry-standard pinout configuration. \$100 (25).

Wall Industries Inc, 5 Watson Brook Rd, Exeter, NH 03833. Phone (800) 321-9255; in NH, (603) 778-2300. **Circle No. 364**

VME Chassis

- Can accommodate two drives
- Comes with a power supply

The VCV-11/Model 38 chassis includes a 3-slot card cage, which accommodates 6U×160 VME cards, a J1 backplane, and mounting and power wiring for two half-height drives. If the application requires it, a J2 backplane is available. The chassis features a function-control panel, which includes Reset and

Flawless.

The jeweler's equivalent of zero defects. And the prime attribute of value, no matter what your product is. Only Micro Power Systems assures you of this exceptional level of DAC product quality and reliability.

And only Micro Power ensures the result.

A new enhancement to our proprietary thin-film resistor process and in-house laser trimming for CMOS and BiCMOS enable us to extend DAC accuracy from 12- to a leading edge 16-bits. In addition, we provide 100% burn-in for 96 hours at 125°C on all thin-film products at no charge, and offer a one year warranty.

The result is a more stable, more reliable device. And lower manufacturing costs for you because there is less rework, no infant mortality and far fewer administrative headaches.

We were going to include a graph of accuracy drift over a 1000 hour burn-in period. But a straight line at zero is boring—so we dropped it from this ad. Call us if you'd like a copy.

So remember—while our larger competitors are going through the painful process of “merge and purge,” not knowing what their final

product offering will be, we make it easy for you by supplying pin-for-pin and enhanced second-source versions of their devices, and of course our own high performance D/A and A/D products. We also have friendly, helpful applications engineers.

Call 408/562-3660 for your free DAC Pack or Flash Pack including quality and reliability reports, short form catalog and data sheets. Or FAX us at 408/562-3605.

Anything this perfect usually requires insurance.



DACs		
8-bit	MP7523, MP7528, MP7628	MP7524 MP7529A/B
10-bit	MP7520, MP7530, MP7633	MP7522 MP7533
12-bit	MP1208-1210 MP7541/A MP7543, MP7622, MP7645,	MP1230-1232 MP7542 MP7542G MP7545/A MP7623 MP7680/A
14-bit	MP7614	
16-bit	MP7616,	MP7626/36A
A/Ds		
6-bit	MP7682,	MP7686
8-bit	MP0820, MP7683, MP7690/A,	MP7574 MP7684/A MP7693
10-bit	MP7695	
12-bit	MP574A	



Micro Power Systems

3100 Alfred St., Santa Clara, CA 95054

© 1990 Micro Power Systems

NEW!

LOW DROPOUT REGULATORS

NEW!

TK114xx

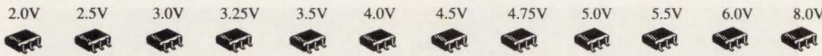

- 200 mW Power Rating
- Super Small SOT23L Package
- ON/OFF Switch
- Internal Protection Features

TK115xx



- 600 mW Power Rating
- Low Noise
- Internal Protection Features
- ON/OFF Switch
- Active HIGH and Active LOW Control
- External Boost Transistor Connectable

TK116xx

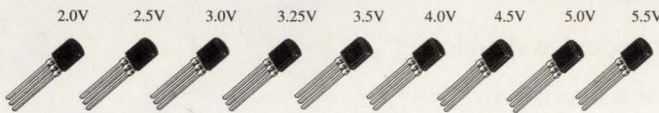

- 500 mW Power Rating
- Internal Protection Features

Call Your TOKO Representative For Data Sheets and Additional Information

TOKO AMERICA, INC.
1250 Feehanville Drive
Mount Prospect, IL 60056



MIDWEST: (708) 297-0070
EAST: (203) 748-6871
SOUTHEAST: (205) 772-8904
WEST: (408) 432-8281

CIRCLE NO. 32

It takes a huge setup to test ISDN terminal equipment...

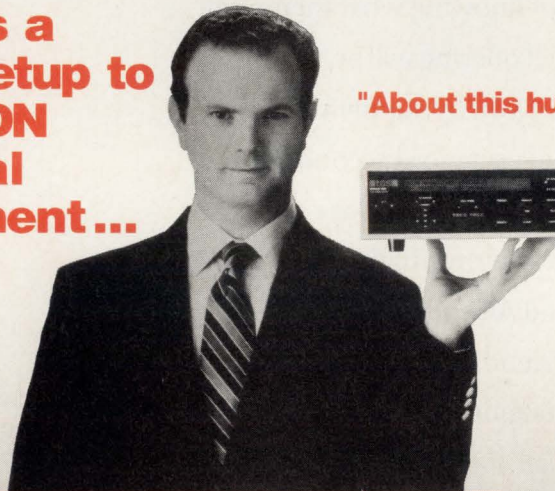

"About this huge."

TAS Apollo 802 ISDN Emulator puts an ISDN network in the palm of your hand.

- Drastically reduces the cost and complexity of ISDN terminal equipment test setups
- More economical and more thorough than testing with "real" ISDN lines
- Tests analog and digital functions of ISDN terminal equipment
- Saves you money by interfacing your non-ISDN test equipment (scopes, signal generators, data analyzers) to your ISDN terminal equipment
- Makes ISDN training and demonstrations a snap!



Apollo 802:
Huge Capability in a Small Package

Telecom Analysis Systems, Inc.

34 Industrial Way East, Eatontown, NJ 07724-9917 • Phone (908) 544-8700 • FAX (908) 544-8347

CIRCLE NO. 33

COMPONENTS & POWER SUPPLIES

Abort switches and Sysfail and DC-ok indicators. The unit comes with a 300W power supply and two fans that have 75-cfm moving capabilities. Airflow is side to side through the card cage. The chassis is designed for mounting in a 19-in. RETMA rack, but a decorative cover is available for desk-top applications. \$1000. Delivery, four to six weeks ARO.

Zoltech Corp, 7023 Valjean Ave, Van Nuys, CA 91406. Phone (818) 780-1800. FAX (818) 780-1978.

Circle No. 365

Motor Control

- Handles 10-hp motors
- Regulates speed within $\pm 2\%$

The 2745-10 controls the speed and direction of dc motors as large as 10 hp. The units have an isolated μ P/TTL-compatible (10-bit parallel input) speed input or an isolated analog voltage (± 5 V) speed input. The control features 1500V dc isolation between signal inputs and motor/power line outputs. A failsafe circuit brings the motor to a full stop if the control signal is not present, preventing unsafe or uncontrolled operation. The unit regulates motor speed within $\pm 2\%$ against line and load variations. All controls are set at the factory for use with 180V dc motors. The unit is packaged on an open-frame heat-sink bracket. Built-in forced-air cooling fans are included. Plug-in boards for acceleration and deceleration control, encoder feedback, and electronic braking are available. \$574 (100). Delivery, stock to 10 weeks ARO.

Powr-Ups Corp, 1 Roned Rd, Shirley, NY 11967. Phone (516) 345-5700. FAX (516) 345-3106.

Circle No. 366

ATTENTION!

p-cad
PERSONAL CAD SYSTEMS INC.

PADS-PCB™
CADSTAR

AUTOCAD®

**THE
CAD
T.E.A.M.**

**NORTH AMERICA'S #1
"SUPERVAR"**

FREE DEMO DISKS

The CAD T.E.A.M. is a three-phase company:

- DESIGN SERVICE BUREAU
 - CAD SOFTWARE/HARDWARE DISTRIBUTION
 - CAD TRAINING CENTRE

We offer both the services/software and training you require to get the job done! Fast!

**WE USE WHAT WE SELL,
AND WE SELL WHAT WE USE.**

Project Management
**VIEWPOINT
TELEMAGIC**

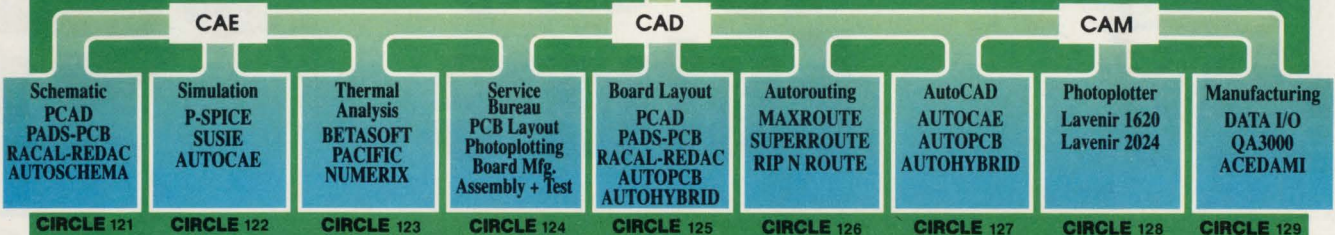

CIRCLE 121

CIRCLE 122

CIRCLE 123

CIRCLE 124

CIRCLE 125

CIRCLE 126

CIRCLE 127

CIRCLE 128

CIRCLE 129

**PROJECT MGMT
VIEWPOINT**



**CAD Systems for
Project
Management**

- No limits • Windows 3.0
- Mouse-operated

* Free Demo Disks

CIRCLE 130

TRAINING

Complete training courses from our CAD CLUB

- ViewPoint • PCAD
 - AutoCAD • PADS PCB
 - Simulation
 - Autorouting
- Call for next class

CIRCLE 131

HARDWARE

- 386/486 CAD Workstations
- Sun Workstations
- H.P. Pen Plotters
- Electrostatic Plotters
- LAN's • Printers/Mouse
- Laptop CADStations

CIRCLE 132

**SIMULATION
PSPICE**

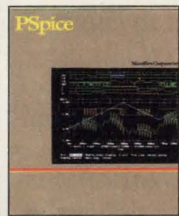

**Analog and Mix
Mode Simulator
from \$995.00 US**

- Breadboard on screen
- Save months in design
- Reduce number of revs
- Save money
- Greater product reliability

* Free Demo Disks

CIRCLE 133

SUSIE

**The industry
standard digital
simulator**

- From \$995 US
- Support for all PC CAE vendors schematic capture

* Free Demo Disks

CIRCLE 134

PADS

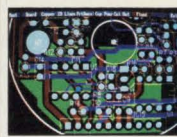

PADS-LOGIC

- 3rd generation schematic
- Multisheet database
- Unmatched group functions
- Interfaces to all CAD systems
- \$450 US

PADS-PCB

- World's most popular low cost ECAD system
- Completely upgradable to 2000 from \$995 US
- SuperRoute option

CIRCLE 135

PADS-2000

- 3rd generation PCB layout
- Full 32 bit system
- Virtual memory
- No limits
- On the fly design
- T-Routing
- Over 2000 IC capability
- Push n' shove
- \$6,995 US

* Free Demo Disks

CIRCLE 136

SERVICE



**SPECIAL
FROM
99¢ A PIN
FROM
\$13 A FILM**

**We can design
your board and
return it in any
CAD system format!**

- SMT and analog specialists
- Concept Engineering
- Schematic Capture
- Simulation
- Board Layout
- Autorouting
- Photoplotting/MIVA25
- PCB Manufacture
- Assembly and Test
- CAD Translations: to Mentor to PCAD to PADS-PCB to Racal Redac

CIRCLE 137

**ASK US ABOUT
THE CAD CLUB
for exclusive
Savings on both
services &
software**

CIRCLE 138

MAXROUTE

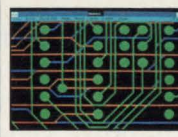

**If you're using...
RACAL-REDAC, P-CAD,
PADS-PCB ...you owe it
to yourself to see the
MAXROUTE Autorouting
tool in action!
FREE BENCHMARKS!**

- UNIX and DOS
- Push/Shove/Rip up
- Use in conjunction with your present CAD

* Free Demo Disks

CIRCLE 139

PCGERBER

**If you work with Gerber
data, you need:**

PCGERBER - View and edit your Gerber files before you photoplot...\$995 US

GPlot - PenPlot & Print Gerber files...\$595 US

CIRCLE 140

ECAM

ECAM for only \$2,995 US yet provides PCB CAM features found in products retailing between \$7,000 and \$30,000 US.

* Free Demo Disks

CIRCLE 141

**AUTOCAD®
for Electronic Engineers
AUTOCAE**

- Schematic capture
- Analog/Digital
- PSpice/Susie simulation

CIRCLE 142

AUTOPCB

- PCB design
- SMT support
- Push & Shove Routing
- Real-Time DRC
- Bill of material

CIRCLE 143

AUTOHYBRID

- Hybrid circuit design
- World's only PC solution
- Component synthesis
- Auto die geometry
- Definable substrate pads
- Automatic ink list

* Free Demo Disks

CIRCLE 144

FABMASTER

**Putting CAD data on the
factory floor**

- Input any CAD data
- Output any manufacturing data
- Board tester
- Auto insertion
- Drilling profile

* Free Demo Disks

CIRCLE 145

THE CAD T.E.A.M.

BOSTON • NEW YORK • TORONTO • ORLANDO • VANCOUVER • SAN FRANCISCO • L.A.

1-800-668-0726

US HEAD OFFICE: 1313 Main Street, Niagara Falls, NY 14301

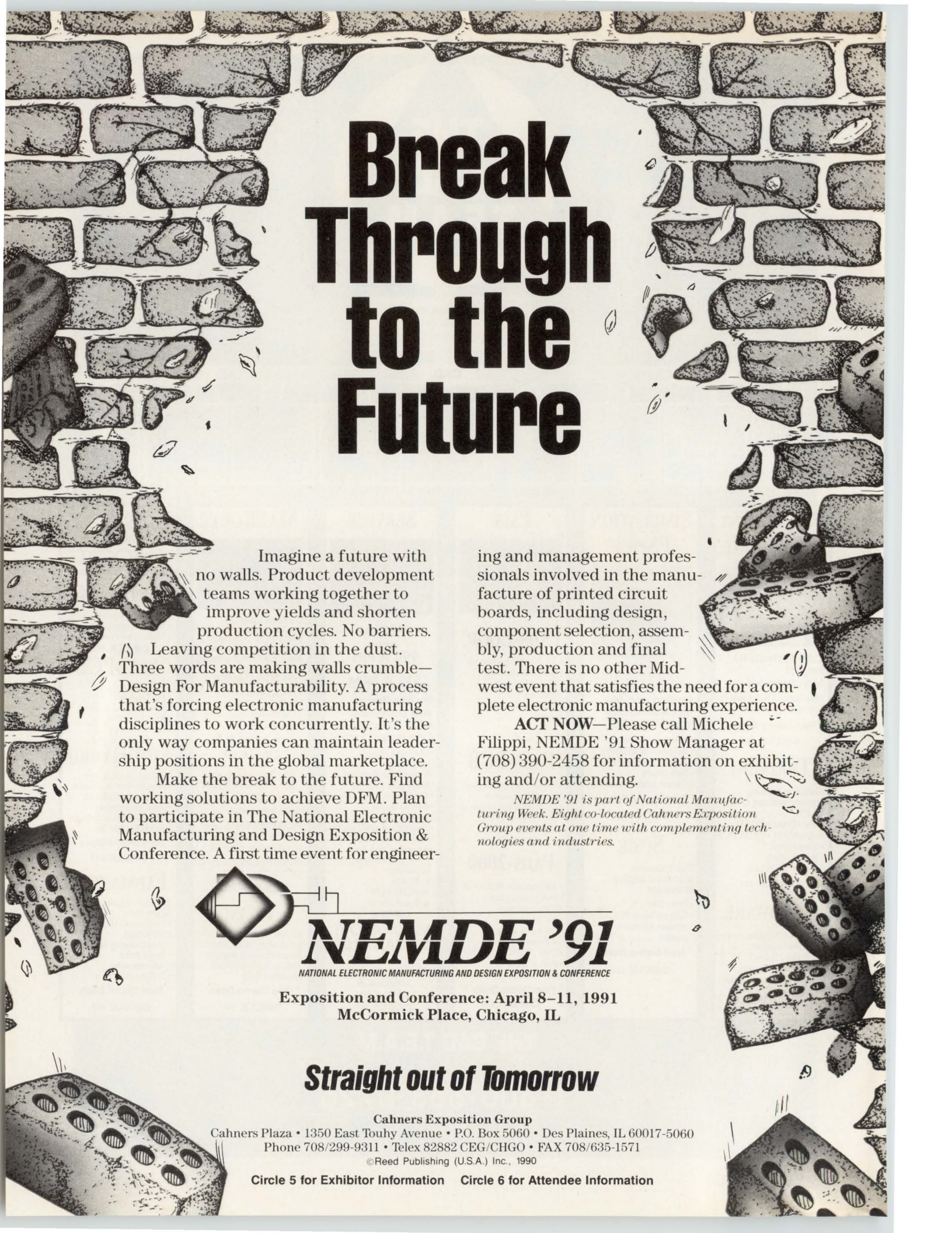

Break Through to the Future

Imagine a future with no walls. Product development teams working together to improve yields and shorten production cycles. No barriers.

Leaving competition in the dust. Three words are making walls crumble—Design For Manufacturability. A process that's forcing electronic manufacturing disciplines to work concurrently. It's the only way companies can maintain leadership positions in the global marketplace.

Make the break to the future. Find working solutions to achieve DFM. Plan to participate in The National Electronic Manufacturing and Design Exposition & Conference. A first time event for engineer-

ing and management professionals involved in the manufacture of printed circuit boards, including design, component selection, assembly, production and final test. There is no other Midwest event that satisfies the need for a complete electronic manufacturing experience.

ACT NOW—Please call Michele Filippi, NEMDE '91 Show Manager at (708) 390-2458 for information on exhibiting and/or attending.

NEMDE '91 is part of National Manufacturing Week. Eight co-located Cahners Exposition Group events at one time with complementing technologies and industries.

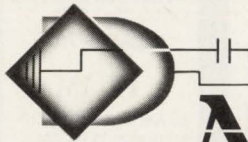

NEMDE '91

NATIONAL ELECTRONIC MANUFACTURING AND DESIGN EXPOSITION & CONFERENCE

Exposition and Conference: April 8–11, 1991
McCormick Place, Chicago, IL

Straight out of Tomorrow

Cahners Exposition Group

Cahners Plaza • 1350 East Touhy Avenue • P.O. Box 5060 • Des Plaines, IL 60017-5060
Phone 708/299-9311 • Telex 82882 CEG/CHGO • FAX 708/635-1571

©Reed Publishing (U.S.A.) Inc., 1990

Circle 5 for Exhibitor Information Circle 6 for Attendee Information

SIEMENS

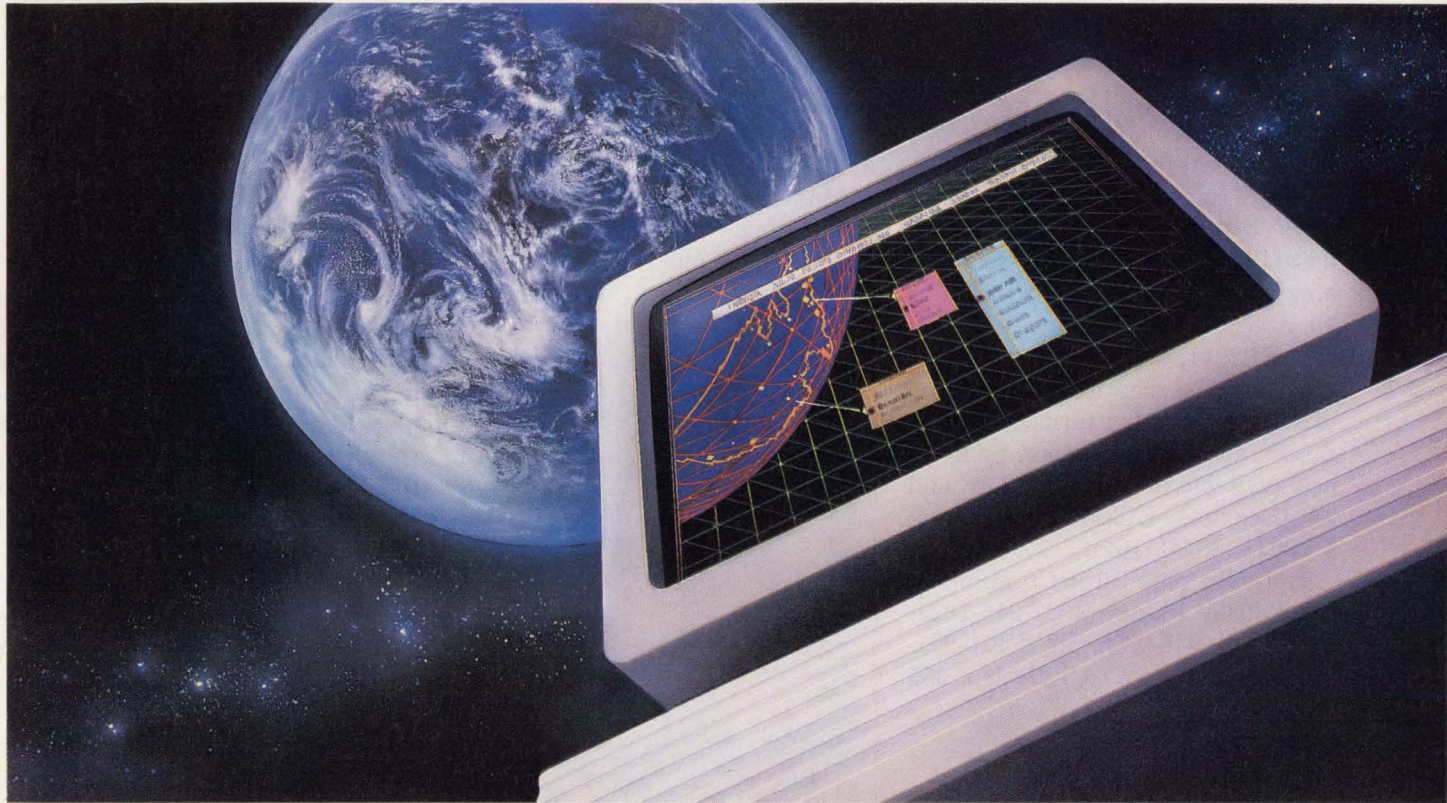

Universal Intelligence.

Siemens is a worldwide supplier of systems solutions for the workstation and embedded control markets.

Siemens is continuing to demonstrate the innovation which has made us the universal choice in advanced IC technology.

Siemens offers industry-standard MIPS 32-bit RISC microprocessors, which are ideal for workstations, file servers and multiprocessor systems, as well as high-performance embedded applications. Of the five certified CMOS MIPS semiconductor suppliers, we're the sole European source, to offer you solutions worldwide.

We're also the only European DRAM

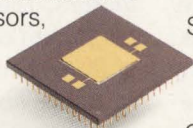

High-performance RISC 32-bit microprocessors.



Reliable 1-Mb and 4-Mb DRAMs.

manufacturer, providing high-quality 1-Mb and 4-Mb DRAMs. In fact, we're one of the world's leading suppliers, with DRAMs available worldwide, in volumes which have doubled since 1989. And we are continuing to advance this technology with our 16-Mb and 64-Mb DRAM programs.

Siemens CMOS ASIC technology features both Sea-of-Gates and standard-cell product families. Our 1.5, 1.0 and sub-micron technologies are compatible with Toshiba even at the GDS2 database level, for true alternate sourcing worldwide. And they come with European content and U.S. design support, as well as



ASIC solutions in both Sea-of-Gates and standard-cell.

the best service in the industry.

Plus, we offer the most comprehensive communication IC family in the world, to support the networking requirements of high-performance workstations.

If you're manufacturing or marketing worldwide, find out what makes our embedded control and workstation systems solutions the universal favorites.

For details, call **(800) 456-9229**, or write:

Siemens Components, Inc.
2191 Laurelwood Road
Santa Clara, CA 95054-1514

Ask for literature package M20A 001.

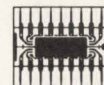

**Siemens
World Wise, Market Smart.**

NEW PRODUCTS

INTEGRATED CIRCUITS

Current-Feedback Op Amp

- Has 150-MHz bandwidth
- Operates from $\pm 5V$ supply

The EL2171 current-feedback op amp provides a bandwidth of 150 MHz at a gain of 20. The device, which is stable at gains beyond ± 7 , has a typical phase deviation of 0.2° at 50 MHz. Current drain with a $\pm 5V$ supply is only 15 mA. Rise and fall times are 2.5 nsec for a 2V step, and settling time to 0.1% is 10 nsec. The company also offers the EL2071, which is identical to the EL2171 except for the addition of a disable pin that turns the amplifier on and off in 200 nsec. Samples are available now in 8-pin DIP and SO packages. EL2171, from \$8.45; EL2071, \$8.70 (100).

Elantec, 1996 Tarob Ct, Milpitas, CA 95035. Phone (408) 945-1323. FAX (408) 945-9305. TWX 910-997-0649. **Circle No. 355**

Micropower Op Amp

- Operates at 1.2 μA
- Offset voltage is 0.5 mV

Designed for low-voltage, battery-powered applications, the MAX406 op amp needs only 1.2 μA max of supply current. The amplifier operates from a single supply of 2.4 to 10V or from dual supplies of ± 1.2 to $\pm 5V$. The ultralow quiescent current extends the operating life of a battery to its shelf life. When powered from a 9V battery, the op amp's output can source 2 mA. The output voltage swings rail-to-rail while the input-voltage range extends down to the negative supply rail. An input bias current of 0.1 pA typ and an input offset voltage of 0.5 mV max minimize errors when amplifying low-level signals. Two pin-selectable operating modes optimize stability and speed for a range of designs. In the unity-gain mode, which is optimized for stability, the gain-bandwidth product is

typically 8 kHz, and slew rate is 5V/msec. In the high-speed mode, the gain-bandwidth product is typically 40 kHz, and slew rate is 20V/msec with the device remaining stable at gains of two or more. The MAX406 is available in 8-pin DIP and SO packages. From \$3 (1000).

Maxim Integrated Products, 120 San Gabriel Dr, Sunnyvale, CA 94086. Phone (408) 737-7600. **Circle No. 356**



BiCMOS Logic Family

- Can drive heavily loaded buses
- Can source 15 mA, sink 64 mA

When fully released, the 54/74BCT family of BiCMOS logic devices will include more than 60 logic functions. The first two are the 74BCT240, an inverting octal buffer/line driver with 3-state outputs, and the 74BCT2240 octal buffer/line driver with a 25Ω series output termination. With a source/sink-current capability of 15/64-mA, all BCT devices can drive heavily loaded capacitive buses. The devices have a typical propagation delay of 2.5 nsec. In the case of multiple output drivers, the devices also feature a guaranteed skew of less than 1.5 nsec between drivers. The logic devices are available in plastic DIP and SOIC packages. The

74BCT240, \$1.50; the 74BCT2240, \$1.92 (100).

National Semiconductor, Box 58090, Santa Clara, CA 95052. Phone (207) 775-8868.

Circle No. 357

4M-Bit EPROM In PLCC Package

- Organized 256k \times 16 bits
- Access times are 150 or 200 nsec

Organized as 256k \times 16 bits, the 27C240 4M-bit EPROM is available in both 40-pin ceramic DIPs and 44-pin PLCCs (plastic leaded chip carriers). According to the company, the PLCC version has the smallest footprint of any 4M-bit EPROM currently available. The chip's 16-bit width makes it useful in 16- and 32-bit systems. Key specifications include access times of 150 nsec or 200 nsec, and a standby current drain of 100 μA . The EPROM accommodates a minimum of 50 programming cycles and provides 10 years of data retention. 150-nsec version in a PLCC package, \$62.75; in a ceramic DIP, \$67 (100).

Philips Components-Signetics, Box 3409, Sunnyvale, CA 94088. Phone (408) 991-2000.

Circle No. 358



Smart-Power, 3-Phase High-Voltage Bridge

- Rated at 600V and 30A
- Can operate from a 270V bus

Designed for driving high-power motors, the PWR-82333 features a maximum continuous current rating of 30A. The smart-power hybrid IC contains six insulated-gate bipolar transistors (IGBTs) and six antiparallel fast-recovery diodes connected in a 3-phase bridge arrangement. Each IGBT is driven from an internal level translator, which has programmable logic inputs of 0 to 5V and 0 to 15V. Internal protection



NO OTHER LITHIUM BATTERY MANUFACTURER POWERS AS MANY DIFFERENT PRODUCTS AS EAGLE-PICHER. PERIOD.



Get The Fax!

Fill Out This Card And Fax It To (417) 776-2257

EDN031491

Name _____ Job Title _____

Company _____ Phone _____

Address _____

Have A Rep Call Send Me Information Commercial Military Both



EAGLE PICHER

Electronics Division (Lithium Batteries)

Military: P.O. Box 47 • Joplin, MO 64802 • (417) 623-8000 • Commercial: P.O. Box 130 • Seneca, MO 64865 • (417) 776-2256

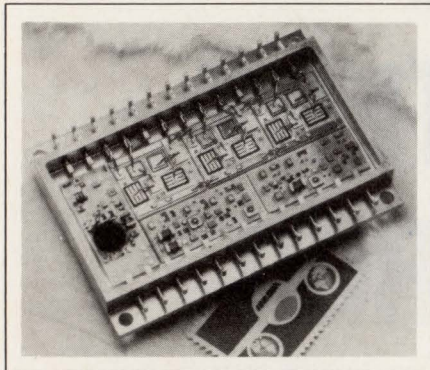

circuitry prevents in-line transistors from simultaneous conduction. An external shut-down input provides fast turn-off of the output drive stage. Digital input circuits provide compatibility for all types of motor controllers. The hybrid also has a constant-voltage drive stage, which provides uninterrupted performance even in a stalled-motor situation. Housed in a 3.0×2.1×0.39-in. copper package, the PWR-8233 offers a low

thermal resistance of 0.85°C/W. Unit pricing, from \$1250. Delivery, stock to 12 weeks ARO.

ILC Data Device Corp, 105 Wilbur Pl, Bohemia, NY 11716. Phone (516) 567-5600, ext 420. FAX (516) 567-7358. **Circle No. 359**

T1/E1 Transceivers

- Operate at low power
- Provide jitter attenuation

The LXT304A and LXT305A are T1/E1 PCM baseband transceivers for use in the design of T1/E1 multiplexers, SONET equipment, and PCM channel banks. The transceivers' low power requirement of 400 mW permits higher densities in applications with fixed power budgets, such as remote switching units. The LXT304A, which provides jitter attenuation on the receiver side, offers diagnostic features including transmit/receive signal monitoring.



Transmit pulse shapes are programmable for various line lengths and cable types. The LXT305A is a similar device, except that it provides jitter attenuation on the transmit side. The devices, which work over a temperature range of -40 to 85°C, are available in 28-pin DIP and 28-pin PLCC (plastic leaded chip carrier) packages. From \$15.75 (1000).

Level One Communications, 105 Lake Forest Way, Folsom, CA 95630. Phone (916) 985-3670.

Circle No. 360

LAMB®
DC Motors add speed control and reliability to pumps

These 12-24 VDC brushless motors give you controllability for smart pumping applications. Either 2.0" or 3.2" diameters, with stall torque to 84 oz-in, puts high power in a compact package. And, no brushes to wear means more reliable operation. AMETEK, Lamb Electric Division, 627 Lake Street, Kent, OH 44240. Tel: 216-673-3451. Fax: 216-673-8994. In Europe, Friedrichstrasse 24, 6200 Wiesbaden, Germany. Tel: 611-370031. Fax: 611-370033.

AMETEK
 LAMB ELECTRIC DIVISION

CIRCLE NO. 34

Be An Author!

When you write for EDN, you earn professional recognition. And you earn \$75 per published magazine page.

EDN publishes how-to design application information that is read by more than 137,300 electronics engineers and engineering managers worldwide. That's an audience that could belong to you.

If you have an appropriate article idea, send your proposal and outline to: EDN, 275 Washington Street, Newton, MA 02458-1630.

For a FREE EDN Writer's Guide—which includes tips on how to write for EDN and other technical publications—please circle number 800 on the Information Retrieval Service Card.

EDN
 First in Readership among Design Engineers and Engineering Managers in Electronics.

CIRCLE NO. 35

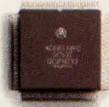

68332
Available
Mar. 1990



HP emulator
available
Dec. 1989

*(Got a little ahead
of ourselves.)*



68331
Available
Sept. 1990



HP emulator
available
Nov. 1990



68302
Available
Oct. 1989



HP emulator
available
Aug. 1990

*(We didn't start until
Feb. 1990, but we finished
it in 6 months.)*



68040
Available
Q4 1990



HP emulator
available
Q1 1991

Coincidence? We don't think so.

Nobody supports the Motorola line of microprocessors better than the Hewlett-Packard 64700 Series of emulators.

You see, HP has agreements with key chip manufacturers. Like Motorola. So while they're working on the next hottest chip design, we're simultaneously developing an emulator.

Our relationship with Motorola has allowed us to provide emulators this quickly for the new 68302, 68331 and 68332 processors.

As well as for the upcoming 68040. And, of course, we've always had broad support for the 68000, 68010, 68020 and 68030.

HP emulators also provide a complete solution. Logic and performance analysis tools and code coverage are all in the same box. They come with C cross compilers, simulators/debuggers and branch validators.

Even better, HP emulators work in real time without halting your target system. Which means you'll ensure a thorough analysis

of your design by executing it at full speed. Not by second-guessing.

All of this is accompanied by HP's renowned service and support. So call **1-800-752-0900, Ext. 1904** for a free demo disk or videotape. They'll demonstrate all the benefits of using an HP emulator. And by the way, if we answer your call quickly, it's no coincidence.



**HEWLETT
PACKARD**

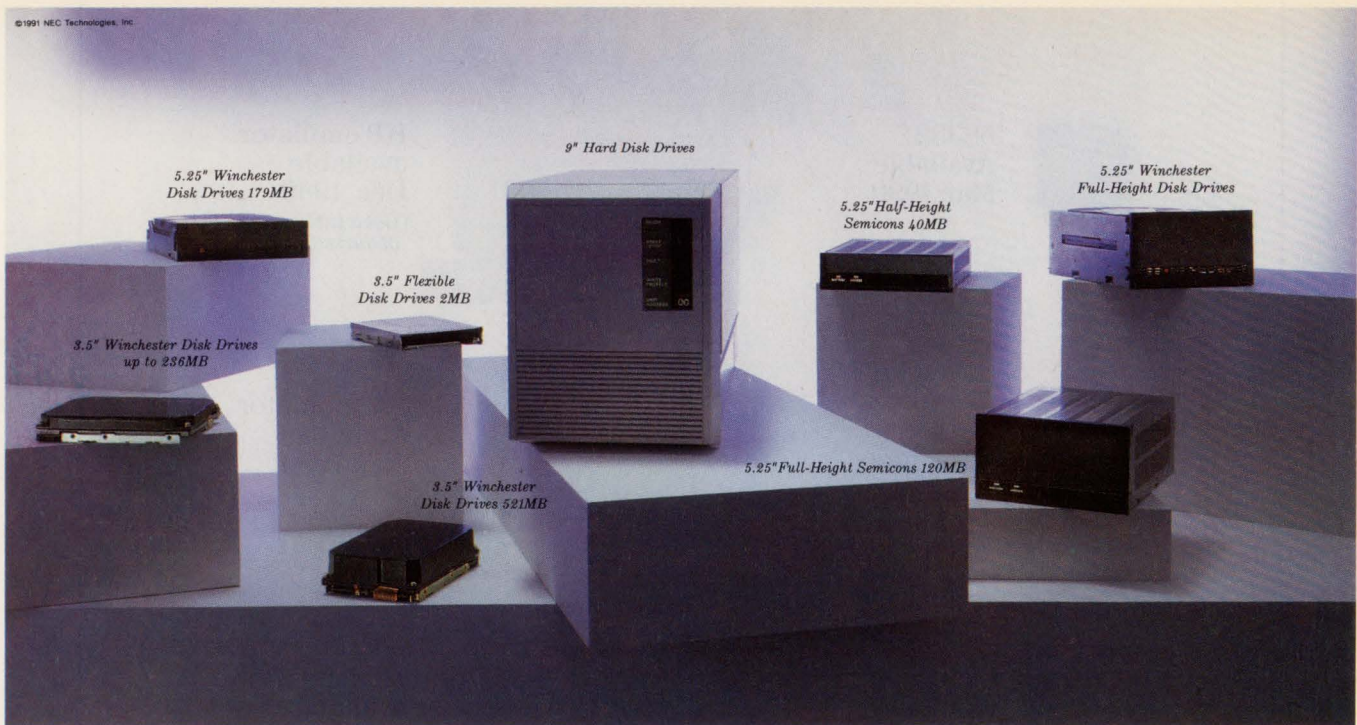

5.25" Winchester
Disk Drives 179MB

3.5" Flexible
Disk Drives 2MB

9" Hard Disk Drives

5.25" Half-Height
Semicons 40MB

5.25" Winchester
Full-Height Disk Drives

3.5" Winchester Disk Drives
up to 236MB

3.5" Winchester
Disk Drives 521MB

5.25" Full-Height Semicons 120MB

For a complete line of disk drives with the most advanced technical features, just look for the NEC logo. For more information call 1-800-NEC-INFO.

The full line.

The bottom line.

EDN PRODUCT MART

This advertising is for new and current products.

Please circle Reader Service number
for additional information from manufacturers.

Interactive/Real-Time

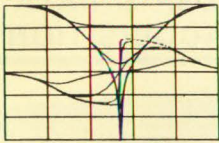

Analog Circuit Simulation

ECA-2 Electronic Circuit Analysis offers: • AC, DC, Transient, Fourier, and Temperature Analysis with Nominal, MonteCarlo and/or Worst-Case component values • Interactive or batch modes • Full nonlinear simulation • Sine, Pulse, PWL, SFFM, and Exponential generators • IBM PC/Mac • Multiple plots • On-line real time graphics - 2 to 50 times faster than SPICE • Over 500 nodes • Advanced component parameters • Component optimization sweeping • Full editing, built-in or external • New detailed 424 page manual

Call for **FREE DEMO!**



Tatum Labs, Inc.

3917 Research Park Dr. B-1, Ann Arbor, MI 48108
313-663-8810

CIRCLE NO. 325

☆☆☆☆
"The Best 8051 Emulator"

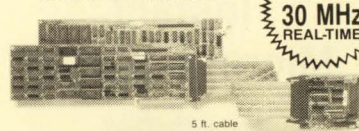

NEW
30 MHz
REAL-TIME

8051

SEE EEM 90/91
Pages D 1320-1323

PC based emulators for the 8051 family

8031, 8032, 8051, 8052, 80C152/154/321451/452/51FA/51GB/51S/517/535/537/552/562/652/851, 80532, 83C451/552/652/751/752/851, 8344, 87C451/552/751/752, 8751, 8752, DS5000 • CMOS ... more.

- PC plug-in boards or RS-232 box.
- Up to 30 MHz real-time emulation.
- Full Source-level Debugger w/complete C-variable support.
- 48 bit wide, 16K deep trace, with "source line trace."
- "Bond-out" pods for 8051, 83C552, 83C451, 83C652, 83C751, 80C515/80C517, 83C752.

Prices: 32K Emulator 8031 \$1790; 4K Trace \$1495*

CALL OR WRITE FOR FREE DEMO DISK!

Ask about our demo VIDEO

NOHAU
CORPORATION

51 E. Campbell Avenue
Campbell, CA 95008
FAX (408) 378-7869
(408) 866-1820

*US only

CIRCLE NO. 326

PLD Design Software

Get Started with CUPL™ for only
\$149.95

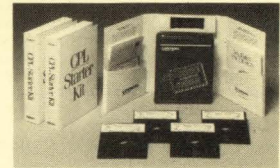

Now you can have a PLD Starter Kit that gives you all the horsepower that the CUPL PLD compiler offers, at a fraction of the cost. For more information, call 1-800-331-7766 or 305-974-0967.

LOGICAL
DEVICES, INC.

CIRCLE NO. 327

X.25 SDLC
QLLC HDLC
ADCCP PAD

- C source code
- ROM-able
- Full porting provided
- No OS required



GCOM, Inc.
1776 E. Washington
Urbana, IL 61801
(217) 337-4471

Specialists in Computer Communications
FAX 217-337-4470

CIRCLE NO. 328

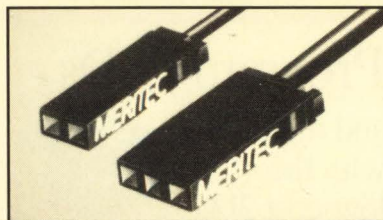

Single Signal Interconnects That Terminate High Cost

Meritec's economical 1x2 and 1x3 Single Signal Interconnects (SSI™) are engineered to match your requirements for controlled impedance and propagation rate while minimizing crosstalk. A spring latch connects the termination to the housing or to Meritec's Single Signal Carrier Systems (SSC™), which allow grouped interfacing with single, dual or triple row headers. Tel: 216-354-3148, Fax: 216-354-0509.

Meritec

CIRCLE NO. 329

Analog Circuit Simulation

SPICE FOR THE PC (XT, AT, 386, 486)

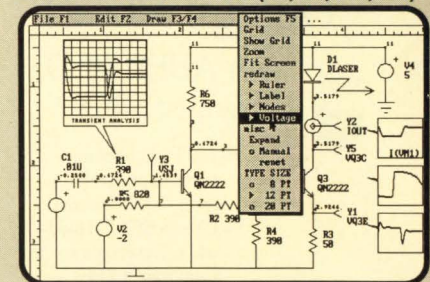

From Schematic Entry, through SPICE Simulation, to Graphical Post Processing, only \$790

- ISPACE - Full Featured SPICE Circuit Simulation
- SPICENET - Graphical Schematic entry for SPICE
- INTUSCOPE - Waveform Display and Plotting
- PRESPACE - Model Libraries, Monte Carlo analysis
- SPICEMOD - SPICE Model generation from data sheets

intusoft

P.O. Box 710 San Pedro, CA 90733-0710
Tele (213) 833-0710
FAX (213) 833-9658

CIRCLE NO. 330

To advertise in Product Mart, call Joanne Dorian, 212/463-6415

ROM Turbo or Microsoft-C

C thru ROM is the complete full-featured ROM development kit you need to ROM your application. C thru ROM contains a CodeView-like remote debugger and the Turbo Debugger interface for debugging on your target system. It also contains a powerful 80x86 locator, startup code, and a ROMable library in source.

Call 1 (800) 221-6630 Today, and get full details on C thru ROM or ROM-DOS for embedded system.

Datalight

17455 - 68th Avenue N. E. Suite # 304
Bothell, WA 98011 USA
Phone (206) 486-8086 FAX: (206) 486-0253

CIRCLE NO. 331

DEVICE INTERCONNECT

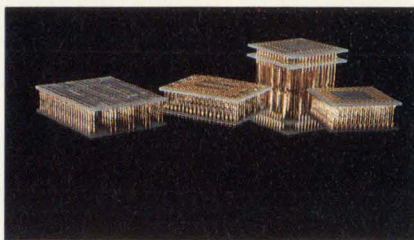

SOLUTIONS

IRONWOOD Electronics offers a comprehensive line of devices for your interconnect needs. We have hundreds of prototyping adaptors and sockets for PGA, QFP, PLCC, LCC, PGA, ZIP, and many more packages. Our line of clips for probing all different sizes of the different packages also number in the hundreds. We also do custom designs quickly and inexpensively including SMT components and tight spacing and supply the highest quality solutions. Call us for your interconnect needs.

IRONWOOD ELECTRONICS

P.O. BOX 21151, ST. PAUL, MN 55121
(612) 431-7025; FAX (612) 432-8616



CIRCLE NO. 332

At Last a Truly Industrial 386 AT System for the OEM

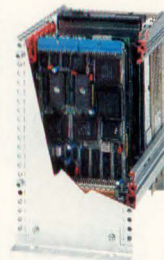

16 or 20 MHz 80386 SX CPU with 80387 Arithmetic Unit
1.2, 4 or 8 Mbytes of on-board RAM. Full support for LIM EMS and BIOS Shadowing
Onboard support for COM1, COM2, LPT, keyboard, clock, floppy and hard disk
Two boards make a complete 386 computer with your choice of EGA or VGA display
Extremely rugged 100 x 160 mm Eurocard construction, with pin-in socket bus connector
Fully expandable with over 200 G-64/G-96 bus I/O functions including: parallel and serial I/O, networking, MIL 15553, motion control and vision

For more information please call



USA
(800) 4-GESPAC or (602) 962-5559
EUROPE (FRANCE)
(33) 94-30-34-34
International (Switzerland)
(41-22) 794-3400

CIRCLE NO. 333

Control Cross-C

ANSI C Compiler for the HD64180/Z80

- ◆ DOS based cross-compiler for ANSI and K&R C code including prototypes and argument type checking.
- ◆ Complete with high-speed assembler, linker, and librarian. Includes macros to interface C and assembly.
- ◆ One-pass design produces FAST compile times.
- ◆ Full MMU support for up to 1 megabyte programs.
- ◆ ANSI preprocessor provided at compile time.
- ◆ Optimized code generation for char and int data types and operators. Also supports long types.
- ◆ Allows in-line assembly with access to C variables.
- ◆ All code is reentrant and ROMable.
- ◆ Fast ANSI/IEEE 754/INTEL floating point support.
- ◆ Z280 and 8085 compilers coming soon.

AVAILABLE FOR ONLY \$699!

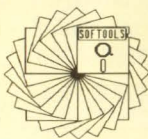

SOFTTOOLS, INC.

8770 Manahan Drive
Ellicott City, MD 21043
(301) 750-3733
FAX/BBS (301) 750-2008

CIRCLE NO. 334

Instant Microcontroller

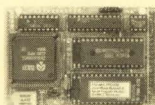

Instant C Programming

Don't use a microprocessor, use a **SmartBlock™** microcontroller module to build your custom controller. Our low cost Dynamic C™ makes programming a snap. 3.5 x 2.5 inch module includes microprocessor, memory, time/date clock, eeprom, watchdog, serial ports and more. As low as \$59. The efficiency of a custom design without the headaches.

Z-World Engineering

1340 E. Covell Blvd., Davis, CA 95616
Tel: (916) 753-3722

Fax: (916) 753-5141

CIRCLE NO. 335

DSP & DATA ACQUISITION

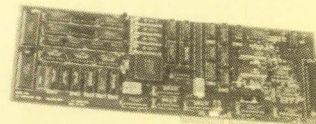

- 40 Mhz TMS320C25 DSP
- Up to 192 Kwords RAM
- 12 Bit 250 KHz, 8 Channel A/D & 2 Channel D/A
- Development Software
- FFT, Signal Display, Data Acquisition & Waveform Editor Software
- No Gap Sampling to Playback from Disk at Very High Rates
- Supports Multiboard & Standalone Operation
- Other DSP Products Available

DALANCO SPRY

89 Westland Avenue, Rochester, NY 14618

(716) 473-3610

CIRCLE NO. 336

Design PLDs

with ABEL-PLD,
now just \$495.*

FREE
ABEL-PLD
start-up
kit!

- 150 PLD architectures supported (over 4000 devices)
- Uses ABEL™ Hardware Description Language (ABEL-HDL™)
- Intelligent synthesis and optimization
- Upgradable to full-featured ABEL

Call for your
FREE
ABEL-PLD
start-up kit!

1-800-247-5700

*U.S. list price only.
Limited-time offer.

DATA I/O
Corporation

CIRCLE NO. 337

Program PLDs

and memories
with the
low-cost 212.

- Supports more than 450 CMOS devices
- Memory cards for easy updates
- Extensive editing capabilities
- Compatible with JEDEC standard programming files



Now
supports the
27C4001, 87C51
and
22CV10!

Call for
your FREE
212 15-day trial!

1-800-247-5700

DATA I/O
Corporation

CIRCLE NO. 338

Elegant, concise, fast & standardized FLOATING POINT libraries for embedded applications

Based on the IEEE 754 standard, FPAC (32 bit) and DPAC (64 bit) libraries are mature, well documented, and fully tested. The libraries are fully ROMable and include the following:

- Basic Operations
- Square Root
- Trigonometric
- ASCII Conversion
- Integer Conversion
- Logarithmic

U S Software supports most Intel, Motorola, Zilog and Hitachi micros, including 80X86, 80386, 680X0, 80960, 8051, 8096, 68HC11, Z80, 6809 and 6301.

For additional information, please contact:



U S SOFTWARE

United States Software Corporation
14215 NW Science Park Drive
Portland, Oregon 97229
800-356-7097
503-641-8446
503-644-2413 (FAX)

CIRCLE NO. 339

To advertise in Product Mart, call Joanne Dorian, 212/463-6415

DEVELOPERS' TOOLS

The Total Solution Programmer.
The best-selling Programmer since 1985
Appreciated by over 50,000 users worldwide

TUP-300
Universal Programmer
& Tester (PC based)
from \$ 595-

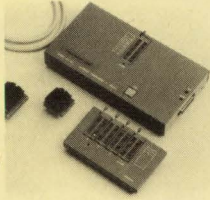

- 40 Pin ZIF socket can be expanded up to 68 Pin for 8 to 68 Pins DIP or PLCC chips.
 - Programs 20 to 68 Pin PLD (PAL, CPAL, IFL, GAL, PEEL, EPLD, EEPLD), EPROM (up to 16 Mbit), EEPROM, Serial PROM, Special PROM, Bipolar PROM & MPU (8741/42/48/49, 8051/51FA, FB, FC/52/1/41/252/751/752/652/451, 8796/97, 68705, Z86E11/21, TMS7742, TMS77C82, 8755A, ...)
 - Tests TTL (74/54), CMOS (40/45), SRAM, DRAM, SIP DRAM and SIM DRAM.
 - Full screen edit, HEX to OBJ, 2-way or 4-way Binary File Splitter and Shuffler, 6 MPU Dis-assemblers.
 - 34 various adapters (4 sockets, ROM-RAM, PLCC, ...) from \$95.
 - Other high quality programmer cards at low cost available from \$119 - UV Eraser (UV-32) for 32 pcs at \$95.
- Call us today for complete product line
- 1 year warranty, 30 days money back guarantee
 - 1 year free software updates and Customer Support

Sales
Rep
Wanted

TRIBAL MICROSYSTEMS
Tel: (415)623-8859 Fax: (415)623-9925
44388 S. Grimmer Blvd. Fremont CA 94538

CIRCLE NO. 340

DEVELOPERS' TOOLS

TPT-100 \$145.-
POCKET IC TESTER

- Tests TTL (74/54), CMOS (40/45) and DRAM
- 9V battery operated
- LCD display
- Search unknown IC

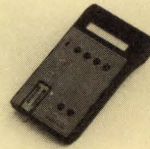

TRE-200 \$295.-
8/16 BIT
ROM/RAM EMULATOR
(PC based)

- 8 or 16 Bit
- ROM: 2764, 128, 256, 512
- RAM: 6264, 62256
- Fast download load
- Screen edit
- Dis-assembler for 6 MPUs

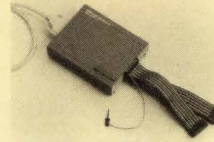

TLK-PLD PLD Learn Kit \$85.- TLK-GAL GAL Learn Kit \$85.-
TLK-PEEL PEEL Learn Kit \$85.- TLK-8051 8051 Learn Kit \$85.-

- Enable beginners to design their own PLD/PEEL/GAL/MPU within a short period of time.
- Design & Experiments manuals and Experiment PCB Kit

Call us today for complete product line
■ 1-year warranty 30 days money back guarantee

TRIBAL MICROSYSTEMS
Tel: (415)623-8859 Fax: (415)623-9925
44388 S. Grimmer Blvd. Fremont CA 94538

CIRCLE NO. 341

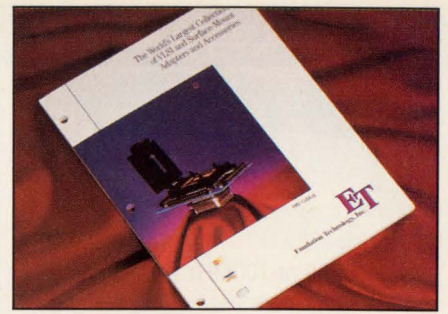

Free Catalog

The World's Largest Collection of Adapters & Accessories for VLSI/Surface Mount Devices

- Emulator Pods & Adapters
- Debug Tools
- Programming Adapters
- Socket Converters
- Debugging Accessories
- Prototyping Adapters
- Custom Engineering

Emulation Technology, Inc.
2344 Walsh Ave. Santa Clara, CA 95051
Phone: 408-982-0660 FAX: 408-982-0664



CIRCLE NO. 342

There is a Difference!
Lifetime Free Updates

CP-1128
\$1295

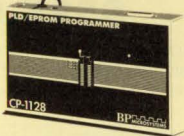

A programmer is not just another programmer. That is why BP Microsystems is committed to bringing our customers the highest quality programmers at an affordable price. This commitment is evident in our CP-1128 Combination PROM/EPROM/PLD Programmer supporting over 1800 devices up to 28-pins. Call today!

BP MICROSYSTEMS
1-800-225-2102
713/461-9430

CIRCLE NO. 343

48 Channel 25 MHz Logic Analyzer

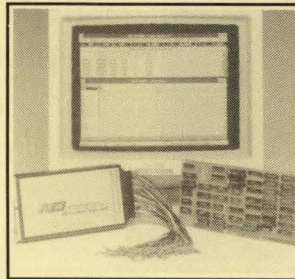

Complete System \$1695.00
New Windows 3.0 Compatible Software

- 48 Channels @ 25 MHz x 4K words deep
- 16 Trigger Words/16Level Trigger Sequence
- Storage and recall of traces/setup to disk
- Disassemblers available for: 68000, 8088, 8086, 6801, 6811, Z80, 8085, 6502, 6809, 6303, 8031

NCI 6438 UNIVERSITY DRIVE,
HUNTSVILLE, AL 35806
(205) 837-6667 FAX (205) 837-5221

CIRCLE NO. 344

PC BASED UNIVERSAL DEVICE PROGRAMMER \$695/895

- Programs EE/PROMs, PALs, GALs, EPLDs, MICROS, BIPOLARS, PEELs.
- Software driven pin drivers. D/A generated programming voltages (8 bit DACs used to generate voltages from 5-25V with 0.1V resolution for all 40 pins)
- Upgradeable for virtually any future programmable devices up to 40 pins.
- Self substituent operation. No additional modules or plug-in adapters required.
- Includes user friendly MEMORY BUFFER FULL SCREEN EDITOR. Commands include: Fill, Move, Insert, Delete, Search, ASCII or HEX entry.
- Friendly Menu-Driven interface. Device selection by P/N and manufacturer.
- Supports 8/16/32 bit data word formats.
- Programming algorithms: Normal, Intelligent I&I, Quick Pulse Programming.
- Verify operation performed at normal & worst case operating voltage.
- Functional test: JEDEC standard functional testing for logic devices.
- TTL Logic functional test for 74xx/54xx series devices.
- File formats accepted: JEDEC (full), JEDEC (kernel), Binary, MOS Technology, Motorola Hex, Intel Hex, Tektronix Hex.
- Customer support via voice line, fax & dedicated BBS. Full 1 year warranty.
- Base price \$695 includes Interface card, cable, Memory/Micro/Bipolar library and 1 year free updates. \$895 with additional Logic Device Library.
- Library updates can be received via floppy or Customer Support BBS.

MC/VISA/AMEX

Call today for datasheets!



B&C MICROSYSTEMS INC.
750 N. Pastoria Ave., Sunnyvale, CA 94086 USA
TEL: (408) 730-5511 FAX: (408) 730-5521

CIRCLE NO. 345

TOTAL RECALL

Fairchild's new **MIL-STD-1553 Data Logger/Processor (DL/P)** with our **DBMC** captures and processes unlimited quantities of 1553 bus traffic with full error and timing information in an IBM PC/AT compatible environment.



FAIRCHILD DEFENSE

Marketing: (301) 428-6629 • Telefax: (301) 428-6885
20301 Century Boulevard • Germantown, MD 20874-1182

CIRCLE NO. 346

C6805 CODE DEVELOPMENT SYSTEM

- First 6805 C compiler
- Built-in cross assembler
- Includes integrated shell
- Expert system optimizations



Call today! 519-888-6911

BYTE CRAFT LIMITED
421 King St., N.
Waterloo, ONT. N2J 4E4

CIRCLE NO. 347

Telecom Solutions from Teltone

R1 and R2 MF Transceivers

M-986 transmits and receives CCITT R1 or R2 forward and backward multifrequency signals. For trunk adapters, test equipment, etc.



- Single or dual channel versions available
- For N. Am. (R1) or Int'l. (R2) toll signals
- Binary or 2 of 6 input/output format
- Complete microprocessor interface
- 40-pin IC, 5-volt power, crystal time base

1-800-426-3926

Or: 206-487-1515 Fax: 206-487-2288

TELSTONE

INNOVATING SOLUTIONS
In Telecom Interface Components

Teltone Corporation, 22121-20th Avenue SE, Bothell, WA 98021

CIRCLE NO. 348

To advertise in Product Mart, call Joanne Dorian, 212/463-6415

200 MHz Logic Analyzer

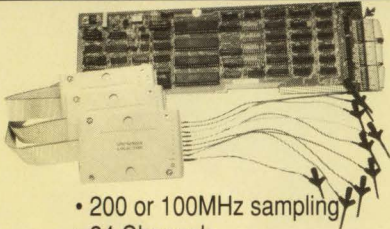

- 200 or 100MHz sampling
- 24 Channels
- Expansion to 72 channels
- 16 Levels of triggering
- 16K samples/channel
- Variable threshold levels
- 3 External Clocks
- 12 Clock Quality lines

\$ 799-12100 (100 MHz)
\$1299-27100 (100 MHz)
\$1899-27200 (200 MHz)

UNIVERSAL PROGRAMMER

PAL
 GAL
 EPROM
 EEPROM
 PROM
 87C51...
 874x

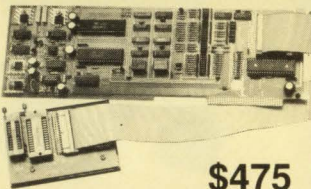

\$475

5ns PALs 4 Meg EPROMs
26V12 & 22V10 Gals
FREE software updates on BBS

GANG PROGRAMMER

- 4 32pin Sockets (8 Socket option)
 - 2716-27010 EPROMs
- \$215**

Call - (201) 994-6669

Link Computer Graphics, Inc.

4 Sparrow Dr., Livingston, NJ 07039 FAX:994-0730

CIRCLE NO. 752

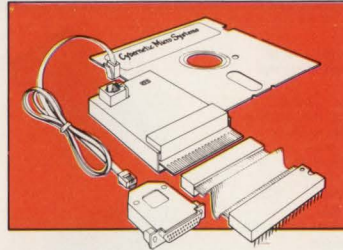

8051 Emulator - \$1250

d²ICE is a low cost, Full Speed, real time 8051 Emulator.. Powerful user interface for Hi-level multi-window source code debugging. Uses IBM-PC COM1/2. No Slots! Portable, fits in shirt pocket. Assembler and test bed included.



Cybernetic Micro Systems
 PO Box 3000 • San Gregorio CA 94074
 Ph: (415) 726-3000 • Fax: (415) 726-3003

CIRCLE NO. 350

A STEP BEYOND.



PROMICE takes ROM emulation a step beyond. It's an affordable, multi-operational development tool with:

- on board intelligence
- modular design
- source level debugging
- future expandability

PROMICE. The Firmware Development System of Tomorrow...

Grammar Engine Inc

3314 Meriso Road
 Columbus, Ohio 43231
 614/471-1113
 FAX: 614/478-6971

1161 Cherry Street
 San Carlos, California 94070
 415/698-2282

CIRCLE NO. 751



Schematic Capture for the Macintosh

DESIGNWORKS

Schematic features Menu-driven, mouse-controlled operations • cut/copy/paste between circuits • right-angle rubber-banding. **Digital simulation** 13-state, event-driven simulation • logic analyzer-style timing window • PLD support. **Libraries** Fully-simulated 7400, 4000, 10K series, PLDs, PROMs and RAMs, non-simulated analog and discrete components • User-definable, simulated custom symbols. **Interfaces** Formats for Douglas CAD/CAM, Cadnetix, Calay, Orcad, Tango, Racal Redac, Spice. • user-definable printers, dot-matrix printers, HP, Houston, Roland pen plotters. **Requirements** Macintosh Plus, SE, II, IIx, IIcx, or Ili.

CALL (604) 669-6343 FOR YOUR FREE DEMO DISK TODAY.

CAPILANO COMPUTING SYSTEMS LTD.

CIRCLE NO. 753

MacAC II

Professional Analog Circuit Simulation

\$595.00

MacAC II integrates a full featured schematic editor, parts library, powerful data manipulation and plotting, and SPICE circuit simulation.

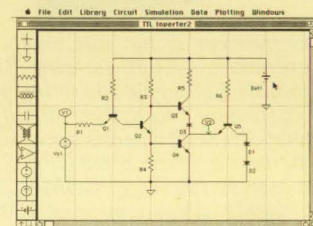

MacAC II was written on and for the Macintosh computer. It takes full advantage of it's powerful graphical user interface.

Call (206) 367-4188
 For FREE information packet

San Juan Software Company
 P.O. Box 27620
 Seattle, WA 98125-2620

CIRCLE NO. 754



Design, Program, Test

TURPRO-1 Universal Pin Driven I.C. Programmer
 Current and Future Devices Supported

- PALs, GALs, PEELs, PLDs, FPGAs, E/EPROMs, PROMs, MPUs, etc.
- 8-40 Pins DIP and 20-188 Pins PLCC Packages.
- PC Remote Control via RS232C or Parallel Port.
- **I.C. MFR. Approved** • Self-Contained Power Supply + 2 CPUs.

=== Only \$1,450 for ===

State-of-the-Art Performance

SYSTEM GENERAL Tel. 408-263-6667
 Fax: 408-262-9220

CIRCLE NO. 755

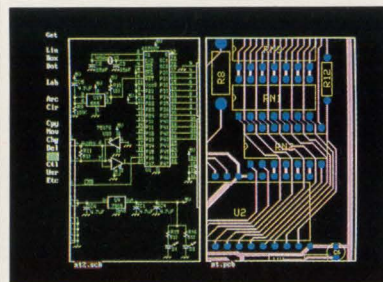

New Schematic and PCB Software

With support for extended and expanded memory, HiWIRE II can handle your most demanding schematic and PCB designs quickly and easily. The unique HiWIRE editor allows you to display and edit schematics and PCBs simultaneously, using the same commands for each. HiWIRE II is \$995, and is guaranteed.

Wintek Corporation

1801 South St., Lafayette, IN 47904
(800) 742-6809 or (317) 448-1903

CIRCLE NO. 756

Half the time/ Half the cost

- Affordable 8, 16 & 32 bit emulators
- Download 250,000 bytes/second
- Built-in performance analysis
- Full speed, zero wait state operation
- C, C++ & PL/M source level support



Z80
 64180/Z180
 8088/86
 V20/30
 647180X
 68000

8085
 64180S
 80188/186
 V40/50
 Z280
 80386

SOFIAD, Inc.
 1-800-433-8812
 Columbia, Md.

CIRCLE NO. 757

To advertise in Product Mart, call Joanne Dorian, 212/463-6415

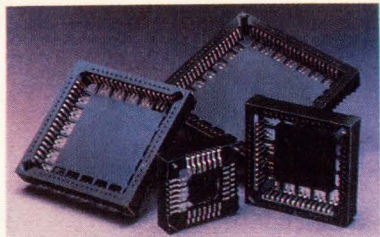

New Surface Mount PLCC Socket

Samtec's new PLCC sockets are LCP plastic for VP and IR soldering, and have an open body for inspection of solder fillets. Precision stamped contacts have solder tails with unique "micro-slots" for added adhesion of solder paste and superior mechanical strength after reflow. They are available with 28, 32, 44, 52, 68, and 84 leads.

Samtec, Inc.
P.O. Box 1147, New Albany, IN 47151-1147
Telephone 800-SAMTEC-9, Telefax 812-948-5047

CIRCLE NO. 758

ADVANTECH

Industrial & Lab Automation with PCs



PC-Based Universal Device Programmer

PC-UPROG **\$895**

- Programs most PLDs and memories up to 40 pins
- Menu driven device selection by P/N and manufacturer
- Full screen editor for fuse maps and memory buffers
- JEDEC standard vector test functions
- New devices can be easily added by yourself
- Self test and diagnosis for high programming yield
- One year warranty and free device update

408-293-6786

1310 Tully Rd., #115, San Jose, CA 95122 FAX 408-293-4697

CIRCLE NO. 759

LOW PROFILE MODEM DAA

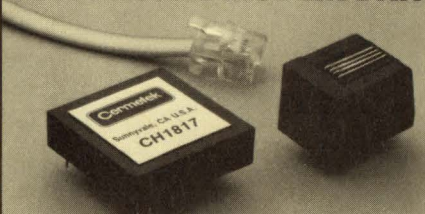

CH1817

- Less than 0.3" high x 1.0" x 1.0"
- FCC Part 68 and DOC Approvable
- UL 1459 Approvable
- Compatible with all modem chip sets including V.32

Your Source for Modem Components:



Tel: 408-752-5000
Fax: 408-752-5004

Cermetek Microelectronics, Inc.
1308 Borregas Ave. • Sunnyvale, CA 94089

CIRCLE NO. 760

Create a DISKLESS PC

IT'S EASY...IT'S SIMPLE...
THERE'S NOTHING TO IT!!

PROMDISK™ III IBM PC DISK EMULATOR CARD

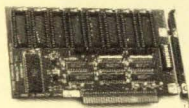

- IBM PC/XT/AT Compatible
- Mix EPROMs, EEROMs, SRAMs
- Emulates up to 1.024Mbyte Drive
- Occupies 32K PC address space
- Supports popular Byte-Wide chips



Phone: (619) 744-8087
FAX: (619) 744-9256

810-208 Los Vallecitos ~ San Marcos, CA

CIRCLE NO. 761



IEEE-488 CONTROL FOR YOUR MACINTOSH II

- Control any instrument in minutes.
- Supports BASIC, Pascal, C and Hypertalk.
- HyperCard utilities included.
- Software library. Risk free guarantee.



Capital Equipment Corp.
Burlington, MA. 01803

Informative catalog 800-234-4232
Applications help (617) 273-1818

CIRCLE NO. 762

CMOS 186 SINGLE BOARD COMPUTER

MULTI-TASKING

This powerful 16-bit computer directly executes EPROM's containing Microsoft C or Turbo C .EXE files. NO LOCATORS! Bundled package including multi-tasking C library allows dozens of C tasks to run concurrently.

- 10 MHz 80C186
- CMOS design
- 512K RAM
- 384K EPROM
- STD BUS Expansion
- COM1 RS232/485
- COM2, LPT1
- RTC Avail
- 80C187 Avail
- OEM discounts

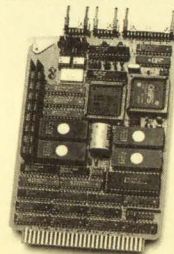

MICRO/SYS

1011 Grand Central Ave., Glendale, CA 91201
(818) 244-4600 Fax (818) 244-4246

CIRCLE NO. 763

FREE

130 PAGE
CATALOG

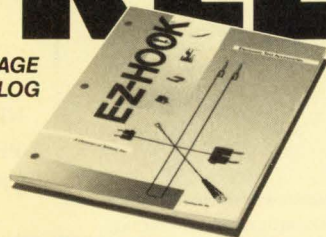

ELECTRONIC TEST ACCESSORIES

Over 12,000 time-saving/problem-solving solutions to common testing, hookup and assembly applications. Just ask for it.

EZ-HOOK

P.O. Box 450, Arcadia, CA 91066
(818) 446-6175 • Fax: (818) 446-0972

CIRCLE NO. 764

LOW COST Data Acquisition Cards for PC/XT/AT



12 Bit A/D & D/A [PCL711S] \$295

- A/D converter: 8 single-ended channels; Uses AD574 device; Conversion time less than 25µsec; Input range: ±5V; Software Trigger Mode only.
- D/A converter: 1 channel; 12 bit resolution; 0 to +5/10V Output Range.
- Digital I/O: 16 In/Out (TTL compatible); External Wiring Terminal Board incl.
- Utility Routines and Demo/Sample Programs for BASIC and Quick-BASIC.

12 Bit A/D & D/A [PCL812] \$395

- A/D converter: 16 single ended inputs; Uses AD574; Conversion time less than 25µsec; Built-in programmable pacer; Input Ranges: ±10V, ±5V, ±1V.
- D/A converter: 2 channels; 12 bit resolution; Output Range 0-5V.
- Digital I/O: 16In/Out (TTL compatible); Programmable Counter/Timer (8254).
- DMA and interrupt capability. Utility software and sample program in BASIC.

Fast 12 Bit A/D/A [PCL718] \$795

- A/D converter: 16 single ended or 8 differential channels; 12 bits resolution; Programmable scan rate; Built-in Interrupt and DMA control circuitry. Conversion speed 60,000 smpls/sec (standard), 100,000 smpls/sec (optional).
- Input Ranges: Bipolar: ±10V, ±5V, ±2.5V, ±1V, ±0.5V; Unipolar: 10, 5, 2, 1V
- D/A converter: 2 channels; Resolution: 12 bits; Settling time: 5µsec; ±5V
- Digital I/O: 16In/Out (TTL compatible); Programmable Counter/Timer (8254).
- Software: Utility software for BASIC & QuickBASIC included. Sample prgm. Supported by LabDAS, ASSYST, LABTECH, UnkeScope.

6 Channel 12 bit D/A [PCL726] \$495

- Output Ranges: 0 to +5V, 0 to +10V, ±5V, ±10V, or sink 4-20mA.
- Settling time: 70µs. Linearity: ±1/2bit. Voltage output drive capacity: ±5mA.
- Digital I/O: 16 digital input and 16 digital outputs (TTL compatible).

MC/VISA/AMEX

Call today for datasheets!



B&C MICROSYSTEMS INC.
750 N. Pastoria Ave, Sunnyvale, CA 94086 USA
TEL: (408)730-5511 FAX: (408)730-5521

CIRCLE NO. 765

FREE FOR ALL

Free for all who call Omatom - a PC board layout demo disk! Try SCHEMA PCB for FREE and optimize designs for boards as large as 32" x 32", 30 layers, right on your PC. Call Omatom for your FREE demo disk today!



1-800-553-9119
214-231-5167

CIRCLE NO. 766

To advertise in Product Mart, call Joanne Dorian, 212/463-6415

RELIABILITY PREDICTION SOFTWARE

ARE YOUR PRODUCTS RELIABLE?

The RelCalc 2 Software Package predicts the reliability of your system using the part stress procedure of MIL-HDBK-217E, and runs on the IBM PC and full compatibles. Say goodbye to tedious, time consuming, and error prone manual methods! RelCalc 2 is very easy to use, and features menu windows, library functions, global editing for what-if? trials, and clear report formats. Try our Demo Package for \$25.

T-CUBED SYSTEMS, 31220 La Baya Drive #110, Westlake Village, CA 91362. (818) 991-0057 • FAX: (818) 991-1281

CIRCLE NO. 767

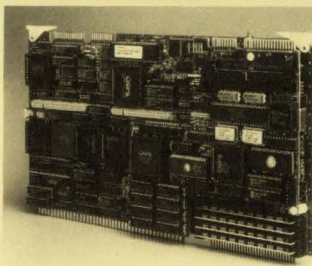

PC/AT™ COMPATIBILITY ON MULTIBUS

In 1989 our MAT286™ SBC brought PC-DOS to Multibus 1. Since then no competitor has come close in terms of features, price, or technical support. We've added capabilities, such as 8 megabytes of onboard EPROM capacity, MATxSSD Solid-State Disk software, EMS 4.0, and low power CMOS components. Now we are announcing our new MATxSYSIO2 daughter-card with 16-bit VGA and LCD flat-panel interfaces, 1-1 interleave MFM/RLI ST506 hard-disk/floppy disk controller, and a PC/AT Bus short-card adaptor. And, yes, we are working on MAT386, the 386-based Multibus AT that will be compatible with the 286-based standard, MAT286.

Phone (408) 253-0250 for more information.
Single Board Solutions, Inc.
20045 Stevens Creek Blvd, Cupertino, CA 95014
PC/AT™ IBM

CIRCLE NO. 768

ROYALTIES

Multi-Tasking EXECS

U S Software offers hi-performance software tools for embedded applications.

Get the full details by calling:

800-356-7097
503-641-8446
503-644-2413 (FAX)

U S SOFTWARE

United States Software Corporation
14215 NW Science Park Drive
Portland, Oregon 97229

NEW!

iceMASTER
8051 68HC11

Your Window to Emulation Productivity

- Easy to learn & use
- Windowed interface - user configurable
- FAST! Download - <3 sec. typ. at 115KB
- Source Level debug

- A 4K frame trace buffer with advanced searching capabilities.
- Hyperlinked On-line help guides you through the emulation process.
- Best Performance Analyzer in the industry.
- iceMASTER connects easily to your PC, requires no disassembly, or expansion slots. Works on any PC (DOS or OS/2), MicroChannel or EISA. Even laptop!
- Supports more than 50 different 8051 family derivatives. M68HC11 support will be available early in 1991.
- Try iceMASTER risk free! Satisfaction Guaranteed or return for a full refund!*
- RENTALS AVAILABLE! Ideal for consultants and researchers!
- Call today for free demo disk and ask about a free 8051 Macro Assembler! **(800)638-2423**

FREE ASSEMBLER

CIRCLE NO. 769

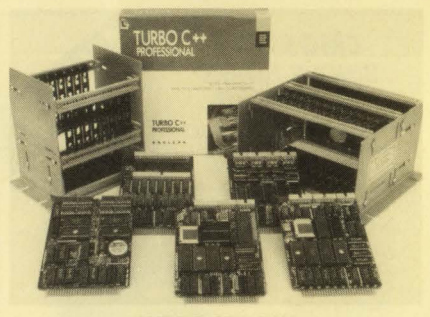

TURBO-STD-BUS

R.L.C.'s large selection of 8 and 16-Bit STD Bus Single Board Computers offer an Intel 80C186/188 CPU and 80C187/8087 Numeric Co-Processor at true bus speeds up to 16 MHz. On-board functions include MEMORY, SERIAL PORTS, REAL TIME CLOCK, TIMERS, DMA, INTERRUPT CONTROLLER, and BATTERY BACK-UP, WATCH-DOG TIMER and much more. R.L.C. also offers 16-Bit support cards, card cages and complete software support using the award winning TURBO-DEBUGGER. For more information and technical assistance please call Robert Coomer.

R.L.C. Enterprises
(805) 466-9717

4800 Templeton Road Atascadero, CA 93422

CIRCLE NO. 770

40-PIN E/EPROM PROGRAMMER

Lifetime S/W via BBS

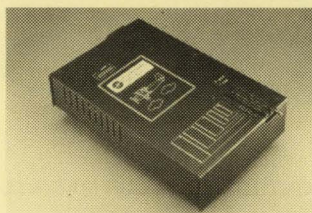

PILOT-144: Powerful PC-driven 40-pin programmer supports E/EPROMs up to 40-pins. Standard parallel port interface means fast thru-put and no need to install high voltage cards inside your PC. Built-in power supply. Upgradable to support 875x and 874x micros. \$795. **SATISFACTION GUARANTEED.**

408-243-7000, 800-627-2456, Fax 408-736-2503



ADVIN SYSTEMS INC.

1050-L E. Duane Ave., Sunnyvale, CA 94086

CIRCLE NO. 771

COMPLETE DATA ACQUISITION CARD

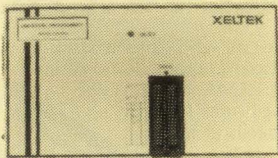

MCP-550

\$739

100% METRABYTE COMPATIBLE

- High performance, low cost data acquisition card with multi-functions: A/D, D/A, D/I, D/O
- Maximum sampling rate of 100K samples/sec (option) or 60K samples/sec (standard)
- Industry standard 12-bit resolution
- 16 single ended or 8 differential A/D channels
- Two 12-bit monolithic multiplying D/A channels
- TTL compatible 24 Digital I/O channels
- Switch selectable analog input range unipolar: 1 - 10V. Bipolar: ±0.5V - ±10V
- Can be used with MCE-730: a versatile 16 channel analog input multiplexing and signal conditioning card
- Complete support of vendor application S/Ws such as Labtech Notebook, ASYST...

Call 1-800-541-1975

XELTEK
764 San Aleso Ave.
Sunnyvale, CA 94086
TEL(408)745-7974
FAX(408)745-1401

CIRCLE NO. 773

MULTI FUNCTION IN ONE MFI-421



\$849

- OVER \$1,200 VALUES IN ONE UNIT**
- Unique high Accuracy and low cost T&M System for Engineer's Work Bench.
 - Full Overload Protection
 - Power Supply
Tripple output : 0-50V (0.5A Max); 15V. 1A(Fixed); 5V, 2A(Fixed).
 - Function Generator
Frequency Range : 0.02 Hz - 2 MHz
Signe, Square(/TTL), Triangle Ramp, Pulse and Skewed wave forms.
Linear and Log sweep.
 - Frequency Counter
Range : 1 Hz -100 MHz; LED display
Accuracy : +/- (1Hz + 1 dgt + Time Base Error)
 - Digital Multimeter
3.5 digit LCD display ; Auto Ranging;
DCV, ACV, DCA,ACA; Diode & Continuity Check
Call 1-800-541-1975

XELTEK
764 San Aleso Ave.
Sunnyvale, CA 94086
TEL(408)745-7974
FAX(408)745-1401

CIRCLE NO. 774

SUPER UNIVERSAL PROGRAMMER



NEW!

SUPERPRO

\$795

FREE MULTIMETER SPECIAL

- programs • PAL, EPROM, GAL, PEEL, FPL (up to 68 pin PLCC)
- E(E) PROM, Flash EPROM up to 4 Mbits (40 pins)
- Microcontroller, Bipolar PROM.
- Tests TTL/CMOS Logic, D/S Memory Device.
- High speed parallel interface card to PC/XT/AT/386
- Pull - down Menu driven, Library Operating software.
- **Fast Device update** on user's request
- 40 - pin **Gold ZIF** Socket
- Lifetime Free Updates (BBS)
- User Device Library Generator (optional)

Call 1-800-541-1975

XELTEK
764 San Aleso Ave.
Sunnyvale, CA 94086
TEL(408)745-7974
FAX(408)745-1401

CIRCLE NO. 775

To advertise in Product Mart, call Joanne Dorian, 212/463-6415



THIS DECADE, MAKE A COMMITMENT TO USE ONLY THE BEST.

FOR TEN YEARS INTROL HAS BEEN CREATING THE WORLD'S BEST HIGH-POWERED TOOLS FOR EMBEDDED SYSTEMS PROGRAMMERS. 🐛 OUR C COMPILERS, MODULA-2 COMPILERS, SOURCE LEVEL DEBUGGERS, AND MACRO ASSEMBLERS ARE IN USE BY MAJOR CORPORATIONS AND SAVVY INDEPENDENT CONSULTANTS FROM SAN FRANCISCO TO SINGAPORE. 🐛 WE HAVE DEVELOPED SUPPORT FOR A WIDE RANGE OF PROCESSORS¹, ON AN EVEN WIDER RANGE OF HOST SYSTEMS². THIS VERSATILITY ALLOWS YOU TO MOVE FROM PROJECT TO PROJECT WITHOUT LOSING VALUABLE TIME LEARNING NEW TOOLS AND TECHNIQUES. 🐛 ALL OUR PRODUCTS ARE COVERED BY COURTEOUS AND HIGHLY EFFICIENT TECHNICAL SUPPORT TO ASSIST YOU WITH ANY PROBLEMS YOU MAY ENCOUNTER. 🐛 SO, THIS DECADE, MAKE A COMMITMENT - TO INTROL.



¹6801,6301, 68HC11,6809, 68000/10,68020/30/40, 68332,32000 • ²MSDOS, MAC-MPW, VAX VMS/ULTRIX, DECSTATION, IBM RS6000, SUN3, SUN4, APOLLO, 386 UNIX SYSTEM V
INTROL CORPORATION • 9220 WEST HOWARD AVENUE • MILWAUKEE, WI 53228 • TEL 414.327.7171 • FAX 414.327.7734

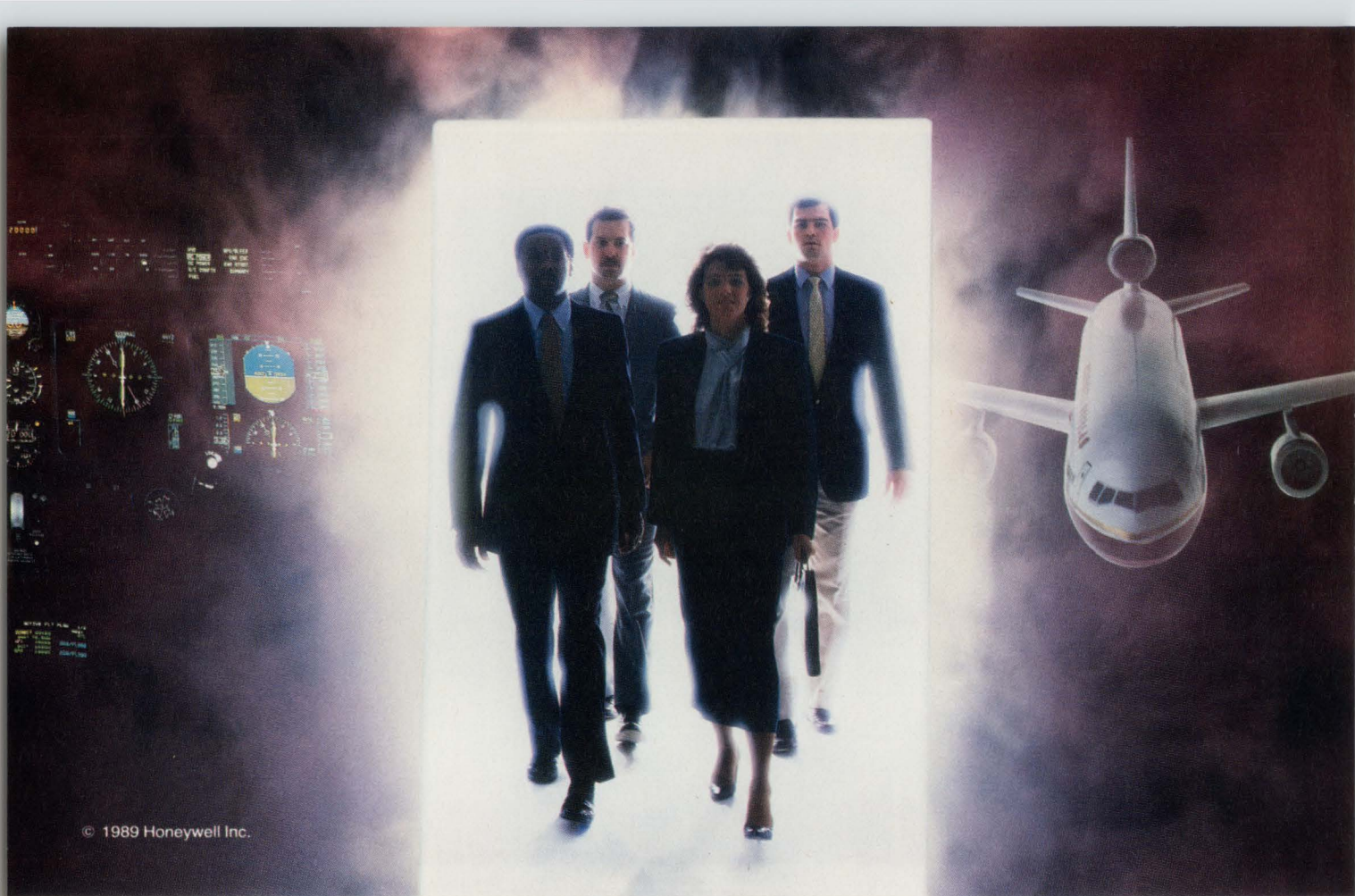

© 1989 Honeywell Inc.

HONEYWELL: OPENING THE DOOR TO AVIONICS TECHNOLOGY OF THE 90s.

Honeywell in Phoenix offers a variety of career opportunities in our Commercial Flight Systems Group. Our continuing growth has created the following positions:

Systems Design Engineer — In this area, you will be involved in guidance and control systems analysis and hardware/software design trade-offs. Specification designs, including guidance, navigation and control algorithm development, as well as systems integration and installation, flight test and customer liaison activity, are a part of these positions.

System Software Development — This area involves development of flight software for advanced guidance and control systems for aircraft using modular and structured programming techniques. You will be involved with algorithms and development of real-time programs in both assembly (8086 family Z8002, 68000) and high order languages such as Pascal, "C," Ada and PLM/86, with subsequent hardware integration.

Electronics Engineering — These positions involve the development of new processor/bus architectures and specifications

to support fault tolerant/redundant airborne applications.

Display Systems — These positions offer systems, software and hardware opportunities with CRT/LCD display technology. You should be familiar with digital hardware design and/or real-time programming. Systems functions include overall system definition, design and customer interaction.

To qualify for the positions listed above, you should have a BSEE or a BSCS degree and at least three years of experience.

Quality Engineering — To qualify for this position, you should have a BS degree in an engineering curriculum. A minimum of two to five years of experience in quality engineering/assurance, reliability and/or product engineering is required. You should have computer applications experience. Customer interface experience is preferred.

Additional opportunities are available in:

- CRT/LCD Display Technology
- Avionics Systems Simulation

- CAE Engineering (Apollo Mentor Systems)
- Artificial Intelligence
- VAX Systems Administration
- Fiber Optic Pressure Sensors
- EMI/HERF
- Software Tools Development

Make a career move. Honeywell offers you a competitive salary and benefits package. All new employees are required to successfully complete a drug screening test. Send your resume and salary history, in confidence, to Honeywell, Commercial Flight Systems Group, Professional Employment (EDN-E845), P.O. Box 21111, M/S I-17C, Phoenix, AZ 85036.

Honeywell

HELPING YOU CONTROL
YOUR WORLD

Equal Employment Opportunity/Affirmative Action Employer
U.S. citizenship required for some positions

High Tech Innovation And A Great Location.

ZENITH
data systems



Groupe Bull

Zenith Data Systems engineers can have it all. The challenge and excitement of working in the personal computer design center of one of the world's top 10 information technology companies. A well defined project role with considerable project responsibility. And a St. Joseph, Michigan, location that's light on stress and heavy on outdoor fun and natural beauty.

We've enjoyed consistent strong growth to become a \$1.4 billion leader in the PC industry. Now, as we expand our development efforts we're seeking dozens of new engineers. If you have a related degree and 3 or more years' related experience, use your skills to contribute to our reputation for innovation.

Design Engineers

Requires digital logic design of micro-processor based systems. Experience in ASIC/VLSI design is a plus. Must be familiar with "XXX 86" architecture.

Systems Firmware Engineers

Individual will define computer systems architecture, create systems firmware for Zenith PC compatible 80286/386/386SX, laptops and desktops. We require experience with IBM PC/AT and compatibles, 8086/286/386 assembly/"C" language programming, and I/O and/or device drivers.

Mechanical Engineers

Requires experience in product design and development, electronic packaging, plastic injection molding and sheet metal. CAD experience essential.

Federal/OEM Systems Engineers

Will provide support for Federal Sales, Domestic and European accounts, plus work with custom configurations. Unix/Xenix and multiprocessor experience desired.

OEM Product

Evaluation Engineers

To develop and evaluate new mass storage products, you'll need in-depth knowledge of mass storage related products including tape subsystems, controller and disk drives.

Technical Training Engineers

Will need teaching and course development experience in a Technical environment. Must have ability to perform a thorough design analysis and excellent communication skills.

Test Engineers

Incumbents will develop test software and hardware for in-circuit test systems, and write models for PAL's gate arrays and ASIC's. Familiarity with GenRad test equipment and knowledge of "C", Basic, and Pascal required. Knowledge of Intel microprocessor family is essential.

Continuing Engineers

Responsibilities require providing engineering support to Manufacturing or field support by troubleshooting existing design from hardware/software standpoints.

Group Leader MS/DOS

Will manage the activities surrounding the development of MS/DOS and networking products. Requires minimum of BSCS, 5 years of system software design, in-depth knowledge of MS/DOS and previous management experience.

We offer an attractive compensation package while St. Joseph offers a reasonable cost of living, year round recreation and heartland values. All on the shores of Lake Michigan, just a 90 minute drive from Chicago. If interested, send resume and salary history to: Zenith Data Systems, Hilltop Rd., St. Joseph, MI 49085. Attn: Steve Slonkosky. An affirmative action employer.



Engineering

WARM UP TO FLORIDA.

And heat up your career with an industry leader.

Situated between the shores of Daytona Beach and metropolitan Orlando, talented professionals set the pace at **Sparton Defense Electronics**, a Fortune 900 company involved in the design and high volume manufacture of expendable submarine tracking devices.

The following opportunities are currently open to qualified design engineering personnel for exploration:

- BSEE's (no EET degrees) with 2 to 4 years current experience in board level audio/voice frequency (0-20 kHz) analog product design for a high volume manufacturer. Background must include microprocessor programming (i.e., 6800/assembly) and exposure to SMT (surface mount technology). U.S. citizenship required for clearance.
- BSEE's (no EET degrees) with 5 years current RF (UHF/VHF) experience specifically in a.m. receivers and multichannel synthesized f.m. transmitters. Small stowable antenna design is highly desirable. U.S. citizenship required for clearance.
- BSME's (no MET degrees) with 2 to 5 years current experience in the design of injection molded plastic, die cast metal, and stamped metal parts for a high volume/low cost manufacturer. Solid experience in finite element analysis (FEA) and knowledge of design for assembly (DFA) concepts is highly preferable. Tooling vendor interface and production floor support backgrounds are necessary. U.S. citizenship is required for clearance.

As a team member of **Sparton Defense Electronics**, expect a stimulating, career-building technical challenge, a high quality lifestyle with a low cost of living, no state income tax, proximity to exciting Florida attractions, and a fine compensation package that rewards your skill, knowledge, imagination, and performance. Relocation package is available. For prompt, confidential consideration, please present your credentials with salary expectations to:

SPARTON DEFENSE ELECTRONICS

ATTN: Mr. John S. Gould, Employment Manager
5612 Johnson Lake Road • DeLeon Springs, Florida 32130
NO AGENCIES PLEASE/NO PHONE CALLS PLEASE/EEO-M/F/H/V



Research Engineer to conduct research in the area of electromechanical systems and controller formulation for multibody systems. Models, analyzes and simulates the operation of electromechanical systems as well as aerospace related systems and control mechanisms. Develops efficient object oriented computer simulation methods using high performance computer architectures and hardware interfaces for modeling of space related dynamical systems. Must have M.S. in Aerospace or Electrical Engineering plus one year job experience or one year graduate assistant (Aerospace/Electrical Engineering). Knowledge of C, Pascal, FORTRAN, Ada, DCAP and Nastran software tools. Hrs. Forty hour week. Sal \$19.50 hr. Resume to: **Ms. Pat Ganno, Job Service of Florida, P.O. Box C, Clearwater, Fla. 34618-4090. Job Order No. 0400284.**

Computer Programming Manager to coordinate computer programming and database work assignments for the cardiology division and/or BARI/TIMI III core ECG laboratory on the IBM/AT, Macintosh, and MicroVAX II computer systems. Duties and responsibilities include: 1. Design ingress databases within a UNIX operating system (MicroVAX II) based upon the needs of the NHLBI grants as assigned by various coordinating centers or lab supervisors; 2. Programming assignments on the MicroVAX II will be coordinated by the programming manager; 3. Programming on the MicroVAX II will be accomplished in C and Turbo C; 4. Work with the IBM PC/AT graphics bit pad interface to maintain and revise existing programs in the basic languages; 5. Work with the University of Pittsburgh in the BARI grant to establish a communication network through the Bitnet Network; 6. Work with Maryland Medical Research Institute for data transfer of quality control files and data files for the TIMI III Grant; 7. Coordinate transfer of data or file modification on a timely basis to meet deadlines within each grant; 8. Provide written documentation of all programs written within core laboratory for use by the various coordinating centers or by lab staff; 9. Provide weekly update reports on current projects of all lab programmers to the lab supervisor; 10. Document source code written in a modular fashion so that it can be followed by another programmer; 11. Organize maintenance on the MicroVAX II computer and IBM PC computers; 12. Provide documentation support user instructions and training. Design and coordinate monthly in-services for all lab staff on various programs created within the lab; 13. Provide file set-up and programming in FORTRAN for use in SAS, SPSS, and BMDP statistical software. Salary: \$28,666.00 per year/40 hour week. Requirements: Experience with UNIX operating systems, IBM PC and Macintosh computers. Previous experience with programming in C, BASIC, FORTRAN languages, BMDP-SAS-SPSS statistical software. Applicant must have a B.S. in computer science plus two years of computer programming/analysis experience. A Master's degree in Computer Science will be accepted in lieu of two years of experience as a programmer/analyst. Respondents must presently be eligible for permanent employment in the U.S. An employer paid ad. Resumes to: **Mrs. Jimmie Gaston, ALC Specialist, Job Service, 505 Washington, St. Louis, Missouri 63101. Refer to JOB Order #438017. EOE M/F/H/V**

ENGINEER-ELECTRONICS

Responsibilities relating to developing electronic drives for advanced motors. Major responsibilities include: designing, building, and testing advanced motor controls; translating customer specs/application needs to hardware; oversee generating the appropriate manufacturing documentation; and assisting in design of automated factory test specs for the product. Apply highly technical expertise in the design of PM brushless DC motors/controls, switched reluctance motors/controls, induction motor controls and high-voltage IC's for motor control. Develop algorithms to improve the motor drive performance. Ph.D. or completion of all requirements for Ph.D. in Electrical Engineering required plus 1 year in job offered or 1 year experience as pre or postdoctoral researcher developing new algorithms and new technology for advanced motor drives. Experience must involve design of PM brushless DC motors/controls, switched reluctance motors/controls, induction motors/controls and high-voltage IC's for motor drives.

40 hrs./wk., 8:00-5:00, salary \$43,000/yr. Must have proof of legal authority to work in U.S. Submit resume with social security number to the **Indiana State Employment & Training Services, 10 North Senate Avenue, Indianapolis, Indiana 46204, Attention: W.F. Shepherd, Ref. I.D. 3288141.**

The right tools make all the difference...

Introducing *j*OMEGA!

Tired of Using RF Design Tools That Don't Measure Up to the Task?

EEsof introduces *j*OMEGA, the first design automation software developed expressly for RF engineers. *j*OMEGA has the features you need for fast, manufacturing-oriented design at frequencies below 3,000 MHz: easy-to-use schematic entry, fast linear and nonlinear circuit simulation, an RF-oriented model set including large-signal BJT transistor library, and built-in documentation capability.



*j*OMEGA Has the Edge You Need to Create Better RF Designs in Less Time:

*j*OMEGA's harmonic-balance simulator gives you fast optimization of linear and nonlinear circuits with simultaneous access to circuit response in both time- and frequency-domains. And *j*OMEGA has advanced features, like manufacturing yield optimization and optional board layout, that let you make manufacturing tradeoffs during engineering design.

Breaking the Barriers...

EEsof

Call Us Today, Let Us Show You How *j*OMEGA Can Make the Difference on Your Next RF Design!

We'd like to send you an informative product brochure which describes the many features of *j*OMEGA. Call us at (800) 624-8999, ext. 155. Or if you prefer, contact us by FAX at (818) 889-4159. In Europe, call (49) 8105-24005 or FAX (49) 8105-24000.

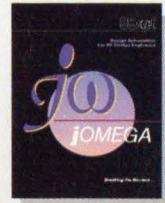

CIRCLE NO. 113



“We saved over \$19,000 at the demo!”



C A H N E R S
CAPS[®]
Computer Aided
Product Selection

**It's easy to find out more
about CAPS! For your free
information kit, call Jill
Adams at 800-245-6696.
Do it today!**

Cahners Technical Information Service • 275 Washington Street • Newton, MA 02158-1630
Telephone: 617-558-4960 • Facsimile: 617-630-2168 • Telex: 940573 • Toll-free: 800-245-6696
CAPS is a registered trademark of Reed Publishing (USA) Inc.

**CAPS[®] is a productivity-boosting
engineering tool that helps you
find, select, and specify ICs and
semiconductors faster and
easier than ever before.**

“The microfilm system we purchased for IC and semiconductor search and selection just wasn't working out. It was hard to use and there weren't enough people using it to justify the cost. So, we decided to evaluate CD-ROM-based systems.

“While all this was happening, our purchasing people found a new IC vendor. They wanted to know if the new vendor made equivalents for some of our most commonly-used components. They thought we could get a better price. It would take us hours to find equivalents on the microfilm system, so we decided to challenge a couple of new CD-ROM-based systems.

“The first demonstration was a flop. Their system didn't even include the new vendor. Needless to say, we weren't impressed.

“Then Cahners came to demonstrate the CAPS system. In less than 20 minutes, CAPS found equivalents for the components we wanted. **I figure we saved over \$19,000 at the demo!**

“Oh yes . . . we bought the system!”

—*Frank Lucas*
Test Engineering Manager
Welch Allyn
Data Collection Division

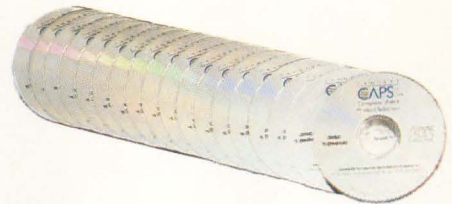

Updated monthly, the CD-ROM (Compact Disc – Read-Only Memory) based CAPS system gives you fast, easy, query-driven access to technical specifications and applications data for over 575,000 ICs and semiconductors made by nearly 500 companies worldwide. Best of all, CAPS provides instant access to hundreds of thousands of pages of complete, unabridged manufacturers' datasheets, so you have everything you need right at your fingertips.

EDN's INTERNATIONAL ADVERTISERS INDEX

Advin Systems	180	MicroSys	176
Aerospace Optics	47	Mini-Circuits	
Alpha Industries	108	Laboratories	20-21, 36-37, 139, 188
ALS Design Corp	34	Motorola*	38-39
Altera Corp	54-55	Murrietta Circuits	158
American Advantech	179	National Instruments	2
American Automation	134	National Semiconductor Corp	10-11
Ametek	170	NCI	177
AMP	78-79	NEC Corp	114, 133, 174
Ampro Computers Inc	66-67	Nohau Corp	175
Analog Devices Inc	77, 161	OKI Semiconductor	30-31
Annabooks	170	Omaton Inc	179
Antex Electronics	158	Orbit Semiconductor	186
Atlanta Signal Processors Inc	148	OrCAD Systems Corp	149
B&C Microsystems	177, 179	Pico	88, 187
Bourns	32-33	Raltron	160
BP Microsystems	177	Rapid Systems	1
Bytecraft	177	Raytheon	80-81
CAD Software Inc	157	Rayovac	65
Cad TEAM	165	RLC Enterprises	180
Cadre Technologies	45	Rockwell International	94
Cahners CAPS	142, 180	Samtec Inc	179
Cahners Exposition Group	166	San Juan Software	178
Capilano Computer Systems Inc	178	Seagate Technology	22-23
Capital Equipment Corp	150, 179	Seiko Instruments	152-154
Carroll Touch Inc	107	Sharp Electronics	103
Cermetek	179	Siemens	14, 167
Connector Corp	156	Siemens AG**	14
Connor Peripherals	12-13	Siliconix Inc	4
Cybernetic Micro Systems	26, 178	Single Board Solutions	180
Cypress Semiconductor	6	Softaid Inc	178
Dalanco Spry	179	Softools	176
Dale Electronics Inc	19	Sony	72
Data I/O Corp	176, C6	Spectrum Software	27
Datalight	176	Sprague Goodman	50
Dexter Magnetics	160	Stimpson Co Inc	156
Dialight Corp	141	System General	178
Eagle Picher	169	Tatum Labs	175
Echelon	109-111	T-Cubed Systems Inc	180
EDN Caravan	112-113	TEAC Corp	C2
EG&G Wakefield Engineering Inc	64	Tek	51-53, 68-71
Elco Corp	131	Telecom Analysis Systems	164
Electronic Measurements Inc	125	Teledyne	151
Emulation Technology	177	Teltone Corp	177
E-Z Hook	179	Teradyne Inc	24-25
Fairchild Defense	177	Texas Instruments Inc	90-91
Frequency Devices	155	Toko America Inc	58, 164
Fujitsu APD	40	Toshiba America Inc	146-147
Fujitsu Microelectronics Inc*	C2	Tribal Microsystems	177
GCOM Inc	175	US Software	176, 180
Gespac Inc	176	Valid Logic Systems Inc	105
Glassman High Voltage Inc	159	Versatec	29
Grammar Engine Inc	178	Vicor	89, 127
Graphtec Corp	60	Viewlogic Systems Inc	143
Harting Electronics	129	Wavetek	3
Hewlett-Packard Co	8-9, 171-173	Wickmann Werke	108
ILC Data Device Corp	49	Wintek Corp	178
Intel	42	Xeltek	180
International Rectifier	C3	Xerox Engineering	
Intrac Corp	181	Systems/Versatec Products	29
Intusoft	175	Zilog Inc	75
Ironwood	176	Z-World	176
ITT Pomona Electronics**	11		
Jandel Scientific	150		
John Fluke Manufacturing			
Co Inc	56-57, 94A-1		
Keithley	123		
Kepeco Inc	92-93		
Linear Technology Corp	135-136		
Link Computer Graphics Inc	178		
Loctite Luminescent Systems Inc	144-145		
Logical Devices Inc	175		
MCSI	179		
Megatel	28		
Meritec	176		
Micro Power Systems	163		
MicroSim Corp	17		
Microsoft	63		

Recruitment Advertising 182-185

*Advertiser in US edition

**Advertiser in International edition

This index is provided as an additional service. The publisher does not assume any liability for errors or omissions.

Lowest Profile
0.5" ht.,
up to 55 Watts

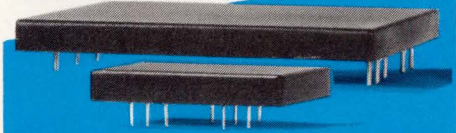

PICO AC-DC Power Supplies

- Input Voltage 90 to 130 VAC (47/440Hz)
- Single, Dual, Triple Outputs
- 1200V Rms Isolation
- Low Isolation Capacity Available
- Continuous Short Circuit Protection
- High Efficiency
- Fully Regulated Voltage Outputs
- Operating Temperature -25°C. to +70°C. with No Heat Sink or Electrical Derating Required
- Expanded Operating Temperature Available (-55°C. to +85°C. ambient)
- Optional Environmental Screening Available

PICO manufactures complete lines of Transformers, Inductors, DC-DC Converters and AC-DC Power Supplies

Delivery—
stock to
one week

SEE EEM,
OR SEND DIRECT FOR
FREE PICO CATALOG

PICO
Electronics, Inc.

453 N. MacQuesten Pkwy. Mt. Vernon, N.Y. 10552

Call Toll Free **800-431-1064**

IN NEW YORK CALL **914-699-5514**

incredible!

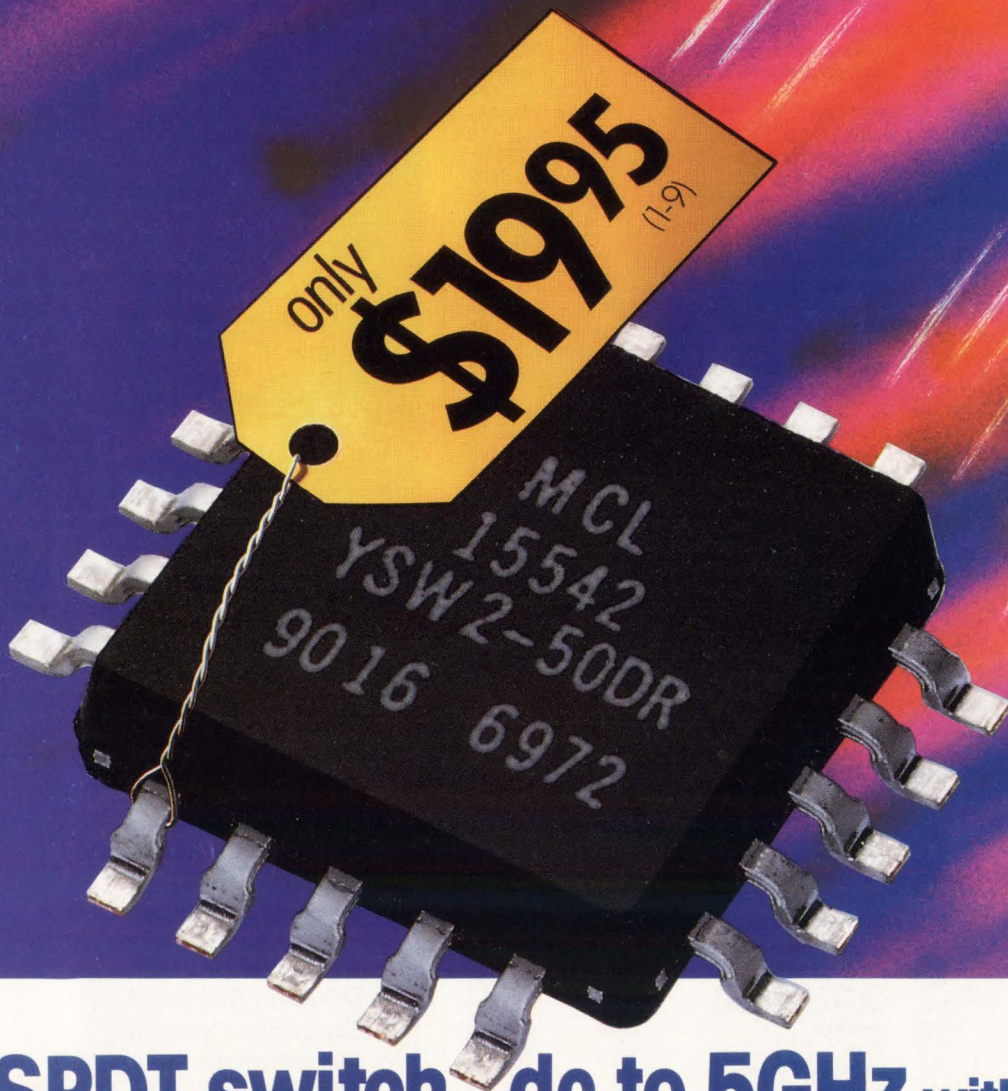

SPDT switch dc to 5GHz with built-in driver

Truly incredible... a superfast 3nsec GaAs SPDT reflective switch with a built-in driver for only \$19.95. So why bother designing and building a driver interface to further complicate your subsystem and take added space when you can specify Mini-Circuits' YSW-2-50DR?

Check the outstanding performance specs of the rugged device, housed in a tiny plastic case, over a -55° to +85° C span. Unit-to-unit repeatability for insertion loss is 3-sigma guaranteed, which means less than 15 of a 10,000-unit production run will come close to the spec limit. Available for immediate delivery in tape-and-reel format for automatic placement equipment.

SPECIFICATIONS YSW-2-50DR

	dc- 500MHz	500- 2000MHz	2000- 5000MHz
Insertion loss, typ (dB)	0.9	1.3	1.4
Isolation, typ(dB)*	50	40	28
1dB compression, typ (dBm @ in port)	20	20	24
RF input, max dBm (no damage)	22	22	26
VSWR (on), typ	_____	1.4	_____
Video breakthrough to RF, typ (mV p-p)	_____	30	_____
Rise/Fall time, typ (nsec)	_____	3.0	_____



*typ isolation at 5MHz is 80dB and decreases 5dB/octave from 5-1000 MHz

finding new ways ...
setting higher standards



Mini-Circuits

WE ACCEPT AMERICAN EXPRESS

P.O. Box 350166, Brooklyn, New York 11235-0003 (718) 934-4500 Fax (718) 332-4661 Telexes: 6852844 or 620156

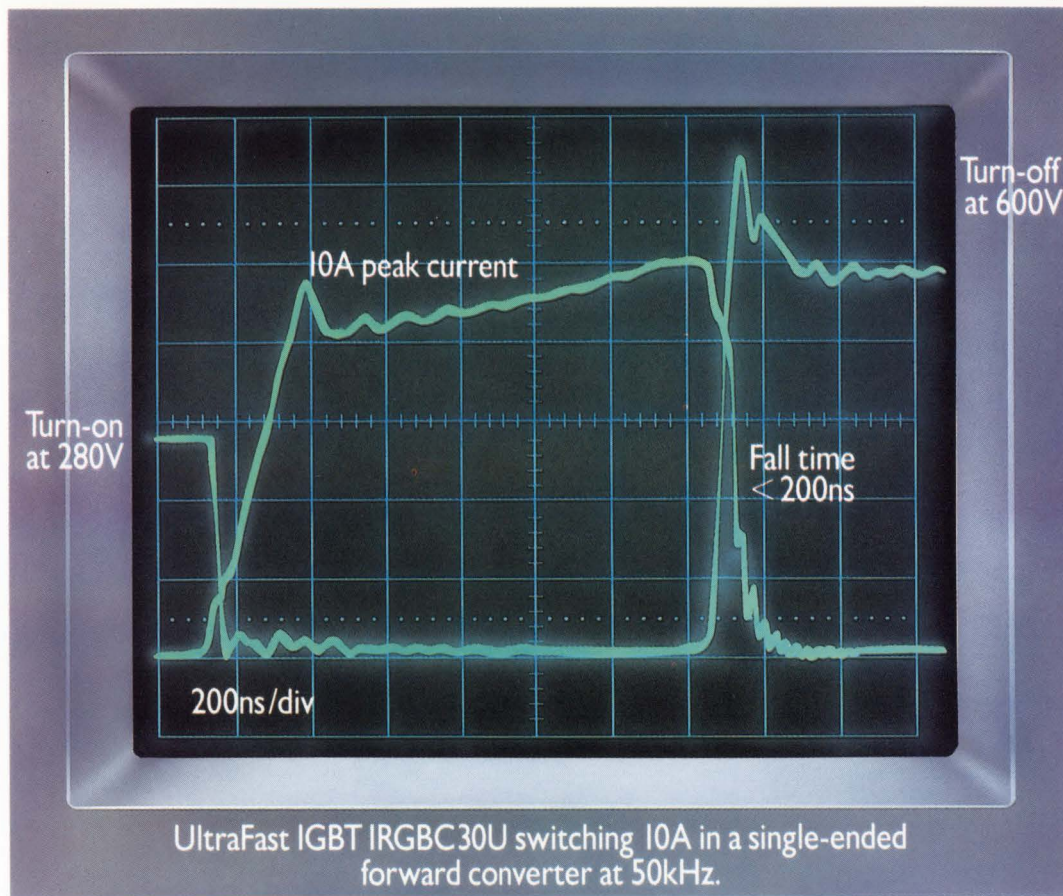

IGBTs Without A Trace of Competition.

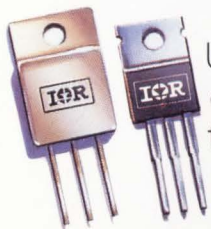

IR announces Ultra Fast IGBTs: our 600V power transistors that switch faster and run cooler than any you've ever used.

Forget about bipolar. Put these

breakthrough devices in your high-voltage, high-current, medium-frequency applications and get performance unparalleled for the price.

Which should come as no surprise. IR IGBTs build on the same proprietary technology that made IR's HEXFETs® world leaders.

Call 1 (213) 640-6534 and ask about Standard, Fast or Ultra-Fast IGBTs, optimized for your operating frequency. And available from 10A to 70A, in commercial or hi-rel packages.

We'll be happy to arrange a screening.

IR International Rectifier

WORLD HEADQUARTERS: 233 KANSAS ST., EL SEGUNDO, CA 90245, U.S.A. (213) 772-2000. TWX 910 348-6291. TELEX 472-0403. EUROPEAN HEADQUARTERS: HURST GREEN, OXTEY, SURREY RH8 9BB, ENGLAND TELEPHONE (0883) 713215, TELEX 95219

CIRCLE NO. 3

Recommended by
Advanced Micro Devices
for MACH™ parts.



Program your hot new parts here.

And Now. Just one thing stands between you and your "hot" new design: a device programmer that can handle it. That's why the UniSite™ Universal Programmer is the designer's first choice.

UniSite is always first to support the latest devices like the Altera Max, AMD MACH™ and the newest FPGAs. It also supports more



packages—including PLCCs and LCCs up to 84 pins, pin grid arrays, and SOICs. UniSite is designed for the future. Data I/O's universal pin-driver technology eliminates pinout adapters, for single-site programming of each device type. And its new PinSite™ programming module uses Data I/O's new Universal Package System™ to support all surface-mount packages from one site.

Adding device support is easy too, with UniSite's update diskettes. They're released quarterly, so you'll always have support for the latest devices—first.

FREE Programming Tutorial. For a FREE copy of our programming technology tutorial and more information about UniSite, call now.

1-800-247-5700

The Personal Silicon Experts

DATA I/O
Corporation

Data I/O Corporation 10525 Willows Road N.E., P.O. Box 97046, Redmond, WA 98073-9746, U.S.A. (206) 881-6444/1-800-247-5700
Data I/O Canada 6725 Airport Road, Suite 302, Mississauga, Ontario L4V 1V2 (416) 678-0761
Data I/O Europe World Trade Center, Strawinskylaan 633, 1077 XX Amsterdam, The Netherlands +31 (0)20-6622866
Data I/O Instrumatic Electronic Systems Vertriebs GmbH Lochhamer Schlag 6A, 8032 Graefelfing, W. Germany, +49 (0)89-858580
Data I/O Japan Sumitomoseimei Higashishinbashi Bldg., 8F, 2-1-7, Higashi-Shinbashi, Minato-Ku, Tokyo 105, Japan
011-81-3-3432-6991/Telex 2522685 DATAIO J

©1991 Data I/O Corporation

CIRCLE NO. 4