

EDN[®]

Smart cards gear up
for belated success pg 51

Video-compression ICs pg 67

Wescon '91 preview pg 80

Componic '91 preview pg 87

The Jim Williams papers
on analog design pg 135

ELECTRONIC TECHNOLOGY FOR ENGINEERS AND ENGINEERING MANAGERS

Special Report:
Existing networks reach
new age with ISDN ICs
pg 112



A PROMISE
FOR BOTH OF US
TO KEEP.

Promises only count when they're kept. This one is no exception.

In the coming months, you will see a number of corporate advertisements from AVX. Each is different by virtue of its subject matter – our diverse product line, our advanced manufacturing capability, quality assurance, to name but a few. Yet all give voice to a single, steadfast goal. *AVX will do whatever it takes to surpass customer expectations, in every area of the company, every working day.*

AVX is so determined to hold to this promise, we'd like you to hold it as well. So we invite you to tear out this page and place it on the wall beside your desk. From that moment forward, call any AVX location anywhere in the world whenever you need our assistance, whether it's finding the right component or solving a special requirement. And call us on it if we ever fail to measure up to your expectations.

At AVX, we believe nothing is more important than the trust between you – the customer – and us. So this promise is not one we make lightly. We intend to keep it. We must keep it. We hope you will, too.

Thank you.



Marshall D. Butler
Chief Executive Officer
AVX Corporation

Ask the World of Us.

AVX CORPORATION
A KYOCERA GROUP COMPANY

RUGGED SOLUTIONS TO TOUGH DESIGN PROBLEMS.



Portable data products from Datakey are meeting the needs of electronic OEM design engineers in a wide range of commercial and military applications. They can help you:

- Save valuable system space
- Reduce system power requirements
- Cut the cost of memory/feature expansion
- Improve system and facility security
- Speed data transfer, make data handling more convenient
- Make ROM upgrades quicker, easier
- Simplify system design and manufacturability
- Ruggedize your system or I/O device
- Reduce repetitive data input
- Differentiate your product in the marketplace

These versatile devices withstand rough handling and retain your data even when exposed to dust, dirt, moisture, magnetic fields, and other environmental hazards.

We've developed a whole array of solutions for tough portable data applications — including the access device for the U.S. government's secure phone system. Hundreds of thousands of these devices are in use today.

Choose from our standard products, including *Serial Memory Keys* (1K, 2K, or 4Kbit capacity), *Parallel Memory Keys* (64K to 512Kbit capacity), *Memory Cards* (chip-on-card or edge-connect with embedded memory), *Low-Cost Personal ID and Memory Tokens*, *Mechanical/Electronic Keys*, and more.

We also design and manufacture *custom* portable data devices.

So, call today for our free booklet. It just may help you solve some of the toughest design problems around. *Yours.*

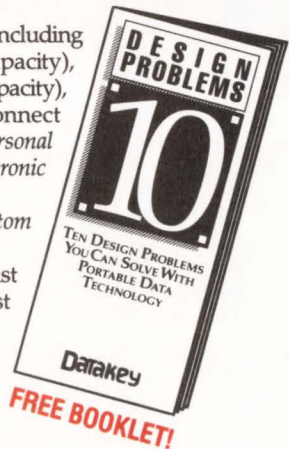

FREE BOOKLET!

Datakey®

*Advanced Solutions
in Portable Data
Technology.™*

Call 1-800-328-8828

Need it fast? We'll fax it.

Datakey, Inc. • 407 West Travelers Trail, Minneapolis, MN 55337 U.S.A. • Phone (612) 890-6850 • Fax (612) 890-2726
United Kingdom: 44 730 816502 • **West Germany:** 49-06173-68872 • **Belgium:** 32 3 325 19 10 • **Netherlands:** 023-31 91 84

Circle No. 1

Local Bus Graphics Solutions

The Next Standard in VGA Performance

The industry's first local bus VGA controller, the HT216, dramatically improves the performance of all graphics applications.

Local Bus CPU Implementation— The Bus of the Future

The standard VGA controller is limited by the 8MHz ISA Bus bottleneck. The HT216's CPU local bus allows commands and pixel data to be transferred at CPU speeds up to 33MHz. That means the HT216 takes full advantage of fast 386 and 486 clock speeds. The result—greatly improved performance without the high cost of a graphics co-processor.

Optimizes Windows™ Performance

The HT216 features a 32-bit system address bus interface, and an independent dot and memory clock, which permit the processing of

asynchronous events. By placing the VGA graphics controller on the CPU local bus and incorporating Windows raster operations functions, the HT216 displays Windows applications two to four times faster than standard VGA controllers—at very little added cost.

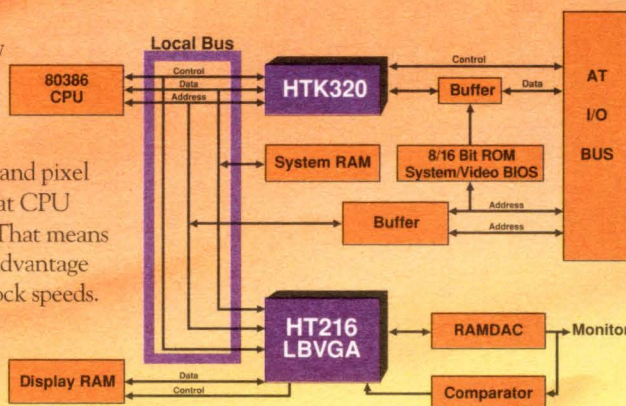

20MHz—offering the best price performance for an entry level 386SX system.

Core Logic that Supports Local Bus

Headland also offers a family of 386SX/DX core logic products that supports the local bus HT216.

The HTK320 supports the 386DX at system frequencies of up to 40MHz and supports local bus peripherals, including the HT216. The HT15 runs at zero wait states with the 386SX to

Catch the Bus of the Future

Call Headland Technology to find out more about the HT216 and our other local bus graphics and core logic products. Catch the local bus now. Don't get left behind.

Headland
Technology Inc
Call 800-238-0101

All brand and product names are registered trademarks of their respective companies.

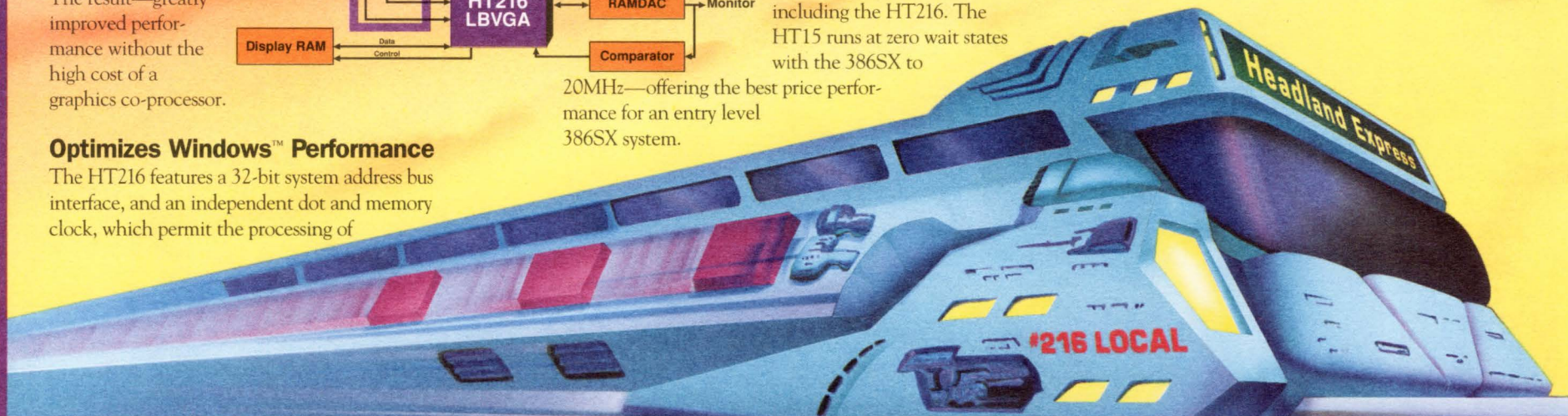

CATCH THE LOCAL BUS

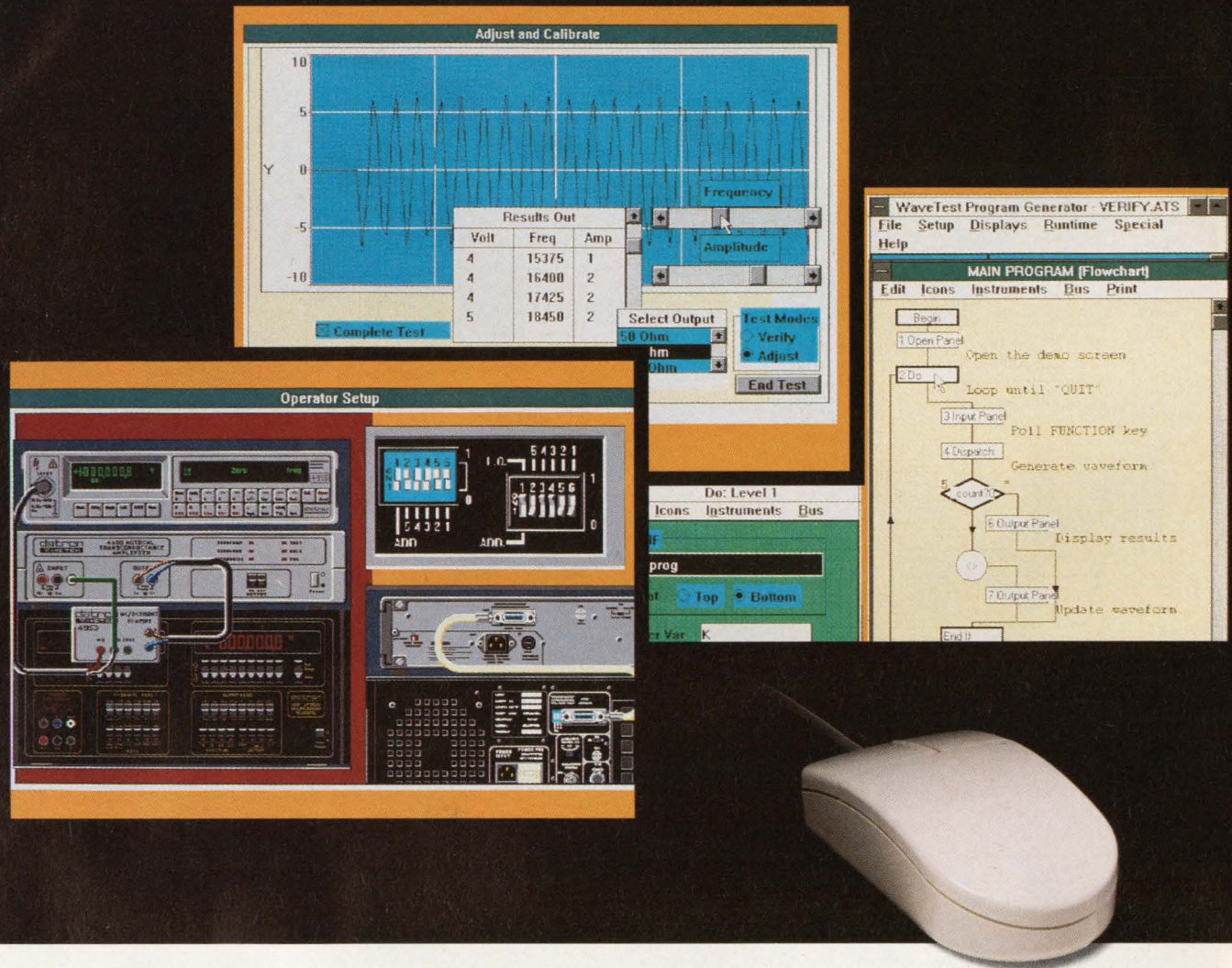

Some very sophisticated test programs are being written by mice.

Actually, they're not being written, they're being drawn. With WaveTest® software for PCs and workstations.

WaveTest provides a complete graphical programming environment, using Windows™ on a PC, or X Window™ on DEC™ workstations. Just draw a flow chart and you've written a program.

There are no more lines of code to deal with. Even loops and subroutines can be handled with simple program icons. And documentation is

automatic, making your programs simple to maintain.

Call up an instrument front panel (from a library of over 200 different manufacturers' instruments), adjust the controls, and you've written a GPIB/ VXI command sequence. An Instrument Search and Replace function makes it easy to change instruments for new or existing tests.

And when your test is running, you can see real-time data analysis, including statistics, FFTs and plots.

Dynamic Data Exchange with other Window's applications adds to WaveTest's flexibility in solving your test problems.

WaveTest has been proven in the field, so you know your test program will be reliable and of the highest quality.

Call 1-800-874-4835 for information about WaveTest and other Wavetek software, including WaveForm DSP for arbitrary function generators.

WaveTest® is a registered trademark of Wavetek Corporation. DEC™ is a trademark of Digital Equipment Corporation. Windows™ is a trademark of Microsoft Corp. X Window System™ is a trademark of MIT. ©1991 Wavetek Corporation

Circle #18 for Literature

Circle #19 for Demonstration

WAVETEK®

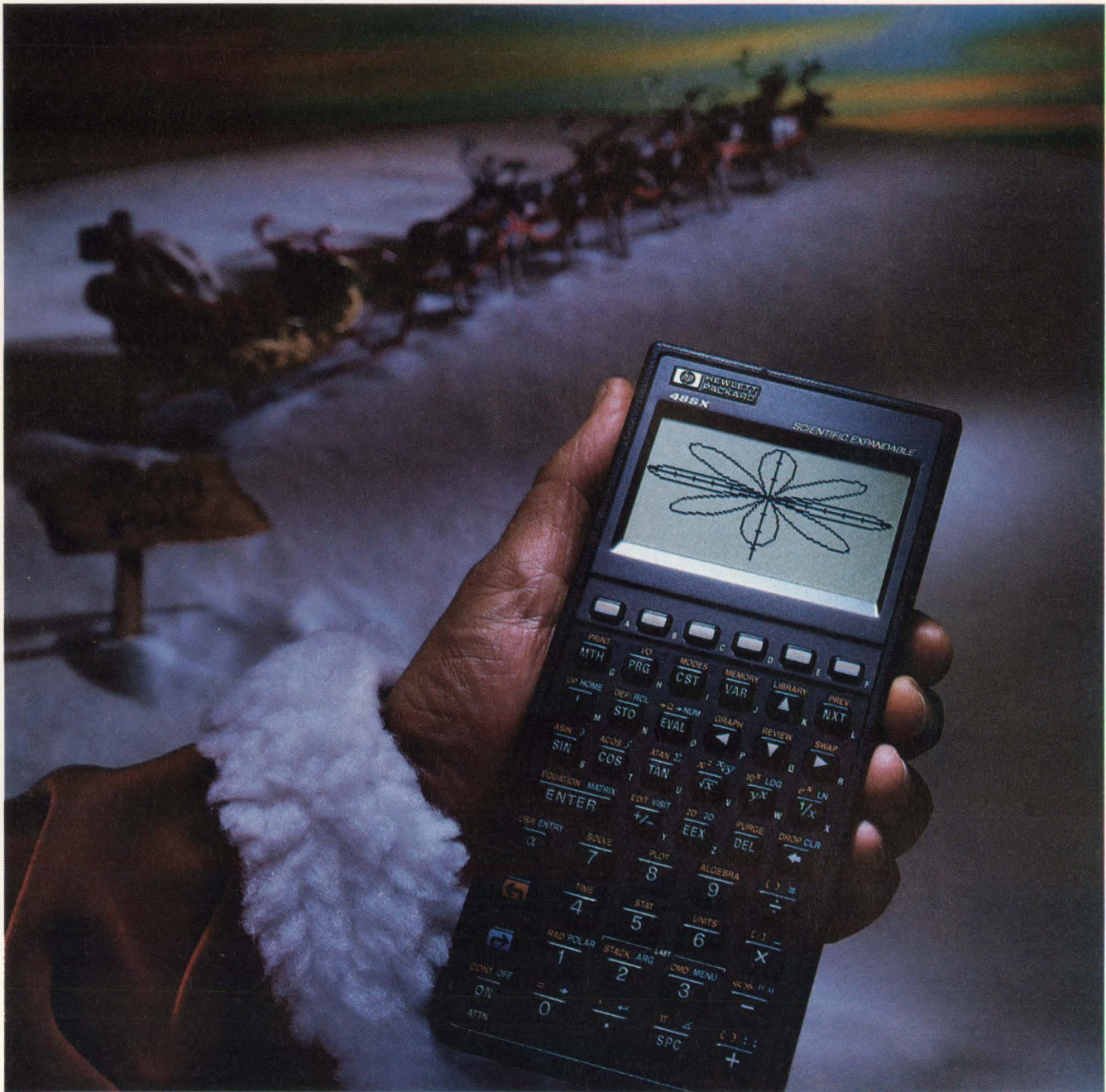

As you would expect, the perfect Christmas calculator can do polar plots.

The HP 48SX will revolutionize the way you work.

No wonder the revolutionary HP 48SX is on so many wish lists this year. It's the only scientific calculator that has over 2100 built-in functions and custom capabilities.

You can type an equation just like it appears in a textbook. Graph an equation and determine its characteristics while

viewing it. Or, with automatic unit management, enter data in any given unit and get the answer in the unit you want. And all with the option of accessing PCs via a built-in serial I/O.

And when you buy an HP 48SX this holiday season, you'll also be helping America's kids excel! Your purchase of an HP 48SX will help equip selected high schools with a \$5,000 set of cal-

culators and other key teaching materials.

So put an HP 48SX on your shopping list now, and see your nearest HP retailer today.

HP calculators. The best for your success.

 **HEWLETT
PACKARD**

© 1991 Hewlett-Packard Company PG12104A

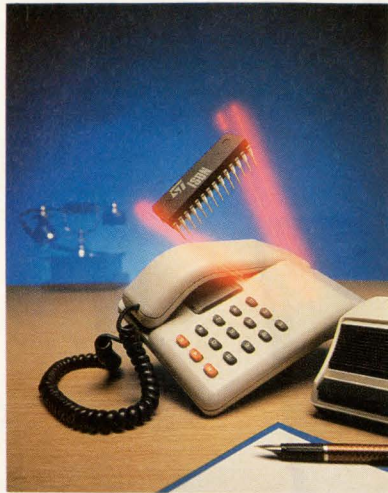

On the cover: Although twisted-pair phone wires are inadequate for digital-data relay, basic-rate ISDN ICs modernize these existing networks for voice and data communications. See our Special Report on pg 112. (Photo courtesy SGS-Thomson Microelectronics)

SPECIAL REPORT

Basic-rate ISDN ICs

112

The network of twisted-pair wires running along our walls and streets is an unsuitable transmission medium for digital data. But with millions of miles of copper already in place, overcoming the gross deficiencies of this widest of wide-area networks presents IC designers with an alluring and supreme challenge.

—Brian Kerridge, *European Editor*

DESIGN FEATURES

The Jim Williams Papers

EDN presents three more articles on high-speed analog design.

Subduing high-speed op-amp problems

135

The application of high-speed op amps requires special attention to a multitude of potential problems. You need to guard against noise intrusion, capacitance-loading effects, and parasitic conductive paths—without neglecting the compromises you may have to make between compensation and gain.

High-speed amplifiers with low offset and drift

149

Amplifiers designed for wide bandwidth or fast settling often exhibit inferior characteristics at dc—that is, high voltage, current offset, and drift. Used with care, the techniques described here let you build circuits that exhibit exemplary performance from dc to MHz.

High-speed amplifiers in application circuits

157

Once you acquire some familiarity with high-speed amplifiers and a respect for their design requirements, you can use these devices' speed to design a variety of application circuits. These circuits include DAC current-to-voltage converters, video amplifiers, and power boosters.

TECHNOLOGY UPDATES

Smart cards gear up for belated success

51

Computer chips packaged as credit cards have not become, as once predicted, a ubiquitous medium for electronic money. But, finally, smart cards are finding new applications and wider acceptance.—Gary Legg, *Senior Editor*

Continued on page 7

EDN® (ISSN 0012-7515, GST Reg. #123397457) is published 48 times a year (biweekly with 2 additional issues a month, except for February, which has 3 additional issues and July and December which have 1 additional issue) by Cahners Publishing Company, A Division of Reed Publishing USA, 275 Washington Street, Newton, MA 02158-1630. Terrence M McDermott, President; Frank Sibley, Executive Vice President; Jerry D Neth, Senior Vice President/Publishing Operations; J J Walsh, Senior Vice President/Finance; Thomas J Dellamaria, Senior Vice President/Production and Manufacturing; Ralph Knupp, Vice President/Human Resources. EDN® is a registered trademark of Reed Properties Inc., used under license. Circulation records are maintained at Cahners Publishing Company, 44 Cook Street, Denver, CO 80206-5800. Telephone: (303) 388-4511. Second-class postage paid at Denver, CO 80206-5800 and additional mailing offices. **POSTMASTER: Send address corrections to EDN®, PO Box 173377, Denver, CO 80217-3377.** EDN® copyright 1991 by Reed Publishing USA; Ronald G Segel, Chairman and Chief Executive Officer; Robert L Krakoff, President and Chief Operating Officer; William M Platt, Senior Vice President. Annual subscription rates for nonqualified people: USA, \$119.95/year; Mexico, \$169.95/year; Canada, \$181.85/year; all other nations, \$209.95/year for surface mail and \$329.95/year for air mail. Single copies are available for \$15. Please address all subscription mail to Ellen Porter, 44 Cook Street, Denver, CO 80206-5800.

TAKE THE SPEED LEAD.

PAL™ 22V10: 7.5ns.

World's fastest programmable 22V10.

Here is the logic for high-performance systems running up to 111 MHz. Set-up is just 3 ns. Fast logic for fast systems. You get the same high speed and low noise with the 22VP10. It offers additional flexibility, including an I/O feedback path to accelerate state machine applications.

BiCMOS. The first BiCMOS 22V10, from the company that delivered the first CMOS 22V10. ECL core path for record-setting performance. CMOS logic outside the speed path, for low power. The speed of smaller PLDs, the convenience of the popular, flexible 22V10 and field programmable too.



The new 7.5 ns field programmable PLD.

Broad 22V10 PLD family and more. Cypress's 15 ns CMOS 22V10 consumes less power than any electrically erasable alternative. It's just one of a broad range of low-power CMOS PLDs. Also get 28-pin applications-tailored PLDs, and our high-capacity MAX™ PLDs too.

Call Today. Order our PLD Kit and we'll ship it right away. Why wait?

Hotline: 1-800-952-6300.*
Ask for Dept. C4Q.



*1 (800) 833-0306 in Canada. (32) 2-652-0270 in Europe. ©1991 Cypress Semiconductor, 3901 North First Street, San Jose, CA 95134. Phone: 1-(408) 943-2600, Telex: 821032 CYPRESS SNJ UD, TWX: 910-997-0753. Trademarks: PAL, Advanced Micro Devices, Inc. MAX, Altera Corporation.



**CYPRESS
SEMICONDUCTOR**

VP/Publisher
Peter D Coley

Associate Publisher
Mark Holdreith

VP/Editor/Editorial Director
Jonathan Titus

Executive Editor
Steven H Leibson

Managing Editor
Joan Morrow Lynch

Assistant Managing Editor
Christine McElvenny

Home Office, Editorial Staff
275 Washington St, Newton, MA 02158
(617) 964-3030

Gary Legg, *Senior Editor*
Tom Ormond, *Senior Editor*
Charles Small, *Senior Editor*
Jay Fraser, *Associate Editor*
John A Gallant, *Associate Editor*
Michael C Markowitz, *Associate Editor*
Dave Pryce, *Associate Editor*
Carl Quesnel, *Associate Editor*
Susan Rose, *Associate Editor*
Julie Anne Schofield, *Associate Editor*
Dan Strassberg, *Associate Editor*
Chris Terry, *Associate Editor*
Helen McElwee, *Senior Copy Editor*
James P Leonard, *Copy Editor*
Gillian A Caulfield, *Production Editor*
Brian J Tobey, *Production Editor*

Editorial Field Offices
Doug Conner, *Regional Editor*
Atascadero, CA: (805) 461-9669
J D Mosley, *Regional Editor*
Arlington, TX: (817) 465-4961
Richard A Quinnell, *Regional Editor*
Aptos, CA: (408) 685-8028
Anne Watson Swager, *Regional Editor*
Wynnewood, PA: (215) 645-0544
Ray Weiss, *Regional Editor*
Woodland Hills, CA: (818) 704-9454
Maury Wright, *Regional Editor*
San Diego, CA: (619) 748-6785
Brian Kerridge, *European Editor*
(508) 28435
22 Mill Rd, Loddon
Norwich, NR14 6DR, UK

Contributing Editors
Robert Pease, Don Powers,
David Shear, Bill Travis

Editorial Coordinator
Kathy Leonard

Editorial Services
Helen Benedict

Art Staff
Ken Racicot, *Senior Art Director*
Chinsoo Chung, *Associate Art Director*
Cathy Madigan, *Staff Artist*

Production/Manufacturing Staff
Andrew A Jantz, *Production Supervisor*
Sheilagh Hamill, *Production Manager*
Melissa Carman, *Production Assistant*
Diane Malone, *Composition*

Director of Art Department
Robert L Fernandez
Norman Graf, *Associate*

VP/Production/Manufacturing
Wayne Hulitzky

Director of Production/Manufacturing
John R Sanders

Business Director
Deborah Virtue

Marketing Communications
Kathy Calderini, *Manager*
Pam Winch, *Promotion Assistant*

TECHNOLOGY UPDATES (CONTINUED)

Video-compression chips: Monolithic circuits expedite desktop video 67

Dedicated ICs can ease the burden of implementing existing and emerging image-compression standards for video systems.

—Dave Pryce, *Associate Editor*

Show previews: Wescon '91 80
Componic '91 87

EDITORS' CHOICES

Real-time signal processor 95
Multifunction modem IC 98

PRODUCT UPDATES

D/A converters 100
CD-quality audio ICs 102
SPARC CPU module 104

DESIGN IDEAS

Optical interrupter detects tiny parts 171
Offset varies PLL's phase shift 172
Backup time-out saves battery 174
Isolation barrier preserves bandwidth 174
Diagnostic debugger manipulates reset 180
Feedback and Amplification 182

NEW PRODUCTS

Integrated Circuits 188
Components & Power Supplies 192
CAE & Software Development Tools 200
Computers & Peripherals 206
Test & Measurement Instruments 210

DEPARTMENTS

News Breaks 23
Signals & Noise 35
Editorial 47
Career Opportunities 232
EDN's International Advertisers Index 239

Cahners Publishing Company, A Division of Reed Publishing USA □ Specialized Business Magazines for Building & Construction □ Research □ Technology □ Electronics □ Computing □ Printing □ Publishing □ Health Care □ Foodservice □ Packaging □ Environmental Engineering □ Manufacturing □ Entertainment □ Media □ Home Furnishings □ Interior Design □ and Lodging. Specialized Consumer Magazines for Child Care □ Boating □ and Wedding Planning.



It's Also More Power

Introducing The 40MHz Am386™ Microprocessor— The Speediest 386 On The Planet.

It looks like a mild mannered 386. In fact, it is: A genuine, plug-in replacement for the i386. Except it's faster. Burns less power. Costs no more. And it's available now.

The Am386DX-40 microprocessor



can transform any ordinary 33MHz system into an invincible, 25% faster, 40MHz Am386 system. So you can easily offer the world's fastest 386 performance.

It's not only super-fast, it's also super-efficient, thanks to its truly static



ful Than A Locomotive.

operation. That means even notebooks and palmtops can attain breakthrough performance.

Best of all, the 40MHz Am386 micro-processor is available now, available to everyone, and available at surprisingly low prices. How's that for Truth, Justice and the American Way?

So find a phone booth and call AMD

at **1-800-222-9323**. And let the world's fastest 386 come to your rescue.



Advanced Micro Devices

"We're Not Your Competition."

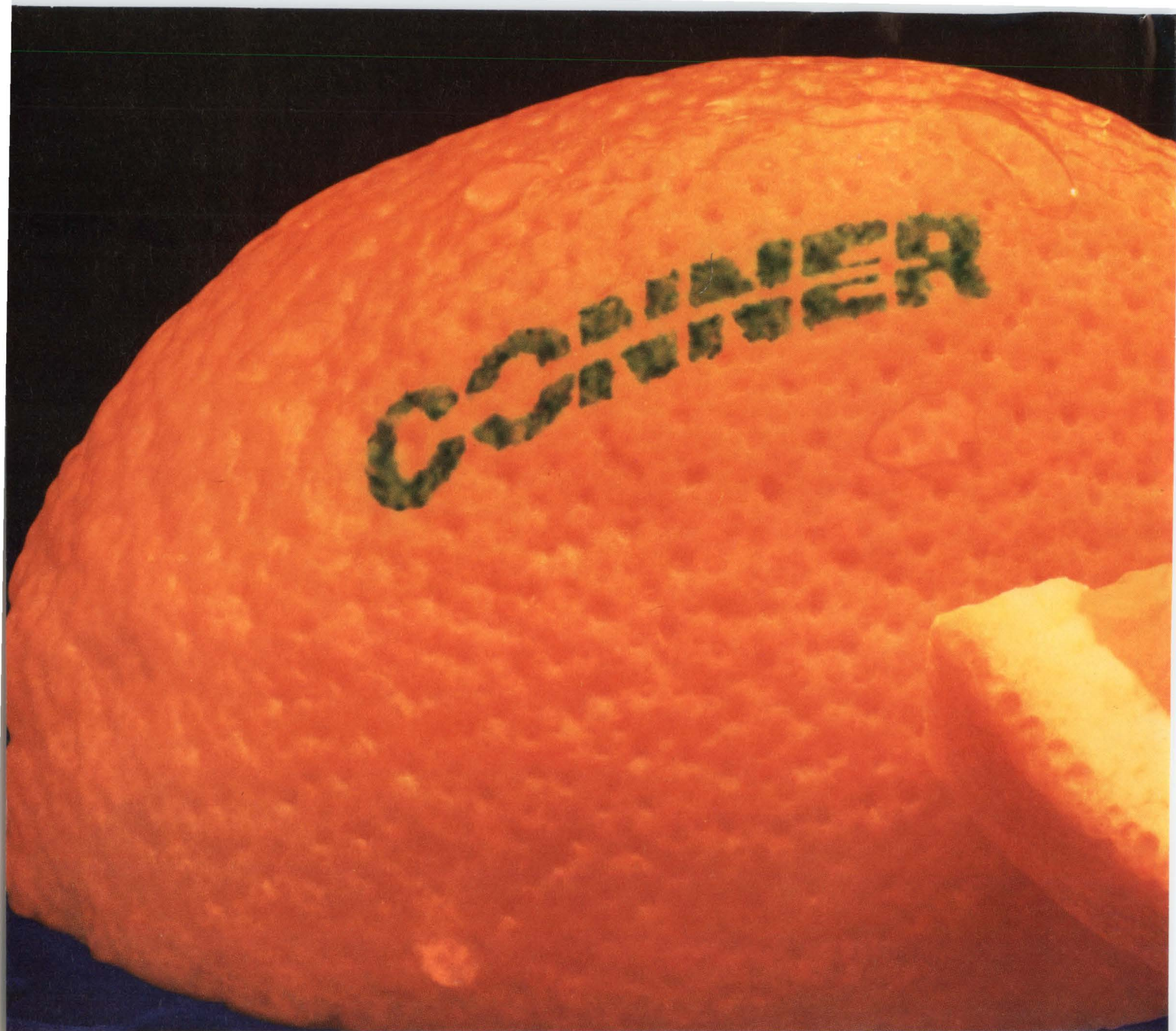

ANY WAY YOU SLICE IT, GENERATION COVERS EVERY

The squeeze is on. Today the PC market is rapidly concentrating into three segments: Notebooks, Desktops and Workstations. And once again, Conner has anticipated these changes.

Which is why we're introducing our newest wave of high-performance 2.5-inch and 3.5-inch drives to meet the needs of each of these evolving market segments.

For the notebook market, take our newest Pancho drive.

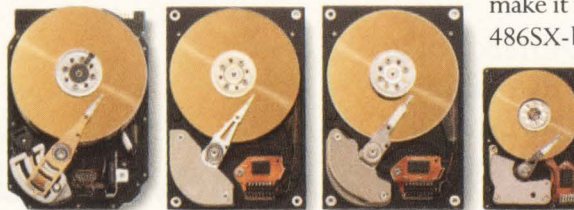

Summit 540 MB

Cougar 210 MB

Jaguar 85/170 MB

Pancho 85 MB

With 85 Mbytes, it offers the highest capacity available in a light weight, patented 2.5-inch form factor. Low power consumption, rugged packaging and a compact form factor make it the ultimate choice for 386SX and 486SX-based notebook computers.

Then there's our new Jaguar Series for the desktop market—3.5-inch drives offering 85 and 170 Mbytes. A 17 msec. average seek time and a light weight, patented 1-inch

World Headquarters: 3081 Zanker Road, San Jose, CA 95134 Telephone: (408) 456-4500 FAX: (408) 456-4501 **Sales Offices:** *Asia*—Singapore: (65) 296-1992 • Taipei: (886) 2-718-9193 • Tokyo: (81) 3-3485-8901 • Seoul: (82) 2-551-0511 **Europe**
© 1991 Conner Peripherals, Inc.

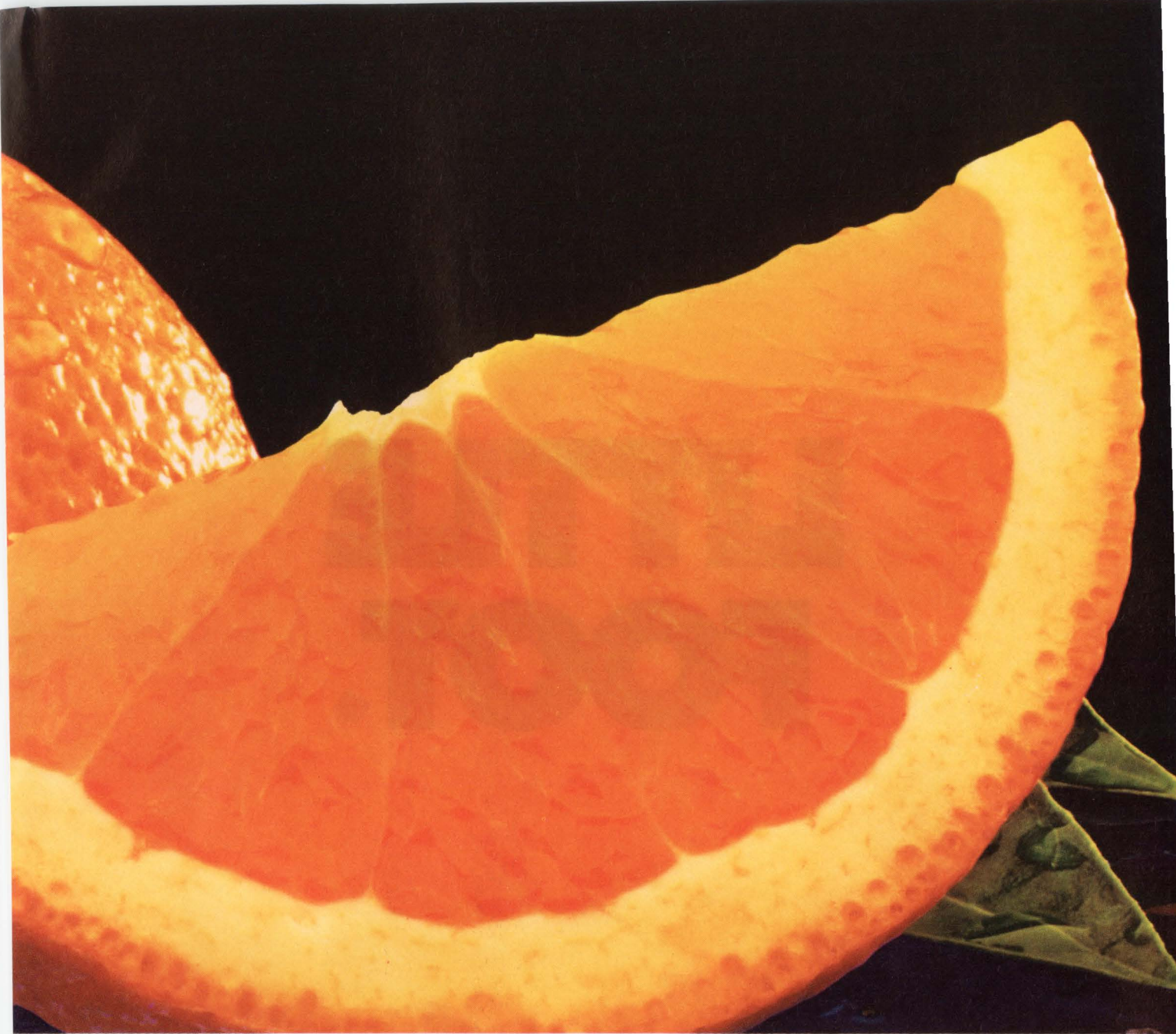

CONNER'S NEWEST SEGMENT OF THE MARKET.

high form factor make them ideal for a full range of desktop computers.

For workstations, we're introducing two new 3.5-inch drives—the 210 Mbyte Cougar and 540 Mbyte Summit. Cougar is the highest performance low-profile drive on the market today. While Summit delivers the greatest capacity and performance of any 3.5-inch drive. Both provide a fast average seek time of 12 msec., a 2.5 Mbyte per second sustained transfer rate and a SCSI-2 interface.

It's all a part of our innovative sell-design-build business philosophy. To identify our customer's needs sooner. Then

fill them faster with the most advanced products. In fact, we're the technological leader with nine patents issued and 27 pending. Which is why more and more PC users are asking for systems with Conner drives.

So if the changing market segments are putting the squeeze on your systems, call us today. We'll guarantee you the most refreshing results.

CONNER
Delivering A Generation Ahead

—London: (44) 071-409-0090 • Munich: (49) 89-129-8061 • Paris: (33) 1-47-47-41-08 • Aosta: (39) 125-800260 • U.S.—Boston: (617) 449-9550 • Dallas: (214) 680-2913 • Irvine: (714) 727-2462 • Minneapolis: (612) 449-5186 • San Jose: (408) 456-4500.

LITTLE FOOT.



CONVERTERS REWIND
BEHIND TO THE MARKET

ALWAYS OVERSHADOWED, NEVER OUTPERFORMED.

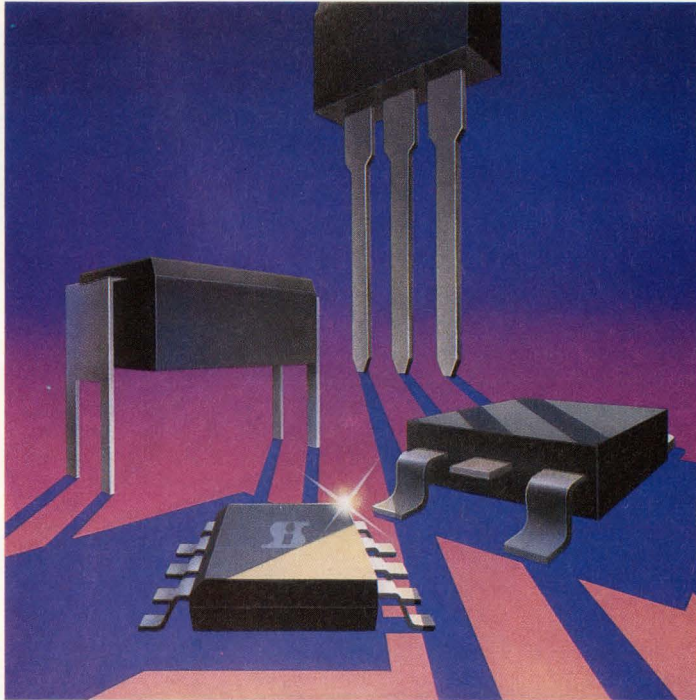

Overshadowed!

It happens all the time when you're the shortest, smallest component on the board.

We admit it — LITTLE FOOT™ just can't stand up to other power devices.

But as long as it runs circles around them, it doesn't have to. And performance-wise it does — with the industry's highest power density and lowest on-resistance. Just what you need for motor control, load switching, and DC/DC conversion.

This tiny 8-pin SOIC package contains your choice of one or two powerful MOSFETs produced with our SiMOS 2.5 technology (2.5 million cells/sq.in.), allowing you to design it into your system in less than five one hundredths (0.05) of a single square inch, far less space than a single transistor DPAK, 4-pin DIP, or TO-220.

LITTLE FOOT is designed for manufacturability.

LITTLE FOOT simplifies your assembly process because Siliconix's SOIC packaging is compatible with the digital devices on your board. And its two-MOSFET capability means you use fewer components and get higher system reliability.

LITTLE FOOT is designed for manufacturability — to cut your costs. It requires less set-up time and has the same process flow as the other SMDs on your board. It also has a standard soldering profile and reduces your visual inspection time. And there are no solder voids, no lead trimming, and no tube jamming.

Saving space and money is good. But often saving time is even better. And in many cases designing with LITTLE FOOT allows you to reduce the number of steps in your production cycle to get your product to market faster.

Get the LITTLE FOOT big advantage.

It runs cooler, saves space, improves reliability, increases efficiency, simplifies design, extends battery life, reduces costs, and cuts time to market. When you design-in this kind of performance you'll never be overshadowed.

LITTLE FOOT comes in different versions that are ideal for motor control, load switching, and DC/DC conversion.

- N-ch MOSFETs (duals & singles)
- P-ch MOSFETs (duals & singles)
- N- & P-ch MOSFETs

Voltage: 20-50 V (200 V coming)
On-resistance: 50-300 mΩ
Max Current: 4.5 A

Call our toll-free hot line now!
1-800-554-5565, ext. 963. Ask for your LITTLE FOOT design kit and evaluation board. And remember, at Siliconix we're bringing a seamless power interface to the digital world.

Siliconix

2201 Laurelwood Rd, Santa Clara CA 95056

© Copyright 1991 Siliconix
LITTLE FOOT is a trademark of Siliconix



Make all these disappear.

Poof, they're gone. Bulky battery packs, slow hard disks and more. You see, where memory cards make sense, the new Intel 4MB Flash Memory Card provides a high-density, read/write, truly nonvolatile portable storage solution.

The real trick, of course, is that it allows you to store large amounts of code or accumulate data in a small, rugged card that uses less power than traditional memory technologies. So now you can design products that are faster, lighter, tougher and more energy efficient.

Not tomorrow, but today. Thanks to our System Developer's Kit. A DOS-compatible package that includes a 1MB Flash Memory Card, an add-in board as well as design information. In addition, it includes an evaluation copy of Microsoft's Flash File System software. All the stuff to get you started—now!

Plus, Intel's Flash Memory Card is the first to comply with the 68-pin PCMCIA/JEIDA standard. This allows the card and its data to be interchangeable between a host of

Come see us at Comdex
Booth #1916 and at the
Sahara Hotel from 4:30-8:30 p.m.

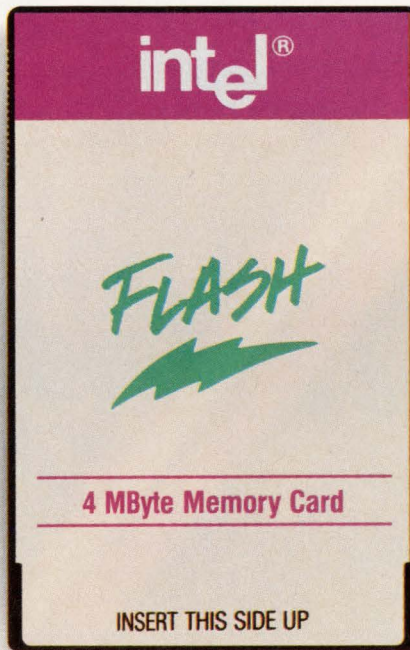

Actual Size.

With this simple card trick.

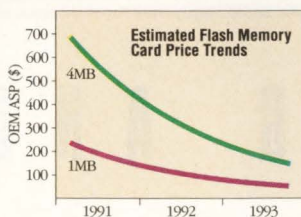

systems—from PCs to fax machines to bar-code readers.

The secret of the card's magic is Intel's ETOX™II Flash technology—combining RAM, ROM and mass storage capabilities onto a solid-state, energy-

efficient medium. A technology so successful that volume continues to rise and prices continue to drop.

Want to know more about the secrets of this amazing technology? Then call (800) 548-4725 today and ask for Literature Packet #C8A01. And start performing your own disappearing tricks.

intel[®]
The Computer Inside.™

**GIVING
MANUFACTURING
SYSTEMS A
NEW SPIN ON
QUALITY.**



S I G N A L P R O C E S S I N G A N D



HARRIS
SEMICONDUCTOR

Rotating at more than 800 mph, precisely formed turbine blades easily withstand the volcanic fury of 1000°F temperatures, thanks to manufacturing systems based on signal processing and power control components from Harris Semiconductor.

Signal processing and power control is our specialty. It involves gathering real-world signals — like density, pressure and magnetic flux — processing them, and driving devices that perform real-world tasks. And no one does it better than Harris, combining the technologies of analog, mixed signal, DSP and power semiconductors.

Harris offers a complete range of semiconductors to help build *your* products to the most exacting tolerances. And ensure their reliability, even in the most hellish environments. So how can we help you? For more information, call 1-800-4-HARRIS, Ext. 1123.

POWER CONTROL FROM HARRIS.

You have to build a to build just

The new Tek TDS Series

More than a million Tektronix oscilloscopes have all been leading up to this: the most powerful, versatile, and intuitive instruments ever developed for the mainstream of test and measurement.

The new TDS 500 Series is the culmination of everything Tek has learned in the design, manufacture and use of digitizing oscilloscopes. It's an achievement made possible only by the unique integration of acquisition functions and combinational trigger logic onto a single board.

Only by the development of a milestone multiprocessor architecture.

Only by the addition of Tek's TriStar™ Digital Signal Processor (DSP).

Only by Tek's capacity for taking the hard work out of high performance.

The TDS Series performs, *live*, up-

dates and measurements that inhibit most other digitizing scopes. Its real-

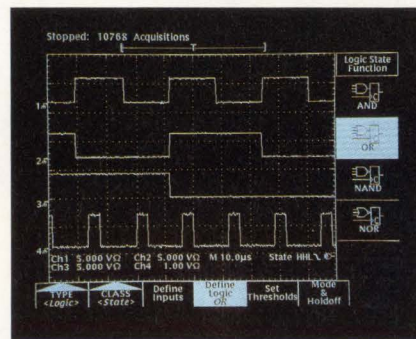

time DSP lets you perform single-shot averaging and extend resolution to 12 bits. The TDS Series arms you with up to four full-featured channels. 500 MHz bandwidth. Up to 1 GS/s sampling and 4 ns peak detect.

Up to 50K record lengths. Time interval, 2 ns glitch, runt, pattern and state triggers. With acquisition sensitivity and fast overdrive recovery bringing greater waveform detail within your grasp.

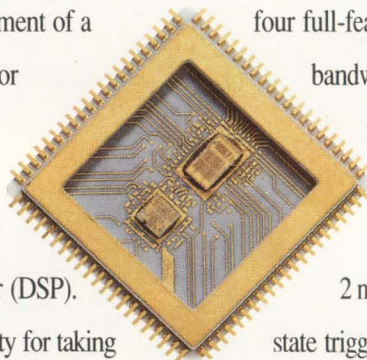

And if you think oscilloscopes aren't as easy to use and comprehend as they

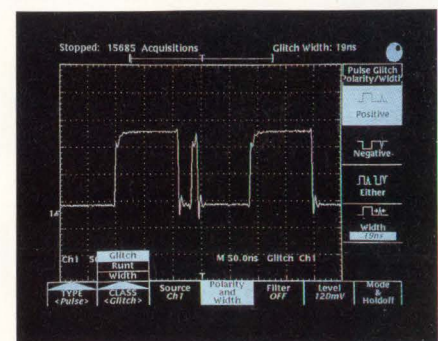

million oscilloscopes one like this.

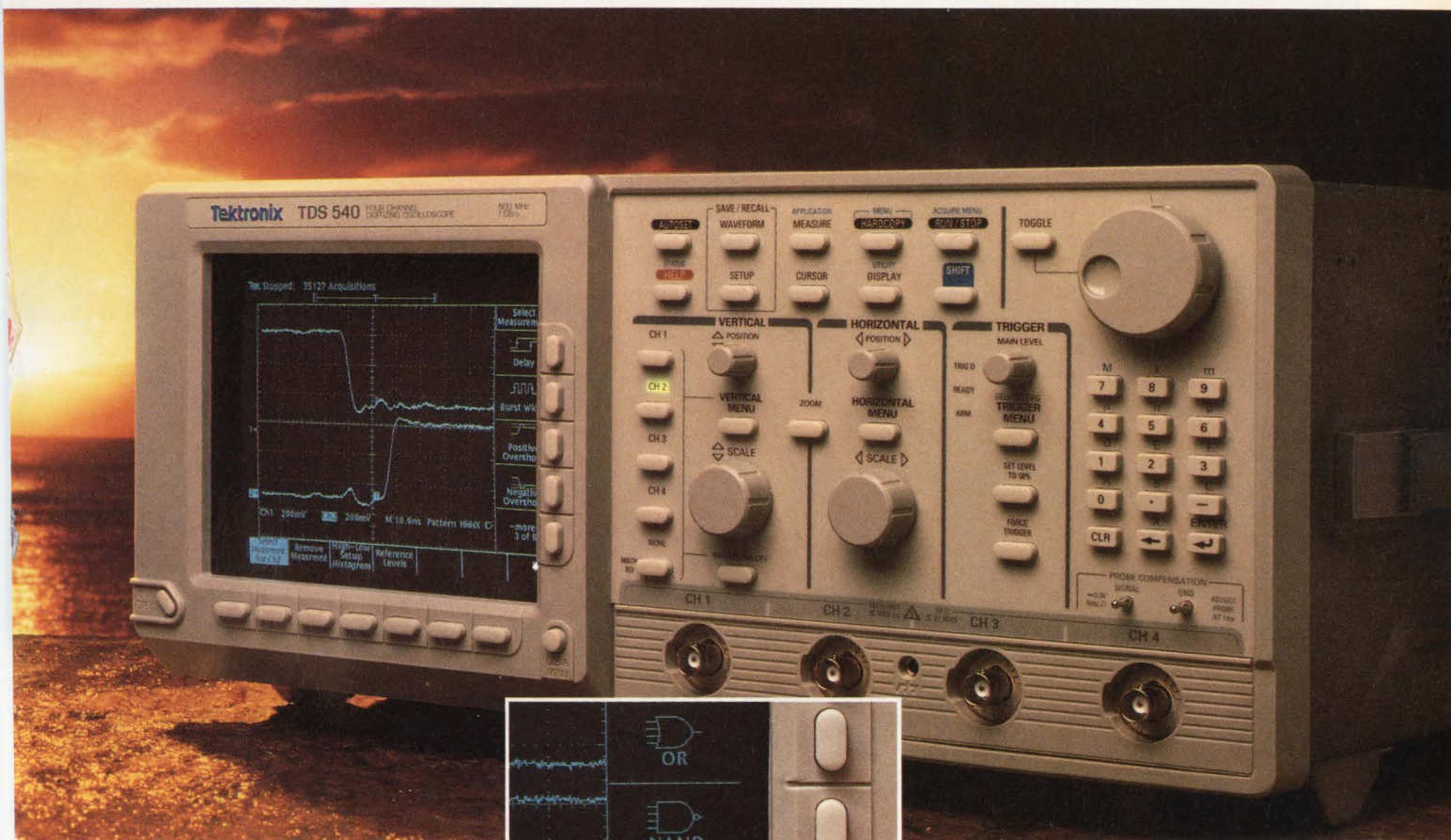

could be, you owe yourself a demo of the TDS. Its simplified front panel, VGA-quality display resolution, on-line help text, innovative icons that instantly differentiate menu functions — all add up to a scope that makes the user's manual more a formality than a necessity.

The TDS Series signals the start of a new generation of friendlier, more

powerful instruments from the world's leading supplier of digitizing and analog oscilloscopes. To get a first-hand feel for why performance like this only comes along about once in a million scopes, contact your Tek sales engineer or call **1-800-426-2200**.

One company measures up.

Tektronix
COMMITTED TO EXCELLENCE

SIEMENS

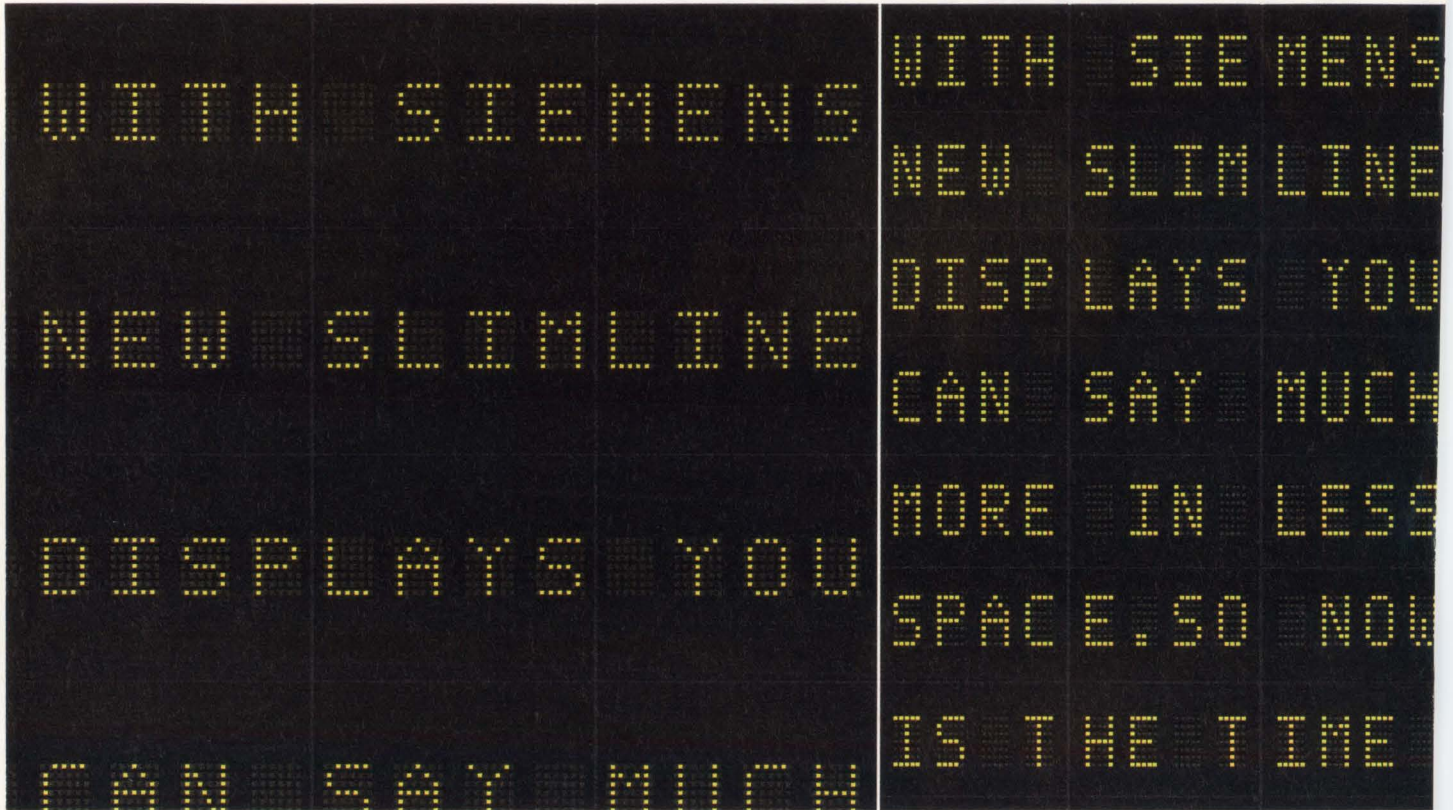

We Admit This Test Of Our Slimline Display Is Stacked In Our Favor.

Our new LED dot matrix Intelligent Display® has proven once again why Siemens is at the forefront of display device technology. And has left the competition at a loss for words.

Because its package size is 60% smaller, the Siemens SLx2016 Slimline allows you to say a lot more, in a lot less space. The Slimline family features a .4-inch package height, rather than the .8-inch height industry standard, while keeping a .19-inch character

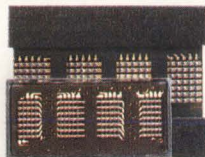

height. Plus, our displays are X and Y stackable, to give you maximum flexibility in your design.

The SLx2016 is the first in a series of Siemens Slimline Intelligent Displays, all of which will give you on-board display drivers with control logic and easy addressability.

And it's available now, in four bright colors including red, yellow, green, and High-Efficiency Red.

So if you're looking for the slimmest Intelligent Display

available, compare us to the competition. You'll see that they just don't stack up.

For more information, call (408) 725-3423, FAX (408) 725-3439, or write:

Siemens Components, Inc.
Optoelectronics Division
19000 Homestead Road
Cupertino, CA 95014-0799

Distributors: Advent Electronics, Inc.,
Hall-Mark, Insight Electronics,
Marshall, Summit,
Western Microtechnology.

NEWS BREAKS

EDITED BY SUSAN ROSE

TELECOM PC-BOARD TESTER TAPS VXI TECHNOLOGY

The GR9000 telecommunications test-and-measurement system from GenRad Inc uses the largest VXI boards (the so-called D size) to minimize cabling and to accommodate very large amounts of computing power. The test system suits complex mixed-signal pc boards used in large numbers in telephone central offices and private-branch exchanges. The system achieves some of its capabilities by harnessing a feature of the VXIbus modular-instrument standard that until now has attracted only limited interest. Because the VXI modules mount in the system's test head and contain connectors not found on smaller VXI boards, the system needs a minimum of cabling to connect to a unit under test—regardless of whether the connections are made by pogo pins or edge connectors. Moreover, the large VXIbus boards permit each system to include multiple-array processors, thus enabling high-speed number crunching. Adapters let the system hold smaller VXI units needed in specific applications. To provide users with a flexible set of test-program development tools, the vendor based its software on Labwindows from National Instruments (Austin, TX). The system costs \$120,000, and a typical configuration costs \$225,000. GenRad Inc, Concord, MA, (508) 369-4400.—Dan Strassberg

STATIC 80186 MINIMIZES POWER AND UPS PERIPHERALS

Intel has shifted its 80186 to a static core, adding a 3-level power-management control for low power applications. There are three new power modes: Idle (freezes CPU, keeps peripherals active), Powerdown (freezes internal clocks), and Powersave (a programmable internal clock divider to run at slower rates). With Idle and Powerdown, power consumption is less than 100 μ A typ. There are three new microcontrollers: The 80C186EC has four DMA channels, two interrupt controllers, 22 I/O pins, four timers, and standard peripherals; the 80C186EA combines the power management modes with 5 and 3V operation and a static core; and the 80C186XL is compatible with the existing processor, but adds a static core and a 20-MHz clock. Prices start at \$17.70, \$11.80, and \$11.80 (1000), respectively. Intel Corp, Santa Clara, CA, (408) 987-8080.—Ray Weiss

MAC LINE EXPANDS BY SIX, INCLUDING LAPTOPS

Apple Computer is adding six new machines to its Macintosh line of personal computers: three desktops and three laptops. The 68030-based Mac Classic II, an extended version of the Mac Classic, executes applications programs at approximately twice the speed of its predecessor and rivals the performance of the Mac SE30, which will be phased out of production. You can upgrade your computer for \$699.

The company has also started two new product lines. The Macintosh Quadra computers use 25-MHz 68040 CPUs and feature built-in support for all of the company's monochrome and color monitors, offering as many as 32 bits/pixel for graphics. Both the \$6499 700 and \$8699 900 include SCSI and Ethernet ports as well as Appletalk and the company's Desktop Bus. They also offer Nubus expansion slots; two and five, respectively. Owners of the Mac IIcx can upgrade to a 700 for \$3500.

The other new line, the Powerbook series, brings the company into the laptop-computer market. All three units, the 100 (\$2500), 140 (\$3200), and 170 (\$4600), feature 640 \times 400 displays, a built-in trackball, and internal hard-disk drives. The 140 and 170 also have built-in floppy drives. The three units use different CPUs: 68000s, 16-MHz 68030s, and 25-MHz 68030 with a coprocessor, respectively. Apple Computer Inc, Cupertino, CA, (408) 996-1010, TLX 171576.—Richard A Quinnell

NEWS BREAKS

VXIBUS CONSORTIUM MEMBER UNVEILS TEST PRODUCTS

Brüel & Kjaer's range of VXIbus products form the basis of the model 3538 modular test system. The system includes a size C, 13-slot cardframe controller, slot-0 modules, a signal processor, a configurable switch, a memory module, and a development card. Software support includes an object-oriented operating system, Pascal, system device drivers, and generic device-driver development software. Three versions of controller and slot-0 modules offer interfacing via IEEE-488 (model 7513, \$6800), Ethernet (model 7514, \$7300), or both (model 7527, \$8900). The multitasking DSP module, model 3152 (\$9500), handles signal-analysis and waveform-generation tasks with 32-bit floating-point accuracy. Switch module, model 3153 (\$3350), lets you connect twelve 6-MHz signals in a variety of multiplex or matrix configurations. Memory module, model 7403 (\$2350), expands storage of the 3538 system from 4 to 128 Mbytes by adding single in-line memory modules. The 7630 multiuser Felix operating system (\$5400) lets you develop system software on a Unix workstation connected to the system via Ethernet. Multiuser capabilities of Unix and Felix, combined with LAN support, enable remote users to work on program development and production test simultaneously. You can use C or FelixPascal program languages for embedded control. FelixPascal (7602, \$3800), is an extension of standard Pascal to suit the operating system and enable parallel programming. Brüel & Kjaer, Naerum, Denmark, 4280-0500, FAX 4280-1405. In US, (508) 481-7000, FAX (508) 485-0519.—Brian Kerridge

SOFTWARE ROUTES MULTIPLE FPGA ARCHITECTURES

NeoCAD is developing a tool suite to route field-programmable gate arrays (FPGAs) from several vendors. The product includes place-and-route algorithms tailored to specific FPGAs, unlike current tools from Data I/O, Exemplar Logic, and Viewlogic Systems that provide FPGA-device independence via individual FPGA mapping routines. The software will accept timing constraints that ensure that layouts meet design specifications. The initial release will include place-and-route algorithms for at least Actel and Xilinx FPGAs. The software will accept data in EDIF (Electronic Design Interchange Format), LPM (Library of Parametrized Models), and Xilinx and Actel proprietary formats. Scheduled for January availability, the software runs on 386 or 486 PCs and Unix workstations under X-Windows and Motif. The software is expected to cost less than \$20,000. NeoCAD, Boulder, CO, (303) 442-9121, FAX (303) 442-9124. Xilinx, San Jose, CA, (408) 559-7778. —Michael C Markowitz

GYROSCOPE-BASED POINTING DEVICE HANDLES 3-D

The Gyropoint pointing device from Gyration Inc looks like a mouse, but it's a mouse with wings. The gyroscope-based device isn't confined to a table top. In its mouse-compatible mode, you can move the pointer in free space to control the cursor on your computer monitor. In the pointer's 3-D mode, it provides an additional degree of freedom, giving you your choice of XYZ position or roll, pitch, and yaw.

The pointer is a demonstration vehicle for the company's core technology, a miniature gyroscope. This device, called the Gyroengine, uses optical sensing and a built-in microcontroller to provide angular position measurements directly to a computer in RS-232C and serial-data formats. The device measures 1.75 x 1.25 in., runs on 3V, and consumes 0.1W while running. A developer's kit for the engine, comprising a pointer, interface schematics, and technical data, is available for \$1000. Gyration Inc, Saratoga, CA, (408) 255-3016. Contact Laurie Schuler.—Richard A Quinnell

From Conception to Realization— We Have Your Circuit Design in Mind

Let MicroSim Corporation help you achieve your circuit engineering goals with our family of CAE packages—Genesis, Circuit Analysis, and Circuit Synthesis.

New Schematic Capture Front-End

Our new Genesis package includes Schematics, a versatile schematic capture front-end to our popular Circuit Analysis programs, PSpice and Probe. Circuit definition is simple and flexible with Schematics' graphical circuit and symbol editors. Iterative adjustment of PSpice analysis parameters and invocation of PSpice simulations is convenient and direct through Schematics' pull-down menus and dialog boxes. Visual inspection of simulation results is just as straightforward since Probe is run directly from Schematics.

Expanded PSpice Back-End

In-depth examination and processing of PSpice simulation results is more powerful than ever with Probe's new Performance Analysis and multiple Y axes features. Together with Probe's high resolution plotting, simultaneous display of analog and digital waveforms, and all of the other features that have made Probe so popular, the power is at your fingertips.

Filter Synthesis Made Easy

Active RC biquad and switched capacitor filters are a breeze to design and evaluate with Filter Designer in our Circuit Synthesis package. It doesn't stop there! Using PSpice and Probe, it is easy to simulate and further analyze your filter circuit design.

For further information on MicroSim Corporation's family of products, call toll free at (800) 245-3022 or FAX at (714) 455-0554.



MicroSim Corporation
Expanding the Standard for Circuit Simulation

20 Fairbanks • Irvine, California 92718 USA

PSpice is a registered trademark of MicroSim Corporation. All other brands and product names are trademarks or registered trademarks of their respective holder.

CIRCLE NO. 28

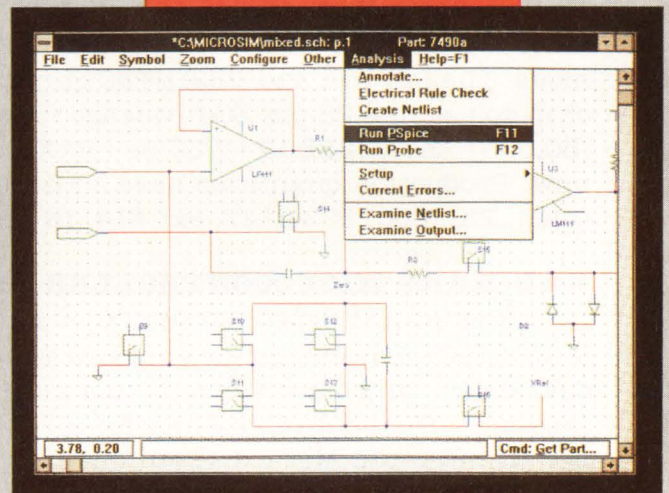

Schematics as a Windows 3.0 application

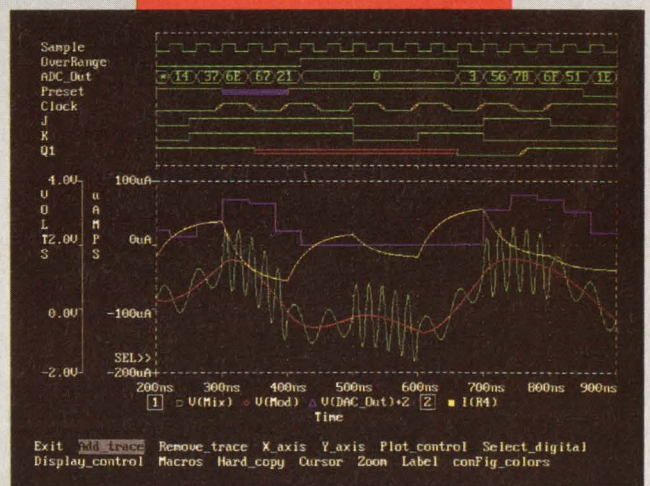

Analog and digital waveforms with multiple Y axes in Probe

NEWS BREAKS

LOW-POWER MODEM CHIP SET HAS V.32BIS/FAX CAPABILITY

Available in two versions, a 3-chip set from AT&T Microelectronics targets low-power, high-speed applications in laptop computers and pocket modems. Consuming 450 mW of power, the chip sets support either V.32 + fax (9600-bps data and send/receive fax) or V.32bis + fax (14,400-bps data and 9600-bps send/receive fax). Each chip set contains a ROM-coded DSP16A to handle modem protocol processing, a T7525 coder/decoder serving as the analog front-end, and a V32INTFC data-pump interface that integrates peripheral circuitry. Needing no extra memory, the chip sets minimize power consumption and board space—important considerations in laptop computers.

The chip sets are downward-compatible with other modem standards, such as V.22bis, V.22, V.23, V.21, and Bell 212A and 103. Both chip sets also support fax-modem standards V.29, V.27ter, and V.21. They also feature a voice pass-through mode. The DSP16A and V32INTFC chips come in 84-pin quad flatpacks, and the T7525 chip comes in a 28-pin SOJ package. The V32F-LT (V.32 + FAX) chip set costs \$75 (50,000); the V32FB-LT (V.32bis + FAX) chip set costs \$85. Samples are available now. Production quantities have a 12-week lead time. AT&T Microelectronics, Allentown, PA, (800) 372-2447, ext 814; in Canada, (800) 553-2448, ext 814.—Dave Pryce

RAD-HARD MICROCONTROLLER EXECUTES 8 MIPS PEAK

United Technologies' UT69R000 is a 16-bit, 16-MHz, Rad-hard CMOS microcontroller (μ C). The controller guarantees single-event upset of less than $25.6E-6$ errors/device-day, which corresponds to a minimum linear-energy threshold of 40 MeV (mg/cm^2). Total dose immunity for all static and dynamic specifications is 1 Mrads(Si) per MIL-STD-883 Method 1019. The fully static design consumes less than 500 mW at 16 MHz. The μ C features a $64k \times 16$ -bit address space for data and a $1M \times 16$ -bit address space for instructions. Embedded peripherals include a 9600 baud UART, two 16-bit interval timers, and nine hardware interrupts. The controller executes 35 instructions, most of which execute within two clock cycles, using a 32-bit accumulator and twenty 16-bit data registers that you can concatenate to 32 bits. The processor supports multiprocessor operation, DMA, and bus arbitration through bus handshaking. In a 144-pin PGA, tested to level S screening, the part costs \$4744 (100); delivery is 26 weeks ARO. United Technologies Microelectronics Center, Colorado Springs, CO, (719) 594-8000.—Michael C Markowitz

CHAIRMAN AND CHIEF EXECUTIVE OF CAHNERS DIES

Ronald Segel, chairman and chief executive of Cahners Publishing Co, which publishes EDN, and deputy chief executive of parent-company Reed International PLC, died on August 31. Mr Segel died at the age of 56, after a year-long bout with cancer. A native of Boston, MA, he was a graduate of Harvard University and the Harvard Business School. Mr Segel was a quiet and private man who spoke most eloquently through his vision for Cahners and his dedication to its employees. His vision and judgment ensures that Cahners' publications will continue to increase their value to readers and advertisers for many years.

When Mr Segel joined the company as vice president of finance in 1971, Cahners was a trade-magazine company with annual revenues of \$50 million. Twenty years later, Cahners is the core of a \$1.3 billion communications company. Cahners, under Mr Segel's guidance, grew to a company with 84 publications, and is the leading trade publisher in the US and a growing force in consumer publishing.—EDN staff

What's the quality of our quality

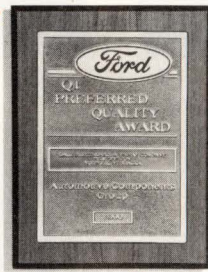

Ford



General Electric



Rockwell International

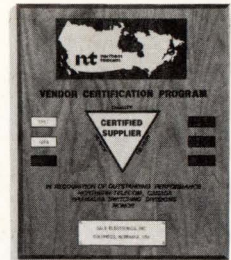

Northern Telecom

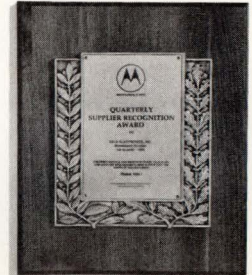

Motorola Inc.

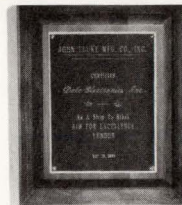

John Fluke Mfg. Co., Inc.



Rockwell International



Honeywell Inc.

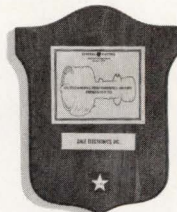

General Electric



Tektronix



Department of Energy

Talk to any of the major manufacturers who, during the past three years, have recognized Dale's ability to meet their exacting quality standards. Then talk to us. We have a wall full of awards—perhaps as many as anyone in the industry—and we're always pleased to receive more. However, we'd much rather discuss what these awards represent: A soundly structured quality system able to quickly interface with your manufacturing process—and make you more competitive. That's the quality of our quality.

For more information on Dale quality procedures and systems, write Joe Matejka, Vice President of Quality Assurance, Dale Electronics, Inc., 1122 23rd Street, Columbus, Nebraska 68601-3647. Phone (402) 563-6511.

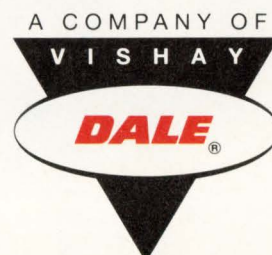

FILTERS



dc to 3GHz from \$1145

lowpass, highpass, bandpass, narrowband IF

- less than 1dB insertion loss • greater than 40dB stopband rejection
- 5-section, 30dB/octave rolloff • VSWR less than 1.7 (typ) • meets MIL-STD-202 tests
- rugged hermetically-sealed pin models • BNC, Type N; SMA available
- surface-mount • over 100 off-the-shelf models • immediate delivery

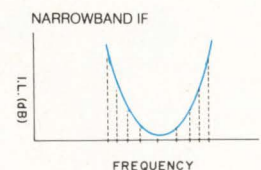
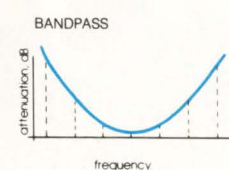
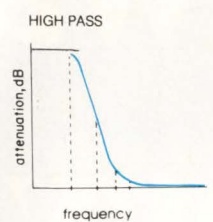
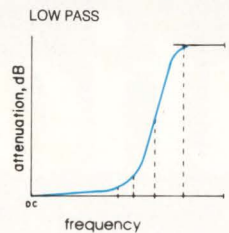

low pass dc to 1200MHz

MODEL NO.	PASSBAND, MHz (loss <1dB)		fco, MHz (loss 3db)	STOP BAND, MHz (loss >20dB)		VSWR pass-band typ.	VSWR stop-band typ.	PRICE \$ Qty. (1-9)	
	Min.	Max.		Min.	Max.				
PLP-10.7	DC-11	14	14	19	24	200	1.7	18	11.45
PLP-21.4	DC-22	35	24.5	32	41	200	1.7	18	11.45
PLP-30	DC-32	35	35	47	61	200	1.7	18	11.45
PLP-50	DC-48	55	55	70	90	200	1.7	18	11.45
PLP-70	DC-60	67	67	90	117	300	1.7	18	11.45
PLP-100	DC-98	108	108	146	189	400	1.7	18	11.45
PLP-150	DC-140	155	155	210	300	600	1.7	18	11.45
PLP-200	DC-190	210	210	290	390	800	1.7	18	11.45
PLP-250	DC-225	250	250	320	400	1200	1.7	18	11.45
PLP-300	DC-270	297	297	410	550	1200	1.7	18	11.45
PLP-450	DC-400	440	440	580	750	1800	1.7	18	11.45
PLP-550	DC-520	570	570	750	920	2000	1.7	18	11.45
PLP-600	DC-580	640	640	840	1120	2000	1.7	18	11.45
PLP-750	DC-700	770	770	1000	1300	2000	1.7	18	11.45
PLP-800	DC-720	800	800	1080	1400	2000	1.7	18	11.45
PLP-850	DC-780	850	850	1100	1400	2000	1.7	18	11.45
PLP-1000	DC-900	990	990	1340	1750	2000	1.7	18	11.45
PLP-1200	DC-1000	1200	1200	1620	2100	2500	1.7	18	11.45

high pass dc to 2500MHz

MODEL NO.	PASSBAND, MHz (loss <1dB)		fco, MHz (loss 3db)	STOP BAND, MHz (loss >20dB)		VSWR pass-band typ.	VSWR stop-band typ.	PRICE \$ Qty. (1-9)
	Min.	Max.		Min.	Max.			
PHP-50	41	200	37	26	20	1.5	17	14.95
PHP-100	90	400	82	55	40	1.5	17	14.95
PHP-150	133	600	120	95	70	1.8	17	14.95
PHP-175	160	800	140	105	70	1.5	17	14.95
PHP-200	185	800	164	116	90	1.6	17	14.95
PHP-250	225	1200	205	150	100	1.3	17	14.95
PHP-300	290	1200	245	190	145	1.7	17	14.95
PHP-400	395	1600	360	290	210	1.7	17	14.95
PHP-500	500	1600	454	365	280	1.9	17	14.95
PHP-600	600	1600	545	440	350	2.0	17	14.95
PHP-700	700	1800	640	520	400	1.6	17	14.95
PHP-800	780	2000	710	570	445	2.1	17	14.95
PHP-900	910	2100	820	660	520	1.8	17	14.95
PHP-1000	1000	2200	900	720	550	1.9	17	14.95

bandpass 20 to 70MHz

MODEL NO.	CENTER FREQ. MHz F0	PASS BAND, MHz (loss <1dB)		STOP BAND, MHz (loss > 10 dB)				VSWR 1.3:1 typ. total band MHz	PRICE \$ Qty. (1-9)
		Max. F1	Min. F2	Min. F3	Max. F4	Min. F5	Max. F6		
PIF-21.4	21.4	18	25	4.9	85	1.3	150	DC-220	14.95
PIF-30	30	25	35	7	120	1.9	210	DC-330	14.95
PIF-40	42	35	49	10	168	2.6	300	DC-400	14.95
PIF-50	50	41	58	11.5	200	3.1	350	DC-440	14.95
PIF-60	60	50	70	14	240	3.8	400	DC-500	14.95
PIF-70	70	58	82	16	280	4.4	490	DC-550	14.95

narrowband IF

MODEL NO.	CENTER FREQ. MHz F0	PASS BAND, MHz I.L. 1.5dB max.		STOP BAND, MHz I.L. > 20dB		STOP BAND, MHz I.L. > 35dB		PASS-BAND VSWR Max.	PRICE \$ Qty. (1-9)
		F1-F2	F3-F4	F5-F6	F7-F8-F9				
PBP-10.7	10.7	9.5-11.5	7.5	15	0.6	50-1000	1.7	18.95	
PBP-21.4	21.4	19.2-23.6	15.5	29	3.0	80-1000	1.7	18.95	
PBP-30	30.0	27.0-33.0	22	40	3.2	99-1000	1.7	18.95	
PBP-60	60.0	55.0-67.0	44	79	4.6	190-1000	1.7	18.95	
PBP-70	70.0	63.0-77.0	51	94	6	193-1000	1.7	18.95	

CIRCLE NO. 30

Mini-Circuits

P.O. BOX 350166, Brooklyn, New York 11235-0003 (718) 934-4500 FAX (718) 332-4661 TELEX 6852844 or 620156 WE ACCEPT AMERICAN EXPRESS

F132-2 REV. ORIG.

**Presenting the
biggest little
innovation
in hardware
history.**

The big news in hardware today is small. Staying ahead means being first with the smallest, lightest, and fastest. Which is exactly what we've done with our new family of 68-pin memory cards.



(Actual size.)

From desktop PCs to laptops to notebooks to medical instruments and test equipment. The most innovative systems are also the smallest. So how do you keep up? With the new family of 68-pin memory cards from Fujitsu Microelectronics.

Rugged, reliable, and completely portable, Fujitsu memory cards deliver the fast, high-density storage that users of your hand-held systems demand in a compact, power-lean package.

In fact, Fujitsu pioneered the 68-pin memory card and was the driving force

in making it an international standard. And if that's not big enough news, Fujitsu is the first to offer a complete family of 68-pin products including Flash EPROMs, Mask ROMs, EPROMs, and OTPROMs. As well as a full line of connectors, card drives, and interface chips.

Not to mention enough design and programming support — every step of the way — to get your products to market in record time.

All of which makes our little memory card a pretty big idea all by itself. Imagine what it could do for you. Then call Fujitsu Microelectronics at 1-800-642-7616, and start making some news of your own.

FUJITSU

FUJITSU MICROELECTRONICS, INC.
Integrated Circuits Division
3545 North First Street, San Jose, CA 95134-1804.
1-800-642-7616.

Every step of the way.SM

See us At Wescon—Booth #917

CIRCLE NO. 31

© 1990, Fujitsu Microelectronics, Inc.
Every step of the way is a service mark of Fujitsu Microelectronics, Inc.

How Teradyne helps Northern Telecom

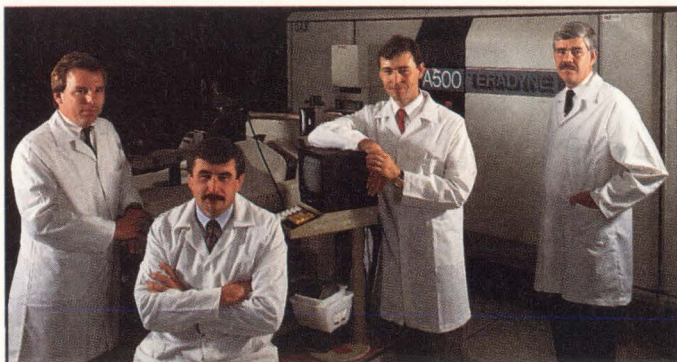

John Haydon, Ken Bradley, Gary Hobin, Terry Caves of Northern Telecom Electronics, Ottawa.

"To us, time is a strategic tool, a way of getting the edge it takes to gain a leadership role in world markets. With Teradyne testers, test development and manufacturing setup times are shorter, and actual test performance is far superior."

KEN BRADLEY, General Manager

Northern Telecom believes a quality message begins with a commitment: to deliver the highest performance products at the lowest cost – quickly and on time.

That's why Northern Telecom Electronics chose the Teradyne A500 Family of systems to test its most advanced mixed-signal chips. Pushing the performance envelope can be risky, but Teradyne is helping Northern Telecom avoid the pitfalls.

"Our Norstar key system is extremely silicon intensive. The A500 provided virtually unlimited test capability and reduced test time."



send the world a quality message.

I believe without it, the entire project would not be nearly as successful as it is."

GARY HOBIN, Manager,
Test & Product Engineering

Because the A500 Family's IMAGE™ programming environment permits full tester simulation at off-line workstations, test program development parallels design. That cuts product development times dramatically. And because test data is fed back quickly and early in the process, Northern Telecom engineers can eliminate bottlenecks, enhance manufacturability, and accelerate time-to-market.

"Teradyne helps us meet our high-volume production goals — on time. And they perform beyond our expectations in terms of operating costs; tester maintenance cost is 80% lower than budget — and tester uptime measures in the 98%-plus range."

JOHN HAYDON, Business Unit Manager,
Test Operations

Teradyne's A500 Family testers run reliably, producing the accurate, repeatable results that let Northern Telecom engineers ramp up fast to high-yield, high-volume production. So when a customer needs devices, Northern Telecom Electronics is ready to deliver quantity as well as quality.

"Teradyne's service continues after the sale. It's as if they take our priorities as their own. That's helped us achieve the quality it takes to succeed in such highly competitive markets as the U.S., U.K., Germany, and Japan."

TERRY CAVES, Director of Operations

Teradyne's A500 Family of Test Systems. Helping companies like Northern Telecom send their customers the right message. To see how we can help you, call Beth Sulak at (617) 422-2746. Or write today to:
Teradyne, Inc.,
321 Harrison Ave.,
Boston, MA 02118.

TERADYNE



Introducing a revolutionary new idea in a 1000-watt, “shoe box” power supply.

It's TODD SUPERMAX 1000, an extraordinary OEM power supply of revolutionary proportions. *And those proportions are small.* Smaller than anything in its class. At just 3.38”H x 8”W x 12”L, its compact size allows for great flexibility in a system's mechanical design. In fact, three SUPERMAX 1000 units can be mounted where two standard shoe box units fit before.

SUPERMAX 1000 is the 1000-watt power supply designed right from scratch with Power Factor Correction built in for maximum performance and economy.

Long recognized as the leading innovator in the power supply industry, TODD now brings its advanced open frame switching power supply technology to the high-power shoe box world. SUPERMAX 1000 requires fewer components, so reliability, efficiency—even “no-fan” cooling—are greatly enhanced.

For a smaller, more reliable, lower cost 1000-watt power supply that meets every US and international requirement, evaluate the TODD SUPERMAX 1000. When it comes to quality and innovation, no one can fill our shoes.

To receive a catalog showing our broad line of switching power supplies, for an evaluation unit, or to speak with an engineer who can supply immediate response and immediate solutions to your power supply problems, call the TODD Power-Phone:

800 223-TODD
THE 911 OF THE POWER SUPPLY INDUSTRY.

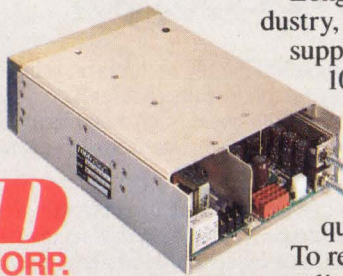

TODD
PRODUCTS CORP.

50 Emjay Boulevard
Brentwood, NY 11717-3386
TEL: 516 231-3366
800 223-8633
FAX: 516 231-3473

SIGNALS & NOISE

Company increasing, not ceasing, LED production

In the September 2, 1991, Ask EDN, EDN stated that Rohm is phasing out its LED product lines. This statement is completely false; the reality is quite the opposite.

Rohm has no plans whatsoever to curtail the availability of its LED product offerings. There has been an international, industry-wide increase in demand for LED lamps for the past 12 months, and Rohm has made significant progress to comply with this demand, both for existing and prospective customers.

Other manufacturers may choose to discontinue LED products, but Rohm has exhibited an increased commitment to fulfilling customer requirements in this important product line.

*Ray Ponkey, Product Manager, Optoelectronics
Rohm Corp
Antioch, TN*

Government's role doesn't end with defense

I must take exception to the last statement by L Alan Kudravy (EDN, March 1, 1991, pg 27) where he asserts that the only obligation of the government is to provide defense. I fear this is a common perception, especially among us defense contractors. However, the Constitution spells out federal obligations in its preamble:

"WE THE PEOPLE of the United States, in order to form a more perfect Union, establish Justice, insure domestic Tranquility, provide for the common Defence, promote the general Welfare, and secure the Blessings of Liberty to ourselves and our Posterity, do ordain and establish this Constitution for the United States of America."

You can see for yourself the numerous obligations listed, including "Defence." Many additional powers and obligations are spelled out in

ARTICLE I, SECTION B. These facts are more than 200 years old, and I think we'd all do better to become more familiar with them.

*David Telford
Abilene, TX*

Updated phone number

An outdated phone number for Circuit Search, Breslau, Ontario, was inadvertently published in the Product Showcase CAE Section (EDN, July 18, 1991, pg 126). The new number is (519) 241-1252.

Mea culpa

EDN made a typo in the Innovation writeup of the Gates Energy Products Genesis battery (EDN, August 5, 1991, pg 68). Readers can call (904) 462-3911 for more information.

Also, we inadvertently printed the fax number instead of the phone number in the Benchmarq Innovation writeups (pg 52). Readers should contact the company at (214) 407-0011, which is the correct phone number.

Correction

In the fourth line down, first column, (EDN, July 18, 1991, pg 92) the package name should read SO-8 packages, not TO-8 packages. General Semiconductor Industries Inc of Tempe, AZ, manufactures the SO-8 packages.

HAVE YOUR SAY

EDN's Signals & Noise column provides a forum for readers to express their opinions on issues raised in the magazine's articles or on any topic that affects the engineering industry. Send your letters to Signals & Noise Editor, EDN Magazine, 275 Washington St, Newton, MA 02158, or leave a note via MCI mail at EDNBOS. Or use EDN's bulletin-board system at (617) 558-4241: From the Main System Menu, enter SS/SOAPBOX, then W to write us a letter. You'll need a 2400-bps or less modem and a communications program set for 8,N,1.

LCD Proto Kit

Everything you need to start your LCD application create complex screens in just a few hours!

240 x 64 pixel Supertwist LCD mounts directly onto CYB003 prototyping board.

Kit provides serial interface to IBM PC for quick prototyping. Board also supports displays up to 240 x 128 pixels.

Interface to 6 soft keys or 4 x 4 key matrix.

Dial 0-25k ohms for LCD contrast.

* The CY325 LCD Windows Controller provides parallel or serial high-level control of instrument-size LCDs. Up to 256 built-in windows support window-relative text, bargraphs, waveforms, and plots. Text and graphics are maintained in separate planes, facilitating special effects. Complete User Manual included.

Wirewrap area for custom circuitry or back-light.

RJ 11 serial jack for Rx/D, Tx/D, CTS, and GND, plus 2 spares.

5 Pin Power DIN.

Alternate Power Connector.

Add your own 8051 CPU for stand alone operation.

Kit also includes:

Power supply provides +5v and Gnd for board, -12v for LCD, and +12v spare.

Sample routines in 8051 Assembler and QuickBasic.

LCD Paint™ for creating your own graphics images.

4-wire RJ11 style cable with DB25F connector for your IBM PC.

Demo routines preprogrammed into 8751 for immediate gratification.

\$495 - Kit
Popular LCD Starter Kit.



(\$595 pre-assembled & tested)

*The CY325 40-pin CMOS LCD Controller IC is available from stock @ \$75/singles, \$20/1000s (Surface mount also avail in qty.)

CyberneticMicroSystems

Box 3000 • San Gregorio CA 94074
Tel: 415-726-3000 • Fax: 415-726-3003

News Flash

SPORTS	SCIENCE AND TECHNOLOGY
The 90 Nanosecond Workout An Exhaustive Look At High Tech Training Equipment	Virtual Reality Close But No Cigar
PAGE 2B	PAGE 8H

Silicon Valley

25 CENTS

SERVING NORTHERN CALIFORNIA SINCE 19

FANTASTIC FL

AMD Ships 2 PLCC Flash

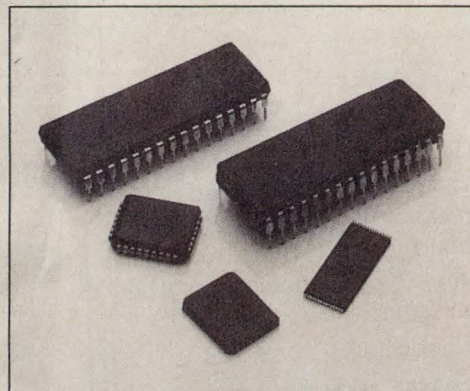

How Fast Is A Flash? A Direct Comparison

Density	AMD	Fastest Competitor
256K	90ns	120ns
512K	90ns	120ns
1 Mbit	90ns	120ns
2 Mbit	90ns	150ns

SUNNYVALE — The computer industry takes a giant leap forward in performance with the help of the new Flash memory family from Advanced Micro Devices, Inc.

Flash memory is a high-density, reprogrammable, non-volatile technology that has a bright future in computation, laser printers, network and telecommunications hardware. Many military systems use Flash technology in radar and navigational applications.

Flash memory also has the potential to eliminate mechanical hard disks and the need for cumbersome batteries. These are two of the biggest and heaviest obstacles in laptop and notebook computer applications.

Today, Flash memory is the most cost effective replacement technology for UV EPROMs and EEPROMs in applications that require in-system programming. Flash memories can literally be reprogrammed in a flash —

hence the name.

Standard, But With A Little More Flash

AMD's Flash memory family effectively etches in silicon the de-facto standard for this burgeoning technology that is compatible with Intel's initial Flash architecture.

Because AMD Flash memories are pin-for-pin compatible with the now standard architecture, AMD is positioned as an alternate source for design engineers and purchasing agents alike.

"Alternate source may be an inadequate term," said Jerry Sanders, chairman and CEO of Advanced Micro Devices. "Given our speed and feature set, our customers think of us as a superior resource."

Indeed, AMD's Flash memory family offers designers significant performance advantages (see chart), with speeds almost twice as fast as the nearest competitor.

Engineer Spontaneously
Combusts At Meeting

Vice Pr
At Loc

From AMD.

FOOD

Chips And Salsa

A Business Person's Guide To Silicon Valley Restaurants

PAGE 7F

ette

MORNING EDITION

ASHES!

Megabit, 90ns, Memories

The AMD Flash family offers designers and purchasers many packaging options. Particularly popular is AMD's advanced 2 Megabit, PLCC part. Other packaging options include PDIP, CDIP and LCC in 256K, 512K, 1 Mbit and 2 Mbit capacities. TSOP packages will be available in the second half of this year. (LCC not currently available in 2 Mbit.)

AMD's 2 Mbit Flash memories come complete with embedded program and erase algorithms on board. These automatic algorithms speed up the design process and considerably shorten time to market. Previously, engineers were required to develop tedious and time-consuming algorithms to implement in-system reprogrammability. AMD's automatic algorithms also allow several Flash memories to be written or erased at once, without tying-up the CPU. The system is now free to perform other tasks while these operations are in

progress. AMD plans to include embedded algorithms in a future release of its 1 Mbit part.

The Ultra-Violet Blues

Flash technology is particularly suited to applications requiring reprogramming in place, because these devices can be reprogrammed in seconds, and within the system.

To update the code on a UV EPROM, the part must first be removed from the system. Once removed, erasure can take up to a full 20 minutes. After reprogramming, the part is then plugged back into the system. The process can result in damage to other components, costly service calls, and headaches.

Flash memories, on the other hand, can be bulk erased in about one to two seconds, without system disassembly. Reprogramming can then be accomplished via floppy disk, overphone lines, or even ISDN
(continued)

ident To Speak

Spelling Bee

EDN October 24, 1991

Stop the presses!

Advanced Micro Devices makes big news again—this time with an enhanced family of Flash memory devices.

That's good news for veteran and new Flash users alike.

Because our Flash devices are pin-for-pin compatible with Intel's existing Flash memory architecture, they establish the *de facto* industry standard.

Our standards, however, are a bit higher.

And so are yours.

That's why our Flash Memory family offers densities, speeds and packaging options that improve performance and save board space. For instance, our advanced 2 Mbit PLCC part with a scant 90 nanosecond delay.

You can also choose from Flash devices in 256K, 512K and 1 Mbit densities. As well as packaging options that fit your design best, including CDIP, PDIP, LCC, TSOP, and PLCC.

And you'll find implementation faster and easier than ever, because we've included automatic programming algorithms on all our 2 Mbit devices, and soon on our 1 Mbit parts, too. So you'll spend less time writing code, and take less time getting products to market.

To keep up to date with all the latest and greatest in Flash memory, call AMD today at **1-800-222-9323**. And start making some headlines of your own.



Advanced Micro Devices

901 Thompson Place, P.O. Box 3453, Sunnyvale, CA 94088. © 1991 Advanced Micro Devices, Inc.

CIRCLE NO. 33

37

Oki MCUs— For Total Toolset Support.

If incomplete support is preventing your MCU design from moving forward, it's time to join the nX crew at Oki. Our nX MCUs provide the high-performance upgrades and powerful toolset support needed to propel your design swiftly to the finish line.

Choose from a range of nX-generation 8-bit or 16-bit MCUs—all available in OTP versions—and with a variety of on-chip features such as timers, A/Ds, I/Os, and PWMs.

Our OMFICE (In-Circuit Emulator) and evaluation modules (EVMs) expedite programming and emulation. The OMFICE has real-time hardware tracing, which simplifies debugging of time-critical programs. And with nX, you receive complete software support—including assemblers, debuggers, converters, and translators.

So whether you're starting a new design or want to convert your resident 80C51 codes, look to the team that won't leave your design dead in the water. With nX and Oki's total tool support, your design glides smoothly from concept to code—in record time.

Call 1-800-OKI-6388 for our nX Brochure (ask for Package 052), and get your MCU design off to a fast start.

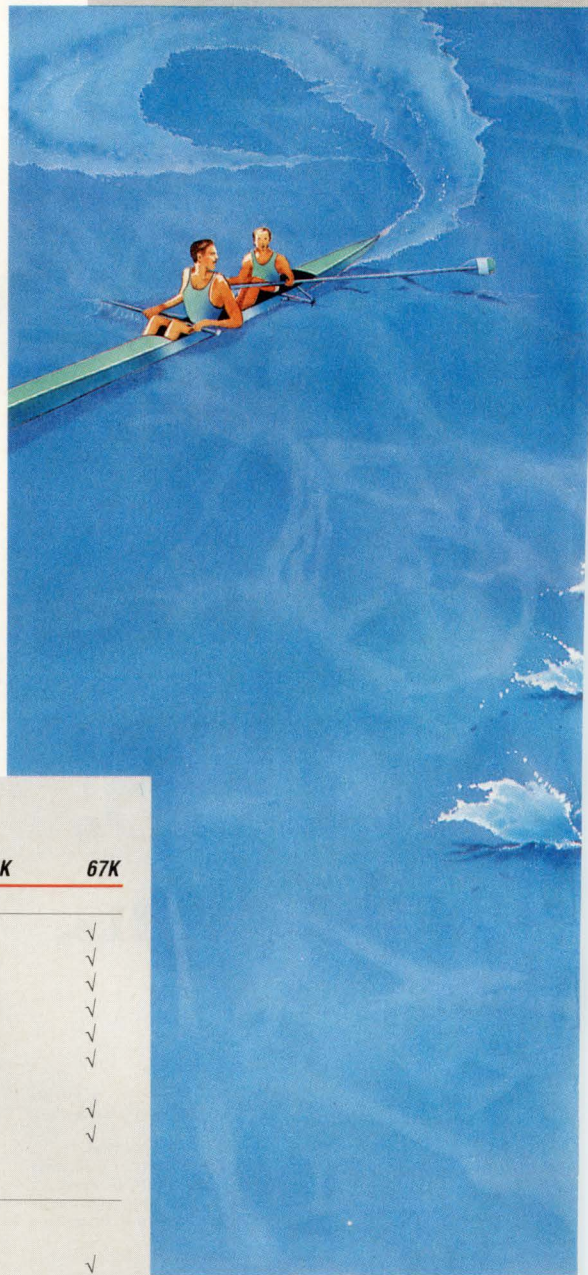

Oki Toolset Support for nX

Description	65K	66K	67K
Software			
Relocateable Assembler	√	√	√
Linker	√	√	√
Librarian	√	√	√
Symbolic Debugger	√	√	√
Object Converter	√	√	√
Object Analyzer			√
80C51 Translator	√		
C-Compiler	*	*	√
C-Debugger	*	*	√
Hardware			
OMFICE + EVM65524	√		
OMFICE + EVM66201		√	
OMFICE + EVM67620			√

* Under development

TRANSFORMING TECHNOLOGY INTO CUSTOMER SOLUTIONS

JOIN THE TEAM WITH ALL THE MCU TOOLS.

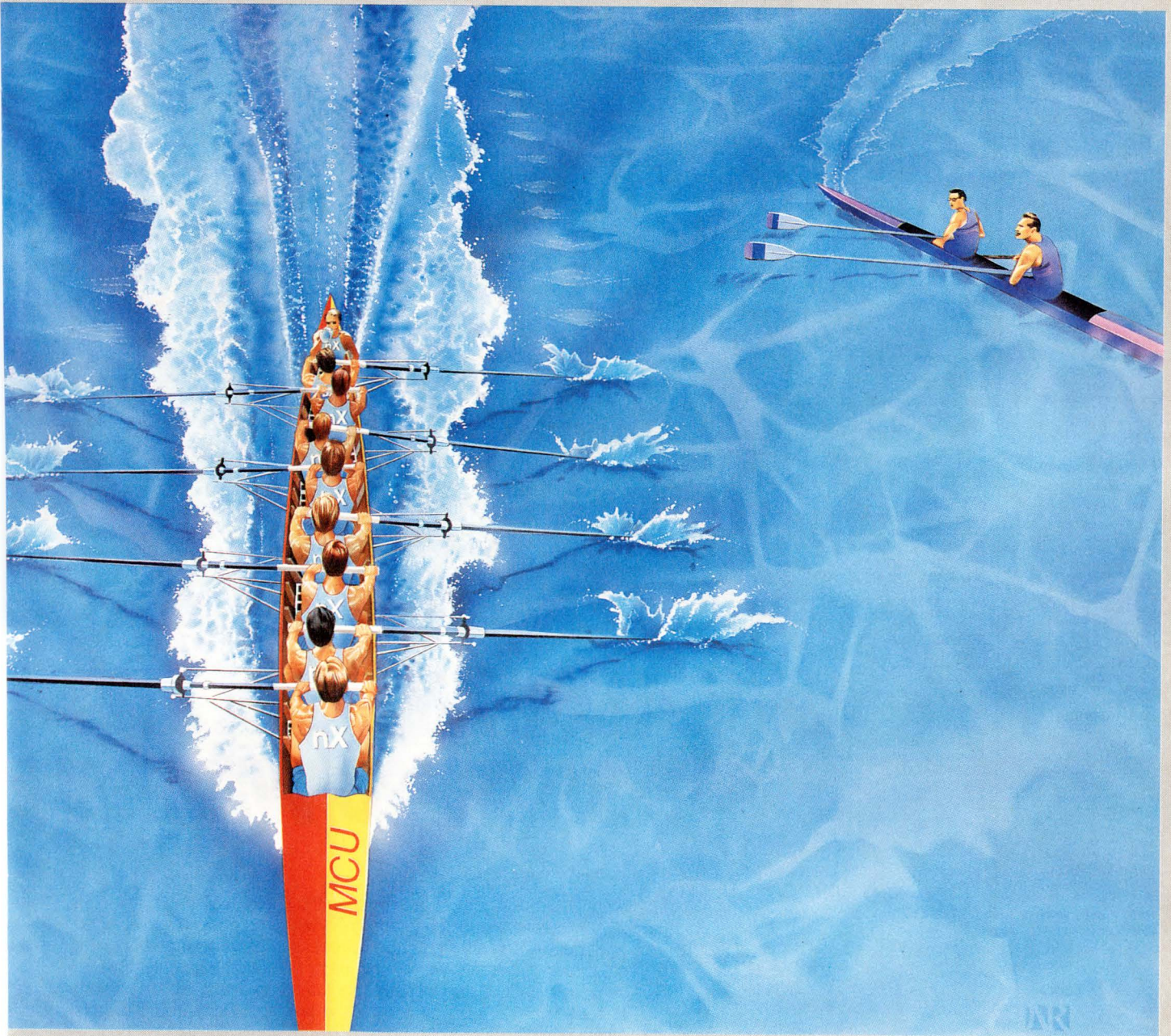

OKI
Semiconductor

785 North Mary Avenue
Sunnyvale, CA 94086-2909
1-800-OKI-6388
(Ask for Package 052)

DISTRIBUTION CENTERS

UNITED STATES

△ MINI-CIRCUITS
P.O. Box 350166
B'klyn., NY 11235-0003
(800) 247-6343
(718) 934-4500

Missouri
(800) 654-7949
(417) 335-5935



AMERICAN EXPRESS
VISA

EUROPE WEST & EAST

△ MINI-CIRCUITS/DALE
DALE ELECTRONICS LTD.
Dale House
Wharf Road
Frimley Green
Camberley, Surrey GU16 6LF
England
44-252-836094



MASTERCARD/VISA/
ACCESS/EUROCARD

LOCAL DISTRIBUTORS

NORTH AMERICA

UNITED STATES

MID-ATLANTIC
* MLC Distributors Ltd.
Conshohocken, PA 19428
(800) 442-3177
(215) 825-3177

MIDWEST
* CFC Distributors, Inc.
Mundelein, IL 60060
(708) 540-9962

SOUTHEAST
* Component Distributors, Inc.
Huntsville, AL 35810
(800) 888-0331
(205) 851-7800

Palm Bay, FL 32905
(800) 558-2351
(407) 724-9910

Norcross, GA 30092
(800) 874-7209
(404) 441-3320

SOUTHWEST
* Component Distributors, Inc.
Dallas, TX 75243
(800) 848-4234
(214) 644-0373

WEST
ARIZONA, NEW MEXICO
Spirit Electronics
Scottsdale, AZ 85260
(602) 998-1533

CALIFORNIA
△ Mini-Circuits
Tustin, CA 92680
(800) 654-7949
(714) 838-5144
(417) 335-5935

Los Altos, CA 94022
(800) 654-7949
(415) 948-6533
(417) 335-5935

NORTHWEST
△ Mini-Circuits
Bellevue, WA 98004
(800) 654-7949
(206) 462-2118
(417) 335-5935

CANADA
Eastern
* Giga-Tron Assoc. Ltd.
Ottawa, Ontario
K2E 7T7 Canada
(613) 225-4090

Western
△ Mini-Circuits
Bellevue, WA 98004
(800) 654-7949
(206) 462-2118
(417) 335-5935

* participating distributors
△ Distribution Centers

INTERNATIONAL

EUROPE

BELGIUM, LUXEMBOURG
ETS Freddy Leger
B-1080 Brussels, Belgium
32-2-410-1421

FINLAND
Integrated Electronics, Oy AB
Helsinki, Finland
358-0-351-3133

FRANCE
SCIE-DIMES
91430 Igny, France
33-1-6-941-8282

GERMANY, AUSTRIA,
DENMARK, SWITZERLAND
Industrial Electronics GMBH
D-6236 Eschborn, Germany
49-6196-48689

ITALY
Dale Electronics, Ltd.
GU16 6LF, England
44-252-836094

NETHERLANDS
BFI IBEXSA BV
2130 KA Hooldorp
The Netherlands
31-0-20-6531350

SPAIN
BFI IBEXSA Electronica, SA
28049 Madrid, Spain
34-1-358-47-77

SWEDEN
Integrerad Elektronik
Bromma, Sweden
46-8-804685

UNITED KINGDOM
BFI IBEXSA GROUP
Aylesford, Kent
ME20 7NA England
44-622-882467

MIDEAST

ISRAEL
Vitel Limited
Shikun Dan
Tel Aviv 61131 Israel
972-3-479-153

JAPAN

Densho Kaisha Limited
Minato-Ku, Tokyo, Japan
813-3436-0041

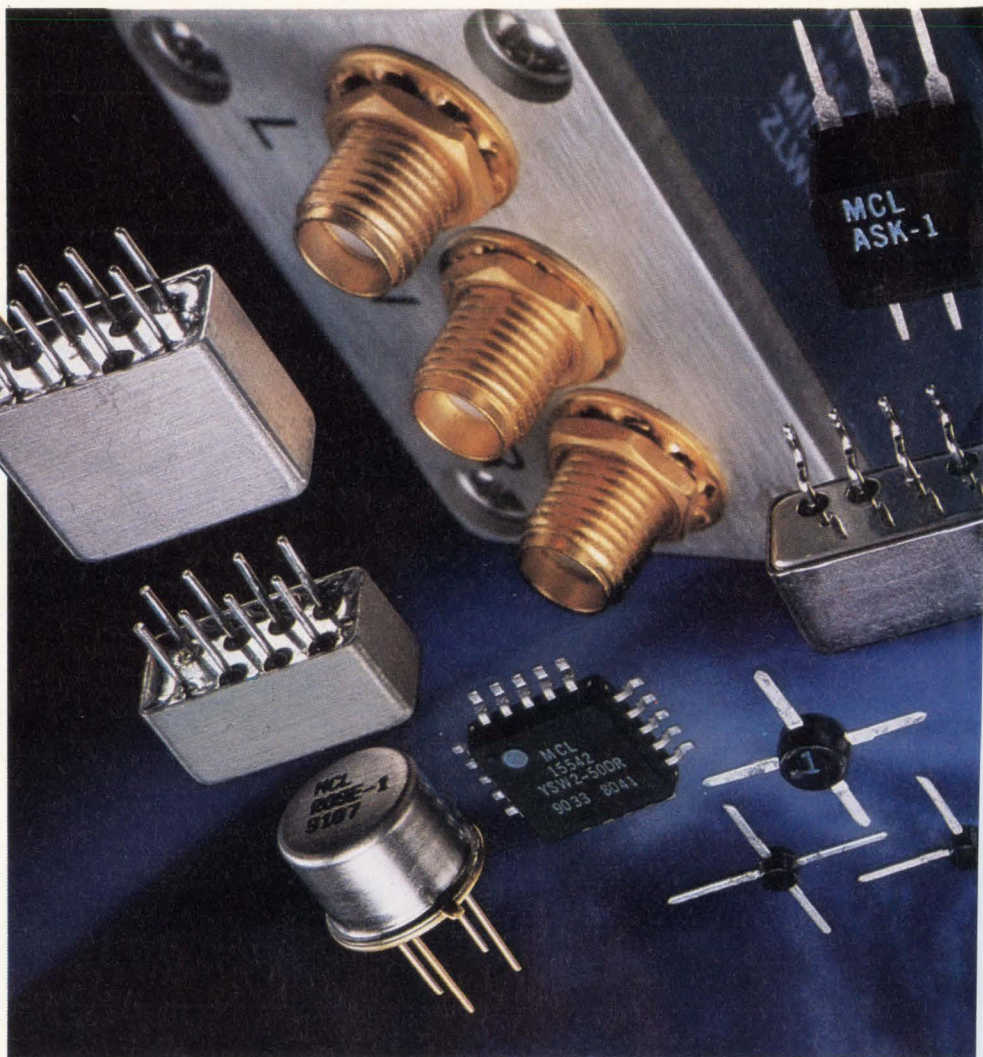

ALL MINI-CIRCUITS SHIPPED WITHIN

*Amplifiers
Frequency Mixers
RF Transformers
Frequency Doublers
Phase Detectors
Power Splitter/Combiners
& Q/QPSK Modulators
Fixed Attenuators
Precision TTL-Controlled Attenuators
Switches and Drivers
Directional Couplers
Terminations
Limiters
Filters*

All Mini-Circuits' components listed in the latest published catalog, in all configurations and connector types, will be processed and shipped within one week after an order is received, or if the order calls for scheduled shipments, we will ship on or before the due date. If we're late, we'll deduct one percent per day from your bill (maximum deduction up to 25%, as allowed by law); but don't count on this discount since we intend to meet each and every scheduled shipment.

What makes this fast turnaround possible? First, fast manufacturing throughput achieved using powerful statistical process-control techniques coupled with the latest computer-automated production and test equipment. Second, a worldwide distribution network, with a major Distributor Center in the U.S. and in England, backed by 16 regional distributors.

We wholeheartedly encourage you to place your orders with your local distributor. But let's be realistic. Although our distributors stock our products, not every distributor will carry every single catalog item, especially in substantial quantities. In such instances, when the need for components is urgent, contact a Mini-Circuits' Distribution Center listed and you will be covered by our shipment guarantee.

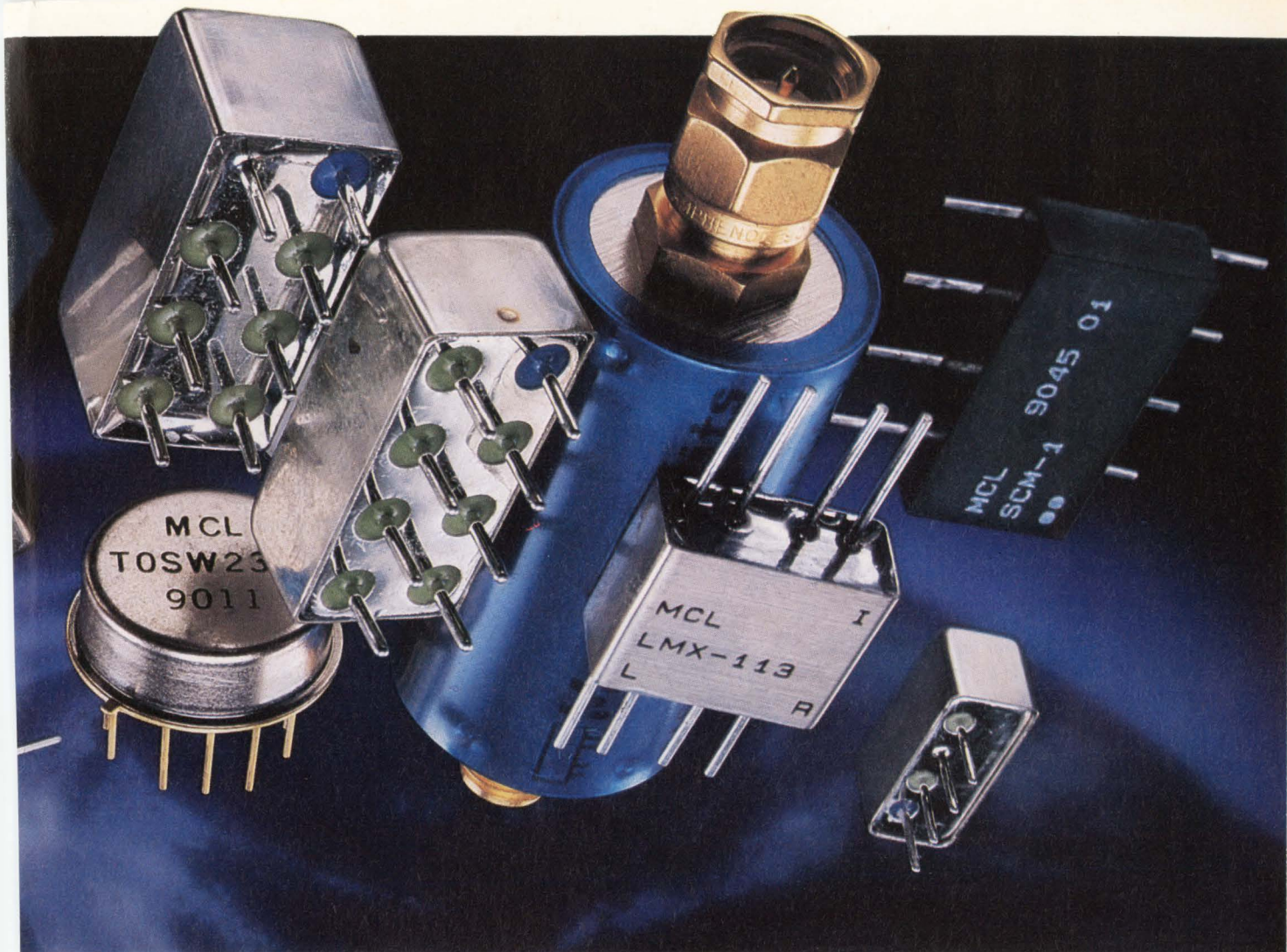

RF/IF CATALOG PRODUCTS ONE-WEEK... GUARANTEED!

United States

△Mini-Circuits

NEW YORK
8AM-5:30 PM EST
(phone) 800-247-6343
(phone) 718-934-4500
(fax) 718-332-4661

MISSOURI
9AM-8PM EST
(phone) 800-654-7949
(phone) 417-335-5935
(fax) 417-335-5945

Europe

△Mini-Circuits/Dale

8:30 AM-5:30 PM
(phone) 44-252-835094 (fax) 44-252-837010

Guaranteed order processing is another expression of Mini-Circuits' dedicated effort for world-class quality... meeting and exceeding customers' expectations. Write, phone, or fax your order and be confident that it will be shipped on time, every time by Mini-Circuits.

finding new ways ...
setting higher standards

Mini-Circuits

P.O. Box 350166, Brooklyn, New York 11235-0003 (718) 934-4500 Fax (718) 332-4661 Telexes: 6852844 or 620156

CONDITIONS OF GUARANTEE

- ORDER PLACEMENT—guarantee applies only to orders placed with Mini-Circuits' distribution center[△] or with a participating distributor.*
- ORDER REQUIREMENT—guarantee starts after all details of the purchase order is received complete.
- SHIPMENT TIME—guarantee applies for work days Monday through Friday, holidays excluded.
- TRANSPORTATION—does not apply to situations where shipping is inhibited due to strikes, weather, or conditions beyond our control.
- GOVERNMENT REGULATIONS—does not apply to purchase orders inhibited by government rules, regulations, export licenses, and/or customs approval.
- QUANTITIES—guarantee applies to normal distribution quantities, which vary according to product line.
- CREDIT RATING—guarantee limited to companies with approved credit rating at time of shipment.
- LETTERS OF CREDIT—guarantee limited to meeting terms of LC.

No guts.

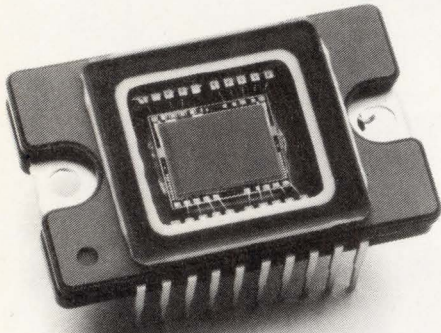

CCD Image Sensors

The CCD technology that led to Sony's leadership in color video cameras is now available to you.

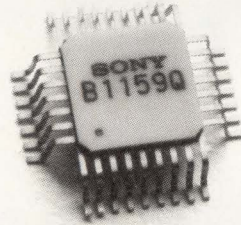

ECL Standard Logic

Wide range of high-speed, high-performance ECL logic devices. Low cost and design simplicity.

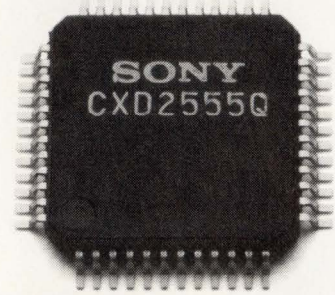

Digital Audio

Consumer-based leading-edge technology. Compact design. Small package. Capable of CD-ROM interface.

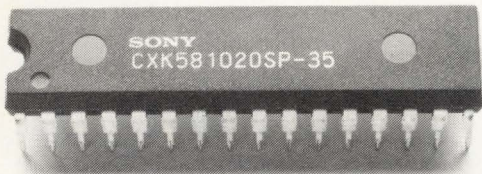

High Speed SRAMs

Broad family covers all your fast-processor, cache-memory requirements.



ECL Gate Arrays

Super high-speed operation combined with low power consumption and extensive I/O interfaces.



Interactive Video

Sony's A/V IC leadership applies directly to new multimedia systems. Superior bipolar linear technology in encoder/decoder.



1-Meg SRAMs

Largest, most diverse family in the industry. The first products scheduled to come from our new San Antonio fab.



STRAM

High speed performance, self-timed RAM with register, synchronous SRAM.

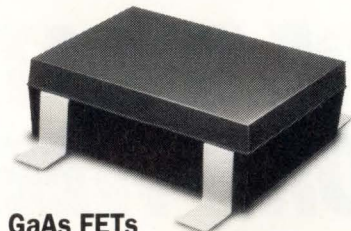

GaAs FETs

State-of-the-art performance, reliability and uniformity. Ideal when low noise is critical.



D/A Converters

High speeds to 500 MHz, low glitch energy, and low power consumption in very small packages.

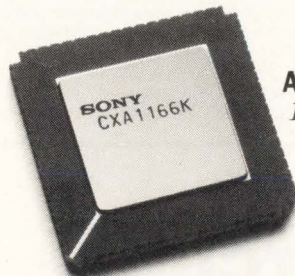

A/D Converters

18 models including the world's fastest. Fewer pins, smaller packages, low power consumption, and guaranteed low error rates.

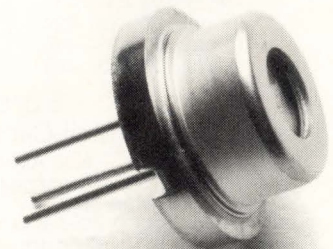

Laser Diodes

Wide power range, high reliability, huge selection. Ideal for optical disk, laser printer and microsurgery designs.

No glory.

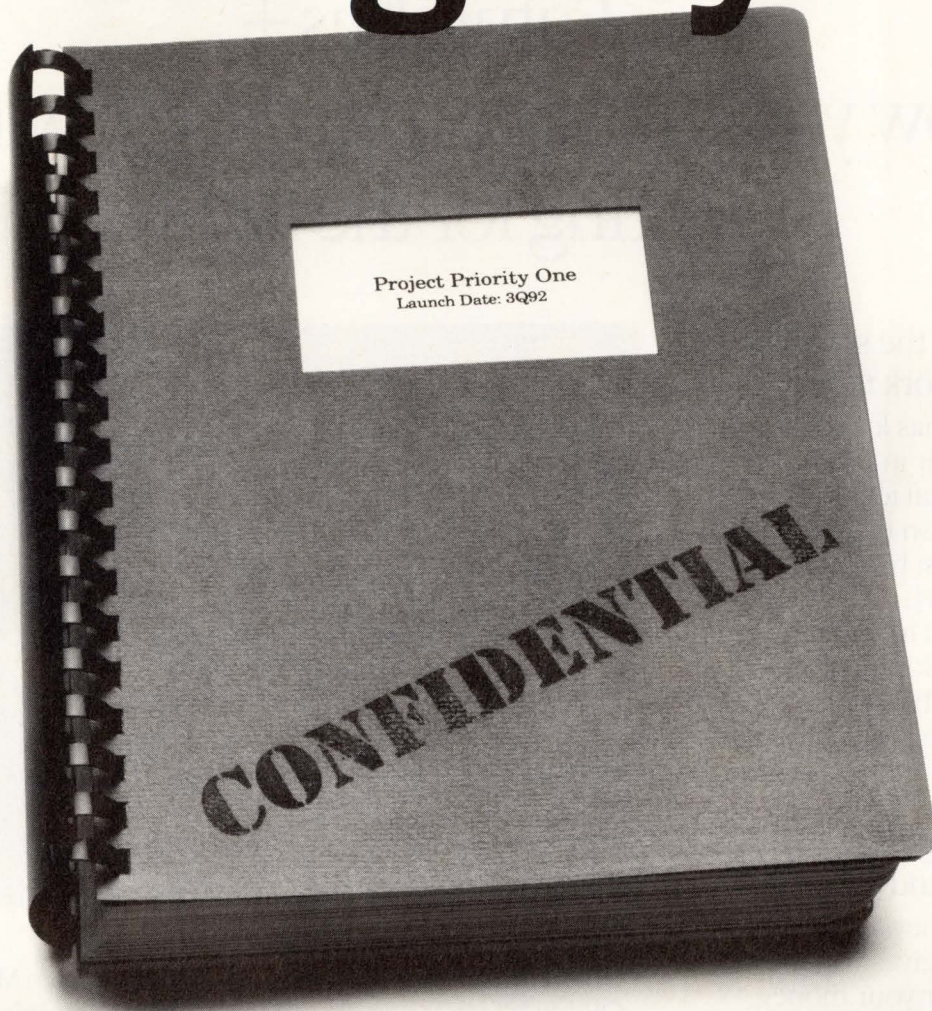

If you can't get the parts you need, you can't get your best designs out the door.

And that's where we can help. With cutting edge SRAMs—high and low speed. With high speed A/D and D/A converters. With high speed ECL logic chips. And with a long list of other components—the same components that have made Sony's consumer electronics so successful.

Perhaps more important, we're always here to help. With a design center to support your design engineers, in developing applications all the way through

production. With a service department to answer your questions and expedite your orders. And with world-class manufacturing, plus new facilities in San Antonio, Texas, to produce the technology you'll need next year.

To learn more about our custom design support, our competitive prices, and our full line of components, just call us today at (714) 229-4331 or (416) 499-1414 in Canada. You can even FAX us your current requirements at (714) 229-4285 or (416) 499-8290 in Canada.

SONY®

Sony Corporation of America, Component Products Company, 10833 Valley View Street, Cypress, CA 90630.
Sony Canada, 411 Gordon Baker Road, Willowdale, Ontario M2H 2S6.

Sony is a registered trademark of Sony Corporation. Prices and specifications are subject to change without notice. The purchase of products is subject to availability and Sony's standard terms and conditions of sales.

Futurebus +.

Now you can start your design without waiting for the future.

Putting the standard to work today.

National has long been the industry leader in BTL and mixed analog + digital technology. Now we've drawn on that heritage to make the most highly integrated Futurebus + ICs available today. We've also put together a full range of development tools to help you put that chipset to work. And the entire package is available now.

Making high-speed buses reliable and affordable.

With our new chipset, Futurebus + gives you more bandwidth for your money, making it—for the first time—fully cost-competitive with VME and Multibus®. In addition to an Arbitration Controller, our chipset contains four advanced BTL devices: two 9-bit Data Transceivers (latched and unlatched), a Handshake Transceiver, and an Arbitration Transceiver.

Between them, they offer you a variety of features designed to break the throughput bottleneck in high-performance computer systems:

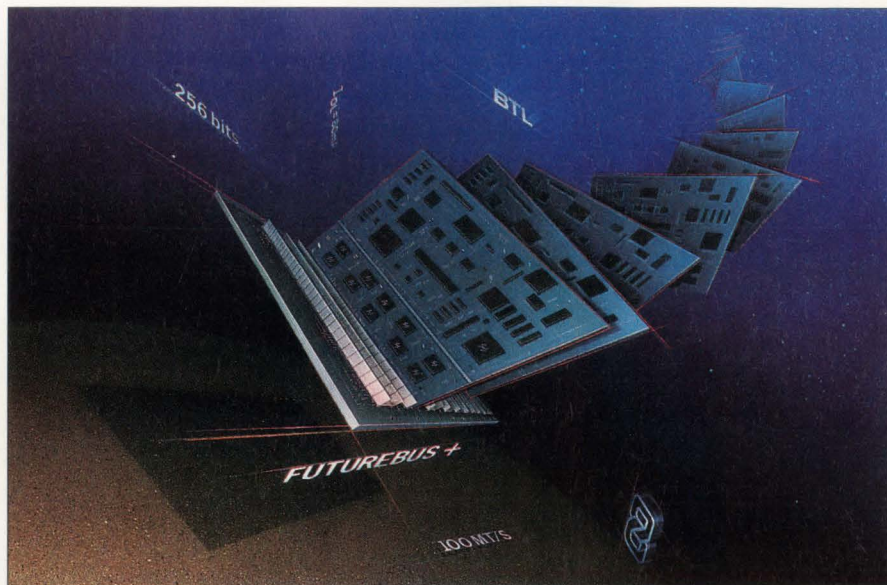

- Glitch filters (to eliminate wire OR-ing effects)
- Filtered and non-filtered receiver outputs
- Efficiently partitioned arbitration logic (the fastest available)
- Fault-tolerant circuitry
- Live-insertion support

Providing a broad range of development tools.

Start with our Designer's Handbook, with a slave-memory-board application note, product data sheets, and application notes on BTL design technology. Other tools include wire-wrap

boards from Mupac and Hybricon, Spice models, and Verilog® behavioral models.

Bringing Futurebus + into the present.

Call us at 1-800-NAT-SEMI, Ext. 127. We'll send you a Designer's Handbook, and you can start your Futurebus + design today.

Because there's nothing left to wait for.



Multibus is a registered trademark of Intel Corporation. Verilog is a registered trademark of Cadence Design Systems, Inc.
© 1991 National Semiconductor Corporation

EDITORIAL

CDI technology: It's ready now



During a trip to the Midwest last week, I stopped by Microware (Des Moines, IA) to talk with the people there about their work on real-time operating systems and to learn more about the company's efforts in compact-disk interactive (CDI) products. Unlike audio compact disks, interactive disks also store images that you can display on a television screen. But, more important, CDI programs give you the opportunity to control what happens on the screen.

CDI products will go far beyond entertainment. In fact, the biggest promise for CDI products is in education and information. For example, I saw a Sesame Street disk that lets children select activities such as counting, saying alphabet letters, and matching colors. Even though the starting point of the CDI program looks the same each time you start the disk, the letters, numbers, and colors start at random each time you run through an activity. Thus, the potential for boring youngsters is low.

Another CDI program puts an interactive photography course on your TV. In the sample lesson I tried, I learned how to shoot pictures by candlelight. I pointed the light meter—a pointer on the TV screen—at various places on the TV image and then “shot” the photograph. The CDI program showed me what the resulting photograph would look like, and it let me reshoot the picture until I learned how to take light readings properly for low-light photographs. I could take as many photographs as I wanted.

That's the great potential for CDI technology—interactive products that let students “play” with information. You can structure lessons and complete courses around CDI products so that students can see what happens when they try different approaches to solving problems. It won't be long before we find engineering students trying different circuits and playing “what-if” games with complex formulas on CDI systems. Sure, many computer-based programs can do similar things, but compared with CDI programs, they're inflexible, slow, and difficult to learn to use.

CDI players cost about \$1000 and disks cost upwards of \$20 each, so the technology won't appeal to everyone—at least not right away. However, when you compare the cost of a CDI player and a set of disks with the cost of a technical college course, CDI is competitive now. It won't be too long before the costs of CDI equipment and disks come down, and soon creative and enterprising people will start developing many of the technical “what-if” courses that go on CDI disks. There are many opportunities here, and CDI technology could be the next killer application the electronics industry has been waiting for.



Jesse H. Neal
Editorial Achievement Awards
1990 Certificate, Best Editorial
1990 Certificate, Best Series
1987, 1981 (2), 1978 (2),
1977, 1976, 1975

American Society of
Business Press Editors Award
1988, 1983, 1981

A handwritten signature in black ink, appearing to read "Jon Titus". The signature is fluid and cursive, with a long horizontal line extending from the end.

Jon Titus
Editor

Send me your comments via FAX at (617) 558-4470, or on the EDN Bulletin Board System at (617) 558-4241 300/1200/2400, 8, N, 1.

WE DESIGNED THE BEST
A/D CONVERTER IN NO TIME AT ALL.
BUT THEN, WE HAD A 30-YEAR
HEAD START.

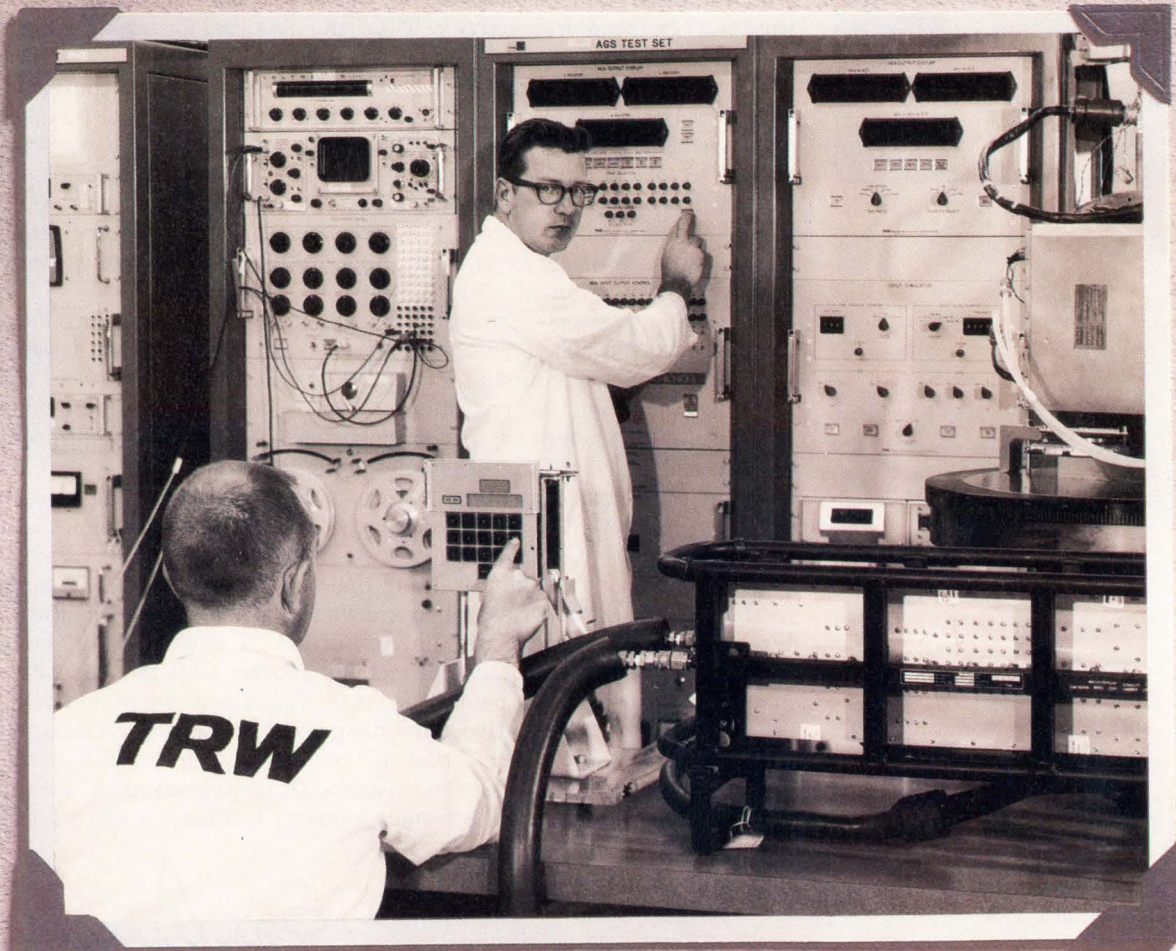

8-bit resolution. 40 Msps. Two-step architecture and CMOS technology that reduces power dissipation to less than 180mW.

All with a significant cost advantage. And all from a single +5 Volt power supply.

That is the TMC1175, developed in only months by TRW LSI Products Inc. But then, that's what you can expect from the industry leader in high-performance A/D converters.

Our years of setting standards have given us the ability to respond quickly to changing needs in the industry, continually improving our line of products in terms of performance and cost. The same dedication to perfection that earned us an Emmy award in 1989 for video technology.

With the TMC1175, video driving amplifiers can be eliminated. The Track-and-Hold circuit is built-in; so is the voltage reference. All digital inputs and three-state outputs are TTL-compatible. And all performance specifications are guaranteed over the -20°C to 75°C temperature range.

All of which makes the TMC1175 excellent for Digital Television designs. Video Digitizing. Image Scanners. Multimedia. And low cost, high speed Data Conversion. It can even be used in PC video board designs.

The TMC1175 is available in 24-pin plastic skinny DIP, 28-lead PLCC and 24-lead plastic SOIC (small outline) suitable for surface mount applications.

And of course, TRW LSI backs you with all the support you need. With field and in-house application engineers. Application notes. And a full line VLSI Data Book.

All with the full spec performance that is synonymous with TRW standards.

Ask for the Data Sheet, applications and other information on the TMC1175 today. You'll agree, it's an A/D converter that meets your standards. From the company that has been setting them for years.

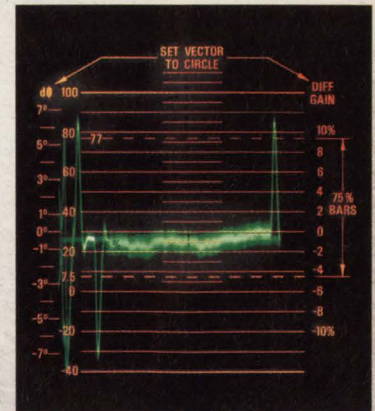

TMC1175 differential phase

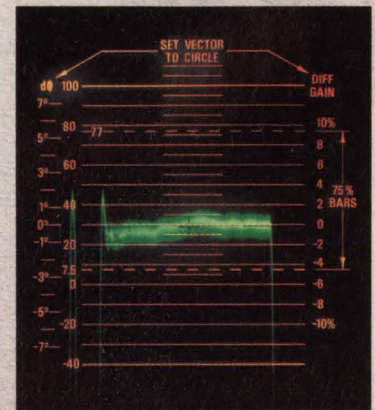

TMC1175 differential gain

Call or write: TRW LSI Products Inc.,
P.O. Box 2472, La Jolla, CA 92038
(619) 457-1000, FAX (619) 455-6314
(800) TRW-LSIP (800) 879-5747



TRW LSI Products Inc.

STANDARDS SET. STANDARDS TO BE MET.

Only one of these bug killers runs on Sun.



Your deadline is looming. The budget stopwatch is ticking. The scope and the complexity of your project are mounting. To weed out your design problems, you need sophisticated system analysis and integration tools which run on your Sun workstation.

Hewlett-Packard's latest emulators provide just that. They control time-critical functions in your target system. Cover the Motorola chips 020, 030, 040. As well as the 68000, 68302, 68331 and 68332. And their real-time

analysis capabilities will make sure you catch the bugs in your software.

Because logic and performance analysis tools and code coverage are consolidated, and with C cross compilers, simulator/debuggers and branch validators also available, you'll never have to worry about bogging down when performing comprehensive evaluations.

And thanks to HP's LAN, you'll be platform independent. Now everyone on the network can share information and link up

with essential team members.

So if you want an emulator with the service, support and reliability you've come to expect from Hewlett-Packard, call our Microprocessor Development Hotline at **1-800-447-3282, Ext. 104**. We'll send you a free demo disk and information package. You'll see that with our emulators, killing bugs is a snap.



Smart cards gear up for belated success

Computer chips packaged as credit cards have not become, as once predicted, a ubiquitous medium for electronic money. But, finally, smart cards are finding new applications and wider acceptance.

*Gary Legg,
Senior Editor*

Inquiring minds might want to know why smart cards, if they're so smart, haven't been more successful. Only a few years ago, the credit card containing a computer chip seemed destined to affect the daily lives of practically everyone in the industrialized world. The predicted proliferation of smart cards in financial applications never materialized, however, and other applications have been slow to develop. Only in Europe, where government monopolies and subsidies have encouraged or mandated smart-card use in communications and banking, have smart cards found any kind of widespread use.

There are signs, however, that smart cards might finally be nearing a critical mass of viability for new applications. Over the last few years, evolving standards have contributed to a gradually growing infrastructure of smart-card applications and equipment. At the same time, advances in semiconductor-manufacturing technology have lowered smart cards' prices. More important, application developers have learned to target areas where cheaper magnetic-stripe cards can't compete.

Ironically, the smart card's lofty potential may have been the biggest detriment to its early success. Because smart cards are relatively cheap and are ideal for numerous applications, it was easy to overlook some basic factors that worked against them. One factor, paradoxically, was cost. At less than a dollar, a simple (memory-only) smart card seems cheap. However, compared to 20

cents for a magnetic-stripe card, the smart card is very expensive. Never mind that the smart card can do so much more; the magnetic-stripe card already did what customers wanted. Magnetic-stripe cards also had a large installed base of card terminals and development equipment; smart cards had none at all.

But smart cards have, nevertheless,



Applications of smart cards in Europe have far outpaced applications elsewhere. The initial impetus came from governments that encouraged or mandated use in telecommunications and banking. (Photo courtesy Motorola)

made notable progress. The biggest success story so far involves a memory-only card, which some people don't consider to be a smart card (see **box**, "What is—or isn't—a smart card?"). Some 50 million or more credit-card-sized memory cards, most containing only a small amount of EPROM, were sold last year in France alone, mainly for use as prepaid telephone cards. Phone cards are

Type TN Lab Grade **New** Low TC Precision Resistors

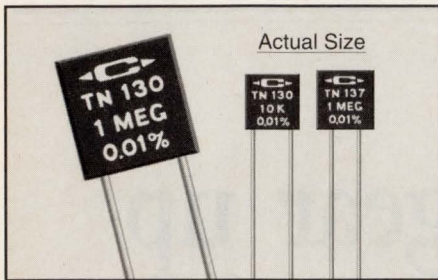

- 1 K to 1 Meg, Tolerance to $\pm 0.01\%$
 Low TC to 5 ppm/ $^{\circ}\text{C}$, 0 $^{\circ}\text{C}$ to 70 $^{\circ}\text{C}$
- Non-Inductive Design
 - Tolerance of $\pm 0.01\%$, $\pm 0.025\%$, $\pm 0.05\%$, $\pm 0.1\%$, $\pm 0.25\%$, $\pm 0.50\%$ or $\pm 1\%$
 - Low TC of 5, 10 or 20 ppm/ $^{\circ}\text{C}$, 0 to 70 $^{\circ}\text{C}$
 - Space Efficient Radial-Lead Design
- For Type TN data, circle number 101

Type TK Low TC Precision Radial-Lead Film Resistors

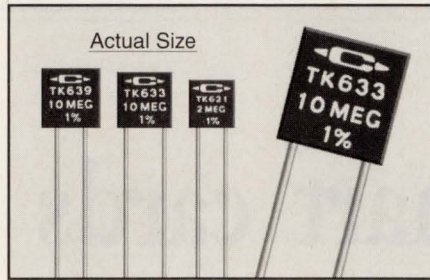

- Low TC to 5 ppm/ $^{\circ}\text{C}$, -55 $^{\circ}\text{C}$ to 125 $^{\circ}\text{C}$
- Non-Inductive Design
 - Resistance Range 1 Kohm to 10 Meg
 - TC of 5, 10 or 20 ppm/ $^{\circ}\text{C}$, -55 to 125 $^{\circ}\text{C}$
 - Tolerance of $\pm 1\%$ (available to $\pm 0.05\%$)
 - Space Efficient Radial-Lead Design
- For Type TK data, circle number 102

Type MK Precision Power Radial-Lead Film Resistors

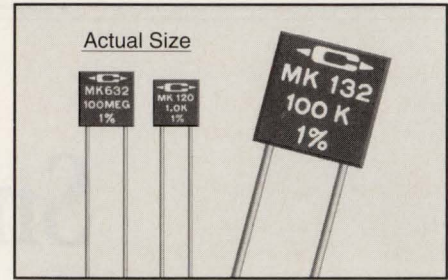

- 0.50 Watt (CK05), 0.75 Watt (CK06)
- Non-Inductive Design
 - Resistance Range 1 Ω to 100 Meg
 - TC as low as 50 ppm/ $^{\circ}\text{C}$, -15 $^{\circ}\text{C}$ to 105 $^{\circ}\text{C}$
 - Tolerance of $\pm 1\%$ (available to $\pm 0.1\%$)
 - Space Efficient Radial-Lead Design
- For Type MK data, circle number 103

CADDOCK[®] Resistor Technology

Precision and Ultra Precision Resistors and Resistor Networks with a 25 year record for solving problems across the board!

Type T912 and Type T914 Precision Resistor Networks

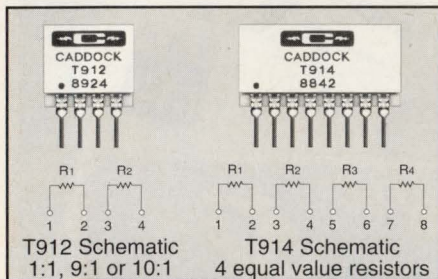

- Ultra Precise Ratios to 0.01%
- 14 Standard Resistance Values from 1 Kohm to 1 Meg (Custom to 2 Meg)
 - Ratio Tolerance from 0.01% to 0.1%
 - Ratio TC of 2, 5 or 10 ppm/ $^{\circ}\text{C}$, 0 to 70 $^{\circ}\text{C}$
 - Custom ratios available, 1:1 to 250:1
- For Type T912/T914 data, circle 104

Type 1776 Precision Decade Voltage Dividers

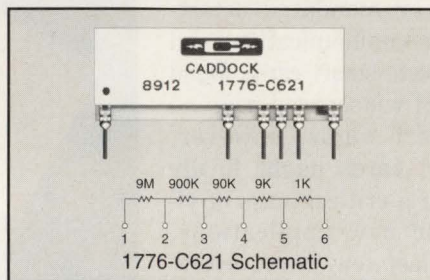

- Voltage Division 10:1 to 10,000:1
- Ratio Tolerance 0.02%, 0.05%, 0.1%, 0.25% or 0.5%
 - Ratio TC of 5, 10, 25 or 50 ppm/ $^{\circ}\text{C}$, from 0 $^{\circ}\text{C}$ to 70 $^{\circ}\text{C}$
 - Select from 39 Different Models
 - Voltage Rating to 1,200 Volts
- For Type 1776 data, circle number 105

Custom Precision and Ultra-Precision SIP Networks

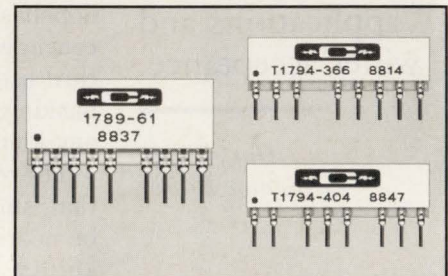

- Ratio Tolerance to 0.01%
- Resistance Range 0.5 ohm to 50 Meg
 - Abs. Tolerance from $\pm 0.025\%$ to $\pm 1\%$
 - Ratio Tolerance from 0.01% to 1%
 - Abs. TC of 15 ppm, 25 ppm, 50 ppm or 80 ppm/ $^{\circ}\text{C}$, from 0 $^{\circ}\text{C}$ to 70 $^{\circ}\text{C}$
 - Ratio TC of 5 ppm, 10 ppm, 25 ppm or 50 ppm/ $^{\circ}\text{C}$, from 0 $^{\circ}\text{C}$ to 70 $^{\circ}\text{C}$
- For Custom data, circle number 106

More high performance resistor products from



Please call or write for the 23rd Edition of the Caddock General Catalog which includes specifications for over 200 models of high performance film resistor products.

Applications Engineering
 Caddock Electronics, Inc.
 17271 North Umpqua Hwy.
 Roseburg, Oregon 97470
Phone: (503) 496-0700
Fax: (503) 496-0408

Sales Office - USA and Canada
 Caddock Electronics, Inc.
 1717 Chicago Avenue
 Riverside, Calif. 92507
Phone: (714) 788-1700
Fax: (714) 369-1151

These products are manufactured with Caddock's exclusive Micronox[®] or Tetrinox[®] Resistance Film Technologies.

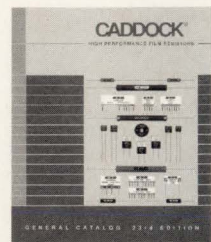

TECHNOLOGY UPDATE

Smart cards

in use in other European countries, too, but France has the highest volume of cards in use because of its early involvement with smart cards.

A telephone smart card comes "charged" with a certain monetary value; as a customer uses a card for pay-phone services, the telephone's card terminal subtracts a monetary value by altering EPROM cells. When the card's monetary value reaches zero, the customer has to buy another card. Each card costs the French phone company (a government-supported monopoly) about a dollar. However, the company recovers most of the cost by selling advertising space on the back of the card.

Other smart-card applications won't match the high-volume usage of phone cards anytime soon, but some markets seem to have good potential (see **box**, "What smart cards are doing"). Memory cards are finding use as portable data carriers and as "electronic purses;" cards with microcontrollers find use in applications requiring tight security, such as controlling access to buildings, computers, or funds.

Security, in fact, is high-end

smart cards' best selling point. Motorola claims "zero break-ins" of 25 million cards produced with its chips, and SGS-Thomson last year introduced the ST16 family of smart-card microcontrollers with security features not previously available. The ST16 chips guard against hacking techniques ranging from the downloading of memory-dump routines to physically opening the chip.

For example, to prevent someone from downloading a memory-dump routine into RAM or EEPROM and then running the routine, a customer-defined access matrix (implemented at the time of chip manufacture and thereafter unalterable) determines whether an instruction executed in one memory area can access data in another. The ST16 device performs the access check on every instruction fetch.

Several sensors in an ST16 chip guard against other security breaches. A clock-frequency sensor, for example, detects attempts to operate the device at any frequency below 250 kHz, thus foiling attempts to analyze operation by single stepping. Other sensors detect the presence of light, indicating

that someone has physically altered the chip.

Another security feature involves scrambling the chip's supply current. Otherwise, someone could conceivably observe the current during read cycles and gain information about the number of bits set or cleared in a particular ROM or EEPROM byte. ST16 devices even make it difficult to read ROM contents should someone go to the extreme of chemically removing the chip passivation layer and examining the mask layer with a microscope. At the time of manufacture, SGS-Thomson creates a 512-bit matrix that scrambles physical and logical ROM addresses.

In Motorola's 68HC05-based smart-card chips, memory contents are accessible only from application software in on-chip mask ROM; once customer software has been manufactured in ROM, fusible links can be blown to prohibit any future ROM access except via processor instruction fetches. And, like other manufacturers, Motorola points to the ability of a single-chip microcontroller to run encryption and decryption algorithms that reside in internal ROM. On-chip encryption

What is—or isn't—a smart card?

By some definitions, a smart card must have on-board intelligence in the form of a microcontroller. By other accounts, a card containing any form of electronics is a smart card.

The disagreement stems from the semiconductor manufacturers who supply the chips that go into cards. Motorola, long noted for its microcontroller prowess, insists that only a card with a microcontroller has intelligence, and is therefore "smart." SGS-Thomson, the leading supplier of memory-only cards, makes no such distinction, lumping memory cards and controller cards together. A spokesperson for Catalyst Semiconductor concurs, claiming that "a card that can remember information is smart,

right?" Hitachi says its memory-only cards are smart, and its cards with microcontrollers are "super smart."

There's even disagreement about the physical configuration of smart cards. Credit-card-sized memory modules for computers (**Ref 1**) sometimes get dubbed as smart cards, even though they have 68 pins on one end rather than eight contacts on the side as recommended by the ISO smart-card standard. Some people even say a smart card can take forms completely different from that of the standard-sized credit card. Electronic keys, buttons, and dog tags, for example, would qualify as smart "cards."

TECHNOLOGY UPDATE

Smart cards

and decryption eliminate the need to transmit unprotected data between a smart card and a card terminal, thus removing a potential security vulnerability.

Indeed, security is only as strong as its weakest link, so chip suppliers concentrate not only on what's in their chips, but on what happens to the chips during and after manufacture. Motorola and SGS-Thomson, for example, track and account for all wafers and use only secure areas for manufacture and test. Both companies even document the destruction of unused wafers and will arrange for secure shipping to customers.

Security requires a controller

Your most sophisticated smart-card applications, and especially those that have strict requirements for security, will need to use a card that contains a microcontroller.

Motorola, with chips based on the familiar 6805 core, sells more controller-based smart-card chips than anyone else, but both SGS-Thom-

Table 1—Microcontroller-based smart-card chips

Supplier	Device	RAM (bytes)	ROM (bytes)	EPROM (bytes)	EEPROM (bytes)	Clock rate (ext/int)
Catalyst	CAT62C580	128	3k	N/A	2k	5 MHz/5 MHz
	CAT62C780	192	6k	N/A	8k	5 MHz/5 MHz
Hitachi	H8/310	256	10k	N/A	8k	10 MHz/5 MHz
Motorola	MC6805SC01	36	1600	1k	N/A	4 MHz/1 MHz
	MC6805SC03	52	1904	2k	N/A	4 MHz/1 MHz
	MC68HC05SC11	128	6k	8k	N/A	5 MHz/2.5 MHz
	MC68HC05SC21	128	6k	N/A	3008	5 MHz/2.5 MHz
SGS-Thomson	ST1821	44	2k	1k	N/A	333 kHz/333 kHz
	ST1834	76	3k	4k	N/A	333 kHz/333 kHz
	ST16301	128	3k	N/A	1k	5 MHz/5 MHz
	ST16612	160	6k	N/A	2k	5 MHz/5 MHz
	ST16623	224	6k	N/A	3k	5 MHz/5 MHz

Note: N/A = Not applicable.

son and Hitachi America note that sales of controller-based chips are looking up. SGS-Thomson claims that the ST16 family, which it introduced early in 1990, sold more than a million chips last year. Hitachi's H8/310, which began shipping in 1987, finally began selling in enough volume that the company "introduced" it as a product in April of this year. The 310 has more mask ROM (10 kbytes) than any other

smart-card chip, and ties with Catalyst's CAT62C780 for the most EEPROM (8 kbytes) (Table 1).

Even the simplest EPROM-based smart cards offer security features that magnetic-stripe cards don't. SGS-Thomson's ST1200 256 × 1-bit EPROM chip, for example, has a polysilicon fuse that protects 96 bits of memory from write operations. A smart-card developer can program application-specific in-

What smart cards are doing

Smart cards are succeeding mostly in new application areas, where they offer convenience and value without running up against entrenched competition. Perhaps the most widespread use is as an "electronic purse."

An electronic purse (an EPROM- or EEPROM-based card) holds electronic money that you buy with real money. You spend the electronic money by using the card in some sort of terminal. The prepaid telephone card is an electronic purse of sorts, although the money it contains can be spent in only one way—on phone calls. A racetrack in Ohio uses the same idea for a prepaid betting card, and certain ski resorts in Austria and Switzerland let you use a prepaid card for any expenses you incur during your stay.

Some European hotels take the concept further, using an EEPROM-based card to store transaction

records while tracking your expenses. You can use the card for any hotel expenses, including purchases at restaurants and gift shops; at checkout, you plug your card into a reader and get an itemized bill. In the US, smart-card companies are targeting universities for a similar application. The goal is to give each student a personal EEPROM-based smart card that can be used for identification, tuition and fees, on-campus purchases, and even access to dormitories and labs.

Optical-disk technology is going into cards, too. At West London Hospital, British Telecom is conducting a pilot program in which each obstetric patient's medical record is stored on a card. Each card, from Drexler Technology Corp (Mountain View, CA), holds 2.8 Mbytes of data, or about 1000 pages of typed text.



Finally, a SPARC chip set that comes equipped with everything you need for the Sun.

VISIT
BOOTH #1018
AT
WESCON

Now, from the Advanced Products Division of Fujitsu Microelectronics — something new under the Sun. A SPARC® chip set that offers the world's most advanced, cost-effective solutions for Sun-compatible workstation designs and specialized, compute-intensive applications. Including voice response, medical imaging and pattern recognition systems.

Our new SPARC chip set is packed with all of the advanced features you need to differentiate your systems from Sun and yesterday's Sun clones. Such as higher integration. More system flexibility. Clock speeds of up to 40 MHz. And graphics options. All at a price to help

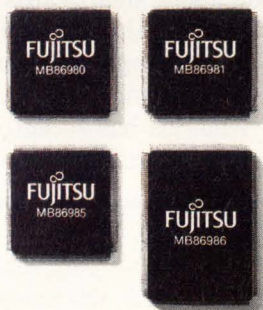

you outshine the competition.

Plus, to get you to market faster, we offer three distinct hardware designs: Busless, Sbus and VME bus. What's more, from our alliance with INTERACTIVE Systems Corporation — the premier independent UNIX® source — comes the latest SunOS™ 4.1.1 ported to each design.

And with comprehensive documentation and training, you'll find your place in the Sun more quickly.

So equip yourself with everything you need to develop the highest performance SPARC-based systems. Call us at 1-800-523-0034. And discover why our new SPARC chip set is the perfect Sun set.

FUJITSU

Delivering the Creative Advantage.

FUJITSU MICROELECTRONICS, INC., Advanced Products Division, 77 Rio Robles, San Jose, CA 95134-1807. Ph: 408-456-1161 Fax: 408-943-9293.
 FUJITSU MICROELECTRONICS ASIA PTE LTD. (Head Office, Singapore): Ph: 65-336-1600 Fax: 65-336-1609. HONG KONG SALES OFC: Ph: 852-723-0393 Fax: 852-721-6555.
 TAIPEI SALES OFC: Ph: 886-2-757-6548 Fax: 886-2-757-6571. JAPAN SALES OFC: Ph: 81-3-3216-3211 Fax: 81-3-3216-9771. KML CORP. (Rep., Korea): Ph: 82-2-588-2011 Fax: 82-2-588-2017.
 PACIFIC MICROELECTRONICS, PTY. LTD., (Rep., Australia): Ph: 61-2-481-0065 Fax: 61-2-484-4460.
 FUJITSU MIKROELEKTRONIK GmbH (Dreieich-Buchschlag, Germany): Ph: 06103-6900 Fax: 06103-690122.

SPARC is a registered trademark of SPARC International. UNIX is a registered trademark of UNIX System Laboratories, Inc. SunOS is a trademark of Sun Microsystems, Inc.

TECHNOLOGY UPDATE

Smart cards

formation in the 96 bits and then blow the fuse to prevent code or data modifications by unscrupulous parties. The ST1301A 416×1-bit EEPROM chip takes memory-card security a step further. It contains logic circuitry that verifies a personal identification number (PIN) and "locks" the card if someone presents four consecutive PINs that don't match the one stored in the card.

You do pay for security, though. A typical magnetic-stripe card costs between \$0.17 and \$0.25; the cost of a smart card can range from less than a dollar for an EPROM card to ten dollars or more for a card containing a microcontroller. Prices vary widely with the quantity purchased.

For EEPROM, you have more options. In addition to the previously mentioned 416-bit ST1301A from SGS-Thomson, you can also get 2-kbit (256×8-bit) chips from Motorola and 4-kbit (512×8-bit or 256×16-bit) chips from Catalyst Semiconductor. Note that chips for smart cards have serial data access; smart cards' limited number of contacts precludes parallel transfers.

Start with the chip makers

If you're interested in developing a smart-card application, perhaps the best way to start is by contact-

Acronyms used in this article

EEPROM—Electrically erasable programmable ROM
EPROM—Erasable programmable ROM
ISO—International Standards Organization
PIN—Personal identification number
RAM—Random access memory
ROM—Read only memory

ing the semiconductor manufacturers that produce the cards' electronics. These companies can give you information about their devices' operation and about available development systems. You may, in fact, want to choose a smart-card vendor based on that vendor's semiconductor supplier, especially if you want a microcontroller-based card and have a particular controller in mind.

The semiconductor companies can, in turn, put you in touch with companies that make the actual smart cards and supporting equipment, such as card readers. The US has a handful of smart-card companies, and Europe has scores, perhaps a hundred or more. Little information about smart cards comes out of Japan, although sources in the US and Europe say there is a lot of Japanese smart-card activity. Hitachi America has recently been pushing its smart-card chips, and

Oki Semiconductor has long been the supplier of smart-card chips for California-based Catalyst Semiconductor.

Smart-card devices usually come in wafers or in micromodules with the bond-out pattern specified by ISO standard 7816. Manufacturers' delivery can take anywhere from 8 to 16 weeks after you provide the ROM-based application code. And bear in mind that getting the chip is only the first step for most application developers; in most cases, you'll want a second company to put the chips in cards. Also, some chips may just be approaching volume production, so you should be wary of delays. A spokesperson for Motorola's smart-card operation suggests verifying that a device is already in volume production before placing an order.

Development systems for smart-card chips are available from the

For more information . . .

For more information on the smart-card products discussed in this article, circle the appropriate numbers on the Information Retrieval Service card or use EDN's Express Request service. When you contact any of the following manufacturers directly, please let them know you read about their products in EDN.

Catalyst Semiconductor
2231 Calle de Luna
Santa Clara, CA 95054
(408) 748-7700
Fax (408) 980-8209
Circle No. 700

Hitachi America Ltd
Semiconductor and IC Div
2000 Sierra Point Pkwy
Brisbane, CA 94005
(800) 448-2244
Circle No. 701

Motorola
Kelvin Industrial Estate
East Kilbride, Scotland
Glasgow G75 0TG
(44) 3552-39101
Brian Reid
Circle No. 702
In the US,
116501 William Cannon Dr W
Austin, TX 78735
(512) 891-3245
FAX (512) 891-3236
Beverly Sharp
Circle No. 703

SGS-Thomson Microelectronics Inc
ZI Rue Rousset Peynier
BP2 12790 Rousset, France
(33) 42-258800
FAX (33) 42-5352288
Michel Betirac
Circle No. 704
In the US,
1000 E Bell Rd
Phoenix, AZ 85022
(602) 867-6100
Tom Tyson (Carrollton, TX)
(214) 466-6088
Circle No. 705

VOTE . . .

Please also use the Information Retrieval Service card to rate this article (circle one):

High Interest 476
Medium Interest 477
Low Interest 478

Actual size

Actual output

20 WATTS

Now AC to DC

Actually meets

- MIL-STD-2000
- MIL-STD-810C
- MIL-S-901C
- MIL-STD-461C
- MIL-STD-704D
- NAVMAT GUIDELINES

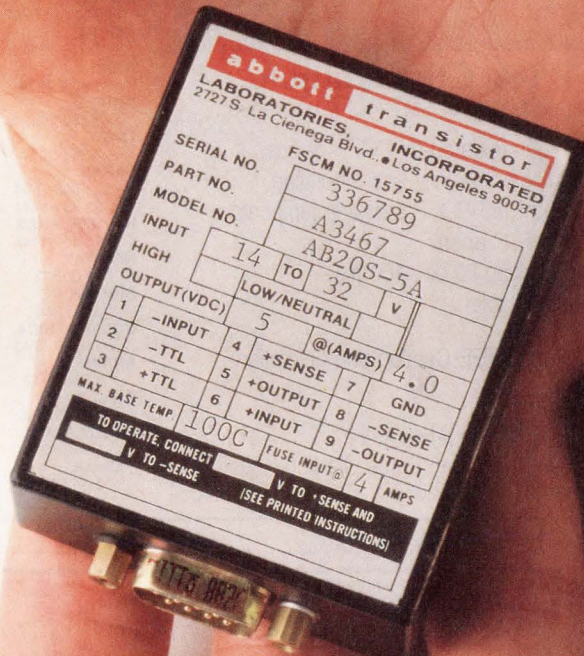

Mil/Pac™ high-density military power supplies.

Now you can order Abbott's full mil-qualified compact power supplies in both DC and AC input models.

Mil/Pacs come in 20W, 35W and 50W configurations, with single (5, 12, 15, 24, or 28V) or dual (±12V; ±15V) outputs.

DC-to-DC models accept input from 14V to 32V. AC-to-DC models accept 103.4 to 126.5V rms, 47-440 Hz single phase.

All Mil/Pacs operate at temperature extremes from

-55°C to +100°C. All are designed with a field-proven topology that has been verified by rigorous environmental stress screening.

Mil/Pacs are available with or without MIL-STD-2000. Either way, the specs are worth reading. Just write us at 2727 South La Cienega Bl., Los Angeles, CA 90034. Or call (213) 936-8185.



WHEN RELIABILITY IS IMPERATIVE.™

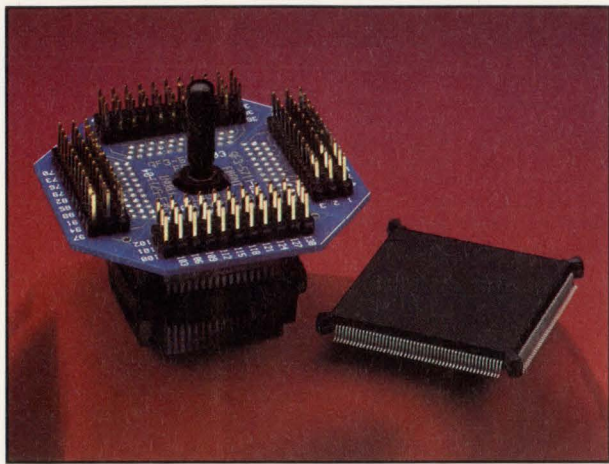

The PQFP Test Clip Solution...

... for hands-free testing of SMT PQFP packages.

- Clips directly onto your soldered-on PQFP device.
- Support for testing, logic analysis, and emulation.
- Converts JEDEC and EIAJ PQFP package footprints to standard test points .1" apart.
- Available in package sizes 80 pin--160 pin.
- Custom sizes also available!

Call for FREE Catalog and Quotation:



Emulation Technology Inc.
2344 Walsh Ave. Santa Clara, CA 95051
Phone: 408 982-0660 FAX: 408 982-0664

Call your Emulation
Technology Distributor:

AUSTRIA
222-603-1953
AUSTRALIA
613-764-5199
BELGIUM
15-212223
CANADA
613-725-2177
DENMARK
44-532244
ENGLAND
234-266455
FINLAND
0-334133
FRANCE
1-69412801
GERMANY
89-4602071
89-61208199
HONG KONG
3-460985
HUNGARY
361-116-2287
KOREA
2-516-1144
INDIA
11-6421114
ISRAEL
3-260-148
ITALY
2-353-8041
JAPAN
33-988-7534
33-791-6411
NETHERLANDS
10-450-1444
NORWAY
2-900900
SINGAPORE
281-7244
SOUTH AFRICA
11-789-1743
SPAIN
1-555-8112
SWEDEN
8-744-0300
SWITZERLAND
55-48-52-00
TAIWAN
2-507-9556
2-721-9533

CIRCLE NO. 43

UPDATE

Smart cards

semiconductor manufacturers; development occurs much as it would for any microcontroller-based application except for the differences resulting from the limit of six pins per chip. (ISO specifies eight contacts, but two are reserved for future use.) Some special equipment is available, both from semiconductor manufacturers and card manufacturers, for use after the chips are in cards.

Same processors, more memory

Near-term enhancements to smart cards probably will not be dramatic. Eight-bit processors appear to be adequate for now, although memory capacity—both in controller-based cards and memory-only cards—will undoubtedly increase. Flash memory, occupying less space than conventional EEPROM, will allow die sizes to remain small and keep the chips from breaking as the cards flex.

In the longer term, perhaps five years, more significant changes will occur. Until then, however, smart-card applications of existing products will need to prove as successful as glowing forecasts once predicted.

EDN

Reference

1. Small, Charles H, "Small memories take on wider applications," *EDN*, June 20, 1991, pg 67.

Article Interest Quotient (Circle One)

High 476 Medium 477 Low 478

BEYOND EXPECTATION

No two emulators run the same. The trick is to get the best functionality you can for your investment. With the SIGNUM 8051 family in-circuit emulator you get even more... you get:

- Outstanding price/performance
- Easy window interface & flash download
- Free user support
- C and PL/M debuggers
- Local variable support
- 512K Mappable emulation RAM with 256K H/W breakpoints
- Break on register ranges
- Program & external data access on the fly
- Bank switching
- A no-risk, iron-clad guarantee

8051/52 • 8096/196

SIGNUM also has the Intel 8048, Zilog Z8 and Super-8, Texas Instruments DSP, the 8051/52 (from AMD, Siemens and Signetics), and more chips covered.

So, don't just look at in-circuit emulators. The only way to truly test an emulator is to use it. Call for your own free trial and demo disk.

You owe it to yourself to find how much emulator you can really get for your money.

10 DAY FREE TRIAL

SIGNUM SYSTEMS

171 East Thousand Oaks Blvd.
Thousand Oaks, CA 91360
Tel: 805-371-4608 • Fax: 805-371-4610

Synchronous Communications

An easy link to higher intelligence.

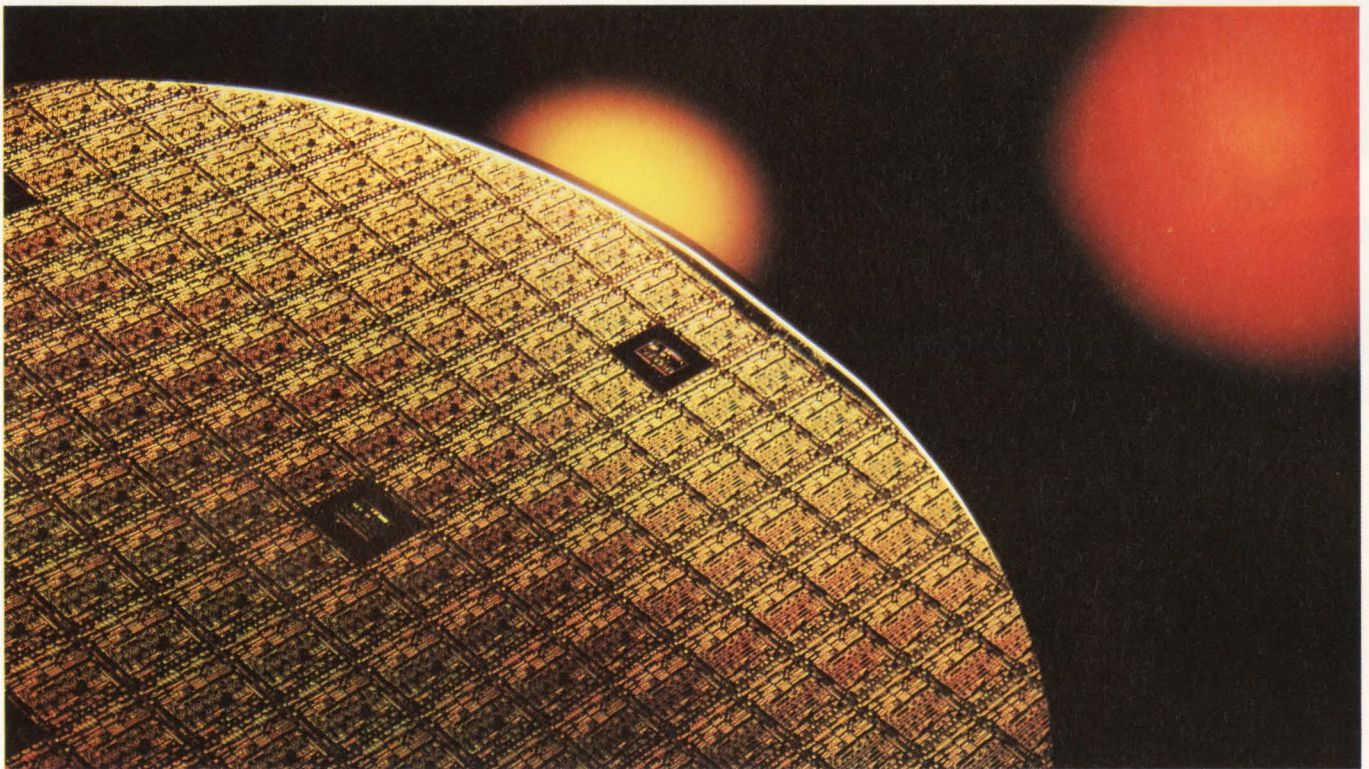

To a PC, workstation or communications card, it seems like just another asynchronous UART. But to the intelligent, synchronous universe of high-speed data communications it looks and functions like the world's first virtual communications packet controller.

"It" is our exclusive new M650 Serial Packet Controller. In a single-chip CMOS package you now can add high-speed (14,400+ bits/sec) modems to your PC peripheral bus or integrate with most high-speed synchronous communications networks.

The M650's dual-port mode

Circle #14 for product information

architecture accomplishes in hardware what you can't do as well in software. Even after you've linked up multiple UARTs and messed with glue logic.

So the M650 can take the heat off your CPU and function comfortably as a communications sub-processor. And, in power-down mode, be sensitive to the low power demands of your laptop and notebook PC designs.

Clearly, it's the intelligent asynch/synchronous communications link your next-generation product designs are waiting for. To find out more, call us for literature package CPD-10. We'll connect

Circle #15 for career information

you with your nearest Silicon Systems representative and update you on our latest developments.

1-800-624-8999, ext. 151.

Silicon Systems, Inc.

14351 Myford Road, Tustin, CA 92680
Ph (714) 731-7110 Fax (714) 731-6925

European Hdq. U.K. Ph (44) 79-881-2331
Fax (44) 79-881-2117

silicon systems[®]
A TDK Group Company

EVOLVING



The next generation of IDC Interconnection:

Same performance,
one-half the size.

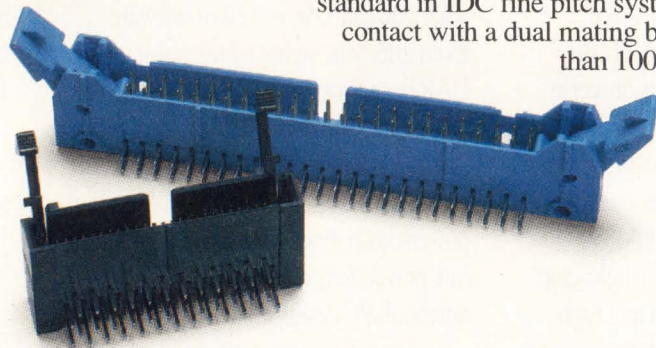

System 311 is the next generation of reliable high performance IDC mass termination systems from Thomas & Betts, a pioneer in the development of IDC.

A natural evolution, the new System 311 combines the finest capabilities of our proven Ansley® IDC System, downsized and precision engineered to terminate .025 pitch cable.

Performance-oriented features make System 311 the new standard in IDC fine pitch systems – a beryllium copper contact with a dual mating beam that provides greater than 100 grams normal force (150

KPSI Hertz Stress), a unique “coined-slot” IDC contact joint, one piece housing design,

• **NORTH AMERICA** – Canada: 708-357-0404; Mexico: Naucalpan, 905-393-85-10 • **PACIFIC** – Australia: Wyong North, NSW, 61-43-53-2300; Hong Kong: Kowloon, 852-739-1286; Japan: Tokyo, 81-3-3791-6411; Singapore: 65-747-0244; Taiwan: Taipei, 886-2-713-0509

ITION

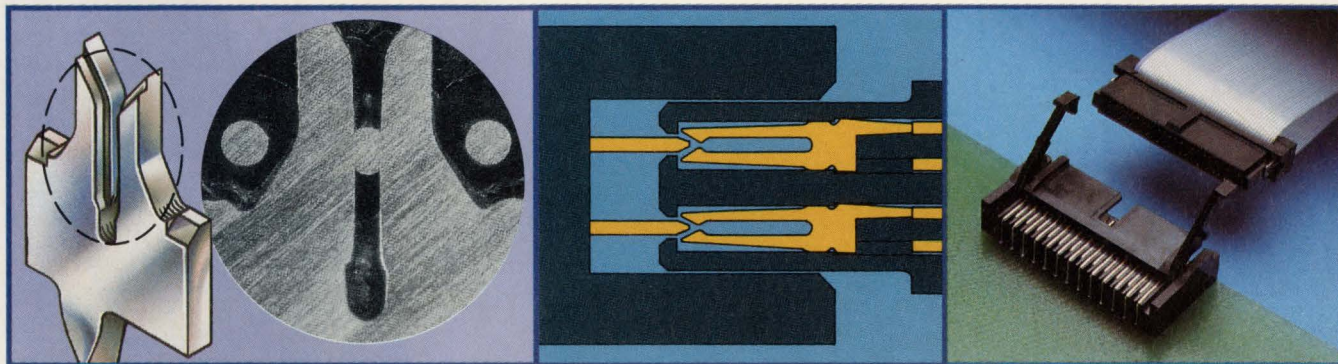

Contact-to-Conductor Relationship –
Thomas & Betts' "coined-slot" contacts are designed to position the terminated conductors within a specified region for maximum conductivity and reliability.

Precision Lead-In Design –
assures that repeated connect/disconnect functions are consistently smooth and without pin damage.

Our Own Vertical Eject Design –
saves board real estate and ensures positive locking and easy disengagement of header from mating socket without stress to cable, contacts, or solder joints.

and high performance materials are combined to ensure excellent system integrity and maximum reliability.

System 311 incorporates these customer-requested features into a compact interconnect system with board space savings of up to 50%.

From cable to connectors to application tooling, System 311 is designed to meet or exceed the most stringent customer requirements for fine pitch IDC mass termination.

For complete information or help with a specific application, call or fax: Thomas & Betts Corporation, Electronics Division, 200 Executive Center Drive, Greenville, S.C., Phone: 803-676-2900, Fax: 803-676-2991.

For the new System 311 Catalog call 800-344-4744.

Thomas & Betts

• **EUROPE – England:** Marlow, 44-6284-6055; **France:** Rungis Cedex, 33-1-4687-2385; **Germany:** Egelsbach, 49-6103-4040; **Italy:** Milano, 39-2-6120451; **Luxembourg:** Foetz, 35-255-0002; **Spain:** Barcelona, 34-3-3002252; **Sweden:** Upplands Vasby, 46-760-88110

EDN October 24, 1991

Move into the right 32-bit architecture and you'll be comfortable there for a long, long time.



Since nobody really relishes the thought of moving, you want to find an architecture you can stay with. And with the most complete line of 32-bit embedded processors, the Intel i960™ family is the perfect place to call home.

It's not only the most complete line, it's also the most complete solution. For starters, you get compatibility across the entire i960 line. So whatever direction you want to move within the family, the move is easy.



And with a price/performance path from under \$20 all the way up to 100 MIPS, you'll have plenty of room to grow.

Obviously, a complete solution would be incomplete without a comprehensive set of development tools and support. Which is why we put together the Solutions960 Collection. Over 100 hardware and software products from debuggers to printer controller boards to help

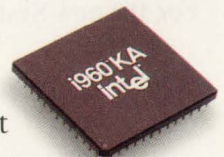

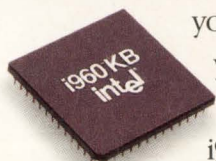

you get started, to develop and to get your products to market quickly.

And when you move into the i960 line, you'll be among some impressive neighbors. People like Dell, Seiko Instruments and Hewlett-Packard who've found the i960 processors are perfect for today's more demanding applications—everything from laser printers to communication products.



So when you're ready to settle into the most complete line of 32-bit architecture, call 800-548-4725 and ask for the 960 Welcome Guide for a more in-depth view of the i960 line.

Then sit back, relax and enjoy some very interesting reading.

intel[®]

The Computer Inside.[™]

At 1 Meg There's Simply No Faster SRAM.



1 Meg. 20ns. Available Now!

Order them in a 256K x 4 or 128K x 8 configuration.
In a high density plastic SOJ package. Part of a full line of fast SRAMs.
For samples, orders or more information, call 1-206-834-8959.

SHARP
FROM SHARP MINDS
COME SHARP PRODUCTS™

SRAMs • MROMs • FIFOs • PSRAMs • Core Micro • Displays • Opto • RF
Sharp Electronics Corporation Microelectronics Group 5700 N.W. Pacific Rim Blvd. Camas, WA 98607 (206)834-2500

VIDEO-COMPRESSSION CHIPS

Monolithic circuits expedite desktop video

Dedicated ICs can ease the burden of implementing existing and emerging image-compression standards for video systems.

*Dave Pryce,
Associate Editor*

Although advances in processing speed, memory density, and mass-storage capacities have made the desktop computer a viable platform for video applications, these advances don't provide the power and capacity to handle the enormous amounts of data in video images. The person that said "a picture is worth a thousand words" would probably have said "a few million words," given knowledge of today's computer-based image demands. For desktop computers to deal with the millions—actually billions of bytes—they need some help from video-compression chips.

A single 24-bit color image with a resolution of 1024×768 pixels consumes about 2.3 Mbytes of storage. The capac-

ity problem worsens if your application requires storing 15 minutes of such images in full-motion video running at 30 frames/sec. Such applications boost storage requirements to about 60 Gbytes. If you've got two-hundred 300-Mbyte drives lying around, you're home free. If not, you're in serious trouble.

Transferring such images is an equally daunting problem. A fast hard disk transfers about 1 Mbyte/sec, and an Ethernet LAN is typically even slower. Forget about modem transfer, you might not live long enough to receive the transmission.

Storing and transmitting video information—particularly full-color, full-motion images—has inherent limitations. Recognizing these limitations,

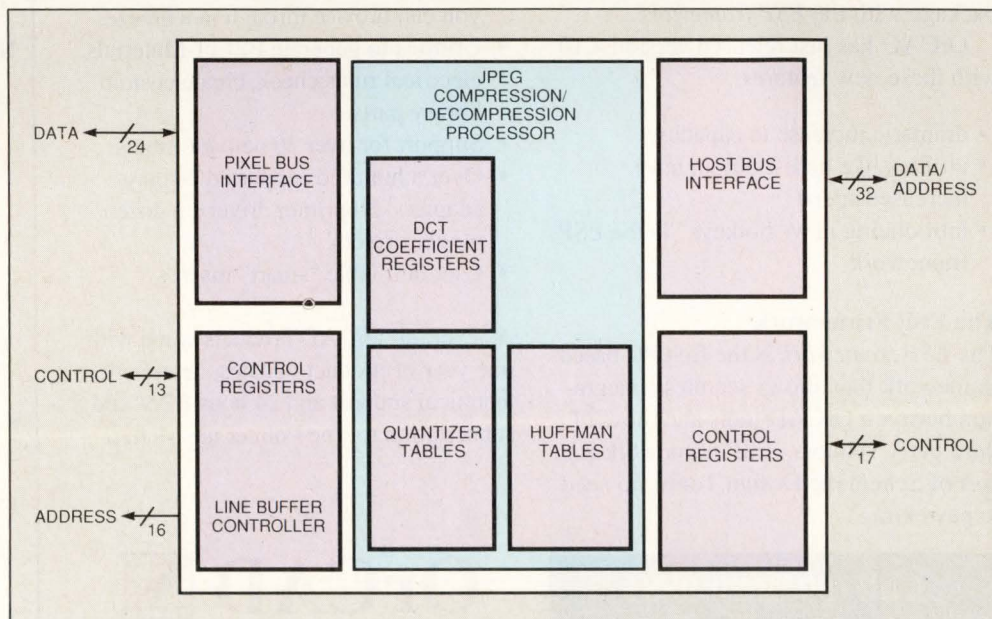
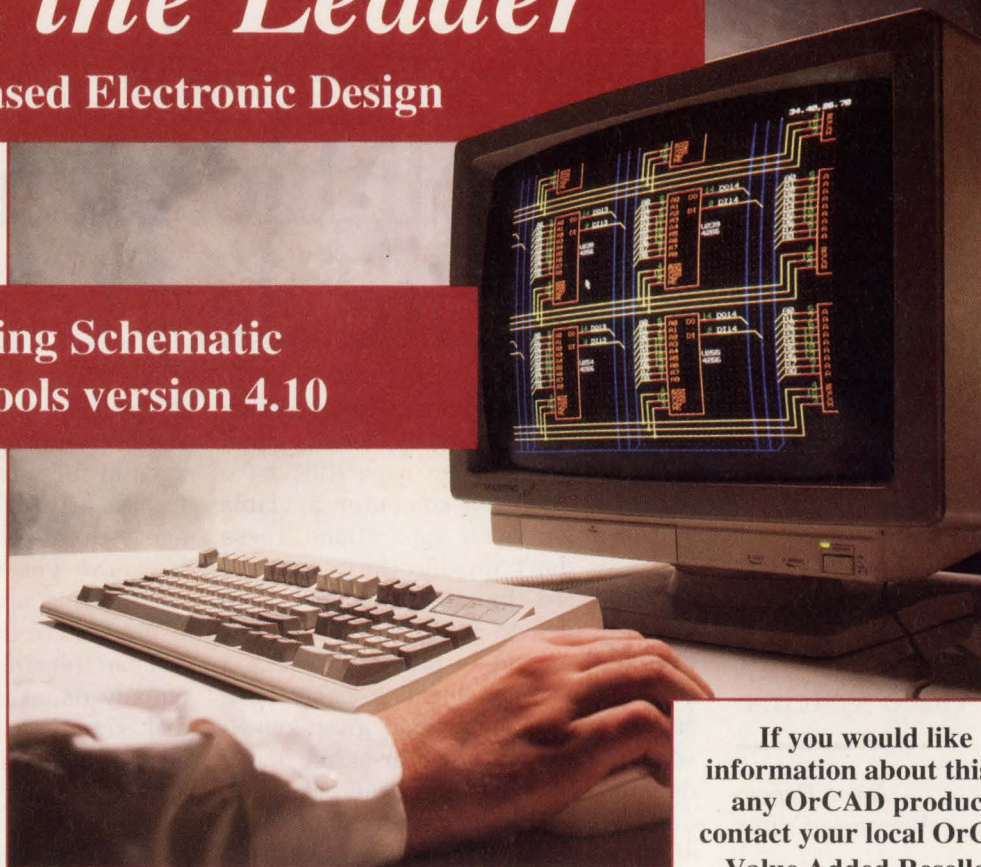

Fig 1—Shown here in block-diagram form, the CL550 JPEG chip from C-Cube Microsystems can handle compression ratios from 8:1 to 100:1. The chip supports 8-bit gray-scale, RGB, CMYK, and YUV color-space representations.

Still the Leader

in DOS based Electronic Design

Introducing Schematic Design Tools version 4.10



The leader in PC based EDA tools.

Why? Because we never stop improving our products. One example is our world famous *Schematic Design Tools* package with the *ESP framework*.

OrCAD has just released version 4.10 with these new features.

- dramatic increase in capacity
- utilities like netlist output have increased speed
- introducing new "hotkeys" in the ESP framework

The ESP Framework

The *ESP framework* is the first PC based framework that allows seamless integration between OrCAD tools and those of third party vendors. ESP framework is a part of Schematic Design Tools; no need to pay extra.

The OrCAD Difference

Schematic Design Tools still comes with the features you'd expect to pay more for:

- A library of over 20,000 unique parts you can browse through in a breeze.
- Utilities to generate Bill-of-Materials, electrical rules check, create custom library parts.
- Support for over 30 netlist formats.
- Over a hundred supported display adapters, 50 printer drivers, a dozen plotter drivers.
- User definable "smart" macros

As ever, all OrCAD products come with one year of product updates, telephone technical support and 24 hour BBS, and a subscription to The Pointer newsletter.

If you would like information about this or any OrCAD product, contact your local OrCAD Value Added Reseller.

WA, OR, MT,
ID, AK, WY
Avcom/EDA
(206) 462-4040

N. CA, HI, Reno
NV
Elcor Associates
Inc.
(408) 980-8868

So. CA
Advanced Digital
Group
(714) 897-0319

Las Vegas NV,
UT, AZ, NM,
CO
Tusar Corporation
(602) 998-3688

TX, OK, AR, LA
Abcor, Inc.
(713) 486-9251

ND, SD, MN,
MI, WI, IL, IN,
OH, KY, WV,
W. PA, NE, KS,
IA, MO

MacKellar
Associates, Inc.
(313) 335-4440

VA, TN, NC,
SC

Tingen Technical
Sales
(919) 870-6670

E. PA, NJ, NY,
DE, MD, DC
Beta Lambda,
Inc.

(800) 282-5632

CT, RI, MA,
VT, NH, ME
Tri-Logic
(508) 658-3800

CANADA
Pegasus Circuits
(416)567-6840

Call (503)690-9881
or write today for your
FREE demo disk!

OrCAD 

3175 N.W. Aloclek Drive
Hillsboro, OR 97124
FAX (503)690-9891

TECHNOLOGY UPDATE

Video-compression chips

several vendors of integrated circuits have recently introduced dedicated ICs (Table 1) that can compress video data by factors ranging from about 15:1 to well over 250:1, depending on the application. These devices incorporate special circuit architectures and use algorithms tailored to the intended application.

Most of these compression chips use the discrete cosine transform (DCT), an algorithm that has become popular for image coding. Although most use the same algorithm, different image-compression chips are targeted for specific applications and fall under different standards generated by the International Standards Organization (ISO) or the International Consultative Committee for Telephony and Telegraph (CCITT).

The ISO has its Joint Photographic Experts Group (JPEG) and Motion Picture Experts Group (MPEG) standards. The JPEG stan-

Feature	JPEG	Px64	MPEG I	MPEG II
Full color still images	✓	✓	✓	✓
Full-motion video		✓	✓	✓
Real-time video capture/playback	✓	✓		
Broadcast-quality full-motion				✓
Compression ratios	10:1 to 80:1	100:1 to 2000:1	up to 200:1	up to 100:1
Bandwidth		64 kbps to 2 Mbps	1.5 Mbps	5 to 10 Mbps

dard primarily applies to still images and supports compression ratios to about 25:1 without any visible degradation in image quality. The MPEG standard applies to full-motion video and achieves compression ratios of 50:1 or more. The CCITT has its Px64 standard, which applies to full-motion video and to real-time video applications such as teleconferencing. Systems

using the Px64 standard achieve typical compression ratios of 200:1 to 500:1. Table 2 summarizes the standards in use for various applications and the features they offer. For a more complete discussion of these standards, see the box, "Video compression techniques and standards." For a more in-depth treatment of compression and decompression approaches, see Ref 1.

Table 1—Representative video-compression chips

Company	Part no.	Standard	Speed rating	Package(s) available	Price (qty)
C-Cube Microsystems	CL550	JPEG	10, 30, or 35 MHz	144-pin PGA ¹ 144-pin quad flatpack	\$95 to \$165 (10,000)
Integrated Information Technology	VP	JPEG MPEG Px64	N/S	144-pin quad flatpack	\$150 (10,000)
Intel Corp	i750 (2-chip set): 82750PB 82750DB	—	25 MHz 28 MHz	132-pin quad flatpacks	\$39 \$46 (10,000)
LSI Logic	3-chip set: L64735, L64745, L64765	JPEG	20 or 27 MHz	68- and 84-pin PGA 100-pin quad flatpack	\$220 to \$287 (1000) (set) \$149 (10,000) (set)
SGS-Thomson	STV3200	JPEG MPEG	N/S	40-pin DIP 44-pin PLCC ²	\$91
	STV3208	JPEG MPEG		40-pin DIP	\$52
	STI3220	MPEG Px64		68-pin PLCC 68-pin CLCC ³	\$78 \$140 (1000)

Note: 1. PGA=pin-grid array
2. PLCC=plastic leaded chip carrier
3. CLCC=ceramic leadless chip carrier
N/S=Not specified

JPEG chips are popular

The first monolithic image-compression processor based on the JPEG standard, the CL550 from C-Cube Microsystems, received almost instant acceptance by satisfying video systems manufacturers' needs. The CL550 speeds overall performance, reduces storage requirements, and minimizes transmission times. The device can shrink high-resolution, full-color images by a 25:1 ratio. But it can handle compression ratios from 8:1 to 100:1, depending on the application's quality, storage, and bandwidth requirements. Compression ratios are controlled by on-chip quantization tables. The device also works in the reverse mode to decompress images.

The CL550 (Fig 1) has on-chip video- and host-bus interfaces. The video (pixel) interface supports 8-bit gray scale, RGB (red, green,

TECHNOLOGY UPDATE

Video-compression chips

blue), CMYK (cyan, magenta, yellow, black), and YUV (luminance, chrominance) color-space representations. In the compression mode,

the device takes pixels from the pixel bus, compresses them, and makes the compressed data available on the host bus. In the decom-

pression mode, the device acquires host-bus compressed data, decodes it, and makes pixel data available on the pixel bus.

Video-compression techniques and standards

Most video compression techniques use a set of four basic processing functions: spatial-to-frequency domain translation, quantization, entropy (Huffman) coding, and motion compensation.

Spatial-to-frequency translation converts the red, green, and blue (RGB) pixels into YUV form, where Y represents an intensity value, and U and V represent color values. A discrete cosine transform (DCT) then converts the block of YUV pixels into a set of coefficients that represent the frequency components of the intensities and colors in the block. The DCT outputs a 2-D matrix that

can be inversely transformed back into pixel values.

Quantization—a lossy, approximation function that is similar to division—compresses the overall range of the frequency matrix. For example, a data set comprised of integers from 0 to 255 needs 256 discrete values (8-bit numbers) to represent it. By dividing each value by 8, it's possible to represent the entire set using only 32 values, albeit with some loss of definition. Varying the quantization applied to the DCT-generated frequency matrix changes the compression ratio—and the quality of the decompressed image. Because human vision is less sensi-

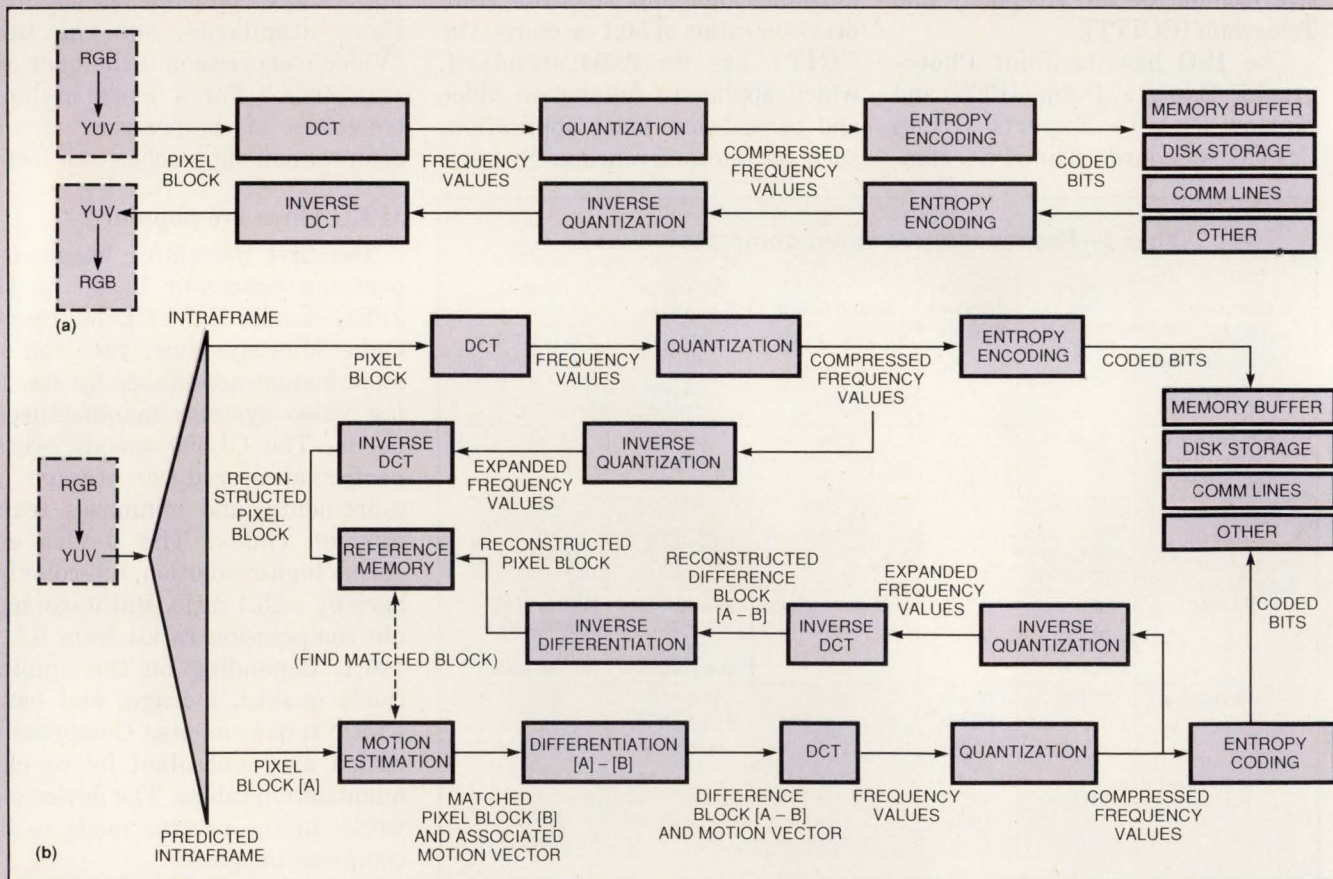

Fig A—Three standards currently govern the compression and decompression of still and full-motion video. The block diagrams show implementations of these standards in increasing order of complexity: JPEG encoding and decoding (a), Pxl64 encoding (b), and MPEG encoding (c).

TECHNOLOGY UPDATE

JPEG-standard compression operates on 8x8-pixel blocks. Because many applications work with raster graphics instead of pixel

blocks, the CL550 provides address and control for an external line-buffer RAM. The chip can use this RAM to organize raster images into

blocks of 8x8 pixels for compression, or to organize 8x8-pixel blocks after decompression into a raster pixel stream.

tive to high-frequency details than to low-frequency details, the relative quantization can be greater for high frequencies without sacrificing perceived image quality.

Entropy (Huffman) coding is a variable-length coding technique that assigns bit patterns of varying length to data codes, depending on the statistical occurrence of those codes. Frequently occurring patterns receive short codes; infrequent patterns receive longer codes. For example, because quantized video frequency matrices tend to contain many zeros, the entropy encoding operation generally as-

signs very short bit strings to represent the various run lengths of zeros.

Motion compensation compares the frame-to-frame variation in a video sequence and attempts to reduce the amount of information needed to describe one frame, given some information about one or more related frames. This process is called *interframe* coding. Initially, however, an *intraframe* (single frame) establishes the reference.

Driving the efforts to establish standardized methods for video compression are the Joint Photo-

Text continued on pg 72

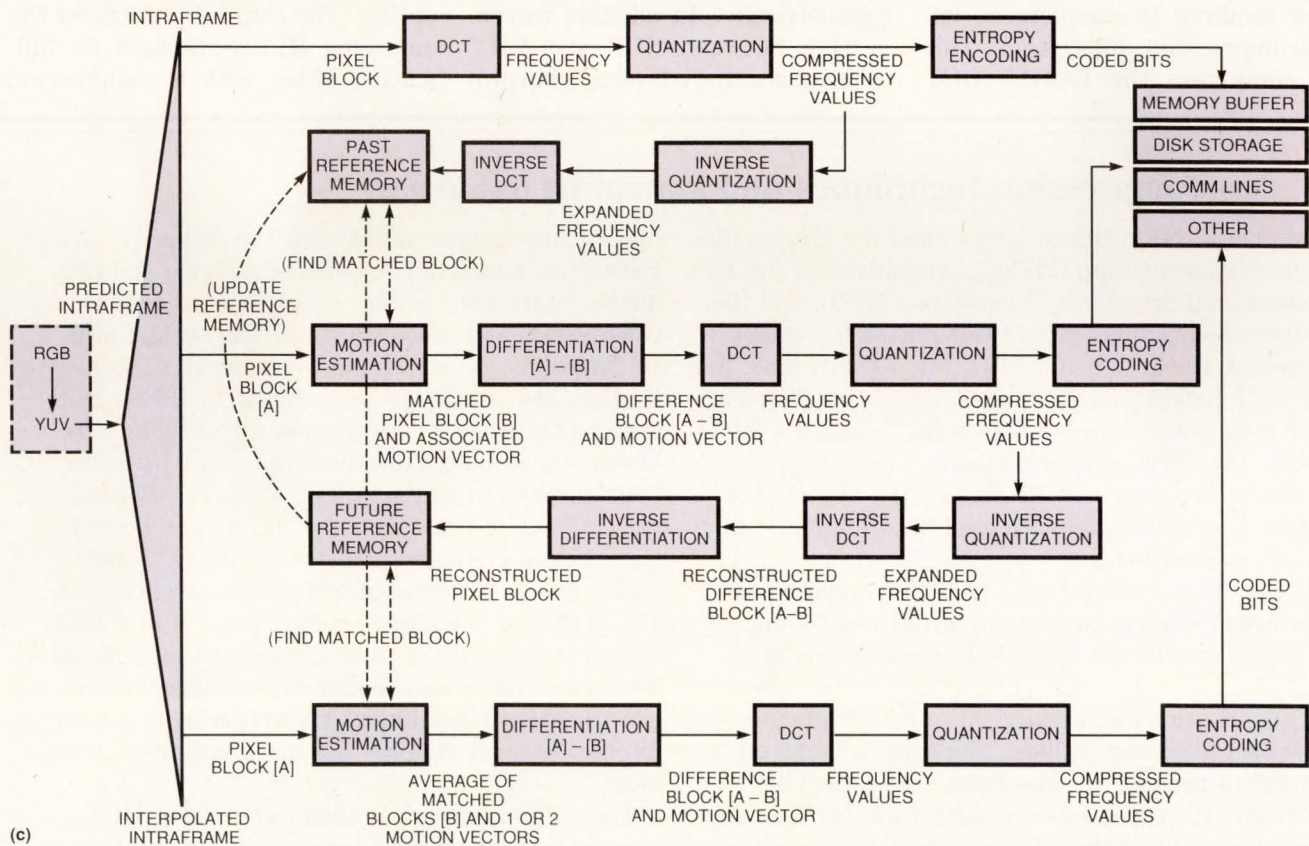

TECHNOLOGY UPDATE

Video-compression chips

As an example of the increased speed provided by the CL550, it can compress a 30-Mbyte, 24-bit/pixel color image in 1 sec. By comparison, a 68030 microprocessor would take 5 minutes to compress the same image.

Chip sets simplify circuitry

One thing you need to keep in mind when dealing with image-compression systems is that no single chip can provide all of the functions necessary to support JPEG, or any other standard. All compression systems require numerous support chips to accomplish the task. In an effort to reduce the total chip count, LSI Logic offers a 3-chip set that reduces the number of static RAM (SRAM) and register-buffer chips required to complete an image-compression subsystem. This set comprises the L64735 DCT

processor, the L64745 JPEG coder, and the L64765 color and raster-block converter. The chip set is targeted for desktop publishing systems, color copiers, laser printers, medical imaging equipment, and other applications that need to compress still-image data.

Although some image-compression chips break down at high speed and low compression ratios, the pipeline architecture of the LSI Logic chip set can continuously code and decode any data stream, regardless of the amount of data or its compression ratio. The DCT processor and the JPEG coder chips perform the cosine transfer, quantization, and variable-length (Huffman) coding functions. The bidirectional chip set performs encoding and decoding symmetrically. In addition to converting between RGB and YUV color spaces, the converter chip pro-

vides the control logic to convert pixel data between a raster-ordered signal and a JPEG block-ordered signal. The chip set supports both color and gray-scale images.

The L64745 JPEG coder chip includes a lossless mode as an extension to baseline JPEG. The simpler design of a lossless system requires only the L64745 chip, bypassing quantization and run-code circuitry. The chip codes or decodes data using one of two internally stored code tables. A statistics mode lets the user collect image statistics in a first pass to optimize the Huffman code tables.

LSI Logic also offers a 7-chip set for implementing the CCITT Px64 standard for full-motion applications such as video teleconferencing. The chip set also tracks the emerging MPEG standard for full-motion video with a compression

Video-compression techniques and standards (*continued*)

graphic Experts Group (JPEG) and the Motion Picture Experts Group (MPEG) committees of the International Standards Organization (ISO), and the International Consultative Committee for Telephony and Telegraphy (CCITT). Finalized in 1989, the CCITT Px64 standard applies to real-time video applications such as teleconferencing. Finalized this year, the JPEG standard applies to still images. Under development, with finalization expected in 1992, the MPEG standard applies to full-motion video applications.

JPEG: This standard uses DCT, quantization, and entropy encoding to perform intraframe coding. JPEG compression uses DCT to convert each YUV pixel to a matrix of frequency values. Next, a quantization operation yields a matrix of compressed frequency values, which are entropy encoded to produce the resultant compressed bit stream. The coded bits are then stored, or transmitted digitally and then decompressed through a reverse process, regenerating the pixel image. **Fig A** illustrates the basic process. JPEG coding can achieve compression ratios from 10:1 to 80:1. For

high-quality images, ratios of 15:1 to 25:1 are typical. **Px64:** This standard combines intraframe and predictive interframe coding to provide on-the-fly video compression and decompression. The system (**Fig B**) first codes an intraframe block using DCT, quantization, and entropy coding, similar to JPEG. However, as the system converts the coded block to a bit-stream output, it also decompresses the coded block through a reverse process and stores the information in an internal memory buffer. The system then applies predictive interframe coding to code each subsequent frame in terms of its predecessor. The predictive interframe-coding process first loads a pixel block from the current image. A motion estimator then executes a search-and-compare operation to output a pixel block that represents the difference between the previous block and the current block.

The difference block is then coded using DCT, quantization, and entropy encoding. This block is output as coded bits, along with an encoding of the associated motion vector needed to reconstruct the original block upon decompression. That block is also

TECHNOLOGY UPDATE

bit-stream of 1 Mbps. The set contains an error-correcting codec, a motion-estimation processor, a DCT processor, a quantization processor, a Huffman encoder, a Huffman decoder, and an intra-/inter-frame decision processor. The price of the complete set in plastic packages is under \$700 (1000). As a subset of the complete system, the company also offers a 3-chip set for a full-motion video playback system on a computer platform for \$250.

Designed for multimedia applications, Intel's i750 2-chip video processor lets you combine text, graphics, and video images in a computer display. The chip set contains the 82750PB, a programmable pixel processor for manipulating image data, and the 82750DB display processor, which handles the video interface. Fig 2 is a block diagram of a basic system using these two de-

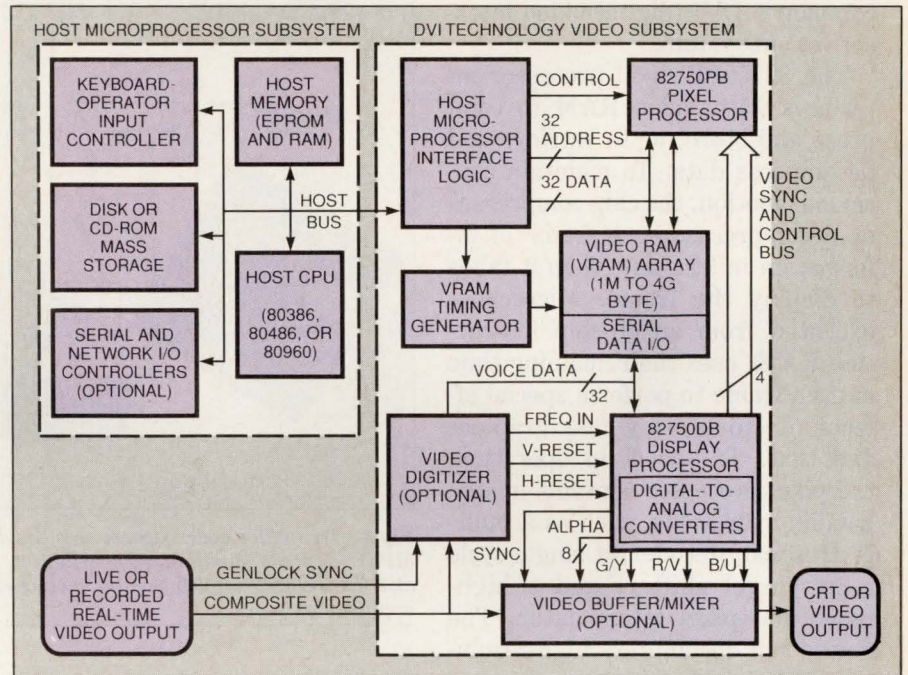

Fig 2—Providing the basis for a video subsystem, the 82750PB pixel processor and the 82750DB display processor from Intel interface with other components and the host micro-processor subsystem.

decompressed internally and stored in the memory buffer as the new reference for the next block. Optimized for video-based telecommunications and other real-time applications that are not motion intensive, the Px64 algorithm incorporates limited motion-search and estimation capabilities to achieve compression ratios of 100:1 to 2000:1, depending on the desired image quality.

MPEG: This method (Fig C) uses all of the basic intraframe compression functions and also combines predictive interframe and interpolative interframe coding for motion compensation. The MPEG algorithm first compresses an initial intraframe block using DCT, quantization, and entropy encoding. The coded block is also decompressed and stored in an internal past-memory buffer. The system then uses predictive interframe coding similar to that used in Px64 to code a non-adjacent future frame. This future-frame block is decompressed and stored in the internal future-memory buffer. Then, interpolated interframe coding estimates and codes the intervening frames between subsequent intraframes or interframes.

The interpolated interframe coding used in MPEG is very similar to the predictive interframe, except that the motion estimation involves a comparison and search with respect to both images in the past- and future-frame buffers. Differentiation produces a new pixel block that represents the difference between the current block and the *average* of the past and future blocks. DCT, quantization, and entropy encoding are then applied to the difference block, and the coded bit-stream is stored or transmitted, along with the associated motion vectors needed to reconstruct the original pixel block. The system then moves the image data in the future memory buffer to the past memory buffer and codes a new future frame. Optimized for motion-intensive video applications, MPEG can achieve compression ratios as high as 200:1 but needs high bit rates for transmission. *Note:* The preceding summary of compression techniques and standards is an edited version of selected material from "Video Compression Technology Overview," a 27-page report available from Integrated Information Technology of Santa Clara, CA.

TECHNOLOGY UPDATE

Video-compression chips

vides as the core elements in the company's DVI (digital video interactive) subsystem.

The 82750PB pixel processor interfaces with video RAM to compress and store, or to retrieve and decompress data. To maintain continuous motion, the chip compresses or decompresses each frame of information in less time than it takes to display the frame. Microcode, executed from an on-chip instruction RAM, uses the remaining time of each frame to perform special effects, or to overlay fast graphics and text. To speed up operation, the pixel processor contains image-handling functions, such as a built-in Huffman decoder, a single-cycle n-bit barrel shifter, and a high-resolution pixel interpolator. The device can decompress high-resolution JPEG still images at the rate of 30 images/sec.

The 82750DB display processor retrieves bit-map image data from video RAM, performs post-processing operations (such as 2-D UV interpolation), translates the data from YUV digital video format to RGB analog format, and generates CRT synchronization and control signals. The device delivers the output from the pixel processor to a wide range of video displays, including VGA, NTSC, PAL and SECAM. You can also synchronize the chip with an external video source.

SGS-Thomson offers several

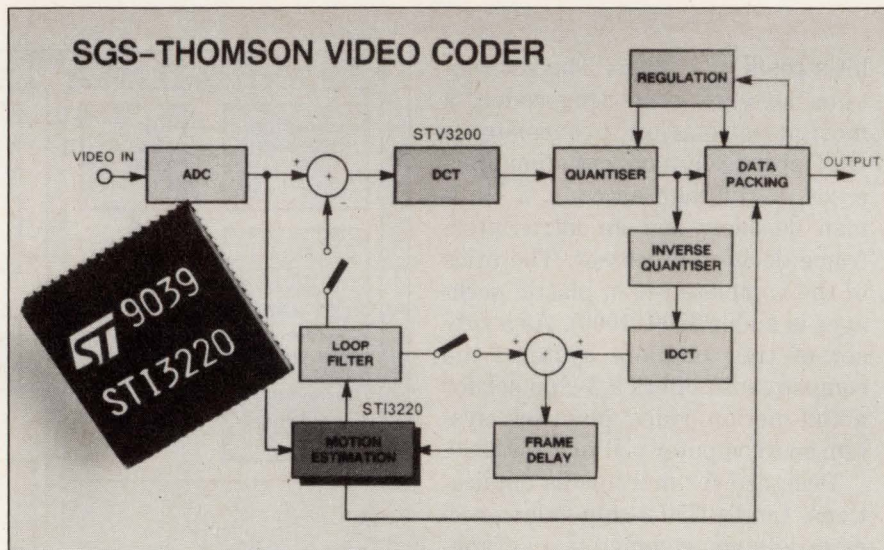

Fig 3—This video coder system uses two dedicated chips from SGS-Thomson to implement MPEG or Px64 standards. The STV3200 provides DCT compression and decompression, and the STI3220 implements the motion-estimation circuitry needed for full-motion video applications.

chips for use in video compression/decompression applications. Notable are its STV3200 and STV3208 DCT processors, which perform both forward and inverse transforms. The circuit architecture for these chips is fully bidirectional with a 9-bit pixel-data bus and a 12-bit coefficient-data bus. You can program each bus as either the input or the output, depending on the selection of either a forward or an inverse DCT.

The 3200 can handle seven different pixel-block sizes, including 8×8 and 16×16. An 8×8 block is typically used in JPEG applications to

convert 64 values to a single value. The 16×16 block is typically used in high-compression video conferencing applications to convert 256 values to a single value. The chip handles pixel rates to 15 MHz.

The 3208 chip performs a DCT only on 8×8 pixel blocks. The chip handles pixel rates to 27 MHz in the single-precision mode, and to 20 MHz in the double-precision mode.

SGS-Thomson's latest chip, the STI3220 motion-estimation processor, is designed for full-motion video applications such as those using MPEG or Px64 standards. **Fig 3** is a block diagram of a video coder

Acronyms used in this article

CCITT—International Consultative Committee for Telegraphy and Telephony
CMYK—Cyan-magenta-yellow-black
DCT—Discrete cosine transform
DIP—Dual in-line package
DMA—Direct memory access
DSP—Digital signal processing
DVI—Digital video interactive
ISO—International Standards Organization
JPEG—Joint Photographic Experts Group
LAN—Local area network
MPEG—Motion Picture Experts Group

NTSC—National Television Standard Committee
PAL—Phase-alternation line
PGA—Pin-grid array
PLCC—Plastic leaded chip carrier
RAM—Random access memory
RGB—Red-green-blue
ROM—Read-only memory
SECAM—Sequential couleur à memorie
SRAM—Static random-access memory
VGA—Video graphics array
VP—Vision processor
YUV—Luminance, chrominance

True portables are totally off the wall.

No outlets. No rechargers. No reliance on AC whatsoever. That's true portability. It's what the world is coming to. And it runs on easy-to-replace primary batteries. The next generation promises even smaller, lighter weight, more convenient portables. That depends on you, and you can depend on us.

Duracell is the primary source for primary power. We offer you a world of technical expertise and marketing experience in developing powerful solutions for computers, cellular phones and more. Let us help you

select a primary battery system from our broad line that includes alkaline and high power lithium manganese dioxide batteries.

Call us for application-specific data, design-in assistance, or just more information. Our OEM hotline number is (800) 544-5454, Ext. 3281. Or fax us at (203) 791-3273.

True portability is the cutting edge. And it's in your power.

DURACELL[®]
PORTABILITY IS PRIMARY

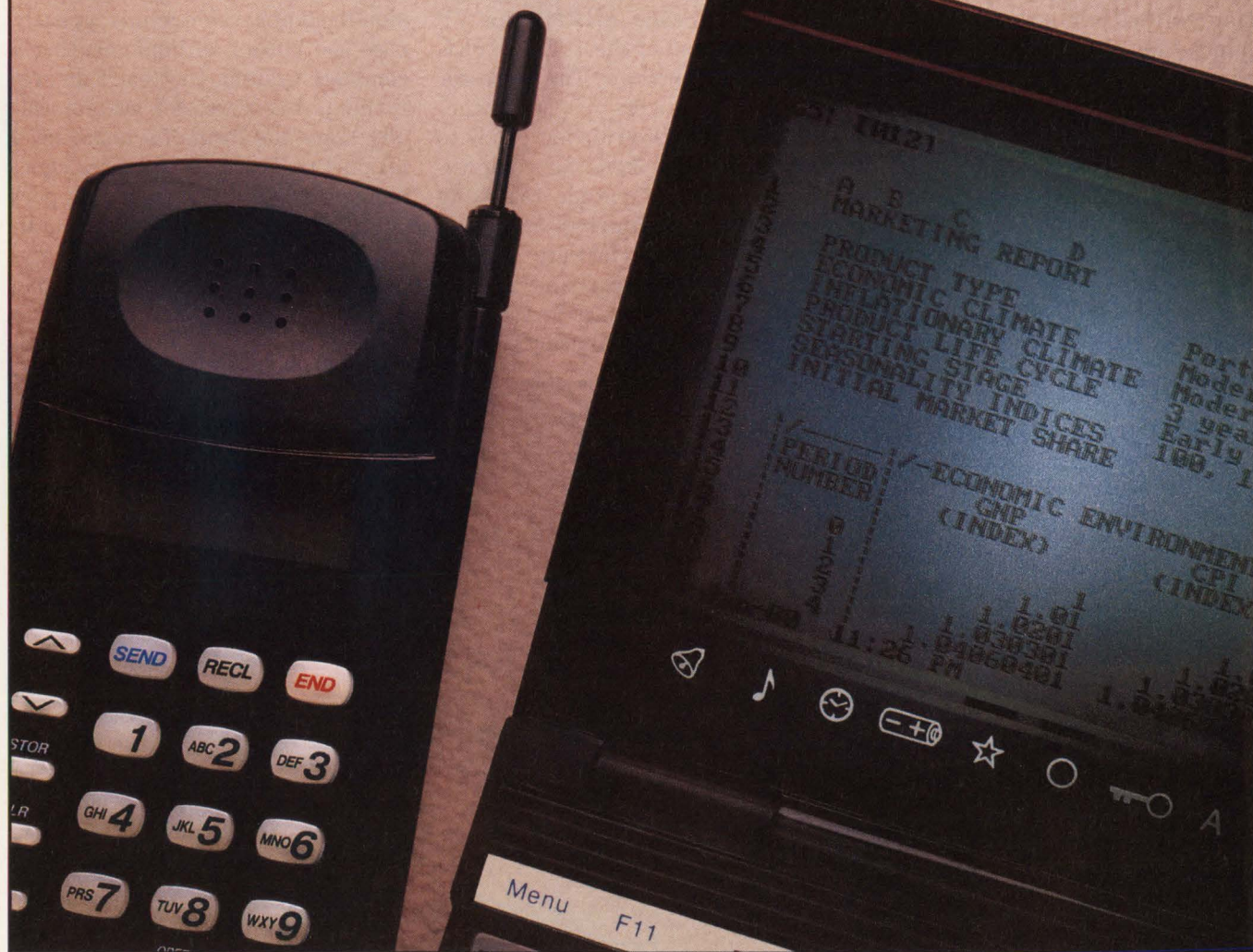

TECHNOLOGY UPDATE

Video-compression chips

using the STV3200 DCT chip and the STI3220 processor.

Motion-estimation circuitry greatly reduces the amount of data required to store or transmit a video signal. Motion estimation exploits the fact that successive images are often similar and consist of the same elements in slightly different positions. Rather than transmit every pixel in every frame, the coder identifies these movements and transmits only the information required to reproduce the same movements at the decoder. In most algorithms, motion estimation is combined with DCT compression to achieve overall compression ratios of 200:1.

Using these algorithms, the motion-estimation processor determines the motion of pixel blocks by comparing each block with all of the surrounding blocks while looking for the best match. The processor then outputs a motion vector (indicating direction) and a distortion factor (indicating the degree of matching). This procedure requires enormous computational power. As an array of 256 processors, the STI3220 can achieve 14 billion op-

erations per second. The chip supports operations on pixel blocks to 16×16 in a search window with a maximum displacement of +7 or -8 pixels, corresponding to 256 vectors. Random access to the distortion factors calculated by the chip allows the use of more elaborate algorithms such as half-pixel interpolation.

Chip handles JPEG/MPEG/Px64

Integrated Information Technology (IIT) offers a versatile chip called the Vision Processor (VP). The VP is a highly parallel, microcode-based video processor for use in DCT-based compression/decompression systems. Using internal microcode ROM and (optional) external microcode SRAM, the VP can execute all of the JPEG, MPEG and Px64 algorithms. The processor handles all stages of these algorithms such as converting pixels to run/amplitude tokens for compression, and run/amplitude tokens to pixels for decompression. Other functions include forward and inverse DCT, forward and inverse quantization, motion estimation and compensation, and filtering.

The company provides the microcode for use with JPEG, MPEG, and Px64 standards, thus relieving the system designer from the burden of writing the microcode. Algorithm parameters such as quantization values are customer programmable. The VP's 64-bit parallel architecture performs more than 1.9 billion operations per second. A high-speed DMA port transfers pixel or run/amplitude data to the chip. A command port allows an external processor to initialize the VP, execute microcode subroutines, and control the DMA port. In Q1 1992, IIT plans to introduce a companion vision controller and a complete integrated vision module.

Although the dedicated compression/decompression chips greatly ease the burden of implementing a complete system, they can't do everything. A compression system usually takes the form of a board-level product that also incorporates logic, memory, and other types of support chips. Both dedicated and general-purpose DSP chips are also beginning to play a more important role in compression applications and, in many cases, software is used to implement a specific algorithm. Whatever the final form of the complete system, however, dedicated compression chips will play an increasingly important role as manufacturers strive to simplify and reduce the cost of end products. **EDN**

For more information . . .

For more information on the image-compression products discussed in this article, circle the appropriate numbers on the Information Retrieval Service card or use EDN's Express Request service. When you contact any of the following manufacturers directly, please let them know you saw their products in EDN.

C-Cube Microsystems
339-A W Trimble Rd
San Jose, CA 95131
(408) 944-6300
FAX (408) 944-6314
Circle No. 706

Intel Corp
Box 58130
Santa Clara, CA 95052
(800) 548-4725
Circle No. 708

SGS-Thomson Microelectronics Inc
1000 E Bell Rd
Phoenix, AZ 85022
(602) 867-6228
FAX (602) 867-6102
Circle No. 710

Integrated Information Technology
2445 Mission College Blvd
Santa Clara, CA 95054
(408) 727-1885
FAX (408) 980-0432
Circle No. 707

LSI Logic Corp
1551 McCarthy Blvd
Milpitas, CA 95035
(408) 433-8000
FAX (408) 434-6457
Circle No. 709

Reference

1. Swager, Anne Watson, "Image compression lightens storage and transport burdens," *EDN*, July 18, 1991.

Article Interest Quotient (Circle One)

High 512 Medium 513 Low 514

Simple Filter Design

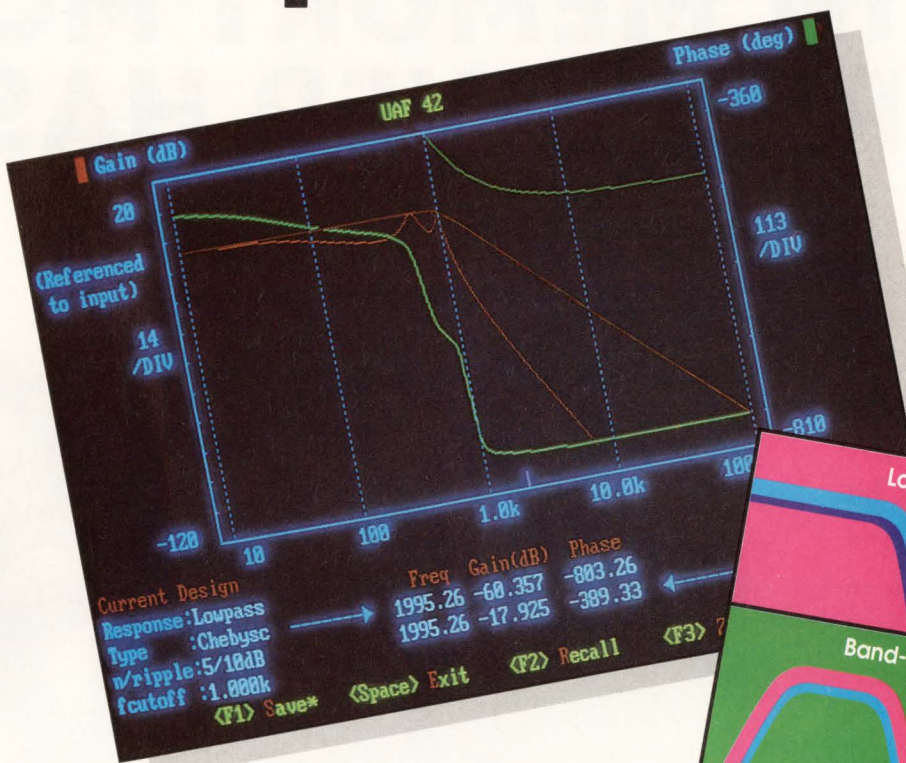

Key Specifications

- DC to 100kHz
- filter Q to 400
- 14-pin plastic or ceramic DIP
- from \$6.95*

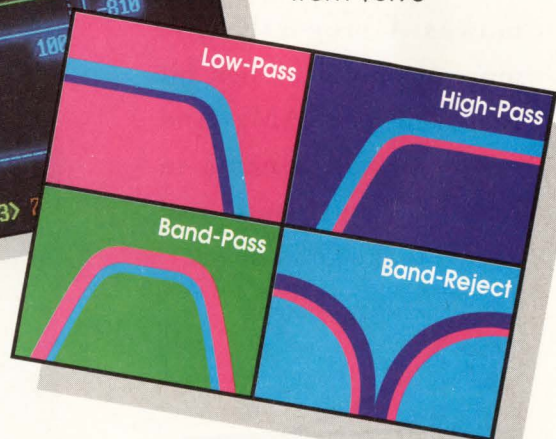

New Universal Active Filter

Our new monolithic UAF42 makes it easy to design a wide variety of filter types. Complete with four op amps, on-chip precision capacitors and resistors, UAF42 reduces external components to a minimum. Its classical state-variable topology forms a time-continuous filter, free from the switching noise and aliasing of switched-capacitor filters. UAF42's flexibility makes it the best choice for a variety of applications.

FREE Design Kit

The design kit includes a FREE sample, filter design software, data sheet, and an application bulletin... everything you need to make filter designing simply easy. The DOS-compatible program saves you hours of design time by eliminating tedious computations. On-screen prompts guide you through the selection process, showing the advantages and disadvantages of various filter types.

Now, you can easily design low-pass, high-pass, band-pass, and notch filters. Response types include Butterworth, Bessel, Chebyshev and Inverse Chebyshev.

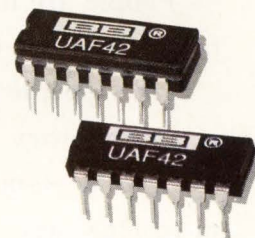

Call 1-800-548-6132 today for your free design kit.

Burr-Brown Corp.
P.O. Box 11400
Tucson, AZ 85734

* U.S. OEM prices, in 100s.

BURR - BROWN®
BB

SAMSUNG
NOW

IN MEMORY MOD CROSSOVER HAS J

You've heard the old saying, "we'll cross that bridge when we come to it." Well, we have.

Cost crossover today makes 4-meg DRAMs more economical per bit than 1-meg DRAMs. And given all the benefits in reliability and board real estate, that's good news.

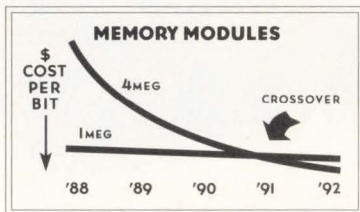

People are lining up to take advantage of it.

One specific advantage is in memory modules. Samsung 4-meg-based modules are actually more cost-effective today than their 1-meg-based counterparts.

All the modules listed here have reliability specs based on 600 temperature cycles (0-125°C) and 500 hours (85°C, 85% RH). Available features include 70, 80, and 100 ns access

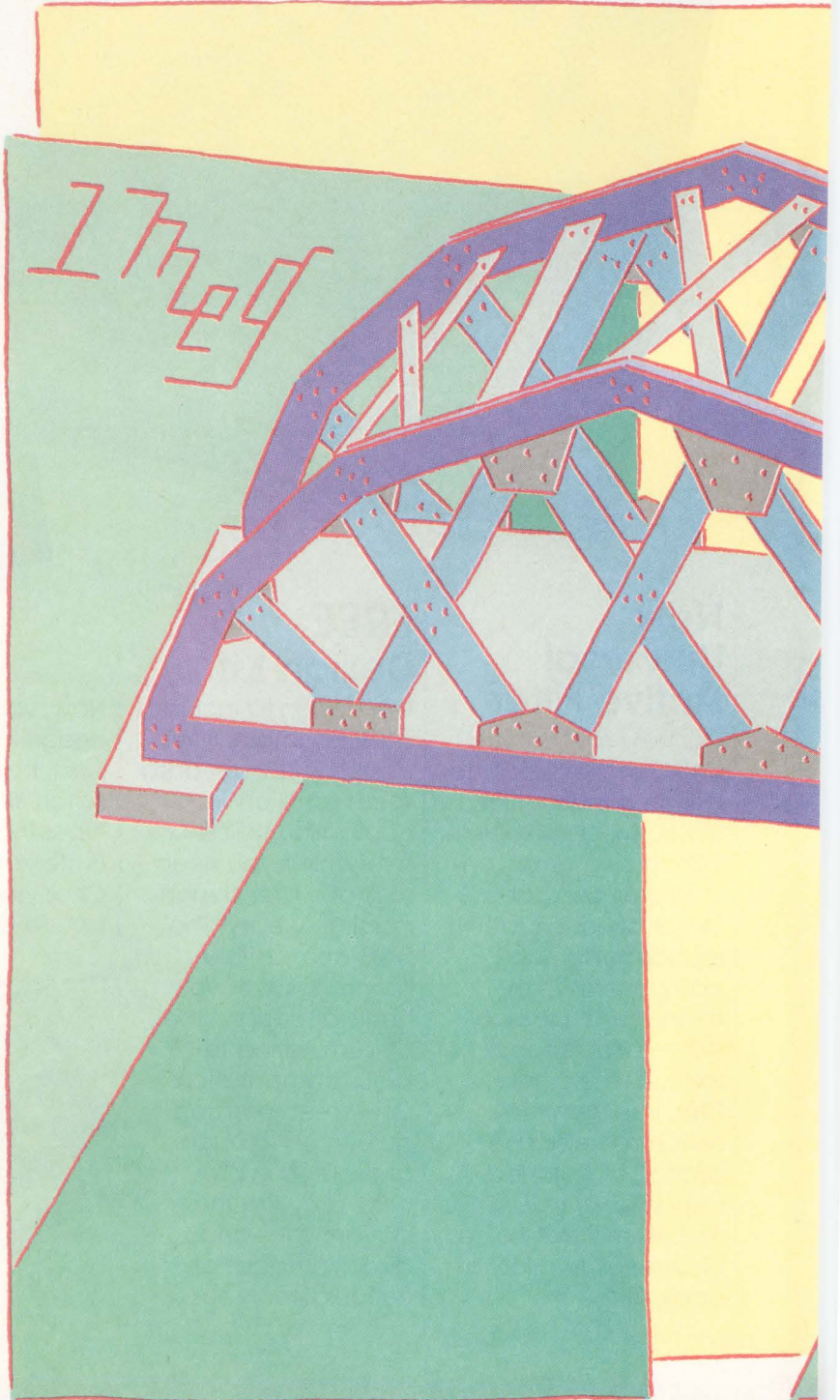

ULES, COST-PER-BIT UST BEEN COMPLETED.



times, fast page mode, low-power versions, gold lead finish, and customer-specific labeling.

SAMSUNG MEMORY MODULES BASED ON 4-MEG DRAMs

Megabytes	Part Number	Organization
1	KMM581000AN	1M x 8
1	KMM591000AN	1M x 9
4	KMM584000A	4M x 8
4	KMM594000A	4M x 9
4	KMM5321000A	1M x 32
4	KMM5331000A	1M x 33
4	KMM5361000A	1M x 36
8	KMM5322000A	2M x 32
8	KMM5332000A	2M x 33
8	KMM5362000A	2M x 36

Samsung is one of the world's leading manufacturers of both DRAMs and memory modules. Our outstanding quality, reliability, and availability have helped us gain this leading position.

For data sheets on our 4-meg DRAMs and 4-meg-based modules, call 1-800-423-7364 or (408) 954-7229 today. Or write to Memory Module Marketing, Samsung Semiconductor, 3725 No. First St., San Jose, CA 95134.

 **SAMSUNG**

Technology that works for life.

CIRCLE NO. 50

SHOW PREVIEW

Wescon '91 offers a treasury of technology

November will find Moscone Convention Center in San Francisco opening its doors for the West Coast's annual sampling of electronic engineering's state of the art.

*Carl Quesnel,
Associate Editor*

San Francisco will be swarming with engineers from November 19 to 21 for Wescon '91. High-speed logic design, memory systems, and PC applications and architectures are only a few of the topics that will be covered in 30 technical sessions. Nine technical courses will give engineers access to technology at the forefront of electronic design and manufacturing. And more companies than you can count will field representatives on the show floor.

Conference sessions will treat different engineering disciplines each day (Table 1). Tuesday, November 19, will feature sessions on neural networks and robotics, FPGAs, high-speed logic design, memory systems, and flat-panel displays. The Wednesday sessions will address networks, PLDs, sensors, image compression, and virtual reality. Thursday will round out the conference with sessions on embedded controls,

PCs, ASICs and multichip modules, and design for testability and manufacturability. Among many other participants, companies organizing these sessions will include VLSI Technology, Xilinx, Integrated Device Technology, Viewlogic, National Semiconductor, Chips and Technologies, Texas Instruments, Advanced Micro Devices, and Hitachi.

Session 3, "Next-generation FPGAs accelerate system design," will present four papers describing how next-generation FPGAs have overcome limitations that previously held these devices behind masked ASICs in performance, density, and flexibility. A few hours later, participants in **session 4** will discuss the features and benefits of recently introduced CAE tools for creating FPGAs. Thursday morning, ASIC supporters will have their chance to rebut in **session 27**, "ASIC directions for the '90s." Session participants will examine technology trends that will soon make it possible to integrate an entire system on a single chip.

PCs vs workstations

Although workstations remain more powerful, PCs enjoy a much larger installed base and thus present a tempting opportunity for engineering-software vendors. Many design engineers remain convinced, however, that a PC just cannot perform CAD, CAM, CAE, and CASE functions well enough to justify the cost savings. A special session on Tuesday afternoon will feature a panel discussion on the assertion of EDA (electronic design automation) companies that it is the applications software rather than the hardware that drives EDA productivity. Panel members, representing both computer manufacturers



San Francisco Convention & Visitors Bureau photo by Kerrick James.

and EDA companies, will go head to head over this issue.

In addition to technical sessions, Wescon '91 offers nine technical courses for engineers (Table 1). Topics will include concurrent engineering, surface-mount technology, optical-based sensors, design for testability, FPGA design, data storage, and high-performance packaging. Those interested in engineering management have three management seminars to choose from. Most sessions are day long—the half-day sessions are on Thursday—and require an extra fee. The fee for day-long seminars is \$250

to \$300; for half-day seminars, the fee is \$150 to \$200.

Concurrent engineering and design for testability will get their share of attention in **short course T1** on Tuesday and **short course T4** on Wednesday, respectively. "Concurrent engineering: Tying it all together" will provide attendees with the knowledge they need to produce high-quality products quickly through the simultaneous design of products and their associated manufacturing and test processes and support services. "Design for testability" will present testable designs of actual products and have atten-

dees remedy untestable configurations of the same products. Attendees will also learn how to use this basic knowledge to work effectively within a team.

Come and see the show

When you're tired of sitting down, you can stretch your legs on the show floor and pick up some product literature from your favorite companies. This year, the show floor will feature three focus areas. These areas—for semiconductors, EDA tools, and test and measurement equipment—will group companies by field to make it easier for

Table 1—Wescon '91 technical conferences and courses schedule

Tuesday November 19, 1991	Neural networks and robotics	Advances in FPGAs	High-speed logic design	Memory systems	Image display	Technical courses (9:00 am to 5:00 pm)
9:00 am to 11:00 am	Session 1 The "new wave" in computing: Advanced technologies facilitate today's neural-network applications	Session 3 Next-generation FPGAs accelerate system design	Session 5 Solving clock distribu- tion problems in high- speed systems	Session 7 Specialty memories: A rapidly evolving set of tools for the designer of high- performance products	Session 9 Implementation of flat- panel displays	Short course T1 Concurrent engineer- ing: Tying it all together Short course T2 Surface-mount technology: Principles and practices Short course T3 An introduction to optical-based sensors
2:00 pm to 4:00 pm	Session 2 Machine-vision systems	Session 4 Advanced CAE tools for FPGA design	Special session PCs vs workstations: The software implications	Session 8 Design advances of memory cards for portable systems		
Wednesday November 20, 1991	Communication networks	Advances in PLDs	High-speed logic design	Memory systems and sensors	Image display	Technical courses (9:00 am to 5:00 pm)
9:00 am to 11:00 am	Session 11 The framework of an OSI network manage- ment system	Session 14 Innovative, high-density PLD architectures	Session 17 High-speed logic to the rescue . . .	Session 20 Hassle-free cache design (without compro- mising performance)	Session 10 Image compression: A key enabler of multi- media	Short course T4 Design for testability Short course T5 Surface-mount/fine- pitch technology Short course T6 Short-run statistical process control for electronics manufacturing Short course T7 3000-series FPGA design
11:30 am to 1:30 pm	Session 12 FDDI design issues		Session 18 Interconnect issues for high-speed electronic systems	Session 21 Recent trends in embedded control memory		
2:00 pm to 4:00 pm	Session 13 The emerging 10BaseT standard: Trends in silicon and software	Session 16 New PLD design tools enable flexible and efficient systems-level design	Session 19 Combating EMI in high-speed electronic systems	Session 20 Enabling sensor tech- nologies—markets, trends, and applications	Special session Virtual reality	
Thursday November 21, 1991	Embedded controls	PC applications and architectures	ASICs and multichip modules	Design for testability and manufacturability		Technical courses (9:00 am to 1:00 pm)
9:00 am to 11:00 am	Session 23 Real-time and embedded systems development and deployment	Session 25 Portable applications for PC-compatible chip sets	Session 27 ASIC directions for the '90s	Session 29 Electronic product design for manufactur- ability and testability		Short course T8 Data storage; magnetic, optical, and systems Short course T9 From DIPs to multi- chips: An introduction to high-performance packaging
11:30 am to 1:30 pm	Session 24 High-performance embedded control devices	Session 26 PC bus architectures: Beyond the standard AT bus performance	Session 28 The impact of multichip modules in the '90s	Session 30 Using the IEEE boundary-scan and test-access port (JTAG)		

AT BUS EXPANSION THAT REALLY WORKS!

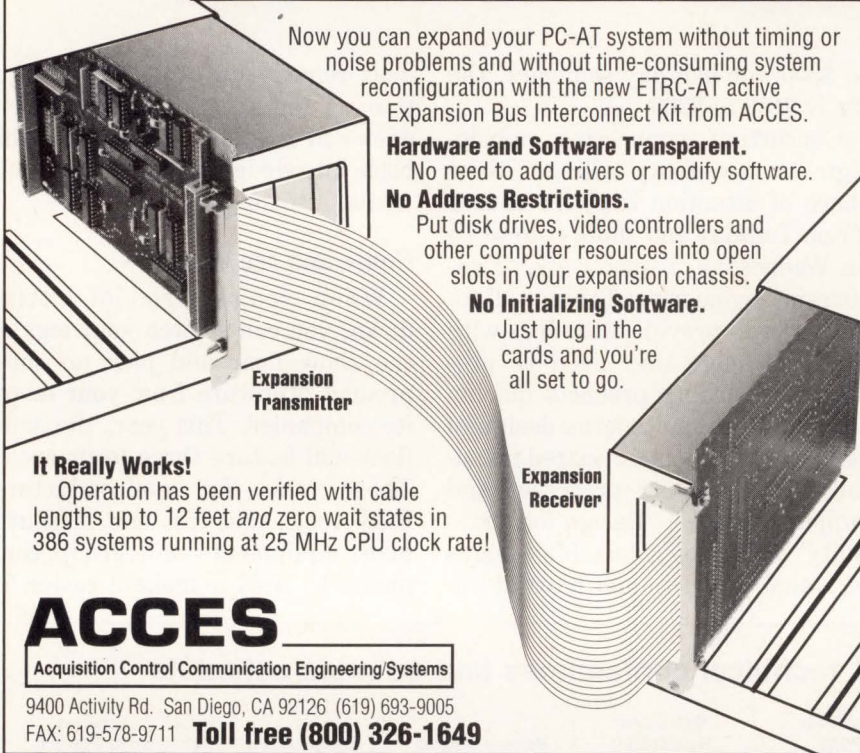

Now you can expand your PC-AT system without timing or noise problems and without time-consuming system reconfiguration with the new ETRC-AT active Expansion Bus Interconnect Kit from ACCES.

Hardware and Software Transparent.
No need to add drivers or modify software.

No Address Restrictions.
Put disk drives, video controllers and other computer resources into open slots in your expansion chassis.

No Initializing Software.
Just plug in the cards and you're all set to go.

Expansion Transmitter

Expansion Receiver

It Really Works!
Operation has been verified with cable lengths up to 12 feet and zero wait states in 386 systems running at 25 MHz CPU clock rate!

ACCES
Acquisition Control Communication Engineering/Systems

9400 Activity Rd. San Diego, CA 92126 (619) 693-9005
FAX: 619-578-9711 **Toll free (800) 326-1649**

CIRCLE NO. 51

Surface Mount Inductors From Stock



"1210" Inductors from .01 uH to 220 uH; "1812" inductors from .1 to 1000 uH...in 99 values.

Most values in stock for immediate shipment... "1210" inductors on 2000-piece reels and "1812" inductors on 500-piece reels... Solderability per MIL STD 202 Method 208.

Catalog on request.

J.W. Miller Division
BELL INDUSTRIES
306 E. Alondra Blvd., Gardena, CA 90248
Phone: 310-515-1720 FAX: 310-515-1962
Since 1924, Leading Manufacturer of Standard and Custom Inductors

See Us At
WESCON
Booth 312

CIRCLE NO. 52

Wescon '91

Acronyms used in this article

ASIC—Application-specific integrated circuit
CAD—Computer-aided design
CAE—Computer-aided engineering
CAM—Computer-aided manufacturing
CASE—Computer-aided software engineering
EDA—Electronic design automation
FPGA—Field-programmable gate array
PC—Personal computer
PLD—Programmable logic device

you to gather information. In addition, companies will present information on components, hardware, subsystems, manufacturing materials, and engineering and manufacturing services.

EDN will be at Wescon to celebrate advances in electronics at its annual Innovation Dinner and Awards Ceremony during the show. The event will take place at the Mark Hopkins Hotel on Tuesday, November 19. If you want to attend and show your support for innovative work in electronic design, get a reservation order form by faxing Pam Winch at (617) 558-4470.

The show will be open from 9:00 am to 5:00 pm Tuesday and Wednesday and 9:00 am to 4:00 pm on Thursday. General admission is \$15 at the door. For more information, write Wescon '91, 8110 Airport Blvd, Los Angeles, CA 90045, call (800) 877-2668, or fax (213) 641-5117.

EDN

Article Interest Quotient
(Circle One)

High 515 Medium 516 Low 517

Risky Business



In today's competitive business climate, product development is a perilous journey. One slip can mean lost opportunity... or worse. You've got to plan intelligently, execute on time, and use the best available technology. If you don't, your competitors undoubtedly will.

Why put up with risks and shortcomings associated with obsolete power technologies... bulky, one-of-a-kind designs; program delays; agency approval cycles; last minute surprises; and unproven field reliability. Vicor's power component approach has been proven by thousands of users to be the fastest and most predictable path to successful power system development. And Vicor's complete line of "plug and play" power system building blocks offer unprecedented design flexibility and result in smaller, cooler, more cost-effective products.

Tired of power development cliffhangers? The solution is right at your fingertips... just give us a call.



Component Solutions For Your Power System



23 Frontage Road Andover, MA 01810
TEL: (508) 470-2900 • FAX: (508) 475-6715

Until Now, Density A Pretty Awkwa



And Speed Were rd Combination.

AMD Presents The MACH™ Family Of High Speed, High Density PLDs.

Nothing can squash an elegant, high density design faster than a slow, unpredictable and expensive PLD. That's why we've developed the MACH PLD family—for both density, and speed.

The MACH family gives you everything you need in a PLD on state-of-the-art CMOS: Densities up to 128 macrocells or 3600 equivalent gates. Clock speeds up to 66.7 MHz. And absolutely predictable, worst-case delays as low as 12ns per 16 product term macrocell.

And they work for peanuts. The MACH family can bring your costs down as low as a penny per gate—up to 40%

less than other high density PLDs.

With the MACH family you'll get to market faster, too. Because it's supported by most popular design tools: Including ABEL™, CUPL™, LOG/iC™, MINC, OrCad®, and AMD's own PALASM® software. There's also

hardware and software support from over 20 additional FusionPLD partners.

Every MACH part migrates easily to a pin-compatible hard-wired MASC™ counterpart—for high volume orders with no redesign, no NRE, no performance glitches, no problems.

So don't horse around with slow, unpredictable, high density PLDs—start designing with the MACH family from AMD. Call **1-800-222-9323** for more information.

Model Number	Equiv. Gates	Macro Cells	Max. Delay	System Speed	I/O Pins	Hard-Wired Option
MACH 110	900	32	12ns	66.7 MHz	44	MASC 110
MACH 210	1800	64	12ns	66.7 MHz	44	MASC 210
MACH 120*	1200	48	15ns	50 MHz	68	MASC 120
MACH 220*	2400	96	15ns	50 MHz	68	MASC 220
MACH 130	1800	64	15ns	50 MHz	84	MASC 130
MACH 230*	3600	128	15ns	50 MHz	84	MASC 230

* Available Q4 1991.



Advanced Micro Devices

901 Thompson Place, P.O. Box 3453, Sunnyvale, CA 94088 © 1991 Advanced Micro Devices, Inc. MACH and MASC are trademarks, and PALASM is a registered trademark of Advanced Micro Devices, Inc. All brand or product names mentioned are trademarks or registered trademarks of their respective holders.

CIRCLE NO. 54

The Next World Standard for Embedded Systems

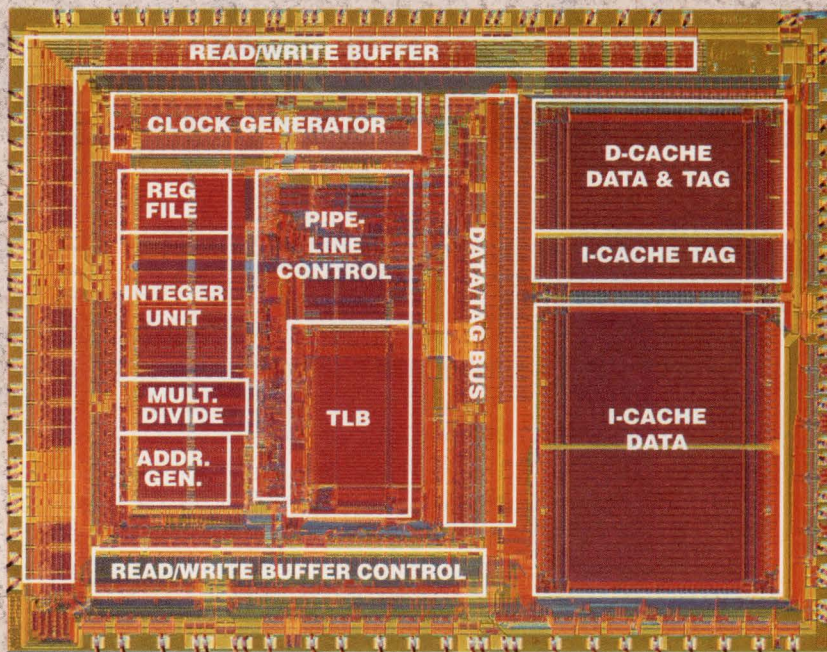

IDT's R3051 RISController™

MIPS® RISC for \$30

The 32-bit R3051™ outperforms the i960 and AMD29K, and has everything you need in a high-performance, low-cost CPU:

- **Larger Cache**—up to 10KBytes of I and D cache on-chip for PostScript®, networking, or X protocols.
- **4-Deep Read and Write Buffers**—allow the CPU to run at full speed, even in low-cost DRAM designs.
- **Multi-Sourcing**—provides form, fit, and function interchangeable products at competitive prices.
- **Development Support**—100% software compatible with low-cost MIPS and IDT development tools on PC, SPARC, MIPS, and Macintosh® host platforms.
- **In Production Now!**

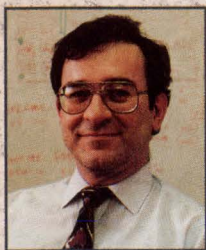

"We selected the R3051 for its outstanding performance at remarkably low cost."

John Wakerly
Vice President of Engineering
Alantec, Leader in internetworking systems

Evaluate the R3051 Today

For a limited time, we're offering a complete R3051 Evaluation Kit, including an evaluation board and software, for \$595 (an \$895 value).

Call our toll-free hotline to get an IDT RISC Product Roadmap and complete information on the R3051 Evaluation Kit, so you can evaluate the next μ P standard for embedded systems today.

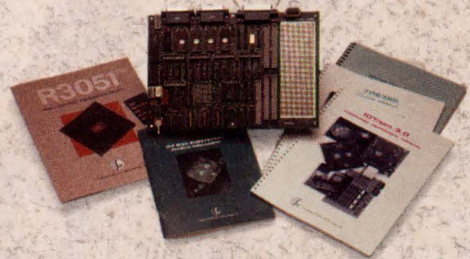

Integrated Device
Technology, Inc.

(800) 345-7015 • FAX: 408-492-8674
ASK FOR KIT CODE 5071

Componic '91



Raymond Boult

Componic '91, one of the dominant European electronics exhibitions, will run from November 18 to 22 at the Paris-Nord Exposition Center ("Parc des Expositions"). The Center is located on the express subway line, which links Charles de Gaulle Airport to Paris. Manufacturers will exhibit their products in 70,000 square meters of allotted space. Semiconductors, printed circuits, electromechanical components, test and measurement instruments, and commercial-distribution products will be on display for attendees.

In addition to taking in the show, you will be able to participate in a series of roundtable discussions on various topics, which will bring together key people in the appropriate fields. Componic is being organized by SDSA (part of the Paris Exposition Commission on behalf of SYCEP (Syndicat des Industries de Composants Electroniques Passifs), the French passive-electronics-components trade federation. Five sections of SYCEP are each sponsoring a roundtable debate, and each topic corresponds to each section's specialty.

At press time, four of the five sections had been finalized. They will cover

- printed circuits (roundtable topic is "Better buying for constant improvements in customer service at optimal cost")
- magnetic components (topic is "Magnetic components for SMT")
- connectors (topic is "Trends in the use of the metric system")
- hybrid circuits (topic is "Miniaturization with optimization of costs and services").

To give you an idea of what the Componic show has in store, EDN asked Europe's "Big Three" electronics com-

ponent manufacturers—Philips (The Netherlands), Siemens (Germany), and SGS-Thomson Microelectronics (a Franco-Italian concern)—to provide a preview of the main attractions on display at their booths. (The addresses given are for these companies' French subsidiaries, which are the respective booth organizers.)

Philips, for instance, is introducing the Euro-90 switchers, a range of compact power supplies for 19-in. rack mounting for the DIN 41494 standard. Rated at 40, 50, and 60W (higher power models are already under development), these supplies are suitable for powering a range of applications in the general electronic equipment and computer sectors, particularly process control, medical, and automation systems, as well as industrial PCs. Philips's use of SMDs and hybrids on compact boards allows a creepage distance of 8 mm as required by the SELV (safety extra low voltage) circuit VDE 0806 standard. MTBF is guaranteed at more than 180,000 hours. (Philips Composants, 117 quai du President Roosevelt, BP 75, 92134 Issy-Les-Moulineaux Cedex, France.)

Siemens's booth at Componic will feature the SAB-R4000 family of 64-bit RISC microprocessors, as well as the Arcofi-SP audio ringing codec filter with speakerphone function. The R4000 family is suitable for wide-ranging applications including embedded controllers, desktop systems, workstations, and departmental servers and for such high-end applications as multiprocessing and fault-tolerant systems. Features include compatibility with earlier 32-bit devices, 64-bit integer and floating-point operations, registers and virtual addresses, a 50-MHz clock frequency, and a 5V power supply. On-chip features include

If you can see it, we can print it.



No matter what application you're using, no matter what monitor you're viewing it on, the CH5500 video color printer can produce a hard copy. It supports over 350 video sources—more than any other printer.

Moreover, since the CH5500 doesn't use software, it captures your image fast—so you can get back to work. And it offers outstanding 300 dpi quality in both A and B sizes.

To find out more, give us a call at 1-800-873-4561, Dept. SI-C4.

After all, we pioneered video color printing. And we still do it best. Anybody can see that.

SII 
Seiko Instruments

8-kbyte instruction and data caches, a memory-management unit whose variable page size ranges from 4 kbytes to 16 Mbytes, and an ANSI/IEEE-754-standard floating-point unit.

The Arcofi-SP codec filter is designed for digital terminal-equipment applications requiring voice functions. Codec functions are performed using digital signal processing, in accordance with the CCITT G.714 specification. Siemens recommends use of the IOM-2 serial data interface, rather than the SLD interface; although implemented in the Arcofi-SP, the SLD is not guaranteed. Dual analog inputs for the microphone in the handset and the speakerphone, plus an auxiliary differential analog input, are combined with two differential outputs for a handset earpiece and a loudspeaker, for which the drive capability is 100 mW (sine wave). (Siemens SA, 39/47 boulevard Ornano, 93527 St Denis Cedex, France.)

Pact leads to video chips

SGS-Thomson Microelectronics' UK subsidiary, Inmos, announced an agreement with IBM to manufacture and market chip sets for the US firm's Extended Graphics Array (XGA) PC video standard. Currently manufactured by IBM, the chips will be known as the IMS G200 display controller and the IMS G190 serializer palette DAC. Prototypes will be on display at the company's booth. The European firm will immediately begin work on porting XGA technology to AT-compatible versions of the chip set, which will be manufactured at Inmos's production site at Newport, UK, and at SGS-Thomson's site at Carrollton, TX.

The G200 contains three major on-chip elements: a system bus interface, a CRT and memory controller, and a graphics coprocessor. The

bus interface is designed to provide a 16- or 32-bit bus-master facility for IBM's Micro Channel Architecture; the controller manages pixel transfers to the G190 chip. The G200's graphics coprocessor supports user environments such as Microsoft's Windows or OS/2 Presentation Manager. The G190 serializer palette DAC features a pixel serializer, a color palette, three DACs, and a sprite and VGA font/attribute controller. The device delivers a stream of pixels from the video memory to the color palette, which is then transmitted to the DACs for on-screen display. Finally, the sprite and VGA font/attribute controller determines the position of a 64×64-pixel overlay image ("sprite" or "cursor") on the display, which is often used for graphics windowing. The controller also determines the attributes such as underlining and highlighting and the position and color of displayed texts.

The agreement with Inmos follows similar technology-exchange deals made earlier this summer by IBM with Germany's Siemens covering 16-Mbit dynamic RAMs, and with US-based Apple (and indirectly with Motorola) covering RISC microprocessors. (SGS-Thomson Microelectronics, 7 avenue Gallieni—BP 93, 94253 Gentilly Cedex, France.)

These major European manufacturers' offerings are just but a glimpse of the products that will be on display at Componic. You'll be able to see and hear about a lot more—that is, if you're lucky enough to get to Paris in November.

EDN

Raymond Boulton is an independent journalist based in Paris, France.

Article Interest Quotient
(Circle One)

High 506 Medium 507 Low 508

Sprague-Goodman

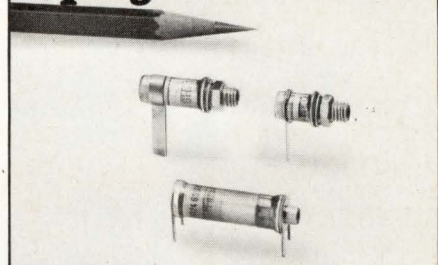

Glass and Quartz Pistoncaps®

- Designed to meet MIL-C-14409D
 - QPL models
 - Extremely stable over temperature, frequency, voltage, etc.
 - Cap ranges: 0.5-3.0 pF to 1.0-120 pF
 - Zero backlash multiturn adjust mechanism
 - Operating temp: -55° to +125°C (models to +200°C)
 - Q to 1500 at 20 MHz
 - Wide variety of configurations for PC and panel mounting
 - Voltage ratings from 500 to 5000 V
- Phone, fax or write today for Engineering Bulletin SG-205A.



134 Fulton Ave., Garden City Park, NY 11040
Phone: 516-746-1385 • Fax: 516-746-1396

CIRCLE NO. 56

Sprague-Goodman

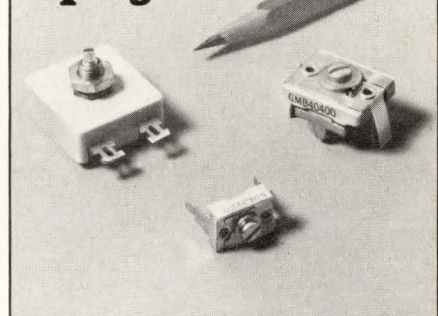

Mica Compression Trimmer Capacitors

- Cap ranges: 2.5-7.0 pF to 1400-3055 pF
- Q to 600 at 1 MHz
- Rated working voltage to 500 V
- Can handle higher RF currents
- Operating temp: -35° to +85°C
- 8 mounting styles for PC, panel, and bracket mounting

Phone, fax or write today for Engineering Bulletin SG-500B.



134 Fulton Ave., Garden City Park, NY 11040
Phone: 516-746-1385 • Fax: 516-746-1396

CIRCLE NO. 57

Advanced Pressure Sensors

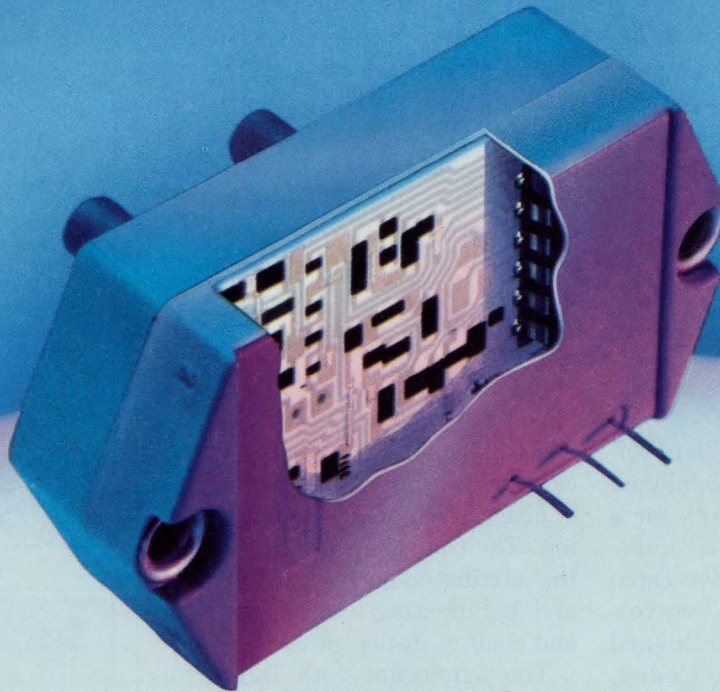

FOR: MEDICAL INDUSTRIAL HVAC

Sensym's 142/163 Series

Features Include:

- Guaranteed precision over temperature: $\pm 1\%$ Max (-18°C to $+63^{\circ}\text{C}$)!
- High level calibrated output:
1.0V ± 50 mV offset
5.0V ± 50 mV span
- Linearity: $< 0.75\%$ FSO Max

These precision transducers are priced starting at **\$40 ea / 100's. Stock delivery.**

Available parts:

- 163SC01D48** ... -20 to $+120$ cmH₂O
- 142SC series** ... 0 to 1psi up to 0 to 150psi



Free Handbook



Sensym's new 1990 Sensor Handbook gives complete product specifications plus over 200 pages of application notes and ideas.

Call or fax us today for your free Sensor Handbook.

CIRCLE NO. 66

1244 Reamwood Avenue ■ Sunnyvale, CA 94089 ■ Tel: (408) 744-1500 ■ Fax: (408) 734-0407

Discover the one source of power guaranteed to stay hot.

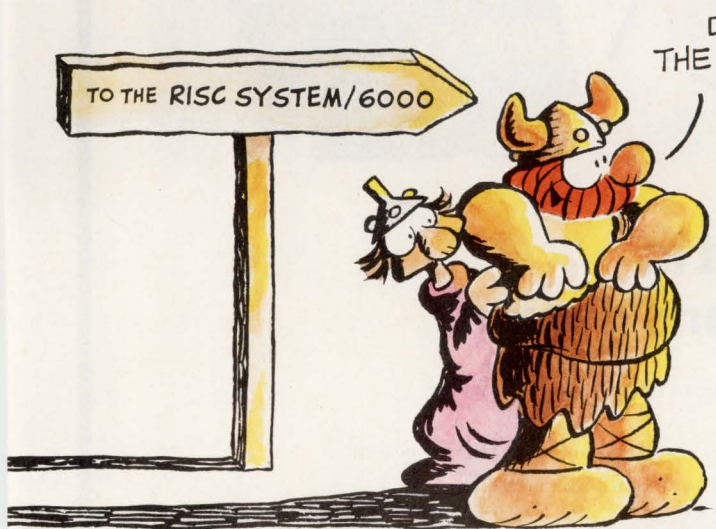

DID YOU BRING
THE MARSHMALLOWS?



DIK
BROWNE

Stars cool. Volcanos fizzle. Even suns burn out. But the IBM RISC System/6000™ family of POWERstations and POWERservers only gets hotter. Today's performance ranges from 9 to 25 MFLOPS and from 33 to 72 SPECmarks. At prices that won't fry your budget.

	Hardware Price	MFLOPS	SPECmarks™
POWERserver 550	\$62,000	25.2	72.2
SPARCserver™ 470	\$77,800	3.8	19.4
DECsystem™ 5500	\$74,700	4	21.5

An operating system that sizzles. The RISC System/6000 family operates on AIX®, IBM's enhanced open standards version of the UNIX® operating system. AIX runs across the broadest range of platforms in the industry, and supports all major industry

standards and programming languages.

The RISC System/6000 family already runs over 3,500 applications in mechanical design, visualization, software engineering, accounting, retail store management and many more.

IBM support: an eternal flame. There's never been anything lukewarm about IBM's commitment to its customers. With the RISC System/6000, you get service 24 hours a day, 365 days a year, worldwide.

To find out more, contact your IBM marketing representative or Business Partner. For literature call 1 800 IBM-6676, ext. 845. Sorry, marshmallows not included.



For the Power Seeker.

MFLOPS are LINPACK double-precision where n=100. AIX XL FORTRAN Version 2.1 and AIX XL C Version 1.1 compilers were used for these tests. SPECmark is a geometric mean of the ten SPECmark tests. All prices current at publication. IBM and AIX are registered trademarks and RISC System/6000 is a trademark of International Business Machines Corporation. UNIX is a registered trademark of UNIX Systems Laboratories. SPARCserver is a trademark of Sun Microsystems, Inc. DECsystem is a trademark of Digital Equipment Corporation. SPECmark is a trademark of Standard Performance Evaluation Corporation. HAGAR THE HORRIBLE Character(s) ©1991 King Features Syndicate, Inc. ©1991 IBM Corp.

IBM®



How to stay ahead in telecommunications design

When you need to keep at the leading edge of telecommunications technology, talk to Ericsson.

Our 100 years of experience in the industry could take months off your system development time and cut the cost and size of your final product. Whether it's a PCM repeater or a complete line card.

Ericsson offers the ultimate in integration for every application. Like customised or semi-standard Complete Line Interface Circuits which only need the addition of relays and line protection. Or regenerative PCM repeaters for 2.048 or 1.544 Mbit/s lines.

Then there's a comprehensive range of SLICs for PBX and DLC systems, complemented by Central Office versions with on chip regulators. In addition, a SLAC and a range of Line Protection Circuits.

But Ericsson is more than just another component supplier. As a truly international telecommunications company, Ericsson has developed close partnerships with customers in many countries. So the design of our components reflects this by conformance to every major national and international specification. And quality is assured.

The telecommunications world constantly threatens to leave you one step behind. Ericsson can help you stay ahead. Simply call us for more information.

Ericsson Components Inc.

403 International Parkway Richardson TX 75081
Tel: 214-669-9900 Fax: 214-680-1059

Representatives: Alabama (205) 880-8050. Arizona (602) 991-6300. California (408) 253-1960, (619) 292-1771, (714) 891-4621. Colorado (303) 758-4884. Connecticut (203) 243-9343. Florida (407) 352-3755. Georgia (404) 448-1215. Illinois (312) 968-0118. Indiana (317) 577-9950. Iowa (319) 354-8894. Massachusetts (508) 692-2500. New Jersey (201) 525-8000. New York (516) 929-5756, (716) 586-0777, (518) 383-2239. N. Carolina (919) 847-8800. S. Carolina (803) 233-4637. Texas (214) 553-1200, (512) 834-8374, (713) 370-8177. Washington (206) 882-0962, (206) 254-4572. Wisconsin (414) 781-1730.



Please send me your latest Telecom IC Shortform data

Name _____

Company _____

Job Title _____

Address _____

Telephone _____

Fax _____

Signal processor implements analog and digital functions in real time

Representing a major departure from the architecture and programming methods of other digital signal processors, the Sproc 1400 and future members of the 1000 family consist of a central memory unit shared by as many as four 24-bit, fixed-point processors. Programming the IC requires no manual coding—you can enter your entire design graphically at the block-diagram level using the company's development-system software. That block diagram can include both analog and digital functions resident in the software's cell library.

The processor incorporates all processor units, interprocessor communications circuitry, and memory required to implement signal-processing functions. A single stand-alone processor can replace analog circuits in applications that don't require a host μ P or can work in conjunction with a host in a more complex system.

Unlike other DSP architectures, which base real-time operation on allocating processing power as interrupts occur, this processor time-division-multiplexes its central memory to provide concurrency between the various processors. The central multiplexed memory consists of $1k \times 24$ bits of program RAM and $1k \times 24$ bits of data RAM. A patented memory multiplexing scheme simplifies the programming and coordination of multiple processors that together run a single application. The four processors work individually or collectively, depending on the requirements of your application. Development software in-



Combining the Sproc 1400's multiprocessing architecture with the company's development tools allows you to design analog and digital signal-processing functions at the block-diagram level. Without your having to write any code, software then automatically allocates execution tasks to each processor for the fastest runtime.

forms you how many processors the chip actually uses for each design.

Input and output data-flow managers handle the switching between concurrent tasks. These managers communicate with the processors and other on-chip elements through a 12-bit address and 24-bit data bus, and with off-chip data converters and digital data streams through programmable serial ports.

The processor includes two types of I/O interfaces that are compatible with most existing μ Ps' memories and peripherals. Four completely independent serial ports, two input and two output, each can operate with their own internal or external clocks, I/O word widths, and bit or-

dering. The parallel port is a single 24-bit, asynchronous bidirectional interface. Users can select word width to 24-bits and byte ordering for data transferred over the parallel port. Through the parallel port, you can program the IC dynamically using a host processor by operating in slave mode.

Despite the fact that the IC is purely digital, its architecture makes it possible for the IC to perform digital- and analog-type functions in real time. The analog nature of any digital device is initially difficult to fathom. However, if you consider that most analog components, such as amplifiers and integrators, are performing a mathe-

High Voltage DC-DC Converters



ACTUAL
SIZE

**.5" x .5" x .4" Ht.
1000 VDC Output**

- **New Series AV—
56 Standard Models**
- **100 VDC to 1000 VDC
Output**
- **Ultra-miniature Size
Weight: 4 Grams
0.1 Cubic Inch Volume**
- **Standard Input Voltages
5, 12, 24 and 28 Volts DC**
- **Operating Temperature
Standard: -25°C to +70°C
Optional: -55°C to +85°C**
- **MIL-STD-883
Screening Available**
- **Isolated: Input to Output
up to 1500 VDC**

PICO also manufactures over 800 regulated and isolated DC-DC Converters and AC-DC Power Supplies and over 2500 standard ultra-miniature Transformers and Inductors.

Delivery—
stock to
one week

SEE EEM,
THOMAS REGISTER
OR SEND DIRECT FOR
FREE PICO CATALOG

PICO
Electronics, Inc.

453 N. MacQuesten Pkwy. Mt. Vernon, N.Y. 10552

Call Toll Free **800-431-1064**

IN NEW YORK CALL **914-699-5514**

EDN EDITORS' CHOICE

mathematical function, the chip is simply computing these functions digitally. Just as digital filtering offers certain advantages over analog filtering, digital computation also offers higher precision, stability, and noise immunity than the corresponding analog approaches. One limitation is the processor's 250-kHz bandwidth. The 24-bit internal data bus theoretically offers a dynamic range of 144 dB and provides enough head room for processing of 16-bit analog signals.

Designing and programming the device requires four steps: creating a signal-flow diagram, compiling and linking processor-executable code, downloading code to the chip, and system calibrating, debugging and refining. The MS DOS-based Sproclab development system (\$8950) consists of software and hardware that perform each of these steps. The system automatically allocates execution tasks to available processors and schedules those tasks during compile time for the fastest possible operation.

The software tools include a signal-flow editor, a cell library, custom filter-design software, an automatic compiler, and loading and debugging tools. Hardware tools include a μ P-based interface from the processor's target system to the development system, and an evaluation/prototyping board that contains one Sproc 1400, interface converters, and logic. The development system's cell library currently includes 50 basic building blocks, including such traditional analog functions as filters, amplifiers, summing junctions, integrators, rectifiers, multipliers, and phase-locked loops.

A probe feature makes the system particularly useful during debugging by allowing you to observe and control system functions and performance under various conditions. An access port links the proc-

essor through the company-designed interface box to the development system. While the system is running, you can select and direct a signal from anywhere in the processing chain to this port. You can then view this signal on a scope. While observing the signal, you can change various parameters of your function blocks to view the effects.

The processor comes in a 132-pin ceramic pin-grid array and runs off 5V. The company is now selling a 20-MHz version of the 1400 through distributors at the suggested price of \$495 (25). Sometime in the first quarter of 1992, the company will upgrade the chip to 50 MHz. Prices for 10,000-piece quantities will be \$80. Sometime in the second quarter, 1- and 2-processor versions of the IC will also be available for \$32 and \$38 (10,000), respectively.

—*Anne Watson Swager*

Star Semiconductor Corp, 25 Independence Blvd, Warren, NJ 07059. Phone (908) 647-9400. FAX (908) 647-4755.

Circle No. 730

EDN's Editors' Choice

On occasion, a new product will show a great deal of innovation and thus appear as an EDN Editors' Choice selection. To qualify for special coverage by our editors, an innovative product must:

- Offer significantly higher levels of performance in ways not previously available
- Solve a continuing problem much more effectively than its predecessor
- Exhibit a marked degree of cleverness, which differentiates it from earlier products
- Embody new technology that advances the state of the art or use older technology in a unique and innovative way.

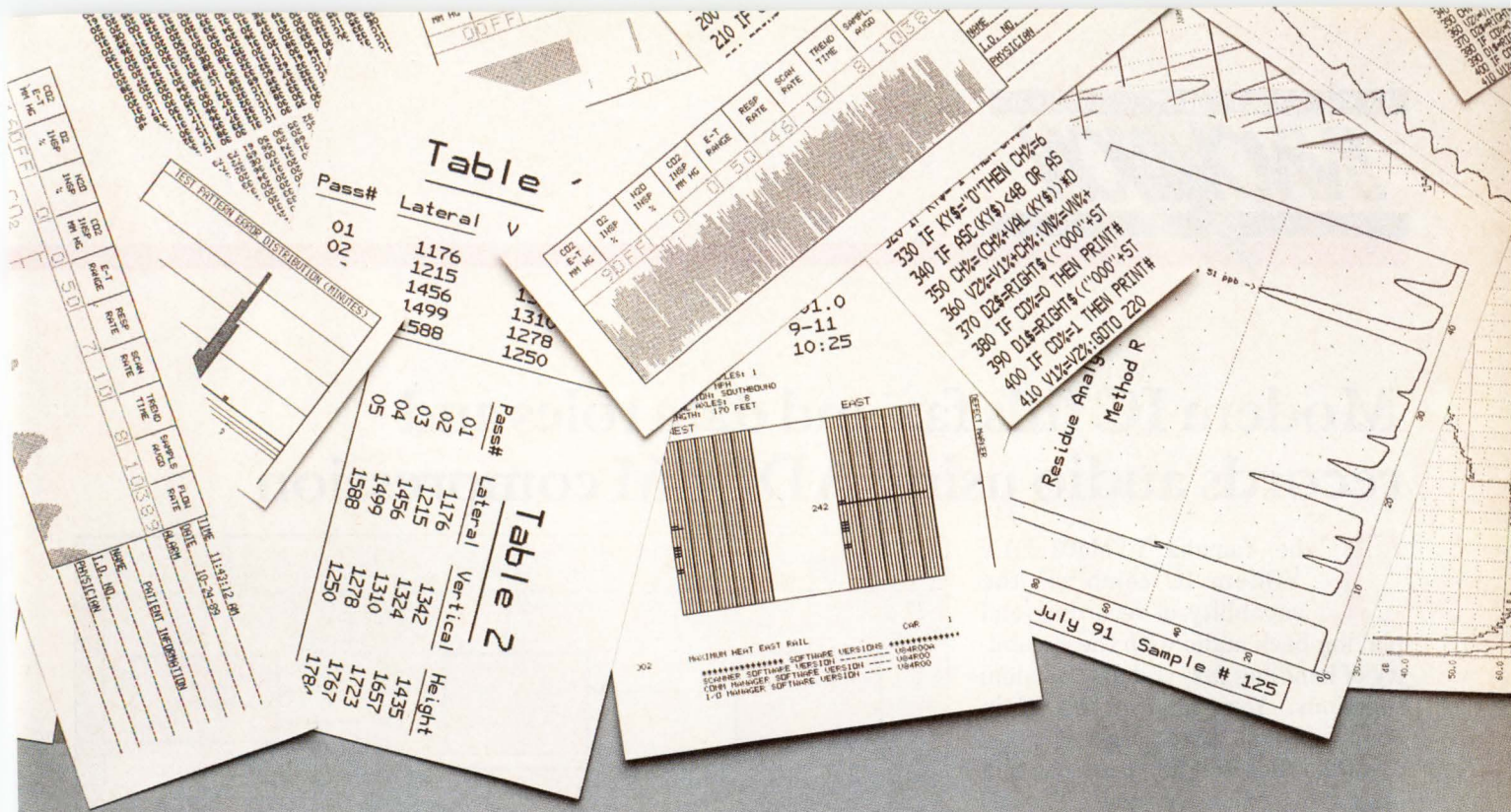

Hard Copy Was Never Easier.

Here's how B-G Instruments' OEM printer family can simplify production of high-quality data printout.

Simple from the start. Our unique DataPlot software cuts development time and effort to a minimum. Just 14 commands let you create printouts with multiple columns, orientations, fonts and graphics. And if you'd prefer, we'll write a custom program for you.

Multiple choices. Hardware options include print mechanisms like those listed here — plus a powerful array of control boards and accessories. So custom systems can be configured quickly and easily to meet your precise needs.



DataPlot Thermal Print Mechanisms					
Model Number	Paper Width	Columns Across ²	Dots / Inch	Dots / Line	OEM Price ¹
PM1224	2.6 inches	18 to 37	100	224	\$311
PM1320	2.6 inches	23 to 53	150	320	\$296
PM1416	4.5 inches	29 to 69	100	416	\$443

¹ This is the 300-piece OEM price. It is subject to change without notice.
² The maximum number of columns depends on the font and size selected. The higher number is for 5 x 7 characters, approximately 16 characters/in.

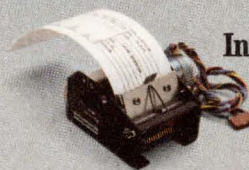

Instantly apparent quality. Features like thick-film printheads, high-torque stepper motors and heavy-gauge construction provide long life. While permanently lubricated gear trains and gold-plated connectors ensure reliable operation. And special touches such as automatic paper loading simplify operation.

Smart solutions. The power of our software and microprocessor control electronics have helped many customers use our printers to create smart instrument systems. So the same basic tools can serve a variety of different applications.

Get the details. For brochures, sample printouts and an OEM price list, or to arrange for a demonstration at your facility, call or write: B-G Instruments, P.O. Box 1867, Vashon, WA 98070. Phone 206-567-5000. FAX 206-567-5010.



Modem IC fills fax and data roles and records audio using ADPCM compression

The Yamaha YTM403 FAX Vodem IC combines the capability of recording and playing back audio with the capability of handling fax- and data-modem functions. You can use the IC in board designs that transmit faxes and data files and fill voice-mail and answering-machine roles. The IC can also automatically identify the phone number on incoming calls. The company offers a companion controller IC and firmware that simplify the product design, using the modem IC.

The modem IC uses a DSP core to implement the modem and voice capabilities. Fig 1 depicts the chip architecture and illustrates the minimum amount of analog circuitry used in the modem. The IC has an HDLC (high-level data-link control) framing USART that performs the bit stripping and cyclic redundancy check required for Group 3 fax communications in error-correction mode. You can use the IC in 9600-bps fax communications, including applications that use the 9600-bps binary-file-transfer protocol to transfer files between PCs.

Compatibility with synchronous half-duplex communications at speeds ranging from 300 to 9600 bps ensures that boards based on the modem IC will work with older fax products. The IC supports full-duplex asynchronous data communications at speeds ranging from 300 to 2400 bps. It's also compatible with a number of international communications standards, such as Bell 212A and 103, CCITT V.29, V.27 ter, V.26 bis, V.23, V.22 bis, and V.21.

Other features of the modem chip

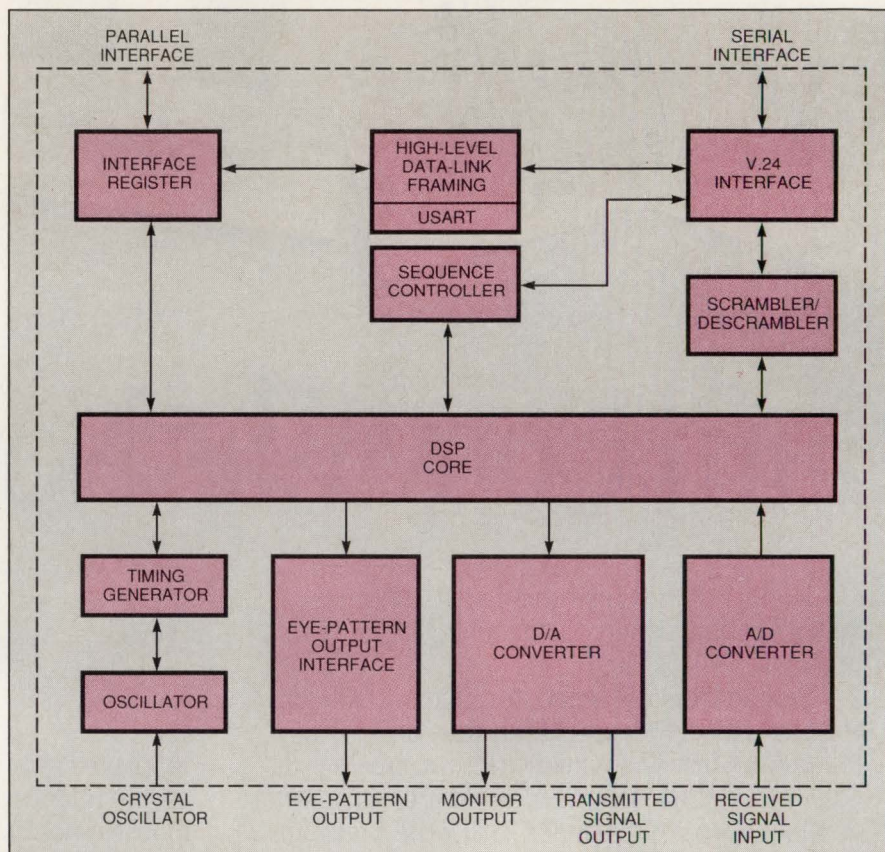

Fig 1—The DSP-based modem IC provides fax and data capabilities and can record and play back voice transmissions using ADPCM compression and decompression.

include a programmable tone generator and DTMF tone detection. In fact, the DTMF detection can remain active during voice operations to interrupt messages during voice-mail operations. The caller-identification feature implements a database program that automatically accesses data of an incoming phone number before the user answers the call.

The IC can detect whether incoming calls are voice, data, or fax calls. Therefore, a user of a YTM403-based board could use the

board with a single phone line. The IC's serial and parallel interfaces perform equally well in board designs for PCs and stand-alone modem devices.

You can use the modem chip to perform ADPCM (adaptive differential pulse-code-modulation) compression and decompression of audio. The IC can perform 8- to 4-bit 2:1 compression as most ADPCM-compatible devices do. Its enhanced compression mode offers 12- to 4-bit 3:1 compression, providing better audio quality.

The GTM407 companion controller IC features an 8051- μ P-compatible core. The company's firmware makes a modem that's based on the pair of ICs compatible with the industry-standard Hayes AT command set. The controller IC can address as much as 128 kbytes of external EPROM or RAM. You can use the external memory to customize the controller firmware for your applications. The controller IC's serial interface connects with non-volatile RAMs.

The standard controller-IC firmware supports voice and modem functions and implements automatic baud detection. The controller firmware is also compatible with V.42 and MNP-1-4 (Microcom Networking Protocol) error-correction code, and V.42 bis and MNP-5 data compression.

The 0.8- μ m CMOS chip dissipates 300 mW from a single 5V supply, and a standby mode critical to applications in notebook computers requires only 1 mW. The 64-pin IC comes in shrink-DIPs and quad flatpacks and costs \$40 (1000). The 80-pin GTM407 controller IC costs \$15 (1000) and includes power-down circuitry that minimizes power consumption on both chips.

—Maury Wright

Yamaha Corp of America, 981 Ridder Park Dr, San Jose, CA 95131. Phone (408) 437-3133. FAX (408) 437-8791.

Circle No. 734

LOW DROPOUT REGULATORS

TK114xx



- 200 mW Power Rating
- Super Small SOT23L Package
- ON/OFF Switch
- Internal Protection Features

TK115xx



- 600 mW Power Rating
- Low Noise
- Internal Protection Features
- ON/OFF Switch
- Active HIGH and Active LOW Control
- External Boost Transistor Connectable

TK116xx

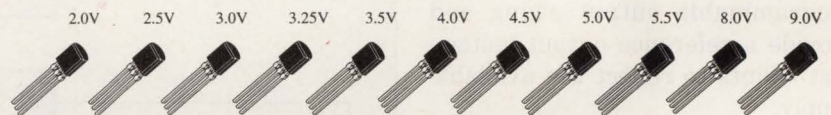

- 500 mW Power Rating
- Internal Protection Features

Call Your TOKO Representative For Data Sheets and Additional Information

TOKO AMERICA, INC.
1250 Feehanville Drive
Mount Prospect, IL 60056

TOKO

MIDWEST: (708) 297-0070
EAST: (203) 748-6871
SOUTHEAST: (205) 772-8904
WEST: (408) 432-8281

CIRCLE NO. 64



IEEE-488

You can control any IEEE-488 (HP-IB, GP-IB, 488.2) device with our cards, cables and software for the PC/AT/386, EISA, Micro Channel and Macintosh II. You get fast hardware and software support for all the popular languages, plus a software library of time saving utilities. Instrument control has never been easier.

FREE Informative Catalog **800-234-4CEC**
Applications help **617-273-1818**



Capital Equipment Corp.
Burlington, MA. 01803

Micro Channel is a trademark of IBM

CIRCLE NO. 65

DACs offer programmable output range and single- or dual-supply operation

The ML2340/41/50/51 D/A converter (DAC) family gives you a lot of freedom in choosing supply and output voltages. The devices can operate from a single or dual supply while working in either bipolar or unipolar mode. They also offer a programmable output swing and provide a reference output voltage that adapts to reflect the available supply.

At each device's core is a CMOS 8-bit DAC that operates with a 4.5 to 13.2V single supply or a ± 2.25 to $\pm 6.6V$ dual supply, drawing a maximum of 5 mA at 5V. Two reference signals control both the DAC's output signal range and its operating mode.

The zero-scale voltage (V_{ZS}) determines what output the DAC will provide for an all-zero digital input. It also determines the device's operating mode. If V_{ZS} is $<1.0V$, the DAC will operate as a unipolar device with an output signal that swings from V_{ZS} to full scale. If V_{ZS} is $>1.5V$, the DAC will operate as a bipolar device and produce a signal with a symmetric range centered on V_{ZS} . In bipolar mode the DAC treats its digital inputs as 2's-complement binary numbers.

The input reference voltage (V_{REFIN}) controls the DAC's full-scale output range. This range also depends on the DAC's programmable output buffer. The buffer converts the DAC's current-based output signal to a voltage base. Two gain programming pins determine the output voltage swing. The swing can be $\frac{1}{4}$, $\frac{1}{2}$, $1\times$, or $2\times$ the reference voltage.

This programmable output capability is especially useful in servo applications where the steady-state condition is near the DAC's zero

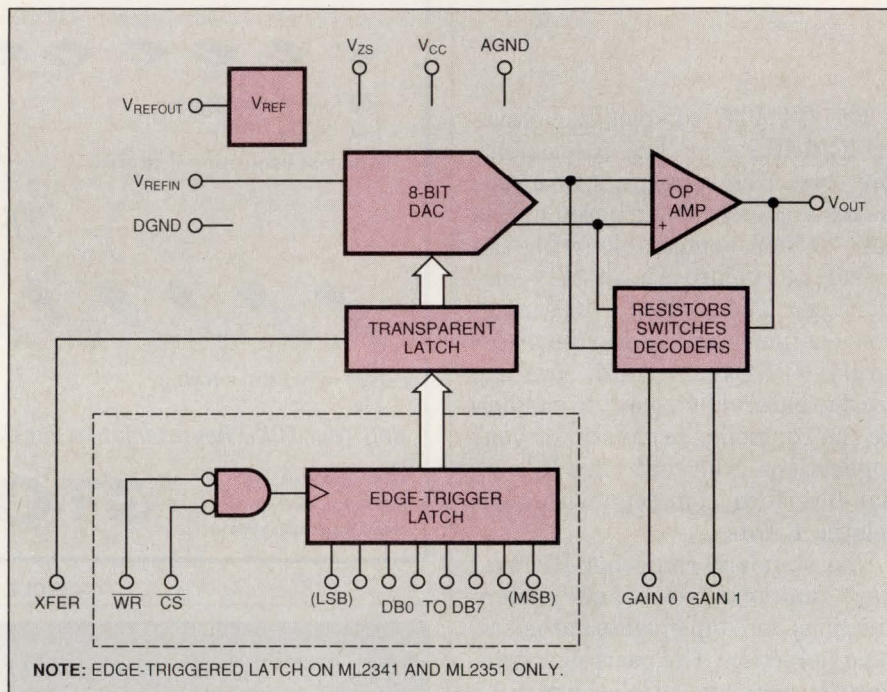

Flexibility is the hallmark of this DAC family, offering you a variety of operating modes, output voltages, and digital interfaces.

output. You can use the high-gain condition for coarse adjustments over the DAC's greatest possible range. As your system approaches its steady-state condition, you can then switch to a lower gain, effectively increasing the resolution of your DAC.

To simplify the provision of an input reference voltage, the DACs offer an on-chip reference voltage source with a 1% tolerance. The reference voltage assumes a low value if the supply voltage is $<7V$ and assumes a high value if the supply exceeds 8V. The exact voltage varies with the specific family member. The ML2340 and ML2350 offer 2.25 and 4.5V, respectively; the ML2341 and ML2351 offer 2.5 and 5.0V, respectively.

The nature of the digital interface also varies with each family mem-

ber. The ML2340 and ML2350 have 8-bit transparent latches, activated by a single control line. The ML2341 and ML2351 have an additional buffer between the input pins and the latch. This second buffer acts like an addressable register, requiring both a chip-select signal and a write strobe in order to accept data. Both interfaces have a power-on reset feature that sets the latches to zero if the supply voltage reaches 2V.

Both devices are available in DIP and SOIC packages. The ML2340 and ML2350 cost \$3.75; the ML2341 and ML2351 cost \$3.85 (100) and are also available in plastic leaded chip carriers.—**Richard A Quinnell**

Micro Linear Corp, 2092 Concourse Dr, San Jose, CA 95131. Phone (408) 433-5200.

Circle No. 731



**Any kind of
surface mount
in no time.
Flat.**

You already know General Instrument's reputation for quality, reliability and high volume production capacity.

You also know the advantages of surface mount rectifiers: How they withstand mechanical strain and thermal stress, facilitate high-speed pick and place and reduce board size by increasing surface density.

Now you can have all the advantages of General Instrument *plus* all the benefits of flat pack – because General Instrument has the industry's broadest range of chip technology in surface mount.

SMA, B and C. In standard, fast and ultrafast recovery. Schottky, Zener and TVS. And when reliability is most critical, only General Instrument has the flat pack *Superrectifier*.™

Of course, cylindrical MELF-style surface mounts are still available, too.

The answer to every rectifier application has come to the surface – at General Instrument.

For more information, contact General Instrument, Power Semiconductor Division, 600 West John Street, Hicksville, NY 11802; (516) 933-3333.

**GENERAL
INSTRUMENT**
POWER SEMICONDUCTOR DIVISION

CD-quality audio ICs let PC mother boards meet multimedia specs

As the PC industry continues to herald the approaching era of multimedia, system developers can now select from two ICs that simplify the problem of upgrading computer hardware. In a straightforward and cost-effective manner, the CS4215 and CS4216 stereo-audio codecs provide monolithic CMOS alternatives for adding CD-quality sound on a PC mother board.

Both of these ICs perform 16-bit A/D and D/A conversion and operate from a single 5V power supply. Both provide a S/N ratio of >80 dB and contain antialiasing and output-smoothing filters. However, the CS4216 is the simpler of the two chips, acting strictly as an audio data-conversion device with internal delta-sigma modulation and $64\times$ oversampling. The CS4215 adds a microphone input, a headphone driver, a 32Ω monophonic speaker drive, and on-chip crystal oscillators that grant you 10 software-programmable conversion rates ranging from 8 to 48 kHz.

You can attach as many as four CS4216 codecs to a single hardware bus. The CPU communicates with this device via a serial port that has separate pins for input and output data. You can control the sample rate by changing the serial-port bit rate. The chips' filters and converters operate over a sample-rate range of 1 to 48 kHz. You can also adjust the input gain and output attenuation from 0 to 22.5 dB in 1.5-dB steps.

A soft power-down mode occurs when the chip's serial-clock frequency drops to less than one-twelfth the master-clock frequency. In this mode, power dissipation drops from a normal 50 mA to 100

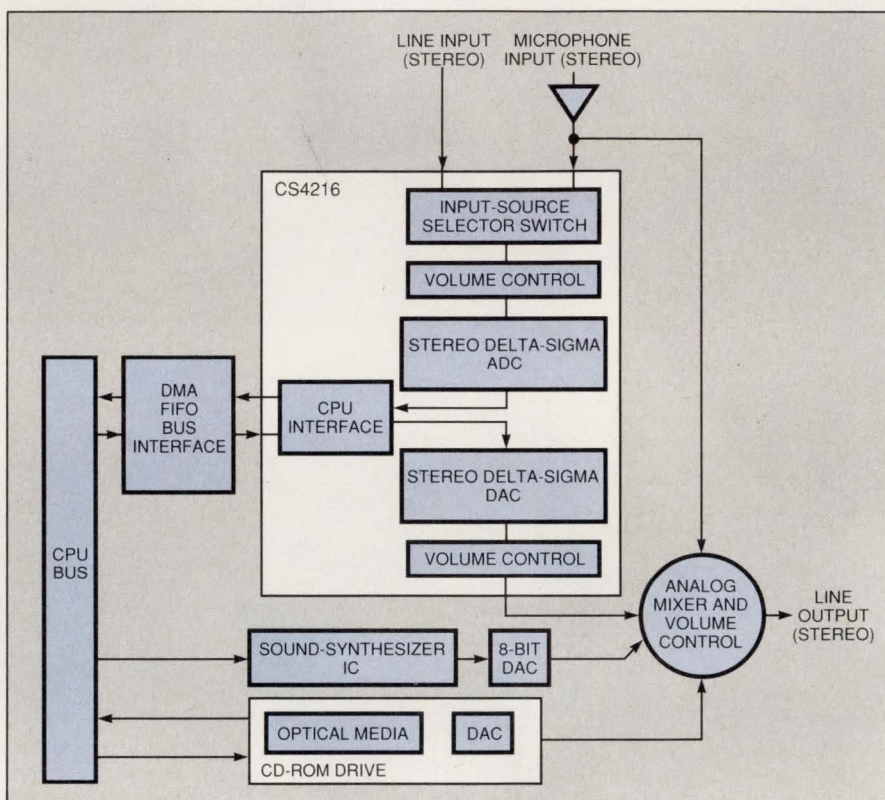

By incorporating CPU interface circuitry, stereo A/D and D/A converters, volume controls, and input selection in a single chip, the CS4216 simplifies your development task and makes a PC compatible with Microsoft's Multimedia PC specification.

μA , making this IC useful for portable and battery-powered designs. And although the chip's parallel-bit I/O continues to function, its serial-data output will indicate invalid data and present the appropriate error code.

In contrast, the CS4215 has additional circuitry that lets it drive a 32Ω loudspeaker and a 20Ω set of headphones. On-chip controls let you mute these outputs, if you wish. An internal multiplexer toggles between line-level inputs and microphone-level inputs. To monitor the input audio signal, the chip routes the output of its A/D converters though a monitor-path at-

tenuator. An internal calibration cycle minimizes both output offset voltage and input offset error. The CS4215's I/O capabilities suit it for applications that include CD-quality music, FM radio-quality music, telephone-quality speech, and modems.

Both ICs are packaged in 44-pin plastic leaded chip carriers. The CS4215 sells for \$30; the CS4216 costs \$23 (1000).—**JD Mosley**

Crystal Semiconductor Corp, Box 17847, Austin, TX 78760. Phone (512) 445-7222. FAX (512) 445-7581.

Circle No. 732

WE'RE GIVING THE 22V10 A WELL DESERVED REST.

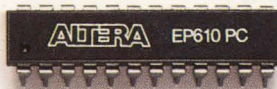

The 22V10 was a pretty good part in its day. But now its days are numbered.

Because Altera's new 15ns EP610 is more dense, flexible and less costly.

In fact, the EP610 delivers 60% more macrocells than the 22V10. Which lets you pack a lot more functionality into the same board space and give any design a shot of new life.

And while the 22V10 was rigid, the EP610's programmable clocks and flip-flops give you incredible flexibility. Which means you can program the EP610's registers for D-, T-, JK- or SR-operation or for asynchronous clocks. So it's perfect for all kinds of applications, including counters, state machines, memory and peripheral

interfaces, asynchronous logic and more.

Best of all, you get all this at a lower price than the 22V10.

The EP610 also gives you a wide selection of low-cost Altera and third-party development tools to choose from. And a great future to look forward to—the rest of the Altera Classic™ EPLD family. Like our 68-pin, 48-macrocell, 20ns EP1810 with more density and I/O than other mid-range CMOS PLDs. And our 12ns, 20-pin EP330 that replaces over 20 kinds of PAL*s and GAL*s.

So call (800) 44-EP610 for a Classic EPLD data book and a free Altera EP610 sample.

And breathe new life into your designs.

2610 Orchard Pkwy., San Jose, CA 95134-2020
(408) 984-2800/Fax: (408) 248-6924

CIRCLE NO. 53

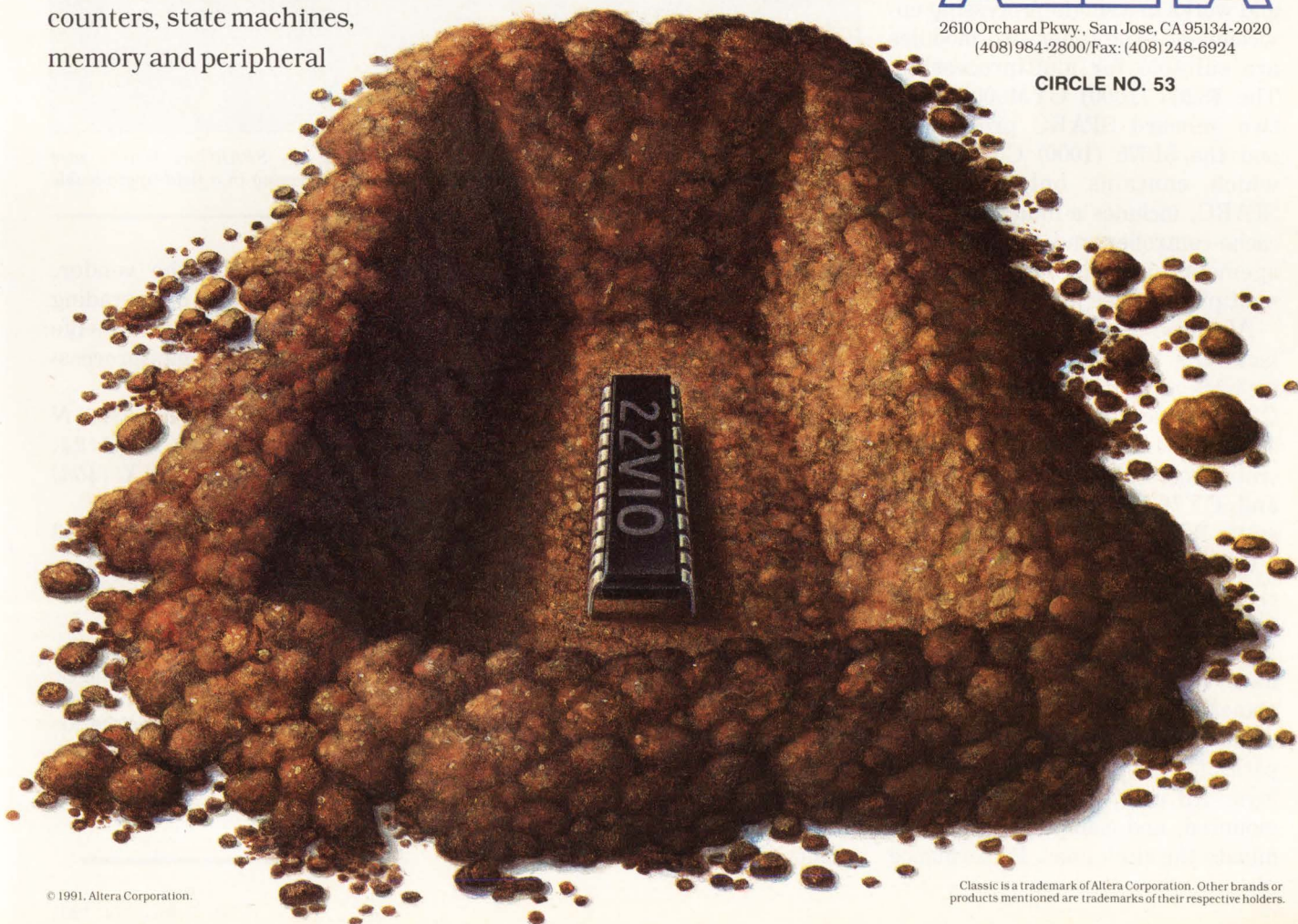

SPARC CPU module offers easy upgrade path from single to multiprocessing

System designers can now tap the 40-MHz, 29-MIPS power of SPARC processors and skip the nonrecurring engineering (NRE) costs normally associated with designing a multiprocessing compute engine for a new product. Just select from any of three SPARC Core modules that offer one or two onboard processors and built-in single or multiprocessing capability. By using these modules, system upgrades become a simple matter of changing daughter boards and loading a multiprocessing operating system.

The \$1450 (1000) CYM6001K module contains one SPARC CPU and works in a single-processing environment. The other two modules are suitable for multiprocessing: The \$3200 (1000) CYM6002K has two onboard SPARC processors; and the \$1675 (1000) CYM6003K, which contains only a single SPARC, includes a multiprocessing cache-controller and memory-management unit that lets you plug multiple modules into your chassis.

All three modules use the manufacturer's SPARC chip set, which includes a CY7C601 integer unit; a CY7C602 floating-point unit; either a CY7C604 or CY7C605 cache controller/memory-management unit; and CY7C157 16k \times 16-bit cache static RAMs. The modules come in a selection of 25-, 33-, and 40-MHz speeds and add a 4-kbyte page of virtual-memory management.

The 3.3 \times 5.78-in. modules each have two power and two ground planes. Each board was designed using Spice simulation of critical paths for shorter interconnect delays. All components are surface mounted, and clamping diodes terminate the clock lines. Performance

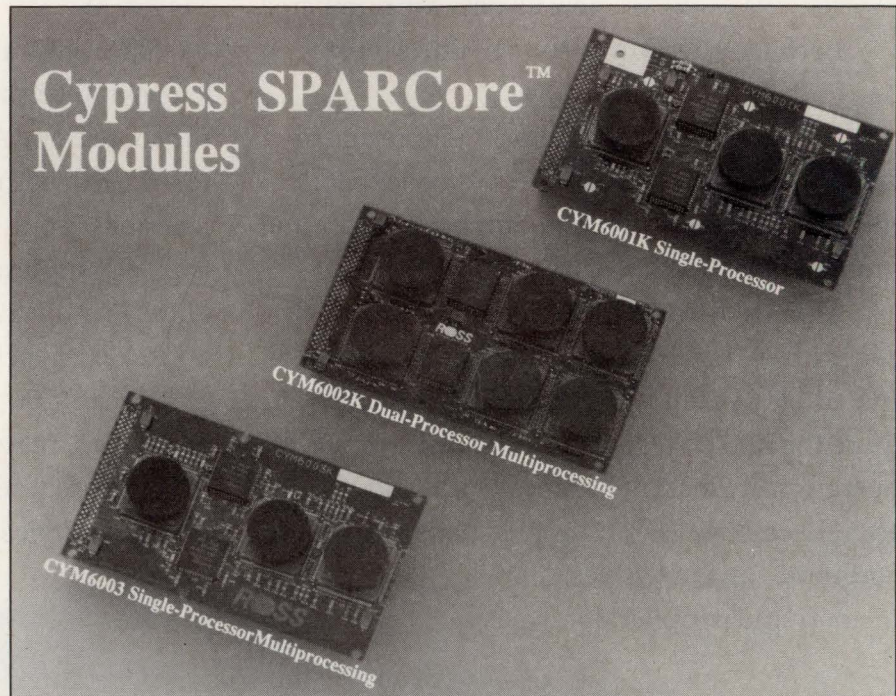

Providing a selection of plug-in SPARC CPU modules, the SPARC Core boards ease multiprocessing system design by providing factory-tested processing in a field-upgradeable format.

ranges from 32 to 59 MIPS and from 5 to 13 Mflops. Each of the modules plugs into a standard SPARC Mbus backplane.

The Mbus offers fully synchronous operation at 40 MHz with multiple-master and overlapped-arbitration capabilities. With 64-bit, multiplexed address and data paths, the Mbus facilitates shared-memory multiprocessor signals and transactions. The bus also provides for as much as 64 Gbytes of physical-address space and supports a write-invalidate, cache-consistency protocol.

By using this modular method for system design, the SPARC Core boards reduce your design-cycle time. They also improve system quality and reliability because each

module is tested by the vendor. Furthermore, the ease of upgrading lets you lengthen your product's life cycle by advancing to multiprocessing capability.—**JD Mosley**

Cypress Semiconductor, 3901 N First St, San Jose, CA 95134. Phone (408) 943-2600. FAX (408) 943-2796.

Circle No. 733

ASK EDN

Got a design problem that's driving you nuts? Ask EDN for help. If one of our editors can't solve your problem, we'll find someone who can. Write to us at Ask EDN, 275 Washington St, Newton, MA 02158 or send a fax to (617) 558-4470. Or put something on MCI at EDNBOS.



**WE HAVE WHAT IT TAKES
TO COMPLETE YOUR
SIMPLE HIGH-SPEED
CIRCUITS...**



...AND WHAT IT TAKES TO YOUR MORE DIFFICULT

Frequency Convertors. Prescalers. Amplifiers. Switches. Small Signal and Power Transistors. And more. If you're looking for more design margin...

- Higher f_T 's
- Greater gain bandwidth
- Wider dynamic range
- Lower propagation delay

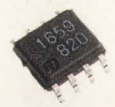

PRESCALERS
Silicon and GaAs,
100MHz to 14GHz, Dual Modulus,
Multiple Divide Ratios,
Low Phase Noise, Low
Supply Current/Voltage.

circuit designs and layouts don't always behave the way you'd expect.

Which can be extremely frustrating—unless you've chosen a vendor that can also give you solid technical support. We can.

We're the exclusive North American source for NEC high-speed semi-conductors. And we back our parts with the kind of engineering support that can shave weeks off your design cycle.

... you won't find a broader range of cost-effective high-speed devices than we offer at California Eastern Laboratories.

But at higher speeds, conventional



BIPOLAR TRANSISTORS
Over 40 types, f_T 's to 116GHz,
NF under 1.0dB at 500MHz,
Gain to 18dB at 500MHz, dozens
of different packages.

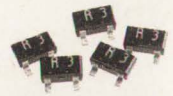

SILICON ANALOG ICs
DC to 1900MHz, Power to 20dBm,
Gain to 24dB, NF low as 2dB.
Amplifiers, Frequency Convertors,
Arrays, and LED Drivers.





COMPLETE ONES.

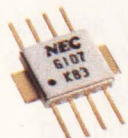

GaAs ANALOG ICs
10MHz to 20GHz,
Power to 18dBm, 35dB isolation.
Amplifiers and Switches.

Just call.
We have 25 years worth of applications information, all within an arm's reach.

So there's no waiting for answers to your questions.

And when it comes to data, our lab can provide device characterization specific to your project. And, if necessary, special selections specific to your circuit.

Best of all, most parts can be shipped immediately, direct from onshore stock.

So if your projects demand parts with higher speeds and greater design margin, our *Product Selection Guides* are a good place to find them. To get a set, just fill out and mail this card.

California Eastern Laboratories
4590 Patrick Henry Drive,
Santa Clara, CA 95056-0964
Phone (408) 988-3500
FAX (408) 988-0279



**California
Eastern
Laboratories**

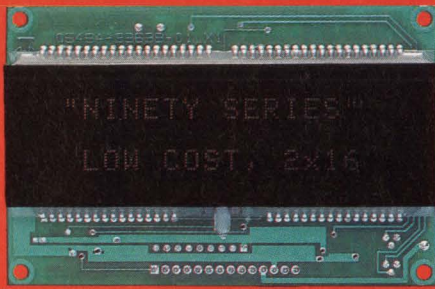

-97



-91A



-92

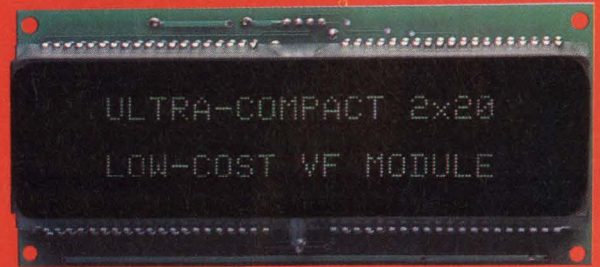

-95B



The Answers for the '90s

You know that a front-panel display is the first thing your customers will notice about your product. You need something to set your product apart from the competition, but you've got tight budget and packaging constraints. Now, IEE has a **new** family of **brilliant answers!**

You can have the **outstanding appearance** of a vacuum fluorescent display at an **affordable** price, with IEE's latest generation of enhanced "Ninety Series" FLIP™ VFD modules.

Price isn't the only thing that's unusually trim. Surface mount technology makes these modules exceptionally **compact**. Other features include:

- **Bright, easy to read** 5x7 dot matrix characters
- Software-controlled dimming
- Extended/Euro character set
- User-defined characters
- Only a single +5 VDC supply required
- On-board microprocessor accepts parallel ASCII data
- RS-232-C and 20mA loop serial data cards available

Call or write today and tell us your problems. We offer a wide variety of display technologies; what you see here are just a few of the answers we can give you.

Industrial Electronic Engineers, Inc.
Industrial Products Division
7740 Lemona Avenue
Van Nuys, CA 91409-9234
Tel.: (818) 787-0311, ext. 418
FAX: (818) 901-9046



TAB and Lead Frames from the Supplier of Choice

SMM Expertise Means Quality Semiconductor Assembly Materials



Device makers around the world have come to rely on SMM's semiconductor assembly materials. Our exclusive technologies for copper plating directly onto polyimide film, for example, produce 2-Layer TAB and 2-Metal TAB with straight side walls on Cu leads, a low profile Cu/Polymide interface and flexible design capabilities.

Moreover, our three-layer TAB, with high lead counts of more than 500, has acquired a reputation for reliability in applications—such as supercomputers—that require a multi-pin TAB.

Quality lead frames, essential elements in the infrastructure of ICs, can often make the difference in final product quality. Copper alloy or iron/nickel lead frames from SMM, created through our advanced, fully integrated in-house production system, provide the flexibility and durability you need.

SMM's many other advanced products, including connectors, switches and plastic package boards, combine with our TAB and lead frames to satisfy all your semiconductor assembly needs.

SMM



SUMITOMO METAL MINING CO., LTD.

11-3, 5-chome Shimbashi, Minato-ku, Tokyo 105, Japan
Phone: 3-3436-7901 Telex: 2422386 SMMINE J Fax: 3-3436-7746

Sumitomo Metal Mining U.S.A., Inc. Boston Office:

12 Allred St., Suite 300, Woburn, MA 01801 Phone: 617-932-6208 Fax: 617-938-8199

Basic-rate ISDN ICs

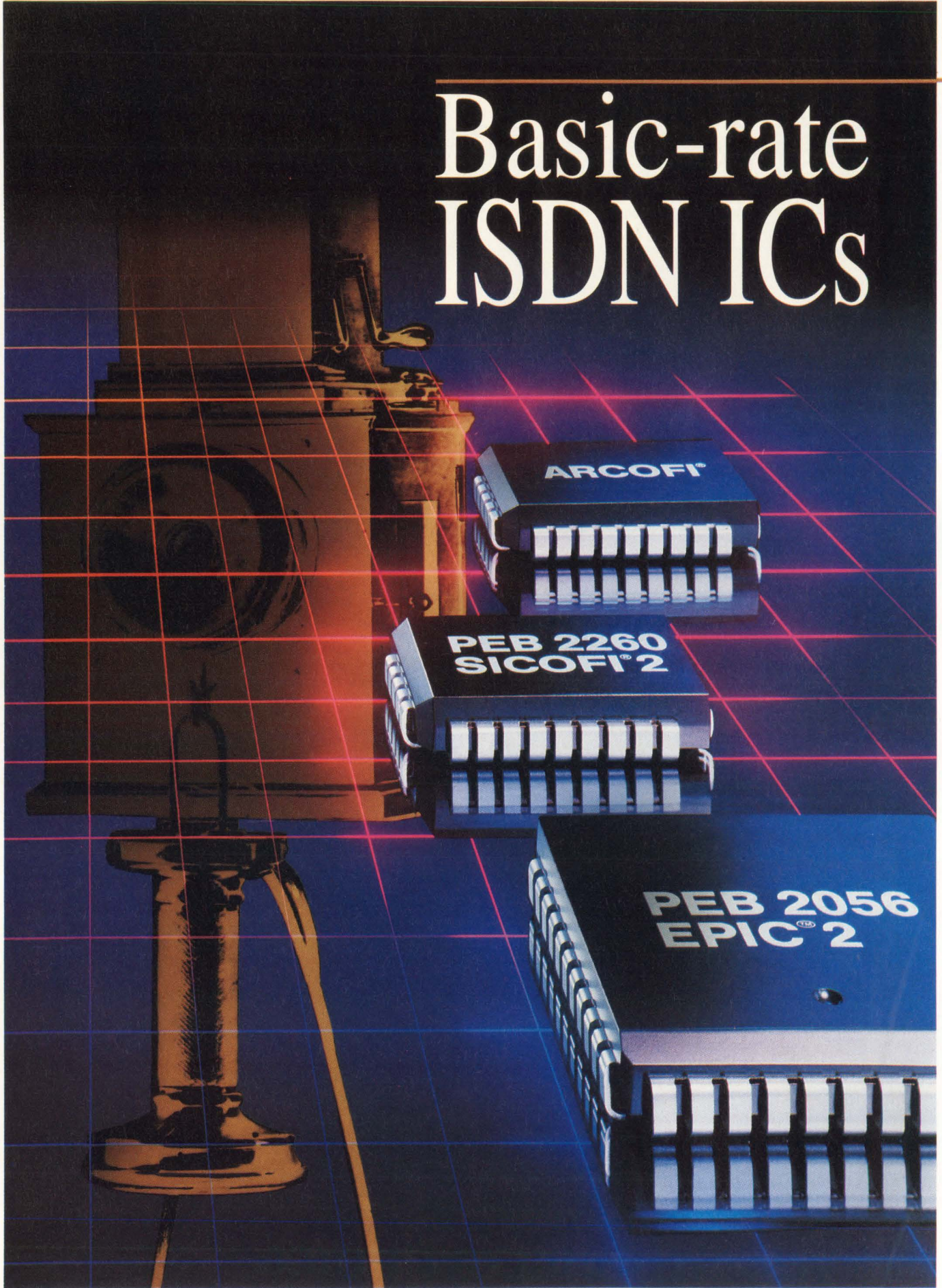

EDN Special Report

Brian Kerridge, *European Editor*

One objective of the Integrated Services Digital Network (ISDN) is to bring multiple channels of voice and data to small business and domestic users along a single twisted-pair wire.

Until recently, this part of the service, known as "basic-rate ISDN," failed to materialize. One of the reasons has been difficulty in designing vital ICs that reliably overcome transmission deficiencies of all twisted-pair configurations.

Now, a wider range of vendors offers these important ICs. Known as U- and S-interface ICs, some have a performance certified to operate over worst-case, twisted-pair wires. Vendors have reset prices too, down 5 to 10 times, to further attract the interest of telecommunications-equipment designers.

ISDN ICs have successfully developed past the laboratory and field-test phase, and now the commercial phase begins, says Flavio Benetti, network system manager with SGS-Thomson in Milan. Benetti reports a big increase in demand for ISDN ICs over the last 6 to 12 months.

The 160-kbps basic-rate service contains separate channels of two 64 kbps and one 16 kbps, called "bearer" and "data" channels, respectively (and known as 2B+D). Basic-rate service uses single twisted-pair wiring originally installed for phone communications in a 4-kHz baseband. The gross inadequacy of these wires for transmitting digital data limits the speed, capacity, and reach of ISDN. A key factor in realization of ISDN is the way IC designers exploit silicon to exploit copper. U- and S-interface ICs are prime examples of this ingenuity and combine VLSI, mixed-mode ASIC, and DSP technologies. For background on the difficulties of transmitting digital data along

twisted pairs and an outline of the compensation techniques today's ICs employ, see **box**, "Straightening out twisted pairs."

Considering the ambitious objectives of ISDN, it's no surprise the system did not develop overnight. Jim Pickard, ISDN marketing manager with British Telecom, cites earlier absence of solid standards and lack of approved equipment as the main reasons for the general delay in launching an ISDN system. British Telecom launched basic-rate

The network of twisted-pair wires running along our walls and streets is an unsuitable transmission medium for digital data. But with millions of miles of copper already in place, overcoming the gross deficiencies of this widest of wide-area networks presents IC designers with an alluring and supreme challenge.

ISDN in January this year, and around 700 towns and cities in the UK offer access. At present, equipment approved by the British Approvals Board for Telecommunications is available for fax, teleconferencing, and PC communications. Several ISDN telephones are in the approval pipeline and should be available later this year. Pickard expects ISDN to attract mainly business users, who show an increasing demand for data services. ISDN telephones will appear though, almost by default, and in time he expects phone communications to be the main ISDN service. In his view, there is a major requirement now for stand-alone terminal-adaptor equipment

Basic-rate ISDN ICs let you use old single twisted-pair lines for multiple channels of voice and data communications. (Photo courtesy Siemens)

The 2B1Q line code is mandatory in the US, and likely to supersede other line codes in use elsewhere.

as users realize the possibilities of connecting existing products to ISDN. This requirement will eventually disappear as more products include ISDN interfaces as standard. Pickard emphasizes that ISDN is now set to become the preferred customer interface into British Telecom's network, and most definitely has a long-term future.

ISDN communication within national boundaries is a reality, but international ISDN is still to be completely implemented. Even in Europe, ISDN services between European Economic Community (EEC) member countries is not straightforward. The main difficulty results from a lack of common approval procedures for ISDN equipment, leading to noncompatibility at detail level. For example, some approvals in Germany conform to the CCITT Red Book, while in the UK it's the later issue Blue Book. In France, users can operate five equipments on one line; in the UK the number is eight.

The EEC's harmonization program addresses issues such as compatibility. But, with 26 phone companies in 18 countries operating at different stages of development, progress is slow. Member countries place great faith in a future "memo of understanding" agreement, known as Net 3, which promises to normalize principal differences by 1993.

ISDN products for basic-rate operation fall into ge-

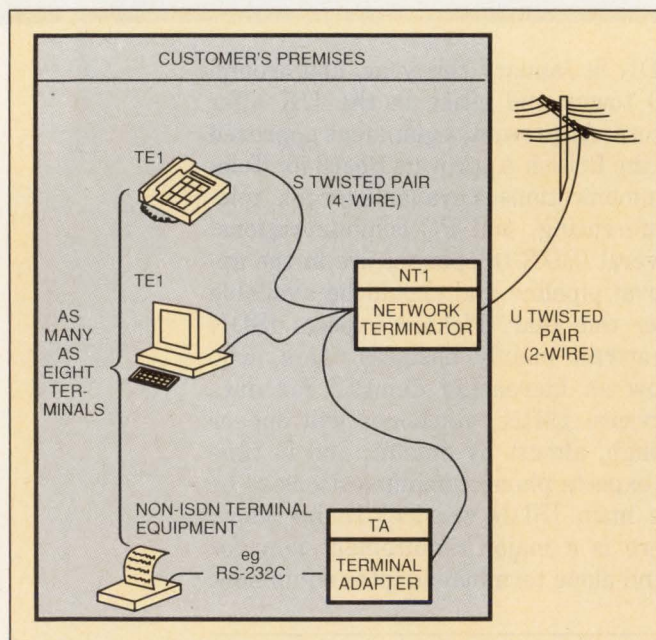
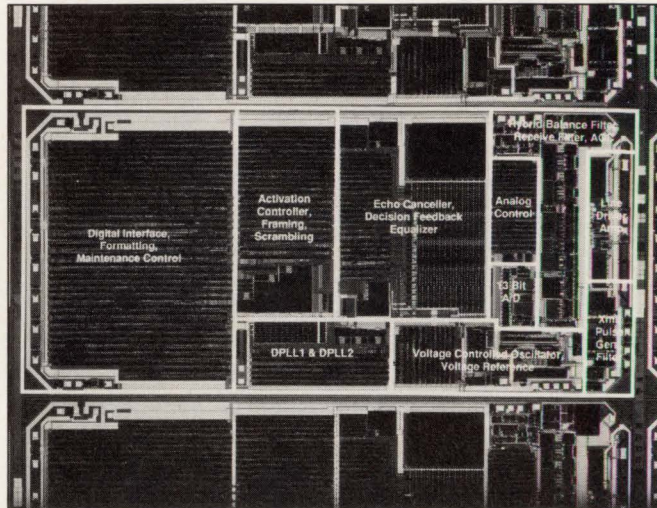

Fig 1—This diagram shows a typical arrangement of the main functional blocks for basic-rate ISDN.



A single-chip U-interface IC is very complex. National Semiconductor's TP3410 is typical of the apportionment of silicon in these chips.

neric categories with mundane titles of NT1 (network terminator), TE1 (terminal equipment), and TA (terminal adapter). A typical arrangement appears in Fig 1.

NT1 describes a wall box that forms a transition point between twisted-pair wires inside and outside your premises. NT1s contain the important U- and S-interface ICs, which together convert 2-wire 160-kbps data to 4-wire 192-kbps data. The U-interface IC also contains the circuit blocks to compensate for twisted-pair wire characteristics. An additional power-controller IC resides in an NT1 to convert incoming twisted-pair voltage to a 5V power-rail for the ICs.

TE1 describes the range of telephones, video phones, faxes, and computers that you may connect to ISDN. You can connect as many as eight TE1s to the same NT1. CCITT recommendations cater to an assortment of wiring configurations, ranging from 1 km to 200m between one to eight TE1s, respectively. Each TE1 requires at least another S-interface IC in its internal ISDN section, together with dedicated-controller ICs for protocol handling and microcontroller interfacing. If the TE1 is an audio terminal, then a codec IC is an additional requirement.

In theory, it's possible for terminal equipment to house a U interface, enabling direct connection to street wiring. This arrangement obviates the need for an NT1 terminal box. In practice, European phone companies do not permit this arrangement, as NT1s are phone-company property and are a mandatory requirement. Other countries, such as the US, have less

The complexity of a single-chip U interface is illustrated by Level One's LTX500. This interface includes an on-chip adaptive-balance network (ABN), which optimizes performance of the hybrid and reduces the need for accurate components external to the IC.

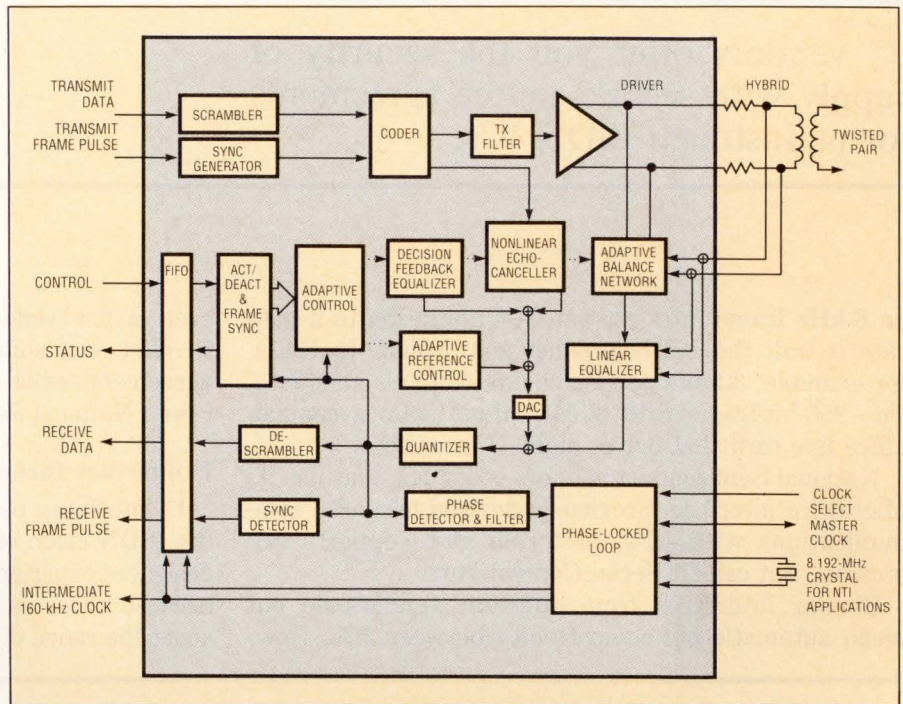

stringent views on NT1s, and the temptation exists to eliminate the cost of this item for small-scale users. ISDN PC plug-in interfaces that also contain phone links seem likely products to fill this application.

The last category of basic-rate ISDN products specifies a TA for linking non-ISDN telecommunications products into ISDN. A TA includes ICs used in TE1s. In addition, a bit-rate adapter IC translates bit-rates of other data-service standards, such as RS-232C, V.24, X.21, and X.25, into ISDN format. **Tables 1 and 2** show examples of ICs suitable for basic-rate designs.

ICs use different serial links

Distinctions between ICs from different vendors are not only in their ability to meet drive and sense requirements of twisted-pair wires, but also in dif-

ferent methods of interfacing the ICs themselves.

Vendors adopt a variety of methods for communicating between ICs at the pc-board level. All methods use some form of serial bus communication, synchronized to ISDN data rates. Typically, the interface employs two data lines and two control lines. Selecting a proprietary interfacing method does not necessarily lock you to one vendor. A serial interfacing technique for ISDN ICs described as General Circuit Interface (GCI), was devised by European manufacturers Alcatel, Italtel, Plessey, and Siemens to avoid this situation. Currently, ICs from Mietec, National Semiconductor, Siemens, and SGS-Thomson support the GCI. (Siemens calls the GCI IOM-2 (ISDN-oriented modular) and Mietec calls it V^{*}). The GCI uses a message-based serial system that packs 32, 90, or 256 bits into

Table 1—Representative U-interface ISDN ICs

Manufacturer	Part number	Line-code	Features	Price
Advanced Micro Devices	Am2091	2B1Q	GCI compatible, 340 mW typ, 44-pin PLCC ¹	\$45 (1000)
AT&T	T7262A T7263	2B1Q	Dual chip set, K2 serial interface, both in 44-pin PLCC	\$18.50 (10,000)
	T7264	2B1Q	K2 serial interface, 275 mW typ, 44-pin PLCC	\$27 (10,000)
Level One Communications	LXT500	2B1Q	Next margin 3 dB on ANSI loops 1 to 3, 6 dB on loops 4 to 15; adaptive hybrid-balance network; 300 mW typ; 28-pin DIP or PLCC	\$35 (10,000)
Mietec	MTC2071	4B3T	GCI compatible, 250 mW max, 28-pin DIP or PLCC	\$20 (10,000)
Mitel	MT8910	2B1Q	250 mW typ, 28-pin DIP or 44-pin PLCC	\$55 (1000)
Motorola	MC145472	2B1Q	Next margin 1 dB on ANSI loop 1, 6 dB on loop 2, 5 dB on loop 3; 68-pin ceramic quad flatpack	\$49.59 (1000)
National Semiconductor	TP3410	2B1Q	GCI or Microwire interface selectable, adaptive hybrid balance network	\$60 (1000)
Philips	PCD2392HP PCD2393T	2B1Q	Dual chip set, GCI compatible, 300 mW typ, samples end 1991	\$20 (10,000)
SGS-Thomson	ST5110	2B1Q	GCI or Microwire interface selectable, adaptive hybrid balance network	\$35 (10,000)
Siemens	PEB2091	2B1Q	GCI compatible, 300 mW max, 44-pin PLCC	\$35 (10,000)

Note: 1. PLCC=plastic leaded chip carrier.

IC vendors offer you the security of supply with second-source agreements for mainstream ISDN ICs.

an 8-kHz frame. You can set GCI operation to a data rate to suit the ISDN product you design. In NT1s, for example, 32 bits per frame (256 kbps) is adequate. The 256-bit/frame rate (2.048 Mbps) suits a central-office line card that drives eight U interfaces.

National Semiconductor offers other ICs that use its Microwire interface, previously devised for serial communications with μ Ps. Motorola also supports Microwire, but calls it Serial Control Port.

Similar interfaces from different vendors do not mean automatic pin compatibility between ICs. How-

ever, a few vendors have second-source agreements to offer you some assurance of supply. Currently, agreements exist between AMD and Siemens, and between National Semiconductor and SGS-Thomson.

U interface forms vital link

U interfaces perform the most critical functions in the ISDN chain of communication. It is here where IC designers experience the greatest challenge, especially, because there is a shortage of detailed information about the range of twisted-pair characteristics. The Am-

Straightening out twisted pairs

The twisted-pair line from your premises to the central office (in Europe, the exchange) presents a variety of obstacles to the smooth transmission of 160-kbps data streams. Principal difficulties arise from attenuation, crosstalk, and variations in characteristic impedance.

At ISDN (Integrated Services Digital Network) basic-rate frequencies, attenuation is not severe. Around 8 dB/km of attenuation at 100 kHz is typical, depending on wire gauge. The average distance a twisted pair carries data along the street is 5 km, giving rise to an end-to-end attenuation of 40 dB.

Crosstalk results from signals coupling your line to a bunch of adjacent lines in the network. As your line nears the central office, more and more lines come close, and cross-coupling becomes a limiting factor governing the maximum transmission distance. The length of the line becomes critical when the magnitude of your attenuated signal matches the magnitude of a stray cross-coupled signal.

Both attenuation and crosstalk effects increase with the fre-

quency content of the digital data stream. Although basic-rate ISDN must transport a 160-kbps data rate, designers play tricks with line coding to reduce the baud-rate bandwidth and frequency of the signal.

Techniques for line coding involve translating sequential sets of bits in the data stream into discrete signal-amplitude levels. Both U and S lines in an ISDN

utilize line coding, but the effects are more beneficial on the longer U lines. CCITT (Consultative Committee on International Telegraphy and Telephony) standards specify line codes for S interfaces, with the objective of making customer-premise equipment globally compatible. U interfaces are country specific, and as yet, only ANSI in the US has specified the line interface (2B1Q).

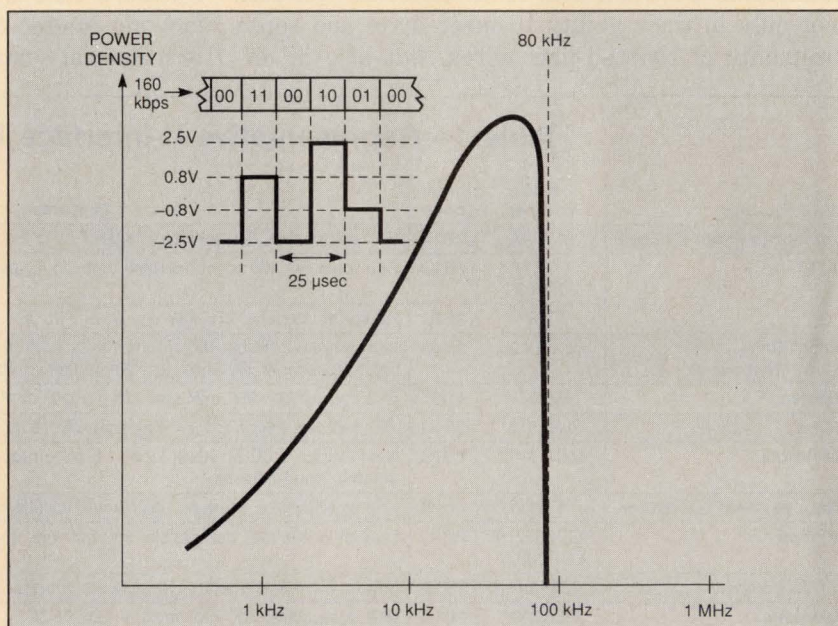

Fig A—The 2B1Q line code restricts frequency components of 160-kbps data to below 80 kHz.

erican National Standards Institute (ANSI) has specified 15 typical twisted-pair configurations—ANSI TI.601/1991. These configurations represent the toughest loops any U-interface is likely to connect to in the US. In the absence of specifications elsewhere, the ANSI requirement is currently accepted as an international guideline. The European Telecommunications Standards Institution (ETSI), is working on an equivalent specification for typical European loops. Publication of the specification is expected before the end of 1991.

Several vendors frankly admit difficulties in meeting

ANSI-specified performance for all loops in early versions of U interfaces. Even in new-generation ICs, vendors disagree over some aspects of U interface design. The main differences of opinion relate to single-chip vs 2-chip examples, and to the merits of on-chip vs off-chip hybrid components.

So-called U-interface, single-chip solutions means integration of analog circuits that interface to the twisted pair, with digital blocks for communicating serially with other ICs in the chain. The basic disagreement is whether proximity of digital signals to highly sensi-

Experts generally agree 2B1Q line coding offers the best compromises, but other line codes operate satisfactorily elsewhere. Essentially, a 2B1Q waveshape offers the best compromise between crosstalk limit and circuit complexity when driving a typical twisted-pair wire.

The 2B1Q line code involves translating sequential pairs of bits into four voltage levels (+2.5, +0.8, -0.8, and -2.5V) at the transmitting end of the twisted-pair wire. The net effect of this line code is to limit frequency components in the transmitted waveform to well below 80 kHz (Fig A). Compressing the frequency components in this way reduces attenuation and crosstalk, thereby increasing the range of a twisted-pair wire.

An undesirable by-product of using a line code such as 2B1Q is the distortion experienced by the pulse, because of the presence of more low-frequency components. The distortion shows up particularly as long trailing edges to the pulses. Distortion is sufficiently acute that one pulse can run into another, an effect usually described as intersymbol interference (ISI).

To combat ISI, all U interfaces include equalization filtering in the receive path to restore pulse shape. The equalization filter often takes the form of an FIR-adaptive digital filter having around 25 taps. A key feature of the filter is its adaptive nature to modify its response with variations of cable characteristics, often referred to as a decision feedback equalizer (DFE).

As if this level of complexity were not enough, other characteristics of twisted-pair transmission cause a need for compensation. A major requirement of the U interface is that it operates in full-duplex mode. This requirement means that the receiver must be kept clear of transmissions from the same end of the line in order to detect what may be a heavily attenuated signal from the far end. The transmit and receive ports of the U-interface IC are isolated by a balanced hybrid, consisting of a transformer and resistive network. The hybrid is only partially effective in keeping the two paths separate because variations in characteristic impedance of the line destroys the balance. In prac-

tice, the hybrid inserts around 15 dB of isolation, although a worst-case figure may be as low as 6 dB. In consequence, a large chunk of transmitted signal bridges the hybrid, and must be canceled out in order to sustain duplex operation. In addition, echoes of transmission data reflect back to the receiver from discontinuities along the line. One of the main functions of a U-interface IC is to neutralize effects of hybrid unbalance and reflections. This function is called echo cancellation.

A second FIR filter handles echo cancellation. For optimal effect, the filter needs 60 dB of cancellation. An FIR adaptive filter similar to a DFE filter provides this function. An additional nonlinear adaptive filter helps to reduce the linearity required in the ADC and transmitter.

Acknowledgment

Thanks go to Simon Cox, group leader in Copper Access Systems with British Telecom, for suggesting many of the points in this box.

Basic-rate ISDN ICs

tive receiver circuitry degrades S/N ratio performance. Yves Durieux, telecommunications IC marketing manager with Philips, has no doubt that 2-chip versions are superior. He says Philips' measurements show consistently better results in loop tests using a 2-chip interface. He maintains IC users also benefit from different production-test methods associated with 2-chip designs. This approach leads to optimal yield and cost figures for the complete U-interface function. He claims that additional pc-board area taken up by two chips is relatively small in comparison to area needed for more complex hybrids and additional microcontrollers in other designs.

According to Jerrell Hein, marketing manager for ISDN basic-rate ICs with AT&T, the company's newly released T7264 single-chip U interface shows better margin against ANSI loop-test specifications than its earlier 2-chip alternative. Hein points to other single-chip advantages, such as lower power consumption. The T7264's typical power consumption is 275 mW as compared with around 800 mW for a dual-chip version.

Hybrid design may be important

The term hybrid refers to a network of passive components that connects separate transmit and receive channels of a U interface to a single twisted-pair line.

National Semiconductor's TP3410 and SGS-Thomson's ST5410 single-chip U interfaces include some hybrid line-balance components on chip. You still need to mount seven resistors and the line interface trans-

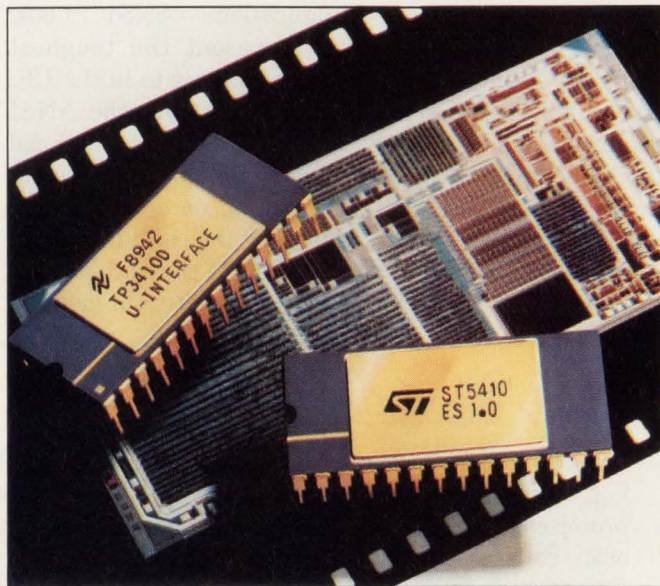

Several vendors have second-source agreements to supply single-chip U interfaces, such as National Semiconductor, SGS-Thomson, AMD, and Siemens.

former externally to the chip. Three of the resistors currently specify 0.1% tolerance, although SGS-Thomson intends to relax this requirement. The TP3410 and ST5410 also include two PLL circuits, instead of the single PLL offered by most vendors. When you design an NT1, you need two PLLs; one to synchronize with the incoming clock signal, and the other to measure frame-signal delay.

Table 2—Representative S-interface ISDN ICs

Manufacturer	Part number	Features	Price
Advanced Micro Devices	Am2080	GCI compatible, 60 mW max, 28-pin PLCC ¹	\$8.45 (1000)
	Am2081	GCI compatible, adaptive equalizer, 80 mW max	\$10.65 (1000)
AT&T	T7250B	Optimized for TE applications, 44-pin PLCC	\$7.87 (10,000)
	T7252A	Optimized for NT applications, 44-pin PLCC	\$8.83 (10,000)
Mietec	MTC2072	GCI compatible, 22-pin DIP or PLCC	\$4.95 (10,000)
Mitel	MT8930	High-level digital link control, Intel and Motorola μ P-compatible 8-bit port	\$12.60 (1000)
Motorola	MC145474	2.5-km point-to-point range, 22-pin DIP	\$7.42 (1000)
National Semiconductor	TP3420	Microwire interface, 1.5-km point-to-point range, adaptive equalizer receiver, 75 mW typ	\$12.50 (1000)
SGS-Thomson	ST5420	Microwire interface, 1.5-km point-to-point range, adaptive equalizer receiver, 75 mW typ	\$8 (10,000)
	ST5421	GCI compatible, 1.5-km point-to-point range, adaptive equalizer receiver, 75 mW typ	\$8 (10,000)
Siemens	PEB2085	GCI compatible, includes link-access-protocol on D-channel, 44-pin PLCC	\$11 (10,000)

Note: 1. PLCC=plastic leaded chip carrier.

PLCC sockets. Now half off.

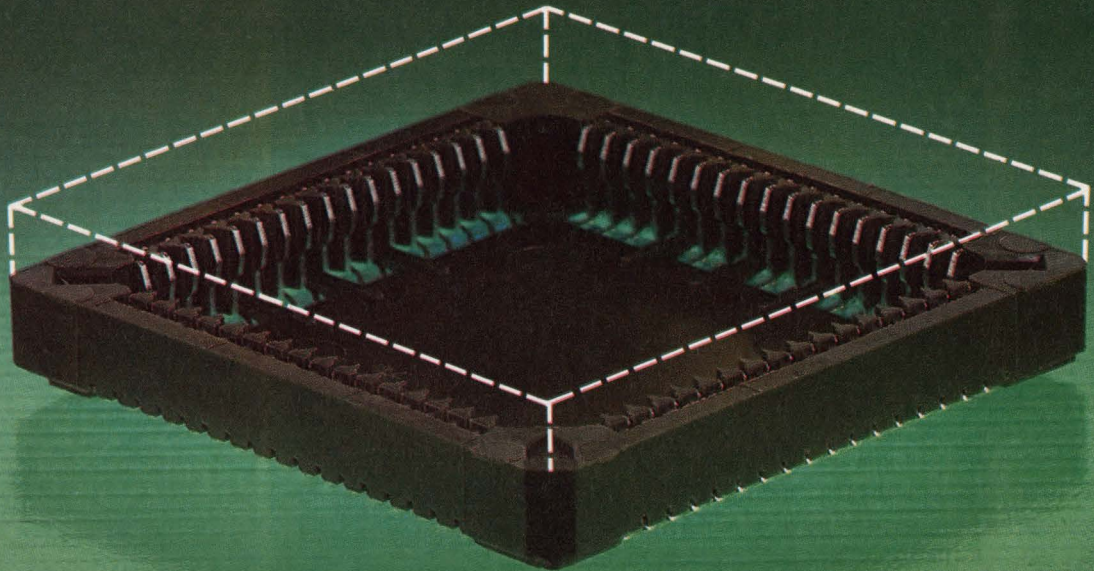

THIS IS AMP TODAY.



Save big where it counts most: real estate and stack height. Our PLCC sockets address your two major concerns—the tight space requirements of today's compact designs, and the need for positive chip retention.

The newest low-profile surface-mount versions, in all popular sizes, take space savings to the max—with half the clearance of our standard types. Now you can get the advantages of socketing in barely more room than the chip itself, and hold on to the low profile you need for tight board stacking and efficient thermal management. Surface-mount styles match PLCC footprints, too, so there's no board redesign.

And all our PLCC sockets get solidly into contact, and stay in contact. Their proprietary, controlled-angle interface establishes very high normal forces to ensure positive retention. Short-signal-path contacts float in the housing to accommodate expansion.

Get the help you need: interconnections for your most advanced designs. And get all the advantages of better design where your PLCC meets the board. Call our Product Information Center, 1-800-522-6752 (fax 717-561-6110), for literature. In Canada call 416-475-6222. AMP Incorporated, Harrisburg, PA 17105-3608.

AMP

Basic-rate ISDN ICs

Manfred Omenzetter, ISDN IC specialist with Siemens in Munich, believes strongly that all components of a hybrid should be external to the U-interface chip. In his view, totally external components offer you the opportunity to optimize performance to a wider range of loops. This arrangement also means that the highest tolerance resistor becomes 1%, as in the case of the hybrid for the company's PEB2091 single-chip interface. Omenzetter stresses though that all hybrid circuits need careful design. The line-balance transformer is particularly important and often troublesome to manufacture. He explains that using 2B1Q line code, a transformer must operate linearly with dc current to 80 mA. The pc-board layout in the region of the hybrid is another factor affecting performance. You must adopt methods normally associated with much higher-frequency designs, such as symmetrical layout, maximum separation from clock and other digital lines, and meticulous attention to decoupling and grounding.

Not all U-interface ICs demand such high precision for hybrid components. AT&T's T7264 uses just two external 1% resistors with a line-balance transformer. This design anticipates low-balance performance of only 3 dBs from the hybrid, but relies on enhancements in the echo-cancellation loop to restore overall performance.

Andrew Sorowka, product marketing manager at Level One Communications, explains how the company's LTX500 U interface gets away with a transformer and two 5% resistors for its hybrid arrangement. The IC design uses a dedicated compensation arrangement for first-order echo precancellation. Called adaptive-balance network, the on-chip hybrid achieves around 25-dB cancellation for cables of different characteristic impedance. Sorowka believes single-chip U interfaces exemplify a steady trend to further functional integration in ISDN circuits. He says next-

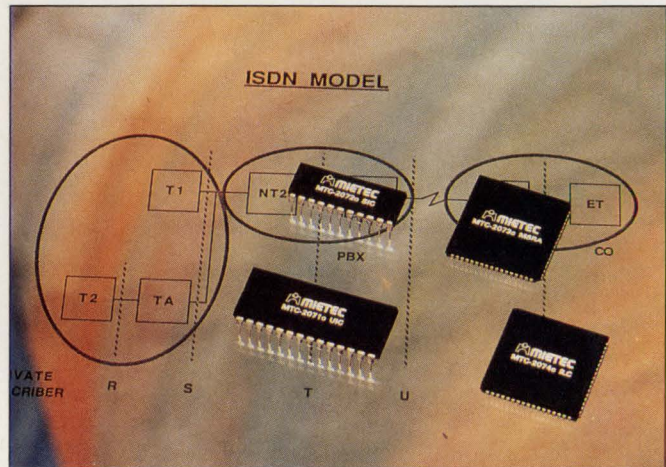

Many basic-rate ISDN ICs use general circuit interface (GCI) for interchip communication. Mietec calls the interface V'.

generation ICs will see integrated versions of complete ISDN functions such as an NT1. Level One Communications already has an integrated NT1 at design phase and expects first samples in late 1992.

Essential for the development of any product using a U interface is a vendor's pc-board evaluation kit. Boards contain peripheral components needed to make up a product and provide an example of pc-board layout. Most evaluation kits come as a PC plug-in board with chip drivers and development software. Cost ranges from \$500 to \$2000, although AT&T will lend you its kit free of charge.

S lines cause less fuss

Communicating along 4-wire lines, S twisted pairs that make up the internal wiring of your premises are much less of a design headache than using 2-wire U lines. In the first place, the 4-wire arrangement keeps

Acronyms used in this article

ABN—Adaptive-balance network
ADC—Analog-to-digital converter
AMI—Alternate-mark inversion
ANSI—American National Standards Institute
ASIC—Application-specific integrated circuit
CCITT—Consultative Committee on International Telegraphy and Telephony
Codec—Coder/decoder
DSP—Digital signal processing
DFE—Decision feedback equalizer

EEC—European Economic Community
ETSI—European Telecommunications Standards Institution
FIR—Finite impulse response
GCI—General circuit interface
ISDN—Integrated Services Digital Network
ISI—Intersymbol interference
Net 3—"Memo of understanding" agreement between EEC member countries for ISDN compatibility
NT1—Network termination 1

PC—Personal computer
PLL—Phase-locked loop
S interface—Communicates over internal twisted pairs
S/N ratio—Signal-to-noise ratio
TA—Terminal adapter
TE1—Terminal equipment 1
TE2—Terminal equipment 2
U interface—Communicates over external twisted pairs
VLSI—Very large-scale integration

*The winning edge for any
game in town.*

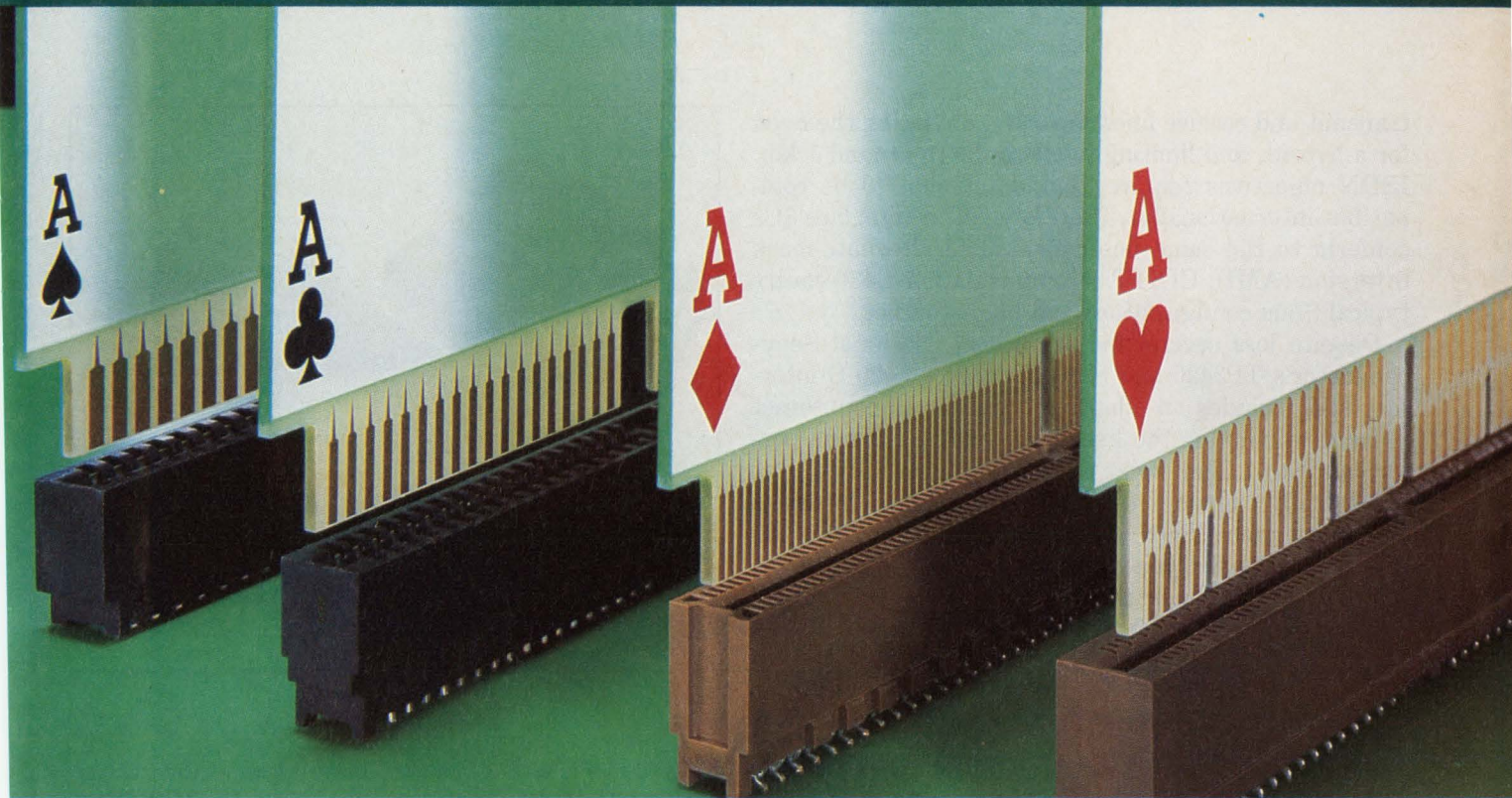

THIS IS AMP TODAY.

Whether you're looking for .050" center MCA styles, dual-function ISA/EISA types, or .100" or .125" center versions, you can be sure you get the edge connector you need, when you need it.

AMP Standard Edge Connectors come in all the right styles and sizes, with all the engineering advantages you'd expect from the people who established edge connectors as an industry standard. And the immediate availability and in-depth application support you need, from the largest supplier in the world.

Whatever you're looking for in edge connectors, compare selection, value, and delivery with the industry standard—the AMP Standard Edge lines—and come up a winner. For information on AMP Standard Edge II (.100" and .125"), Standard Edge .050, or Standard Edge EISA connectors, call our Product Information Center at 1-800-552-6752 (fax 717-561-6110). In Canada call 416-475-6222. AMP Incorporated, Harrisburg, PA 17105-3608.

Basic-rate ISDN ICs

transmit and receive lines separate, obviating the need for a hybrid, and limiting line lengths to around 1 km. ISDN objectives require Sbus equipment to be compatible internationally. Therefore, all S-interface ICs conform to the same line code, called alternate-mark inversion (AMI). CCITT recommendation I.430 covers typical Sbus configurations and noise sources.

Despite less severe line conditions, National Semiconductor's TP3420 and SGS-Thomson's 5420 S interface still includes an adaptive equalizer to counteract pulse distortion on the line. This feature extends performance to 1.5-km point to point.

Normally, vendors offer you the same S-interface IC for all your ISDN applications, although this arrangement leaves you with redundant protocol logic associated with one or the other end of an Sbus. AT&T avoids this situation by optimizing the use of silicon

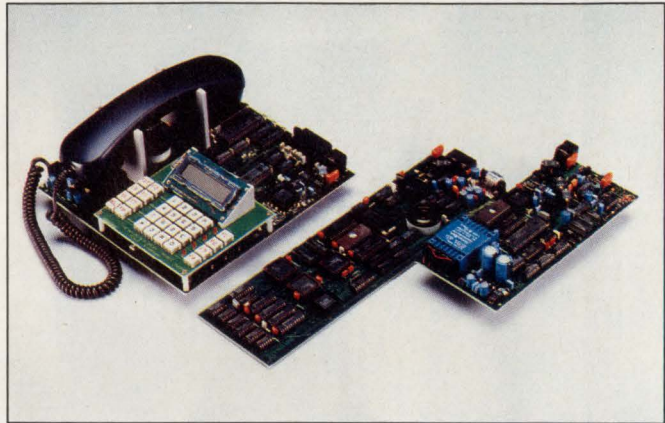

You can build an integrated services terminal (IST) bus as an extension to the ISDN Sbus using Philips' PBC2310 interface IC. The IST bus lets you concurrently communicate locally and externally without the need for a local exchange.

Manufacturers of ISDN ICs

For more information on basic-rate ISDN ICs such as those described in this article, circle the appropriate numbers on the Information Retrieval Service card or use EDN's Express Request service. When you contact any of the following manufacturers directly, please let them know you read about their products in EDN.

Advanced Micro Devices
5900 E Ben White Blvd
Austin, TX 78741
(512) 462-5395
FAX (512) 462-5101
Circle No. 650

AT&T Microelectronics
Dept 52AL040420
555 Union Blvd
Allentown, PA 18103
800 372-2447
FAX (215) 778-4106
Circle No. 651

British Telecom
Dowgate Hill House
Dowgate Hill
London EC4R 2SU, UK
(71) 356-8353
FAX (71) 329-0662
Circle No. 652

Fujitsu Microelectronics
Am Siebenstein 6-10
6072 Dreieich-Buchschlag, Germany
(6103) 6900
FAX (6103) 690122
Circle No. 653

Hitachi Europe Ltd
Whitebrook Park
Lower Cookham Rd
Maidenhead SL6 8YA, UK
(628) 585000
FAX (628) 778200
Circle No. 654

Level One Communications
105 Lake Forrest Way
Folsom, CA 95630
(916) 985-3670
FAX (916) 985-3512
Circle No. 655

Mietec
Raketstraat 62
B-1130 Brussels, Belgium
(2) 728-1811
FAX (2) 242-7552
Circle No. 656

Mitel Corp
360 Legget Dr
Kanata, Ontario
Canada K2K 1X3
(613) 592-2122
FAX (613) 592-4784
Circle No. 657

Motorola Telecom Marketing
3501 Ed Bluestein Blvd
Austin, TX 78762
(512) 928-6888
FAX (512) 928-7991
Circle No. 658

National Semiconductor Corp
2900 Semiconductor Dr
MS11-125
Santa Clara, CA 95052
(408) 721-6944
FAX (408) 733-0613
Circle No. 659

NEC Electronics Inc
401 Ellis St
Mountain View, CA 94038
(415) 965-6000
FAX (415) 965-6130
Circle No. 660

Philips Components
Building BAF-1
Box 218
5600 MD Eindhoven
The Netherlands
(40) 722091
FAX (40) 724825
Circle No. 661

SGS-Thomson Microelectronics Inc
1000 E Bell Rd
Phoenix, AZ 85022
(602) 867-6100
FAX (602) 867-6102
Circle No. 662
In Europe,
Via C Olivetti 2
Agrate Brianza 20041, Italy
(39) 603-1
FAX (39) 603-5700
Circle No. 663

Siemens
2191 Laurelwood Rd
Santa Clara, CA 95054
(408) 980-4562
FAX (408) 980-4510
Circle No. 664
In Europe,
Siemens AG
Balanstrasse 73
D-8000 München 80, Germany
(89) 4144-8080
FAX (89) 4144-8082
Circle No. 665

VOTE...

Please also use the Information Retrieval Service card to rate this article (circle one):
High Interest 470 Medium Interest 471 Low Interest 472

Should you use power factor correction in your 400W-2,500W power supplies?

Phone for this free report.

Now it's easy for you to evaluate the benefits of power factor correction. Phone to reserve your copy of this exclusive report and discover:

- ✓ The systems most prone to low power factor, with a graphical example of how the problem occurs.
- ✓ How to quickly determine whether power factor correction is appropriate for your applications.
- ✓ How to get 30% more power out of any standard wall socket—and meet UL's spec requiring that equipment plugged into a 15A outlet draw no more than 12A.
- ✓ The most cost-effective way to eliminate potential safety hazards from harmonic distortion.

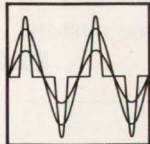

With power factor correction, the input current is virtually sinusoidal.

- ✓ An update on the IEC 555.2 harmonic distortion spec.
- ✓ The critical advantages of an active over a passive power factor correction scheme.
- ✓ Special benefits of power factor correction for companies that operate sensitive equipment on an A/C line.
- ✓ Tips on selecting converter topology to ensure maximum efficiency and reliability in a power factor corrected supply.
- ✓ How to use the same supply anywhere in the world without modification.
- ✓ How to use power factor correction as a marketing tool for your products.

How to instantly become an expert on power factor correction.

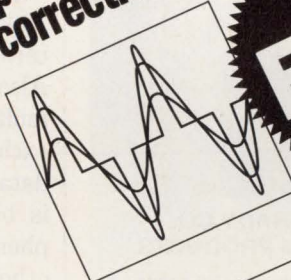

FREE

MTBF exceeds 200,000 hours.*

Power Components' power factor corrected supplies have a MTBF of more than 200,000 hours (using Mil-217E standards).

A statistical process control system with 20 measurement points ensures consistent quality. Our QA system follows Mil-I-45208 and ESD standards.

For exceptional reliability, a half-bridge power converter is used to reduce the transformer's operating temperature and minimize thermal stress.

Power supplies are inspected and tested repeatedly. Each supply is burned-in at 50°C at full load while being cycled "on" and "off." You get a printout of final test results with each supply.

Get power factor corrected supplies for about the same price as many standard supplies.

Power Components uses a modular, conservative design approach. You don't pay extra for features you don't need.

And since manufacturing takes place in our low-cost facility in Mexicali, Mexico, a major savings is passed on to you.

The result? Power factor corrected supplies from Power Components—with exactly the features you need—cost about the same as many standard supplies from other makers.

For your free report or more information, phone:

1-800-828-7289

Extension 103

*Single output supply. (All other Power Components' supplies contain a minimum MTBF of 160,000 hours.)

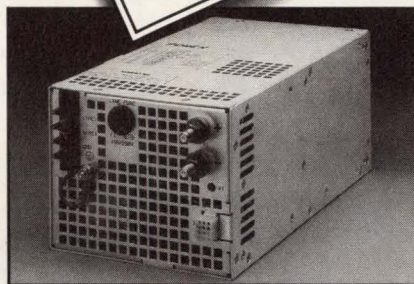

Power Components makes 250W-2,500W switching power supplies with and without power factor correction.

Specialists in power factor correction.

We're Power Components, makers of high performance switching power supplies in the 250W-2,500W range—and a leader in power factor correction. We were among the first to produce a 1,000W power supply with .998 power factor.

Power factor corrected supplies from Power Components meet UL, CSA, VDE and FCC standards, and IEC 555.2 harmonic requirements.

The Power Factor Correction Specialists

POWER COMPONENTS

Subsidiary of Vanguard Electronics Co., Inc.

1480 West 178th Street, Gardena, CA 90248 213-323-8120 (fax) 213-329-8427

TOUCH SCREEN PROJECT?

We stock touch screens, decoding electronics and software for immediate delivery.

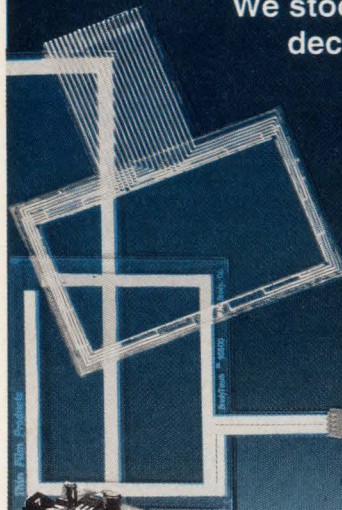

- Analog and matrix touch screens.
- Decoding electronics and software (enables screen to function as a mouse).
- High gloss and anti-glare surface finishes.
- Custom manufactured screens also available.

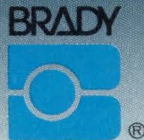
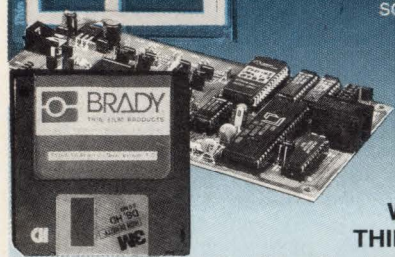

W.H. BRADY CO.
THIN FILM PRODUCTS

8225 W. Parkland Ct. • P.O. Box 571 • Milwaukee, WI 53201
Phone: 414-355-8300 • Fax: 414-354-0453

Copyright 1991 W.H. Brady Co. All rights reserved.

CIRCLE NO. 74

DIE CUT COMPONENTS

Computers • 2-Way Communication Devices

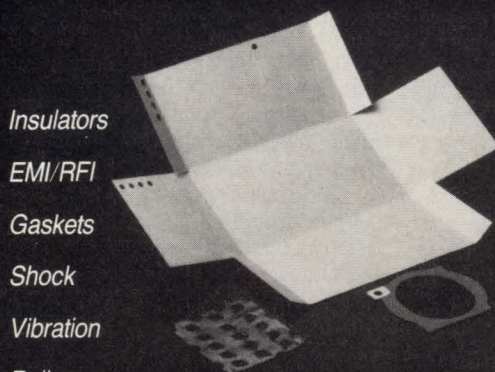

Insulators

EMI/RFI

Gaskets

Shock

Vibration

Rolls or individual pieces with or without adhesive

Class 10,000 clean room
35% RH

Histol will:

Slit

Laminate

Print

Die Cut

Crease

Seal

Assemble

Package

J.I.T.

the hirol company

1170 West McNab Road, Ft. Lauderdale, FL 33309
305/974-4900 • 1-800-327-2362 • FAX 305/975-4734

Quality Parts On Time

CIRCLE NO. 75

Basic-rate ISDN ICs

in two different versions of S interface. The design of ICs T7252A and T7250B match precisely the requirements of NT1s and TE1s, respectively.

As an adjunct to an ISDN Sbus, Philips offers a PBC2310 IC to let you build an alternative local communications network between end-user terminals. Philips calls this network integrated-services terminal (IST) bus. The network carries nine 64-kbps channels, in contrast to ISDN's two 64-kbps B-channels, and one 16-kbps D-channel. This structure lets you operate 31 terminals on IST, instead of the normal eight on ISDN. Also, you can communicate locally and externally simultaneously—not possible with ISDN without a local exchange. Another advantage is that four separate data transfers run concurrently before further access is blocked. With ISDN, just one internal phone-to-phone conversation per Sbus blocks the system. Another significant difference is that IST operates in duplex mode along 300m of a single twisted pair, instead of the normal 1-km, 4-wire arrangement for ISDN. Philips intends IST to complement rather than compete with ISDN. The PCB2310 (\$15 (10,000)) IST bus interface IC lets you build a gateway from IST to an ISDN Sbus, or to an existing analog phone system.

EDN

References

1. Griffiths, John M, British Telecom, "ISDN Explained," John Wiley & Sons, 1990.
2. Leibson, Steven H, "ISDN," *EDN*, November 12 1987, pg 118.
3. Markowitz, Michael C, "ISDN-based concurrent design," *EDN*, March 1, 1991, pg 80.

Article Interest Quotient (Circle One)
High 470 Medium 471 Low 472

WHAT'S COMING IN EDN

Processing power is here. Today's 32-bit, floating-point digital signal processors offer new levels of dedicated power for math-intensive applications. The November 7, 1991, issue of *EDN Magazine* introduces the newest member of its technical team, Ray Weiss, as he examines these number crunchers in his Special Report. Look for our regular departments, too.

Announcing a night to recognize greatness

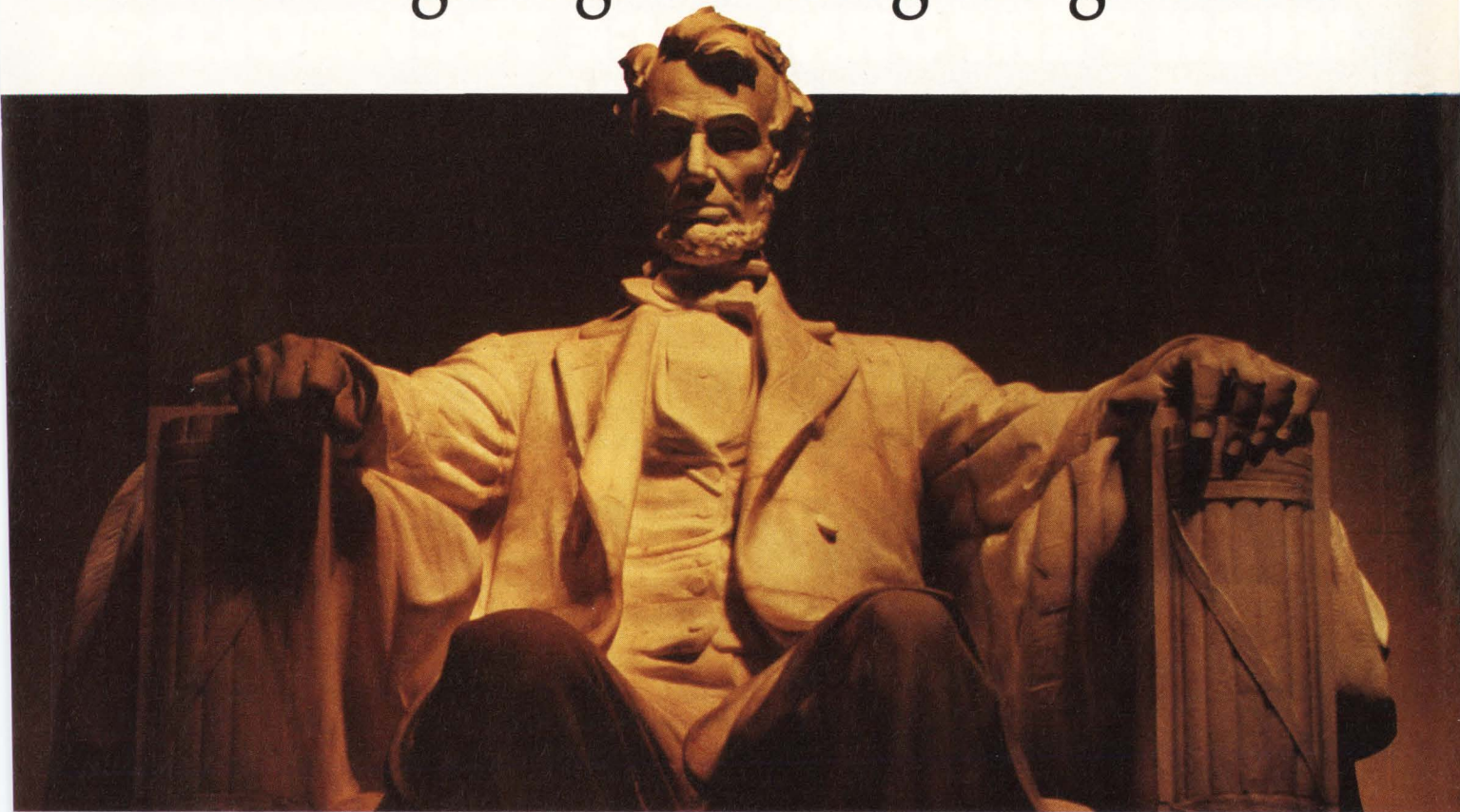

EDN's Innovation and Innovator of the Year Awards Ceremony

On the night of November 19 during Wescon, EDN will present the 1991 Innovation and Innovator of the Year awards at the Mark Hopkins Hotel in San Francisco. You are invited to show the finalists that you support greatness in innovation by attending the awards ceremony that is the culmination of their hard work. Through its Innovation Crusade, EDN hopes to inspire

engineering professionals within the electronics field to reach for higher plateaus of inspiration and creativity.

The dedication and involvement of EDN readers, like yourself, have made the Innovation Crusade and awards ceremony a reality. By taking the time to nominate your peers and, in

fact, select the winners, you show commitment to quality and creativity in electronics and are driving this crusade. But don't stop there ... order your ticket to the industry event of the year and show these innovators that greatness does not go unrecognized. All proceeds of the dinner will be donated to the EDN Scholarship Fund.

To receive a reservation order form to the EDN 1991 Innovation Dinner and Awards Ceremony, fax Pam Winch at (617) 558-4470.



EDN Magazine
Edition
News
Edition

To receive an Innovation Ceremony Reservation form, please circle no. 59

HIGH PERFORMANCE TECHNOLOGY

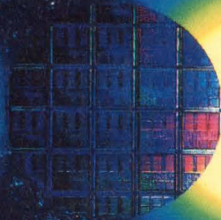
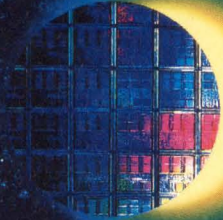

THAT SHEDS A NEW LIGHT.

In-depth VLSI experience and process technology enable MHS to offer 0.7 μ CMOS/ BiCMOS devices TODAY!

This is the driving force behind our balanced product offering.

The MHS OPEN ASIC concept, supported by market leading CAD tools, offers smart solutions for system integration: composite/gate arrays, sea-of-gates, PLD replacement, standard cells and full custom devices.

Our range of application-specific DATACOM products includes voice combos, network protocol controllers and compressed imaging.

And when it comes to fast and/or very low power SRAMs, FIFOs or Dual Port RAMs, we can provide versions down to 8ns access time or down to 1 μ A stand-by.

We have chosen the RISC 32 bit SPARC architecture to produce chip sets and embedded solutions, in addition to 8 bit microcontrollers built around an 80C51 core.

MHS HIGH RELIABILITY products and services are an integral part of today's most sophisticated programs in Aerospace, Defense and Avionics, based on RAQ1/AQAP1, 883C, CECC, ISO 9001 and SCC certifications or standards.

Want more information about our service-oriented organization and highly skilled teams?

Call us today, we'll send you our brochure.

Tel. : 800 554 44 50



THE EXPERT
IN SUBMICRON CMOS

CIRCLE NO. 76

NANTES · PARIS · LONDON · MILAN · MUNICH · STOCKHOLM · SANTA CLARA · HONG KONG

FUTABA

Sets the Standards in Custom Vacuum Fluorescent Displays and Vacuum Fluorescent Modules



CUSTOM DESIGN

Futaba is the leading global supplier of vacuum fluorescent displays and modules. We have the capability, technology, and market knowledge to provide you with the most cost effective display system tailored to your specific application.

Futaba's high brightness fluorescent display products range from simple numeric and dot matrix displays to large multi-color graphic panels.

TECHNICAL SUPPORT

Futaba engineers have a broad range of application experience including automotive, point of sale, appliance, medical, and instrumentation products. They are ready to assist you in optimizing your display system design.

U.S. MANUFACTURING

Futaba's state-of-the-art SMD manufacturing facility in Schaumburg, Illinois provides local service, JIT delivery, and reinforces its commitment to supply the North American market.

QUALITY

Futaba's number one commitment is supplying products having the highest level of quality. Quality begins with the initial design and is controlled throughout the manufacturing process by using SPC and having well trained and motivated employees.

Futaba is dedicated to the principal of continuous improvement and always strives to provide the highest level of customer satisfaction.

Pick up the phone - take advantage of our superior technical background and design expertise. Call or write for more information on Futaba custom vacuum fluorescent display modules.



Electronic Instrument Panel to J.I. CASE Tractors.



NCR "S1" Supplier.



Appliance Control Display.



711 E. State Parkway
Schaumburg, IL 60173
708-884-1444
FAX 708-884-1635

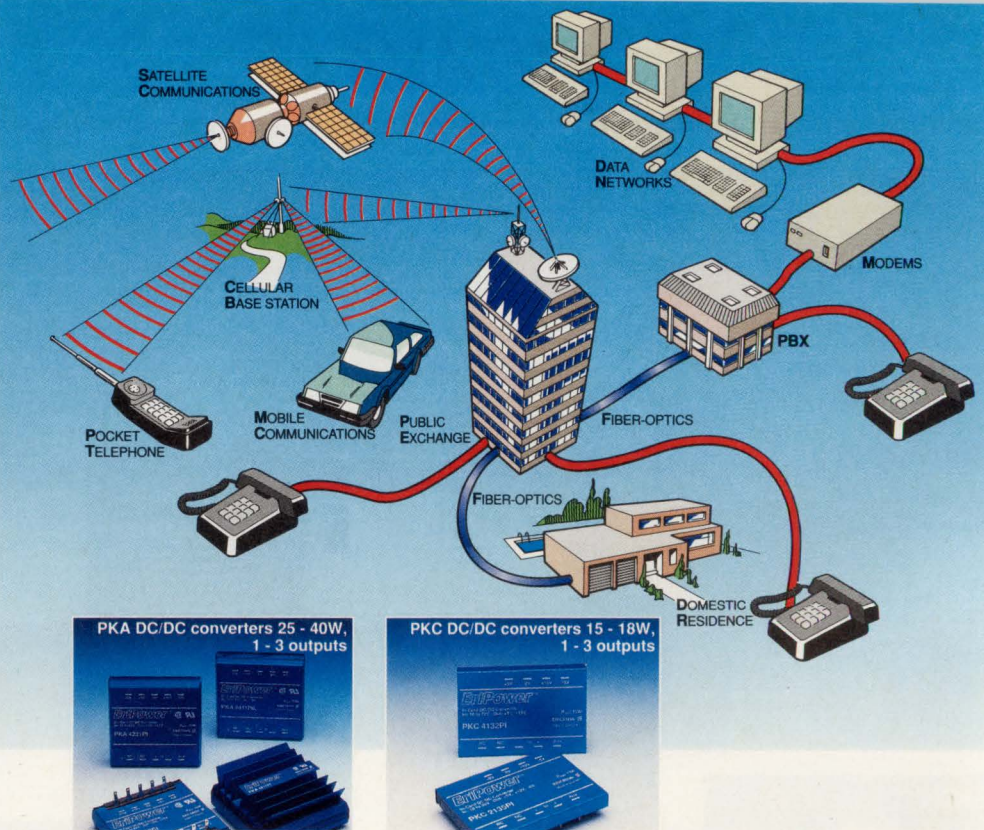

The Power in Telecommunications

How component power is contributing to the future of telecom networks

Of all the developments in the 1990's, advances in telecom technology may well have the most profound impact on our daily lives.

The integration of speech/data and video technology, computers and communications systems will bring businesses and individuals closer together.

But as the power of communications increases, so must its reliability. And nowhere is that more important than in the power supplies which power the systems.

Here, Ericsson has been at the forefront of technology for decades, and is ready to provide many more innovative, highly reliable solutions in the years to come.

When the PKA DC/DC converter was launched in 1983 it represented the first real power supply 'component', starting a trend towards distributed power architectures which has gained global acceptance.

In 1988 these 25 - 40 Watt units were complemented by 15 - 18 Watt DC/DC converters in the PKC series. Power components the size of a credit card.

Both series boast a remarkable MTBF of over 200 years.

Ericsson continues to lead the way in smaller, more reliable power supplies for advanced power architectures. They are vital components - enabling technologies which shape the telecom networks of the future.

A complete technical information pack is just a 'phone call away. Alternatively, just fax us the coupon.

Sweden	Ericsson Components AB , Stockholm Tel:(08) 721 62 47 Fax:(08) 721 70 01
France	Ericsson Components Europe , Guyancourt Tel:(01) 30 64 85 00 Fax:(01) 30 64 11 46
Germany	Ericsson Components Europe GmbH , Neu-Isenburg, Tel:(06102) 200 50 Fax:(06102) 20 05 33
Great Britain	Ericsson Components Europe , Coventry Tel:(0203) 553 647 Fax:(0203) 225 830
Hong Kong	Ericsson Components AB East Asia , Wanchai Tel:575 6640 Fax:834 5369
Italy	Ericsson Components Europe , Milano Tel:(02) 3320 0635 Fax:(02) 3320 0641
Norway	Ericsson Components A/S , Oslo Tel:(02) 650 190 Fax:(02) 644 138
United States	Ericsson Components Inc , Richardson, TX Tel:(214) 997 6561 Fax:(214) 680 1059

Please send me your latest information

Name _____

Company _____

Job Title _____

Address _____

Telephone _____

Fax _____

ERICSSON 

Shrink Your Power Supplies with TOKIN SMDs

The continuous integration of high-density electronic equipment has created a burgeoning demand for thinner, more compact switching power supplies. To meet this demand, TOKIN has come up with an outstanding lineup of SMD (Surface Mount Devices) transformers. And to help you counter noise emissions

from compact, high-frequency power supplies, TOKIN offers a full selection of SMD-type EMC components including High-Capacitance Multilayer Ceramic Capacitors. Give us a call.

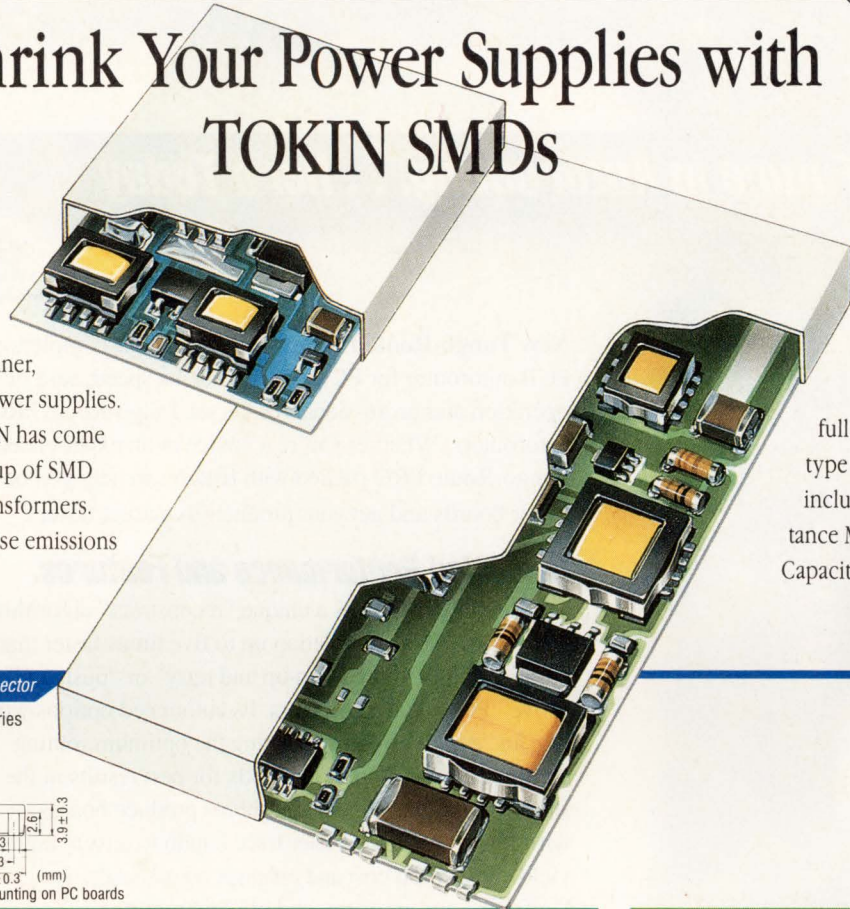

Common-mode Choke Coils at output sector

EMC Chip Filters • M-600 Series

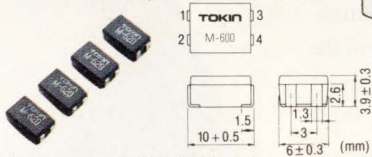

Common-mode chip filters ideal for surface-mounting on PC boards

Ceramic Capacitor for Converters

Multilayer Ceramic Capacitors

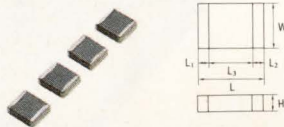

Chip-type ceramic capacitor with large capacitance using Y5U materials

	mm				
	W	L	H	L ₁ , L ₂	L ₃
C205 (SD)	2.7 ± 0.3	5.9 ± 0.4	2.5 max.	0.3 ~ 2.5	0.3 min.
C505 (SE)	5.0 ± 0.4	5.6 ± 0.5	3.0 max.	0.3 ~ 2.5	0.3 min.
C408 (SA)	4.0 ± 0.4	8.0 ± 0.5	3.2 max.	0.3 ~ 2.5	0.3 min.
C610 (SB)	6.3 ± 0.4	10.0 ± 0.5	4.5 max.	0.3 ~ 2.5	0.3 min.
C812 (SC)	8.0 ± 0.4	12.5 ± 0.5	4.5 max.	0.3 ~ 2.5	0.3 min.

Products above are sold only in the U.S.

Normal-mode Choke Coils at input/output sector

SN Coils • SN-S3M Series

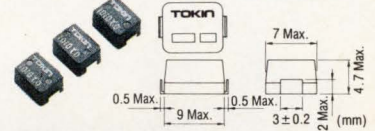

Excellent absorption characteristics for countering high impulse noise; ideal for high-density mounting

Bead Inductors for eliminating switching/spike noise

Solid Chip Inductors • NZ Series

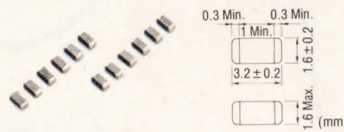

Thin, ultra-small, with monolithic structure and excellent frequency characteristics; designed for automatic mounting

Transformers for Converters

SMD Transformers • FEY9.1/7.3

• FEY12.8/11.5

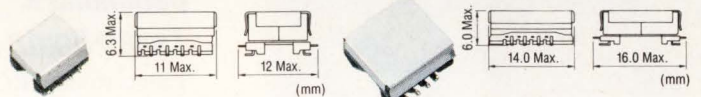

• FEY15.3/13.0

• FED11.6

• FEP7T

• FEE5

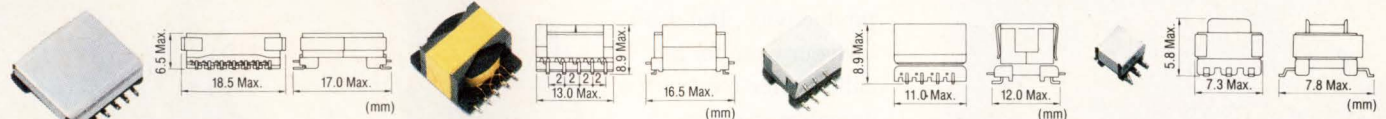

Superior magnetic circuit design technology ensures excellent frequency characteristics; compact, thin; ideal for ultra-high density mounting; SMD discrete monolithic structure



Tokin Corporation

Hazama Bldg., 5-8, Kita-Aoyama 2-chome, Minato-ku, Tokyo 107, Japan
 Phone: 03-3402-6166 Fax: 03-3497-9756

Korea Representative Office

602, Champs-Elysees Bldg., 889-5, Daechi-Dong, Kangnam-gu, Seoul, Korea
 Phone: (2) 569-2582 ~ 5 Fax: (2) 544-7087

Tokin America Inc.

155 Nicholson Lane, San Jose, California 95134, U.S.A.
 Phone: 408-432-8020 Fax: 408-434-0375

Chicago Branch

9935 Capitol Drive, Wheeling, Illinois 60090, U.S.A.
 Phone: 708-215-8802 Fax: 708-215-8804

Boston Branch

945 Concord Street, Framingham, Massachusetts 01701, U.S.A.
 Phone: 508-875-0389 Fax: 508-875-1479

Tokin Electronics (HK) Ltd.

Room 806 Austin Tower, 22-26A Austin Avenue, Tsimshatsui, Kowloon, Hong Kong
 Phone: 367-9157 Fax: 739-5950

Taiwan Liaison Office

3F-4, No. 57 Fu Shing N. Road, Taipei, Taiwan
 Phone: (02) 7728852 Fax: (02) 7114260

Singapore Branch

140 Cecil Street, No. 13-01 PIL Bldg., Singapore
 Phone: 2237076 Fax: 2236093, 2278772

Tokin Europe GmbH

Knoorrstr. 142, 8000 München 45, Germany
 Phone: 089-311 10 66 Fax: 089-311 35 84 Telex: 5 24 537 tokin d

The Future in Autorouting. . . Here Today

Tango

For complete specs
and FREE evaluation
package, call
800 488-0680



New **Tango-Route PRO** is the fastest, high-completion PCB autorouter for PC workstations. Its speed, ease of operation and professional results set Tango-Route PRO apart from all other autorouters. Whether you're a novice or an experienced designer, you'll find Tango-Route PRO packed with features to help you be more productive, design better boards and get your products to market faster.

Unrivaled Performance and Features.

Tango-Route PRO has a unique "reconstruct" algorithm which iterates to 100% completion up to five times faster than comparable PC-based "rip-up and retry" or "push and shove" PC-based autorouters. Its automated options work like an "expert system" selecting the optimum routing configuration right out of the box for best results in the shortest time. Intelligent algorithms produce boards with fewer vias and shorter trace length to ensure high yields, lower fab cost and enhance board aesthetics. Uniform-, non-uniform- and off-grid routing offer performance equal to or better than "gridless routers." The program fully supports the 32-bit power of 386/486 computers, virtual memory and all current PCB technologies including advanced SMD. And you'll drive Tango-Route PRO with the easy-to-use, Windows™-like Tango interface.

Benchmark Tango-Route PRO.

Tango-Route PRO, together with our design editor, Tango-PCB PLUS, can greatly enhance your productivity. But don't take our word for it... call toll-free for complete specs and a free evaluation package to see the future in auto-routing for yourself.



Tango®

Helping good ideas become great products.

ACCEL Technologies, Inc.
6825 Flanders Drive • San Diego, CA 92121 USA
Service & Support 619/554-1000 Fax 619/554-1019

CIRCLE NO. 80

Subduing high-speed op-amp problems

The application of high-speed op amps requires special attention to a multitude of potential problems. You need to guard against noise intrusion, capacitance-loading effects, and parasitic conductive paths—without neglecting the compromises you may have to make between compensation and gain.

Jim Williams, *Linear Technology Corp*

Compared with their low-speed siblings, high-speed op amps are subject to many problems, many of which can result in oscillation. The forte of the operational amplifier is negative feedback, which stabilizes the operating point and fixes the gain. However, positive feedback or delayed negative feedback can cause oscillation. Thus, even a properly functioning amplifier constantly lives in the shadow of oscillation.

When oscillation occurs, several major candidates for blame are present. If the power supply is unby-passed, the impedance the amplifier sees at its power terminals is high, particularly at high frequency. This impedance forms a voltage divider with the amplifier, letting the supply vary as internal conditions in the amplifier change. This variation can cause local feedback, resulting in oscillation. The obvious cure is to bypass the amplifier. Power-supply impedance must be low to ensure stable operation.

A second common cause of oscillation is positive feed-

back. In most amplifier circuits feedback is negative, although the circuit may also use controlled amounts of positive feedback. In a circuit that normally has only negative feedback, unintended positive feedback may occur with poor layout. Check for possible parasitic feedback paths and unwanted or overlooked feedback action. To the extent possible, minimize the impedances seen by the amplifier inputs. A low impedance helps to attenuate the effects of parasitic feedback paths to the inputs. Similarly, minimize exposed input-trace area. Route the amplifier outputs and other signals well away from sensitive nodes. Sometimes no amount of layout finesse will work, and shielding is required. Use shielding only when required—extensive shielding is a sloppy substitute for good layout practice.

Watch out for time delays

A third cause of oscillation is negative feedback that arrives significantly delayed in time. Under these conditions, the amplifier hopelessly tries to servo-control a feedback signal that consistently arrives “too late.” The servo action takes the form of an electronic tail chase, with oscillation centered around the ideal servo point. The most common causes of this problem are reactive loading of the amplifier (most notably capacitive loads such as cable) and circuitry (such as power amplifiers) within the amplifier’s feedback path. In many cases, isolating the reactive load from the amplifier’s output (and feedback path) with a resistor will solve the problem. Sometimes rolling off the amplifier’s frequency response will fix the problem, but in high-speed circuits this may not be an option.

Placing power-gain or other types of stages within

THE
JIM WILLIAMS
P A P E R S

the amplifier's feedback path adds time delay to the stabilizing feedback. If the delay is significant, oscillation commences. Stages operating within the amplifier's loop should have a minimum time lag compared with the amplifier's speed capability. At lower speeds, this is not too difficult, but a stage within a 100-MHz amplifier's loop must be fast. As mentioned before, rolling off the amplifier's frequency response eases the job, but is usually undesirable in a wideband circuit. You should make every effort to maximize the bandwidth of the added stages before resorting to amplifier roll-off. In this way, you can achieve the fastest overall bandwidth while maintaining stability. (See the **box**, "The oscillation problem and frequency compensation," which discusses power-gain stages and other types of stages operating within amplifier loops.)

In certain cases, it may appear that there is an oscillation problem when there really isn't. For example, the low-level, square-wave output in **Fig 1** appears to suffer from parasitic oscillation. In actuality, the disturbance is typical of that caused by fast digital clocking or switching-regulator noise getting into critical circuit nodes. Plan for parasitic radiative or conductive paths and eliminate them with appropriate layout and shielding.

The **Fig 2** display underscores the previous statement. The scope trace shows the output from a gain-of-ten inverter with a 1-k Ω input resistance. The output exhibits severe peaking induced by only 1-pF of parasitic capacitance across the 1-k Ω resistor. The 50 Ω -terminated input source provides only 20 mV of drive, but that's more than enough to cause problems, even with only 1 pF of stray coupling. In this case the solution was a ground-referred shield at a right angle to, and encircling, the 1-k Ω resistor. Plan for parasitic radiative paths and eliminate them with appropriate shielding.

Too low a gain can cause problems

A decompensated amplifier running at too low a gain produced the oscillation shown in **Fig 3**. The penalty for a decompensated amplifier's increased speed is a restriction on the minimum allowable gain. Decompensated amplifiers are simply not stable below some (specified) minimum gain, and no amount of wishful thinking will change this. Such oversight is common with these devices, although the amplifier never fails to remind the user. Observe gain restrictions when using decompensated amplifiers.

Text continued on pg 140

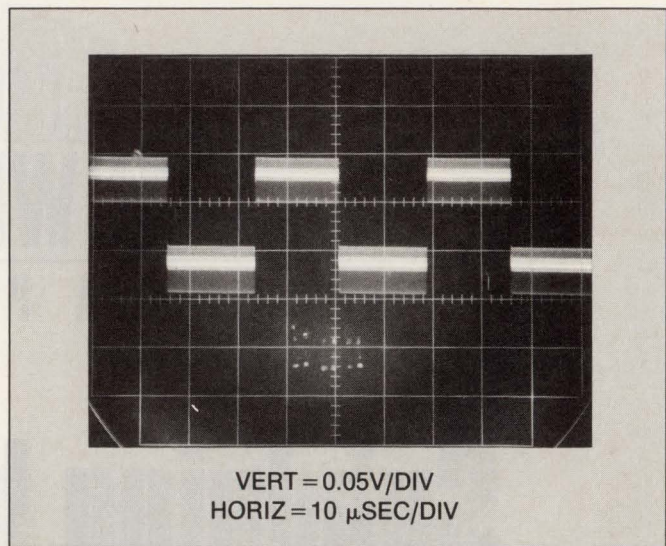

Fig 1—This square-wave output disturbance is typical of switching-regulator noise at critical circuit nodes. Poor layout is the culprit.

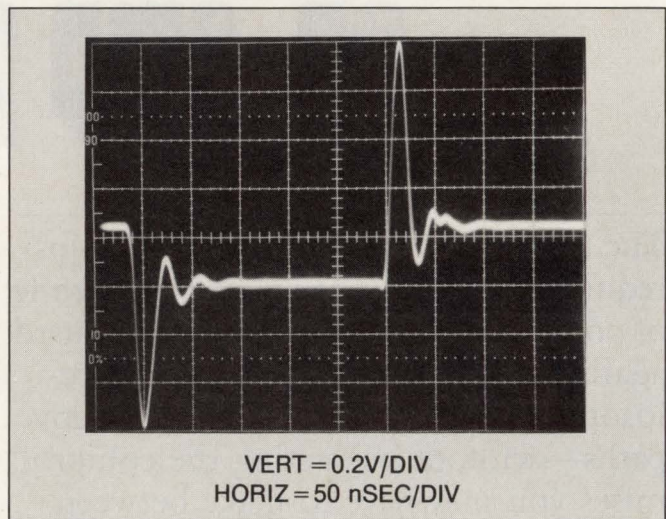

Fig 2—The peaking and ringing at the output of a 10 \times amplifier is the result of only 1 pF of stray capacitance across a 1-k Ω input resistor.

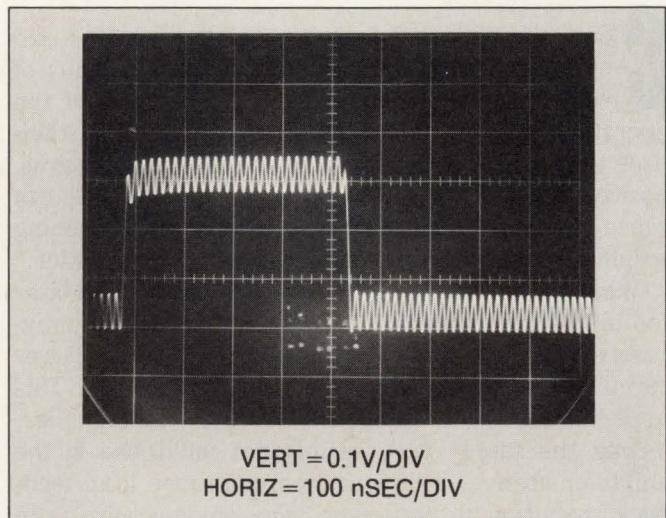

Fig 3—A decompensated amplifier running at low gain produced this oscillation. Such amplifiers are not stable below a specified minimum gain.

The oscillation problem and frequency compensation

All feedback systems have the propensity to oscillate. Basic theory tells us that an oscillator requires both gain and phase shift. Unfortunately, feedback systems, such as operational amplifiers, also have gain and phase shift. The close relationship between oscillators and operational amplifiers requires careful attention when designing op-amp circuits. In particular, excessive input-to-output phase shift can cause the amplifier to oscillate when you apply feedback. Furthermore, any time delay placed in the amplifier's feedback path introduces additional phase shift, increasing the likelihood of oscillation. This phase shift is why feedback-loop-enclosed stages can cause oscillation.

A large body of complex mathematics describing stability criteria is available, and is useful in predicting the stability characteristics of feedback amplifiers. For sophisticated applications, this complex approach is essential for optimum performance. However, comparatively little information is available that discusses, in practical terms, how to understand and address the issues of compensating feedback amplifiers. The following is a practical approach to stabilizing various combinations of amplifier and power-gain stages, although the considerations are also useful to other feedback systems.

Two categories exist

Oscillation problems in amplifier/power-booster combinations fall into two broad categories: local and loop oscillations. *Local* oscillations can occur in the booster stage, but should not appear in the IC op amp, which presumably was debugged prior to sale. These oscillations are the result of transistor parasitics, layout problems, or circuit-configuration

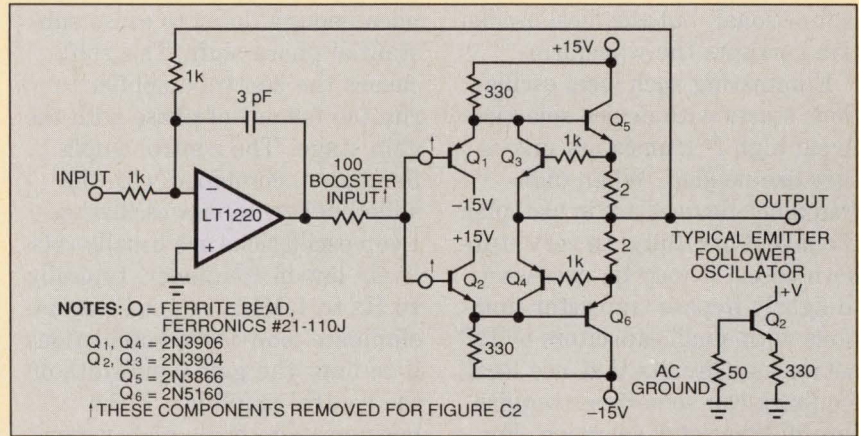

Fig A—In this booster circuit, the 100Ω resistor and the ferrite beads at the inputs of Q₁ and Q₂ play a critical role in maintaining stability.

instabilities. The oscillations are usually relatively high in frequency, typically in the 0.5- to 100-MHz range. Usually, local booster-stage oscillations do not cause loop disruption. The major loop continues to function, but contains artifacts of the local oscillation.

Fig A furnishes an instructive example. The Q₁ and Q₂ emitter-follower pair has a reasonably high f_T . These devices will oscillate if driven from a low-impedance source (Refs 1 and 2). To prevent problems, the 100Ω resistor and the ferrite beads are included to make the op amp's output look like a higher impedance. Q₅ and Q₆, also emitter followers, have an even higher f_T , but 330Ω sources drive them, eliminating the oscillation problem. The **Fig B** photo shows the

action of the **Fig A** circuit without the 100Ω resistor and the ferrite beads. Trace A is the input, and Trace B is the output. The resultant high-frequency oscillation is typical of locally caused disturbances. Note that the major loop

Text continued on pg 138

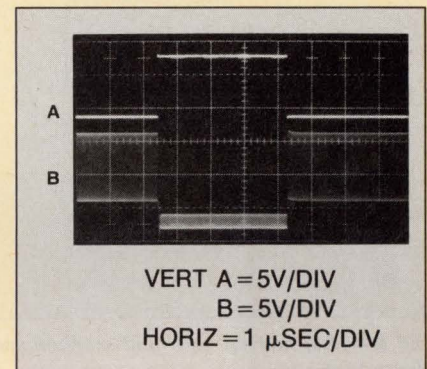

Fig B—Removing the 100Ω resistor and the ferrite beads from the **Fig A** circuit results in local oscillations, such as those shown here.

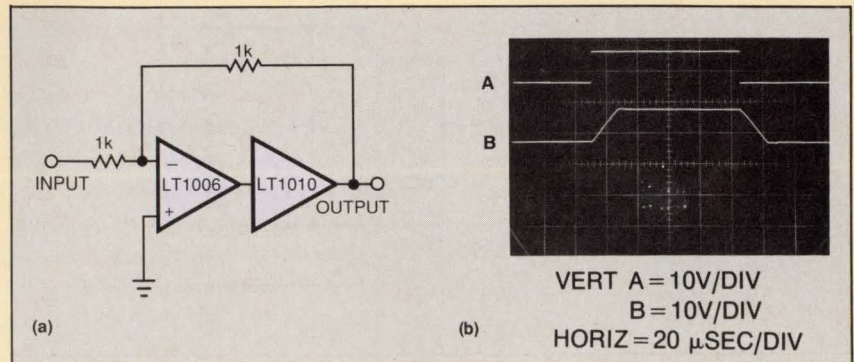

Fig C—This slow op amp and medium-speed booster (a) produced the stable output shown in b.

The oscillation problem and frequency compensation (continued)

is functional, but the local oscillation corrupts the waveform.

Eliminating such local oscillations starts with device selection. Avoid high f_T transistors unless they are needed. When high-frequency devices are in use, plan the layout carefully. In very stubborn cases, it may be necessary to lightly bypass transistor junctions with small capacitors or RC networks. Circuits that use local feedback can sometimes require careful transistor selection. For example, transistors operating in a local loop may require different f_T s to achieve stability. Emitter followers are notorious sources of oscillation, and should never be directly driven from low-impedance sources.

Loop oscillations are caused when the added gain stage sup-

plies enough delay to cause substantial phase shift. This shift causes the control amplifier to run too far out of phase with the gain stage. The control amplifier's gain, combined with the added delay, causes oscillation. Loop oscillations are usually relatively low in frequency, typically 10 Hz to 1 MHz. A good way to eliminate loop-caused oscillations is to limit the gain-bandwidth of the control amplifier. If the booster stage has a higher gain-bandwidth than the control amplifier, its phase delay is easily accommodated in the loop. When the control amplifier's gain-bandwidth dominates, oscillation is ensured. Under these conditions, the control amplifier hopelessly tries to servo-control a feedback signal that consistently arrives

too late, and the oscillation centers around the ideal servo point.

Frequency response roll-off of the control amplifier will almost always cure loop oscillations. In many situations, it is preferable to brutally force the compensation using large capacitors in the major feedback loop. As a general rule, it is wise to stabilize the loop by rolling-off the control amplifier's gain-bandwidth. The feedback capacitor serves to trim only the step response; do not rely on it to stop outright oscillation.

Fig C illustrates these issues. The LT1006 amplifier used with the LT1010 current buffer produces the output shown in Fig Cb. As before, trace A is the input, and trace B is the output. The LT1006 has less than 1-MHz gain-bandwidth. The LT1010's 20-MHz gain-bandwidth introduces negligible loop delay, and dynamics are clean. In this case, the LT1006's internal roll-off is well below that of the output stage, and stability is achieved with no external compensation components. Fig Da uses the LT1223, which has a 100-MHz bandwidth, as the control amplifier. Fig Db shows the results. Here, the control amplifier's roll-off is well beyond the output stages, causing problems. The phase shift through the LT1010

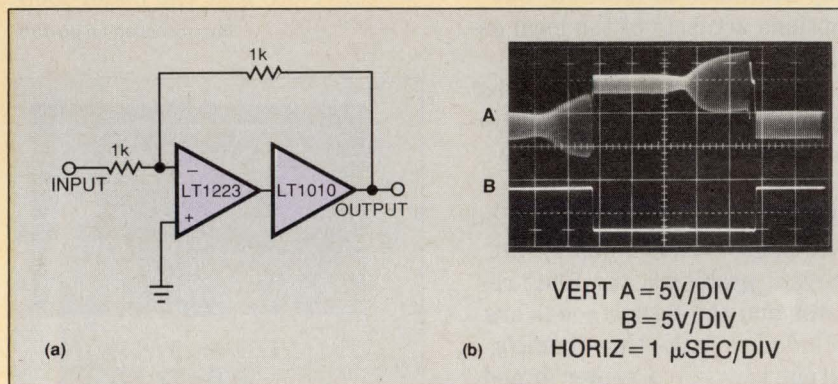

Fig D—This fast op amp and medium-speed booster (a) produced the oscillations shown in b.

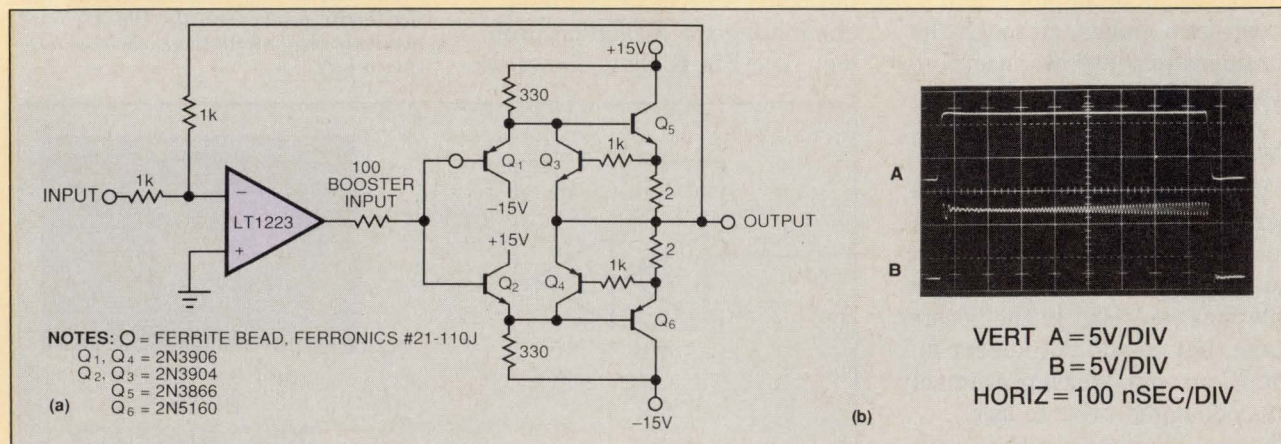

Fig E—The fast amplifier and fast booster combination in a attempts to correct the problems in the Fig Da circuit. Although the result is an improvement, the 100-MHz oscillation indicates that the booster stage is still too slow for the op amp b.

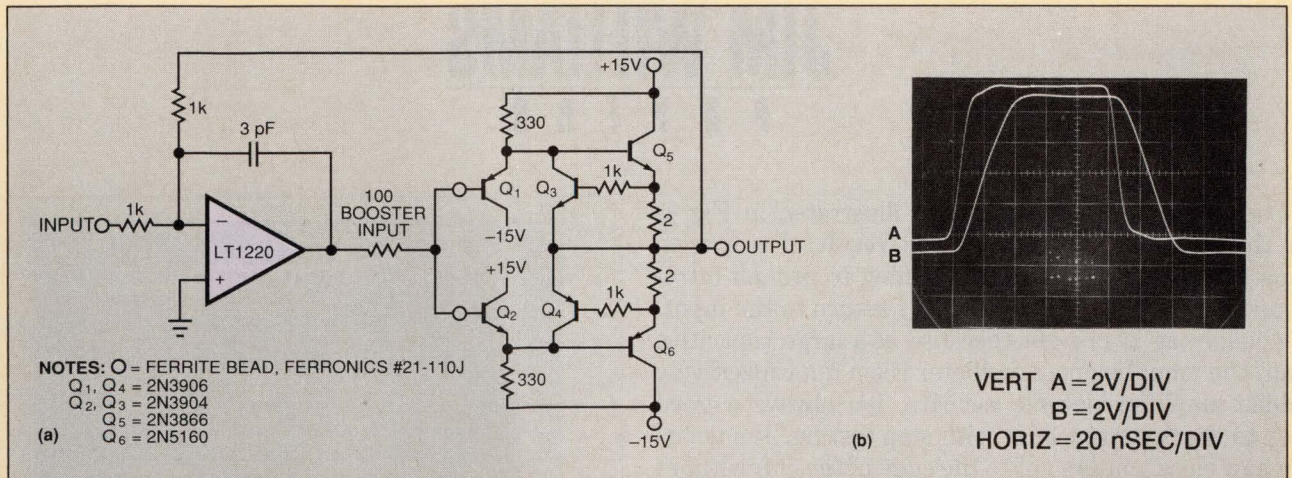

Fig F—This circuit (a) produces more pleasing results than Fig Ea's circuit. The 45-MHz LT1220 replaces the 100-MHz LT1223. The slower amplifier now works well with the booster stage in its loop. The circuit is well controlled, with no sign of oscillation (b).

is now appreciable and oscillations occur. Stabilizing this circuit requires degenerating the control amplifier's gain-bandwidth.

The fact that the slower op-amp circuit doesn't oscillate is a key to understanding how to compensate booster loops. With the slow device, compensation is free. The faster amplifier requires roll-off components for stability. Practically, the LT1223's speed is simply too fast for the LT1010. A somewhat slower amplifier is the way to go. Alternatively, you could use a faster booster. The circuit of Fig Ea attempts using this faster booster, but doesn't quite make it. Although the result (Fig Eb) is less corrupted than before, the 100-MHz oscillation indicates that the booster stage is still too slow for the LT1223.

Nearly identical to Fig Ea, the Fig Fa circuit produces more pleasant results. Here, the 45-MHz LT1220 replaces the 100-MHz LT1223. The slower amplifier, combined with minimum (3 pF) local compensation, works well with the booster stage in its loop. The result (Fig Fb) is a high-speed output that is well controlled, with no sign of oscillations.

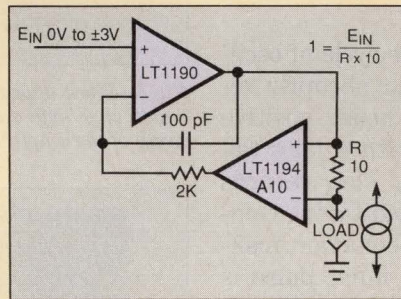

Fig G—This current source uses a 40-MHz LT1194 with a gain of 10 and a 50-MHz LT1190. The 100-pF feedback capacitor ensures a fast, stable loop.

Power boosters are not the only things you can place within an amplifier's feedback loop. The Fig G current source is an interesting variation. There is no power booster in the loop, but rather a 40-MHz differential amplifier with a gain of 10. For stability, the circuit uses the 50-MHz LT1190. The local 100-pF feedback slows it down a bit more, and the loop is fast and stable. What happens if you remove the 100-pF feedback path? Fig H shows that the loop is no longer stable, because the LT1190 control amplifier cannot servo-control the phase-shifted feedback at the higher frequency. So, put that 100-pF capacitor back in.

Even if you broke the output-input connection between the LT1190 and the LT1194 and in-

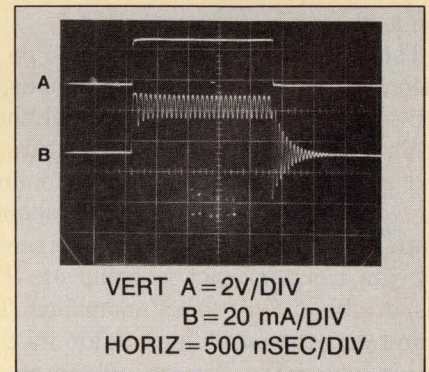

Fig H—Removing the 100-pF feedback capacitor from the Fig G circuit subjects the op amp to phase-shifted feedback, causing the oscillation shown here. Put that capacitor back in.

serted a booster stage, the circuit would still be stable—if you retained the 100-pF feedback capacitor. This tells us that the control amplifier doesn't care what generates the causal feedback between its input and output, as long as there isn't excessive delay.

When compensating loops like these, remember to investigate the effects of various loads and operating conditions. Sometimes a compensation scheme that appears to be proper gives bad results for some conditions. For this reason, check the completed circuit over as wide a variety of operating conditions as possible.

THE
JIM WILLIAMS
P A P E R S

Oscillation is also the problem illustrated in Fig 4. In this case, the oscillation is a result of excessive capacitive loading. Capacitive loading to ground introduces a lag in the feedback signal's return to the input. If enough lag is present (because of a large capacitive load) the amplifier may oscillate. Even if a capacitively loaded amplifier doesn't oscillate, it's always a good idea to check its response with step testing. It's amazing how close you can get to the edge of the cliff without falling off, except when you build 10,000 production units. Avoid capacitive loading. If such loading is necessary, check performance margins, and isolate or buffer the load.

The Fig 5 waveform appears to be one cycle of oscillation. The output initially responds, but abruptly reverses direction, overshoots, and then heads positive again. Some overshoot again occurs, with a long tail and a small dip well before a nonlinear slew returns the waveform to zero. Ugly overshoot and tailing complete the cycle. This is certainly strange behavior, making you wonder what is going on. The input pulse is responsible for all these anomalies. The pulse's amplitude takes the amplifier outside its common-mode limits, inducing the bizarre effects shown. Keep inputs within the specified common-mode limits at all times.

Fig 6 shows an oscillation-laden output (trace B) trying to unity-gain invert the input (trace A). The input's form is distinguishable in the output, but corrupted with very high-frequency oscillation and overshoot. In this case, the amplifier includes a booster within its loop to provide increased output current. The disturbances noted are traceable to local instabili-

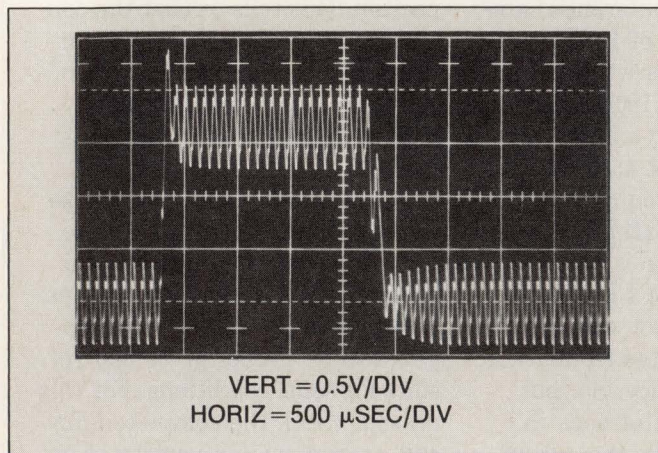

Fig 4—The oscillation shown here is the result of excessive capacitive loading, which causes a lag in the feedback to the input of the amplifier.

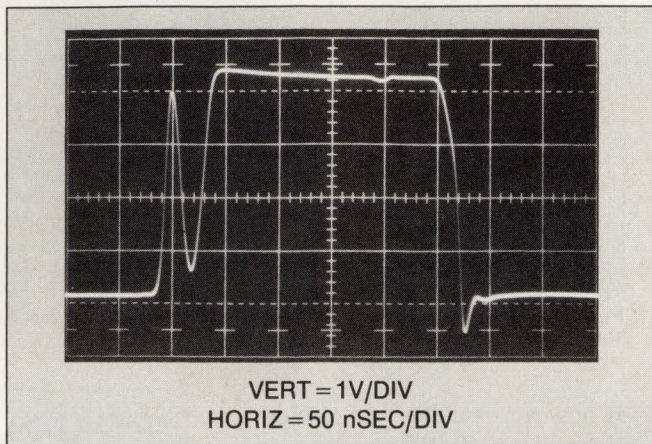

Fig 5—What appears to be one cycle of oscillation is actually the result of a high-amplitude pulse that exceeds the common-mode range of the amplifier.

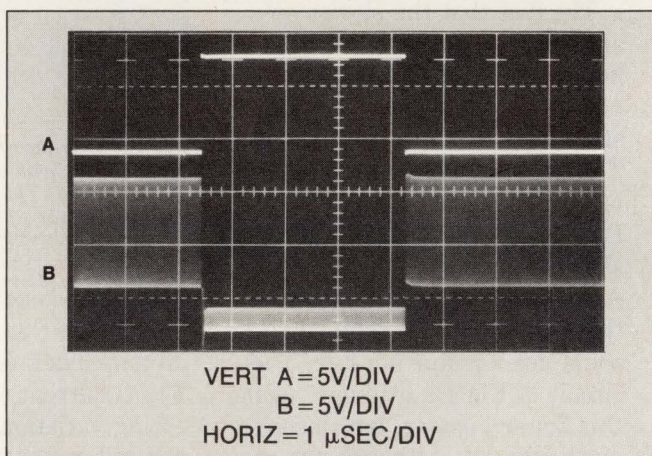

Fig 6—Local oscillation in a booster stage produced this result. Wideband booster stages are prone to high-frequency parasitic oscillation.

ties within the booster circuit. When using output booster stages, make sure they are inherently stable before placing them inside an amplifier's feedback loop. Wideband booster stages are particularly prone to device-level parasitic, high-frequency oscillation.

The booster-augmented, unity-gain inverting op amp in Fig 7 also oscillates, but at a much lower frequency. Overshoot and nonlinear recovery dominate the waveform's envelope. Unlike the previous example, this behavior is not caused by local oscillations within the booster stage. Instead, the booster is simply too slow for the op-amp's feedback loop. The booster introduces enough lag to force oscillation, even as it hopelessly tries to maintain loop closure. Make sure that booster

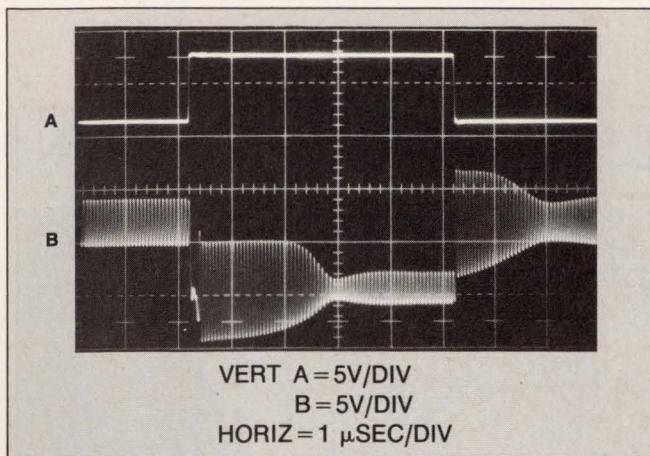

Fig 7—Loop oscillation in a booster stage produced this result. Note the lower frequency of oscillation compared with the local oscillation shown in **Fig 6**.

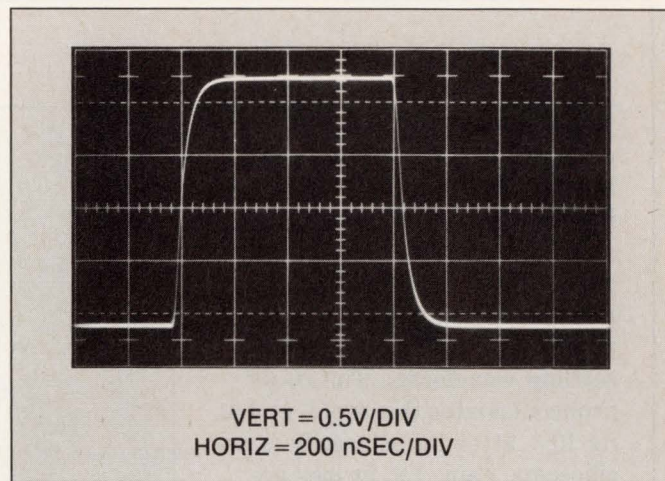

Fig 8—Excessive source impedance produced this serene—but undesired—result.

stages are fast enough to maintain stability when placed in the amplifier's feedback loop.

The serene rise and fall of the **Fig 8** trace's pulse is a welcome relief from the oscillatory screaming of the previous examples. Unfortunately, such tranquilized behavior is simply too slow. This waveform is the result of excessive source impedance. The high impedance combines with the amplifier's input capacitance to band-limit the input, and the output reflects this action. Reduce the source impedance to a level that maintains the desired bandwidth, and minimize stray input capacitance. **EDN**

References

1. Chessman, M and N Sokol, "Prevent Emitter-Follower Oscillation," *Electronic Design*, June 21, 1976, pg 110.
2. DeBella, G B, "Stability of Capacitively-Loaded Emitter Followers—a Simplified Approach," *Hewlett-Packard Journal* 17, April 1966, pg 15.
3. Addis, John, "Vertical Amplifiers and Engineering," *Analog Circuit Design; Art, Science and Personalities*, Butterworths, 1991.
4. Williams, Jim, "Methods for Measuring Op-Amp Settling Time," *Linear Technology Corporation, Application Note 10*, July 1985.

Acronyms used in this article

ac—Alternating current
DAC—Digital-to-analog converter
FET—Field-effect transistor
UHF—Ultrahigh frequency

5. Tektronix, Inc, "Type 1S1 Sampling Plug-In Operating and Service Manual," *Tektronix, Inc*, 1965.
6. Mulvey, J, "Sampling Oscilloscope Circuits," *Tektronix, Inc, Concept Series*. 1970.
7. Addis, John, "Sampling Oscilloscopes," *Private Communication*, February, 1991.
8. Harvey, Barry, "Take the Guesswork Out of Settling-Time Measurements," *EDN*, September 19, 1985, pg 177.

Author's biography

For more information on this article's author, turn to page 163 in the October 10, 1991, issue.

Article Interest Quotient (Circle One)
 High 497 Medium 498 Low 499

Measuring amplifier settling time

High-resolution measurement of an amplifier's settling time is often necessary. Frequently, a DAC drives the amplifier. Of particular importance is the time required for the DAC-amplifier combination to settle to its final value after an input step. This specification lets you set a circuit's timing margins with confidence that the data produced is accurate. The settling time is the

total length of time from the input-step application until the amplifier's output remains within a specified error-band around the final value.

Fig A shows one way to measure DAC-amplifier settling time. The circuit uses the false-sum-node technique. The resistors and amplifier form a summing network. The amplifier output will step positive when the DAC

moves. During amplifier slewing, the diodes limit the voltage excursion at the oscilloscope probe. The summing node is arranged so that, when settling occurs, the oscilloscope probe voltage should be zero. Note that the resistor divider's attenuation means the probe's output will be one-half the actual settled voltage.

In theory, the **Fig A** circuit lets

Text continued on pg 142

you observe settling to small amplitudes. In practice, you can't rely on this circuit to produce useful measurements. Several flaws exist, including the oscilloscope connection. As probe capacitance rises, ac loading of the resistor junction will influence observed settling waveforms. The 20-pF probe alleviates this problem, but its 10× attenuation sacrifices oscilloscope gain. 1× probes are not suitable because of their excessive input capacitance. An active 1× FET probe might work, but another issue remains.

The clamp diodes at the probe point are intended to reduce swing during amplifier slewing, preventing excessive oscilloscope overdrive. Unfortunately, oscilloscope overdrive-recovery charac-

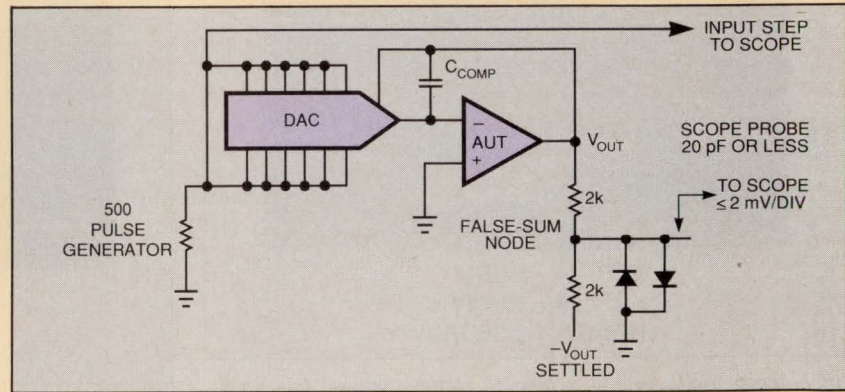

Fig A—Using the false-sum-node technique, this circuit has limitations in its ability to measure DAC-amplifier settling time.

teristics vary among different types and are not usually specified. The 600-mV drop across the diodes means the oscilloscope may see an unacceptable overload, bringing displayed results into question. With the oscillo-

scope set at 1-mV per division, the diode voltage allows a 600:1 overdrive. Schottky diodes can cut this in half, but this is still much more than any real-time vertical amplifier can accommodate (Ref 3). The oscilloscope's

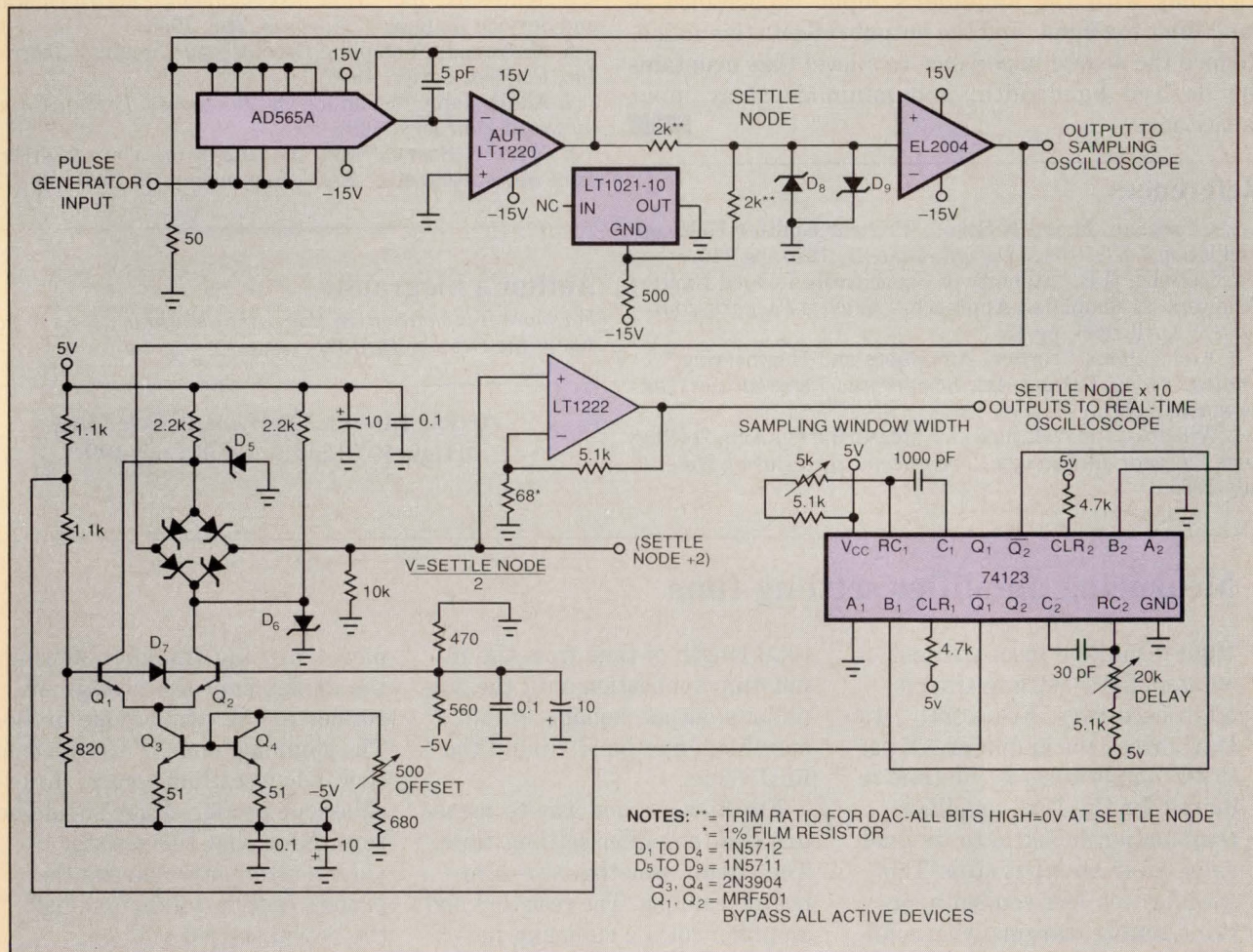

Fig B—This settling-time test circuit uses a sampling bridge to eliminate the oscilloscope overdrive problem of the previous circuit.

overload recovery will completely dominate the observed waveform, and all measurements will be meaningless.

One way to achieve reliable settling-time measurements is to clip the incoming waveform in time, as well as amplitude. If you prevent the oscilloscope from seeing the waveform until settling is nearly complete, you can avoid overload problems. Doing this requires placing a switch at the settle circuit's output and controlling it with an input-triggered, variable delay. FET switches are not suitable because of their gate-source capacitance. This capacitance lets gate-drive artifacts corrupt the oscilloscope display, producing confusing readings. In the worst case, gate-drive transients

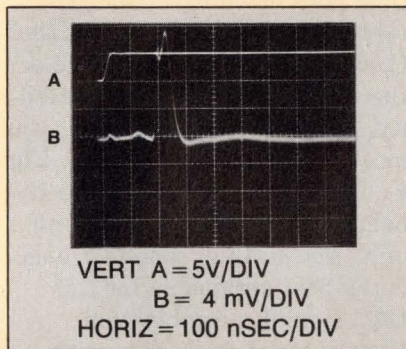

Fig C—The 280-nsec settling time shown here was measured using the Fig B circuit. The sampling switch closes just before the third vertical division, which lets you observe the settling detail without overdriving the oscilloscope.

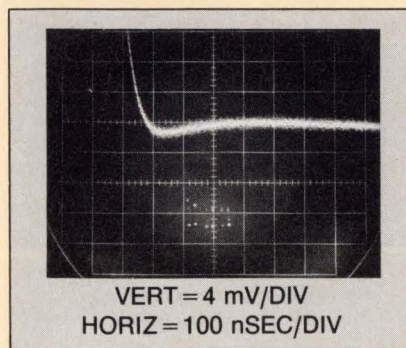

Fig D—This 280-nsec settling-time measurement was obtained using a sampling scope at Fig B's sampling-scope output. The settling time and waveform is identical to that of Fig C.

will be large enough to induce overload, defeating the switch's purpose.

Fig B shows a way to implement a switch that largely eliminates these problems. This circuit lets you observe settling within 1 mV. The Schottky sampling bridge is the actual switch. The bridge's inherent balance, combined with matched diodes and very high-speed complementary bridge switching, yields a clean, switched output. An output-buffer stage unloads the settle node and drives the diode bridge.

The operation of the DAC-amplifier is as before. The additional circuitry provides the delayed switching function, eliminating oscilloscope overdrive. Buffering the settle node and driving the Schottky bridge is the EL2004, a unity-gain broadband FET-input buffer that has a 3-pF input capacitance and a 350-MHz bandwidth. The pulse generator's output fires the 74123 1-shot circuit. The arrangement of the 74123 produces a delayed pulse whose width sets the on-time of the diode bridge. The 20-k Ω potentiometer controls the pulse delay; the 5-k Ω potentiometer controls the pulse width. If you set the delay appropriately, the scope will not see any input until settling is nearly complete, eliminating overdrive. You adjust the width of the sample window so that all remaining settling activity is observable. In this way, the oscilloscope's output is reliable, and you can take meaningful data. Q_1 through Q_4 shift the level of the 1-shot's output, providing complementary switching drive to the bridge. The actual switching transistors, Q_1 and Q_2 , are UHF types, permitting true differential bridge-switching with less than 1 nsec of time skew (Ref 4).

Using an oscilloscope having adequate sensitivity, you can observe the output of the bridge di-

rectly or you can look at the output of the LT1222, which provides a 10 \times amplified version. A third output, taken directly from the EL2004, is also available. This output, which bypasses the entire switching circuitry, provides a monitoring point for a sampling oscilloscope. Because of their operating nature, sampling oscilloscopes are inherently immune to overload (Refs 5, 6, and 7). A good test of this settling-time test fixture (and the above statement) is to compare the signals displayed by the sampling scope and the Schottky-bridge-aided real-time scope.

As an additional test, you can employ a completely different (albeit considerably more complex) method of measuring settling time, described by Barry Harvey (Ref 8). All three approaches represent good measurement techniques, and if you use proper construction, the results should be identical. That is, the data produced by the three methods has a high probability of being valid.

Figs C, D, and E illustrate settling time details of an AD565A DAC and an LT1220 op amp. The photos represent the sampling bridge, sampling scope, and "Harvey" methods, respectively. Photos **Figs C** and **E** display the input step for convenience in ascertaining the elapsed time. Photo **Fig D**, taken with a single-trace sampling oscilloscope (Tektronix 1S1 with a P6032 cathode-follower probe in a 556 mainframe), uses the left-most vertical graticule line as its zero-time reference. All methods agree on a 280-nsec settling time to 0.01% (1 mV on a 10V step). Note that Harvey's method inherently adds 30 nsec, which you must subtract from the displayed 310-nsec to get the real number. Note also that the shape of the settling waveform—in every detail—is

Text continued on pg 144

Measuring amplifier settling time (continued)

identical in all three photographs. This kind of agreement provides a high degree of credibility for the measured results.

Some poorly designed amplifiers exhibit a substantial "thermal tail" after responding to an input step. This phenomenon, caused by die heating, can cause the output to wander outside desired limits long after settling has apparently occurred. After checking the settling at high speed, it is always a good idea to slow down the oscilloscope sweep and look for thermal tails. Often, you can accentuate the thermal tail's effect by loading the amplifier's output. Such a tail can make an amplifier appear to have settled in a much shorter time than it actually has.

Select the feedback capacitor

To get the best possible settling time from any amplifier, you should choose the feedback capacitor, C_F , carefully. The purpose of C_F is to roll off the amplifier gain at the frequency that permits the best dynamic response. The optimum value for C_F will depend on the feedback resistor's value and the characteristics of the source. DACs are one of the most common sources and also one of the most difficult. Usually, you must convert a

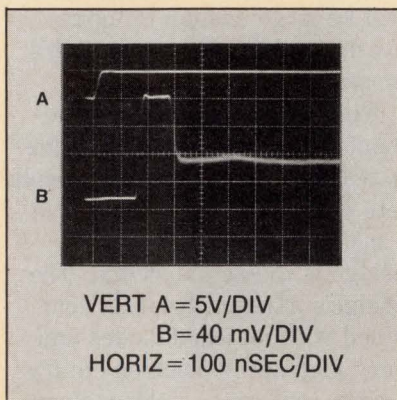

Fig E—Harvey's method was used to obtain this 280-nsec settling-time measurement. After subtracting this method's inherent 30-nsec delay, the settling time and waveform are identical to that of Figs C and D.

DAC's current output to a voltage. Although an op amp can easily do this, care is required to obtain good dynamic performance. A fast DAC can settle to 0.01% in 200 nsec or less, but its output also includes a parasitic capacitance term, making the amplifier's job more difficult. Normally, the circuit unloads the DAC's current output directly into the amplifier's summing junction, placing the parasitic capacitance from ground to the amplifier's input. The capacitance introduces feedback phase-shift at high frequencies, forcing the amplifier to hunt and ring about the final value before settling.

Different DACs have different values of output capacitance. CMOS DACs have the highest output capacitance, which varies with code. Bipolar DACs typically have 20- to 30-pF of capacitance, which is stable over all codes. Because of their output capacitance, DACs furnish an instructive example in amplifier compensation.

Fig Fa shows the response of an industry-standard DAC-80 type and a relatively slow op amp. Trace A is the input, and traces B and C are the amplifier and settle outputs, respectively. In this example, there is no feedback capacitor (C_F), and the amplifier rings badly before settling. In **Fig Fb**, an 82-pF unit stops the ringing and settling time goes down to 4 μ sec. The overdamped response means that C_F dominates the capacitance at the AUT's input, assuring stability. For the fastest response, you must reduce the value of C_F . **Fig Fc** shows the critically damped behavior obtained with a 22-pF unit. The settling time of 2 μ sec is the best obtainable for this DAC-amplifier combination. Higher speed is possible with faster amplifiers and DACs, but the compensation issues remain the same.

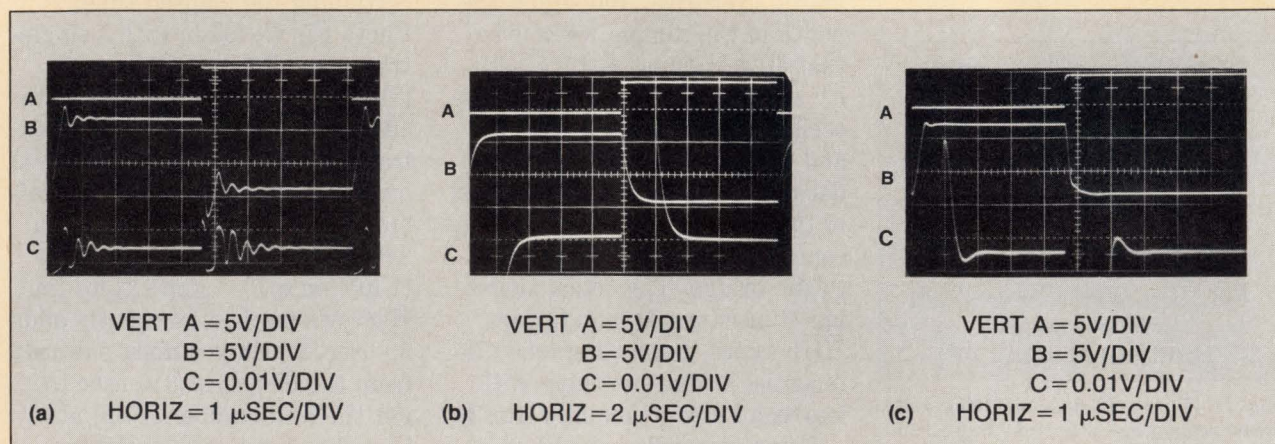
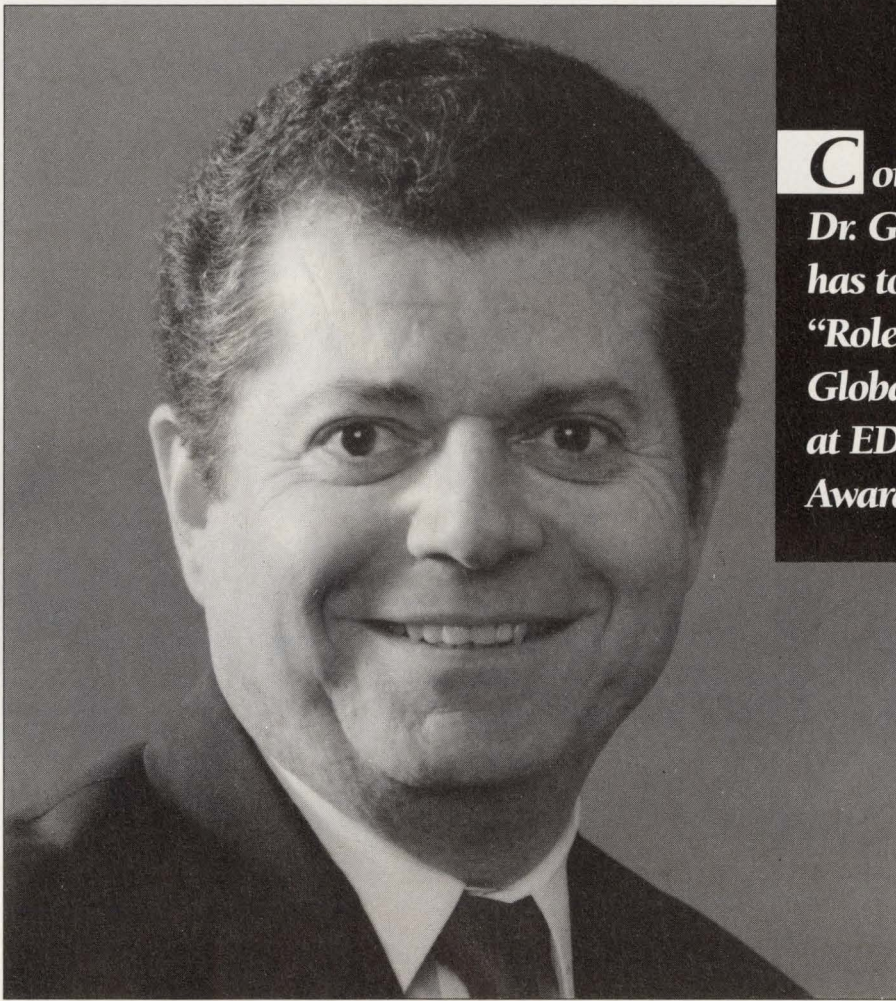

Fig F—These three scope traces show the effects of different values of feedback capacitors on DAC-amplifier combinations. The values for the three photos are no capacitance (a), 82 pF (b), and 22 pF (c).



Come hear what
Dr. Gilbert Amelio
has to say on the
“**Role of Innovation in**
Global Competition”
at **EDN’s Innovation**
Awards Banquet.

Dr. Gilbert F. Amelio,
President and Chief Executive Officer
of National Semiconductor Corporation.



Dr. Gilbert Amelio, President and CEO of National Semiconductor Corporation, will be the keynote speaker at EDN’s Second Annual “Innovation and Innovator of the Year Awards” Banquet on November 19 during Wescon in San Francisco. EDN’s Innovation program recognizes the year’s most innovative products and innovative engineer or engineering team in the electronics industry. Dr. Amelio will speak on the “Role of Innovation in Global Competition.” Dr. Amelio holds 16 patents and is credited with being the co-inventor of the industry’s first charge-coupled image sensor. These devices are used in most consumer video cameras today.

Come hear what the leader of one of the world’s largest semiconductor corporations has to say about innovation. Support these innovative people and products awarded EDN’s 1991 “Innovation and Innovator of the Year Awards.”

To receive a reservation form for the industry event of the year, fax Pam Winch at (617) 558-4470.

EDN Magazine
Edition
News
Edition

'040

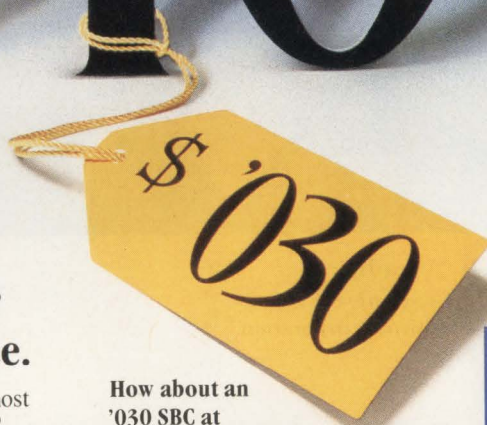

Synergy brings you the power of an '040 SBC at an '030 price.

It's true. For only \$2865*—less than the cost of most '030 boards—you can have a *full-featured* '040 SBC that gives your VME system vastly superior performance.

Synergy's new VME Workhorse VW40 is hardly a stripped-down SBC. There's SCSI and Ethernet on-board with 4 Mbytes of DRAM (2, 8 or 16 MB optional). There's a new multi-channel, intelligent DMA controller that handles both I/O *and* VME transfers—all concurrent with normal '040 operations.

Best of all, there's your choice of over a dozen EZ-bus modules with intelligent I/O—fully compatible with Synergy's entire line of '020, '030 and '040 SBCs. Compare that with any other manufacturer!



How about an '030 SBC at an '020 price?

Our new VW30 SBC can plug '030 power and capability into your '020-based system, and at \$1595* we'll keep your system price competitive.

Just call us and you'll appreciate Synergy's customer support: Application engineers that know VME. Custom I/O designs. Unbeatable documentation. Along with the very best price/performance in VME.

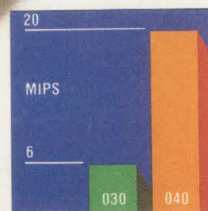

The '040 has 3× the performance of the '030: 20 vs 6 MIPS at 25 MHz.

*Price for qty. 100

 **SYNERGY**
microsystems

Synergy Microsystems, Inc.
179 Calle Magdalena, Encinitas, CA 92024
(619) 753-2191 FAX: 619-753-0903

Power Revelation



Our Westcor division's family of configurable AC or DC input fan cooled StakPAC switchers reveals a new world of power density and output flexibility to the system designer...whatever your power needs. Each StakPAC is built with field proven robotically manufactured Vicor VI-200 Series power components providing you the flexibility of a customized supply combined with the off-the-shelf availability of standard catalog products..."first article" StakPACS are typically delivered in 2 weeks.

Compact, up to 6W/in³, low profile StakPACs set the standard for "box" or open frame switchers. Besides meeting conducted EMI standards, custom configured StakPACs are pre-approved to UL, CSA, TÜV and VDE safety standards (DC Mini- in process).



MODEL	POWER	OUTPUTS	INPUT	DIMENSIONS (inches)
StakPAC	1,200W	up to 8	110/220 VAC	3.2 x 5.5 x 11.5
MINI	600W	up to 5	110/220 VAC	1.9 x 5.5 x 12.2
DC MINI	800W	up to 5	5 Ranges 18-76 VDC	2.5 x 4.3 x 12.2



Whether your application is OFF-LINE or DC INPUT, chances are we have a solution for you...we are designed into computer, telecom, and test measurement systems worldwide. Please call us to discuss your needs, then relax...bulky standards and risky long lead-time custom supplies belong to the past. Discover the new world of configurable supplies: StakPAC, MiniStakPAC and DC Mini.

Call VICOR EXPRESS for information and be sure to ask for a StakPAC or DC Mini Handbook: (800) 735-6200 or (508) 470-2900 at ext. 265. Or call Westcor (west coast) at (408) 395-7050.



Component Solutions For Your Power System

Call now for
a free 85C060/090
sample kit 1-800-548-4725.

A question for designers who aren't yet using high-performance μ PLDs.

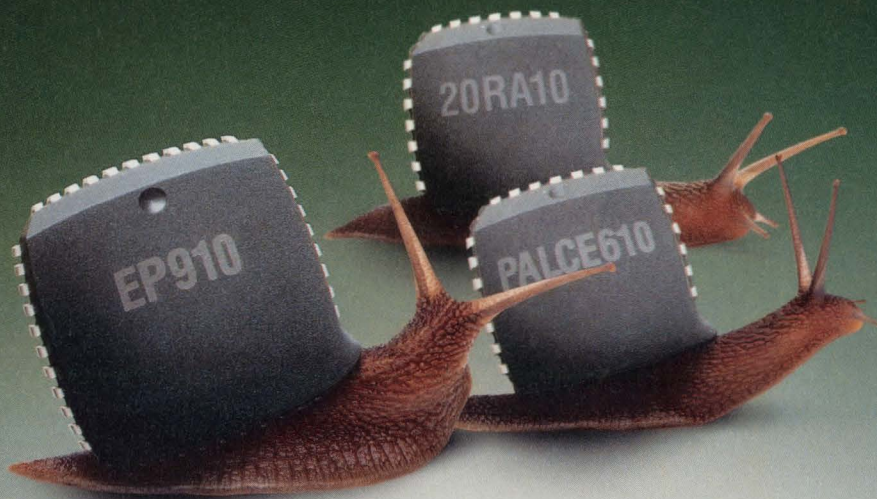

Why the big delay?

Ever feel like your system designs aren't quite up to speed, so to speak? It's probably not your fault. Because PLDs have typically forced designers to sacrifice performance to achieve higher integration.

But not any more.

Now, with Intel's μ PLD family of programmable logic devices, you can finally achieve the higher integration you need—with the low total propagation delay you want.

In fact, with t_{PD} figures as low as 10ns, Intel's 16-macrocell 85C060

and 24-macrocell 85C090 are, without question, the fastest integrated PLDs in the industry.

So what are you waiting for? Call (800) 548-4725 and ask for Literature Packet #IA81.

We'll send you everything you need to know about how to improve system performance. Without delay.

PLD Performance	
PLD	t_{PD}^*
Intel 85C060	10ns
PALCE610	15ns
20RA10	15ns
EP610	16ns
Intel 85C090	15ns
EP910	33ns

*Propagation Delay

©1991 Intel Corporation. All product names are trademarks of their respective owners.

intel
The Computer Inside.™

High-speed amplifiers with low offset and drift

Amplifiers designed for wide bandwidth or fast settling often exhibit inferior characteristics at dc—that is, high voltage, current offset, and drift. Used with care, the techniques described here let you build circuits that exhibit exemplary performance from dc to MHz.

Jim Williams, *Linear Technology Corp*

Often, you must produce an amplifier circuit that has both the low offset of a dc amplifier and the wide bandwidth of a fast device. A number of techniques let you achieve such a result. Which method is best depends heavily on your application. Several circuits follow that you can study, build, and compare to determine what's best for you.

Fig 1 shows a composite amplifier that consists of an LT1097 low-drift device (IC_1) and an LT1191 high-speed amplifier (IC_2). The overall circuit is a unity-gain inverter that has its summing node at the junction of the two 1-k Ω resistors. IC_1 monitors this summing node, compares it to ground, and drives IC_2 's positive input to complete a dc-stabilizing loop around IC_2 . The 100-k Ω -0.01- μ F time constant at IC_1 limits the amplifier's response to low-frequency signals. IC_2 handles

high-frequency inputs, whereas IC_1 stabilizes the dc operating point. The 4.7-k Ω /220 Ω divider at IC_2 's input prevents excessive overdrive during startup. This circuit combines IC_1 's 35- μ V offset and 1.5- μ V/ $^{\circ}$ C drift with IC_2 's 450V/ μ sec slew rate and 90-MHz bandwidth. Bias current, dominated by IC_2 , is about 500 nA.

Fig 2 is similar, except that the sensing is differential, preserving access to both of the fast amplifier's inputs. IC_1 measures the dc error at IC_2 's input terminals and biases IC_2 's offset pin to force the offset to within 50 μ V. IC_2 's offset-pin biasing arrangement always lets IC_1 find the servo point. The 0.01- μ F capacitor rolls off IC_1 's gain at low frequencies, and IC_2 han-

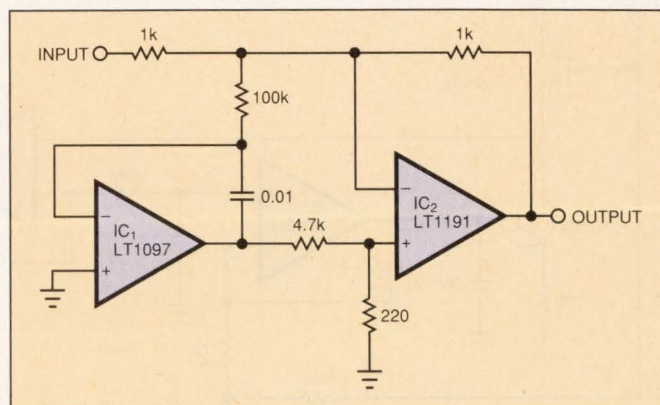

Fig 1—An integrator (IC_1) reduces the drift of a wideband amplifier (IC_2) by applying a signal to the wideband amplifier's noninverting input. That signal holds the wideband amplifier's summing junction at ground.

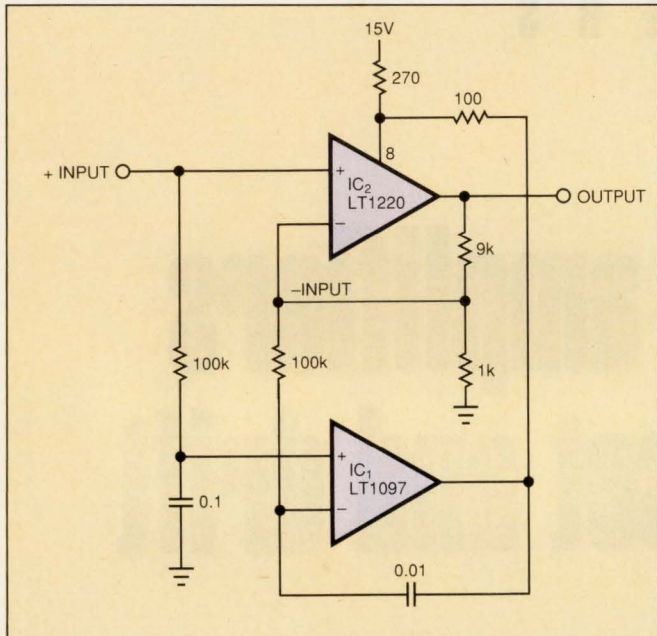

Fig 2—You can also stabilize the offset of a wideband amplifier (IC_2 , in this case) by using a precision dc amplifier (IC_1) to apply correcting signals to the wideband amplifier's offset-trim adjustment pin.

dles high-frequency signals. The combined characteristics of these amplifiers yield an offset voltage of 50 μV , an offset drift of 1 $\mu\text{V}/^\circ\text{C}$, a slew rate of 250 $\text{V}/\mu\text{sec}$, and a gain bandwidth of 45 MHz.

Fig 3 shows wideband, highly stable gain-of-10 amplifier with high input impedance. The input capacitance is about 3 pF. Because of its low input capacitance and low (100 pA) bias current, the circuit is well

suited for use in probing IC wafers or as a pin amplifier in automatic-test systems.

Q_1 and Q_2 constitute a simple, high-speed FET-input buffer. Q_1 functions as a source follower, and the Q_2 current-source load sets the drain-to-source channel current. IC_2 provides a gain of 10 with 100-MHz bandwidth. Normally, this open-loop configuration would drift unacceptably because there is no dc feedback. IC_1 , by comparing the filtered circuit output to a similarly filtered version of the input signal, provides the feedback to stabilize the circuit. The amplified difference between these signals sets Q_2 's bias—and hence Q_1 's channel current—thereby forcing Q_1 's V_{GS} to match the circuit's input and output potentials. The capacitor around IC_1 provides stable loop compensation. The R-C network in IC_1 's output prevents that output from seeing high-speed edges coupled through Q_2 's collector-base junction.

Fig 4a shows a way to combine wide bandwidth with true differential inputs and dc stabilization. IC_1 and IC_2 sense the input differentially at gains of 10. Wideband amplifier IC_1 feeds high-frequency signals to output amplifier IC_3 via a highpass network. Low-frequency and dc information get to IC_3 via the slower IC_2 . The 2-k Ω /200-pF lowpass networks remove the input signal's high-frequency components, so only lower frequencies reach IC_2 . Because the gain and bandwidth of the high- and low-frequency paths complement each other, IC_3 's output is an undistorted, amplified version of the input (see **Fig 4b**, trace D.)

Fig 4b, trace A is one side of a differential input signal applied to the circuit. Trace B is IC_1 's output

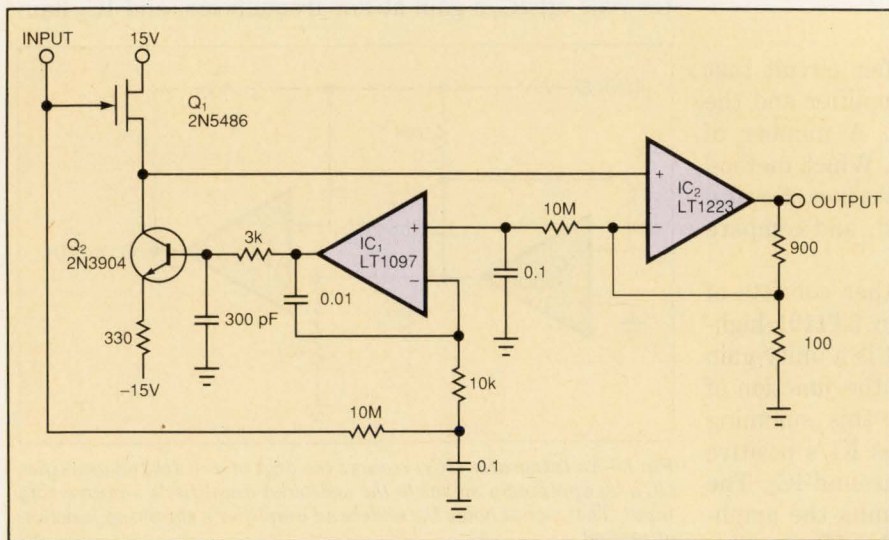

Fig 3—An integrator (IC_1) drives a current source (Q_2), which biases a FET (Q_1) that completes a dc feedback loop around IC_2 to stabilize the amplifier's operation at dc.

taken at the junction of the 500 Ω potentiometer and 0.001- μ F capacitor. Trace C is IC₂'s output. With the "ac-gain" and "dc-gain-match" trims properly adjusted, the two paths' contributions match up and trace D is clean, with no residual artifacts. You can optimize the adjustments by trimming the ac gain for the squarest corners and the dc-gain match for a flat top. Bandwidth for this circuit exceeds 35 MHz; slew rate is 450V/ μ sec; and dc offset is about 200 μ V.

Parallel paths yield the best of two worlds

Fig 5a shows a very powerful extension of the previous circuit. The circuits operate similarly, but this one has a gain of 1000; its bandwidth is about 35 MHz; its rise time is 7 nsec; and its delay is less than 7.5 nsec. Full-power response is available to 10 MHz, and broadband input noise is about 15 μ V. This kind of speed, coupled with true differential inputs, a gain of 1000, high dc stability, and low cost make the circuit broadly applicable in wideband instrumentation.

As before, two differential amplifiers, IC₁ and IC₂, simultaneously sense the inputs. In this case, IC₁ is a 592-733 type operating at a gain of 100. Its differential outputs feed output amplifier IC₃ via 1- μ F/1-k Ω high-pass networks that strip out the dc content of IC₁'s output. IC₂, a precision dc differential amplifier, operates in similar fashion to its counterpart in the previous circuit, supplying dc and low-frequency information to IC₃ at a trimmed gain of 100.

In this case, the output amplifier, IC₃, is not a follower but a differential-input/single-ended-output gain block whose nominal gain is 10. This change is necessary because IC₁'s differential output must become a single-ended signal to provide the circuit's final output. Consequently, IC₂ does not directly apply its low-frequency information to IC₃ as it did before. Instead, IC₄ measures the difference between IC₂'s output and a fraction of IC₃'s output. IC₄'s output, biasing IC₃'s positive input via the 1-k Ω resistor, closes a loop around the circuit's dc and low-frequency path. To make the circuit's dc gain equal to its ac gain, you adjust the divider that feeds IC₄'s negative input.

Fig 5b shows the circuit's response to a 60-nsec, 2.5-mV pulse, trace A. The $\times 1000$ output, trace B, responds cleanly, with both delay and rise time in the 5- to 7-nsec range. Some small amount of overshoot is evident, but you can trim the overshoot with the peaking adjustment at IC₁. Fig 5c plots the circuit's gain vs frequency. The gain is flat within 0.5 dB to 20 MHz, with the -3 dB point at 40 MHz. The overshoot of Fig 5b shows up here as a very slight gain increase starting around 1 MHz and continuing to about 15 MHz. The peaking adjustment eliminates this effect.

To use this circuit, apply a low-frequency or dc signal of known amplitude and adjust the low-frequency gain to $\times 1000$ after the output has settled. Next, adjust the high-frequency gain so that the signal's leading and trailing corners have amplitudes identical to those

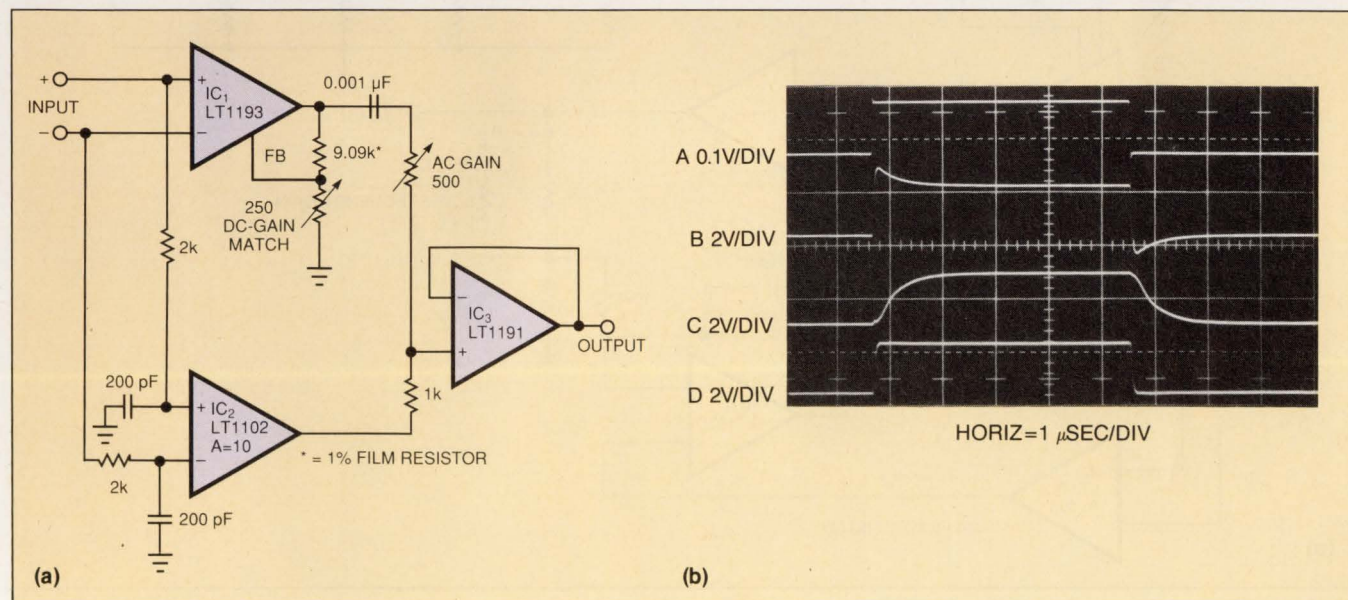

Fig 4—Parallel paths for ac and dc signals (a) provide low offset and good dynamic response—if you correctly adjust the trims (b, trace D).

THE JIM WILLIAMS P A P E R S

of the settled portion. Finally, trim the peaking adjustment for the best settling of the output pulse's corners.

Fig 5d shows the input (trace A) and output (trace B) waveforms with all adjustments properly set. The fidelity is excellent, with no aberrations or other artifacts of the parallel-path operation evident. **Fig 5e** shows the effects of too much ac gain; excessive peaking on the edges, with proper amplitude achieved only after the dc channel takes control of the output. Similarly, excessive dc gain produces **Fig 5f's** traces. The ac-gain path provides proper initial response, but too

much dc gain forces a long, tailing response that finally settles at an incorrect amplitude.

The use of parallel-path schemes to simultaneously achieve wide bandwidth and outstanding dc performance isn't new. In fact, it predates the use of low-drift bipolar differential gain stages. The first parallel-path amplifiers achieved dc stability by using electromechanical choppers to convert dc to ac. Gain stages consisting first of vacuum tubes and later of Germanium transistors amplified the chopped dc. Synchronous rectifiers converted the ac back to dc. AC-coupled amplifi-

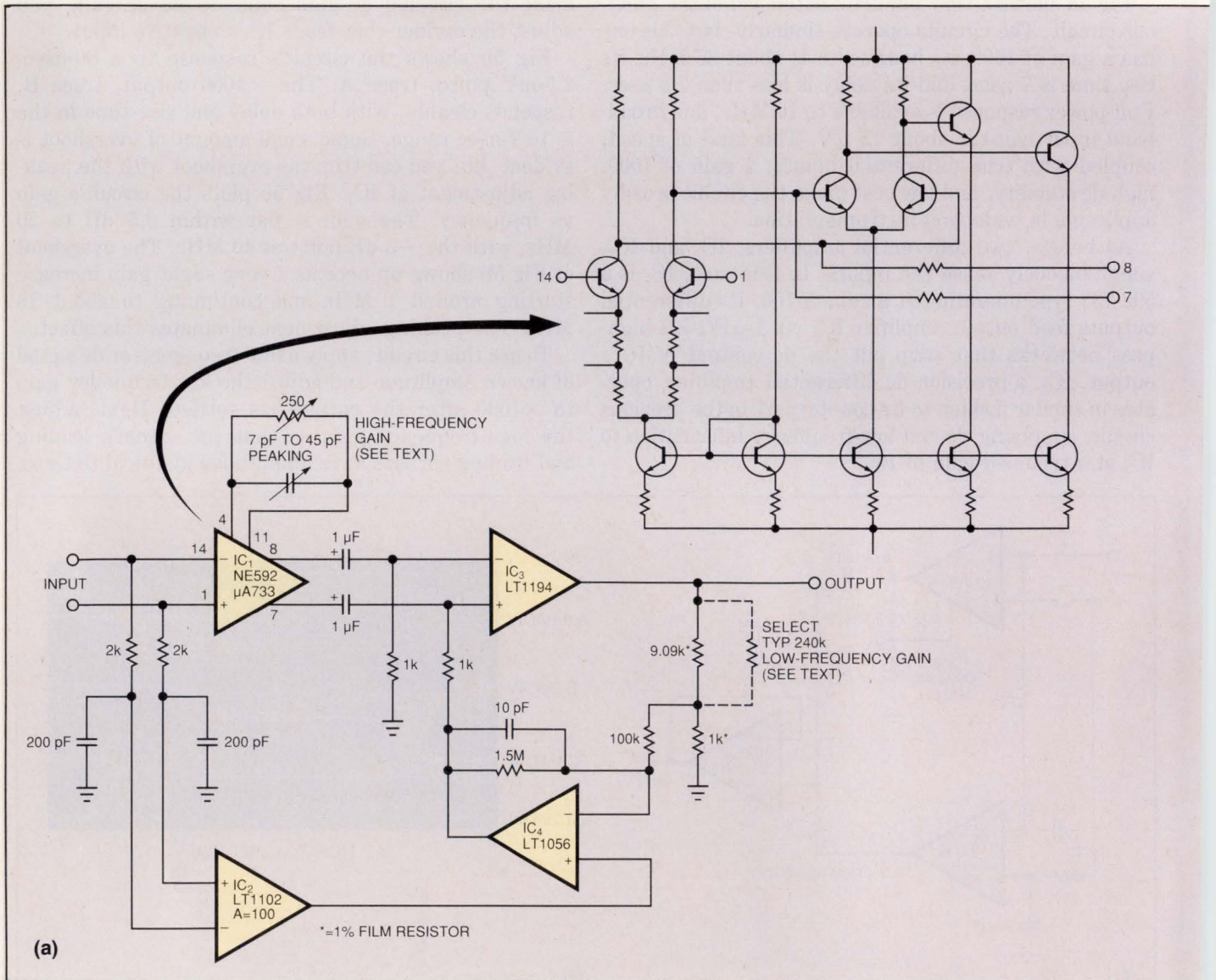

Fig 5—A differential-to-single-ended gain of 1000 with 38-MHz bandwidth and excellent dc characteristics results from extending the parallel-path architecture, (a). The pulse response (b, trace B) shows a minimum of overshoot, which is reflected in the frequency response

ers in parallel with the chopper amplifiers provided good bandwidth. As **Figs 5e** and **5f** illustrate, these schemes have historically had a problem in many applications that demand the best at both dc and high frequencies: Unless you carefully match the dc and ac gains, the amplifiers' response to an input voltage step exhibits a long "tail." Keeping the response free of such tails over wide temperature ranges and long periods of time has always presented a challenge. Modern components make meeting that challenge easier, but the challenge still exists. **EDN**

Author's biography

For more information on this article's author, turn to page 163 in the October 10, 1991, issue.

Article Interest Quotient (Circle One)
High 473 Medium 474 Low 475

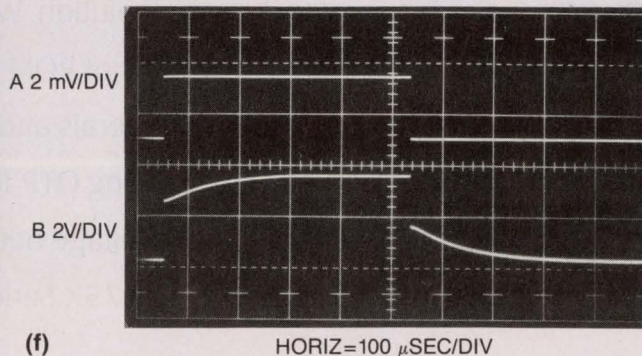
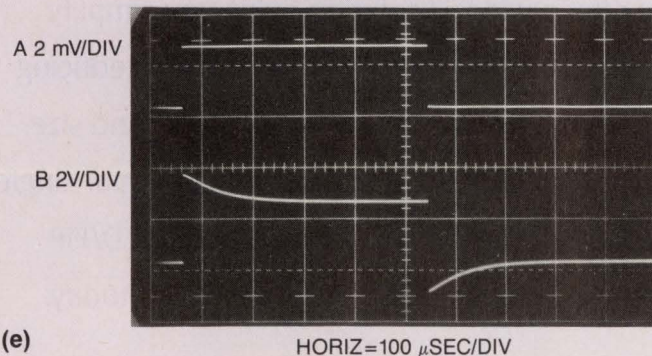
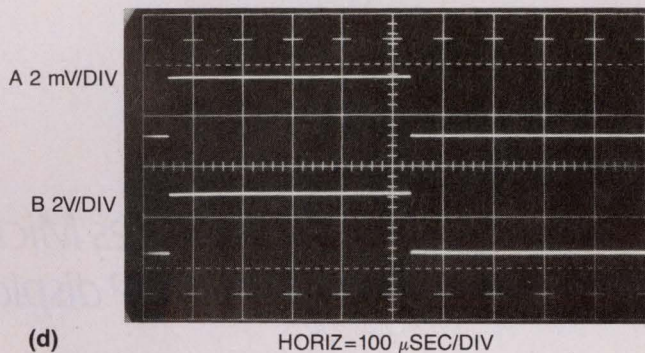
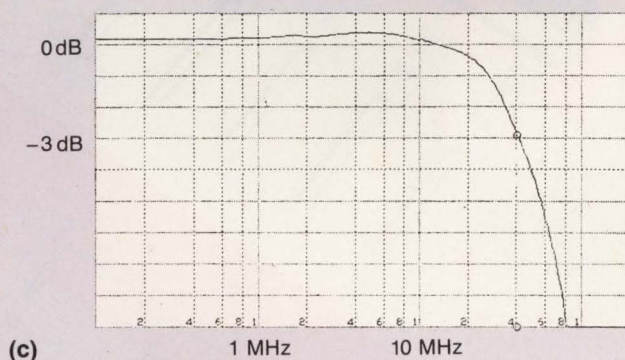
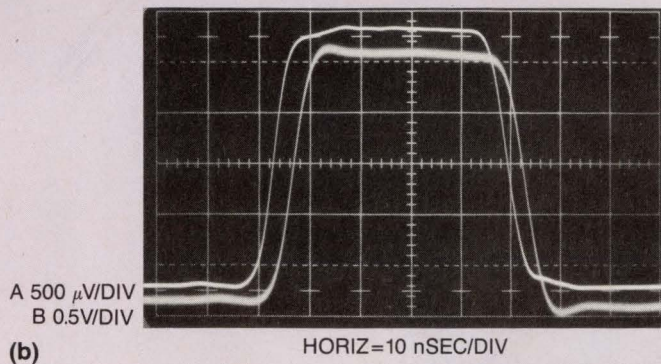

(c) as a slight peak near 6 MHz. In the other three photos, (d, e, and f), you see, respectively, the effects of correctly matching the ac and dc gains, setting the ac gain too high, and setting the dc gain too high.

Single-chip keys for smarter displays.

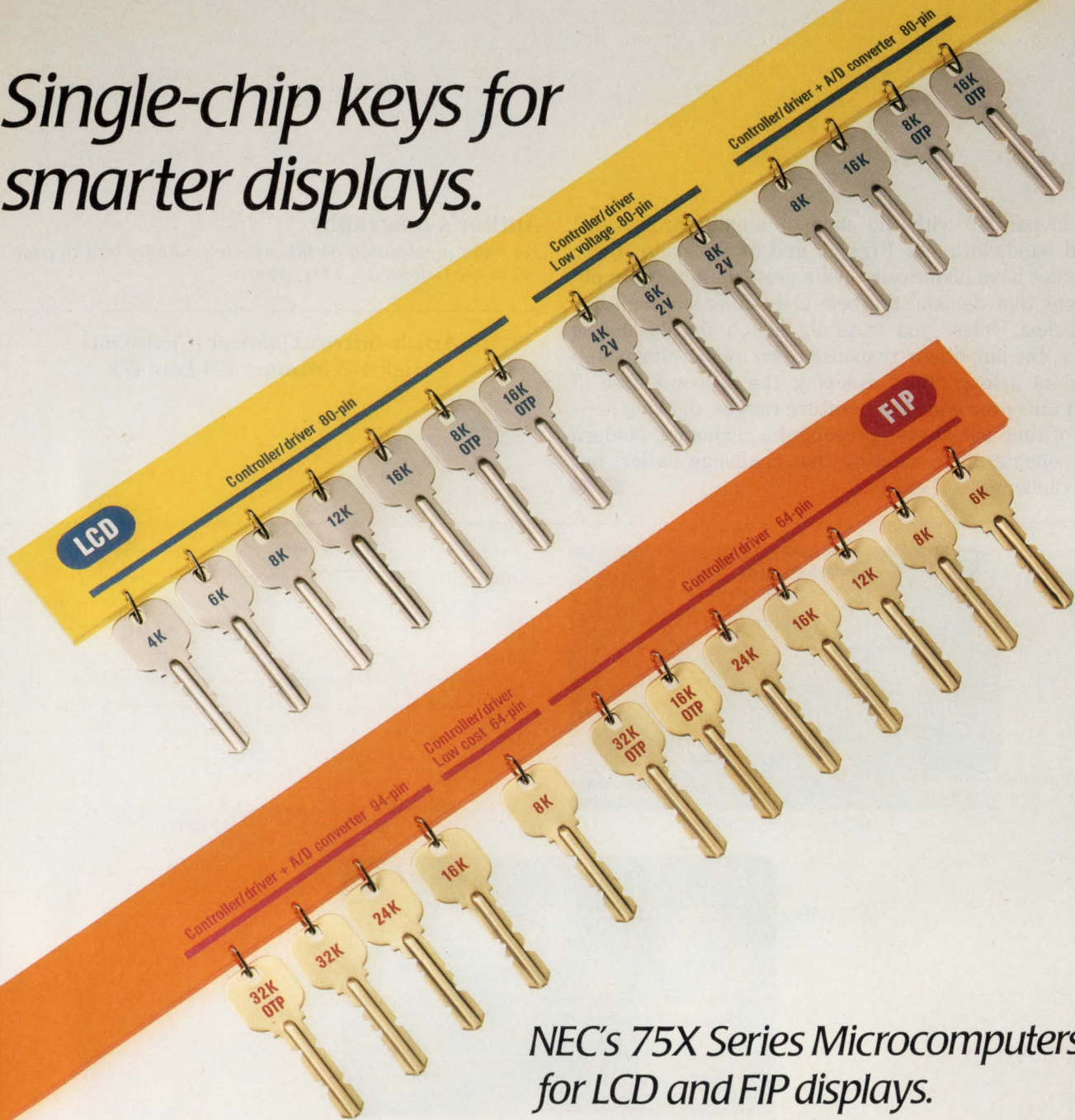

NEC's 75X Series Microcomputers for LCD and FIP displays.

NEC's 75X Series is one of the most powerful and popular in the industry.

LCD/FIP (fluorescent indicator panel) controllers and drivers are all integrated into a single-

chip solution. We offer a wide variety of ROM capacities, peripherals and package types including OTP for specialized low voltage needs.

The 75X Series single-chip

solution helps you simplify programming while reducing overall system cost and size.

To find out which of our single-chip keys fits your LCD/FIP display, contact NEC today.

For fast answers, call us at:

USA Tel:1-800-632-3531. Fax:1-800-729-9288. Germany Tel:0211-650302. Telex:8589960. The Netherlands Tel:040-445-845. Telex:51923. Sweden Tel:08-753-6020. Telex:13839. France Tel:1-3067-5800. Telex:699499. Spain Tel:1-419-4150. Telex:41316. Italy Tel:02-6709108. Telex:315355. UK Tel:0908-691133. Telex:826791. Ireland Tel:01-6794200. Fax:01-6794081. Hong Kong Tel:755-9008. Telex:54561. Taiwan Tel:02-719-2377. Telex:22372. Korea Tel:02-551-0450. Fax:02-551-0451. Singapore Tel:253-8311. Fax:250-3583. Australia Tel:03-267-6355. Telex:38343.

CIRCLE NO. 87

NEC

The compact Deemax P-ICE 8051 costs less, does more.

With a footprint not much bigger than a playing card, the Deemax P-ICE 8051 has all the features you'd ever want in an in-circuit emulator. And at an all inclusive price others can't match.

More of everything.

The P-ICE 8051 comes standard with:

- 3-way interface — command line, pop-up menus or mouse;
- A powerful command-line structure which controls emulator, windows, and file management; capable of loops and conditional control, expressions, line edit and more;
- Up to three complex events in multiple locations, wild card or range, to trigger breakpoints or trace off.
- Two hardware levels for a sequence trigger.

What's more, you can:

- Get error-free inputs with automatic prompts, on-line HELP and realtime syntax verification;
- Define events with a combination of Address, Data, Status, External or Match Count;
- Open up to eight sizable, scrollable, movable windows at a time.

No options.

Unlike some emulators offered a la carte, everything is standard on the P-ICE, including:

- 128K byte emulation memory with 256 byte mapping resolution;
- 4K realtime trace buffer;
- Plus, interface software, cross assembler, pod, power supply, RS232 serial cable, external input probes and manual.

Free proof.

We say the Deemax P-ICE 8051 will let you find more complex bugs, faster and easier, for less money than any other emulator you can buy. To prove it to yourself, call, write, fax or circle the reader service number and we'll send you a demo disk and technical specs. Free.

If finding bugs — on a budget — is your job, find Deemax.

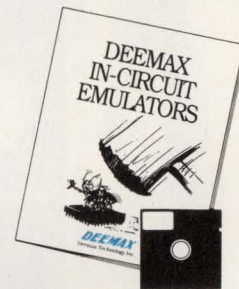

Deemax never misses.



DEEMAX

WHERE INNOVATION COMES FIRST

Deemax Technology, Inc.
12611 Hiddencreek Way, Suite G
Cerritos, CA 90701 U.S.A.
(213) 921-8224 FAX (213) 921-9315

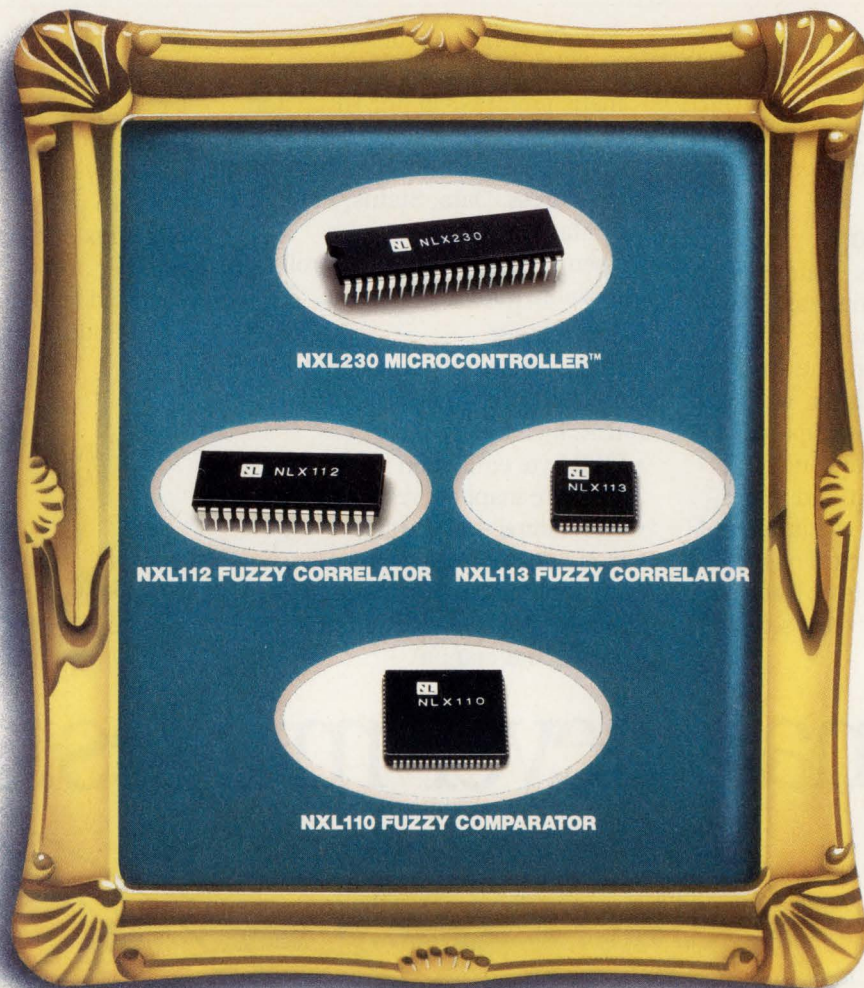

Fuzzy Logic's First Family

NeuraLogix proudly announces the first true family of standard fuzzy logic ICs. Now artificial intelligence applications are no longer constrained by high cost, long development cycles, and complex software.

This ground-breaking line of high-speed, low-power CMOS devices represents the leading edge of fuzzy logic technology, and provides all the options you need for such diverse applications as pattern recognition, robotic control, positioning systems and more.

Devices now available include:
NLX230 Fuzzy Microcontroller™
 The first in a family of true hardware-based fuzzy logic controllers, this device makes artificial intelligence available for a wide

range of consumer and industrial products at a price competitive with standard 8-bit microcontrollers. An applications development kit is available for only \$395.

NLX110 Fuzzy Pattern Comparator. Specially designed for multiple pattern comparisons of serial real-time data, this device adds intelligence to video and speech recognition systems, as well as telemetry applications. An applications development kit is available for \$395.

NLX112 and NLX113 Fuzzy Data Correlators. These chips are as simple to use as ordinary correlators, but are more than twice as fast and operate with noisy and incomplete data. The NLX112

performs 128-bit data comparisons with selective bit masking capability and easy word-length expansion via cascading devices. The more versatile NLX113 offers 32/64/128-bit selectivity, 50 mHz speed and separate clocking for data and reference patterns.

For a family portrait of detailed specifications and prices, contact NeuraLogix today!

NeuraLogix

American NeuraLogix, Inc.
 411 Central Park Drive
 Sanford, FL 32771
 Telephone 407/322-5608
 FAX 407/322-5609

High-speed amplifiers in application circuits

Once you acquire some familiarity with high-speed amplifiers and a respect for their design requirements, you can use these devices' speed to design a variety of application circuits. These circuits include DAC current-to-voltage converters, video amplifiers, and power boosters.

Jim Williams, *Linear Technology Corp*

Recent processing and design advances have made inexpensive, precision wideband amplifiers practical. They are less prone to oscillation and other variations than some much slower amplifiers. High-speed amplifiers' raw speed capabilities, combined with their inherent flexibility as op amps, permit a range of applications. These amplifiers let you create fast linear circuits that are difficult or impractical to create using other approaches. You can use these application circuits to capitalize on the amplifier's speed to improve on a standard circuit. Or you can utilize speed to implement a traditional function in a nontraditional way, with attendant advantages. You can even design completely new, start-of-the-art circuit functions that were previously impractical to implement at the board level.

Simply put, these amplifiers make implementing high-speed functions easier.

One of the most common applications for a high-speed amplifier, transforming a 12-bit DAC's current output into a voltage, is also one of the most difficult. Although an op amp can easily perform the required current-to-voltage conversion, obtaining good dynamic performance requires careful design. A fast DAC can settle to 0.01% in 200 nsec or less, but its output also includes a parasitic capacitance term, making the amplifier's job more difficult. Normally, the DAC's output directly drives an amplifier's summing junction, placing the parasitic capacitance between ground and the amplifier's input. This capacitance introduces feedback phase shift at high frequencies, forcing the amplifier to ring about the final value before settling.

Different DACs have different values of output capacitance. CMOS DACs have the highest output capacitance—in the 100- to 150-pF range, which varies with the input code. Bipolar DACs typically have 20 to 30 pF of capacitance, which is constant over all codes. As such, bipolar DACs are almost always better to use where high speed is required. **Fig 1a** shows the AD565A 12-bit DAC with an LT1220 output op amp. **Fig 1b** shows clean 0.01% settling in 280 nsec (trace B) to a full-scale input step (trace A). The requirements for obtaining trace B's display are not trivial (**Ref 1**).

Another application area requiring good dynamic

THE JIM WILLIAMS P A P E R S

stability is video amplifiers driving cables. **Fig 2** shows a simple way to multiplex two video amplifiers onto a single 75Ω cable. The level of the input-select line determines which of the two amplifiers is active in accordance with the truth table in the figure. Amplifier performance includes 0.02% differential gain error and 0.1° differential phase error. The cable's 75Ω back termination means that the amplifiers must swing 2V_{p-p} to produce 1V_{p-p} at the cable output, but most amplifiers can easily handle this output swing.

Simple video amp

Fig 3 is a simpler version of **Fig 2**. This circuit is a single-channel video amplifier, and it provides for a gain of 10. The circuit retains the double-cable termination of **Fig 2**, and the circuit has a 55-MHz bandwidth.

Fig 4 is another cable-related circuit. Here, the differential amplifier simply hangs across a distribution cable, extracting the signal. The amplifier's true differ-

ential inputs reject common-mode signals. As in the previous circuit, differential-gain and phase errors measure 0.02% and 0.1°, respectively. A separate input permits for adjustment of the dc level.

High-speed analog signals transmitted on a line often pick up substantial common-mode noise. **Fig 5a** shows a simple, fast, differential line receiver using the LT1194 gain-of-10 differential amplifier (IC₁). The differential line is fed to IC₁. The resistor-diode networks prevent overload and ensure sufficient input bias for IC₁ under all conditions. IC₁'s output represents the difference of the 2-line input, times a gain of 10. In theory, the circuit should reject all common-mode noise.

The test-circuit (**Fig 5b**) waveforms (**Fig 5c**) confirm this noise rejection. The sine-wave oscillator drives T₁ (**Fig 5c**, trace A), producing a differential line output at its secondary. T₁'s secondary returns to ground through a broadband noise generator, flooding the line inputs with common-mode noise (traces B and C are

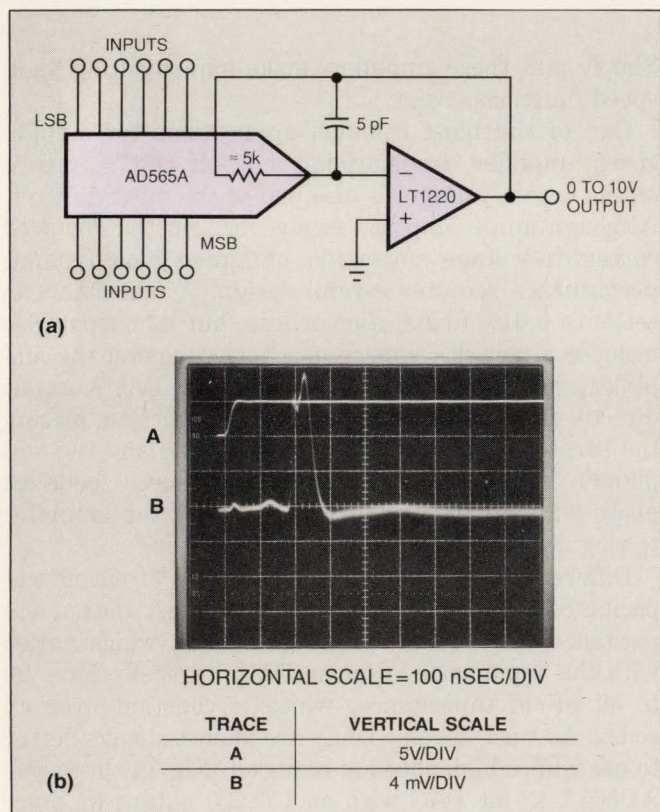

Fig 1—Achieving good dynamic performance while converting a DAC's output current to voltage is a difficult job for many op amps. The output of the circuit in **a** responds to a full-scale step (**b**, trace A) by fully settling in 280 nsec (**b**, trace B).

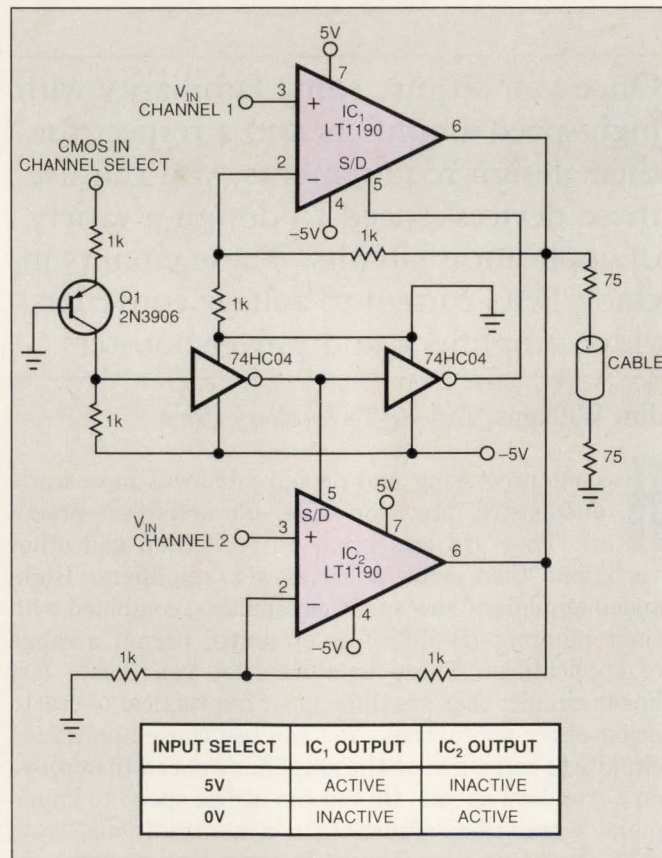

Fig 2—This 2-channel video amplifier features 0.02% differential-gain error and 0.1° differential-phase error.

IC₁'s inputs). Trace D, IC₁'s multiplied-by-10 version of the differential signal at its inputs, shows no visible noise or disturbances. This circuit provides a clean output, even in the presence of noise that dominates the signal by a 100:1 ratio from dc to 5 MHz.

Fig 6a shows another way to achieve high common-mode rejection. Additionally, this circuit has the advantage of true 3-port isolation. That is, the input, gain stage, and output are all galvanically isolated from each other. This configuration is useful where large common-mode differences exist or where ground integrity is uncertain. The circuit configures IC₁ for a simple gain of 11. T₁ feeds IC₁'s positive input, and the output passes through T₂. **Fig 6b** shows the circuit's response to a 4-MHz input, with all transformer leads designated "•" referred to ground. The input (**Fig 6b**, trace A) drives T₁, whose output (trace B) feeds IC₁. IC₁ amplifies the signal, and its output (trace C) feeds T₂. T₂'s output (trace D) is the circuit's output. Phase shift is evident, although tolerable. T₁ and T₂ are very wide-band devices, with low phase shift. Note the negligible phase difference between the A-B and C-D trace pairs. IC₁ contributes the entire phase error. Using the transformers specified, the circuit's low frequency cut-off is about 10 kHz.

It is often desirable to examine or amplify one particular portion of a signal while rejecting all others.

Text continued on pg 162

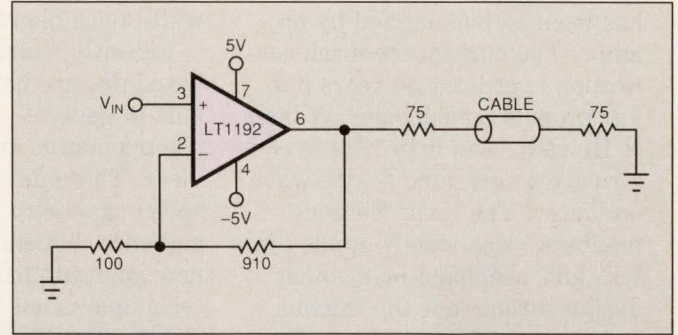

Fig 3—This double-terminated cable driver features a bandwidth of 55 MHz.

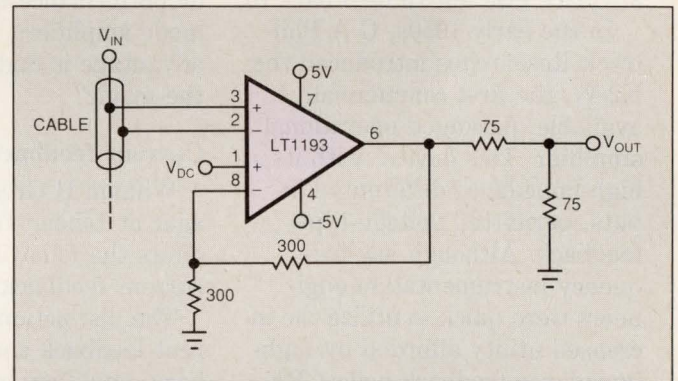

Fig 4—To extract video signals, this cable-sense amplifier features a loop-through connection.

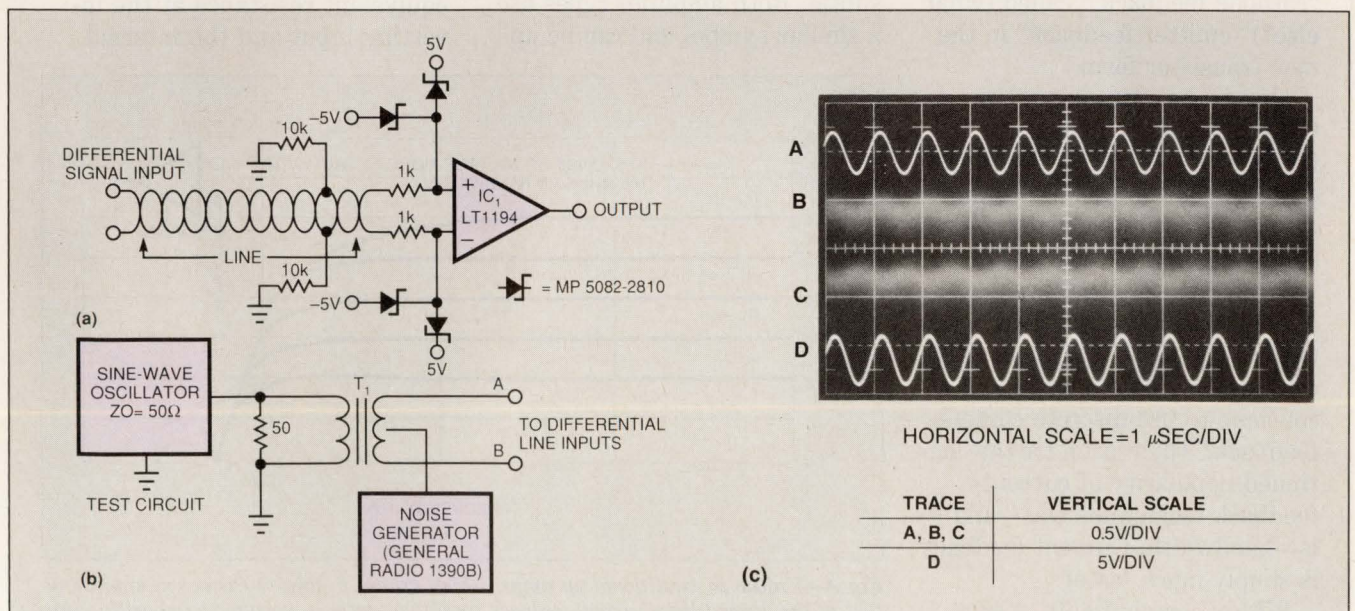

Fig 5—By extracting signals buried in common-mode noise, the output (c, trace D) of this differential line receiver (a) is clean despite the 100-to-1 noise-to-signal ratio. The test circuit in b provides both the input signal (c, trace A), and input noise (c, trace B) and C).

About "current-mode" feedback

Contrary to some enthusiastic marketing claims, so-called current-mode feedback isn't new. In fact, it is much older than the normal voltage-mode feedback that has been so popularized by op amps. The current-feedback connection is at least 50 years old, and probably much older. William R Hewlett used it in 1939 to construct his now-famous sine-wave oscillator. The term "cathode feedback" was widely applied in RF- and wideband-instrument design throughout the thirties, forties, and fifties. It was a favorite form of feedback, if for no other reason than there wasn't anyplace else left to feed back to.

In the early 1950s, G A Philbrick Researches introduced the K2-W, the first commercially available, packaged operational amplifier. This device, with its high-impedance differential inputs, permitted voltage-type feedback. Although low-frequency instrumentation engineers were quick to utilize the increased utility afforded by high-impedance feedback nodes, RF and wideband designers hardly noticed. They continued to use "cathode feedback," called (what else?) "emitter feedback" in the new transistor form.

Numerous examples of the continued use of "current-mode" feedback in RF and wideband instruments are found in designs dating from the 1950s to the present. Ostensibly easier-to-use voltage-type feedback was readily usable during this period, particularly as monolithic devices became cheap. Why did designers continue to use discrete current feedback? The reason for the continued popularity of current-feedback techniques was—and is—bandwidth. Current feedback is simply much faster.

Within certain limits, a current-feedback-based amplifier's

bandwidth does not degrade as the closed-loop gain increases. This feature is a significant advantage over voltage-mode feedback amplifiers, whose bandwidth does degrade.

Recently, current-feedback-based designs have become available in general-purpose, easy-to-use monolithic and hybrid devices. These devices bring high-speed capability to a much wider audience, hopefully opening up new applications. So, while the technique is not new, marketing claims notwithstanding, the opportunity is. Although current-mode-based designs have poorer dc performance than voltage mode amplifiers, their bandwidth advantage is undeniable. What's the magic?

Current feedback basics

William H Gross, Design Manager at Linear Technology Corp, offers the following insight into current feedback.

The distinctions between current-feedback and voltage-feedback amplifiers are not obvious at first because, viewed from the outside, the differences can be subtle. Both amplifier types use a similar symbol and can be ap-

plied on a first-order basis using the same equations. However, their behavior in terms of the gain-bandwidth tradeoff and large-signal response is another story.

Unlike in voltage-feedback amplifiers, small-signal bandwidth in a current-feedback amplifier isn't a straight inverse function of closed-loop gain, and large-signal response is closer to ideal. Both benefits stem from the fact that the feedback resistors determine the amount of current driving the amplifier's internal compensation capacitor. In fact, the amplifier's feedback resistor, R_F , from output to inverting input, works with internal junction capacitances to set the closed-loop bandwidth. Even though the gain-set resistor, R_G , from inverting input to ground, works with R_F to set the voltage gain, just as in a voltage feedback op amp, the closed-loop bandwidth does not change.

The explanation of these effects is fairly straightforward. The equivalent gain-bandwidth product of the current-feedback amplifier is set by the Thevenin equivalent resistance at the inverting input and the internal

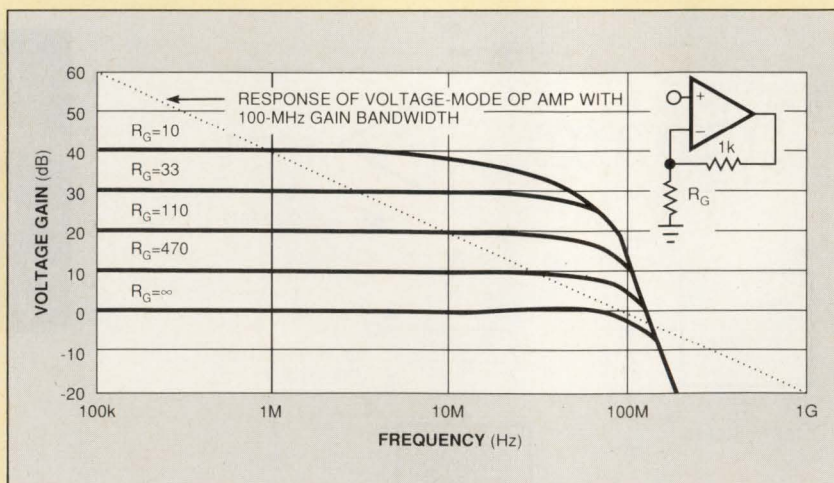

Fig A—Unlike in traditional op amps, which exhibit a gain-vs-frequency similar to that of the dashed line, current-feedback amplifiers have a constant bandwidth, even at different gain settings.

compensation capacitor. If R_F is held constant and gain changed with R_G , the Thevenin resistance changes by the same amount as the gain. From an overall loop standpoint, this change in feedback attenuation will produce a change in noise gain and a proportionate reduction of open-loop bandwidth, as in a conventional op amp.

With current feedback, however, the key point is that changes in Thevenin resistance also produce a compensatory change in open-loop bandwidth, unlike in a conventional fixed-gain bandwidth amplifier. As a result, the net closed-loop bandwidth of a current-feedback amplifier remains the same for various closed-loop gains.

Bandwidth is the key advantage

Fig A shows a plot of voltage gain vs frequency for a representative current-feedback amplifier, the LT1223, for five gain settings, driving 100Ω. For comparison, the figure also shows a plot

of the fixed 100-MHz gain-bandwidth limitation that a voltage-feedback amplifier would have. It is obvious that for gains greater than one, the current-feedback amplifier provides 3 to 20× more bandwidth. The general shape of this bandwidth profile is common to all current-feedback amplifiers.

Because the feedback resistor determines the compensation of the amplifier, you can optimize bandwidth and transient response for almost every application. When operating from ±15V supplies, R_F should be 1 kΩ or more for stability. When operating from ±5V supplies, the minimum value is 680Ω because the junction capacitors increase with lower voltage. For either case, larger feedback resistors can also be used but will slow down the amplifier—which may be desirable in some applications.

The difference in operating characteristics between voltage- and current-feedback op amps results in slight differences in common circuit configurations. Fig B

summarizes some popular circuit types, showing differences between each op-amp type. Gain can be set with either R_{IN} or R_F in a voltage-feedback op amp, but the R_F used with a current-feedback op amp is fixed.

You can control a voltage-mode op amp's bandwidth using a feedback capacitor. However, when using current-feedback op amps, bandwidth must be limited at the input. A feedback capacitor is never used. In an integrator, the 1-kΩ resistor must be included in the current-feedback amplifier's feedback path so its negative input sees the optimal impedance.

There is no correlation between bias currents of a current-feedback amplifier's inputs. Thus, source impedance matching will not improve dc accuracy. Matching input source impedances aids offset performance only in op amps that do not have internal bias-current cancellation.

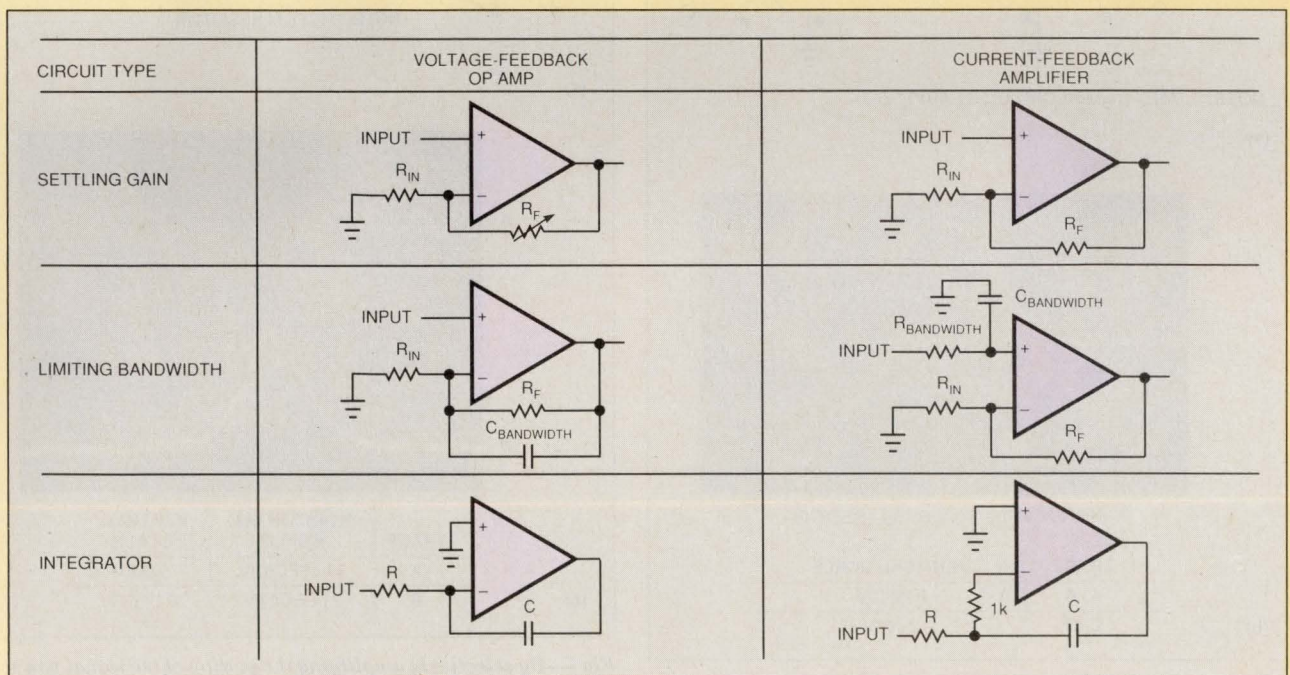

Fig B—Although voltage-mode and current-feedback op amps look alike when viewed from the outside, their internal architectural differences require that you use slightly different circuit topologies when applying them.

THE JIM WILLIAMS P A P E R S

At high speed, this can be difficult because the amplifier may see fast, large common-mode voltage swings. Recovery from such activity usually is dominated by saturation effects, making the quality of the amplifier's output questionable. Differential amplifiers with fast overload recovery can perform this function while maintaining output fidelity to the input signal. The circuit in **Fig 7a** allows you to set the input level at which amplifying begins, allowing any amplitude-defined point to be selected. In **Fig 7a**, IC₁, the LT1019 reference, and associated components form an adjustable, bipolar voltage source that is coupled to differential amplifier IC₂'s negative input. The input signal biases IC₂'s positive input; R₁ and R₂ set IC₂'s gain.

Input signals below IC₂'s negative input levels keep IC₂'s output in saturation, and no signal appears at the output. When the positive input rises above the nega-

tive input's bias point, IC₂ becomes active, providing an amplified version of the instantaneous difference between its inputs. **Fig 7b** shows what happens when you apply the output of a triangle wave generator (trace A) to the circuit. Setting the bias level just below the triangle peak permits high gain and detailed operation of the turnaround at the peak. Trace B clearly shows the switching residue in the generator's output. Appropriate variations in the voltage-source setting would permit more of the triangle slopes to be observed, with attendant loss of resolution due to oscilloscope overload limitations. Similarly, increasing IC₂'s gain allows more amplitude detail while placing restrictions on how much of the waveform you can display.

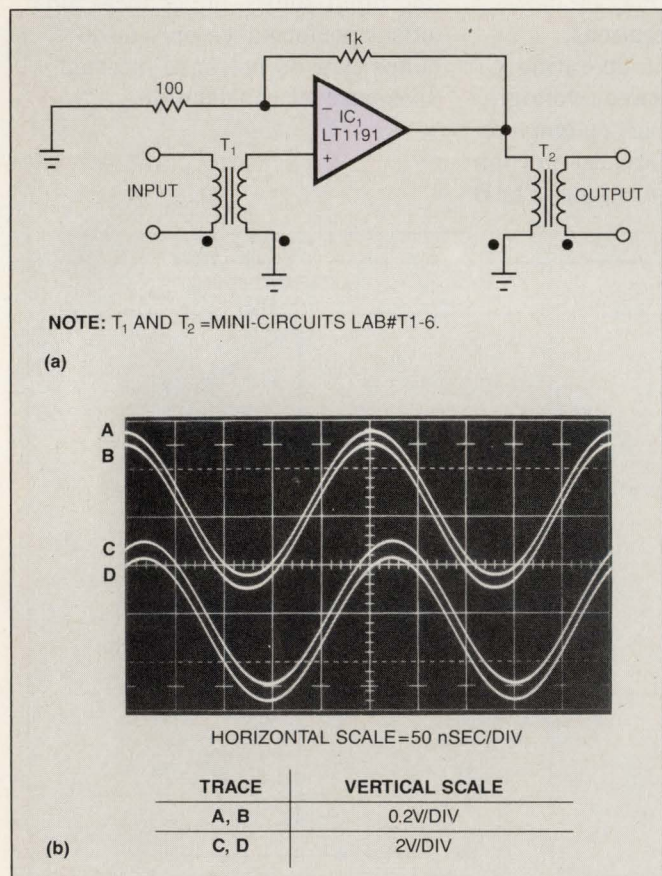

Fig 6—Methods to achieve high common-mode rejection include transformer coupling. The amplifier in a responds to an input (b, trace A) with a slightly phase-shifted output (trace D). Traces B and C are T₁'s secondary and T₂'s primary, respectively.

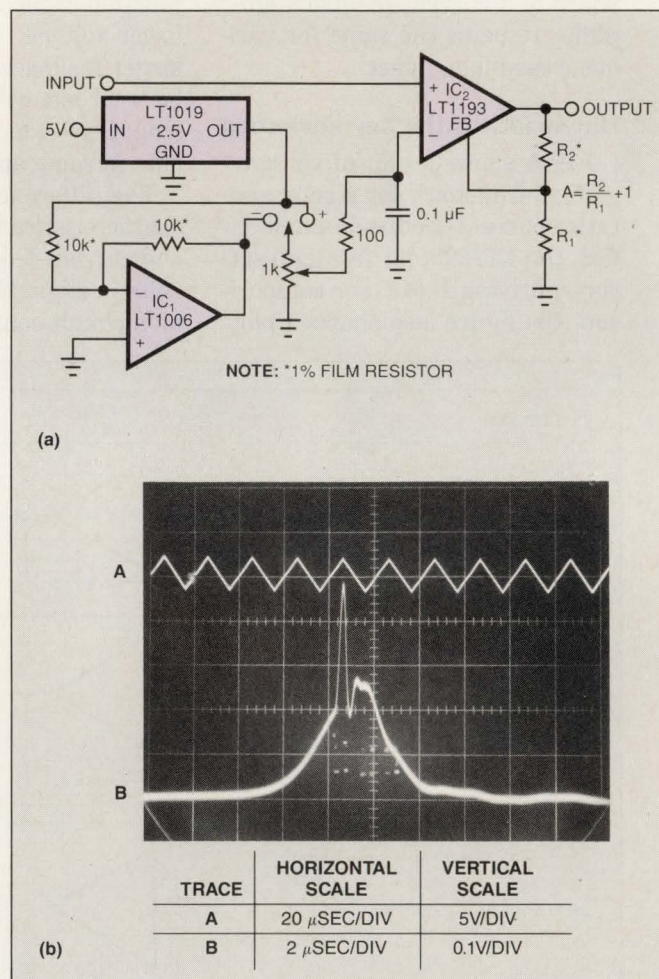

Fig 7—By selectively amplifying the portion of the signal you select, this differential-comparator amplifier (a) enables you to extract signal detail from a triangle waveform (b, trace A). At the triangle wave's peak (b, trace B), the triangle-wave generator's switching artifacts are clearly evident.

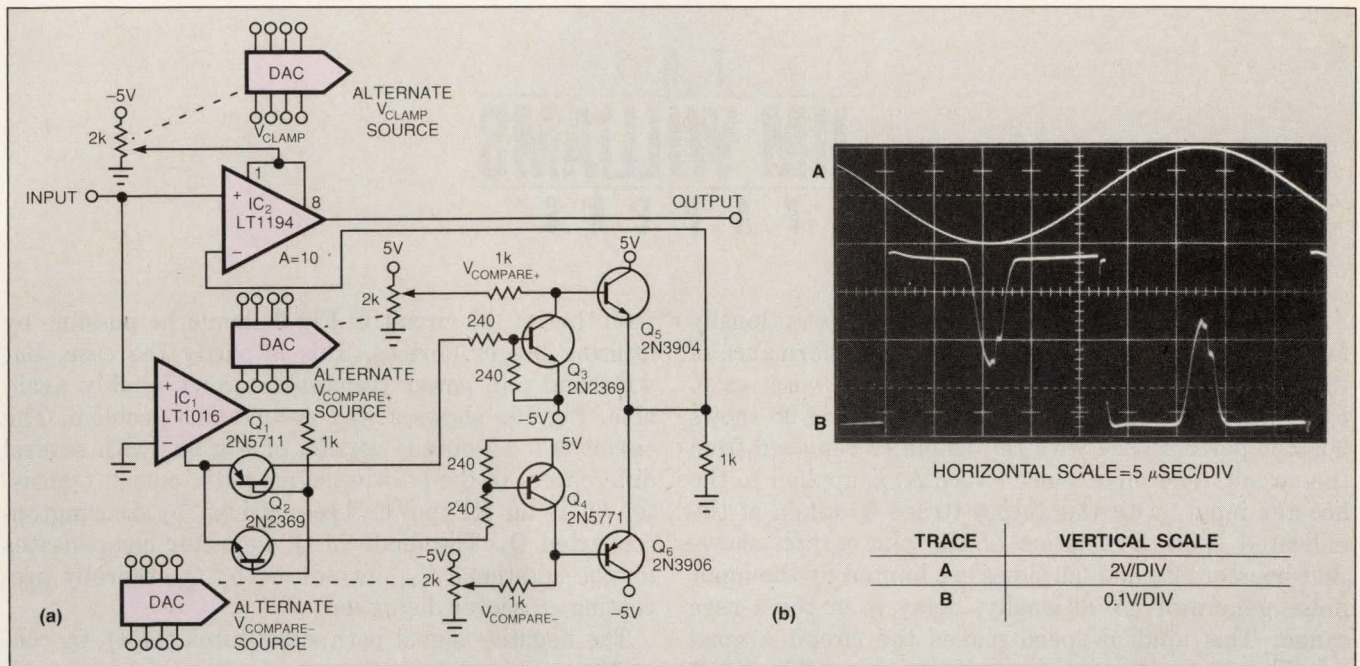

Fig 8—A differential-comparator amplifier (a) allows you to observe signals between two amplitude-defined points that you can set. The amplifier detects switching residuals (b, trace B) in the sine-wave generator's input (b, trace A).

It is worth noting that this circuit performs the same function as differential plug-in units for oscilloscopes. This circuit's output is accurate and settles to 0.1% within 100 nsec after entering its linear region.

Window a waveform

Fig 8a extends the previous circuit's operation, allowing amplified observation of information between two amplitude-defined points that you can set. You can choose both the magnitude and sign of the amplitude setpoints. In this circuit, comparator IC₁'s output state determines the polarity of the offset applied to IC₂'s negative input. IC₁ compares the circuit's input to ground, generating polarity information at its outputs. Two level shifters, consisting of Q₁ and Q₃ and Q₂ and Q₄, bias followers Q₅ and Q₆. Positive circuit inputs result in Q₅ supplying the V_{COMPARE+} potential to IC₂, whereas negative inputs route V_{COMPARE-} to IC₂.

This additional circuitry eliminates the previous circuit's manual polarity switch, permitting automatic selection of the difference polarity and amplitude. Additionally, this circuit takes advantage of IC₂'s input-clamp feature. This feature limits the dynamic range of the input, clamping the amplifier's input operating range. Signals inside the clamp limit are processed normally, while signals outside the limit are precluded from influencing the amplifier. This combination of circuit controls allows you to select very tightly defined "windows" on a waveform for accurate amplification without overload restrictions.

Fig 8b shows the circuit output for a sine-wave input (trace A) from the same function generator used to test the previous circuit. The V₊ and V₋ compare voltages are set just below the sine-wave peaks, with V_{CLAMP} programmed to restrict amplification to the

peaks' excursion. Trace B, the circuit's output, simultaneously shows amplitude detail of both peaks of the sine wave. The observed distortion is directly traceable to this generator's imperfect internal triangle waveform (**Fig 7b**), as well as its sine-wave shaper characteristics.

Occasionally, it is necessary to supply larger output currents than an amplifier is capable of delivering. The power gain stage, sometimes called a booster, is usually placed within the monolithic amplifier's feedback loop, preserving the IC's low drift and stable gain characteristics.

Because the output stage resides in the amplifier's feedback path, loop stability is a concern. This is particularly the case with high-speed amplifiers. You must consider the output stage's gain and ac characteristics to achieve good dynamic performance. Overall circuit phase-shift, frequency-response, and dynamic-load-handling capabilities are issues that you can't ignore when designing a power gain stage for a monolithic amplifier. The output stage's added gain and phase shift can cause poor ac response or outright oscillation. Judicious application of frequency-compensation methods is needed for good results. (See **Ref 1** for discussion and details on compensation methods.)

Fig 9a shows a 200-mA power booster used with a high-speed amplifier. Complementary emitter followers Q₁ and Q₅ provide current gain for positive signals, while Q₂ and Q₆ handle negative excursions. Q₃ and Q₄ are V_{BE}-based current limiters, turning on and thereby robbing drive from the appropriate output transistor when current exceeds about 300 mA. The diodes prevent reverse V_{BE} at Q₁ and Q₂ during current limiting. The 100Ω resistor and ferrite beads prevent the low-impedance amplifier output from causing Q₁ and Q₂ to oscillate (**Ref 1**).

THE JIM WILLIAMS P A P E R S

To be effective, the booster must be exceptionally fast. A slow design will obviate the ac performance of the amplifier by controlling it, or in the worst case, by causing oscillation (again, see Ref 1). Fig 9b shows booster performance with the amplifier removed from the circuit. The input pulse (trace A) is applied to the booster input, with the output (trace B) taken at the indicated spot. Evaluation of the photograph shows that booster rise and fall times are limited by the input pulse generator. Additionally, delay is in the 1-nsec range. This kind of speed makes the circuit a good candidate for acceptable ac performance within a fast amplifier's loop.

Fig 9c shows the pulse response with the LT1220 installed in the circuit driving a 50Ω load. The booster's high speed contributes negligible delay, and overall response is clean and predictable. The local 3-pF compensation across the amplifier optimizes response but is not absolutely necessary in this circuit. The input (trace A) produces a nicely shaped slew-limited output (trace B).

In theory, achieving higher power-booster stages

than that of the circuit in Fig 9 should be possible by utilizing bigger devices. This is partly the case, but wideband pnp power transistors aren't readily available. Fig 10a shows a way around this problem. The circuit is a 1A-output version of Fig 9a, with several differences. In the positive signal path, output transistor Q_4 is an RF power type, driven by Darlington-connected Q_3 . The diode in Q_1 's emitter compensates for the additional V_{BE} introduced by Q_3 , thereby preventing crossover distortion.

The negative signal path substitutes the Q_5 - Q_6 connection to simulate a fast pnp power transistor. Although this configuration acts like a fast pnp follower, it has voltage gain and tends to oscillate. The 2-pF feedback capacitor across Q_5 's collector and base suppresses these parasitic oscillations and stabilizes the composite transistor. This circuit also includes a feedback-capacitor trim to optimize ac response. This trim capacitor, which is not included in the previous circuit, is necessary because of this circuit's slightly slower characteristics and much heavier loading. Current-limit

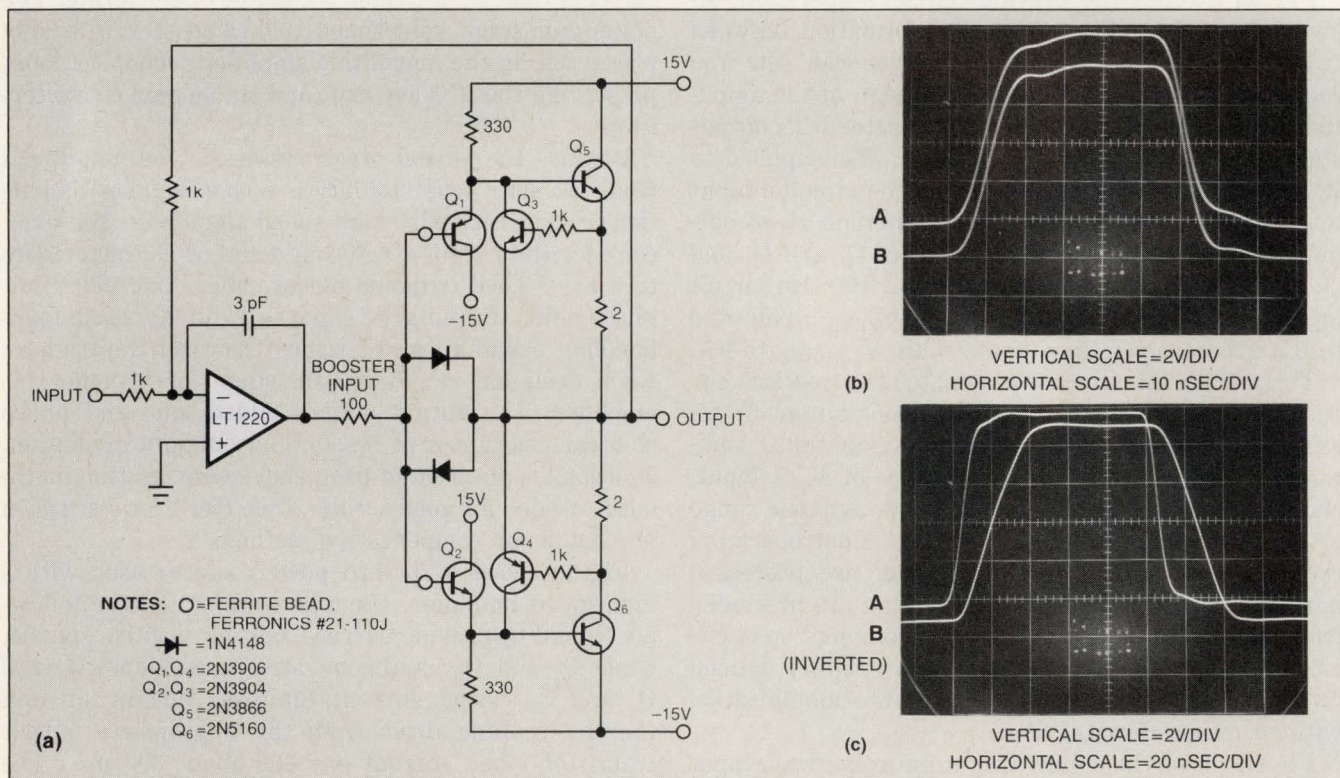
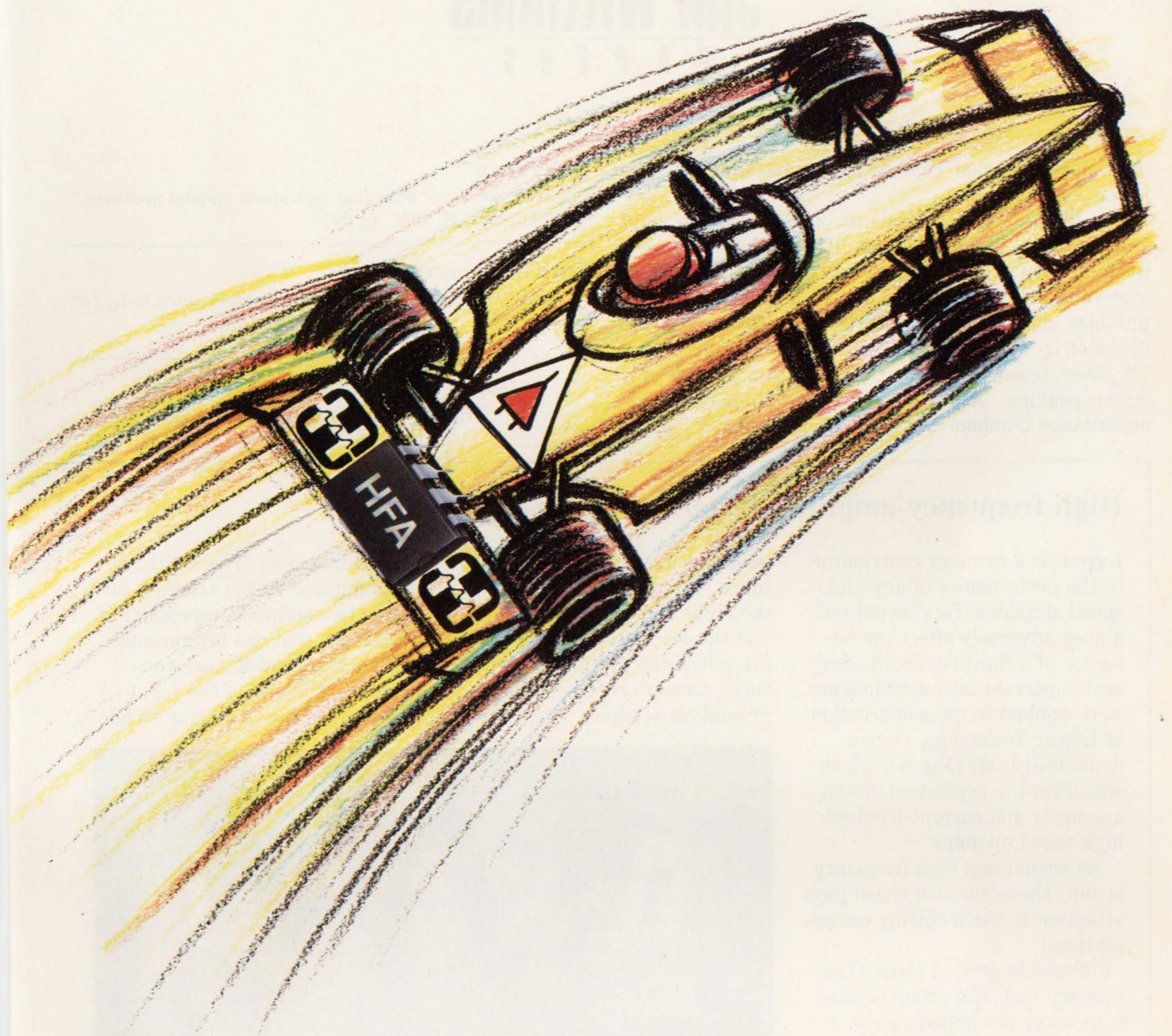

Fig 9—An additional booster stage increases the output of this circuit's wideband amplifier to 200 mA (a). The response of the booster (b, trace B) alone to a pulse input (b, trace A) must be sufficiently fast not to limit the high-speed amplifier. The delay between trace A and B of b is approximately 1 nsec, and the pulse generator's rise and fall times limit those of the boost circuit. When included in the amplifier's feedback loop, the booster's high speed contributes negligible delay, and overall circuit response (c, trace B) is clean and predictable.



Harris presents the world's fastest monolithic op amp.

Gentlemen, start your engines! The world's fastest monolithic op amp is coming down the track.

It's the Harris HFA family, with speeds significantly faster

than any other competitor.

Our HFA-0001 leads the race. With 350 MHz unity gain bandwidth, 25 nanosecond settling time, and a 1000 V/ μ sec slew rate. Other models are available for high output drive and high precision, too.

But whatever the model, Harris

monolithic designs make the age-old problems of hybrids go away. Reliability goes up. Cost goes down.

So find out more about the #1 fastest op amp from the #1 linear supplier. Call 1-800-4-HARRIS, ext. 1101 today.

	Bandwidth	Slew Rate	Settling Time
HFA-0001	Unity Gain: 350 MHz	1000 V/ μ s	25 ns
HFA-0002	High Gain: 1 GHz	250 V/ μ s	50 ns
HFA-0005	Unity Gain: 300 MHz	420 V/ μ s	20 ns

 **HARRIS**
SEMICONDUCTOR

operation and other characteristics are similar to the lower power circuit.

Fig 10b shows waveforms for a 10V negative input step (trace A) and a 10Ω load. The amplifier responds to the input (trace B), and drives the booster to whatever voltage is required to close the loop. The amplifier provides about 1.5V of overdrive to overcome the V_{BE} drops of Q_3 and Q_4 . The booster output, lagging by a few nsec (trace C), drives the load cleanly, with only minor peaking. Adjusting the 5- to 30-pF feedback capacitance trimmer minimizes the peaking. **EDN**

Reference

1. Williams, Jim, "Subduing high-speed op-amp problems," *EDN*, October 24, 1991, pg 135.

Author's biography

For more information on this article's author, turn to pg 163 in the October 10, 1991, issue.

Article Interest Quotient (Circle One)

High 479 Medium 480 Low 481

High-frequency-amplifier layout guidelines

Layout is a primary contributor to the performance of any high-speed amplifier. Poor layout techniques adversely affect the behavior of a finished circuit. Several important layout techniques were applied in the construction of Linear Technology Corp's demo board 009 (**Fig A**), which simplifies the evaluation of voltage-mode and current-feedback high-speed op amps.

As should any high-frequency layout, the evaluation board pays attention to the following considerations:

1. Top-side ground plane: The primary task of a ground plane is to lower the impedance of ground connections. The inductance between any two points on a uniform sheet of copper is less than the inductance of a thin, straight trace of copper connecting the same two points. The ground plane approximates the characteristics of a copper sheet and lowers the impedance at key points in the circuit, such as the grounds of connectors and supply bypass capacitors.

2. Ground-plane voids: Certain components and circuit nodes are

very sensitive to stray capacitance. Two good examples are the summing node of the op amp and the feedback resistor. Voids are put in the ground plane in these areas to reduce stray ground capacitance.

3. I/O matching: The width of the input and output traces is adjusted to a stripline impedance of 50Ω. Note that the terminating resistors, R_3 and R_7 , are connected to the end of the input lines, not at the connector. While

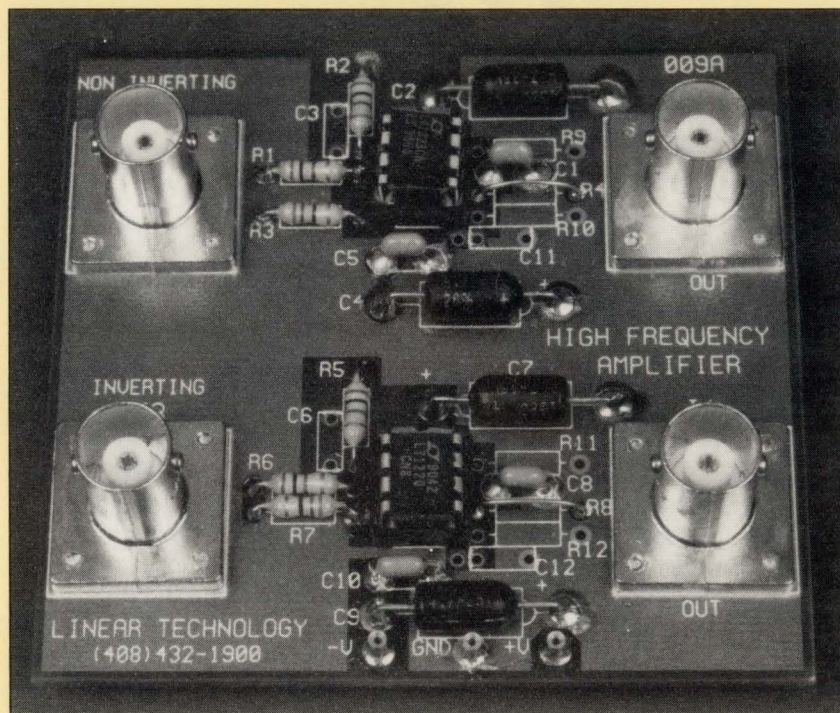

This demo board embodies a number of layout techniques crucial to the performance of high-speed amplifiers: top-side ground plane, ground-plane voids around critical nodes, and proper bypassing.

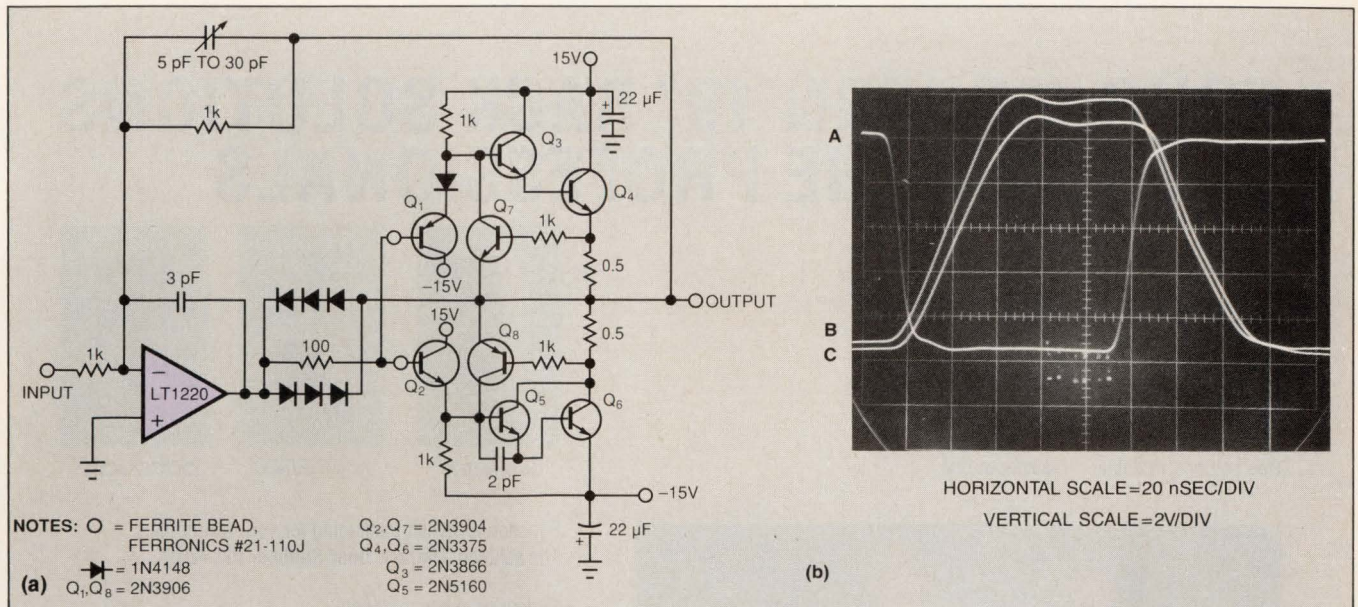

Fig 10—Q₅ and Q₆ simulate a fast pnp power transistor for this power booster (a). The boosted op amp can drive a 1A load to 10V in 50 nsec. Trace A (b) is the 10V input, B is the op amp's output, C is the final circuit output.

stripline techniques aren't absolutely necessary for the demo board, they are important on larger layouts where line lengths are longer. The short lines on the demo board can be terminated

with 50, 75, or 93Ω without adversely affecting performance.
 4. Separation of input and output grounds: Even though the ground plane exhibits a low impedance, input and output

grounds are still separated. For example, the termination resistors, R₃ and R₇, and the gain-setting resistor, R₁, are grounded in the vicinity of the input connector. Supply bypass capacitors C₁, C₂, C₄, C₅, C₇, C₈, C₉, and C₁₀ are returned to ground in the vicinity of the output connectors.

5. Proper bypassing: High-speed op amps work best when you bypass their supply pins with RF-quality capacitors. For example, C₁, C₅, C₈, and C₁₀ should be 10-nF disc ceramic or other capacitors with self-resonant frequencies greater than 10 MHz. The polarized capacitors, C₂, C₄, C₇, and C₉, should be 1- to 10-μF tantalums. Most 10-nF ceramics are self-resonant well above 10 MHz, and 4.7-μF solid tantalums with axial leads are self-resonant at 1 MHz or below. Lead lengths are critical: The self-resonant frequency of a 4.7-μF tantalum drops by a factor of 2 when measured through 2-in. leads. Although a capacitor may become inductive at high frequencies, it is still an effective bypass component above resonance because the impedance is low.

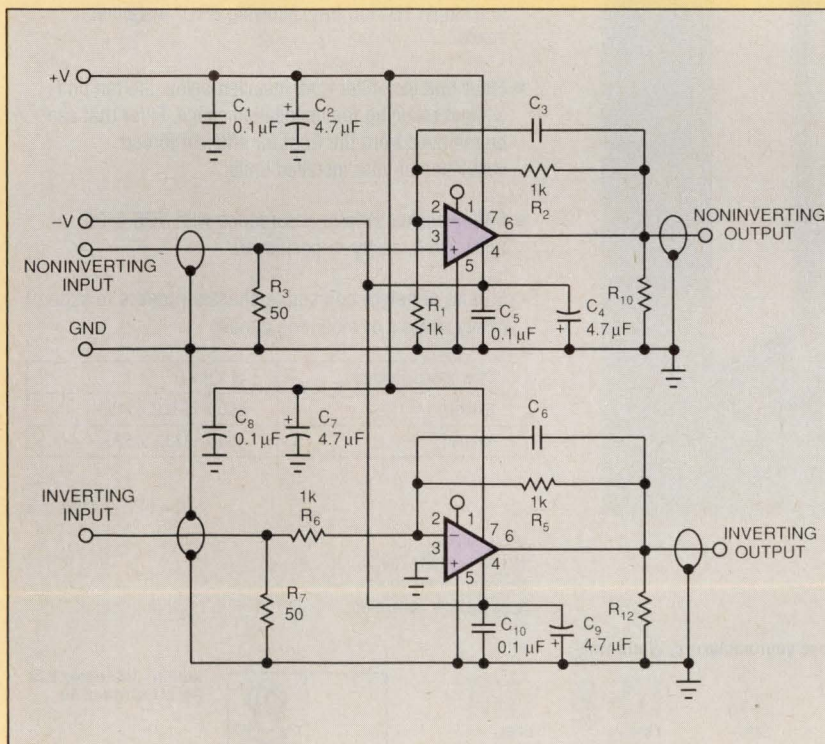
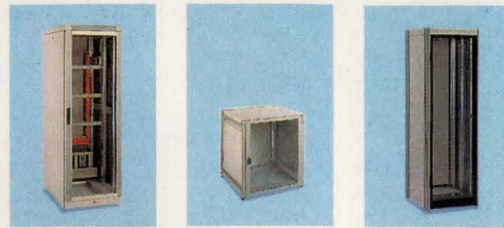

Fig A—Mating the components of this schematic to their placement on the demo board helps you visualize some high-frequency layout techniques and will help you transfer these techniques to your own high-speed boards.

FOUR MODERN 19" RACK SOLUTIONS FROM THE PROFESSIONALS



temprack®

labable pro rack?

dacobas®

One solution in detail: **unirack®**

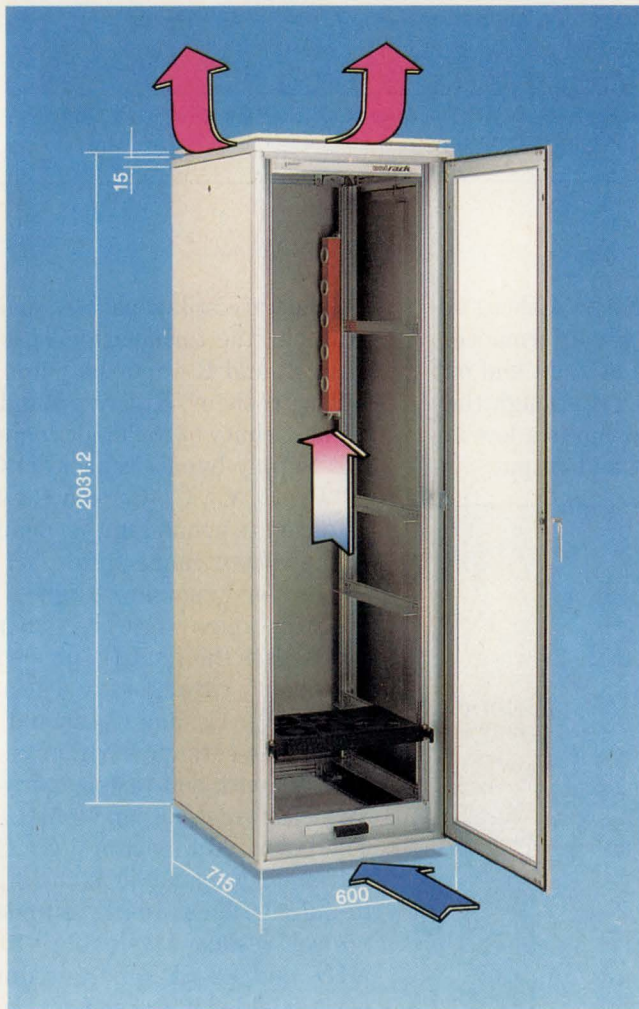

Functional, stylish packaging for your electronics.
The solution: **Unirack Door Softline, 19", 40 U***.

Supply schedule in detail:

- Rugged aluminium basic rack
(Load rating 4000 N, magnetic-field protection).
- 2 Side panels and 1 rear door constructed in sheet steel (removable using standard tools enabling **efficient installation and servicing**).
- **Plexiglass door**, comprising of extruded aluminium frame with handle, and a clear sealed plexiglass panel to enable easy visual inspection and dust protection.
- Top cover as **vent lid** (15 mm continuous air gap).
- **Fan unit** fitted with 3 axial fans (220 V), flow rate 117 m³/h per fan, with a maximum of 9 fans fitted to a single 1U* fan tray, allowing 39U* installation space.
- **Filter unit** incl. filter mat, installed below the fan unit without reducing the installation space. Filter mat can be removed from the front for efficient forced ventilation of your installed units.
- **5-Way socket strip** in accordance with VDE 0100, 250 V, 16 A, easily re-positioned.
- **5 Pairs of height adjustable chassis runners** to support heavy chassis or mounting panels.

Dimensions (in mm)	W x H x D
External	600 x 2031,2 x 715
Internal	450 x 1733,6 x 570

*1U = 1 3/4" = 44.45 mm

Order number:
Mobile: 1.211.798.3
Stationary: 1.211.799.3
Supplied fully assembled

We are at your service, wherever you wish to purchase your enclosure. World-wide.

bfr	ff	£	nkr	sfr	US\$	DM
57.350,- Knürr NV, Tel. 03-326.02.99 Fax 03-325.55.43	9.678,- Knürr s.a.r.l. Tel. (1) 43 77 85 85 Fax (1) 43 39 02 10	963.32 Knürr (UK) Ltd. Tel. 04 80-49 61 25 Fax 04 80-49 63 73	12.528,- Knürr Norge A/S Tel. 02-19.89.00 Fax 02-19.69.66	2.895,- Knürr AG Tel. 01-82 50 707 Fax 01-82 50 803	1.856,- Knürr USA Inc. Tel. (805) 526-7733 Fax (805) 584-8371	2.795,- Knürr AG Tel. (0 89) 4 20 04-0 Fax (0 89) 4 20 04-1 18

All prices exclusive of VAT, packing and carriage.



® KNÜRR - MECHANIK FÜR DIE ELEKTRONIK AG

Schatzbogen 29
D-8000 München 82
Telefon (0 89) 4 20 04 - 0
Telex 5 29 608 - 10
Telefax (0 89) 4 20 04 - 118

See us at
Booth #2500

INTEROP 91

FDDI

AVAILABLE NOW!

*From Interphase,
of course.*

It's no bigger than this ad (6U VMEbus to be exact). It doesn't suck power like less efficient controllers. It's RISC-based for super performance. It connects single or dual attached stations from a single VME slot. It supports a variety of media, from fiber to twisted pair. It's ANSI X3T9 FDDI standard compliant. It's certified by the Advanced Networking Test Center™ and the University of New Hampshire Interoperability Lab (Interphase is a charter member of both).

And,

IT'S AVAILABLE...RIGHT NOW.

The Interphase V/FDDI 4211 Peregrine is at work **right now** in some of the industry's leading open systems networks. Put Interphase high performance expertise to work for you.

Call or FAX us today for information about Interphase FDDI solutions, including VME and Multibus controllers, the new fiberHUB FDDI Concentrator and the FDDI System Designer's Kit. We've also got proven Ethernet and Token-Ring products to tell you about.

(214) 919-9000

FAX: (214) 919-9200

In Europe:

(44) 869-321222 FAX: (44) 869-247720



INTERPHASE
CORPORATION

© 1991 Interphase Corporation. Specifications subject to change without notice. Interphase is a registered trademark of Interphase Corporation. Advanced Networking Test Center is a trademark of Advanced Micro Devices, Inc.

CIRCLE NO. 90

Hold It!

Now there's more . . .

We've just added support for TI's TMS320C50/51, Intel's 80486 including the chip set version and LSI's LR33000 at 50MHz with full disassembly.

So if you didn't know about these features, you'd better check our list of new ML4400 additions:

1 RISC

Supports the i960CA, 88100, R3000A, 29K

- User-modifiable disassemblers for R3000A, LR33000 and 88100 with full instruction mnemonic and data display
- Source code for disassemblers provided; user can customize displays

2 CISC

Full hardware and software support for 680X0, now including 68040

- Intel support — 80386, 80386SX (AMP, TEXTTOOL, Soldered PQFP), i486 at 50 MHz, including chip set version
- Check out our dynamic CACHE ON/OFF trigger function

3 DSP

Disassembler support available

- Supports 56000, ADSP2100, ATT DSP32C, and TMS 320CXX including C50/51

The ML4400 Features:

- Synchronous channels: 160 @ 50 MHz, 64 @ 100 MHz
- Up to four micros simultaneously
- Real-time performance analysis (histograms)
- 400 MHz on 16 ch., with 32K bits/ch. trace depth
- 100 MHz on 80 ch., with 128K bits/ch. trace depth
- Transitional timing, up to one billion virtual samples
- Trigger functions include AND, OR, NOT, RANGE, COUNT, TIME, CACHE ON/OFF, GOTO and CROSS-TRIGGER
- User-defined disassembler

Don't hold back! Call today for your free brochure on the analyzer that stands head and shoulders above the rest. (714) 731-1661

Prices start at \$5895!

Rental Program available

American Arium

Formerly American Automation and Arium Corporation
14281 Chambers Road, Tustin, California 92680

Circle #26 for Logic Analyzer Information See us at Wescon Booth #2134 & 2136 Circle #27 for Development Systems Information

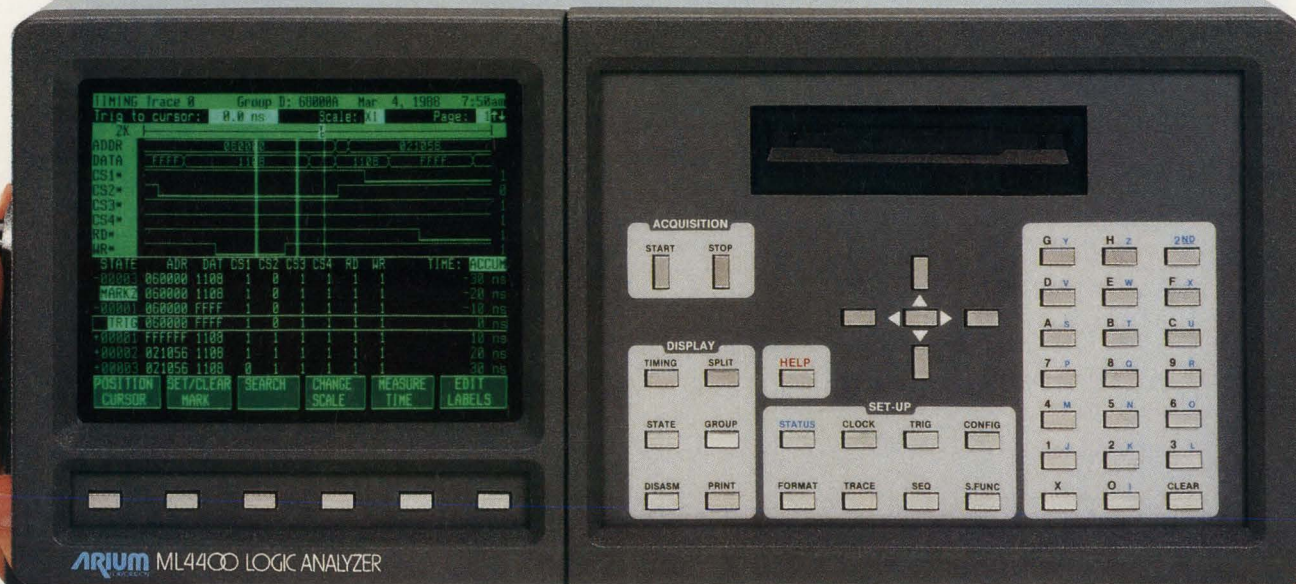

American Arium produces In-circuit Emulators for an extensive list of micros . . . Ask your Rep.

DESIGN IDEAS

EDITED BY ANNE WATSON SWAGER

Optical interrupter detects tiny parts

Leonard Schupak
Irvine, CA

Optical interrupters provide a reliable digital signal when the test part is larger than the interrupter's aperture. For smaller parts, however, the signal output becomes a function of the part size and the degree of saturation of the detector, especially if that detector uses a phototransistor or Darlington transistor. Detection may be missed entirely if the LED saturates the photodetector. Even if the detector doesn't saturate, detection is strongly dependent on temperature and optical-coupling efficiency. To overcome these difficulties, the circuit in **Fig 1** provides a controlled detection threshold and automatic, feedback-controlled adjustment of the LED output.

LED D_2 provides a reference level of about 1V at the input to IC_{1A} , which in turn controls D_1 's current by comparing the photodetector's output with the voltage on C_1 . The feedback-controlled amplifier maintains the LED current at the proper level and maintains the frequency response because of the large amount of feedback. The LED current is monitored by the peak detector composed of IC_{1B} , D_3 , and C_2 . This detector tracks very slow variations because of the presence of R_3 . As long as D_3 is conducting, the Schmitt-trigger output at IC_{2A} remains high. When a small object inter-

rupts the light beam, the LED current increases to maintain Q_1 's output at the reference level. The peak detector goes negative at this point, disconnecting D_3 and switching IC_{2A} 's output low.

This closed-loop control system can accept varied part sizes. In fact, if the aperture is completely obscured, the LED current will saturate, but the detector current will continue to request a higher illumination. At the instant the obscured aperture begins to open, the circuit recovers rapidly because the illumination is already at its maximum level. Minimum part size is less than 1% of the aperture area.

The component values shown in **Fig 1** are representative of a typical interrupter. You can adjust R_1 and R_2 to suit a given mechanical configuration. Using the TLC272 for IC_1 , the maximum LED current is about 6 mA. You can increase this current by adding a pnp emitter-follower stage and reducing the value of R_1 . Because of the peak detector's very high sensitivity, the circuit may respond to background illumination at 60 or 120 Hz. You can reduce this sensitivity by simply eliminating the peak detector altogether—remove C_2 and R_3 and short out D_3 . EDN BBS /DI_SIG #1042

EDN

To Vote For This Design, Circle No. 746

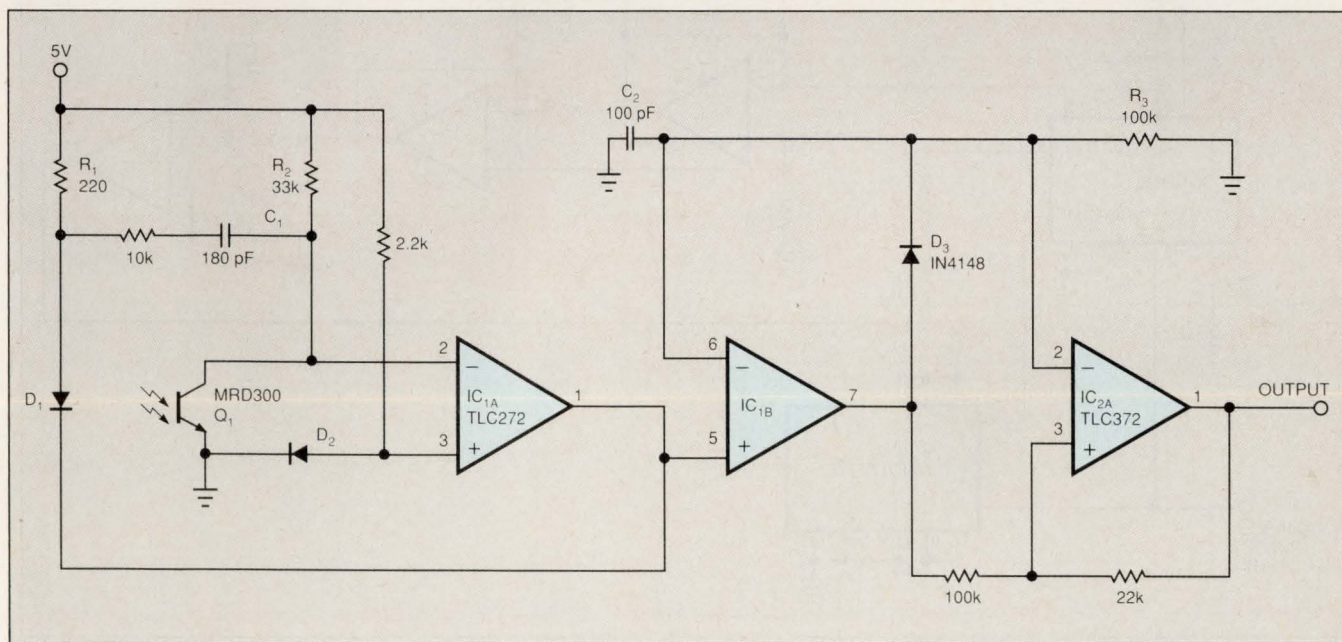

Fig 1—By controlling LED output and detecting changes in LED current, this detection circuit won't overlook small objects.

Offset varies PLL's phase shift

Donald G Stefani
LeRoy, NY

By deliberately introducing a dc offset into the error-signal path of a phase-locked loop (PLL), you can add phase shift between the input reference and the feedback signal that drives the phase detector. The circuit in Fig 1 has a phase-shift range of $\pm 160^\circ$ over a reference-signal range of 1 to 10 kHz. Because the loop uses an integrator, once set, the phase shift remains constant over the entire frequency range.

The positive-edge-triggered frequency/phase detector inside the CD4046B compares the frequency and phase of the input reference signal with the feedback signal from the 74HC193 counter. Since this phase detector is edge triggered, the duty cycle of the reference can be arbitrary. IC_{1A} level shifts the 3-state output of the phase detector. When in lock, if the positive edge of the reference leads the positive edge of the feedback signal, the output of IC_{1A} swings to its lower rail for the time interval between the two edges. IC_{1A}'s

output then returns to 2.5V until the next positive edge of the reference occurs. If the positive edge of the reference lags the positive edge of the feedback, the output of IC_{1A} remains at the upper rail for the time interval between the two edges. It then returns to 2.5V until the next positive edge of the feedback occurs.

Using the quad LMC660C CMOS op amp for IC_{1A} permits dynamic-loop, error-voltage variations over almost the entire range of 0 to 5V. Adjusting the 20-k Ω potentiometer causes the phase shift to change because the average voltage of the pulses at IC_{1A}'s output must change to maintain the constant-feedback-forced value of 2.5V at IC_{1B}'s inverting input. A unity-de-gain lead network stabilizes the loop. This design divides the output of the VCO by 16 before applying it to the phase-detector input. EDN BBS/DI_SIG #1043

EDN

To Vote For This Design, Circle No. 747

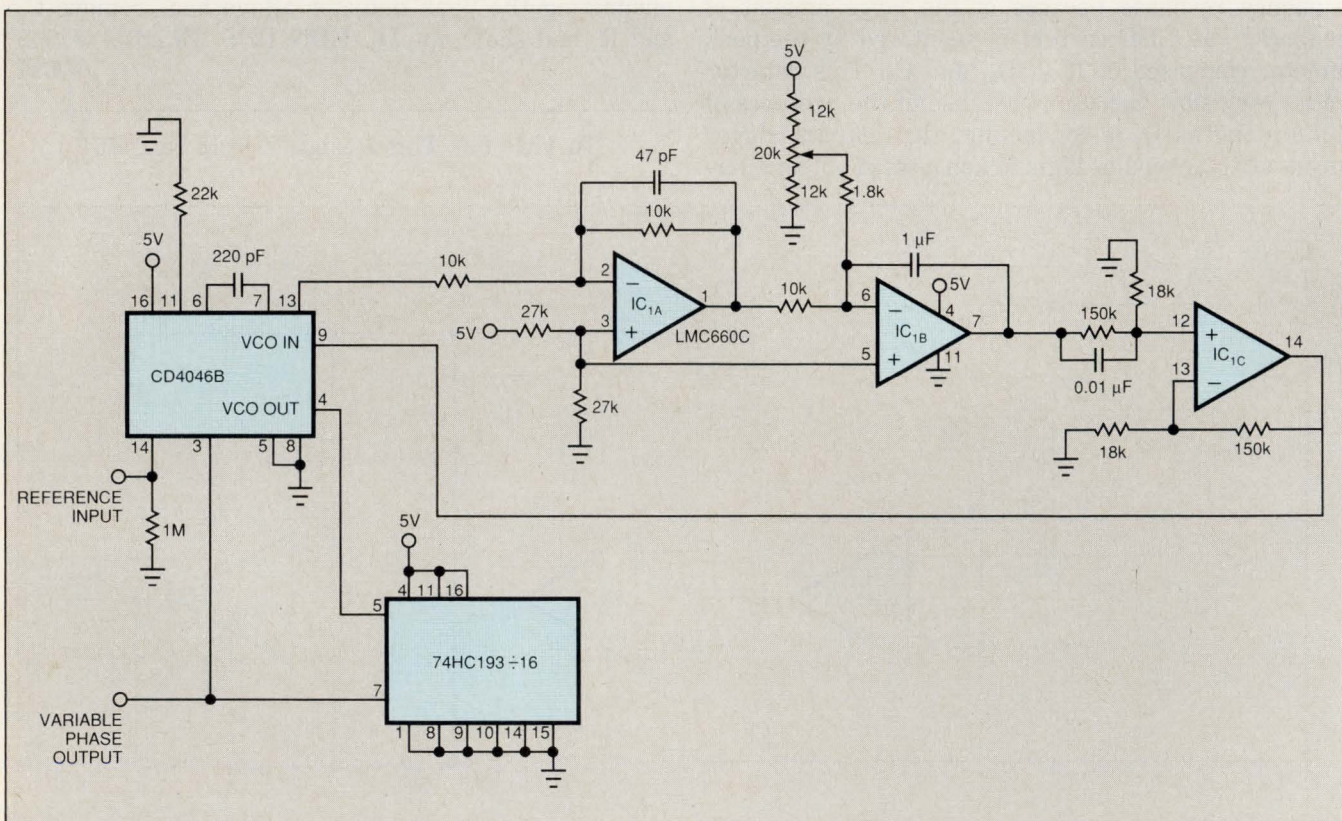
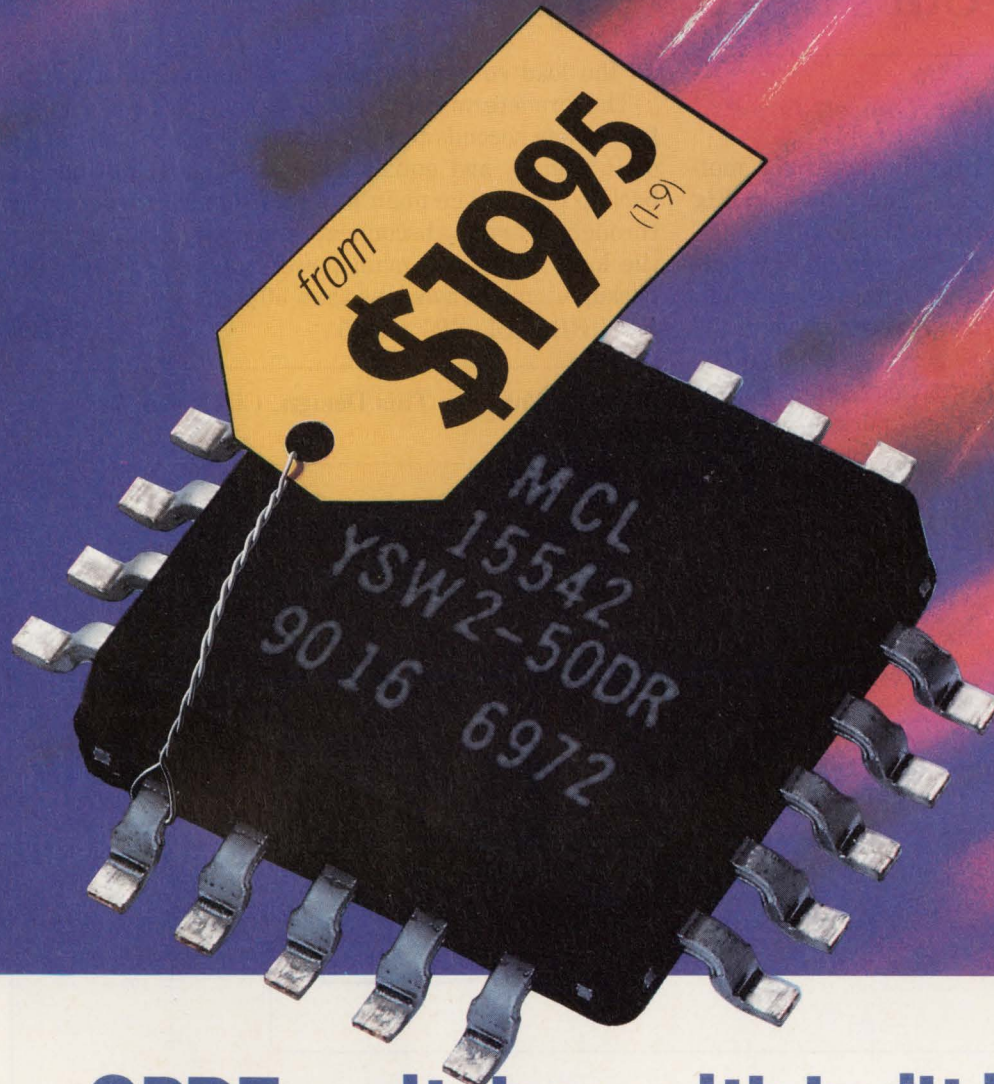

Fig 1—By introducing dc offset into this PLL's feedback, you can vary the phase shift between its input and output by ± 160 degrees.

incredible!



SPDT switches with built-in driver

ABSORPTIVE or REFLECTIVE dc to 5GHz

Truly incredible...superfast 3nsec GaAs SPDT reflective or absorptive switches with built-in driver, available in pc plug-in or SMA connector models, from only \$19.95. So why bother designing and building a driver interface to further complicate your subsystem and take added space when you can specify Mini-Circuits' latest innovative integrated components?

Check the outstanding performance of these units...high isolation, excellent return loss (even in the "off" state for absorptive models) and 3-sigma guaranteed unit-to-unit repeatability for insertion loss. These rugged devices operate over a -55° to +100°C span. Plug-in models are housed in a tiny plastic case and are available in tape-and-reel format (1500 units max, 24mm). All models are available for immediate delivery with a one-year guarantee.

finding new ways ...
setting higher standards

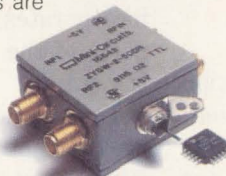

SPECIFICATIONS (typ)

	Absorptive SPDT YSWA-2-50DR ZYSWA-2-50DR			Reflective SPDT YSW-2-50DR ZYSW-2-50DR		
	dc-	500-	2000- 5000	dc-	500-	2000- 5000
Frequency (MHz)						
Ins. Loss (dB)	1.1	1.4	1.9	0.9	1.3	1.4
Isolation (dB)	42	31	20	50	40	28
1dB Comp. (dBm)	18	20	22.5	20	20	24
RF Input (max dBm)		20		22	22	26
VSWR "on"	1.25	1.35	1.5	1.4	1.4	1.4
Video Bkthru (mV.p/p)	30	30	30	30	30	30
Sw. Spd. (nsec)	3	3	3	3	3	3
Price, \$	YSWA-2-50DR (pin) 23.95			YSW-2-50DR (pin) 19.95		
(1-9 qty)	ZYSWA-2-50DR (SMA) 69.95			ZYSW-2-50DR (SMA) 59.95		

Mini-Circuits

P.O. Box 350166, Brooklyn, New York 11235-0003 (718) 934-4500 Fax (718) 332-4661 Telexes: 6852844 or 620156

CIRCLE NO. 91

F141 REV. C

Backup time-out saves battery

Simha Pilot

Tadiran Electronic Industries, Rehovot, Israel

A single backup battery can provide power for multiple, limited-time backup periods. The circuit in Fig 1 provides power for a time determined by an RC time constant without completely using up the battery. During regular operation, Q_1 is on and Q_3 is off. The load (R_L) connects to the main power through Q_1 . When V_{CC} disappears, however, Q_1 turns off, and the positive pulse generated by Q_2 activates timer IC₁ for a predetermined period. During this period, Q_3 turns

on the load current supplied by the backup battery.

The predetermined backup period, which can last from a few seconds to a few hours, is set by the values of R_1 and C_1 and equals $128 \times R_1 \times C_1$. If, during the backup period, the main power resumes, a reset pulse through R_2 and C_2 disconnects the backup battery from the load. When the main power source is active, the backup circuit draws less than 50 μ A.

EDN BBS /DL_SIG #1045

EDN

To Vote For This Design, Circle No. 748

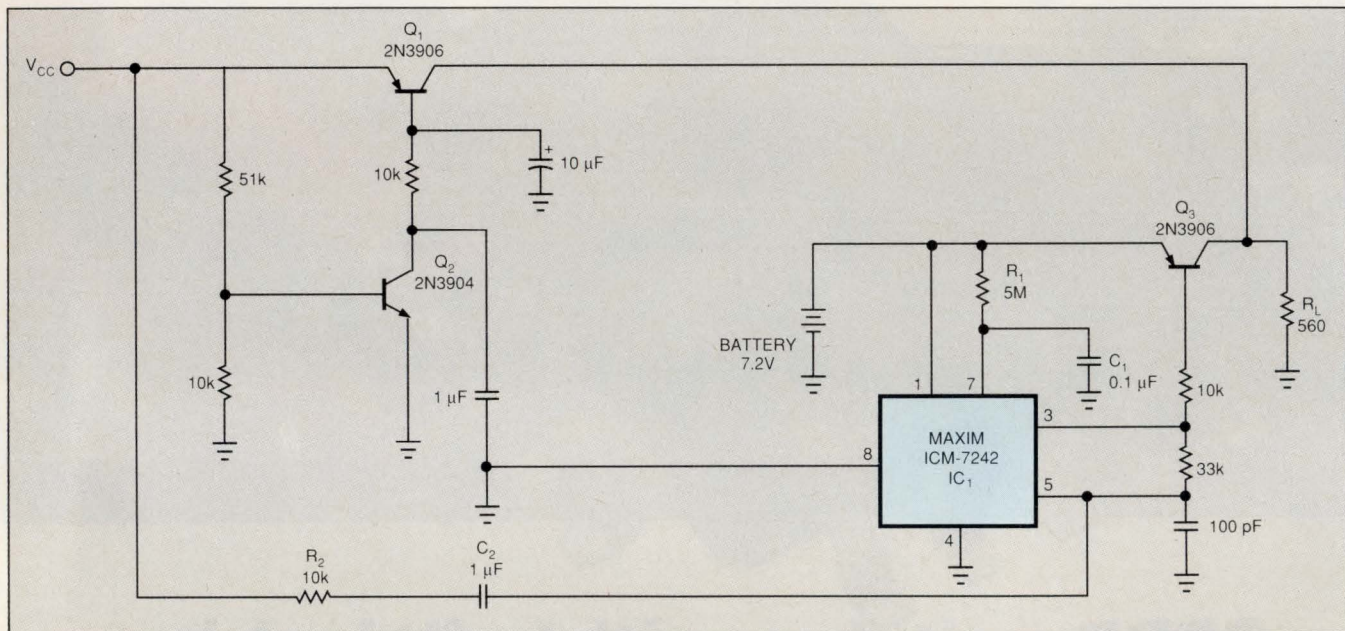

Fig 1—This limited-time battery-backup circuit conserves your battery in those cases where only short main-power failures are expected.

Isolation barrier preserves bandwidth

Giovanni Stochino

Arision-Ericsson FATME S p A, Rome, Italy

The interface circuit in Fig 1 provides high isolation while maintaining wide bandwidth and low distortion. The circuit's bandwidth is 2.7 MHz when driving a 50 Ω load. Its isolation is greater than 2.5 kV ac for 1 sec

and greater than 1.4 kV ac for 1 minute. The circuit incorporates a suitable dc/dc converter to power those parts of the interface that need to be insulated from the output.

The circuit implements the isolation barrier that breaks the ohmic continuity between the input and output ports by optically coupling the signal path and

Aluminum Electrolytics

NON-POLARIZED

Surface Mount

2000

HOUR
LIFE
TEST
RELIABILITY

POLARIZED

CAUTION
LOW CEILING
MAX. HEIGHT
5.5 mm

EXPANDED
-55°C
+105°C
TEMPERATURE

Lead-time,
Cost,
Production
Savings

ANTI-SOLVENT

All signs point to Nichicon surface mount electrolytics.

When you need surface mount aluminum electrolytic capacitors, remember that all signs point to Nichicon.

Because now there are seven surface mount electrolytic series ready to help your products meet their marketing window—on time and on budget.

Save time. Save space. Save money.

Who isn't under pressure these days to reduce costs?

Well now you can, without sacrificing performance, when you design your new products or replace comparable tantalum capacitors with Nichicon surface mount electrolytics.

More Nichicon advantages.

Your real bottom line though is still capacitor performance. And with seven series with 1,000 to 5,000 load life ratings to choose from, your chances of finding your capacitor choice are better than ever.

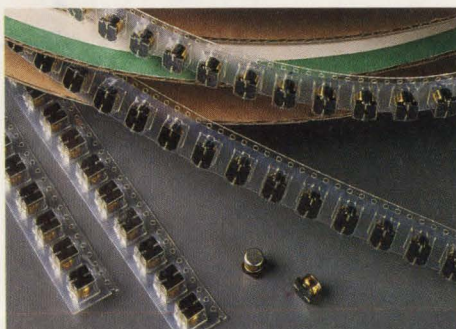

Each series is carrier-taped and reeled and features Nichicon's anti-solvent design.

SERIES	FEATURE
WT	1,000 hr. life/5.5mm max. ht. -55~+105°C/0.1~100 μF 4~50V
UX	2,000 hr. life/-55~+105°C 22~470 μF/6.3~50V
UZ	5,000 hr. life/6mm ht./4~50V -55~+105°C/0.1~200 μF
WX	2,000 hr. life/5.5mm max. ht. -40~85°C/0.1~220 μF/4~50V
UT	2,000 hr. life/6mm ht. -55~105°C/0.1~100 μF/4~50V
UP	1,000 hr./6mm ht./Non-polarized -40~+105°C/0.1~47 μF 6.3~50V
UK Muse	2,000 hr./6mm ht./For audio -40~+85°C/0.1~220 μF 4~50V

For your free Nichicon Capacitor catalog or more information, call your local Nichicon representative or distributor, or call us at (708) 843-7500. Fax (708) 843-2798.

nichicon[®]
The capacitor choice.

927 E. State Parkway • Schaumburg, IL 60173 • (708) 843-7500

CIRCLE NO. 92

One good idea after another.

DESIGN IDEAS

by using magnetic coupling within the converter. A pair of optocouplers form the core of the interface. The HCPL-4562 couplers are ideal for wide-bandwidth isolation because of their inherent high speed and linearity. This circuit uses local feedback through resistors R_1 through R_4 and collector-voltage bootstrapping via Q_1 through Q_4 and D_2 to increase the bandwidth and simplify the frequency compensation of the output amplifier.

Fig 1's input circuitry consists of an input amplifier, IC_1 , that is referred to a floating common ground (note the schematic's two different ground symbols). The signal $-V_{REF1}$ biases IC_2 's LED to ensure good linearity and dynamic range. The input circuit provides a high-impedance interface to the signal source and converts V_{IN} into a proportional current (I_1) that flows through IC_2 's LED. The output circuit is a composite feedback amplifier whose input stage comprises the light-receiving diodes and respective transistors of IC_2 and IC_3 . IC_4 , D_1 , and R_5 stabilize these transistors' collector currents at about 3 mA; their collector-emitter

voltages are at an approximately 5.6V constant. These levels keep the amplifier frequency response and output offset voltage stable regardless of temperature and supply-voltage variations.

IC_6 establishes a linear relationship between V_{OUT} and the current I_2 flowing through IC_3 's LED. This linear relationship is essential for achieving low distortion. The circuit in Fig 1 also establishes a feedback loop around the output amplifier. Due to the feedback action and the high gain of IC_5 , the circuit reaches a stable output state only when collector currents I_3 and I_4 are equal, that is, when the differential input stage is balanced. This technique of driving the LEDs with well-defined currents cancels out any influence in the input/output relationship if their forward voltages mismatch. R_6 and C_1 govern the frequency-response flatness of the entire isolation interface.

EDN BBS /DL_SIG #1046

EDN

To Vote For This Design, Circle No. 749

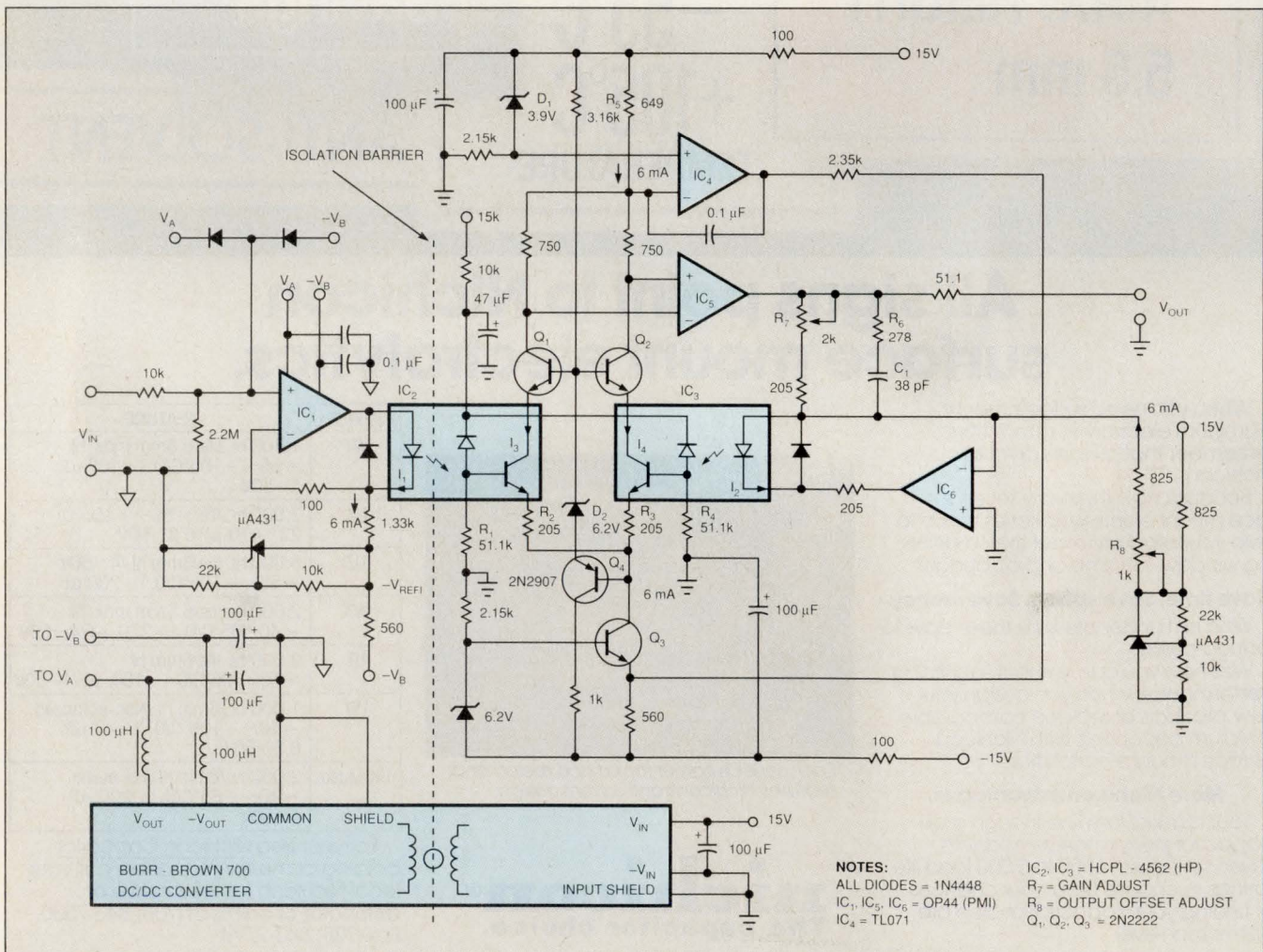
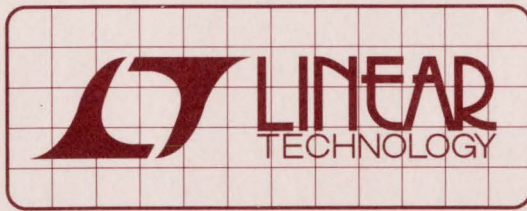

Fig 1—By driving LEDs with defined currents, this isolation interface maintains wide bandwidth and low distortion.



DESIGN NOTES

High Performance Frequency Compensation Gives DC-to-DC Converter 75 μ s Response With High Stability — Design Note 53

Ron Vinsant

This Design Note describes four high performance, low cost, 1.75A step-down converter circuits based on the LT1076 five terminal switching regulator. All four circuits have exceptional transient response; indeed, it is superior to most three terminal linear regulators. Transient response is important to loads that are switched on and off or that require high peak currents. Examples are digital circuits that are turned on and off, disk drive motors, stepper motors and linear amplifiers. The frequency compensation schemes shown in this Design Note, when compared to the usual R and C technique, allow greater variation in output capacitor ESR without causing stability problems. This is important in applications where wide temperature variations occur (which changes capacitor ESR) such as industrial control, automotive and military, and when the use of multiple capacitor vendors with different capacitor specifications is required.

Phase margin is always more than 50° and gain margin is a minimum of 18dB. Bode plots are available from the factory upon request.

The efficiency of these circuits is typically 80% with output ripple less than 50mV. Input voltages can be as high as 45V. Input ripple rejection is an exceptional 60dB due to the feedforward architecture of the LT1076. These circuits use a small number of external parts that are available off-the-shelf.

Many of the problems associated with five terminal switching regulators have been addressed by these circuits. Start-up overshoot is less than 5% with the optional soft start circuit. On recovery from a short circuit, a 10% overshoot is realized.

For a 15V output, line regulation is typically 0.06% (10mV) for a 20V to 40V input voltage change. Load regulation is difficult to measure; in fact, it is only 1mV to 2mV at the point of regulation. This applies to all output voltages.

Each circuit has been built in our lab and evaluated for stability, temperature, component life and tolerance. Two circuit options are shown: a simple soft start circuit and an output voltage adjustment (see Figure 1).

Inductors

The inductors shown in Table 3 are designed around two different core materials. The first is powdered iron based for low cost. The second is tape wound steel for smaller size and higher efficiency but greater cost. For rapid evaluation of these circuits, powdered iron cores are available in sample quantities from Micrometals at 1-800-356-5977. Completed inductors are available from Coiltronics at 305-781-8900.

Capacitors

Ripple current in the output capacitor is 150mA maximum with the input voltage at 40V and maximum load. At 35°C ambient estimated life-time with the specified capacitor and full load is 28 years.

The input capacitor, which undergoes higher stress, has a ripple current of 830mA maximum at 14V input and maximum load. The life-time of this capacitor is 14 years at 35°C. If the ambient temperature is higher, the life of the capacitor will be cut in half for every 10°C increase. The ESR specification affects the output ripple as well as frequency compensation. Its value of capacitance is not critical.

The capacitors in the frequency compensation network should be at least X7R ceramic, never Z5U, and, if broad temperature operation is expected, polyester or polycarbonate film caps should be used.

Manufacturing technologies must also be taken into account. If an IR furnace is used for soldering, use only ceramic capacitors. A wave or hand soldering operation is suggested for both film and electrolytic capacitors.

This is an area of continuing development so be sure to contact the capacitor manufacturers for temperature profiles.

Layout

In order to achieve proper performance it is important to lay out the circuit as the schematic indicates. Use a single point ground at the output of the converter as shown. The term "short" indicates that the trace should be as short as possible between the two points shown. These traces should have a minimum width of 0.2 inches in 2oz. copper for a length of less than 1.5 inches. Traces longer than this should be avoided on the heavily shaded portions of the schematic.

Output Adjustment

A potentiometer can be added to the output divider string, provided the string does not change its overall resistance value. A table showing resistance values is shown with the schematic.

Heatsinking

Any heatsink of 30°C/W (~2 square inches) or lower will keep the LT1076 at an acceptable temperature up to a 70°C ambient. See LT1076 data sheet for further information.

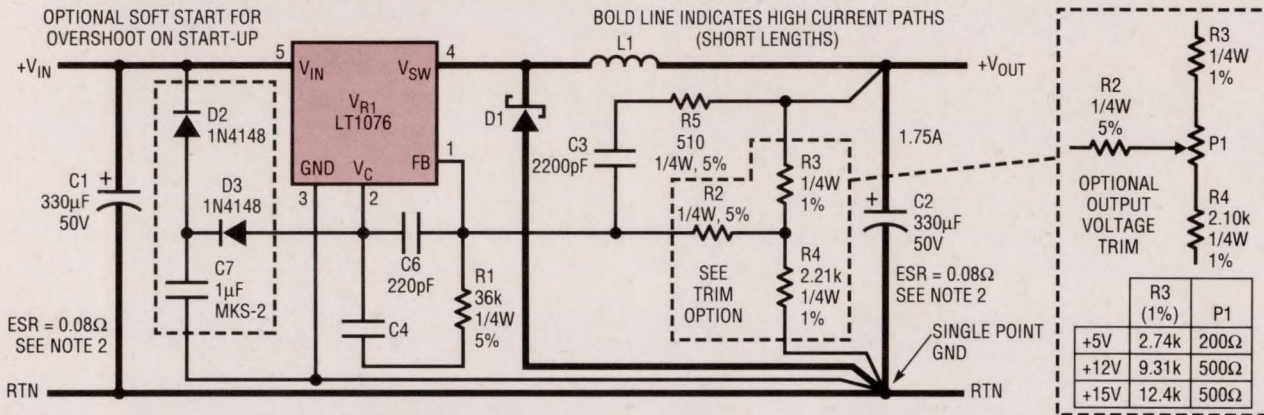

NOTE 1: DO NOT SUBSTITUTE COMPONENTS WITHOUT COMPLETE EVALUATION.
NOTE 2: C1 AND C2 MUST BE 0.07Ω MIN ESR AT ROOM TEMPERATURE (25°C).
 UNITED CHEMICON SXE50VB331M10X30LL, SPRAGUE 672D337F020DM4D.

NOTE 3: ALL CAPS EXCEPT C1 AND C2 ARE WIMA FKC-2 OR X7R CERAMIC, ±10% TOLERANCE. WIMA 914-347-2474

DN53 • TA01

Figure 1. High Performance DC-to-DC Converter

Table 1. Components

#	V _{IN}	V _{OUT}	e (%) @ V _{IN}	L (µH)	D1	R2 (5%)	R3 (1%)	C4 (10%)
1	8V-20V	+5V	83% @ 10	75	MBR330P	1.5k	2.80k	0.0068µF
2	8V-40V	+5V	76% @ 24	91	MBR350	1.5k	2.80k	0.0068µF
3	15V-40V	+12V	86% @ 24	180	MUR415	1.2k	9.79k	0.01µF
4	18V-40V	+15V	86% @ 24	240	MUR415	1.2k	12.7k	0.01µF

Table 2. Performance

#	V _{OUT}	MIN LOAD	REGULATION (MIN TO MAX) LOAD LINE	RIPPLE REJECTION 50Hz-400Hz	OUTPUT RIPPLE
1	+5V	0.200	0.1% 15mV	60dB	50mV
2	+5V	0.175	0.1% 15mV	60dB	50mV
3	+12V	0.175	0.1% 15mV	60dB	50mV
4	+15V	0.175	0.1% 15mV	60dB	50mV

Table 3. Inductor

L (µH)	NUMBER TURNS	CORE	COILTRONICS P/N	SMALLER TOROID
75	37 #18	T68-52A	CTX75-2-52	CTX75-2-KM
91	38 #18	T80-52B	CTX91-2-52	CTX91-2-KM
180	53 #18	T80-52B	CTX180-2-52	CTX180-2-KM
240	61 #18	T80-52B	CTX240-2-52	CTX240-2-KM

Note 1: ΔL with DC current is 20% max.

Note 1: V_{IN} = 24V except #1 at 14V.

Note 2: Temperature = 25°C.

Note 3: Periodic and random deviation (P.A.R.D.).
 With optional adjustment = ±2.5%.
 Without optional adjustment = ±4.5%.

For literature on our Switching Regulators, call (800) 637-5545. For applications help, call (408) 432-1900, Ext. 456

Linear Technology Corporation

1630 McCarthy Blvd., Milpitas, CA 95035-7487
 (408) 432-1900 • FAX: (408) 434-0507 • TELEX: 499-3977

BA/GP 1091 180K

 © LINEAR TECHNOLOGY CORPORATION 1991

How do you create a *little* lightning?



At Astec we create it by design.
The result is the new Lightning
power supply series.

Astec introduces the new Lightning ALS Series, the smallest medium wattage power supplies in the industry.

The ALS Series achieves its small size through unique thermal packaging by integrating an efficient heat sink with the housing. This results in higher density, more efficient performance, and higher reliability through fewer parts.

The ALS Series is available in the wattage range from 300 watts to 550 watts and one to four outputs. The multiple output ALS 304 offers 325 watts in an 8.5" long package, and the single output ALS 301 offers 300 watts in 6.5".

Standard features include universal input, high auxiliary channel peak loading capability, power fail and inhibit signals, and a versatile mounting design.

The ALS lives up to the Astec standard of high reliability, outstanding quality, and leading edge technology. It accommodates an almost endless range of applications, from serving the fundamental needs of computer and peripheral applications to the more complex power requirements of communication and network systems.

To find out how Lightning can strike your application, call the toll-free number below for literature.



ASTEC STANDARD POWER
Division of Astec America, Inc.
401 Jones Road
Oceanside, CA 92054-1216
Telephone: 619-757-1880
Facsimile: 619-439-4243

For information or literature please call:
1-800-233-9973

CIRCLE NO. 95

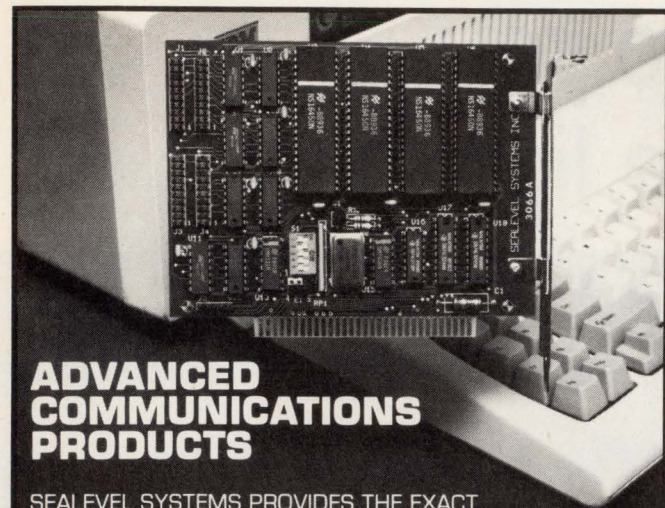

ADVANCED COMMUNICATIONS PRODUCTS

SEALEVEL SYSTEMS PROVIDES THE EXACT COMMUNICATION CARDS YOU NEED.

PRODUCTS:

- 1, 2 OR 4 PORT RS-232 AND RS-422/485 BOARDS
- CURRENT LOOP SERIAL INTERFACES
- HIGH SPEED SYNC (HDLC, SDLC) AND ASYNC WITH DMA
- RS-530 AND V.35 INTERFACE BOARDS
- DIGITAL AND RELAY I/O BOARDS.
- DISKLESS EPROM BOARD WITH PROMKIT SOFTWARE BY ANNABOOKS.
- NEW LAP-TOP ADD ONS!
- MADE IN USA
- DELIVERY FROM STOCK
- SATISFACTION GUARANTEED
- EXCELLENT TECHNICAL SUPPORT



SEALEVEL SYSTEMS INC.
PO BOX 830
LIBERTY, SC 29657
(803) 843-4343

CIRCLE NO. 93

DESIGN IDEAS

Diagnostic debugger manipulates reset

ER Greenwood
IBM Storage Systems Products Div,
San Jose, CA

Finding problems during the development of μ P-controlled test equipment that includes sequentially dependent operations can be particularly difficult. However, manipulating the μ P's reset pulse proves to be a powerful diagnostic tool, enabling you not only to correct hardware design and implementation errors, but also to help the software design team to accurately pinpoint μ P code discrepancies. By connecting a pulse generator to the reset line of the μ P module, you can use reset pulses to force the system's hardware and software to return to a nominal known state of initialization, and then allow the software to continue execution up to the point of the next reset pulse. By varying the pulse-width, duration, and duty-cycle knobs on the pulse generator, you can time the second reset pulse to coincide with the equipment's point of failure. The technique enables you to observe the progress of the hardware and software actions on a real-time oscilloscope as the equipment sequences through its operations. Also, you can arbitrarily chop off the sequence and restart it anywhere you choose. You should select the sync point for the scope somewhere within the properly operating sections of the hardware just prior to the time of failure. EDN BBS /DI_SIG #1044

EDN

To Vote For This Design, Circle No. 750

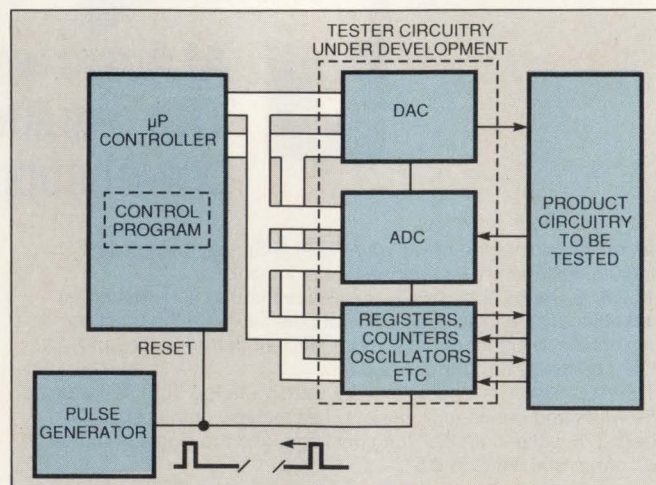
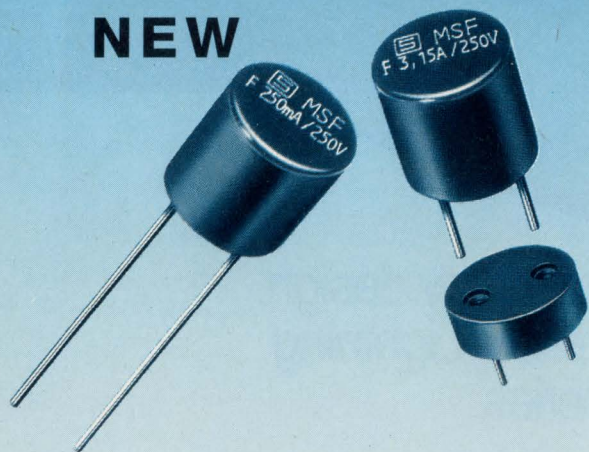

Fig 1—By connecting a pulse generator to your system's software and hardware reset points, you can manipulate reset pulses to coincide with failures, and thereby more easily find design errors.

SCHURTER

NEW



Save valuable board space with MSF 250 V.

New quick acting microfuse MSF 250 according to IEC 127 is available from 50 mA - 5 A. This 250 volt fuse can be soldered directly to the PCB or plugged into a fuseholder. Available 750 pcs taped or loose in boxes of 100 pcs.

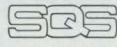

IEC 127 Standard

ISO 9001/EN 29001

SCHURTER AG
Electronic and Electrical
Components
Werkhofstr. 8-12, CH-6002 Lucerne
Phone 041 40 31 11
Fax 041 40 33 33

CIRCLE NO. 94

DESIGN IDEAS

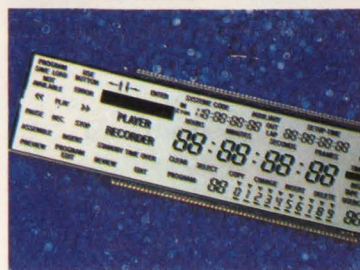

VARITRONIX LIMITED VL ELECTRONICS, INC.



SOPHISTICATED ONE-STOP CUSTOM SERVICES

LCD DISPLAYS AND CUSTOM MODULES
TOTAL TURNKEY ASSEMBLY PROJECTS
TOUCH SENSITIVE COMPUTER HANDHELD TERMINALS

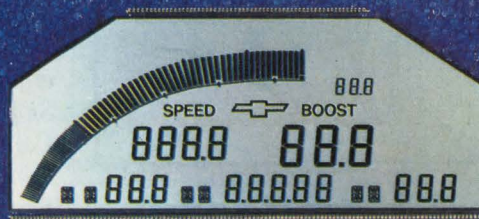
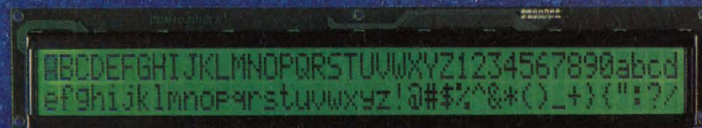

VARITRONIX LTD.
4/F, LIVEN HOUSE,
61-63 KING YIP STREET,
KWUN TONG, KOWLOON,
HONG KONG.
TEL: (852) 389-4317
FAX: (852) 343-9555

VL ELECTRONICS, INC.
3250 WILSHIRE BLVD., SUITE 1301,
LOS ANGELES,
CA 90010,
U.S.A.
TEL: (1) (213) 738-8700
FAX: (1) (213) 738-5340

VARITRONIX (UK) LTD.
P.O. BOX 200,
MAIDSTONE,
KENT ME15 0SH
UNITED KINGDOM.
TEL: 0627-2759
FAX: 0627-2317

VARITRONIX (FRANCE) S.A.R.L.
74 AVENUE CHARLES DE GAULLE,
91420 MORANGIS,
FRANCE.
TEL: (33) 1 69 09 70 70
FAX: (33) 1 69 09 05 35

* NOW AVAILABLE FROM VARITRONIX, EXTENDED TEMPERATURE STN DISPLAYS AND MODULES *

Please see our exhibit at **COMPONIC 91, Paris, Hall 6, Allee X, Stand 30**

DESIGN IDEAS

Design Entry Blank

\$100 Cash Award for all entries selected by editors. An additional \$100 Cash Award for the winning design of each issue, determined by vote of readers. Additional \$1500 Cash Award for annual Grand Prize Design, selected among biweekly winners by vote of editors.

To: Design Ideas Editor, EDN Magazine
Cahners Publishing Co
275 Washington St, Newton, MA 02158

I hereby submit my Design Ideas entry.

Name _____

Title _____ Phone _____

Company _____

Division (if any) _____

Street _____

City _____ State _____

Country _____ Zip _____

Design Title _____

Home Address _____

Social Security Number _____
(US authors only)

Entry blank must accompany all entries. Design entered must be submitted exclusively to EDN, must not be patented, and must have no patent pending. Design must be original with author(s), must not have been previously published (limited-distribution house organs excepted), and must have been constructed and tested. Fully annotate all circuit diagrams. Please submit software listings and all other computer-readable documentation on a 5¼-in. IBM PC disk.

Exclusive publishing rights remain with Cahners Publishing Co unless entry is returned to author, or editor gives written permission for publication elsewhere.

In submitting my entry, I agree to abide by the rules of the Design Ideas Program.

Signed _____

Date _____

ISSUE WINNER

The winning Design Idea for the June 20, 1991, issue is entitled "Low-battery detector polls threshold," submitted by Yongping Xia of Department of Electrical and Computer Engineering, West Virginia University (Morgantown, WV).

ISSUE WINNER

The winning Design Idea for the July 4, 1991, issue is entitled "Ordinary DMM measures high resistances," submitted by Alfred E Hess of Boulder, CO.

FEEDBACK AND AMPLIFICATION

Hardware change saves cycles

I have just received a letter from Design Ideas Editor Charles H Small suggesting a change to my Design Idea, "Z80 acquires extra interrupt lines," in the August 19, 1991, issue. The suggested change is to connect the 8259's D₀, D₁, and D₂ lines to the Z80's D₁, D₂, D₃ lines. The purpose of the change is to multiply the interrupt vector by 2, thus simplifying the interrupt-vector jump table.

You are right! If you pay special attention to writing command words and reading status words (which will also be shifted), it is an ingenious solution.

*András Pomozi
H-1025. Budapest
Tömörkény út 15/d.
Hungary*

Contributor writes from China

I was delighted to hear from EDN. I didn't receive the letter you sent on March 27, by air mail, until June 17. By the end of June, I received your second letter and the check for my Design Idea. It took almost a month.

Though the post office delayed your letters much too long, I was very happy. I thank you for your encouragement and help. Without your appreciation, I might never have been published in a foreign country. This is a great success for me. I don't know how to express my thankful feelings so, as my workmates suggested, I am sending some Chinese paper cuttings to you.

The large one is an eagle, which symbolizes EDN's power, wisdom, and bright future. The others are little animals which symbolize that EDN has great glamour for the world's readers. We all love her. I hope you enjoy them.

*Shu Zheng Ping
Computer Center
Central South University of Technology
Shangsha City, Hunan Province, PRC*

EDN's bulletin board is on line

Call EDN's free bulletin board system (BBS) at (617) 558-4241 (1200/2400,8,N,1). From the Main System Menu, enter SS/DL_SIG to get additional information or to comment on these Design Ideas.

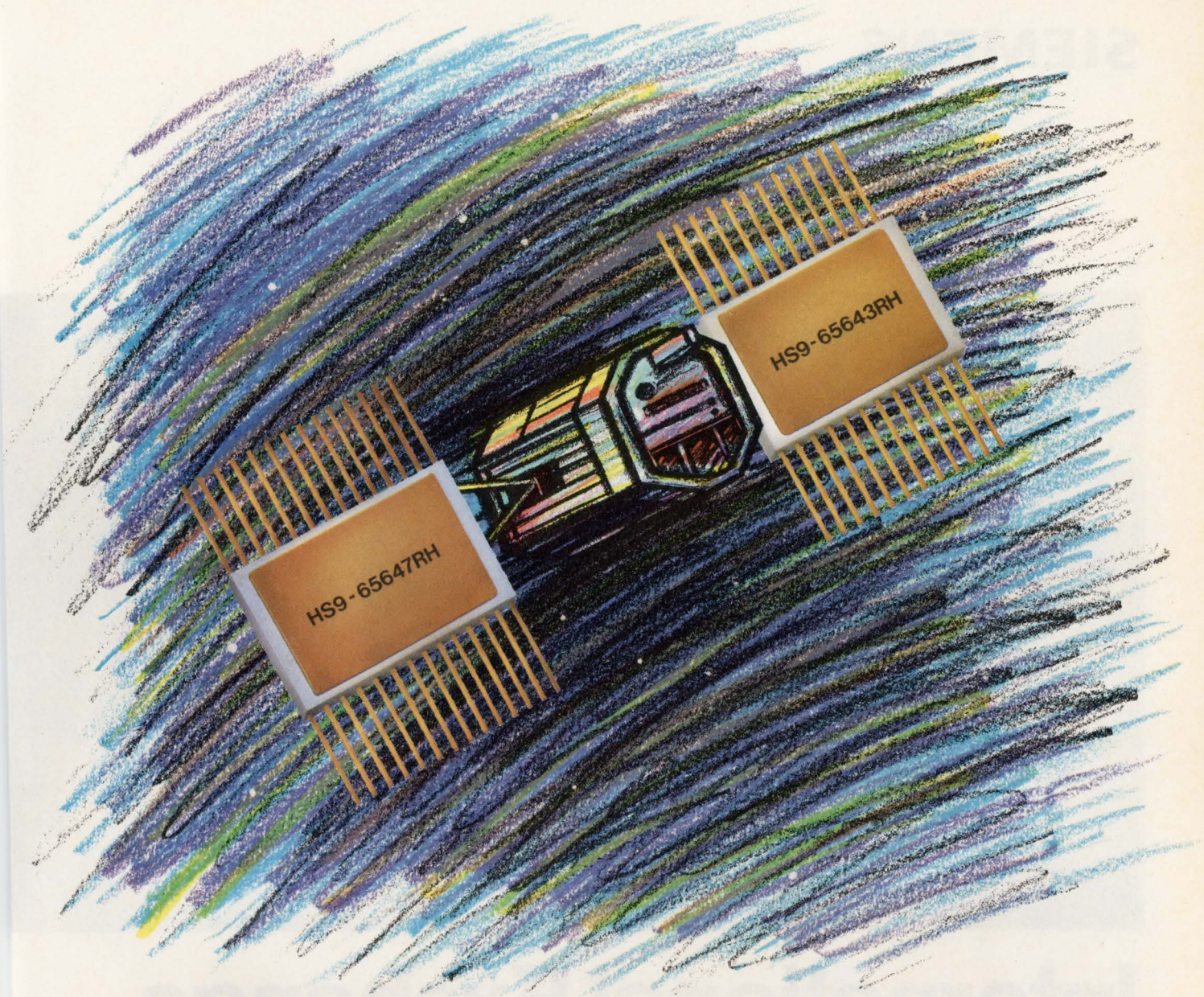

The world's fastest 64K SRAMs for space applications.

Give your space applications the boost they need. With two new Rad Hard 64K SRAMs from Harris. Our 64K SRAMs aren't only the world's fastest for high-

Process:	1.25 micron TS0S4
Configuration:	64K x 1, 8K x 8
Access Speed:	50 ns
SEU Error Rate:	<1x10 ⁻¹² Errors/Bit Day
Functionality:	Beyond 1M rad (si)

dose radiation environments. They're the world's most accurate.

How does 50 ns access speed, an SEU error rate of less than 1 x 10⁻¹² Errors/Bit Day, and full functionality beyond 1M rad sound? (Pretty out of this world, wouldn't you say?) And remember, Harris is the largest Class S Rad Hard supplier in the universe.

So if it sounds like we're handing you the best of all possible worlds, it's because we are.

So don't delay. Make immediate contact with a Harris 64K SRAM. Call 1-800-4-HARRIS, Ext. 1023. And give all your systems a go.



SIEMENS

Transmit

Speed Dial

View Text

Access Network

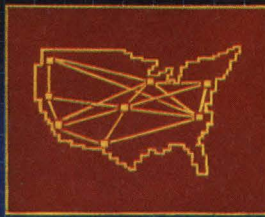

International Exchange.

Siemens integrated circuits help bring the world closer together with telecommunications.

Siemens is continuing to provide innovative solutions in communications which are making a sound impact, throughout the industry. And the world.

We offer the most comprehensive communication IC family in the world, facilitating the incorporation of data, speech, and picture sources, to meet your application-specific needs.

With the development of our PEB2091 ISDN Echo Cancellation Circuit (IEC-Q), we introduced the industry's first single-chip CMOS solution for the standardized U-interface. It can double the traffic-handling capability of existing



High-integration echo cancellation transceiver for ISDN.

telephone lines. And it's ideal for transmission systems such as digital added main line and other pair gain systems and intelligent channel banks.

For applications such as cellular or full-featured telephones or line cards, which require lower power consumption, we offer CMOS 8-bit microcontrollers based on the 8051 architecture. Like the SAB80C537, which features 16-bit hardware multiply/divide, and 8 data pointers.



CMOS 8-bit Microcontrollers.

Siemens CMOS ASIC technology features both Sea-of-Gates and standard-cell families. Our 1.5, 1.0 and sub-micron technologies are compatible with Toshiba even at the GDS2 data-base level, for true alternate sourcing

worldwide. And they come with the European content and U.S. design support you need, as well as the best service in the industry.

For the most advanced telecommunications ICs, hook up with the leader.

For details, call **(800) 456-9229**, or write:

Siemens Components, Inc.
2191 Laurelwood Road
Santa Clara, CA 95054-1514.

Ask for literature package M12A 010.



ASIC solutions in both Sea-of-Gates and standard-cell.

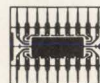

**Siemens
World Wise, Market Smart.**

VME à la Card

\$1795

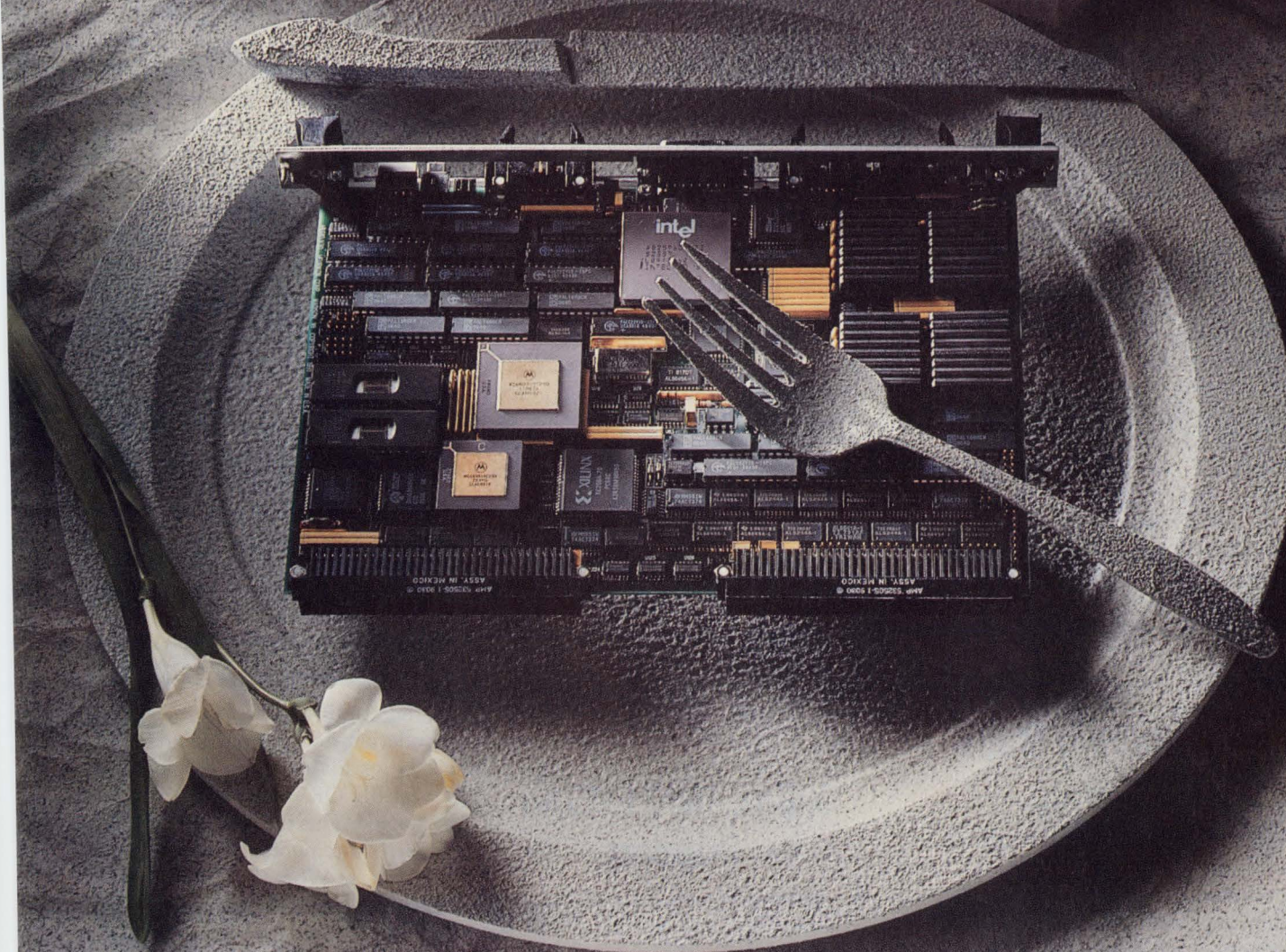

VME performance at a price you can sink your teeth into! Heurikon's HK68/V3D offers VME standardization and design flexibility with a 33 MHz Motorola 68EC030 and 2 Mbytes of memory for only \$1795 (less in quantity). That makes the V3D a cost efficient entry point into VME single-board computers. As a complement to our main course, you can add more memory, SCSI or Ethernet. VxWorks and OS-9 are also available.

While our price indicates good value, it's our service which makes that value great. Our VME boards, real-time operating systems and software development environments are backed by superior technical support before and after the sale. The Heurikon V3D is the first in a series of new 680X0 value priced entrees. If you're hungry for more information, give us a call. **1-800-356-9602. Bon Appétit.**

Partners in Real-Time
HEURIKON
CORP.

CAE Technology Report

Multiple FPGAs

Growing circuit size and complexity, coupled with board real estate constraints, are today, forcing more and more designs into FPGAs. This trend has caused many designers to use multiple FPGAs in a single design and even multi-vendor FPGAs in the same circuit. However, CAE tools have not kept pace with this development, and most simulators today can support only a single FPGA in a design. ALDEC Inc., Newbury Park, CA., has responded to this challenge with a new release of its SUSIE logic simulator which now supports simulation of circuits containing multiple same-vendor FPGAs and even multiple-vendor FPGAs. This development means shorter verification cycles, since multiple simulation passes for the same design is now unnecessary.

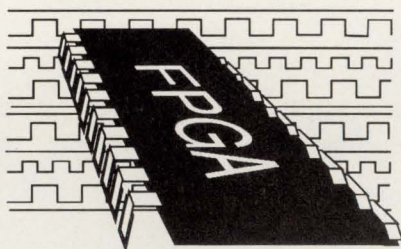

Modelling Made Simple

With the emphasis today, on system level design in general and VHDL capability in particular, device modelling has taken on much more significance, and many suppliers have stepped in to fill this void. However, most designers are still discovering that some of their more esoteric parts are unavailable in model form. VHDL has gone a long way in curing this ill, but has a rather steep learning curve. Now ALDEC Inc. Newbury Park, CA has taken this one step further by introducing MOBIC 6.0, the new modelling capability that makes device modelling a cinch. MOBIC lets modellers build models by using Boolean equations and also by specifying a model by its output waveforms. This form of behavioral modelling negates the need for detailed knowledge of the internal architecture of a device, thereby facilitating quick-turn models for simulation.

"Design Viewing Aperture" Technology

Today, designs are becoming increasingly larger and more complex. It is not uncommon to routinely have circuits over 300,000 gate-equivalents. However, during the logical verification phase of the design process, designers are usually interested in only a small part of the design at any given time. Because of their "batch" orientation, traditional simulators have forced the engineer to compile and simulate the entire design. The SUSIE logic simulator, release 6.0 from ALDEC Inc., solves this problem by supporting partial simulation. This feature allows the

designer to choose the portion of the design on which he/she wishes to focus and to simulate just those components. The result is more manageable simulation results and shorter design cycles.

Xilinx 4000 FPGAs Support

By announcing support of the new XC4000 FPGAs from Xilinx by SUSIE 6.0 simulator, ALDEC Inc. has cemented its position as a leader in the CAE market place. This development means that designers can continue to simulate their entire designs even if they contain the latest Xilinx technology. ALDEC also recently released SUSIE/XNF, which simulates single FPGA designs in any of XC2000, XC3000 or XC4000 technologies. The XNF/VT library is also available for SUSIE-CD board level simulator to verify multiple Xilinx FPGAs at the board level. Interest in designs using XC4000 technology is now shifting from research departments into mainstream design organizations. SUSIE 6.0, by supporting this new FPGAs family is helping to support this trend.

New Simulation Alternatives

ALDEC Inc. has introduced a new family of dedicated simulation products targeted at the FPGA market. These stand-alone simulation engines are meant to support a variety of FPGAs from different vendors. There is the SUSIE/ACT which is the dedicated engine for ACTEL ACT and ACT2 parts, SUSIE/MAX, a similar product for Altera MAX parts and SUSIE/XNF for Xilinx parts. Because each product offers full timing and functional capability, designers who need to simulate only a single device are able to purchase simulation capability for a fraction of the cost of the full-board simulator, SUSIE-CD. In addition, since each of these stand-alone units is fully compatible with SUSIE-CD, single-chip simulations can be modified to the full-board level with complete data integrity.

Selective Simulation

In the traditional approach to logic simulation, it was imperative that models be available for all devices in a design BEFORE a simulation run could be started. This was due to the compilation requirements of "batch-oriented" simulators. What this meant was that even if a single model was missing, simulation could not proceed. But now, with the release of SUSIE 6.0 from ALDEC, the designer is not hamstrung by the lack of models. Simulation can be performed with missing or incomplete (FPGA) models. No longer does the designer have to "design" the entire circuit before starting simulation. This new feature facilitates true incremental design and results in shorter design cycles and greater design flexibility.

ALDEC
 AUTOMATED LOGIC DESIGN COMPANY
 3525 Old Conejo Rd. #111
 Newbury Park, CA 91320
 Phone (805) 499 6867
 Fax (805) 498 7945

SUSIE and MOBIC are trademarks of ALDEC Inc.
 Actel, ACT, Altera, MAX, Xilinx are
 trademarks of their respective holders.

Introducing the biggest thing in slides since ball bearings.



Ball Bearing



**Green Button™
Release**

**No pinched fingers. Just smooth slide action.
The new Green Button™ release. Only from General Devices.**

Stop damaged digits by spec'ing Chassis Trak® slides with the new Green Button release. Safe, simple and superior to its spring-clip counterparts, Green Button is standard on our most popular ball bearing slide models. A feature available at *no additional cost* to you.

Be part of the push. Push these buttons now: 1-800-626-9484.

We'll rush you a copy of our new ball bearing slide catalog and all the info on Green Button...the biggest thing in slides since ball bearings.



**GENERAL®
DEVICES**
Electronic Hardware
Manufacturers

General Devices Company, Inc. P.O. Box 39100, 1410 S. Post Rd., Indianapolis, IN 46239-0100

© 1991 General Devices Company, Inc.

NEW PRODUCTS

INTEGRATED CIRCUITS

Conversion-Function IC For Projection TV

- Generates complex waveforms
- Capable of multistandard operation

The MC44615 waveform generator provides the necessary ramps, parabolas, and cubic and combination waveforms for application to the convergence control circuitry in projection TVs. The device provides a total of 18 waveforms, 9 positive and 9 negative, which are of constant amplitude and independent of frequency. The waveforms are synchronized to horizontal frequencies to 64 Hz, and to vertical frequencies of 50 to 120 Hz. Other key features and specifications include complementary outputs, phase-locking of the internal horizontal oscillator to the external sync signal, blanking control of output waveforms, and adjustable hor-

izontal time delay from the sync input to the waveform output. The IC, which operates from a $\pm 5V$ supply, comes in a 40-pin DIP. \$3.66 (10,000).

Motorola Inc., Analog IC Div, EL340, 2100 E Elliot Rd, Tempe, AZ 85284. Phone (602) 897-3615. FAX (602) 897-4193. **Circle No. 355**

Wideband Op-Amp Family

- Bandwidths to 600 MHz
- Slew rates to 625V/ μ sec

Optimized for high-speed signal processing, the HA-2839, HA-2840, and HA-2850 op amps compete in price and performance with the EL2039, EL2040, and AD840. The HA-2839 and HA-2840 feature 625V/ μ sec slew rates and 600-MHz gain-bandwidth products. The HA-2850 offers a 340V/ μ sec slew rate and a 470-MHz gain-bandwidth product.

All three devices also feature an input noise voltage of only 6 nV/ $\sqrt{\text{Hz}}$. An input-offset voltage of 0.6 mV provides input precision, eliminating the need for a precision front-end amplifier. The full-power band-

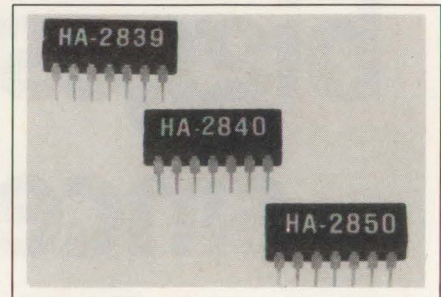

width of 10 MHz (10V step) for the 2839 and 2840, and 5.4 MHz for the 2850 satisfy high-resolution video applications. A complementary bipolar dielectric-isolation process keeps maximum supply currents to 15 mA for the 2839 and 2840, and

Every connecting product for every kind

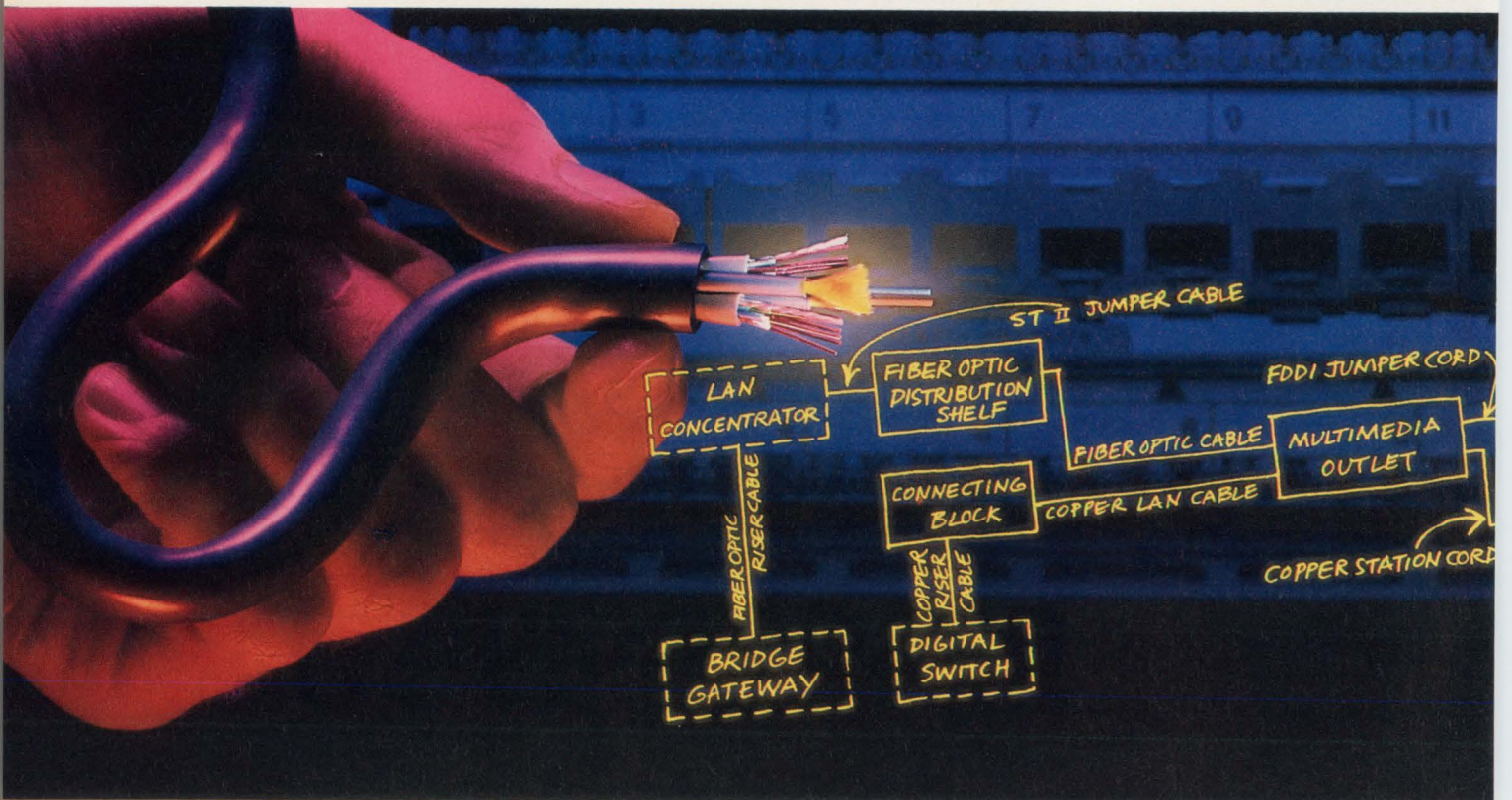

only 8 mA for the 2850. The op amps are available in 8- and 14-pin plastic DIPs. \$3.55 to \$3.95 (100).

Harris Semiconductor, Box 883, Melbourne, FL 32901. Phone (800) 442-7747, ext 1132. **Circle No. 356**

Dual-Channel Read/Write IC

- For 2-terminal MIG heads
- Comes in a 20-pin thin SO package

The HA166102T read/write circuit is encapsulated in a 20-pin plastic, thin small-outline package. It measures 4.4×6.7×1.1 mm. The small size aids the miniaturization efforts critical in 1.8- and 2.5-in. drives. In larger 3.5-in. drives, the device's small size allows placement directly on the actuator arm. Special circuitry optimizes the chip for use with the newer 2-terminal MIG (metal in gap) read/write magnetic

heads. The chip's write driver has a detection circuit that inhibits write operations at low supply volt-

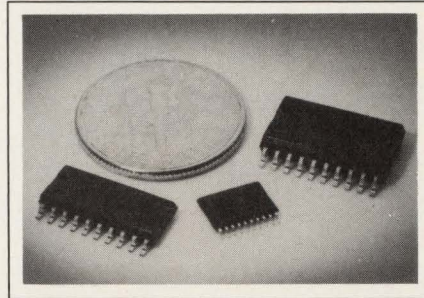

ages, and its read amplifier features a differential gain of 250 and low noise. The circuit operates from a 5V supply, and a standby function limits current drain to 1 mA typ in the idle mode. \$3.45 (1000).

Hitachi America, Semiconductor Div, 2000 Sierra Point Pkwy, MS-080, Brisbane, CA 94005. Phone (415) 589-8300. **Circle No. 357**

High-Speed FET Op Amp

- Bandwidth is 35 MHz
- Typical input bias current is 5 pA

The OPA671 FET-input op amp is fabricated in the company's Difet process. It features a gain-bandwidth product of 35 MHz, a 100V/ μ sec slew rate, and a 0.01% settling time of 240 nsec. Complementing the ac performance is a typical input bias current of only 5 pA, approximately one-millionth that of most bipolar-input wideband op amps. Output voltage-swing capability is $\pm 10.5V$ with a 200 Ω load. The op amp operates from ± 4.5 to $\pm 18V$ supplies and is specified for the industrial temperature range. 8-pin plastic DIP, \$5.95 (100).

Burr-Brown Corp, Box 11400, Tucson, AZ 85734. Phone (602) 746-1111. FAX (602) 889-1510.

Circle No. 358

of connection.

© 1991 AT&T

That's AT&T "Customerizing."

AT&T is your one-stop quality source for everything from cable to splicing and test equipment.

Whether it's data cable, composite cable, optical cable or fiber, AT&T has it all.

Along with 110 Connecting Blocks, ST® Connectors, FDDI Jumpers, and any number of other connecting products.

Everything you need in copper and fiber optics for the transmission of voice, data, image, and remote sensing.

Everything you need for all your applications, such as LAN and harsh environment, off-the-shelf or custom designed.

Technical support? We'll work side-by-side with you to design special situation connections. And we'll provide system as well as component solutions.

You also have AT&T's assurance of product quality and reliability. Backed by the design and technology expertise of AT&T Bell Laboratories. And by a century of AT&T cable and apparatus manufacturing experience.

Everything you need. Exactly the way you need it. That's "Customerizing."

For more information, just give AT&T a call at 1 800 344-0223, ext. 1053. Or FAX us at 602 233-5888.



CIRCLE NO. 100

BEND THE LIGHT, NOT THE LEADS.

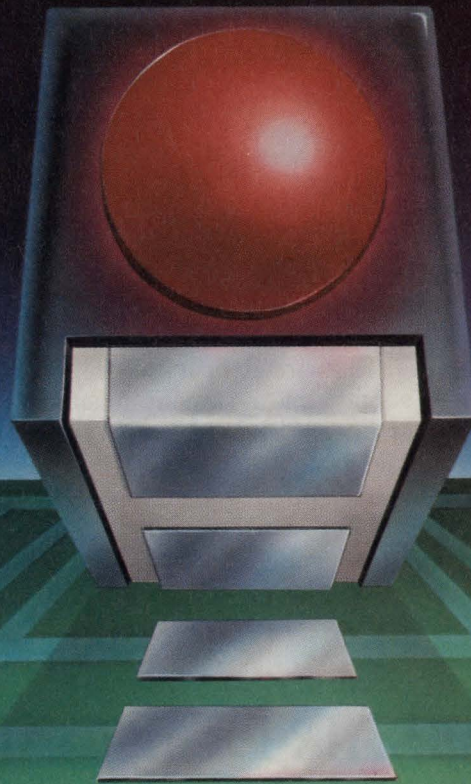

INTRODUCING PRISM CBISM THE FIRST TRUE SURFACE MOUNTABLE LED INDICATOR.

The new surface mount CBI from Dialight is another breakthrough idea whose time has come. Instead of bending the leads on a through-hole version to make it look like a surface mount device, Dialight uses a patented high transmission prism and clear lens to bend the light from an upwards-facing surface mount LED. This approach offers a uniform illumination of the lens over a wide viewing angle. Finally, a truly leadless indicator developed for reflow-soldering and compatible with a wide variety of pick and place equipment.

The PRISM CBI is available in T-3/4 (1mm), T-1 (3mm) and T-1 3/4 (5mm) lens sizes. This unique product is offered in package sizes of 0.130 x 0.098 x 0.138 for the T-3/4, 0.240 x 0.185 x 0.200 for the T-1 and 0.250 x 0.245 x 0.282 for the T-1 3/4 size.

The introduction of the PRISM CBI means there is one less component on the board that has to be through-hole mounted because now a reliable surface mount version exists. Using this approach, an extremely high "post-process" reliability rate can be achieved.

Available in red, yellow or green, packaged in ESD-shielded tape on EIA standard 7" or 13" reels, the PRISM CBI is ready for a whole spectrum of demanding SMD applications.

For more information, contact:
Dialight Corp., 1913 Atlantic Ave.,
Manasquan, NJ 08736; Tel.: (908) 223-9400
Fax: (908) 223-8788.

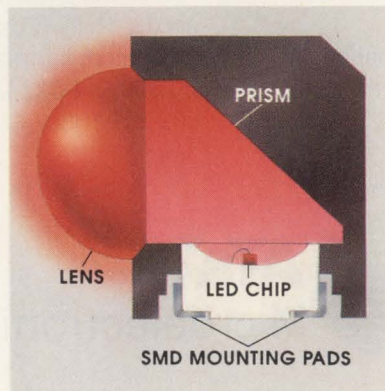

ALL INDICATIONS ARE
DIALIGHT

8051 C Compilers

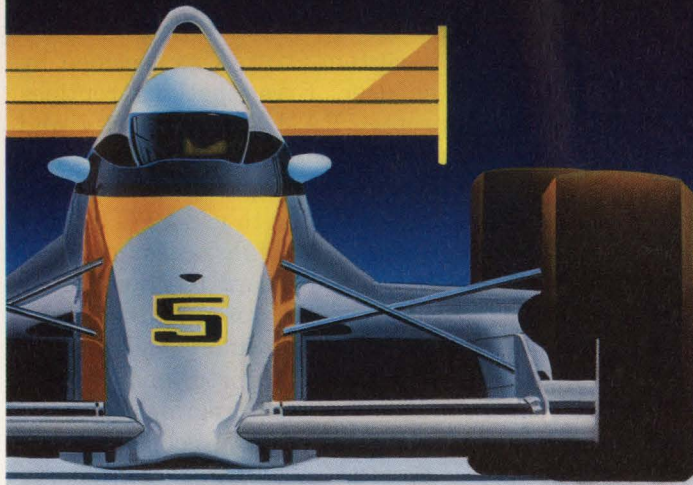

Us

Them

		Whitesmiths	Franklin	Archimedes
Dhystone	per sec.	205	203	96
	size (bytes)	3064	3926	3528
Pointer	speed (microsecs)	280	921	1144
	code/data (bytes)	82/40	233/48	316/52
Tint	speed (microsecs)	407	683	1168
	code/data (bytes)	642/84	628/84	630/84
Array	speed (microsecs)	102K	129K	158K
	code/data (bytes)	347/2056	284/2056	325/2056
ANSI C		FULL	Partial	Full
In-Line Assembly		YES	No	No
C Source Debugger		FULL (CXDB)	Partial	Partial
Price (PC)		\$1200	\$1595	\$1295

Dhystone v.1.1.1 from CACM vol. 27; Pointer, Tint, Array from Byte Magazine 8/83. Whitesmiths v.3.32, Franklin v.3.07, Archimedes v.4.05A

Whitesmiths 8051 C Compilers win the race for small, fast code. And with the CXDB Debugger, you can get your product to market ahead of the competition. Call or fax today for more information about our free demo products.

Make Every Bit Count

Call 800-356-3594

MA: (617)661-0072 CA: (714)891-4631 Fax: (617)868-2843

EDN October 24, 1991

Intermetrics
Microsystems Software, Inc.
733 Concord Avenue Cambridge, MA 02138

CIRCLE NO. 110

191

NEW PRODUCTS

COMPONENTS & POWER SUPPLIES



Sealed Toggle Switch

- *Totally sealed construction*
- *Available in 4-pole versions*

NT Series toggle-switch construction features molded-in elastomer lever-to-bushing and cover-to-case seals, which allow the switches to be used where panels are subjected to periodic splash and washdowns. The terminal inserts are molded into the high-impact-strength thermoplastic case. The switches are available in 1-, 2-, or 4-pole versions with screw, quick-disconnect, or solder terminations in momentary- or maintained-action configurations. The toggle lever is 0.68 in. long and has a nonglare matte nickel finish. Pull-to-unlock versions are available in addition to the standard toggle designs. Operating range spans -40 to $+71^{\circ}\text{C}$. The switches are UL recognized and CSA certified. \$11.59 to \$26.44. Delivery, four to six weeks ARO.

Micro Switch, 11 W Spring St, Freeport, IL 61032. Phone (815) 235-6600. **Circle No. 359**

Touchscreen Display

- *Displays 6 lines of 48 characters*
- *Includes a message memory*

Model PEP 4283-AX combines a 6-line \times 40-character, vacuum fluorescent display with an optoelectronic touch input system. The unit features a RAM message memory

that can accommodate as many as 127 240-character messages. The unit operates on 5V and has RS-232C (with CTS and DTR) and RS-422 interfaces. A switch border around the display area can be used for fixed function switches defined by custom artwork as specified by the user. Error-checking routines protect RAM data integrity and monitor software execution. PEP-WARE programming software allows designers to use a PC to compose display messages utilizing standard keyboard functions. Messages can be stored in the PC or the display's memory and recalled for editing. The programming software allows the programmer to determine the HEX coordinates of any location on the screen simply by touching that area. The unit will operate over a -40 to $+85^{\circ}\text{C}$ range. \$800 (100).

IEE Inc, Industrial Products Div, 7740 Lemona Ave, Van Nuys, CA 91409. Phone (818) 787-0311, ext 418. FAX (818) 901-9046.

Circle No. 360

TTL-Controlled Attenuator

- *Housed in a hermetically sealed TO-8 package*
- *Operates to 1000 MHz*

The TOAT-51020 TTL-controlled precision attenuator is housed in a



hermetically sealed TO-8 package. It provides accurate attenuation over a 10- to 1000-MHz span and

Ready to
make the
jump to
surface
mount?

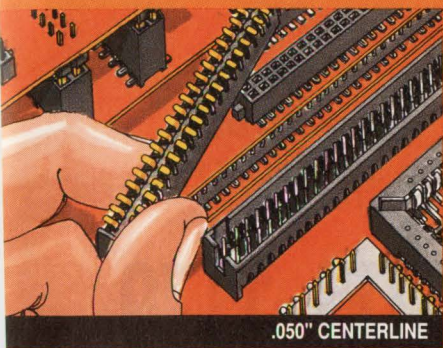

.050" CENTERLINE

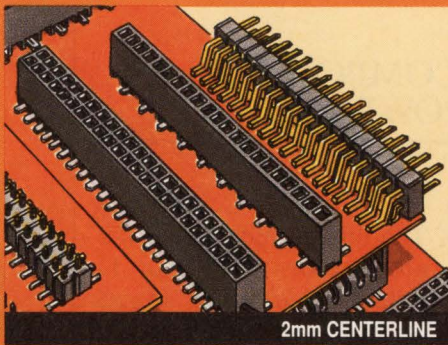

2mm CENTERLINE

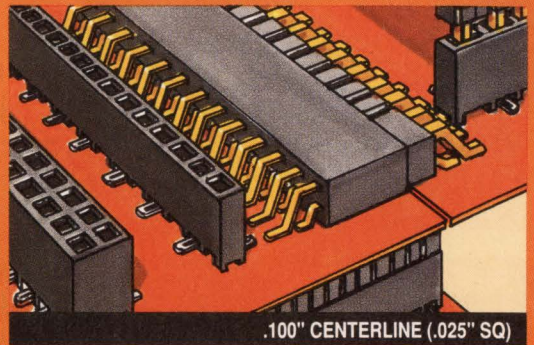

.100" CENTERLINE (.025" SQ)

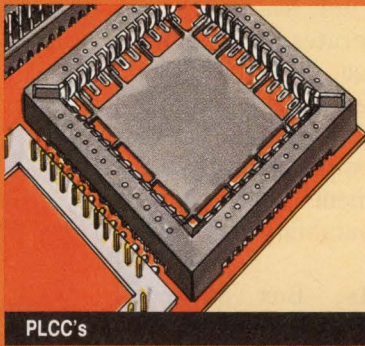

PLCC's

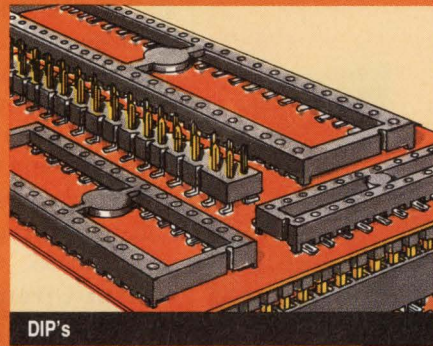

DIP's

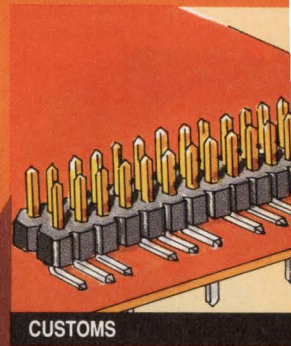

CUSTOMS

Samtec SMT solutions assure a safe landing!

Nobody knows more about surface mount interconnects than Samtec.

Samtec surface mount Strips, DIP's and PLCC's are designed for automated assembly, VP or IR soldering and to optimize electrical and mechanical properties.

Our new Surface Mount Guide shows thousands of Interconnect solutions. And, if you don't see the solution you need, we'll design one to satisfy your most demanding application. Call today.

1-800-SAMTEC-9

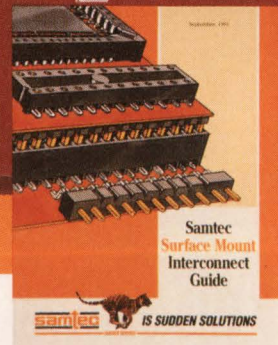

samtec

IS SUDDEN SOLUTIONS

SUDDEN SERVICE

New Albany, Indiana USA • Cumbernauld, Scotland UK • Singapore

SAMTEC, INC. P.O. Box 1147 • New Albany, IN 47151-1147 USA • Phone 812-944-6733 • Fax 812-948-5047 • TWX 810-540-4095 • Telex 333-918

simplicity pays...

Advanced **HYBRID TECHNOLOGY** from Taiyo Yuden can reduce complex designs to a single effective thick-film component!

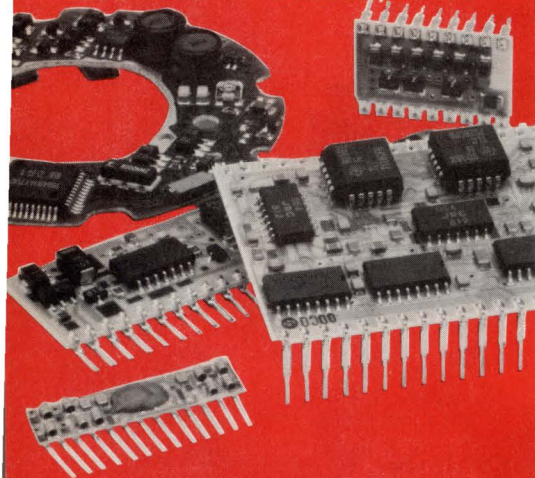

■ **COMPLEXITY CRAMPING YOUR STYLE?**—Let Taiyo Yuden's domestic engineering staff show you how to combine the best of circuit design with circuit packaging. By combining multiple functions into a simple-to-use package, you can shave time to market, cost, size, and those nagging **cramps**. Simplicity pays!

■ **EXTENSIVE EXPERIENCE PAYS**—With world wide experience in telecom, computer, industrial, and instrumentation markets—to mention a few, Taiyo Yuden can provide you with the expertise needed to make your designs pay, and pay, and pay...

■ **ADVANCED TECHNOLOGY...MADE SIMPLE**—By combining the largest manufacturing capacity world-wide, with the most extensive experience base, technology works for you instead of against you. Effective design starts with relationships, not technology...it's that simple!

■ **SIMPLY COMPETITIVE**—Our capacity and manufacturing base allow us to provide fast lead times and competitive pricing.

■ **SIMPLY RELIABLE**—Reliability starts with great designs, the right components, the best processes, and a QC attitude of excellence. Taiyo Yuden's philosophy revolves around these basic principles.

EXPERIENCE SIMPLICITY AND TECHNOLOGY TOGETHER... Our advanced capabilities in hybrid design and manufacturing can help to simplify your product's **life**. Our new brochure can show you how to start...

 **TAIYO YUDEN (USA), INC.**

714 West Algonquin Road, Arlington Heights, IL 60005
Tel 1-800-34-TAIYO (1-800-348-2496)
Fax (1-708) 870-7828

EASTERN REGION: 1-800-36-TAIYO (1-800-368-2496)
WESTERN REGION: 1-800-25-TAIYO (1-800-258-2496)

Power supply needs?...contact Xentek, Inc. (a subsidiary of Taiyo Yuden) at (1-619) 727-0940 or ask your Taiyo Yuden representative.

CIRCLE NO. 122

COMPONENTS & POWER SUPPLIES

has a -55 to $+100^{\circ}\text{C}$ operating range. The unit includes three discrete attenuators that can be switched to produce seven attenuation levels—5, 10, 15, 20, 25, 30, and 35 dB. The unit has a 50Ω impedance and operates at switching speeds of $6\ \mu\text{sec}$. The attenuator can handle power levels as high as 0 dBm and can withstand the shock, vibration, and temperature stresses of MIL requirements. Three-sigma unit-to-unit repeatability is guaranteed. \$55.95.

Mini-Circuits, Box 350166, Brooklyn, NY 11235. Phone (718) 934-4500. FAX (718) 332-4661. TLX 620156. Circle No. 361

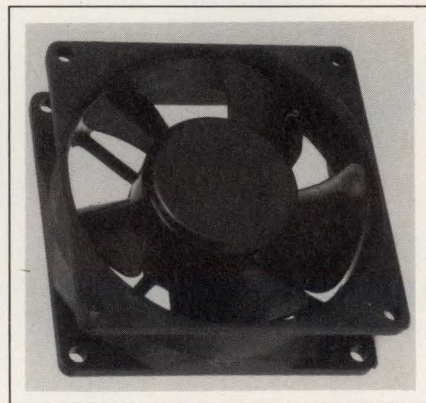

Brushless Fans

- Available in two models
- Rated for 53-cfm air flow

P0053 Series solid-state brushless dc cooling fans are rated for 53-cfm air movement. Featuring low acoustic noise and low EMI, the units are available in versions that operate from 12 or 24V dc. Construction employs precision ball bearings. Termination is via #24 AWG wire leads. Each fan has adjustable airflow and features polarity protection as a standard. The units also offer automatic restart capability. The units measure $3.62 \times 3.62 \times 1.26$ in. \$10.60 (1000).

Interfan, Box 4188, Burlingame, CA 94011. Phone (415) 347-1203. FAX (415) 340-1670.

Circle No. 362

NEW from
STANFORD
TELECOM

STEL-1179

shown
actual size

**The Lowest Cost
Single NCO**

Priced below \$5
(Commercial Quantities)

- Lowest Cost Single NCO Available
- 28 Pin PLCC Package
- Smallest NCO Available
- 25 MHz Maximum Clock Frequency
- 0 to 11 MHz Output Bandwidth
- 24-bit Frequency Resolution
- 1.5 Hz @ 25 MHz
- 3-bit Phase Modulation
- High Spectral Purity
- 12-bit Outputs
- All Spurs $<-75\text{dBc}$
- Serial Control Port
- Low Power Dissipation
- Proprietary Noise Reduction Technology Utilized

For more information
Write or call:
Stanford Telecom
ASIC & Custom Products Division
2421 Mission College Blvd.
Santa Clara,
CA 95056-0968
Tel: (408) 980-5684
Fax: (408) 727-1482

ASIC
Custom
Products
Division

CIRCLE NO. 123

EDN October 24, 1991

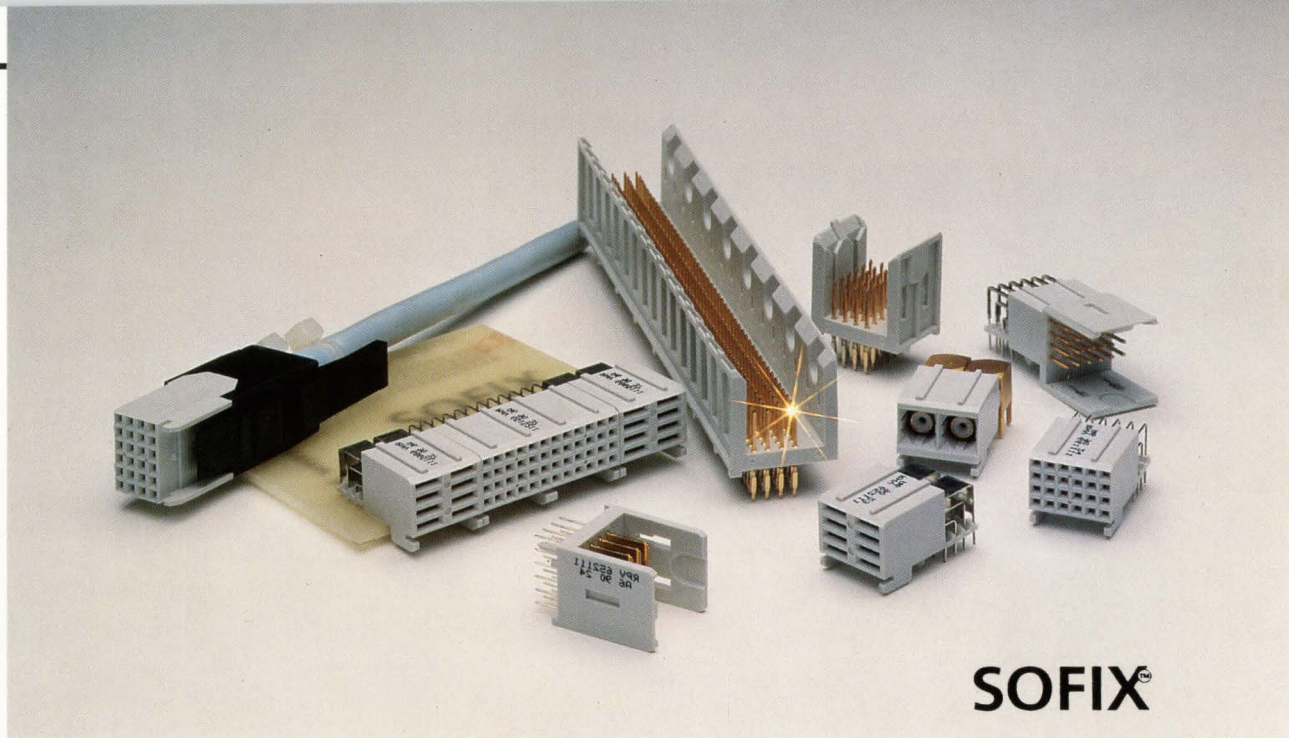

2MM INTERCONNECTION

- * Modularity
- * High Density
- * Flexibility
- * Standardization

A NEW HIGH DENSITY modular interconnection system Sofix, based on 2mm Pin spacing, is BORN.!

MODULARITY

- * Stackable segments; 12, 24, 48 & 96 mm Lengths.
- * Easy-to-assemble w/Hot Riveting tool.
- * No unused slots at end of modules.

HIGH DENSITY

- * Four rows of 2 mm spacing achieves 100% more density than DIN-41612 (Euroconnector).

FLEXIBILITY

- * Mix signal, power coax & fiber-optics side-by-side; independent of the module size.

STANDARDIZATION

- * SOFIX has been standardized by IEEE 1301.1, IEC917 and accepted by FUTUREBUS+ and SCI Bus EIA IS64.

MOUNTING & TOOLS

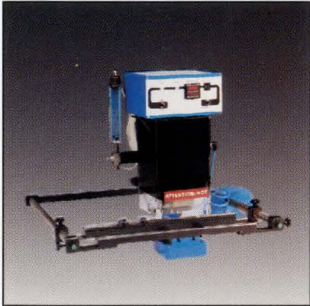

HOT RIVET

* Hot Riveting tool: To obtain END-TO-END stacking, the 90° connector is riveted from the PCB's rear side, by a plastic mounting peg which gives the connector a firm fit. The Hot Riveting tool is a very slim unit that can be modularized; 1 to 20 rivets at once.



PRESS-FIT

* The Pin connectors for backpanels are available for both solder-to-board or pressfit. Tools for pressfit connectors are available as a BENCHPRESS, for small series; or Automatic Pneumatic Press, for full production.



IDC

* The Cable connectors are designed with IDC (INSULATION DISPLACEMENT CONNECTION) for ease of assembly. Hand tools for lab or field assembly is available, as well as Semi-automatic units for full production.

Ericsson Components, Inc.
403 International Parkway
Richardson, TX 75085
Tel: (214) 669-9900
Fax: (214) 680-1059

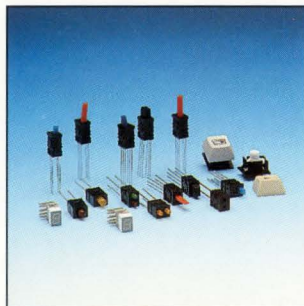

“We saved more than \$50,000 last year!”



CAPS[®] is a productivity-boosting engineering tool that helps you find, select, and specify ICs and semiconductors faster and easier than ever before.

“Tekelec designs and manufactures custom diagnostic systems for the communications industry. Every piece of equipment we build is unique, so we spend a lot of time searching for ICs and semiconductors for new designs. That’s why we invested in the CAPS system.

“With CAPS, it’s a snap to find the right components. When we need information, it’s there. We no longer have to look through catalogs or play telephone tag with vendors. CAPS identifies alternate sources and gives us technical specs, pricing information, and hardcopy printouts—all on one PC. Since we installed the system, we’ve saved hundreds of component engineering hours. **CAPS saved us more than \$50,000 last year alone!**

“Productivity-boosting tools like CAPS pay for themselves and help Tekelec maintain our competitive advantage.”

— Tom Cannon
Senior Vice President,
Research and Development
Tekelec



C A H N E R S
CAPS[®]
Computer Aided
Product Selection

It’s easy to find out more about CAPS! For your free information kit, call Jill Adams at 800-245-6696. Do it today!

Updated monthly, the CD-ROM (Compact Disc – Read-Only Memory) based CAPS system gives you fast, easy, query-driven access to technical specifications and applications data for over 600,000 ICs and semiconductors made by nearly 500 companies worldwide. Best of all, CAPS provides instant access to hundreds of thousands of pages of complete, unabridged manufacturers’ datasheets, so you have everything you need right at your fingertips.

See us at Wescon Booth #1759

Cahners Technical Information Service • 275 Washington Street • Newton, MA 02158-1630
Telephone: 617-558-4960 • Facsimile: 617-630-2168 • Telex: 940573 • Toll-free: 800-245-6696
CAPS is a registered trademark of Reed Publishing (USA) Inc.

C-2008-A/0691

CIRCLE NO. 116

195

Add up the savings.

**NEC
chip tantalum capacitors
make it easy.**

NEC chip tantalum capacitors deliver big three-way savings. Our surface-mount packages save precious board real estate. Standard 8 or 12mm tape supply formats, designed for automatic placement, minimize assembly time. And NEC caps are 100% burned-in for optimum reliability and greater MTBF.

NEC has 149 different types available for immediate shipment. Capacitance values range from 0.047 to 100 μ F and working voltages from 2.5 to 50VDC.

Contact your local NEC representative today and discover 149 ways to save space, time and trouble with surface-mount tantalum capacitors.

μ F	VDC	2.5	4	6.3	10	16	20	25	35	50
0.047									A	
0.068									A	
0.10							A ₂		A	A
0.15							A ₂		A	A
0.22							A ₂		A	B ₂
0.33							A ₂		A	B ₂
0.47							A ₂	A	A·B ₂ ·B	B ₂
0.68						A ₂	A ₂ ·A		A·B ₂ ·B	C
1.0					A ₂	A ₂ ·A		A	B ₂ ·B	C
1.5				A ₂	A ₂ ·A	A	A	B ₂ ·B	B ₂ ·B·C	
2.2			A ₂	A ₂ ·A	A	A	B ₂ ·B	B ₂	B ₂ ·B·C	D
3.3			A ₂ ·A	A	A	A·B ₂ ·B	B ₂	B ₂ ·B·C	C·D	
4.7	A ₂		A	A	A·B ₂ ·B	B ₂	B ₂ ·B·C	C	D ₂ ·D	
6.8			A	A·B ₂ ·B	B ₂	B ₂ ·B·C	C	D ₂ ·D	D ₂ ·D	
10			A·B ₂ ·B	B ₂	B ₂ ·B·C	C	C·D ₂	D ₂ ·D		
15	A		B ₂	B ₂ ·B·C	C	C·D ₂	D ₂ ·D			
22			B ₂ ·B·C	C	C·D ₂ ·D	D ₂ ·D	D ₂ ·D			
33			C	C·D ₂ ·D	D ₂ ·D	D ₂ ·D				
47			C·D ₂ ·D	D ₂ ·D	D ₂ ·D					
68			D ₂ ·D	D ₂ ·D						
100			D ₂ ·D							

	W	L	H
A ₂ case	1.6 (.063)	3.2 (.126)	1.2 (.039)
A case	1.6 (.063)	3.2 (.126)	1.6 (.063)
B ₂ case	2.8 (.110)	3.5 (.138)	1.9 (.075)
B case	2.6 (.102)	4.7 (.185)	2.1 (.083)
C case	3.2 (.126)	6.0 (.236)	2.5 (.098)
D case	4.3 (.169)	7.3 (.287)	2.8 (.110)
D ₂ case	4.6 (.181)	5.8 (.228)	3.2 (.126)

mm (inch)

For fast answers, call us at:

USA Tel:1-800-632-3531. Fax:1-800-729-9288. Germany Tel:0211-650302. Telex:8589960. The Netherlands Tel:040-445-845. Telex:51923.
 Sweden Tel:08-753-6020. Telex:13839. France Tel:1-3067-5800. Telex:699499. Spain Tel:1-419-4150. Telex:41316. Italy Tel:02-6709108. Telex:315355.
 UK Tel:0908-691133. Telex:826791. Ireland Tel:01-6794200. Fax:01-6794081. Hong Kong Tel:755-9008. Telex:54561. Taiwan Tel:02-719-2377. Telex:22372.
 Korea Tel:02-551-0450. Fax:02-551-0451. Singapore Tel:253-8311. Fax:250-3583. Australia Tel:03-267-6355. Telex:38343.



EDN October 24, 1991

THE WORLD'S SMALLEST SURFACE MOUNT DIP SWITCH!



SAME SIZE AS AN IC!

American Research & Engineering's strip molding process makes for a more reliable switch

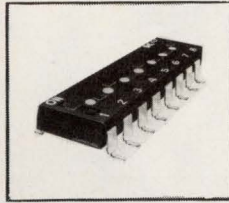
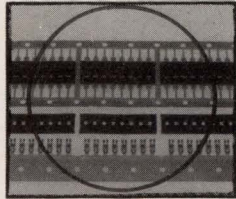

It's More Reliable

Three simple components: two composite metal/plastic strips and one plastic molded cover replaces a 25 piece assembly to make a switch that's more reliable because it's more consistent.

SAME SIZE AS AN IC!

If you don't have automatic insertion equipment, we're banking that some day you will. In the meantime, your board will look neater, better and more professional. And if you have insertion equipment, you'll save the cost of hand insertion!

Three New Patent Designs That Use 40% Less Parts

1 The sides are split, or bifurcated, so there are two separate slides for each contact point. This doubles the contact reliability because you have two independent gold plated contacts at each switch point.

2 The switches are flush with the cover to eliminate accidental, on-off movement once the DIP is programmed. Simple.

3 The package is sealed. The lead frame is molded directly into the housing to provide a one piece, no leak construction. The cover is ultrasonically welded to the housing after the switch is assembled. There is no better construction. The surface mount housing is made of polyphenylene sulfide with a Kapton tape seal to withstand the high temperatures of the reflow soldering process.

4 The slides are made from beryllium copper, heat tempered to a full hardness, spring formed, plated in a 100 micro inch nickel bath and then spot gold plated 30 micro inch deep at all the contact points. This is the best proven switch contact surface that money can buy.

5 Every one of the switch contact surfaces on the main lead frame are plated with 30 micro inch of gold over 100 micro inch of nickel.

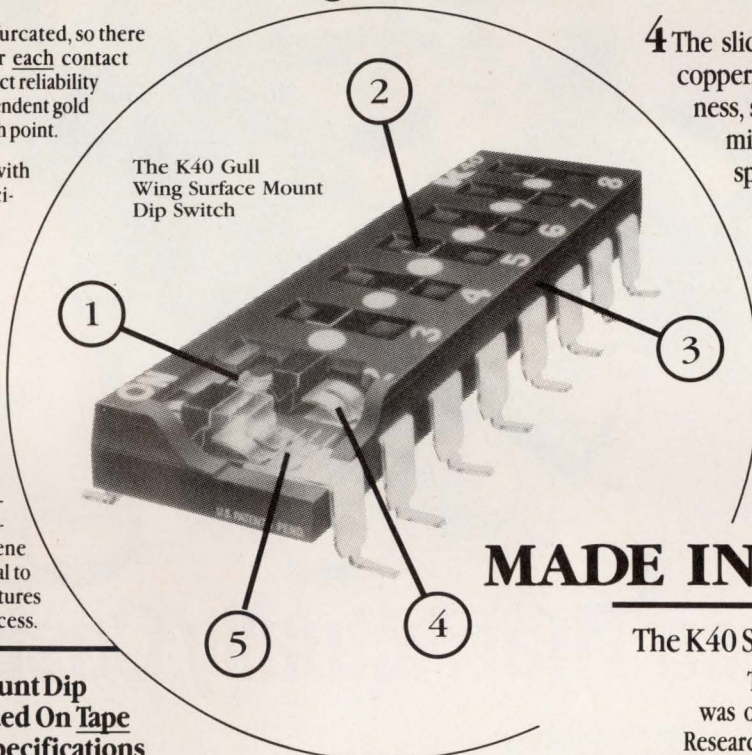

The K40 Gull Wing Surface Mount Dip Switch

MADE IN AMERICA

The K40 Standard Pin Dip Switch

The K40 standard pin DIP Switch was originally designed by American Research & Engineering in 1982 as the world's smallest DIP Switch. It was with its incredible small size and durability that the K40 standard pin DIP Switch led to the development of the new K40 Surface Mount DIP Switch lineup. Lead time for the K40 standard pin DIP Switch is seven to fourteen days and fourteen to twenty-one days for the K40 Gullwing DIP Switch. All K40 switches are manufactured at our plant in Elgin, Illinois.

The K40 Surface Mount Dip Switches Are Provided On Tape and Reel per EIA Specifications or In Standard IC Tubes.

All K40 Dip Switches Are Available In Positions Two Thru Eight!



FREE SAMPLE! Send Us Your Business Card Stapled To Your Letterhead

AMERICAN RESEARCH & ENGINEERING

1500 EXECUTIVE DRIVE, ELGIN, IL. 60123 1-708-888-7245

FAX [708] 888-7094

CIRCLE NO. 114

OakGrigsby On Rotary Switches

2

OF A SERIES

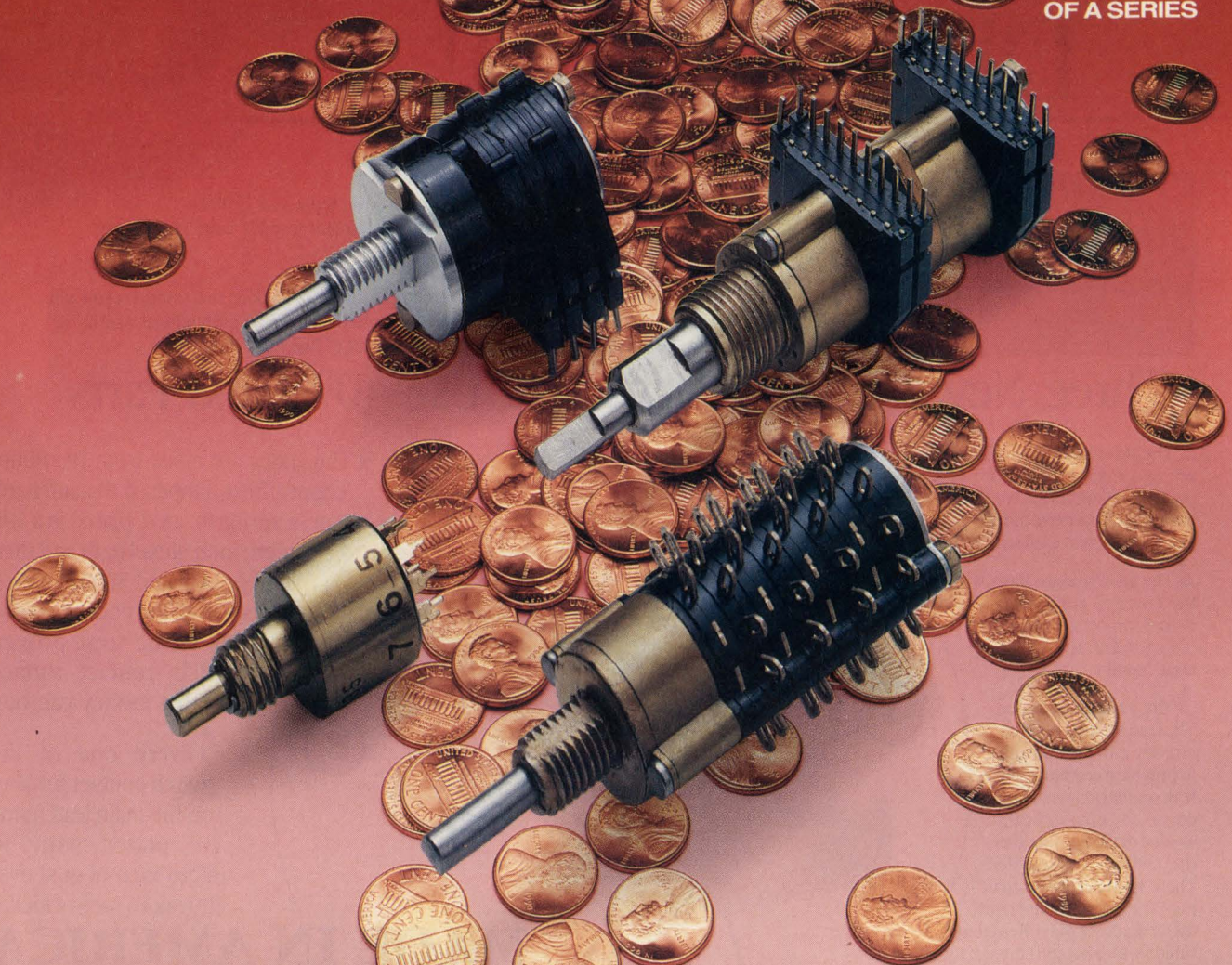

Excellence That Actually Costs Less.

At a progressive company like OakGrigsby, excellence is expected. Which is one reason it costs less.

Take our rotary switches, which we offer *customized* for significantly less cost than the *standard* components of our leading competitor.

They are produced in a quality-driven manufacturing environment which, therefore, lowers production cost. They may be purchased through a flexible customization program which allows us to react quickly to customer needs . . . shortening lead times.

Discover affordable excellence . . . the hallmark of today's most progressive electronics manufacturer.

Discover OakGrigsby.

OAK GRIGSBY

Committed to customer satisfaction.

88 North Dugan Road • P.O. Box 890
Sugar Grove, Illinois 60554-0890
Phone: 708/556-4200 • Fax: 708/556-4216

Features

- 1/2" Enclosed Rotary Switches and Binary Coded Switches
- Compact sizes (.500" and .562" diameter)
- PC or solder lugs
- Sealed versions
- Fixed or adjustable stops
- Commercial or to military specifications

UNIVERSAL INPUT SWITCHING POWER SUPPLIES

FEATURING:

- 90-264 VAC (continuous) UNIVERSAL INPUT
- FCC CLASS 'B', VDE 0871 'B' OPTIONAL
- HIGH SURGE CURRENTS ON +12V OUTPUTS
- PRICE, DELIVERY AND QUALITY

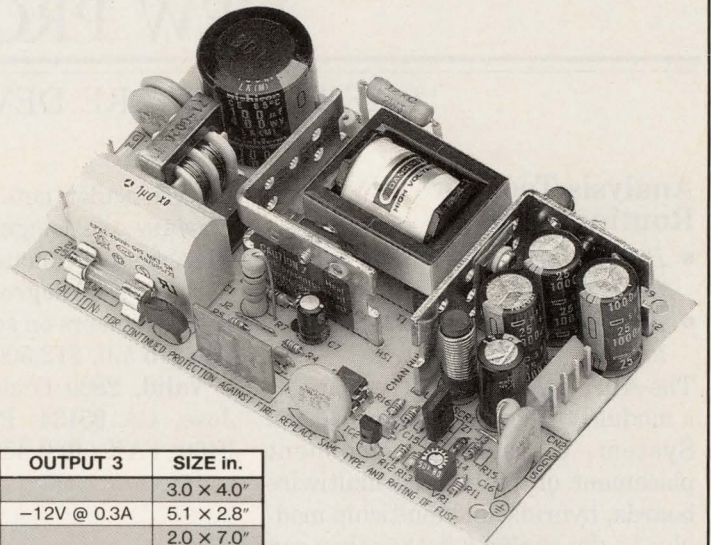

WATTS	MODEL NUMBER	OUTPUT 1	OUTPUT 2 (Peak)	OUTPUT 3	SIZE in.
20	UPS20 - 5002	+5V @ 1.6A	+12V @ 1.0A (2.0)		3.0 X 4.0"
30	UPS30 - 4003	+5V @ 1.5A	+12V @ 1.5A (3.0)	-12V @ 0.3A	5.1 X 2.8"
40	UPS40 - 1002	+5V @ 3.0A	+12V @ 2.0A (4.5)		2.0 X 7.0"
40	UPS40 - 2002	+5V @ 3.0A	+12V @ 2.0A (4.5)		3.0 X 5.0"
40	UPS40 - 2003	+5V @ 3.0A	+12V @ 2.0A (4.0)	-12V @ 0.3A	3.0 X 5.0"
50	UPS50 - 1002	+5V @ 3.0A	+12V @ 3.0A (5.5)		2.0 X 7.0"
50	UPS51 - 2002	+5V @ 4.0A	+12V @ 3.0A (5.5)		3.0 X 5.0"
65	UPS65 - 1002 -X	+5V @ 3.5A	+12V @ 4.0A (7.0)		3.5 X 6.0"
65	UPS65 - 1003	+5V @ 6.0A	+12V @ 2.5A (4.0)	-12V @ 0.5A	3.5 X 6.0"

SINGLE AND QUAD OUTPUT MODELS ARE AVAILABLE.

AP AUTEC
POWER
SYSTEMS

CALL NOW...

818-341-6123

9301-101 JORDAN AVENUE
CHATSWORTH, CA 91311
FAX: 818-341-5726

CIRCLE NO. 121

“Microsoft Project for Windows’ intuitive interface and impressive features add up to a Best Buy.” —PC WORLD

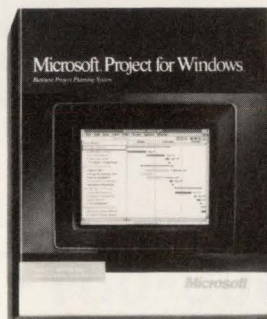

To order a working model of Microsoft® Project for Windows™ for \$9.95*, or if you'd like more information, call (800) 541-1261, Dept. V33.

Microsoft

*Applicable sales tax, shipping and handling not included. Offer good only while supplies last and only in the 50 United States. When ordering the working model, inquire about specific system requirements. In the 50 United States, call (800) 541-1261, Dept. V33. For information only. In Canada, call (416) 568-3503; outside the U.S. and Canada, call (206) 536-8661. ©1991 Microsoft Corporation. All rights reserved. Microsoft and the Microsoft logo are registered trademarks and Windows is a trademark of Microsoft Corporation. Reprinted with the permission of PC World, Mark Burgess, September 1990.

NEW PRODUCTS

CAE & SOFTWARE DEVELOPMENT TOOLS

Analysis Tool For Routing Ability

- Provides a quick estimate of routing ability
- Analyzes as many as 48 signal layers

The Allegro Placement Evaluator is a module within the Allegro Design System. It analyzes component placement on pc boards, multiwire boards, hybrids, and multichip modules to determine whether they can be manufactured. You can constrain the analysis by the number of signal layers and for feature sizes and spacings. The software, because it understands the routing algorithms of its companion tool, evaluates and predicts likely areas of congestion. Analysis output consists of a color map representing density and overflow areas. A trace map identifies

the particular nets likely to try to traverse the congested areas. The Placement Evaluator is included as part of the Allegro 5.0 release and is free to users on software support. Allegro 5.0, \$12,500 to \$50,000.

Valid, 2820 Orchard Pkwy, San Jose, CA 95134. Phone (408) 432-9400. FAX (408) 432-9430.

Circle No. 363

Graphical Spreadsheet

- Permits as many as 100 windows
- Allows zooming, scrolling, and overlaying graphs

Dadisp (Data Analysis and Display) 3.0 is an analysis tool that operates as a graphical spreadsheet. The software allows you to input data in several formats from numerous sources, including ASCII, 8-bit

byte, 16-bit integer, IEEE floating point, binary files, or most data-acquisition systems. The software can perform matrix math functions

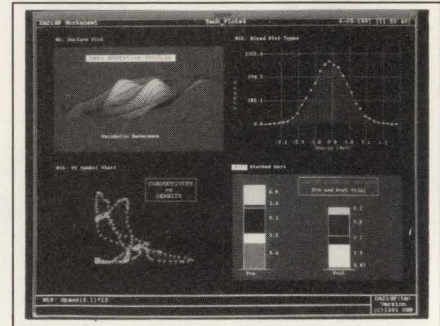

such as invert, balance, and rotate. Such 3-D graphics as contour plotting, depth- or height-density plots, XYZ surface plots, and spectral plots are supported as are a range of 3-D manipulation functions. As

Honda Connectors

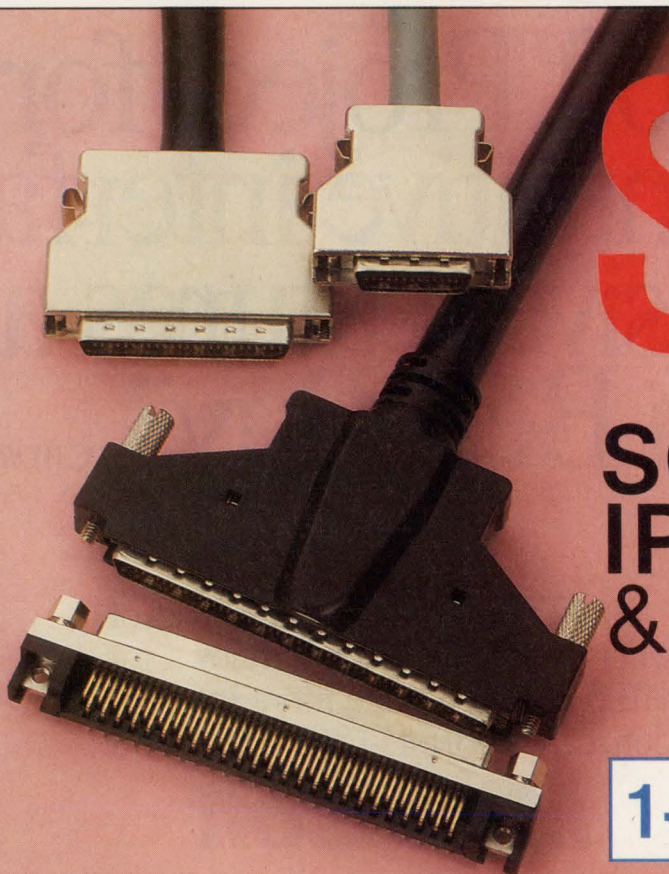

SCSI

SCSI-2 & 3 IPI-2 / HiPPI & RS-232

1-800-637-7865

See us at Wescon booth #4302

CIRCLE NO. 112

ANNOUNCING THE NEW
PADS-UNIX

WE'LL GIVE YOU THE WORLD

PADS-PRODUCT SEMINARS

October 24
Dayton, OH
The CAD T.E.A.M.
416-842-1303

October 24
Houston, TX
Collins Technology Corp.
214-869-3250

October 30
Detroit, MI
Collins Technology Corp.
214-869-3250

PADS-PRODUCT SEMINARS

October 30
Phoenix, AZ
Assembly Technology
602-944-2166

October 30
Montreal, QC
The CAD T.E.A.M.
416-842-1303

October 31
Phoenix, AZ
CADware
714-759-6975

October 31
Ottawa, ON
The CAD T.E.A.M.
416-842-1303

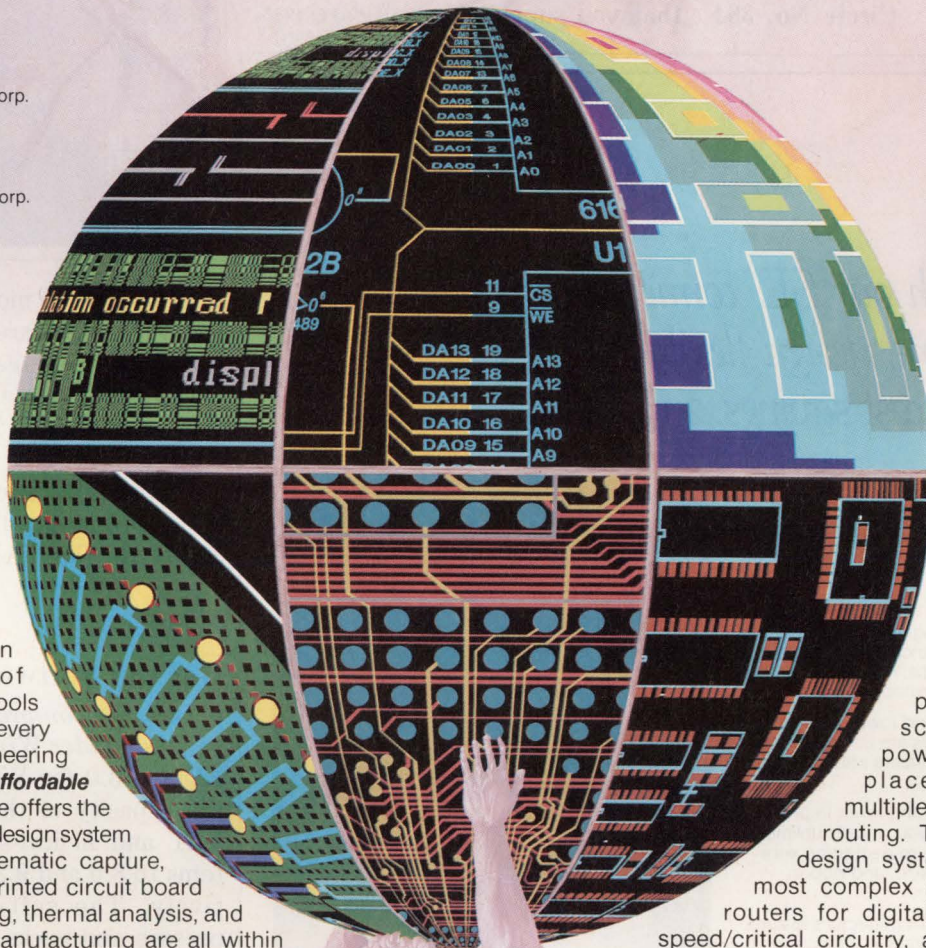

... Of Electronic Design

You asked for an integrated set of CAE/CAD design tools which could deliver every aspect of your engineering design needs **at an affordable price**. CAD Software offers the highest performing design system for your PC. Schematic capture, logic simulation, printed circuit board design, auto-routing, thermal analysis, and computer aided manufacturing are all within the PADS Design system.

Your design begins with **PADS-Logic**, the only PC-based schematic capture system which has a true multi-sheet database for quick and accurate design capture and data transfer to your PCB design. PADS-Logic has a large circuit capacity of over 1,000 equivalent IC's per design, a Hierarchical design ability with an unlimited number of levels, superb analog design capability, forward and backward annotation, a Part Editor and Graphical Library browsing.

PADS-PCB sets the standard for affordable high performance PCB design. A one mil database, 30 layers, automatic design rules checking, SMD ability, excellent interactive routing, and a set of ECO routines which ensure fast accurate changes, are just some of the features which have made PADS-PCB the #1 selling PC based PCB design system.

NEW! PADS-UNIX operates on the Sun Sparc Station family and contains all of the advanced features of the widely used **PADS 2000** product, including schematic capture, powerful component placement aids, and multiple approaches to track routing. This advanced PCB design system can handle the most complex designs, with auto-routers for digital, analog and high speed/critical circuitry, an unlimited design capacity, ERC and DRC checking, intelligent copper pour and T-routing, 0.1° parts/pads rotation, and much more!

Call CAD Software today for your local Authorized Reseller, or for a no-cost Evaluation Package, and experience the world of electronic engineering design:

CAD
Software, Inc.

(800) 255-7814
Inside MA
(508) 486-8929

119 Russell Street, Littleton, MA 01460

CIRCLE NO. 111

with a spreadsheet, the software allows you to manipulate data in one window before it recalculates all dependent data in other windows. From \$895.

DSP Development Corp, 1 Kendall Sq, Cambridge, MA 02139. Phone (617) 577-1133. FAX (617) 577-8211. **Circle No. 364**

Loop-Tuning Software

- Accommodates as many as 1000 data points
 - Operates in batch mode
- LT/Tune 2.0 provides for tuning, testing, and simulation of process control loops. Using plant input/output data or model parameters that you supply, the software rec-

ommends PI (proportional integral) and PID (proportional, integral, and derivative) settings. The simulator provides both open- and closed-loop responses for combina-

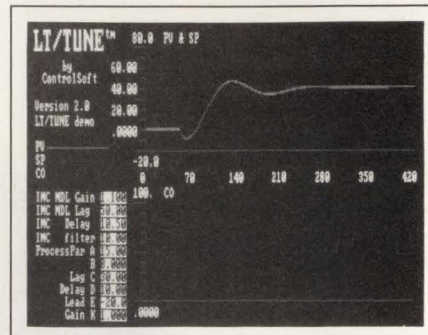

tions of process models and controllers. The software displays model parameter values and measures model prediction error and correlation coefficients. It runs on PCs. \$995.

Controlsoft Inc, 4122 Wyncote Rd, Cleveland, OH 44121. Phone (216) 234-5759. FAX (216) 381-5001. **Circle No. 365**

Backup Software

- Includes compression algorithms
- Runs under Windows 3.0

EZtape 3.0 for Windows increases the capacity of the vendor's 4-mm DAT and helical-scan backup systems to 8.0 and 9.2 Gbytes, respectively. The software also compresses and backs up as much as 1 Gbyte of data onto the vendor's 7000 Series DC 600 data cartridges and 250 Mbytes onto minicartridge systems. You can back up and restore bindery and trustee rights under Novell Netware 2.2 and 3.11. The software, which complies with Windows' Common User Access Windows-management guidelines, also offers an integrated tape librarian. This librarian stores and manages directory information. Software, \$169; upgrades, \$59.

Irwin Magnetic Systems Inc, 2101 Commonwealth Blvd, Ann Arbor, MI 48105. Phone (313) 930-9000. **Circle No. 366**

With our SL™ connector system, design flexibility and cost savings are yours.

Automatically.

You'll find Molex SL connectors in some of the world's leading—and most dependable—makes of electrical and electronic equipment. Of course, reliability is a big reason for this preference.

But the versatility and lower applied cost that SL provides are critical factors, too, especially in systems with several interconnections.

Modular, stackable, and lower in profile, SL connectors give you virtually unlimited flexibility when you're designing wire-to-wire, wire-to-board, and ribbon cable systems.

The single-piece IDT connectors feature, pre-assembled terminals in the housings, and interconnects with locking shrouded headers. In short, they're ideal for high-speed, high-efficiency automated assembly.

Ask your Molex representative about SL connectors, and learn how they can multiply design options and automate assembly.

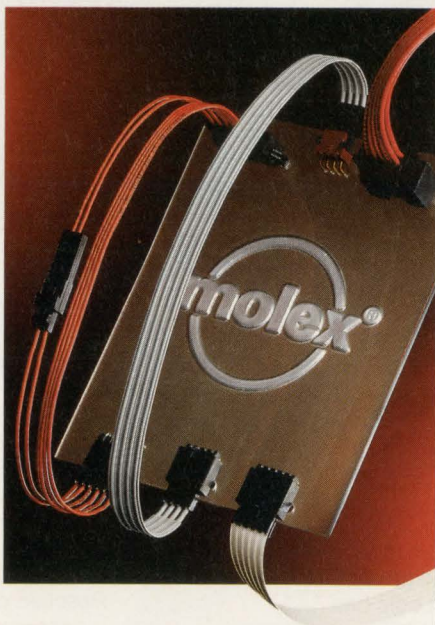

Bringing People & Technology Together, Worldwide™

Corporate Headquarters: 2222 Wellington Ct., Lisle, IL 60532 U.S.A., Tel: (708) 969-4550
European Headquarters: Munich, West Germany, Tel: 49-89-413092-0
Far East North Headquarters: Tokyo, Japan, Tel: 81-427-21-5539
Far East South Headquarters: Jurong Town, Singapore, Tel: 65-660-8555

© 1990, Molex Incorporated

CIRCLE NO. 113

If You Need 256K E²PROMs Now, You Want Fast Action. Not Fast Talk.

256K

Ask a lot of vendors about 256K E²PROMs these days, and you get a lot of talk. But not much action.

Then call Catalyst. Tell us how many of our low-power CMOS E²PROMs you need. And how soon: overnight, 2-day or 3-week delivery.

We'll give you the specs, configuration options and packaging types you're looking for—which include JEDEC-approved PDIP, CERDIP, PLCC and LCC. Then we'll quote you an unbeatable price.

So if you need 256K E²PROMs in volume, go where the action is—Catalyst. Ask us too about our full line of CMOS serial and parallel E²PROMs, Flash memories, NVRAMs and EPROMs.

For your nearest distributor or Catalyst Sales Office, call (408) 748-7700. Or write Catalyst Semiconductor, Inc., 2231 Calle de Luna, Santa Clara, CA 95054.

CATALYST
SEMICONDUCTOR

CIRCLE NO. 124



We Deliver More For Less.

Check Out What Hamilton/Avnet Has in Storage for You.

Hamilton/Avnet now has, in stock, the industry's first 1 megabyte and 4 megabyte, PCMCIA-compatible flash memory cards to help you achieve higher functionality in portable and dedicated applications. In fact, when it comes to data acquisition and firmware updates, Hamilton/Avnet has the knowledge and expertise to help you design-in flash memory cards...today!

And for applications incorporating DOS, Intel offers a flash system developer's kit that enables you to check out how easy it is to design-in flash memory cards.

To order your flash system developer's kit, a \$499.95 value, simply call Hamilton/Avnet. For the branch nearest you, call toll free, 1 (800) 888-9236. Or, for further details, simply send in the coupon below.

I'd like additional information on Intel's Flash Memory Card offering.

Name _____

Title _____

Company _____

Address _____

City _____

State _____ Zip _____

Phone _____

Application _____

Hamilton/Avnet, Dept. 175
P.O. Box 9000
San Fernando, CA 91341-9981



CIRCLE NO. 125

“WE’VE HAD GREAT SUCCESS WITH CARROLL TOUCH. WHY CHANGE IF IT’S WORKING?”

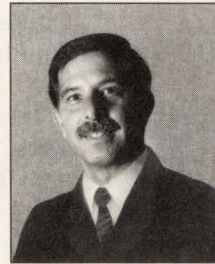
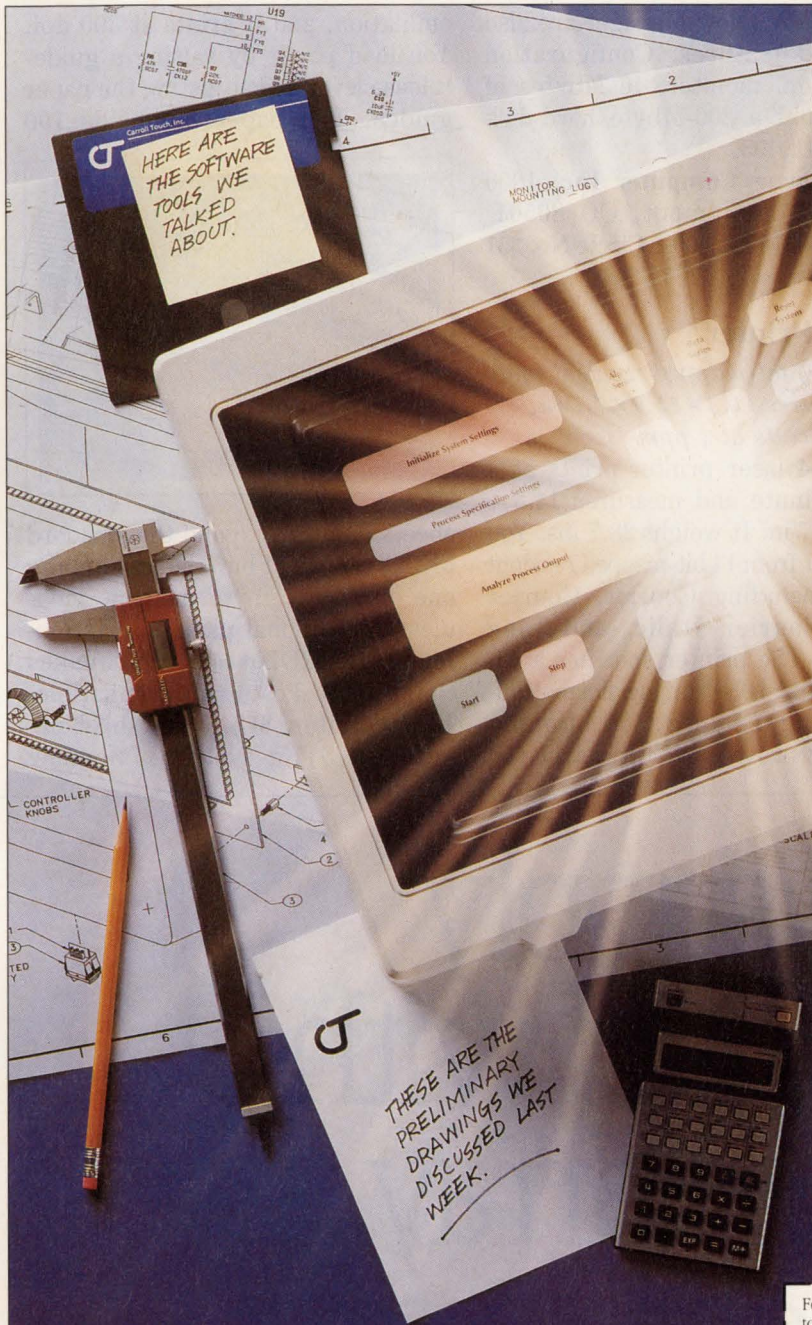

John Santacroce
Mechanical Engineering
& Project Manager
Hewlett-Packard Company

“As a diverse international corporation, Hewlett-Packard manufactures everything from computers, measurement and computation equipment, medical equipment, analytical equipment and more. We’re known for our high level of test and measurement systems capabilities.

“We recently developed a touch-based automotive test system for a customer and there was no debate over using Carroll Touch in designing this. Our past experience with them has been very successful.

“From my point of view, Carroll Touch has provided good, reliable touch frame assemblies. They also bring a high level of engineering expertise to our team, especially in the materials selection area.

“Carroll Touch people really approach our projects as a team project.”

“Working with Carroll Touch people is great because everybody is part of the team – which helps us create a very successful product. Their willingness to go that extra step makes our job much easier.

“In developing a recent functional spec for a touch frame, Carroll Touch engineers worked closely with us in making sure that the assemblies would survive electrostatic discharge.

“We held design reviews of the various approaches and all of our recommendations were considered very sincerely by Carroll Touch. Comments were intelligently relayed back to us and everything we asked for was delivered in the specified time.”

For more information on how Carroll Touch can help you create success with your touch technology applications, call 512/244-3500, or simply mail your business card with this coupon to Carroll Touch, P.O. Box 1309, Round Rock, Texas 78680.

Name _____ Title _____

Company Name _____

Address _____

City _____ State _____ Zip _____

Carroll Touch
The Next Level of Contact

Carroll Touch
The Next Level of Contact
EDN 10/24/91

NEW PRODUCTS

COMPUTERS & PERIPHERALS

Desktop Workstation

- Has a custom SPARC CPU that delivers 28 MIPS
- Contains as much as 128 Mbytes of RAM

The S4000DX desktop workstation contains a custom SPARC CPU that delivers 28.3 MIPS, 2.3 double-precision Mflops, and 18.3 Specmarks. The workstation also has a 256-kbyte second-level cache that supports the CPU's on-chip 8-kbyte cache. You can install as much as 128 Mbytes of RAM and 1 Gbyte of internal hard-disk-drive memory. Error-correction code protects against single-bit RAM errors. Other standard features include an Ethernet controller, two RS-423A ports, a SCSI-2 port, an audio port, an OS/MP Unix operating system, and a C-language compiler. Sunview, X-Window System, OI Library, PDB debugger, and the com-

pany's X-Window Manager are also standard features. Configuration with 19-in. monitor, 16 Mbytes of RAM, and a 200-Mbyte hard-disk drive, \$12,495.

Solbourne Computer Inc., 1900 Pike Rd, Longmont, CO 80501. Phone (303) 772-3400. **Circle No. 351**

Laser Printer

- Has 14 bit-mapped resident fonts
- Measures 14.3×15.9×7.7 in. and prints at 4 ppm

The CI-4 laser printer prints at 4 pages/minute and measures 14.3×15.9×7.7 in. It weighs 28.7 lbs. You can select from 14 bit-mapped resident fonts, including Courier, Courier Bold, Courier Italic, and Line Printer. The printer specifies a 46-dBA sound level during normal operation and 35-dBA in standby mode. It provides HP Laserjet IIP

emulation, and it prints at 300 dpi. You load paper by raising a guide-release lever and adjusting the paper guides. The paper bin holds 100



sheets. You can expand the standard 512-kbyte RAM buffer by installing one or two 1-Mbyte memory modules. An optional page-description-language (PDL) cartridge makes the printer Postscript compatible. Laser printer, \$1245; 300-sheet paper bin, \$175; 1-Mbyte memory

We supply
our clients with
a wide array
of connector parts,
even if they go to parts
unknown.

- Lyn Bresnen
Multi-National
Account Executive

module, \$230; PDL cartridge, \$450.
C-Tech Electronics Inc, Box 19673, Irvine, CA 92713. Phone (714) 833-1165. **Circle No. 352**

Bubble Jet Printer

- 360 dpi on plain bond paper
- Character pitch is 10, 12, or 17 cpi

The BJ-10ex bubble-jet printer emulates an Epson LQ-510 and IBM Proprinter X24E printer. It can print with 360-dpi resolution on plain bond paper, envelopes, or transparencies. You can select the following character pitches when printing in high-quality mode—10 cpi (83 cps), 12 cpi (100 cps), or 17 cpi (142 cps). The printer also accepts graphic images from a scanner. You set DIP switches to control such functions as image density, automatic sheet-feeder mode, automatic line feed, page length,

character set, emulation mode, and alternate-graphics mode. The printer operates at a noise level of 45 dBA. Printer, \$499; 30-sheet paper feeder, \$90; print-head and ink-supply cartridge, \$25.

Canon USA, Printer Div, 1 Canon Plaza, Lake Success, NY 11042. Phone (516) 488-6700. **Circle No. 353**

Ethernet Concentrators

- Have 12 10Base-T ports and network management
- Dual AUI ports accommodate fiber-optic communication

These two Ethernet concentrators in the Elite line have 12 10Base-T ports. The 3512TPi concentrator comes with an installed network-management module; using an optional module, you can upgrade the 3512TP concentrator in the field. The module implements the Simple

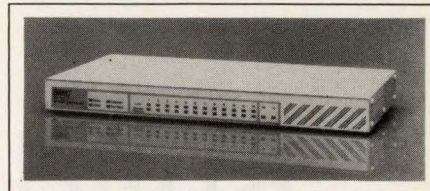

Network Management Protocol (SNMP). A 16-MHz 80C186 μ P provides the intelligence to communicate with SNMP-compliant stations, and you can load the latest protocol firmware over the cable into an on-board 128-kbyte flash PROM. The concentrators also have a fixed attachment-unit-interface (AUI) connector and switch-selectable AUI to BNC connector. Dual AUI ports accommodate fiber-optic communication. Concentrators, \$1095; network-management module, \$699.

Standard Microsystems Corp, 80 Arkay Dr, Hauppauge, NY 11788. Phone (516) 273-3100. **Circle No. 354**

Some of the biggest names in electronics are making



big plans for global expansion.

But even

the



international date line can't stop people like Antonia and Dennis when it comes to

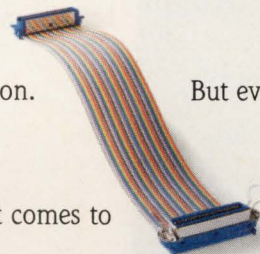

on-time delivery and zero defects. Amphenol has new facilities in Scotland, Mexico,

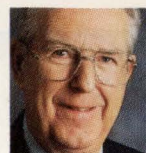

Spain, and soon in Korea,

Thailand and Australia. We'll



be right next

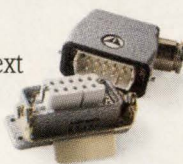

door to major customers. So no matter how far away



you go, people like Efrain and Normand aren't far away. That's what makes us a



world class connector manufacturer,



and second to none for customer service.

Amphenol
An L.P.L. company
 We're all connected.

Visit us at Wescon Booth #417

How Many Times Do You Build Your Product?

**Now EEsosf Has the Answer
to Faster Time-to-Market for
Microwave and RF Product
Design...**

**THE SOLUTION?
EEsOSf SOFTWARE!**

With today's emphasis on commercial applications, faster time-to-market is critical to insure profit. But the cut 'n try design of microwave and RF circuits can wipe out those profits before manufacturing

**VERSION
3.0**

begins. And component tolerance and aging, process variation, and temperature effects can kill a product after it's gone to manufacturing. Not much to keep the boss happy...

EEsOSf's Design-for-Manufacturing software brings advanced CAE/CAD technology to high-frequency analog engineers and lets you optimize designs under realistic manufacturing conditions. Even difficult nonlinear designs—amplifiers, mixers, and oscillators—become straightforward. EEsOSf's system and circuit simulation programs, including Touchstone[®]

OmniSys[®], jOMEGA[™] and Libra[®], let you simulate and optimize manufacturing yield while accounting for component statistical variations.

Send today for your free copy of EEsOSf's "Solutions in Design for Manufacturing," and let us show you how to eliminate prototype rework and get your product through manufacturing faster. Call us at (800) 624-8999, ext. 155. Or if you prefer, contact us by FAX at (818) 889-4159. In Europe, call (49) 8105-24005 or FAX (49) 8105-24000.



Breaking the Barriers...

EEsOSf[®]

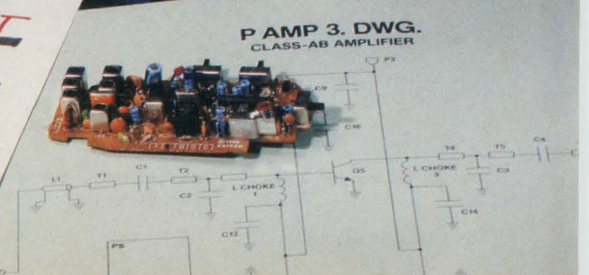
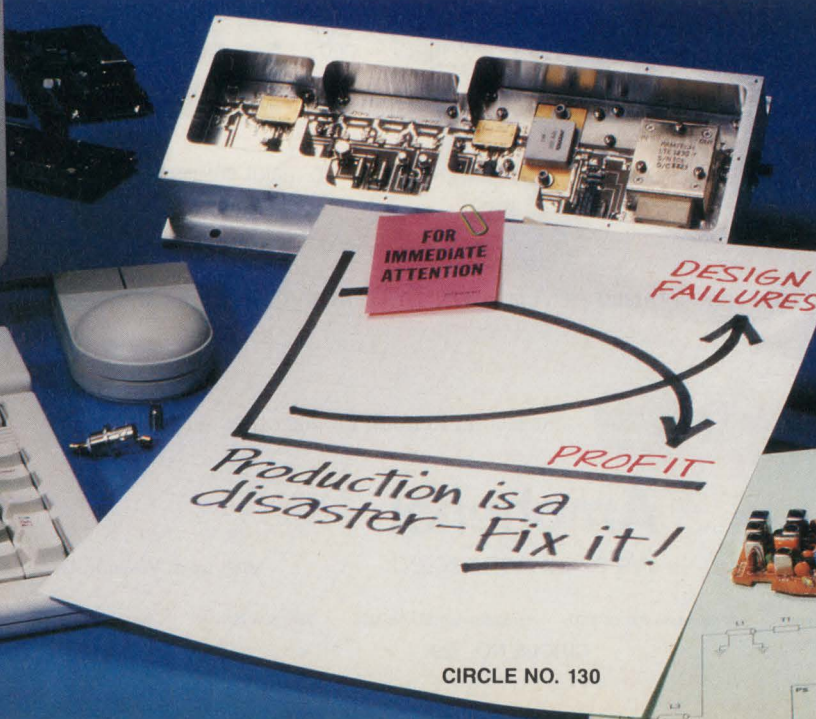
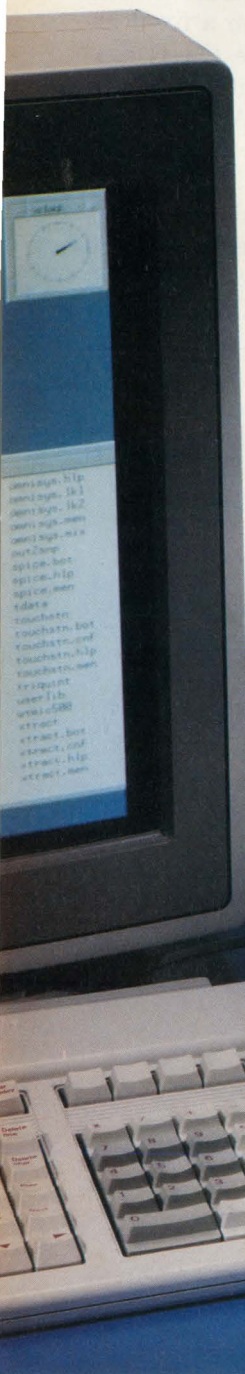

Our newest line of defense against heat.

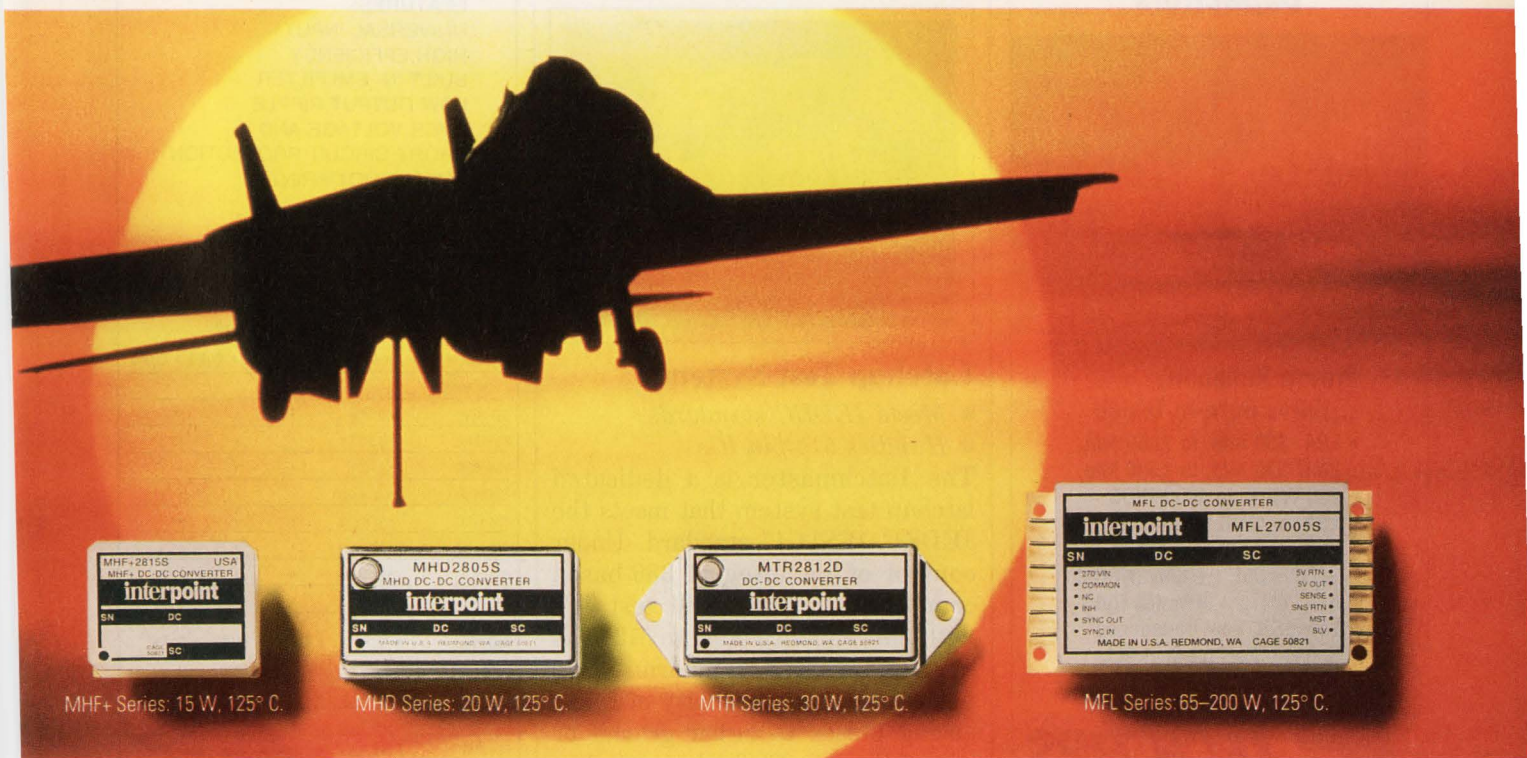

MHF+ Series: 15 W, 125° C.

MHD Series: 20 W, 125° C.

MTR Series: 30 W, 125° C.

MFL Series: 65–200 W, 125° C.

Insist on Interpoint.

A full line of high-temperature DC-DC converters from the industry leader.

Get the hottest technology in board-mounted power supplies. Full military temperature range. Unsurpassed reliability. The lowest profiles. You can get it all with Interpoint's new line of DC-DC converters.

From arctic blasts to desert storms, Interpoint's new generation DC-DC converters stand up to the toughest military environments. They deliver full power over the entire -55° to +125° C. temperature range. And over an unprecedented power range, too. Interpoint can now offer you an off-the-shelf hybrid power supply for any power level from 2 to 200 watts.

For more than a decade, Interpoint DC-DC converters have proven their reliability in many of the world's most

MSA Series: 5 W, 125° C.

Interpoint's new line of DC-DC converters features constant PWM switching frequencies from 500 to 700kHz. Built-in sync. Parallel operation. Up to 50 dB audio rejection. Line and load regulation as low as 0.1%. And full MIL-STD-704 input for 28- and 270-volt systems.

advanced weapons systems — including mission-critical electronics on the Patriot and Tomahawk missiles, the Bradley Fighting Vehicle and F/A-18 aircraft. Our new generation converters are the most reliable yet. Each of them was designed with the specific intent of being qualified to the full performance and reliability standards of MIL-STD-883C.

And Interpoint continues to lead the way in power supply miniaturization. With power densities as high as 40 watts per cubic inch and package heights as low as .270 inch, this new generation of converters is built for the tightly packed boards in today's military and commercial avionics, ground vehicles and portables.

It's the hottest new technology in DC-DC converters. And it's available only from Interpoint. For more information, call 1-800-822-8782. In Europe, 44-276-26832.



interpoint

10301 Willows Road P.O. Box 97005
Redmond, WA 98073-9705

ic[®] LBA/LMU

Snap-Mount Aluminum Electrolytic Capacitors

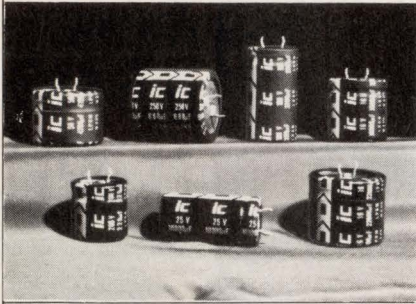

Proven Reliability

...100% Burn-In Tested

- LBA 300 Mfd. to 1,800 Mfd.
LMU 300 Mfd. to 1,500 Mfd.
- 200 WVDC to 400 WVDC
- LBA -40°C to +85°C
LMU -40°C to +105°C
- ±20% Std. (±10% (K) Opt.
or -10%, +30% (Q) Opt.)
- Low ESR, Low Impedance
- Solvent Tolerant Seal Std.

ic[®] TECH TIPS

Type LBA and Type LMU Snap Mount electrolytic capacitors offer extremely high CV density and have very long operating life. The Low ESR design allows for operation at maximum rated ripple current levels, enabling the designer to streamline circuitry with fewer devices. The modern rugged Snap Mount design allows quick and efficient attachment to a printed circuit board. These rugged capacitors are perfect for the latest design filters in both conventional and switch mode power supplies. Designed with welded terminations, low ESR and low inherent inductance. Types LBA and LMU provide the range of configuration for present and future designs.

The source for Quality.
Performance and Delivery.

ic[®] ILLINOIS CAPACITOR, INC.

3757 West Touhy Avenue
Lincolnwood, Illinois 60645
(708) 675-1760
Fax (708) 673-2850

NEW PRODUCTS

INSTRUMENTS

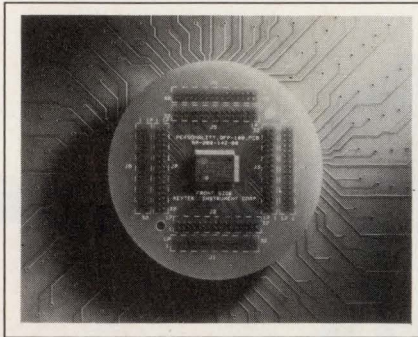

Latchup Test System

- Meets JEDEC standards
- Handles 512-pin ICs

The Latchmaster is a dedicated latchup test system that meets the JEDEC JESD 17 standard. Under control of an integral 386-based computer, the unit will test ICs with pin counts ranging to 512. The system includes 4-quadrant test pulses with the capability of referencing pulses to either ground or one of the two DUT (device-under-test) power buses. The system also includes fundamental preconditioning to let users define the state of output. Bidirectional pins ensure testing under fully controlled and repeatable conditions. Test-pulse parameters under full software control include pulse voltage amplitude, pulse-current amplitude, rise and fall times, and selection of either logic ground or one of the V_{CC} power supplies as the pulse reference. From \$70,000.

Keytek Instrument Corp, 260 Fordham Rd, Wilmington, MA 01887. Phone (508) 658-0880. Circle No. 367

High-Speed Emulator

- Supports SPARClite μ P
- Offers 40-MHz operation

The Excell-930 emulator supports Fujitsu's SPARClite μ P. It offers 40-MHz operation, debugging features, high-speed download, cache trace, and nonintrusive operation. Emulator features include an 8-

Text continued on pg 214



UNIVERSAL VOLTAGE POWER SUPPLIES FOR NOTEBOOK PCS

FEATURES:

- UNIVERSAL INPUT
- HIGH EFFICIENCY
- BUILT-IN-EMI FILTER
- LOW OUTPUT RIPPLE
- OVER VOLTAGE AND
- SHORT CIRCUIT PROTECTION
- SMALL FOOT PRINT

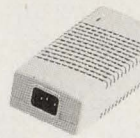

COMTEC '91
R8605

MODEL • O/P1 • O/P2 • O/P3 • O/P4

MODEL	O/P1	O/P2	O/P3	O/P4
30W ADAPTER				
PSA-093(P)	• 9.5V/3A	•	•	•
PSA-122(P)	• 12V/2.5A	•	•	•
PSA-152(P)	• 15V/2A	•	•	•
PSA-161(P)	• 16.5V/1.8A	•	•	•
PSA-171(P)	• 17V/1.75A	•	•	•
PSA-181(P)	• 18V/1.65A	•	•	•
PSA-241(P)	• 24V/1.25A	•	•	•
PSM-3021	• 5V/2A	• 12V/1.5A	•	•

MODEL • O/P1 • O/P2 • O/P3 • O/P4

MODEL	O/P1	O/P2	O/P3	O/P4
40W ADAPTER (CHARGER OUTPUT)				
PSA-4641	• 18V/1.4A	• 1A	•	•
PSA-4642	• 11V/2A	• 1.8A	•	•
PSA-4643	• 5.6V/2.5A	• 2.5A	•	•
PSA-4631	• 5V/3A	• 12V/1.5A	• 12V/0.3A(W/O CHARGER)	•

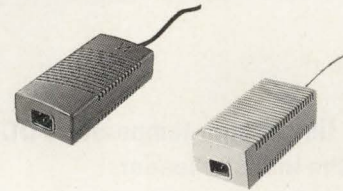

MODEL • O/P1 • O/P2 • O/P3 • O/P4

MODEL	O/P1	O/P2	O/P3	O/P4
50W ADAPTER				
PSA-124(P)	• 12V/4.2A	•	•	•
PSA-153(P)	• 15V/3.6A	•	•	•
PSA-162(P)	• 16.5V/2.5A	•	•	•
PSA-163(P)	• 16.5V/3.0A	•	•	•
PSA-173(P)	• 17V/3.2A	•	•	•
PSA-183(P)	• 18V/3A	•	•	•
PSA-242(P)	• 24V/2.2A	•	•	•



PHIHONG ENTERPRISE CO., LTD.

Taiwan:
16, LANE 530, CHUNG CHENG NORTH ROAD, SAN CHUNG CITY TAIPEI, TAIWAN, R.O.C.
FAX: 886-2-9817086 & 886-2-9833222
TEL: 886-2-9882126 & 886-2-9805255

PHIHONG U.S.A. INC.
920 HILLVIEW DR., SUITE # 195 MILPITAS, CA 95035 TEL: 408-263-2200
TEL: 408-263-2213

EUROPE:
HN ELEKTRONIK
POSTFACH 1113 D-6456 LANGENSELBOLD W. GERMANY
TEL: 06184-2872 FAX: 06184-62316

Heard the news about Keithley's new switching system?



It's on all 80 channels.

Introducing the Keithley Model 7001 High-Density Switching System.

Now, get up to 80 channels of two-wire switching from just one half-rack mainframe and two high-density cards.

Monitor all channels at once, too. The unique vacuum fluorescent display shows the open/close status of *all* channels simultaneously. Program, modify, or debug your test systems with remarkable ease.

Plus, have the capability to switch a variety of signals. From femtoamps to amps. Nanovolts to kilovolts. And DC to 500MHz. It's the kind of measurement integrity that has made Keithley switches a preferred choice for nearly two decades.

Call 1-800-348-3735. Or return the card. An applications engineer will provide details, arrange a demonstration, even help you design your test system.

Contact Keithley today. We'll be watching for your reply.

KEITHLEY INSTRUMENTS

ULTRA-MINIATURE SURFACE MOUNT

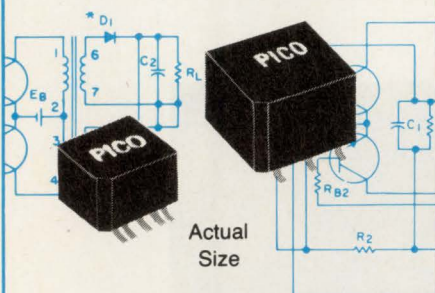

DC-DC Converter Transformers and Power Inductors

These units have gull wing construction which is compatible with tube fed automatic placement equipment or pick and place manufacturing techniques. Transformers can be used for self-saturating or linear switching applications. The Inductors are ideal for noise, spike and power filtering applications in Power Supplies, DC-DC Converters and Switching Regulators.

- Operation over ambient temperature range from -55°C to $+105^{\circ}\text{C}$
- All units are magnetically shielded
- All units exceed the requirements of MIL-T-27 ($+130^{\circ}\text{C}$)
- Transformers have input voltages of 5V, 12V, 24V and 48V. Output voltages to 300V.
- Transformers can be used for self-saturating or linear switching applications
- Schematics and parts list provided with transformers
- Inductors to 20mH with DC currents to 23 amps
- Inductors have split windings

Delivery—
stock to
one week

SEE EEM,
THOMAS REGISTER
OR SEND DIRECT FOR
FREE PICO CATALOG

PICO
Electronics, Inc.

453 N. MacQuesten Pkwy. Mt. Vernon, N.Y. 10552

Call Toll Free **800-431-1064**

IN NEW YORK CALL **914-699-5514**

INSTRUMENTS

kbyte trace buffer, hardware and software breakpoints, 32 user-defined external inputs, and a logic-analyzer interface. Other features include a Microtec Research Xray source-level-debugger interface, remote debugging from the Sun-4, and a system-expansion bus. \$15,875. Delivery, eight weeks ARO.

Step Engineering, Box 3166,
Sunnyvale, CA 94088. Phone (408)
733-7837. **Circle No. 368**

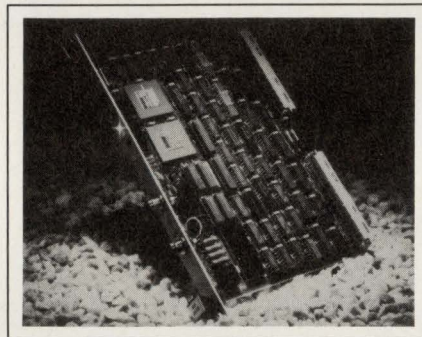

VME/VXI Interface

- Interface to MIL-STD-1553B
- Features software controls

The BUS-65522II provides an interface between the serial MIL-STD-1553B data bus and the parallel VME/VXI bus. Software controls allow the unit to operate as either a 1553B bus controller (BC), remote terminal (RT), or bus monitor (MT). The card has an onboard dual-access RAM, which is double buffered. This prevents partially updated data from being read by the VME/VXI host or transmitted to the 1553B data bus. All MIL-STD-1553 functions are provided without host intervention. The board includes 11 registers that allow the VME/VXI host to configure its operation under software control. The interface supports four groups of vectored interrupts and a custom interrupt, which can be programmed by an onboard PROM interrupt enable/disable. From \$4995. Delivery, five to 12 weeks ARO.

ILC Data Device Corp, 105 Wilbur Pl, Bohemia, NY 11716. Phone (516) 567-5600, ext 545. **Circle No. 369**

DESIGNING LED SOLUTIONS

DDP® custom lamp-based design
U.S. Patent No. 4,965,457.

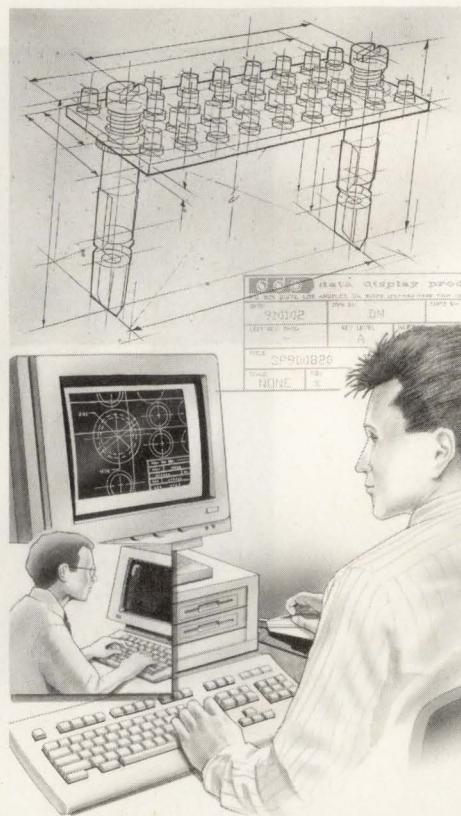

Since 1970, Data Display Products has pioneered the development of DDP® LEDs as replacements for incandescent lamps, panel-mounted lights and PC Board indicators.

DDP® LEDs Feature:

- Over 10 Year Life
- Vibration/Shock Resistance
- Better Visibility

Let us design an LED solution for you!



Data Display Products

(213) 640-0442, Ext. 116

(800) 421-6815

Fax (213) 640-7639

CIRCLE NO. 135

COMPLETE *FLASH* MEMORY PROGRAMMER IN 1/2 SQ. INCH!

Step-Up From +5V to +12V $\pm 4\%$ at 200mA with 88% Efficiency

The new MAX732 200mA step-up regulator is a simple, compact flash memory programming supply that has direct microprocessor-controlled shutdown.

The most basic application needs only four external components and a miniature 22 μ H inductor to deliver 60mA with 88% efficiency — with a footprint of less than 1/2 in² (3.2 cm²).

To ease design, a pre-assembled surface mount evaluation board is available.*

- ◆ **Completely Assembled Programmer EV-Kit in Surface Mount**
- ◆ **Small 22 μ H Inductor**
- ◆ **Direct Microprocessor Control**
- ◆ **Space-Saving Footprints: 16-Pin SOIC and 8-Pin DIP Packages**
- ◆ **Pre-Trimmed +12V Output with $\pm 4\%$ Accuracy**
- ◆ **Wide Input Range: +4.0V to +9.3V**
- ◆ **Guaranteed Output Currents up to 200mA**
- ◆ **Low-Noise Operation and Excellent Transient Responses**
- ◆ **Short-Circuit and Soft-Start Protection**

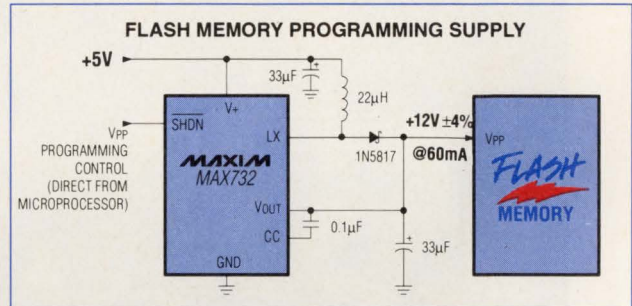

This MAX732 flash memory programmer supplies +12V $\pm 4\%$ at 60mA with 88% efficiency from a +5V source. The shutdown current for this entire circuit is 75 μ A.

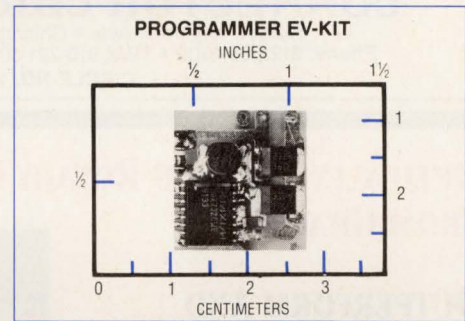

The complete surface mount MAX732 flash memory programmer fits into less than 1/2 in² (3.2 cm²). Additional capacitors can be added for higher current operation — up to 200mA.

POWER SUPPLIES ANALOG

Data Sheets • Application Notes • Free Samples

+5V To +15V DC-DC Converter Delivers 30W

No Design Required—Just Drop It In

The MAX732 is a 200mA step-up regulator that has direct microprocessor-controlled shutdown. The MAX732 is a 200mA step-up regulator that has direct microprocessor-controlled shutdown. The MAX732 is a 200mA step-up regulator that has direct microprocessor-controlled shutdown.

Evaluation Kit Highlights Prototyping

Maxim's new MAX732 evaluation kit is a complete, ready-to-use, surface-mount, pre-assembled, and tested. The MAX732 is a 200mA step-up regulator that has direct microprocessor-controlled shutdown.

Production Kit Offers Performance and Business Reliability

Maxim's new MAX732 production kit is a complete, ready-to-use, surface-mount, pre-assembled, and tested. The MAX732 is a 200mA step-up regulator that has direct microprocessor-controlled shutdown.

ANALOG

MAXIM

FREE Power Supply Design Guide

Includes: Application Notes ◆ Data Sheets ◆ Cards For Free Samples

To receive your free design guide, simply circle the reader response number, or contact Maxim Integrated Products, 120 San Gabriel Drive, Sunnyvale, CA 94086, (408) 737-7600, FAX (408) 737-7194.

MAXIM

Distributed by Arrow, Bell/Graham, Elmo, Hall-Mark, Nu Horizons, Pioneer, and Wyle. Authorized Maxim Representatives: Alabama, (205) 830-0498; Arizona, (602) 730-8093; California, (408) 248-5300, (619) 278-8021, (714) 261-2123; (818) 704-1655; Colorado (303) 779-8060; Connecticut, (203) 384-1112; Delaware, (609) 778-5353; Florida, (305) 426-4601, (407) 830-8444; Georgia, (404) 447-6124; Idaho, (503) 292-8840; Illinois, (708) 358-6622; Indiana, (317) 844-8462; Iowa, (319) 393-2232; Kansas, (816) 436-6445; Maryland, (301) 644-5700; Massachusetts, (617) 329-3454; Michigan, (313) 352-5454; Minnesota, (612) 941-9790; Mississippi, (205) 830-0498; Missouri, (314) 839-0033, (816) 436-6445; Montana, (503) 292-8840; Nebraska, (816) 436-6445; Nevada, (408) 248-5300; New Hampshire, (617) 329-3454; New Jersey, (201) 428-0600, (609) 778-5353; New Mexico, (602) 730-8093; New York, (516) 351-1000, (607) 754-2171; N. Carolina, (919) 851-0010; Ohio, (216) 659-9224, (513) 278-0714, (614) 895-1447; Oregon, (503) 292-8840; E. Pennsylvania, (609) 778-5353; W. Pennsylvania, (614) 895-1447; S. Carolina, (919) 851-0010; Tennessee, (404) 447-6124; Texas, (214) 234-8438, (713) 782-4144, (512) 346-9186; Utah, (801) 561-5099; Virginia, (301) 644-5700; Washington, (206) 823-9535; W. Virginia, (513) 278-0714; Wisconsin, (414) 476-2790; Canada, (416) 238-0366, (613) 225-5161, (604) 439-1373, (514) 337-7540.

* Order "MAX732EVKIT"

Maxim is a registered trademark of Maxim Integrated Products. © 1991 Maxim Integrated Products.

Quality Sockets and Plugs



Standard, Customized
and New Designs



Prototype through
Production

CONNECTOR CORPORATION

6025 N. Keystone Ave. • Chicago, IL 60646-5290
Phone: 312/539-3108 • TWX 910-221-6059 • FAX: 312/539-3825
CIRCLE NO. 150

INSTRUMENTS

Frequency Synthesizer

- Covers to 310 MHz
- Has 1-Hz resolution

The PTS 310 frequency synthesizer covers a 0.1- to 310-MHz range with a standard resolution of 1 Hz. Resolution to 0.1 Hz is available as an option. Spurious suppression equals 60 or 65 dB, and switching speed ranges from 1 to 20 μ sec. The unit is a direct synthesizer, combining direct analog with direct digital technologies. The synthesizer is available in two configurations: a standard model (type 1) and a less expensive version with reduced spurious performance for applications where spurious performance isn't critical. Both models occupy 3.5 in. of rack space. \$6000.

Programmed Test Sources Inc.
Box 517, Littleton, MA 01460.
Phone (508) 486-3008. FAX (508) 486-4495. **Circle No. 370**

OPTICALLY COUPLED ROTARY ENCODER SWITCHES FROM GRAYHILL

**OUTPERFORM AND
OUTLAST
ELECTROMECHANICALS
BUT DON'T
OUTCOST THEM!**

Use affordable Grayhill Series 61 Switches to

- Move an icon on a display
- Select menu items, ranges, limits
- Set radio frequency, drill depth, RPM, etc.
- Activate data entry with integral pushbutton

Bulletin 508 describes 16 and 32 detent position Grayhill Series 61 switches with 2 Bit Quadrature Code Output and million-cycle reliability. Ask for your free copy.

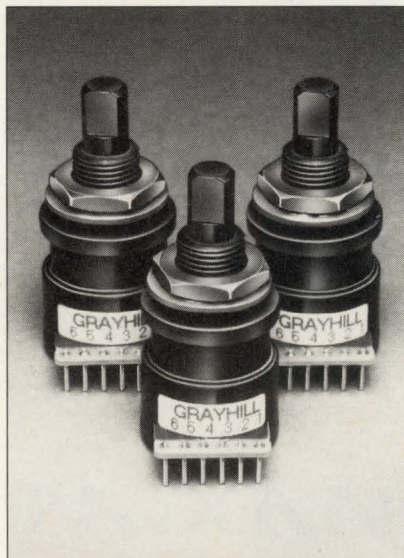

Grayhill
INC.

561 Hillgrove Avenue, P.O. Box 10373
LaGrange, Illinois 60525-0373 USA
Phone: (708) 354-1040 FAX: (708) 354-2820
TLX or TWX: 190254 GRAYHILL LAGE

The world's
broadest line
of EL flat
panel displays.



ALVAR
503-690-1100

4 COMPARATORS WITH ON-CHIP DAC ADJUSTABLE THRESHOLDS

Automate Calibration, Minimize Part Count - \$6.00*

Maxim's new MAX516 - 4 BiCMOS comparators with DAC-programmed input thresholds - satisfies limit and level detection requirements for applications such as bar code readers, automatic test, and process control. The 4 DACs drive comparator inverting inputs so that trip thresholds can be digitally set, which is ideal for μ P-controlled calibration. The new device comes packaged in space-saving 24-pin DIPs and SOs.

- ◆ 4 Comparators & 4 DACs
- ◆ μ P Set Thresholds: 256 Levels 5mV to 45mV per Level
- ◆ 24-Pin DIP and SO Packages
- ◆ 1.5 μ s Propagation Delay
- ◆ Low Power: 50mW Max
- ◆ Single +5V to +15V Operation
- ◆ 8-Bit μ P Interface

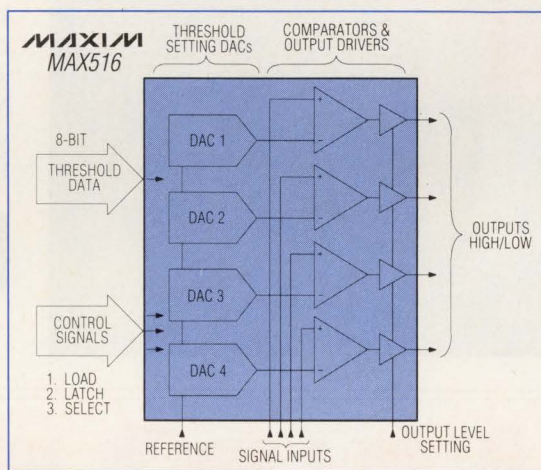

First Quad comparator with 8-bit DACs on-chip to digitally set thresholds.

4 Results Simultaneously in 1.5 μ s!

The 4 comparator outputs respond within 1.5 μ s (typ.) to 8-bit digital threshold data and analog input changes. And the MAX516's separate output driver supply provides logic-compatibility when the analog supply is other than +5V.

D/A CONVERTERS ANALOG DESIGN GUIDE

Quad DAC Replaces 8 ICs!
12-Bit Voltage Output Resolves to 1/2LSB in Less Than 1 μ s

Quad 8-Bit DACs Digitally Adjust On-Chip Comparator Thresholds
Build Window Comparators and Limit Detectors with Minimum Part Count and Design Time

FREE D/A Converter Design Guide

Including: Application Notes ◆ Data Sheets ◆ Cards For Free Samples

To receive your design guide, simply circle the reader response number, or contact Maxim Integrated Products, 120 San Gabriel Drive, Sunnyvale, CA 94086, (408) 737-7600, FAX (408) 737-7194.



Distributed by Arrow, Bell/Graham, Elmo, Hall-Mark, Nu Horizons, Pioneer, and Wyle. Authorized Maxim Representatives: Alabama, (205) 830-0498; Arizona, (602) 730-8093; California, (408) 248-5300, (619) 278-8021, (714) 261-2123; (818) 704-1655; Colorado (303) 779-8060; Connecticut, (203) 384-1112; Delaware, (609) 778-5353; Florida, (305) 426-4601, (407) 830-8444; Georgia, (404) 447-6124; Idaho, (503) 292-8840; Illinois, (708) 358-6622; Indiana, (317) 844-8462; Iowa, (319) 393-2232; Kansas, (816) 436-6445; Maryland, (301) 644-5700; Massachusetts, (617) 329-3454; Michigan, (313) 352-5454; Minnesota, (612) 941-9790; Mississippi, (205) 830-0498; Missouri, (314) 839-0033, (816) 436-6445; Montana, (503) 292-8840; Nebraska, (816) 436-6445; Nevada, (408) 248-5300; New Hampshire, (617) 329-3454; New Jersey, (201) 428-0600, (609) 778-5353; New Mexico, (602) 730-8093; New York, (516) 351-1000, (607) 754-2171; N. Carolina, (919) 851-0010; Ohio, (216) 659-9224, (513) 278-0714, (614) 895-1447; Oregon, (503) 292-8840; E. Pennsylvania, (609) 778-5353; W. Pennsylvania, (614) 895-1447; S. Carolina, (919) 851-0010; Tennessee, (404) 447-6124; Utah, (801) 561-5099; Virginia, (301) 644-5700; Washington, (206) 823-9535; W. Virginia, (513) 278-0714; Wisconsin, (414) 476-2790; Canada, (416) 238-0366, (613) 225-5161, (604) 439-1373, (514) 337-7540.

*1000-up FOB USA, suggested resale.

Whatever strikes your microprocessor, you'll be ready.

Mitsumi safeguards more microprocessors than any other company in the world. Not so surprising when you realize that our power guarding ICs are more reliable at half the cost of any others. It's helped us become the number one OEM supplier of quality peripherals over the last 38 years, with more than \$1 billion in sales and over 14,000 employees in 27 facilities worldwide, manufacturing more than 100 million IC pieces each year. If you have high volume IC needs, call today, (214) 550-7300, and discover how, with Mitsumi power guarding ICs, you're protected and ready for anything.

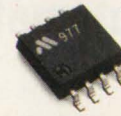

WATCHDOG TIMER.
Protects micro-processor from external noise and electric current.

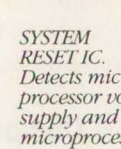

SYSTEM RESET IC.
Detects micro-processor voltage supply and keeps the microprocessor under control.



BATTERY BACKUP IC.
Saves data as it senses when portable batteries are running low.



MITSUMI

CIRCLE NO. 131

FRESH

COMING IN JANUARY 1992

EDN Magazine
Edition
News
Edition

5.00V, 200mA OUTPUT 5.15V INPUT

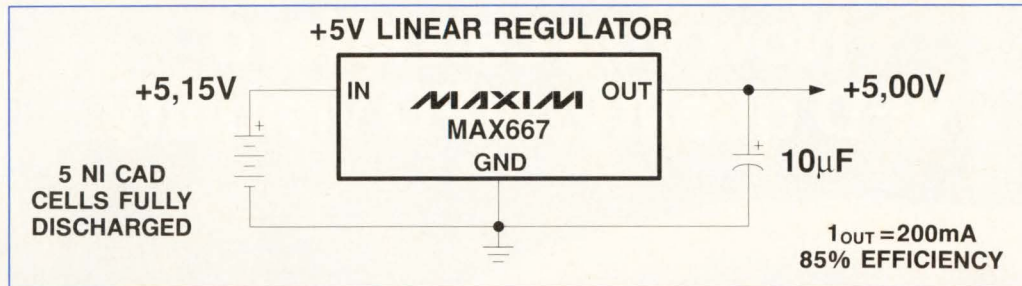

Linear Regulator Uses Only 0.2µA Shutdown Current

Maxim's new MAX667 is the only CMOS linear voltage regulator that has both low dropout and ultra-low quiescent current. The minimum input-output voltage differential (dropout voltage) is only 150mV at 200mA. No-load quiescent current is 20µA. With a 200mA load, quiescent current is 5mA. All this adds up to efficiencies of over 85%—even when delivering 1 Watt from 5 NiCad cells. The MAX667 features pin-controlled shutdown for systems that require intermittent loading, such as pagers, detectors, portable scanners, and cameras, which can sleep for days before springing to life. In shutdown, the MAX667's output turns off and quiescent current drops to a mere 0.2µA, extending battery life. And, its low battery detector tells you when your battery has finally had it.

- ◆ **150mV typ (250mV max) Dropout at 200mA**
- ◆ **Quiescent Current:**
Shutdown – 0.2µA typ (1µA max)
Normal – 20µA typ (35µA max)
- ◆ **250mA max Output Current**
- ◆ **Fixed +5V or Adjustable**
+1.3V to +16.5V Output Range
- ◆ **For only \$2.35***

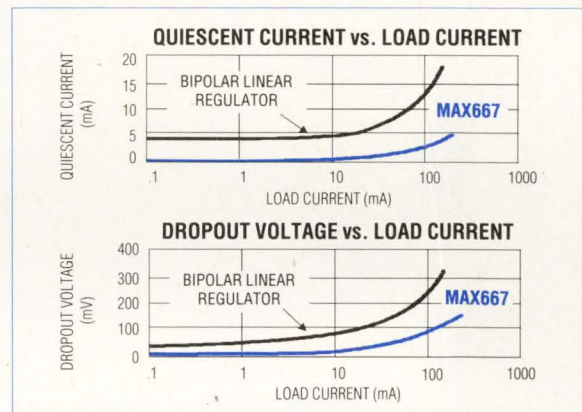

The MAX667 outperforms typical bipolar linear regulators.

FREE DC-DC Converter Design Guide

Includes: ◆ Application Notes ◆ Data Sheets ◆ Cards For Free Samples

Simply circle the reader response number, contact your Maxim representative or Maxim Integrated Products, 120 San Gabriel Drive, Sunnyvale, CA 94086, (408) 737-7600, FAX (408) 737-7194.



POWER SUPPLIES ANALOG DESIGN GUIDE

+5V To ±15V DC-DC Converter Delivers 30W

The Design Requirements—Just Drop It In

The MAX667 MAX667 DC-DC converter... (text continues)

Production Kit Saves Prototyping and Increases Reliability

MAXIM

Distributed by Arrow, Bell/Graham, Elmo, Hall-Mark, Nu Horizons, Pioneer, and Wyle. Authorized Maxim Representatives: Alabama, (205) 830-0498; Arizona, (602) 730-8093; California, (408) 248-5300, (619) 278-8021, (714) 261-2123; (818) 704-1655; Colorado (303) 779-8060; Connecticut, (203) 384-1112; Delaware, (609) 778-5353; Florida, (305) 426-4601, (407) 830-8444; Georgia, (404) 447-6124; Idaho, (503) 292-8840; Illinois, (708) 358-6622; Indiana, (317) 844-8462; Iowa, (319) 393-2232; Kansas, (816) 436-6445; Maryland, (301) 644-5700; Massachusetts, (617) 329-3454; Michigan, (313) 352-5454; Minnesota, (612) 941-9790; Mississippi, (205) 830-0498; Missouri, (314) 839-0033, (816) 436-6445; Montana, (503) 292-8840; Nebraska, (816) 436-6445; Nevada, (408) 248-5300; New Hampshire, (617) 329-3454; New Jersey, (201) 428-0600, (609) 778-5353; New Mexico, (602) 730-8093; New York, (516) 351-1000, (607) 754-2171; N. Carolina, (919) 851-0010; Ohio, (216) 659-9224, (513) 278-0714, (614) 895-1447; Oregon, (503) 292-8840; E. Pennsylvania, (609) 778-5353; W. Pennsylvania, (614) 895-1447; S. Carolina, (919) 851-0010; Tennessee, (404) 447-6124; Texas, (214) 234-8438, (713) 782-4144, (512) 346-9186; Utah, (801) 561-5099; Virginia, (301) 644-5700; Washington, (206) 823-9535; W. Virginia, (513) 278-0714; Wisconsin, (414) 476-2790; Canada, (416) 238-0366, (613) 225-5161, (604) 439-1373, (514) 337-7540.

Maxim is a registered trademark of Maxim Integrated Products. © 1991 Maxim Integrated Products.

from
Noritake

**Now you can afford
VFD quality...VFD visibility**



NORITAKE VFD MODULES
NEW COMPACT T-SERIES

Actual size

itron[®] VFD T-Version Module

- Low power
- Long-term reliability
- Easy user interface
- Surface mount technology
- Flexible control data
- Parallel and serial input
- Built-in test function
- ASCII, European, Japanese Katakana characters
- 9 Modules to choose from

Call or write to see our entire line:

Noritake

CIRCLE NO. 132

Los Angeles
23820 Hawthorne Blvd.
Suite 100
Torrance, CA 90505
Tel. 213-373-6704
Fax 213-772-3918

Chicago
415 E. Golf Rd.
Suite 109
Arlington Heights, IL 60005
Tel. 708-439-9020
Fax 708-593-2285

Boston
263 Winn St.
Suite 1D
Burlington, MA 01803
Tel. 617-270-0360
Fax 617-273-2892

Dallas
2454 Trade Mart
Dallas, TX 75207
Tel. 214-742-9389
Fax 214-747-5065

Europe
Frankfurter Strasse 97-99
6096 Raunheim
F. R. Germany
Tel. 06142-43095/96/97
Fax 06142-22799

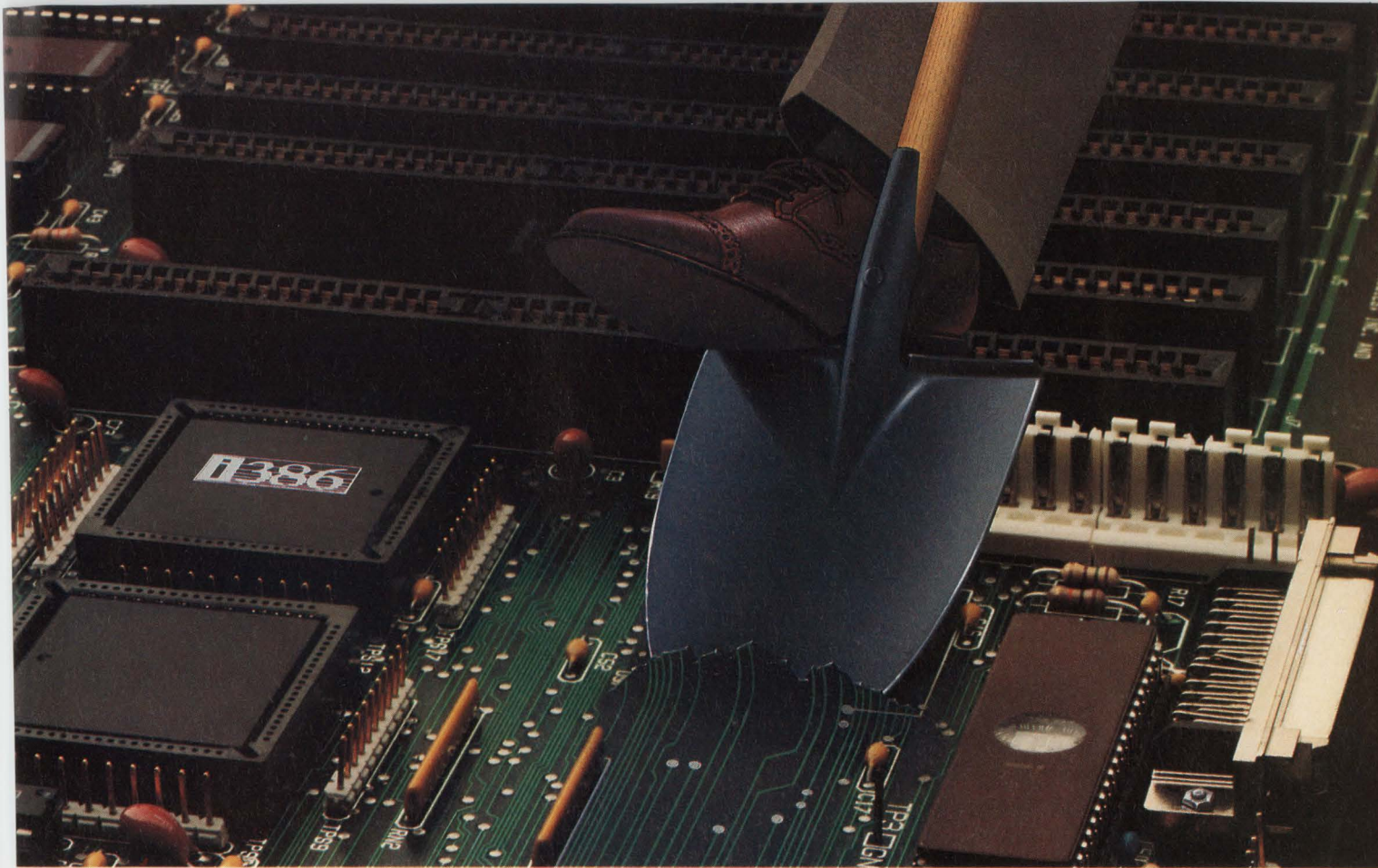

WE'RE BREAKING NEW GROUND BY MAKING IT EASY TO PUT SCSI ON THE MOTHERBOARD.

Introducing Adaptec's new AIC-6260.

You're already a big believer in the performance and connectivity of SCSI. But you're also digging around for an uncomplicated way to design-in SCSI to your AT motherboard. Well...Eureka! Now with Adaptec's new AIC-6260, you've just hit pay dirt.

After all, it makes a lot of sense that a single-chip solution is easier to design-in than multiple chip packages. They're also more reliable. And take up less real estate. Plus, since we've built the AT bus in, designing SCSI in is as easy as connecting signal lines dot-to-dot.

What's more, we get you to market in the fastest

possible time. That's because industry-standard, Adaptec-developed SCSI software drivers and BIOS are ready and available. For all major peripherals – under all major operating systems. All this, and a complete design-in package, too. Which means, you can now afford to design the performance and connectivity of SCSI in your system as a standard feature.

So step on it. And call us at **1-800-227-1817, ext. 52** today. We think you're going to really dig it.



adaptec

When you're serious about SCSI.

Tek's complete digital characterization system. Because a mask is a terrible thing to waste.

Even the smallest timing errors can trash today's high-speed designs. But for the cost of a single turn, you can beat the odds and reduce your time to market with the world's best AC characterization system.

On the stimulus side, Tek's new HFS pulse generators feature a revolutionary digital architecture with up to 18 channels and full functionality to 630 MHz. You can stress timing margins by adjusting each channel's edge

placement with 10 ps resolution *at all frequencies*.

In acquisition, Tek's 11801A with modular sampling heads measures crosstalk, metastability, setup and hold times, and characterizes controlled impedances using TDR — with 1 ps measurement resolution, up to 136 channels, and high-impedance probing to 2.5 GHz and .25 pF.

Push the limits without pushing your luck: let your Tek sales engineer show you the characterization system that easily pays for itself. Or call **1-800-426-2200** for assistance.



One company measures up.

Tektronix
COMMITTED TO EXCELLENCE

EDN PRODUCT MART

This advertising is for new and current products.

Please circle Reader Service number
for additional information from manufacturers.

Instant Microcontroller

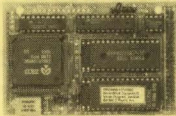

Instant C Programming

Don't use a microprocessor, use a **SmartBlock™** microcontroller module to build your custom controller. Our low cost **Dynamic C™** makes programming a snap. 3.5 x 2.5 inch module includes microprocessor, memory, time/date clock, eeprom, watchdog, serial ports and more. As low as \$59 in quantity. The efficiency of a custom design without the headaches.

Z-World Engineering

1340 Covell Blvd., Davis, CA 95616 USA

Tel: (916) 753-3722

Regular Fax: (916) 753-5141

Automatic Fax: (916)-753-0618

(Call from your fax, hear computer voice, use touchtone dial to request desired data sheets.)

CIRCLE NO. 325

☆☆☆☆
"The Best 8051 Emulator"



5 ft. cable

FULL
80X51
FA/FB/FC
SUPPORT

8051

SEE EEM 91/92
Pages D 1300-1303

PC based emulators for the 8051 family

8031, 8032, 8051, 8052, 80C152/154/321/451/452/51FA/51GB/51S/517/535/537/552/562/652/651/8051, 80512, 83C451/552/652/751/752/8051, 8344, 87C451/552/751/752, 8751, 8752, DS5000 + CMOS ... more.

- PC plug-in boards or RS-232 box.
- Up to 33 MHz real-time emulation.
- Full Source-level Debugger w/complete C-variable support.
- 64 bit wide, 256k deep trace, with time stamp.
- Bond-out/hooks pods for 8051, 83C552, 83C451, 83C652, 83C751, 80C515/80C517, 83C752, 80X51FA/FB/FC, and more.

Prices: 32K Emulator 8031 \$1790; 4K Trace \$1495* (*US only)

CALL OR WRITE FOR FREE DEMO DISK!
Ask about our demo VIDEO

NOHAU
CORPORATION (408) 866-1820
Please see us at Wescon Booth #460

51 E. Campbell Avenue
Campbell, CA 95008
FAX (408) 378-7869

Call 408-378-2912
NoHau's 24-hour
information center to
receive info via your FAX

CIRCLE NO. 326

DSP-BASED DATA ACQUISITION & SIGNAL PROCESSING SYSTEM

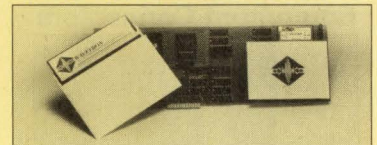

- PC-based 10 or 12 MIPS DSP
 - 3μS, 12-bit ADC & 1.5μS, dual 12-bit DAC
 - Programmable anti-aliasing filter
 - Programmable reconstruction filter
 - Isolated & differential input
 - 10 input ranges from 200V to 20 mV
 - AC/DC coupling
 - Direct serial port interface to the DSP
 - Standard application library includes FFT analysis, IIR & FIR filtering, and arbitrary signal generation
 - Graphical interface software is included
- PRICE: \$ 895**



WAVETRON microsystems
1135 Oddstad Drive • Redwood City, CA, 94063
Tel: (415) 598-0123

CIRCLE NO. 327

Total Auto-MMU

Z280, Z180, Z80 & 8085 Full ANSI C Compilers

- ♦ Completely automatic MMU support (no programming effort) for UP TO ONE MEGABYTE Z180 programs.
- ♦ DOS based cross-compilers for ANSI and K&R C code.
- ♦ Complete with high-speed assembler, linker, and librarian. Includes macros to interface C and assembly.
- ♦ **NOT A SMALL C!** Full ANSI C at a small C price.
- ♦ All ANSI .H files and applicable functions provided.
- ♦ Optimized code generation for all data types. Char types are not promoted to int. Generates inline port I/O.
- ♦ Allows in-line assembly with access to C variables.
- ♦ All code is reentrant and ROMable.
- ♦ Fast ANSI/IEEE 754/INTEL floating point support.
- ♦ Supports C interrupt service routines and pseudo variables to access registers at the C level. Can compile to user defined segments.

ANSI C Compiler, Assembler, Linker - \$699
Assembler and Linker Only - \$279

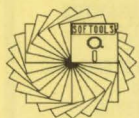

SOFTTOOLS, INC.
8770 Manahan Drive
Ellicott City, MD 21043
(301) 750-3733
FAX/BBS (301) 750-2008

CIRCLE NO. 328

Thermal Analysis of Boards & Systems

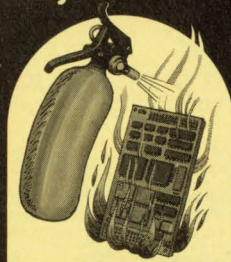

BETAsoft
gives you

- * Board & System Thermal Analyses
 - * Analyze Cabinets and Card-Cages
 - * 3-D Modelings for SMT boards
 - * Failure Rate of each component
 - * Interface P-Cad, PADS-PCB, Auto CAD, CadStar, MENTOR, VALID...
 - * Menu-driven, 2500 comp. library
 - * on PC-DOS & Sun SPARCstation
- BETAsoft \$1,995, \$2,995, \$5,995**
Dynamic Soft Analysis, Inc.
Tel 412-781-3016 Fax 412-781-3098

CIRCLE NO. 329

Analog Circuit Simulation SPICE FOR THE PC

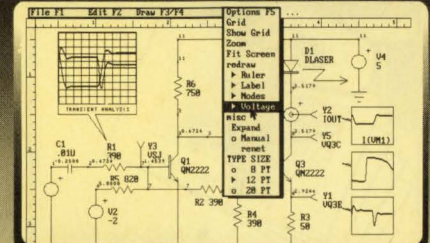

- Schematic Entry • SPICE Simulation
 - Model Libraries • Waveform Graphics
- Intusoft has it all at an Affordable Price!**

INTEGRATED, EASY TO USE SIMULATION ENVIRONMENT, FEATURING:
A powerful SPICE (IsSpice) simulator performing AC, DC, Transient, Noise, Fourier, Distortion, Sensitivity, Monte Carlo, and Temperature analyses. Extensive model libraries, Schematic entry, and Waveform processing. Starting at \$95 for IsSpice, complete systems are available for \$890.

Call Or Write For
Your Free Demo and
Information Kit!
intusoft P.O. Box 710 San Pedro,
CA 90733-0710
Tel. 213-833-0710 Fax 213-833-9658

CIRCLE NO. 330

To advertise in Product Mart, call Joanne Dorian, 212/463-6415

RELIABILITY AND MAINTAINABILITY PREDICTION AND FMECA ANALYSIS SOFTWARE

Hundreds have used this leading computer-aided engineering software since 1982.

Powertronic Systems offers software to predict Reliability and Maintainability and for Failure Modes Effects and Criticality Analysis. Hundreds of users have selected from PSI's large, versatile and integrated software family for military and industrial equipment and for both electrical and mechanical systems. And, data inputs to these programs may be interactive or batch mode from other CAE or database programs. Programs implement MIL-STD-1629; MIL-HDBK-217 including E Notice 1; and MIL-HDBK-472.

PSI Powertronic Systems, Inc.
P.O. Box 29109 New Orleans 70189
(504) 254-0383 FAX (504) 254-0393

CIRCLE NO. 331

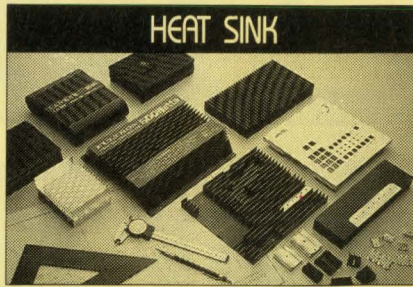

HPIC is a specialist manufacturer of aluminum products since 1972. Our experience and integrated production including extrusion, cutting, punching, drilling, lathing, CNC milling and anodizing etc. guarantee you the best price, quality products and prompt delivery. Many famous makers of household electronic/electric appliances, computers etc. purchase their heat sinks, front panels and metal parts from HPIC. Your inquiry are most welcome.

HUANG PIN IND. CO., LTD.
NO.254, CHUNG CHENG RD., LOU-JOU HSIANG TAIPEI HSIEN TAIWAN, R.O.C.
TEL: (02)2816636~8 Telex: 33485 HPIC Fax: (02)2828180



CIRCLE NO. 332



MultiTask!™ Executives Accelerate Design

Get standard real-time services on 68xxx, 68HC11, Z80/180/64180, 8051, 80x86/V-Series, 8096/196, i960 and ProtoTask!™ PC design executive. Source code keeps you in control. Call: 503-641-8446; FAX 503-644-2413; or 800-356-7097 for free EasyTask!™ Info Diskette.



14215 NW Science Park Drive
Portland, OR 97229
U S SOFTWARE®

© 1991 U.S. Software Corporation. MultiTask!, ProtoTask! and EasyTask! are trademarks of U.S. Software Corporation.

CIRCLE NO. 333

High Density Circular Process and Medical Equipment Connectors

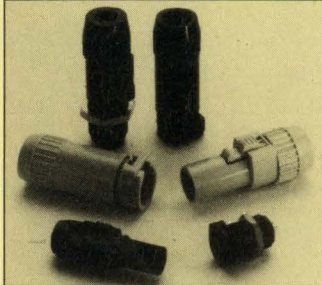

D Series 7, 9 and 12 contact cable to cable and chassis connectors provide MIL quality contacts in impact resistant Polycarbonate housing. Keyed simple push button lock minimizes use problems. Solder cup or crimp contacts are useable in either housing. For additional information, contact:

Hypertronics Corporation
16 Brent Drive, Hudson, MA 01749
(800) 225-9228 FAX: (508) 568-0680

CIRCLE NO. 334

ROM-IT EPROM EMULATION SYSTEM



NEW 4-MEGABIT VERSION

- Emulates up to 8 4-Megabit EPROMs with one control card.
- Downloads 2-Megabit programs in less than 23 seconds.
- Allows you to examine and modify individual bytes or blocks.
- Accepts Intel Hex, Motorola S-Record and Binary files.
- Software available for IBM PC and compatibles and Macintosh systems.
- Base 27256 EPROM System \$395.00 Other configurations available.

**ORDER TODAY—IT'S EASY
CALL OR FAX FOR MORE INFORMATION**



Incredible Technologies, Inc.
(708) 437-2433
(708) 437-2473 Fax

VISA now accepted.

CIRCLE NO. 335

Now
Networkable!

Facts about 500,000 ICs and Semiconductors at Your Fingertips

Cahners CAPS is the newest component search and selection tool for electronic design engineers:

- PC-driven, CD-ROM-based
- Includes unabridged manufacturers' datasheets
- Represents more than 450 manufacturers worldwide

Call toll-free: 1-800-245-6696

CAHNER'S



Computer Aided
Product Selection

275 Washington Street
Newton, MA 02158-1630
Telephone: 617-558-4960
Facsimile: 617-630-2168
Telex: 940573

CIRCLE NO. 336

Pick Of The Week



RGB Splitter

- 1-In/2-Out RGBS Video Splitter ■ 150 MHz Bandwidth ■ Outputs are buffered and short circuit protected ■ 4 and 6 output models available ■ Only \$440 (Model IN3012)—Lifetime warranty!

Communications
 Specialties, Inc.

TEL: 516-273-0404 FAX: 516-273-1638

CIRCLE NO. 337

- CONTROL SYSTEM
- FEEDBACK LOOP
- SERVO
- POWER SUPPLY
- AMPLIFIER
- ELECTRO-MECHANICAL

STABILITY ANALYSIS WORKSTATIONS

- DESIGN, ANALYZE, TEST, STABILIZE and DOCUMENT any analog circuit IN MINUTES — not hours or days
- Venable's Model 350 engineering workstation vastly improves final product quality in a fraction of the time required by conventional and other CAD techniques
- Venable's 350 enables you to model, capture actual readings, use Bode, Nyquist, plus measure and specify performance margins etc. The system synthesizes electronic circuits complete with schematics, components and supporting engineering.
- Contact us for literature and demonstration.

VENABLE
Industries, Inc.

3555 LOMITA BLVD.
TORRANCE, CA 90505
800 • 262 • 2522
FAX • 213 • 539 • 4139



CIRCLE NO. 338

EZ - ROUTE PLUS

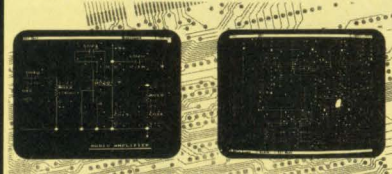

**SCHEMATIC TO ERROR-FREE ARTWORK \$650
INCLUDES AUTO ROUTER**

EZ-ROUTE PLUS system from AMS for IBM PC, PS/2 and compatibles is an integrated system and includes schematic capture, PCB layout, Automatic Router, Design Rule checker and ability to view gerber plot files. The schematic capture module from EZ-ROUTE system supports A through E size sheet, comes with user expandable library and outputs netlists compatible to several different formats such as Futurcut, PCAD, and EDIF. The PCB Layout Module supports 256 layers, trace width from 0.001 inch to 0.25 inch, flexible grid, SMD components on both the sides of the board and outputs on penplotters, gerber photoplotter, and dot matrix printers.

Schematic Capture \$100, PCB Layout \$250, Auto Router \$250.
FREE EVALUATION PACKAGE

30 DAYS MONEY BACK GUARANTEE

1-800-972-3733 or (305) 975-9515

Fax: (305) 975-9698

ADVANCED MICROCOMPUTER SYSTEMS, INC.

ams 1321 N.W. 65 Place

Ft. Lauderdale, FL 33309

CIRCLE NO. 339

To advertise in Product Mart, call Joanne Dorian, 212/463-6415

UNIVERSAL PROGRAMMER, EMULATOR & TESTER

TUP-300

\$ 695.00

- Programs virtually any device in the market today. Programs PLD (PAL, GAL, FPL, EPD, PEEL, MAX, MACH...), E (EPROM (up to 16 Mbit), Flash EPROM, Special PROM, MPU (87XX, 68XX, Z8, PSD301...).
- Covers DIP, PLCC, QFP and PGA with 8 to 84 pins. Gang programming adapters available also.
- EPROM EMULATION capability.
- Tests digital ICs and DRAMs (ISIMM/SIP adapter available).
- Free software updates and new devices added upon request!!
- IC Manufacturers' approval.
- \$695 includes 40 pin ZIF socket programmer, s/w, and parallel interface card with D-25 cable.



Distributors are welcome!
1 year warranty,
30 day money back guarantee.
Call today for a free demo diskette.



Tribal Microsystems Inc.
44388 S. GRIMMER BLVD. FREMONT, CA 94538
TEL: (510)823-8859 FAX: (510)823-9925

CIRCLE NO. 340

DEVELOPER'S TOOLS

A Quail comes from Asia....



- Single Side PCB
- Double Side PCB
- Multi-Layers PCB
- Carbon, Silver Printing, PTH Gold Plating, Peelable Protective Film.

Besides better quality and lower price, there is no different buying PCBs from us in Taiwan, than a supplier at another State in America.
Welcome Prototype Samples and Low quantity orders.

USA OMNI STARS INC.

1303 Columbia Drive #201, Richardson, TX75081
Tel: (214)669-9661 Fax: (214)669-9919

CIRCLE NO. 341

LEMO'S NEW CIRCULAR CONNECTOR CATALOG

LEMO's new circular connector catalog highlights expanded shell and insert designs. Insert configurations are available in single, multi or mixed designs

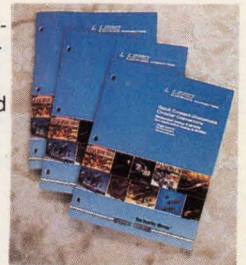

including signal, coaxial, triaxial, high voltage, fiber optic and fluidic/pneumatic. Shell styles are available in standard chrome plated brass, anodized aluminum or stainless steel.



P.O. Box 11488, Santa Rosa, CA 95406
Phone (800) 444-LEMO, Fax 707/578-0869

CIRCLE NO. 342

DB-51

DEVELOPMENT BOARD

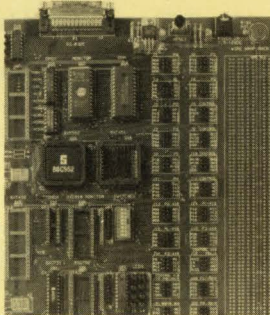

DB-51 is a system design board dedicated to the Signetics 80C51 family of microcontrollers. The software includes On-line Assembler and Disassembler and a Source Level Debugger for PLM and C. DB-51 has a special wire-wrap area for prototyping.

CEIBO 1 BALLARD TERRACE LEXINGTON MA 02173
TEL: 617-863-9927 FAX: 617-863-9649

GERMANY TEL: 89-6127087 FAX: 89-6128101
ITALY TEL: 51-727252 FAX: 51-727515
SWEDEN TEL: 58-919250 FAX: 58-916153
TAIWAN TEL: 2-9171873 FAX: 2-9126641

CIRCLE NO. 343

DS-51

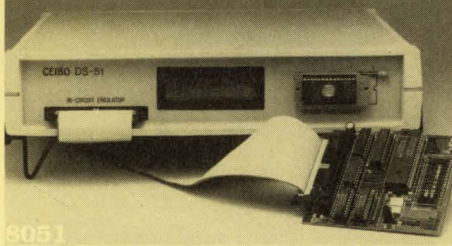

IN-CIRCUIT EMULATOR + TRACE
Personality Probes support 80C31/2, 80C51/2, 83C751, 83C652/4, 83C552, 83C562, 83C528, 83C550, 83C451, 83C851 and more.
Real-time Development System serially linked to PC, 128K Memory, 32K-deep Trace, On-line Assembler and Disassembler, Source Level Debugger for PLM and C.

CEIBO 1 BALLARD TERRACE LEXINGTON MA 02173
TEL: 617-863-9927 FAX: 617-863-9649

GERMANY TEL: 89-6127087 FAX: 89-6128101
ITALY TEL: 51-727252 FAX: 51-727515
SWEDEN TEL: 58-919250 FAX: 58-916153
TAIWAN TEL: 2-9171873 FAX: 2-9126641

CIRCLE NO. 344

MP-51

EPLD, MICROCONTROLLER AND EPROM PROGRAMMER

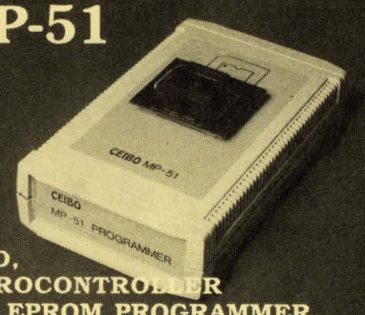

Supported Devices: DIP and PLCC Microcontrollers (8751H/BH, 87C51/2, 87C51FA/FB/FC/GB, 87C751/2, 87C652/4, 87C528, 87C550, 87C552, 87C562, 87C451, 87C592 and more), EPROMs (2716 to 27512 NMOS and CMOS) and EPLDs (Signetics/Atmel 22V10, ATV750, ATV2500 and ATV5000).

Serially linked to a PC. Lock Bits, Encryption Tables and Security bits are supported.

CEIBO 1 BALLARD TERRACE LEXINGTON MA 02173
TEL: 617-863-9927 FAX: 617-863-9649

GERMANY TEL: 89-6127087 FAX: 89-6128101
ITALY TEL: 51-727252 FAX: 51-727515
SWEDEN TEL: 58-919250 FAX: 58-916153
TAIWAN TEL: 2-9171873 FAX: 2-9126641

CIRCLE NO. 345

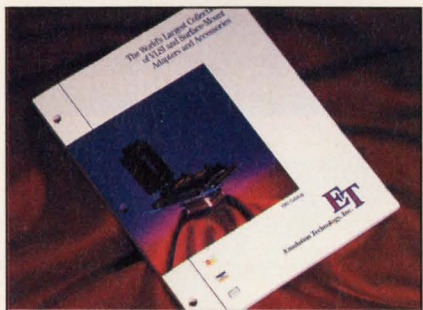

Free Catalog

The World's Largest Collection of Adapters & Accessories for VLSI/Surface Mount Devices

- Emulator Pods & Adapters
- Debugging Accessories
- Debug Tools
- Prototyping Adapters
- Programming Adapters
- Custom Engineering
- Socket Converters

Emulation Technology, Inc.
2344 Walsh Ave. Santa Clara, CA 95051
Phone: 408-982-0660 FAX: 408-982-0664



CIRCLE NO. 346

MICROPAK™
SMALL ELECTRONIC INSTRUMENT ENCLOSURES

"If I didn't have a product to put in it, I'd design one."

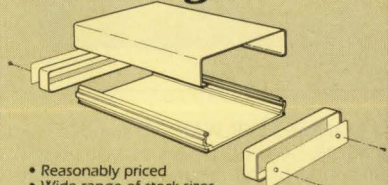

- Reasonably priced
- Wide range of stock sizes
- Readily customized by you or us
- Shortens time for prototyping and production
- For literature, pricing, and No-Risk Offer, call:

800-847-3535
Anywhere in the US or Canada



Copyright © 1991, Lansing Instrument Corp., P.O. Box 730, Ithaca, NY 14851-0730

CIRCLE NO. 347

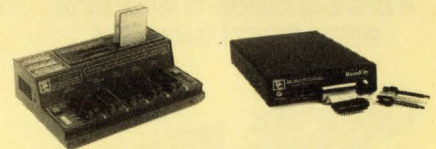

RS232 EE/EPROM, MICRO & MEMORY CARD PROGRAMMER \$345*/495*

- Programs EE/EPROMs, Flash EPROMs, ZPRams, Intel Micros, Memory Cards.
- Stand-Alone Mode for EE/EPROMs and Memory Card Duplication / Verify.
- All 24/28/32 pin EE/EPROMs to 8 Mbits (upgradable to 32 Megabits).
- Micros: 8741A, 2/A, 4, 8, 9, 51, CS1, CS1A/B, 52, 53, 55, CS21, CS41, 9761.
- Accepts dedicated modules: Memory Card Programming Module (Seiko/Epson) - \$145, Eraser/Timer Module - \$50, Gang Module (4 sockets) - \$145. Simultaneously duplicates up to 5 devices in stand-alone mode (with Gang).
- Can be operated with any computer containing an RS-232 serial port.
- User Friendly Menu-Driven Interface Program for IBM-PC or compatible.
- Full 1 year warranty. Customer support via voice line or dedicated BBS.

INTELLIGENT ROM EMULATOR \$395*

- Emulates 2716 through 27512 EPROMs with a single unit. Access time 120ns.
- Connects to the standard parallel printer port via a standard printer cable.
- User friendly software. Command set includes: Load (data), Write (data), Display (memory), Type (of EPROM), Edit (memory), Fill (memory), Calculator, Reset (target system), Activate (debugging feature), Monitor (selected feature).
- Address Compare with Halt output, Address Snapshot, Trigger input.
- Fast data loading via parallel printer port (64k bytes in less than 10 sec).
- Cascadable up to 8 units. Includes target cable with Trigger/Reset/Halt clips.
- CMOS (stand-alone) model with rechargeable NiCad battery backup: \$495

MC/VISA/AMEX

* U.S. list price only.



750 N. PASTORIA AVE., SUNNYVALE, CA 94086 USA
Tel: (408) 730-5511 Fax: (408) 730-5521

CIRCLE NO. 348

To advertise in Product Mart, call Joanne Dorian, 212/463-6415

EP-1140 E/EPROM PROGRAMMER

SEE US AT
WESCON:
BOOTH
1532

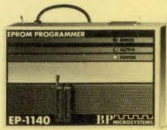

\$895.00

- ✓ Programs NEC's **27C8001, 8-Mbit EPROM** and all **1, 2, & 4-Mbit, 16 bit EPROMs**
- ✓ Supports all 87C51 derivative Microcontrollers, including Intel's **87C51GB**
- ✓ **Qualified** and recommended by Intel, National Semi and Signetics.
- ✓ Supports encryption array programming for microcontrollers
- ✓ Call for a DEMO disk and literature packet
- ✓ Risk-free 30-day money-back guarantee
- ✓ Lifetime **FREE** software updates via BBS and US Mail

BP MICROSYSTEMS

10681 Haddington • Houston, TX 77043-3239
800/225-2102 • FAX 713/461-7413

CIRCLE NO. 349

Protel Autotrax™

Best PCB design solution for mixed Digital, Analog, and SMT boards

Our NEW and POWERFUL Protel Autotrax™ is a fully integrated PCB layout system with automatic component placement and autorouting in a single working environment. Its latest features will definitely push the price/performance of mixed technology PCB designs to the highest level, boost your design productivity, and deliver your products to the marketplace faster than your competitors.

- Integrated automatic component placement and autorouting
- On-the-fly library components creation
- 45°, 90° and curve tracks routing
- Powerful user-definable Macros
 - Auto-panning
 - PostScript™ printing
- Switchable Metric/Imperial grid
- Intelligent Pad to Pad autorouting
- Automatic power/ground relief for SMD pads
- Automatic Copper Pour leaves clearance for tracks & pads from schematic design, manual and automatic PCB design. Rip-up and Retry autorouting, to Gerber viewing and editing, we offer free tech and EMS support, 24-hour BBS and 30-day money back guarantee and our prices start at \$395.

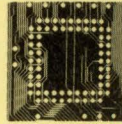

Free Evaluation Package

Toll Free: 800-544-4186

Protel Technology, Inc.
50 Airport Parkway, San Jose, CA 95110
Tel: 408-437-7771 Fax: 408-437-4913



CIRCLE NO. 350

\$249. TERMINAL

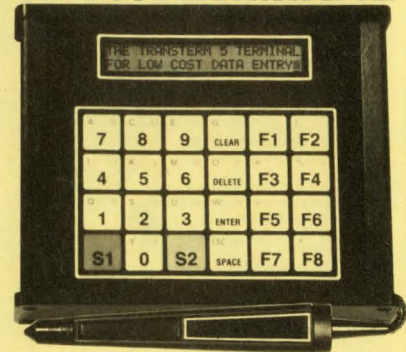

- Featuring
- Standard RS-232 Serial Asynchronous ASCII Communications
 - 48 Character LCD Display (2 Lines of 24 Each)
 - 24 Key Membrane Keyboard with embossed graphics
 - Ten key numeric array plus 8 programmable function keys
 - Optional RS-422 multidrop protocol mode
 - Keyboard selectable SET UP features—baud rates, parity, etc.
 - Size (5.625" W x 6.9" D x 1.75" H), Weight 1.25 lbs.
 - 5 x 7 Dot Matrix font with underline cursor
 - Displays 96 Character ASCII Set (upper and lower case)
 - Optional Bar Code Wand (shown)

COMPUTERWISE, INC.

302 N. Winchester • Olathe, KS 66062 • 800-255-3739 • FAX (913) 829-0810

CIRCLE NO. 751

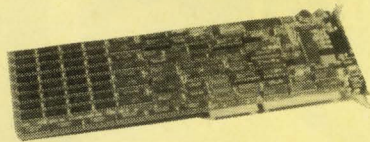

SILICON VIDEO® MUX™

Flexible Frame Grabber For The PC/AT

- 8 to 8000 pixels per line
- 2 to 40 MHz sampling/display rate
- 2 to 1020 lines per field
- 1 or 4 Mbytes of Reconfigurable Image Memory
- Standard/Nonstandard Video Acquisition
- 6 Input Video Multiplexer
- CT, MR video capture
- Interface to high-resolution CCD cameras
- Extensive software

EPIX®

3005 MacArthur Blvd., Northbrook, IL 60062
Tel. 708-498-4002 FAX: 708-498-4321

CIRCLE NO. 752

NoiseKen

IEC Pub. 801-2 HIGH REPRODUCIBLE ESD TESTING.



ELECTROSTATIC DISCHARGE SIMULATOR ESS-630A

U.S.A WATAHAN NOHARA INTERNATIONAL, INC.
TEL (800)366-3515

CIRCLE NO. 753

48 Channel 50MHz Logic Analyzer

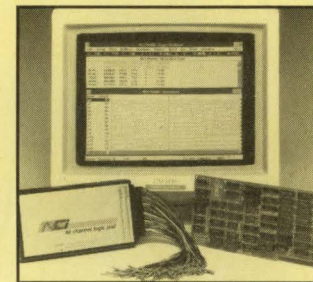

Complete System \$1895.00

New Windows 3.0 Compatible Software

- 48 Chnlns @ 50 MHz x 4K words deep
- 16 Trigger Words/16Level Trigger Sequence
- Storage and recall of traces/setups to disk
- Disassemblers available for: 68000, 8088, 8086, 6801, 6811, Z80, 8085, 6502, 6809, 6303, 8031

NCI 6438 UNIVERSITY DRIVE,
HUNTSVILLE, AL 35806
(205) 837-6667 FAX (205) 837-5221

CIRCLE NO. 754

RS-232/GPIB-488 SOLUTIONS FOR INSTRUMENTATION PROGRAM STORAGE & TRANSFER NEEDS

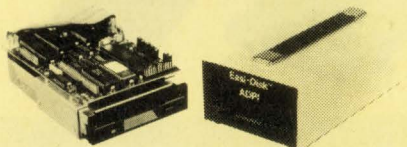

The Easi-Disk Simplifies Your Data Acquisition, Transfer, and Retrieval Needs Completely

- IBM/MS-DOS PC Compatible
- RS-232, GPIB-488, 8-Bit Parallel, RS-485, RS-422, and other Interfaces
- Host or Manual Controls
- Remote Polling
- 3 1/2" and 5 1/4" Floppy Disks or Removable RAM
- Stand-Alone, Rackmount or "Built-In" OEM
- 110VAC, 220VAC, 6VDC, 12VDC, or Battery Operation
- Stand-Alone Price is \$795, Controller Card Price is \$495, in Singles with Quantity Discounts
- Application Notes Available

ADPI™ "One for All" Tape Backup System Featuring
160 Meg of Storage for Multiple PC Backup.

ANALOG & DIGITAL PERIPHERALS, INC.



P.O. BOX 499
TROY, OHIO 45373
PHONE 513/339-2241
FAX 513/339-0070

CIRCLE NO. 755

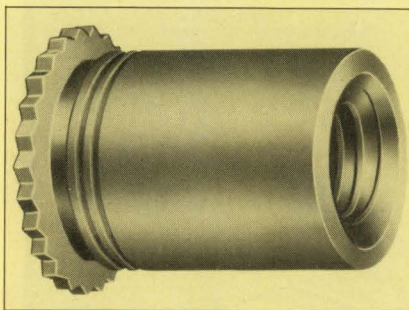

PEM CONNECT 'R WARE™ standoffs can dramatically lower the costs associated with D-sub connector mounting. When installed, the standoffs are permanently fixed in the chassis. These standoffs replace the loose female screwlocks and washers currently being used, which greatly reduces handling, inventory and assembly costs. For a free brochure circle the number below or contact us at: 1-800-237-4736, FAX (215) 766-0143.

CIRCLE NO. 756

More Expandable More Dependable

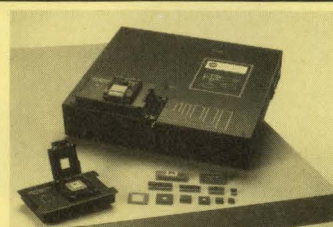

- PILOT-U40: 24 to 40-pin Universal Programmer
- PALS, GALS, PEELS, ECLS, Micros
- PROMs, EPROMs, EEPROMs, FLASH
- AMD MACHs, Altera/Cypress MAX, Xilinx
- Qualified by AMD and other major manufacturers
- Industrial quality • From \$995

408-243-7000, 800-627-2456, Fax 408-736-2503



Advin Systems Inc.

1050-L E. Duane Ave., Sunnyvale, CA 94086

CIRCLE NO. 757

To advertise in Product Mart, call Joanne Dorian, 212/463-6415

SCHEMA III 3.3

Schematic Capture

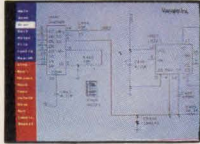

COMPLETE DESIGNS ON YOUR PC OR UPLOAD TO YOUR WORKSTATION

FREE DEMO DISK

One schematic capture program stands alone in features, speed, user friendliness & performance - SCHEMA. The new SCHEMA III 3.3 is still only \$ 495.



800-553-9119

CIRCLE NO. 758

A STEP BEYOND.



PROMICE takes ROM emulation a step beyond. It's an affordable, multi-operational development tool with:

- on board intelligence
- modular design
- source level debugging
- future expandability

PROMICE. The Firmware Development System of Tomorrow...



3314 Meiss Road
Columbus, Ohio 43221
614/471-1113
FAX: 614/475-6871

CIRCLE NO. 759

QUAD FLATPAK

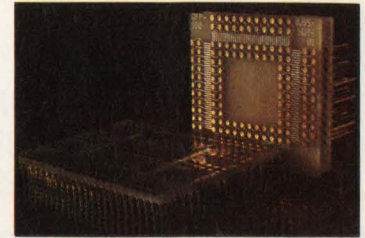

PROTOTYPING

IRONWOOD offers a complete line of prototyping adaptors for QUAD FLATPAK devices for all sizes of EIAJ and JEDEC QFP's. The line includes surface mount adaptors for highest reliability or socketed adaptors for convenience. Parts sizes go from 60 to 208 pins and include all EIAJ pin spacings. Parts are constructed with gold plated solder tail or wirewrap pins and high quality sockets for highest reliability. Most wirewrap and PGA patterns available.

IRONWOOD ELECTRONICS

P.O. BOX 21151, ST. PAUL, MN 55121
(612) 431-7025; FAX (612) 432-8616

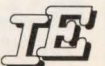

CIRCLE NO. 760

Relax Reliability Software

Innovative Software Designs offers an unbeatable set of reliability analysis software tools with its Relax product line. The Relax line includes electronic reliability analysis according to MIL-HDBK-217, Bellcore, and CNET, mechanical reliability, and failure modes and effects analysis. Also available are packages for thermal and Weibull analysis.

Relax products are noted for their outstanding quality, ease-of-use, flexibility, and comprehensive array of features. A wide range of packages are available to meet your price and product requirements. And all products are fully guaranteed!

Call today for more information and join ISD's long list of satisfied customers!

217 CNET
Bellcore
FMCA
Mechanical
217 Parts Count
Calculs Simplifiés
BETAsoft Thermal
WeibullSMITH Analysis

Innovative Software Designs, Inc.

One Kimball Ridge Court • Baltimore, MD 21228
(301) 747-8543 • Fax (301) 747-8599

CIRCLE NO. 761

THE LOGIC ANALYZER

MODEL 3625 32CH. 100MHZ
MODEL 3620 24CH. 100MHZ



- Runs on PC; Drives HGA, CGA, EGA, VGA, and MCGA.
- Up to 32 timing/state data channels. 2045 bits/channel.
- Sample rate up to 100 MHz asynchronous, 25 MHz sync.
- Sample data by rising, falling, both edge of two EXT clocks AND/OR logic combinations.
- Over 4000 multilevel combinational trigger conditions.
- Level/Edge trigger capability.
- Data qualification with 8 channels qualifier.
- Easy-to-use menu-driven system software.
- FORMAT, TIMING, LIST, and DOS display Mode.
- Full color display enhances user interface.
- User-definable color set.
- 8 acquisition templates provide rapid setup and operation.
- 4 user-definable groups those can be displayed in separate BIN, OCT, HEX, ASCII, and DEC radices.
- Save/load acquisition data file and edit testing comment in DOS Mode.
- Hardcopy at any moment, and dump the data of interest in timing diagram or state table.

OEM AND DISTRIBUTOR WANTED!



ARGOSY TECHNOLOGY CO., LTD.

8F, NO. 196, SEC. 2, KEELUNG RD., TAIPEI, TAIWAN, R.O.C.
TEL: 886-2-7371325 FAX: 886-2-7371342

CIRCLE NO. 762

NEW! iceMASTER™

COP8 8051 68HC11

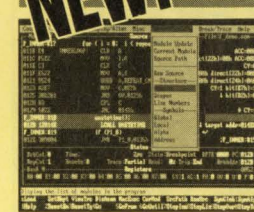

YOUR WINDOW TO EMULATION PRODUCTIVITY

- Easy to learn & use
- Windowed interface -- user configurable
- FAST! Download -- < 3 sec. typ. at 115KB
- Source Level debug

- A 4K frame trace buffer with advanced searching capabilities.
- Hyperlinked On-line help guides you through the emulation process.
- iceMASTER connects easily to your PC, requires no disassembly, or expansion slots. Works on any PC (DOS or OS/2), MicroChannel or EISA. Even laptops!
- iceMASTER is versatile: iceMASTER-8051, iceMASTER-68HC11 and iceMASTER-COP8 support most family derivatives.
- Try iceMASTER risk free! Satisfaction Guaranteed or return for a full refund!*
- RENTALS AVAILABLE! Ideal for consultants and researchers!
- Call today for free demo disk and ask about a free 8051 Macro Assembler! (800) 638-2423



MetaLink Corporation P.O. Box 1329 Chandler, Az 85244-1329
Phone: (602) 924-0197 Fax: (602) 926-1198 TELE: 4998050MTLTK
* With 10-day trial period

FREE ASSEMBLER

CIRCLE NO. 763



Schematic Capture for the Macintosh

DESIGNWORKS

Schematic features Menu-driven, mouse-controlled operations • cut/copy/paste between circuits • right-angle rubber-banding. **Digital simulation** 13-state, event-driven simulation • logic analyzer-style timing window • PLD support. **Libraries** Fully-simulated 7400, 4000, 10K series, PLDs, PROMs and RAMs, non-simulated analog and discrete components • User-definable, simulated custom symbols. **Interfaces** Formats for Douglas CAD/CAM, Cadnetix, Calay, Orcad, Tango, Racal Redac, Spice. • user-definable printers, dot-matrix printers, HP, Houston, Roland pen plotters.

CALL (800) 444-9064 TODAY FOR YOUR FREE DEMONSTRATION KIT!

CAPILANO COMPUTING

(604) 522-6200 Fax (604) 522-3972

CIRCLE NO. 764

LOW COST INTERFACE CARDS FOR PC/XT/AT

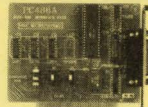

RS-485/422 Card [PC485A] \$95*/125*

- Serial Async. Communication up to 4,000ft, 2 or 4 wires; NS16450 UART
- COM1-4; Max. Baud Rate 56KB; High speed version (256KB) - \$165
- Dual drivers/receivers/Handles 64 devices; Compatible with most comm S/W
- DB9 or phonejack; Sample programs included; Optional sourcecode - \$150

Dual-Port RS-485/422 [PC485B] \$175*

- Two independent channels/UARTs; 2 or 4 wire operation. Max. Baud 56KB
- Dipswitch configurable as COM1-4 (IRQ2-7); On board terminator resistor
- Optional version protected with TRANSZORBs (transient voltage suppressors) and Poly Switches (auto reset electronic fuses)

Digital I/O & Counter [PCL720] \$175*

- 32 Digital Input & Output channels; Output: sink 24mA/source 15mA
- Timer/Counter (8253 chip); Selectable Clock Sources (2MHz, 1MHz, 500KHz, 250KHz) Breadboard area

IEEE-488 Card [PC488A/C] \$145*/295*

- Includes DOS Device Driver and sample Communication program in BASIC
- Additional sample programs in C, Pascal & Assembly - \$ 50
- Selectable IRQ (1-6); DMA channel 1 or 2; Up to four boards per computer
- I/O Addresses and Control registers compatible with NI's GPIB-PC11A
- PC488C card version with Built-In Bus Analyzer hardware and software

Stepper Motor Card [PCL838] \$395*

- Capable of independent and simultaneous control of up to 3 stepper motors
- Programmable speed from 1 to 10,000 pps; Steps per command 1 to 65535
- DIP switch selectable I/O port base address and wait state; 24 bit TTL I/O port
- Crystal based timing; All control signals opto-isolated

MC / VISA / AMEX

* U.S. list price only.



CIRCLE NO. 765

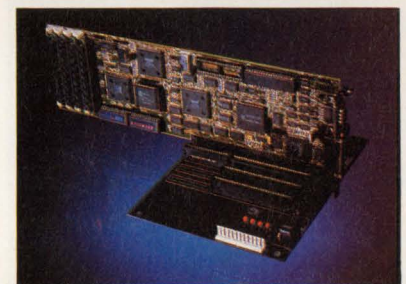

20 MHz 286 CPU CARD — \$595

- 2 Serial/1 Parallel Ports
- Up to 4 Meg DRAM: 0/1 WS
- Low Power 6-layer PCB
- Award BIOS — Norton SI 21.1
- Optional 287 Co-Processor
- Small Size (XT-Form Factor)
- User Replaceable Battery
- Made in USA
- \$595 qty 10 w/OK



295 Airport Road
Naples, FL 33942

TEMPUSTECH, INC.

1-800-634-0701

CIRCLE NO. 766

To advertise in Product Mart, call Joanne Dorian, 212/463-6415

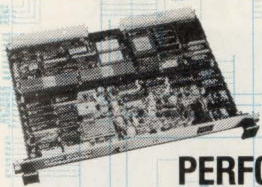

HIGH PERFORMANCE VME MODULES

SRT VMEbus products are ideal for real-time applications that require minimal software development time. Each board is complete with its own set of software drivers. The SRT-602 is a graphics overlay processor and video digitizer that is MAXbus compatible. The SRT-608 corrects common amplitude and timing defects in analog video. The SRT-610 is a multi-function I/O controller. Commercial, ruggedized and military configurations are available.



P.O. Box 12727
Birmingham, AL
35202-2727
TEL: 205-581-2900
FAX: 205-581-2903

SOUTHERN RESEARCH TECHNOLOGIES, INC.

CIRCLE NO. 767

DC-DC CONVERTER

- * 5W-60W, SINGLE, DUAL TRIPLE OUTPUT
- * Input Range: 9 to 18 V, 18 to 36V, 36 to 72V
- * Output Range: $\pm 5V$, $\pm 12V$, $\pm 15V$, $\pm 24V$
- * Input Pi Filter, EM/RFI Shielding
- * Special and Custom Design

GALAXY MICROCRAFT SYSTEMS CO., LTD.
7FL., NO. 25, LANE 23, RUI-AN ST.,
TAIPEI, TAIWAN, R.O.C.
P O BOX 24-543, TAIPEI
TEL: 886-2-705 1622
FAX: 886-2-701 6600

CIRCLE NO. 770

SOLUTIONS



EDAK cases offer the ruggedized solutions you require. In transit or in operation, EDAK cases provide ultimate protection for transportable electronics. Ask about EDAK's new HARD MOUNT case.

EDAK Fax (407) 242-3430
1-800-462-8478
285 North Dr., Ste. H, Melbourne, FL 32934 (407) 242-2953

CIRCLE NO. 773

200 MHz Logic Analyzer

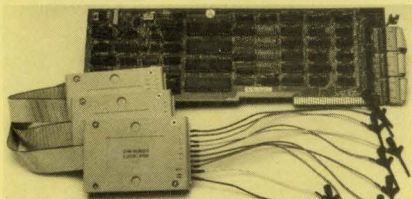

- 24 Channels (up to 50 MHz), Timing and State
- 200/100 MHz Max Sampling Rate (6 channel)
- Timing and State Simultaneous on Same Probe
- 16K Samples/Channel (6 channel mode)
- 16 Levels of Sequential Triggering
- Optional Expansion to 72 Channels
- Variable, TTL, or ECL Logic Threshold Levels
- 3 External Clocks and 11 Qualify Lines
- FREE Software Updates on 24 Hour BBS

\$799 - LA12100 (100 MHz)

\$1299 - LA27100 (100 MHz) Price includes Card, Pods, and Software

\$1899 - LA27200 (200 MHz)

UNIVERSAL PROGRAMMER

- PAL
- GAL
- EPROM
- EEPROM
- PROM
- 87xxx...
- 22V10

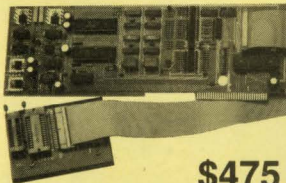

\$475

- 16Bit EPROMs FLASH EPROMs
- 5ns PALs 4 Meg EPROMs
- FREE software updates on BBS

GANG PROGRAMMER

- 4 32pin Sockets (8 Socket option)
- 2716-27010 EPROMs

\$215

Call--(201) 808-8990

Link Computer Graphics, Inc.

369 Passaic Ave, Suite 100
Fairfield, NJ 07004 FAX:808-8786



CIRCLE NO. 771

8051, 8096, 68HC11, 68332 SINGLE BOARD COMPUTERS

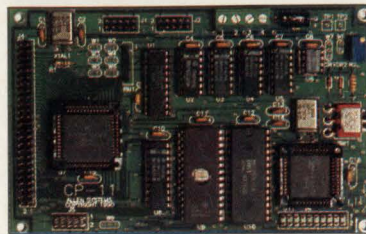

We feature a series of single board computers for process control applications. Each is available as a bare printed circuit board, or fully assembled and tested. Optional development software is also available. Please contact us to discuss your requirements and receive a literature package covering technical specs and pricing.

ALLEN SYSTEMS

2346 Brandon Road, Columbus, OH 43221
614-488-7122

CIRCLE NO. 769

4 Color Product Mart Ads Are Now Available In EDN's Magazine and News Editions!

Call Joanne Dorian for more information

(212) 463-6415

CIRCLE NO. 772



RUGGED & HIGH PERFORMANCE COMPUTER SYSTEMS WITH FOLD DOWN KEYBOARD & VGA MONITOR FOR RACK, BENCH OR PORTABLE APPLICATIONS

- STANDARD FEATURES INCLUDE:
- 12 SLOT PASSIVE BACK PLANE, 250W POWER SUPPLY
 - 80386 CPU CARD AT 20/25/33 MHz, UP TO 8MB OF ZERO WAIT STATE RAM
 - SONY TRINITRON TUBE, HIGH RESOLUTION VGA (640 x 480) MONITOR AND CARD
 - ROOM TO MOUNT THREE HALF HEIGHT DRIVES
 - 2 SERIAL, 1 PARALLEL PORT, MS DOS/GW BASIC
- ALSO AVAILABLE WITH 80486 OR 80286 CPU CARDS IN VARIOUS CONFIGURATIONS. FOR FURTHER DETAILS CONTACT:

**IBI SYSTEMS INC., 6842 NW 20 AVE.
FT. LAUDERDALE, FL 33309. 305-978-9225
FAX: 305-978-9226**

CIRCLE NO. 774

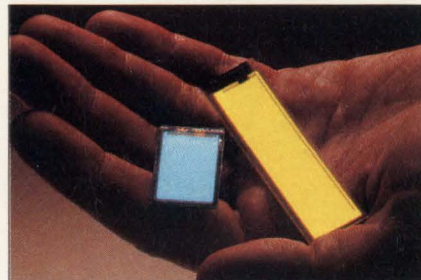

Finally, an EL with Longer Life and Higher Brightness

Thanks to our new proprietary Aurora phosphor, our EL (electroluminescent) lamps outperform every other EL in the industry. And, are even further enhanced with our new series of performance matched DC-AC inverters. Solid-state, low current and sized to your specs. Customized to your life/brightness requirements.

Loctite Luminescent Systems, Inc.
Etna Rd., Lebanon, NH 03766 603/448-3444

CIRCLE NO. 775

To advertise in Product Mart, call Joanne Dorian, 212/463-6415

America
rides, protects,
measures, monitors,
tunes, plays,
communicates,
computes
and displays
with **Optrex** LCDs

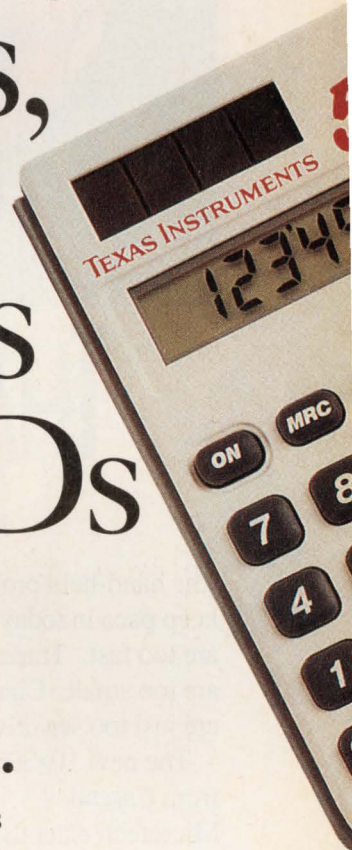

And that's just the beginning.

The applications for LCD's keep growing. And so does Optrex. In fact, today we're the largest supplier of LCDs in the world. Why? Innovative engineering and design support. Exceptional quality. And a nationwide distribution network. The point is, being bigger makes it easier to be more helpful to our customers — in developing new applications and in enhancing the performance of existing products. Our customers like that. You will, too. For more information, call (313) 471-6220, or fax 471-4767 today.



23399 Commerce Drive Farmington Hills, MI 48335 Phone: (313) 471-6220 Fax: (313) 471-4767

REMEMBER WHEN PROBES KEPT PACE WITH YOUR CIRCUITS?



Hand-held probes were fine for PWBs and slower speeds.

Today, high-speed microprobes are the only way to accurately measure sub-nanosecond MCMs, hybrids and other fine geometry structures

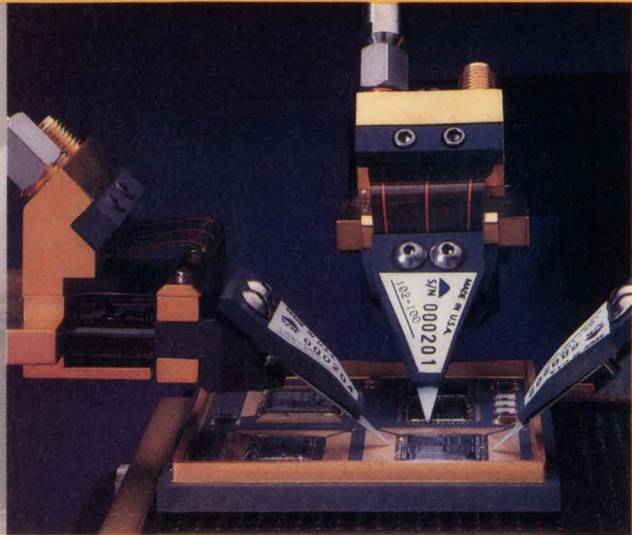

THAT WAS THEN. THIS IS NOW.

The hand-held probe you've always trusted just can't keep pace in today's sub-nanosecond world. Speeds are too fast. Traces are too small. Circuits are just too sensitive.

The new 10X Probe from Cascade Microtech extends the accuracy of your high frequency test equipment right down to the circuit. To help you speed development, reduce design turns, and produce faster, more reliable circuits.

- Measure rise times less than 30 ps
- Access lines as narrow as 2 mils
- Less than .060 pF load through 20 GHz
- Micropositioned for accuracy and device protection

You can accurately access multichip modules, hybrids and high density PWBs with just .060 pF capacitive load. So you can identify timing problems, ground bounce, crosstalk and other high-speed problems more easily, without affecting the characteristics of your circuit.

Discover how easily and economically you can put the Cascade Microtech 10X Probe to work. To request your free copies of our informative new booklets, just write or call Ken Smith at (503) 626-8245.



 **CASCADE MICROTCH[®]**

14255 SW Brigadoon Court
Beaverton, Oregon 97005
In Japan call: 03-320-6410

©1991 Cascade Microtech, Inc. Module courtesy of Alcoa Electronic Packaging.

HOW TO GET IT RIGHT THE FIRST TIME, EVERY TIME.

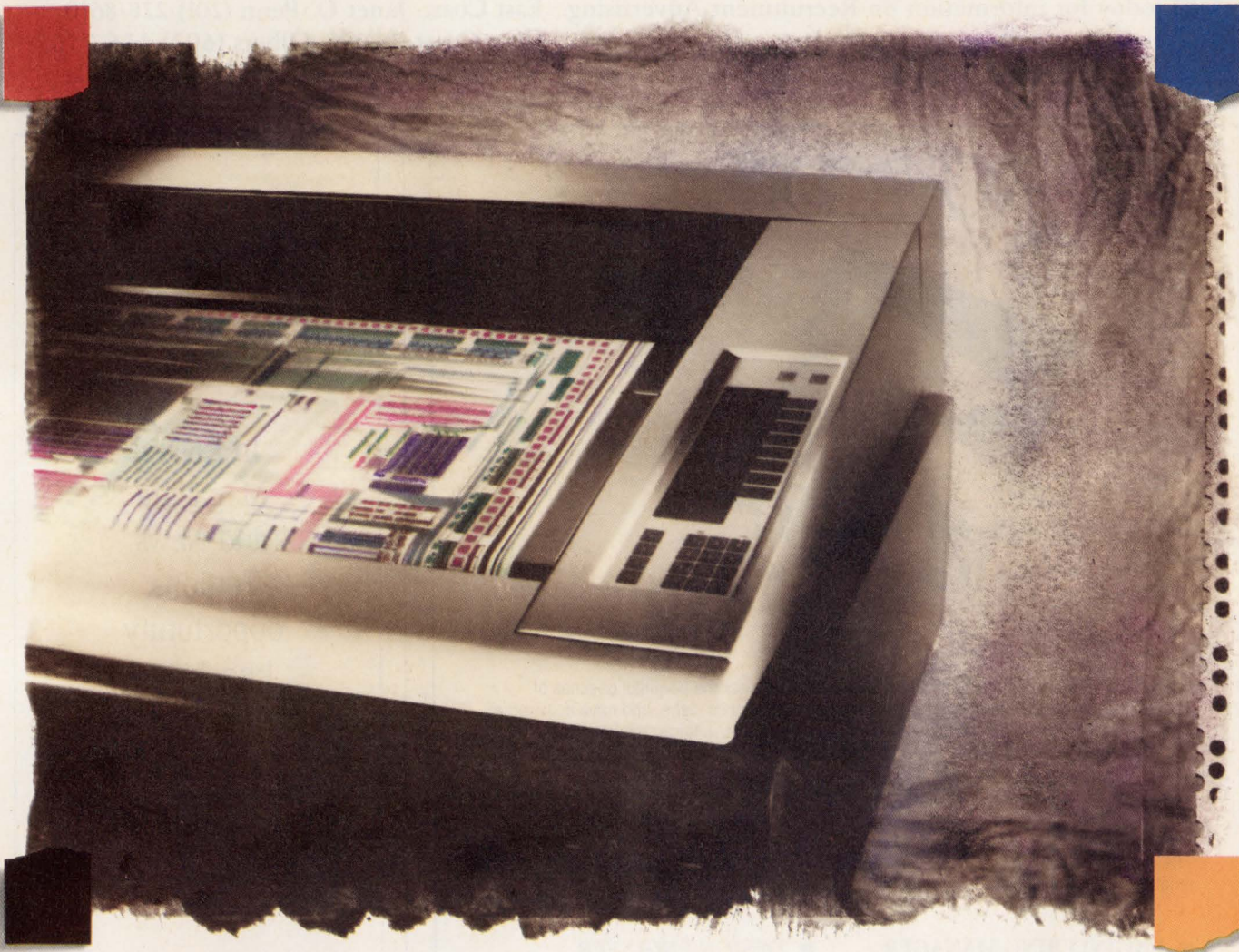

There are a number of advantages inherent in doing it right the first time. Synergy's ColorWriter™ 400 series electrostatic plotting systems produce full color output in *one pass*.

Imagine getting your plot as much as four times faster, with better registration and more consistent color the first time out. And with fewer moving parts, the 36" wide format, 400 dpi ColorWriter is not only faster and more accurate, it's more reliable.

With *one connection*, and no special hardware or software, the ColorWriter 400 series performs as an

Ethernet® node on your network. Its built-in Sun SPARCengine™ lets you process and plot several data formats simultaneously, including HP-GL/2™, CalComp™, Versatec VRF™, GDS-II Stream™, Cadence™, PostScript®, AutoCAD™ and raster.

It made sense to us to build it right the first time, so you can get it right the first time. If that makes sense to you, we should talk. Call us at 800-926-0968.

SYNERGY
COMPUTER GRAPHICS CORPORATION

CIRCLE NO. 140

CAREER OPPORTUNITIES

1991 Recruitment Editorial Calendar

Issue	Issue Date	Ad Deadline	Editorial Emphasis
Magazine Edition	Nov. 21	Oct. 31	18th Annual Microprocessor Directory • Test & Measurement, CAE/ASICs, ICs & Semiconductors
News Edition	Nov. 28	Nov. 8	PC Cards, Board Level**, Regional Profile: Wisconsin, Illinois, Michigan**, EDN's Innovator/Innovation Awards Coverage •

Call today for information on Recruitment Advertising: East Coast: Janet O. Penn (201) 228-8610
West Coast: Nancy Olbers (603) 436-7565
National: Roberta Renard (201) 228-8602

ENGINEERING INNOVATORS

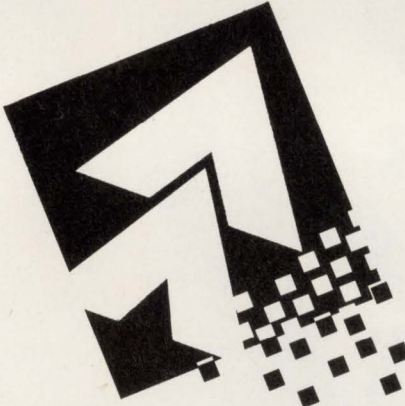

Digital Design is an expanding technology firm situated near the beautiful beaches of Jacksonville, Florida. We've set the standard for our business niche, and have acquired a healthy list of Fortune 500 clients. Now we're out to win over a larger market share. Your engineering expertise could be just what we're looking for.

In addition to projects revolving around our successful line of laser printing hardware and software, Digital Design develops and integrates a vast array of new technologies. Each member of our engineering team is charged with discovering and developing new solutions. The excitement level is high; so are the challenges. Your solid engineering background and innovation may qualify you for a place on our team.

■ ENGINEERING MANAGER

To lead a team of experienced hardware engineers. Duties include product design, development and management. 3-5 years management and design experience along with a BSEE a must.

■ DESIGN ENGINEER

Responsible for PCB design and analysis, full custom ASIC design and VHDL level ASIC design. Comprehensive knowledge and experience in hardware design is a must. MSEE preferred.

Digital Design provides an outstanding compensation package which includes employer-paid health/life/dental/vision care and 401K plan.

Qualified applicants send resume to:

8400 Baymeadows Way
Jacksonville, FL 32256
Attn: Ken Keating

800-733-0908



Digital Design
INCORPORATED

Knock, Knock.

In EDN's
Magazine
and News
Editions,
opportunity
knocks all
the time.

EDN Magazine
Edition
News
Edition

AN EQUAL OPPORTUNITY EMPLOYER

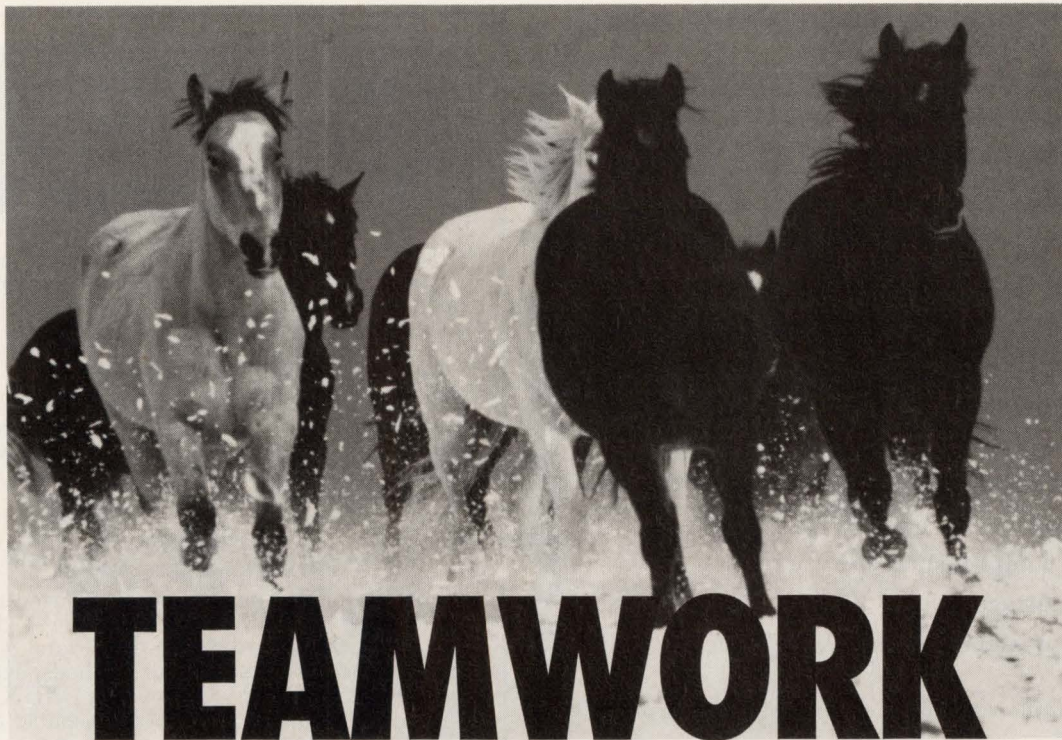

TEAMWORK IN THE TRUEST SENSE.

They're calling it an alliance of world class design and manufacturing talents. A combination of technology strengths unrivaled in industry today.

We call it teamwork in the truest sense. And the world is watching as Motorola, IBM and Apple come together to propel desktop computing into a new era.

If you have the expertise required to create the next generation of microprocessors, your talents are needed for this innovative team effort. In addition to exciting, ground-floor career opportunities, we offer the attractive location and lifestyle of Austin, Texas.

Openings now exist for individuals with expertise in the following areas. Positions require a BSEE/CS or advanced degree with emphasis on computer engineering. Experience in RISC architecture, microprocessor, and CMOS VLSI design is essential, as well as strong circuit and logic design skills. Proficiency in C and UNIX would be a plus.

LOGIC DESIGNERS Responsible for definition, logic design and verification of high performance RISC microprocessor. Expertise in specifying, modeling and design is essential.

SYSTEM VERIFICATION ENGINEERS

Develop verification programs/behaviorals to verify RISC microprocessor functions and perform failure analysis at system and chip levels. Proficiency in Cad UNIX is required.

CIRCUIT DESIGNERS Design CMOS circuitry for RISC based microprocessor functions. Must be able to design complex CMOS circuits and perform circuit analysis, verification and design for test.

CAE DESIGNERS Develop an integrated VLSI CAD platform based on vendor tools and design/code. Includes evaluation, design methodology and tool support. Requires experience in workstation tool development and software integration. Knowledge of relational database and graphical user interfaces (X, motif) would be a plus.

PRODUCT ENGINEERS From wafer probe and assembly through final test, will ensure effective product yield/cost management. Involves customer interface and characterization of products to support design, manufacturing and quality improvements for RISC microprocessors.

SYSTEM ADMINISTRATORS Administrate a distributed UNIX workstation environment of multivendor platforms. Will also provide network management and system software support to engineering programming departments. Familiarity with installation/maintenance of VLSI CAD tool software preferred.

There's no company—or opportunity—in the world like this one. Be a part of it. For consideration, send your resume to: **Motorola Recruitment, Dept. ATX-9118, 505 Barton Springs Rd., One Texas Center, Suite 400, Austin, TX 78704. (800) 531-5183; (512) 322-8811 FAX.** Equal Opportunity/Affirmative Action Employer.



MOTOROLA

Microprocessor and Memory Technologies Group

**CMOS LOGIC AND CIRCUIT DESIGN · SYNTHESIS · BUS INTERFACE
SIMULATION · RISC ARCHITECTURE · MICROPROCESSOR DESIGN
MICROPROCESSOR ARCHITECTURE · CACHE MEMORY
SYSTEMS · DEVELOPMENT TOOLS**

**EMBEDDED
COMPUTING INSTITUTE
NAVAL WEAPONS CENTER,
CHINA LAKE, CALIFORNIA**

The Naval Weapons Center invites applications for the position of Director, Embedded Computing Institute. The Institute is being organized to provide research, development, technology insertion, and training in real-time embedded computing systems on board tactical missiles and aircraft. It is a cooperative venture between industry, academy and the Naval Weapons Center. Areas of interest include but are not limited to:

- Increasing computational density
(mips/watt/cu-in/lb)
- Shortening system design and implementation time
- Modeling and simulation of embedded computer systems
- Incorporating new technology into the acquisition process

The Naval Weapons Center is located at China Lake, California, in the Indian Wells Valley, approximately 150 miles north of Los Angeles. Characterized as high desert, the Indian Wells Valley averages 2500 feet in elevation and lies in the northernmost corner of the Mojave Desert, adjacent to the eastern slopes of the Sierra Nevada Mountain Range. Comprised of over 5000 employees, and over a million acres of land for both Laboratories and test facilities, this full spectrum center researches, develops and tests tactical air launched systems for the Navy and other services. The city of Ridgecrest is located outside the main gate. Cost of living is moderate, and the surrounding area offers a variety of outdoor activities. The Center intends to fill this position through the Intergovernmental personnel act (IPA). An assignment under the IPA may be made for up to two years and may be extended for up to two more years. Personnel from federal, state, or local government, institutions of higher education, federally funded research centers, and certain other organizations may apply. Applicants should send an SF-171 to K. Berry, Code 226, Naval Weapons Center, China Lake, CA 93555. Questions may be directed to Ms. Berry at 619-939-2577.

SOFTWARE ENGINEER

Coulter Corporation, the world leader in the field of biomedical instrumentation and automated hematology, has excellent opportunities available for the following experienced professionals.

Software Engineer

This position requires a BSEE/BSCS along with 2-4 years experience in the design of software for the embedded systems. Additionally, you will need experience with device drivers, proficiency in 16-bit assembly, and knowledge of "C" language.

Senior Software Engineer

To qualify for this position, you will need a BSEE/BSCS along with 4-8 years experience in design of real-time software for the embedded systems. Knowledge of structured design methods, experience in real-time operating systems (e.g. VRTX, pSOS, RMX), and proficiency in 16-bit assembly and "C" language are also required.

Coulter offers excellent salaries and comprehensive benefits. Qualified applicants, please send resume to: **Department MB, Coulter Corporation, 650 West 20th Street, Hialeah, FL 33010.** Equal Opportunity Employer.



If you're looking
for work,
just look here.

EDN Magazine
Edition
News
Edition

**Your
Future
Starts
Here**

ENGINEERS

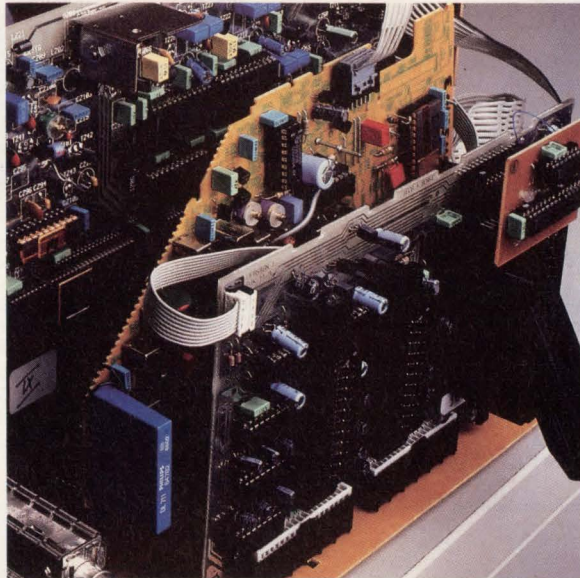

NEW GUTS. NEW GLORY.

Redefining the future of home entertainment is a monumental challenge. It takes vision. Knowledge. And the guts to believe in your ideas to see them through from start to finish.

These qualities typify the Research & Development Engineers at Thomson Consumer Electronics, designer and manufacturer of quality RCA and GE brand consumer electronics products.

Research & Development Engineers at our Indianapolis advanced development facility, part of an international network of R&D centers, are hard at work developing exciting new television technologies including High Definition Television.

If you're an R&D Engineer with a gutsy approach to Video Signal Processing (Digital or Analog), Microcomputer Development or Audio Design expertise, you may have what it takes to share in the glory of bringing exciting new products from concept to reality at Thomson Consumer Electronics.

To explore these opportunities, please send your resume and recent salary history, in confidence, to: **Professional Relations, M.S. 27-134-GN, Thomson Consumer Electronics, P.O. Box 1976, Indianapolis, IN 46206-1976, or FAX to (317) 231-4052.** An Equal Opportunity Employer.

EDN Magazine
Edition
News
Edition

 **THOMSON**

CONSULTING OPPORTUNITIES



Local.



Regional.



National.

The Computer Merchant, Ltd. has become the recognized source for software consulting excellence among Fortune 500 Companies. Due to expanding demand for our services, the following opportunities currently exist for experts with a minimum of 3 years experience:

'C'/RDB (Florida)

NETWORK INTEGRATION

IBM SYSTEM PROGRAMMERS

EDI/IMAGE PLUS

MS-WINDOWS DEVELOPERS

4D/MacINTOSH

PROGRESS P/A's

VAX/'C' (Mult. Openings)

INGRES DEVELOPERS

HOGAN

ACMS (Mult. Openings)

TANDEM-TAL

MICROFOCUS P/A's

AS-400/COBOL/RPG III

For more information on The Computer Merchant, Ltd.'s professional services and opportunities, contact us by mail, fax or call:



THE COMPUTER MERCHANT, LTD.

CORPORATE HEADQUARTERS

80 Washington St., Bldg. E, Norwell, MA 02061 (617) 878-1070 FAX: (617) 878-4712

449 Pleasant Hill Rd., Suite 301
Lilburn, GA 30247 (404) 279-8009

180 Newport Center Dr., Suite 180
Newport Beach, CA 92660 (714) 720-8435

DSP

Without Tears

Take the Mystery out of Digital Signal Processing and put your knowledge to work immediately!

"By taking this 3-day workshop you will really learn DSP" Guaranteed!

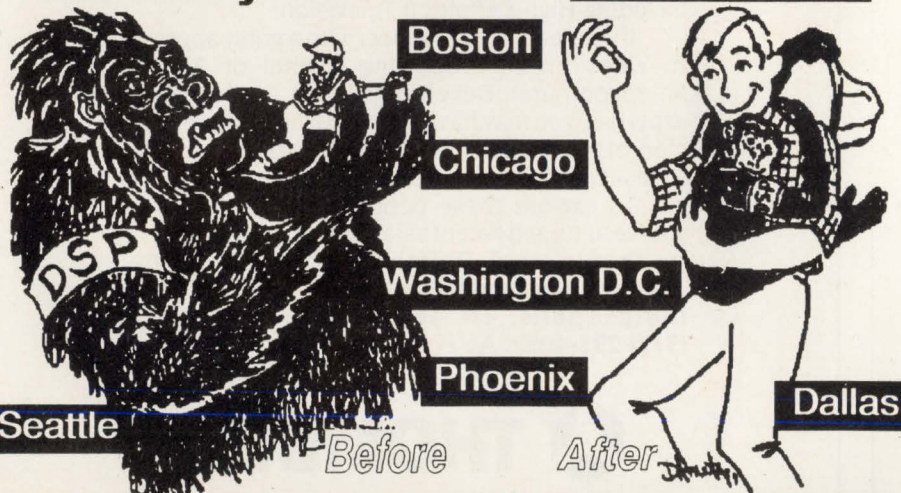

CALL (800) 967-5034 or (404) 975-6577

San Jose

Get a Job!

EDN Magazine
Edition
News
Edition

Push the limits of ASIC and ASSP technology.

Just as DaVinci stretched the limits of imagination, our mixed signal, high-speed semicustom ASIC and ASSP technology is giving engineers everywhere a new sense of the possible. This is largely due to our commitment to quality and our progressive team approach, which lets engineers influence the whole process, from working with the customer to developing designs through production and even marketing. We simply hire the best people and give them the responsibility and power to do the job right.

It's happening at **RAYTHEON SEMICONDUCTOR**, one of the Valley's only full-line commercial manufacturers, where 80% of our sales are for industrial and commercial applications.

So if you want to push the limits of creativity in commercial IC technology, talk to Raytheon.

MARKETING

Strategic Marketing/Product Planning Manager

As part of our new product planning function, you will manage our Strategic Marketing Engineers, defining new products from concept to complete functional specifications. Requires MSEE and 8+ years experience in IC product planning for mixed analog/digital applications. Knowledge of end-system applications in wireless communications, image processing, or measurement and control desirable. An understanding of semicustom design methodology a plus.

Strategic Marketing/Product Planning Engineers

You will define new mixed signal IC products from concept to complete functional specifications. Requires BS/MS in EE and 5+ years of experience, with a background in IC or system design combined with IC product planning. Knowledge of end-system applications in wireless communications, image processing, or measurement and control desirable. MBA a plus.

Product Marketing Manager

Managing a group of Product Marketing Engineers, you will be responsible for developing our targeted markets for mixed signal ASICs, identifying and developing custom and semicustom opportunities, as well as overseeing promotions, seeding and introduction of new ASSP products. Requires BSEE and 8+ years of related experience. MSEE or MBA preferred.

Product Marketing Engineers

You will adapt to markets and key accounts development by giving technical presentations to potential custom and semicustom customers, coordinating customer specifications with both Raytheon and Customer Design Engineers, and traveling to customer/sales regions in support of analog/digital opportunities. Requires BSEE, 4+ years of semiconductor industry experience, and an understanding of analog and mixed signal products. MSEE or MBA preferred.

APPLICATIONS

Applications Engineer

You will write papers and application notes and interact with the customer in an analog/mixed signal IC environment. Requires

Raytheon

Where quality starts with fundamentals.

EDN October 24, 1991

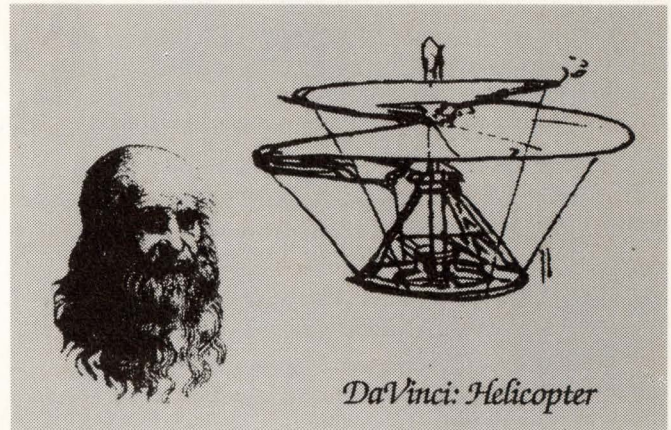

BSEE, 5+ years of experience, and excellent communication skills. MSEE preferred. Knowledge of end systems application in datacom, telecom, wireless communications, image processing or measurement and control desirable.

DESIGN

Analog/Mixed Signal Designers

You will design mixed signal ASIC and standard products using cell-based and semicustom array methodologies. Requires BS/MS in EE and 5+ years of IC design experience with emphasis on high-speed Phase-Locked Loop and/or data conversion circuits. Knowledge of high-speed analog/digital circuit techniques such as high-speed data conversion, clock and data recovery or transmitter and receiver circuits is highly desirable.

CAD

CAD/Physical Design Support Engineer

You will develop code for interface program to be internally used by physical design tool, as well as generate command files to run physical design verification. Requires BSEE (MSEE preferred) and 5+ years experience, including solid experience in one of the following: PCs; Sun platform; place and route tools; or verification tools.

CAD Engineers — Simulation

You will write specifications and "C" code for gate array cells and design kits for Mentor, Dazix and Valid workstations, interacting with senior engineers, marketing/sales and outside vendors. Requires BS in EE or Computer Engineering, 2+ years related experience and working knowledge of Cadence tools.

If you want to help control the future of a company that's making a global impact, send your resume, indicating position of interest, to: Raytheon Semiconductor Division, Attn: Nylca Van-Dillen, Dept. EDN1091, 350 Ellis Street, Mountain View, CA 94039-7016. Or call (415) 966-7835. Or FAX resume to (415) 969-8556. Raytheon supports a drug-free workplace. An Equal Opportunity Employer.



Quietly Saving Space.

TDK EMC Technology Suppresses EMI/RFI Through Low Profile Designs.

Thanks to our advances in EMC, TDK components offer you EMI/RFI suppression capabilities in the smallest packages on the market.

New low profile designs (our chip suppressor can fit between the 0.1" lead spacings of an IC) enable you to create higher density circuit designs that are less vulnerable to noise problems.

Only TDK's complete line of functionally versatile EMI/RFI suppressors can provide the high performance and outstanding noise suppression characteristics you demand.

Call or write us today for more information.

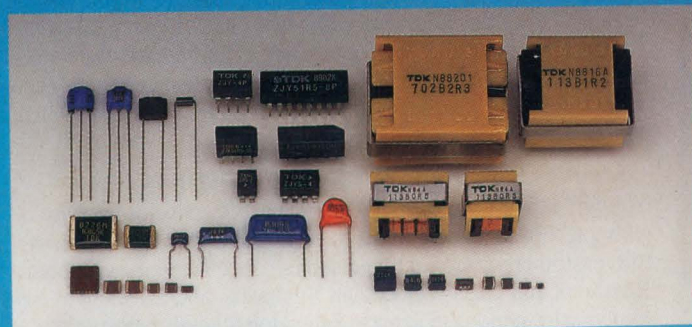

■ EMI/RFI Suppression Filters ■ Through Hole EMI/RFI Filters ■ Ferrite Chip EMI Suppressors (Ferrite Chip Beads) ■ Micro Chip EMI Filters ■ Leadless EMI Filters ■ Power-line Leadless Inductors ■ Leadless Line Choke SF Coils ■ Common Mode Choke Coils/Line Choke Coils (SF Type) ■ UL Recognized (CSA, VDE, SEV, SEMKO, BS) Ceramic Capacitors ■ Feed-Through Ceramic Capacitors ■ EMI/RFI Suppression Ferrites ■ Ferrite Bead Cores ■ Varistors ■ Radio Wave Absorbents



Come See Us at Wescon '91 Booth #528.



TDK CORPORATION OF AMERICA 1600 Feehanville Drive, Mount Prospect, IL 60056, USA Phone: 708-803-6100 INDIANAPOLIS Phone: 317-872-0370 NEW YORK Phone: 908-494-0100 SAN FRANCISCO Phone: 408-437-9585 LOS ANGELES Phone: 310-539-6631 DETROIT Phone: 313-462-1210 BOSTON Phone: 508-624-4262 HUNTSVILLE Phone: 205-464-0222 GREENSBORO Phone: 919-292-0012 DALLAS Phone: 214-506-9800

GERMANY • FRANCE • ITALY • U.K. • KOREA • TAIWAN • HONG KONG • SINGAPORE • THAILAND • P.R. OF CHINA • BRAZIL TDK CORPORATION Tokyo, Japan

CEL, TDK's Component Engineering Laboratory in Torrance, CA, can custom design and test manufacture TDK EMI/RFI suppression components to meet your specific requirements. For more information, call (213) 530-9397

CIRCLE NO. 144

EDN's INTERNATIONAL ADVERTISERS INDEX

Abbot Electric	57	Futaba	131	Phillips Components Inc**	233-235
ACCEL Technologies Inc	134	Galaxy Microcraft Systems	228	Pico	96, 214
Acces	82	General Devices	187	Planar Systems	216
Adaptec Products Co	221	General Instrument	101	Power Components	123
ADPI	226	Grammar Engine Inc	227	Powertronic	224
Advanced Microcomputer Systems Inc	224	Grayhill Inc	216	Protel Tech Inc	226
Advanced Micro Devices	8-9, 36-37, 84-85	Hamilton Avnet Electronics	204	Rad	184
Advin Systems	226	Harris Semiconductor	16-17, 165, 183	Samsung Semiconductor	78-79
Alcatel**	145	Headland Technology	2	Samtec Inc	192-193
Aldec	186	Heurikon Corp	185	Schurter AG	180
Allen Systems	228	Hewlett-Packard Co	4, 50	SeaLevel Systems	180
Altera Corp	103	Hiro Company	124	Seiko Instruments	88-90
American Arium	170	Honda Connectors	200	SenSym	92
American Neuralogix	154	House	129, 145, 218	Sharp Electronics	66
American Research and Engineering	197	Hwang Piin	224	Siemens Components Inc*	22, 184
AMP	119, 121	Hypertronics Corp	224	Signum Systems	58
Amphenol	206-207	IBI Systems Inc	228	Silicon Systems Inc	59
Argosy Technology Co Ltd	227	IBM Corp	93	Siliconix Inc	12-13
Asahi Glass Optrex	229	IDT	86	Softools	223
Asahi Kasei Microsystems**	50	IEE	110	Sony	42-43
Astec Ltd	179	Illinois Capacitor	210	Southern Research	228
AT&T	188-189	Incredible Tech	224	Sprague Goodman	91
Autec Power Systems	199	Innovative Software Designs	227	Stanford Telecom	194
Bayer AG**	38-39	Intel	14-15, 62-65, 148	Sumitomo Metal Mining	111
B&C Microsystems	225, 227	Intermetrics Inc	191	Synergy Computer Graphics	231
B-G Instruments Corp	97	International Rectifier	C3	Synergy Microsystems	146
BP Microsystems	226	Interphase Corp	169	Taiyo Yuden (USA) Inc	194
Burr-Brown Corp	77	Interpoint	209	TDK Corp of America	238
Caddock Electronics Inc	52	Intusoft	223	TEAC Corp**	22
CAD Software Inc	201	Ironwood	227	Tektronix	18-21, 222
Cahners CAPS	195	J W Miller Div/Bell Industries	82	Tempustech Inc	227
California Eastern Labs Inc	105-109	Keithley Instruments	211-213	Teradyne Inc	32-33
Capital Equipment Corp	99	Kepeco Inc	125-128	Thomas & Betts Corp	60-61
Capitano Computer Systems Inc	227	Knuerr AG	168	Todd Products Corp	34
Carroll Touch Inc	205	Lansing Instrument	225	Tokin Corp	133
Cascade Microtech	230	Lemo USA Inc	225	Toko America Inc	99
Catalyst Semiconductor Inc	203	Linear Technology Corp	177-178	Tribal Microsystems	225
Ceibo Ltd	225	Link Computer Graphics Inc	228	TRW LSI Products Inc	48-49
Communications Specialties Inc	224	Loctite Luminescent Systems Inc	228	US Software	224
Computerwise Inc	226	Matra MHS	130	USA Omnisters	225
Connector Corp	216	Maxim Integrated Products	215, 217, 219	Venable Industries	224
Conner Peripherals	10-11	MetaLink Corp	227	Vicor	83
Cybernetic Micro Systems	35	MicroSim Corp	25	VL Electronics	181
Cypress Semiconductor	8	Microsoft	199	Wavetek	3
Dale Electronics Inc	27	Mini-Circuits Laboratories	28-29, 40-41, 173, 240	Wavetron	223
Data Display Products	214	Mitsumi Electronics	218	Westcor	147
Data I/O Corp	C4	Molex Inc	202	W H Brady	124
Datakey	1	National Semiconductor Corp	44-46	Z-World	223
Deemax Technology	155	NEC Corp	156, 196		
Deltron Inc	144A-D	NCI	226		
Dialight Corp	190	Nichicon Corp	175		
Duracell	75	Nohau Corp	223		
Dynamic Soft Analysis	223	Noise Laboratory Co	226		
Edak Inc	228	Noritake Electronics Inc	220		
EEsof	208	Oak Grigsby	198		
Emulation Technology Inc	58, 225	OKI Semiconductor*	38-39		
EPIX Inc	226	Omaton Inc	227		
Ericsson	94	OrCAD Systems Corp	68		
Ericsson Components	132, 194A-B	Penn Eng & Mfg Corp	226		
Fujitsu, APD	55	Phihong Enterprise Co Ltd	210		
Fujitsu Microelectronics Inc	30-31				

Recruitment Advertising 232-237

The Computer Merchant
Coulter Corporation
Digital Design Inc
Motorola-SPS
Naval Weapons Center
Right Brain Technologies
Thomson Consumer Electronics

*Advertiser in International edition

**Advertiser in European edition

This index is provided as an additional service. The publisher does not assume any liability for errors or omissions.

SURFACE MOUNT MIXERS

...with a difference



actual size

up to 1900MHz from **\$6.25**

Now available, a large variety of tiny, ultra-rel high performance mixers to handle your applications from extra wideband, high isolation, low two-tone third-order IM, to very low +3dBm LO power.

Mini-Circuits' new LRMS-series Ultra-Rel™ mixers are offered with a difference... unprecedented reliability. Units are manufactured with Ultra-Rel diodes, all-welded construction, metal stubs to all connections, and to 4.5 sigma performance repeatability. Each Ultra-Rel™ LRMS mixer can withstand strenuous shock and vibration, will perform over a -55° to +100°C range, and is guaranteed for five years.

Aim for 4.5 sigma repeatability in your product designs by specifying Mini-Circuits' Ultra-Rel™ LRMS mixers, available for immediate delivery in tape-and-reel format (500 units, 16mm width) at prices from \$6.25.

ULTRA-REL™ MIXERS
5-YR. GUARANTEE *

with extra long life due to unique HP monolithic diode construction, 300°C high temp. storage, 1000 cycles thermal shock, vibration, acceleration, and mechanical shock exceeding MIL requirements.

SPECIFICATIONS: all spec limits are 4.5 σ from mean

Model	Freq. Range LO. RF	(MHz) IF	LO Level (dBm)	Conv. Lgss Mean (X̄) mid-band (dB)	L-R Isol. Mean (X̄) mid-band (dB)	Price \$ (1-9)
LRMS-2L	800-1000	DC-200	+3	6.6	24	6.95
LRMS-1	0.5-500	DC-500	+7	6.4	45	6.25
LRMS-1W	2.0-750	DC-750	+7	5.8	45	6.75
LRMS-2	5-1000	DC-1000	+7	6.8	38	6.95
LRMS-2D	5-1000	DC-1000	+7	6.8	40	7.25
LRMS-2U	10-1000	10-1000	+7	6.5	46	11.45
LRMS-5	5-1500	DC-1000	+7	6.0	41	13.95
LRMS-11A	1400-1900	40-500	+7	7.0	25	16.95
LRMS-1LH	2.0-500	DC-500	+10	5.8	47	7.95
LRMS-2LH	5-1000	DC-1000	+10	6.6	40	8.95
LRMS-5LH	10-1500	DC-900	+10	5.4	38	14.95
LRMS-1MH	2.0-500	DC-500	+13	5.7	44	8.95
LRMS-2MH	5-1000	DC-1000	+13	6.6	44	9.95
LRMS-5MH	10-1500	DC-900	+13	5.8	46	15.95
LRMS-1H	2.0-500	DC-500	+17	6.3	44	10.95
LRMS-2H	5-1000	DC-900	+17	7.2	36	11.95
LRMS-2UH	10-1000	10-750	+17	7.1	38	14.45
LRMS-5H	10-1500	DC-900	+17	7.2	45	17.95

CIRCLE NO. 145

finding new ways...
setting higher standards

Mini-Circuits

WE ACCEPT AMERICAN EXPRESS AND VISA

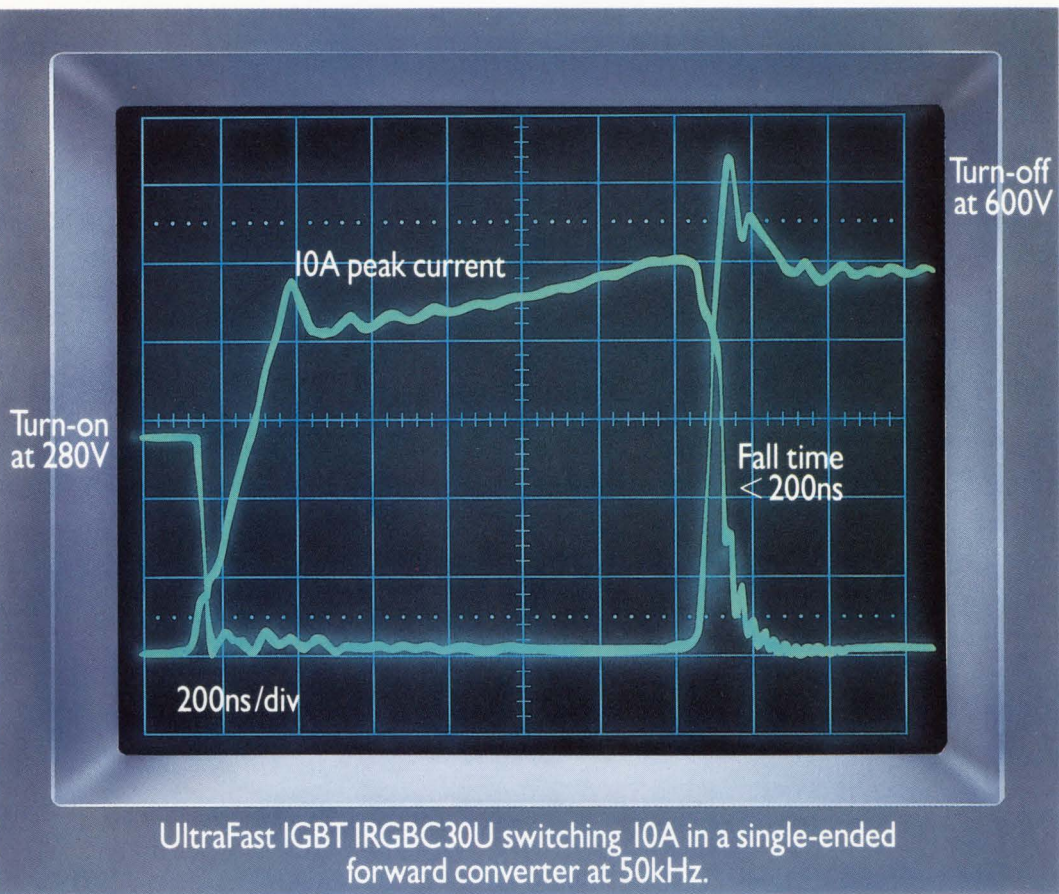

IGBTs Without A Trace of Competition.

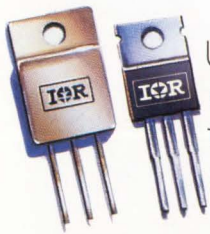

IR announces Ultra Fast IGBTs: our 600V power transistors that switch faster and run cooler than any you've ever used. Forget about bipolar. Put these

breakthrough devices in your high-voltage, high-current, medium-frequency applications and get performance unparalleled for the price.

Which should come as no surprise. IR IGBTs build on the same proprietary technology that made IR's HEXFETs® world leaders.

Call 1 (213) 640-6534 and ask about Standard, Fast or Ultra-Fast IGBTs, optimized for your operating frequency. And available from 10A to 70A, in commercial or hi-rel packages.

We'll be happy to arrange a screening.

IR International Rectifier

WORLD HEADQUARTERS: 233 KANSAS ST., EL SEGUNDO, CA 90245, U.S.A. (213) 772-2000. TWX 910 348-6291, TELEX 472-0403. EUROPEAN HEADQUARTERS: HURST GREEN, OXTED, SURREY RH8 9BB, ENGLAND TELEPHONE (0883) 713215, TELEX 95219

CIRCLE NO. 146

NEW
2900/3900
Programming Series starts at \$2995!



The new 3900 takes you wherever technology goes.

At the speed technology is advancing, you need to be ready for anything. On a limited budget.

The NEW 3900 Programming System keeps up with your most advanced designs while keeping device-programming costs down. It offers leading-edge support for FPGAs, PLDs, memory devices, and microcontrollers up to 88 pins, with future device and package capa-



bilities built in. Yet this support is offered in device libraries so you pay for only what you need, when you need it. And you can get into the 2900/3900 Programming Series for as little as \$2995*. Move up to 88-pin support and beyond with a

simple upgrade.

Find out how the 3900 can make your future affordable.

Call today for more information and we'll also send you a FREE copy of Data I/O's all-new, and expanded 1991 Wall Chart of Programmable Devices (a \$24.95 value).

To qualify, just call us with the brand name and serial number of any programmer you are currently using.

1-800-3-DataIO
(1-800-332-8246)

The Personal Silicon Experts

DATA I/O
Corporation

Data I/O Corporation 10525 Willows Road N.E., P.O. Box 97046, Redmond, WA 98073-9746, U.S.A. (206) 881-6444
1-800-3-DataIO (1-800-332-8246)

Data I/O Canada 6725 Airport Road, Suite 302, Mississauga, Ontario L4V 1V2 (416) 678-0761

Data I/O Europe World Trade Center, Strawinskylaan 537, 1077 XX Amsterdam, The Netherlands +31 (0)20-6622866

Data I/O GmbH Lochhamer Schlag 5A, 8032 Graefelfing, Germany, 089 858580

Data I/O Japan Sumitomoseimei Higashishinbashi Bldg., 8F, 2-1-7, Higashi-Shinbashi, Minato-Ku, Tokyo 105, Japan
033 432 6991/Telex 2522685 DATAIO J

Data I/O Limited 660 Eskdale Road, Winnersh, Wokingham, Berkshire, United Kingdom RG11 5TS, 0734 440011

©1991 Data I/O Corporation

CIRCLE NO. 148