

INTERNATIONAL EDITION

# EDN<sup>®</sup>

ELECTRONIC TECHNOLOGY FOR ENGINEERS AND ENGINEERING MANAGERS WORLDWIDE

BBS Update  
PG 7

A CAHNERS PUBLICATION

February 3, 1992

## SPECIAL REPORT

**Bus-driver ICs**  
pg 78

## TECHNOLOGY UPDATES

**16-bit  $\mu$ C  
evaluation  
boards**  
pg 41

**Innovation  
software  
stimulates  
engineering  
creativity**  
pg 59

## DESIGN FEATURE

**Human-interface  
rules reduce  
test-program  
operator errors**  
pg 95

## DEPARTMENTS

**New: Inside EDN**  
pg 9

**New: Acronyms  
& Abbreviations**  
pg 141

**New: Hands On!**  
pg 143

**Product Updates**  
pg 73

**Design Ideas**  
pg 107

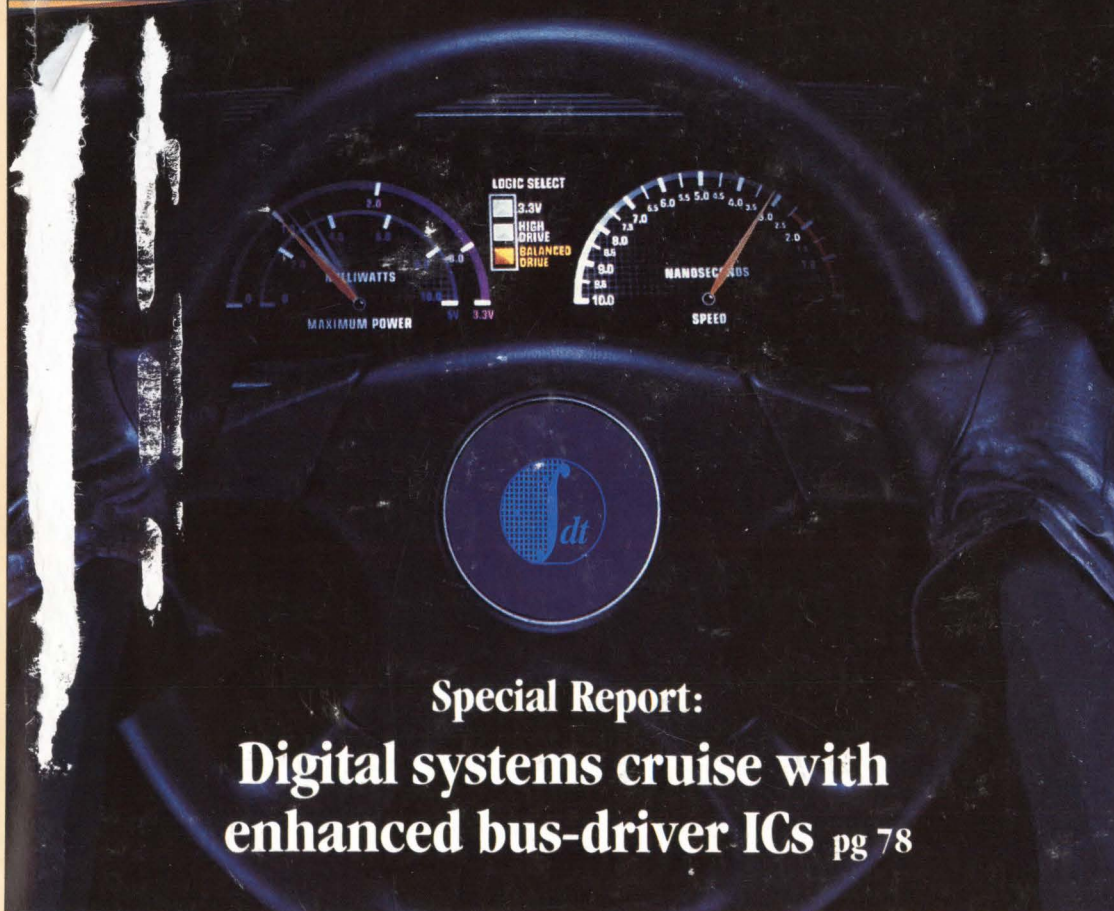
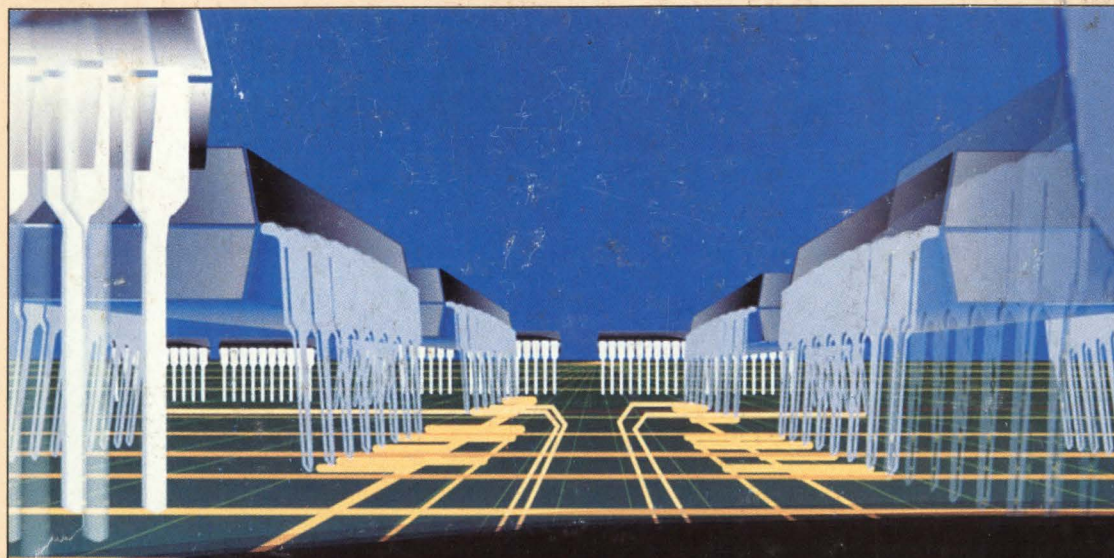

**Special Report:**

**Digital systems cruise with  
enhanced bus-driver ICs** pg 78

# Let DATEL get you up to speed...

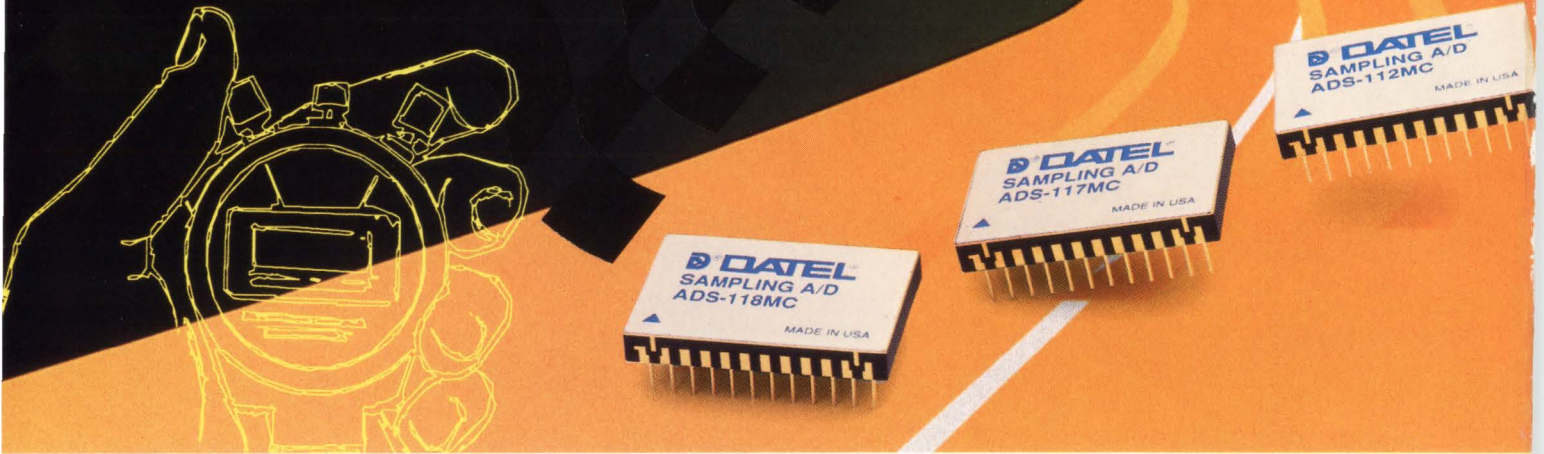

## and down in Power and Size

Get on track with DATEL's expanding line of high speed and high performance Sampling Analog to Digital Converters.

- 12-BIT RESOLUTION • INTERNAL SAMPLE HOLD • FUNCTIONALLY COMPLETE
- SAMPLES TO NYQUIST • NO MISSING CODES • THREE-STATE OUTPUT BUFFERS
- COMMERCIAL AND MILITARY TEMPERATURE RANGE MODELS • PIN COMPATIBLE

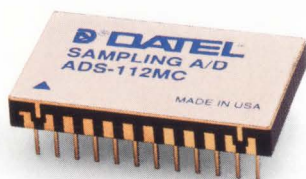

### 1MHz

1.3 Watts  
24-pin DIP

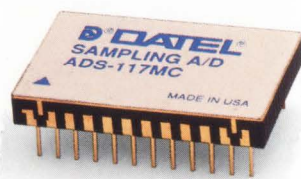

### 2MHz

1.6 Watts  
24-pin DIP

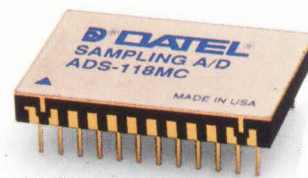

Actual Size

### 5MHz

2.3 Watts  
24-pin DIP

Specification	ADS-112	ADS-117	ADS-118
THD (dB)	-78	-78	-73
SNRD (dB)	70	70	66
Effective Bits	11.4	11.4	10.5
Peak Harmonic (dB)	-81	-81	-75

Contact DATEL for availability of SMT packaging and MIL-STD-883 models

For complete data call or write today. DATEL, Inc., 11 Cabot Boulevard, Mansfield, MA 02048. Telephone: (508)339-3000, FAX: (508)339-6356. For immediate assistance: all USA, EST business hours 1-800-233-2765; Western region only, PST business hours 1-800-452-0719.

**DATEL**  
INNOVATION and EXCELLENCE



# PROFILES IN PARTNERING

## Motorola® and Dale®

**PRODUCTS:** Metal film resistors manufactured to MIL-R-39017 (RLR) and MIL-R-55182 (RNC).

**OBJECTIVE:** Integrate Dale RNC and RLR resistors into Motorola Government Electronic Group's (GEG) Approved Manufacturer's Part Program.

**UNITS INVOLVED:** Motorola GEG and Dale Film Resistor Division.

**D**ale and Motorola have a long history of working together in a conventional vendor/customer mode. One of the major product lines supplied by Dale has been metal film resistors.

During the second quarter 1990, GEG and Dale's Metal Film Division began a Supplier Continuous Improvement Plan. This plan initially targets specific Military and Established Reliability metal film resistors (RLR/RNC) for integration into Motorola GEG's Approved Manufacturer's Parts Program (AMPP).

Following this, the plan is keyed to integrating all Dale Film Resistor products into AMPP — which is a "no-inspect" dock-to-stock program. The agreement was an outgrowth of intensive Total Quality Management pro-

grams at both companies and was driven by Motorola's well-known Six Sigma commitment and Dale's Commitment to Continuous Quality Improvement.

The Supplier Continuous Improvement program is administered by Passive Commodity personnel from Motorola's GEG Supply Management Organization in conjunction with a Dale team which includes top management and extends throughout the work force. Its framework was established beginning with a thorough evaluation of Dale's overall quality management system and its metal film resistor manufacturing process control and SPC plans.

As a part of this plan, RNC and RLR resistors were received by Motorola GEG at a 99.70% acceptance rate in 1990 and a

99.82% acceptance rate in early 1991. In both cases, Dale's Metal Film Division exceeded the continuous improvement plan acceptance rate goals. To facilitate this, the two companies established a system of open communication which: (1) permits quick identification of areas where corrective action is needed; (2) establishes a reporting system to identify action taken to isolate the root cause and prevent reoccurrence; and (3) uses regular Quality/Business Reviews as a means to track progress toward the goal of Zero Defects on all material delivered to Motorola.

In conjunction with the plan, Dale is actively expanding its own partnering program for certifying the suppliers of raw material to all of its divisions and is preparing to be a competitor for the Malcolm Baldrige Quality Award.

If you would like more information about how Dale's Commitment to Total Quality Management (TQM) Improvement can be applied to your project goals, please contact Joe Matejka, Vice President Quality Assurance, Dale Electronics, Inc., 1122 23rd Street, Columbus, Nebraska 68601-3647. Phone 402-563-6511. Fax 402-563-6418.

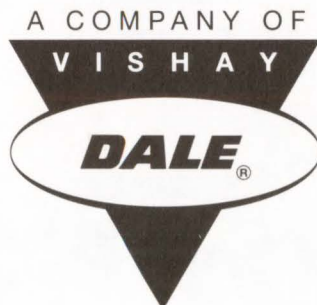

# ***MEASURE LEADTIMES IN HOURS, NOT DAYS!***

***At Digi-Key, more than 99 percent of  
all orders are shipped within 24 hours!***

***For all your electronic component needs and  
free catalog, call toll free: 1-800-344-4539***



***Digi-Key***  
CORPORATION

701 Brooks Avenue South  
Thief River Falls, MN 56701

Toll-Free: 800-344-4539, FAX: 218-681-3380

# incredible!



## SPDT switches with built-in driver

### **ABSORPTIVE or REFLECTIVE dc to 5GHz**

Truly incredible...superfast 3nsec GaAs SPDT reflective or absorptive switches with built-in driver, available in pc plug-in or SMA connector models, from only \$19.95. So why bother designing and building a driver interface to further complicate your subsystem and take added space when you can specify Mini-Circuits' latest innovative integrated components?

Check the outstanding performance of these units...high isolation, excellent return loss (even in the "off" state for absorptive models) and 3-sigma guaranteed unit-to-unit repeatability for insertion loss. These rugged devices operate over a -55° to +100°C span. Plug-in models are housed in a tiny plastic case and are available in tape-and-reel format (1500 units max, 24mm). All models are available for immediate delivery with a one-year guarantee.

#### SPECIFICATIONS (typ)

	Absorptive SPDT YSAWA-2-50DR ZYSAWA-2-50DR			Reflective SPDT YSW-2-50DR ZYSW-2-50DR		
	dc- 500	500- 2000	2000- 5000	dc- 500	500- 2000	2000- 5000
Frequency (MHz)	500	2000	5000	500	2000	5000
Ins. Loss (dB)	1.1	1.4	1.9	0.9	1.3	1.4
Isolation (dB)	42	31	20	50	40	28
1dB Comp. (dBm)	18	20	22.5	20	20	24
RF Input (max dBm)	20			22		
VSWR "on"	1.25	1.35	1.5	1.4	1.4	1.4
Video Bkthru (mV,p/p)	30	30	30	30	30	30
Sw. Spd. (nsec)	3	3	3	3	3	3
Price, \$ (1-9 qty)	YSAWA-2-50DR (pin) 23.95 ZYSAWA-2-50DR (SMA) 69.95			YSW-2-50DR (pin) 19.95 ZYSW-2-50DR (SMA) 59.95		



finding new ways ...  
setting higher standards

## Mini-Circuits

P.O. Box 350166, Brooklyn, New York 11235-0003 (718) 934-4500 Fax (718) 332-4661 Telexes: 6852844 or 620156

CIRCLE NO. 3

F141 REV. C

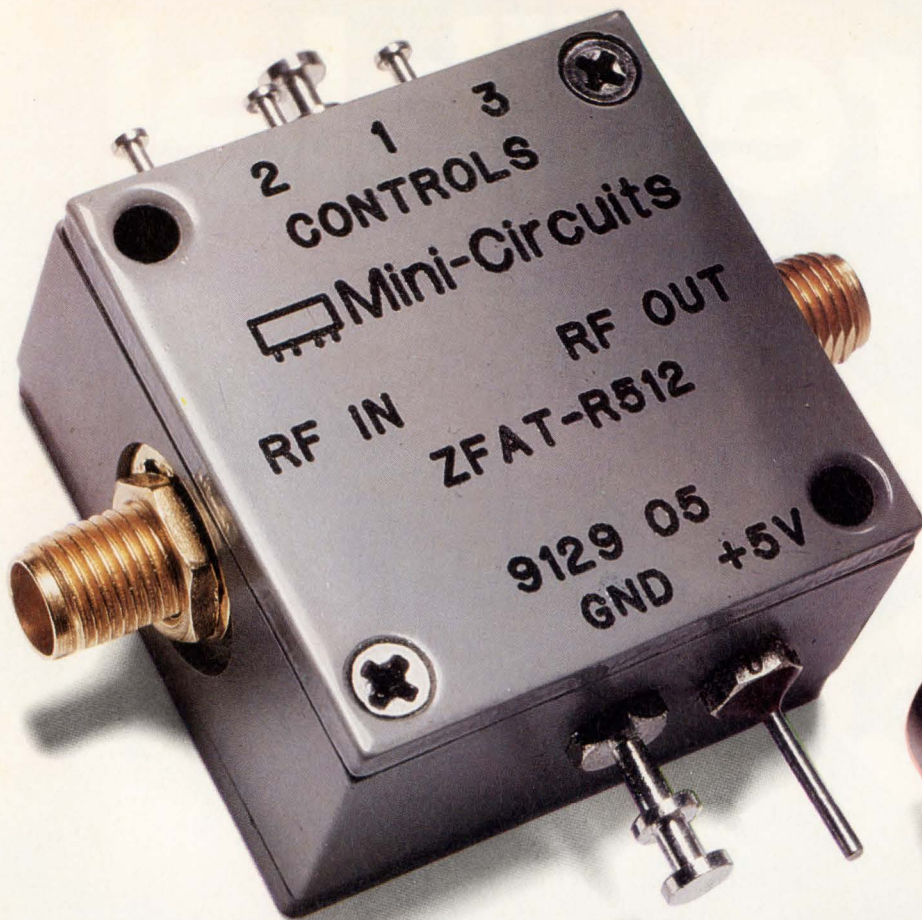

# PRECISION TTL- CONTROLLED ATTENUATORS

up to 35dB  
10 to 1000MHz  
FROM **\$59.95**

Finally...precision attenuation accurate over 10 to 1000MHz and -55°C to +100°C. Standard and custom models are available in the TOAT(pin)- and ZFAT(SMA)-series, each with 3 discrete attenuators switchable to provide 7 discrete and accurate attenuation levels.

The 50-ohm components perform with 6μsec switching speed and can handle power levels typically to +10dBm. Rugged hermetically-sealed TO-8 units and SMA connector versions can withstand the strenuous shock, vibration, and temperature stresses of MIL requirements. TOAT pin models are priced at only \$59.95 (1-9 qty); ZFAT SMA versions are \$89.95 (1-9 qty).

Take advantage of this striking price/performance breakthrough to stimulate new applications as you implement present designs and plan future systems. All units are available for immediate delivery, with a one-yr. guarantee, and three-sigma unit-to-unit repeatability.

TOAT-R512 ZFAT-R512 Accuracy (dB) (+/-dB)	TOAT-124 ZFAT-124 Accuracy (dB) (+/-dB)	TOAT-3610 ZFAT-3610 Accuracy (dB) (+/-dB)	TOAT-51020 ZFAT-51020 Accuracy (dB) (+/-dB)
<b>0.5</b>	<b>0.12</b>	<b>1.0</b>	<b>0.2</b>
<b>1.0</b>	<b>0.2</b>	<b>2.0</b>	<b>0.2</b>
1.5	0.32	3.0	0.4
<b>2.0</b>	<b>0.2</b>	<b>4.0</b>	<b>0.3</b>
2.5	0.32	5.0	0.5
3.0	0.4	6.0	0.5
3.5	0.52	7.0	0.7
		<b>3.0</b>	<b>0.3</b>
		<b>6.0</b>	<b>0.3</b>
		9.0	0.6
		<b>10.0</b>	<b>0.3</b>
		13.0	0.6
		16.0	0.6
		19.0	0.9
			<b>5.0</b>
			<b>0.3</b>
			<b>10.0</b>
			<b>0.3</b>
			15.0
			0.6
			<b>20.0</b>
			<b>0.4</b>
			25.0
			0.7
			30.0
			0.7
			35.0
			1.0

Price \$ (1-9 qty) TOAT \$59.95/ZFAT \$89.95  
bold faced values are individual elements in the units

finding new ways...  
setting higher standards

 **Mini-Circuits**

WE ACCEPT AMERICAN EXPRESS AND VISA

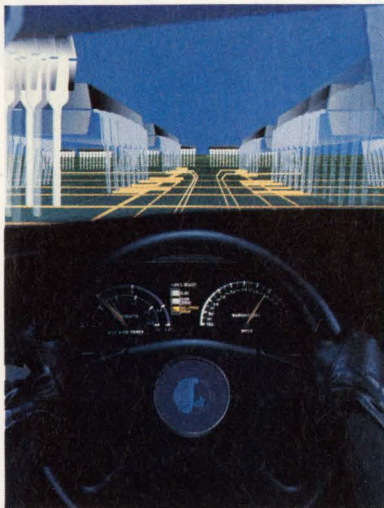

On the cover: Bus-driver manufacturers have successfully maneuvered ground-bounce problems to turn out ICs that are faster, quieter, and have more drive than those previously available. (Photo courtesy Integrated Device Technology)

PAGE 78

EDN Magazine offers Express Request, a convenient way to retrieve product information by phone. See the Reader Service Card in the front for details on how to use this free service.

**Express Request** 

## SPECIAL REPORT

### Bus-driver ICs

As ASICs and programmable logic sweep up most discrete logic, bus-driver ICs are becoming the bulk of standard logic products. Manufacturers have tamed ground bounce and are adding capabilities such as built-in logic.—*Richard A Quinnell, Technical Editor*

78

## DESIGN FEATURE

### Human-interface rules reduce test-program operator errors

The way a program displays data and interacts with its operator can either invite human error or minimize it. Following some simple rules can make all the difference.—*John A Dinan, Raytheon Corp*

95

## TECHNOLOGY UPDATES

### 16-bit- $\mu$ C evaluation boards: Boards let you try out $\mu$ C architectures

The processor selection stakes are high. Even the odds: Get an evaluation system, run some code, fool around with the software tools, and try out the on-chip peripherals.—*Ray Weiss, Technical Editor*

41

### Innovation software stimulates engineering creativity

Personal-computer software can help you hatch new ideas and overcome creative blocks.—*Charles H Small, Senior Technical Editor*

59

*Continued on page 7*

EDN® (ISSN 0012-7515, GST Reg. #123397457) is published 48 times a year (twice monthly with 2 additional issues a month, except for March and October, which have 3 additional issues and July and December which have 1 additional issue) by Cahners Publishing Company, A Division of Reed Publishing USA, 275 Washington Street, Newton, MA 02158-1630. Terrence M McDermott, President/Chief Operating Officer; Frank Sibley, Executive Vice President; Jerry D Neth, Senior Vice President/Publishing Operations; J J Walsh, Senior Vice President/Finance; Thomas J Dellamaria, Senior Vice President/Production and Manufacturing; Ralph Knupp, Vice President/Human Resources. EDN® is a registered trademark of Reed Properties Inc., used under license. Circulation records are maintained at Cahners Publishing Company, 44 Cook Street, Denver, CO 80206-5800. Telephone: (303) 388-4511. Second-class postage paid at Denver, CO 80206-5800 and additional mailing offices. **POSTMASTER: Send address corrections to EDN®, PO Box 173377, Denver, CO 80217-3377.** EDN® copyright 1992 by Reed Publishing USA; Robert L Krakoff, President and Chief Executive Officer. Annual subscription rates for nonqualified people: USA, \$119.95/year; Mexico, \$169.95/year; Canada, \$181.85/year; all other nations, \$207.95/year for surface mail and \$329.95/year for air mail. Single copies are available for \$20 USA and \$25 foreign. Please address all subscription mail to Ellen Porter, 44 Cook Street, Denver, CO 80206-5800.

# A REVOLUTIONARY ADVANCE IN SPARC MULTIPROCESSING.

## The industry's first integrated SPARC® multiprocessing solution — the CY7C605 Multiprocessing Cache Controller/MMU.

High-performance systems designers have migrated to RISC in a race for performance. Just as rapidly, there is a movement to multiprocessing, which represents the most cost-effective way to load more power into a single system.

Multiprocessing RISC design is not simple. There are substantial technological challenges, particularly in the area of multi-level memory systems.

Now we offer a breakthrough to help you implement multiprocessing systems rapidly.

## Cache coherency without stealing processor cycles — a leap in performance.

Maintaining cache coherency is one of the biggest problems to solve in shared memory multiprocessing systems.

This approach solves it.



Pin compatible with our CY7C604 Uniprocessing Cache Controller/MMU, this new device lets you cascade to build cache size to 256K.

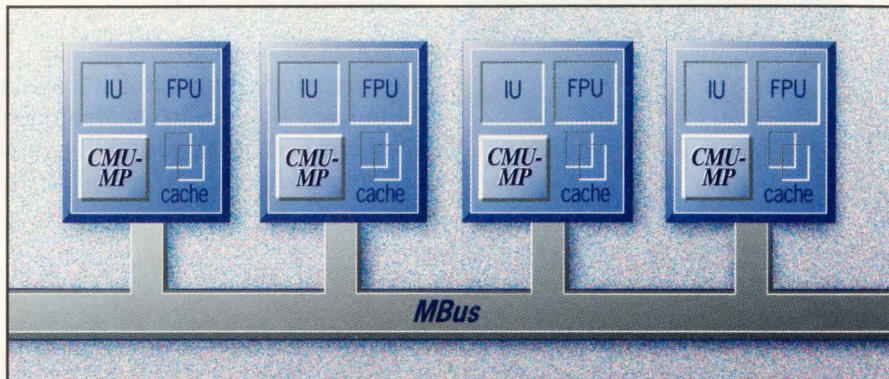

SPARC multiprocessing is now enabled. Now you can design-in multiple high-performance SPARC chipsets. Our revolutionary Multiprocessing Cache Controller and Memory Management Unit (CMU-MP/CY7C605) provides memory management facilities and a unique cache architecture for higher performance. Our complete SPARC chipset solution shortens your time to market.

It is the only VLSI solution that performs concurrent bus snooping and processor execution.

Our unique dual cache tag directories provide for simultaneous bus snooping and processor access to cache. No other cache management unit provides dual tags on-chip.

As a result, your system maintains cache coherency without stealing execution cycles from the microprocessor.

You get multiprocessing with the most efficient cache coherency protocol available, allowing data to pass from CPU to CPU in a single clock cycle. That translates directly to higher performance systems.

## MBus compliant.

MBus compliance means you have a SPARC-standard, plug-and-play route to even more powerful, higher performing systems.

## An integrated part of the industry's highest performance SPARC chipset.

Our chipset approach simplifies the complexities of multiple CPUs working together in a shared memory system.

This VLSI solution means you don't have to design and pay for boards full of logic to accomplish fast multiprocessing.

It is all available now.

For more information on the industry's most complete multiprocessing solution, please call for our literature package today.

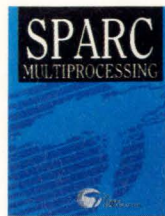

**Multiprocessing  
Information  
Hotline:**

**1-800-952-6300.\*  
Ask for Dept. C4V.**



\*(32) 2-652-0270 in Europe. © 1991 Cypress Semiconductor, 3901 North First Street, San Jose, CA 95134. Phone: 1 (408) 943-2600, Telex: 821032 CYPRESS SNJ UD, TWX: 910-997-0753. SPARC is a registered trademark of SPARC International, Inc. Products bearing the SPARC trademark are based on an architecture developed by Sun Microsystems, Inc.



**Home Office**

275 Washington St, Newton, MA 02158  
 EDN Bulletin Board: (617) 558-4241  
 MCI: EDNBOS  
 (617) 558-extension

**VP/Publishing Director**

Peter D Coley -4673

**VP/Publisher**

Roy Forsberg -4367

**VP/Editor/Editorial Director**

Jonathan Titus -4573

**Executive Editor**

Steven H Leibson -4214

**Managing Editor**

Joan Morrow Lynch -4215

**Assistant Managing Editor**

Christine McElvenny -4741

Gary Legg, *Senior Technical Editor* -4404

Tom Ormond, *Senior Technical Editor* -4414

Charles Small, *Senior Technical Editor* -4556

John A Gallant, *Technical Editor* -4666

Michael C Markowitz, *Technical Editor* -4743

Dave Pryce, *Technical Editor* -4326

Dan Strassberg, *Technical Editor* -4205

Jay Fraser, *Associate Editor* -4561

Carl Quesnel, *Associate Editor* -4484

Susan Rose, *Associate Editor* -4738

Julie Anne Schofield, *Associate Editor* -4619

Helen McElwee, *Senior Copy Editor* -4311

James P Leonard, *Copy Editor* -4324

Gillian A Caulfield, *Production Editor* -4263

Brian J Tobey, *Production Editor* -4309

**Editorial Field Offices**

Doug Conner, *Technical Editor*  
 Atascadero, CA: (805) 461-9669  
 MCI: EDNDCONNER

J D Mosley, *Technical Editor*  
 Arlington, TX: (817) 465-4961  
 MCI: EDNMOSLEY

Richard A Quinell, *Technical Editor*  
 Aptos, CA: (408) 685-8028  
 MCI: EDNQINNELL

Anne Watson Swager, *Technical Editor*  
 Wynnewood, PA: (215) 645-0544  
 MCI: EDNSWAGER

Ray Weiss, *Technical Editor*  
 Woodland Hills, CA: (818) 704-9454  
 MCI: EDNWEISS

Maury Wright, *Technical Editor*  
 San Diego, CA: (619) 748-6785  
 MCI: EDNWRIGHT

Brian Kerridge, *Technical Editor*  
 (508) 28435  
 22 Mill Rd, Loddon  
 Norwich, NR14 6DR, UK  
 MCI: EDNKERRIDGE

**Contributing Editors**

Robert Pease, Don Powers,  
 David Shear, Bill Travis

**Editorial Coordinator**

Kathy Leonard -4405

**Editorial Services**

Helen Benedict -4681

**Art Staff**

Ken Racicot, *Senior Art Director* -4708  
 Chinsoo Chung, *Associate Art Director* -4446  
 Cathy Madigan, *Associate Art Director* -4599

**Marketing & Business Director**

Deborah Virtue -4779

**Marketing Communications**

Kathy Calderini, *Manager* -4526  
 Pam Winch, *Promotion Specialist* -4660

**PRODUCT UPDATES**

Windows-based test-development software	73
Erasable programmable logic devices	75

**NEW PRODUCTS**

Integrated Circuits . . . . .	116
Components & Power Supplies . . . . .	121
Computers & Peripherals . . . . .	123
Test & Measurement Instruments . . . . .	127
CAE & Software Development Tools . . . . .	130

**DEPARTMENTS**

Inside EDN . . . . .	9
News Breaks . . . . .	17
Ask EDN . . . . .	25
Editorial . . . . .	33
Design Ideas . . . . .	107
EDN's Acronyms & Abbreviations . . . . .	141
EDN's International Advertisers Index . . . . .	141
Hands On! . . . . .	143

**EDN BBS Update**

EDN continues to upgrade the Bulletin Board System (BBS) to make it easier for you to access the information you need, when you need it. The BBS ((617) 558-4241) now has a 220-Mbyte drive, courtesy of Quantum. The additional disk space accommodates 1000 public-domain and shareware postings as well as more than 50 computerized tutorials, covering all popular programming languages and other topics. The BBS also features an expanded FORTH section and a free 32-bit 80386/486 compiler for use on IBM PCs. You can access the expanded scientific-calculator program library on the /sci\_calc Special Interest Group or the new math-software library on the /math Special Interest Group. Stay tuned for more.

**Cahners Publishing Company**, A Division of Reed Publishing USA  Specialized Business Magazines for Building & Construction  Research  Technology  Electronics  Computing  Printing  Publishing  Health Care  Foodservice  Packaging  Environmental Engineering  Manufacturing  Entertainment  Media  Home Furnishings  Interior Design  and Lodging. Specialized Consumer Magazines for Child Care  Boating  and Wedding Planning.

# FINALLY, One Company Offers an Integrated Design Solution for Every Hardware Platform

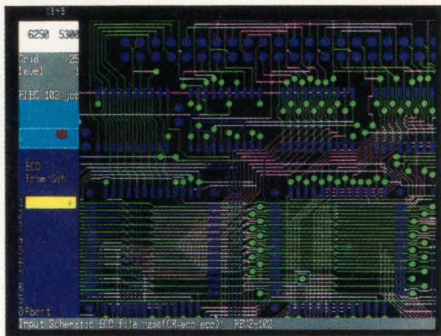

## World's Most Popular PADS-PCB

- ▲ 16-bit, 1 mil resolution
- ▲ Simple, Graphical User Interface
- ▲ Integrated Schematic package
- ▲ Blind and buried via support
- ▲ Dynamic rubberbanding of conns.
- ▲ Autoplace and route
- ▲ Design rules checking to 1 mil accuracy
- ▲ 400 IC design capacity

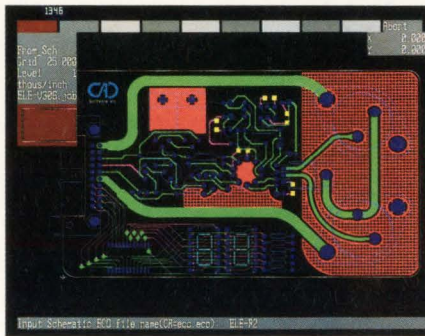

## World's Most Powerful PADS-2000

- 32-bit, 1 micron resolution
- Full SMT support
- Blind, buried & micro via
- Component rotation to 1/10
- Curved Trace and Polygons
- Full design rules checking to +10
- Intelligent copper pour and edit
- 32,000 IC design capacity

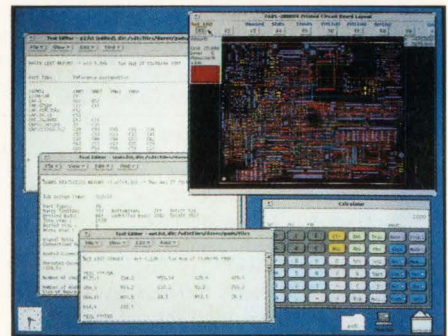

## World's Most User-Friendly PADS-2000/UX

- 32-bit design software for Sun SPARCStations
- Multi-tasking user environment
- Full Analog Design support, all angle place
- ECL technology support
- State-of-the-art "Nudge" placement
- Real time checking with interactive route
- Multi-layer batch router
- On-Line design rules checking in router

**PADS** offers hardware independent EDA Solutions to meet your budget and your toughest engineering needs. For database compatibility and a common design philosophy from PC's to Workstations, call **1-800-255-7814**.

**PADS**

**PADS**

**PADS**

**PADS**

119 Russell Street, Littleton, MA 01460 Tel. (508) 486-9521 Fax: (508) 486-8217 Toll Free: 1-800-255-7814

**Software, Inc.**

## INSIDE EDN

A summary and analysis of articles  
in this issue.

Just a year or two ago, it seemed that the notorious ground-bounce problem threatened to overcome further advances in bus speeds. However, as Technical Editor Richard A Quinnell discovered while researching bus drivers for this issue's cover story, IC vendors have effectively kicked ground bounce off of the bus. At the same time, vendors are enhancing bus drivers by adding logic, such as internal latches, test logic, and power-up-disable circuits, which permits boards using these drivers to be inserted into live systems.

If you're looking for more creative ways to use bus drivers, software, and other components in your designs, take a look at Senior Technical Editor Charles H Small's unusual article on innovation software. He reviews several products that help you use guided problem solving and brainstorming to overcome mental blocks. He also takes a look at the dark side of creative design, reviewing stress-management software and programs for overcoming depression. Small's venture into the untrodden territory of self-help software may seem unusual for a design publication like EDN, but such topics are interwoven into the design engineering occupation as into any other.

Also in this issue, you'll find the second part of Technical Editor Ray Weiss' review of  $\mu$ C evaluation boards. This time, Weiss looks at boards for the 16 biters. As in the first part, he explains how these products can help you pick the right processor and get up to speed quickly.

**Steven H Leibson,**  
Executive Editor



**IEEE-488**

You can control any IEEE-488 (HP-IB, GP-IB, 488.2) device with our cards, cables and software for the PC/AT/386, EISA, Micro Channel and Macintosh II. You get fast hardware and software support for all the popular languages, plus a software library of time saving utilities. Instrument control has never been easier.

**FREE**  
Informative Catalog 800-234-4CEC  
Applications help 617-273-1818

**cec** Capital Equipment Corp.  
Burlington, MA. 01803

Micro Channel is a trademark of IBM

CIRCLE NO. 6

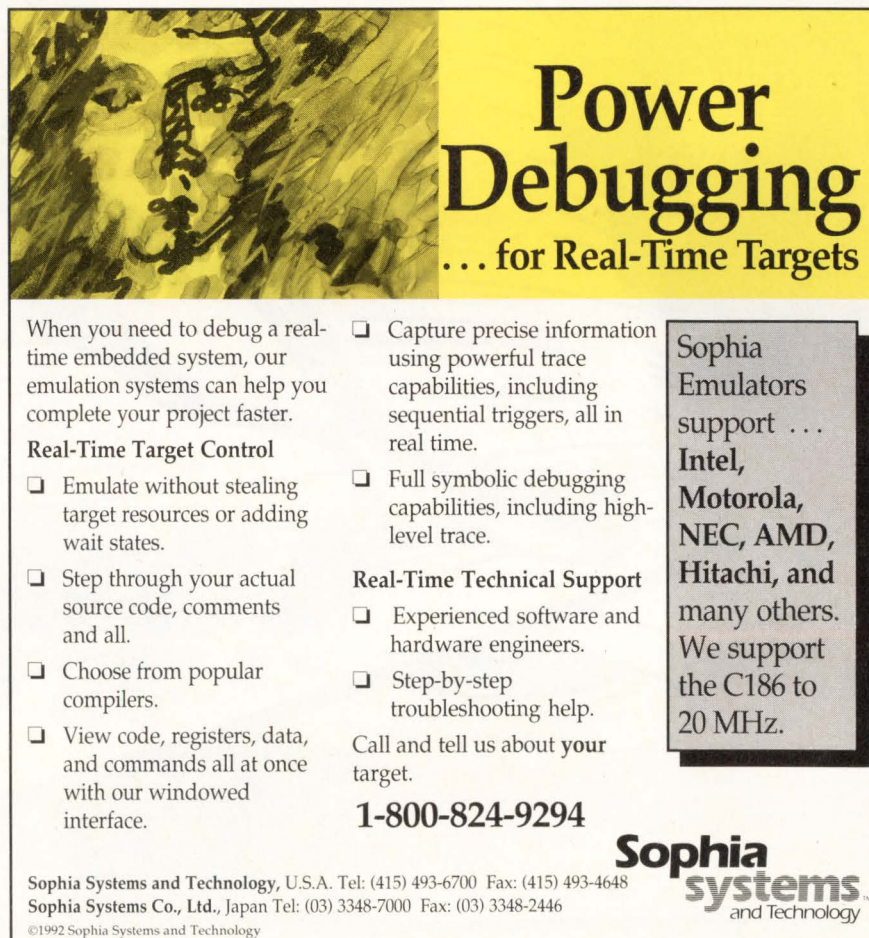

## Power Debugging ... for Real-Time Targets

When you need to debug a real-time embedded system, our emulation systems can help you complete your project faster.

**Real-Time Target Control**

- Emulate without stealing target resources or adding wait states.
- Step through your actual source code, comments and all.
- Choose from popular compilers.
- View code, registers, data, and commands all at once with our windowed interface.

Capture precise information using powerful trace capabilities, including sequential triggers, all in real time.

Full symbolic debugging capabilities, including high-level trace.

**Real-Time Technical Support**

- Experienced software and hardware engineers.
- Step-by-step troubleshooting help.

Call and tell us about your target.

**1-800-824-9294**

Sophia Emulators support ... Intel, Motorola, NEC, AMD, Hitachi, and many others. We support the C186 to 20 MHz.

**Sophia systems**  
and Technology

Sophia Systems and Technology, U.S.A. Tel: (415) 493-6700 Fax: (415) 493-4648  
Sophia Systems Co., Ltd., Japan Tel: (03) 3348-7000 Fax: (03) 3348-2446  
©1992 Sophia Systems and Technology

# It Takes Some Characteristics To



The Silver Surfer and The Incredible Hulk are trademarks of Marvel Entertainment Group, Inc. © 1991. All rights reserved.

# Very Special Be #1 In EPROMs.

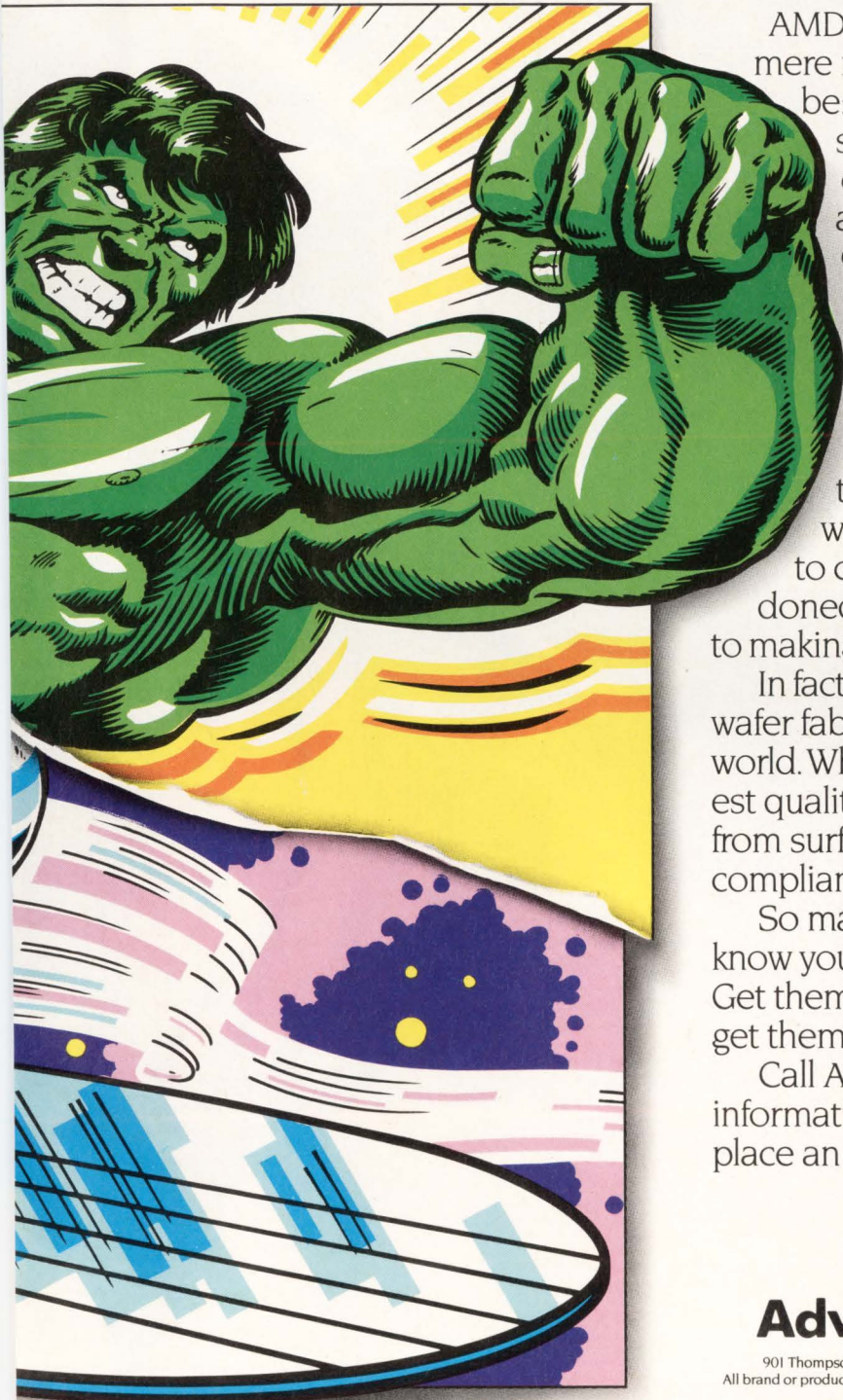

AMD EPROMs today are what other mere mortal EPROMs can only aspire to be: high density, of course. But also high speed. Able to store massive amounts of information, with lightning fast access times. All in our superior CMOS technology.

EPROMs have always been our strength—thanks to our unparalleled performance, selection, reliability, and quality.

That's why we sell more EPROMs than any other vendor.\* Period. And we're ready to do the same for years to come. While other vendors have abandoned EPROMs, we're still committed—to making the fastest, highest density EPROMs.

In fact, we've got the most advanced EPROM wafer fab, assembly and test facilities in the world. Which produce the most reliable, highest quality EPROMs available. In everything from surface mount plastic to mil spec compliant packages.

So make yourself a hero. The instant you know your EPROM requirements, get them fast. Get them dense. Get them in volume. And get them right away.

Call AMD at **1-800-222-9323** for more information. Or call your local sales office to place an order.



**Advanced Micro Devices**

901 Thompson Place, P.O. Box 3453, Sunnyvale, CA 94088 © 1991 Advanced Micro Devices, Inc.  
All brand or product names mentioned are trademarks or registered trademarks of their respective holders.  
\*Dataquest, March 1991, based on 1990 data.

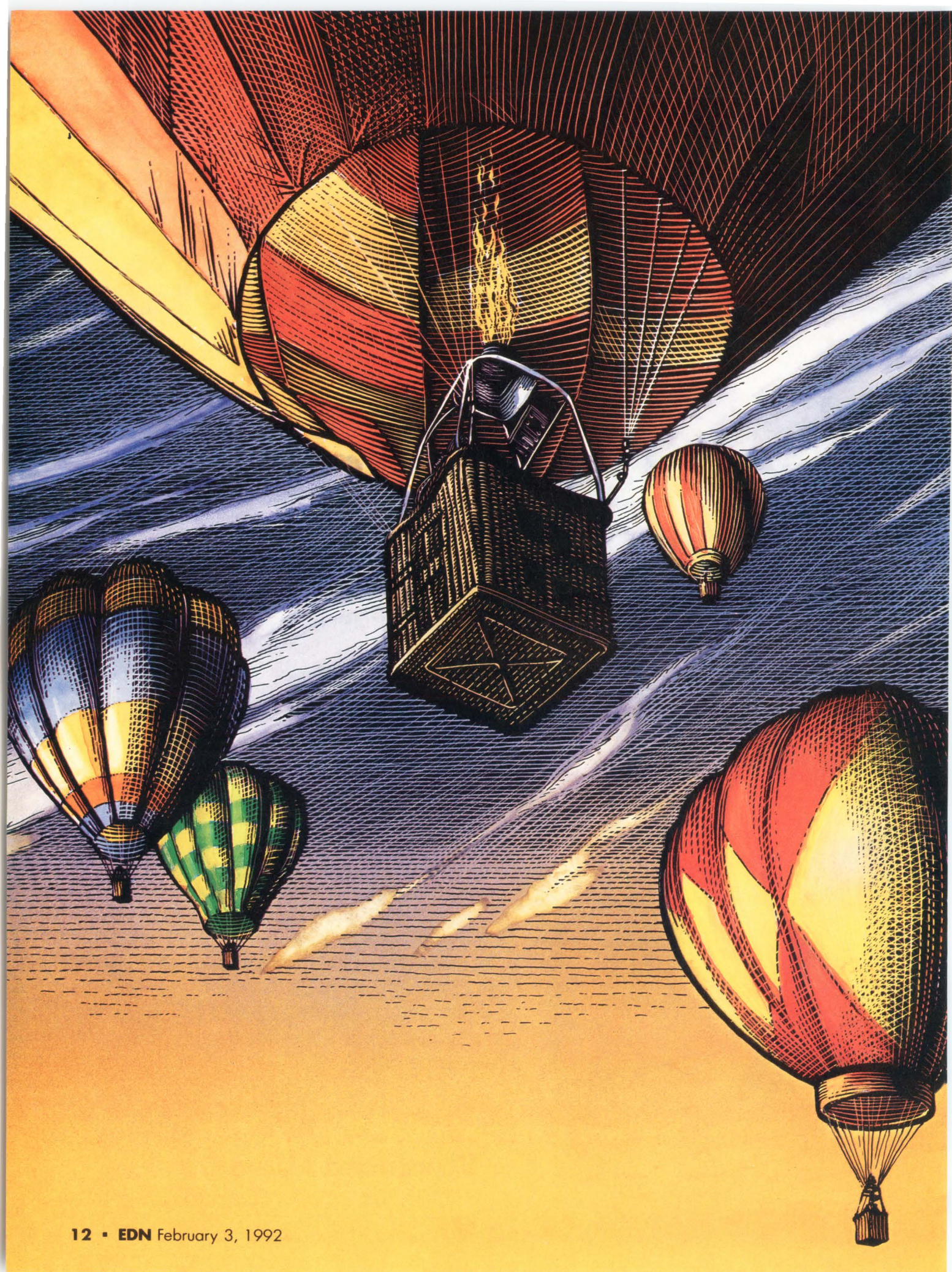

# OUR LOW-COST 68HC05 CSICs CAN TAKE YOUR DESIGNS TO NEW HEIGHTS.

It's more than low-cost that helps our 8-bit microcontrollers get your design off the ground.

It's Customer-Specified Integrated Circuits designed to meet real world needs.

Whether you're moving up from 4-bit, or replacing discrete components, Motorola's newest 68HC05 CSICs make it easier and more affordable than ever.

As part of our growing family, the K-Series, J-Series, and P-Series of 68HC05 microcontrollers offer a high level of subsystem integration in a variety of pin counts. Options include a full range of memory combinations, communication interfaces, A/D converters, and many of the subsystems that have made Motorola the world's leading 8-bit supplier.

Virtually every 68HC05 CSIC is supported by One-Time Programmable EPROM-versions for prototyping and limited-production when code changes for model variations are required. Plus, every 68HC05 is backed by extensive development tool support.



Whether your application requires a simple alert tone, personality EPROM for a remote control, or processing power for precision motor control, our 68HC05 CSICs have the features and prices to fit your needs.

Take your next design to new levels of performance. Complete the coupon below for your free copy of our 68HC05 K-Series Source Level Simulator. Develop, debug, and simulate hardware execution with this extremely versatile and easy-to-use PC-based software program.

## FREE Source Level Simulator!

Help your design rise above the rest! For a free copy of the 68HC05 K-Series Source Level Simulator and more information on our low-cost 68HC05 MCUs, return this coupon to:

Motorola, Inc. P.O. Box 1466, Austin, Texas 78767

Name \_\_\_\_\_

Title \_\_\_\_\_

Company \_\_\_\_\_

Address \_\_\_\_\_

City \_\_\_\_\_

State \_\_\_\_\_ Zip \_\_\_\_\_

Phone \_\_\_\_\_ Fax \_\_\_\_\_

Free Source Level Simulator offer ends May 29, 1992.

EDN 2/3/92

## THE PATHWAY TO PERFORMANCE.



# MOTOROLA

 and Motorola are registered trademarks of Motorola, Inc. © 1992 Motorola, Inc.

# Move into our i960™ CA processor and get our 32-bit architecture in its most sophisticated form.



Welcome to life in the fast lane. We hope you can handle the pace, because there is no stopping the i960™ CA RISC microprocessor.

It not only delivers the highest level of system throughput, but it's also the only superscalar processor that delivers high

power for embedded applications.

Of course, just because the i960 CA processor is sophisticated doesn't mean it's hard to use. Quite the contrary. Its highly integrated design with Bus, Interrupt and DMA controllers all on-chip makes it easier to design with and increases its cost-effectiveness.

And while the i960 CA processor may be

©1991 Intel Corporation. i960 is a trademark of the Intel Corporation. All rights reserved.





your dream architecture, its design gives you plenty of room for upward growth. Add to that the comprehensive array of development tools, and your high-end imaging, communication and distributed I/O products will be set for life.

So if your design calls for something sophisticated, call 800-548-4725 for the i960

Family Welcome Guide (ask for literature packet A9A22). And make your move into a neighborhood with real power.

**intel**®

The Computer Inside.™

# Control Tower

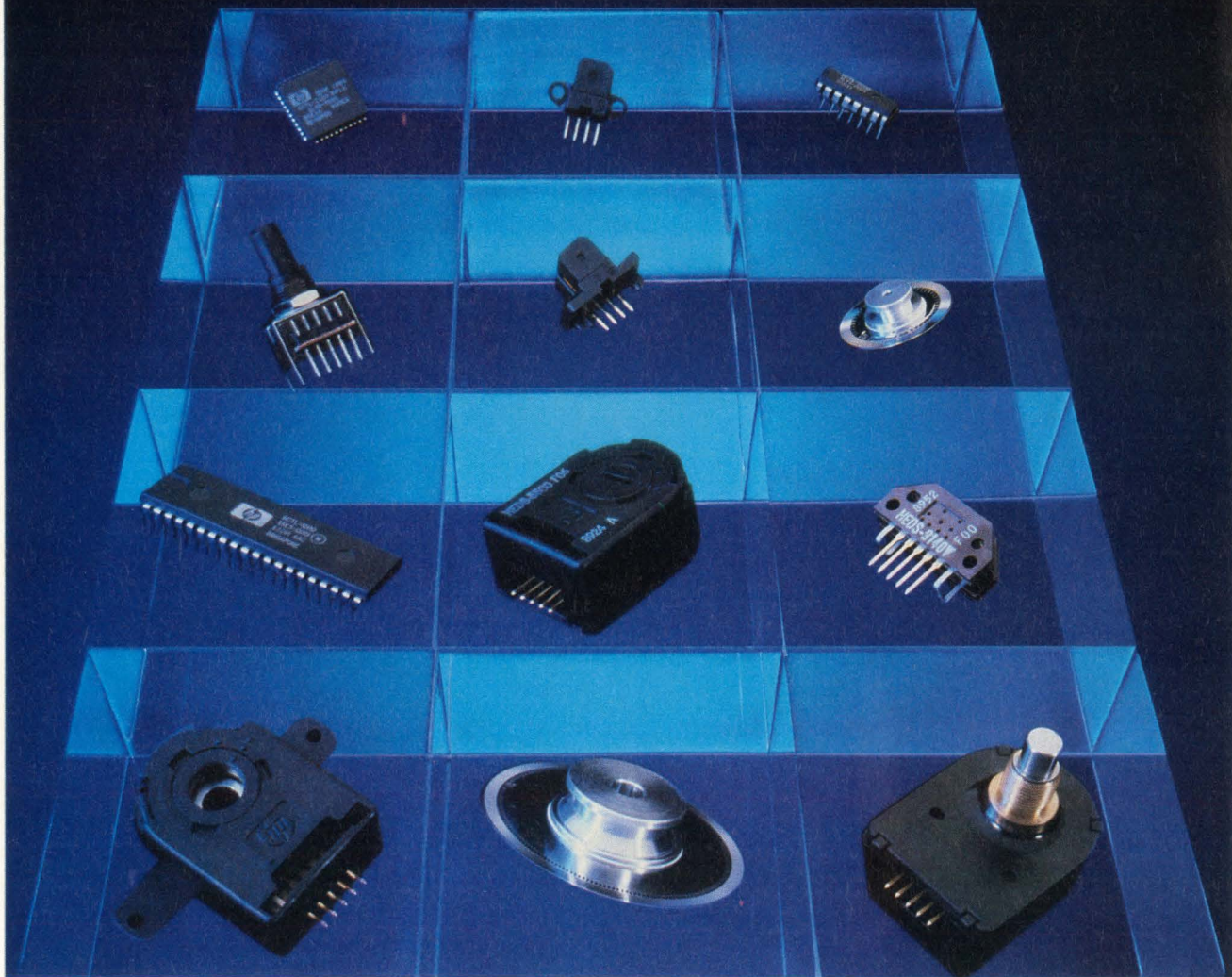

When it comes to motion control products, Hewlett-Packard towers over the rest with a more diversified and innovative line of solutions. Giving you one source to meet all your design needs.

Just look at our award-winning HEDS 9000 series of encoder modules. Using HP's unique optical technology, these modules are the ideal building blocks for creating precision high-speed linear or rotary applications.

Your choices include everything from a 3-channel module for industrial applications to the small footprint of our 9700 collection for business equipment.

## **Control panel: the HRPG series.**

For front panel applications, turn to our RPG series of potentiometers. Offering you full configuration flexibility, improved rotational feel, and small footprint, HP delivers the perfect line of data entry devices for your test, medical, analytical, and computer equipment.

## **Controlled performance: the HCTL series.**

Our new line of high-speed HCTL ICs give you high performance servo control in low-power CMOS. The result: superior performance and more microprocessing

power left over for your laboratory, medical, and industrial automation designs.

And because these motion control solutions come from HP, you're assured of our on-going commitment to excellence in service, support, and reliability.

So why take a chance, when you can take control. With motion control products from HP. Call for our free brochure: 1-800-752-0900, ext. 1497.

**There is a better way.**



In Europe, fax inquiries  
to (49) 7031-14-1750

## Graphics IC quintuples Windows performance

Graphics performance has been one of the key limitations of the Microsoft Windows environment for PCs. Existing graphics-coprocessor boards provide the necessary performance boost but at a price that relatively few people are willing to pay. The OTI-087 super VGA controller IC offers a less expensive way for system designers to solve this problem. The \$31 (1000) chip boosts the display speed of Windows by a claimed factor of five through a high-speed bus interface and hard-wired graphics functions. In addition, the device supports 1280 × 768-pixel noninterlaced and 1280 × 1024-pixel interlaced displays, both with 256 colors. It can also control 24-bit display memories for full-color applications with a 640 × 480-pixel resolution.

The IC's bus interface is designed to couple closely to the host processor bus and operates at speeds to 40 MHz. Most VGA controllers interface to a PC's 8- or 16-bit expansion bus operating at 8 or 10 MHz. The chip also incorporates a write cache memory to further speed bus transactions, a read cache memory for zero-wait-state bitblt (bit-block-transfer) operations, and a 64 × 64-pixel hardware cursor with 2 bits/pixel.

Systems based on this controller can immediately take advantage of the higher bus speed. To make use of the hard-wired graphics functions, you must add software drivers. The company plans to offer drivers for Microsoft Windows in February and an evaluation board in March. Oak Technology Inc, Sunnyvale, CA, (408) 737-0888, FAX (408) 737-3838.

—Steven H Leibson

## Test-method availability to exceed 50%

With the addition of NEC Corp as a licensee for its embedded test matrix, Crosscheck Technology's approach to testability soon will be available on ASICs from vendors who collectively deliver more than half of the world's CMOS gate arrays. The license grants NEC the right to include

*Crosscheck's on-chip test electronics in a variety of semiconductors and to use Crosscheck's fault simulation, test-pattern generation, and device diagnostics software. A by-product of the test electronics is high observability of internal nodes. This observability ensures fault coverage exceeding 98% and reduces test-pattern, test-development, and device-debug times.*

—Michael Markowitz

## Windows-based data-acquisition software standards posed

With the announcement of open standards for applications- and systems-programming interfaces, collectively named DT-Open Layers for MS-Windows, Data Translation Inc has addressed problems that have plagued PC-based data acquisition since its inception: lack of a standard interface between applications programs and commonly used functions, and lack of standards for interfacing hardware to software.

MS-Windows, with its provision for dynamic-link libraries (DLLs), handles communications among applications programs, function libraries, drivers, and standard I/O devices. Because of its broad acceptance, MS-Windows has become the environment of choice for new PC-based real-time software. By using function libraries and drivers that conform to the new programming interface standards, software engineers and even end users will, without rewriting or recompiling their applications code, be able to use new hardware and extend the functional capabilities of their software.

Actually, the new standards apply to a field wider than data acquisition. The company has made image-processing boards for several years;

the new standards apply to such boards. The standards also apply to hardware accelerators such as DSP boards. Indeed, there is nothing in the standards that limits their applicability to boards that plug into the ISA and EISA buses.

Data Translation is now distributing copies of the standards free of charge. It is also shipping 1.0 versions of the data-acquisition and signal-processing libraries for its \$1495 Global Lab Data Acquisition and \$1995 Global Lab Image applications software. The data acquisition library is free with a purchase of the firm's data-acquisition hardware (\$95 without such a purchase). The image library costs \$1995. Users of Global Lab V2.1, which does not support Windows, will receive a \$500 credit when they upgrade to the MS-Windows-compliant version.

Three firms are announcing their support of the new hardware hardware programming interfaces: Ariel Corp, IOtech, and Optivision. Data Translation Inc, Marlborough, MA, (508) 481-3700, FAX (508) 481-8620.—Dan Strassberg

## Interconnect succumbs to software programmability

Although ASIC designers have been able to reprogram the connections

between gates for several years, system designers haven't had the same flexibility with their building blocks. An interconnect technology from Aptix Corp provides the ability to change, via software, the connections among board-level components.

The capability, like a huge digital crosspoint switch, lets you connect any input to any output or outputs. The device is packaged in a proprietary 1024-pin land-grid array—a multilayer ceramic package. The architecture, FPIC (field-programmable interconnect components), is being developed in two components; static RAM-based reprogrammable and one-time-programmable versions. Typical pin-to-pin delays are less than 10 nsec. The technology will be commercially available in the second quarter of this year. Aptix Corp, San Jose, CA, (408) 428-6200.

—Michael Markowitz

## Busless single-board computer is still flexible

RLC Enterprises' SBXC-186EB offers the simplicity of a single-board computer without the expense of a card cage and backplane for embedded applications. What gives the board flexibility are

four SBX expansion connectors that let you add special functions to the card with industry-standard SBX modules. Hundreds of SBX cards from multiple manufacturers offer a variety of functions, including A/D and D/A conversion and speech synthesis. The SBX cards also have video controllers, LAN controllers, and SCSI adapters. The single-board computer is built around the Intel 80C186EB 16-bit CPU and the 80C187 coprocessor running at speeds as high as 16 MHz. The computer supports as much as 512 kbytes of battery-backed static RAM and 512 kbytes of EPROM or flash memory. The board provides a 32-bit parallel I/O port, a real-time clock, watchdog reset, and two communications ports that support RS-232C, RS-422, and RS-485 drivers. An 8-MHz board without the math coprocessor costs \$319 (100). RLC Enterprises, Atascadero, CA, (805) 466-9717, FAX (805) 466-9736.—Doug Conner

## QIC Technical Committee Adopts New Standards

The Quarter-Inch Cartridge (QIC) technical committee recently adopted recording format stan-

dards for 385- and 410-Mbyte minicartridges. In addition, the committee defined standards for the magnetic heads in each device. The standards permit vendors to create QIC drives that have more capacity than QIC-40 and QIC-80 3½-in. drives.

QIC Drive Standards Inc is an international trade association. The group provides a forum for identifying and evaluating user needs and for technical discussions leading to the adoption of standards. The QIC technical committee comprises 10 member companies and 34 associ-

ate companies. The members are Archive Corp, Costa Mesa, CA; Carlisle Memory Products Group Inc, Bedford, TX; Colorado Memory Systems Inc, Loveland, CO; Gigatek Memory Systems, La Costa, CA; Summit Memory Systems Inc, Scotts Valley, CA; Sony Corp, Park Ridge, NJ; Tandberg Data Inc, Oslo, Norway; Teac Corp, Tokyo, Japan; 3M, St Paul, MN; and Wangtek Inc, Simi Valley, CA. QIC Drive Standards Inc, Santa Barbara, CA, (714) 497-8138, contact Tony Miller. —John Gallant

## US firm continues emphasis on memory-IC testers

Even though most of the ICs the systems test come from Japan and Korea, memory testers don't have to be products of the Orient. A US firm willing to devote significant resources to developing memory-test systems can sell its products to the Asian firms that dominate the memory field. So goes the thinking at Teradyne Inc's Semiconductor Test Div. The firm feels that existing testers from either side of the Pacific won't test the new generations of memory chips as economically as necessary. And, the shift toward using application-specific chips demands testers that can readily adapt to testing many more device types than earlier testers could.

To overcome these problems, the J997, optimized for use in engineering and for wafer probing, runs at speeds to 200 MHz and exhibits an overall timing inaccuracy of 300 psec. It can test as many as 32 devices in parallel on two test stations. The corresponding specs for the J994, a model optimized for final test of packaged ICs, are 120 MHz, 500 psec, and 64 devices. Both models accommodate devices that store as much as 1 Gbit each. Pricing begins at \$1 million. Teradyne Inc, Semiconductor Test Div, Agoura Hills, CA, (818) 991-2900, FAX (818) 707-2805.—Dan Strassberg

# Still the Leader

in DOS based Electronic Design

## Introducing Schematic Design Tools version 4.10

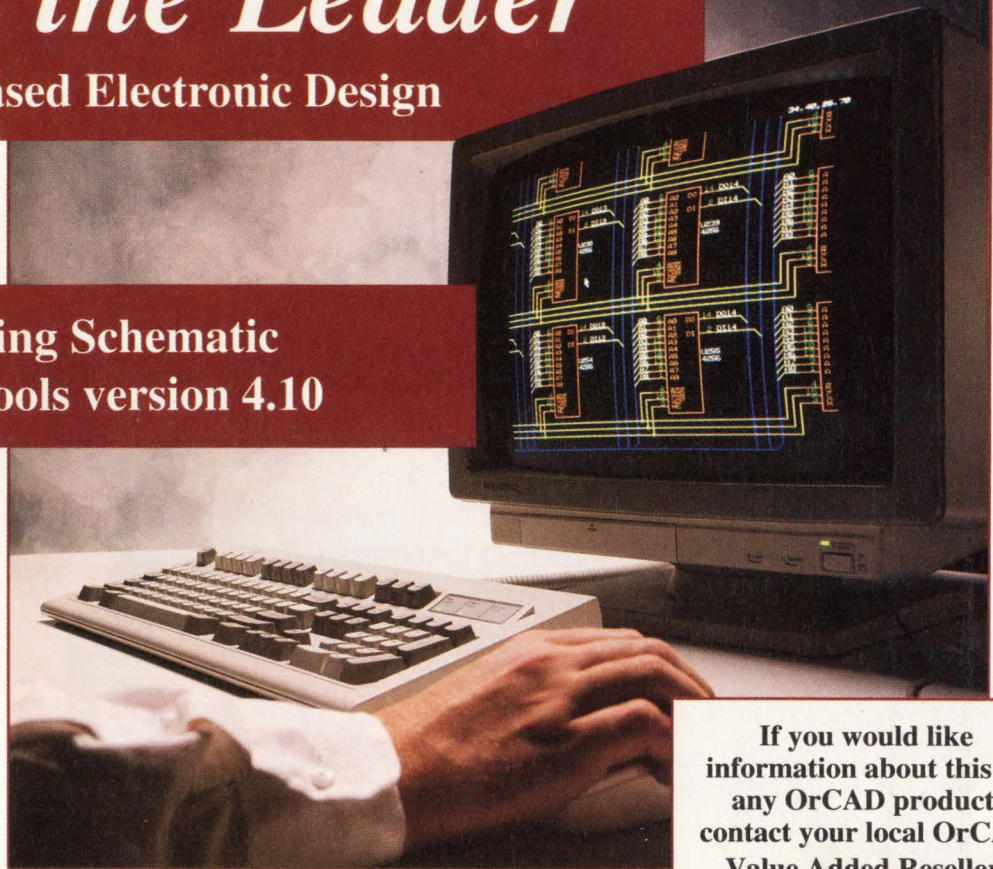

### The leader in PC based EDA tools.

Why? Because we never stop improving our products. One example is our world famous *Schematic Design Tools* package with the *ESP framework*.

OrCAD has just released version 4.10 with these new features.

- dramatic increase in capacity
- utilities like netlist output have increased speed
- introducing new "hotkeys" in the ESP framework

### The ESP Framework

The *ESP framework* is the first PC based framework that allows seamless integration between OrCAD tools and those of third party vendors. ESP framework is a part of Schematic Design Tools; no need to pay extra.

### The OrCAD Difference

*Schematic Design Tools* still comes with the features you'd expect to pay more for:

- A library of over 20,000 unique parts you can browse through in a breeze.
- Utilities to generate Bill-of-Materials, electrical rules check, create custom library parts.
- Support for over 30 netlist formats.
- Over a hundred supported display adapters, 50 printer drivers, a dozen plotter drivers.
- User definable "smart" macros

As ever, all OrCAD products come with one year of product updates, telephone technical support and 24 hour BBS, and a subscription to The Pointer newsletter.

If you would like information about this or any OrCAD product, contact your local OrCAD Value Added Reseller.

WA, OR, MT,  
ID, AK, WY  
Avcom/EDA  
(206) 828-2726

ND, SD, MN,  
MI, WI, IL, IN,  
OH, KY, WV,  
W. PA, NE, KS,  
IA, MO

N. CA, HI, Reno  
NV  
Elcor Associates  
Inc.  
(408) 980-8868

MacKellar  
Associates, Inc.  
(313) 335-4440

So. CA  
Advanced Digital  
Group  
(714) 897-0319

VA, TN, NC,  
SC  
Tingen Technical  
Sales  
(919) 870-6670

Las Vegas NV,  
UT, AZ, NM,  
CO  
Tusar Corporation  
(602) 998-3688

E. PA, NJ, NY,  
DE, MD, DC  
Beta Lambda,  
Inc.  
(800) 282-5632

TX, OK, AR, LA  
Abcor, Inc.  
(713) 486-9251

CT, RI, MA,  
VT, NH, ME  
Tri-Logic  
(508) 658-3800

CANADA  
Pegasus Circuits  
(416)567-6840

Call (503)690-9881  
or write today for your  
FREE demo disk!

**OrCAD**  <sup>®</sup>

3175 N.W. Aloclek Drive  
Hillsboro, OR 97124  
FAX (503)690-9891

# RF TRANS

Over 50 off-the-shelf models...

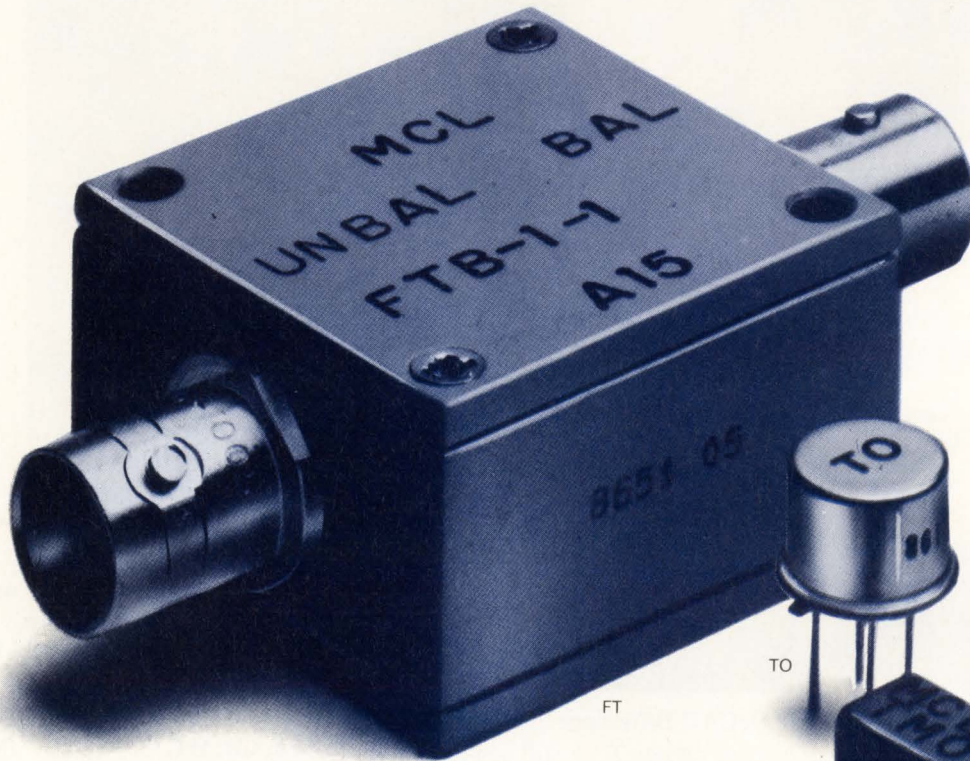

Having difficulty locating RF or pulse transformers with low droop, fast risetime or a particular impedance ratio over a specific frequency range?... Mini-Circuits offers a solution.

Choose impedance ratios from 1:1 to 36:1, connector or pin versions (plastic or metal case built to meet MIL-T-21038 and MIL-T-55831 requirements\*). Ultra-wideband response achieves low droop and fast risetime for pulse applications. Ratings up to 1000M ohms insulation resistance and up to 1000V dielectric voltage. For wide dynamic range applications involving up to 100 mA DC primary current, use the T-H series. Coaxial connector models are offered with 50 and 75 ohm impedance; BNC standard; request other types. Available for immediate delivery with one-year guarantee.

Call or write for 68-page catalog or see our catalog in EEM, or Microwaves Product Data Directory.

\*units are not QPL listed

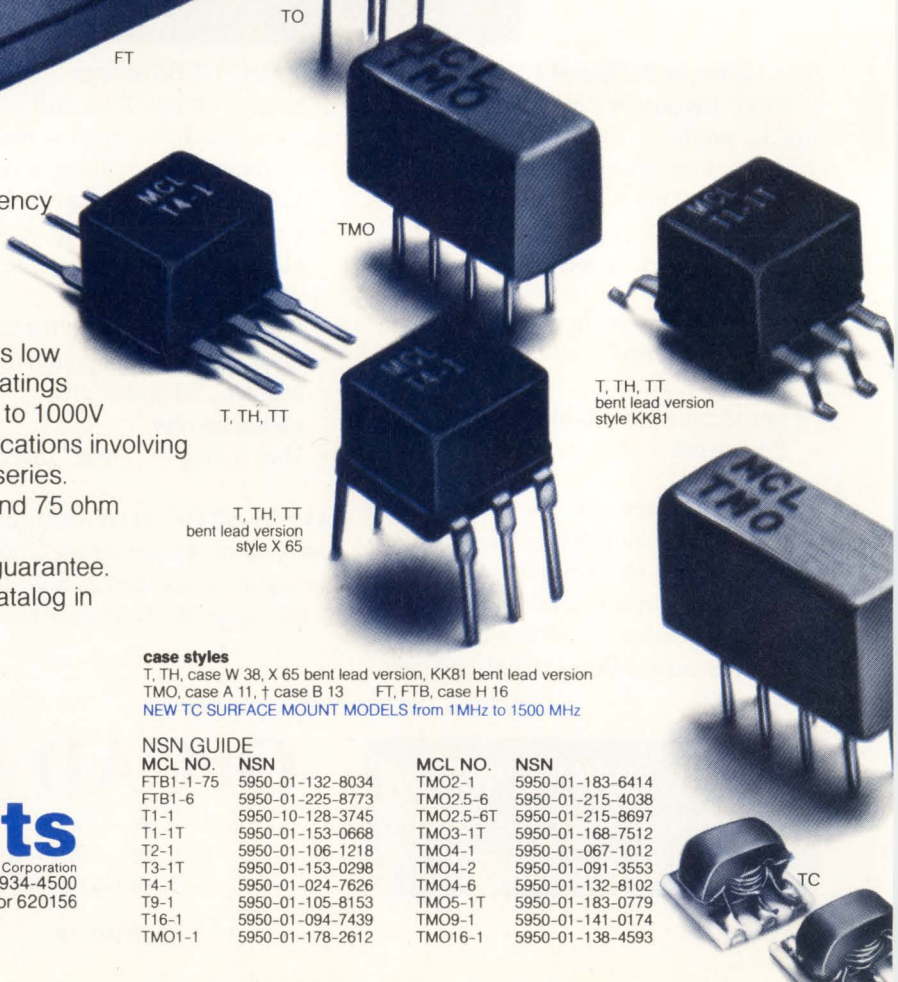

#### case styles

T, TH, case W 38, X 65 bent lead version, KK81 bent lead version  
TMO, case A 11, † case B 13 FT, FTB, case H 16  
NEW TC SURFACE MOUNT MODELS from 1MHz to 1500 MHz

#### NSN GUIDE

MCL NO.	NSN	MCL NO.	NSN
FTB1-1-75	5950-01-132-8034	TMO2-1	5950-01-183-6414
FTB1-6	5950-01-225-8773	TMO2.5-6	5950-01-215-4038
T1-1	5950-10-128-3745	TMO2.5-6T	5950-01-215-8697
T1-1T	5950-01-153-0668	TMO3-1T	5950-01-168-7512
T2-1	5950-01-106-1218	TMO4-1	5950-01-067-1012
T3-1T	5950-01-153-0298	TMO4-2	5950-01-091-3553
T4-1	5950-01-024-7626	TMO4-6	5950-01-132-8102
T9-1	5950-01-105-8153	TMO5-1T	5950-01-183-0779
T16-1	5950-01-094-7439	TMO9-1	5950-01-141-0174
TMO1-1	5950-01-178-2612	TMO16-1	5950-01-138-4593

finding new ways ...  
setting higher standards

## Mini-Circuits

A Division of Scientific Components Corporation

P.O. Box 350166, Brooklyn, New York 11235-0003 (718) 934-4500

Fax (718) 332-4661 Domestic and International Telexes: 6852844 or 620156

# FORMERS

3KHz-800MHz from \$3<sup>25</sup>

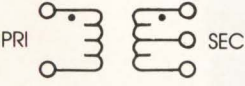
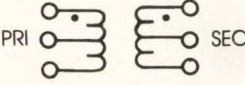
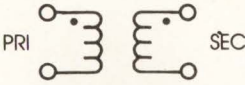
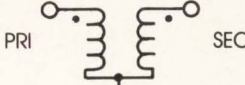
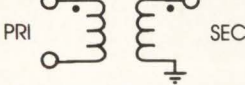
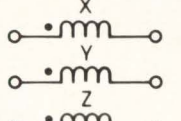
case style number see opposite page	MODEL NO.	$\Omega$ RATIO	FREQUENCY MHz	INSERTION LOSS			PRICE \$ Qty. (1-9)			
				3dB MHz	2dB MHz	1dB MHz				
<b>A*</b> 	T	T1-1T	1	05-200	05-200	08-150	2-80	4.45		
		T1-6T	1	003-300	003-300	01-150	02-50	6.95		
		T2-1T	2	07-200	07-200	1-100	5-50	4.95		
		T2.5-6T	2.5	01-100	01-100	02-50	50-20	4.95		
		T3-1T	3	05-250	05-200	1-200	5-70	4.95		
		T4-1	4	2-350	2-350	35-300	2-100	3.25		
		T4-6T	4	02-250	02-250	05-150	01-100	4.45		
		T5-1T	5	3-300	3-300	6-200	5-100	4.95		
		T8-1T	8	03-140	03-140	10-90	1-60	7.95		
		T13-1T	13	3-120	3-120	7-80	5-20	4.95		
		T16-6T	16	03-75	03-75	06-30	1-20	5.65		
		T4-1H	4	10-350	10-350	15-300	25-200	5.95		
		TH	TMO1-1T	1	05-200	05-200	08-150	2-80	7.95	
			TMO2-1T	2	07-200	07-200	1-100	5-50	8.45	
			†TMO2.5-6T	2.5	01-100	01-100	02-50	05-20	8.45	
			†TMO3-1T	3	05-250	05-250	1-200	5-70	7.95	
TMO4-1	4		2-350	2-350	35-300	2-100	6.25			
TMO5-1T	5		3-300	3-300	6-200	5-100	8.45			
TMO13-1T	13	3-120	3-120	7-80	5-20	8.45				
<b>B*</b> 	TT	TT1-6	1	004-500	004-500	02-200	1-50	6.95		
		TT1.5-1	1.5	075-500	075-500	2-100	1-50	5.95		
		TT2.5-6	2.5	01-50	01-50	025-25	05-10	6.45		
		TT4-1	3	05-200	05-200	2-50	1-30	5.95		
		TT4-1A	4	01-300	01-300	02-250	03-180	6.95		
		TT25-1	25	02-30	02-30	05-20	1-10	9.95		
		TTMO	TTMO25-1	25	02-30	02-30	05-20	1-10	11.95	
			TTMO1-1	1	005-100	005-100	01-75	05-40	11.45	
			TTMO4-1A	4	01-300	01-300	02-250	03-180	13.95	
			<b>C</b> 	T	T1-1	1	15-400	15-400	35-200	2-50
T118-3	1.18	001-250			001-250	002-200	003-50	5.65		
T1-6	1	01-150			01-150	02-100	05-50	5.65		
T1.5-1	1.5	1-300			1-300	2-150	5-80	4.45		
T1.5-6	1.5	02-100			02-100	05-50	01-25	5.65		
T2.5-6	2.5	01-100			01-100	02-50	05-20	4.45		
T4-6	4	02-200			02-200	05-150	1-100	4.45		
T9-1	9	15-200			15-200	3-150	2-40	3.95		
T16-1	16	3-120			3-120	7-80	5-20	4.45		
T36-1	36	03-20			03-20	05-10	1-5	6.95		
TO-75	1	10-500			—	10-500	40-250	6.95		
TH	T1-1H	1			8-300	8-300	10-200	25-100	5.95	
	T9-1H	9			2-90	2-90	3-75	6-50	6.45	
	T16-H	16			7-85	7-85	10-65	15-40	6.45	
	TMO	TMO1-02			1	1-800	1-800	2-500	—	9.45
TMO1-1		1			15-400	15-400	35-200	2-50	6.25	
TMO1.5-1		1.5	1-300	1-300	2-150	5-8	8.45			
†TMO2.5-6		2.5	01-100	01-100	02-50	05-20	7.95			
†TMO4-6		4	02-200	02-200	05-150	1-100	7.95			
TMO6-1		6	3-200	3-200	5-150	5-50	7.95			
TMO9-1		9	15-200	15-200	3-150	2-40	7.95			
TMO16-1		16	3-120	3-120	7-80	5-20	7.95			
<b>D</b> 	T	T2-1	2	050-600	050-600	1-400	5-200	3.95		
		T3-1	3	5-800	5-800	2-400	—	4.45		
		T4-2	4	2-600	2-600	5-500	2-250	3.95		
		T8-1	8	15-250	15-250	25-200	2-100	3.95		
		T14-1	14	2-150	2-150	5-100	2-50	4.95		
		TMO	TMO2-1	2	050-600	050-600	1-400	5-200	7.95	
			TMO3-1	3	5-800	5-800	2-400	—	8.45	
			TMO4-2	4	2-600	2-600	5-500	2-250	7.95	
			TMO8-1	8	15-250	15-250	25-200	2-100	7.95	
			TMO14-1	14	2-150	2-150	5-100	2-50	8.45	
			FT	FT122-1	1.22	005-100	005-100	01-50	05-25	35.95
		FT1.5-1		1.5	1-400	1-400	5-200	1-100	35.95	
		<b>E</b> 	FTB	FTB-1	1	2-500	2-500	5-300	1-100	36.95
				FTB1-6	1	01-125	01-125	05-50	1-25	36.95
■FTB-1-75	1			5-500	5-500	5-300	10-100	36.95		
<b>F</b> 	T	T-622	1	01-200	01-200	05-100	5-80	3.25		
		T626	1	001-10	001-10	02-5	04-2	3.95		

■ Denotes 75 ohm models

\* FOR A AND B CONFIGURATIONS

Maximum Amplitude Unbalance  
0.1 dB over 1 dB frequency range  
0.5 dB over entire frequency range

Maximum Phase Unbalance  
1.0° over 1 dB frequency range  
5.0° over entire frequency range

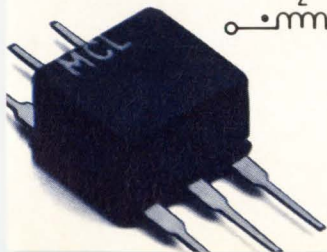

# LITTLE FOOT.





# "SIZE IS POWER" DEBUNKING THE MYTH

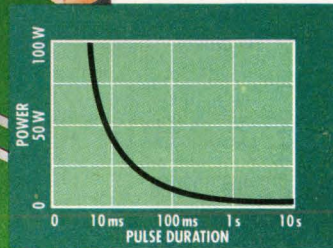
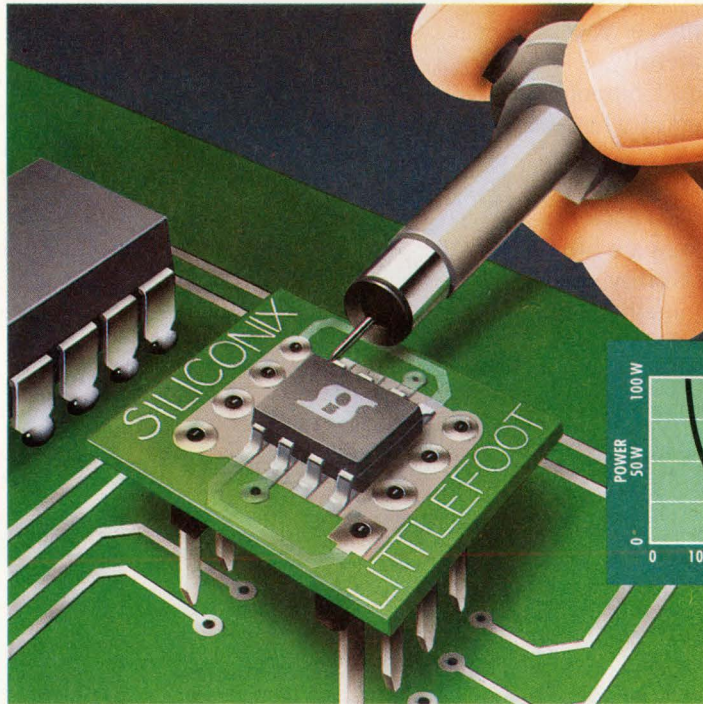

## The myth of mass.

Many say, "Size is power."

We say different, but understand a few of you

may have doubts. Sometimes it's just hard to believe a device so small can dissipate so much power. A full 2 watts.

But LITTLE FOOT™ does.

It also delivers the highest current rating available, up to 3.5 amps, in a tiny SOIC-8 package. This results from a combination of our unique copper lead-frame design that conducts heat directly from the backside of the die to optimize thermal performance, and our SiMOS 2.5 (2.5 million cells/sq.in.) technology that creates the industry's highest power density and lowest on-resistance. Just what you need for motor control, load switching, and DC/DC conversion in applications where space and heat are critical constraints.

How else can you design one or two powerful MOSFETs into your system in less than five one hundredths (0.05) of a single square inch?

## Use the world's smallest evaluation board... and see for yourself.

Siliconix simplifies circuit testing by providing you with a mini-evaluation board. It's only 1/2" x 1/2". Just solder LITTLE FOOT to the mini-board and drop it into your socket. It takes only a few minutes to prove to yourself that 2 watts can be dissipated easily by this remarkable SOIC-8 packaging technology.

## LITTLE FOOT is designed for manufacturability.

LITTLE FOOT simplifies your assembly process because Siliconix's SOIC packaging is compatible with the digital devices on your board. And its two-MOSFET capability means you use fewer components and get higher system reliability.

LITTLE FOOT cuts your costs and reduces set-up time. And there are no solder voids, no lead trimming, and no tube jamming. It can also eliminate steps in your production cycle to get your product to market faster.

## Get the LITTLE FOOT big advantage.

It runs cooler, saves space, improves reliability, increases

efficiency, simplifies design, extends battery life, reduces costs, and cuts time to market. With this kind of designed-in performance it's not surprising that LITTLE FOOT sales have surpassed 20 million devices.

And that's fact — not myth.

*LITTLE FOOT comes in different versions that are ideal for motor control, load switching, and DC/DC conversion.*

- N-ch MOSFETs (duals & singles)
- P-ch MOSFETs (duals & singles)
- N- & P-ch MOSFETs

Voltage:	20-50V (200V coming)
On-resistance:	50-300 mΩ
Current Rating:	4.5 A
Power Dissipation:	2 W

Call our toll-free hot line now!

**1-800-554-5565, ext 964.** Ask for your LITTLE FOOT design kit and evaluation board. And remember at Siliconix we're bringing a seamless power interface to the digital world.

# Siliconix

2201 Laurelwood Rd, Santa Clara CA 95056

# Why Settle for 1/2 an '040 Board?

You've chosen the '040 because you need maximum performance in your VME system. But look carefully, because other Single Board Computers may only give you only half of what you expected from the '040.

Compare Synergy's SV430 performance to any other SBC. Compare bus speed, MIPs, support, flexibility, documentation, reliability, I/O intelligence or any spec you can think of. We think you'll find the same thing we did—the

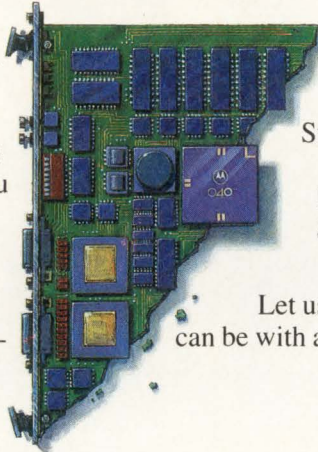

SV430 outperforms every other SBC on the market by as much as 150%.

Surprisingly, this kind of quality won't cost you any extra, because Synergy products lead in another important area—value. At Synergy, you don't have to pay a premium price for premium performance.

Let us show you just how far ahead your system can be with a Synergy processor board. Call us today, and get the *whole* '040 story.

## Compare our specs. Synergy is superior across the board!

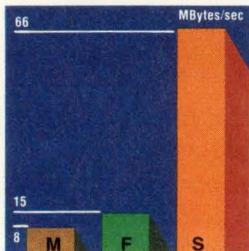

### VME Transfers

VME64 doubles bus performance to 66 MB/s—and the SV430 is the only '040 board that has it. But we don't need VME64 to win this comparison.

Even normal 32-bit transfers race at 33 MB/s. That's 200% faster than Force or Motorola.

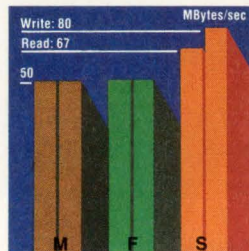

### DRAM Burst Rates

A 25 MHz '040 is capable of accessing memory at 80 MB/s. The closer you are to this maximum, the more '040 performance you're gaining. SV430 bursts are 26% faster than Force and Motorola.

SV430 bursts are 26% faster than Force and Motorola.

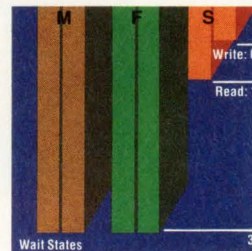

### DRAM Random Accesses

Non-burst '040 performance is measured in wait states. Fewer wait states mean higher performance. The SV430 is not only 66% faster than Force or Motorola, it supports twice the on-board memory—32 MB.

SV430 is not only 66% faster than Force or Motorola, it supports twice the on-board memory—32 MB.

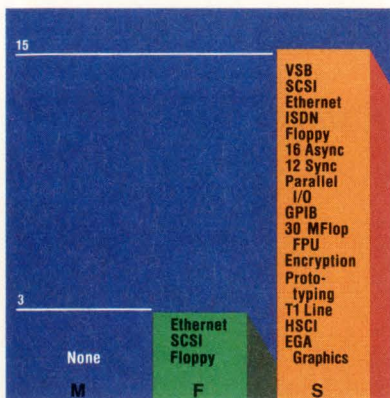

### I/O Modules

VSB  
SCSI  
Ethernet  
ISDN  
Floppy  
16 Async  
12 Sync  
Parallel  
I/O  
GPIB  
30 MFlop  
FPU  
Encryption  
Proto-  
typing  
T1 Line  
HSCI  
EGA  
Graphics

### I/O Modules

Synergy's EZ-Bus modules are compatible with our entire line of SBCs. This means Synergy's current line of 12 intelligent I/O modules are immediately available for the SV430—today. No other vendor comes close for selection, functionality or availability.

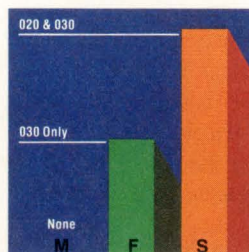

### '020/'030 Compatibility

Software compatibility between Synergy SBCs means users have simple upgrades to the SV430 from our '020 and

'030 SBCs. Force offers compatibility only from the '030 level, and Motorola offers "upward migration"—a polite phrase that means rewriting your code.

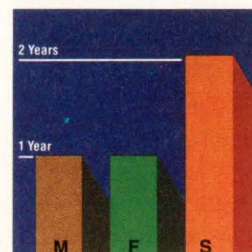

### Product Warranty

Synergy backs the reliability of its SBCs with a two year standard warranty. Force and Motorola only offer you one.

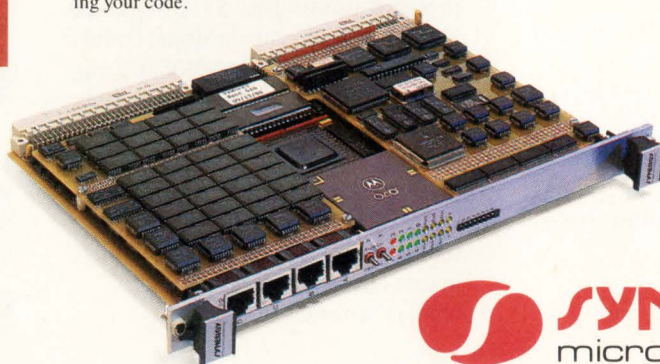

Data from Motorola MVME165 data sheet dated 2/90, and Force CPU-40 data sheet A1 Rev. 1. DRAM measurements shown are with parity. VMEbus transfers are to a 60ns slave.

VME64 is a trademark of Performance Technologies, Inc.

## Readers help themselves via EDN BBS

*My question is in reference to D Fletcher's design idea "PC printer port performs I/O" in the October 10, 1991, issue of EDN. The Turbo C listing does not include the definition of the function outportb(). Does anyone know what the definition could be?*

*Jim DeFilippis  
Boeing Computer Services  
Seattle, WA*

Reader Phil Hartman (KABL Radio, San Francisco, CA) replies via the EDN BBS: *outportb()* is included in *dos.h* in Turbo C. The function outputs a byte to argument "port". Another Turbo C function, *outport()*, outputs a whole word. I think this second function is similar to the Microsoft C function *outp()*.

Use the following C construct:

```
void outportb(int port, unsigned char
byte); /*int port=port address, un-
signed char=byte to be written out*/
```

Good luck.

## Achieving electromagnetic compatibility with Europe

*Where may we obtain copies of the CISPR and IEC standards, specifically CISPR-15, IEC-555, and IEC-801? The CISPR and IEC standards were mentioned in your excellent article "European EMC Regulations: Europe lays down EMC law" in the September 16, 1991, issue of EDN.*

*J Ned Chatham  
The Ripley Corp  
Ripley, OH*

European Technical Editor Brian Ker-ridge wrote the article you allude to and supplied the following UK and US sources for the EMC (Electromagnetic Compatibility) standards:

BSI Sales  
Linford Wood  
Milton Keynes MK14 6LE, UK  
(908) 221166  
FAX (908) 322484

American National Standards Institute  
11 W 42nd St  
New York, NY 10036  
(212) 642-4400  
FAX (212) 302-1286

See **Table 1** for expanded information about the CISPR (International Special Committee on Radio Interference (from its title in French)) and IEC (International Electrotechnical Commission) standards you seek.

## Readers come through

About half a dozen readers wrote or faxed in response to the "Orphaned meter needs new LCD" question in the November 7, 1991, issue of EDN. The LCD in question was and still is manufactured by LXD Inc, which makes standard and custom LCDs.

LXD Inc  
7650 First Pl  
Oakwood Village, OH 44146  
(216) 786-8700  
FAX (216) 786-8711

Thanks also go to David Hadaway (D B Systems, Ringe Center, NH), who offered his manual for the ECD 100 meter, which is the predecessor of Mr Edester's Doric 130A, and to A Tony Maluta, who has a complete Doric 130A for Mr Edester.

And last but not least, Jan Piet de Vries (Hydra-Electronic, Emmen, The Netherlands) dug up hundreds of the NE544 servo decoder drivers that Keith Gutierrez requested in the July 18, 1991, issue.

## Justify this calculation

*For tolerance stack-up analysis, we usually do a root-mean-square calculation using the maximum possible error of each component. In talking to engineers at other companies, we find that this seems to be a common way of doing an analysis. Unfortunately, no one has been able to supply the theoretical justification. We would appreciate any references that would let us defend this technique or that would provide a better method.*

*Gary Altman  
Project Director  
Sea MED Corp  
Bothell, WA*

We think you are referring to root-sum-squared (the square root of the sum of the squares), not root-mean-square, calculations. Regardless, we do not in fact know the theoretical justification of the technique or whether a better technique exists. If any reader has such information, let us know.

## Scan EDN BBS for FFTs

*I'm looking for a fast Fourier transformation written in Quick Basic. Are you aware of a such a program listing or shareware version?*

*W Schwartz  
Brissard, France*

Log onto the EDN Bulletin Board System ((617) 558-4241, 300/1200/2400/9600, 8,N,1) and check out the /DSP and /misc Special Interest Groups. We have a variety of Basic and C FFTs.

**Table 1—Selected European EMC standards**

Standard		Subject	Price	
CISPR 15		Lighting equipment	£62.43	\$50
IEC 555	Part 1	Definitions	£29.38	\$32
	Part 2	Harmonics	£39.10	\$58
	Part 3	Voltage fluctuations	£81.16	\$58
IEC 801	Part 1	General introduction	£14.68	\$18
	Part 2	Electrostatic discharge	£71.71	\$66
	Part 3	Radiated electromagnetic field	£51.84	\$58
	Part 4	Fast transients	£51.81	\$63
	(draft) Part 5	Surges	£8	\$28
	(draft) Part 6	Conducted >9 kHz	£8	\$32

Ask EDN solves nagging design problems and answers difficult questions. Address your letters to Ask EDN, 275 Washington St, Newton, MA 02158. FAX (617) 558-4470; MCI: EDNBOS. Or send us a letter on EDN's bulletin-board system at (617) 558-4241: From the Main System Menu, enter SS/ASK\_EDN and select W to write us a letter.

# POWER SPLITTERS/ COMBINERS

the world's largest selection  
2KHz to 8GHz from \$4<sup>95</sup>

With over 300 models, from 2-way to 48-way, 0°, 90° and 180°, a variety of pin and connector packages, 50 and 75 ohm, covering 2KHz to 8000MHz, Mini-Circuits offers the world's largest selection of off-the-shelf power splitter/combiners. So why compromise your systems design when you can select the power splitter/combiner that closely matches your specific package and frequency band requirements at lowest cost and with immediate delivery.

And we will handle your "special" needs, such as wider bandwidth, higher isolation, intermixed connectors, etc. courteously with rapid turnaround time.

Of course, all units come with our one-year guarantee. Unprecedented 4.5 sigma unit-to-unit repeatability also guaranteed, meaning units ordered today or next year will provide performance identical to those delivered last year.

For detailed specs and performance data, refer to the MicroWaves Product Directory, EEM or Mini-Circuits RF/IF Signal Processing Handbook, Vol. II. Or contact us for our free 68-page RF/IF Signal Processing Guide.

finding new ways ...  
setting higher standards

## Mini-Circuits

A Division of Scientific Components Corporation  
P.O. Box 350166, Brooklyn, New York 11235-0003 (718) 934-4500  
Fax (718) 332-4661 Domestic and International Telexes: 6852844 or 620156

CIRCLE NO. 61



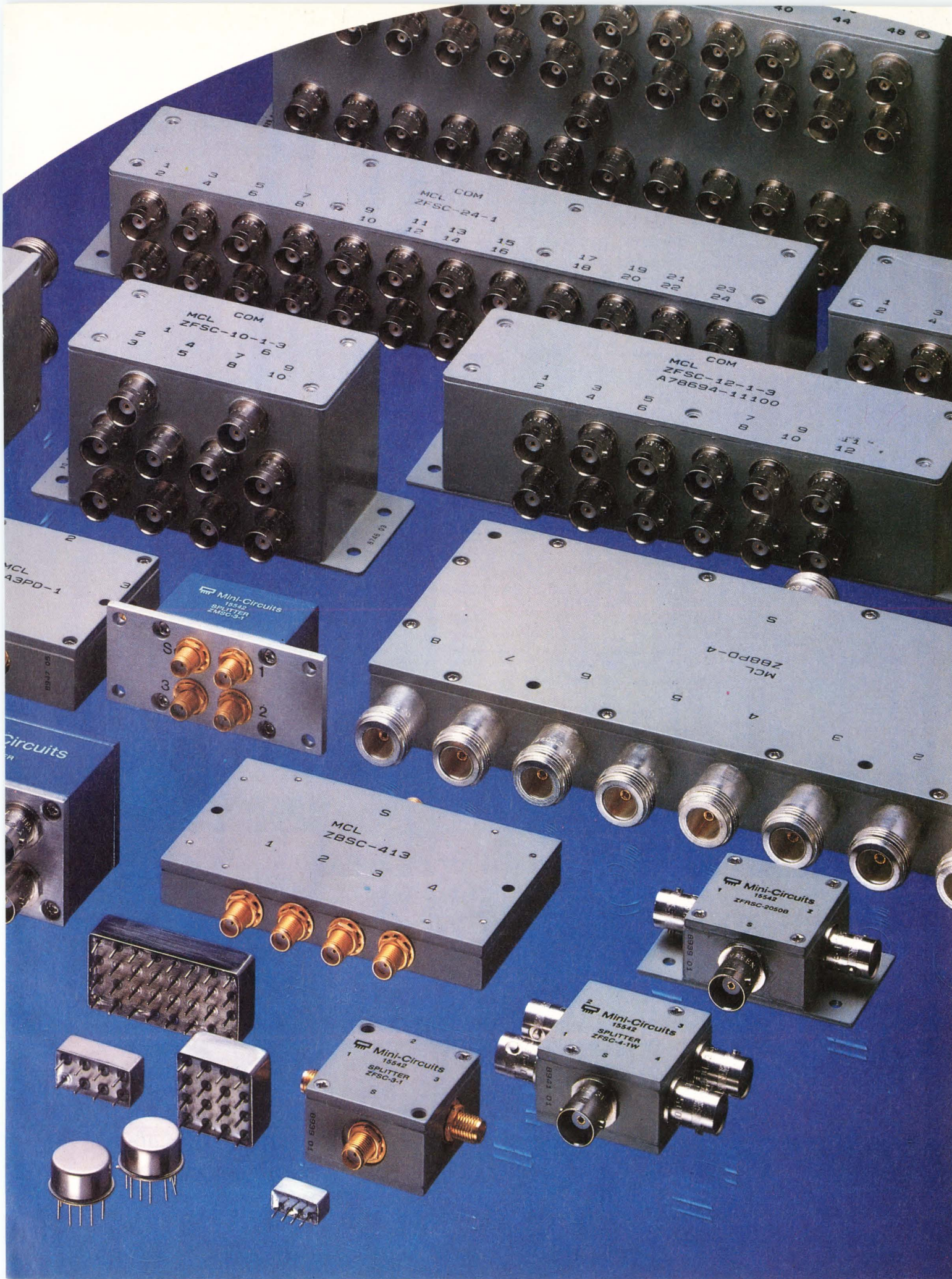

*.050 centerline stackers.  
Close, closer, closest.*

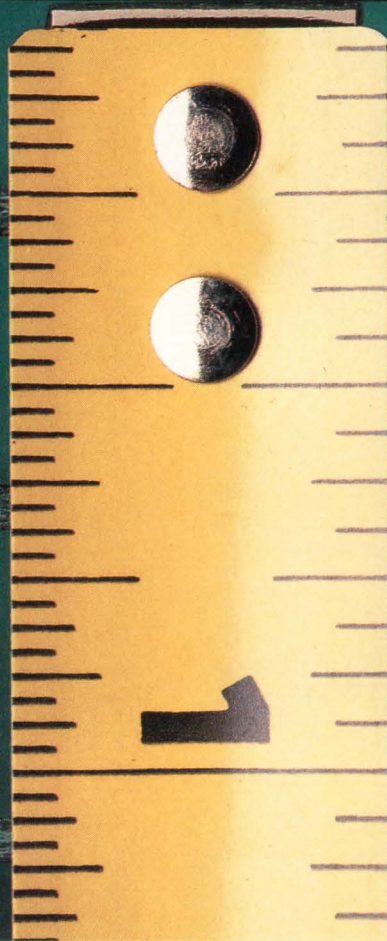

***THIS IS AMP TODAY.***

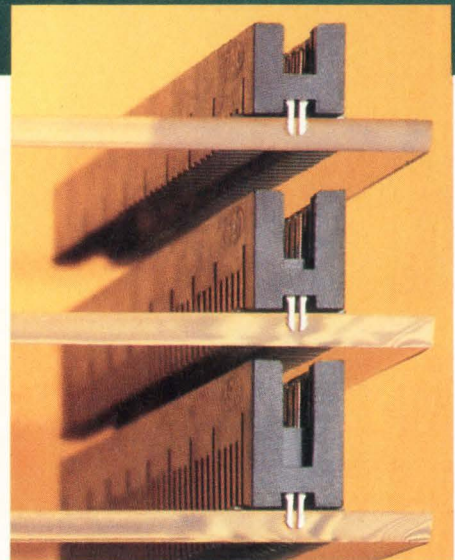

*Surface-mount stack heights: .250" / .320" / .390"*



AMPMODU 50/50 Grid Connectors give you a choice of parallel pcb stack heights: .390", .320", and a very close .250" (the tightest in the industry). So you can squeeze everything possible out of (or into) your design.

This surface-mount system utilizes a .050" contact grid in double row, polarized shrouded headers and receptacles, and offers our exclusive plated copper alloy holddowns. On standard .062" thick boards, the

barbed holddowns do their job without protruding through, allowing surface mounting on both sides. And holddowns are soldered during reflow, providing long-term strain relief.

Dual-beam receptacle contacts and duplex gold plating provide high reliability, in selected sizes from 10 to 100 positions. Dimensional tolerances, reference datums, holddown characteristics, and packaging support robotic application; materials are fully

compatible with IR and vapor phase reflow processing.

Ask us for more information on the AMPMODU 50/50 Grid Surface-Mount Connector System. Call the AMP Product Information Center at 1-800-522-6752 (fax 717-986-7575). In Canada call 416-475-6222. AMP Incorporated, Harrisburg, PA 17105-3608.

# AMP

# Whether it's 57 varieties, 31 flavors, 80 you know a leader by the

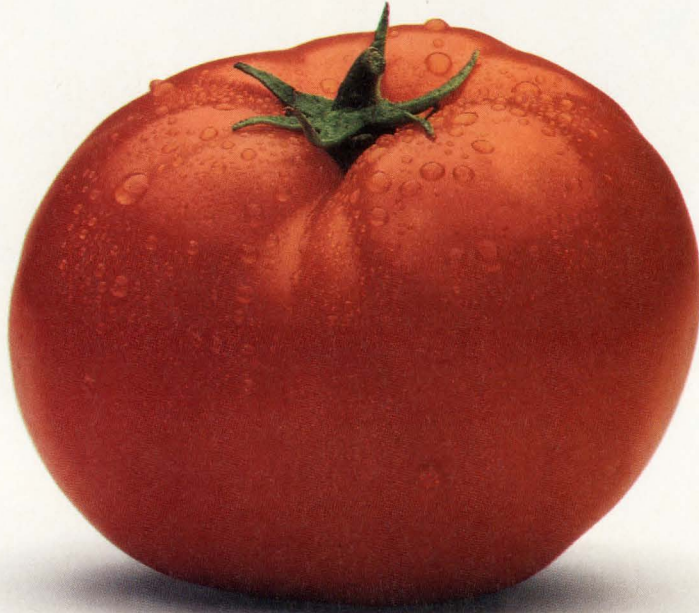

There is only one company that offers you a choice of more monolithic sampling analog-to-digital converters – 35 in all – than anyone else. Analog Devices.

But what makes us the leader isn't just the breadth of our product line. It is also its depth. For no other line of sampling ADCs encompasses a wider range of specs. A range that virtually guarantees we have the exact part for your specific application. Making it far easier for you to complete your design.

Incorporating a sample/hold front end onto an a/d converter is just one more example of our



# billion served, or 35 sampling ADCs, breadth of its product line.

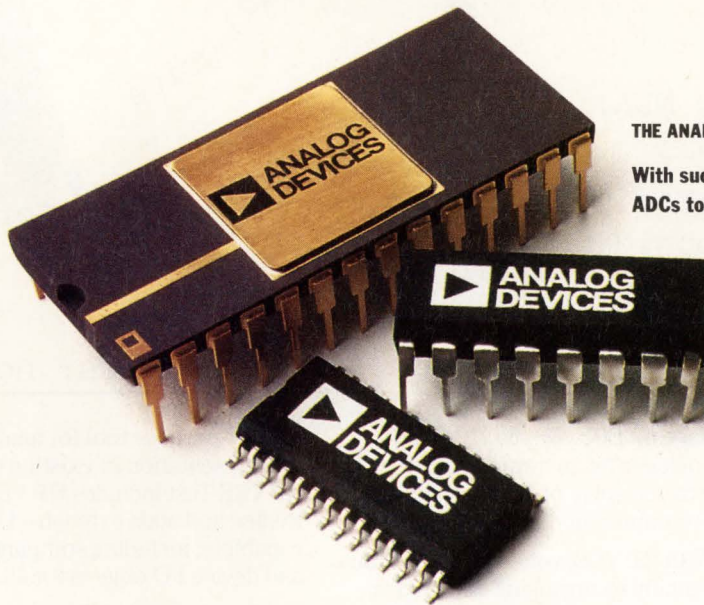

#### THE ANALOG FAMILY OF SAMPLING ADCs

With such a broad selection of sampling ADCs to choose from, you can find the exact part for your design.

For example, our family offers parts from 8 to 16 bits, from 50 kSPS to 1.25 MSPS, and some with up to 8 input channels. All low cost and easy to use.

expertise at integrating high-performance analog and digital circuitry on the same IC. And it is this same expertise that has made us the acknowledged leader in advanced mixed-signal technology.

So before you even think about beginning your next design, give us a call at 1-800-262-5643. Or write to us at the address below. We'll gladly send you a free copy of our complete monolithic sampling ADC guide.

It isn't very edible, but it does make for very tasteful reading.



# Finally, engineering software that clears the way to problem solving without programming.

```

void service(eid)
int eid;
{ int stat, byte;
/*serial pollinst
byte=hpib_spoll(ex
if ( (byte<0) !
printf("SRQ Problem
return; }
stat=my_read(eid, DVM_
if (stat>0) {
buffy[stat] = '\0';
printf("Data from instrument:
else printf("I/O read error\n");
return; )
main()
int busid, stat, MTA, MLA;
char command[MAXCHARS];
busid=open("/dev/hpib7", O_RDWR); /* open raw HP-IB
MTA=hpib_bus_status(busid, CURRENT_BUS_ADDRESS) + 64;
MLA=hpib_bus_status(busid, CURRENT_BUS_ADDRESS) + 32;
stat = BUTTON_BIT ;
sprintf(command, "KM%02o", stat); /* 2 octal digits; no
    
```

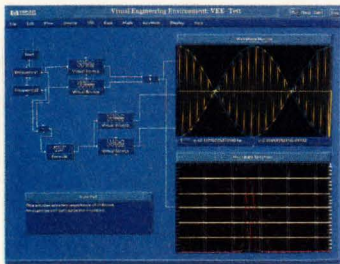
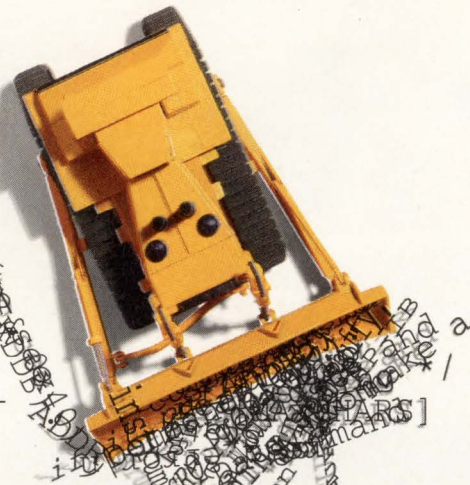

## With HP VEE, you simply link the icons.

Computers are great for problem solving, if only programming didn't get in the way and slow you down. And now, it doesn't

have to. Because the HP visual engineering environment (HP VEE) lets you solve problems without programming.

With HP VEE, you explore solutions visually by arranging and linking icons on the CRT. Each icon represents and executes a specific function for data collection, analysis—from simple mathematics to complex algorithms—and presentation. You don't have to write a single line of code.

There are two HP VEE software packages for prototyping, experimentation, and problem modeling. HP VEE-Engine, at \$995\*, is a

general-purpose tool for analysis and presentation of existing data. HP VEE-Test includes HP VEE-Engine and adds extensive I/O capability, including soft panels and device I/O objects for \$5,000\*.

So, if programming is keeping you from solutions, call **1-800-452-4844**.\*\* Ask for Ext. 2380, and we'll send you a brochure on clearing the way with HP VEE.

There is a better way.



\* U.S. list prices.  
\*\* In Canada call 1-800-387-3867, Dept. 430.

## You've got to have fun



When my brother Chris was a youngster, Mom or Dad would prod him to break away from his hobbies and other interests so he could do homework or chores. Chris would reply, "Gee, a guy's got to have a little fun around here." Even though the electronics industry is still in the doldrums, that's pretty good advice for today, too. With companies fighting for survival, it's not easy for many of us to have a little—or any—fun. Also, with many engineers out of work, life can be a lot less than fun. But fun remains an important goal for most of us.

I've always thought that without some fun, a job just isn't worth having. I'm not saying that all jobs should be a laugh a minute. Many seemingly dull and boring jobs still offer a measure of fun, and that's why people keep doing them. Perhaps that fun comes from the people we meet and know on the job, or even from some of the small things we do—things that aren't part of our main job.

Some people I know seem to have a great deal of fun with their jobs. Jim Williams at Linear Technology sent me a copy of his company's Application Note 45 (June 1991), "Measurement and control circuit collection." The note starts off, "During my wife's pregnancy, I wondered what life would really be like when the baby was finally born." If that sentence didn't make readers do a double take, the circuits inside the app note must have.

Symbols of baby bottles accompany each circuit diagram. It seems that Jim and his newborn son Michael did circuit design in the middle of the night while Michael was guzzling bottles of baby formula. Jim assigned the circuits "bottles of merit" according to how many feedings it took to complete a circuit. The circuits range from a 1-bottle current source to a 48-bottle fluorescent-lamp power supply. There's even a picture on the app note's back page showing Michael propped up on his Dad's ancient oscilloscope. It sounds like Jim is having fun, although I don't envy him those midnight feedings.

Not everyone can have Jim's type of fun, and many people take and keep jobs simply because they have to. No fun there. Nonetheless, looking for the fun in a job and striving to get enjoyment out of what we do should be on everyone's list of goals. Without a little fun at work, we'd all go insane—or look for new jobs.

Some people think that being a magazine editor is fun. After all, we get to meet interesting people, write about neat things, and hear from readers. We also get to be among the first to know about new products and technologies. Sometimes we even get to try out new products before they reach the market. But to me, the most fun is working with interesting colleagues and coworkers. Coming up with ideas for editorials isn't always fun, but you can mark this one with two cups of black coffee.



Jesse H. Neal  
Editorial Achievement Awards  
1990 Certificate, Best Editorial  
1990 Certificate, Best Series  
1987, 1981 (2), 1978 (2),  
1977, 1976, 1975

American Society of  
Business Press Editors Award  
1991, 1990, 1988, 1983, 1981

Jon Titus  
Editor

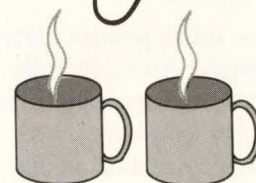

Send me your comments via FAX at (617) 558-4470, or on the EDN Bulletin Board System at (617) 558-4241 300/1200/2400, 8, N, 1.

# P-CAD Master Designer, the shortest distance from PCB design concept to reality.

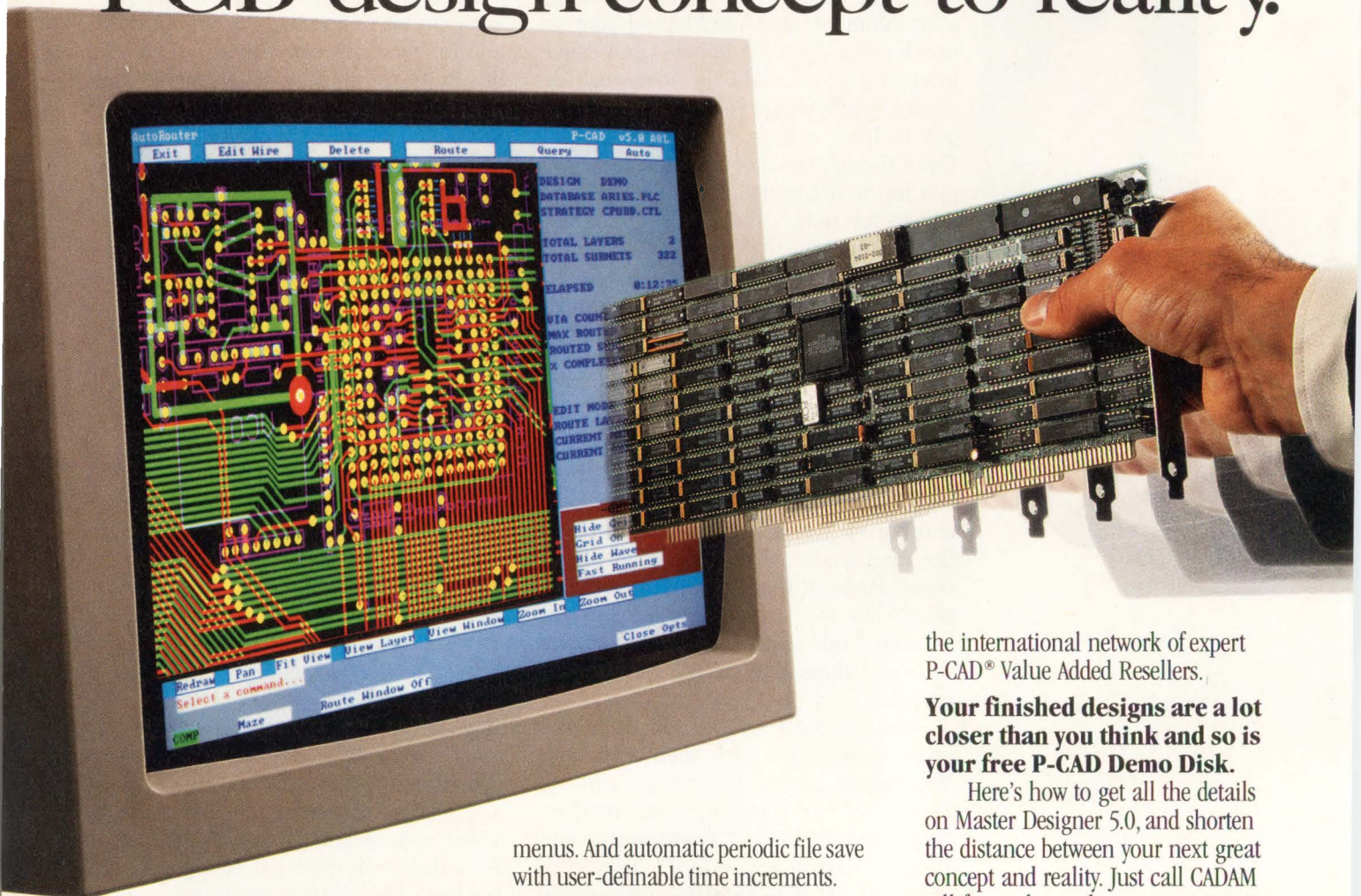

Master Designer™ 5.0 is the shortest distance from PCB design concept to reality. And the fastest, most productive and reliable way to get your designs to market using an IBM® or compatible PC.

And now Master Designer 5.0 has been enhanced with more than 100 new features, requested by PCB master design engineers like you.

### New features, more productivity.

Master Designer 5.0 shortens the entire design cycle with new features like extended memory for 4-times larger designs. Automatic real-time on-line design rule checking. User configurable

menus. And automatic periodic file save with user-definable time increments.

### First with 20,000 PCB designers.

You can rely on Master Designer 5.0 for the quality and dependability that has made it the choice of more than 20,000 PCB designers worldwide.

Master Designer 5.0 gives you the interactive support of Master Layout™ to handle surface mount, analog, and digital technology. The flexibility of Master Schematic™, fully automated optional Rip-n-Route, and our optional Master Placer™. Not to mention the plus of a consistent menu-driven interface.

With Master Designer 5.0, you're backed by CADAM, the world's leading CAD/CAM/CAE software supplier, and

the international network of expert P-CAD® Value Added Resellers.

**Your finished designs are a lot closer than you think and so is your free P-CAD Demo Disk.**

Here's how to get all the details on Master Designer 5.0, and shorten the distance between your next great concept and reality. Just call CADAM toll-free today and we'll send your free Master Designer 5.0 Demo Disk absolutely free.



**1-800-255-5710**



**CADAM**  
AN IBM COMPANY

*World Class PCB CAD Productivity*

IBM is a registered trademark of International Business Machines Corp. P-CAD is a registered trademark and Master Designer, Master Layout, Master Schematic, and Master Placer are trademarks of CADAM INC. CADAM INC., 1935 N. Buena Vista St., Burbank, CA 91504. ©1992 CADAM INC.

# Coilcraft

# Data Line

# Magnetics

Precision components for signal filtering,  
network interface and EMI reduction

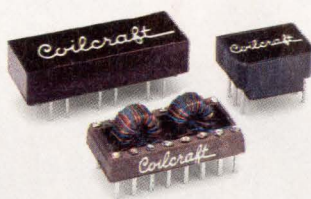

## LAN Transformers

We can provide everything from complete sets of 10BaseT interface magnetics to individual isolation transformers for Token Ring, StarLAN, Arcnet, Ethernet or compatibles. All have fast rise times, excellent common mode rejection and meet international safety requirements.

Call for free evaluation samples.

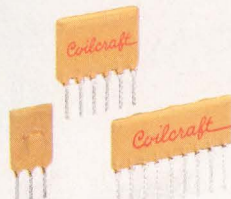

## LC Filter Networks

Choose from low, high, and bandpass filters in a variety of alignments. We offer 3, 5, or 7 pole filters in SIP, DIP or surface mount configurations. Plus our tight-tolerance chip inductors permit easy customization of cutoff frequency, rolloff, insertion loss, passband impedance, and delay.

Designer's Kit D102 contains 4 each of our 3, 5 and 7 pole low pass filters (18 MHz cutoff). \$50.

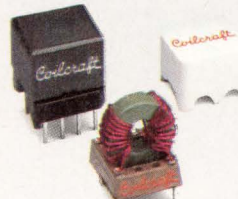

## Telecom Magnetics

Our family of telecommunications products includes transformers for T1, T3/DS-3, ISDN S and U Interface and impedance matching. They're compatible with most chip sets or we can customize to meet your specifications. We also offer common mode filters for "tip and ring" circuits.

Call for free evaluation samples.

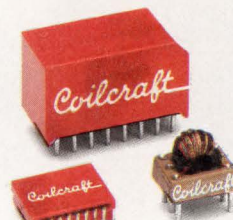

## EMI Filters

These board-mount filters virtually eliminate the problem of conducted EMI in data lines. They provide both differential and common mode noise attenuation from 1 MHz to over 500 MHz in a compact, easy to install package. Choose from 2, 3, 4 or 8-line versions, or we'll custom design parts to meet your specific EMC requirements.

Designer's Kit D101 contains 4 samples each of 2, 3, 4 and 8-line filters. \$65.

*Coilcraft*

**OEM / electronic engineers master** See our catalog in Vol. A, Section 1800

1102 Silver Lake Rd., Cary IL 60013 800/322-COIL Fax 708/639-1469

**Power  
tool**



# Power tools

## KEPCO TEST/BENCHTOP POWER SUPPLIES

The correct tool makes any job easier. Kepco's Power Supplies for workbench, for burn-in, and float-charging batteries are just some of the tools at your disposal.

For your workbench choose a multi-out array that you configure for the application by plugging-in modules with adjustable outputs. You can combine one, two or three modules in convenient bench-top housings or put six of them together in a rack. Other experimentalist power includes a nice selection of 100W single output instruments (MSK), a triple output logic-analog model (MPS), and burn-in/float chargers (TBC) that range from 300 to 3000 Watts in all the popular voltages.

Custom power assemblies allow you to create your own toolkit with just the selection of voltage and power to fit your need.

Other power tools from Kepco include: *ac power* to 18KVA, precision *programmable dc* for test applications, *high voltage* models and four-quadrant *bipolar power*. For these, and our broad selection of *switching power* models, including *d-c to d-c converters*, please ask for one of the three catalogs illustrated below.

SEE OUR PAGES IN VOLUME D

**cem**

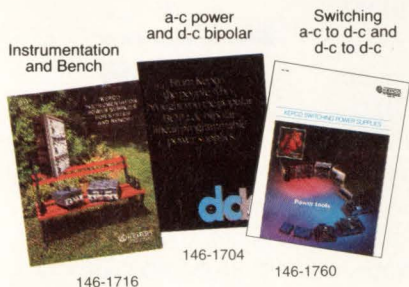

**NEW! Low-Cost...\$429**



### Keyboard controlled power

- 75 Watt voltage stabilizers.
- Linear design, microprocessor controlled.
- 0-12.5V, 6A; 0-25V, 3A; 0-40V, 2A; 0-125V, 0.5A.
- RS232 talk-listen.

**Kepco Group DPS Bench-top Power Supplies**

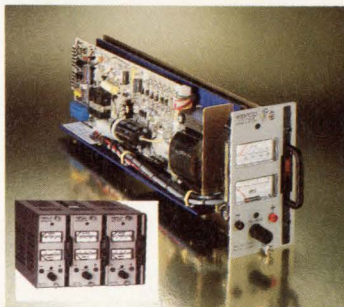

### Plug-in power

- 20 Watt modules, either voltage stabilizers (series PCX-MAT) or current stabilizers (series CC).
- Sized to plug-in six abreast in a 19" rack or in bench-top housings for 1, 2 or 3 units.
- Mix or match.
- Select from six voltage ranges up to 100V.

**Kepco Group PCX-MAT and CC Power Supplies**



### 100 Watts of precision benchtop power

- LCD meters to set the level accurately, a preview feature to check your setting before applying power to your load.
- Linear design for low-noise high stability.
- Ten-turn controls for good resolution.
- Five models offer outputs up to 125 Volts.

**Kepco Group MSK Power Supplies**



### A triple output design for maximum convenience

- 0-6V at 5A for logic and a tracked  $\pm$  0-20V, 1A for analog.
- Each output current limited, the 0-6V output has an overvoltage protector.

**Kepco Group MPS Power Supply**



### Battery/float-chargers

- For telecommunications: maintain 12V, 24V and 48V batteries, built-in equalize timer.
- For burn-in: power up to 3000 Watts, current limited, over-voltage protected. Two output settings, remotely selectable for margining.

**Kepco Group TBC Float Chargers/Power Supplies**

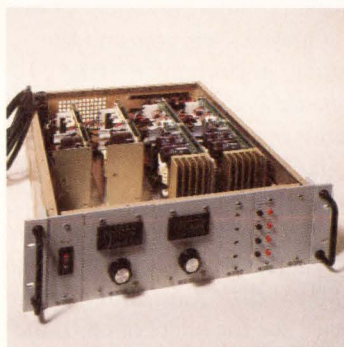

### Kepco Custom System Power Assemblies

We will stuff a 19" rack (5 1/4 or 7") full of switchers to your requirement. With modules from 3 Watts to 3000 Watts, in a wide selection of voltage ranges, we can accommodate most needs.

- LCD output meters.
- Test points.
- Pilots, trimmers, circuit breakers. Convenient 1/8 rack panel format allows multiple control and monitoring.

**Kepco Power Assemblies**

**CIRCLE NO. 29**

Call/fax/write to Dept. MPM-12 for any of our three catalogs.

**Kepco, Inc.**, 131-38 Sanford Avenue, Flushing, NY 11352 USA • Tel: (718) 461-7000 • Fax: (718) 767-1102 • Easylink (TWX): 710-582-2631  
**Eastern Region:** 131-38 Sanford Avenue, Flushing, NY 11352 USA • Tel: (718) 461-7000 • Fax: (718) 767-1102 • Easylink (TWX): 710-582-2631  
**Western Region:** 800 West Airport Freeway, Suite 320 LB 6018, Irving, TX 75062 USA • Tel: (214) 579-7746 • Fax: (214) 579-4608  
**Kepco Europe, Ltd.**, London, England: Salamander Quay West, Park Lane, Harefield, Middlesex UB9 6NZ • Tel: +44 895 825046 • Fax: +44 895 825045



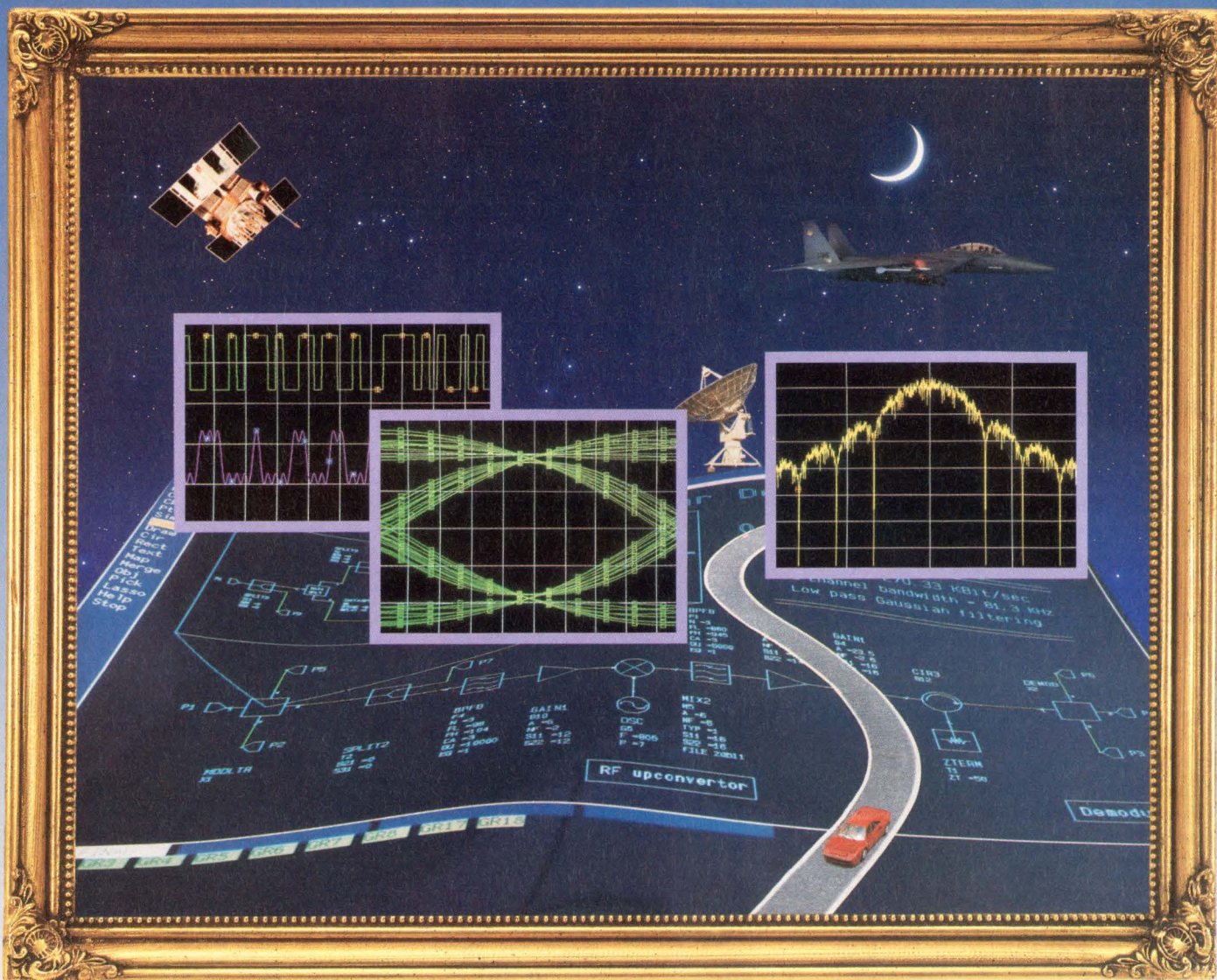

# Modulation-Domain Simulation Gives You the Big Picture.

## Introducing OmniSys Version 3.5.

Analyzing communication systems and complex modulated signals with the usual simulators? *Time-* and *frequency-*domain simulators like SPICE and harmonic balance are great, but circuit simulators don't give you the big picture. OmniSys®, EEsof's system simulator, gives you the new insight you need!

OmniSys lets you simulate system performance in the *modulation-domain* so you can see how your system will work with today's chirp, MSK, pi/4 DQPSK, and other complex modulated signals. Look at BER I-Q constellations, spectral regrowth, AM/PM distortion, and more. You'll see the effect of hardware trade-offs on your complete transmitter and receiver and you'll get your system to market faster without costly redesigns.

## See the Big Picture with OmniSys.

Contact us for literature at (800) 34-EESOF...or, if you prefer, by FAX at (818) 879-6462. In Europe, call (49) 8105-24005 or FAX (49) 8105-24000.



*Breaking the Barriers...*

# EEsof®



16-BIT- $\mu$ C EVALUATION BOARDSBoards let you try out  $\mu$ C architectures

RAY WEISS, Technical Editor

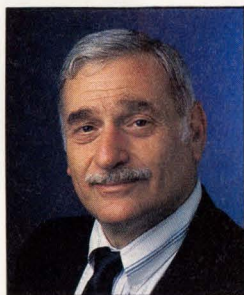

**The processor selection stakes are high. Even the odds: Get an evaluation system, run some code, fool around with the software tools, and try out the on-chip peripherals.**

The good news is that today's 16-bit microcontrollers ( $\mu$ Cs) are affordable for a wide range of embedded applications. The bad news is that it's easy to choose the wrong part. One way to stack the odds in your favor is to get real, hands-on experience with actual 16-bit  $\mu$ C hardware and software.

Evaluation systems—boards and development software—provide a quick means to try out and match a  $\mu$ C architecture and tool set against your application needs (Fig 1). These systems let you get a feel for a  $\mu$ C's instruction set and peripherals. You can write trial code to time key algorithms, test out on-chip timers, and judge the  $\mu$ C's overall effectiveness.

Many 8-bit-system designers are reluctant to make the move to 16-bit systems. Sixteen bits bring higher processing power, more memory addressing, and the ability to handle more complex

or integrated applications. But these benefits come at the expense of adapting a new architecture and development tools. Evaluation systems help ease this transition by giving developers a chance to get acquainted early with the  $\mu$ C and its tools.

## A diverse 16-bit world

The 16-bit-microcontroller world is diverse. Some  $\mu$ C families suit low-end applications; others suit larger, more complex applications. Some microcontrollers have as much as 62 kbytes of program ROM and can work in single-chip applications. Others take advantage of low-cost, high-density off-chip memory. Many of these  $\mu$ Cs have 64-kbyte banks and use bank switching to address 1 to 16 Mbytes of external memory.

First-generation 16-bit microcontrollers tend to be accumulator oriented;

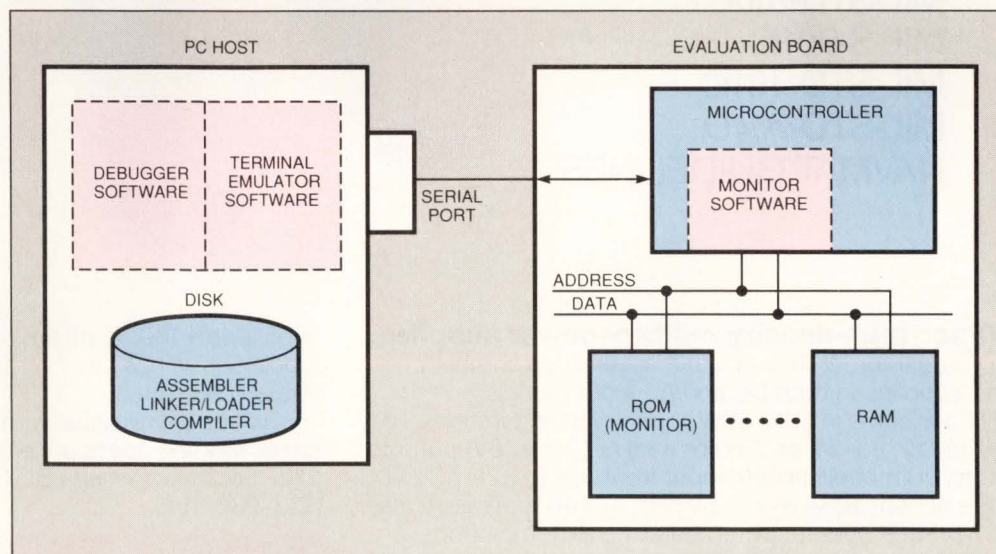

**Fig 1—**Most evaluation systems consist of an evaluation board with a serial link to a host PC. Users can control and monitor the evaluation-board  $\mu$ C by using a terminal-emulator program that works through a ROM monitor running in the  $\mu$ C.

**Actual size**

**Actual output**

20 WATTS

**Now AC to DC**

**Actually meets**

MIL-STD-2000  
MIL-STD-810C  
MIL-S-901C  
MIL-STD-461C  
MIL-STD-704D  
NAVMAT GUIDELINES

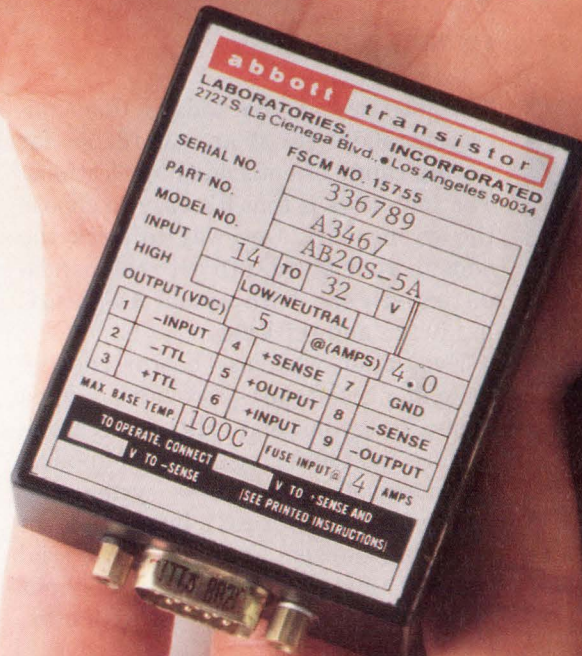

**Mil/Pac™ high-density military power supplies.**

Now you can order Abbott's full mil-qualified compact power supplies in both DC and AC input models.

Mil/Pacs come in 20W, 35W and 50W configurations, with single (5, 12, 15, 24, or 28V) or dual ( $\pm 12V$ ;  $\pm 15V$ ) outputs.

DC-to-DC models accept input from 14V to 32V. AC-to-DC models accept 103.4 to 126.5V rms, 47-440 Hz single phase.

All Mil/Pacs operate at temperature extremes from

-55°C to +100°C. All are designed with a field-proven topology that has been verified by rigorous environmental stress screening.

Mil/Pacs are available with or without MIL-STD-2000. Either way, the specs are worth reading. Just write us at 2727 South La Cienega Bl., Los Angeles, CA 90034. Or call (213) 936-8185.

**abbott**

**WHEN RELIABILITY IS IMPERATIVE.™**

## 16-BIT- $\mu$ C EVALUATION BOARDS

that is, they're designed around a small set of specific registers. In many of these chips, most I/O and data-movement operations must move through the accumulator, indexed by other registers. Second-generation 16-bit  $\mu$ Cs tend toward a set of general-purpose registers arranged in one or more register banks. Second-generation designs give users the advantage of more, easier-to-use registers and fast context switching between register banks.

Don't discount first-generation  $\mu$ Cs: Some are quite fast, and their minimal architectures keep die sizes and costs down. However, second-generation  $\mu$ Cs tend to be faster due to better real-estate usage and relatively recent design techniques such as pipelining.

This article covers seven 16-bit microcontroller architectures and their evaluation systems. Many of these systems were run and tested for this report. Although not quite as inexpensive as 8-bit- $\mu$ C evaluation systems, most 16-bit- $\mu$ C systems are fairly low cost. All but three of the systems in **Table 1** cost less than \$1000.

### Intel's 80C186 follows the PC

Many engineers have designed the 80186, the embedded version of the 8086, into their applications. A key advantage of the 80186 is the large software-tool and application base for Intel 808xx architectures.

The 80186 is half microcontroller and half microprocessor. Like a microprocessor, it relies on external memory and peripherals. But like a microcontroller, it has a timer, I/O port lines, and serial channels. Intel added programmable power management to the chip for low-power applications. The 186 is based on the classic 16-bit 80x86 architecture, which has a fixed register set of four general/index, four segment,

and four pointer registers. A 20-bit address serves the 1-Mbyte segmented address space.

You can develop and debug application code on a PC host and then download it to an embedded  $\mu$ C. A simulator is not needed to test code: The PC host's CPU core is the same as the 80186 core—a 386, for example, will execute 8086 code (in real mode). Thus, you can simply code for a PC. Additionally, a trend is emerging to embed the PC itself. Embedded DOS is available, and Microsoft's Flash Memory system can serve as a substitute for disk storage. Both products are available from Annabooks.

#### Intel 80C186EC

Clock speed	13, 16 MHz
Instruction cycle	240 nsec min
Multiply/divide	7.3/6.7 $\mu$ sec
Registers	4 data, 4 index/pointer, 4 segment, IP, status
Program memory	none
Data memory	none
Bus	multiplexed 20-/16-bit or 20-/8-bit address/data, 4-cycle read/write
Address space	1 Mbyte (segmented)
Interrupts	1 external
Serial ports	2 channel
I/O	22 lines
Timers	watchdog
Miscellaneous	4 DMA channels, clock generator, refresh controller
Package†	100-lead PLCC, PQFP
Price	\$17.70 (1000)

\*Ratings at selected clock rate.  
†PLCC=plastic leaded chip carrier; PQFP=plastic quad flatpack.

Intel's EV80C186EB is a compact evaluation board that includes a ROM-monitor and PC-host software. The monitor source code is supplied for you to modify. The package comes with runtime libraries for Microsoft C.

You can get PC-like interactivity by using Paradigm Systems' Locate and Debug packages for the evaluation board. These packages let you run PC C, C++, Pascal, and assembler code. You can debug the code using Paradigm's version of

Borland's Turbo Debugger. Using this software, you can interactively debug at the source-code level, as you would native PC code using Borland tools—the user environment is the same.

### Adding DSP to 16-bit $\mu$ Cs

National Semiconductor's HPC1600 is a 16-bit  $\mu$ C for high-speed applications. The register-based chip has an SP and a PC register and four 16-bit registers: A, B, X, and K (address boundary). Peripherals are memory mapped, and all transfers pass through the chip's main 16-bit bus. The  $\mu$ C has a 64-kbyte address space. On-chip program memory ranges from 0 to 8 kbytes of ROM and as much as 256 bytes of SRAM (static RAM).

Although a first-generation  $\mu$ C with a small set of registers, the HPC1600 delivers 100-nsec instruction cycles with a 40-MHz clock. The chip achieves that speed through the automatic extension of 8-bit values for 16-bit processing and an automatic increment/decrement for index registers speed the chip's performance. Also, instead of branch-and-test operators, many instructions have a built-in skip. When a data-move instruction's index passes a boundary condition, control skips the next instruction, thus providing a fast mechanism to terminate a loop.

National Semiconductor engineers further upped power by adding a DSP-like MAC (multiply-and-accumulate) unit to the  $\mu$ C. The MAC unit hangs on the main bus. It loads two 16-bit numbers, multiplies them, and accumulates the 32-bit signed result in nine clock cycles (450 nsec).

National Semiconductor's evaluation systems for the HPC1600 start with the HPC Designer Kit. The kit is built around an evaluation

*Text continued on pg 46*

## 16-BIT- $\mu$ C EVALUATION BOARDS

### Table 1—Representative 16-bit- $\mu$ C evaluation boards

Board vendor	Microcontroller	Board		Price	Comments	Circle number
		Hardware	Software			
<b>AT&amp;T Microelectronics</b> 555 Union Blvd Allentown, PA 18103 (800) 372-2447	DSP16A 30 MHz 8-kbyte ROM 4-kbyte RAM	DSP16A-BD-EVAL		\$2200	Board runs on PC/AT bus. Window-based debugger; utilities link host C code to DSP board.	659
		PC/XT plug-in board 32-kbyte program RAM sigma-delta codec 8-kbyte dual-port RAM, 128-kbyte RAM	Assembler linker/loader windowed debugger			
<b>Forth System</b> Box 1103 D-7814 Breisach AM Rhein Germany	<b>Siemens</b> SAB80C166 20 MHz 1-kbyte SRAM 32-kbyte ROM	Modunorm 80C166		\$399	Surface-mount evaluation and application board. Requires simple bread-board circuit to link to PC host. EPROM set costs \$100.	660
		As much as 192-kbyte EPROM wrapped-wire area 64-kbyte RAM real-time clock battery backup	Assembler (from Siemens) Swiss-Forth (\$2950)			
<b>Hitachi America Ltd</b> Semiconductor & IC Div 2000 Sierra Point Pkwy Brisbane, CA 94005 (415) 589-8300 FAX (415) 583-4207	H8/325 10 MHz 32-kbyte PROM/ROM 1-kbyte SRAM	H8/325 EVB		\$415	Has a 28-pin programming adapter (can program $\mu$ C as EPROM). Can interface to both terminal and host CPU. Uses Microtek X-ray debugger and Motorola S file format.	661
		64-kbyte EPROM 32-kbyte SRAM dual UART 6-LED display EPROM program adapter	Line assembler/ disassembler ROM monitor terminal emulator C compiler optional linker/loader assembler available X-ray debugger interface			
<b>Intel Corp</b> Embedded Processor Group 5000 W Chandler Blvd Chandler, AZ 85226 (602) 554-2649	87C196KR 16 MHz 16-kbyte EPROM 744-byte RAM UART port	EV80C196		\$390	Has software for peripherals and porting 8051 assembly code for the 196. Has 2 single-step modes and flexible memory configuration to match application (8, 16 bits, multiple wait states).	662
		Uses on-chip EPROM precision ADC configurable board (EPLD)	Line assembler/ disassembler ROM-monitor host interface assembler, C compiler available			
	80C186EA 16 MHz 2 DMA channels	EV80C186EA/XL		\$400	Can add as much as 512 kbytes of DRAM using an expansion bus. Board has digital I/O: status port, LED block, 4-bit port to define board parameters.	663
		32-kbyte EPROM (with monitor) 32-kbyte SRAM 512-kbyte DRAM (expansion) configurable board (EPLD) socketed for 80C187	ROM-monitor host interface C assemblers available can use PC software			
<b>International Microsystems Inc</b> 621 Valley Way Milpitas, CA 95035 (408) 942-1001 FAX (408) 942-1051	<b>Toshiba TMP68303F</b> 16 MHz	SBC303		\$495	Has memory-expansion connector with sample code. Emulator board for ICE optional.	664
		128 kbytes to 2 Mbytes EPROM 256 to 512 kbytes SRAM 512 kbytes to 8 Mbytes DRAM 3 serial, 1 parallel ports clock/calendar flash-EPROM programmer	monitor line assembler disassembler			
<b>Motorola</b> Microprocessor Products Group 6501 William Cannon Dr W Austin, TX 78735 (512) 440-2000	68HC16Z1 16 MHz 1-kbyte SRAM	M68HC16Z1 EVB		\$168 (1st quarter of 1992)	Has integrated assembler, monitor, debugger. Windowed development tools. Full set of software including a Quickstart set of application routines. Each port has its own easy-to-use header.	665
		64-kbyte SRAM (or EPROM) 64-kbyte SRAM (not populated) UART sockets for $\mu$ P ports wrapped-wire area	Assembler/disassembler monitor symbolic debugger real-time kernel filter-design package floating-point software			
	68302 20 MHz	M68302ADS		\$2800 board, \$500 interface card, \$700 cable, \$4000 total	Comes with software support package for developing communications software. Has protocol modules for OSI layer 2 (LAPB/D), 3 (X.25) protocols.	666
		256-kbyte EPROM 500-kbyte DRAM 2-kbyte EEPROM (socket for 500-kbyte DRAM) optional emulation cable	Uses existing 68000 tools event-driven OS chip driver communications software monitor			

# EDN-TECHNOLOGY UPDATE

Board vendor	Microcontroller	Board		Price	Comments	Circle number
		Hardware	Software			
Motorola <i>continued</i>	DSP56156 40 MHz 4-kbyte ROM 4-kbyte SRAM	DSP5615 ADS		\$3000	Has 2-board development system: interface board (PCs, Macintoshes, Sun workstations) and stand-alone evaluation board. ICE-like debugger uses on-chip emulation features. Assembler/linker/simulator option (\$495).	667
			Assembler linker/loader monitor terminal emulator disassembler assembler/linker/simulator			
National Semiconductor Corp 2900 Semiconductor Dr Santa Clara, CA 95051 (408) 721-5000 FAX (408) 730-0764	HPC16003/83 30 MHz 8-kbyte ROM 256-byte RAM	HPC Designer Kit		\$950	Board comes with C compiler limited to 3 kbytes of code; full C compiler optional. Board can be used to emulate target $\mu$ C. System handles as many as 1000 lines of code. Board has emulation plug for 32-pin EPROM socket.	668
		8-kbyte overlay RAM 32-kbyte ROM monitor as much as 64-kbyte RAM target emulation cable	Assembler linker/loader monitor host interface C compiler (limited) function library			
	HPC46100 40 MHz 1-kbyte RAM	HPC+ Development Kit		\$950	16-bit $\mu$ C with DSP capabilities. Kit includes target board, test board, and ROM emulator. Logic-analyzer interface for real-time trace.	669
		64-kbyte RAM on logic-analyzer-interface board, 64-kbyte RAM on evaluation board	Assembler linker/loader monitor host interface disassembler library			
NEC Electronics Inc 401 Ellis St Mountain View, CA 94039 (415) 960-6000 FAX (800) 729-9288	$\mu$ PD78334 16 MHz 32-kbyte EPROM 768-byte SRAM	EB-78K334-PC		\$595	The evaluation board can be used as an ICE for applications using on-chip memory. An optional emulation plug plugs into target socket.	670
		32-kbyte SRAM 32-kbyte EPROM ROM programmer	Assembler linker/loader monitor terminal emulator source debugger C compiler			
Oki Semiconductor Inc 650 N Mary Ave Sunnyvale, CA 94086 (408) 720-1900	67620	EVA67K		\$450	The 67620 is a 200-nsec, 16-bit, second-generation $\mu$ C and has two 8-bit and three 16-bit timers and a 64-kbyte address space.	671
		64-kbyte SRAM 512-kbyte video RAM	Assembler linker/loader librarian debugger (C and assembly) C compiler available			
Siemens Components Inc Semiconductor Group 2191 Laurelwood Rd Santa Clara, CA 95054	SAB80C166 20 MHz 32-kbyte ROM 1-kbyte SRAM	EVA-166		\$450	All chip pins to DIN connector. Can add expansion board, to 256 kbytes.	672
		4-kbyte EPROM (with monitor) 64-kbyte RAM wrapped-wire area	Line assembler terminal emulator monitor			
Signetics (Phillips Components) 811 E Arques Ave Sunnyvale, CA 94088 (408) 991-2000 FAX (408) 991-2311	SCC6870 10 MHz 4-kbyte ROM 256-byte RAM SCC66470B	SM68070 SK		\$695	This board is a complete video-frame-grabber system. It handles 640x240-pixel screens with 16 colors/pixel and drives TV/monitor RGB signals.	673
		256-kbyte ROM/EPROM 512-kbyte RAM I <sup>2</sup> C serial port color-monitor interface video-system controller wrapped-wire area	Assembler/disassembler loader monitor symbolic debugger			
Texas Instruments Inc Box 1443 MS 719 Houston, TX 77251 (713) 274-2000 FAX (713) 274-2445	TMS320C16 35 MHz 16-kbyte ROM 512-byte RAM	TMS320C16 EVM		\$995	PC/AT plug-in board. Acts as coprocessor to PC host.	674
		128-kbyte RAM PC/AT half card analog interface optional	Assembler disassembler linker/loader symbolic debugger			

Notes: 1. DRAM=dynamic RAM; ICE=in-circuit emulator; SRAM=static RAM.

2. For more information on the 16-bit- $\mu$ C evaluation boards listed in this table, circle the appropriate numbers on the Information Retrieval Service card or use EDN's Express Request service.

## 16-BIT- $\mu$ C EVALUATION BOARDS

module that has an HPC1600  $\mu$ C and 62 kbytes of EPROM for program test. The kit includes a cable for emulating target  $\mu$ Cs, a monitor, host-interface software, an assembler, and a limited C compiler. (A full C compiler is an option.)

### National Semiconductor HPC46100

Clock speed . . . . . 20, 30, 40\* MHz  
 Instruction cycle . . . . . 100 nsec typ  
 Multiply/divide . . . . . 4 1.5/1.5  $\mu$ sec,  
 450-ns MAC cycle  
 Registers . . . . . A, B, X, K, SP, PC  
 Program memory . . . . . off chip  
 Data memory . . . . . 1-kbyte SRAM (banks,  
 stack), 128-byte EEPROM  
 Bus . . . . . 16-/16-bit or 16-/8-bit address/data  
 Address space . . . . . 64-kbyte instructions/data  
 Special feature . . . . . 32-/16-bit DSP MAC unit  
 Interrupts . . . . . 3 external  
 Serial ports . . . . . 3 UARTS, Microwire +  
 (serial network bus)  
 I/O . . . . . 51 lines  
 Timers . . . . . seven 16-bit (with watchdog)  
 Miscellaneous . . . . . 8-channel, 8-bit ADC; PWM  
 Package† . . . . . 80-pin QFP  
 Price . . . . . \$16.44 (10,000)

\*Ratings at selected clock rate.  
 †QFP = quad flatpack.

The HPC+ Development Kit includes an evaluation module and an emulation board. The board plugs directly into a target system's EPROM socket and emulates the target-board ROM with easy-to-change SRAM. The kit also has an interface for the Hewlett-Packard 1650/16500 logic analyzer for solving hard-to-test problems.

## K3 bridges 8- and 16-bit worlds

The NEC K3  $\mu$ C bridges the gap between the 8- and 16-bit worlds. The  $\mu$ C has a 16-bit ALU, but relies on an 8-bit, 8085-like external bus. The chip is organized around banks of 16 general-purpose 8-bit registers or eight 16-bit registers. Programs can address as much as 64 kbytes of instructions and data in a single address space. The  $\mu$ C holds 32 kbytes of instructions and 1 kbyte of data on chip.

The K3 provides three interrupt handling methods: the standard vectored-interrupt method, context switching, and Macroservice. In the first method, interrupt processing transfers to the code the interrupt-vector-table entry references for that interrupt. In the second, the active register bank changes to the bank specified by the interrupt-table entry; each bank includes a program-counter value. And in the third method, hardware performs programmed functions on a cycle-stealing basis. The hardware moves data blocks and checks and modifies data without interrupting or using the CPU.

### NEC K3 $\mu$ PD78334

Clock speed . . . . . 12, 16\* MHz  
 Instruction cycle . . . . . 250 nsec min  
 Multiply/divide . . . . . 1.2/4.8  $\mu$ sec  
 Registers . . . . . eight 16 bit (8 banks)  
 Program memory . . . . . 8-/32-kbyte EPROM/  
 ROM  
 Data memory . . . . . 768-byte SRAM  
 Bus . . . . . 16-/8-bit address/data (8085)  
 Address space . . . . . 64 kbytes  
 Interrupts . . . . . 3 hardware (0.4  $\mu$ sec)  
 Serial ports . . . . . 46  
 I/O . . . . . 48 lines  
 Timers . . . . . watchdog, two 16 bit,  
 two 16-bit up/down counters  
 Miscellaneous . . . . . 8-channel, 10-bit ADC;  
 dedicated memory-expansion chip  
 Package† . . . . . 84-/94-pin PLCC/QFP  
 Price . . . . . \$15.15 (10,000) with ROM

\*Ratings at selected clock rate.  
 †PLCC=plastic leaded chip carrier; QFP = quad flatpack.

NEC has simplified assembly-language processing for its microcontrollers, which have a structured assembler. Essentially, a preprocessor enables programmers to use higher-level control structures for looping, case select (switch), incrementing, and decrementing. The preprocessor converts these higher-level statements to assembly language prior to assembly.

The NEC EB-78330 evaluation board holds 32 kbytes of SRAM for program and data. The board comes with a monitor and a symbolic de-

bugger. A terminal emulator lets users download, query, and control application code running in the board's K3  $\mu$ C under the monitor. The monitor lets you set up as many as four parallel, complex-instruction breakpoints. An optional emulation pod plugs into a target board for single-chip applications. The pod functions as an ICE (in-circuit emulator) by controlling target execution.

## Motorola adds DSP to 16-bit $\mu$ C

Motorola's new 16-bit  $\mu$ C, the 68HC16, provides an easy upgrade path for 16-bit processing: The chip is upwardly compatible with the company's popular 68HC11 8-bit microcontroller. The 16-bit chip follows the older accumulator-based architecture, but it has two accumulators and three index registers, compared with the 68HC11's single accumulator and two index registers. Unlike the earlier 8-bit  $\mu$ C, the initial 68HC16Z1 chip isn't for single-chip applications: It has only 1 kbyte of SRAM. Future releases will have on-chip ROM or EEPROM.

The 68HC16 is more than just a 16-bit extension to the 68HC11: It includes a DSP MAC unit as well as two 16-bit multiply registers and a 35-bit result register. Additionally, the 68HC16 uses peripherals Motorola developed for its 683xx family of 16- and 32-bit  $\mu$ Cs. These peripherals include a serial controller, a general-purpose timer, and a system-integration module for I/O. The peripherals are linked to the CPU via an intermodule bus.

The 68HC16Z1 evaluation module is a compact, well-designed board. It has a prototyping area and headers for each of the  $\mu$ C's ports. This module stands out in the amount and range of software bundled with it. The board has an integrated assembler, editor, windowed debugger (MASM); a ROM

# CONDITIONED "FRONT END" POWER

## RUGGED AC-DC OFF LINE SOURCES



**AC INPUTS**  
1 $\phi$  and 3 $\phi$  available

**NEW**

### PB Series

**IDEAL FOR USE  
WITH DISTRIBUTED POWER  
DC-DC CONVERTERS AND SYSTEMS**

Features include 600 watt low profile 2" high package; lightweight, unpotted designs; environmental performance to Mil-Std-810D; -55°C to +85°C operation without derating; extended MTBF greater than 350,000 hours...

Call **toll free** for additional technical information and application assistance **1-800-421-8181** (in California 805/484-4221)

- True N+1 current sharing for loads to kilowatts.
- .99 power factor correction—provides 25% more usable power with low harmonic distortion.
- Line isolation/EMI suppression to D0160B and Mil-Std-461 (including CE01, CE03, RE02).
- Surge/spike protection per Mil-Std-704D and Mil-Std-1399.

### DC OUTPUTS

24 to 300V available  
(including 28V, 48V, 155V, 270V)

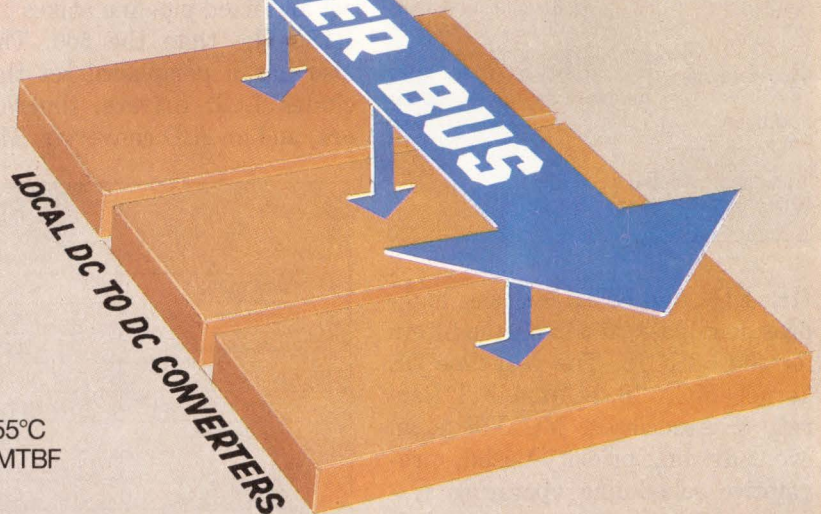

**ARNOLD MAGNETICS**

## ARNOLD MAGNETICS CORPORATION

4000 Via Pescador, Camarillo, California 93012 • Phone: (805) 484-4221 • Fax: (805) 484-4113

CIRCLE NO. 32

## 16-BIT- $\mu$ C EVALUATION BOARDS

monitor; a real-time kernel, and a DSP filter-design package. The Quickstart package gets the board up and running with a minimum of fumbling around.

P&E Microsystems developed MASM, which provides the same interactive, windowed interface used for other Motorola  $\mu$ Cs. Momentum Data Systems Inc supplies the filter-design package, which is a subset of Momentum's QEDesign Series. The package lets you build

### Motorola 68HC16Z1

Clock speed	16.78* MHz
Instruction cycle	360 nsec typ (120 nsec min)
Multiply/divide	0.48/2.3 $\mu$ sec, 720-nsec MAC cycle
Registers	16 bit: 2 accumulate, 3 index, SP, PC, 4 multiply/accumulate
Program memory	off chip
Data memory	1-kbyte SRAM
Bus	20-/16-bit address/data (byte sizeable), 2-cycle access
Address space	1-Mbyte instruction, 1-Mbyte data, sixteen 64-kbyte banks
Interrupts	7 hardware (3.3 $\mu$ sec), 256 sources
Serial ports	queued serial module
I/O	50 lines
Timers	general-purpose timer, watchdog
Miscellaneous	8-channel, 10-bit ADC; hardware background debug
Package†	132-pin PQFP
Price	\$20 (1000)

\*Ratings at selected clock rate.  
†PQFP = plastic quad flatpack.

IIR, FIR, and EFIR lowpass, high-pass, bandpass, and bandstop filters for the 68HC16. The real-time OS kernel, MCX-16, is from A T Barrett & Associates. MCX-16 is an event-driven, priority-based, preemptive scheduling operating system and has a 20- $\mu$ sec task-switch time. The OS takes up 2 kbytes of memory and can dynamically create and schedule tasks.

Motorola is developing a low-cost test alternative to evaluation boards and ICEs for the 68HC16. This test alternative, which will be announced in the first quarter, takes advantage of the  $\mu$ C's back-

ground debug mode. This mode lets you do host-controlled debugging without an ICE. You must design in a small 10-pin header on the target board to provide the host access to the  $\mu$ C's background-control mode.

## H8 family covers all the bases

Hitachi's H8 families of 16-bit microcontrollers suit mid- to high-end applications. The second-generation  $\mu$ Cs have a general-purpose register set and a pipeline core. The two H8 families are the H8/300 and H8/500. The 300 family bridges the 8- and 16-bit- $\mu$ C worlds. H8/300 registers can be addressed as bytes, and the chip is limited to a 64-kbyte address space. The 500 series suits 16-bit applications. Members of this family have 16-bit registers, a 16-Mbyte addressing range, and a high-level-language architecture.

The 300's 2- or 4-byte instruction set and fixed pipeline makes it more RISC-like than the 500. The  $\mu$ C also has a peripheral set that includes LCD drivers, timer/counters, and an A/D converter. The 500

is an upgrade of the 300 and suits high-level languages like C. It has an orthogonal instruction set (all instructions can use all addressing options) with automated stack and frame pointers. The 500 has as many as nine I/O ports, seven external interrupts, and a PWM for real-time control. An automatic increment/decrement feature for register indirect addressing speeds up table walking.

The H8 family suits single-chip applications: The H8/300 holds as much as 32 kbytes of on-chip program EPROM or ROM; the H8/500 has 64 kbytes of on-chip ROM. The 300 and 500 have 1 and 2 kbytes of on-chip SRAM, respectively.

The H8/300 evaluation board has 32 kbytes of zero-wait-state RAM and 32 kbytes of EPROM, which holds the ROM monitor. The board includes a programming adapter that lets you program the  $\mu$ C in standard 28-pin, 27C256 EPROM programmers.

C compilers exist for both families, as does a fuzzy-logic compiler from Togai Infralogic Inc. Also, Hitachi has ported the popular x-

### Hitachi H8 family

	Hitachi H8/330	H8/536
Clock speed	6, 8, 10* MHz	6, 8, 10 MHz
Instruction cycle	200 nsec min	200 nsec min
Multiply/divide	10/100 $\mu$ sec	2.3/2.6 $\mu$ sec
Registers	8 16 bit or 16 8 bit	8 16 bit
Program memory	8-/32-kbyte EPROM/ROM	64-kbyte ROM
Data memory	512 bytes	2-kbyte SRAM
Bus	16-/8-bit address/data	24-/16-bit or 24-/8-bit address/data
Address space	64 kbytes	16 Mbytes (64-kbyte banks)
Interrupts	9 external (2 to 3 $\mu$ sec)	7 external
Serial ports	1 channel	2 channels
I/O	58 lines (16 LCD drivers)	57 lines (16 LCD drivers)
Timers	watchdog, two 8 bit, one 16 bit	watchdog, one 16-bit counter, one 8-bit, 1 PWM
Miscellaneous	8-channel, 8-bit ADC	8-channel, 10-bit ADC
Package†	80-/84-pin PQFP/PLCC	80-/84-pin PQFP/PLCC
Price	\$16 (1000)	\$34.10 (1000)

\*Ratings at selected clock rate.

†PLCC=plastic leaded chip carrier; PQFP=plastic quad flatpack.



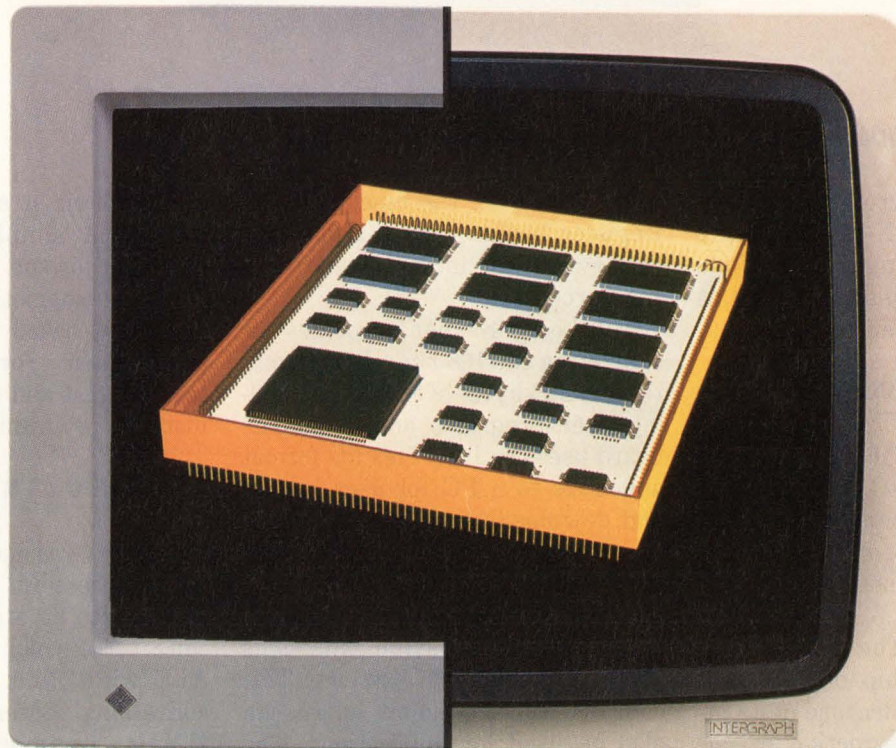

## The Most Powerful MCM Design Tools Now Run On Your Choice Of Platforms.

**Freedom of choice.** You can run the industry's most powerful MCM tools on two of the industry's leading engineering workstations. Because DAZIX MCM design tools are now available on both Intergraph CLIPPER and Sun SPARC platforms.

**No. 1 choice of MCM designers.** DAZIX supports today's leading technologies – MCM-L, MCM-C, MCM-D, MCM-D/C, and MCM-Si. Plus, our MCM tools will adapt to the packaging and interconnect technologies you'll encounter in the future.

These robust tools, backed by the billion-dollar Intergraph Corporation, have proven themselves in thousands of designs. In fact, MCM designers have made DAZIX their No. 1 choice.

**Simplified MCM design.** Intergraph. Or Sun. Whichever you choose, DAZIX can help shorten design cycles and make your job easier. Call today for our newest MCM literature. In the U.S., call 800-239-4111. In Europe, call 33-1-4537-7100. In the Asia Pacific area, call 852-8661966.



**DAZIX**<sup>®</sup>  
An Intergraph Company

DAZIX<sup>®</sup>, Intergraph<sup>®</sup>, and CLIPPER<sup>®</sup> are registered trademarks of Intergraph Corporation. Other brands and product names are trademarks of their respective owners.  
Copyright 1992 Intergraph Corporation, Huntsville, AL 35894-0001. DDAD048A0.

## 16-BIT- $\mu$ C EVALUATION BOARDS

ray debugger (Microtec Research) to the H8 family. X-ray lets users interactively debug target code running on the evaluation board at the source-code level.

### Siemens 166 delivers

Siemens's SAB80C166 is a second-generation 16-bit  $\mu$ C built for high performance. Its compact execution unit has a 4-stage pipeline and is built around sixteen 16-bit general-purpose registers, 8 of which are byte addressable. The  $\mu$ C can function as a single chip or run with external memory. Because of its internal pipeline, instruction execution takes one 100-nsec machine cycle; 16-bit multiplies and 32-bit divides execute in 0.5 and 1.0  $\mu$ sec,

text pointer in the on-chip RAM. Register banks provide a fast context switch for interrupt and real-time processing.

The board Siemens provides for evaluating the 166 has a ROM monitor and 32 kbytes of SRAM for holding user programs and data. The board uses the Intel Hex file format and links to a PC for user control and downloading. A line assembler and terminal emulator come with the board. An assembler and C compiler are optional.

Another evaluation board is available from Forth Systeme. This compact surface-mount board can also be used for applications. The board has 64 kbytes of RAM and provisions for as much as 256 kbytes of EPROM. It has two headers (128 pins total) for interfacing and links

to a PC via a simple breadboard circuit. A simple ROM Forth is available for the board as is Swiss-Forth—a sophisticated Forth with a window-based host development environment. Forth provides an extremely fast and interactive mechanism for program development.

### The 68000 as a microcontroller

The 68000 was one of the first 16-bit microprocessors. It made its reputation with its straight-forward architecture, which combines a 16-bit ALU with 32-bit registers for easy addressing. Later, Motorola added MMUs (memory management units) to ease managing large address spaces and to introduce a level of indirection and memory mapping.

#### Siemens SAB80C166

Clock speed . . . . .	20 MHz
Instruction cycle . . . . .	100 nsec min
Multiply/divide . . . . .	0.5/1.0 $\mu$ sec
Registers . . . . .	16 (banks)
Program memory . . . . .	8-/32-kbyte EPROM/ ROM
Data memory . . . . .	1-kbyte SRAM, 128-byte EEPROM
Bus . . . . .	16-/8-bit or 16-/16-bit address/data
Address space . . . . .	256 kbytes, 64-kbyte segments
Interrupts . . . . .	3 hardware (0.5 $\mu$ sec)
Serial ports . . . . .	2 UARTs
I/O . . . . .	76 lines
Timers . . . . .	watchdog, seven 16-bit
Miscellaneous . . . . .	10-bit ADC (9.75 $\mu$ sec), peripheral service, 16 PWM channels
Package† . . . . .	100-pin PQFP
Price . . . . .	\$46 (1000)

†PQFP=plastic quad flatpack.

respectively. Jumps are sped from 200 to 100 nsec by using a branch target cache to hold recent jump addresses.

The 166 has a 256-kbyte address space organized as four 64-kbyte segments. The  $\mu$ C has three off-chip memory modes for an 18-bit address: 16-bit data, 16-bit data multiplexed with address, and 8-bit multiplexed data. The 166's general-purpose registers function as a bank for easy relocation via a con-

### For more information . . .

For more information on the software described in this article, circle the appropriate numbers on the Information Retrieval Service card or use EDN's Express Request service. When you contact any of the following manufacturers directly, please let them know you read about their products in EDN.

#### Annabooks

12145 Alta Carmel Ct, #250  
San Diego, CA 92128  
(619) 271-9526  
FAX (619) 592-0061

Circle No. 705

#### A T Barrett & Associates

11501 Chimney Rock, Suite R  
Houston, TX 77035  
(713) 728-9688

Circle No. 706

#### Microtec Research Inc

2350 Mission College Blvd, #500  
Santa Clara, CA 95054  
(408) 980-1300  
FAX (408) 982-8266

Circle No. 707

#### Microware Systems Corp

1900 NW 114th St  
Des Moines, IA 50322  
(515) 224-1929  
FAX (515) 224-1352

Circle No. 708

#### Momentum Data Systems Inc

1520 Nutmeg Pl, Suite 108  
Costa Mesa, CA 92626  
(714) 557-6884

Circle No. 709

#### Paradigm Systems

3301 Country Club Rd, Suite 2214  
Endwell, NY 13760  
(607) 748-5966  
FAX (607) 786-0705

Circle No. 710

#### P&E Microsystems Inc

Box 2044  
Woburn, MA 01888  
(617) 944-7585

Circle No. 711

#### Software Development Systems

4248 Belle Aire Lane  
Downers Grove, IL 60515  
(708) 971-8170  
FAX (708) 971-8513

Circle No. 712

#### Togai Infralogic Inc

30 Corporate Park, Suite 107  
Irvine, CA 92714  
(714) 975-8522  
FAX (714) 975-8524

Circle No. 713

#### US Software

14215 NW Science Park Dr  
Portland, OR 97229  
(503) 641-2413  
FAX (503) 644-2413

Circle No. 714

### VOTE . . .

Please also use the Information Retrieval Service card to rate this article (circle one):

**High Interest 485 Medium Interest 486 Low Interest 487**

# Power Revelation

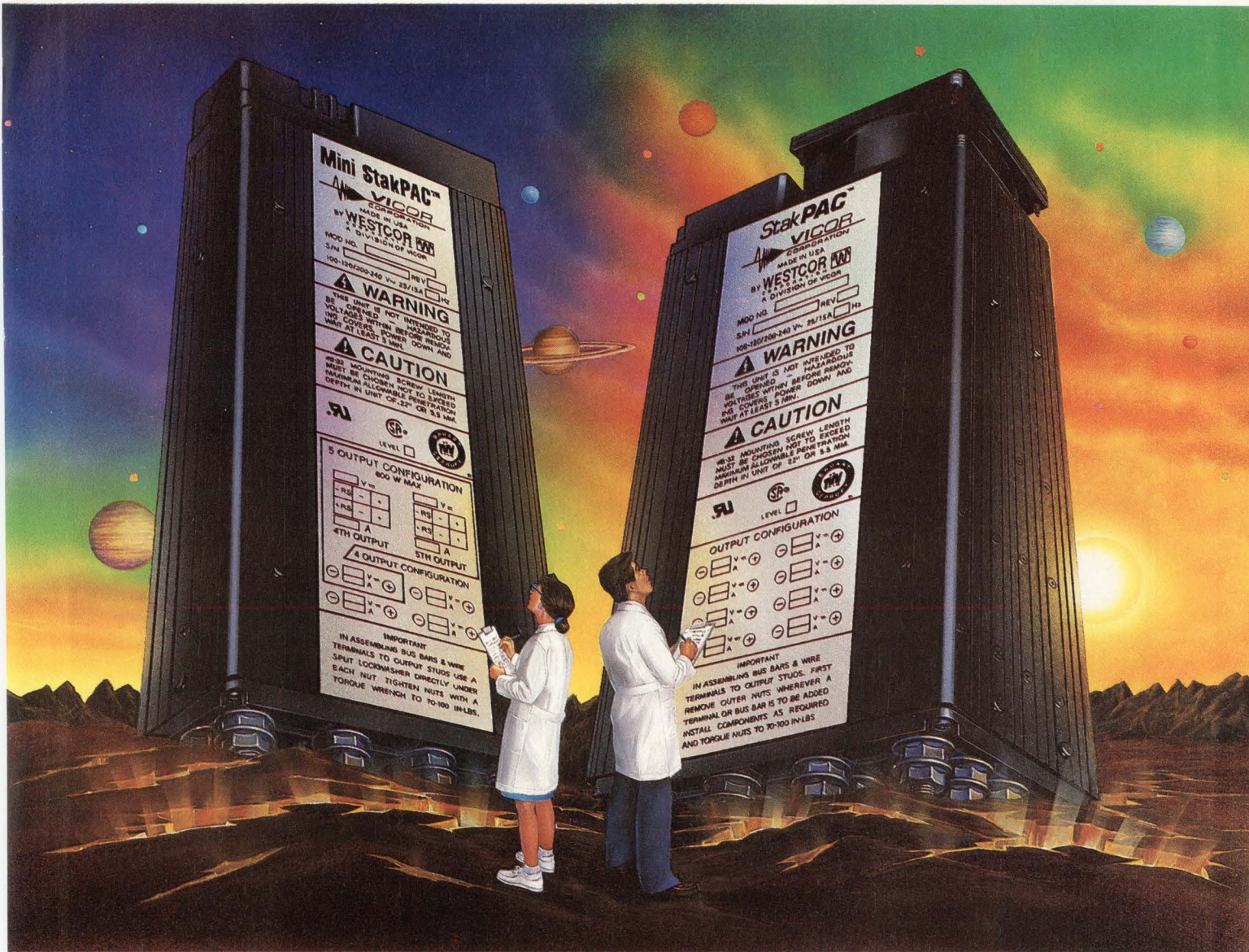

Our Westcor division's family of configurable AC or DC input fan cooled StakPAC switchers reveals a new world of power density and output flexibility to the system designer...whatever your power needs. Each StakPAC is built with field proven robotically manufactured Vicor VI-200 Series power components providing you the flexibility of a customized supply combined with the off-the-shelf availability of standard catalog products...“first article” StakPACS are typically delivered in 2 weeks.

Compact, up to 6W/in<sup>3</sup>, low profile StakPACs set the standard for “box” or open frame switchers. Besides meeting conducted EMI standards, custom configured StakPACs are pre-approved to UL, CSA, TÜV and VDE safety standards (DC Mini- in process).



MODEL	POWER	OUTPUTS	INPUT	DIMENSIONS (inches)
StakPAC	1,200W	up to 8	110/220 VAC	3.2 x 5.5 x 11.5
MINI	600W	up to 5	110/220 VAC	1.9 x 5.5 x 12.2
DC MINI	800W	up to 5	5 Ranges 18-76 VDC	2.5 x 4.3 x 12.2



CIRCLE NO. 34

Whether your application is OFF-LINE or DC INPUT, chances are we have a solution for you...we are designed into computer, telecom, and test measurement systems worldwide. Please call us to discuss your needs, then relax...bulky standards and risky long lead-time custom supplies belong to the past. Discover the new world of configurable supplies: StakPAC, MiniStakPAC and DC Mini.

Call VICOR EXPRESS for information and be sure to ask for a StakPAC or DC Mini Handbook: (800) 735-6200 or (508) 470-2900 at ext. 265. Or call Westcor (west coast) at (408) 395-7050.



Component Solutions For Your Power System

# NEW

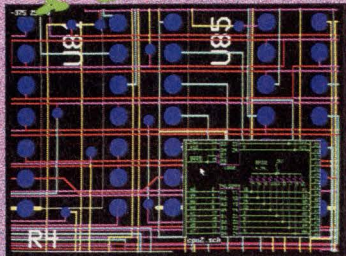

**Integrated schematic and PCB software that was designed that way, not kludged that way.**

- Imagine using the same drawing tools for both schematic drawings and PCB artwork.
- Picture the convenience of displaying and editing schematic and PCB drawings simultaneously.
- Visualize being able to create or modify library symbols in seconds using the same commands you use for other drawings.
- Envision a 100% completion rip-up-and-re-route autorouter that costs thousands less than comparable autorouters.
- Suppose you could unleash all this power by spending less than eight hours with the tutorial.
- Now fancy a toll-free number provided for no-charge technical support, and a 30-day, no-hassle, money-back guarantee.

Call today and let HiWIRE II turn your imagination into reality.



**Wintek Corporation**  
 1801 South Street  
 Lafayette, IN 47904  
 Fax: (317) 448-4823  
 Phone: (317) 448-1903 or  
**(800) 742-6809**

## 16-BIT- $\mu$ C EVALUATION BOARDS

### 68XXXX $\mu$ Cs

	Signetics 68070	Toshiba 68301	Motorola 68302
Clock speed	10, 12.5, 15* MHz	12, 16* MHz	16.77, 20 MHz
Instruction cycle	0.9 $\mu$ sec typ	1.0 $\mu$ sec	1.0 $\mu$ sec
Multiply/divide	5/10.7 $\mu$ sec	4.7/9.5 $\mu$ sec	3.0/7.8 $\mu$ sec
Registers	32-bit, 16-bit ALU; 8 data, 7 address, 2 stack pointers, 1 program counter	32-bit, 16-bit ALU; 8 data, 7 address, 2 stack pointers, 1 program counter	32-bit, 16-bit ALU; 8 data, 7 address, 2 stack pointers, 1 program counter
Program memory	none	none	none
Data memory	none	none	1152-byte RAM
Bus	24-/16-bit address/data	24-/16-bit address/data	24-/16-bit address/data
Address space	8-segment MMU, 16 Mbytes	8-segment MMU	8-segment MMU
Interrupts	6 hardware (0.4 $\mu$ sec)	3	7
Serial ports	UART, I <sup>2</sup> C	3 UARTs	3 communications channels
I/O	none	16 lines	28 lines
Timers	one 16 bit	one 16 bit	three 16 bit
Package†	84-/120-pin PLCC/PQFP	100-pin PQFP	132-pin CQFP/PGA
Price	\$15.25 (1000)	\$24.55 (100)	\$35.16 (1000)

\*Ratings at selected clock rate.

†CQFP=ceramic quad flatpack; PGA=pin-grid array; PLCC=plastic leaded chip carrier; PQFP=plastic quad flatpack.

Today, there are  $\mu$ Cs that use the 68000 as a core. Motorola's 68302 is built around the 68000. The chip suits communications processing and includes an on-chip RISC CPU for processing on-line data. Both Signetics and Toshiba also have versions of the 68000  $\mu$ C. These chips are beefed up for embedded systems with I/O lines, serial ports, and 16-bit timers. All of these 68000  $\mu$ Cs have an MMU and run existing 68000 code.

Motorola's 68302 Application Development System (ADS) helps users develop embedded communications applications. The system includes communications protocols, an event-driven operating system, and an evaluation board that has as much as 1 Mbyte of DRAM (dynamic RAM) and 256 kbytes of program EPROM. The board has hooks for a logic analyzer.

Signetics' Microcore board integrates the company's SCC68070  $\mu$ C with a video-system controller. The board can be used to drive a color

video display as well as check out the SCC68070. Microware has ported its OS/9 real-time operating-system kernel and C development tools to the Microcore board. Additionally, Microtec Research has a C compiler, assembler, and version of its x-ray debugger for the board.

International Microsystems Inc makes an evaluation board, the SBC303, for the Toshiba TMP68303  $\mu$ C. This board has as much as 2 Mbytes of EPROM, 512 kbytes of SRAM, and 8 Mbytes of DRAM. It includes a clock/calendar and parallel and serial ports as well as a ROM monitor and boot and I/O drivers. The board works with Software Development Systems' Freeform C source-level debugger and US Software's Multitask real-time operating system. **EDN**

Article Interest Quotient  
(Circle One)

High 485 Medium 486 Low 487

# FM SERIES MODUFLEX SWITCHERS WITH 0.99 POWER FACTOR

SINE WAVE CURRENT

HARMONICS MEET IEC 555-2

1-7 OUTPUTS, 600-2000 WATTS

MODELS FOR VME, VXI, FUTUREbus, etc.

120 kHz. MOSFET DESIGN

UNIVERSAL INPUT

OUTPUTS REGULATED & FLOATING

MEET UL, CSA, TUV/VDE



1000 Watts Output Without  
Exceeding UL Limits For  
Ordinary Duplex Outlets

Call Toll Free 1-800-523-2332  
In PA: 215/699-9261

**Deltron** inc.  
POWER PRODUCTS

# OUTPUT LOCATIONS

## 600 Watt FM Configurations

12	#1 M5			
24	#1 M4	#2 K		
26	#1 M4	#2 L		
30	#1 M3	#2 L	#3 K	
36	#1 M3	#2 K	#3 K	
48	#1 M3	#2 K	#3 K	#4 K
56	#1 M3	#2 K	#3 K	#5 J #4 J
64	#1 M3	#2 K	#6 J #3 J	#5 J #4 J
72	#1 M3	#7 J #2 J	#6 J #3 J	#5 J #4 J

## 1000 Watt FM Configurations

11	AC			
	#1 M7			
21	AC			
	#2 L	#1 M6		
31	AC			
	#3 L	#2 L	#1 M6	
41	AC			
	#4 G	#3 G	#2 G	#1 M6
43	AC			
	#4 K	#3 G	#2 G	#1 M6
51	AC			
	#5 J #4 J	#3 G	#2 G	#1 M6

AC			
#5 J	#6 J	#2 G	#1 M6
#4 J	#3 J		

AC			
#5 J	#6 J	#7 J	#1 M6
#4 J	#3 J	#2 J	

## 2000 Watt FM Configurations

AC			
#1 M9			

AC			
		#2 M7	#1 M7

AC			
#3 L	#2 M6	#1 M7	

AC				
#4 L	#3 L	#2 M6	#1 M7	

AC				
#5 G	#4 G	#3 G	#2 M6	#1 M7

AC				
#5 K	#4 G	#3 G	#2 M6	#1 M7

AC				
#6 J	#4 G	#3 G	#2 M6	#1 M7
#5 J				

AC				
#6 J	#7 J	#3 G	#2 M6	#1 M7
#5 J	#4 J			

# FM SERIES DIMENSIONS

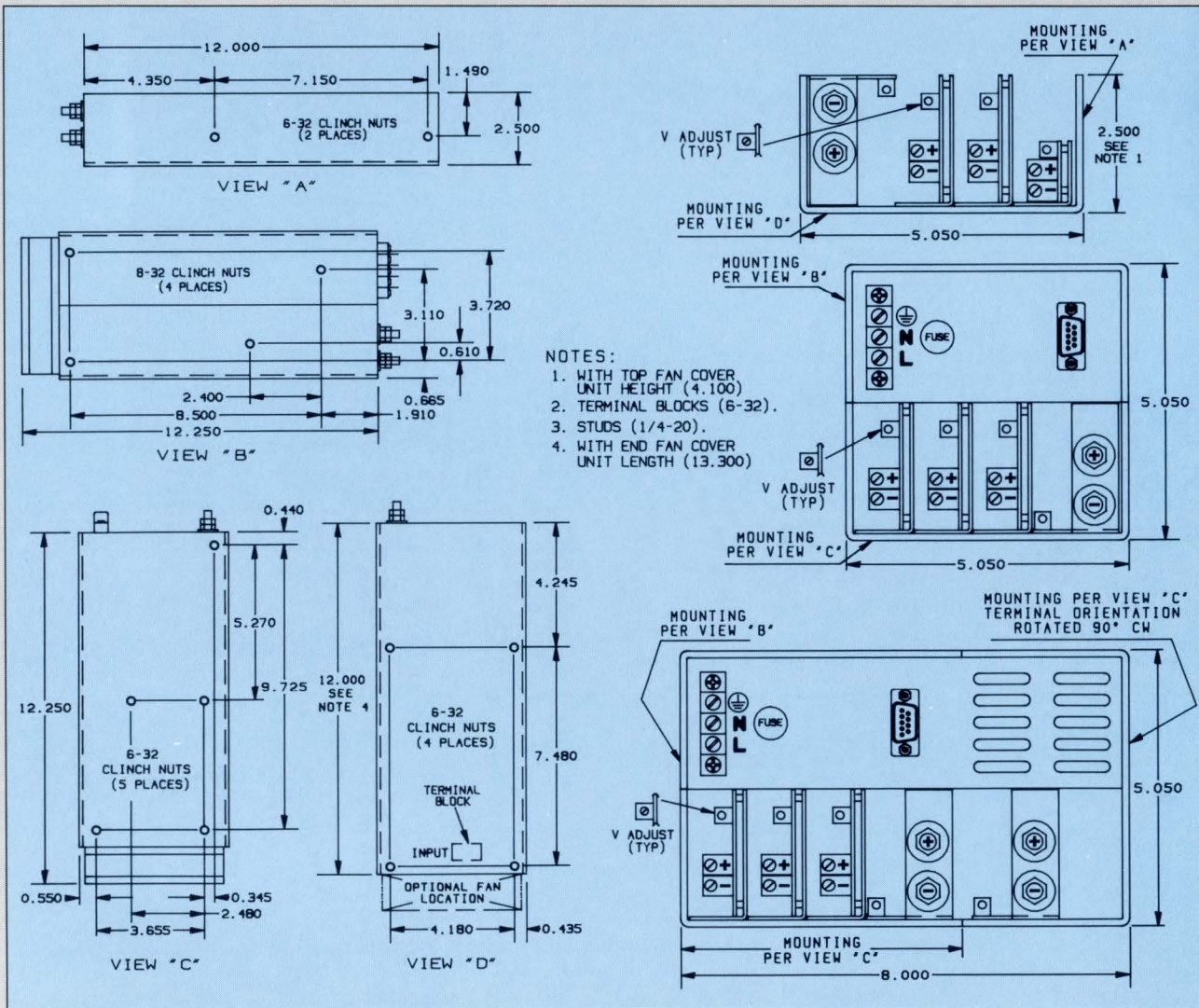

## DESCRIPTION

Moduflex switchers form a comprehensive line of open frame power supplies assembled from standard "off the shelf" modules. These subunits and assembly hardware are pre-approved by safety agencies so that certifications can automatically apply to custom models. Additional advantages include first piece delivery within two weeks and the elimination of engineering costs for qualified "OEM" requirements using stock modules.

FM Series are corrected to produce a 0.99 power factor. The resultant input current waveform is nearly a perfect sine wave compliant to the harmonic requirements of IEC 555-2.

Modular construction permits high volume manufacturing with an outstanding quality level and at competitive cost.

## FEATURES

- 0.99 power factor.
- 5 watts per cubic inch.
- 600-2000 watts output.
- 120 kilohertz design.
- TUV/VDE, UL, CSA.
- All outputs:
  - Adjustable
  - Fully regulated
  - Floating
  - Overload and short circuit proof
  - Overvoltage protected
- Standard features include:
  - System inhibit
  - Fan output

## MODEL SELECTION

Input modules are available in ratings of 600, 1000, and 2000 watts with corresponding code letters of C, E and G. Refer to Power Code Table.

Output modules are available in ten types ranging in nominal power from 75 to 2000 watts. Refer to Output Code Table for codes and nominal power output.

Input Power Codes	
Codes	Watts
C	600
E	1000
G	2000

Output Codes	
Codes	Nominal Power
J	75
K	150
G	300
L	300
M3	400
M4	500
M5	600
M6	750
M7	1000
M9	2000

The Table of Ratings for the various types of output modules lists the maximum current for each type as a function of corresponding voltage rating.

Ratings in the shaded area are Preferred and are stocked for fast delivery.

Note: When computing output load power, multiply the fraction of actual current to max. rated current by the nominal power rating of the output module.

## RATINGS OF OUTPUT MODULES

Nominal Power	75W	150W	300W	300W	400W	500W	600W	750W	1000W	2000W	
Code	Volts	J	K	G	L	M3	M4	M5	M6	M7	M9
0	2	10	20	20	30	80	100	120	150	200	400
1	3.3	10	20	20	30	80	100	120	150	200	400
2	5	10	20	30	30	80	100	120	150	200	400
3	12	6	12	20	24	34	42	50	62	84	168
4	15	5	10	20	20	26	33	40	50	67	134
5	18	4	8	16	16	22	28	33	42	56	112
6	24	3	6	12	12	17	21	25	31	42	84
7	28	2.5	5	10	10	14	18	21	27	36	72
8	36	2	4	8	8	11	14	17	21	28	56
9	48	1.5	3	6	6	8	10	12	16	21	42

## HOW TO ORDER

Select the letter F for power factor correction, then select the letter M to designate the series. Choose the desired configuration of output modules and list the configuration code. Insert the power code letter and follow with the output code numbers for each individual output. Enter a dash and from the option table insert the sum of the option codes. See example below.

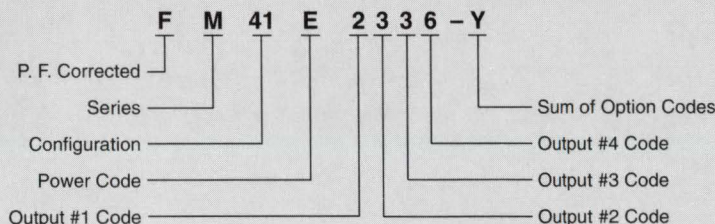

OPTIONS	
Option Code	Function
1	Power Fail Monitor
2	Cover (600W only)
4	End Fan Cover (600W only)
8	Top Fan Cover (600W only)

# SPECIFICATIONS

## INPUT

90-264 VAC, 47-63 Hz.  
190-264 for 2000W units.

## POWER FACTOR

0.99 at full load.

## HARMONIC CURRENTS

Compliant to IEC 555-2.

## INPUT SURGE

230 VAC – 75A max.  
115 VAC – 40A max.

## HOLDUP TIME

20 milliseconds from loss of AC power.

## OUTPUTS

See model selection table.

## ADJUSTABILITY

±5% trim adjustment.

## OUTPUT POLARITY

All outputs are floating from chassis and each other and can be referenced to each other or ground as required.

## LINE REGULATION

Less than ±0.1% or ±5mV for input changes from nominal to min. or max. rated values.

## LOAD REGULATION

±0.2% or ±10mV for load changes from 50% to 0% or 100% of max. rated values.

## MINIMUM LOAD

Main output requires a 10% minimum load for full output from auxiliaries. Main output is #1 on 600W and 1000W units and #2 on 2000W units.

## REMOTE SENSING

On all outputs except type J modules.

## RIPPLE & NOISE

1% or 100mV pk-pk, 20 MHz bandwidth.

## OPERATING TEMPERATURE

0-70°C.- Derate 2.5%/°C above 50°C.

## COOLING

A min. of 10 LFS cooling air directed on cooling surfaces over the 600W units for full rating. Two test locations on chassis rated for max. temperature of 90°C. 1000W and 2000W models have built-in ball bearing fan.

## TEMPERATURE COEFFICIENT

±0.02%/°C.

## EFFICIENCY

70% to 80%.

## SAFETY

Units meet UL 1950, CSA 22.2 No. 234, IEC 950, EN 60 950, VDE 0804, VDE 0805, VDE 0806. Certifications in process.

## DIELECTRIC WITHSTAND

3750 VRMS input to ground.  
3750 VRMS input to output.  
700 VDC output to ground.

## SPACING

8 mm primary to secondary.  
4 mm primary to grounded circuits.

## LEAKAGE CURRENT

3.5mA max.

## EMISSIONS

Units meet FCC 20780 Part 15 Class A and VDE 0871 Class A for conducted emissions. Compliance with Class B limits by use of additional external filter.

## DYNAMIC RESPONSE

Peak transient less than ±2% or ±200mV for step load change from 75% to 50% or 100% max. ratings.

## RECOVERY TIME

Recovery within 1%.  
M3, M4, M5, M6, M7, and M9 modules – 200 microseconds.  
J, K, G, and L modules – 500 microseconds.

## UNDERVOLTAGE

Protects against damage for undervoltage operation.

## OVERVOLTAGE PROTECTION

Standard on all outputs.

## REVERSE VOLTAGE PROTECTION

All outputs are protected up to load ratings.

## OVERLOAD & SHORT CIRCUIT

Outputs protected by duty cycle current foldback circuit with automatic recovery. Auxiliaries have additional backup fuse protection.

## THERMAL SHUTDOWN

Circuit cuts off supply in case of local over temperature. Units reset automatically when temperature returns to normal.

## SOFT START

Units have soft start feature to protect critical components.

## FAN OUTPUT

Nominal 12 VDC @ 12 watts maximum.

## INHIBIT

TTL compatible system inhibit provided.

## SHOCK

MIL-STD 810-D Method 516.3, Procedure III.

## VIBRATION

MIL-STD 810-D Method 514.3, Category 1, Procedure I.

## MECHANICAL

600W – Case 1. – 2.5 x 5.05 x 12  
1000W – Case 2. – 5.05 x 5.05 x 12  
2000W – Case 3. – 5.05 x 8 x 12

## POWER FAIL MONITOR

Optional circuit provides isolated TTL and VME compatible power fail signal providing 4 milliseconds warning before main output drops by 5% after an input failure.

## FAN COVER

Optional covers with brushless DC ball bearing fan which provides the required air flow for full rating of 600W units. Choice of low profile or top mounted types.

Specifications subject to change without notice.



290 WISSAHICKON AVENUE, P.O. BOX 1369, NORTH WALES, PA 19454  
PHONE: 215/699-9261 • FAX: 215/699-2310

Int'l. Units: Delaire • Sallynoggin Road, Dun Laoghaire, Co. Dublin, Ireland. Tel: + 353-1-2851411 • FAX: + 353-1-2840267  
Delinc • Padre Mier y Dr. Mina, Reynosa, Tamps., Mexico 08866. Tel.: (892) 38723 Prefix – from USA – (01152) FAX: (892) 38776

Printed in U.S.A.



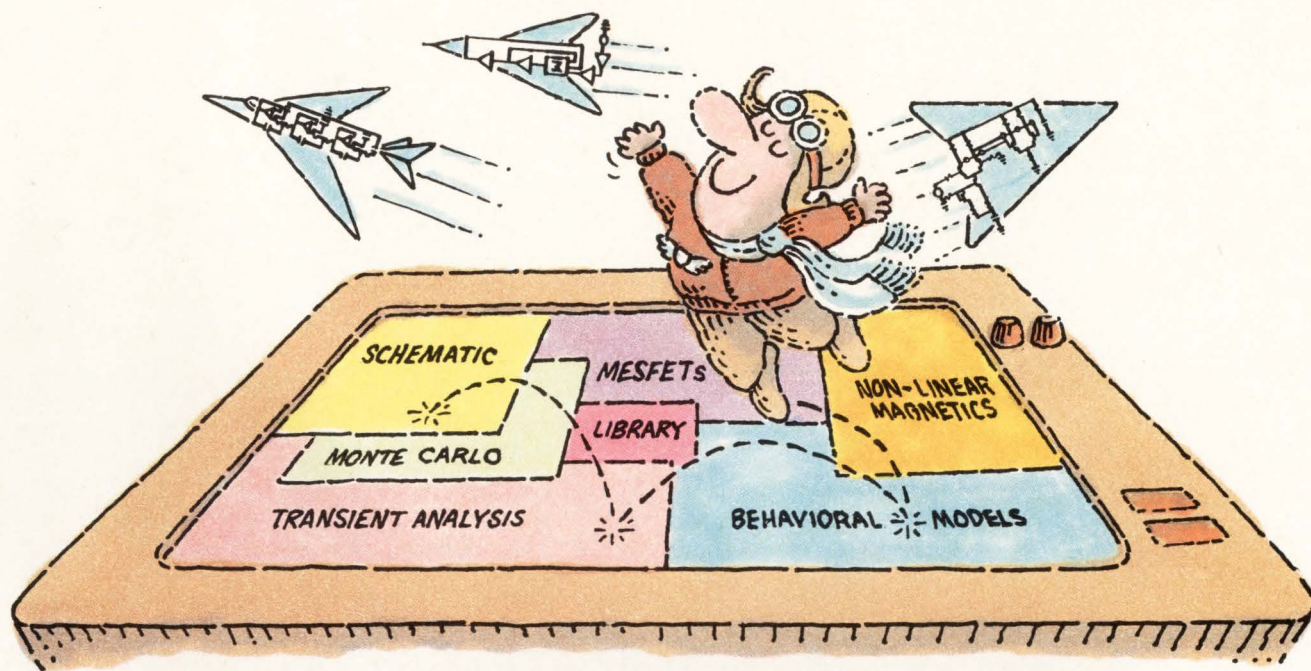

# THE NEW MICRO-CAP III.™ SO YOU CAN TEST-FLY EVEN MORE MODELS.

It wasn't easy. But we did it. Made the long-time best-selling IBM® PC-based interactive CAE tool even better.

Take modeling power. We've significantly expanded math expression capabilities to permit comprehensive analog behavioral modeling. And, beyond Gummel Poon BJT and Level 3 MOS, you're now ready for nonlinear magnetics modeling. Even MESFET modeling.

Analysis and simulation is faster, too. Because the program's now in "C" and assembly language. That also means more capacity — for simulating even larger circuits.

As always, count on fast circuit creation, thanks to window-based operation and a schematic editor. Rapid, right-from-schematics analysis — AC, DC, Fourier and transient — via SPICE-like routines. The ability to combine digital/analog circuit simulations using integrated switch

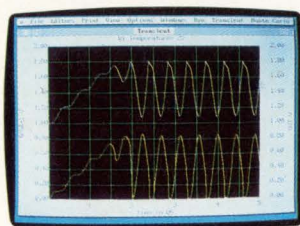

*Transient analysis*

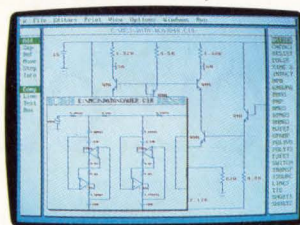

*Schematic editor*

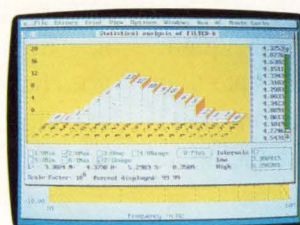

*Monte Carlo analysis*

models and parameterized macros. And stepped component values that streamline multiple-plot generation.

And don't forget MICRO-CAP III's extended routine list — from impedance, Nyquist diagrams and BH plots to Monte Carlo for statistical analysis of production yield. The algebraic formula parsers for plotting virtually any function. The support for Hercules, CGA, MCGA, EGA and VGA displays. Output for plotters and laser printers.

Cost? Still only \$1495. Evaluation versions still only \$150. Brochure and demo disk still free for the asking. Call or write for yours today. And see how easily you can get ideas up and flying.

**Spectrum**

1021 S. Wolfe Road  
Sunnyvale, CA 94086  
(408) 738-4387

# Now you can afford to

Presenting a very small development in Ethernet.\*

Chipsets that are matched to your system and your budget. In fact, they cost you as little as 5 square inches. Which, by the way, is less total real estate than any competitive solution. But sizable reductions don't stop with board space, because we're also reducing the price up to 30 percent.

Needless to say, true plug-and-play simplicity requires an intelligent network interface. So our new high-integration 82503 Dual Serial Transceiver goes beyond IEEE 802.3 to include automatic port selection, polarity switching and a jumperless interface to AUI or TPE.

For unmatched desktop performance, we offer

© 1992 Intel Corporation. Intel386 and Intel486 are trademarks of Intel Corporation. \*Ethernet is a registered trademark of Xerox and Diamond is a registered trademark of Diamond Brands, Inc.

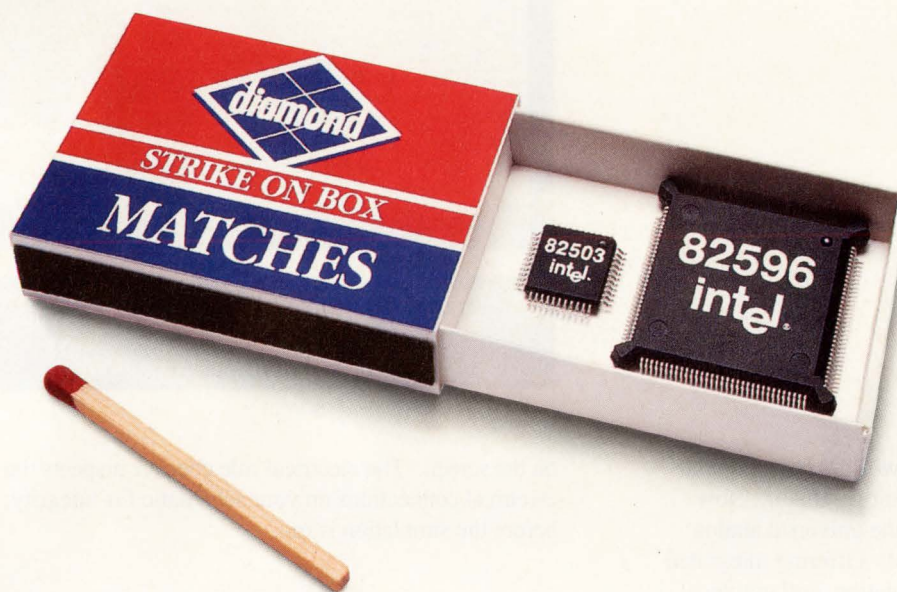

# put Ethernet in any box.

a complete family of 82596 LAN coprocessors, each optimized to a specific Intel486™ CPU for maximum throughput. And our 82593 is the perfect LAN controller for Intel386™ SL notebooks.

Best of all, these true two-chip solutions give you the flexibility to simplify your design and deliver your product to market in the smallest of timeframes.

So look into today's hottest Ethernet chipsets. Call (800) 548-4725 and ask for Lit. Packet #YA23. And learn why we have the perfect match for your next box.

**intel**®

The Computer Inside.™

# Where would you go to answer all of your analog and digital circuit design questions?

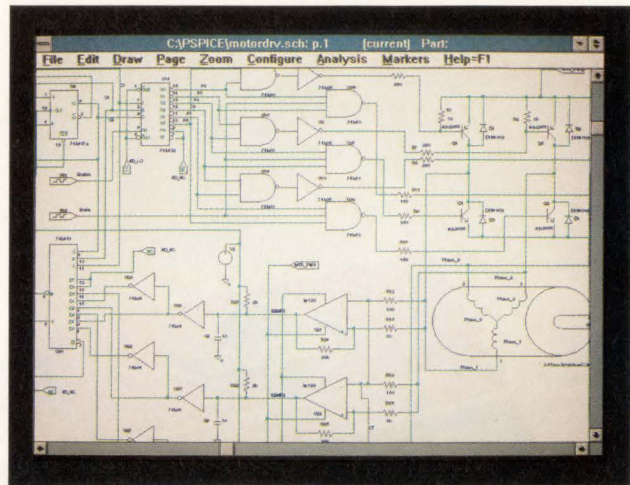

A sensorless brushless DC motor control system is graphically defined using part symbols from our analog and digital libraries, as well as symbols customized for the application.

We brought you PSpice — the world's most popular mixed analog and digital circuit simulator. Now we bring you the **Design Center** — the universal analog and digital circuit design environment! Offering integrated schematic capture, mixed-mode simulation, and graphical waveform analysis, the **Design Center** will take you and your circuit design from conception to realization with ease and efficiency.

## Graphically Capture Your Circuit Design

Using the **Design Center**, circuit drawings are simple to create and edit. Select from over 5,700 analog and digital components maintained in our continually expanding device and symbol libraries. Or create your own devices and symbols to suit your individual application.

## Run PSpice Simulations Directly from Your Schematic

When your circuit drawing is complete, you can initiate PSpice analyses from choices on the pull-down menus. Netlists are generated automatically and can be examined

on the screen. The electrical rule checker inspects the electrical connections on your schematic for integrity, before the simulation is run.

## Maintain the PSpice Mixed-Mode Simulation Advantage

The **Design Center** provides analog-only, mixed analog/digital, and digital-only electrical circuit simulation by integrating the capabilities of our well-known PSpice simulator. With the **Design Center**, these features are standard:

- analog behavioral modeling,
- Monte Carlo and sensitivity/worst-case statistical analyses,
- fully integrated, event-driven digital simulation supporting state, strength, and timing modeling, as well as worst-case timing simulation,
- extensive device libraries containing over 4,000 analog and 1,700 digital devices,
- analog and digital stimulus generation,
- analog device characterization, and
- graphical waveform analysis of simulation results.

# THE DESIGN CENTER™!

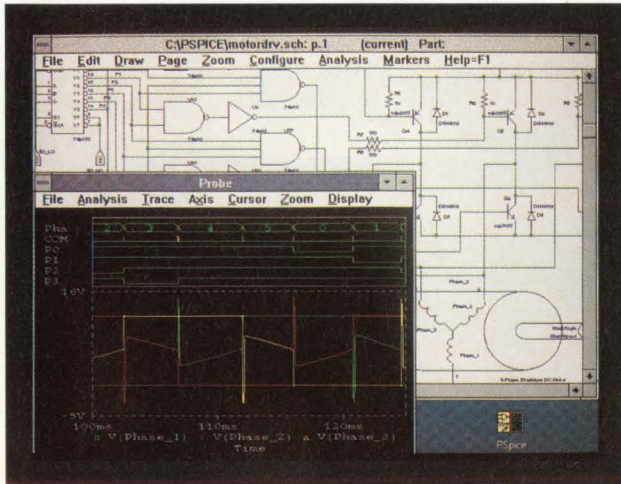

Using analog behavioral models for the motor, and devices from our analog and digital libraries, the Design Center simulates the closed-loop control system.

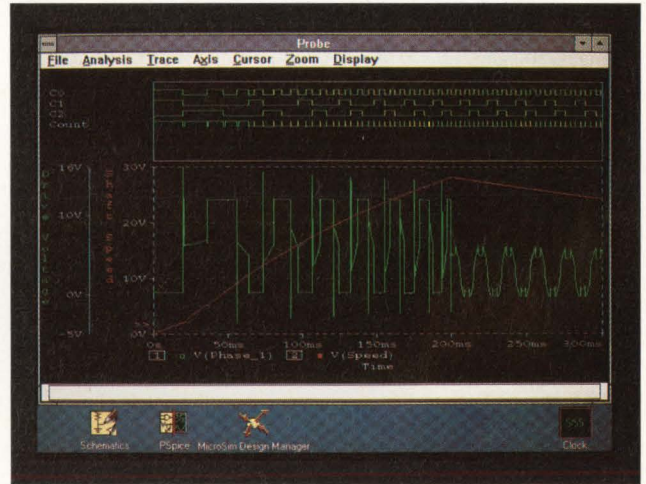

The Design Center displays PSpice simulation results for both analog and digital waveforms together on the same plot.

## View Waveforms Directly from Your Schematic

Analog waveforms and digital signals can be displayed simultaneously along a common time axis, while remaining within your circuit drawing environment. Simulation results can be interactively viewed in a variety of ways including fast Fourier transforms, derivatives, integrals, user-defined functions, and buses, as well as analog and digital waveform expressions. Performance analysis, multiple Y axes, and flexible plot control are a few of the additional reasons why you'll benefit from graphical waveform analysis.

## Choose from Several Configurations

Whether you run on a windows platform, or not, there is a configuration of the **Design Center** for you. Choose our full-featured system with schematic capture, available under Windows 3.0 or OpenWindows. Or choose one of our

reduced configurations without schematic capture, available on a variety of platforms; you'll continue to benefit from the **Design Center's** powerful simulation and analysis features. Whichever configuration you choose, we feel that the **Design Center** provides the most comprehensive system for circuit design available today.

## We're Making Mixed Analog and Digital Circuit Design the Standard!

Why not make it yours! For further information on MicroSim Corporation's **Design Center**, call toll free at (800) 245-3022 or FAX at (714) 455-0554.



**MicroSim Corporation**

*The Standard for Circuit Design*

20 Fairbanks • Irvine, CA 92718

**THE MAKERS OF PSpice**

PSpice is a registered trademark of MicroSim Corporation

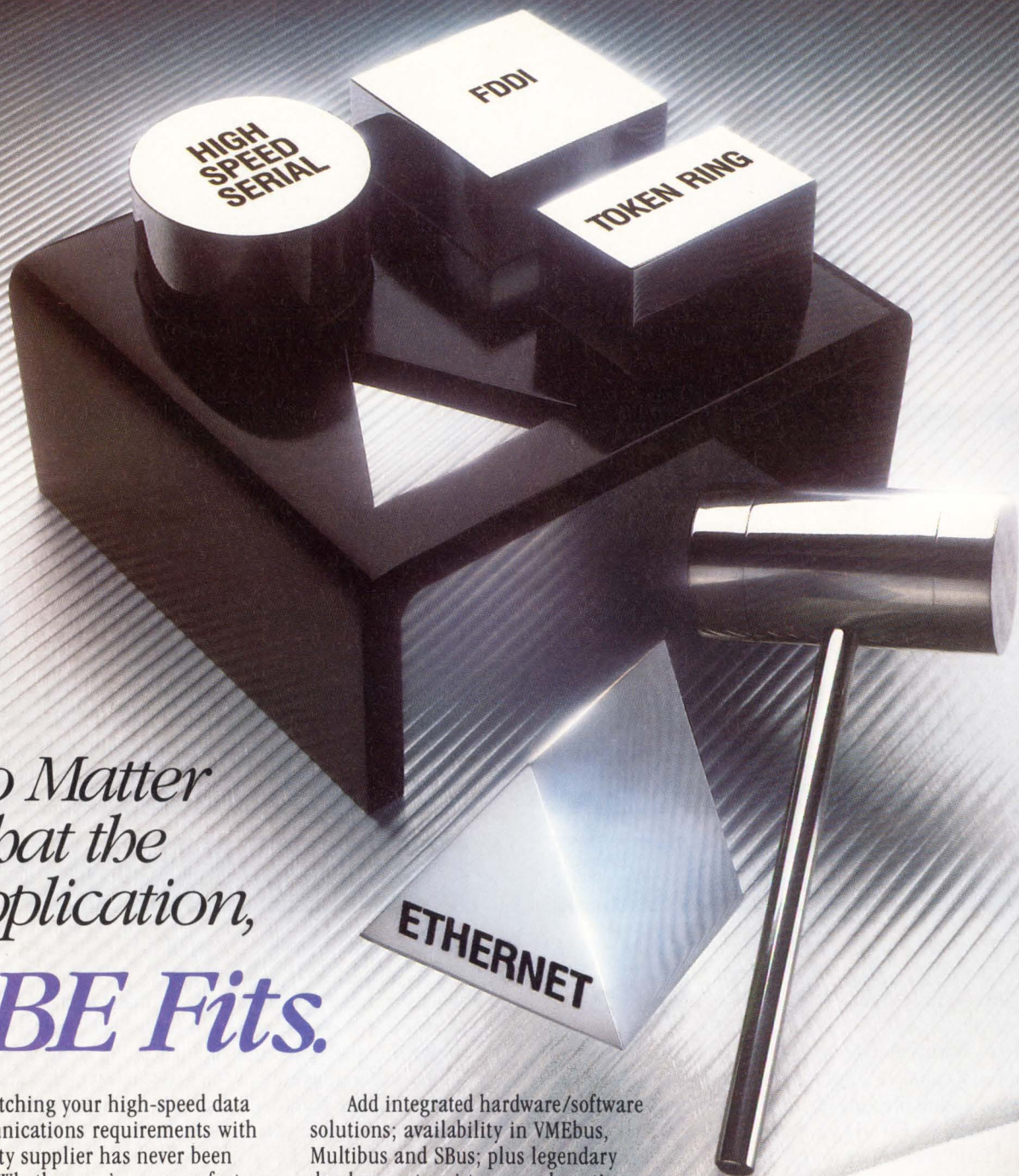

*No Matter  
What the  
Application,  
SBE Fits.*

Matching your high-speed data communications requirements with a quality supplier has never been easier. Whether you're a manufacturer of mini/superminicomputers, workstations or high-performance data communications products, *only* SBE provides a perfect fit.

Only SBE offers a complete line of intelligent high-performance communications controllers for all major interface technologies: FDDI, Token Ring, Ethernet and High Speed Serial. Only SBE adds premium features, without a premium cost, for the best price/performance in the industry.

Add integrated hardware/software solutions; availability in VMEbus, Multibus and SBus; plus legendary development assistance and continuing product support.

Discover how SBE's intelligent high-performance controllers can meet your LAN and WAN interface requirements. Turn to SBE today.

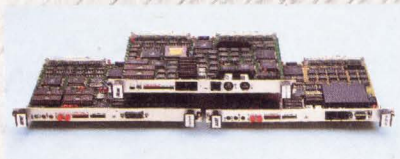

*For fast action, call: 1-800-347-COMM*

Germany: 0130-810588

United Kingdom: 0800-378-234

*SBE, Inc., 2400 Bisso Lane, Concord, CA 94520*

# Innovation software stimulates engineering creativity

CHARLES H SMALL, Senior Technical Editor

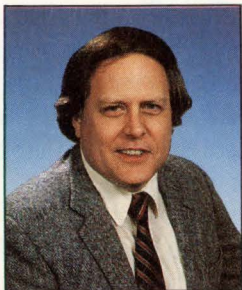

**Personal-computer software can help you hatch new ideas and overcome creative blocks.**

A gaggle of inexpensive personal-computer programs is available to help you be more innovative and deal with the stress of today's short design cycles. Some of these programs deliberately force you to think in nonlinear, nonlogical, playful ways. The idea behind them is to divert your thinking from the channels that day-to-day work has forced it into, sparking new ideas and new ways of thinking. Others focus your attention on the psychological aspects of overwork, such as motivation, stress, and depression. These programs are poles apart from logical, mathematical, engineering programs.

Bold, speculative, even outrageous thinking is the mainspring of innovation. Because logic begins with assumptions, when solutions depend on connections yet to be made, logic must fail. Therefore, activities such as brainstorming can be an important first step in finding new and easier ways to deal with today's crushing workloads. Of course, after brainstorming, you, as a working engineer, must convert your speculation into multiple, affordable experiments.

Speculative innovation and the resulting experiments are worthwhile endeavors even if you do not develop saleable products. As Buckminster Fuller pointed out, "There is no such thing as a failed experiment. Because the outcome is unexpected, the experiment is rich in potential learning. Too often, in the business environment, it is viewed as a

'failure,' to be covered up, swept under the carpet and forgotten as quickly as possible instead of being applauded for its courage and imagination and studied for the new insights it must contain."

Innovational and motivational programs draw on the techniques of itinerant seminar-givers. Instead of paying these folks lots of money to come to your site to conduct their workshops, the following programs let you engage in their drills and use their methods at your convenience.

Innovational programs use one or two general techniques: guided problem-solving and brainstorming. Guided problem-solving supplies frameworks into which you plug your ideas. The main advantage of computerized, guided problem-solving is that the programs will prompt you for your ideas in a thorough manner.

Mountain House Publishing's Ideatree (shareware) is a simple graphics editor for organizing your thoughts into

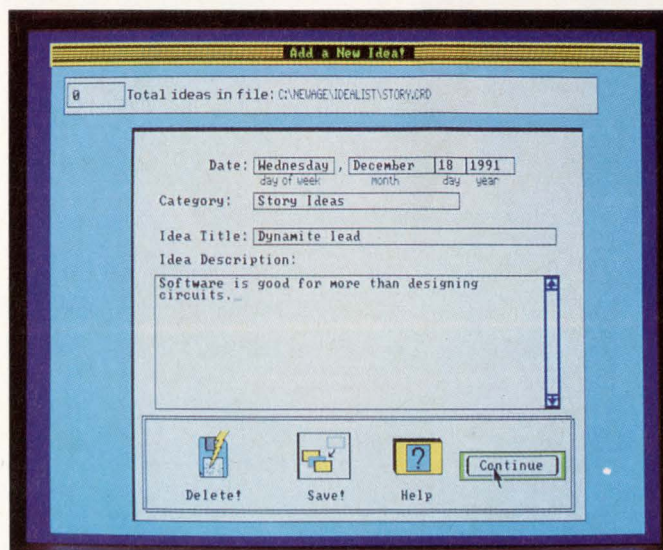

By providing a database that simulates a stack of 3x5-in. cards, Ideatree lets you first capture, and then arrange, your thoughts.

Seagate's Low-Profile 3.5" Drives

THE FINE ART OF DISC DRIVES

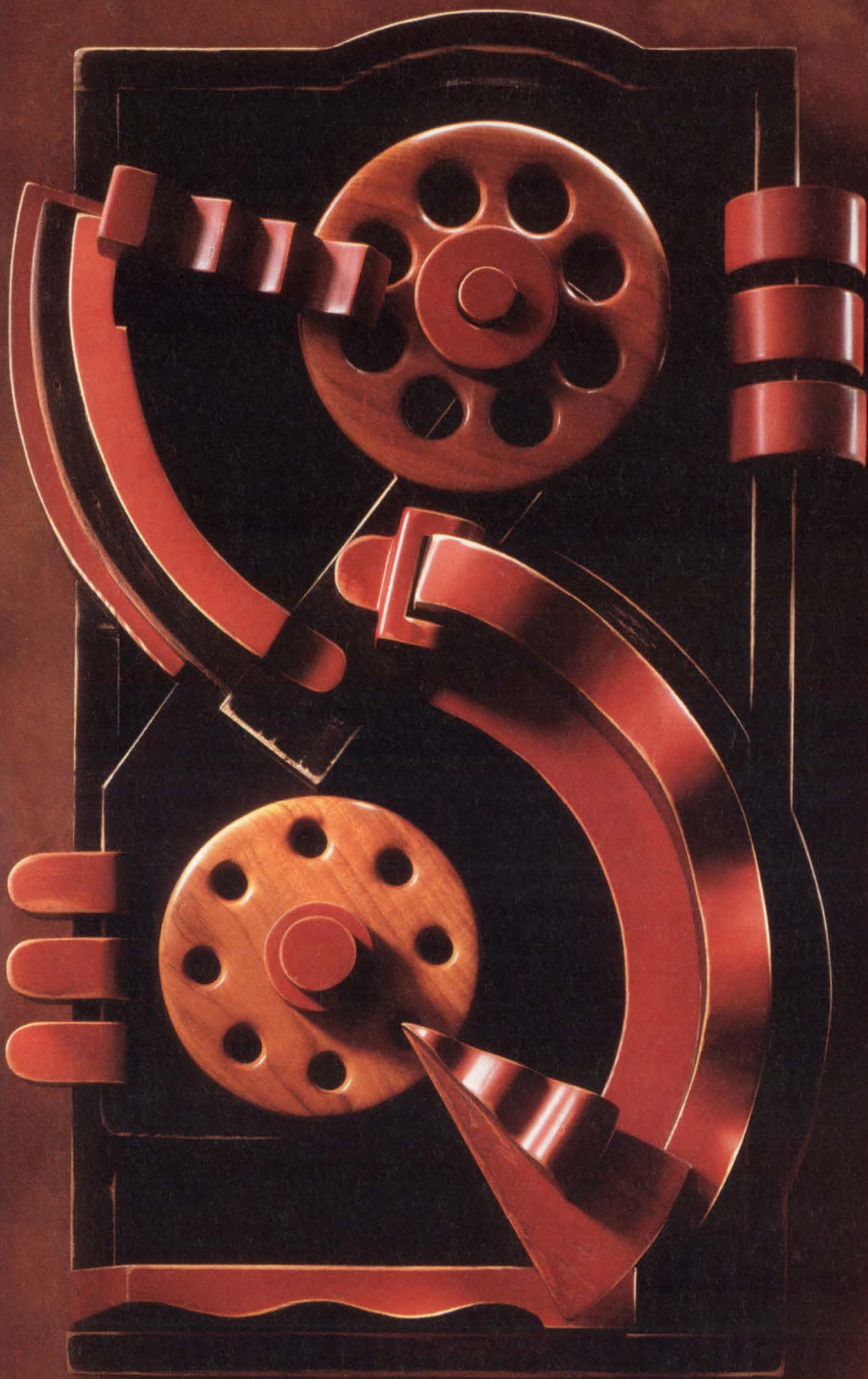

**B**alance, motion,  
volume: the  
raw materials

of art—and technology. At Seagate, we've consistently excelled in packing the features you want, plus the performance you need, into an elegantly compact package.

Seagate's 1" high, 3.5"-inch disc drives—the ST3120, ST3144, ST3283, ST3500 and ST3600—offer performance levels unusual even in full-form-factor drives. These advanced drives are ideal for performance-oriented applications where size, weight and power must be kept to a minimum, such as high-end laptops and portable workstations.

Available in AT, SCSI-2 and Fast SCSI-2 interfaces, the drives combine a 3,600 RPM or 4,500 RPM spindle motor with Zone Bit Recording (ZBR) to offer access times as low as 9.9 msec. Power consumption is from 3.5 to 5 watts, and capacities range from 106 to 525 formatted megabytes.

When creativity and craftsmanship combine, the result is art. For complete product specifications, contact your authorized Seagate distributor or call Seagate directly at 800-468-DISC or 408-438-6550.



 **Seagate**

AT is a trademark of International Business Machines Corporation. Seagate and the Seagate logo are registered trademarks of Seagate Technology, Inc.  
© 1991 Seagate Technology, Inc.

Wood Sculpture by  
Daryl Kalmus  
Cincinnati, Ohio



## INNOVATION SOFTWARE

little boxes hung from the branches of descending trees. The program lets you build extensive organization charts—ones that are bigger than a single computer screen. Uses range from simply outlining a project to performing a complete top-down decomposition of a design or process.

Michael R Sleeter's Idealist (shareware) is a simple database that you use like a stack of 3×5-in. cards to jot down and sort your ideas. In fact, each database field is fixed in size and will hold about one 3×5-in. card's worth of free-formatted information. After recording all your thoughts, in no particular order, you can search through your "cards," ordering and printing them as you choose. The program has on-line help, a graphical user interface (GUI), and only a few simple commands, trading off the power, flexibility, and complexity of full-blown database programs for ease-of-use. You should be able to operate the program now and then without recourse to a manual.

David L Salahi's Dynamind (shareware) is one of several programs that purport to help you clarify and focus your thinking. It prompts you to fill in screens that identify and prioritize your goals. Once you have clearly defined your situation and your goals, the program helps you generate ideas

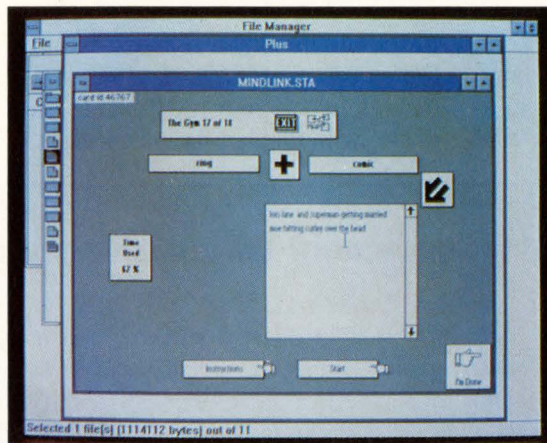

By encouraging you to think in nonlinear, nonlogical, playful ways, innovation programs such as Mindlink divert your thinking from the channels that day-to-day work has forced it into, sparking new ideas and new ways of thinking.

through a variety of techniques that stimulate creativity and imagination. Finally, it directs you to evaluate your alternatives and choose the best one.

Rosemary West's Creativity Package (shareware) contains, among other things, the Think Thunder brainstorming system. The package also contains a program that randomly assembles "poetry" from lists of words, phrases, and sentence fragments you have previously entered. The brainstorming program proceeds in a similar fashion. In response to prompts from the program, you enter spontaneous thoughts about your design problem. The program then mixes up your responses, hoping that juxtaposing unrelated thoughts will kindle new ideas.

Mindlink's Mindlink (\$299) is the

most elaborate brainstorming and guided problem-solving program listed here. The program runs under Windows 3.0 or Macintosh and requires 4 Mbytes of memory; the others will all run under DOS. The program combines brainstorming and guided problem-solving.

The program's "gym" gives your creative powers a workout using game-like exercises developed for participants in creativity seminars. In a similar vein, it has an extensive series of screens for guided problem-solving and brainstorming. The program also comes with a copy of Vincent Nolan's "The Innovator's Handbook: The Skills of Innovative Management."

And, in case you find your motivation flagging, Lightning Creative Software's lighthearted Mind Strategies (\$129.95) program will

## Try program to multiply options

You can get free trial copies of the programs noted as "shareware" from the EDN Electronic Bulletin Board ((617)558-4241,300-9600,N,E,1) or from shareware distributors such as The Software Labs. You can try the shareware out for free, paying a fee only if you like the program. Trying out all the different approaches these programs embody is a good idea because creative people typically have many strategies that they employ when innovating, trying one after the other until they reach their goals.

EDN supports the shareware concept and encourages readers to pay for shareware they adopt; using shareware beyond a reasonable trial period without paying is unethical. The programs noted with a dollar amount, and other creativity software along the lines of the shareware listed, are available from Mindware or directly from the listed programs' authors.

## INNOVATION SOFTWARE

juice you up again. Following the precepts of motivational speakers, the program lets you set up short- and long-term goals for personal as well as public success. If you find

you are too stressed out, the program will display a relaxing picture for you to contemplate. If you have lost sight of your goals, the program will display an inspirational

picture to help you remember just why you are working so hard (a Porsche is one option).

If your motivation is flagging, perhaps your spirits are too. No

## Production-oriented management stifles innovation

Think about these two facts for a minute: Engineers are under tremendous pressure to become more "productive." And, according to IEEE salary surveys, engineering salaries have dropped slightly over the last two decades (after adjustment for inflation). In other words, your boss wants you to do more work for less money.

Further, creative engineers, more and more, suffer under management practices developed for rote production work. Shortsightedly, in pursuit of ever-shorter time-to-market intervals, management deprives engineers of the chance to learn new techniques, experiment, play, or—most important—fail.

An engineering manager interviewed for an EDN Special Report on field-programmable gate arrays (FPGAs) exemplified this attitude when he said, "I don't want my engineers using any design software that takes more than an afternoon to learn."

No wonder, then, that engineers express high levels of dissatisfaction with their jobs. Tellingly, in one EDN News survey, one in five engineers would choose another profession if he or she could start over. In another survey, a significant percentage of engineers said that they would not want their children to become engineers. Perhaps these engineers would feel better if their management followed the principle of Apple's John Sculley. "If innovation is our only chance, then only a respect for individual creativity will lead to innovation. We desperately need new tools to help us become more creative."

Software that will help you squeeze every spare second out of your schedule does exist, making your days more like living on a production line. For example, 1Soft, a company specializing in "high-achievement" software, offers scheduling programs for individuals and design teams: Active Life (shareware) and 1 Team (\$295). The software not only generates schedules for every minute of every day, it can also warn you that a due date is nigh.

The team version provides the same features for groups. For example, your boss can set up or rearrange your schedule. And secretaries can enter phone messages into your to-do lists for you to follow up on.

Now, if you have to lug a laptop computer around

with you 24 hours per day to keep track of your life, you have as much as admitted that you are overworked. To the clamor of your boss's orders, your family's demands, your parents' half-remembered admonitions, and your unfulfilled dreams, you can add constant nagging from your computer. Computerizing this nightmare does offer one advantage: You will have a minute-by-minute record of your descent into burnout. You can while away your spare time, as you recuperate in the rest home, extracting charts and graphs of your accelerating overwork for your therapist's perusal.

Applying the assembly-line philosophy to engineering development yields illusory results in the short run, but proves disastrous to both the company and its engineers in the long run. Simply honing and computerizing existing design methods forces engineers into a production-line-like rut, channelizing their thought processes. Thus, the company that is logical, analytical, orderly, decisive, aggressively single-minded, and *always right the first time*, paradoxically is taking the biggest risk of all: being blindsided by innovators. As Honda's Sichiro Honda said, "There is no success for those who cannot tolerate failure."

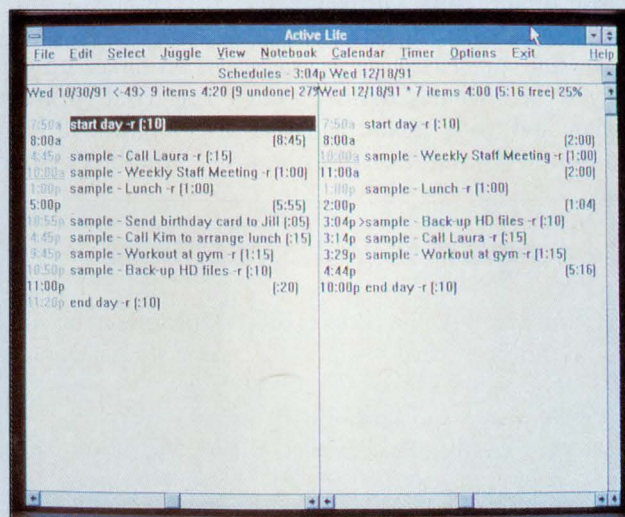

With the aid of a computerized appointment book, you can juggle every second of your public and private life, making sure that you are never inactive.

**NEW**  
2900/3900  
Programming Series starts at \$2995!



# The new 3900 takes you wherever technology goes.

At the speed technology is advancing, you need to be ready for anything. On a limited budget.

The NEW 3900 Programming System keeps up with your most advanced designs while keeping device-programming costs down. It offers leading-edge support for FPGAs, PLDs, memory devices, and microcontrollers up to 88 pins, with future device and package capa-

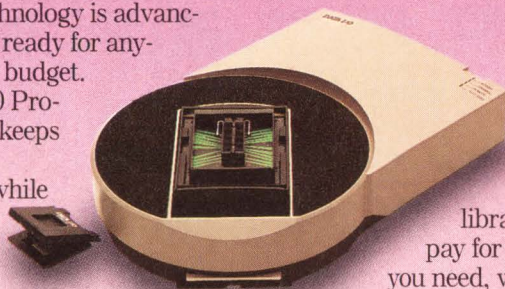

bilities built in. Yet this support is offered in device libraries so you pay for only what you need, when you need it. And you can get into the 2900/3900 Programming Series for as little as \$2995.\* Move up to 88-pin support and beyond with a

simple upgrade.

Find out how the 3900 can make your future affordable.

Call today for more information and we'll also send you a FREE copy of Data I/O's all-new, and expanded 1991 Wall Chart of Programmable Devices (a \$24.95 value).

To qualify, just call us with the brand name and serial number of any programmer you are currently using.

**1-800-3-DataIO**  
(1-800-332-8246)

\*U.S. list price only.

**Data I/O Corporation** 10525 Willows Road N.E., P.O. Box 97046, Redmond, WA 98073-9746, U.S.A. (206) 881-6444  
1-800-3-DataIO (1-800-332-8246)  
**Data I/O Canada** 6725 Airport Road, Suite 302, Mississauga, Ontario L4V 1V2 (416) 678-0761  
**Data I/O Europe** World Trade Center, Strawinskylaan 537, 1077 XX Amsterdam, The Netherlands +31 (0)20-6622866  
**Data I/O GmbH** Lochhamer Schlag 5A, 8032 Graefelfing, Germany, 089 858580  
**Data I/O Japan** Sumitomoseimei Higashishinbashi Bldg., 8F, 2-1-7, Higashi-Shinbashi, Minato-Ku, Tokyo 105, Japan  
033 432 6991/Telex 2522685 DATAIO J  
**Data I/O Limited** 660 Eskdale Road, Winnersh, Wokingham, Berkshire, United Kingdom RG11 5TS, 0734 440011  
©1991 Data I/O Corporation

CIRCLE NO. 41

The Personal Silicon Experts

**DATA I/O**  
Corporation

EDN February 3, 1992 • 63

## INNOVATION SOFTWARE

### For more information . . .

For more information on the programs discussed in this article, circle the appropriate numbers on the Information Retrieval Service card or use EDN's Express Request service. When you contact any of the following manufacturers directly, please let them know you saw their products in EDN.

**1Soft Corp**

Box 1320  
Middletown, CA 95461  
Circle No. 715

**Lightning Creative Software Inc**

16885 Via Del Campo Ct, Suite 220  
San Diego, CA 92127  
Circle No. 716

**Malibu Artificial Intelligence Works**

25307 Malibu Rd  
Malibu, CA 90265  
(213) 456-7787  
Circle No. 717

**Mindlink Inc**

The King's Hwy  
Box 247  
North Pomfret, VT 05053  
(802) 457-2025  
Circle No. 718

**Mindware**

1803 Mission St, Suite 414  
Santa Cruz, CA 95060  
(800) 447-0477  
FAX (408) 429-5302  
Circle No. 719

**Mountain House Publishing**

Ideatree  
RR 1, Box 205-8  
Waitsfield, VT 05673  
Circle No. 720

**David L Salahi**

Dynamind  
90 Streamwood  
Irvine, CA 92720  
Circle No. 721

**Self-Health Systems**

2850 6th Ave, Suite 222  
San Diego, CA 92103  
Circle No. 722

**Michael R Sleeter**

Idealist  
Computer-Ease  
Box 14857  
Albuquerque, NM 87191  
Circle No. 723

**The Software Labs**

Shareware Distributor  
3767 Overland Ave, #112-115  
Los Angeles, CA 90034  
(800) 359-9998  
(213) 559-5456  
FAX (213) 559-3405  
Circle No. 724

**Rosemary West**

Creativity Package  
RK West Consulting  
Box 8059  
Mission Hills, CA 91346  
Circle No. 725

DTI's  
CRP806  
Takes The Guess  
Work Out Of Setting  
Up Your Disk Emulator

# GOOD BYE FLOPPIES — GOOD Disk Emulator - Up To 64Mbytes With

Up to 16Mbytes  
SRAM/EPROM  
per board

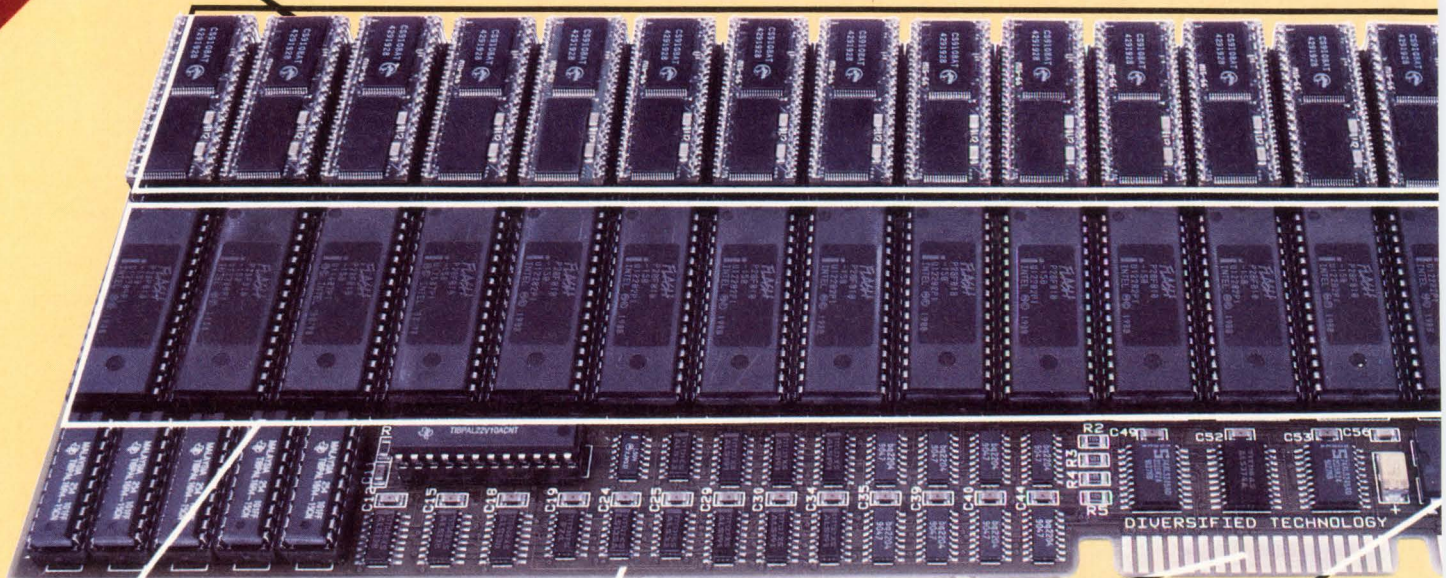

Up to 8Mbytes  
FLASH per board

UP TO 4 BOARDS PER SYSTEM (64MB)

/AT Bus  
Architecture

Field Programmable  
"FLASH BIOS"

doubt about it, today's short design cycles place engineers under terrible stress. Engineers—who would otherwise seek counseling or hire itinerant seminar-givers—could use personal-computer, self-help programs to overcome stress and depression to become more innovative.

One advantage of these personal-computer programs is that you can use them at home without leaving any record in your personnel or medical files. In fact, if your work involves a personal computer, you could engage in surreptitious, self-inflicted brainstorming or therapy on the job, fooling others into thinking you are actually working.

The 6-Step Stress Management System is a program from Self-Health Systems (shareware). The program guides you through assess-

ing your stress levels, identifying the "stressors" in your life, learning relaxation skills, and charting your progress (or lack thereof) in overcoming stress. The program also assists you in preparing your own audio cassette tapes for relaxation.

Long periods of unremitting stress, among many other causes, can lead to depression. Figures from the National Institute of Health indicate that one-quarter of all people experience a significant bout of depression in their lives. In any given month, more than 1 in 20 of us are depressed.

Overcoming Depression, a program from the Malibu Artificial Intelligence Works (\$195), is an artificial-intelligence program tailored to personal computers that simulates interactions between you and your

therapist. The program is the result of a collaboration between programmers and therapists. The program records your sessions with the "therapist" so that you can study them later. It also provides constructive advice on psychology, antidepressant drugs, and suicide prevention. **EDN**

Article Interest Quotient  
(Circle One)  
High 476 Medium 477 Low 478

# BYE HARD DRIVES

## No Moving Parts!

**Design Enhancement For U.L. Compliance**

**On-Board Floppy Controller (optional)**

**FLASH SRAM EPROM Non-Volatile RAM**

**Easy Setup Options**

**Dual Redundant Battery Backup**

**DTI Battery Saver Input**

**Configuration Data Stored in Non-Volatile "FLASH"**

**16Bit I/O Interface**

### CRR806 Disk Emulator Functions

<b>Non-Volatile Solid State Disk Emulation</b>
IBM PC/AT & EISA Bus Compatible Plug-In Card Form Factor
High Capacity - Up To <b>64 Mbytes</b> Storage Per System
Emulates Both <b>Hard</b> and <b>Floppy</b> Disk Drives On Same Board
Floppy Drive Types Emulated: 360Kb, 720Kb, 1.2Mb, 1.44Mb
Co-exists With Actual Hard and Floppy Devices
Configurable As <b>System Boot Device</b>
High Performance <b>16-bit Data Bus Transfers</b>
No System DMA or Interrupt Channels Required
<b>Sub-Millisecond</b> Disk Emulator <b>Access Times</b>
MS-DOS/PC-DOS Compatible <b>BIOS Stored In FLASH</b>
Emulation Transparent To PC-DOS/BIOS Level Calls
<b>Microsoft FLASH File System</b> Compatible
<b>FLASH-Disk</b> Support - 256 Kbytes to <b>8 Mbytes Per Board</b>
<b>SRAM-Disk</b> Support - 256 Kbytes to <b>16 Mbytes Per Board</b>
<b>EPROM/PROM-Disk</b> Support - 256 Kbytes to 16 Mbytes Per Board
<b>Write Protect</b> Option For Sensitive SRAM Disk Applications
<b>NVRAM-Disk</b> Support - Dallas Semiconductor NVRAM Compatible
NVRAM-Disk Capacity - 256 Kbytes to 16 Mbytes Per Board
EPROM/PROM-Disk Generation Utilities Provided
Uses <b>Standard 32-pin JEDEC</b> Memory Devices
BIOS Is <b>Field Upgradeable</b> From Floppy Diskette
Up To <b>2 Years</b> Static RAM Data Retention
External AC/DC <b>Battery Saver</b> Option
Up To <b>6 Total</b> Emulated/Physical Hard or Floppy Drives Per System

Call For Free  
CRR806 Disk Emulator  
Demo Disk

**Diversified Technology**  
An Ergon Co.

Call us toll free for orders and information.

**1-800-443-2667**

Outside U.S.A. - (201) 891-8718 Fax (201) 891-9629

Product names are trademarks or registered trademarks of their respective companies.

CIRCLE NO. 42

**Memories of Tomorrow. Available Today.**

---

A futuristic digital landscape featuring a glowing red sphere in the center, emitting rays of light. The sphere is set against a dark blue sky with wispy clouds and two thin white lines. Below the sphere is a checkered floor that recedes into the distance, creating a sense of depth. The text "4M FAST SRAM" is overlaid in large, golden, 3D-style letters across the middle of the image.

**4M FAST SRAM**

## The fastest 4M SRAM in the industry. 20ns access speed.

Superior Static RAMs can give your workstation, mainframe or supercomputer a critical edge in tomorrow's markets.

With 20ns access time, our Fast SRAMs boost processing speed. And with 4M density, they reduce system size. It's a winning combination you'll get only from NEC.

NEC 4M Fast SRAMs feature a 0.5 $\mu$ m CMOS process and advanced lead-on-chip technology. They're packaged in

400-mil SOJs. Memory organizations are x1, x4, and x8. To enhance reliability, we've included a special circuit that stabilizes internal supply voltage.

NEC meets all your requirements with a comprehensive line of Fast SRAMs — 12ns/64K, 15ns/256K, 20ns/1M, and now 20ns/4M.

To enhance your system

with the highest access speed and the greatest density available in SRAMs today, come to NEC.

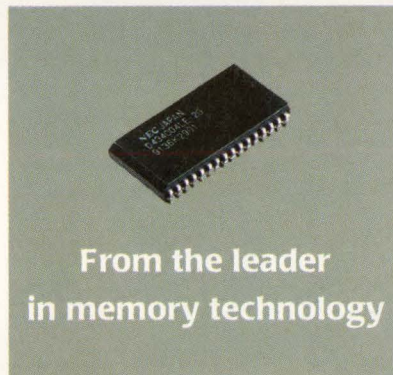

### **For fast answers, call us at:**

USA Tel:1-800-632-3531. Fax:1-800-729-9288. Germany Tel:0211-650302. Fax:0211-6503490. The Netherlands Tel:040-445-845. Fax:040-444-580.  
Sweden Tel:08-753-6020. Fax:08-755-3506. France Tel:1-3067-5800. Fax:1-3946-3663. Spain Tel:1-504-2787. Fax:1-504-2860.  
Italy Tel:02-6709108. Fax:02-66981329. UK Tel:0908-691133. Fax:0908-670290. Ireland Tel:01-6794200. Fax:01-6794081. Hong Kong Tel:755-9008.  
Fax:796-2404. Taiwan Tel:02-719-2377. Fax:02-719-5951. Korea Tel:02-551-0450. Fax:02-551-0451. Singapore Tel:253-8311. Fax:250-3583.  
Australia Tel:03-8878012. Fax:03-8878014. Japan Tel:03-3454-1111. Fax:03-3798-6059.

IN THE ERA OF MegaChip™ TECHNOLOGIES

**We've squeezed more  
ABT Widebus as fast**

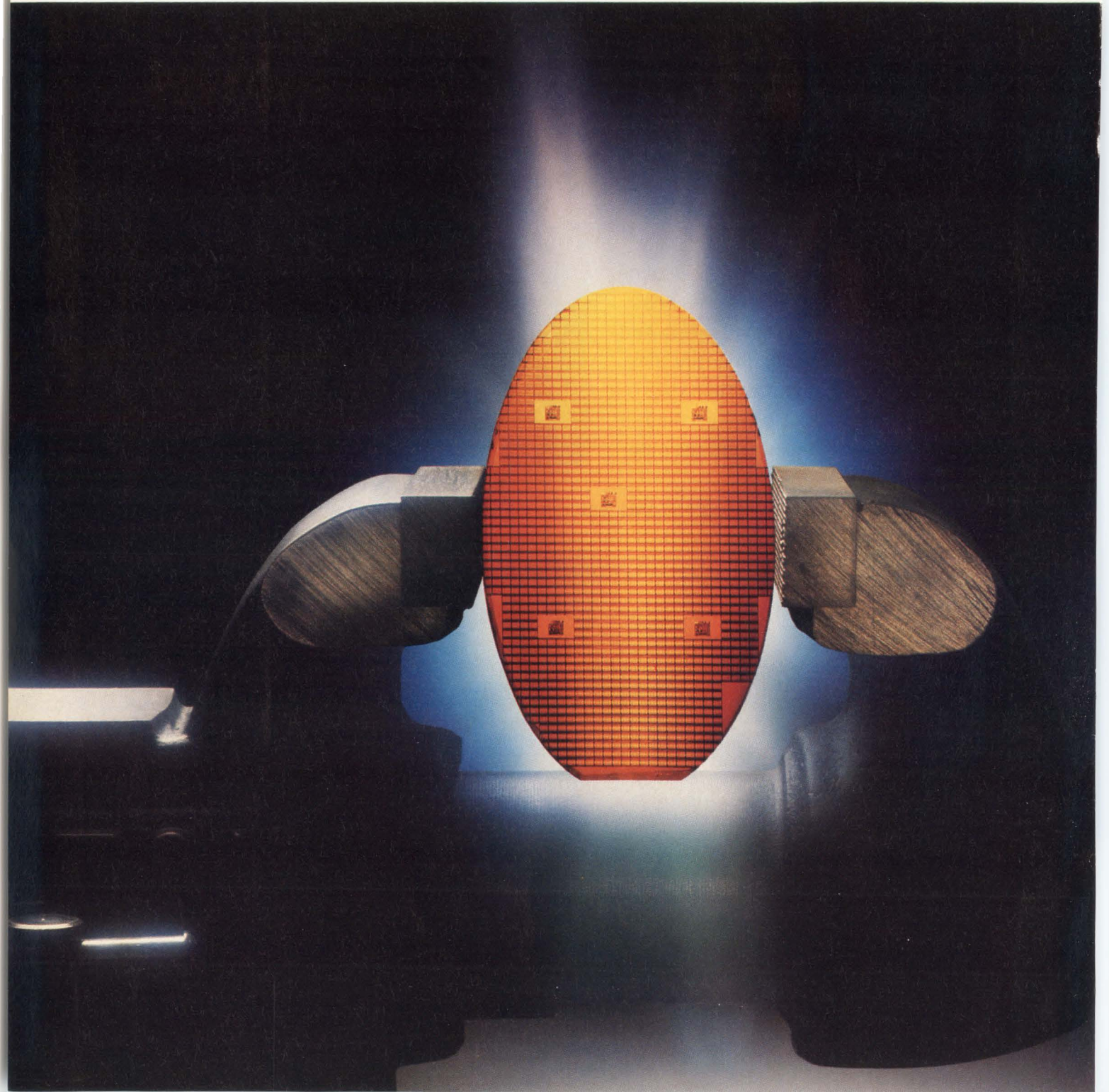



# speed from our logic. as 4.1 ns!

With our new Advanced BiCMOS interface logic (ABT) family, you get the speed, drive and low power you need to optimize the performance of processors operating at 33 MHz and above.

Fabricated in our 0.8-micron BiCMOS process, this new family delivers maximum speeds down to 4.1 ns over recommended operating conditions. Typical performance of the devices is in the 2.5- to 3.0-ns range.

Other critical performance parameters are as impressive. Drive capability is 32 to 64 mA. Static power consumption is typically 2 mA ( $I_{CCH}$ ,  $I_{CCZ}$ ) and 30 mA ( $I_{CCL}$ ). Ground bounce is less than 800 mV typ.

## All this in Widebus

Our ABT family, a second-generation advance of our leadership BiCMOS (BCT) family, includes versions of our 16-, 18- and 20-bit-width Widebus™ functions.

Among the many ABT Widebus functions released is the 'ABT16244, a 16-bit buffer and line driver. It exhibits much greater stability of propagation delay (see chart), which results in a lower derating factor across the number of outputs switched.

Also in volume production are the Widebus 'ABT16245 16-bit bidirectional bus transceiver and the 'ABT16543 and 'ABT16952 16-bit bidirectional registered bus transceivers.

As in our successful Advanced CMOS Logic (ACL) Widebus family, these devices come in our leadership surface-mount shrink small-outline package (SSOP) that gives you twice the number of I/Os as a standard small-outline package in the same space.



## Unique additions included

There are also new devices in our ABT Widebus family featuring greater density and functionality. Our 'ABT16500A is a good example. An 18-bit registered transceiver, it combines D-type latches and D-type flip-flops to allow data flow in transparent, latched and clocked modes.

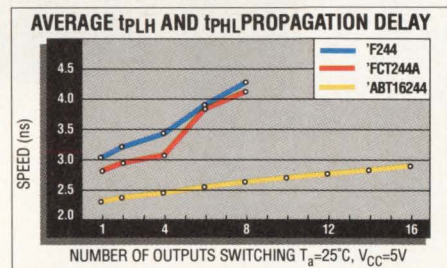

**TI's speed advantage:** In a one-to-one comparison, a TI 'ABT16244 16-bit Advanced BiCMOS driver proves to be much faster and more stable than Advanced Bipolar and standard CMOS octal drivers.

To complement our full line of Widebus products, our ABT family will include at least 39 octal buffers/drivers, flip-flops, transceivers and registered transceivers.

**Squeeze more out of your system with a free sample 'ABT16500A: Call 1-800-336-5236, ext. 3009**

To learn firsthand how our new ABT family can boost the performance of your bus-interface designs, get a free 'ABT16500A transceiver and data sheet. Just complete and mail the return card or call the number above.



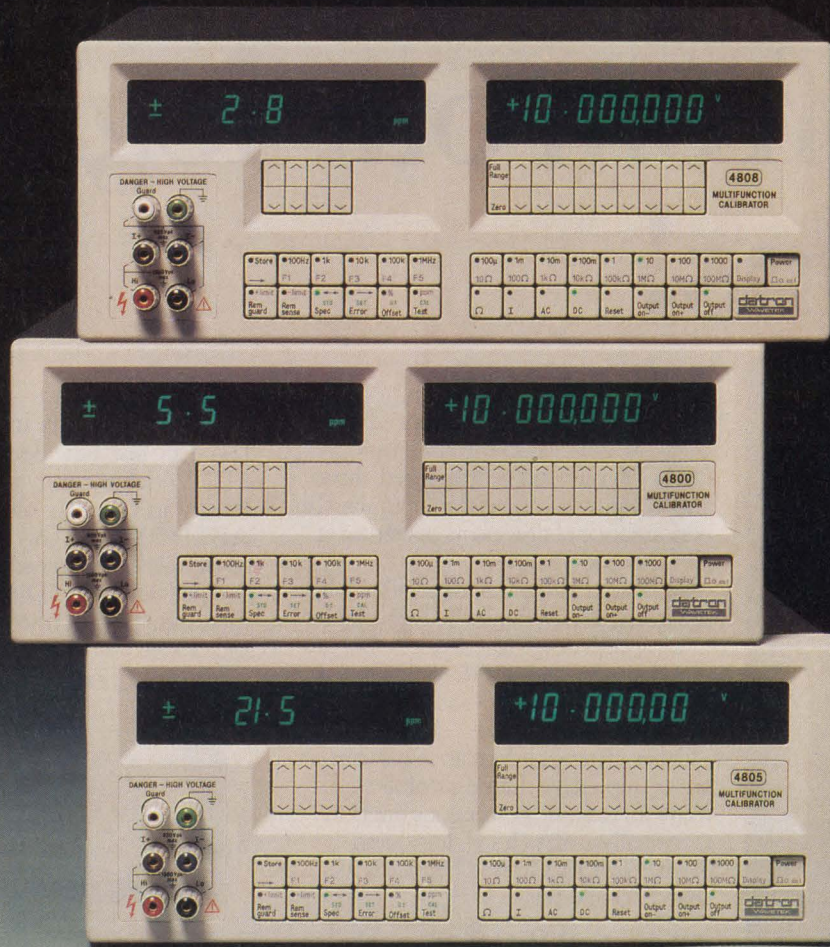

# Introducing DMM calibrators for perfectionists, pragmatists and realists.

Our new family of multi-function calibrators (DCV, ACV, DCI, ACI,  $\Omega$ ) has something for everyone.

If you demand the best in standards laboratory accuracy and performance, Model 4808 delivers: 3 ppm/year.

Model 4800 offers an exceptional combination of capability and price. With performance to 6.5 ppm/year, it can calibrate up to 7½ digit DMMs. And for the ultimate in economy, Model 4805 can calibrate analog or digital

multimeters up to 5½ digits.

Whichever you choose, you'll have the added benefits of an integral full-function 1000V power amplifier — unique to Datron calibrators. This means you can cover the widest DMM and analog meter calibration workload without worrying about separate boxes or extra connection.

The Model 4808 and 4800 calibrators have modular construction. Start with only the functions you need, knowing you can retrofit

additional options later.

So whether your major consideration is accuracy, price, or simply the perfect answer to your needs, you'll find it in the new Series 4800 Calibrators from Datron.

For more information, call our United States Sales Offices:

Western: (619) 565-9315

Eastern: (516) 454-8440

## Trio of software tools tailors MS-Windows to test applications

If you use an MS-DOS PC to develop and run test applications, Hewlett-Packard figures that sooner or later—probably sooner—you're going to be doing your development and running your programs under MS-Windows V3.0 or higher. Therefore, the firm is announcing a trio of Windows-based test-development packages.

Of the three latest offerings, Instrument Basic for Windows provides the best place for neophyte test programmers to get started. The language is designed for engineers and scientists who want to write their own test software to run under Windows. (Despite Basic's reputation as a beginner's language—Basic stands for *Beginners'* all-purpose symbolic instruction code—HP claims that test engineers still program as many test applications in Basic as in all other languages combined.)

This Basic is interpreted, preserving the language's interactive flavor, and is much more test oriented than other Windows languages. Unlike earlier versions of HP Instrument Basic, the Windows version runs on 80x86-based PCs without a 680x0-based coprocessor board.

ITG II is a tool for programmers looking for assistance in creating Windows-based test programs. It doesn't allow you to program solely by creating, interconnecting, and manipulating icons. (Last year, for people totally averse to text-based programming, the vendor introduced a workstation-based package called VEE that lets you control instruments and data solely by working with icons.)

ITG II targets test engineers



Graphics displays that appear in windows while you develop and debug your test program are just one of the features of Instrument Basic for Windows. The language is one of three packages the vendor is targeting at test engineers who use MS-DOS-based PCs to develop and run test applications.

with programming experience who will find the graphics-based features handy for generating code segments in several languages. But text-based code will still be needed for linking the segments, which themselves are text based, into working applications. ITG II is the successor to the vendor's earlier ITG/DOS, a package that does not support MS-Windows.

One of ITG II's new features is a driver-writing tool. Although you cannot use the tool for writing complex instrument drivers, you can use it to rapidly write drivers that control an instrument's most-often-used functions. You write the drivers by following a structured question-and-answer process that is embedded in the tool.

The vendor characterizes the third package, HP-IB for Windows and DOS, as a safety net for DOS/Windows programmers who are working with Windows-compatible languages and applications and

want to control IEEE-488 instruments. In other words, if you are using a language that doesn't handle instrument control, you can enhance this language with the instrument-control functions you need by using HP-IB for Windows and DOS. If, instead of a language, you are using a Windows application, such as Excel, and you want to do instrument control and data acquisition from your spreadsheet, this Windows and DOS package will allow you to do the job.

HP E2200A, Instrument Basic for Windows, costs \$395; HP E2020B, ITG II, including a library of 220 instrument drivers, costs \$1495. HP 82335B, HP-IB for Windows and DOS, including an ISA bus IEEE-488 interface card, costs \$525.—Dan Strassberg

Hewlett-Packard Co, 19310 Pruneridge Ave, Cupertino, CA 95014. Phone (800) 752-0900 for information; (800) 452-4844 for orders.

Circle No. 730

# For everyone who's tried to copy our AD574, here's your assignment for the next ten years.

A decade ago, we revolutionized the 12-bit a/d converter market when we created the original AD574. It delivered higher levels of functional integration and performance, yet at half the cost of alternative solutions.

And we didn't stop there. We went on to add the AD674 and AD774 to create a full range of pin-compatible converters. Each as popular as our AD574 which, since its introduction, has left a lot of other companies playing catch-up.

Now these companies have a new goal. Because now there is the AD1674.

As a member of our AD574 family, the pin-compatible AD1674 offers designers unparalleled performance and integration. With the added benefits of an on-chip sample/hold amplifier, DC and



AC guaranteed specs, faster throughput, and a list of other features too long to mention here.

In other words, the AD1674 redefines 'industry standard' the same way the AD574 did ten years ago.

Why wait for an imitation when you can have the real thing now? Get more information today on

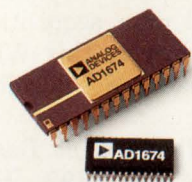

**The AD1674 retains the pinout and functionality of the AD574, AD674 and AD774, while integrating a high-bandwidth sample/hold circuit, higher speed, lower power, and lower price – from \$14.15 (suggested, 100s). The AD1674 accepts input signals of  $\pm 5V$ ,  $\pm 10V$ ,  $0-10V$  or  $0-20V$ , while operating from its standard  $10V$  on-chip voltage reference (available for driving external loads).**

the AD1674, AD574, AD674 or AD774 converter family by writing to us at the address below. Or by calling 1-800-262-5643.



Analog Devices, Inc., One Technology Way, P.O. Box 9106, Norwood, MA 02062-9106. Headquarters: (617) 329-4700. Offices, applications support and distribution available worldwide.

Authorized North American Distributors: Alliance Electronics 505-292-3360 • Allied Electronics 817-595-3500 • Anthem Electronics 408-453-1200 • Bell Industries 213-826-6778 • Future Electronics 514-694-7710 • Hall-Mark Electronics 214-343-5000 • Newark Electronics 312-784-5100 • Pioneer Standard 216-587-3600 • Pioneer Technologies Group 1-800-227-1693

## EPLD combines 80-MHz counter rate with 256 logic cells and 164 I/Os

Logic designers carve out their creations under tight constraints, limited by logic delays, interconnection costs, and available I/O pins. They can, however, use the Altera MAX 7000 series EPLDs (erasable programmable logic devices) to gain some sorely needed design elbow room. The top-of-the-line EPM7032 brings together an 83.3-MHz ( $f_{CNT}$ ) counter clock rate, with 256 logic macrocells, special shared logic-expander terms, a fixed cell-to-cell signal delay of 3 nsec, and 164 I/O pins. Logic delay for a signal, coming on chip through a gate to a flip-flop, is 12 nsec ( $t_{PD}$ ).

Engineers can build designs from the logic macrocells using expander terms to widen logic product terms. The company furnishes a comprehensive macro design library of SSI and MSI parts that are mapped onto the MAX macrocells from the earlier MAX 5000 line. The MAX 7000 series supports faster clocks, a minimized intercell delay to 3 nsec, and higher I/O pin counts. In addition, for the first time the MAX programmable logic is available in an electrically erasable PLD (EPLD).

The first two members of the MAX 7000 family are the EPM7256GC192, a 10,000-gate EPLD with 192 I/Os; and the EPM7032LC44, a 1250-gate EPLD with 36 I/Os (4 dedicated inputs). Most applications can use approximately 50% of these gates. Future chips will push to 300 pins and 20,000 usable gates.

The MAX family sits in the middle of the large-scale programmable logic world. On one hand, RAM-based FPGAs (field-programmable gate arrays), like Xilinx's, have an

array of logic cells that are programmed by setting underlying RAM control bits. This RAM controls each cell as well as on-chip interconnects. On the other hand, antifuse FPGAs modeled after gate arrays have an array of cells with one-time-programmable interconnects. Vendors such as Actel, Quicklogic, and Crosspoint use low-impedance antifuses to program macrocell interconnects. MAX EPLDs are reprogrammable, but they must be taken out of the system to do so.

Altera's approach to complex FPGAs is to build fixed hierarchies of macrocells. For example, the EMP7032 has 256 macro or logic

cells. These cells are ordered into logic array blocks. An EPM7256 has 16 logic blocks, each with 16 macrocells. Each logic block is like a mini PAL—the macrocells share a logic array or bus of signals. These signals are routed to an individual cell input term by programming its EPROM connection bit, just like a PAL. Each macrocell logic input acts as an implicit AND gate with multiple product terms. Thus, you can build fairly complex logic using a simple macrocell.

However, the MAX EPLDs differ from PALs in that Altera engineers added a programmable interconnect array for linking signals between logic blocks. This array is

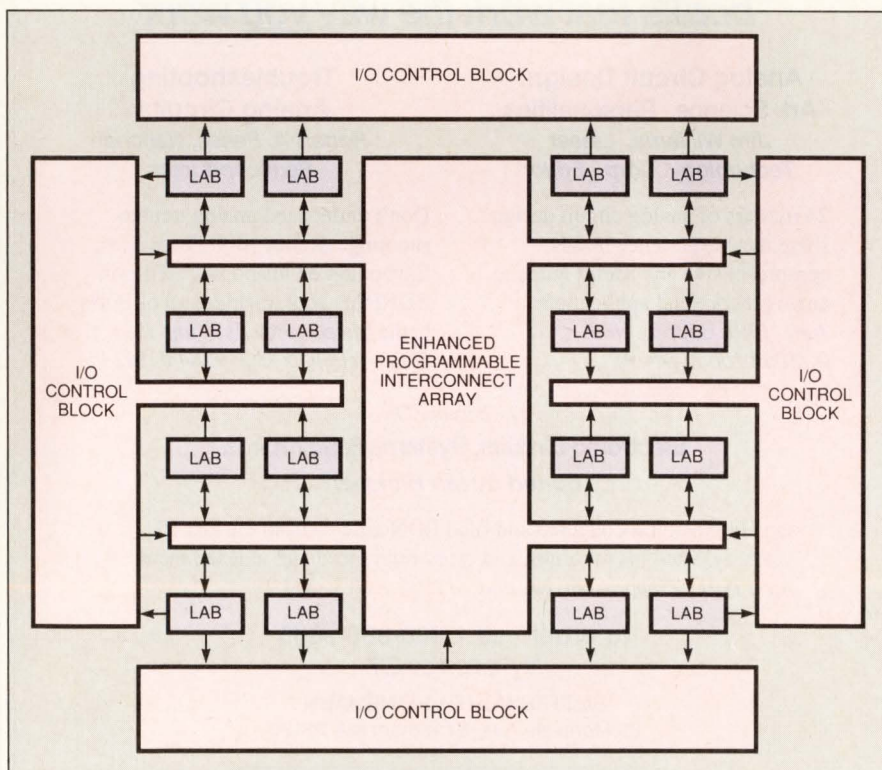

With this EPLD architecture, intercell signal delays are held to 3 nsec. Using the MAX 7000 series, you can build complex logic without worrying about unconstrained routing delays.

# The First **8mm** Profiles

## for Telecommunication PC Transformers

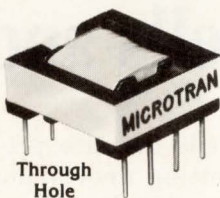
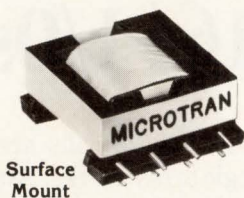

- 8mm (.32") high
- For interconnect of voice & data modem terminals
- Meets FCC Part 68
- For wet & dry circuits
- Coupling and hybrid
- Frequency response 300 to 3500 Hz  $\pm$  0.5 dB
- -45 to +7 dBm rating
- Impedance matching  $\pm$  10%
- Distortion 0.5% max.
- Longitudinal balance 60 dB
- 1500 V RMS hipot
- Flammability per UL94VO
- Solderability per MIL-STD-202
- Packaging for automatic pick & place
- Request Product Bulletin F267
- From stock through distributors.



**MICROTRAN**  
company, inc.

145 E. Mineola Ave., P.O. Box 236, Valley Stream, NY 11582-0236  
Tel: 516-561-6050; Fax: 516-561-1117

U-4

See us  
in EEM

CIRCLE NO. 47

### books that work the way you work

**Analog Circuit Design:  
Art, Science, Personalities**  
*Jim Williams, Linear  
Technology Corp., Editor*

24 masters of analog circuit design share their experience in this comprehensive and useful guide to analog theory and applications.  
*June 1991 352pp. cloth  
0 7506 9166 2 \$44.95*

**Troubleshooting  
Analog Circuits**  
*Robert A. Pease, National  
Semiconductor*

Don't understand analog troubleshooting? Relax. Bob Pease does. Expanding on his popular series in EDN, this book includes all of Bob's battle-tested methods.  
*June 1991  
208pp. cloth 0 7506 9184 0 \$32.95*

*The best of EDN*

**Electronic Circuits, Systems & Standards**  
*Edited by Ian Hickman*

Ian Hickman has collected and filed EDN articles from the last 15 years, selected his favorites, and cross-referenced and indexed them.  
*April 1991 256pp. cloth 200 illus. 0 7506 0068 3 \$32.95*

**to order call 1-800-366-2665**

M-F 8:30-4:30 E.T.

BUTTERWORTH-HEINEMANN  
80 Montvale Ave. Stoneham MA 02180

**The EDN Series  
for Design Engineers**

laid out so routing delays between any two logic-block signals remain constant at 3 nsec. This tactic eliminates the routing problems that many designers experience with other FPGAs, where timing depends on efficient routing. MAX timing delays are fixed, with perhaps higher delays than an efficiently routed FPGA layout.

To increase potential logic complexity, Altera engineers added expander product terms to the logic blocks. These are unallocated AND gates that can be programmed and shared by the logic-block macrocells. With expanders, designers can fit as many as 76 product terms into a single macrocell using one additional logic level of delay.

The MAX7000 macrocell is a simple logic block. It consists of a product term-select matrix (5 PAL-like AND gates) with simple logic ORed and the result fed to a flip-flop or directly out. Without expanders, a macrocell takes as many as 32 product terms. The logic handles D, T, JK, and SR flip-flops. Global clocks, clears, and output enables are also provided.

The company's development software, MAX+PLUS II, is for the MAX programmable logic and runs on a PC under Windows 3.0. This tool set includes a graphic schematic editor, a text editor, a waveform editor, and a logic simulator for testing designs. It includes Altera's Hardware Description Language for textually defining designs such as state machines. The system also provides a tool for partitioning large designs into multiple chips.

The 192-pin pin-grid-array EPM-7256GC192 costs \$395 (single qty). The 44-lead plastic-leaded-chip-carrier EPM7032LC44 costs \$14.75 (100).—**Ray Weiss**

*Altera Corp, 2610 Orchard Pkwy,  
San Jose, CA 95134. Phone (408)  
984-2800. FAX (408) 248-7097.*

**Circle No. 731**

**The FS700 LORAN-C frequency standard**

# 10 MHz cesium stability

**\$4950**

**Cesium long term stability at a fraction of the cost**

**Better long-term stability than rubidium**

**Not dependent on ionosphere position changes, unlike WWV**

**Complete northern hemisphere coverage, unlike GPS.**

The FS700 LORAN-C frequency standard provides the optimum, cost-effective solution for frequency management and calibration applications. Four 10 MHz outputs from built-in distribution amplifiers provide cesium standard long-term stability of  $10^{-12}$ , with short-term stability of  $10^{-10}$  ( $10^{-11}$  optional). Reception is guaranteed in North America, Europe and Asia.

Since the FS700 receives the ground wave from the LORAN transmitter, reception is unaffected by atmospheric changes, with no possibility of missing cycles, a common occurrence with WWV due to discontinuous changes in the position of the ionosphere layer. Cesium and rubidium standards, in addition to being expensive initially, require periodic refurbishment, another costly item.

The FS700 system includes a remote active 8-foot whip antenna, capable of driving up to 1000 feet of cable. The receiver contains six adjustable notch filters and a frequency output which may be set from 0.01 Hz to 10 MHz in a 1-2-5 sequence. A Phase detector is used to measure the phase shift between this output and another front panel input, allowing quick calibration of other timebases. An analog output with a range of  $\pm 360$  degrees, provides a voltage proportional to this phase difference for driving strip chart recorders, thus permitting continuous monitoring of long-term frequency stability or phase locking of other sources.



**FS700: The optimum frequency management system**



**STANFORD RESEARCH SYSTEMS**

1290 D Reamwood Avenue ■ Sunnyvale, CA 94089 ■ Telephone: (408) 744-9040  
FAX: 4087449049 ■ Telex: 706891 SRS UD

CIRCLE NO. 49

# Bus-driver ICs

Richard A Quinnell, Technical Editor

As ASICs and programmable logic sweep up most discrete logic, bus-driver ICs are becoming the bulk of standard logic products and the focus of manufacturers' attention. Manufacturers have tamed ground bounce and are now boosting bus-driver performance and adding capabilities such as built-in logic.

Bus-driver ICs are so common in circuit design they tend to get ignored, so you probably haven't noticed that they've gotten a lot quieter lately. Bus-driver manufacturers have successfully attacked the problem of device-generated noise with a combination of circuit-design and packaging techniques. The knowledge gained, together with process-technology advances, has let manufacturers broaden their range of bus-driver products and make bus drivers that are faster, quieter, and have more drive than those available three years ago.

Device-induced noise first became a major bus-driver issue with the introduction of high-speed CMOS logic in the mid 80s. IC families such as Harris Semiconductors' ACT, Integrated Device Technology's FCT, and Texas Instruments' AC se-

ries suffered to such a degree that EDN devoted several articles to addressing the problem (Refs 1 to 3), culminating in its own testing program (Ref 4).

The noise source of greatest concern was ground bounce, also known as simultaneous switching noise. Fig 1 shows a simplified output-circuit model that helps explain ground bounce. The model is too simple for circuit simulation; fortunately, most manufacturers provide Spice models of their ICs for ground-bounce prediction.

As the model shows, when an output stage switches to logic low, it discharges load capacitance  $C_L$  through the lead inductance of the IC's ground pin. The induced voltage, in this model given by

$$V_L = -LC \times d^2V/dt^2,$$

shifts the reference voltage seen by the IC's transistors relative to system ground.





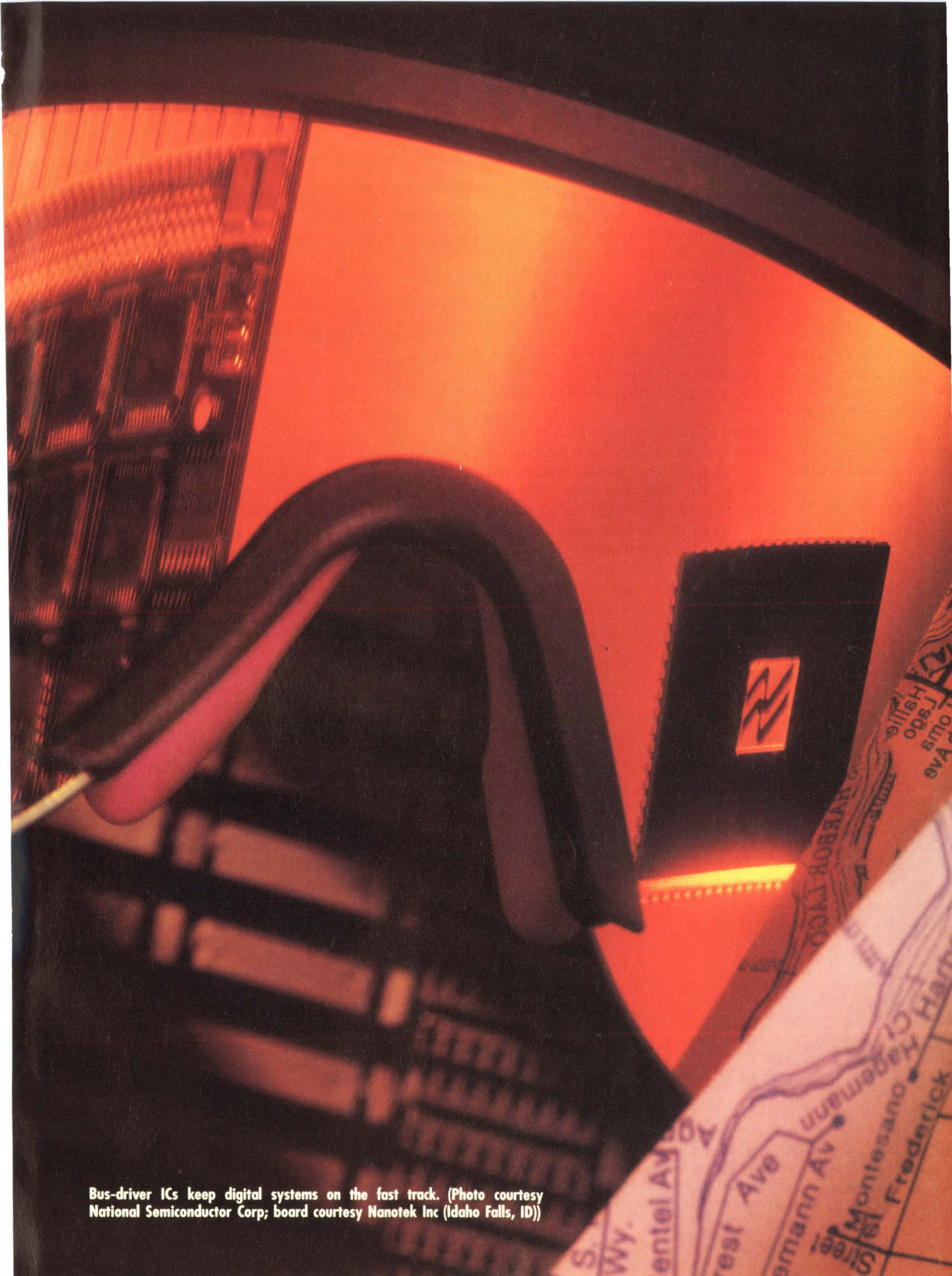

Bus-driver ICs keep digital systems on the fast track. (Photo courtesy National Semiconductor Corp; board courtesy Nanotek Inc (Idaho Falls, ID))

# BUS-DRIVER ICs

The induced voltage, if great enough, can affect a circuit in two ways. First, it will cause a fluctuation (ground bounce) in an output held low by one stage as another stage switches. The positive portion of the ground bounce can falsely trigger any edge-sensitive input stage connected to the affected output line. The negative portion can damage succeeding input stages by driving them below ground. Second, the induced voltage can raise the threshold of the IC's input stages, causing them to perceive a change in the incoming signal's logic level, and consequently, the IC produces an output glitch.

Since the appearance of EDN's ground-bounce study in 1989, bus-driver IC manufacturers have introduced several circuit and packaging changes to reduce and control ground bounce. The first step most took was to reduce the voltage swing of the output signal, which reduces the energy stored in the load capacitors. As Table 1 shows, most of the logic families have TTL output swings regardless of their base technology. IDT's FCT-T family, for example, uses the same CMOS process technology as the company's earlier FCT fam-

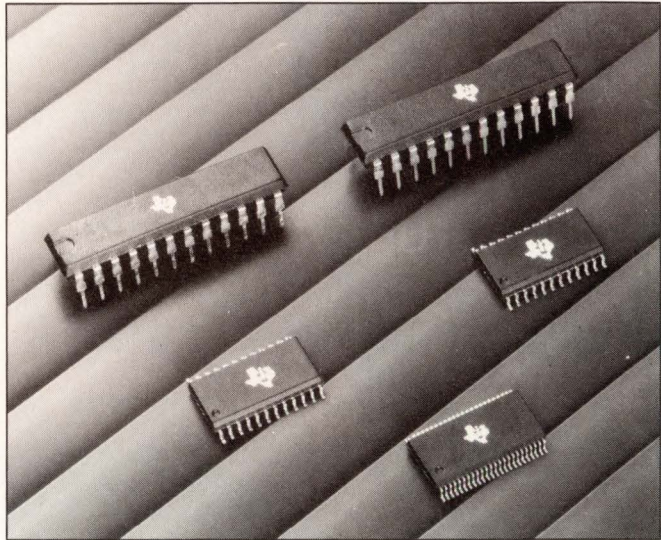

Bus-driver ICs are becoming denser and are migrating to smaller packages. Both trends combine to reduce ground bounce and increase the number of available channels per IC.

ily but doesn't have the rail-to-rail swing usually characteristic of CMOS logic. By limiting the  $V_{OH}$ , IDT was able to reduce FCT-T ground-bounce noise as much as 40% from the FCT family's levels.

### Controlling turn-on reduces noise

Another step many bus-driver-IC manufacturers have taken is to control the output stage's turn-on rate. The magnitude of the ground-bounce pulse is proportional to the output signal's second time derivative. Implementing a gradual turn-on reduces the initial ground-bounce pulse, which is the one that adversely affects logic levels. Manufacturers accomplish this gradual turn-on in CMOS logic by using the circuit in Fig 2. The control-signal line first activates  $Q_1$ , a rela-

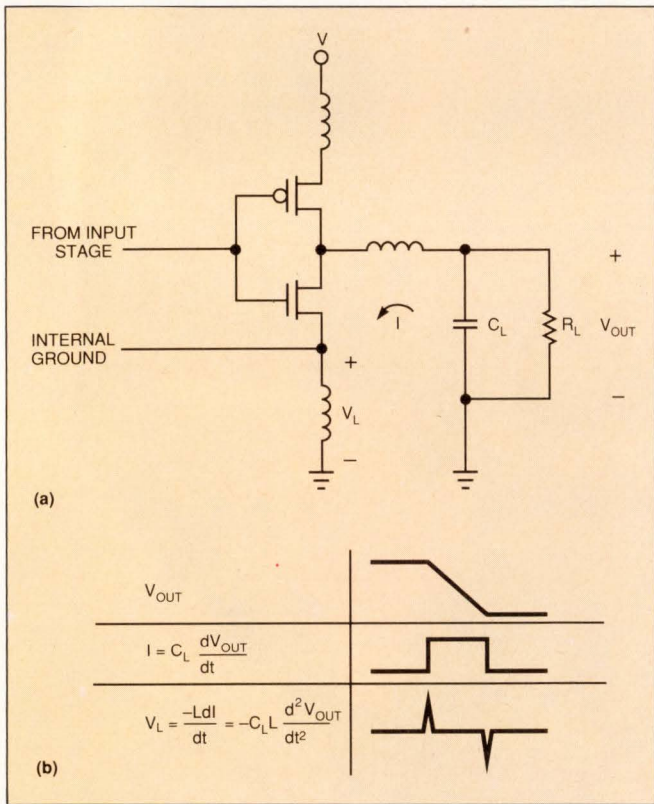

Fig 1—This simplified model of a bus-driver output stage (a) gives insight into the cause of ground bounce. As the load capacitance discharges through the IC's ground-lead inductance, the induced voltage shifts the device's internal ground reference (b).

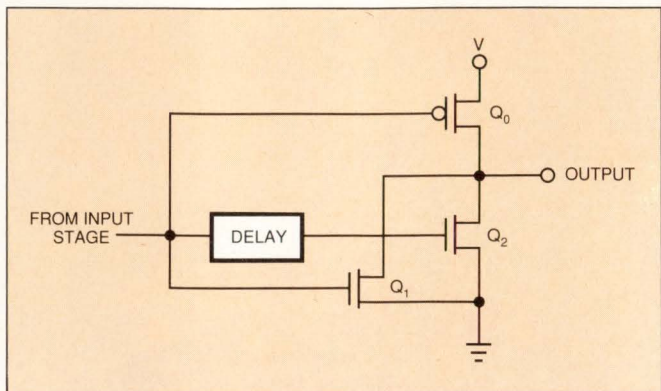

Fig 2—Controlling the output stage's turn-on rate is one technique for reducing ground bounce. For CMOS circuits, activating two transistors in succession yields a gradual turn-on.

tively small transistor with limited current-handling capability. Following a brief delay, the control signal activates the larger  $Q_2$ , which provides most of the output stage's current-handling capability.

In addition to circuit changes, manufacturers have reduced ground bounce by making packaging changes. The most obvious change has been a move to surface-mount packages. Surface-mount packages exhibit lower lead inductance than DIP packages, hence less ground bounce. Another change is that manufacturers have added ground pins to DIPs. The Texas Instruments 74ACT16xxx parts, for example, have eight ground and four power leads. Some DIPs also have a

redesigned lead frame. Both National Semiconductor and Philips/Signetics have altered the IC's internal lead-frame construction as Fig 3 shows. The additional ground finger lets the companies reduce chip-to-lead inductance by using two ground bond wires in parallel.

National Semiconductor provides separate ground references for the input and output stages of ACTQ series parts (Fig 4). Because the chip-to-lead inductance on the input side's ground helps isolate the input reference from the output reference, the input stage sees reduced ground bounce. National Semiconductor uses the input ground as a quiet on-chip reference. This reference lets the IC detect ground bounce and

**Table 1—Bus-driver-IC families**

Manufacturer	Family	Number of channels	Propagation delay (nsec)	I <sub>OL</sub> (mA) (sink)	I <sub>OH</sub> (mA) (source)	V <sub>OH</sub> (min)	V <sub>OL</sub> (max)	I <sub>CC</sub> (mA) (high Z)	Package styles	Price (100)	Notes
Harris Semiconductor	CD74FCTxxx	8	6.5	64	15	2.4	0.55	0.08	DIP, SOP	\$0.95	No I/O clamp diode to V <sub>CC</sub> . No I/O clamp diode to V <sub>CC</sub> .
	CD74FCTxxxAT	8	5.3	64	15	2.4	0.55	0.08	DIP, SOP	\$1.55	
Hitachi America Ltd	HD74ACQxxx	8	5.0	24	24	4.4	0.1	0.08	DIP, QFP	\$0.72	
	HD74ACTQxxx	8	5.0	24	24	4.4	0.1	0.08	DIP, QFP	\$0.73	
	HD74BCxxx	8	4.5	64	0.5	2.4	0.6	0.5	DIP, QFP	\$0.80	
Integrated Device Technology	74FCTxxxCT	8	4.1	64	15	2.4	0.55	1.5	DIP, SOIC, SSOP, LCC	\$4	25Ω series resistor. 3.3V supply.
	FCT16xxxCT	16	4.1	64	32	2.4	0.55	0.1	SSOP	\$8	
	162xxxCT 163xxx	16 16	4.1 4.8	24 24	24 8	2.4 2.4	0.55 0.5	0.1 0.1	SSOP SSOP	\$8 \$3	
National Semiconductor Corp	74ACTQxxx	8	7.0	24	24	3.76	0.44	0.08	DIP, SOIC	\$1.62	25Ω series resistor.
	74BCTxxx	8	5.5	64	15	2.4	0.55	9	DIP, SOIC	\$1.62	
	74BCT2xxx	8	6.7	15	15	2.4	0.55	9	DIP, SOIC	\$2.07	
	74FRxxx	8	3.9	64	15	2.4	0.55	50	DIP, SOIC	\$2.36	
	74FR16xxx	16	4.3	64	15	2.4	0.55	50	PLCC, SSOP	\$4.71	
Philips Components/Signetics	74ABTxxx	8	2.9	64	32	2.5	0.55	0.05	DIP, SOL	\$1.83	
	MB2xxx	16	2.9	64	32	2.5	0.55	0.1	PQFP	\$5.63	
Quality Semiconductor Inc	QSFCTxxxT	8	3.8	64	15	2.4	0.8	1.5	DIP, ZIP, SOIC, QSOP	\$5.21	25Ω series resistor.
	QSFCT2xxxT	8	4.1	12	15	2.4	0.8	1.5	DIP, ZIP, SOIC, QSOP	\$3.37	
Texas Instruments	SN74ABTxxx	8	4.6	64	32	2.0	0.55	0.05	DIP, SOIC, SSOP	\$1.80	26Ω series resistor.  Universal bus-transceiver design. Similar to 16500. Holds last output when bus goes to high impedance. Demand-based power-reduction circuitry.
	SN74ABT2xxx	8	5.5	12	12	2.0	0.55	0.05	DIP, SOIC, SSOP, TSOP	\$2.20	
	SN74ABT16xxx	16	9.5	24	24	3.7	0.44	2	SSOP	\$3.50	
	SN74ABT16500	18	4.6	64	32	2.0	0.55	3	SSOP	\$10.80	
	SN74ABT32500	36	5.0	64	32	2.0	0.55	4	SQFP	\$19.80	
	SN74ACT16xxx	16	4.1	64	32	2.0	0.55	0.08	SSOP	\$4.50	
Toshiba America Electronic Components Inc	74ABTxxx	8	3.0	64	15	2.4	0.55	0.05	SOIC	\$2.20	
	74BCxxx	8	4.2	48	15	2.7	0.55	0.05	DIP, SOIC	\$1.87	

Notes: 1. Parameters listed are for -244 type buffer in each family.

2. PLCC=plastic leadless chip carrier, PQFP=plastic quad flatpack, QFP=quad flatpack, SOP=small-outline package, SQFP=shrink quad flatpack, SSOP=shrink small-outline package, TSOP=thin small-outline package, ZIP=zig-zag in-line package.

## BUS-DRIVER ICs

take corrective action. In the ACTQ series, the chip's response is to inject current into the affected output circuits to reduce the negative ground-bounce pulse.

### Forgotten but not gone

Given all the techniques manufacturers have devised to reduce ground bounce, you might be tempted to conclude that ground bounce is no longer a concern for bus-driver ICs. However, manufacturers have only controlled ground bounce, not eliminated it. Such noise will continue to exist in high-speed systems and has joined propagation delay and power consumption as factors bus-driver IC manufacturers must trade off in their designs.

What each manufacturer has done is chosen a voltage limit for ground bounce in its parts—a value it feels will relieve designers from the need to address ground bounce specifically in their designs. With today's parts, then, using ground planes and power-supply decoupling should keep ground bounce from affecting your system's operation. If your system has noise sources that might gang up with ground bounce, you may want to consider some of the design options described in the **box**, "A little more margin, please." You might also want to consider alternatives to using a bus driver in your design. The **box**, "Bus-driver alternatives" describes some options for common bus-driver applications.

Developing an array of ground-bounce reduction

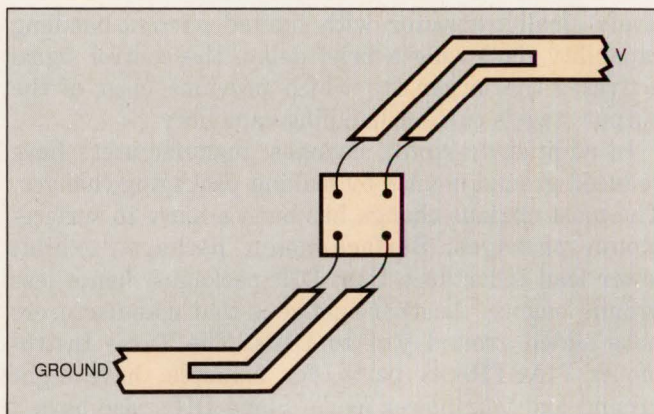

**Fig 3—Using a split lead frame reduces ground bounce by letting two bond wires in parallel carry the ground signal, thus lowering the ground lead's inductance.**

techniques, together with increasing IC transistor density, has enabled manufacturers to broaden their range of bus-driver products. Several manufacturers are offering bus-driver ICs that can handle 16 or more signals while still controlling ground bounce. Such manufacturers include Texas Instruments, National Semiconductor, and IDT. Early 1992 should see the introduction of 18- and 20-bit-wide parts from Motorola and a 36-bit-wide part, the SN74ABT32500, from Texas Instruments.

Ground-bounce control lets conventional 8-channel bus drivers quietly handle more current and greater

### A little more margin, please

Manufacturers have made progress in removing ground bounce from their ICs, but you can give yourself an extra margin of safety through careful circuit design. The first step is to use synchronous design techniques wherever possible. Because ground bounce occurs only when outputs switch, a synchronous design may never see any ill effects from ground bounce occurring on data lines. The noise generated when output data changes on one clock edge will decay before the clock edge that latches that data into the next stage occurs.

If you're concerned about ground bounce affecting a clock

line or if your design uses asynchronous logic, you can reduce the occurrence of problems by carefully assigning signals to ICs. Ground bounce increases with the number of signals switching simultaneously, so avoid running edge-triggering or clock signals through the same bus-driver ICs you use for data buses. An IC with four simultaneously switching output lines has less than 70% the ground bounce of one switching eight signal lines at once.

Even if you're stuck routing a sensitive signal through a noisy IC, you can still minimize potential problems with pin assignment. Because the lead inductance of an IC varies for

each pin, the pins will see differing amounts of ground bounce. The pin closest to the IC's ground will be the quietest, exhibiting as little as half the noise of other pins.

Finally, you can use a series termination resistor in your critical signal path if you don't need a high drive current. The resistor will reduce the magnitude of a ground-bounce pulse. Several logic families have such resistors (generally  $25\Omega$ ) built in, including the National Semiconductor 74BCT2xxx, Texas Instruments 74ABT2xxx, and Quality Semiconductor 74FCT2xxxT series.

load capacitance. Devices sinking at least 48 mA are the norm, and 64-mA capability is common. Texas Instruments' SN74BCT25xxx series can sink a whopping 188 mA, or source 80 mA, and suit designs with low-impedance ( $25\Omega$ ) buses and backplanes. Some families offer lower, but balanced drive capability, such as 24 mA; these parts sink and source current with equal facility.

### Bus drivers acquire more logic

The additional die space that shrinking transistor sizes make available has let manufacturers add functions to the basic bus driver. Many of the device families listed in **Table 1** include parts with logic as well as bus-driver functions. **Table 2** (pg 86) lists commonly available combined-function parts.

Manufacturers are also combining several bus-driver functions within a single package. Texas Instruments, for example, offers the SN74ABT16500 18-bit bus transceiver. This device incorporates both D-type latches and D flip-flops into the basic transceiver design. By using the appropriate control logic you can operate the device in transparent, latched, or registered modes, thus emulating a variety of the devices in **Table 2**.

Another chip that has combined bus functions is the IDT 49FCT804 3-port bus multiplexer (\$10). This device provides three 10-bit bidirectional ports that have 48-mA current-sinking ability. The part can connect

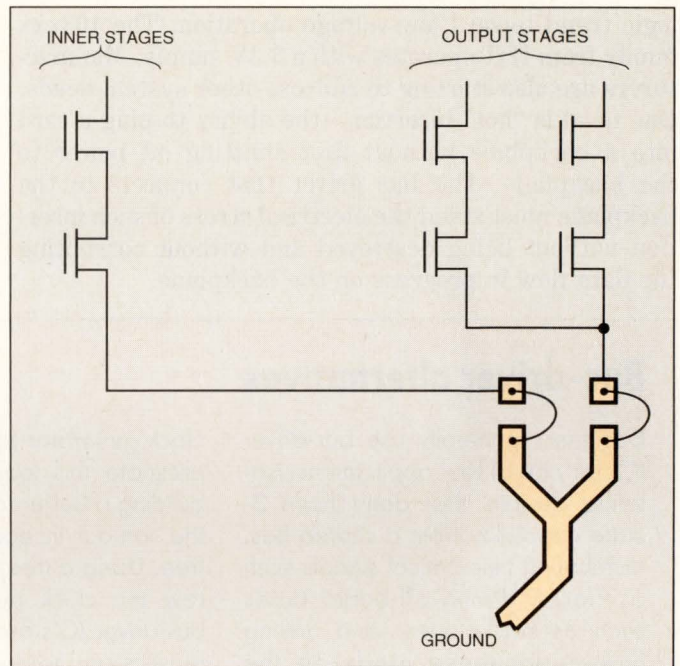

**Fig 4—Splitting the on-chip ground among several pins isolates the IC's input stages from the output stage's ground bounce.**

any two of the three ports. Each port has a latch that also works in transparent mode, so you can use the part in both synchronous and asynchronous systems.

Bus-driver-IC manufacturers are evolving their products in other ways as well. Some are following the

## Manufacturers of bus-driver ICs

For more information on bus-driver ICs such as those described in this article, circle the appropriate numbers on the Information Retrieval Service card or use EDN's Express Request service. When you contact any of the following manufacturers directly, please let them know you saw their products in EDN.

**Harris Semiconductor**  
Box 883  
Melbourne, FL 32902  
(407) 724-3978  
FAX (407) 724-3111  
Arnold Dubin  
**Circle No. 650**

**Hitachi America Ltd**  
Semiconductor & IC Div  
2000 Sierra Pt Pkwy  
Brisbane, CA 94005  
(800) 448-2244  
**Circle No. 651**

**Integrated Device Technology**  
Box 58015  
Santa Clara, CA 95052  
(408) 492-8675  
FAX (408) 492-8362  
Randy Frederick  
**Circle No. 652**

**Motorola Inc**  
Logic IC Div  
2200 W Broadway Rd  
Mesa, AZ 85202  
(602) 962-2908  
FAX (602) 898-5020  
Eric Neely  
**Circle No. 653**

**National Semiconductor Corp**  
333 Western Ave  
South Portland, ME 04106  
(207) 775-8305  
FAX (207) 775-8745  
Paul Kierstead  
**Circle No. 654**

### VOTE . . .

Please also use the Information Retrieval Service card to rate this article (circle one):

**High Interest 470 Medium Interest 471 Low Interest 472**

**Philips Components/Signetics**  
Box 3409  
Sunnyvale, CA 94088  
(408) 991-2531  
FAX (408) 991-2265  
Michael Polacek  
**Circle No. 655**

**Quality Semiconductor Inc**  
851 Martin Ave  
Santa Clara, CA 95050  
(408) 450-8061  
FAX (408) 496-0591  
Zwie Amitai  
**Circle No. 656**

**Texas Instruments**  
8330 LBJ Freeway  
M/S 8323  
Dallas, TX 75265  
(214) 997-5206  
FAX (214) 997-5250  
Susan Ogle  
**Circle No. 657**

**Toshiba America Electronic Components Inc**  
9775 Toledo Way  
Irvine, CA 92718  
(714) 455-2199  
FAX (714) 859-3963  
Brach Cox  
**Circle No. 658**

## BUS-DRIVER ICs

logic trend toward low-voltage operation. The 163xxx family from IDT operates with a 3.3V supply. Manufacturers are also starting to address other system needs. One need is "hot" insertion—the ability to plug a card into a backplane without first shutting off power to the backplane. The bus driver that connects to the backplane must stand the electrical stress of such insertion without being destroyed and without corrupting the data flow in progress on the backplane.

Several product families address hot insertion by providing power-up disable circuits. These bus drivers hold their output lines in a disabled state while the drivers are powering up. During the disabled state, logic elsewhere on the card can begin functioning and take control of the bus interface. Toshiba's 74ABTxxx family goes a step further by providing an I/O structure that prevents the IC from powering itself with current drawn from the bus.

### Bus-driver alternatives

Designers generally use bus-driver ICs for one of four applications: isolating devices that don't have 3-state capability from a shared bus, distributing time-critical signals such as clocks, driving off-board buses such as backplanes, and driving high-capacitance loads on the same pc board. For many of these applications, bus drivers are not the only solution.

You can accomplish bus isolation, for example, by using a logic switch instead of a bus driver. The 74QST3384 (\$3.55) from Quality Semiconductor is one such device. Its on-resistance of  $5\Omega$  lets it pass currents as great as 64 mA in either direction. The switch's current leakage when off is less than 1  $\mu$ A. Using the switch for isolation instead of a noninverting driver has the advantage of letting you build a faster system. The switch adds no more than 250 psec of propagation delay to signals.

#### Avoid planting clock trees

If you're using a bus driver to distribute a clock signal on a pc board, you're probably minimizing onboard skew by replicating the clock using multiple output lines, then routing separate clock lines to various parts of the board. However, the combined input capacitance of the parallel driver lines may be too great a load for the

clock generator to handle. You can eliminate this loading problem by building a buffer tree and restricting the fan-out in each branch of the tree. Using a tree, though, can narrow the clock pulse because the bus-driver IC's rise and fall characteristics are not symmetric.

An alternative to bus drivers for this type of clock distribution is a phase-locked-loop device such as the GA1110 (\$35) from Triquint Semiconductor (Beaverton, OR). This device replicates the incoming clock via a programmable phase shift at the output lines. Each output can have a different shift. Thus, you can pre-skew the clock before distribution so the clocks are in sync when they reach their respective destinations.

For driving an off-board load, such as a backplane, you have a variety of choices. You can use high-capacity TTL-level drivers, such as the 188-mA 74BCT25xxx family from Texas Instruments, or you can use non-TTL levels on the backplane.

Using a bus-translator IC, such as the Cypress Semiconductor (San Jose, CA) CY101E383 dual 10-channel ECL/TTL translator, simplifies the use of ECL in your system. Using ECL lets you run the backplane with a reduced voltage swing, thus easing noise and EMI problems. As an alternative to ECL,

you can use the backplane translators National Semiconductor and Philips Components/Signetics developed for Futurebus+ systems. These devices can drive a backplane impedance as low as  $12\Omega$ .

#### Try altering backplane

You might even want to reconsider the nature of your backplane. If your system can support one, a star topology offers several advantages over a bus-oriented backplane. Star topologies place less of a burden on bus drivers because they limit bus connections to a single, fixed load. This limitation lets you use less drive current to maintain system speeds, which reduces both power-supply and cooling-capacity needs. The star topology also gives you more control over load impedances by letting you tune termination networks to control EMI and other electrical noise.

For driving high-capacitance loads on the same pc board, you'll probably need a bus-driver IC. First, check the drive capability of your other logic to see if it can handle the job without a driver. In some families, such as the Philips Components/Signetics and Texas Instruments 74ABTxxx series, all members have the same output drive capability—in this case, 64 mA.

# TWO ROOMS. TWO BUSINESS DEALS. TWICE THE PRODUCTIVITY.



## EMBASSY SUITES®. TWICE THE HOTEL.™



For people who travel a lot on business, there is no better partner than Embassy Suites hotels.

+Subject to state and local laws.

**TWICE THE ROOM.** A large private bedroom. A separate spacious living room with a well-lit work area perfect for small meetings. Each suite also has two telephones, two TVs, a wet bar with refrigerator, coffee maker and microwave. Computer modem hookup available in most suites.

**TWICE THE VALUE.** A free, cooked-to-order breakfast is served each morning. Two hours of complimentary

beverages+ each evening. Both sure to help keep your expense report in line.

Next time you need a hotel room, Think Twice.™ Then call your travel agent or Twice The Hotel.™ 1-800-EMBASSY.



**EMBASSY  
SUITES**™

In Canada, call 1-800-458-5848. In Mexico, call 95-800-362-2779.  
Hawaii, call 1-800-GO-2-MAUI.

**BUS-DRIVER ICs**

**Table 2—Bus-driver functions**

Functional description	Part designator
Inverting buffer	240, 540
Buffer	241, 244, 541
D flip-flop	273, 374, 534, 574
Transparent D latch	373, 533, 573
Transceiver	245
Latched transceiver	543
Inverting latched transceiver	544
Transceiver with storage register	646

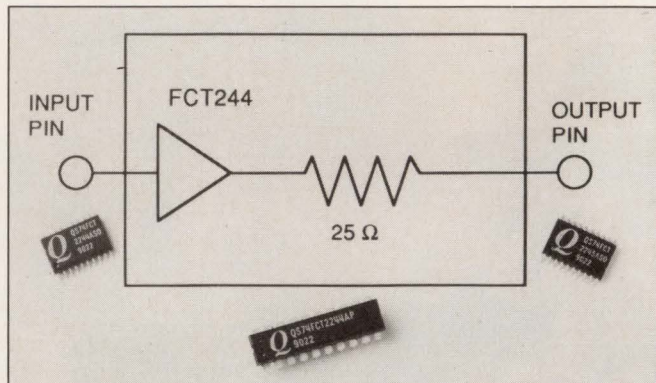

Series termination resistors help control ground bounce and other noise sources. Parts such as the QSFCT2xxx from Quality Semiconductor have such resistors built in.

Bus-driver manufacturers are also addressing board testability. Traditional bed-of-nails testing techniques are often unsuitable for surface-mount pc boards, which therefore need some form of built-in test. Bus-driver ICs are beginning to supply testability in the form of boundary scan. Parts emerging from Texas Instruments, Motorola, and National Semiconductor incorporate boundary-scan cells and control logic that meet the JTAG test specification IEEE 1149.1.

The evolution of bus-driver ICs will continue throughout the decade. Because including bus-driver circuits in an ASIC would consume die area and could increase heat production beyond the capacity of plastic packaging, bus-driver ICs are likely to remain discrete products. And as long as discrete devices can pay for themselves in reduced ASIC silicon and packaging costs, designers will continue to leave the driving to them.

**EDN**

**References**

1. Tripp, Tim and Bill Hall, "Good design methods quiet high-speed CMOS noise problems," *EDN*, October 29, 1987, pg 229.
2. Dike, Charles, "Equivalent circuits model subtle traits of advanced CMOS ICs," *EDN*, April 14, 1988, pg 189.
3. Hall, William and Charles Pace, "Limit noise in design using advanced CMOS logic," *EDN*, November 9, 1989, pg 215.
4. Shear, David, "EDN's advanced CMOS logic ground-bounce tests," *EDN*, March 2, 1989, pg 88.

Technical Editor Richard A Quinnell can be reached at (408) 685-8028.



Article Interest Quotient (Circle One)  
High 470 Medium 471 Low 472

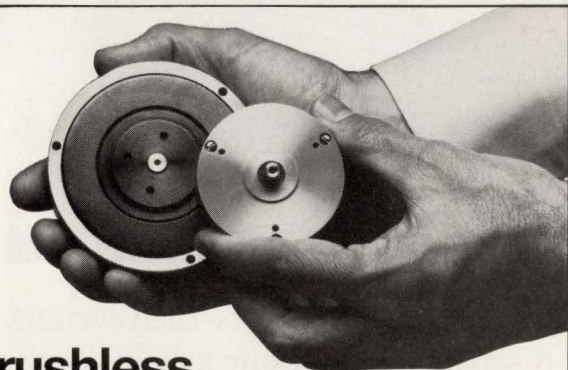

**Brushless DC motors provide extended life in demanding applications**

These compact 12-24 VDC motors are designed for tape cartridge drives, business machines, medical equipment, pumps/compressors and similar applications. Available in 2.0" and 3.2" diameters with stall torque from 10 to 84 oz-in. Custom shaft and housing and configurations to match your requirements. AMETEK, Lamb Electric Division, 627 Lake Street, Kent, OH 44240. Tel: 216-673-3451. Fax: 216-673-8994. In Europe, Friedrichstrasse 24, 6200 Wiesbaden, Germany. Tel: 611-370031. Fax: 611-370033.







**FOR THOSE WHO THINK SOMETHING  
HAS TO BE BIG TO BE POWERFUL,  
CHEW ON THIS.**

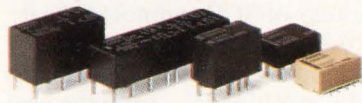

Small and powerful. These three little words are giving Omron a big name among relay users. That's because Omron's advanced family of high-tech low-signal and RF relays have been designed for higher board densities and lower power consumption without sacrificing high performance specifications. Omron's G6N, for example, meets the new telecom industry surge withstand requirement of 2.5 kV (nearly double the previous standard) in a package almost half the size. And the new surface-mountable G6H provides superior performance in a low profile design to eliminate I.R. shadowing. These and other Omron low signal relays provide cost-PC board applications. When take a bite out of the big jobs, more information about our

effective solutions for advanced you need a small relay that can call us at 1-800-62-OMRON for full line of control components.

**OMRON**  
WE HAVE THE FUTURE IN CONTROL.

# Proven Unmatched Quality and Performance



## STRADIVARIUS — Circa 1700

The standard by which all violins  
are compared.



## JEEP — Circa 1941

Designed to reliably carry troops  
over any terrain.



## 1Ø & 3Ø SCR High Power DC Power Supplies — Circa 1980

And still sets the standard for quality and performance.

- 600 Watts to 10 KW
- More watts per \$ for the best price/performance value in SCR type power supplies
- 65 Standard models. 100's of custom and modified models
- Complies with VDE-875, Level N and VDE-871, Level A for line conducted RFI
- Remote Programmable via IEEE-488
- Highest Power Per Cubic Inch In Industry
- 5 Year Warranty

E/M has a well documented history of SCR technology that dates back to 1967. Today, there are over 50,000 Series TCR power supplies that have been shipped since 1980. The quality and performance is unmatched ... worldwide ... from the heat and humidity of Kuala-Lumpur to the frigid wastelands of Greenland.

*For more information or literature, call Toll Free 1-800-631-4298 or write:*  
Electronic Measurements, Inc.  
405 Essex Road  
Neptune, NJ 07753  
(In NJ, HI, AK & Canada, call 908-922-9300)



**ELECTRONIC  
MEASUREMENTS  
INC.**



# Human-interface rules reduce test-program operator errors

John A Dinan, Raytheon Corp

*The way a program displays data and interacts with its operator can either invite human error or minimize it. Following some simple rules can make all the difference, especially in a complicated test program.*

You can design the human-interface part of a test program to minimize the number of errors an operator makes when using the program. In most cases, properly formatting your test data and giving the operator suitable guidance will help you avoid many known sources of human error.

For example, suppose you're running tests on a series of chips and displaying the results as follows:

	<b>A</b>	<b>B</b>	<b>C</b>	<b>D</b>	<b>E</b>	<b>F</b>	<b>G</b>	<b>H</b>	<b>I</b>	<b>J</b>	<b>K</b>
<b>Test 1</b>	P	F	F	P	P	P	F	P	P	F	P
<b>2</b>	P	P	P	P	P	P	P	P	P	P	P
<b>3</b>	P	P	F	P	F	P	P	F	P	P	P
<b>4</b>	P	F	P	F	P	F	P	P	F	P	P
<b>5</b>	P	P	P	P	P	P	P	P	P	P	P
<b>6</b>	P	F	P	P	P	P	P	P	P	P	P
<b>7</b>	F	P	F	P	F	P	P	F	P	P	F

You can expect an error rate of about 5% when a test operator reads these results. The similarity of the characters P (pass) and F (fail) invites error, as does the large number of characters in the display. Another contributor to error is the lack of spacing every few lines of data. (It's a good idea to insert a blank line for every five printed lines.)

You could reduce the error rate somewhat by displaying failures in a different color, such as red. But in so doing, you might introduce another error source: 9% of men are red-green color blind.

Instead, consider displaying failures only:

<b>Test 1</b>	B, C, G
<b>3</b>	C, E, H
<b>4</b>	B, D, F, I
<b>7</b>	A, C, E, G, K

The error rate for reading this format approaches zero.

A display should present useful data in a way that isn't contrary to cultural experiences and thus operator expectations. We are all conditioned, for example, to read from left to right and from top to bottom.

Consider the following display format:

	Input		Output	
Frequency	Pulse length	Pulse length	Frequency	

This layout has a pair of problems that could contribute to operator error. First of all, units of measurement are missing for frequency and pulse length. Second, and more important, the input and output subcolumns are in reverse order. This reverse order will result in confusion at best and possibly operator error. The psychological phenomenon known as perseveration—the tendency to continue a learned behavioral pattern—is responsible; the operator tends to read the output table as if its format is the same as that of the input table.

## HUMAN-INTERFACE ROLES

In displays of data, justify columns for rapid scanning. Compare the following layouts for ease of reading, first unjustified:

```
Channel number: NN
Frequency error: 10 Hz
Output: 1V
Self-test faults: none
Calibration faults: none
```

and then justified:

```
Channel number:      NN
Frequency error:    10 Hz
Output:             1V
Self-test faults:  none
Calibration faults: none
```

Also, always justify numeric data about the decimal point. It's much harder to scan this column of numbers:

```
26.53
106.21
50.25
87.50
1007.20
46.39
153.63
1365.60
```

than this one:

```
26.53
106.21
50.25
87.50
1007.20
46.39
153.63
1365.60.
```

A simple and effective guideline for displaying data is to lay out the data for smooth visual scanning in both the horizontal and vertical directions. The more complex the patterns, the greater the potential for error. Simple is better.

The following guidelines can also help you create user-friendly data displays:

- Display input data to the left of or above output data.
- When displays take more than one page, identify the page numbers (1 of 4, 2 of 4, and so forth).
- Place the data-entry area at the bottom of the screen just over the keyboard. It should be just under the error-message area and within the operator's immediate visual field.
- Display a symbol to indicate when tests are running and the keyboard is locked out.

- On each page of each display, indicate a key that will allow the operator to return to "home base" on a master menu with a single keystroke.

The layout in Fig 1 illustrates some of these guidelines. This scheme won't be appropriate for every situation, but it is simple and free of any obvious sources of error.

A well-designed display can also minimize data-entry error. Perseveration again illustrates the point. An operator who has to put data into a certain spot on one data form may automatically (and erroneously) put similar data into the same spot in the next form. You can avoid this type of error by clearly defining data-entry fields and by making your forms' layouts consistent.

You can reduce other types of data-entry errors, too. You can't prevent simple keystroke errors or errors of short-term memory (trying to remember a long string of characters while keying them), but you can prevent many of the errors that result from operator confusion.

For example, an operator who is unsure that a program has accepted data or a command is likely to make errors in succeeding steps. You can minimize these errors in two ways—first by letting the user confirm data or commands before the program accepts them and then by informing the operator of their acceptance. By confirming data before accepting it, a program gives an operator an additional opportunity to correct keystroke errors before they result in corrupted data. Similarly, for commands such as "delete" that can result in the loss of data, your program can warn that

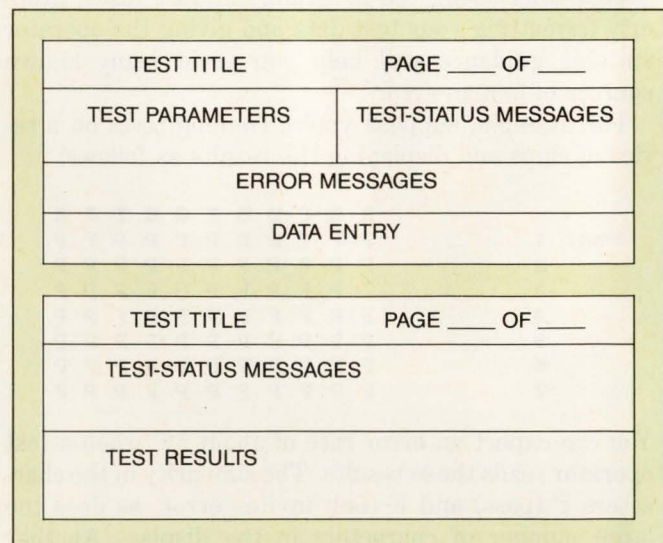

Fig 1—A test program's display should reduce the likelihood of error by the operator. This format for a 2-page display follows guidelines to achieve that objective.

data will be destroyed and ask if that is the operator's actual intent.

If your program detects an operator error, it should respond with a message that specifies how to recover from the error. For example, instead of simply saying that a specified test parameter is invalid, tell the operator that only a 4-digit entry is acceptable.

### Ease of learning reduces errors

At the heart of a user interface is the human/computer dialog. In general, dialogs that are easy to learn lead to fewer user errors. As **Table 1** shows, dialogs that use menu selections or questions and answers are your best bets.

A good way to see if your program is easy to learn is to conduct a "naive user" test. Select someone unfamiliar with your program and explain how to use the program to work a single-thread problem (a problem that exercises all the program's features). Then have the user work a typical problem while you watch for errors and confusion. Ask for comments and suggestions during and after the test. Repeat the process until the user is comfortable with the program and the user interface seems free of obvious sources of error and confusion.

The most common error source in a user interface is the "smart" shortcut. By building smart shortcuts into an interface, you give knowledgeable users more freedom, but you abandon design consistency. Beware: Smart shortcuts depend on users having perfect memory. You should not abandon consistent control procedures if you want to minimize user error.

Sequence control in a program, as described in **Ref 2**, "governs the transition from one transaction to the next." Because the potential for user error is at its highest at these transitions, you need to design sequence control carefully. To design a good sequence-control portion of a user interface,

- Give the user control in starting and stopping test sequences.
- Give feedback for all user actions and for all computer activities that affect the user.
- Consider function keys for frequently used or critical commands.
- Indicate the status of processing and control lockout.
- Allow user override of lockout with a function key or with a double action on a key.
- Display error messages that tell how to recover from the error conditions.

## Military displays

Test programs to be used by the military will probably have to meet the requirements of MIL-STD-1472 (**Ref 1**). By referring to the user-computer-interface information in Section 5.15, you can easily make a design checklist.

In some cases, your system specification will require the more

complete guidelines of ESD-TR-86-278 (**Ref 2**). This document is perhaps the most comprehensive user-interface design source available. Note, however, that it contains guidelines, not requirements. You should tailor the guidelines to your specific application.

- Provide a "help" function that supplies increased detail when needed.
- Prompt users at points in the control sequence that appear confusing or complex—especially those that confused your naive user.
- Provide an easy way for a user to correct entries before the program acts on them.

Another part of a user interface that deserves extra attention is user guidelines—error messages, alarms, prompts, and labels, and other instructional material. Some helpful rules for creating user guidelines are

- Use affirmative statements ("Clear screen before entering data") rather than negative wording ("Do not enter data before clearing screen").
- Use the active voice ("Clear screen by pressing reset") rather than the passive ("The screen is cleared by pressing reset").
- Provide a list of valid options in each display.
- When the user selects an item from a display, highlight that item.
- If a fault can set off an alarm, provide an alarm-reset function that turns off the alarm but still leaves a visual reminder that the fault needs tending to.

**Table 1—User training for computer interfaces**

Dialog type	Required user training
Menu selections . . . . .	Little/none
Q & A . . . . .	Little/none
Form filling . . . . .	Moderate/little
Function keys . . . . .	Moderate/little
Natural language . . . . .	Moderate/little
Query language . . . . .	High/moderate
Command language . . . . .	High
Graphic interaction . . . . .	High

# GREASE Q-PAD II®

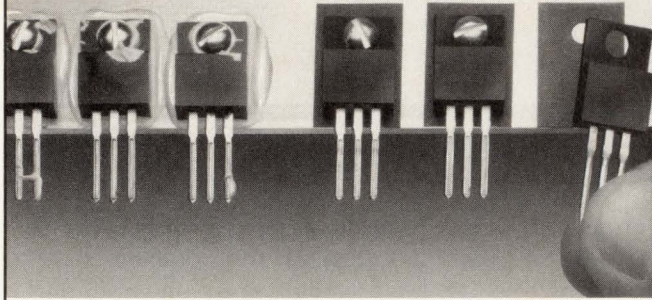

## Replace Messy Grease Under Isolated Transistors

- Q-Pad II replaces grease in applications where isolation is not required (isolated transistors).
- Q-Pad II provides maximum heat transfer between interfaces. 0.1 °C/Watt TR.
- .006 in. thickness, Silicone / Alum. Foil construction, 2.5 W/m-k Therm. Cond., available in standard configurations and custom shapes.

Contact Bergquist for a Free Copy of the New Sil-Pad Design Guide, 1-800-347-4572

**BERGQUIST**

5300 Edina Industrial Blvd., Minneapolis, MN 55439  
Tel: (612) 835-2322 • Fax: (612) 835-4156

CIRCLE NO. 55

## WHEN IT COMES TO SURFACE MOUNT CRYSTAL UNITS, ONLY RALTRON HAS IT ALL.

RALTRON manufactures one of the industry's most complete lines of high quality crystal units. Call us for all your crystal needs from micro-processor to AT strip to tuning fork to high accuracy. Or call us for our 28 page catalogue.

### NEW! SURFACE MOUNT CRYSTAL UNIT- 2.5 MM HEIGHT - T25 SMD

- Frequency Range: 3.5 MHz-50 MHz
- Oscillation Mode: Fundamental to 3rd O.T.
  - Frequency Tolerance: ± 50 ppm @ 25°C
- Frequency Stability: ± 50 ppm (-10°C to + 60°C)

### NEW! SURFACE MOUNT CRYSTAL UNIT- 3.0 MM HEIGHT- HC-49 SHORT SMD

- Frequency Range: 8 MHz-50 MHz
- Oscillation Mode: Fundamental to 3rd O.T.
  - Frequency Tolerance: ± 50 ppm @ 25°C
- Frequency Stability: ± 100 ppm max (-10°C to + 60°C)

• Crystals • Crystal Oscillators • Crystal Filters • Ceramic Resonators

**RALTRON** ELECTRONICS CORP.

2315 NW 107th Avenue, Miami, Florida 33172 U.S.A.  
FAX (305) 594-3973 TELEX 441588 RALSEN  
(305) 593-6033

CIRCLE NO. 56

## HUMAN-INTERFACE ROLES

- Write error messages that provide instruction ("Test ID # requires three digits"), not just a simple error indication ("Invalid input").
- Cue users when and where to enter data (by displaying a colon followed by an underscored data field, for example).
- Write your program so that at startup it briefly explains what the user needs to do and tells how to get help at any time.

If you follow all these rules when you design a user interface and then test the interface with a naive user, you should uncover most of the pitfalls that can cause user errors. Your displays will never eliminate user error, but they can minimize it. **EDN**

## References

1. MIL-STD-1472D: *Human engineering design criteria for military systems, equipment and facilities*, 1989.
2. Smith, Sidney L and Jane N Mosier, ESD-TR-86-278: *Guidelines for designing user interface software*, Mitre Corp, Bedford, MA, 1986. Available as ASTIA (Armed Services Technical Information Agency) Document AD 271 477.
3. *Human factors engineering standard for information processing systems* (LMSC-D877141), Lockheed Missiles and Space Co, Sunnyvale, CA, 1983.
4. Sinaiko, H Wallace (editor), *Selected papers on human factors in the design and use of control systems*, Dover Publications, New York, NY, 1961.

## Author's biography

John Dinan, a senior engineer at Raytheon Corp in Wayland, MA, specializes in human-factor and safety engineering on large ground-based radar systems. John has a BA degree from Salem State College (Salem, MA) and an MA from Boston University (Boston, MA). He has done additional graduate work at George Washington University (Washington, DC). John's hobbies include collecting, researching, and writing about old popular literature such as dime novels and pulp magazines.

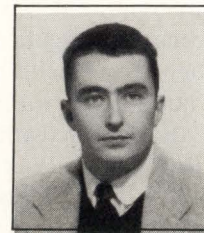

Article Interest Quotient (Circle One)  
High 473 Medium 474 Low 475

WE'VE LOWERED  
THE COST  
OF HIGH  
PERFORMANCE  
FOR FRAMEMAKER.



THE PERSONAL  
DECSTATION  
STARTS AT \$3995.

Today's applications like FrameMaker® demand the balanced performance of a complete workstation and only the Personal DECstation™ gives it to you at such an affordable price.

Many of the features other low-priced workstations offer, such as an open bus, 8-plane graphics and color, are add-ons. With the Personal DECstation, they're standard. And it's built for the future with new CPU and graphics cards, network interconnects and upgrades, multimedia technology and full Advanced

**DIGITAL'S SPEED AND FLEXIBILITY ARE PERFECT FOR FRAMEMAKER.**

FrameMaker and Digital combine to provide a complete document publishing system for creating business and technical documents. FrameMaker incorporates full-featured WYSIWYG word processing, graphics, page layout, tables, conditional text, equations editing, and structured document tools into a single, easy-to-use application.

FrameMaker supports the Motif windowing environment and takes advantage of the innovative tools available with Digital, such as Display PostScript. In addition, FrameMaker supports Digital's multimedia capabilities and allows you to seamlessly incorporate audio and video into your FrameMaker document. FrameMaker on the Digital platform is the complete solution for your document publishing needs.

For a trial version of FrameMaker, please call 1-800-U4FRAME, extension 145.

Computing Environment (ACE) compatibility.

The Personal DECstation from Digital. The power of a workstation. The productivity of a workstation. The price of a PC.

**ADVANCED COMPUTING ENVIRONMENT**

**digital™**

© Digital Equipment Corporation 1991. The DIGITAL logo, DECsystem, DECstation, DECwindows and ULTRIX are trademarks of Digital Equipment Corporation. UNIX is a registered trademark of UNIX Systems Laboratories, Inc. in the USA and other countries. FRAME is a trademark and FrameMaker is a registered trademark of Frame Technology Corporation. Motif is a registered trademark of Open Software Foundation, Inc. PostScript is a registered trademark of Adobe Systems, Inc.

**DIGITAL. THE OPEN ADVANTAGE.**



# Until now, DOS and couldn't run

## Introducing iRMX<sup>®</sup> for Windows: Real-Time Windows<sup>™</sup> for PCs.

Running DOS or Windows\* and real-time on a PC used to create some rather formidable challenges. After all, you could only run one at a time.

Fortunately, there's a whole new direction in real-time processing. It's called iRMX<sup>®</sup> for Windows. And it's a proven environment



that lets DOS and iRMX software work together to generate powerful applications.

This reliable operating system takes full advantage of the protected-mode features of the popular Intel386<sup>™</sup> architecture. So it opens new avenues for cost-effective solutions.

Of course, iRMX for Windows also opens some powerful options for software

© 1991 Intel Corporation. iRMX is a registered trademark and Intel386 and Real-Time Windows are trademarks of Intel Corporation. \*Windows is a trademark of Microsoft Corporation. iRMX for Windows is an EDN Innovation of the Year Award winner for 1991.



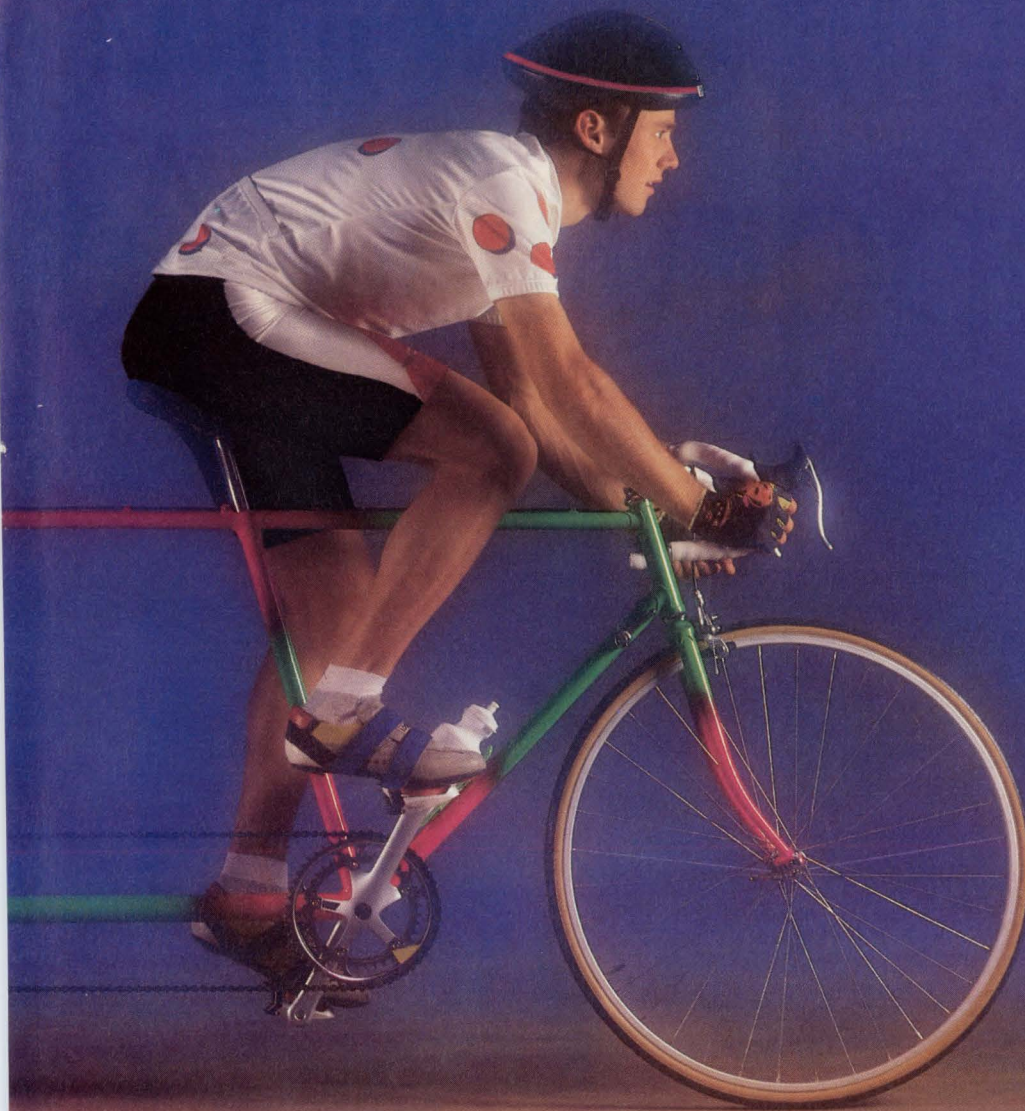

# real-time applications concurrently.

engineers. Like bringing the huge installed base of DOS applications, tools, and the popular Windows environment to real-time development. What's more, as a developer, you'll receive professional support from Intel engineers.

All of which is important when you're racing to bring your application to market.

So make the shift to iRMX for Windows.

Call 1-800-GET-iRMX and ask for Lit. Packet #1C. You'll receive our Real-Time Response Kit. And give your next application some serious momentum.

**intel**®

The Computer Inside.™

# Toshiba Non-Vo Support You At



# olatile Memories Every Level.

**Toshiba: the surest path to quality EPROM, OTP and MROM.** If you entered the CMOST Expressway with Toshiba memory, get ready to broaden your perspective. We've mapped out a three-ramp approach to non-volatile memory that'll get you where you're going in no time.

At the first stages of prototype, or for reprogrammable designs, Toshiba supports your brainchild with x8 and x16 varieties of 4 megabit (Mb) EPROM. As the design matures, we'll show the way with the only byte-selectable 4Mb OTPs in the industry. Then, once the code is fully proven, we'll gear up for your high-production run with reliable, 16Mb, 150ns MROMs.

Not only will the performance and cost-per-bit benefits of Toshiba MROMs impress you, you'll also be amazed at the time you'll save by using Toshiba's new MROM code transmission system. It's like knowing a shortcut through the most congested part of town.

It should come as no surprise that we're leading the non-volatile technology race. Our success is based on our proven CMOS process and backed by our high-volume production capability. No matter where your design is headed, we'll accompany you from beginning to end.

For technical literature, call 1-800-321-1718.



*All roads to a successful design process emanate from Toshiba's proven CMOS process.*

In Touch with Tomorrow  
**TOSHIBA**

TOSHIBA AMERICA ELECTRONIC COMPONENTS, INC.

# Adjust your battery to any voltage.

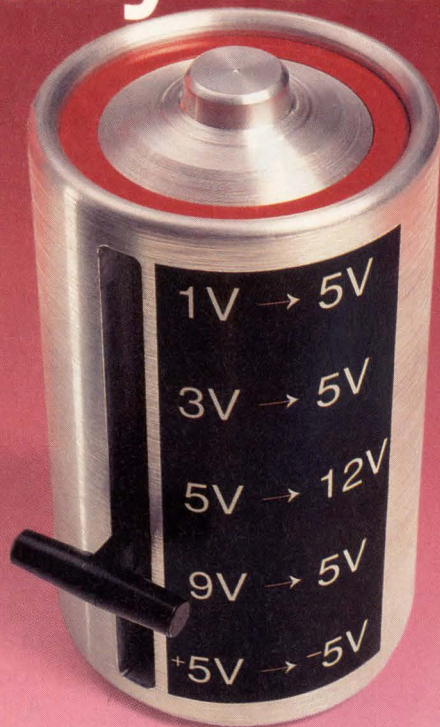

## Micropower DC to DC converter. 1 volt, 1 inductor, 1 cap.

Finally, a true micropower switching regulator with user-adjustable current limit. Linear's new LT1073 is a versatile micropower switching regulator optimized for single-cell inputs. It's small, simple, efficient, and delivers all the features you need right now.

- Only three external parts needed
- Operates at supply voltages from 1.0V to 12V
- Startup guaranteed at 1.0V
- Consumes only 95 $\mu$ A supply current
- Space-saving 8-pin Mini-DIP or SO8 package
- Works in step-up, step-down, or inverting mode
- Low-battery detector comparator on-chip
- User-adjustable current limit
- Internal 1 amp power switch
- Fixed or adjustable output voltage versions
- Programmable current limit with single resistor
- No frequency compensation required

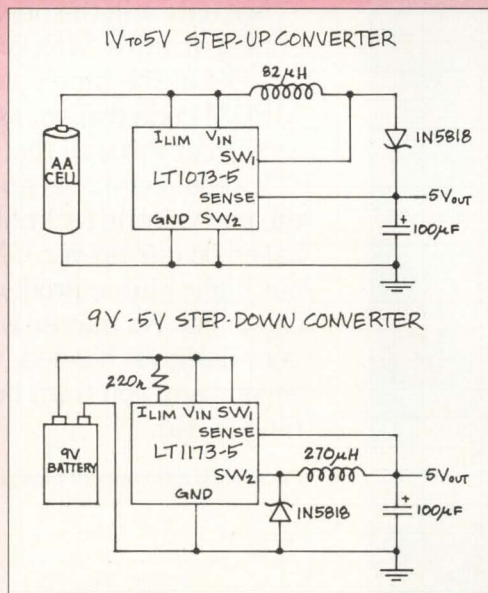

Operation of the LT1073 is guaranteed down to 1.0V, so you can squeeze more useful energy out of a battery. Its duty cycle is set at 72%, optimizing operation where  $V_{OUT} = 3V_{IN}$ . And the LT1073 delivers 5V at 40mA from a single cell, and 5V at 100mA from a 3V input.

**The LT1173 is optimized for higher input voltages (two or more cells) up to 30V.**

It's ideal for low-to-medium power step-down applications. The 1173 features a 50% duty cycle and operates with as little as 2 volts input. Both the LT1073 and LT1173 are available now. Pricing in quantities of 100 are \$3.15 for the LT1073CN8 and \$2.40 for the LT1173CN8. For true micropower switching solutions and more details on these new parts contact: Linear Technology Corporation, 1630 McCarthy Blvd., Milpitas, CA 95035. Or call toll free **800-637-5545**.



TOUGH PRODUCTS  
FOR TOUGH APPLICATIONS.  
CIRCLE NO. 65

## Circular RAM buffer generates long delays

Yongping Xia, West Virginia University, Morgantown, WV

The circuit in Fig 1 provides a delay interval for streams of 8-bit numbers. The delay for each number is equal to the RAM's total number of memory locations, divided by the clock frequency ( $T = 2^L / f_c$ ). For the components in the figure, delays range from 8.2 msec to 0.82 sec, depending on clock speed. The 6264's 300-nsec access time limits clock frequencies to under 2 MHz. Because the 6264 is a static device, the circuit has no low-frequency limit.

This 8k x 8-bit static RAM functions as a circular buffer. The 74HC14s generate an adjustable clock for the 74HC4040 address counter. The address counter continuously cycles through the RAM's addresses. The

2-phase clock also coordinates the input and output buffers. The RC-delay networks in the RAM's  $\overline{WE}$  line and the 74HC374 input-data buffer's OC line cause the circuit to first read out the contents of a particular memory location via the 74HC273 data-out buffer and then write the contents of the input buffer into that memory location. This process repeats for each memory location. Thus, the circuit holds a given datum only until the counter makes one complete cycle.

EDN BBS /DI\_SIG #1080

EDN

To Vote For This Design, Circle No. 744

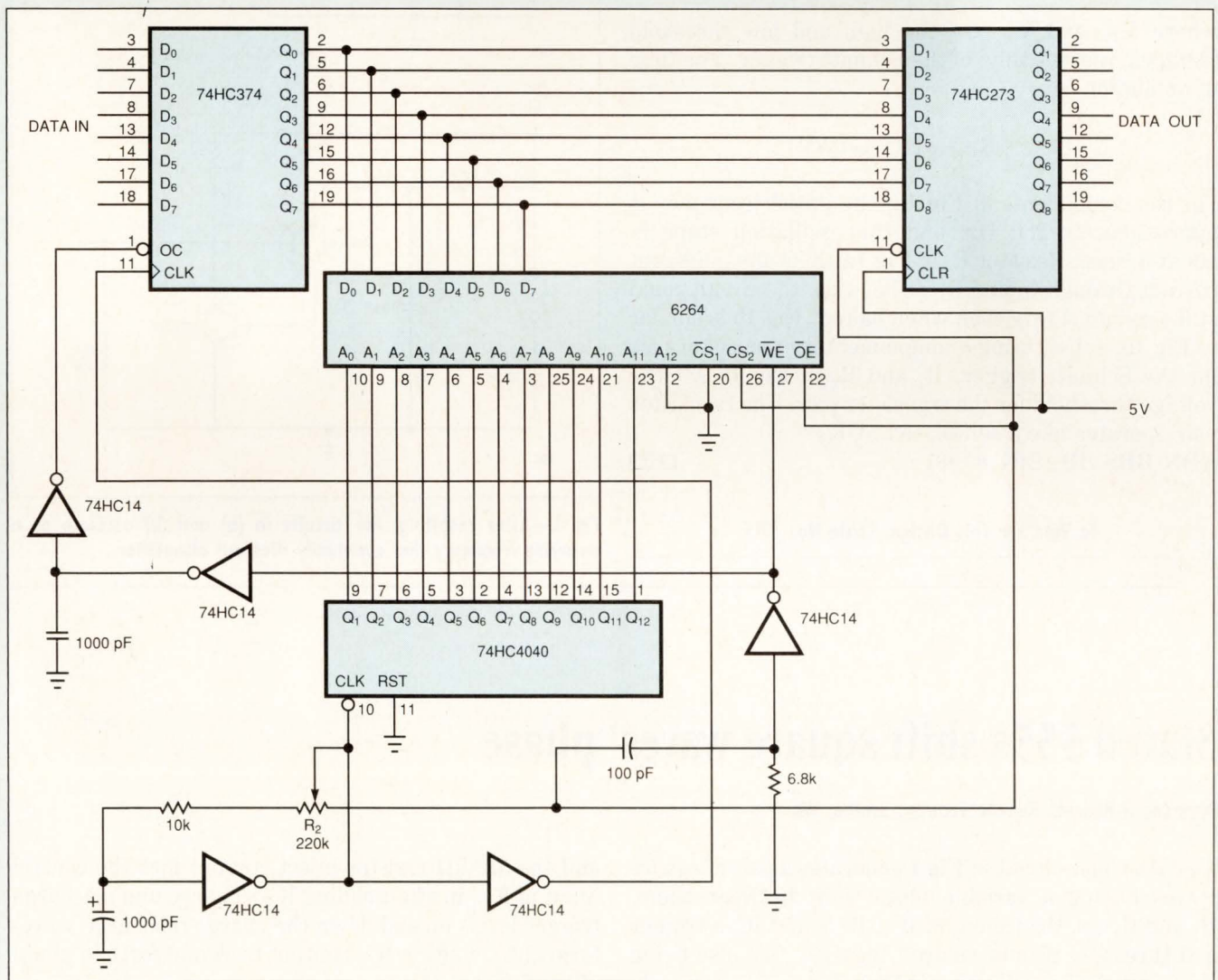

Fig 1—Functioning as a circular buffer, the 6264 static RAM provides a variable delay for streams of 8-bit data.

## Decaying oscillator dies out

Gregor Said Jackson, Azad International, Hamburg, Germany

After resetting, the output frequency of the circuits in Fig 1 decays exponentially, eventually dying out altogether. In Fig 1a, the voltage on capacitor  $C_1$  determines the rate at which transistor  $Q_1$  charges capacitor  $C_2$ . After resetting,  $C_1$ 's low voltage causes  $Q_1$  to charge  $C_2$  quickly. When  $C_2$ 's voltage exceeds the Schmitt trigger's (IC<sub>1</sub>'s) threshold, the Schmitt trigger changes state, discharging  $C_2$ . As  $C_1$  charges up,  $C_2$  takes longer to charge up, lengthening the period of the output. The time-dependent equation for the circuit's frequency is

$$f = ((V_{DD}/\exp(t/R_1C_1)) - 0.7V) / ((V_{TH} - V_{TL})/R_2C_2),$$

where  $V_{TH}$  and  $V_{TL}$  are the high and low threshold voltages, respectively, of the Schmitt trigger. The time of oscillation is

$$t_{OSC} = R_1C_1 \times \ln(V_{DD}/0.7V).$$

For the components in Fig 1a, the initial frequency is approximately 280 Hz, and the oscillation stops in about 3.9 sec. Resistor  $R_4$  in Fig 1a sinks any quiescent current through  $Q_1$  and  $D_1$ . Otherwise, the circuit could still oscillate slowly even when halted. Fig 1b is similar to Fig 1a, substituting a complementary transistor pair for the Schmitt trigger.  $R_1$  and  $R_2$  in Fig 1b set the voltage threshold for the transistor pair. The transistor pair operates like a self-biased SCR.

EDN BBS /DL\_SIG #1081

EDN

To Vote For This Design, Circle No. 745

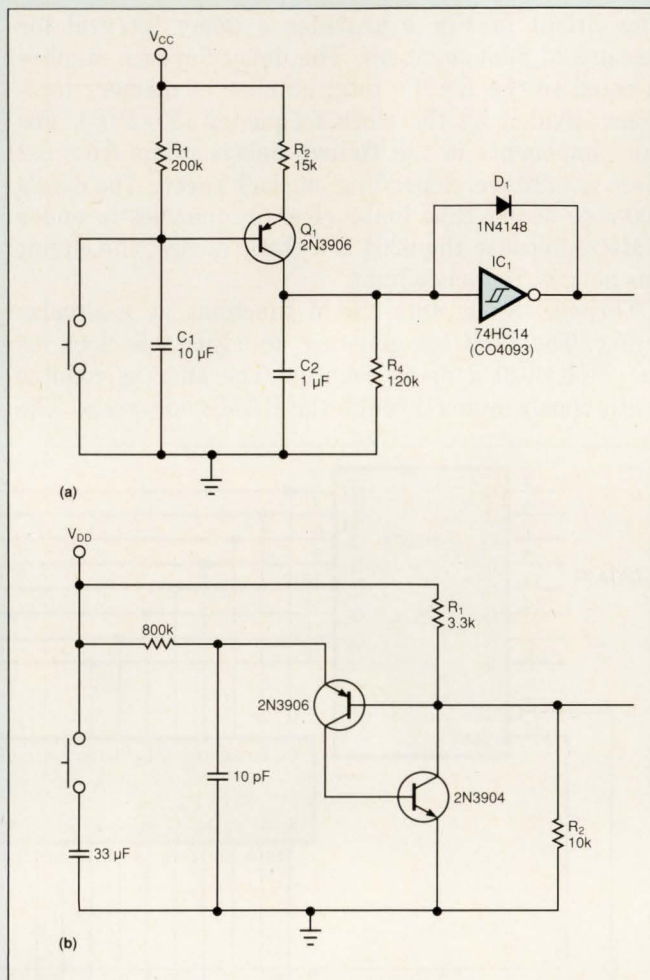

Fig 1—After resetting, the circuits in (a) and (b) oscillate at a decaying frequency that eventually dies out altogether.

## Slaved 555s shift square waves' phase

Raymond N Bennett, Remote Security, Seattle, WA

The 555-timer circuit in Fig 1 generates a pair of square waves having a variable phase shift between them.  $R_1$  and  $C_1$  set the timing of IC<sub>1</sub>. IC<sub>1</sub>'s and IC<sub>2</sub>'s trigger and threshold pins are slaved together. All else being equal, the two timers should therefore produce nearly identical square waves. However, potentiometer  $R_2$

and the 510-kΩ resistor inject current into the control input of IC<sub>2</sub>, in effect sliding IC<sub>2</sub>'s charge and discharge trigger levels up and down the charge-discharge waveform of  $C_1$ , shifting IC<sub>2</sub>'s output back and forth in phase with IC<sub>1</sub>'s output.

The circuit is not perfect. Because the 555s' charge

# rugged plug-in amplifiers

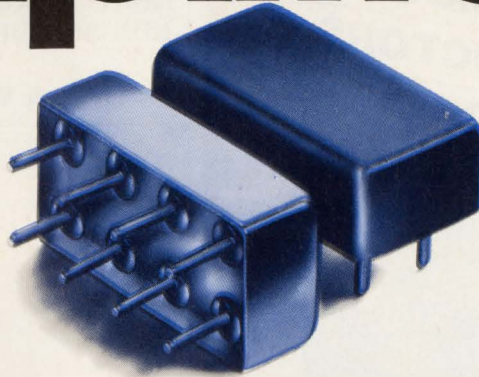

**0.5 to 2000 MHz** from **\$13<sup>95</sup>** (10 to 24 qty)

Tough enough to meet full MIL-specs, capable of operating over a wide  $-55^{\circ}$  to  $+100^{\circ}\text{C}$  temperature range, in a rugged package... that's Mini-Circuits' new MAN-amplifier series. The MAN-amplifier's tiny package (only 0.4 by 0.8 by 0.25 in.) requires about the same pc board area as a TO-8 and can take tougher punishment with leads that won't break off. Models are unconditionally stable and available covering frequency ranges 0.5 to 2000 MHz, NF as low as 2.8dB, gain to 28dB, isolation greater than 40dB, and power output as high as +15dBm. Prices start at only \$13.95 *including* screening, thermal shock  $-55^{\circ}\text{C}$  to  $+100^{\circ}\text{C}$ , fine and gross leak, and burn-in for 96 hours at  $100^{\circ}\text{C}$  under normal operating voltage and current.

Internally the MAN amplifiers consist of two stages, including coupling capacitors. A designer's delight, with all components self-contained. Just connect to a dc supply voltage and you are ready to go.

**The new MAN-amplifiers series...**

- wide bandwidth • low noise • high gain
- high output power • high isolation

MODEL	FREQ. RANGE (MHz)	GAIN dB		MAX PWR <sup>†</sup> dBm	NF dB (typ)	ISOL. dB (typ)	DC PWR V/ma	PRICE \$ ea. (10-24)
		min	flat <sup>††</sup>					
MAN-1	0.5-500	28	1.0	+8	4.5	40	12/60	13.95
MAN-2	0.5-1000	18	1.5	+7	6.0	34	12/85	15.95
MAN-1LN	0.5-500	28	1.0	+8	2.8	39	12/60	15.95
◇MAN-1HLN	10-500	10	0.8	+15	3.7	14	12/70	15.95
MAN-1AD	5-500	16	.05	+6	7.2	41	12/85	24.95
MAN-2AD	2-1000	9	0.4	-2	6.5	28	15/22	22.50
MAN-11AD	2-2000	8	0.5	-3.5	6.5	22	15/22	29.95

<sup>††</sup>Midband  $10f_L$  to  $f_{U/2}$ ,  $\pm 0.5\text{dB}$  <sup>†</sup>1dB Gain Compression <sup>◇</sup>Case Height 0.3 in. Max input power (no damage) +15dBm; VSWR in/out 1.8:1 max.

Free... 48-pg "RF/MW Amplifier Handbook" with specs, curves, handy selector chart, glossary of modern amplifier terms, and a practical Question and Answer section.

finding new ways ...  
setting higher standards

**Mini-Circuits**

A Division of Scientific Components Corporation  
P.O. Box 350166, Brooklyn, New York 11235-0003 (718) 934-4500  
Fax (718) 332-4661 Domestic and International Telexes: 6852844 or 620156

# PICO Transformers & Inductors

**PLUG-IN  
SURFACE MOUNT  
AXIAL INDUCTORS  
TOROIDAL  
INSULATED LEADS**

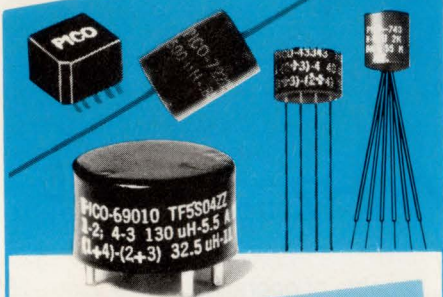

## TRANSFORMERS

QPL standards available  
MIL-T-27/103-1 thru 16, MIL-T-27/172-1 thru 50,  
MIL-T-27/357-1 thru 114, MIL-T-27/358-1 thru 123,  
MIL-T-27/359-1 thru 147

- Audio Transformers ranging in size from  $\frac{1}{4}'' \times \frac{1}{4}''$  to  $\frac{3}{4}'' \times 1\frac{3}{16}''$ . 20 Hz to 250 KHz. Up to 3 watts.
- Pulse Transformers .05 $\mu$ SEC to 100 $\mu$ SEC miniaturized construction.
- Ultra-miniature DC-DC Converter Transformers. 40 watts.
- Miniaturized Switchmode Inverter Transformers. 60 watts.
- 400 Hz Power Transformers. Primary voltages of 115V or 26V. Plug-in construction. Ultra-miniature
- Microphone/Transducer Audio Input.
- MIL-STD-1553 Interface Multiplex Data BUS Pulse Transformers.

## POWER INDUCTORS

QPL standards available MIL-T-27/356-1 thru 63

- Inductance values to 20mH with DC currents to 23 amps

## COMMON MODE INDUCTORS

## HIGH "Q" INDUCTORS

**PICO  
Electronics, Inc.**

453 N. MacQuesten Pkwy. Mt. Vernon, N.Y. 10552

Call Toll Free **800-431-1064**

IN NEW YORK CALL **914-699-5514**

FAX **914-699-5565**

See EEM  
or send direct for  
FREE PICO Catalog

CIRCLE NO. 67

## EDN-DESIGN IDEAS

and discharge slopes are not linear, the duty cycle of IC<sub>2</sub> changes with phase changes. In the worst case, if either threshold moves outside the limits of the charge-discharge waveform, IC<sub>2</sub> will stop oscillating. If you use NMOS timers instead of CMOS devices, you will have to reduce the 510k- $\Omega$  resistor's value.

EDN BBS /DL\_SIG #1078

EDN

To Vote For This Design, Circle No. 746

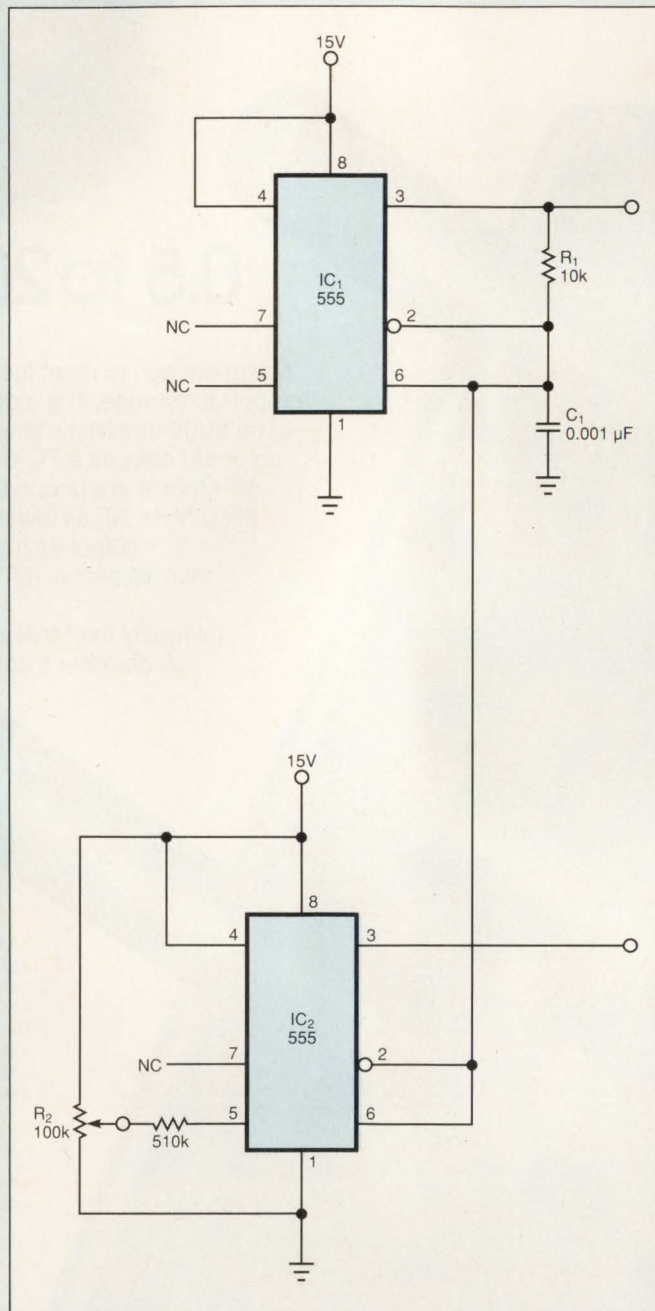

Fig 1—In this circuit, the bottom 555 timer is slaved to the top timer. However, the potentiometer and resistor at pin 5 of the bottom 555 injects current that slews the phase relationship of the two timers' outputs.



## Impedance matched PCB Solderable Interconnects

- Solders directly to the PCB
- Low profile

Meritec's PCB Solderable Interconnects can be soldered directly to the PCB for a permanent connection. Pin lengths of .110" and .160" are available for different board thicknesses. The impedance matched connectors feature precision, high strength molded terminations for reliability in critical applications. Available in 1x2 and 1x3 configurations, the connectors are side-to-side stackable and feature heights as low as .150" from the PCB, making

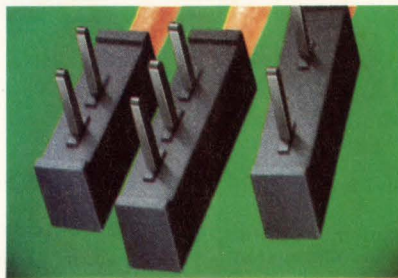

them ideal for dense package applications. The connectors can be terminated to a variety of different cable styles.

CIRCLE NO. 68



## 96 Position DIN Cable Assembly

- Impedance matched
- Programmed grounds and signals

Meritec's impedance matched 96 Position DIN Cable Assemblies feature an internal PCB which allows programming of grounds and signals to customer specifications. The high speed, low noise controlled impedance assemblies are designed for TTL fast, fast CMOS and ECL logic. Standard impedances are available from 50 to 120 ohms using low dielectric FEP cable to ensure less propagation delay. EMI/RFI electrical shielding is optional. Signal and ground wires are mass solder terminated to the PCB. Insert molded strain relief provides high reliability in critical applications.

CIRCLE NO. 69



## BNC Cable Assemblies for critical applications

- Impedance matched
- High strength molded terminations

Meritec's impedance matched BNS cable assemblies feature precision, high strength molded terminations for high reliability in critical applications. The assemblies are available in a variety of configurations, including cable end plug, cable end jack, front panel mount jack, front panel mount jack with isolated ground and rear panel mount jack. The connectors are terminated using subminiature coax cable and feature standard BNC and cable impedances of 50 and 75 ohms. The assemblies may be terminated with Meritec's SSI™, SSC™ or PCB Solderable interconnects on the opposite end.

CIRCLE NO. 70

## Digital and analog interconnect systems that maximize board density and budget.

*If you need speed and performance in a digital or analog interconnect system but have a limited budget, turn to Meritec. Meritec digital and analog interconnect systems are designed to meet the requirements of electrically sensitive applications using high speed CMOS, ECL or GaAs logic. Our systems are engineered to provide controlled impedance and propagation delay while minimizing crosstalk. You get ship to stock quality, backed up with technical service and applications support. All at a cost that's well in line with tight project budgets.*

*For more information and free literature on the complete line of Meritec digital and analog interconnect systems, call 216-354-3148.*



Where quality assures performance

1359 West Jackson Street  
P.O. Box 8003  
Painesville, Ohio 44077  
Phone: 216-354-3148  
FAX: 216-354-0509



CIRCLE NO. 71

## THE SILENT CHALLENGER

TASCO Electronics, a recognized leader of digital technology in Japan, is introducing a new and exceptionally silent integrated thermal driver, for installation in many OEM products. The amazingly quiet (70dB) and unparalleled high speed (maximum 300 LPM), reproduces the finest graphic details. Its compact and maintenance free carriage is a gift any design engineer will be thrilled receiving and put to good use in a hurry.

The PE-525 being introduced to the world market is worthy of your most critical acclaim. Call now for more information about the SILENT CHALLENGER.

TASCO PE-525  
High speed,  
high resolution  
thermal driver

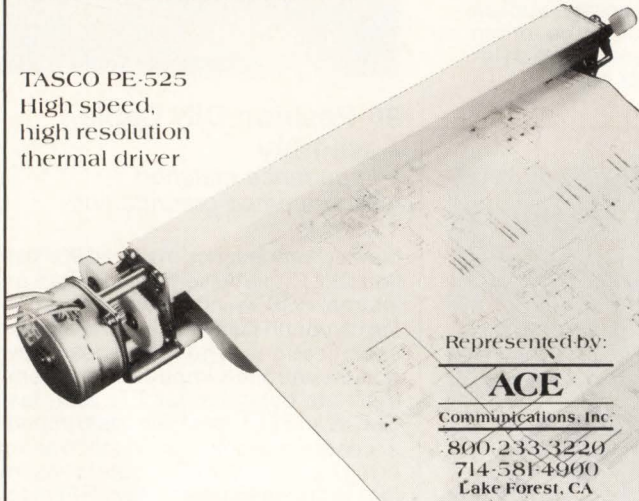

TASCO Electronics Co., Ltd.  
22511 Aspan St. Lake Forest, CA 92630  
Tel (714) 581-5197 Fax (714) 581-4941

CIRCLE NO. 72

## TOUCH SCREEN PROJECT?

We stock touch screens,  
decoding electronics  
and software for  
immediate  
delivery.

- Analog and matrix touch screens.
- Decoding electronics and software (enables screen to function as a mouse).
- High gloss and anti-glare surface finishes.
- Custom manufactured screens also available.

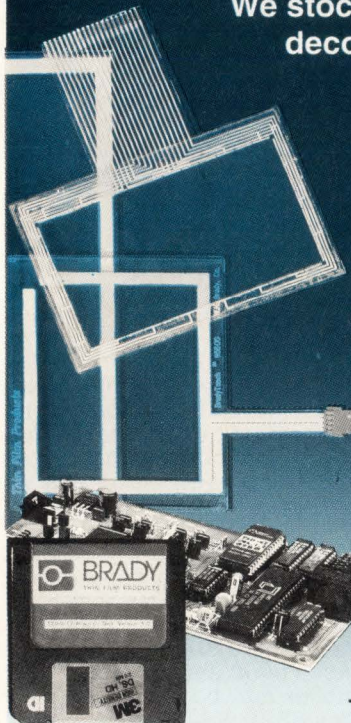

BRADY



W.H. BRADY CO.  
THIN FILM PRODUCTS

8225 W. Parkland Ct. • P.O. Box 571 • Milwaukee, WI 53201  
Phone: 414-355-8300 • Fax: 414-354-0453

Copyright 1991 W.H. Brady Co. All rights reserved.

CIRCLE NO. 73

## EDN-DESIGN IDEAS

### Software Shorts

## 8051 moves blocks 100% faster

*Peter Kielbasiewicz, Hewlett-Packard,  
Böblingen, Germany*

The listing in EDN BBS /DI\_SIG #1063 doubles the speed of an 8051 microcontroller's block move by using a page-addressing algorithm.

To Vote For This Design, Circle No. 747

## Spreadsheet aids PLL design

*Bruce Acker, Engineering Solutions,  
Tarzana, CA*

Two Excel spreadsheets in EDN BBS /DI\_SIG #1066 calculate the open-loop frequency response and the compensation stage's R and C values for phase-locked-loop (PLL) designs.

To Vote For This Design, Circle No. 748

## 22V10 handles 680xx DMA and interrupts

*Sean Powers, Stratus Computer,  
Marlboro, MA*

The Boolean equations in EDN BBS /DI\_SIG #1059 program a 22V10 to handle three functions for 680xx  $\mu$ Ps: 7-level interrupt prioritizing, generating a  $\mu$ P-halt signal, and managing DMA-controller retries.

To Vote For This Design, Circle No. 749

## DSP program determines $\mu$ P type

*Jerzy R Chrzyszcz  
Warsaw University of Technology,  
Warsaw, Poland*

EDN BBS /DI\_SIG #1072 contains a compressed, concatenated file consisting of an extensive discussion of compatibility among various Texas Instruments DSP  $\mu$ Ps. The file also includes an assembly-code listing that lets a program test for the TI DSP  $\mu$ P it is running on.

To Vote For This Design, Circle No. 750

These Software Shorts listings are too long to reproduce here. You can obtain the listings from the Design Idea Special Interest Group on EDN's bulletin-board system (BBS): (617) 558-4241, 300/1200/2400, 8, N, 1. From Main Menu, enter ss/DI\_SIG, then rknnnnn, where nnnn is the number referenced above.

Design in our fully static V20HL or V30HL microprocessor and you'll

# Run rings around the competition.

## Sparkling performance for handheld devices.

Our 16MHz V20HL and V30HL microprocessors run 60% faster than 10 MHz 80C88 and 80C86 devices.

But the V20HL/30HL give you more than just a faster clock. You'll blaze through multiply/divide operations in half the time, even if you choose to set the V20HL/30HL at the same clock rate as the 80C88/80C86.



## Just three little volts.

If your embedded controller or handheld PC must run on 3 volts, remember that only NEC offers both 3-volt and 5-volt operation for our V20HL/30HL microprocessors.

For any application requiring a fully static DOS-compatible cpu, you'll get lower power consumption and better performance when you specify V20HL/30HL.



## Smaller. Lighter. Faster. Better.

Lower power consumption and 3-volt operation mean your design will weigh less and take up less space. And later, you can shrink even the smallest design by converting to NEC's DOS Engine™ (PC-on-a-chip) or application-specific standard product based on V20HL/30HL cpu core.

That's why Hewlett-Packard engineers chose our V20HL microprocessor as the heart of the amazing new 11 ounce HP 95LX "palmtop" PC, which runs Lotus 1-2-3 on just two AA batteries.

	V20HL	80C88
DOS COMPATIBLE	YES	YES
POWER (5V) (3V)	6mA/MHz 4mA/MHz	10mA/MHz N/A
# INSTRUCTIONS	101	90
MAX CLOCK SPEED	16MHz	10MHz
DEDICATED TEMPORARY REGISTERS	YES	NO
DUAL INTERNAL DATA BUS	YES	NO
BIT OPERATION	YES	NO
8080 MODES	YES	NO

**Free Information Fast. Ask for Info Pack 155.  
Call 1-800-632-3531. FAX 1-800-729-9288.**

# EPSON

THE CRYSTALMASTER™

leads new  
crystal oscillator  
technologies into  
the 90's with...

the most cost effective hi-temp  
SMD crystals and oscillators and  
low cost plastic thru-hole crystal  
oscillators.

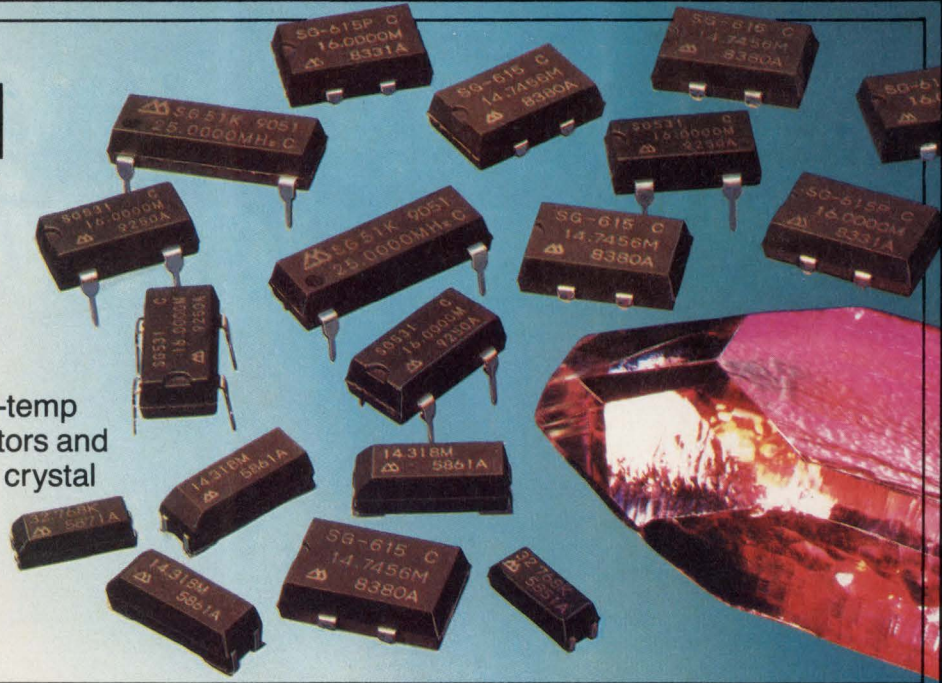

## EPSON SURFACE MOUNT CRYSTALS AND OSCILLATORS

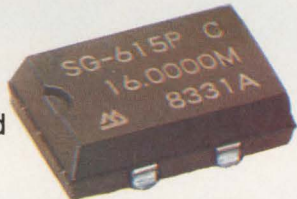
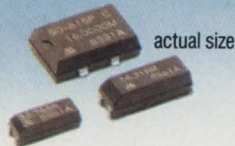

Epson has pioneered the first truly heat resistant crystal for use in its surface mount crystals and crystal oscillators. Capable of withstanding 260°C for 20 seconds... far above the demands of standard IR and vapor phase reflow processing systems... these labor-saving high-temp SMD crystals have become the accepted standard for surface mount crystal and oscillator components.

**MODEL SG-615 OSCILLATOR**  
Frequency: 1.5 to 66.7 MHz  
Symmetry: 45/55 (TYP)  
Rise/Fall Time: 5 nsec (TYP)  
Tristate: Available  
Compatible Technology: CMOS and TTL  
Op. Temp. Range: -40°C to 85°C

**MODEL MA 505/506 CRYSTAL**  
Frequency: 4.00 to 66.7 MHz  
**MODEL MC-405 CRYSTAL**  
Frequency: 32.768 KHz

**EPSON®** EPSON AMERICA, INC.  
Component Sales Department Telephone: 213/787-6300

## EPSON THRU-HOLE OSCILLATORS REPLACE METAL CAN OSCILLATORS

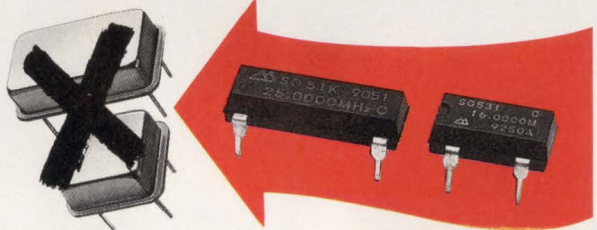

Epson has introduced the first plastic low cost, high performance auto-insertable thru-hole crystal oscillator. Its unique hermetically sealed crystal, embedded in a plastic package, gives the same EMI protection and higher performance than metal can oscillators... at a much lower cost. And, the auto-insertion feature reduces manufacturing costs associated with hand inserting metal cans... into standard full-size or half-size hole patterns.

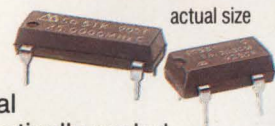

**MODEL SG-51/SG-531 OSCILLATOR**

Frequency: 1.5 to 66.7 MHz  
Symmetry: 45/55 (TYP)  
Rise/Fall Time: 5 nsec (TYP)  
Tristate: Available  
Compatible Technology: CMOS and TTL

**EPSON®** EPSON AMERICA, INC.  
Component Sales Department Telephone: 213/787-6300

CALL YOUR SALES REP TODAY

EPSON Sales Representatives: AL-GA-TN Concord Components 205/772-8883 • AZ-NM Fred Board Assoc. 602/994-9388 • CA-No. Costar 408/446-9339 • CA-So. Bager Electronics 714/957-3367 • CO-UT Wn. Region Mktg. 303/428-8088 • FL Dyne-A-Mark 407/831-2822 • IL-WI LTD Technologies 708/773-2900 • IN-KY C C Electro 317/921-5000 • KS-MO-IA Microtronics 913/262-1444 • MA-NH-CT Rosen Assoc. 617/449-4700 • MD-VA Tech Sales Assoc. 301/461-7802 • MN Electro Mark 612/944-5850 • NC-SC WLA Assoc. 919/231-9939 • NJ JMR Sales 201/525-8000 • NY Elcom Sales 716/385-1400 • Metro, NY Niktronix 516/929-4671 • OH-MI J. D. Babb Assoc. 216/934-4454 • OR-WA Matrex 503/245-8080 • PA Omega Sales 215/244-4000 • TX-OK Component Tech. 214/783-8831 9101

CIRCLE NO. 75

“Speed fascinates me. The Air Force has a jet that hit 2,193 mph. Instant face lift. A Lamborghini Diablo can push the needle over 200 mph. There’s a guy who once served a tennis ball 138 mph. And the fastest mile ever run? 3:46.32. Now that’s fast. Especially when you consider it takes a snail five days to cover the same ground. And speaking of speed, there’s Altera’s MAX 7000 family of programmable logic. With pin-to-logic delays of 12ns and system clock frequencies over 80 MHz. Plus fast, low skew routing with a predictable delay of 3ns or less. Whoosh! It just doesn’t get any faster than Altera’s MAX 7000. We’re talking warp speed.”



They're big. They're fast. They're everything you've asked for. Want to know more? Speed dial 1-800-800-7256.

**MAX7000**

CIRCLE NO. 76

# EDN-NEW PRODUCTS

## Integrated Circuits

### Current-Feedback Op Amps With 100-MHz Bandwidth

- Slew rate is 1000V/ $\mu$ sec
- 15-M $\Omega$  input impedance

The LT1229 (dual) and LT1230 (quad) are current-feedback op amps whose 100-MHz bandwidth and 1000V/ $\mu$ sec slew rate remain fairly constant over a range of closed-loop gains. The dc-coupled amplifiers have only 6-nV/ $\sqrt{\text{Hz}}$  of noise and an impedance of 15 M $\Omega$  at the noninverting inputs. The op amps are specified for operation at supply voltages from  $\pm 2$  to  $\pm 18$ V. The maximum supply current (each amplifier) is 9.5 mA. When operating at a gain of two and driving a 75 $\Omega$  cable, the differential gain and phase of the op amps are 0.04% and 0.1 $^\circ$ , respectively. In RGB (red, green, blue) video systems, the fast rise time of 3.5 nsec eliminates smearing. The amplifiers also have an output-drive capability of 30 mA, which allows them to drive low-

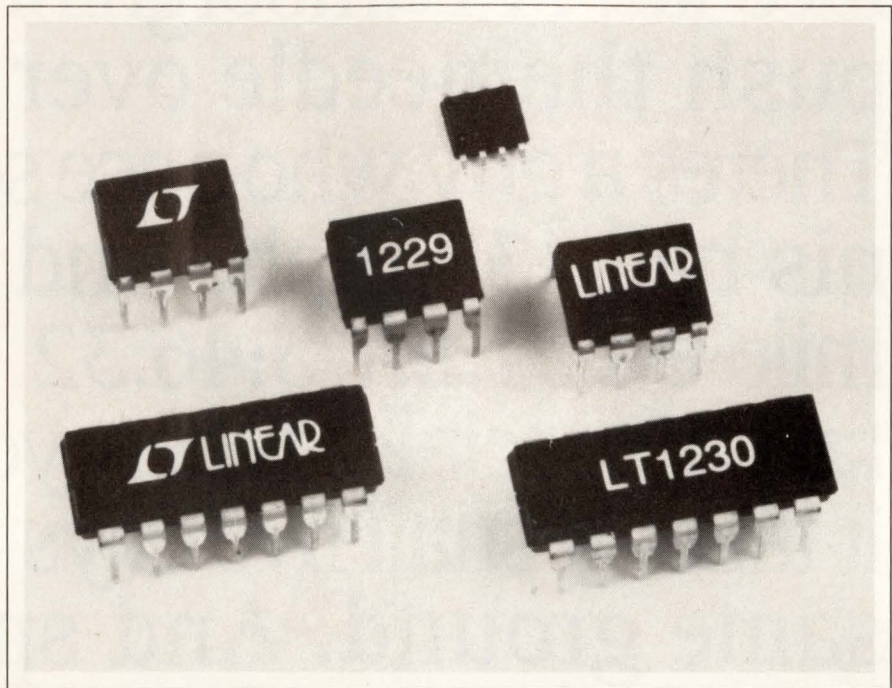

impedance loads. The 8-pin LT1229 and 14-pin LT1230 are available in DIP and SO packages. \$3.95 and \$7.25, respectively, (100).

**Linear Technology Corp**, 1630 McCarthy Blvd, Milpitas, CA 95035. Phone (800) 637-5545; (408) 432-1900. **Circle No. 351**

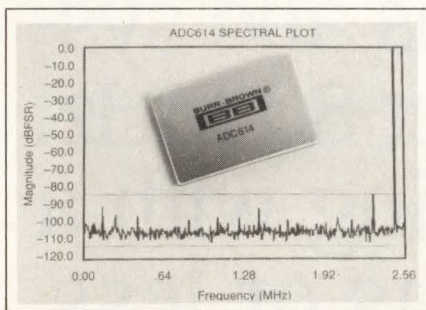

**14-Bit subranging A/D-converter system.** The ADC614 hybrid IC, a subranging ADC subsystem, contains a 14-bit A/D converter, a sample/hold amplifier, a voltage reference, and timing circuitry. The IC, which comes in a 46-pin ceramic and metal package, features a sampling capability from dc to 5.12 MHz and a Nyquist spurious-free dynamic range of -88 dB. Other key specifications include no missing codes, an analog-input bandwidth of 40 MHz, and a S/N ratio of 74 dB at 2.3 MHz. \$990 (100). **Burr-Brown Corp**, Box 11400, Tucson, AZ 85734. Phone (800) 548-6132; (602) 746-1111. FAX (602) 889-1510. TWX 910-952-1111. **Circle No. 352**

**32-bit microcontroller.** The 68F333 32-bit microcontroller contains 64 kbytes of flash EEPROM, allowing you to alter or update electronic modules by reprogramming the software. Other features include an 8-channel 10-bit A/D converter, 512 bytes of standby RAM, 3.5 kbytes of general RAM, a 16-bit timer, and a serial peripheral interface. The 68F333, in a 160-pin quad flatpack, \$199.95. Sample quantities will be available in the second quarter of 1992. **Motorola Inc**, 6501 William Cannon Dr W, Austin, TX 78735. Phone (512) 891-3465. **Circle No. 353**

**Color coprocessor chip.** The Render-Ready Graphics Array (RRGA) compresses 24-bit pixel data for use with an 8-bit graphics frame buffer. Suiting CRT or flat-panel display controllers, the RRGA uses a linear 256-color RGB (red, green, blue) palette to provide photo-quality images. The chip features a 25-MHz conversion throughput, which is fast enough to process 30 1024 $\times$ 768 frames/sec. In a 68-pin plastic leaded chip carrier, \$25. **Vermont**

**Microsystems**, 11 Tigan St, Winooski, VT 05404. Phone (802) 655-2860. FAX (802) 655-9058. **Circle No. 354**

**High-speed RAMDAC.** A 150-MHz version of the Bt459 triple 8-bit RAMDAC complements the company's 80-, 110-, and 135-MHz speed grades. Designed for workstation applications, the device supports resolutions to 1280 $\times$ 1024 pixels. The RAMDAC also handles European refresh standards of 76 and 77 Hz. Available in 132-pin, pin grid arrays and plastic quad flatpacks, \$120 and \$107, respectively, (100). **Brooktree Corp**, 9950 Barnes Canyon Rd, San Diego, CA 92121. Phone (619) 452-7580. FAX (619) 452-1249. TLX 383596. **Circle No. 355**

**High-density programmable logic.** The 84-pin CY7C341 erasable programmable logic device (EPLD) features 7500 equivalent gates and runs to 50 MHz. Consolidating approximately 30 22V10s, the 192-macrocell EPLD is the fourth and highest-density

ANALOG

Digital

ANALOG

Digital

Analog

DIGITAL

Analog

digital

ANALOG

.digital.

ANALOG

DIGITAL

# DON'T BUY IT.



There is a far side to the world of oscilloscopes, a place filled with all sorts of bizarre characters. Like those who swear you need digital, for the sole reason that digital is all they wish to sell. Then there's the gang

that wants to push nothing but analog. Luckily, there's also a place called Tektronix. Where they manufacture a complete line of analog and digital scopes. Making them uniquely qualified to provide you with a more honest assessment of your needs. With anyone else, you could be hearing only half the story. For complete information



on the full line of Tektronix analog and digital oscilloscopes, get in touch with a Tek representative today. **TALK TO TEK/1-800-426-2200**

**Tektronix**  
Test and Measurement

03W-188147 Copyright © 1991, Tektronix, Inc.

# EDN-NEW PRODUCTS

## Integrated Circuits

member of the company's MAX family. In plastic-leaded-chip-carrier and pin-grid-array packages, the CY7C341, \$337 (100). **Cypress Semiconductor**, 3901 N First St, San Jose, CA 95134. Phone (408) 943-2600.

Circle No. 356

**Dual-port video RAMs.** Designed to speed system performance by off-loading screen refresh from the data bus, these video RAMs are available in two versions. The 24-pin KM424C64, a 256-kbit device organized as 64k x 4 bits, is available in access times of 100 and 120 nsec. The 28-pin KM424C256, a 1-Mbit device organized as 256k x 4 bits, is available in access times of 80, 100, or 120 nsec. In 100-nsec versions, the KM424C64 and KM424C256 are \$3.10 and \$8, respectively, (1000). **Samsung Semiconductor**, 3725 N First St, San Jose, CA 95134. Phone (800) 423-7364; (408) 954-7000.

Circle No. 357

**Video switch and amplifier.** The CA3256 video switch and amplifier provides five channels of CMOS multiplex switching and a bipolar output amplifier on a single chip. Channels 1 through 4 are digitally selected and include LED output drivers to indicate the "on" channel. Channel 5 is independent and can function as a monitoring output for signal information on the other channels. The CA3256, in 18-pin DIPs and 20-pin SOICs, \$4 (100). **Harris Semiconductor**, Box 883, Melbourne, FL 32901. Phone (800) 442-7747, ext 1042; (407) 724-3704.

Circle No. 358

**Analog multiplexer.** Able to switch in 17 nsec, the CLC532 2:1 analog multiplexer can pass either of its inputs to the output with better than 0.01% accuracy. Other key specifications include channel isolation of -80 dB, harmonic suppression of -80 dBc, and differential gain and phase of 0.05 dB and 0.01°, respectively. CLC532, in 14-pin DIPs or SOICs, \$9.49 (1000). **Comlinear Corp**, 4800 Wheaton Dr, Fort Collins, CO 80525. Phone (303) 226-0500.

Circle No. 359

**12-bit multiplying DACs.** The MAX501 and MAX502 are 12-bit, 4-quadrant, voltage-output multiplying D/A converters. They combine a BiCMOS amplifier having a ±10V drive capability with a laser-trimmed, thin-film resistor DAC on a single chip. The

DACs accept a dc or ac reference and have buffered input latches. The MAX501 acquires data in an 8+4-bit format, and the MAX502 in a 12-bit format. In 24-pin DIP and SO packages, from \$5.65 (1000). **Maxim Integrated Products**, 120 San Gabriel Dr, Sunnyvale, CA 94086. Phone (408) 737-7600.

Circle No. 360

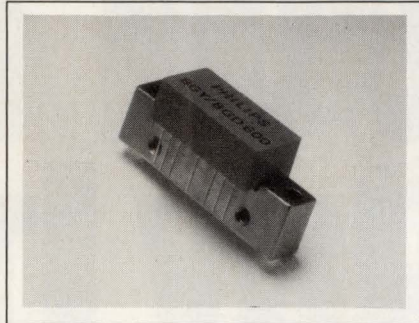

### Wide-bandwidth CATV modules.

Designed for use as repeater amplifiers in CATV networks, the BGY600 series of amplifier modules and the BGD600 series of power-doubler modules feature a bandwidth of 40 to 600 MHz. The BGY series amplifiers offer six different power gains from 12.5 to 27 dB. The BGD series power doublers have a power gain of 12.5 or 18.5 dB. Both series feature low noise figures. The modules utilize thin-film technology and are housed in SOT-115 packages, which suits them for upgrades to existing equipment. The 18.5-dB BGY685A amplifier, \$29.16; the BGD602 power doubler, \$38.88 (500). Delivery, 8 to 10 weeks ARO. **Philips Components**, Literature Center, 2001 W Blue Heron Blvd, Riviera Beach, FL 33404. Phone (800) 447-3762; (407) 881-3308. Outside the US: Philips Components, Marketing Communications Dept, Bldg BA, 5600 MD, Eindhoven, The Netherlands.

Circle No. 361

**PC/AT chip set.** The DXBB chip set adds a local bus to the ISA bus and uses EISA connectors. The local bus transfers data at 66 Mbytes/sec. The chip set consists of the 82C496 CPU block-interleave dynamic RAM and AT bus controller, the 82C206 peripheral controller, and the 82C497 write-back caching controller. The chips work with 80386/486 CPUs from Intel and AMD. The 82C496 and 82C206 pair, \$27.50; the 82C497, \$17.50 (10,000/quarter). **Opti Inc**, 2525 Walsh Ave, Santa Clara, CA 95051. Phone (408) 980-8178. FAX (408) 980-8860.

Circle No. 362

**Frequency Synthesizer.** The MC145191, a phase-locked-loop (PLL) frequency synthesizer, runs to 1.1 GHz. A byte-oriented interface can operate at 4 Mbps. Tuning is via a 3-byte serial transfer to the 24-bit A register. The R, N, and A counters are fully programmable, and the C register configures the part to meet various applications. The C register can also shut off unused outputs to minimize system noise. In a 20-pin SO package, \$5.50 (500). **Motorola Inc**, Box 6000, Austin, TX 78762. Phone (800) 521-8274.

Circle No. 363

**SCSI controller.** Designed for 32-bit CPU-based systems, the  $\mu$ PD72611 SCSI controller supports data-transfer rates to 10 Mbytes/sec over an 8-bit SCSI bus. The device also provides a selectable host bus, supporting 32-, 16-, and 8-bit widths. Other features include a 24-bit transfer counter, single-ended SCSI bus drivers, and Schmitt-type receivers. In a 100-pin quad flatpack, \$17.50 (10,000). **NEC Electronics Inc**, 401 Ellis St, Mountain View, CA 94039. Phone (415) 960-6000. TWX 910-379-6985.

Circle No. 364

**Opto-isolated 12-bit ADC.** MAX171 is a 5.8- $\mu$ sec, 12-bit A/D converter that provides over 1500V-rms isolation between its analog input and the digital interface pins. The device combines a serial-output ADC, three optocouplers, and a low-drift buried-zener reference in a standard 16-pin DIP. You can drive the 2.5-MHz clock input from an external source. The MAX171 operates from 5V and -12 to -15V supplies. From \$20.25 (1000). **Maxim Integrated Products**, 120 San Gabriel Dr, Sunnyvale, CA 94086. Phone (408) 737-7600.

Circle No. 365

**16-bit D/A converter.** The AD669 DACport integrates on a single chip a 16-bit DAC, a reference, a span-programmable output amplifier, and double-buffered latches. The output amplifier is pin-programmable for unipolar or bipolar spans of 0 to 10V or -10 to +10V. Specifications include 15-bit monotonicity over the operating temperature range,  $\pm 1$ -LSB differential and integral nonlinearity, THD+N of 0.0009% (max), and a S/N ratio of 84 dB. In 28-pin DIP and SO packages, from \$16 (100). **Analog Devices**, 181 Ballardvale St, Wilmington, MA 01887. Phone (617) 937-1428. FAX (617) 821-4273.

Circle No. 366



# EDN-NEW PRODUCTS

## Components & Power Supplies

### Clock Oscillators

- Operate to 120 MHz
- Provide a CMOS output

These clock oscillators develop outputs in the 50- to 120-MHz-range standard frequencies of 50, 60, 64, 66, 66.667, 80, and 100 MHz and are available from stock. The output is High-speed CMOS compatible and can drive 15 standard TTL loads. The units are available in a choice of package styles: a 4-pin model in a 14-pin metal DIP; a 4-pin model in an 8-pin miniature DIP; a 0.3×0.5-in. surface-mount package with J leads; and a 0.3×0.5-in. surface-mount package with gull-wing leads. The crystal operates in the fundamental mode at all outputs, minimizing mode-shift problems. Oscillator outputs are 3-state types

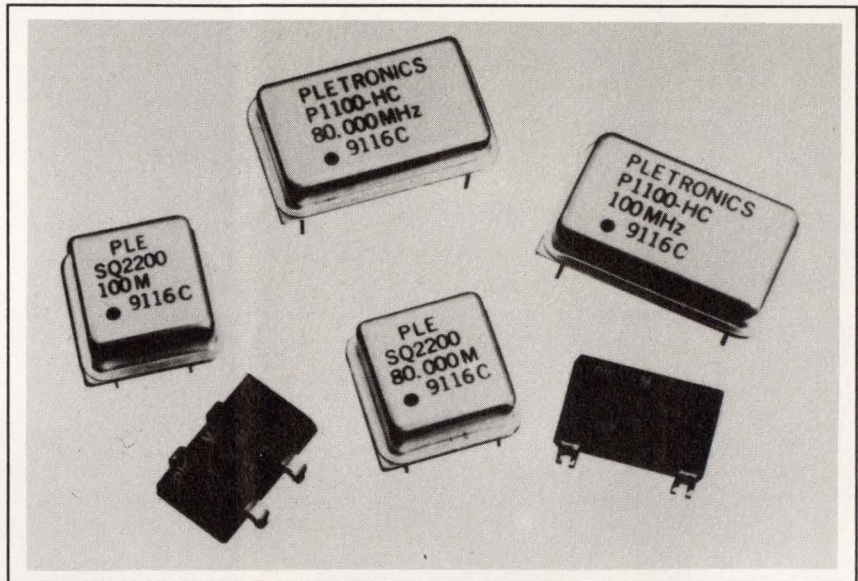

and are short-circuit protected. Inputs and outputs are also ESD protected. \$3 to \$8 (1000).

**Pletronics Inc**, 19015 36th Ave W, Suite H, Lynwood, WA 98036. Phone (206) 776-1880. **Circle No. 367**



**Stepping motor drives.** Models IB104, 106, and 1010 bipolar stepping motor drives utilize MOSFET technology to develop 1800W of power. Housed in a package measuring 6 in.<sup>3</sup>, the units operate from a supply voltage of 24 to 100V dc. The 104 develops 4A/phase, and the 106 and 1010 develop 6 and 9A/phase, respectively. With optically isolated inputs and onboard logic for full- and half-step operation, these drives are suitable for pc-board mounting, direct-frame, or chassis mounting. IB104, \$138 (100). **Intelligent Motion Systems Inc**, 511 Norwich Ave, Taftville, CT 06380. Phone (203) 889-8353. FAX (203) 889-8720. **Circle No. 368**

**Signal conditioner.** The Model 161MK strain-gauge signal-conditioner system operates with a ±15V supply.

A DIP-switch selection chart printed on the card shows you how to select corner frequency (10, 100, 1000 Hz). The unit is designed for use with metal-foil gauges. The unit's excitation regulator can supply from 0 to 100 mA. A trimmer mounted on the card selects bridge excitation levels between 4 and 12V dc. **Calex Mfg Co Inc**, 3355 Vincent Rd, Pleasant Hill, CA 94523. Phone (800) 542-3355; (510) 932-3911. FAX (510) 932-6017. **Circle No. 369**

**Plastic connectors.** ABC solderless, plastic connectors are capable of bidirectional operation because each mated half of the unit can contain both pin and socket contacts. The rectangular connector shells are available in either 1- or 2-in. sizes. Standard plugs mate with three types of receptacles—in-line stack mount, flange mount, and pc-board mount. EMI/RFI shielded back shells are also available. Approximately \$65 (100). Delivery, four to six weeks ARO. **Deutsch Co**, Municipal Airport, Banning CA 92220. Phone (714) 849-7822. FAX (714) 922-1544. **Circle No. 370**

**Image sensor.** The E3W2 programmable-line-array, image-sensor system consists of a light source, a sensing head, and a controller. The system has

a sensing accuracy of 0.5 mm through a 25- to 500-mm field of vision. The system controller features a 100-step programmable memory that can store as many as four independent programs. The controller provides three relay outputs and also accepts two gate inputs. It features a built-in power supply for external sensors. \$1500. **Omron Electronics Inc**, 1 E Commerce Dr, Schaumburg, IL 60173. Phone (800) 826-6766; (708) 843-7900. FAX (708) 843-7787. **Circle No. 371**

**Power transistors.** MRF10070, 10150, 10350, and 10500 microwave power transistors operate in the 1025- to 1150-MHz frequency band. Output power capability for the four devices equals 70, 150, 370, and 500W, respectively. Each transistor operates from a 50V supply and has a typical gain ranging from 9 to 10 dB. All four parts are supplied in hermetic, metal-ceramic packages and are internally matched for broadband operation. \$185 to \$435 (25). **Motorola Inc**, E-114, 5005 E McDowell Rd, Phoenix, AZ 85008. Phone (602) 244-3818. FAX (602) 244-4597. **Circle No. 372**



# Build a Better Test System

Developing a PC-based test system with standard hardware and software saves valuable development time and produces a higher quality system. That's why National Instruments hardware and software products are built upon industry standards.

Our GPIB boards use the NAT4882™ chip for complete IEEE-488.2 compatibility. And our LabWindows® software combines powerful development tools with standard programming languages.

With LabWindows, you have the software tools you need to integrate all of the hardware in your test system. Use high-level 488.2 routines to simplify system programming or use drivers from the LabWindows Instrument Library to control your GPIB and VXI instruments without programming them at all.

LabWindows has tools for all phases of your development—data acquisition, analysis, and presentation. You can even create a graphical user interface so your test system is easy to operate.

To learn how to build a better test system, give us a call.



**Corporate Office**  
6504 Bridge Point Parkway  
Austin, TX 78730-5039  
512) 794-0100  
(800) 433-3488 (U.S. and Canada)

**International Branch Offices**  
AUSTRALIA (03) 879 9422 • DENMARK (45) 76 73 22  
FRANCE (1) 48 65 33 70 • GERMANY (089) 714 5093  
ITALY (02) 4830 1892 • JAPAN (03) 3788 1921  
NETHERLANDS (01720) 45761 • NORWAY (03) 846 866  
SWITZERLAND (056) 45 58 80 • SPAIN (908) 604 304  
UNITED KINGDOM (0635) 523 545

© Copyright 1991 National Instruments Corp. All rights reserved.

# EDN-NEW PRODUCTS

## Computers & Peripherals

### Laser Printer

- Connects to Ethernet or Token Ring networks
- 25-MHz 80960  $\mu$ P produces 600  $\times$  600 dpi resolution

The QMS-PS 1700 laser printer connects directly to an Ethernet or Token Ring network when you install optional interface cards. The printer also includes standard RS232C serial, Centronics parallel, and Localtalk ports. An 80960  $\mu$ P and 8 Mbytes of RAM, which is expandable to 16 Mbytes, produce 600  $\times$  600-dpi or 300  $\times$  300-dpi resolution. The printer serves as many as 20 users on Netware, Ethertalk, TCP/IP, or DECnet networks. The printer employs a proprietary Crown operating system that permits selectable printer resolutions and automatic sensing of Postscript, HP PCL, HP-GL, or optional LN03 Plus printer languages. Job spool-

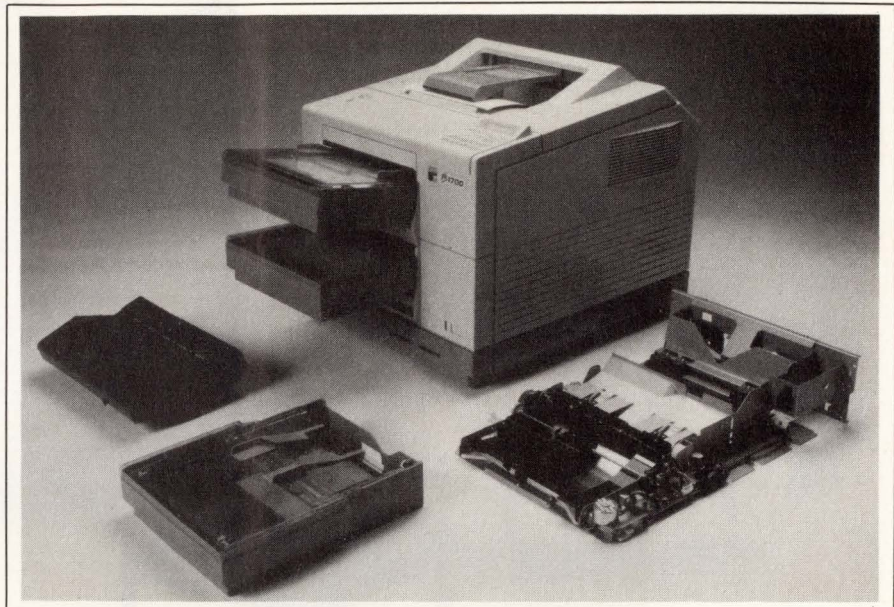

ing permits each of the printer's four ports to receive print jobs while a job from another port is printing. For 20 users, less than \$10,000; optional TCP/IP

or DECnet Ethernet card, \$1995.

**QMS Inc**, 1 Magnum Pass, Mobile, AL 36689. Phone (205) 633-4300. FAX (205) 633-0013.

Circle No. 373

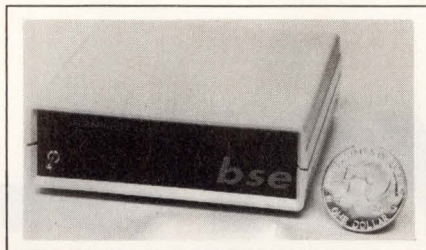

**Portable hard-disk drives.** The Flashdrive comprises portable hard-disk drives for laptop and notebook computers. They are tested and approved by Atari, NEC, Poqet, and Toshiba. The drives add from 20 to 750 Mbytes of external storage to the host's internal capacity. For example a 40-Mbyte drive increases the total capacity of a computer having a 20-Mbyte internal drive to 60 Mbytes. The drives' software occupies 1.5 kbytes of the host's main memory. The model 25 is 1.5-in high and comes with 20-, 40-, 60-, and 80-Mbyte capacities. The Model 35 is 2.5-in. high and has capacities ranging to 750 Mbytes. 20-Mbyte Model 25, \$399; 40-Mbyte Model 35, \$499. **BSE Co**, 1622 Edinger Ave, Suite F, Tustin, CA 92680. Phone (714) 258-8722. FAX (714) 258-8815.

Circle No. 374

**I<sup>2</sup>C bus adapter.** With the ICA-90 I<sup>2</sup>C serial-bus adapter for the ISA bus, you can select one of eight I/O addresses and one of four interrupts for the half-length card. The card employs the Philips PCD8584 bus-controller chip and supports the 2-wire I<sup>2</sup>C protocol. The board operates as a master or slave in receiver and transmitter modes. Popular languages can either poll or interrupt the board. The board interfaces to the bidirectional serial-data and serial-clock lines through a 9-pin D-style connector. \$299. **The Saelig Co**, 1193 Moseley Rd, Victor, NY 14564. Phone (716) 425-3753. FAX (716) 425-3835.

Circle No. 375

**80386 single-board computer.** The CAT990 single-board computer for passive ISA or EISA bus backplanes employs a 25-MHz or 33-MHz 80386  $\mu$ P and 1M to 32 Mbytes of dynamic RAM. The board achieves a Landmark v1.14 speed rating of 41.0 when operating at 25 MHz and 54.1 when operating at 33 MHz. An onboard cache controller manages 64 or 128 kbytes of cache RAM. Peripheral controllers interface to IDE/AT hard-disk and floppy-disk drives.

25-MHz version without RAM, \$1345; 33-MHz version without RAM, \$1495. **Diversified Technology Inc**, Box 748, Ridgeland, MS 39158. Phone (800) 443-2667; (601) 856-4121. FAX (601) 856-2888. TLX 585326.

Circle No. 376

**Frame grabber.** The HI\*DEF II HS frame-grabber-board 2-board set has an effective sampling rate of 55 MHz in single-pass and 110 MHz in dual-pass mode. The boards can simultaneously accommodate data from one digital and four independent analog video sources. You can program the sampling rate from 2 to 110 MHz to capture analog video signals at various resolutions. \$5490. **Imagraph Corp**, 11 Elizabeth Dr, Chelmsford, MA 01824. Phone (508) 256-4624. FAX (508) 250-9155. TLX 4946300.

Circle No. 377

**Stepper motor controller.** The nuStep stepper-motor-controller board for the NuBus permits a Macintosh II computer to control 3 axes of motion at programmable step rates as fast 750,000 steps/sec. A 68000  $\mu$ P controls unipolar and bipolar motor drivers in



8836 II Large-format  
laser plotter

8840 C High volume  
engineering copier

8810 Desktop laser plotter

# Step Savers.

If getting your engineering drawings plotted and printed is costing you shoe leather, you need to talk to Xerox.

Because with our advanced "step-saver" plain paper engineering plotters and printers, you can print, cut, roll, label, stack and sort plots and copies—all without leaving your workstation.

Take our 8836 II—the world's most popular E size large-format laser plotter. It's a high-performance system that's perfect for both fast check plots and presentation-quality plots.

Add our 8810 desktop laser plotter and you have a high-speed solution for generating manageable A and B size check plots and final plots.

And for fast high volume prints of drawings and documentation in mixed sizes and formats, there's our 8840 printer family. The 8840 takes data from a variety of sources and makes crisp, high resolution prints and plots in A through D sizes.

For economy and flexibility, all these step-saver systems use plain paper. And at 400 ppi resolution, they deliver laser-sharp lines, smooth diagonals and superior gray scales. Even better, they work with all your favorite applications, like AutoCAD.\*

Plus, you can take your pick of RS-232, Versatec or Centronics parallel interfaces for easy connection to all

major networks, computers, workstations and PCs.

It's just what you'd expect from Xerox Engineering Systems. The leading supplier of engineering copiers, printers and Versatec plotters for document management.

To find out more, call 800-538-6477; in California, 800-341-6060. And see how much more productive you can be when you step up to Xerox.

**XEROX**

*The engineering document company.*

**Xerox Engineering Systems**

2710 Walsh Ave., Santa Clara, CA 95051 Xerox is a trademark of Xerox Corporation. AutoCAD is a registered trademark of Autodesk, Inc. © 1991 Versatec, Inc.

For more information on the 8836 II **Circle 250**, for the 8810 **Circle 251**, and for our 8840 **Circle 252**.

# where's

# the book?

If your copy of  
the all-new  
Acces I/O  
Board Catalog  
is missing from  
this issue, call  
us today and  
we'll get you  
another copy.

Analog & Digital I/O

Digital I/O

Communications

PC Bus Expansion Kits

Software

**ACCES**  
I/O Products, Inc.

**800-326-1649**

9400 Activity Rd. San Diego, CA 92126

CIRCLE NO. 80

## EDN-NEW PRODUCTS

### Computers & Peripherals

real-time open- or closed-loop systems. \$1595. **nuLogic Inc.**, 475 Hillside Ave, Needham Heights, MA 02194. Phone (617) 444-7680. FAX (617) 444-2803.

Circle No. 378

**Token Ring bridge.** The Plexbridge 8039 bridge connects to 4-Mbps or 16-Mbps Token Ring networks. The bridge employs the Simple Network Management Protocol (SNMP) to manage compliant network-management stations. The bridge implements the Spanning Tree algorithm, which automatically determines the most efficient network route, and it accommodates multiple parallel paths and hops. \$4495. **Plexcom Inc.**, 65 Moreland Rd, Simi Valley, CA 93065. Phone (805) 522-3333. FAX (805) 583-4764.

Circle No. 379

**Console-to-computer switch.** The SC-6X3-15V6M matrix switch connects six consoles to three computers. The consoles can consist of VGA monitors and keyboards having 6-pin miniDIN connectors. A remote switch-control unit, the RMT-3C, can be located 500 feet away. Switch, \$2700; remote control, with 25-ft cable, \$105. **Network Technologies Inc.**, 7322 Pettibone Rd, Chagrin Falls, OH 44022. Phone (800) 742-8324; (216) 543-1646. FAX (216) 543-5423.

Circle No. 380

**Media attachment unit.** The 2100 ultraminiature MiniMAU allows an attachment-unit interface on data-terminal equipment to transmit and receive data on a 10Base-T, twisted-pair, Ethernet network. It doesn't require ac or battery power and conforms to the IEEE-802.3 and FCC Class A standards. The unit measures 2 x 1.68 x 0.79 in. and comes in a plastic case with LED status indicators. \$89. **Patton Electronics Co.**, 7958 Cessna Ave, Gaithersburg, MD 20879. Phone (301) 975-1000.

Circle No. 381

**Ethernet adapter.** The Pocket Print Server enables a printer to connect directly to a 10Base-T Ethernet network. The unit attaches to the printer's parallel port and transfers data at 60 kbytes/sec. The adapter is compatible with Novell's Print Server standard software and supports Novel Netware 2.15 and Netware 386 protocols. \$495. **Extended Systems**, 6123 N Meeker Ave, Boise, ID 83704. Phone (208) 322-7575. FAX (208) 377-1906.

Circle No. 382

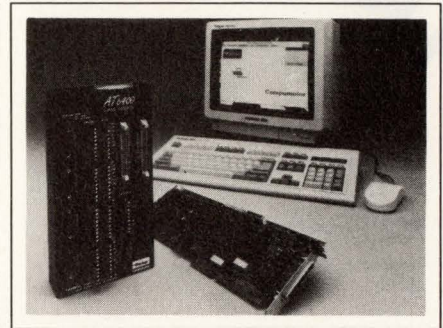

**Stepper motor controller.** The AT6400 stepper motor controller for ISA bus computers can synchronize 2, 3, or 4 axes of motion and accept incremental-encoder-feedback signals on all four axes. The controller has 24 programmable I/O ports. Its software command language features feed-rate override, 2-axis contouring, conditional programming, unit scaling, registration, and mathematical functions. \$2275. **Parker Hannifin Corp.**, Compumotor Div, 5500 Business Park Dr, Rohnert Park, CA 94928. Phone (800) 358-9070; (707) 584-7558. FAX (800) 328-8087.

Circle No. 383

**386DX single-board computer.** The TEK-AT3 contains a 33-MHz 80386  $\mu$ P; 1, 4, or 16 Mbytes of dynamic RAM; 2 Mbytes of solid-state disk RAM; 1 Mbyte of flash EPROM; and 1 Mbyte of static RAM with battery backup. In addition, the board has hard- and floppy-disk-drive controllers; two serial ports; and 1 parallel port. The board plugs into a passive 16-bit ISA bus backplane, and its all-CMOS design consumes 6W typ. \$1495. **Teknor Microsystems Inc.**, CP 455, Sainte-Therese, Quebec, Canada J7E FJ8. Phone (514) 437-5682. FAX (514) 437-8053.

Circle No. 384

**Signal-conditioning board.** The VMIVME-3413 conditions signals from 32 low-level analog sources. The conditioned signals are compatible with the company's VMIVME-3112 and VMIVME-3118 scanning A/D boards. Each channel accepts differential or single-ended inputs and has jumper-selectable gain adjustments of  $\times 1$ ,  $\times 10$ ,  $\times 100$ , or  $\times 1000$ . Each channel also has a 3-pole lowpass filter, which is adjustable from 4 Hz to 10 kHz. \$1695 to \$2375. **VME Microsystems International Corp.**, 12090 S Memorial Pkwy, Huntsville, AL 35803. Phone (800) 322-3616; (205) 880-0444. FAX (205) 882-0859.

Circle No. 385

**LANIER**

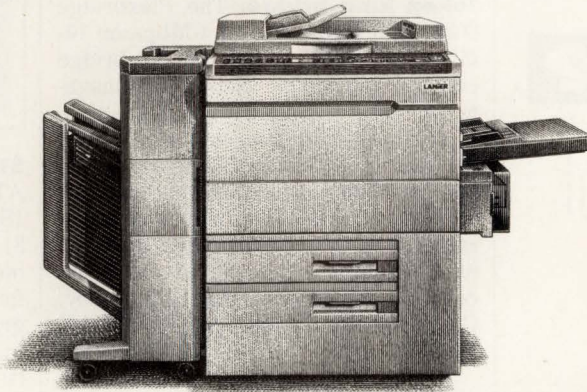

**Possibly The Only Thing  
In Your Office That  
Works 98% Of The Time.**



No offense, but your employees probably don't work as hard as a Lanier copier. They can't compete with its guaranteed up and running time of 98%. And if it's off the job more than 8 hours, we'll

give you a free loaner. That's our Performance Promise\*. For details and a free copier information package, call your local Lanier rep. Or **1-800-852-2679**. Who knows, maybe a Lanier copier could set an example for some people in your office.

\*Some restrictions may apply.

 HARRIS

LANIER RESPONDS

Copying Systems Division

### i960CA Emulator

- Provides enhanced cache analysis
- Offers multilevel, logic-analyzer-style hardware triggering

The Express III emulator for the i960CA  $\mu$ P performs more complete cache analysis than did earlier instruments. In addition, it couples its logic-analyzer-style triggering to the  $\mu$ P's cache and uses the IC's on-chip debugging facilities to detect trigger conditions and to control program execution from cache. Among the emulator's features are a 32k $\times$ 256-bit trace buffer with passive trace and time stamping; multilevel hardware and software triggering that includes store-control facilities; 71 hardware-range

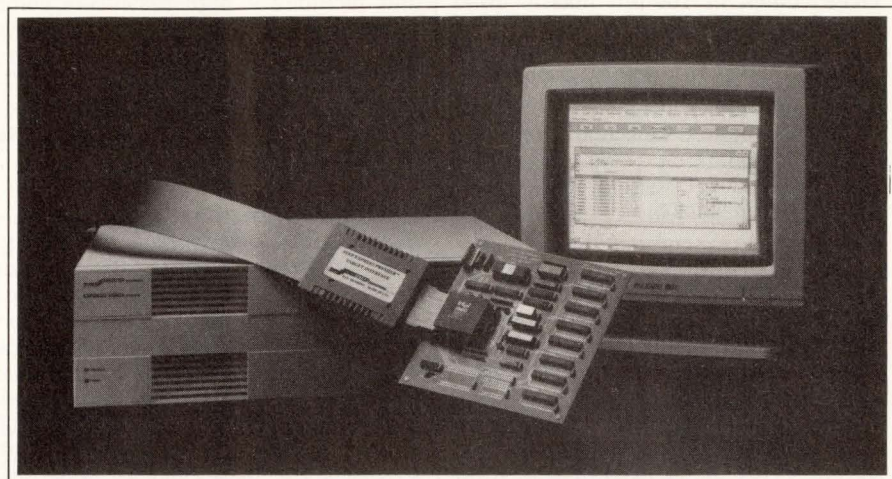

matchwords and breakpoints; performance-analysis capabilities; and an integrated MS-Windows-based debugger with a graphical user interface. \$35,000.

**Step Engineering Inc.**, Box 3166, Sunnyvale, CA 94088. Phone (800) 538-1750; (408) 733-7837. FAX (408) 773-1073. TWX 910-339-9506.

Circle No. 386



**Analog signature-comparison tester.** The Pro-line 5300 autotracer is an analog signature-comparison tester that—without applying dc power—isolates failed components on pc boards containing analog, digital, and mixed-signal devices. The unit also works with diodes, transistors, resistors, inductors, capacitors, regulators, and ICs not mounted on boards. An MS-DOS PC stores signatures measured at various nodes of a known-good board. The tester measures as many as eight signatures at a node (four impedance levels, two frequencies). An autoranging feature then selects the most meaningful of these signatures for permanent storage. From \$4500. **Maxtec International Corp.**, 6470 W Cortland St, Chicago, IL 60635. Phone (312) 889-1448.

Circle No. 387

**6-slot VXIbus chassis.** The 1246U has a hinged front panel and a removable outer shell. It has a 450W power supply and cooling that removes 55W

per slot. \$3875. Delivery, four to six weeks ARO. **Racal-Dana Instruments Inc.**, 4 Goodyear St, Irvine, CA 92718. Phone (800) 722-3262. FAX (714) 859-2505.

Circle No. 388

**ISA bus IEEE-488.2 interface.** The KPC-488.2 transfers data as fast as 1.5 Mbytes/sec. A built-in bus analyzer lets you track down bus problems without special instruments. Software support is provided for MS-DOS, MS Windows 3.0, SCO Unix, and OS/2, and for several Microsoft and Borland languages. \$495. **Keithley Metrabyte**, 440 Myles Standish Blvd, Taunton, MA 02780. Phone (508) 880-3000. FAX (508) 880-0179.

Circle No. 389

**ISA bus data-acquisition board.** Model 30 has 24 lines of TTL I/O, an 8-channel multiplexer, an 8-bit ADC, and a 12-bit counter. It comes with sample programs on a 5 $\frac{1}{4}$ -in. floppy disk. You can get it with open-collector TTL drivers that handle 30V and 0.5A. \$79. **Prairie Digital Inc.**, 846 17th St, Prairie du Sac, WI 53578. Phone or FAX (608) 643-8599.

Circle No. 390

**PC-based in-circuit emulator.** The Emul16/300PC consists of an ISA bus emulator board containing 1 Mbyte of

shadow RAM, a 5-ft twisted-pair ribbon cable, a pod board containing 1 Mbyte of breakpoint RAM, and an optional trace board. You can display the contents of the shadow RAM while the emulator continues to run at full speed. \$1995; pod \$1995. **Nohau Corp.**, 51 E Campbell Ave, Campbell, CA 95008. Phone (408) 866-1820. FAX (408) 378-7869.

Circle No. 391

**L-C-R meter.** The HP 4263A LCR meter measures inductance (L), capacitance (C), and resistance (R) from 100 Hz to 100 kHz. Inaccuracy is 0.1% and resolution is five digits. Using option 001 transfer-measurement function, the unit quickly displays parameters of low-frequency transformers. LCR meter, \$3800; transformer test fixture, \$540; option 001, \$660. Delivery, six weeks ARO. **Hewlett-Packard Co.**, 19310 Pruneridge Ave, Cupertino, CA 95014. Phone (800) 752-0900.

Circle No. 392

**Capacitance meter.** The JAC-380123 measures 0.1 pF to 20,000  $\mu$ F in nine ranges. The 7.3 $\times$ 3.4 $\times$ 1.5-in. unit is bright yellow and weighs 10 oz; its LCD has 0.7-in.-high characters. \$99. **Extech Instruments Corp.**, 335 Bear Hill Rd, Waltham, MA 02154. Phone (617) 890-7440. FAX (617) 890-7864.

Circle No. 393

## EDN-NEW PRODUCTS

### Test & Measurement Instruments

#### 350-MHz PQFP probe adapter.

This adapter for testing high-speed devices comes in 100-pin plastic quad flatpacks. It fits over the device under test and provides a 100-pin pin-grid-array socket for connecting probes. Removable pins let you connect to retractable probe tips or to a logic analyzer's square-pin adapters. \$260. **Tektronix Inc.**, Box 1520, Pittsfield, MA 01201. Phone (800) 426-2200. **Circle No. 394**

#### 4-channel thermal-array chart recorder.

The 31-lb Easygraf 4-channel recorder has a printhead with a dot pitch of 4 dots/mm. Chart speeds range from 0.01 to 125 mm/sec. Frequency response extends to 500 Hz. The unit accepts plug-in signal conditioners. Recorder, \$5495; signal conditioners, from \$315/channel. **Gould Inc.**, 8333 Rockside Rd, Valley View, OH 44125. Phone (216) 328-7000. FAX (216) 328-7400. **Circle No. 395**

**Visual-inspection system.** The AV-560 benchtop system inspects pc boards produced in moderate volume and con-

tains surface-mount components. It handles boards as large as 12-in. square and includes a high-resolution color video display. \$23,500. **Benchmark Industries Inc.**, 215 St Anselm's Dr, Goffstown, NH 03045. Phone (603) 627-8484. FAX (603) 627-6788. TLX 881404. **Circle No. 396**

**VMEbus digitizers.** The Comet 6U-size VMEbus board holds four ADCs. You can select converters that digitize to 12 bits at 1, 2, or 5 Msamples/sec. A board with four 5-Msamples/sec ADCs can acquire single-channel data at 20 Msamples/sec. Each converter has 64k words of acquisition memory. Board with four 5-Msamples/sec ADCs, \$2444 (100). **Omnibyte Corp.**, 245 W Roosevelt Rd, West Chicago, IL 60185. Phone (708) 231-6880. FAX (708) 231-7042. **Circle No. 397**

**Data-acquisition software.** DAQware runs with the vendor's ISA bus, EISA bus, and data-acquisition boards for the Micro Channel bus, and is included in the price of these boards. Be-

sides displaying data in strip-chart format and producing arbitrary waveforms, it stores data on disk in binary, ASCII, and Lotus 1-2-3 formats. The vendor will supply the source code on request at no extra charge. LabWindows package, \$695. **National Instruments Corp.**, 6504 Bridge Point Pkwy, Austin, TX 78730. Phone in USA and Canada, (800) 433-3488; (512) 794-0100. FAX (512) 794-8411. **Circle No. 398**

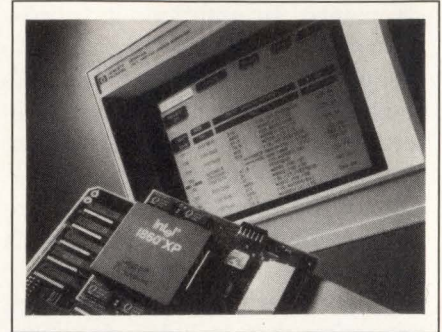

#### 100-MHz logic-analysis card set.

The combination of an HP 16540D and one to four 16541Ds equip the vendor's 16500 logic-analysis systems to do 100-

# SAFETY.

It's this simple.

Maxell offers an incredibly wide range of long life Lithium Thionyl Chloride and Lithium Manganese Dioxide Batteries, covering more of your industrial/engineering applications than most others.

Every Maxell Lithium Battery is built with our unique manufacturing process and rigorous chemical purity and process control to assure maximum battery safety and performance.

Every one is engineered with controlled internal resistance for slower discharge and longer shelf life. Some are even available with built-in resistors and diodes to safeguard memory backup.

So when you're looking for the ultimate in Lithium Battery selection, performance and safety, look to Maxell.

It's that simple.

## maxell®

Maxell Corporation of America, 22-08 Route 208,  
Fair Lawn, NJ 07410, 1-800-533-2836.

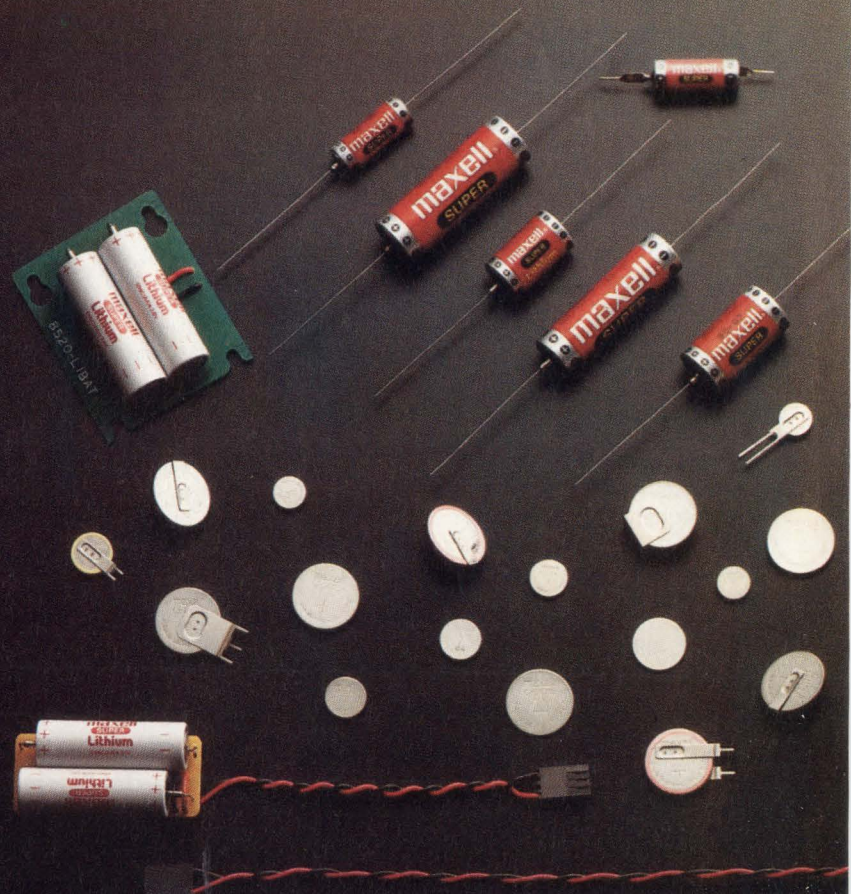



## EDN-NEW PRODUCTS

### Test & Measurement Instruments

MHz state and timing analysis on as many as 208 channels. The card set, which includes facilities for cross-triggering of additional card sets, provides a buffer that stores a 16k-frame trace time-tagged with 10-nsec resolution. It also offers 10-nsec, 4-level trigger sequencing with four pattern terms and a 32-bit range term. Using the card set, the logic analyzer displays interleaved traces for time correlation. Master card (16 channels), \$8400; 48-channel expander, \$9900; preprocessor for i860XP  $\mu$ P, \$5300. Delivery, four to eight weeks ARO. **Hewlett-Packard Co.**, 19310 Pruneridge Ave, Cupertino, CA 95014. Phone (800) 752-0900.

Circle No. 399

**Test set for European cellular phones.** The HP 8922G test set performs protocol, signaling, and bit-error-rate tests on European digital cellular telephones that conform with the GSM (Group Speciale Mobile) standard. \$79,000. Delivery, eight weeks ARO. **Hewlett-Packard Co.**, 19310 Pruneridge Ave, Cupertino, CA 95014. Phone (800) 752-0900.

Circle No. 400

**Frequency synthesizer.** The SI-102 frequency synthesizer provides  $5\frac{1}{2}$ -digit resolution from 0.1 Hz to 16 MHz. From 0 to 50°C, the output frequency is stable to  $\pm 10$  ppm ( $\pm 1$  ppm optional). The output will drive a 50 $\Omega$  load. \$779. **Syntest Corp.**, 40 Locke Dr, Marlboro, MA 01752. Phone (508) 481-7827. FAX (508) 481-5769. Circle No. 401

**Drivers for Turbo C and Pascal.** NI-DAQ DOS and NI-DAQ Windows help you write Turbo C and Turbo Pascal programs that control and acquire data with 20 types of the vendor's ISA bus and Micro Channel Architecture bus data-acquisition boards. The driver packages accompany the boards at no extra charge. **National Instruments Corp.**, 6504 Bridge Point Pkwy, Austin, TX 78730. Phone in USA and Canada, (800) 433-3488; (512) 794-0100. FAX (512) 794-8411.

Circle No. 402

**Analog-output boards for 16-bit ISA bus.** The AT-AO-6 analog-output board has six multiplying DACs, and the AT-AO-10 analog-output board con-

tains ten multiplying DACs; both boards accept 200,000 updates/sec. They boards also have voltage references for the DACs. Each channel has a 4-to-20-mA current output and a voltage output that can be either unipolar or bipolar. AT-AO-6, \$895; AT-AO-10, \$1295. **National Instruments Corp.**, 6504 Bridge Point Pkwy, Austin, TX 78730. Phone in USA and Canada, (800) 433-3488; (512) 794-0100. FAX (512) 794-8411.

Circle No. 403

**Data-logger software.** The Hydra data-logger application software package works with the vendors' data-acquisition instruments and runs under MS Windows. The package allows you to create custom interfaces using a spreadsheet such as Excel or 1-2-3 for Windows. \$350. **John Fluke Mfg Co Inc.**, Box 9090, Everett, WA 98206. Phone (800) 443-5853; (206) 347-6100. FAX (206) 356-5116.

Circle No. 404

**Philips Test and Measurement**, Bldg TQIII-4, 5600 MD Eindhoven, The Netherlands.

Circle No. 405

# IN NUMBERS.



CIRCLE NO. 82

### High-Frequency Package

- Linear and nonlinear simulation at the block level
- Provides Monte Carlo and yield analysis

The HP 85150B microwave-design system is a software package for RF and microwave designers for high-frequency circuits and systems. Revision 4.0 allows linear and nonlinear simulation at the block and device levels and provides Monte Carlo and yield analysis to aid in manufacturing design. The software permits simulation directly from layout; you can modify portions of a design at the layout state and resimulate without entering an electrical schematic. Before the simulator performs analysis, the system automatically breaks meandering transmission lines, capacitors, via, thin-film resistors, and other planar components into electrical

transmission lines, bends, and other electrical components. The package includes the HP 85172A Triquint foundry library of HA (0.5- $\mu\text{m}$ ) and QED/A (1.0- $\mu\text{m}$ ) gallium-arsenide processes. Software package, \$38,000; libraries, \$3000 to \$6000.

**Hewlett-Packard Co**, Inquiries, 19310 Pruneridge Ave, Cupertino, CA 95014. Phone (800) 752-0900.

Circle No. 406

### ROM Operating System

- ROM-based or disk-based OS for embedded applications
- Compatible with MS-DOS 3.31

This version of ROM-DOS, a disk-based or ROM-based operating system for embedded applications, is compatible with MS-DOS 3.31 and works with a flash-memory "disk." The OS uses little RAM during operation, running applications di-

rectly and thus not needing the RAM normally used by COM-MAND.COM. With all its functions, the OS takes about 34 kbytes of ROM and as little as 10 kbytes of RAM; you can eliminate unneeded functions to reduce ROM usage further. The flash-memory-disk driver lets you read and write to a "disk" of flash EPROMs with standard DOS system calls. The flash disk uses the standard DOS-installable file system (IFS) interface and works with all applications or commands except those that directly access disk information and bypass standard DOS file-system calls. License for software, as low as \$5/copy; license for source code, \$10,000.

**Datalight**, 17455 68th Ave NE, Suite 304, Bothell, WA 98011. Phone (800) 221-6630; (206) 486-8086.

Circle No. 407

**Unix for 386/486.** Version 3.0 is a new release of the Interactive Unix System V Release 3.2 for Intel's 80386 and 80486 processors. Enhancements allow easier use and also include support for additional hardware, including the EISA architecture and foreign languages. The user interface features pull-down menus and pop-up dialogue boxes and forms that guide you through operations such as system installation, kernel configuration, copying disks, configuring printers, adding users, and installing applications. Single-user system, \$495; multiuser extension, \$400. **Interactive Systems Corp**, 2401 Colorado Ave, Santa Monica, CA 90404. Phone (800) 346-7111; (213) 453-8649, ext 3130. FAX (213) 828-6453. TWX 910-343-6255. TLX 182030. Circle No. 408

**Linear-circuit analyzer.** Analyser III analyzes designs for filters, crossover networks, wideband amplifiers, antenna-matching networks, radio and TV IF amplifiers, chroma filters, linear integrated circuits, and more. It displays the frequency response of a circuit (from 0.001 Hz to tens of GHz), not only in terms of gain but also input and out-

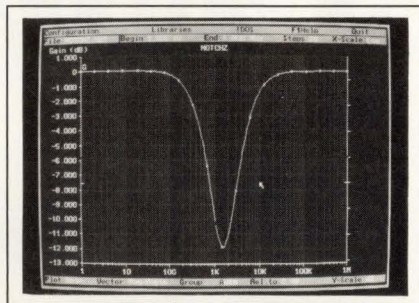

put impedances, phase responses, and group delay. \$375. **Number One Systems Ltd**, Harding Way, Somersham Rd, St Ives, Huntingdon, Cambs PE17 4WR, England. Phone (0480) 61778. FAX (0480) 494042.

Circle No. 409

**Unix for 68040 VME.** A version of Unix System V Release 4 is now available for the supplier's 68040-based VMEbus single-board computers. The software conforms to the IEEE 1003.1 specification developed by the Posix standards committee. \$3000. **Radstone Technology**, 20 Craig Rd, Montvale, NJ 07645. Phone (800) 368-2738; (201) 391-2700. FAX (201) 391-2899.

Circle No. 410

**Timing program.** Timeplus lets you document exact minimum and maximum execution times and stack depth for your assembly-language programs. Not a simulator, the program examines all possible paths in your software and alerts you to possible stack imbalances. The package is available for the 6800, 68HC11, 6805, 8048, and 8051 families. \$250. **BE Inc**, Box 29419, Indianapolis, IN 46229. Phone (800) 628-9085; (317) 894-7021.

Circle No. 411

**Unix for TI 1500.** TI System V Release 3.3, an enhanced version of Unix for the TI 1500 computer, offers improved data integrity in the event of a system crash. A dynamic buffer cache also relieves system administrators from having to decide how to partition memory between the file-system buffer cache and the virtual-memory subsystem. Other features include shared libraries, a CD-ROM file system, and a network spooler. Free to customers with software subscription service agreements. **Texas Instruments Inc**, Information Technology Group, Box 202230, ITG-9141, Austin, TX 78720. Phone (800) 527-3500.

Circle No. 412

# EDN PRODUCT MART

This advertising is for new and current products.

Please circle Reader Service number  
for additional information from manufacturers.

## ROM-IT EPROM EMULATION SYSTEM



### NEW 4-MEGABIT VERSION

- Emulates up to 8 4-Megabit EPROMs with one control card.
- Downloads 2-Megabit programs in less than 23 seconds.
- Allows you to examine and modify individual bytes or blocks.
- Accepts Intel Hex, Motorola S-Record and Binary files.
- Software available for IBM PC and compatibles and Macintosh systems.
- Base 27256 EPROM System \$395.00 Other configurations available.

ORDER TODAY--IT'S EASY  
CALL OR FAX FOR MORE INFORMATION



Incredible Technologies, Inc.  
(708) 437-2433  
(708) 437-2473 Fax  
VISA now accepted.

CIRCLE NO. 325

☆☆☆☆  
"The Best 8051 Emulator"

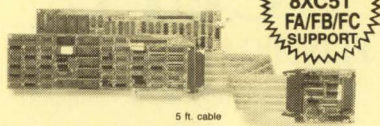

5 ft. cable

FULL  
8XC51  
FA/FB/FC  
SUPPORT

## 8051

SEE EEM 91/92  
Pages D 1300-1303

PC based emulators for the 8051 family

8031, 8032, 8051, 8052, 80C152/154/321/451/452/51FA/51GB/51S/517/53S/537/  
552/562/652/651, 80532, 83C451/552/652/751/752/851, 8344, 87C451/552/751/  
752, 8751, 8752, DS5000 + CMOS ... more.

- PC plug-in boards or RS-232 box.
- Up to 33 MHz real-time emulation.
- Full Source-level Debugger w/complete C-variable support.
- 64 bit wide, 256k deep trace, with time stamp.
- Bond-out/hooks pods for 8051, 83C552, 83C451, 83C652, 83C751, 80C515/80C517, 83C752, 8XC51FA/FB/FC, and more.

CALL OR WRITE FOR FREE DEMO DISK!

Ask about our demo VIDEO

**NOHAU**  
CORPORATION (408) 866-1820

51 E. Campbell Avenue  
Campbell, CA 95008  
FAX (408) 378-7869

Call 408-378-2912  
Nohau's 24-hour  
information center to  
receive info via your FAX

CIRCLE NO. 326

## BACKGROUND MODE EMULATOR

68332  
68340  
68HC16

and 68330, 68331, 68333

Complete hardware testing and C source  
level debugging for thousands less  
than an ICE. Call for a free trial unit.



(617) 828-5588

**EST** Embedded  
Support  
Tools Corp.

10 Elmwood St. Canton, MA 02021

CIRCLE NO. 327

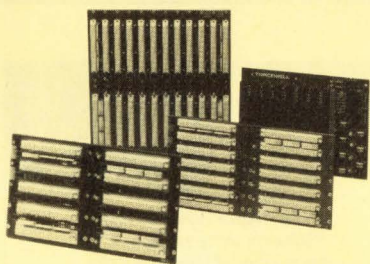

## Low noise backplanes

Ultra quiet backplanes for VME, VXI,  
PC bus, and live insertion/20MHz  
Multibus II. All-stripline construction  
and distributed high and low frequen-  
cy decoupling capacitors contribute to  
extremely low crosstalk and EMI  
radiation. Call 1-800-848-4525.

**TRACEWELL**

567 Enterprise Drive, Westerville, OH 43081.

CIRCLE NO. 328

## UNIVERSAL PROGRAMMER, EMULATOR & TESTER

TUP-400 \$745.00  
TUP-300 \$645.00

- New improved hardware and software.
- The most complete PC-based Universal Programmer. Programs PLD (PAL, GAL, FPL, EPLD, PEEL, MAX, MACH ...), E(E) PROM (up to 16 Mbit), Flash EPROM, BPROM, Special PROM, MPU (87XX, 68XX, Z8, PSD301, PIC16XX, TMS320CXX, UPD75PXXX, HD637XXX ...).
- Covers DIP, PLCC, QFP, SOP, and PGA with 8 to 84 pins. Gang Programming adapters available also.
- EPROM EMULATION capability.
- Tests digital ICs and DRAMs (SIMM/SIP adapter available).
- Free software updates and new devices added upon request.
- IC Manufacturers' approval.
- 1 year warranty, 30 day money back guarantee.



CALL TODAY  
FOR MORE INFORMATION.  
Distributors are welcome!



**Tribal Microsystems Inc.**  
44388 S. GRIMMER BLVD, FREMONT, CA 94538  
TEL (510) 623-8859 FAX (510) 623-9925

CIRCLE NO. 329

## Instant Microcontroller



### Instant C Programming

Don't use a microprocessor, use a **SmartBlock™** microcontroller module to build your custom controller. Our \$195 interactive **Dynamic C™** development system makes programming easy. 3.5 x 2.5 inch module includes microprocessor, memory, time/date clock, eeprom, watchdog, serial ports and more. As low as \$59 in quantity. The efficiency of a custom design without the headaches.

### Z-World Engineering

1724 Picasso Ave., Davis, CA 95616 USA

Tel (916) 757-3737

Regular Fax: (916) 753-5141

Automatic Fax: (916)-753-0618

(Call from your fax, request data sheet #14.)

CIRCLE NO. 330

To advertise in Product Mart, call Joanne Dorian, 212/463-6415

# MICROPROCESSOR EMULATORS

Zax provides a comprehensive series of real-time emulation support for Motorola, Intel, NEC, Zilog, and Hitachi microprocessors. Some of the highlighted features include source-level debug, real-time trace, and performance analysis.

Call now for more information:

(800) 421-0982  
(714) 474-1170 (Inside CA)  
(714) 474-0159 (Fax)

**ZAXTEK**

2572 White Rd., Irvine, CA 92714

CIRCLE NO. 331

## PROM DISK EMULATOR

### Features Include:

- \* On-board microcontroller protects the EPROM against software piracy
- \* 1 MB EPROM, SRAM, or both
- \* Watch-Dog Timer
- \* PGM module for on-board programming
- \* Auto-boot from driver A to driver D
- \* Switch selectable driver unit (A to D)
- \* Occupies only 8K of memory space
- \* Battery back-up for data retention
- \* Up to 4 units may be included in a computer

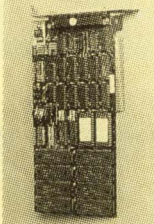

\$249/0K

## INDUSTRIAL AT CPU CARD

- \* Up to 2 Meg DRAM
- \* 7 DMA channels
- \* Keyboard Interface
- \* Clock/Calendar
- \* 16 level H/W interrupts
- \* 3 16-Bit programmable Timers
- \* Optional 80287 Co-processor
- \* 12/16 MHz

\$249/0K

## TURBO XT CPU CARD

- \* 512K DRAM w/256K on board
- \* 3 16-Bit Programmable Timers
- \* Keyboard Interface
- \* 8 level H/W Interrupts
- \* 4 DMA Channels
- \* Video Switch

\$129/256K

Call for more information

**INLOG** 13353 Alondra Blvd. #106, Santa Fe Springs, CA 90670  
Microsystems TEL:(310)802-9767 FAX:(310)802-2048

CIRCLE NO. 332

# Relax Reliability Software

Innovative Software Designs offers an unbeatable set of reliability analysis software tools with its Relax product line. The Relax line includes electronic reliability analysis according to MIL-HDBK-217, Bellcore, and CNET, mechanical reliability, and failure modes and effects analysis. Also available are packages for thermal and Weibull analysis.

Relax products are noted for their outstanding quality, ease-of-use, flexibility, and comprehensive array of features. A wide range of packages are available to meet your price and product requirements. And all products are fully guaranteed!

217  
CNET  
Bellcore  
FMECA  
Mechanical  
217 Parts Count  
Calculs Simplifiés  
BETAsoft Thermal  
WeibullSMITH Analysis

Call today for more information and join ISD's long list of satisfied customers!

Innovative Software Designs, Inc.

One Kimball Ridge Court • Baltimore, MD 21228  
(301) 747-8543 • Fax (301) 747-8599

CIRCLE NO. 333

Library Doubled and WINDOW 3.0 with VMS

## DC/CAD

CAD Showdown Results!

### HIGH DENSITY EXPERTS!

Integrates Schematic Capture, PCB Layouts & Autorouting

This top-rated CAD out-routed the competition in the 1990 CAD Showdown. DC/CAD displayed its power and flexibility when routing a double-sided board while competing routers used four to six layers. This non-copy protected package with surface mount support includes:

- Multi-strategy 1-mil parts autoplacer
- "1-mil" autorouting w/ripup & retry
- Thorough annotating design rule checker
- Full 2-way GERBER and DXF support
- Optional autoground plane support with cross-hatching
- Optional simulation capability & protected mode for 386 users

Call today  
DC/CAD \$595  
(priced from \$495)

LEASE PROGRAM & SITE LICENSE AVAILABLE  
30 DAY MONEY BACK GUARANTEE

DESIGN COMPUTATION

Rt. 33, Sherman Square Farmingdale, NJ 07727  
(908) 938-6661 • (908) 938-6662 (FAX)

DC/CAD... Innovative, Intelligent & Integrated Software

CIRCLE NO. 334

# CUPL

## PLD/FPGA Design Software

### Now Featuring Mach™ Support

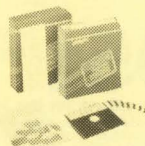

Get the popular CUPL development software with the newest and latest features for PLD/FPGA logic design and shorten your time to market. CUPL's powerful "C-Like" syntax allows you to develop custom logic design quickly. CUPL starts at \$495.

Call your order in TODAY - Start customizing Tomorrow!

1-800-331-7766  
or (305) 974-0967.

**LOGICAL DEVICES, INC.**

CIRCLE NO. 335

# MIL-STD-1553

## TEST EQUIPMENT

- Complete error injection/detection capability for 1553 A/B terminals and systems
- Simulates a Bus Controller, up to 32 Remote Terminals and/or a Bus Monitor
- Supports all phases of testing: Development, Validation and Production
- Dynamic/Real-time simulation

## 2-DAY SEMINAR

- Comprehensive discussion of MIL-STD-1553 and testing
- Lab session illustrates 1553 communication and provides experience in trouble-shooting
- Offered in Phoenix three times a year and available on-site

## VALIDATION TESTING

- Approved by the Air Force
- Testing to the RT VALIDATION TEST PLAN
- Approved test procedure and test report
- Assistance in analyzing test results and trouble-shooting

## TEST SYSTEMS, Inc.

217 W. Palmyra • Phoenix, AZ 85021 • (602) 861-1010  
Supporting MIL-STD-1553 since 1979

CIRCLE NO. 336

## Analog Circuit Simulation

- Schematic Entry
- SPICE Simulation
- Model Libraries
- Waveform Processing

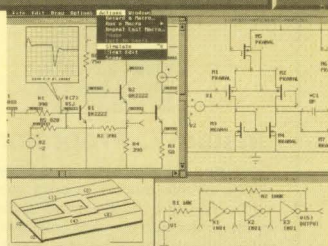

### Powerful - Affordable

FULLY INTEGRATED, EASY TO USE, ANALOG CIRCUIT SIMULATION ENVIRONMENT, FROM ONE VENDOR, FEATURING: A powerful SPICE simulator performing AC, DC, and Transient analyses, extensive model libraries, schematic entry, graphical waveform processing, and report quality printouts.

Call Or Write For Your Free Demo and Information Kit!  
Tel. 310-833-0710

**intusoft**

P.O. Box 710 San Pedro, CA 90733-0710  
Fax 310-833-9658

CIRCLE NO. 337

## CP-1128 COMBINATION PROGRAMMER



\$1295.00

Introducing programming support for AMD's complete MACH family of devices. The CP-1128 provides programming support for the MACH 110/210/120/130/230.

Qualified and recommended by AMD, Lattice, National Semiconductor and Signetics.

Immediate programming support for Cypress' CY7C361, Lattice's ispLSI1032 and pLSI1032, as well as National AIM devices.

Call 1-800-225-2102 for a literature pack and a demo disk.

Lifetime FREE software updates available via BBS 24-hours a day or via US Mail.

**BP MICROSYSTEMS**

10681 Haddington • Houston, TX 77043-3239 • FAX 713/461-7413  
© 1991 BP Microsystems, Inc.

CIRCLE NO. 338

## REMOVE HARDWARE LOCKS

PROTECT YOUR INVESTMENT!  
MAINTAIN PRODUCTIVITY!  
Software utility that allows for the removal of hardware locks.

Available for most major CAD/CAM and PCB software programs

Easy - Simple - Guaranteed  
Programs start at \$99.00 U.S.  
Visa and Mastercard Welcome  
Call or Fax for more Information

SafeSoft Systems Inc.  
202-1100 Concordia Ave. Phone (204) 669-4639  
Winnipeg, Mb. R2K 4B8 FAX (204) 668-3566  
Canada

CIRCLE NO. 339

To advertise in Product Mart, call Joanne Dorian, 212/463-6415

## R&M PREDICTION AND FMECA SOFTWARE

**P**owertronic Systems offers software to predict reliability, maintainability and FMECA. Since 1982, hundreds of users have selected from our large, versatile, integrated software family for military and industrial equipment, electrical or mechanical. Program highlights include: visible assembly hierarchy, defaults and library data, extensive report sorting, user defined reports, what-if and derating analysis, and concurrent engineering data links.

- ◆ MIL-HDBK-217
- ◆ MIL-HDBK-472
- ◆ MIL-HDBK-338
- ◆ Bellcore
- ◆ DTRC-90/010
- ◆ MIL-STD-1629
- ◆ MIL-STD-756B
- ◆ NPRD-91

**PS POWERTRONIC SYSTEMS, INC.**

13700 Chef Mentour Hwy.  
New Orleans, LA 70129  
504-254-0383 ◆ FAX: 504-254-0393

CIRCLE NO. 340

## TELEPHONE INTERFACE

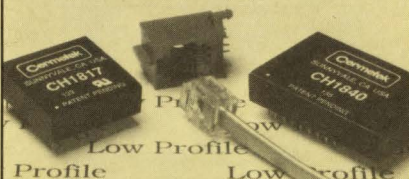

### Modem DAA for Production or Prototype

- Build prototypes with CH1840 (FCC/68 pre-approved)
- Production with CH1817 (UL 1459 recognized and FCC approvable)
- 0.3" high, 1.0 in.<sup>2</sup> (1.5 in.<sup>2</sup> — CH1840)

Your Source for Modem Components

**Cermetek**  
microelectronics

Tel: 408-752-5000  
Fax: 408-752-5004

Cermetek Microelectronics, Inc.  
1308 Borregas Ave. • Sunnyvale, CA 94089

CIRCLE NO. 341

## Tiny Industrial PC

-40° to +85° C

The palm-sized 5016 Micro PC™ is 100% hardware & software AT compatible. "Instant DOS" operation.

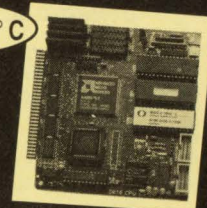

Three 512K solid-state disks on card—no floppy or hard disks required. Keyboard & monitor not required for operation.

- ▶ EPROM programmer
- ▶ 4 MB DRAM
- ▶ COM1 serial port
- ▶ Keyboard/speaker port
- ▶ 5V only operation
- ▶ Auron capability
- ▶ 16 MHz operation
- ▶ DOS 3.31 in ROM
- ▶ Passive backplane operation
- ▶ Full line catalog
- ▶ 3 year warranty

Tel: 303-430-1500, Fax: 303-426-8126

**MICRO** OCTAGON SYSTEMS  
6510 W. 91st Avenue  
Westminster, CO 80030

CIRCLE NO. 342



## Free Catalog

The World's Largest Collection of Adapters & Accessories for VLSI/Surface Mount Devices

- Emulator Pods & Adapters
- Debug Tools
- Programming Adapters
- Socket Converters
- Debugging Accessories
- Prototyping Adapters
- Custom Engineering

Emulation Technology, Inc.  
2344 Walsh Ave. Santa Clara, CA 95051  
Phone: 408-982-0660 FAX: 408-982-0664



CIRCLE NO. 343

## G-64 BUS BOARDS

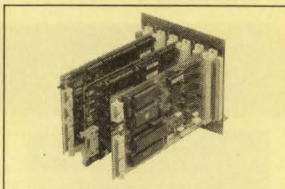

### INTEL 8051/8096 FAMILIES BASED SINGLE-BOARD SYSTEMS:

- > FA51CPU—(8032+EPROM SOCKET+RAM +PPI+RS232)
- > FA52BASIC—(8052BASIC+EPROM SOCKET +RAM +PPI+RS232/485+ADC)
- > FA44BITBUS—(BITBUS 8044 NETWORK CONTROLLER)
- > FA196CPU—(80C196KC+EPROM SOCKETS +RAM+2\*RS232/485+ADC+MUART)

Ask for our catalogue! Distributors welcome!

**FATRONICA, LDA.**

Rua Manuel dos Santos  
17A - 1900 Lisboa, Portugal  
Tel. 351.1.8473711 FAX 351.1.8473712

CIRCLE NO. 344



**An Established Foothold In The Device Programming Arena**



**The Traditional Market Leader In Japan**

U.S. Tel./Fax 1-619-727-4683 / 5232  
Europe Tel./Fax 353-1-2892136 / 2892070  
Japan Tel./Fax 81-3-3344-2001 / 2007  
Daisan Maruzen Bldg., 6-16-6 Nishi Shinjuku, Shinjuku-Ku, Tokyo 160, Japan.

**AVAL CORPORATION**

CIRCLE NO. 345

## NOISE REDUCTION FOR SMT-PLCCs

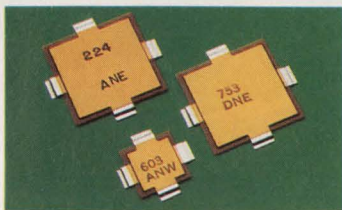

Micro/Q® 3500SM family of surface mount capacitors designed to fit under PLCCs. Pads absorb CTE between board and device during soldering. Low inductance, 0.5 - 0.6 nanoHenries. Choose Z5V or X7R dielectric. Tape and reel format available. Use under MPUs, DSPs, GSPs, FPPs, gate arrays, standard cells, fully custom ASICs. Send for your free sample.

**Rogers Corp.**

2400 S. Roosevelt St., Tempe, AZ 85282  
Tel: 602/967-0624

CIRCLE NO. 346

## 8051 80C196 80C186 68HC11 64180



### Orion's 8620 Analyzer-Emulator Supports These Processors & Over 180 More!

- Cost-effective, PC-based emulation for over 180 8- and 16-bit CPUs
- Source level and symbolic debug support
- Interactive triggering
- Program Performance Analyzer
- Tremendous macro capabilities
- Built-in EPROM programmer
- Two-week evaluation program
- Backed by over 11 years of emulation experience!

Call or fax today for more info and a FREE DEMO DISK.

Limited offer — 1 month free with 3 month rental!  
1-800-729-7700  
Fax 415-327-9881

**ORION**  
INSTRUMENTS

180 Independence Dr., Menlo Park, CA 94025

CIRCLE NO. 347

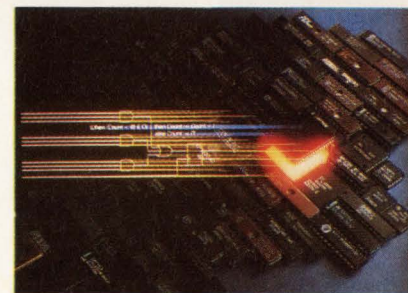

### MacABEL

PLD Design on the Apple Macintosh!

Data I/O's industry-standard ABEL PLD design package is now available on the Macintosh, exclusively from Capilano Computing!

- Use Boolean and integer equations, state machines and truth tables to describe your design
- Communicates directly with any serial PLD programmer
- Best device support in the industry, including ALTERA, AMD, ATMEL, CYPRESS, GOULD, HARRIS, ICT, INTEL, LATTICE, NATIONAL, RICOH, SAMSUNG, SGS, SIGNETICS, SSS, TI, VTI and others
- Interactive "in-circuit" schematic entry and simulation when used with DesignWorks

Call (800) 444-9064 Today for your free Demonstration Kit!  
**Capilano Computing**  
FAX: (604) 522-3972  
(604) 522-6200

CIRCLE NO. 348

To advertise in Product Mart, call Joanne Dorian, 212/463-6415

## SCHEMA III 3.3

### Schematic Capture



COMPLETE  
DESIGNS ON  
YOUR PC OR  
UPLOAD  
TO YOUR  
WORKSTATION

### FREE DEMO DISK

One schematic capture program stands alone in features, speed, user friendliness & performance - SCHEMA. The new SCHEMA III 3.3 is still only \$ 495.



800-553-9119

CIRCLE NO. 349

## 48 Channel 50MHz Logic Analyzer

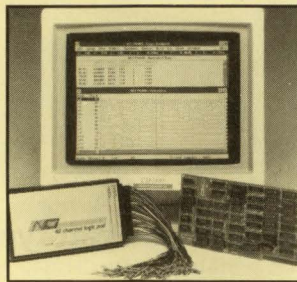

Complete System \$1895.00

New Windows 3.0 Compatible Software

- 48 Chnns @ 50 MHz x 4K words deep
- 16 Trigger Words/16Level Trigger Sequence
- Storage and recall of traces/setup to disk
- Disassemblers available for: 68000, 8088, 8086, 6801, 6811, Z80, 8085, 6502, 6809, 6303, 8031

NCI □ 6438 UNIVERSITY DRIVE,  
HUNTSVILLE, AL 35806  
(205) 837-6667 FAX (205) 837-5221

CIRCLE NO. 350

## 400 MHz Logic Analyzer

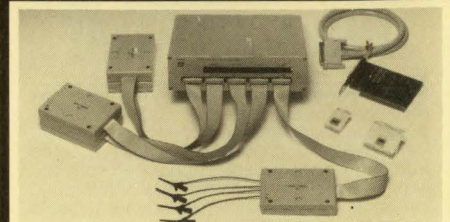

- upto 128 Channels, Timing and State
- 400 MHz Max Sampling Rate
- Timing and State Simultaneous on Same Probe
- 16K Samples/Channel (high speed mode)
- 16 Levels of Sequential Triggering
- Variable, TTL, or ECL Logic Threshold Levels
- 8 External Clocks
- FREE Software Updates on 24 Hour BBS

\$799 - LA12100 (100 MHz)

\$1299 - LA32200 (200 MHz-32channels)

\$1899 - LA32400 (400 MHz-32channels)

\$1950 - LA64200 (200 MHz-64channels)

\$2750 - LA64400 (400 MHz-64channels)

## UNIVERSAL PROGRAMMER

PAL  
GAL  
EPROM  
EEPROM  
PROM  
87xxx...

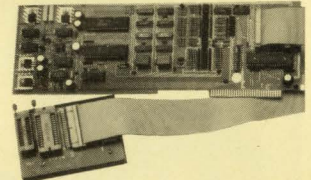

22V10  
26CV12  
16Bit EPROMs FLASH EPROMs  
5ns PALs 4 Meg EPROMs  
FREE software updates on BBS

\$475

Call - (201) 808-8990  
Link Computer Graphics, Inc.  
369 Passaic Ave., # 100, Fairfield, NJ 07004 FAX:879-8786

CIRCLE NO. 754

## Program Your Chips

In Sets of 4 for \$495.00

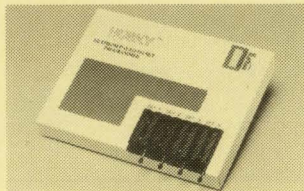

Special offer Now Includes:  
Free UV eraser, CUPL starter Kit and  
a \$300.00 Rebate with the PDT-1  
Universal Programmer System\Kit.

LOGICAL DEVICES, INC. 1-800-331-7766

CIRCLE NO. 752



## Complex PLDs

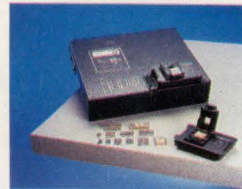

If your good old Data I/O can do the job, stay with it. If not, you can count on Advin. Our PILOT-U84 supports all Altera/Cypress MAX devices, all AMD MACH devices, all Lattice LSI devices, Atmel 5000, Xilinx and others. Qualified by all major manufacturers. Please call and ask for a technical staff.

408-243-7000, 800-627-2456, Fax 408-736-2503



Advin Systems Inc.  
1050-L E. Duane Ave., Sunnyvale, CA 94086

CIRCLE NO. 753

## The Lion



## The Mouse

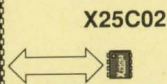

## X25C02 SERIAL E<sup>2</sup>PROM

- SPI Bus Interface
- 3 V To 5.5V Power Supply
- 1 MHz Clock
- 256 X 8 Bits
- Low Power CMOS
- Inadvertent Write Protection
- High Endurance, 100,000 Cycles
- 8 Pin DIP & SOIC Packages



XICOR, Inc., 851 Buckeye Court  
Milpitas, California 95035-7493  
(408) 432-8888, X3549 FAX 408-432-0640

CIRCLE NO. 755



## FULL FEATURED KERNEL

- task manager
- intertask comm.
- i/o, events, & timing
- preemptive
- memory manager
- error manager
- resource manager
- ROM'able

## EASY TO USE

- libraries for Microsoft C, Borland C/C++, Zortech C/C++ and assembler
- Quick Start, User's Guide, and Reference manuals
- standalone, PC, and DOS platforms
- smxProbe task debugger
- 6 months free support and updates

## FAST & SMALL

- 15 usec max. interrupt latency
- 150 usec typical task switch
- 8 to 25 KB code size

Ask about our \$95 evaluation kit.

MICRO pd DIGITAL  
6402 Tulagi St.  
Cypress CA 90630-5630

Call for information:  
1-800-366-2491  
FAX 714-891-2363

CIRCLE NO. 756

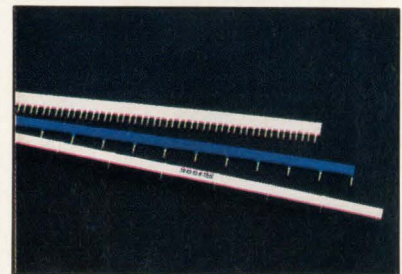

## SAVE SPACE WITH MINI/BUS® BARS

Improve power distribution  
Reduce required board layers  
Eliminate up to half the decoupling capacitors

Fit between or beneath IC's  
Also available in surface mount

Send for Rogers Mini/Bus® Bars  
Application Bulletin.

Rogers Corp., 2400 S. Roosevelt St.  
Tempe, AZ 85282 602/967-0624

CIRCLE NO. 757

To advertise in Product Mart, call Joanne Dorian, 212/463-6415

**SUPER SPECIAL OFFER**



**SUPERPRO™ UNIVERSAL PROGRAMMER**

Special offer of this month at **\$699** (U.S. only) includes at no charge one of  
• 4 socket adapter or • PAL compiler or • EPROM eraser (9 chips)

- Super easy-to-use menu driven S/W
- Free & continual updates on BBS
- Universal programming for PAL, GAL, EPLD, EPROM, & Microcontrollers, etc.
- 1 year warranty & telephone support

- ▶ low cost UNIPRO at \$399
- ▶ EPROM programmer at \$149

**XELTEK** SUNNYVALE, CA (408)745-7974  
FAX (408)745-1401 BBS (408)745-7256

CIRCLE NO. 758

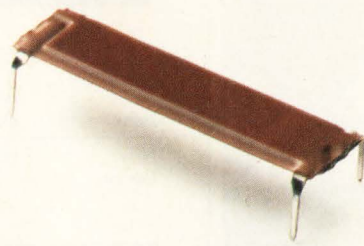

### SIMPLIFY BOARD LAYOUT

MICRO/Q 1000 ceramic decoupling capacitors share board mounting holes with IC pins to simplify board design. Now add more active devices with increased density in the same space, or design the same package on a smaller board. Rogers Corp. 2400 S. Roosevelt St., Tempe, AZ 85282. 602/967-0624

CIRCLE NO. 759

### SM LAND/SOCKET

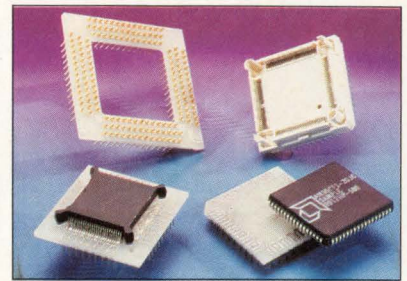

### PLUGGABLE SURFACE MOUNT

The QFP and PLCCSM LAND/SOCKET provides a very reliable solution for socketing QFPs or PLCCs in production or ZIF (test/burn-in) patterns. The device is surface mounted to the SM LAND/SOCKET which converts the QFP or PLCC to a base pin array of the production or ZIF QFP socket and can then be soldered to target board or socketed using Ironwood's sockets receptacles. This results in a reliable connection at a reasonable cost. From \$20.

**IRONWOOD ELECTRONICS**  
P.O. BOX 21151, ST. PAUL, MN 55121  
(612) 431-7025 FAX (612) 432-8616

CIRCLE NO. 760

### Interactive/Real-Time

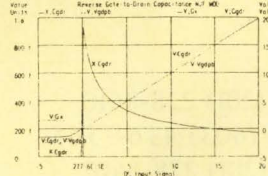

**ECA-2**  
Engineering a Better Way

### Analog Circuit Simulation

- AC, DC, Transient, Fourier, Temperature, MonteCarlo and/or Worst-Case Analysis
- Interactive or batch modes
- Full nonlinear simulation
- On-line real time graphics
- Multiple plots
- 2 to 50 times faster than SPICE
- Component optimization sweeping
- New 424 pg. manual

All the Features, Twice the Speed  
at Half the Cost

Call for **FREE DEMO!**

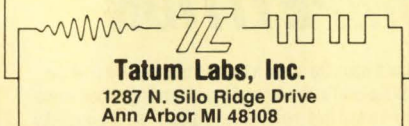

CIRCLE NO. 761

### 8051 68HC11 COP8

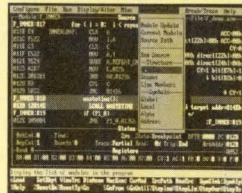

### iceMASTER Your Window To Emulation Productivity

- Easy to learn & use
- Windowed interface -- user configurable
- FAST! Download -- < 3 sec. typ. at 115KB
- Source Level debug

- A 4K frame trace buffer with advanced searching capabilities.
- iceMASTER connects easily to your PC, requires no disassembly, or expansion slots. Works on any PC (DOS or OS/2), MicroChannel or EISA. Even laptops!
- iceMASTER is versatile: iceMASTER-8051, iceMASTER-68HC11 and iceMASTER-COP8 support most family derivatives.
- Rental and 10-day trials available.
- 68HC11 A,D,E,F; 8XC528; 8XC552; 8XC515A and 8XC517A support.
- Call today for free demo disk and ask about a free 8051 Macro Assembler! (800) 638-2423

**MetaLink**  
Corporation

MetaLink Corporation P.O. Box 1329 Chandler, AZ 85244-1329  
Phone: (602) 926-0797 FAX: (602) 926-1198 TELEX: 499850MILINK



CIRCLE NO. 762

### Tango

The Complete Electronic Design Solution.

For **FREE** evaluation software and product specs, call **800 488-0680**



Tango, the leader in PC-based tools for:

- Schematic entry
- PCB layout and autorouting
- PLD design
- Simulation, timing verification and thermal reliability

ACCEL Technologies, Inc.  
6825 Flanders Drive  
San Diego, CA 92121-2986  
Service 619 554-1000  
Fax 619 554-1019

CIRCLE NO. 763

Just \$495!\*

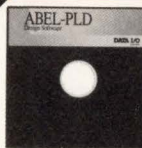

### ABEL-PLD: Logic design for less.

- 150 PLD architectures supported (more than 4000 devices)
- Uses ABEL™ Hardware Description Language (ABEL-HDL™)
- Intelligent synthesis and optimization
- Upgradable to full-featured ABEL Design Software

1-800-3-DataIO  
(1-800-332-8246)

\*U.S. list price only.



Call Data I/O® Direct today to order ABEL-PLD.

**DATA I/O**

CIRCLE NO. 764



Save \$1000 on our entry-level logic system.

- Includes the 212 Multi Programmer with logic module, ABEL-PLD™ and PROMlink™ Ltd. PC Interface Software
- Supports 20- and 24-pin CMOS logic devices
- Full-hex keypad for extensive editing
- Optional EPROM and microcontroller modules

1-800-3-DataIO  
(1-800-332-8246)

\*U.S. list price only.



Call Data I/O® Direct today to order the 212 Logic System.

**DATA I/O**

CIRCLE NO. 765

Telecom Solutions from Teltone

### R1 and R2 MF Transceivers

M-986 transmits and receives CCITT R1 or R2 forward and backward multifrequency signals. For trunk adapters, test equipment, etc.



- Single or dual channel versions available
- For N. Am. (R1) or Int'l. (R2) toll signals
- Binary or 2 of 6 input/output format
- Complete microprocessor interface
- 40-pin IC, 5-volt power, crystal time base

**1-800-426-3926**

Or: 206-487-1515 Fax: 206-487-2288

**TELSTONE**

INNOVATING SOLUTIONS  
In Telecom Interface Components

Teltone Corporation, 22121-20th Avenue SE, Bothell, WA 98021

CIRCLE NO. 766

To advertise in Product Mart, call Joanne Dorian, 212/463-6415

## EDN-CAREER OPPORTUNITIES

### 1992 Recruitment Editorial Calendar

Issue	Issue Date	Ad Deadline	Editorial Emphasis
News Edition	Feb. 20	Feb. 6	ICs & Semiconductors • ISSCC Hot Products • Computers & Peripherals • Regional Profile: Colorado, Utah, Idaho
Magazine Edition	Mar. 2	Feb. 6	COMMUNICATIONS SPECIAL ISSUE • Test & Measurement • Local-area Networks • Microprocessors Memory Technology
News Edition	Mar. 5	Feb. 20	Memory Technology • CPU Boards • Computers & Peripherals • Diversity Special Series
Magazine Edition	Mar. 16	Feb. 20	COMPUTER & PERIPHERAL SPECIAL ISSUE • Multimedia Components • Memory Technology • Computer Peripherals • International Technology Update—Japan

# THERE ARE INNOVATIVE FORCES SHAPING TOMORROW.

As a recognized leader in the development of innovative defense systems, our focus is years, sometimes decades, into the future. This commitment has created exceptional opportunities for engineering professionals who are well-versed in leading-edge defense technologies.

## LEAD SYSTEMS ENGINEER

- Knowledge of communications ECM systems preferred
- Knowledge of modern communications signals and signal analysis techniques
- Familiarity with SIGINT systems
- Familiarity with airborne & ground based platforms
- Test planning and the test/evaluation processes

## MANAGER, DIGITAL DESIGN

- Experience in DSP technologies and applications
- Experience in state-of-the-art design methods
- CAE
- Familiarity with MIL DESIGN practices
- Proven management skills

## DIGITAL SYSTEMS ENGINEER

Must have a familiarity with the following:

- Performing time-line analysis
- HW/SW architecture design & trade offs
- Algorithm definition
- System modeling & simulation
- Processor performance analysis
- Experience w/communication ECM a must

## SR. SYSTEMS ENGINEERS

Requires expertise in either 1) Electronic Combat, Aircraft Survivability, RWR, and/or Radar ESM (or) 2) COMINT, COM ECM, and/or DF. Candidates for these positions should also have:

- Ability to lead business development activities
- Good system conceptualization skills to translate system requirements to system designs and HW/SW specs.

Candidates for all positions should have a BSEE; MSEE preferred and at least 10 years experience in Electronic Warfare.

We offer a competitive salary and a full range of benefits. Please forward your resume to AEL Defense Corporation, Dept. ML/D, 305 Richardson Road, Lansdale, PA 19446. Equal Opportunity Employer



Call today for information on Recruitment Advertising:

East Coast: Janet O. Penn (201) 228-8610  
 West Coast: Nancy Olbers (603) 436-7565  
 National: Roberta Renard (201) 228-8602

## GaAs EXPLOSION ROCKS COMPETITION

Vitesse Semiconductor Corporation burst upon the scene a few years ago and is now the world's leading supplier of digital VLSI GaAs IC's. Our technology is sending shock waves through the high performance industry. To fuel this mushrooming growth, we are currently seeking qualified and motivated people for the following highly visible and technically challenging positions:

- **DEVICE MODELING ENGINEER**
- **TELECOM PRODUCT ENGINEER**
- **SR. PRODUCTION PLANNER**
- **MATERIAL REQUIREMENTS PLANNER**
- **PROCESS ENGINEERING MANGER**
- **BACKEND ENGINEERING MANAGER**
- **SR. ETCH ENGINEER**
- **MODULE (PACKAGE) DEVELOPMENT ENGINEER**

Vitesse is headquartered in Camarillo, California, 40 miles south of Santa Barbara and only minutes from the beach. Our Product Development Center is located in Sunnyvale, California, in the heart of Silicon Valley. We offer a generous compensation package that includes relocation assistance, tuition reimbursement, and equity participation. If you have a keen interest in becoming a part of the GaAs explosion and not a part of the fallout, FAX/mail your resume to: **Vitesse Semiconductor Corporation, 741 Calle Plano, Camarillo, CA 93012, Attn: Phil Helmrich, Dept. EDN 2/3/92.** We are an equal opportunity employer supporting Affirmative Action. M/F/H/V. Principals only please.





# Knock, Knock.

In EDN's  
Magazine  
and News  
Editions,  
opportunity  
knocks all  
the time.

**EDN** Magazine  
Edition  
News  
Edition

## EMPLOYMENT OPPORTUNITIES AT GENERAL DYNAMICS ELECTRONICS DIVISION TALLAHASSEE OPERATION

General Dynamics Electronics Division has a growth program in advanced radio technology and production in its Secure Communications facility in Tallahassee, Florida. We are seeking experienced engineers ready to meet the challenge of creating a world-class military radio program headquarters in its new northern Florida location.

### General Requirements

Engineers are needed who have recent experience in military radio systems. Of special interest are background with SINCGARS or other tactical, VHF, communication systems that employ ECCM and COMSEC techniques. In addition to experience with Mil-Std programs, candidates should identify special experience in TQM, SPC, design-to-cost, design-for-reliability, and design-for-productivity. A minimum of a full BS Degree in Engineering or an appropriate discipline is required. Must be U.S. citizens.

### Radio Systems Engineer

The minimum requirement is five years experience in communication system analysis, signal processing, waveform acquisition, interface definition, design requirement definition, system integration and system test. Both analog and digital backgrounds are needed.

### Hardware Engineer (Digital)

Electrical engineers are needed with a minimum of five years recent experience in digital design. Of special interest is experience in low-power consumption, high reliability design; ASIC design and simulation; microcontroller/microprocessor board design; EMI and TEMPEST; Internal EMI suppression; integration and test.

### Hardware Design (Analog)

Electrical engineers are needed with a minimum of five years recent experience in analog design and test. (Spectrum of interest is dominantly baseband through HF). Of special interest is a background in techniques for: filtering, FSK, CVSD, low-power consumption, high reliability, EMI, TEMPEST, internal EMI suppression, power supply, simulation, integration and test.

### Software Design

Design Engineers are needed with a minimum of five years recent experience with Mil-Standard software engineering and documentation requirements, including three years recent experience with real-time, microprocessor-based, interrupt-driven systems. Of special interest is recent experience with waveform acquisition, bit synchronization, frequency hopping algorithms, and interface requirements to COMSEC and TRANSEC devices.

### Systems Integration and Test

Engineers are needed with minimum of five years recent experience in integration and test of military radios. Of special interest is specific experience in trouble-shooting and isolating system-level problems to failed components, during the engineering development; as well as field test experience with the U.S. Army as a customer.

### Reliability Engineer

Minimum three years recent experience in Mil-Standard reliability disciplines. Of special interest will be experience with PRAT, reliability calculations,

reliability growth models, and auditing reliability programs at subcontractor sites.

### Component Engineer

Minimum three years recent experience in Mil-Standard electronic component engineering disciplines. Experience should include preparing and defining Mil-Standard source control drawings, assessing component tolerances, assessing (sub-contractor) electronic component production processes, and processing component deviating and waiver requests.

### Mechanical Engineer

Minimum five years experience in electronic packaging design, product liaison and support of MRB activity. Familiarity with Mil-Std 454, ANSI Y14.5 tolerance and Mil-Std-810 environmental test requirements is necessary.

### Engineering Drawing Checker

Experience should include electronic equipment to perform form, fit and function checking. Training operation of CAD equipment such as Computervision and Scicards is desirable, along with familiarity with castings, assembly drawings, parts lists, cable assemblies, circuit card assemblies, PWBs, component parts, SCDs and detail drawings. Working familiarity with the following specifications is required: DOD-D-100, Mil-F-14072, DOD-STD-100, MIL-STD-275, ANSI Y14.5M-1982, MIL-STD-454, MIL-STD-2000, MIL-STD-2175, MIL-M-13231, and MIL-STD-1189. Drawing requirements are Level III of DOD-D-1000.

### DESIGN DRAFTSMAN/PCB DESIGNER

A minimum of five years experience with electronic equipment design and packaging is mandatory. Familiarity with castings, PCBs, schematics, wire lists, assembly drawing, parts lists, component parts, SCDs and detail drawings. Familiarity with the following specifications is required: ANSI Y14.5M-1982, DOD-D-1000, DOD-STD-100, MIL-STD-275, MIL-STD-2000, and MIL-STD-2175. Extensive experience in documentation of military drawings utilizing Computervision Cadds 4x with 3-D modeling as well as a Scicards cad station for circuit card assembly design and documentation is required. Tasks will include updating and creating mechanical drawings and parts lists as well as PCB layout and documentation.

All qualified candidates please send resumes, including salary history/requirements to: W.T. Ondrus, General Dynamics, Tallahassee Operation, 2930 Commonwealth Boulevard, Tallahassee, Florida 32303.

An Equal Opportunity Employer M/F

Lear Astronics Corp. is a leading supplier of Avionics, Radar and Advanced Electrical Systems.

**If your experience is flight control computers, we would like to hear from you.**

**Flight Control Systems Engineers**

Responsible for definition of fly-by-wire and fly-by-light flight control systems. Must be familiar with redundant systems, HW/SW system level design, aircraft interfaces and busses and V&V. BSEE and 5 years experience required.

**System Engineering Manager—AFCS**

15+ years experience in automatic flight control computer system design. Proven leadership ability, 5+ years in management and a strong understanding of aircraft systems/SW are essential. Will manage engineering section, responsible for proposal and design of AFCS.

**Program Development Manager—AFCS**

15+ years design/development experience with digital flight control computer systems. Will be responsible for proposal management/generation; system level conceptual design and development of new business.

**WE WILL BE COMING TO YOUR AREA SOON.  
FOR A LOCAL INTERVIEW APPOINTMENT, CALL CHUCK DOYLE AT:  
1-800-LEAR-JOB**

Lear Astronics Corp., Dept L70, 3400 Airport Ave., Santa Monica, CA 90406. FAX (310) 915-8387. EOE. Employment offers are contingent on satisfactory pre-employment drug tests. You will be contacted only if we are considering you for the positions advertised.



**MICROPROCESSOR SOFTWARE ENGINEER**

Opening available for an applications oriented microprocessor software engineer who will be responsible for developing, coding and modifying software for an Intel 8051 or similar processor. The processor monitors and directs the power electronics to control D. C. motors on battery powered vehicles.

Compensation will range from the mid to upper \$30's with a standard benefits package. A bachelor degree is required with a minimum 3 years experience of assembly language along with a working knowledge of analog and digital circuits. The candidate must be a self starter and be able to converse with customers. Some travel is required.

Sevcon, a north Boston firm, has been supplying motor controls for over 30 years and will be expanding its market share through the development of custom software for its customers. Please submit a complete resume and salary history to:

**SEVCON, INC.  
40 NORTH AVENUE  
BURLINGTON, MA 01845  
(FAX) 617-272-1953**

**Get  
a  
Job!**



**Knock,  
Knock.**

In EDN's Magazine and News Editions, opportunity knocks all the time.



**Your  
Future  
Starts  
Here**

## Create the Industry's Most Advanced Digital Loop Carrier Systems!!

Pulse Communications, with 28 years' experience in the Telecommunications market, has just completed another successful record-setting year. Pulsecom is increasing its design and development staff by 50% in 1992. The increased staff will be developing next generation TR-303 compliant digital loop carrier and SONET transport systems. Join an industry leader during our vigorous growth phase.

Qualified applicants will have a BSEE, BSME, or BSCS and a minimum of two years experience in a telecommunications environment. An advanced degree, knowledge of Bellcore standards, and demonstrated capabilities in the design of advanced voice and data transmission products are definite pluses. Specific opportunities are available for:

### SOFTWARE ENGINEERS

- Embedded real-time systems
- C programming on a UNIX platform
- Intel 8051 and Motorola 68XXX processors

### EQUIPMENT ENGINEERS

- Mechanical Design on AutoCad
- Outdoor equipment cabinets
- Electronic equipment packaging and thermal analysis
- Power system design

### ASIC DESIGNERS

- VHDL design
- Valid running on Sun Workstations
- SONET, ADM, TSI

### LINE CARD DESIGNERS

- Analog and digital
- Voice and data transmission
- Microprocessor control
- EPLD, ASIC, FPGA
- ISDN, T1

### COMMON CONTROL DESIGNERS

- Motorola 68XXX microprocessors
- ASIC or FPGA
- Remote test
- High speed backplanes
- X.25, LAN

Pulsecom offers excellent and competitive salaries and a liberal fringe benefits package.

Pulsecom is a subsidiary of Hubbell, Inc. and is located on the western edge of Fairfax County, Virginia, adjacent to Dulles International Airport, and 30 minutes from downtown Washington, D.C.

If you have the background we seek, send your resume and salary history to: **Pulsecom, Human Resources, 2900 Towerview Road, Herndon, Virginia 22071** or call (703) 471-2900 or (800) 821-7924. An Equal Opportunity Employer M/F/H/V.

**EDN** Magazine  
Edition  
News  
Edition



**pulsecom**

# The Industrial Color Portable PC



How many times have you been wishing to bring your desktop computer to a job site without having to carry a monitor, a desktop body and a keyboard? Now you can with Bi-Link's PORTABLEdesktop color display PC.

The PORTABLEdesktop comes with a choice of three processors of 80486-33, 80386-33 to 80386-25 CPU board with memory up to 32 megabytes and an internal hard disk drive up to 500 megabytes! The advanced on-board write-back cache controller even out perform many more expensive full size desktop computers! Besides the above features, it also has 3 full length 16-bit ISA expansion slots for your add-on peripherals and a built-in color SVGA monitor. We built the PORTABLEdesktop for all the engineers and scientists that demand the absolute best. For more information on the PORTABLEdesktop and other products, please call our toll free number today.

**1-800-888-5369**

For information or order

**BI-LINK**

A PC OEM/ODM Company



#### 9" Color SVGA Monitor

This high resolution color monitor is suitable for all industrial and commercial applications. It is ideal for special project cabinets, data acquisition stations, point of sales machines, system control centers, vending machines, security systems and on.



#### PORTABLEworkstation System

A portable computer that comes with a choice of 486-33, 386-33 and 386-25 CPUs and a hard disk drive of up to 500MB! Three full length ISA or EISA expansion slots are available for add-on peripherals. The display is a high contrast gas plasma screen.

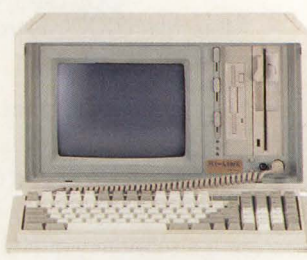

#### PORTABLEdesktop System

The PORTABLEdesktop is a desktop computer in disguise. This portable come with a choice of 3 processors: 486-33, 386-33 and 386-25. An affordable scientific instrument as well as a powerful PC complete with a built-in color SVGA monitor.



#### Rack Mounted Industrial PC (IPC)

The IPC comes with a built in 9" color SVGA or a monochrome MGA monitor. An 8 slot ISA backplane is standard for add-on CPU cards for the lowest MTBR. Two 3.5" drive slots for floppy and hard disk drive are standard and available CPU cards including 286, 386SX/DX and 486SX/DX CPU.

Bi-Link Computer Inc. 11606 E. Washington Blvd. Suite AB, Whittier, California 90606 Tel: (310)692-5345 Fax: (310)695-9623.  
All brand or product names mentioned are trademarks or registered trademarks of their respective holders.

140 • EDN February 3, 1992

CIRCLE NO. 83

# EDN-ACRONYMS & ABBREVIATIONS

**ADC**—analog-to-digital converter  
**ALU**—arithmetic logic unit  
**ASIC**—application-specific integrated circuit  
**BiCMOS**—bipolar and complementary metal-oxide semiconductor. An integrated-circuit process technology that combines bipolar and metal-oxide transistor types.  
**CMOS**—complementary metal-oxide semiconductor. An integrated-circuit technology that uses two metal-oxide transistors of differing polarities in pairs as the basic design element. Logic circuits built from such elements have a logic threshold midway between the device's power and ground voltages.  
**CPU**—central processing unit  
**CQFP**—ceramic quad flatpack  
**DIP**—dual in-line package  
**DMA**—direct memory access  
**DRAM**—dynamic random-access memory  
**DSP**—digital signal processing  
**ECL**—emitter-coupled logic  
**EEPROM**—electrically erasable programmable read-only memory

**EFIR**—equiripple finite-impulse-response filter  
**EMI**—electromagnetic interference  
**EPLD**—erasable programmable logic device  
**EPROM**—erasable programmable read-only memory  
**FIR**—finite-impulse-response filter  
**FPGA**—field-programmable gate array  
**GUI**—graphical user interface  
**I/O**—input/output  
**IC**—integrated circuit  
**ICE**—in-circuit emulator  
**IEEE**—Institute of Electrical and Electronics Engineers  
**IIR**—infinite-impulse-response filter  
**JTAG**—Joint Test Action Group. A subcommittee of the IEEE with the charter to develop standards for embedding test circuits into integrated circuits.  
**LCC**—leadless chip carrier  
**LCD**—liquid-crystal display  
**LED**—light-emitting diode  
**MAC**—multiply and accumulate unit  
**MMU**—memory-management unit  
**OS**—operating system  
**pc board**—printed-circuit board

**PGA**—pin-grid array  
**PLCC**—plastic leaded chip carrier  
**PQFP**—plastic quad flatpack  
**PROM**—programmable read-only memory  
**PWM**—pulse-width modulator  
**QFP**—quad flatpack  
**RAM**—random-access memory  
**RGB**—red, green, blue—analogue color signals to a cathode-ray tube  
**RISC**—reduced-instruction-set computer  
**ROM**—read-only memory  
**SOIC**—small-outline integrated circuit  
**SOP**—small-outline package  
**SQFP**—shrink quad flatpack  
**SRAM**—static random-access memory  
**SSOP**—shrink small-outline package  
**TSOP**—thin small-outline package  
**TTL**—transistor-transistor logic. A design technique that uses bipolar transistors. Logic circuits designed using this technique have a static threshold of 1.5V.  
**UART**—universal asynchronous receiver transmitter  
**ZIP**—zig-zag in-line package

# EDN-INTERNATIONAL ADVERTISERS INDEX

Abbott Electronics . . . . . 42  
 ACCEL Technologies Inc . . . . . 135  
 Access I/O Prod . . . . . 125  
 Advanced Micro Devices . . . . . 10-11  
 Advin Systems . . . . . 134  
 Altera Corp . . . . . 115  
 Ametek . . . . . 86  
 AMP . . . . . 28-29  
 Analog Devices Inc . . . . . C3, 30-31, 74  
 Arnold Magnetics Corp . . . . . 47  
 Aval Corp of Ireland . . . . . 133  
 Berquist Co . . . . . 98  
 Bi-Link Computer . . . . . 140  
 BP Micro . . . . . 132  
 Capital Equipment Corp . . . . . 9  
 Capilano Computer Systems Inc . . . . . 133  
 Cermetek . . . . . 133  
 Coilcraft . . . . . 37  
 Cypress Semiconductor . . . . . 6  
 Dale Electronics Inc . . . . . 1  
 Data I/O Corp\* . . . . . 37, 63, 135  
 Datal . . . . . C2  
 Datron Wavetek . . . . . 72  
 Delltron Inc . . . . . 52A-D  
 Design Computation Inc . . . . . 132  
 DigiKey . . . . . 2  
 Digital Equipment Corp . . . . . 99  
 Diversified Technology . . . . . 64-65  
 Dolphin Integration . . . . . 144  
 EEsosf . . . . . 40  
 Electronic Measurements Inc . . . . . 94  
 Embassy Suites . . . . . 85  
 Embedded Support Tools Corp . . . . . 131  
 Emulation Technology Inc . . . . . 133  
 Epson America Inc . . . . . 114  
 Ericsson Components\* . . . . . 142  
 Fatronica . . . . . 133  
 General Motors\* . . . . . 86A-D

Hewlett-Packard Co . . . . . 16, 32  
 Incredible Tech . . . . . 131  
 Inlog . . . . . 132  
 Innovative Software Designs . . . . . 132  
 Intergraph . . . . . 49  
 Intel . . . . . 14-15, 54-55, 100-103  
 Intusoft . . . . . 132  
 Ironwood Electronics Inc . . . . . 135  
 Kepco Inc . . . . . 38-39  
 Lambda Electronics Inc . . . . . 87-92  
 Lanier/Copier . . . . . 126  
 Linear Technology Corp . . . . . 106  
 Link Computer Graphics Inc . . . . . 134  
 Maxell . . . . . 128-129  
 Meritex . . . . . 111  
 Metalink Corp . . . . . 135  
 Micro Digital . . . . . 134  
 MicroSim Corp . . . . . 56-57  
 Microtran . . . . . 76  
 Mini-Circuits Laboratories . . . . . 3, 4, 20-21, 26-27, 109  
 Motorola Semiconductor Products Inc . . . . . 12-13  
 National Instruments . . . . . 122  
 NEC Corp . . . . . 66-67, 113, 115  
 NCI . . . . . 134  
 Nohau Corp . . . . . 131  
 Octagon Systems . . . . . 133  
 Omation Inc . . . . . 134  
 Omron Electronics Inc . . . . . 93  
 OrCAD Systems Corp . . . . . 19  
 Orion Instruments . . . . . 133  
 PADS Software Inc . . . . . 8  
 P-Cad . . . . . 34-36  
 Pico . . . . . 114, 144  
 Powertronic . . . . . 133  
 Raltron . . . . . 98  
 Rogers Corp . . . . . 133, 134, 135  
 Safe Soft Systems . . . . . 132

SBE . . . . . 58  
 Seagate Technology . . . . . 60  
 Signal Transformer Co Inc . . . . . C4  
 Siliconix Inc . . . . . 22-23  
 Sophia Systems Inc . . . . . 9  
 Spectrum Software . . . . . 53  
 Stanford Research Systems Inc . . . . . 77  
 Synergy Microsystems . . . . . 24  
 Tasco Electronic Services Inc . . . . . 112  
 Tatum Labs . . . . . 135  
 Tektronix . . . . . 117, 119-120  
 Teltone Corp . . . . . 135  
 Test Systems . . . . . 132  
 Texas Instruments Inc . . . . . 68-71  
 Toshiba America Electronic Components . . . . . 104-105  
 Tracewell Enclosures . . . . . 131  
 Tribal Microsystems . . . . . 131  
 Versatec . . . . . 124  
 Westcor . . . . . 51  
 W H Brady . . . . . 112  
 Wintek Corp . . . . . 52  
 Xeltek . . . . . 135  
 Xerox Engineering Systems/Versatec Products . . . . . 124  
 Xicor . . . . . 134  
 Zaxtek . . . . . 132  
 Z-World . . . . . 131

## Recruitment Advertising 136-139

\*Advertiser in European edition

This index is provided as an additional service. The publisher does not assume any liability for errors or omissions.

# Simulator Multi-degree Analog-Structural Hierarchical on your personal workstation

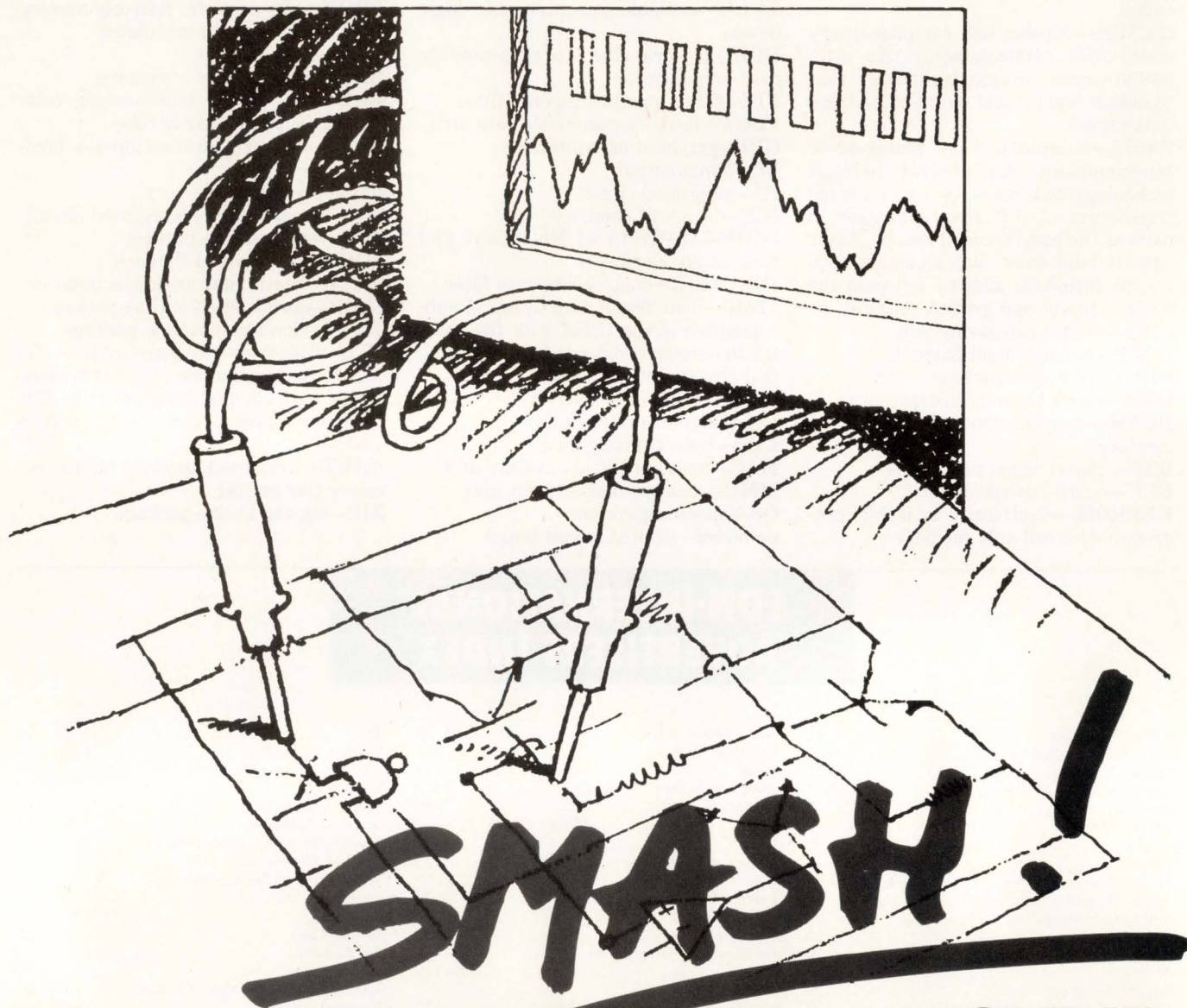
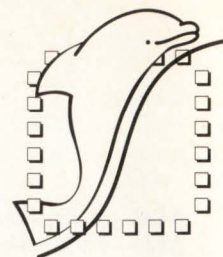

## SMASH™ and your simulation becomes revelation...

### Main features:

- Mixed electrical, structural, analog behavioral and digital behavioral simulation.
- Data base: SPICE-like and HILO-like (pending VHDL) netlists from various schematics editors with hierarchy.
- Libraries: compatibility with most common libraries of ASICs and PCBs, capability given to the user to write his own modules in a C-like language at behavioral degree, or available from Dolphin Integration upon request.

- Interactive set up and simulation display for all analyses: AC transfer function (including operating point and temperature analysis), AC transfer function, transient analysis.
- Delays at structural level.
- Processing capability in background mode.
- Device visibility through analog behavioral modeling.
- Modularly designed to enable separation of three modules: initializer, engine and visualizer (ICD).
- Results: EXCEL files, ICD format files.
- Available on your personal computer (Mac, PC) and UNIX workstation (SUN...).

CIRCLE NO. 91

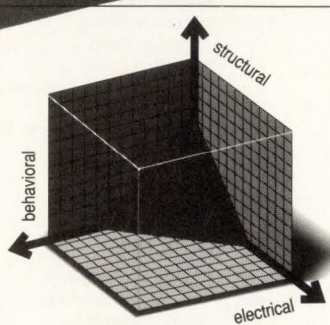

SMASH™ processes simultaneously  
12000 gates, 250 transistors  
and 12000 steps or events.

- Various complexity packages
- Evaluation (A and B)
  - Switch mode with digital syntax (U and V)
  - Full capability with C Compiler (Y and Z)

## DOLPHIN INTEGRATION

The strategist for Circuitware™

Dolphin - US  
Suite 130  
3333 Bowers Avenue  
Santa Clara - CA 95054  
Phone: (408) 727 - 4123  
Fax: (408) 727 - 2541

### Put this PLD text on your library shelf

Here is a book that gives an excellent introduction to programmable logic devices (PLDs). Although the authors of *Practical Design Using Programmable Logic* claim to be industry "insiders," they write thoughtfully for engineers and for managers who might know little about PLDs. You won't get lost in complex device descriptions or in examples that only experts could fathom.

The authors start with an overview of the origins of PLDs, a nice touch that sets the stage for an introduction to device technologies and simple devices and architectures. The book includes chapters on design and development tools and on high-level design techniques. You'll also learn about field-programmable gate arrays (FPGAs), which are becoming more and more popular. Appendices list acronyms and device and design-tool manufacturers.

If you need a detailed and techni-

cal understanding of PLDs, you won't find it here, but that isn't what the authors had in mind when they wrote the book. Instead, you'll get a thorough overview of what PLDs can do, what you need to think about before deciding to use them, and design implications of various architectures. I recommend this book to engineering or project managers who need to know what their engineers are talking about, and to engineers who are approaching a PLD project for the first time. Engineers who are using simple PLDs such as the 16L8, 16R8, or derivatives, and who want to move on to more complex devices, will find much useful information in this book, which is worth having in your library.—Jon Titus

*Practical Design Using Programmable Logic*, David Pellerin and Michael Holly, Prentice Hall, Englewood Cliffs, NJ 07632, USA, 1991, 385 pgs, \$43.

### Real-world wisdom for setting up data-acquisition PCs

The book, *Data Acquisition Techniques Using Personal Computers* by Howard Austerlitz, is a mix of tutorial and reference information for engineers setting up or using a PC-based data-acquisition system. Spanning many disciplines, this well-illustrated book gives readers enough information to build a system from scratch or to simply piece together appropriate commercial hardware and software products.

The book, broken into 14 chapters, contains diverse information rarely found in a single source. It begins with an introduction to data acquisition and describes why a PC

is such a useful tool for acquiring, analyzing, and displaying data. The major topics cover transducers, analog signal conditioning, analog/digital conversions, personal-computer hardware and software, programming languages, and signal-processing techniques. In addition, the book discusses standard interfaces, such as RS-232C, Centronics, and IEEE-488, as well as special topics such as data-compression techniques.

This text contains detailed information on the IBM PC/XT/AT family of computers and their clones, including reference tables of memory maps, I/O address maps, and BIOS functions. The book discusses the PC/XT and PC/AT (ISA) buses in great detail and presents timing diagrams and sample circuit diagrams of hardware interfaces.

One chapter in the book covers other personal-computer families suitable for data acquisition: IBM's MCA-based PS/2 machines and Apple's NuBus-based Macintosh II computers.

In line with stressing IBM-compatible hardware, the author discusses the MS-DOS software environment in great detail. This book contains tutorial information on using MS-DOS for those unfamiliar with PCs, but it also covers more advanced topics, such as disk and file structures. Program listings and examples support the author's software-interfacing techniques.

For engineers who don't want to design their own hardware or software, the book contains descriptions of commercially available hardware and software products from several major vendors, such as Keithley Metrabyte and Laboratory Technologies. The author includes guidelines on how to choose the appropriate hardware or software product for your application, and he gives specific examples. The appendices contain listings of commercial data-acquisition product manufacturers.

The final chapter provides examples of real-world applications for PC-based data acquisition. One application is an ultrasonic measurement system as an example of high data rates. Another is an electrocardiogram measurement system, which uses low data rates.

The author provides frequent examples to explain topics. The subject matter can vary from following a sigma-delta ADC's conversion process cycle by cycle to an example of Huffman encoding, which illustrates how to design a code tree and calculate the data-compression ratio.

A large number of figures and tables supplement the wide-ranging contents of this book, which also contains many illustrative program listings, mostly in C, assembler, and Basic. *Data Acquisition Tech-*

Now up to  
100V DC Output

## PICO DC-DC Converters

Wide Input Range  
5 to 72V DC



Regulated 5 to 30 Watts

- 365 Standard Models
- Single, Dual & Triple Output
- Remote Disable Pin Standard
- Up to 100V DC Output now Standard
- 500V DC Isolated Input to Output
- All Units Shielded

### MIL-STD-883 UPGRADES AVAILABLE

- Expanded operating temp. (-55°C to +85°C)
- No Heat Sink Required
- Stabilization Bake (125°C ambient)
- Temperature Cycle (-55°C to +125°C)
- Hi temp., full power burn in (100% power, 125°C case temp.)

PICO also manufactures over 850 standard DC-DC converters and over 2500 ultra-miniature transformers, inductors and new AC-DC power supplies.

Delivery—  
stock to  
one week

See EEM or  
FAX 914-699-5565  
or send direct for  
FREE PICO Catalog

**PICO**  
**Electronics, Inc.**

453 N. MacQuesten Pkwy. Mt. Vernon, N.Y. 10552

Call Toll Free 800-431-1064  
IN NEW YORK CALL 914-699-5514

## EDN-HANDS ON!

*niques Using Personal Computers* is a useful book for anyone who wants to use their PC to acquire, analyze, or display data.

—Charles H Small

*Data Acquisition Techniques Using Personal Computers*, Howard Austerlitz, Academic Press, Harcourt Brace Jovanovich, Department #11029, 1250 Sixth Ave, San Diego, CA 92101, (800) 321-5068, 306 pages, ISBN: 0-12-068370-9, Hardcover, \$59.95.

## Taking this bus isn't worth the trip

When it comes time to learn about computer buses, steer clear of *Microcomputer Buses* by R M Cram. Although the book promises information on popular computer buses, all you get is a quick overview and few of the necessary details of bus design.

For example, the book spends only six pages on VMEbus arbitration. In fact, the book devotes only 126 pages to describing real bus architectures. Although the book includes quite a bit of introductory information and two chapters on programmable logic devices (PLDs) and field-programmable gate arrays (FPGAs), you can find that information elsewhere and in much more detail. Two final chapters cover real examples of bus-interface circuits, but instead of describing how to design such circuits, the author simply dissects commercial designs. You'll learn how those specific designs work, but little more.

To learn more about computer buses, look for another book. You can also contact bus-product manufacturers for application notes and talk with industry groups that support bus standards.—Jon Titus

*Microcomputer Buses*, R M Cram, Academic Press, San Diego, CA, 1991, 246 pgs, \$49.95.

## EDN REPRINTS

### A Designer's Guide to Linear Circuits

#### Volume I

This original, 186-page collection by Jim Williams offers a wealth of analog design information. It includes practical and efficient ways to use op amps, comparators, data converters, and other analog ICs.

### A Designer's Guide to Linear Circuits

#### Volume II

Jim Williams' analog design articles - from 1983 to 1986 - in Volume II. Volume II covers more complex circuits and systems in 66 pages.

## Surface- Mount Technology Design Project

This 48-page, four-color reprint follows the progress of EDN editor Steve Leibson as he designs a 2M-byte memory board using surface-mount technology. He includes typical problems you might encounter and objectively reports about both good and bad design decisions made along the way.

### CALL NOW!

Cahners Reprint Services  
708/390-2777



# Our DSP development tool kit hammers the competition on performance.



## And at \$499, it nails them on price.

Granted, that's a pretty tough statement. But it wouldn't be made if it couldn't be backed up.

Our EZ-KIT is a complete package, with everything you need to define, code, debug, evaluate and demonstrate your DSP design, yet it costs about half of what the nearest competitor demands for equivalent tools.

To help get your design to market even faster, we've made the EZ-KIT the easiest kit to use. Its comprehensive Applications Textbook contains a full library of source code, while the algebraic assembly language lets you code your DSP algorithms just the way you would write them. Plus the kit includes a simulator for debugging, and an EZ-LAB™ Evaluation Board that lets you test your code in real time at 12.5 MIPS.

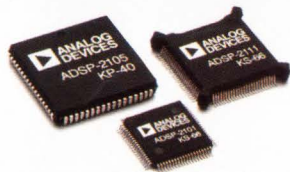

The code compatibility of the ADSP-2100 fixed-point DSP processors lets you easily migrate within the family, even as your designs get more complex.

Now, if all that's not enough to hammer the competition, we also hit them on compatibility. The ADSP-2100 family is a complete line of code-compatible fixed-point DSP processors, so programs you develop with the EZ-KIT can be easily ported and used on your next design.

The low cost and high performance of our EZ-KIT opens the possibility of using DSP to a whole new range of applications – even yours. For more information, or to charge a kit by phone, call us at (617) 461-3771.



The EZ-KIT includes our EZ-LAB™ Evaluation Board with preprogrammed demos, and microphone and speaker jacks; software which includes an assembler; a simulator for the ADSP-2101 and ADSP-2105; a comprehensive DSP Lab Book; an Applications handbook with sample source code; and a discount coupon for our 3-day System Programming and Development workshop.



Analog Devices, One Technology Way, P.O. Box 9106, Norwood, MA 02062-9106. Distribution, offices and applications support available worldwide.

Authorized North American Distributors: Alliance Electronics 505-292-3360 • Allied Electronics 817-595-3500 • Anthem Electronics 408-453-1200 • Bell Industries 213-826-6778 • Future Electronics 514-694-7710 • Hall-Mark Electronics 214-343-5000 • Newark Electronics 312-784-5100 • Pioneer Standard 216-587-3600 • Pioneer Technologies Group 1-800-227-1693

CIRCLE NO. 88

## Specify Signal Planar SMPS Transformers and Inductors.

Signal has taken the magic out of SMPS off-line magnetics design...and production...with the introduction of its PLANAR Series, the first off-the-shelf transformers and inductors for switch mode power supplies.

Utilizing the latest in high-power density PLANAR technology, Signal's SHF-2000 Series accommodates the full international range of input voltages, operates at frequencies up to 1 MHz, and delivers up to 200 watts of dc power at the most commonly used output voltages. And, all with remarkably low, repeatable leakage inductance.

Even more importantly, they're worry free. No need to prepare complex manufacturing drawings with detailed winding instructions, or to use special wire and difficult winding separation techniques to satisfy safety requirements. Signal does it all without demanding height you can't afford! One-, two-, and three-output magnetic sets are off-the-shelf and ready to drop into your power supply.

Signal transformers and inductors are available through Signal's PRONTO 24-Hour Off-the Shelf shipment program. For additional technical data and application notes, contact: Signal Transformer, 500 Bayview Ave., Inwood, NY 11696.

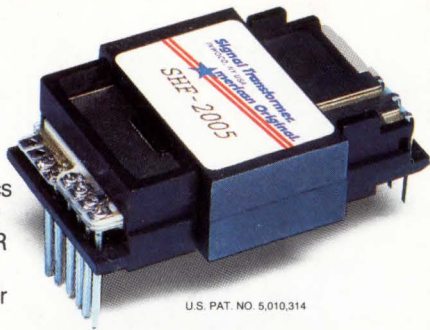

U.S. PAT. NO. 5,010,314

- Low, Repeatable Leakage Inductance
- Low Profile
- High Efficiency
- High Power Density
- High Frequency
- Light Weight
- Off-the-Shelf
- Universal Input
- Meets IEC 950, and UL 506 Requirements\*

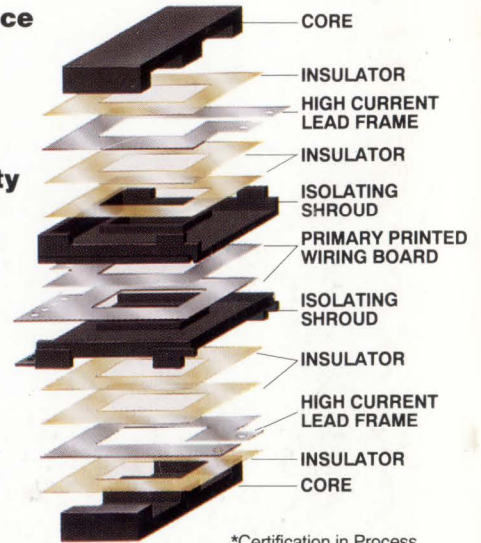

\*Certification in Process

# To Improve Your Switch Mode Power Supply, It Takes Repeat Performance.



BUY DIRECT  
(516) 239-5777  
Fax: (516) 239-7208

**signal**  
TRANSFORMER  
The American Original.™

CIRCLE NO. 89