

# Electronic Design 13

VOL. 14, NO.

THE MAGAZINE OF ESSENTIAL NEWS, PRODUCTS AND TECHNOLOGY

MAY 24, 1966

## Will electric cars come back?

Noiseless and fumeless electrics may answer the urgent pleas of urban ears and nostrils. Unlike this 1908 Kimball Electric, the

new cars can sport a silver-zinc battery and solid-state controls. But do not scrap your present gasoline car until you read the timely analysis starting on p.17.





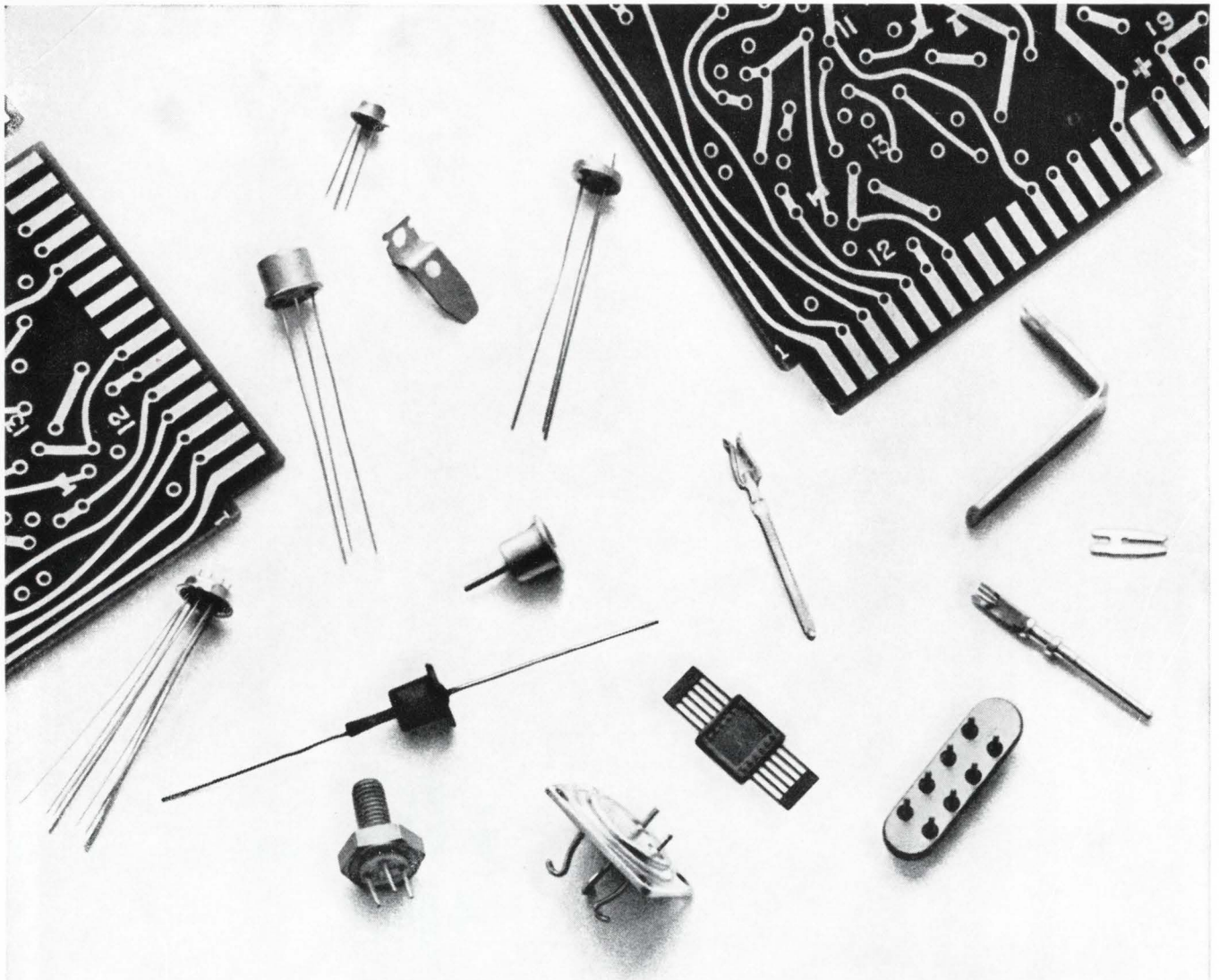

Gold-plated components  
conduct better,  
solder easier,  
reflect heat,  
and resist wear,  
corrosion,  
oxidation,  
galling.

Now let us give you the details.

The details are in our comprehensive reference guide—a voluminous encyclopedia of precious metal electroplating processes. Here you'll find charts, graphs, technical papers, magazine articles. A compendium of today's most advanced knowledge of gold-plating—the facts that have put gold into computers, communications equipment, jet aircraft, missiles, space probes. Write for your copy of "Gold Electroplating Processes."



Sel-Rex Corporation, Dept. A-5, 75 River Road, Nutley, N. J., 07110.

ON READER-SERVICE CARD CIRCLE 242



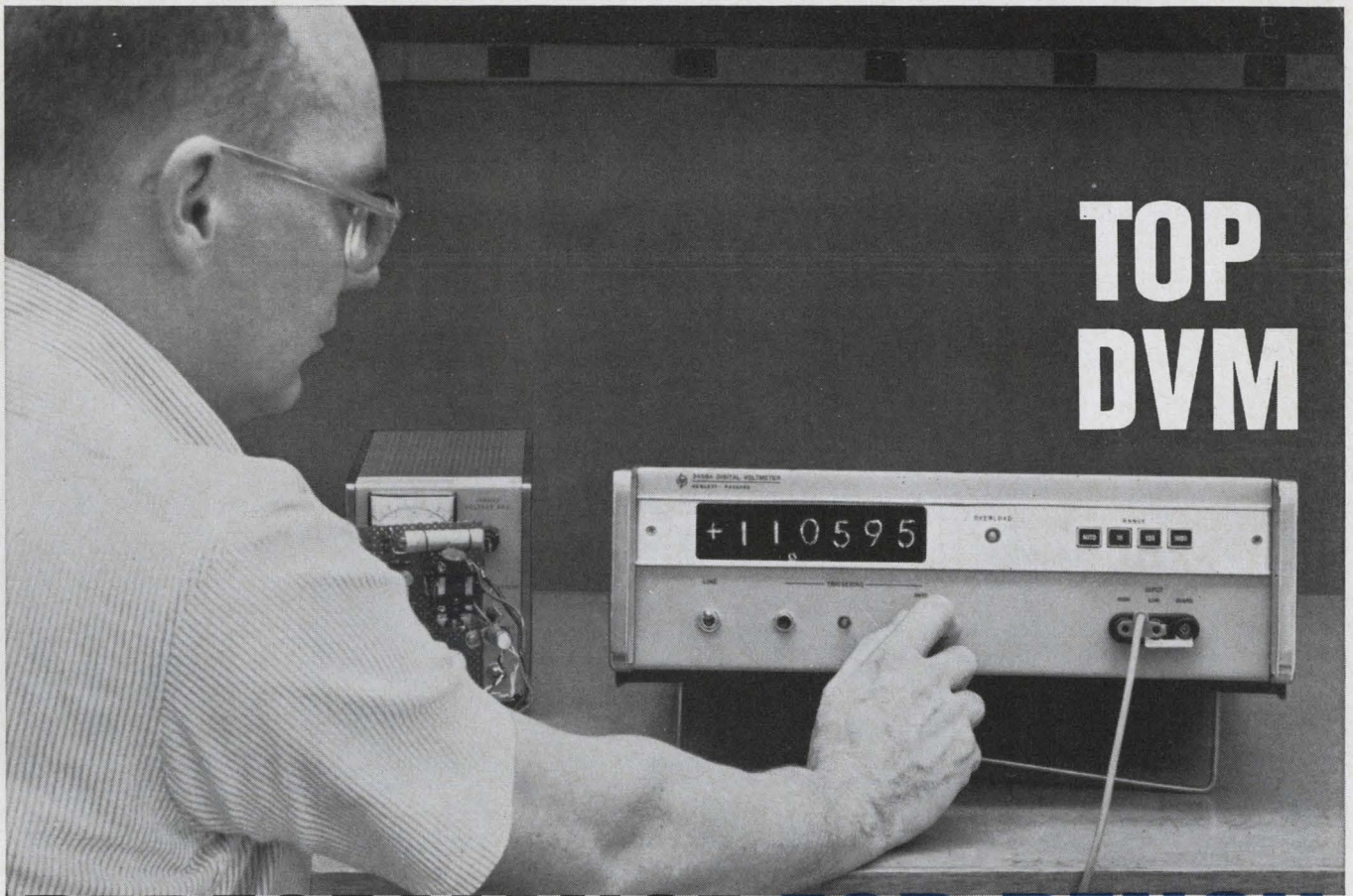

**TOP  
DVM**

**PERFORMANCE FOR BENCH  
USE**

*the 3459A from Hewlett-Packard*

- high accuracy*
- high common mode rejection*
- constant high input impedance*
- high resolution*
- pushbutton convenience*

All these performance characteristics make the hp 3459A the ideal digital voltmeter for your bench use.

It gives you 5-digit (100  $\mu$ v resolution) readout, for measurements 10 V to 1000 V full scale, 3 ranges, with standards lab accuracy (0.008%), 20% over-ranging with a sixth digit, readings from 2/second to 1/5 seconds.

A unique combination of integrating and potentiometric techniques gives you effective common mode rejection better than 150 db at all frequencies, 120% of full-scale superimposed noise can be tolerated.

Ranging is automatic or manual by pushbutton selection, depending on your bench task. Solid-state design insures reliability. Display storage gives you

a non-blinking readout. BCD output is optional.

Here's a bench DVM, easy to use, dependable, with best available performance... at a price that makes sense for your application: \$2850.

Ask your Hewlett-Packard field engineer for a demonstration. Or write for complete specifications: Hewlett-Packard, Palo Alto, Calif. 94304, Tel. (415) 326-7000; Europe: 54 Route des Acacias, Geneva.

*Data subject to change without notice. Price f.o.b. factory.*

**HEWLETT  PACKARD**  
*An extra measure of quality*

ON READER-SERVICE CARD CIRCLE 2



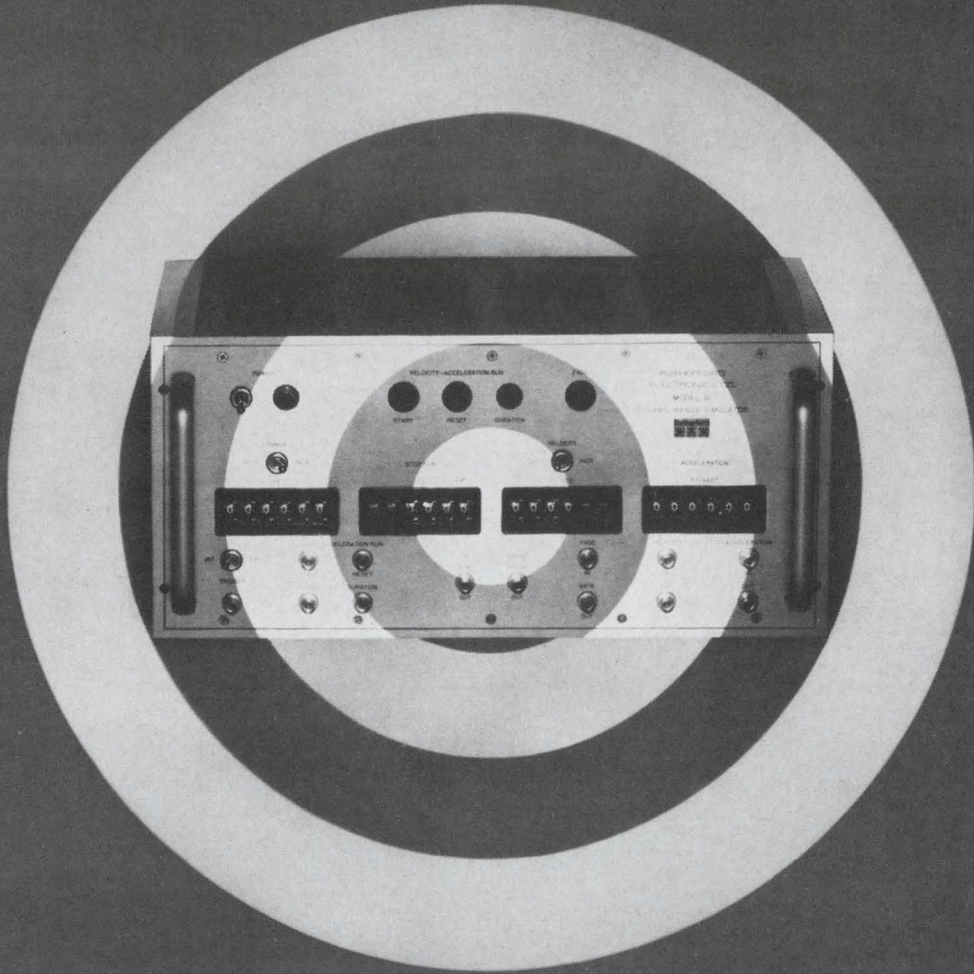

## We make enemies

Simulated enemies are available in a compact package labeled the RUTHERFORD S1 Dynamic Range Simulator. It is the most accurate, reliable, stable video target simulator ever developed. With it you can evaluate, check, and calibrate range, range rate, target tracking, and tracking memory of the most sophisticated weapons control and tracking systems. Forget the limitations and problems built into old-fashioned analog simulators.

Check these parameters: Target Range in one-foot increments from 0 to 1 million feet. Target Velocity

from 0 to 100,000 ft/sec in 0.1 ft/sec increments. Target Acceleration from 0 to 10,000 ft/sec/sec with 0.01 ft/sec/sec resolution. Check all the specs. They meet or exceed the rigid performance requirements of any known weapons control system or tracking system used for air traffic control, satellite surveillance, etc. The Rutherford S1 is an example of



12973 Bradley • San Fernando, California • Phone (213) 772-6321 • TWX 213-647-5170

the advanced design that has established Rutherford as the leader in pulse and time delay instrumentation. Other sophisticated instruments will soon be developed by the new CMC/Rutherford team. Our intent is to give you a wide range of instruments that are always the best quality and best buy.

So join the Rutherford Rampage (a division of the CMC Crusade) and write today for the complete specs on the S1. Learn how you can earn your own glorious Crusading Engineers medal with special Rutherford stripe. You'll look so handsome!

THE RUTHERFORD DIVISION OF CMC IS A LEADING DESIGNER AND MANUFACTURER OF PULSE GENERATORS, TIME DELAY GENERATORS, AND DYNAMIC RANGE SIMULATORS.

ON READER-SERVICE CARD CIRCLE 3



## NEWS

- 14 News Report
  - 17 **Electric cars: a special report**  
Research revives interest in electric autos, but their usefulness still hinges on a new power source.
  - 24 **Thick or thin films: panel debates pros and cons**  
The best approach to hybrid circuits is discussed by a panel at the Electronic Components Conference.
  - 26 Simple optical radar fires like a spark plug.
  - 29 Washington Report
  - 32 New system transmits documents by telephone.
  - 33 Letters
  - 35 **Editorial: Need better calibrations? Then, speak out!**
- 

## TECHNOLOGY

- 38 **Take the fog out of field-effect design.** Use only those FET and MOS parameters that are essential to amplifier and switching applications.
  - 46 **A good diode phase-shifter** is one that combines low insertion loss with high power-handling ability in an economical package.
  - 54 **Keep sampled-data systems accurate** with this technique for sensing common-mode error voltages and compensating for their effects.
  - 58 **One-bit comparator uses FETs** to achieve a low component count and simple circuitry. The next step—monolithic integration.
  - 62 **Pick a delay equalizer** and stop worrying about the math. A set of tables lists the normalized component values for four typical circuits.
  - 70 **Work hard to get less done!** Unchain your creative talents and discover a whole new world of non-accomplishment. Try Project Evasion!
  - 79 NASA Tech Briefs
  - 82 Ideas for Design
- 

## PRODUCTS

- 94 **Semiconductors:** Low-cost 5-watt laser diode
  - 112 **Systems:** Pre-programed transistor classification system
  - 95 Components 124 Microelectronics
  - 110 Microwaves 126 Test Equipment
- 

## Departments

- 132 New Literature 140 Reprints
  - 138 Design Aids 142 Advertisers' Index
  - 138 Application Notes 144 Designer's Datebook
-



# Electro Instruments,

## Now, Honeywell offers one of the broadest instrumentation

Electro Instruments, Inc. of San Diego, California, a pioneer and leader in the field of digital instrumentation and X-Y recorders, and Electro International, Inc. of Annapolis, Maryland, specialists in the field of radio frequency engineering, have joined Honeywell's Denver operation to form the new, expanded Test Instruments Division.

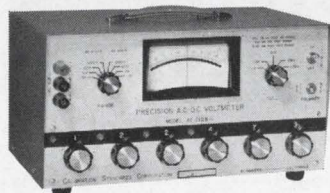

EI AC-DC VOLTMETERS

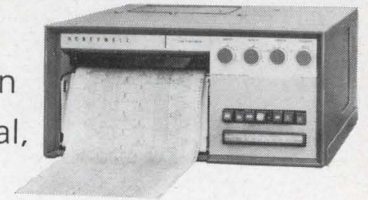

HONEYWELL VISICORDER  
OSCILLOGRAPHS

**New convenience for you** is an important result of this association – virtually one-stop service for everything from digital voltmeters and precision laboratory potentiometers to data loggers and magnetic tape systems. From Honey-



EI DIGITAL VOLTMETERS



EI DIGITAL DATA LOGGERS

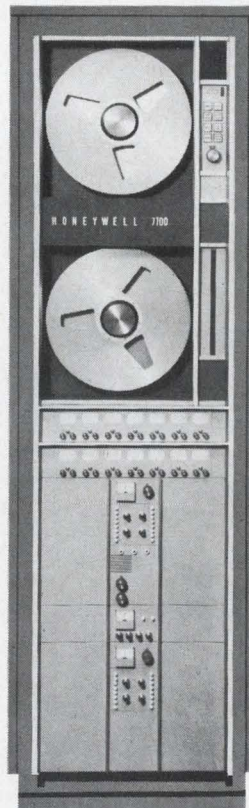

HONEYWELL ANALOG AND  
DIGITAL TAPE SYSTEMS

well-pioneered Visicorder recording oscillographs to automatic spectrum analyzers. Now one man can handle everything – specifications, ordering, arrange-



# Inc. joins Honeywell!

lines available—fully backed by unmatched service.

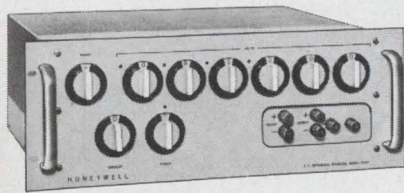

HONEYWELL HIGH-VOLTAGE CALIBRATORS

ments for installation of a single instrument or a complete system, and provision for regular maintenance by trained Honeywell technicians.

**For complete information** on this newly-expanded product line,

contact your Honeywell Representative. He'll show you the great products from Electro Instruments, plus some brand new ones from Honeywell. Or, if you're a long-standing EI customer, get in touch with the EI man who's been calling on you — he's

a Honeywell man now and he'll show you lots of new things! For up-to-the-minute condensed full-line catalogs on Test Instruments Division products, including both Honeywell and EI, and a listing of Honeywell

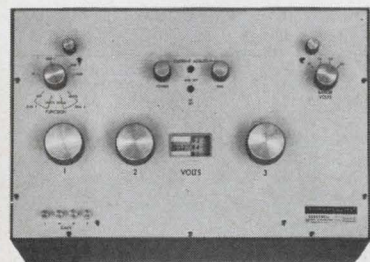

HONEYWELL POTENTIOMETERS

sales offices, please mail the coupon below.

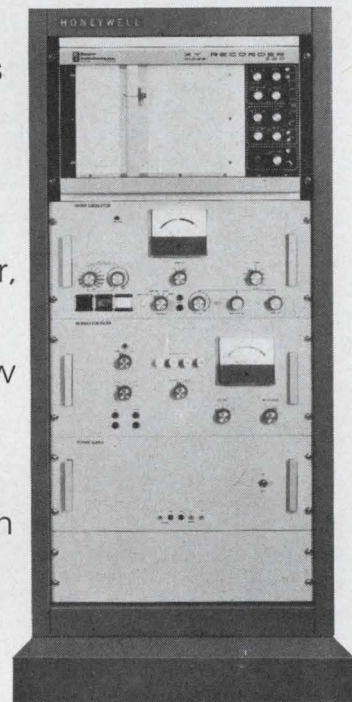

HONEYWELL SPECTRUM ANALYZERS WITH EI X-Y RECORDERS

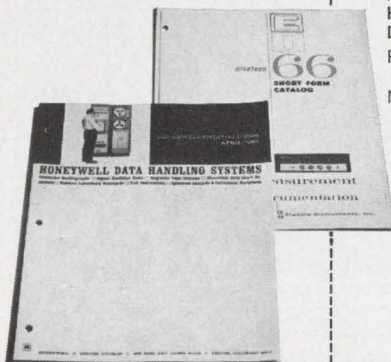

Alan Dallas  
Mail Station 414  
Honeywell Test Instruments Div.  
Denver, Colorado 80217

Please send Honeywell and EI catalogs and sales office listing to:

NAME \_\_\_\_\_

COMPANY \_\_\_\_\_

ADDRESS \_\_\_\_\_

CITY \_\_\_\_\_ STATE \_\_\_\_\_ ZIP \_\_\_\_\_

DATA HANDLING SYSTEMS  
**Honeywell**

ON READER-SERVICE CARD CIRCLE 4





Call your local Weston Distributor for additional information. He stocks the complete Weston line, has what you need, and is primed for fast delivery!

## New VOM sits up so you can sit down

Put an end to the stoop and squint routine—use the VOM that gives you real legibility with  $5\frac{1}{2}''$  scale and refractive plastic scale overlay for parallax-free readings. New Weston Model 80 VOM permits you to reverse polarity even under load, provides a single switch for controlling functions and range, and gives you both fuses and diode overload protection. Matching family of multi-function test instruments also available.

**ACCURACY:** 1% dc, 1.5% ac. **DC Volts:** 0.25v to 5Kv in ten steps @ 20K ohms/volt. **AC Volts:** 2.5v to 5Kv in seven steps @ 5K ohms/volt. **DC Current:** 50 $\mu$ a to 10 amps in six steps. **Five Ohmmeter Ranges:** 2K to 20 meg full scale; 20 to 200K center scale. **DB Scale:** -10 to +10 db.

Ask for the portable Model 80, or the convenient rack-mounted version, MODEL 80R, for 19" relay rack panel installation.

Contact your Weston Distributor, or **Weston Instruments, Inc., Newark Division, Newark, N.J. 07114**

**WESTON®** prime source for precision... since 1888



# Now—Bourns Gives You a Complete Choice Of 7/8" Precision Potentiometers

Take your pick from the industry's finest, most extensive 7/8" diameter precision potentiometer line:

BUSHING MOUNT	SERVO MOUNT
Model 3500, 10-turn	Model 3550, 10-turn
Model 3507, commercial 10-turn	Model 3560, 3-turn
Model 3510, 3-turn	Model 3570, 5-turn
Model 3520, 5-turn	Model 3580, single-turn*
Model 3530, single-turn	

\*Meets all requirements of MIL-R-12934C; can be ordered by Bourns model number or by MIL-Spec designation RR09.

In quantity and quality, this line is unmatched. Exclusive

SILVERWELD® multi-wire termination eliminates the chief cause of potentiometer failure. All-sealed construction insures MIL-Spec humidity performance (cycling and steady state). One hundred per cent inspection and the double-check follow-through of the Bourns Reliability Assurance Program are your final quality guarantees.

No matter what your requirements in precision potentiometers, you will find the answer at Bourns—the complete source. Write for technical data on our entire line of bushing- and servo-mount models, KNOBPOT® potentiometers, and turns-counting dials.

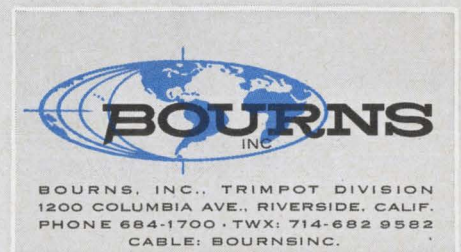
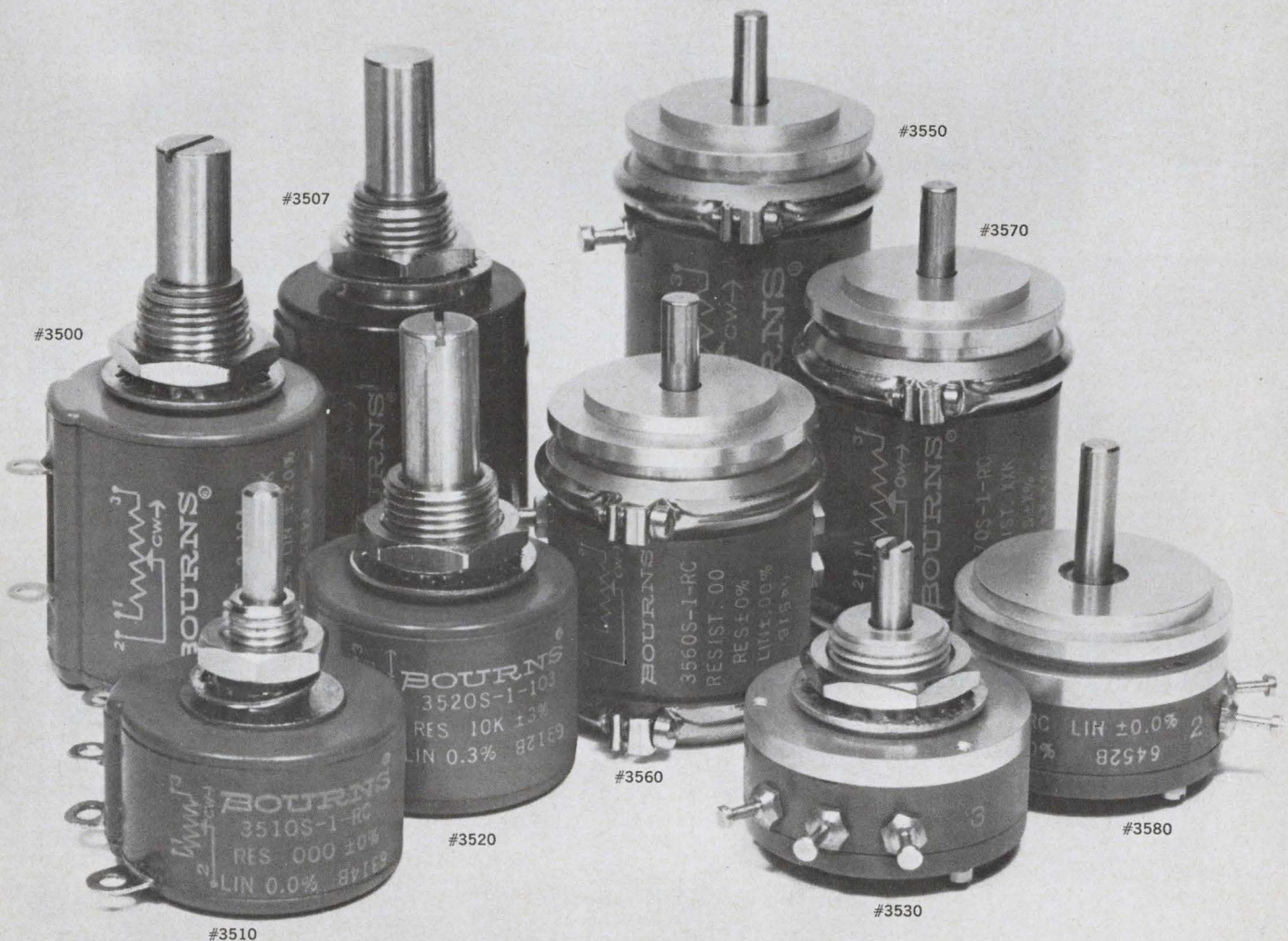



From the expanding line of Sigma relays...

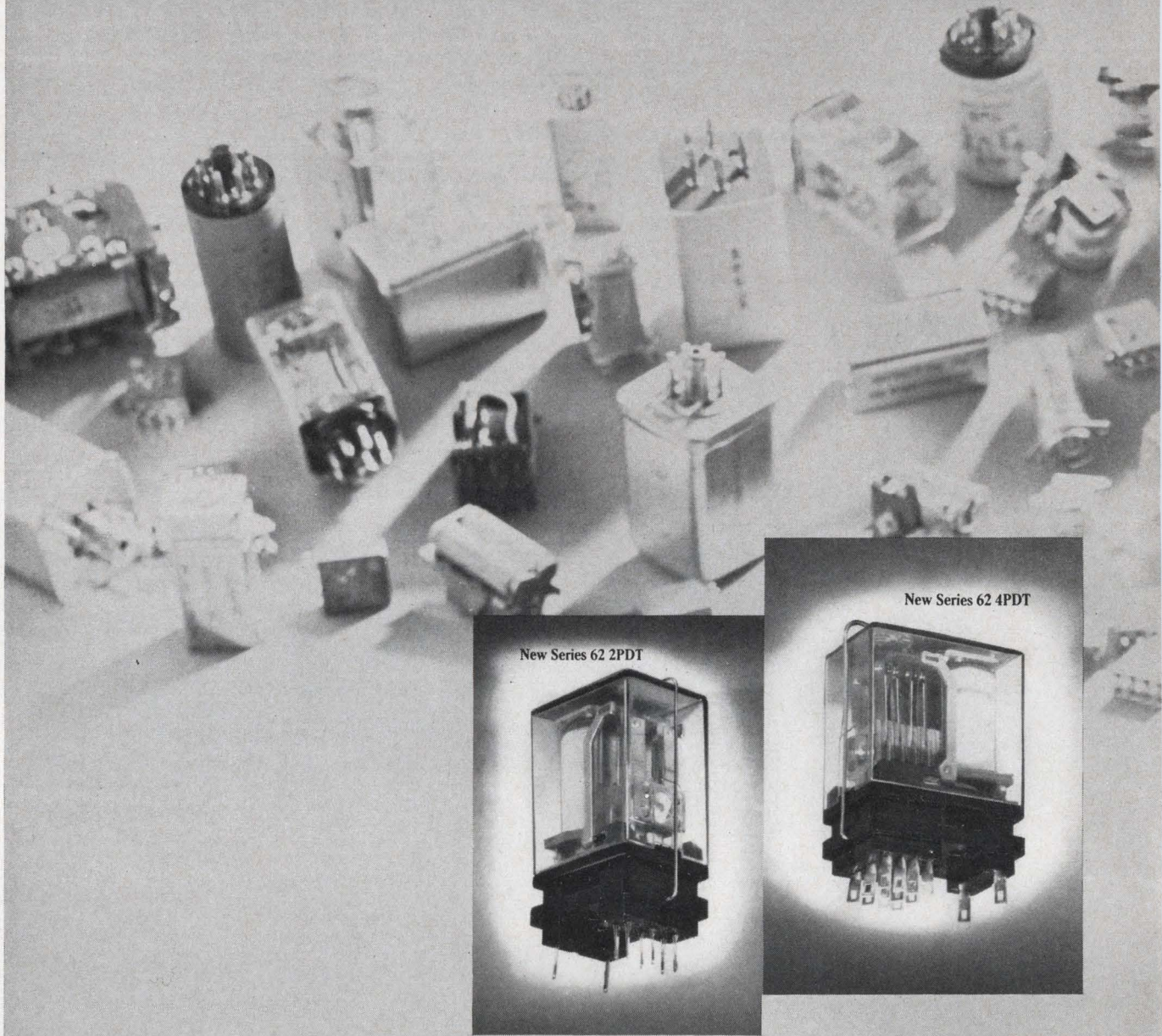

New Series 62 2PDT

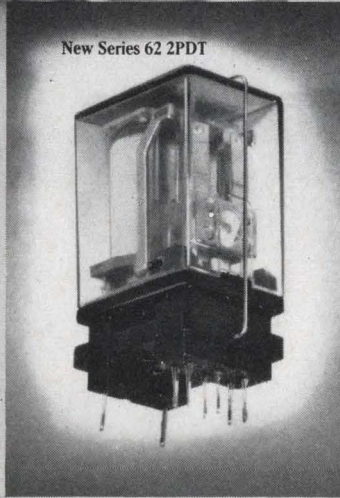

New Series 62 4PDT

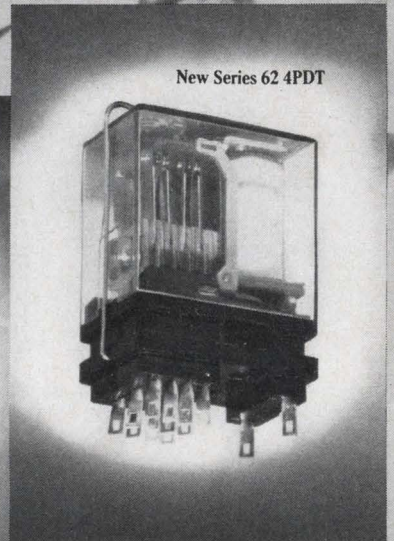

## New 2, 4 and 6 pole relays\* you

Here's today's closest approach to a "universal" relay—the new Sigma Series 62. These versatile, miniature relays are being used in more than 1,001 applications. Ranging from communications equipment, data processing equipment and measuring instruments to process controls, recording devices, alarm systems and many more.

You get both electrical and mechanical versatility in the new Series 62 relays. They are available in 2, 4 and 6 pole versions for lower cost switching of multiple circuits. Installation is fast and simple with solder-terminal or printed-circuit-terminal sockets designed to provide maximum space for easy soldering.

**\*Order them off-the-shelf.**





New Series 62 6PDT

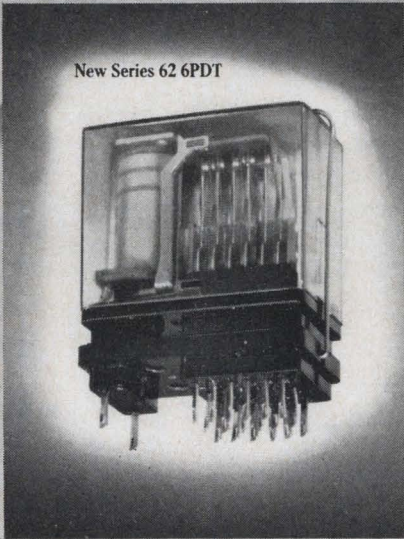

# can use in 1,001 applications.

The new Series 62 exhibits excellent electrical and mechanical stability at low-level to 2 amp loads. It has an exceptionally long mechanical life of 100 million operations minimum. Each relay is available in all popular coil voltages.

There are more features you'll want to check-out in these new Series 62 "universal" relays. Your

Sigma representative or distributor will be glad to help you.

**Free Catalog:** Contact Sigma direct. We'll send you our new 16-page Sigma Preferred Standard and Stock Relay Catalog and an up-to-date stock listing to help you select the relays immediately available in quantity.

SIGMA DIVISION  SIGMA INSTRUMENTS INC  
*Assured Reliability With Advanced Design / Braintree, Mass. 02185*











Sigma's line of over 100,000 relays includes Sensitive, High Performance, Pulse and Telegraph, General Purpose, Power, and Special Purpose types.

ON READER-SERVICE CARD CIRCLE 6

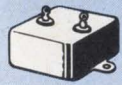

# All from Sprague!

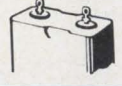
## TWELVE OF OUR MOST POPULAR METALLIZED CAPACITOR TYPES

SPRAGUE TYPE	Case And Configuration	Dielectric	Temperature Range	Military Equivalent	Engineering Bulletin
 <b>680P</b>	hermetically-sealed metal-clad tubular	metallized Metfilm* 'A'	-55 C, +85 C	no specification	2650
 <b>431P</b>	film-wrapped axial-lead tubular	metallized Metfilm* 'E' (polyester film)	-55 C, +85 C	no specification	2445
 <b>155P, 156P</b>	molded phenolic axial-lead tubular	metallized paper	-40 C, +85 C	no specification	2030
 <b>218P</b>	hermetically-sealed metal-clad tubular	metallized Metfilm* 'E' (polyester film)	-55 C, +105 C	CH08, CH09 Characteristic R	2450A
 <b>260P</b>	hermetically-sealed metal-clad tubular	metallized Metfilm* 'K' (polycarbonate film)	-55 C, +105 C	no specification	2705
 <b>121P</b>	hermetically-sealed metal-clad tubular	metallized paper	-55 C, +125 C	no specification	2210C
 <b>118P</b>	hermetically-sealed metal-clad tubular	metallized Difilm® (polyester film and paper)	-55 C, +125 C	CH08, CH09 Characteristic N	2211D
 <b>143P</b>	hermetically-sealed metal-clad "bathtub" case	metallized paper	-55 C, +125 C	no specification	2220A
 <b>144P</b>	hermetically-sealed metal-clad "bathtub" case	metallized Difilm® (polyester film and paper)	-55 C, +125 C	CH53, CH54, CH55 Characteristic N	2221A
 <b>284P</b>	hermetically-sealed metal-clad rectangular case	metallized paper	-55 C, +105 C	no specification	2222
 <b>283P</b>	hermetically-sealed metal-clad rectangular case	metallized Difilm® (polyester film and paper)	-55 C, +125 C	CH72 Characteristic N	2223
 <b>282P</b> (energy storage)	drawn metal case, ceramic pillar terminals	metallized paper	0 C, +40 C	no specification	2148A

For additional information, write Technical Literature Service, Sprague Electric Company, 347 Marshall St., North Adams, Massachusetts 01247, indicating the engineering bulletins in which you are interested.

\*Trademark

### SPRAGUE COMPONENTS

CAPACITORS  
TRANSISTORS  
RESISTORS  
INTEGRATED CIRCUITS  
THIN-FILM MICROCIRCUITS  
45C-910A

PULSE TRANSFORMERS  
INTERFERENCE FILTERS  
PULSE-FORMING NETWORKS  
TOROIDAL INDUCTORS  
ELECTRIC WAVE FILTERS

CERAMIC-BASE PRINTED NETWORKS  
PACKAGED COMPONENT ASSEMBLIES  
BOBBIN and TAPE WOUND MAGNETIC CORES  
SILICON RECTIFIER GATE CONTROLS  
FUNCTIONAL DIGITAL CIRCUITS



'Sprague' and '®' are registered trademarks of the Sprague Electric Co.



# ED News

Research revives interest in electric cars PAGE 17

Panel argues thin films versus thick films PAGE 24

Simple optical radar has advantages over laser-type systems PAGE 26

New facsimile system sends pictures by telephone PAGE 32

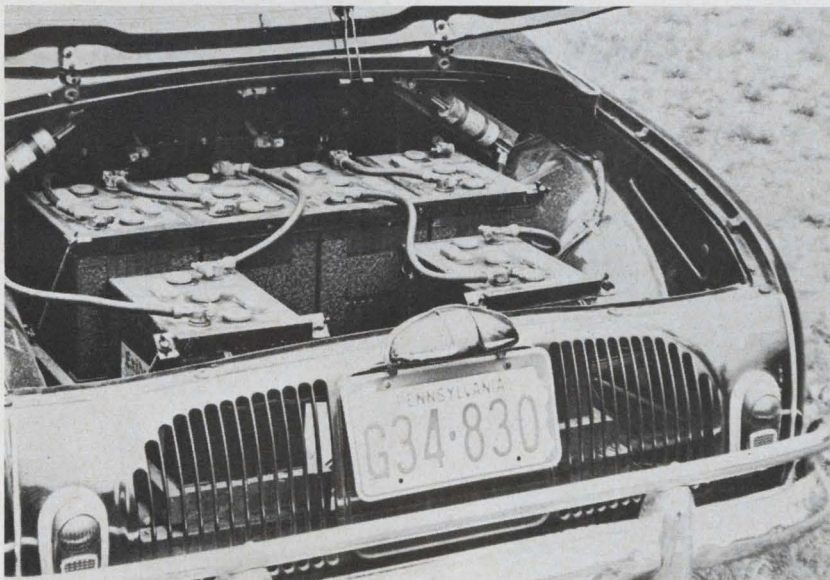

High power luggage . . . 17

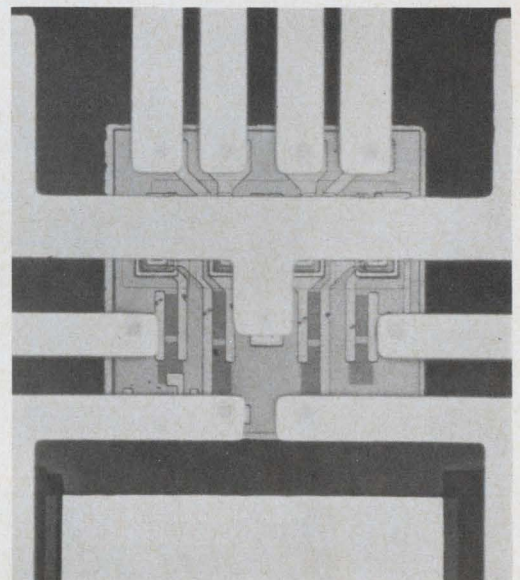

Flip your chip. . . 24



Missiles home on mirror . . . 23



# New from Sprague!

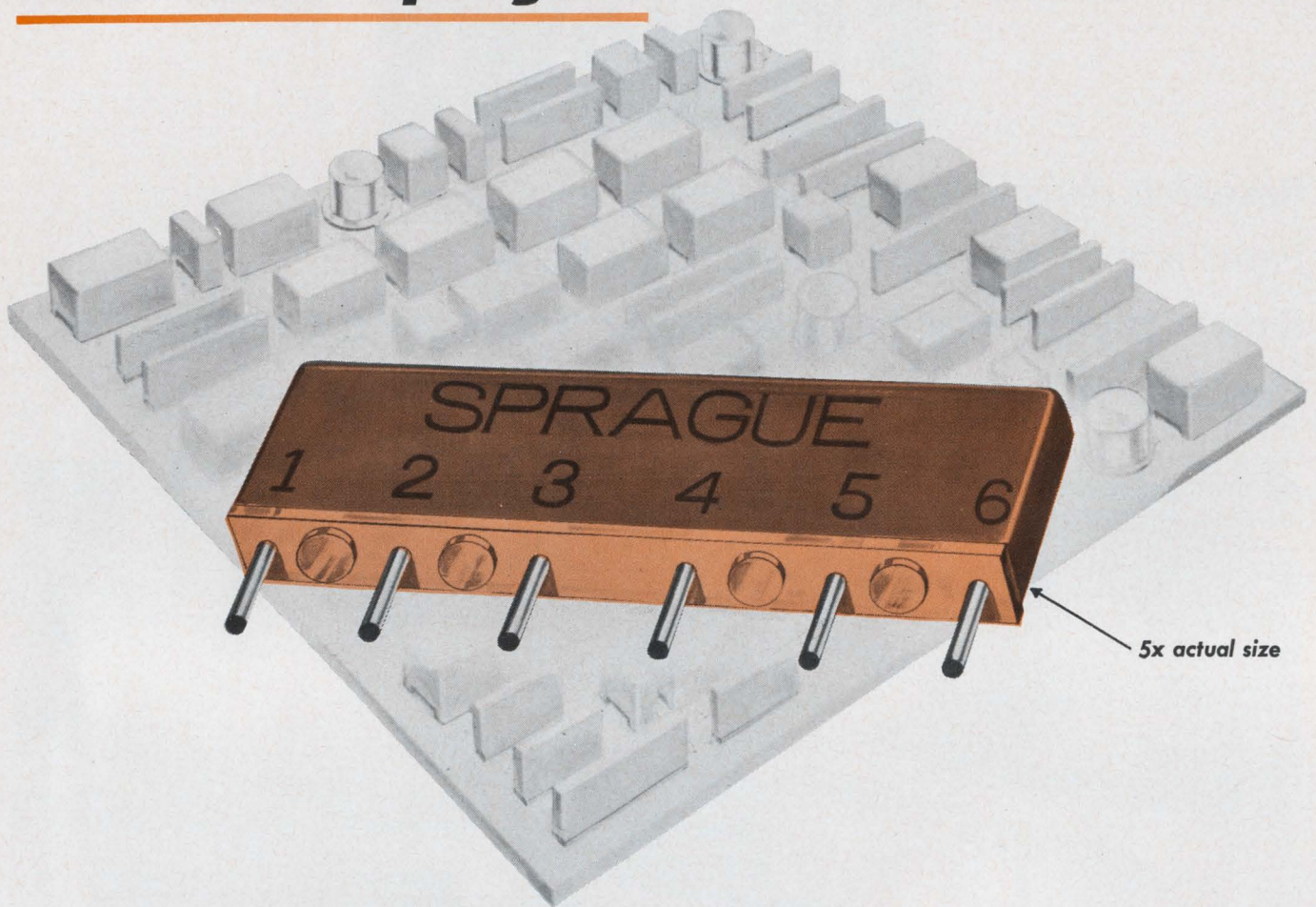

## METANET<sup>®</sup> TRUE METAL-FILM NETWORKS PRECISION RESISTOR

### Save Space, Time, and Money

- High packaging density—4 to 8 times that of individual components.
- Fewer components to stock, handle, inspect, install. Entire module can be hand-inserted faster than one axial-lead component.
- Permit substantial savings over equipment assembled with individual components.
- Epoxy terminal board keeps pin terminals free of resin coating, unlike conventional dipped components, and provides uniform lead spacing.
- Stand-off bosses permit efficient flux removal after soldering. Also prevent dirt and moisture traps around leads.
- Extremely stable and reliable. Meet performance requirements of MIL-R-10509E. Resistance tolerances to  $\pm 1\%$ .
- Ceramic capacitors can be incorporated for further savings and size advantages over individual components

For complete information write to  
Integrated Circuit Application Engineering Dept.,  
Sprague Electric Company, 347 Marshall St.,  
North Adams, Massachusetts 01248

#### SPRAGUE COMPONENTS

RESISTORS  
CAPACITORS  
TRANSISTORS  
INTEGRATED CIRCUITS  
THIN-FILM MICROCIRCUITS

PULSE TRANSFORMERS  
INTERFERENCE FILTERS  
PULSE-FORMING NETWORKS  
TOROIDAL INDUCTORS  
ELECTRIC WAVE FILTERS

CERAMIC-BASE PRINTED NETWORKS  
PACKAGED COMPONENT ASSEMBLIES  
BOBBIN and TAPE WOUND MAGNETIC CORES  
SILICON RECTIFIER GATE CONTROLS  
FUNCTIONAL DIGITAL CIRCUITS



\*Sprague\* and \*®\* are registered trademarks of the Sprague Electric Co.

ON READER-SERVICE CARD CIRCLE 7



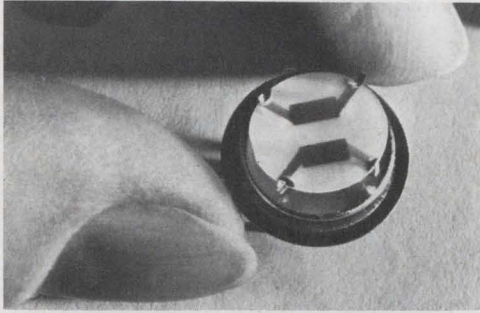

### Quartz crystal passes narrow band

A single quartz crystal with two electrodes can replace a crystal filter that contains two crystals, two hybrid transformers, four variable capacitors and all its wiring or printed circuit board.

Developed by Roger Sykes and William Beaver of Bell Labs at Allentown, Pa., the new single crystal filter can be made to pass a bandwidth of 0.1% of its center frequency. Its center frequency can be anywhere from one to 150 MHz.

A high-frequency crystal is usually supported by two leads soldered to plated electrodes at the center of the round crystal. It then resonates at one sharply defined frequency. The new crystal is supported at its edge by four leads. These attach to two pairs of electrodes that are deposited gold films.

The crystal still has a single fundamental frequency. But when the two pairs of electrodes are properly placed on its surface and connected, the crystal resonates at two different frequencies—one just above and one just below the crystal's fundamental frequency. These two frequencies determine the upper and lower cutoff of the filter. Sykes and Beaver have found that the filter's characteristics can be altered by adding even more electrodes.

### Experts probe computerized design

Circuit design by computer is a reality but it still has a lot of growing to do. That's the impression conveyed by a well attended conference on computer-aided solid-state circuit design held at the University of Wisconsin on May 3-4.

Three of the more significant points made by the conference speakers were:

- Experts are still looking for a really universal transistor model that can be stored in a computer and made to function in any application merely by tabulating information on changes in parameter values.
- Experts differ in opinion on what mathematical techniques are most suitable for computerized circuit design. Matrix methods are said to be systematic and

# News Report

within the capability of just about every existing computing center. Proponents of topological techniques maintain that their approach is more straightforward than matrix methods and provides the designer with greater insight into a circuit's operation. In time, both techniques should find their most effective application.

- All agree that more exchange of information is needed between those actually involved in computer-aided design to avoid duplication of effort and exploit advances to the maximum.

Computers have already been used to help design circuits, but much remains to be done to simplify engineer-computer dialogue before they'll become an everyday tool of the circuit designer.

### Is this equality?

As the plant whistle blows for quitting time, a voice says over the loudspeaker: "All male employees who desire, please stay and work two hours' overtime at premium pay. All female employees please leave." Farfetched? Not if the plant is in California, which has a state law that prohibits women from working more than eight hours a day.

This law is now under fire from the Western Electronic Manufacturer's Association. WEMA spokesman Daniel E. Foster says: "Rather than protecting women, the hours law arbitrarily declares them to be unequal to men, deprives them of opportunities to earn premium pay, and—most important—limits their opportunities to positions of progressively greater employment."

The law is mostly a hindrance, Foster adds, in those sporadic, unforeseeable situations where operations are impaired because the ladies must leave the job at quitting time. Then, if the employer asks only male employees to stay on the job, he is put in the position of disobeying federal law, which states that it is "an unlawful employment practice" to deny women the same chance to earn premium pay as men.

Besides WEMA, the California Conference of Employer Associations and the



# News Report

CONTINUED

California Manufacturers' Association are supporting either repeal or substantial modification of the women's eight-hour law.

## Advanced programs slated by Douglas

The term "way out" well describes the research projects to be carried out at Douglas Aircraft's new Advanced Research Laboratory in Huntington Beach, Calif. Among the programs planned for the center are:

- A target signatures program in which the nature of animal sonar systems will be studied.
- An empirical epistemological study which may lead to a fully automated, unmanned spacecraft that makes "judgments" rather than follows a pre-programmed or on-command schedule.
- Fundamental studies of crystals, including crystal growth, magnetic resonance phenomena, lattice dynamics, surface physics and solid-state kinetics, which may lead to development of new electronic devices.
- A general relativity program that will attempt to develop a unified-field theory in which both electro-magnetics and gravitation can be described within the same geometrical framework.

## U.S. lagging in international standards

"U.S. electronics producers must work to amplify the voice of their industry in international standardization endeavors or endure the consequence of dwindling markets abroad." So said Dr. Leon Podolsky, technical assistant to the president, Sprague Electric, at the recent Electronic Components Conference.

According to Dr. Podolsky, the electronics industry has increased its foreign trade in recent years faster than any other industry. But, he declared, "as our companies strive to compete more in foreign markets, they find that one of the strongest barriers to trade has nothing to do with tariffs, freight rates, money exchange rates, or interest—but rather with the inability to have our goods accepted because they don't meet the performance, test, size or safety standards of the customer overseas."

To remedy the situation, Dr. Podolsky called for expanded participation by U.S. electronic firms in the work of the International Electrotechnical Commission, a 40-member group for promulgation of international standards. This can be done, said Dr. Podolsky,

through more company-supplied delegates to the commission, a firmer basis for industry- and government-financial support, enactment of legislation and establishment of a new federal program to expand the U.S. role, and more volunteers for "expert committees" working in particular areas of electronic standardization.

---

**A 1-GHz microcircuit amplifier** for use in military field communications equipment is now under development at Fairchild Semiconductor. The 12-month development program is being sponsored by the U.S. Army Electronics Command.

**Basic inventions** in the field of holography will be developed by a new corporation formed by Scientific Advances, Inc., and the Du Pont Company. The new company, to be known as the Holotron Corporation, holds exclusive rights to inventions growing out of research on holography at the University of Michigan and at the Columbus and Pacific Northwest Laboratories of Battelle Memorial Institute.

**The Society of Women Engineers** has been cited in "Who's Who in America" for outstanding gifts to education in America. The citation noted: "The 700 members of the organization have given liberally of their time and limited resources to establish scholarships and awards, hold conferences and publish brochures to the end that other young women may be made aware of the opportunities that exist in this (engineering) field."

**To keep pace** with the booming semiconductor industry, Dow Corning Corp. is planning an \$8 million expansion of its silicon production facility at Hemlock, Mich. According to Dr. Earl L. Warrick, General Manager of Dow Corning's Electronic Products Division, increased use of silicon in microcircuits, computer components and silicon controlled rectifiers is responsible for much of the increased demand for silicon.

**A space rescue system** may become a reality, as a result of the tenuous recovery of Gemini-8 on March 16. Within a few months NASA is expected to issue requests to industry for outlines of possible emergencies that astronauts can conceivably encounter during a mission and their possible solutions. Though there are no funds now available for this possible program, NASA is hoping that existing vehicles could be used for rescue purposes. This would provide for cutting of both cost and time from any proposed system design.



Boeing wants it that way. One Microstack provides permanent nondestructive memory for operating instructions and data words with a design reliability goal of 100,000 hours MTBF. The other provides a temporary memory for incoming and outgoing messages with a design reliability goal of 5,000,000 hours MTBF.

One of the reasons Boeing uses Microstacks is their unique design. A folded-array originated by Indiana General. The

"X" and "Y" axis of all the memory planes are continuously wired. This reduces solder connections 80%, greatly increasing reliability as well as cutting size and weight. This folded-array is specially-packaged to meet Mil. Spec. temperature, humidity, shock and vibration, and extreme environment requirements.

Another reason was our ability to develop cores to Boeing's specifications. We invented the ferrite memory core and

make and sell more of them than anyone. Our facilities for developing and producing cores and stacks are second to none.

If you need Mil. Spec. type memory units find out about Microstacks and our core capabilities. Write Mr. Thomas Loucas, Manager of Sales, Indiana General Corporation, Electronics Division/Memory Products, Keasbey, N. J.

**INDIANA GENERAL** 

**There are two Microstack<sup>®</sup> memory units  
in Minuteman II. One remembers. The other forgets.**





# MODEL TDH-9 PAR Waveform Educator



The PAR WAVEFORM EDUCATOR extracts repetitive waveforms or transients from noise.

Experimental information in the form of repetitive waveforms can best be extracted from noisy signal channels by obtaining the cross-correlation function of the waveform-plus-noise with a train of delta-functions having the same repetition rate. The cross-correlation function will be the waveform of interest, noise having averaged to zero. Approximations of this operation may be performed digitally, but generally there are drawbacks in time efficiency, speed, and expense. The PAR TDH-9 WAVEFORM EDUCATOR is an analog averaging instrument having one hundred channels of capacitor memory. The cross-correlation approximation is obtained by dividing that part of the input waveform of interest into one hundred segments. These are switched sequentially and synchronously through a resistor to the memory capacitors where the average is obtained and stored. The information in the memory bank is continuously observable on a monitor scope and the average can finally be photographed or read out on an X-Y or strip-chart recorder. The TDH-9 has the advantages of speed, efficiency, and low price.

## SPECIFICATIONS

**Resolution:** 100 channels. Output smoothing provides continuous output waveform rather than "stairstep."

**Sweep Duration:** Continuously adjustable from 100  $\mu$ S to 11 Sec in five ranges. (Dwell time/channel: 1  $\mu$ S to 110 mS.)

**Characteristic Time Constants:** 5 Sec to 100 Sec in 1-2-5 sequence. The characteristic time constant is that time constant with which the output waveform responds to changes in the input waveform. Because the stored waveform is held during the time between sweeps, the observed time constant can be larger than the setting of the Characteristic Time Constant Switch.

**Sweep Delay:** A delay of 10  $\mu$ S to 11 Sec can be inserted between receipt of trigger pulse and initiation of sweep.

**Output:** Full scale is  $\pm 10$  volts, capable of driving oscilloscopes, X-Y recorders, and strip chart recorders. Readout can be as slow as 100 Sec (dwell time/channel 1 Sec).

**Dynamic Range:** Noise and interference five times the full-scale input will not cause overload. Output noise

with shorted input for most combinations of Sweep Duration and Characteristic Time Constant is below 0.2% of full scale.

**Power:** 105-125 or 210-250 volts AC, 50-60 Hz; 25 watts.

**Price:** \$4200.00 Request Bulletin 126.

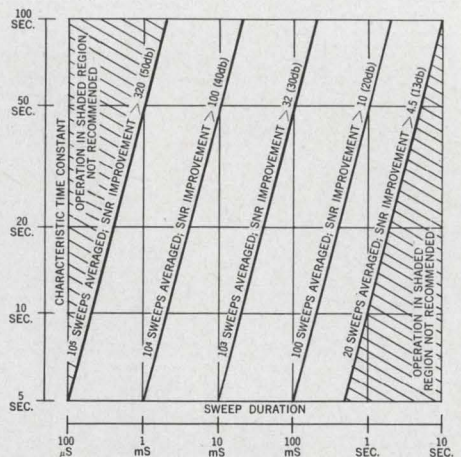

NUMBER OF SWEEPS AVERAGED AND VOLTAGE SIGNAL-TO-NOISE RATIO IMPROVEMENT AS A FUNCTION OF CHARACTERISTIC TIME CONSTANT AND SWEEP DURATION

**PAR** PRINCETON APPLIED RESEARCH CORP.  
Dept. E  
Box 565, Princeton, N. J., Tel. (609) 799-1222



# Electric car makers preparing to rally

**Research revives interest in auto, but its usefulness still hinges on a new power source.**

**Roger Kenneth Field**  
News Editor

Researchers in the electronic and automobile industries, seeking a car that will be cheap, noiseless and fumeless, are hoping to turn many radiator caps into paperweights.

Why? Because recent advances in batteries and fuel cells, as well as cheaper solid-state control devices, have brought design engineers almost within reach of a marketable electric automobile. Expectations of how soon the goal may be achieved range from a couple years to a dec-

ade. But once the anticipated power-source breakthroughs occur, electric cars may rapidly take over a significant portion of the billion-dollar automobile industry.

Evidence of renewed activity is apparent in these developments:

- General Motors Lab, Warren, Mich., is experimenting with battery-powered passenger cars. Publicly the company answers "no comment" to all inquiries, but according to a reliable source, it has installed a 50-horsepower electric motor in a Corvair. The car is said to have reached a speed of 80 mph, powered by 500 pounds of rechargeable silver-zinc batteries.

- Westinghouse, Pittsburgh, has clear intentions of manufacturing several small electric autos for town use. Having recently purchased a firm making electric golf carts and industrial trucks, Westinghouse is now conducting extensive market

surveys on what might be the most advantageous design for a two- to four-passenger electric auto.

- General Dynamics is working to perfect a zinc-air (yes—air) battery specifically for use in electric vehicles. The firm's General Atomic Division in San Diego, Calif., is presently putting together a prototype that will deliver 32 kW. A one-kW unit has already been successfully built.

- An English firm, Telearchics, Ltd., has just completed a prototype small three-wheeled electric auto, called the Winn City Car, after its inventor Russell E. Winn. Because it has front-wheel drive and its rear wheels are weighted down by batteries, the car can make a right-angle turn at its 40-mph top speed. Winn indicates that he plans to put the car into production.

- The Exide Battery Co., Philadelphia, has purchased a substantial interest in Batronics, Inc., a local manufacturer of electric trucks, and is currently negotiating to take a



**A Henney Kilowatt** charges its batteries while Morrison McMullan works in his office at the Exide Battery Co. Its batteries last 4-1/2 years.



**Michel Yardney**, president of Yardney Electric Corp., thinks it may be some while before a driver can recharge the batteries of his electric auto by plugging into any wayside tree. Yardney has a novel idea for financing the cost of buying expensive silver-zinc cells.



(electric car, continued)

half share in the firm.

Why all this interest in an all but abandoned propulsion system? Some reasons are new, some date back half a century.

### The early competition

In the early 1900's vehicles were powered about equally by electricity, gasoline or steam. The steam cars were fast but dangerous; a popular saying had it that "no living man ever ran a Stanley Steamer to full throttle." And the driver had to wait five or ten minutes after starting up to build up pressure. The early gasoline cars were noisy, smelly and undependable.

The electric car, on the other hand, was clean, extremely quiet and almost maintenance-free. It was also exceptionally dependable—so dependable, indeed, that it became the almost unanimous choice of transportation for doctors. But usually it was slow and could go only a few score miles on each full battery charge.

Rural America needed inexpensive transport that would not quit after a mere hour or two. An industrialist named Henry Ford delivered precisely what was wanted: the Model "T". Simultaneously he delivered a near fatal blow that has reduced the electric car to little more than a curiosity for some fifty years. Though the electric car's controls and motor left room for improvement, its most serious shortcoming was its batteries.

### Batteries: The crux of the problem

The speed and range of an electric car are, as a rule of thumb, inversely proportional to its weight. But its batteries are so very heavy that they represent a considerable part of the auto's total weight. Experience has shown that once the weight of the batteries reaches 45 per cent of the auto's over-all weight, no additional speed or mileage can be obtained by adding any more storage cells. Therefore the only way to improve the car's performance is to use batteries with an extremely high energy-to-weight ratio.

Two battery companies have put

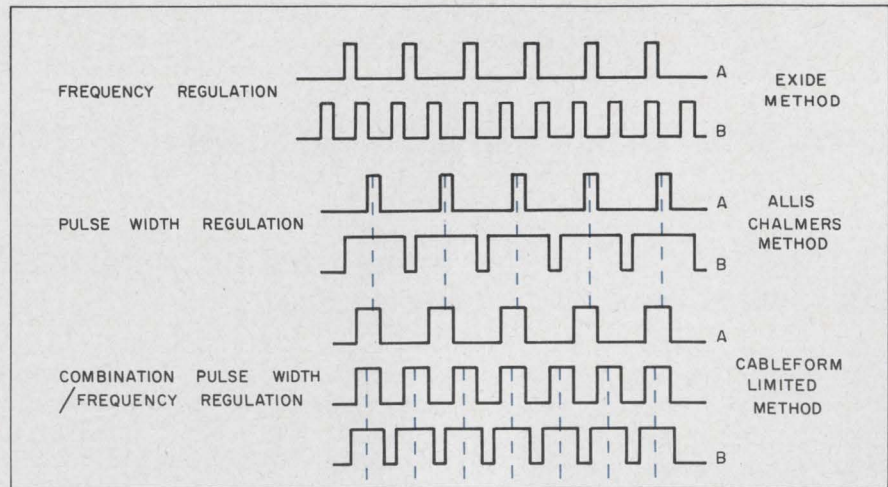

Three methods of controlling the effective current to dc traction motors are illustrated by these graphs. In each case, "A" gives less average current than "B". A fourth method designed by the I-T-E Circuit Breaker Co. uses two separate pulses to control a compound motor.

their product into a modern electric car. It is called the Henney Kilowatt. This is a Renault Dauphine that has been converted to electricity by the Henney Motor Co., a division of National Union Electric of Bloomington, Ill. As original equipment, Henney supplied twelve 6-volt lead-acid batteries to power the Kilowatt's General Electric series-wound dc motor. An Exide executive, Morrison McMullan, Jr., has been driving a Henney Kilowatt to and from work. It will hit 43 mph on level ground, but becomes sluggish on hills. In part, this is because the little car carries 900 pounds of Exide lead-acid batteries. But with only 300 pounds of Yardney silver-zinc batteries, a Kilowatt has lots of pep, even with four persons on board. The car with silver-zinc batteries has a top speed of 55 mph, and Yardney reports that it will run for 77 miles on one full charge, compared with 35 miles with lead-acid batteries. Unlike the lead-acid version, the silver-zinc version has room for even more batteries. This range and performance is adequate for a city car, but there is a flaw: Silver-zinc batteries are very expensive. The Kilowatt's set of Yardney batteries cost \$3600.

Further, since they can be recycled only about 150 times, they would have to be replaced at least twice a year if the car were used daily. While a little Renault that eats up over \$7000 in batteries each year seems something of an extravagance, Michel Yardney, president of the firm that bears his name, points out how economies can be

made. To start with, this adaptation from gasoline to electric operation is not efficient, he says. An electric car should be much lighter, and it should be built from the ground up as an electric. The batteries in his Kilowatt, he notes, were made for aircraft, not for cars. And \$1000 of their \$3600 cost is in the silver electrode, and is completely recoverable. When a set similar to these is designed for car use, he claims it would probably cost \$2800 and contain \$2000 in recoverable silver.

Yardney ventures that, since the batteries contain silver, they could serve as collateral for a loan. "When you buy the car," he says, "you could lease the silver from the bank" then the batteries would only cost \$800." He also believes that it may be possible to increase the number of times that the silver-zinc cells can be recycled.

Another possibility on the horizon is the use of zinc-air batteries. A number of firms, including Yardney's, have been investigating this high-density power source. General Dynamics' nearly completed 32-kW prototype could run a car very nicely. A zinc-air battery of the same 900-pound weight as the lead-acid battery in McMullan's Kilowatt should boost the car's range from 35 miles to at least 200 miles.

Yet a third solution may be somehow to use a lithium-paste electrode. Developed recently by Gulton Industries, the lithium-nickel-fluoride battery has a higher storable energy density than even silver-zinc. Like the zinc-air battery, the ma-



# OUR CUSTOMERS HAVE NEVER SEEN THE LIGHT

and the day they do will be the day we lose business

Rolling metals to uniform standards is a specialty. Rolling metals for ultra-thin gauge foils for photo etching, shims, strain gauges, honeycomb structures, capacitors, etc; and rolling them virtually free of pin holes is a dedication.

We, at Arnold Engineering have the dedication and capability of precision rolling more than fifty-five metals. We've already rolled alloys and metals as soft as copper to a "thinness" of 0.000069" — alloys as hard as

Type 302 stainless and Elgiloy to 0.0002" and less. All our mills, slitters and centerless grinding facilities are housed in a separate air conditioned filtered and pressurized clean room to minimize foreign particles which could cause pin holes in finished work. With dual source, non-contacting beta-ray gauges, we have held tolerances totalling 0.000017" on a week's run of .0011 ga. When you're ready to roll, give us the nod. We would like to show you how we can keep you in the dark.



**ARNOLD**

SPECIALISTS in MAGNETIC MATERIALS

THE ARNOLD ENGINEERING COMPANY, Main Office: MARENGO, ILL.  
BRANCH OFFICES and REPRESENTATIVES in PRINCIPAL CITIES

Speed Inquiry to Advertiser via Collect Night Letter  
ON READER-SERVICE CARD CIRCLE 9



**New from Sprague!**

# ISOLAYER<sup>\*</sup> DIFFERENTIAL AMPLIFIERS WITH DIELECTRIC ISOLATION



**$V_{BE}$  voltage differential down to 3 mV  
Tight beta matching · Low capacitance**

	UD-2118	UD-2119	UD-2120	UD-2121
$BV_{CEO}$	50V	50V	30V	30V
$h_{FE}$	@ 10 $\mu$ A	80	80	40
	@ 1 mA	150	150	100
$ V_{BE_1} - V_{BE_2} $	3mV	5mV	3mV	5mV
$\Delta  V_{BE_1} - V_{BE_2} $	5 $\mu$ V/ $^{\circ}$ C	10 $\mu$ V/ $^{\circ}$ C	5 $\mu$ V/ $^{\circ}$ C	10 $\mu$ V/ $^{\circ}$ C
$C_{ob}$	2pF	2pF	2pF	2pF

**Sprague Electric also makes a broad line of standard differential amplifiers, pairs, quads, and Darlington amplifiers**

\*trademark For complete information, write to Technical Literature Service,  
Sprague Electric Co., 347 Marshall St., North Adams, Mass. 01247

**SPRAGUE COMPONENTS**

- TRANSISTORS
- CAPACITORS
- RESISTORS
- INTEGRATED CIRCUITS
- THIN-FILM MICROCIRCUITS
- INTERFERENCE FILTERS
- PACKAGED COMPONENT ASSEMBLIES
- FUNCTIONAL DIGITAL CIRCUITS
- MAGNETIC COMPONENTS
- PULSE TRANSFORMERS
- CERAMIC-BASE PRINTED NETWORKS
- PULSE-FORMING NETWORKS



Sprague' and '2' are registered trademarks of the Sprague Electric Co.

NEWS

(electric car, *continued*)

materials of which it is made are inexpensive. The Applied Research Dept., of Globe Union Inc., is examining its usefulness for large electric vehicles.

And still a fourth possibility lies in a device that has aroused the interest of even the most pessimistic: the fuel cell. Supplied with hydrogen and oxygen, hydrazine or any one of many hydrocarbons, the fuel cell is quiet, efficient and its exhaust is non-toxic.

A team at the U.S. Army Engineer Research and Development Lab., Fort Belvoir, Va., is experimenting with two fuel cells for use in vehicles. One produces 5 kW with ordinary hydrocarbon fuel, but its limited power will run only a golf cart. (11.4 kW is needed to power a car that has a 15-hp motor.) Another cell produces 40 kW, but in a vehicle it would derive about the same mileage from its fuel (hydrazine at \$1.60 a pound) as the same vehicle equipped with an internal combustion engine would obtain from gasoline (at 3¢ a pound). Since

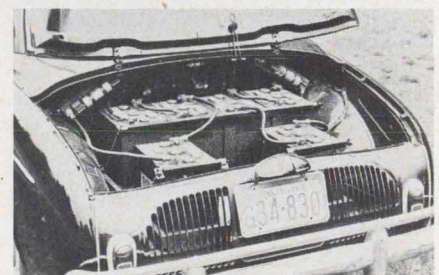

A Kilowatt's hood (above) and trunk (below) are filled with 900 pounds of lead-acid batteries. The car's range is only 35 miles.



hydrazine would probably never cost less than 25¢ a pound, even mass-produced, the hope for the fuel cell lies in increasing the efficiency and power of the hydrocarbon-fueled units.

### Controls combat back emf

Electric vehicles have always been slow. (One significant early exception was the Baker Torpedo Car, which in 1905 became one of the first cars to break 100 mph.) The electric auto's dc field-wound motor has high torque at low rpm, but as its speed increases—and its back emf also increases—the torque decreases. But the car needs more torque as its body encounters greater air resistance at higher speeds. This can be achieved by a variety of switching techniques.

In the Kilowatt, acceleration is controlled by a six-position floor pedal. Using mechanical relays, the pedal switches the batteries from parallel to series operation. This gives the motor lots of current at low voltage when, at low rpm, it needs torque for starting. Then as the motor's speed increases and a back emf starts inhibiting the cur-

rent flow, the batteries are hooked together in series. This increases the voltage across the motor to counter the back emf.

Similar considerations go into the design of the various solid-state control systems. In all the systems available, SCRs control the effective current to the motor with pulses (see diagram p. 18).

A Lansing Bagnall (English) industrial vehicle uses a solid-state control, which the Exide Co. is licensed to produce (see photos p. 21). In this control the pulse frequency determines the effective current. As the driver depresses the accelerator, the frequency is increased and the motor receives a higher effective current.

Allis-Chalmers, of Milwaukee, uses a different solid-state control in a small fork-lift truck. This control keeps the pulse frequency constant and varies the width of the pulse. The wider the pulse, the more current.

Another English firm, Cableform, Ltd., combines the two methods. The frequency is increased until "ON" time equals "OFF" time. Then the pulse is widened to decrease the "OFF" time further.

The most sophisticated control was designed by I-T-E Circuit Breaker Co., of Philadelphia, for a Post Office truck (see photo p. 21.) It uses two circuits: each controls the width of two synchronized pulses. In a simple, but elegant circuit, consisting of diodes and SCRs, the two pulses are fed to field windings of a dc motor. The field windings can be connected either in series with the armature winding or in parallel to it. The accelerator pedal simply adjusts the pulse widths. The SCRs and diodes connect the batteries in parallel or in series and the field windings in series or in parallel, respectively, to provide the proper torque at each speed. Transitions from series to parallel operation of the field windings and the battery are completely continuous and the operator enjoys the feel of a smooth response.

The remaining member of the drive system of the electric car, the dc motor, has been available for years from major manufacturers, such as General Electric, Westinghouse and Bendix.

An important advantage that the electric power train offers designers is freedom from the conventional

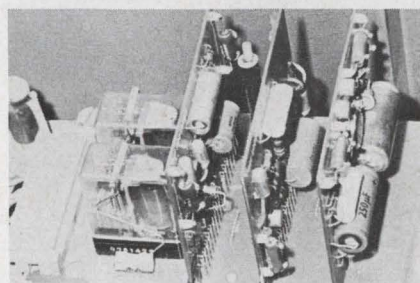

This Lansing Bagnall is driven by Pete Riggs (above), at the Exide plant. Exide has been licensed to make its solid-state controls (below).

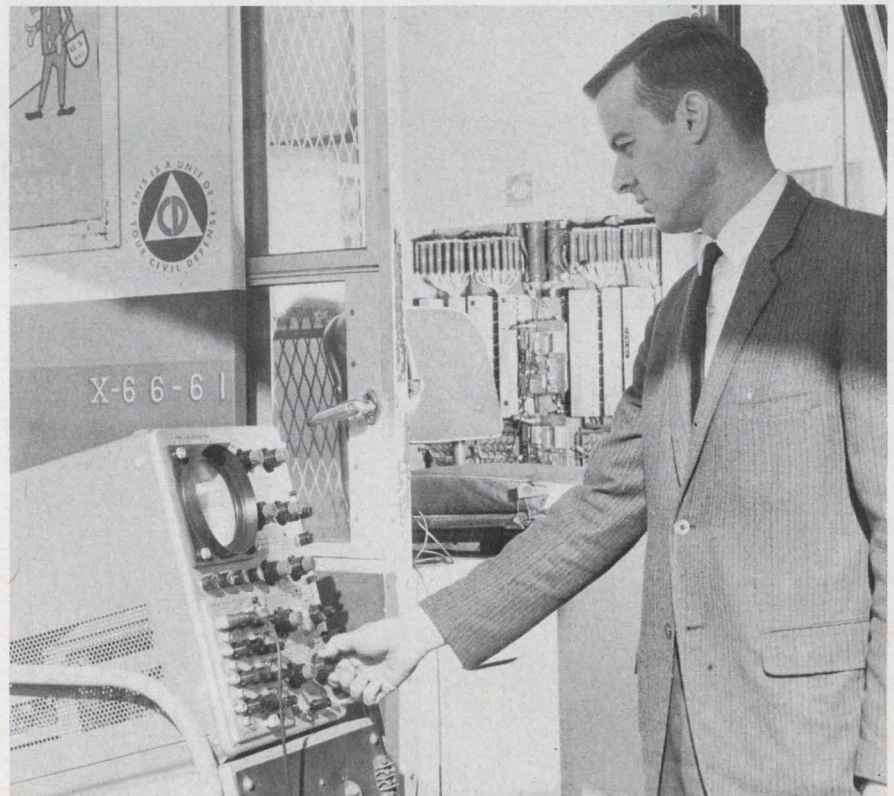

Electric vehicles can be tested easily with standard electronic test equipment. I-T-E Circuit Breaker Co. controls help the driver maneuver this big Post Office truck easily. Even these extremely sophisticated controls are quickly checked with an oscilloscope.



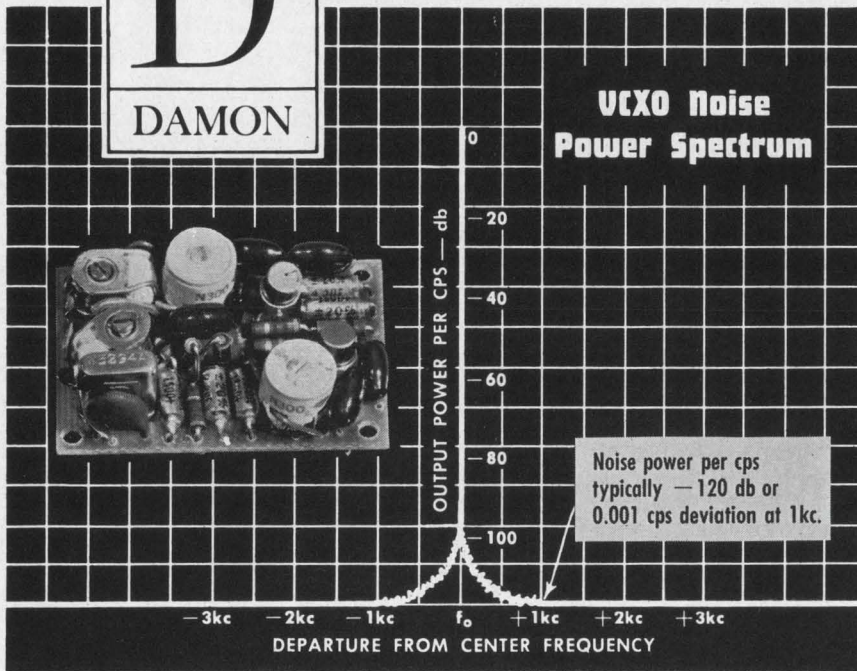

# Low Noise VCXOs (Voltage Controlled Crystal Oscillators)

## for an Important Reduction in Phase Jitter

Another FIRST from DAMON . . . Low Noise VCXOs with extremely low phase-jitter (—120 db or 0.001 cps deviation at 1kc.) This excellent short term stability is typified in the VCXO output spectrum illustrated, above.

Damon Low Noise VCXOs may now be inserted into systems as simple components with no auxiliary compensating circuitry. Only a source of power and a control signal are required.

Applications include: Doppler Radar (CW, CW-FM, FM and Pulse Doppler); Phase Locked Receivers and Transmitters; Doppler Simulation and Compensation; Frequency Synthesizers and other applications requiring electronic frequency control with crystal stability and extremely low phase jitter.

Write for Data on Low Noise VCXOs

**DAMON ENGINEERING, INC.**  
240 HIGHLAND AVENUE, NEEDHAM HEIGHTS 94, MASS.  
(617) 449-0800  
Speed Inquiry to Advertiser via Collect Night Letter  
ON READER-SERVICE CARD CIRCLE 11

## NEWS

(electric car, continued)

wheel-and-body configurations of gasoline-driven vehicles. The cells of the batteries, the sections of the control system, and even several small electric motors can be distributed in remote, but accessible, corners of the vehicle. Designers, unencumbered by the radiator-motor-transmission-differential sequence between four wheels, have already come up with some rather off-beat ideas.

W & E Vehicles, Ltd., of Shrewsbury, England, introduced a five-wheeled dairy truck in 1965. It has two sets of double wheels on the rear axle and a single wheel up front. The floor of the cab is flat and the front of the truck comes to a point. The dc motor is mounted in the middle of the rear axle.

The designer is not restricted to using one motor. Giant earth-moving machines use enormous rubber wheels, each of which contains a dc motor right in the hub. R. G. LeTourneau, Inc., of Longview, Tex., powers the separate motors with a diesel engine that drives a dc generator. A typical log-stacker develops 475 hp and, unladen, weighs 145,000 pounds.

The designer isn't even constrained to use dc motors. Lear-Siegler of Maple Heights, Ohio, has powered four wheels of a 2-1/2-ton six-wheel army truck with ac squirrel-cage induction motors. These motors have no brushes, and can deliver 200 hp each at 16,000 rpm. They are powered by a gasoline-engine-ac-generator set. The truck's speed is controlled by a frequency converter, and it will reach a maximum of 75 mph.

In view of the billions of dollars poured into development of the gasoline car, some wistful observers wonder where similar disbursements of capital could have placed the electric.

One fact is certain: Some early observers were a little too optimistic. Immediately following his invention of the nickel-iron battery in 1905, Thomas Alva Edison said to Walter Baker: "If you continue to produce your present quality of electric automobile, and I my present battery, the gas buggy industry won't stand a chance." ■ ■



## New missile testers measure accuracy

Two missile manufacturers recently unveiled new test facilities for optical guidance systems. Both use computers, and they simulate flight patterns as well as conditions that might impair the missile's ability to track a target.

One test system, installed in Orlando, Fla., by the Martin Co., uses an eight-ton model of terrain, scaled down 600-to-1. The model rides on rails, powered by a dc motor, and the entire landscape—complete with Hoover Dam, Boston Harbor and Vietnamese rice paddies—moves toward an optical-guidance sensor set in a test rig.

A "pilot" sitting in a cockpit can control the angle of the sensor by moving a stick. The sensor can turn through any angle in its gimbal. It can slide across the beam that supports it and swoop down with the beam toward any target on the terrain. All these movements enable the pilot and the computer to simulate a bombing mission, while the pilot observes whether the missile hits or misses its target.

Another simulation facility that tests how accurately a missile homing device stays on target has been developed by the Boeing Company.

The main elements of the electro-optical guidance simulator are a projection unit and screen, a precision zoom lens, a gimballed mirror, a three-axis table and a computer. A homing unit is placed in the carriage of the three-axis table, which can be programmed to simulate a missile's aerodynamic characteristics: roll, pitch and yaw.

A slide or movie representing the strike scene is projected by the zoom lens and gimballed mirror onto the screen. The homing unit sees this as the target. As the simulated run starts, the lens zooms in on the slide, magnifying its details up to 50 times. When the zoom lens stops, the computer reads out the final position of the homing device in number of feet from the center of the target. For a target the size of a truck, the 50-to-1 ratio of the zoom lens permits a simulated run by a missile that starts 15,000 feet from the strike zone and ends just 300 feet short. ■ ■

*basic measuring tools from*

**HEWLETT  
PACKARD**



### *Field-proven hp 200CD Wide-range Oscillator*

Accurate test signals, 5 Hz to 600 kHz  
Balanced output, better than 1% over entire range  
10 volts output into 600 ohms, 20 volts open circuit  
Distortion less than 0.2% below 200 kHz

#### *Use it for:*

Lab work, subsonic to radio frequencies  
Source for testing servo, vibration systems  
Testing medical and geophysical equipment  
Checking audio amplifiers, circuits and transducers  
Testing sonar and ultrasonic apparatus  
Checking carrier telephone systems, video frequency circuits,  
low radio frequency equipment

Here is a true standard of the industry. Small and compact, the 200CD was designed for extreme ease of use. Waveform purity is retained even with loads of a few ohms. Output balance is better than 0.1% at lower frequencies and approximately 1% at high frequencies. A nominal source impedance of 600 ohms makes it suitable for both audio and carrier applications. Price: 200CD (cabinet), \$195; 200CDR (rack mount), \$200.

A special low-distortion model, the H20-200CD, also is available. Distortion

is 0.06% or less, 60 Hz to 50 kHz; 0.1% or less, 50 kHz to 400 kHz; 0.5%, 5 Hz to 600 kHz. Output is 7.5 volts into 600 ohms. Price: H20-200 CD (cabinet), \$245; H20-200 CDR (rack mount), \$250.

Ask your Hewlett-Packard field engineer for a demonstration of these oscillators or write for complete information: Hewlett-Packard, Palo Alto, Calif. 94304, Tel. (415) 326-7000; Europe: 54 Route des Acacias, Geneva.

*Data subject to change without notice.  
Prices f.o.b. factory.*

**HEWLETT  PACKARD**  
*An extra measure of quality*

1042



ON READER-SERVICE CARD CIRCLE 12



# The great film debate: thick vs thin

## Panelists at components conference stir wide interest in a battle of pros and cons

**Rene Colen**  
Microelectronics Editor

Thick film or thin film?

That was the question at an evening panel discussion at the 1966 Electronic Components Conference in Washington, D.C. this month. Judging by the hundreds who attended and expressed views, it is a question in the minds of many electronic engineers and managers in the country.

Thin films are generally defined as vacuum-deposited types that are under 10,000 Å thick. Thick films are defined as those that are more than 10,000 Å thick, usually deposited by a "simple" process, such as silk screening.

Robert Berry, supervisor of the Thin Film Circuits Group, Bell Telephone Laboratories, began the discussion by pointing out that it would be simple to decide whether to use thick or thin films if one had only to produce circuits with loose tolerances. However, he noted, most circuit demands are for precise component values and good aging qualities, and these are only attainable with thin-film components. Furthermore, Berry pointed out, the cost of active semiconductor devices, either monolithic or discrete, varies directly with the area of silicon that is used. He said that by using thin-film conductors, which can be spaced as close as 7 mils on center, the designer can make the bonding pads on the silicon chips smaller, thus reducing costs.

Though thick films can be used sometimes, Berry said, thin-film applications predominate and there is no need to establish facilities to make both types.

John Sprague, vice president of research and development for the Sprague Electric Co., supported Berry by pointing out some of the advantages of thin-films. For one thing, he contended, thin-film capacitors can be made as large as 1  $\mu\text{F}/\text{in.}^2$ , whereas thick-film capaci-

tors are limited to 0.1  $\mu\text{F}/\text{in.}^2$ , at best. Also, Sprague said, thin-film circuits are better suited for coupling to semiconductor devices, either in the flip chip configuration or directly deposited on the active substrates.

Speaking in favor of thick films, G. Selvin, manager of the Microelectronics Group at Sylvania Electric Products, Inc., pointed out that until last year he had been a strong proponent of thin films, but after taking a hard look at the market, his company has decided to make thick-film circuits.

Selvin listed these advantages of thick-film circuits: low investment, low operating costs, high reliability, high resistance value, high volume capabilities. He said that—after performance and size—cost was the factor that influenced choice. Thick films are cheaper.

In answering one criticism of thick-film circuits (Selvin prefers to call them "screen and fire" circuits); the Sylvania manager pointed out that conductor patterns with only a 3.5-mil separation had been made at Sylvania. He also showed and described a thick-film multilayered interconnection board that he said was less expensive than the more widely used plastic multilayer boards.

The chairman of the panel session, John O'Connell, manager, Microelectronics, ITT Federal Labs., spoke in favor of thick films and supported Selvin's arguments.

### Papers show the trend

Of the 50 papers presented at the conference, almost half dealt directly or indirectly with the thick- and thin-film technologies; the remaining ones were concerned with resistors, capacitors, inductors and other discrete components.

Stephen Markoe of Univac (Sperry Rand Corp.), presented a paper on "Face-Down Bonding of Monolithic Integrated Circuit Logic Ar-

rays." The technique used has these major advantages:

- Instead of attaching "solder balls" to the IC chips, as is customary in most flip-chip circuits, the designer forms aluminum islands on the substrate to match the bonding pads of the IC devices. This allows the use of the standard chips, without modifications, provided by semiconductor manufacturers.

- An ultrasonic bonder is used, instead of the more common thermo-compression bonders. By varying the bonding pressure, the designer can remove the chips by twisting, without damage to either the substrate or the chips. With an increase in the bonding pressure, the chips can be bonded so tightly that removal would cause breakage of the substrate lands.

- A glass substrate is used that permits a simple, visual method for aligning the chip to the substrate, without resort to the more sophisticated optical systems now being marketed for flip-chip bonding operations.

The entire development was undertaken to develop logic processors consisting of up-to-200 active chips per circuit, with requirements for minimum propagation delay and signal distortion. The final integrated circuit version operated 25% faster than an equivalent version built in TO-5 cans.

Another application report, by Dr. James O'Connell of ITT Federal Labs., discussed in part the use of thick-film circuits in the PICO II Microwave Terminal, a microwave transmitter-receiver. Except for the microwave-frequency front end and the power supplies, all the circuitry in this system is placed in standardized thick-film modules. The thick-film circuits themselves are all manufactured by the same process. Of interest is the fact that discrete capacitors and resistors are used to achieve operating characteristics that would otherwise have been unattainable at low cost. The unit, operating from 7.125 to 8.5 GHz with an output power of 125 mW, weighs 17 pounds and measures 13 by 13 by 7 inches. ■ ■



# Degrees and Minutes

Not angles. Temperature. Time. Wherever more accurate, more sophisticated high speed time-control devices are called for, as in critical process control applications, the new HAYDON QT Solid State Delay/Interval Timer is meeting the demands of design engineers. Completely interchangeable and compatible with the full line of HAYDON Panel Mounted electromechanical timers, the QT Solid State Timer assures such important advantages as accuracy specified at set value rather than full scale, and absolutely dependable accuracy at constant voltage and temperature. Unlike unijunction transistor and thyatron-controlled units, interruptions of timing do not cause momentary closing of relay contacts with resultant shortening of the next time interval.

As specialists in timing and application skills, HAYDON engineers are at your call—ready to assist you with any time problem. To put HAYDON and time to work circle the number on the card, phone or write today.

## Important Features

- Completely new approach to Solid State timing circuit design.
- Fully compatible with all HAYDON Panel Mounted timers. Complete interchangeability with other HAYDON units.
- Life expectancy 10 million mechanical operations.
- Voltages: 20VDC; 117,230 VAC, 50/60 cps. Power requirements approximately 3 watts.
- Comparatively insensitive to shock and vibration. Compensates for voltage variations.
- Not damaged by X-ray radiation or voltage spikes.
- Instantaneous reset even within a timing cycle. Repeat accuracy for Delay/Interval Timers is specified as "percent of set value" rather than the more customary "percent of full scale" with the resulting user benefit.
- Delay/Interval Timer; Full Scale—30 sec. maximum. Repeat accuracy  $\pm 2\%$  of set value above 1 sec for temp range of  $0^\circ$  to  $60^\circ\text{C}$ , & operating line voltage within  $\pm 10\%$  of rated value.

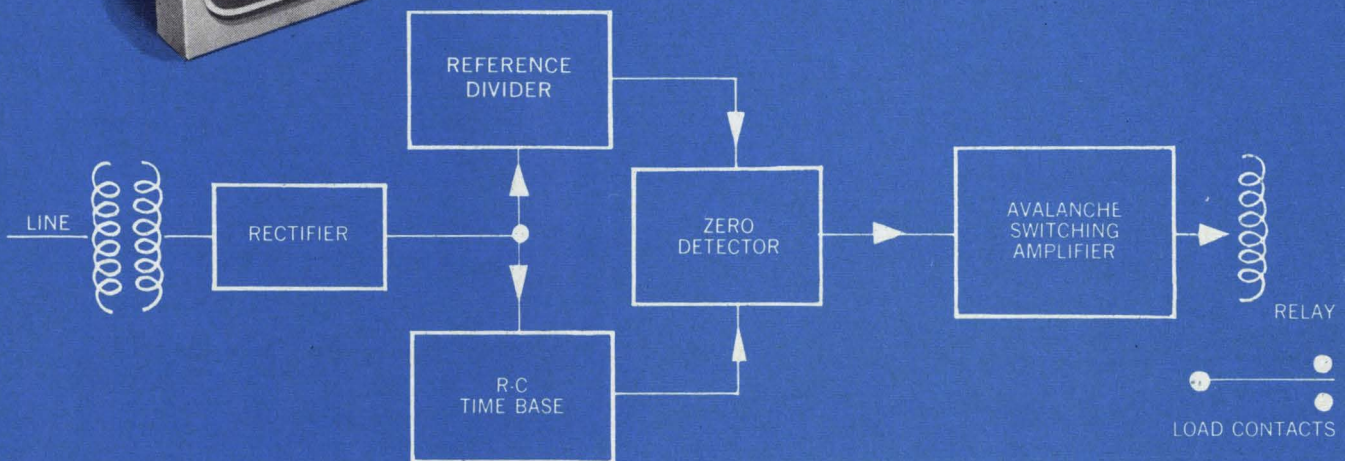
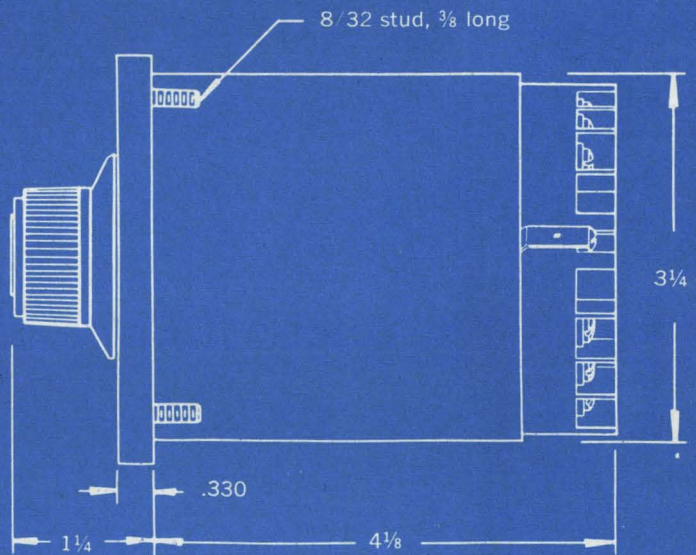
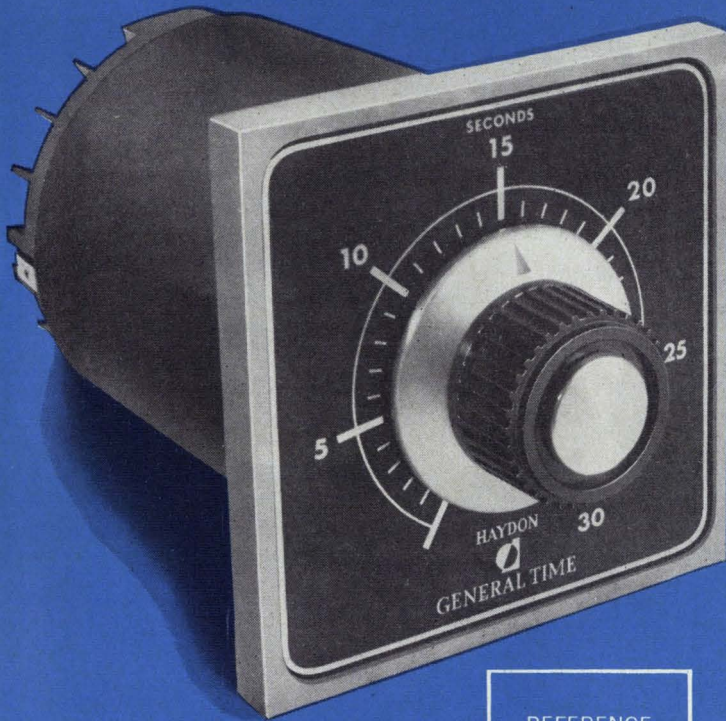



# Simple optical radar said to top laser

## Brilliant, non-coherent nanosecond flashes emitted by system are effective for short-distance ranging

Neil Sclater

East Coast Editor

A new short-range optical radar system with a transmitter that looks and fires like spark plug is reported to have many advantages over laser optical radars.

The non-coherent, light-ranging concept, called the Nanolite, was demonstrated by its inventor, Dr. Heinz Fischer, at the Air Force Cambridge Research Laboratories, Bedford, Mass. It generates extremely intense flashes with pulse lengths measurable in billionths of a second, which are obtained by charging and discharging a special low-inductance capacitor.

The sharply defined pulses are focused on nearby targets of unknown range. As in conventional microwave radar, delay time between the pulses permits the light echoes to return and be detected. Accuracies within inches have been obtained in the range determination of targets approximately 100 feet from the set. Dr. Fischer states that the system is more practical, simpler and capable of producing higher light-pulse-repetition rates than laser optical radars.

The most important element of the Nanolite is its coaxial capacitor, which Dr. Fischer designed. Its ability to charge and discharge up to 10,000 times a second is due to the virtual absence of inductance. Consequently, extremely sharp rise and decay times are possible. The physicist said the time elements are difficult to measure but he estimated the charge-discharge action at more than 10 times faster than that obtainable from a conventional capacitor of equivalent value.

Powered by a light, portable battery, the unit needs no complex circuitry to achieve its rapid flashing. This is because of its self-pulsing

or free-firing ability.

The eye integrates the flashes so that they appear as a bright, bluish arc. Dr. Fischer says the flashes are about a million times brighter than they appear. In fact, the individual pulses have an intensity in excess of 30 million candles per square centimeter. The radiation forms a continuous spectrum extending well into the ultraviolet region.

Current densities in excess of 10 million amperes per square centimeter at 500 to 1000 volts produce this illumination level. But because of the short duration of the flashes, electrode heating and erosion are no problem. No cryogenic or forced cooling is needed anywhere in the system.

Each time the capacitor discharges, flashing an arc, an electrical signal is sent from the Nanolite to trigger an oscilloscope time base. Correlation between the trigger pulse and the return of the de-

tected energy establish the timing, and hence the distance.

A practical, portable optical radar set based on the Nanolite would require a receiver and timing device to translate light-pulse travel time into distance. So far Dr. Fischer has given little time to perfecting such a receiver. His experimental receiver is a standard laboratory oscilloscope coupled to a photomultiplier. He believes, however, that the necessary circuitry for obtaining meaningful ranging and detection data could be built into a simple, lightweight package that would be as relatively inexpensive as the Nanolite itself.

The light source of the system has already been used to pulse semiconductor lasers and to illuminate rapidly moving objects for high-speed photography. Dr. Fischer foresees further application as an aircraft or spacecraft landing aid.

Dr. Fischer divides his time between the Bedford laboratories and the Technical University in Darmstadt, West Germany, where he is Professor of Applied Physics. ■ ■



**Optical radar transmitter** electrodes under examination by the system's inventor, Dr. Heinz Fischer of the Air Force Cambridge Research Laboratories. The system is said to be superior to the laser for short-distance ranging. The lens shown at left focuses the light to increase range.



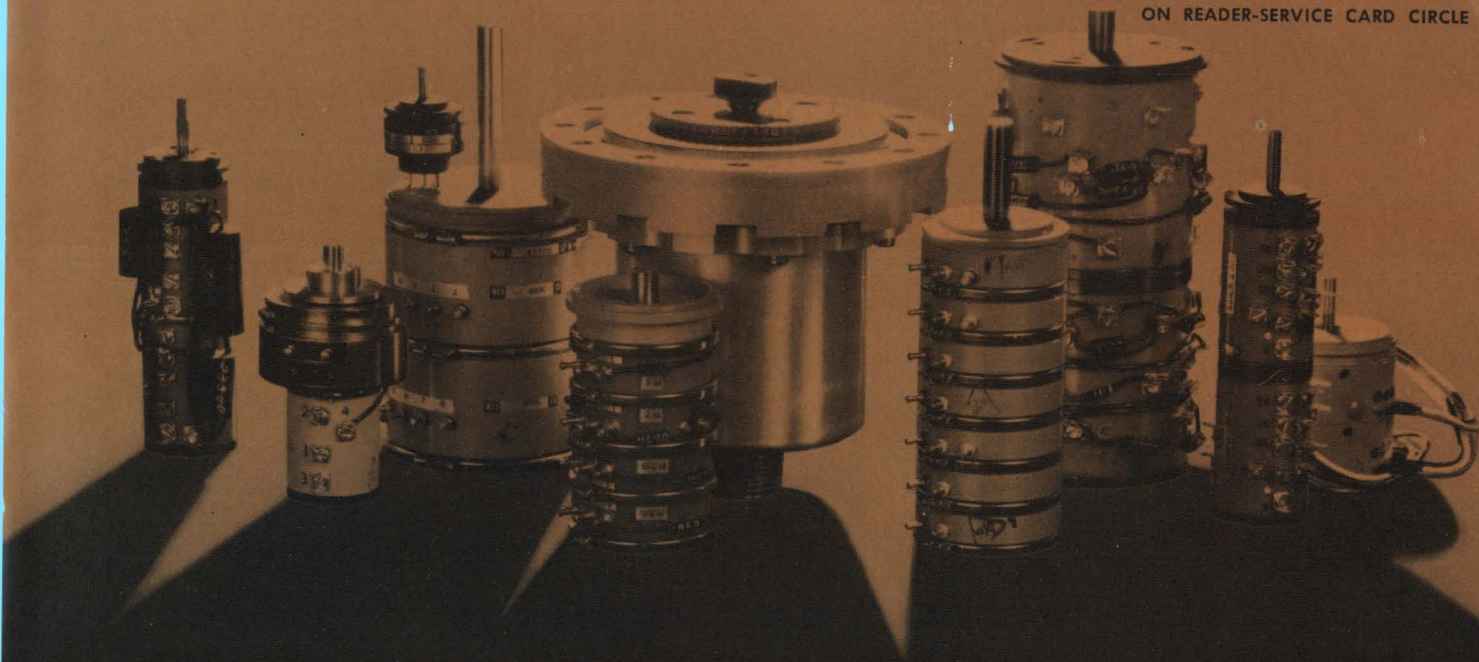

## Preposterous Pots? You bet!

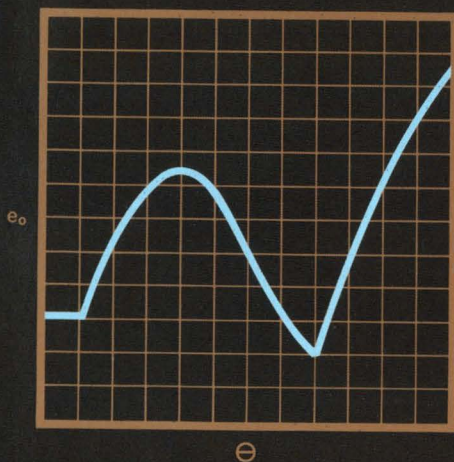

Send us your most impossible non-linear functions. We'll build a pot to them or you can be sure it can't be done! We have a well-earned reputation for extraordinary responsiveness to customer requirements, and our technical capabilities and manufacturing facilities are unsurpassed by anyone else in the industry.

Who else uses an in-house digital computer exclusively to calculate the winding of non-linear pots? This not only saves time, but it provides full digital accuracy in the manufacture of the finished product.

To put it simply: "What is impossible for others, we often do routinely." So if you have a non-linear requirement, send for our "Pot Specifier's Checklist."

Here are just a few more reasons why Spectrol is first in the design and manufacture of non-linear precision pots:

1. We will provide any kind of special function, from the most conventional to the most sophisticated, in pot configurations to meet customer requirements.
2. We also have the broadest variety of pre-calculated non-linear functions that can be produced readily in standard pot configurations.
3. And, since the proof is in the pudding, you will find that Spectrol precision pots are on more systems throughout the world than any other pots.

**SPECTROL ELECTRONICS CORPORATION**  
17070 EAST GALE AVENUE CITY OF INDUSTRY, CALIFORNIA 91745

**spectrol**





### ■ COUNT 'EM! WHY SHOULD YOUR NUMERICAL READOUT CIRCUITS USE MORE COMPONENTS?

After all, why waste money? The more components you use, the more your readout circuits cost.

Both binary-to-decimal circuits shown in Figures 1 and 2 will not only reduce your component counts and circuit costs, but will also provide the gain necessary to drive, directly, the lamps in the readout.

Take the Figure 1 circuit—a standard decoder with transistor drivers on the output. This circuit not only drives the incandescent lamps, but is excel-

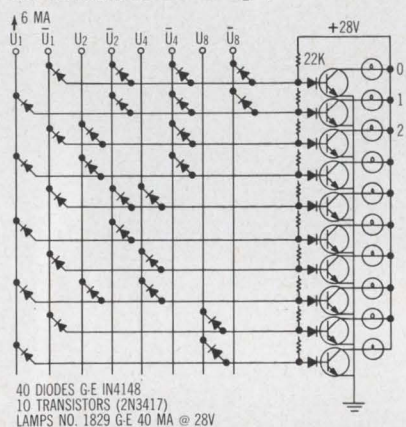

Fig. 1. Binary-to-decimal converter with drivers

lent wherever projection-type displays are needed. Use a 2N3877A transistor in it and you'll find you can also use such high voltage indicators as gas-filled, cold cathode numerical types. The Figure 2 circuit, meanwhile, is designed for incandescent lamps specifically. You'll find it a bit different in that its transistor matrix permits the transistor to do both the amplifier and the logic job required. But you need far less input current with this circuit to drive the same size lamp shown in Figure 1. Each input turns on only one transistor.

Studying applications where the readout device is driven from a counter? Try the circuit shown in Figure 3. The key to component reduction, here, lies in the economical ring counter

requiring only one active device per stage. Used to drive 250 milliamper lamps, this circuit delivers outstanding

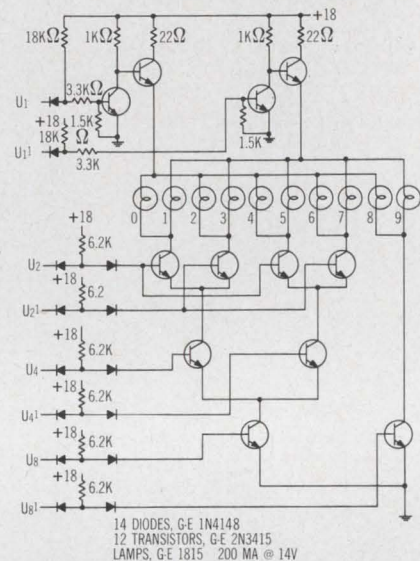

Fig. 2. Binary-to-decimal decoder drivers

savings through its use of both a G-E 2N3403 economy transistor and G-E C106 low-cost SCR. Try it. You'll find its maximum repetition rate is even

greater than 2 kilohertz and that it will operate even with the lamp burned out.

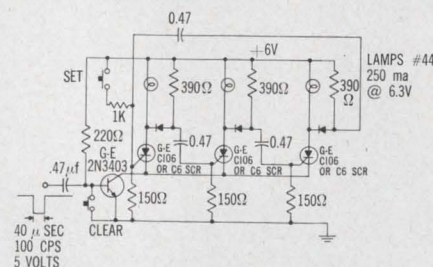

Fig. 3. High current ring counter

Circle Number 811 on the Reader's Service Card if you're interested in any of these, or any other, recent G-E readout circuit developments. They're just one more example of General Electric's total electronic capability. Or ask your G-E engineer/salesman or distributor for more information or write to General Electric Company, Schenectady, New York. In Canada: Canadian General Electric, 189 Dufferin St., Toronto, Ontario. Export: Electronic Component Sales, IGE Export Division, 159 Madison Ave., New York, N. Y. 10016.

### HOT OFF THE PRESSES

Are you taking advantage of all our latest free bulletins? Specification sheets, application notes, conference papers, brochures and other useful materials... all are yours just for the asking. Try any of these, for example:

- Using the Triac for Control of AC Power—Jim Galloway. How to simplify many of your newest circuits with General Electric TRIAC's. Circle Number 812.
- Progress Report on Solid State Appliance Controls—John Mungenast. Word-for-word reprint of John's well-received paper presented at the 1965 IEEE Los Angeles Conference. Circle Number 813.
- Seminar Notes 671.3—Rick Spofford, Bob Muth, Dwight Jones. Latest circuits and application information on the new SBS and SUS, visual readouts,

timers and low-frequency oscillators. Circle Number 814.

A Low-cost, Ultrasonic-frequency Inverter Using a Single SCR—Neville Mapham. A simplified, new high frequency inverter circuit with good load regulation, even with reactive loads. Circle Number 815.

Using the Silicon Bilateral/Unilateral Switch—Bob Muth. Reprinted exactly as it originally appeared in the March, 1966 issue of EEE. Circle Number 816.

Full Line Bulletin on G.E.'s Complete Line of Semiconductor Products. Circle Number 817.

Circle the Reader's Service Card number indicated or check those you'd like on this coupon and mail it, together with your business card, to General Electric Company, Section 220-31, Schenectady, New York 12305.





Tower of Babel?

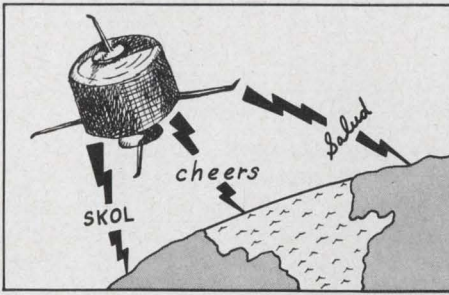

# Washington Report

S. DAVID PURSGLOVE,  
WASHINGTON EDITOR

## Communications satellites cause concern

Communications satellites have become the latest international bone of contention. They could become the Space Age's Towers of Babel, or merely new instruments of cold-war propaganda for use against enemy or supposed ally alike and provoking the same defensive reactions that a poised nuclear warhead would.

This latter, grim picture of the future—some would say the very near future—has aroused serious concern in certain White House offices, at the State Department, at the Agency for International Development, even in the purely domestic Department of Health, Education and Welfare. And this worry has not been lost on such firms as Comsat, AT&T, Hughes Aircraft Company and their European equivalents like Eurovision and Hawker Siddeley.

U.S. and European government officials have for some time publicly owned to low-level concern over the propaganda potential of comsats and have realized that the use of them for education in underdeveloped areas would require widespread prior agreement. Now the growing list of political worries is being further complicated by technical considerations.

The recent American Institute of Aeronautics and Astronautics Conference on satellite systems provided a forum for sounding off about both the technical and political difficulties. Views expressed there have sent government officials into hasty huddles to draft plans that almost deserve the label "emergency."

One of the loudest warnings came from an expert on geopolitical and legal matters. Columbia University law professor Richard N. Gardner, a former Deputy Assistant Secretary of State, voiced alarm at the proliferation of budding systems for direct broadcasts into the home by way of comsats. The United States, he warned, had "better take the leadership to forestall attempts to develop a number of competing systems" in Europe. The only alternative, he said, would be to "foreclose direct broadcasts altogether."

France, Britain and a number of other nations are talking of developing their own and European communication-satellite systems. At

the same time, other nations are talking of prohibiting direct broadcasts. A Swedish member of a UNESCO panel recently proposed that United Nations members should have veto power over direct broadcasts if they should offend so much as a single member. Washington has interpreted this to mean that the U.S.S.R. or, later, China could veto an agreement where, for instance, the U.S. undertook to supply educational broadcasts direct to schools or homes in India or an African nation.

Africa, above all, is seen as a comsat battleground. Internal communications there are primitive and most African states cannot afford the cost of introducing modern telecommunications. Agency for International Development experts have already proved that low-cost television sets in villages and schools can supplement, even replace, teachers in many cases. Worried State and A.I.D. officials say that whoever gets to Africa first with those TV sets and sets up the direct comsat system to feed them will control the continent.

Propaganda aside, comsat service to Africa poses technical problems. Two AIAA conference speakers from Hawker Siddeley Dynamics, Ltd., noted that only six to 12 channels would be needed for several years to serve most of the African nations. G.K.C. Pardoe and L.W. Steines contended that if comsat systems are to serve such areas, they must be designed for multiple access. For this the satellite has to act as a central processing point for information received from a number of transmitters. Ideally, the satellite transponder should retransmit this information to receivers at selected earth stations. The problem is then further compounded, Pardoe and Steines pointed out, when different forms of traffic, especially TV, are taken into account.

## Electronics to battle water pollution

Not to be outdone in its role in the battle against air pollution, the electronic industry is now moving into the water pollution control field. The industry will be offering equipment in a wide price range for monitoring pollution levels. The market will be good, thanks to a new Federal requirement that state and local governments must act by the middle of next



# Washington Report

CONTINUED

year to clean up interstate streams and lakes. Public Health Service officials point out that almost every manufacturing plant that faces onto water will need such equipment.

A pilot project on the Potomac near Washington will employ 10 monitoring stations to sample, analyze, record and transmit data on dissolved oxygen, temperature, chlorides, turbidity, acidity and conductivity. The stations will incorporate light sensors, electrodes and transducers. Each will cost about \$15,000 and be linked by leased lines to a \$25,000 central station in Washington, where tapes will be cut for storage and print-out. Variations for use by cities and manufacturing plants are becoming available at prices ranging from \$350 to more than \$100,000.

## NASA to review observatory satellites

A five-man board has been established by NASA to conduct a broad review of the agency's observatory-class Earth satellites. The board will attempt to determine why these heavy satellites have been considerably less than a resounding success.

## N.I.H. commends microelectronics

The National Institute of Health has boosted the potential role of microelectronics in medical research. The huge Government medical research complex, embodying the National Cancer Institute, National Heart Institute, National Institute of Mental Health and others, has formally asked for the electronic industry's aid in developing applications. The N.I.H. Special Research Resources Branch recently published a request for proposals of ways for the industry to give its "assistance in the development and utilization of advances in microelectronics devices for biomedical research."

N.I.H. wants contractors to develop models of complete packages small enough to be implanted in animals or humans for research or therapy. The devices would probably have to be encapsulated, an official said, adding that hopefully they would replace, augment or inhibit specific glandular, muscular or nervous organs "to make feasible a new area of research and therapy."

The thought behind the request, the official said, was "recognition at N.I.H. that microelectronics has developed to a stage where complete instrumentation packages—including sensing, logical processing of the signal and

production of a control and monitoring signal—can be constructed for biomedical research purposes."

## "NASA needs an inspector general"

An office of "Inspector General" should be set up in the National Aeronautics and Space Administration with a staff specially to watch over spending. This proposal was contained in a minority report—surprisingly well supported by the majority—by the House Committee on Science and Astronautics. It was submitted as part of Committee's formal report authorizing NASA spending for fiscal 1967. The minority report, which had the backing even of several staunch NASA partisans, was largely the handiwork of Pennsylvania Republican James G. Fulton. It contends that in NASA "almost nothing is being done today to see that the bookkeeping is straight, not enough in view of the huge amounts passing through NASA."

The report also restates "the failure of NASA to follow the Congressional directive concerning the need for greater geographical distribution of research contracts."

## Engineer volunteers sought

The Volunteers for International Technical Assistance is seeking engineers and scientists willing to give of their skills—at home—to various technical assistance programs around the world. The organization would match volunteers and their engineering specialties to specific projects in developing countries. Interested engineers may obtain further information from VITA, Inc., 230 State St., Schenectady, N. Y. 12305.

## P.O. makes major electronics awards

The Post Office Department has chosen to announce its biggest electronic automation contracts to date at the height of Congressional hearings into why the Department has not moved more rapidly on automation. Contracts totaling \$26 million, largely for data-processing equipment, went to Control Data Corporation, Honeywell Corporation and Hardy Scale Company of Ogden, Utah. All delivered goods will become part of what the P. O. has been billing as "the largest electronic source-data complex in the world."

Control Data will receive \$22.7 million for new source-data equipment to be installed in 75 post offices and several central data-processing offices. Included in the contract is the \$4.5 million Hardy subcontract for electronic scales. Honeywell gets \$3.3 million for new equipment to replace data-processing systems now in use in the six postal data centers and at P.O. headquarters.



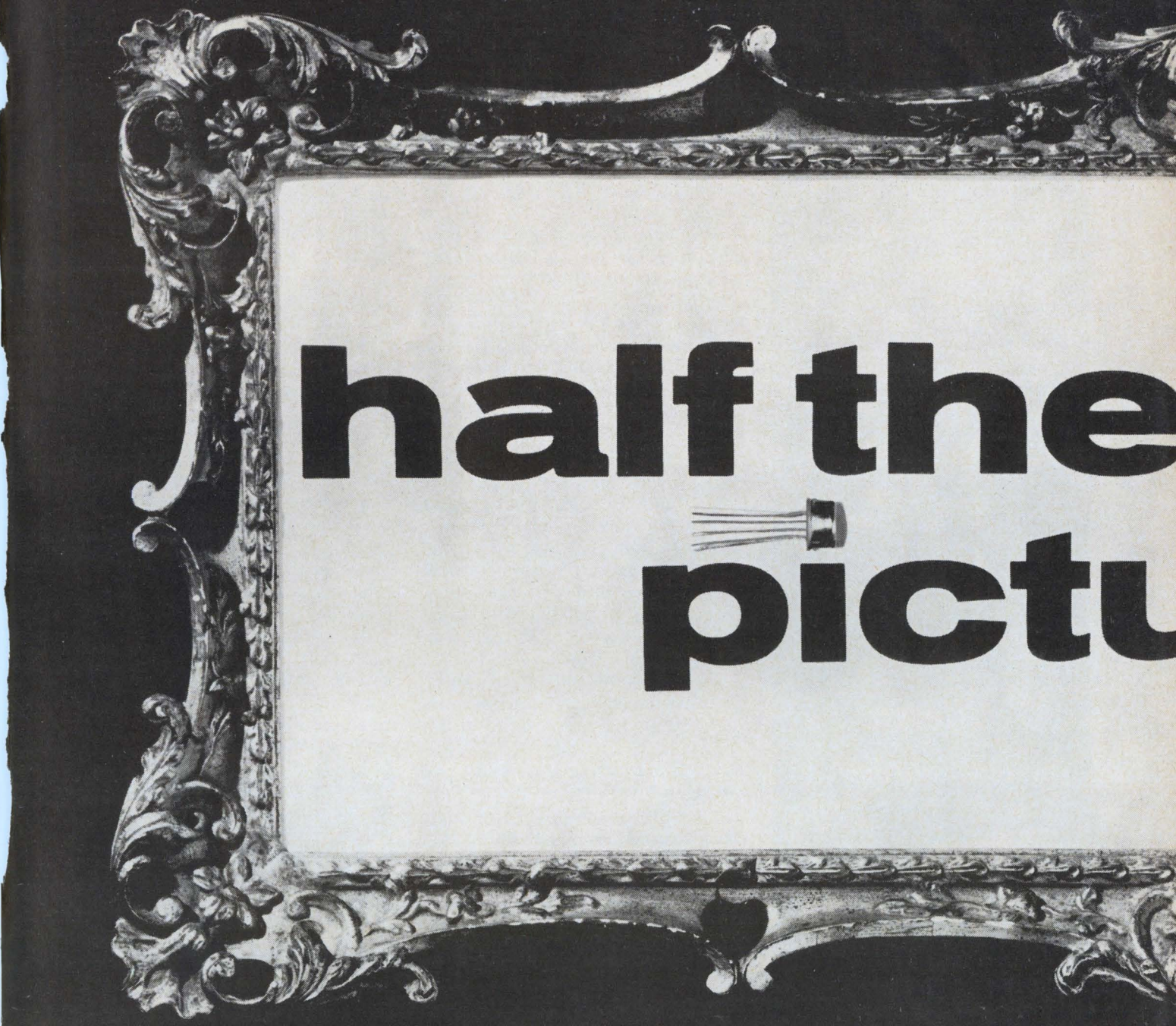

# half the picture

## *When you look at electronic components are you seeing only half the picture?*

We're the last people to argue with component purchasers who put performance, price and delivery first — meeting these three basic requirements is what keeps us in business. But most engineers are also on the lookout for something more, and many of them find it at Mullard.

Take research and development for instance. Out of Mullard R&D have come outstanding devices such as the travelling wave tubes for the New York — San Francisco and Montreal — Vancouver microwave links. Production resources? Mullard

plants are among the most efficient anywhere, with a reputation for the production of tight-tolerance devices to proved standards of reliability. As for circuit know-how, Mullard has the best equipped applications laboratories in Britain. And when it comes to technical services, you will find that Mullard provides the kind of comprehensive performance specs, survey documents and application reports that are just that much more useful.

If you want to get the *whole* picture, why not ask us to help you with some of your component problems?

ON READER-SERVICE CARD CIRCLE 215

DIODES · TRANSISTORS · PHOTO-DEVICES AND RADIATION DETECTORS · RECTIFIER DIODES AND STACKS · THYRISTORS AND STACKS · INTEGRATED CIRCUITS · CATHODE RAY TUBES · RECEIVING TUBES · ELECTRON OPTICAL DEVICES · PHOTSENSITIVE DEVICES · COLD CATHODE DEVICES · POWER DEVICES · TRANSMITTING TUBES · MICROWAVE DEVICES · CAPACITORS · FERRITE MATERIALS AND ASSEMBLIES · COMPUTER COMPONENTS AND ASSEMBLIES · MAGNETIC MATERIALS · SPECIAL PURPOSE MAGNETS · VACUUM DEVICES · WOUND COMPONENTS.

# Mullard

*where the product is only part of the deal*

MULLARD LIMITED · TORRINGTON PLACE · LONDON WC1 · ENGLAND



# System transmits documents by telephone

"Hello, operator? I just got the wrong picture."

It's not likely that you'll ever have to say this to a telephone operator, but the capability is now there. Pictures and printed matter are being transmitted by telephone.

The new development is a facsimile transceiver, built by the Magnavox Co. and marketed by the Xerox Corp. It transmits and receives over normal telephone lines.

The Xerox Magnafax Telecopier, as the device is called, prints at a rate of 1.875 inches a minute, which means that a full 8-1/2-by-11-inch document can be transmitted in about six minutes. Its scan rate of 180 lines a minute corresponds to a scan density of 96 lines per inch. This provides acceptable resolution even for photographs.

The Telecopier consists of a basic unit and an associated acoustic cradle. The document or picture to be transmitted is inserted into the sender's machine, and a carbon paper, called a Telecopy, is put into the receiver's machine. The telephone hand-sets of both sender and receiver are placed in their respective acoustic cradles, and a button is pressed to begin transmission.

The material in the transmitting unit is illuminated and scanned by an optical scanning mechanism. The

varying amounts of reflected light are focused and passed through a rotating chopper to a photocell. The photocell output is amplified and then converted to an FM audible signal, which is transmitted over the telephone lines.

At the receiving end the signal is converted back into a varying dc voltage that drives a stylus printing mechanism. Synchronization between the sending and receiving units is accomplished during the first 15 seconds of operation by a transmitted signal, which positions the printing stylus for the beginning of the message. The scan and print drive motors are then kept synchronized by their own crystal-controlled oscillators.

As with other Xerox-marketed equipment, the Telecopier initially will be leased. The meter operates only when the unit is sending or receiving a document. ■ ■

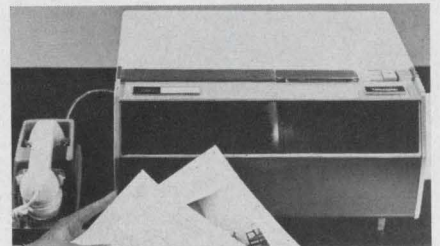

Telecopier unit weighs only 46 pounds. Its acoustic cradle is shown at the left.

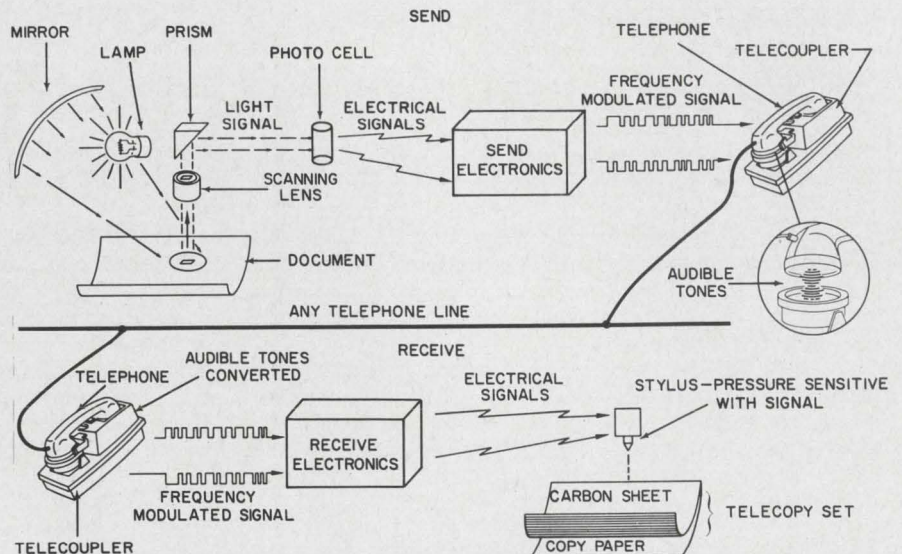

Audible signals that correspond to the black-and-white variations on the document being sent are produced by the transmitting unit. The receiving unit converts these to movement of the printing stylus.

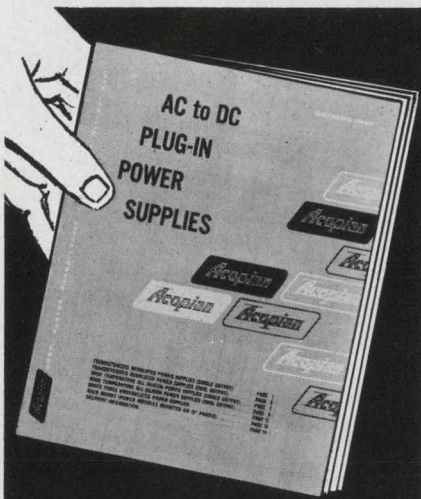

with this catalog  
you can  
choose  
from  
62,000  
different  
power supplies...

all available  
for shipment  
in  
3 DAYS!

Write for  
your copy today to  
Acopian Corp.  
Easton, Pennsylvania  
or telephone  
(215) 258-6149.





**DISCOVER** *what your circuit is really doing in the 1-1000 MHz Range*



*Add full 360° range and 0.1° resolution phase information to your design data with the*

## **NEW HEWLETT-PACKARD** **8405A VECTOR VOLTMETER**

For the performance achieved, the time saved and the convenience gained, no electronic designer can afford to be without this unique new wideband RF millivoltmeter/phase meter. The 8405A, which replaces complex combinations of instruments and systems, is so easy to use that it will find application on both the production line and the lab bench.

The 8405A reads voltage with each of two pencil-size high-impedance probes and it simultaneously and directly reads phase angle between the two. Having both the voltage and phase information allows you to define completely all the network parameters needed to optimize your design.

The 8405A automatically tunes to the signal when a single knob is set anywhere within an octave of the operating frequency. The voltmeter searches and phase-locks to the signal at the first probe in 10 msec. Tuned bandwidth is 1 kHz, eliminating unwanted harmonics or other signals which would affect accuracy in gain and phase measurements.

Maximum input to either channel is 10 v, and phase measurement range is  $\pm 180^\circ$  with a  $\pm 6^\circ$  end scale maximum sensitivity. A phase offset control, in precise  $10^\circ$  steps, permits resolution to  $0.1^\circ$ .

The RF signals under measurement are converted to 20 kHz waveforms which are identical to the RF in amplitude, waveshape and phase relationship. The 20 kHz outputs from each channel of the 8405A Vector Voltmeter are available for use with conventional low frequency instruments such as oscilloscopes or wave analyzers, resulting in important new measurement convenience in the 1-1000 MHz frequency range.

**HEWLETT**  **PACKARD**  
*An extra measure of quality*

*Turn the page for brief specifications*



# BRIEF SPECIFICATIONS Hewlett-Packard 8405A Vector Voltmeter

<b>Instrument type:</b>	2-channel sampling RF millivoltmeter/phase meter which measures voltage level in two channels and simultaneously displays the phase angle between the two signals	<b>Resolution:</b>	0.1° at any phase angle
<b>Frequency range:</b>	1 MHz to 1 GHz in 21 overlapping octave bands	<b>Meter offset:</b>	±180° in 10° steps
<b>Meter bandwidth:</b>	1 kHz	<b>Phase accuracy:</b>	Within ±1°, not including phase response vs frequency, amplitude, and test-point impedance
<b>Tuning:</b>	Automatic within each band. Automatic phase control (APC) circuit responds to the channel A input signal	<b>Phase response vs frequency:</b>	<±0.2° 1 MHz to 100 MHz, <±3° 100 MHz to 1 GHz
<b>Voltage range:</b>	Channel A: 1.5 mv to 1 v rms 1 to 5 MHz, 300 μv to 1 v rms 5 to 500 MHz, 500 μv to 1 v rms 500 MHz to 1 GHz; can be extended by a factor of 10 with 10214A 10:1 Divider Channel B: 100 μv to 1 v rms full scale (input to channel A required); can be extended by a factor of 10 with 10214A 10:1 Divider Meter Ranges: 100 μv to 1 v rms full scale in 10-db steps	<b>Phase response vs signal amplitude:</b>	<±2° for an amplitude change from 100 μv to 1 v rms
<b>Full scale voltage accuracy:</b>	Within ±2% 1 to 100 MHz, within ±6% to 400 MHz, within ±12% to 1 GHz, not including response to test-point impedance	<b>Phase response vs test-point impedance:</b>	<±2° 0 to 50 ohms, <-9° 25 to 1000 ohms
<b>Voltage response to test-point impedance:</b>	+0, -2% from 25 to 1000 ohms. Effects of test-point impedance are eliminated when 10214A 10:1 Divider or 10216A Isolator is used	<b>Isolation between channels:</b>	>100 db, 1 to 400 MHz; >75 db, 400 MHz to 1 GHz
<b>Residual noise:</b>	Less than 10 μv as indicated on the meter	<b>Input impedance (nominal):</b>	0.1 megohm shunted by approx. 2.5 pf; 1 megohm shunted by approx. 2.5 pf when 10214A 10:1 Divider is used; 0.1 megohm shunted by approx. 5 pf when 10216A Isolator is used; ac coupled
<b>Phase range:</b>	360°, indicated on zero-center meter with end-scale ranges of ±180, ±60, ±18, and ±6°. Meter indicates phase difference between the fundamental components of the input signals	<b>Maximum input (for proper operation):</b>	3 v p-p (30 v p-p when 10214A 10:1 Divider is used); ±150 v dc max.
		<b>20 kHz output (each channel):</b>	Reconstructed signals, with 20 kHz fundamental components, having the same amplitude, waveform and phase relationship as the input signals
		<b>Recorder outputs:</b>	Amplitude output 0 to +1 v dc proportional to voltmeter reading; phase output 0 to ±0.5 v dc proportional to phase meter reading
		<b>Price:</b>	\$2500

Data subject to change without notice. Price f.o.b. factory.

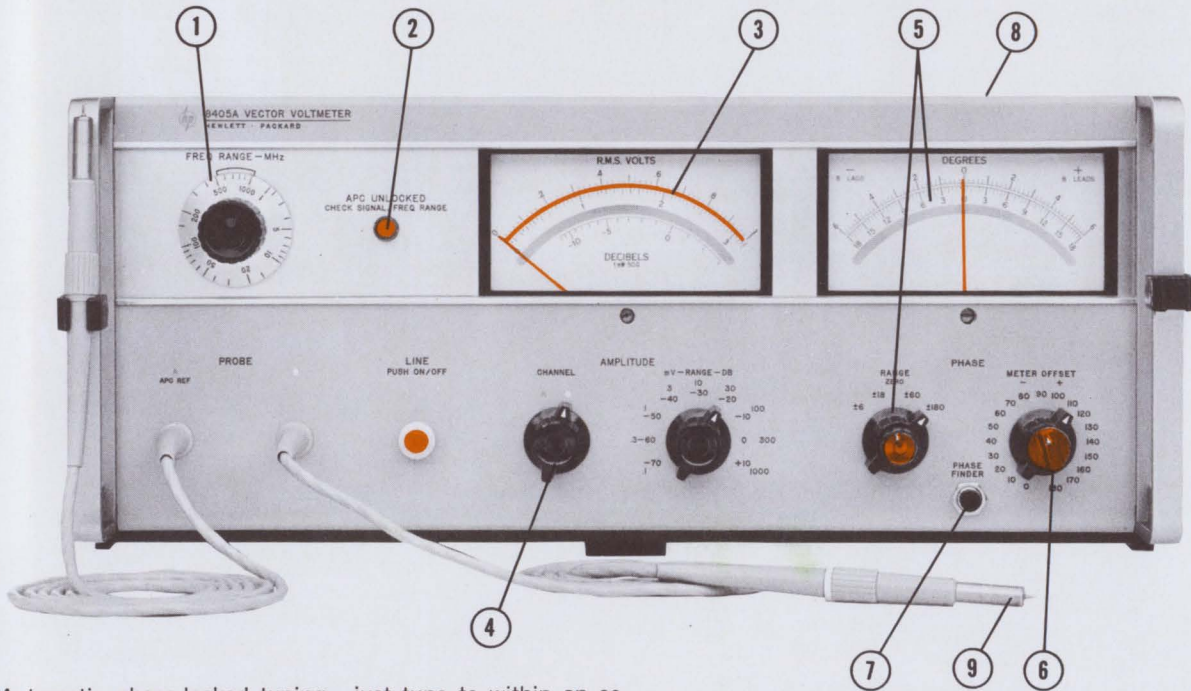

- ① Automatic phase-locked tuning—just tune to within an octave of the signal frequency and . . .
- ② APC unlocked light goes out. The 8405A locks with <math>< 500 \mu\text{V}</math> at Channel A over most of the band (<math>< 1.5 \text{ mv}</math> full band).
- ③ 100 microvolts full-scale sensitivity.
- ④ Dual-channel voltmeter.
- ⑤ 0.1° phase resolution with an expanded  $\pm 6^\circ$  phase scale.
- ⑥  $\pm 180^\circ$  meter offset to allow expansion of any angle to the  $\pm 6^\circ$  range.
- ⑦ Phase finder—returns Phase Range to  $\pm 180^\circ$  and Meter Offset to  $0^\circ$  for direct readout of phase regardless of the position of these controls.
- ⑧ Rear-panel outputs—20 kHz reconstructed RF for analysis with low frequency instruments; also recorder outputs for amplitude and phase meter readings.
- ⑨ High-impedance probes with high isolation between channels.

**HEWLETT**  **PACKARD**  
An extra measure of quality



# Letters

## Engineers must improve professional standards

Sir:

I would like to comment on your article entitled "EE Societies—Are They Doing Enough?" in the March 15th issue [ED 5, p. 86]. I want to say they are not blameless but there are other factors which should be considered.

The engineer is not treated as a professional because normally he doesn't act like one. Mill-like hiring is prevalent because he sells himself to the highest bidder regardless of location and professional working conditions. Perhaps he rationalizes by saying, "The job will not last anyway" or "I'm not going to work here very long." In short, he considers it just a job, not a position.

Everyone stresses technical competence, but what about professional integrity? When the engineer begins to take the time to better his lot, then and only then will he be treated in accordance with professional dignity. Adding a long chain of degrees after his name is not the solution. Professional engineers should not belong to unions. They should not accept jobs that are not *bona fide* engineering positions. Too many job-function titles contain the word engineer when the actual job description clearly outlines duties which are not ordinarily performed by an engineer.

What is an electronic engineer? He must have a degree, but it can be from almost anywhere in the world and in almost any related course of study. He must have experience. A year is enough to rate the title of engineer. Only professional engineering fields, such as civil and electrical, require technical experience of a high level over a reasonable period of time as a prerequisite for the position of engineer.

I think the solution to the problems outlined in your article must come from the engineers—professional engineers. Data which are presented in unorthodox units or twisted for sales appeal should be rejected by the engineer; honest, straightforward specifications must be a firm requirement.

Professional attitudes, integrity and ethics must be encouraged and promoted. Engineers should be required to take and pass examinations upon graduation and upon completion of a specified length of service. Other professions, including some engineering branches, do this, thus regulating quality and performance to the highest possible degree. Why can't the electronic or electrical engineer be required to earn a license just as doctors, lawyers, etc? Engineers also serve the public in all phases of technology.

The engineer can work closely with professional organizations such as the Consulting Engineers' Council and the Society for Professional Engineers to promote and improve the profession. Improvements can be effected by increased professional registration, by legally defining the position and title of an engineer and by education of present and future professional candidates. Every state has a professional engineering program. This is a good place to begin to elevate the engineering profession.

D. Lawrence George  
232 Windsor Avenue  
Southampton, Pa.

## Accuracy is our policy

F. W. Bell, Inc., tells us that their model 1390 Magnetic Reaction Analyzer (ED 7, Mar. 29, 1966, p. 102) is simply an accessory that adds differential capability to their model 1090. Our description of the unit's identity and function is wrong.

Marvin Silverstein, co-author of "Design high-frequency amplifiers . . .," was incorrectly listed in ED 8, Apr. 12, 1966, p. 48. He is a senior engineer at Electronic Communications, Inc., St. Petersburg, Fla.

In ED 10, Apr. 26, 1966, p. 14, Dr. Dennis Gabor was quoted as saying that bandwidth requirements for holography television exceeded present capabilities by  $30 \times 30^3$ . The figure should be  $30 \times 10^3$ .

Varian Associates points out that reflector voltage in their VA-298 klystron is incorrectly given in ED 10, Apr. 26, 1966, p. 126. Correct reflector voltage is -600 Vdc, not -150 to -160 Vdc.

## 60-cycle source?

Stability  $\pm 0.2\%$   
to a second  
per month

( $3 \times 10^{-8}$  per 24 Hour)

Price \$60 up.

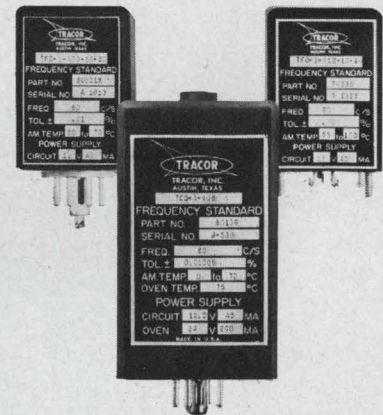

TFA-866

Think **TRACOR**®

For further information:

TRACOR, Inc.

General Sales Office

6500 Tracor Lane

Austin, Texas 78721

Phone: 512-926-2800



**COMPONENTS**

REPRESENTATIVES IN PRINCIPAL CITIES

We are looking for EE's, ME's and Physicists for design consultation or systems development in ASW and undersea problems—experience in penetrations aids—design studies, tests, analysis and reports on electronic and mechanical systems. Your reply strictly confidential.

ON READER-SERVICE CARD CIRCLE 15



# TRW ANNOUNCES

# 10 W 400 mc 60% $\eta$

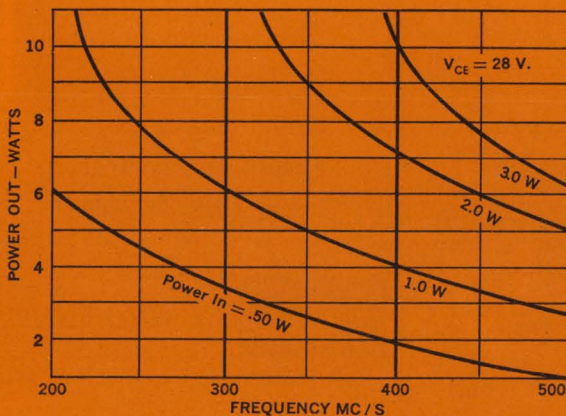

## NEW UHF POWER TRANSISTOR

The new TRW 10W/400Mc (2N4040) UHF Power Transistor provides full rated performance in conventional circuits...no need to resort to emitter tuning or other techniques which contribute to circuit instability. TRW 2N4040 is available now at competitive prices.

For detailed technical information phone, write or wire: TRW Semiconductors, Transistor Plant, 14520 Aviation Blvd., Lawndale, Calif. 90260. Phone: (213) 679-4561, Ext. 477 TWX: 213 647-5113

TRW designs and manufactures high performance transistors for the communications industry and specialized types for military and industrial applications.

# TRW SEMICONDUCTORS

ON READER-SERVICE CARD CIRCLE 16



**Co-Publishers**

James S. Mulholland, Jr.  
Robert E. Ahrens Dorf

**Editorial Director**

Edward E. Grazda

**Editor**

Howard Bierman

**Managing Editor**

Robert C. Haavind

**Technical Editors**

Joseph J. Casazza  
Rene Colen  
Maria Dekany  
Richard Harnar  
Mark B. Leeds

**News Editors**

Frank Egan  
Roger K. Field

**East Coast Editor**

Neil Sclater

**West Coast Editors**

Ralph Dobriner  
Peer Fossen

**Copy Editor**

Peter Beales

**New Products Editor**

David Surgan

**Washington Editor**

S. David Pursglove

**Editorial Production**

Dollie S. Viebig  
Anne T. Lombardi

**Art Director**

Clifford M. Gardiner

**Art Assistant**

William Kelly

**Technical Illustrators**

Lewis D. Hill  
Leonard P. Levenson  
Cheh Nam Low

**Production Manager**

Thomas V. Sedita

**Asst. Production Manager**

Helen De Polo

**Production Assistants**

Carl Merkin  
Bernard Wolinsky

**Circulation Manager**

Nancy L. Merritt

**Reader Service**

Diane Pellechi



## Need better calibrations? Then, speak out!

Just how valuable is accurate measurement to the progress of technology and to development of the national economy?

This question is hard enough to answer in engineering terms. It is next to impossible when the answer has to be set down in terms of dollars and cents. Yet this is exactly the task that has faced the National Bureau of Standards the past few years when it has sought to increase its annual budget. Most Congressmen are lawyers, not engineers, and they are hard to convince.

The engineer may have some difficulty in spelling out an answer, but he can certainly sense the importance of exact measurement. How far would the economy ever have advanced if designers couldn't specify fairly close machine tolerances or voltage levels, and be confident that their designs were producible? How would today's high-performance aircraft or large, interlinked computer networks ever have been possible without careful calibration procedures and precise standards?

It is reassuring for the engineer to know that his peer on the opposite coast is using measurements traceable directly to the same rock-solid base—the "ultimate standard" at the Bureau. But what happens in the case where this "ultimate standard" either does not exist or does not match the degree of accuracy demanded by his latest design?

This very situation, unfortunately, is beginning to recur more and more often (ED 11, May 10, p. 17). The aerospace industry has expanded tenfold while the NBS operating budget has remained practically unchanged over the last few years.

In consequence, the Bureau has fallen sorely behind industry's needs. Our own investigation of the situation had led us to the following conclusions about what must be done:

- **NBS budget-makers must ask for more funds.** While the House has trimmed the budget request every year, the total amount sought has stayed almost the same. NBS managers will have to make more forceful demands.

- **Industry should give the Bureau the evidence that it needs to back its demands, instead of sniping at it.** The National Conference of Standards Laboratories has unearthed 128 specific requests for services presently unavailable, yet only five of these included estimates of the cost of the lack of these services.

You can help in this effort by reporting any cases familiar to you to Rep. John J. Rooney, House of Representatives, Washington, D.C. 20515, with a copy to ELECTRONIC DESIGN. Congressman Rooney heads the Subcommittee on State, Justice and Commerce within the House Appropriations Committee. And do include estimates of the cost of being without the desired service(s).

Before dashing off your letter, however, be sure to check "Calibration and Test Services of the National Bureau of Standards," NBS Misc. Pub. 250 (1965 edition), available for \$1 from the Superintendent of Documents, Government Printing Office, Washington, D.C. 20402. Additional services can sometimes be arranged if you call the Bureau directly.

ROBERT HAAVIND



# Micro Low Noise FET

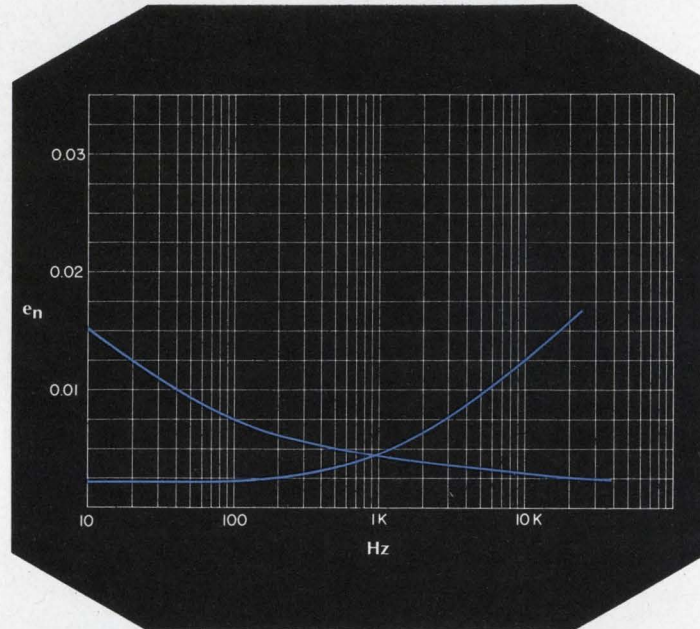

$$e_n = 0.02 \mu\text{V}/\sqrt{\sim} @ 10 \text{ Hz}$$

Simplify your amplifier designs with micro low noise Field Effect Transistors. UNION CARBIDE ELECTRONICS produces both N and P-Channel FET's with the lowest noise voltages available. In addition,  $I_{GSS}$  is less than 100 pA and noise current as low as  $0.01 \text{ pA}/\sqrt{\sim} @ 10\text{Hz}$ . These FET's are produced to satisfy the most exacting low noise designs. Representative devices are shown at the right; your UCE distributor can supply the right device for your application. Call him today.

## CHECK THE SPECS!

Type	Channel	$BV_{GSS}$ Volts Min.	$I_{DSS}$ mA Min.	gm umhos Min.	$V_p$ Volts Max.	$e_n$ $\mu\text{V}/\sqrt{\sim}$ Max.	Price 1-99
2N3684	N	50	2.5	2000	5.0	0.15	\$12.55
2N3685	N	50	1.0	1500	3.5	0.15	14.45
2N3686	N	50	0.4	1000	2.0	0.15	16.45
2N3687	N	50	0.1	500	1.2	0.15	18.30
2N3695	P	30	1.25	1000	5.0	0.2	12.55
2N3696	P	30	0.5	750	3.5	0.2	14.45
2N3697	P	30	0.2	500	2.0	0.2	16.45
2N3698	P	30	0.05	250	1.2	0.2	18.30
UC-240	N	50	1.0	1200	5.0	0.02	24.50



UNION CARBIDE CORPORATION 365 Middlefield Road, Mountain View, California 94041 TWX: 415-969-9166; Telephone: (415) 961-3300

Speed Inquiry to Advertiser via Collect Night Letter  
ON READER-SERVICE CARD CIRCLE 17



# ED Technology

Take the fog out of field-effect design PAGE 38

Two approaches to diode phase-shifter design PAGE 46

Preserve the accuracy of sampled-data systems PAGE 54

FETs simplify a one-bit comparator PAGE 58

Easy plays to make your project job really last PAGE 70

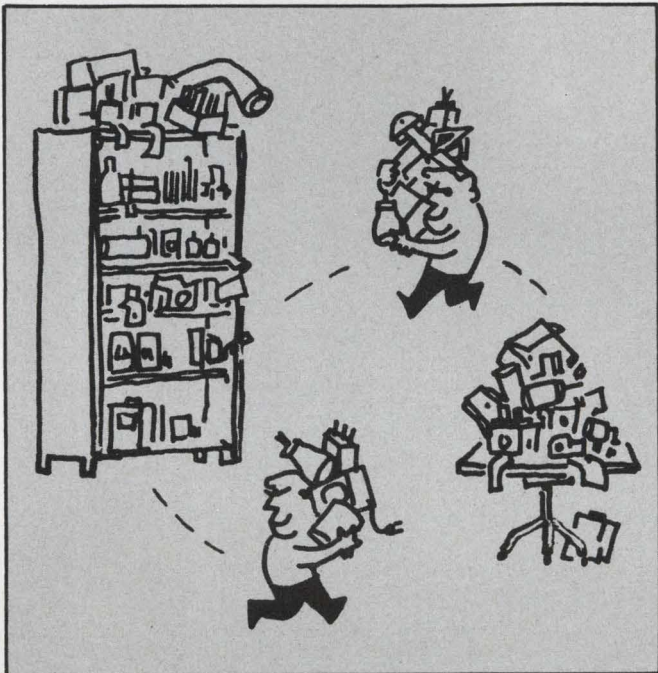

Shuffle your equipment . . . p. 70

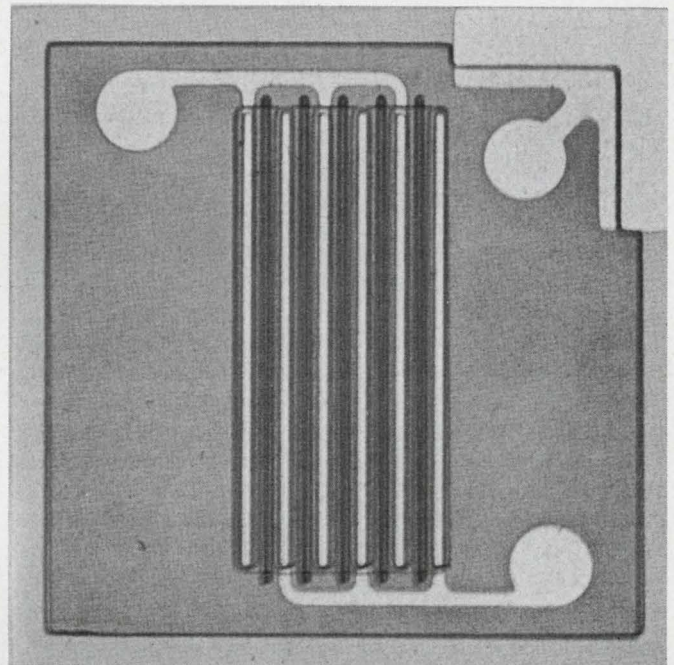

The right channels for FET design . . . p. 38

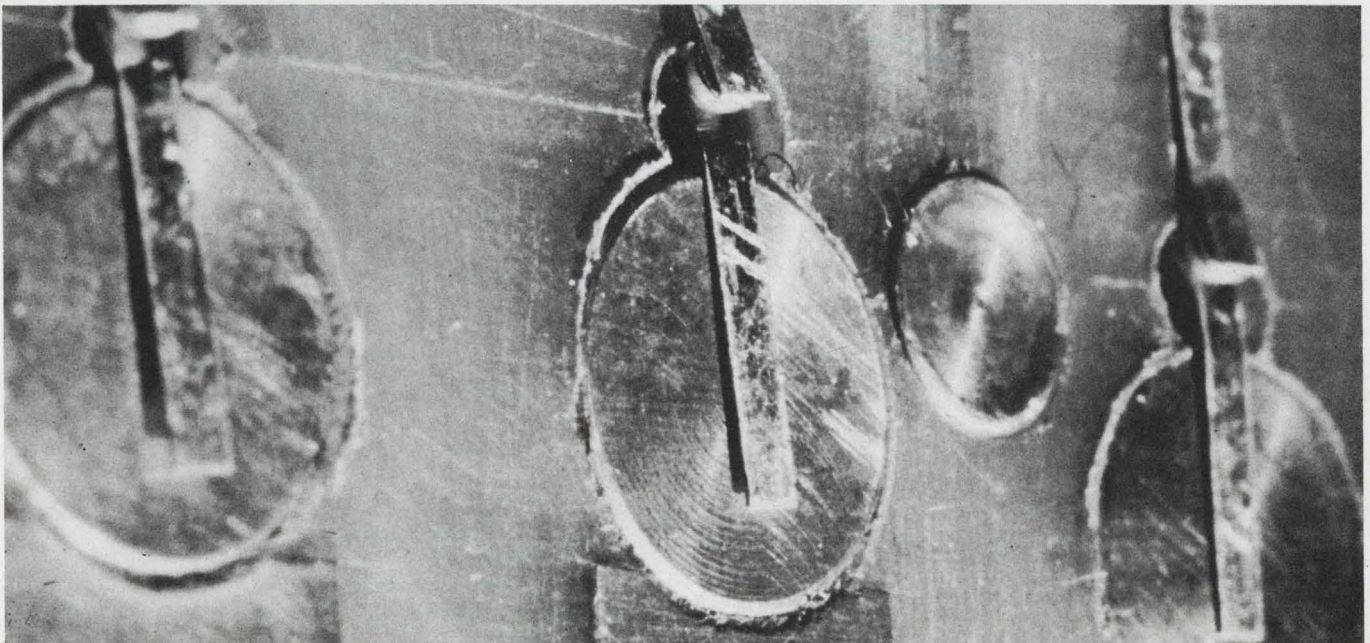

Diodes toe the line . . . p. 46



# Take the fog out of field-effect design. Use only those FET and MOS parameters that are essential for amplifier and switching applications.

Part 1 of a three-part article.

Confused about where to apply field-effect devices? Are your designs getting bogged down because of incomplete specifications or cluttered up by a plethora of parameters? Well, here's how to take the guesswork out of FET and MOS design.

The short cut involves using only those parameters which reflect the device's suitability for a specific application.\* The properties of the semiconductor itself indicate which of the various parameters govern. Knowing which of the characteristics to look for is almost as important as using them properly, and the application at hand serves as the best guide for this.

The two main categories of FET and MOS applications are amplifiers and switching networks. Our study will examine the critical design criteria for:

- Analog switching systems.
- Digital switching systems.
- General-purpose amplifiers (typified by operating frequencies below 1 MHz).

The remaining major classes of field-effect amplifier applications (low-noise amplifiers, high-frequency amplifiers, low-drift single-ended dc amplifiers and differential dc amplifiers) will be covered in parts 2 and 3 of this article in the next issues (ED 14 and 15, June 7 and 21).

In each case, we will first consider the important characteristics of FETs and MOSs, then separate the governing parameters from those of secondary importance, and finally, develop the actual design procedure for a representative application. The meaning of each parameter specification (for the application categories cited above) and their associated test conditions are included for reference purpose (See Box).

## FET fine for analog switching

The FET as an analog switch offers significant advantages over the bipolar transistor, particularly

\*Consult the May 17 Semiconductor Reference issue of Electronic Design (pp 104 to 112) for a detailed examination of FET and MOS specifications. The material is tailored to the data that appear on field-effect specification sheets and in the Semiconductor Reference issue. It also shows how to choose between units of the same type and from among competing FETs and MOSs.

James S. Sherwin, Senior Applications Engineer, Siliconix Inc., Sunnyvale, Calif.

is low-level multiplexers. The analog gate in its simplest form appears in Fig. 1. More sophisticated forms differ only in the method of referencing and coupling switching waveforms to the FET gates.<sup>1</sup> When the FET is gated OFF with a  $V_{GS} \cong V_{GS(OFF)}$ , it appears as an open circuit in series with the signal line. When a zero or a negative gate level exists at the switching input, the control gate voltage is decoupled from the FET by a diode, and the FET gate is referenced by a resistive path to the source. Then,  $V_{GS} = 0$  and the FET is full ON with minimum  $r_{ds(on)}$  appearing in the signal line. Switching FETs typically exhibit

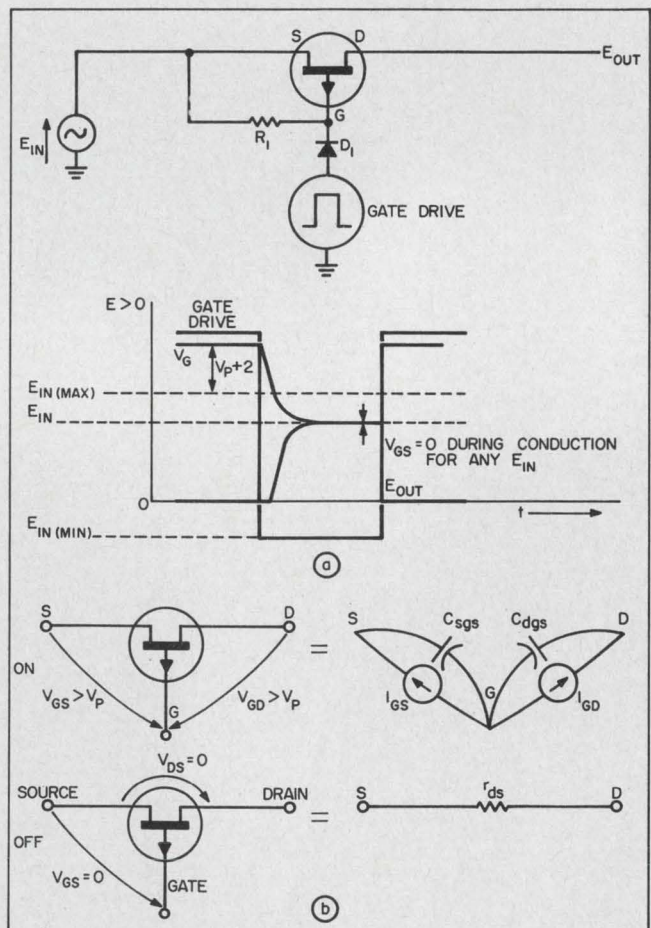

1. FET analog gate circuit (a) provides a zero gate-to-source voltage for any input signal. Positive gate (see waveform) turns the switch OFF. Equivalent circuits for the OFF and ON states appear in (b). In the ON condition there is no offset voltage and the switch may be represented by a resistor.



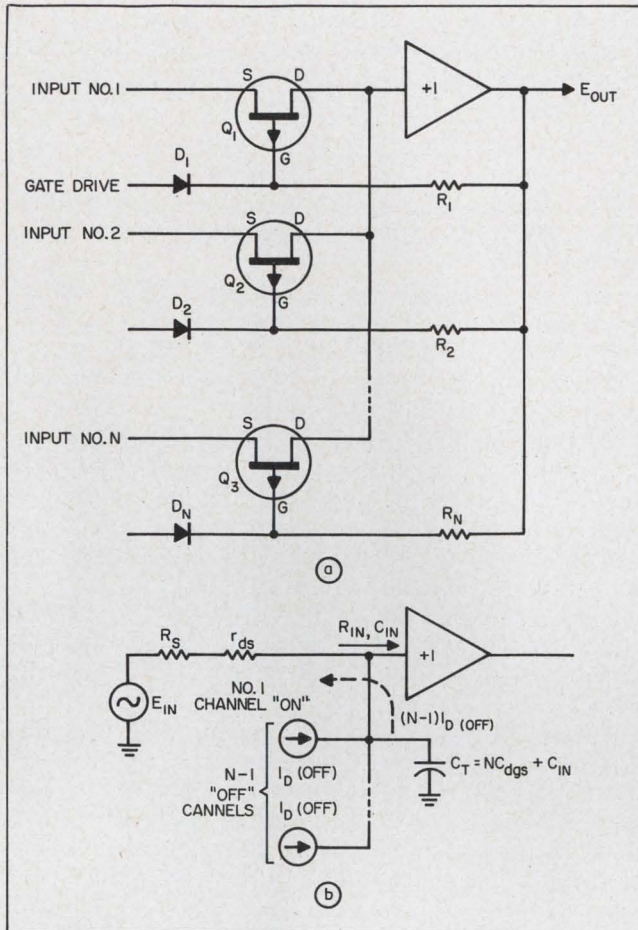

2. In the analog multiplexer circuit (a) the FET switch is used with a buffer amplifier. The commutative network (b) is shown with the first channel ON and all other channels OFF.

$r_{ds(on)}$  of a few tens to a few hundreds of ohms. This impedance is negligible if a high-impedance amplifier follows the multiplexer. Such a circuit is easily affected with a FET input storage.

When MOS-FETs are used as the analog switches, the decoupling diodes and source return resistors are unnecessary, as there is no possibility of drawing gate current. The substrate, however, must be biased below the maximum peak negative input signal. Observe that  $I_{D(OFF)}$ , while flowing from drain to substrate rather than from drain to gate, is not necessarily lower than with the FET. The real advantage of the MOS in switching circuits lies in the ease of coupling switching waveforms without the need for clamping at  $V_{GS}=0$ .

FET performance as an analog switch hinges on only a few parameters. These are  $r_{ds(on)}$ ,  $I_{D(OFF)}$ ,  $V_{GS(OFF)}$ ,  $C_{sgs}$  and  $C_{dgs}$ . The effect of each of these characteristics may be seen from the ON and OFF equivalent circuits of Fig. 1b.

#### Interelectrode capacitances limit speed

The capacitances between drain and gate and source and gate tend to couple switching transients to the signal line and limit switching speed.  $C_{dgs}$  and  $C_{sgs}$  should therefore be as low as possible. The OFF drain current of all the OFF gates flows



Prescription for design: Author Sherwin pencils out application-oriented FET parameter guidelines.

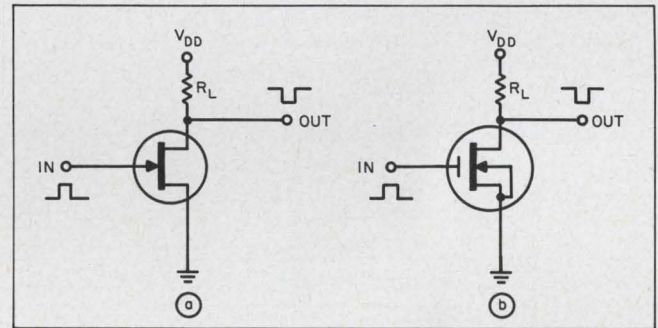

3. Digital switching circuits may use either a FET (a) or MOS (b). The MOS is preferable because of easier coupling requirements and the option of normally-OFF or normally-ON structures.

through  $r_{ds(on)}$  of the ON gate to ground via the signal source. It is therefore desirable that both  $I_{D(OFF)}$  and  $r_{ds(on)}$  be small.  $V_{GS(OFF)}$  is important because its value determines the magnitude of signal level required to gate the FET OFF. The ideal FET analog switch would exhibit very small values of all of the above listed characteristics.

Analog gate performance may be determined by referring to the 8-channel ( $N=8$ ) multiplexer of Fig. 2. Assume that the leakage current and  $C_{in}$  of the amplifier, and  $R_S$  are all negligible. The FET characteristics are as follows:  $r_{ds(on)} < 200 \Omega$ ,  $I_{D(OFF)} < 3 \text{ nA}$  at  $85^\circ\text{C}$  and  $C_{dgs} = C_{sgs} < 3 \text{ pF}$ . The design and performance can be summarized as follows:

1. **System accuracy** is dependent on the ratio of  $r_{ds(on)}$  to amplifier input resistance and on the dc offset due to OFF channel current  $I_{D(OFF)}$  flowing through  $r_{ds(on)}$ . If max  $r_{ds(on)}$  is  $200 \Omega$ , the multiplexer transfer accuracy is 1/10% or better if the amplifier  $R_{in} > 200 \text{ k}\Omega$ .
2. **The dc offset voltage** is  $< [N-1] [I_{D(OFF)}] [r_{ds(on)}]$ . This is equal to  $4.2 \mu\text{V}$  at  $85^\circ\text{C}$ . It represents a temperature-sensitive error of less than 1/10% of a 5-mV signal.
3. **Commutating speed** is determined by the response time to a change in input signal level. The input time constant is



$$T = [r_{ds(on)}] [N] [C_{dgs}] = 4.8 \text{ ns.} \quad (1)$$

Note that in a complete design the effects of finite generator resistance and amplifier input capacitance must be included.

### MOS is superior for digital switching

A typical FET digital switching circuit is the shunt switch (Fig. 3) used in computer logic systems. The important device characteristics here are  $r_{DS(ON)}$ ,  $V_{GS(OFF)}$  (or  $V_{GS(th)}$ ) and  $t_{ON} + t_{OFF}$ .

Although FETs find applications as digital switches, the MOS will be more widely used in digital computers because of the ease of coupling control waveforms and the choice of normally-OFF or normally-ON structures offered by the MOS.

The best bet device for digital switching is the enhancement MOS with a low  $r_{DS(ON)}$  and a low total ( $t_{ON} + t_{OFF}$ ) switching time.  $V_{GS(th)}$  must be several volts greater than the product of  $r_{DS(ON)}$  and  $I_{D(ON)}$  to ensure a margin of noise stability. Parameter  $r_{DS(ON)}$  differs from  $r_{ds(on)}$  as indicated in Fig. 4. Whereas  $r_{ds(on)}$  is a small-signal measurement at a fixed  $V_{GS}$  with  $V_{DS} = 0$ ,  $r_{DS(ON)}$  is a dc measurement at a specified  $I_D$  and  $V_{DS}$ . The values of  $r_{DS(ON)}$  and  $r_{ds(on)}$  may be equal if  $I_D$  and  $V_{GS}$  are specified as a point on the steep slope of the  $I_D - V_{DS}$  characteristic. Then,  $r_{ds(on)}$  is the limiting value of  $r_{DS(ON)}$  and normal circuit operation places  $V_{DS(ON)}$  in the so-called triode region (point A on Fig. 4). In any event, switching time ( $t_{ON} + t_{OFF}$ ) is the sum total of  $t_{rise} + t_{delay(on)} + t_{fall} + t_{delay(off)}$ ,

and may be as low as tens of nanoseconds. In an actual switching-circuit design,  $I_{D(ON)}$  is determined largely by the selected  $V_{DD}$  and  $R_L$ , using

$$I_{D(ON)} = \frac{V_{DD}}{R_L + r_{DS(ON)}}. \quad (2)$$

The step-by-step design procedure for field-effect (MOS-type) digital switching circuits is as follows:

Let us assume we have an MOS device with the following characteristics— $BV_{DSS} = 30$  volts,  $V_{GS(th)} = 5.0-8.0$  volts,  $C_{iss} < 6$  pF,  $r_{DS(ON)} < 200 \Omega$  at  $V_{DS} = 2$  v and  $V_{GS(ON)} = 20$  v, and,  $r_{DS(ON)} < 1000 \Omega$  at  $V_{GS(ON)} = 12$  v.

1. Determine  $V_{GS(th)}$  and  $V_{GS(ON)}$  of the MOS.
2. Select  $V_{DD} > \max V_{GS(ON)}$ . This is necessary to ensure provision of adequate turn-on voltage to the following stage.  $V_{GS(ON)}$  is somewhat arbitrary, and is largely determined by the  $r_{DS(ON)}$  required for adequate fan-out, switching speed and stability margin. Let us say  $V_{DD} = 25$  v. For  $r_{DS(ON)} = 200 \Omega$  and a fan-out (F.O.) of five, the switching  $T$  is given by  $(r_{DS(ON)})(F.O.)(C_{iss}) = (200)(5)(6 \times 10^{-12}) = 6.0$  ns.

3. Select  $R_L$  large enough for the  $R_L$  load line plotted on the output characteristics to intersect the  $V_{GS(ON)}$  ( $< V_{DD}$ ) line on the steeply rising portion at  $V_{DS(ON)} < V_{GS(th)}$  (min), say 2.0 v.  $V_{DD}$  should exceed  $V_{GS(ON)}$  only by the required margin of stability, otherwise  $R_L$  will be larger than necessary. Here,  $R_L$  is given by  $V_{DD} - V_{DS(ON)} / I_{D(ON)} = 470 \Omega$ .

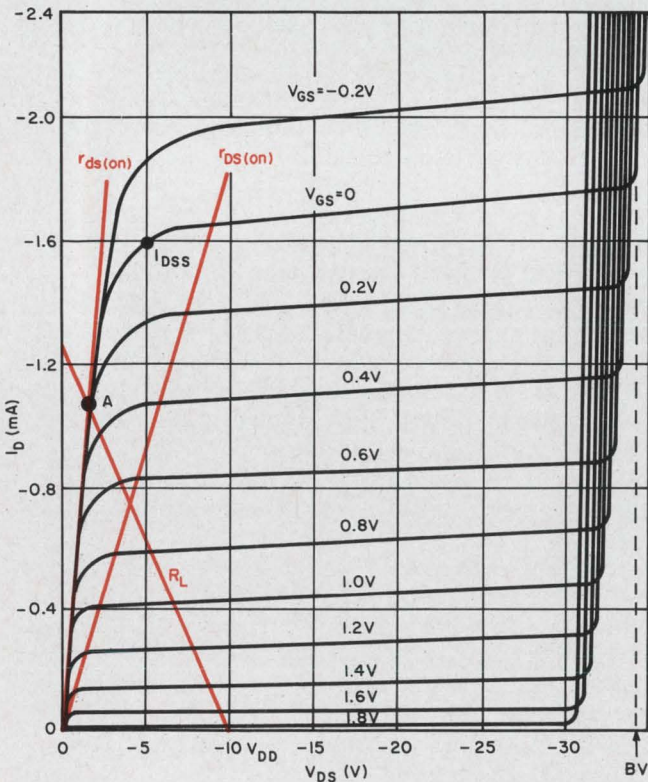

4. Devices for digital switching applications should have low values of  $r_{DS(ON)}$  and a short switching time ( $t_{ON} + t_{OFF}$ ). Note that  $r_{DS(ON)}$  is a dc measurement whereas  $r_{ds(on)}$  is a small-signal parameter.  $r_{ds(on)}$  may be the limiting value of  $r_{DS(ON)}$  under triode operation (Point A).

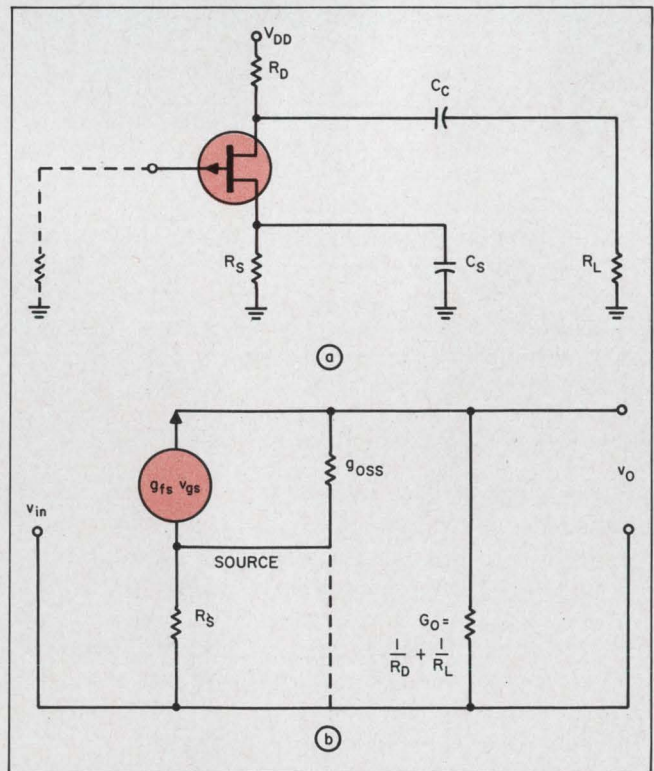

5. A FET RC-coupled amplifier (a) may be considered as a general purpose ( $f < 1$  MHz) type. The equivalent circuit appears in (b). FETs are superior to bipolars here because of their lower intermodulation distortion products.



4. Fall time is limited by the product of  $r_{DS(ON)}$  and the load capacity. Rise time is similarly limited by  $R_L$  and the load capacity. Here, fall time,  $t_f$  equals switching time  $T$  (see item 2 above) and the rise time,  $t_r = (R_L) (F.O.) (C_{iss}) = 14.0$  ns. With the MOS, the delay time ( $t_d$ ) is usually less than a nanosecond—it can therefore be neglected.

### Less distortion in FET amplifiers

By arbitrary definition, the general-purpose amplifier operates at frequencies below 1 MHz. The RC-coupled amplifier circuit of Fig. 5 is then applicable. The important dc FET parameters required for complete circuit design are  $I_{DSS}$  and  $V_{GS(OFF)}$ . The small-signal ac parameters of interest are  $g_{fs}$ ,  $g_{oss}$ ,  $C_{iss}$  and  $C_{rss}$ .

The FET is superior to the bipolar transistor here in that it exhibits lower values of intermodulation distortion. This is because the FET square-law transfer characteristic produces only second-order distortion products, while the bipolar transistor's exponential transfer curve generates very high orders of distortion products. Low-frequency stage gain may be determined from (Fig. 5b) as

$$A_v = \frac{-g_{fs}}{g_{oss} + G_o} \approx \frac{g_{fs}}{G_o} \quad (3)$$

If  $R_s$  is unbypassed, then

$$A_v = \frac{-g_{fs}}{G_o + g_{oss} + R_s G_o (g_{oss} + g_{fs})} \quad (4)$$

Note that  $A_v \approx -g_{fs}/G_o(1 + R_s g_{fs})$

In the special case of the common-drain amplifier (source-follower) of Fig. 6, the gain function is

$$A_v = \frac{g_{fs}}{g_{oss} + G_s + G_L + g_{fs}} \approx \frac{-g_{fs}}{G_s + G_L + g_{fs}} \quad (5)$$

To produce maximum gain with this amplifier, a high value of  $g_{fs}$  and a low value of  $g_{oss}$  are desired. Usually,  $g_{oss}$  is so small (typically,  $g_{oss} \approx 0.01 g_{fs}$ ) that it can be ignored in gain calculations. As operating frequency increases, circuit capacitances begin to affect both the gain and phase response of the circuit. Then,  $C_{iss}$  and  $C_{rss}$  should be as small as possible to obtain the greatest bandwidth. As the effect of  $C_{rss}$  is a function of stage gain,  $C_{rss}$  is often more important than  $C_{iss}$ .

Because FET data sheets usually indicate a two- or three-to-one spread in characteristics, choice of a dc operating point should receive special attention. A bias point, or the bias resistor  $R_s$ , must be selected to suit any device within specifications. To accomplish this, it is almost essential to have both minimum and maximum transfer curves, as in Fig. 7a. If data sheets do not include this information, it is possible to determine it from the manufacturer's specified values of  $I_{DSS(max)}$ ,  $V_{GS(OFF)max}$ ,  $I_{DSS(min)}$ ,  $V_{GS(OFF)min}$ , and, the relationship:

$$I_D = I_{DSS} \left[ 1 - \frac{V_{GS}}{V_{GS(OFF)}} \right]^2 \quad (6)$$

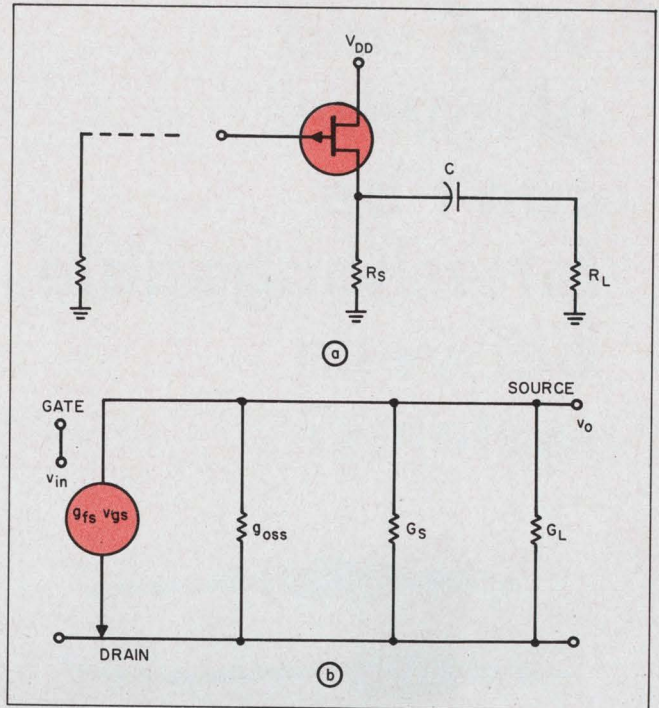

6. The source-follower is still another version (a) of a FET general-purpose amplifier. Here the key parameters are high  $g_{fs}$  and low  $g_{oss}$ . The equivalent circuit (b) shows that the  $C_{iss}$  and  $C_{rss}$  values should be minimal for greatest bandwidth.

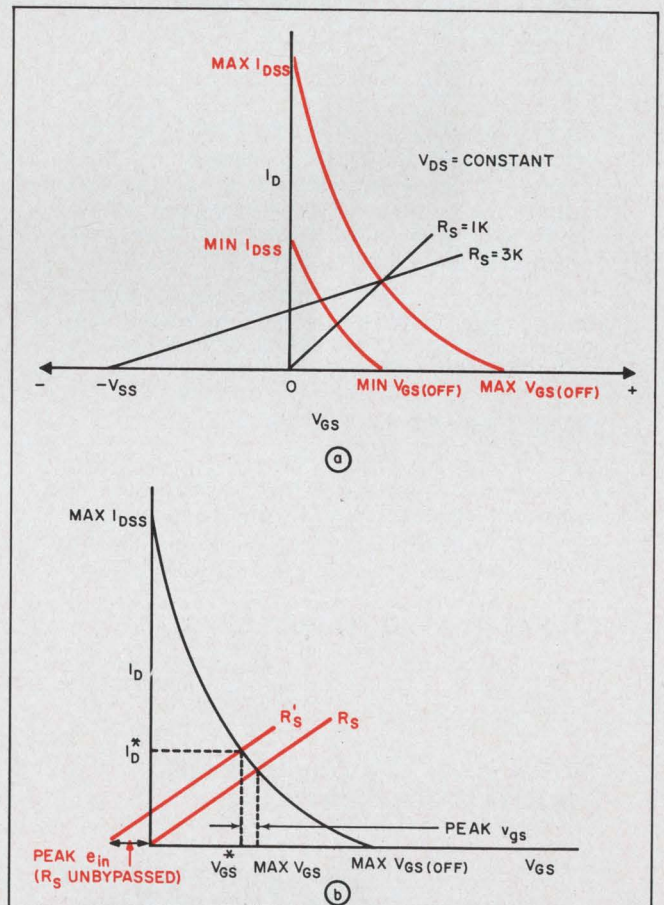

7. Minimum and maximum transfer curves (a) are needed to determine the bias point in FET amplifiers. The transfer curve is also used in a construction procedure for establishing the value of  $R_D$  (b).



# who said plugwires can't be interchangeable between systems?

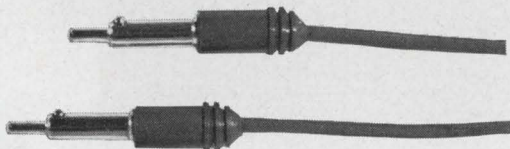

## MAC Panel's series 140 are!

MAC Panel's new Series 140 Plugwires are interchangeable with most existing systems. Another important engineering feature is the Ball-D-Tent design. It prevents accidental dislodging of the plugwires, and yet provides closely controlled extraction forces. Won't mar insert surface, either.

The complete line of Series 140 Plugwires is available in color-coded lengths ranging from 5 to 35 inches, and is available with Gold or Nickel plating in the following types:

### GOLD PLATED 140 WIRES

Manual Single Conductor Stack Plugs	Manual Dual Conductor Manual Single Conductor Shielded
Manual 3 Pin Common	Two Conductor Shielded
Manual 4 Pin Common	Three Conductor Shielded
Manual 6 Pin Common	Four Conductor Shielded

### NICKEL PLATED 140 WIRES

Manual Single Conductor Stack Plugs	Manual 4 Pin Common Manual 6 Pin Common
Manual 3 Pin Common	Manual Dual Conductor

**ORDER NOW . . . AVAILABLE FOR IMMEDIATE DELIVERY**

**MAC**  
O.E.M. DIVISION

**MAC PANEL CO. High Point, N.C.**

ON READER-SERVICE CARD CIRCLE 18

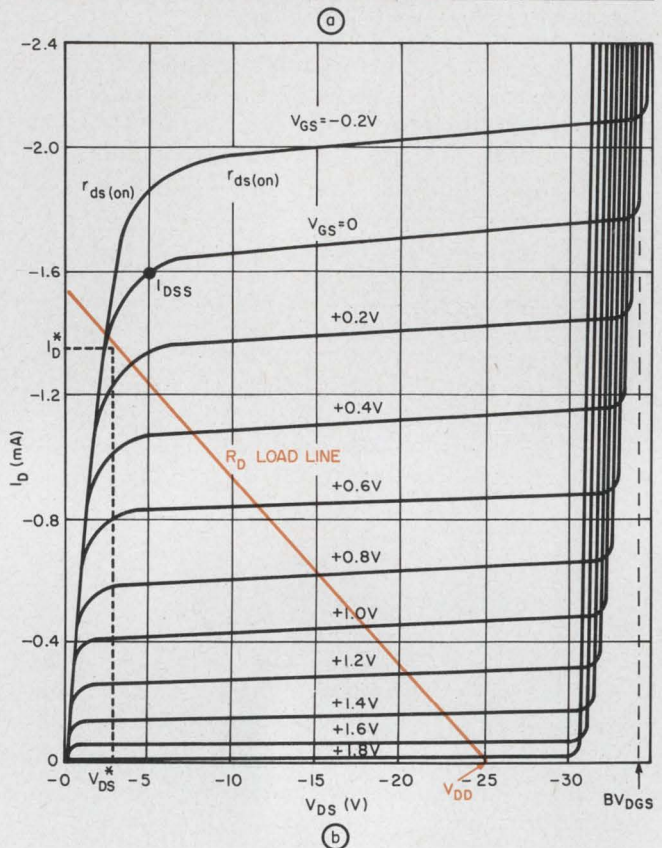
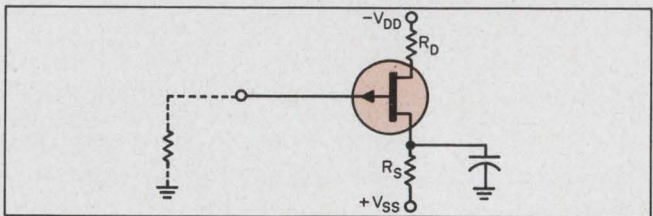

8. With two power supplies (a), the difference between  $I_{D(MIN)}$  and  $I_{D(MAX)}$  is lessened. When the FET output characteristic (b) is available, the value of  $R_D$  is quickly and easily determined. Note that in the absence of this plot, Fig. 7b may be used for constructing a value of  $R_D$ .

### Bypass makes a difference

A straight line drawn from the origin in the first quadrant and crossing both curves represents the  $R_S$  load line. The operating point will be on this load line somewhere between the minimum and maximum transfer curves. If  $R_S$  is bypassed, a signal at the gate has the effect of translating the  $R_S$  line horizontally along the  $V_{GS}$  axis by an amount equal to the applied signal. If  $R_S$  is bypassed, the operating point merely swings about the  $R_S$  intercept with the transfer curve by an amount equal to the instantaneous signal level (see Fig. 7b).

With this pair of curves and a known signal level, it becomes fairly simple to establish a value of  $R_S$  sufficient to provide a suitable operating bias for any device within the full range of specifications. Once the value of  $R_S$  is chosen, minimum and maximum  $I_D$  may be found from the  $R_S$  intercepts with the two curves. The difference between  $I_{D(MIN)}$  and  $I_{D(MAX)}$  may be de-



FET Specification Parameters

Parameter	Test conditions (must be specified)	Meaning of specification	Parameter	Test conditions (must be specified)	Meaning of specification
$I_{GSS}$	$V_{GS}$ $V_{DS}=0$	Gate-channel leakage with $V_{DS} = 0$ . This represents total gate leakage current at a point below breakdown voltage (Fig. 3) Specified at $1/2$ to 1 times the minimum specified $BV_{GSS}$ . When specified at min $BV_{GSS}$ , $I_{GSS}$ may replace the $BV_{GSS}$ specification in that $I_{GSS}$ is $< I_G$ in the $BV_{GSS}$ specification.	$r_{ds(on)}$	$V_{GS}$ $V_{DS} = 0$ or $I_B$ frequency	Drain-to-source resistance when biased to full ON condition (max operating $I_B$ ).
$I_{DSS}$	$V_{DS}$ $V_{GS} = 0$	Drain saturation current, the value of $I_D$ measured above the knee of the $V_{DS}-I_D$ characteristic curve, where $V_{DS} > V_P$ (Fig. 1). $I_{DSS}$ is actually defined as $I_D$ at the $V_{DS}$ required for channel pinch-off when the two gate-channel-junction depletion regions meet near the drain. <sup>6</sup> $V_{GS}$ must be zero. At this point $I_D$ is self-limiting, and any increase in $V_{DS}$ causes only slight increase in $I_D$ . <sup>7</sup> In Type-C MOS devices, $I_{DSS}$ is essentially the drain-substrate leakage plus any residual drain-source channel current.	$ g_{rs} $		Magnitude of common-source forward transfer conductance. Sometimes the magnitude signs are omitted. This is perhaps a more informative term than $y_{fs}$ . At 1kHz, $y_{fs} \approx g_{rs}$ . However, at high frequencies $y_{fs}$ includes the effect of gate-drain capacity, hence may be misleadingly high. The term $g_{rs}$ should be used for all high-frequency measurements.
$I_{D(ON)}$	$V_{DS}$ $V_{GS}$	Drain current under specified bias conditions. Specified for Type-B and Type-C MOS devices as a max intended operating drain current when $V_{GS}$ is biased for max channel conduction.	$g_m$		Mutual conductance. Sometimes used in lieu of $g_{fs}$ .
$I_D$	$V_{DS}$ or $V_{DG}$ $V_{GS}$	Drain-source current under certain specified operating conditions.	$g_{iss}$	$V_{DS}$ $V_{GS}$ $v_{ds}=0$ frequency	Common-source input conductance with output shorted. This must be specified for high-frequency applications as $g_{iss} \propto 1/\omega^2$ .
$I_{D(OFF)}$	$V_{DS}$ $V_{GS}$	Drain-gate leakage current with $V_{GS} > V_{GS(OFF)}$ . This represents the drain current observed in an analog-gate circuit which has been biased to the OFF state. $I_{D(OFF)}$ is slightly lower than $I_{DGO}$ (Fig. 7a).	$y_{oss}$		Common-source output admittance with input shorted.
$V_{GS(OFF)}$	$V_{DS}$ $I_D$	Gate cut-off voltage. Gate-source voltage required to cut-off channel current (Fig. 5b).	$C_{iss}$	$V_{DS}$ $V_{GS}$ $v_{ds}=0$ frequency	Common-source input capacitance, output shorted. $C_{iss} = C_{dg} + C_{gs}$ . (Fig. 6).
$V_P$		Pinch-off voltage, interchangeable with $V_{GS(OFF)}$ .	$C_{is}$		Same as $C_{iss}$ if $v_{ds}=0$ .
$V_{GS(th)}$	$V_{DS}$ $I_D$	Gate-threshold voltage. Gate-source voltage required to initiate channel conduction in Type-C MOS devices (Fig. 5b).	$C_{gss}$		Same as $C_{iss}$ .
$V_{GS}$	$V_{DS}$ $I_D$	Gate-source voltage at any given operating point.	$C_{rss}$	$V_{DS}$ $V_{GS}$ $v_{gs}=0$ frequency	Reverse transfer capacitance, input shorted.
$r_{DS(ON)}$	$I_D$ $V_{DS}$ &/or $V_{GS}$	Static drain-source resistance when biased to full ON condition (maximum operating $I_D$ ).	$C_{rs}$		Same as $C_{rss}$ .
			$C_{dg}$		Same as $C_{rss}$ , actual value of drain-gate capacitance.
			$C_{oss}$	$V_{DS}$ $V_{GS}$ $v_{gs}=0$ frequency	Common-source output capacitance, input shorted. $C_{oss} = C_{rss} + C_{ds}$ . However, $C_{ds}$ is essentially header capacitance.
			$C_{os}$		Same as $C_{oss}$ if $v_{gs}=0$ .
			$C_{dgs}$		Same as $C_{oss}$ .
			$C_{sgs}$	$V_{DS}$ $V_{GS}$ $v_{dg}=0$ frequency	Source-to-gate capacitance, gate and drain shorted. $C_{sgs} = C_{gs} + C_{ds}$ .
			$t_{delay(on)}$	$V_{DD}$ $I_{D(ON)}$ $V_{GS(ON)}$	Delay time before turn on when pulsed from OFF to ON condition.
			$t_{fall}$	$V_{GS(OFF)}$ Test circuit Pulse rate	Fall time when pulsed from OFF to ON condition.
			$t_{delay(off)}$	Input pulse characteristics	Delay time before turn off when pulsed from ON to OFF condition.
			$t_{rise}$	Oscilloscope characteristics	Rise time when pulsed from ON to OFF condition.
			$t_{on}$		$t_{fall} + t_{delay(on)}$ .
			$t_{off}$		$t_{rise} + t_{delay(off)}$ .



creased if a source-supply voltage is available (see Fig. 8a). If this is the case, the  $R_s$  load line originates not at the origin, but on the  $V_{GS}$  axis at the value of the source-supply voltage  $V_{SS}$ .

Once  $I_{D(MAX)}$  is determined from the preceding exercise, a maximum value of  $R_D$  may be established. It is assumed maximum gain is desired at a low level of distortion, and signal level and  $V_{DD}$  are known. If a plot of FET output characteristics (Fig. 8b) is available for the maximum specified device, the choice of  $R_D$  is easily seen. However, the exercise may be completed from Fig. 7 alone by the following procedure:

### Step-by-step amplifier design

1. Find  $V_{GS(MAX)}$  from the  $R_s$  intercept with the maximum transfer curve of Fig. 7b.
2. Subtract the peak signal from  $V_{GS(MAX)}$  and assume  $R_s$  bypassed to find  $V_{GS}^*$ .
3. Enter the graph at  $V_{GS}^*$  and determine  $I_D^*$  from the curve at that value of  $V_{GS}^*$ . This is the maximum  $I_D$  to be found under combined condition of maximum signal on the maximum specified device.
4. Knowing that  $V_{DS}$  should not fall below the knee of the output characteristic curve of Fig. 8b, a minimum value of  $V_{DS}^+$  may be found for  $I_D^*$ . Or, a value equal to or greater than  $V_{GS(OFF)max}$  may be selected for good measure.
5. Using the minimum value of  $V_{DS}^+$  selected, the maximum allowable  $R_D$  may be found from

$$R_D + R_s = \frac{V_{DD} - V_{SS} - V_{DS}^+}{I_D^*} \quad (7)$$

The assumption here was that  $R_s$  was bypassed. If  $R_s$  is unbypassed,  $I_D^*$  is determined not by subtracting the peak signal from  $V_{GS(MAX)}$ , but by translating the  $R_s$  line to the left by an amount equal to the peak signal.  $I_D^*$  is then the intercept of the translated  $R_s$  line with the transfer curve. Stage gain may be determined from Eqs. 3 or 4 if  $g_{fs}$  can be determined at the operating point. Min and max  $g_{fs}$  may be determined from the curves of Fig. 9, if they are supplied. The  $R_s$  intercepts with the minimum and maximum transfer curves establish  $V_{GS(MIN)}$  and  $V_{GS(MAX)}$ . Entering the  $g_{fs}$ - $V_{GS}$  minimum and maximum curves at these points, the  $g_{fs(min)}$  and  $g_{fs(max)}$  may be found directly. There is only a slight difference between  $g_{fs}$  minimum and its maximum value if  $R_s$  is large. If these curves are not available, an approximation may be made from

$$g_{fs} = \frac{2 I_{DSS}}{V_{GS(OFF)}} \left[ 1 - \frac{V_{GS}}{V_{GS(OFF)}} \right] \quad (8)$$

Using the general-purpose FET amplifier as a basic building block, we will proceed to special-purpose amplifiers, (low-noise and high-frequency types) in Part 2 of this article. ■ ■

#### Reference:

M. M. Shipley, "Analog Switching Circuits Using FETs," *Electronics*, Dec., 1964, p. 45.

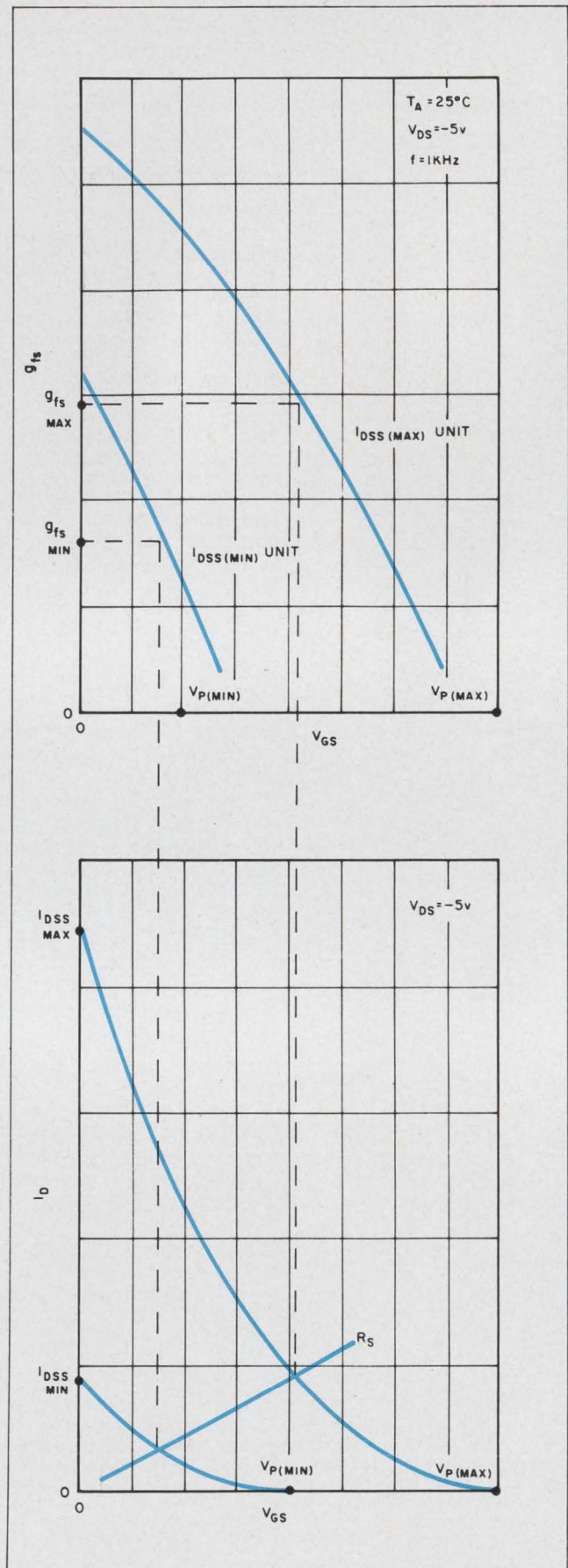

9. The relationship between  $I_D$  and  $g_{fs}$  as functions of  $V_{GS}$  are used in calculations of gain in FET amplifiers. Minimum and maximum values of  $g_{fs}$  are established by a construction procedure based on  $R_s$  intercepts.



# New products. New markets. New acquisition. New look.



Diversification...worldwide facilities...increasing emphasis on commercial and industrial markets...this and more is reflected in our new corporate symbol. Over the years, the well known Bourns potentiometer and transducer lines have been augmented by relays, time-delay devices, microcomponents, medical electronic equipment and—through acquisition of more than 80 per cent of Chicago Aerial Industries, Inc.—a wide range of photographic products and services. Geographically, Bourns has expanded to include operations in Canada, Great Britain, Switzerland, the Netherlands, Puerto Rico and Japan. Behind this growth is success...and behind the success, ideas. Our new trademark sums it up: there's dynamic expansion in the world of Bourns.



BOURNS, INC., CORPORATE HEADQUARTERS  
RIVERSIDE, CALIFORNIA

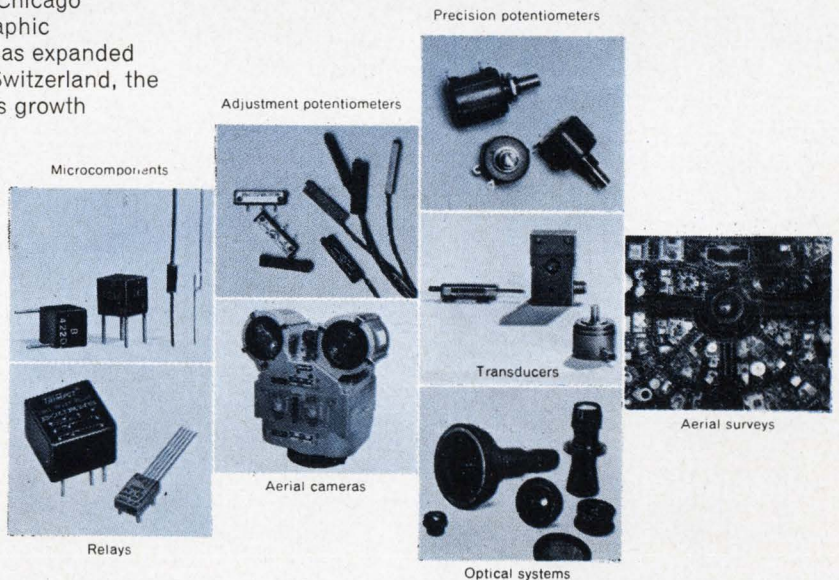

Electronic Components—Microcomponents—Transducers—Medical Electronics—Photographic Systems—Optics

Speed Inquiry to Advertiser via Collect Night Letter  
ON READER-SERVICE CARD CIRCLE 216



# Phased arrays vie with other radars, thanks to efficient and economical phase shifters. Up to 5 kW peak power, diode types are preferred.

Many excellent phased-array radar designs have never left the drawing board because of skyrocketing costs and weight. Their phase-shifters have been too lossy and too heavy. Now the picture is changing rapidly. Reciprocal digital phase-shifters, with the help of either pin diodes or ferrites, are making these arrays competitive and practical.

The digital mode of operation provides phase shifts in incremental binary steps upon command. Only the two end points of the capacitance-vs-voltage curve are used. Besides being able to work directly with a digital computer, the device eliminates variations from diode to diode by the proper bias at the two points.

The design of diode types, preferred to ferrites at power levels up to about 5kW peak in L, S and C bands, should aim for low insertion loss and high power-handling ability, with low switching powers. These points require careful consideration of the design approach and, in particular, careful choice of the diode. Much depends on the diode because the changes in its capacitance with voltage yield the phase shift.

## Two states of diode shift the phase

A simple equivalent circuit of the diode is shown in Fig. 1a. The diode consists essentially of a three-layer pin material.

When a forward voltage is applied, the capacitance approaches infinity, and the diode resembles a simple series resistance. With negative bias, the capacitance is reduced to a minimum value, and the diode is represented as a series resistance-capacitance combination.

To evaluate the diode, a quality factor,  $Q$ , may be used.  $Q$  relates the insertion loss of the phase-shifter to the impedance of the diode in the two states: a high  $Q$  means low insertion loss.  $Q$  is defined as:

$$Q = \frac{1}{2\pi f_o C_j \sqrt{R_f R_r}}, \quad (1)$$

where

- $f_o$  = frequency at which  $Q$  is defined,
- $C_j$  = junction capacitance at reverse bias,
- $R_f$  = series resistance at forward bias, and
- $R_r$  = series resistance at reverse bias.

The peak inverse voltage (PIV) breakdown

rating of the diode limits the maximum value of instantaneous RF voltage that can be applied across the diode junction. The peak RF voltage is equal to the PIV rating minus the bias voltage.

The amount of current that can flow through the diode junction, when it is forward-biased, depends upon the  $Q$  of the diode, the transient thermal impedance and the permissible junction temperature rise.

The transient thermal impedance relates the temperature change of the diode, per watt dissipated, to the length of time during which the incident power is applied. The diode's thermal time constant,  $\tau$  (the time at which the transient thermal impedance is 63% of its final value), should be determined. In all pin diodes tested to date,  $\tau$  is approximately 300  $\mu$ s.

The permissible temperature rise in the junction is not a well defined value. The average power limitation of a diode is set by a maximum temperature rise of 50°C.

The design goals of these phase-shifters are twofold: (1) maximum power-handling and (2) low insertion loss. The first requirement means that the voltage should be as large as possible,  $V_m$ , when the diode is back-biased, and the current should be as large as possible,  $I_m$ , during forward bias. These values can occur only at one impedance level, called the switching impedance,  $Z_s$ , which is equal to  $V_m/I_m$ . The second requirement means that the diode should be matched in both states to the transmission line with an impedance of  $Z_o$ . In the case of an ideal design,  $V_m$  and  $I_m$  can be so selected that  $Z_m$  be-

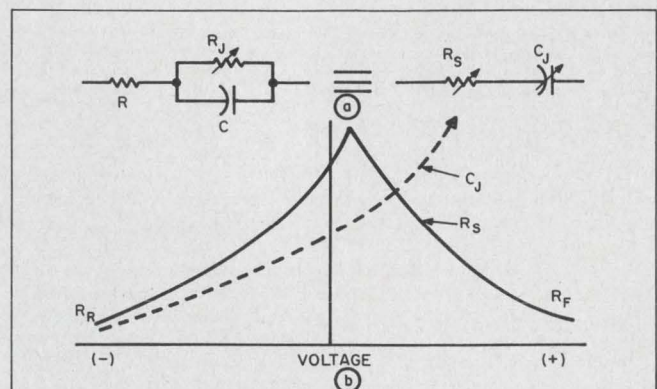

1. Equivalent circuit of a pin diode reduces to a series resistance and capacitance (a). The impedance of the intrinsic region changes with the voltage applied across the diode (b), but capacitance-changes yield the phase shift.

Gerard L. Hanley, research section head, Microwave Engineering Dept., Sperry Gyroscope, L. I., N. Y.



comes equal to  $Z_o$ .

There are two basic designs for digital diode phase-shifters. The first uses the change in the reflection coefficient of a diode mounted at the end of a transmission line. The second uses the change in the transmission coefficient of a diode mounted across a transmission line and is called a loaded-line phase-shifter. Since the diodes are placed a quarter wavelength apart in the latter configuration, it resembles a periodically loaded line. Both approaches are combined in the phase-shifter shown in Fig. 2.

### Convert one-port diode to two-port network

The reflection-coefficient design requires the conversion of a basic one-port device to a two-port network, to obtain a transmission phase shift. One way is to use a three-port ferrite circulator (Fig. 3). In the figure, the two bias states of the diodes are denoted by the subscript  $i = 1, 2$ . The output of the network in Fig. 3 is:

$$V_{out2} - V_{out1} = |\Gamma_2| \angle \theta_2 - |\Gamma_1| \angle \theta_1, \quad (2)$$

where  $\Gamma_1$  and  $\Gamma_2$  are the reflection coefficients of the diode for its two states. If the magnitude of impedances of the diode in the two states are equal, then  $|\Gamma_1|$  becomes equal to  $|\Gamma_2|$  and the voltage will be shifted by an angle  $\Delta\phi = \theta_2 - \theta_1$ . Here large  $\Gamma$  indicates a large reflected, or output, power and little dissipation.

An alternative technique is to terminate the bi-conjugate arms of a 3-dB directional coupler with identical diodes and matching networks. (Fig. 4).

The 90° phase characteristic of the 3-dB coupler combines the reflected power from the bi-conjugate ports in the output port. The phase relationships for such a one-port-to-two-port conversion scheme are shown in Fig. 4. All line lengths are assumed to be zero, which introduces no error, since the line lengths are common to both bias states of the diode. With a lossless coupler, the insertion loss can be expressed in terms of reflection coefficient of the diode and of the matching network:

$$\text{loss} = \left| \frac{V_{out}}{V_{in}} \right|^2 = |\Gamma_i|^2 \quad (3)$$

$$\text{loss} = 20 \log |T_i| \text{ (dB)},$$

where  $i$  is again a running variable, representing the two bias states.

### Shunt inductance to yield needed phase shift

To obtain the required phase shift, the simplest approach is to shunt the diode with an inductance (Fig. 5). For an ideal diode, this inductance would be coupled to the network when the diode is reverse-biased; when the diode is forward-biased, the inductance would be decoupled, making it negligible in comparison to  $R_f$ . Decoupling does not affect the short-circuit or forward-bias state of the diodes for various amounts of phase shifts

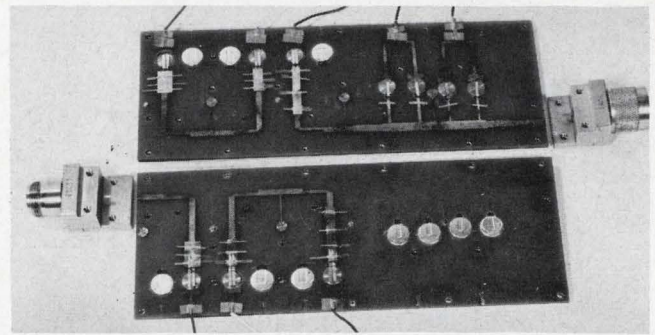

2. Typical 5-bit diode phase-shifter combines both the transmission and reflective methods for low coupler losses.

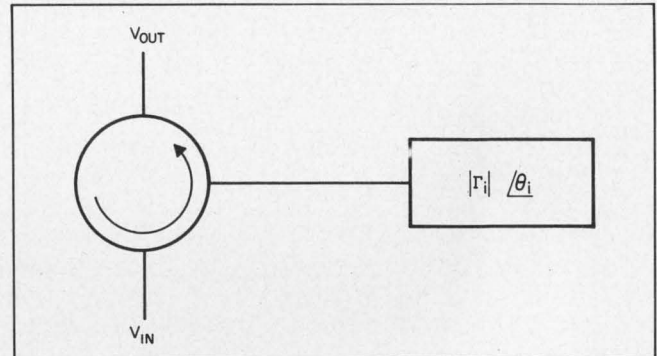

3. With the reflection-coefficient design approach, the diode is converted to a two-terminal network by a 3-port ferrite circulator. The subscript  $i$  is a variable, for the two states of the diode.

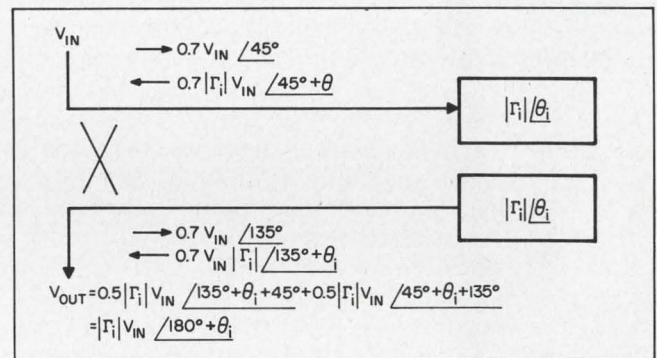

4. Alternate conversion of the diode to a two-port network with a 3-dB directional coupler gives rise to errors caused by the finite directivity of the coupler.

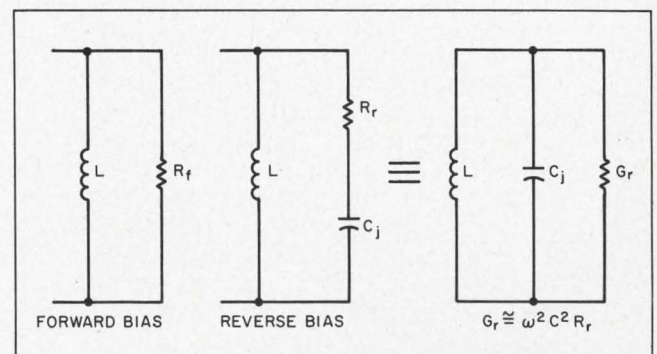

5. Simplest matching network is a shunt inductance that becomes negligible during forward bias. During reverse bias, it parallel-tunes the diode and adjusts the phase shift, by reducing the voltage across the diode.



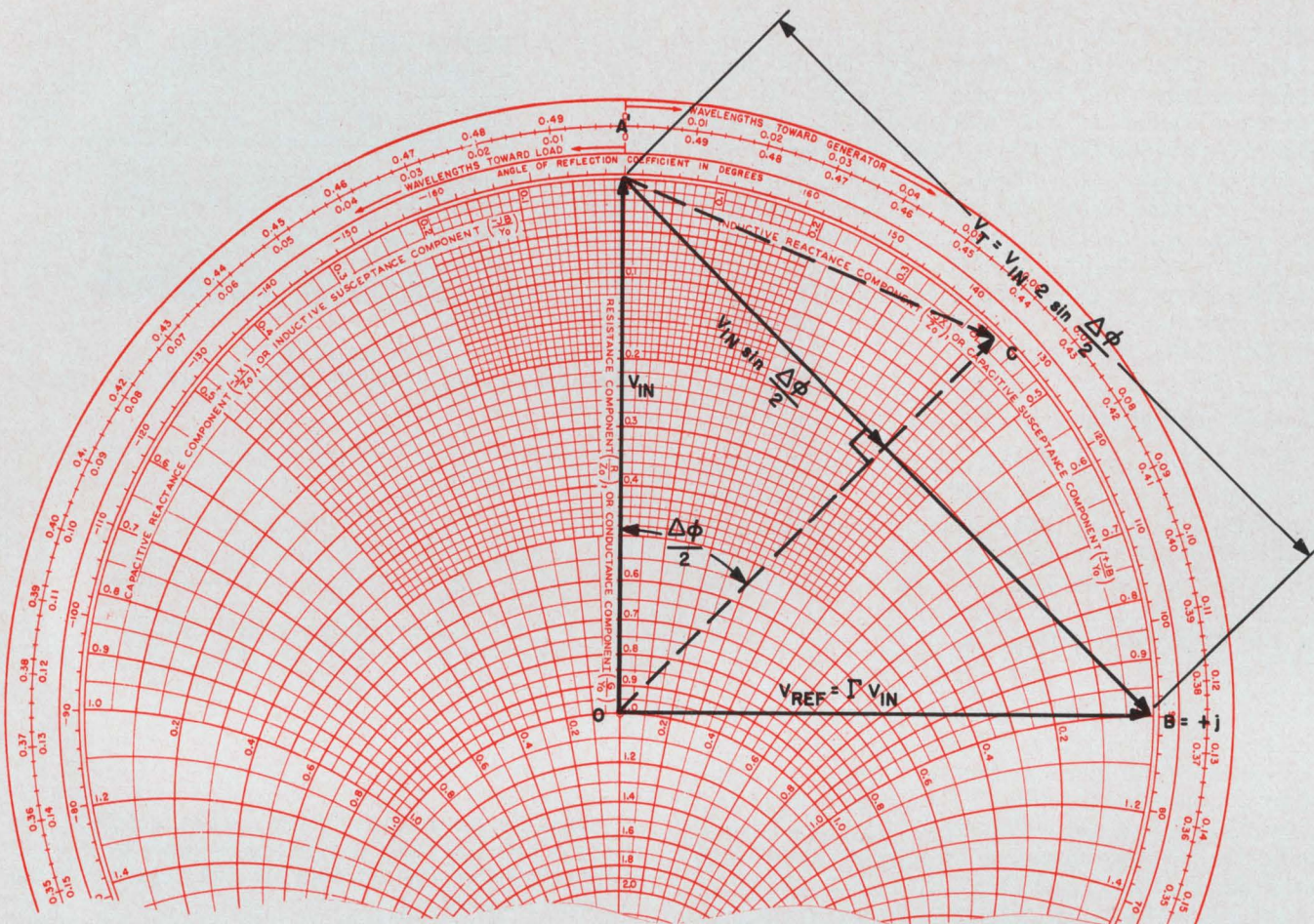

6. Impedance plot of an ideal diode and its inductive matching network shows  $90^\circ$  (points A'B) and  $45^\circ$  (points A'C) phase shifts. Points AA' represent the com-

bined impedances of the diode and the inductance. (A is exactly below A', at  $0.25 + j0$ ).

(bit sizes), which means that the same current will flow through the diode regardless of the phase shift obtained. On the other hand, the voltage across the diode, when reverse-biased, will be reduced in proportion to  $\sin(\phi/2)$  (Fig. 6). The incident voltage is the line OA' and the reflected voltage is the line OB. The total voltage,  $V_T$ , of the diode is the sum of the incident and reflected voltages, A'B. It is related to the difference in the reflection coefficients as:

$$V_T = 2V_i \sin \frac{\theta_2 - \theta_1}{2}, \quad (4)$$

where  $\theta_2$  is the angle of the incident voltage and  $\theta_1$  is the angle of the reflected voltage. The reflective losses for the reverse-biased diode are then proportional to  $\sin^2[(\theta_2 - \theta_1)/2]$ .

Since the losses for the forward-biased diode are independent of the phase shift (bit size), (i.e., the current remains the same), the forward loss of an  $n$ -bit phase-shifter is just  $n$  times the loss of the  $180^\circ$  phase bit. Thus the average loss of both states of an  $n$ -bit shifter can be expressed as:

$$(\text{loss})_n = (\text{loss})_{180^\circ} \times \left[ \frac{n + \sum_1^n \sin^2 \frac{180}{2^k}}{2} \right], \quad (5)$$

where  $n$  is the number of phase bits.

The loss for the circuit in Fig. 5 may be found by considering the input reflection coefficient or the input voltage standing-wave ratio (vswr). During forward bias:

$$\text{vswr} \cong \frac{Z_o}{R_f} \quad (6)$$

and during reverse bias:

$$\text{vswr} = \frac{Y_o}{G_r}, \quad (7)$$

where

$Z_o$  = characteristic impedance of transmission line,

$Y_o$  = characteristic admittance, and

$G_r$  = equivalent parallel conductance of reverse-biased diode.

For equal vswr's:

$$\frac{Z_o}{R_f} = \frac{Y_o}{G_r} = \frac{Y_o}{\omega^2 C^2 R_r}. \quad (8)$$

Note that  $Y_o = 1/Z_o$ . Solving for  $Z_o$ , we find that:

$$Z_o = X_c \sqrt{\frac{R_f}{R_r}}. \quad (9)$$







At microwave frequencies, transforming is best performed by quarter-wavelength transformers (see Fig. 7). The impedance points  $A'$  and  $A$  must be transformed to the impedance points  $+j1$  and  $-j1$ , respectively, by transferring the diode's impedance at a reference plane one-eighth wavelength in front of the diode. The input impedances for the two states of the diode at this plane are conjugates of each other, and any impedance transformation will operate on both values identically. Therefore, the magnitude of the reflection coefficient for the two states of the diode also remains the same. It is related to the reflection coefficient of the  $180^\circ$  bit by  $\sin(\Delta\phi/2)$ . The average losses in this case can be expressed as:

$$(\text{loss})_n = (\text{loss})_{180^\circ} \times \left[ \sum_1^n \sin \frac{180}{2^k} \right] \quad (15)$$

The comparison of Eqs. 5 and 15 shows that the symmetrical decoupling results in the lower average insertion loss.

The transformation ratio,  $a^2$ , of the ideal transformer will determine the required phase-bit size. For example, a combination of an ideal diode that produces a  $180^\circ$  phase bit and an ideal transformer in which  $a^2=0.414$  results in a  $90^\circ$  phase bit, as shown by the points  $C-C'$  in Fig. 7.

The general expression for determining the value of the transformer ratio is given by:

$$a^2 = \tan(\Delta\phi)/4.$$

The frequency sensitivity of the phase bit is determined by the sensitivity of the quarter-wavelength transformer and the diode-matching network. For a typical diode, including its parasitic elements, the phase deviations of  $\pm 2.6^\circ$ ,  $\pm 1.6^\circ$  and  $\pm 0.4^\circ$  for the  $180^\circ$ ,  $90^\circ$ , and  $45^\circ$  bits, respectively, were calculated for a 10% frequency band. For wider bandwidths, multiple-section quarter-wavelength transformers must be used.

### Two states provide matching reactances

The *loaded-line technique* for obtaining a transmission phase shift can be explained by considering an elemental section that contains only two reactances (separated by a quarter wavelength) shunted across a transmission line. The equivalent circuit of this network is shown in Fig. 8. The two states of the diode are used to obtain the required values of the  $\pm jB$ s. The magnitude of  $B$  and the characteristic admittance  $Y_1$  are related to the amount of required phase shift:

$$\begin{aligned} Y_1 &= \sec \frac{\phi}{2}, \\ B &= Y_0 \tan \frac{\phi}{2}. \end{aligned} \quad (16)$$

For an ideal diode, the value of  $\pm jB$  can be realized by a one-eighth-wavelength line and an ideal transformer. This line is used because the slopes  $dB/d\omega$  of the input admittance of the stub are identical for both diode bias states. Since the normalized admittance of a one-eighth-wavelength line, terminated in a short or open circuit,

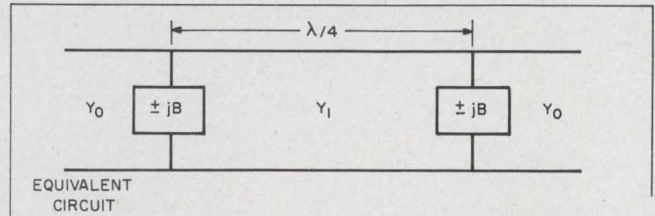

8. **Loaded-line design** involves the consideration of an elemental section of two reactances. The two states of the diode yield the needed values of  $\pm jB$ .

is  $\pm j1$ , the magnitude of  $B$  determines the required transformer ratio. The voltage transmission coefficient,  $T$ , and the voltage reflection coefficient,  $\Gamma$ , can be found from a  $2 \times 2$  matrix representation of the circuit:

$$\begin{aligned} T &= \frac{2}{A + B + C + D}, \\ \Gamma &= \frac{A + B - C - D}{A + B + C + D}. \end{aligned} \quad (17)$$

The two states of the diode result in different values for the matrix elements  $A$ ,  $B$ ,  $C$ , and  $D$ . The transmission phase and vswr, as a function of frequency, are shown in Fig. 9. The slopes of the transmission phase for both states of the diode are equal over a reasonably wide frequency range. This results in a phase shift almost independent of frequency.

The limitation of the loaded-line approach is the vswr. Since a number of these sections are required to obtain larger phase shifts, the interaction of the vswrs will distort the over-all response. For wider bandwidths and lower vswrs, we can increase the number of sections to obtain the same phase shift. This approach works well because the loaded line can be visualized as a low- or high-pass filter for the two bias states, and standard filter techniques can reduce the vswr in their respective pass bands.

The phase variations and the vswrs in a 10% frequency band for an 11-diode 11-stub, 4-bit phase-shifter are shown in Table 1. If no care is taken in coupling the various phase bits, the maximum vswr would be only 1.33.

The insertion loss and power-handling capability of the loaded-line design are limited by the diode characteristics in the same manner as in the reflective phase-shifter. All the equations derived previously are applicable to this design technique.

### Power-handling capacity is limited

The power-handling capability of a diode phase-shifter is given by the rms current and voltage ratings of the diode  $I_m$  and  $V_m$ . When both ratings are reached simultaneously, the maximum safe power level of the phase-shifter is obtained. A simple and very useful expression has been derived, in which the maximum peak power is related to the diode rating and to the value of phase shift desired:<sup>1</sup>



$$P = \frac{nV_m I_m}{4\sin\Delta\phi/2}, \quad (18)$$

where  $n$  is the number of diodes used and  $\Delta\phi$  is the size of phase shift.

The power handling capacity can be increased by either reducing  $\Delta\phi$  or increasing  $n$ . Diodes with peak inverse breakdown voltages of  $-1000$  V and maximum forward peak currents of  $31$  A will be used to calculate the maximum RF power levels that diode phase-shifters can safely handle. (The 31-A rating is based upon a junction temperature rise of  $50^\circ\text{C}$  for a typical diode at  $1300$  MHz.) This value will decrease as the frequency of operation increases because the  $Q$  of the diode varies inversely with frequency. Thus the loss or the power dissipated in the diode will increase with frequency (Fig. 10). The curve will have the same shape for all frequencies. For a  $40$ -kW peak-power capability, the maximum phase shift for each pair of diodes is  $22.5^\circ$ . Thus eight pairs of diodes would be required to obtain  $180^\circ$ . It must be realized however, that no safety factors are included in the calculation.

The maximum permissible incident power may be found by assuming ideal performance for the two states. An ideal diode, when forward-biased, presents a short-circuit termination at the end of a transmission line. Thus the current through the diode is twice the incident current. Similarly, when the ideal diode is reverse-biased, it appears as an open circuit and the voltage across the diode is twice the incident voltage. Thus the maximum power is:

$$P = V_i \times I_i = \frac{V_d I_d}{4}. \quad (19)$$

The average power limitation of the diode is determined by the peak power, the duty cycle, and the signal waveform. When the pulse repetition frequency is such that the spacing between pulses is greater than  $4\tau$ , then the average power limitation is determined by a single pulse.

For some applications, pulse bursts are useful. However, in these cases, the spacing between the pulses in the burst is less than one time constant and the diode does not have time to cool off before the next pulse is applied. To calculate this effect, it is necessary to determine the transient thermal impedance of the diode junction and mount.<sup>2</sup>

A graphical solution for a train of pulses is shown in Fig. 11. The junction temperature can also be evaluated by considering the average power of the pulse burst to be the amplitude of a single pulse whose width is equal to the length of the pulse burst (see broken line). However, a small error, approximately equal to one half the temperature rise of one pulse of the pulse burst is introduced.

#### Experimental results agree with prediction

Phase-shifters have been designed in the frequency range from  $1200$  to  $6000$  MHz. The experi-

#### Theoretical response

Phase-bit size (deg)	No. of diodes (per bit)	Phase variation (deg)	VSWR (max)
180	4	$\pm 1.5$	1.10
90	3	$\pm 0.7$	1.05
45	2	$\pm 0.5$	1.10
22.5	2	$\pm 0.25$	1.05

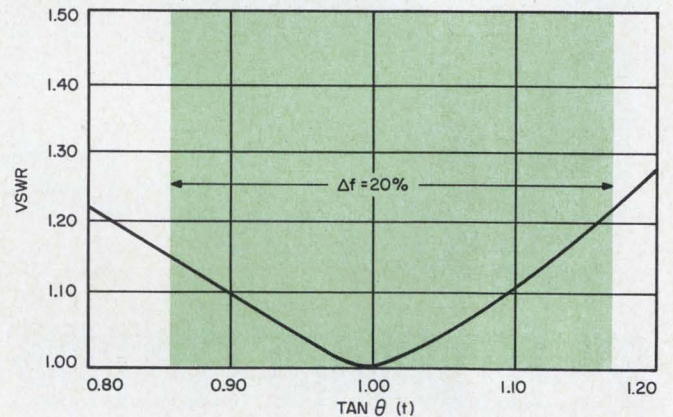
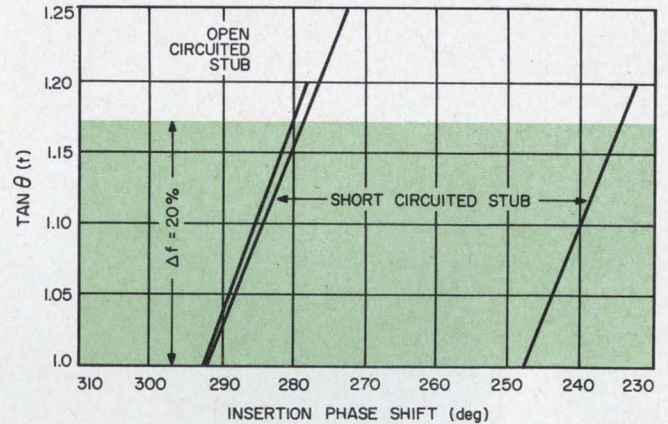

9. Important characteristics of a typical two-stub  $45^\circ$  phase-shifter include the insertion phase shift (a) and the vswr (b). The slopes of the phase curves remain the same for both states over a wide range, resulting in a phase shift that is almost independent of frequency.

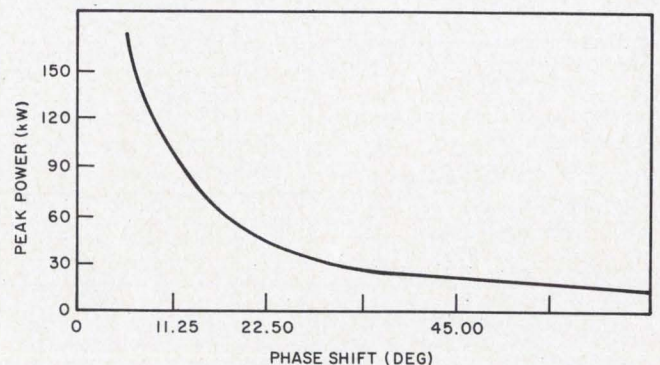

10. Peak power-handling ability of a pair of diodes decreases with the phase-bit size. The curve was plotted with diodes having a  $V_m$  of  $1000$  V and an  $I_m$  of  $31$  A.



# NEW LOWER PRICES

## INDUSTRIAL

### BLUE COVER LINE

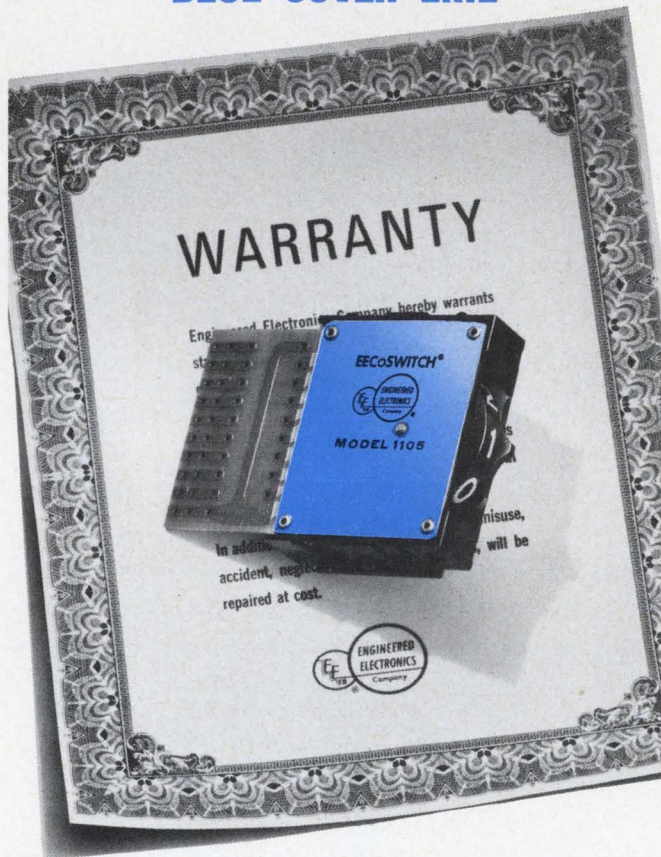

## GET EECoswitch® EXCLUSIVE 2-YEAR WARRANTY

SERIES	DESCRIPTION	SERIES	DESCRIPTION
8-POSITION		10-POSITION	
1135	BCD W/Comp., 2 Commons	1129	Single Pole, N.S. Connector Terminal
10-POSITION		1130	Single Pole, N.S. Wire Terminal
1105	BCD W/Comp., Diode Provision	1133	BCD & Decimal, 2 Commons
1106	BCD W/Comp.	1155	2 Pole, N.S.
1114	BCD, Diode Provision Connector Terminal	1160	5-Line Teletype
1119	BCD, Wire Terminal	12-POSITION	
1124	BCD, Diode Provision Wire Terminal	1181	BCD Connector Terminal
1128	BCD, Connector Terminal	1182	BCD Wire Terminal

DIGITAL CIRCUIT MODULES ■ CUSTOM WELDED and PACKAGED CIRCUITS ■ SYSTEMS  
 Area Phone Numbers: Boston (617) 275-0540 ■ New York City (201) 444-3220  
 Washington, D.C. (301) 779-3636 ■ San Francisco (408) 253-5951

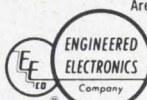

**ENGINEERED ELECTRONICS Company**  
 1441 East Chestnut Ave. Santa Ana, California 92702  
 Phone: (714) 547-5651 TWX: 714-531-5522 Cable: ENGELEX

ON READER-SERVICE CARD CIRCLE 19

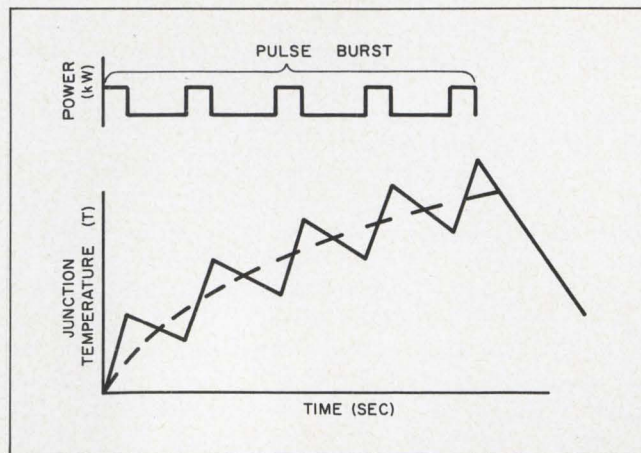

11. In pulse-burst applications, the diode has no time to cool off between the pulses. Therefore the junction temperature rises, as shown by the ragged line.

mental results agree closely with the predicted values determined by the preceding theory. The main source of error arises from the inability to realize an ideal 3-dB coupler with infinite directivity. The finite directivity results in an unexpectedly large frequency deviation. Couplers with directivity greater than 30 dB are satisfactory and introduce only small errors.

A typical 5-bit phase-shifter uses both the reflective and transmission type of design to eliminate the coupler losses for the two smallest phase bits. Printed-circuit stripline techniques minimize size, weight, and cost. The 3-dB couplers were quarter-wavelength parallel-line couplers.<sup>3</sup> Two 750-V breakdown diodes in parallel are used per mount in the larger bits to permit the use of a lower characteristic impedance level, which is required for higher peak power capability. The phase-shifter has an average loss of 1.15 dB and a vswr of 1.20. Its peak power rating is 5 kW, with a 50-W average rating. Its weight is 6 ounces.

By increasing the number of diodes, diode phase-shifters are feasible for power levels of 100 kW, although those of more than 10 kW may not be practical because of the large number of diodes needed. Insertion losses of 1 dB are obtainable up to C-band frequencies with the diodes available today. The cutoff frequencies of these diodes presently range up to 400 MHz, and values approaching 1000 MHz do not seem unreasonable. With such diodes, low-loss phase-shifter designs for frequencies up to 16 GHz are possible. ■ ■

#### Acknowledgment:

The author wishes to thank D. Churchill and C. Kraus, of the Sperry Radiation Div. for their contributions.

#### References:

1. M. E. Hines, "Fundamental Limitations in RF Switching and Phase Shifting Using Semiconductor Diodes," *Proceedings of the IEEE*, LII, No. 6 (June, 1964), 697-708.
2. F. W. Gutzwiller and T. P. Sylvan, "Power Semiconductor Rating Under Transient and Intermittent Loads," *AIEE Transactions, Communications & Electronics*, No. 51 (January, 1961), 699-705.
3. J. K. Shimizu, *A Strip-Line 3-dB Coupler* (Stanford Research Institute, June, 1957), AFCRC-TN-57-565.



# PLUG-IN

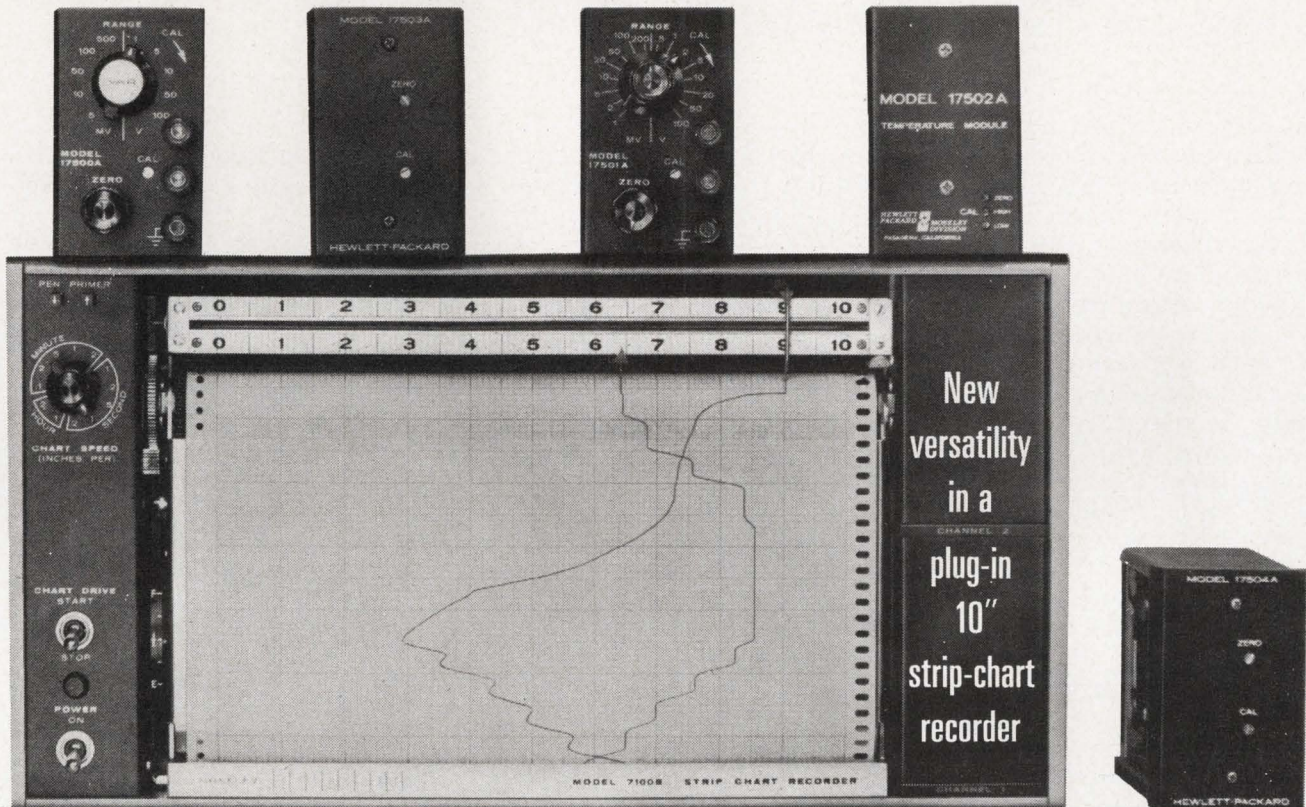

- Input modules provide special purpose capabilities
- Mainframe available with one or two pen flexibility
- 12 instantly selected chart speeds, 1 in/hr-2 in/sec
- Half-second response time
- Chart tilts in three positions for easy viewing and notation
- Easy chart loading, tear off or storage, paper supply indicator
- All solid-state circuitry
- Rack-mount, metric models available

The basic mainframe of the 7100B (two pens) and 7101B (one pen) provides 10" strip-chart recording capabilities. Each channel accepts any of the wide variety of input modules which determine the electrical span or special-purpose recording capability.

Features offered, in addition to those above, include event markers, electric pen-lift and chart drive start-stop—all remotely controlled. Retransmitting potentiometers, adjustable high-low limit switches on both channels and remote 10-1 speed changers are also available.

Standard input modules (more to come) offer multiple span ranges, high input resistance (1 meg at null), high cmr and floating inputs to 500 v above ground. Model 17500A has 10 calibrated spans 5 mv-100 v full scale; Model 17501A has 16 calibrated spans 1 mv-100 v full

scale. Variable span and full scale zero controls are provided. Model 17502A, a temperature input module with automatically compensated reference junction, linearizes recorder presentation with standard paper. Additional low-cost single range input modules (Model 17503A, 1 mv input with filter; Model 17504A, 5 mv-100 v with plug-in range cards) are also available:

- Model 7100B** 2-pen Recorder, \$1300
- Model 7101B** 1-pen Recorder, \$1000
- Model 17500A** Input Module, \$250
- Model 17501A** Input Module, \$350
- Model 17502A** Input Module, \$250
- Model 17503A** Input Module, \$250
- Model 17504A** Input Module, \$200

Ask your Hewlett-Packard field engineer for a demonstration or write for complete information to Hewlett-Packard, Palo Alto, Calif. 94304, Tel. (415) 326-7000; Europe: 54 Route des Acacias, Geneva.

*Data subject to change without notice.  
Prices f.o.b. factory.*

**HEWLETT  
PACKARD**  **MOSELEY  
DIVISION**



# Keep sampled-data systems accurate

with this technique for sensing common-mode error voltages and compensating for their effects.

Modern sampled-data test systems are ordinarily highly accurate, but false data can result from common-mode voltages. These voltages are generated by potential differences between power-supply grounds and by inductive noise pickups on long signal-return leads. It would be nice just to eliminate the source of the error, but it isn't always practical: usually there are too many long, cabled interconnections of random length between units of the system. A practical solution is to sense the unwanted signal and compensate for it.

In most high-accuracy test instrumentation it is possible to examine simultaneously many data sources, both analog and digital. The data are processed, converted to digital format and recorded on magnetic tape. This technique makes it possible to sample an analog function with an amplitude accuracy of 0.03% or better, as long as the test system is properly calibrated. This method of instrumentation is made economically feasible through the use of time multiplexing and only one analog-to-digital converter. A typical analog processing system, as shown in Fig. 1, consists of sensing and buffering, low-pass filtering, multiplexing, A/D conversion and recording equipment.

The low-pass, or pre-sampling, filter limits the frequency spectrum reaching the multiplexer to the data bandwidth of interest, and thereby reduces the higher-frequency components that generate "aliasing errors"—that is, errors that result when time-varying data are sampled at too low a rate.

The sensor-buffer and the active filter are contained in the same unit, and their signal returns are tied to the unit common. The multiplexer is a separate unit; it has its own unit common and contains its own power supply (Fig. 2). To complete the signal-return loop, both these commons are electrically connected. The common-mode voltage drop across the return line is the result of currents generated by:

(1) Potential imbalance between power supply commons.

(2) Inductive pickup of noise by the return lead.

These are the two major sources of common-

mode error. In a 0.03% instrumentation system such errors are significant and must be compensated for.

The common-mode voltage,  $e_c$ , appears directly at the multiplexer input as part of the signal (Fig. 3). Voltage  $e_c$  may comprise any and all frequencies within the operational amplifier's open-loop bandwidth.

The relationship between  $e_c$  and multiplexer input  $e_L$  can be shown as follows: Summing currents at  $e_1$  we find:

$$\frac{e_L - e_1}{2R} = \frac{e_1 - e_c}{R} \quad (1)$$

$$e_1 = 1/3(2e_c - e_L), \quad (2)$$

$$e_L = Ae_2 - Ae_1. \quad (3)$$

Substituting (2) into (3) we find

$$e_L \left(1 + \frac{A}{3}\right) = Ae_c - \frac{2}{3}Ae_c,$$

and since  $A/3 \gg 1$ ,

$$e_L \cong \frac{A}{3} e_c / \frac{A}{3}, \quad (4)$$

$$e_L \cong e_c$$

One would expect the introduction of a compensating signal on the non-inverting input to the filter amplifier to subtract from the amplifier output and thereby cancel the common-mode signal. This is exactly what happens, and the degree to which this is accomplished is shown by the following equations, which apply to Fig. 4. Summing currents at  $e_1$ :

$$\frac{e_o - e_1}{R_o} = \frac{e_1 - e}{R_1}, \quad (5)$$

$$e_1 = e \left( \frac{R_o}{R_o + R_1} \right) + e_o \left( \frac{R_1}{R_1 + R_o} \right), \quad (6)$$

$$e_o = Ae_1 + Ae_s; \quad (7)$$

and substituting (6) into (7), we find

$$e_o \left( 1 + A \frac{R_1}{R_o + R_1} \right) = -Ae \left( \frac{R_o}{R_1 + R_o} \right) + Ae_s;$$

and since  $A R_1 / (R_1 + R_o) \gg 1$ ,

$$e_o = -e \frac{R_o}{R_1} + e_s \left( \frac{R_1 + R_o}{R_1} \right) \quad (8)$$

Aldo J. Burdi, Electronics Engineer, Interstate Electronics Corp., Anaheim, Calif.



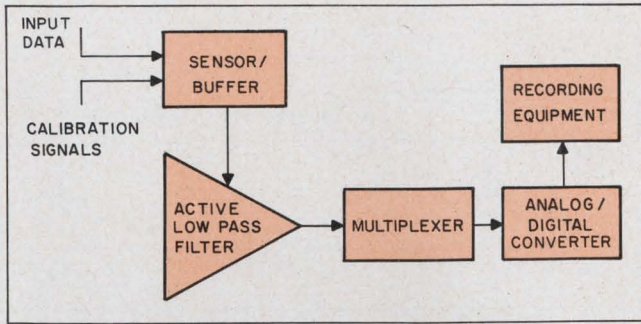

1. Typical analog processing system consists of sensing and buffering, low-pass filtering, multiplexing, A/D conversion and recording.

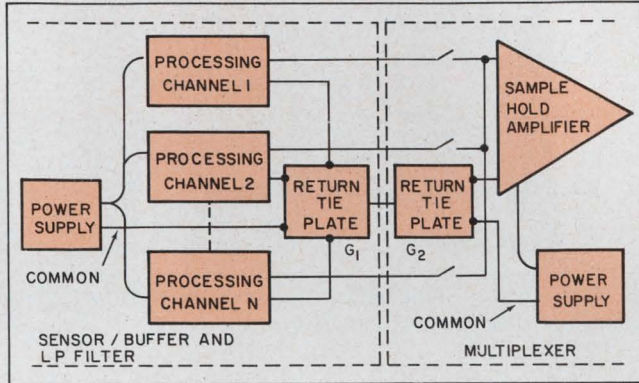

2. Sensor/buffer and filter are contained in a single unit. The common connection ( $G_1$ - $G_2$ ) between this unit and the multiplexer is a source of common-mode error voltages.

The derivation shows the output voltage  $e_o$  of the active filter to be a function of the signal  $e_s$ .

Suppose we were to sense some portion of the common-mode signal,  $e_c$ , by carrying a sense lead from the non-inverting input to the multiplexer signal-return common and use it as a compensation signal. This would provide a means for initiating a cancellation method. For the circuit shown in Fig. 5, setting the input to zero and solving for  $e_o = 0$  yield the correct value to  $e_s$  to cancel the common-mode voltage completely.

$$e_L = e_o + e_c \quad (9)$$

$$= e_s \left( \frac{R_o + R_1}{R_1} \right) + e_c;$$

Setting  $e_L = 0$ .

$$e_s = -e_c \left( \frac{R_1}{R_o + R_1} \right). \quad (10)$$

The circuit equivalent that implements the solution is shown in Fig. 6.

#### Design example demonstrates technique.

A typical problem that is of current interest is the instrumentation of 200 (a realistic figure) dc signal sources, all part of a hypothetical missile weapons system. This weapons system may be either shipboard or ground-based. In either case the errors encountered are generally greater than that calculated here, because of noise inductively

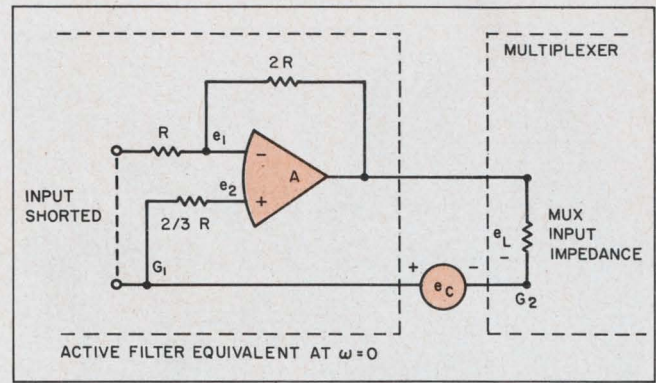

3. Active filter equivalent shows how common-mode error voltage,  $e_c$ , appears at the multiplexer input. Analysis of this circuit shows that  $e_c$  and  $e_L$  are approximately equal.

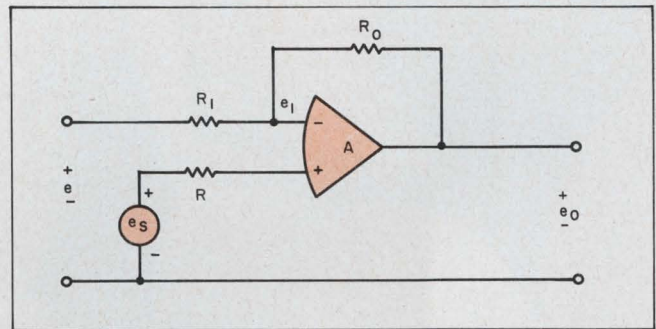

4. Introducing the compensating signal,  $e_s$ , at the non-inverting input of the filter amplifier subtracts from the amplifier's output.

coupled on to the return line.

It is desirable to keep the common-mode error to 0.1 or less of the total processing error. This is a rule of thumb and is by no means strict. It is a function of the system's noise environment.

The 200 transducers are in scattered locations throughout the weapons system. Their output is  $0 \pm 1$  Vdc, and the highest-frequency component of data is 0.1 Hz. The sensor-buffers are placed as close to the source as possible and have a gain of 5. There is 100 feet of cable (8-gauge return cable) between the sensor-buffer and the multiplexer (Fig. 7). The multiplexer has an input impedance of 10 M $\Omega$ . This processing channel must record data to an accuracy of 0.03% of full scale. For simplicity, one of the 200 transducers is used for the calculations.

Without sensing:

Assuming  $e_c = 0$ ,

$$I_{in} = 5 \times 10^{-7} \text{ A.}$$

For 200 transducers:  $I_{return} = 200 (5 \times 10^{-7}) = 10^{-4} \text{ A,}$

$$e_c = 0.64 (10^{-4}) = 6.4 \times 10^{-5} \text{ V.}$$

Eq. 4 shows that the full effect of  $e_c$  is felt at the multiplexer input.

For a 1-volt input signal,  $e_{in}$  (multiplexer) = 5 V +  $e_c$  where  $e_c$  is an instrumentation error.

$$\% \text{ error} = \frac{6.4 \times 10^{-5} \text{ V}}{1 \text{ V}} \times 100 = 0.064\%.$$

This error is more than twice the maximum



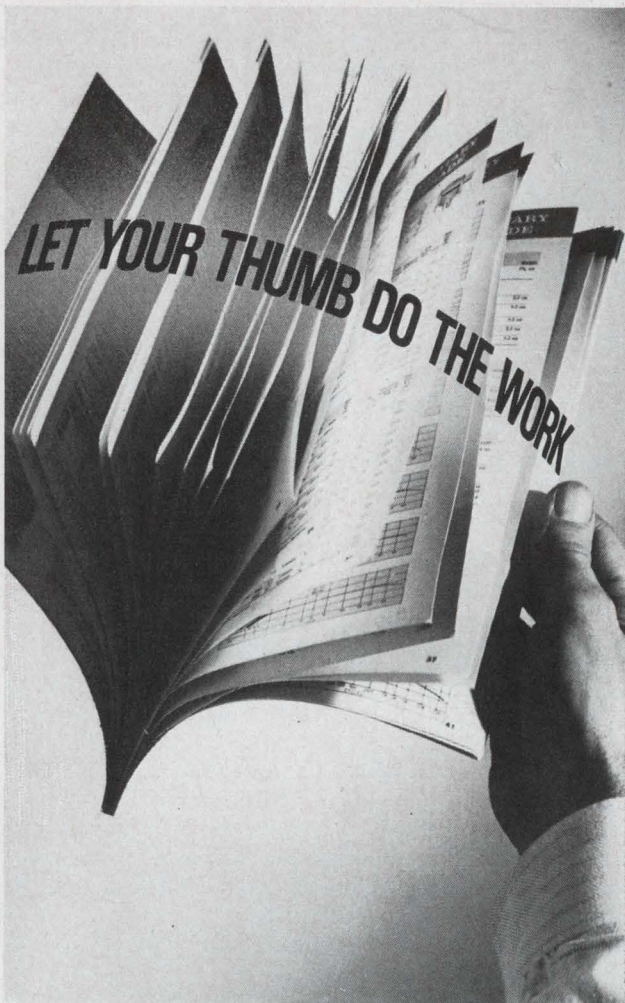

**when your design is only an idea...put in TRIAD off-the-shelf transformers!**

You'll get new prototypes on their way faster. And cut out costly sampling. Just turn first to the TRIAD catalog for the transformers and reactors you need. Chances are the unit you thought would have to be custom made is ready off-the-shelf from your TRIAD distributor.

The way to be sure is to thumb through the TRIAD catalog. You'll find more than 1700 items immediately available. More added each month. It's your most complete source for what's new and in stock. Of course, it's free. Even better than free, it will save you money in the long run. And help your ideas pay off.

Get your TRIAD catalog from your distributor or write us direct:  
305 North Briant Street,  
Huntington, Indiana.



**Triad Distributor Division**  
LITTON INDUSTRIES



ON READER-SERVICE CARD CIRCLE 21

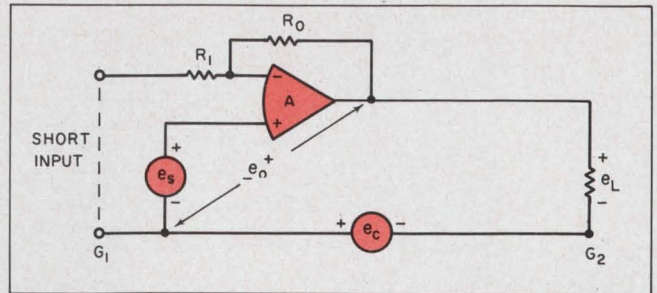

5. Sensing a portion of error-signal,  $e_c$ , at the non-inverting multiplexer input provides a means to achieve error cancellation. Calculations are made with the input shorted.

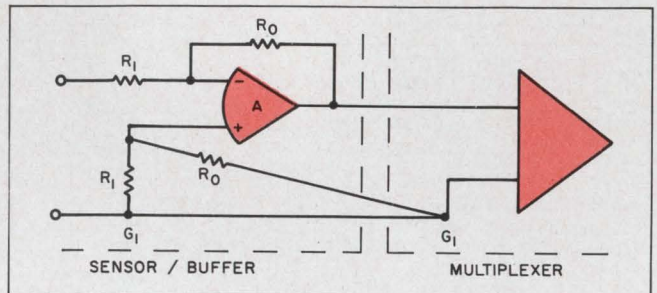

6. This circuit implements the error-voltage sampling technique described in the text.

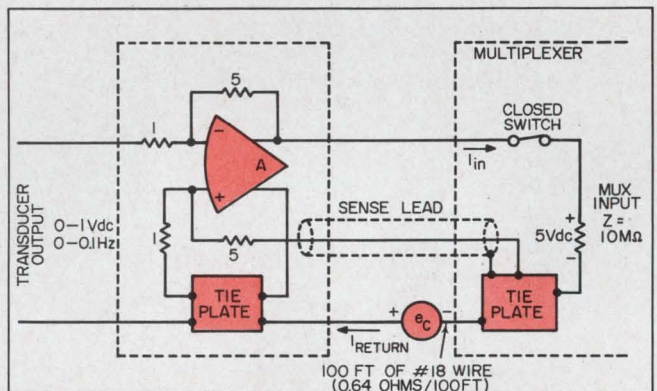

7. Here is a typical application of the common-mode error-canceling techniques described in the article.

allowed (i.e. 0.03%). The sense and cancellation technique described can now be applied.

With a shielded sense lead connected, as shown in Fig. 7, and using Eq. 8 and 10, we find

$$\begin{aligned}
 e_o &= e_{in}(\text{mux}) = -e \left( \frac{R_o}{R_1} \right) + e_c + e_s \left( \frac{R_1 + R_o}{R_1} \right) \\
 &= -5 + e_c + \left( \frac{-e_c}{6} \right) \left( \frac{6}{1} \right) \\
 &= -5 + e_c - e_c = -5 \text{ V.}
 \end{aligned}$$

The common-mode voltage,  $e_c$ , has been sensed and canceled.

The techniques just described, together with grounding schemes that employ short leads and minimum inductive coupling, may be used in any system that suffers from this type of common-mode problem. ■ ■



# new

## Low cost metal glaze resistor for MIL-R-22684

uniform molded body  
power-safety factor  
thick-film stability

Diamond spiraled  
metal glaze element  
Ceramic substrate  
Plated-on  
copper end cap  
High temperature  
soldered  
termination



IRC, the developer of Metal Glaze, now offers a new, low-cost *molded* Metal Glaze resistor that meets or exceeds all performance and environmental requirements of MIL-R-22684. Value engineered for optimum precision and reliability, it is the most economical MIL-R-22684 unit available today.

Load life stability is four times better than MIL allowance. Maximum resistance change is only 0.5% after 1000 hours, 1/4-watt at 70°C. Even when operated at higher temperatures, stability is still typically well within MIL limits.

This is the direct result of IRC's thick-film Metal Glaze resistance element. 100 times thicker than conventional films, Metal Glaze defies catastrophic failure, withstands high temperatures and high overloads, and is impervious to environmental extremes.

The resistor is designed for faster, easier automatic insertion. Its smooth, tough, molded body resists solvents, corrosion and the mechanical stresses of high-speed inserting machines.

This new IRC molded Metal Glaze resistor provides an ideal low cost solution to stability, reliability and precision for a wide range of applications. Write for complete data, prices and samples. IRC, Inc., 401 N. Broad St., Philadelphia, Pa. 19108.

### CAPSULE SPECIFICATIONS

MIL-R-22684A:	RL07
POWER:	1/4-watt @ 70°C
RESISTANCE:	51Ω thru 150KΩ
TOLERANCES:	±2% and ±5%
TEMPERATURE	
COEFFICIENT:	±200 ppm/°C, max.
VOLTAGE:	250V, max.
IRC TYPE:	RG07

MOLDED BODY  
.250" x .090"



Speed Inquiry to Advertiser via Collect Night Letter  
ON READER-SERVICE CARD CIRCLE 22



# One-bit comparator uses FETs to achieve a low component count and simple circuitry. The next step—monolithic integration.

In developing integrated circuits, an important design aim is to lower the component count in order to achieve the simplest circuit possible. Metal-oxide-semiconductor (MOS) field-effect transistors (FETs) can be used for this purpose, since:

- Passive load devices (resistors) can be made by using FETs and simply rearranging their lead connections.
- The MOS technology is a relatively simple manufacturing process, because of its high device densities, single diffusion region, and the absence of an isolation diffusion.

As an example of this approach, the one-bit digital comparator described here was built with only eight components—all FETs. Though only the discrete circuit was evaluated, its possible implementation in integrated form, and associated advantages, are also discussed.

## Comparator works with discrete devices

One application for this comparator is in a digital servo system where a binary command signal and a binary position signal, corresponding to a shaft position, are compared and a correcting signal issued. When both inputs are equal, the comparator outputs are a logical "1". When inequality exists, one output is at "1" and the other at "0", depending on which of the inputs is a "1" or "0". This ability to distinguish between inputs is

desirable because it causes a change in the position input in a particular direction to achieve input equality.

The comparator can also be used in logic circuits, with minor modifications, as a dual exclusive OR circuit; in power supply systems as a high-input-impedance comparator; and in other applications where two inputs are sensed and a proportional error voltage is produced.

Operation of the comparator can be understood by referring to the schematic and truth table shown in Fig. 1. The FET devices *C*, *D*, *1* and *3* serve as fixed resistors, since their gates are connected to the drain terminals and therefore  $|V_{GS}| = |V_{DS}|$ . The resulting load line is shown in Fig. 2. In order to provide a satisfactory load impedance, the FETs used as load devices should have a gain that is at least ten times lower than the gain of the active FETs used as switches.

When a logical "0" (ground potential) is applied to gates  $G_A$  and  $G_B$ , devices *A* and *B* are biased OFF and the potential at node *X* equals the potential at node *Y*. The potential at node *X* is applied simultaneously to gate  $G_2$  and source  $S_1$ , while the potential of node *Y* is applied to gate  $G_1$  and source  $S_2$ . As a result, devices *2* and *4* see essentially zero gate-to-source potential and are biased OFF. This sets nodes *K* and *L* both at logical "1" (-V potential), because the supply voltage is coupled through load devices *1* and *3*, and an equality of inputs is achieved.

Similarly, when both inputs  $G_A$  and  $G_B$  are at logical "1", devices *A* and *B* are forward-biased and nodes *X* and *Y* are clamped near ground.

J. R. Dailey, Senior Associate Engineer, IBM Systems Development Div., Endicott, N. Y.

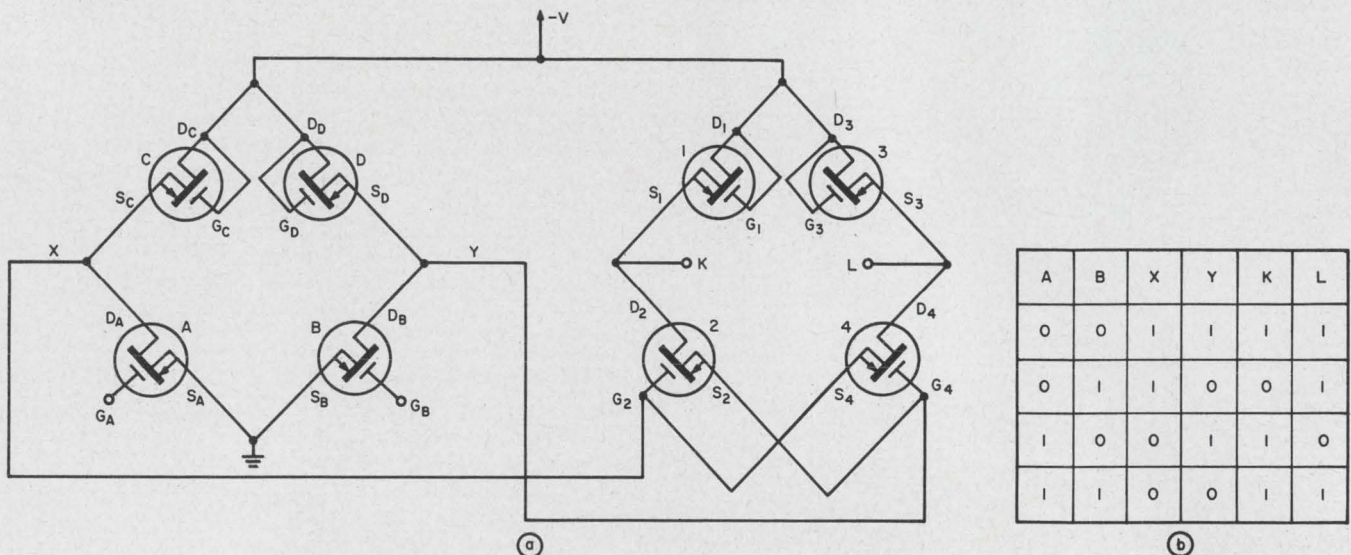

1. FETs are used as fixed resistors (devices *C*, *D*, *1*, and *3*) in this digital comparator (a). As shown in the truth

table (b), a differential input to *A* and *B* results in a differential output at *K* and *L*.



Since devices 2 and 4 see essentially zero gate-to-source potential, they are biased OFF, nodes K and L remain at logical "1", and input equality is again achieved.

To study the circuit for unequal input signals, assume a logical "1" is applied to  $G_A$  and a logical "0" to  $G_B$ . This condition forward-biases device A and reverse-biases device B. Node X becomes a logical "0" and node Y becomes a logical "1". The resultant gate-to-source potential forward-biases device 4 and reverse-biases device 2. This places output K at logical "1" and output L at logical "0". If the inputs are reversed, the action is similar except that device 2 turns ON and device 4 turns OFF, resulting in a "0" at output K and a "1" at output L.

The input and output waveforms of the digital comparator, built in discrete form, are shown in Fig. 3. A logical "1" is represented by the negative voltage, and a "0" by zero voltage. When input  $G_A$  is at "1" and input  $G_B$  is at "0", output K remains at "1" and output L goes to "0". If the inputs are reversed, the outputs also reverse. If both outputs are either at "1" or at "0", then both outputs remain at "1", a negative voltage.

In each instance of input equality, the outputs are not taken across an ON device, but are coupled through the load devices to the supply. If the outputs were taken across ON devices, they would be dependent on variations of the saturated, device characteristics; this would result in an error voltage output from the comparator. Coupling the outputs through the load devices keeps them independent of any of these voltage variations. Typical operating values are:

Input voltage = -2 to -20 V,

Drain supply = -20 V.

Frequency = 100 kHz,

Switching current = 5 to 10 mA.

If desired, the gates of the load devices need not be kept at drain potential. Instead, a separate gate potential can be applied to provide an adjustment of device characteristics. This potential can be varied to adjust the threshold voltages of the load devices so that a horizontal translation of the load lines is possible. This is also shown in Fig. 2.

The comparator circuit is not restricted only to binary comparison, but may also be used quite readily for analog comparison. For example, if devices A, B, 2, and 4 are operated as depletion devices, bipolar inputs to  $G_A$  and  $G_B$  would be compared, both in amplitude and phase. Operation as depletion devices is necessary since one or both of the inputs can be bipolar, as in the case of small-signal sinusoidal variations, and the comparison must be made over the complete waveform. By operation in the depletion mode (normally-ON), any variation of the input signal causes an increase or decrease about the normally-ON quiescent point, as shown in Fig. 4, and allows for comparison of the complete waveform. If the two inputs are identical in phase and amplitude, no output will be indicated. If a difference exists, the output becomes proportional to the amount of difference. This principle is useful for analog

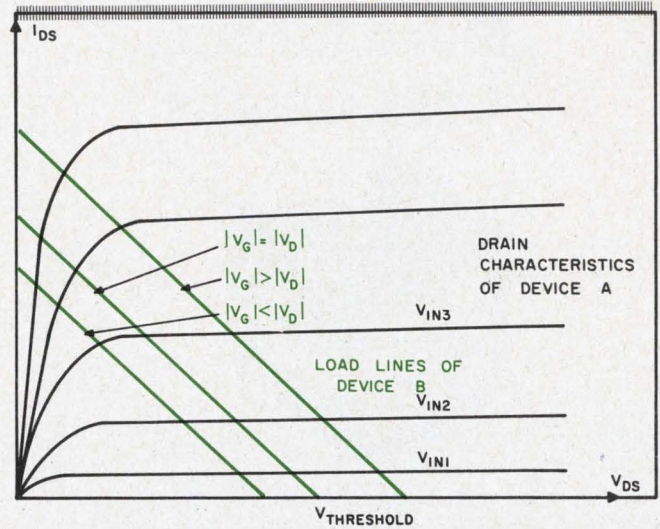

4. By setting the bias point so that the FET is normally-ON (depletion mode operation), the comparator will accommodate bipolar inputs and can be used to compare analog signals.

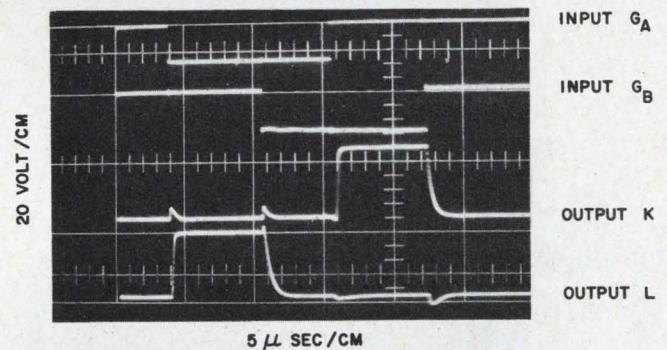

3. Input and output waveforms of the comparator, built with discrete components, show the relationship of outputs, K and L, to inputs,  $G_A$  and  $G_B$ .

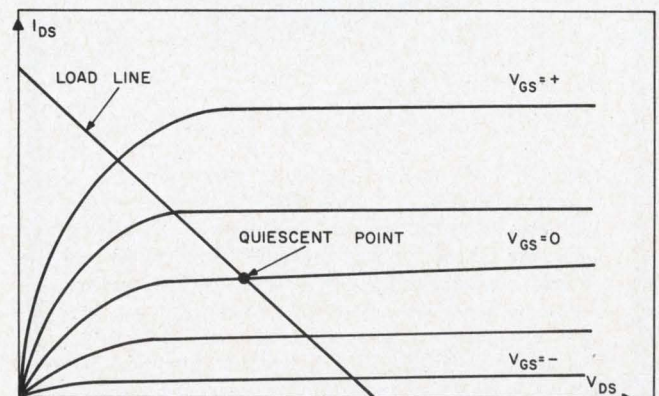

2. Characteristic curve of FET has the load lines of the resistive device superimposed. As the gate voltage to the resistive device is varied, its resistance changes and the load line shifts.



# More torque, Less weight

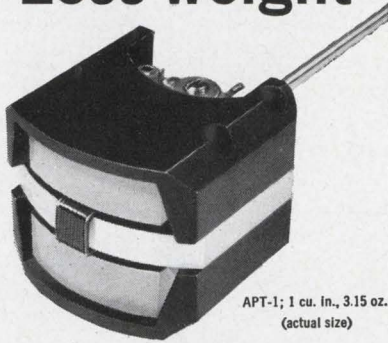

APT-1; 1 cu. in., 3.15 oz.  
(actual size)

## in moving coil mechanism

Stable, linear, accurate mechanism for indicating, control or recording systems. 1% linearity over 18-0-18° and greater accuracy assured by coil design with over 75% of winding "working" in high energy, uniform field air gap. Coil system weighs 0.85 gm, develops 26.4 mmg of torque; 31:1 T/W. Vibration resonance negligible; acceleration errors sharply attenuated. Standard pivots and jewels—custom damping—wide range of sensitivities.

# AMMON

AMMON INSTRUMENTS, INC.  
345 Kelley Street, Manchester, N. H. 03105

ON READER-SERVICE CARD CIRCLE 23

GLOBE

## 1/10 hp, d.c. motor

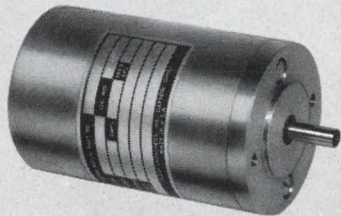

Type GRP, 2 1/4" Dia.

Globe Type GRP permanent magnet d.c. motors are rated at 1/10 hp at 6,000 to 10,000 rpm, 6 to 115 v.d.c. Motors are 2 1/4" diameter by 3 3/4" long and weigh 2 lbs. 8 oz. Type GRP motors are designed to meet applicable MIL specs for construction and environmental protection. They are available with a wide variety of accessories including geartrains, governors, brakes, clutches, radio noise filters, and others. Wound field designs are also available in this frame size for series, split series, shunt, split shunt, or universal a.c./d.c. operation. For further information, request Bulletin GRP.

Globe Industries, Inc., 2275 Stanley Ave., Dayton, Ohio 45404.  
Tel: 513 222-3741

ON READER-SERVICE CARD CIRCLE 24

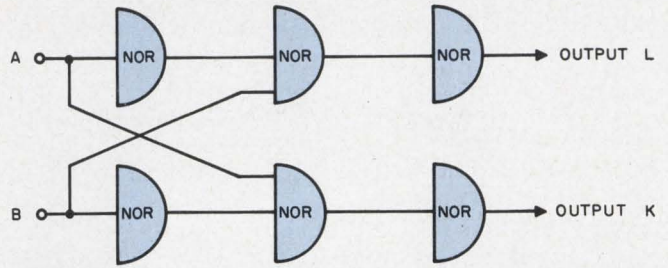

5. Bipolar monolithic integrated circuits could also be used to build a digital comparator. However, this design would require six NOR gates with a total of 26 active and passive components.

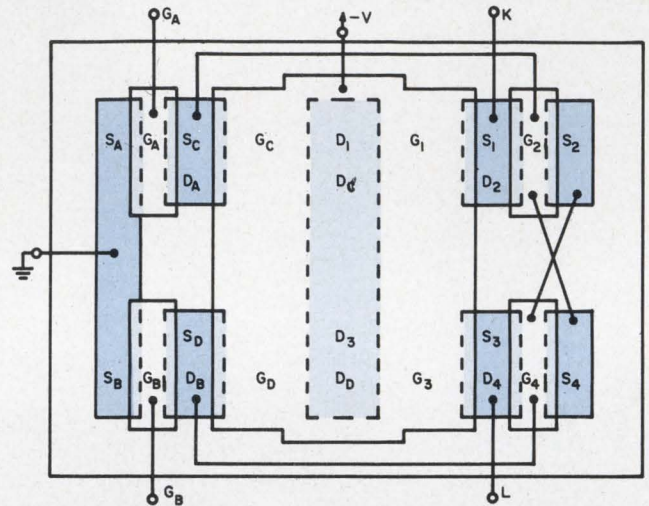

6. The monolithic layout of the MOS FET comparator illustrates the simple fabrication layout that is involved with this approach.

multiplication of two signals, where one variable can be represented by phase difference and the other by amplitude difference. The area under the output waveform then represents the product of the two variables.

### Integration is possible

An existing comparator implementation, using resistor-transistor logic (RTL) NOR circuitry, is shown in Fig. 5. Six NOR blocks are used and each has 4 to 5 components, depending on the number of inputs required. This configuration results in the use of a total of 26 active and passive components. The circuit of Fig. 1, however, uses only 8 discrete devices, or, if fabricated monolithically (all FETs diffused on a single chip), the equivalent of 4 MOS devices.

This is better illustrated in the proposed layout of a monolithic chip that is shown in Fig. 6. The letter designations correspond to the terminals called out in Fig. 1. Since some of the devices have common connections, a single diffusion can be used at these points; for example, the drains of devices C, D, 1, and 3 are tied together since they all go to the supply voltage. As a result, only eight diffusion areas are necessary, and this is equivalent to four devices (four sources and four drains). The monolithic comparator has not been built and tested yet. ■ ■



# THE ONLY FIELD PROVEN 2MC PORTABLE

## RECORDER / REPRODUCER

P-5000 field history has established Fairchild/Winston as the leader in wideband portable instrumentation recorder/reproducers. Results of extensive field applications have proven the P-5000's ability to consistently provide unparalleled performance. A combination of compactness and laboratory-quality performance, the P-5000 offers the most advanced instrumentation tape recorder/reproducer in a truly portable package — designed for predetection, telemetry and general instrumentation — applicable to airborne, shipboard and mobile use. Bi-directional operation provides 50 minutes of 2.0 mc recording. Qualified to military environmental and RFI specifications.

- 2.0 mc at 120 ips
- Flutter — 0.3% peak-to-peak, DC to 10 kc at 60 ips
- Bi-directional operation
- Five electrically selectable speeds
- 7 or 14 track, IRIG configuration
- 140 pounds
- 17 $\frac{5}{8}$  x 24 $\frac{1}{2}$  x 11 inches



FOR ADDITIONAL INFORMATION CONTACT:

# FAIRCHILD

## WINSTON RESEARCH CORPORATION

A SUBSIDIARY OF FAIRCHILD CAMERA AND INSTRUMENT CORPORATION

6711 So. Sepulveda Blvd., Los Angeles,  
Calif. 90045 Telephone: 213-670-3305  
TWX: 910-328-6128

1625 "I" Street, NW, Washington,  
D.C. 20006 Telephone: 202-628-2588  
TWX: 710-822-9558

Hyer Electronics Company  
Englewood, Colorado  
Telephone: 303-771-5285

Hyer Electronics Company  
Albuquerque, New Mexico  
Telephone: 505-268-6744

Wild & Associates, Inc.  
Syosset, Long Island, N.Y.  
Telephone: 516-921-7100

ON READER-SERVICE CARD CIRCLE 25



# Pick a delay equalizer and stop worrying about the math. A set of tables lists the normalized component values for four typical circuits.

The design of parabolic delay equalizers usually starts with time-consuming mathematics that lead only to the equations that permit the designer to evaluate changes in parameters. Here is a set of computer-derived tables that offers a shortcut by presenting the component-values for typical circuits. All that's necessary then is a little slide-rule work.

Delay equalizers are needed to correct the non-uniform delay responses of IF amplifiers in frequency modulation systems, multiple-channel data transmission systems, and other communication equipment. In these systems complex waveforms have to be preserved accurately to ensure satisfactory transmission of information.

The delay of a single-section delay equalizer is given by:<sup>1</sup>

$$T_d = \frac{\frac{1}{\pi \sqrt{d} f_o} \left(1 + \frac{f_o^2}{f^2}\right)}{\frac{1}{d} + \left(\frac{f}{f_o} - \frac{f_o}{f}\right)^2}, \quad (1)$$

where  $T_d$  is the total delay of the network,  $d$  is the shape factor (analogous to the  $Q$  of a resonant circuit),  $f$  is the frequency of operation and  $f_o$  is the resonant frequency of one of the arms of an equivalent lattice. The resonant frequency,  $f_o$ , is given by:<sup>2</sup>

$$f_o = f_p \left[ \sqrt{4 - \frac{1}{d}} - 1 \right]^{-1/2}, \quad (2)$$

where  $f_p$  is the frequency of peak delay. Eq. 1 may be readily transformed into polar coordinates with the transformations:

$$f_o = \rho f_B, \quad (3)$$

$$d = \frac{1}{4 \cos^2 \theta}, \quad (4)$$

where  $f_B$  is a reference frequency.

The advantage of polar coordinates is that all circuit components can be expressed in terms of  $\theta$ . Thus  $\theta$  is the only variable.

The quantity  $\rho/f_o$  is sometimes referred to as  $b$  in the literature. It is related to the shape factor  $d$ :

$$b = 2\sqrt{d} \quad (5)$$

The substitution of Eqs. 3 and 4 into Eq. 1 yields:

$$T_d = \left(\frac{f_B}{2\pi}\right) \frac{4\rho \cos \theta (\rho^2 f_B^2 + f^2)}{\rho^4 f_B^4 - 2\rho^2 f_B^2 f^2 (1 - 2 \cos^2 \theta) + f^4} \quad (6)$$

If this expression is normalized and expanded around the frequency of the peak delay,<sup>3</sup> we arrive at the expression that depends only on  $\theta$ :

$$M = \frac{T_p f_p}{B^2} \approx \frac{\cos \theta (2 \sin \theta - 1)^{5/2}}{16\pi \sin^3 \theta (1 - \sin \theta)^2}, \quad (7)$$

where:

$f_p$  is the frequency of peak delay,

$T_p$  is the difference between the peak delay and the delay at the band edge,

$B$  is the normalized bandwidth  $(f_1 - f_2)/f_p$ , where  $f_1$  and  $f_2$  are at an equal distance from  $f_p$ .

The designer has only to compute the value of  $M$  from the delay specifications and to denormalize the circuit values for the required frequency and impedance.

Consider the simple delay equalizer shown in Fig. 1. The normalized values of the components are a function of the impedance,  $R_o$ , and  $\theta$ :

$$C_{na} = \frac{1}{4\pi f_o R_o} (2 \sin \theta - 1)^{1/2} \left( \frac{1}{2 \cos \theta} - 2 \cos \theta \right) \quad (8)$$

$$C_{nb} = \frac{\cos \theta}{\pi f_o R_o} (2 \sin \theta - 1)^{1/2} \quad (9)$$

$$L_{na} = \frac{2R_o}{\pi f_o} \cos \theta (2 \sin \theta - 1)^{1/2} \quad (10)$$

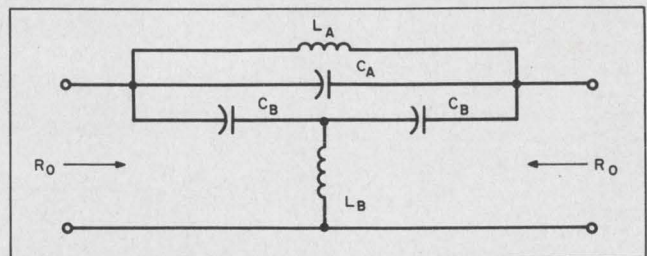

1. Simple parabolic delay equalizer illustrates the use of the tables—see text. The normalized values of the components can be read off from the tables, depending on the given specifications.

Vernon R. Cunningham, Research & Development Engineer, Collins Radio Company, Dallas, Tex.



### Normalized components for parabolic delay equalizers

Log M	M	$\theta$	$f_o/f_p$	d	$C_{na}$	$C_{nb}$	$L_{na}$	$L_{nb}$
-0.401	0.397	60.120	1.167	1.007	0.0005	0.1359	0.2717	0.0684
-0.381	0.416	60.475	1.162	1.029	0.0020	0.1350	0.2699	0.0695
-0.361	0.436	60.828	1.158	1.052	0.0035	0.1340	0.2681	0.0705
-0.341	0.456	61.180	1.153	1.076	0.0050	0.1331	0.2662	0.0716
-0.321	0.478	61.530	1.148	1.100	0.0066	0.1321	0.2642	0.0727
-0.301	0.500	61.878	1.144	1.125	0.0082	0.1311	0.2623	0.0738
-0.281	0.524	62.225	1.140	1.151	0.0098	0.1301	0.2602	0.0749
-0.261	0.549	62.569	1.136	1.178	0.0115	0.1291	0.2582	0.0760
-0.241	0.574	62.912	1.132	1.206	0.0132	0.1281	0.2561	0.0772
-0.221	0.601	63.252	1.128	1.234	0.0149	0.1270	0.2540	0.0784
-0.201	0.630	63.590	1.124	1.264	0.0166	0.1259	0.2519	0.0796
-0.181	0.659	63.926	1.121	1.294	0.0184	0.1249	0.2497	0.0808
-0.161	0.691	64.259	1.117	1.325	0.0201	0.1238	0.2475	0.0820
-0.141	0.723	64.591	1.113	1.358	0.0219	0.1227	0.2453	0.0833
-0.121	0.757	64.919	1.110	1.391	0.0238	0.1215	0.2431	0.0846
-0.101	0.793	65.245	1.107	1.426	0.0256	0.1204	0.2408	0.0858
-0.081	0.830	65.568	1.104	1.461	0.0275	0.1193	0.2386	0.0872
-0.061	0.869	65.889	1.101	1.498	0.0294	0.1181	0.2363	0.0885
-0.041	0.910	66.207	1.098	1.536	0.0314	0.1170	0.2340	0.0899
-0.021	0.953	66.522	1.095	1.575	0.0333	0.1158	0.2317	0.0912
-0.001	0.998	66.835	1.092	1.616	0.0353	0.1147	0.2294	0.0926
0.019	1.045	67.145	1.089	1.657	0.0373	0.1135	0.2270	0.0941
0.039	1.094	67.451	1.087	1.700	0.0393	0.1123	0.2247	0.0955
0.059	1.146	67.755	1.084	1.744	0.0414	0.1112	0.2223	0.0970
0.079	1.200	68.056	1.081	1.790	0.0435	0.1100	0.2200	0.0985
0.099	1.257	68.354	1.079	1.837	0.0456	0.1088	0.2176	0.1000
0.119	1.316	68.649	1.077	1.886	0.0477	0.1076	0.2153	0.1015
0.139	1.378	68.941	1.074	1.936	0.0498	0.1065	0.2129	0.1031
0.159	1.443	69.230	1.072	1.988	0.0520	0.1053	0.2106	0.1047
0.179	1.511	69.516	1.070	2.042	0.0542	0.1041	0.2082	0.1063
0.199	1.582	69.799	1.068	2.097	0.0564	0.1029	0.2059	0.1079
0.219	1.657	70.079	1.066	2.154	0.0587	0.1018	0.2035	0.1096
0.239	1.735	70.356	1.064	2.212	0.0610	0.1006	0.2012	0.1113
0.259	1.816	70.630	1.062	2.273	0.0633	0.0994	0.1988	0.1130
0.279	1.902	70.901	1.060	2.335	0.0656	0.0983	0.1965	0.1147
0.299	1.992	71.169	1.058	2.399	0.0679	0.0971	0.1942	0.1165
0.319	2.086	71.433	1.056	2.466	0.0703	0.0959	0.1919	0.1183
0.339	2.184	71.695	1.055	2.534	0.0727	0.0948	0.1896	0.1201
0.359	2.287	71.953	1.053	2.605	0.0751	0.0936	0.1873	0.1220
0.379	2.395	72.209	1.052	2.678	0.0776	0.0925	0.1850	0.1238
0.399	2.507	72.461	1.050	2.753	0.0801	0.0914	0.1827	0.1257
0.419	2.626	72.711	1.048	2.830	0.0826	0.0902	0.1804	0.1277
0.439	2.749	72.957	1.047	2.910	0.0851	0.0891	0.1782	0.1297
0.459	2.879	73.201	1.046	2.993	0.0877	0.0880	0.1760	0.1317
0.479	3.015	73.441	1.044	3.078	0.0903	0.0869	0.1737	0.1337
0.499	3.157	73.679	1.043	3.166	0.0929	0.0858	0.1715	0.1358
0.519	3.305	73.913	1.042	3.256	0.0955	0.0847	0.1694	0.1379
0.539	3.461	74.145	1.040	3.349	0.0982	0.0836	0.1672	0.1400
0.559	3.624	74.373	1.039	3.445	0.1009	0.0825	0.1650	0.1421



Normalized components for parabolic delay equalizers (continued)

Log M	M	$\theta$	$f_o/f_p$	d	$C_{na}$	$C_{nb}$	$L_{na}$	$L_{nb}$
0.579	3.795	74.599	1.038	3.545	0.1036	0.0814	0.1629	0.1443
0.599	3.974	74.822	1.037	3.647	0.1064	0.0804	0.1608	0.1466
0.619	4.161	75.042	1.036	3.752	0.1092	0.0793	0.1587	0.1488
0.639	4.357	75.259	1.035	3.861	0.1120	0.0783	0.1566	0.1511
0.659	4.563	75.473	1.034	3.973	0.1148	0.0772	0.1545	0.1535
0.679	4.778	75.685	1.033	4.089	0.1177	0.0762	0.1524	0.1558
0.699	5.003	75.893	1.032	4.209	0.1206	0.0752	0.1504	0.1583
0.719	5.239	76.099	1.031	4.332	0.1236	0.0742	0.1484	0.1607
0.739	5.486	76.302	1.030	4.459	0.1266	0.0732	0.1464	0.1632
0.759	5.744	76.503	1.029	4.589	0.1296	0.0722	0.1444	0.1657
0.779	6.015	76.701	1.028	4.724	0.1326	0.0712	0.1425	0.1683
0.799	6.298	76.896	1.027	4.864	0.1357	0.0703	0.1405	0.1709
0.819	6.595	77.088	1.026	5.007	0.1389	0.0693	0.1386	0.1735
0.839	6.906	77.278	1.025	5.155	0.1420	0.0684	0.1367	0.1762
0.859	7.232	77.466	1.025	5.308	0.1452	0.0674	0.1348	0.1789
0.879	7.572	77.650	1.024	5.465	0.1484	0.0665	0.1330	0.1817
0.899	7.929	77.832	1.023	5.628	0.1517	0.0656	0.1311	0.1845
0.919	8.303	78.012	1.023	5.795	0.1550	0.0647	0.1293	0.1873
0.939	8.694	78.189	1.022	5.968	0.1584	0.0638	0.1275	0.1902
0.959	9.104	78.364	1.021	6.146	0.1617	0.0629	0.1257	0.1932
0.979	9.533	78.536	1.021	6.329	0.1652	0.0620	0.1240	0.1962
0.999	9.982	78.706	1.020	6.518	0.1686	0.0611	0.1222	0.1992
1.019	10.453	78.874	1.019	6.714	0.1721	0.0603	0.1205	0.2023
1.039	10.946	79.039	1.019	6.915	0.1757	0.0594	0.1188	0.2054
1.059	11.461	79.202	1.018	7.123	0.1793	0.0586	0.1171	0.2086
1.079	12.002	79.362	1.018	7.337	0.1829	0.0577	0.1155	0.2118
1.099	12.567	79.521	1.017	7.557	0.1866	0.0569	0.1138	0.2151
1.119	13.160	79.677	1.017	7.785	0.1904	0.0561	0.1122	0.2184
1.139	13.780	79.831	1.016	8.020	0.1941	0.0553	0.1106	0.2218
1.159	14.429	79.982	1.016	8.262	0.1980	0.0545	0.1090	0.2252
1.179	15.109	80.132	1.015	8.511	0.2018	0.0537	0.1075	0.2287
1.199	15.821	80.279	1.015	8.769	0.2058	0.0530	0.1059	0.2322
1.219	16.567	80.424	1.014	9.034	0.2097	0.0522	0.1044	0.2358
1.239	17.348	80.567	1.014	9.308	0.2137	0.0515	0.1029	0.2395
1.259	18.165	80.709	1.013	9.590	0.2178	0.0507	0.1014	0.2432
1.279	19.021	80.848	1.013	9.881	0.2220	0.0500	0.1000	0.2469
1.299	19.918	80.985	1.013	10.181	0.2261	0.0493	0.0985	0.2508
1.319	20.856	81.120	1.012	10.491	0.2304	0.0485	0.0971	0.2546
1.339	21.839	81.253	1.012	10.810	0.2347	0.0478	0.0957	0.2586
1.359	22.869	81.384	1.011	11.139	0.2390	0.0471	0.0943	0.2626
1.379	23.946	81.513	1.011	11.478	0.2434	0.0465	0.0929	0.2666
1.399	25.075	81.641	1.011	11.828	0.2479	0.0458	0.0916	0.2708
1.419	26.257	81.766	1.010	12.189	0.2524	0.0451	0.0902	0.2750
1.439	27.494	81.890	1.010	12.561	0.2570	0.0445	0.0889	0.2792
1.459	28.790	82.012	1.010	12.945	0.2616	0.0438	0.0876	0.2835
1.479	30.147	82.132	1.010	13.341	0.2663	0.0432	0.0863	0.2879
1.499	31.568	82.250	1.009	13.749	0.2711	0.0425	0.0851	0.2924
1.519	33.055	82.367	1.009	14.170	0.2759	0.0419	0.0838	0.2969
1.539	34.613	82.482	1.009	14.603	0.2808	0.0413	0.0826	0.3015



Normalized components for parabolic delay equalizers (continued)

Log M	M	$\theta$	$f_o/f_p$	d	$C_{na}$	$C_{nb}$	$L_{na}$	$L_{nb}$
1.559	36.245	82.595	1.008	15.051	0.2858	0.0407	0.0814	0.3061
1.579	37.953	82.707	1.008	15.512	0.2908	0.0401	0.0802	0.3109
1.599	39.741	82.817	1.008	15.988	0.2959	0.0395	0.0790	0.3157
1.619	41.614	82.925	1.008	16.479	0.3011	0.0389	0.0778	0.3206
1.639	43.575	83.032	1.007	16.984	0.3064	0.0383	0.0767	0.3255
1.659	45.629	83.137	1.007	17.506	0.3117	0.0378	0.0755	0.3306
1.679	47.780	83.240	1.007	18.044	0.3171	0.0372	0.0744	0.3357
1.699	50.031	83.342	1.007	18.599	0.3225	0.0367	0.0733	0.3409
1.719	52.389	83.443	1.007	19.171	0.3281	0.0361	0.0722	0.3461
1.739	54.858	83.542	1.006	19.761	0.3337	0.0356	0.0712	0.3515
1.759	57.444	83.639	1.006	20.369	0.3394	0.0350	0.0701	0.3569
1.779	60.151	83.735	1.006	20.996	0.3452	0.0345	0.0691	0.3624
1.799	62.986	83.830	1.006	21.643	0.3511	0.0340	0.0680	0.3681
1.819	65.954	83.923	1.006	22.310	0.3570	0.0335	0.0670	0.3737
1.839	69.063	84.015	1.005	22.997	0.3630	0.0330	0.0660	0.3795
1.859	72.317	84.106	1.005	23.706	0.3691	0.0325	0.0650	0.3854
1.879	75.726	84.195	1.005	24.438	0.3753	0.0320	0.0641	0.3914
1.899	79.294	84.283	1.005	25.192	0.3816	0.0316	0.0631	0.3974
1.919	83.031	84.369	1.005	25.969	0.3880	0.0311	0.0622	0.4036
1.939	86.945	84.455	1.005	26.771	0.3945	0.0306	0.0612	0.4098
1.959	91.042	84.538	1.005	27.598	0.4011	0.0302	0.0603	0.4161
1.979	95.333	84.621	1.004	28.450	0.4077	0.0297	0.0594	0.4226
1.999	99.826	84.703	1.004	29.330	0.4145	0.0293	0.0585	0.4291
2.019	104.531	84.783	1.004	30.236	0.4213	0.0288	0.0576	0.4358
2.039	109.457	84.862	1.004	31.171	0.4283	0.0284	0.0568	0.4425
2.059	114.616	84.940	1.004	32.135	0.4354	0.0280	0.0559	0.4493
2.079	120.017	85.016	1.004	33.129	0.4425	0.0275	0.0551	0.4563
2.099	125.674	85.092	1.004	34.154	0.4498	0.0271	0.0543	0.4634
2.119	131.596	85.166	1.004	35.211	0.4572	0.0267	0.0535	0.4705
2.139	137.798	85.240	1.003	36.301	0.4646	0.0263	0.0526	0.4778
2.159	144.292	85.312	1.003	37.425	0.4722	0.0259	0.0519	0.4852
2.179	151.093	85.383	1.003	38.584	0.4799	0.0255	0.0511	0.4927
2.199	158.213	85.453	1.003	39.779	0.4877	0.0252	0.0503	0.5003
2.219	165.670	85.522	1.003	41.012	0.4957	0.0248	0.0496	0.5081
2.239	173.478	85.590	1.003	42.282	0.5037	0.0244	0.0488	0.5159
2.259	181.653	85.657	1.003	43.593	0.5119	0.0240	0.0481	0.5239
2.279	190.214	85.723	1.003	44.944	0.5202	0.0237	0.0473	0.5320
2.299	199.179	85.788	1.003	46.337	0.5286	0.0233	0.0466	0.5402
2.319	208.566	85.852	1.003	47.774	0.5371	0.0230	0.0459	0.5486
2.339	218.397	85.915	1.003	49.256	0.5458	0.0226	0.0452	0.5571
2.359	228.687	85.977	1.002	50.784	0.5546	0.0223	0.0446	0.5657
2.379	239.464	86.038	1.002	52.359	0.5635	0.0219	0.0439	0.5744
2.399	250.752	86.098	1.002	53.984	0.5725	0.0216	0.0432	0.5833
2.419	262.569	86.157	1.002	55.659	0.5817	0.0213	0.0426	0.5924
2.439	274.943	86.216	1.002	57.387	0.5910	0.0210	0.0419	0.6015
2.459	287.902	86.273	1.002	59.168	0.6005	0.0206	0.0413	0.6108
2.479	301.472	86.330	1.002	61.005	0.6101	0.0203	0.0407	0.6203
2.499	315.675	86.385	1.002	62.899	0.6198	0.0200	0.0401	0.6299



$$L_{nb} = \frac{R_o (2 \sin \theta - 1)^{1/2}}{8\pi f_o \cos \theta} \quad (11)$$

Eqs. 7 through 11 were solved with a computer for a large number of thetas. The computer was programmed to print out values at equal increments of log  $M$ .

Note that Eq. 7 is an approximation, whose error increases with percentage bandwidth. The error involved is negligible in most cases.<sup>4</sup>

The correct circuit values can be found quite simply:

$$C_A = \frac{C_{na}}{f_p R_o},$$

$$C_B = \frac{C_{nb}}{f_p R_o},$$

$$L_A = \frac{L_{na} R_o}{f_p},$$

$$L_B = \frac{L_{nb} R_o}{f_p}.$$

The values of  $C_{na}$ ,  $C_{nb}$ ,  $L_{na}$  and  $L_{nb}$  are listed in the tables.

If one of the three circuits in Fig. 2 is preferred to the circuit in Fig. 1, the designer must change some of the component values. The shape factor  $d$  must be included, as indicated in Fig. 3. The values of  $d$  are also included in the tables. The ratio of  $f_o$  to  $f_p$  is also listed, since  $f_o$  is sometimes desirable to tune the network.

Let us consider a simple design example. The delay present in a 70-MHz IF amplifier must be equalized. The delay is parabolic, and it reaches the maximum of 5 ns (referenced to the delay at the edge of the band) at a frequency of 74 MHz.

The delay is to be equalized over a bandwidth of 10 MHz from the center frequency of 70 MHz. The equalizer network is to have input and output impedances of 75 ohms.

Since the peak delay does not occur at the center frequency of the IF amplifier, the bandwidth of the equalizer is not the same as the bandwidth of the amplifier. The equalizer's bandwidth is twice the distance from the peak delay to the most distant band edge, or  $2(74 \text{ MHz} - 60 \text{ MHz}) = 28 \text{ MHz}$ .

The normalized bandwidth,  $B$ , is:

$$B = \frac{28}{74} = 0.378$$

The value of  $M$  is:

$$M = \frac{(5 \text{ ns})(74 \text{ MHz})}{(0.378)^2} = 2.58$$

From the tables we find values tabulated for  $M$  equal to 2.62, which is sufficiently close:

$$\begin{aligned} C_{na} &= 0.0826 \\ C_{nb} &= 0.0902 \\ L_{na} &= 0.1804 \end{aligned}$$

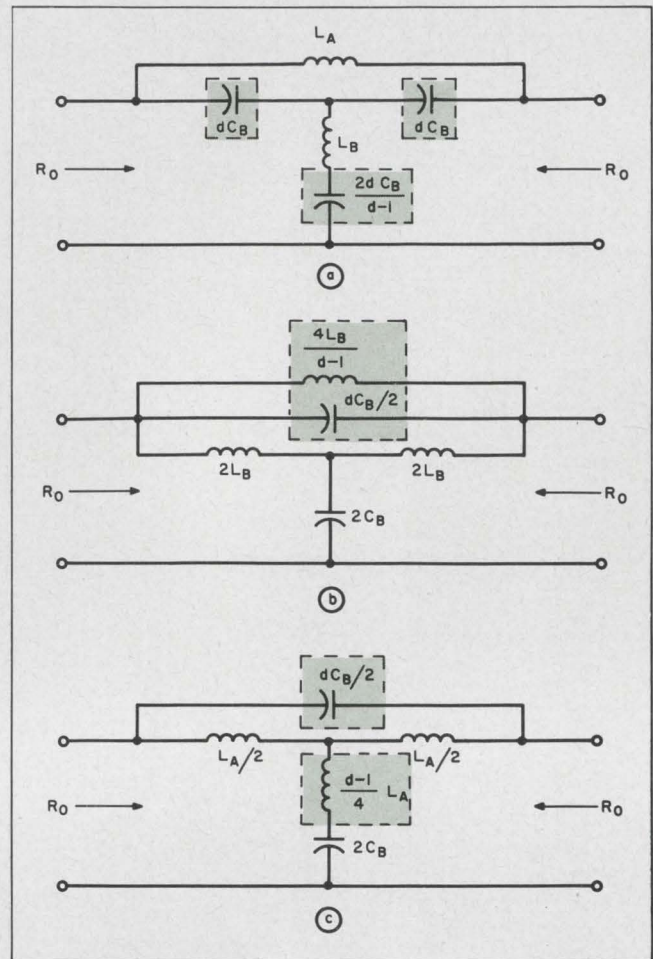

2. Alternate circuits of Fig. 1 also perform as parabolic delay equalizers. The shape factor,  $d$ , modifies some of the component values.

$$L_{nb} = 0.1277$$

Denormalizing the above values, we find the values of the components:

$$C_A = \frac{C_{na}}{f_p R_o} = \frac{0.0826}{(74 \times 10^6)(75)} = 14.9 \text{ pF}$$

$$C_B = \frac{C_{nb}}{f_p R_o} = \frac{0.0902}{(74 \times 10^6)(75)} = 16.2 \text{ pF}$$

$$L_A = \frac{L_{na} R_o}{f_p} = \frac{75(0.1804)}{74 \times 10^6} = 0.183 \text{ } \mu\text{H}$$

$$L_B = \frac{L_{nb} R_o}{f_p} = \frac{75(0.1277)}{74 \times 10^6} = 0.129 \text{ } \mu\text{H}$$

These are the final values for the circuit shown in Fig. 1. ■ ■

#### References:

1. E. J. Turvey, "A Graphical Method of Equalizing Envelope Delay," report for M. S. degree in Electrical Engineering, Southern Methodist University, 1963.
2. *Ibid.*
3. J. K. Skwirzynski and E. J. C. B. Dunlop, "Group Delay Equalization of Bandpass Filters at Intermediate Frequencies," *The Marconi Review*, Fourth Quarter, 1964.
4. T. R. O'Meara, "The Synthesis of 'Band-Pass' All-Pass Time-Delay Networks with Graphical Approximation Techniques," Hughes Research Report No. 114, September 1960.



# Announcing Westinghouse CYW6... The Only Glass-Type Capacitor with 'feet' (and no 'pants')

THEY PUT YOU A STEP AHEAD FOR  
FASTER, MORE RELIABLE SOLDERING  
AND BOARD CLEANING

Satisfy military glass capacitor requirements at low cost with Westinghouse's new CYW6. Every capacitor is tested to MIL-C-11272.

CYW6's construction is unique. Its capacitor plates are molded in glass for ultimate stability. Its case is injection-molded from a low-loss, high-temperature glass-filled silicone material. The result is precision. Flash or "pants" never form on the leads. And case dimensions are exact.

CYW6's exclusive "feet" space the capacitor body above the circuit board for more reliable soldering and efficient board cleaning. No other capacitor gives you this combination of outstanding electrical performance plus features for low-cost, reliable circuit production.

CALL YOUR WESTINGHOUSE DISTRIBUTOR — Or for detailed technical data, write G. Blackman, Marketing Manager, Westinghouse Capacitor Department, P. O. Box 868, Pittsburgh, Pa. 15230.

CYW6 CHARACTERISTICS: • Capacitance range 1 through 560 pf. • 300 volts, DCW at  $-55^{\circ}$  to  $+125^{\circ}\text{C}$ . No derating required. Dissipation factor less than .001 at  $25^{\circ}\text{C}$  and 1 KC. • Capacitance drift less than 0.1% per decade of frequency. J-09303

You can be sure  
if it's Westinghouse





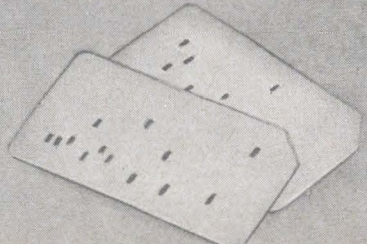
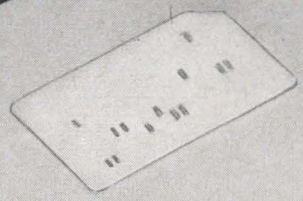
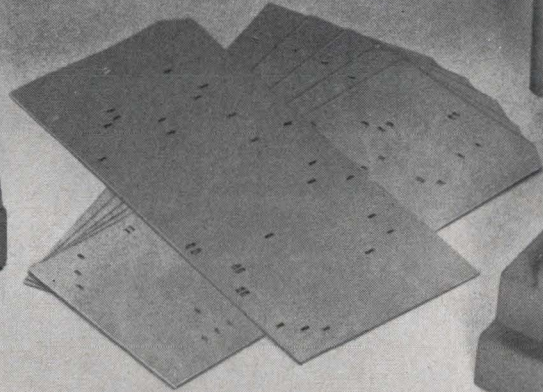
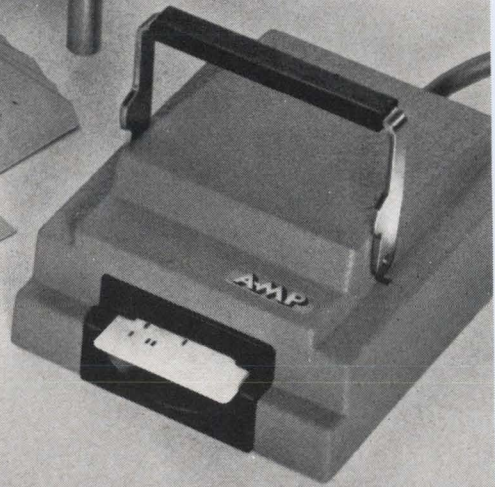
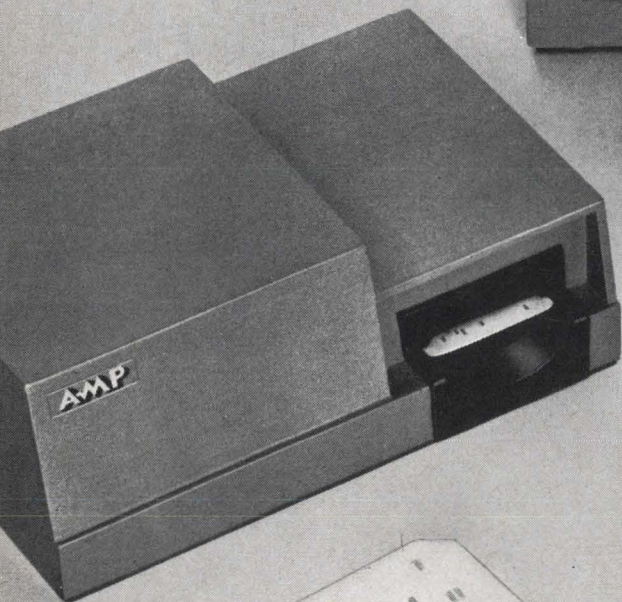
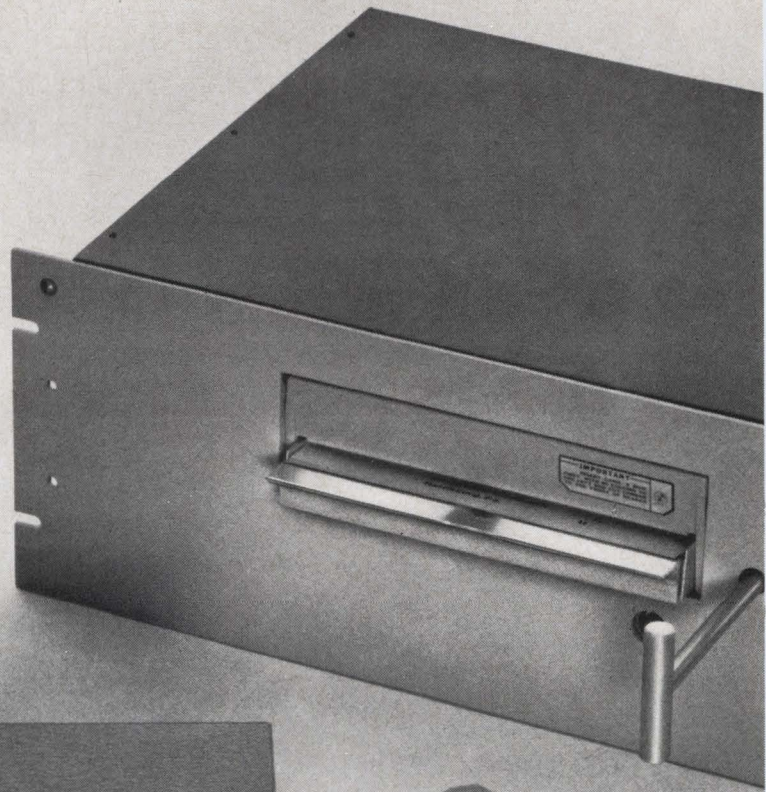
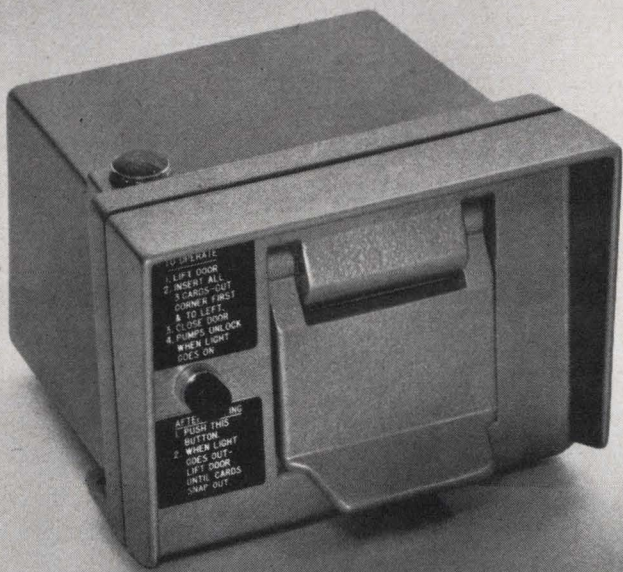



# Have you tried out your card tricks on this family?

Here's a modern family of card readers that fits right in with the current and future needs of industry. No matter what kind of cards a system may use, one of these compact, handsomely styled A-MP\* SYSCOM\* card readers can handle them.

The unlimited number of programs that can be handled and the convenience of punched tabulating or credit cards make these units practical for many varied applications. In production control and reporting, where data must be randomly gathered from many sources into a central computer, the A-MP Card Reader functions as data input equipment. Location and status of production parts can be determined in seconds instead of hours or days; production machinery breakdowns and schedule changes can be ascertained before they seriously affect production.

In batch mixing or blending operations, a card reader can program changes in formula, mixing times, sequence, quantity measurements, and the like. It reduces the operator's work to inserting the appropriate tabulating card and checking on proper functioning of the equipment. It also reduces the chance of human error and ensures consistent product quality.

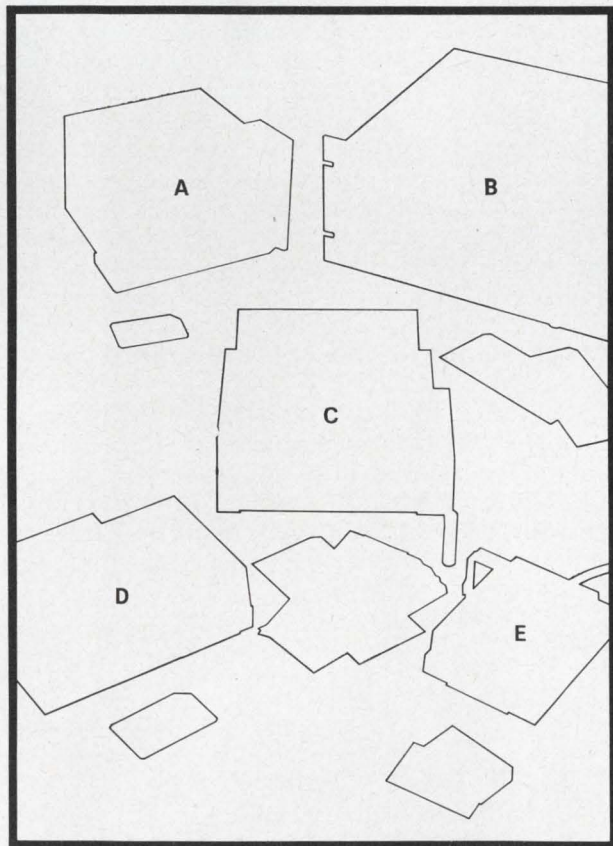

A. All Weather Credit Card Reader. B. Rack Mounted Standard Size Card Reader. C. Desk Top Standard Size Card Reader. D. Motorized Credit Card Reader. E. Credit Card Reader.

Warehouse inventory and supply procedures have been vastly speeded up by the use of tabulating card systems. By inserting a punched card into an A-MP Card Reader, a dispatcher could select a quantity of a product for an order. This quantity is deducted from the inventory and a new total is derived from the card. The same card can also be used to initiate the billing process to the customer.

Bulk plant dispensing can be accomplished with the All-Weather Card Reader. The driver simply inserts a wallet-size card, which unlocks the pumps. When the driver finishes loading his truck, he depresses a button on the card reader front panel. This automatically locks the pumps, records the transaction, unlocks the reader and partially ejects the card(s). Training devices can employ a card reader to simulate anything from control servo inputs on an aircraft trainer to missile guidance system outputs. Card programming is an economical approach to unlimited program flexibility.

From design to material selection, utmost care has been exercised to assure the engineering soundness and practicality of these card readers. This is evidenced by their reliability, efficient operation, and attractive appearance. Examine their outstanding features and you'll see why these card readers are exceptional:

- Cast metal housing
- Exclusive double wiping action pre-cleans contacts
- Interlocks ensure accurate positioning and sensing of cards
- Indicator lights to show when the card is in "read" position (on B & C only)
- Various matrix arrangements available—240-bit capacity for credit cards; 960-bit for tab cards
- Redundant contacts—two contacts sense each hole (on A, D & E only)
- Long operating life—1,000,000 cycles, minimum (on A, D & E only)
- Desk top, rack, or outdoor models available
- Automatic or semi-automatic reading and card ejection available

If you want to automate your operation, check on AMP's family of Card Readers. Write today for more information.

\*Trademark of AMP Incorporated

**AMP**  
INCORPORATED  
Harrisburg, Pennsylvania

A-MP\* products and engineering assistance are available through subsidiary companies in: Australia • Canada • England • France • Holland • Italy • Japan • Mexico • Spain • West Germany

ON READER-SERVICE CARD CIRCLE 26



## Work harder to get less done! Unchain your creative talents and discover a whole new world of non-accomplishment. Try Project Evasion!

It takes little or no technical training to loaf; almost anyone can do it. But it is a matter of high skill to work ostensibly with diligence on some project while, in fact, contributing nothing to its success. This skill, which can approach a fine art, is the essence of Project Evasion.

The reasons why an engineer, operations analyst, or scientist might wish to become involved in Project Evasion are many. Some of us find little challenge, are even bored, by proceeding from problem to approach to data-gathering to analysis to write-up to review. Others in higher echelons realize that when the project is over, so, too, is their income, and the soul-searing search for another funded project will soon follow. Some are temperamentally better suited to the gentlemanly pursuits of Project Evasion than to the hurly-burly rough-and-tumble of actually prosecuting a project. There are yet others who find more outlets for their exuberant talents in Project Evasion than in the pedestrian, even trivial, demands of "The Job." Indeed, such is the obvious appeal of Project Evasion that it is really amazing that anything ever gets done at all!

Some dodges are so well known that they can be regarded as standard, off-the-shelf designs, and as such scarcely qualify their practitioners for a constructive part in Project Evasion.

From time immemorial time has been consumed by coffee breaks, vendor-furnished lunches, office romances, and so forth. Project Evasion calls for far more sophisticated techniques.

### What are the general techniques?

We do not pretend to give an exhaustive analysis of the complete technology, but to consider only some of the more usual techniques employed in the successful evasion of projects. Sufficiently motivated, the talented reader should be able to develop a number of others through his own investigations. Let us now examine some of the more general Project Evasion techniques. They are presented here in order of increasing subtlety:

#### 1. Progress Reports.

It may seem a paradox that progress reporting can form a part of Project Evasion. It might be asked whether some progress does not need to

have been made before time can be taken out to draft a lengthy report.

The case is quite the contrary. A genuine progress report is a model of terseness: "Assembly drawings, delivered; preliminary specifications, issued; environmental testing, completed." It is when progress has been meager that a smoke screen of words is necessary. The less the progress, the denser the fog. An impression of feverish activity must be created; each tiny, halting step in the wrong direction has to be made to look like a giant stride forward. This inverse ratio of verbiage to accomplishment is the key factor. Once it has been grasped, the possibilities for its application will be seen to be virtually endless.

#### 2. Periodic Time and Expense Reporting.

Evasion potential here varies widely from company to company, depending on the detail, complexity, and general irrationality of its reporting forms. In extreme cases, the logical convolutions of such forms leave little to the Evader's ingenuity. But even where requirements are simple and direct, hope need not be lost. Trivial arithmetical errors and a studied carelessness in assigning charges to accounts or work orders may result in many hours of backtracking and rechecking. And the gifted Evader who finds these techniques still insufficient may draw comfort from the fact that the government authorities are, in the long run, on the side of the procrastinator.

#### 3. Field Trips.

Field trips offer the perceptive Project Evader wide opportunities for practicing his skill. But first, of course, he has to secure the approval, however grudgingly, of Higher Authority for the trip. Some ingenuity may be required; indeed, it may even be necessary to bring back some seem-

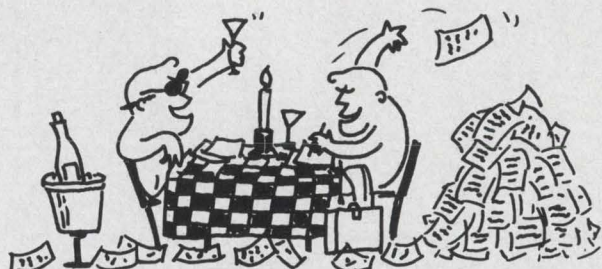

The talented Project Evader is likely to have well developed social instincts and is therefore able to derive maximum evasion benefits from combined business-social contacts. Bon appetit!



ingly useful tidbit of technical information, or some lead on potential business for the company, if field trips are to remain in the Evader's repertoire for any time.

One technique for gaining approval is the "Colleague Caper." In principle, this is simplicity itself. Suppose a project encounters, or is caused to encounter, some technical snag. The Evader off-handedly reminds his supervisor that his closest colleague at the company where the Evader last worked has spent a lifetime of specialization in the very subject which is the key to the problem. This friend is now head of a department in which this technology is being pressed to the ultimate. Moreover the Company firmly believes in sharing basic research results. All that's needed to break the bottleneck is an informal visit to good old Joe. A quick hop out to the Coast and back, the price of a dinner and a day in the lab will avert disaster. Nine times out of ten, the trip is on.

Exhaustive treatment of the field trip is beyond the scope of this article, but a brief compendium of the main field-trip subcategories will alert the reader to other approaches:

- Attendance at bidders' conferences (for other projects, naturally).
- Inspection of potential subcontractors' facilities (usually good for a night on the town at the other company's expense).
- Visits to another division of one's company in the capacity of technical expert or adviser on something or other.

#### 4. Technical Societies

The able Project Evader will belong to as many professional societies as possible, preferably at company expense. This policy serves several purposes. It makes for an impressive resume; it provides opportunities for attending technical meetings (see "Field Trips",) and it helps to enlarge the circle of friends which may be drawn upon in working the Colleague Caper. It also greatly increases the exposure to personnel brokers—no small advantage for the successful Evader.

While attending a technical meeting the astute Evader is in a position to gather all sorts of impressive data whose importance and relevance he can communicate to Higher Authority in a series of conferences, memoranda, etc. etc.

Data collection need take only a small portion of the Evader's time leaving him free to chat with



Well-placed questions and comments by the Project Evader can shift a group's attention to somebody else's controversy. This is a great ploy after a night on the town, and also permits really creative day-dreaming.

old friends (remember the Colleague Caper!), sightsee or whatever non-job related activity may strike his fancy. The opportunities are many and are left to the reader as an exercise.

#### 5. Group Working Meetings.

The word "working" should not faze the dedicated Project Evader. His sole concern is to do what he can to effect a protracted, unfruitful meeting, without being too obvious about it. A useful guide to procedures is contained in "Committee meetings waste time . . ." (ED 5, Mar. 1, 1966, pp. 66 ff.).

Several approaches are recognized, but a most useful gambit is the Continued Consideration technique.<sup>1</sup> When purely technical questions are before the meeting, the integrated series of questions, "Did you consider. . . ? Well, did you consider. . . ? And did you consider. . . ?" and so on, can lead to the exploration of countless fascinating irrelevancies, limited only by the number of technological fields in which the Evader can term-drop. With care, this technique can lead discussion into someone else's area of controversy. Thereafter, the Evader may sit back and nap.

#### 6. Recruitment.

Interviews of aspirants can be a most useful technique, particularly if the Boss asks you to take "Joe, Here, (and yourself, of course) to lunch on the company." Even the most pallid interview will seem worth the candle if followed by a few leisurely Martinis and a good steak. For dessert, one can prepare an inventive report that will both save the company from the clutches of Joe Here, and demonstrate how fortunate the company is to have your continued presence.

As for Being Recruited, a slow period can be enlivened no end by conniving, ideally with a top-drawer personnel service, to get a steady stream of good luncheon invitations. These may be preceded by some fumbling interviews, but one will uniformly "win" the fumbling when it comes to check time. Naturally, these exercises have nothing to do with actually changing jobs, but they are a lot of fun and either (i) deductible or (ii) non-declarable, depending.

#### Now for some specific techniques

The following specific Project Evasion techniques follow a time scale from initiation of a project to submission of a preliminary draft for review.

##### 1. Development of CPM Networks.

The Critical Path Method (CPM) for "scientific scheduling" has been a boon to management, enabling top-level executives to keep an eye on every detail leading to the nuts-and-bolts stage.\* But the managerial fruits of CPM are as nothing compared to the refinement that CPM has made possible in Project Evasion technology.

According to the CPM, an involved new

\*Particularly useful to these august gentlemen when engaging in Decision Evasions. The latter appears to be the Front Office, or Corporate, version of what has been studied on the operating level in terms of Non-Decision Theory.<sup>2</sup>



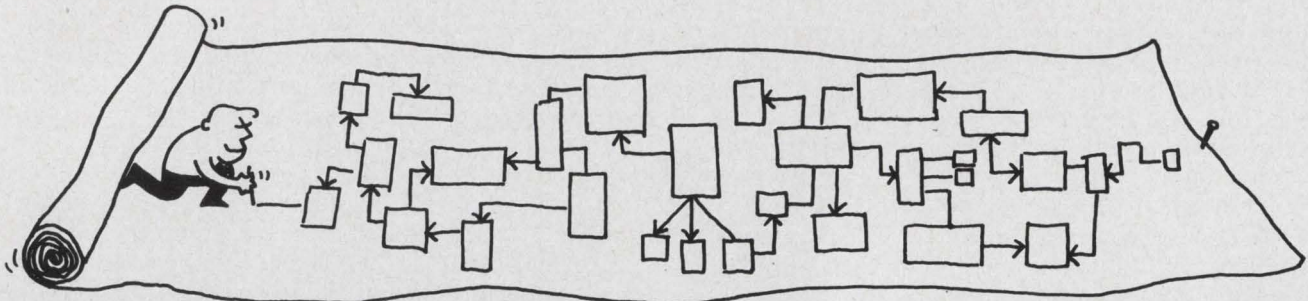

The Critical Path Method for "Scientific Scheduling" offers unlimited possibilities to the creative Project Evad-

er. The CPM chart can be made to resemble a vector field gone wild. There are, of course, other possibilities.

project must first be approached as a whole in all its bewildering complexity. Those on the "working level," so-called, must be assessed for their "inputs." This must then be recast into "arrow-diagram" form. In competent hands this step alone can be spun out into months. More or less by default, "events" become defined by the activities plotted on this impenetrable forest of arrows, which will end up resembling nothing so much as a vector field run amuck. With skill, this should need redrafting several times over.

Should this charting process adequately cover the ground, a large-scale computer will then have to determine the "critical path." The opportunities at this stage may be fewer than those described under "Computer Runs," but when a simple check (one trial run) of available CPM software can produce an eight-inch stack of print-out, there are, obviously, chances for good Project Evasion activity.

## 2. Computer Runs.

Computer applications are limited only by human ingenuity. The more important facets of this technique include:

- **Model Development.** The availability of software that can cope with sub-scripted variables makes it possible to take vast numbers of variables into account without having to worry excessively about their relevance. This will encourage the perfection-minded to build more and more intricate models—never finished, but ever more refined.
- **Flow Charting.** A basic concept of flow charting is that the whole thing should fit on a single sheet of paper. This may be accom-

plished in incremental, or modular, fashion by starting with a normal-sized sheet and then taping additional ones to the original as the problem grows. Before completion of flow charting, the original tapes should have rotted; the adroit operator can then start all over again.

There are, of course, other approaches, such as beginning with a very big sheet of paper in the first place.

- **De-bugging.** For abstruse reasons there is inevitably a huge amount of correcting, colorfully called "de-bugging," required. This is best done by highly experienced, costly personnel—the Digital Doges. Even with such elite assistance, it should take virtually forever to get a program even to compile, much less actually to compute something.

## 3. Laboratory Cleanups.

Recognizing that a tool put in its proper storage place is a tool forever lost, the adept Project Evader at the bench level will spare no effort to maintain an impeccably neat working area. Since untold equipment is required for such a relatively simple operation as determining and installing the proper value of a load resistor under "Live circuit conditions," it is obvious that this effort is no mean one.\* With proper scheduling, the Evader can spend at last 90% of his time putting equipment away and getting other equipment out.

Management may abet this technique by insisting upon a moderate standard of neatness in the laboratory. This, of course, plays right into the hands of the Evader who may even earn suggestion-box money by proposing such niceties as:

- Locking cabinets for all tools and instruments.
- No lathes, drill presses, bending brakes, shears, etc. in laboratory areas (they make chips); Central shop to be used for all machining operations, however small.
- Local component stocks to be discouraged; small parts (resistors, capacitors, terminals, etc., to be drawn from main stockroom in another building and only at certain times

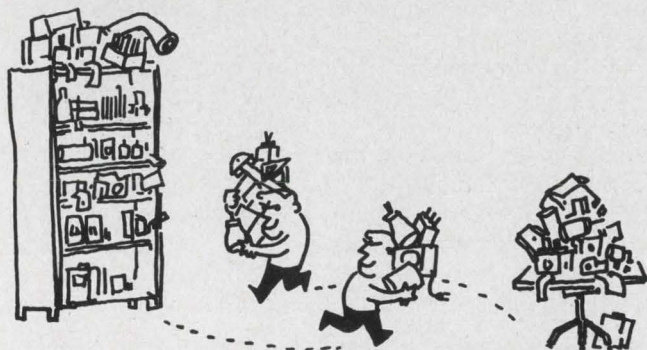

By scheduling operations properly, the Project Evader can devote at least 90% of his laboratory time to putting equipment away and taking other equipment out.

\*Partial list: Oscilloscope, current probe, calibrator, laboratory power supply, signal generator, substitution box, dummy load, soldering pencils, "Solder-Gobbler," spool of solder, wire brush, needle-nose pliers, diagonal cutters, clip-on heat sink spaghetti, resistor caddy, and assorted boxes of spare parts to replace those which were ruined in the process of installing the resistor.



(subject to change). Similarly with instruments.

#### 4. Outside Consultants.

It is universally acknowledged that the incompetence of those outside the organization should be more highly regarded—and more handsomely rewarded—than the in-house variety. When called in, these eminent gentlemen need to be thoroughly briefed on all aspects of the project, in order that the extensive talents they document in their expensive brochures may be brought properly to bear. Naturally, it takes quite a few days to “bring them on board.”

#### 5. Design & Drafting.

By the time graphs and charts are completed—stripped in, pasted up, lettered, photographed, and printed—the whole course of a project may have changed. At the very least, some crucial details that simply were not apparent when the given graph was in its initial, smudged form will have been omitted.

Inured to working on a crash basis, these departments frequently arrange their work so that even a non-crash job will be deferred until it, too, must be done on overtime. Much of this work is done at night, or on weekends, when the people involved in the project will not be available and necessary materials will be locked away.

#### What will the future bring?

Project Evasion is obviously applicable to all phases of technical life. But what of the future?

Basic research is being conducted in Project Evasion, with the usual division of labor. Practical work is going on in industry, while in universities people are earning degrees and writing papers on Evasive techniques. For example, the following theses have recently been written on Project Evasion topics.

- Solid-State Project Evasion
- Microminiature Project Evasion
- Photochromic Aspects of Project Evasion
- Contributions of Ergodic Theory to Project Evasion (You can get there from here)
- Stochastic Project Evasion, Including the Canonical Form
- Digital Routines for Real-Time Project Evasion
- Heuristic Project Evasion and Related Algorithms
- Pathological Semantic Reactions in Project Evasion
- The Impact of Non-Decision Theory on Project Evasion

The field has so much potential and obvious attractiveness that it seems unlikely there will be much dropping-off in Project Evasion. In short, the future looks implacably rosy. ■ ■

#### References:

1. D. D. Bourland, Jr., “Techniques in the Review of Technical Papers,” *Datamation*, August, 1963.
2. D. D. Bourland, Jr., “Non-Decision Theory,” *Datamation*, May, 1964.

May 24, 1966

# Refreshing new ideas in packaging



## CABINET RACKS

Exceptionally sturdy all assembled unit with welded frame. Placement of louvres insures ventilation under all conditions.

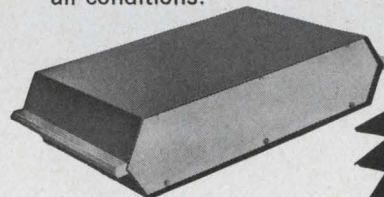

## GRAND PRIX CABINETS

Imaginative, yet practical design in standard cabinetry. Offers innumerable possibilities for instrument and control housings.

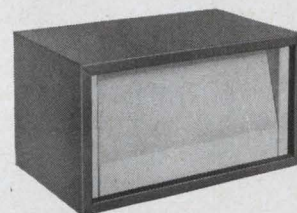
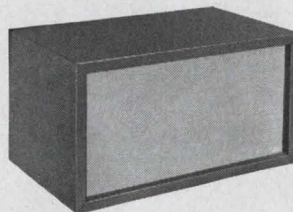

## FUTURA CABINETS

Highly functional, two piece cabinet embodying a design feature of holding front panels in place without the use of hardware.

**MORE DISTINCTIVE NEW PRODUCTS  
WILL SOON BE AVAILABLE AT YOUR  
BUD DISTRIBUTORS. WATCH FOR THEM.**

You are invited to see these distinctive new products at your Bud Distributors. Literature, prices and the names of your nearest Authorized Bud Distributors may be obtained by writing to the plant.



**BUD RADIO, INC.**  
WILLOUGHBY, OHIO

ON READER-SERVICE CARD CIRCLE 27





## WHICH CROW IS THE REAL ME?

A multiple-image mirror will confuse even the craftiest country crow. But every wise "old crow"\* who wants to **revitalize** his career and detach himself from the flock, will want to investigate the career opportunities now offered at Motorola.

Mature EW engineers who want to join in the development and application of sophisticated electronic confusion techniques will share in the excitement and rewards of our expanding EW activity. Qualified "Old Crows" who take wing and join Motorola now will participate in the benefits and profits which their experience, imagination and talents help create. \***Electronic Warfare specialist**

Other Specific Opportunities are:

Space Communications  
Radar Systems  
Tracking & Telemetry  
Fuzing  
Digital Data Transmission  
Guidance & Navigation  
ECM & CCM

Checkout Systems  
Coherent Transponders  
Radar Transponders  
Integrated Electronics  
Antennas & Propagation  
Reliability Analysis  
Advanced RF & Microwave Techniques

Contact Phil Nienstedt, Manager of Recruitment, Department 625

**MOTOROLA**



**in PHOENIX**

Military Electronics Division • Western Center • P.O. Box 1417, Scottsdale, Arizona  
MOTOROLA ALSO OFFERS OPPORTUNITIES AT CHICAGO, ILLINOIS — AN EQUAL OPPORTUNITY EMPLOYER

## Looking for a New Job?

- Fill out one application . . .
- Check off the companies that interest you . . .
- We do the rest

Contacting the job market takes only ten minutes with ELECTRONIC DESIGN's Career Inquiry Service. To put Career Inquiry Service to work for you, fill in the attached resume. Study the employment opportunity ads in this section. Then circle the numbers at the bottom of the form that correspond to the numbers of the ads that interest you.

ELECTRONIC DESIGN will be your secretary, type neat duplicates of your application and send them to any number of companies you select—the same day the resume is received.

Career Inquiry Service is a fast, efficient way to present your job qualifications to companies recruiting engineering personnel—as confidentially and discreetly as you would in person. This service is the first of its kind in the electronic field, and one that engineers have used effectively since its inception in 1959.

We take the following precautions to ensure that your application receives complete, confidential protection:

- All forms are delivered unopened to one reliable specialist at ELECTRONIC DESIGN.
- Your form is kept confidential and is processed only by this specialist.
- The "circle number" portion of the form is detached before the application is sent to an employer, so that no company will know how many numbers you circled.
- All original applications are placed in confidential files at ELECTRONIC DESIGN and after a reasonable lapse of time they are destroyed.



# CAREER INQUIRY SERVICE

After completing, staple, fold and mail career form to ELECTRONIC DESIGN, 850 Third Avenue, New York, N. Y. Our Reader Service Department will forward copies to the companies you select below.

(Please print with a soft pencil or type.)

Name \_\_\_\_\_ Telephone \_\_\_\_\_

Home Address \_\_\_\_\_ City \_\_\_\_\_ Zone \_\_\_\_\_ State \_\_\_\_\_

Date of Birth \_\_\_\_\_ Place of Birth \_\_\_\_\_ Citizenship \_\_\_\_\_

Position Desired \_\_\_\_\_

### Educational History

College	Dates	Degree	Major	Honors

Recent Special Training \_\_\_\_\_

### Employment History

Company	City and State	Dates	Title	Engineering Specialty

Outstanding Engineering and Administrative Experience \_\_\_\_\_

Professional Societies \_\_\_\_\_

Published Articles \_\_\_\_\_

Minimum Salary Requirements (Optional) \_\_\_\_\_

Use section below instead of Reader Service Card. Do not write personal data below this line. This section will be detached before processing.

Circle Career Inquiry numbers of companies that interest you

- 900 901 902 903 904 905 906 907 908 909 910 911 912 913 914 915 916 917 918 919 920 921 922 923 924
- 925 926 927 928 929 930 931 932 933 934 935 936 937 938 939 940 941 942 943 944 945 946 947 948 949



Fold here, staple and Mail.

FIRST CLASS  
Permit No. 725  
New York, N.Y.

**BUSINESS REPLY MAIL**

No Postage Stamp Necessary if Mailed in the United States

POSTAGE WILL BE PAID BY

**ELECTRONIC DESIGN**

**READER SERVICE**  
850 THIRD AVENUE  
NEW YORK, NEW YORK 10022







**George Washington couldn't sleep here.**

## **There's too much going on.**

"Here" is IBM's Federal Systems Center in Bethesda, Maryland. What's going on? Plenty!

Our principal mission is to develop and build special information processing equipment to solve individual and unique problems for command/intelligence, marine, tactical and communications systems.

As a member of our creative Federal Systems Center team, you'll work on some of the most advanced, sophisticated systems development problems we believe you've ever seen.

If your discipline is listed below, we may have an immediate opening for you. Look and see if your talent and training are needed.

It's kind of great to get to the job when you know you're needed, important, and growing.

Sonar systems design • Advanced communications systems design • Systems engineering • Digital and analog circuit design • Digital systems logic design • Mechanical

packaging design • Electrical systems design • Optical mechanical design. IBM is an Equal Opportunity Employer.

Direct your resume in complete confidence to:

Mr. J. B. Farrington, Dept. 555S4,  
IBM Federal Systems Center,  
Federal Systems Division,  
7220 Wisconsin Avenue, **IBM**<sup>®</sup>  
Bethesda, Maryland.



# When we tell you these jobs take deeper insight, we've got **POSEIDON'S "aims"** in mind.

**(All sixteen of them).**

As though coming up with two generations of fire control systems and inertial platforms for Polaris—each appreciably more complex and more fool-proof than the one before it—wasn't tough enough. Now we've really got to make sixteen the hard way.

Because each of POSEIDON'S sixteen missiles will carry double the payload with twice the accuracy plus a good deal more and faster targeting flexibility than the most advanced Polaris system going. And with even less room to spare.

Unlike Cape Kennedy where time and space are easier to come by, and where the launch pad is conveniently stationary, the system you help us design for shoe-horning into a submarine will have to have the bedrock reliability to withstand extraordinary environmental extremes and operational hazards...and to do its job (including elaborate

self-checking) with instant infallibility. To make things worse (or better, if you happen to like some depth to your engineering challenges) the target trajectory is a mass of variables—among them the sub's position and direction at the moment of launch, its motion such as pitch, roll, yaw and velocity, not to mention the weather topside.

One thing's for sure. Whether you're helping us develop standardized micro-module building block circuits, helping us configure them in advanced and easily accessible ways, helping us develop a precise 3-gimbal temperature-constant guidance platform, or the fire control system, or the support equipment, there's no room for shallow thinking.

On the other hand, the room and the opportunity for engineers with insight is practically unlimited. So why not look into the jobs listed to the right, and then send us a copy of your resume.

Ordnance Department

**GENERAL  ELECTRIC**



# Think deep

**DIGITAL LOGIC DESIGN ENGINEERS**—Responsible for the subsystem mechanization of development digital control systems. Keep abreast of new knowledge about digital memory design software techniques and microminiature modules and apply this knowledge to the logic design of control systems. Experience in mechanization techniques, tape readers, printer and compiler organization.

**SYSTEMS ENGINEERS**—Conceive and analyze the feasibility of concepts for weapon control systems. Develop the digital analog and combined analog digital approaches to the solution of weapon systems problems. Determine the methods and data requirements for the evaluation of a given weapons system.

**COMPONENTS ENGINEERS**—Determine tests necessary for evaluation of new components to be used in special circuits. Investigate integrated circuits and supply design criteria and specifications to technical personnel. Position requires a dynamic and enthusiastic personality; some background in circuits is desired.

**INERTIAL GUIDANCE CONTROL DEVELOPMENT ENGINEERS**—Responsible for designing servo controls for inertial systems. Should be capable of servo loop analysis and of supervising the design of required solid state circuitry. Individuals must possess initiative and creativity to promote development work and to supervise other technical personnel.

**ELECTRONIC CIRCUIT ENGINEERS**—Develop, design, package and evaluate digital and analog electronic circuits to meet requirements of Weapon Control systems and subsystems. Analyze, design and evaluate circuits and packaging techniques—using both discrete solid-state components and integrated microelectronic circuits for applications such as submarine fire control, gun mount and antenna drives, digital servos, sophisticated space power conversion and control equipments.

**COMPUTER APPLICATION ENGINEER**—To direct technical efforts of engineering group providing the conception, development and evaluation of new and unique designs associated with the application of General Purpose Computers to Weapon Control Systems. Responsible for establishing requirements for general purpose computing subsystems. Requires direct knowledge of Logical Design techniques, General Purpose Computer organization and programming. Knowledge of numerical techniques and analytical methods is desirable.

**QUALITY INFORMATION EQUIPMENT ENGINEERS**—To develop, design and evaluate production test consoles to assure the performance of inertial guidance, attitude reference and fire control equipments. Emphasis on advanced design of electronic measurement and control circuits, functional simulation of interfacing of analog and digital subsystems, and application of tape controlled automatic test equipment. Incumbents have project responsibility from development through installation requiring integration with internal operations and the customer.

If you have the qualifications, and interest, please send full details including salary requirements to: Mr. D. F. Kline, General Electric Co., Room 59 D Ordnance Department, 100 Plastics Avenue, Pittsfield, Mass.

Ordnance Department

**GENERAL ELECTRIC**

An Equal Opportunity Employer

ON CAREER-INQUIRY FORM CIRCLE 906

May 24, 1966

NASA TECH BRIEFS

## FET for ac amplifiers

**Problem:** Design an ac amplifier that will present a high and stable input impedance and operate efficiently at low intrinsic noise levels.

**Solution:** A four-stage transistorized amplifier that uses a field-effect transistor in the first stage.

The input signal is applied to the gate of the field effect transistor,  $Q_1$ , which is a majority-carrier device and hence free of the noise associated with minority-carrier current flow. The gate presents an impedance on the order of  $10^9$  ohms, therefore the actual impedance presented to the signal is determined by the magnitude of  $R_{in}$  (107 ohms). The first stage provides a voltage gain of 20. Direct-coupled transistors  $Q_2$ ,  $Q_3$  and  $Q_4$  provide three additional stages of amplification. The total open-loop voltage gain of all four transistors is  $3 \times 10^6$ .

The low-frequency cutoff, determined by  $R_1$  and  $C_3$ , occurs at 150 Hz. The high-frequency response

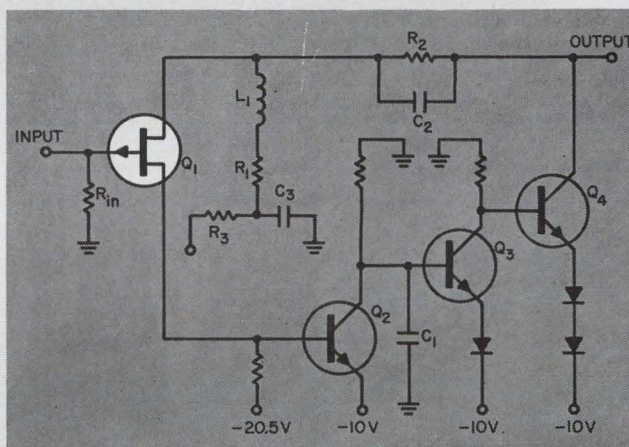

is determined by the time constants of the four transistors and the feedback network,  $R_1$ ,  $L_1$ ,  $R_2$  and  $C_2$ .

A closed-loop midband voltage gain of 1000 is attained with a feedback factor of 3000. A low closed-loop gain for dc prevents input drifts from producing excessive shifts in output operating points.

Temperature variations from  $-55^\circ\text{C}$  to  $+125^\circ\text{C}$  produce a closed-loop midband gain variation of approximately  $\pm 0.1\%$ . The circuit has a 3-ms rise time and an 8% overshoot. It consumes less power than conventional bootstrap amplifiers.

It is suited to carrier or narrow-band sine wave applications since the band-pass and gain may be easily controlled. Its large intrinsic bandwidth and good transient response would also make it useful in pulse systems.

For further information, contact: Technology Utilization Officer, Jet Propulsion Laboratory, 4800 Oak Grove Drive, Pasadena, California, 91103. Reference: (B65-10232).







**The 6200 is this  
year's curve tracer.**

**It shows you sights  
you can't see on  
last year's model.**

**It shows you what  
really goes on  
inside a FET,  
a unijunction,  
an SCR.**

**Get proof.**

**Get our data sheet.**

**FAIRCHILD**  
INSTRUMENTATION



# SCS and UJT form count generator

Electronic counting is obtained simply and economically by triggering a silicon controlled switch (SCS) with a unijunction transistor (UJT) oscillator. The resulting count generator essentially duplicates the function of a telephone dial.

The number of counts that the circuit (see schematic) will handle is proportional to the number of SCS stages. By momentarily depressing  $S_1$ , one pulse will be generated; with  $S_2$  momentarily depressed, two pulses are generated and so forth.

The SCS elements approximate to a ring counter. They would be a true ring counter if the stage containing  $SCS_0$  was coupled back to  $SCS_3$  in the same manner that  $SCS_1$  is coupled to  $SCS_0$ . The SCS anode gate leads are left unconnected. This allows the device to function as an SCR.

Input line A triggers the counter and causes the count to progress, to the right, through the group of SCSs. The UJT will not operate if  $SCS_0$  is turned on, because the switch's anode voltage will hold point B to a level below the firing potential of

the UJT triggering stage.

The UJT's output pulse is squared and its pulse width regulated by the pulse-forming network consisting of transistors  $Q_2$ ,  $Q_3$  and  $Q_4$ . When the UJT fires, its sharply rising pulse is developed across the 200-ohm resistor. Transistor  $Q_3$ , which is normally saturated, is then turned off by the negative step appearing at the collector of  $Q_2$ . Emitter-follower  $Q_4$  provides impedance matching.

To see how an actual count progresses, assume  $S_3$  is momentarily depressed.  $SCS_3$  will turn on, forcing  $SCS_0$  to turn off because of voltage developed across  $R_0$  ( $R_1$ ,  $R_2$ , and  $R_3$  are low-value resistors). Capacitor  $C$  will begin to accumulate charge through  $R_A$ . When the voltage at point B reaches the firing potential of the UJT, one pulse will be generated. This causes  $SCS_2$  to turn on and forces  $SCS_3$  off. The cycle then repeats until  $SCS_0$  is turned on and the circuit is returned to its stable condition. Therefore, it is seen that momentary depression of  $S_3$  causes the generation of three output pulses.

This counting circuit has been used successfully in coin-counting applications and is also suitable for counter programing and similar uses.

*James J. Klinikowski, Design Engineer, Burroughs Corp., Plainfield, N. J. VOTE FOR 110*

IDEAS FOR DESIGN: Submit your idea for Design describing a new or important circuit or design technique, the clever use of a new component, or a cost-saving design tip to our Ideas for Design editor. If your idea is published, you will receive \$20 and become eligible for an additional \$30 (awarded for the Best of Issue Idea) and the grand prize of \$1000 for the Idea of the Year.

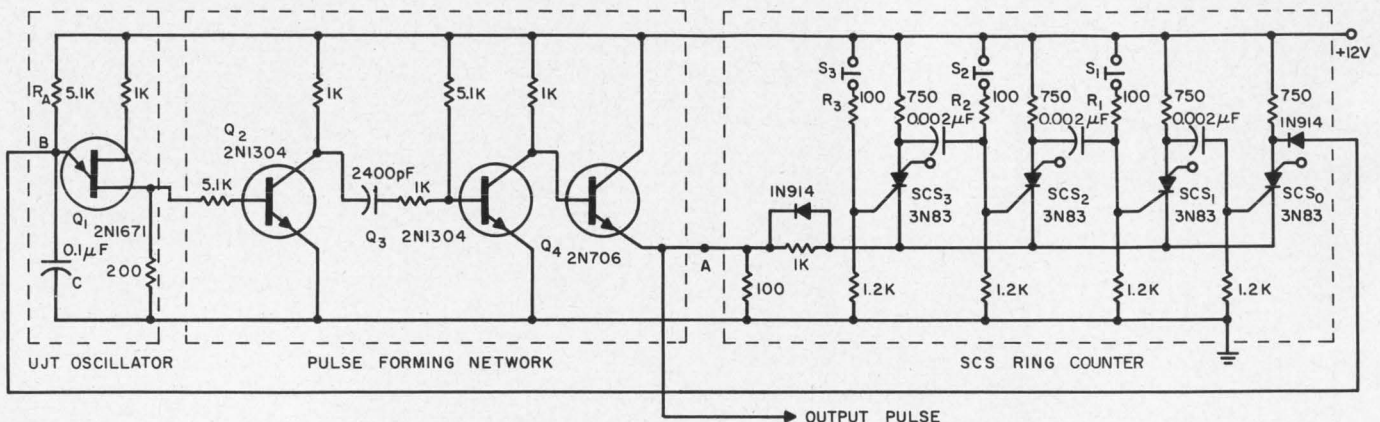

Key elements in this count generator are the UJT oscillator and the SCS ring counters.



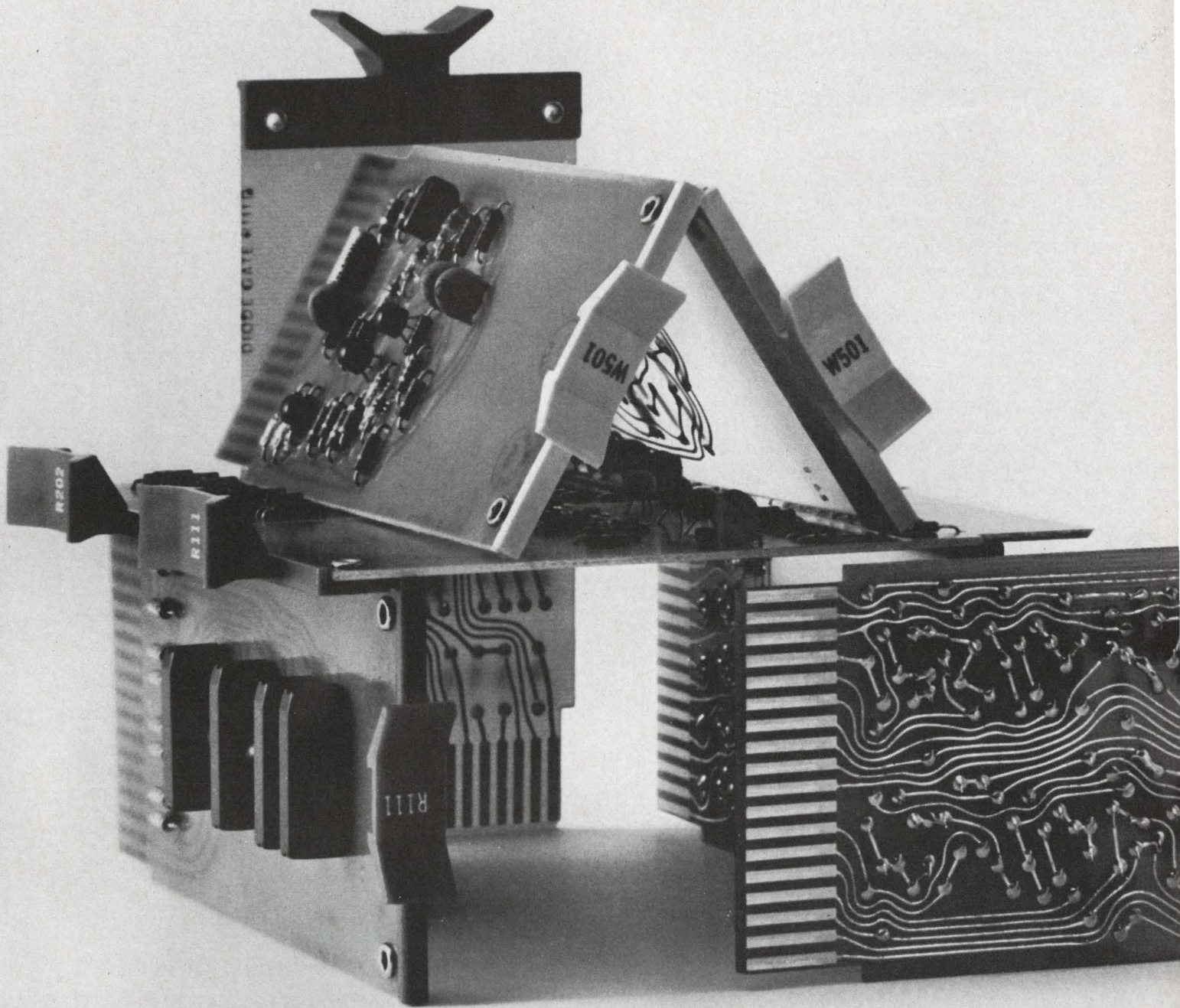

## Prefab

Building with pre-tested, standardized digital Flip Chip™ modules has these advantages.

You can build what you need now and expand later. You can get another piece exactly like the one you already have. Everything fits with everything else. Plans are available. Mass production allows favorable pricing. You have a wide selection to choose from.

Experience has eliminated the bugs. Every module is guaranteed for 10 years.

Power supplies, mounting panels, cabinets and assorted hardware are also standard. Try a prefab. Try a whole Levittown.

Write for a catalog.

**digital**  
MODULES • COMPUTERS

DIGITAL EQUIPMENT CORPORATION, Maynard, Massachusetts 01754. Telephone: (617) 897-8821 • Cambridge, Mass. • Washington, D. C. • Parsippany, N. J. • Rochester, N. Y. • Philadelphia • Huntsville • Orlando • Pittsburgh • Chicago • Denver • Ann Arbor • Los Angeles • Palo Alto • Seattle • Carleton Place and Toronto, Ont. • Reading, England • Paris, France • Munich and Cologne, Germany • Sydney and West Perth, Australia • Modules distributed also through Allied Radio



## Circuit protects memory against power interruptions

Unwanted triggering of memory flip-flops because of power-interruption transients can be prevented by using a 4-stage circuit. This type of protection is especially useful for airborne digital computers which employ electronically regulated, low-output capacitance power supplies.

Basically the protection circuit (see illustration) provides fast closing of the logic gate on detection of below-tolerance voltage, and slow opening of the gate as the system returns to normal voltage. The fast closing and slow opening of the gate block all system transients due to momentary power interruptions.

The circuit uses a differential amplifier to compare the voltage supplied to the low-cost logic with a reference voltage supplied by  $CR_1$ . When

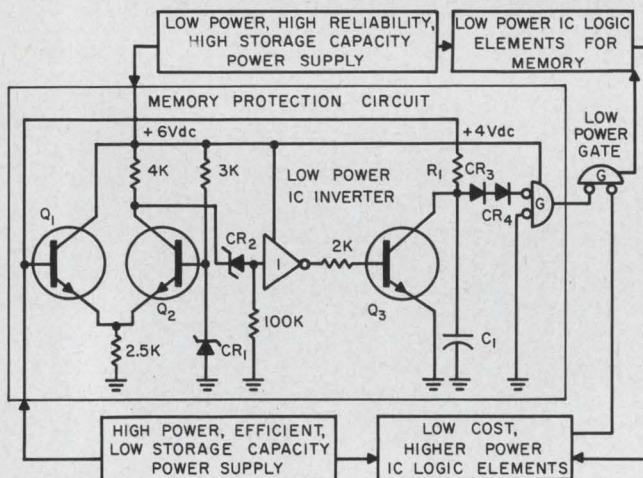

**Computer memory is protected** from source voltage interruptions by this circuit. The  $Q_1 - Q_2$  differential amplifier compares memory supply voltage level with a reference voltage across  $CR_1$ . Its output activates the logic circuits which hold memory contents constant during brief power interruptions.

the logic voltage becomes smaller than the reference voltage, the input signal to the low-power IC inverter becomes low, its output goes high and transistor  $Q_3$  is turned on. This quickly discharges  $C_1$ . The voltage on  $C_1$  is the logical input, which is coupled through level-shifting stabistor diodes  $CR_3$  and  $CR_4$  to the low-power IC gate used as the inverter. When the supply voltage returns to normal, the voltage on  $C_1$  rises slowly, at a rate determined by resistor  $R_1$ . The circuit output controls the gate which logically connects the memory elements to the remainder of the system logic.

The circuit has operated satisfactorily in an airborne digital erection and operation mode sequencer and can provide protection against power transients that meet the requirements of MIL-STD-704.

*Lell Barnes, Research Engineer, General Precision Aerospace, Little Falls, N. J.* VOTE FOR 111

## Cell and LC network form frequency-selective photo relay

A tuned, resonant LC-network employing an electroluminescent capacitor may be combined with a photosensor to produce a light-controlled frequency-selective relay. Here the capacitor cell is used as both a network component and an indicating element.

The basic circuit (see schematic) emits light

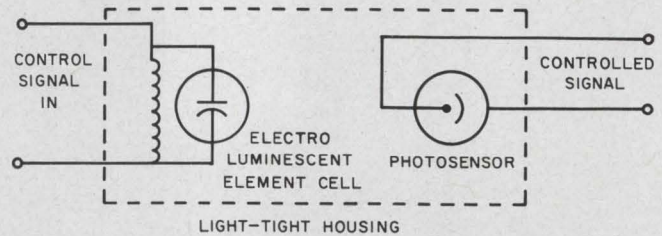

**A tuned, resonant LC-network** employing an electroluminescent capacitor combines with a photosensor to produce a light-controlled, frequency-selective relay.

only when excited at resonance, and may be used with various types of photosensors. Note that linear photosensor types, as opposed to light-controlled SCR's, will pick up the light variations emitted by the electroluminescent element. Although these variations are being super-imposed on the controlled signal, this limitation is easily overcome by filtering techniques.

The LC characteristics of the electroluminescent element and its shunt inductor determine the resonant frequency. Such units have been used in a prototype selective calling system.

*R. M. Zilberstein, Senior Project Engineer, Laboratory For Electronics, Waltham, Mass.*

VOTE FOR 112

## CdS photocells smooth electronic-organ transients

A cadmium sulphide (CdS) photocell in place of each note-selection contact in an electronic organ smooths the unpleasant transients generated by conventional "on-off" contact operation.

The CdS cell produces smooth, variable attack and decay, permitting sound control by different key-depression techniques, i.e., it gives the organ "touch." It also makes it possible to simulate the starting harmonic "chiff" of a pipe organ through the addition of a shutter that will partly uncover the photocell when a key is partially depressed.

Depression of the organ key moves a shutter away from the cell (see Fig. 1), allowing light to fall on it and changing its resistance, typically, from 1 M $\Omega$  to 100  $\Omega$ . The signal from the oscillator is fed through the photocell into a 100  $\Omega$  resistor, and the output amplitude rises and falls smoothly as the key is depressed or returned to rest. The rate of change of sound level can be varied by altering the rate of depression of the key; the final level can be varied by only partially depressing the





## SERENDIPITY IS A \$985 INTEGRATING DIGITAL VOLTMETER

What makes the VIDAR 500 a rare and worthwhile find is not its price alone. It is the combination of low price and performance features that include:

Five full-scale ranges from  $\pm 100$  mv to  $\pm 1000$  volts

Three significant digit display (over-ranging adds a fourth from one to three times full scale)

Accuracy better than  $\pm 0.05\%$  of reading  $\pm 1$  digit

Up to nine readings per second

Variety of plug-in options

Built in voltage-to-frequency converter produces pulses at a rate precisely proportional to the input voltage. A precision electronic counter counts the pulses over a fixed time interval and displays an integral or average value. This technique virtually eliminates errors caused by noise superimposed on the data signal.

Used as a frequency counter, the

VIDAR 500 ranges from 10 cps to 200 kc with a four digit display and selectable gate times of 0.1 and 1.0 seconds.

You can own a VIDAR 500 Integrating Digital Voltmeter for \$985! Send today for the complete performance data. Your copy awaits you at: 77 Ortega Ave., Mountain View, Calif.

# VIDAR CORPORATION



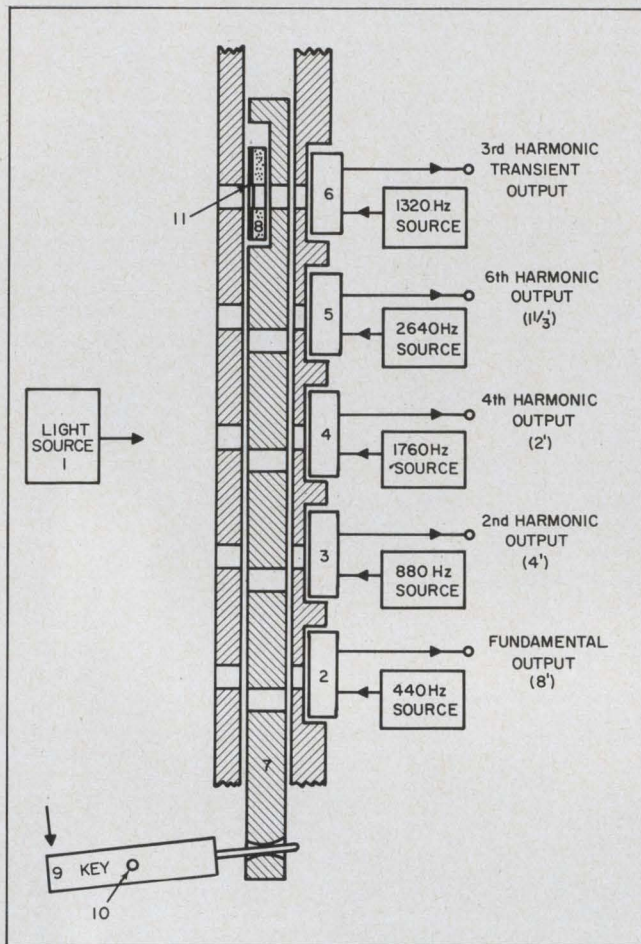

1. Cross-section of mechanism of an A note in an electronic organ using CdS-photocell keying system. The mechanism is shown with the key half depressed.

key. With a carefully made shutter system, attenuations greater than 75 dB have been measured. It is necessary to have a minimum of one cell for each note in a complete instrument, and it greatly simplifies ton-selection switching if one cell is used for each note of each pitch (e.g., 8 ft, 4 ft, 2 ft, 1-1/3 ft).

In this example, 244 cells are required, as well as a considerable amount of shutter mechanism, but the results justify the extra cost and complexity. With this system it is no longer necessary to apply considerable high-frequency attenuation to mask the effects of keying transients. Thus an organ can break away from the inevitable "mellow" tone of conventional instruments.

When a key is depressed on a pipe organ, a valve is opened, allowing the air pressure to reach the appropriate pipe. The air pressure in the pipe builds up gradually, and during this build-up the pipe may speak briefly at an incorrect frequency (usually a multiple of the correct frequency) before settling to normal operation. This characteristic starting transient, called "chiff" by organists, is a vital part of the character of organ tone, particularly in the crisp, clear, quick-speaking pipes typical of the 17th and 18th centuries and much in favor today. To produce this effect in an

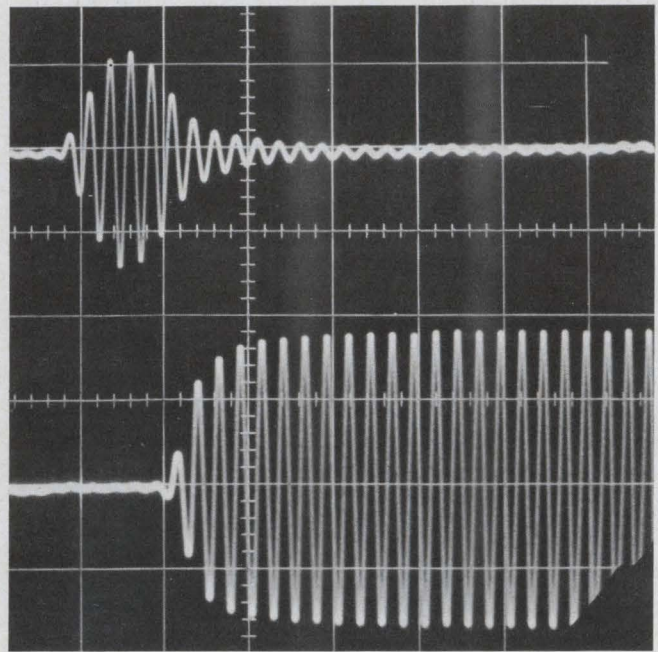

2. Upper trace shows "chiff" output from the transient cell. Output from main cell is the lower trace. The photo was taken during key depression at a sweep speed of 20 ms/div. Signal frequency is approximately 200 Hz.

electronic organ, the following system is used.

A shutter is arranged to uncover a photocell when the key is partially depressed. The cell is dark when the key is at rest or fully depressed, and a "lost-motion" secondary shutter keeps the cell dark during the key return. Each note has such a shutter and cell assembly. The cell is connected to a source of a multiple of the frequency of that note. Thus, when the key is operated, a small burst of a harmonic of the tone appears out of the cell, simulating the "chiff" of an organ pipe. Figure 2 shows a comparison of the length of "chiff" and normal outputs.

An organ using these principles has been partly constructed, and initial results are very encouraging. Clear bright organ tone, with "chiff" if desired, and a good chorus effect, have been demonstrated.

K. L. Fuller, 1 Godolphin Close, Cheam, Surrey, U.K. VOTE FOR 113

### 3-stage pulse limiter has short recovery time

A nanosecond, low-voltage pulse limiter with a very short recovery time and good linearity in the non-limited region uses an emitter-coupled pair of fast transistors. With this circuit, overloading of both fast amplifiers and logic systems with small dynamic ranges can be avoided.

Referring to the schematic, we see that  $Q_3$  is initially cut off and  $Q_2$  acts as emitter-follower for small input signals. For negative, medium-height input pulses of amplitudes  $E_T$ ,  $Q_3$  starts to conduct and the emitter current of  $Q_2$  decreases. If a large input pulse exceeds the  $E_T$  threshold,  $Q_2$  will be cut off, and the current delivered through  $R_4$  flows in  $Q_3$ . Further increases in the input do not affect



# Why specify Mallory wet slug tantalum capacitors?

One reason:

- lowest weight and smallest size per microfarad-volt

Check these characteristics:

	Wet Slug Mallory MTP	Solid Mallory TAS
Mfd-volts/in <sup>3</sup>	178,000	37,200
Wt: grams/mfd-volt	0.00067	0.0024

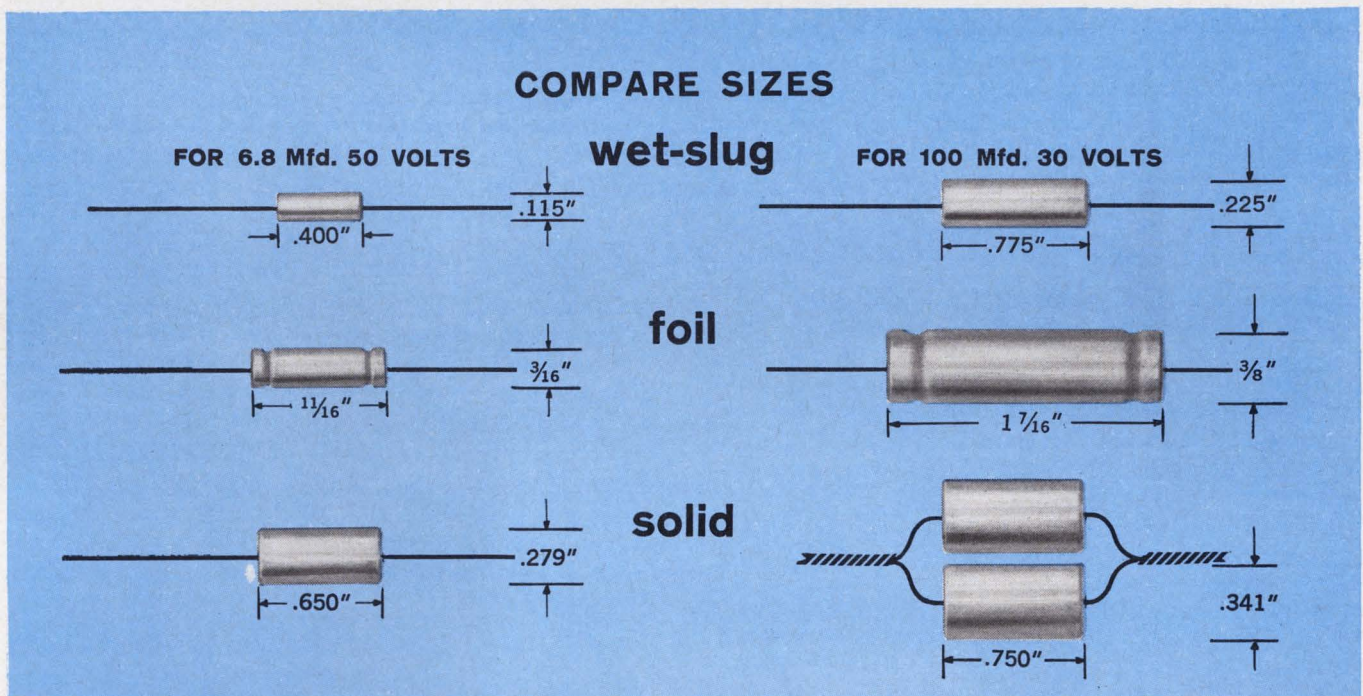

Specify Mallory wet slug tantalum capacitors wherever you need lowest DC leakage, and proven freedom from catastrophic failure. Note: they don't need voltage derating. We'll help you by recommending the best type for your application.

And we'll recommend without bias, because we make a complete line of wet slug, solid and foil types. Write or call Mallory Capacitor Company, a division of P. R. Mallory & Co. Inc., Indianapolis, Indiana 46206.

**50<sup>th</sup>**  
ANNIVERSARY

**MALLORY**

ON READER-SERVICE CARD CIRCLE 29



## IDEAS FOR DESIGN

the output signal height.

The limitation level is established by the base voltage of  $Q_3$  and the setting of  $R_5$ . The maximum input pulse height is approximately equal to  $BV_{EBO}$ , a level which just avoids the base-break-down voltage on  $Q_2$ .

If  $i_1$  (by adjusting  $R_2$ ) and  $R_1$  are suitably chosen, the pulse distortion through  $Q_1$  will partly compensate for the distortion in  $Q_3$ , so that good small-signal linearity is achieved. The adjustment

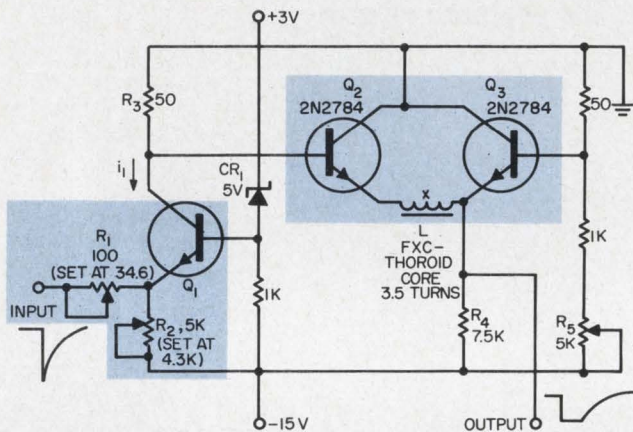

**Fast low-level limiter** with good small-signal linearity and short recovery time is formed by an emitter-coupled pair ( $Q_2 - Q_3$ ) and a linear riser stage ( $Q_1$ ). Inductance  $L$  suppresses Colpitts-ringing in the output, and  $R_1$  and  $R_2$  determine gain for the grounded-base driver stage.

of  $R_1$  and  $R_2$  for a specific value of  $R_3$  is made so that, for 10% and 50% of the limitation level, the gain is unity. Inductance  $L$  suppresses Colpitts-ringing in the output. The recovery time of the circuit is primarily a function of the storage time of  $Q_3$ , and remains small if the current through  $R_4$  is low.

The limiter has the following characteristics: limitation level is 200 mV, small-signal gain is unity, small-signal rise time is 1.0 ns and non-linearity up to 160 mV < 0.5 mV. Also, its maximum pulse, broadening up to an overloading factor of 20 (for a -4-volt input),  $\leq 5$  ns, and it accommodates a maximum input pulse of -4 volts in amplitude.

*Erich A. Keroe and Otto Mutz, Electronic Engineers, International Atomic Energy Agency's Laboratory, Vienna, Austria.*

VOTE FOR 114

## Voltage, current transients suppressed by relay.

A relay with a high armature mass provides a simple means of protecting power transformer circuits against voltage and current transients. The relay and a resistor are the only components required.

If the primary circuit of a power transformer

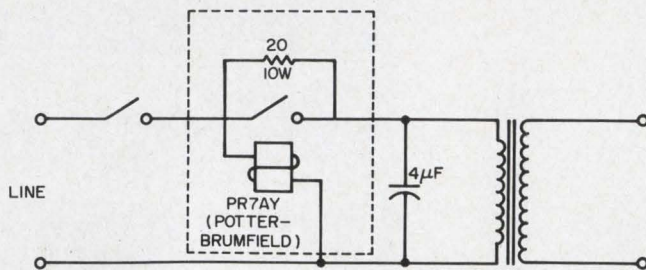

**Relay-resistor combination** protects circuit against voltage and current transients.

(see schematic) is closed at the zero voltage point of the supply waveform, a very high current-surge may occur one-half cycle later. This is due to core saturation caused by a double-amplitude flux wave that exists during the first half-cycle.

When the primary circuit is broken at the peak voltage point, a high secondary voltage spike can be generated because of the energy stored in the secondary inductance. The relay-resistor circuit can greatly reduce both types of surges.

The relay must have a high armature mass so that it closes relatively slowly. A series of double-pole relays have been found to work well. When the main switch or relay closes, the series resistor limits the current surge but allows a symmetrical flux wave to be generated in the transformer core, such that there is no additional surge when the relay closes 10 ms later.

The resistor value is not critical; it is selected for minimum current transients. Values of 10 to 40  $\Omega$  worked well for a 2-kVA, 240-volt transformer. The primary bypass capacitor, which must be rated for ac use, absorbs the inductive kick when the primary is opened, thus preventing secondary voltage spikes. With the above transformer, a capacitor value between 2.0 and 4.0  $\mu\text{F}$  is effective.

This circuit, used with a series of microwave cooking ranges, reduced primary current surges from 400 A to 80 A, and unloaded secondary voltage spikes from 100 per cent of normal peak down to about 5 per cent. The circuit should be particularly useful in protecting high-voltage silicon diodes.

*Tom Lamb, Research Engineer, Tappan Co., Mansfield, Ohio.*

VOTE FOR 115

IFD Winner for Feb. 15, 1966

**Andrew Chao**, Design Engineer, The Bendix Corp., North Hollywood, Calif.

His idea, "Slide-rule procedure directly yields equivalent resistances," has been voted the \$50 Most Valuable of Issue Award.

**Cast Your Vote for the Best Idea in this Issue.**



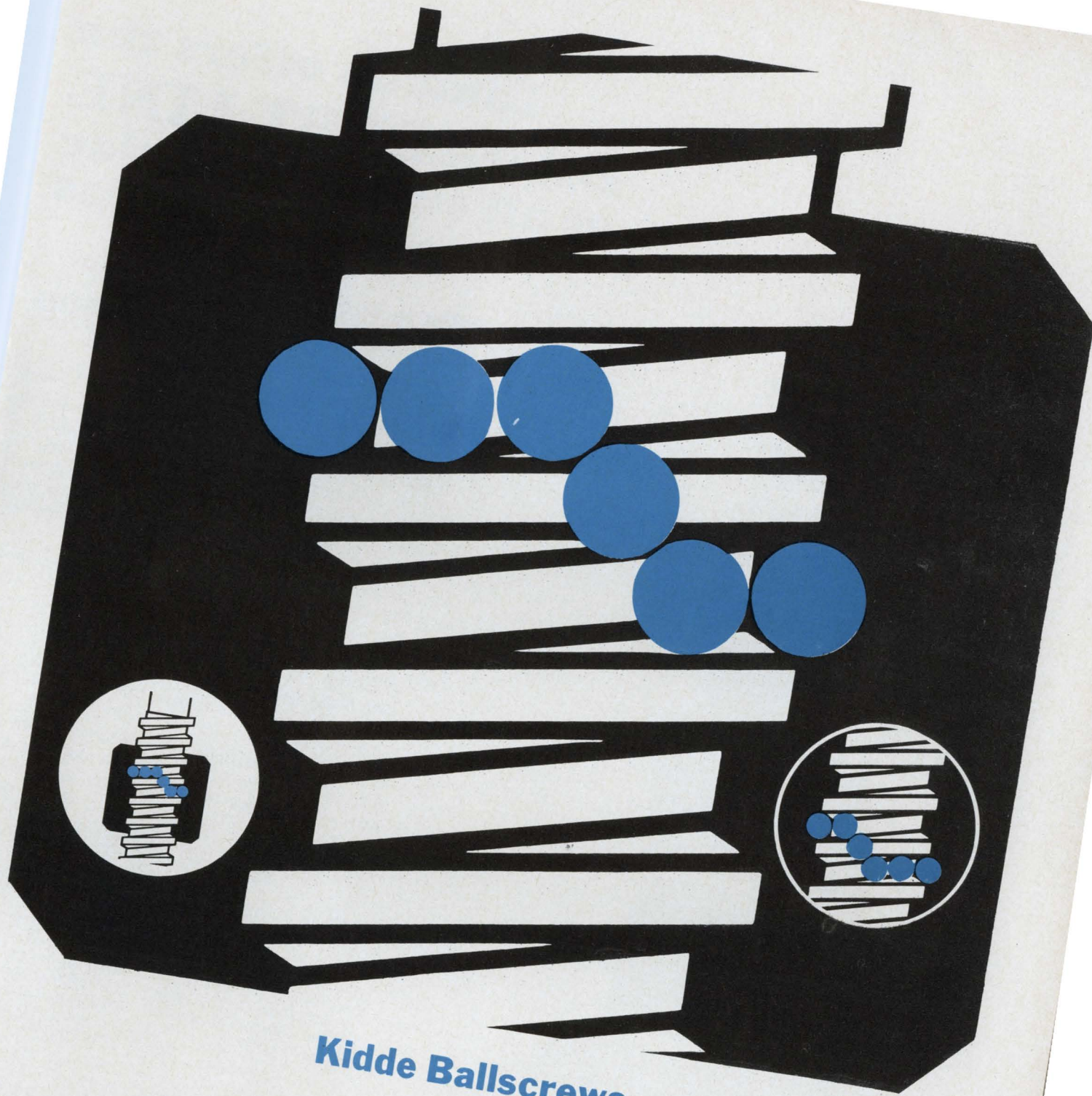

## Kidde Ballscrews

### SIZE AND WEIGHT PROBLEM SOLVERS

Kidde Ballscrews do more than solve friction problems of prime movers and drives. They can solve size and weight problems, too—and meet the demands for high efficiency transfer of motion and power. Here's why:

Their compact design results in smaller envelope dimensions. Weight is reduced because external tubes and fittings are eliminated. Kidde designs allow optimum usable power, due to extremely high efficiencies.

To solve these major problems, Kidde has designed a

wide range of Ballscrew sizes—from units less than 1" long to 32 foot custom assemblies. From 6" diameters down to 1/8"; sizes 3/16" to 1-1/2" (with various lead) are stocked.

Learn how Kidde Ballscrews can become your problem solver. Write for your free copy of "Standard and Precision Ballscrews." Walter Kidde & Company Inc., 675 Main Street, Belleville, New Jersey 07109.



May 24, 1966

ON READER-SERVICE CARD CIRCLE 30



# Lambda offers the BROADEST LINE of all silicon modular power supplies

Up to 150 volts / Up to 90 amps  
7 power packages **\$69<sup>00</sup>**  
Prices starting at

**Features and Data** Meet Mil. Environment Specs. RFI—MIL-I-16910: Vibration: MIL-T-4807A: Shock: MIL-E-4970A • Proc. 1 & 2: Humidity: MIL-STD-810 • Meth. 507: Temp. Shock: MIL-E-5272C • (ASG) Proc. 1: Altitude: MIL-E-4970A • (ASG) Proc. 1: Marking: MIL-STD-130: Quality: MIL-Q-9858: Fungus Proofing (optional) all models available with MIL-V-173 varnish for all nutrient components.

Convection cooled—no heat sinking or forced air required  
Wide input voltage and frequency range—105-132 VAC, (200-250 VAC, optional at no extra charge) 45-440 cps  
Regulation (line) 0.05% plus 4MV (load) 0.03% plus 3MV: Ripple and Noise—1 MV rms, 3MV p to p  
Overvoltage protection available for all models up to 70 VDC

High Performance Option—All models available with these specifications for \$25.00 extra: Line regulation—.01% + 1MV; Load regulation—.02% + 2MV: Ripple and Noise—½MV rms; 1½MV p to p: Temp. Coef.—.01%°C

## RACK ADAPTERS

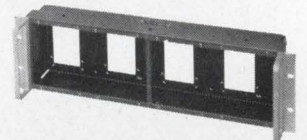

LRA-3—5¼" height by 27/16" depth. Mounts up to 4 A, B or C package sizes; 2 D or 2 E package sizes; or 2 A, B or C and 1 D or 1 E package sizes. Price \$35.00

LRA-6—5¼" height by 14" depth. (For use with chassis slides) Mounts up to 4 A, B or C package sizes; 2 D or 2 E package sizes; or 2 A, B or C and 1 D or 1 E package sizes. Price \$60.00

LRA-4—3½" height by 14" depth. (For use with chassis slides) Mounts up to 4 A package sizes; 3 B or C package sizes; or 2 A and 1 B or C package sizes. Price \$55.00

LRA-5—3½" height by 27/16" depth. Mounts up to 4 A package sizes; 3 B or C package sizes; or 2 A and 1 B or C package sizes. Price \$35.00

Send for complete information on LM series and accessories.

 **LAMBDA**  
ELECTRONICS CORP.  
515 BROAD HOLLOW ROAD • MELVILLE, L. I., NEW YORK • 516 MYRTLE 4-4200

A  SUBSIDIARY

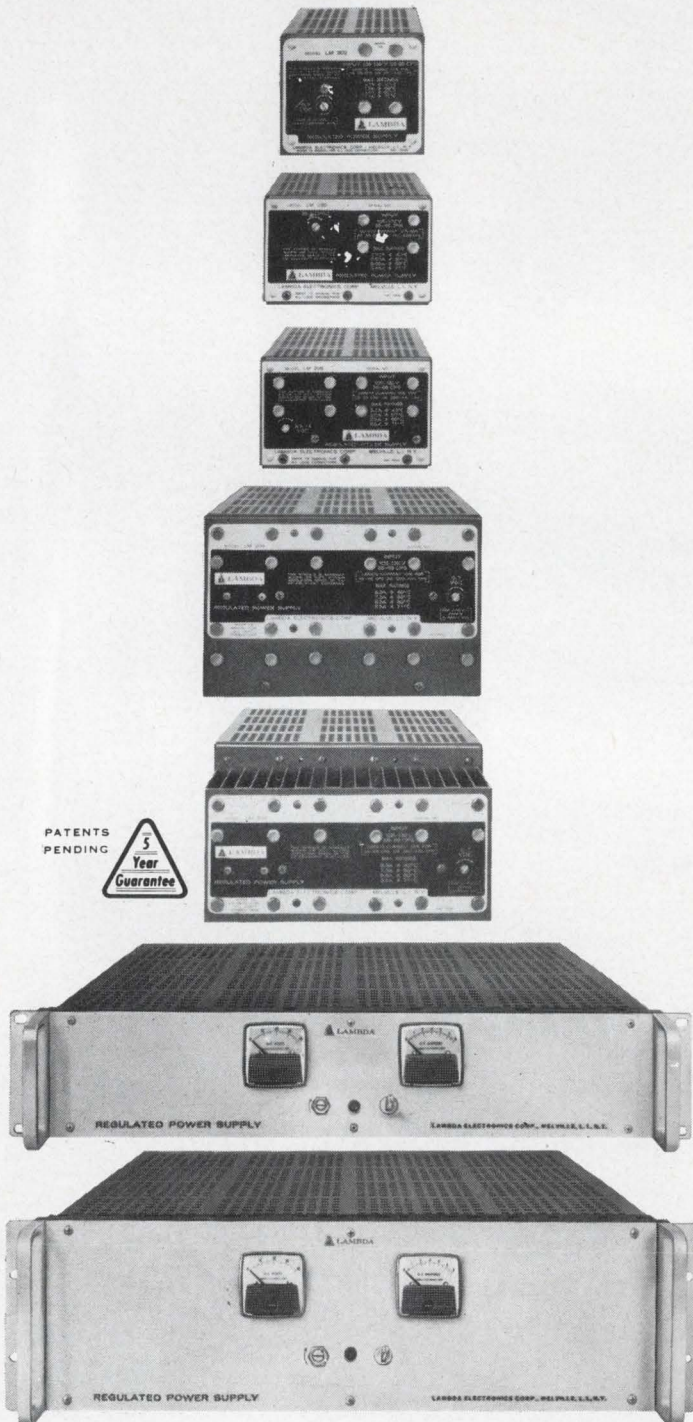

PATENTS  
PENDING





# LAMBDA LM Series

## Package A 3 1/8" x 3 3/4" x 6 1/2"



MP-3



MP-5

Accessory Metered Panels: \$40.00

Model	ADJ. VOLT. RANGE VDC	I MAX. AMPS				Price
		40°C	50°C	60°C	71°C	
LM 251	0-7	0.35	0.31	0.29	0.27	\$ 69
LM 201	0-7	0.85	0.75	0.70	0.55	79
LM 202	0-7	1.7	1.5	1.4	1.1	89
LM 252	0-7	2.0	1.8	1.4	1.1	99
LM 253	0-10	0.31	0.27	0.26	0.25	69
LM 254	0-10	0.65	0.55	0.50	0.45	79
LM 255	0-10	1.20	1.10	1.00	0.75	89
LM 256	0-10	1.5	1.4	1.2	0.90	99

## Ordering Information

METERS—3 1/2" Metered panel MP-3 is used with rack adapters LRA-4, LRA-5 and packages A, B and C.

5 1/4" Metered panel MP-5 is used with rack adapters LRA-6, LRA-3 and packages A, B, C, D and E.

To order these accessory metered panels, specify panel number which MUST BE FOLLOWED BY the MODEL NUMBER of the power supply with which it will be used.

Note—F and G LM Packages are full rack power supplies available metered or non-metered. For metered models, add suffix M to the Model No. and \$30 to the non-metered price.

Model	ADJ. VOLT. RANGE VDC	I MAX. AMPS				Price
		40°C	50°C	60°C	71°C	
LM 257	0-14	0.27	0.24	0.23	0.22	69
LM 203	0-14	0.45	0.40	0.38	0.28	79
LM 204	0-14	0.90	0.80	0.75	0.55	89
LM 258	0-14	1.2	1.1	1.0	0.80	99
LM 259	0-24	0.18	0.16	0.15	0.14	69
LM 260	0-24	0.35	0.30	0.25	0.20	79
LM 261	0-24	0.70	0.65	0.60	0.45	89
LM 262	0-24	0.80	0.75	0.70	0.60	99

Model	ADJ. VOLT. RANGE VDC	I MAX. AMPS				Price
		40°C	50°C	60°C	71°C	
LM 263	0-32	0.14	0.12	0.11	0.10	69
LM 205	0-32	0.25	0.23	0.20	0.15	79
LM 206	0-32	0.50	0.45	0.40	0.30	89
LM 264	0-32	0.66	0.60	0.50	0.32	99
LM 265	0-60	0.08	0.07	0.07	0.06	79
LM 207	0-60	0.13	0.12	0.11	0.08	89
LM 208	0-60	0.25	0.23	0.21	0.16	99
LM 266	0-60	0.35	0.31	0.28	0.25	109

## Package B 3 1/8" x 4 15/16" x 6 1/2"



MP-3



MP-5

Accessory Metered Panels: \$40.00

Model	ADJ. VOLT. RANGE VDC	I MAX. AMPS				Price
		40°C	50°C	60°C	71°C	
LM 217	8.5-14	2.1	1.9	1.7	1.3	\$119
LM-218	13-23	1.5	1.3	1.2	1.0	119
LM 219	22-32	1.2	1.1	1.0	0.80	119
LM 220	30-60	0.70	0.65	0.60	0.45	129
LM B2	2 ±5%	3.8	3.3	2.6	1.6	119
LM B3	3 ±5%	3.8	3.3	2.6	1.6	119
LM B3P3	3.3±5%	3.8	3.3	2.6	1.6	119
LM B3P6	3.6±5%	3.8	3.3	2.6	1.6	119
LM B4	4 ±5%	3.8	3.3	2.6	1.6	119
LM B4P5	4.5±5%	3.7	3.2	2.5	1.5	119
LM B5	5 ±5%	3.7	3.2	2.5	1.5	119
LM B6	6 ±5%	3.2	2.9	2.4	1.4	119
LM B8	8 ±5%	3.2	2.9	2.4	1.4	119
LM B9	9 ±5%	3.0	2.8	2.4	1.4	119
LM B10	10 ±5%	2.7	2.5	2.2	1.4	119
LM B12	12 ±5%	2.5	2.3	2.1	1.3	119
LM B15	15 ±5%	2.2	2.0	1.8	1.3	119
LM B18	18 ±5%	2.0	1.8	1.7	1.3	119
LM B20	20 ±5%	1.8	1.6	1.5	1.2	119
LM B24	24 ±5%	1.4	1.3	1.2	1.1	119
LM B28	28 ±5%	1.3	1.2	1.1	1.0	119
LM B36	36 ±5%	1.1	1.0	0.90	0.85	129
LM B48	48 ±5%	0.9	0.85	0.80	0.75	129
LM B60	60 ±5%	0.7	0.65	0.60	0.54	129
LM B100	100 ±5%	0.37	0.34	0.30	0.28	139
LM B120	120 ±5%	0.30	0.28	0.25	0.23	139
LM B150	150 ±5%	0.25	0.23	0.20	0.19	149

## Package C 3 1/8" x 4 15/16" x 9 3/8"



MP-3



MP-5

Accessory Metered Panels: \$40.00

Model	ADJ. VOLT. RANGE VDC	I MAX. AMPS				Price
		40°C	50°C	60°C	71°C	
LM 225	0-7	4.0	3.6	3.0	2.4	\$139
LM 226	8.5-14	3.3	3.0	2.5	2.0	139
LM 227	13-23	2.3	2.1	1.7	1.4	139
LM 228	22-32	2.0	1.8	1.5	1.2	139
LM 229	30-60	1.1	1.0	0.80	0.60	149
LM C2	2 ±5%	5.4	4.7	3.7	2.6	139
LM C3	3 ±5%	5.3	4.6	3.7	2.5	139
LM C3P3	3.3±5%	5.2	4.5	3.6	2.5	139
LM C3P6	3.6±5%	5.2	4.5	3.6	2.5	139
LM C4	4 ±5%	5.2	4.5	3.6	2.5	139
LM C4P5	4.5±5%	5.1	4.4	3.5	2.4	139
LM C5	5 ±5%	5.1	4.3	3.4	2.4	139
LM C6	6 ±5%	4.8	4.1	3.3	2.4	139
LM C8	8 ±5%	4.6	3.9	3.2	2.1	139
LM C9	9 ±5%	4.5	3.8	3.1	2.1	139
LM C10	10 ±5%	4.2	3.6	3.0	2.0	139
LM C12	12 ±5%	4.0	3.5	2.9	1.9	139
LM C15	15 ±5%	3.5	3.2	2.8	1.9	139
LM C18	18 ±5%	3.2	3.0	2.7	1.9	139
LM C20	20 ±5%	3.1	2.9	2.6	1.8	139
LM C24	24 ±5%	2.5	2.4	2.2	1.5	139
LM C28	28 ±5%	2.3	2.1	2.0	1.4	139
LM C36	36 ±5%	2.0	1.8	1.7	1.3	149
LM C48	48 ±5%	1.6	1.4	1.3	1.0	149
LM C60	60 ±5%	1.1	1.0	0.90	0.80	149
LM C100	100 ±5%	0.55	0.51	0.47	0.42	164
LM C120	120 ±5%	0.49	0.45	0.42	0.38	164
LM C150	150 ±5%	0.39	0.36	0.33	0.30	169

## Package D 4 15/16" x 7 1/2" x 9 3/8"



MP-5

Accessory Metered Panels: \$40.00

Model	ADJ. VOLT. RANGE VDC	I MAX. AMPS				Price
		40°C	50°C	60°C	71°C	
LM 234	0-7	8.3	7.3	6.5	5.5	\$199
LM 235	8.5-14	7.7	6.8	6.0	4.8	199
LM 236	13-23	5.8	5.1	4.5	3.6	209
LM 237	22-32	5.0	4.4	3.9	3.1	219
LM 238	30-60	2.6	2.3	2.0	1.6	239
LM D2	2 ±5%	13.1	11.3	9.2	6.2	199
LM D3	3 ±5%	13.1	11.3	9.2	6.2	199
LM D3P3	3.3±5%	13.1	11.3	9.2	6.2	199
LM D3P6	3.6±5%	13.1	11.3	9.2	6.2	199
LM D4	4 ±5%	13.1	11.3	9.2	6.2	199
LM D4P5	4.5±5%	13.1	11.3	9.2	6.2	199
LM D5	5 ±5%	12.6	10.8	9.2	6.1	199
LM D6	6 ±5%	12.4	10.6	8.9	6.0	199
LM D8	8 ±5%	12.2	10.3	8.8	5.9	199
LM D9	9 ±5%	11.3	10.0	8.6	5.7	199
LM D10	10 ±5%	10.8	9.7	8.5	5.7	199
LM D12	12 ±5%	10.0	9.2	8.3	5.7	199
LM D15	15 ±5%	9.0	8.4	7.9	5.3	209
LM D18	18 ±5%	7.9	7.4	6.9	5.0	209
LM D20	20 ±5%	7.4	6.9	6.5	4.9	209
LM D24	24 ±5%	6.7	6.3	5.8	4.8	219
LM D28	28 ±5%	6.0	5.6	5.2	4.7	219
LM D36	36 ±5%	5.4	5.0	4.7	4.3	239
LM D48	48 ±5%	4.1	3.9	3.6	3.1	239
LM D60	60 ±5%	2.8	2.6	2.4	2.1	239
LM D100	100 ±5%	1.7	1.5	1.3	1.1	249
LM D120	120 ±5%	1.5	1.3	1.1	1.0	249
LM D150	150 ±5%	1.1	1.0	0.90	0.80	254

## Package E 4 15/16" x 7 1/2" x 11 1/8"



MP-5

Accessory Metered Panels: \$40.00

Model	ADJ. VOLT. RANGE VDC	I MAX. AMPS				Price
		40°C	50°C	60°C	71°C	
LM E2	2 ±5%	23.0	20.0	16.5	10.0	\$269
LM E3	3 ±5%	22.0	20.0	16.5	10.0	269
LM E3P3	3.3±5%	21.0	19.0	16.5	10.0	269
LM E3P6	3.6±5%	21.0	19.0	16.5	10.0	269
LM E4	4 ±5%	21.0	19.0	16.5	10.0	269
LM E4P5	4.5±5%	20.0	18.0	16.4	10.0	269
LM E5	5 ±5%	20.0	18.0	16.4	10.0	269
LM E6	6 ±5%	19.0	17.3	15.6	10.0	269
LM E8	8 ±5%	18.0	16.4	14.7	10.0	269
LM E9	9 ±5%	17.0	15.5	14.0	9.5	269
LM E10	10 ±5%	16.0	14.5	13.0	9.5	269
LM E12	12 ±5%	15.0	13.6	12.3	9.5	269
LM E15	15 ±5%	14.0	12.7	11.5	8.6	269
LM E18	18 ±5%	13.0	11.8	10.6	8.6	269
LM E20	20 ±5%	12.0	10.9	9.8	8.5	269
LM E24	24 ±5%	11.0	10.0	9.0	7.6	269
LM E28	28 ±5%	10.0	9.0	8.0	7.1	269
LM E36	36 ±5%	8.0	7.3	6.5	5.7	279
LM E48	48 ±5%	6.0	5.4	4.9	4.3	299
LM E60	60 ±5%	3.5	3.3	3.0	2.6	299
LM E100	100 ±5%	2.0	1.7	1.6	1.5	299
LM E120	120 ±5%	1.7	1.5	1.4	1.2	299
LM E150	150 ±5%	1.4	1.3	1.2	1.0	299

## Package F 3 1/2" x 19" x 16 1/2"



For metered models, add suffix (M) to model number and \$30.00 to the price below.

Model	ADJ. VOLT. RANGE VDC	I MAX. AMPS				Price
		40°C	50°C	60°C	71°C	
LM F2	2 ±5%	44.0	39.0	32.0	24.0	\$425
LM F3	3 ±5%	44.0	39.0	32.0	24.0	425
LM F3P3	3.3±5%	44.0	39.0	32.0	24.0	425
LM F3P6	3.6±5%	44.0	39.0	32.0	24.0	425
LM F4	4 ±5%	44.0	39.0	32.0	24.0	425
LM F4P5	4.5±5%	44.0	39.0	32.0	24.0	425
LM F5	5 ±5%	44.0	38.0	31.0	24.0	425
LM F6	6 ±5%	43.0	37.0	30.0	23.0	425
LM F8	8 ±5%	40.0	34.0	28.0	22.0	425
LM F9	9 ±5%	38.0	32.0	26.0	21.0	425
LM F10	10 ±5%	36.0	31.0	25.0	20.0	425
LM F12	12 ±5%	30.0	26.0	21.0	16.0	425
LM F15	15 ±5%	25.0	22.0	18.0	15.0	425
LM F18	18 ±5%	23.0				



# Design a new circuit? It only takes 10 seconds to find out that maybe you didn't.

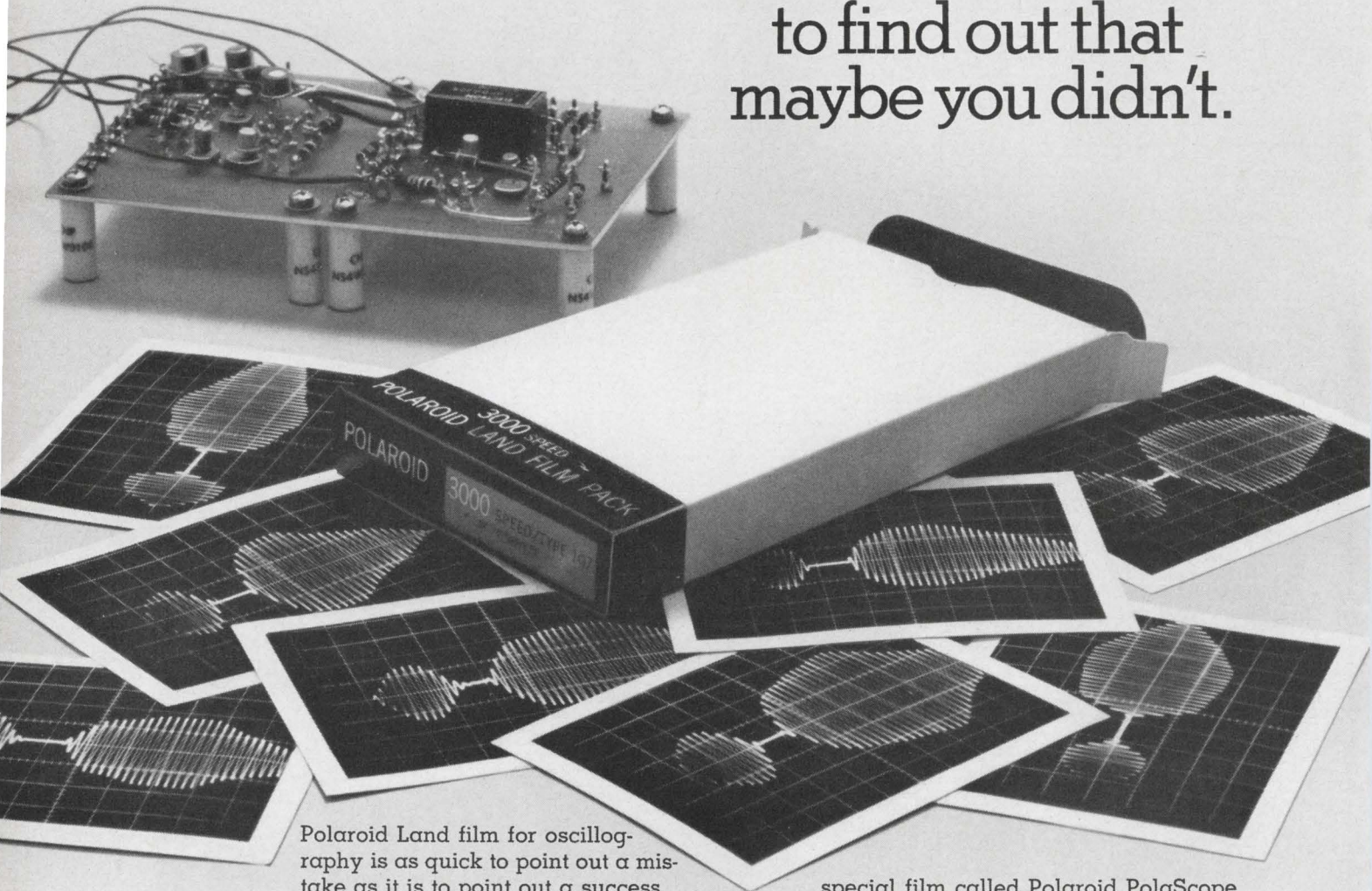

Polaroid Land film for oscillography is as quick to point out a mistake as it is to point out a success.

You never have to wait for darkroom development only to find out that your new breadboard needs more work.

You get your results in 10 seconds flat. And it's always a sharply detailed, high-contrast trace recording.

You can study it, attach it to a report, send it as a test record along with a product shipment, or file it for future use.

Choice of films? Yes. There are four different films for oscilloscope recording in pack, roll, and 4 x 5 formats.

The standard film speed has an ASA equivalent rating of 3000.

If you want to take a picture of a trace so fast you can't even see it, we've got a

special film called Polaroid PolaScope Land film with an ASA equivalent rating of 10,000. It's the fastest film around. It will actually record a scintillation pulse with a rise time of less than 3 nanoseconds.

To use these films on your scope, you need a camera with a Polaroid Land Camera Back. Most manufacturers have them (Analab, BNK Associates, Coleman Engineering, EG & G, Fairchild, General Atronics, Hewlett-Packard, Tektronix).

You can get complete details from one of these manufacturers, or by writing to Polaroid Corporation, Technical Sales, Dept. 30, Cambridge, Massachusetts 02139.

**Polaroid Land Film for Oscilloscope Trace Recording**



# ED Products

Pre-programmed transistor tester PAGE 112

Pocket-sized pulser PAGE 96

Low-cost laser PAGE 94



Battery-powered ns pulses . . . 96

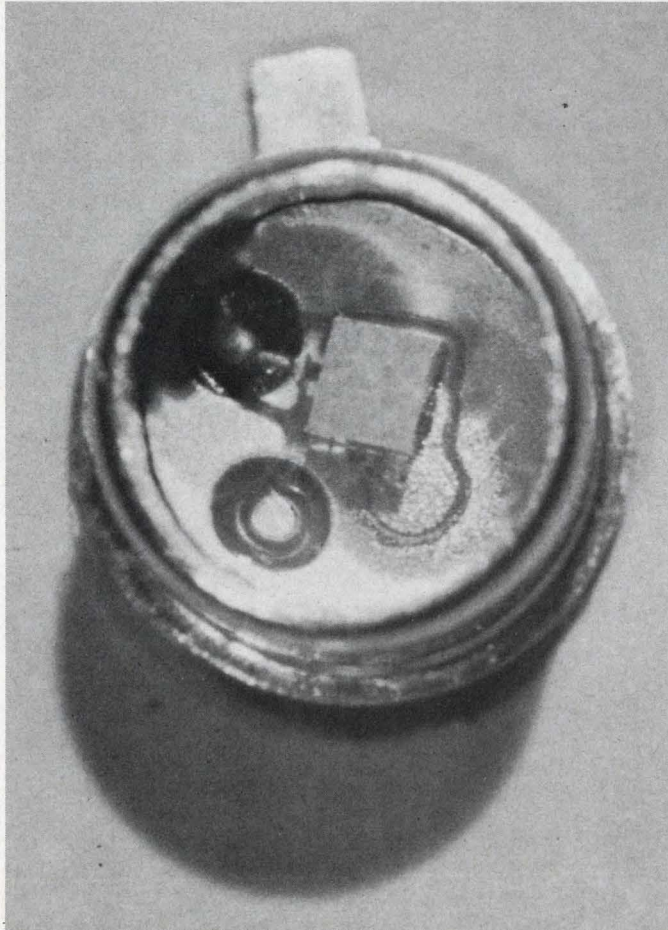

Five watts for \$95 . . . 94

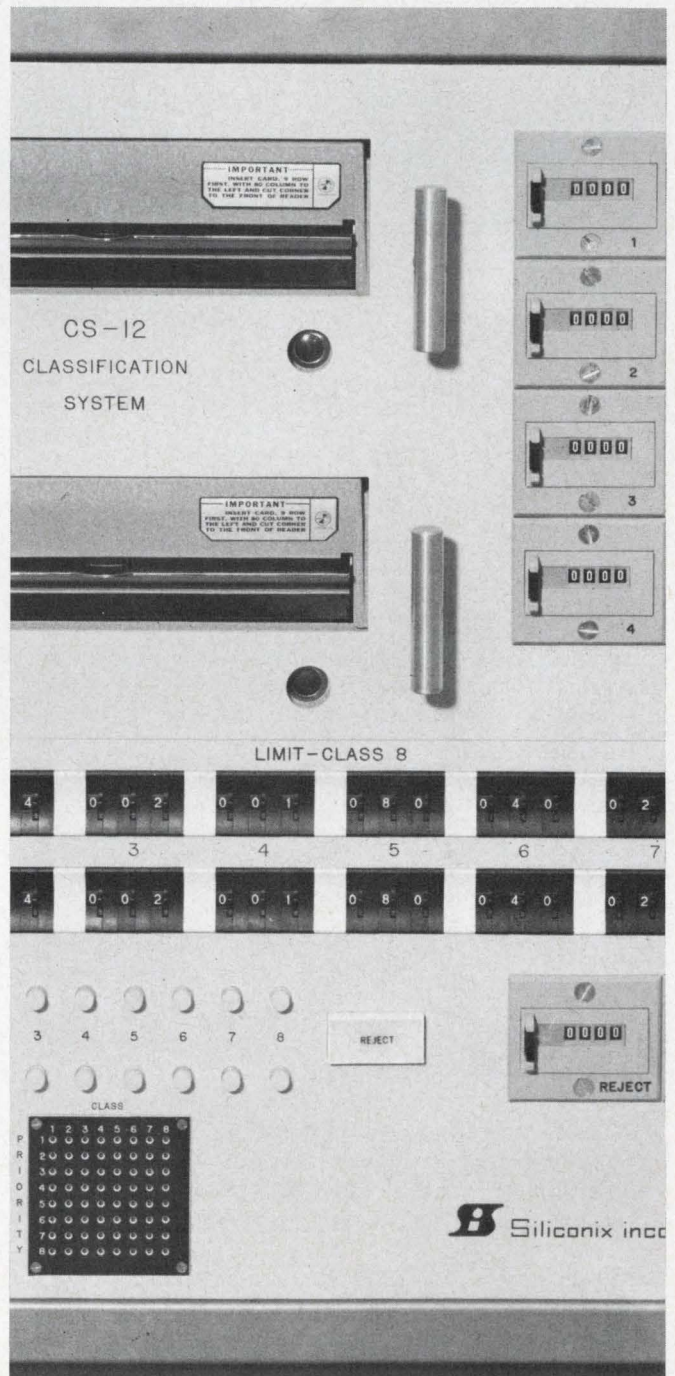

Accept, reject, sort . . . 112



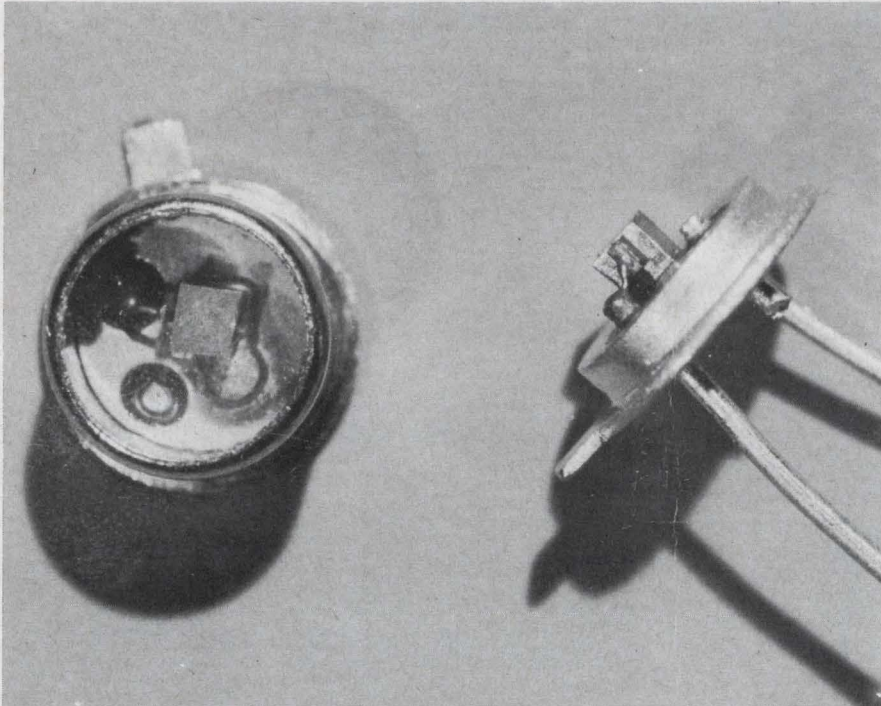

## Low-cost laser diode for commercial use

A further transition of lasers from a blue-sky era to the age of everyday applications may be accelerated by a new low-cost (\$95) pulsed room-temperature injection laser diode. The H1D1 gallium arsenide laser lends itself to a variety of military, industrial and commercial applications. These include communications links, isolated coupling, instrumentation and measurement. Uses in night surveillance, intrusion alarms, plant protection and optical range finders are projected by the manufacturer.

The laser diode is designed to produce coherent infrared light pulses over a temperature range of 77°K to 75°C. It emits 5-W peak power at a 25°C case temperature and 100 A peak current. The low price is made possible by a substantially increased GaAs chip yield and accurately controlled surface interfaces. Room-temperature wavelength is 9000 Å, which permits its use with standard, readily available silicon detectors. It is mounted on a TO-46 header and hermetically sealed in a metal can with a flat glass window at the top.

At a case temperature of 25°C, reverse breakdown voltage is 1 Vdc max and peak current is 120 A. Pulse width is 300 ns and rep rate is 500 Hz max. At an ambient temperature of 25°C, power dissipation is 150 mW derating at 1.5 mW/°C above 25°C. At the same case temperature, the laser dissipates 1300 mW derating at 13 mW/°C. Junction temperature range is 77°K to 100°C.

Peak power output is typically 5 W (2 W min), and forward voltage is 22 V at 100 A peak. Lasing threshold current is 65 A at 25°C and 2 A at a 77°K case temperature. Power efficiency is 0.25% at 25°C and 4% at 77°K. Resistance is 0.2 Ω. Spectral width of 150 Å includes thermal shift caused by a 100-A peak current, 0.3-μs pulse width and 500-Hz rep rate. Beam divergence is 20 x 20° and radiating area is 10 x 200 microns.

P&A: \$95 (1 to 9); stock. General Electric Co., Semiconductor Products, Electronics Park, Syracuse, N. Y. Phone: (518) 374-2211.

Circle No. 373

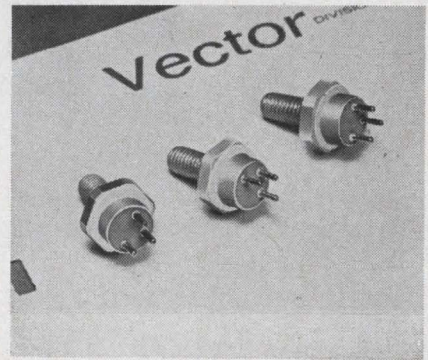

## Npn transistor

As a frequency multiplier in the uhf band, the 2N4012 transistor has a 2.5-W output at 1 GHz. In combination with the manufacturer's 2N3866 npn power transistor, conversion gain is 4.0 dB with a collector efficiency greater than 25%. The device is an epitaxial silicon planar transistor with a multi-emitter. Packaging is in a JEDEC TO-60 can with isolated electrodes.

Vector Div. of United Aircraft Corp., Southampton, Pa. Phone: (215) 355-2700.

Circle No. 374

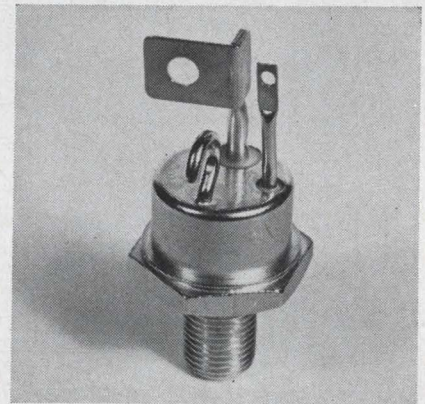

## 90 A npn transistor

MHT8920 through MHT8923 npn silicon power transistors control and/or switch a 90 A collector current and dissipate up to 350 W. The devices sustain up to 150 V and typically respond to 20 MHz. Min dc gain is 10 at 75 A and 5 at 90 A. Saturation voltage is less than 1.5 V (collector-to-emitter) at 50 A collector and 5 A base currents. Switching speed at 50 A is typically less than 200 ns rise or fall.

Solitron Devices Inc., 1177 Blue Heron Blvd., Riviera Beach, Fla. Phone: (305) 848-4311.

Circle No. 375





## New JFD Air Variable Capacitors offer higher frequencies with negligible loss of Q

### Plus

- Ultra Stability
- Highest Q
- Small Size
- Rugged Construction

Now JFD air variable capacitors offer circuit designers the advantages of extremely high "Q" and greater capacitance values in a rugged miniature size unit. Offered in both a printed circuit (VAM 010W) and a panel mounting model (VAM 010), the new units operate at far higher frequencies with negligible loss of "Q" in comparison to other types.

Internal air meshing shells are silver plated to provide good surface conductivity and to prevent corrosive effects. Three internal contact springs assure positive electrical contact of rotor at all times. Leads on printed circuit model are tinned for ease in soldering.

The high density insulator between stator and rotor has excellent electrical properties and contributes to overall structural strength. Rubber gasketed threaded end caps effectively seal the units against dirt entrance or atmospheric contamination after tuning.

WRITE FOR JFD BULLETIN VAM-65

JFD 120-A



Components Division  
 JFD ELECTRONICS CORPORATION, 15th Ave. at 62nd St., Brooklyn, N. Y. 11219  
 Tel: 212 DE 1-1000  
 JFD NORTHEASTERN, Ruth Drive, P. O. Box 228, Marlboro, Mass. 07152  
 JFD NEW YORK-NORTHERN, Damiano Pl., P. O. Box 96, New Hartford, N. Y. 13503  
 JFD MID-ATLANTIC, P. O. Box 5055, Philadelphia, Pa. 19111  
 JFD MID-ATLANTIC-MARYLAND, P. O. Box 7676, Baltimore, Md. 21207  
 JFD MIDWESTERN, 6330 W. Hermione St., Chicago, Ill. 60646  
 JFD MIDWESTERN-OHIO, P. O. Box 8086, Cincinnati, Ohio 45208  
 JFD WESTERN, 9 Morlan Place, Arcadia, California 91006  
 JFD ISRAEL LTD., Industrial Area B, Bldg. 23, Azor, Israel  
 JFD ELECTRONICS, EUROPE S A, 7 Rue de Rocroy, Paris, 10, France

Precision Piston Trimmer Capacitors ■ Metalized Inductors ■ LC Tuners ■ Ceramic Fixed and Variable Capacitors ■ Fixed and Variable Distributed and Lumped Constant Delay Lines

Speed Inquiry to Advertiser via Collect Night Letter  
 ON READER-SERVICE CARD CIRCLE 31



"I SUSPECT FILTERS HAS A NEW HALF-SIZE LATCHING RELAY."

"PROBABLY SO..."

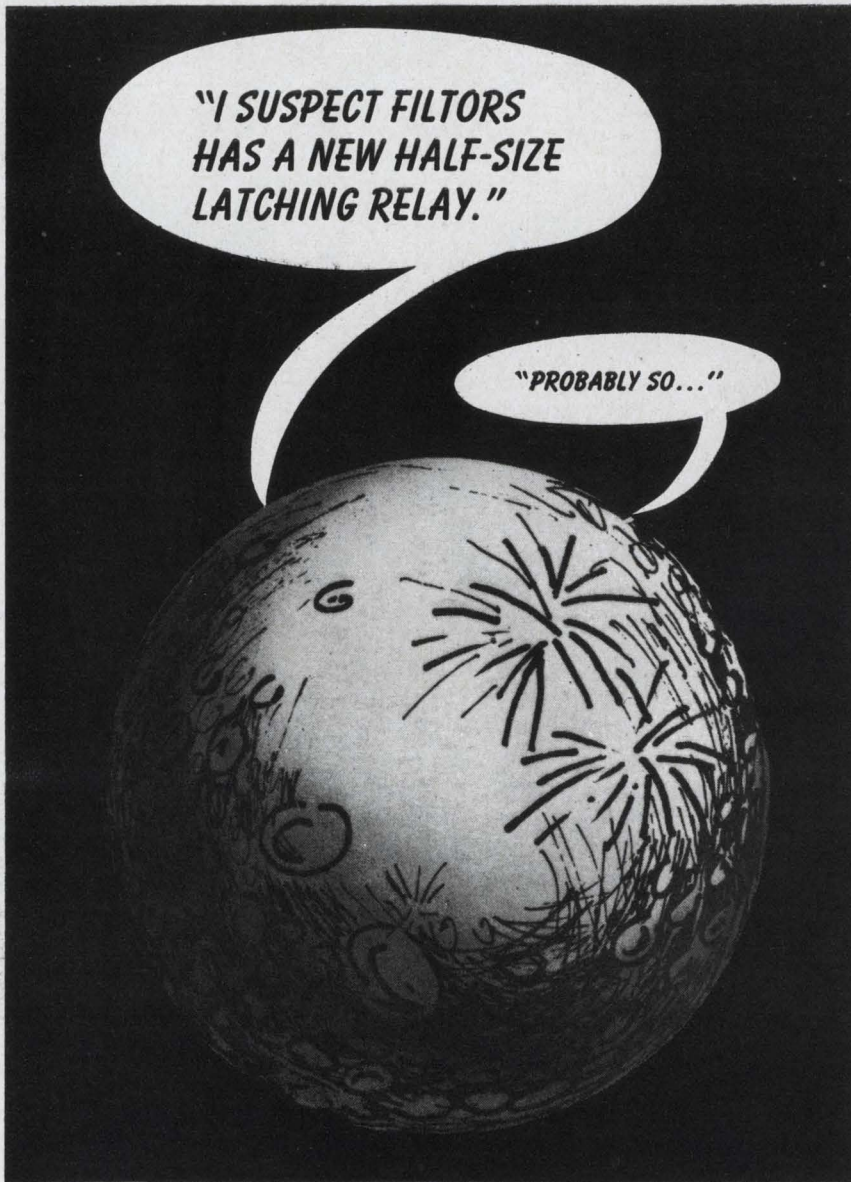

Filters has. The miracle-working DJL—a microminiature, two-pole latching relay offering full-size crystal-case performance on 20% less power than conventional units require, and in just 50% of the space normally required. Designed to meet MIL-R-5757. It is sealed in a vacuum with Filters' electron beam welder . . . no contamination. And Filters has already taken it through more tortures than you will ever subject it to. They've frozen, boiled, pressurized and shock tested it. And more. And now it is available for immediate High-Rel applications.

**Partial specifications:**

- Sensitivity .....200 milliwatts
- Contact rating .....2 amperes, resistive, dry circuit available
- Vibration rating .....30 g's from 5 to 2,000 cps
- Shock rating .....150 g's at 11 milliseconds duration
- Latch and reset time .....4 milliseconds maximum at 25°C with nominal coil voltage

Filters Relays are born reliable. Born "Miracle Workers." They have to be. They are put aboard every major U. S. space shot. For complete specifications, write . . . . .

**FILTERS INC./RELAYS**



FILTERS INC., EAST NORTHPORT, NEW YORK (516) AN 6-1600



ON READER-SERVICE CARD CIRCLE 32

COMPONENTS

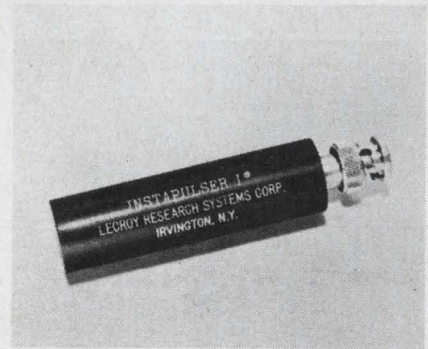

**Pulse generator**

A 3-in., 3-oz "Instapulser" is a source of known and stable ns pulses for testing high-speed amplifiers, discriminators, logic circuits and scopes. Low-current drain from the 5.4-V mercury battery eliminates the need for an off/on switch. The all-silicon, potted circuitry is protected against incoming transients up to 600 V. Output risetime is 2 ns, rep rate is 10 kHz and pulse duration is 7 ns. Amplitude is 700 to 900 mV into open circuit or 350 to 450 mV into a 50-Ω load. Output impedance is 50 Ω.

P&A: \$90; stock to 2 wks. Le-Croy Research Systems Corp., 8 Station Rd., Irvington-on-Hudson, N. Y. Phone: (914) 591-7668.

Circle No. 371

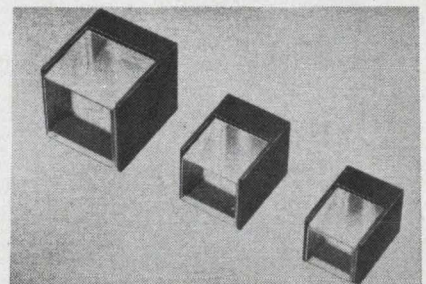

**Beam splitters**

These polarizing beam splitters are designed for laser control where the rejected ray is utilized or externally absorbed. The unit is placed between the rod and the Kerr cell. The unit is a variation of the Glan-Taylor prism with 37.25° air interface. For transmitted polarization, reflection loss at the interaces is about 2%. Normal faces are low-reflection coated magnesium fluoride.

Kappa Scientific Corp., 5785 Thornwood Dr., Goleta, Calif. Phone: (805) 967-2396.

Circle No. 372

FOR COMPUTER CONTROL COMPANY, INC. INSERT, ON READER-SERVICE CARD CIRCLE 246 ➤



# New Catalog $\mu$ -PAC-2

## Integrated Circuit Modules —

This newly expanded catalog details 3C's complete line of 5 mc  $\mu$ -PAC silicon monolithic integrated circuit digital logic

modules. Included are new high density mounting hardware, new logic circuits, and new accessories.

 3C COMPUTER CONTROL COMPANY, INC.

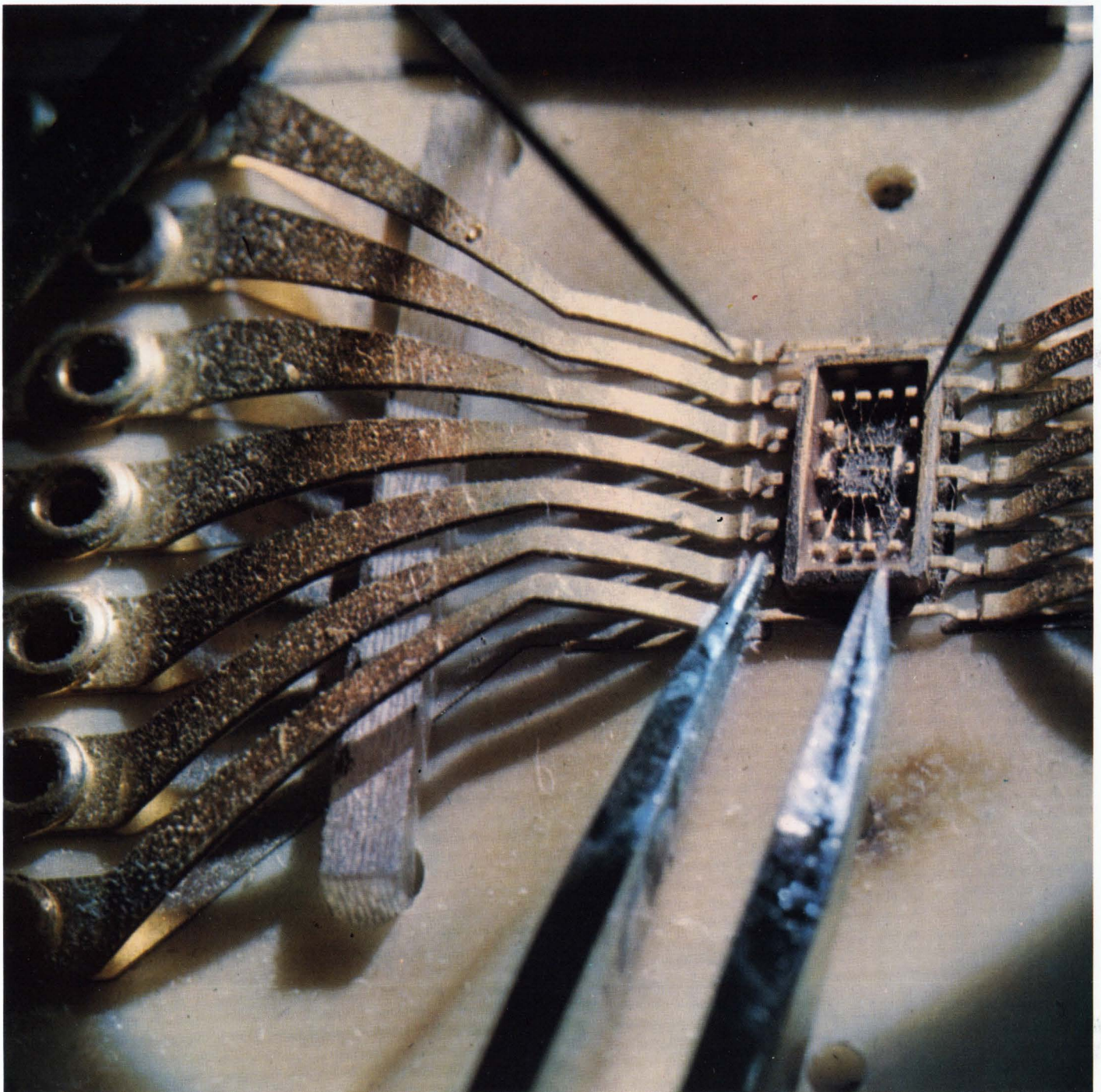



# NEW THIS CATALOG

- High Density Mounting Hardware
- 16-Stage Shift Register PAC
- Non-Inverting Power Amplifier PAC
- High Drive Lamp Driver PAC
- Negative Logic Level Driver PAC
- Utility PACS and Accessories
- Custom System Wiring Capability

## $\mu$ -PAC Catalog Contents

Introduction	1
Capability	2-3
Reliability	4
$\mu$ -PAC Logic	5
Mechanical Features	6
Electrical Features	7
Specifications	8
Waveform Characteristics	9
$\mu$ -PAC Symbology	10
$\mu$ -PACS	11-39
Mounting Hardware	40-41
Power Supplies	42
Supplementary $\mu$ -PACS and Accessories	43-47
$\mu$ -PAC Index	48



# FEATURES

- High packaging density
- Low cost per logic function
- Noise protection in excess of one volt
- Low power consumption
- Universally accepted NAND logic
- DC coupled circuitry throughout
- DTL monolithic semiconductor integrated circuits

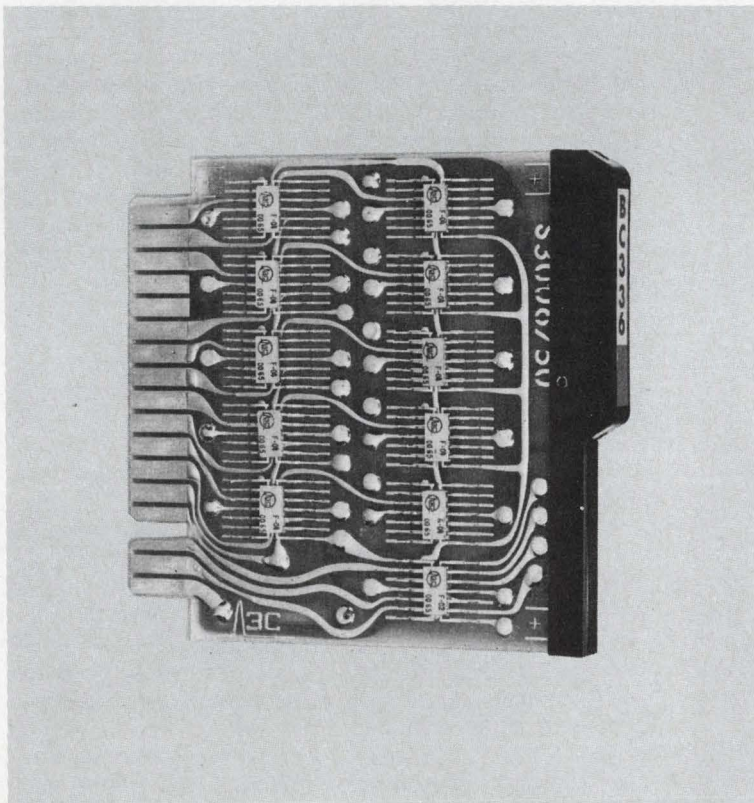

## INTRODUCTION

$\mu$ -PACS<sup>™</sup> combine low price, size, and reliability advantages of silicon monolithic integrated circuits with the straightforward logic design and implementation of 3C's discrete modular building block lines.

A static asynchronous digital logic series,  $\mu$ -PACS utilize diode transistor logic for noise rejection and speed capabilities. In addition,  $\mu$ -PAC circuits achieve input gate expansion, output cascading, high fan-out, high noise thresholds, and low propagation delays.

Individual integrated circuit assemblies in 14-lead flat packs are resistance soldered on copper etched glass-impregnated epoxy cards. With all circuit inputs and outputs available at connector pins,  $\mu$ -PACS make possible traditional systems construction, permit modification and simplified procedures for check-out and maintenance.

More than twenty months of in-house funded research went into development of the standard  $\mu$ -PAC line. As a direct result of this project, 3C has established a capability for producing special  $\mu$ -PACS to meet customer requirements and for expansion of the standard product line. In addition, 3C offers custom solderless-wrap capabilities for volume system fabrication.



## CAPABILITY

Since introduction 11 years ago of the first 3C PAC®, Computer Control Company, Inc., has designed, manufactured and delivered over one million discrete digital logic modules. These have met both general and special purpose needs of the military, government and industry for modular building block logic circuits. From early vacuum tube circuits, to the first transistorized circuits and the innovation of NAND operation, to uniquely designed and packaged circuits for the JPL/NASA Mariner Mars vehicle, 3C has made a total commitment to the design and manufacture of an extensive range of electrically, mechanically and logically complete circuit module lines. The success of these applied circuit design and packaging capabilities is due to the user orientation of all development efforts. This sensitive awareness to user needs for flexibility and reliability has in large measure grown out of 3C experience with its own general and special purpose systems business.

The company's first module line was the 1 mc vacuum tube V-PAC developed in 1955. The following year 3C introduced 100 kc M-PACS, the first commercially available fully transistorized digital circuit module. In 1957 1 mc T-PAC was announced, featuring synchronous dynamic logic and packaging economies. To this day, T-PAC sales still represent a significant contribution to the company and the industry. Three years later H-PAC became the first commercially available clocked 20 mc digital module line. This same line included unique serial memory glass delay line modules which have become one of the most popular features of this active module line. Shortly after the H-PAC introduction, 3C released S-PAC, a 1 mc, 5 mc, and 200 kc family of modules with over 150 standard models, extensive hardware options, design aids, and specials. If there is an industry standard today, S-PAC, which has achieved the largest single share of the module market, best represents that standard.

Late in 1960, parallel to these commercially-oriented developments, 3C embarked on a development program to produce low power, high density digital circuits and, ultimately, pellet components for JPL/NASA scientific Mariner Venus, Mariner Mars, and Ranger space probes. Unique packaging techniques developed for these programs led to the design of forerunners to 3C's new  $\mu$ -PAC integrated circuit module line.

Almost two years ago during early developments in microcircuit technology — the fabrication of smaller, cheaper, and more reliable digital logic modules — 3C instituted a company-funded, analytical study to evaluate all implications of this relatively new technology and determine its present and future effect on the general electronics industry. Broad areas of investigation included circuit design, logic design evaluation, packaging, fabrication techniques, and other appropriate areas of study.

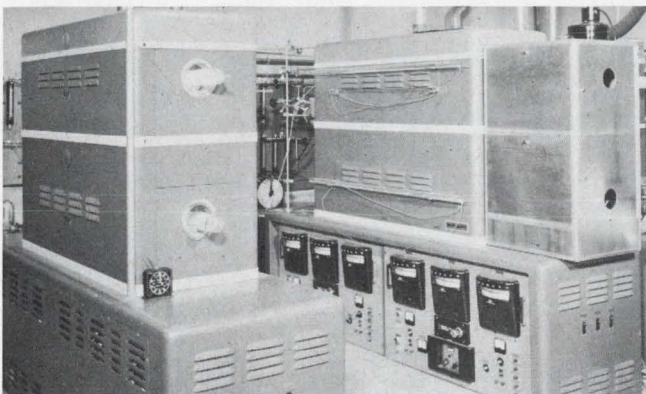

COMPUTER CONTROL COMPANY, INC.  
OLD CONNECTICUT PATH. FRAMINGHAM, MASS.



In further support of these studies, 3C established a fully equipped and staffed microelectronic techniques laboratory. During the course of study, 3C laboratory scientists investigated all forms of microelectronic circuitry to evaluate every possible technique and their respective required trade-offs.

The laboratory staff evaluated thick films, thin films, monolithic integrated circuits, and hybrid circuits (the combination of one or more of the previous techniques or the combination of one or more of those techniques with various types of discrete components).

Simultaneously, 3C circuit design engineers analyzed and evaluated specific integrated circuits commercially available to industry. They tested characteristics, flexibility, and usability of each of these integrated circuits. 3C circuit design engineers also investigated various trade-off options in the design of digital circuits. They developed a capability for responding to various limitations in types of components, values, and tolerances. As the program matured, design breadboards of discrete components for various prototypes were built in conformance with the trade-offs determined by the techniques laboratory group.

Mechanical engineers drew upon extensive past product experience in the recommendation of appropriate size, shape, and configuration of related integrated circuit module equipment. They investigated the overall question of packaging to determine whether to combine cordwood capability with microelectronics, or go for still greater packaging economies. Interconnection schemes (including backboard wiring build-up in various logic configurations) and the capabilities of solderless-wrap, solder, push-on and taper pin type connections were investigated. In addition, various types of materials for boards and cordwoods were examined, as well as multi-layer and double-sided printed circuit techniques, and the interconnection and mounting methods for the microcircuits.

3C computer and systems engineers determined logical capabilities of microcircuits used in different digital systems. They also examined historical logic configurations in order to assist in specifying necessary parameters for the proposed 3C product line.

By mid-1964, the techniques laboratory group had largely completed their evaluation of various microelectronic alternatives. They had developed the equipment and capability for producing not only components, but complete digital circuits. By achieving this capability, they were able to present to the circuit design group detailed restrictions and trade-off parameters for each type of microelectronic circuit. Similarly, circuit designers were capable of determining the 3C capability for design of specific general purpose product circuits within the trade-off specifications outlined by the techniques laboratory.

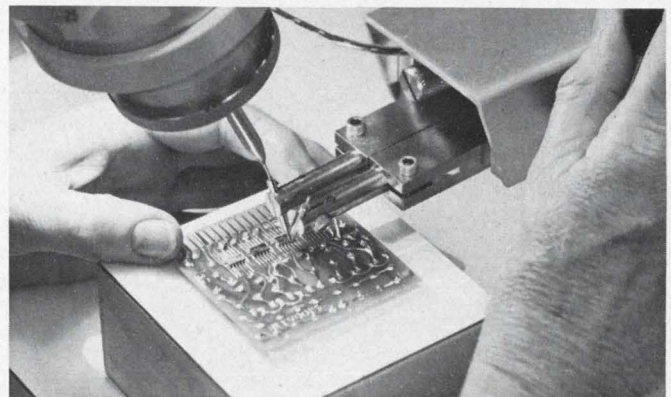



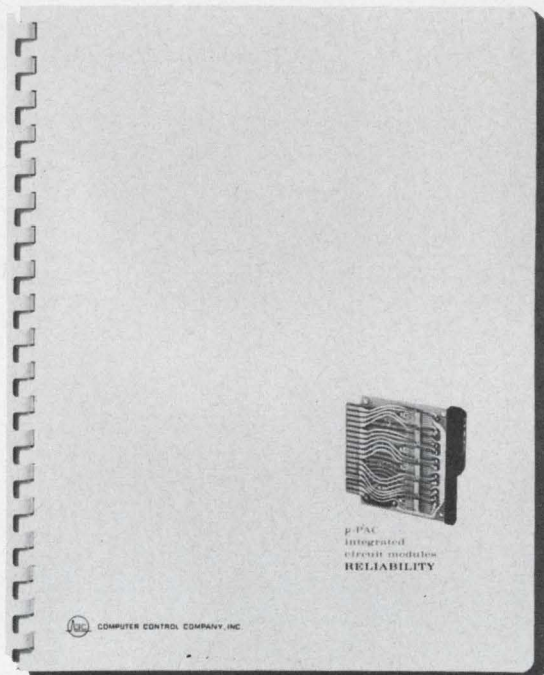

## RELIABILITY

11 years of 3C circuit design experience have been drawn on to develop  $\mu$ -PACS with optimum reliability characteristics. Extensive consideration has been given to circuit design approaches, component values, component tolerances, margins, heat transfer and performance specifications. In addition, 3C circuit designers have capitalized on unique inherent features of the integrated circuit to achieve reductions in the number of thermal compression bonds required on a typical circuit, reduction in component interconnections, reduction in sealed packages required per circuit, minimization of variability between individual circuits, as well as simplified production assembly, and testing programs leading to easier tracing of defective circuits. (Hybrid circuits used in the  $\mu$ -PAC line employ high quality, high stability discrete components. All semiconductor components are silicon.)

From design of proprietary circuitry and logic functions through every step in the production of integrated circuits, 3C research and development efforts have been guided by reliability engineers toward the formulation of standards and procedures to be utilized in vendor procurement for volume  $\mu$ -PAC manufacture.

Individual integrated circuits fabricated in the 3C Techniques Laboratory during research and development are on life test in a continuous running, self-checking series system. As of March 15, 1966, this system has operated 12,744 hours, or 764,640 circuit hours, without a component failure.

Manufacturing procedures — both at 3C and at its high volume production facility Electropac, Incorporated — are governed by thoroughly documented controls. Rigid inspection, testing and overall quality assurance programs are an integral part of the  $\mu$ -PAC manufacturing process.

### LIFE TEST PROGRAM

Integrated circuit devices used in the  $\mu$ -PAC line are custom fabricated for 3C by leading I/C manufacturers who call upon millions of hours of life test data to substantiate specified circuit performance. Currently operating is a  $\mu$ -PAC Life Test Program consisting of nine integrated circuit systems; each system contains 24  $\mu$ -PACs. This includes 144 dual NAND gates, 135 Quad NAND gates, 36 power amplifiers, 358 flip-flops, and one of each of the following power supplies — PB-330, PB-331, RP-330. In addition, both solderless wrap and taper pin systems are used to make backboard connections using both high and low density standard  $\mu$ -BLOCs.

Each of the nine systems is self contained such that it is continuously operating in a self-checking manner. Making use of two sets of identical registers and counters, a comparator network senses the signals from each. Any difference in pulse pattern is recorded in the comparator activating sense amplifiers and automatically records malfunctions by extinguishing an indicator lamp.

Reliability predictions for the basic  $\mu$ -PACs have been prepared and include stress rating for the discrete components and the ratio stress/rating. The failure rates have been computed on the basis of 25°C ambient and 35°C ambient.

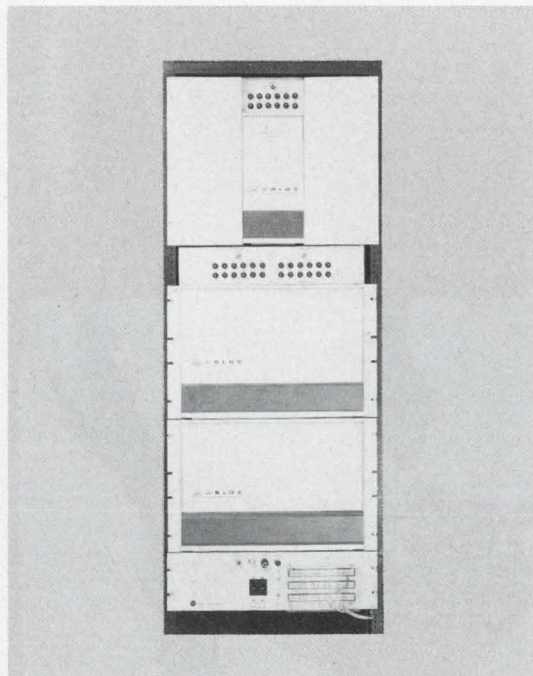

$\mu$ -PACS undergoing life test.



COMPUTER CONTROL COMPANY, INC.  
OLD CONNECTICUT PATH, FRAMINGHAM, MASS.



## QUALIFICATION TEST PROGRAMS

The basic flat packs have been subjected to extensive qualification tests per MIL-S-19500 "Semiconductor Devices, General Specification For". The qualification test schedule for 3C integrated circuits was derived from MIL-STD-750 and MIL-S-19500 for semi-conductor devices. Similar qualification schedules are conducted by most semiconductor manufacturers for military and high grade commercial products. The qualification tests include operating life, storage, shock, vibration, centrifuge, solder, heat temperature cycle, thermal shock, moisture resistance, salt atmosphere, and lead fatigue. In addition to the qualification tests, each lot is subjected to high temperature storage, constant acceleration and 100% electrical test.

The Quality Control techniques implemented in the manufacture of  $\mu$ -PACS meet the requirements of MIL-Q-9858.

Detailed information concerning any aspect of the  $\mu$ -PAC reliability program can be obtained by requesting  $\mu$ -PAC Reliability Manual, Document Number 71-383.

## $\mu$ -PAC LOGIC

$\mu$ -PAC circuits operate from DC to 5 mc and utilize the NAND function for positive logic. They can be used to directly implement the NOR function for negative logic or AND-OR logic.

3C chose the universally accepted NAND operator for positive logic for its  $\mu$ -PAC family of digital modules because of simplicity and usage symmetry made possible by the basic NAND gate circuit.

All modules are DC coupled and hence are directly compatible with no intermodule coupling required.

### J-K FLIP-FLOP LOGIC

The  $\mu$ -PAC J-K Flip-Flop utilizes double rank circuitry whereby two flip-flops are used to perform the necessary AC operations. The basic double rank circuit has DC Set and Reset inputs, Set and Reset Control inputs, and a Clock input. The AC input portion of the Flip-Flop is composed of the Clock input and the Set and Reset Control inputs. (See Figure 1.)

Control inputs are activated by logical ONES (not logical ZEROS as in S-PAC). A ZERO-ONE-ZERO pulse on the Clock will cause the Flip-Flop to assume the state determined by the condition of the Control inputs, there being no ambiguous state with J-K circuitry.

Control input information is entered into the first of the double rank flip-flops on the ZERO-to-ONE transition of the Clock input and is shifted to the second flip-flop on the Clock's ONE-to-ZERO transition.

In addition to steering Clock pulse, control inputs can be used as direct inputs or, when tied together, as a clock input. The DC Set and Reset inputs override any activity in the AC portion of the Flip-Flop.

The Clock inputs provide intrinsic pulse dodging by means of trailing edge triggering. This feature permits strobing of the Flip-Flop output with input signals. See " $\mu$ -PAC Waveform Characteristics" for input timing requirements.

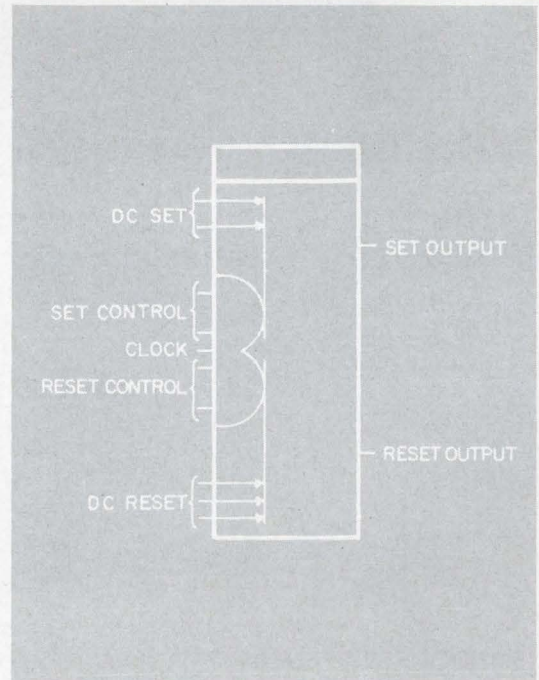
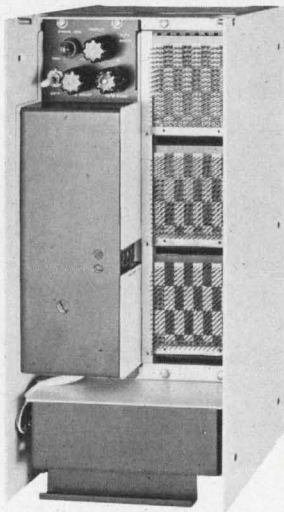

FIGURE 1. J-K FLIP-FLOP LOGIC DIAGRAM



## MECHANICAL FEATURES



$\mu$ -PAC modules are monolithic integrated circuit assemblies supplemented by some discrete hybrid combinations mounted on 2.9 x 2.7 x .24 inch glass-impregnated epoxy cards.

All PACS feature gold-plated, etched fingers to guarantee reliable electrical contact with a 34-pin polarized connector.

Individual integrated circuits are assembled in 14-lead, .250 x .125 x .065 inch flat packs soldered to the etched wiring.

Up to 22 flat packs can be mounted on a single  $\mu$ -PAC card for counting or shift register operations. Resistance soldering methods enable simple replacement of components.

$\mu$ -PAC modules plug into precious metal solderless-wrap or taper pin connectors assembled in standard  $\mu$ -BLOCS which permit flexible, low-cost backwiring techniques.

Solderless-wrap terminals can be employed for other contact methods, including push on, stackable contact, soldering, and percussion welding.

Power and ground pins are factory prewired in all  $\mu$ -BLOCS with laminated copper and epoxy glass distribution lines. The copper and glass planar arrangement permits maximum decoupling of spurious signals from power and ground lines.

Connector plane and power bus assembly can be easily removed from the  $\mu$ -BLOC to permit convenient bench wiring of system logic.

Built-in cooling units are contained in each BLOC and are designed such that temperature rise within an integrated circuit is well within specified limits when outside ambient temperature of the BLOC is within the rated 55°C. When two BLOCS are used together in a cabinet, it is possible to arrange the units for push-pull fan action.

Plug-in power supplies are designed for easy BLOC insertion and removal. Rack-mount power supplies are available for driving a series of BLOCS.

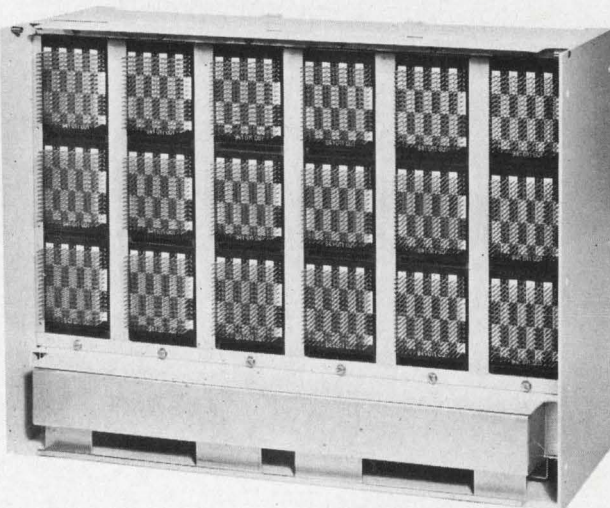

COMPUTER CONTROL COMPANY, INC.  
OLD CONNECTICUT PATH, FRAMINGHAM, MASS.



## ELECTRICAL FEATURES

$\mu$ -PAC is a static asynchronous digital logic line similar to S-PAC. Diode transistor logic (DTL) is employed for its noise rejection, speed and expandable input capabilities. Circuit designs meet the specification needs of a 5 megacycle product line featuring input gate expansion, output cascading, high fan-out, high noise thresholds, and low propagation delays.

Performance specifications are conservative — all applicable circuitry has been laboratory tested to operate at 8 megacycles under full load over the entire temperature range.

The basic logic unit, the NAND gate, performs a NAND function for positive logic and a NOR function for negative logic. Inputs are generally expandable by addition of diode clusters available on selected gate modules.

Most  $\mu$ -PAC flip-flop modules utilize a single, versatile flip-flop circuit. This basic circuit is a double rank J-K flip-flop. In addition, a flip-flop consisting of two cross-coupled NAND circuits is used to provide an RS type flip-flop module.

The Power Amplifier PAC adds high drive capability gating to the line with the added feature of short delay time. Built-in short circuit protection (patent applied for) limits the output current when the output is short circuited.

Other electrical features:

1. All logic circuits operate from a single voltage source of +6 volts. Power supplies provide current at +6 volts and also supply current at -6 volts for auxiliary circuits such as the Multivibrator Clock, Master Clock or the Schmitt Trigger.
2. Input noise rejection is 1.35 volts typical.
3. All  $\mu$ -PAC circuits are DC coupled.
4. Excessive stray capacitance loading will slow down circuit operation but will not cause failure.
5. Signal levels are nominally 0 volts for logical ZERO and +6 volts for logical ONE.
6. All inputs are diode coupled/isolated.
7. Loading numbers are expressed in easy-to-use unit numbers, and include wide safety margins at maximum operating frequency. In addition to indicated fan-out, ample margin is included for the specified stray capacitance to permit greater freedom in PAC-to-PAC wiring. Nominal  $\mu$ -PAC unit load is 1.6 milliamperes.
8. Listed performance specifications are based on "worst case" stack-up of tolerances. Performance will usually exceed these specifications considerably.
9. All modules have standard power input connections.

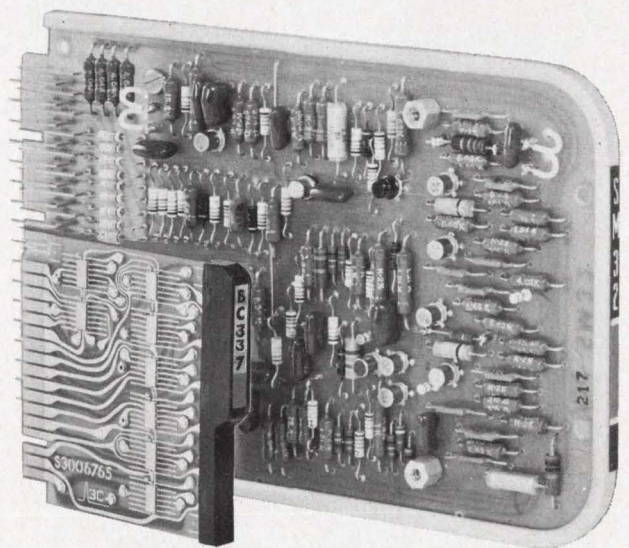



## GENERAL $\mu$ -PAC SPECIFICATIONS

Frequency	DC to 5 mc*
Logic Levels:	+2.5 volts to +6.3 volts (or an open circuit at the input)
Logic ONE	circuit at the input)
Logic ZERO	0 volt to +1.1 volts, maximum
Noise Rejection	1.35 volts, typical 1.05 volts, minimum
Ambient Operating Temp. Range	0°C to +55°C
Storage Temp. Range	-65°C to +150°C
Power Supply Voltage	+5.1 volts to +6.3 volts (-6 volts also available for some auxiliary non-logic circuits)

### NAND GATE SPECIFICATIONS

Input Loading	1 unit load
Fan In	12
Fan Out	8
Stray Capacitance**	40 picofarads
Circuit Delay (measured at +1.5 volts, averaged over 2 stages)	24 nanoseconds, typical 30 nanoseconds, maximum

### J-K FLIP-FLOP SPECIFICATIONS

Inputs:	Loading:
DC Set Input	$\frac{2}{3}$ unit load
DC Reset Input	$\frac{2}{3}$ unit load
Clock	1 unit load
Control	1 unit load
Fan Out	8
Stray Capacitance**	40 picofarads
Circuit Delay (measured at 1.5 volts):	
Clock input (ONE to ZERO transition) to flip-flop output	45 nanoseconds, typical 60 nanoseconds, maximum
DC Set input to Set output	45 nanoseconds, typical 80 nanoseconds, maximum
DC Set input to Reset output	45 nanoseconds, typical 60 nanoseconds, maximum
Set Control input to Set output	45 nanoseconds, typical 60 nanoseconds, maximum
Set Control input to Reset output	45 nanoseconds, typical 60 nanoseconds, maximum

### POWER AMPLIFIER SPECIFICATIONS

Input Loading	1 unit load
Fan In	12
Output Drive Capability	25 loads
Stray Capacitance**	250 picofarads
Circuit Delay (measured at +1.5 volts, averaged over 2 stages)	24 nanoseconds, typical 30 nanoseconds, maximum

\*At a 5 mc clock rate there is enough usable logic time in one clock cycle to preset and propagate through the clocked flip-flop, and pass through 3 series NAND gates.

\*\*Specified at maximum circuit delay times. Additional stray capacitance affects only circuit delay times. See  $\mu$ -PAC manual for additional details.



COMPUTER CONTROL COMPANY, INC.  
OLD CONNECTICUT PATH, FRAMINGHAM, MASS.



# μ-PAC WAVEFORM DEFINITIONS AND CHARACTERISTICS

Negative Time: Signal duration below +1.5 volts.

Positive Time: Signal duration above +1.5 volts.

Set and Reset outputs denote voltage levels and appear at the output of gates and flip-flops.

Assertion and Negation outputs denote pulses and appear at the output of clocks and delay multivibrators.

Timing is measured and specifications set at the +1.5 volt circuit switching point. Since all μ-PAC circuitry is DC coupled, rise and fall time specifications are less important.

## ACTIVATION OF CLOCK INPUT

Negative time ( $T_1$ ) = 60 nanoseconds, minimum

Positive time ( $T_2$ ) = 40 nanoseconds, minimum

Voltage (V) = +2.5 volts, minimum

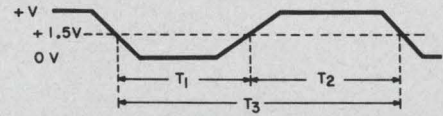

## TIMING OF CONTROL UNITS (When used to steer clock pulse\*)

Negative time of control input before clock pulse goes positive ( $T_1$ ) = 0 nanoseconds, minimum

Positive time of clock pulse ( $T_2$ ) = 40 nanoseconds, minimum

Positive time of control input before clock pulse goes negative ( $T_3$ ) = 40 nanoseconds, minimum

Time from negative clock transition to set output ( $T_4$ ) = 60 nanoseconds, maximum

Voltage (V) = +2.5 volts, minimum

No control input should go from +V to 0 volts while clock is at +V

\*When control inputs are used as a clock input, refer to "activation of clock input" waveform.

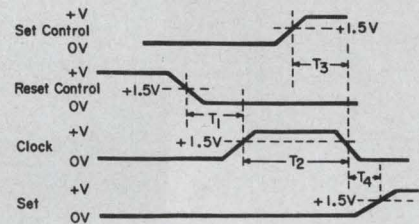

## ACTIVATION OF DC SET AND RESET INPUTS

Negative time (T) (clock in ZERO state) = 80 nanoseconds, minimum

Negative time (T) (clock in ONE state) = 60 nanoseconds, minimum

Voltage (V) = +2.5 volts, minimum

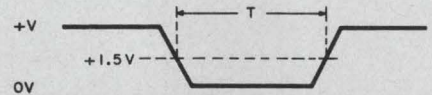

## OUTPUT PULSE CHARACTERISTICS

Pulse duration (T) = 50 nanoseconds, nominal

Voltage (V) = +3.5 volts, minimum

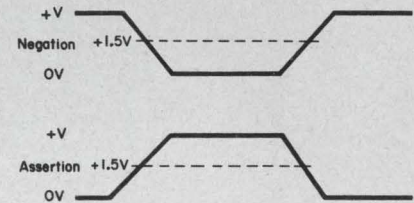

GATE PAIR DELAY  
TWO 5 MC GATES IN SERIES

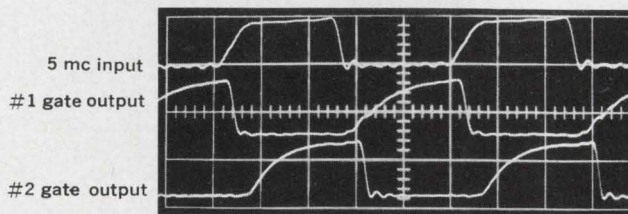

Voltage: 5 volts/cm Time Base: 0.04 μsec/cm



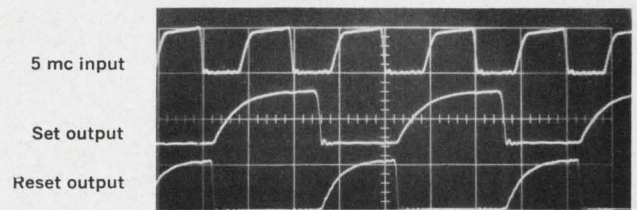



BINARY COUNTER (÷ 2) OPERATION  
5 MC FLIP-FLOP



Voltage: 5 volts/cm Time Base: 0.1 μsec/cm

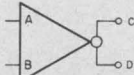

## μ-PAC SYMBOLOGY

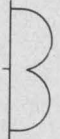
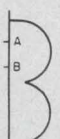
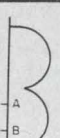
Symbol	Explanation	Boolean Expression (For Positive Logic)
	NAND Gate	$C = \overline{AB}$
	Diode cluster for expanding PAC inputs. Output node n is actually only one connector pin.	$n = AB$
	NAND gate with expandable input capability. Input node n, when used with diode clusters, provides input expandability. Node n is actually only one connector pin.	$C = \overline{ABn}$
	NAND gate with separate load circuit for paralleling gate outputs without decreasing drive capability. The paralleled gate outputs perform an AND operation for ONES and OR operation for ZEROS.	$D = H = \overline{AB+EF} = \overline{AB} \cdot \overline{EF}$
	Power Amplifier	$C = D = \overline{AB}$
	Basic flip-flop	$C = \overline{A} + ABC'$ $D = \overline{B} + ABD'$ where ' indicates previous state, and for $AB = 1$ , $C' = \overline{D}$
J-K Flip-Flop Input Descriptions		
Symbol	Type Input	Explanation
	DC set or reset inputs	OR gate for ZEROS ( $\overline{A} + \overline{B}$ ) or NAND gate for ONES ( $\overline{AB}$ )
	Clock input	
	Set control inputs	AND gate for ONES (AB)
	Reset control inputs	AND gate for ONES (AB)



counter  
 $\mu$ -PAC  
 BC-335

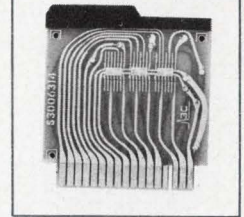

Counter PAC, BC-335, contains six independent flip-flops with appropriate inputs for operation as binary counters.

Individual DC set and reset inputs allow presetting in all modes. A common DC reset input is shared by all circuits.

When used in conjunction with external gating, the BC-335 also may be used for frequency division, BCD counting, up-down counting, and instantaneous carry counting.

Each stage has a complementing input which is activated by a ONE-ZERO-ONE transition sequence count signal pulse.

A counter output can be gated with the count signal pulse without the need for delay circuits or two-phase clocks.

**SPECIFICATIONS**

Frequency	DC — 5 mc
Input Loading:	
DC Set and Reset Inputs	$\frac{2}{3}$ unit load each
Common Reset Input	4 unit loads
Complement Inputs	1 unit load each
Output Drive Capability	8 unit loads each
Circuit Delay:	
Complement Input to Flip-Flop Output	60 nanoseconds, maximum
DC Set Input to Set Output	80 nanoseconds, maximum
DC Set Input to Reset Output	60 nanoseconds, maximum
Current Requirements per PAC:	
+6 volts	100 milliamperes, maximum
Power Dissipation	0.600 watt, maximum
Handle Color Code	blue

**6 FLIP-FLOPS FOR BINARY COUNTING**

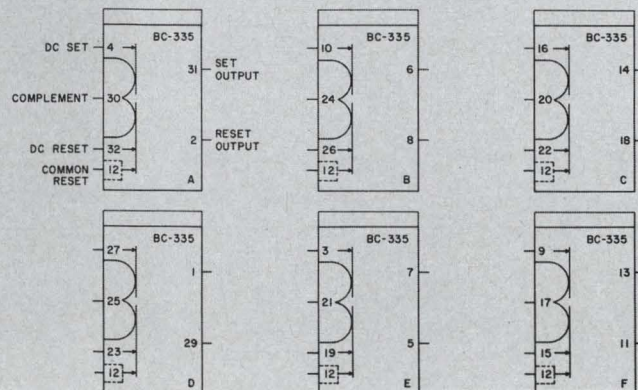



binary  
counter  
 $\mu$ -PAC  
BC-336

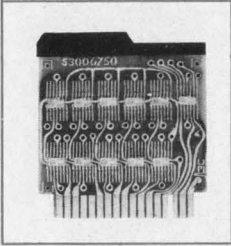

Binary Counter PAC, BC-336, contains between 8 and 20 prewired binary counter stages. The standard stocked BC-336 contains 8 stages and is custom assembled to 20 stages as specified by the user. The PAC also contains one independent two input NAND gate.

This high density module employs ripple carry counting and can be used as a binary counter.

Two reset inputs are provided to reset individually half of the counter stages. A common two input gated reset will allow resetting of all counter stages. Reset inputs and gated reset inputs are interdependent.

Set output of each counter stage is accessible at PAC terminals.

<b>SPECIFICATIONS</b>	<b>BC-336</b>
Frequency	DC — 5 mc
Input Loading:	
Count Input	1 unit load
Reset Inputs	1 unit load each
Gated Reset Inputs	1 unit load each
NAND Gate	1 unit load each
Reset Timing Requirements:	
Reset	80 nanoseconds, minimum at logic ONE
Gated Reset	100 nanoseconds, minimum at logic ZERO
Output Drive Capability:	
Counter	7 unit loads each
NAND Gate	8 unit loads
Circuit Delay:	
Counter Propagation Delay per Stage	60 nanoseconds, maximum
Clearing Counter from Reset Inputs	100 nanoseconds, maximum
Clearing Counter from Gated Reset Inputs	120 nanoseconds, maximum
NAND Gate Delay (measured at +1.5 volts, averaged over 2 stages)	30 nanoseconds, maximum
Current Requirements per PAC: (20 counter stages) + 6 volts	379 milliamperes, maximum
Power Dissipation (20 counter stages)	2.280 watts, maximum
Handle Color Code	blue

8 TO 20 FLIP-FLOPS PREWIRED FOR BINARY COUNTING

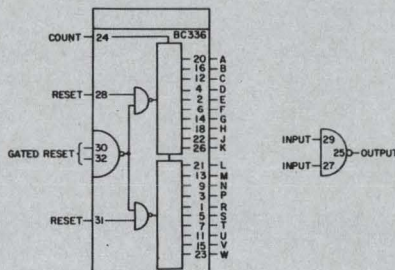

COMPUTER CONTROL COMPANY, INC.  
OLD CONNECTICUT PATH, FRAMINGHAM, MASS.



fast carry  
counter  
 $\mu$ -PAC  
BC-337

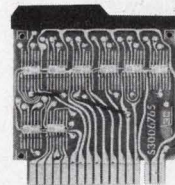

Fast Carry Counter PAC, BC-337, contains a prewired eight-stage counter. By utilizing a few jumper connections at the PAC terminals, the counter can be operated in either a binary or an 8421 BCD mode.

A common reset input is available for clearing all stages simultaneously.

Each stage has a DC set input which allows presetting any desired number in the counter.

Carries are anticipated on gating structures to reduce counter propagation delays to one half that of a ripple carry counter structure.

**SPECIFICATIONS**

Frequency	DC — 5 mc
Input Loading:	
DC Set Inputs	$\frac{2}{3}$ unit load each
Common Reset Input	5 unit loads
Complement Input	2 unit loads
Output Drive Capability	5-8 unit loads
Circuit Delay:	
Counter Propagation Delay per Group of 4 Stages	100 nanoseconds, maximum
Counter Propagation Delay for 8 Stages	200 nanoseconds, maximum
DC Set Input to Set Output	80 nanoseconds, maximum
DC Set Input to Reset Output	60 nanoseconds, maximum
Current Requirements per PAC:	
+6 volts	133 milliamperes, maximum
Power Dissipation	0.800 watt, maximum
Handle color code	blue

8 FLIP-FLOPS FOR BINARY OR BCD COUNTING

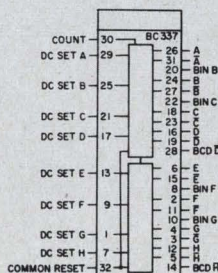



buffer  
register  
 $\mu$ -PAC  
BR-335

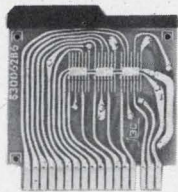

Buffer Register PAC, BR-335, contains six independent flip-flops for use in serial and parallel transfer applications.

Independent DC set inputs are available at each flip-flop for pre-setting operations.

A common clock input, associated with individual set and reset control inputs, provides simultaneous serial or parallel transfer operations in a variety of applications including shifting and accumulating.

A common DC reset input is shared by all circuits.

**SPECIFICATIONS**

Frequency

Input Loading:

DC Set Inputs

Control Inputs

Common Reset Input

Common Clock Input

Output Drive Capability

Circuit Delay:

Clock Input to Flip-Flop Output

DC Set Input to Set Output

DC Set Input to Reset Output

Current Requirements per PAC:

+6 volts

Power Dissipation

Handle Color Code

**BR-335**

DC — 5 mc

$\frac{2}{3}$  unit load each

1 unit load each

4 unit loads

6 unit loads

8 unit loads each

60 nanoseconds, maximum

80 nanoseconds, maximum

60 nanoseconds, maximum

100 milliamperes, maximum

0.600 watt, maximum

blue

6 FLIP-FLOPS PREWIRED WITH COMMON CLOCK AND COMMON RESET INPUT

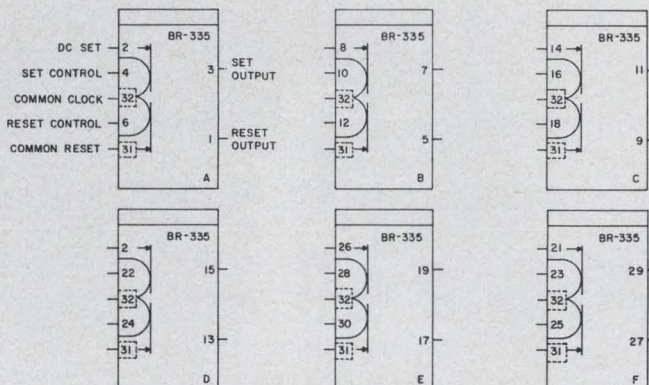

COMPUTER CONTROL COMPANY, INC.  
OLD CONNECTICUT PATH, FRAMINGHAM, MASS.



gated  
flip-flop  
 $\mu$ -PAC  
FA-335

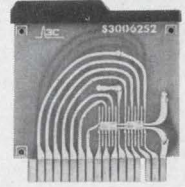

Gated Flip-Flop PAC, FA-335, contains four independent general purpose flip-flops, each with clocked and DC inputs and a common reset.

Each flip-flop has individual DC set and DC reset inputs for RS type applications.

Set and reset control inputs combine with the clock input for clocked operation of each flip-flop. Two of the four stages have dual set control inputs. A common DC reset is provided.

The versatile input structure allows for control of the flip-flop from a variety of level and pulse inputs. Typical uses of the Gated Flip-Flop PAC include storage, counting, shifting, and parallel transfer.

**SPECIFICATIONS**

Frequency	FA-335 DC — 5 mc
Input Loading:	
DC Inputs	$\frac{2}{3}$ unit load each
Control Inputs	1 unit load each
Common Reset Input	3 unit loads
Clock Inputs	1 unit load each
Common Reset Timing Requirements	60 nanoseconds, minimum, at logic ZERO
Output Drive Capability	8 unit loads each
Circuit Delay:	
Clock Input to Flip-Flop Output	60 nanoseconds, maximum
DC Set Input to Set Output	80 nanoseconds, maximum
DC Set Input to Reset Output	60 nanoseconds, maximum
Current Requirements per PAC:	
+6 volts	66 milliamperes, maximum
Power Dissipation	0.400 watt, maximum
Handle Color Code	blue

4 FLIP-FLOPS WITH DC, CLOCK AND CONTROL INPUTS

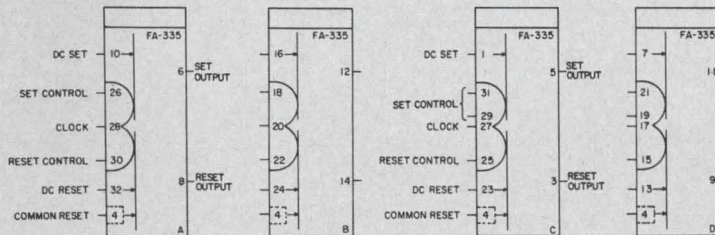



**basic  
flip-flop  
 $\mu$ -PAC  
FF-335**

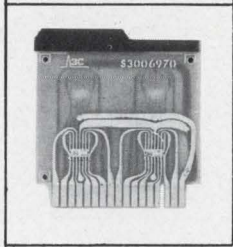

Basic Flip-Flop PAC, FF-335, contains eight independent, low-cost DC operated flip-flops. Individual DC set and DC reset inputs are provided.

These flip-flops are used for economical implementation of logic functions which do not require additional flip-flop inputs. Examples are control operations, input-output registers, storage and buffer applications.

**SPECIFICATIONS**

Frequency	FF-335
DC — 5 mc	
Input Loading:	
DC Inputs	1 unit load each
Output Drive Capability	7 unit loads each
Circuit Delay	60 nanoseconds, maximum
Current Requirements per PAC:	
+6 volts	140 milliamperes, maximum
Power Dissipation	0.800 watt, maximum
Handle Color Code	blue

**8 FLIP-FLOPS WITH DC INPUT GATING**

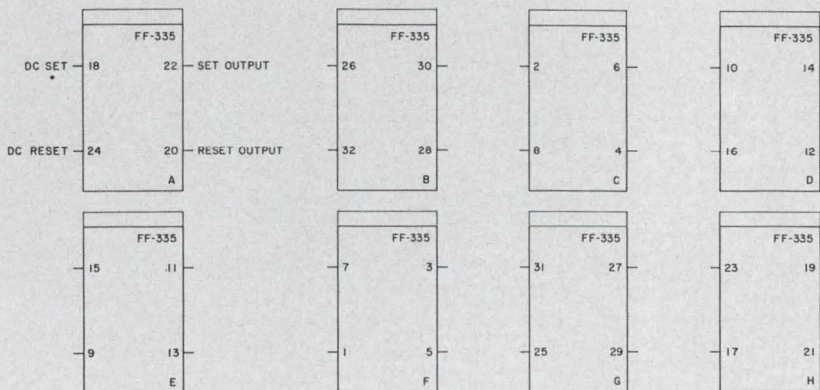



shift  
register  
 $\mu$ -PAC  
SR-335

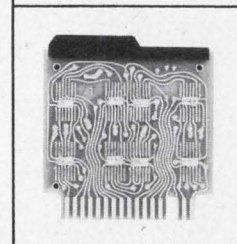

The Shift Register PAC, SR-335, contains between 8 and 16 prewired shift register stages. The standard stocked SR-335 contains 8 stages and is custom assembled to 16 stages as specified by the user.

This high density module can be used for processing serial or serial/parallel information. In addition to the shift line and common reset input, DC set inputs are available in the first 8 stages. Also set level control and reset level control information inputs are provided at the input of the first stage to allow for cascading of SR stages. Set outputs are available at all stages whereas reset outputs are brought out at the 8th and 16th stages.

**SPECIFICATIONS**

Frequency	SR-335 DC — 5 mc
Input loading:	
DC Set	$\frac{2}{3}$ unit load each
Information Inputs	1 unit load each
Common Reset	$\frac{2}{3}$ unit load per stage
Shift	1 unit load per stage
Output Drive Capability	7 unit loads each
Circuit Delay	60 nanoseconds, maximum
Current requirements per PAC (16 stages)	400 milliamperes, maximum
+6 volts	2.4 watts, maximum
Power Dissipation (16 stages)	
Handle Color Code	blue

8 TO 16 FLIP-FLOPS PREWIRED FOR SHIFT REGISTER OPERATION

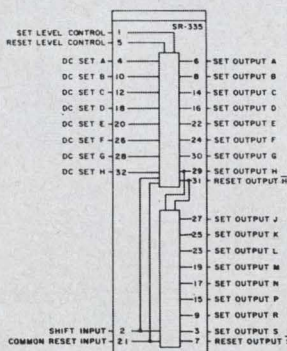



**universal  
flip-flop  
 $\mu$ -PAC  
UF-335**

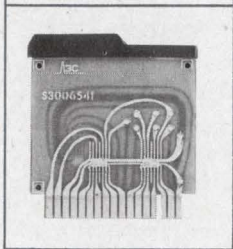

Universal Flip-Flop PAC, UF-335, contains three independent general purpose flip-flops, each with independent clocked and DC input gating and a common DC reset.

Each flip-flop contains two DC set and two DC reset inputs. Each flip-flop also contains individual clock, dual reset control and dual set control inputs.

With this range of inputs, these flip-flops can perform all the functions of any other  $\mu$ -PAC flip-flop module. In addition, the Universal Flip-Flop PAC can be used in shifting, up/down counting, control, accumulating, parallel transfer, and complementing applications.

**SPECIFICATIONS**

Frequency	DC — 5 mc
Input Loading:	
DC Inputs	$\frac{2}{3}$ unit load each
Control Inputs	1 unit load each
Clock Inputs	1 unit load each
Common Reset Input	2 unit loads
Output Drive Capability	8 unit loads each
Circuit Delay:	
Clock Input to Flip-Flop Output	60 nanoseconds, maximum
DC Set Input to Set Output	80 nanoseconds, maximum
DC Set Input to Reset Output	60 nanoseconds, maximum
Current Requirements per PAC:	
+6 volts	50 milliamperes, maximum
Power Dissipation	0.300 watt, maximum
Handle Color Code	blue

**UF-335**

**3 FLIP-FLOPS WITH CLOCK AND DC INPUT GATING**

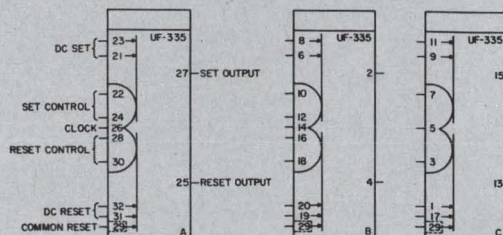



multi-  
input  
NAND  
 $\mu$ -PAC  
DC-335

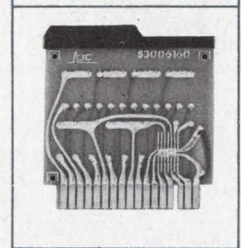

Multi-input NAND PAC, DC-335, contains 2 six-input NAND gates with nodes and 4 three-diode clusters. The diode clusters can be tied to the gate nodes of this or other  $\mu$ -PACS to expand the number of gate inputs.

The basic logic element of the  $\mu$ -PAC logic line, the NAND gate, is a diode gating structure followed by an inverting transistor amplifier. The NAND gate performs the AND-NOT logic function with positive voltage logic and the OR-NOT logic function with negative voltage logic.

**SPECIFICATIONS**

Frequency	DC — 5 mc
Input Loading	1 unit load each
Fan In	12
Output Drive Capability	8 unit loads each
Maximum Circuit Delay*(measured at +1.5 volts, averaged over 2 stages)	30 nanoseconds, maximum
Current Requirements per PAC:	
+6 volts	24 milliamperes, maximum
Maximum Power Dissipation	0.140 watt, maximum
Handle Color Code	red

\*Add 3 nanoseconds delay with each diode cluster that is tied to a node.

4 THREE-INPUT DIODE CLUSTERS

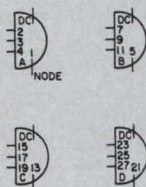

2 SIX-INPUT NAND GATES WITH NODES

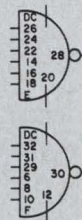



**NAND  
type 1  
μ-PAC  
DI-335**

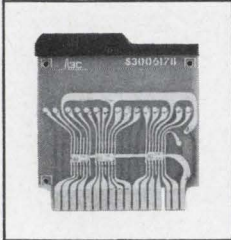

NAND Type I PAC, DI-335, contains 10 two-input NAND gates. Two of the gates have disconnected collector loads which are brought out on separate terminals.

By tying the gate collector outputs to a single load circuit, a number of these gates can be connected in parallel without reducing output drive capability.

When outputs of gates are connected in parallel, the AND-OR-INVERT function is formed. That is, if all the inputs to a single gate are at logical ONE, the output of the structure goes to ground.

The logic function of the independent DI-335 gates is identical to gates in the DC-335 PACS.

**SPECIFICATIONS**

Frequency  
Input Loading  
Fan In  
Output Drive Capability  
Circuit Delay\* (measured at +1.5 volts, averaged over 2 stages)  
Current Requirements per PAC:  
+6 volts  
Power Dissipation  
Handle Color Code

**DI-335**

DC — 5 mc  
1 unit load each  
12  
8 unit loads each  
30 nanoseconds, maximum  
117 milliamperes  
0.700 watt, maximum  
red

\*Add 3 nanoseconds delay for each unloaded gate output connected in parallel.

8 TWO-INPUT NAND GATES

2 TWO-INPUT NAND GATES WITH SEPARATE LOAD CIRCUITS

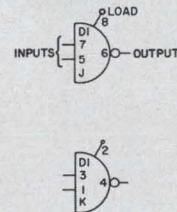
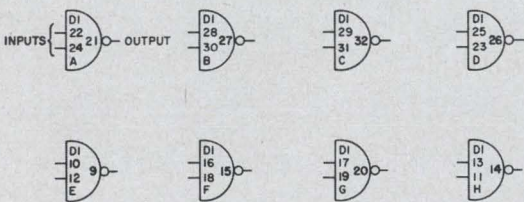

COMPUTER CONTROL COMPANY, INC.  
OLD CONNECTICUT PATH, FRAMINGHAM, MASS.



**NAND  
type 2  
μ-PAC  
DL-335**

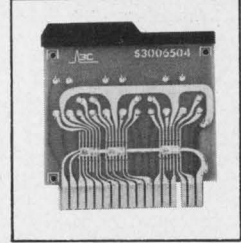

NAND Type 2 PAC, DL-335, contains 6 four-input NAND gates. Two of the gates have disconnected collector load resistors which are brought out on separate terminals.

By tying the gate outputs to a single load circuit, a number of these gates can be connected in parallel without reducing output drive capability.

When outputs of gates are connected in parallel, the AND-OR-INVERT function is formed. That is, if all of the inputs to a single gate are at logical ONE, the output of the structure goes to ground.

The logic function of the independent DL-335 gates is identical to gates in DC-335 PACS.

**SPECIFICATIONS**

<b>DL-335</b>	
Frequency	DC — 5 mc
Input Loading	1 unit load each
Fan In	12
Output Drive Capability	8 unit loads each
Circuit Delay* (measured at +1.5 volts, averaged over 2 stages)	30 nanoseconds, maximum
Current Requirements per PAC: +6 volts	70 milliamperes, maximum
Power Dissipation	0.420 watt, maximum
Handle Color Code	red
*Add 3 nanoseconds delay for each unloaded gate output connected in parallel.	

4 FOUR-INPUT NAND GATES

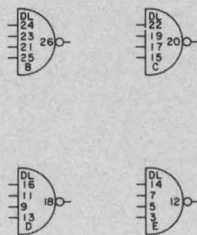

2 FOUR-INPUT NAND GATES WITH SEPARATE LOAD CIRCUITS

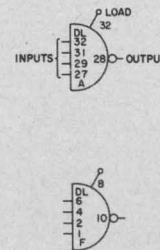



**expandable  
NAND  
 $\mu$ -PAC  
DN-335**

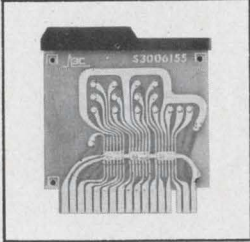

Expandable NAND PAC, DN-335, contains 6 three-input NAND gates with nodes. Two of the gates have disconnected collector loads which are brought out on separate terminals.

By tying the gate outputs to a single load circuit, a number of gates can be connected in parallel without reducing output drive capability.

When outputs of gates are connected in parallel, the AND-OR-INVERT function is formed. That is, if all the inputs to a single gate are at logical ONE, the output of the structure goes to ground. The gate node input allows for expansion of the number of gate inputs by attachment of diode clusters. The logic function of the independent DN-335 gates is identical to gates of the DC-335 PACS.

**SPECIFICATIONS**

Frequency	DC — 5 mc
Input Loading	1 unit load each
Fan In	12
Output Drive Capability	8 unit loads
Circuit Delay* (measured at +1.5 volts, averaged over 2 stages)	30 nanoseconds, maximum
Current Requirements per PAC: +6 volts	70 milliamperes, maximum
Power Dissipation	0.420 watt, maximum
Handle Color Code	red
*Add 3 nanoseconds delay with each diode cluster tied to a node or unloaded gate output added in parallel.	

**DN-335**

2 THREE-INPUT NAND GATES WITH NODES AND SEPARATE LOAD CIRCUITS

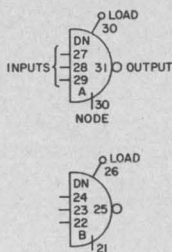

4 THREE-INPUT NAND GATES WITH NODES

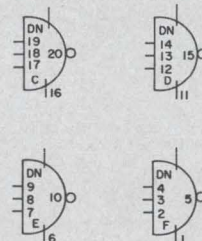

COMPUTER CONTROL COMPANY, INC.  
OLD CONNECTICUT PATH, FRAMINGHAM, MASS.



power  
amplifier  
 $\mu$ -PAC  
PA-335

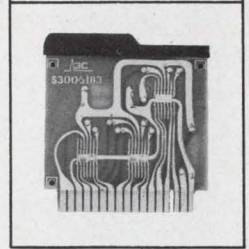

Power Amplifier PAC, PA-335, contains 6 three-input high drive NAND gates, each capable of driving 25 unit loads and 250 picofarads stray capacitance.

Each circuit has two electrically common output leads to reduce load distribution over any single wire. Built-in short circuit protection limits output current when the output is accidentally grounded.

Logically, the Power Amplifiers act as  $\mu$ -PAC NAND gates, performing either AND gating for conventional positive  $\mu$ -PAC logic or OR gating for negative logic, followed by logic inversion.

The Power Amplifier is useful for heavy load applications such as driving shift lines, common reset lines or long information leads. Also, two circuits can be wired back-to-back to form a DC set-reset power flip-flop.

**SPECIFICATIONS**

Frequency  
Input Loading  
Output Drive Capability  
Circuit Delay (measured at +1.5 volts, averaged over 2 stages)  
Current Requirements per PAC:  
+6 volts  
Power Dissipation  
Handle Color Code

**PA-335**

DC — 5 mc  
2 unit loads each  
25 unit loads each  
30 nanoseconds, maximum  
41 milliamperes, maximum  
0.360 watt, maximum  
green

6 THREE-INPUT INVERTING POWER AMPLIFIERS

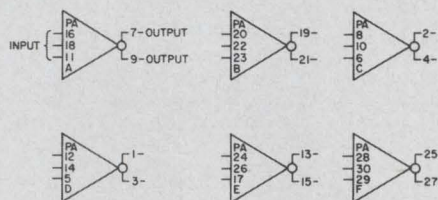



**non-  
inverting  
power  
amplifier**  
*μ*-PAC  
**PN-335**

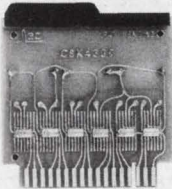

The Non-Inverting Power Amplifier PAC, PN-335, contains 6 three-input high-drive AND gates, each capable of driving 25 unit loads and 250 picofarads stray capacitance.

Each circuit has 2 electrically common output leads to reduce load distribution current on any single wire. Built-in short circuit protection limits output current if the output is accidentally grounded.

Logically, each circuit performs the AND function for positive logic and the OR function for negative logic.

**SPECIFICATIONS**

Frequency	PN-335
Input Loading	DC — 5 mc
Output Drive Capability	2 unit loads each
Circuit Delay (measured at +1.5 volts averaged over 2 stages)	25 unit loads
Current Requirements per PAC	50 nanoseconds, maximum
+6 volts	41 milliamperes, maximum
Power Dissipation	1.2 watts, maximum
Handle Color Code	green

**6 THREE-INPUT NON-INVERTING POWER AMPLIFIERS**

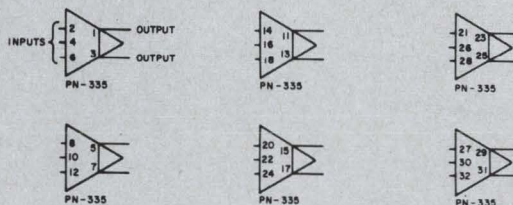



delay  
multi-  
vibrator/  
pulse  
shaper  
 $\mu$ -PAC  
DM-335



Delay Multivibrator PAC, DM-335, contains two independent monostable (one-shot) multivibrators capable of generating assertion and negation pulses in a variety of widths. Each circuit has two NAND inputs, an enable, a range control and three discrete variable delay taps.

With no external pin connections made, the output pulse width will be 100 nanoseconds. Pulse widths between 50 nanoseconds and 100 microseconds can be obtained by using the proper jumper connections. External capacitors may be used to obtain pulse widths up to several seconds.

A positive signal at the input will result in a positive pulse at the assertion output. If either input is at ZERO, triggering is inhibited at the other input.

The enable input controls circuit operation. If the enable input is at ONE or disconnected, the circuit will operate. If this input is set at ZERO, no output pulses will result. If ZERO is applied while an output pulse is being generated, the output pulse will end.

The range control input can be used to increase the existing pulse width by a factor of 5:1.

**SPECIFICATIONS**

<b>DM-335</b>	
Frequency	DC — 5 mc or $\frac{0.75}{\text{Pulse Width}}$ whichever is lower
Pulse Width:	
Internal Connections	0.05, 0.1, 0.5, 1.0, 5.0, 10, 50, and 100 microseconds up to several seconds
External Capacitors	1 unit load each
Input Loading	50 nanoseconds at logic ONE
Input Signal Requirement	
Output Drive Capability:	
Assertion	8 unit loads
Negation	7 unit loads
Circuit Delay:	
Assertion	60 nanoseconds, typical
Negation	30 nanoseconds, typical
Recovery Time (for 5% reduction in pulse width)	100 nanoseconds or 100% of pulse width whichever is greater
Current Requirements per PAC:	
+6 volts	94 milliamperes, maximum
Power Dissipation	0.560 watt, maximum
Handle Color Code	yellow

2 MONOSTABLE MULTIVIBRATORS, STEP ADJUSTABLE PULSE WIDTH

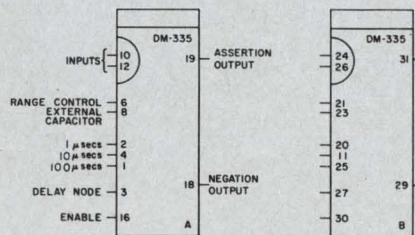



master  
clock  
 $\mu$ -PAC  
MC-335

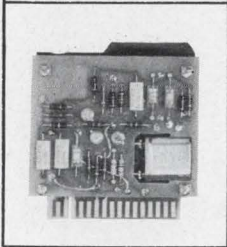

Master Clock PAC, MC-335, contains a crystal controlled oscillator, a pulse shaper and a power amplifier. The Negation pulse is available at the output of the power amplifier section. The additional power amplifier circuit is available to provide the Assertion output when tied in series with the Negation output.

The crystal oscillator section operates between 200 kc and 5 mc. When the crystal is removed, the oscillator can be driven by external signals in the form of sine waves or pulses.

The pulse shaper section controls the pulse width of the output signal by means of a built-in potentiometer-capacitor network. The potentiometer provides continuous pulse width adjustment. The standard range for Assertion pulse widths is from 45 to 200 nano-seconds. Increased pulse widths may be obtained by replacing the stud-mounted capacitor with a larger capacitor. Maximum pulse width is 50% of the oscillator's time period.

Two gated inputs are brought in at the power amplifier section and allow signal transfer to the Negation output. A ZERO at either gated input will block the signal to the output.

Using a clocked flip-flop, output pulse splitting can be prevented by synchronous start/stop control of the MC-335.

**SPECIFICATIONS**

Frequency*	200 kc — 5 mc
Input Loading:	
Gated Input	2 unit loads each
Frequency Accuracy	.01%
Frequency Stability	.005%
Output Drive Capability:	
Negation	25 unit loads
Sync	2 unit loads
Current Requirements per PAC:	
+6 volts	70 milliamperes, maximum
-6 volts	40 milliamperes, maximum
Power Requirements per PAC:	0.680 watt, maximum
Power Amplifier Circuit	(see PA-335 specifications)
Handle Color Code	yellow

\*5 mc and 1 mc are standard frequencies. Non-standard frequencies are available at slight additional cost.

**MC-335**

1 CRYSTAL-CONTROLLED CLOCK

FUNCTIONAL DIAGRAM

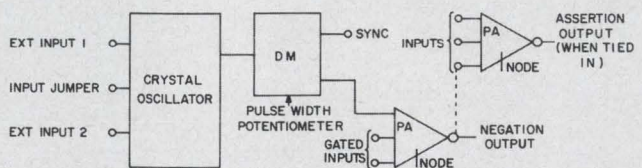
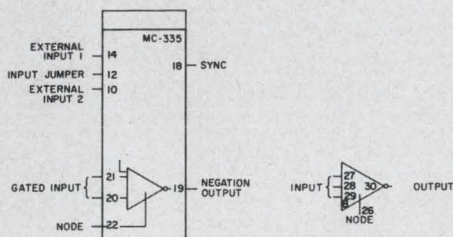



**multi-  
vibrator  
clock  
 $\mu$ -PAC  
MV-335**

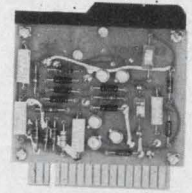

Multivibrator Clock PAC, MV-335, contains a self-starting, free running, variable frequency multivibrator, a pulse shaper section, and a power amplifier section. The Negation pulse is available at the output of the power amplifier section. The additional power amplifier circuit is available for providing an Assertion output when tied in series with the Negation output.

The multivibrator section functions as a variable frequency clock. Frequency of operation is from 200 kc to 5 mc in two overlapping ranges. The lower of the two frequency ranges is obtained by jumpering the frequency control terminals. Potentiometer adjustments provide continuous frequency changes in the respective range.

Frequencies lower than 200 kc can be obtained by mounting a capacitor on the stud-mounts provided.

The pulse shaper section controls the pulse width of the output signal by means of a built-in potentiometer-capacitor network. Standard Assertion pulse width range is from 45 to 200 nanoseconds. The pulse width range can be increased by use of stud-mounted capacitors.

Using the oscillator inhibit input, the MV-335 is wired to provide start/stop capability from external asynchronous signals.

A gated input is brought in at the power amplifier section and serves to control the signal transfer to the Negation output. A ZERO at the gated input blocks any signal to the output.

SPECIFICATIONS	MV-335
Multivibrator Circuit	
Frequency	
Without Capacitor Changes	200 kc — 5 mc
With Capacitor Changes	Less than 5 cps to 200 kc
Input Loading:	
OSC Inhibit	2 unit loads
Gated Input	2 unit loads
Output Drive Capability	25 unit loads
Pulse Width:	
Without Capacitor Changes	45 to 200 nanoseconds
With Capacitor Changes	150 nanoseconds to 70 microseconds
Power Amplifier Circuit	(SEE PA-335 specifications)
Current Requirements per PAC:	
+6 volts	95 milliamperes, maximum
-6 volts	50 milliamperes, maximum
Power Dissipation	0.870 watt, maximum
Handle Color Code	yellow

1 FREE-RUNNING MULTIVIBRATOR CLOCK

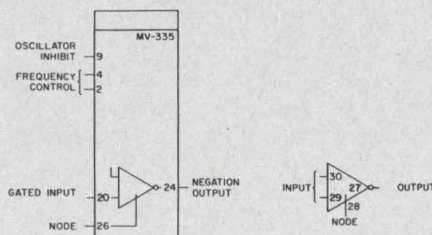

FUNCTIONAL DIAGRAM

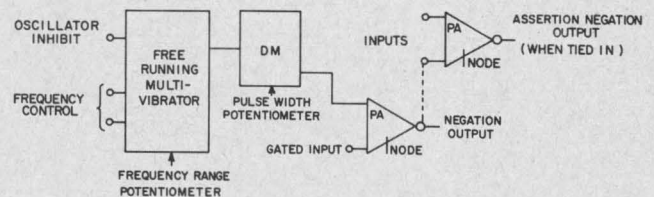



selection  
gate  
type 1  
 $\mu$ -PAC  
DG-335

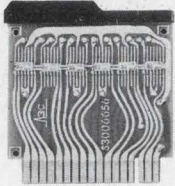

Selection Gate Type 1 PAC, DG-335, contains four independent functional gate structures. Each gate structure has 3 two-input NAND gates with separate load circuits and performs the AND-OR-INVERT function.

By using one gate input as a control and the other as a signal input, each structure can be used for transfer control of three data signals. By tying the various gate structures to a common load, gating arrangements for the transfer control of the desired number of signals can be performed.

**SPECIFICATIONS**

Frequency  
Input Loading  
Output Drive Capability  
Circuit Delay\* per Gate (measured at +1.5 volts, averaged over 2 stages)  
Current Requirements per PAC:  
+6 volts  
Power Dissipation  
Handle Color Code

**DG-335**

DC — 5 mc  
1 unit load each  
8 unit loads each  
30 nanoseconds, maximum  
141 milliamperes, maximum  
0.840 watt, maximum  
red

\*Add 3 nanoseconds delay for each unloaded gate output connected in parallel.

4 SELECTION GATE STRUCTURES

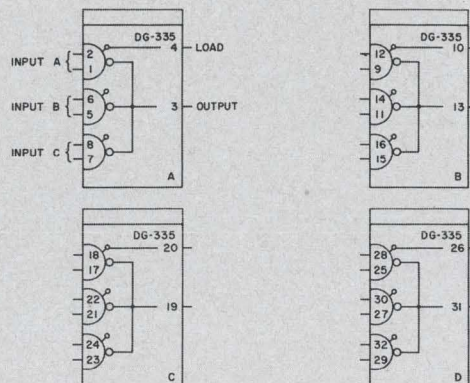

COMPUTER CONTROL COMPANY, INC.  
OLD CONNECTICUT PATH, FRAMINGHAM, MASS.



selection  
gate  
type 2  
 $\mu$ -PAC  
DG-336

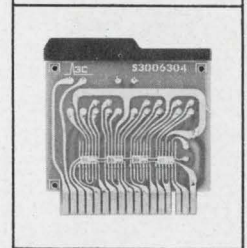

Selection Gate Type 2 PAC, DG-336, contains two independent functional gate structures. Each gate structure has 4 three-input NAND gates with separate load circuits and performs the AND-OR-INVERT function.

By using one gate input as a control and the other inputs as data inputs, each structure can be used for transfer control of four sets of data signals. Both gate structures can be tied to a common load and thereby allow transfer control of the desired number of data signals.

**SPECIFICATIONS**

Frequency	DC — 5 mc
Input Loading	1 unit load each
Output Drive Capability	8 unit loads each
Circuit Delay* per Gate	30 nanoseconds, maximum
Current Requirements per PAC:	
+6 volts	94 milliamperes, maximum
Power Dissipation	0.560 watt, maximum
Handle Color Code	red
*Add 3 nanoseconds delay for each unloaded gate output connected in parallel.	

**DG-336**

2 SELECTION GATE STRUCTURES

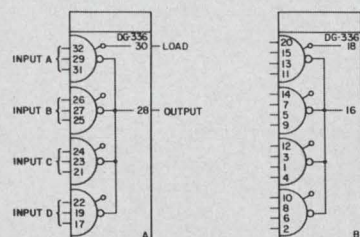



**exclusive  
OR  
 $\mu$ -PAC  
EO-335**

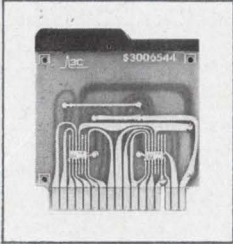

Exclusive OR PAC, EO-335, contains five independent functional gate structures and one independent single input NAND gate. Each gate structure contains 3 two-input NAND gates and performs AND-OR and AND-OR-INVERT functions.

Each gate structure can be used for sensing the Exclusive OR and for sensing equality of two inputs.

**SPECIFICATIONS**

Frequency	EO-335
Input Loading	DC — 5 mc
Output Drive Capability:	1 unit load each
Output 1	8 unit loads each
Output 2	4 unit loads each
NAND Gate Output	8 unit loads
Circuit Delay (measured at +1.5 volts, averaged over 2 stages):	
Output 1	60 nanoseconds, maximum
Output 2	30 nanoseconds, maximum
NAND Gate Output	30 nanoseconds, maximum
Current Requirements per PAC:	
+6 volts	187 milliamperes, maximum
Power Dissipation	1.120 watts, maximum
Handle Color Code	purple

**5 EXCLUSIVE OR GATE STRUCTURES WITH 1 ONE-INPUT NAND GATE**

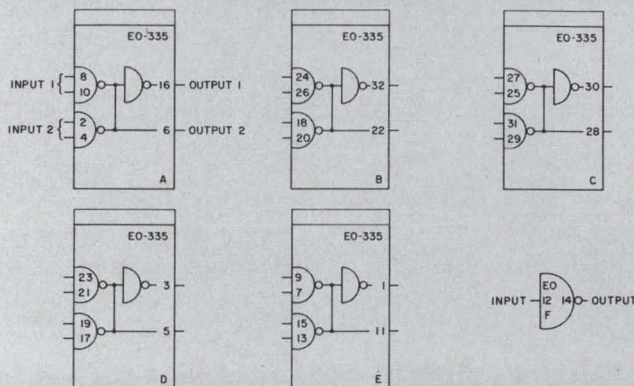



octal/  
decimal  
decoder  
 $\mu$ -PAC  
OD-335

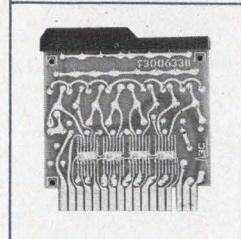

Octal/Decimal Decoder PAC, OD-335, contains a prewired binary-to-octal decoder and two additional independent NAND gates to expand the matrix for BCD-to-decimal decoding.

Three additional inputs, in addition to the six binary inputs, are provided to permit the matrix to be expanded to 16, 32, or 64 outputs by connecting additional decoders.

In the BCD-to-decimal mode, the octal matrix is used for the "zero" through "seven" output lines and two additional independent gates included on the PAC are used for output lines "eight" and "nine."

The two independent gates are standard NAND gates and may be used as such if BCD-to-decimal decoding is not required. One of these gates has six inputs, the other has five. Both gates have nodes for increasing the number of inputs.

**SPECIFICATIONS**

Frequency  
Input Loading  
Binary-to-octal and multi-octal matrices  
8 Output Decoder (3 bits)  
16 Output Decoder (4 bits)  
32 Output Decoder (5 bits)  
64 Output Decoder (6 bits)  
BCD-to-decimal Decoder:  
 $2^0$  and  $2^2$   
 $2^1, 2^1, 2^2$  and  $2^2$   
 $2^3$   
 $2^3$   
Output Drive Capability  
NAND Gate Specifications  
Current Requirements per PAC:  
+6 volts  
Power Dissipation  
Handle Color Code

**OD-335**

DC — 5 mc  
3 unit loads each  
4 unit loads each  
7 unit loads each  
14 unit loads each  
4 unit loads each  
3 unit loads each  
2 unit loads each  
5 unit loads each  
8 unit loads  
(see DI-335 specifications)  
117 milliamperes, maximum  
0.70 watt, maximum  
purple

1 PREWIRED BINARY-TO-OCTAL DECODER

1 SIX-INPUT NAND GATE

1 FIVE-INPUT NAND GATE

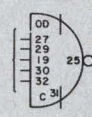
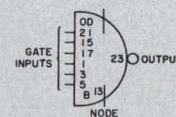
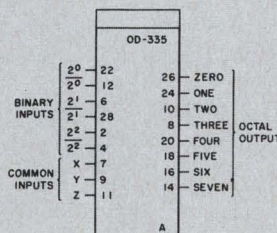



transfer  
gate  
 $\mu$ -PAC  
TG-335

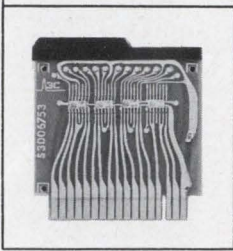

Transfer Gate PAC, TG-335, contains four independent functional gate structures. Two of the structures have 4 two-input NAND gates, one input on each gate being common to the other four gates.

The remaining two structures have 3 two-input NAND gates, one input being common to the three gates. Each gate structure can be used for the common transfer control of three or four data signals, respectively. Common inputs can be connected to transfer 14 data signals simultaneously on one module.

**SPECIFICATIONS**

Frequency

Input Loading:

Input

Common Input

Output Drive Capability

Circuit Delay (measured at +1.5 volts, averaged over 2 stages)

Current Requirements per PAC:

+6 volts

Power Dissipation

Handle Color Code

**TG-335**

DC — 5 mc

1 unit load each

1 unit load for each gate in the structure

8 unit loads

30 nanoseconds, maximum

164 milliamperes, maximum

0.980 watt, maximum

red

**4 TRANSFER GATE STRUCTURES**

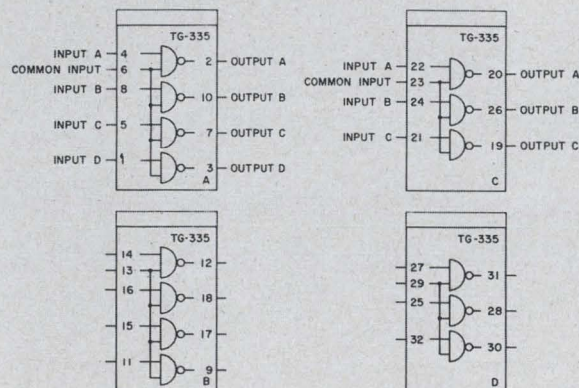

COMPUTER CONTROL COMPANY, INC.  
OLD CONNECTICUT PATH, FRAMINGHAM, MASS.



negative  
logic  
level  
converter  
 $\mu$ -PAC  
LC-335

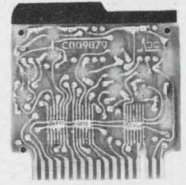

The Negative Logic Level Converter PAC, LC-335, contains 10 independent circuits which accept negative voltage logic signals and convert them to  $\mu$ -PAC signals. Each circuit has 2 inputs. The N input accepts signals at ground and  $-4$  to  $-15$  volts and provides a  $\mu$ -PAC output (0 volts and  $+6$  volts). The  $\mu$ -input uses a  $\mu$ -PAC signal to control or gate the negative voltage logic signal.

**Voltage Truth Table**

N	$\mu$	Output
0V	0V	+6V
0V	+6V	0V
-V	0V	+6V
-V	+6V	+6V

The LC-335 can be used for mating almost all negative logic systems including S-PAC and H-PAC to  $\mu$ -PAC. Also each circuit can be used as an inverter for  $\mu$ -PAC signals by using the  $\mu$ -input and grounding the N-input.

**SPECIFICATIONS**

Frequency  
Input Logic Levels  
Input Loading  
N-input  
 $\mu$ -input  
Output Drive Capability  
Conversion Circuit Delay  
(measured from  $-1.5$ v at input to  $+1.5$ v at output)  
Positive-going input:  
Negative-going input:  
Current Requirements  
 $+6$  volts  
 $-6$  volts  
Power Dissipation  
Handle Color Code

**LC-335**

DC — 5 mc  
See Voltage Truth Table  
2 ma  
1 unit load  
8 unit loads each  
65 nanoseconds, maximum  
45 nanoseconds, maximum  
125 milliamperes, maximum  
35 milliamperes, maximum  
0.96 watt, maximum  
orange

**10 NEGATIVE LOGIC CONVERTER CIRCUITS**

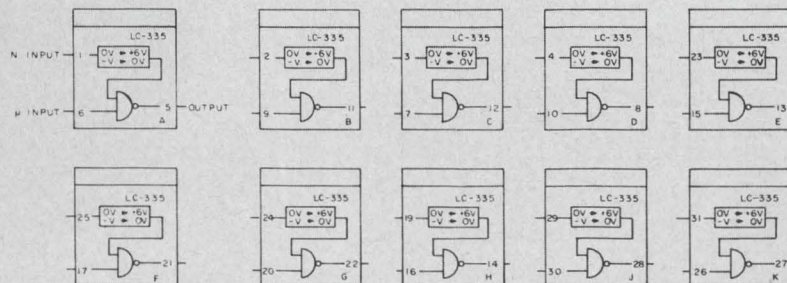



**lamp  
driver  
 $\mu$ -PAC  
LD-330**

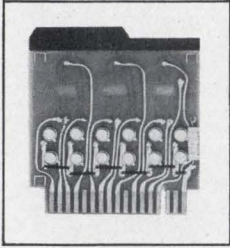

Lamp Driver PAC, LD-330, contains twelve identical independent lamp driver circuits. Each circuit is capable of switching up to 70 milliamperes of current from any positive voltage up to 20 volts at a maximum frequency of 100 kc.

If logic ONE (+6 volts) is applied to the input, the output voltage will be high (positive supply voltage). If ZERO is applied at the input, the output will be ZERO (ground).

The circuit can handle an initial in-rush current of 150 milliamperes, maximum.

**SPECIFICATIONS**

Frequency  
Input Loading  
Output Drive Capability:  
Quiescent  
Current Requirements per PAC:  
+6 volts  
Power Dissipation  
Handle Color Code

**LD-330**

DC — 100 kc  
1 unit load  
70 milliamperes at up to 20 volts  
140 milliamperes, maximum  
0.840 watt, maximum  
orange

**12 INDICATOR LAMP DRIVER CIRCUITS**

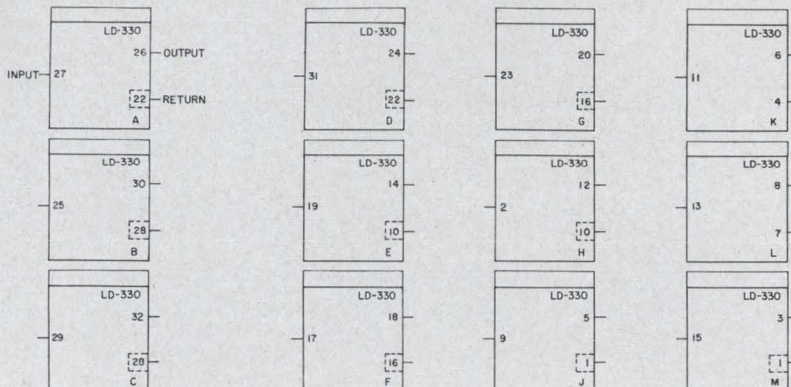

COMPUTER CONTROL COMPANY, INC.  
OLD CONNECTICUT PATH FRAMINGHAM, MASS.



high  
drive  
lamp  
driver  
 $\mu$ -PAC  
LD-331

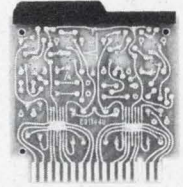

The High Drive Lamp Driver PAC, LD-331, contains 8 independent lamp driver circuits. Each circuit is capable of switching 300 milliamperes of current from any positive voltage up to 35 volts at a maximum frequency of 10 kc.

If logic ONE (+6 volts) is applied to both inputs, the output transistor is on and current is supplied. If either input is at ZERO (0 volts), the output transistor is off and no current is supplied.

The LD-331 can be used for driving lamps, relays or resistive loads.

**SPECIFICATIONS**

Frequency  
Input Loading  
Output Drive Capability  
  
Current Requirements per PAC  
+6 volts  
Power Dissipation  
Handle color code

**LD-331**

DC — 10 kc  
1 unit load each  
300 milliamperes  
at 35 volts, maximum  
  
220 milliamperes, maximum  
1.32 watts, maximum  
orange

8 HIGH-CURRENT DRIVER CIRCUITS

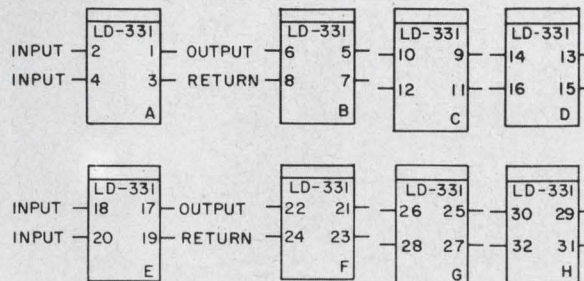



**negative  
logic  
level  
driver  
 $\mu$ -PAC  
LD-335**

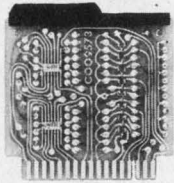

The Negative Logic Level Driver PAC, LD-335, contains 8 identical independent circuits. Each circuit is capable of converting standard  $\mu$ -PAC signals to negative voltage levels of 0 volts and a minus voltage of up to 25 volts.

When both inputs are at +6 volts, the output is at ground. When either input is at 0 volts, the output is at the negative voltage of the external supply (-25 volts maximum).

The LD-335 can be used to convert  $\mu$ -PAC signals to negative signals and/or drive low current filament lamps.

**SPECIFICATIONS**

Frequency  
Input Loading  
Output Drive Capability  
Rise Time (positive slope)  
Fall Time (negative slope, 10 to 90 percent points)  
Circuit Delay  
Turn on  
Turn off  
Current Requirements per PAC  
+6 volts  
-6 volts  
External Supply  
Power Dissipation  
Handle Color Code

**LD-335**

DC — 5mc  
1 unit load each  
60 milliamperes at up to minus 25 volts  
2 nanoseconds per volt, typical  
200 nanoseconds, typical  
25 nanoseconds, typical  
60 nanoseconds, typical  
200 milliamperes, maximum  
40 milliamperes, maximum  
60 milliamperes, maximum, at minus 25 volts, maximum  
1.44 watts, maximum  
orange

**8 NEGATIVE LOGIC DRIVER CIRCUITS**

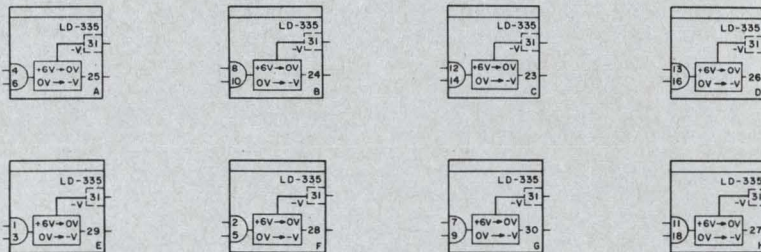



**solenoid  
driver  
 $\mu$ -PAC  
SD-330**

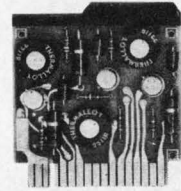

Solenoid Driver PAC, SD-330, contains three independent circuits for driving heavy resistive, capacitive or inductive loads in such applications as solenoid or relay driving. The PAC also contains an independent two-input NAND gate.

Each solenoid driver has a two-input NAND gate which drives a transistor amplifier inverter and is capable of switching up to one ampere of current at 500 cycles per second from a positive supply of up to 28 volts.

When both inputs are at logic ONE, the output is high and the solenoid is de-energized. When either input is at logic ZERO, the output is low and the solenoid is energized.

<b>SPECIFICATIONS</b>	<b>SD-330</b>
Solenoid Driver Circuits:	
Frequency	DC — 500 cps
Input Loading	1 unit load each
Output Drive Capability	1 ampere at 28 volts, supplied externally
Circuit Delay (switching 1.0 ampere):	
Turn on	400 nanoseconds, typical
Turn off	150 nanoseconds, typical
NAND Gate	(see DI-335 specifications)
Current Requirements per PAC:	
+6 volts	47 milliamperes, maximum
Power Dissipation	0.280 watt, maximum
Handle Color Code	orange

**3 SOLENOID DRIVER CIRCUITS WITH ADDITIONAL GATE**

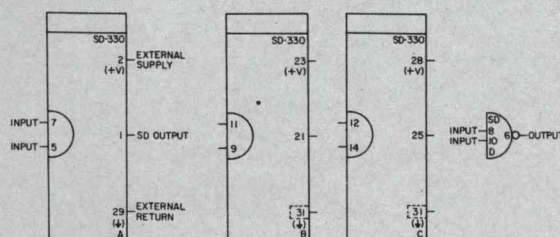



**schmitt  
trigger  
 $\mu$ -PAC  
ST-335**

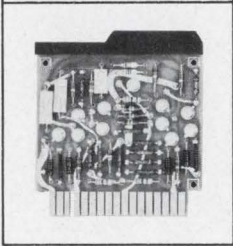

Schmitt Trigger PAC, ST-335, contains two independent trigger circuits, each capable of converting arbitrarily shaped inputs into  $\mu$ -PAC compatible outputs.

Switching level can be varied from +2.5 volts to -2.5 volts by making use of appropriate pin connections, by mounting resistors on available stud-mounts and/or by employing an external voltage source.

Standard sensitivity (hysteresis) is typically one volt but can be reduced by using stud-mounted resistors.

When the input signal is greater than +6 volts on the positive side or greater than -20 volts on the negative side, an attenuating network will be needed. This consists of mounting a resistor pair on the available stud-mounts.

Differentiation and integration of input signals can be performed by use of stud-mounted RC networks.

**SPECIFICATIONS**

Frequency	DC — 5 mc
Circuit Delay	20 nanoseconds, typical
Output Drive Capability	8 unit loads
Current Requirements per PAC:	
+6 volts	90 milliamperes, maximum
-6 volts	60 milliamperes, maximum
Power Dissipation	0.900 watt, maximum
Handle Color Code	orange

**ST-335**

**2 SCHMITT TRIGGER CIRCUITS**

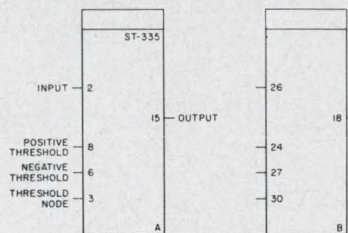



transmission  
line driver  
 $\mu$ -PAC  
XD-335

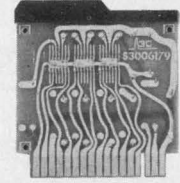

Transmission Line Driver PAC, XD-335, contains 6 two-input driver circuits. Each circuit is capable of driving standard 50 ohm, 75 ohm and 93 ohm coaxial cables or twisted pair cables at up to 5 mc repetition rates.

When transmission line termination other than the provided 62 ohms is required, the proper resistor can be mounted on available studs.

The transmission line should be terminated in a high impedance such as a standard  $\mu$ -PAC gate or the DC input of a  $\mu$ -PAC flip-flop.

Logically, the Transmission Line Driver circuit is identical to a  $\mu$ -PAC two-input gate, performing NAND gating logic for conventional positive  $\mu$ -PAC logic.

**SPECIFICATIONS**

Frequency  
Input Loading  
Output Drive Capability:  
50, 75 or 93 $\Omega$  cable  
Twisted pair cable  
Circuit Delay  
Current Requirements per PAC:  
+6 volts  
Power Dissipation  
Handle Color Code

**XD-335**

DC — 5 mc  
2 unit loads each  
10 feet\*  
10 feet\*  
30 nanoseconds, maximum  
41 milliamperes, maximum  
0.250 watt, maximum  
green

\*Considerably longer drive length can be obtained by careful application of terminating resistors. See  $\mu$ -PAC Instruction Manual for details.

6 TWO-INPUT TRANSMISSION LINE DRIVERS

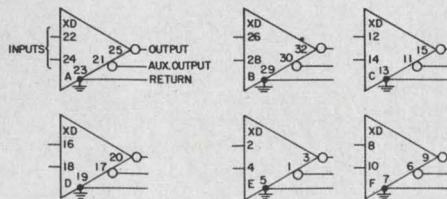



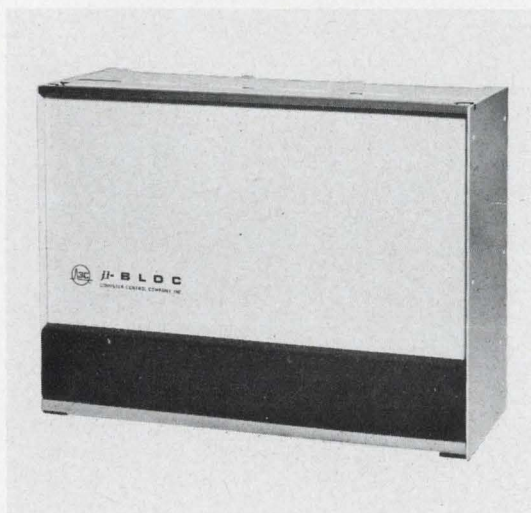
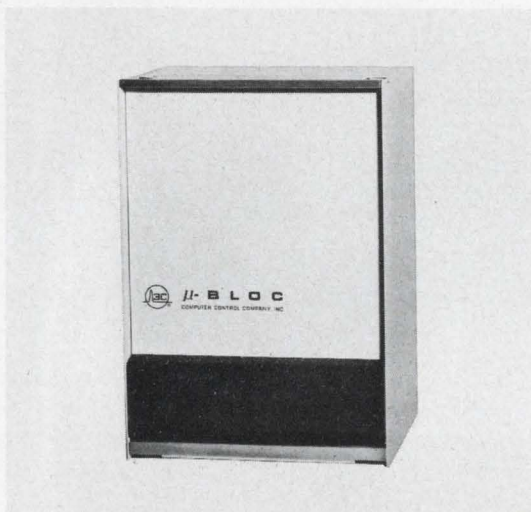

Seven different μ-BLOC units are available for housing μ-PACS. All BLOCS use the same basic structure but differ in width dimension, provisions for plug-in power supply and types and number of connectors (see table).

These BLOCS offer a choice of either solderless-wrap or taper-pin connectors. Each connector slot contains 34 contacts and is polarized. PAC capacity between 24 and 144 is provided in the combination of μ-BLOCS. Fan cooling units equipped with washable filters are located at the base of each assembly.

Mounting ears are detachable and allow front or back mounting of the connector plane. Laminated copper strips insulated by mylar are used for power distribution. PAC connectors are prewired for +6 volts and ground. Height and depth dimensions are standard for all BLOCS at 12 $\frac{1}{4}$ " by 5 $\frac{1}{4}$ " respectively.

**BM Series**

The BM μ-BLOC Series includes models BM-330, BM-335 and BM-337. The BM-330 is 6 inches wide, contains solderless-wrap connectors, and can house 24 μ-PACS. In addition, it has provision for mounting PB-330 plug-in power supply which can drive all of the contained modules.

The BM-335 is 8 $\frac{1}{2}$  inches wide and has 24 taper pin connector slots. As with the BM-330, it also has provision for housing the PB-330 plug-in power supply. When used in conjunction with a standard mounting panel, the BM-335 can be mounted in a 19-inch rack. The mounting panel can also be used as a control panel if desired. The BM-335 can also be coupled for side-by-side mounting in a 19-inch rack.

The BM-337 is identical to the BM-335 except that it has 36 taper pin connector slots and has no provision for the plug-in power supply.

**Mounting Panels**

The Mounting Panels, PM-330 and PM-331, are used to mount the BM series μ-BLOCS to 19 inch RETMA relay racks. They can be fastened to either the PAC side or connector side of the BLOC. Panel space can be used to mount switches, indicator lights, meters, etc.

The PM-330 is 8 $\frac{7}{16}$  inches across and mounts the BM-330.

The PM-331 is 5 $\frac{1}{16}$  inches across and mounts the BM-335 and BM-337.

**BL Series**

The BL μ-BLOC Series consists of the BL-330, BL-331, BL-332 and BL-333. Each BLOC is directly mountable in a 19-inch rack. The BL-330 and BL-331 have provisions for housing a PB-331 plug-in power supply which can drive up to 96 modules. The accompanying table details the difference in connector type, PAC capacity, etc. One μ-PAC Extractor Tool will be supplied with each BLOC.

**SPECIFICATIONS**

Model	PAC Capacity	Connector Type	MECH. DIMENSIONS			Housing for Power Supply	Weight (Lbs.)
			Height	Depth	Width		
BM-330	24	solderless-wrap	12 $\frac{7}{32}$	5 $\frac{1}{8}$	5 $\frac{1}{16}$	PB-330	8.2
BM-335	24	taper pin	12 $\frac{7}{32}$	5 $\frac{1}{8}$	8 $\frac{7}{16}$	PB-330	9.6
BM-337	36	taper pin	12 $\frac{7}{32}$	5 $\frac{1}{8}$	8 $\frac{7}{16}$	(none)	10.4
BL-330	96	solderless-wrap	12 $\frac{7}{32}$	5 $\frac{1}{8}$	16 $\frac{1}{16}$	PB-331	16.0
BL-331	48	taper pin	12 $\frac{7}{32}$	5 $\frac{1}{8}$	16 $\frac{1}{16}$	PB-331	16.0
BL-332	144	solderless-wrap	12 $\frac{7}{32}$	5 $\frac{1}{8}$	16 $\frac{1}{16}$	(none)	18.3
BL-333	72	taper pin	12 $\frac{7}{32}$	5 $\frac{1}{8}$	16 $\frac{1}{16}$	(none)	18.3



# mounting hardware

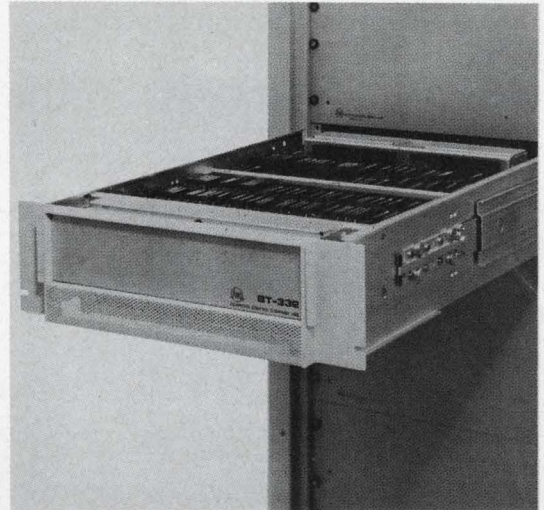

## BT-332 Tilt Drawer Unit

The BT-332 Tilt Drawer Unit contains 240  $\mu$ -PAC slots employing solderless-wrap connectors.

This front access drawer unit is mounted on slides which allow the drawer to be pulled out clear of the mounting rack. A pivot then permits the drawer to be easily tilted about the horizontal axis for access to the PAC side and/or the connector side. Several detents hold the drawer securely in the desired angle position. Cooling fans are provided at the front and rear. The drawer mounts in standard 19-inch panel width cabinets and occupies  $21\frac{7}{8}$  inches of depth from the rear surface of the front panel housing. An additional 1 to  $1\frac{1}{2}$  inches is required for cable exiting and handling. The front panel offers  $3\frac{3}{8}$  inches of height, 14 inches of width, and  $1\frac{1}{8}$  inches of clearance for mounting controls, switches, indicators, etc.

On special order, BT-332's can be modified to accommodate  $\mu$ -PAC's plug-in supplies (PB-330 and PB-331), taper pin connectors, and/or specially mounted connectors for inter-BLOC wiring.



## SPECIFICATIONS

Model	PAC Capacity	Connector Type	MECH. DIMENSIONS			Weight (lbs.)
			Height	Overall Depth	Panel Width	
BT-332	240	Solderless Wrap	$5\frac{1}{16}$	$22\frac{7}{8}$	19	60

## E-PAC Solderless Wrap Capability

Electropac, 3C's wholly owned subsidiary in Peterborough, New Hampshire is now capable of offering its solderless-wrap capability to all of 3C's  $\mu$ -PAC customers. E-PAC has long engaged in logic system wiring for 3C's computer and systems programs and has an established history of experience and field tested performance in this area.

For price, delivery or other information regarding the solderless wrapping of  $\mu$ -PAC systems, contact Sales Manager, Electropac, Peterborough, New Hampshire, Telephone: (703) 924-3821

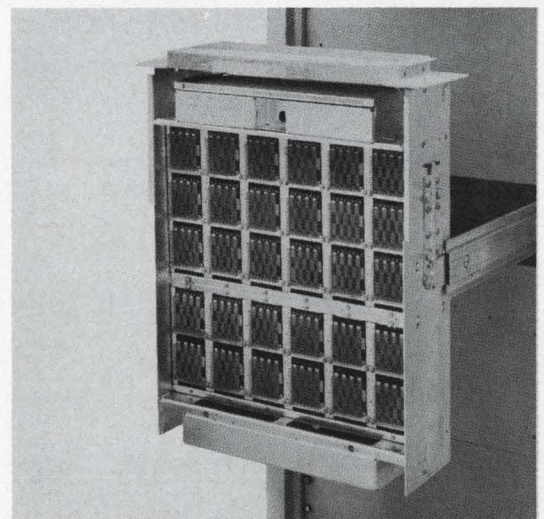



## plug-in power supplies

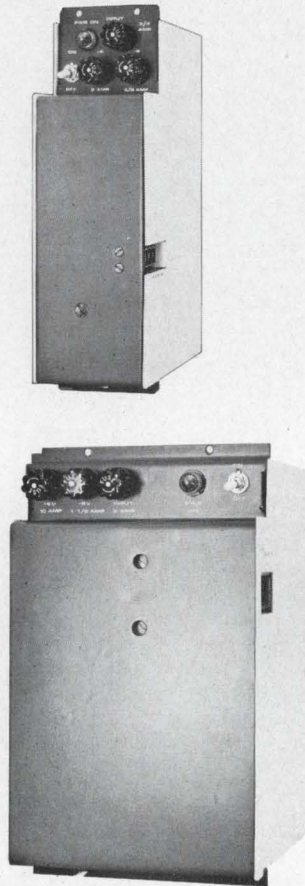

Plug-in Power Supplies, PB-330 and PB-331, are integrally packaged units that can be mounted directly into  $\mu$ -BLOCS. The PB-330 mounts directly in model BM-BLOCS and the PB-331 mounts into model BL-BLOCS. They supply current at both  $\mu$ -PAC voltage levels, +6 and -6 volts, and are designed to drive all modules contained in their respective BLOCS.

Overall voltage level variations due to worst-case combinations of line voltage, DC load regulation, dynamic load regulation, ripple and long-term drift are less than  $\pm 2\%$ . This is well within  $\mu$ -PAC voltage level tolerances.

The +6 and -6 volt circuits are Zener diode regulated. Each consists of a full wave rectifier, error detector, differential amplifier and pass transistors. Internal interconnections allow for an input voltage range of 100 volts to 240 volts. Input frequency can range from 48 to 400 cps. Voltage adjustments of  $\pm 2\%$  can be made on both voltage levels. Ambient operating temperature range is  $0^{\circ}\text{C}$  to  $+55^{\circ}\text{C}$ .

Front panel features include an on-off switch, power-on indicator, three fuses, and voltage adjustment potentiometers.

Power Supply	+6 Volts DC	-6 Volts DC	Line Current Full Load	Overall Dimensions	Weight
PB-330	2.5 A	.25 A	0.3 A @ 100 VAC	$8\frac{3}{4} \times 2\frac{3}{4} \times 4\frac{1}{2}$	8 lbs.
PB-331	10 A	1.0 A	5.0 A @ 100 VAC	$8\frac{3}{4} \times 5\frac{1}{2} \times 4\frac{1}{2}$	17 lbs.

## RP-330 power supply

The RP-330 rack-mounting power supply is a regulated power source capable of supplying current at both +6 volts and -6 volts  $\mu$ -PAC voltage levels.

Overall supply voltage variations due to worst-case combinations of input line voltage, DC load regulation, dynamic load regulation, ripple and long-term drift are less than  $\pm 2\%$ . This is well within  $\mu$ -PAC voltage level tolerances.

Input frequencies of either  $50 \pm 2$  cps or  $60 \pm 2$  cps can be used. At 50 cps, input voltage taps of 100 to 240 volts  $\pm 10\%$  are available. At 60 cps, input voltages of 100, 115, and 120 volts  $\pm 10\%$  can be used. Ambient operating temperature range is  $-20^{\circ}\text{C}$  to  $+55^{\circ}\text{C}$ .

Power supply front panel includes an AC power-on indicator, two fast-acting circuit breakers with associated indicator lights, voltage adjustment potentiometers and an AC line input fuse.

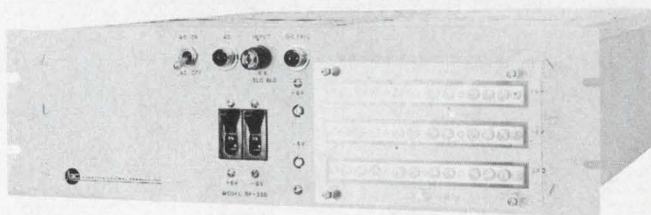

Power Supply	+6 Volts DC	-6 Volts DC	Line Current Full Load	Overall Dimensions	Weight
RP-330	25 A	2.5 A	5.0 A @ 100 VAC	$5\frac{1}{4} \times 15 \times 19$	60 lbs.



COMPUTER CONTROL COMPANY, INC.  
OLD CONNECTICUT PATH, FRAMINGHAM, MASS.



## auxiliary solderless-wrap kit WK-330

The Auxiliary Solderless-Wrap Kit WK-330 is designed to provide all associated equipment and material necessary to facilitate the implementation of  $\mu$ -BLOC interwiring. WK-330 is intended for use with either the battery operated solderless-wrap gun or the manually operated solderless-wrap tool. Contents of the kit include:

- wire stripper
- solderless-wrap aid
- unwrap tool
- tweezers
- dressing fingers
- dummy solderless-wrap connector
- 30 gauge wire (25 feet)
- solderless-wrap manual

The wire stripper provides a simple method of stripping wire to the correct length. Both a connector and 25 feet of 30 gauge wire are provided for practice solderless-wrap operations. Detailed instructions are contained in the solderless-wrap manual.

## solderless-wrapping tools

### BATTERY OPERATED SOLDERLESS-WRAP GUN

The Battery Operated Solderless-Wrap Gun provides a simple method for interwiring  $\mu$ -BLOC solderless-wrap connectors with the prescribed 30 gauge wire.

The nickel-cadmium battery provides sufficient power to make up to 4,000 connections without recharging. For recharging the battery can be removed easily and plugged into a standard 110 volt wall socket. The entire unit including battery bit and sleeve weighs 16 ounces.



### MANUALLY OPERATED SOLDERLESS-WRAP GUN

The Manually Operated Solderless-Wrap Tool provides a simple inexpensive method of solderless wrapping 30 gauge wire to  $\mu$ -BLOC solderless-wrap connectors. It is useful for small one-shot wiring tasks, for prototype checkouts, demo units, etc.



## taper pin insertion tool

The Taper Pin Insertion Tool is used to insert taper pin jumper leads into taper pin connectors. The tool's spring loaded action and ease of use greatly facilitates the taper pin wiring operation.





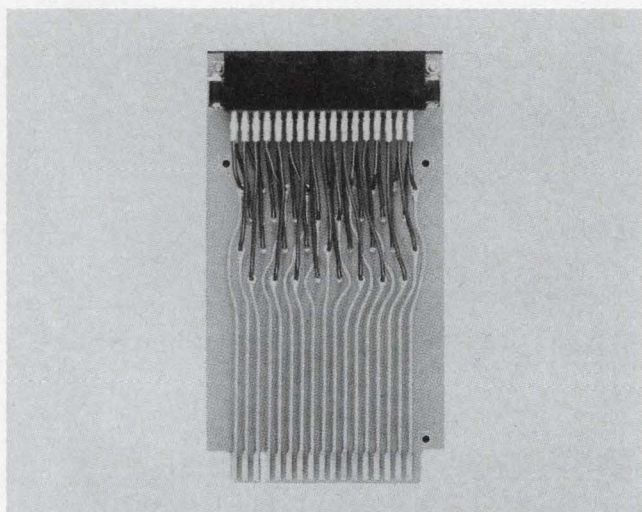

### XP-330 extender PAC

The Extender PAC, XP-330, provides unobstructed access to any  $\mu$ -PAC while the PAC is still electrically connected to its  $\mu$ -BLOC connector slot.

The connector terminals on the front end of the XP-330 will mount into any  $\mu$ -BLOC connector and the connector on the rear of the XP-330 will accept the  $\mu$ -PAC which it is displacing. Front and rear terminals are directly tied together electrically.

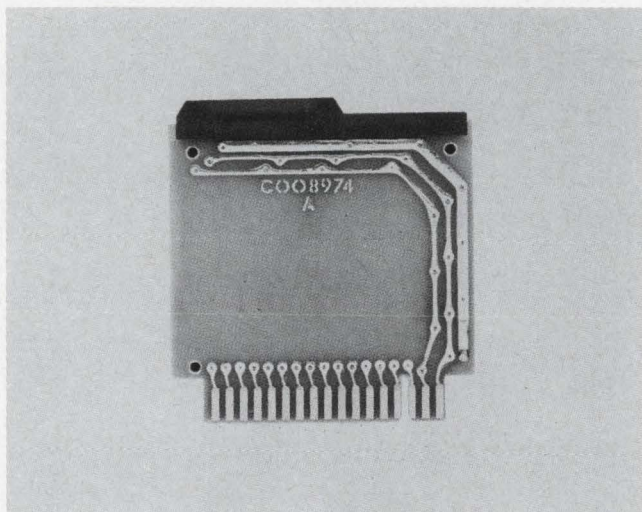

### BP-330 blank PAC

The Blank PAC, BP-330, is a standard  $\mu$ -PAC card with etched power and ground busses originating at the appropriate connector terminals and distributed around the card's periphery. The remainder of the card space (approximately 3.5 square inches) is available for the mounting of any desired special circuits or components by use of standard lugs and point-to-point wiring. 15 of the card's connector fingers are available for connecting to the BP-330 circuitry.

When mounted in a solderless-wrap  $\mu$ -BLOC, maximum allowable height of components is 0.115 inches on the component side and 0.080 inches on the etch side. For use in a taper pin  $\mu$ -BLOC, maximum heights are .36 inches and .32 inches respectively. If adjacent PAC slots are left vacant or if end slots are used, correspondingly increased component heights can be used.





## TP-330 test point PAC

The Test Point PAC, TP-330, facilitates the observation of waveform characteristics for various circuit positions within the system. It contains 34 test points, each of which is prewired to a connector terminal and bears the number of the appropriate terminal. The PAC is plugged into a prewired  $\mu$ -PAC connector.

The TP-330 is  $2\frac{3}{8}$  inches longer than the standard  $\mu$ -PAC card, the additional length allowing easy access to the test points.

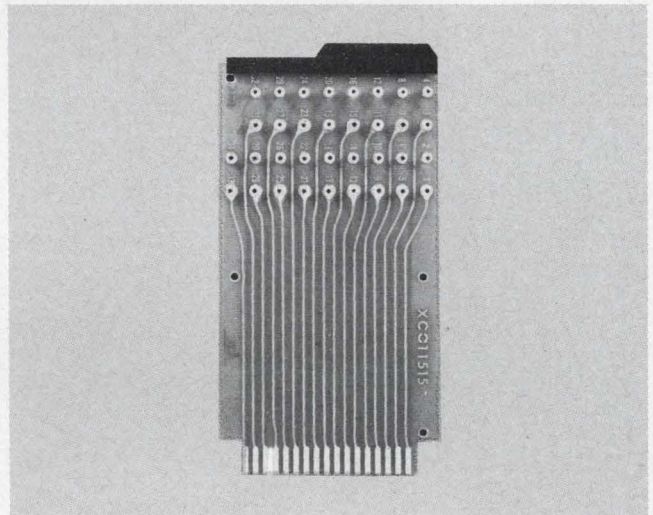

## AS-330 copper clad PAC kit

The Copper Clad PAC Kit, AS-330, consists of a standard  $\mu$ -PAC card, a separate handle and retaining roll pins. The card portion contains the standard 34 gold plated fingers attached to 5.5 square inches of copper plate on each side of the card. This allows for custom etching of desired interconnection patterns.

When mounted in a solderless-wrap  $\mu$ -BLOC, maximum allowable height of components is 0.115 inches on the component side and 0.080 inches on the etch side.

For use in a taper pin  $\mu$ -BLOC, maximum heights are .36 inches and .32 inches respectively. If adjacent PAC slots are left vacant or if end slots are used, correspondingly increased component heights can be used.

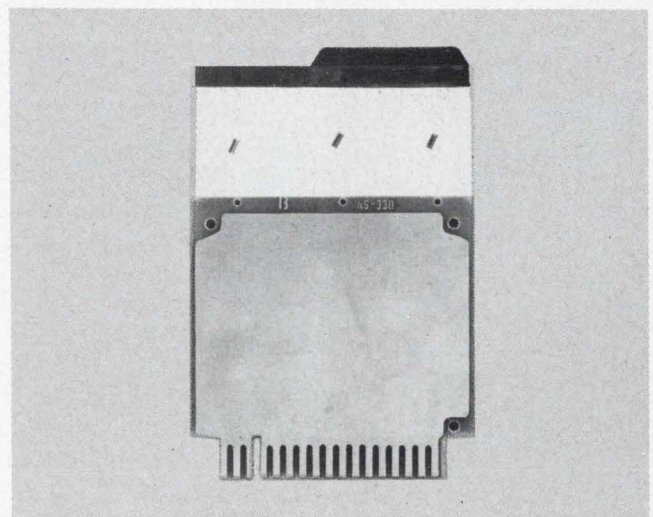



## jumper lead set JT-330

The JT-330 Jumper Lead Set contains 420 assorted lengths of taper pin jumper leads. The leads are made of plastic insulated #24 stranded wire with gold-plated AMP taper pins at each end. Lead lengths designate tip-to-tip taper pin distances.

Wire Color	2"	QUANTITIES			Per Color Quantity	Recommended PAC Type
		Lead Length 3½"	5"	6½"		
Blue	35	35	30	15	115	flip-flops
Red	35	35	30	15	115	gates
Yellow	25	25	20	10	80	amplifier/ I/O circuits
Orange	10	10	5	5	30	clocks, DMS
White	10	10	5	5	30	miscellaneous
Black	30	20	—	—	50	ground
TOTAL	145	135	90	50	420	

Jumper leads in the above lengths and colors are also available separately on special order in lots of 100 leads.

## UI-110, UI-330 unit indicators

The Unit Indicator Models UI-110 and UI-330 are self-contained transistorized neon indicators for displaying the state of any  $\mu$ -PAC flip-flop, gate, or other logic unit.

The UI-110 uses a +90 volt supply and is driven by standard  $\mu$ -PAC signals. When Logic ONE is applied to the input circuit, the neon indicator ignites. This unit is equipped with a clear plastic lens and taper pin connections. It mounts in a  $\frac{3}{8}$  inch hole,  $\frac{5}{8}$  inch on center and projects  $1\frac{1}{4}$  inches behind the panel.

The UI-330 is identical in performance to the UI-110 except that it can be powered from +6 volts. In addition to its standard clear plastic lens and taper pin connections, colored lenses and solder-pin connections are available on special order. The UI-330 mounts in a  $\frac{3}{8}$  inch hole,  $\frac{5}{8}$  inch on center and projects  $2\frac{1}{8}$  inches behind the panel.

### specifications

	UI-110	UI-330
Frequency of Operation	DC to 50 kc	DC to 50 kc
Input loading	1 unit load each	1 unit load each
Input voltage margins		
Indicator On	+3.5v to +20v	+5v to 10v
Indicator Off	+1.6v to -5.0v	+1.5v to -3v
Estimated Lamp Life	Over 10,000 hrs.	Over 10,000 hrs.
Current Requirements	+90 volts, 1.8 milliamperes	+6 volts, 20 milliamperes
Power Dissipation	.162 watts max.	.180 watts max.

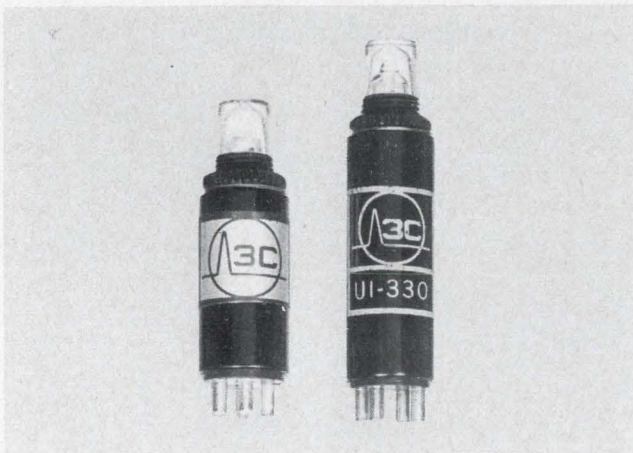

COMPUTER CONTROL COMPANY, INC.  
OLD CONNECTICUT PATH, FRAMINGHAM, MASS.



## $\mu$ -PAC instruction manual

The  $\mu$ -PAC Instruction Manual contains detailed information on the complete  $\mu$ -PAC line. Included are product descriptions, performance specifications, design equations, timing diagrams, logic symbols, schematics, basic applications, parts lists, component call-outs and identifications, and other pertinent electrical and mechanical information.

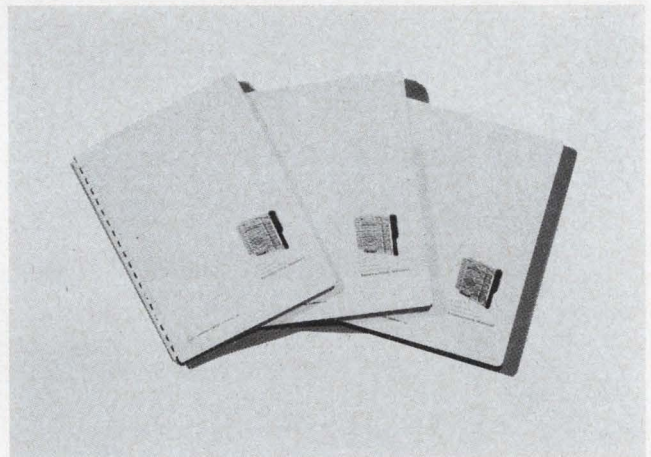

## logic symbol sheets

Logic Symbol Sheets are available for each applicable product type in the  $\mu$ -PAC line. Use of the logic symbol sheets greatly simplifies system logic design and wiring, and effectively minimizes drafting requirements for the production of final engineering drawings.

Printed on each sticker are logic symbol, pin connections and circuit identifiers. Space is provided for designating physical location in the respective  $\mu$ -BLOC.

The symbols are printed on 8½" x 11" sheets and are pre-cut in block form for easy removal from the basic symbol sheet. A dull surface coating permits pencil or ink lettering on the symbol stickers.

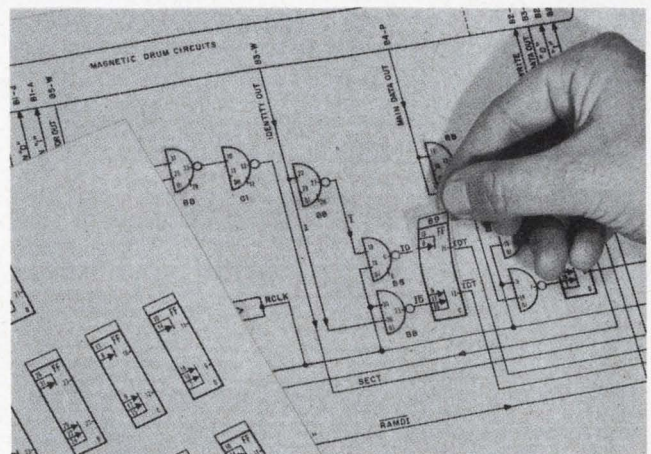



## μ-PAC INDEX

MODEL	NAME	DESCRIPTION	PAGE
<b>FLIP-FLOP PACS</b>			
BC-335	Counter PAC	6 flip-flops for binary counting	11
BC-336	Binary Counter PAC	8 to 20 flip-flops prewired for binary counting	12
BC-337	Fast Carry Counter PAC	8 flip-flops for binary or BCD counting	13
BR-335	Buffer Register PAC	6 flip-flops prewired with common clock and common reset input	14
FA-335	Gated Flip-Flop PAC	4 flip-flops with DC, clock and control inputs	15
FF-335	Basic Flip-Flop PAC	8 flip-flops with DC input gating	16
SR-335	Shift Register PAC	8 to 16 flip-flops prewired for shift register operation	17
UF-335	Universal Flip-Flop PAC	3 flip-flops with AC and DC input gating	18
<b>GATE PACS</b>			
DC-335	Multi-Input NAND PAC	2 six-input NAND gates with nodes 4 three-input diode clusters	19
DI-335	NAND PAC	8 two-input NAND gates 2 two-input NAND gates with separate load circuits	20
DL-335	NAND Type 2 PAC	4 four-input NAND gates 2 four-input NAND gates with separate load circuits	21
DN-335	Expandable NAND PAC	4 three-input NAND gates with nodes 2 three-input NAND gates with nodes and separate load circuits	22
<b>AMPLIFIER PACS</b>			
PA-335	Power Amplifier PAC	6 three-input inverting power amplifiers	23
PN-335	Non-Inverting Power Amplifier PAC	6 three-input non-inverting power amplifiers	24
<b>DELAY PACS</b>			
DM-335	Delay Multivibrator PAC	2 monostable multivibrators, step adjustable pulse width	25
<b>CLOCK PACS</b>			
MC-335	Master Clock PAC	1 crystal-controlled clock	26
MV-335	Multivibrator Clock PAC	1 free-running multivibrator clock	27
<b>FUNCTIONAL GATING PACS</b>			
DG-335	Selection Gate Type 1 PAC	4 selection gate structures	28
DG-336	Selection Gate Type 2 PAC	2 selection gate structures	29
EO-335	Exclusive OR PAC	5 exclusive OR gate structures with 1 one-input NAND gate	30
OD-335	Octal/Decimal Decoder PAC	1 prewired binary-to-octal decoder 1 six-input NAND gate 1 three-input NAND gate	31
TG-335	Transfer Gate PAC	4 transfer gate structures	32
<b>SYSTEM INPUT/OUTPUT PACS</b>			
LC-335	Negative Logic Level Converter PAC	10 negative logic converter circuits	33
LD-330	Lamp Driver PAC	12 indicator lamp driver circuits	34
LD-331	High Drive Lamp Driver PAC	8 high current driver circuits	35
LD-335	Negative Logic Lamp Driver PAC	8 negative logic driver circuits	36
SD-330	Solenoid Driver PAC	3 solenoid driver circuits with additional gate	37
ST-335	Schmitt Trigger PAC	2 schmitt trigger circuits	38
XD-335	Transmission Line Driver PAC	6 two-input transmission line drivers	39



## 3C PRODUCTS

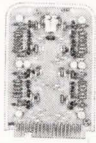

**S-PAC Logic Modules**  
200 kc,  
1 mc, 5 mc  
and 1 mc  
Silicon  
1

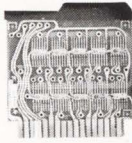

**μ-PAC Logic Modules**  
5 mc  
2



**H-PAC Logic Modules**  
20 mc  
3



**Integrated Circuit Core Memories**  
1 μsec full cycle  
(<500 nsec access time)  
4



**Pulse Current Generators**  
5

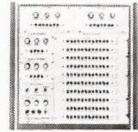

**Digital Program Generators**  
5 mc and 20 mc  
6

## 3C GENERAL PURPOSE COMPUTERS

### DDP-124

24-bit word DDP-124 features monolithic integrated circuit construction; binary, parallel, sign/magnitude, single address with indexing, powerful command structure. Over 285,000 computations per second. 4096 words (expandable to 32,768) directly addressable; cycle time 1.75 μsec. (Strong optional I/O capability and broad range of peripheral equipment.) FORTRAN IV, assembler, executive, utility and service routines. Fully program-compatible with DDP-24 and DDP-224.  
7

### DDP-116

DDP-116 features a 16-bit-word, 1.7 μsec cycle, 4K memory, keyboard and comprehensive instruction repertoire, powerful I/O bus structure, multi-level indirect addressing, indexing, priority interrupt, extensive software package, diagnostic routines. Add time is 3.4 μsec. Options include high-speed arithmetic option, memory expansion to direct memory interrupt, real-time clock, and a full line of peripherals.  
8

### DDP-224

24-bit word DDP-224 features: 1.9 μsecs (0.8 access) memory cycle, and powerful command structure, 260,000 computations per second. Transfer rates up to 325,000 words per second. 3.8 μsecs add, 6.46 μsecs multiply, 17 μsecs divide. 4096-word memory expandable to 65,536. Typical add time with optional floating point hardware 7.6 μsecs (24-bit mantissa, 9-bit characteristic). Fully program compatible with DDP-24.  
9

### DDP-224 MULTI-PROCESSOR

Fully buffered control unit, access distribution unit and time multiplex unit make it possible to combine several DDP-224's into integrated large scale computer systems with functionally common and/or private memory, control arithmetic, system input/output facilities and peripherals.  
10

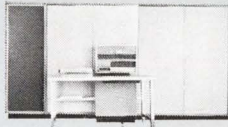
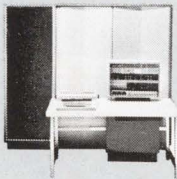
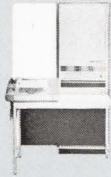
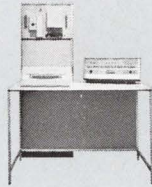

Please send the information indicated\*

1      2      3      4      5      6      7      8      9      10

μ-PAC prices       Have sales engineer call

NAME \_\_\_\_\_

TITLE \_\_\_\_\_

FIRM \_\_\_\_\_

STREET \_\_\_\_\_

CITY \_\_\_\_\_ ZONE \_\_\_\_\_ STATE \_\_\_\_\_

\*If requesting four or more items, please reply on letterhead. Thank you.

For further information on μ-PACS or any of the 3C products listed on this page -- fill out and mail the attached postage paid return card.



# New Catalog $\mu$ -PAC-2

**Integrated Circuit Modules —**  
This newly expanded catalog details 3C's complete line of 5 mc  $\mu$ -PAC silicon monolithic integrated circuit digital logic

modules. Included are new high density mounting hardware, new logic circuits, and new accessories.

 **COMPUTER CONTROL COMPANY, INC.**



**BUSINESS REPLY MAIL**  
First Class Permit No. 113, Framingham, Mass.

Postage will be paid by . . .

COMPUTER CONTROL COMPANY, INC.  
OLD CONNECTICUT PATH  
FRAMINGHAM, MASSACHUSETTS 01701





# ALLOYS CUSTOM BLENDED TO YOUR SPECS

through powder metallurgy

Need a nickel alloy that will perform exactly as you want? No tramp elements, low carbon and gas content, exact performance reproducibility, uniform etching properties, excellent surface and mechanical characteristics?

Here at Magnetics Inc. we call such metals Blendalloy®. With more than 10 years' experience in powder metallurgy, we are now prepared to formulate and produce custom blended alloys to your specs—and to guarantee performance under the conditions you name.

*Example:* Blendalloy 52. We developed this 52% nickel controlled expansion alloy for dry reed switches and mercury wetted relays. Blendalloy 52 is made to match with precision the expansion characteristics of Corning 0120 glass. When used with other types of glass, Blendalloy 52 is modified to match any change in expansion characteristics. Dilatometry and polarimetry tests on both laboratory and production runs assure this match for both standard and modified alloys.

Magnetics Inc. produces Blendalloy metals in bar, rod, strip and wire, in lots from one pound to 50 tons or more. For information, write for our Blendalloy 52 technical data sheet. For general information, ask for our new metals capabilities brochure: *Metals From Magnetics*, Magnetics Inc., Dept. M-98, Butler, Pa. 16001

**METALS  
FROM  
MAGNETICS**

Guaranteed Performance  
Reproducibility through  
Powder Metallurgy  
Techniques

**MAGNETICS inc.**





# Mix & match.

## From breadboard to prototype to production.

Sub-miniature coax, standard machined or formed strip contacts can be intermixed instantly in the same connector block.

You can begin wiring your breadboard or prototype with standard wire. If noise develops, just switch signal leads to sub-miniature coax without changing the connector block.

Here's a twist. You can also convert standard leads to twisted pair. In case we forgot to mention it, the sub-minia-

ture coax contacts take twisted pairs as well as coax cable.

And the formed contact is a big money saver in initial and installed costs. Throw in the automatic Burndy Hyfematic™ and crimp up to 3000 contacts per hour. Blocks available for 14 to 152 positions.

Now put it all together. Contact intermixing, economy, universality. Get in touch with Burndy for all the details. Hurry.

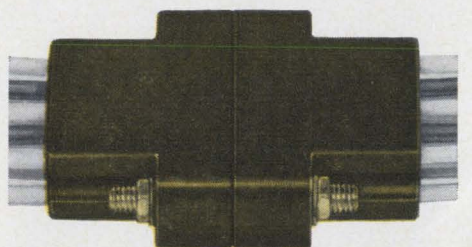

# BURNDY

Norwalk  Connecticut

ON READER-SERVICE CARD CIRCLE 102



- ① Fast Response —  $50 \mu\text{s}$
- ② Low Distortion —  $< 0.25\%$
- ③ Isolation — 100 db
- ④ Precise Regulation —  $\pm 0.05\%$
- ⑤ Wide Frequency Range —  $\pm 3 \text{ c/s}$

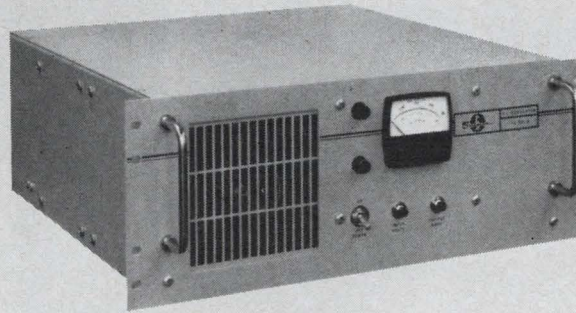

# Sorensen High Precision AC Line Regulators

The Sorensen FR Series AC Line Regulators provide pure power for critical circuitry; applications include powering of pulse-type circuits for analog and digital computers where false triggering is not permissible, powering of medical instrumentation, and control of line voltage for spectrographic equipment. Output power is 0 - 1 kVA • Power factor is 0.7 lagging to 0.7 leading • Three switchable input ranges are provided for each model—95-115, 105-125 and 115-135 Vac for FR1000 and FR1020; 190-230, 210-250 and 230-270

Vac for FR1010 and FR1030. Temperature Range 0-55° C. Check the rest of our specifications in the chart below and you'll find that spec for spec, dollar for dollar, the Sorensen FR Series is your best value in precision line regulators. For additional details on the FR Series, or for data on other standard/custom AC line regulators, DC power supplies, high voltage supplies or frequency changers, call your local Sorensen representative, or write: Raytheon Company, Sorensen Operation, Richards Ave., Norwalk, Conn. 06856.

#### ELECTRICAL SPECIFICATIONS

Model	Output Voltage Vac	Regulation Line & Load Combined	Distortion w/10% Input Harmonics	Response Time $\mu\text{s}$	Input Frequency c/s	Isolation In/Out db	Price
FR1000	115	$\pm 0.05\%$	$< 0.25\%$	50	57-63	100	\$1425
FR1010	230	$\pm 0.05\%$	$< 0.25\%$	50	47-53	100	\$1650
FR1020	115	$\pm 0.05\%$	$< 1.0\%$	50	380-420	100	\$1525
FR1030	230	$\pm 0.5\%$	$< 0.25\%$	50	57-63	100	\$1650

**RAYTHEON**

ON READER-SERVICE CARD CIRCLE 103

Sorensen represented in California by Ward-Davis Assoc., 770 S. Arroyo Parkway, Pasadena, Phone 213-684-2840; 3921 E. Bayshore, Palo Alto, Phone 415-968-7116; 3492 Pickett Street, San Diego, Phone 714-297-4619.





**RELIABILITY**  
TOTAL CAPABILITY IN  
PRECISION RESISTANCE



"It's the  
new  
DALE CW...  
good  
power/size  
ratio."

"Good price,  
too."

## ***New DALE CW Wirewounds let you specify higher performance at commercial prices***

Only Dale's new CW Series gives you all these advantages at low commercial resistor prices:

- Complete All-Welded Construction
- Multi-Layer High Temp. Silicone Coating
- High Power/Size Ratio — see chart
- Excellent Stability In Operation

Write or phone now for more information about the CW Resistors—they're absolutely the closest you can come to precision quality and performance at commercial prices. If standard axial lead models won't work Dale engineers can readily suggest one of hundreds of proven modifications.

**WRITE FOR CATALOG A**

**CW SPECIFICATIONS**

DALE TYPE	POWER RATING	RESISTANCE RANGE	BODY LENGTH (±.062)	BODY DIA. (±.032)	LEAD LENGTH (±.125)	LEAD DIA.
CW-2	4.25 W	1 Ω to 47.1K	.625	.250	2	.040
CW-2A	3 W	1 Ω to 42.1K	.812	.188	1.5	.032
CW-2B	3.75 W	1 Ω to 24.5K	.562	.188	1.5	.032
CW-2C	3.25 W	1 Ω to 32.3K	.500	.250	1.5	.040
CW-5	6.5 W	1 Ω to 95.2K	.875	.312	2	.040
CW-7	9.0 W	1 Ω to 154K	1.218	.312	2	.040
CW-10	13 W	1 Ω to 273K	1.781	.375	2	.040

**Tolerance:** Standard tolerance is ±5%  
**Temperature Coefficient:** ±260 PPM/°C  
**Lead Material:** Tinned copperweld, standard  
**Operating Temp. Range:** -55°C to +350°C



**DALE ELECTRONICS, INC.**  
1328 28th Avenue, Columbus, Nebraska

ON READER-SERVICE CARD CIRCLE 104





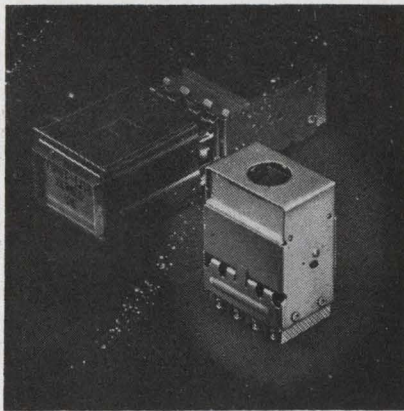

### Sequence actuators

Series 22 miniature binary coded sequence actuators program the switching modes of four integral spdt switch modules to provide any one of 16 combinations at each of 12 sequential steps. Each switch module is actuated by an independent coding disc and all discs are driven by a common shaft. The disc may be binary coded or can be supplied with a modified code sequence. The units are rated at 5 A at 125 or 250 Vac, or 3 A inductive/5 A resistive at 30 Vdc.

Availability: 6 wks. Master Specialties Co., 1640 Monrovia, Costa Mesa, Calif. Phone: (714) 642-2427.

Circle No. 301

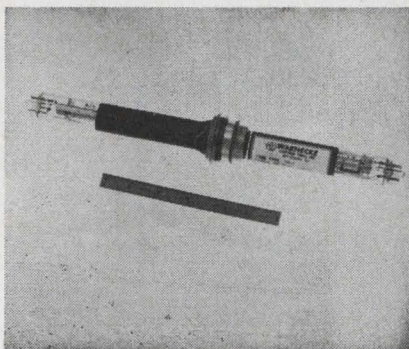

### Storage tubes

The RW-5EM dual-gun miniature storage tube resolves a minimum of 1200 TV lines on a 1-in. target diameter. Storage times are from a fraction of a second to a few minutes. The tube uses electromagnetic focus and deflection on both read and write sides and meets air-borne requirements of MIL-E-5400.

P&A: \$1400; stock to 4 wks. Warnecke Electron Tubes, Inc., 175 West Oakton St., Des Plaines, Ill. Phone: (312) 299-4436.

Circle No. 302

# To make or buy a power supply ...let SOLA quote you both ways

Make the decision a realistic one. Let SOLA quote you on a custom built CV transformer and CVDC power supply. You will then have the costs and specifics to make the right decision.

#### Building your own d-c supply?

Start with the SOLA CV, custom built to match your power supply's outputs, exactly. Save extra component costs in your design. Get short circuit protection, regulation within  $\pm 1\%$  for line variations to  $\pm 15\%$ . Send output power and circuit requirements, we'll return price of CV and values of circuit components.

#### Buying a complete d-c supply?

Choose the SOLA CVDC, custom built to your specified output requirements. Get a high watts-per-pound package combining the CV's tight regulation, low forward voltage drop of the rectifier and low output impedance of the capacity filter.

Let SOLA quote both ways. Send us your specs for custom-built CV's and CVDC's, or call your distributor and ask about his line of standard CV's and CVDC's.

Sola Electric Division, Sola Basic Industries, 1717 Busse Road, Elk Grove Village, Illinois 60007 (312) 439-2800.



Sola CV transformer matched to your output requirements

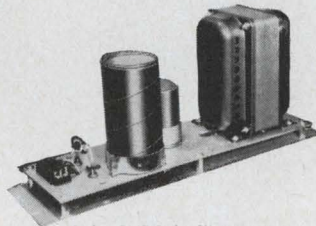

Sola CVDC built to your output requirements

### CUSTOM VOLTAGE REGULATION HEADQUARTERS

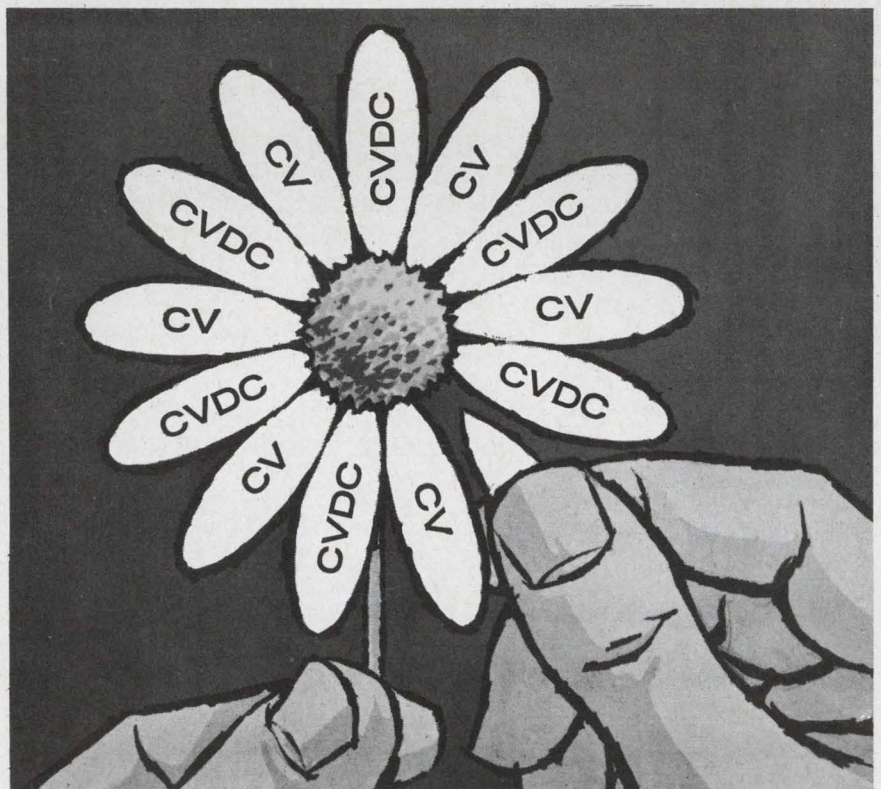

**SOLA ELECTRIC** **SB**

DIVISION OF SOLA BASIC INDUSTRIES

Speed Inquiry to Advertiser via Collect Night Letter  
ON READER-SERVICE CARD CIRCLE 33



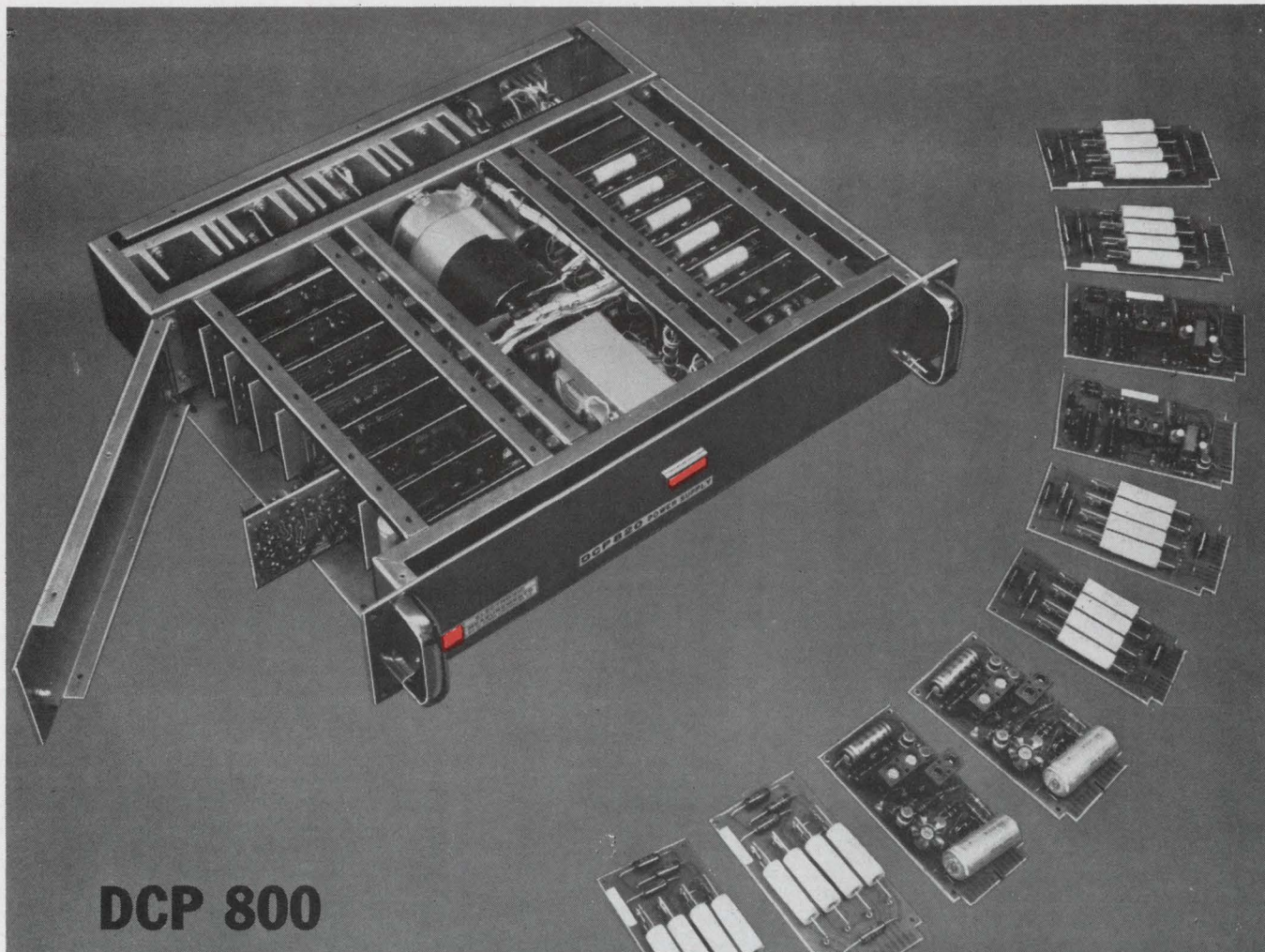

## DCP 800

The DCP 800 Power Supply is a high performance, solid state DC power supply with exceptional versatility. It is a digitally programmed unit suitable for automatic test equipment. It provides automatic crossover from regulated voltage to regulated current.

### POWER INPUT:

105-125 Volts — 50-63 cps — single phase.

### CONTROL INPUT:

Voltage — Binary Coded Decimal Five Digit Programming in 1 mv steps.

Current — Binary Coded Four Digit Programming in 1 ua steps with 10 to 1 and 100 to 1 range expansion. The DCP-812 only has a 10 to 1 range expansion.

Excitation — Provided by 24 Volts to Reed Relay Input Circuit.

OUTPUT:	DCP-812	DCP-813	DCP-814	DCP-820	DCP-821
Voltage	0-100V	0-50V	0-100V	0-50V	0-100V
Current	0-0.1A	0-1A	0-1A	0-0.5A	0-0.5A

### ABSOLUTE VOLTAGE ACCURACY: 0.1% or 1.5 mv. Includes:

Line regulation measured for an input voltage step change of 105-125 Volts at 50-63 cps.

Load regulation measured for a no load to full load or full load to no load change within range.

Stability for 8 hours after 30 minutes warm-up.

### ABSOLUTE CURRENT ACCURACY: 0.35% or 0.25 uamp. Includes:

Line regulation measured for an input voltage step change of 105 to 125 Volts at 50-63 cps.

Load regulation measured for 100 Volt step change increase or decrease.

Stability for 8 hours after 30 minutes warm-up.



Write for more information.

THE

CONTROLLER COMPANY • ELECTRONIC MEASUREMENTS  
OCEANPORT, NEW JERSEY 07757

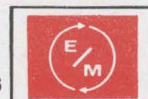

DIV.



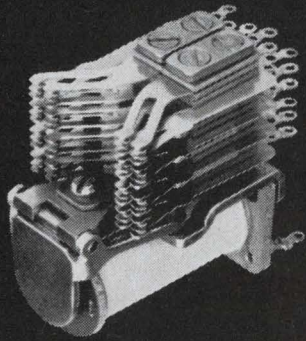

**For ideal hang-up**

**go magnetic**

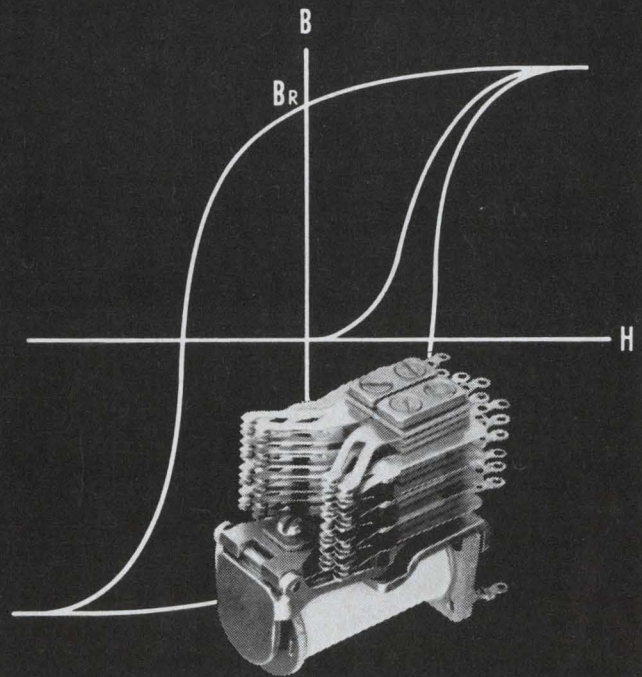

## with AE's new Series ERM Magnetic Latching Relay

The new Series ERM relay is the first of its kind to use remanent magnetism of the coil core to lock it up. Because of its simplicity, the relay has numerous advantages over the conventional types with mechanical latching.

In the ERM, two opposed windings provide bi-stable operation. When the "operate" coil is pulsed, the special alloy core retains sufficient remanent magnetism to hold the armature locked up *indefinitely*. A second pulse through the "release" coil demagnetizes the core and drops the armature.

Since the "operate" and "release" coils are separate, they can be operated on different voltages—for instance, 24 volts DC and 110 volts AC, respectively. There is no constant current drain on the control circuit as there is with electrically latched relays.

Because of the absence of "friction parts" common to

mechanically latched relays, the Series ERM relays are virtually maintenance-free and provide exceptionally long service life.

The Series ERM opens up a number of new applications. They are ideal for pre-programming, where a time delay is required between preparation and operation. When used with rotary stepping switches or industrial timers, the ERM can provide extremely long time delays which are impossible with slow-to-release relays or RC networks. Banks of ERM relays are also useful wherever memory storage or pulse stretching is desired, since they remain operated without current drain.

Series ERM relays are available with solder, taper-tabs, wire wrap and printed circuit terminals, as well as EIN sockets. For full information, write the Director, Control Equipment Sales, Automatic Electric Company, Northlake, Illinois 60164.

**AUTOMATIC ELECTRIC**  
SUBSIDIARY OF  
**GENERAL TELEPHONE & ELECTRONICS GTE**

ON READER-SERVICE CARD CIRCLE 35



**E NOW AVAILABLE!!** A complete series of switching matrices for analog or digital switching up to 5 mc., and coax or twinax video switching up to 60 mc. The matrices allow any input or series of inputs to be connected to any output or multiple of outputs. They are available in 1 by 2 up to 20 by 20 crosspoint versions. Also available are multiple pole (up to 25 points) single and multiple throw coaxial switches. Switching control can be accomplished by a remote control panel, pre-programmed punched card or tape, or computer control for automatic checkout applications.

# COAXIAL SWITCHING MATRICES

(remote controlled pre-programmable matrices and switches)

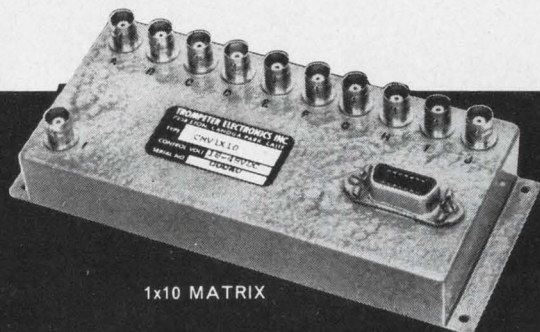

1x10 MATRIX

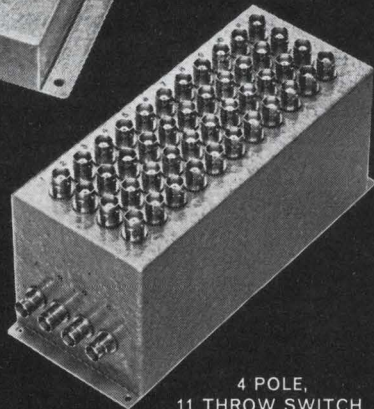

4 POLE,  
11 THROW SWITCH

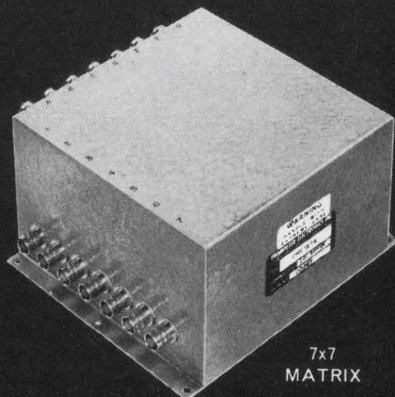

7x7  
MATRIX

For low level shielded audio switching to 50kc; analog, digital or video switching to 5mc; L.F. switching to 60mc. To fit programming requirements, three levels of crosstalk/isolation are available with the following characteristics: low isolation to 45 db, medium isolation to 75 db; high isolation to 110 db minimum.

## TROMPETER ELECTRONICS

8936 Comanche Ave., ■ Chatsworth, Calif. 91311 ■ (213) 882-1020

## COMPONENTS

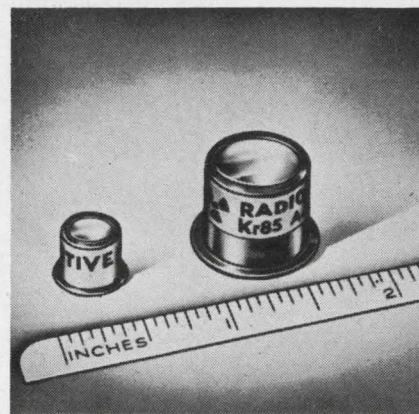

### Self-luminous light

A series of self-luminous lights, "I-LITES," are independent of electrical power, are not subject to failure and do not burn out. The sources use a radioisotope, Krypton 85, to excite phosphor crystals into low-level luminescence from 0.1 to 10 ft-lamberts. Half-life is 8 to 10 years. The sources are available in 0.23 and 0.5-in. diameters encapsulated or unencapsulated. Emitted light is yellow-green and filters provide other colors.

American Atomics Corp., 425 S. Plumer, Tucson, Ariz. Phone: (602) 622-4881.

Circle No. 303

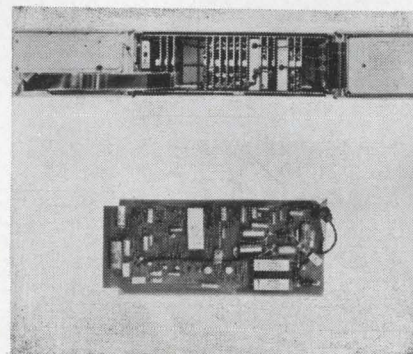

### Preamplifier

Model 12 preamplifier for the manufacturer's digital volt/ratio-meters decreases the time for mV measurements to 100 ms max. Accuracy is 0.01% full scale. Ranges of  $\pm 10$ ,  $\pm 100$ , and  $\pm 1,000$  mV are available. Range and polarity are automatically selected, with 0.4 s required for automatic range change. Input resistance 100 M $\Omega$  min. Circuitry is on single plug-in circuit board.

Dana Labs., Inc., Irvine, Calif. Phone: (714) 546-1130.

Circle No. 304



# New Microwave Ferrite Devices – New Standard of Performance.

## high-speed latching circulators

Now Scientific-Atlanta research makes available a series of latching 3-port circulators with unprecedented performance. These devices combine extremely fast switching speeds and low driving energy requirements with the high reliability associated with microwave ferrite components.

Model 105-1,  
X-band waveguide latching circulator  
with integral driver.

Switching Time	4 $\mu$ s
Switching Energy (incl. loss in driver)	500 $\mu$ J
Bandwidth	9.7-12.2 GHz
Insertion Loss	0.5 dB Max
Isolation	20.0 dB Min
VSWR	1.25 Max
Driver supply voltage	+ 28 Vdc



Scientific-Atlanta latching circulators are available in both waveguide and stripline configurations. They are supplied complete with solid-state drivers—all you furnish is a single trigger pulse, say 10 volts into 50 ohms, for each switching operation. Consider these typical examples:

Model 202-1,  
S-band strip-line latching circulator  
with integral driver.

Switching Time	10 $\mu$ s
Frequency:	2.0 – 3.5 GHz
Insertion Loss:	
	0.5 dB Max (2.5–3.5 GHz)
	1.0 dB Max (2.0–3.5 GHz)
Isolation	20 dB Min
VSWR	1.25 Max
Driver supply voltage	+28 Vdc



## reciprocal latching phase shifters

These are truly reciprocal latching TEM ferrite phase shifters for your telemetry, radar, or communication systems. Scientific-Atlanta can supply you with single-bit units in C-band strip line. And, development of 4-bit units is nearing completion.

Reciprocity differentiates these units from other latching ferrite phase shifters. Switching is now only required for beam scanning. A new close-range capability is brought to phased-array radars. Other applications include reciprocal ferrite switches, synthetic conical scanners, and modulators. And since these phase shifters are latching, they offer you great switching speed with low power drain, and assure simple digital control.

Typical performance is indicated in the accompanying graph. This shows phase shift and insertion loss for a 180° bit at C-band. Phase shift is reciprocal within lab accuracy (approx 1°); switching time is less than 3  $\mu$ s. Switching energy is less than 250  $\mu$ J including loss in driver.

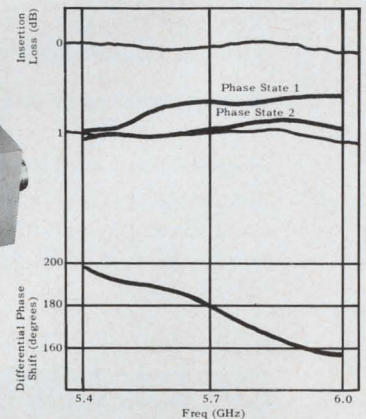

## high performance 3-port circulators

Want to make accurate phase measurements? If your device under test sees a significant VSWR in each direction, you may experience a high measurement error. With Scientific-Atlanta's low VSWR circulator-isolator, this possible error is cut appreciably. Model 242-1, shown below, maintains a VSWR of 1.05:1 or less over 15% bandwidth in S-band. Typical isolation and insertion loss characteristics are shown in the graph. C-band units are also available.

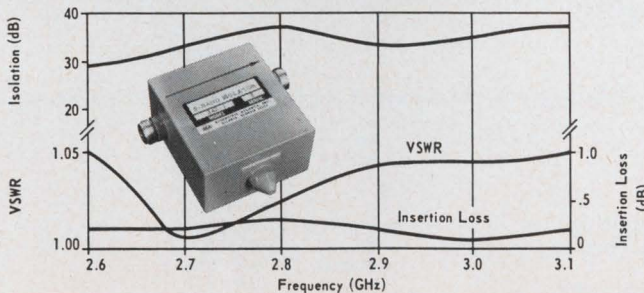

Need broadband UHF circulators or isolators? Try one of these:

Model	MHz
235-2	140-200
235-3	200-300
235-4	300-400
235-5	400-600
235-6	600-800

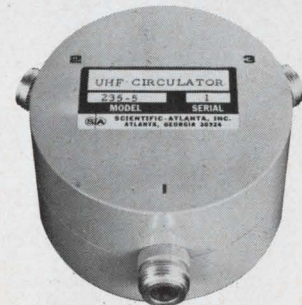

Got a size problem? Our L-band miniature circulator, Model 231-1, measures 1-5/16" x 1-1/8" x 1-1/2". It maintains 20 dB isolation with 0.3 dB insertion loss from 1485 MHz to 1535 MHz.

SCIENTIFIC-ATLANTA, INC.

Box 13654, Atlanta, Ga. 30324

Representatives in major cities throughout the world.





# CLARE *MERCURY-WETTED*

## High-speed, billion-operation relays for.....

Whether your relay must operate billions of times, or only once with certainty, CLARE Mercury-Wetted Contact Relays are designed, manufactured and tested to meet your most rigid requirements.

### Check these important design considerations:

**High speed** • Mercury contact relays can be operated at speeds as fast as 1.0 ms.

**Low and consistent contact resistance** •

CLARE Mercury-Wetted Contact Relays hold their original contact resistance to within  $\pm 2$  milliohms throughout life, an important consideration where contact resistance is critical. Example: Switching low level analog signals requires known, stable and minimal contact resistance. These relays provide it.

**Versatile power-handling capabilities** •

CLARE Mercury-Wetted Contact Relays switch small or large loads at high rates of speed. Their life need not be de-rated with loads up to maximum contact ratings. Example: The same contacts can be used to pass a microvolt analog signal or switch a 250 va motor load.

**High power gain characteristics** •

CLARE Mercury-Wetted Contact Relays are ideal components as economical isolated output power amplifiers. Example: One of these relays can be driven at a 5 mw level from diode or transistor logic and handle a 100 va ac or dc power load on its contacts.

**No contact bounce** •

CLARE Mercury-Wetted Contact Relays are completely free of contact bounce. They are ideal components for any circuit whose accuracy may be destroyed by contact chatter. Example: Eliminating contact bounce prevents error and allows faster operation in tape transport read-write head switching which involves passing information through the contacts in digital form.

### ELECTRICAL CHARACTERISTICS

	FOR WIRED ASSEMBLIES							FOR PRINTED CIRCUIT BOARDS					
	HG	HGP	HGS	HGSL				HGM	HGSM				
				Series 1000	Series 5000	Series 10000	Series 50000		Series 1000	Series 5000	Series 10000	Series 50000	
Contact Arrangement	Up to 6 Form D	1 Form D	1 Form C or 1 Form D	1 Form D	1 Form C	1 Form D	1 Form C	1 & 2 Form D	1 & 2 Form D	1 & 2 Form C	1 Form D	1 Form C	
Contact Rating Low Level	0-100 microamps			0-300 millivolts									
Power (With Contact Protection)	5 amp max 500 v max 250 va max		2 amp max 500 v max 100 va max				5 amp max 500 v max 250 va max		2 amp max 500 v max 100 va max				
Contact Circuit Resistance	50 milliohms max.		35 milliohms max.					20 milliohms max.					
	Variation less than $\pm 2$ milliohms from initial value through $20 \times 10^9$ operations. (Independent of current or voltage)												
Nominal Operating Voltage	Up to 440 vdc (Note 1)		Up to 220 vdc				Up to 90 vdc						
Nominal Operate Time at Maximum Coil Power	As low as 3.0 ms (Note 1)		3.0 ms		1.1 ms		1.2 ms Single Side-Stable 1.0 ms Bi-Stable		1.0 ms		As low as 2.4 ms (Note 1) 1.2 ms Single Side-Stable 1.0 ms Bi-Stable (Note 1)		1.0 ms
Sensitivity	As low as 250 mw (Note 1)		35 mw Single-Side-Stable 7 mw Bi-Stable		As low as 5 mw Single-Side-Stable 2 mw Bi-Stable		115 mw Single-Side-Stable 25 mw Bi-Stable		40 mw Single-Side-Stable 20 mw Bi-Stable		As low as 550 mw (Note 1) 115 mw Single-Side-Stable 25 mw Bi-Stable (Note 1)		40 mw Single-Side-Stable 20 mw Bi-Stable

NOTE 1: Depending on number of switches



# CONTACT RELAYS

.....input analog switching,  
output power conversion  
switching, solid-state input  
and output buffering

## FOR PRINTED CIRCUIT BOARDS

CLARE Mercury-Wetted Contact Relays are available as steel-enclosed modules for mounting on printed circuit boards.

## AS PRINTED CIRCUIT BOARD ASSEMBLIES

CLARE will design and produce complete assemblies, combining mercury-wetted contact relays with other components (capacitors, resistors, diodes, etc.) mounted on printed circuit boards, supplied by CLARE or customer. Tough vinyl skin-pack available for protection against dirt, moisture, abrasives, chemicals — without added bulk.

## FOR WIRED ASSEMBLIES

CLARE Mercury-Wetted Contact Relays are available with plug-in or solder terminals, in contact multiples from one to six poles. Military-type connectors are also available.

For complete information contact your  
nearest CLARE Sales Engineer

**CALL—NEEDHAM** (Mass.): (617) 444-4200  
• **GREAT NECK, L. I.** (N. Y.): (516) 466-2100 • **SYRACUSE:** (315) 422-0347 • **PHILADELPHIA:** (215) 386-3385 • **BALTIMORE:** (202) 393-1337 • **ORLANDO:** (305) 424-9508 • **CHICAGO:** (312) 262-7700 • **MINNEAPOLIS:** (612) 920-3125 • **CLEVELAND:** (216) 221-9030 • **XENIA** (Ohio): (513) 426-5485 • **CINCINNATI:** (513) 891-3827 • **COLUMBUS** (Ohio): (614) 486-4046 • **MISSION** (Kansas): (913) 722-2441 • **DALLAS:** (214) 741-4411 • **HOUSTON:** (713) 528-3811 • **SEATTLE:** (206) 725-9700 • **SAN FRAN-**

**CISCO:** (415) 982-7932 • **VAN NUYS** (Calif.): (213) 787-2510  
**AUSTRALIA:** C. E. Electronics Pty. Ltd., Baukham Hills, N.S.W.: 639-4261...  
**Kenelec Imports Pty. Ltd.,** Mount Waverly, Victoria: 272-818 • **BELGIUM:** C. P. Clare International, N.V. Tongeren, Limbourg: 211-5726-9 • **CANADA:** C. P. Clare Canada Ltd., Toronto, Ont.: 789-4335 • **ENGLAND:** C. P. Clare International Ltd., Watford, Herts.: (WAT) 42277 • **GERMANY:** C. P. Clare Elektronik GmbH, München: (0811) 262187 • **JAPAN:** Westrex Orient, Tokyo: 211-5726-9.

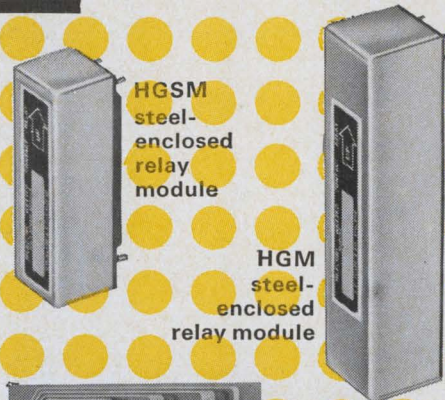

HGSM  
steel-  
enclosed  
relay  
module

HGM  
steel-  
enclosed  
relay  
module

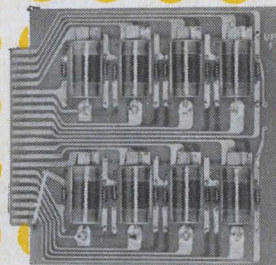

HGSY  
functional  
circuit,  
incorporating  
additional  
components  
with vinyl  
skin pack

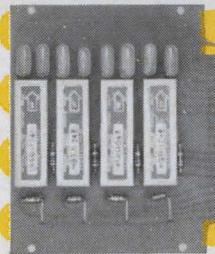

HGSW  
functional  
circuit  
incorporating  
HGSM steel-  
enclosed modules  
and additional  
components

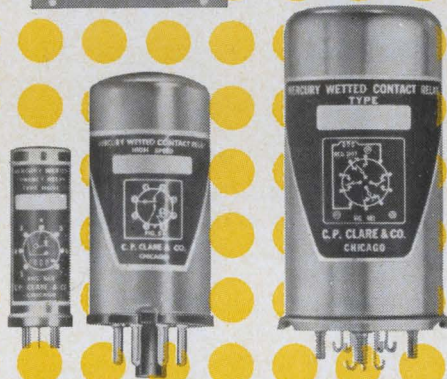

Single pole relays  
Seven-pin miniature  
(HGSL) (left). Octal  
plug (HGS) (right)

Four-pole HG4B  
relay with  
solderlug base

Write Group 05A8 C.P. CLARE & CO.  
3101 Pratt Boulevard Chicago, Illinois 60645



relays and related control components

Speed Inquiry to Advertiser via Collect Night Letter  
ON READER-SERVICE CARD CIRCLE 38



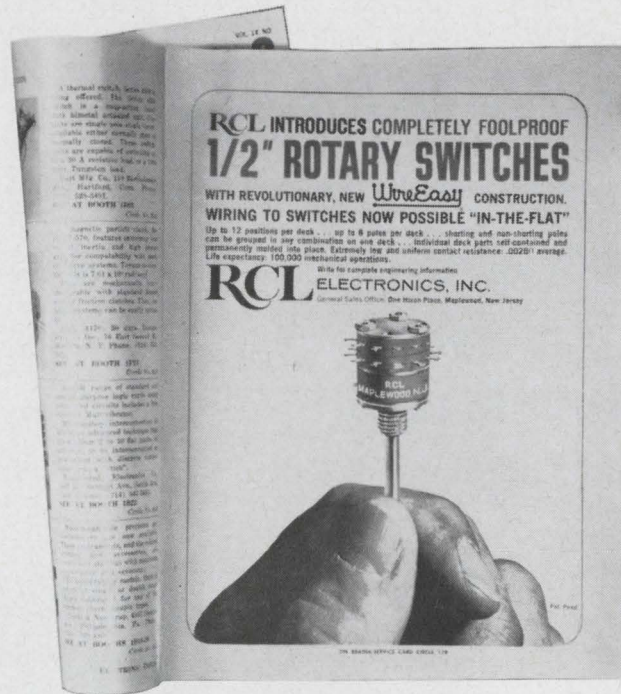

# "an unexpected bonus!"

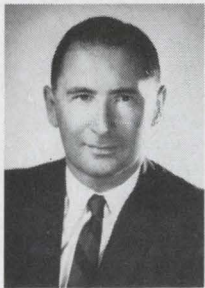

E. L. Grayson  
President  
RCL ELECTRONICS, INC.

*telephone calls brought additional purchase orders for RCL's 1/2" rotary switch*

**E. L. Grayson, President of RCL Electronics, Inc., believes that complete information, sufficient for ordering, is one of the secrets of ad success. He writes:**

"I would like to tell you a little about the response to our full page advertisement in the November 22nd issue of *Electronic Design*.

"We had previously decided that *Electronic Design* would carry our initial product announcement exclusively on our miniature rotary switch. The reason for this was due to prior excellent results on our precision wire wound resistor line.

"This initial announcement has produced over 190 inquiries through the use of the Reader Service Cards. In addition to this was an unexpected bonus in the form of telephone calls from interested users all over the United States. These phone calls, which started two to three days after the ad appeared, actually resulted in the placement of purchase orders at the time of the telephone call.

"In addition to the prototype orders, a number of production orders have been generated, which in itself is quite surprising due to the short time cycle. Apparently the advertisement reached people who had a real need and immediate application for this item.

"The features which were stressed in the ad, such as, 'up to 12 positions per pole' and 'as many as 6 poles per deck' in this extremely small 1/2" size switch, created interest and produced results to a point where we are convinced that our choice of *Electronic Design* was a good one.

"The advertisement contained sufficient information for immediate ordering without even the normal follow-on request for catalogs and further technical information."

**If you have a case history of interest to *Electronic Design's* engineering management readers, please let us know. We'll pass it along in this ad series.**

**Electronic Design**  
SERVES BY COMMUNICATING





**Good blade.  
Good razor.  
Bad shave.**

Interface problems are just as injurious in magnetron/modulator applications too.

That's why Litton has come up with a new solution to interface incompatibility. We've developed compact, lightweight magnetron/magnetic modulator packages that are rugged, reliable, and highly efficient.

Take the Ku-band, 10 KW package shown here—the Model 466 Modulator and L-3958 Magnetron. Volume is only 70 cubic inches. Power requirements are only 40 watts at 1.5 microsecond pulse length and 800 pulses per second. Other packages are available from 1 to 250 KW, from C through the Ku-band.

Litton's compatible packages, including TWT/power supplies and magnetron/magnetic modulators, are already finding universal acceptance as readily available, easy to use microwave power sources for laboratory or military systems. Maybe they can help you find painless solutions to your interface problems.

Contact Electron Tube Division, 960 Industrial Road, San Carlos, California, (415) 591-8411.

**LITTON INDUSTRIES**   
**ELECTRON TUBE DIVISION**

San Carlos, Calif./Williamsport, Penn.  
Canada: 25 Cityview Drive, Rexdale, Ont.  
Europe: Box 110, Zurich 50, Switzerland

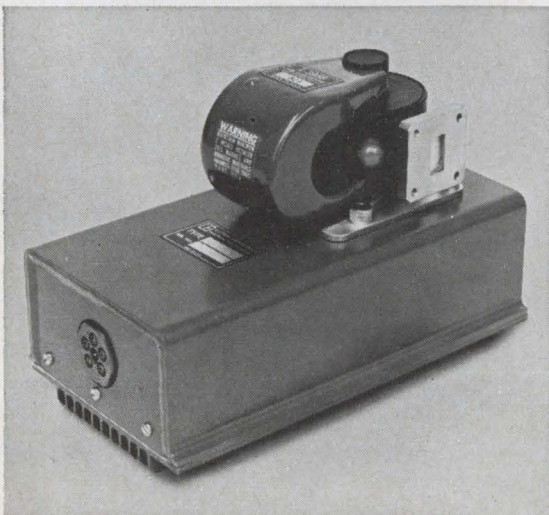



## Pressure transducers

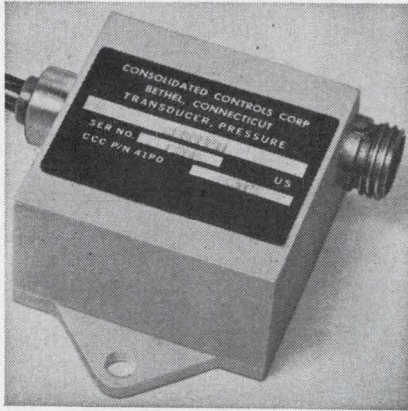

A series of 5-oz hermetically sealed pressure transducers consumes less than 7mA. Series 41PD67 transducers measure absolute, gauge or differential pressures in ranges from 0 to 1.5 psi to 0 to 5,000 psi. Output voltage is 0 to 5 Vdc and output impedance is less than 100  $\Omega$ . The units will perform under conditions of 40-G vibration and 50-G shock.

Consolidated Controls Corp., 40 Durant Ave., Bethel, Conn. Phone: (203) 743-6721.

Circle No. 305

## Metal film resistor

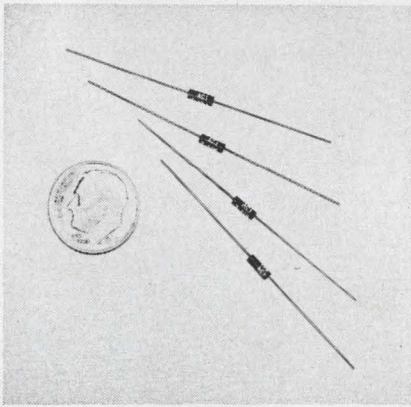

The MRE-1/8 is a molded micro-miniature metal film resistor rated at 250 V and 0.125 W at 100°C. Resistance values range from 10  $\Omega$  to 110 k $\Omega$ . Tolerances available are  $\pm 1$ , 1.5, 2 and 5% and temperature coefficients are  $\pm 150$ , 100, 50 and 25 ppm/ $^{\circ}$ C. Leads are tinned copper, gold-flashed dumet or bare nickel.

P&A: \$0.70 to \$3.63; stock to 6 wks. American Components, Inc., 8th Ave. at Harry St., Conshohocken, Pa. Phone: (215) 828-6240.

Circle No. 306

## Noise generators

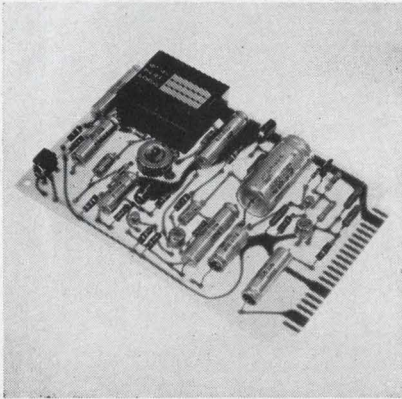

Plug-in, fixed-frequency Gaussian noise generator cards cover 5 Hz to 500 kHz. Output flatness is typically  $\pm 1/2$  dB to  $\pm 3$  dB. Both high and low frequency roll-off are variable with standard ranges of 5 Hz to 20 kHz, 5 Hz to 50 kHz, 5 Hz to 100 kHz, 5 Hz to 200 kHz, and 5 Hz to 500 kHz. The cards accept a standard 22-pin connector.

P&A: \$144 to \$389; stock to 30 days. Elgenco Inc., 1550 Euclid St., Santa Monica, Calif. Phone: (213) 451-1635.

Circle No. 307

## Oscillator control

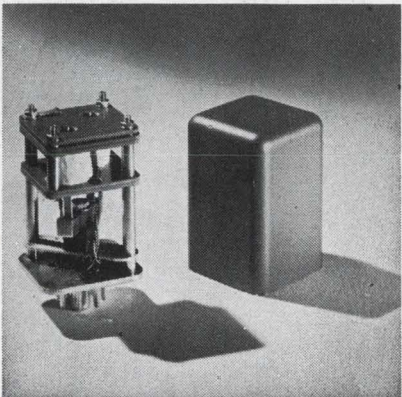

The RE2 twin-tine oscillator stabilizer and bandpass filter has two independent resonant reeds coupled to separate coil and biasing magnet assemblies. The octal-base plug-in unit operates on a continuous basis without degradation to output or frequency stability. Frequency range is 67 to 1600 Hz with accuracy to 0.15%.

P&A: \$26.50 (1 to 9); stock to 4 wks. Ledex Inc., College & South Sts., Piqua, Ohio. Phone: (513) 773-8271.

Circle No. 308

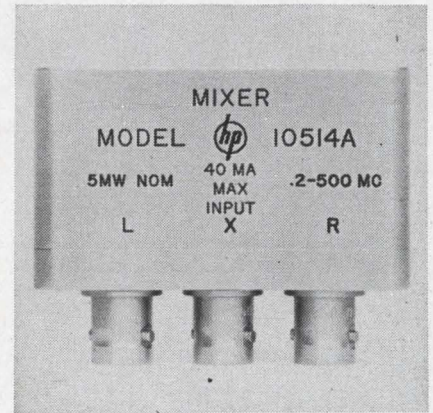

## Mixer

Model 10514 double-balanced mixer has a typical 6-dB conversion loss and 7-dB noise figure when mixing input signals ranging from 200 kHz to 500 MHz. The de-coupled output delivers signals from dc to 500 MHz. Operating levels range to 40 mA in the isolated input ports and to 20 mA in the output port. The mixer may be used for phase or frequency stability measurements, or as a phase detector, current-controlled attenuator or balanced modulator.

P&A: \$250; stock to 10 wks. Hewlett-Packard, 1501 Page Mill Rd., Palo Alto, Calif. Phone: (415) 326-7000.

Circle No. 309

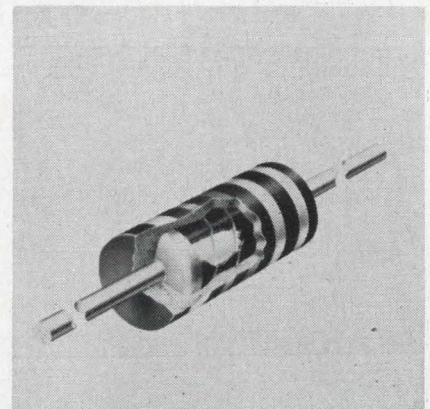

## Metal glaze resistor

A metal glaze resistor, RG07, is rated at 0.25 W at 70°C. It is available in EIA resistance values over a 51- $\Omega$  to 150-k $\Omega$  range, with  $\pm 2$ % and  $\pm 5$ % tolerances. The resistor meets or exceeds MIL-R-22684.

P&A: \$89/thousand in 5,000 lots; stock to 3 wks. IRC, Inc., 401 N. Broad St., Philadelphia. Phone: (215) 922-8900.

Circle No. 310



# Why is this \$5 NIXIE<sup>®</sup> tube better than anyone else's readout?

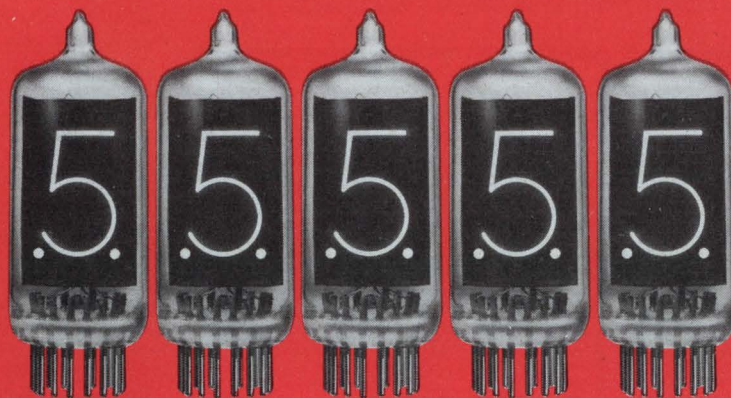

## it packages better!

Lowest cost of any electronic readout is only *part* of the story of our Type B-5440 NIXIE tubes.

Another part of the story is how well they package.

Like their size. Overall tube width is 0.75" maximum. You can line them up with less than 0.80" center-to-center spacing. This means you can get 10 digits in a panel 8 inches wide.

The seated height of the B-5440 is a mere 1.8" maximum. Yet, you get a full-size 0.6" character readable at 30 feet.

The tube stem has been especially designed to permit the use of printed-circuit boards with maximum line width

and spacing. This reduces pc-board costs.

And finally there's a socket assembly we've designed that not only allows flush-mounting with the front of the instrument panel, but also is compatible with the latest printed-circuit board techniques. Result: up-front viewing, reduced assembly cost, best packaging density.

For a slight additional cost, you can have independently operable decimal points positioned left and right, as shown above (Type B-5441).

Price of the B-5440? Oh, yes. *Under \$5 in 1000 quantities.* Compact price for a compact package.

Use the reply card, or call us for full information.

*Only Burroughs manufactures NIXIE Tubes*



**Burroughs Corporation**

ELECTRONIC COMPONENTS DIVISION

PLAINFIELD, NEW JERSEY 07061





**LOOK TO THE LEADER**  
IN INTEGRATED CIRCUITS

# New TTL complex-function for lower-cost,

Your equipment designs can now take advantage of the latest integrated-circuit technology with TI's new TTL complex functions. These units include more than ten circuit functions interconnected on a single silicon bar.

These new complex circuits make possible reductions of 50 percent or more in parts alone, with one package now doing jobs formerly requiring five to nine standard TTL integrated-circuit packages. Additional savings are realized through simplified board layout and reduced handling and assembly.

The new complex functions are the initial units of a family now being designed which complements and expands TI's standard Series 54 TTL logic line. The full benefits of Series 54 performance are retained, along with improvements in speed and power drain. Most of the new complex functions are available both in military (Series 54) and industrial (Series 74) versions.

## SN5491/SN7491 8-bit Shift Register

This high-speed 8-bit serial shift register replaces nine standard TTL units. Power dissipation at 190 mW is one-third that of the equivalent nine packages. Shift frequency is 15 MHz, two orders of magnitude faster than comparable MOS circuits. The 60 by 130-mil silicon bar uses 144 component elements to perform 11 circuit functions, including eight flip-flops, input gating, and a clock buffer.

The serial-in/serial-out shift register requires only one signal input, since an inverter is included internally. The SN5491 can also be used for delay-line applications.

## SN5480/SN7480 Gated Full Adder

The SN5480 is a single-bit, high-speed, binary full adder with gated complementary inputs, complementary sum outputs, and inverted carry output. The adder is designed for medium-to-high-speed, multiple-bit, parallel-add/serial-carry applications, and is compatible with both TTL and DTL circuits. The need for extensive "look-ahead" and "carry-cascading" circuitry has been eliminated. Performance is substantially better than can be attained with five standard TTL integrated circuits connected to perform comparable full-adder functions. Speed (70-nsec add time, 8-nsec carry time) is about 35 percent faster, and power dissipation (105 mW) is 20 percent lower. Price of the SN5480 is less than half that of the equivalent five multi-function packages, with additional savings in circuit boards, assembly, and inventory.

## SN7490 BCD Decade Counter

The SN7490 is a decade counter with binary-coded decimal output. It can be used as a divide-by-five circuit, a divide-by-two circuit, or a divide-by-ten circuit with symmetrical square-wave output. This flexibility is achieved by external connection of the leads. The counter

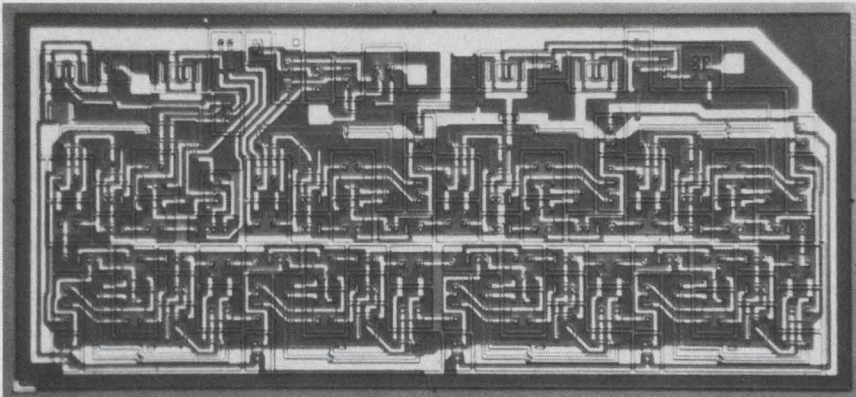

Figure 1. 8-bit shift register uses 144 component elements to perform 11 circuit functions.

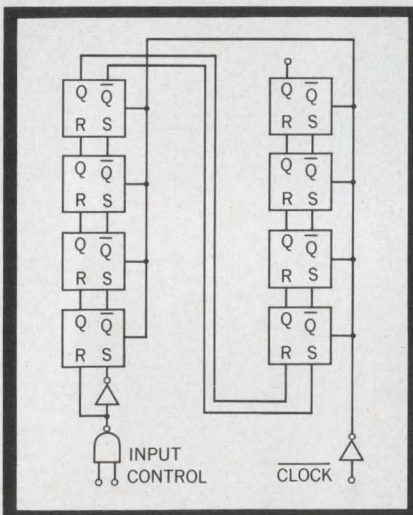

Figure 2. Shift frequency of 8-bit shift register is 15MHz, an order of magnitude faster than comparable MOS circuits.

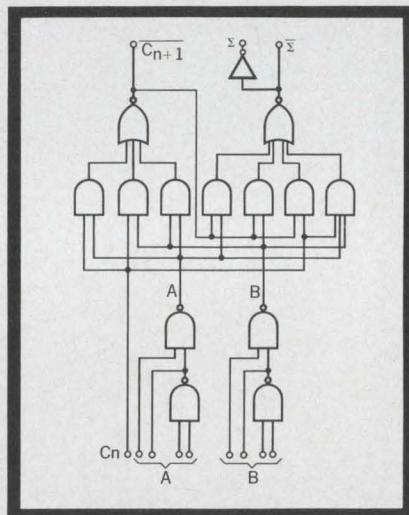

Figure 3. Gated Full Adder eliminates need for extensive "look-ahead" and "carry-cascading" circuitry, greatly improving performance.



# integrated circuits from TI better-performing systems

can be reset to zero or a BCD count of nine. Count frequency is 12 MHz, and power dissipation is 150 mW. In addition to counters, applications include frequency synthesizers and digital test and readout equipment. Versions of this unit which will divide by 12 and 16 will be available soon.

## New Multi-function Circuits Also Available

In addition to the new circuits with "third generation" complexity, TI also has expanded the family of standard Series 54 TTL multi-function circuits to 13. These multi-function units incorporate up to four circuit functions, with all inputs and outputs brought outside the package.

**SN5453 - Quadruple 2-input AND/OR/INVERT Gate.** This unit performs the OR function internally. It is expandable to 24 inputs using the SN5460 expander. Propagation delay is 30 nsec, power dissipation is 40 mW, and fan-out is 10.

**SN5472 Master/Slave Flip-flop.** This circuit features two 3-input AND gates at the J and K inputs. It has reset capability independent of the clock state. Propagation delay is 30 nsec, power dissipation is 40 mW, and fan-out is 10.

**SN5473 Dual Master/Slave Flip-flop.** This is a dual version of the SN5472. When supplied in the 16-pin plug-in package, separate inputs are provided for preset, clear, and clock lines for each flip-flop. Power dissipation is 40 mW per flip-flop.

**SN5474 Dual Latch.** The unit consists of two single-input master/slave flip-flops with set and reset. The gated latches are clock-controlled. Propagation delay is 30 nsec, power dissipation is 40 mW per latch, and fan-out is 10.

## New Molded Package Gives You Broad Selection

Most of the 130 standard TI integrated circuit types are now available in a variety of packages. The newest addition is a molded package with 14 plug-in pins on 100-mil centers, with the rows spaced 300 mils apart. The new package is designed for economical high-speed assembly and testing, with an index notch for automatic insertion. The solid, molded construction provides maximum protection against shock and vibration. Reliability of the transfer-molding technique and the encapsulating material has been proved by TI's production of millions of SILECT™ transistors over the past two years.

## Design Trends Toward TTL

TI's new complex-function and multi-function units emphasize the current design trend toward TTL for high-speed saturated logic. For an optimum combination of high performance and low cost, specify TI Series 54 TTL integrated circuits.

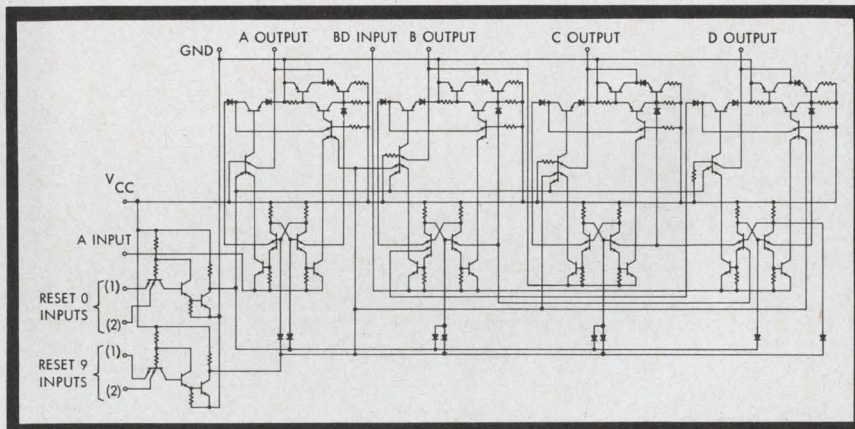

Figure 4. BCD decade counter can also be applied as divide-by-five, -two or -ten circuit.

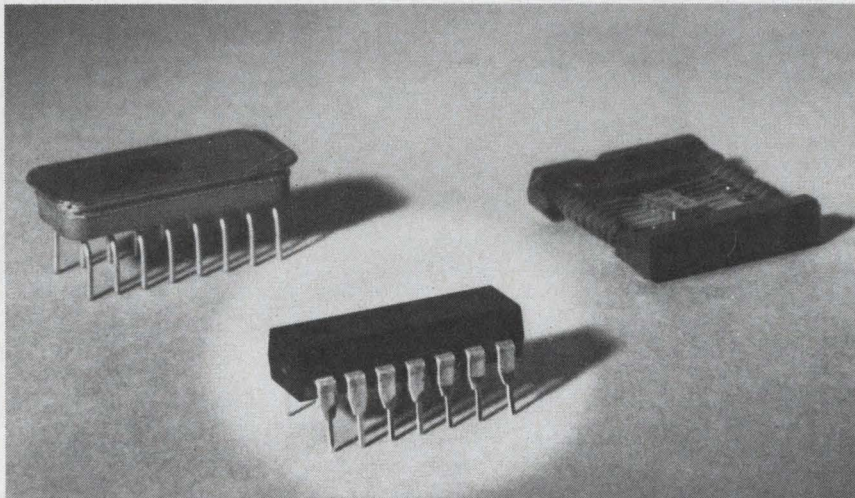

Figure 5. New package with solid molded construction is TI's newest addition to a full line of packages for every integrated-circuit application.



**TEXAS INSTRUMENTS**  
INCORPORATED  
13500 N. CENTRAL EXPRESSWAY  
P. O. BOX 5012 • DALLAS 22, TEXAS



# Think of a number between 1 and 6,000.

That's how many lines per minute the MC 4000 can print.



Monroe Datalog<sup>®</sup>'s MC 4000 ultra high speed optical printer records 6000 lines per minute, or any speed less that your application requires. Truly synchronous or asynchronous. Completely silent. Absolutely reliable—only two moving parts. Available in numeric or alphanumeric models—both 32 columns wide. Any 4 or 6 line code with any logic level.

Features: character serial input, bit parallel. 6 microseconds per character data transfer time. Exceptional compactness— $10\frac{1}{2}''$  x  $10\frac{3}{4}''$  x  $21\frac{1}{2}''$ . All

solid state. Cathode ray tube with fiber optics.

Permanent copy option available. And a full year's warranty. Price: \$5650 for numeric model; \$5850 for alphanumeric model.

For information, contact Monroe Datalog Division of Litton Industries, 343 Sansome St., San Francisco 94104. (415) 397-2813.

**MONROE DATALOG**   
DIVISION OF LITTON INDUSTRIES

ON READER-SERVICE CARD CIRCLE 40



# Militarized versions of MC 4000 also available.

The Monroe DATALOG MC 4000 is available in any configuration or to any military specifications that your application requires.

For further information, call the Monroe DATALOG Division of Litton Industries, 343 Sansome St., San Francisco 94104. (415) 397-2813.

**MONROE DATALOG**   
DIVISION OF LITTON INDUSTRIES

ON READER-SERVICE CARD CIRCLE 41

May 24, 1966

## MICROWAVES

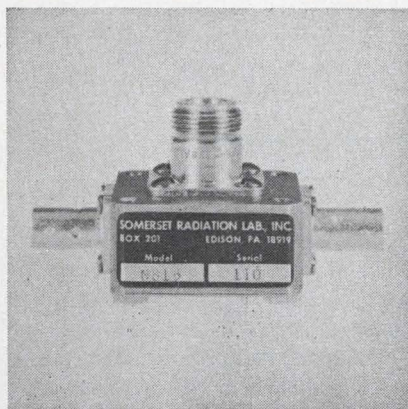

### Diode multiplier

Model N815 step-recovery diode multiplier has a 4-octave output range of 0.75 to 12.0 GHz and dissipates 400 mW max. Power in the 50 to 2,000 MHz range at the input BNC receptacle is fed to the diode where multiplication results in an harmonic frequency of 2 to 240 times the excitation frequency. Output of at least -20 dBm is available at a type N connector. For connecting a self-biasing resistor, a separate BNC is provided.

P&A: \$110, stock to 10 days. Somerset Radiation Labs., P. O. Box 201, Edison, Pa. Phone: (215) 348-8883.

Circle No. 311

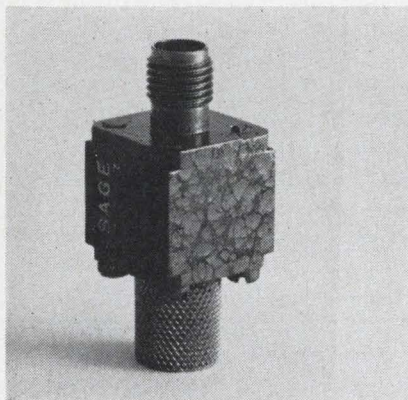

### Coax attenuators

Four miniature "Copad" coaxial attenuators cover dc to 12 GHz and use male and female 1/4-36 miniature connectors. The four models provide attenuation values of 3, 6, 10 and 20 dB. Vswr is less than 1.3 and power rating is 1 W. Male-male and female-female connectors are available.

P&A: \$35, stock. Sage Laboratories, Inc., 3 Huron, E. Natick Industrial Park, Natick, Mass. Phone: (617) 653-0844.

Circle No. 312

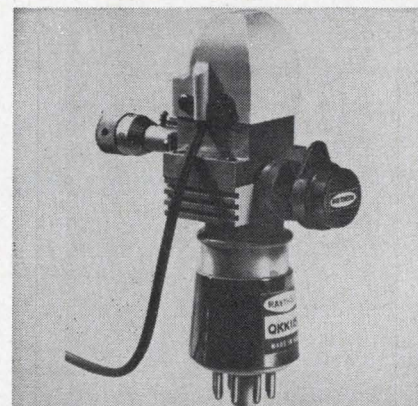

### Reflex klystrons

Millimeter-region reflex klystrons are offered at any specific frequency from 50 to 101 GHz. The fixed-frequency tubes are trimmable by  $\pm 1.0$  GHz. Average power outputs range from 50 to 300 mW. The single-mode klystrons are warranted for one year or 500 hours.

Raytheon Co., Microwave and Power Tube Div., Willow St., Waltham, Mass. Phone: (617) 862-6600.

Circle No. 313

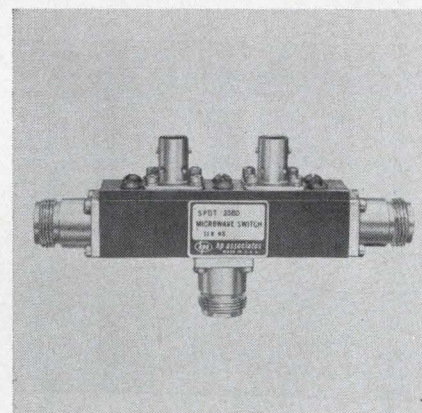

### Coax switch

The hpa-3580 spdt coaxial microwave switch consists of a series of fast switching diodes integrated into a 50- $\Omega$  coaxial microwave structure. Filtering, bypassing and blocking elements are also integral. Over the 4- to 8-GHz operating band, max insertion loss ranges from 1.6 to 2.5 dB and min isolation from 70 to 90 dB. Switching from insertion loss to full isolation is accomplished in 10 ns and from full isolation to insertion loss in 20 ns. Vswr with the switch on is 2.0 max. The unit handles 2 W cw at 25°C.

P&A: \$495 (1 to 9); stock to 6 wks. hp associates, 620 Page Mill Rd., Palo Alto, Calif. Phone: (415) 321-8510.

Circle No. 314



# Transistor classification system accepts, rejects and sorts

It is now possible to classify and sort p- and n-channel junction transistors and MOS FETs into eight categories with established priorities. The CS-12 classification system expands the go-no go capabilities of the manufacturer's "MONITOR II" FET/transistor test set by sampling its analog output and comparing it with a set of pre-programmed test limits. Under separate program control, these limits are grouped in max-min pairs to define classes. Devices may also be sorted into any one of the class categories according to pre-programmed priorities. Typical test rates are 800 to 1500 devices/hour. For a full set of 8 classifications, devices are handled only once.

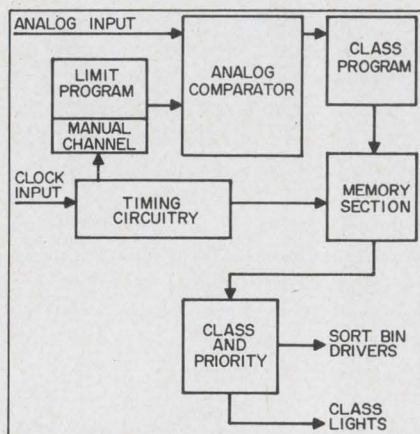
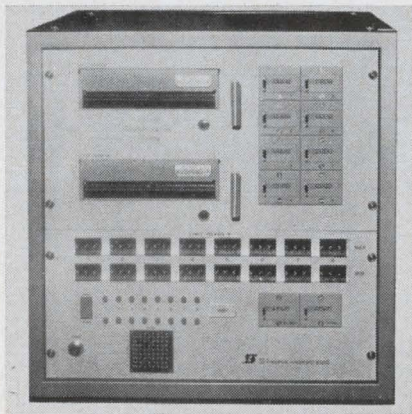

**Major components** are functional interface between test set and optional sorter and data log.

A front-panel pinboard establishes sort priorities if a device satisfies more than one programed class. A switch on the front panel permits selection of either class or sort lights for visual indication.

The basic system is supplied with three limit comparator units each containing 2 comparators. Additional units are available to increase capability to a maximum of eight classes. Seven classes are automatically programed by punched cards while the eighth is independently programed by digit switches.

Operational amplifiers compare the input signal with a given limit. Each amplifier has two outputs; one "true" for a signal greater than the comparator level, indicating a minimum limit, and the other "true" for the "lesser than" condition, indicating a maximum limit.

A punched card reader programs the limits into the comparator. A separate reader determines which of the comparator maximum and minimum outputs apply to each class. Both read a standard 12 x 80 card. A series of memory devices stores the class information and determines which classes can be satisfied by each of the eight test input signals.

Use of the IBM-type punched cards enables off-line preparation of class and limit programs. Thus, a library of standard programs may be built and set-up and changeover time held to less than 1 minute.

In the class and priority section, AND gates are used to determine those classes that have been satisfied by the test inputs and establish priority on overlapping classes. Eight 4-digit counters automatically register class or sort decisions. Two additional 4-digit counters register total devices tested and total rejected.

A data log and 16-bin rotary sorter are available.

P&A: \$12,950; 90 days. Siliconix, Inc., 1140 W. Evelyn Ave., Sunnyvale, Calif. Phone: (408) 245-1000.

Circle No. 315

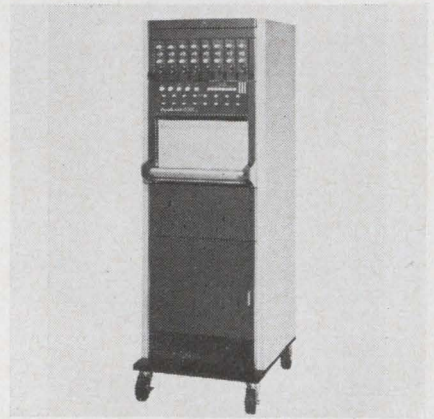

## Write/record system

DG 5510 is an 8-channel thermal writing recording system consisting of a recorder and 8 preamps. The recorder has integral driver amplifiers and power supply. Three plug-in preamps are available: attenuator, medium gain and medium low gain. Sensitivity is 25 mV to 500 V full scale and linearity is 1%. Frequency response is dc to 150 Hz and calibrated zero suppression is  $\pm 100$  V max.

P&A: about \$5,000; 90 days. Consolidated Electrodynamics, 360 Sierra Madre Villa, Pasadena, Calif. Phone: (213) 796-9381.

Circle No. 316

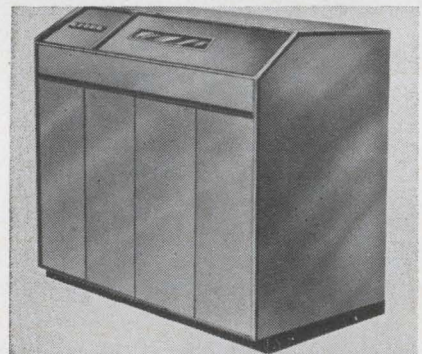

## High-speed printer

A high-speed line printer, model 400, has reduced RFI through solenoid and firing circuit design and short lead lengths. Speeds are up to 1200 lines/minute (alphanumerics) and up to 2400 lines/minute (numerics only). Column capacity is from 1 to 200 characters/print line. Operation is synchronous or asynchronous with any input of up to 6 binary digits.

Shepard Labs., Inc., 430 Morris Ave., Summit, N. J. Phone: (201) 273-5255.

Circle No. 317





**Hung up by overdue relay shipments?  
Next time call Leach!**

There won't be any hold up on Leach shipments. We've built up our materials inventory at the plant and finished units at our distributors in order to give you one week delivery on most items. Even our newest—the SERIES J!

This subminiature 10 amp, 2PDT unit to Mil-R-6106E provides the high shock and vibration resistance required for aerospace applications. Special design features guard against rupture and overloads, while the all-welded construction contributes to superior operat-

ing characteristics like 100g shock, 30g, 70 to 3000 cps vibration, 10 milliseconds operate and release time. All in a compact, 1.4 ounce package, measuring only 1.000" x .515" x 1.015". Need one? A dozen, a hundred? Even a thousand? Then call us today. You'll have them right on time.

Leach Corporation, Relay Division, 5915 Avalon Boulevard, Los Angeles, California 90003

Phone (Area code 213) 232-8221

Export: LEACH INTERNATIONAL S.A.

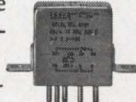

**LEACH**



# Check out P&B as a big new source for precision snap-action switches

## with this 28-page catalog



This catalog shows a wide variety of precision snap-action switches including general purpose, miniature, subminiature and appliance. Most are directly interchangeable with many competitive types. All meet U/L and CSA requirements and are available with

a wide choice of actuators, contact arrangements and terminals. Mounting dimensions and materials meet military specifications. The designs lend themselves to almost limitless modification for adaptation to individual requirements. Send for your copy.

### PRECISION GENERAL PURPOSE SWITCHES

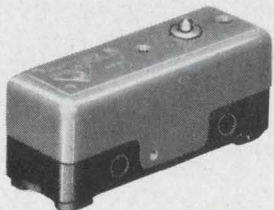

Accurate performance and high repeatability for heavy load application. Available with 15 and 20 ampere ratings with a broad variety of actuators.

### PRECISION MINIATURE SWITCHES

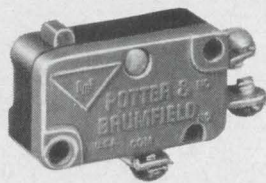

These high speed snap-action switches are highly sensitive and feature small size long operating life and high electrical capacity. Available with various contact and terminal arrangements.

### PRECISION SUBMINIATURE SWITCHES

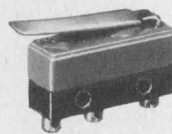

Designed for applications requiring small size and low operating force. Suitable for electronic equipment, business machines and other precision equipment.

### LOW COST NYLON-ENCASED APPLIANCE SWITCHES

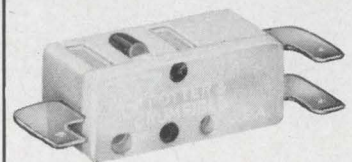

Sturdy mechanical construction capable of withstanding considerable impact at full overtravel thus reducing positioning adjustment.



## POTTER & BRUMFIELD

Division of American Machine & Foundry Company, Princeton, Indiana  
Export: AMF International, 261 Madison Avenue, New York, N. Y.

P&B Precision Switches are available at Authorized Distributors

Speed Inquiry to Advertiser via Collect Night Letter  
ON READER-SERVICE CARD CIRCLE 42



Before specifying these components...

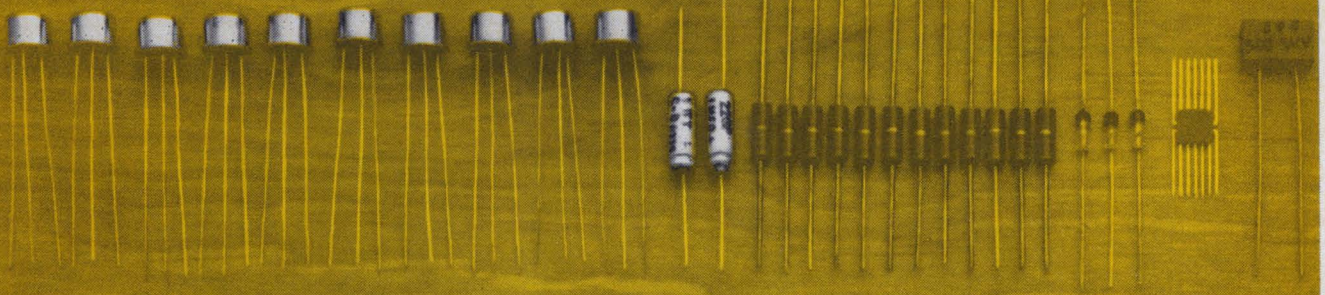

in your circuit, consider...

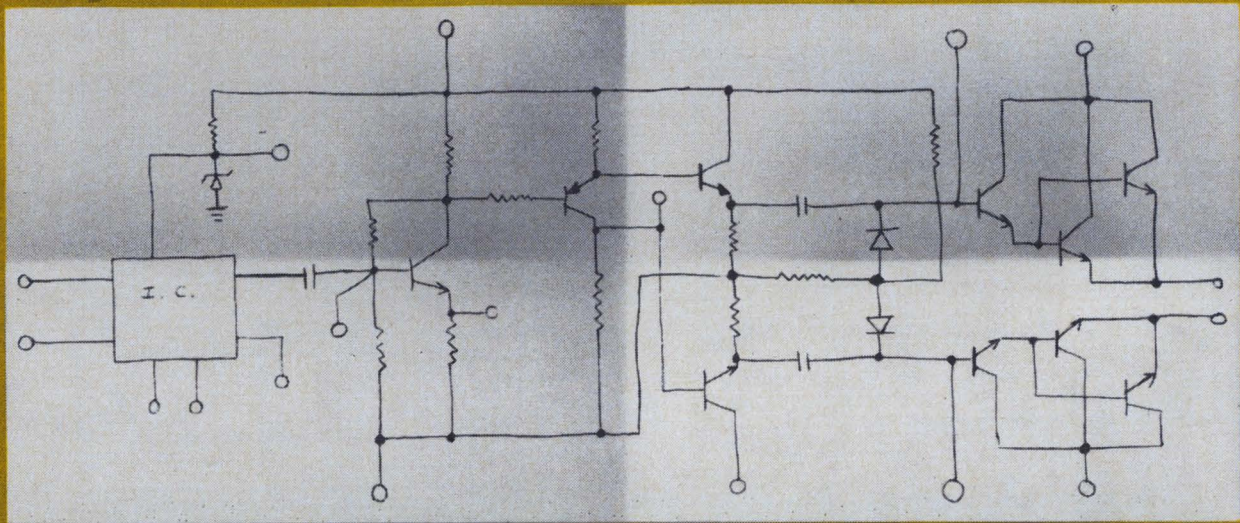

**Hamilton Standard  
could give you the function...**

**...in this microelectronic package.**



The Hamilton Standard advanced microelectronic packaging technology permits interconnecting and intermixing monolithic integrated circuits, transistors, diodes, thin film, thick film and discrete components.

It facilitates the use of matched transistors and often solves tight TCR tracking requirements.

• **Reliability is enhanced** through the

use of welded interconnections and a welded hermetically sealed package.

• **Weight and volume of circuit are reduced.**

• **Design, component testing, and system assembly are simplified** through use of this functional package. It has axial leads for soldering, welding, or plug-in to a connector.

Whether your circuit is analog or

digital, integrated or hybrid, you can probably benefit and profit from the use of this advanced packaging technology.

Talk it over with our experienced design team by contacting our Marketing Manager at the Electronics Department, Hamilton Standard, Broad Brook, Connecticut 06016, or call 203/623-1621, Ext. 6106.

**Hamilton Standard** DIVISION OF UNITED AIRCRAFT CORPORATION

**U  
A**

ELECTRONICS • ATTITUDE CONTROLS • STABILIZATION SYSTEMS • ENVIRONMENTAL CONTROLS • FUEL AND AIR INDUCTION CONTROLS  
ELECTRON BEAM MACHINES • PROPELLERS • STARTERS • TURBOMACHINERY • GROUND SUPPORT EQUIPMENT • OVERHAUL AND REPAIR

ON READER-SERVICE CARD CIRCLE 43





***no sleight-of-hand here!***  
***you leave nothing to chance with Uni-Sel***

Unisel—the newest development in selenium rectifiers—a high density selenium cell, superior to all other types—is found where manufacturers are troubled with high temperature, high voltage conditions. Nothing is left to chance! The product of an extensive research and development program coupled with the industry's most complete selenium facility—this entirely new type of selenium cell has current carrying capability that makes possible reduction in cell size never before achieved.

Available in all cell sizes with voltage ratings as high as 45 volts.

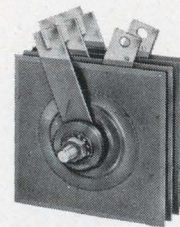

**SYNTRON**

**SYNTRON COMPANY**  
283 LEXINGTON AVENUE • HOMER CITY, PA.

66R19



## SYSTEMS

### Punched tape reader

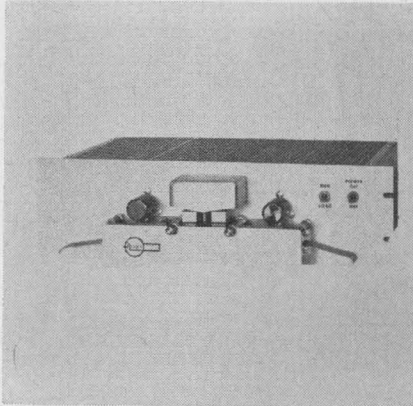

An integrated circuit, bi-directional photocell punched tape reader is available in speeds to 1000 characters/s. All micrologic components are contained on 2 PC boards. The unit has automatic compensation in real time for all ranges of tape transparency, regardless of color. A self-cleaning quartz lamp has a 15,000-hour life expectancy.

P&A: \$2,695; August. Remex Electronics, 5250 W. El Segundo Blvd., Hawthorne, Calif. Phone: (213) 772-5321.

*Circle No. 318*

### Load cycle tester

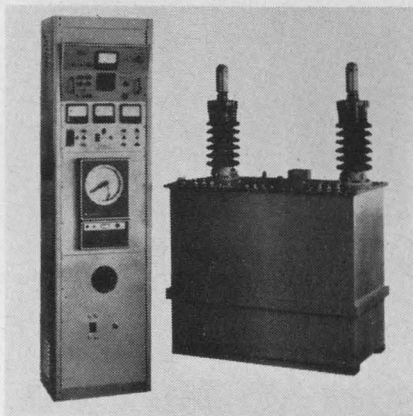

A load-cycle, high-potential test set for power cables holds sheath temperature constant indefinitely and performs corona and dielectric tests simultaneously. The system consists of a 0- to 75-kV rms corona-free dielectric tester, separation filter, corona detector, pC calibrating system, 1200-A low-voltage conductor heating supply and 7-day chart recorder.

P&A: \$12,000, 4 months. Hipotronics, Inc., P. O. Box 1, Brewster, N. Y. Phone: (914) 225-4075.

*Circle No. 319*

### Laser range finder

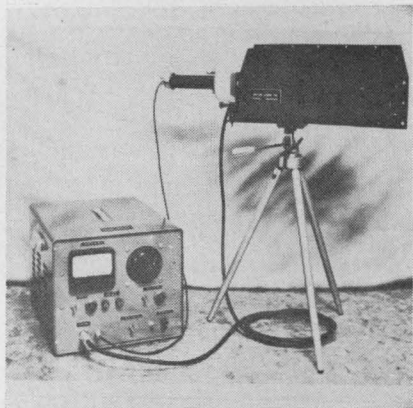

A laser range finder with a neodymium doped glass and a lithium metaniobate crystal has a 500-kW pulse output in 40 ns. The temperature-controlled crystal generates a second harmonic of 5300 Å from the glass rod. The system is capable of transmitting and receiving a signal of up to 20 kilometers. Power supply is dependent on rep rate and output power desired.

P&A: \$11,000. Applied Lasers, Inc., 72 Maple St., Stoneham, Mass. Phone: (617) 438-0790.

*Circle No. 320*

### Data scanner

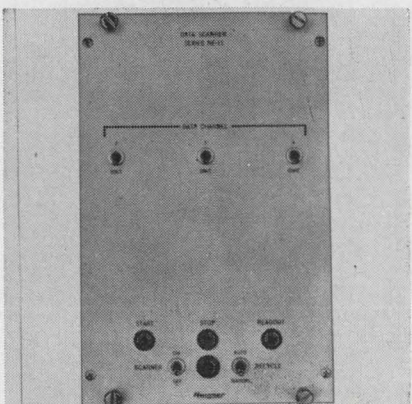

Model NE-11 scanner converts scaler or timer inputs directly into computer-compatible format. The matrix scanner uses shift registers to drive the X and Y coordinates of an 8 x 4 electronic crossbar. Model NE-11A converts 1-2-4-8 parallel BCD into printed output punched tape while NE-11B converts the same input into eight level odd parity punched tape.

Hamner Electronics Co., P.O. Box 531, Princeton, N. J. Phone: (609) 737-3400.

*Circle No. 321*

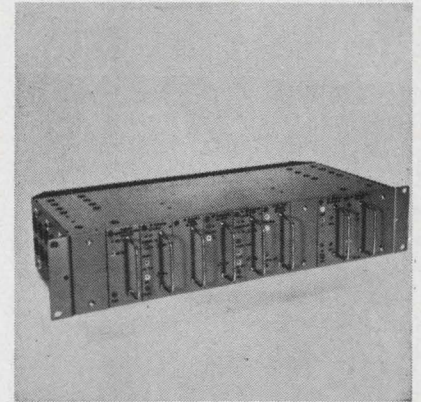

### Data channel

The model 2056 data channel is capable of full and half duplex circuit operation and will interface with most data communication equipment. The nonsynchronous channel is capable of up to 2,000 bit speed operation in a voice band. Channels with various carrier frequencies and bandwidths are available. Silicon transistors and tantalum capacitors contribute to a predicted MTBF of 50,000 hours.

Radio Frequency Labs., Inc., Powerville, Boonton, N. J. Phone: (201) 334-3100.

*Circle No. 322*

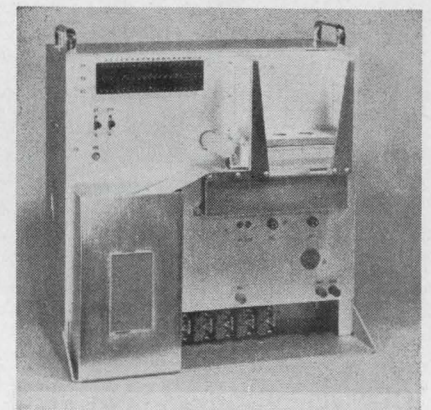

### Punched card reader

Model PD 260 reads 80-column IBM cards with automatic or manual advance and translates to a voice readout. The audio readout may be switched from an internal loudspeaker to a headset. The basic unit reads 20 bits per card and can be expanded. Switches select information to be read from each card and program pauses into the readout. Front panel or remote switching accomplishes start and repeat/read.

P&A: \$4,500; 8 wks. Automation Dynamics, Industrial Pkwy., Northvale, N. J. Phone: (201) 768-9200.

*Circle No. 323*



## SYSTEMS

### Antenna switch matrix

A motorized antenna switching matrix connects any number of transmitters and antennas. Model SLS-1M enables remote control switching. Motor-driven lineal actuators accomplish switching within the matrix. Each switch handles 50 kW average at 0 to 30 MHz. Peak power rating is 200 kW. Characteristic impedance is 50  $\Omega$  with a max vswr of 1.15. Cross-channel

isolation is 65 dB min. An interlock system prevents feeding of one transmitter into another or two transmitters into one antenna. Switch mechanism is a plunger type and the matrix contains no vacuum components.

Delta Electronics, Inc., 4206 Wheeler Ave., Alexandria, Va. Phone: (703) 836-3133.

Circle No. 324

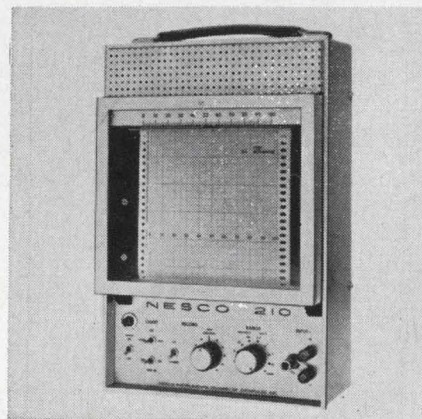

### Chart recorder

Recorded chart paper may be pulled out for review and then re-rolled automatically in the model 210 strip chart recorder. The unit utilizes a transistorized amplifier. Sensitivity is 1 mV to 10 V full span in 9 ranges, accuracy is  $\pm 0.5\%$  and full span response is 0.5 s. Chart width is 5 in. and zero-position is panel-controlled.

P&A: \$670; stock to 4 wks. Nesco Instr. Div of Datapulse, Inc., 509 Hindry Ave., Inglewood, Calif. Phone: (213) 671-4334.

Circle No. 325

## RFI/EMI FILTERS

### FOR COMMUNICATIONS AND DATA LINES

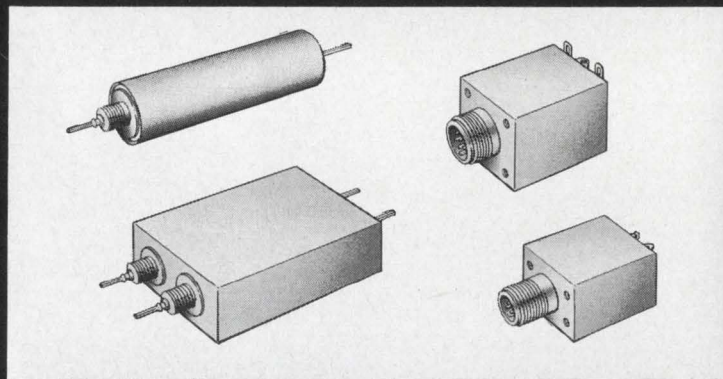

Reliability is the key word in literally thousands of filters currently in use on telephone, teletype, digital and audio transmission lines. ■ Your requirements for custom filter designs as well as standard products, can be met by Potter's extensive engineering capability and high performance criteria.

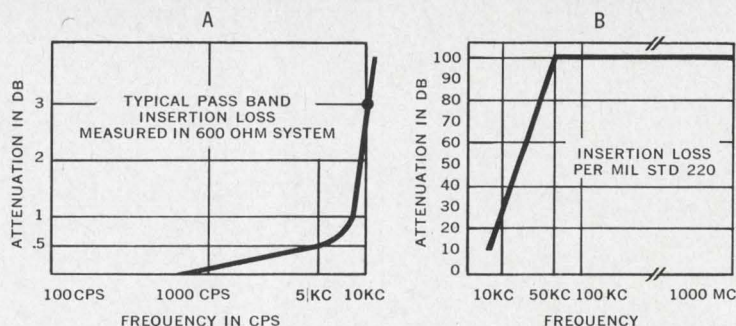

Graphs A and B show typical characteristics of Potter signal line filters. These filters are used on systems which must meet Defense Communications Agency criteria and provide maximum attenuation above the pass band with less than  $\frac{1}{2}$  db attenuation in the pass band. ■ Write for further information on these and other Potter filters.

## THE POTTER COMPANY

Pioneering in Imagination Since 1925

7351 North Lawndale Avenue ■ Skokie, Illinois

ON READER-SERVICE CARD CIRCLE 45

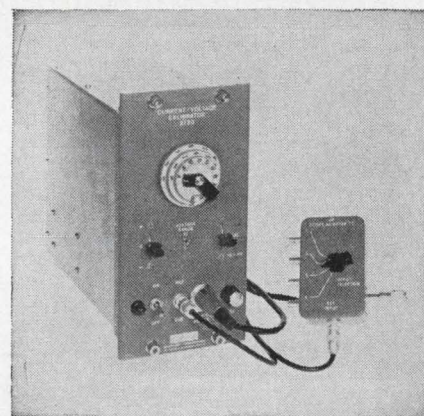

### Calibrator

Type 2720 current/voltage calibrator is used with a display scope to compare internally generated reference levels with test waveforms passed through a computer core memory plane or stack. A zener-regulated supply and resistive dividers supply 1- and 10-V reference levels. Amplitudes are controlled by a decade pot with 0.01% linearity. Commutation between the test and reference sources is provided by two mercury-wetted relay choppers.

Digital Equipment Corp., 146 Main St., Maynard, Mass. Phone: (617) 897-8821.

Circle No. 326



# HIGH-GAIN, LINEAR PNP TRANSISTORS

Two new series of Planar II PNP transistors are now available from Fairchild for use in circuits requiring high gain and linearity.

2N3962, 2N3963, 2N3964, 2N3965 — This series features high current gain, low noise figure, and excellent beta linearity. The devices can be used over a wide range of current ratings, from less than  $1\mu\text{A}$  to 50mA. Typical applications include low-noise audio pre-amps, DC amplifiers, micro-power flip-flops, linear amplifiers in sub-audio to HF frequencies, and IF amplifiers in the 20Kc to 500Kc range.

2N4030, 2N4031, 2N4032, 2N4033 — This series has high voltage capability, low saturation, and excellent beta linearity. Use these transistors in amplifier driver and output circuits, up to 300mA and 1 watt for Class A, up to 800mA and 5 watts for Class B. Use them also in TV vertical sweep circuits, operating from 60-70V B<sup>+</sup> lines, or as medium-frequency linear amplifiers, or as complementary devices for use with supply voltages up to 80V.

These new PNP devices are available under the FACT program. Current-ly at Fairchild Distributors. Sample specifications shown below. Write for complete data sheets.

**FAIRCHILD**  
SEMICONDUCTOR



**2N3965**

NF ..... 2db Max. @ 1Kc,  $I_c=20\mu\text{A}$   
 ..... 4db Max. @ 100cps,  $I_c=20\mu\text{A}$   
 ..... 8db Max. @ 10cps,  $I_c=20\mu\text{A}$   
 $h_{FE}$  ..... 180 Min. @  $I_c=1\mu\text{A}$   
 ..... 250-500 @  $I_c=10\mu\text{A}$   
 ..... 180 Min. @  $I_c=50\text{mA}$   
 $LV_{CEO}$  ..... 60V Min.  
 $f_t$  ..... 50Mc Min.  
 $C_{ob}$  ..... 6pf Max.



**2N4033**

$h_{FE}$  ..... 75 Min. @  $I_c=100\mu\text{A}$   
 ..... 100-300 @  $I_c=100\text{mA}$   
 ..... 70 Min. @  $I_c=500\text{mA}$   
 ..... 25 Min. @  $I_c=1000\text{mA}$   
 $LV_{CEO}$  ..... 80V Min.  
 $V_{CE(SAT)}$  ..... 0.5V Max. @  $I_c=500\text{mA}$   
 $f_t$  ..... 150Mc Min.

Planar is a patented Fairchild process.

FAIRCHILD SEMICONDUCTOR/A Division of Fairchild Camera and Instrument Corporation ■ 313 Fairchild Drive, Mountain View, California (415) 962-5011 ■ TWX: 910-379-6435

ON READER-SERVICE CARD CIRCLE 46





*when  
you're  
tied  
down  
by  
promises...*

**REMEMBER — CLAROSTAT CAN DELIVER ALL  
OF YOUR POWER RESISTOR REQUIREMENTS**

Everything is in your favor when you do business with Clarostat . . . dependable quality . . . dependable performance . . . and dependable delivery schedules. For all your power resistor and rheostat requirements Clarostat can provide *instant delivery* on most standard units and better than average cycles on *specials*. What's more, this includes MIL-R-26C, MIL-R-22A and MIL-R-6749 types. Only Clarostat gives you that "across-the-board" completeness of line for all industrial, military and commercial applications. And when you need small orders in a hurry there's a Clarostat stocking distributor just a phone call away with just the resistors you need. Don't be bugged by delivery failures and bum promises . . . CALL CLAROSTAT!



**CLAROSTAT**

CLAROSTAT MFG. CO., INC. DOVER, NEW HAMPSHIRE



# REAL MEASURE OF PERFORMANCE:

## *Exclusive with the 175A Oscilloscope:*

**20 MHz bandwidth at 1 mv/cm sensitivity, 50 MHz at 10 mv/cm, dual-channel!**

**4-channel 40 MHz bandwidth plug-in!**

**Plug-in recorder, pushbutton trace recordings with 30 MHz bandwidth!**

**Plug-in trace scanner for high resolution recording on external x-y recorder!**

**Time mark generator plug-in for 0.5% accuracy time measurements!**

**Mixed sweep for error-free time interval measurements!**

Measurement performance is what you get with the 175A 50 MHz Scope, performance not available elsewhere. The performance spotlighted above is yours with the 175A...high sensitivity and bandwidth for dual- or 4-channel broadband measurements, inexpensive recordings of signals (improves signal to noise ratio of noisy signals, plus it gives clear recordings of dim low-duty-cycle signals), the unique benefits of a delay generator plug-in...all exclusive with the 175A. And 14 plug-ins to choose from, for maximum versatility to match your specific application.

And every combination of scope and plug-ins gives you Hewlett-Packard design and manufacturing quality. Backed up, too, by your Hewlett-Packard field engineer, who can help solve your measurement problem with a scope or with other tools from the broad line of high-quality instrumentation he offers.

Give him a call. Take a look at the 175A Scope. A comparison with other scopes will show you the real measure of performance you get exclusively from Hewlett-Packard. Full specifications on the 175A are available by writing Hewlett-Packard, Palo Alto, California 94304, Tel. (415) 326-7000; Europe: 54 Route des Acacias, Geneva.

175A Oscilloscope, \$1325  
1755A 50 MHz Dual-Trace Vertical Amplifier, \$575  
1754A Four-channel Vertical Amplifier, \$595  
1784A Recorder Plug-in, \$775  
1782A Trace Scanner, \$425  
1783A Time Mark Generator, \$130  
1781B Delay Generator, \$325

Prices f.o.b. factory.

964

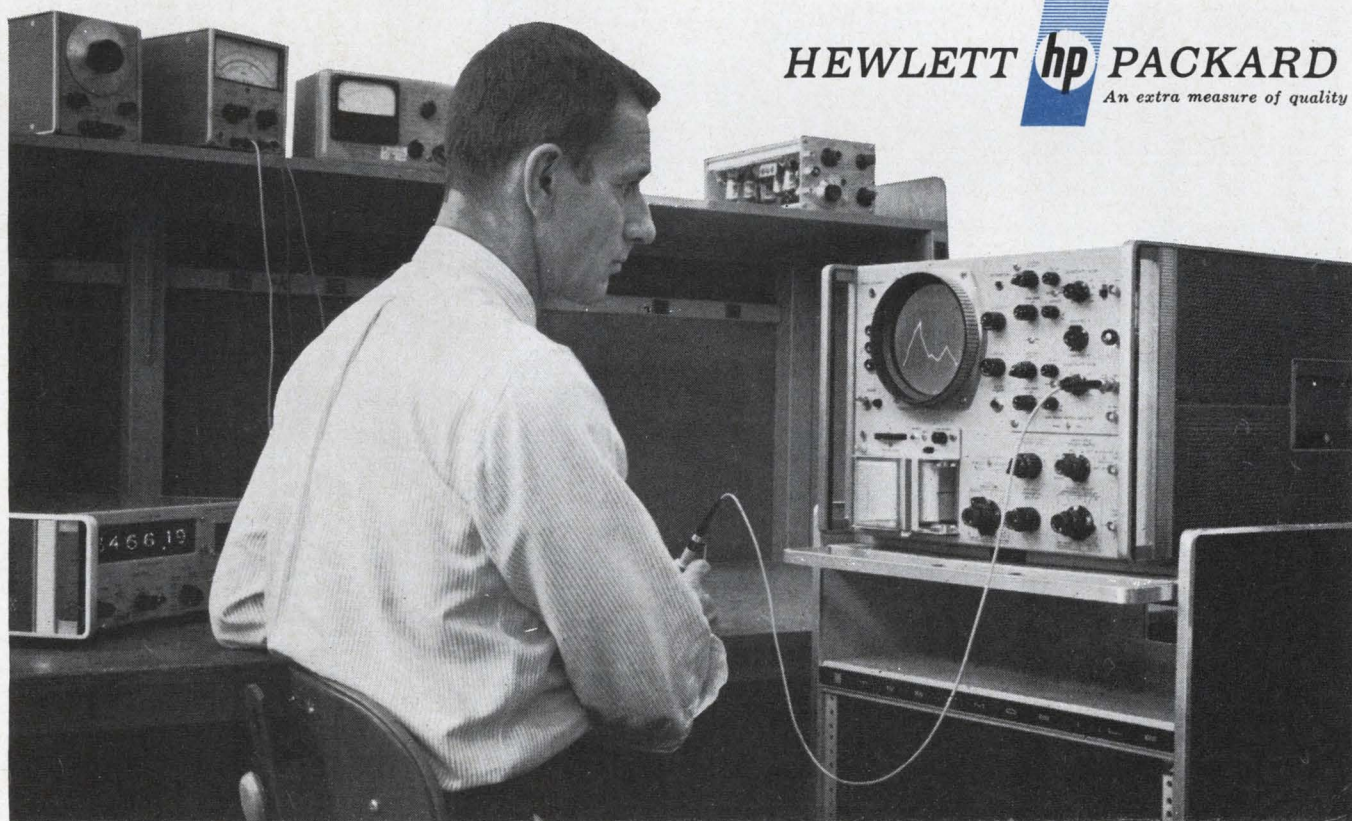

**HEWLETT  PACKARD**  
An extra measure of quality

*The 175A Scope, 1755A Vertical Amplifier Plug-in and 1781B Sweep Delay Generator give you the exclusive 20 and 50 MHz dual-channel performance listed above—for only \$2225!*

ON READER-SERVICE CARD CIRCLE 48



**quality in quantity**  
for high performance at low cost!

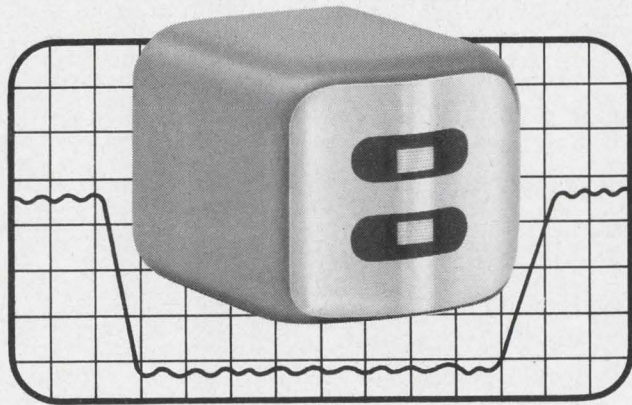

High-volume production and one hundred percent on-the-line inspections—mean uniform, high-precision tape heads that produce consistently fine results. And at low unit cost. An unbeatable combination. Send us your specifications and let us prove it to you.

Send for new  
full-line catalog



**MICHIGAN MAGNETICS, INC.**

VERMONTVILLE, MICHIGAN  
A Subsidiary of VSI Corporation

ON READER-SERVICE CARD CIRCLE 49

**WE'VE  
SIMPLIFIED  
PHOTOCELL-  
LAMP DESIGN**

New Clairex® PHOTOMODS® combine selected photoconductive cells and lamps into one compact module ready for use as noiseless pots, circuit isolators, automatic gain controls and for numerous other control applications. 11 standard PHOTOMODS are now available combining hermetically sealed CdS and CdSe photocells coupled to 5000 hour lamps rated at 6, 12, 24, and 120 volts.

Custom PHOTOMODS are also available based on your specific control and signal circuit parameters.



For  
additional  
design data  
request  
technical  
bulletin  
ITD 465.

**CLAIREX**

"The LIGHT Touch in Automation and Control"

1239 Broadway, New York, N.Y. 10001, 212 MU 4-0940

ON READER-SERVICE CARD CIRCLE 50

CL-105

SYSTEMS

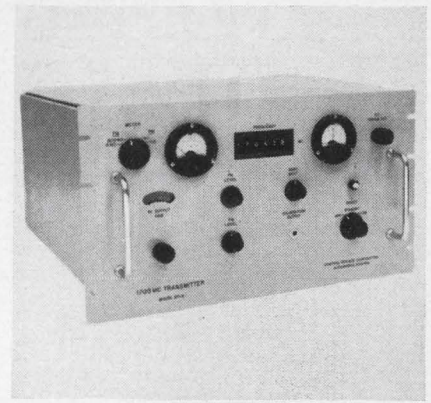

**Test transmitter**

A 1700-MHz test transmitter digitally changes frequency with 0.05% accuracy with the turn of a switch. Three variable-frequency oscillators are referenced to the crystal oscillator by phase-locked loops. Outputs are combined so as to generate an output of 1700 to 1710 MHz in 10-kHz steps. A step-recovery diode multiplier generates the final 1700-MHz output. Frequency stability is  $\pm 75$  ppm from 50 to 100°F. Output power is 10 dBm,  $\pm 1$  dB. Output impedance is 50  $\Omega$  and vswr is 1.1.

Control Science Corp., 4810 Beau-  
regard St., Alexandria, Va. Phone:  
(703) 354-1500. *Circle No. 327*

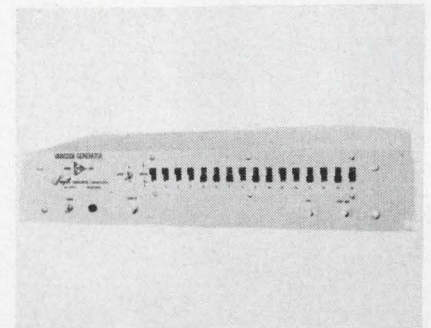

**Code generator**

The SRA-6301 fully transistorized "Varicode" generator provides a repetitive digital sequence of arbitrary structure and length. A sequence of 2 to 16 bits is selected by means of 16 front-panel slide switches and is advanced one bit each time the input signal exceeds 500 mV of pre-selected polarity. The unit responds to clock rates greater than 2 megabits/s.

P&A: \$725; 6 wks. Smyth Re-  
search Assoc., 3555 Aero Ct., San  
Diego, Calif. Phone: (714) 277-  
0543.

*Circle No. 328*

ON READER-SERVICE CARD CIRCLE 225 ➤



Schjel-Clad\*  
Flexible  
Laminates

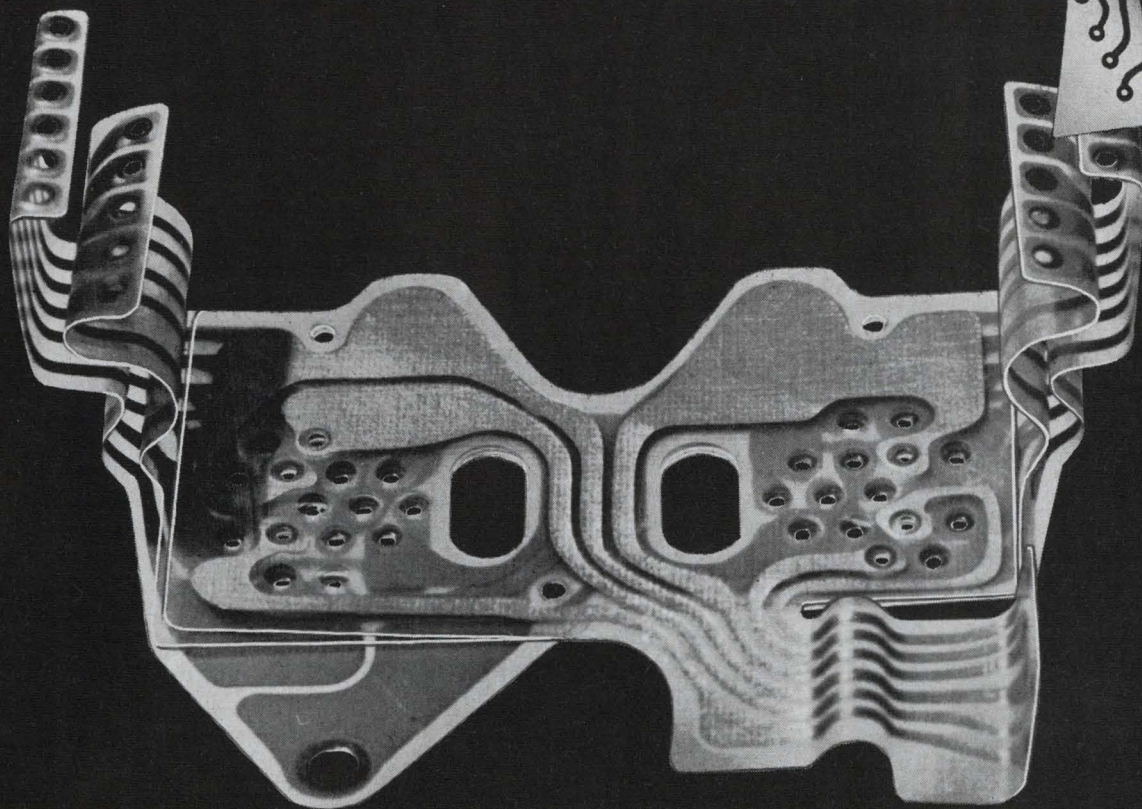

## Low-cost GT-5500 makes high-class circuits

GT-5500 Schjel-Clad\* is our copper-polyester film laminate for precision-etched *flexible printed circuits*. Many economy-minded engineers are specifying it now. That's because when they tally total system wiring costs, they find Schjel-Clad offers significant savings in many applications.

First, there are the obvious savings of flexible printed circuitry: continuous roll production and virtually reject-free wiring. Second, among materials for flexible printed circuits, GT-5500 is one of the least costly.

Yet even at its relatively low cost, GT-5500 exhibits excellent physical and electrical characteristics. Its polyester base resists most chemicals and has a tensile strength of 22,000 pounds. Its

dielectric strength is 7,000 volts/mil. GT-5500 is suitable for use in systems with ambient temperatures ranging from  $-60^{\circ}\text{C}$  to  $110^{\circ}\text{C}$ . These characteristics suit GT-5500 to application in all but the most unusually severe environmental conditions. A special characteristic is the base film memory which permits production of formed circuits (as shown above).

But GT-5500 is unlike most other polyester-base laminates in some important ways. Conductor spacing from layout to finished circuit can remain as accurate as  $\pm 0.1\%$  with Schjel-Clad. This accuracy is a product of the proprietary adhesive system Schjeldahl uses in laminating. It doesn't permit conductor shifting to the extent common in fusion-bonded materials.

Schjeldahl stocks GT-5500 in base film thicknesses from 1-mil to 5-mil. Standard types include treated and untreated electrodeposited copper and hard and soft rolled copper in several thicknesses, laminated to one or both sides of the flexible film. The material for your circuits can probably be shipped from stock—at stock item prices.

Naturally, we make other materials for flexible circuits. But check on GT-5500—its price and characteristics are right for most jobs. If you're interested in flexible circuits but don't want to make them, call us anyway. We'll make them for you. Write or call for information. Don't let pronunciation stop you. Say "Shell-Doll."

\*Trademark, G. T. Schjeldahl Company



**Schjeldahl**

ELECTRICAL  
PRODUCTS  
DIVISION



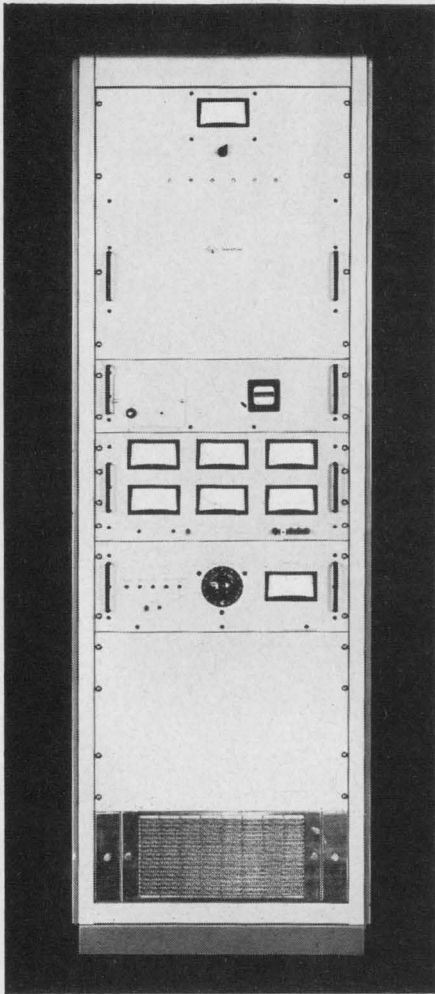

## 1966 Squareback Volts Wagon

AC POWER: 10,000 VA

Unlike the famous "bug," the INVERTRON<sup>®</sup> pictured above does come in a variety of models and power options. Just a few of the single phase: 160VA, 350VA, 750VA, 1500VA, 5000VA. Some of the three phase: 120VA, 500VA, 1000VA, 2250VA, 4500VA. Plenty more ratings — up to 45,000VA in more than 960 configurations—a line wide enough for almost any AC requirement!

All INVERTRON<sup>®</sup> AC supplies feature fixed or variable frequency plug-in oscillators from 45 to 5000Hz (higher on special order) with frequency accuracies to 0.001%.

No matter what your AC requirement is, chances are that B-I has exactly the supply to fit. Don't specify until you've looked over the broadest line with the best specifications in AC — write now for Behlman-Invar's shortform catalog.



Power to match the art

**BEHLMAN-INVAR  
ELECTRONICS CORP.**

1723 Cloverfield Blvd., Santa Monica, Calif. 90404  
Representatives in principal U.S. Cities & Canada

ON READER-SERVICE CARD CIRCLE 51

## MICROELECTRONICS

### Thin film hybrids

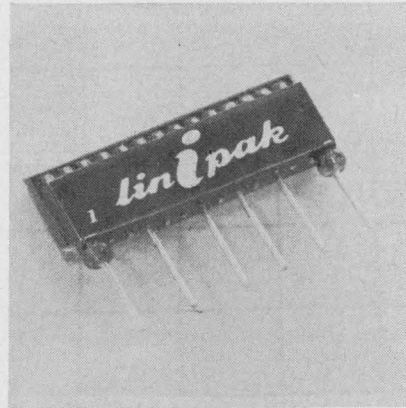

The "Linipak" is a combination of tin oxide/glass passive elements and flat discrete active components. Typically, 6 semiconductors and the appropriate RC network are accommodated in a 0.0375-in.<sup>3</sup> case. Pin spacing is 100 mils from a 50-mil grid. Typical noise immunity is 3 V. Adjustment of 0- and 1-state logic levels by as much as 12 V is possible. Series LA of level transformation devices is for ECL use.

Intellux, Inc., 26 Coromar, Goleta, Calif. Phone: (805) 968-3541.

Circle No. 329

### Oscillator

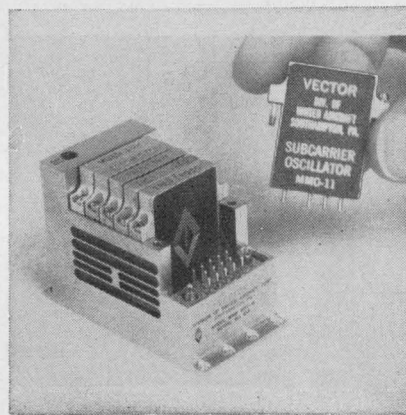

The MMO-11 voltage-controlled oscillator occupies 0.108-in.<sup>3</sup> and weighs 3.8 grams. Using this unit, a 5-channel FM multiplex system can fit into less than 1.8 in.<sup>3</sup>.

Power required is 28 Vdc  $\pm 10\%$  at 5 mA. Operating temperature range is  $-40$  to  $+100^\circ\text{C}$ . Center frequency is stable to within  $\pm 0.5\%$  of design bandwidth after shocks of 2,000 G.

Vector Div. of United Aircraft Corp., Southampton, Pa. Phone: (215) 355-2700.

Circle No. 330

### IC gates

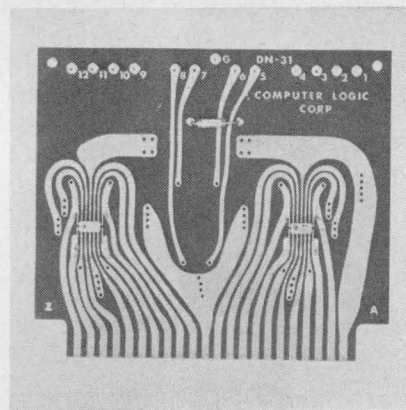

Series DN-30 logic modules provide 2, 3 and 5-input and 5-input expandable NAND/NOR gates. All gates operate as high-true NAND or low-true NOR. The series uses modified DTL logic.

Typical noise rejection at any input in 0.9 to 2 V and 1.5 V can be tolerated on the power or ground bus of any system.

P&A: From \$56; stock. Computer Logic Corp., 1528 20th St., Santa Monica, Calif. Phone: (213) 451-9754.

Circle No. 331

### Digital logic cards

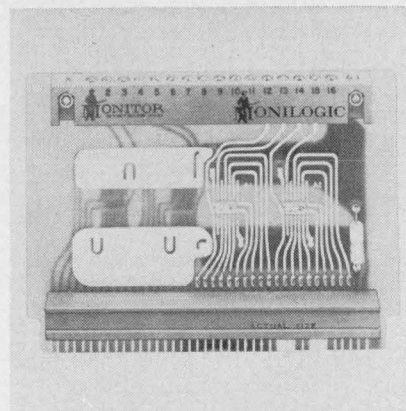

"Monilogic" series 5 IC digital logic cards use silicon flat-pack elements on a 3.3- x 4.05-in. board. Rapid switching dc-coupled DTL is used for asynchronous clock rates to 5 x 10<sup>6</sup> pulses/s. Noise rejection is 1 V. High fan-out, short-propagation delays and low-power consumption are featured. Counters, comparators, shift registers, triggers and D/A converters are available on a single card or portion thereof.

Monitor Systems Inc., Ft. Washington, Pa. Phone: (215) 646-8100.

Circle No. 332



*A Motorola Innovation  
that made your  
design job easier...*

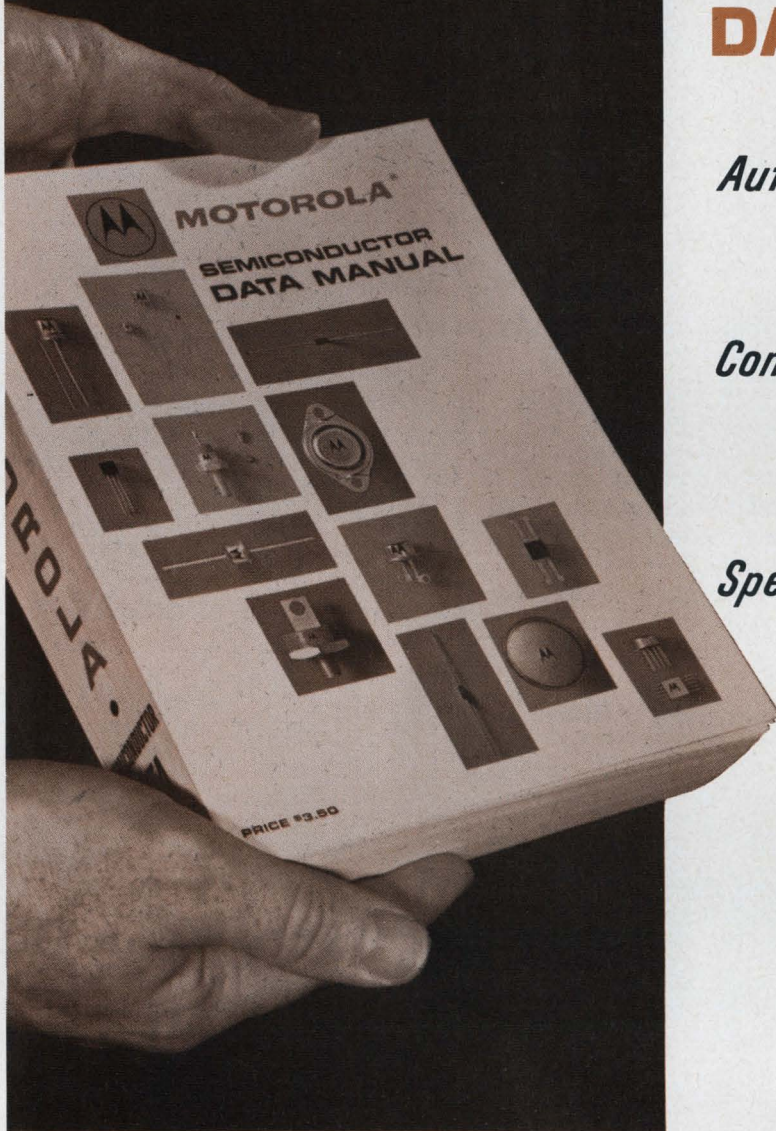

## THE SEMICONDUCTOR DATA MANUAL

### *Authoritative*

- First quick selection guides — 14 pages of them.
- Full 50 pages of articles on the meaning of specifications for various parameters and valuable "how to" information

### *Comprehensive*

- Over 18 categories of standard and special device types
- Data for over 2600 devices in one bound reference
- Complete cross reference guides

### *Special Features*

- Alpha-Numeric device index
- Device outline dimensions
- Pertinent electrical specifications
- Military spec device lists

Motorola's Semiconductor Data Manual is much more than a handy package of data sheets.

Its 908 pages are designed to overcome the major problems of device identification and selection facing the electronics field. Wasted hours and even days spent filing and hunting through binder after binder are eliminated. Borrowing references and copying data sheets are practices of the unenlightened past.

And best of all, this wealth of information is arranged to make using the manual as simple as turning a page. Send for your copy today.

**SEND ME A COPY OF THE SEMICONDUCTOR DATA MANUAL TODAY!**



**MOTOROLA**  
Semiconductor Products Inc.

Please send me \_\_\_\_\_ copies of the new Motorola Semiconductor Data Manual. My check (payable to Motorola Inc.) for \$\_\_\_\_\_ is enclosed (\$3.50 per copy).

Name \_\_\_\_\_

Company \_\_\_\_\_

Address \_\_\_\_\_

City \_\_\_\_\_ State \_\_\_\_\_ Zip \_\_\_\_\_

Mail to: **Motorola Semiconductors**  
**Box 955, Dept. 64, Phoenix, Arizona 85001**

Speed Inquiry to Advertiser via Collect Night Letter  
ON READER-SERVICE CARD CIRCLE 52



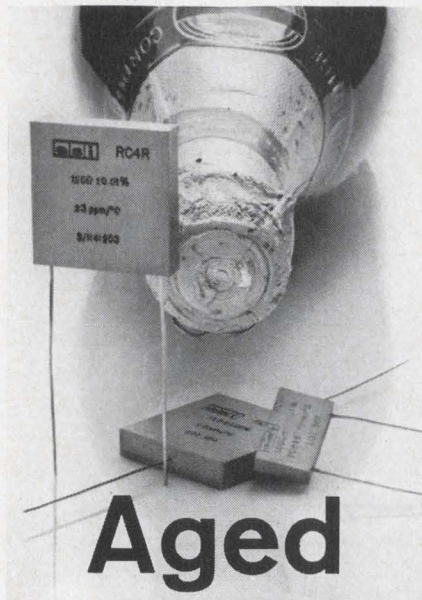

# Aged

Our precision resistors are aged to improve reliability, and we guard the process like a vintage champagne maker. Ageing is just one of many extra steps that make our precision components the most reliable you can specify. A few of our components are described briefly below.

## 1. Precision Wire-Wound Card Resistors

Consider ESI resistors whenever small changes in the resistive element can affect the performance of the final assembly. Initial accuracy to  $\pm 0.0015\%$ . Yearly stability to  $\pm 10$  ppm.

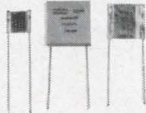

## 2. Dekastat® Decade Resistors

Designed for use with dc and at audio frequencies, these multi-decade resistors feature an accuracy of  $\pm 0.02\%$ . All units carry a two-year guarantee.

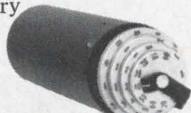

## 3. Dekapot® Resistive Voltage Dividers

These rapid-setting potentiometers have a terminal linearity up to 0.002%. Kelvin-Varley circuitry provides constant input impedance.

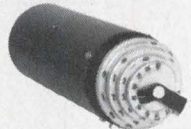

## 4. Dekatran Transformer Voltage Divider

The patented coaxial dial is easy to read and adjust. Accuracy of 0.001% and long-term stability are achieved through gapless toroidal cores of very high permeability.



**esi**

Electro Scientific Industries, Inc.  
13900 NW Science Park Drive  
Portland, Oregon 97229

ON READER-SERVICE CARD CIRCLE 53

## TEST EQUIPMENT

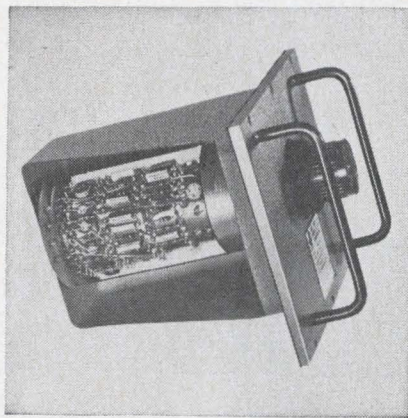

### Frequency standard

Model JKT066 5-MHz frequency standard has stabilities of  $5 \times 10^{-10}$ /day and  $10^{-9}$  over an ambient range of  $-15$  to  $+65^\circ\text{C}$ . A front-panel dial sets output frequency with a resolution of  $10^{-10}$ /minor division. An internal frequency adjustment of  $10^{-6}$  is provided for major calibration. The silicon-transistorized oscillator and critical circuitry are housed in an inner oven mounted in a Dewar flask enclosed by an outer oven. Input to oscillator and oven is 24 Vdc  $\pm 10\%$ . Output is 250  $\mu\text{W}$  sine wave into 50 to 1,000  $\Omega$  with distortion less than 10%.

CTS Knights, Inc., Sandwich, Ill.  
Phone: (815) 786-2141.

Circle No. 333



### Voltmeter

Model 360A ac/dc voltmeter offers accuracy of  $\pm(0.1\% + 25 \mu\text{V})$  over 70 Hz to 10 kHz from 0.001 to 1100 Vac and  $\pm(0.01\% + 5 \mu\text{V})$  from 0 to 1100 Vdc. Oil-filled resistors, a photo-resistive chopper in the 100  $\mu\text{V}$  null detector and 6-digit resolution are featured. Input impedance is infinite to 1100 Vdc.

Precision Standards Corp., 2663 N. Lee Ave., S. El Monte, Calif.  
Phone: (213) 448-6254.

Circle No. 334

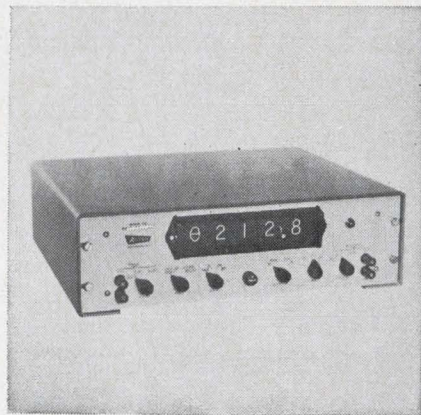

### Phase meter

Digital phase meter model 331 provides direct, four-digit angle reading from 0 to  $360^\circ$  with  $0.1^\circ$  resolution. The transistorized instrument requires no warmup and operates with inputs from 0.2 to 150 V, 200 Hz to 35 kHz for half-degree accuracy (5 Hz to 500 kHz useful range). Provisions are made for addition of automatic ranging dc DVM and ratiometer, ac DVM and printer readouts.

Acton, Labs. Inc., 531 Main St., Acton, Mass. Phone: (617) 263-7756.

Circle No. 335

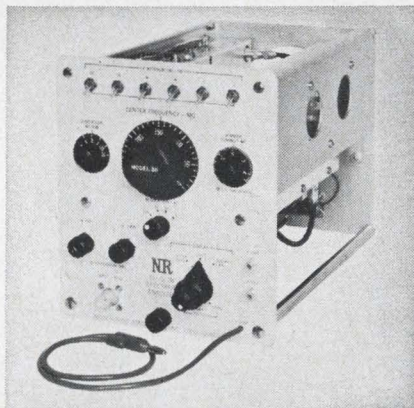

### Spectrum analyzer

Two vhf/uhf plug-in spectrum analyzers covering 1 to 300 MHz are for use with Tektronix or Hewlett-Packard scopes. Both use calibrated center and vernier tuning dials. Scan widths from 100 kHz to 100 MHz are provided with a 300 MHz full scan. IF resolutions of 5, 10, 20 and 100 kHz are front-panel selectable. Sensitivity is 90 dBm.

P&A: \$1200 & \$1300; stock to 30 days. Nelson-Ross Electronics, 5-05 Burns Ave., Hicksville, N. Y.  
Phone: (516) 433-2730.

Circle No. 336



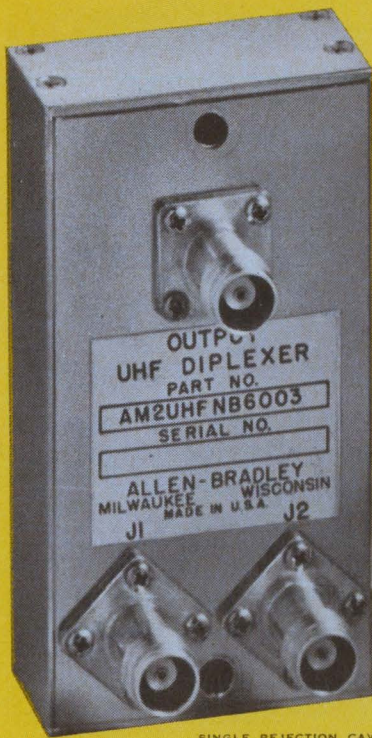

SINGLE REJECTION CAVITY TYPE DIPLEXER—COMPARABLE TO A PACK OF REGULAR SIZE CIGARETTES IN SIZE

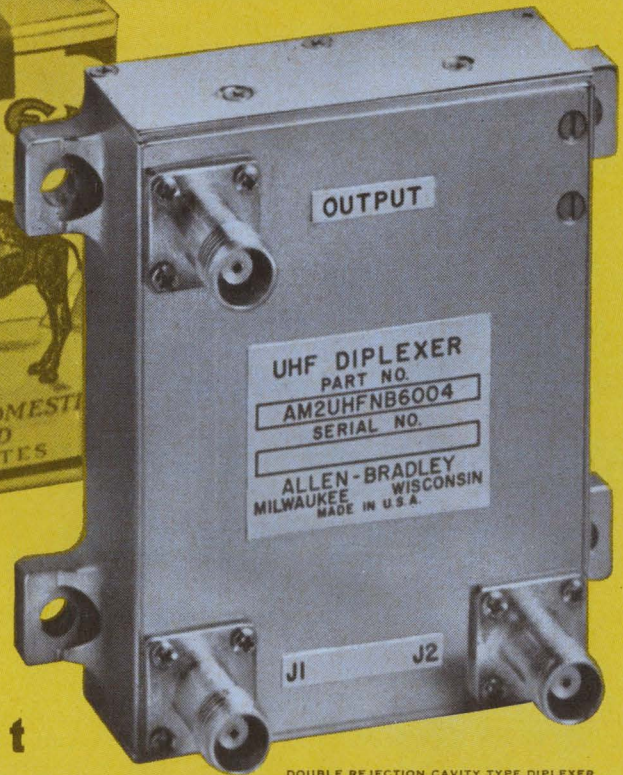
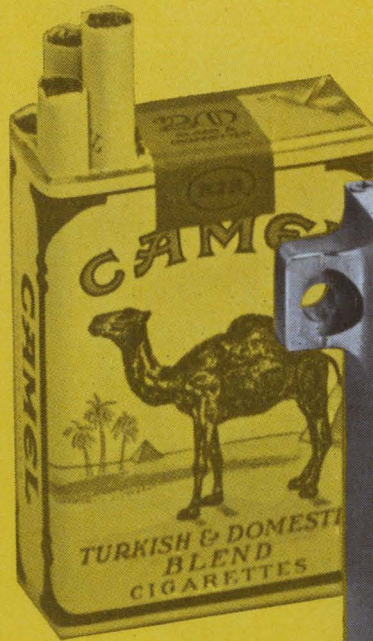

DOUBLE REJECTION CAVITY TYPE DIPLEXER

## New Ultra-Compact UHF antenna diplexers

for use in the 2.2 to 2.3 GHz frequency range

■ Allen-Bradley high frequency laboratories are pioneering the development of antenna multiplexers for use at ultra-high frequencies. The two diplexers for the 2.2 to 2.3 GHz band shown above are representative of Allen-Bradley's high frequency capability. These diplexers are rugged—designed to withstand acceleration of 15 G's; shocks of 100 G's (1 msec.); and vibration of  $\pm 10$  G's (30-2000 Hz). They're hermetically sealed for use at unlimited altitude and are stable over the temperature range from  $-50^\circ$  to  $+170^\circ\text{F}$ . The power handling capacity per channel is 20 watts.

Allen-Bradley engineers will be pleased to work with you. Please write: Allen-Bradley Co., 222 West Greenfield Ave., Milwaukee, Wis. 53204. In Canada: Allen-Bradley Canada Ltd. Export Office: 630 Third Avenue, New York, N. Y., U.S.A. 10017.

### TYPICAL RESPONSE CURVES

WITH ONE REJECTION CAVITY PER CHANNEL

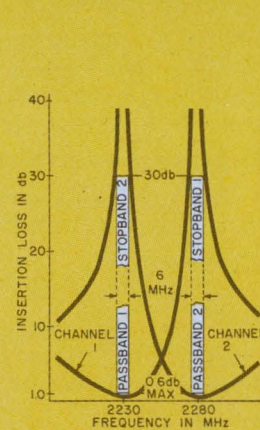

WITH TWO REJECTION CAVITIES PER CHANNEL

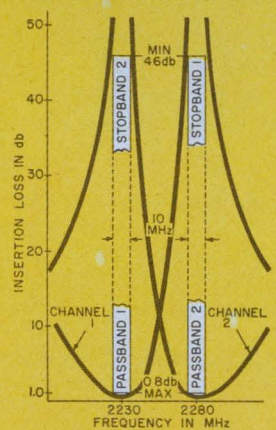

**ALLEN-BRADLEY**  
QUALITY ELECTRONIC COMPONENTS

965-1A8

ON READER-SERVICE CARD CIRCLE 54



# Ballantine AC-DC Digital Voltmeter

Model 355

Price: \$590



1/4% Accuracy f.s. for AC & DC Voltages up to 500 and for mid-band AC Frequencies

## Measures Full Scale ac to 10 mV ...ac & dc from 0 to 1,000 V

Ballantine's Model 355 is the only digital voltmeter of its type in the U.S.A. . . with a versatility that makes it ideal for production line and quality control applications.

Use the 355 in place of analog instruments, for example, in reducing personnel errors, for speeding up production. You can depend on Ballantine's high standards of accuracy, precision, and reliability to reward you with savings of time and money the first day you place it in service.

The instrument features a servo-driven, three-digit counter with over-ranging . . . combines many virtues of both digital and analog voltmeters in one small, compact, economical package. Its large, well-lighted readout with illuminated decimal point, range and mode information, allows fast, clear readings, while the indicator can follow and allow observation of slowly varying signals. The position of the last digit can be interpolated to the nearest tenth, thus avoiding the typical "± 1 digit" restriction of a fully digitized display.

Desire even faster production? An optional foot-operated switch of the Model 355 retains voltage readings, and enables you to cut materially the time between readings. Another aid in reducing personnel errors is provided by an over-range indicator that signals excessive input of the wrong polarity.

### PARTIAL SPECIFICATIONS

Voltage Range	AC	DC	Accuracy in % of Full Scale	AC	DC
	0 to 1000	0 to 1000		1 mV	1/4%, 50 Hz to 10 kHz
Full scale, most sensitive range	10 mV	100 mV	to 500 V	1/2%, 30 Hz to 50 kHz	
Frequency Range	30 Hz to 250 kHz	DC		1%, 50 kHz to 250 kHz	
Optional Model 600 Resistors	are available for measuring current directly in volts		Power Requirements	115/230 V, 50-60 Hz, 52 W	
			Relay Rack Version	Model 800 rack mounting kit is optional	

Write for brochure giving many more details

Member Scientific Apparatus Makers Association

— Since 1932 —



**BALLANTINE LABORATORIES INC.**  
Boonton, New Jersey

CHECK WITH BALLANTINE FIRST FOR DC AND AC ELECTRONIC VOLTMETERS/AMMETERS/OHMETERS, REGARDLESS OF YOUR REQUIREMENTS. WE HAVE A LARGE LINE, WITH ADDITIONS EACH YEAR. ALSO AC/DC LINEAR CONVERTERS, AC/DC CALIBRATORS, WIDE BAND AMPLIFIERS, DIRECT-READING CAPACITANCE METERS, AND A LINE OF LABORATORY VOLTAGE STANDARDS FOR 0 TO 1,000 MHZ.

Speed Inquiry to Advertiser via Collect Night Letter

ON READER-SERVICE CARD CIRCLE 55

### TEST EQUIPMENT

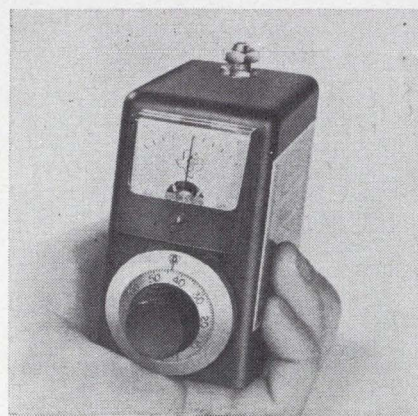

### Temperature controller

The "Klixon" 21701 proportional controller supplies continuous power equal to system heat loss. A thermistor provides a control signal to the magnetic amplifier. The amplified signal triggers an SCR to modulate the full-wave ac controller output. Power output applied to the heater provides 0.05°C temperature stabilization from full to zero power in a 3 to 6° band around the control point. A 10-turn deviation indicator pot affords repeatability with 0.25°C accuracy. Capacity is 6 A, 120 Vac.

Texas Instruments, Metals and Controls Div., 34 Forest St., Attleboro, Mass. Phone: (617) 222-2800.

Circle No. 337

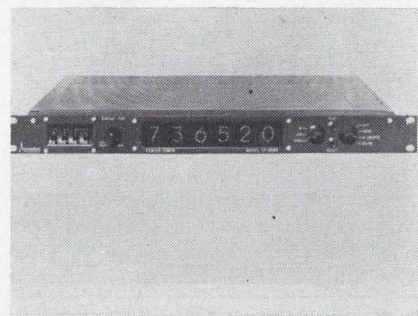

### Scaler/timer

A scaler/timer for event ratio computing, rate normalizing and random event time interval measurement features 500 ns pulse pair resolution and 2 MHz count rate. Model CF-204-6R consists of 2 counters and a 100 kHz crystal-controlled time base generator. Switch-selected operating modes are pre-set time, pre-set count and ratio.

P&A: \$1700; 3 to 4 wks. Anadex Instruments Inc., 7833 Haskell Ave., Van Nuys, Calif. Phone: (213) 782-9527.

Circle No. 338



# The Standard Reference For Electronic Test Instruments

## DIRECTORY OF TECHNICAL SPECIFICATIONS

5

### FREQUENCY METERS

upper frequency limit 1 - 15Mc

Photo See Page	MANUFACTURER	MODEL	FREQUENCY					Stability		SENSITIVITY		OUTPUT		Calibration	Operating Power Required	Circuit Type	Connector Type
			Min Mc	Max Mc	Number of Bands	Meas Acc %	Long Term	Short Term	Min @ Freq	Max @ Freq	Interpolation	Main	Aux				
29	MILLEN (A)	90619	350kc	1	1	1.5	N/A	N/A	N/A	N/A	N/A	N/A	*	N/A	direct	none	re-act
	SELL-TRONIC	401A	10cps	1	9	1na	1na	1na	100mv	200mv	ina	phone jack	none	direct			
	GENERAL RADIO (A)	1142-A	3cps	1.5	5	**0.2 full scale	0.2% warm up	0.2% warm up	10cps-700kc	*200mv rms	0.64V/4800Ω	*1-5ma					
	GENERAL RADIO (A)	1106-A	100kc	2	9	+0.1	1na	1na	15uv	0.1ma							
	MILLEN (A)	90611	1.5	3.5	1	* 1.5	N/A	N/A									
	MEASUREMENTS (A)	59LF	100kc	4.5	4												
	AIRCRAFT RADIO	H-37A	1														
	MILLEN (A)	90625															
	MILLEN (A)	90612															
TECHNICAL MATERIEL (A)	PMO-5																
MILLEN (A)	90682	61															
MILLEN (A)	90605	3															

6

1 - 15Mc

### FREQUENCY METERS

Type	Width Inches	MECHANICAL Height Inches	Depth Inches	Weight Pounds	Price Dollars
	3	2 1/2	3 3/4	1 1/2	22.50
				1na	249.00
			7 5/8	16	525.00
	5 7/8	12	47 3/4	15.00	1050.00
	1 1/2	12 3/4		1/2	15.00

#### NOTES

10. Neon indicator. 16. Dimensions are of contour fitting cover.  
 ACCEPTABLE WAVE FORM: pulse square sawtooth, sine, etc.  
 DFT CYCLE: 1% to 100% 2% above 100kc. INPUT IMPEDANCE:  
 10kΩ & 100kΩ. TRANSISTORIZED, full scale. 7.8. From 20cps-150kc.  
 4. 1% of reading above 10% of full scale. 10. 1ma @ 2.7kΩ maximum. 10 5ma @ 190Ω.  
 20ma @ 30Ω & 1.3kc. 10. 1ma @ 2.7kΩ maximum. 10 5ma @ 190Ω.  
 maximum 16. Back adapter available.  
 14. Also transfer oscillator. CALIBRATION: 10kc @ highest frequency; 1kc @ lowest frequency.  
 4. Straight line frequency. 16. Dimensions are of contour fitting cover.  
 GRID CURRENT METER: 100ua, 50 divisions.  
 Special order. 4. 1 part in whatever range selected.  
 16. Dimensions are of contour fitting cover.  
 16. Dimensions are of contour fitting cover.  
 16. Dimensions are of contour fitting cover.  
 16. Dimensions are of contour fitting cover.

- #### SYMBOLS
- C - Cabinet
  - R - Rack
  - P - Portable
  - ina - information not available
  - N/A - not applicable
  - coc - cross over counter
  - (A) - this manufacturer has cooperated by checking the accuracy of this compilation prior to final printing and printing.
  - \* - See NOTES following column numbers.
  - q - photo of similar instrument appears on page noted.

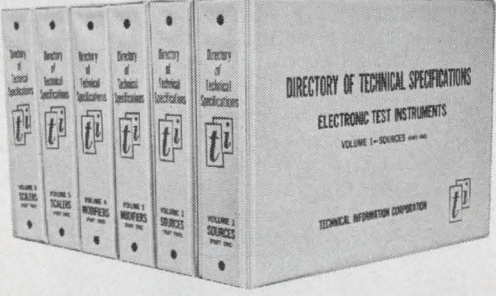

## CONVENIENT TABULAR FORMAT PROVIDES QUICK AND EASY MODEL-TO-MODEL COMPARISONS

One look at the specimen pages will show you—better than words—the extent of the information furnished by the DIRECTORY OF TECHNICAL SPECIFICATIONS and the comparative arrangement of the data. These convenient tables are designed for rapid and accurate point-by-point comparison of instruments having similar functional capabilities. By providing a thorough across-the-market analysis, all alternatives can be considered in selecting the right instrument for any application.

#### SAVE HOURS OF ENGINEERING TIME

The Directory eliminates once and for all the necessity of searching catalogs, sales literature and periodicals to find suppliers, specifications, performance characteristics and prices. It provides in one comprehensive source, arranged and indexed for convenient use, all the information you need to keep completely up-to-date on available instruments, to evaluate competitive products and to select the best instrument at the best price.

#### NO NEED FOR CATALOG FILES

Keeping and maintaining your own files of manufacturers catalogues, brochures and loose data sheets is completely unnecessary. The DIRECTORY OF TECHNICAL SPECIFICATIONS

gives you all the required data to select and specify electronic test instruments—all in one compact and easy to use reference. No other reference source is as complete or efficiently organized. The six-volume Directory lists approximately 14,000 instruments of more than 500 manufacturers and comprises 46 sections, each covering a different type of instrument.

#### ALWAYS COMPLETE AND UP-TO-DATE

The constant changes in specifications and performance of electronic test instruments is making it increasingly difficult to keep abreast of the latest developments. The Directory is kept continuously up-to-date by the mailing of section revisions to subscribers at the rate of approximately one each week. The information in the entire Directory is completely revised in less than a year.

#### AVAILABLE ON FREE 30-DAY TRIAL

The DIRECTORY OF TECHNICAL SPECIFICATIONS may be obtained on a FREE 30-DAY TRIAL BASIS for your examination and use. A one-year subscription includes the six-volume set of 46 sections plus the up-dating service to keep all information complete and current.

PRICE... \$300. per year

For further information write or telephone...

# TECHNICAL INFORMATION CORP.

P. O. Box 514, Smithtown, N. Y. (516 234-0100)





## TEST EQUIPMENT

### Sweep generator

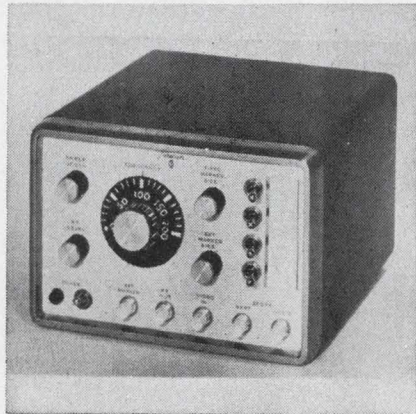

Model TH-200 sweep generator covers the FM and vhf TV bands with a range of 0.5 to 230 MHz. Sweep width is variable from 0.1 to 230 MHz and leveled output is greater than 0.25 V rms. The unit accepts up to 4 plug-in single-frequency or harmonic markers, has external marker capability, and can be supplied with a 0- to 70-dB turret attenuator.

P&A: \$525; stock to 3 wks. Texscan Corp., 51 S. Koweba La., Indianapolis. Phone (317) 632-7351.

Circle No. 339

### Angle position indicator



Model 2035 angle position indicator is intended for test equipment to measure the angular position of synchros and resolvers. The half-rack instrument features a digital read-out in degrees and minutes. Specifications include a range of 0 to 360° continuous rotation, accuracy of 6 minutes, repeatability of 30 s and slew speed of 25°/s. Power required is 115 Vac and 0.5 A.

Occo Mfg. Corp., 8 Romanelli Ave., S. Hackensack, N. J. Phone: (201) 342-8984.

Circle No. 340

### IC tester

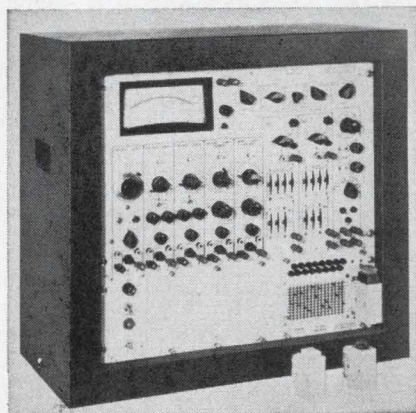

An integrated circuit tester may be programmed to handle dc and pulse tests. Model RFS 1600 has 5 programmable dc voltage supplies, 2 pulse generators, resistance and capacitance loads and a standard 16-lead plug-in unit. A zero-center, taut-band FET voltmeter provides visual readout and a slide-switch cross-point matrix facilitates programming.

RFS Engineering Co., 2nd and Westmoreland, Philadelphia. Phone: (215) 425-7911.

Circle No. 341

### Signal modifier

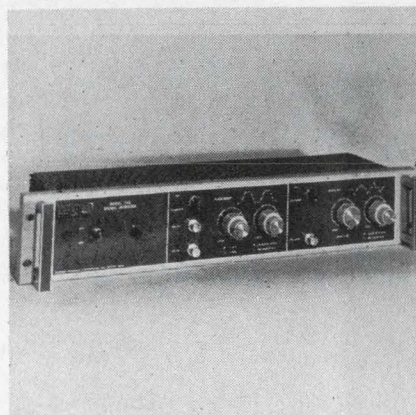

Model 245 signal modifier independently or simultaneously clips and slices to eliminate noise and transients in the dc to 5 MHz range. Variable controls permit rejection above or below a pre-set level. Slicing about the reference axis removes low-level signals or noise and clipping of peaks limits peak amplitude.

P&A: \$850; stock to 45 days. Systems Research Labs, Inc., 500 Woods Dr., Dayton, Ohio. Phone: (513) 426-4051.

Circle No. 342

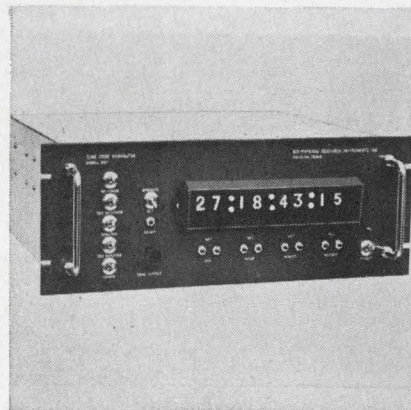

### Time code generator

Model 981 time code generator is fully transistorized for encoding and displaying data for periods up to 99 days. A temperature-stabilized crystal reference makes accuracy independent of power line frequency. Max error is 20 s/day. Outputs are serial BCD AM audio, serial and parallel BCD logic levels, pulsewidth-modulated audio, and variable-width square wave.

Bio-Physical Research Instruments Inc., P. O. Box 36010, Houston. Phone: (713) 774-2533.

Circle No. 343

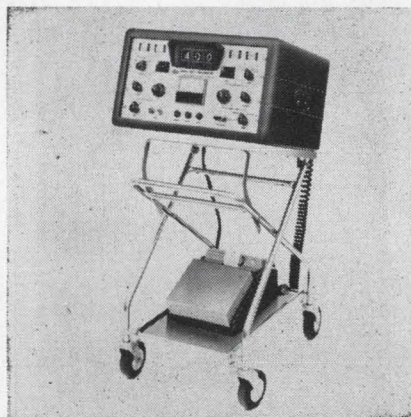

### Cable tester

Model 400-C cable tester displays and prints insulation resistance, continuity, and dielectric strength on up to 400 test points. Ranges include dielectric strength to 3000 Vac and dc, and insulation resistance to 5 G  $\Omega$ . Dwell time to 3 minutes/circuit may be selected. Max test rate 120 circuits/minute.

P&A: \$7900, \$8400 with printer; stock to 45 days. Accurate Electronics Corp., 13215 Leadwell St., N. Hollywood, Calif. Phone: (213) 781-0876.

Circle No. 344



# HELIPOT CUTS THE SIZE OF ITS 10-TURN POT



## but there's not a spec of difference

It's true . . . Helipot *actually* cut the length of its  $\frac{7}{8}$ " diameter 10-turn in half. No hocus pocus. The new Model 7266 is  $\frac{3}{4}$ " long . . . the shortest 10-turn  $\frac{7}{8}$ " diameter precision potentiometer you can buy. Yet its precision performance is unscathed, and the wirewound resistance element is actually *longer* than that of its predecessor. It is a *precision* pot in every respect. Resolution is better, the total resistance range is still 10 ohms to 125K, with  $\pm 0.2\%$  linearity as good as ever.

How much was the price raised? Not a penny — it's priced at \$10 for 1—9 pieces and well below \$8 in quantity. (And you get two for the size of one.) Complete product information is available now from your local Helipot sales office.

**Beckman**® INSTRUMENTS, INC.

HELIPOT DIVISION

FULLERTON, CALIFORNIA • 92634

INTERNATIONAL SUBSIDIARIES: GENEVA; MUNICH;  
GLENROTHES, SCOTLAND; TOKYO; PARIS; CAPE TOWN; LONDON

ON READER-SERVICE CARD CIRCLE 56



# New Literature



## Air capacitors

A line of high "Q" variable air capacitors is described and illustrated in this new catalog. Types covered include miniature, micro-miniature and high-reliability. Johanson Manufacturing Corp.

Circle No. 345

## Coincidence module

Bulletin NL-16 describes a fast ramp coincidence module for experiments requiring fast coincidence/anti-coincidence logic in the  $2t = 10$  to 30-ns resolving range. Use of the unit in determinations of the time interval between the leading edge of two pulses is detailed. A block diagram and performance curves are included. Hamner Electronics Co., Inc.

Circle No. 346

## Nanosecond data

A wall-mounting 10- x 14-in. chart of engineering data provides measurements, ratios and design information in the nanosecond range. Rise time/band pass, coax conductor ID/OD and dB/voltage conversion are among the ratios tabulated. Illustrations include diagrams for attenuator design, step response of terminations and pulse response setup for impedance. General Applied Science Labs.

Circle No. 347

## RF connectors

A 12-page catalog describes 27 types of microminiature RF connectors. Included are photographs, engineering drawings and dimensional specifications for screw-on, snap-on and slide-on types for both flexible and semi-rigid cables. Sealectro.

Circle No. 348

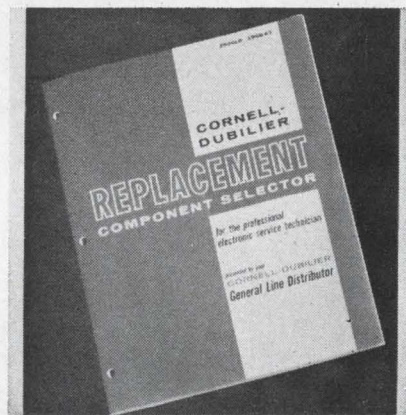

## Replacement components

An expanded and revised replacement component selector is offered. This 65-page catalog includes the addition of 16 major replacement products to the manufacturer's line. Cornell-Dubilier Electronics.

Circle No. 349

## Resolvers/synchros

A 40-page gimbal resolver/synchro catalog incorporates 40 specifications, schematics and outline drawings. Multi-pole and dual-speed concepts are cited and applications are illustrated. Reeves Instrument Co.

Circle No. 350

## PC digest

Currently featuring a story on multi-layer circuitry, a periodical, "Printed Circuit Digest" is offered. The publication is complete with application suggestions and illustrations. Electralab.

Circle No. 351

## System of units

Gilberts, teslas, stilbs and other measurement units are defined, converted and derived using the International System of Units (SI). Starting with six elemental SI units, derived units, prefixes, preferred usage and style are presented. The 28-page handbook is complete with a full bibliography.

Available for \$1.00 (1 to 49) from Brown Engineering Co. Inc., 300 Sparkman Dr., Huntsville, Ala.

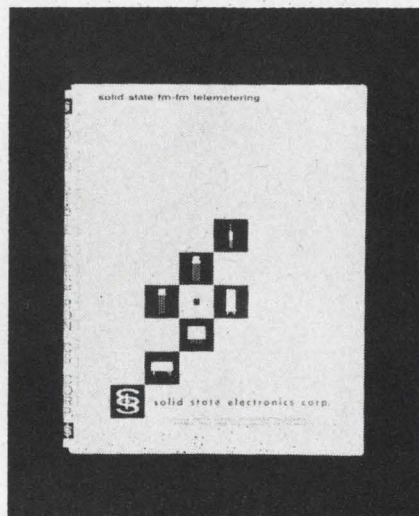

## Telemetering modules

A 40-page catalog describes AM/FM telemetering modules. Voltage controlled oscillators, dc amplifiers, dc signal isolators, frequency-to-dc converters, tone oscillators, pressure transducers and a laboratory telemetering system are described. Solid State Electronics Corp.

Circle No. 353

## Real-time computer

"Sigma 7," designed to perform real-time data processing in a time sharing environment, is described in a 20-page brochure, 64-06-01A. Basic concepts, operating characteristics, programming, hardware and software are fully covered. Scientific Data Systems.

Circle No. 354



# VOLTAGE-TO-FREQUENCY

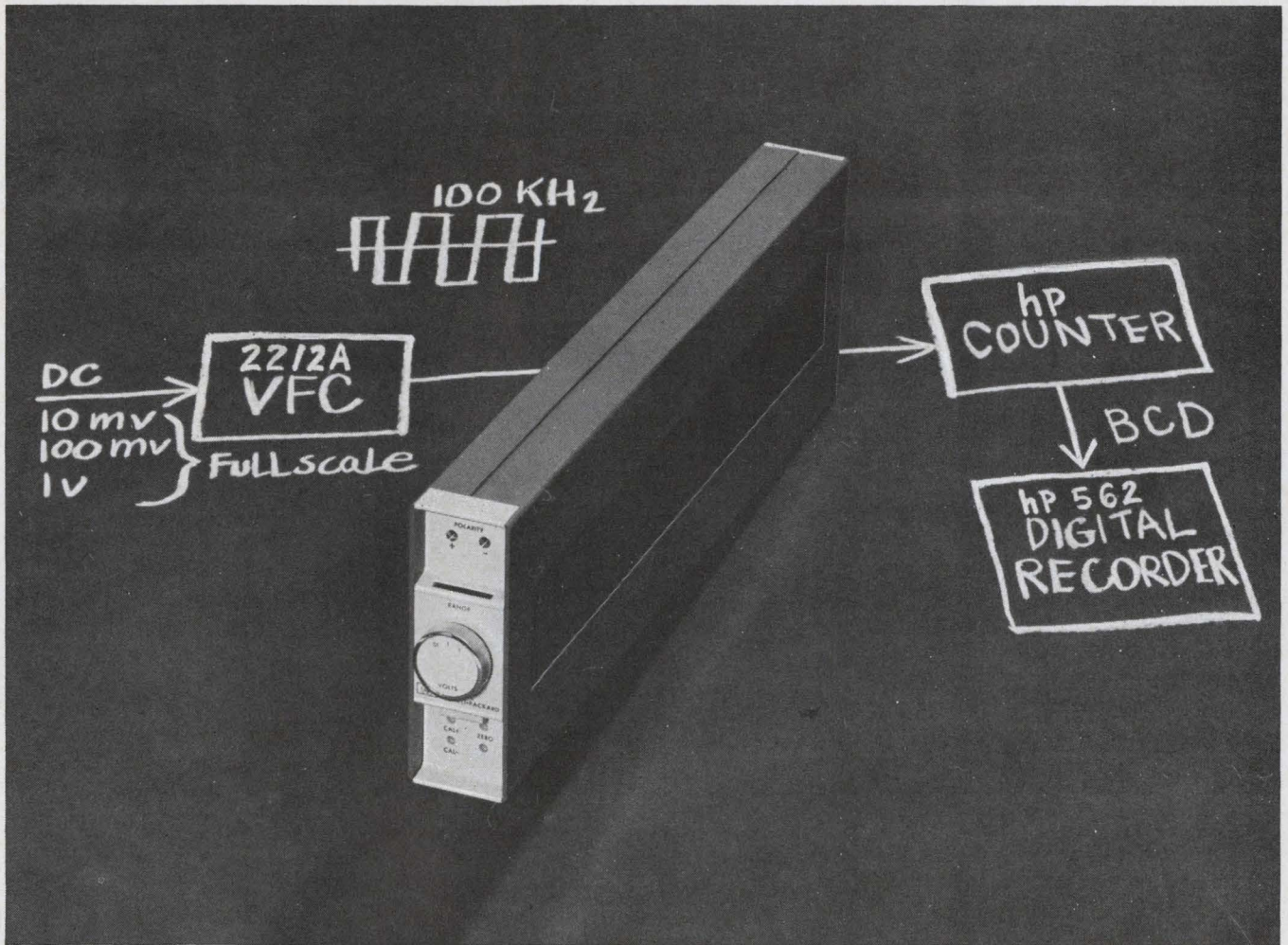

## CONVERTER

### *High-performance low-level analog-to-digital conversion*

The Hewlett-Packard 2212A Voltage-to-Frequency Converter delivers an output pulse train with rate directly proportional to the magnitude of a dc input signal. Full-scale inputs of 10 mv, 100 mv and 1 v produce an output frequency of 100 kHz; 150% overranging on all ranges. Other ranges, precision vernier control and internal calibration source are optional.

Here's a converter ideal for all types of low-level analog-to-digital conversion applications. Used with an electronic counter it tracks an input voltage by repetitive sampling to form a noise rejecting integrating digital voltmeter. The VFC responds to both positive and negative input voltages; used with a reversing counter it tracks around zero with no crossover error. Provides polarity indication and output signal.

Differential input for low drift, high cmr (120 db all ranges); true integration averages out noise superimposed on signal. Input impedance is 1000 megohms all ranges for minimum circuit loading; input and output circuits are isolated by internally driven guard shields. Fast 100  $\mu$ sec settling, 100  $\mu$ sec overload recovery gives maximum usefulness in multi-channel system applications.

The 2212A MTBF is predicted in excess of 10,000 hours. Hermetically-sealed silicon transistors are used throughout, and passive and active components are selected for reliability, as well as performance. VFC speci-

fications are guaranteed at 95% relative humidity at 40°C. A factory 100-hour "run-in" test at elevated temperature assures reliable operation.

A rugged, unique molded dielectric case encloses VFC circuitry and built-in power supply...all in a package less than 5¼" high. A combining case is available to hold 10 instruments side-by-side in a rack-width module. The 2212A VFC costs \$900.

Call your Hewlett-Packard field engineer for complete information or write the Dymec Division of Hewlett-Packard, 395 Page Mill Road, Palo Alto, Calif. 94306, Tel. (415) 326-1755; Europe: 54 Route des Acacias, Geneva.

*Data subject to change without notice. Price f.o.b. factory.*

**HEWLETT  
PACKARD**  **DYMEC  
DIVISION**

1317



## NEW LITERATURE

### Friction compensators

Three new friction compensators, or vibrators, exerting up to 2 G vibration are described in data sheet CJ 200. Theory, applications and specifications are detailed with the aid of schematics. Vibrionics Ltd.

Circle No. 355

### Servo components

An illustrated 60-page "Servo Systems" catalog offers thousands of electronic and electromechanical components. Items covered include accelerometers, gyros, precision pots; servo motors and synchros. Servo Systems Co.

Circle No. 356

### Transistor guide

A 16 x 21-in. chart covers 32 transistor geometries with applications and package outline dimensions. Also listed are generic family classifications with basic parameters. Schweber Electronics.

Circle No. 357

### Optical encoder

A 2-page data sheet describes an incremental optical encoder having resolution of  $2^{16}$ . Included are photos, operational data, detailed specifications and a block diagram. Sequential Electronic Systems Inc.

Circle No. 358

### Machinable ceramic

Product bulletin 502 describes a new line of machinable ceramics. Listed are 5 basic ceramics ranging in useful temperatures from 750 to 2200°F. Properties such as hardness, specific gravity, mechanical strength and electrical properties are tabulated. Aremco Products Inc.

Circle No. 359

### Electronic materials

"A Selection Guide to Electronic Materials" offers a guide to coatings, potting and encapsulating materials. Physical, chemical, mechanical and electrical characteristics are completely tabulated. Dow Corning.

Circle No. 360

### Mounting pads

A new catalog, #66-1, describes a line of 26 standard types of diallyl phthalate and color-coded nylon transistor mounting pads and lead spreaders. All types of pads are shown for TO-5, TO-18 and TO-8 transistors. Emphasis is placed on pads and lead spreads for 8, 10, and 12-lead IC types. Actual product samples are furnished for testing purposes. Thermalloy Co.

Circle No. 361

### Transformer sections

Two 3-page data sheets cover types "A" and "V" transformer sections. Values are given for distortion, crosstalk, operating temperature, input and breakdown voltages, power output, max rotor and stator currents and winding inductance and resistance. Power dissipation formulas and curves for determining upper half-power point, lower half-power point and mid-band gain are included. S. Himmelsstein Co.

Circle No. 362

## PERFORATED SCREENS FOR CENTRIFUGES

Stainless steel etched screens for extracting juices and crystals are resistant to acids, easy to clean, long lived — may be used wherever centrifuge requires small regular holes. Openings may be as small as .005 inches, on centers to your specification. \*\*\* Also available, back up plates for filter particle determination. Send us your problem in etched or formed metal — we produce to tolerances of  $\pm .000039$  inches.

**BUCKBEE MEARS CO.**

245 E. 6th ST., SAINT PAUL, MINN.

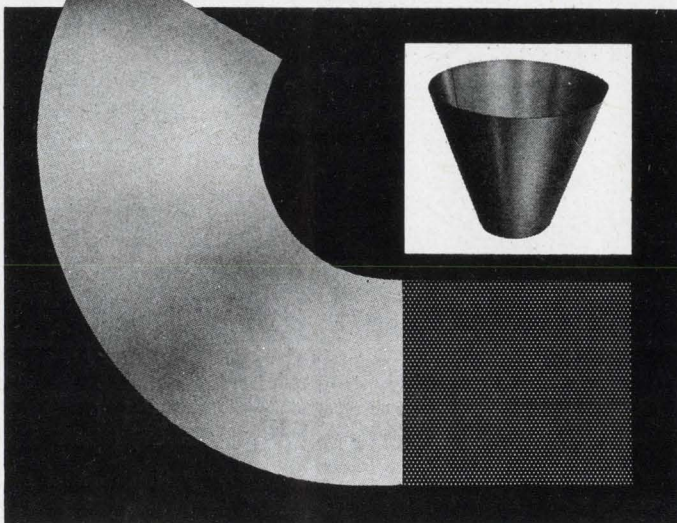

ON READER-SERVICE CARD CIRCLE 58

**DISCOVER**  
THIS  
FASTER,  
MORE  
ACCURATE,  
DISTORTION-FREE  
"PRESS and PEEL"  
METHOD  
for making  
printed circuit  
master  
drawings

**BY-BUK**

### "TAPE-LIFT"

**PRINTED CIRCUIT DRAFTING AIDS** in flat 8" strips packaged in handy slip-pack boxes. Featuring our NEW Black Matte Finish, Clear Adhesive Centerless Donuts, Teardrops and Oval Pads in many new stock sizes, also Tees, Elbows, Fillets, Adapters, Register Marks, Drafting Film and Grids, Conductor line tapes in Matte or Creped finish in widths from  $\frac{1}{64}$ " up.

Write for our **NEW CROSS-REFERENCE DRAFTING AIDS GUIDE & PRICE LIST NO. P-41 — FREE SAMPLES.**

**BY-BUK COMPANY**

4326 W. Pico Blvd., Los Angeles, Calif. 90019 • (213) 937-3511

Speed Inquiry to Advertiser via Collect Night Letter

ON READER-SERVICE CARD CIRCLE 59

ELECTRONIC DESIGN



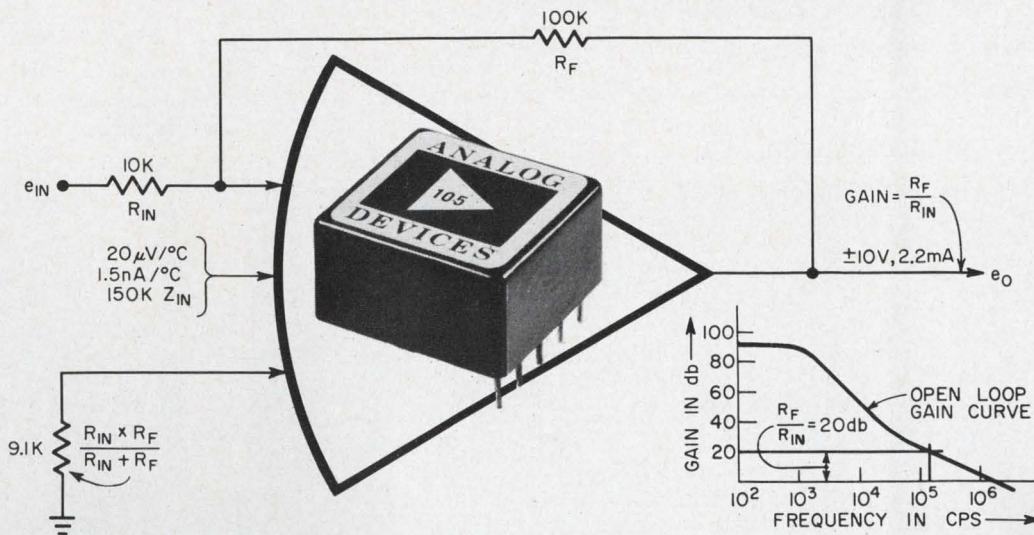

ALL YOU NEED TO BUILD PRECISION CIRCUITS IS

# Ohm's Law + \$19 Op Amp

Transistor design knowhow is no longer necessary: that's built right into our new Model 105 operational amplifier

Use Model 105 op amp as a universal building block to avoid designing circuits from the ground up. Amplifier's advanced specs save engineering time, actually improve many circuits.

External feedback components turn the amplifier into a null-detector, active filter, linear rectifier, meter driver, ramp generator, current or voltage source, comparator . . . many more. Ohm's law fixes feedback values, makes operation virtually independent of op amp's internal specifications.

Total cost is less than a couple of hours design time.

Model 105 actually provides

superior specs to op amps advertised at \$50 a year ago. So if you'd ruled out op amps because of price, its time to think again.

Drift specs of  $20 \mu\text{V}/^\circ\text{C}$  &  $1.5 \text{ na}/^\circ\text{C}$  from  $-25^\circ\text{C}$  to  $+85^\circ\text{C}$ , coupled with one-inch-square by half-inch-high packaging, make Model 105 today's best low-priced op amp buy. Priced at \$14 in 1,000 lots, the new amplifier really makes it uneconomical to design your own circuits.

**TRIAL AMPLIFIER:** Indicate on coupon which amplifier you'd like to try out in your application. If you'd like application manual, mark that too.

MODEL NO.	105	106	107	108
Minimum DC Gain	30,000	150,000	150,000	50,000
Max. Offset* @ $25^\circ\text{C}$	150 na	150 na	20 na	2 na
Max. Drift* $-25^\circ\text{C}$ $+85^\circ\text{C}$	$1.5 \text{ na}/^\circ\text{C}$ $20 \mu\text{V}/^\circ\text{C}$	$1.5 \text{ na}/^\circ\text{C}$ $20 \mu\text{V}/^\circ\text{C}$	$1.5 \text{ na}/^\circ\text{C}$ $20 \mu\text{V}/^\circ\text{C}$	$0.2 \text{ na}/^\circ\text{C}$ $20 \mu\text{V}/^\circ\text{C}$
Bandwidth	1.5 MHz	1.5 MHz	1.5 MHz	500 KHz
Output Rating	$\pm 10 \text{ V}$ $\pm 2.2 \text{ ma}$	$\pm 10 \text{ V}$ $\pm 5 \text{ ma}$	$\pm 10 \text{ V}$ $\pm 5 \text{ ma}$	$\pm 10 \text{ V}$ $\pm 2.5 \text{ ma}$
Price (1-9)	\$19	\$26	\$31	\$35

\*Figures refer to offset current at each input, not differential offsets

ANALOG

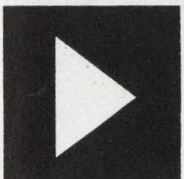

DEVICES

ANALOG DEVICES, INC.  
221 FIFTH STREET  
CAMBRIDGE, MASS. 02142  
PHONE: 617/491-1650

Analog Devices, Inc., 221 Fifth Street, Cambridge, Mass.

Send Op Amp Application Manual  Send Model \_\_\_\_\_ For Evaluation

Name \_\_\_\_\_ Title \_\_\_\_\_

Firm \_\_\_\_\_

Address \_\_\_\_\_

City \_\_\_\_\_ State \_\_\_\_\_ Zip \_\_\_\_\_

ON READER-SERVICE CARD CIRCLE 60



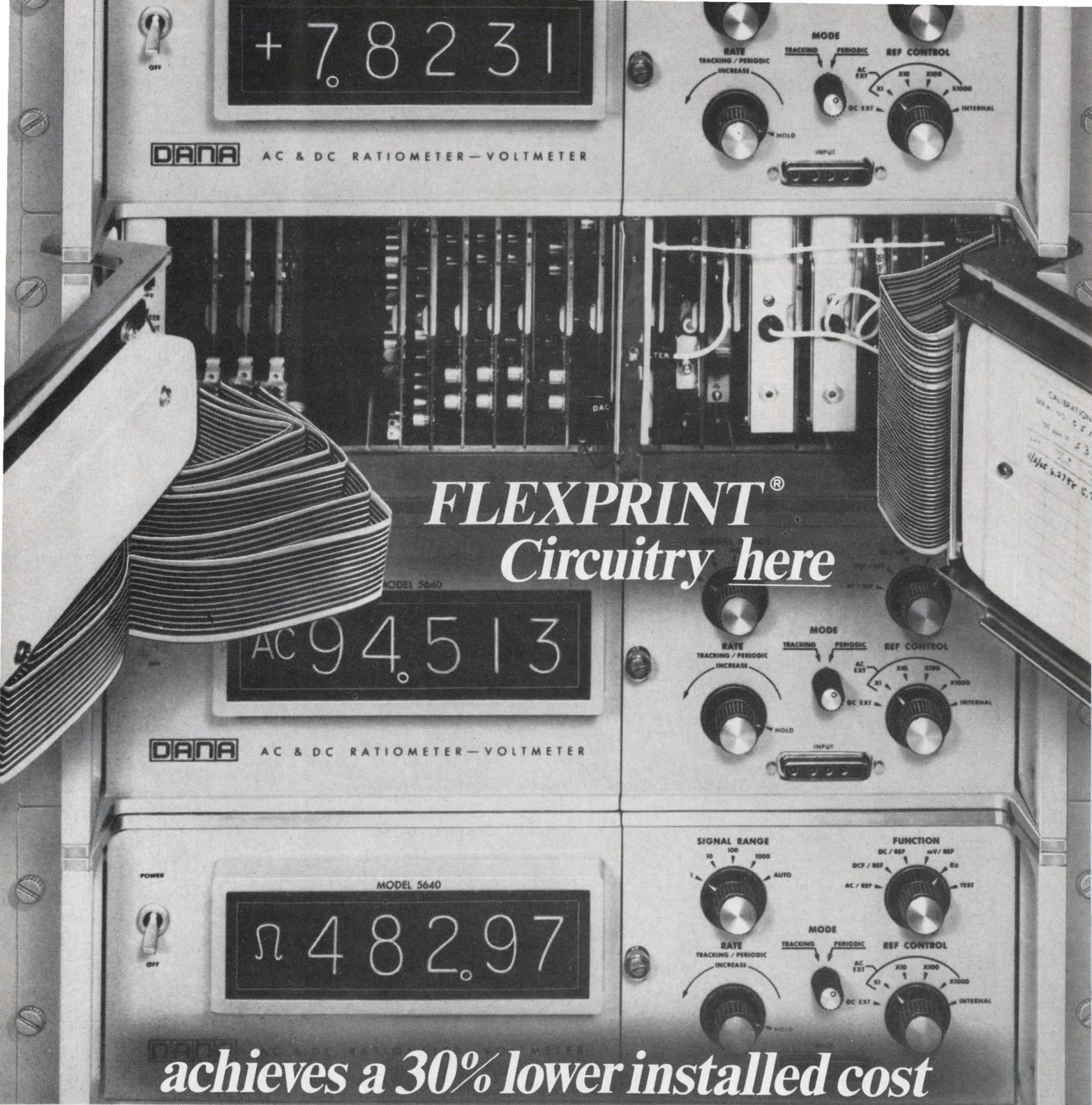

## FLEXPRIENT<sup>®</sup> Circuitry here

*achieves a 30% lower installed cost*

That's only the half of it. The other big reason Dana Laboratories, Inc., chose Sanders FLEXPRIENT Flexible Printed Circuitry is reliability.

Because FLEXPRIENT Circuitry bends, rolls, folds, curves, and can be formed, it meets the restrictive geometry of the package. Technicians can open and close the front panel doors whenever necessary without damaging wires or risking the operating reliability of the instrument.

Only seven pieces of FLEXPRIENT are used to interconnect the readout circuits, all front panel controls and the main electronics. There are no wires to solder, color code or cut . . . no harnesses to lace, no costly inventory to control.

As a result, Dana Labs produces a compact, digital ratiometer/voltmeter with greater reliability, improved performance and a 30% reduction in wiring costs.

Sanders has produced more custom-built FLEXPRIENT

Circuitry than any other manufacturer in the industry. We have acquired all the skills and necessary facilities to provide you with a single plant responsibility for all your circuit requirements.

In a continuing effort to improve the state of the art, Sanders has also developed FLEXMAX, the unique flexible multilayer printed circuitry designed for high density interconnections. For more information on the complete line of Sanders FLEXPRIENT Techniques, call or write Sanders Associates, Inc., FLEXPRIENT Products Division, Nashua, New Hampshire 03060. Phone 603-883-3321.

\*T.M., Sanders Associates, Inc.

**SANDERS ASSOCIATES, INC.**  
FLEXPRIENT PRODUCTS DIVISION



*Creating New Directions in Electronics*



NEW LITERATURE



**Components holders**

Catalog C66 illustrates a wide range of holders for components, transistors, crystals, diodes, lead wires, PC boards, heat dissipating tube shields and liners. A complete part index is included. Atlee Corp.

Circle No. 368

**Reed switch relays**

The 2-page bulletin GR-6 gives dimensions, resistances, operating characteristics and specifications of adjustable-sensitivity, automatic-reset spdt reed switch relays. General Reed Co.

Circle No. 369

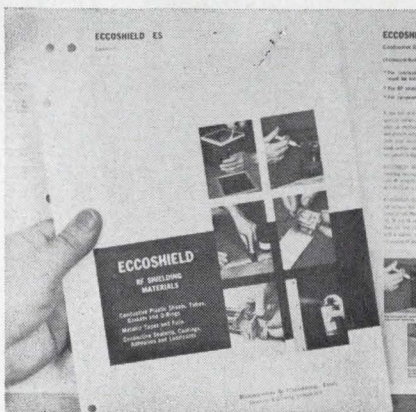

**RF shielding materials**

A 2-color brochure covers RF shielding materials. Conductive plastic sheet, gaskets, tubing and O-rings, as well as adhesives, coatings, sealants, lubricants and metallic foil are described. Emerson & Cuming Inc.

Circle No. 370

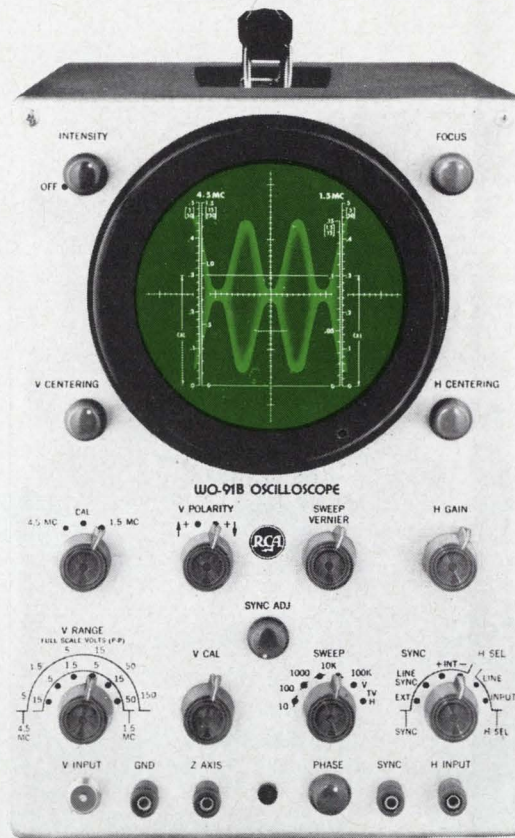

THE 'SCOPE WITH THE HIGH IQ\*

RCA WO-91B... \*INEXPENSIVE QUALITY

**Why pay for Oscilloscope capabilities you don't really need?**

There are many situations—production line work, product quality checks, basic laboratory measurements—that require a large number of scopes or employ standard measurements... and where simplicity of operation is essential.

**That's where you need the RCA WO-91B!**

Of course the so-called "industrial/laboratory" type scopes will make certain measurements that ours won't. They may feature triggered sweep, horizontal deflection in microseconds, and other costly refinements. Whenever you need these extras... capability for those extremely precise measurements... spend the money and buy an expensive scope.

Actually, for many very precise research, experimental and lab measurements, we don't even recommend ours (we use theirs).

**But if your requirements call for scopes with characteristics such as the following, the RCA WO-91B is probably your best buy:**

- Built-in voltage calibration—large 5-inch screen with VTVM-type voltage scales for fast, simultaneous peak-to-peak measurements and waveshape display
- Flat response ( $\pm 1$  dB) from 10 cps to 4.5 Mc
- 0.018 rms volt per inch maximum sensitivity for use at low signal levels
- Continuously adjustable (to 100 kc) sweep oscillator with excellent linearity
- Z-axis input for direct modulation of CRT permitting use of timing and calibration markers on trace
- Provision for connecting signals directly to the vertical deflection plates of the CRT.

The Optional User Price of the RCA WO-91B is \$249.50. It is available locally from your Authorized RCA Test Equipment Distributor. Ask to see it or write for complete specifications to RCA Commercial Engineering, Section E18W-4, Harrison, N. J.

RCA ELECTRONIC COMPONENTS AND DEVICES



The Most Trusted Name in Electronics

ON READER-SERVICE CARD CIRCLE 61



## What is really important when evaluating crystal frequency standards?

## How much can you find out from aging-rate data?

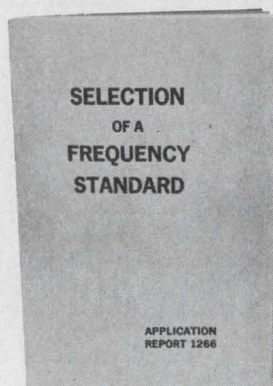

TFA-1166

Two reports will be of special help if you want to know the fine points in evaluating a crystal frequency standard.

One is "Selection of a Frequency Standard", Application Report 1266.

The other is a National Bureau of Standards report on a specific oscillator of this type.

Both are yours via the reader-service card in this magazine — or for faster response write directly to:

TRACOR, Inc.  
General Sales Offices  
6500 Tracor Lane  
Austin, Texas 78721  
Phone: 512-926-2800



**SULZER  
DIVISION**

® REPRESENTATIVES IN PRINCIPAL CITIES

## Design Aids

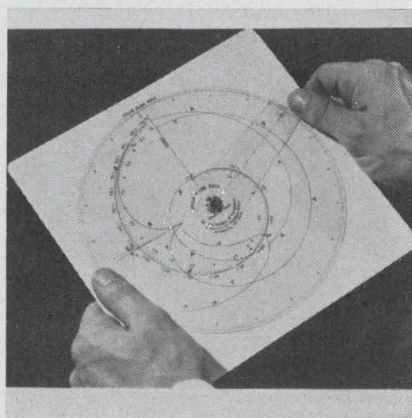

### Circular slide rule

A new circular slide rule uses a single spiraled numbered scale for trigonometric, geometric, algebraic and logarithmic calculations. This new, "Tyler" rule has a transparent cursor arm and a rotating disk mounted on a flat plastic base. The spiral-shaped C scale is the only working scale and is imprinted on the rotatable disk. All other scales found on a conventional rule are replaced with curved hair-line indexes inscribed on the base. The "Tyler" rule will perform all the operations of the standard 10-in. slipstick.

For all algebraic calculations: turn the disk to multiply, turn the cursor to divide. In problems expressed proportionally, both logarithms and functions of angles may be used without extraction, providing solutions in a single operation.

Available for \$6.00 from Weems & Plath Inc. Suite 61D, 48 Maryland Ave., Annapolis, Md.

### Oscillator guide

"The Designer's Guide for Specifying Oscillators" is a 24-page brochure covering oscillators in the 1 Hz to 100 MHz range. Crystal, tuning-fork, LC, RC, magnetostrictive, torsional, and integrated circuit oscillators are defined and described.

Output and interface design considerations are given, as are information on typical specifications, Schematics, block diagrams, graphs, photographs, tables, and charts help with the presentation of information. Accutronics Inc.

Circle No. 363

## Application Notes

### Tone-burst measurement

Application data sheet 562 deals with instrumentation systems for brief ac pulses or "tone-bursts." The technique described consists of rectifying the ac carrier and measuring the resulting dc pulse. Advantages over the conventional method of displaying bursts on a scope and estimating average or p-p value are discussed. Dana Labs, Inc.

Circle No. 364

### Composite filters

Technical bulletin 102 discusses the use of composite filters having the usual stop and pass bands and discrete notches within the pass-band. Use of the pass-reject technique to eliminate a discrete noise frequency is discussed with the aid of three frequency/attenuation curves. Notch-lowpass, -highpass and -bandpass characteristics are detailed. TT Electronics, Inc.

Circle No. 365

### Silicon wafer defects

A 6-page reprint on the observation of "Surface Defects in Silicon Epitaxial Wafers" describes and illustrates the use of interference contrast equipment on a Reichert microscope permitting direct photography of semiconductor faults without etching the wafer. Discussion of the technique is complete with photomicrographs and a full bibliography. William J. Hacker & Co., Inc.

Circle No. 366

### Bridge circuitry

Instrument note No. 38 offers a comprehensive report on Wheatstone bridge circuit applications in electromechanical transducers. The paper reviews the electrical aspects of the transducer bridge and general bridge theory, and gives complete bridge equations for various combinations of active and inactive bridge elements. Statham Instruments Inc.

Circle No. 367



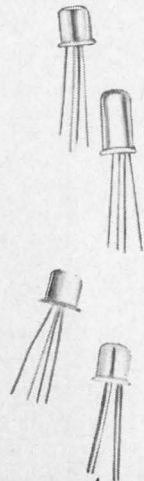

...and now  
from the  
nation's  
number one  
source of  
AM/FM  
transistors...

## instant engineering —if that's what you want!

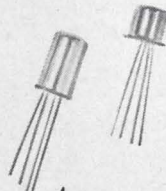

We have developed more production-ready circuits for AM/FM applications than any other semiconductor manufacturer. High-performance, ultra-reliable circuits for pocket radios, table models, FM tuners and AM/FM receivers. If instant engineering is what you want, that's what we've got for you.

## instant reliability —if that's what you want!



25 million Amperex transistors have proved their reliability during the past 7 years in the millions of radio sets designed around them! If reliability is what you want, millions of high-performance radios say you've got it.

## instant production —if that's what you want!



With our circuits and our specialized RF applications lab in back of you—you can go right into production. Our own automated mass-production manufacturing techniques guarantee instant delivery in any quantity. We'll deliver the transistors and the engineering right up to breadboarded prototypes—all you have to do is make the radios!

## instant profit —we know you want that!

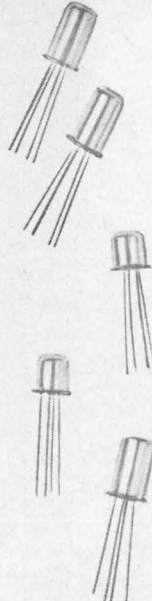

When you buy RF transistors from Amperex you get the benefit of the best mechanized production line in the industry... the best price and performance package in the world. Combine that with the specialized applications support you'll get from Amperex... and you end up with a profitable, competitive line. And we know you want that. There's an Amperex RF transistor for every AM/FM front-end design. Check your design requirements against the applications chart.

For application information for circuit designs and for complete data, contact: Amperex Electronic Corporation, Semiconductor and Receiving Tube Division, Dept. 371, Slatersville, Rhode Island 02876.

Transistor	FM RF	FM Mixer	FM Osc.	FM IF	AM RF	AM Conv.	AM IF
2N990	•	•	•	•	•	•	
2N993					•	•	•
2N3588	•	•	•	•	•		
2N2496	•	•					

# Amperex®

ON READER-SERVICE CARD CIRCLE 63



# Design Data from Manufacturers

Advertisements of booklets, brochures, catalogs and data sheets. To order use Reader-Service Card.

(Advertisement)

## Solid State Sweep Signal Generators



A new twenty-four page catalog has been announced by Texscan Corporation. The catalog describes Texscan's Solid State product line consisting of sweep generators, attenuators, detectors, coaxial switches, and large screen display oscilloscopes. Texscan sweepers cover the frequency range from audio to 2.3 GHz. This illustrated catalog includes general laboratory instruments as well as special production equipment. The catalog gives physical and electrical characteristics, applications, and also discusses general sweep generator techniques.

**Texscan Corporation**  
Indianapolis, Indiana 46207  
Telephone: 317-632-7351

**171**

## Manual on Lock Nuts



This eight page booklet is a condensation of MacLean-Fogg's general catalog of lock nuts, locking screws, and fasteners of all types. Tables for each product give dimensional data, part number, and weight. There are also application sketches that serve as an idea file for engineers. Included in the MacLean-Fogg line are three styles of prevailing torque lock nuts, free spinning Whiz-Lock nuts and screws in hex and flange styles, Weld Nuts, Flange Nuts, Clinch Nuts and Cap Nuts. MacLean-Fogg's line of products is so complete that the company is known throughout industry as "Lock Nut Headquarters."

**MacLean-Fogg Lock Nut Company**  
1060 Allanson Road  
Mundelein, Illinois

**172**

## The A.F. Book #1—Marconi Instruments

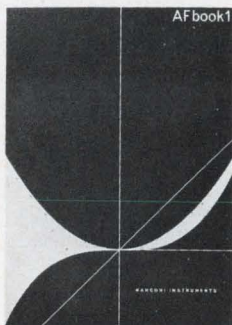

The A.F. Book #1 is a new publication available from Marconi Instruments. It deals with the measurement of A.F. parameters in amplifiers, filters and active networks covering such subjects as harmonic analysis, inter-modulation measurement (SMPTE and CCIF), etc. For your copy, write:

**Marconi Instruments**  
Dept. WAB, 111 Cedar Lane  
Englewood, New Jersey

**173**

## APPLICATION NOTES

### Accelerometer calibration

NBS technical note 269 discusses construction of an accelerometer calibrator from a machinist's dividing head on a surface plate and a precision level. The system utilizes the earth's gravitational field to provide a force simulating inertial accelerational force. A detailed discussion of this "tilting support" method calibrator includes techniques for error compensation. The results of tests on three types of accelerometers, supported by charts, give additional information on operation, flexibility and precision.

Available for \$0.20 from Clearinghouse, U.S. Dept. of Commerce, Springfield, Va.

### Reprints Available

The following reprints are available free and in limited quantities. To obtain single copies, circle the number of the article you want on the Reader-Service Card.

*High Volume—Low Cost: Designers' Challenge* (No. 740)

*Which Device for High Power Switching? Part I* (No. 741)

*Which Device for High Power Switching? Part II* (No. 742)

*Harmonic Generators: Is the Step Recovery Diode Best?* (No. 743)

### Subscription Policy

ELECTRONIC DESIGN is circulated free of charge to qualified design engineers in the U.S., Western European Continent and Britain. To establish your qualifications, send ELECTRONIC DESIGN the following information on your company's letterhead: Your name, engineering title, description of your design duties and a list of your company's major products. The letter must be signed by you personally.

Subscription rates for nonqualified subscribers—\$25 a year in the U.S., \$35 in all other countries. Single copy, \$1.50.

### Change of Address

An address change for a subscriber requires a restatement of his qualifications. To expedite the change, and to avoid missing any issues, send along a label from a back copy.

Microfilm copies of all 1961, 1962, 1963, 1964 and 1965 issues of ELECTRONIC DESIGN are available through University Microfilms, Inc., 313 N. First Street, Ann Arbor, Mich.



# Electronic Design

## Advertising Representatives

### New York 10022

Robert W. Gascoigne  
Thomas P. Barth  
Samuel M. Deitch  
Richard W. Nielson  
850 Third Avenue  
(212) PLaza 1-5530  
TWX: 867-7866

### Philadelphia 19066

Fred L. Mowlds, Jr.  
P. O. Box 206  
Merion Station, Pa.  
(215) MO 4-1073

### Marblehead 01945

Richard Parker  
7 Redstone Lane  
(617) 742-0252

### Chicago 60611

Thomas P. Kavooras  
Berry Conner, Jr.  
720 N. Michigan  
(312) 337-0588

### Cleveland 44107

Robert W. Patrick  
8410 Treetower Drive  
Chagrin Falls, Ohio  
(216) 247-7670

### Los Angeles 90005

Stanley I. Ehrenclou  
Terrence D. Buckley  
W. James Bischof  
2930 W. Imperial Highway  
Inglewood, Calif. 90303  
(213) 757-0183

### San Francisco 94306

Ashley P. Hartman  
541 Del Medio  
Suite # 301  
Mountain View, Calif.  
(415) 327-6536

### Southwestern 75235

Tommy L. Wilson  
6200 North Central Express-  
way  
Dallas, Tex. 75206  
(214) EMerson 1-2311

### London W. 1

Brayton C. Nichols  
44 Conduit Street

### Tokyo

Yoshihiro Takemura  
International Planning  
Service, Inc.  
Room No. 512 Nikkoh  
Mita Building  
1, Nishidaimachi, Shiba-  
Takanawa  
Minato-ku, Tokyo



## New Multi-Purpose VHF Receivers



### • 54-260 MHz; AM, FM, CW • Compact, Self-Contained • All Solid State Design

CEI's versatile and feature-packed new 500 Series VHF Receivers tune the 54-260 MHz range in a single band, utilizing a long steel tape dial for easy and precise frequency setting.

Types 501A, 501A-1, and 504A are identical except that the 501A-1 provides Automatic Frequency Control and the 504A includes a Crystal Marker Oscillator for quick dial calibration to the nearest 1-MHz or 5-MHz mark.

The operator can select from two IF bandwidths (300 KHz or 10 KHz) and five video bandwidths between 1 KHz and 150 KHz. Sensitivity, stability and other specifications are outstanding, and advanced solid state design helps assure top reliability as well as compactness and low power drain (just 1½ watts!). For complete information about these superior VHF receivers, please contact:

### COMMUNICATION ELECTRONICS INCORPORATED

6006 Executive Boulevard, Rockville, Md. 20852 • Phone: (301) 933-2800 • TWX: 710-824-9603

ON READER-SERVICE CARD CIRCLE 64

## Pressure-tight at Elevated Temperatures



Latronics Part 35.5040  
Actual size

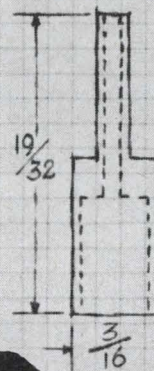

## Latronics

## High-Temperature Hermetic Seal

This special Latronics ceramic-to-metal hermetic seal, successfully used in critical aircraft fire-detection equipment, is ideal for many other high-temperature, high-reliability applications. Remains vacuum-tight after assembly by welding or brazing. Application tests prove seal integrity at 1000°F. Prompt deliveries. Send for catalog 100-266-1 describing this and other Latronics Ceramic and Glass-to-Metal Hermetic Seals.



### Latronics Corporation

1004 Lloyd Avenue, Latrobe, Pa. 15650 • Phone 412-539-1626 • TWX 412-594-7857

ON READER-SERVICE CARD CIRCLE 65



Look  
carefully

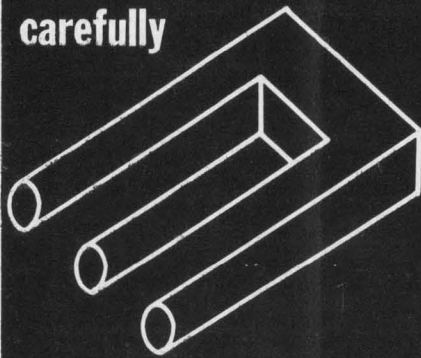

This is an optical illusion

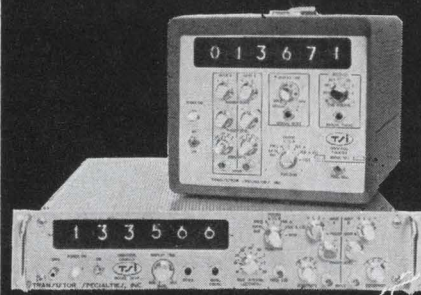

these are not

\$995

**TSI offers the lowest cost all solid state 2.5MHz universal Counter Timer on the market—And backs up its quality performance with a warranty covering all parts unconditionally for two years**

Models 361 and 361-R have every facility for counting events and frequency, measuring period, frequency ratios, pulse width, and time interval—without plug-ins, adapters or attachments.

Many optional features for special applications.

Write today for detailed specifications or call for a demonstration.

Delivery: Stock to 30 days.

**TRANSISTOR SPECIALTIES, INC.**  
TERMINAL DRIVE, PLAINVIEW, N.Y. 11803  
(516) 935-8700

ON READER-SERVICE CARD CIRCLE 66  
142

# Advertisers' Index

## \*PARTICIPANTS IN NIGHT LETTER PROGRAM

Advertiser	Page	Advertiser	Page
*AMP, Incorporated	68, 69	*Leach Corporation	113
Acopian Corporation	32	*Litton Industries, Electron Tube Division	105
Allen-Bradley Co.	127		
Ammon Instruments, Inc.	60	MacLean-Fogg Lock Nut Company	140
Amperex Electronic Corporation	139	Mac Panel Company	42
Analog Devices, Inc.	135	Mallory Capacitor Company	87
*Arnold Engineering Company, The	19	Marconi Instruments	140
Automatic Electric, A Subsidiary of		Michigan Magnetics, Inc.	122
General Telephone & Electronics	99	Monroe/Data Log, Division of	
		Litton Industries	110, 111
*Ballantine Laboratories, Inc.	128	*Motorola Semiconductor	
*Beckman Instruments, Inc.,		Products, Inc.	125, 144
Helipot Division	131	Mullard, Ltd.	31
Behlman-Invar Electronics Corp.	124		
*Bourns, Inc.	7, 45	Polaroid Corporation	92
Buckbee Mears Co.	134	Potter Company, The	118
Bud Radio, Inc.	73	*Potter & Brumfield Division of American	
*Burroughs Corporation	107	Machine & Foundry Company	114
*By-Buk Company	134	Princeton Applied Research Corp.	16
Clairex Corporation	122	RCA Electronic Components	
*Clare & Co., C. P.	102, 103	and Devices	137, Cover IV
Clarostat Mfg. Co., Inc.	120	Rowan Controller Co., The	98
*Clevite, Brush Instruments		Rutherford Division of CMC, The	2
Division	Cover III		
Communication Electronics, Incorporated	141	Sanders Associates, Inc.	136
Computer Control Company, Inc.	96—97	Schjeldahl Company, G. T.	123
		Scientific Atlanta, Inc.	101
*Damon Engineering, Inc.	22	Sel-Rex Corporation	Cover II
Digital Equipment Corporation	83	Sigma Instruments, Inc.	8, 9
		*Sola Electric, Division of Sola	
ESI/Electro Scientific Industries	126	Basic Industries	97
Electronic Design	104	Spectrol Electronics Corporation	27
Electronic Engineering Co. of California	52	Sprague Electric Company	10, 12, 22
		Syntron Company	116
Fairchild Instrumentation, A Division of			
Fairchild Camera and Instrument		TWR Semiconductors,	34
Company	80, 81	Technical Information Corp.	129
Fairchild Semiconductor, A Division		Texas Instruments Incorporated, Semicon-	
Fairchild Camera and Instrument		ductors-Components Division	108, 109
Corporation	119	Texscan Corporation	140
Filtors, Inc. Relays	96	Tracor, Inc.	33, 138
		Transistor Specialties, Inc.	142
General Electric Company, Electronic		Triad Distributor Division,	
Components, Sales Operation	28	Litton Industries	56
Globe Industries, Inc.	60	Trompeter Electronics	100
Gudebrod Bros. Silk Co., Inc.	143		
		*Union Carbide Corporation	36
Hamilton Standard, Division of			
United Aircraft Corporation	115	Vidar Corporation	85
Hayden Products/Industrial Controls			
Division, General Time	25	Westinghouse Capacitor Department	67
Hewlett-Packard .1, 23, 32A-B-C, 53, 121, 133		Weston Instruments, Inc.	6
Honeywell Test Instruments Division	4, 5	Winston Research Corporation	61
*IRC, Inc.	57	<b>Regional Advertising</b>	
Indiana General Corporation	15	Burndy Corporation	96B
		*Dale Electronics, Inc.	96D
*JFD Electronics Corporation	95	*Magnetics, Inc.	96A
		Sorensen Operation, Raytheon Company	96C
Kidde & Company, Inc., Walter	89	<b>Career Advertising</b>	
		General Electric Company	
Lambda Electronics Corp.	90, 91	Ordnance Dept.	78, 79
Latronics Corporation	141	IBM Federal Systems Center	77
		Motorola Military Electronics Division	74



# GUDEBROD LACING TAPE CAN SAVE YOU MONEY—



**HERE'S  
WHY-**

**1 SPECIAL FINISHES  
SPEED HARNESING**

Gudebrod has Lacing Tape that almost laces itself—the worker guides it instead of having to fight it. *Work goes fast!*

**2 BETTER HARNESSES  
—FEWER REJECTS**

Gudebrod Lacing Tape makes proper ties that do not slip. *Saves money on assembly! Saves costly rejects!*

**3 WORKER SAFETY  
APPRECIATED**

Gudebrod Lacing Tape is easy on the hands, feels good to work with . . . so the work goes better, is faster. *Saves money on harnessing time!*

**4 GUDEBROD CABLE-LACER  
*another money saver***

Handle holds bobbin of lacing tape, feeds tape as needed, grips it for knotting. Speeds harnessing. Has paid for itself in a day. *Another money saver.*

Gudebrod Lacing Tape is engineered for the job it has to do—saves money where it counts—in the harness room. More than 200 different tapes in the Gudebrod Line—Write for our Product Data Book!



**GUDEBROD BROS. SILK CO., INC.**

FOUNDED IN 1870



*Electronics Division*

12 SOUTH 12th STREET, PHILADELPHIA, PENNSYLVANIA 19107

ON READER-SERVICE CARD CIRCLE 67



Motorola's  
New 35 nsec  
Turn Off  
Silicon Annular\*  
Switch

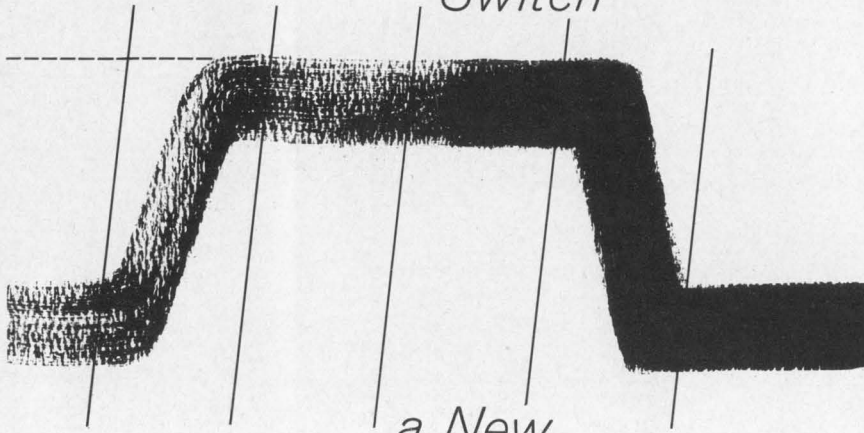

a New  
record  
for  
PNP Saturated  
Switching

You can take a giant step forward in faster PNP saturated switching with the new Motorola 2N3546 that combines a highly efficient, optimized geometry . . . an ultra-small emitter . . . and improved gold diffusion to give you unprecedented performance for PNP silicon transistors! Plus, it features the annular structure — Motorola's exclusive device design to guarantee the highest order of over-all performance and stability.

Just look at these added features of the PNP 2N3546 —

At 50 ma with Force Gain ( $B_f = 10$ )

- Extremely low turn-on time —  $t_{on} = 25$  ns. max.
- Very fast turn-off time —  $t_{off} = 35$  ns. max.
- Exceptionally low saturation voltage —  
 $V_{CE(sat)} = 0.25$  volts max.

In addition, an extremely high  $f_T$  — over 700 MHz

**EVALUATE THIS PACESETTER DEVICE FROM MOTOROLA — NOW!**

Your Motorola distributor or district sales representative can supply a test unit to try in your circuit designs. Or get your Copy of the Designer\*\* Data Sheet, showing complete specifications, including "worst-case" limit curves. Write Technical Information Center, Motorola Semiconductor Products Inc., Box 955, Phoenix, Arizona 85008.



**MOTOROLA**  
Semiconductors

\*Annular semiconductors patented by Motorola Inc. \*\*A trademark of Motorola Inc.

Speed Inquiry to Advertiser via Collect Night Letter  
ON READER-SERVICE CARD CIRCLE 68

## Designer's Datebook

MAY						
S	M	T	W	T	F	S
1	2	3	4	5	6	7
8	9	10	11	12	13	14
15	16	17	18	19	20	21
22	23	24	25	26	27	28
29	30	31				

JUNE						
S	M	T	W	T	F	S
		1	2	3	4	
5	6	7	8	9	10	11
12	13	14	15	16	17	18
19	20	21	22	23	24	25
26	27	28	29	30		

### June 7-9

20th Annual Convention of the Armed Forces Communications and Electronics Association (Wash., D. C.) Sponsor: AFCEA; W. J. Baird, 1725 Eye St., N. W., Washington 6, D. C.

### June 13-14

Filmed Data & Computers Seminar (Boston, Mass.) Sponsor: United States Air Force, Electronic System Div.; Dr. H. L. Kasnitz & G. M. Shannon, MIT Lincoln Lab., Lexington, Mass.

### June 15-17

1966 IEEE Communications Conference (Philadelphia, Pa.) Sponsor: IEEE, Philadelphia Section; William H. Forster, Philco Corp., Communication Electronics Div., Philadelphia, Pa.

### June 15-17

1966 IEEE Solid-State Device Research Conference (Evanston, Ill.) Sponsor: IEEE; Dr. B. J. Rothlein, National Semiconductor Corp., P. O. Box 443, Danbury, Conn.

### June 15-20

XIIIth International Scientific Congress on Electronics (Rome, Italy); Secretariat of the Congress, Via Crescenzo 9, Rome, Italy.

### June 21-23

Conference on Precision Electromagnetic Measurements (Boulder, Colo.) Sponsor: Institute for Basic Standards of the National Bureau of Standards; John Cronland, University of Colorado, 328 University Memorial Center, Boulder, Colo.

### June 27-29

2nd Annual Conference & Exhibit on "Exploiting the Ocean" (Wash., D. C.) Sponsor: Dr. James H. Wakelin Jr., Scientific Engineering Institute, Waltham, Mass.



Another Brush Innovation in Recording:

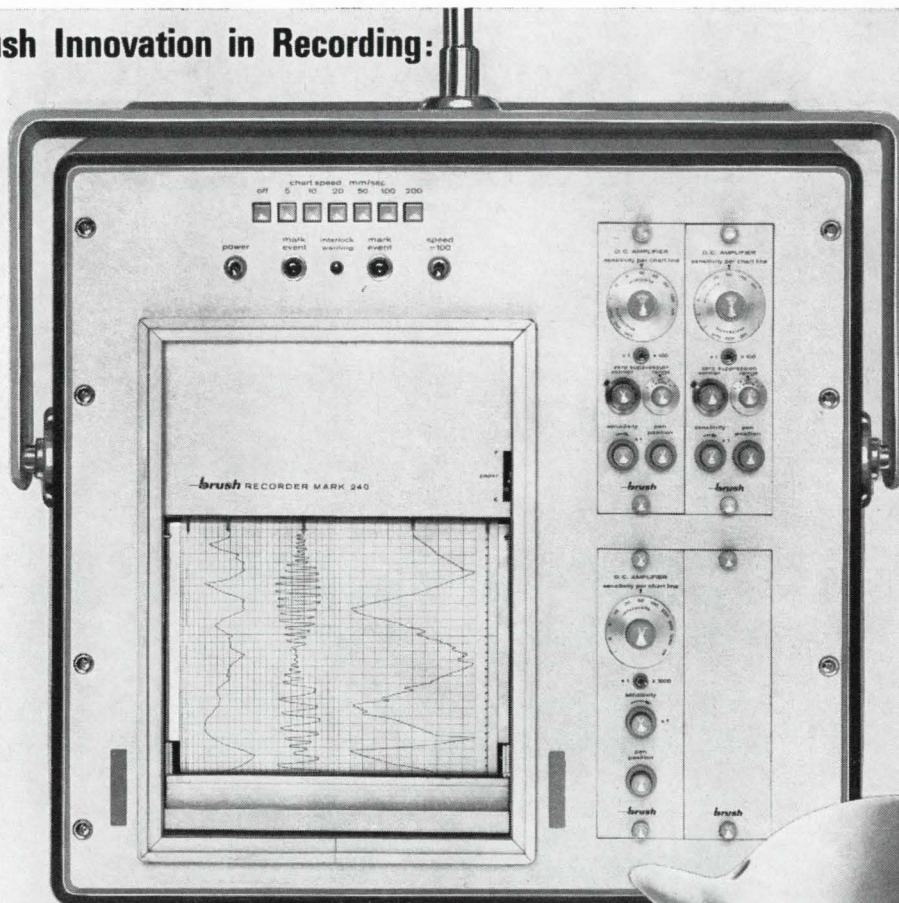

## The Brush Mark 240

If you can't record it  
with this recorder,  
chances are  
it didn't happen!

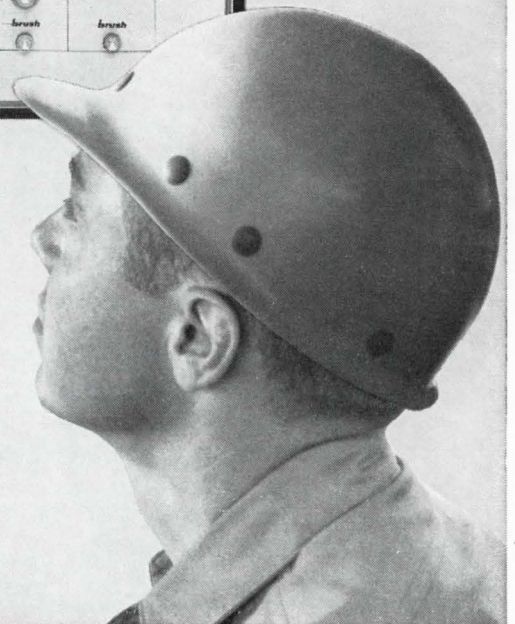

What we've done is this:

We took our famous Mark 200 Recorder and made a 'compact' version for general purpose and medical requirements. Performance? The new 240 will do everything the Mark 200 will do. And as Aerospace people will tell you, that's plenty: System linearity better than  $\frac{1}{2}\%$ . Pressurized fluid writing system assures incredibly crisp traces on low cost chart paper. Presentation is true rectilinear and there's push-button choice of 12 chart speeds.

Cost? The Mark 240 runs about

half as much as a Mark 200. Still, you have a choice of either four 40 mm analog channels, two 80 mm channels, or a combination\* of two 40s and one 80. (You can also have 8-channel event-marker modules). There's a choice of 17 plug-in pre-amplifiers, too. High gain d-c units, straight-through couplers and strain-gage and demodulator types. The Mark 240 is just 17½" high x 19" wide x 20½" deep. Mount it vertically or horizontally in standard 19" racks to RETMA specs, on table-top carts or you name it!

If your kind of recording calls for the utmost in resolution, precision and recording flexibility, ask your Brush representative for complete details about the new Brush Mark 240. There's nothing else like it . . . anywhere! Brush Instruments Division, Clevite Corporation, 37th & Perkins, Cleveland, Ohio 44114. *Just out! Three information-packed booklets on strain recording, temperature recording and techniques of low-level recording. Write us today for your copies. They're yours for the asking!*

\*see photo

# CLEVITE

**brush** INSTRUMENTS DIVISION

Speed Inquiry to Advertiser via Collect Night Letter  
ON READER-SERVICE CARD CIRCLE 243



# Simplify Circuits and Reduce Costs in New Microwave Equipment with RCA "overlay" Transistors

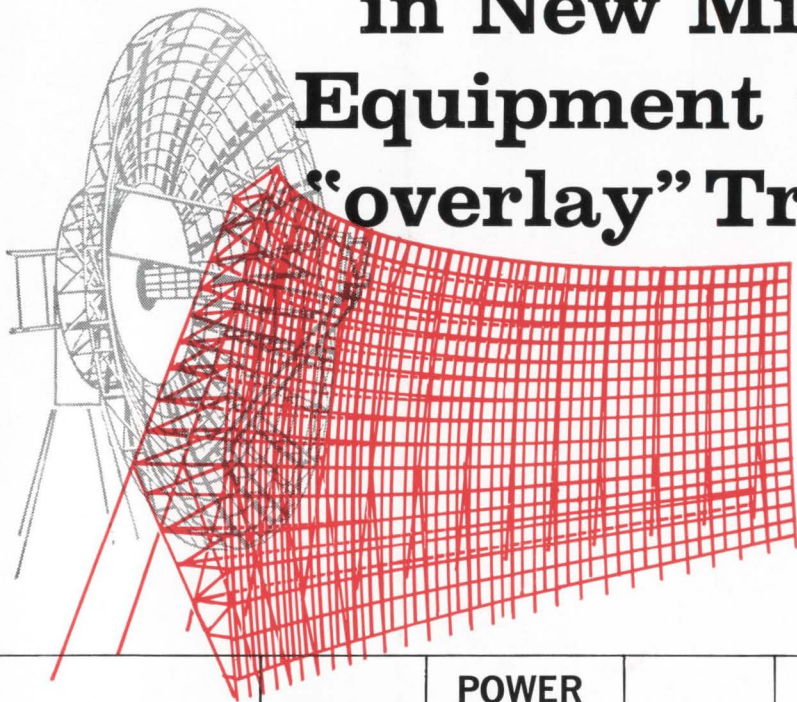

TYPE	FREQ. Mc/s	POWER OUTPUT WATTS (Min)	GAIN dB	V <sub>CC</sub> VOLTS	C <sub>ob</sub> pF (Max.)	EFF. %	PKG.
2N3375	400	3	5	28	8	40	TO-60
2N3733	400	10	4	28	15	45	TO-60
2N3866	400	1	10	28	3	45	TO-39
2N4012	1050	2.5	4	28	10	25	TO-60

As Much as 2.5 W Power Output With Power Gain at 1 Gc/s. RCA "overlay" technology extends transistor performance into the microwave region with greater power, gain, efficiency, and frequency capability. This solid performance means you can design doubler, tripler, and quadrupler microwave stages with fewer solid-state devices and less complex circuitry, reducing the cost of your equipment design while increasing total circuit reliability.

At microwave frequencies, RCA "overlay" transistors are your best choice for functions such as frequency multiplication. Not only do you get exceptional power gain, you also cut circuit costs by reducing the number of components needed. In the "overlay" design, the non-linear capacitance of the collector-to-base junction acts as a built-in varactor diode, thereby eliminating the diode as

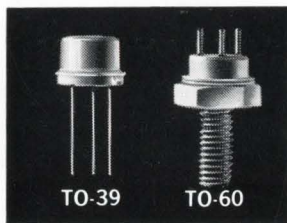

well as the transistor amplifier previously needed.

Combine this inherent frequency multiplication capability with the frequency performance of "overlay" and you have all the ingredients needed for an efficient oscillator frequency multiplier. RCA "overlay" transistors operated in oscillator-quadrupler circuits have achieved outputs as high as 300 mW at 1.7 Gc/s. And "overlay" offers comparable design benefits for straight-through amplifiers and oscillators.

For more information on RCA "overlay" transistors at microwave frequencies, consult your RCA Representative. For technical data and a copy of a new application note "Frequency Multiplication Using 'overlay' Transistors" (SMA-40), write: RCA Commercial Engineering, Section 1G5-4, Harrison, N. J.

**Also Available From Your RCA Distributor**



RCA Electronic Components and Devices

**The Most Trusted Name in Electronics**