

# Electronic Design 23

VOL. 15 NO.

FOR ENGINEERS AND ENGINEERING MANAGERS

NOV. 8, 1967

**Electronics in the USSR:** theory and aspirations ride high, but the hardware keeps them grounded. Their newest computers are, for instance, what we would label

second-generation-type machines. Monolithic circuits as we know them simply do not exist. For a status report on Soviet electronic technology trends, see page 17.







**HI-FI**

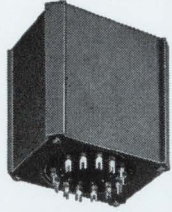

Transistor output; matches any PP transistor to 4, 8, 16  $\Omega$  speaker. Primary 48, 36, 12  $\Omega$  C.T.; 20  $\sim$  to 20 KC; 40 watts.

**MINIATURE MIL TYPE**

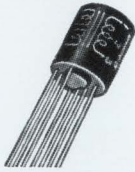

Metal case hermetically sealed to MIL-T-27B. Gold Dumet leads spaced on 0.1 radius, for printed circuit application.

**CHOPPER**

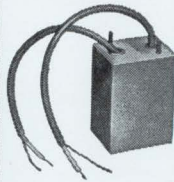

Magnetic shielded plus electrostatic shield for voltage isolation of 2x10<sup>6</sup>. Primary 200K C.T. to within 0.1%. Secondary 50K.

**HIGH POWERED AUDIO**



Low distortion 2.5 KW output transformer, PP 450 TH's 18,500 ohms C.T. to 24/6 ohms, 20 KV hipot. 520 lbs.

**CATHODE FOLLOWER OUTPUT**



Provides equal voltages to 5 loads. Primary inductance maintained to 5% with 20% change in DC unbalance and 30% change in AC voltages.

**“SPECIAL” CUSTOM BUILT AUDIO TRANSFORMERS TO YOUR SPECIFICATIONS**

**HI-FREQUENCY CARRIER TO MIL-T-27B**



Electrostatically shielded, humbucking, +30 dbm level. Within .5 db 250 cycles to 110 KC. 600/135:600 centertapped to .1% tolerance.

**HYBRID TRANSFORMER**

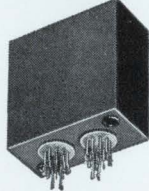

Two transformers each 600  $\Omega$  primary, 40K  $\Omega$  C.T. secondary 250 cycles to 5 KC within 1/4 db. 40 db isolation over band.

**MICROMODULE**



Life tested per micromodule specs.: no failures. 10K  $\Omega$  C.T. to 10K  $\Omega$ , 100 mw from 400  $\sim$  to 20KC.

**SUBMINIATURE MOLDED TRANSFORMER**

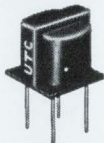

Grade 3 with printed circuit leads for transistor application. 150  $\Omega$  to 150  $\Omega$  at 10 dbm level. Size 1/2 x 1/2 x 1/2"; weight 5 grams.

**BOLOMETER TRANSFORMER**

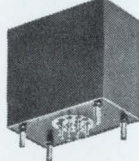

Primary 10 ohms, secondary 530K ohms, 230:1 ratio, response from 1/2 cycle to 25 cycles. 120 db magnetic shielding, plus full electrostatic shielding.

**ULTRA-MINIATURE**

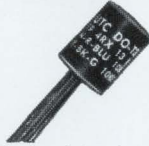

Electrostatically & magnetically shielded output transformer 1/4 D. x 1/4" H. Pri. 15K CT, Sec. 8K CT; max. level 50 mw; audio range response. To MIL-T-27B, grade 4.

Exceptional quality and reliability is provided in all UTC designs. Over 30 years of engineering knowledge and experience substantiated by extensive field performance assure the highest quality and most reliable components in the industry. Complete environmental testing facilities are incorporated to prove out new designs. Full analysis and evaluation of materials are conducted in UTC's Material and Chemical Laboratories. Rigid quality control measures coordinated with exhaustive statistical findings and latest production procedures results in the industry's highest degree of reliability. Range covered in Audio Transformers is from 0.1 cycles to 400 MC . . . microwatts to 50 KW.

**MILITARY AND COMMERCIAL TYPES FOR EVERY PHASE OF THE ELECTRONICS ART**

- POWER TRANSFORMERS • AUDIO TRANSFORMERS • INDUCTORS • PULSE TRANSFORMERS • ELECTRIC WAVE FILTERS • LUMPED CONSTANT DELAY LINES • HIGH Q COILS • MAGNETIC AMPLIFIERS • SATURABLE REACTORS • REFERENCE UNITS

Write for catalog of over 1,300 UTC TOP QUALITY STOCK ITEMS IMMEDIATELY AVAILABLE from your local distributor.

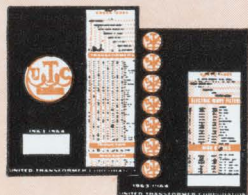

**UNITED TRANSFORMER CO.**

DIVISION OF TRW INC. • 150 VARICK STREET, NEW YORK, N. Y. 10013  
IN CANADA: A. C. SIMMONDS & SONS LIMITED, AGINCOURT, ONTARIO



<1% distortion sine, <250 ns square,  
<1% linear triangular waveform outputs.

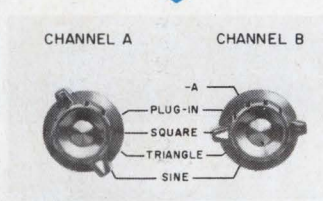

**COVER THE SIGNAL  
SPECTRUM TO 100kHz  
WITH HP MODEL 3300A  
FUNCTION GENERATOR  
AND HP MODEL 3302A  
TRIGGER/PHASE  
LOCK PLUG-IN!**

hp 3302A TRIGGER/PH

Multiple or Single bursts,  
controlled by external signal with 360°  
variable Start/Stop Phase.

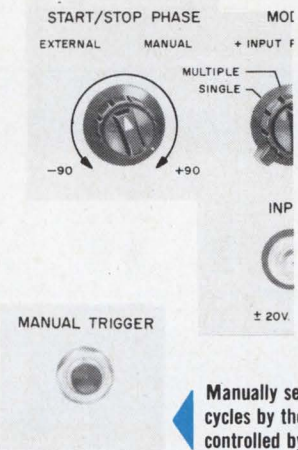

Manually select single or multiple  
cycles by the push of a button. Frequency is  
controlled by Frequency dial.

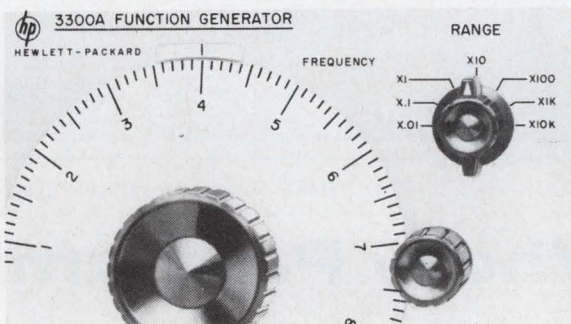

Frequency range  
0.01 Hz to 100 kHz through  
seven decade ranges.

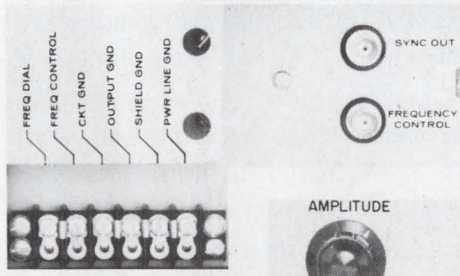

External frequency programming  
greater than 1 decade can be achieved  
with 0 to -10 V input.

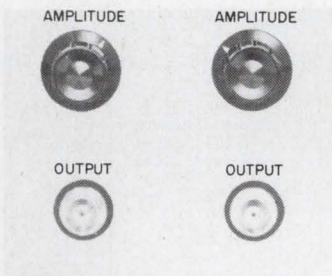

Two independently amplified fully floating  
outputs with separate controls for 35 V p-p.



Any two functions  
(sine, square or triangle) can  
be phase locked to any external  
periodic signal. Phase can be  
controlled 360° ±10°.

Price: hp 3300A Function Generator Mainframe,  
\$625.00; hp 3301A Auxiliary Plug-In, \$20.00; or hp  
3302A Trigger/Phase Lock Plug-In, \$190.00. For full  
specifications, contact your nearest hp field engineer.  
Or, write Hewlett-Packard, Palo Alto, California 94304.  
Europe: 54 Route des Acacias, Geneva.

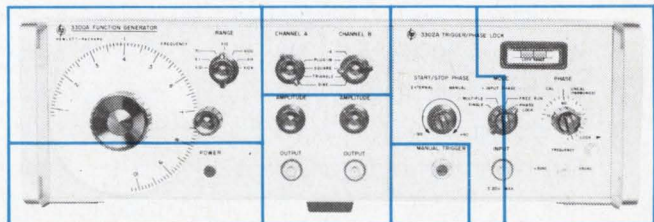

097/12

**HEWLETT** **hp** **PACKARD**  
An extra measure of quality

ON READER-SERVICE CARD GIRCLE 1



110FP-A2 Programming Unit \$3590.00

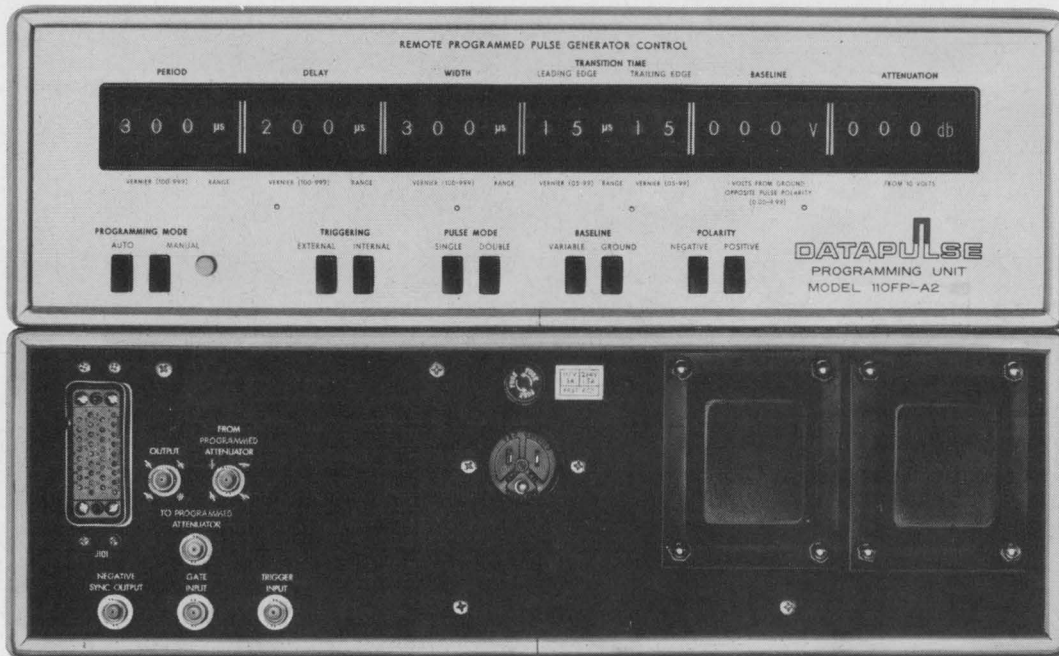

110FP Programmable Pulse Generator \$2530.00

# Wholly Programmable Pulses

The back view of the Datapulse 110FP Programmable Pulse Generator is more interesting than the front . . .

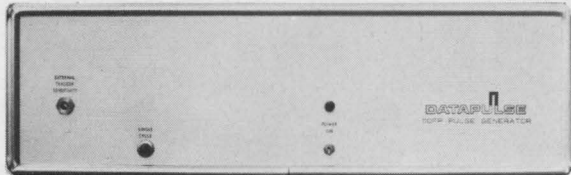

110FP Front View (Look! No Knobs!)

. . . Output characteristics are controlled from remote resistor values and ground contact closures.

With an external stepping switch or relay matrix, the 110FP can be automatically or manually sequenced through a preset program of rep rates, delays, and widths. An external switch panel can be used to select resistor values to set-up test combinations.

Wide range pulse control covers most programmed testing requirements. Programmed functions include rep rates from 10 Hz to 10 MHz, delays from 10 ns to 100 ms, widths from 10 ns to 10 μs, linear transition times from 5 ns, and closed-loop baseline offset to 10V. External or internal trigger, single or double pulse, positive or negative polarity, and output disconnect are also programmable. Fixed ±10V outputs are provided.

Utility is extended with a companion programmer, the Datapulse 110FP-A2. The 110FP-A2 provides programmed attenuation. It permits programming from parallel digital logic lines (memory capability optional). It allows manual control of programmed functions. Thumbwheel switches and digital readout minimize operator error and speed test set-ups and changes.

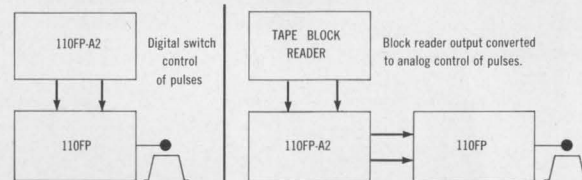

The 110FP-A2 is also compatible with card reader or contact closure input.

The **whole** story on Datapulse automated pulse generation is yours for the asking. Ask for technical bulletin 110FP. For additional information or assistance, contact us or your nearest Datapulse sales representative.

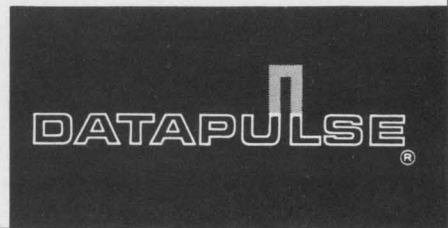

Datapulse Incorporated — A Subsidiary of Systron Donner Corporation, 10150 West Jefferson Blvd., Culver City, California 90230. Telephone: (213) 836-6100, 871-0410. TWX: 910-340-6766. CABLE: Datapulse • Microwave Division: DeMornay-Bonardi.

ON READER-SERVICE CARD CIRCLE 3



---

## NEWS

- 13 News Scope
- 17 **News Feature: Soviet electronics—Hot theory, cold hardware**  
Despite shortcomings, impressive gains are made with relatively simple methods.
- 26 'See-through' ceramic creates optical memory.
- 29 Washington Report
- 35 Revised phone rules may spur digital facsimile.
- 38 **Billion-bit holographic memories by 1970?**  
IBM scientists seek better photodiode IC arrays to achieve goal.
- 46 Letters
- 62 Sidelights of the Issue
- 65 **Editorial: How can the engineer keep up technologically?**

---

## TECHNOLOGY

- 68 **Use discrete-component logic circuits** for those do-it-yourself jobs where speed counts more than cost and the 'last performance decimal.'
- 74 **How 'hot' are you on thermal ratings** of power transistors? Here is a short refresher course that considers what they are and how they should be used.
- 78 **Which fm recording method is best?** There are wide-band, narrow-band and constant-bandwidth types, and the selection is by no means simple.
- 84 **Measure high power pulses accurately** with current transformers and capacitive dividers. These simple methods can be used in the lab or field.
- 90 **Design a pulse generator with 10 ICs.** This approach uses off-the-shelf digital microcircuits and a crystal for stability.
- 96 **Profit by learning cost analysis.** Any engineer can spur his advance to the ranks of management by knowing how to control business expenses.
- 104 NASA Tech Briefs
- 110 Ideas for Design

---

## PRODUCTS

- 126 **Components:** Magnetic reed switch handles 1875 V/A at 125 V ac.
- 164 **Semiconductors:** LSA diodes yield 100 W in X band.
- 170 **Test Equipment:** All-electronic kV pulser sparks to life in 50 ns.
- 158 Materials
- 178 Microwaves
- 188 Systems
- 194 Production Equipment

---

## Departments

- |                       |                         |
|-----------------------|-------------------------|
| 106 Book Reviews      | 217 Reprints            |
| 200 Design Aids       | 220 Advertisers' Index  |
| 206 Application Notes | 222 About the Magazine  |
| 210 New Literature    | 223 Designer's Datebook |



# Do something nice

**National Semiconductor Corporation**  
2975 San Ysidro Way  
Santa Clara, California 95051

*Please send nice, new short form catalog to my friend.*

FRIEND'S NAME \_\_\_\_\_  
FRIEND'S COMPANY \_\_\_\_\_  
FRIEND'S TITLE \_\_\_\_\_  
FRIEND'S ADDRESS \_\_\_\_\_ FRIEND'S ZIP \_\_\_\_\_

**National Semiconductor Corporation**  
2975 San Ysidro Way  
Santa Clara, California 95051

*Please send nice, new short form catalog to my friend.*

FRIEND'S NAME \_\_\_\_\_  
FRIEND'S COMPANY \_\_\_\_\_  
FRIEND'S TITLE \_\_\_\_\_  
FRIEND'S ADDRESS \_\_\_\_\_ FRIEND'S ZIP \_\_\_\_\_

**National Semiconductor Corporation**  
2975 San Ysidro Way  
Santa Clara, California 95051

*Please send nice, new short form catalog to my friend.*

FRIEND'S NAME \_\_\_\_\_  
FRIEND'S COMPANY \_\_\_\_\_  
FRIEND'S TITLE \_\_\_\_\_  
FRIEND'S ADDRESS \_\_\_\_\_ FRIEND'S ZIP \_\_\_\_\_

**National Semiconductor Corporation**  
2975 San Ysidro Way  
Santa Clara, California 95051

*Please send nice, new short form catalog to my friend.*

FRIEND'S NAME \_\_\_\_\_  
FRIEND'S COMPANY \_\_\_\_\_  
FRIEND'S TITLE \_\_\_\_\_  
FRIEND'S ADDRESS \_\_\_\_\_ FRIEND'S ZIP \_\_\_\_\_

**National Semiconductor Corporation**  
2975 San Ysidro Way  
Santa Clara, California 95051

*Please send nice, new short form catalog to my friend.*

FRIEND'S NAME \_\_\_\_\_  
FRIEND'S COMPANY \_\_\_\_\_  
FRIEND'S TITLE \_\_\_\_\_  
FRIEND'S ADDRESS \_\_\_\_\_ FRIEND'S ZIP \_\_\_\_\_

**National Semiconductor Corporation**  
2975 San Ysidro Way  
Santa Clara, California 95051

*Please send nice, new short form catalog to my friend.*

FRIEND'S NAME \_\_\_\_\_  
FRIEND'S COMPANY \_\_\_\_\_  
FRIEND'S TITLE \_\_\_\_\_  
FRIEND'S ADDRESS \_\_\_\_\_ FRIEND'S ZIP \_\_\_\_\_

**National Semiconductor Corporation**  
2975 San Ysidro Way  
Santa Clara, California 95051

*Please send nice, new short form catalog to my friend.*

FRIEND'S NAME \_\_\_\_\_  
FRIEND'S COMPANY \_\_\_\_\_  
FRIEND'S TITLE \_\_\_\_\_  
FRIEND'S ADDRESS \_\_\_\_\_ FRIEND'S ZIP \_\_\_\_\_

**National Semiconductor Corporation**  
2975 San Ysidro Way  
Santa Clara, California 95051

*Please send nice, new short form catalog to my friend.*

FRIEND'S NAME \_\_\_\_\_  
FRIEND'S COMPANY \_\_\_\_\_  
FRIEND'S TITLE \_\_\_\_\_  
FRIEND'S ADDRESS \_\_\_\_\_ FRIEND'S ZIP \_\_\_\_\_



# for someone, today.

**National Semiconductor Corporation**

2975 San Ysidro Way  
Santa Clara, California 95051

*Please send nice, new short form catalog to my friend.*

FRIEND'S NAME \_\_\_\_\_

FRIEND'S COMPANY \_\_\_\_\_

FRIEND'S TITLE \_\_\_\_\_

FRIEND'S ADDRESS \_\_\_\_\_ FRIEND'S ZIP \_\_\_\_\_

**National Semiconductor Corporation**

2975 San Ysidro Way  
Santa Clara, California 95051

*Please send nice, new short form catalog to my friend.*

FRIEND'S NAME \_\_\_\_\_

FRIEND'S COMPANY \_\_\_\_\_

FRIEND'S TITLE \_\_\_\_\_

FRIEND'S ADDRESS \_\_\_\_\_ FRIEND'S ZIP \_\_\_\_\_

**National Semiconductor Corporation**

2975 San Ysidro Way  
Santa Clara, California 95051

*Please send nice, new short form catalog to my friend.*

FRIEND'S NAME \_\_\_\_\_

FRIEND'S COMPANY \_\_\_\_\_

FRIEND'S TITLE \_\_\_\_\_

FRIEND'S ADDRESS \_\_\_\_\_ FRIEND'S ZIP \_\_\_\_\_

**National Semiconductor Corporation**

2975 San Ysidro Way  
Santa Clara, California 95051

*Please send nice, new short form catalog to my friend.*

FRIEND'S NAME \_\_\_\_\_

FRIEND'S COMPANY \_\_\_\_\_

FRIEND'S TITLE \_\_\_\_\_

FRIEND'S ADDRESS \_\_\_\_\_ FRIEND'S ZIP \_\_\_\_\_

**National Semiconductor Corporation**

2975 San Ysidro Way  
Santa Clara, California 95051

*Please send nice, new short form catalog to my friend.*

FRIEND'S NAME \_\_\_\_\_

FRIEND'S COMPANY \_\_\_\_\_

FRIEND'S TITLE \_\_\_\_\_

FRIEND'S ADDRESS \_\_\_\_\_ FRIEND'S ZIP \_\_\_\_\_

**National Semiconductor Corporation**

2975 San Ysidro Way  
Santa Clara, California 95051

*Please send nice, new short form catalog to my friend.*

FRIEND'S NAME \_\_\_\_\_

FRIEND'S COMPANY \_\_\_\_\_

FRIEND'S TITLE \_\_\_\_\_

FRIEND'S ADDRESS \_\_\_\_\_ FRIEND'S ZIP \_\_\_\_\_

**National Semiconductor Corporation**

2975 San Ysidro Way  
Santa Clara, California 95051

*Please send nice, new short form catalog to me.*

MY NAME \_\_\_\_\_

MY COMPANY \_\_\_\_\_

MY TITLE \_\_\_\_\_

MY ADDRESS \_\_\_\_\_ MY ZIP \_\_\_\_\_

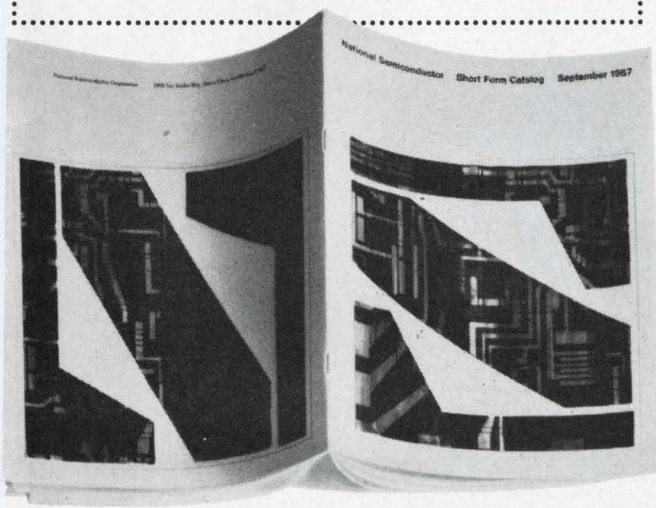

*Nice, new short form catalog*

ON READER-SERVICE CARD CIRCLE 4



# CERAMIC MAGNETS

Remington takes advantage of the high energy of Allen-Bradley ceramic permanent magnets to achieve the small size required for the ideal performance of their 500 *Selektronic* shaver

This custom designed ceramic magnet is the result of cooperative efforts by Remington and Allen-Bradley engineers. Despite the complex geometry of the magnets, Allen-Bradley was able to achieve high volume production at reasonable cost.

Allen-Bradley MO5-C ceramic permanent magnets are radially oriented and can be furnished in segments for d.c. motors measuring no more than  $\frac{3}{4}$ " diameter up to a maximum rating of 10 hp. Coordinated and adequate manufacturing facilities at Allen-Bradley and tight quality control assure delivery in quantity—on time!

Allen-Bradley application engineers will be pleased to cooperate in the design of your motor magnets to obtain optimum performance. Allen-Bradley Company, 1344 South Second Street, Milwaukee, Wis. 53204. In Canada: Allen-Bradley Canada Limited. Export Office: 630 Third Ave., New York, N. Y., U.S.A. 10017.

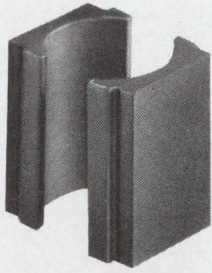

**A-B ceramic magnets**  
used in the 500 *Selektronic* shaver  
shown actual size.

**TYPE MO5-C CERAMIC PERMANENT MAGNETS** Typical Characteristics—stated values have been determined at 25° C.

Property	Unit	Nominal Value
Residual Induction ( $B_r$ )	Gauss	3300
Coercive Force ( $H_c$ )	Oersteds	2300
Intrinsic Coercive Force ( $H_{ci}$ )	Oersteds	2400
Peak Energy Product ( $B_d H_d$ max)	Gauss-Oersteds	$2.6 \times 10^6$
Reversible Permeability	—	1.09
Curie Temperature	+°C	450
Temperature Coefficient of Flux Density at $B_r$	%/°C	-0.20
Specific Gravity	—	4.85
Weight per Cu. In.	Lb.	0.175



The 500 *Selektronic* shaver features a unique dial which adjusts the shaving heads to four shaving positions for any combination of skin and beard, plus TRIM position for sideburn trimming and CLEAN position for instant cleaning. The shaver operates on its rechargeable energy cells or from an electric cord.



**ALLEN-BRADLEY**  
QUALITY MOTOR CONTROL  
QUALITY ELECTRONIC COMPONENTS

567-4AB

ON READER-SERVICE CARD CIRCLE 5



# 1 to 110 MHz in one sweep...

## with 0.5% linearity

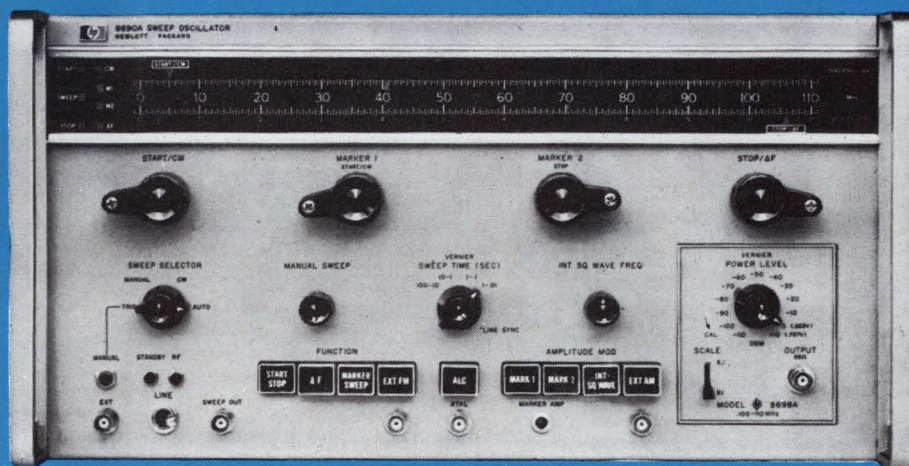

Swept frequency testing of broadband RF devices and systems is fast and accurate with the new HP 8698A RF Plug-in for the HP 8690A Sweep Oscillator. High linearity, calibrated power levels and flat output simplify your test set-ups. And this same unit is ideal for narrow-band and CW tests because of its low residual FM and high-resolution frequency dial. Then too, the 8690A main unit accepts 17 other sweeper units covering 1 to 40 GHz in octave and waveguide bands.

#### Major performance specifications 8698A installed in 8690A Sweep Oscillator.

Operating modes: START/STOP and MARKER sweeps (end points continuously and independently adjustable over entire frequency range);  $\Delta F$  sweep (calibrated width adjustable from 0 to 10% of frequency range); CW operation.

Sweep modes: Automatically recurring, manual, triggered, external FM (DC to 2 kHz rate); sweep times from 0.01 to 100 seconds.

Frequency range: 0.1 to 11 MHz and 1 to 110 MHz, selected by front-panel switch.

Frequency accuracy:  $\pm 1\%$  of full scale.

Frequency linearity:  $\pm 0.5\%$  of sweep width.

Residual FM: 0.1-11 MHz  $< 150$  Hz peak, 1-110 MHz  $< 500$  Hz peak.

Power output: At least +20 dBm max. (2.24 VRMS) into 50 ohms; Calibrated output adjustable in 10 dB steps from +10 dBm to -110 dBm, full vernier adjustment between steps. Source impedance 50 $\Omega$ .

Output accuracy (vernier in CAL position):  $\pm 2$  dB (+10 to -60 dBm),  $\pm 3$  dB (-70 to -110 dBm). Output flatness,  $\pm 0.25$  dB (typically  $\pm 0.1$  dB over any 10 MHz range).

Price: Model 8698A, \$950. (Model 8690A, \$1550.)

Get full information about this new RF Sweeper-Generator from your local HP field engineer, or write Hewlett-Packard, Palo Alto, Calif. 94304; Europe: 54 Route des Acacias, Geneva.

HEWLETT  PACKARD

SWEEP OSCILLATORS

04721

ON READER-SERVICE CARD CIRCLE 6



# Semiconductor Report



ABOUT SPACE-SAVING MICRO-T TRANSISTORS FOR OPTIMUM DESIGN FLEXIBILITY

## NEW MICRO-T TRANSISTORS SOLVE HIGH-DENSITY PACKAGING PROBLEMS

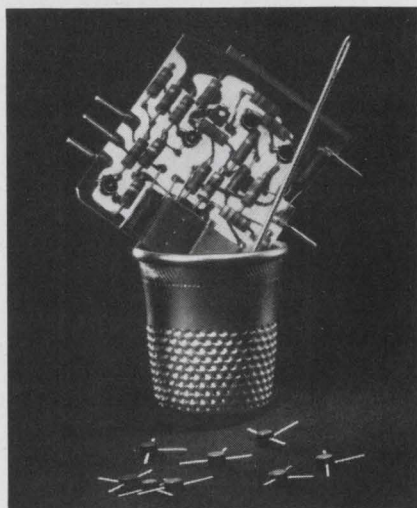

Motorola's Micro-T\* molded Unibloc\* plastic transistors now provide the ultra-small devices you've needed to make those high-density, miniaturized equipment designs a practical reality. The new Micro-T is only about one-tenth the volume of standard plastic or TO-18 packages. Handling problems disappear too . . . because the leads of the Micro-T radiate from the center, making it particularly well-suited to "drop-in" PC-board mounting.

The Micro-T is "at home" anywhere high-density packaging is required . . . electronic watches, hearing aids, satellites, high-frequency instruments and many, many more. In short, the Micro-T lets you design circuits that provide *discrete device* performance and design flexibility; while, at the same time, achieve the component densities and space reductions approaching that of integrated circuits. For example, it makes an ideal device for use in thick-film and unitized circuit assemblies.

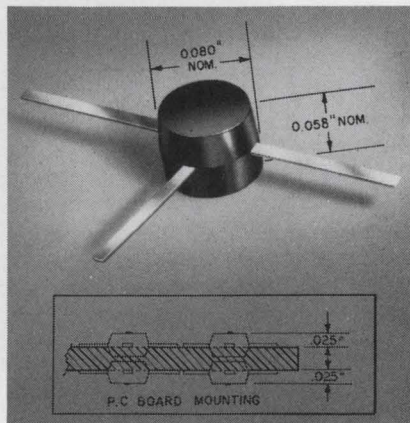

## COMPLEMENTARY SWITCHING AND AMPLIFIER TYPES FIRST MICRO-T's AVAILABLE

MMT3903-04 (NPN) and MMT3905-06 (PNP) Micro-T transistors boast a host of premium specs for general purpose switching and amplifier applications, as well as for complementary circuitry. In fact, the specifications are identical to those of their standard (TO-92) plastic-packaged counterparts—2N3903-06. Yet, you gain the added advantages of space-saving and handling-ease—available only with Motorola's Micro-T!

Here are the specs that make these Micro-T types an "evaluation must":

CHARACTERISTICS	TYPES			
	NPN		PNP	
	MMT3903	MMT3904	MMT3905	MMT3906
$BV_{CEO}$	40 V	40 V	40 V	40 V
$C_{ob}(max)$	4 pF	4 pF	4 pF	4 pF
$P_o @ T_A = 25^\circ C$	225 mW	225 mW	225 mW	225 mW
$h_{FE} @ V_{CE} = 1.0 V_{dc}, I_C = 100 \mu A, I_C = 10 mA$	20 (min)	40 (min)	30 (min)	60 (min)
	50-150	100-300	50-150	100-300

Operating and storage junction temperature range:  $-55^\circ$  to  $+135^\circ C$

Prices are moderate *too* — only \$1.45 for the MMT3903 and MMT3905; \$1.80 for the MMT3904 and MMT3906 (1000-up). Production quantities are immediately available.

ON READER-SERVICE CARD CIRCLE 211

## CHIP FROM FAMED 2N2369 SWITCH ALSO IN MICRO-T

For several years, the 2N2369 has been "a standard of the industry" for high-speed, low-current switching applications . . . *except* in micro-miniature equipment.

Today, the MMT2369 is "the standard of the industry." Period!

Now, in the reliable, space-saving Micro-T, Unibloc plastic package, you can have all the advantages you always had — plus! Plus what? Plus the cost-savings on layout, assembly, and even P.C. boards . . . It's also ideal for thick-film digital circuit applications.

In case you've forgotten, here are some of the specs that made the 2N2369 great and make the MMT-2369 even greater now:

CHARACTERISTIC	SYMBOL	MIN	MAX	UNIT
Collector-Emitter Breakdown Voltage	$B_{CEO}$	15	—	Vdc
Collector Cutoff Current	$I_{CBO}$	—	100	nAdc
DC Current Gain	$h_{FE}$	40	120	
Current-Gain Bandwidth Prod.	$f_T$	500		MHz
Turn-on Time	$t_{on}$	—	12	ns
Turn-off Time	$t_{off}$	—	18	ns

Immediately available in production quantities, the MMT2369 is moderately priced at \$.97 (1000-up). For complete details, send for the data sheet: write P.O.Box 955, Phoenix, Arizona 85001.

ON READER-SERVICE CARD CIRCLE 212

# MOTOROLA Semiconductors

*— where the priceless ingredient is care!*



\*Trademark of Motorola Inc.



...NOW IN A NEW MINIATURIZED SIZE

# Hermetically Sealed ERIE BUTTON® MICA capacitors designed for -55° to +200°C at 2000 Mc.



*Featuring* 508 MECHANICAL VARIATIONS TO SUIT  
**ANY HIGH TEMPERATURE—HIGH FREQUENCY CAPACITOR APPLICATION**

With the addition of these new miniatures, Erie further broadens the most complete selection of Button Mica Capacitors in the industry. These new miniaturized micas provide 33% reduction in mounting area.

Erie Button Mica Capacitors are designed for use in radio frequency circuits for tuning, bypassing and coupling. The outstanding properties of metallized mica dielectric combined with the radial current pattern, make Erie Button Capacitors ideal for low inductance, high frequency applications.

These high quality capacitors are designed for microwave and filter applications, for use in carrier equipment, parametric and RF amplifiers, oscilloscopes... any application where high temperature and high frequency are factors.

The welded hermetic seal of these excellent broad frequency Gold Seal® capacitors for military and commercial use is 100% tested under pressure steam/salt water during production to guarantee a positive moisture seal.

Consider the advantages of Erie Button Mica Capacitors in the equipment you are designing. Write for Gold Seal Bulletin 500-2 or Resin Seal Bulletin 318-3.

**GENERAL SPECIFICATIONS**

Capacitance:	5 pf. thru 2500 pf.	Frequency Range:	to 2Gc and beyond
Tolerance:	1% or .25 pf thru ±20%	Operating Temp.:	-55°C to +200°C
Working Voltage:	500 WVDC for 1/2" dia. units		-55°C to +150°C
	250 WVDC for 3/8" dia. units		-55°C to +85°C

Q: per MIL-C-10950

**TYPES AVAILABLE**

HERMETICALLY SEALED (GOLD SEAL®) .410" O. D. or .505" O. D.

RESIN SEALED .375", .447" or .657" O. D.



**MINIATURE BYPASS CAPACITOR SYSTEMS FOR TRANSMITTING TUBES...**

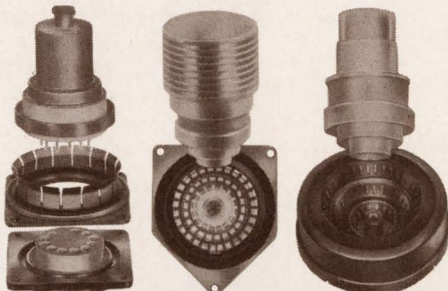

**Designed for the 10 to 3,000 megacycles range—and beyond**

Erie now provides effective capacitive bypassing and coupling or filtering of all RFI signals in the range of 10 to 3,000 megacycles. Variety of systems to meet your requirements.

Write for Bulletin 525-R

Formerly Erie Resistor Corporation

Another Series of Components in Erie's Project "ACTIVE"  
Advanced Components Through Increased Volumetric Efficiency

**ERIE**  
**TECHNOLOGICAL**  
**PRODUCTS, INC.**

644 West 12th Street  
Erie, Pennsylvania

ON READER-SERVICE CARD CIRCLE 8



# 60 MHz flip-flops, 5 nsec gates

## Sprague SSL\* is the fastest TTL

(Super-Speed Logic)



and they're pin compatible with series 8000



for maximum systems speed, check out  
Sprague SSL Super-Speed Logic

PROPAGATION DELAY .....	5 nsec
POWER DISSIPATION .....	25 mW
NOISE IMMUNITY .....	1.0 V
FANOUT .....	11
FLIP-FLOP TOGGLE FREQUENCY .....	60 MHz

For additional information  
write to:  
Semiconductor Division  
Sprague Electric Company  
115 Northeast Cutoff  
Worcester, Mass. 01606

★Trademark

SPRAGUE WORCESTER... the world's finest microcircuit facility

**SPRAGUE**<sup>®</sup>  
THE MARK OF RELIABILITY

\*Sprague' and '®' are registered trademarks of the Sprague Electric Co.

ON READER-SERVICE CARD CIRCLE 9

ELECTRONIC DESIGN 23, November 8, 1967



# News

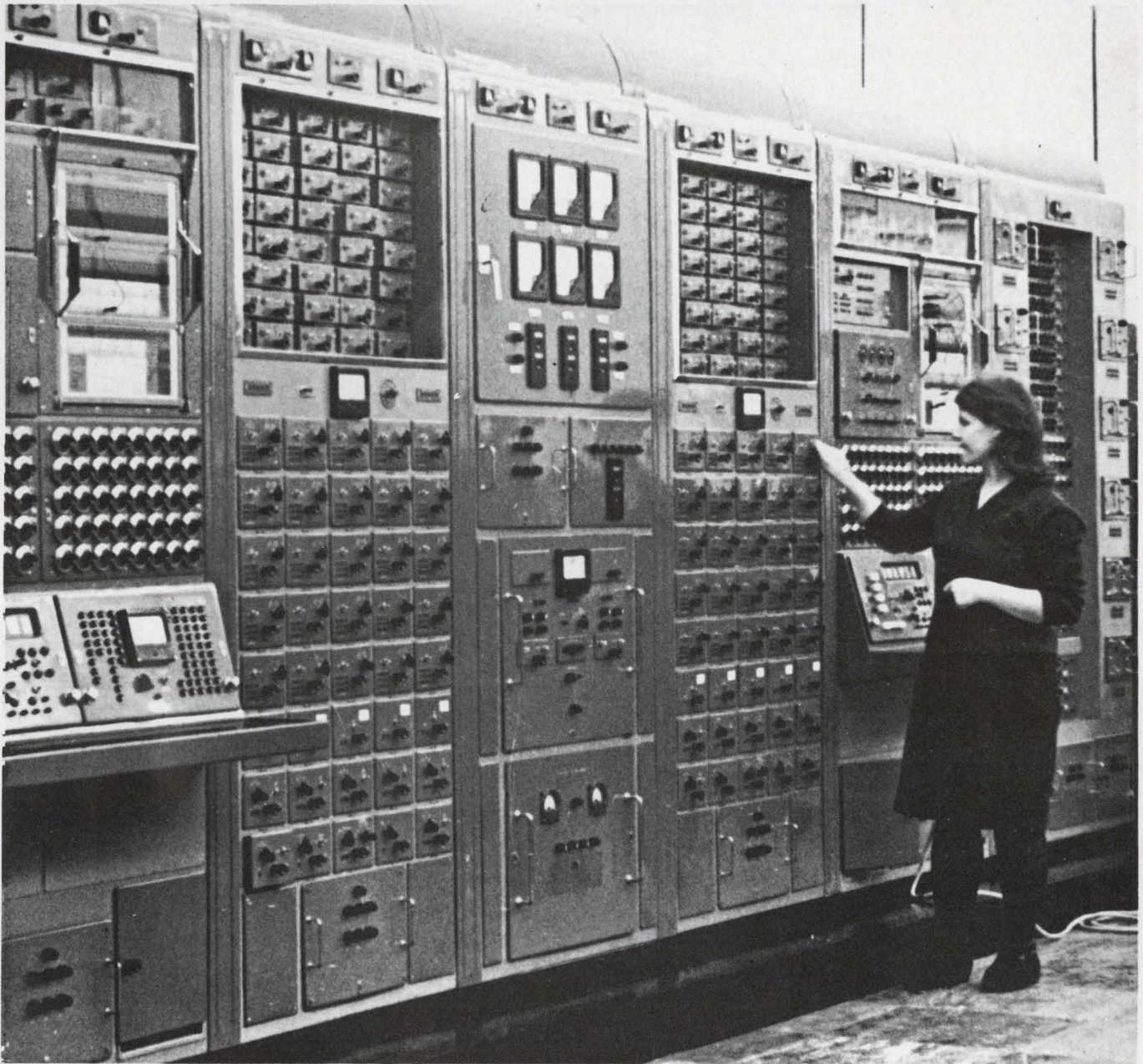

**Soviet electronics is evolving** rapidly, though practice often lags theory, as is

shown by this huge analog computer, that contains only 100 op-amps. Page 17.

## Also in this section:

**New phone rules may give boost** to digital facsimile. Page 35

**Billion-bit holographic memories** by 1970 are research goal. Page 38

**News Scope**, Page 13...**Washington Report**, Page 29...**Editorial**, Page 65



**Obviously from Sprague Electric!**

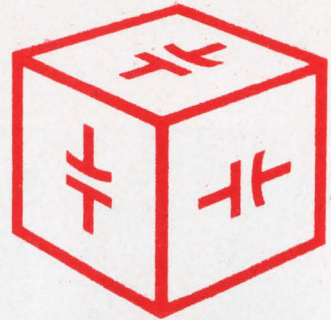

**Higher CV product per cubic inch  
than any other solid tantalum capacitor!**



**Red Top® Miniature Solid-Electrolyte Tantalex® Capacitors**

Red Top® Capacitors are TOPS when your circuit design calls for reliable, low-cost, commercial/industrial solid tantalums for printed wiring boards, packaged circuit modules, and other applications where miniaturization is a must.

Their special construction employs a metal case and plastic resin end seal, providing the price advantages but eliminating the mechanical disadvantages often associated with molded capacitors, such as "off-center" units with consequent "thin" walls, secondary cathode connection prior to molding, and limited humidity resistance.

Red Top® Capacitors are ideally suited for today's circuit design requirements which demand filtering at specific locations. Their small size permits "salting" or "sprinkling" wherever needed.

With capacitance values that range from 68  $\mu\text{F}$  to .016  $\mu\text{F}$  in voltage ratings from 2 to 100 WVDC, Sprague Red Top® Capacitors are available with axial or "single-ended" leads.

For complete technical data, write for Engineering Bulletin 3536A to Technical Literature Service, Sprague Electric Company, 347 Marshall Street, North Adams, Massachusetts 01247.

**SPRAGUE COMPONENTS**

CAPACITORS  
TRANSISTORS  
RESISTORS  
INTEGRATED CIRCUITS  
THIN-FILM MICROCIRCUITS

PULSE TRANSFORMERS  
INTERFERENCE FILTERS  
PULSE-FORMING NETWORKS  
TOROIDAL INDUCTORS  
ELECTRIC WAVE FILTERS

CERAMIC-BASE PRINTED NETWORKS  
PACKAGED COMPONENT ASSEMBLIES  
BOBBIN and TAPE WOUND MAGNETIC CORES  
SILICON RECTIFIER GATE CONTROLS  
FUNCTIONAL DIGITAL CIRCUITS



Sprague and ® are registered trademarks of the Sprague Electric Co.

ON READER-SERVICE CARD CIRCLE 10



# News Scope

## FCC weighs wider use of telephone attachments

A Texan and a company named Carter may be remembered by the electronics industry some day, not so much for one of their devices as for a milestone decision affecting the United States telephone system.

At issue specifically is whether a customer may attach an electronic device called the Carterfone to his telephone. But a broader question is involved: Are the present restrictions on unauthorized telephonic attachments too stringent?

Carter says yes. American Telephone & Telegraph, Associated Bell System Companies and the General Telephone Co. of the Southwest—all say no. The case has been heard by a Federal Communications Commission examiner, and Carter has won the first round. A ruling by the review board of the FCC is awaited.

If the board upholds Carter and the ruling is not upset in the courts, the way may be open for electronics manufacturers throughout the country to market a variety of attachments that are now prohibited for telephone users.

The prohibitory rule is Tariff 132, under which the FCC permits AT&T and its subsidiaries to charge certain rates and to ban the use of telephone attachments that tend to degrade performance. There are exceptions to the ban—such as the transmission of electrocardiographs by phone—but the general effect of the rule is to give Western Electric and General Telephone a virtual monopoly in the supply and installation of terminal equipment.

In mid-1965 Thomas F. Carter and the Carter Electronics Corp. of Dallas sued AT&T, the Associated Bell System and General Telephone because of a ban against the Carterfone. The instrument, a solid-state cradle device, inductively and acoustically couples any telephone handset to a mobile radio station. The

device serves as a relay point, but no physical electrical connection or modification of the telephone unit is required at that point.

Over 3500 Carterfones have been sold since 1957. Carter was advised by the FCC on April 23, 1965, of the prohibition of such devices under Tariff 132. When Carter filed an antitrust suit in the Federal District Court, the court requested a ruling by the FCC. An FCC examiner was appointed, and hearings were held earlier this year.

The examiner, Chester F. Naunowicz, Jr., found that the Carterfone was indeed a violation of Tariff 132. But he didn't stop there: He ruled that the tariff was "an unwarranted interference with the telephone subscriber's right to use his telephone reasonably in a way that is privately beneficial without being publicly detrimental." He recommended that use of the Carterfone be permitted.

The FCC's Common Carrier Bureau, which has made itself a party to the case, has recommended a broad rewriting of Tariff 132 to permit wider use of electronic attachments by telephone users. And the Dept. of Justice has filed a brief in support of this broader interpretation.

The key element in both these recommendations, which the FCC review board will consider, is a reversal of responsibility in the use of telephone attachments. The customer would no longer have to prove the suitability of equipment, but rather the telephone companies would have to show cause for denial.

## New missile defense to replace the Hawk

Details of an improved mobile missile system that will replace the present Hawk defense have been disclosed by the Army.

Designated the SAM-D, for surface-to-air guided missile development, the new system will be deployed in the 1970s for both battlefield defense and area defense in the U.S. It will be effective against high-performance aircraft and short-range missiles.

Unlike the Hawk system, which is limited by mechanically scanned radars that can guide only one missile at a time, SAM-D will use phased-array radars, controlled by digital computers. The radars will be capable of tracking several targets and guiding several missiles on a time-sharing basis.

Hawk missiles are now deployed by the Army, Marine Corps and some allied countries. Mounted on mobile launching vehicles that tow their own guidance radars, Hawks are designed for defense primarily against low-flying aircraft.

A complete SAM-D battery would be deployed on 12 vehicles, but as few as three basic vehicles can form a functional group. Any SAM-D battery will contain these three units: the fire-control unit, with radar and a beam-steering computer; the battery-control center, with the main fire-control computer; and the missile-carrier launcher. All will carry communications equipment and power sources.

Managed by the Army Missile Command at the Redstone Arsenal,



**Basic Units of a SAM-D battery** are shown in this Army drawing. A 3-D radar phased-array, with its beam-steering computer, is mounted on the vehicle in the foreground. The battery-control vehicle (right background) has a computer for processing fire-control data. Missiles are contained in the angled box on the vehicle in the left background.



Ala., SAM-D will use electronic features similar to those proposed for the "thin" Nike-X program. Communications for the battery will be coordinated from the control-center vehicle. That vehicle will house the digital computer, which will process and coordinate information between the fire-control radar vehicles and will transmit target data over line-of-sight links connecting with the launching vehicles.

The C-band radar arrays will be corporate-fed from many low-power microwave sources and will use diode phase-shifters. The multi-function array will be mounted on a mechanically rotating base, so its pencil beam can scan in three dimensions.

A launching vehicle will carry up to six missiles, each mounted on Teflon-coated launching rails inside a plastic-covered box.

When ignited, the rocket motor will blow out the rear plastic cover, and the missile will rip through the front cover. The launcher will be able to fire the missiles either singly or in groups.

The prime contractor, the Raytheon Co., of Bedford, Mass., will produce the radar, guidance and communications. The single-stage, solid-fuel-propelled missile will be built by the Martin Marietta Corp., of Orlando, Fla., and the propellant will be furnished by the Thiokol Chemical Corp., of Huntsville Ala.

## Autonetics to offer custom LSI chips

The first move by a major systems manufacturer into the field of large-scale integration is in the planning stage. The Autonetics Div. of North American Rockwell is setting up a separate manufacturing plant and expects, within a year, to offer large-scale microcircuit arrays employing many thousands of active elements and hundreds of gates.

The LSI circuits will be strictly custom-made for selected customers. Cedric F. O'Donnell, vice president and director of R&D for Autonetics, stresses that the company has no intention of competing with

semiconductor manufacturers by turning out standard circuits. It will, in fact, continue to be a large buyer of the latter, O'Donnell says.

Metal-oxide semiconductor field-effect transistor (MOS-FET) and silicon-on-sapphire techniques will be used in the new Autonetics operation, according to O'Donnell. The company's Anaheim (Calif.) Div. now has an LSI production section for in-house use and has sold special circuits in limited quantities to outside concerns in the last few months.

The division, O'Donnell says, will not attempt to establish a market distribution capability for the new operation but rather will sell its complex circuits much as it would offer conventional subsystems to a military customer. Autonetics has been regularly approached by other companies seeking advanced semiconductor circuitry, the vice president reports.

O'Donnell emphasizes that Autonetics has fully developed the software required to produce LSIs competitively with satisfactory yields. The yield in producing the original masks for complex circuitry must be high, he indicates. In manufacturing, he says, it is easier to turn out MOS-FETs in large-scale arrays, because of the high input impedance levels. The yield of MOS devices employing 400 to 600 elements, he says, is comparable to conventional bipolar integrated circuits.

## IC market due for big jump by 1973

The market for all types of integrated circuits will more than double in the next six years, but the structure of the industry will remain intact. Such is the prediction of a top industry executive.

Patrick E. Haggerty, Board Chairman of Texas Instruments, Inc., told the 1967 International Electron Devices Meeting in Washington, D.C., that 1973 estimates "suggest a total market for integrated circuits and integrated electronic components of \$865 million". This compares with a 1967 market of \$334 million.

Haggerty said the top producers of integrated circuits would remain in the picture during the next six years and the top 50 electronics companies would probably get bigger during

that period. He anticipates mergers and dropouts among lesser manufacturers but definitely saw no trend toward the consolidation of the electronics component market among a few giants, as in the case of computers, TV sets and even automobiles.

The chairman explained that computers and TV sets are products, but component development is a continuously changing technology that has not remained static long enough for one or two companies to gobble up their competitors and dominate the industry.

He estimated an over-all \$27 billion market in 1973 for electronics, including all components, equipment and replacements.

## U.S. and Soviet agree on Venus—almost

The Scientists at California's Jet Propulsion Laboratory are still processing data from the successful Mariner 5 Venus flyby mission. Discrepancies persist, however, between information relayed by Mariner and that obtained by the Russians from their more spectacular planetary probe, Venus 4 (see "Soviet electronics: Hot theory, cold hardware," p. 17).

Mariner 5 data indicate that all instrumentation functioned as designed—so well, in fact, that some scientists believe that the data received may turn out to be of more value than data from the Soviet craft.

The discrepancies between the findings of the Soviet and U.S. spacecraft are:

- The Russians say that carbon dioxide comprises 98 per cent of the Venusian atmosphere, whereas Mariner 5 data show it to vary between 72 and 87 per cent.

- The Russians detected no nitrogen in the Venusian atmosphere.

- The Mariner detected a hydrogen corona around the planet. U.S. scientists say that the Russians might have missed this phenomenon because their probe entered the Venusian atmosphere on the side away from the Sun, where the corona may not form.

The JPL scientists are more impressed by the Soviet instrument package's ability to transmit data as it descended through the dense Venusian atmosphere than they are by the Russians' ability to launch and guide the 2427-pound spacecraft.





## Reduce friction and keep cool with Mystik Teflon® Tapes

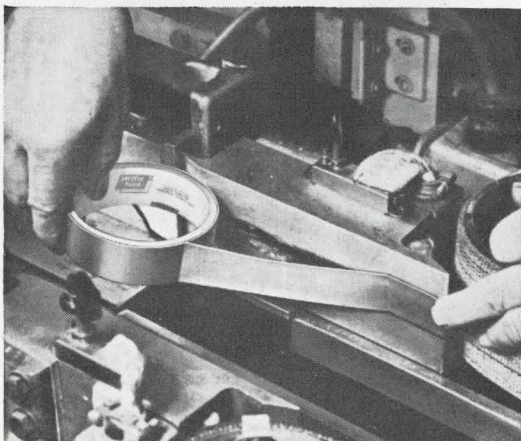

Mystik's Teflon tapes combine the advantages of TFE Teflon film with a silicone pressure-sensitive adhesive. As a result, they offer high dielectric strength, low coefficient of friction, and high performance within a temperature range from  $-100^{\circ}\text{F}$  to  $+450^{\circ}\text{F}$ .

These remarkable tapes are particularly useful in reducing friction on high speed equipment and as insulators of electrical apparatus, but they have many other applications in the electrical and electronic industry.

Of course, Mystik Teflon Tapes represent only a few of the high quality paper, film, and glass cloth tapes available for special applications. For assistance in selecting the best ones for your needs, contact your local Mystik distributor. He's listed in the Yellow Pages under "Tape" or write The Borden Chemical Co., Mystik Tape Div., 1700 Winnetka Avenue, Northfield, Illinois 60093.



**BORDEN  
CHEMICAL**

ON READER-SERVICE CARD CIRCLE 11





# Tuned Amplifier/Oscillator is Six Instruments in One

- LOW-NOISE AMPLIFIER
- WAVE ANALYZER
- DISTORTION ANALYZER
- LOW-DISTORTION OSCILLATOR
- SENSITIVE AC VOLTMETER
- ALLPASS DELAY PHASE SHIFTER

The PAR Model 110 Tuned Amplifier/Oscillator is a versatile high-gain, low-noise, low-distortion frequency selective amplifier operating over the frequency range of 1 Hz to 110 kHz with Q variable from 1 to 100 with no gain change. It provides four outputs simultaneously: a second order (resonance) bandpass; a second order band-reject (notch) providing rejection of the center frequency in excess of 100 dB; a second order allpass characterized by an amplitude response which is flat with frequency and a phase lag which increases monotonically with frequency; and a flat output. Each of the 600 ohm outputs is capable of providing 5 volts rms into a 5K ohm load. A front panel AC voltmeter permits measurement of any one of the four outputs.

The instrument can function as a wave analyzer with bandwidth adjustable from 1% to 100%; as a flat

or selective AC voltmeter with sensitivity ranging from 10 microvolts to 5 volts rms full scale; as a distortion analyzer to measure distortion levels as low as 0.1% (as low as 0.001% when used in conjunction with a second Model 110); as a low-noise amplifier (typical noise figure of 1 dB) with voltage gain ranging from 1 to  $10^4$ ; as a stable general-purpose low-distortion oscillator providing up to 5 volts rms into 600 ohms, capable of being synchronized by an external signal; and as an AC-DC converter with ground-based output.

**Price:** \$1195. Export price approximately 5% higher (except Canada).

For additional information, write for Bulletin T-140 to Princeton Applied Research Corporation, Dept. E, P.O. Box 565, Princeton, New Jersey 08540. Telephone: (609) 924-6835.



**PRINCETON APPLIED RESEARCH CORP.**

ON READER-SERVICE CARD CIRCLE 12



# Soviet electronics: Hot theory, cold hardware

## But despite the shortcomings, impressive gains are being made with relatively simple methods

**Peter N. Budzilovich**  
Technical Editor

The world has witnessed a number of Soviet "firsts" in space in the last decade, including the softlanding of an instrument package on Venus three weeks ago. What is the state of the Soviet electronics industry on the 50th anniversary of the founding of the U.S.S.R.?

Information gathered by ELECTRONIC DESIGN's staff, including data from the Aerospace Technology Div. of the Library of Congress and the Soviet Embassy in Washington, D.C., all point to one trend: Soviet theory is excellent, but in hardware, industry is lagging behind its U.S. counterpart.

Yet, in spite of this hardware gap, Soviet scientists, aided by a knack for solving complex problems simply, are scoring impressively in a variety of endeavors. Examples of this ingenuity include their lunar TV cameras (see "Russian lunar TV simple but sharp," ED 13, June 21, 1967, p. 20) and the recent use of sugar as a liquid-sensor and spring-release in the capsule that was landed on Venus. One suspects that U.S. engineers, spoiled by a super-abundance of sophisticated devices, would have performed the latter task with some super, all-solid-state Rube Goldberg device. A Russian engineer, often handicapped by limited equipment resources, is forced to come up with simple, but elegant, solutions.

It is difficult for an American publication to obtain a detailed picture of Soviet electronics. For one thing, the release of information is controlled by the Government. For another, what the Soviet Union decides to emphasize in its economy is purely arbitrary. Products and technologies are developed not to meet an existing or anticipated demand but to fulfill a master plan—or "all union" plan, as the Soviet calls it. As a result, an achievement in any one area does not necessarily imply an equal level of development in related areas. Rather, it means that the central planners have decided to push this area, often with

no regard for the high cost of simultaneously evolving supporting technologies.

The theoretical treatises of Soviet scientists are almost without exception very impressive. They call for the use of electronic equipment to automate factories, offices and homes; to smash atoms with new powerful machines (one proton accelerator reached an energy level of 76 GeV last month, the highest in the world); to adapt ultrasonics to medical tasks, and to employ lasers as telephone links.

But the hardware and schematics show the reverse of the coin: the wide use of vacuum tubes, the drab appearance of even the most sophisticated equipment, which looks like a breadboard by U.S. standards.

For example, Soviet scientists are credited with some of the most advanced work in nonlinear mechanics.

But where could one get a modern Soviet computer to control some nonlinear process in the manufacture of a chemical, say? Such computers are not being marketed. Every engineer has heard of Chebyshev polynomials and their use for filter design, but it is sometimes easier for a Soviet scientist to get a signal from Venus than to place a phone call on a Soviet long-distance line; if he overcomes the phone noise, chances are he'll lose the connection.

The term "zapchasti" (Russian for "spare parts") means long delays to a Soviet engineer with broken down equipment. The lack of spare parts has created a new profession in the U.S.S.R.—"tolkach," meaning "pusher." The tolkach is a fast operator who, for a fee, can obtain through his "connections" anything from a transistor to a truck.

The inescapable conclusion is that there is a wide gap between the level of much of Soviet theoretical work and



Science fiction? it's part of the setup in a super-high-voltage electronic





the sophistication of the actual hardware.

### Boom in medical electronics

Perhaps nowhere have Soviet scientists been more successful than in applying electronics to medicine. But here again, a look at the equipment reveals that the most sophisticated concepts (from the medical standpoint) are being implemented with outmoded components.

For example, consider the Soviet electroanesthesia generator (MID-2). It is a simple three-tube circuit—a multivibrator, a cathode-follower output tube and a power supply. The circuit applies rectangular current pulses (0.5-3.0 mA at 100 Hz) to the central nervous system to induce sleep.

On the theoretical side, though, while there is a paucity of Western material on electrosleep and electroanesthesia, abundant Soviet work has been done. Thus in 1966 a total of 828 papers in these fields were published in the Communist countries, mostly in the U.S.S.R.; only 308 relevant papers appeared elsewhere.

It has been speculated that electro-sleep or some other electroneural approach is finding application in the Soviet manned spaceflight program. This has been deduced from several releases by the Soviet press. As one put it: "With the aid of electronics, it is possible to construct a device that will force a cosmonaut to sleep for as long as necessary (*Ogonek*, No. 8, 1966, p. 25).

Much Soviet research, both pure and applied, is being reported in the area of ultrasonic diagnosis. Ultrasonic generators are used, pretty much as sonars, to diagnose tumors and other diseases in surgery, urology, gynecology and obstetrics—in short, in numerous cases where a doctor needs a more detailed picture of an internal organ than an X-ray can reveal.

Another interesting device, a cardiographic teletransducer, was reported last August. Developed by Vladislav Yakovlev and Yuri Dykhnilkin of the Biophysics Institute of the Soviet Ministry of Health, it consists of two disks 20 mm in diameter by 5 mm thick. Each weighs about 5 grams. The two elements wired together re-

cord heart biopotentials from two points. A small storage battery, that is nonetheless larger than the amplifying and transmitting circuitry, is housed inside the electrode (disks). The lower part of each transparent acrylic disk contains a 10-mm metal hemisphere coated with chemically pure tin. Each disk is coated with adhesive for attachment to the patient's skin. A radio-receiver is used to listen to the frequency of the heart beat, or the signal may be recorded on a portable electrocardiograph.

### Where to get information

Several hundred of Soviet scientific periodicals are presently being translated in the West. The main source for these translations in the U.S. is the Clearinghouse for Federal Scientific and Technical Information, Port Royal and Braddock Roads, Springfield, Va. 22151.

Since much Soviet scientific literature deals with purely theoretical problems, however, *ELECTRONIC DESIGN* has selected a number of electronic publications that may be of interest to a practicing design engineer. This list can be obtained by circling 250 on the Reader Service Card.

### Communicating across U.S.S.R.

While Soviet scientists are setting up satellite relay stations and using lasers to carry telephone conversations, the service, particularly the long distance, is notoriously poor, as reflected in Soviet newspapers and

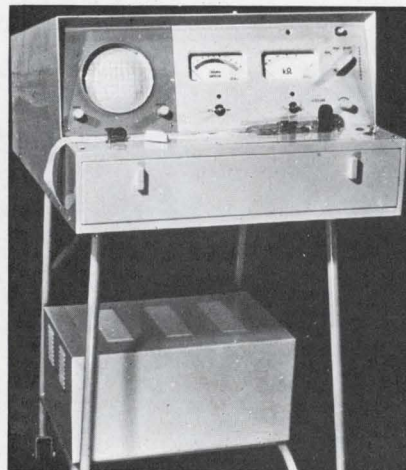

A surgeon can tell the depth of anesthesia by glancing at this instrument, model ISM-1M, made by the All-Unin Research Institute of Medical-Instrument-making.

such critical magazines as *Krokodil*.

One advanced feature of the Soviet telecommunications network is the extensive use of facsimile. The first facsimile installations date to 1929. Today practically each major city has a facsimile service. It is available to the public like a telegraph service.

While much station equipment for such networks as radio, vhf, uhf, railroad and pipeline communications employs vacuum tubes, more and more is being transistorized.

The Soviet consumer industry is now producing several models of small transistor radios. Some portable receivers, however, such as Mukha (Fly) and Zaliv (Bay) intended, respectively, for communication between a glider and the ground and a parachutist and the ground, use hybrid (vacuum tubes and transistors) circuits.

Of course, there also exist completely transistorized, portable transceivers, such as the Nedra-P. This is a ssb unit with the following frequencies: 1640, 1730, 1880, and 1935 kHz. Its radiated power is between 0.3 and 0.4 watt; bandwidth is 4 kHz; carrier frequency stability is  $2 \times 10^{-4}$ ; receiver sensitivity for 1-volt output is 1.5 watts and during reception 0.5 watt. The unit weighs just under two pounds, but the power supply weighs about seven pounds. It has a range of 6 to 12 miles with a 6-foot antenna, or up to 30 miles with a 40-foot sloping-wire antenna.

As far back as 1947 I.P. Zakharov designed and built a small television set for use in conjunction with a telephone so that callers could see each other. There are no reports, however, of plans to incorporate the system into the Soviet telephone network.

### Lasers: do-it-yourself

Soviet publications on maser and laser research date to the nineteen fifties. On the whole, the early papers indicated a lag of about two years behind the U.S. though Soviet writers always insisted that their early work was abreast of American. They even claimed to be first with the basic concept of oscillators and amplifiers that employ the stimulated-emission principle.

Quantum electronics research in the U.S.S.R. is heavily concentrated in one organization, the Lebedev Physics Institute of the Soviet Academy of Sciences. The deputy director



# MOS Breakthrough



## MOS Field Effect Transistor P-Channel Enhancement Mode UC 1700

A maximum rating of  $\pm 150$  volts  $V_{\text{ESS}}$  is the MOS breakthrough that puts this FET in the important "no precautionary handling needed" category. Superior stability and reliability in operation are assured: Each device is burned-in at  $-30$  volts,  $200^{\circ}\text{C}$ .

- $10^{15}$  ohms input resistance
- Normally off with zero gate voltage
- Square law transfer characteristics
- Minimum breakdown voltage of 40 volts
- Minimum gm of  $2000 \mu\text{mhos}$
- TO-72 JEDEC package

**Applications:** High impedance amplifiers, electrometers, series shunt choppers, and multiplex and commutating setups.



**ELECTRONICS**

Semiconductor Department / 365 Middlefield Road / Mountain View, California 94040 / Telephone: (415) 961-3300 / TWX: 910-379-6942

ON READER-SERVICE CARD CIRCLE 15





# introducing the "PIXIEPOT"<sup>TM</sup> at an IMPossibly low price!

Duncan Electronics now offers for the first time in the history of the potentiometer industry a PRECISION, TEN-TURN WIREWOUND pot for less than \$6.00. In fact, the new Model 3253 "PIXIEPOT" potentiometer is yours for as low as \$3.97 each in production quantities and only \$5.95 each for 1-24 units.

#### Outstanding "PIXIEPOT" potentiometer features:

- Length: ONLY 3/4"
- Diameter: 7/8"
- Linearity: ±0.25%
- Resistance Range: 100 ohms to 100K ohms
- Power Rating: 2 watts @ 20°C
- Temperature Range: -25°C to +85°C
- Resolution: Better than any precision pot twice its size.

The Model 3253 "PIXIEPOT" potentiometer incorporates all of the fine engineering workmanship you've come to expect from other Duncan products. Only our new, unique production techniques enable us to bring this potentiometer to you at these unheard of prices.

And if you need your "PIXIEPOT" potentiometers in a hurry, we guarantee they'll be on an airplane out of Los Angeles within 24 hours after receipt of your order!

How can a "PIXIEPOT" potentiometer help you?

Call or write your Duncan representative (listed on the facing page). He will personally deliver to you, FREE, a 1K "PIXIEPOT" potentiometer for your evaluation in exchange for the filled out certificate.

This certificate redeemable for one 1K "PIXIEPOT"



(TYPE OR PRINT)



MY APPLICATION IS \_\_\_\_\_

NAME \_\_\_\_\_

COMPANY \_\_\_\_\_

ADDRESS \_\_\_\_\_

CITY \_\_\_\_\_

TITLE \_\_\_\_\_

DIVISION \_\_\_\_\_

STATE \_\_\_\_\_

ZIP \_\_\_\_\_

This offer expires December 1, 1967



DUNCAN ELECTRONICS, INC. • 2865 FAIRVIEW ROAD, COSTA MESA, CALIFORNIA 92626

ON READER-SERVICE CARD CIRCLE 13



## ENGINEERING SALES REPRESENTATIVES

ALABAMA, Huntsville  
Orbe, Inc.  
Tel: (205) 881-8230

ARIZONA, Phoenix  
Southwest Engineering Company  
Tel: (602) 944-1521

CALIFORNIA, Costa Mesa  
Duncan Electronics, Inc.  
(Factory Sales Office)  
Tel: (714) 545-8261

CALIFORNIA, San Francisco  
Jack Pyle Company  
Tel: (415) 349-1266

CONNECTICUT, New Haven  
Gerber Sales Co., Inc.  
Tel: (203) 777-6279

FLORIDA, Orlando  
Orbe, Inc.  
Tel: (305) 424-0978

FLORIDA, St. Petersburg  
Orbe, Inc.  
Tel: (813) 894-0687

ILLINOIS, Chicago  
Carlson Electronic Sales Co.  
Tel: (312) 774-0277

MARYLAND, Baltimore  
Biechler Associates, Inc.  
Tel: (301) 825-8222

MARYLAND, Rockville  
Biechler Associates, Inc.  
Tel: (301) 762-6210

MASSACHUSETTS, East Longmeadow  
Gerber Sales Co., Inc.  
Tel: (413) LAurel 5-3059

MASSACHUSETTS, Waltham  
Gerber Sales Co., Inc.  
Tel: (617) 891-8040

MINNESOTA, Minneapolis  
Carlson Electronic Sales Co.  
Tel: (612) 788-4111

MISSOURI, Kansas City  
Harris-Hanson Company  
Tel: (816) 444-9494

MISSOURI, St. Louis  
Harris-Hanson Company  
Tel: (314) 647-4350

NEW JERSEY, Harrington Park  
B. B. Taylor Corporation  
Tel: (201) 768-0969

NEW YORK, Baldwin, L.I.  
B. B. Taylor Corporation  
Tel: (516) 223-8000

NEW YORK, Rochester  
Reed Electronics, Inc.  
Tel: (716) 473-2767

NEW YORK, Syracuse  
Reed Electronics, Inc.  
Tel: (315) 468-5488

NEW YORK, Vestal  
Reed Electronics, Inc.  
Tel: (607) 748-7391

OHIO, Cleveland  
Rockford Controls Ohio, Inc.  
Tel: (216) 531-4841

OHIO, Dayton  
Rockford Controls Ohio, Inc.  
Tel: (513) 274-1911

PENNSYLVANIA, Millersville  
Biechler Associates, Inc.  
Tel: (717) 872-2793

PENNSYLVANIA, Pittsburgh  
Rockford Controls Ohio, Inc.  
Tel: (412) 731-4600

TEXAS, Dallas  
Robert R. Thomas Company  
Tel: (214) 363-8591

TEXAS, Houston  
Robert R. Thomas Company  
Tel: (713) 644-2369

WASHINGTON, Seattle  
Hamilton-Electro Corporation  
of the Pacific Northwest  
Tel: (206) 624-5930



DUNCAN electronics, inc.



of the institute, Dr. N.G. Basov, is a principal figure in the Soviet laser research and is largely responsible for formulating policy in this field. Both Dr. Basov and A.M. Prokhorov, director of the oscillation laboratory and professor at the Moscow State University, received the Nobel Prize in physics in 1964 (together with Dr. C.H. Townes) for work on lasers.

Soviet literature on laser development and applications reveals some impressive advances. One is the first successful semiconductor (CdS crystal) electron beam-pumped laser. Its development was recorded in a paper dated Nov. 12, 1963.

What about applications? There is a report (*Pravda*, Aug. 24, 1966) about a laser voice channel in use as part of the Moscow telephone net. It links a tower of Moscow University and Zubovskaia Square and carries all conversations dialed 4-6 on the Moscow telephone.

Laser TV channels are being experimented with, and lasers have been used for microsurgery.

How would you go about buying a Soviet laser? Well, according to an article in *Pravda*, Sept. 19, 1967 by A. Prokhorov: "The assortment of Soviet-made lasers is still limited. Moreover they are not easy to purchase. Production of laser components is not set up. Accordingly many laboratories have to build lasers on their own."

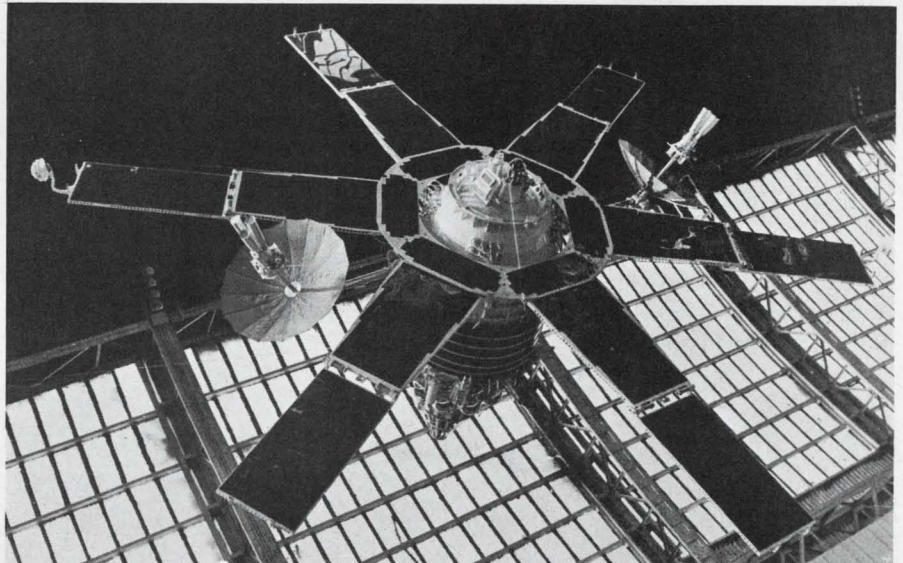

The sky's no limit for the Soviet communications satellite Molniya-1 shown here at the U.S.S.R. Exhibition of economic Achievement in Moscow. The seventh Molniya was launched Oct. 22. (Novosti from Sovfoto).

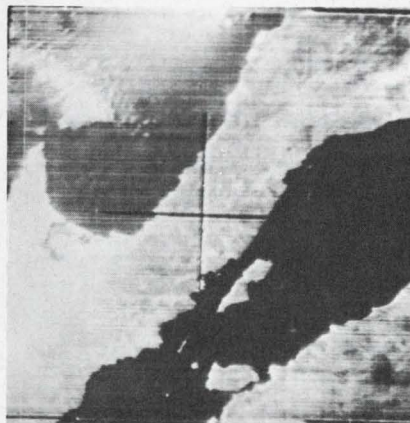

California as seen by the Cosmos-156 satellite on April 28, 1967, at 1:27 a.m. Moscow time. The weather in California was fair with scattered clouds. (Tass from Sovfoto).



Is she tuned in to the latest steel production figures on her miniature transistor receiver, the Etiud (Russian for "etude")? We doubt it. (Tass from Sovfoto).





# Soviet computers: A 'sterile flower' blooms

**Jeffrey N. Bairstow**  
Computer Editor

"While Russian machines lag badly in hardware development and are relatively slow, they are organizationally less retarded."

A Western view of the Soviet computing scene? No. It was V. I. Loskutov of the Moscow Central Statistical Board discussing in *Pravda* the relative merits of U.S. and Soviet computers. The reasons for the backwardness of Soviet machines range from political to practical.

Political scientists say that Stalin's distrust of cybernetics, the science of control and communication, created a gap that mathematicians and engineers have yet to close. Engineers say the lack of coordination in the Soviet computer industry has stunted the growth of a market and slowed both development of new machines and the acquisition of experience.

Statistics on Soviet computers are difficult to evaluate. The latest Soviet computer, the BESM-6, for instance, is claimed to have a speed of about one million operations per second, but Western experts speculate that its actual performance is nearer 300,000 operations per second. In some respects the BESM-6 would appear to be organizationally as sophisticated as an IBM 360 (see table). It

has several levels of instruction look-ahead, indirect addressing, multiple address modification and some provisions for time-sharing. Yet the machine is said by Western specialists to be unreliable and to suffer from temperature problems.

Stalin's hostility toward cybernetics, which he called "a sterile flower," seriously hobbled computer development in the Soviet Union. In the U.S. Eckert and Mauchly were able to go to another company to evolve their ideas after initial rebuff by one large manufacturer of business machines. Soviet scientists had no alternative. Thus it was not until 1950 that the Institute of Precision Mechanics and Computer Technology was set up in Moscow. It was not until 1954, a year after Stalin's death, that the first significant stored-program electronic computer was completed.

This computer, the BESM-1, was a tube machine with a 1023-word Williams-tube storage and 5120-word magnetic-drum storage. It had a 39-bit word and was capable of about 500 operations per second. The BESM-1 was followed by the BESM-2 in 1959; the BESM-4 in 1964 and the BESM-6 in 1966 (see table).

## A modern Soviet computer

The BESM-6 is a solid-state com-

puter consisting of a central processor with 16 registers and a 300-ns access time. The main storage is a ferrite core with 32,000 fifty-bit words. The backup storage is both tape and drum. Most Soviet machines use drum storage; disks are under development and are expected to appear within a year. The input is handled by two 700-card-per-minute readers, and the output by a 600-lines-per-minute printer, which is said to produce fairly readable copy. The character set contains 96 symbols and includes both the Cyrillic and Roman alphabets.

Unlike the situation in the U. S., the manufacturer of the BESM-6 does not have to produce the software for his machine. The software package is therefore being developed by several computing centers. It will have an autocoder (symbolic assembler), ALGOL, FORTRAN and COBOL compilers and a time-sharing system.

The entire machine, excluding the cost of software, is reputed to have cost about 3 million rubles or \$3.3 million at the official exchange rate.

Although the BESM machines appear to have been important scientific computers, they have never been made in very large numbers. Only one of the latest models is operational at the Academy of Sciences Computing

**Table. Recent Soviet computers**

	Word size bits	CPU speed ( $\mu$ s) add multiply		Core storage capacity & speed	Auxiliary storage	Software available
BESM-4 (1964)	45	47	95	8192 (10 $\mu$ s)	Magnetic tape drum	Alpha* & Assembler
RAZDAN-2 (1965)	36	200	400	2048	Tape	
MINSK-22 (1965)	37	50	100	8192 (24 $\mu$ s)	Magnetic tape	ALGEK
URAL-11 (1966)	24	20	40	16,384	Magnetic tape drum	Assembler
BESM-6 (1966)	50	1.1	1.9	32,000 (2 $\mu$ s)	Magnetic tape drum	ALGOL Alpha* Assembler
IBM 360/65† (1966)	32 or 64	1.3	2.25	1,048,000 (4 $\mu$ s)	Magnetic tape Magnetic disk	COBOL, FORTRAN compilers Assembler. Time sharing system.

† for comparison

\*ALGOL subset



Center in Moscow and perhaps a couple more are being constructed.

Almost parallel developments are reported in the Minsk medium-scale and Ural small-scale series of computers, named for the areas in which the Soviet's principal computer factories are situated. The present generations—the Minsk-22 and the Ural-11 series—are transistorized machines of about the sophistication of an IBM 704 (see table).

Typical is the Ural-11, a solid-state computer capable of about 50,000 operations per second. It has a ferrite core memory with a maximum of 16,384 words, and drum and tape back-up storage. The input is by punch cards at 500 cards per minute, and the output by a line printer or plotter. None of the Ural series has cathode-ray-tube displays or light-pen consoles. CRT displays seem to be unknown in the U.S.S.R.

A team of U.S. computer specialists visiting the Minsk factory in 1964 found that the plant's output at that time was "about seven or eight a month." This was interpreted to mean that Soviet production was then about 10 years behind that of the U.S. More recently Western experts have estimated that the Soviet lag is now only about five years, but one expert has noted that the U.S.S.R. could overcome the gap "whenever that country's national goals dictate such a move."

### Hardware is weak

Reliability is still a headache with Soviet computers. Recent studies estimate that the mean time between failures (MTBF) of Soviet machines is at least an order of magnitude greater than that of U.S. machines.

Early computers used vacuum tubes, so failures were frequent. Even the advent of second-generation transistorized machines has not, however, solved all the problems. One computer, the Dnepr, a small (20,000 operations-per-second, 26-bit, 2048-word storage) process-control machine, had an MTBF of 142 hours. A fault breakdown showed that 65 per cent of the failures were caused by bad contacts and only 10 per cent by diode and transistor defects. Most of the transistor faults were in the triggers and read amplifiers for the memory, giving the core memory the worst MTBF of any part of the computer. The semiconductor failures seem to be



### FREQUENCY STABILITY

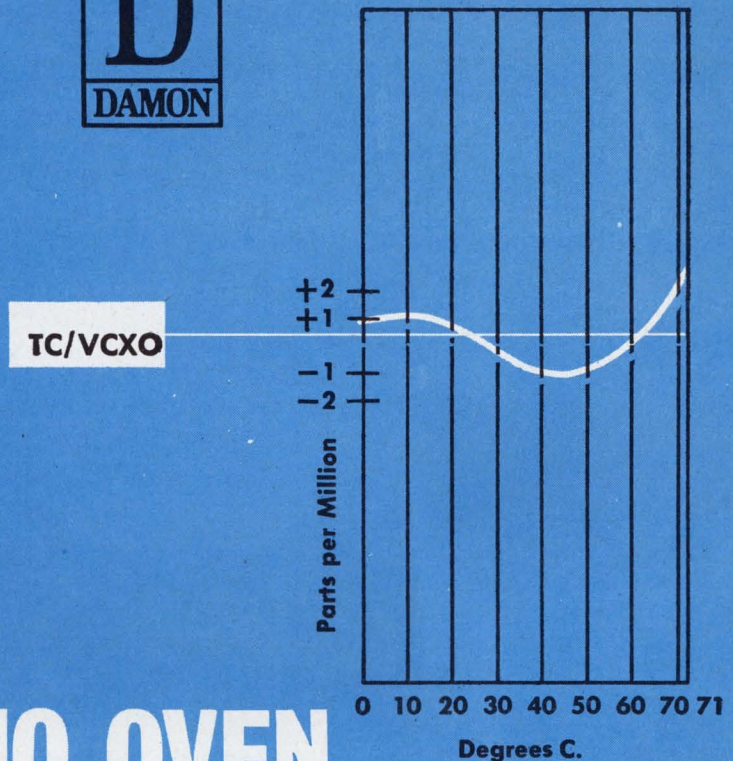

# NO OVEN

# TC/VCXO

Frequency Stability  
within  $\pm 2 \times 10^{-6}$   
over 0 to 71°C range



Typical TC/VCXO Model 5968WA  
Center Frequency: 6.8 MHz  
Size: approx. 2½" L x 1⅛" W x ¾" H

If space and power are limited in your telecommunication system, consider the advantages of the Damon Temperature Compensated Voltage Controlled Crystal Oscillator (TC/VCXO). This rugged, miniaturized unit provides a frequency deviation of  $\pm 100$  Hz about center frequency and maintains a stability comparable to that of an "ovenized" unit without the need for added circuitry and power.

The illustration, above, shows a frequency stability curve for a simple Damon TC/VCXO. To achieve comparable frequency stability an "ovenized" unit would require more space and more power.

Tight temperature compensation is only one example of Damon VCXO capability. Low noise, small size and increased reliability are other Damon VCXO accomplishments. Perhaps your telecommunication system suggests new VCXO problems? Consultations between circuit designers and Damon engineers are the best route to proper VCXO selection. As a starter, may we invite you to write for the Damon VCXO Brochure. Damon Engineering, Inc., 115 Fourth Avenue, Needham Heights, Mass. 02194 (617) 449-0800.

# DAMON

ON READER-SERVICE CARD CIRCLE 14





caused by poor manufacturing quality control rather than poor circuit design.

The record for peripheral equipment is reputed to be even worse. Mechanical failures are frequent and often inefficiently repaired, according to a report in *Pravda* last year by Academician Viktor Glushkov. A major handicap for the Soviet computer user is the quality of magnetic tape, he said. He complained that data could not be stored for more than a month without suffering losses.

### Software is tough

Software would seem to be another problem for the Soviet. Most machines use autocoders or simple symbolic assemblers. In common with much of Western Europe, the principal high-level language is ALGOL, and compilers do exist for this language for several of the computers at the Academy of Sciences Computing Center. ALGOL, ALPHA (a subset of ALGOL), FORTRAN and COBOL compilers are under development for the BESM-6 machine. The ALGOL compiler is being developed by a team of only 10 persons, and is expected to be ready by the end of 1967 after two years' work. Simulation languages are very popular, as might be expected in view of Soviet interest in cybernetic systems.

Despite the adoption of ALGOL as the standard language throughout the Soviet Union, FORTRAN is reported to be preferred by the large Dubno Nuclear Research Center because of the large number of prepared programs available to FORTRAN users. This suggests that the Soviet has access to programs published in the U.S. and Western Europe.

Time-sharing has made very little headway, although executive and monitor programs are being written for the BESM-6 and may be ready in a year. Suitable terminals, however, have not yet been developed, and this implies that time-sharing is still a long way off.

### A shortage of specialists

A frequent complaint in the U.S.S.R. as in the U.S., is the lack of

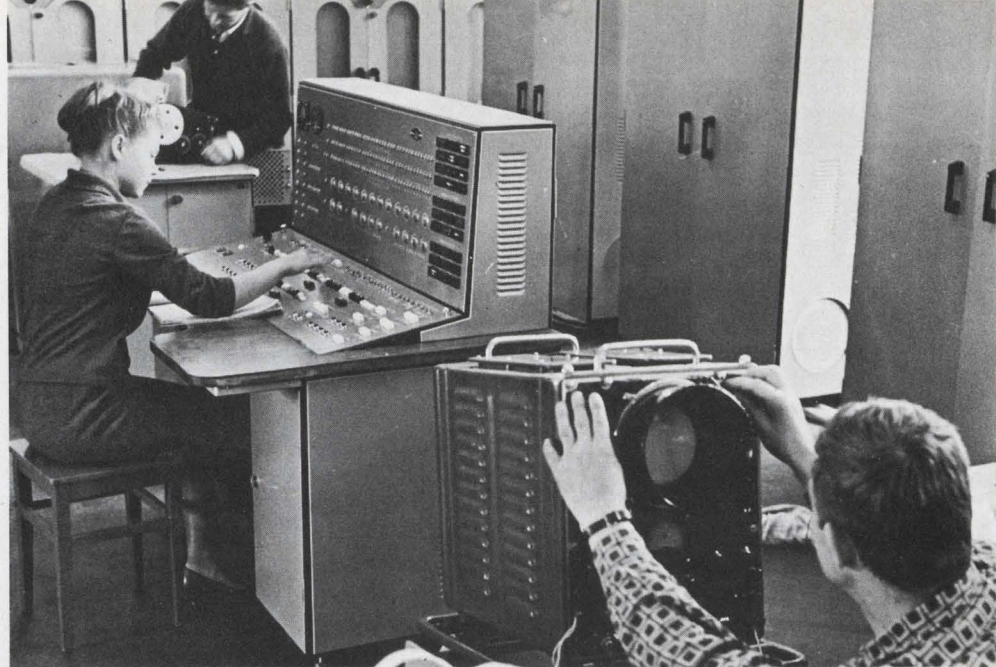

Typical small Soviet computer is the minsk-22, here undergoing checkout at a factory in Minsk. (Novosti from Sovfoto).

capable programming, operating and maintenance personnel. The Gorky car factory was cooperating with two other plants for more than five years to prepare a large computer program. It still had not finished the job in 1966.

Several institutes have started training programs for computer specialists. Typical of the dogged Soviet approach to education is the Economics-Statistics Institute in Moscow. About half the institute's 4000 students are enrolled in the data-processing program, which requires five years of full-time study or six years of correspondence. The director of the institute was U.S.-trained under the U.S.A.-U.S.S.R. cultural exchange program.

### Cryogenic research is pushed

Despite the shortcomings of its manufactured computers, the Soviet is very active in computer research. At the Ukrainian Physico-Technical Institute in Kharkov a small-scale cryogenic computer has been built. This machine has 504 lead-tin wire cryotrons. It can add, subtract and multiply four-bit words, but it has a clock period of six seconds and requires refilling with helium every three hours. The experimenters have expressed the highly optimistic hope that they will be able to increase the clock frequency to bring the speed into the megahertz range.

In the memory field thin films are under serious investigation. One group of Moscow researchers has de-

scribed a destructive-readout, thin-film memory (64 fifty-six bit words) with a 500-ns cycle time. Each storage element is a 1.2-by-2.4-mm magnetic film, 1000 Å thick, on a highly polished Duralumin substrate. By comparison, similar thin films in the U.S. have typical cycle times of 250 ns.

### Soviet computer utility

Academician Glushkov has proposed that the Soviet Union have 10,000 computer centers in operation by 1971. These computers would meet the needs of industry and commerce for routine data processing. In addition Glushkov has suggested that 50 large computer centers be interconnected and run by a single Moscow ministry as an enormous computer utility. At present the output of the U.S.S.R.'s computer factories is probably less than 500 computers a year. Since the total of computers in the U.S.S.R. has been estimated at 2500 (there are estimated to be 25,000 computers in the U.S.), it would seem unlikely that Glushkov's plans can be fulfilled on time.

Academician Anatolli A. Dorodnitsyn, head of the Moscow Computing Center, has appealed to the Soviet Government to buy computers from the West—a prospect attractive to British manufacturers, who have already sold computers to several satellite countries. Such a market could be worth \$100 million a year initially and could expand rapidly as the Soviet developed its applications experience.



# What the Soviet is not doing in ICs

**Roger K. Field**

Microelectronics Editor

During the last decade, little information about Soviet micro-miniature electronics has been available. Soviet silence about an important area of technology generally means one of two things: either they know something important that they know we don't know, or they are embarrassingly far behind.

I recently had the good fortune at Expo 67, Montreal's world's fair, to run across a Soviet microcircuit designer who offered a glimpse at Soviet technology. Let us call him R—. The conversation, as I recall it, went as follows:

"We are still three years behind American companies," he said.

"Both we and the Europeans are either up to you or not far behind in most areas of semiconductor research. But we are at a considerable disadvantage when it comes to high-volume production of integrated circuits. Like the Europeans, we can make most thick- or thin-film circuits and some fairly complex monolithic circuits in the laboratory, but they are making them in production quantities and we cannot."

*"Is it simply a lack of interest on your part, or are there problems that prevent you from setting up production lines?"*

"There are always many problems when you start production, but we have an additional one, peculiar to the Socialist world: we do not have the sophisticated instrumentation that the high-volume production of integrated circuits requires, and your State Department prohibits American companies from selling such equipment to us. Your engineers, for example, wouldn't think twice about installing a small computer for automatic testing, but we don't make these computers, and we do not have the integrated circuits to make them."

*"How complex are your production monolithics? That is, how many components can you integrate on a chip?"*

"We recently started production of a monolithic operational preamplifier. It contains several transistors

and several resistors—I think three or four of each. It has a gain of about 1000 and a temperature drift of 15 or 20 mV/°C. It is used in the probe of an electrocardiograph.

"This is also our present production limit for monolithic digital circuits—six to eight components. We can put that number of components on a chip and make a gate, but a flip-flop requires more than that."

*"Do you make these monolithic circuits with the planar process?"*

"Yes. We do."

*"Have you pulled ahead of the American manufacturers in any area of integrated circuits?"*

"We used to use nichrome for our thin-film circuits, but we have developed a secret alloy that gives us excellent stability and considerably higher sheet resistivity than nichrome's 50  $\Omega$ /square. We call it Sitall."

At this point R— fished into his pocket and showed me a small sample of Sitall. It looked like a highly polished gold film on a white ceramic substrate. He continued: "We have been working with thin-films for several years now. In fact, our country introduced a very small radio three years ago that contained all its circuitry on one thin-film substrate. But it was a very simple circuit, not even what you call superheterodyne, and it still sells for 17 rubles—a working man's wage for several days."

*"Do your computers use thin-film or monolithic circuits?"*

"Neither. Our logic circuits do not make extensive use of capacitors, so our computers are built with small thick-film circuits."

R— removed a small computer circuit from his inside jacket pocket and showed it to me. It was a rather simple circuit, but four thick-film resistors were applied to each side of the substrate, and it was quite obvious that transistors were to be bonded, face down, to both sides. It had 12 leads.

R— had as many questions for me as I had for him. Some of his were very illuminating. He inquired, for example, whether U.S. industry was able to produce beam-lead microcircuits.

He admitted that Soviet semiconductor plants were not capable of this.

He also indicated that his colleagues were investigating MOS transistor arrays but haven't made any yet. He was surprised to hear that U. S. manufacturers had succeeded in integrating well over a thousand MOS transistors on a single silicon chip of relatively small size.

Before R— left, he placed the small sample of Sitall and a thick-film digital circuit in my hand.

I sent the sample of Sitall to Advanced Metals Research, Inc., at Burlington, Vt., where Sheldon Moll, laboratory director, and his colleagues analyzed it with an electron microprobe. This machine is capable of determining the composition of a sample in an area as small as 2 microns in diameter. Moll found that Sitall is nothing more than a 200-Å layer of nichrome (84% Ni, 16% Cr) covered by a 5000-Å film of gold. The gold is undoubtedly etched away, except where bonding pads and conductors are desired. The substrate seemed exceptionally smooth for a ceramic. Moll evaluated it, too, with the microprobe. It contains, by weight, silicon (20-25%), calcium (15-20%), titanium (10-12%), aluminum (6-8%) and oxygen.

I visited the Soviet pavilion after leaving R—, to examine the integrated-circuit display. The public gawked at the tiny circuits. The three-year-old thick-film radio appeared to cause considerable comment. Close scrutiny of the circuits revealed them to be very primitive. In the radio, for example, transistors in metal cans were soldered upside down to the thin-film circuit, and their leads were bent over and bonded to oversized pads. Another showcase contained computer memory modules, but they were made with ordinary ferrite cores. There were no monolithic circuits on display. And the only production equipment was an extremely crude ultrasonic bonder. This bonder, incidentally, was not working, but it used what appeared to be copper wire at least an order of magnitude thicker than the one-mil wire used in U.S. circuits. ■ ■



# 'See through' ceramics create optical memory

## Binary and octal units switch in nanoseconds; million-bits-per-square-inch capacity forecast

David H. Surgan  
Technical Editor

A 256-bit optical memory has been designed with ceramics.

By using thin polished plates of crystalline ferroelectric ceramic, researchers at the Sandia Laboratory, Albuquerque, N.M., have designed a prototype that stores more information in a given space and in more states than the two binary modes

The laboratory reports that one bit of information can be written or erased in about  $0.2 \mu\text{s}$  (200 ns).

The inventors are Cecil E. Land, a member of Sandia's Ferroelectric Research Div.; Ira McKinney, also with the division, and G.H. Haertling, supervisor of the Sandia Active Ceramics Div. and developer of the ceramic. Land described the new memory in a paper at the International Electron Devices Meeting in Washington, D. C. (Oct. 18 through 20).

### Two types of memories

Two kinds of memories were described by Land:

■ A binary memory that uses a voltage pulse to change the transparency of a coarse-grained (over 2 microns) ceramic. The switched areas of the ceramic act like a shutter.

■ A multistate memory (Fig. 1) that uses a voltage pulse to produce a number of precise, detectable variations in the intensity of light passing through a fine-grained ceramic between two crossed polarizers.

The multistate memory acts as a light filter rather than as a shutter, with the intensity of light that passes to the photodiode dependent upon the angle between the light beam and the field induced by the applied voltage. Information is stored at each bit location depending on the alignment of dipoles. This is quite a contrast to conventional memories, which are capable of storing only a binary number, 0 or 1, at each location. Sandia has built an octal version.

Voltage switches the polarization in the ceramic between two energized electrodes. Even when the voltage is removed, the dipoles in this very small area remain aligned until switched.

In their initial state, the ceramic plates are isotropic (they transmit light equally in all directions). After they have been subjected to a poling voltage, light propagates faster in the poling direction than in any other direction, and the material is then anisotropic and birefringent (birefringent ceramics have two refractive indices, one along the poling direction

and another at a right angle to it). In the coarse-grained materials the birefringence is hidden by scattering of the transmitted light. But in the finer materials, where the grain dimensions approach the wavelength of light, the birefringence permits entirely different light-scattering behavior. The material appears birefringent when viewed in plane-polarized light. However, when viewed in ordinary light, it appears uniformly translucent.

Hot-pressed lead zirconate-lead titanate ceramics have been used in most of the work. Other materials—barium titanate and sodium potassium niobate—also work.

When a small area (a binary bit location) of a coarse-grained plate (Fig. 2) is poled or switched at a right angle to its major surface, light striking the surface at the same angle is scattered in a narrow central beam. This area then appears transparent. When the same area is switched parallel to the major surface, light transmitted in the central beam is reduced and the area appears opaque.

The microscopic domains are switched parallel to the major plate surfaces, and the information state, or stored number, is determined at each bit location by the angular orientation or the poling direction (polar axis) with respect to the direction of the plane polarizer. It is possible to change the orientation of the polar

(continued on p. 32)

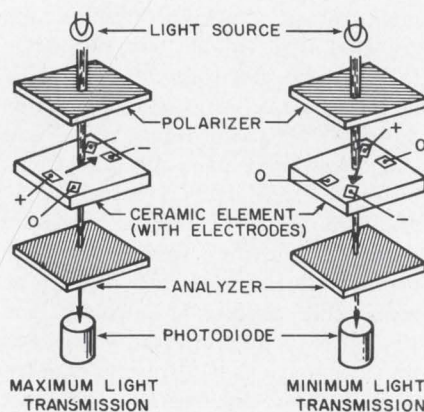

1. **Ceramic polarization** determines light transmission when the polarization of polarizer and analyzer differ by 90°.

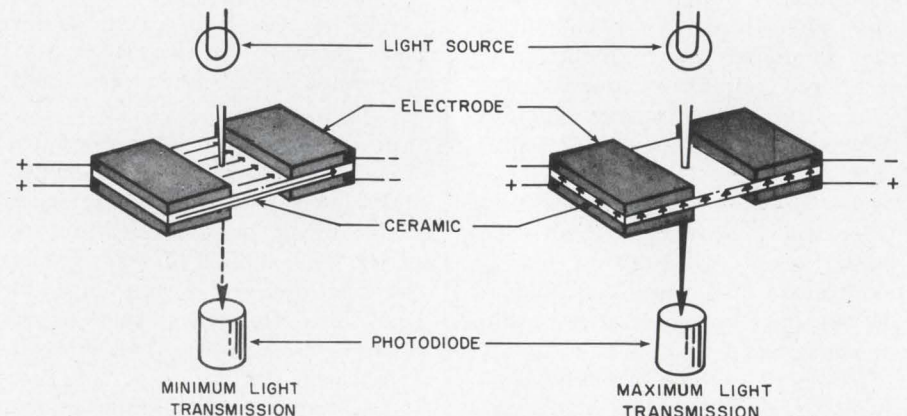

2. **Application of voltage at right angles** to the light source aligns the domains, which scatter the light. This results in virtual extinction of

light transmitted to the photodiode. When the domains are aligned parallel to the light source, maximum transmission of light is achieved.



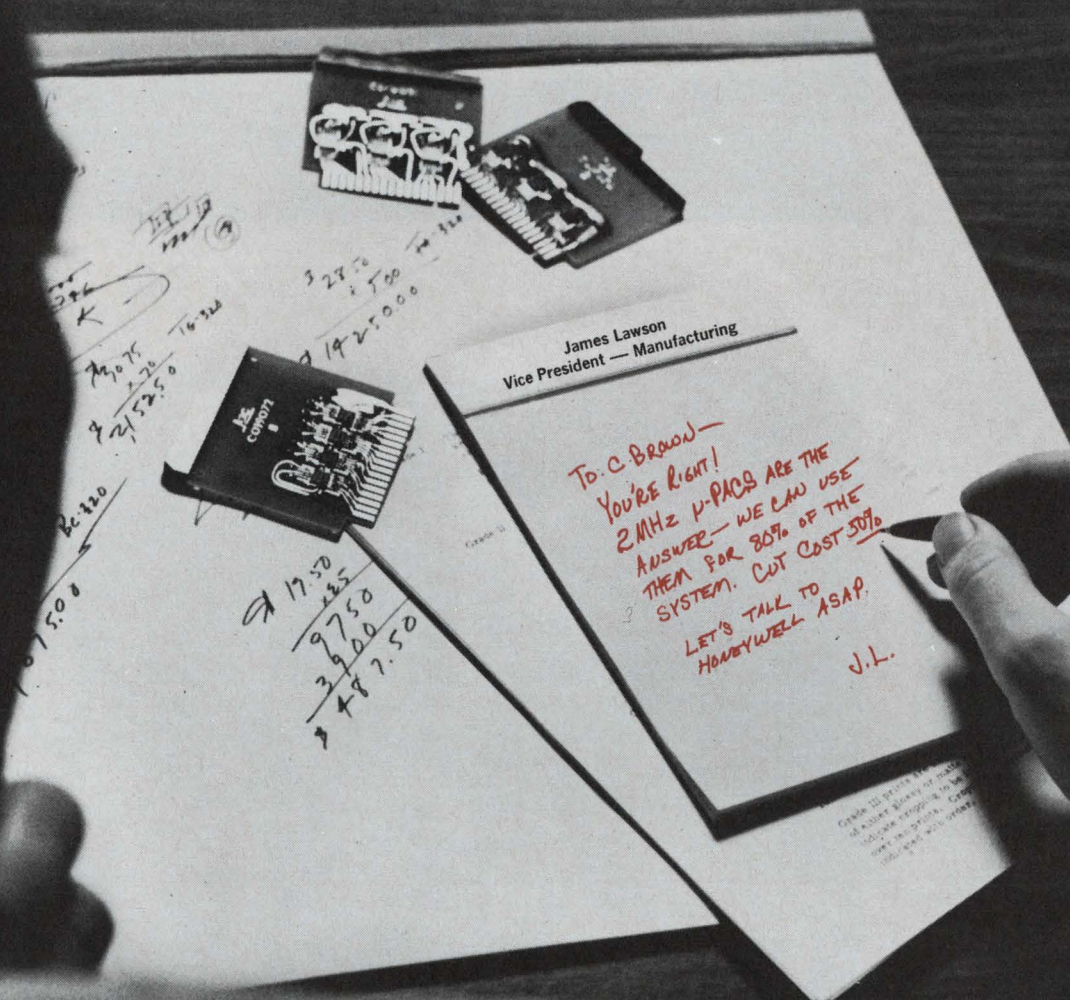

## Low-cost 2MHz $\mu$ -PACS...

...let you save  
up to half the cost  
of system logic.

If you face a make-or-buy evaluation for system logic, maybe you've considered  $\mu$ -PACS. Now, you can use new I/C 2MHz  $\mu$ -PACS for up to 80% of your logic needs. Cut costs as much as 50%.

Take another look at your make-or-buy: Think  $\mu$ -PACS at half the cost. Add more savings for volume discounts. Forget the people and equipment you'd need just to begin making your own. Remember  $\mu$ -PAC quality and reliability. (Both 2MHz and 5MHz  $\mu$ -PACS are compatible.) If this changes your cost analysis, write for new spec/price brochure. Honeywell, Computer Control Division, Old Connecticut Path, Framingham, Massachusetts 01701.

# Honeywell

 **COMPUTER CONTROL**  
DIVISION





# SEMICONDUCTORS

NEW IDEAS IN APPLICATION AND DESIGN

■ **FRUSTRATED WITH UNIJUNCTION SPECS? WANT TO DESIGN YOUR OWN UJT? IT'S A CINCH!**

Just start with a new GE D13T Programmable Unijunction Transistor (PUT), housed in GE's TO-98 epoxy package. Now connect it up in the following fashion:

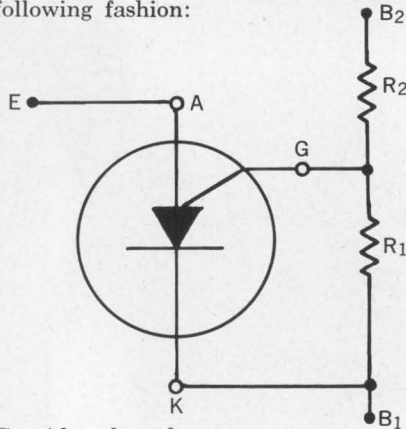

Consider the advantages:

- $\eta$  can be set at any desired value by selecting  $R_1$  and  $R_2$ .
- $R_{BB}$  can be made high for low power consumption.
- $I_p$  can be reduced to less than 150 nA for long time delay applications by increasing  $R_G$ . ( $R_G = \frac{R_1 R_2}{R_1 + R_2}$ )
- $I_V$  can be adjusted to higher values for relaxation oscillator applications by lowering  $R_G$ .
- 80 nanosecond rise to 6 volt output pulses is guaranteed.
- $I_{EO}$  is less than 10 nA.
- 2-volt to full line voltage operation is possible.
- Less than 35¢ in volume.

That's what you get with General Electric's new "PUT". Order some today from your local General Electric distributor and join the exciting world of UJT design engineers. Want specs and other details? **Circle Number 811.**

**More metal-cap transistors are going epoxy. Result: equivalent performance and cost savings up to 50%**

You receive the same high performance levels as electrically equivalent metal-cap units. GE epoxy transistors also have comparable hermetically sealed stability. Latest types to make the change are these high grade devices for critical industrial and military applications:

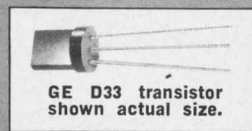

Metal-Cap Type	GE Epoxy Equivalents	Device Description
2N759,A 2N760,A 2N915,6 2N2220-22	D33A Series	general purpose amplifiers
	D33B Series 2N4951-4	medium current, general purpose switch/amplifier/driver
2N697, 2N1613, 2N1711, 2N2192, 2N2193	D33D Series	high gain driver
2N706, 2N708, 2N914, 2N753, 2N834	D33E Series 2N3605A 2N3606A	high speed digital switch
2N2368,9, 2N743,4	D33G Series 2N5029 2N5030	low current, high speed digital switch
Also	D33K	high current core driver and medium current, high speed switch
	D33L	low voltage, very high speed switch

For our latest epoxy transistor reliability report, **Circle Number 813.**

■ **C106 ECONOMY SCR LINE ADDS 300-VOLT SELECTION**

Now you can choose from several 2-amp C106 voltage ratings: C106Y at 30 volts; C106F at 50 volts; C106A at 100 volts; C106B at 200 volts; and finally our new 300-volt selection, C106C.

GE C106 SCR's are priced, in volume, from 35¢ to 60¢ depending on voltage selection. Standard lead configuration is in-line, with several



Actual size C106 SCR with flat leads and heat sink tab.

alternate lead configurations offered to meet special mounting requirements. The C106 is plastic encapsulated, planar passivated, and features excellent gate sensitivity and up to 300-volt blocking voltage. *Readily available in volume.* **Circle Number 812.**

These are just three more examples of GE's total electronic capability. For more information, call your GE engineer/salesman or distributor. Or write to Section 220-61, General Electric Com-

pany, Schenectady, N.Y. In Canada: Canadian General Electric, 189 Dufferin St., Toronto, Ont. Export: Electronic Components Sales, IGE Export Division, 159 Madison Ave., New York, N.Y., U.S.A.





### **Integrated Army communications stressed**

The pressing need for a fully integrated and compatible military communications system, both strategic and tactical, was the main theme of an address by Maj. Gen. Walter E. Lotz, Jr., to the recent annual meeting of the Association of the U. S. Army. The Army's Chief of Communications-Electronics told his Washington audience that the next generation of tactical voice radios must consist of a basic set of modules capable of assembly in a variety of combinations "to meet all manpack, vehicular and aircraft needs, including integral voice security." He also stressed the necessity of automatic switching in place of present manual field telephone switchboards.

The burden of his address, however, was on total military communications compatibility. A line can no longer be drawn between purely strategic and purely tactical communications, he said. There must be one single set of engineering standards, one system design philosophy, common operating procedures, common personnel and training, and compatible organizational structures for all communications networks, the general declared. He cited Project Mallard, the new four-nation integrated digital tactical communications system, as a typical broad approach to the problem.

During the IEEE Electronic Aerospace Systems Technical Conference (EASTCON) a week later, Brig. Gen. Paul A. Feyereisen also laid stress on the need for improvements in tactical communications. The program manager of Project Mallard noted that today's U. S. infantry division has a standard issue of about \$12 million in communications equipment out of the total \$95 million laid out for all its matériel—that is; about 13% of total outlay. Similarly, 12% of the division's manpower is required to operate and maintain communications equipment.

### **Intelsat growth continues**

The International Telecommunications Satellite (*Intelsat*) consortium is expected to include well over 70 nations, or nearly the entire free world,

# Washington Report

CHARLES D. LAFOND  
WASHINGTON BUREAU

by the mid-seventies. The addition of Kenya last month brought the list to 59 nations. In the near future, Turkey and Iran are expected to join the consortium followed by Uganda, Ecuador, Paraguay and Panama within the next two years.

The installation of Earth stations by member nations is progressing rapidly, according to John Johnson, Vice President (International) of Comsat Corp., the U. S. representative in the consortium. In Mexico and South America, nine Earth stations will be completed by 1970—Mexico, Panama and Chile plan completion of their stations by the summer of 1968; Brazil, Peru and Argentina will finish by 1969; and by 1970 Colombia, Venezuela and Ecuador will have theirs completed.

An upcoming Mexico City meeting, which will be at the member-state level, will have important implications for the future operation of the consortium. A major item on the agenda will be a country-by-country estimate of use of the global satellite system through 1975. The U. S. is expected to propose permanent continuation of the annual assembly of all consortium members, analogous to a shareholder's meeting but with limited decision-making.

Another matter expected to be considered is the international legal aspects of an diversification by Intelsat into satellite systems not intended solely for communications, such as navigational systems. Although no problems are anticipated, such facets of future applications must be clarified. The high point on the agenda, however, will be discussion of the U. S. proposals for the final Intelsat agreements to be signed in 1969 (see "Comsat ready to give up ruling vote in global body," ED 22, Oct. 25, 1967, p. 13).

### **Lasers train Army gunners**

Laser tank-cannon simulators used by the Army to train heavy-tank gunners are helping to cut training time, the Army claims. The simulators are being built under initial contracts totaling \$500,000 by Kollsman Instrument Corp., Elmhurst, N. Y. The low-power devices, called weapon-fire



simulators, replace the previous machine-gun trainers for M-48 and M-60 tank gunners and are now considered standard issue for armored units.

In training operation, the gunner aligns his target in an optical sight as he would when firing a 105-mm gun, pulls the trigger, and checks his accuracy immediately by where the light spot hits the target.

The laser simulator reduces the need for firing live ammunition and permits indoor target practice. Because of the success of the laser simulator in this application, the Army is now considering similar equipment purchases for other artillery and antipersonnel-weapon simulators. In the realm of automatic weapons, several million dollars a year could be saved in training cost alone, the Army said, since the cost of one laser shot is about 0.1 cent.

## F-111B inadequacies minimized

The official military attitude toward the developmental problems of the F-111B has been made clear in an address by Robert A. Frosch, Assistant Secretary of the Navy for Research and Development, to the recent IEEE Electronic Aerospace Systems Technical Conference (EASTCON). His approach was to compare F-111B deficiencies with those experienced with the early trials of previous successful Naval aircraft, such as the F-4 Phantom series.

Frosch described reports by the press and in Congress as misleading because they refer to defects revealed in standard Navy Phase-I Preliminary evaluation testing. These flight tests, he stated, are intended to reveal aircraft design or operational problems of any nature, and are in no way relevant to final acceptance testing. He quoted a long list of deficiencies discovered during early F-4 testing in 1958; these bore a remarkable resemblance to present F-111B shortcomings. Yet the F-4 today is one of the most successful of all fighter aircraft, he told the Washington, D. C., meeting.

The weakness of his argument, informants later commented, was the way he equated the F-111B's very serious overweight problem with lesser, easily corrigible aircraft design problems. The assistant secretary noted the weight reduction—some 3000 lb,—but neglected to mention that the aircraft is still some 15,000 lb, overweight. He stated that higher-thrust engines would be used, but passed over lightly the extensive modifications that will be required by existing aircraft carriers to accommodate the F-111B. In short, he stated

that, despite the fact that the contractor (General Dynamics) has failed to meet design specifications, the aircraft will meet the requirements of fleet air defense by the Seventies.

## Fluidic yaw control to be developed

As part of its efforts to obtain improved attitude control for attack helicopters, the Army has awarded Honeywell, Inc., an \$83,250 contract to develop the first fluidic yaw stability augmentation system for helicopter use. Flight testing will be performed early next year on a Bell UH-1B helicopter. The fluidic yaw control will be hydraulic, employ no moving parts and be coupled with the helicopter's hydraulic servo system. Since the same medium is used to sense motion and actuate servos, signal transducers will not be required, the Army said. The contracting agency is the Army Aviation Materiel Laboratories at Ft. Eustis, Va.

The new contract brings Honeywell's total awards during the last two years to nearly \$350,000 for the application of fluidic technology to helicopter flight controls. Under previous contracts, Honeywell proved the feasibility of a no-moving-part yaw damper using a vortex rate sensor, fluidic cascaded amplifiers and a compensating circuit network. The yaw control system is now undergoing life testing for reliability data during 45,000 operating hours.

## Automatic enemy locator/killer touted

A fully automatic airborne ground-fire detection and counterfire system could produce a 10,000-to-1 improvement in kill probability over present methods now in use in Vietnam, according to General Dynamics. Its Pomona Div. in California is developing a fully automatic system for use on relatively low-speed, low-altitude aircraft and helicopters to suppress small-arms ground fire.

The concept involves the detection by radar of oncoming .30- and .50-caliber weapons, and the automatic return of fire in short bursts from a Mini-gun (multibarrel, 5.56 mm, 6000 rounds per minute). A complete system weighing some 300 lb would provide suppressive fire for up to 400 seconds using random short bursts of less than 2 seconds each, the firm says.

The developer claims that such a system would provide effective ground-fire suppression without the enemy's being visually sighted. The system could be applied to any rotary- or fixed-wing aircraft with speeds up to 350 knots.

The system's control logic is said to be capable of modification to fit a particular mission or airborne gun platform. The present system is designed to detect all bullets approaching the aircraft within 300 ft.





**Don't try to sell her  
on the challenging career  
Hughes has offered you.**

**Just mention . . .**



**The climate.** Often it's compared with the Riviera's. In truth, Southern California's is better. Drier in summer: no mosquitos, little mugginess. Balmy in winter: seven hours of sunshine a day. You'll save on galoshes!



**Family fun.** You literally can ski and sunbathe the same day here. Swimming pools and ski runs are an hour apart. The kids will love mountain climbing, surfing, sailing, desert rockhounding. Every weekend's a vacation.

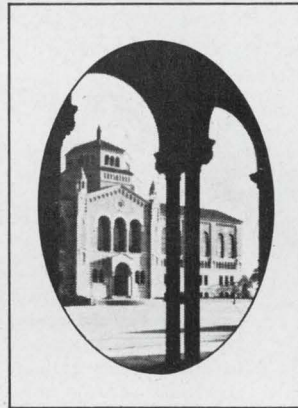

**Great schools.** Some of America's most respected school systems are in the Los Angeles area. Also, many fine city colleges; three branches of California State; U.C.L.A., U.S.C., Caltech, Occidental, Loyola, and *more*.

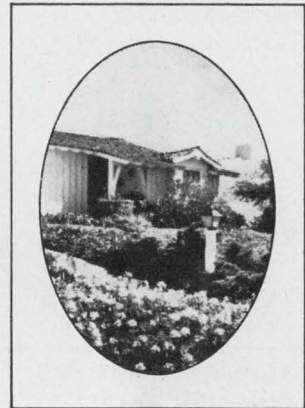

**The good life.** You can find it in communities like Westchester, Redondo, Playa del Rey. Or Sherman Oaks, Canoga Park or Pasadena. We have literally scores of beautiful residential areas within easy reach of Hughes plants.

**About that challenging career . . .** The Hughes Aerospace Divisions have over 200 openings now for graduate engineers. Opportunities exist on advanced projects and programs like ATS, VATE, TOW, PHOENIX, Communications Satellites, and many others. Please send resume to:

**Mr. Robert A. Martin  
Head of Employment, Dept. 15  
Hughes Aerospace Divisions  
11940 W. Jefferson Blvd.  
Culver City, California 90230**





# The original lacing tape is still the best...

# ... and saves money too!

*That's*

## GUDELACE 18

You ought to try  
a sample...



### GUDELACE ties tight, makes firm harnessing—fast!

It is important, of course, for you to use tape that complies with military specs, or commercial stipulations, but the usual allowances for wax content in such specs give no consideration to the best lacing conditions. Gudebrod GUDELACE is made within the specs—BUT, it's made too, for easy handling, tight knotting, firm harnessing. THAT'S WHERE IT SAVES MONEY, in the harnessing operation. GUDELACE, the original harness lacing tape, is manufactured under strict control. Every yard is impregnated exactly the same, exactly right. You can count on that—and on getting better harnessing—fast—with minimum rejects. Why not send for a sample, test it any way you want. Let your harness crew try it. You'll be glad you did! (Remember, the Gudebrod Lacing Tape line includes tape for nearly every special situation—ask for The Product Data Book.)

NOW—GUDEBROD HAS  
TWO AIDS TO FASTER—  
BETTER HARNESSING

**CABLE-LACER®  
& GUDE-SNIPS®**



The production tested Cable-Lacer is now reduced in price—only \$9.95. Holds bobbin of tapes—makes tight knots. The palm held GUDE-SNIPS provide convenient tape cutting—using either right- or left-hand, \$3.75.

# G UDEBROD

GUDEBROD BROS. SILK CO., INC.

Founded 1870

12 SOUTH TWELFTH STREET  
PHILADELPHIA, PA. 19107

*Electronics Division*

ON READER-SERVICE CARD CIRCLE 18

## NEWS

(ceramic, continued)

axis by the application of voltage in one of a number of possible directions.

The birefringence of the fine-grained ceramic is used to detect or read out the digit stored at each bit location. Light-emitting diodes may be used to illuminate word locations, and a photodiode detector may be used to determine the light intensity at each bit location.

### Large storage capacity

When a bit location on the ceramic plate is illuminated, a photodiode easily distinguishes between the transparent condition, a binary 0 and the opaque condition, a binary 1.

The Sandia coarse-grained memory measures one-quarter by one-fifth inch and is four mils thick. The elements are arranged as a matrix array in four 64-bit word segments. Each segment may be interrogated independently with a light-emitting diode source. With light sources and photodiode detectors in place, the total configuration is about a quarter of an inch thick, comparable in size to ferrite systems. Storage density is 5120 bits per square inch, about five times that of conventional memories.

Land says it appears theoretically possible to store a million bits per square inch by employing more sophisticated write and read techniques. A unit now being developed stores 20,480 bits per square inch.

It is not yet known whether the ceramic will retain its switching properties during the billions of cycles required for computer core memories. For this reason, it is expected that initial applications will be in such systems as peripheral, catalog and content-addressable memories not requiring extensive cycling.

### TV without a CRT?

With time and further development, Land believes that each memory cell, on command, could assume one of as many optically identifiable states of polarization as there are letters in the alphabet.

Because of its high optical resolution, the fine-grained ceramic could even replace the present cathode-ray picture tube. An electron beam would control the individual translucency of the tens of thousands of tiny spots in a thin ceramic plate. ■ ■



## Aerospace group helps fight disease

At the Royal National Orthopaedic Hospital in London doctors faced the problem of making measurements on patients with arthritis. The clinicians needed to measure the loads on the feet of patients with diseased hip joints as the patients walked about in the course of their normal day-to-day activities.

A chance dinner-table conversation with scientists from Britain's Royal Aircraft Establishment led to a solution. The RAE, already experienced in miniaturized electronics, came up with a James-Bond-like shoe intended to bug the loads sustained by the wearer.

The sole of the sandal consists of a load-measuring capacitor formed by sandwiching flexible metal filigree sheets between layers of sponge rubber. This load-dependent capacitor controls the frequency of a transistor oscillator mounted in the heel. The amplified oscillations are radiated by an antenna formed around the edge of the sole and picked up by a loop placed around the room at floor level. The resulting signal, showing the duration and intensity of each step for both feet, is recorded for later analysis by the clinicians.

The doctors hope that this collaboration of engineer and medical researcher will help keep a check on the progress of the disease and the effectiveness of treatment. Such information will also assist in the design of artificial hip joints. ■ ■

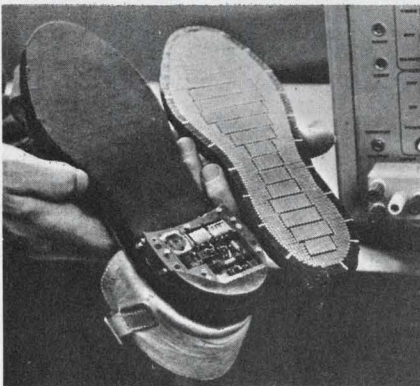

**It doesn't belong to James Bond**  
The sandal is designed to measure the loads on the feet of people with arthritic hip joints. The sole is a load-measuring capacitance transducer and the heel is a transmitter.



**FOR BETTER, FASTER  
WIRE HARNESSING—**

**GUDEBROD  
CABLE-LACER®**

**NOW REDUCED TO \$9.95 ea.**  
[10% OFF, LOTS OF 50]

Production economics enable Gudebrod to offer the production tested Cable-Lacer at a new low price. Holds bobbin of tape. Facilitates lacing and knotting.

**GUDEBROD  
GUDE-SNIPS®**

**NEW HANDY TOOL— \$3.75 ea.**  
[\$37.50 IN DOZEN LOTS]

Unique, palm held tape snips. Allow free use of fingers while holding in hand. Right- or left-hand use. Sharp, drop-forged cutlery steel blades. Spring action.

*Special Offer!*

So that you may try them and see the money-saving way they facilitate the harnessing operation—we'll send you postpaid, one Cable-Lacer, one Gude-Snips and a bobbin of lacing tape for just \$14.00. Test for yourself how these tools can help you make better harnesses, faster and for less money.

**GUDEBROD BROS. SILK CO., INC.**

Founded in 1870  
12 South Twelfth Street  
Philadelphia, Pa. 19107

Check enclosed, send me, postpaid:

- The special offer of Cable-Lacer, Gude-Snips and bobbin— **\$14.00\***
- I just want the Cable-Lacer— **\$9.95\***
- Send only the Gude-Snips— **\$3.75\***

Name \_\_\_\_\_

Company \_\_\_\_\_

Address \_\_\_\_\_

**GUDEBROD**

\*In Pennsylvania please add sales tax.

*Electronics Division*

ON READER-SERVICE CARD CIRCLE 19



# Always connect subminiatures with Winchester Electronics.

Take cable and panel mounted rectangulars. We've got them with solder or crimp removable contacts. From 4 to 50 contacts with current ratings of 3 to 7.5 amps. Standardized high-density rectangulars also, that allow you three current ratings — 3, 5, or 7.5 amps — with one size connector and one size panel cutout.

Need pc connectors? We've got edge-board, right-angle or flat-mounted pc's on .050, .078 or .100 contact centers. With solder, eyelet or dip solder terminations for 1/32 to 1/4-inch boards. And we've got micro-miniature pc connectors for use

with integrated thin film and semi-conductor circuitry.

If you're looking for circular cable or panel mounted connectors, you'll find them with 1 to 12 contacts. Contact centers from .025 to .040 with current ratings of 3 to 7.5 amps.

They're all on the shelf of





your Winchester Electronics distributor. You'll find him close as your phone—make the connection now. Winchester Electronics, Main St. & Hillside Avenue, Oakville, Conn. 06779.

**WINCHESTER ELECTRONICS**  
LITTON INDUSTRIES

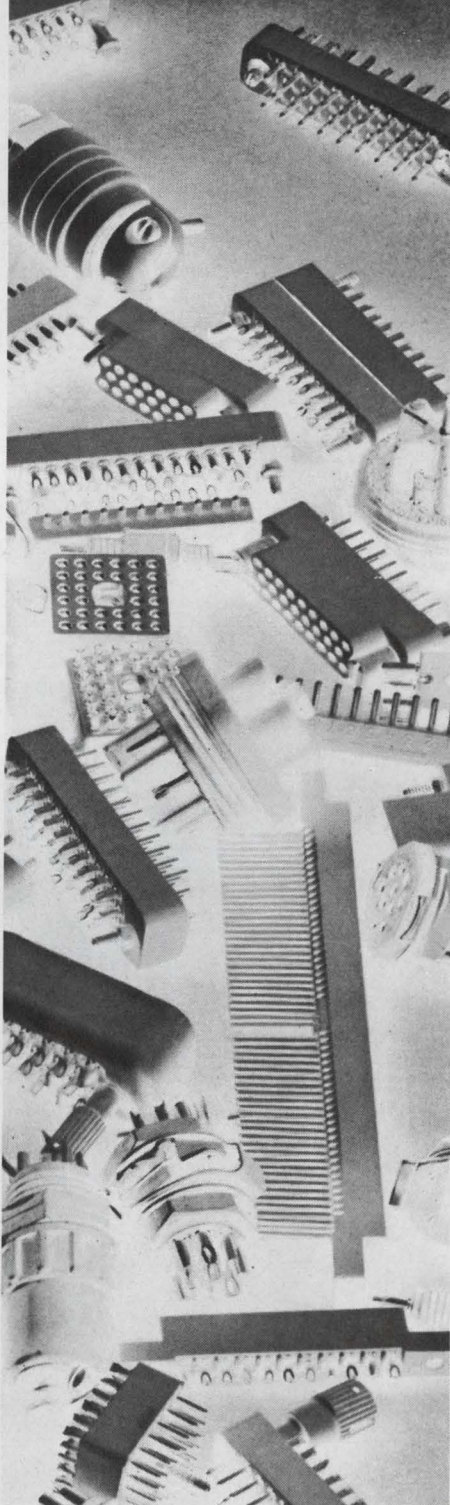

ON READER-SERVICE CARD CIRCLE 20

## Revised telephone rules may spur digital facsimile

Commercial applications for digital facsimile over telephone lines may get a boost from the recent Carterphone decision of the Federal Communications Commission.

In this decision the FCC overruled American Telephone & Telegraph's objections to a system that transmits telephone conversations over a radio link. The Justice Department has urged the FCC to require revision of long-standing telephone company rules against attaching certain external devices to phone lines (see Newscope, page 13).

A digital facsimile transmission system developed by Edgerton, Germeshausen & Grier, Inc., Bedford, Mass., is one type of equipment that might benefit if the telephone line attachment rules are changed. This system is under development for the Air Force 433-L program. Under this program facsimile signals, primarily weather data, will be transmitted digitally from 20 transmitters to 125 receivers at Air Force bases. Initial installations will be in the United States in late 1969 and a worldwide system should be operational sometime in 1970. The initial contract is for \$3.5 million with EG&G, but an option for 300 additional receivers could increase this considerably.

The key element in the EG&G system is a bandwidth compression scheme that allows five times more data to be sent over the same line than by direct analog transmission. The compression is achieved by a two-dimensional, line-to-line correlating method called Predictive Differential Quantizing (PDQ). Aside from this proprietary development, the Air Force system will include the ability to send diagrams stored on magnetic tape directly onto a telephone link without any intermediate steps. It will also include a new type of toner and a new flat-bed scanner.

The terminal equipment will cost about three times as much as conventional analog-type facsimile systems, according to EG&G, but the telephone bill will be about a fifth the cost. Thus this is an economical approach for large-volume facsimile transmission systems. Microcircuits are used extensively in the design of the new equipment.

This type of facsimile transmission could make possible telephone attachments that allowed someone at one

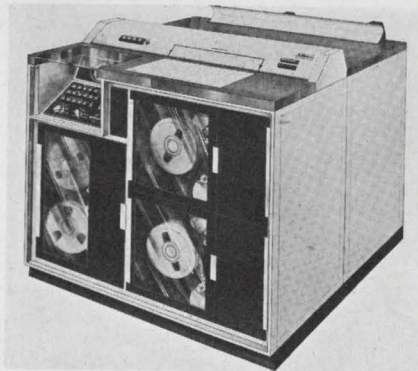

**Digital facsimile transmitter** for the Air Force 433L weather observing and forecasting system will send maps five times faster than present analog-type equipment. This is EG&G's model GMT-3 Weather Plotter Transmitter.

phone to send a document to someone at another phone quite rapidly, much as copies are presently made on a Xerox machine. Digital transmission would allow high speed and, if necessary, coded transmission so that the message could not be intercepted. ■ ■

## Argon laser for space

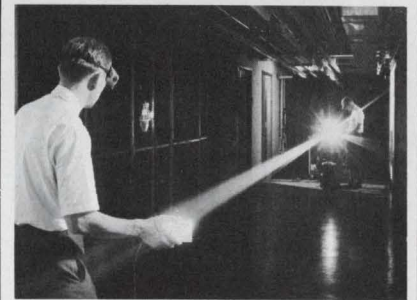

**Satellite-tracking** and communications experiments will be performed with a 10-watt argon gas laser developed by RCA, according to NASA. The laser has a unique tube containing many graphite disks which carry off heat and protect the tube walls from ion bombardment. The lasing plasma is confined to holes in the center of the disks. This allows radiation cooling rather than the complex high-pressure water cooling normally used with gas lasers. Some water is still needed to cool focusing magnets.



# Why Astro/348™ won the high contact density design competition

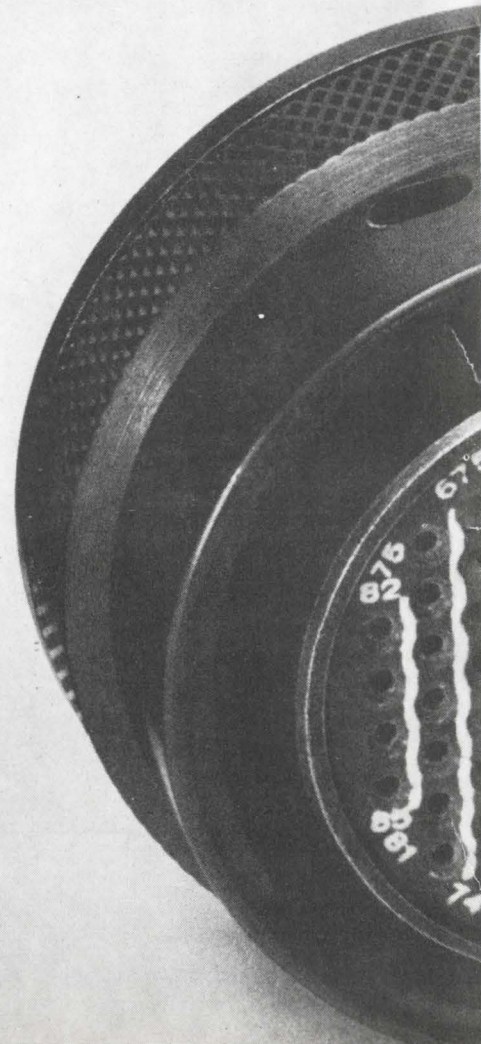
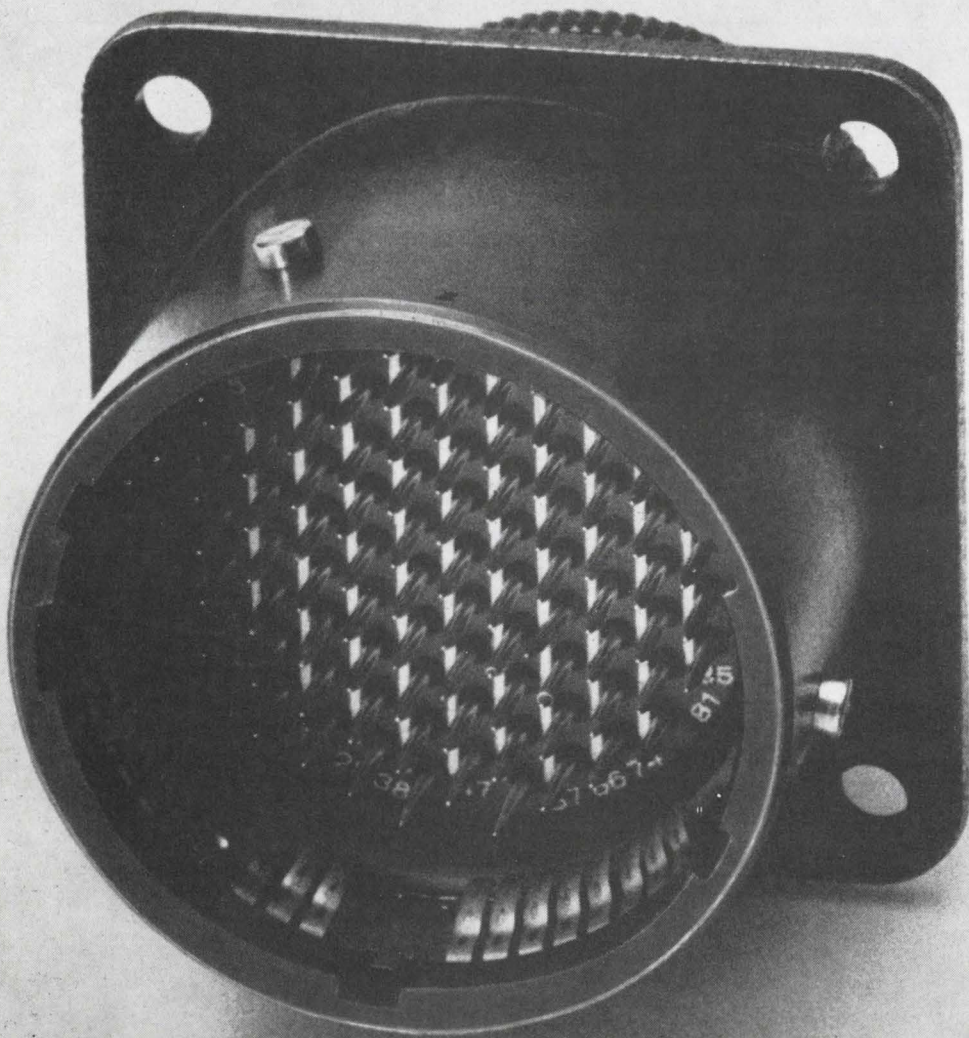



### Better features

- One-piece dielectric retention system eliminating metal retention clips.
- Contact dielectric separation of .021 in on .085-in centers, equivalent to existing miniatures with .130-in centers.
- Monoblock construction eliminating air voids between contacts. Wire sealing range of .030 to .054 in.
- Dual environmental mating protection providing interfacial and shell "O" ring seals.
- Damage-proof mating. Pins recessed beyond reach of shells. Closed entry hard socket inserts, prod-proof socket contacts.
- Grounding springs that mate prior to electrical engagement. Shielding for EMI/RFI protection.
- Front release, rear serviceable crimp contacts.
- Front or rear mounted receptacles on 1/8" panels.

A complete family (6 shell styles, 4 to 85 contacts) is now being qualified to MIL-C-81511 (Navy).

Ask an Amphenol sales engineer about Astro/348. Or write Amphenol Connector Division, 1830 S. 54th Ave., Chicago, Ill. 60650.

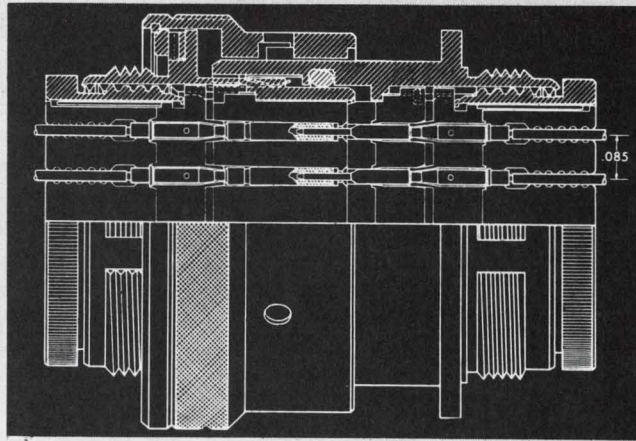

# AMPHENOL



# Billion-bit holographic memories by 1970?

## IBM scientists, now studying million-bit system, seek better photodiode IC arrays to achieve goal

Jeffrey N. Bairstow,  
Computer Editor

Read-only memories that store information on holographic films may lead to inexpensive, high-speed, billion-bit stores.

Scientists at the Systems Development Div. of the International Business Machines Corp., Poughkeepsie, N. Y., expect such optical memories to become a reality by 1970. They already have achieved holographic storage of a million bits in an experimental system.

Previous optical memories have used the conventional method of recording each bit as an image or absence of an image on the film. Difficulties have been encountered in locating the information areas mechanically and in preventing inaccuracies caused by dust or scratches on the film.

But holograms store each point of the image evenly as an interference pattern across the film. Thus even a small portion of the hologram can recreate the entire image.

The main advantages of holographic storage, according to Dr. Harold Fleisher, IBM's manager of

advanced technology, Systems Development Div., are their enormous potential capacity and the redundancy of storage. The latter results from the spread of the grating pattern created by the hologram.

Dr. Fleisher expects that a typical read-only memory system (Fig. 1) will use a laser beam to scan a film on which the information is stored as a series of holograms. The holograms will correspond to the bit patterns to be stored. A hologram splits a laser beam into a main beam and a diffracted beam. In the system of the future, the diffracted beam will produce an image that is read by a photo-detector array for input to the computer.

IBM's experimental arrangements do not yet include the connection to a computer. A technical feasibility study of the over-all arrangement will begin later this year, Dr. Fleisher says.

In the present experimental setup, the laser is a commercially available neon-helium laser with an output of 100 mW at 6328 A. Although this is adequate for his present purposes, Dr. Fleisher is looking forward to lasers with en-

ergies of 1 W or more and lifetimes of 10,000 hours or more for installation in practical computers. Such advances would result in greater resolution and hence increased capacity.

The present scanner uses an electro-optic switch as a digital light deflector. This switch has an array of birefringent calcite crystals and potassium dideuterium phosphate (KD\*P) crystals (see box). The arrangement shown in Fig. 1 has only three pairs of crystals that give eight possible positions. Dr. Fleisher has successfully built units with 16 pairs of crystals that give more than 65,000 possible positions.

The information is stored as a series of holograms, each 2mm in diameter, formed side by side on a photographic plate. The mask used to form the interference pattern consists of an array of 32 x 32 bits, each containing 1024 bits. Thus the capacity of a single plate is more than one million bits. The holograms are being produced manually, but automatic means are being investigated.

After passing through the hologram, the laser beam produces a diffracted beam whose image is formed at an array of photodiodes. For Dr. Fleisher's experiments, dis-

(continued on p.42)

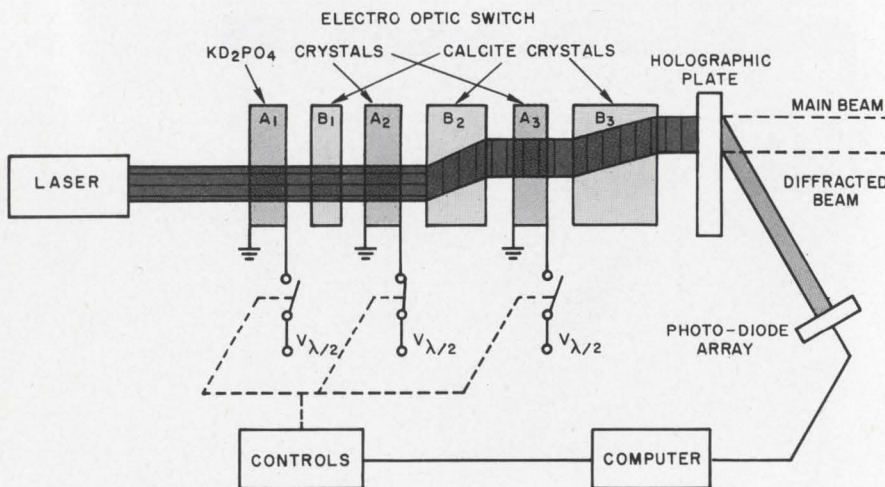

1. The read-only memory stores information photographically on a holographic plate. An electro-optic switch positions the laser beam to select a group of data. The hologram produces a diffracted beam whose image is read by the photo diode array. (The components of this sketch are not to scale.)

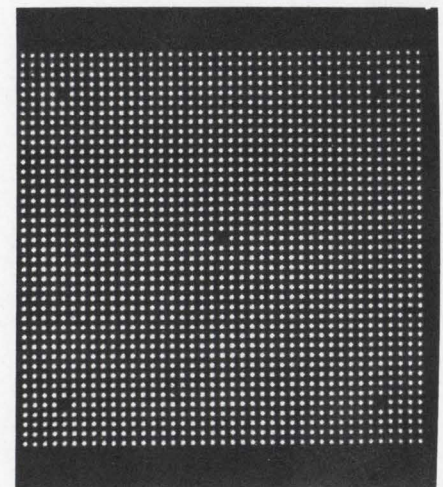

2. The image of the bit pattern shows an experimental 32 x 32 array. The blanks are an aid for recognition in a specific experiment.



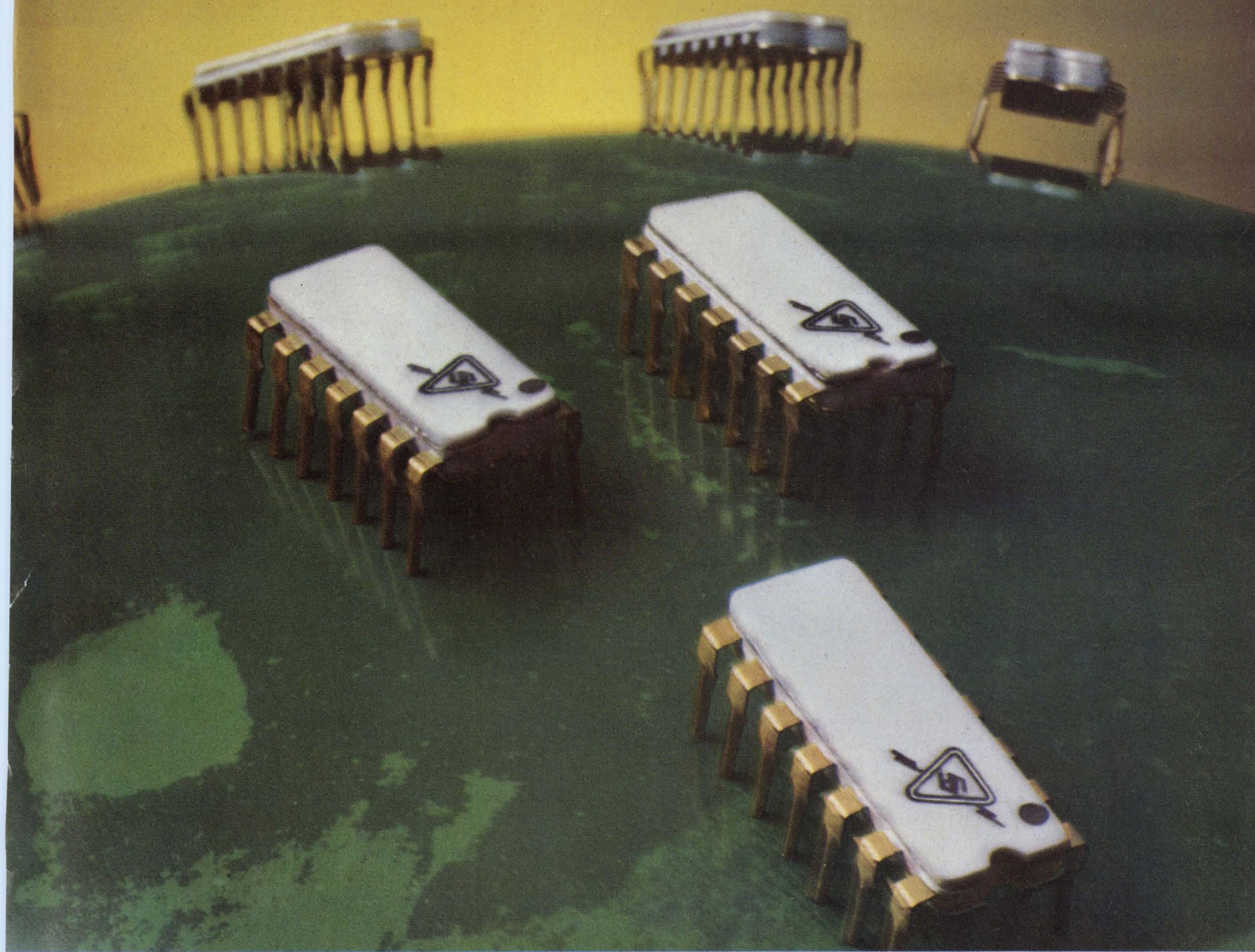

## It pays to pick the fastest... in the computer race, it's SUHL/TTL.

We became deeply involved in TTL before anyone. That's why in TTL we're way ahead with SUHL<sup>™</sup> ICs, the fastest IC line in the industry.

Our SUHL line keeps breaking speed records—now down to 5 nsec—without compromising noise immunity and power dissipation. That's why we're the prime source for TTL and why Sylvania Universal High-level Logic ICs are being second-sourced. In fact, several of the largest electronic manufacturers standardized on SUHL ICs,

even though Sylvania was their only source.

We have the most modern manufacturing facilities in the industry. All our ICs are made with one optimum process to maximize performance characteristics of every unit. Automated test equipment insures the ultimate in production monitoring, final testing, and quality control. So get SUHL's speed and reliability.

Sylvania Semiconductor Division, Electronic Components Group, Woburn, Massachusetts 01801.

**SYLVANIA**  
SUBSIDIARY OF  
GENERAL TELEPHONE & ELECTRONICS **GT&E**



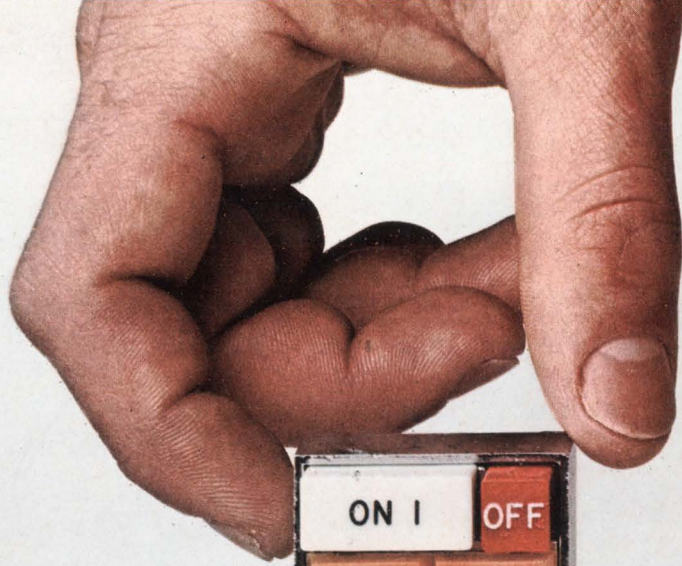

Now! Cutler-Hammer  
puts up to six heavy-duty  
oiltight units...

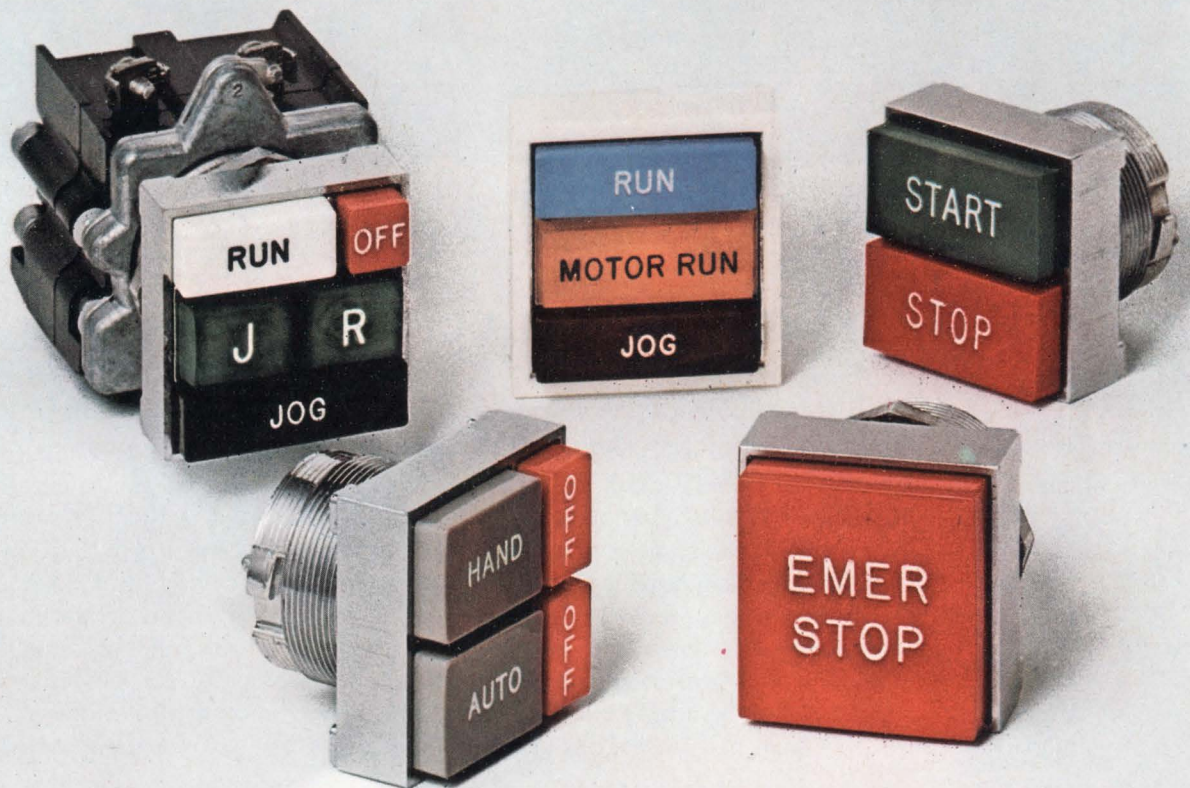

New Cutler-Hammer compact pushbuttons  
use the same  $1\frac{3}{16}$ " round industry-standard  
mounting holes as your present  
full-size oiltight pushbuttons.



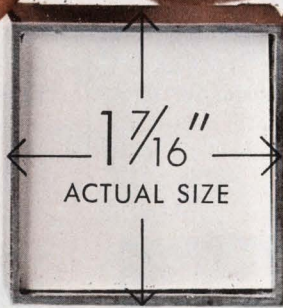

**...in one  
compact pushbutton.  
(We' ve gone square!)**

It took a little squeezing. Some pushing and pulling. And a lot of design savvy.

But we did it.

We developed a new compact oiltight pushbutton line with up to six heavy-duty control functions in the space of a single operator, only  $1\frac{7}{16}$ " square.

Think of the space you'll save on the panel!

But note we said "square." Why a new square shape? Some people simply reduce the size of their full-size pushbuttons and call them "miniature" pushbuttons. The result is: they're reduced in voltage ratings and limited in circuitry and terminal types. They can be difficult to operate, too.

Not so with our new compact pushbutton line.

By going to a new square shape, we not only give you more pushbuttons in less space. But you get full 600-volt construction. Unlimited circuit flexibility (you can stack the contact blocks in the field). Both screw type and quick connect terminals. And easier operation.

You also get a full selection of pushbuttons and indicating lights, in a wide range of sizes, shapes and colors of buttons and lenses.

And of course the same protection against oil, dust, dirt or coolants you've always had with Cutler-Hammer full-size oiltight pushbuttons.

Get the full story and start saving now! Your Cutler-Hammer Distributor or Sales Engineer will square you away.

*See your Cutler-Hammer Distributor—the man who has everything.*

**CUTLER-HAMMER**

Milwaukee, Wisconsin 53201



ON READER-SERVICE CARD CIRCLE 867



**(Laser memory, continued)**

crete diodes have been used. In a practical system the array would probably be an integrated silicon bipolar array developed from IBM's solid-logic technology. Such an array would need 32 x 32 diodes in order to read each block of data on the holographic plate. Dr. Fleisher admits that considerable development work remains to be done in this area. Smaller arrays have been built, but extremely high yield is required; if one diode is faulty, the whole array is unusable.

Further problems remain in de-

veloping economical circuitry for the readout, since it is anticipated that over one thousand bits will be read out simultaneously, each requiring an amplifier. The alternative would be to have fewer amplifiers and to scan the array. This would give cheaper electronics but would reduce the speed of readout.

Some day, Dr. Fleisher expects, large optical memories will store 100 million bits on a single hologram plate six inches square. This type of memory would have parallel readout and a consequent data transfer rate of more than 50 million bits a second. It would be used

for archival storage of very large quantities of data or for permanent programs frequently used by the computer—for example, executive and compiler programs.

At present, even with automated methods, several hours are needed to write information on the hologram, but Dr. Fleisher holds out hope for new materials such as photochromics. Photochromics not only change color when exposed to light, but the effect is also reversible. Thus they may permit direct writing and also erasure. These materials may bring writing times down to those of present magnetic disk stores, Dr. Fleisher says. ■ ■

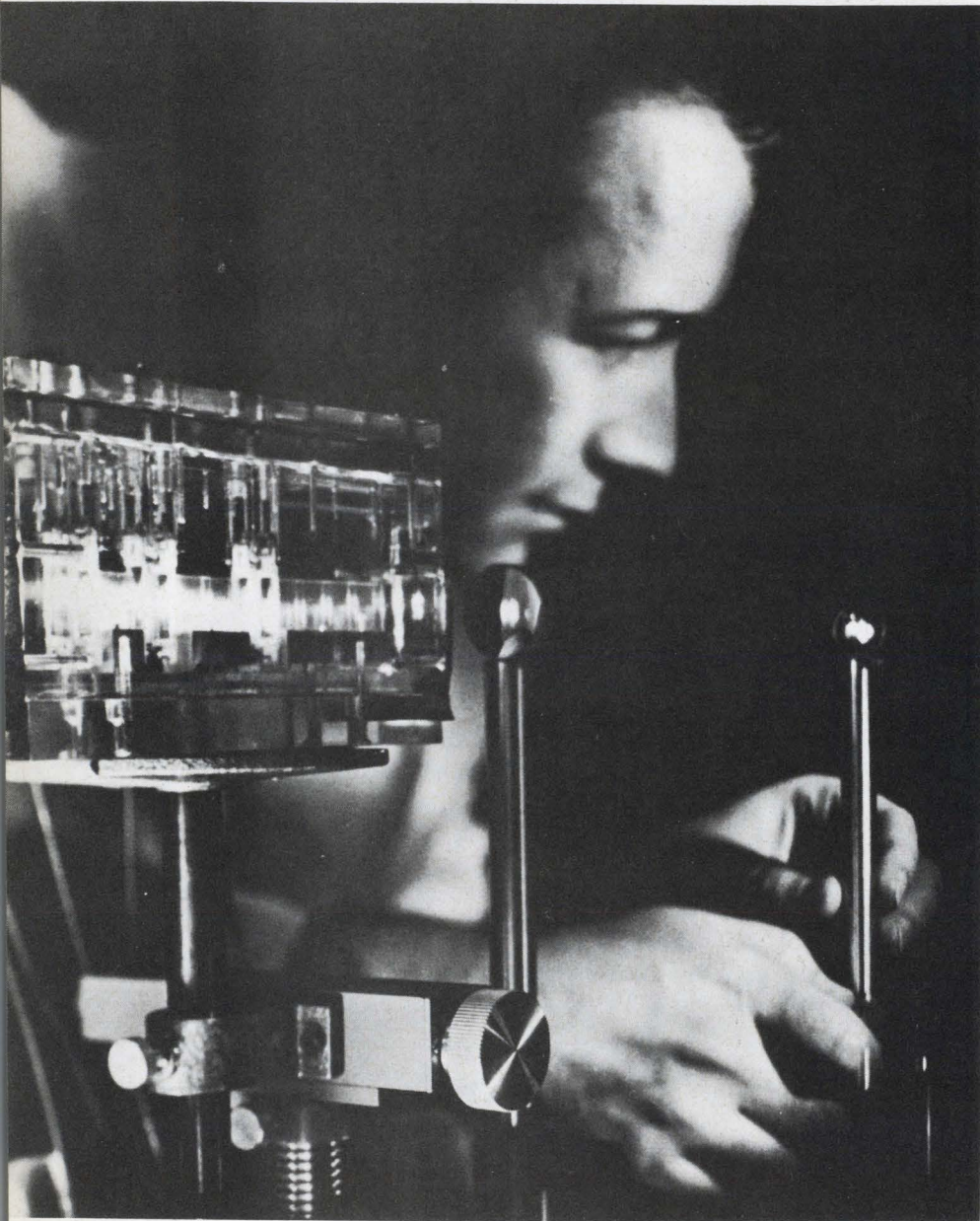

3. High-speed positioning of the laser beam is achieved with a digital light deflector. This deflector has three elements that give a total of eight possible positions. Units with 16 pairs of crystals have been built.

### Deflecting light digitally

The digital light deflector depends on two properties—birefringence and the Pockels effect.

A properly oriented birefringent crystal separates a nonpolarized light beam into two beams of light. One beam will have linear vertical polarization and the other linear horizontal polarization (Fig. 3). Both beams leave the crystal in their original directions but are displaced by a distance dependent on the length of the crystal and on the orientation of the crystal's optic axis relative to the light beam.

If the incident light beam is exclusively polarized in either direction, the beam will follow a path determined by the polarization selected.

Birefringence is found in uniaxial crystals, such as calcite or sodium nitrate.

The Pockels Effect occurs in such crystals as potassium dihydrogen phosphate ( $KD_2PO_4$ , abbreviated to  $KD^*P$  in the text). Two orthogonal polarizations are obtained by application of no voltage or the half-wave voltage,  $V\lambda/2$ , across the crystal faces.

In a digital light deflector the two types of crystal are arranged alternately (Fig. 1), with differing thicknesses of calcite crystals to give several switching positions.

Thus a horizontally polarized beam is not deflected until after it passes through a switched-on  $KD^*P$  crystal. A vertically polarized beam is deflected by each calcite crystal that it passes through.



# Our digital voltmeter costs \$349, and measures Ohms free.

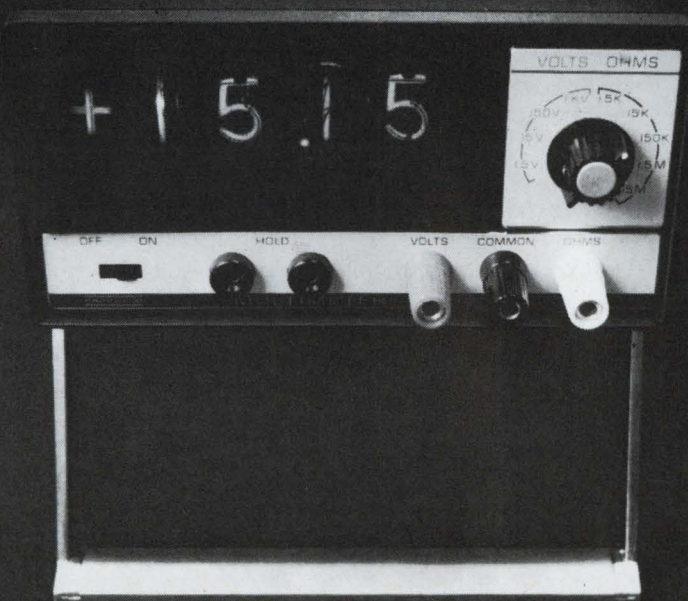

The Fairchild 7050 DVM is a digital rebuttal to analog meters. It measures volts or ohms with a resolution of 1mV or 1 ohm, and with an accuracy of 0.1%. Integrated circuits, dual slope integration, automatic polarity, floating input and display storage are all included as standard. The 7050 weighs less than four pounds and costs \$349. The tilt stand doubles as a handle and costs \$16 extra. Our data sheet is free. Circle Reader Service Number 72.

**FAIRCHILD**  
INSTRUMENTATION



# IBM Circuit Design and Packaging Topics

- packaging cost reductions
- high-speed switching
- reed switch application data

## packaging cost reductions

Performance Measurements Co., Detroit, Michigan, reports significant savings in packaging their new electronic recording system. The packaging method previously employed required two gates to mount the components in the main console. Now, with IBM's modular packaging as pictured below, only one gate is needed. That's because the IBM technique makes the most efficient use of console space with compactly mounted and connected circuit boards, relays and hardware.

Mounting time has been saved too. Pluggable components, low-cost card receptacles and interlocking card guides have so simplified the packaging job, that Performance Measurements now saves 70% on the cost of mounting hardware. Fewer and shorter wires are needed in the compact console — eliminating three feet of 1½-inch cable and shortening a second cable by eight inches. The modular chassis gave designers freedom to experiment freely with various mounting configurations. It also permits easy access for servicing and diagnostic analysis.

The same design freedom, plus significant hardware and labor savings are available in many applications.

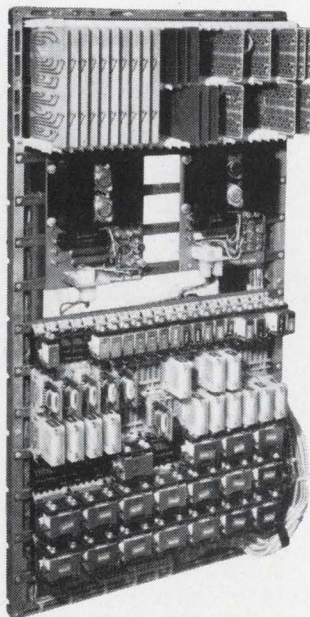

IBM components and packaging can help you in timing control, digital logic testing, telemetering, process or numerical control.

## high-speed switching

IBM wire contact relays were originally designed for data processing use. Now they are being used extensively in machine tool and assembly applications. One of these assembly applications is a numerically-controlled component insertion machine. It sequentially inserts random combinations of up to 24 different types of axial lead resistors and diodes into printed circuit boards. Such machines have been widely used, often on a round-the-clock, three-shift basis, in IBM's electronic assembly operations.

Insertion rates range from 3,000 to 4,500 components per hour, depending upon the type of components being inserted.

Instructions from an 8-channel punched paper tape provide the logic input to the relay gate. The gate employs three rows of 6- and 12-pole IBM wire contact relays. These relays control the movement of each printed circuit

board through the X and Y axis positioning of the board for each component insertion. They also control the component feed, component insert, and cut-and-clinch cycles for each insertion operation.

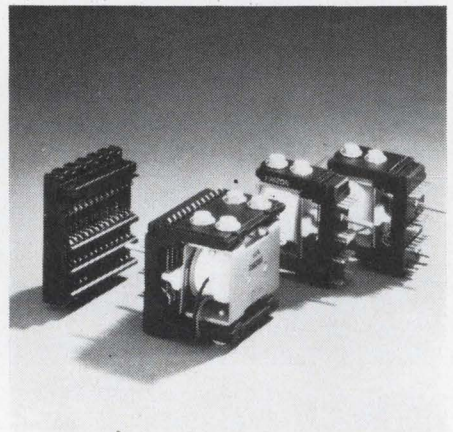

IBM wire contact relays can perform in excess of 200 million operations with an operate speed as fast as 4.5 ms, a release time of 5 ms maximum. The product line includes 4-, 6-, and 12-pole Form C relays, 4- and 6-pole latch models, all with compact, solderless, pluggable mountings—with coil-voltages up to 100 VDC.

## reed switch application data

Data on the magnetic switching characteristics of miniature dry reed switches is available to design engineers on request. The data was compiled from ex-



tensive tests conducted by IBM to help the design engineer use these switches most effectively. It can also help him determine the motion and position of the magnet required.

Simply described, a miniature dry reed switch operates under the influence of a permanent magnet. When the magnet is adjacent to the reed switch,

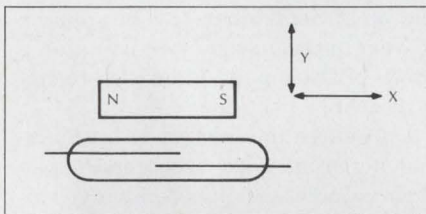

the flux of the magnet flows through the cantilever beams, as illustrated. While this magnetic flux is being carried by the beams, a polarity exists across the beams. Look at the overlap area of the beams. The north pole of one beam and south pole of the other beam are in proximity. Since unlike poles of a magnet attract each other, when the magnetic force becomes great enough to overcome the physical mass of the beams, they "snap" together, thus switching.

On the graph the X axis represents the displacement (in degrees for rotary motion, inches for lateral motion) of a magnet's center with reference to the center of the reed switch. The Y axis represents displacement (in inches) of the magnet from the outer edge of the

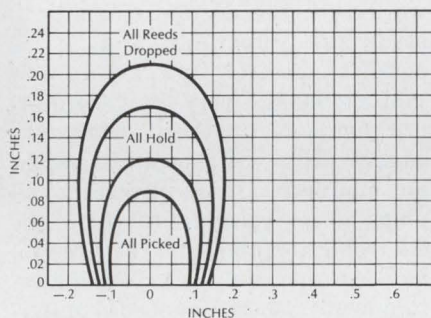

dry reed switch glass envelope. Dimensions shown along both axes represent displacement from the center of the magnet in alignment with the center of the reed switch.

There are some "gray areas" where performance varies due to minor differ-

ences in the characteristics of each switch. In these areas the status of each switch is not completely predictable.

Assume the zero point on the X axis is the magnetic center of an IBM reed switch. The magnet is positioned with its center at +.5 on the X axis, and .04 inches above the glass envelope. If the magnet is set in motion along the X axis toward the center of the switch, some reeds will pick when the center of the magnet reaches the point +.12 on the X axis. (The magnet has then reached the "gray area"). If motion is continued toward the center of the switch, all reeds will pick when the center of the magnet reaches the point +.09 on the X axis.

**IBM Industrial Products Marketing Dept. T1**  
**1000 Westchester Avenue**  
**White Plains, New York 10604**

- packaging cost reductions
- high-speed switching
- reed switch application data

name \_\_\_\_\_

position \_\_\_\_\_

company \_\_\_\_\_

address \_\_\_\_\_

city \_\_\_\_\_ state \_\_\_\_\_ zip \_\_\_\_\_

**IBM**  
 INDUSTRIAL  
 PRODUCTS

ON READER-SERVICE CARD CIRCLE 25



# New Dual-Tracking Power Modules from ERA



## Ultra-Compact, High Temperature

Drive operational amplifiers, IC's and other devices requiring dual-tracking DC with ERA's fully repairable DV series Transpacs®. Two independent power sources provide continuously adjustable and proportional outputs,  $\pm 12$  VDC through  $\pm 15$  VDC, reducing variations in operational amplifier performance resulting from power supply changes.

### SPECIFICATIONS

**Input:** 105-125 VAC, 50-400 cps  
**Voltage output:**  $\pm 12$  through 15 VDC, Dual  
**Current rating:** See table  
**Ripple:** Less than 800 microvolts, RMS  
**Line, load regulation:** Less than 0.05%, full line or load change  
**Transient response:** Less than 50 microseconds  
**Operating temperature:**  $-20^{\circ}\text{C}$  to  $+71^{\circ}\text{C}$   
**Temperature coefficient:** 0.02% per degree C  
**Heat sinking:** Internal, convection cooled

### STANDARD MODELS

Output Voltage VDC	Current 71°C	Model	Price
+ (12-15)	0-60 ma	DV60	\$96.00
- (12-15)	0-60 ma		
+ (12-15)	0-500 ma	DV500	\$149.00
- (12-15)	0-500 ma		
+ (12-15)	0-1 amp	DV1000	\$189.00
- (12-15)	0-1 amp		

Write for Catalog # 151



## ELECTRONIC RESEARCH ASSOCIATES, INC.

67 Sand Park Road, Cedar Grove, N. J. 07009  
(201) 239-3000

Subsidiaries: ERA Electric Co. • ERA Acoustics Corp.  
ERA Dynamics Corp. • ERA Pacific, Inc.

ON READER-SERVICE CARD CIRCLE 26

## Letters

### Doctor's attitude inhibits good equipment design

Sir:

Your article, "The tiny flaws in medical design can kill" [ED 18, Sept. 1, 1967, pp. 22-26] was very good, in that it presented a serious problem. I think, however, that there is a more important point that was only hinted at, not explained in detail. From the article it can be seen that it takes a certain type of personality to be able to work with the doctors on medical-electronics programs and it is doubtful whether such a person is going to make a very good engineer.

From p. 24 I quote: "Dr. Stanley suggests that all hospitals employ an engineer [for] inspecting all plugs . . . replacing tubes in the electronic equipment at recommended intervals . . . , checking instruments at recommended intervals, to ensure that they are properly calibrated." (And if they are not, does he send them to a technician to have the work done?)

I think that this job description is highly indicative of the doctors' opinion of engineers, and as long as they insist on paying and treating men as technicians, that is just what they will get. The *real* engineers will go to engineering jobs.

When Dr. Stanley finds the engineer to check the plugs and change the tubes, perhaps he can release a doctor to monitor the chemical baths on some production lines. I understand that doctors study some chemistry.

Dr. Stanley's proposal that all supplies be connected through isolation transformers with a separate ground for each room is an excellent one for workers using isolated equipment on construction jobs, but it does not belong in a laboratory or other multiple-instrument location. In multiple installations there should be an isolation transformer in every source with both 60-Hz output wires completely isolated from ground. A second 500-volt source limited to 10  $\mu\text{A}$  should be permanently connected from 60-Hz

power to ground and through an SCR circuit. Any current flow in the 500-volt source would indicate another ground somewhere and proper action should be taken to switch the SCRs so current will cease at the next current zero. Done this way, it would be possible to use isolation transformers in each piece of equipment and then ground the equipment case to provide RFI protection. Merely using a separate isolation transformer for each room and a separate ground is *not* sufficient. There must be complete isolation and continuous monitoring of the isolation.

John M. Graham

Professional Engineer  
Graham and Associates  
Glendale, Ariz.

### Neglect of inventions threatens U.S. industry

Sir:

Licensing of inventions outside the originating organization is an important matter and your excellent editorial of 13 September "The solution to your problem may be sitting on a shelf." [ED 19, p. 67] did well to emphasize it.

Uncounted inventions of commercial potential have been reported to their supervisors by company employees (who thus relinquish all rights in the inventions under their employee agreements) and then never exploited by the companies. The new knowledge there has simply been lost and buried.

This situation has been discussed in the patent profession and several consulting firms have been formed in the last five years to match companies' technological requirements with unused inventions and developments in other companies. Moreover, there is now publicly expressed concern that European industrial technology, particularly in the field of consumer products, may be outstripping U. S. technology and so may further threaten America's position in international trade. Many European countries have more liberal laws on employee invention rights than the U.S.; this may in the long run give them an industrial advantage.

The invention and licensing situation is a hot one at present and very much in a state of flux. No definite  
(continued on p. 50)



# For a clear picture of Centralab...

...keep an eye on our ripples

In our years of manufacturing miniature and subminiature components, we've made many ripples, and a few splashes, in the electronics industry:

**Centralab designed** and produced the world's first carbon composition potentiometer and for more than 40 years has been an industry leader. In 1936 we introduced the first temperature-compensating ceramic capacitor in America. We were first to offer dual controls and to add integral line switches to variable resistors. Our exclusive  integrated circuits have been key elements in the miniaturization of electronic equipment. During World War II days Centralab developed the ceramic disc capacitor design for military requirements. And our Ultra-Kap<sup>®</sup> ceramic disc capacitor has replaced millions of larger, more costly devices.

**Centralab sales** have increased substantially every year and our services have grown proportionately. Our products are sold, by separate sales groups and from separate warehouses, to original equipment and distributor markets.

**Centralab's tested and proven** products include capacitors, packaged circuits, rotary switches, potentiometers and technical ceramics. In October, 1966, we erected a push button switch manufacturing plant and in May, 1967, we acquired solar devices and semiconductor facilities.

Innovation, growth and stirring the waters are nothing new at Centralab; and we don't intend to stop. As technology advances and components become smaller, more complex and more sophisticated, we'll keep our feet wet.

To help keep abreast of Centralab developments, we'll be happy to send you our periodical "This Is Centralab." Write for future issues.



**CENTRALAB**

Electronics Division  
GLOBE-UNION, INC.  
5757 NORTH GREEN BAY AVENUE  
MILWAUKEE, WISCONSIN 53201



ON READER-SERVICE CARD CIRCLE 27



# Vernistats expensive? Not this one.

## And look at the design problems it solves.

Our new Size 11 Series 8 Vernistat a.c. Potentiometer is the first of a series of units in which modular design gives you significant cost reductions. In the offing is a family of Vernistats which can cut costs and space requirements in your electronic systems. Even if you've got only *one* of the problems listed below, it will pay you to specify our new Vernistat.

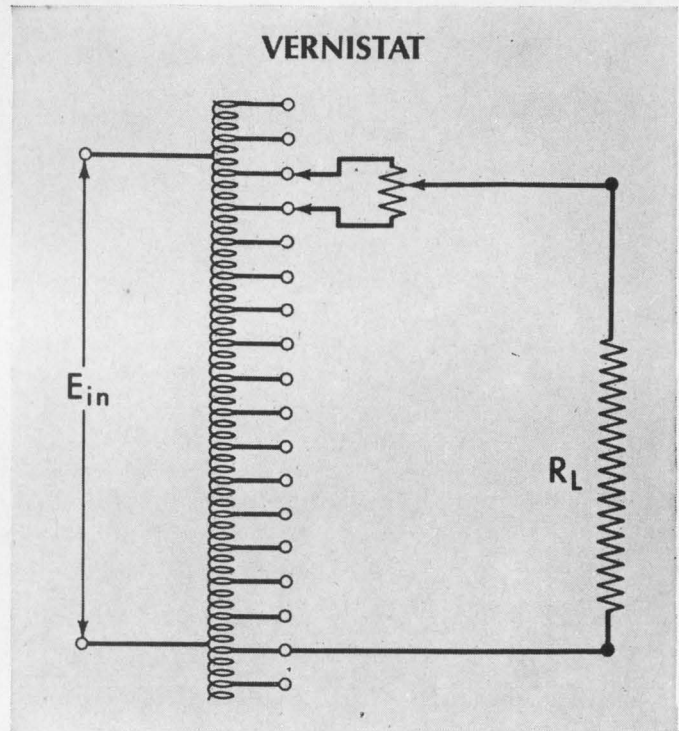
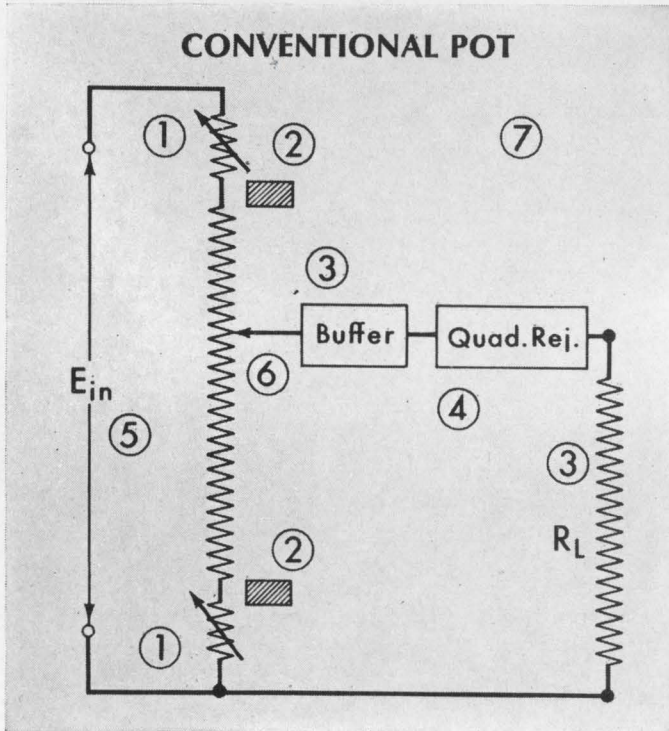

### COMPARE THESE CIRCUITS

1. Need trimmers? None are required in the circuit at right, because Vernistat always provides absolute linearity. This saves cost of trimmers, space and adjustment time.
2. Fragile stops? Does the servo hang up in overtravel? Vernistat is a continuous-rotation, multiturn device that can provide extended slope-output beyond the 0% and 100% points.
3. Piping signals over long distances? Loading error too high? Vernistat's low output impedance eliminates buffers, load compensation and shielded leads.
4. Quadrature too high? The low quadrature output of Vernistat cuts out quadrature rejectors.
5. Power dissipation creating a heat problem? Can't put components where they really belong? Heat

rise in the Vernistat is insignificant, because only a small portion of the input voltage appears across the interpolating element.

6. Element wear ruining linearity? Oscillating over a small portion of the element? Wear is minimized by using precious metal wire of adequate size. Voltage *never* changes at the multiple transformer taps of the Vernistat.

7. Reliability troubles? Vernistats are just barely "run in" when conventional pots are experiencing serious degradation of linearity and noise.

Need more proof? We give you the linear facts in a new brochure. Drop us a line. Address: Electronic Products Division, Perkin-Elmer Corporation, 131 Danbury Road, Wilton, Connecticut 06897.



# PERKIN-ELMER

ON READER-SERVICE CARD CIRCLE 28



# ARNOLD IS



## MAGNETIC SHIELDING

### Two Miles of Shielding in the Stanford Linear Accelerator

Arnold can handle any magnetic shielding requirement . . . from CRT shields to shielding the full two mile length of the Stanford Linear Accelerator. Mumetal, 4750 and 4-79 Mo-Permalloy is stocked in quantity to meet any demand. Fabricating facilities include a high speed 750 ton hydropress and other capacity presses from 4 to 100 tons for high production work. Modern furnaces anneal shields in a dry hydrogen atmosphere to obtain maximum permeabilities for each material.

Arnold is also ■ Permanent Magnets ■ Tape Wound Cores ■ Bobbin Cores ■ MPP Cores ■ Iron Powder Cores ■ Electrical Alloy Transformer Laminations ■ Transformer Cans & Hardware ■ Silectron Cores ■ Special Magnetic Materials

Write for Catalog PD-122A

 **ARNOLD**  
SPECIALISTS in MAGNETIC MATERIALS

THE ARNOLD ENGINEERING COMPANY, Main Office MARENGO, ILL  
BRANCH OFFICES and REPRESENTATIVES in PRINCIPAL CITIES

ON READER-SERVICE CARD CIRCLE 29



# Why pay more for a fan that... delivers less air? creates more noise? breaks easily?

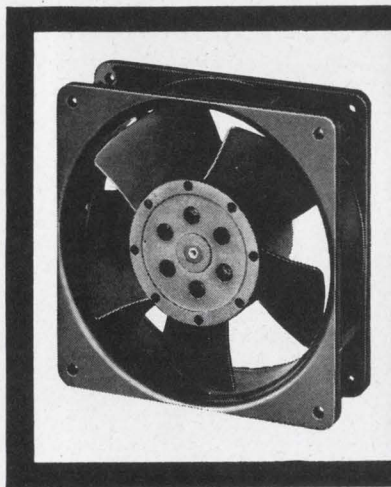

Get the Pamotor Model 4500 4½" axial fan that delivers 115 cfm, runs at a noise level of 37.5 dB SIL, is of all-metal construction, and has UL Yellow Card Recognition. It has a lubrication-free life in excess of 20,000 operational hours, continuous duty at 55°C. Yet it costs only \$8.55 in lots of 100.

## Now is the time to switch to PAMOTOR!

Get complete information. Fill out the coupon below.  
Better yet, call (415) 863-5440 now.

Yes, give me the facts on the 4½" all-metal Model 4500 fan that delivers more air with less noise . . . reliably.

Have sales representative call  Send me complete data

Name ..... Title .....

Company ..... Phone ..... Ext.....

Address ..... City ..... State ..... Zip .....

**PAMOTOR, INC.**

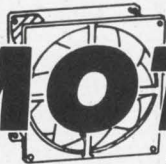

312 Seventh Street, San Francisco, Cal. 94103

ON READER-SERVICE CARD CIRCLE 30

### LETTERS

(continued from p.46)

answers are available yet. Discussion, however, is a healthy and urgent need.

Lawrence Fleming  
Registered Patent Agent  
Pasadena, Calif.

[Editor's note: The following firms are involved in the sale and licensing of inventions and have earned a certain reputation for trustworthiness:

Market Potential Corp.  
969 Third Avenue  
New York, N. Y. 10022  
(Robert Singer, President)

\* \* \*

Product Development Consultants  
150 West Street  
Waltham, Mass. 02154  
(John F. Rockett, Jr., President)

\* \* \*

Research Corp.  
405 Lexington Avenue  
New York, N. Y. 10017

\* \* \*

Patents Management Corp.  
501 Georgia Savings Bank Bldg.  
Atlanta, Ga. 30303

\* \* \*

Kessler Sales Corp.  
410 South Front Street  
Fremont, Ohio 43420

\* \* \*

Institute for New Products, Inc.  
200 Park Avenue  
New York, N. Y. 10017  
(H.D. Alberts, Administrator)]

### Post Office must help engineers fill its needs

Sir:

The article, "USPO drives to streamline nation's mailing needs" [ED 18, Sept. 1, 1967, p. 13], helps to close a gap between two communities—the engineers and government. It is good to know that the pendulum is on the upswing again.

Once before there was such an upswing and industry took up the challenge. At its own expense industry developed and tested advanced sorting equipment. These systems were reviewed by an official Committee for Mail Automation and one was recommended for further developmental

(continued on p. 54)

ON READER-SERVICE CARD CIRCLE 31 ►



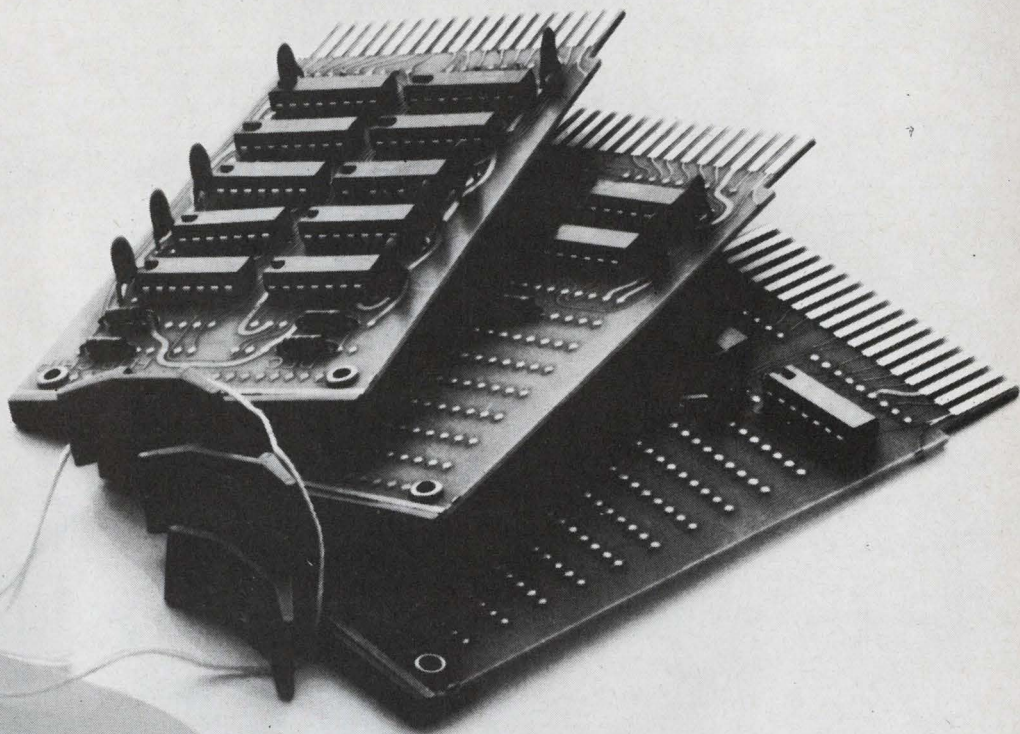

**Digital  
M Series  
I/C Modules  
do more,  
cost less.**

**What more  
can we say?**

Cost vs. performance is what every designer ultimately judges. So judge!

DIGITAL's new M series are high fan out modules, with high capacitance drive, excellent noise margins — and they are fast. DC to 10 MHz fast.

They do more. Dual in-line TTL packages on a 36-pin circuit card permit functional logic arrays never available before. One small module contains 4 JK flip-flops as a general purpose counter. Another contains an 8-bit shift register. Still another holds an 8-bit up or down counter; a BCD to Decimal, or a Binary to Octal, decoder is just one circuit card.

And the prices. Lowest cost per gate in the industry. And we're not afraid to publish them.

#### M Series Price List

Type	Function	Price
M050	12 — Lamp Driver	\$31.00
M113	10 — 2 Input Nand	23.00
M115	8 — 3 Input Nand	24.00
M117	6 — 4 Input Nand	24.00
M121	6 — And/Nor Gates	25.00
M161	BCD to DEC /BIN to Octal Decoder	60.00
M203	8 — R/S Flip Flops	32.00
M204	4 JK Flip Flops, General Purpose Counter	36.00
M206	6 D Type Flip Flops	42.00
M207	6 JK Flip Flops	42.00
M208	8 Bit Shift Register	84.00
M209	8 Bit Up/Down Counter	84.00
M302	Dual Delay Multi	46.00
M401	Variable Clock	55.00
M502	2 — Negative Input Conv.	26.00
M602	2 — Pulse Amplifiers	28.00
M617	6 — 4 Input Power Nand	27.00
M627	6 — High Speed Nand Power Amplifier	32.00
M652	Negative Output Converter	26.00

Effective Aug. 1, 1967 until further notice

Write for further details and free Logic Handbook.

**digital**  
MODULES • COMPUTERS



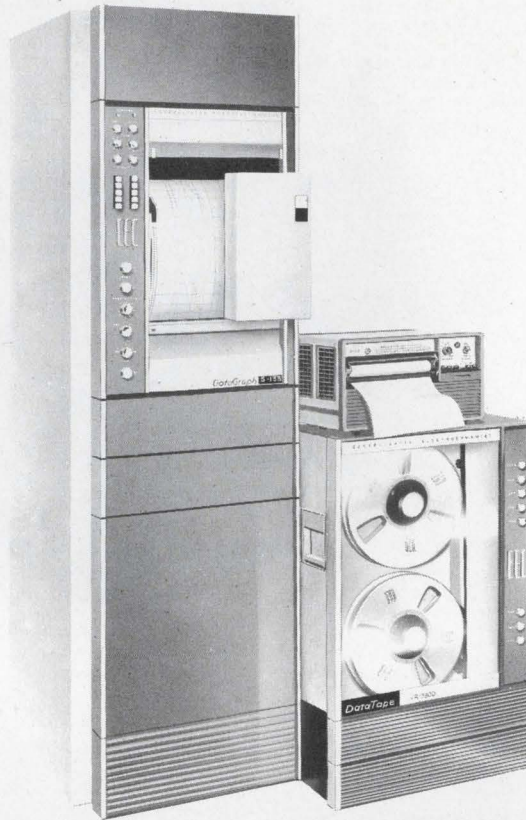

## High impedance comes to oscillography

For the first time, you can attach a recording oscillograph directly to a data tape recorder or telemetry system *without* attenuation or external signal conditioning equipment.

Result: a dramatic saving in weight, power and rack space. For example, in a 14-channel system, this would represent a weight reduction of approximately 60 pounds and a saving of 7 inches in space.

The advance has been made possible through the use of five new CEC high impedance galvanometers: Type 7-601-0001 (0 to 100 Hz); Type 7-602-0001 (0 to 500 Hz); Type 7-603-0001 (0 to 1000 Hz); Type 7-604-0001 (0 to 2000 Hz); Type 7-605-0001 (0 to 3000 Hz).

Now consider the advantages which these galvanometers share in common. D-C sensitivity:  $\pm 1.414$  volts will produce  $\pm 2$  inches,  $\pm 5\%$  deflection. Input impedance to high impedance galvo: 100,000 ohms minimum.

And here are the oscillographs!

CEC's new 5-124A-H and 5-133-H are not only the first high impedance oscillographs—but are "first" in other ways as well.

The portable 5-124A-H is the ideal answer to a host of industrial problems. It provides up to 18-channel print-out recording, 10 speed ranges, and record-drive systems with 16 options from 0.25 ipm to 128 ips. And—with CEC's DataFlash Takeup Accessory, the 5-124 A-H requires only *1 second to readout*.

The advanced 5-133-H utilizes two galvanometer magnet assemblies. Galvo recording lamp intensity is individually controlled so as to permit recording from *either* magnet assembly, or *both*. Thus two data setups can be made at one time and recorded simultaneously, or be made alternately and recorded sequentially utilizing full chart width for each. Furthermore, if so desired, standard CEC galvanometers may be used interchangeably with the high impedance units.

The 5-133-H offers 5 recording modes—3 direct writing and 2 develop-out, and is available in 12-, 24-, 36- and 52-channel configurations. Graphic reasons why the new 5-133-H is the logical choice for FM data analysis, telemetry discriminator output recording and communications applications.

For complete specifications and all the facts about these new high impedance oscillographs, write Consolidated ElectroDynamics, Pasadena, California 91109. A subsidiary of Bell & Howell. Ask for Bulletin Kit 351-X5.

### CEC/DATAGRAPH PRODUCTS

 **BELL & HOWELL**

ON READER-SERVICE CARD CIRCLE 32



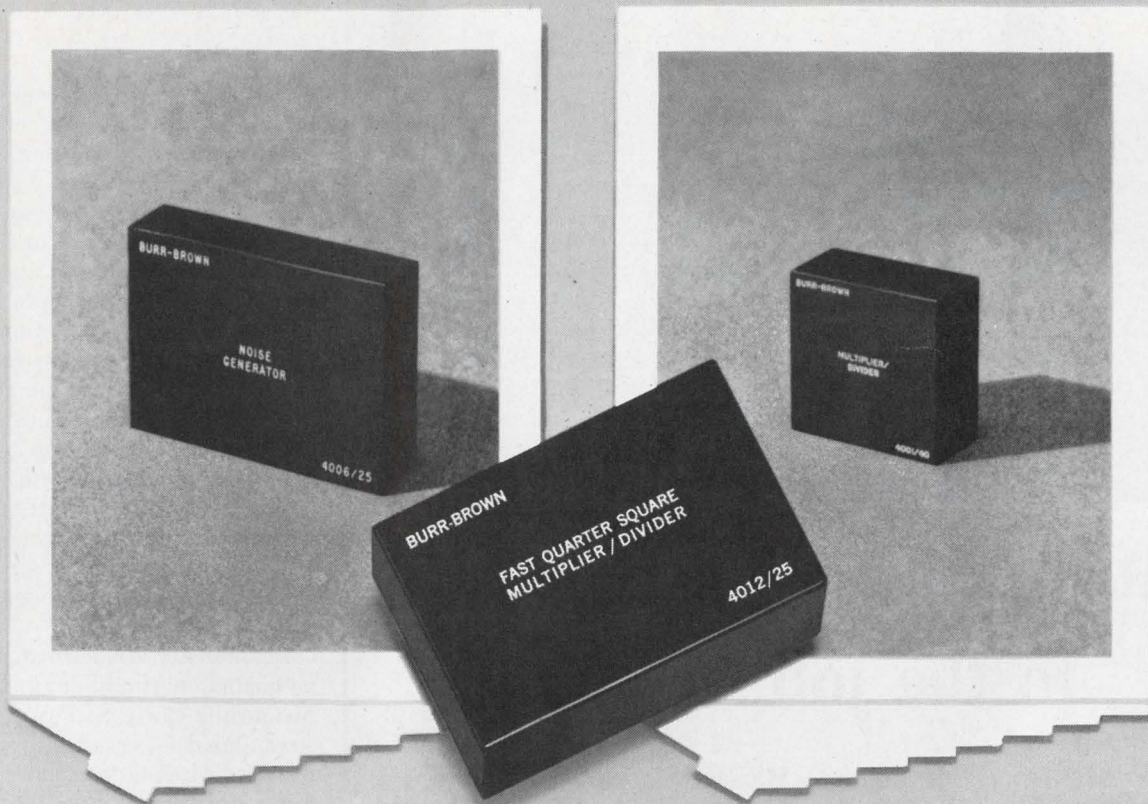

## for Instant Analog Systems

### Burr-Brown Encapsulated Function Modules

Cut costs, simplify design, and achieve maximum performance from your analog and hybrid circuits by utilizing Burr-Brown encapsulated function modules. These compatible sub-systems are designed to mount and work side by side with operational amplifiers. You save money on component and assembly costs, design time is reduced to an absolute minimum, and you gain the performance advantage of Burr-Brown's specialized experience in analog applications.

Currently, Burr-Brown is supplying fifteen 10V, encapsulated function modules from stock. Each one provides the type of performance you'd expect from the company that "wrote the book" on operational amplifier applications. Available units include:  Quarter Square Multiplier — Fast,  $E_o = -E_1 E_2 / 10$ .  Squaring Modules —

Four separate units are offered.  Noise Generator — Random digital output.  Logarithmic Amplifiers — Both 40 db and 60 db log units.  Adaptive Analog Comparator — Switched hysteresis.  Electronic Switches — Including Fast Sample/Hold, Sample/Hold, Integrate/Hold, and Reset/Integrate/Hold units.

**Rack Mounting Units** — For your rack-mounting applications, Burr-Brown offers fourteen modules. These pre-engineered circuits are ready for you to plug in, wire together, and put to use immediately.

**FOR COMPLETE INFORMATION** on these maximum value units, contact your nearest Burr-Brown Engineering Representative and ask him for a copy of the new 20-page Burr-Brown catalog. He also has demonstrator units available for your immediate evaluation.

**BURR-BROWN**  
RESEARCH CORPORATION

International Airport Industrial Park • Tucson, Arizona 85706  
TELEPHONE: 602-294-1431 • TWX: 910-952-1111 • CABLE: BBRCORP



Operational Amplifiers  
Instrumentation Amplifiers  
Function Modules  
Analog Simulators  
Geophysical Instruments

ENGINEERING REPRESENTATIVES: ALABAMA, HUNTSVILLE (205) 534-1648 / ALASKA, ANCHORAGE (907) 272-5231 / ARIZONA, PHOENIX (602) 254-6085 / CALIF., LOS ANGELES (213) 665-5181, SAN FRANCISCO (408) 245-3321 / COLO., DENVER (303) 388-4391 / CONN., ENFIELD (203) 749-7888 / D.C., WASHINGTON (SEE MARYLAND) / FLORIDA, ORLANDO (305) 425-2764 / ILLINOIS, CHICAGO (312) 286-6824 / LA., NEW ORLEANS (504) 888-2266 / MD., SILVER SPRING (301) 588-8134 / MASS., BOSTON (617) 245-4870 / MICH., DETROIT (313) 353-3822 / MINN., MINNEAPOLIS (612) 781-1611 / MO., ST. LOUIS (314) 524-4800 / N.C., GREENSBORO (919) 273-1918 / N.J., CAMDEN (215) 925-8711 / N.M., ALBUQUERQUE (505) 255-1638 / N.Y.,

ALBANY (518) 436-9649, BINGHAMTON (607) 723-9661, MT. VERNON (914) 968-2200, NEW HARTFORD (315) 732-3775, ROCHESTER (716) 473-2115 / OHIO, CINCINNATI (513) 761-5432, CLEVELAND (216) 237-9145, DAYTON (513) 277-8911 / OKLA., TULSA (918) 835-2481 / OREGON, PORTLAND (503) 292-8762 / PENN., PHILADELPHIA (SEE CAMDEN, N.J.), PITTSBURGH (412) 243-6655 / TEXAS, DALLAS (214) 363-1671, HOUSTON (713) 928-5251 / UTAH, SALT LAKE CITY (801) 466-3709 / VIRGINIA, (SEE MARYLAND) / WASH., SEATTLE (206) 767-4260 / CANADA, TORONTO (416) 293-7011, VANCOUVER (604) 736-6377

ON READER-SERVICE CARD CIRCLE 33



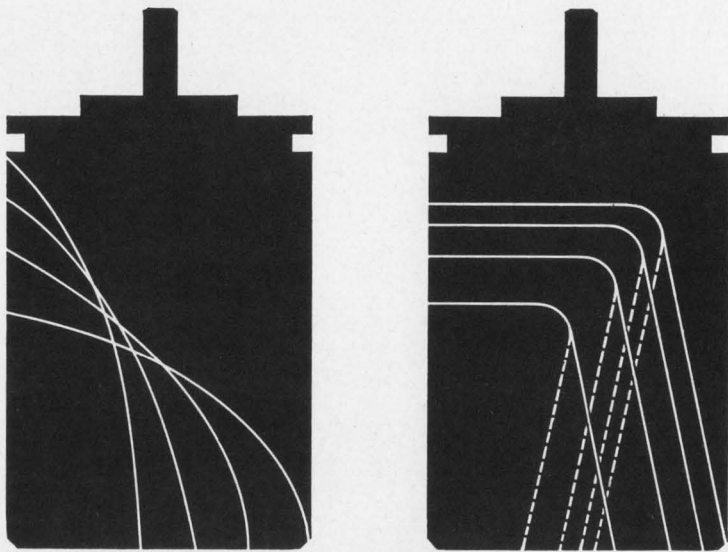

## Match performance exactly to the job with...

**Harowe Steppers** give you an almost unlimited choice of stepping rates and torque levels, because their inherent design flexibility provides for a wide range of characteristics in standard designs.

And you can virtually write your own speed/torque curve by proper selection of motor-controller combination and excitation mode. In fact, you can even vary the torque and step rate of a given motor—a plus for breadboarding.

Harowe steppers come in sizes 5 through 18, in PM and VR types. Step rates are up to 1000 steps/second synchronizing, 8000 slewing; with step angles of 15°, 30°, 45°, 60°, and 90°. Stepping accuracy of all models is 2% non-cumulative.

What if all these options still don't give you an exact match? Maybe you need an inverted or pancake type motor. Also, we can build integral gearheads into any stepper or synchronous motor.

**Harowe Synchronous Motors** begin with a patented design that generates higher torque per watt. Their pull-in torque exceeds their pull-out torque—so you can be sure the motor will bring into synchronization any load it can drive.

Beyond this, you write the specs. Fast acceleration... minimum power input... high rotor inertia for minimum flutter... all are available designs.

Harowe hysteresis synchronous motors come in sizes 5 through 23, with up to 8 poles, in a wide choice of operating frequencies. All can be driven by square-wave sources.

Send your requirements to—



**Harowe SERVO CONTROLS, INC.**

00 Westtown Road • West Chester, Pa. 19380

Servo, Stepper & Synchronous Motors • Motor Generators  
Synchros • Resolvers • Pancakes • Gearheads

ON READER-SERVICE CARD CIRCLE 34

### LETTERS

(continued from p. 50)

work. The Post Office research and development people asked for funds to develop critical components and proposed installing a pilot system. This system involved hardware that increased the rate of mail processing by ten—to 360,000 letters an hour. It was all-modular and had a magnetic escort memory for solid-state (or glass reed) readouts. It had provision for entirely new processing methods.

During this earlier upswing, the ZIP code, a government idea, was born. From all its efforts, however, industry derived no benefits: no contracts were awarded. The recommended system is still in existence, with patents granted or pending, and that is as far as it has gone.

Big industry was burned, has made no further effort and has lost interest. Meanwhile the U.S. Post Office has streamlined its organization and has restaffed with new personnel who were never involved in the recommended system or any of the other six proposals considered at that time.

Now that the Post Office has begun a new drive, it would be beneficial to all concerned if it would brief all potential bidders not only on the equipment that it needs but also on such empirical engineering data as the parameters for speed, size, volume, cost, operator qualifications, processing overheads, operating programs. This would help bidders to prepare their proposals and to keep costs down.

A further helpful step would be to publish a list of existing hardware with a "trade-off" analysis of the systems already in operation, and a list and description of systems developed under contract but not implemented for technical or economic reasons. Of especial value would be a government clearinghouse for engineering data on the state of the postal art, where industry could make available information of noncritical competitive value about its unsolicited proposals.

This kind of homework would ensure cost effectiveness as much for industry as for the Post Office itself. Someone must do this job. If the Post Office has inadequate staff for it, then it must be done the same way that other government agencies cope with such problems—on a contract basis for program analysis and definition. Engineers will take up the chal-

(continued on p. 58)





## Nearly everything that flies... flies with Cutler-Hammer power relays!

You've made us Number One. And we thank you.

For years, you've been buying more Cutler-Hammer power relays for your airborne projects than anybody else's.

Probably because our relays combine the utmost in small size, light weight and resistance to severe environmental conditions.

Now, we'd like to tactfully remind you that more and more of your fellow engineers are using our relays in ground support as well. And in ordnance and shipboard electronics, too.

Like in the tank above, and in trucks, radar, power systems and fire-control systems.

We're delighted. But not surprised. Because the relays are very much the same.

Same proved reliability under severe environmental conditions. Same in-process inspection and rigid quality control.

On your next project—ground, marine or airborne—specify Cutler-Hammer power relays. Call our local stocking distributor, or write for new Catalog LL-292-W217



Typical of Cutler-Hammer's full line are these 25-, 50-, and 100-amp hermetically sealed power relays (front), our new 175-amp hermetically sealed generator contactor, and a 400-amp environmentally sealed relay.

Switch  
to No. 1

More than just products:  
prompt availability,  
field help, innovation,  
quality assurance too.



**CUTLER-HAMMER**

Milwaukee, Wisconsin 53201

ON READER-SERVICE CARD CIRCLE 35





## The Kind of Knowledge that makes traffic control possible...

Every year more cars join the traffic scramble. As congestion thickens, bottlenecks occur more often. And traffic flow screeches to a halt.

How can we help keep the nation's expressway traffic moving from coast to coast? One way is with remote traffic control systems, like the one pictured above on the Kennedy Expressway in Chicago.

This system reverses lane directions as changes occur in traffic density during morning and evening rush hours. Through a system of gates, signal arrows and directional lights, an express lane can be changed from inbound to outbound—and vice versa. To date, this unique system is doing a great job helping keep Chicago traffic moving.



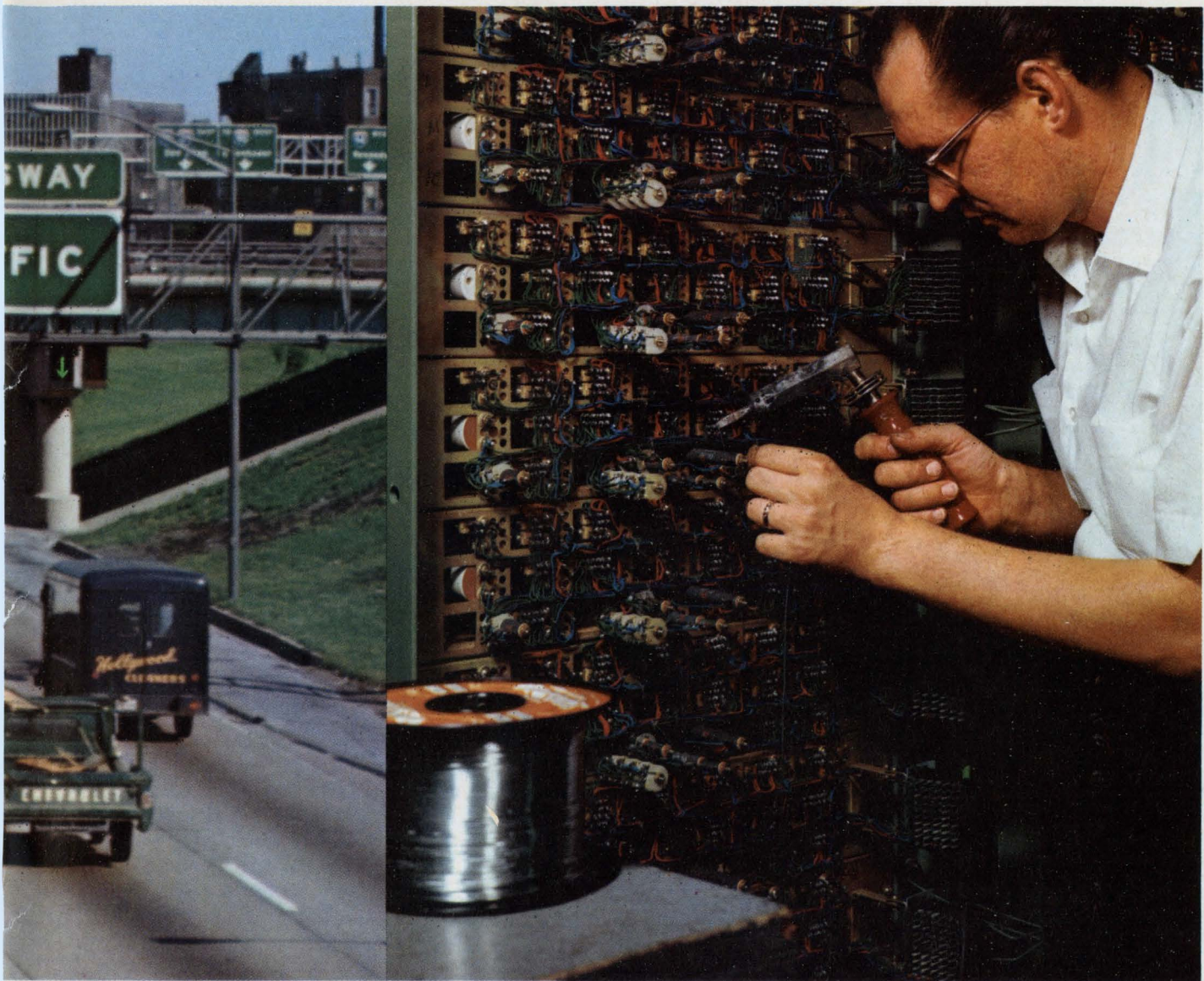

## IS THE KIND OF KNOWLEDGE YOU GET FROM KESTER

Regulating such a complex control system takes hundreds of precision electromechanical relays and stepping switches. That means connections must be soldered for maximum reliability.

In assembling this traffic control system the manufacturer used Kester Solder. Both the solder and flux were specially formulated to meet stringent requirements.

The kind of knowledge that goes into traffic control systems is the kind of knowledge you get from Kester Solder. From formulating the finest solder and flux to expert assistance on soldering applications, Kester stands ready to serve you. Write, phone or wire for specific information.

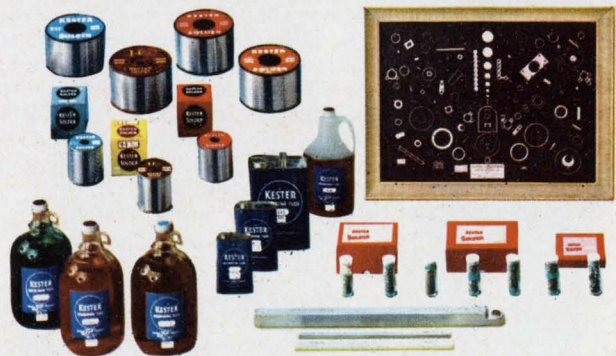

**KESTER SOLDER COMPANY** 

DIVISION OF LITTON INDUSTRIES

4201 Wrightwood Avenue, Chicago, Illinois 60639 • Newark, New Jersey 07105 • Anaheim, California 92805 • Brantford, Ontario, Canada

1899-1967—68 years devoted to production of products of the highest reliability—solders and fluxes

ON READER-SERVICE CARD CIRCLE 36



# A COMPUTER DESIGNED FILTER CAN MAKE YOUR ENGINEERING EASIER

Telonic RF and Microwave Filters cover such a wide range of frequencies, types, and performance characteristics that you don't have to design "around" them. Your specific requirements are programmed into an engineering computer, the filter designed and then produced to those precise parameters.

Basically modular, Telonic filters can be manufactured from elements in stock, providing another benefit in fast delivery.\* With over 100,000 filter designs already produced, even so-called special types may already be standard. Here is the broad selection you have in designing — Frequencies from 30 MHz to 12 GHz • Lowpass • Bandpass • Tubular • Miniature • Cavity • Interdigital • Tunable. With that variety, quick delivery, and high performance, do you even need a second source?

\*Three-day, Jet Order Service Available.

**Telonic ENGINEERING CO.**

A Division of Telonic Industries, Inc.

Box 277 • Laguna Beach, Calif. 92652 • Tel.: 714-494-9401

Representatives throughout the U.S. and foreign countries. Factory offices in Maidenhead, England, Frankfurt, Germany, and Milan, Italy.

• 52 PAGE FILTER TEXTBOOK •

Telonic's new catalog contains never before published data on filter insertion loss, attenuation, physical size, frequency and bandwidth tolerances, and pass band relationships. Send for your copy.

ON READER-SERVICE CARD CIRCLE 37

## LETTERS

(continued from p. 54)

lence so long as their efforts have a fair chance of securing a contract.

Werner Hauer

Sayre, Pa.

## Accuracy is our policy

In "Stepped-up torque from small motor," in the Computers & Data Processing listing on p. U-136 of ED 17, August 16, 1967, the second sentence should read: "Responding at rates of up to 100 (not \$10, as printed) pps in 90° steps, etc...."

In the Idea for Design headlined "Voltage follower has high impedance, can handle large signals" (ED 19, Sept. 13, 1967, p. 124), the author reports a typographical error in Fig. 1a. The collector of Q1 should not be connected to the collector of Q2, but should cross over and connect only to the base of Q2.

In "Reduce delay distortion at the source," ED 19, Sept. 13, 1967, pp. 116-120, author Jerome Horwitz has made the following corrections:

On p. 117, in Eqs. 10, 12 and 13,  $\varphi$  should be  $\theta$ , wherever it occurs.

On p. 117, in Fig. 2c, the capacitor should be labeled  $C_s$ , not  $C_x$ .

On p. 120, the ninth line from the bottom of the left-hand column should read:

$= -2000/172.7\pi \times 10^{-6} = -3.7 \mu s$ ,  
inserting  $10^{-6}$  factor.

On p. 120, the ninth line from the top of the right-hand column should read:

$f/f_0 = 6 \times 10^3/10^6 = 6 \times 10^{-3}$ ,  
not  $6.10^{-3}$  as printed.

In the last line but two, the equation should read:

$2 \times 10^3/(500 \times 1500 \times 2\pi \times 10.5) = 41 \mu F$ ,  
inserting the omitted result,  $41 \mu F$ ,  
and correcting the erroneous  $2.10^3$ .

In "Three ways to read distortion," ED 20, Sept. 27, 1967, pp. 56-59, author Malvin Shar draws attention to an inaccuracy in the ninth paragraph on p. 56. It should read:

"Therefore the measurement should consider simultaneously the following two factors: the importance of higher-order intermodulation products (not harmonics, as printed) and etc...."



**new...**

**smaller...**

**4 amp**

**50-100 nanosec.**

**ultra-fast recovery**

**controlled avalanche**

**high voltage epitaxial**

**rectifiers**

**THE UNIQUE UNITRODE CONSTRUCTION**

With the silicon die metallurgically bonded between terminal pins of the same thermal coefficient, the hard glass sleeve is fused to the entire outer silicon surface. Result — a voidless, monolithic structure.



ACTUAL SIZE

---

**the only  
lead mounted 4 amp with  
100 nanosec. max recovery  
PIV's to 250 V  
80 amp surge capacity  
Full power operation  
at frequencies up to  
100 kHz square wave  
and 350 kHz sine wave  
1/10 the size . . .  
1/14 the weight of  
a comparable stud-mount.**

ON READER-SERVICE CARD CIRCLE 38

ACTUAL SIZE

---

**2 amp  
typically 50 nanosec. recovery  
PIV's to 250 V  
25 amp surge capacity  
Full power operation  
at frequencies up to  
100 kHz square wave  
and 350 kHz sine wave  
1/7 the size . . .  
1/3 the weight of  
comparably rated devices.**

ON READER-SERVICE CARD CIRCLE 38

**UNITRODE®**

580 PLEASANT ST., WATERTOWN, MASS. 02172  
TELEPHONE (617) 928-0404 TWX (710) 327-1296



OF COURSE YOU CAN DESIGN A MULTIPLE  
CIRCUIT THAT CAN PERFORM THE FUNCTION  
OF A ROTARY STEPPING SWITCH.  
BUT WHY BOTHER ?

There are hundreds of sequential switching applications that can be answered immediately with a stock rotary stepping switch from Guardian. And that's much quicker and cheaper than designing your own multiple circuit.

No other relay manufacturer makes as many different types of stepping switches as we do. So if you don't have our catalog, it's easy to see why you may have had to do it yourself at times.

The Guardian line puts all these types at your disposal: sequence selecting, automatic resetting, continuous rotation, circuit selecting, pulse multiplying, counting, slave and master, automatic homing, add and subtract, and remote homing. They're available with up to 52 contacts per deck . . . up to 8 undivided circuits. And, they test up to 7½ million steps on the life test rack.

So before you resign yourself to doing-it-yourself again, look into the Guardian Stepping Switch engineer's manual. You'll save lots of time and money. Just ask for Bulletin F32. Guardian Electric Mfg. Co., 1550 W. Carroll Ave., Chicago, Illinois 60607.

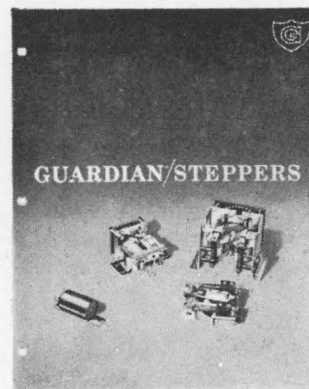

**GUARDIAN**  **ELECTRIC**

ON READER-SERVICE CARD CIRCLE 39



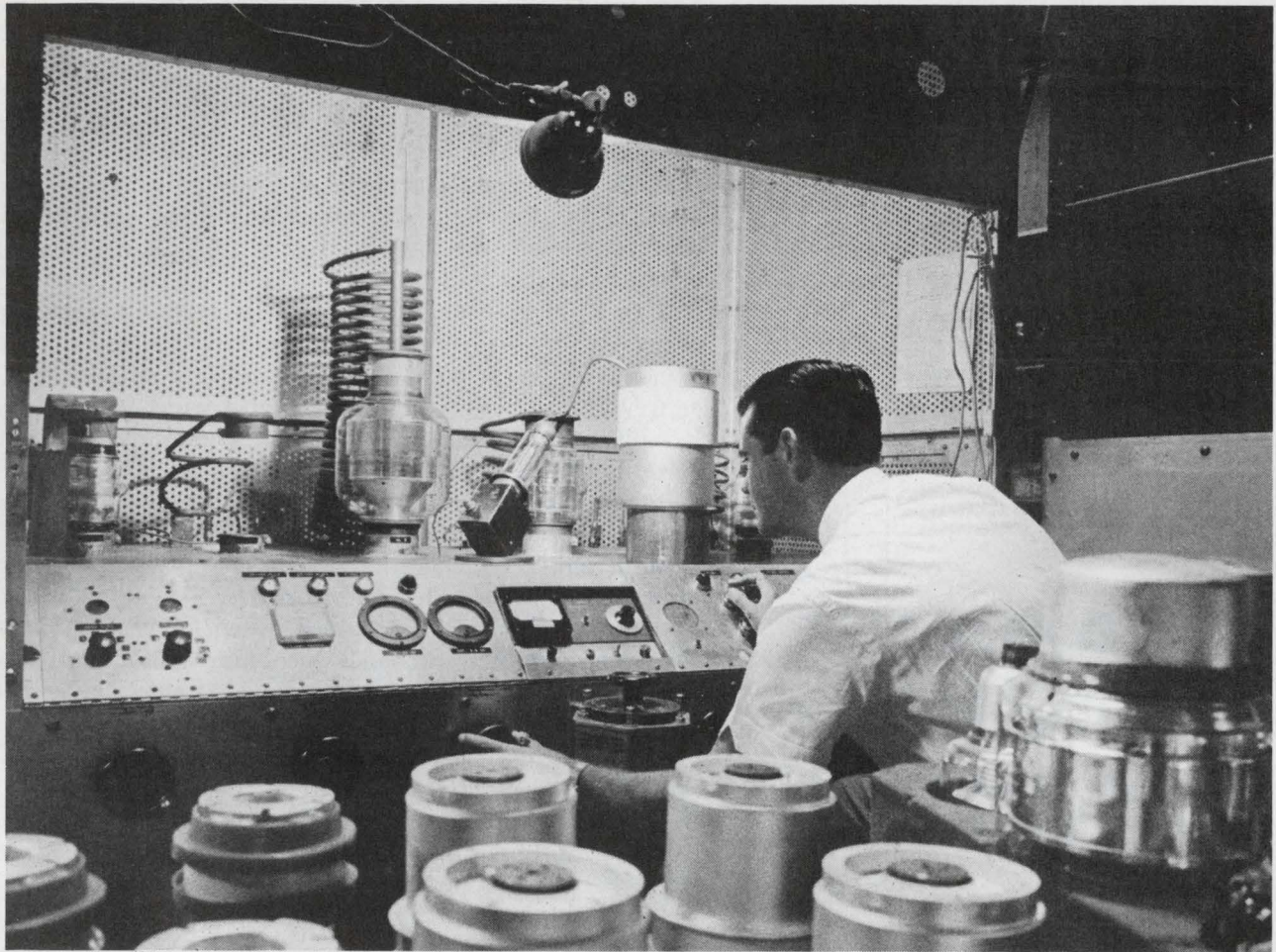

## Our vacuum capacitor testing is the next best thing to the worst field conditions.

Only ITT Jennings maintains the facilities to test vacuum capacitors in an environment that exactly duplicates actual operating conditions—and then some. In fact, as a government-approved facility equipped to perform capacitor qualification testing under MIL-C-23183A, we carry our testing to extremes far beyond the worst possible field conditions.

Our vacuum capacitors are rf tested at rated voltage and current or to customer specifications on transmitters ranging in frequency from 17 kc to 600 mc and up to 100 kw cw power.

ITT Jennings environmental testing includes capacitance shift versus temperature from  $-65^{\circ}\text{C}$ . to  $+125^{\circ}\text{C}$ .; dynamic vibration; static vibration; shock; salt spray; humidity; and bellows life testing.

All of this testing is done to assure you the most reliable performance from every vacuum capacitor we make: units up to 5000 pf in the 15 kv range, 1000

pf to 55 kv and 200 pf to 120 kv. Current ranges of our ultra high vacuum dielectric capacitors are available up to 250 amps rms at 16 mc with convection air cooling and 1000 amps rms with water cooling. Small units for lower power or space-saving use range from less than 1 pf to 25,000 pf.

### TYPICAL SPECIFICATIONS

	CADA 600	CVTW 1600	CVDD 1000
Capacity Range (PF)...	40-600	100-1600	25-1000
Peak Test Voltage (kv)...	10, 15	55, 60, 65	7.5, 10, 15
Amps rms (16MHz)....	65	600	125
Overall Length.....	5.8 in.	23 in.	8 in.

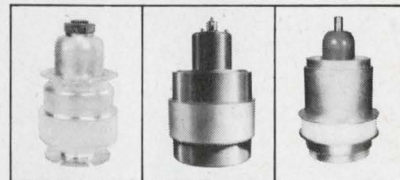

CADA 600

CVTW 1600

CVDD 1000

ITT Jennings has more to offer than the industry's only complete testing facility. To back up our reputation for design leadership—which began with the first vacuum variable capacitor ever built and has been responsible for virtually every significant new development since—we rely on a staff of experienced communications engineers. This staff directs its capacitor design capabilities toward meeting the anticipated communication equipment needs of the future. This is why new developments in advanced vacuum capacitor design are always on their way from ITT Jennings. Before they ever reach you, however, they must first pass the most rigid quality control in the industry: testing in our own testing facility.

For complete information on vacuum capacitors, write for Catalog No. 101. ITT Jennings, a division of International Telephone and Telegraph Corporation, 970 McLaughlin Avenue, San Jose, California 95108.

**JENNINGS** **ITT**

ON READER-SERVICE CARD CIRCLE 40



## Soviet electronics move ahead

Fifty years ago the great upheaval of the October Revolution brought the U.S.S.R. into being. Since then the Soviet Union has made extraordinary technological strides. In the light of these advances and on this semicentennial, this issue's cover story surveys Soviet electronics today.

Appropriately enough, this project was a real international effort, involving semiconductor editor Peter Budzilovich, who was born in Russia, computer editor Jeffrey Bairstow, an Englishman with wide experience in Britain's data-processing industry, and microelectronics editor Roger Field, a native of Brooklyn, N.Y.

Budzilovich, who holds a master's degree in control theory from MIT, spent two days in the Library of Congress in Washington, D.C. There he worked closely with the translators in the Aerospace Technology Div., speaking the language in which they were all most fluent—Russian. He was also able to profit by a chance encounter with a third secretary of the Soviet Embassy, who sent us a thick folder of releases in English and Russian on Soviet electronics.

Bairstow's part was more pedestrian. "Most of my research was done on foot," he remarked, after trudging from one New York library to another. The library of the Association for Computing Machinery became his prime source. His other major reference was a weighty tome on Soviet computers from Computer Consultants, Ltd., of Enfield, England.

Montreal's Expo 67 was the main source of inspiration for Field, a physics graduate of Columbia University. At the world's fair, he struck up an acquaintance with a Russian microcircuit designer, with whom he exchanged ideas at length. Who was his informant? That has to remain a secret. "I'm not bashful," his friend told him, "but in Russia it's not healthy to be known to talk too much." ■ ■



**Budzilovich, Bairstow and Field** (l. to r.) ponder Pravda.

(Hats courtesy of J.B. Stetson Co.)



Please send me the latest Acopian catalog that lists

**62,000  
DIFFERENT  
POWER  
SUPPLIES**

available  
for shipment  
in 3 days.

Name \_\_\_\_\_

Title \_\_\_\_\_

Company \_\_\_\_\_

Address \_\_\_\_\_

City \_\_\_\_\_

State \_\_\_\_\_

ZIP \_\_\_\_\_

ACOPIAN CORP.  
EASTON, PENNSYLVANIA  
TEL: (215) 258-5441

**Acopian**

ON READER-SERVICE CARD CIRCLE 41





# Measure, monitor, actuate...

When decisions regarding design and devices are to be made, Clare capability can put you in control. In instrumentation, simple or complex, or in cost-conscious industrial process control. In demanding communications networks, or sophisticated data processing systems. In aerospace or ground support systems, where utmost reliability is required.

Knowledgeable contact switching can optimize control systems—wherever long life, high reliability, advanced capability, and maximum economy are needed. So let Clare put you in control.



C. P. Clare & Co.—worldwide.

GENERAL INSTRUMENT company

# Clare puts you in control

Clare contact switching ... for optimty in

Industrial Process Control    Electronic Data Processing    Aerospace and Ground Support    Communications    Instrumentation





# TRW SPACE SAVING SOLID TANTALUM CAPACITORS

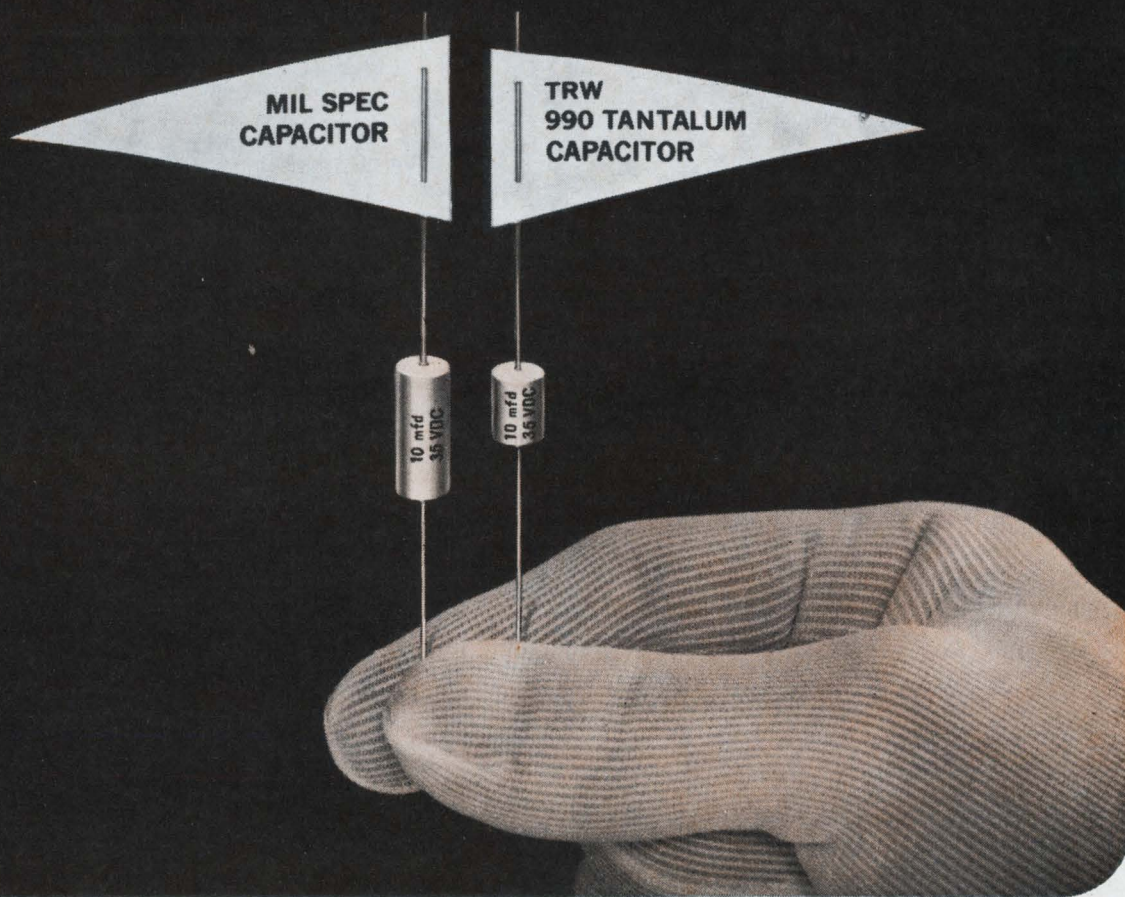

## MIL spec performance...in half the space!

Type 990 miniature solid tantalums typify TRW's creative engineering. They're *designed* to fit in half the space. *Designed* to give better shock and vibration resistance. *Designed* to MIL

specs. They're *designed* to be the best hermetically sealed tantalums you can buy. Values from 8.2 to 330 mfd, 6 to 35 V.

Get the TRW tantalum story on space-savers like the 990,

on standard MIL types and tantalum hi rel capability. Contact TRW Capacitor Division, TRW INC., Box 1000, Ogallala, Nebraska. Phone (308) 284-3611. TWX: 910-620-0321.

# TRW

ON READER-SERVICE CARD CIRCLE 43



**Co-Publishers**

James S. Mulholland, Jr.  
Hugh R. Roome

**Editor**

Howard Bierman

**Managing Editor**

Robert C. Haavind

**Technical Editors**

Jeffrey N. Bairstow  
Peter N. Budzilovich  
Roger K. Field  
David H. Surgan

**Management and Careers Editor**

Howard S. Ravis

**News Editors**

Ralph Dobriner, Chief  
Richard N. Einhorn

**Washington News Bureau**

Charles D. LaFond, Chief

**East Coast Editor**

Neil Sclater

**West Coast Editor**

Ron Gechman

**New Products Editor**

Steven B. Futterman

**Copy Editor**

Peter Beales

**Editorial Production**

Dollie S. Viebig  
Marian Arkin

**Art Director**

Clifford M. Gardiner

**Art Assistant**

William Kelly

**Technical Illustrators**

Cheh Nam Low  
Sheila F. Ward  
William Alvarez

**Production Manager**

Thomas V. Sedita

**Asst. Production Manager**

Helen De Polo

**Production Assistants**

Bernard Wolinsky  
Gregory A. Bannon

**Circulation Manager**

Nancy L. Merritt

**Reader Service**

Diane Mandell

## EDITORIAL



## How can the engineer keep up technologically?

Have you ever wanted to enroll for a short-term updating or refresher course? If so, chances are you had difficulty finding one.

In response to a letter from *ELECTRONIC DESIGN*, only nine (4.1%) of the 217 U.S. accredited engineering colleges, universities and institutes say they offer any sort of comprehensive program of short-term courses between January and May, 1968. Eighteen others offer a mere handful of very specialized or isolated courses during the same period.

These are some of the typical reasons given for not offering these courses:

"Workshops and short courses are arranged on demand from interested groups, and we get no demand."

"We only have a place in our curriculum for semester-long regular or evening courses."

"As a matter of policy, we are committed to full-time graduate and undergraduate study. As a consequence, we offer no short courses."

"Industries in the area never come to us."

"We get little inquiry from engineers."

This disturbs us. It reflects unfavorably on the entire engineering world—colleges, industry and societies.

Most colleges seem to have little interest in helping the engineer to remain technically up to date.

Industry apparently makes little effort to encourage the engineer to take courses or to encourage colleges to offer them. This becomes all the more clear when engineers say that they take courses during their summer vacation because their companies won't let them do so during the year. Can industry dare to say it is doing all it can to keep its engineers abreast of technology if that is the attitude?

Professional societies, which should be in the forefront of educational effort, are relatively inactive. They are not yet playing the catalytic role that they could.

IEEE plans a program for its 1968 convention on continuing education. At this session, we'll undoubtedly hear once again how important it is for the engineer to keep up with technology.

Everyone keeps talking about it—talk is cheap!—but no one does anything to make it easier for the engineer to do so. More than just talk is necessary. It's time for action. It's obvious where colleges and industry—and societies, too, for that matter—should direct their common efforts. And, they had better start now.

HOWARD S. RAVIS

**HOW'S YOUR RETENTION?** After you've read any technical article in this issue, try to answer the questions at the end. You'll find out whether you picked up the main points. You should also retain the information better. Let us know what you think of this innovation. We're planning to continue it in future issues and your reactions may help us.



# program your Tektronix Type 561A or 564 oscilloscope for DC-to-15 MHz applications

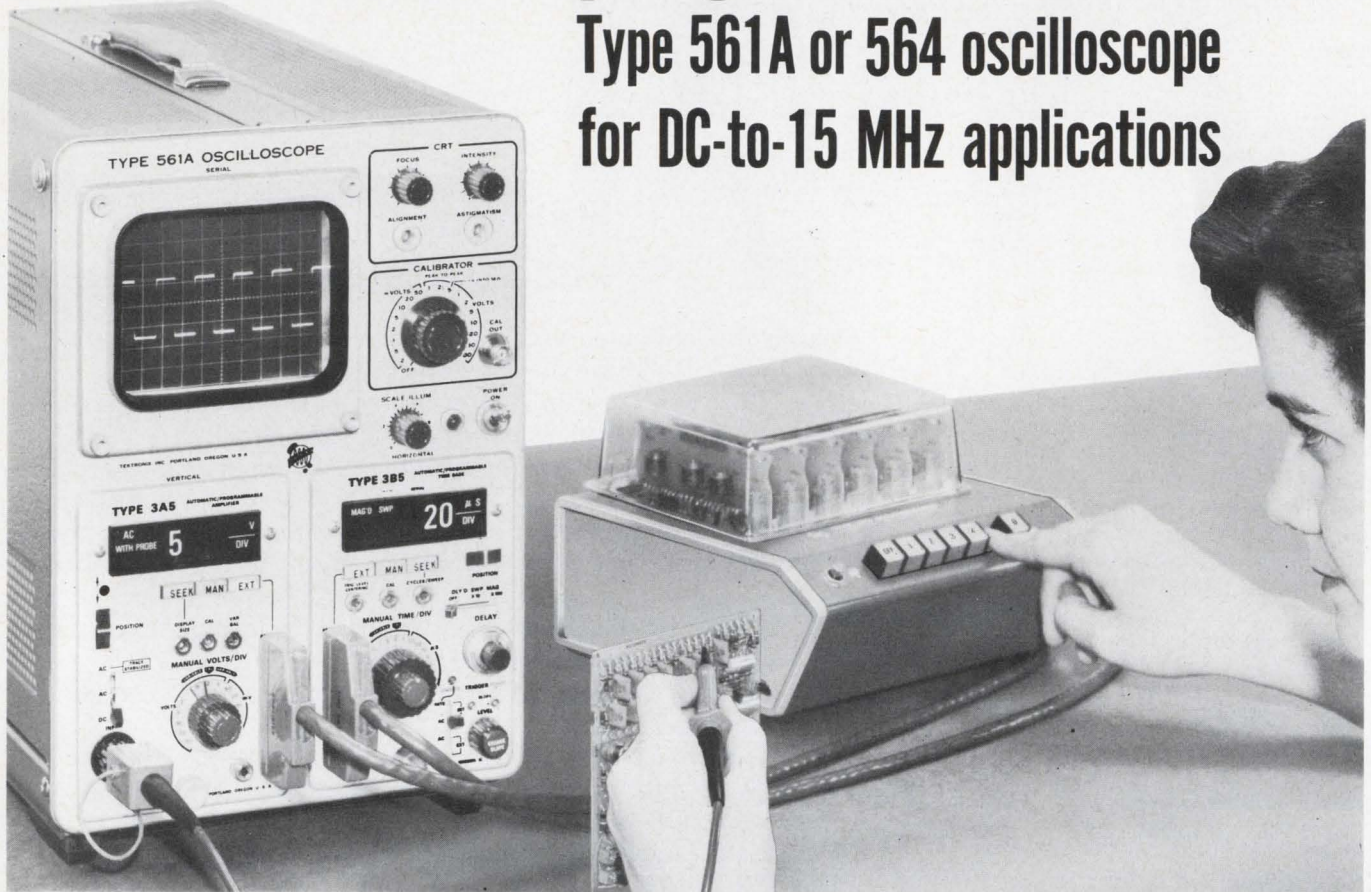

Here's new convenience for many Type 561A or 564 applications.

You can program the Tektronix oscilloscope for 6 measurement setups — using the Type 263 Programmer and the Type 3A5 and 3B5 Automatic/Programmable Plug-In Units.

## PUSHBUTTON PROGRAMMING

In this mode, both plug-ins can be programmed using the Type 263 Programmer, which accepts up to 6 plug-in type program cards. Each program card, after initial set-up, establishes the plug-in control functions required for a particular test or measurement . . . with actual measurements made conveniently from the CRT display, as usual. Any number of programmers can be cascaded for applications requiring pushbutton control of more than six measurement set-ups. In REMOTE PROGRAMMING mode, the deflection factor is 10 mV/div to 50 V/div and sweep range is 5 s/div to 10 ns/div.

Programmable Functions: **from Type 3A5**—V/div, 10X probe indication, and AC, AC Trace Stabilized, or DC coupling, by program card jumper connection . . . vertical positioning by program card potentiometer setting; **from Type 3B5**—Time/div, X10 or X100 magnifier, trigger mode with coupling, and trigger slope, by program card jumper connection . . . horizontal positioning, trigger level, and magnifier delay, by program card potentiometer setting.

## AUTOMATIC SEEKING

In this mode upon SEEK command from the probe or the plug-ins, the oscilloscope automatically presents an optimum display. The SEEK command to the plug-in units automatically adjusts the time and amplitude settings and automatically checks the trigger logic — switching to auto trigger mode, if not correctly triggered, to present a stable display whenever possible. Indicators on the plug-ins light automatically to show the time and amplitude settings. Measurements can then be made quickly and accurately from the CRT display. In AUTOMATIC SEEKING mode, the deflection factor is 10 mV/div to 50 V/div and sweep range is 5 s/div to 0.1  $\mu$ s/div.

## MANUAL OPERATION

In this mode, both plug-ins are controlled conventionally. Indicators on the plug-ins show the time and amplitude settings. In MANUAL OPERATION mode, deflection factor is 1 mV/div to 50 V/div (5 MHz bandwidth at 1, 2 or 5 mV/div and 15 MHz at 10 mV/div to 50Vdiv) and sweep range is 5 s/div to 10 ns/div.

Type 263 Programmer (complete with 6 program cards)	\$ 325
Type 3A5 Automatic/Programmable Amplifier Unit	\$ 790
Type 3B5 Automatic/Programmable Time-Base Unit	\$ 925
<b>Oscilloscopes which accept both Automatic/Programmable Plug-Ins:</b>	
Type 561A Oscilloscope	\$ 530
Type RM561A Oscilloscope	\$ 580
Type 564 Storage Oscilloscope	\$ 925
Type RM564 Storage Oscilloscope	\$1025

U.S. Sales Prices f.o.b. Beaverton, Oregon

For a demonstration, contact your nearby Tektronix field engineer or write: Tektronix, Inc., P. O. Box 500, Beaverton, Oregon 97005.



*Depth and breadth of product line*

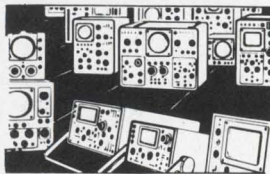

*. . . part of the Tektronix commitment  
to continuing customer service*

ON READER-SERVICE CARD CIRCLE 44



# Technology

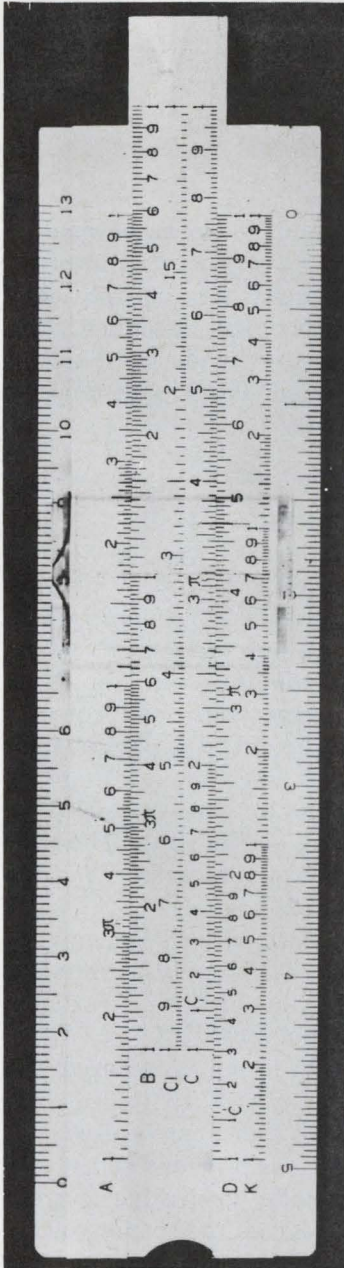

**Profit by learning** basic cost analysis. Page 96



**High power pulses can be measured** accurately and simply with current transformers or with capacitive dividers. Page 84

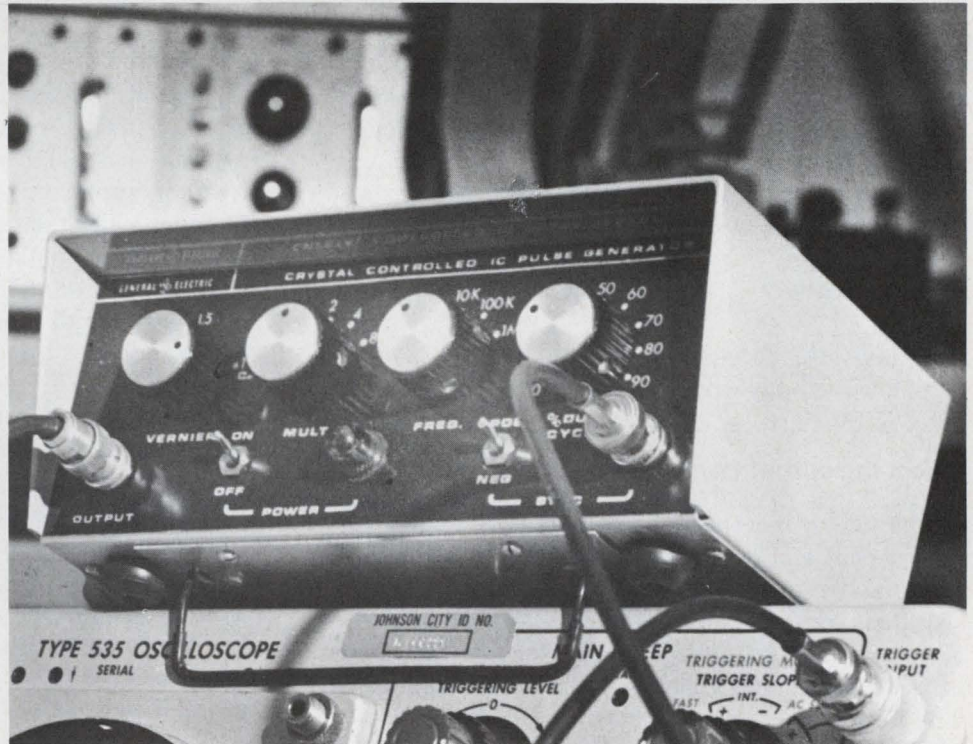

**A pulse generator can be designed with ten ICs** (off-the-shelf digital microcircuits) and just one crystal for stability. Page 90

## Also in this section:

**Discrete-component logic excels** where speed counts more than cost. Page 68

**Thermal ratings of power transistors:** what they are and how to use them. Page 74

**Selecting the right fm recording method** is by no means easy. Page 78



# Use discrete-component logic circuits

for those do-it-yourself jobs where speed counts more than cost and the 'last performance decimal.'

Very often the design engineer is called on to provide logic for test fixtures, or to modify existing equipment in the field. In many cases, design time is at a premium. The engineer simply can't afford to wait while a printed-circuit board layout is worked out. Squeezing the last penny out of the design and designing for minimum component count are far less important than getting the job done quickly.

In such cases discrete-component logic circuitry, rather than integrated-circuit logic, is by far the most economical method.

An examination of some of the more useful circuits that have been built under such circumstances shows that they meet the following requirements:

- Provide low-impedance output for both logic 1 and logic 0.
- Operate reliably from a single power source.
- Are capable of driving loads up to several hundred milliamps.
- Are capable of sinking as well as supplying current.
- Have high noise immunity.
- Work reliably without tinkering.

## Select the output stage

The key to meeting the above requirements is the proper choice of the output stage. Figure 1 illustrates the final design. Its operation is as follows:

When the input is grounded,  $Q_A$  and  $Q_C$  are turned off and  $Q_B$  acts as an emitter-follower. When current is supplied to the input,  $Q_A$  and  $Q_C$  turn on. The base of  $Q_B$  is held near ground potential by  $Q_A$ , which turns  $Q_B$  off. The output is held close to ground by  $Q_C$  and is capable of sinking current. In addition to its load-handling ability, several other factors were considered in choosing and building this output stage. With no other modification than changing the value of  $R_A$ , almost any  $V_{CC}$  can be used. This is particularly handy when there is a requirement to interface with integrated-circuit logic or to drive such loads as relays or lamps.

Since the circuit might be called upon to drive anything from another logic stage to a small motor,

additional flexibility can be gained by providing a dual hole pattern for  $Q_B$  and  $Q_C$  to accommodate transistors of at least two sizes. For most applications, small-signal silicon transistors can be used.

On rare occasions, when the load impedance is unpredictable, it is desirable to provide short-circuit protection for the output stage. This can be done by selecting  $R_A$  and the beta of  $Q_B$ .

$$I_{load(max)} = (V_{CC} - 0.6)(\beta + 1) R_A$$

Thus the output current is beta-limited, which affords a degree of short-circuit protection for  $Q_B$ . In addition to high noise immunity and the capability of supplying or sinking large load currents (large by logic standards), the circuit is very easy for technicians to trouble-shoot. The logic levels are insensitive to varying loads and are always quite close to  $V_{CC}$  or ground, depending on the state. Thus, for a 10-volt  $V_{CC}$ , if a logic 1 level is measured and the voltmeter reads 8 V, something is wrong.

The output stage can be used with the general circuit of Fig. 2. The use of a 20-V supply permits the designer, by changing the value of the Zener diode, to adjust the  $V_{CC}$  for the output stage.

In cases where a full 20-V output is required, the Zener diode can be shorted out. With typical low-voltage logic ( $V_{CC}=4V$ , a 16-V Zener can be used.

A 10-k $\Omega$  resistor to ground was provided on the output side of the Zener to provide "keep alive" current for the Zener diode. This prevents the output voltage from exceeding  $(20 V - V_z)$  when no load is connected ( $V_z$  is the Zener voltage). The 0.3- $\mu$ F filter capacitor across the 20-V input was selected for good high frequency characteristics and provides adequate power supply decoupling.

## The inverting amplifier

The inverting amplifier is a simple extension of the basic output stage and is illustrated in Fig. 3.  $Q_E$  and  $Q_D$  provide enough additional gain to make the inverting amplifier useful for shaping slow input signals. Using 2N3704 transistors throughout, we get an output rise time that is approximately 200 ns and



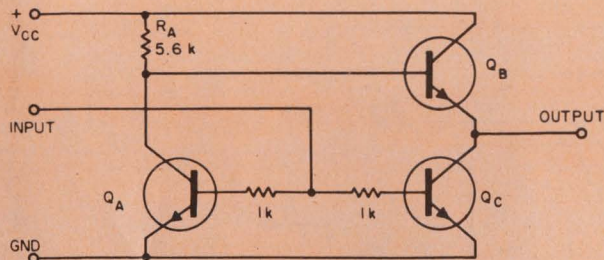

1. **Output stage has low output impedance** in both states (0 or 1), can sink or deliver several hundred milliamps, and can operate off a wide range of  $V_{CC}$  by changing  $R_A$ .

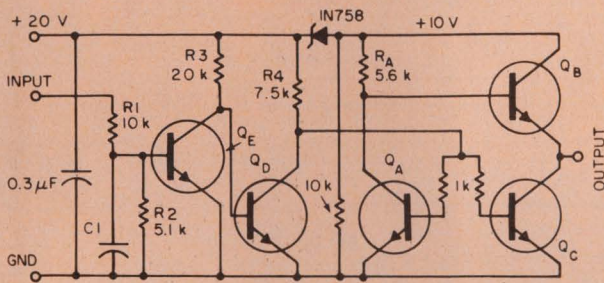

ALL TRANSISTORS - 2N3704  
 OUTPUT - NO LOAD  
 LOGIC 1  $\approx$  9.6 V  
 LOGIC 0  $\approx$  0.2 V  
 RISE TIME  $\approx$  300 NS  
 FALL TIME  $\approx$  200 NS  
 REDUCE VALUE OF  $R_A$  FOR LOAD CURRENTS IN EXCESS OF 20 mA

3. **Inverting amplifier** with the basic output stage can provide a wide range of currents by changing  $R_A$ .

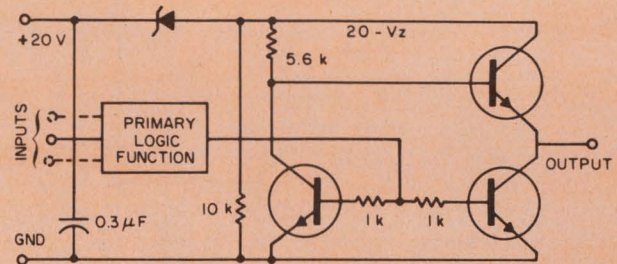

2. **Generalized logic stage** is connected to the output stage of Fig. 1, as shown. Note that use of the Zener diode in series with the output stage permits one to obtain any desired output up to +20 V.

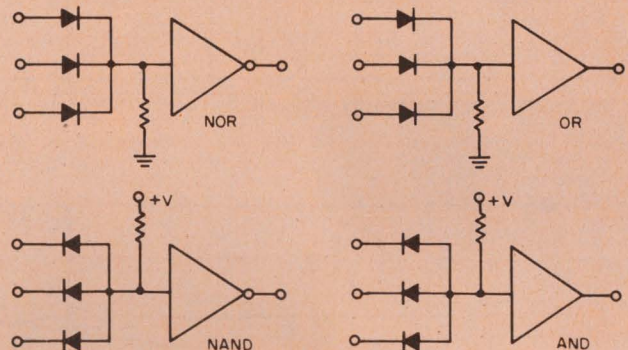

EXTERNAL GATES USED WITH THE INVERTING AMPLIFIER

EXTERNAL GATES USED WITH THE NONINVERTING AMPLIFIER

4. **A variety of external gates** can be used with the logic circuits described.

the fall time is about 150 ns. Much faster rise and fall times can be achieved by using faster transistors in the output stage.

$R_1$  services to limit the input current to about 1 mA when the amplifier is driven by another standard logic circuit. With  $R_1 = 10$  k $\Omega$ , the value of  $C_1$  determines the input time constant.

For applications where a noninverting amplifier is required, the circuit is easily modified and can be built on the same chassis as follows:

- Remove  $R_3$ ,  $R_4$  and  $Q_D$ .
- Substitute a 7.5-k $\Omega$  resistor for  $R_3$ .
- Place a jumper from the base pad to the collector pad on the  $Q_D$  hole pattern.

This modification is useful for level shifting, wave shaping (where inversion is not required), and in the construction of AND gates (see Fig. 4).

### Building the set-reset latch

Figure 5 illustrates how the basic latch function is coupled to the standard output stage.

$Q_2$  and  $Q_3$  form the heart of the latch circuit and are connected in such a way that, together, they act as an SCR. When high currents are not required, this "build your own" SCR costs less than most available ones.

The circuit is latched (output = logic 1) when a positive voltage (logic 1) is applied to the SET input. The output will remain at logic 1 until a RESET signal is provided. For maximum versatility, two RESET inputs are provided. In one case,  $Q_4$  is turned off (thus unlatching  $Q_2/Q_3$ ) by grounding its base (logic 0) through  $CR_1$ .  $Q_4$  may also be turned off by turning  $Q_1$  on with a logic 1 at its input. In this circuit the unlatching inputs always have priority over the latching and unlatching signal coincide.

Figure 6 illustrates another latching circuit that is more akin to the familiar SET-RESET -flip-flop. It offers the advantage of providing both true and complementary outputs. The true output assumes a logic 1 state when the SET line is brought to zero volts (logic 0). Resetting is done by bringing the RESET line to zero volts. Although this is a conventional technique and the circuit has many applications, the latching circuit in Fig. 5 is much more versatile.

### Use a wide-range single-shot

The single-shot multivibrator has historically been one of the most troublesome logic circuits. Most conventional single-shots suffer from one or more of the following problems:



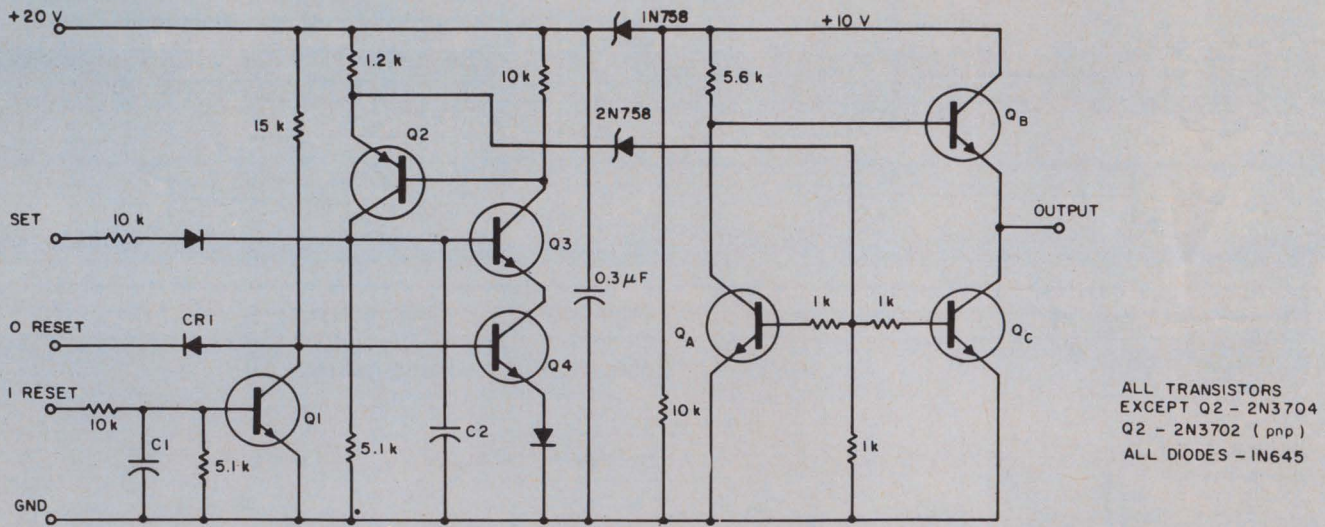

5. **Set-reset latch operates like an SCR:** It latches (output-logic 1) for a positive voltage at the SET input.

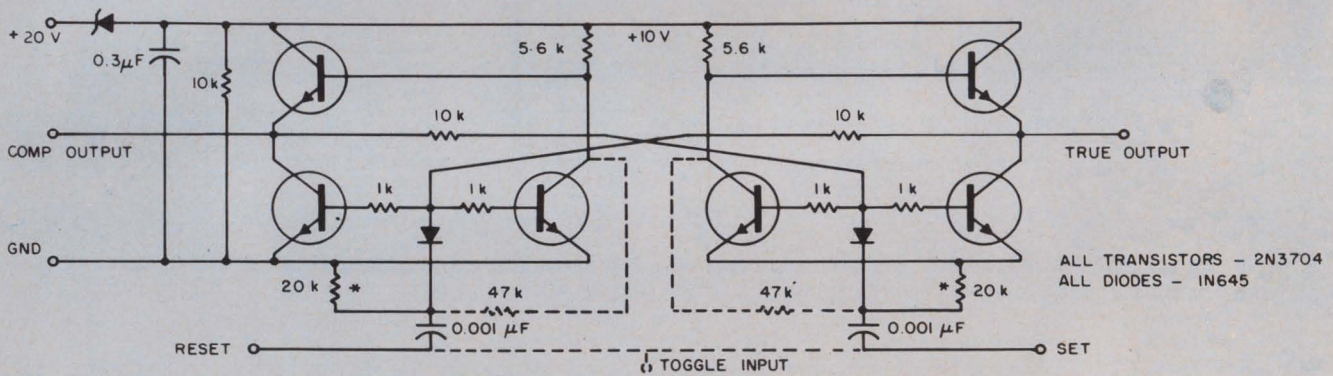

6. **Flip-flop circuit** uses the output stage for higher outputs. Dashed lines show how it can be converted

into a counting or toggling flip-flop, but the two 20-k $\Omega$  resistors marked with asterisks must be removed.

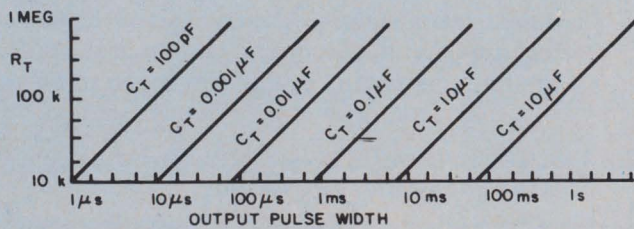
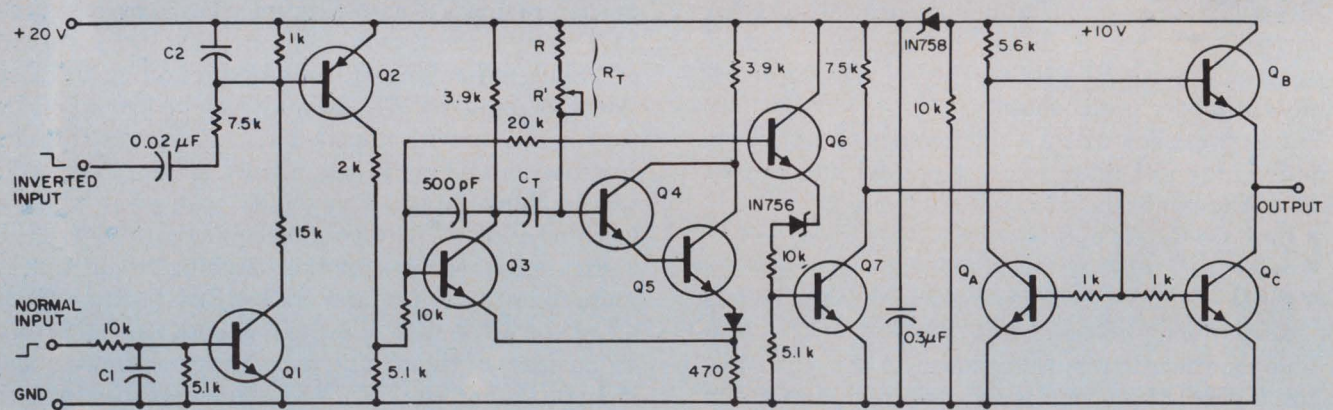

WIDTH OF OUTPUT PULSE IS DETERMINED BY  $C_T$  AND  $R_T$  WHERE  $R_T = R + R'/2$

7. **Wide range single-shot output pulse width** can be adjusted by selecting  $C_T$  and  $R_T$ , as shown in the ac-

companying timing diagram. Note the use of the Darlington pair,  $Q_4$  and  $Q_5$ .



- Noise sensitivity.
- Sloppy turn-off characteristics.
- Lack of wide range.

Figure 7 illustrates a wide-range single-shot circuit that overcomes these problems.

The basic single-shot circuit is composed of  $Q3$ ,  $Q4$  and  $Q5$ . The only departure from "computer type" single-shots is the use of the Darlington pair,  $Q4$  and  $Q5$ . In more conventional circuits, a single transistor is normally used. The Darlington pair allows much higher resistance to be used in the timing circuit ( $R_T$ ). This provides a wider range of time constants for any given value of the timing capacitor ( $C_T$ ). In conventional single-shots the maximum value of  $R_T$  depends on the beta of  $Q4$  and  $Q5$ . The combination of a low-beta device and a long-pulse-width requirement has led to the downfall of many a conventional single-shot. With the Darlington pair, the circuit can tolerate an  $R_T$  well in excess of 1 M $\Omega$ .

$Q6$  and  $Q7$  serve as a buffer between the basic single-shot and the standard output stage. The Zener diode in the emitter circuit of  $Q6$  helps provide an excellent trailing edge characteristic at the output.

$Q1$  and  $Q2$  function as the input stage and isolate the single-shot from the surrounding hardware. The normal input (base of  $Q1$ ) allows the single-shot to be fired from a positive signal. Note that the input time constant can be tailored by selecting the value of  $C1$ . A negative-going signal can fire the single-shot if the inverted input is used. In such a case,  $C2$  should be selected on the basis of expected input noise. In most applications 100 to 500 pF would be a good nominal choice for  $C1$  and  $C2$ .

The timing chart in Fig. 7 will aid in finding the proper  $R_T$  and  $C_T$  for a given pulse width. If precise adjustment of pulse width is required,  $R'$  (the variable portion of  $R_T$ ) should be approximately  $R_T/5$ .  $R$  should never be small enough to allow excessive base current to flow in  $Q4$  and  $Q5$ . A minimum value of 2 k $\Omega$  should provide safe operation.  $C_T$  should be a nonpolarized capacitor with at least a 20-V rating.

### Constructing a system

Regardless of how noise-immune a digital circuit is, its power-supply wiring, grounding and interconnections to the rest of the system must be handled with care. Each chassis should be connected to the power supply with an independent twisted pair ( $V_{CC}$  and common). This insures a minimum area in each  $V_{CC}$ -common loop and thus provides minimum inductance between the power supply and logic circuit. The power-supply common should be connected to the system ground with a short braided wire.

Interconnections between logic functions should pose no problem. The low-impedance output for both logic 1 and logic 0 provide excellent noise immunity, even with long cable runs. Even better noise immu-

nity can be achieved if a twisted pair is used between the output and ground of one circuit to the input and ground of the next.

To interface these logic circuits to the rest of the system, consider several factors. If +10- and 0-V input signals are available, the logic circuits can be used with no input modifications. If the input signal source is any type of mechanical switch (including dry reed switches), the input capacitor should be increased to about 0.5  $\mu$ F to eliminate possible errors caused by the switch bounce.

In many cases the input source voltage may far exceed the nominal +10-V (logic 1) level. In such cases substitution of a higher resistance for the 10-k $\Omega$  input resistor is the only modification required. For instance, if the input signal swings between 0 and +300 V, a 250-k $\Omega$  resistor substituted for the 10-k $\Omega$  input resistor would be the only change necessary. If the input signal is below 10 V, the input resistance would have to be reduced. For the most reliable operation, provide between 1 and 2 mA to turn on the input transistor.

If an output stage is required to furnish more or less than +10 V to a load, the 1N758 series Zener diode can be replaced with a different value of Zener voltage, or it can be shorted to provide +20-V output. If more than +20 V is required, an extra driver transistor or relay will have to be added.

### What about costs?

The component cost of each stage of this logic is typically \$2 to \$8 a stage—quite high compared with that for either integrated-circuit logic or discrete-component "computer type" logic. But, particularly in small electromechanical systems, the extra dollar or two for each stage is amply repaid by flexibility and noise immunity of the circuits and by the fact that when you plug them in, they work. ■ ■

### Test your retention

Here are questions based on the main points of this article. They are to help you see if you have overlooked any important ideas. You'll find the answers in the article.

1. When should discrete-component logic be used instead of ICs?
2. How can you adjust the output-signal amplitude of the output stage?
3. How can you get faster rise and fall times from the output stage?
4. How is latching accomplished in the SET-RESET latch without the use of SCRs?
5. How is wide timing range obtained in the single-shot circuit?



# Reduce circuit costs with 16 new plastic-package transistors from TI

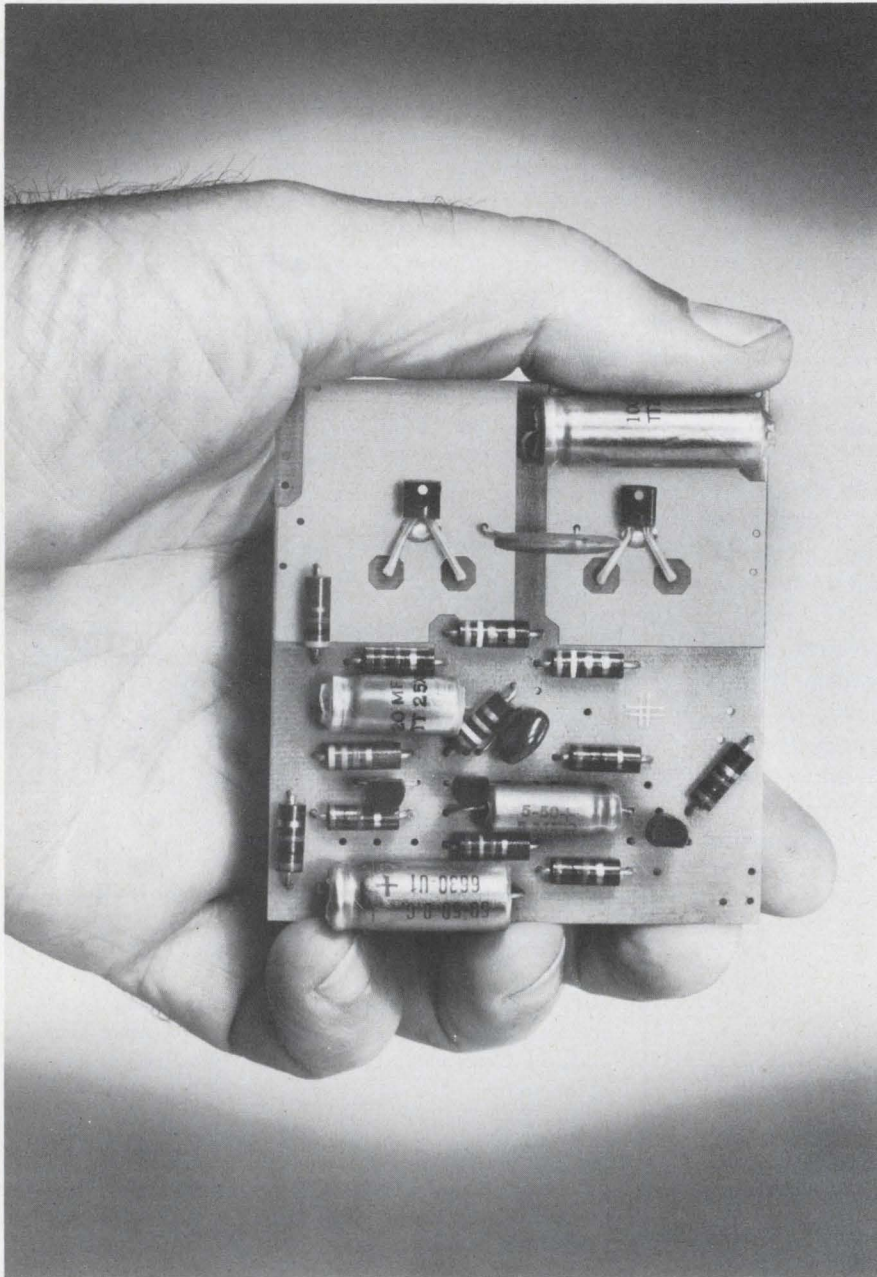

Texas Instruments announces 16 new transistors to improve performance, simplify circuitry and reduce your product costs. Included are silicon amplifiers, oscillators and switches. An economy version of the 2N4416 FET is available, too.

All the new transistors are offered in TI's exclusive SILECT™ economy plastic package. Lead configurations include: in-line, TO-18, and high-frequency. The new HF arrangement provides improved isolation and lower feedback capacitance for VHF and UHF devices.

TI's SILECT package, backed by 30,000,000 hours of testing, is fully capable of meeting military specifications. Reliability has been found to be equivalent to metal-can devices tested under the same conditions.

#### High-dissipation SILECT package eliminates heat sinks

Here are the first economy small-signal transistors to feature power dissipation of 1.6 watts at 25°C case temperature — nearly twice that of devices with comparable packages. Specially processed, high-thermal conductivity leads achieve this added dissipation. Designated as NPN types TIS90 and TIS92, and PNP types TIS91 and TIS93, these complementary devices are also available in matched pairs (TIS90M/TIS91M and TIS92M/TIS93M).

The new, high-dissipation packaging allows plastic transistors to be used in applications formerly



restricted to metal-case, medium power devices or to the use of elaborate and expensive heat sinks.

An effective heat sink can be obtained *at no extra cost* by leaving an area of copper on the face of the etched circuit board and connecting the high-conductivity collector lead to it (as shown at left).

The complementary pairs are designed for low-cost audio driver and output circuits up to two watts for phonograph applications.

Electrical characteristics are similar to the 2N2222 NPN and 2N2907 PNP families.

Circle 325 for data sheet.

#### New high-frequency FET doubles previous frequency capability

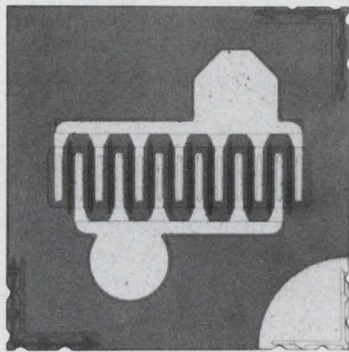

The new TIS88 silicon FET—plastic-encapsulated equivalent of the 2N4416 also offered by TI—features a frequency capability twice that of similar devices previously available in low-cost plastic packages. The high-performance FET operates up to 400 MHz with 10 dB minimum power gain. High transconductance and low feedback capacitance make this new

device especially useful for consumer, industrial and military applications, including FM RF amplifiers, cascode-connected VHF amplifiers and sonobouy input amplifiers. Performance characteristics include a low noise figure (4 dB maximum at 400 MHz) and low leakage ( $I_{GSS} = 1\text{nA}$  maximum).

Circle 326 for data sheet.

#### New low-cost NPN devices for TV and audio applications

TIS83. Designed for use in UHF tuners, the new TIS83 transistor features a high injection current ( $I_{osc} = 2.5\text{ mA}$  minimum at 930 MHz). Transconductance is high ( $Y_{fs} = 70\text{ mmhos}$  at 200 MHz), permitting use with Schottky-barrier or AFC diodes.

Circle 328 for data sheet.

TIS84-85. New TIS84-85 transistors are designed for RF amplifiers and first and second video IF applications. They feature low noise figures (3.3 dB max @ 200 MHz for the TIS84), low feedback capacitance (0.4 pF maximum) and excellent forward AGC characteristics. The AGC control-voltage range is narrow, making only one device necessary for both IF sockets. The 100-mil B-E-C high frequency pin configuration isolates input and output circuitry.

Circle 329 for data sheet, which includes 10 performance curves and two application circuits.

TIS86-87. New TIS86-87 high-frequency silicon transistors are designed for such TV applications as mixers, reverse-AGC IF, and third IF. Feedback capacitance is

low at 0.45 pF maximum, permitting unneutralized IF-stage design. Real and imaginary parts of y-parameters at 45 and 200 MHz simplify circuit design. Pin configurations are 100-mil, B-E-C.

Circle 330 for data sheet.

TIS94-99. This is a complete family of low-noise, low-to-medium current SILECT transistors for use in hi-fi audio amplifiers and general purpose low-frequency applications. They feature excellent Beta linearity to 100 mA, high current gain, low noise figures and high breakdown voltage (65 V min  $V_{(BR)CEO}$  for the TIS96 and TIS99).

Circle 331 for data sheet.

#### New economy semiconductor designer's kit

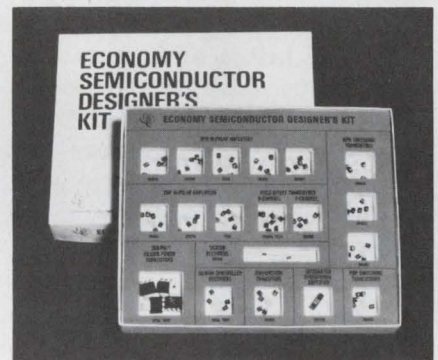

TI's new designer's kit enables you to evaluate a wide variety of 94 economy semiconductors for only \$24.50\*—less than one-fourth their usual low cost. Order your kit TODAY from your authorized TI distributor.

\*suggested manufacturer's retail price



# TEXAS INSTRUMENTS

INCORPORATED



# How 'hot' are you on thermal ratings

of power transistors? Here is a short refresher course that considers what they are and how they should be used.

Practically every engineer, at one time or another, has experienced confusion over application of semiconductor thermal ratings. Much of this confusion can be eliminated by reviewing how transistor manufacturers draw up the specified ratings and by examining some common pitfalls in applying thermal ratings.

The ultimate power-handling capability of any semiconductor device is a function of its maximum nondestructive junction temperature, junction geometry, chip size and thermal resistance from junction to the ambient air. Maximum junction temperature, junction geometry, junction-to-chip body thermal resistance and chip size are constants for a given semiconductor device type and manufacturer, but the quality of the thermal bonds from chip to header and header to case varies significantly. It is not uncommon to find significant differences in junction-to-case or junction-to-ambient resistances in the same device type. Semiconductor manufacturers make approximate calculations for each new type before production, and, they verify these calculations later by experimentally measuring the actual thermal resistance. Several hundred samples of each new type are selected randomly from production, and their thermal resistances are measured. Maverick devices with very high thermal resistances are not considered in the ratings; the upper band of statistically significant devices is used to specify thermal resistance. Both junction-to-case and junction-to-ambient thermal resistances are derived in this manner.

## Calculating maximum power dissipation

Absolute maximum power dissipation referenced to 25°C case temperature is calculated by using the absolute maximum junction temperature ( $T_{max}$ ) and the specified thermal resistance from junction to case ( $\theta_{JC}$ ) with the following formula:

$$P_{max} \text{ 25}^\circ\text{C Case Temperature} = (T_{max} - 25^\circ\text{C}) / \theta_{JC} \quad (1)$$

Similarly the absolute maximum allowed power dissipation referenced to 25°C ambient temperature is:

$$P_{max} \text{ 25}^\circ\text{C Ambient Temperature} = (T_{max} - 25^\circ\text{C}) / \theta_{JA} \quad (2)$$

---

A.D. Marquis, Reliability Engineer, Cedar Rapids, Iowa

where  $\theta_{JC}$  is the specified thermal resistance from the junction to ambient.

## Check your knowledge

Let's try four problems now to test your ability to apply thermal ratings. The solutions are given after the fourth problem. If you can work all of the problems with ease, be assured that you have a good working knowledge of transistor thermal ratings.

### PROBLEM 1

Zap Semiconductors claims that its epoxy version of the 2Nxxx transistor is a 1200-mW device at 25°C case temperature. It also says that 325°C is the absolute maximum allowable junction temperature for its device. Data on transistor failure rates gathered by Reliability Engineering indicates that 150°C is a more realistic figure for the absolute maximum junction temperature. Assuming this to be the case, what is the adjusted power dissipation at 25°C case temperature for the Zap 2Nxxx epoxy transistor?

### PROBLEM 2

Herman Letherburn, Reliability Engineer, is performing stress analysis on a new 6000kW hf transmitter. One of the driver transistors is rated at 50 W for 25°C case temperature and 5 W for 25°C ambient temperature. The maximum forced cooling air temperature inside the transmitter never exceeds 100°C. The maximum allowable junction temperature is 175°C. What power stress ratio—that is, the ratio of maximum allowable power dissipation to actual power dissipation—should Herman assign to this transistor if it dissipates 15 W in the transmitter and is heat sunk?

### PROBLEM 3

Herman Letherburn, Reliability Engineer, has consulted Silvestor Twistbolt, Mechanical Engineer, and obtained the case-to-ambient thermal resistance for forced air cooling in the 6000 kW hf transmitter. What power-stress ratio should Herman use if the case-to-ambient thermal resistance  $\theta_{CA}$  is 2°C/W?

### PROBLEM 4

Lester Runitcool, Reliability Engineer, is ana-



lyzing a 500-Hz cycle square-wave generator. One of the output transistors puts out the power waveform shown in Fig. 1.

The transistor can dissipate 10 W at 25°C case temperature. The maximum junction temperature is 175°C, and the case temperature is 100°C. The thermal time constant of this transistor is 1 ms.

Lester would like to know if this transistor is overstressed.

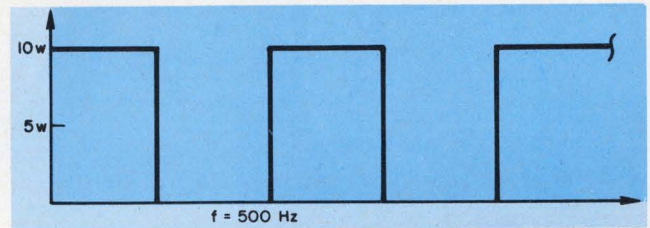

1. Given a transistor that can dissipate 10 W at 25°C case temperature and is putting out the wave shown above, is it overstressed if the case temperature is 100°C? See problem 4 for additional data.

#### ANSWER TO PROBLEM 1

$$P_{\max} = 500 \text{ mW}$$

Here is how Ziggi Blotus, Ace Reliability Engineer, arrived at the solution:

1. Calculate the thermal resistance, junction-to-case, from Eq. 1 as follows:

$$P_{\max} = (T_{\max} - 25^\circ \text{C})/\theta_{JC},$$

so that

$$\begin{aligned} \theta_{JC} &= (T_{\max} - 25^\circ \text{C})/P_{\max} \\ &= (325^\circ \text{C} - 25^\circ \text{C})/1200 \text{ mW} \\ &= 0.25^\circ \text{C/mW}. \end{aligned}$$

2. Using this result and Eq. 1, we get

$$\begin{aligned} P_{\max} &= (150^\circ \text{C} - 25^\circ \text{C})/0.25^\circ \text{C/mW} \\ &= 500 \text{ mW}. \end{aligned}$$

We can now also find the maximum allowed power dissipation at any case temperature from the following expression:

$$P_{DTC} = P_{\max} - (T_c - 25^\circ \text{C})/\theta_{JC},$$

where  $T_c$  stands for the case temperature.

$$\begin{aligned} &= 30 - (100^\circ \text{C} - 25^\circ \text{C})/5^\circ \text{C/W} \\ &= 15 \text{ W}. \end{aligned}$$

From the data given in the Problem 2, we know that the driver transistor is dissipating 15 W; therefore the stress ration is equal to one.

#### ANSWER TO PROBLEM 4

Yes, the transistor is thermally overstressed.

It is true that the average power dissipation is 5W and does not exceed the allowed power dissipation, but the transistor's thermal time constant is fast enough to allow the junction to exceed  $T_{\max}$  during the ON portion of the cycle. Before using average power dissipation as an approximation, be sure that the transistor's fastest significant time constant is much slower than the power pulse period.

#### ANSWER TO PROBLEM 2

Not enough information has been given to solve the problem. It would be incorrect to use ambient temperature and junction-to-air thermal resistance  $\theta_{JA}$ , S since  $\theta_{JA}$  is measured by semiconductor makers in still air, not forced air. It is also incorrect to use ambient temperature and junction-to-case thermal resistances, because there would be a definite temperature gradient from case to heatsink to ambient in most applications.

#### ANSWER TO PROBLEM 3

The stress ratio = 1

Ziggi Blotus Ace Reliability Engineer, gives this explanation:

1. Calculate  $\theta_{JC}$  as follows:

$$\begin{aligned} \theta_{JC} &= (T_{\max} - 25^\circ \text{C})/50 \text{ W} \\ &= (175^\circ \text{C} - 25^\circ \text{C})/50 \text{ W} \\ &= 3^\circ \text{C/W}. \end{aligned}$$

Using the measured value of  $\theta_{CA} = 2^\circ \text{C/W}$  and the above result, we obtain:

$$\theta_{JA} = \theta_{CA} + \theta_{JC} = 2^\circ \text{C/W} + 3^\circ \text{C/W} = 5^\circ \text{C/W}.$$

2. Calculate  $P_{\max}$  referenced to forced-air ambient:

$$\begin{aligned} P_{\max} &= (T_{\max} - 25^\circ \text{C})/\theta_{JA} \\ &= (175^\circ \text{C} - 25^\circ \text{C})/5^\circ \text{C/W} \\ &= 30 \text{ W}. \end{aligned}$$

3. Calculate maximum power dissipation at 100°C forced-air ambient temperature:

$$P_D = P_{\max} - (T_A - 25^\circ \text{C})/\theta_{JA}$$

#### What is the point?

What has been shown here is simply this: When you are faced with any power transistor application, evaluate manufacturer's specs and your operating conditions carefully. A "slight" misunderstanding of either can be costly after the design has been completed, drawings prepared and the production department is setting up to turn out the units based on your calculations. ■■

#### Test your retention

Here are questions based on the main points of this article. They are to help you see if you have overlooked any important ideas. You'll find the answers in the article.

1. What factors determine the power dissipation ability of a transistor?
2. How does a manufacturer arrive at a specified thermal resistance value?
3. What is the power-stress ratio?
4. What value of the junction-to-air thermal resistance do you use when the transistor is cooled by forced air?



# VOMs



RANGES and SPECIFICATIONS	160	230	240	250	255	260-5	260-5M	260-5P	261	270-3
DC Volts	0-0.25/1.0/2.5/10/50/250/500/1000	0-10/50/250/1000	0-15/75/300/750/3000	0-0.05/0.25/2.5/10/50/250/500/1000	0-0.05/0.25/1/2.5/10/50/250/1000	0-0.25/2.5/10/50/250/1000/5000				
AC Volts	0-2.5/10/50/250/500/1000	0-10/250/1000	0-15/150/750/3000	0-2.5/10/50/250/500/1000	0-2.5/10/50/250/1000	0-2.5/10/50/250/1000/5000				
DC Microamperes	0-50 (250 mV drop)	NONE	NONE	0-50 (Both 50 and 250 mV drop)		0-50 (250 mV drop)				
DC Milliamperes	0-1/10/100/500 (250 mV drop)	0-10/50/250 (150 mV drop)	0-15/150/750 (150 mV drop)	0-1/10/100/500 (50 mV drop)		0-1/10/100/500 (250 mV drop)				
DC Amperes	NONE	NONE	NONE	0-10 (50 mV drop)	NONE	0-10 (250 mV drop)				
AC Amperes	NONE	NONE	NONE	NONE*	0-5/25/100/250 (w/ adapter No. 0531)	NONE*	NONE*	NONE*	NONE*	NONE*
DB Scale ("0" = 1 mw into 600)	-20 to +10/-8 to +22/+6 to +36/+20 to +50	NONE	NONE	-20 to +10/-8 to +22/+6 to +36/+20 to +50	NONE	-20 to -10/-8 to -22/-6 to -36/-20 to -50				
Output Ranges	NONE	NONE	NONE	NONE	NONE	0.1 ufd in series with all AC voltage ranges through 250 volts.				
Resistance Ranges	RX1 (30 Ω ctr.)/RX10/RX100/RX1K/RX10K	RX1 (12 Ω center)/RX100	RX1 (30 Ω center)/RX100	RX1 (12 Ω center)/RX100/RX10K						
Temperature Range	NONE	NONE	NONE	NONE*	+100°F. to +1050°F.	NONE*	NONE*	NONE*	NONE*	NONE*
Accuracy (% of Full Scale)	±3% DC, ±4% AC			±2% DC, ±3% AC			±1.5% DC, ±3% AC			
Temperature Compensated	NO	NO	NO	NO	NO	NO	NO	NO	NO	YES
Meter Movement Protection	YES	NO	NO	YES	YES	YES	YES	YES	YES	YES
Resettable Tester Circuit Protection	NO	NO	NO	NO	NO	NO	NO	YES	NO	NO
Mirror Scale	NO	NO	NO	NO	NO	NO	YES	NO	YES	YES
Scale Length	2.9 inches	2.36 inches			4.2 inches					
Dimensions	4 1/16" x 3 3/16" x 1 3/4"	3" x 5 1/8" x 2 1/2"			5 1/4" x 7" x 3 1/8"					
Net Weight	12 oz.	1 1/2 lbs.			3 1/2 lbs.					
Price	\$50.00	\$40.00	\$40.00	\$63.00	\$90.00	\$58.00	\$60.00	\$88.00	\$68.00	\$70.00
Movement Type	Self Shielding Annular—Taut Band	Self Shielding Annular—Pivot and Jewel		Self Shielding Annular—Taut Band		Self Shielding Annular—Pivot and Jewel				Self Shielding Annular—Taut Band
Sensitivity	20,000 Ω/V DC, 5000 Ω/V AC	1000 Ω/V DC, 1000 Ω/V AC			20,000 Ω/V DC, 5000 Ω/V AC					

\*Temperature, AC current, and other ranges can be added with exclusive Simpson Add-A-Tester adapters.

makes other specialized VOMs, adapters and accessories, too! And if we can't fill your needs from stock . . . we'll build it! Send your specifications, or write for test equipment brochure 2076.





# ...if Simpson doesn't have it... forget it!



Simpson is the one place to look when you need a VOM. We pioneered the multitester®, and today we offer the widest selection. All with Simpson's "Stay Accurate" dependability.

See your Electronic Parts Distributor.

262-3	263	267	268	269-2	355	2700
0-1.6/8/40/160/400/1600/4000	0-0.15/0.3/0.75/1.5/3/6/7.5/15/30/60/75/150/300/600/750/1500/3000/6000	0-0.25/2.5/10/50/250/500/1000	0-3/12/60/300/600/1200	0-1.6/8/40/160/400/800/1600/4000	0-3/12/60/300/1200	0-1/10/100/1000
0-3/8/40/160/400/800	0-2.5/5/7.5/15/30/60/150/300/750/1500	0-2.5/10/50/250/500/1000	0-3/12/60/300/600/1200	0-3/8/40/160/400/800	0-3/12/60/300/1200	0-1/10/100/1000†
0-80/160 (267 mV drop)	0-75/150 (150 and 300 mV drops)	0-50 (250 mV drop)	0-60 (264 mV drop)	0-16/160 (215 mV drop)	NONE	NONE
0-1.6/16/160 (267 mV drop)	0-0.75/1.5/7.5/15/75/150/750 (150 and 300 mV drops)	0-1/10/100/500 (250 mV drop)	0-1.2/12/120 (264 mV drop)	0-1.6/16/160 (215 mV drop)	NONE	0-1/10/100†
0-1.6/8 (267 mV drop)	0-1.5/7.5/15 (150 and 300 mV drops)	0-10 (250 mV drop)	0-12 (264 mV drop)	0-1.6/8 (215 mV drop)	NONE	NONE
NONE	NONE	NONE	NONE	NONE	NONE	NONE
-12 to +11/ -3.5 to +19.5/ +10.5 to +33.5/ +22.5 to +45.5	-20 to +10/-14 to +16/-10.5 to +19.5/ -4.5 to +25.5/+1.5 to +31.5/+7.5 to +37.5/+15.5 to +45.5/+21.5 to +51.5/ +29.5 to +59.5/+45.5 to +75.7	-20 to +10/ -8 to +22/ +6 to +36/ +20 to +50	-12 to +11/ -1 to +22/ +13 to +36/ +27 to +50	-12 to +11/ -3.5 to +19.5/ +10.5 to +33.5/ +22.5 to +45.5	NONE	NONE
0.1 ufd through 160 volts	0.1 ufd in series with all AC voltage ranges through 300 volts			0.1 ufd through 160 volts	NONE	NONE
RX1 (4.5 Ω center)/RX10/RX100/RX1K/RX10K/RX100K		RX1 (12 Ω center)/RX100/RX10K		RX1 (12 Ω center)/RX10/RX100/RX1K/RX10K/RX100K	RX1 (120 Ω center)/RX10/RX100/RX1K	RX1K (0-1K Ω)/RX100K/RX10Meg/RX100Meg†
NONE	NONE	NONE	NONE	NONE	NONE	NONE
±3% DC, ±4% AC	±1.5% DC, ±2.5% AC	±3% DC, ±5% AC		±2% DC, ±3% AC	±3% DC, ±5% AC	±0.05%, ±1 digit, DCV
NO	NO	NO	NO	NO	NO	YES
NO	YES	NO	NO	YES	NO	YES (digital)
NO	NO	NO	NO	NO	NO	NO (not needed)
NO	NO	NO	NO	NO	NO	DIGITAL READOUT
		6.2 inches			2.24 inches	4 digits
		6" x 7¼" x 3"			2¾" x 4½" x 1"	8¼" x 11" x 4"
		4 lbs.			8 oz.	8 lbs.
\$75.00	\$88.00	\$65.00	\$65.00	\$90.00	\$47.00	Under \$550.00 for basic unit
Self Shielding Annular—Pivot and Jewel						Digital; Integrated Circuits
20,000 Ω/V DC, 5000 Ω/V AC	20,000 and 10,000 Ω/V DC, 10,000 and 5000 Ω/V AC	20,000 Ω/V DC, 5000 Ω/V AC		100,000 Ω/V DC, 5000 Ω/V AC	10,000 Ω/V AC-DC	10 Meg Ω, DC

†With optional plug-in adapters.



## SIMPSON ELECTRIC COMPANY

5200 W. Kinzie Street, Chicago, Illinois 60644 • Phone: (312) 379-1121

Export Dept: 400 W. Madison Street, Chicago, Illinois 60606, Cable, Simelco

IN CANADA: Bach-Simpson Ltd., London, Ontario

IN INDIA: Ruttonsha-Simpson Private Ltd., International House, Bombay-Agra Road, Vikhroli, Bombay



ON READER-SERVICE CARD CIRCLE 46



# Which fm recording method is best?

There are wideband, narrowband and constant-bandwidth types, and the selection is by no means simple.

There is no such thing as an ideal all-purpose fm data-recording system. There is only a "best choice" among three data-recording techniques: wideband, narrowband and constant-bandwidth.

What you choose depends on your application. The instrumentation engineer must determine in each case how good the signal-to-noise ratio should be and what modulation index should be used. An over-engineered recording system is wasteful, but the opposite will lower the recording quality. With this in mind, let's review, first, the individual techniques, then point out basic selection criteria. These will be applied later to a simple example.

## Wideband fm: Little flutter effect

In general, wideband fm recording systems are not effected much by flutter noise—which is an advantage. But they need one track for each channel, and this can become costly if many channels are needed. A typical system is shown in Fig. 1.

Wideband systems can accommodate a total carrier deviation change of about 80%, or a carrier deviation of  $\pm 40\%$ .

In most wideband systems a modulation index of 2 ( $m=2$ ) is used. The reason is the limit on the amount of data bandwidth that is allotted by IRIG standards. For example, with a 54-kHz carrier frequency and the standard data bandwidth of 10 kHz,  $m=54 \times 0.4/10 \approx 2$ . (A  $\pm 40\%$  carrier deviation was assumed.)

In all recording systems the total information bandwidth, as a function of the modulation index,  $m$ , determines the signal-to-noise ratio, or redundancy. The modulation index is given by the ratio of carrier deviation in hertz to the allotted data bandwidth. The sidebands at each side of the carrier extend  $(m+1)$  in each direction, yielding a factor of  $2(m+1)$ . When this factor is multiplied by the allotted data bandwidth, the result is the total information bandwidth. The redundancy, or the effective signal-to-noise ratio, is therefore determined by the factor  $2(m+1)$ , which is the ratio of the information bandwidth and allotted bandwidth.

In the system previously discussed,  $m$  is equal to

**Richard S. Anderson**, General Manager, Genisco Technology Corp., Compton, Calif.

2. Therefore the total information bandwidth is:

$$\Delta f = 2(m+1) \times 10 \text{ kHz} = 60 \text{ kHz},$$

and the data is recorded with a redundancy of 6.

Depending on tape speed, multiples or submultiples of the basic carrier frequency may be used, with corresponding alterations in bandwidth. The 108-kHz frequency, twice the 54-kHz carrier, provides dc to 20-kHz response while the first submultiple (27 kHz) permits recording in the dc-to-5-kHz range (a modulation index of 2 is assumed).

Flutter noise causes very little signal degradation in wideband systems. If we take a 1.5% peak-to-peak flutter as a representative value, then the system noise level for 80% total carrier deviation is still less than 2%. (The noise level is the ratio of the peak-to-peak flutter and the total carrier deviation:  $0.015/0.80 < 0.02$ .) Selective filtering can further suppress this noise level to some 40 to 50 dB below full scale. This makes wideband fm particularly attractive for facilities where older telemetry discrimination equipment, which does not have flutter compensation, is already on hand. Discriminators can be modified easily by adding new center-frequency networks and filtering assemblies.

## Narrowband fm: High-data capacity

In contrast with wideband recording, a narrowband system usually incorporates a mixing amplifier and several subcarrier oscillators that provide the input (Fig. 2). The output is a complex sinusoidal waveform. With this design approach, several data channels can be placed on a single recording track.

While wideband fm uses generally one track per channel and has a square-wave output, narrowband fm, with its sinusoidal output, can handle several channels on one track. On the other hand, total deviation and the resultant bandwidth of narrowband subcarriers is much smaller—usually  $\pm 7.5\%$  or  $\pm 15\%$ , with a modulation index of 5 ( $m=5$ ).

Without further refinements, a 1.5% peak-to-peak flutter in a tape system with 15% total subcarrier deviation would impose a 10% peak-to-peak noise on the data playback. (The noise is, again, the ratio of the flutter and deviation:  $0.015/0.15 = 0.1$ , or 10%). In most recording situations, this would be an intolerably high contribution to the total noise spectrum.



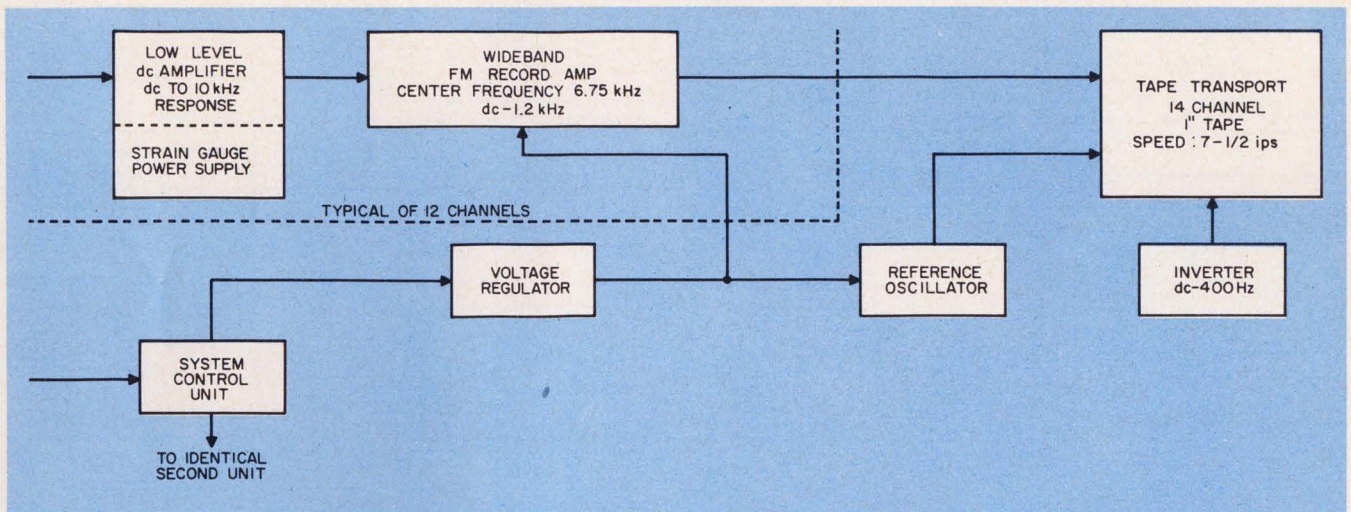

1. **Wideband fm recording system** needs a separate track for each channel. A 24 data-channel input requires two

of these systems; one tape transport can accommodate only 14 channels.

The remedy lies in recording a reference channel on each recording track to "police" the unwanted recording. This channel contains only the flutter noise. On playback, a flutter compensation system electronically cleans the data.

This leaves two main disadvantages of narrowband systems: one is the need to allocate "policing" channels for noise suppression, rather than for incoming desired data; the other is the limited bandwidth, ranging from a few hertz to 1.2 kHz for a 15% total subcarrier deviation, and to some 2.1 kHz for 30% bandwidth types.

So far we have considered data recorders that have a constant percentage of deviation for all subcarriers, or constant-deviation types. But there is a data-recording approach in which the absolute bandwidth in hertz is the constant factor—which results in a changing percentage of deviation. This approach is constant-bandwidth recording.

### Constant bandwidth: Many channels on a track

Constant-bandwidth recording is a relatively new concept. In this approach all subcarrier oscillators provide the same data bandwidth. The block diagram of such a system is shown in Fig. 3. Since different center frequencies must be employed, the per-

centage of total deviation is different for each subcarrier. At first sight, this might seem to be an unattractive option, because of the seemingly complex filtering requirements. But the following analysis will show that this is no problem.

All fm modulators are basically square-wave devices. They generate not only a basic spectrum around the center frequency but also a set of similar spectra, with decreasing amplitudes around odd-numbered higher-order harmonics of the center frequency. These higher-order harmonics are undesired parasitic components and should be filtered off at the modulator output before the information is multiplexed with other channels.

Under what conditions is this feasible?

Consider, first, a common narrowband system with only a  $\pm 7.5\%$  deviation. The deviation around the third harmonic will then be correspondingly small with a large frequency difference between the upper end of the fundamental spectrum and the lower end of the third-harmonic spectrum. Therefore a filter can be built with enough frequency ratio to pass the highest desired frequency, while stopping the lowest undesired frequency.

In a typical wideband system with  $\pm 40\%$  deviation, the fundamental spectrum extends somewhat beyond 140% of the center frequency  $f_0$  while the lower

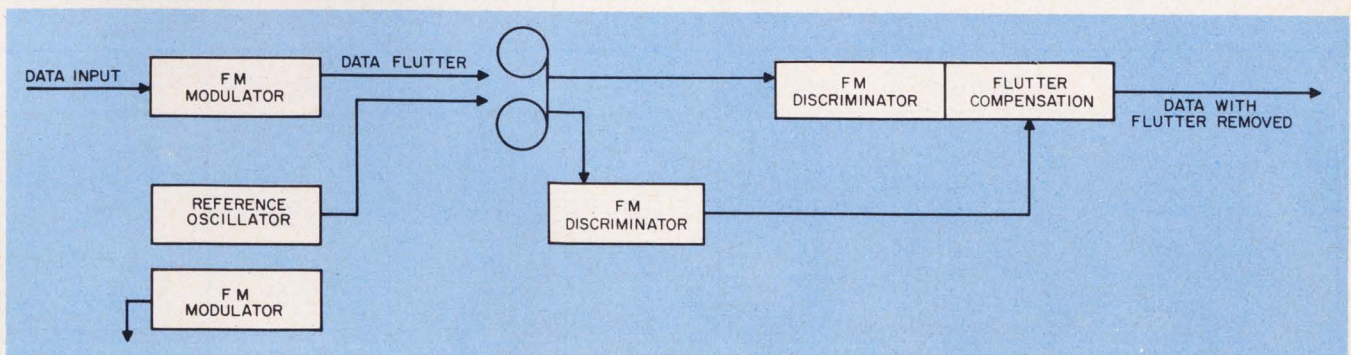

2. **Narrowband fm** uses a mixing amplifier and several subcarrier oscillators. It is limited by bandwidth and by

difficulty in maintaining an acceptable signal-to-noise ratio, but one track can handle several channels.



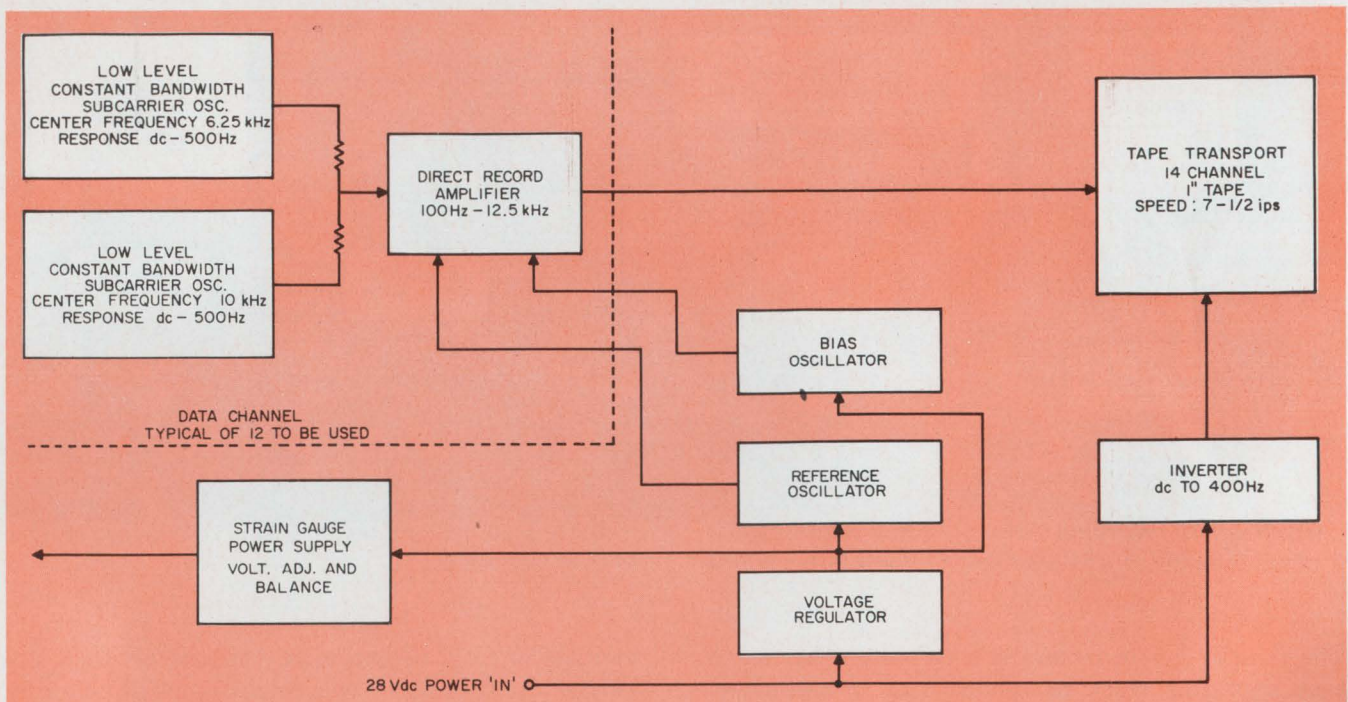

3. **Constant-bandwidth fm** needs only one tape transport for 24 channels. It requires a separate power supply for

its transducers or gauges. The synchronization of data tracks is ensured by the constant bandwidths.

end of the nearest undesirable parasite spectrum is found slightly below  $3 \times 60\% = 180\%$  of  $f_o$ . The difference between  $1.4f_o$  and  $1.8f_o$  is too narrow for a practical filter. As a result, wideband recording, with exemplarily  $\pm 40\%$  deviation, does not permit multiplexing of several information channels into a single rf channel or tape channel.

Constant bandwidth is a narrowband system and avoids the filter design problem. In addition it eliminates a second problem relating to the frequency-dependent delay in filters, for which constant deviation does not offer an inherent solution: Any actual lowpass filter has a time delay inversely proportional to the frequency response at the filter's upper cutoff frequency. In a constant percentage deviation system, if we assume constant modulation index, bandwidth per channel increases as we go up the frequency range of the subcarriers. For each channel,

the associated filter will have a different delay time, decreasing with increasing subcarrier frequency. As the channels are played back through an fm discriminator, it is thus very difficult to maintain time correlation between channels.

Constant-bandwidth recording solves the problem by maintaining a deviation for each channel that is constant in absolute kilohertz rather than in relative percentages. Therefore a given low-pass filter, when used on each channel, will have identical time delays, and the synchronization of data tracks on playback is ensured. The disadvantage obviously is that the percentage deviation decreases with increasing center frequency, and the flutter problem is more severe. But despite this difficulty, many channels can still be put on the same track, just as in conventional narrowband systems.

The center frequencies and data bandwidths now

## Constant-bandwidth FM systems

		Data bandwidth					
Dc to	500 Hz	1000 Hz	2000 Hz	4000 Hz	8000 Hz	% Deviation	
Center Frequencies in 1000 Hz	6.25	12.5	25	50	100	$\pm 16\%$	
	10.0	20	40	80	160*	$\pm 10\%$	
	13.75	27.5	55	110	220*	$\pm 7.3\%$	
	17.5	35	70	140	280*	$\pm 5.75\%$	
	21.25	42.5	85	170	340*	$\pm 4.7\%$	
Deviation	$\pm 1$ kHz	$\pm 2$ kHz	$\pm 4$ kHz	$\pm 8$ kHz	$\pm 16$ kHz	Mod Index = 2	

\*Tentative values



becoming generally accepted are listed in the table on the opposite page.

### Selection criteria: Data needs plus skill

The data input rate (channel capacity) is only one in a set of factors that govern the selection of a recording technique. Other data-oriented factors are accuracy, bandwidth and running time requirements vs volume and available space. Obviously there are budget considerations.

Finally, operating skill must be taken into account. Wideband fm recording involves saturating the tape, while narrowband and constant-bandwidth techniques both require precise adjustments of bias and signal current levels.

Let us assume you are designing your system from scratch. The data requirements may be as follows: 24 information channels (10 from strain gauges, 14 from accelerometers) to be recorded continuously. Their response should include the dc level.

In this situation wideband fm offers a number of advantages. The recording currents do not require careful adjustment; data quality is likely to be enhanced with little effort. Extended bandwidth not only provides a much wider frequency response; it also permits a lower tape speed and more recording time than other recording techniques using the same tape transport. The one disadvantage is the single-channel recording limitation. The 24 data channels that are required would call for two tape transports each having 14 tracks. IRIG standards call for 14 channels on a 1-in. tape.

If the twin-transport setup proves undesirable, then the next choice would be a constant-bandwidth system. This puts several data channels into a single recording track. The complications are two-fold: system adjustment before recording calls for much greater care and skill, and flutter compensation equipment is indispensable. The highest frequency subcarrier then has a very small total deviation percentage. In addition most existing telemetry discriminators cannot be used for constant-bandwidth playback; new discriminators have to be purchased.

Narrowband fm in this case comes in a poor third. The primary reason is simply the fact that its bandwidth is limited. In addition there may be problems in maintaining an acceptable signal-to-noise ratio.

Thus far comparisons have been made exclusively on the basis of technical merits. Some cost estimates are in order. The wideband and constant-bandwidth systems for our example are shown in Figs. 1 and 3. The strain gauges are assumed to be wire, requiring low-level amplifiers.

For the wideband system (Fig. 1) the amplifiers have self-contained strain-gauge power supplies. The dc amplifier signals enter the fm recording amplifier, where they are converted into fm signals and recorded. The outputs of the reference oscillators are recorded in the head stacks of the two tape trans-

ports; this improves playback data quality. The cost estimate for the wideband system in the figure is \$40,000.

The block diagram for the constant-bandwidth system (Fig. 3) differs in several aspects. A separate transducer or gauge power-supply pack is required. The system also needs low-level constant-bandwidth subcarrier oscillators, which are available commercially. The output of the oscillators is mixed (in this case, two for each track) and recorded by the direct-recording amplifiers with the help of a bias oscillator. A reference oscillator compensates for the flutter noise. The cost estimate for this system is \$43,500.

### Frequency range: Just common sense

Suppose you are interested in recording a number of variables in an aircraft flight test. Beginning at the low end of the spectrum, variables like air temperature, airframe temperatures, altitude and fuel reserve vary slowly; 1 Hz will take care of them. In the next frequency range there are attitude variables — pitch, roll, yaw, and their rates of change. The natural frequency of the aircraft limits the time rates of parameter change, so that 5 Hz will be adequate. Aerodynamic flutter calls for some 10 Hz. Vibration and shock may need 2 kHz and more.

Many variables have a constant or nearly constant time average. Pressure fluctuations in flutter for example, occur about an average pressure that is readily determined from altitude, ambient air temperature and wind-tunnel tests. For that reason, dc response is not needed; a suitable lower frequency limit is probably found in the 5-to-20 Hz range. Vibration data rarely extend below 10 Hz with any utility; a response from 100 Hz up to whatever top frequency is desired, will yield all relevant data. ■ ■

#### **Test your retention**

*Here are questions based on the main points of this article. They are to help you see if you have overlooked any important ideas. You'll find the answers in the article.*

- 1. How does flutter compensation influence the choice of the recording system?*
- 2. Is time correlation of playback data an important criterion?*
- 3. What are the advantages of systems with constant bandwidths?*
- 4. Are there any filtering problems in constant-bandwidth systems?*



new ideas for  
moving electrical energy

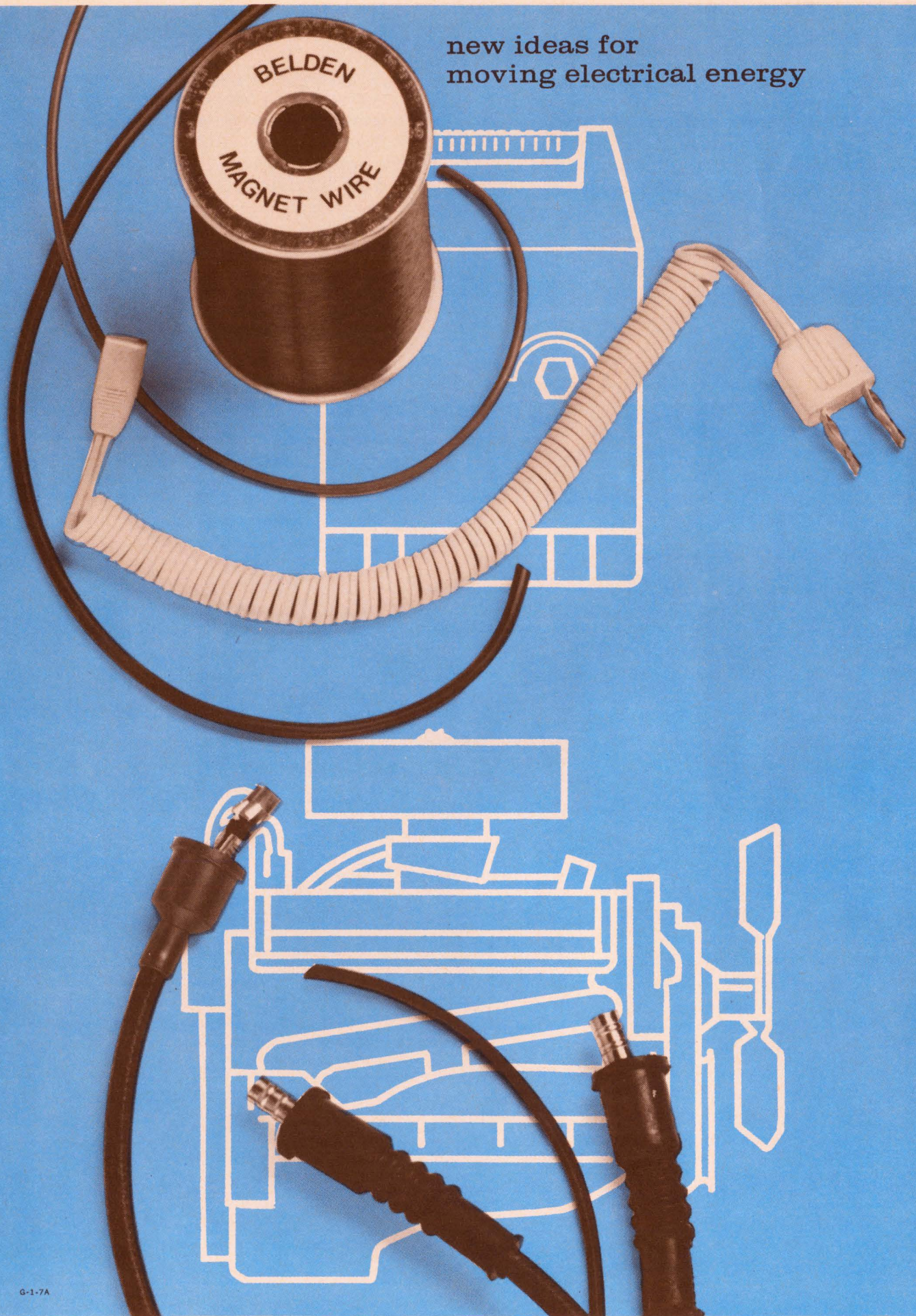

G-1-7A



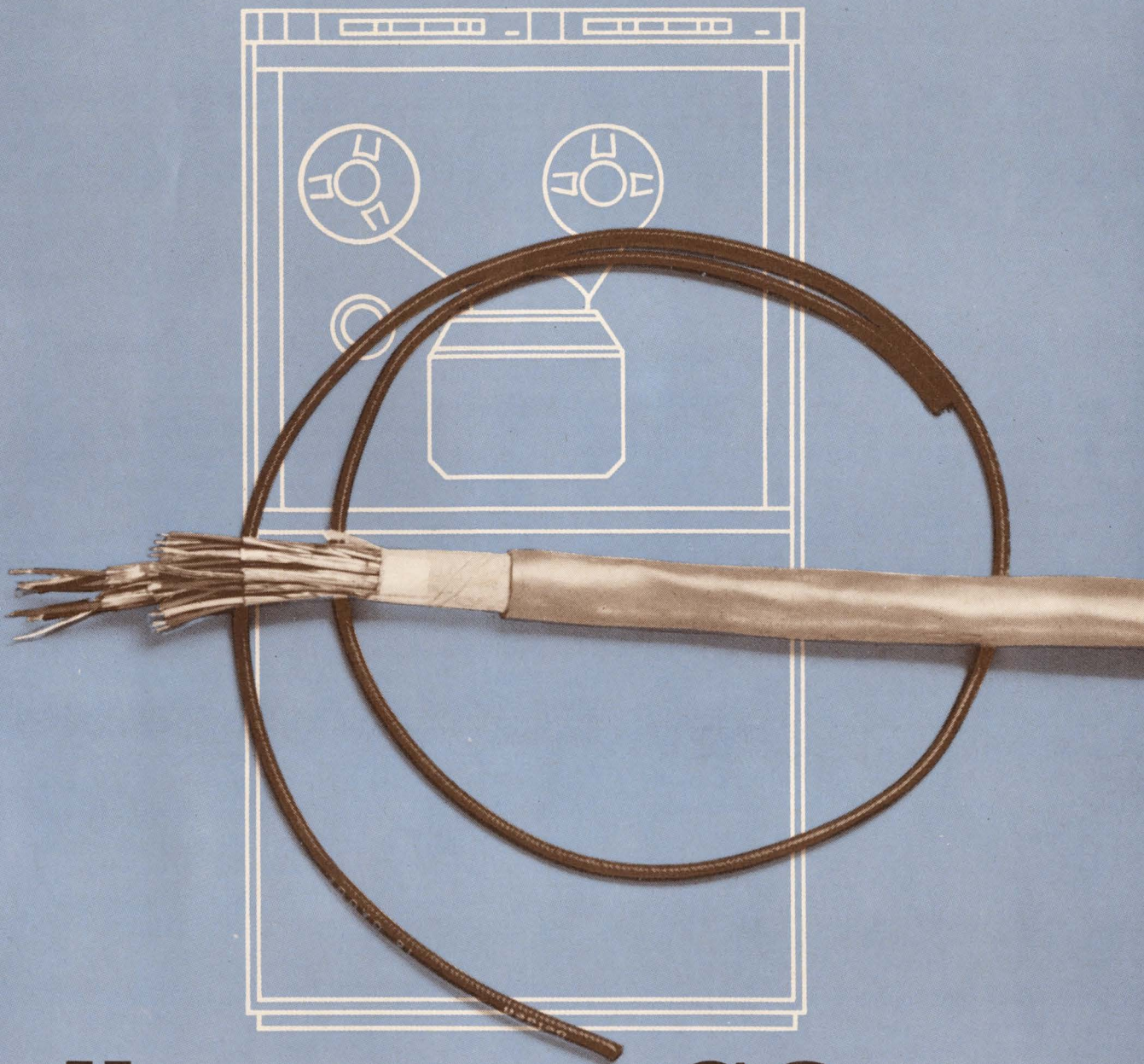

# all systems GO

...when a Belden team of wire specialists shows you their dozen or so ways to wring out hidden values and costs. For example you can delve into design..maneuver with materials..analyze assembly..pry into processing..pick different packaging..or a host of others. But success takes a supplier who is really perceptive – one who makes all kinds of wire for all kinds of systems. Want to join us in wringing out values and costs? Just call us in...Belden Corporation **BELDEN**   
P.O. Box 5070-A, Chicago, Illinois 60680.

ON READER-SERVICE CARD CIRCLE 47



# Measure high-power pulses accurately

with current transformers and capacitive dividers.

These simple methods can be used in the lab or field.

Having trouble measuring high-voltage pulses? A novel current transformer to measure current and a capacitive divider to measure voltage—simple to put together and use—can solve most of your problems.

High-voltage and current measurements are often made inaccurately with methods that are more than 20 years old.<sup>1</sup> And although precise methods have been developed,<sup>2</sup> they are unduly expensive and cumbersome for ordinary laboratory or field work. But careful design and proper calibration of the simple range-extending devices make them accurate even for short-duration, high-power pulse measurement.

## Current resistors are too inductive

Checking or observing current in high-voltage pulse systems is usually done by observing the voltage across a series resistor with one end of the resistor grounded.<sup>3</sup> One example would be the checking of pulse current in a magnetron (Fig 1a). This circuit is often difficult to construct in practice, for the magnetron must be insulated from ground and the series resistor,  $R$ , must be noninductive at all the component frequencies of the pulses involved. From the equivalent circuit of Fig. 1b, the difficulties are clearly seen. The output voltage as a function of the measured current is

$$|V(t)| = |I(t)| R + \sqrt{1 + (\omega L/R)^2} l \quad (1)$$

which shows that  $\omega L$  must be small with respect to  $R$ . In other words, the inductance of the circuit must be low. If a 10-ohm resistor is used to observe 50-nanosecond pulses, its series inductance must be less than a hundredth of a microhenry or the observed pulses will be distorted. The self-inductance of even two centimeters of wire may be 0.02 to 0.2 microhenry, which means that good pulse reproduction is difficult with such a circuit.

## Current transformers may be broadband

A simple current transformer overcomes the problems of the series resistor circuit. It can operate on the high-side instead of the ground-side of a system;

it can be designed to reproduce or enhance any particular type of pulse, or it can be made broadband. Clip-on ammeters and current-sampling probes<sup>4</sup> use current transformers, but they are not suitable for high-voltage pulse work. Clip-on ammeters are usually designed for narrowband line-frequency operation, and current probes are usually expensive and limited to 300-to-600-V operation.

The basic principle of a pulse-current transformer is shown in Fig. 2a. The flux surrounding a current-carrying wire produces potential differences in a pick-up loop. When the pick-up loop is made up of many turns on a high-permeability toroid, the flux surrounding the current-carrying wire is concentrated in the toroid, resulting in a current transformer of ratio very nearly equal to the turns on the toroid.

A practical current transformer comprises a toroidal ferrite core with a wound secondary, a single primary lead and a shield to reduce electrostatic coupling (Fig. 2a). The diameter of the core's window is determined mainly by the operating voltage level of the primary lead. The maximum electric field between the grounded secondary shield and the primary lead is:

$$E_{\max} = V/a [\ln(b/a)] \quad (2)$$

where  $V$  is the primary lead peak voltage and  $b$  and  $a$  are the shield's inner and primary lead's outer radii.  $E_{\max}$  should not exceed the dielectric strength of the insulating material used.

## Check rise time and droop

The current transformer's output voltage must be as near a replica of the input current as possible. The transformer rise time and droop, which can degrade the reproduced pulse, can be evaluated from the equivalent circuit of Fig. 2b.

For a high-permeability toroid, the coupling of the transformer is very nearly equal to 0.99, and the requirement for critical damping (no overshoot) can be written as:

$$L_s = 0.4R_m^2(C_w + C_m) \quad (3)$$

where secondary inductance  $L_s$  is in millihenries and winding capacitance  $C_w$  and measuring circuit capacitance  $C_m$  are in picofarads. For a toroidal core of cross-sectional area  $A$ , mid-core length  $l$  and average permeability  $\mu$ :

M. Michael Brady, Research Engineer, NERA, Oslo, Norway.



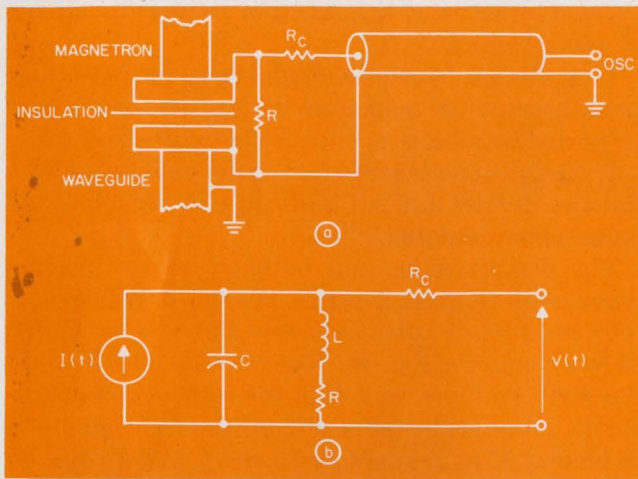

1. Current measurement with a series resistor (a) is difficult. The equivalent circuit (b) shows that the output voltage is dependent on the ratio of inductance to resistance of the resistor.

$$L_s = \mu N^2 A / l, \quad (4)$$

which gives the core parameters in terms of the measuring circuit resistance and capacitance. Droop<sup>5</sup> is expressed as:

$$\text{droop} = 100RT / (N^2L) \%, \quad (5)$$

where  $T$  is the pulse length,  $N$  is the turns ratio, and  $R$  and  $L$  are the equivalent primary resistance and inductance.

### Transformer checks magnetron current

A typical simple current pulse transformer for laboratory and field has been built to check magnetron current in a 15 kV, 10 A, 0.05-to-2-microsecond pulse modulator circuit (Fig. 3). The core used is a Philips K300502 ferrite toroid ( $\mu = 2700$ ), with a 19-mm inner and 29-mm outer diameter. The secondary winding comprises 50 turns of No. 25 (0.3-mm diameter)

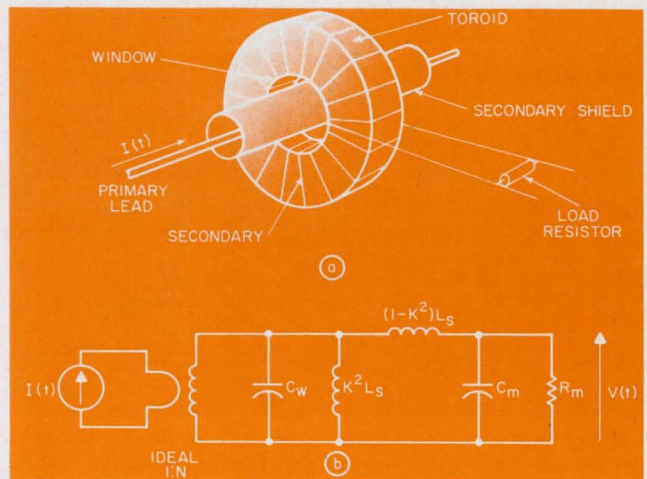

2. The single primary lead current transformer (a) can be made with a narrow frequency response or broadband. The equivalent circuit (b) gives the equations for rise time and droop.

enameled wire, loaded with a 50-ohm resistor. The output cable is 75 cm of RG-55/U coax, fitted with a BNC plug. The entire inside of the core holder, save for a 0.5-mm gap in the press-fitted core cover, is painted silver to form a shield. The gap in the shield keeps it from making a closed turn around the secondary. The transformer shield, the output-cable shield, one side of the secondary winding and a ground clip lead are all connected to a one-point common ground inside the handle.

When working into an oscilloscope with an input impedance of 1 megohm shunted by 37 pF, the transformer gives 1 volt output per ampere through the core window opening.

### Voltage dividers can cause distortion

Normally high voltages are measured with a conventional lower-voltage instrument and a range-

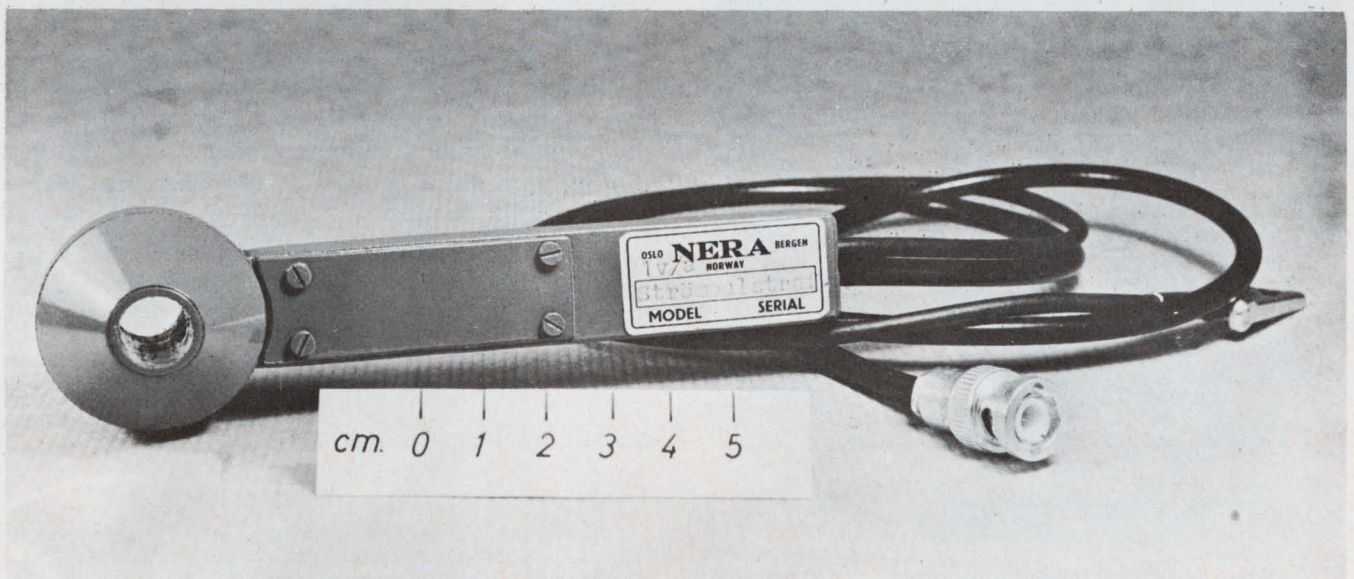

3. Magnetron currents of up to 10 A with pulse widths of 0.05 to 2  $\mu$ s may be checked with this current pulse

transformer. The core shield has a 0.5-mm gap to avoid making a closed turn around the secondary.



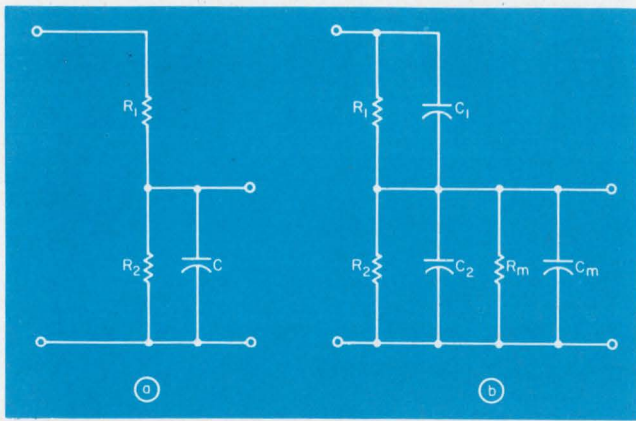

4. **Stray capacitance causes losses** in the simple resistive divider (a). The capacitive divider (b) has resistive losses ( $R_1$  and  $R_2$ ), but for high frequencies they will be large compared with the reactances of the divider capacitances.

extending device to divide the high voltage down to a lower level.<sup>6</sup> For ac the range-extending device would be a voltage transformer with its accurately-known single-frequency ratio of primary-to-secondary voltage and current. For dc it would be a resistive divider, although electric-field measuring devices have been common in X-ray work for many years.

Voltage transformers for power-transmission applications are designed to operate at only one specified frequency. Since the operating frequency determines the transfer impedances, the precision of a voltage transformer is dependent on the accuracy of the effective turns ratio. But pulses have a bandwidth. Thus for pulse measurements, a wider frequency response is needed, particularly for short pulses. Thus determining the effective turns ratio for a pulse voltage-transformer is difficult.

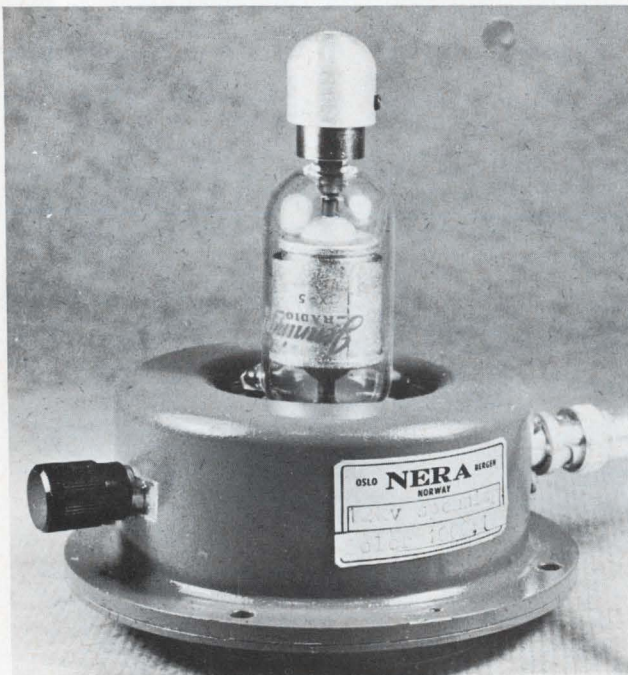

5. **An accuracy of +2% is achieved** with this capacitive divider by using a vacuum capacitor and a ceramic-trimmed precision mica.

One alternative is the resistive divider. But there are two objections:

1. A divider for high voltages may be physically large, because the maximum voltage across any part of the divider must not cause electrical breakdown.

2. Stray capacitances often make calibration of a resistive divider difficult and cause distortion of the pulses to be measured.

The first objection can be overcome by placing many small resistors in series, but this only increases the various stray capacitances of the system. This is shown clearly in Fig. 4a. Resistors  $R_1$  and  $R_2$  form the divider proper, and  $C$  is the sum of the instrument's input capacitance and all stray capacitances to ground. If  $R_2$  is about 10 k $\Omega$  and  $C$  is the capacity of 6 to 7 meters of RG-55/U cable used to connect the low-voltage measuring instrument, then the division ratio is dependent on frequency, such that at 15 kHz the ratio is 70% of whatever it was at 1000 Hz. This loss of high-frequency components results in distortion in the measured pulse. One solution is to lower the values of  $R_1$  and  $R_2$ . This, however, increases the current drawn by the divider, and it results in a need for higher power resistors.

Some efforts have been made to compensate dividers, and compensated dividers have been calibrated to function in radar systems. However, a well-built resistive divider is usually far too complex and expensive for general laboratory or field work.

### Capacitive divider has high accuracy

The shortcomings of the resistive divider are not present in the capacitive divider, whose straightforward design has led to its adoption as a standard for pulse work.<sup>7</sup> The equivalent circuit of a capacitive divider is shown in Fig. 4b. Capacitors  $C_1$  and  $C_2$  form the divider. Resistors  $R_1$  and  $R_2$  represent the losses in the capacitors, and  $R_m$  and  $C_m$  represent the output and measuring-circuit resistance and capacitance.

For the range of frequency components encountered in most pulses down to the nanosecond range, resistance  $R_1$  and  $R_2$  are very large with respect to the reactances of capacitances  $C_1$  and  $C_2$ . The input resistance,  $R_m$ , of most modern pulse-measuring instruments is usually several megohms. Stray-capacitance and instrument-capacitance,  $C_m$ , merely change the ratio of the system. For pulses whose frequency spectrum lies in the hundreds-of-hertz-to-several-megahertz range, the divider's division ratio is

$$K = C_1 / (C_1 + C_2 + C_m), \quad (6)$$

and its input capacitance is

$$C_{in} = C_1 (1 - K). \quad (7)$$

The design goals for a capacitive divider are to choose  $K$  and  $C_1$  to achieve the desired division ratio, while retaining the lowest possible input capacitance  $C_{in}$ , so that the divider does not load the mea-



sured system and alter the character of the pulses to be measured. High-voltage standards for the several-hundred-kilovolt range now use completely oil-filled structures<sup>8</sup>, while for ordinary laboratory work for the several-to tens-of-kilovolt range, vacuum-capacitors are best.<sup>9</sup>

A simple divider has been made to operate on a 15-kV radar modulator (Fig. 5). The entire unit is less than 12-cm tall. The capacitor  $C_2$  is a parallel combination of a 4900-pF precision mica and a ceramic trimmer that is adjusted to give the desired division ratio. The division ratio has been calibrated to be  $100 \pm 20$  with 1m of RG-55/U cable; a wideband oscilloscope was used as an indicator. The input capacitance is 4.99 pF.

### Bridge circuit gives accurate calibration

Voltage dividers are most easily and accurately calibrated with ordinary laboratory-standard decade resistance and capacitance boxes in a bridge circuit (Fig. 6). The bridge detector is assumed to be a balanced-input device, with input resistance  $R_D$  and input capacitance  $C_D$  on each channel. Resistance boxes  $R_a$  and  $R_b$  and capacitance boxes  $C_a$  and  $C_b$  make up the bridge. A range of operating frequencies, corresponding to the major components of the pulses to be observed with the divider, should be used in calibration. The voltages,  $V_2$  and  $V_3$ , that feed into the detector are equal at bridge balance:

$$V_2 = V_3 = A V_1 e^{j\phi} \quad (8)$$

Writing the ratios  $V_2/V_1$  and  $V_3/V_1$  and substituting in Eq. 8 and separating the result into real and imaginary parts—we get four equations, the most useful of which are:

$$\frac{1}{A} = \left[ 1 + \frac{R_a}{R_b} + \frac{R_a}{R_D} \right] \left[ \frac{\sqrt{1 + \tan^2 \phi}}{1 + \omega C_a R_a \tan \phi} \right] \quad (9)$$

$$\tan \phi = \frac{\omega C_1 R_1 \left[ \left( 1 + \frac{R_a}{R_b} + \frac{R_a}{R_D} \right) - \left( 1 + \frac{C_b}{C_a} + \frac{C_D}{C_a} \right) \right]}{1 + \frac{R_a}{R_b} + \frac{R_a}{R_D} + \omega^2 R_a^2 C_a^2 \left( 1 + \frac{C_b}{C_a} + \frac{C_D}{C_a} \right)} \quad (10)$$

Thus for any single frequency, Eqs. 9 and 10 can be used to arrive at a ratio to a degree of accuracy limited only by the precision of the standard boxes used.

Current transformers can be readily calibrated at low-voltage levels, because their output is not voltage-dependent. A pulse generator loaded by a non-inductive resistor forms the test circuit; the current transformer is used to read load current. The same indicating instrument used to read the output of the current transformer is used to read load voltage. The calibration of the current transformer is thus independent of the accuracy of the indicating instrument but dependent on its ability to measure ratios. The attenuators on most high-quality oscilloscopes will

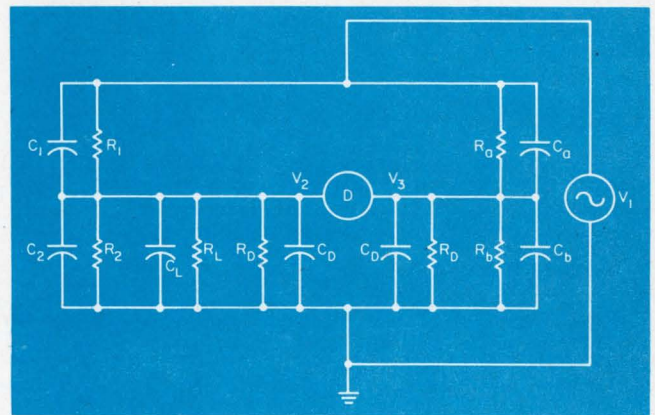

6. Voltage divider calibration requires a bridge circuit that uses laboratory-standard decade resistance and capacitance boxes. A range of frequencies is used so that the divider will not degrade the measured pulses.

provide one-decade accuracy, which is good enough to insure better than 5% calibration of the pulse transformer. ■ ■

### References:

1. G. B. Collins, *Microwave Magnetrons*, MIT Radiation Laboratory, VI, New York: McGraw-Hill, 1948.
2. Minutes of the National Bureau of Standards, 1965 Seminar on High Pulse Voltages.
3. G. B. Collins, *op. cit.*
4. C.O. Forge, "A New Clip-On Oscilloscope/Voltmeter Probe for 25c-20 Mc Current Measurements," *HP Journal*, XI, No. 11-12, (1960).
5. J. H. Smither, "Simplified Pulse Transformer Design," *Electronic Engineering*, XXIX, No. 357, (Nov., 1957), 551-555.
6. A. Vorobyev, G. A. Vorobyev et al., "High Voltage Testing Equipment and Measurement," 1962 translation of a 1960 Russian report, Document MCL-1265/1+2, Technical Documents Liaison Office, WP-AFB.
7. W.R. Fowkes and R.M. Rowe, "Refinements in Precision Kilovolt Pulse Measurements," *IEEE Trans.*, IM-15, No. 4, (Dec., 1966) 284-292.
8. M. M. Brady and K. G. Dedrick, "High-Voltage Pulse Measurement with a Precision Capacitive Voltage Divider," *Review of Scientific Instruments*, XXXIII, No. 12, (Dec., 1962) 1421-1428.
9. E.F. Kiernan, "Vacuum Capacitor Voltage Dividers," *Electronics*, XXII, No. 9, (Sept., 1949) 140-146.

### Test your retention

Here are questions based on the main points of this article. They are to help you see if you have overlooked any important ideas. You'll find the answers in the article.

1. Why are current transformers considered accurate for pulse measurements, yet voltage transformers are not?
2. In designing a capacitive divider, what design goals should you aim for in addition to the desired division ratios? Why?
3. In designing a current transformer, will (a) resistance and (b) inductance increase or decrease the droop? Why?
4. What order of accuracy is to be expected from (a) a pulse current transformer and (b) a capacitive voltage divider for normal laboratory work?



18

These ~~14~~ Low-Cost Devices  
Make RCA

# the Triac Leader of the Industry

*And now we're introducing  
the industry's first 40 amp Triacs!*

Now, RCA offers you the industry's broadest line of Triacs, with an unmatched choice of ratings and triggering characteristics in space-saving packages ...all at truly economical prices! Triacs are today's most modern, effective component for ac phase-control and load switching. Because they can perform the functions of two SCR's, Triacs make possible new economies in full-wave power circuit design and cost for industrial and commercial applications.

So for efficient, inexpensive solid-state control of motors, lighting, and heating, look to RCA, the Triac Leader. Your RCA Sales Representative will be happy to give you more details, including price and delivery. Also, ask him about RCA's complete line of SCR's. For additional technical data, write RCA Commercial Engineering, Section RG11-1, Harrison, N.J. 07029. See your RCA Distributor for his price and delivery.

Current Rating $I_T(\text{rms})$	Low Voltage (100V)	120V Line (200V)	240V Line (400V)	Package
2.5A ( $I_{GT} = 3 \text{ mA max}$ )	40525	40526	40527	modified 3-lead TO-5
2.5A ( $I_{GT} = 10 \text{ mA max}$ )	40528	40529	40530	modified 3-lead TO-5
6A		40429	40430	TO-66
6A		40485	40486	modified 2-lead TO-5
6A		40431 (with integral trigger)	40432	modified 2-lead TO-5
15A		40575	40576	TO-66
<b>40A</b>		<b>TA2836</b> <b>TA2838</b>	<b>TA2837</b> <b>TA2839</b>	<b>press fit stud</b>

\*Priced in quantities of 1,000 and up.

RCA Electronic Components and Devices



The Most Trusted Name in Electronics



### Sensitive-Gate Triacs under \$1.00\*

Extremely high gate sensitivity...rms (on-state) current = 2.5A...and a price level that makes possible a new generation of controls for small appliances, induction motors, and sensing circuits. Maximum gate sensitivities of 3 mA or 10 mA are actually many times greater than that of conventional Triacs! This means simplified triggering circuits and reduced component costs. The 100V versions (40525 and 40528) sell for \$0.95\*; the 200V types (40526 and 40529) are priced at \$0.98\*; and the 400V units (40527 and 40530) are available at \$1.40\*!

### 6A Triacs in 2-lead TO-5 to Control up to 1440 Watts

With the new 40485 and 40486 6A Triacs, RCA doesn't have to use an expensive press-fit package to control a lot of power. Both types employ the low-cost TO-5 case which can be easily mounted on heat spreaders using mass produced pre-punched parts and batch soldering techniques for improved heat-sinking ability. The 40485 sells for only \$1.50\* and controls 720 watts. The 40486 can control 1440 watts and sells for \$1.98\*. And reliability is assured with surge current protection up to 100A!

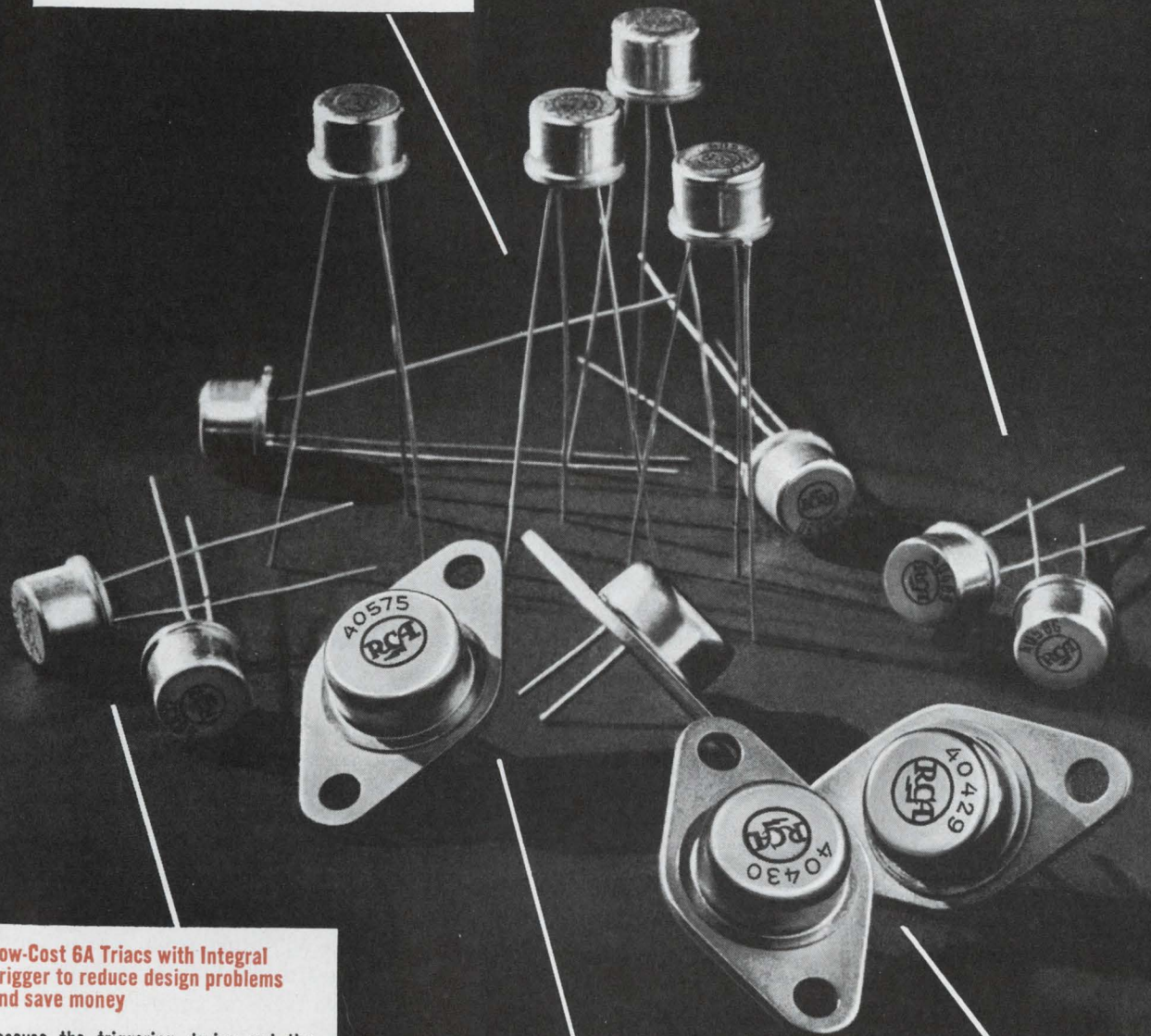

### Low-Cost 6A Triacs with Integral Trigger to reduce design problems and save money

Because the triggering device and the firing characteristics of the 40431 and 40432 Triacs are coordinated inside a compact TO-5 case, you don't have to worry about designing in additional triggering components. You benefit further from reduced circuit and assembly costs, plus improved packaging densities! So if your ac-load control circuits require a trigger, why not have it built-in for you? The 40431 controls 720 watts at 120V and costs \$1.80\*; the 40432 controls 1440 watts at 240V and costs only \$2.48\*.

### 15A Triacs for Load Control up to 3600W

RCA developmental types 40575 and 40576 Triacs extend solid-state control way up into the kilowatt range. These powerful TO-66 units have surge current protection up to 100A, plus all of the other design benefits of RCA's lower current Triacs. Possible applications include power supplies, heating controls, motor drivers, and many other industrial and commercial usages.

### 6A Triacs in Popular TO-66 Package

Need full-wave control of up to 1440 watts in a TO-66 package? RCA 40429 and 40430 Triacs are your answer. Featuring surge current protection up to 80A, these devices are ideal for lighting, heating, and motor control circuits. The 200V 40429 costs \$1.50\* the 400V 40430 only \$1.98\*.



# Design a pulse generator with ten ICs.

This approach uses off-the-shelf digital microcircuits and a crystal for frequency stabilization.

Take ten digital microcircuits off the shelf. Add a crystal oscillator and a few discrete components. Mix gently. And what do you have?

You have a crystal-controlled pulse generator that uses only \$100 worth of parts. And it produces pulses of variable width at frequencies from 50 Hz to 16 MHz.

Conventional pulse generators produce the required range in frequency by varying R, L or C values: the high frequencies require small components; the lower frequencies require large components. In this design the actual frequency of oscillation is varied only over one octave, from 8 to 16 MHz. Therefore only one small variable capacitor is used. The remaining frequencies are obtained by frequency division—first by binary and then by decimal division. A variable pulse width is obtained by the logical gating of internally generated signals.

The pulse generator possesses many features of conventional instruments as well as many additional ones. Here are the main features of the prototype:

- Frequency range: 50 Hz to 16 MHz
- Crystal controlled at five decimal multiples of 0.5, 1, 2, 4 and 8 (a total of 25 frequencies)
- Pulse width: 10% to 90% of period in 10% steps
- Rise and fall times of less than 10 nanoseconds

## Pulse generator uses frequency division

Industrial, commercial and military computing and control systems are using integrated circuits in ever-increasing numbers. A pulse generator is therefore needed that not only has a wide frequency range but is also compatible with the signal level requirements of the majority of available integrated circuits. In addition it should be both accurate and stable. This instrument meets these criteria. Its output is as accurate and stable as the crystal-controlled oscillator it contains. There is no theoretical lower frequency limit. The upper frequency limit is strictly a function of the logic modules used. And it is fairly simple to use.

The pulse generator consists of only one master oscillator, two sets of frequency dividers and two

selector switches, as shown in Fig. 1. In the crystal mode the master oscillator generates a fixed 7-MHz pulse signal. In the variable mode the frequency of oscillation is determined by a tuned L-C circuit, which has a variable capacitor to alter this frequency.

## What the first flip-flops do

The first frequency-dividing chain consists of four flip-flops, each of which divides the incoming signal by two. Starting with an 8-MHz pulse signal, the outputs by the four flip-flops will be 4, 2, 1 and 0.5 MHz, respectively. Rotary switch  $S_1$  selects the desired frequency and connects it to the input of the second frequency-dividing chain. The second chain consists of four decade counters, each of which divides the incoming frequency by a factor of 10. Starting with a 4-MHz input signal, for instance, the outputs of the four decade counters are 400, 40, 4 and 0.4 kHz, respectively. Selector switch  $S_2$  connects the desired decade counter output signal to the ensuing pulse-width gating circuit. Thus manipulation of the two 5-position selector switches permits the selection of 25 different frequencies. The final output frequency,  $f_x$ , can be expressed mathematically as:

$$f_x = 2^{-i} \cdot 10^{-j} \cdot f_c,$$

where  $i$  is the number of flip-flops and  $j$  is the number of decade counters through which the output of the master oscillator,  $f_c$ , must pass. In the prototype,  $i$  and  $j$  can each take on values from zero to four. All frequencies that are attainable from the various combinations of the two types of counters will have the accuracy and stability of the crystal oscillator that drives them. When the master oscillator frequency is made variable over a range of one octave, all of the gaps between the 25 crystal-controlled frequencies are closed, and the generator can now provide a continuous frequency spectrum from 50 Hz to 16 MHz.

By using the intermediate outputs of the decade counters and by suitably gating them together, it is possible to generate variable-pulse-width signals of a width that is a function of the logic gating. In this way, very accurate pulse widths are attainable in steps of 10% of the maximum pulse width.

A circuit is also included in the pulse generator to

---

David S. Busch, Design Engineer, and Hermann Schmid, Senior Engineer, General Electric Co., Binghamton, N.Y.



provide narrow trigger, or synchronization pulses. These pulses are generated by "differentiating" the output signal, and can be used to trigger external equipment, such as an oscilloscope.

### Use only ten microcircuits

Except for the power supply and the oscillator, the complete pulse generator is built with only 10 off-the-shelf digital integrated circuits. The logic diagram of Fig. 2 shows the interconnections of the various circuit components and their functions.

The master clock oscillator consists of a two-stage transistor amplifier with positive feedback through a series tuned L-C circuit. A one-stage buffer amplifier is provided at the output, to isolate the oscillator and to provide an adequate signal for driving the remainder of the logic circuitry. A variable capacitor is used to change the frequency of oscillation from 8 to 16 MHz. A variable coil adjusts the lower frequency limit to 8 MHz. A switch on the variable capacitor shorts out the crystal in all but the lowest-frequency position. In this position the 8-MHz crystal, which is in series with the L-C circuit, determines the frequency of oscillation, while the L-C circuit serves to suppress higher-order harmonics of the crystal.

The frequency-dividing circuits consist of a succession of flip-flops, each of which divides its incoming pulse frequency by a factor of two, and a succession of decade counters each of which divides its incoming frequency by a factor of 10. The four flip-flops are contained in a single flat pack. The internal circuit contains a divide-by-eight counter and a single flip-flop, which must be connected together externally. Frequency selection is accomplished by tapping the appropriate one of the four outputs with  $S_1$ . Each of the decade counters is contained in a single flat pack and consists of four flip-flops internally connected as a divide-by-five and a divide-by-two counter. Division by 10 is accomplished by externally connecting the two sections.

### Vary the pulse widths

The availability of the intermediate outputs of the individual decade counters can be used to form

pulses of various widths. The decades, which consist of a divide-by-five and a divide-by-two counter, are externally connected to form a 1-2-4-5 weighted bi-quinary counter. By appropriately gating the 2, 4 and 5 outputs, positive logic signals may be generated that are in the 1 state for from 10% to 90% of the pulse period in increments of 10%. To select a frequency with a given pulse width, it is necessary only to tap the 2, 4 and 5 outputs of the appropriate decade counter and then properly gate them together. The four-pole, five-position switch,  $S_2$  in Figs. 1 and 2, connects the 2, 4 and 5 outputs of the counter stage having the desired frequency with the logic circuitry that generates the various pulse widths. The required pulse width signal is then selected by



**Editor's note:** While the integrated pulse generator designed by David Busch and Hermann Schmid is not being offered for sale by General Electric, the company is prepared to license the design to other companies that would like to offer it as a product. Inquiries should be addressed to John Schobel, Patent Technology Marketing Dept., Building Five, General Electric Co., Schenectady, N. Y. Above, it is perched atop an oscilloscope to show its compact size.

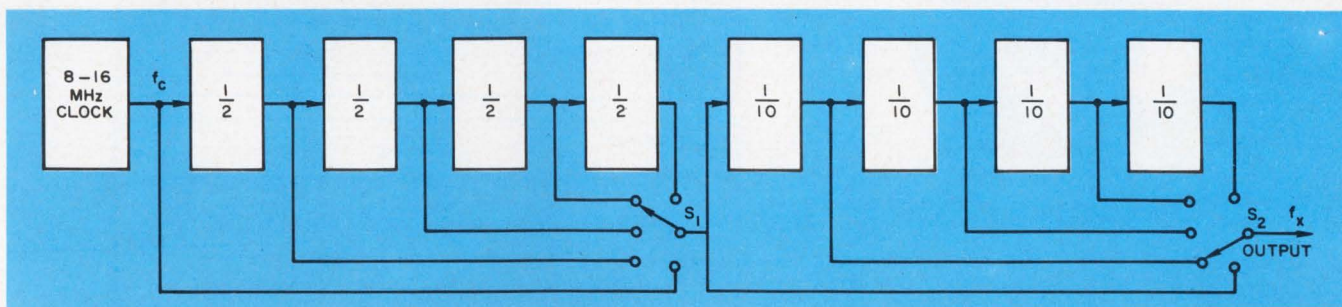

1. The flip-flops halve the original frequency,  $f_c$ , the number of times determined by the setting of switch  $S_1$ . Similarly  $S_2$  determines how many times decade counters divide the output of the first bank of flip-flops by 10. Thus the crystal-controlled output is the 16 possible

fractions of the crystal's frequency plus the undivided frequency itself. All other frequencies are filled in by varying the output of a small transistor oscillator over a range of one octave. Increasing the number of microcircuits extends the frequency range downward.







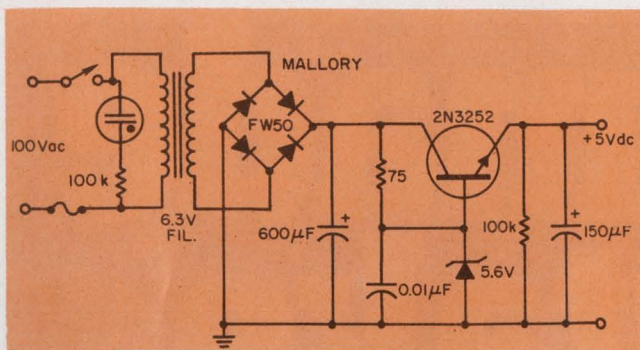

3. The power supply is made with a handful of discrete parts. The 5.6-V diode properly biases the transistor (2N3252). The pulse generator can be portable, if this power supply is replaced with a 5-V battery.

switch  $S_3$ . Three outputs of a decade counter are required to generate variable pulse widths. At the highest frequency range of  $S_2$ , however, the signal is tapped off prior to the first decade, thus precluding the variable-pulse-width feature.

### The synchronization pulse

The generation of a synchronization pulse is accomplished by "differentiating" the output signal. This is performed by exploiting the propagation delay of the logic devices.<sup>1</sup> By differentiation of either the output waveform or its logical complement, it is possible to generate the synchronization pulse at either the positive-going or the negative-going edge of the output pulse.

The output stage of the pulse generator consists of two parallel integrated-circuit line-drivers. These provide current-sinking for a fan-out of approximately 60 unit loads, where one unit load equals about 1.5 mA. The self-contained power supply for the generator consists of a full-wave rectifier, an R-C filter and a series regulating transistor with a Zener diode as a reference (see Fig. 3). An output capacitor is added to the supply, to filter out digital noise originating in the logic circuitry.

Tests of the prototype showed rise and fall times to be less than 10 nanoseconds for all frequency ranges. In the crystal-controlled mode, the output frequencies were stable and accurate to within 0.01% at room temperatures. The variable-width pulses were, for all frequencies, within 0.1% of their stated duty cycle. The output of the trigger circuit was a negative-going pulse of about 4 volts' amplitude and approximately 31-nanosecond duration.

### Improve the design

Although the pulse generator works well, many improvements are possible. Texas Instruments' TTL 7400 series logic was used. By using higher-speed TTL or ECL modules, the upper frequency limit can be extended beyond 20 MHz. The lower frequency

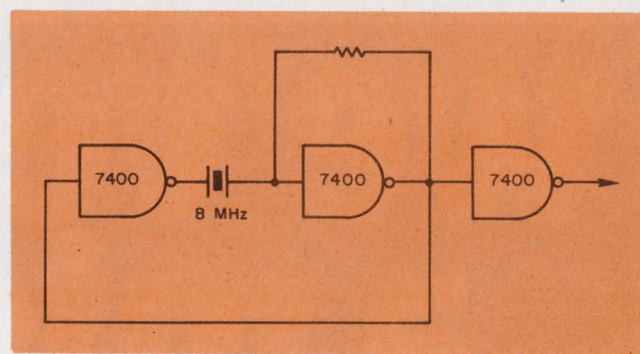

4. Even the master oscillator can be designed with microcircuits. Here's a simple design that uses three gates, a resistor and a crystal. The original prototype that we made, however, used discrete transistors.

limit is entirely a function of the number of counters used, and so is limited only by size and cost restrictions. Depending on the application of the instrument, different output configurations may be desirable. For example, an emitter follower might be required for impedance matching. Providing an interface circuit with a negative voltage swing enables the pulse generator to be used with MOS integrated circuitry. In addition the overall parts count can be greatly reduced by constructing the oscillator around a single IC, as shown in Fig. 4.

The size and weight of the pulse generator are determined only by the number of controls required and by the power supply. The pulse generator can be made completely portable by use of a single 5-volt battery capable of delivering 200 mA in place of the power supply. ■ ■

### Reference:

1. Herman Schmid, "Shrink A/D Conversion Costs," ELECTRONIC DESIGN, XIV, No. 25 (Nov. 8, 1966), 96-99.

### Test your retention

Here are questions based on the main points of this article. They are to help you see if you have overlooked any important ideas. You'll find the answers in the article.

1. How many frequencies in this design are crystal controlled?
2. What determines the working limit of the frequency range?
3. Over what range must the frequency of the master oscillator be variable to produce all frequencies from the lowest to the highest?
4. Does the generator produce synch pulses?
5. How many microcircuits were used in this prototype?



# we've made a mistake

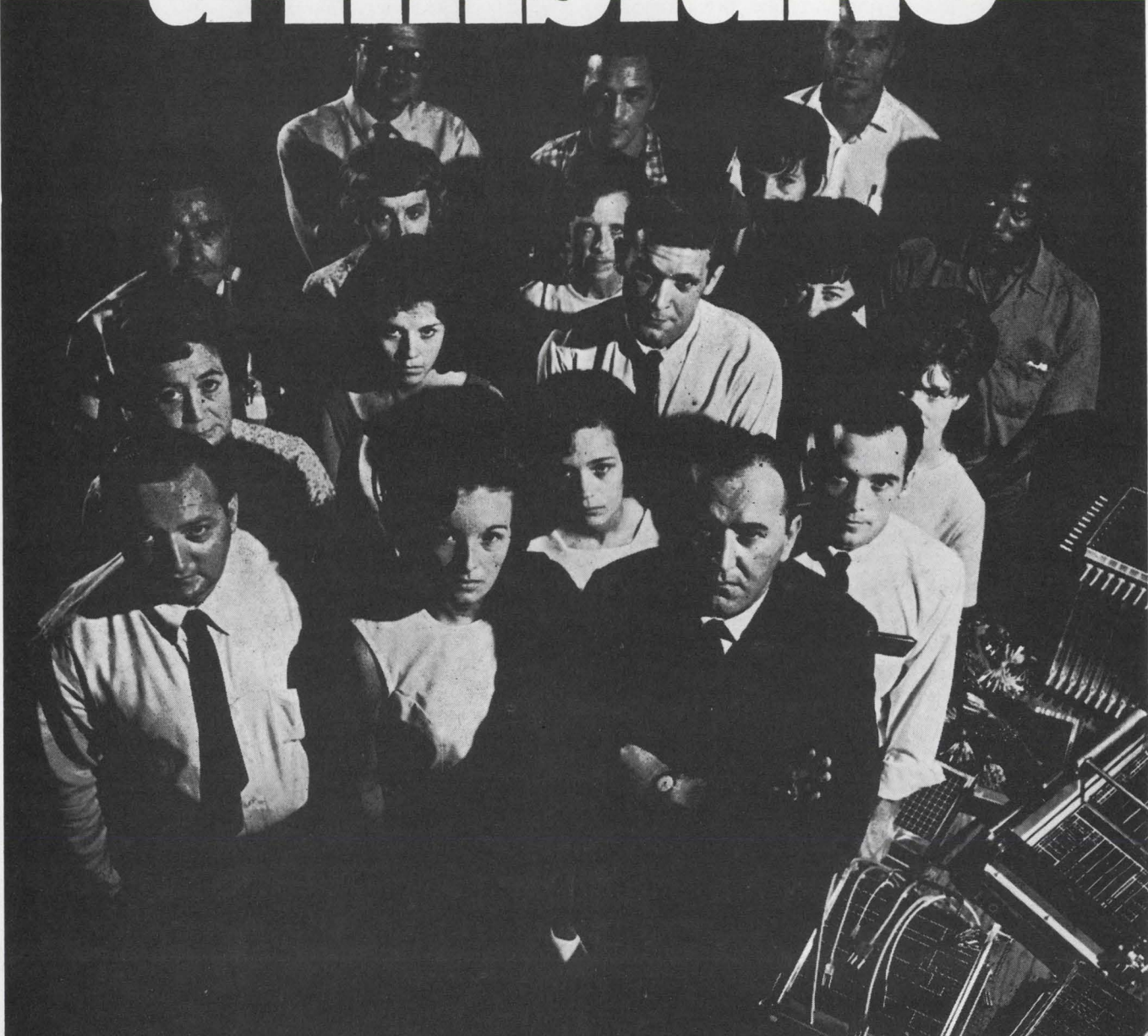

**...unless** there's no further engineering development in patchboard programming systems. We've made a mistake unless there's no need for faster deliveries. We've made a mistake unless there's no need for innovation and design improvements in receivers, removable patchboards, patchcords and accessories. □ Most of us have been in the programming business long enough to know these needs exist. So... here we are. Give us a try. If we're right you'll be hearing a great deal about us... if we're wrong you won't see us again. Send for Catalogs 567 and 667 and find out. ALLIED SYSTEMS CORP., 4 Tri-Port Circle, Greensboro, N.C. 27420

# A

ON READER-SERVICE CARD CIRCLE 50

ON READER-SERVICE CARD CIRCLE 49 ▶



# If you make (or use) educational TV cameras, here's good news.



There's a new Taylor-Hobson-Cooke family of lenses for Image Orthicon, Plumbicon, or Vidicon Cameras, both color and black and white. We call them the Varotal XX series of Zoom Lenses. These lenses do just about everything our other Varotals do for more than 600 professional broadcasters, but are lighter, smaller, and considerably lower-priced.

And they work equally well inside or outside. For instance, since there's no movement of external glass components during focusing, there's no change in air volume within the lens. This means no change in pressure to cause spongy movements. No pumping action to permit entry of dust or humid air. At last, a zoom lens sealed as tightly as one with a fixed focal length.

But don't think the lower price was made possible by fudging on quality. Our cantankerous English craftsmen wouldn't stand for that. Every lens still has to pass some 450 inspections before it reaches your camera. The optical axis must be centered to less than .0005 inches. The coating

has to give better than 83% light transmission.

What are the specs? The lens for the Image Orthicon Camera ranges from 40 to 400mm at f/5.6 and weighs 10 lbs. The lens for the Plumbicon ranges from 21 to 210mm at f/2.8 and weighs only 7 lbs. The Vidicon lens ranges from 16 to 160mm at f/2.2, and also weighs only 7 lbs.

So if you sell color or black and white cameras, the Varotal XX gives you a competitive edge when you're bidding. And if you buy cameras, congratulations. You're on the receiving end.

For more information, call Jim Tennyson at 914-358-4450. Or write Albion Optical Company, Inc., 260 North Route 303, West Nyack, N.Y. 10994. Telex 137442.



SOLE U.S. AGENTS FOR RANK TAYLOR HOBSON



## Profit by learning cost analysis.

Any engineer can spur his advance to the ranks of management by knowing how to control business expenses.

### First of three articles

You're a design engineer, and there's no reason why you should be concerned with costs and budgets. After all, that's the job of the controller's department. Right?

Wrong.

Regardless of your engineering responsibility, a working knowledge of costs and budgets is an asset.

As a design engineer, it will give you a better understanding of the total company structure and where you and your department fit into it. If you want to move into management, you will find a background in cost and budgets invaluable.

Even front-line or middle managers may need a refresher course to live successfully within their budgets and make the best use of allotted funds.

Fortunately, as an engineer you have a head start in learning about costs. Your engineering training has stressed rationality, analysis and decision-making based on facts. These same techniques are used in cost analysis.

### Three kinds of costs

There are three types of costs: *fixed*, *variable* and *mixed*. All costs are classified on the basis of how they are affected by changes in volume.

*Fixed costs* are those that remain constant regardless of production or sales volume. Typical examples are depreciation, property taxes, rent, most insurance and salaries.

*Variable costs* vary directly with volume. The best example of a pure variable—one that varies directly with sales volume—is a commission. Two other examples are materials and direct labor.

A true variable cost has these characteristics:

- There is a direct relationship between the cost and the level of activity.
- The initial cost is incurred at the start of production or sale of the product and not when the plant is established.

In between these two are *mixed costs* which combine the characteristics of fixed and variable. Some mixed costs have a fixed base and then an additional increment that increases in a straight line as volume—usually production volume—increases.

Other costs are mixed in that they stay at a given

### Advice from the summit



If engineering managers could relive their past, what training would they seek more of before moving up to management?" "More business and finance."

That was the answer given by 80% of engineering managers in a survey by ELECTRONIC DESIGN

(ED 21 and 22, Oct. 11 and 25).

Recognizing the need for such training, therefore, we begin a three-part series with this issue, designed to give engineers who hope to move up, as well as engineering managers who want a review, some of the basics of business and finance. The articles will explain how to analyze, evaluate and control costs.

The first article deals with the identification and formulation of costs. The second (Nov. 22) will show how such data are used in budgeting. The third (Dec. 6) will evaluate the effects of costs and volume in management decisions.

The series is being written by Lawrence M. Matthews, vice president of Stevenson, Jordan & Harrison of New York City, management consultants.

Matthews conducts seminars in a variety of management subjects for the Industrial Education Institute. His programs have also been sponsored by the American Management Association and by universities.

level for a relatively narrow range of activity, then step upward for the next higher range, such as indirect labor. For example, maintenance costs go up in steps as each man is added to the force.

If you examine costs closely, you'll soon realize that there are very few pure variable or absolutely fixed costs. Most fall somewhere between the two extremes.

Here are examples to illustrate this point:

---

Analyzing costs (opposite) are Newton Chapnick (left), manager of reliability engineering, and George O'Sullivan (right), vice president, engineering, Consolidated Avionics, Division of Condec Corp., Westbury, N. Y.





*“Regardless of the level of your responsibility, a working knowledge of costs and budgets is a definite asset.”*



■ The fixed costs just cited are not fixed ad infinitum. At some point, as volume increases or decreases substantially, corresponding increases or decreases can be expected. For example, if additional product lines are added, more engineers may be needed. Thus the fixed cost of salaries will rise.

■ Even the cost of materials is not always a pure variable. For example, you invariably have scrap. Therefore, some portion of the material—namely, the scrap—may have to be treated as an accepted and fixed cost. This scrap, then, is a portion of the material that is not a pure variable.

### Why analyze costs?

The reason you are breaking down costs this way is that you are looking for a better basis for management to make decisions, such as setting up flexible operating budgets and determining into which products the marketing department should put its major effort, as well as looking for areas of potential cost improvement. For these reasons, you must analyze, identify and formulate your costs.

To illustrate, consider fixed costs. The examples previously cited are also called *burden costs* (or overhead), which gives a clue to what they mean in the over-all financial picture.

Your company has relatively little control over burden costs. Regardless of production volume, these costs will occur and must be paid. Before your company can show a profit, it must first meet this overhead.

Therefore, assuming things don't become so bad that workers must be discharged and a smaller plant leased, you must look to variable and mixed costs for cost improvement. Both have one thing in common: variable increments. Both rise in relation to volume. Thus, they are termed *controllable costs*.

To control these costs, you must first analyze them and calculate the size of the variable increments of each over a period of time. It is from these increments that you usually will find areas to control costs.

Also, determine the variable cost for each product. A total of all variable costs will not give a true picture of any individual product.

### How to analyze costs

Now that you know what types of costs there are and why you should analyze them, start the analysis:

1. Select a measure that is representative of departmental activity over, say, the most recent 12 months. The measure selected will depend upon the department being analyzed, and it may be the number of pieces produced, the direct labor hours involved, tons, yards or gallons produced.

2. For the given cost being analyzed, match the actual dollars spent in each of the 12 months against

the activity measure for each month. Thus, dollars of cost in January is matched against January's activity as expressed by the selected measure.

3. It is helpful next to plot the dollars of cost versus the activity on graph paper. The resulting data are then studied in the light of the manager's experience to determine the realistic formula or tabulation that can be used to predict how this cost will or should act in the future.

To illustrate this procedure, plots for the two most common types of mixed costs, *linear* and *step*, will be worked out.

Assume that at a given plant, cost data are being compiled to be used in product cost estimating to set up flexible operating budgets. The two particular costs to be analyzed are "electrical power" and "receiving and shipping labor." It has been determined that the total direct labor hours in the plant are a realistic measure of total plant activity. This activity measure is the base against which variations in this and other costs will be gauged in your cost analysis.

(The costs to be analyzed in this situation happen to involve the total plant operation. The same procedure can be followed for a specific department, division or product. Also, in this instance "total plant direct labor hours" is used as the measure; "total direct labor wages," "total materials used" or some other measure could have been chosen.)

The data to be analyzed are:

Month	Activity measure direct labor hrs.	Power cost	Rec., Ship. labor cost
Jan.	5900	\$2900	\$2900
Feb.	6000	3400	2800
Mar.	6600	3500	3200
Apr.	6500	3100	3000
May	5200	3000	2600
June	3400	2100	1700
July	3200	1800	1850
Aug.	3600	2400	2000
Sept.	3900	2100	1800
Oct.	4400	2600	2200
Nov.	5000	2500	2300
Dec.	4600	2200	2400

Before you plot the costs, ask yourself why these two costs, electrical power and receiving and shipping labor, are mixed—that is, why both fixed and variable costs are combined.

Now, plot the two costs on separate graphs. Are they linear (straight line) or step costs?

Figure 1 shows what your graph for electrical power should look like. The activity measure (direct labor hours) is scaled along the *x* axis and electrical power costs along the *y*. Once the scattered points are plotted, they are best described by a straight line. It is preferable to determine this line by the Method of Least Squares (see box on page 99).

The manager's knowledge of how electrical power



# Least Squares Method yields best fit

The Method of Least Squares is widely used to draw a straight line of best fit through a set of experimentally obtained points. It consists of determining all deviations of observed points from such a line, squaring them, and then minimizing this sum of squares.

Here is the essence of the method:

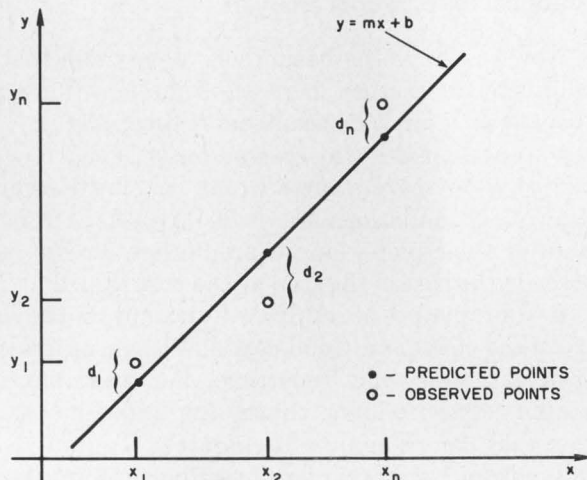

A straight line that comes closest to fitting a set of experimentally observed points is determined by finding all deviations of this line from the observed values of  $y$ , squaring and adding them, and then minimizing this sum.

Consider a set of experimentally observed points (above) such as  $(x_1, y_1), (x_2, y_2), \dots, (x_n, y_n)$ . The problem is to find a straight line

$$y = mx + b \quad (1)$$

that best fits all these points.

Corresponding to each value of  $x$  are two values of  $y$ —namely, the observed value,  $y_{obs}$ , and the value predicted by the straight line  $mx_{obs} + b$ . This difference

$$y_{obs} - (mx_{obs} + b) \quad (2)$$

will be called a deviation,  $d$ . Each deviation measures the amount by which the predicted value of  $y$  falls short of the observed value. The set of all the deviations

$$d_1 = y_1 - (mx_1 + b), \dots, d_n = y_n - (mx_n + b) \quad (3)$$

is indicative of how closely the predicted line, Eq. 1, coincides with the observed data. If you can minimize these deviations, you will obtain the line of best fit.

Obviously some of the deviations will be positive, some negative. Their squares, however, will be all positive, and the equation

$$f(m, b) = (y_1 - mx_1 - b)^2 + (y_2 - mx_2 - b)^2 + \dots + (y_n - mx_n - b)^2 \quad (4)$$

counts both positive and negative deviations equally. Note that in this expression the desired constants  $m$  and  $b$  are treated as variables for the time being. This sum of squares of deviations depends on the choice of  $m$  and  $b$ ; it is never negative, and it can be zero only if  $m$  and  $b$  have values that produce a straight line of perfect fit. Another way of saying this is: "Take as the line  $y = mx + b$  of best fit that one for which the sum of squares of the deviations

$$f(m, b) = d_1^2 + d_2^2 + \dots + d_n^2 \quad (5)$$

is a minimum."

To determine such a minimum, we apply the standard minimization procedure—that is, that of taking derivatives of this sum with respect to  $m$  and  $b$ , setting the results equal to zero and solving the two equations with two unknowns for  $m$  and  $b$ .

Here is an example: Suppose we have a set of observed points  $(0, 1), (1, 3), (2, 2)$ . The first numbers in each parentheses are the observed values of  $x$ , and the second numbers are the observed values of  $y$ .

We must first form the deviations and their squares. Let's do this in this table:

$x_{obs}$	$y_{obs}$	dev. = $y_{obs} - mx_{obs} - b$	dev. <sup>2</sup>
0	1	$1 - b$	$1 - 2b + b^2$
1	3	$3 - m - b$	$9 - 6b + b^2 - 6m + 2mb + m^2$
2	2	$2 - 2m - b$	$4 - 4b + b^2 - 8m + 4mb + 4m^2$

Adding all expressions in the last column, we get the sum of deviations:

$$f(m, b) = 14 - 12b + 3b^2 - 14m + 6mb + 5m^2 \quad (6)$$

Now we differentiate this expression with respect to  $m$  and set it equal to zero:

$$\partial f(m, b) / \partial m = -14 + 6b + 10m = 0 \quad (7)$$

Then we do the same for  $b$ :

$$\partial f(m, b) / \partial b = -12 + 6b + 6m = 0 \quad (8)$$

Rearranging Eqs. 7 and 8, we get

$$6b + 10m = 14, \quad (9)$$

$$6b + 6m = 12. \quad (10)$$

Subtracting Eq. 10 from 9, we get

$$4m = 2,$$

$$\therefore m = 1/2.$$

Substituting this value of  $m$  into Eq. 9 or 10, we get

$$b = 1 - 1/3.$$

Consequently the best equations for the best straight line for the set of points of this example is

$$y = x/2 + 1 - 1/3.$$



is used and paid for, combined with the line describing the 12 plotted points, indicates that a linear relationship exists between this cost and activity. Thus, the power is a linear mixed cost.

Why? All evidence shows that it does not start from a base of zero dollars at zero activity. Instead the data show a fixed base and then a direct, linear increase as activity rises.

With the Method of Least Squares, the formula for this cost is:

$$\text{Monthly power cost} = \$408 + 42\text{¢} \times \text{direct labor hours}$$

With this formula, you can predict what the cost will be for intermediate activity levels. At the end of a budget month, when the total direct labor hours are known, the formula can be applied to establish the budgeted allowances for electrical power costs. Similarly, it can be used in estimating product costs and in profit planning.

Now examine the data for receiving and shipping labor (see Fig. 2). Again, activity data are scaled along the x axis and dollars of cost along the y.

If you consider only the plotted points, you might conclude that a linear relationship exists between this cost and activity, as in the previous analysis. However, if you are familiar with the operations of individual departments, you know that this would be an incorrect conclusion.

Often in indirect labor use, which this is, a given crew size is sufficient only up to a certain level of activity. Above that activity, additional manpower must be added. Thus the cost literally rises in steps.

This analysis illustrates why the cost analyst must be familiar with company operations. Often cost figures alone don't give a true picture. Subjective evaluations are also necessary at times.

The step mixed cost is usually expressed in table form. The tabulation in this case would be:

**Monthly cost of receiving & shipping labor**

Direct Labor Hours	\$ of Cost
3000 to 4000	= 1800
4001 to 5000	= 2250
5001 to 6000	= 2700
6001 to 7000	= 3150

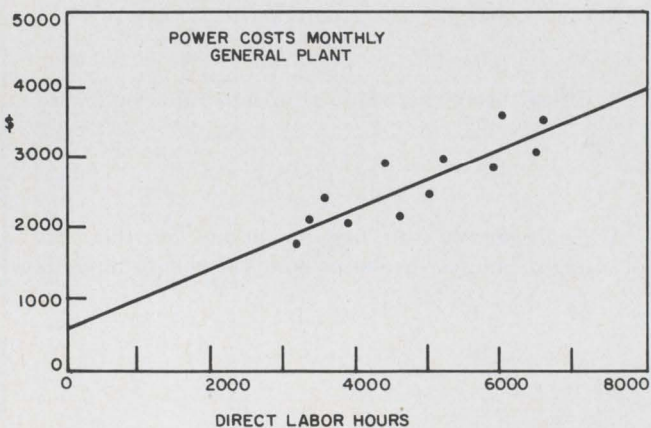

figure 1

You may think it is illogical to say that when direct labor hours rise from 4000 to 4001, an additional \$450 monthly cost will result. But some arbitrary break between step levels must be selected, and the evidence supports this selection.

Here's one final point on plotting mixed costs:

You may logically expect that certain items of cost will vary directly with volume at a decreasing or increasing incremental value, rather than at a constant increment. However, in practice, such parabolic curves are a rare phenomenon in cost analysis, budgeting and estimating work.

**Practical hints in cost analysis**

Now you have the basic tools of cost analysis. To complete the picture here are some additional tips to make your analysis results more meaningful:

- Your first duty in cost analysis is to know the company operation. Some wrong conclusions can be drawn if formulations are developed solely from the data or their plots. One example has already been given in the case of the step mixed cost (Fig. 2).

- Your analytical results will depend on the quality of the cost data. Good cost analysis requires good cost gathering and reporting. For example, you should segregate large, continuing items of costs, so that they can be analyzed separately. To lump welding rods and gasses under operating supplies, for example, may result in inadequate control of both.

- Within practical limits, charge costs as close to the time of use as possible. When a three months' supply of an item is charged to a department at one time, the costs are distorted for all three months. They are overstated in the month charged and understated for the two other months. This is particularly important on high-cost items.

- The very act of plotting your cost data against activity can yield clues to recent cost performance. If the plot shows a wide deviation and you are satisfied with the quality of the cost reporting, chances are the cost is relatively uncontrolled. As a result, you have a good area for potential cost savings.

- When one or more plotted points fall well above the line, further and detailed study of those months

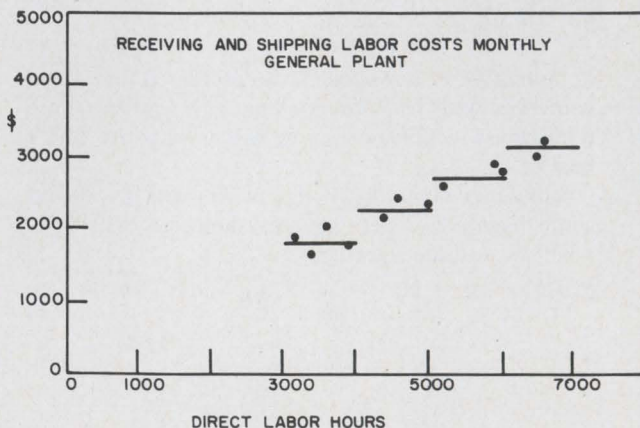

figure 2



## Glossary of terms

**Activity measure**—This is the specific yardstick that is felt accurately reflects or measures the level of activity of a cost center. It is against this activity measure that costs in the center will be matched, to predict how the costs may act in the future.

**Cost center**—A segment of the enterprise under the direction of a specified member of management who is responsible for the effective operation of that segment. A typical example of a cost center in a capacitor plant would be electrolytic capacitor winding, which is under a specific foreman. When a given cost center is very large or involves great amounts of money, subdivisions of the center, called subcenters, may be used.

can uncover poor operating practices that warrant correction. Conversely, points well below the line reveal a temporary method or practice that should become standard.

- If you plot cost versus activity monthly and end up with too diverse a pattern to make a meaningful decision, then try plotting for two-month periods. The 6 points may reveal a pattern and relationship not apparent with 12 points.

- The relationship between cost and activity often forms a pattern only when one month's cost is plotted against the previous month's activity. This is because your company will usually charge off the bill a month after the service or material is used.

- The cost analyst often has to use the data available to him without being able to make a detailed, intensive investigation of them. In these cases, when working in an area of relatively uncontrolled costs, he should base his cost formulations on lower levels than those experienced in the past.

- Whenever possible and practical, use the Method of Least Squares and avoid eyeballing the line to describe the plotted points. When a mixed cost is erroneously formulated as a pure variable, it is understated or under-allowed at the lower levels of activity and overstated or over-allowed at the higher levels of activity.

- Be realistic in analyzing and formulating costs. Utilize the available data. You are predicting costs for levels of activity that are actually going to be experienced, not for some unrealistic theoretical minimum. ■ ■

*The second article in this series will discuss cost information as it relates to preparing and interpreting budgets.*

### Bibliography:

Maynard, H. B. *Handbook of Business Administration*. New York: McGraw-Hill Book Co., 1967 (\$29.95).

Moroney, M.J. *Facts from Figures*. Baltimore, Md.: Penguin Books, 1951 (\$1.95).

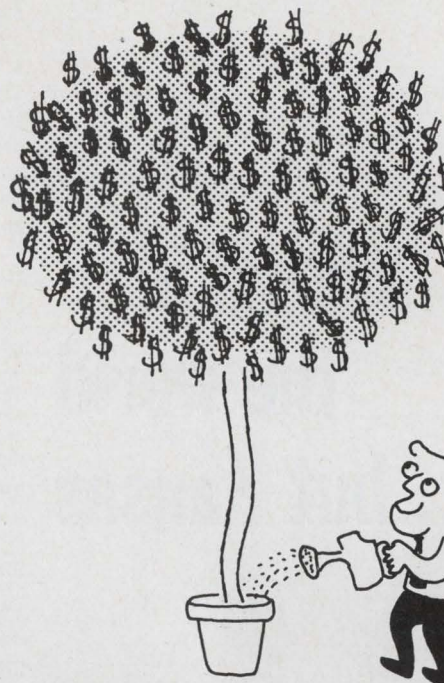

**Profits don't grow on tress:** The successful company doesn't leave cost control to chance. Cost analysis is the first step in preparing a budget. The entire budgeting process is the single most effective method for a company to control costs and then attain or increase its profits.

### Test your retention

*Here is a problem based on the main points of this article. It will help you see if you understand the article. You'll find the solution on page 218.*

*An electronics components plant has a capacitor winding department. The winding machine operators are on a standard hour incentive plan so that when an operator produces 10 standard hours of work in an 8-hour shift, she is paid 2 hours of bonus. The standards hours produced by all operators have been determined to be a meaningful measure of departmental activity. Along with other items of cost, it is necessary to analyze, identify and formulate two specific costs—namely, operating supplies and set-up labor. You have these data:*

Month	Std. hrs. produced	Set-up labor cost	Operating supplies cost
Jan.	3200	\$1600	\$440
Feb.	3900	1850	680
Mar.	3800	1950	560
Apr.	4100	2050	540
May	4700	2100	680
June	5300	2400	760
July	6500	3050	800
Aug.	5500	2650	720
Sept.	4800	2550	620
Oct.	3900	2200	640
Nov.	3300	1550	540
Dec.	2800	1400	520



# Where in the world ...but Kansas

Kansas' waterways, lakes and reservoirs provide ample opportunity to enjoy the great outdoors with the family. This is sand-beached Lake Afton, located just west of Wichita. Let us tell you more about Kansas and send your free musical recording of "Where In The World But Kansas." Fill out, and mail us the coupon on this page.

**FLIGHT TEST:** Design airborne instrumentation. Test and analysis related to production or prototype aircraft systems.

**OPERATIONS ANALYSIS:** Develop conceptual missions for future military aircraft. Use advanced mathematical techniques and cost effectiveness methodology to define aircraft systems which satisfy the mission and cost requirements.

**STRUCTURAL DESIGN:** Design of major air-frame structural components and perform preliminary stress analysis.

**STRESS ANALYSIS:** Research of load-paths and strength characteristics of aircraft structure. Perform strength checks and formal stress analysis.

**STRUCTURAL DYNAMICS:** Perform analysis of complex structure vibration, aeroelastic and design loads.

**AVIONICS:** Analysis and development of electro-optical sensor systems, long range airborne communications, forward looking infrared systems, ELINT/DF systems, radar, navigation/guidance systems. Integration design and installation of aircraft electrical/electronic equipment.

**ANTENNA SYSTEMS:** Perform design, performance evaluation and analysis of antennas, radomes and RF transmission systems, utilizing both digital computer and laboratory test evaluations.

**MECHANICAL SYSTEMS:** Design and development of air systems, engine systems or equipment systems.

**HYDRAULICS:** Perform analysis and design of aircraft hydraulic systems, including hydraulic pumps, motors, actuators and other system components.

**CONTROL DYNAMICS:** Perform servo control analysis; involves analog and digital computer application in development of automatic flight controls. Analysis techniques include both classical and modern control theory.

**FLIGHT CONTROL SYSTEMS:** Establish design criteria and specifications for automatic flight control systems, subsystems and components; establish systems configurations and coordinate procurement and testing phases.

**SCIENTIFIC COMPUTING SYSTEMS:** Programming engineering applications (structural analysis, digital simulation, fluid dynamics, propulsion systems analysis) with emphasis on the integrated system approach. Use of geometric mathematical models is also involved.

**Inquiries are also invited in other areas of Technical Competence.** Salaries are competitive and commensurate with experience and educational background. Travel and moving allowances are paid to newly hired personnel. Boeing is an equal opportunity employer and complies with the provisions of the Civil Rights Act of 1964.



**TELEPHONE COLLECT**  
Area Code 316, MUrray 7-2239

Monday through Friday  
8:00 AM to 4:30 PM, CST

Details of a career with Boeing in your specific area of engineering interest will be promptly provided. For a free 45 RPM recording of "Where In The World But Kansas" by composer Bill Post and Chorus, mail the coupon below, or write in confidence to G. A. Caywood.

GERALD CAYWOOD, DEPT. B7K BOEING PROFESSIONAL EMPLOYMENT OFFICE WICHITA, KANSAS 67210	Name _____
	Address _____
	City _____
	State _____ Zip _____

**BOEING**

**Wichita (Kan.) Division 67210**

OTHER DIVISIONS: Commercial Airplane • Missile and Information Systems • Space • Vertol • Also Boeing Scientific Research Laboratories



# Free Career Inquiry Service

## Absolutely Confidential

Respond to the career opportunities advertised in this issue. Fill out and send us this handy resume. **Electronic Design** will do the rest – neatly typed copies of this form will be mailed to the companies of your choice, indicated by the circled Career Inquiry Numbers at the bottom of this page.

# 23

<b>Name</b>		<b>Home Phone</b>	
<b>Home Address (Street)</b>		<b>City</b>	<b>State</b>   <b>ZIP Code</b>
<b>Age</b>	<b>U.S. Citizen</b> <input type="checkbox"/> Yes <input type="checkbox"/> No	<b>Security Clearance</b>	

Prime Experience	Secondary Experience

<b>Desired Salary</b>	<b>Availability Date</b>
-----------------------	--------------------------

**Employment History – present and previous employers**

Company	City, State	Dates	Title
		to	
		to	
		to	

**Education – indicate major if degree is not self-explanatory**

Degree	College	City, State	Dates
			to
			to
			to

**Additional Training – non-degree, industry, military, etc.**

---



---

**Professional Societies**

---

**Published Articles**

---

**Career Inquiry Numbers:**

900	901	902	903	904	905	906	907	908	909
910	911	912	913	914	915	916	917	918	919

**ELECTRONIC DESIGN**  
 850 Third Avenue  
 New York, New York 10022



## Efficiency raised to 94% in switching regulator

**Problem:** Reduce the losses in the control networks of series regulators. A switching type of series regulators needs a control network for the switching element. Such a network is usually operated by the source that supplies power to the load, and it draws considerable power that is dissipated as a resistive loss. This resistive loss must be removed from the regulator with a bulky heat sink, so that the switching element can operate stably. The loss reduces the efficiency of the regulator circuit.

**Solution:** Design a switching series regulator circuit in which substantially all of the current applied to the control circuit is fed to the load through an inductive network.

The improvement in efficiency can be understood with the aid of the accompanying circuit diagrams.

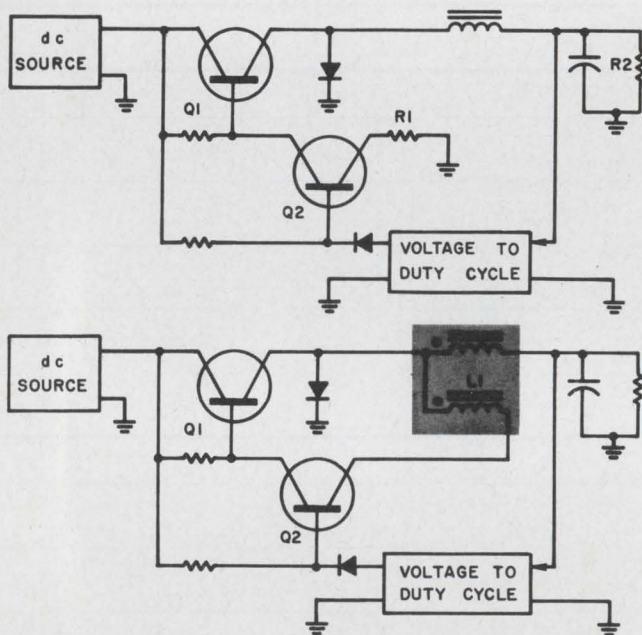

In the upper figure, the driver transistor  $Q_2$  derives its collector current  $I_c$  through  $R_1$ , which causes a considerable power loss,  $I_c^2 R_1$ .

In the lower figure, collector current  $I_c$  is obtained from secondary winding, or tap, on inductance  $L_1$  which is otherwise unchanged. In this way current  $I_c$  is obtained from a low-impedance circuit with resultant low  $I_c^2 R$  losses. In addition  $I_c$  contributes to the load current flowing through  $R_2$  because of the transformer action of the modified inductance  $L$  as the load current increases. Thus the base driving current  $Q_1$  increases as the load current is increased, and this causes  $Q_1$  saturation voltage to remain low.

This approach raises the efficiency of a regula-

tor from 83.8% to 94.5%. With virtually no increase in complexity or cost, appreciable reduction in size is achieved by elimination of the heat-sink requirement.

*Inquiries about this invention may be directed to: Technology Utilization Officer, Manned Spacecraft Center, Houston, Tex. 77058. Reference: B67-10190.*

## Adjustable marker calibrates spectrum analyzers rapidly

**Problem:** Calibrate spectrum analyzers rapidly. Present methods use internal crystal-controlled markers at only one given frequency and spacing, thus limiting over-all measurable accuracy. An external signal generator with a known frequency can be used, but it is very time-consuming.

**Solution:** Devise a system that has a family of adjustable markers at any point in the spectrum.

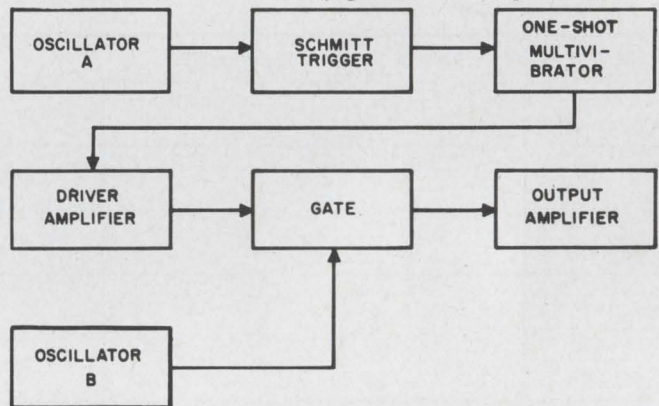

In the accompanying diagram, oscillator A drives the Schmitt trigger that inhibits the one-shot multivibrator. The output pulse-width is determined by the timing capacitors and a variable resistor, manually operated from a front panel.

The one-shot multivibrator output is fed to a driver amplifier that operates a gate, which controls the signal supplied by oscillator B. The number of markers is determined by the pulse-width controls. The unit will operate with a repetition rate of 300 Hz to 40 kHz at a center frequency of 10 kHz to 2 MHz.

Used as an airborne system, selective calibration of various spectral data could be readily accomplished by replacing oscillators A and B with VCOs, controlled by ground-based telemetry.

*Inquiries about this invention can be made to: Technology Utilization Officer, Manned Spacecraft Center, Houston, Tex., 77058. Reference: B67-10254.*





# EE'S

with military communications  
equipment experience

## call us collect

area code 317/459-2808

Rapid expansion of our ground based and airborne military communications capability has created urgent requirements for electrical engineers (B.S. or M.S.) at Delco Radio.

Opportunities at all levels—beginning, through supervisory, with 2-10 years experience—in the following areas:

Digital communications in the HF, VHF, and UHF bands

Single side band design, HF, and VHF

Frequency synthesizer techniques in all frequency ranges

Wide range electronic tuning

Retransmission techniques

Secure communications techniques

Man-portable and vehicular battle area communications equipment

Acoustic transducers, antennas, and micro-electronics applications.

Call us collect for an interview or more information. Area Code 317/459-2808. Ask for C. D. Longshore. Or send your resume to Mr. Longshore, Supervisor, Salaried Employment, Dept. 203, Delco Radio Division of General Motors, Kokomo, Indiana.



MARK OF EXCELLENCE

## DELCO RADIO

DIVISION OF GENERAL MOTORS • KOKOMO, INDIANA

An equal opportunity employer



## ENGINEERS

# Univac Twin Cities is a young exciting place to work!

Univac is an exciting, big league company in a young, big league city. *We like it here.*

We like the choice of colorful major league football, baseball or hockey. We like to pick and choose from dozens of fine restaurants with big league flavor.

We like to swim, ski, skate, fish and hunt. We like to choose from over 10,000 lakes.

We like to live in the leisure of suburbia—minutes driving time from our offices.

We like the challenge and career growth that comes from belonging to the finest hardware/software manufacturer in the computer field.

We'd like to have you join us. Do you have experience in the following areas?

- **Computer Logic Design**
- **Computer Graphics and Displays**
- **Advanced Manufacturing Techniques**
- **Reliability and Failure Analysis**
- **Industrial Engineering**

If you do, write and tell us your goals for today and tomorrow. Write R. K. Patterson, Employment Manager, Dept. 113, address below:

# UNIVAC

FEDERAL SYSTEMS DIVISION  
2750 WEST SEVENTH BLVD.  
ST. PAUL, MINNESOTA 55116  
AN EQUAL OPPORTUNITY EMPLOYER M.F.

ON CAREER-INQUIRY FORM CIRCLE 902

## Book Reviews

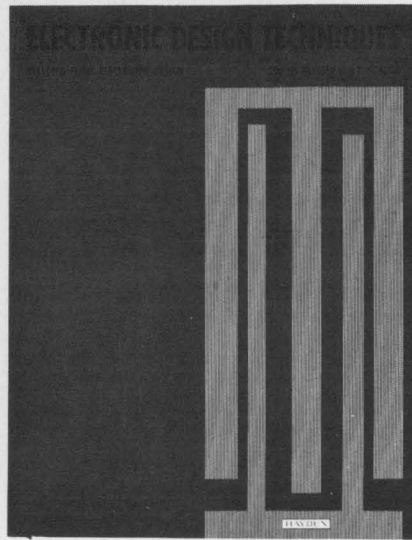

### Technique Guide

*Electronic Design Techniques*, Edited by Edward E. Grazda (Hayden Book Co., Inc., New York) 312 pp. \$12.75.

Here is a book that in 312 pages packs as much practical information on a variety of engineering subjects as a small technical library. More than 55 outstanding technical articles have been selected from past issues of *ELECTRONIC DESIGN* to cover theory, design examples and nomographs for digital systems, automatic control, network theory and circuit design.

All of it is written for practicing engineers by practicing engineers. All articles include design examples.

Edward E. Grazda, the Hayden Publishing Co.'s editorial director, scanned all issues of *ELECTRONIC DESIGN* for the last few years to retrieve these technical articles. Seven general areas of engineering are covered—from amplifier design to tests and measurements.

Recommended for all design engineers as a desk-top reference.

CIRCLE NO. 457

As a further service to our readers, *ELECTRONIC DESIGN* is now including a Reader's Service number with book reviews. Publishing companies have agreed to supply information about their books to interested readers.

### Oscillography Manual

*Manual of Oscillography*, Howard J. Hoadley (Focal Press, London), 384 pp. \$28.

A sweeping view of oscillography, the technique of analog graphic recording is offered. Beginning with the history of oscillography, the author discusses many varieties of oscillographers, including transducers, light-beam oscillographs and oscilloscope recorders. Step-by-step procedures, as well as abundant charts, tables and photographs, give the book practical value.

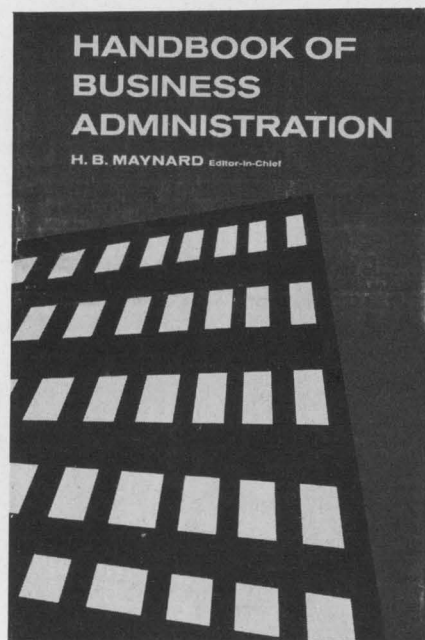

### Administration Handbook

*Handbook of Business Administration*, H. B. Maynard, Editor (McGraw-Hill, New York), 2050 pp., \$29.50.

This massive volume is exactly what its title says it is. It covers just about every area of management. It can help the engineering manager solve problems within his department and it can give all engineers insights into all areas of the company setup.

Seventeen sections range from problems relating to profitable R&D operation to management of human resources; from the vital function of marketing to financial management.

Nearly all of its 166 chapters contain a bibliography.

It's a valuable addition to any company library, as well as a useful reference for engineers.

CIRCLE NO. 458



# Lockheed's, "secret weapon" for winning electronics engineers

It's scope. A unique range of projects and assignments at Lockheed, covering the entire spectrum of electronics from major systems to solid state devices.

Programs include:

Poseidon and  
Advanced

Polaris, strategic  
ballistic missiles; P-3C Orion, the U.S.  
Navy's foremost ASW search plane and  
other airborne anti-submarine

systems; YF-12, the  
world's fastest jet,  
now in major develop-  
ment phase; airborne monitoring  
systems; gunfire control systems;  
electronic sub-systems; MADAR (Mal-  
function Detection Analysis and Record-  
ing) equipment; computer-aided design;  
memory devices and systems; advanced  
3D radar systems; and many more.

Immediate openings at Lockheed include:

Circuit design, hardened circuitry,  
metrology, flight control electronics,  
reentry electronics, reentry elec-  
tronics systems design, underwater  
instrumentation, optical/radar  
systems, airborne electrical power  
systems, hybrid microelectronics,  
electromechanical packaging, radar  
communications, RF and solid

state circuit design, CRT  
and solid state displays,  
real-time programming,  
memory core design, elec-  
tronics systems design, antenna systems,  
phased array antennas, microwave de-  
vices, and others.

To summarize: Electronics engineers at  
Lockheed find themselves in a "choice"  
position. With a choice of projects,  
assignments and geographic locations  
from coast-to-coast.

Address inquiries to Electronics  
Engineering  
Employment  
Manager  
at the Company  
of your choice.

*Lockheed-California  
Company, Burbank,  
California. Lockheed Electronics  
Company, Plainfield, New Jersey—*

for locations in Plainfield as well as  
Houston, Texas, Los Angeles, California,  
Greenbelt, Maryland. *Lockheed-Georgia  
Company, Atlanta, Georgia. Lockheed  
Missiles & Space Company, Sunnyvale,  
California—for locations in Sunnyvale  
and Palo Alto, California, or Huntsville,  
Alabama. Lockheed is an equal  
opportunity employer.*

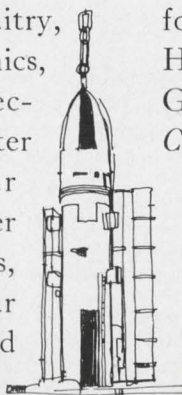
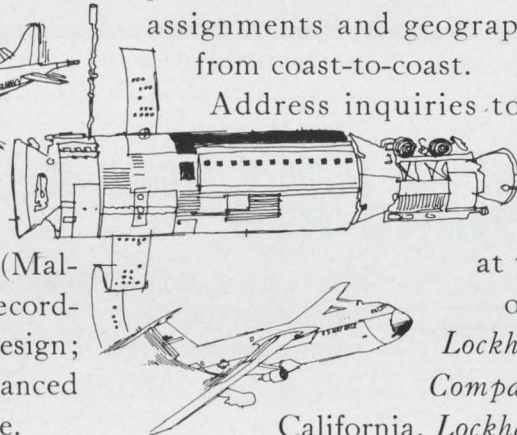
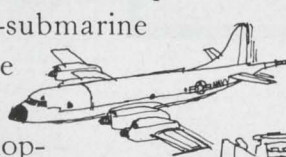
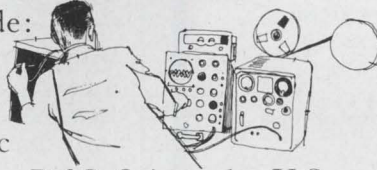
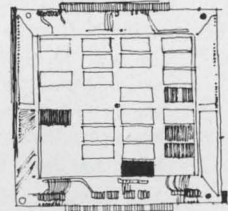

**LOCKHEED**  
LOCKHEED AIRCRAFT CORPORATION

ON CAREER-INQUIRY FORM CIRCLE 903



## Why Make Trade-offs in Your Career?

You make trade-offs all the time in engineering—giving up cost advantages, say, for miniaturization and light weight. But are you making trade-offs with your personal career, too? Giving up a pleasant place to live for a good salary? Or submerging yourself in a mammoth engineering staff so you can work on big aerospace projects? You don't have to, you know! Look into L.S.I. We design and produce advanced flight reference, navigation, communication and display systems. As a result, we have a team of 450 crack engineers making important contributions to every major aerospace program. They've gained recognition—and are well rewarded, too—because everybody here knows that our engineers are the backbone of the company. And our men live in a pleasant, medium-size city just minutes from the office and high-rated schools, in the heart of Michigan's year 'round vacationland. If you'd like to have your cake and eat it too, write in confidence to L. A. Mellinger, Professional Employment Manager. Some of the many opportunities now available include these disciplines:

COMMUNICATION SYSTEMS  
RECEIVER SYSTEMS  
NAVIGATION SYSTEMS

CIRCUIT DESIGN  
ELECTRONIC PACKAGING  
SYSTEMS ANALYSIS

LEAR SIEGLER, INC.



AN EQUAL OPPORTUNITY EMPLOYER

INSTRUMENT DIVISION

4141 EASTERN AVE. S. E., GRAND RAPIDS, MICHIGAN 49508

ON CAREER-INQUIRY FORM CIRCLE 904

## BOOK REVIEWS

### Basic IC technology

*Integrated Circuit Engineering, Basic Technology*, The Staff of Integrated Circuit Engineering Corp., Phoenix, Ariz.: (4th ed. Boston Technical Publishers, Inc., Cambridge, Mass.), 391 pp.

It's a rare opportunity when an engineer can find a truly comprehensive reference dealing with a relatively young technology. This book presents that opportunity.

From chapter 1, "The Economic Impact of Integrated Circuits" through chapter 20, "Future Capabilities," every aspect of integrated-circuit technology is treated in considerable detail.

Of special value to the electrical engineer are those chapters dealing with the materials and processing aspect of IC technology. The diminutive circuits have made it necessary for electronic engineers to learn to communicate effectively with his chemical and metallurgical counterparts. This task can be greatly simplified by taking maximum advantage of the material presented in this book.

Also of interest and importance are those chapters dealing with the testing, reliability considerations and failure analysis of integrated circuits. Certainly as ICs become more complex and see wider use, these areas will become of increasing importance to the designer.

### Using MOS-FET devices

*MOSFET in Circuit Design*, Robert H. Crawford (McGraw-Hill, New York), 136 pp. \$10.00.

This text explains certain basic principles necessary in MOS-FET device and circuit engineering and includes much background material. Among the special features of the book are a detailed description of an actual MOS-FET complex integrated circuit; threshold variation with backgate bias; gate voltage dependency of channel mobility, including equations for mobility; and transient response of MOS-FET load resistors. The book is the outcome of actual work with MOS-FET devices and complex integrated circuits.

CIRCLE NO. 459

## NEW! smallest axial shielded inductor available the "NANO-RED"

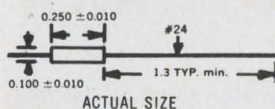

Range: 0.10 $\mu$ h to 1,000 $\mu$ h in 49 stock values

Size: 1/10 dia. by 1/4 lg.

Inductance Tolerance:  $\pm 10\%$

This new "NANO-RED" offers the highest inductance to size ratio available in an axial shielded inductor. Exceptional "Q" and self-resonance characteristics. Max. coupling 2% units side by side. Non-flammable envelope. Designed to MIL-C-15305C. Operating temperature -55°C to 125°C.

### Other Lenox-Fugle Subminiature Shielded Inductors:

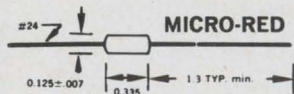

The "Micro-Red" is a shielded inductor that offers the largest inductance range in its size: 0.10 $\mu$ h to 10,000 $\mu$ h. "Q" to "L" ratio unsurpassed, with excellent distributed capacity. Inductance tolerance  $\pm 10\%$ . Designed to MIL-C-15305C. Stocked in 61 pre-designed values.

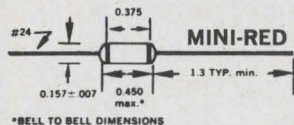

The "Mini-Red" offers the highest "Q" to "L" ratio available over inductance range 0.10 $\mu$ h to 100,000 $\mu$ h in its size. Inductance tolerance  $\pm 10\%$  measured per MIL-C-15305C. Stocked in 73 pre-designed values.

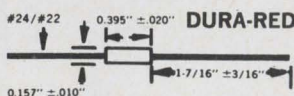

The "Dura-Red" is designed to MS-90537 with inductance range 0.10 $\mu$ h to 100,000 $\mu$ h with tolerance  $\pm 10\%$ . Stocked in 73 pre-designed values.



Data Sheets: write or phone

**LENOX-FUGLE ELECTRONICS, INC.**

475 Watchung Avenue, Watchung, N. J. 07060

Telephone: Code 201, 756-1164-1165

ON READER-SERVICE CARD CIRCLE 51



# Caught with their "ceramics" down

## all similarly rated tubes are not equal

Construction of the high-gain Cermolox<sup>®</sup> RCA-4628 is far superior. For example, the G-1 and G-2 "cups" are locked together in a rigid assembly, then simultaneously electrically machined to produce grid wires precisely aligned with respect to each other. The result: a simplified, unitized construction. In SSB Communications and FM Broadcast service, particularly, the RCA-4628 delivers even more outstanding performance as a result of its compact coaxial structure, precision-aligned electronically-machined grids, and ceramic-to-metal seals.

RCA-4628, rated to 400 MHz, provides 10 kW PEP output in the 2 to 30 MHz range with lower distortion and better gain than its nearest counterpart. In FM Broadcast service, it offers higher gain with non-critical broadband neutralization techniques.

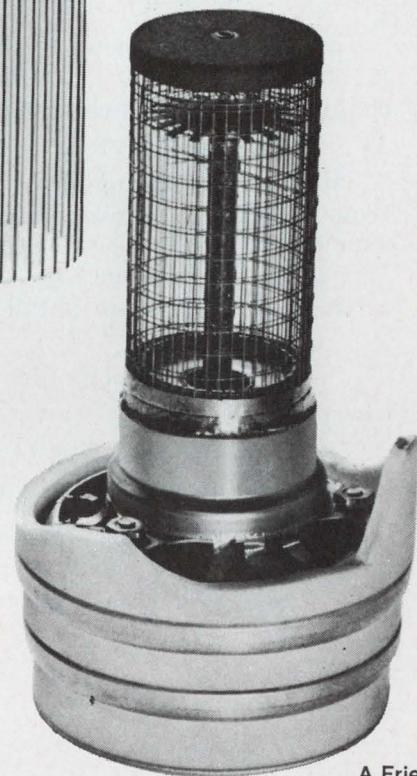
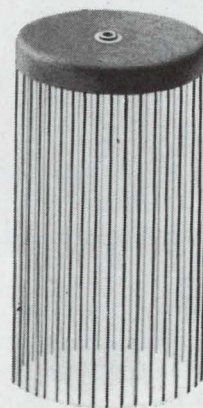
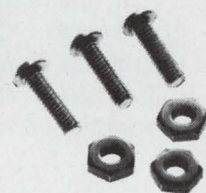
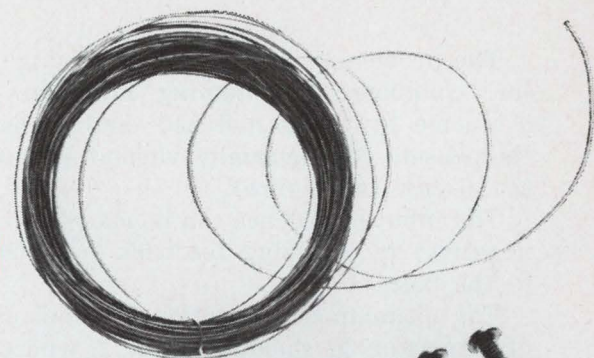

A Friend

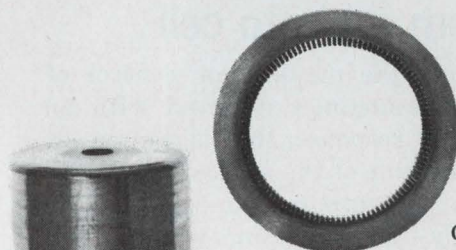

G-2 "Cup"

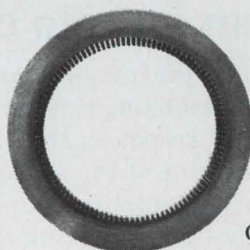

Electrical  
Machining  
Tool



G-1 "Cup"

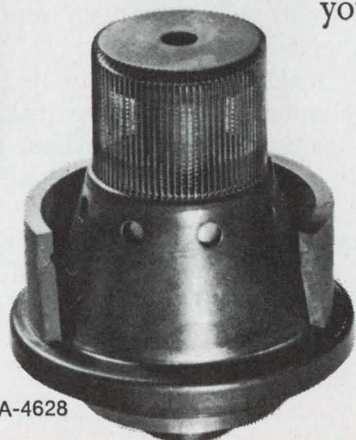

RCA-4628

From now on, look "inside" as well as outside when you need tubes. In the RCA-4628, you'll find ruggedness, compactness, and long-life reliability. Mechanically-induced noise is very low and, because of UHF capabilities, you have no need for complex neutralization circuits at HF. The RCA-4628 is your obvious choice.

For more information on this and other RCA Cermolox<sup>®</sup> tubes, see your RCA Representative. For technical data on specific tube types, write: RCA Commercial Engineering, Section K18Q-1, Harrison, New Jersey 07029.

ALSO AVAILABLE FROM YOUR RCA INDUSTRIAL TUBE DISTRIBUTOR

RCA Electronic Components and Devices



The Most Trusted Name in Electronics



# Stable summing amplifier has low input impedance

The problem of thermal drift in single-transistor, common-base summing amplifiers can be overcome by using matched dual transistors to compensate for thermally variant parameters in the circuit (see figure).

The input impedance can be made zero (or even negative) by applying feedback from the output to the base of *Q1*.

For optimum compensation, the emitter current of transistor *Q1* should equal  $I_s/2$ , where  $I_s$  is the maximum input current to the summing point.

For good thermal stability, the resistors are proportioned so that

$$R_3 = R_4,$$

and

$$R_1 R_2 / (R_1 + R_2) = 2V_s / I_s.$$

To calculate the value of the feedback resistor  $R_6$ , it is first necessary to determine the required change in  $V_s$ . If this change is denoted  $\Delta V_s$ , then  $\Delta V_s = \Delta V_{BE2} + I_s R_4 / (1 + \beta)$ .

$\Delta V_{BE2}$  (for  $I_{E2}$  changing by  $I_s$ ) can be obtained from the manufacturer's data sheet, and  $\beta$  is the common-emitter, large-signal current gain.

If  $R_p$  is the resistance of  $R_1$ ,  $R_2$  and the input resistance of *Q1*, all in parallel, then  $R_6$  is given by:

$$R_6 + R_p (V_o - 1) / \Delta V_s,$$

where

$$V_o = I_s R_5 \beta / (1 + \beta).$$

When the circuit is constructed with low-tem-

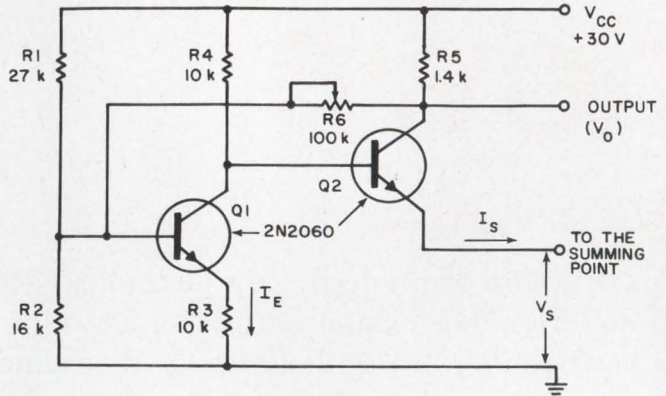

Matched transistors compensate for temperature variations and control input impedance in a summing amplifier.

perature coefficient resistors, the drift of  $V_o$  is typically less than 0.0035%/°C. To compensate for the  $\beta$  changes from unit to unit, a potentiometer was used for  $R_6$ .

*Michael Cadwallader, Marconi Instruments Ltd., St. Albans, Hertfordshire, England.*

VOTE FOR 110

# True Lambert-law response obtained from a photo cell

In work involving the measure or control of light, a detector is sometimes required with an ideal or Lambert-law response, that is, an output proportional to the cosine of the angle of incidence of incoming light. The outputs of most detectors fall off more rapidly than the cosine, so that compensation of some kind is required.

The detector response can be easily tailored by putting a piece of masked ground glass in front of the cell. (If the ground glass were a perfect diffuser it would suffice in itself and the masks would not be needed.)

The inner mask, the one closer to the cell (see figure), is simply a transmitting disk. The outer mask is an opaque disk (or sometimes an annulus) which shades the inner opening nonlinearly as a function of the angle of incidence. It blocks a smaller portion of incoming light for larger off-axis angles and so transmits more light to compensate for the cell characteristic. The price of this compensation is a reduction in the normal

**VOTE!** Go through all Idea-for-Design entries, select the best, and circle the appropriate number on the Reader-Service-Card.

**SEND US YOUR IDEAS FOR DESIGN.** You may win a grand total of \$1050 (cash)! Here's how. Submit your IFD describing a new or important circuit or design technique, the clever use of a new component or test equipment, packaging tips, cost-saving ideas to our Ideas-for-Design editor. You will receive \$20 for each accepted idea, \$30 more if it is voted best-of-issue by our readers. The best-of-issue winners become eligible for the Idea Of the Year award of \$1000.



VARIABLE  
BANDWIDTH  
MARKERS  
PINPOINT THE  
FREQUENCY



## *Sweep Oscillator gives top performance in the 100 kHz to 110 MHz range*

All solid-state Hewlett-Packard 3211A Sweep Oscillators with RF and marker plug-ins meet virtually all of your swept frequency testing requirements. Variable bandwidth markers permit accurate, well defined marking under a variety of test conditions.

The main frame of the 3211A contains everything you could hope to find in a sweeper. RF plug-ins operate at fundamental frequencies with good linearity and spurious mixing products are eliminated. Plug-in markers offer not only variable bandwidth, but also Z-axis or pulse-type marking. An accurate 59-db attenuator makes the unit a valuable tool for testing both high- and low-gain circuits.

The 3211A is ideal for general testing in the video to VHF range where flat, linear output and an accurate marking system is required. Typical applications are: alignment, calibration and design of FM tuners and receivers and testing filters, amplifiers, transformers, resonant circuits and IF sections of TV receivers, radar and communications systems. For complete specifications, contact your local Hewlett-Packard field engineer or write Hewlett-Packard, Green Pond Road, Rockaway, N.J. 07866.

HEWLETT  PACKARD  
measuring instruments  
for science and industry



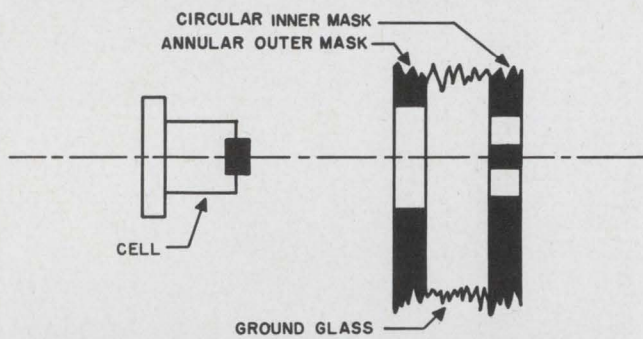

Output proportional to the cosine of the angle of incidence from a photo cell is obtained by placing a piece of masked ground glass in the path of the incident light.

incidence sensitivity.

The dimensions of the system depend on the size and response curve of the cell and the thickness and transmission characteristic of the ground glass. For one system, a 1/8-inch-thick ground glass placed about 12 mm from the cell, with an inner mask of 12-mm diameter and an outer, annular mask of 8-mm OD and 4-mm ID, gave a good cosine response with a reduction in normal sensitivity to 20% of the original.

*Jesse Roth, Senior Engineer, Raff Analytic Study Associates, Inc., Silver Spring, Md.*

VOTE FOR 111

## Inexpensive 6-V reference is also temperature-stable

A simple 6-V reference source can be built by utilizing the collector-emitter breakdown characteristic of a bipolar transistor and the constant-current property of junction field-effect transistors (J-FETs). The typical cost for the entire circuit (shown in Fig. 1a) is less than \$1 in quantities of more than 100.

The collector-emitter zener characteristic of the 2N3638A transistor is due to a 6-V emitter-base,  $BV_{EBO}$ , in series with the collector-base diode junction. The result is an approximate 6.6-volt reference that has a temperature coefficient of zero at a particular current. From the reference characteristics shown in Figs. 1b and 1c of a sample lot of ten 2N3638A transistors, it is apparent that at a forward current of 5 mA any one of the ten transistors exhibits a reference voltage of 6.66 volts (within  $\pm 3\%$ ) and a temperature coefficient within  $\pm 40$  ppm/ $^{\circ}\text{C}$ .

Transistor  $Q1$  of Fig. 1a is a J-FET biased with a gate-source voltage,  $V_{GS}$ , of zero volts. If the drain-to-source voltage of  $Q1$  is greater than the pinch-off voltage  $V_p$ , then the device provides effectively a constant-current supply to the reference element  $Q2$ . Moreover regulation of the

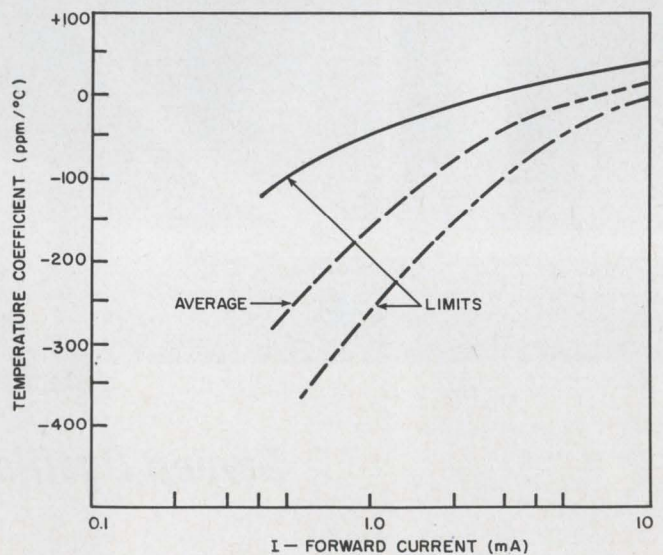
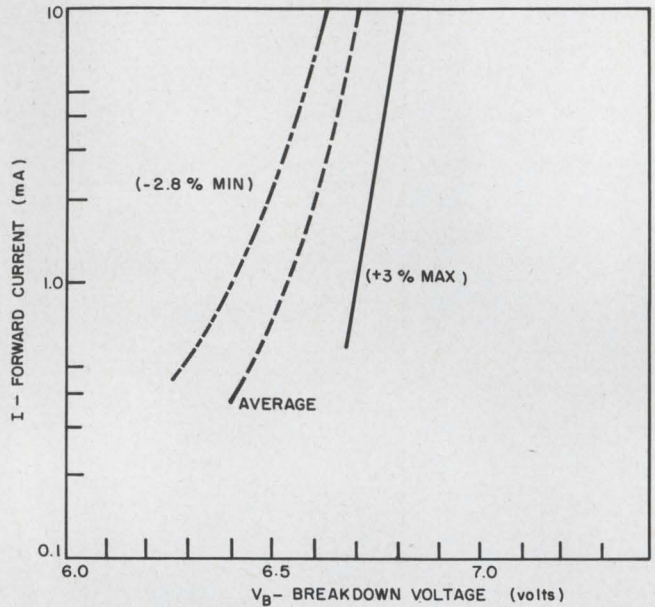
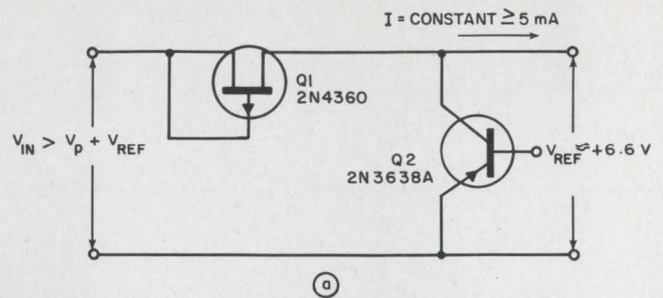

Temperature-stable 6-volt reference (a) uses a single transistor having characteristics shown in (b) and (c) and a J-FET to supply the steady current.

reference voltage in the presence of input voltage changes is greatly improved (by a factor of 100 to 1) by using a J-FET instead of a series resistor. The large drain-to-source resistance value of the transistor does the trick.

The only disadvantage in using a J-FET for  $Q1$  is its negative temperature coefficient. This can be



## CTS Cermet Trimmers

± 100 PPM/°C T.C. Available (Series 185)



Series 180\*  
1-1/4" x .325 x .295  
Rectilinear

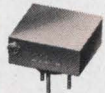

Series 170\*  
1/2" Square

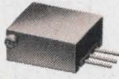

Series 171\*  
1/2" Square

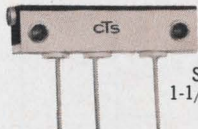

Series 180PC\*  
1-1/4" x .325 x .295  
Rectilinear



Series 385\*  
11/32" dia., single turn



Series 172\*  
1/2" Square



Series 660PC  
3/8" dia., single turn



Series 600LT\*  
2" dia., single turn  
locking bushing



Series 630  
1/2" dia., single turn



NEW Series 630 P  
1/2" dia.  
single turn

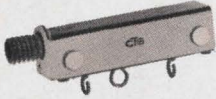

NEW Series B180  
1.30 X .378 X .385  
Rectilinear



NEW Series B185  
1.30 X .378 X .385  
Rectilinear

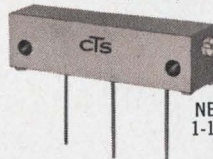

NEW Series 185 PC  
1-1/4" x .345 x .290  
Rectilinear



NEW Series 185  
1-1/4" x .345 x .290  
Rectilinear

## CTS Wirewound Trimmers

Infinite Resolution Available. Stability .025% (Series IRW)



Series K350\*  
1/2" dia., single turn  
knob operated

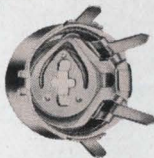

Series 110\*  
3/4" dia., single turn

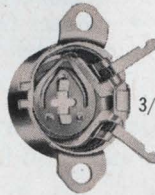

Series 112\*  
3/4" dia., single turn



Series P115\*  
3/4" dia., single turn

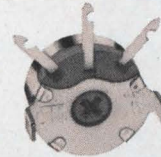

Series 115  
3/4" dia., single turn



Series 350\*  
1/2" dia., single turn

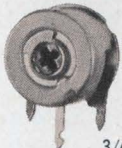

Series XPC110  
3/4" dia., single turn

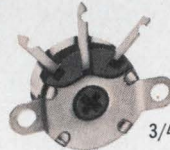

Series 117\*  
3/4" dia., single turn

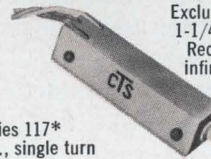

Exclusive Series IRW  
1-1/4" x .325 x .295  
Rectilinear spiral  
infinite resolution



Series 160  
1" x .320 x .180  
Rectilinear



NEW Series 116  
3/4" dia.  
single turn

## CTS Carbon Trimmers

for Lowest Prices

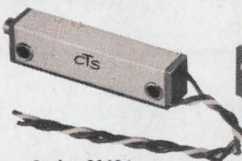

Series C140\*  
1-1/4" x .325 x .295  
Rectilinear

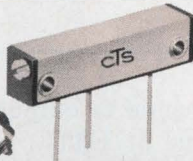

Series C140PC\*  
1-1/4" x .325 x .295  
Rectilinear



Series 220\*  
7/16" x 1/2" single turn



Series 330  
1/2" dia., single turn



Series U201\*  
19/32" dia., single turn  
knob operated









Series X201\*  
19/32" dia., single turn  
knob operated



NEW Series 330 P  
1/2" dia.  
single turn

# 7 New Trimmers added to CTS' Extensive Line

CTS TECHNOLOGICAL SUPERIORITY GIVES YOU:

- 
**Broadest Line of cermet trimmers.**
- 
**Wide range of wirewound and carbon trimmers.**
- 
**Prices from 10¢ to \$17.60 for industrial, military and entertainment applications.**
- 
**Engineering versatility for challenging design requirements.**
- 
**Precision controlled production from raw materials to finished product.**
- 
**Unsurpassed mass production capability.**

*\*Immediately available from distributor stocks.*

CTS will also design to your exact specifications. CTS is a major trimmer supplier.

Founded 1896



**CTS**  
CORPORATION  
Elkhart, Indiana

Request New Time-Saving Trimmer Selection Catalog. Contains complete technical data for every CTS trimmer.



Sales Offices and Representatives conveniently located throughout the world

### Principal Products

Variable Resistors  
Selector Switches  
Loudspeakers  
Trimming Potentiometers  
Microminiature Components & Circuit Packages  
Crystals, Filters,  
Oscillators & Ovens

### Subsidiaries:

CTS of Asheville, Inc., Skyland, N. C.  
CTS of Berne, Inc., Berne, Indiana  
CTS of Paducah, Inc., Paducah, Kentucky  
Chicago Telephone of California, Inc.,  
South Pasadena, California  
CTS of Canada, Ltd., Streetsville, Ontario  
CTS Microelectronics, Inc., Lafayette, Ind.  
CTS Research, Inc., Lafayette, Indiana  
CTS Knights, Inc., Sandwich, Illinois

ON READER-SERVICE CARD CIRCLE 53



somewhat alleviated by placing a diode in series with the source terminal of the FET, thereby providing about 2 mV/°C compensation and a resultant  $V_{GS}$  of 0.6 V.

Research for this reference source was sponsored by the Atomic Energy Commission under contract to the Union Carbide Corp.

*E. J. Kennedy, Development Engineer, Instrumentation and Controls Div., Oak Ridge National Laboratory (operated by Union Carbide Corp., Nuclear Div.), Oak Ridge, Tenn.*

VOTE FOR 112

## Symmetrical ramp generator uses new devices

With General Electric's D5K1 complementary unijunction transistor and field-effect diodes by Siliconix, it is possible to make a symmetrical ramp generator. Each of the two ramps that it generates starts near zero volts and then departs linearly (one positive and the other negative) in the opposite direction to the other.

Since the D5K1 complementary unijunction transistor (see figure) has a low and tightly specified value of intrinsic standoff ratio, it will break over before the 2N2647 does. The negative

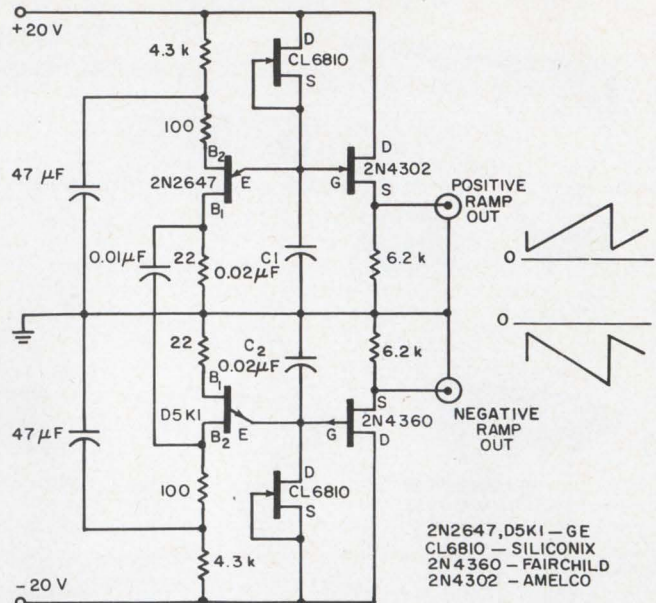

**Symmetrical bidirectional ramps** are produced by this circuit, which uses two majority carrier devices—complementary unijunction transistor D5K1 and field-effect diodes.

spike produced at  $B_1$  of the D5K1 as it breaks over is used to lower the  $E_{B2}$  of the 2N2647, causing it, too, to break over. If  $C_1$  and  $C_2$  are made equal, the ramps will be nearly identical in slope magnitude but opposite in sense.

*Henry Olson, Research Engineer, Stanford Research Institute, Menlo Park, Calif.*

VOTE FOR 113

## Get high input, low output impedances from a fast pulser

The circuit (see figure) is triggered at input by a voltage which is somewhat higher than that required to fire the UJT. The voltage divider is so designed that the voltage across  $C_1$  does not exceed the firing voltage. Diode  $D_1$  prevents the incoming pulse from charging capacitor  $C_1$ , so the

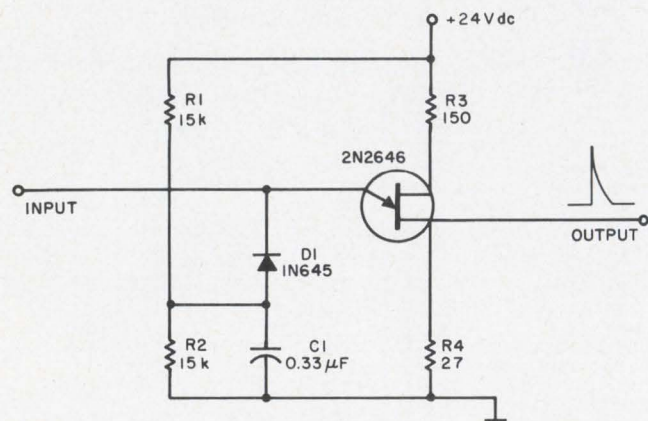

**Fast pulse** can be obtained at the output in response to a slow input voltage wave.

pulse will be released to output. The time delay is the reaction time of UJT.

*O. Tedenstig, Laboratory Engineer, L. M. Ericsson, A.-b., Stockholm, Sweden.*

VOTE FOR 114

## O ring improves operation of waveguide tuning screw

A rubber O ring is placed under the nut on a tuning screw (see figure). The nut is set so that

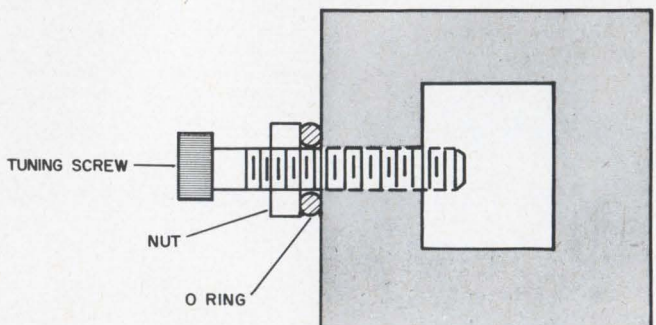

**Tuning screw does not come loose** under vibration when its set nut is cushioned with an O ring.



**Spurious-free  
3 GHz Dispersion!**

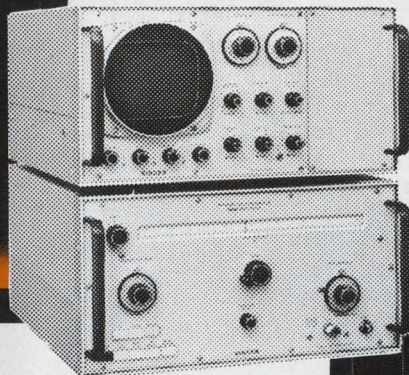
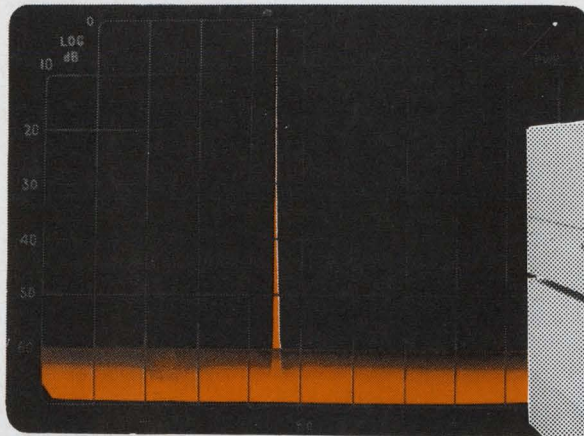

**Calibrated  
10 kHz Dispersion!**

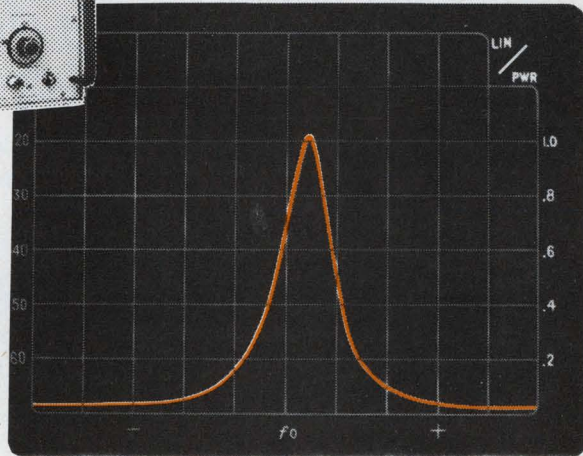

**only one...**  
**the Panoramic SPA-3000**  
**Microwave**  
**Spectrum Analyzer**  
**delivers both!**

You can have full 3 GHz dispersion in the 0.01 to 9.0 GHz range and greater than 2 GHz dispersion up to 40 GHz at sensitivities from  $-105$  dbm with the new Panoramic Model SPA-3000. And, you don't have to buy an expensive preselector to eliminate inband images and multiple responses — even at maximum dispersions. In addition, the SPA-3000 provides calibrated dispersion ranges as low as 10 kHz.

Ideal for wideband surveillance and narrow pulse measurements, the Model SPA-3000 is a stable solid-state swept-front-end analyzer, with an easy-to-use internal phase-lock for the BWO, resulting in less than 100 Hz peak-to-peak incidental FM for a true 1 kHz resolution capability. A calibrated 60 db on-screen log display permits accurate comparison of CW and pulse signals of greatly differing levels, even those requiring the wide 1-MHz Bandwidth for optimum frequency analysis. Time domain measurements can also be made using the synchroscope capability offered by the unique combination of wide bandwidth and fast sweep rates.

This new analyzer features built-in stepped RF, as well as stepped and continuously variable IF attenuators to preclude IM products; RF and IF frequency markers for auto-calibration; stepped and continuously-variable dispersion and bandwidth settings; smallest size, lowest weight and power consumption.

The Model RF-3000 Tuning Unit is also available separately as an add-on module to convert Panoramic's moderately-priced Models SPA-100 and SPA-100A into the Model SPA-3000; offering maximum flexibility to meet any combination of application and budgetary requirements.

Call or write for a demonstration or complete technical data.

**SINGER**  
**INSTRUMENTATION**

PANORAMIC • EMC • EMPIRE • GERTSCH • SENSITIVE RESEARCH

THE SINGER COMPANY, METRICS DIVISION • 915 Pembroke St., Bridgeport, Conn. 06608, U.S.A. • Phone (203) 366-3201 • TWX 710-453-3483



the screw moves freely. This will allow the screw to move in and out without unnecessary slack. After the screw is adjusted, finger-tighten the nut. The screw will not come loose.

*Jeffrey E. Lennox, Developmental Technician, Rantec Div., Emerson Electric Co., Calabasas, Calif.*

VOTE FOR 115

## Trimming improves response of waveguide band-reject filter

A popular waveguide band-reject filter structure uses cavity resonators coupled to the broad walls of rectangular waveguides by apertures (Fig. 1a). The cavity resonators are of nominal

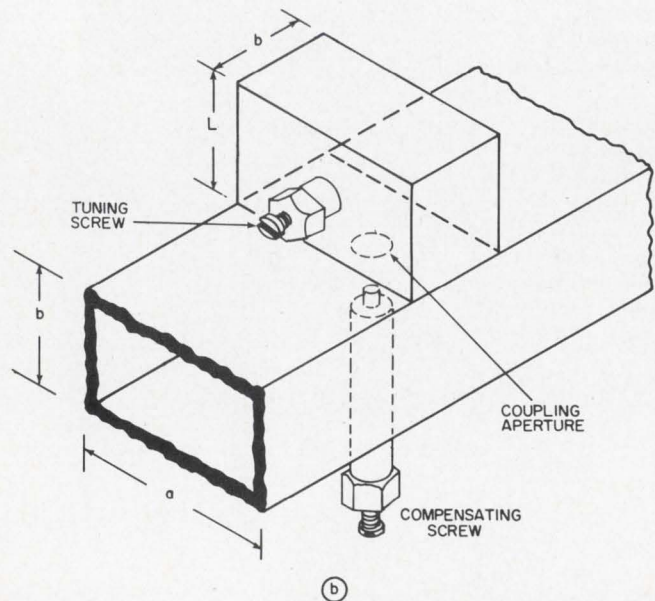
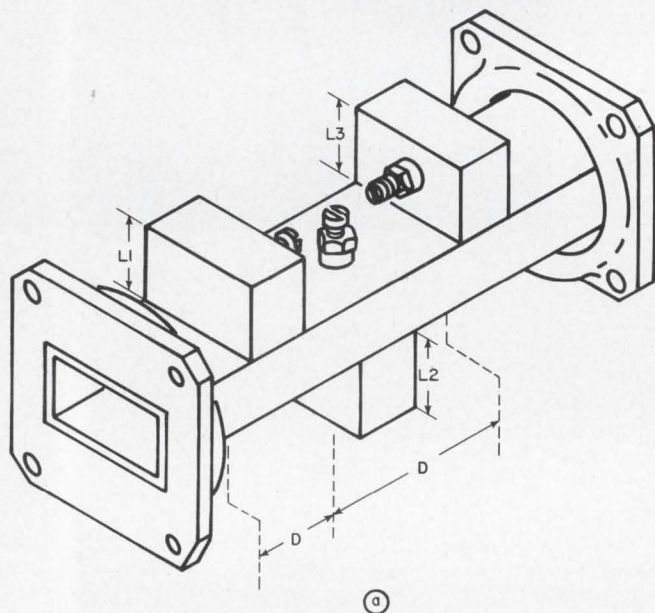

BAND-REJECT FILTER RG-52/U WAVEGUIDE ( $\alpha=0.900$  in.)  
INDUCTIVE COUPLING APERTURE: 0.338 in.-dia CIRCLE  
NO.8-32 CAPACITIVE COMPENSATING SCREW

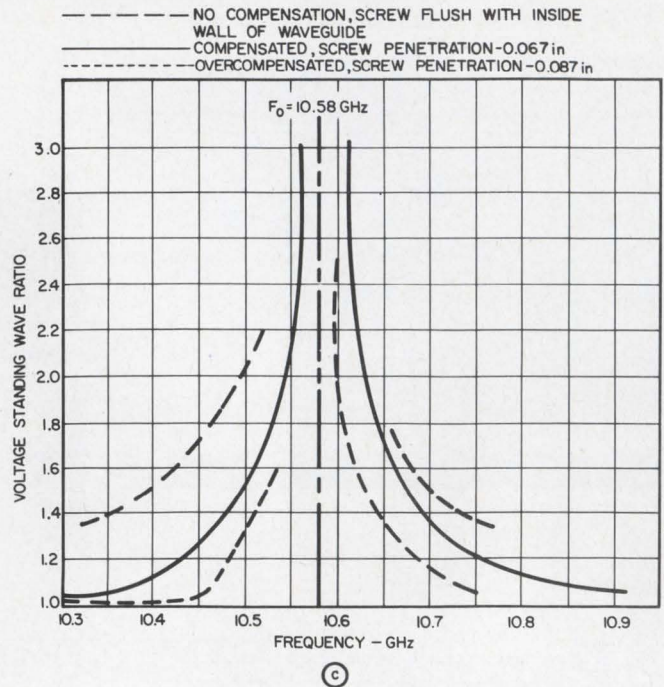

1. Addition of a compensating screw (b) to a typical multiresonator waveguide band-reject filter (a) improves the filter response (c).

lengths  $L$ , somewhat less than a half guide wavelength when inductive coupling apertures (circular or oblong shape) are employed. Capacitive screws are used to tune each cavity to resonance (Fig. 1b). Such a band-reject cavity resonator will display an asymmetrical response shape (Fig. 1c) in which abnormally low VSWRs appear on the high-frequency skirt. By using a capacitive compensating screw in the main-line waveguide directly below the coupling aperture (Fig. 1b), the symmetry of the response shape can be restored. Excessive screw penetration results in overcompensation and abnormally low VSWRs on the low-frequency skirt (Fig. 1c).

*Richard M. Kurczok, New York.*

VOTE FOR 116

## Monitor your equipment with a 'forget me not' circuit

Many applications call for a visual indication of the ON state of equipment and an audio signal if it stops or fails. One such application is the monitoring of "stop" and "start" of several computers (see figure).

In the circuit, neon lamps glow and a buzzer is silent when the computers are operating normally. But if one computer—say, the one connected to  $K_4$ —stops, the relay pulls in, extinguishing the lamp and simultaneously sounding the buzzer. A toggle switch shuts off the buzzer and restores the



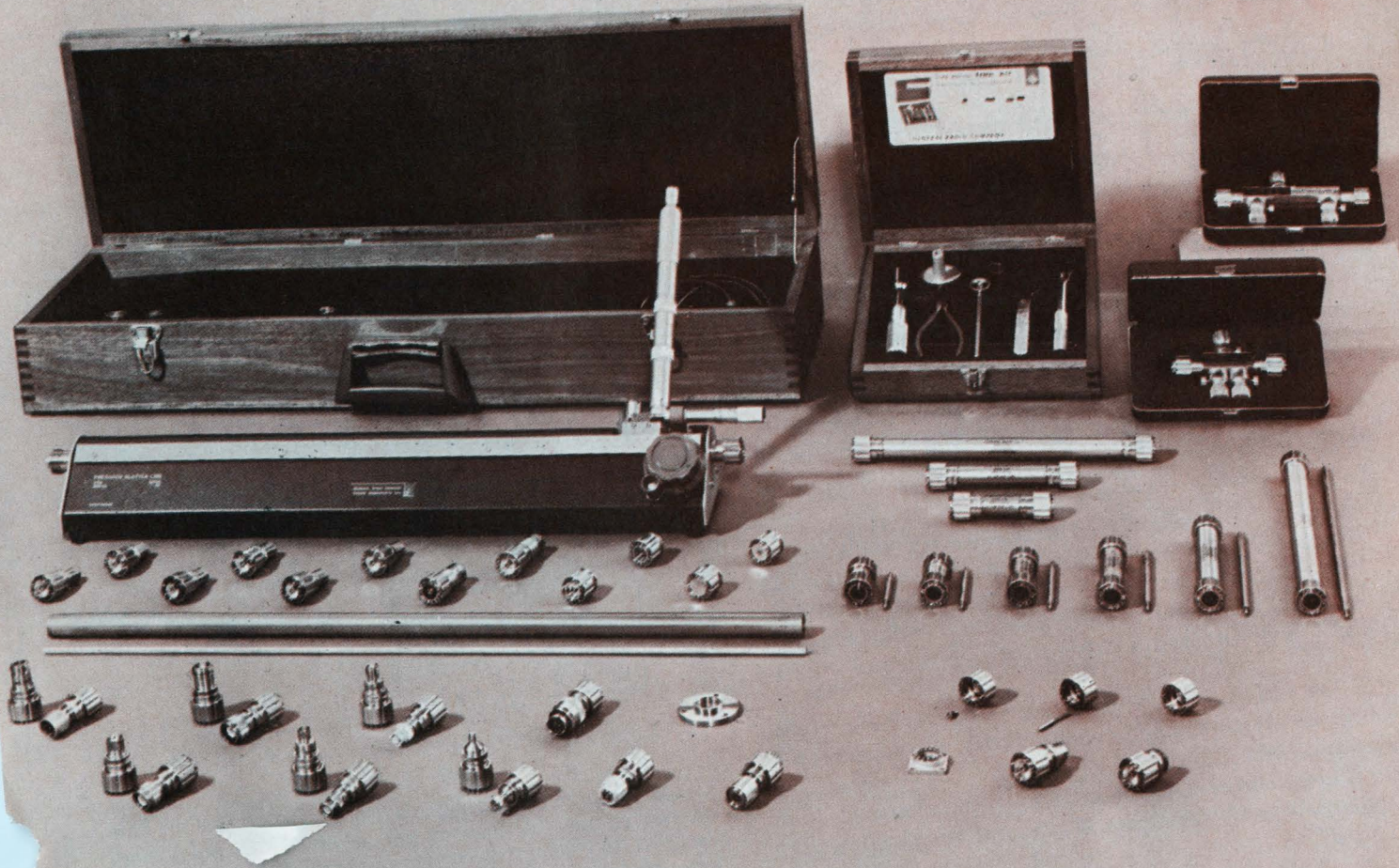

## Today's standards for precision coaxial measurements

The GR900 connector gives new meaning to accuracy in microwave measurements. With VSWR less than  $1.001 + 0.001 f_{\text{GHz}}$  to 8.5 GHz, characteristic impedance accurate to 0.1%, shielding better than 130 dB, and repeatability within 0.03%, the 14-mm GR900 has become a recognized industry standard.

Today the GR900 line of coaxial components contains air lines, standards, terminations, a slotted line, tuners, elbow, and adaptors to most other popular coaxial connectors (N, TNC, BNC, C, SC, OSM/BRM, GR874, Amphenol APC-7, and 7-mm Precifix). And the GR900 product line is still growing.

For high-accuracy microwave measurements, you won't find anything that will outperform the GR900. For complete information, write General Radio Company, W. Concord, Massachusetts 01781; telephone (617) 369-4400; TWX (710) 347-1051.

## GENERAL RADIO



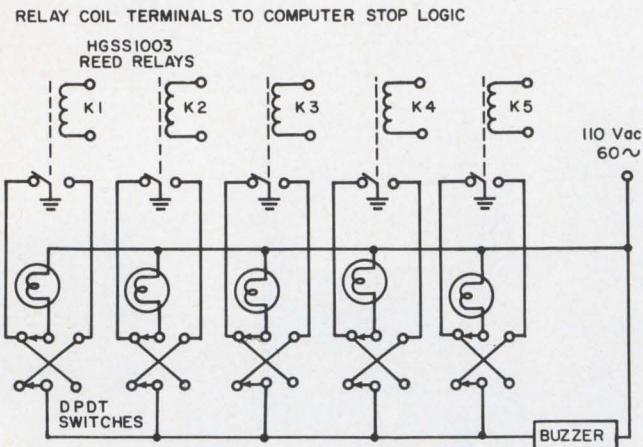

All lamps glow and buzzer is silent under the normal (ON) condition. When any computer stops, its light goes out, and the buzzer sounds. The toggle switch silences the buzzer and restores the light. When the computer starts, the buzzer sounds again, alerting the operator to turn it off.

light while repairs or adjustments are made to the computer. When the computer starts again, the buzzer sounds and the light goes out, but as soon as the toggle switch is reversed, the buzzer and light are restored to their former normal condition.

The only parts required are five relays, five dpdt toggles five neon lamps one 110-V ac buzzer and an indicator panel.

Jack Eliezer, System Engineer, Information Systems and Services, Western Union, Mahwah, N. J.

VOTE FOR 117

## Servo programmer generates linear on and off ramps

In many industrial control systems, it is desirable to ramp the command signal linearly from an initial level to the operating or mid level in a preset, independently adjusted time, as shown in Fig. 1a. Likewise, the operation ends with a linear ramp from the mid level to a preset final level. Convenience is greatly improved when the three levels, as well as the upslope and downslope times, can be directly calibrated and independently adjusted.

The analog circuit shown in Fig. 1b does exactly this. The program is initiated by manually activating relay *K1* and is terminated by activating relay *K2* (the coils are not shown). Before *K1* is activated, integrating amplifier *A1* is clamped at -10 volts because of its positive input and 10-volt Zener *Z1*. The initial level is taken as a portion of this from the initial-level-adjustment potentiometer,

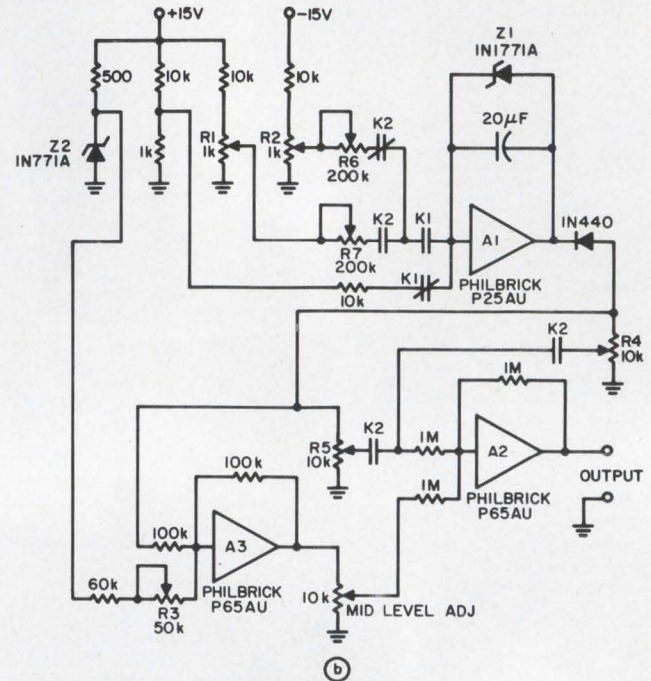
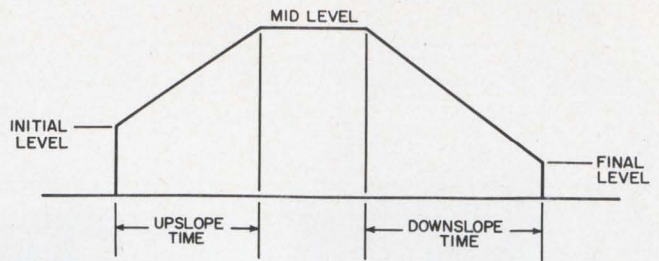

Linear ramp command signals (a) are generated by the control circuit (b). The operation starts by energizing relay *K1* (coil not shown). The downslope is initiated by activating *K2*.

eter, *R4*, and fed into summing amplifier *A2*. The second input to the summing amplifier is zero, because of the cancellation of Zener voltages, *Z1* and *Z2*, at the input of *A3*. Thus before the sequence is begun, the programmer output is a positive voltage equal to the value set on *R4*.

When relay *K1* is activated, the input to integrating amplifier *A1* is negative, so its output ramps linearly from -10 volts to zero. The time is determined by the setting of *R6*. During the same time interval, the output of *A3* varies linearly from zero to -10 volts, as fixed by the Zener *Z2*. The input to the summing amplifier thus consists of two linear, negative ramps, one varying from the initial-level setting to zero and the other varying from zero to the mid-level setting. Since the sum of two linear functions is itself a linear function, the output of *A2* will be a positive voltage varying linearly from the initial-value setting to the mid-value setting. The time required for the programmer output to ramp from the initial level to the mid level is completely independent of these settings, and is a function only of the upslope-time-adjustment potentiometer, *R6*.



# We're all set to double-Cross you.

[and you'll love it.]



**We've doubled our plant and manufacturing facilities. So you can hand us twice as many of those tough jobs... or tough jobs twice the size. We mean the ones where you want zero defects. Which Cross promises and delivers.**

For instance, molybdenum and tungsten rolled down to  $\pm .0001$ " on a production run. Or rhenium tungsten, rhenium moly, columbium, zirconium, titanium, copper, nickel, alloys and other metals rolled to  $\pm .00005$ ". You name it . . . you've got it.

Cross has built its business by handling the tough jobs that had to be perfect. So pile your ribbon and strip problems on us . . . big, medium or small. *Challenge us with your close tolerance requirements. We're twice as ready as before to roll right over them.*

**H.CROSS**  
COMPANY



Once the programmer output reaches the mid-level value, it will remain at this level until relay *K2* is activated. When it is activated, a positive voltage is applied to *A1* causing its output to ramp from zero to  $-10$  volts in a time interval determined by the downslope-time-adjustment potentiometer, *R7*. During the same time interval, the output of *A3* varies linearly from  $-10$  volts to zero. Again the input to summing amplifier *A2* consists of two linear negative ramps, one varying from the mid-level setting to zero and the other

varying from zero to the final-level setting on *R5*. The output of *A2* is therefore a linear ramp from the mid level to the final level. As was true for the upslope portion, the time duration of the downslope is completely independent of the mid- and final-level settings.

Calibration potentiometer *R3* is used to equalize the peak outputs of amplifiers *A1* and *A3*. *R1* and *R2* are used to calibrate the desired time spans of the upslope and downslope portions of the program. In the system designed by the author, these time spans were calibrated for 0 to 100 seconds.

*Dr. George E. Cook, Vice President, Merrick Engineering, Nashville, Tenn.*

VOTE FOR 118

## Bistable dc-coupled switch has 5-nanosecond rise time

The circuit in the figure puts out a 10-volt peak-to-peak square wave with 5-ns rise time and less than 0.1-dB change in output magnitude from dc to beyond 1 MHz. Excellent isolation between input and output is maintained over the pass band. *Q7* through *Q10* form a bistable regenerative output switch driven by the hysteresis switch made up of *Q1* through *Q6*. *Q1* and *Q2* form a comparator for the negative hysteresis level. The

dividers in the bases of *Q1* and *Q4* set the precise firing levels. *Q3* and *Q6* conduct abruptly when a firing point is reached, ensuring very stable firing points. The circuit shown is designed to have hysteresis levels of  $\pm 2.5$  volts, that is, the output is  $+5$  volts for the input of  $+2.5$  volts and  $-5$  volts for  $-2.5$  volts. Changing the dividers allows other levels to be chosen. The output switch is designed for putput currents of  $\pm 16$  to 21 mA.

*Jerry F. Foster, Chief Engineer, Wavetek, San Diego, Calif.*

VOTE FOR 119

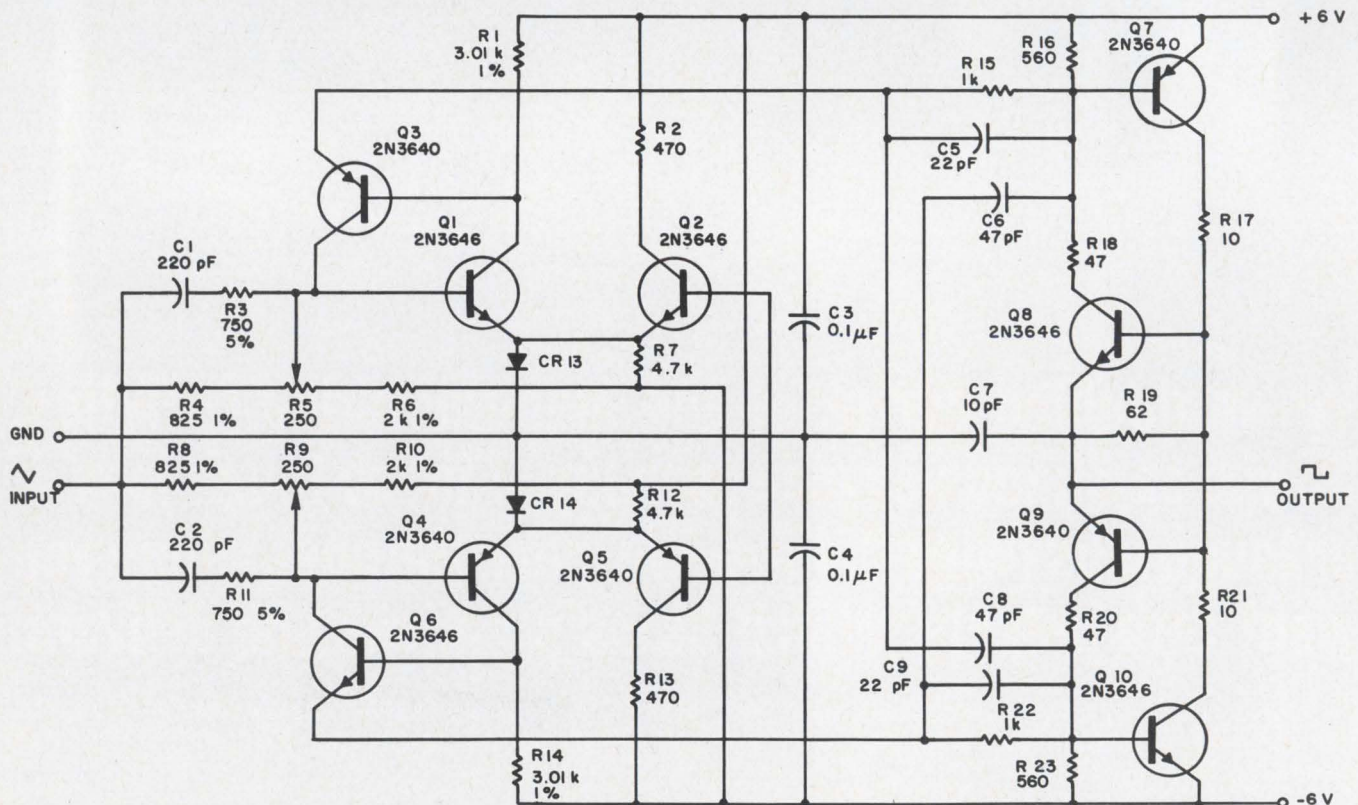

Ten-volt peak-to-peak square wave appears at the output in response to  $\pm 2.5$  V applied to the input. The rise time

is 5 ns and only a 0.1-dB change in the output is observed from dc to 1 MHz





# High Strength Dielectric

Coors Alumina Ceramics were originally developed to provide high mechanical strength insulators used in extremely high voltage applications. With Coors Ceramics you have high dielectric strength, plus a material with physical properties far superior to porcelain, glass or plastic. They are good structural materials, compressive strengths extend to 380,000 psi. They are inert, have long endurance at high voltages, are impervious to moisture or fungus, and are stable under intense radiation. Use Coors Ceramics, in sizes from micro wafers to large 24" x 60" cylinders. They can be glazed for easy-to-maintain cleanliness, or metalized for brazed ceramic-metal assembly. Faced with a high potential design decision? Get on-the-spot answers, dial Coors—303/279-6565, Ext. 361. For complete design criteria, write for new Coors Alumina and Beryllia Properties Handbook 952.

*consider  
Coors  
ceramics*



# Coors

## CERAMICS

ALUMINA • BERYLLIA • MAGNESIA • SPECIAL OXIDES

Coors Porcelain Co., Golden, Colo.



## Inexpensive IC comprises low-power flip-flop

A search for a cheap, low-power counting flip-flop for use in suborbital payloads led to the circuit shown in the figure.

It is constructed from a quad two-input NOR

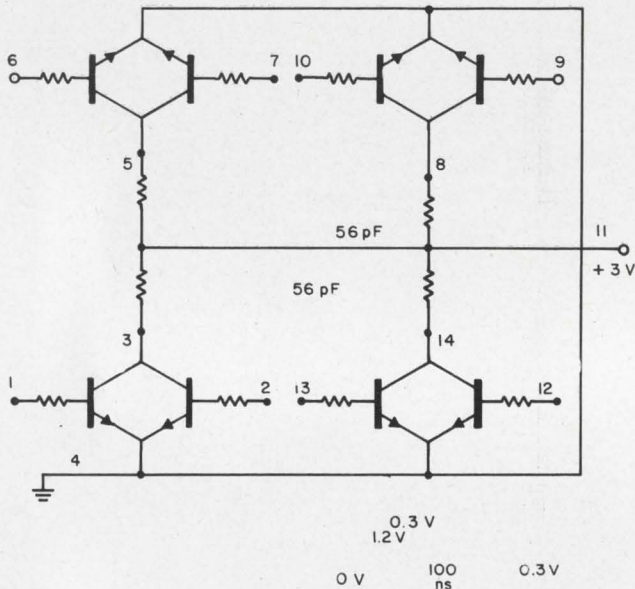

1. **2-MHz counting flip-flop** obtained with quad two-input NOR gate. It draws only 3 mA at 3 V

gate Motorola MC717P costing 81 cents, and uses only two external components—two 56-pF capacitors.

Counting rate is 2 MHz and power consumption 3 mA at 3 V, though operation is satisfactory from 2 V to 6 V. Comparably priced J-K flip-flops use more than twice this power. The input pulse should be greater than 0.7 V with less than 0.5- $\mu$ s rise time. The output will drive four gates.

*John M. Firth, Electronic Engineer, National Research Council, Ottawa, Canada*

VOTE FOR 120

## Simple circuit solves position display problem

A few readily available low-cost components will increase the accuracy and operating range of a circuit for potentiometer position display. In most such cases, the designer must choose between bridge circuits with high resolution at the expense of range and highly sophisticated indicating systems.

Figure 1 shows a simple transistor amplifier that

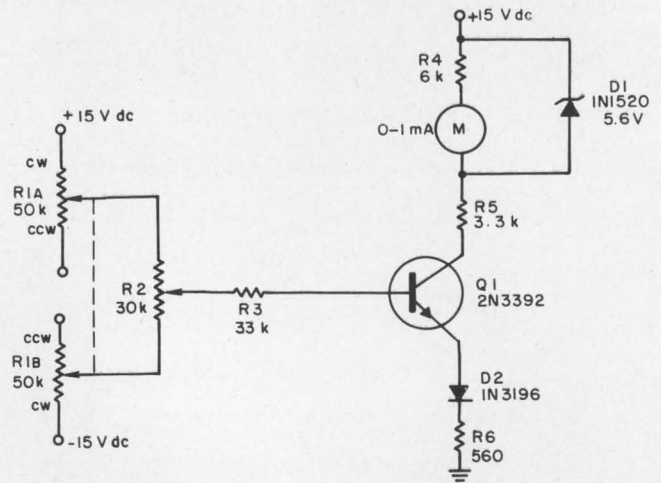

1. **Potentiometer position** is displayed on the meter with a single transistor amplifier to increase the meter range. D1 protects the meter against large potentiometer-position changes.

allows the display of potentiometer position. By varying amplifier gain, any convenient portion of the potentiometer operating range can be used to give linear, full-scale meter deflection on a common, low-sensitivity meter. Zener diode D1, in conjunction with R4 and R5, gives meter protection for large changes in potentiometer position.

The dual potentiometer in this circuit permits electrical zero to be set at any potentiometer position. This is done by connecting the ganged zero potentiometer, R1b and R1b, in such a manner that the resistance of R1b decreases as the resistance of R1a increases. A constant reference potential can then be maintained across measuring potentiometer R2. Resistors R3 and R6 provide current limits, while diode D2 establishes emitter reference and provides reverse-voltage protection for Q1.

This circuit has been used to resolve approximately 1.5% of full scale of rectilinear potentiometer travel over a full stroke range of 4.5 inches.

*(This work was supported in part by Public Health Service grants NB 05199 and FR 05457.)*

*Robert M. Reinking, Senior Electronic Technician, and David R. McCusker, Senior Electronic Technician, Physiological Science Dept., University of Calif., Davis, Calif.*

VOTE FOR 121

### IFD Winner for August 2, 1967

**James M. Loe**, Project Engineer, Communications & Electronics Div., Philco-Ford Corp., Blue Bell, Pa. His Idea, "Grounded-load current source uses one operational amplifier," has been voted the \$50 Most Valuable of Issue Award.

**Cast Your Vote for the Best Idea in this Issue.**



**Design engineer Bob Alden searched for nearly an hour to find he didn't have the information he needed.**

**Chances are 10 to 1 he'd have found it in less than 5 minutes in the new Sweet's Industrial Information System\***

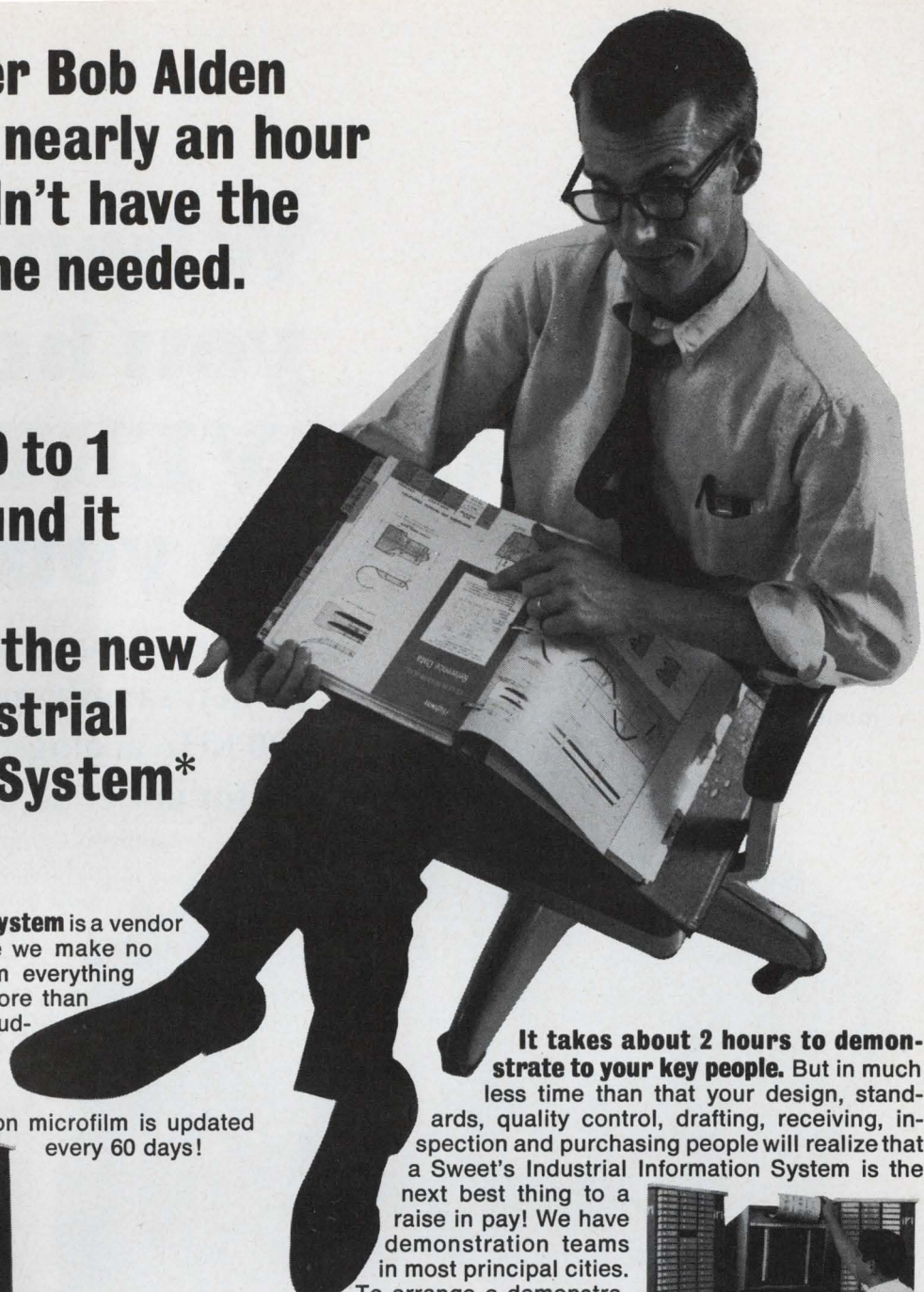

**Sweet's Industrial Information System** is a vendor catalog file on microfilm. Because we make no charge to vendors, and microfilm everything they have in print, Sweet's has more than 600,000 pages of vendor data including application notes, reliability tests, price lists and names of distributors and reps. What's more, the Sweet's vendor catalog file on microfilm is updated every 60 days!

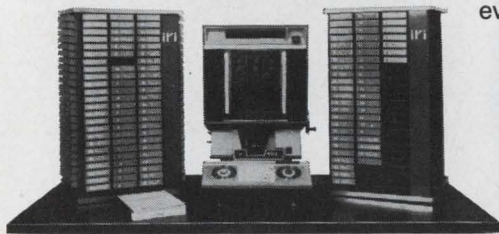

Small wonder.

**In addition, the Sweet's system is tailored to your needs by adding the vendors you want – at no extra cost.** We start with a basic file of the most wanted information. Update it regularly, and then—to top it off—"personalize" the file by adding the complete vendor information you request. It also reduces storage area by 98%, cuts redundancies in design efforts and increases sources and use of standard items.

**You can install a Sweet's vendor catalog file on an annual subscription for less than the cost of a file clerk.** Sweet's vendor catalog files are in use in plants with as few as fifty employees. The "user-orientated" idea not only provides current knowledge of the component state-of-the-art, but also expedites the purchasing function. Because of its complete coverage, more than 60% of our recent installations have replaced other microfilmed vendor catalog systems.

**S Sweet's Industrial Information System**

\* A new McGraw-Hill Information Service

**It takes about 2 hours to demonstrate to your key people.** But in much less time than that your design, standards, quality control, drafting, receiving, inspection and purchasing people will realize that a Sweet's Industrial Information System is the next best thing to a raise in pay! We have demonstration teams in most principal cities. To arrange a demonstration, send the coupon today, or call collect: George Stevens, (212) 971-3941.



Find it fast. Make a print-out in 6 seconds.

**SWEET'S INDUSTRIAL INFORMATION SYSTEM**  
330 W. 42nd St., New York, N.Y. 10036  
Dept. F-54

- I'd like to see a demonstration of the Sweet's Industrial Information System. Have your representative call me for an appointment.
- I'm not ready for a demonstration at this time, but please send further information.

Name \_\_\_\_\_ Title \_\_\_\_\_  
 Company \_\_\_\_\_  
 Address \_\_\_\_\_  
 City \_\_\_\_\_ State \_\_\_\_\_ Zip \_\_\_\_\_  
 Telephone \_\_\_\_\_ Ext. \_\_\_\_\_  
 Number of employees at this location \_\_\_\_\_

We  have  have not had experience with a vendor catalog file on microfilm.

In addition to the Vendor Catalog File on microfilm we're interested in  Mil Specs  Mil Standards.



# When you hold a MINIVERTER™ in your hand

... You'll have a 16-channel multiplexer, sample-and-hold and 10-bit, 100 KHz analog-to-digital converter for under \$2,000.

Raytheon Computer's new MINIVERTER packs a multiplexer, sample-and-hold amplifier and ADC into just ten IC modules. The MINIVERTER (or the ADC) is assembled and pre-wired, ready to plug in and use. ■ Two more new analog IC modules make up a 10-bit digital-to-analog converter. ■ These instruments are built from Raytheon's standard M-Series IC modules and there's a whole stockroom full of compatible systems hardware. More than 40 analog and digital modules, power supplies, three different chassis—all so thoroughly engineered all you do is design your logic. ■ Our literature is almost as exciting as our products. Write or call today. Raytheon Computer, 2700 South Fairview Street, Santa Ana, California 92704. Phone: (714) 546-7160.

**RAYTHEON**

Test points in  
module handles.

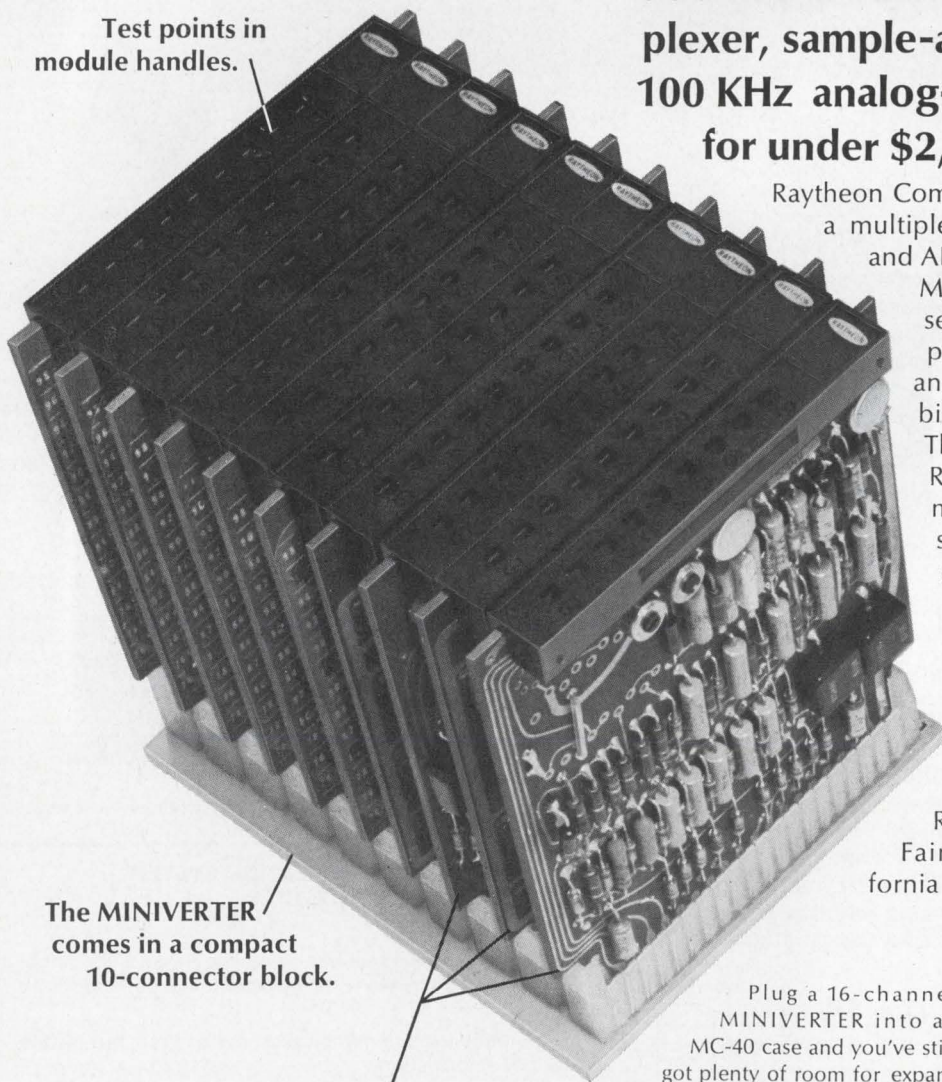

The MINIVERTER  
comes in a compact  
10-connector block.

These three cards make up the ADC. An optional fourth card is a DC power supply that runs on + 5 volts and provides all necessary ADC power.

Plug a 16-channel MINIVERTER into an MC-40 case and you've still got plenty of room for expansion and logic. For fast system assembly, module connectors come in blocks of 10, 30 and 40. Power and analog and digital ground are available in module cases via laminated bus bars. And you can have automatic wire wrap if you want it.

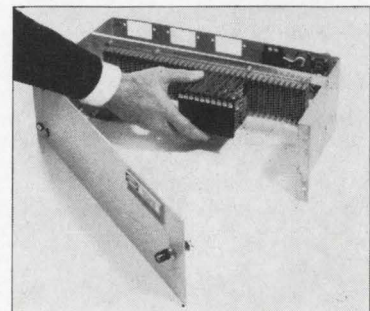

ON READER-SERVICE CARD CIRCLE 58



# Products

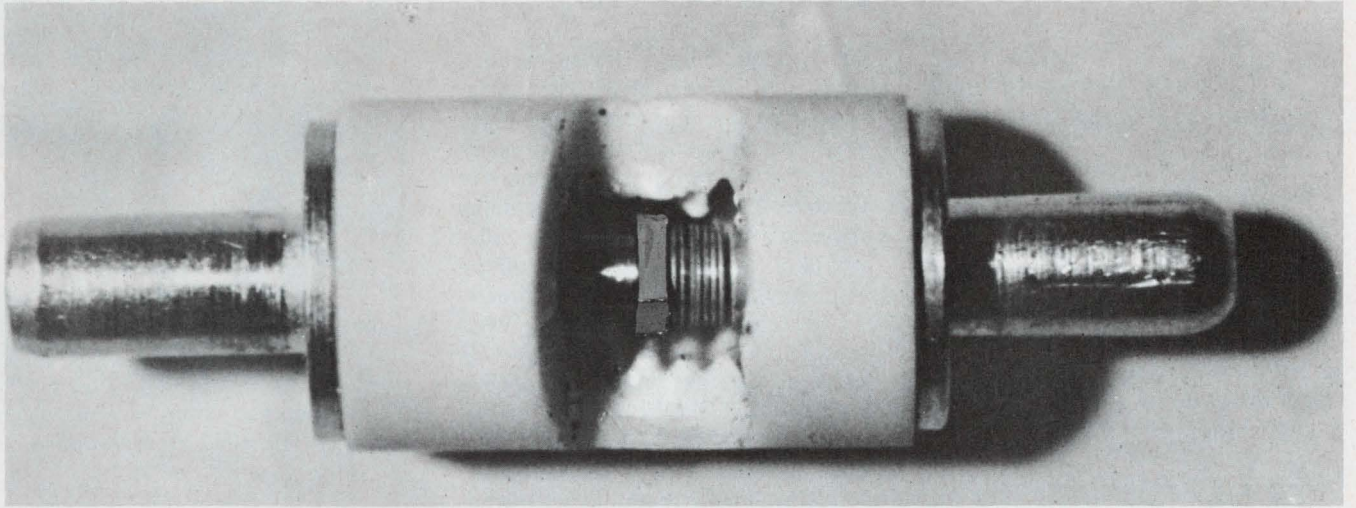

**LSA diodes are the newest** solid-state power sources available. The gallium-arsenide

chip yields 100 W pulses in X band. Levels of 615 W have been seen. Page 164

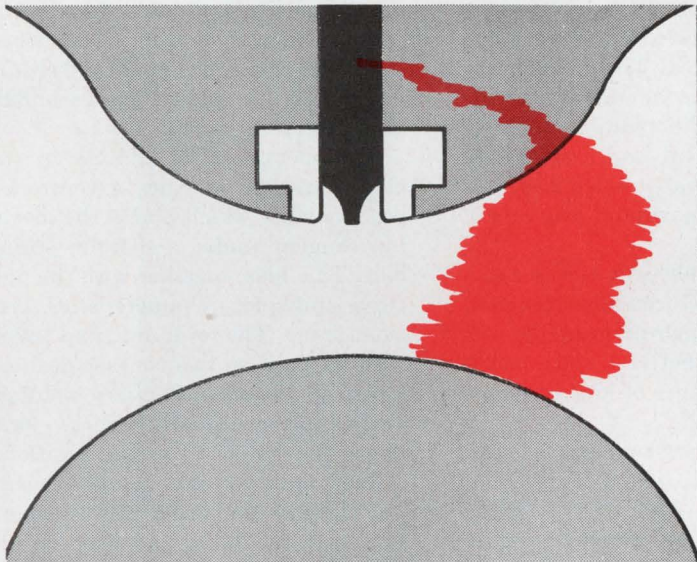

**A gas-filled triggered spark-gap** switches to fire the energy on a pulse generator. Page 170

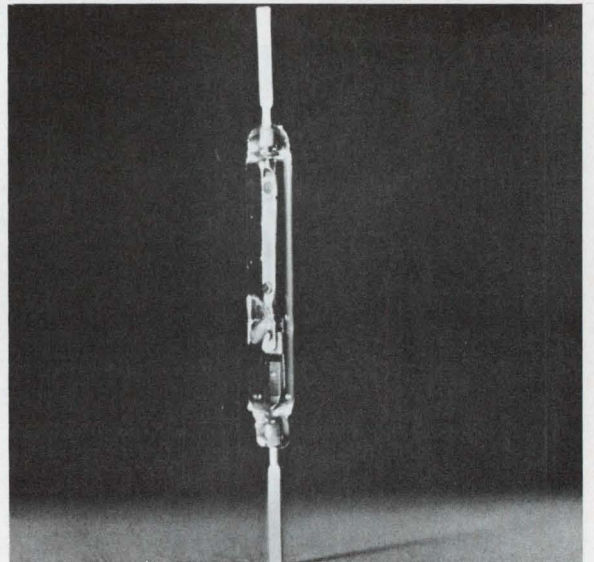

**Reed switches handle high current** and cause an inrush of 15 A. Page 126

## Also in this section:

**Crystal oscillator in TO-5 package** eliminates trimmer capacitors. Page 128

**Silicon npn power transistors** in TO-3, TO-61 and TO-66 packages hit 700 V. Page 166

**Pole-finding paper turns red** on contact with the active anode. Page 172

**Design Aids**, Page 200... **Application Notes**, Page 204 ... **New Literature**, Page 210



## Magnetic reed switch handles 1875 V/A at 125 Vac

Cutler Hammer, Inc., 4201 North 27th St., Milwaukee, Wis. Phone: (414) 442-7800. P&A: \$3 ea; in evaluation quantities.

Reed switches until now have not been able to handle the currents typical of industrial loads without elaborate protection circuitry. This switch can cope with industrial loads and needs no arc suppression circuitry for contact protection or interposing relays for amplification.

When operated at 125 V ac, the unit will cause an inductive current inrush of 15 A or 1875 V/A and break inductive current loads of 3 A or 375 V/A without arcing. Operating at 250 V ac, the switch will make an inductive inrush of 10 A or 2500 V/A and break current loads of 2 A or 500 V/A.

The switch is activated by magnetic

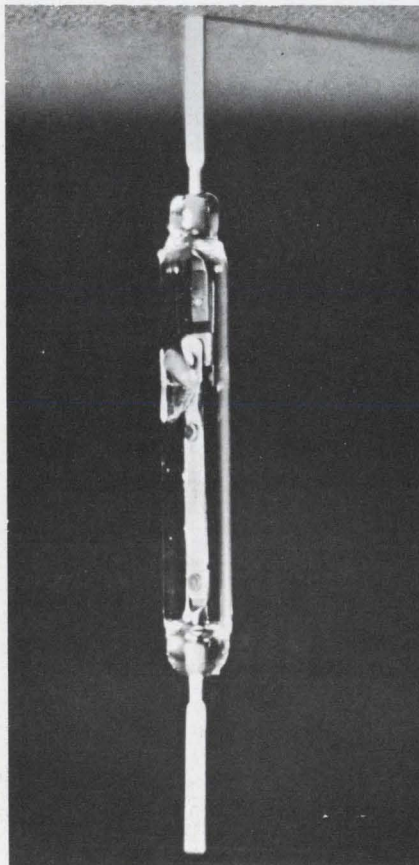

When operated at 125 V ac, the switch will cause an inductive current of 15 or 1875 V/A.

flux generated by either an external permanent magnet or an electromagnetic coil induced into the ferromagnetic portions of the reed members. The internal overlapping ends of the ferro-magnetic elements assume opposite polarity, attract each other and close the contacts. Removing the magnetizing force opens the contacts.

Reed switches were originally developed by Bell Laboratories to provide better contact switching in telephone circuits. Their switch consists of two ferro-magnetic reeds encapsulated in glass and actuated by induced magnetic flux. Though commercially available around 1953, the switches did not come into widespread use until 1957. During the last ten years, the reed has gained popularity as a switching device.

Cutler Hammer's engineers have now departed from the customary design with a solid armature reed and a solid stator reed. Their switch has separate members for current-carrying and the magnetic path. It contains a movable element and a stationary element hermetically sealed in a glass envelop with a maximum leak rate of  $1 \times 10^{-8} \text{ cm}^3/\text{s}$ .

The movable element consists of a gold-plated nickel-iron alloy terminal, an armature of high-permeability soft iron with low retentivity, and a movable contact member of low-resistance silver alloy.

The stationary element consists of a gold-plated nickel-iron alloy terminal, a stator of high-grade ferromagnetic material and a gold-plated stationary contact. A contact spring provides

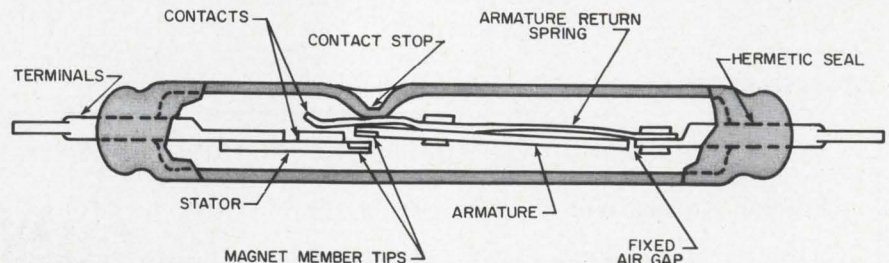

The switch has separate members for current-carrying and the magnetic path. The unit is hermetically sealed in glass with a leak rate of  $1 \times 10^{-8} \text{ cm}^3/\text{s}$ .



The Powered handles industrial loads with no need for arc-suppression circuitry or relays.

initial and final contact pressure; an armature return spring contributes to fast dropout and returns the armature to the open position. The armature return spring also provides force in the open position, to prevent creep when the coil is energized. Since nickel-iron is difficult to solder, the terminals have been gold-plated.

An indentation or dimple in the glass envelope provides a controlled positive stop, which places the movable element under a definite spring bias. This bias, together with the pull curve and spring characteristics, prevents creep. The resultant snap action with its positive two contact position (open or closed) minimizes welding. The dimple also greatly reduces vibration of the switch in the open position.

Reed switches can be used where fast speed, low drive power, small size, high reliability and long life are needed.

CIRCLE NO. 251





**Standard Optima Enclosures are small, big, in-between, portable, rackable, stackable, solid, perforated, smooth, textured, colorful, soothingly quiet, rigid, lightweight, with color-coordinated accessories, and have received design awards for two consecutive years.**

**If your instruments hate to look average, call Marty Bethune, Marketing Manager.**

# **Optima<sup>®</sup>**

**made by Scientific-Atlanta, Inc.  
Box 13654, Atlanta, Ga. 30324.  
Tel. 404-938-2930**

ON READER-SERVICE CARD CIRCLE 59



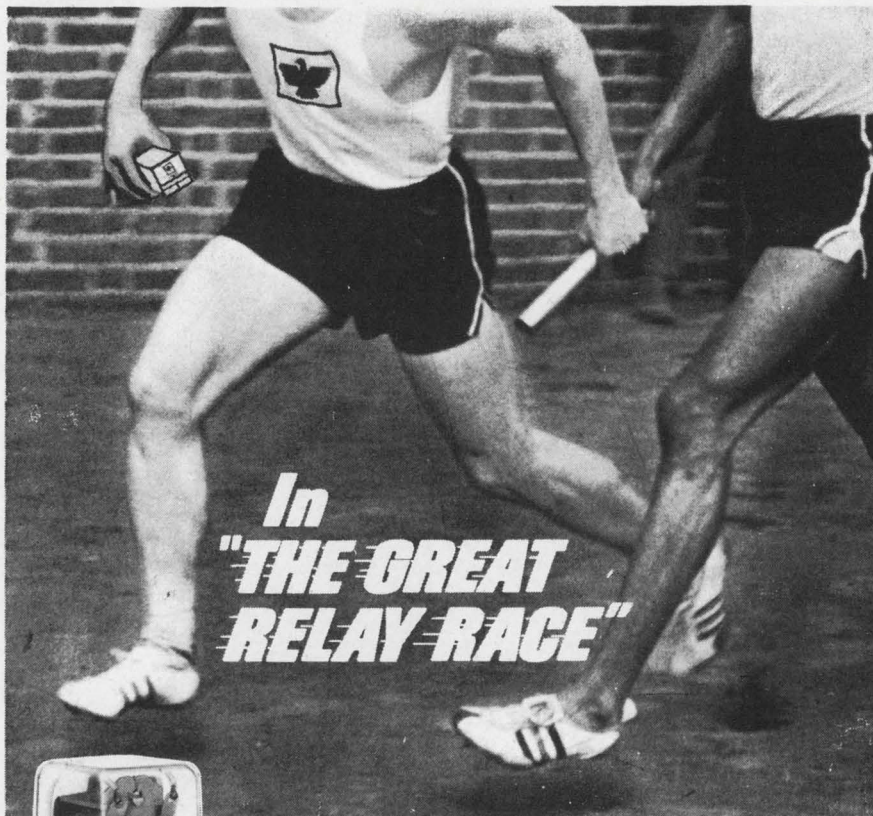

## In "THE GREAT RELAY RACE"

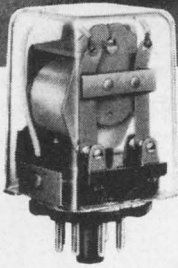

**A FREE RELAY IS YOURS . . .** to run your own relay race (evaluation test) in your own plant . . . under your own conditions.

**YOU BE THE OFFICIAL JUDGE!** You'll find out what we already know (see our race results below). Eagle Relays run longer . . . and better. There's no premium in cost . . . and they're readily available.

**YOU'LL BE A WINNER EVERYTIME!** Send for your Official Judge's Entry Blank now by contacting: R. W. Emelander, Eagle Signal Division, E. W. Bliss Company, 736 Federal Street, Davenport, Iowa, 52808 or circle reader service number below.

CONTACTS Arrangement Rating	COMPETITIVE BRANDS						EAGLE RELAYS
	"A"	"B"	"C"	"D"	"E"	"F"	
3 PDT 5 Amp.	3 PDT 5 Amp.	3 PDT 5 Amp.	3 PDT 5 Amp.	3 PDT 5 Amp.	3 PDT 5 Amp.	3 PDT 5 Amp.	3 PDT 5 Amp.
<b>LIFE</b> Mechanical	15,061,261 Operations	14,077,866 Operations	28,808,000 Operations	21,625,333 Operations	16,923,133 Operations	29,433,600 Operations	34,492,950 Operations
<b>ELECTRICAL</b> 5 Amp. Resistive	295,466 Operations	490,433 Operations	129,600 Operations	235,700 Operations	778,200 Operations	921,400 Operations	948,675 Operations
1.6 Amp Inductive	488,666 Operations	1,071,666 Operations	496,000 Operations	284,333 Operations	3,529,466 Operations	1,842,000 Operations	3,102,200 Operations

These "track records" show that Eagle Relays have a consistently longer life. A 20% greater life than the closest competitor at 5 amps resistive. An almost 70% greater electrical life than the average of the six competitors tested.

Like to prove us wrong? Chances are you're more likely to set a new "track record!"

**BLISS**



**EAGLE SIGNAL**

A DIVISION OF THE E. W. BLISS COMPANY

"IN CANADA: EAGLE SIGNAL DIVISION, E.W. BLISS COMPANY OF CANADA LTD. GEORGETOWN, ONTARIO"

ON READER-SERVICE CARD CIRCLE 60

## COMPONENTS

### Trigger transformer operates at 25 kV

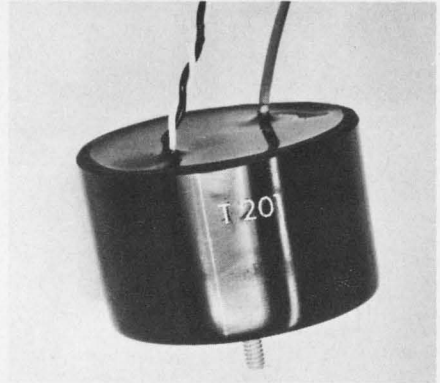

Pek, Inc., 825 E. Evelyn Ave., Sun-nyvale, Calif. Phone: (408) 245-4111. P&A: \$17.60; stock.

A 25 kV trigger transformer is designed to provide external triggering of xenon flash lamps and meet other applications requiring high-voltage trigger generation and spark gap triggering. Key performance characteristics include a 50 A primary current capability and low rise and delay times (0.35  $\mu$ s and 0.1  $\mu$ s, respectively).

CIRCLE NO. 350

### Pneumatic switch controls air flow

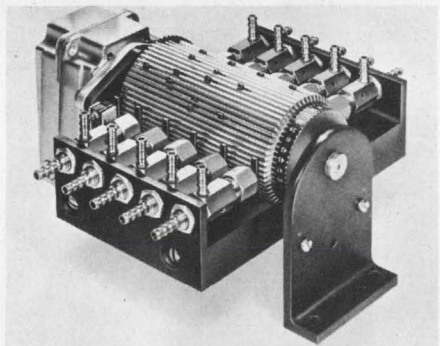

Sealectro Corp., Mamaroneck, N. Y. Phone: (914) 698-5600.

Drum programmer, designed to control the flow of air at pressures from 70 to 100 psi eliminates the need for solenoid-actuated valves, and provides for the safe interlocking of the sequence functions among all the pneumatic cylinders. The unit is capable of controlling ten pneumatic circuits with a memory drum. It has the capacity to store as many as 60 different programs and is equipped with an electrical stepping drive.

CIRCLE NO. 406



The Electronic Countermeasures System, a valuable penetration and survival tool for B-52's, posed a tough isolator problem which was successfully solved by Sperry.

What was so tough about the isolator spec? Among other things were power handling capability (400W CW, 4kW peak); isolation VSWR limited to 1.18:1; insertion loss (only 1 db permitted), and RFI shielding to prevent interference with other aircraft systems. All parameters had to be met at altitudes up to 60,000 feet and over the temperature range of  $-55^{\circ}\text{C}$  to  $+55^{\circ}\text{C}$  without cooling.

Sperry met the challenge with Model No. D-44S9, a specially engineered isolator that helps assure the reliability of B-52 ECM.

Is there a particularly difficult isolator problem Sperry can solve for you? There's a broad line of standard items, plus plenty of engineering talent if you need it. For full details, contact your Cain & Co. man or write Sperry Microwave Electronics Division, Sperry Rand Corporation, Box 4648, Clearwater, Florida 33518.

## SPERRY

MICROWAVE ELECTRONICS AND  
ELECTRONIC TUBE DIVISIONS  
SPERRY RAND CORPORATION  
CLEARWATER AND GAINESVILLE, FLORIDA

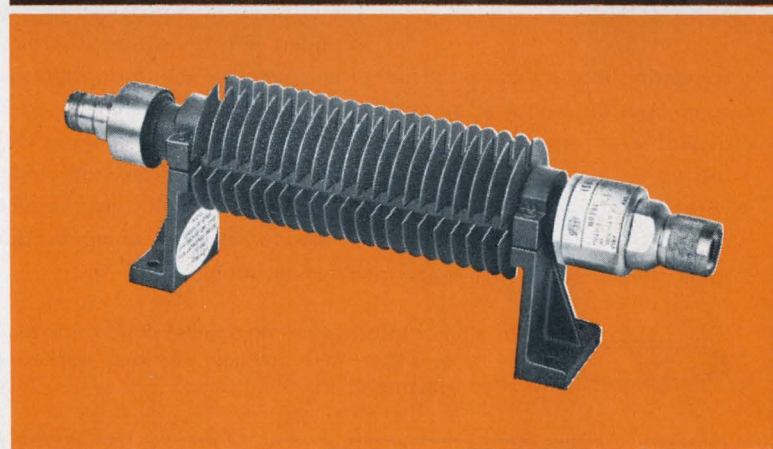

**When B-52's count on ECM, they count on isolators from Sperry . . . the first name in microwaves.**

ON READER-SERVICE CARD CIRCLE 61



# YIG Tuned Microwave Receivers Scan 1-12.4 Gc in a Single Sweep!

E/D's YIG tuned crystal video receivers are packaged in a portable hand-held survey unit for RFI/EMI surveillance and in a plug-in module for Tektronix oscilloscopes.

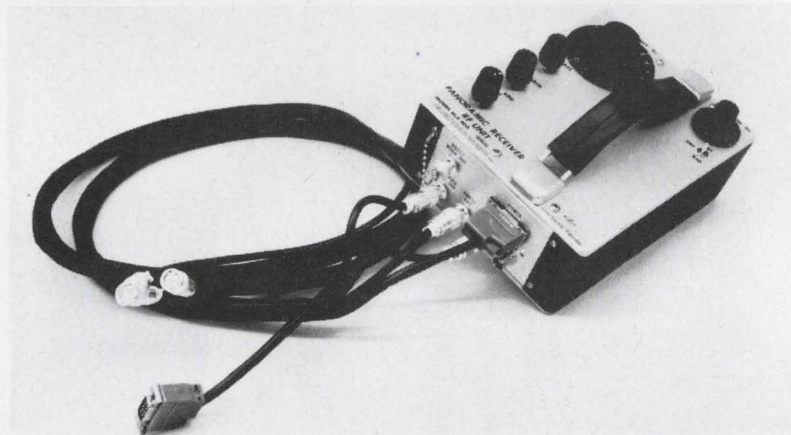

Electro/Data's YIG tuned crystal video microwave receivers are capable of sweeping the entire microwave spectrum from 1 to 12.4 Gc using all solid-state circuitry. Illustrated above is the RLX-100, a small hand-held battery powered RF unit useful for RFI surveys and as a manpack countermeasures receiver.

Shown at left is the PN1011 panoramic receiver module which may be plugged into a Tektronix oscilloscope

converting it to a wide band panoramic receiver with instantaneous and continuous display of all signals from 1 Gc to 12.4 Gc (other models are available at frequencies down to 120 Mc). The PN1000 plug-in modules are useful in the adjustment and development of transistor oscillators, varactor and step recovery diode frequency multipliers, gunn-effect and avalanche diode oscillators and for monitoring and tuning broadband noise sources and other signal generating equipment.



For information on special panoramic receivers or other YIG devices, contact marketing department:

## ELECTRO/DATA INC.

3121 Benton Street

Garland, Texas

Area Code 214, 276-6167

ON READER-SERVICE CARD CIRCLE 62

## COMPONENTS

### Crystal oscillator arrives in TO 5 package



General Electric, Communication Products Dept., Lynchburg, Va. Phone: (703) 846-7311

At G.E. they say that placing a trimmer capacitor in a micro-miniaturized crystal oscillator is like trying to put an elephant into a small wash tub. The trimmer capacitor was eliminated from this thick-film hybrid. Compensating for the missing trimmer capacitor, GE set the frequency a little higher than required on the crystal. After mounting the crystal in the all-in-one circuit package, the complete unit was tested and its frequency measured. A prescribed frequency was then set in the crystal oscillator by vacuum-depositing silver onto the crystal's electrodes, thus adjusting the frequency.

CIRCLE NO. 460

### Crystal oscillator ascends to 100 MHz



Varo Time and Frequency Products, 402 E. Gutierrez, Santa Barbara, Calif. Phone: (805) 963-2055.

The model 7003 crystal oscillator is available at frequencies up to 100 MHz with a stability of  $\pm 0.005\%$ . Hermetically sealed in a volume of  $1/3$  in.<sup>3</sup>, its output will drive integrated circuitry from dc input voltages between 5 and 30 V. The unit will withstand shock to 100 g and a vibration of 20 g rms at 2000 Hz.

CIRCLE NO. 351



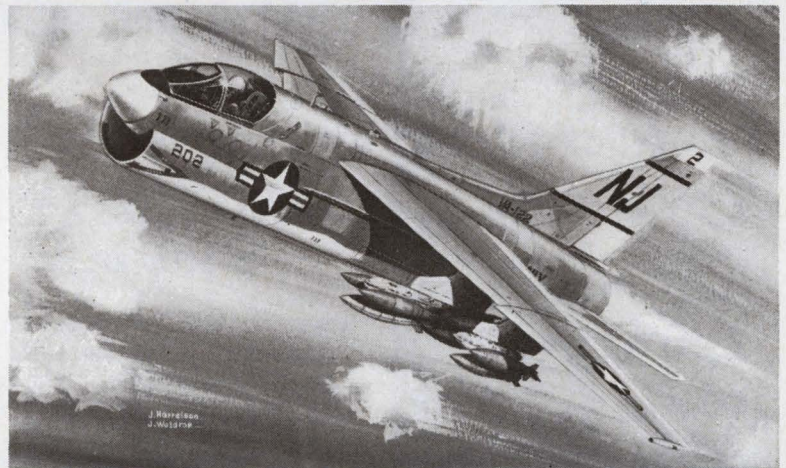
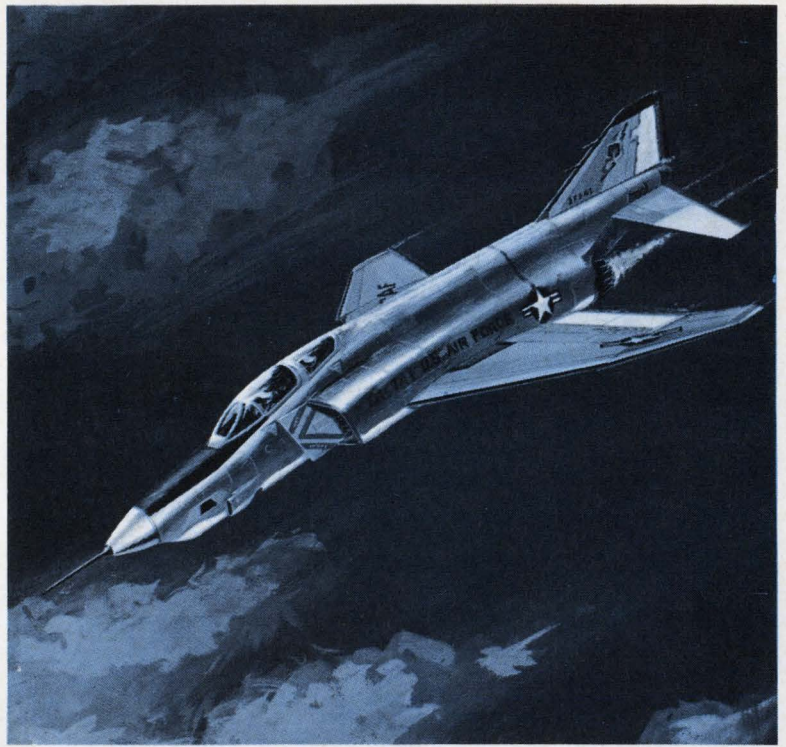

Sperry Rand Corporation has solved a unique oscillator application problem for multi-mode radars on the RF-4C and the A-7A. Texas Instruments Incorporated, prime contractor for both radar systems, needed a dual function tube — one which could serve as local oscillator in the radar, and would also work in the test and check-out circuit.

Sperry suggested the SRU-2161, and tests proved they were right. Today every AN/APQ-99 (for the RF-4C) and AN/APQ-116 (for the A-7A) system carries two of these Sperry reflex klystron oscillators.

The SRU-2161 delivers 50 mW at Ku band, while operating from a 300 V power supply. Since the oscillator has Sperry's unique adjustable reflector voltage, both tubes in the system can be driven from a single power supply. Mode shapes can be controlled to comply with the exacting tolerances of both systems.

If you need unusual performance from klystron oscillators, Sperry is the place to look. Contact your Cain & Co. representative, or write Sperry Electronic Tube Division, Sperry Rand Corporation, Gainesville, Florida 32601.



**SPERRY**  
**MICROWAVE ELECTRONICS AND**  
**ELECTRONIC TUBE DIVISIONS**  
**CLEARWATER AND GAINESVILLE, FLORIDA**

**Why multi-mode radars for RF-4C and A-7A depend on dual-purpose oscillators from Sperry... the first name in microwaves.**

ON READER-SERVICE CARD CIRCLE 63



# Waters

JP/2  
CONFORMS TO  
MIL-R-39002

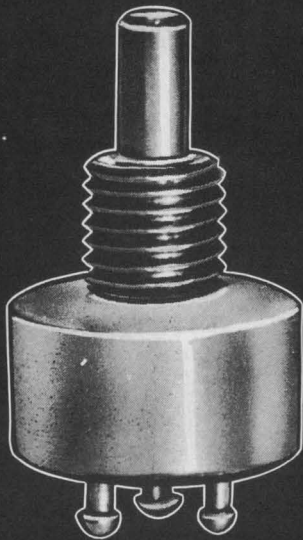

JP/2

only a half-inch

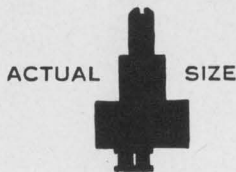

and a half-ounce

but... what a pot  
for performance

When paramount performance in restricted space is the trimmer-pot problem, the JP/2 could well provide an easy answer! Built to Waters exceptional standards, this little pot in the 100 ohm to 10K ohm range has every fine characteristic developed at Waters to insure accurate resistance control throughout a phenomenally long operational life.

### Need a Particular Pot?

If you have a worthwhile need for the potentiometer that doesn't exist . . . Waters has the engineering know-how and shop facilities to fulfill that need. Like to talk it over?

#### EXPORT

Charles H. Reed, Export Director  
Waters Manufacturing, Inc.  
Wayland, Mass. 01778 U. S. A.

## COMPONENTS

### Tuning fork oscillator vibrates to 15 kHz

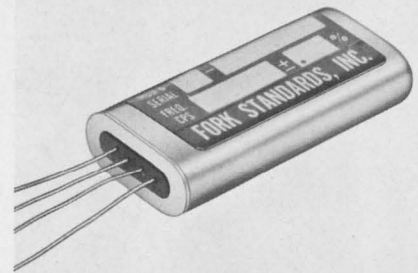

Fork Standards, Inc., P.O. Box 177,  
West Chicago, Ill. Phone: (312) 231-  
3511. P&A: \$80, 3 wks.

The model MO oscillator is built in a 1½ in. long crystal can, ⅜ in. high by ¼ in. wide to be mounted flat on a board or in a spring clip. It has a frequency range of 1 to 15 Hz with accuracy of 0.002% over a limited temperature range, or 0.01% from 55 to +85°C. Supply voltage is 3.5 to 12 V dc square wave output.

CIRCLE NO. 347

### Voltage dividers range to 50 kV



Julie Research Labs., Inc., 211 W.  
61st St., New York. Phone: (212)  
245-2727. P&A: \$450 to \$750; 30 days.

Kilovolt dividers with ranges from 10 to 50 kV for high-voltage power supplies and high-voltage calibration has been made available. Each divider has a 1 and 10 V readout tape for universal circuit compatibility. A 1000 V tap is available as an option. Accuracy is in the range of 0.0025% to 0.01%. Each divider is enclosed in a hermetically sealed case. The internal resistors are oil-immersed for stability and to provide reduction in transient current temperature effects.

CIRCLE NO. 353

ON READER-SERVICE CARD CIRCLE 64

 **WATERS**  
MANUFACTURING INC.  
WAYLAND, MASSACHUSETTS



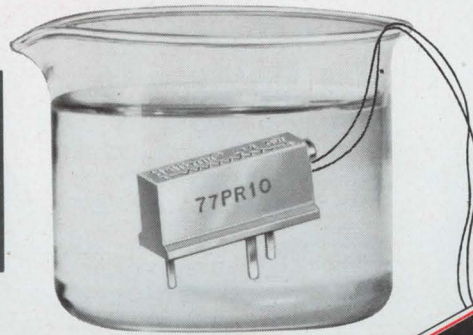

# Designed Sealed Delivered



## Helipot's New Model 77P Cermet Trimming Potentiometer

Here's the new Model 77P, the first low-cost, general purpose trimmer with a sealed housing and cermet resistance element! DESIGNED to wider performance parameters than any other adjustment potentiometer in its price range. It is directly interchangeable with competitive Models 3067 and 3068—SEALED to permit p.c. board solvent cleaning and potting without trimmer contamination or failure—DELIVERED from local stock at the low list price of \$1.95. In large quantities, Model 77P sells for as little as \$1.10. ■ Compare Model 77P specifications with those of unsealed trimmers, then call your local Helipot representative for an evaluation sample.

	 Helipot Model 77P	 Model 3067 Wirewound	 Model 3068 Carbon
Resistance Range, ohms	10 - 2 meg	50 - 20K	20K - 1 meg
Resolution	Essentially Infinite	1.7 (100) to 0.3 (20K)	Essentially Infinite
Sealing	Yes	No	No
Power Rating, watts	0.75	0.5	0.2
Maximum Operating Temp. °C	105	85	85

**Beckman**

INSTRUMENTS, INC.

HELIPOT DIVISION

FULLERTON, CALIFORNIA • 92634

INTERNATIONAL SUBSIDIARIES: GENEVA; MUNICH; GLENROTHES, SCOTLAND; TOKYO; PARIS; CAPETOWN; LONDON; MEXICO CITY

ON READER-SERVICE CARD CIRCLE 65



# TRANSFORMERS FOR INDUSTRIAL APPLICATIONS MILITARY QUALITY AT COMMERCIAL PRICING

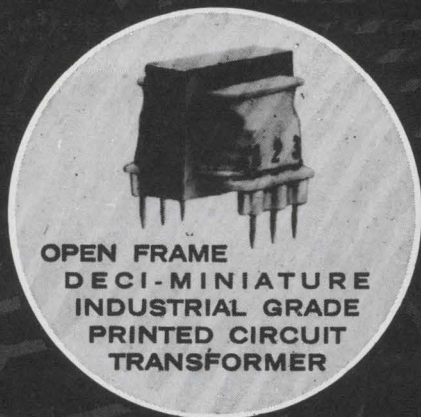

**OPEN FRAME  
DECI-MINIATURE  
INDUSTRIAL GRADE  
PRINTED CIRCUIT  
TRANSFORMER**

Miniature Printed Circuit Transformer specially designed for transistorized control and instrumentation • Molded-in terminals provide fixed mounting centers usually found only in expensive molded transformers • Size:  $\frac{3}{4}$ " x  $\frac{13}{16}$ " x  $\frac{19}{32}$ " —  $\frac{3}{16}$ " x .042 pins. Weight:  $\frac{1}{2}$  oz. • These units can be used as input, interstage, output and isolation applications.

Part No.	Primary Impedance	Secondary Impedance	Pri. D.C. Unbalance Ma.	Operating Level DBM
DCM1-PC	25000 C.T.	1200 C.T.	2	18
DCM2-PC	15000 C.T.	15000 C.T.	3	19
DCM3-PC	15000 C.T.	600 C.T.	3	19
DCM4-PC	10000 C.T.	5000 C.T.	4	20
DCM5-PC	10000	2500/625 Split	2	20
DCM6-PC	10000 C.T.	1500 C.T.	4	20
DCM7-PC	5000 C.T.	80,000 C.T.	6	15
DCM8-PC	4000 C.T.	1200 C.T.	6	20
DCM9-PC	4000 C.T.	600 C.T.	6	20
DCM10-PC	4000	600/150 Split	3	20
DCM11-PC	2500 C.T.	2500 C.T.	8	20
DCM12-PC	2500	2500/625 Split	4	20
DCM13-PC	2500 C.T.	625 C.T.	8	20
DCM14-PC	2500 C.T.	200 C.T.	8	20
DCM18-PC	600 C.T.	50,000 C.T.	16	20
DCM19-PC	600	8000/2000 Split	8	20
DCM20-PC	600 C.T.	200 C.T.	16	20
DCM21-PC	600 C.T.	600 C.T.	16	20
DCM22-PC	250 C.T.	600 C.T.	25	20

## DECI-MINIATURE — INDUSTRIAL GRADE — OPEN FRAME PRINTED CIRCUIT CHOKES

Part No.	Oma d.c.	Inductance rated current conditions	DCR
DCM51-PC	10 hy	5 hy-3 ma	300
DCM52-PC	5 hy	2 hy-5 ma	155
DCM53-PC	2.5 hy	1 hy-7 ma	75

Immediate Delivery from Franchised Distributors • Write for NEW 32 page catalog



# MICROTRAN

COMPANY, INC.

GARDENA, CALIF.

VALLEY STREAM, NEW YORK

ON READER-SERVICE CARD CIRCLE 66

## COMPONENTS

### Deflection amplifiers operate from 15 to 35 V



Beta Instrument Corp., 377 Elliot St., Newton Upper Falls, Mass. Phone: (617) 969-6510. P&A: \$1000 to \$2000; 6 to 8 wks.

Dc coupled, operational type, difference amplifiers are designed for application in any cathode ray tube or storage tube display system employing magnetic deflection. The DA 223, DA224 and DA225 supply plus/minus 2, 4 and 6 A of deflection current respectively to each axis of a directly-coupled deflection yoke.

CIRCLE NO. 464

### Pin diode attenuator range from 2 to 500MHz.

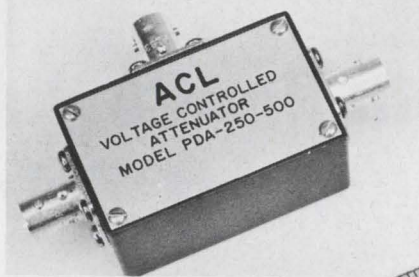

Astro Communication Laboratory, Inc., 9125 Gaither Rd., Gaithersburg, Md. Phone: (301) 948-5210. P&A: \$175; stock.

Pin diode attenuators are available for use at hf, vhf and uhf ranges. These units feature low insertion loss and are suited for applications at low signal levels when the noise figure is of utmost importance. The pin-diode used is a double diffused junction with an intrinsic layer separating the p and n regions. Because of this separation, the shunt capacitance of the pin-diode is quite small. At higher frequencies the diode ceases to be a rectifier and becomes an electrically variable resistor whose conductivity may be varied by a dc bias current.

CIRCLE NO. 324

ON READER-SERVICE CARD CIRCLE 67



SM709 RAYTHEON SM709 RAYTHEON SM709 RAYTHEON SM709 RAYTHEON  
RAYTHEON SM709 RAYTHEON SM709 RAYTHEON SM709 RAYTHEON SM709  
SM709 RAYTHEON SM709 RAYTHEON SM709 RAYTHEON SM709 RAYTHEON  
RAYTHEON SM709 RAYTHEON SM709 RAYTHEON SM709 RAYTHEON SM709  
SM709 RAYTHEON SM709 RAYTHEON SM709 RAYTHEON SM709 RAYTHEON  
RAYTHEON SM709 RAYTHEON SM709 meets NASA Spec. 85M02717

for a steady date with Apollo!

Our selected SM709's will provide a steadying influence on NASA's Apollo-borne earth-orbiting telescope. If you can use a high yield, low-cost linear amplifier that conforms to the toughest set of electrical and mechanical reliability specifications in the business, write or call Raytheon Company, Semiconductor Operation, 350 Ellis Street, Mountain View, California 94040 (415) 968-9211

RAYTHEON



# GCC makes every type of Teflon coated wire you need today. And some you may need tomorrow.

Everyone agrees Teflon® insulated wire is more than a match for outer space. But, can you depend on getting it to your plant on time to meet your production schedule?

GCC is ready to meet your needs, wherever your plant happens to be. 51 GCC distributing centers and a nationwide network of manufacturing facilities are ready, willing and able to back up every order. GCC's delivery

policy goes one step further; tell us your needs and we'll be sure to stock your most popular items, so you'll always have a readily available source close by.

For specific data on the scope of our Teflon insulated product capabilities, drop us a line.

**General Cable Corporation,  
730 Third Avenue,  
New York, New York 10017.**

## GCC



**WE'RE IN THE TEFLON  
INSULATED WIRE BUSINESS.  
AND WE'RE IN IT BIG.**

Teflon® is a DuPont trademark

**ON READER-SERVICE CARD CIRCLE 68**

## COMPONENTS

### Temperature transducer has 10 K $\Omega$ resistance

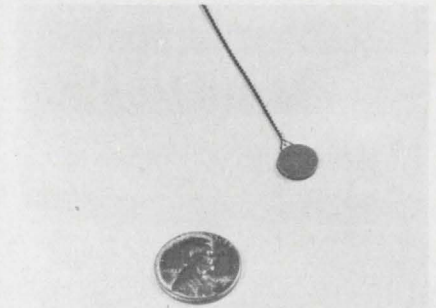

*EON Instrumentation, Inc., 15547 Cabrito Rd., Van Nuys, Calif. Phone: (213) 781-2185. P&A: \$42; stock.*

Designed for surface temperature measurement in the range of -100 to +350°F, this transducer, when used with a suitable bridge network, will yield a high level output of more than 10 mV/F (without amplification) as a linear function of temperature. It measures  $\frac{3}{8}$  in. in diameter by 0.05 in. thick. The unit is intended for space and airborne applications as well as laboratory applications.

**CIRCLE NO. 369**

### Miniature 0.05 $\Omega$ resistor measures magnitude



*Reynolds industries, Inc., 2105 Colorado Ave., Santa Monica, Calif. Phone: (213) 451-1741. P&A \$30.50, stock.*

In-line coaxial cable current viewing resistor is designed to measure both magnitude and shape of transient current pulses in high-energy detonating devices. The unit is 0.59 in. in diameter and 1.89 in. in length. Nominal resistance is 0.05  $\Omega$ . Exact resistance value of each unit is determined with a Kelvin bridge to +0.25% and is recorded on the body of the unit.

**CIRCLE NO. 367**



Now, your Babcock 10 amp. full size crystal can relay will also switch dry circuit with the same set of contacts. These exclusive universal contacts have greatly simplified your relay stocking requirements. You can order one model to meet a given set of performance parameters without concern for load requirement —at no cost premium. Get complete information about this versatile relay, and the entire Babcock line, all with universal contacts.



The Babcock Model BR14 provides 4-pole, dry circuit to 10 Amp. operation in a small package . . . with time-tested reliability in aerospace applications.

**SPECIFICATIONS**

SIZE: 1.3000" h. x 1.075" l. x 1.000" w.	FULL-IN POWER: Low as 400 mw.
WEIGHT: Approx. 3.0 oz.	LIFE: 100,000 operations, min.
OPERATE TIME: 7.5 - 8.5 ms.	TEMP. RANGE: -65°C to +125°C

Write Babcock Relays, Division of Babcock Electronics Corporation, 3501 Harbor Boulevard, Costa Mesa, California 92626; or telephone (714) 540-1234.



**FROM THE BABCOCK FAMILY OF CRYSTAL CAN RELAYS**

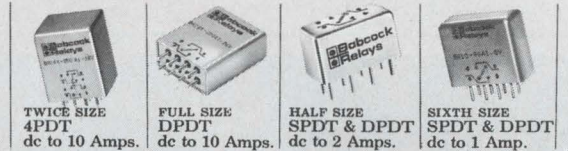

**Babcock**  
**Model BR 14**  
**four-pole,**  
**dry circuit to**  
**10 amp. relay...**  
**with**  
**universal contacts**

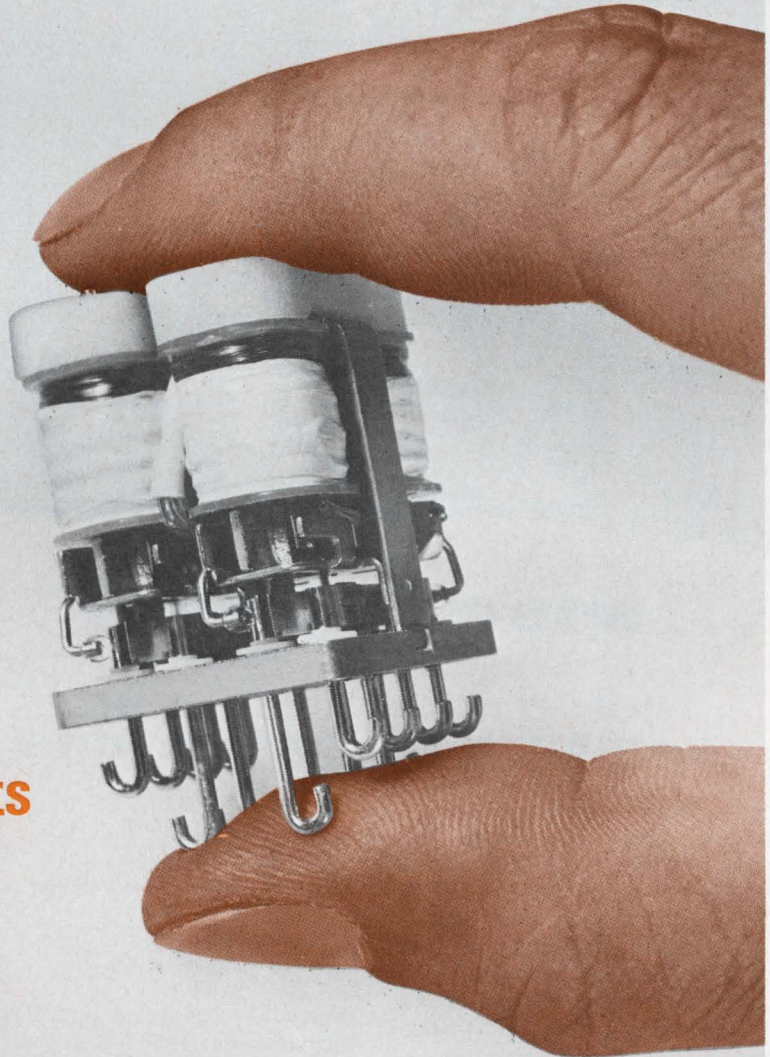



COMPONENTS

**Dc-dc motion transducer delivers 5 V output**

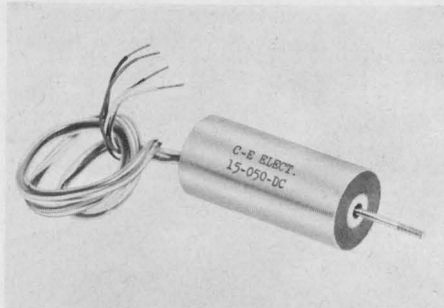

C-E Electronics, Inc., 363 Glenside Ave., Glenside, Pa. Phone: (215) 887-8900. Price: \$145 up.

With 10 V dc input the transducer delivers 5 V dc output for 0.01 in. travel with 1/2% linearity. The dc-dc system incorporates a conventional LVDT with a completely integrated oscillator - demodulator - amplifier built into the potted enclosure. Package size is 7/8 in. dia. x 2 in. long. For airborne applications the electronic package is specially cushioned for resistance to high g forces.

CIRCLE NO. 366

**Bridge amplifier settles in 6.5 μs**

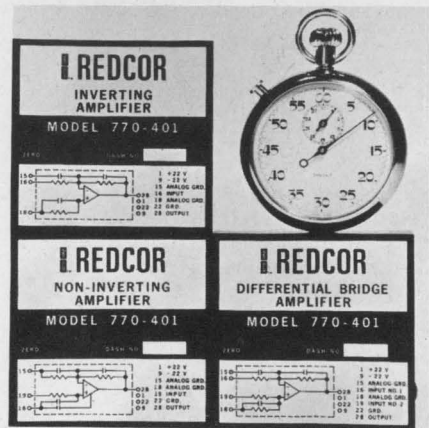

Redcor Corp., 7800 Deering Ave., Canoga Park, Calif. Phone: (213) 348-5892.

The new three-configuration module, designated model 770-401, was designed as a fast-settling, high-accuracy amplifier. Settling time is typically 6.5 μs with a full-range step change (20 V). Accuracy is within 0.025% at standard gains of 1, 2, 5, 10, 20, and 50. Other features of the unit include input and feedback networks compensated for constant bandwidth, minimum settling time at all gains; high common-mode rejection of 100 dB at gain of 50; recovery from overload of 5 μs; and temperature drift of 50 μV/°C. An internal floating power supply makes the module insensitive to power-supply variances. An offset adjustment control is provided within the module. Its size is 2.9 in.<sup>3</sup>.

CIRCLE NO. 372

**Power resistors use tin oxide**

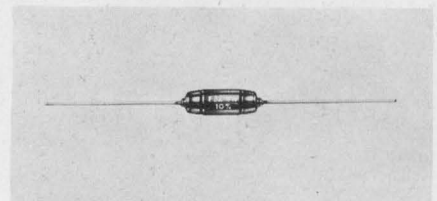

Welwyn International Inc., 811 Sharon Dr., Westlake, Ohio. Phone: (216) 871-7980. P&A:5¢ up; stock.

Flameless insulated power resistors are available in 2 through 10 W, from 20 Ω to 91 KΩ and at 1, 2, 5 and 10% tolerances. Units will withstand overloads of over 10 times rating without opening or flaming.

CIRCLE NO. 370

**When reliability is the rule**

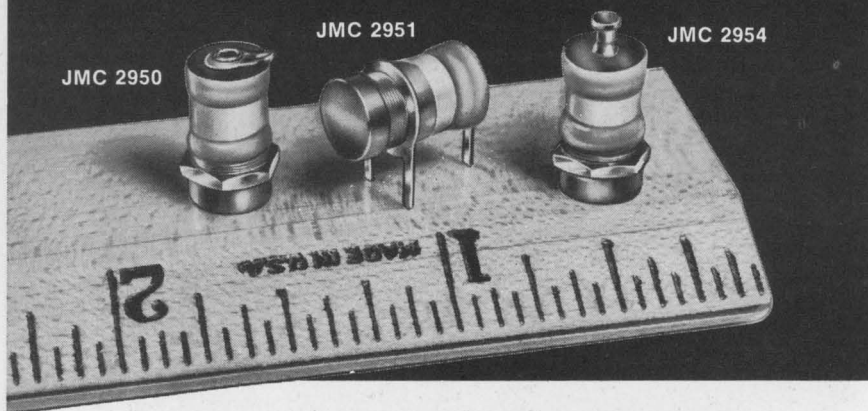

**... specify Johanson**

**HIGH Q, HIGH FREQUENCY VARIABLE AIR CAPACITORS**

This versatile series provides, in miniature size, exceptionally high Q, superior ruggedness for protection against shock and vibration, -55° to +125°C operating temperature range, protection against fungus, salt spray and humidity . . . plus all the other construction and performance features that have made Johanson capacitors the industry standard for excellence.

**Specifications**

- Capacitance Range:** 0.8 — 10.0 pF
- Dielectric Withstanding Voltage:**  
Rating 250 VDC breakdown >500 VDC
- Insulation Resistance:** >10<sup>6</sup>, megohms @ 500 VDC
- Q:** >2000 @ 100 mc
- Temperature Coefficient:** 0 ± 20 ppm/°C
- Rotational Life:** >800 revolutions

Write Today for Complete Catalog, Prices.

**Johanson MANUFACTURING CORPORATION**  
400 Rockaway Valley Rd., Boonton, N.J. 07005, (201) 334-2676  
Electronic Accuracy Through Mechanical Precision  
ON READER-SERVICE CARD CIRCLE 70



# We've been making these

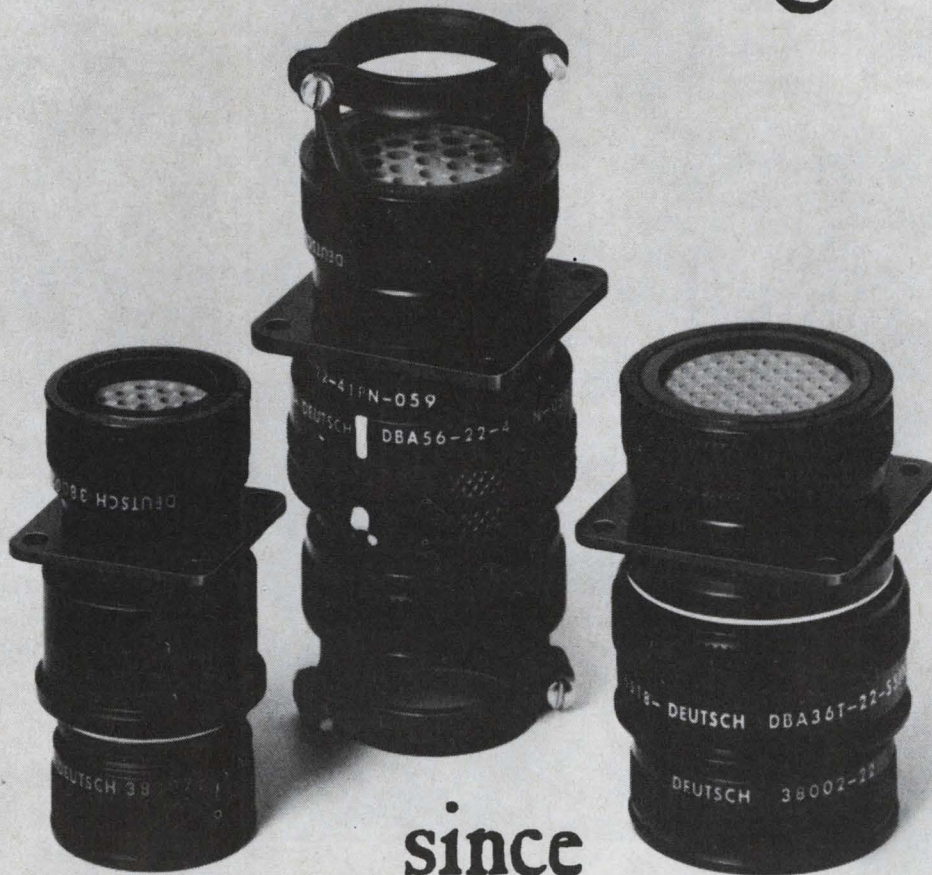

since

# 1599

Deutsch was the first manufacturer to make a rear release connector that met the requirements of NAS 1599. Now our DBA series is fast becoming the industry standard. Probably because these connectors are reliable, economical and easy to use.

DBA's let you upgrade your systems to new standards without involving costly circuit design changes. These connectors withstand higher temperatures than required by the NASC standard. The hard plastic socket interface is designed to also act as a pin straightener. Rear release of contacts (that meet NAS 1600) makes these connectors completely compatible with the Deutsch Integrated Termination System.

Threaded couplings, quick disconnect push-pull versions and bayonet locking Tri-Kam types are available.

The threaded versions are intermateable and interchangeable with existing Mil C 26500 types. The bayonet versions intermate and interchange with existing Mil C 26482 bayonet types.

For extreme environmental performance, DBA hermetic receptacles are available, and feature silicone rubber interfaces and full compression glass seals.

A wide range of insert configurations and sizes are available. For complete information on the rear release DBA, write Deutsch, Electronic Components Division, Municipal Airport, Banning, California 92220.

## DEUTSCH

DBA CONNECTORS



**μsec/millisecond delays**

**VIDEO**

**5 to 500 MHz**

**MULTI-CHANNEL**

**TRIPLE TRAVEL**

**PROPORTIONAL CONTROL**

**analog**

**ISOTHERMAL**

**WIDEBAND**

**AMPLIFIERS**

**LOW LOSS**

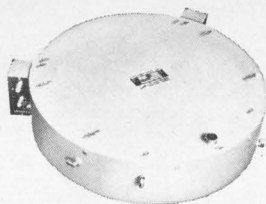
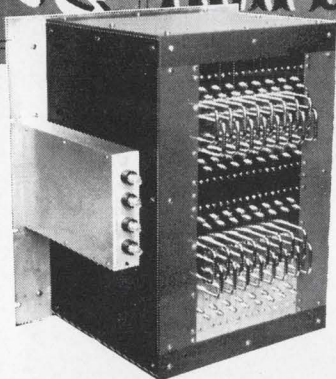

**In a word, LFE**

**for quartz or glass ultrasonic delay lines**

You'll find the complete text — applications information — theory — technical data — specifying information for standard and custom delay lines for your application — in these authoritative LFE Catalog-Handbooks. Get them, now!



**ELECTRONICS DIVISION**

Laboratory For Electronics, Inc.  
WALTHAM, MASSACHUSETTS 02154  
Tel: 617-894-6600 • TWX: 710-324-0681

ON READER-SERVICE CARD CIRCLE 74

**COMPONENTS**

**Rotary transducer uses reed switch**

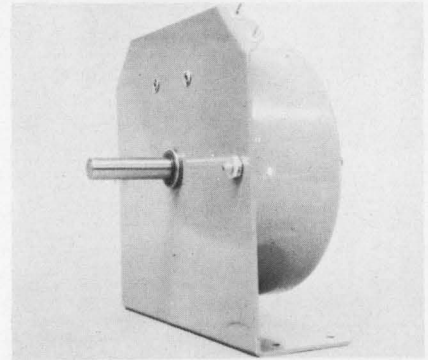

*Amtron, Inc., 14820 S. Kedzie Ave., Midlothia, Ill. Phone: (312) 389-3955.*

This unit detects shaft rotation and yields a fixed number of pulses per revolution at speeds from 0 to 2000 rpm. It is encased in a lightweight aluminum housing. Teflon feed-through terminals are used for external connections. The rotating shaft is 3/8 in. in dia. polished steel, and is mounted in a sleeve bearing. The switch is normally open, 10 closures per revolution is standard, and it handles 10 W, up to 0.5 A, at 400 V dc. Its shock range is 15 g without false operation.

CIRCLE NO. 391

**FET op amp puts out 20 mA**

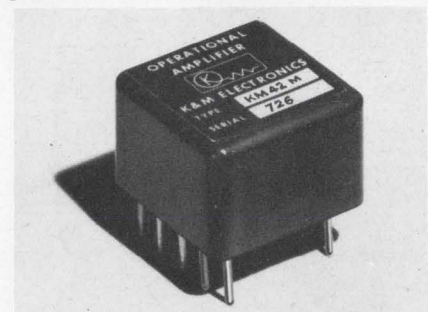

*K&M Electronics Corp., Hackensack, N.J. Phone: (201) 343-4518. Price: \$95.*

FET operational amplifier, model KM-42M, has a full power output of 20 mA at 20 kHz. This amplifier will find use in integrators, sample and hold circuitry, and high impedance VTVM systems. It is available in a package measuring 0.6 x 0.6 x 0.4 in. Additional features include low-leakage current, 50 pA, an input impedance of  $1 \times 10^{12} \Omega$ , a gain of 200,000 and a voltage offset drift vs temperature of  $25 \mu\text{F}/^\circ\text{C}$  over a temperature range of  $-55$  to  $+125^\circ\text{C}$ .

CIRCLE NO. 398



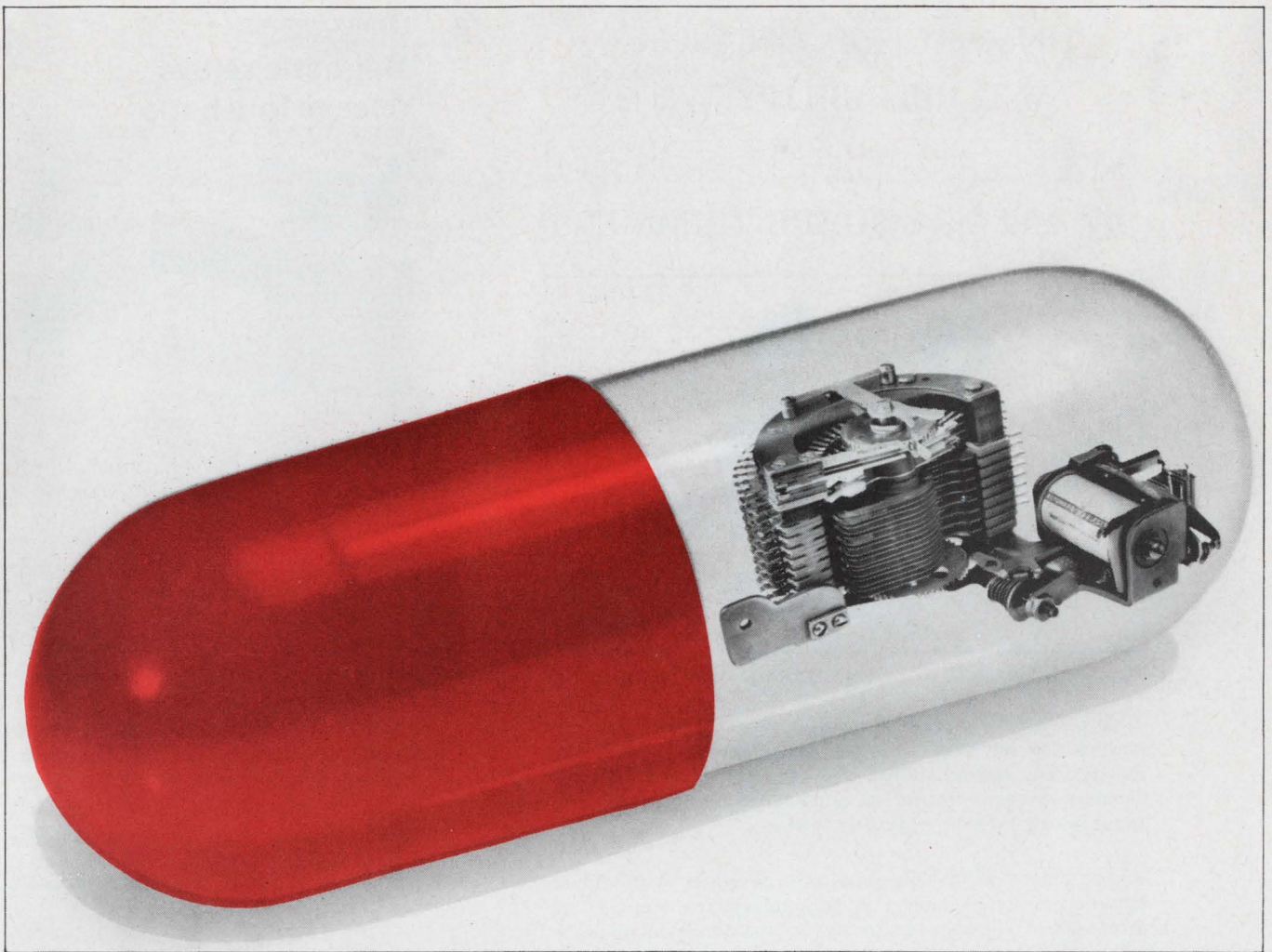

## Remedy for nightmares: AE's Type 45NC stepping switch with "shorting" levels.

Many of today's complex switching circuits look like an engineer's nightmare. Why not simplify them? You can replace whole groups of components with an AE Type 45NC "stepper."

This switch has normally closed ("shorting") levels. It's designed so that pairs of contacts *open* successively when the rotor is stepped.

The Type 45NC can solve almost any circuit-transfer or testing problem.

It's ideal for self-interrupted hunting, and you don't need auxiliary relays.

You get one or two electrical levels of either 26 or 52 point normally-closed contacts. For extra versatility, you can specify addi-

tional levels of *normally-open* contacts—on the same switch.

Contacts are gold-plated phosphor bronze. Contact resistance: a maximum of 50 to 100 milliohms, measured at 6 volts 100 milliamperes.

When you specify AE rotary stepping switches, you get the benefit of our continuous research—in design, in metals and insulating materials. All this plus *positive positioning* — a unique AE design

feature that locks the rotor and makes overthrow impossible.

Find out more about AE rotary stepping switches—an economical, rugged and reliable way to simplify switching circuits. There's a lot of helpful application information in our new reference circular 1698-L. To get your copy, just ask your AE representative. Or write to the

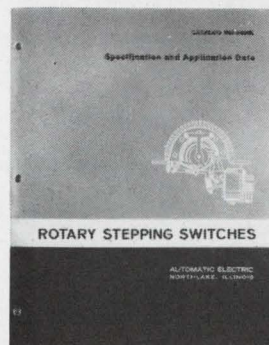

Director,  
Relay Control Equipment Sales,  
Automatic Electric,  
Northlake, Illinois  
60164.

**AUTOMATIC ELECTRIC**  
SUBSIDIARY OF  
GENERAL TELEPHONE & ELECTRONICS **GTE**

ON READER-SERVICE CARD CIRCLE 75



UNMATCHED ACCURACY  
AND RELIABILITY WITH  
**MIDGI-TRIM**<sup>®</sup>  
1/2" and 3/8" SQUARE TRIMMERS

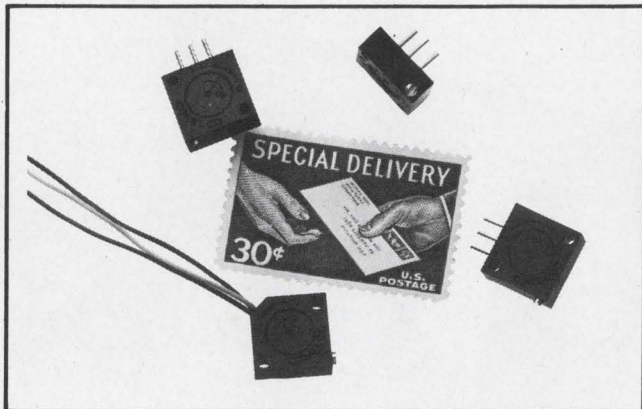

**MIDGI-TRIM** wirewound-square trimming potentiometers have acknowledged acceptance in the industry for accuracy and reliability. They meet or exceed the most demanding requirements of applicable missile and aerospace specs, including MIL-R-27208B.

**MIDGI-TRIM** pots are designed with fewer moving parts than most conventional square trimmers. A drive wheel replaces six parts or functions common to other square trimmers and functions as a mechanical actuator, slip ring, spring preload, slip clutch, and positive rotating stop.

**MIDGI-TRIM** pots feature a stainless steel adjustment screw insulated from the contact mechanism, which makes the case completely non-conductive.

**MIDGI-TRIM** pots contain precious metal alloys of platinum, silver, and gold, together with low-temperature coefficient resistance material, that provide minimum resistance change over wide temperature ranges.

**MIDGI-TRIM** pots offer many other features that can't be found in other square trimmers:

- Encapsulating problems are eliminated
- No loose lead screws
- No loose pins
- No open windings

A new four-page, two-color brochure details these features. Write for yours today — no obligation, of course.

**CONELCO COMPONENTS**

Subsidiary of **SYSTRON**  **DONNER**  
CORPORATION

wirewound/slidewire/multi-element/cermet/metalfilm trimming potentiometers

465 W. FIFTH ST., SAN BERNARDINO, CALIF. 92401  
PHONE: (714) 885-6847, TWX (910) 390-1157

COMPONENTS

**Magnetic relays  
release in 1.5 ms**

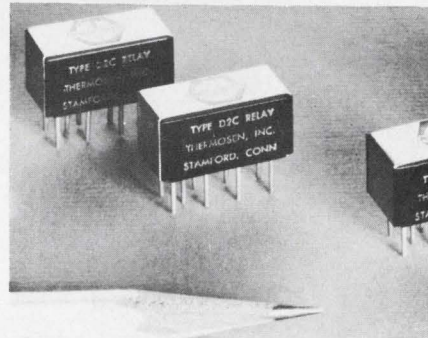

*Thermosen, Inc., 375 Fairfield Ave., Stamford, Conn. Phone: (203) 324-6125.*

The type D relay incorporates two form C contact groups in a half-crystal can size package. Operate and release times, including bounce, are in the order of 1.5 ms. Thermal emf, generated by coil warm-up, is less than 3  $\mu$ V. Dynamically generated noise, measured 0.2 ms after end-of-bounce, is less than 3  $\mu$ V pk-pk. The units are suitable for printed circuit applications, either socket-mounted or soldered-in.

CIRCLE NO. 400

**Reed relays  
spst orientated**

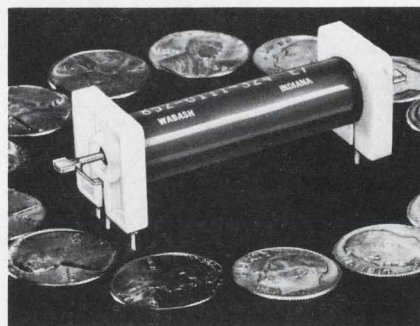

*New Product Engineering, Wabash, Ind. Phone: (219) 563-2191. Price: 77¢ (77 or more)*

These Form A standard size spst reed relays are available in three coil voltages: 6, 12 and 24 V. Contacts are normally open and have maximum ratings of 150 V dc, 1.5 A, 25 W, and contact resistance of 100 M $\Omega$ . Power sensitivity is approximately 480 mW. The relays are the open type, for printed circuit board construction. The package is 1.95 in. long, 0.7 in. wide and 0.725 in. high.

CIRCLE NO. 455



# Adlake Mercury Displacement Relays —Application Data

## Operates Under a Wide Range of Temperature Conditions

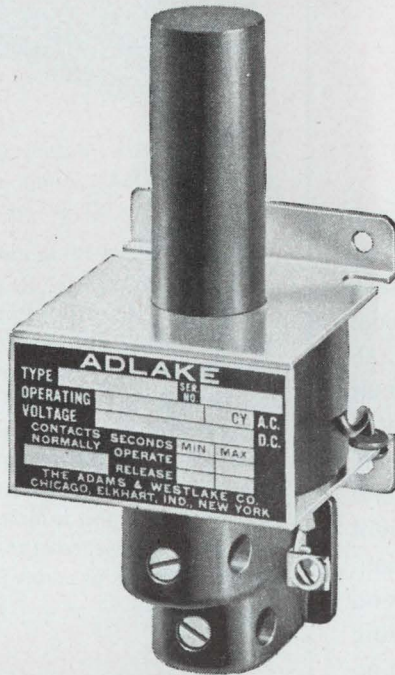

Varying ambient temperatures have little or no effect on Adlake Mercury Displacement Time Delay relays. From the graphic illustrations, ambient temperatures up to 200° F or down to -37.8° F (freezing point of mercury), the change in timing is less than 10%.

Adlake relays have been subjected to temperatures well below -37.8° F for extended periods. Upon raising the temperature to a point above the freezing point of mercury, the relay will again become operative. The relay will not suffer any damage as a result of the extended exposure to low temperature. This portrays the ruggedness of Adlake Relays due to their simplicity of design.

## Mercury Displacement Relays — Temperature vs. Time Delay

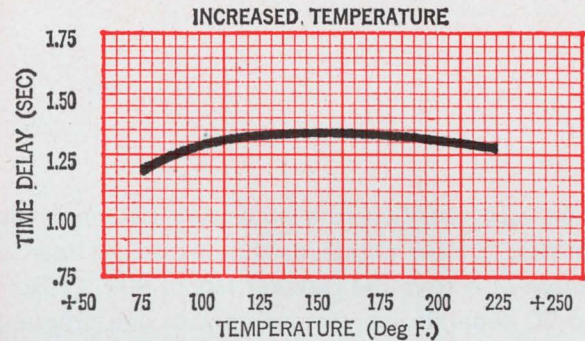

Effect of increased temperature on time delay characteristics. Curve is typical for a normally open, slow-make relay having nominal time delay of 1.25 seconds.

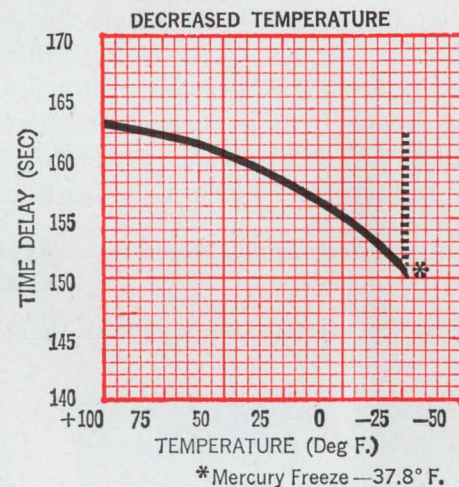

Effect of decreased temperature on time delay characteristics. Curve is typical for a normally open, slow make relay having nominal delay of 160 sec.

Backed by sound research and disciplined engineering, Adlake applies the industry's broadest line of mercury displacement and mercury wetted relays to the creative solution of design circuit problems. However unique or special your application, Adlake can assist you in

developing it. For prompt, personal and knowledgeable attention to your relay needs, contact the one source that is the complete source in the mercury relay field. Contact Adlake today for catalog and further information.



**THE ADAMS & WESTLAKE COMPANY**

A SUBSIDIARY OF ALLIED PRODUCTS CORPORATION

ELKHART, INDIANA 46514 • AC 219 • 264-1141

TRANSPORTATION EQUIPMENT • ARCHITECTURAL PRODUCTS • MERCURY RELAYS • DOORS AND ENTRANCES • CONTRACT MANUFACTURING



# HIGHEST

$m_T/t_{SU}$

We call your attention to a whole new parameter by which to compare IC testers: number-of-test-measurements-per-time-spent-setting-up. You get more of it from the Birtcher Model 800. □ Not only can you make up to 50 separate measurements with one programming of the Model 800's matrix; you can also perform complete functional testing of digital-type IC's without reprogramming. Test speeds like 24 microcircuit parameters in 30 seconds are routine. And the Model 800 is a manual tester, with a manual tester's price tag. □ It has five digitally-settable integral power supplies (one of them a constant current source), and provision for five more external inputs. The matrix is the convenient crossbar type, rather than a pin board. □ Other features include push-button test sequencing; 1% accuracy of internal readout; and hook-up for external readout. A full complement of adapters is available, covering all types of IC's. □ Construction is modular, and there are options on matrix size and accessory modules. □ Price is in the \$2000-\$3000 range.

Write for catalog and applications data.

**the BIRTCHER CORPORATION**  
INSTRUMENT DIVISION

1200 Monterey Pass Road • Monterey Park, California 91754 • (213) 264-6610



ON READER-SERVICE CARD CIRCLE 77

## COMPONENTS

### Encapsulated lamps for printed circuits

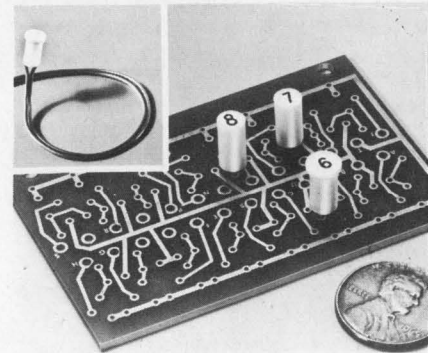

Leecraft Manufacturing Co., Inc.  
21-10 44th Rd., Long Island City,  
N. Y. Phone: (212) 392-8800.

Encapsulated incandescent lamps measure 3/8 in. in length and 316 in. in dia. Mounting pins are spaced 1/8 in. apart. It is designed for printed circuit and instrumentation applications, including panel and sub-panel utilization. Units are available in a power range from 1-1/4 through 28 V and in a variety of colors. Numeric or alpha information can be stamped on the face of the lamp where display or readout is desired.

CIRCLE NO. 392

### Tantalum capacitors span 0.004 to 22 $\mu$ F

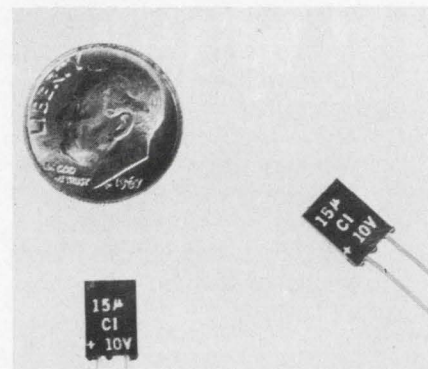

Components, Inc., Smith St., Biddeford, Maine. Phone: (207) 284-5956.

Molded epoxy solid tantalum capacitors are designed for high-volume commercial applications. The units have  $\pm 20\%$  and  $\pm 10\%$  tolerances and 35 and 50 working V dc ratings are standard. Capacitance values range from 0.004 to 22  $\mu$ F. Leakage is 0.02  $\mu$ A/ $\mu$ FV and impedance is less than 1 $\Omega$  at 1 MHz.

CIRCLE NO. 404

ELECTRONIC DESIGN 23, November 8, 1967



# OHMITE has another answer



this is a relay...a new solid state relay unlike any you've ever seen or heard about. Another answer from Ohmite to today's circuitry problems.

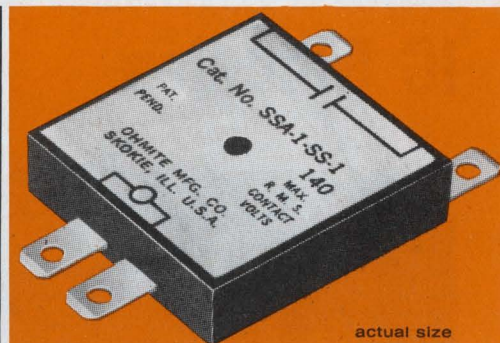

How would you like to work with one relay instead of evaluating five or ten for an application or different projects? If your answer is yes, collect some of your relay design parameters and follow along . . .

#### Universal "Coil" Input

The "coil" voltage in this new Ohmite relay is AC/DC. That's right, it accepts both . . . AC to surprisingly high frequencies. This universal "coil" input capability means that one relay can now satisfy a number of operating requirements. Look here . . .

DC—3 to 200 volts  
AC—3 to 140 volts  
(to 25,000 Hz)

#### Input Isolated

Unlike many solid state relays on the market, Ohmite has isolated input from switching elements giving you a true relay in a completely solid state device.

#### High Sensitivity

Another important plus is the fact that the new relays will operate on as little as 6 milliwatts. They can be used to operate directly from integrated circuits, and will serve as an ideal interface between linear or digital systems and power circuits.

#### "Contacts"

The Ohmite relay is designed to switch 10 amps, 50/60 Hz, AC at 40°C (on metal panel). It is supplied in contact configurations of SPST (N.O.), DPST (N.O.), and SPDT. The relay is capable of accommodating current surges of 10 times its rated current. Having no moving parts, there is no contact bounce, arcing or wear.

#### Transient Protected

In addition to providing protection of relay elements, the design prevents false actuation—unwanted contact closure due to transients, spurious signals or vibration.

#### Mounts Several Ways

- Single screw panel mount with untinned terminals
- Single screw panel mount with tinned terminals
- Printed circuit board mounting
- Octal base with heat sink
- Octal base mounting

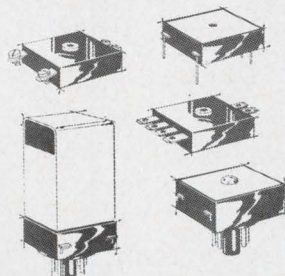

#### Reliable . . . You Bet

Extraordinary life, sensitivity, speed . . . even under severe shock and vibration applications . . . have been built into this solid state design. You won't find another relay like this anywhere, for only Ohmite makes a relay this way.

The new Model SSA solid state relay is another example of how Ohmite is continually developing new product answers for circuitry. In basic and special components . . . in solid state or electro-mechanical design . . . you'll find no better source for products, ideas and answers.

All the facts about Ohmite's new line of Model SSA solid state relays are contained in "Ohmite Answer Book 710". For answers to other circuitry problems in the area of resistors, rheostats, relays, variable transformers, tap switches, tantalum capacitors, solid state controls and R.F. chokes, write Ohmite Manufacturing Company, 3643 Howard Street, Skokie, Illinois 60076. Phone: (312) ORchard 5-2600.

**OHMITE**  
has the answer  
in products for today's & tomorrow's circuitry

ON READER-SERVICE CARD CIRCLE 78



# reduce system size 7:1 with MicroVersaLOGIC IC Modules

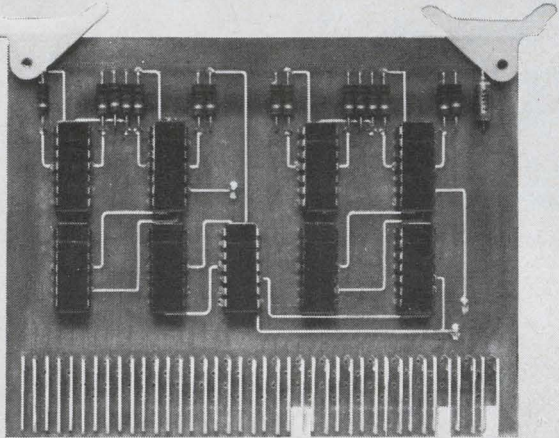

The complete MicroVersaLOGIC line gives you all the ready-made building blocks you need for anything from a register to an entire digital system—with a 7:1 size reduction because of MicroVersaLOGIC's high density IC packaging.

MicroVersaLOGIC also means increased reliability over discrete components, lower power requirements, greatly reduced costs. MicroVersaLOGIC features NAND, NOR logic with wired OR capacity at the collector, operates to 5v. logic levels, has excellent noise rejection of over 1v. There are over 20 basic module types, all meticulously designed and assembled to give you utmost reliability.

Our new MicroVersaLOGIC brochure will show you how easy and economical it is to design digital systems with MicroVersaLOGIC IC Modules. Write or call.



**varian data machines**  
a varian subsidiary

Formerly Decision Control, Inc.  
1590 Monrovia Ave., Newport Beach, Calif.  
(714) 646-9371 TWX (910) 596-1358

ON READER-SERVICE CARD CIRCLE 79

## COMPONENTS

### Molded block rectifiers recover in 300 ns

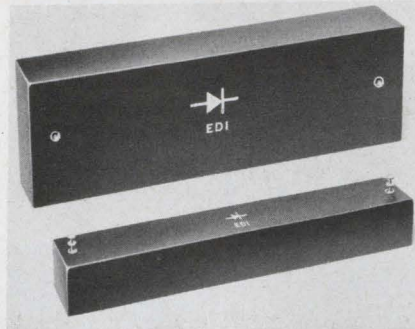

Electronic Devices, Inc., 21 Gray Oaks Ave., Yonkers, N. Y. Phone: (914) 965-4400. Price: \$82.75 (100 lots).

Molded block silicon rectifiers offer a forward current of 2.25 to 2.5A at 50°C ambient and a PIV rating of 3000 to 50,000 V with a recovery time of 300 ns when measured from 1 A forward current to 30 V blocking. These voltage blocks show a surge rating of 150 A and are suited to high power discharge equipment, radio and radar transmitters, modulators, accelerators, induction heating equipment and pulse applications.

CIRCLE NO. 403

### Solid-state amplifiers respond up to 2 GHz

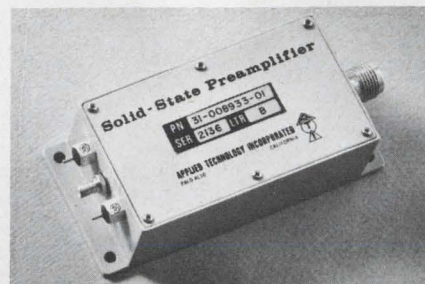

Applied Technology, 3410 Hillview Ave., Palo Alto, Calif. Phone: (415) 321-5135. P&A: \$400 to \$1750; 60 to

Transistor vhf/uhf low noise amplifiers are available in any bandwidth up to an octave at any frequency from 100 MHz to 2 GHz. This is reflected in a model numbering system which incorporates the center frequency and bandwidth. For example, an SP 750/500 provides 750 MHz, center frequency, 500 MHz bandwidth; an SP 1200/400 is 400 MHz wide centered at 1200 MHz. Options include full MIL units, internal video detectors and multiple outputs.

CIRCLE NO. 397

ON READER-SERVICE CARD CIRCLE 80



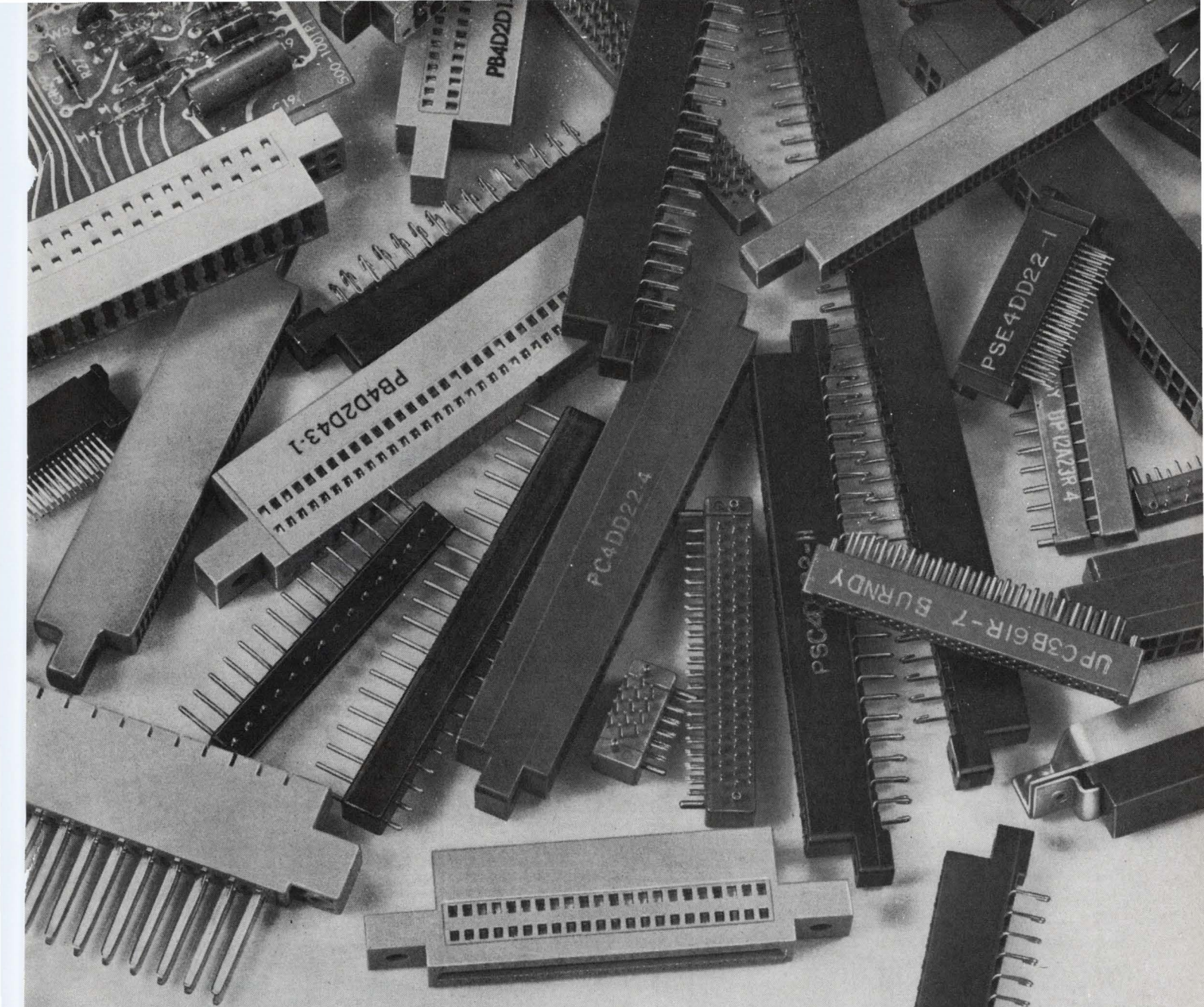

## This is no line. This is a choice.

The way new uses for printed circuits are being found, it stands to reason that there should be enough different PC connectors available to insure that your application requirements are met squarely.

Burndy gives you that choice.

In fact, we have more than 200 different PC connectors to choose from. And it's likely you'll find a connector that will meet the requirements of several projects. Individually, and as a group, the application potential is enormous. Call it choice . . . call it versatility. You're right on both counts.

This is part of what you have to choose from:

### Card Receptacles

- Crimp removable contacts per MIL-C-

21097/B .156" spacing. Non-spec types for .078" .100" and .156" spacing. (The flexibility and convenience of crimp removable contacts often indicates new applications.)

- Solder or weld termination in spacings down to .050".
- Solderless wrap termination on .150" and .200" spacing.

### Two-Piece Connectors

- Crimp removable contacts on .100" and .150" centers meet the requirements of the most rugged environments. Round socket contacts support wires against severe vibration and shock.
- Solder dip types on .100" and .150" spacing. 11 sizes from 13 to 92 contacts conform to several NASA drawings and

Signal Corps specifications  
SCL6250B  
(MIL-C-55302).

Are they reliable?

Today, Burndy PC connectors are being used in everything from business machines and

computers to telemetry systems. They wouldn't be if they weren't exactly that . . . reliable.

If you're involved with printed circuitry you'll want a copy of our PC connector catalog. Write now for catalog PC.

**BURNDY**  
Norwalk, Connecticut



# PLOTAMATIC

x-y recorders offer more performance, features, value

just compare the specs

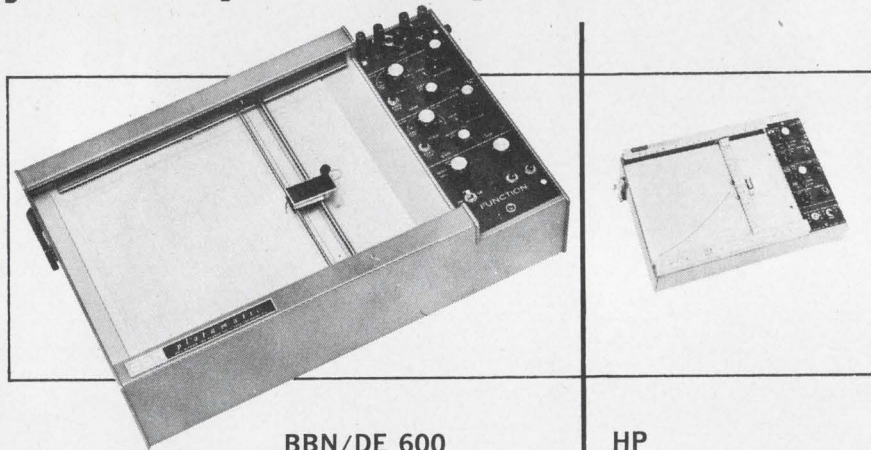

<b>Input Impedance</b>	1 megohm, constant all ranges
<b>Paper Holddown System</b>	Vacuum: better holddown, easier line-up, quiet
<b>Servo System</b>	Sealed follow-up pots (no slide wire cleaning kits)
<b>Calibration Check</b>	Push-button zero check on control panel
<b>X-Y Zero Adjustment</b>	No shift from zero calibrate position regardless of full scale input range selected
<b>Price</b>	<b>\$25 less</b>

## BBN/DE 600

## HP

100K on four most sensitive ranges  
Electrostatic: attracts dust particles  
Open slide wires (require frequent cleaning)  
Must remove X-Y input signals  
Shifts from zero calibrate position when attenuator input range is adjusted for proper full scale setting

Plotamatic is a clear winner on these and other basic important features. You'll want to test all features right in your own lab. We have 30 models of X-Y recorders to choose from. Call us, and we'll bring the particular Plotamatic best suited for you to compare and evaluate. Or write for our complete Plotamatic brochure.



**BOLT BERANEK AND NEWMAN INC**  
DATA EQUIPMENT DIVISION

2126 South Lyon Street, Santa Ana, California 92705 ■ Phone: (714) 546-5300

ON READER-SERVICE CARD CIRCLE 81

## COMPONENTS

### Universal bushing grips with flexible shutters

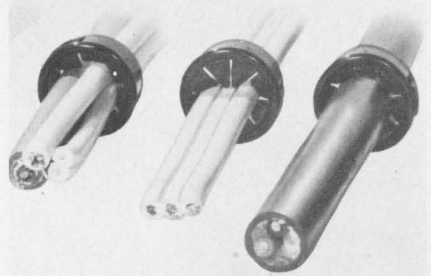

Heyman Manufacturing Co., 100 Michigan Ave., Kenilworth, N. J. Phone: (201) 245-2345.

The bushing has flexible nylon shutters that adjust to accommodate any shape from 1/8 to 9/16 in. It adequately supports and protects even at angle entry and provides a flexible insulated, cushioned hole. The bushing snap locks into 7/8 in. dia. hold in material up to 1/8 in. thick and 1/32 in. increments. It is not effected by oils and is suitable for use under wide temperature variations. At present the bushing is available in black nylon, but it can be had in colors on special order.

CIRCLE NO. 401

### Trimmer potentiometers range from 10 to 100 kΩ

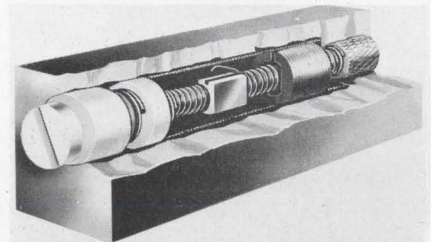

Occidental Equipment Rental System, Mountain View Calif. Phone: (415) 969-9880.

The metal wiper travels inside the one-piece, split alkyd winding core in a close fitting track, ensuring contact and minimum noise. Alkyd molding compound encapsulates both sides of the resistance wire, except for the narrow contact split. Since the alkyd material has a temperature expansion coefficient nearly identical to that of the resistance wire itself, strain gauge effects and drift are eliminated, providing stability. Resistances range from 10 to 100 kΩ, with tolerances of ±5%.

CIRCLE NO. 388



# Phosphor Bronze or Beryllium Copper?\*

No matter what shape your printed  
circuit receptacle problem is in...

## U.S.C. UPCR and UPCR-D edge connectors are in shape to solve them!

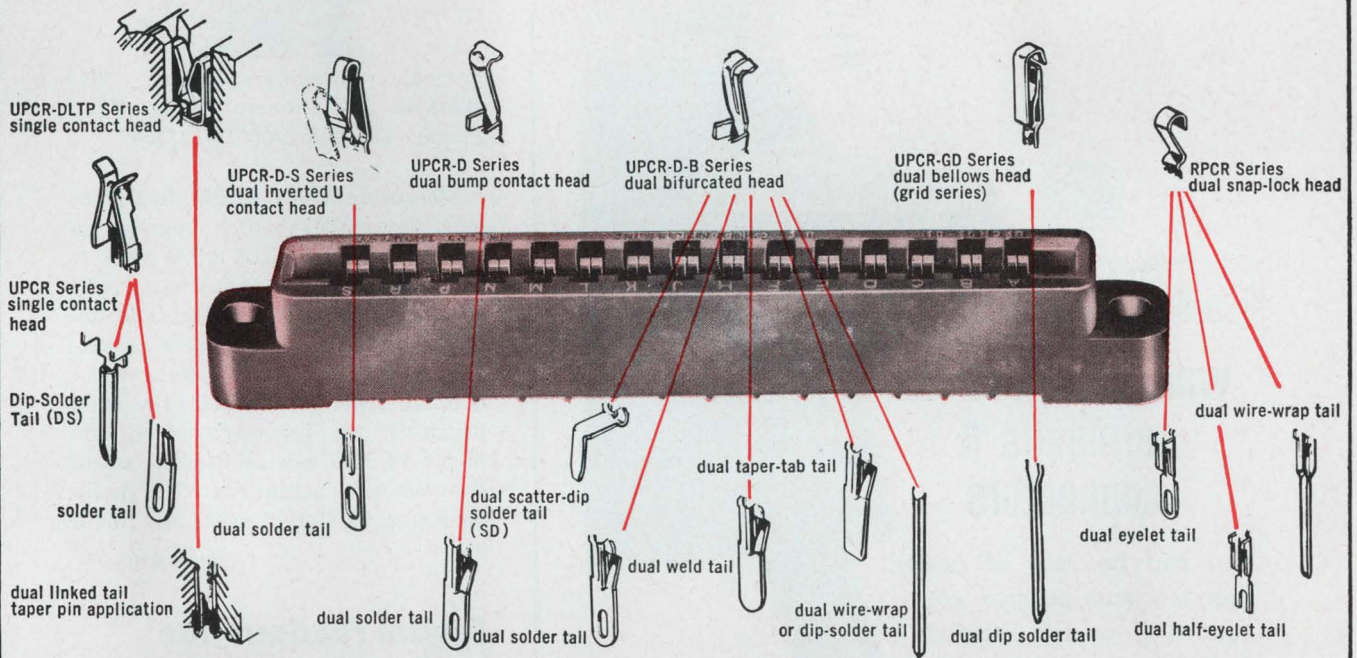

### Heads and tails you win!

U.S.C. UPCR single row and UPCR-D double row printed circuit receptacles offer 1) high reliability, 2) excellent wiping action, 3) constant contact pressure; 4) low insertion force, 5) fool-proof contact alignment, plus...

A wide selection of contact and terminal configurations in different materials and finishes to suit every application. For example, some U.S.C. printed circuit receptacle users pressed for economy and delivery, have switched from beryllium copper to our UPCR-D spring phosphor bronze contacts—with very good results. (See our comparative durability curves for proof.)

Like we said. No matter what shape or how far out your printed circuit connector problem is, call on U.S.C. ER\*\* for a down-to-earth solution. Start by writing for our UPCR-A catalog.

\*\* U.S.C. **E**stablished **R**eliability can do!

Meet all applicable provisions of latest version of MIL-C-21097

U.S. Pat. 2,853,689, 2,909,755

## U.S. COMPONENTS, INC.

1320 ZEREGA AVENUE • BRONX, N. Y. 10462  
or use TWX: 710-593-2141; TEL: 212-824-1600  
TELEX: 01-2411; or Cable: COMPONENTS NYK.

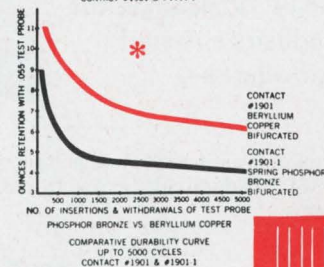
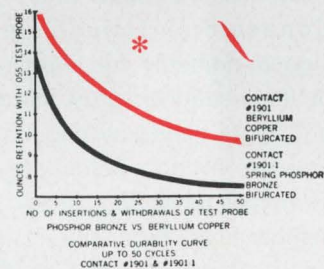

FOR U.S.C. PRINTED CARD RECEPTACLES  
SERIES UPCR D—DOUBLE ROW 1/16" SPRING PHOSPHOR BRONZE CONTACTS  
SERIES BUPCR D—DOUBLE ROW 1/16" BERYLLIUM COPPER CONTACTS



ON READER-SERVICE CARD CIRCLE 82





## waldom solderless terminals & connectors

You can be sure of neater, stronger, more positive terminations if you use Waldom Solderless Terminals and Connectors. Though designed primarily for sophisticated quality circuitry, more and more economy circuits now use Waldom Solderless Terminals for savings in assembly time. From any angle, Waldom is the Industry's fastest growing line.

- \* Broad selection including Quick Disconnects
- \* All construction styles
- \* Absolute dependability
- \* Saves time and labor
- \* Easier servicing
- \* All types made to military specs.

Fast delivery from your electronics or electrical distributor. Write for FREE Waldom catalog listing more than 3000 electronic hardware items.



**waldom**  
ELECTRONICS, INC.

4643 West 53rd Street, Chicago, Illinois 60632

ON READER-SERVICE CARD CIRCLE 83

## COMPONENTS

### SPST pressure switch occupies 1/2 in.<sup>2</sup>



Servonic Instruments, Inc., 1644 Whittier Ave., Costa Mesa, Calif. Phone: (714) 642-2400. Price: \$50.

Measuring 0.5 in. in dia. by 0.5 in. long, this SPST switch operates in the pressure range of 3-300 psig. It has a contact rating of 5 A resistive at 115 V ac at 60 Hz or 28 V dc. The factory adjusted switch point is repeatable to 0.2% of switch point with a nominal differential of 15%. Designed primarily for process control, the model 91 MG can be used in alarm systems or for actual control of pump discharge, suction pressure and liquid levels.

CIRCLE NO. 371

### Digital readout has IC decoder-driver

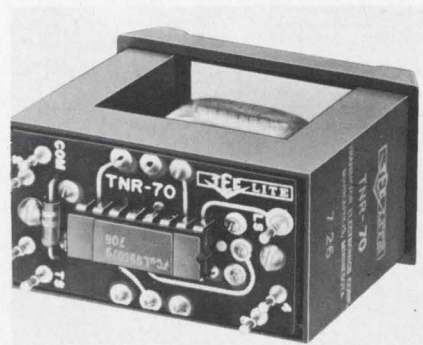

Transistor Electronics Corp., Box 6191, Minneapolis, Minn. Phone: (612) 941-1100.

Replacing the discrete components is a single IC decoder-driver, this readout is 1-7/16 in. long. It will accept 1-2-4-8 binary coded decimal inputs, and produce 10 mutually exclusive outputs. The TNR-70A package includes the complete decoder/driver, tube and bezel.

CIRCLE NO. 396



After  
you've made a  
**waterload**  
this good...

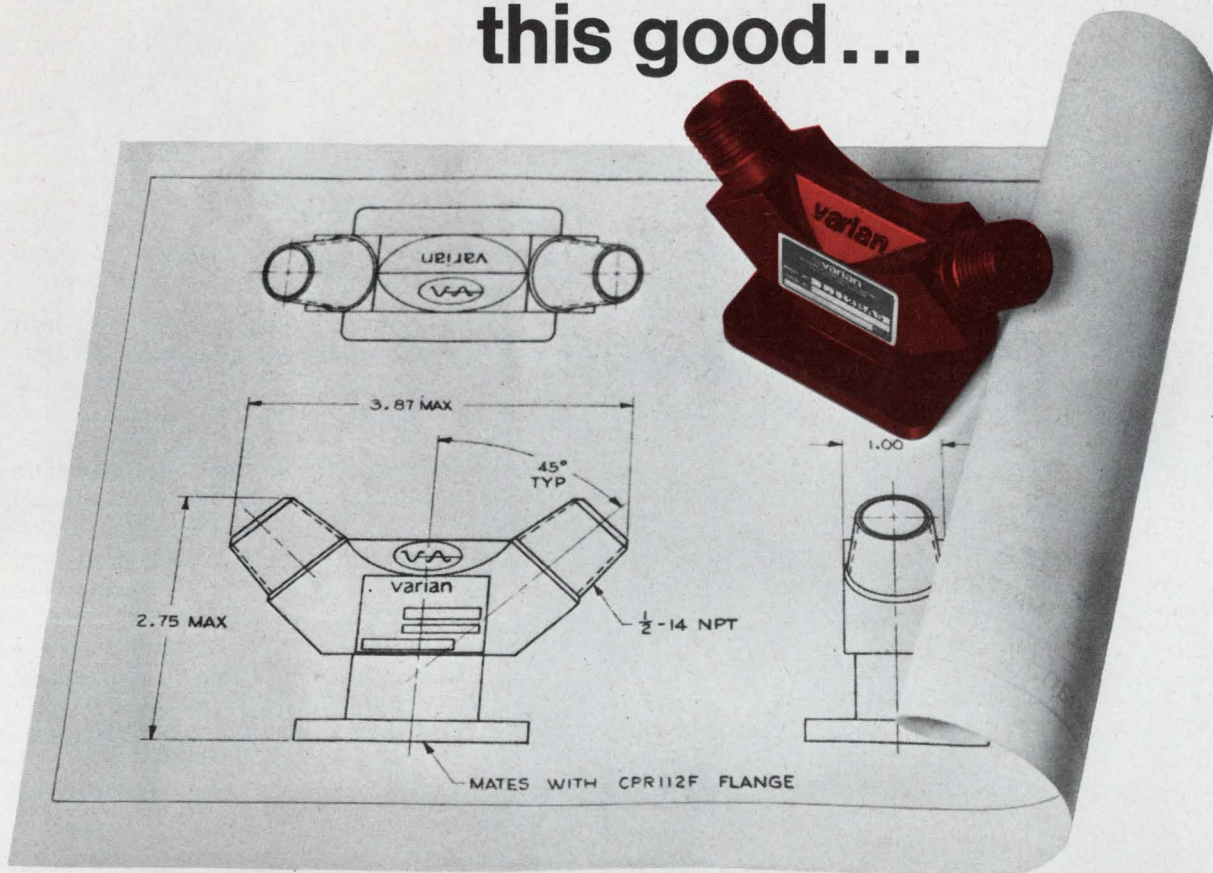

## the rest come easy

This tiny waveguide waterload dissipates more than 100 kilowatts CW in a package only 1 by 2 $\frac{3}{4}$  by 3 $\frac{7}{8}$  inches. It took us more than fifteen years to accumulate the technical experience necessary to build this load. It's typical of the advanced technology that Varian employs in solving the difficult problem of dissipating r-f energy.

We design and manufacture virtually all types of waterloads, covering the spectrum from 200 megahertz to 40 gigahertz... in all sizes and at power levels from watts to megawatts. Standard products include waveguide and coaxial models... Teflon wedge, ceramic block and glass tube. And if our standard units won't fit, we can modify or design and fabricate to your most demanding specifications.

For details, write the Palo Alto Tube Division, 611 Hansen Way, Palo Alto, California. In Europe: Varian A.G., Zug, Switzerland. In Canada: Varian Associates of Canada, Ltd., Georgetown, Ontario, Canada



ON READER-SERVICE CARD CIRCLE 84



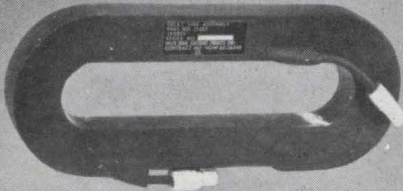

An encapsulated delay line, used between 8 and 12 Gc, exhibits 100 ns of delay. The overall unit weighs less than 8 pounds and the cable is 70 feet long. The cable is .270" diameter, 50 ohm impedance, with an irradiated polyethylene core. Output connectors are TNC Males.

To achieve 122 nanoseconds of delay and fit tight confines, a pancake configuration measuring 11" x 7" x 3/8" containing 45 feet of .141", Phelps Dodge Electronics 50 ohm miniature semi-rigid coax was potted for use with an airborne radio altimeter.

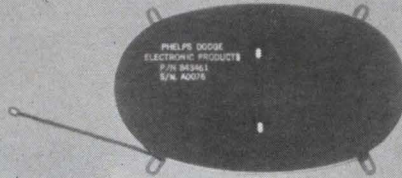

High density delay line is approximately 5" tall. Approximately 13 feet of cable exhibit 20 nanoseconds delay. The cable is a .270" diameter with a polyethylene dielectric and 50 ohm impedance. Connectors are TNC Male.

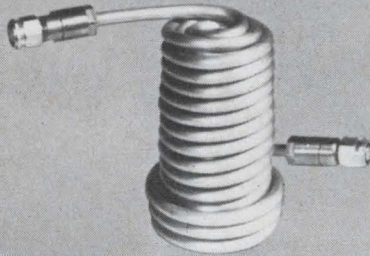

Dual section potted delay line is used for radar calibrating at an operating frequency of 1600 megacycles. The outer race accounts for 980 ns; an inner nest exhibits 61.1 nanoseconds of delay. Aluminum jacketed 50 ohm coaxial cable is .215" diameter with an irradiated polyethylene core. Weight is 25 pounds for the 16" diameter, 3" high package.

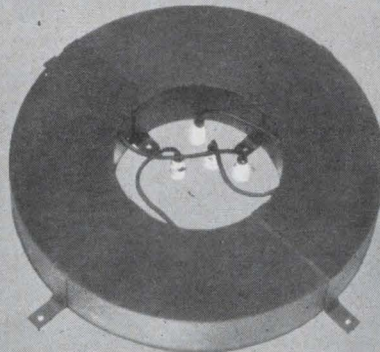

Standard delay line available off-the-shelf for calibration of oscilloscopes, altimeters, radar systems and similar applications. The Foamflex cable unit measures 8½" x 21" x 19" and offers a standard delay of 500 ns, calibrated to ±0.25 ns.

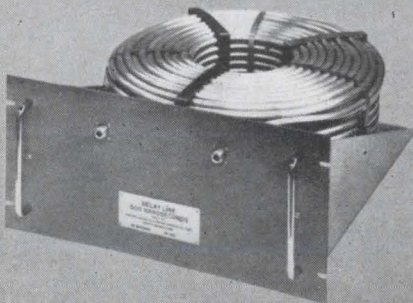

## 28 motor has 0.5 oz. in torque



Kinetics, 410 S. Cedros Ave., Solana Beach, Calif. Phone: (714) 755-1181.

At 28 V dc nominal, the motor operates at a rated speed of 40,000 rpm, and develops 0.5 oz. in. of torque. Stall torque is 3 oz. in. minimum at 28 V dc. Total weight, including integral brake, is under 3 oz. The motor has been qualified to operate under the following environmental conditions: sinusoidal vibrations of 5 to 2000 Hz at 26 g peak, a shock of 100 g for 00 ms each axis and 1000 g for 0.4 ms on each axis and on acceleration of 100 g for 10 minutes on each of three mutually perpendicular axes. Storage and operating temperature range from -80 to +200° F.

CIRCLE NO. 387

## Thermocouple hypodermic installed

Science Products Corp., 280 Route 46, Dover, N.J. Phone: (201) 366-0827.

Thermocouples employ materials such as copper/constantan, chromel alumel and chromel/constantan. These wires are 0.003 in. thick, coated with teflon insulation and twisted together to a final diameter of 0.008 in. A very tiny bead is finally heliarc welded at the sensitive tip. A disposable hypodermic needle is employed. The bead junction of the thermocouple initially lies within the needle and then the needle is forced into the resilient material. Silicone rubber, muscular tissue, plants and soft plastics are equally suitable. The needle is extracted slowly with one hand while the twisted thermocouple is held with the other. The bead of the thermocouple is mechanically gripped by the resilient material and the needle can be extracted completely.

CIRCLE NO. 399

## Suddenly signal delay problems are simple

The capability of Phelps Dodge Electronics coaxial cable delay lines to consistently and uniformly meet ±.02 nanosecond delay tolerances in an endless variety of configurations can help solve complex black box problems.

But, that's not all. Here is broader band operation, lower attenuation per nanosecond of delay, greater stability at microwave frequencies. All conventional packaging techniques are available: containers, shock mounting, standard rack-panel

mounting, strapping, potted or encapsulated coils, with mounting brackets and connectors. Delay lines can also be chemically-treated, painted, or enclosed in standard or customized racks or carrying cases. Design parameters: frequencies from 60 CPS to 12 Gc, power from milliwatts to kilowatts, impedances from 50 to 125 ohms, delays from .020 to 1.0 microseconds.

Want more detail? Write for Bulletin DL, Issue 2.

**PHELPS DODGE** ELECTRONIC PRODUCTS  
NORTH HAVEN, CONNECTICUT



ON READER-SERVICE CARD CIRCLE 85

ON READER-SERVICE CARD CIRCLE 86



**Why take pot luck for reliability?**

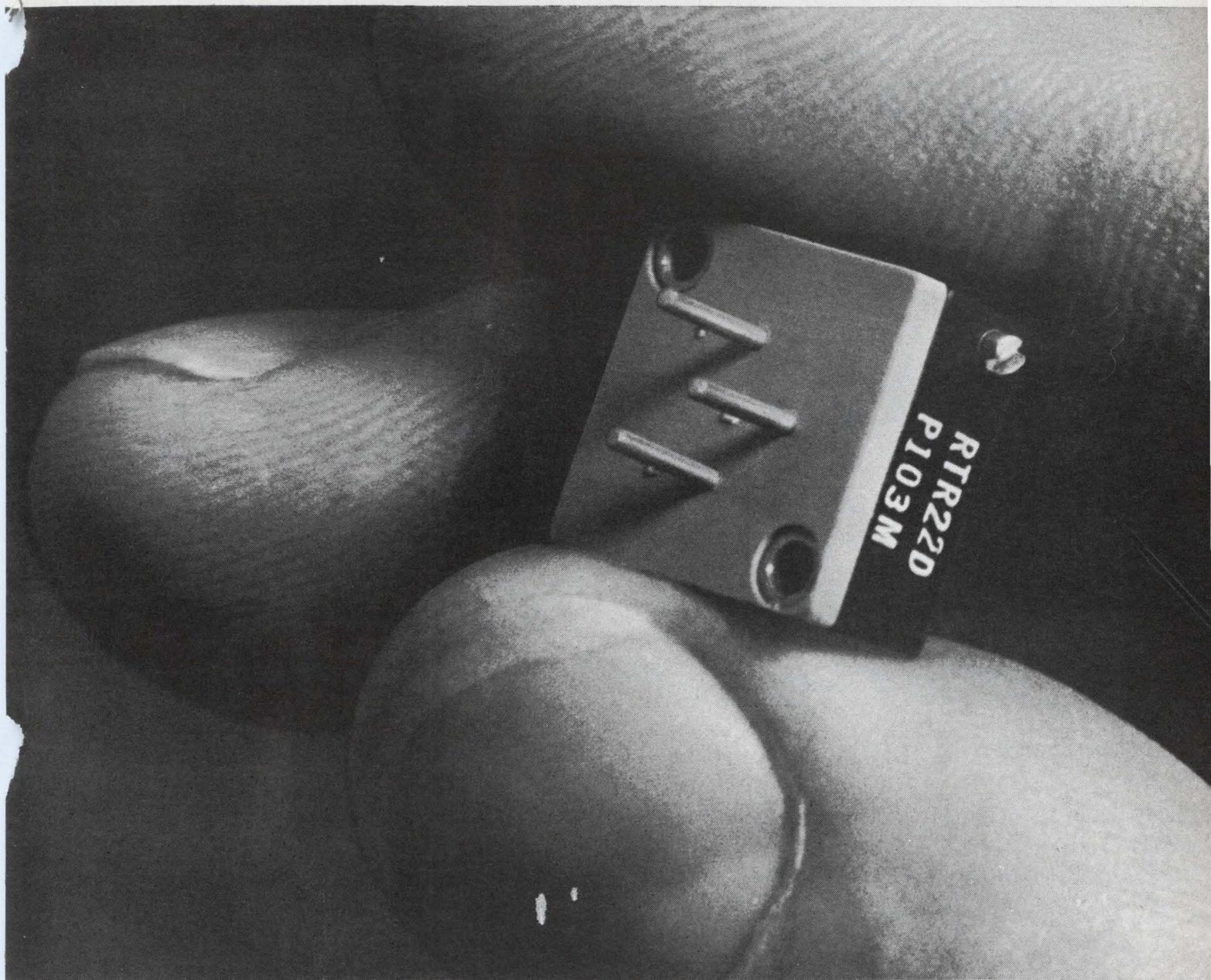

**DAYSTROM HI-RELIABILITY SQUARETRIM® POTS  
ARE MANUFACTURED AND TESTED TO MIL-R-39015**

*The Daystrom Squaretrim 318-160HS is designed, manufactured and tested in complete accordance with MIL-R-39015. This means you no longer have to resort to costly unmonitored programs when you need high reliability potentiometers.*

*The 318-160 Series Squaretrim potentiometers not only give you the best design and materials, but are manufactured with piece part traceability, in-process controls, and*

*the stringent QC program defined in this Specification.*

*So . . . don't trust to luck. Order Daystrom Hi-Reliability Squaretrim pots. They're available in values from 10 ohms through 20K. Prompt delivery on orders. Write or phone today.*

*Daystrom potentiometers are another product of:  
Weston Instruments, Inc. • Weston-Archbald Division,  
Archbald, Pennsylvania 18403 • Phone 717-876-1500*

**WESTON®** *prime source for precision . . . since 1888*





## COMPONENTS

### Aluminum enclosures assemble with lock-joint

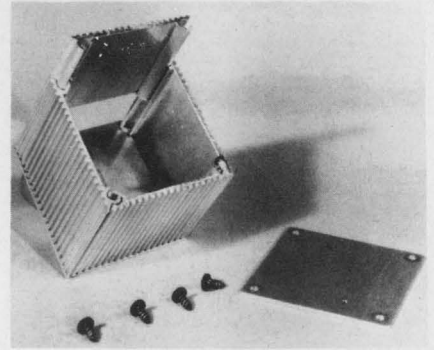

Sarex Corp., Carteret, N.J. Phone: (201) 969-2440. Price: 62¢ to \$2.40.

The MINI-COOL is constructed to contain cable junctions, plug boxes, control modules, transformers, circuitry, solid state devices, and meters. The line is available with integral heat-sink walls. The enclosures can withstand a crushing force of three tons though made of lightweight extruded aircraft alloy aluminum. A lock joint at each corner tightens when the screw fasteners are installed. The units are available in 21 sizes ranging from 2 x 2 x 1½ to 2.6 x 2.6 x 10 in.

CIRCLE NO. 389

## Program wiring patterns from A to Z with automatic *Wire-Wrap* machines

Only automatic "Wire-Wrap" machines provide the flexibility required for point to point wiring of modular electronic panels. Just program the circuit with punched cards or tape. Then "Wire-Wrap" machines take over—connecting wires at an average of 5 seconds per wire—as much as 25 times faster than hand soldering in most applications.

**Reliability**—These solderless wrapped connections are permanently tight—unaffected by temperature changes, atmospheric corrosion, vibration. More than 37 billion such connections are in use today without a single reported failure.

**Economy**—Cost savings in excess of 92% are common when compared to soldering and other techniques. Additional benefits include: No thermal damage to heat-sensitive materials . . . elimination of fire hazards . . . connections that are easily removed in plant or in the field.

Write for Bulletins 14-1, 14-121.

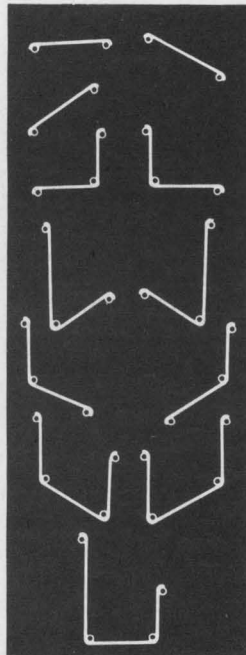

Typical wiring patterns made with automatic "Wire-Wrap" machines.

### Dc transducers take 1 mA input



Airpax Electronics, Inc., Seminole Div., P.O. Box 8488, Fort Lauderdale, Fla. Phone: (305) 587-1100.

Dc transducers produce full-scale outputs from as little as 1 mA dc signal levels. The transducer isolates the output (meter) circuit from the input (metered) circuit in a manner similar to that instrument transformers use in metering ac circuits. Dc in high-voltage circuits can be measured to an accuracy of  $\pm 1\%$  full scale. The transducer retains its accuracy from 0 to  $+50^{\circ}\text{C}$ , with a  $+5\%$  variation in the 115 ac line excitation. The excitation is 60 Hz (50 Hz available on special order).

CIRCLE NO. 449



SEE WHAT AIR IS DOING NOW...SEE

**GARDNER - DENVER**

Gardner-Denver Company, Quincy, Illinois

ON READER-SERVICE CARD CIRCLE 87



DIFF AMP — HIGH  $Z_{in}$

Take Two Resistors

Add one Dual FET

Combine with a CL Diode

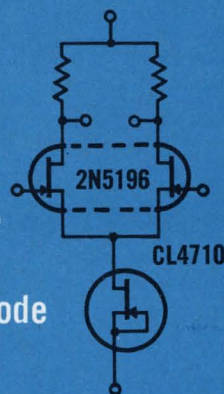

Type	Offset	Tracking	$I_G$
2N5196	5 mV max	5 $\mu V/^\circ C$	15 $\mu A$ max
2N5197	5	10	15
2N5198	10	20	15
2N5199	15	40	15
2N5205	5	10	15

# SELECT THE FET DUAL FOR YOUR DIFF AMP

## TRACKING FROM 5 $\mu V/^\circ C$

A dual matched FET combined with a current limiter diode is all you need for a high impedance diff amp. Input currents are less than 15  $\mu A$  . . . even with transconductances over 1000  $\mu mhos$ . The matching parameters of the dual FETs are the most important for diff amp operation—several guaranteed limit ranges are offered for a trade off between cost and performance. Select the optimum dual for your application by using the Siliconix "Diff Amp Designer's Kit." Start with

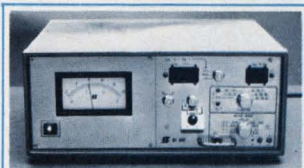

### NEW LOW COST FET TESTER

The S1200 Semiconductor Tester features plug-ins for expandable test capability, simplicity of operation, and low cost.  
 Price: S1200 Tester — \$960  
 Price: S1201 (DC &  $g_{fs}$ ) Plug-in Module — \$1335

the most closely matched pair, the 2N5196 . . . check operation . . . then downgrade to lesser matched units until the minimum acceptable performance is reached.

The CL diode — a two terminal FET with the source and gate connected — is the constant current supply. This avoids the complexity of the bipolar limiter. These diodes are available for current sources ranging from 220  $\mu A$  to 4.7 mA. The CL diodes in the Designer's Kit offer typical currents for diff amp designs.

Get your Siliconix "Diff Amp Designer's Kit," DK7, from your distributor. It contains four dual FETs, the 2N5196 through 2N5199, and two CL diodes for \$84.50. For literature on these and other FETs, just write or check the inquiry card.

 **Siliconix incorporated**  
 1140 W. Evelyn Avenue, Sunnyvale, California 94086  
 Telephone (408) 245-1000 TWX: 910-339-9216

#### Franchised Distributors

- |  |   |   |   |  |
|--|---|---|---|--|
| <b>ALABAMA</b> Cramer Electronics, Inc. Huntsville (205) 536-4493  | Oakland (415) 834-3311 Electronic Supply, Inc. Riverside (714) 683-8110 | Chicago (312) 279-1000  | Bergenfield (201) 384-3643  | Dayton (513) 278-5861  |
| <b>ARIZONA</b> Kierulff Electronics, Inc. Phoenix (602) 273-7331   | <b>COLORADO</b> Kierulff Elec., Inc. Denver (303) 825-7033              | <b>MARYLAND</b> Milgray Elec., Inc. Hyattsville (202) 864-6330    | <b>NEW MEXICO</b> Kierulff Elec., Inc. Albuquerque (505) 268-3901   | <b>OKLA.</b> Oil Capitol Elec. Corp. Tulsa (918) 836-2541  |
| <b>CALIF.</b> Hollywood Radio & Elec. Hollywood (213) 466-3181<br>Menlo Park (415) 322-3431<br>Kierulff Electronics<br>Los Angeles (213) 685-5511<br>San Diego (714) 278-2112<br>Elmar Electronics, Inc.<br>Mountain View (415) 961-3611 | <b>CONNECTICUT</b> Cramer Elec., Inc. Hamden (203) 288-7771             | <b>MASS.</b> Cramer Electronics, Inc. Newton (617) 969-7700       | <b>NEW YORK</b> Summit Dist., Inc. Buffalo (716) 884-3450<br>Milgray Electronics, Inc. New York City (212) 989-1600<br>East Semiconductor Sales, Inc. Syracuse (315) 455-6641 | <b>PENNSYLVANIA</b> Milgray Elec., Inc. Philadelphia (215) 228-2000  |
| <b>FLORIDA</b> Perrott Associates, Inc. Clearwater (813) 446-2535<br>Orlando (305) 275-1132<br>West Palm Beach (305) 585-7761  | <b>ILLINOIS</b> Semiconductor Spec.                                     | <b>MICH.</b> Semiconductor Spec., Inc. Detroit (313) 255-0300     | <b>NORTH CAROLINA</b> Kirkman Elec. Winston-Salem (919) 724-0541  | <b>TEXAS</b> Sterling Electronics, Inc. Austin (512) 452-0271<br>Dallas (214) 357-9131<br>Houston (713) 666-4061<br>Lenert Company<br>Houston (713) 225-1465 |
|  |   | <b>MINN.</b> Semiconductor Spec., Inc. Minneapolis (612) 866-3434 | <b>NORTH CAROLINA</b> Kirkman Elec. Winston-Salem (919) 724-0541  | <b>WASHINGTON</b> Washington Elec. Seattle (206) 682-8981  |
|  |   | <b>MISSOURI</b> Semiconductor Spec. St. Louis (314) 521-8866      | <b>OHIO</b> Alpine Industries, Inc.   |  |
|  |   | <b>NEW JERSEY</b> Tech. Elec. Dist.                               |   |  |

ON READER-SERVICE CARD CIRCLE 88



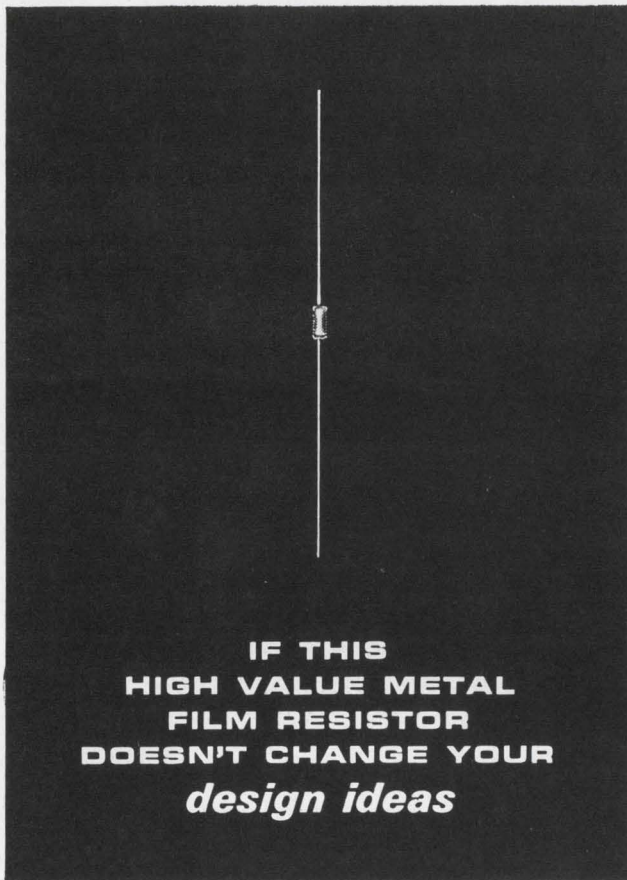

**IF THIS  
HIGH VALUE METAL  
FILM RESISTOR  
DOESN'T CHANGE YOUR  
*design ideas***

*...try one of these*

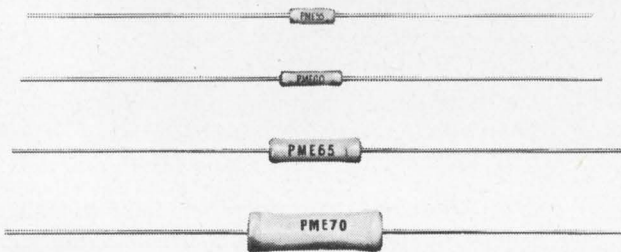

Part No.	Power	Ohms	Tol.	Temp. Coef.
PME 50	1/20 W	10Ω to 1M	±1% to .1%	T-0, T-2, T-9
PME 55	1/10 W	10Ω to 3M	±1% to .1%	T-0, T-2, T-9
PME 60	1/8 W	49Ω to 7.5M	±1% to .1%	T-0, T-2, T-9
PME 65	1/4 W	49Ω to 20M	±1% to .1%	T-0, T-2, T-9
PME 70	1/2 W	24Ω to 30M	±1% to .1%	T-0, T-2, T-9
PME 75	1 W	49Ω to 50M	±1% to .1%	T-0, T-2, T-9

The stability and accuracy of Pyrofilm's PME metal film resistors makes their use ideal in applications where before only wire wound resistors could be used. These resistors are virtually unaffected by environmental conditions and withstand constant exposure to high moisture conditions without change in specifications. PME resistors meet or surpass all requirements of MIL-R-10509F.

Send for fact-filled literature sheet!

**PYROFILM RESISTOR  
COMPANY, INC.**

3 SADDLE ROAD • CEDAR KNOLLS, NEW JERSEY • 201-539-7110

ON READER-SERVICE CARD CIRCLE 89

COMPONENTS

**Polarized relays  
pass 200 mA**

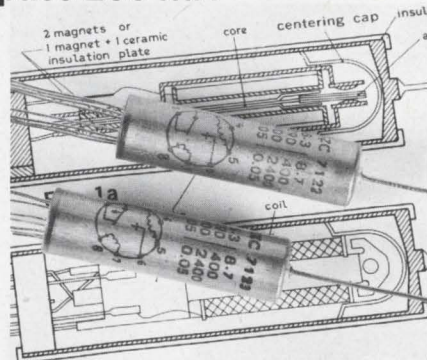

Price Electric Corp., Frederick, Md.  
Phone: (301) 663-5141. Price: \$8.

Polarized relays handle communications and switching systems, instrumentation and logic control functions. Both mono-stable and bi-stable types are available. SZC relays provide up to 50 million electrical operations at 200 Hz switching rates at a maximum of 60 V dc or a maximum of 200 mA current. The relay is housed in a hermetically sealed metal enclosure and covered by an insulating sleeve, with wire lead connections. Relays are not position sensitive with respect to gravity. They will withstand shock up to 20 g for 11 ms and vibration of 10 g at 500 Hz.

CIRCLE NO. 452

**Rotary contact  
handles 600 W**



Leslie Manufacturing Corp., 1025 Grand Ave., San Marcos, Calif.  
Phone: (714) 744-1658

A new rotary contact combines mercury with compatible metals providing rotating electrical connections. The device is suited for circuits involving instrumentation, antenna, computer, servo and sound applications. It is 9/16 in. in dia. x 1 in. in length. With a coaxial plug in convenience, the connector is rated 600 W at 120 V. It may be used in ac or dc circuits up to 1000 V. Ball bearing construction helps endurance at high speed.

CIRCLE NO. 451



*Only* **Solitron**

offers

250v

400v

500v

600v

700v

High Voltage

NPN Silicon Power

Transistors

*in 3 Packages!*

CHARACTERIZATION CURRENT LEVEL			
	$I_c = 1.0A$	$I_c = 2.0A$	$I_c = 3.0A$
$V_{CEX}$	$h_{FE} = 15$ Min $V_{CE(sat)} = 0.5V$ $V_{BE(sat)} = 1.0V$	$h_{FE} = 10-50$ $V_{CE(sat)} = 0.5V$ $V_{BE(sat)} = 1.5V$	$h_{FE} = 10$ Min $V_{CE(sat)} = 0.5V$ $V_{BE(sat)} = 1.5V$
250V	SDT1050 SDT1150 SDT1250	SDT1055 SDT1155 SDT1255	SDT1060 SDT1160 SDT1260
400V	SDT1051 SDT1151 SDT1251	SDT1056 SDT1156 SDT1256	SDT1061 SDT1161 SDT1261
500V	SDT1052 SDT1152 SDT1252	SDT1057 SDT1157 SDT1257	SDT1062 SDT1162 SDT1262
600V	SDT1053 SDT1153 SDT1253	SDT1058 SDT1158 SDT1258	SDT1063 SDT1163 SDT1263
700V	SDT1054 SDT1154 SDT1254	SDT1059 SDT1159 SDT1259	SDT1064 SDT1164 SDT1264

SDT1050 - SDT1064

SDT1150 - SDT1164

SDT1250 - SDT1264



TO-3  
100W @ 75°C



TO-66  
50W @ 75°C



TO-61  
100W @ 75°C

Solitron now offers silicon power transistors, with  $V_{CEX}$  up to 700 Volts, in three different packages: TO-3, TO-61 and TO-66. These high reliability devices, priced low, have many applications including vertical and horizontal TV circuits, audio amplifiers, inverters, converters and relay drivers. They replace similar higher priced units now on the market.

To obtain additional information on these devices,  
Dial 1-800-327-3243 for a no charge telephone call.

*When you think of semiconductors...  
think Solitron!*

**Solitron** DEVICES, INC.

1177 BLUE HERON BLVD. / RIVIERA BEACH, FLA / (305) 848-4311 / TWX: (510) 952-6676

ON READER-SERVICE CARD CIRCLE 90



**This is the smallest optical encoder that can resolve 14 bits in one revolution under avionics conditions. It's one example of what Datex offers you in optical encoders. We'll send you others in return for your name and address. Write:**

Datex Division / Conrac Corporation  
1911 Walker St., Monrovia, California  
(213) 359-5381

Dallas, Texas (214) EM 3-6417  
Dayton, Ohio (513) 253-1104  
Des Plaines, Illinois (312) 827-8141  
Huntsville, Alabama (205) 539-9396  
New York, New York (212) 661-4070  
Pasadena, California (213) 681-7152  
Washington, D.C. (202) 244-8700



Model 01-809  
Actual Size

ON READER-SERVICE CARD CIRCLE 91

MATERIALS

**Polyester tubing shrinks with heat**

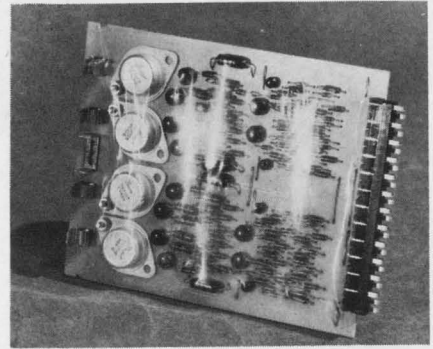

3M Co., 3M Center, St. Paul, Minn.  
Phone: (612) 733-4033. Price:  
\$1.85 up; stock.

Polyester heat-shrinkable tubing is available in sizes up to 6 in. ID. IX-6004 tubing is a class B temperature insulation with a 50 per cent shrinkage, composed of a high dielectric polyester film that is formed by thermally welding the edges of the film into a tube, forming a strong, non-adhesive bond. Sizes of IX-6004 tubing range from 1/8th to 6 in. in diameter.

CIRCLE NO. 461

**Luminescent chemicals doping service**



General Electric Co., Lamp metals & Components Dept., 21800 Tungsten Rd., Cleveland, Ohio. Phone: (216) 266-2121.

Custom doping services for luminescent grade electronic chemicals are available from General Electric Co.'s lamp metals and components dept., Cleveland. Luminescent grade chemicals are widely used as raw or intermediate materials for photoconductive devices. T.E. produces zinc sulfide and selenide and cadmium sulfide and selenide and has facilities for custom doping of these chemicals in accordance with specifications provided by customers.

CIRCLE NO. 345



*the simplest solution  
to switching problems...*

**from 12 PDT to 144 PDT:**

**"off-the-shelf" T-BARS®!**

T-BARS are for switching in computers . . . automatic testers . . . communications . . . process controls . . . telemetry . . . ground support equipment . . . aircraft . . . in fact, almost everywhere!

**T-BAR** SERIES 801  
RELAYS



12 Poles 24 Poles 36 Poles 48 Poles 60 Poles  
1 Wafer Relay 2 Wafer Relays 3 Wafer Relays 4 Wafer Relays 5 Wafer Relays

**BAT HANDLE T-BAR** SERIES 802  
SWITCHES

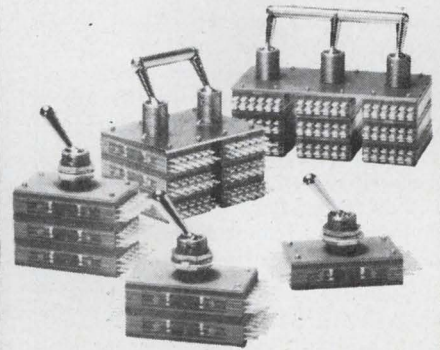

Switch up to 144 PDT . . . in less space!  
Available in Single, Double and Triple . . . as well as Ganged Toggles for controlling 48, 72, 108 poles . . . even more!

**MOMENTARY PUSH BUTTON T-BAR** SERIES 803  
SWITCHES

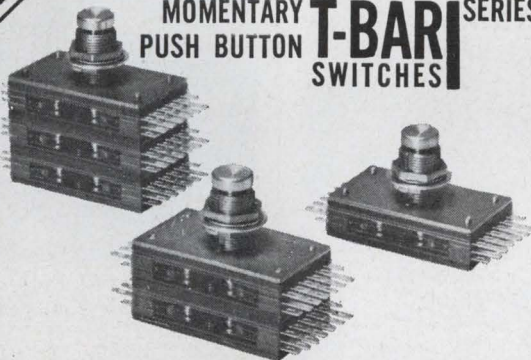

Available in 12, 24 and 36 poles . . . reliable high density multipole switches . . .

**low component cost**

36 PDT—\$21.78 ea. in lots of 100  
48 PST—\$23.54 ea. in lots of 100

**mounting ease**

2 simple screws . . . can mount on panel in any orientation . . . eliminates chassis.

**wiring economy**

Simple crimp snap-on contacts fit into single block connectors for pre-harnessing.

MANUFACTURED BY:

**electronic controls, inc.**

T-Bar Switch/Relay Div. • Danbury Road, Wilton, Conn.

Now available "off-the-shelf" in your immediate area from:

**CALIFORNIA**

Newark Electronics  
4747 W. Century Blvd.  
Inglewood (213) 678-0441  
Kieruff Electronics  
2585 Commerce Way  
Los Angeles (213) OV 5-5511  
Fisher Switches, Inc.  
3199 Park Boulevard  
Palo Alto (415) 321-4080  
Kieruff Electronics  
8133 Engineer Road  
San Diego (714) 278-2112

**CONNECTICUT**

Westconn Electronics  
195 Colorado Avenue  
Bridgeport (203) 367-7747  
Cramer Electronics  
60 Connolly Parkway  
Hamden (203) 288-7771  
Westchester Electronics  
181 Stillwater Road  
Stamford (203) 348-7361

**FLORIDA**

Electronic Equipment Co.  
2701 N. W. 42nd Avenue  
Miami (305) 635-0421  
Electronic Equipment Co.  
Orlando (305) 644-4833

**ILLINOIS**

Allied Electronics  
100 No. Western Avenue  
Chicago (312) 829-9100

**ILLINOIS (Cont'd)**

Newark Electronics Corp.  
500 No. Pulaski Road  
Chicago (312) 638-4411

**MASSACHUSETTS**

Cramer Electronics  
817 Boylston Street  
Boston (617) 267-4700

**MISSOURI**

Texas Instr. Supply Co.  
2328 McGee Street  
Kansas City (816) 421-5670

**NEW YORK**

Westchester Electronics  
602-610 Mamaroneck Ave.  
White Plains (914) 949-2400

**OKLAHOMA**

Texas Instr. Supply Co.  
1124 East Fourth Street  
Tulsa (918) 583-8121

**TEXAS**

Texas Instr. Supply Co.  
6000 Denton Drive  
Dallas (214) 357-6121  
Busacker Electronic Equip.  
1216 West Clay Street  
Houston (718) 526-4661

**FRANCE**

SODIMATEL  
44, Rue Alphonse Penaud  
Paris — 636-4302

**UNITED KINGDOM**

Flight Refueling, Ltd.  
Industrial Electronics Div.  
Wimborne, Dorset 2121

For additional information on these and other T-Bar items refer to Distributor Catalog, "eem", "R/M" or write to E-C-1 for Bulletin TB 801-3.

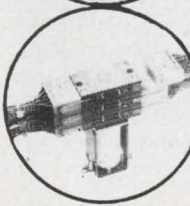

ON READER-SERVICE CARD CIRCLE 92



## PROVEN

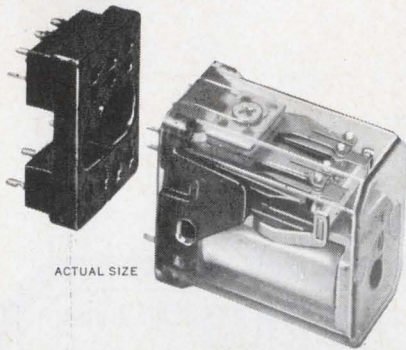

ACTUAL SIZE

## PERFORMER

American Zettler Series AZ-420 miniature relays, produced at the rate of 10,000 units per day, continue to lead the way in applications where space and long life are prime considerations. Computer systems, business machines and data processing equipment, and control and alarm systems are only a few of the many areas where AZ relays have successfully been field-proved.

AZ-420 relays require less than ONE CUBIC INCH of space. When installed with the AZ right-angle socket, their overall height is only  $\frac{3}{4}$ ". Life expectancy of AZ relays is up to 100 MILLION operations. Other outstanding features include:

- International standard-type relay
- Available with plug-in, solder or pc terminals
- Balanced spring-held armature allows same operating data in any mounting position
- Lower cost per unit from mass production techniques
- Available from stock.

AZ miniature relays are available in all common contact and coil configurations. Contacts are capable of carrying loads up to 5 amps, as well as low-level signals. For low-level, high-reliability switching, bifurcated contacts are available.

Write today for complete technical information on the Series AZ-420. Find out why American Zettler can handle all of your relay requirements...from A to Z!



**American  
Zettler,  
inc.**

697 RANDOLPH AVENUE  
COSTA MESA, CALIF. 92626  
PHONE (714) 540-4190

ON READER-SERVICE CARD CIRCLE 93

## MATERIALS

### Epoxy tape indicates when cured

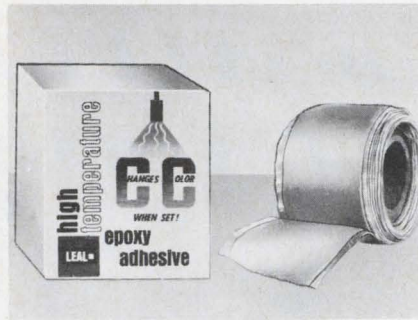

Leal Co., 1716 South Sixth St., Camden, N.J. Phone: (609) 365 0098

This high-temperature double-faced, epoxy-impregnated, adhesive tape is for use in maintenance, assembly work and repair. One feature of the tape is that when it is cured, under high temperature, it signals by changing color from yellow to dark red. It may be cured by a hot-air gun, blow torch, oven, air dryer or soldering iron. It comes in rolls 2 ins. wide x 10 or 25 yards in length. It is obtainable in other widths and lengths in rolls on special order. Leal high temperature CC adhesive is also available in other forms such as aerosol spray, solid stick or liquid.

CIRCLE NO. 332

### Alumina ceramics molded to shapes

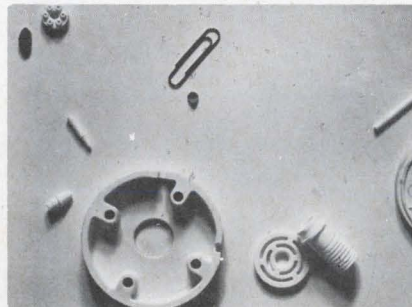

Diamonite Products Mfg., Co., Shreve, Ohio. Phone: (216) 567-4211.

High alumina ceramics are injection-molded into intricate shapes and sizes. Thin walls, ID and OD screw threads and small diameter holes can be molded into the parts, eliminating machining. Alumina ceramics range in tensile strength from 18,000 to 28,500 psi, and in firing temperature from 1520 to 1675°C. A catalog "Aid in Design" is available.

CIRCLE NO. 462

### Ceramic point usable to 4000°F

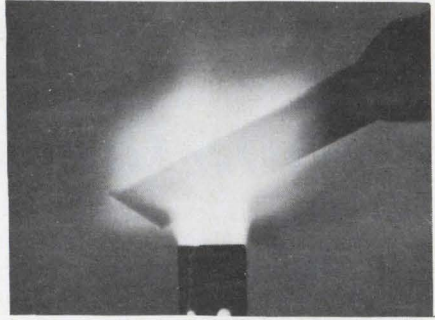

Lithoid, Corp., Lima, Pa. Phone: (215) 566-5502.

Ceramic paints are single mix, water base, and composed of 100% ceramic materials, containing no glass frits or refractory oxides. These paints produce a surface harder than low-carbon steel. Designed for use on all metals, glass, refractory linings, or ceramic components they offer high oxidation and chemical resistance. Maximum temperature ranges are 2500°F on metals, 4000°F on refractories.

CIRCLE NO. 463

### Molded nylon screws span many sizes

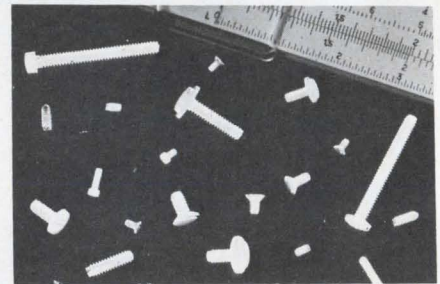

Coats & Clark, Inc., New Rochelle, N.Y. Phone: (914) 633-8600.

Molded nylon screws are available in thread sized 00-90 (90 threads to the in.), 0-80, 1-72, 2-56, 3-48, and 4-40 and an even smaller size, 000, is planned. Head types include binding, round, fillister, washer head, pan and flat (82). Lengths range from  $\frac{3}{32}$  to 1 in. Nylon has a stronger strength to weight ratio than steel and offers considerable weight advantage over comparable metal parts. Where electrical insulation is necessary, nylon's self-insulating properties eliminate the need for screw insulators and other accessory parts.

CIRCLE NO. 356

ON READER-SERVICE CARD CIRCLE 94 ►



**ACDC ELECTRONICS, INC.**  
**2979 North Ontario Street**  
**Burbank, California 91054**

**Gentlemen,**  
**Please send me your 1967 catalog of power supply**  
**modules.**

**(I understand they're guaranteed forever.)**

**Name** \_\_\_\_\_

**Company** \_\_\_\_\_

**Title** \_\_\_\_\_

**Address** \_\_\_\_\_

**City** \_\_\_\_\_ **State** \_\_\_\_\_ **Zip** \_\_\_\_\_





# SQUELCH

## RFI/EMI

**Let Hopkins scan, fix & qualify your equipment to meet specs!**

Hopkins Engineering Co., with more than 20 years of experience in designing, developing and manufacturing power, communication and general purpose filters, now offers complete, expanded, RFI/EMI testing facilities... to scan, fix and qualify your equipment.

Hopkins new RFI/EMI testing services cover frequencies from 30 Hz to 10,000 MHz. Facilities are available for testing all sizes of equipment from miniature DC motors to giant central power distribution systems; and all types of circuits from simple relays to complex sophisticated space packages.

In Hopkins' air conditioned shielded enclosures, latest testing equipment is now ready to make a diagnosis for you. 'Round the clock testing service is available if required. All backed by two

decades of solving RFI/EMI problems with thousands of types of custom-made filters.

Hopkins experience in the RFI/EMI testing, prototype development and filter manufacturing can help you deliver equipment to meet the following MIL SPECS, and others:

MIL-I-6181D	MIL-I-16910C
MIL-I-26600	MIL-I-11748
MIL-Std-826	MIL-Std-461*
MIL-Std-462*	MIL-Std-463*

\*Tentative

Tests to meet special customer-authored EMI specifications are scheduled daily. Save time. Hopkins will design, develop and manufacture prototypes and mass-produce RFI/EMI filters so that your equipment or component will meet any interference or operational requirement.

*For* measurements, analysis, corrective recommendations and filter hardware, try Hopkins service for a welcome change. Contact the local Hopkins representative in your area, or the Marketing Department...

**HOPKINS**  
Engineering Company

12900 Foothill Boulevard, San Fernando, California 91342  
Telephone (213) 361-8691-TWX 213-764-5998 Cable: HOP

*A Subsidiary of Maxson Electronics Corporation*

ON READER-SERVICE CARD CIRCLE 95

## MATERIALS

### Alloy combinations available now

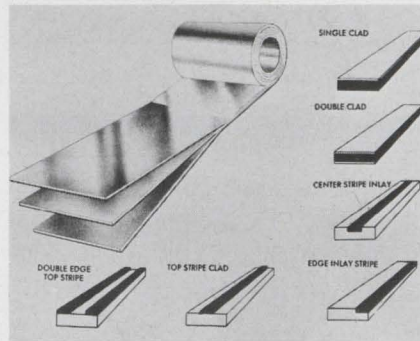

*Semi-Alloys, Inc., 20 N. MacQuessen Pkwy, Mt. Vernon, N. Y. Phone: (914) 664-2800.*

A process has been developed by the company providing for fusible alloys, bismuth alloys and other very brittle alloys to be successfully clad to base metals, such as silver, copper, copper alloys, Kovar, nickel, nickel alloys, steel, precious metals and other alloys. Up until now, parts manufactured from these low-melting brittle alloys had to be cast by a hand method and resulted in high cost and low production. With this new process, bismuth and other low-melting alloys can now be rolled, clad to a base metal, and used in continuous automatic stamping processes with high speed dies and machinery. This technique keeps cladding alloys uniformly distributed and prevents minute-spots of undesirable oxides from forming between the layers.

CIRCLE NO. 299

### Nylon reinforced with glass fibre

*The Polymer Corp., Reading, Pa. Phone: (215) 929-5858*

Four new nylon injection-molding compounds, three composed of 6/6 nylon with 12 1/2, 30, and 40% glass fibre reinforcement, and one of type 6/10 nylon with 30% glass reinforcement, are now available. The glass reinforcement provides increased tensile strength, improved thermal properties and rigidity, less moisture absorption and higher heat distortion temperatures than unmodified 6/6 nylon. Natural in color, these injection-molding compounds are suitable for color coding.

CIRCLE NO. 315



# KuBAND RADAR

**Bomac  
Orthospan<sup>®</sup>  
Mixers**  
with a  
power  
handling  
capability  
of  
**200 mW.**

**Frequency:** any 1 GHz range between  
12.4 and 18.6 GHz.

**Noise, nominal:**

At 1 GHz bandwidth: 8.5 dB  
At 4 GHz bandwidth: 10.0 dB

**Warranty:** 5000 hrs.

Bomac Orthospan Mixers are also available in X band and K band. For details, write: Varian Bomac Division, Salem Road, Beverly, Massachusetts 01915. In Europe: Varian A.G., Zug, Switzerland. In Canada: Varian Associates of Canada, Ltd., Georgetown, Ontario. In Australia: Varian Pty. Ltd., Crows Nest, Sydney, Australia.



ON READER-SERVICE CARD CIRCLE 96

# KuBAND RADAR

**TR-Limiters\***  
from  
**Bomac**

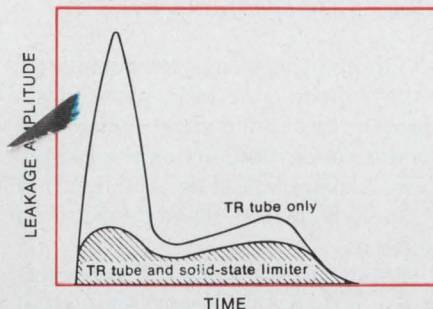

**Frequency Coverage:** 15.8 to 17.2 GHz.

**Operating Range:** 0.5 GHz.

**Recovery Time:** 0.5  $\mu$ s.

**Insertion Loss, typical:** 0.8 dB.

**Power Level, maximum:** 10 kW.

**Warranty:** 2000 hrs.

Bomac TR-Limiters are also available in X band; they will operate over any 0.5 GHz range between 8.5 and 9.6 GHz. For details, write: Varian Bomac Division, Salem Road, Beverly, Massachusetts, 01915. In Europe: Varian A.G., Zug, Switzerland. In Canada: Varian Associates of Canada, Ltd., Georgetown, Ontario. In Australia: Varian Pty. Ltd., Crows Nest, Sydney, Australia.

\*Combined gas-switching TR tube and solid-state limiter.



ON READER-SERVICE CARD CIRCLE 97

# KuBAND RADAR

**Bomac  
Orthospan<sup>®</sup>  
Modulators**  
with a  
power  
handling  
capability  
of  
**500 mW.**

**Carrier Frequency:** any 1 GHz range  
between 12.4 and  
18.6 GHz.

**IF Frequency\*:** 5 to 250 MHz.

**Conversion Loss, maximum:** 10.0 dB.

**Warranty:** 5000 hrs.

Bomac Orthospan Modulators are also available in X band and K band. For details, write: Varian Bomac Division, Salem Road, Beverly, Massachusetts 01915. In Europe: Varian A.G., Zug, Switzerland. In Canada: Varian Associates of Canada, Ltd., Georgetown, Ontario. In Australia: Varian Pty. Ltd., Crows Nest, Sydney, Australia.

\*Under special conditions, this can be extended to 1.5 GHz.



ON READER-SERVICE CARD CIRCLE 98



# Quietly reliable.

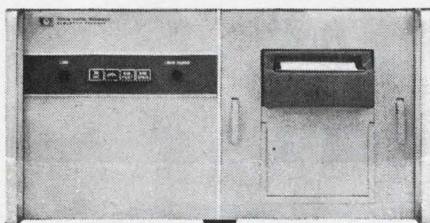

The measured noise level of the 20 lines/sec Hewlett-Packard 5050A Digital Printer is lower than an electric typewriter, making it quieter than other printers in its speed and price class. The removable plastic hopper folds records in a neat stack — seals in the noise.

Economical and rugged, the 5050A uses photo-electric decoding and a continuously rotating ink roller to reduce the number of moving parts. This results in less maintenance, more reliable operation.

Print cycle time is 50 msec asynchronous. It prints up to 18 columns of 4-line BCD data from one or two sources, even if they're in different BCD codes (by changing print wheel segments). Overall coding can be changed by replacing the code disc (\$2.50).

Fully compatible with other HP solid-state equipment, of course. Price: \$1750, plus \$35/column.

For more information, call your local HP field engineer or write Hewlett-Packard, Palo Alto, California 94304; Europe: 54 Route des Acacias, Geneva.

HEWLETT  PACKARD

02709

ON READER-SERVICE CARD CIRCLE 99

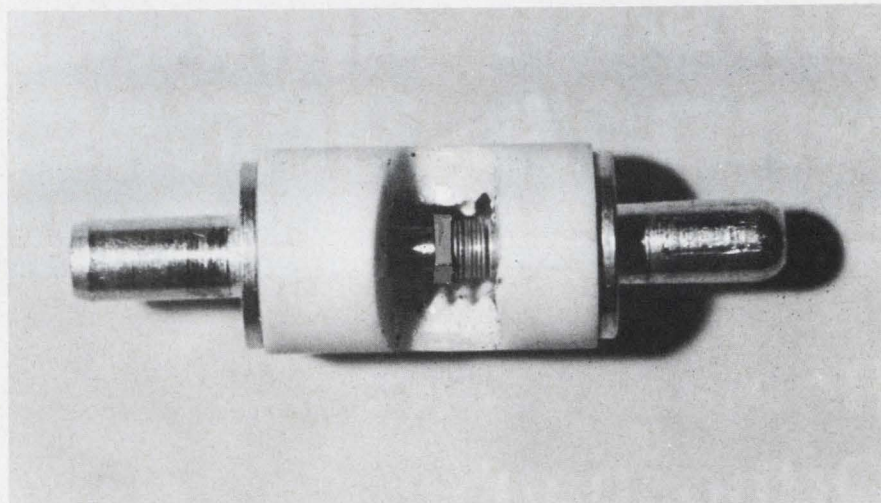

## For sale: LSA diodes yielding 100 W in X band

*Cayuga Associates, Cornell University Research Park, Ithaca, N. Y. Phone: (607) 272-5566. P&A: (25w) \$1000 (100w); 3 wks.*

Limited space-charge accumulation (LSA) diodes, the most powerful approach to solid-state microwave power yet devised, are on the market. Two X-band pulsed devices, the 25-W CA5X1-E and the 100-W CA5X2-E are offered.

Barely a year since the announcement of the LSA concept, commercial units are available for use in prototypes of advanced radar and pulsed communication system (see "Solid-state microwave power growing up," ED 20, Sept. 27, 1967, pp. 17-20). These diodes are the first microwave devices to make use of bulk negative resistance. They can thus generate higher power at convenient impedance levels than any transit-time-limited solid-state device, such as a transistor,

or any transit-time determined solid-state device, such as Gunn or avalanche diodes.

Thanks to the method of operation (see box), thick, large-area gallium arsenide chips can be used to generate high pulse powers. The CA5X1-E is approximately 25 times thicker than a Gunn diode in transit-time oscillation at the same frequency, while the CA5X2-E is about 50 times thicker. The areas and doping allow an approximately 50- $\Omega$  operating-point bias resistance and approximately 150  $\Omega$  of reciprocal negative conductance. Even though 100-ns pulses are typical, pulses as short as 2 ns with reproducible video output envelopes can be obtained at the specified power levels. This pulse length would allow high-definition radars to separate targets only 1 ft apart.

In addition to the two diodes now offered, higher-power units are being developed. A 500-W X-band diode should be available soon and diodes at C, Ku and other bands will also be developed. Experimental power levels of 615 W at 8 GHz with 100-ns pulses have recently been observed.

These diodes are suggested for use in experimental prototypes of next-generation radar systems. Cayuga points out that the specifications given do not represent ultimate performance. Efficiency and operating life are subject to improvement.

### LSA specifications

	CA5X1-E	CA5X2-E
Pulse length	100 ns	100ns
Pulse repetition rate	60pps	60 pps
Pulse voltage	400V	800 V
Pulse current	8A	16 A
Frequency	8-12 GHz	8-12 GHz
Package	1N23 cartridge	1N23 cartridge

CIRCLE NO. 253

ON READER-SERVICE CARD CIRCLE 100





**At last  
I've found it – the  
eatable encoder!**

Actually, we weren't looking for it. Our research and development effort is aimed at more digestible improvements in the state of the art. Like laser encoders, infrared encoders, complex logic circuit encoders, and a whole line of encoder-generated products. Our appetite is for complete encoder systems that translate analog functions into the digital language computers can understand. However, if you do have a requirement right now for an encoder that tastes sort of minty...

Encoder Division, 20745 Nordhoff Street., Chatsworth, Calif.



 **LITTON INDUSTRIES  
ENCODER DIVISION**



You just figure out  
what you need in a

# SPRING WIRE

We'll "draw"  
the conclusions.

Little Falls Alloys specializes in custom work in non-ferrous spring wire. You name the size, shape, tolerance, temper, alloy and quantity . . . and we draw it that way. In fact, we diamond draw it, to ensure the best possible surface and the highest degree of uniformity.

Little Falls Alloys is particularly known for its ability with Beryllium Copper — age hardenable or pre-tempered "Silvercote"® or bare. We are the leader in the development of this wire for commercial use.

So, whether you want us to meet your specifications or you want engineering help in designing your nonferrous spring wire, come to Little Falls Alloys. It's a great place to be when you have a nonferrous wire requirement to fill.

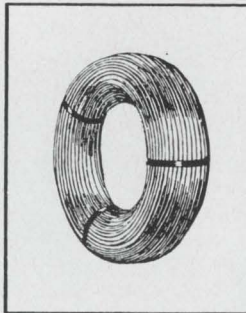

## beryllium copper

Phosphor Bronze ■ Nickel Silver  
Brass ■ Titanium ■ Zirconium Copper  
Nickel (NASA 270) ■ Beryllium Nickel  
OFHC Copper

### CLOSE TOLERANCES



We meet and certify  
all standard specifications

**ROUND, FLAT, SQUARE, RECTANGULAR AND SPECIAL SHAPES**

Write for our technical metals catalog

## Little Falls Alloys, Inc.

189 CALDWELL AVE., PATERSON, N. J. 07501 / 201 - 525-1014

ON READER-SERVICE CARD CIRCLE 101

## SEMICONDUCTORS

### Npn silicon transistors attain 700 V

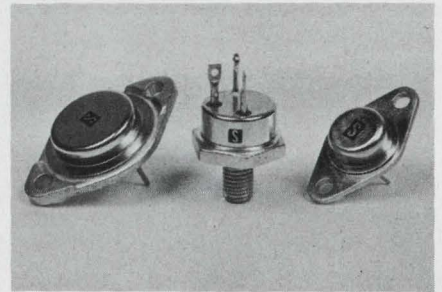

*Solitron Devices, Inc., Riviera Beach, Fla. Phone: (305) 848-4311.*

Npn silicon power transistors up to 700 V in three different packages are available. The packages are the TO-3, TO-61 and TO-66, and are characterized at three current levels, 1, 2 and 3 A. The TO-3 and the TO-61 are both rated at 100 W of power capability at 75°C. The TO-66, is capable of 50-W power dissipation.

CIRCLE NO. 407

### Power transistors covered with plastic

*General Electric, Schenectady, N.Y. Phone: (518) 374-2211. P&A: 30¢ to 45¢ ea. samples available.*

Two series of silicon power transistors are housed in a plastic power tab package. The units have a rated dissipation of 1 W at 50° V ambient, and 4 W at 70° V tab temperature. Two voltage groups are available: The D28C1-3 is 25 V and the D28C4 & 5 is 40 V. The D28C forward transfer ratio ( $h_{FE}$ ) is typically 60 K. Maximum collector current is 500 mA continuous and 800 mA at 50% duty cycle, 50 ms pulse width. Input impedance at 1 kHz is typically 500 K $\Omega$ .

The other new power transistor is the D28D series. The devices feature voltage groups of 25 V for the D28D1-3, and 40 V for the D28D4 & 5. There are three  $h_{FE}$  selections between 50 & 360 at 100 mA, 2 V. Maximum collector current is 900 mA continuous and 1.2 A at 50% duty cycle with a 50 ms pulse width.

CIRCLE NO. 408



# Tips on cooling off hot transistors

See how circuit designers use IERC heat dissipators to protect semiconductors... improve circuit performance and life.

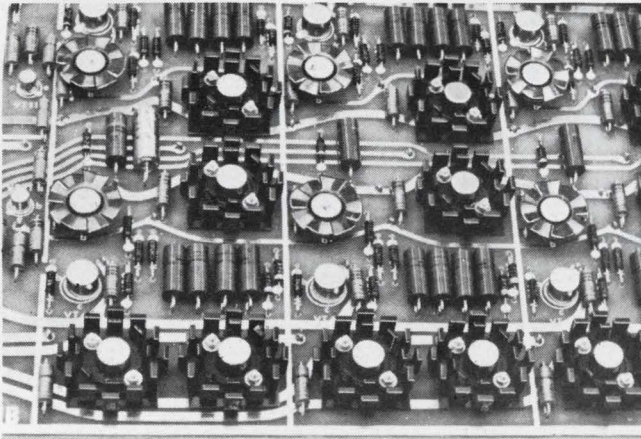

A 2N1837 transistor mounted only to a p-c board with IERC's unique LP dissipator can be operated at 5 watts with a junction temperature of only 153°C. The LP's clamping method makes good thermal contact on both surfaces of the transistor flange, minimizing thermal resistance from transistor to dissipator.

Heat from power transistors or diodes is quickly dissipated with IERC's HP dissipators. Large finger area maximizes efficiency in natural convection or forced air environments. Staggered-finger design which prevents finger surfaces from "looking at each other," radiates heat to the ambient, not back to the dissipator.

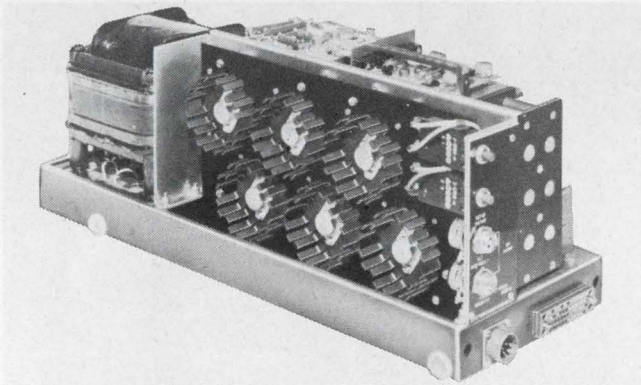

**Send for test reports.** The most thorough test reports in the industry are available on IERC Heat Dissipators. These are multi-page reports complete with graphs showing case and junction temperatures vs. power dissipation for transistors in several mounting conditions. Please indicate which test reports you wish—LP, UP, HP or Therma-Link. On your company letterhead, please.

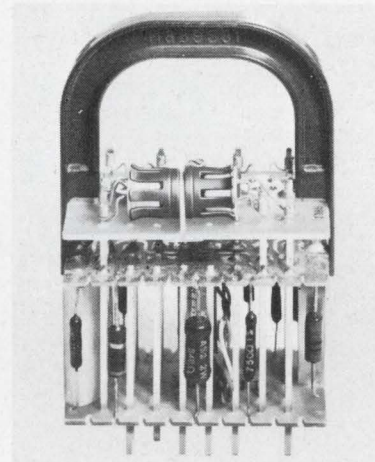

Mounting matched transistors for thermal stability so electrical characteristics stay identical is simple with back-to-back Therma-Link dissipators/retainers. Also used as heat sinks.

Fan-top dissipators increase transistor performance levels, permit use of cheaper transistors. Note how design needs no board space, permits other components to be positioned close by.

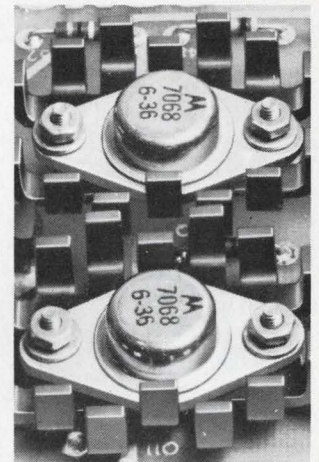
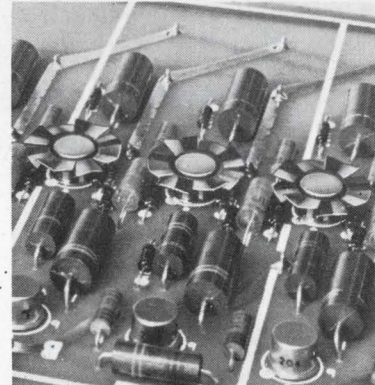

New dissipator for TO-66 transistor uses only 1.7 sq. in. of board space. IERC's unique, staggered-finger design dissipates 9 watts with case temperature of less than 150°C.

Free 8-page catalog gives complete pictorial and ordering data on IERC dissipators, retainers and tube shields, also prices. Send for a copy.

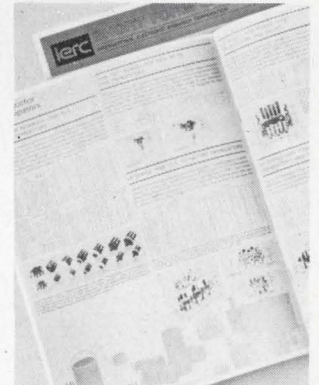

**ierc**  
SEMICONDUCTOR  
HEAT DISSIPATORS



at 500 watts  
or 30KW...

**PEK**

means reliability  
in high pressure  
Xenon Arc Lamps

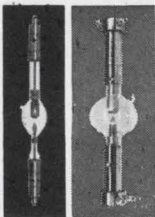

PEK high wattage xenon arc lamps are manufactured with just one criterion in mind—

reliable performance. And, when we say performance we mean performance up to and beyond today's exacting requirements in solar simulation, color projection, instrumentation, or wherever high order radiant energy sources are employed. □ Whether your need is 500 watts or as high as 30KW, you can count on dependable glass-to-metal seals, maximum arc stability and long life when you specify PEK. □ Send for our new Product Reference Guide or tell us what your special need is. There's a PEK lamp to fit your application.

**PEK**

PEK / 825 E. Evelyn Avenue  
Sunnyvale, California  
(408) 245-4111 / TWX 737-9973

ON READER-SERVICE CARD CIRCLE 103

## SEMICONDUCTORS

### Npn transistors won't break before 15V

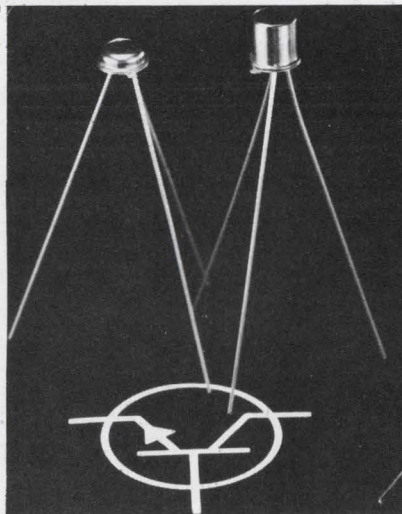

Crystalonics, Inc., 147 Sherman St.,  
Cambridge, Mass. Phone: (617)  
491-1670.

Crystalonics announces four low-level, high-speed switching transistors: the 2N2432, 2N2432A, 2N3153, and the 2N4138. These devices feature low offset voltage (0.5 mV maximum) and high emitter base breakdown voltage (15-V minimum). The 2N2432, 2N2432A and 2N3153 are in TO-18 packages; the 2N4138 is in a TO-46. The JAN 2N2432 and JAN 2N2432A are also available.

CIRCLE NO. 313

### 15 A power transistor in TO-36 package

Solitron Devices, Inc., Transistor  
Div., Riviera Beach, Fla. Phone: (305)  
848-4311.

This 15 A pnp germanium power transistor is available in a TO-36 case. This device is identified as the SDT 2700 series, and includes the 2N173, 2N277, 2N278, 2N441, 2N442 and 2N443. Typical specifications for the SDT 2700 series are:  $BV_{CBO}$  40 to 60 V,  $BV_{CEX}$  40 to 60 V, and  $BV_{CEO}$  25 to 50 V. This device is a general-purpose transistor for use in industrial and commercial power amplifier and switching applications. Some of these applications include invertors, convertors, regulators, and audio power.

CIRCLE NO. 382

### High power SCRs rated to 1200 V

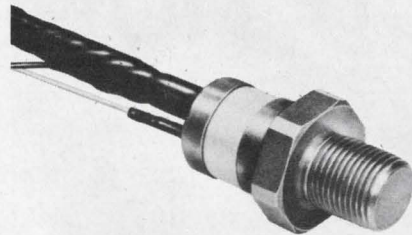

IRC, Inc., 401 N. Broad St., Phila-  
delphia. Phone: (215) 922-8900.

Two series of SCRs with voltage ratings to 1200 peak inverse V feature high surge current capability. One series, rated 275 A rms, conforms to outline TO-92; the second series, rated 110 A rms, conforms to outline TO-94. Gate control of these units enables them to be used as static switches or fast acting protective devices for high-power equipment. Phase-shifting gate-firing circuits can be used to provide a variable controllable output voltage, either ac or dc.

CIRCLE NO. 358

### Microwave diodes switch high power

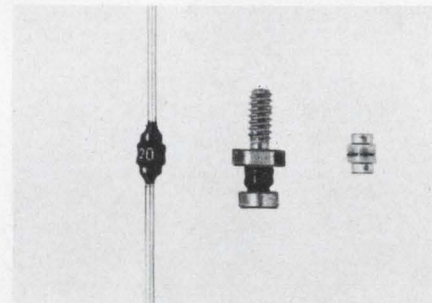

Unitrode Corp., 580 Pleasant St.,  
Watertown, Mass. Phone: (617) 926-  
0404. P&A: \$8 to \$21 (1 to 99 quan-  
tity); 30 days.

A series of high-power microwave switching diodes is capable of switching MW of peak rf power and kW of average rf power. Suitable for applications such as high-power phase shifters, duplexers, receiver protectors, and antenna-switching matrices, these diodes have average-power dissipations to 40 W, peak power dissipations to 300 kW, with series resistance down to 0.2  $\Omega$ , and capacitance to 1 pF.

CIRCLE NO. 333



# Will a bargain bypass/filter capacitor jeopardize your entire system?

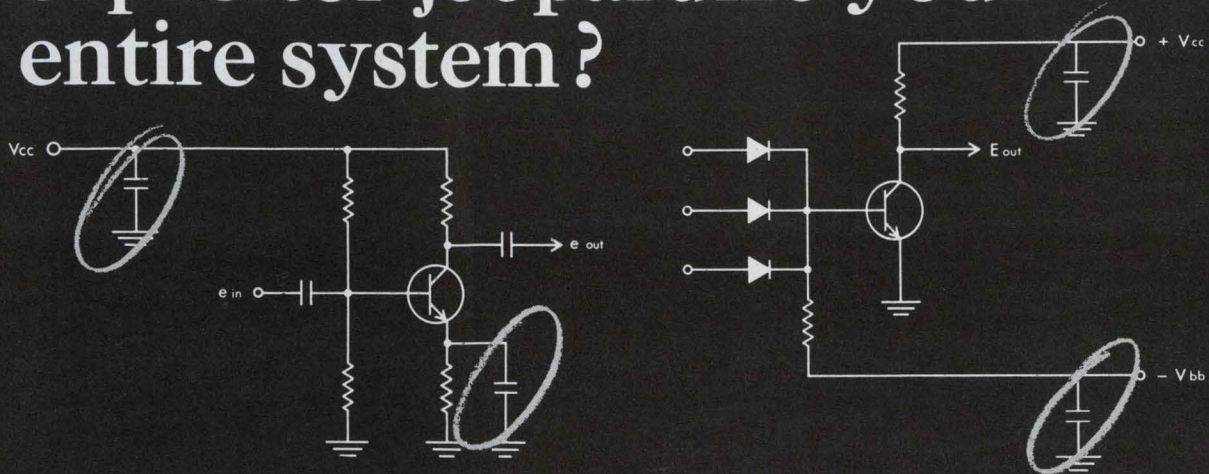

## Specify CORNING® Glass-K Capacitors... for confidence

Considering the finality of bypass failure, anything less than the reliability of glass is false economy.

CORNING Glass-K Capacitors guarantee that reliability in two case sizes. Get 1000 to 51,000 pf in .250" x .100", and 12,000 to 100,000 pf in .250" x .140".

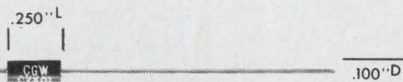

Specify CORNING Glass-K Capacitors when you need:

- bulk capacitance in minimum case size
- the total design flexibility of three stability characteristics, T, U, and V
- capacitor A to track capacitor B with the positive retraceability of glass
- minimum power attenuation and phase error with CORNING Glass-K Capacitors' low power factor

- tight end of life design with the guaranteed low capacitance change of CORNING Glass-K Capacitors
- adaptability to cordwood, printed circuit, and point-to-point packaging.

Get all this in a competitively priced unit that gives  $\Delta C$  with life as tight as 2%, IR greater than 100,000 megohms, D. F. as low as 1%, and standard item delivery of two weeks or less.

Tell us what you want a bypass/filter capacitor to do, and we'll tell you which CORNING Glass-K Capacitor will give you the confidence you need.

For complete data, write to:  
Corning Glass Works,  
Electronic Products Division,  
3909 Electronics Drive, Raleigh, N. C.

**CORNING**  
ELECTRONICS



# All electronic kV pulser sparks to life in 50 ns

Signalite Inc., Neptune, N.J. Phone (201) 666-8210. P&A: \$590; stock.

Capable of producing a pulse of 4 to 10 kV with a 50 ns rise time, this pulse generator uses a gas-filled, triggered spark gap as a switch. Operating on 115 V ac, 60 Hz input, the unit can be set to produce a pulse at a variable rate from 20 to 200V/ns.

The design uses a triggered spark gap to provide the desired closure time, to discharge the input capacitor through the pulse transformer primary. In this device the gap is kept in readiness by holding off the output of the energy storage capacitor. A small trigger pulse, applied between the trigger electrode and the main electrode, is followed by a main gap breakdown that discharges the energy into the output transformer. The gap is cap-



Producing a pulse of 4 to 10 kV with a 50 ns rise time, this pulser uses a spark gap as a switch.

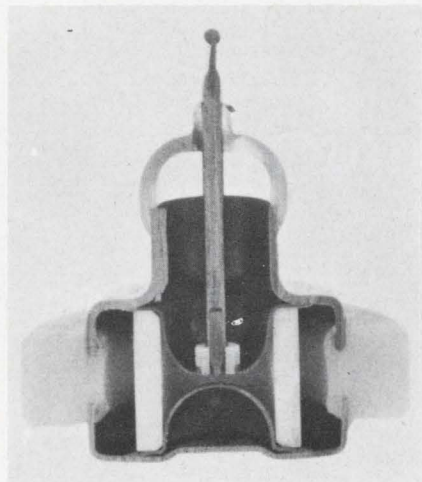

A gas-filled spark gap is electrically triggered by the output of an energy storage capacitor.

able of operating with short time delays, as low as 5 to 10 ns. The triggered gap operates in such a way that the adjacent electrode is ground and the applied trigger pulse is positive. This permits one side of the pulse transformer to be grounded.

The gap in this circuit is a Signalite Type XG 1478 and is substantially smaller than the vacuum relays commonly used in pulse generators. It has no moving parts and requires only a small command energy. The vacuum relay, on the other hand, is large, has moving parts, and requires a sizable outside power source. Use of the spark gap permits the pulse generator to be made of components without moving parts.

The pulse generator can be used for test and evaluation in any high-voltage-breakdown problem area on electronic equipment. Its short ramp provides a test source for evaluating such component characteristics as resistor hold-off capability, capacitor breakdown and peak inverse testing of solid-state rectifier stacks. When used in subassembly testing, such as on wire and harnesses, it can take the place of mechanical pulse generators and other types of equipment, which often occupy 10 to 100 times the volume of the TS 211 pulse generator.

It is possible now, by using the spark gap principle, to produce a pulse generator that will provide ramps rising to 30 kV in 30 ns or 1 kV per ns.

CIRCLE NO. 252

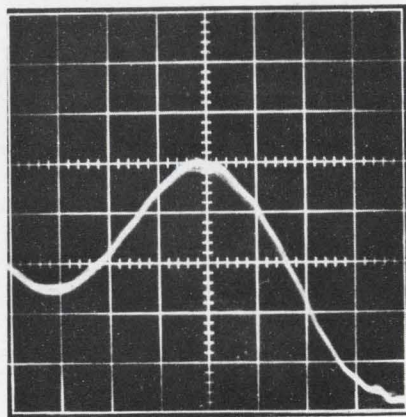

Oscilloscope traces of the pulse for a 10 kV peak show 10 shots made in succession. It's stable!

## Direct writing recorder has 4-channel output

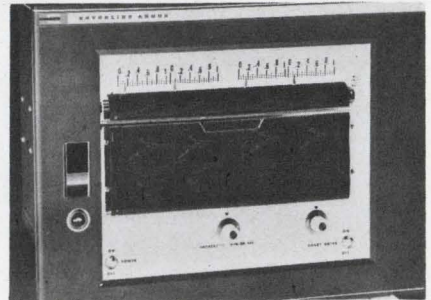

Esterline Angus Instrument Co., Inc., P. O. Box 24000, Indianapolis, Ind. Phone: (317) 632-6501. P&A: \$1700; 8 wks.

In many recording applications, the recorder will be able to provide low-frequency information formerly available only through the use of high-frequency multi-channel oscillographs. This model-E1104R recorder utilizes four permanent-magnet moving-coil measuring elements. Completely independent rectilinear records are written on 4 adjacent 2-3/16 in. channels of the 11 in. chart. Because they are independent, each of the 4 channels can be ordered to record different or similar variables. An electric utility engineer, for example, might choose to record simultaneously, on a single chart, all three phase currents of a three-phase circuit, using the fourth channel for an expanded scale voltage record. Options include an unlimited number of alarm circuits, four event pens and a 240-V power supply. Scale plates for each channel are independent so they can be rearranged.

CIRCLE NO. 409

## Megohmmeters range to $2 \times 10^{13} \Omega$

Freed Transformer Co., Inc., 1718 Weirfield St., Ridgewood, N. Y. Phone: (212) 386-1300

The complete range of insulation resistance measuring equipment covers fixed and variable dc test voltages from 5 to 2500 V. The 2030 series is a unit with a battery-operated transistor power supply. The 2030 A has a range of 10 to 2,000,000 M $\Omega$  and the 2030 B has a range of 1 to 20,000,000 m $\Omega$ .

CIRCLE NO. 335



**Yes. You can get every  
wire and cable you need  
for a computer system in  
one neat package...from  
Brand-Rex**

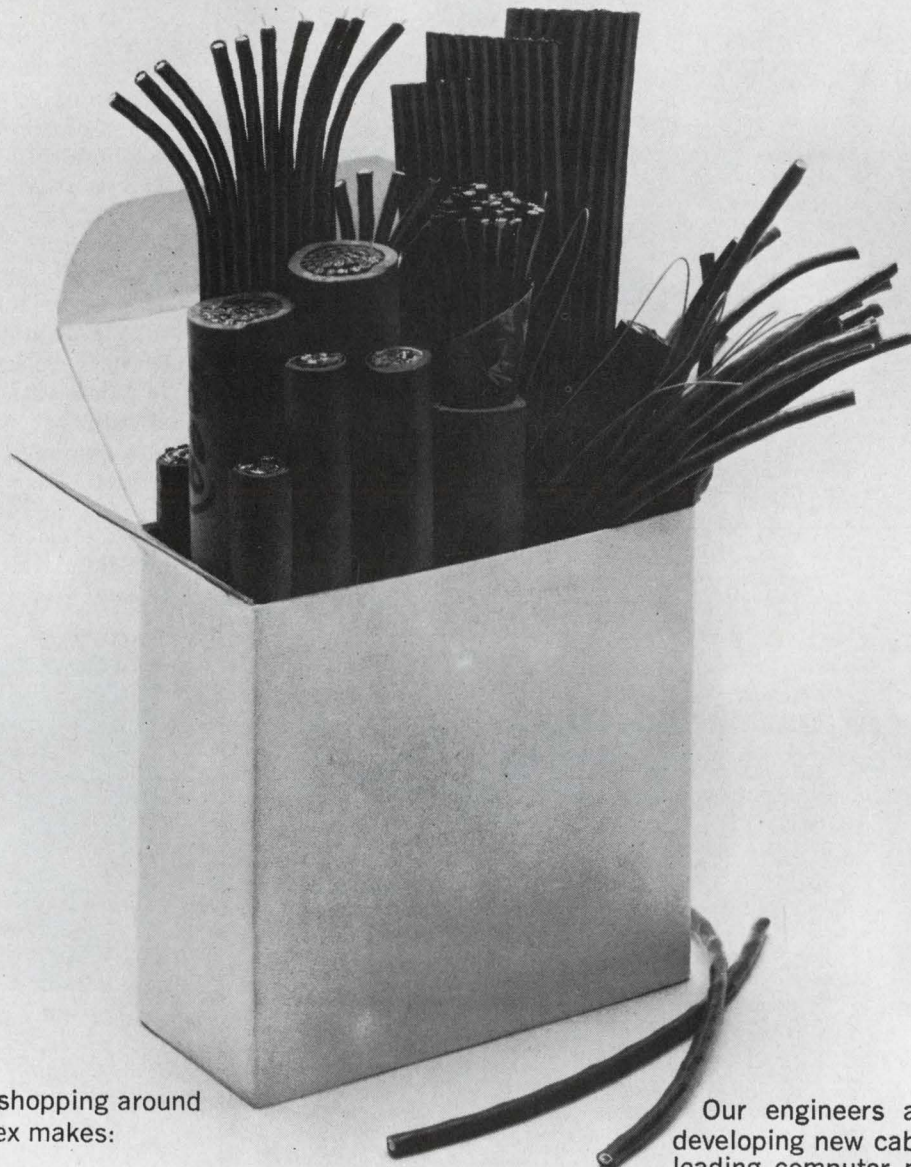

You save a lot of shopping around because Brand-Rex makes:

- **Back-Panel Wires**
- **Hook-Up Wires**
- **Miniature, Air-Spaced Coaxial Cable**
- **Power Supply Wires**
- **Patch Cord Wires**
- **Interconnecting Cables**
- **Communication Cables.**

You can have just about any configuration... single wire, round cable, ribbon cable, custom profiles... and your choice of insulations including Kynar, Polysulfone, Teflon (FEP and TFE), PVC, semi-rigid PVC, PVC/nylon, polyethylene, foamed polyethylene, FEP/nylon, Rulan and Neoprene. Matched colors if you want.

Our engineers are constantly developing new cable designs for leading computer manufacturers. So if existing Brand-Rex products don't meet your needs, we'll come up with new designs that will.

Hooking-up a computer system? Get all the wire and cable from one good source. Ask Brand-Rex.

AMERICAN  CORPORATION  
BRAND-REX DIVISION  
WILLIMANTIC, CONNECTICUT 06226  
PHONE 203 423-7771



ON READER-SERVICE CARD CIRCLE 108



**A specialty of the house...**

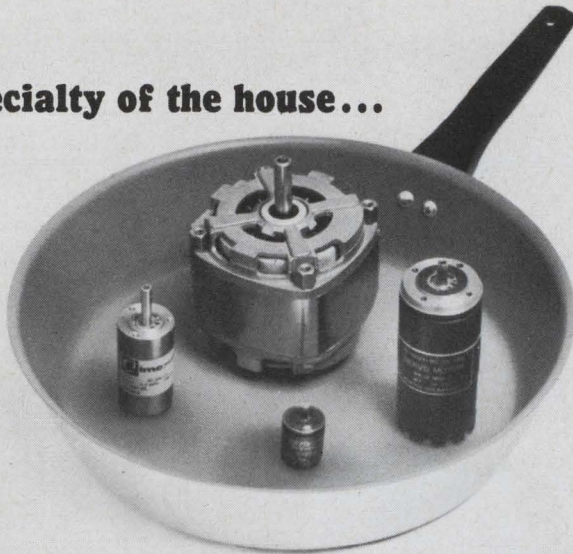

**cooking up new ideas in electric motors.**

Like the GT1612 that runs up to 60,000 rpm on hydrostatic air bearings. Extreme accuracy in locating the beryllium shaft helps make this possible. Other specialties to help you serve up exactly what's needed include induction, hysteresis, torque, synchronous, AC drive, DC drive and servo motors, in the milli- to integral-horsepower range, and without the compromise of run-of-mill

mass-produced motors. For motors for spacecraft, avionics, control, computer peripherals and other systems, contact IMC Magnetics Corp., Eastern Division, 570 Main St., Westbury, N.Y. Phone (516) 334-7070 or TWX 516 333 3319. If you need information for future projects write IMC's Marketing Div., at the same address, or circle the bingo number at the bottom of this ad.



ON READER-SERVICE CARD CIRCLE 238

**Boxer fans speak softly, but carry away loads of hot air.**

(They're durable, efficient, versatile and immediately available.)

**Durable.**  
Ball bearing models withstand high temperature for long periods of time, due to a patented extra-large lube reservoir. Sleeve type Grand Prix (pat. pending) bearings run cool and reliably, offering exceptional life at low cost. Rugged metal frame won't crack under stress like plastic.

**Efficient.**  
Five-bladed aerodynamic impeller delivers maximum flow against high back pressures.

**Versatile.**  
Standard modular size fits almost anywhere, flips to reverse airflow, has seven useful accessories.

**Available.**  
In stock at your nearest distributor.



IMC Magnetics Corp., New Hampshire Division  
Route 16B, Rochester, N.H. 03867.  
Tel: (603) 332-5300

ON READER-SERVICE CARD CIRCLE 239

**TEST EQUIPMENT**

**Pole-finding paper turns red on contact**



Gallard Schlesinger Chemical Mfg. Corp., 584 Mineola Ave., Carle Pl., N. Y. Phone: (516) 333-5600.

This product is used to find negative electrode (cathode) in electrolytic equipment. The white indicator paper is impregnated with phenolphthalein and an electrolyte. The moistened indicator paper is brought into contact with the pair of electrodes to be tested. The electrolytic activity will give an excess of ions at the anode and the resulting alkaline will change the color of the phenolphthalein indicator to red. A catalog containing a large assortment of other test papers is also available.

CIRCLE NO. 410

**Communications monitor tests fm channels**



Cushman Electronics, Inc., 166 San Lazaro Ave., Sunnyvale, Calif. Phone: (408) 739-6760.

Called the CE-3, the instrument gives a choice of plug-in oscilloscopes or meters for deviation display and a choice of three rf plug-ins (20-80, 120-180, and 450-512 MHz). Included on the unit is the feature that allows users to dial in any frequency in the fm communications spectrum. Once frequency is selected, frequency error and fm deviation can be read simultaneously. Frequency accuracy is better than 0.000075% long term.

CIRCLE NO. 411



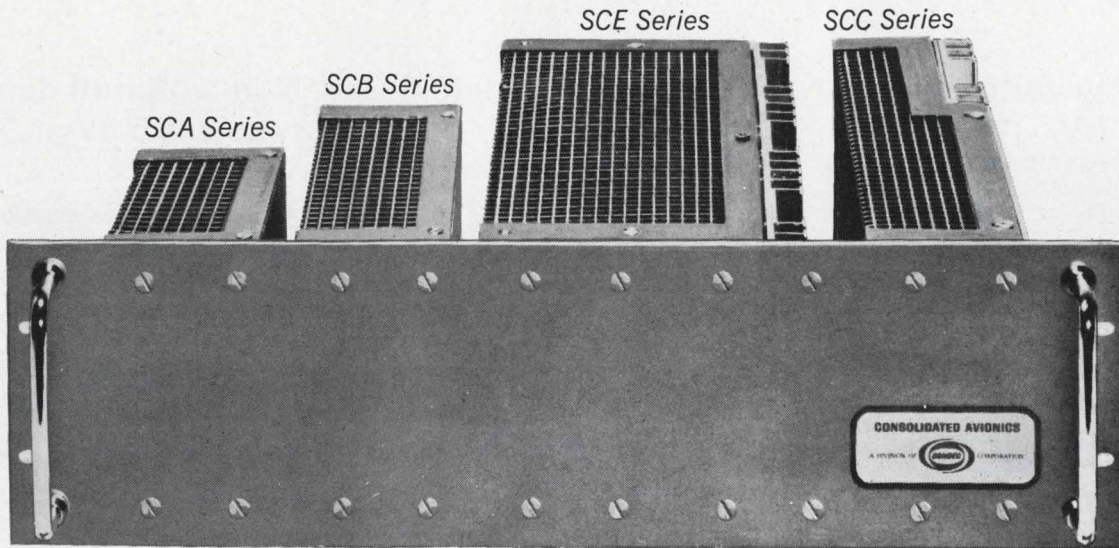

# New Packaging Idea in Systems Power Supplies

*Three Mounting Planes  
And Slim Package Design  
Help You Pack More Power  
In A 19" Rack*

## SPECIFICATIONS

**Input:** 105-125V AC, 47-440 cps

**Regulation (line and load combined):**  
±0.05% or 2 mv, whichever is greater.

**Ripple:** 1mv rms.

**Response Time:** 20 μsecs.

**Temperature Coefficient:** 0.015%/°C or  
1.8mv/°C, whichever is greater.

**Temperature:** 75°C max.

Remote voltage adjustment and remote sensing are standard. Overvoltage protection and metered panels available as options.

You can pack as much as 485 watts into a standard systems rack when you use Con Avionics new SC series of power supplies.

There are 88 modules, in four package sizes, to choose from. You can mount any of the modules on any of three surfaces, including a 3½" panel. A wide variety of rack adapters lets you pick a power supply rack to fit your exact requirements.

The units are self-cooled, saving you precious inches you used to need for heat sinking. They are unconditionally guaranteed for five years. Because they were designed under Worst Case Analysis, they will meet their specifications even under the worst possible combinations of operating conditions.

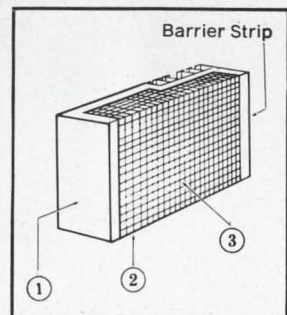

3 Ways To Mount

## CONSOLIDATED AVIONICS

A DIVISION OF  CORPORATION

800 Shames Drive, Westbury, L.I., New York  
(516) ED 4-8400 TWX: 510-222-6151

ON READER-SERVICE CARD CIRCLE 122



**Economy voltmeter senses 100  $\mu$ V**



Roback Corp., 602 Buck Rd., Huntingdon Valley, Pa. Phone: (215) 676-4000. P&A: \$395; stock.

A low-cost, solid-state, 3-digit voltmeter features 100-  $\mu$ V sensitivity on the 100-mV range. Designated as model 304, the meter provides five ranges +100 mV- 1, 10, 100 and 1000 V. A fourth digit provides over range readout at full-rated accuracy to 120% of full scale for all ranges. Input resistance is 10 M $\Omega$  (1 M $\Omega$  on the 100 and 1000 V ranges). Sampling rate of the unit is 4 samples/s.

CIRCLE NO. 455

**Four-digit voltmeter computer option**

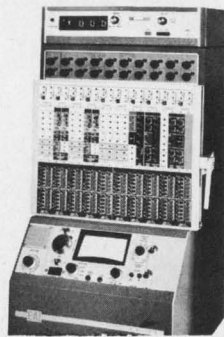

Electronic Associates, Inc., West Long Branch, N.J. Phone: (201) 229-1100. Price: \$495.

The 6250 digital voltmeter magnetically mounts to the top of the computer. The simplicity of operating the unit adds to its usefulness as an accessory to the small scale EAI computers. The 6250 provides four-digit readout of analog voltage signals. The two-voltage ranges available are 1 and 10 V. Input impedance of the meter is 10 M $\Omega$  and conversion time is 100 ms.

CIRCLE NO. 311

**Nanovolt null detector resolves 5 nV at 30  $\Omega$ .**



Leeds & Northrup, 4901 Stenton Ave., Philadelphia, Pa. Phone: (215) 4329-4900.

The 9838 is a guarded, solid-state null detector designed for use with potentiometers or other instruments. Each 2-mm scale-division of the detector can resolve 5 nV with a source resistance of up to 30  $\Omega$ , 10 nV at 300  $\Omega$  and 30 nV at 1000  $\Omega$  source resistance. This detector can be operated from its internal rechargeable battery or directly from line-voltage. Common mode ac rejection is more than 160 dB.

CIRCLE NO. 312

**combination**  
(low-price switch/circuit breaker)



Here is a low-price circuit breaker that reduces assembly cost and adds sales value to your product by combining two components into a single unit. The Model 112 is available in 5 through 50 amp. ratings, is trip free, and is approximately 1 1/2" x 3/4" x 2". Write for Thermal and Magnetic Circuit Breaker Catalog.



244 Broad St., Lynn, Mass. (617) LY 8-5313  
ON READER-SERVICE CARD CIRCLE 123

**This tiny switch could be the start of something big**

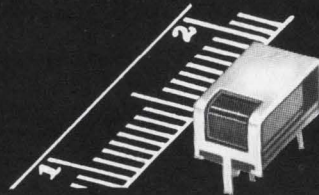

New Chicago ultra-miniature momentary DPDT slide switch handles 500 MA in a space only .250" W x .468" L x .230" H

- Rated 500 MA @ 120 VAC or 250 MA @ 9VDC
- Designed for plug-in or dip-solder pc boards
- Integrated circuit size
- Tested for over 150,000 cycles
- Can be actuated by pins, rods, cams or levers within user's electronic device
- Completely rust and corrosion proof
- Now used in pocket paging equipment, computer cards, test equipment, personalized radio, TV, guidance systems, transistorized and integrated circuits

Want to start something in your product? Write for free sample switch and spec sheet 23-020-003.



ON READER-SERVICE CARD CIRCLE 124



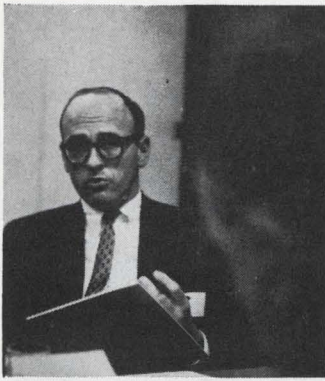

# SWITCH CRAFT FORUM

order, stock, assemble and test the cable assemblies you're now using. Compare your total costs with the price we'll

**I've been itching for a FORUM on molded cable assemblies. I say you**

**can't beat the solder or screw connected assemblies when it comes to fast repairs in the field.**

How about less repairs to begin with? Failure incident rates have proven to be less with molded cable assemblies. Pull tests show why molded assemblies are 50%-100% stronger than soldered plugs. Solder types, like the one shown in fig. 1 (bottom) broke at forces as low as 24 lbs. In fact, in the tests we've run, the cable itself broke before it would pull out of the molded plug.

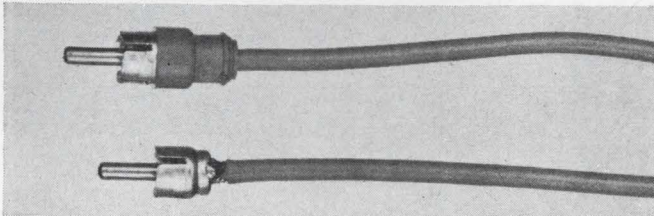

**But when it does break, you're finished. That could mean expensive equipment down-time unless it can be quickly repaired.**

Let's say the molded assembly does break. If you clip off the damaged plug and replace it, you're still better off than with solder or screw type connectors. You want better aspirin; we say, eliminate the headache in the first place.

Repair costs can be expensive, too. Especially, if the connection is poorly soldered and shows up as an intermittent defect. Add this to the possibility of non-molded plug handles coming loose from vibration, poor shielding from moisture and contaminants, or excessive strain due to plug and cable size mis-matches and you've got yourself a potential profit-killer.

**O.K., I'll have to concede your point as far as the cable-plug connection is concerned. But, you'll have to admit that when the molding holds the plug parts together, plastic cold flow can loosen the plug tip and kill reliability.**

You're right. That's why Switchcraft doesn't mold the plug components together.

Fig. 2. shows how we start with a one-piece tip rod, connector and insulators, with the rod solidly staked into the tip terminal. After soldering the center conductor, a bridge sleeve is crimped around the cable and connector flange prior to molding. No tip loosening, no cable strain.

**I'm almost convinced. Now give me the bad news about the cost of molded cable assemblies vs. solder or screw types.**

Brace yourself. Think of what it costs your company to

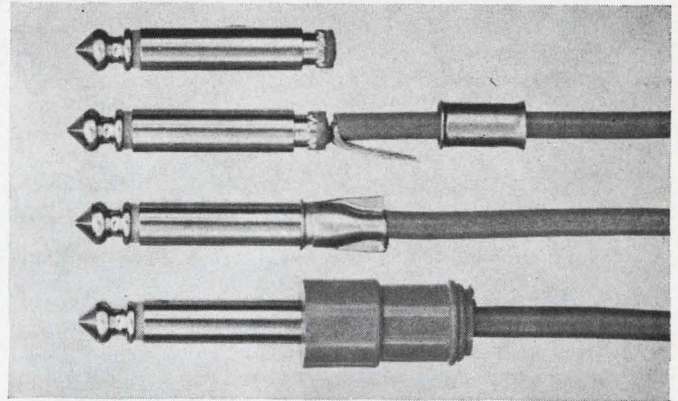

quote for a comparable molded cable assembly, and you'll be money ahead. And that doesn't even include the cost-savings you'll get from the added reliability of our molded cable assemblies.

**That's great for phone and phono plugs, but we often get into some pretty oddball applications where we need a different type of connection.**

You name it, we can produce it. Most of the time, one of our standard straight or right angle phone or phono plugs, microphone connectors or extension jacks will do the job. If not, Switchcraft has the know-how and high production machinery to run an economical, custom-molded unit to your specs. *Just circle the reader service number for more info on these standard and custom made molded cable assemblies.*

**Sounds good, but how can my staff get further technical details on specific applications that back up what you've just told me?**

Simple. Have them join the FORUM by writing their questions or comments on your company letterhead. We'll send

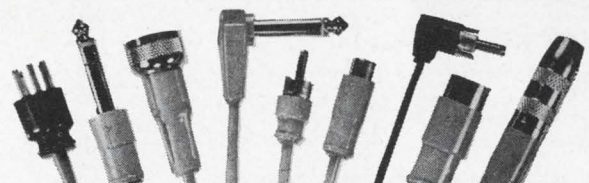

our "Forumfacts on Molded Cable Assemblies" handbook, and also add their name to our TECH-TOPICS mailing list. Every other month, they'll receive this engineering application magazine that we're sure will be useful and interesting to them. 10,000 design engineers can't be wrong!!

**SWITCHCRAFT**  
INC.

5529 North Elston Avenue  
Chicago, Illinois 60630

ON READER-SERVICE CARD CIRCLE 125



# LOW PROFILE IC PACKAGING SOCKET

**New**

Directly interchangeable! Exclusive socket configuration, identical to IC package, saves time, simplifies mounting on PC board.

- Permits card stacking on 1/2" centers
- Accepts packages with flat or round leads
- Easy IC insertion with wiping type beryllium copper contacts
- Easy extraction, minimum lead damage—optional extractor tool available
- Available in diallyl phthalate or black phenolic with gold or tin-plated contacts
- Dimensions .79 L x .49 W x .31 H

Request Data Sheet 166.

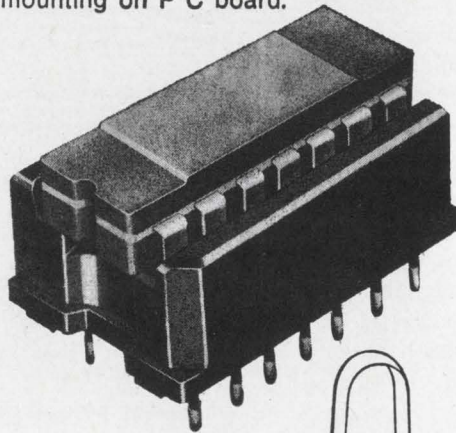

Extractor tool



**AUGAT**

INC. 31 PERRY AVE., ATTLEBORO, MASS. 02703

ON READER-SERVICE CARD CIRCLE 126

## it costs you nothing to call on experience:

Reeves-Hoffman design and manufacture is 100% custom . . .  
let us quote your needs!

★ quartz crystals

★ crystal filters

★ oscillators

★ discriminators

★ standards

★ ovens



**REEVES-HOFFMAN**

DIVISION OF **DCA**

400 W. NORTH ST., CARLISLE, PA. 17013  
TELEPHONE • AREA CODE 717 • 243-5929



Md., D.C., Va., W.Va., N.C.  
Valley Electronics, Inc.  
Baltimore, Maryland  
(301)668-4900; (202)659-1760

New England  
Howard Jappe Company  
Wakefield, Mass.  
(617)245-9359

Pa. (not western), Del., So.N.J.  
Eastern Components, Inc.  
Philadelphia, Pa.  
(215)927-6262

New York (except N.Y.C.)  
Midstate Research Sales Co.  
Syracuse, New York  
(315)478-8314; (315)478-0715

New York City, No.N.J.  
G. M. Moch Company  
Ridgefield, New Jersey  
(201)945-0080; (212)279-6758

So. California  
Ash M. Wood Company  
Arcadia, California  
(213)283-1201; (213)287-0449

No. California  
L & M Engineering  
Santa Clara, Cal.  
(408)243-6661

Ill., Ind., Wisc., Minn.  
PGM Sales, Inc.  
Chicago, Illinois  
(312)622-8183

Ohio, W.Pa., Mich., Ky.  
Tri-State Marketing, Inc.  
Cincinnati, Ohio  
(513)631-5060

Texas, Okla., Ark.  
Carter Associates, Inc.  
Garland, Texas  
(214)276-7151

Ariz., N.M., Las Vegas  
Carter Associates, Inc.  
Scottsdale, Arizona  
(602)947-4355

ON READER-SERVICE CARD CIRCLE 127

## TEST EQUIPMENT

### Low-current tester for semiconductors

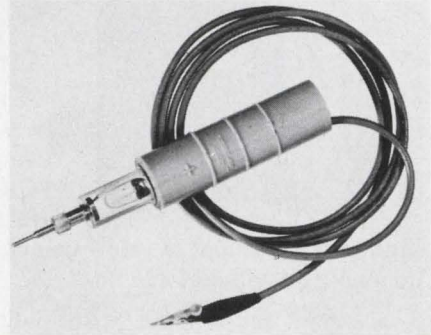

Desco Manufacturing Co., 1530  
Flower St., Glendale, Calif. Phone:  
(213) 241-9560.

This low-current, trouble-shooting tester allows an operator to locate open transistors and diodes and to determine diode polarity in circuit boards and assemblies. It will verify the existence of a junction in any npn or pnp transistor where the leads are accessible without causing damage from overcurrent to the transistor under test or to any other circuit component. It can be used as a continuity tester for circuits up to 400,000  $\Omega$  resistance while the current through the circuit under test is less than 50  $\mu$ A.

CIRCLE NO. 314

### Table-top magnifier sheds some light

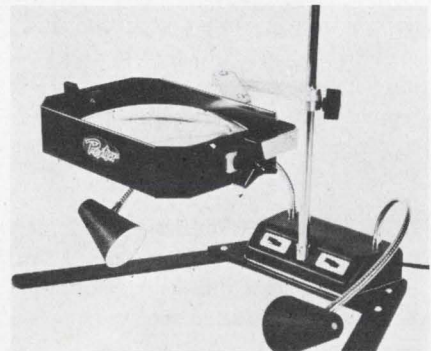

Roxter Corp., 10-11 40th Ave., Long  
Island City, N.Y. Phone: (212) 392-  
5060.

A magnifier and hi-intensity lamp combination provides a 48 in.<sup>2</sup> of viewing area and the equivalent of 300 W of pure white light. The optically ground lens is set in a metal frame which can be rotated 360° in the vertical plane. The arm can be raised to a maximum working height of 15 in.

CIRCLE NO. 343



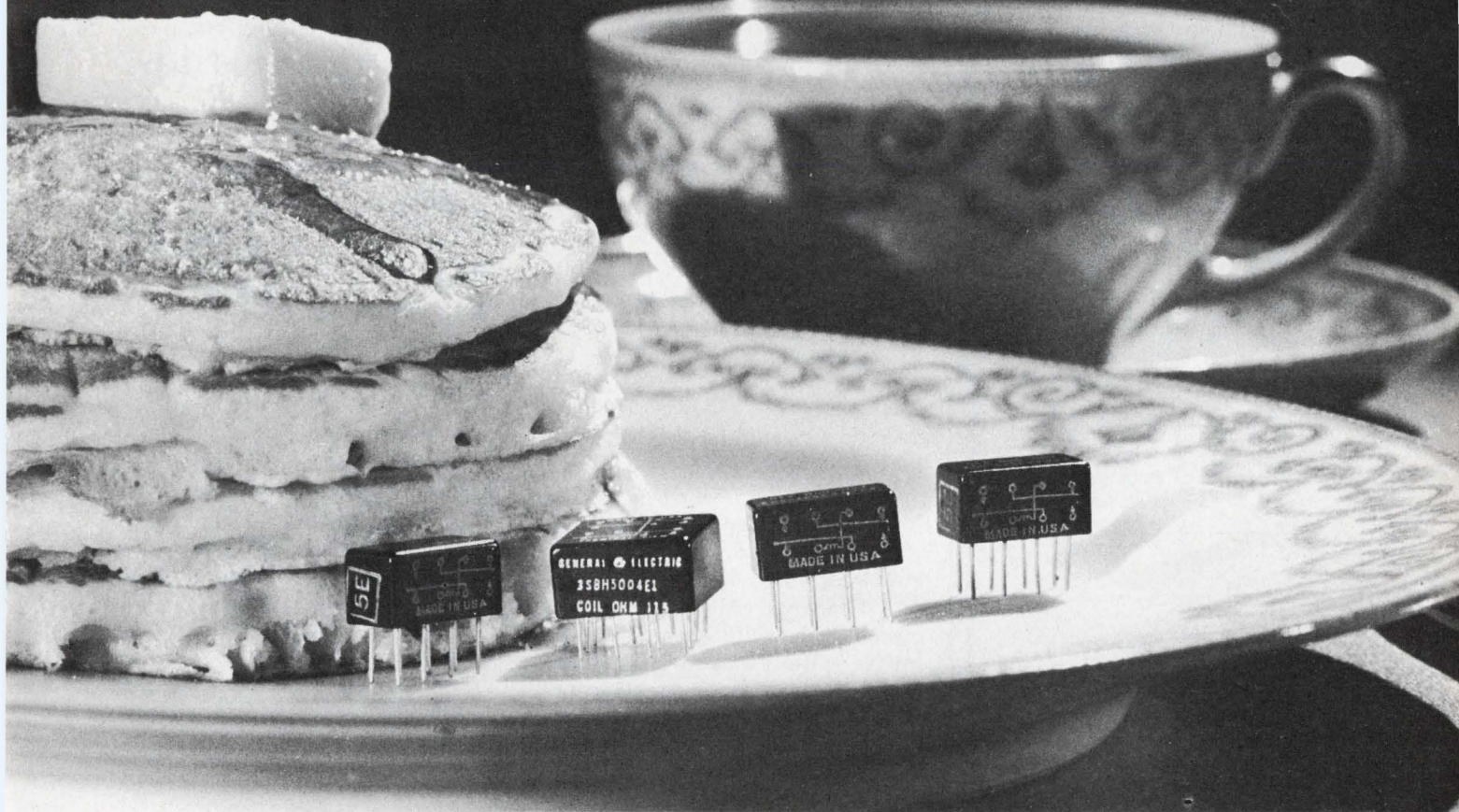

# Flat as a pancake... and selling like hotcakes

And why not?

General Electric's new high performance 150-grid sealed relays are smallest where it counts most—only 0.320" high. What's more they come in 4 versions: 4 Form C, 2 Form C, 4 Form C AND-logic type, and a 50 milliwatt sensitivity 1 Form C (or 1A+1B).

Result: for the first time you can get really small size, a variety of forms to choose from, and exceptional performance all in one relay type.

These General Electric 150-grid space relays meet or exceed the environmental and mechanical specs of much larger Mil Spec micro-miniature relays. And compared to relays of comparable size, GE 150-grid space relays have 3 times the magnetic force and over twice the contact force of the nearest competitor.

Outstanding features include:

- High vibration capability
- Excellent minimum current switching ability
- Excellent thermal resistance
- High overload capability—can withstand 5 amps each contact and make and carry 10 amps for short periods
- No flux contamination because of all-welded construction and design.

For more information on the small relay that's going over big, contact your General Electric Electronic Components Sales Engineer. He can tell you more about them and help with your individual application. Or write for bulletin GEA-8042B, Section 792-41, General Electric Company, Schenectady, New York 12305.

*Specialty Control Department, Waynesboro, Virginia*

**GENERAL**  **ELECTRIC**

ON READER-SERVICE CARD CIRCLE 128





# COMPACT POWER PACKS

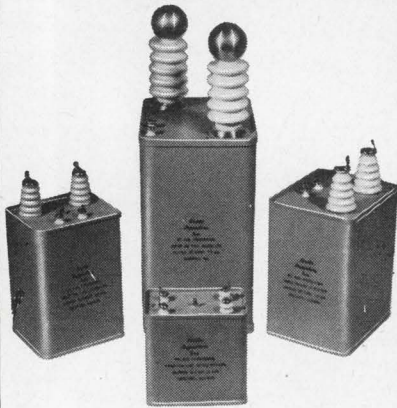

The new Compact "M" Series Power Packs offer you:

- Rated output voltages from 1000 to 75,000 DC
- Rated output currents of 1.5, 5, and 10 milliamperes
- Input voltages of 118, 220, 230, and 240 volts AC
- Variable output from 0 to rated voltage
- Input frequency range 50 to 500 CPS
- Output ripple 1% RMS at rated voltage
- Hermetically sealed construction

Why pay more, and settle for less... PC's new compact power packs give more quality, more versatility, more dependability, plus smaller size, and best of all, most sizes are available in stock to meet your immediate needs.

Write for complete information and new catalog today!



## Plastic Capacitors, INC.

2620 N. Clybourn • Chicago 14, Ill.  
DI 8-3735



ON READER-SERVICE CARD CIRCLE 129

## MICROWAVES

### Telemetry oscillator handles IRIG

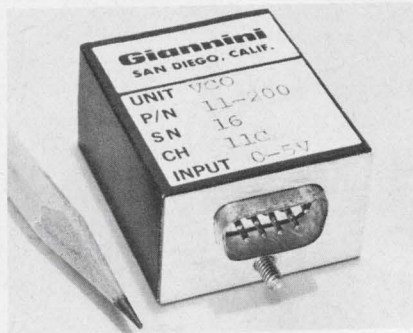

Giannini-Voltex, 8133 Engineer Rd., San Diego, Calif. Phone: (714) 279-0506. P&A: \$225; 30 days.

A miniature transistorized constant bandwidth telemetry sub-carrier oscillator is designed primarily for applications where ruggedness and reliability are required. All IRIG and AIA constant bandwidth channels are available with standard bandwidths up to  $\pm 8$  kHz. These model G-65-11-200 oscillators satisfy the environmental and reliability conditions of missile and satellite telemetry systems. They have mV signal input and isolated signal input models available.

CIRCLE NO. 322

### Microwave switch covers 2 to 12 GHz



Somerset Radiation Lab., Inc., 2060 North 14th St., Arlington, Va. Phone: (703) 525-4255. P&A: \$275; 20 days

With 45-dB isolation, 0.5 to 2 dB insertion loss and 2 W CW and 100 W peak power, the model N410 ranges to 12 GHz. Extra wide range is realized by functionally integrating oxide passivated silicon pin diodes into a low-pass filter along with a shunt-bias circuit that eliminates series blocking capacitors. With zero bias, the junction capacitances of the diodes combine with the filter-shunt capacitors for minimum signal attenuation.

CIRCLE NO. 321

### Noise figure meter measures to 26.6 GHz



Kay Electric Co. Maple Ave., Pine Brook, N. J. Phone: 201) 227-2000.

Solid-state, automatic-noise figure meter offers variable impedance and balanced outputs. The unit, Model 792A, provides measurements up to 26.5 GHz and metered-noise figure ranges of 5 to 30 dB for waveguide and diode sources. Either 6 dB or 15.2 dB excess noise can be selected for accuracy at either high or low-noise figures. Manual operation, including a variable gain control, is front panel selected.

CIRCLE NO. 316

### Reflectometer directs 31 dB at 12.4 GHz

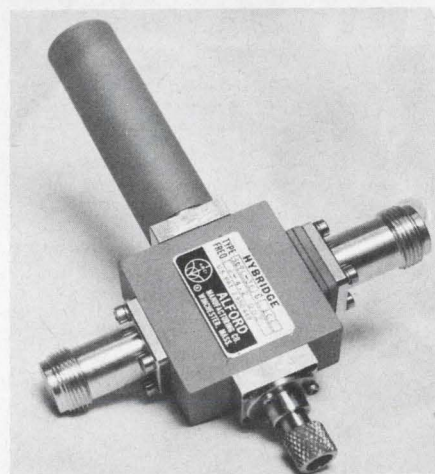

Alford Manufacturing Co., 120 Cross St., Winchester, Mass. Phone: (617) 426-2150. P&A: \$470 to \$570; stock.

Reflectometers are high broadband devices that can be used to obtain accurate swept measurements. The type 4673-35 unit has a residual VSWR under 1.055 (31 dB directivity) over the range of 7 to 12.4 GHz. No special storage oscilloscope or X-Y recorder is required since the entire VSWR vs frequency characteristic of the device under test can be determined in a single sweep cycle of the rf source.

CIRCLE NO. 354

ON READER-SERVICE CARD CIRCLE 130



# Only new Lambda LP Series lab power supplies provide all these big system features in a small, low-cost package.

## Starting at only \$114.

- High power output—up to 28 watts.
- Wide voltage range versatility—0-10 VDC up to 0-250 VDC.
- Bench or rack use—without adapters.
- Unusually wide automatic current limiting—from 1% (or 5 MA) to 105% of rated output current.
- Two meters for voltage and current.
- Both coarse and fine adjustment of voltage and current.
- Over-temperature protection by thermal relay—prevents overheating.
- Convection cooled—no blower failures.

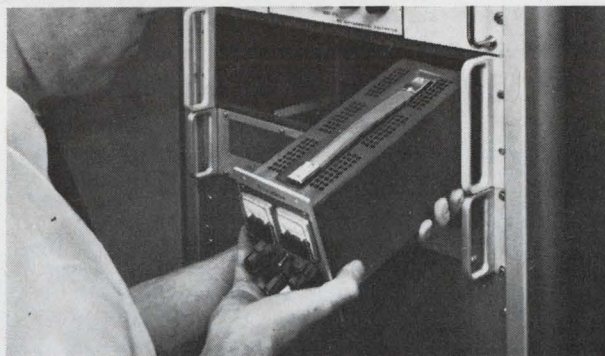

You can mount up to 4 units in a standard LRA-1 or LRA-2 rack adapter.

### Other features

- Regulation (line or load): .01% + 1 MV.
- Ripple: 500  $\mu$ V RMS, 1.5 MV p-p
- Temperature coefficient: .015% + .5 MV/ $^{\circ}$ C.
- CV/CC with automatic crossover.
- A-C input: 105-132 VAC 45-440 Hz (ratings based on 57-63 Hz operation).
- All Lambda power supplies are guaranteed for 5 years.

### Select from six models

Model	Voltage Range	MAX. CURRENT AT AMBIENT OF:				Price <sup>1</sup>
		30 $^{\circ}$ C	40 $^{\circ}$ C	50 $^{\circ}$ C	60 $^{\circ}$ C	
LP 410	0-10 VDC <sup>o</sup>	2A	1.8A	1.6A	1.4A	\$129
LP 411	0-20 VDC <sup>o</sup>	1.2A	1.1A	1.0A	0.8A	119
LP 412	0-40 VDC <sup>o</sup>	0.70A	0.65A	0.60A	0.50A	114
LP 413	0-60 VDC <sup>o</sup>	0.45A	0.41A	0.37A	0.33A	129
LP 414	0-120 VDC	0.20A	0.18A	0.16A	0.12A	149
LP 415	0-250 VDC	80MA	72MA	65MA	60MA	164

<sup>o</sup>Overvoltage Protection available as an accessory—\$40.00 each.

<sup>1</sup>Prices are for non-metered models. For metered models, add suffix (FM) and add \$10.00 to price.

SEND FOR COMPLETE LAMBDA CATALOGUE

 **LAMBDA**  
ELECTRONICS CORP.

515 BROAD HOLLOW ROAD • MELVILLE, L.I., NEW YORK 11746 • (516) 894-4200

A  SUBSIDIARY

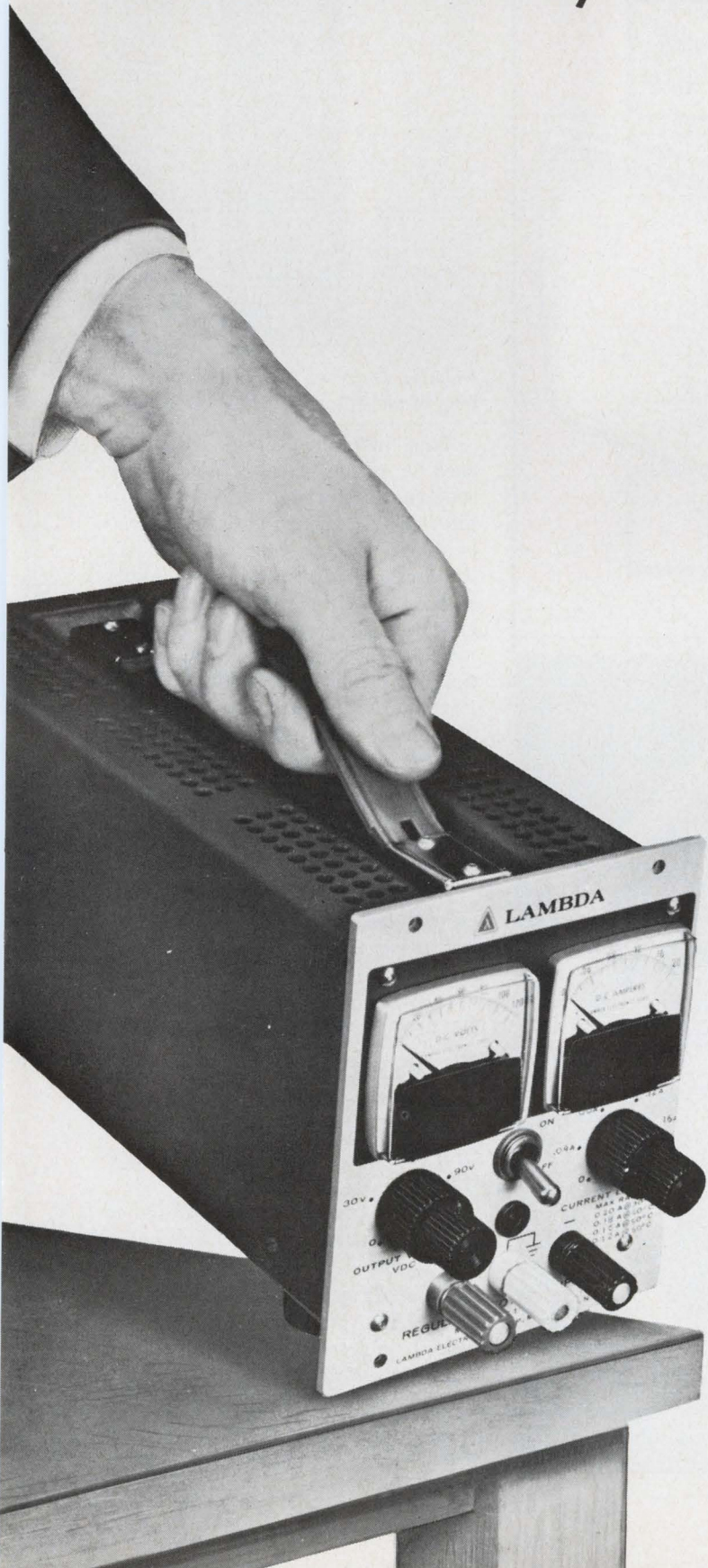



# YOKE SPECIALISTS

## FOR INFORMATION DISPLAYS

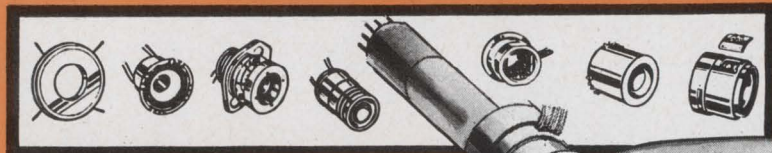

Syntronic's devotion to precision and attention to detail assure skillfully engineered deflection yokes in prototype or full production quantities. A complete line of value engineered yokes offer cost saving solutions to your CRT projects. Consult scientifically oriented Syntronic Yoke Specialists for the right yoke for your display.

***Syntronic*** INSTRUMENTS, INC.  
100 Industrial Road, Addison, Ill.  
Phone: Area 312, 543-6444

ON READER-SERVICE CARD CIRCLE 131

## MICROWAVES

### Pile-up gate module for M-100 system

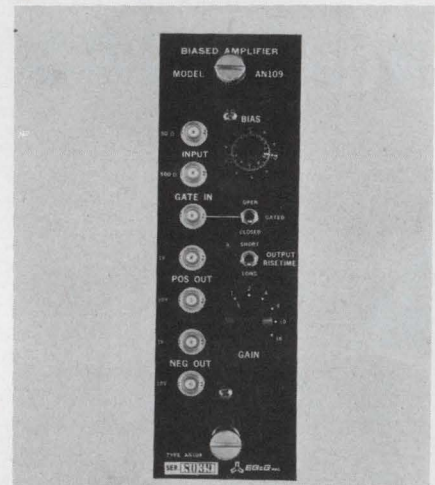

EG&G, Inc., 35 Congress St., Salem, Mass. Phone: (617) 745-3200.

This instrumentation module is used to provide protection against spectrum distortion caused by pulse pile-up. The pile-up gate signal may be used either to control or to gate the flow of information to a multi-channel pulse-height analyzer. Other features of this M-100 system module are: true no-deadtime operation; two bridging inputs to facilitate reuse of input signals for other purposes; two inputs that accept both fast-logic signals and a wide range of linear or digital signals; and two veto inputs, a high, low and synchronous operation with a multi-channel pulse-height analyzer.

The unit has a timer range of 100 ns to 1100  $\mu$ s with pile-up detection resolution of 8 ns on any range.

CIRCLE NO. 412

### Safety spectacles for laser protection

Textron Electronics, Inc., Spectrolab Div., 12484 Gladstone Ave., Sylmar, Calif. Phone: (213) 365-4623, P&A: \$150; stock.

The SN-1 spectacles are designed to offer protection to the neodymium laser (1.06 microns) while providing high visual transmission (80% average, 400-700 milli-microns) and wide peripheral range specified for pilots and flight crews. Most prescription lenses are available as production permits at a nominal extra charge. The color of the lens is clear.

CIRCLE NO. 380

WIDEST  
RANGE OF  
MINIATURE  
(TO-18)  
PHOTOCELLS

Clairex now offers the broadest selection of miniature CdS and CdSe Photoconductive Cells available anywhere. 23 types of CL 900 series offer: ● Resistance values from 2K to 1.4 megohms at 2 ftc ● Voltage ratings from 100 to 250 volts ● All cells hermetically sealed in low-profile TO-18 transistor case. If you need a miniature, high-reliability photocell, send for new Photocell Design Manual.



**CLAIREX**

"The LIGHT Touch in Automation and Control"  
1239 Broadway, New York, N.Y. 10001  
212 MU 4-0940

CL-108

ON READER-SERVICE CARD CIRCLE 132





RCA's new 6LQ6 Novar Beam Power Tube for Horizontal-Deflection Service in Color TV

## withstands 200 W plate dissipation for 40 seconds

Position of getters and subsequent flash improves heat transfer from screen-grid radiators to glass envelope.



Cavity plate made of heavy-gauge carbonized nickel and subjected to special vacuum-firing process. Combination of material and special processing reduces level of occluded gas and minimizes gas emission during periods of high-overload-temperature.

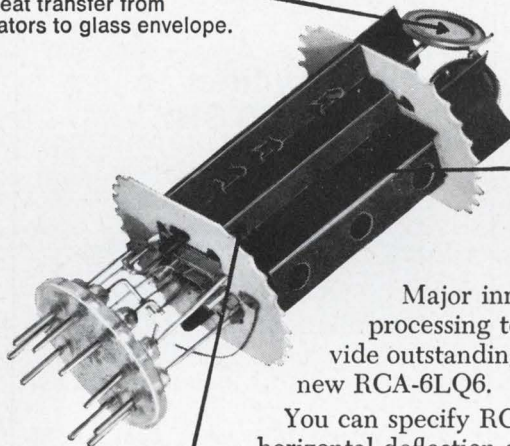

Cavity plate designed for better heat dissipation.

Larger diameter of screen-grid wire reduces screen-grid temperature and improves high-voltage cutoff characteristic.

Major innovations in materials, design and processing techniques make it possible to provide outstanding heat dissipation capability in the new RCA-6LQ6.

You can specify RCA's new 6LQ6 for the demanding horizontal-deflection-amplifier socket of your color-television chassis *with full confidence* that it will provide dependable, high-level performance from tube to tube and throughout life.

The 6LQ6 is a direct replacement for the 6JE6A and 6JE6B.

For complete information on the new RCA-6LQ6 family of Novar Beam Power Tubes, call your nearest RCA District Office or write to RCA Commercial Engineering, Harrison, New Jersey 07029.

RCA Electronic Components and Devices, Harrison, N.J. 07029



The Most Trusted Name in Electronics

**RCA DISTRICT OFFICES—OEM SALES:** EAST, 2075 Millburn Ave., Maplewood, N.J. 07040, (201) 485-3900 • MID-ATLANTIC, 605 Marlton Pike, Haddonfield, N.J. 08034, (609) 428-4802 • MID-CENTRAL, 2511 East 46th St., Bldg. Q2, Atkinson Square, Indianapolis, Ind. 46205, (317) 546-4001 • CENTRAL, 446 East Howard Ave., Des Plaines, Ill. 60018, (312) 827-0033 • WEST, 6363 Sunset Blvd., Hollywood, Calif. 90028, (213) 461-9171 • INTERNATIONAL OPERATIONS, RCA International Division: Central and Terminal Aves., Clark, N.J. 07066, (201) 485-3900 • 118 Rue du Rhone, Geneva, Switzerland, 35 75 00



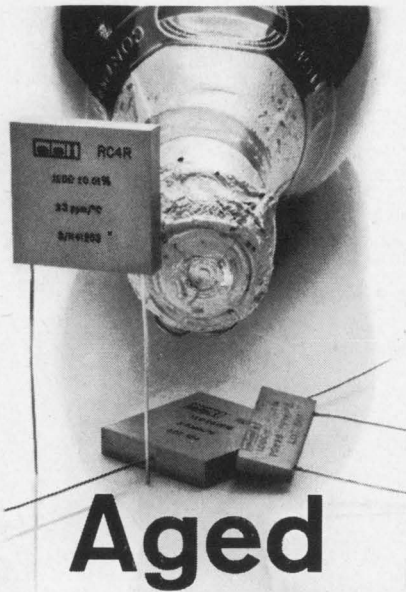

# Aged

Our precision resistors are aged to improve reliability, and we guard the process like a vintage champagne maker. Ageing is just one of many extra steps that make our precision components the most reliable you can specify. A few of our components are described briefly below.

### 1. Precision Wire-Wound Card Resistors

Consider ESI resistors whenever small changes in the resistive element can affect the performance of the final assembly. Initial accuracy to  $\pm 0.0015\%$ . Yearly stability to  $\pm 10$  ppm.

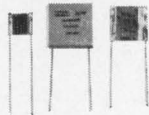

### 2. Dekastat® Decade Resistors

Designed for use with dc and at audio frequencies, these multi-decade resistors feature an accuracy of  $\pm 0.02\%$ . All units carry a two-year guarantee.

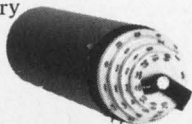

### 3. Dekapot® Resistive Voltage Dividers

These rapid-setting potentiometers have a terminal linearity up to 0.002%. Kelvin-Varley circuitry provides constant input impedance.



### 4. Dekatran Transformer Voltage Divider

The patented coaxial dial is easy to read and adjust. Accuracy of 0.001% and long-term stability are achieved through gapless toroidal cores of very high permeability.



**esi**®

Electro Scientific Industries, Inc.  
13900 NW Science Park Drive  
Portland, Oregon 97229

ON READER-SERVICE CARD CIRCLE 133

## MICROWAVES

### Backward wave oscillators sweep 8 to 26.5GHz

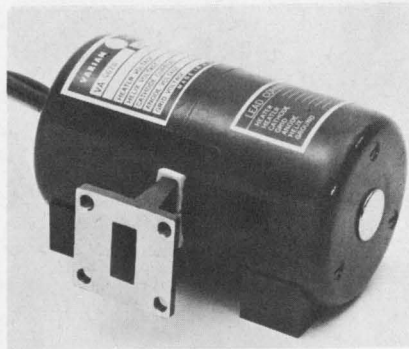

Varian, 611 Hansen Way, Palo Alto, Calif. Phone: (415) 326-4000.

Six miniaturized, voltage-tuned magnetically shielded, back-wave oscillators cover various frequency ranges between 8 and 26.5 GHz. Integral magnetic shielding reduces the stray magnetic field to less than 10 gauss 1/2 in. from the tube. Magnetic shielding, metal-ceramic construction, small size of less than 5 x 6 in., and a weight of 4 pounds make these tubes attractive for airborne applications. Cooling is by convection, requiring no forced air.

CIRCLE NO. 346

### Telemetry filter ranges to 10 GHz



Peninsula Microwave Labs., 855 Maude Ave., Mountain View, Calif. Phone: (415) 969-3303. P&A \$250; 30 days.

The model F512A passes the 2.2-2.3 GHz telemetry band with less than 0.35-dB insertion loss, making it ideal for use as a pre-selector with low-noise front ends. The 60-dB/3-dB form factor is less than 4.5 and the 60-dB stop band extends through 10 GHz. VSWR is less than 1.3. Matched pairs are available with amplitude tracking within 0.05 dB and phase tracking within 2.5. Connectors are N, TNC, or OSM. Dimensions are 5.45 x 1.60 x 1.25 in.

CIRCLE NO. 323

### Aerospace pulse hits 16 kW peak

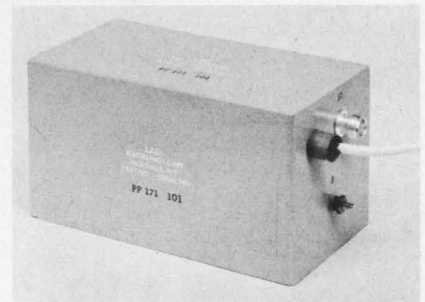

Lad Electronics Corp., 7 Commercial St., Hicksville, N. Y. Phone: (516) 822-1420

A high-power, solid-state aerospace pulser delivers 16 kW peak pulse power over a range of pre-set pulse widths and repetition rates. Known as model PP-171, the pulse source is designed for aerospace use in communications, radar, IFF, beaconry, telemetry, ECM and lasers. Primary power of unit is 28 V dc. Other models are available to accommodate different ac and dc power source. Its size is 6 x 3 x 4 1/4 in. and its operating temperature range is -20 to +80°C. The pulse widths are 1-10  $\mu$ s and it meets MIL specs.

CIRCLE NO. 361

### Argon gas laser develops 5 W

Spacerays, Inc., Northwest Industrial Park, Burlington, Mass. Phone: (617) 272-6220. P&A: \$19,500; 30 days.

An argon gas laser system is described as the lowest-cost 5 W system commercially available. The system may be converted in the field, without modification, from an output power of 5 W with argon to 1 or 2 W with krypton. It is also suited for use with xenon. All major components, including the laser discharge tube, Brewster's angle windows, cathode and heater elements, and external mirror assemblies, may be disassembled and replaced in field operation. The complete system, has both research and industrial applications including spectroscopy, medicine, holography, and metal working of thin film elements. A water-cooled laser head and the 25 kW power supply is included.

CIRCLE NO. 365



Introducing a new circuit element:

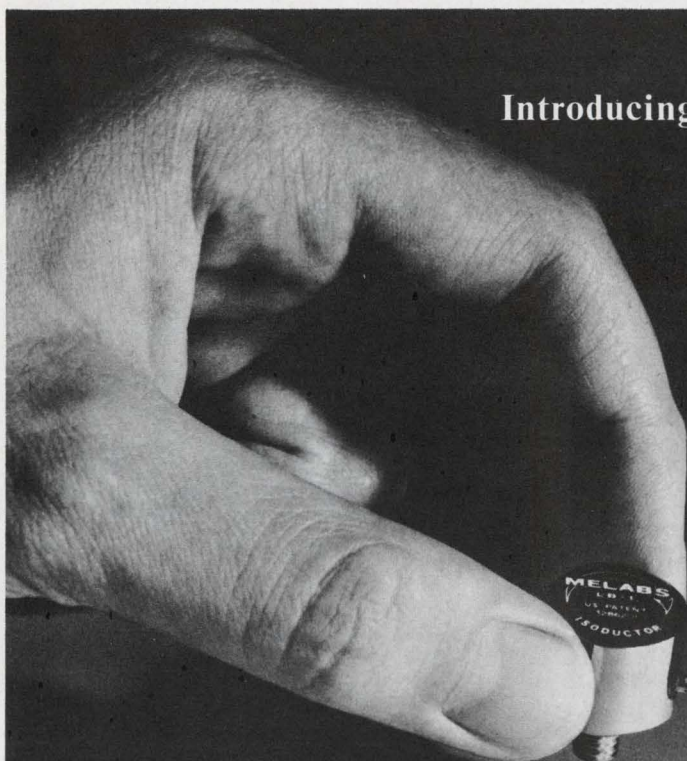

# THE ISODUCTOR

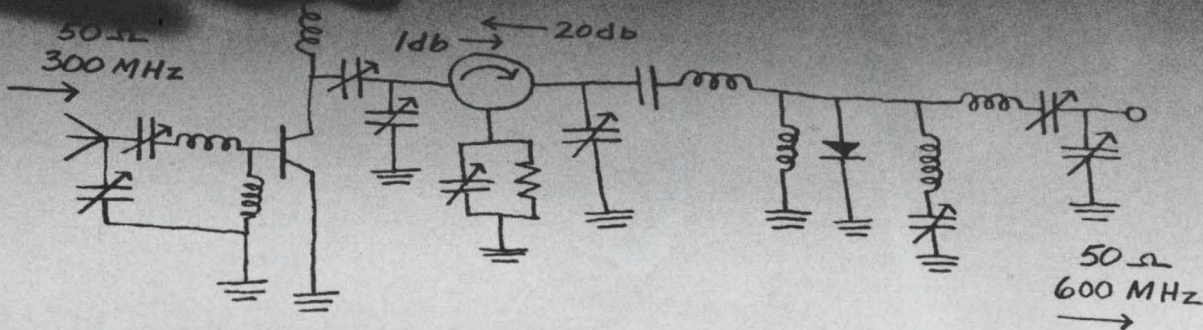

## For improved solid-state circuit stability in the 100-600 MHz band.

For the first time a non-reciprocal, passive, low loss circuit element—the ISODUCTOR—is available to solid-state-circuit designers. ISODUCTORS function like one-way pads. When used with power transistors (both are about the same size and cost), ISODUCTORS' non-reciprocal attenuation characteristic make transistors insensitive to load variations assuring stability with virtually no loss in power output. □ ISODUCTORS are a major breakthrough in component technology, and will eliminate some of the most frustrating circuit stability design problems. Typical performance at 300 MHz is illustrated at the right. □

Our 7-page Application Bulletin, #7-182, fully details the theory and performance of these unique devices. Send for your copy or call your local Melabs representative for a demonstration.

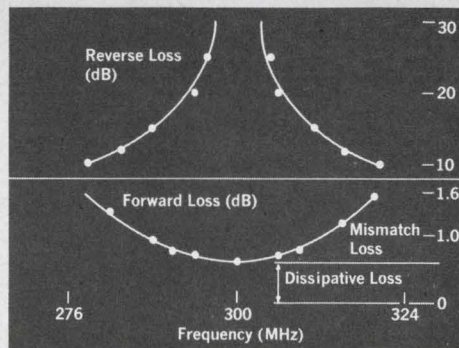

Insertion loss vs. frequency for ISODUCTOR terminated for 300 MHz operation.

3300 Hillview Avenue • Stanford Industrial Park • Palo Alto, California • (415) 326-9500 • TWX: (910) 373-1777  
 MELABS, S.A. • 43 Rue De Namur • Brussels, Belgium • Telephone 12-17-23 • TELEX MELABS BRU 23281 □ Exceptional opportunities exist on our technical staff for qualified engineers and scientists. Melabs is an equal opportunity employer.

ON READER-SERVICE CARD CIRCLE 134



# OVERVOLTAGE PROBLEMS?

## Signalite SOLVES THEM WITH SPARK GAPS

Here are a few applications where Signalite Spark Gaps protect components against overvoltage damage . . .

- Computer Input Voltage
- Broadcast Transmitters
- Power Supplies
- Solid State Circuitry
- Magnetrons
- Pulse Transformers
- Pulse Forming Networks
- Charging Chokes
- High Powered Klystrons
- Filter Chokes & Capacitors

*Need a Spark Gap...*

(Two Electrode or Triggered)

It's probably listed in the SIGNALITE 300 BROCHURE with over 300 others . . . complete with application notes, characteristics, mounting arrangements, photographs, etc.

**IF NOT, WE'LL MAKE IT!**

# Signalite INCORPORATED



SUBSIDIARY  
OF  
GENERAL  
INSTRUMENT  
CORPORATION

NEPTUNE, NEW JERSEY 07753  
(201) 775-2490

## MICROWAVES

### Diffraction system studies crystals

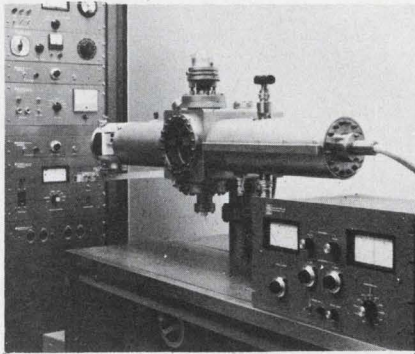

Varian, 611 Hansen Way, Palo Alto, Calif. Phone: (415) 326-4000.

A high-energy electron diffraction (HEED) system permits deeper crystal surface penetration than the earlier developed low-energy electron diffraction did. It is useful for work with polycrystalline specimens and with single crystals. HEED can be used for the study of clean crystal surfaces, absorption, oxidation, corrosion, epitaxial growth, and catalytic processes.

CIRCLE NO. 344

### Self-adjusting heat sinks adapt to TO-transistors

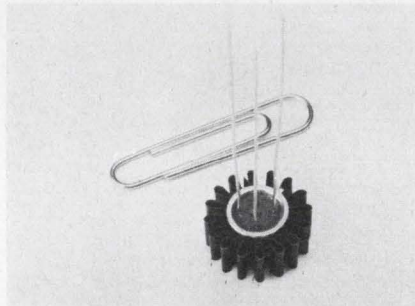

Astrodyne, Inc., 207 Cambridge, St., Burlington, Mass. Phone: (617) 444-0133.

A series of transistor radiators made of beryllium copper provide both elimination of heat and secure mounting of all TO-style transistors. Four basic units in the series adjust to fit various sizes. A convoluted spring design provides from 1 in.<sup>2</sup> (TR-118) to 4 in.<sup>2</sup> (TR-108) of radiating surface in intimate contact with the transistor case. When used with the printed circuits, the heat sinks can be mounted with copper wire clips or in feed-through fashion with the outside diameter of the radiator placed into a hole in the printed circuit board.

CIRCLE NO. 364





# Resolve to get it.

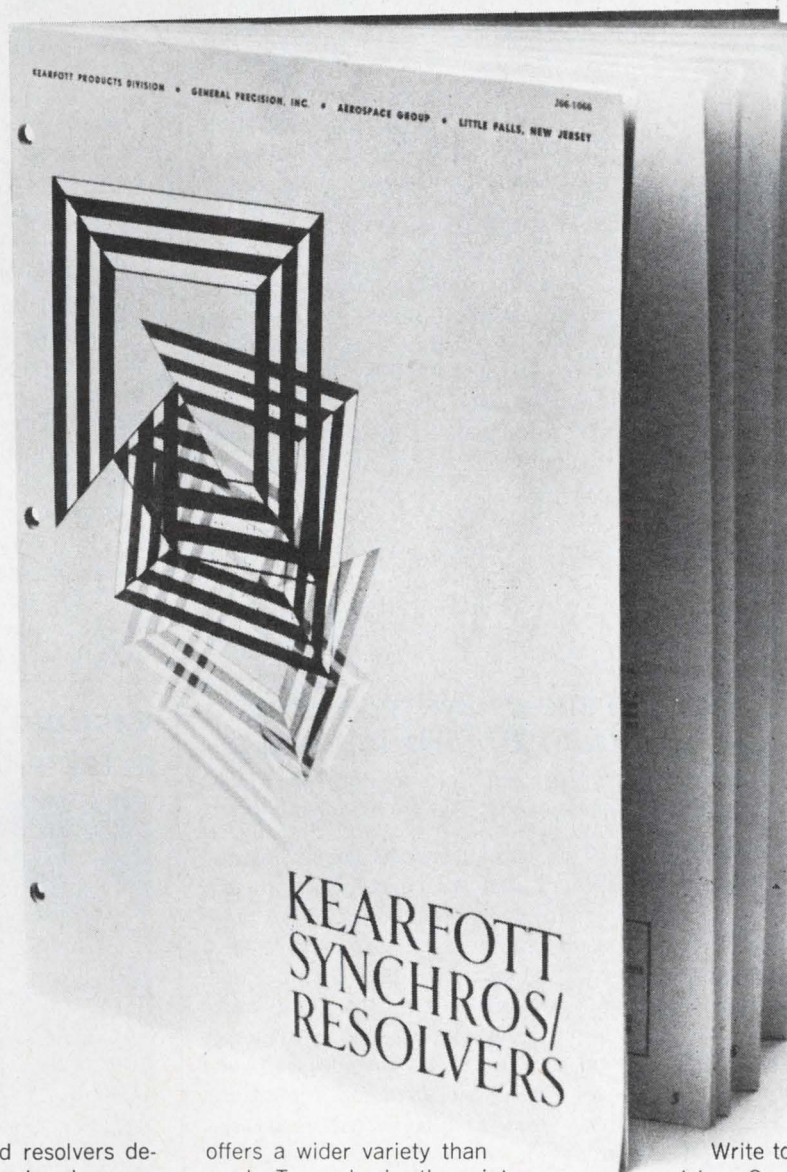

Most of the synchros and resolvers described in this new 32-page brochure are standard only in the sense that they are readily available at competitive prices. Any of the "standard" units can be quickly modified to suit your particular needs, providing thousands of opportunities for you to resolve your problems.

These components reflect the highest order of precision in design, construction and performance and are backed by twenty years of Kearfott engineering and production experience.

We don't think you'll find anyone that

offers a wider variety than we do. To emphasize the point, our catalog covers: Synchros, sizes 5 to 25; resolvers, sizes 5 to 28; winding compensated resolvers; resolver-amplifier combinations; multispeed units; transolvers; tandem synchros; custom-engineered units such as geared and gearhead synchros; rotary transformers; goniometers; phase shifters; etc.

Order the catalog. It's loaded with diagrams, dimensional data, electrical characteristics and application data. There's even a section on design basics.

Write today to: Kearfott Products Division, General Precision Systems Inc., Kearfott Group, 1150 McBride Ave., Little Falls, New Jersey 07424. Dept. 3-1450.

**GP GENERAL  
PRECISION  
SYSTEMS INC.**

**KEARFOTT PRODUCTS DIVISION**  
A SUBSIDIARY OF GENERAL PRECISION EQUIPMENT CORPORATION

ON READER-SERVICE CARD CIRCLE 135





# KEPCO

## ISOLATED POWER FOR TRANSDUCER BRIDGES

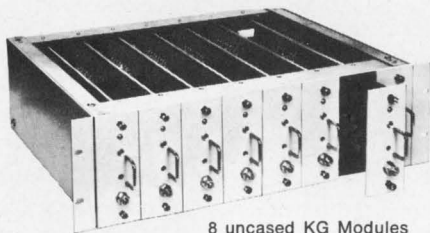

8 uncased KG Modules  
in multiunit Housing RA 19-8

Kepeco's KG Power Supplies have been especially optimized for unusual isolation of its DC terminals. This isolation is reflected in the lumped parameters for input-output coupling, and ground coupling:

### Isolation Ratings:

10,000 megohms to ground in parallel with 200 pF maximum

### Leakage Current:

50 nA maximum

### Input-Output Coupling:

1 pF maximum

### Condensed specifications:

**Line Regulation:** 0.001%

**Load Regulation:** 0.005% or 0.5 mV\*

**Ripple:** 100 microvolts rms

**8-Hour Stability:** 0.005% or 1 mV\*

\*whichever is greater

MODEL	DC OUTPUT RANGE		PRICE
	VOLTS	AMPS	
KG 25-0.2	0-25	0-0.2	\$195.00
KG 100-0.05	0-100	0-0.05	195.00

FOR COMPLETE SPECIFICATIONS  
AND APPLICATIONS NOTES  
WRITE DEPT. G-5



131-38 SANFORD AVENUE • FLUSHING, N.Y. 11352  
(212) 461-7000 • TWX # 710-582-2631

Telex: 12-6055 • Cable: KEPCOPOWER NEWYORK  
ON READER-SERVICE CARD CIRCLE 168

## MICROWAVES

### Phase shifters have 360° reading

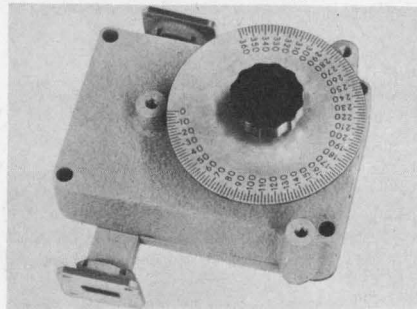

DeMornay-Bonardi, Div. of Data-pulse Inc., 1313 N. Lincoln Ave., Pasadena, Calif. Phone: (213) 798-9144. P&A \$300-700; 30-45 days

This 0-360° direct-reading phase shifter covers 7.05 to 90 GHz.

The instruments have an accuracy of  $\pm 2.5^\circ$  of phase shift, with a VSWR of 1.2 and maximum insertion loss of 1.25 dB.

All models are panel mountable and each phase shifter has linear readout in electrical degrees of phase shift.

Its insertion length (6 in. for X-band) permits use in systems where compactness is of importance; insertion length for Ku band is 5 in.

CIRCLE NO. 413

### Time delays measured from 20 MHz to 18 GHz

Rantec, 24005 Ventura Blvd., Calabasas, Calif. Phone (213) 347-5446.

This time-delay instrument measures rf and microwave time delay (group delay) through active and passive devices. Equipment is insensitive to attenuation variations and signal-source characteristics, thereby allowing frequency translation devices to be tested. Multi-octave swept measurements of time delay and amplitude response are provided for oscilloscope display or recorder presentation. Modulation at 200 KHz and 1 MHz may be selected for the bandwidth of the device being tested. Typical accuracy at 1 MHz modulation fixed is  $\pm 0.1$  ns  $\pm 2\%$  of reading and swept it is  $\pm 0.3$  ns  $\pm 2\%$ . A solid-state indicator unit mates with four interchangeable modulators and three detectors to provide coverage from 20 MHz to 18 GHz (coaxial, 0.2-8 MHz; waveguide 8-18 GHz).

CIRCLE NO. 414

### Power meters handle rf environments

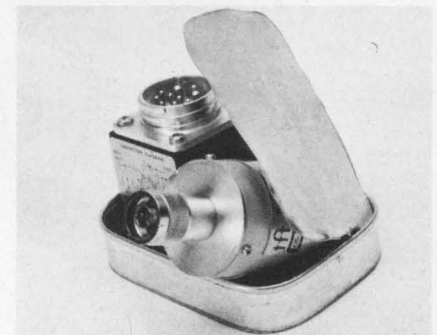

General Microwave Corp., 155 Marine St., Farmingdale, N.Y. Phone: (516) 694-3600. Price: \$160 to \$235.

Thermoelectric microwave power meters are low-noise, solid-state dc amplifiers which operate in conjunction with any model in the General Microwave 420 and 430 line of thin-film thermoelectric (TFT) power heads as precision microwave power meters. These models are assembled in rf shielded enclosures, and employ feedthrough capacitor terminals to minimize conductive interference. Frequency range is dependent only on the power head employed. In coaxial transmission-line systems, each model in the coaxial series operated from 10 MHz to 12.4 GHz.

CIRCLE NO. 337

### Vacuum system in table-top unit

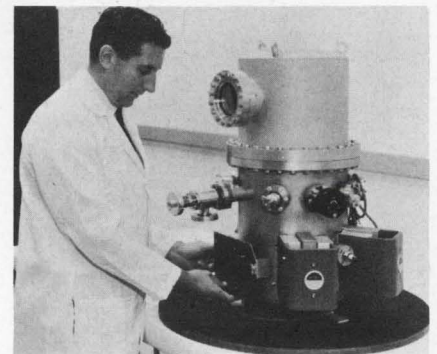

Perkin Elmer Corp., P.O. Box 10920, Mountain View, Calif. Phone: (415) 321-4117. Price: \$7000.

Bakeable, high vacuum table top system designated model TBK, guarantees vacuum levels of  $5 \times 10^{-10}$  Torr in 6 hours and  $5 \times 10^{-11}$  Torr in 16 hours, plus a 250° bakeout cycle. The unit is suited for use in space and solar simulation setups. Its operating temperature is adjustable from 50 - 250° C.

CIRCLE NO. 415



you get a choice,

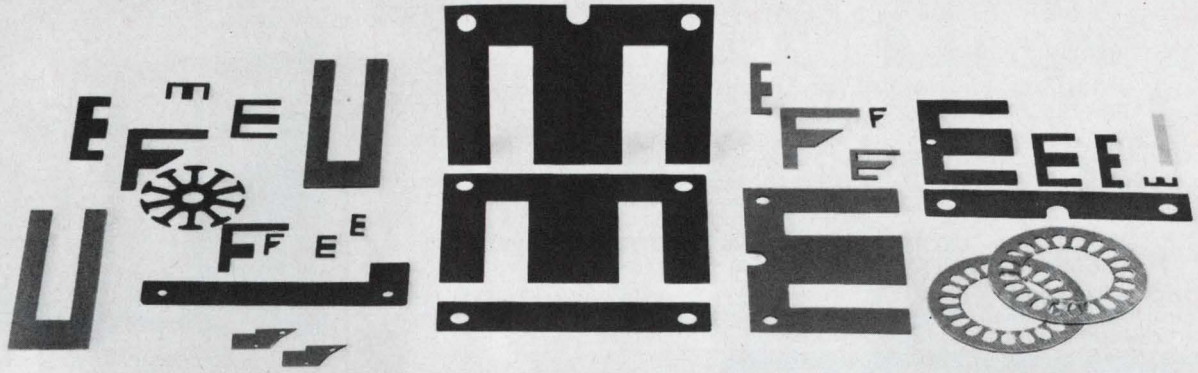

not a challenge

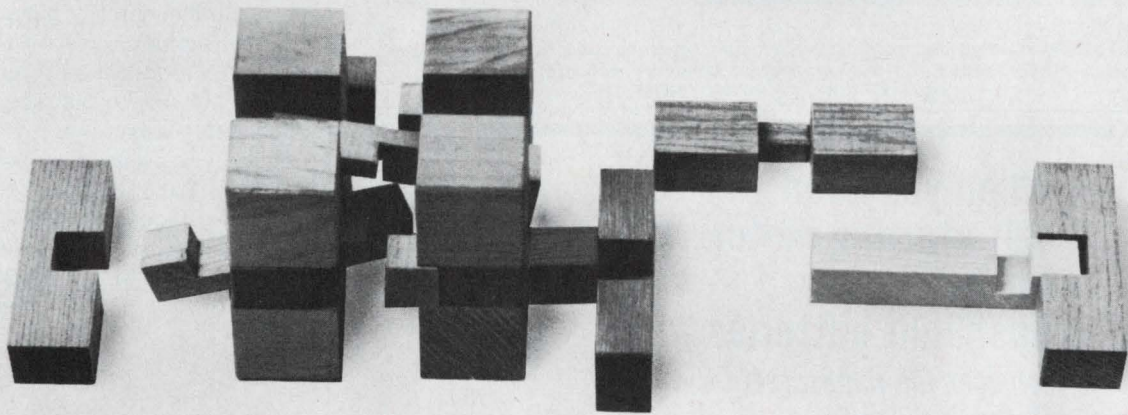

**51 standard shapes of laminations simplify solid-state circuit design**

Magnetics maximizes your chances of finding laminations that dovetail precisely into your designs for transformers, chokes, reactors and transistor circuits. We offer 51 standard shapes in Permalloy 80, Alloy 48 and Orthonol®. Thicknesses of 0.004", 0.006", and 0.014" are available, with sizes ranging from DU-87 and EI-12 down to the

solid-state circuitry sizes—EI-093, EE-30-31, DU-63 and F-094.

All Magnetics' laminations are hydrogen-annealed and manufactured to guaranteed minimum permeability limits. In addition to the catalog shapes and sizes, we have the capability to make special shapes to fit specific needs, including rotors, stators and recording head laminations. Our photo-etch process is ideal for making

prototype-run laminations and small intricate configurations.

Furnishing a broad spectrum of shapes, sizes and materials is Magnetics' way of saving you valuable design time—we believe in giving our customers a choice, not a challenge. Complete information on Magnetics' laminations can be had by writing today for our Catalog ML-303-R, Magnetics Inc., Butler, Pennsylvania 16001





# Low-Frequency Spectrum Analyzer

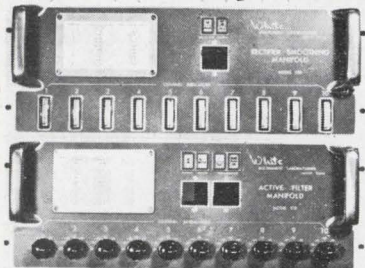

- ★ Infrasonic through audio frequencies
- ★ Continuous coverage from .005 cycle
- ★ Simultaneous ten channel readout
- ★ Operates in real time—no storage, no data acquisition delay

★ **MODEL 110 ACTIVE FILTER MANIFOLD PROVIDES 10 PARALLEL FILTER CHANNELS**

Convenience of plug-in filters, active or passive. Choice of filter bandwidths: 1 octave, 1/2 octave, 1/3 octave and specials. Gain up to 50 db, calibrated controls, 10 volts rms output. Prewhitening input section option: notch filter, 1/f network, band limiting networks—

★ **MODEL 120 RECTIFIER SMOOTHING MANIFOLD PROVIDES 10 RECTIFIED AND FILTERED OUTPUTS**

Simultaneous ten channel ac to dc conversion. Choice of low pass filter integrating times. Plug-in subassemblies for full flexibility. Ten channels of high level output to drive recorders or other devices.

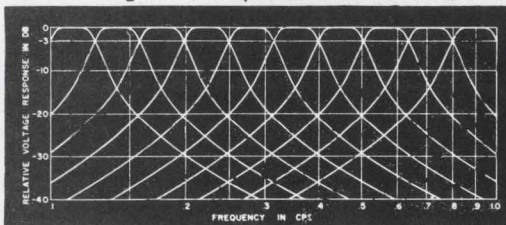

**White**  
INSTRUMENT LABORATORIES,  
INCORPORATED

Plant 5500 Balcones Drive • Phone Area 512 GL 3-6621 • Box 9006, Austin, Texas 78756

- ★ Quick deliveries on standard sets. Write for comprehensive literature on low frequency filters, active and passive. Prompt delivery—Moderate prices.  
**ON READER-SERVICE CARD CIRCLE 137**

**When you need a self-starting motor run by flashlight batteries, consider the Hanksraft DC Motor, Mdl. 3000**

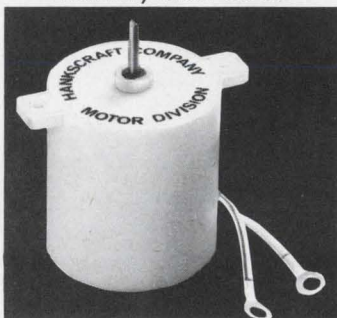

**FEATURES:**

- High torque. Long lasting.
- Compact. Lightweight.
- Twist-on battery case or leads for remote DC power.
- Economical. Safe.
- Can be operated continually for weeks on flashlight batteries.

Suitable for any application where low cost, safe, DC motors are required. Literature available on request. To show the advanced design in this motor, a sample motor will be provided on letterhead request.

**Model 3000.** Size: 1 2/3" L x 1 1/4" D x 2 1/8" W including gear train. Speeds: 1/2-1-2-4-8-18-30 rpm. Others on request. Rated: Volts-3-4 1/2-6 and 12. Torque over 50 in. oz. Weight: 2 1/4 oz. Manufactured and designed in U.S.A.



**HANKSCRAFT COMPANY**

Motor Division. Reedsburg, Wisconsin 53959 • Phone: 608-524-4341

## SYSTEMS

### Constant-phase filters handle data control.

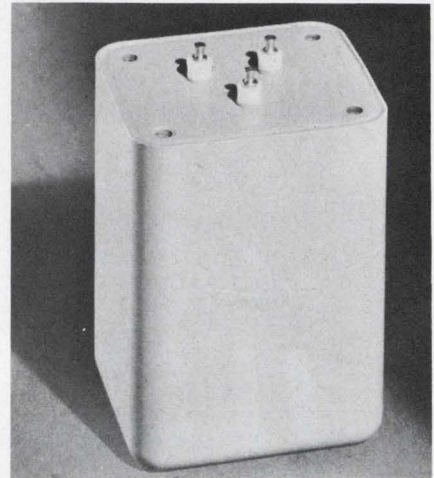

*Electro-Mechanical Research, Inc., P.O.Box 130, Van Nuys, Calif. Phone: (609) 924-9100.*

Bandpass filters having a pass-band phase variation less than  $\pm 0.3$ , suits this filter to many data system applications requiring the extraction of a fundamentally pure harmonic from a complex wave without loss of phase relationship. Center frequencies of 100 Hz to 500 kHz are supplied with passbands of  $\pm 5\%$  of center frequency. Passband response varies less than  $\pm 0.3$  dB from the response at center frequency. These constant-phase bandpass filters meet applicable portions of MIL-F-18327.

**CIRCLE NO. 376**

### Proximity controls use 9 logic modules

*Farmer Electric Products Co., Inc., Tech Circle, Natick, Mass. Phone: (617) 653-8850.*

Proximity controls offer nine plug-in logic modules and a proximity sensor. They are used for detecting, counting and monitoring ferrous and non-ferrous metallic parts, especially very thin metallic coil. It produces a useable high-frequency magnetic field extending forward a distance of approximately 1/4 in. with very little side and back sensitivity. Nine standard logic modules are available including ON-OFF, ON Delay, OFF Delay, One-shot pulse, counter driver, and count by 2, 10 or 12.

**CIRCLE NO. 331**



## Weaved transformers to 1 million bits

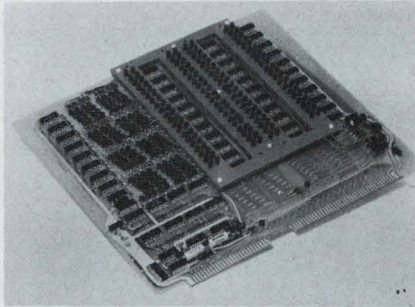

Memory Technology, 223 Crescent St., Waltham, Mass. Phone: (617) 891-8465. P&A: \$750 up; 4 to 6 wks.

A technique for combining the art of weaving and the technology of high-speed switching has been used to produce a nonvolatile, high-speed braid transformer matrix which may be unplugged and replaced with new data. Applications include binary word generators for CRT displays, code conversion, pattern generation and computer microprogramming. Two classes of memory systems are available. The smaller system accommodates from 1000 to 10,000 bits and is available on a single plug-in PC board. Larger systems have capacities ranging from 10,000 to 1 million bits and are of modular design.

CIRCLE NO. 438

## Mass storage options for small computers

Honeywell, Computer Control Div., Old Connecticut Path, Framingham, Mass. Phone: (617) 235-7450.

Honeywell's computer division has added two mass storage devices for DDP-124, DDP-416 and DDP-516 computers. The disc unit is available in either 100- or 200-track configurations, with maximum storage capacities of 115.2 and 230.4 million bits. Basic capacities are 28.8 and 57.6 million bits.

The data format of any track in the unit may be changed without altering any other track. The software package with the option provides program control of the formatting function. A head assembly is assigned to each track of data to provide average access time of 8.5 ms.

CIRCLE NO. 439

ON READER-SERVICE CARD CIRCLE 139

# corona-free power to 4000 volts

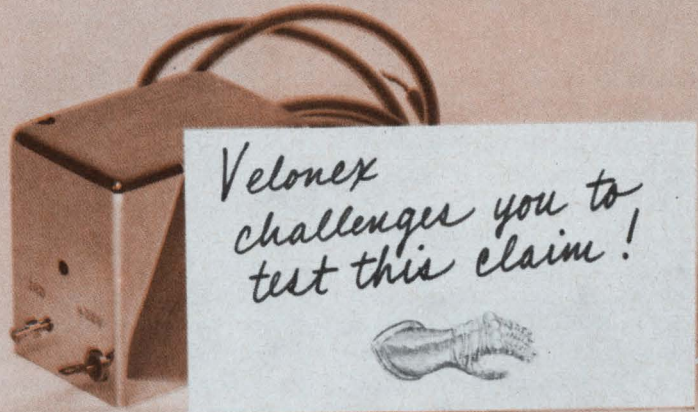

... from Velonex's remarkable 6-ounce Pico-Pac® miniature power supply; assures reliable performance at any altitude, from sea level to outer space. A special encapsulation process purges air, blocks corona.

Unique encapsulation makes Pico-Pac tough as nails. Virtually environment-proof. It shrugs off mechanical shock and extremes of temperature and pressure without breaking stride. That "stride" is a steady supply of dc power to photomultiplier tubes, channeltrons, photodiodes, Geiger-Mueller tubes, and any other low current device.

Five continuously adjustable models offer total output ranges from 400 to 4000 volts. Each is available with either positive or negative output polarity and full protection against damage from polarity reversal at the input.

From bell jar to space simulation chamber, Pico-Pac stands ready to meet your challenge. Fling your gauntlet to the address below. Win, lose or draw, you'll emerge from the encounter in full possession of our newly published power supply catalog.

Parameter	PP-5	PP-6	PP-7	PP-8	PP-9
Voltage	400-750	750-1300	1150-2000	1500-2600	2300-4000
Input	28 vdc nominal; ground negative at input				
Line regulation	Less than 0.4% (24-32V)				
Load regulation	Less than 1.5% (50-250 mW output)				
Ripple	Less than 0.007% p-p				
Output power	250 mW max.				
Single price	\$270	\$280	\$335	\$355	\$395

a division of Pulse Engineering, Inc.

560 Robert Avenue  
Santa Clara, California 95050  
(408) 244-7370



**velonex**  
division of Pulse Engineering, Inc.



### Time code generator uses IC design

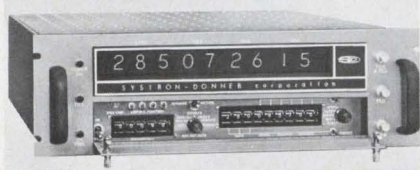

Systron Donner Corp., 888 Galindo St., Concord, Calif. Phone: (415) 682-6161. P&A: \$3775; 60 days.

The model HI-160 features IC design, flexible selection of different time-code combinations, and controls that permit synchronization commands. The in-line time display reads directly in days, hours, minutes, and seconds. Changing a time code requires a plug-in board change; up to five simultaneous serial time codes are provided from a library of twelve codes. The unit may also include a standby battery pack to assure continuous operation in case of a primary power failure. Pre-set switches allow for compensating propagation time delay with respect to an external time reference as WWV.

CIRCLE NO. 378

### Data entry keyboard mounted on a board

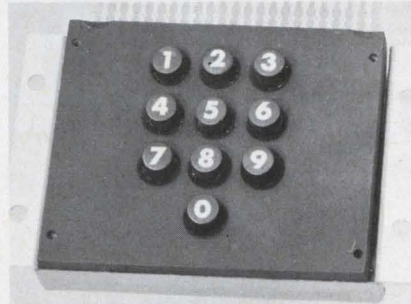

Nutronics, Box 72, Paramus, N. J. Phone: (201) 652-4220, Price: \$1.75 per button.

The keycode KN-10 data-entry keyboard is supplied assembled and wired to a single printed circuit edge for a mating connector or for hard-wiring to external circuitry. The key-buttons are spaced on  $\frac{5}{8}$  in. centers, having momentary contact, with single or double output from a single common. Low contact pressure is coupled with silent operation to minimize operator fatigue. The unit is rated at 5 million cycles at 6 V dc for computer data entry applications.

CIRCLE NO. 374

### Solid state keyboard uses dry reed switch

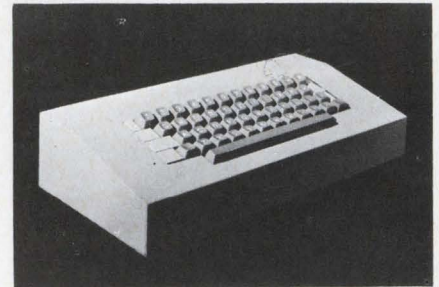

Micro Switch, Div. of Honeywell, 11 W. Spring St., Freeport, Ill. Phone: (815) 232-1122.

The solid-state encoding and dry-reed switch reliability assures maximum up time and minimum service requirements, according to Micro Switch. The keyboards are available in a wide choice of custom-design options. Optional features include an electronic interlock to increase operator speed and efficiency over existing approaches; an electronic strobe to delay the read cycle until output stabilization; and flexibility to match input requirements.

CIRCLE NO. 381

# CURTIS TERMINAL BLOCKS

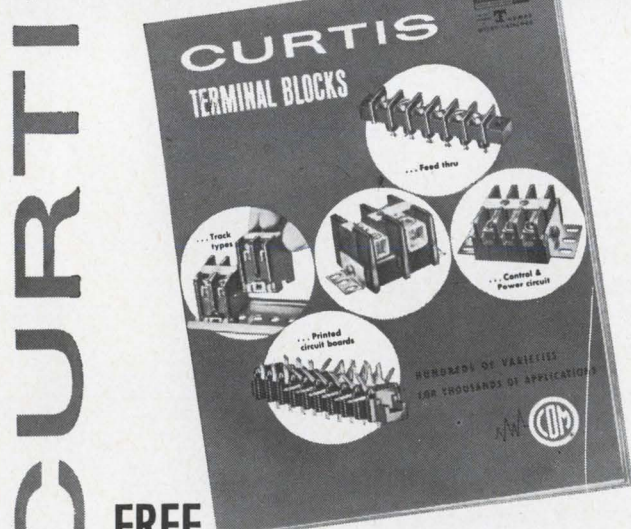

## FREE NEW, INFORMATIVE SELECTION GUIDE

A new, 24-page, completely illustrated catalog contains photos, descriptions, ratings, engineering drawings, and prices of the complete line of Curtis terminal blocks. Included are printed circuit, insulated feed-thru, quick disconnect, track type, and high current terminal blocks.

Send today for your free copy.

**CURTIS DEVELOPMENT & MFG. CO.**

3236 N. 33rd Street, Milwaukee, Wisconsin 53216



ON READER-SERVICE CARD CIRCLE 140

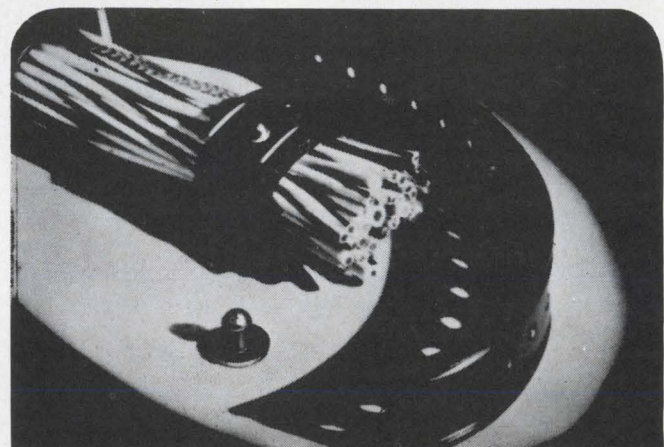

## STRAP-N-SNAP STRAPPING

This flexible PVC strap and nylon stud are all you need for the simplest, fastest and lowest cost wire and cable tying system available today. You simply strap and then snap the stud into place. Straps are easily adjustable for any wire changes. Handy roll packaging permits easy feed-out of desired lengths, and simple inventory control. Comes in  $\frac{3}{8}$ " and  $\frac{1}{2}$ " widths, standard black and special colors.

Send for Free Samples

**ELECTROVERT INC.**

Components Division  
86 Hartford Ave., Mt. Vernon, N. Y. 10553  
Milwaukee, Wis. • Burbank, Calif.



SOLD COAST-TO-COAST THROUGH AUTHORIZED DISTRIBUTORS

ON READER-SERVICE CARD CIRCLE 141



# New Deringer Economet Contacts give you these plus factors:

- + Material cost savings
- + Tighter control of tolerance
- + Improved hardness and longer life
- + Greater electrical performance
- + Larger range of composite limits
- + Improved stackability
- + Better wearability
- + Increased feedability
- + Better availability

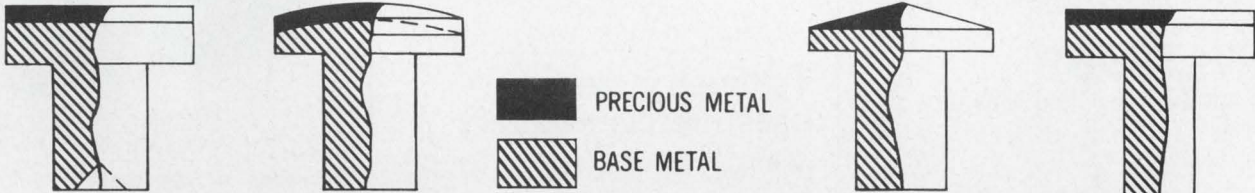

The contact shapes shown here give you an idea of the versatility and some of the applications for the Economet contact. Parts which were formerly impractical to manufacture as a composite can now be produced by the Economet process.

**ECONOMET SIZE RANGE**  
Shank diameters . . . . . .060 thru .156    Head diameters . . . . . .093 thru .375

The exclusive new Deringer Economet Contact is just one of a series of new developments aimed at helping you reduce the cost of your electrical contacts and sub-assemblies. *To coin a phrase, Deringer gives you more for your silver dollar.* For a review of your contact applications to determine if one or more of Deringer's unique processes can save you money while maintaining or improving reliability, contact Deringer.



**METALLURGICAL CORPORATION**  
1250 Town Line Road - Mundelein, Illinois 60060  
ON READER-SERVICE CARD CIRCLE 142



# Very, very Varo.

(Very good. Very inexpensive.)

Each of these Varo epoxy bridge rectifiers has full-wave bridge, controlled avalanche, and 200V, 400V, and 600V ratings.

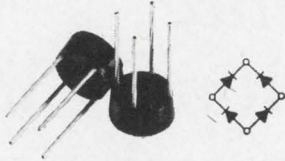

1 amp EBR. For printed circuit board mounting.

**ONLY 91¢**

in 200V rating and quantity of 1,000.

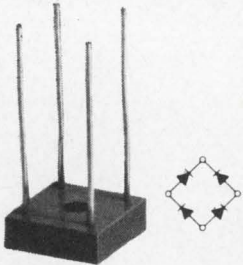

2 amp EBR. For circuit board mounting.

**ONLY 95¢**

in 200V rating and quantity of 1,000.

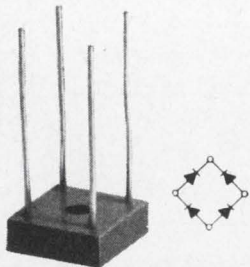

6 amp EBR. For chassis mounting.

**ONLY \$1.59**

in 200V rating and quantity of 1,000.

Write for complete information on Varo rectifier products.



**SPECIAL PRODUCTS DIVISION**  
2203 WALNUT STREET, GARLAND, TEXAS 75040  
(214) 272-3561

ON READER-SERVICE CARD CIRCLE 143

## SYSTEMS

### Correlation computer computes input signals

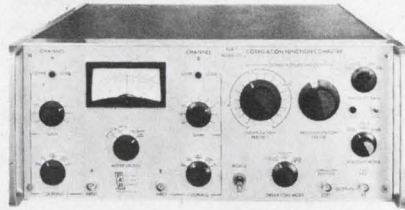

Princeton Applied Research, P.O. Box 565, Princeton, N.J. Phone: (609) 924-6835.

This general-purpose instrument computes in real time either the auto or crosscorrelation function of input signals. The unit simultaneously computes 100 points of the correlation function over delay spans ranging from 100 s to 10 s. The model 101 includes the capability for insertion of fixed-delay increments ahead of the 100 points computed, thereby effectively allowing for expansion of the delay axis to improve resolution.

CIRCLE NO. 317

### Telemetry system uses mercury battery

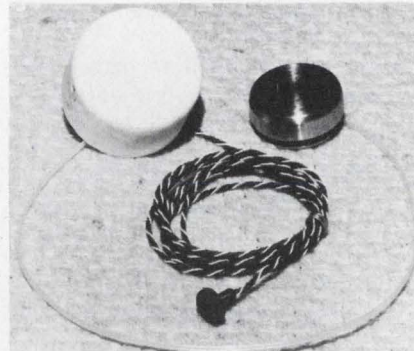

Sensotec, a div. of Scientific Advances, Inc., Holly Ave., Columbus, Ohio. Phone: (614) 294-5436.

This system uses a lightweight transmitter which is 1.1 inch in diameter and 5/8 inch thick. This transmitter is designed specifically to be compatible with the implantable medical transducer. The combination of transducer and telemetry system can be used to sense pressures as low as 0.02 psi.

CIRCLE NO. 440

### Magnetic circulator covers 5 to 5000 Hz

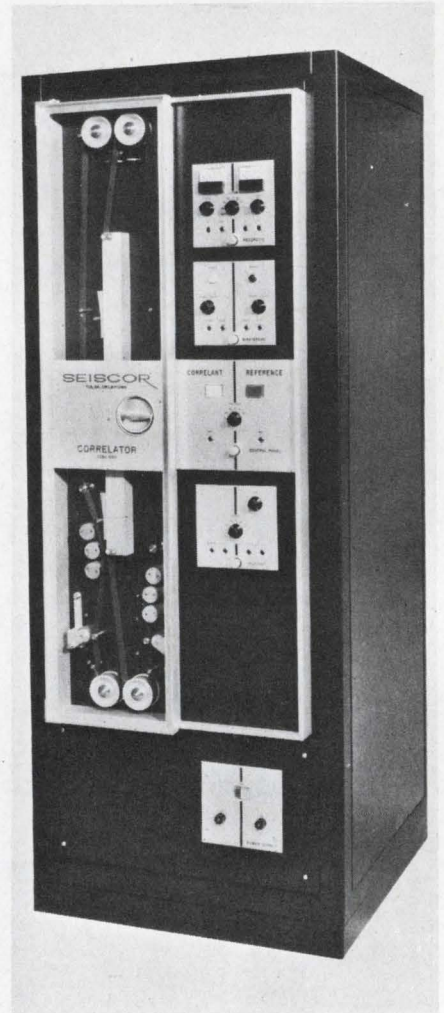

Seiscor, a div. of Seismograph Service Corp., P.O. Box 1590, Tulsa, Okla. Phone: (918) 627-3330.

This magnetic correlator performs the functions of autocorrelation, crosscorrelation, and convolution filtering in real time. Its applications include signal detection and identification in the fields of underwater acoustics, astronomy, sonar, medical electronics, spectroscopy, telemetry, photography, seismology, communications, and process control. Integration is performed in space rather than in time resulting in a real time output. Multiplication is obtained by using the square-law characteristic of the magneto-resistive head in a quarter-square multiplier circuit. Frequency response of the correlator is 5 cycles to 5000 cycles. Maximum integration time is 16 seconds with a time bandwidth product of 2240.

CIRCLE NO. 441



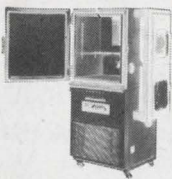

Tenney-Mite TH—  
Temperature &  
Humidity

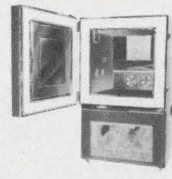

Tenney  
Hi-Low Temperature  
Test Chambers—  
1½ thru 64 Cu. Ft.



Tenney-Mite Strat—  
Altitude Temperature  
Chamber

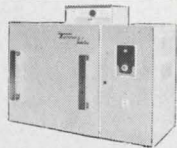

Tenney Jr.—Bench Model,  
Hi-Low Temperature

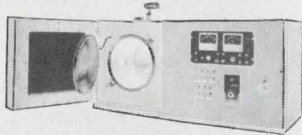

Space Jr.—Deep Space Simulator

## Special Order?

Not at Tenney... These are production run environmental test chambers. Standard, off-the-shelf units ready for immediate delivery. Choose a model best suited for your applications... the cost is lower than you think. Need more information? Write today!



**Tenney**  
ENGINEERING, INC.

1090 Springfield Road, Union, New Jersey • (201) MURdock 6-7870  
Western Div.: 15700 S. Garfield Ave. • Paramount, Calif. 90723

ON READER-SERVICE CARD CIRCLE 144

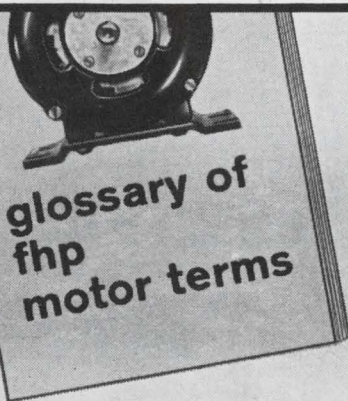

## GLOSSARY OF FHP MOTOR TERMS FREE!

Know the difference between a splash-proof motor and a waterproof motor? Between pull-in torque and pull-out torque? This glossary has clear, concise definitions for these and nearly 100 more terms applying to fractional horsepower motors; helps you and fellow staff members talk the same language. Covers motor classes, enclosure types and general engineering terms. It's free... just ask for the Motor Dictionary.

**BODINE**  
fractional/horsepower  
**MOTORS**

Bodine Electric Co., 2528 W. Bradley Pl., Chicago, Illinois 60618

ON READER-SERVICE CARD CIRCLE 145

# We believe if there's one thing in the world you don't need it's a headache.

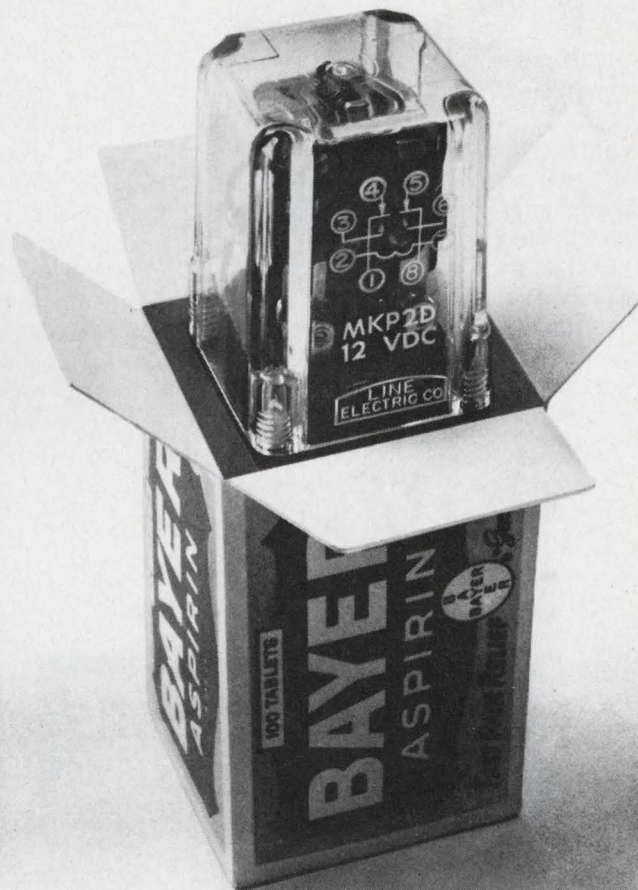

90% of all our orders are shipped ahead of their due date. And normal delivery for us is six weeks, not eight like most companies. We guarantee it.

Every relay we manufacture is put to nine performance tests before it's shipped out. And we're rough: We flunk one out of every 50 produced.

Our sales have quadrupled in the past six years, and this year shipments are 80% ahead of last year. You don't grow that fast by giving people headaches.

So give us a call when you need relays. Without the headaches.



The Line Electric Company  
Division of Industrial Timer Corp.  
Manufacturers of Relays  
and the best service  
in the business.  
Send for 64 page catalog:

305 U.S. Highway 287, Parsippany, N.J. 07054

ON READER-SERVICE CARD CIRCLE 146



## Flat pack sealing using fasers

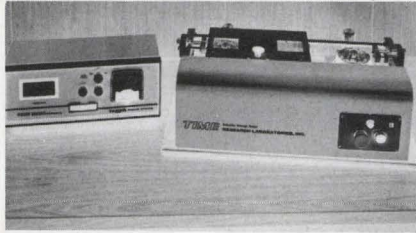

Time Research Laboratories, Inc., Pennington, N. J., Phone: (609) 737-0413.

The model 105 provides a semiautomatic system utilizing two faser heads. Basic energy source is a quartz-iodine lamp utilizing a plated reflector as a lens. The solid-state power supply also includes a timer and a power level indicator. Since light is used as the basic energy source, the system utilizes a surface heating technique. The unit can produce packs at a rate of four per minute dependent on pack configuration.

CIRCLE NO. 442

## Component printers to 12,000 per hour

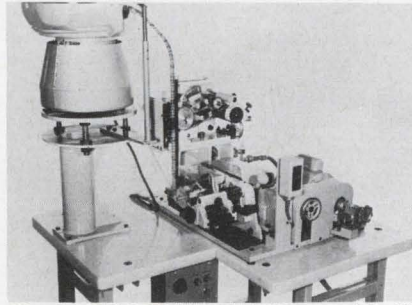

Markem Machine Co., Keene, N. H. Phone: (603) 352-1130.

Up to 12,000 transistors an hour can be printed top and side with the model U-1166. Two transistors are printed with each machine cycle. Components to be printed are placed in a vibratory bowl where they are fed into a feed chute, metered for correct positioning, and top printed. They then continue down the chute and are again metered for correct positioning before side printing at the feed station.

CIRCLE NO. 443

## DIP testing and handling system has 11 magazines

Unitek, Weldmatic Div., 950 Royal Oaks Dr., Monrovia, Calif. Phone: (213) 359-8361.

A modular system for high-speed testing and classifying DIP's handles 2000 units per hour. Consisting of the preload module, the test module, and the sort module, the system accepts all current DIP package styles. Automatic indexing of packages during loading and sorting ensures smooth, continuous operation. For accurate testing, packages receive positive mechanical gating in test head. Test contacts are Delrin, springloaded to deliver repeatable pressure and lowest contact resistance. The sort module operates manually and automatically and contains a memory system to automatically discharge tested packages into one of 11 available classification magazines.

CIRCLE NO. 444

**CLOSE THE TOLERANCE / COST GAP WITH QUALITY B+W MOLDED FLUOROCARBON PARTS**

How does Booker & Wallestad close tolerance/cost gap?  
With the most advanced molding facility in the industry. A complete, self-contained tool and die shop steps away from the newest, automated injection molding machines. Highly trained men, drilled in the science of producing quality parts faster.

Send part or print for quotation or write for free new facilities brochure.

**B+W** BOOKER AND WALLESTAD  
DIVISION OF THERMOTEC INDUSTRIES, INC.  
3326 Gorham Avenue • Minneapolis, Minnesota 55426

ON READER-SERVICE CARD CIRCLE 147

## Audio Amplifier? AC Power Supply?

the Compact  
NA Series  
gives you  
both!

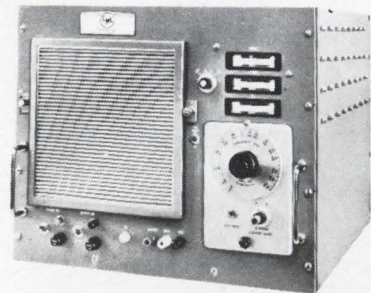

The NA Series of AC Power Supplies are exceptionally flexible sources of audio power. Each power supply consists of a Regulated Audio Power Amplifier with interchangeable fixed or variable Plug-In Oscillators for a wide range of precision AC power

applications. The Amplifier has a full power range of 45-6,000 cycles. With the incorporation of a CML Plug-In Oscillator precise fixed or adjustable output frequencies are available anywhere within this range. For complete information, write today.

**CML, Inc.** 

A subsidiary of Tenney Engineering, Inc.  
350 Leland Avenue • Plainfield, New Jersey  
(201) 754-5502 • TWX: 201-756-2064

ON READER-SERVICE CARD CIRCLE 148





**Good old,  
reliable,  
faithful,  
trustworthy,  
proven,  
tested,  
workable,  
dependable,  
consistent,  
versatile,  
Signetics  
SP-600 series  
is now  
better than ever**

Guaranteed fan-out has been increased from 4 to 8.  
And the operating range is now 0° C to +75° C.  
Signetics SP-600 was the first DTL line in the industry to offer the convenience of the dual in-line silicone package. Find-out for yourself. Send for specs and reliability data based on two years of extensive testing. Write Signetics, 811 E. Arques, Sunnyvale, California 94086. Good old Signetics.

**SIGNETICS  
INTEGRATED  
CIRCUITS**



A SUBSIDIARY OF CORNING GLASS WORKS

**SIGNETICS SALES OFFICES:** Metropolitan New York (201) 992-3980; Upper New York State (315) 469-1072; Southwestern (214) 231-6344; Western Regional (213) 272-9421; Eastern Regional (617) 245-8200; Mid-Atlantic (609) 858-2864; Southeastern (813) 726-3734; Midwest Regional (312) 259-8300; Northwestern (408) 738-2710.

**DISTRIBUTORS:** Compar at all locations listed below. Semiconductor Specialists, Inc. (312) 279-1000; Terminal Hudson Electronics (212) 243-5200; Wesco Electronics (213) 684-0880; Wesco Electronics (405) 968-3475; Hammond Electronics (305) 241-6601; Avnet Electronics Corp. of Massachusetts (617) 272-3060; Pioneer Standard Electronics Inc. (301) 427-3300.

**DOMESTIC REPRESENTATIVES:** Jack Pyle Company (415) 349-1266. Compar Corporation at the following locations: Alabama (205) 539-8476; Arizona (602) 947-4336; California (213) 245-1172; California (415) 697-6244; Colorado (303) 781-0912; Connecticut (203) 288-9276; Florida (305) 855-3964; Illinois (312) 775-5300; Maryland (301) 484-5400; Massachusetts (617) 969-7140; Michigan (313) 476-5758; Minnesota (612) 922-7011; Missouri (314) 428-5313; New Jersey (609) 429-1526; New Mexico (505) 265-1020; New York (518) 436-8536; New York (607) 723-8743; New York (716) 684-5731; New York (201) 471-6090; North Carolina (919) 724-0750; Ohio (216) 333-4120; Ohio (513) 878-2631; Texas (214) EM 3-1526; Texas (713) 649-5756; Washington (206) 725-7800.

**INTERNATIONAL SALES:** France, Germany, Italy, Belgium, Holland, Luxemburg, Spain—Sovcor Electronique, 11, Chemin de Ronde, Le Vesinet, (S.-&O.) France. United Kingdom, Ireland, Sweden, Denmark, Norway, Switzerland, Austria, Portugal—Electrosil Ltd., Lakeside Estate, Colnbrook-By-Pass Slough, Buckinghamshire, Great Britain. Australia—Corning, 1202 Plaza Building, Australia Square, Sydney, N.S.W. 27-4318. Canada—Corning Glass Works of Canada, Ltd., Leaside Plant, Ontario, Canada (416) 421-150. Israel—Optronix, P.O. Box 195, Ramat-Gan, Israel 724-437. Japan—ASAHI Glass Co., Ltd., Corning Products Sales Dept. No. 2, 3-Chome Marunouchi, Chiyoda-ku, Tokyo, Japan.

ON READER-SERVICE CARD CIRCLE 149



## GLASS ENCLOSED Thermostatic DELAY RELAYS

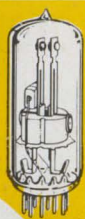

by  
**AMPERITE**

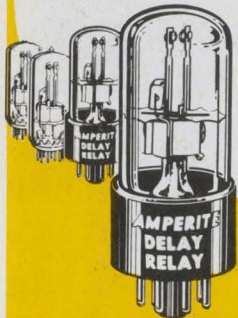

Offer true  
hermetic  
sealing —  
— assure  
maximum  
stability  
and life!

### Delays: 2 to 180 seconds

Actuated by a heater, they operate on A.C., D.C., or Pulsating Current... Being hermetically sealed, they are not affected by altitude, moisture, or climate changes... SPST only — normally open or normally closed... Compensated for ambient temperature changes from  $-55^{\circ}$  to  $+80^{\circ}$ C... Heaters consume approximately 2 W. and may be operated continuously. The units are rugged, explosion-proof, long-lived, and inexpensive! TYPES: Standard Radio Octal and 9-Pin Miniature... List Price, \$4.00  
PROBLEM? Send for Bulletin No. TR-81.

## AMPERITE

### BALLAST REGULATORS

Hermetically sealed, they are not affected by changes in altitude, ambient temperature ( $-50^{\circ}$  to  $+70^{\circ}$  C.), or humidity... Rugged, light, compact, most inexpensive.

List Price, \$3.00

Write for  
4-page  
Technical  
Bulletin  
No. AB-51

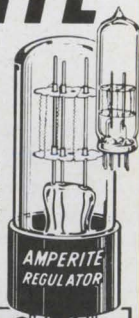
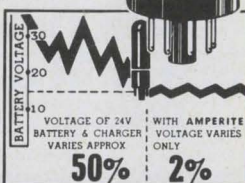

## AMPERITE

600 PALISADE AVE., UNION CITY, N.J. 07087

Telephone: 201 UNION 4-9503

In Canada: Atlas Radio Corp., Ltd.,  
50 Wingold Ave., Toronto 10

ON READER-SERVICE CARD CIRCLE 150

## PRODUCTION EQUIPMENT

### Transistor sorter accepts and rejects

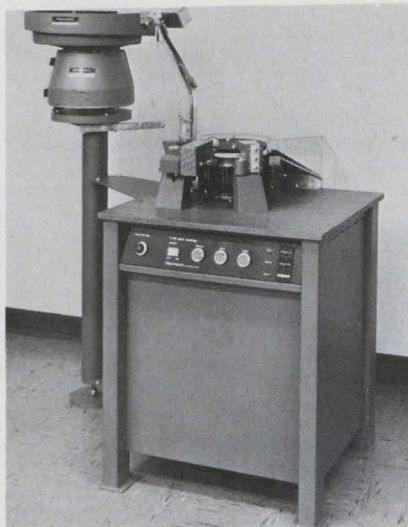

Daymarc Corp., 40 Bear Hill Rd.,  
Waltham, Mass. Phone: (617) 894-  
2105.

When operating with appropriate test equipment, the type 830 sorter automatically inspects and sorts 4000 transistors per hour. Built for incoming/outgoing inspection, the sorter handles TO-5 and epoxy packs. It sorts into three bins: accept, reclassify and reject. Bins hold 20,000 transistors. Components placed in the vibratory bowl are fed, tested and binned automatically.

Six probes make contact with the three transistor leads. Probes are mounted on a suspension which assures contact with all leads, yet prevents any lead damage. The self-contained power supply and memory system provides simplified interconnection to most test equipment.

CIRCLE NO. 445

### Wire saw cuts with 0.003 in. wire

Laser Technology, Inc., 10624 Ventura Blvd., North Hollywood, Calif.  
Phone: (213) 763-7091. Price: \$975.

The model 2005-A wire saw works by drawing a precisely aligned wire at high speed and uniform pressure across material to be cut. The saw does not remove large chunks of material, since it simply laps it away up to the diameter of the wire—0.008 inches. This lapping action causes little or no damage to the cut surfaces.

CIRCLE NO. 446

### Hand solderer develops 1000° F



Browne Engineering Company, 2003 State Street, Santa Barbara, Calif.  
Phone: (805) 965-9600. P&A: \$345; stock.

The model-300 soldering system places all critical aspects of hand soldering under automatic programmed control. Capable of generating temperatures higher than 1000° F in 100 ms, this instrument permits controlled pulse soldering of insulated wires smaller than 0.001 in. This instrument spans a heating range equivalent to conventional soldering irons of 1 to 50 W in size.

CIRCLE NO. 447

### Diffusion furnace covers 650° to 1300° C

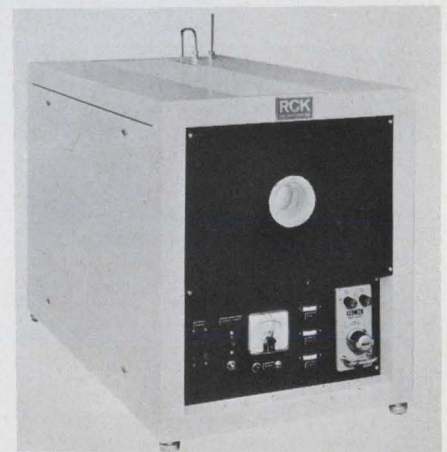

RCK, 242 Commercial St., Sunnyvale, Calif. Phone: (408) 245-6613.

This diffusion furnace is similar in all basic features to the RCK production furnace, but sized for use on a laboratory bench. The furnace utilizes the solid-state controller system, providing close control in the flat zone. The temperature range is 650° to 1300°C. The unit samples thermocouples ten times per second and electronically detects temperature changes of less than 1/50°C.

CIRCLE NO. 448



**A New Waterproof Series**  
**MINIATURE** 1/2" DIA.  
**Rotary Switches**



'O' ring on shaft and bushing. Terminal portion sealed with superior adhesive bonding cement. Withstands water submersion test 9.8 ft. Non-shorting, 36° spacing, 1/8" dia. shaft. Available in One, Two, Three and Four Pole configurations. 1/2" dia. body. Non-adjustable. 500 ma @ 125 VAC.



SPECIFY THE NEW "E" SERIES BY

**ALCOSWITCH**

DIV. OF ALCO ELECTRONIC PRODUCTS INC., LAWRENCE, MASS.

**FREE**  
 PRODUCT  
 PLANNING  
 CATALOG

ON READER-SERVICE CARD CIRCLE 151

**A New Waterproof Series**  
**MINIATURE**  
**TOGGLE SWITCHES**

New case design with double high voltage barriers, and low-loss, high impact, high temperature materials. Wide silver contacts. Waterproof 'O' rings and sealed terminals. Available in One, Two, Three and Four Pole configurations all in compact unitized bodies. 6 Amps @ 125 VAC.

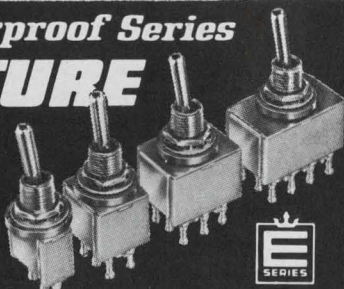

SPECIFY THE NEW "E" SERIES BY

**ALCOSWITCH**

DIV. OF ALCO ELECTRONIC PRODUCTS INC., LAWRENCE, MASS.

**FREE**  
 PRODUCT  
 PLANNING  
 CATALOG

ON READER-SERVICE CARD CIRCLE 152

**NEW and Unique**

**The Lundey Clinch-Loc<sup>®</sup>**  
**HERMETIC TEFLON\* TERMINAL**

*the ultimate in simplicity*  
**IT'S DUAL-PURPOSE**  
*... and economical*

\* Dupont Trademark

Use it as a moisture-proof terminal or a conventional panel feed-thru and get low initial cost, fast and economical assembly, ruggedness and mechanical reliability—plus the excellent thermal and electrical values of Teflon.

U.S. Patent 3,166,634  
 Canadian Patent 727,204  
 Other Foreign Patents  
 Applied For

Designed to meet Mil-T-27B requirements

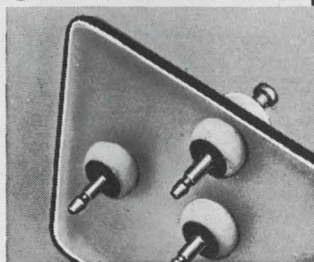

▲ Spring push-nut locks it in position on panel—providing an hermetic seal



Shown actual size  
 No. 601TH

**WRITE NOW FOR SAMPLE KIT**  
 includes product samples and literature

another quality product in THE LUNDEY LINE

**LUNDEY ASSOCIATES, INC.**  
 694 Main St. Waltham, Mass. 02154

ON READER-SERVICE CARD CIRCLE 153



**This could be the**  
**world's most important**  
**lightning arrester!**

Dale's LA24 provides lightning protection for airborne units in an important Air Force low frequency communications system. This special system insures uninterrupted communications under almost any condition. The LA24 uses Dale's patented surge arrester mechanism to protect radio equipment—provided by Westinghouse—against the high degree of lightning attraction of a low frequency antenna. The LA24 was specially selected for its ability to bypass repeated lightning strokes without significantly altering breakdown voltage.

**SOLVE YOUR SURGE PROBLEMS**—from sophisticated antenna systems to low-cost secondary power line arresters, Dale can engineer a better solution to your transient voltage problems.

Call 605-665-9301 or write:



**DALE ELECTRONICS, INC.**  
 SIOUX DIVISION Dept. ED  
 Yankton, South Dakota 57078

Write for New Facilities Report

Producers of: Toroids, Series Resonant Traps, Variable Pitch Inductors, Miniature High Frequency Inductors, Degaussing Coils, Industrial and Military Coils, Sub-Miniature Coils, Surge and Lightning Arresters, Custom Assemblies, Motor Driven Potentiometers.

ON READER-SERVICE CARD CIRCLE 154



### Vacuum probe uses normally closed valve



Air-Vac Engineering Co., Inc., 100 Gulf St., Milford, Conn. Phone: (203) 874-2541. Price: \$14.50.

A hand tool designed for use with small delicate parts incorporates a normally closed button-type valve which prevents unnecessary draining of the vacuum handling system. To allow vacuum to flow through tip, the operator must depress the button. Whenever parts are to be released, the operator releases the button to drop the part.

CIRCLE NO. 453

### Diamond drills bore at 0.01 in.

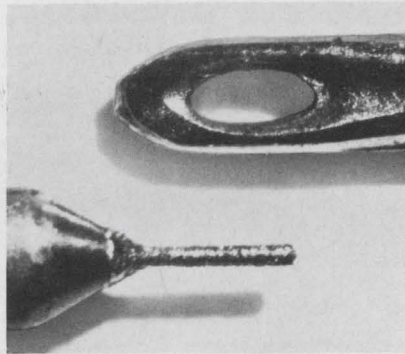

Amplex Corp., Bloomfield, Conn. Phone: (203) 242-8588

Designated MICRO-POINTS, the line ranges from 0.001 to 0.015 in. in dia. Points in the diameter range of 0.001 to 0.004 in. have a fine grit size and are suited for reaming and lapping hard materials. Drills of 0.004 in. dia. and above are for drilling small holes in ceramics and other hard materials. A complete line of larger diameter electroplated diamond points on 1/8 in. shanks are available.

CIRCLE NO. 386

### Cool bonders for substrates

Hughes Aircraft Co., 2020 Ocean-side, Oceanside, Calif. Phone: (714) 757-1200. P&A: \$4300; 6 wks.

A thermocompression bonder, featuring a pulse-heated tip which eliminates pre-heating of parts prior to bonding, is designed for bonding of gold wire to cold substrates. It accomplishes this by passing a current pulse of extremely short duration directly through the capillary tip. The degree of tip heating is controlled by a sensing signal which feeds back to the power supply every 25  $\mu$ s; the current output is altered accordingly. In this way, heat is applied only to the immediate area of the bond, thus permitting bonding of fine gold wires to varying heat sinks with no adjustment of the weld schedule. Duration of the localized heating is typically less than one second.

CIRCLE NO. 454

## LAFAYETTE RADIO ELECTRONICS

# FREE!



**LAFAYETTE**  
1968 CATALOG  
680  
512 pages

Lists Lafayette's Own Value Engineered Components plus Quality Designed Equipment From Many Leading Manufacturers for

- HOME • INDUSTRY
- LABORATORY

Semiconductors • Capacitors • Connectors • Controls • Fuses and Circuit Breakers • Relays • Resistors • Wire and Cable • Transformers • Test Equipment

All Components Are Immediately Available From Stock!

LAFAYETTE Radio ELECTRONICS Dept. 44-7 P.O. Box 10  
Syosset, L.I., N.Y. 11791

Send me the Free 1968 Lafayette Catalog 680 44-7

Name .....

Address .....

City ..... State ..... Zip .....

ON READER-SERVICE CARD CIRCLE 155

# Save with NEG'ATOR<sup>®</sup> counter-balances



Save space, save weight, save more on production costs too, with Hunter's NEG'ATOR springs in your products. A strip of spring steel forming a pre-stressed coil, the NEG'ATOR resists uncoiling with uniform pull, thus providing the same rated force at any extended length. So with the NEG'ATOR constant-force spring, you'll eliminate deadweights and linkages, and simplify mountings. For complete information on the cost and design advantages of the NEG'ATOR spring write Ametek, Inc., Hunter Spring Division 27 Spring Street Hatfield, Pennsylvania 19440.

AMETEK / Hunter Spring



ON READER-SERVICE CARD CIRCLE 156



# How to keep relay contact forces balanced at 30 G's.

Picking a relay for an extreme shock/vibration environment is a tough problem for many a circuit designer. Few relays are designed to meet the problem head on. There is now one notable exception—a 4PDT, 10 ampere relay in a one-inch cube. Using a new design principle—balanced-force—this relay withstands severe shock, vibration or acceleration while maintaining high contact and overload capabilities. It will take more than 30 G's to 3000 Hz vibration, a shock of 100 G's and has a minimum life of 100,000 cycles. This one-inch cube is all welded, weighs 2.5 ounces, and is rated at 2.9 watts coil power.

## EFFICIENT MAGNETIC CIRCUIT

In the conventional relay motor, forces for open and closed contacts are unequal. Energized coil power causes the armature to close the normally open contacts. But, when the coil power is removed and the contacts return to the normally closed position, only the spring forces of the contacts and the return spring provide the force. These combined spring forces are usually low, allowing the contacts to bounce. In addition, the low spring force allows the armature to rebound off the armature stop, again knocking the contacts open—sometimes, for as long as several milliseconds after they have initially closed.

Force-Stroke Curve of Typical Relay and Balanced-Force Relay.

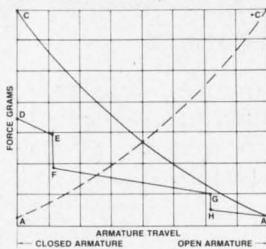

Curve CA—Balanced-Force Relay normally closed contacts.  
Curve AC—Balanced-Force Relay normally open contacts.  
Curve DEFGH—Typical Relay.

Leach Balanced Force Relay by use of an extremely efficient magnetic design. It has to be to

An obvious method of getting rid of a bounce condition is to balance the armature forces exactly. This is achieved in the

keep the forces balanced while ignoring 30 G's. Basically it is a controlled application of magnet and coil flux. In the de-energized position, a permanent magnet flux flows between the armature and the tip of the adjacent pole piece, resulting in a high holding force. The motor is, therefore, relatively immune to shock and vibration. When coil power is applied, the flux from the permanent magnet is nullified by the coil flux flowing in an opposite direction. The armature closes with a rapid build-up of magnetic force driving it against the contact overtravel forces and into a sealed position.

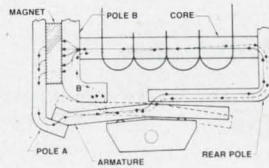

Balanced-Force Motor De-Energized

When coil power is removed and the armature returns, the

restoring force of the permanent magnet builds up quickly. The armature is then driven against the overtravel forces of the normally closed contacts and into its de-energized sealed position. With this type of force-displacement, the armature isn't about to rebound.

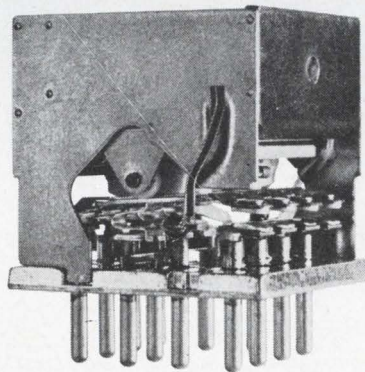

New Leach Model k employs balanced-force concept.

## BUFFERED CONTACTS

The moving contacts are mounted to an armature, which is held firmly at the end of each stroke by high magnetic forces. Since the armature can't move during shock

or vibration, undesirable contact opening is eliminated.

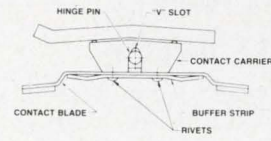

Moving Contact System

Reinforcing the moving contact is a buffer strip which assumes a

variety of chores. It has a bow in the center to act as a spring load while serving as a rivet plate. It works as a heat sink. It will break the contact strip free from a weld if one occurs because of excessive overload. It makes contact with the moving blade which results in excellent low contact drop. It serves as an electrical contact between the moving blade system and the header. And, as the name implies, it buffers the contact blade against extreme shocks and vibrations.

## WELDED ASSEMBLY

In assembling the relay all detail parts are welded. No part is solder assembled. There is no possibility of contamination from solder flux. The unit is then pressed into a can and electron-beam sealed, leaving only an evacuation hole. After a high temperature bake, the relay is filled with a dried inert gas, and the hole is welded shut. Here, ready for shipment, is a relay with a magnetic circuit designed so the force without coil power applied is equal to the force with coil power applied, but in exactly the opposite direction. And you can rest assured those forces stay balanced no matter how you shake them.

Complete Motor and Contact Assembly

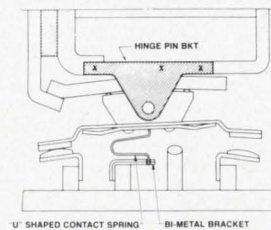

U SHAPED CONTACT SPRING BI-METAL BRACKET

Write for your copy "Tomorrow's Relay Today", a technical paper presented at the

National Relay Conference. Leach Corporation, Relay Division, 5915 Avalon Boulevard, Los Angeles, California 90003  
**LEACH** (213) 232-8221.

ON READER-SERVICE CARD CIRCLE 157





NEW / FROM  
NORTRONICS

EXTENDED  
POLE PIECE  
TAPE HEADS

FOR READING  
SOUND FROM  
FILM

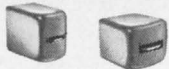

Nortronics extended pole piece record/play heads read sound from 8 mm or 16 mm film without touching the film's optical or sprocket areas. This avoids scratching of the optical surfaces and eliminates possible picture bounce or sound flutter from sprocket hole-to-head contact. The extended tip on these heads is available with Alfenol laminations for long wear or Mumetal laminations for maximum sensitivity.

These heads are also appropriate for a variety of other applications requiring a projecting track, such as card readers, drums and discs.

As small as a 1/4 inch cube, the heads can be supplied with track widths from .006" to .070", with a choice of sizes and case styles. Complete technical data is available upon request.

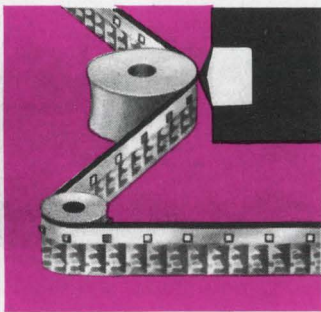

Like all Nortronics tape heads, the extended pole piece type has a fine laminated, precision lapped core structure for low loss, a deposited quartz gap for optimum high frequency resolution, and superb shielding for protection from external magnetic fields. The world's largest manufacturer of tape heads and pace-setter for the industry, Nortronics offers a complete line of heads, including many for replacement and prototype applications off-the-shelf from your local distributor.

**Nortronics**  
COMPANY, INC.

8101 Tenth Avenue North  
Minneapolis, Minnesota 55427

ON READER-SERVICE CARD CIRCLE 158

# Design Aids

## MATHEMATICAL CONSTANTS

$\pi = 3.14$	$\sqrt{\pi} = 1.77$
$2\pi = 6.28$	$\sqrt{\frac{\pi}{2}} = 1.25$
$(2\pi)^2 = 39.5$	$\sqrt{2} = 1.41$
$4\pi = 12.6$	$\sqrt{3} = 1.73$
$\pi^2 = 9.87$	$\frac{1}{\sqrt{2}} = 0.707$
$\frac{\pi}{2} = 1.57$	$\frac{1}{\sqrt{3}} = 0.577$
$\frac{1}{\pi} = 0.318$	$\log \pi = 0.497$
$\frac{1}{2\pi} = 0.159$	$\log \frac{\pi}{2} = 0.196$
$\frac{1}{\pi^2} = 0.101$	$\log \pi^2 = 0.994$
$\frac{1}{\sqrt{\pi}} = 0.564$	$\log \sqrt{\pi} = 0.248$

## Tables of formulas

This is one in a series of pocket books prepared by the Industrial Products Div. of Automatic Electric Co. It provides useful engineering information in a handy form. Tables, formulas and conversion charts contain no original material. However it saves you time during a busy schedule. Automatic Electric Co.

CIRCLE NO. 363

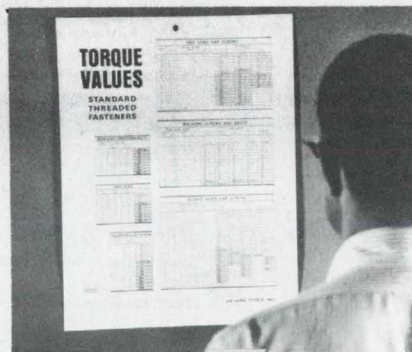

## Torque values

Torque values of standard threaded fasteners are easy to find on this wall chart. Data covered include torque settings for hex head cap screws, socket-head cap screws, and pipe plugs. The tables are arranged so that the proper torque value for any standard fastener can be determined in seconds for any thread size, head style, or material. The chart is set in large, legible type. Jo-Line Tools, Inc.

CIRCLE NO. 349

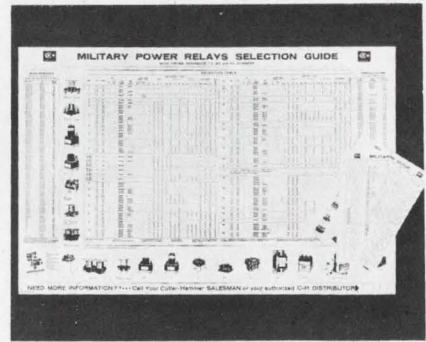

## Military relay reference

Selection charts cover Cutler Hammer, Inc. military power relays. Featuring cross-reference designations between AN and MS to MIL-R-6106 and the firm's power relay order numbers, tabulations provide reference data on hermetically and non-hermetically sealed power relays ranging from 5 to 400 A, 1-, 2- and 3-pole designs in both single and double throw configurations. Data include complete ratings, general test requirement specifications and nominal dimensions. Cutler Hammer, Inc.

CIRCLE NO. 352

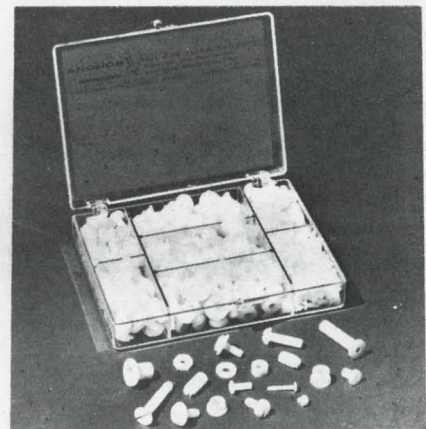

## Nylon fasteners

A trial assortment of nylon fasteners are available for a small charge. The package consists of approximately two hundred and fifty pieces, including various sized machine screws, headless set screws, hex nuts, rivets, washers, bushings, insulators, etc. Although the trial assortment is natural translucent nylon, the products can be obtained in any desired color including black.

Available for \$2.50 from Plaston Div. of Anchor Bolt and Screw Co., 2950 Grand Ave., Chicago, Ill.



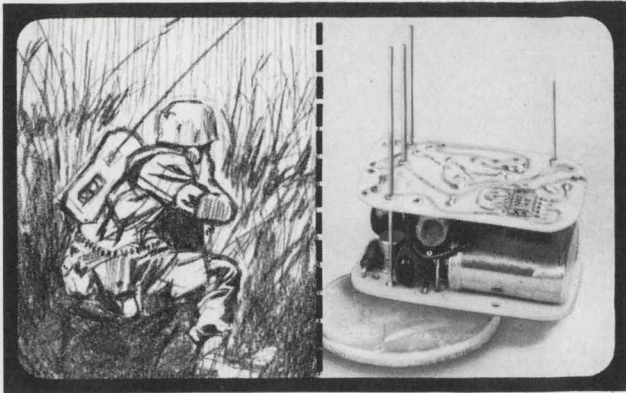

## TC/VCXO

### TEMPERATURE COMPENSATED VOLTAGE CONTROLLED CRYSTAL OSCILLATORS

New Arvin TC/VCXOs for miniaturized communications equipment generate frequencies to 50 MHz with oven-like accuracy. Typical TC/VCXO specifications:

- 5 MHz  $\pm$  2 PPM from  $-40^{\circ}\text{C}$  to  $+70^{\circ}\text{C}$
- Power Input 60 MW ■ Power Output 1 MW
- Deviation  $\pm$  25 PPM ■ Deviation Rate DC to 5 KHz
- Deviation Sensitivity 5 PPM/volt ■ Linearity 2%

Units with other frequencies and stabilities can be designed. TC/VCXOs can be manufactured to conform to all applicable NASA or MIL specs.

ARVIN FREQUENCY DEVICES



2505 North Salisbury Street, West Lafayette, Indiana 47906

ON READER-SERVICE CARD CIRCLE 159

For Epoxy Encapsulating . . .

## VACUUM ENCAPSULATOR

The NEW Vacuum Encapsulator eliminates *trapped air* — the most common cause of encapsulation failure with two-part epoxies. The complete operation is done within the vacuum chamber, therefore the mold and the epoxy is entirely evacuated of air, before and during pouring. For better flow, the epoxy is heated automatically. Work is easily accessible through the large transparent door. Contains built-in light. Clean-up is simple, with most of the feed system disposable. Supplied with an extra 10 disposable feed systems.

**Saves Time!**

**Produces  
Superior Results!**

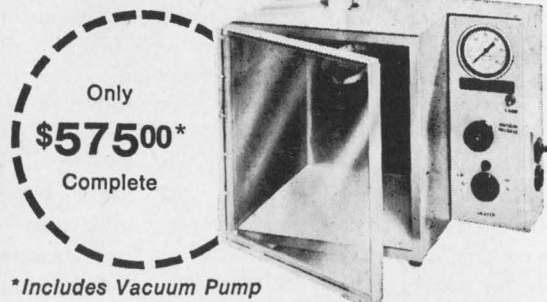

Only  
**\$57500\***  
Complete

\*Includes Vacuum Pump

**WARLOCK SYSTEMS, INC.**

81 Newtown Road, Danbury, Connecticut 06810  
Phone: (203) 744-5545

ON READER-SERVICE CARD CIRCLE 160

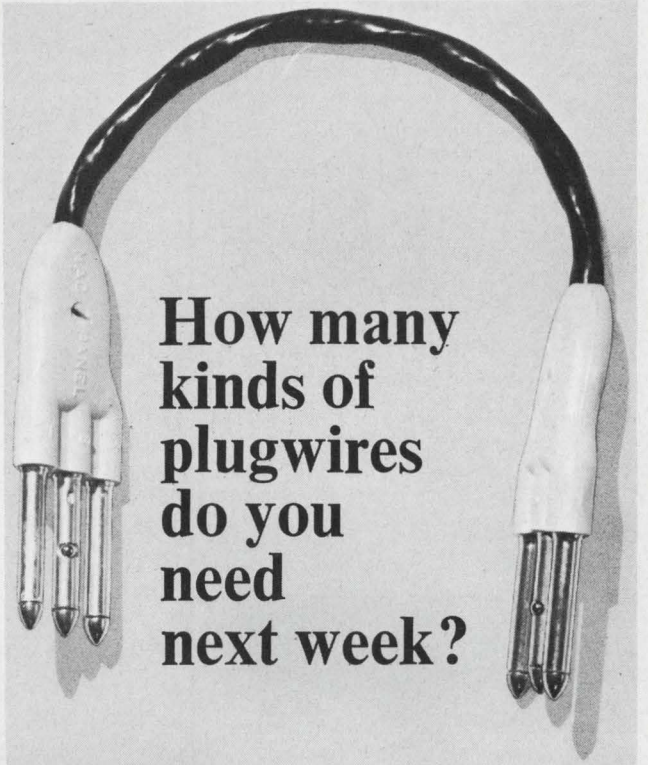

How many  
kinds of  
plugwires  
do you  
need  
next week?

## MAC ships off-the-shelf!

Getting a signal from P to Q—or from P<sub>1</sub>, P<sub>2</sub>, P<sub>3</sub> to Q, or from P to Q<sub>1</sub>, Q<sub>2</sub>, Q<sub>3</sub>, etc.—is the function of the plugwire. MAC maintains a programmer's paradise of plugwires in inventory: single conductor, coaxial, dual conductor, two conductor shielded twisted pair, Y-type with 3, 4, 5 or 6 pin common, just to start the list. Color coded, 6" to 36". Bring order out of chaos. Off-the-shelf. You supply the order, we'll take care of the chaos.

# MAC

O.E.M. DIVISION

MAC Panel Co., Box 5027, High Point, N.C. 27261

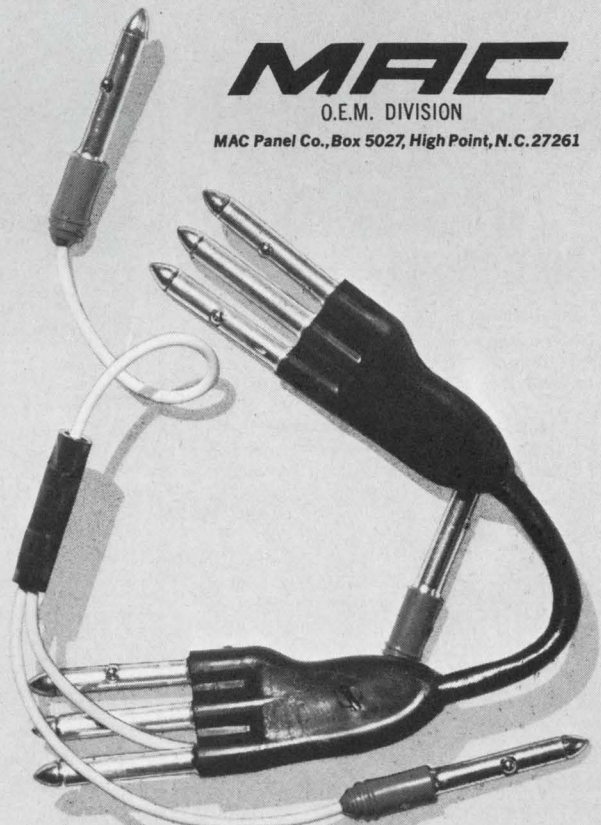

ON READER-SERVICE CARD CIRCLE 161



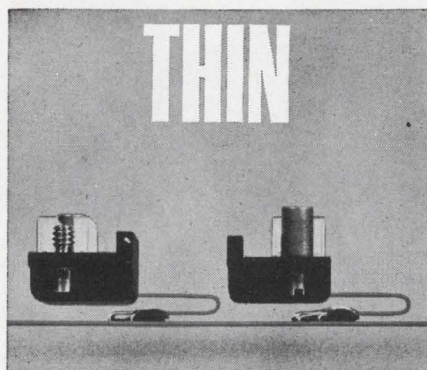

# THIN

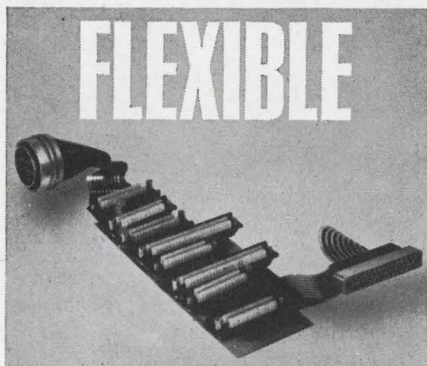

# FLEXIBLE

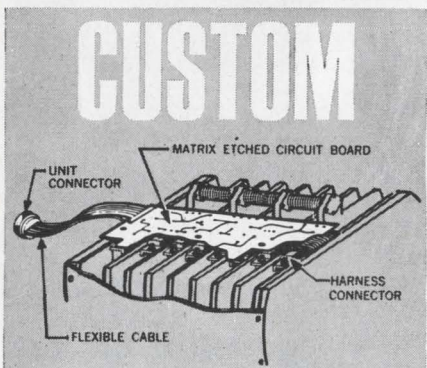

# CUSTOM

## INTER-CONNECT SYSTEMS FOR COMPLEX SPACES

A new form of flat cable inter-connecting system — designed to solve complex inter-connecting problems for small, irregular shaped and very thin areas.

Modular construction allows easy, rapid, modification of circuitry . . . easy to plug in, or out, all or part of the system. The systems are supplied complete (to customers' specifications), with connectors attached, ready to plug in.

The flat cable system shown packs a lot of inter-connections in a very small space. Over 550 random inter-connections connect more than 6000 separate components.



**DIGITAL SENSORS INC.**  
4127 N. Figueroa Street  
Los Angeles, California 90065  
(213) 223-2333 • TWX 213-226-1230

ON READER-SERVICE CARD CIRCLE 162

## DESIGN AIDS

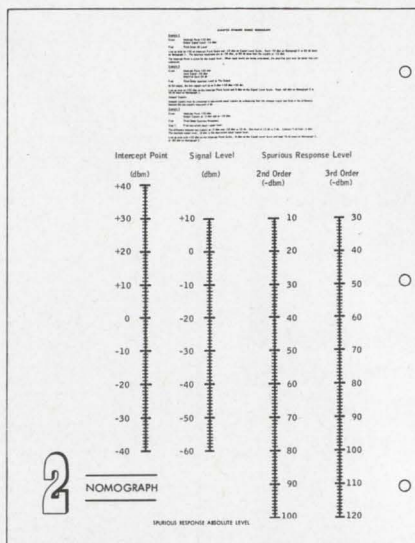

### Dynamic range nomogram

This nomogram comes on card stock and is perforated for insertion in a loose-leaf file. It actually serves two purposes; on one side is a table that can be used to find a spurious response relative level, while on the other side a spurious response absolute level chart can be found. Included on the chart are three sample questions. Avantek Inc.

CIRCLE NO. 431

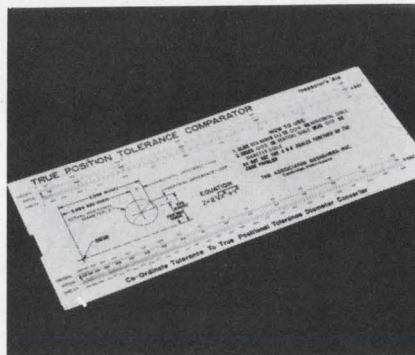

### Pocket comparator

How many times have you needed a tool that you could pull out of your pocket to measure linear dimensions (to 0.005 in.), angles, radii, hole diameters or thread sizes? The Edmund Scientific Co. is now making available 9 six-power pocket comparator with a choice of eight 27-mm dia etched-glass reticles, each priced at \$6.75. Only 1-1/4 in x 2 in., it has a three-element triplet lens that provides a flat field over the entire reticle area.

Available for \$12.75 from Edmund Scientific Co., 301 E. Gloucester Pike, Barrington, N. J.

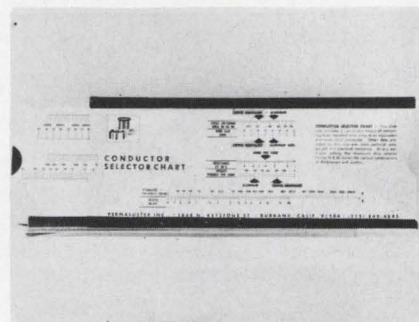

### Conductor selector chart

A slide-rule chart is available that provides a simple method of converting copper wire gauges to an equivalent in aluminum wire. It shows all thicknesses and widths of aluminum strips that will have equal resistance to the desired sizes of copper wire. Included is basic data for the design of electrical windings, also factors about weight, space, and current carrying capacity. Permaluster, Inc.

CIRCLE NO. 432

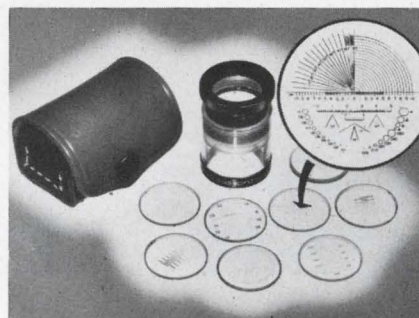

### True position comparator

The comparator is a 4-1/2 x 11 inch, plastic, sliding scale type device that is used by quality control inspectors, shop foremen, engineers, and draftsmen to provide instant analysis of true position tolerancing and dimensioning. The inspector's aid side of the comparator shows coordinate measurements with respect to circular tolerance zones on the drawings. The manufacturer's aid side shows how far from true position the tool settings may deviate (right or left, forward or backward). A handy reference on the comparator illustrates and defines the symbols used in true position tolerancing. The comparator comes with an instruction manual.

Available for \$7.50 from Tad Products Corp., 639 Massachusetts Ave., Cambridge, Mass.



# WIDEST 7/8" SELECTION UNDER THE SUN

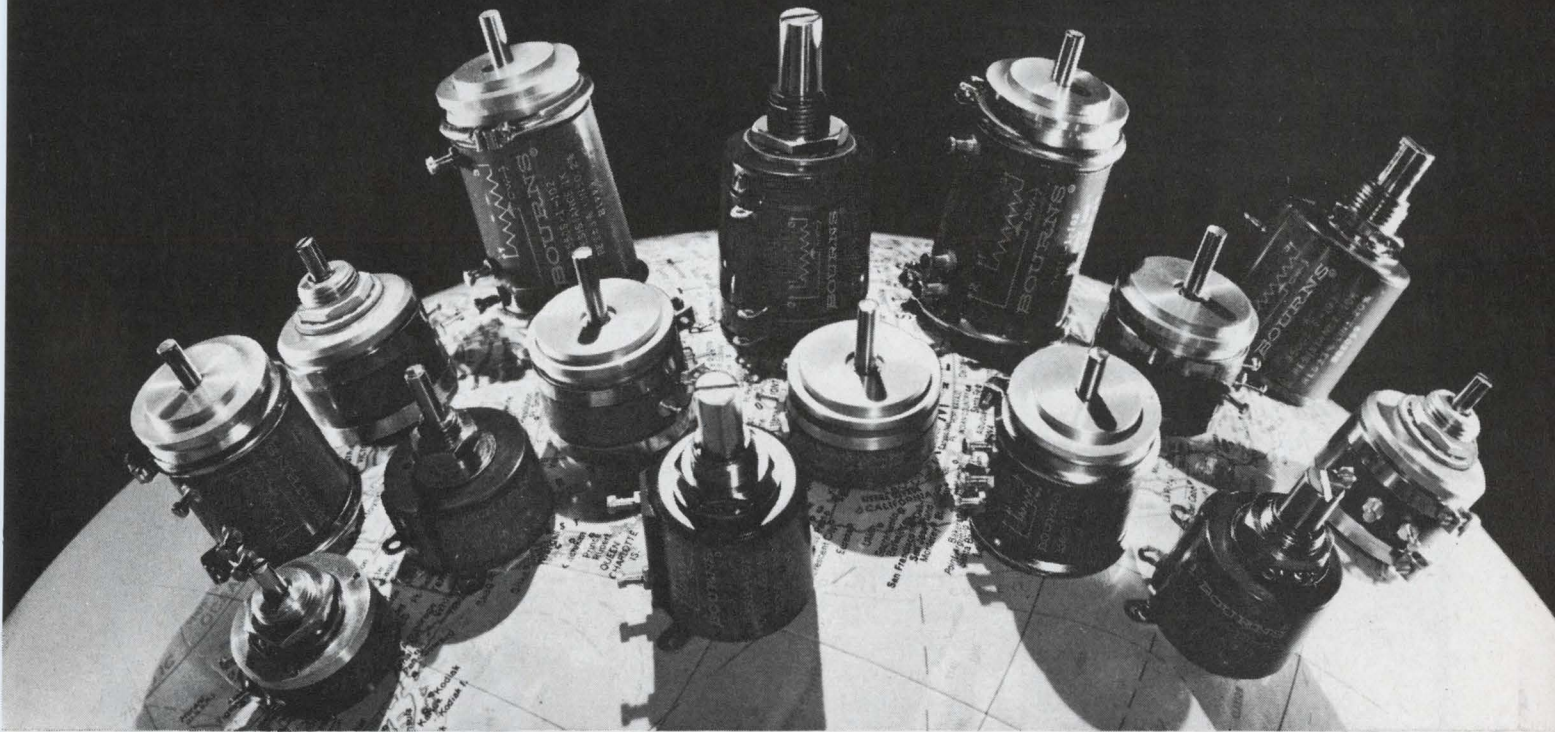

## 15 MODELS FROM BOURNS TO FIT EVERY DESIGN REQUIREMENT

That's right, fifteen 7/8" diameter precision potentiometer models . . . from Bourns, the leader in the design and manufacture of potentiometers. No matter what your needs . . . Bourns can furnish precision potentiometers to fit every requirement—1, 3, 5 and 10-turn models with wirewound or INFINITRON® conductive plastic elements in bushing or servo-mount configurations. Bourns offers a line of 7/8" units, not just a few models! There are units available with outstanding specifications, for Mil-Spec, industrial and commercial applications.

In quantity and quality, this 7/8" line is unmatched. 100% inspection and a double-check follow-through by the exclusive Bourns Reliability Assurance Test Program is your guarantee of quality and the knowledge that published specifications will be met by every unit you purchase.

No matter what your requirements in precision potentiometers, you will find the answer at Bourns—the one **complete source!** Write for technical data on our entire line of bushing and servo-mount models, KNOBPOT® potentiometers and turns-counting dials.



BOURNS, INC., TRIMPOT DIVISION • 1200 COLUMBIA AVE., RIVERSIDE, CALIF.  
TELEPHONE 714 684-1700 • TWX: 910 332-1252 • CABLE: BOURNSINC.

TRIMPOT® and Precision Potentiometers • Miniature Relays • Electronic Modules • Microcomponents.



# Application Notes

## Thyratron application

Containing a thorough discussion of thyatrons, the report's 19 pages contain useful information and data for the engineer. The report features a lengthy introduction on the fundamentals of thyatron operation, their characteristics and circuit considerations. The remaining sections of the booklet cover the "Installation of Ratings." Concluding the booklet is a listing of AmpereX thyatrons with their operating characteristics and descriptive functional data. AmpereX Electronic Corp.

CIRCLE NO. 428

## Dc modules

This 32-page application note provides detailed descriptive information concerning technical specifications, parameters and series/shunt circuit applications. Engineering data sheets are provided for each type of unit. Bendix.

CIRCLE NO. 429

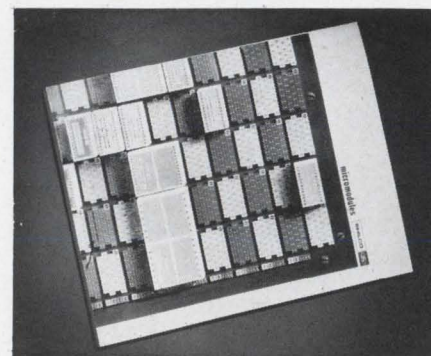

## Micromodules

This two-color booklet is for circuit engineers who design systems utilizing digital building blocks. The 100-page booklet basically describes the functions, testing overall reliability and support hardware of the many modules available. It contains more than 40 pages of specifications of modules in such family types as flip-flops, passive gates, active gates, lamprelay drives and multifunctional types. Philco-Ford Corp.

CIRCLE NO. 430

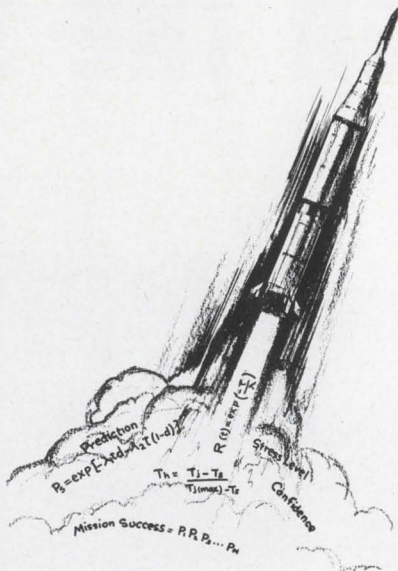

## Diode reliability

A reliability report TR 129 contains a description of the company's high-reliability program. The report summarizes the results of over 27,000,000 diode hours of testing of over 19,000 diodes and assemblies at the maximum rated dissipations. The testing indicated a failure rate in actual usage in a typical application of only 0.0006% per thousand hours. Unitrode Corp.

CIRCLE NO. 405

## Wheatstone transducers

Ideally, the electrical output of a transducer should be zero with no load applied. However, due to practical considerations involved in the manufacturing process, a small residual output usually exists. Additionally, in some applications a tare load may be applied to the transducer, thereby changing the output of the transducer. If the data system is capable of handling the zero balance of the transducer, this factor is of no significance. However, in many systems it is desirable to have zero signal from the transducer at some reference load condition. For these systems, an auxiliary zero-balance network is required. This note describes how to achieve a good balance network. Statham Instruments, Inc.

CIRCLE NO. 295

FOUND: A low cost miniature ceramic capacitor that is stable. (213) 843-4222

FOUND: A low cost miniature ceramic capacitor that is stable. (213) 843-4222

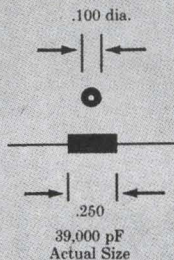

## Did low cost miniature ceramic capacitors turn up missing?

No longer USCC has them for you. ■ The new, C22 Series low cost transfer molded ceramic capacitors, utilizing the exclusive Ceramolithic® process for stability and reliability, are now available off-the-shelf and at a price that is geared to solve design cost problems. ■ The C22 Series is ideal for cordwood stacking and versatile enough for printed circuit boards and point-to-point wiring. ■ Capacitance values range from 10 pF to 120,000 pF with DC voltage ratings of 50 and 100 at 125°C. Tolerances are ±5, 10 or 20%. Test it to MIL-C-11015 or MIL-C-39014. ■ If you have been waiting for the price of ceramic capacitors in quantity to drop where you can economically use them, wait no longer. The time is now. Find out about the C22 Series Ceramolithic® capacitors, today.

**CERAMOLITHIC®**

...advanced design in ceramic capacitor construction

For complete technical information on the new C22 Series, contact:

**USCC**

U. S. CAPACITOR CORPORATION  
2151 NO. LINCOLN STREET • BURBANK, CALIFORNIA 91504  
(213) 843-4222 • TWX: 910-498-2222

ON READER-SERVICE CARD CIRCLE 164



# Reed Relay Problems?

A special hi-reliability relay for the Hawk Missile.

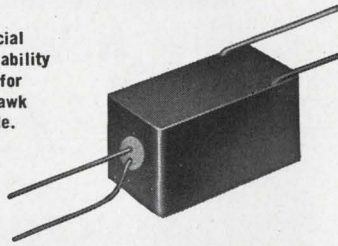

## Can We Solve Your Problem?

**Operating Inputs:** low as 1mA. and 15mW.  
**Standard Coil Voltages:** 6, 12, 24, 32, 48V in stock for immediate delivery.  
**Special Voltage or Resistance,** multiple windings for flip flop, memory and crosspoint selection applications → to customer specifications.  
**Relay Contacts** in Form A, B, C and latching. Also high vacuum type 5000V Form A.

Write for catalog and prices of our standard line of magnetic reed relays. For special requirements, give complete details for quotation.

**Coto-Coil COMPANY INC.**  
 59 Pavilion Ave.  
 Providence, R. I. 02905  
 Phone: (401) 941-3355  
 ON READER-SERVICE CARD CIRCLE 165

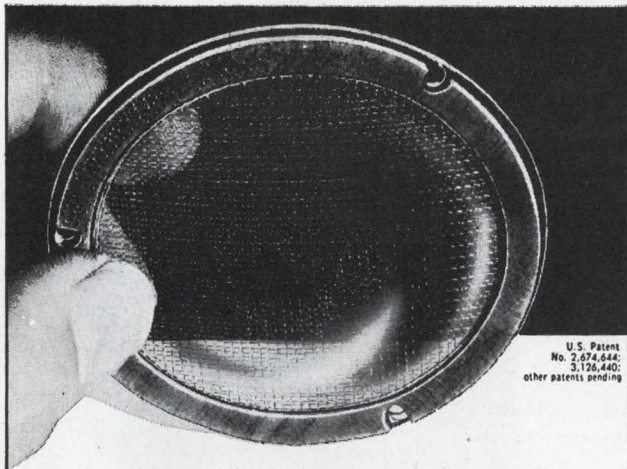

U.S. Patent No. 2,874,644; 3,126,440; other patents pending

## Metex Shield-Vu™

### cuts the interference but not the view

An effective, economical shield, Metex Shield-Vu is available in your choice of mesh (monel, low carbon steel, or an etched metal such as nickel) imbedded in plexiglass. The glass itself can be anti-reflection,

frosted or clear; in any color, size and shape, depending on your requirements. Ask for our assistance, or write for free samples, prices and literature.

## METEX Corporation

970 New Durham Road, Edison, N.J. 08817  
 (201) 287-0800 • TWX 710-998-0578  
 West Coast: Cal-Metex Corp., 509 Hindry Ave., Inglewood, Calif.



ON READER-SERVICE CARD CIRCLE 166

# Off the Shelf...

## \*STANGARD LOW COST QUALITY CAPACITORS

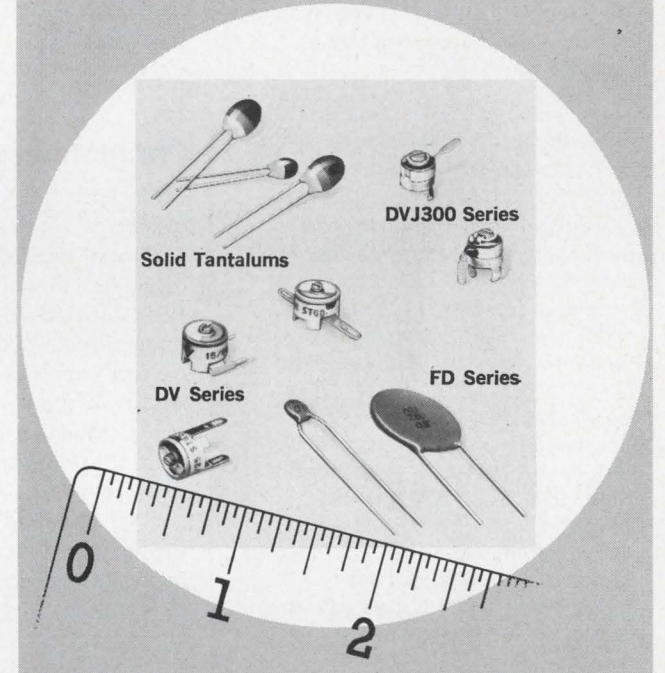

Yes! Quality and Low-Cost are compatible. STANGARD\* proves the point.

The following fixed and variable capacitors are examples of our ever expanding line of components — available, off the shelf.

#### Miniature Solid Tantalum Fixed Capacitors

Capacitance range 0.1 to 50.0 mfd  
 Epoxy resin encapsulation  
 Color coded to facilitate identification  
 Radial leads

#### Barrier Layer Fixed Disc Capacitors — FD Series

Capacitance range .0047 to .47 mfd/3, 12 and 30V; .68 and 1.0 mfd/12V  
 Case is Durez wax impregnated  
 Ideal for transistor circuits

#### Miniature Variable Ceramic Disc Capacitors—DVJ300 Series

Minimum Q for this series is — DVJ300 (2.7 to 20.0 pf) is 500 @ 10 MHz; DVJ301 (1.7 to 6.0 pf) and DVJ302 (1.7 to 10.0 pf) is 200 @ 100 MHz/300 @ 10 MHz  
 Printed circuit and point-to-point wiring configurations available

#### Miniature Variable Ceramic Disc Capacitors—DV Series

Meet or exceed applicable MIL-C-81A.  
 Capacitance ranges from 2.0-8.0 pf up to 15.0-60.0 pf  
 Minimum Q is 500 @ 1 MHz  
 All mounting configurations are available

Write for complete catalogs.

\*STANGARD — A Product Line of JFD

**JFD** "TODAY'S COMPONENTS BUILT FOR TOMORROW'S CHALLENGES"

JFD ELECTRONICS CO. / COMPONENTS DIVISION 15th Avenue at 62nd Street  
 Brooklyn, New York 11219 / Phone 212-331-1000  
 Offices and subsidiaries in principal cities, world-wide.

ON READER-SERVICE CARD CIRCLE 167



# LC Filters?

## We'll try anything!

If you have a tough, tricky or unusual problem in LC filters, try Bulova first! Bulova has built a reputation for being willing to "try anything". Even jobs that other companies "can't be bothered with"!



Are we crazy? Like foxes! Fact is, we can do things others can't—and that's the way we win friends and customers!

We'll custom-design units to solve your unique problems. We'll supply prototypes when you need them—in 2 weeks or less! We'll schedule production units to meet your schedule—and give you solid proof we can do it!

And what a range! High pass, low pass, band pass, lumped constant delay lines, IRIG filters—you name it! Frequencies from DC to 50MHz! Sharpest shape factors! Just tell us your requirements—when you need it—and let us tackle it. Our hot engineering group will show you why you should "Try Bulova first"!

For more information, write to us at Dept. ED-25.

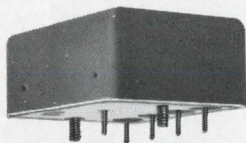

## Try Bulova First!

### FREQUENCY CONTROL PRODUCTS

ELECTRONICS DIVISION  
OF BULOVA WATCH COMPANY, INC.

61-20 WOODSIDE AVENUE  
WOODSIDE, N.Y. 11377, (212) DE 5-6000

ON READER-SERVICE CARD CIRCLE 167

### APPLICATION NOTES

#### Magnetic recording

A 44-page application note, the Magnetic tape-recording handbook, presents the fundamentals of magnetic tape recording with special emphasis on analog instrumentation applications. The publication describes the basic techniques by which electrical signals are stored and recovered from magnetic tape. The function of the bias signal and the factors which limit frequency response and dynamic range are reviewed. Also discussed are fm recording, the IRIG standard parameters, predetection recording and pulse recording. Hewlett Packard.

CIRCLE NO. 360

#### Component vectors

Methods for defining the mutual properties between signals in terms of real and imaginary components are discussed in a technical publication PS-3 entitled "Some uses of real and imaginary component vectors in engineering analysis." Applications are shown in three areas: 1. Defining the model properties of a complex structure; 2. Defining unambiguously the phase between two signals as a function of the frequency, and 3. Establishing the mutual relationships between random signals in the frequency domain. Spectral Dynamics Corp.

CIRCLE NO. 362

#### Hybrid techniques

A frequency requirement in system analysis and control system design is to find a set of parameter values (such as damping factors) which will cause the system to respond in a given way. System parameters often are determined from a measure of the frequency of oscillation and the degree of damping present in the response of the system, to a transient input. The system described indicates the number of overshoots of the response and their relative peak magnitudes, as a measure of frequency and damping, and hence system response. This is done by digital counting circuits, comparison with preset counters, and a performance computer that analyzes the system response. GPS Instrument Co., Inc.

CIRCLE NO. 427

# FREE

## NEW 1968

# ALLIED

## INDUSTRIAL ELECTRONICS CATALOG

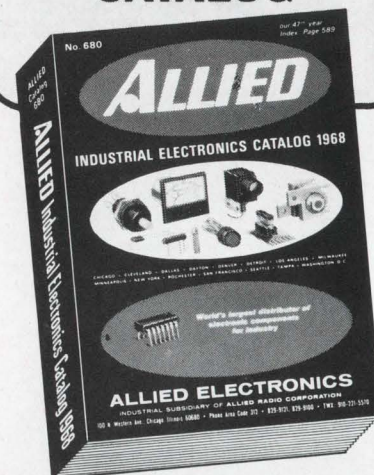

### World's Largest Selection of Electronic Components for Industry

- Scores of new products
- Same-day shipment
- All merchandise stocked in depth
- Factory OEM prices

### 600 VALUE-PACKED PAGES

# P&B

## RELAYS

### SEE THE 1968 ALLIED CATALOG

Allied stocks Potter & Brumfield Relays in depth: General purpose, special purpose, power, high performance, mercury wetted contact, telephone types

Write for Your Copy Today to Dept. 76L

# ALLIED ELECTRONICS

A Subsidiary of Allied Radio Corp.

Our 47th Year

100 N. Western Ave. Chicago, Ill. 60680



# "The Microwave Exposition is the best show we have ever been in!"

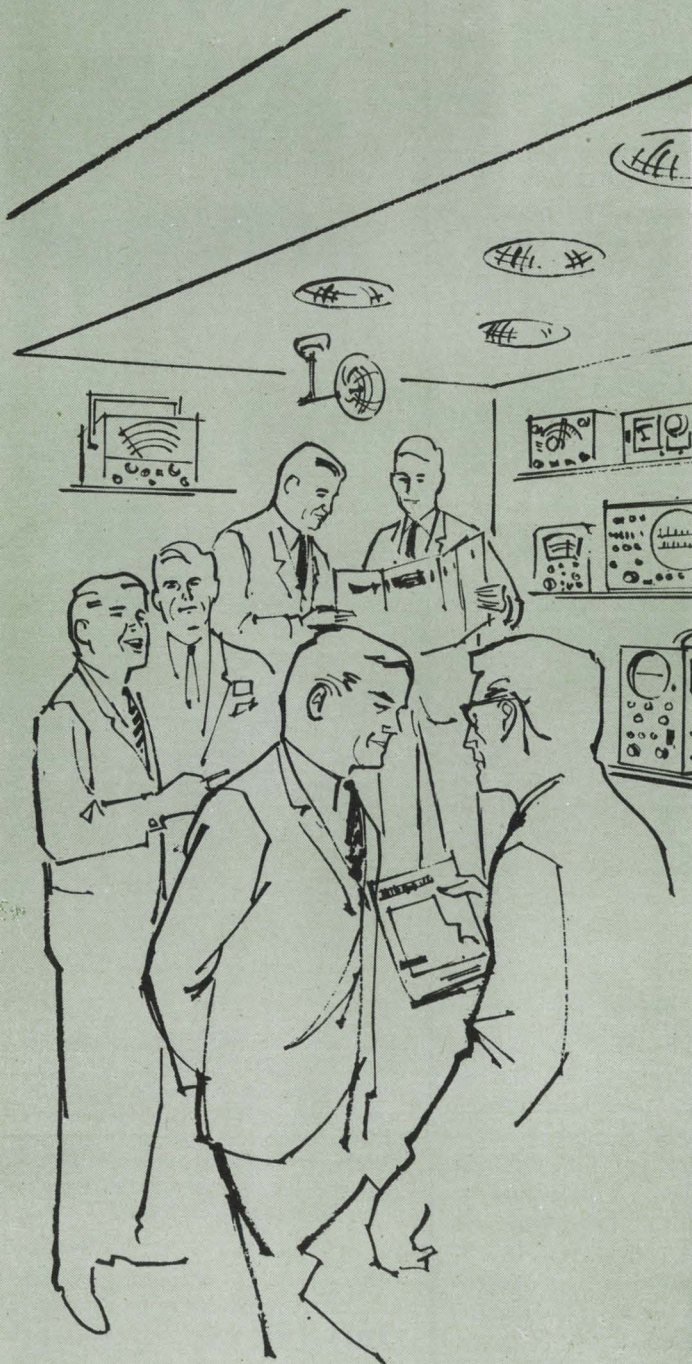

This powerful statement from Mr. Hal Tenney, Vice President of Western Microwave Laboratories, Inc., says more than any advertisement we could create. Western Microwave came away from Microwave Exposition/67 with many new contacts and high promise for future business.

Naturally, Western Microwave will be exhibiting at MICROWAVE EXPOSITION/68 with their quality product line of ferrite and solid state microwave components, sub-systems and low frequency active filters.

Shouldn't you be too?

Reserve space today for

## **MICROWAVE EXPOSITION/68**

**PLACE:** San Francisco Hilton

**DATES:** June 4, 5 and 6 (Tuesday, Wednesday and Thursday)

**COST:** \$600 per 10' x 10' space

**CO-SPONSORED BY:** Hayden Publishing Co.

**ANTICIPATED ATTENDANCE:** 4,000 microwave engineers who can make on-the-spot decisions!

CALL OR WRITE OR WIRE

## **MICROWAVE EXPOSITIONS INC.**

100 Avenue of the Americas  
New York, New York 10013 • 212-925-1200



# DISPLAY & CONTROL

## TEC—Single Source for Discrete or I-C Systems

### DATA ENTRY SYSTEMS

- Electronic Keyboards
- Keyboard Switches

### DISPLAY & CONTROL SYSTEMS

- DATA-PANEL® Displays
- DATA-LINE Displays
- CRT Systems

### READOUTS—

#### Drivers/Decoders

- Neon Display Tube
- Segmented Display
- Projection Display
- Digital Readout Assemblies

### TRANSISTOR CONTROLLED INDICATORS & SWITCH/INDICATORS

- Subminiature
- Miniature
- Neon or Incandescent
- Low Voltage Supply
- Discrete Component or I-C input
- Integral Switches
- Alternate Action
- Momentary Action
- Special Action

### INDICATORS & SWITCH/INDICATORS

- Subminiature
- Miniature
- Neon or Incandescent
- Replaceable Lamp
- Front or Rear Mounting

### SWITCHES

- Subminiature
- Miniature
- Alternate Action
- Momentary Action
- Special Action
- Multi-Pole

### POWER SUPPLIES

- For Readout Tubes
- For Neon Lamps



INFORMATION DISPLAY AND CONTROL DEVICES

**TRANSISTOR ELECTRONICS CORPORATION**

Box 6191  
Minneapolis, Minnesota 55424  
Phone (612) 941-1100

ON READER-SERVICE CARD CIRCLE 181

## APPLICATION NOTES

### Auto and crosscorrelation

This bulletin describes correlation methods applied to the analysis of random data. Normally, correlation is used to detect hidden periodicities within a signal or to provide a quantitative measure of the interdependency between two signals. The problems most often solved are those which require isolation of a known or unknown periodicity from random activity, or distinguishing between two sources of random activity. Autocorrelation measures the similarity of a signal to a time-delayed version of itself, while crosscorrelation measures the degree of similarity of one source or input to a time-delayed second source.

No synchronizing events need be available for the application of correlation techniques. The principal requirements are that the functions of stationary (i.e., their statistics do not change over the period of integration) and that the duration of each signal be sufficiently long in comparison to the period of its lowest frequency component. Technical Measurement Corporation.

CIRCLE NO. 421

### Relay logic

The forward of this 36 page booklet points out that logic circuits are commonly associated with solid-state components, and that logic techniques have been employed since the earliest use of relays. It illustrates basic relay functions and circuits that form the most useful relay logic. Counting circuits that make use of these logic functions are included. Automatic Electric Co.

CIRCLE NO. 422

### MOS shift register

The pL5R100 MOS monolithic 100-bit shift register, with its usage of inherent capacitance storage elements, allows high package density and low cost per bit. Applications include delay replacements, data compressors or rate changers, and recirculating memories. The 8-page description of circuit operation should help the systems designer apply the register to his delay memory, or arithmetic shifting application. Philco-Ford Co.

CIRCLE NO. 423

**This is probably the most reliable 1200 lb vibration test system made.**

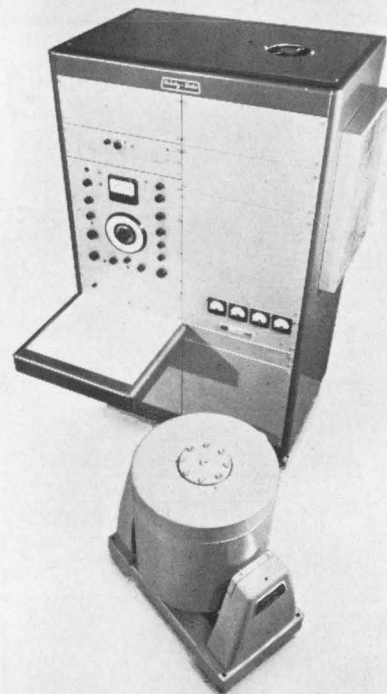

The shaker's moving element and its suspension are warranted for two years — a guarantee unmatched in the industry. System control is "push-button" — simple yet safe. It is thoroughly protected for all overdrive conditions with automatic shutdown circuits. For the complete story on Unholtz-Dickie test equipment, write today.

manufacturers of vibration test systems, advanced instrumentation, accelerometers

**UNHOLTZ-DICKIE**

CORPORATION  
3000 Whitney Ave./Hamden, Conn. 06518

ON READER-SERVICE CARD CIRCLE 182



... IT's the MOST ...  
EXCEPT FOR PRICE

NEW **KH** ALL-SILICON

R-C OSCILLATOR  
holds PERFORMANCE but  
LOWERS PRICE

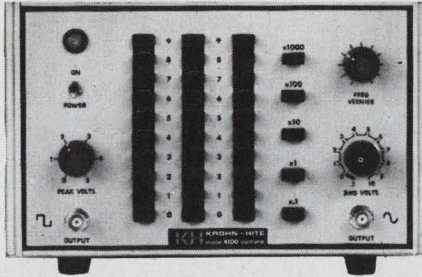

MODEL 4100, brand new R-C Oscillator with push-button frequency control. Sine- and Square-Wave simultaneously from 0.01 Hz to 1 MHz. Price \$550. Provides performance of higher priced units. 5 1/4" H x 8 3/4" W x 1 1/2" D.

Using advanced circuit techniques, Krohn-Hite has produced a new R-C Oscillator, at a medium price, with traditional K-H Quality.

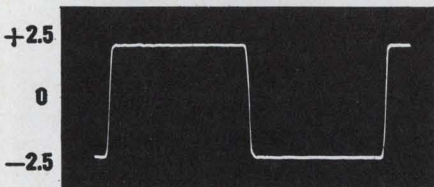
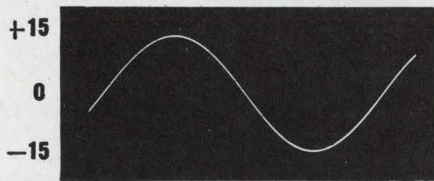

SIMULTANEOUS SINE AND SQUARE-WAVE outputs pack real power (up to 1/2 watt into 50 ohms). Photos show open circuit output voltages at 1 MHz.

These outputs typify the performance of the Model 4100. Add to this half-watt output, 0.5% frequency accuracy, 0.03% distortion, 0.02% hum and noise, 0.02 db frequency response and 0.02%/hr. amplitude stability and you get a clearer picture of what we're talking about.

There's much more in KH Data Sheet 4100

Write for a copy

**KH KROHN-HITE**  
CORPORATION  
580 Massachusetts Avenue, Cambridge, Mass. 02139  
Telephone: 617/491-3211

ON READER-SERVICE CARD CIRCLE 183

## Copper catalog

How coppers differ is discussed and illustrated in a 16-page, illustrated brochure. The origin of the differences between electrolytic tough pitch copper, deoxidized copper and OFHC brand copper is traced to the refining and casting practices followed in producing the metals. The booklet describes and illustrates the effect of particular impurities (such as oxygen in tough pitch copper or phosphorus in deoxidized copper) on the utility of the coppers. AMAX, U.S. Metals Refining Div.

CIRCLE NO. 424

## Thermoelectric devices

A 52-page booklet containing application and selection data on thermoelectric cooling devices contains explanations of how thermoelectric devices operate including physical principles of the semiconductor materials used. The second portion discusses techniques used to apply thermoelectric devices including sample equations and problems. A 12-page appendix with tables for use in applying thermoelectrics is included in the third portion of the booklet and contains: heat transfer coefficient data, temperature conversion tables, conversion factors for metric and BTUs, conversion tables for copper-constant and chromelalumel thermocouples. Borg Warner Thermoelectrics.

CIRCLE NO. 425

## Library of noise control

This four-page, two-color index is a complete reference to the Library of Article Reprints and Technical Papers that are available for the asking. Lord Manufacturing Co.

CIRCLE NO. 426

## Transistor reference guide

A reference guide containing current information supplied by various manufacturers on many commercially available transistors available. The transistor book is indexed by type numbers and cross referenced to an electrical characteristic.

Available on a subscription basis for \$29.50 from D.A.T.A., Inc., P. O. Box 46X, Orange, N. J.

NEW **KH** ALL-SILICON  
DIGITALLY TUNED  
VARIABLE FILTER  
FEATURES

ULTRA LOW FREQUENCY  
96 DB/OCTAVE SLOPE

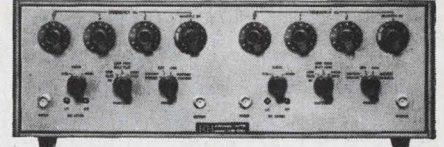

MODEL 3342 DUAL-CHANNEL, MULTI-FUNCTION FILTER provides low-pass and high-pass operation with 96 db attenuation slope or 48 db slopes as band pass or band reject filter. The digital frequency control provides cut-off frequencies from 0.001 Hz to 100 kHz with 2% calibration accuracy and excellent resetability. Size: 5 1/4" H x 19" W x 16 1/2" D.

The new Krohn-Hite Series 3300 operates on either line or batteries, with 0.1% distortion and provides gain of 20 db.

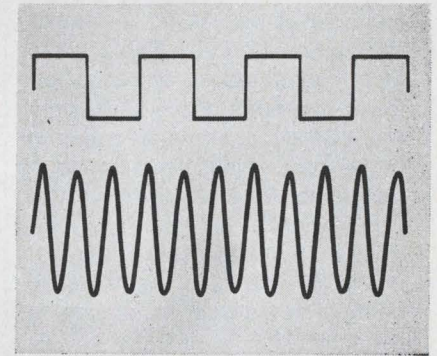

RECORDING ILLUSTRATES gain and selective response of Model 3342, in minimum band-pass operation, to a 0.01 Hz square wave. Output consists primarily of third harmonic component of input.

This kind of low-frequency performance is backed by other important specifications. Examples are:

**Filter Characteristics:** Either 4 or 8-pole Butterworth (maximally flat) and R-C for transient-free operation.

**Digital Tuning:** Six bands, 3 digits; rotary switches.

**Maximum Attenuation:** 80 db.

**Dynamic Range:** 80 db.

**Input Impedance:** 10 megohms.

**Output Impedance:** 50 ohms.

Write for Data

**KH KROHN-HITE**  
CORPORATION  
580 Massachusetts Avenue, Cambridge, Mass. 02139  
Telephone: 617/491-3211

ON READER-SERVICE CARD CIRCLE 184



# VCR FET

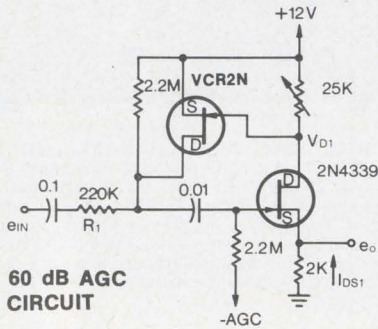

60 dB AGC  
CIRCUIT

SILICONIX ASSUMES NO RESPONSIBILITY FOR THE CIRCUIT SHOWN, OR DO THEY REPRESENT OR WARRANT THAT IT DOES NOT INFRINGE ANY PATENTS.

The AGC circuit above is a good example of the VCR\* in action. Here's how it works. The 2N4339 FET, connected as a source follower, prevents phase shift while the VCR2N controls attenuation of the input signal. An increase in negative AGC voltage to the 2N4339 gate decreases  $I_{DS1}$ .  $V_{D1}$  goes more positive thus decreasing VCR gate bias. As a result, VCR drain-source resistance is reduced. This resistance and  $R_1$  form a voltage divider which attenuates the signal.

Build this or other circuits with the VCR FET Designer's Kit "DK6"—includes 6 VCR FETs worth \$30—available from your distributor for \$19.50. Check inquiry card or write . . . we'll be happy to send literature.

\* VCRs are voltage controlled resistors—a new family of FET devices—featuring a variable resistance range of typically 10,000 to 1.



**Siliconix incorporated**

1140 W. Evelyn Avenue,  
Sunnyvale, California 94086  
Telephone (408) 245-1000  
TWX: 910-339-9216

ON READER-SERVICE CARD CIRCLE 198

## New Literature

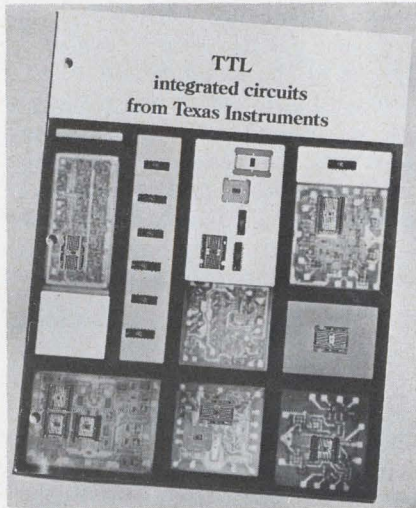

### Integrated-circuits catalog

A 48-page brochure describes a line of TTL monolithic integrated-circuit types, with distinct circuit functions. The illustrated booklet contains product descriptions and applications information on speed and performance stability, noise immunity, worst-case testing, and cost-saving logic flexibility. Logic diagrams and pin configurations for each circuit in the series 54 and series 74-TTL families are included with typical performance specifications. A quick-reference chart indicates what is available in standard series 54-TTL, series 54-TL low-power TTL and series of 74-TL high-speed TTL. Temperature and package options are included. Details and dimensions are shown both for flat packs and for the plastic-encapsulated dual in-line packages. Loading rules for combining TTL with DTL circuits in common systems are also provided. Texas Instruments, Inc.

CIRCLE NO. 420

### Capabilities for control

An 8-page booklet explains how various industries have increased efficiency and profit through the use of the manufacturer's systems engineering computer-control systems. Applications illustrated include a petrochemical plant control which gives a higher yield and through-put, and an on-line process control for a pulp digester. Westinghouse Electric Corp.

CIRCLE NO. 466

### Phased array systems

A 16-page brochure, presenting to the government and the aerospace industries the potential for complete-phased array systems and specialized subsystems and components has been published. Covering all frequencies from uhf through X-band for ground, shipboard, airborne and space applications of this next generation of technology, the booklet describes information on the manufacturer's capabilities for sophisticated components, test equipment, electronics, sub-assemblies and digital computers. Engelhard Industries, Inc.

CIRCLE NO. 340

### Teflon compositions

A brochure covering the manufacturer's line of reinforced teflon alloys which are used for various applications is being offered. The literature describes properties, design guides and available forms for five different compositions. Fluorocarbon Co.

CIRCLE NO. 467

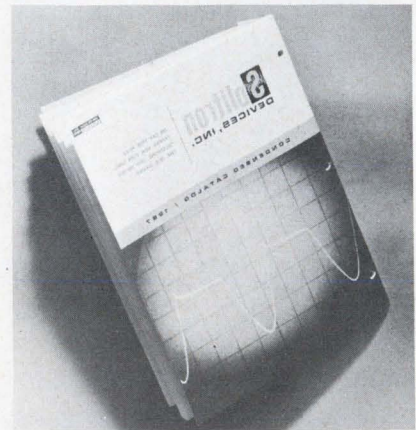

### Condensed catalog

The catalog covers small-signal diodes, power rectifiers, 75 ns power rectifiers, temperature-compensated zeners, silicon-voltage regulator diodes, voltage-variable capacitors, solid-state replacements for vacuum tubes, hi-voltage assemblies and cartridges, component test equipment, hi-pac interconnection systems and a listing of the JEDEC types procurable from the manufacturer. Solitron Devices, Inc.

CIRCLE NO. 468



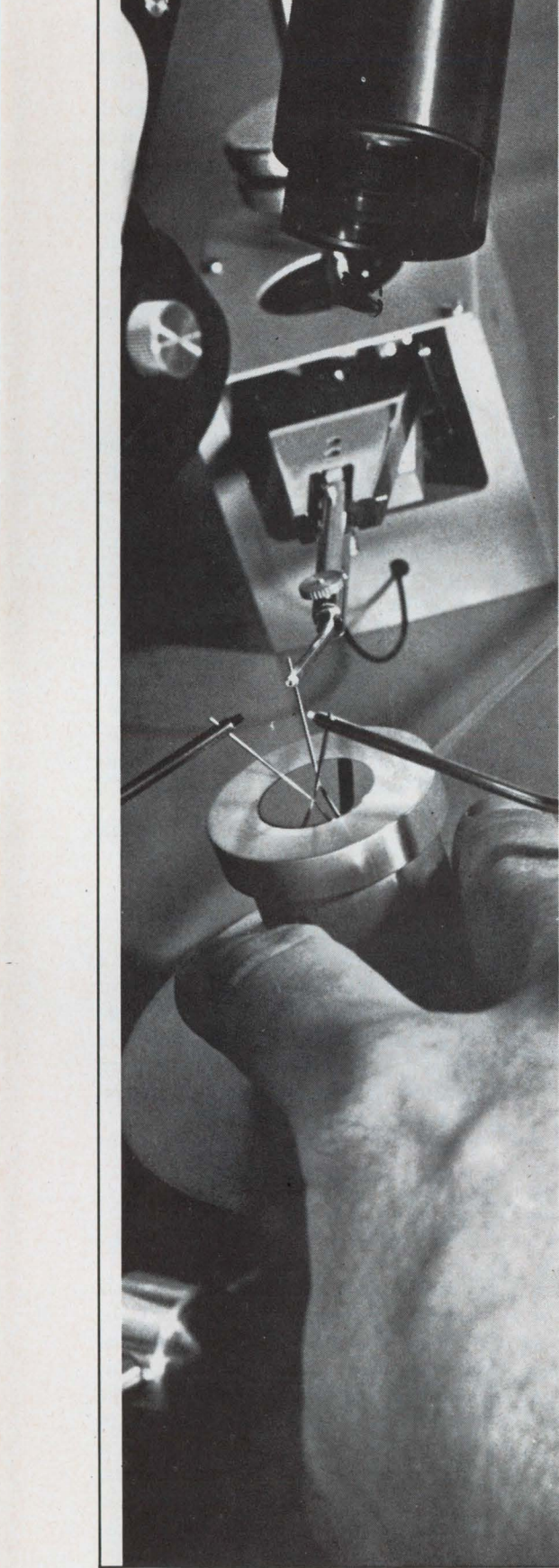

# Lighter, smaller, competitive replacements for glass and metal zeners

## Semcor Silicon Molded Diodes

Before you order or specify another glass or metal zener, you'll find it well worth your while to look over Semcor's outstanding line of molded zener diodes. You'll probably identify a direct replacement that slashes the weight, size and cost of its counterpart. Semcor molded zeners are available in 400-mW,  $\frac{3}{4}$ -W, 1-W and 2-W ratings from 3.3 through 200-V operation. Major features include an epoxy body which meets MIL-S-19500 environmental requirements, thermal exercising before a complete final test, and critical lot acceptance inspection by QA before shipping. Suitable for a broad range of consumer and commercial applications, these economical silicon molded diodes are produced by Semcor Division of Components, Inc.—your finest assurance of fair pricing, prompt delivery and superior reliability in electronic components. For more information and data, see your nearest dealer or write: 3540 W. Osborn Road, Phoenix, Arizona 85019, 602-272-1341.



ON READER-SERVICE CARD CIRCLE 185



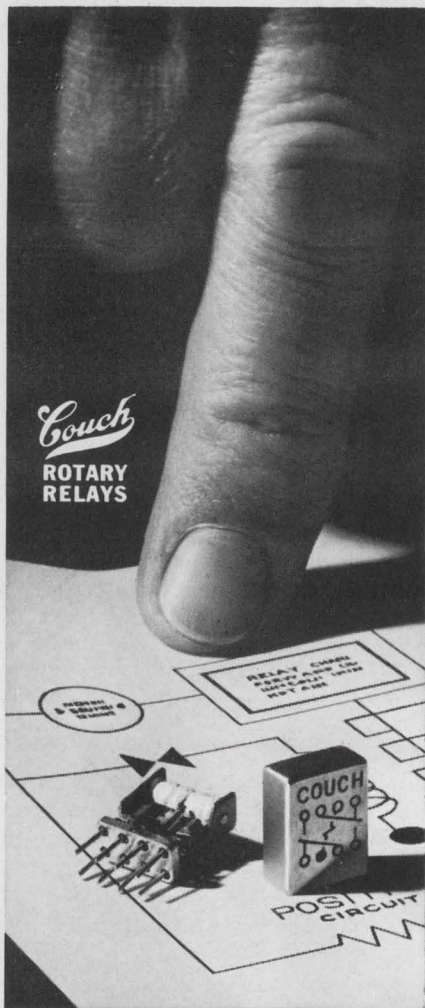

## Cramped for space?

### Use Couch 1/7-size Relays

Space/weight problem? The new Couch 2X 1/7-size crystal can relay gives you tremendous savings in space and weight. 0.1" grid — plus many outstanding specs — *all in micro-miniature*. Thoroughly field-proven in electronics and space applications.

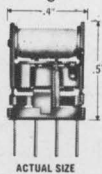

	2X (DPDT)	1X (SPDT)
Size	0.2" x 0.4" x 0.5"	same
Contacts	0.5 amp @ 30 VDC	same
Coil Operating Power	100 mw 150 mw	70 mw 100 mw
Coil Resistance	60 to 4000 ohms	125 to 4000 ohms
Temperature	-65°C to 125°C	same
Vibration	20 G	same
Shock	75 G	same

Broad choice of terminals, coil resistances, mounting styles. Write for detailed data sheets.

RUGGED ROTARY RELAYS  Dynamically and Statically Balanced

## COUCH ORDNANCE INC.

3 Arlington St., North Quincy, Mass. 02171, Area Code 617. CYPress 8-4147 • A subsidiary of S. H. COUCH COMPANY, INC.

ON READER-SERVICE CARD CIRCLE 186

## NEW LITERATURE



### Cash for concepts

Have any creative concepts about knobs now in use? A manufacturer is offering \$200 in cash for "ideas that turn us on." Develop new ideas for knobs or electronic panel components before January 31, 1968 and be rewarded for your efforts. Seven prizes will be awarded each month. First prizes are \$200 apiece, second prizes, \$50 and third prizes, \$5. The corporation sponsoring this contest is open to any new ideas. Kurz-Kasch.

CIRCLE NO. 359

### Solid state choppers

A 62-page catalog describing the manufacturer's line of 30 types of choppers has been made available. The chopper is a solidly encapsulated unit designed to alternately connect and disconnect a load from a signal source. It may also be used as a demodulator to convert an ac signal to dc. All units are of miniature design and have been utilized for military, industrial and research applications. Solid State Electronics Corp.

CIRCLE NO. 294

### Computer control cables

A brochure which facilitates specifying of complex computer control cables contains 12 pages of reference. Representative configurations and constructions for a variety of cables ranging from the simple concentric control cables to the completely isolated, low-loss circuits in multi-paired shielded cables are included. Two insulation systems are dealt with: one for use when circuit reliability, low dielectric constant and hot-spot operation up to 400° F is desired, and the other when low cost, less critical circuitry is involved. Gulton Industries, Inc.

CIRCLE NO. 419

### Semiconductor products

A 16-page catalog describes the industry's variety of semiconductor devices ranging from the largest commercially available transistor-rated at 250 A - to a line of low-cost plastic-case rectifiers. The 1968 condensed catalog includes specifications charts and dimensional diagrams for transistors, thyristors, and rectifiers. It also describes rectifier and thyristor assemblies for a wide range of circuit applications. Westinghouse Semiconductor Div.

CIRCLE NO. 319

### Coaxial switching systems

An 8 page brochure describing the characteristics, construction and application of manufacturer's vacuum coaxial switching systems has been published. A vacuum coaxial switching system is comprised of vacuum coaxial relays, and RF matrix control unit, and the fittings necessary to join the relays into flexible compact crossbar matrices. Several typical matrix systems are illustrated showing their modular construction adaptable to unlimited expansion without major modification or re-wiring. ITT Jennings.

CIRCLE NO. 318

### Plastic fabrication file

"The Shape of Things to Come" is a reference file for those who design or specify formed and fabricated plastics. The engineering data can be a helpful aid in designing formed and machined plastic parts. Commercial plastics & Supply Corp.

CIRCLE NO. 334

### Magnetic instrumentation

A brochure on a line of magnetic instrumentation designed for laboratory and production operations illustrates and describes the manufacturer's balanced magnetic bridge recording permameter. Included in the presentation is information on a magnetic stabilizer, magnechargers, both portable and table top, ac field demagnetizer, magnetic pole indicator, and a constant-current flux reset-test apparatus. Thomas & Skinner, Inc.

CIRCLE NO. 339



# 'BESTSELLER'



Recently published, this magnetic shielding manual has already become the leading reference book in the industry. It is a complete Stocking Guide for Netic and Co-Netic sheet stock and foil alloys. It also contains detailed specifications and general fabrication information assembled for the first time. It is a clear and concise selection of "what's available," "how to specify it" and "how to use it." In actual fact it isn't a "Bestseller" . . . but only because we don't sell it, it's free. For your copy of catalog No. SG-1 write:

## MAGNETIC SHIELD DIVISION

Perfection Mica Company  
1322 N. Elston Ave., Chicago, Illinois 60622

Also available: a complete line of magnetic shield product data sheets and catalogs on fabricated shields, tape preserver containers, and foil. They're yours for the asking.

ON READER-SERVICE CARD CIRCLE 187

# LEADERSHIP

BY

**Celco**

CONCEPT DESIGN DEVELOPMENT PRODUCTION



## FOCUS COILS

PRECISION MAGNETIC LENS

## CERTIFIED PERFORMANCE !!

- Astigmatic Ratio
- Spot Size Figure Of Merit
- Hysteresis
- Residual

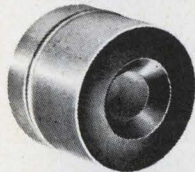

## DEFLECTRON II

PRECISION HIGH RESOLUTION

## CERTIFIED PERFORMANCE !!

- Spot Growth
- Spot Size Figure Of Merit
- Astigmatic Ratio
- Pre-Alignment

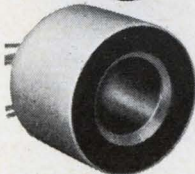

## PRODUCTION YOKES

USED ON  
RADAR-JAMMING DEVICE

## PRICE SLASH !!

- Short Lead Time
- Fast Production Delivery
- Low Cost With Quality

For All Your Display Problems, Call 201-327-1123

Upland, Cal. *Constantine Engineering Laboratories Company* Mahwah, N.J.

ON READER-SERVICE CARD CIRCLE 188



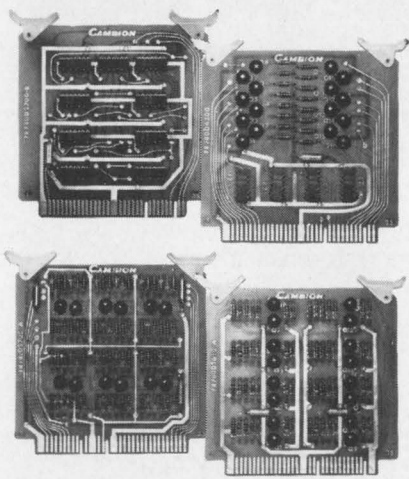

## You've got it made with Cambion<sup>®</sup> Logic Assemblies

Difficult digital application? Noisy environment? Need high speed or a large variety of functions? Ask for CAMBION DTL, TTL or HTL logic assemblies. CAMBION gives you more functions per card and all cards are compatible.

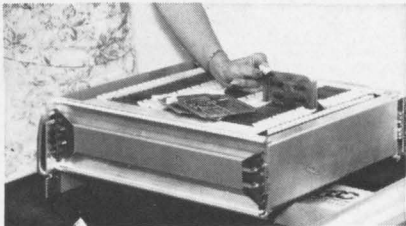

Choose from over 200 assemblies with high package densities and 70-pin input/output capability. That's twice the number of any competitor, and CAMBION assures you the **lowest cost per function**. The complete line includes power supplies, card files, drawers . . . available off the shelf, in the widest variety.

For more information on CAMBION's IC assemblies, contact: Cambridge Thermionic Corporation, Digital Products Division, 433 Concord Avenue, Cambridge, Massachusetts 02138. Phone: (617) 491-5400.

REG. U.S. PAT. OFF.

**CAMBION**<sup>®</sup>

Standardize on CAMBION . . .  
21,541 guaranteed electronic components

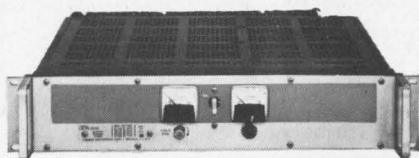

ON READER-SERVICE CARD CIRCLE 189

## NEW LITERATURE



### Transducer technology

To assist the prospective user in his selection of the thin-film transducer best suited to his particular needs, the manufacturer has produced a package—"thin film strain gauge pressure transducers." It contains a description of each transducer, with respect to individual characteristics, features of particular interest, suggestions for general and special purpose applications, and detailed specifications. Statham Instruments, Inc.

CIRCLE NO. 298

### IC brochure

A 28-page catalog describes the manufacturer's 930 series DTL ICs. Flip-flops, gate expanders, multiple gates, dual buffers, ac binary circuits, and monostable multivibrators are discussed. The multiple-gate circuits include dual 4-input, NAND/NOR gates, dual 4-input power gates, triple-input NAND/NOR gates, and quad 2 input NAND/NOR gates. Tabulated electrical characteristics plus logic diagrams and circuit schematics, are presented for the various units. Test circuits and waveforms are also given. Raytheon Co.

CIRCLE NO. 355

### Film-insulated wire

A 16-page illustrated reference that describes and compares film-insulated copper-magnet wire in sizes, 20-44 AWG summarizes various magnet-wire insulations. The bulletin contains a breakdown of dimensional data with the characteristics of synthetic film-coatings and of plain enamel. Information regarding AVC adhesive coated self-bonding wire and a list of film-coatings available from the manufacturer is also included. The bulletin concludes with an index of magnet-wire trade names. Hudson Wire Co.

CIRCLE NO. 416

# HYSTERESIS CLUTCHES HYSTERESIS BRAKES

## MAGTROL TORQUE CONTROL DEVICES

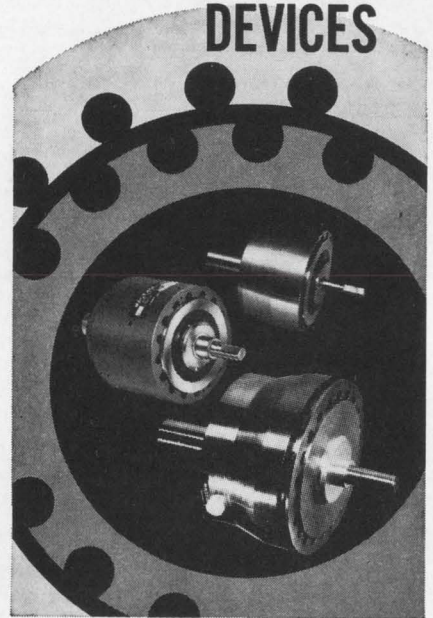

- absolute precision
- infinite variability, infinite repeatability
- longest life
- from 2 oz. inches to 100 inch lbs.

Write or phone for 20-page reference booklet containing hysteresis principles and applications, unit specifications and performance charts. Ask for booklet HCB.



**MAGTROL** INC.  
240 SENECA ST. • BUFFALO, N. Y. 14204  
716 — 856-7451

ON READER-SERVICE CARD CIRCLE 190

ELECTRONIC DESIGN 23, November 8, 1967



## Components catalog

Products of 86 electronics manufacturers are featured in an illustrated brochure that has just been released. Items ranging from acrylic sprays to wrenches, produced by companies ranging alphabetically from Acme to X-Acto, fill the 328-page catalog. Included in the presentation are features designed to make it versatile; for example, a military standards MIL Specs Guide, MIL/EIA Standard Resistance Value Table and quick reference Capacitor and Resistor Code Data Chart, and Industrial Tube Cross Reference are featured. Presented also is an index which lists products by manufacturers as well as by product. Electronic Publishing Company, Inc.

CIRCLE NO. 348

## Gas-laser catalog

A brochure featuring gas lasers and accessories is available. The argon-ion laser is described with specifications for both the laser and the exciter. The Model 140 is designed for applications requiring high-power, blue-green light. It has a minimum of 2-W power output, and individual wave lengths can be selected. Specifications are listed for stabilite lasers, and the following representative applications are illustrated: raman spectroscopy, heterodyne detection, holography, medical research, signal processing, optical alignment, communication research, spatial filtering, atmospheric studies, and geodetic measurement. Accessories such as a power meter and a cavity extension are also discussed. Spectra-Physics.

CIRCLE NO. 417

## Dual 25-bit shift register

This brochure describes National Semiconductor's MM400, a dual 25-bit shift register. Built on a single chip, it uses a 10-V supply voltage and a -160-V clock voltage. Power consumption is 1.2 mW/bit at 1 MHz, and the high-frequency operation is 1 MHz. Applications range from ground systems to airborne computers. The four-page brochure includes a description of the device, all pertinent specifications, and application suggestions. National Semiconductor Corp.

CIRCLE NO. 418

# We've got good connections in high places



Surveyor, Mariner, F-111, OGO, X-15, Apollo, LEM, and most other high flying programs rely on Cinch-Graphik printed circuitry for dependable electronic interconnections. The lunar surface, or 6000 miles above Mars, isn't the place to find out that circuitry doesn't perform to specs. That's why Cinch-Graphik maintains complete in-house facilities for NASA and MIL Spec testing. Cinch-Graphik's unequalled competence in producing single and multilayer printed circuits to these stringent requirements uniquely qualifies them to produce circuits for applications where "it has to be right."

## CINCH-GRAFIK

DIVISION OF UNITED-CARR



200 South Turnbull Canyon Road, City of Industry (Los Angeles), Calif. 91744 • Phone (213) ED 3-1201. Sales offices in 33 principal cities throughout the United States, Great Britain, Canada, Australia and West Germany.

CONSISTING OF CINCH MANUFACTURING COMPANY, CINCH-GRAFIK, CINCH-MONADNOCK, CINCH-NULINE, UCINITE (ELECTRONICS) AND PLAXIAL CABLE DEPT.

ON READER-SERVICE CARD CIRCLE 191



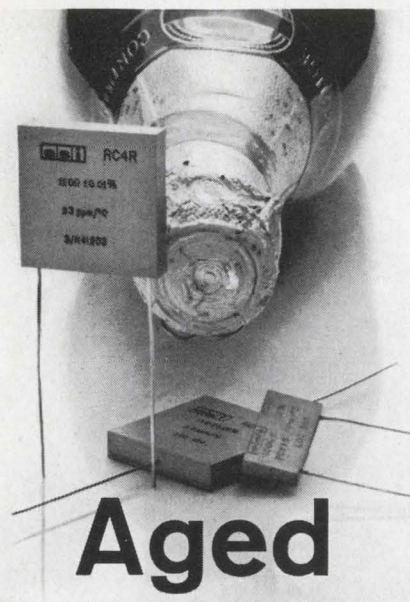

# Aged

Our precision resistors are aged to improve reliability, and we guard the process like a vintage champagne maker. Ageing is just one of many extra steps that make our precision components the most reliable you can specify. A few of our components are described briefly below.

### 1. Precision Wire-Wound Card Resistors

Consider ESI resistors whenever small changes in the resistive element can affect the performance of the final assembly. Initial accuracy to  $\pm 0.0015\%$ . Yearly stability to  $\pm 10$  ppm.

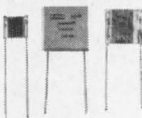

### 2. Dekastat® Decade Resistors

Designed for use with dc and at audio frequencies, these multi-decade resistors feature an accuracy of  $\pm 0.02\%$ . All units carry a two-year guarantee.

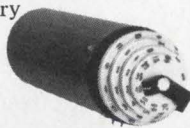

### 3. Dekapot® Resistive Voltage Dividers

These rapid-setting potentiometers have a terminal linearity up to 0.002%. Kelvin-Varley circuitry provides constant input impedance.

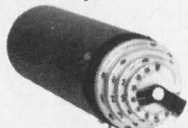

### 4. Dekatran Transformer Voltage Divider

The patented coaxial dial is easy to read and adjust. Accuracy of 0.001% and long-term stability are achieved through gapless toroidal cores of very high permeability.



**esi**

Electro Scientific Industries, Inc.  
13900 NW Science Park Drive  
Portland, Oregon 97229

ON READER-SERVICE CARD CIRCLE 192

## NEW LITERATURE

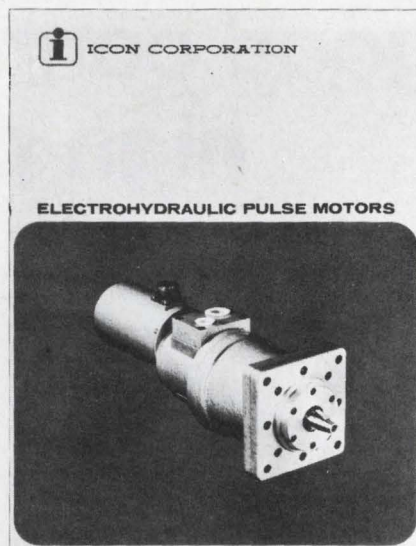

### Electrohydraulic motors

The presentation concerns itself with electrohydraulic pulse motors and their use as actuators for direct digital positioning. The 50-page catalog supplies details on principles of operation, specifications, torque speed curves and dimensions of electrohydraulic motors. Also included is a theoretical appendix which describes the static and dynamic characteristics and driving methods of electrohydraulic motors in detail. Icon Corp.

CIRCLE NO. 436

### Digital products catalog

Included in this issue is a complete listing of brush-type shaft encoders. Also listed are solid-state digital-to-synchro and digital-to-resolver converters. Also manufactured is a line of two-speed solid-state converters, digital servos and synchro-to-digital electro-mechanical and solid-state converters. Special configuration brush-type shaft encoders to meet customer requirements are also available. Vernitron Corp.

CIRCLE NO. 437

### Cryogenic catalog

An 8-page brochure illustrates standard cryogenic installations utilizing the manufacturer's heat transfer panels. The catalog includes applications as used in aerospace simulators, vacuum traps, and freeze-drying panels. A section includes physical property tables of stainless steel. Dean Products.

CIRCLE NO. 336

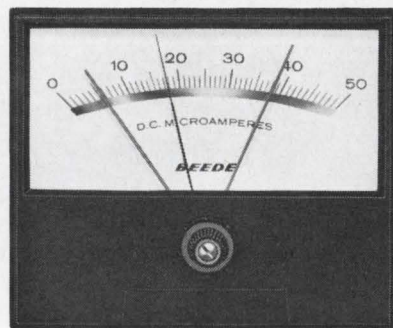
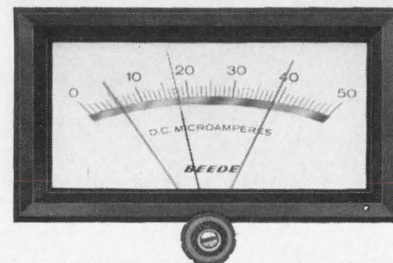

### ... AND GET PREMIUM PERFORMANCE WITH BEEDE'S NEW NON-CONTACTING CONTROL METER RELAY

Beede has greatly simplified the design of the optical meter relay, significantly reducing the number of parts incorporated in the unit.

In addition to the substantial price savings, this development provides the increased accuracy of direct drive set pointers and a control meter relay with high reliability.

#### Some of the features available:

- Single or Double Set Point
- Taut Band Meter Sensitivities
- Front or Behind Panel Mounting
- High Style "Centurion" Case Design
- Complete Package Switching 5 amps or Optical Element Only

Send for complete literature today.

### BUY VALUE / BUY BEEDE



ON READER-SERVICE CARD CIRCLE 193



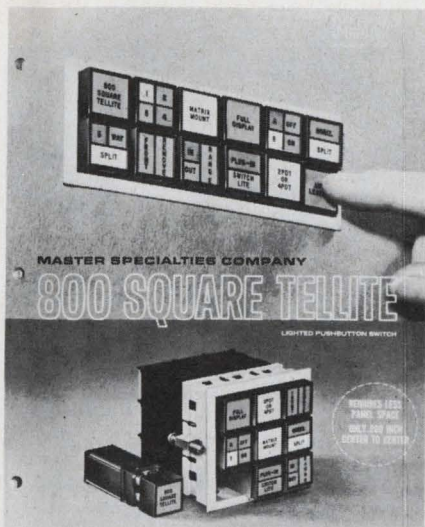

### Pushbutton switch series

A 14-page catalog which details the 800-square tellite-lighted pushbutton-switch series is available. The series features 4-lamp operation and up to 4-way split display configurations in units small enough to mount on 0.8 in. centers. The 800 series deals with pre-assembled matrix mounting racks, crimp-type wiring to integral terminal blocks in the racks, and plug-in switch lite or indicator-lite units. Master Specialties Co. **CIRCLE NO. 296**

### Silicone applications

A 20-page guide to silicones covers all commercially important applications of these materials. A two-page table lists the uses of these and related materials in 17 major industries. Included in the table and in the text is information on silicone fluids; dispersions and emulsions; lubricants and grease-like rubbers; rubbery sealants and adhesives; resins; and reactive organosilicon compounds. Dow Corning. **CIRCLE NO. 297**

### Reprints Available

The following reprints are available free and in limited quantities. To obtain single copies, circle the number of the article you want on the Reader-Service card.

*Planning to Use MOS Arrays?* (No. 433)

*It's What's Up Front That Counts* (No. 434)

*IC's End the 'Driver Gap'* (No. 435)

## KEITHLEY UNWRAPS *FIRST* MOS FET ALL SOLID-STATE ELECTROMETER



### *New Model 602 eliminates the need for frequent zero adjustment*

Using Mos Fets at the input, this new Keithley solid state electrometer measures voltage, current, resistance and charge over 73 ranges. It is so stable the only discernible drift is with temperature. And only at a rate less than  $150 \mu\text{v}/^\circ\text{C}$ .

The 602 exhibits minimum zero shift from shock, vibration or voltage overloads up to 500 volts. Battery-operated, this versatile giant operates up to 1500 volts off ground and has battery life of 1000 hours, even when recording! Fast warm-up time, low  $5 \times 10^{-15}$  ampere offset current and freedom from microphonics make it truly unique!

Call your Keithley man for our technical engineering note. Ask for a free in-plant demonstration, too.

#### **Model 602**

- 1 mv f.s. to 10v, with  $10^{14}$  ohms input resistance
- 100 ohms f.s. to  $10^{13}$  ohms
- $10^{-13}$  to  $10^{-6}$  coulomb
- $10^{-14}$  ampere f.s. to 0.3 amp.
- 500-volt overload protection

\$675, with input leads



**KEITHLEY  
INSTRUMENTS**

28775 Aurora Road • Cleveland, Ohio 44139  
EUROPE: 14 Ave. Villardin, 1009 Pully, Suisse

ON READER-SERVICE CARD CIRCLE 194



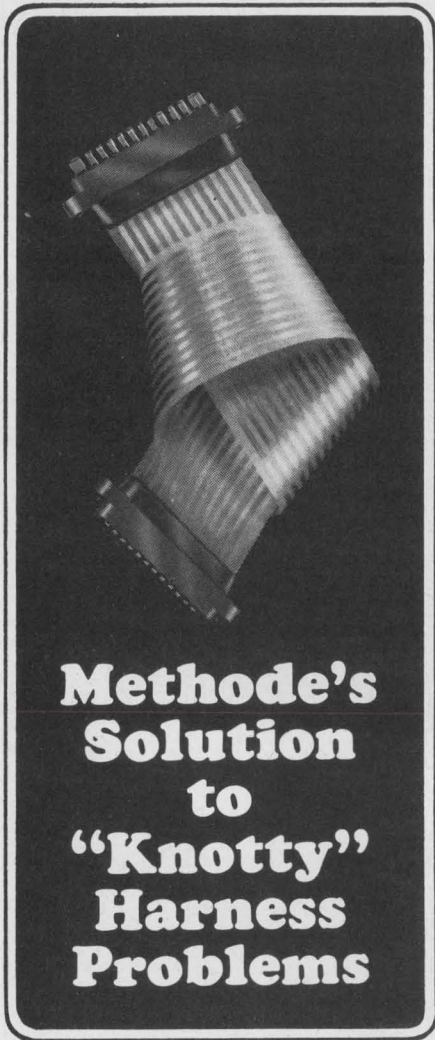

## Methode's Solution to "Knotty" Harness Problems

Methode's unique Plycon harnesses can solve many of your design problems quickly, efficiently!

Available in both straight jumper and extensible styles, Plycon harnesses are ideal for use in drawers or racks or as jumpers between points on a chassis.

Plycon harnesses are a combination of two superior products: long-life Plyo-Duct multi-conductor wiring systems and Reli-Acon connectors.

Through an unusual Methode design, Plyo-Duct has memory characteristics, so that extensible harnesses will extend, then always retract to their original position.

Reliable male or female Reli-Acon connectors are available in a variety of standard sizes and number of contacts to meet your design requirements.

Both single and twin-layer harnesses with from 6 to 48 conductors, and any combination of connector style and number of contacts are available.

Write today for a new, fully-illustrated catalog with complete engineering data.



Connector Division  
**Methode Electronics, Inc.**  
 7447 W. Wilson Ave. Chicago, Ill. 60656  
 312/867-9600

ON READER-SERVICE CARD CIRCLE 195

## Solution to case problem on page 101.

The set-up labor cost is plotted against the activity measure, standard hours produced, as in Fig. 3. The plotted points could be described by a straight line, but such a line—mathematically fitted—would result in the meaningless conclusion that "negative" costs would be incurred prior to zero activity. When we apply our knowledge of how a plant and a winding department are operated, we realize that we have here an indirect labor cost that should have a step relationship to activity. The plotted points can be so described and the result is this tabulation:

### Monthly cost of set-up labor

Std. hrs. produced	\$ of cost
2750-3750	= \$1500
3751-4750	= 2000
4751-5750	= 2500
5751-6750	= 3000

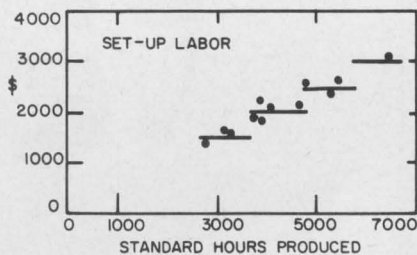

Figure 3

The data for the cost of operating supplies are plotted against the activity measure, standard hours produced, as in Fig. 4.

The plotted points can be described by a straight line and when calculated by the Method of Least Squares, you find that the line of best fit intersects the ordinate at a level greater than zero. Thus the data indicate a fixed increment and a variable increment that increases as activity rises. This is a linear mixed cost that can be formulated as:

$$\text{Monthly cost of operating supplies} = \$246 + \$0.088 \text{ std. hrs. produced}$$

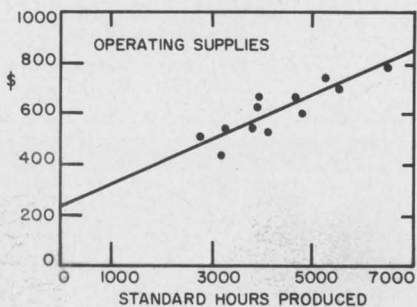

Figure 4



## COMPLETELY TRANSISTORIZED OSCILLATOR . . . AS LOW AS \$160.00

- Available for OEM use with or without Power supply and housing.
- Range from 5 Hz to 500 kHz in 5 bands.  Infinite frequency resolution.
- Ideal for Laboratory use.  Write or call today for details on Series 380.



ENGINEERING LABORATORIES, INC.  
 1233 North Ave., Plainfield, N. J. 07062  
 Telephone Area Code: (201) 755-7080

- IMPEDANCE — ADMITTANCE METERS
- PHASE METERS
- TRANSFER FUNCTION COMPUTERS
- INSTRUMENT TRANSFORMERS
- OSCILLATORS
- COMPLETE INSTRUMENTATION SYSTEMS.

ON READER-SERVICE CARD CIRCLE 196

- \*By interviewing the top integrated circuit designers in the country.
- \*By attending conferences devoted or related to micro-electronics.
- \*By developing and editing state-of-the-art articles covering the latest design techniques.
- \*By writing extensively about the subject.
- \*By working for Electronic Design... the magazine that makes it their business to know.

Good salary, excellent benefits, pleasant atmosphere, and association with top professional engineer-writers are yours. Interested? Write or call Robert Haavind, managing Editor, Electronic Design, 850 Third Avenue, New York, New York 10022 (212) PL-1-5530.



## Advertising Representatives

### New York 10022

Robert W. Gascoigne  
Thomas P. Barth  
Samuel M. Deitch  
Byron Adams  
850 Third Avenue  
(212) PLaza 1-5530  
TWX: 867-7866

### Philadelphia 19066

William C. Repetto  
P.O. Box 206  
Merion Station, Pa. 19066  
(215) MO 4-1073

### Marblehead 01945

Richard Parker  
7 Redstone Lane  
Marblehead, Mass. 10945  
(617) 742-0252

### Chicago 60611

Thomas P. Kavooras  
Berry Conner, Jr.  
720 N. Michigan  
(312) 337-0588

### Cleveland 44107

(216) 247-7670

### Los Angeles 90303

Stanley I. Ehrenclou  
Terrence D. Buckley  
W. James Bischof  
2930 W. Imperial Highway  
Inglewood, Calif.  
(213) 757-0183

### San Francisco

Ashley P. Hartman  
175 South San Antonio Rd.  
Ste. 243  
Los Altos, Calif. 94022  
(414) 941-3084

### Southwestern 75206

Tommy L. Wilson  
6200 North Central Express-  
way  
Dallas, Tex.  
(214) EMerson 1-2311

### London W. 1

Brayton C. Nichols  
44 Conduit Street

### Verviers, Belgium

Andre Jamar  
1, Rue Mallar, 1  
(087) 253.85

### Tokyo

Yoshihiro Takemura  
International Planning  
Service, Inc.  
Room 231 Tokyu-Mita Bldg.  
1, Shiba-Mita, Koun-cho  
Minato-ku, Tokyo



**TRANSFORM**, *v. t.* To change the shape or appearance. 2. To change one thing into another. 3. In the natural disposition and the change of elements, the blood and blood of Christ, to change the content of a substance, by which it is the divine nature.—6. To be changed in form; to metamorphose.

**TRANSFORMED**, *pp.* Changed in form; metamorphosed.

**TRANSFORMING**, *v. i.* To pass from one form into another.

**TRANSFORMATIVE**, *a.* 1. Having the power of passing from one form into another. 2. In grammar, a transitive verb is one which is or may be followed by an object.

**TRANSITION**, *n.* [L. *transitio*.] 1. Passage from one place or state to another; change.—2. In rhetoric, a passing from one subject to another.—3. In music, a change of key from major to minor, or the contrary.—*Transition rocks*, in geology, rocks supposed to have been formed when the world was passing from an uninhabitable to a habitable state.

**TRANSITIONAL**, *a.* Pertaining to transition. *Christian Spectator*.

**TRANSITIVE**, *a.* 1. Having the power of passing from one object to another. 2. In grammar, a transitive verb is one which is or may be followed by an object.

**Mr. Webster didn't have a word for it...  
but we do!**

Three authoritative dictionaries for today's technologies:

**Radio-Television-Electronics Dictionary.** National Radio Institute Staff. Over 5000 terms. 168 pages. #0307, paperbound, \$3.50

**Missile Technology Abbreviations & Acronyms.** Arthur T. Cartier. 8000 entries and 12,000 definitions. 130 pages. #5539, paperbound, \$3.95; #5540, clothbound, \$5.95

**Data Transmission & Data Processing Dictionary.** James F. Holmes. More than 3000 terms. 103 pages. #0396, paperbound, \$2.50

**SPECIAL 30-DAY EXAMINATION OFFER!**  
**Dept. ED-4, HAYDEN BOOK COMPANY, INC.**  
116 West 14th Street, New York, N.Y. 10011

Send me the book(s) checked below and bill me. At the end of 30 days I will either remit payment plus a few cents postage or return the book(s).

#0307    #5539    #5540    #0396    Free 1966 Catalog

Name \_\_\_\_\_  
Street \_\_\_\_\_  
City \_\_\_\_\_ State \_\_\_\_\_ Zip \_\_\_\_\_

You pay postage. I enclose payment of \$..... Same return privileges.



# Advertisers' Index

Advertiser	Page
ACDC Electronics, Inc.	161
Acopian Corp.	62
Adams & Westlake Company, The	143
Albion Optical Company	95
Alco Electronic Products, Inc.	197
Allen-Bradley Co.	6
Allied Electronics, a Subsidiary of Allied Radio	206
Allied Systems Corp.	94
American Zettler, Inc.	160
Ametek/Hunter Spring	198
Amperite	196
Amphenol Corporation	36, 37
Arnold Engineering Company, The	49
Arvin Frequency Devices	201
Augat, Inc.	176
Automatic Electric, A Subsidiary of General Telephone & Electronics	141
Babcock Relays, Division of Babcock Electronics Corporation	137
Beckman Instruments, Inc., Helipot Division	133
Beede Electrical Instrument Co., Inc.	216
Belden Corporation	82, 83
Birtcher Corporation, The	144
Bodine Electric Company	193
Bolt Beranek and Newman, Inc.-Data Equipment Division	148
Booker and Wallestad	194
Borden Chemical Co., The Mystic Tape Division	15
Bourns, Inc.	203
Brand Rex, Division of American Enka Corporation	171
Bulova Electronics Division of Bulova Watch Company	206
Burdny Corporation	147
Burr-Brown Research Corporation	53
By-Buk Company	222
CML, Inc.	194
CTS Corporation	113
Cambridge Thermionic Corporation	214
CELCO Constantine Engineering Laboratories Co.	213
Centralab, the Electronics Division of Globe-Union, Inc.	47
Chicago Switch Division, F & F Enterprises, Inc.	174
Cinch-Graphik, Division of United- Carr	215
Clairex Electronics, Inc.	180
Clare & Co., C.P.	63
Components, Inc., Semcor Division	211
Conelco Components	142
Consolidated Avionics, A Division of Condec Corporation	173
Consolidated Electrodynamics, A Subsidiary of Bell & Howell	52
Coors Porcelain Co.	121
Corning Electronics, Division of Corning Glass Works	169
Couch Ordnance, Inc.	212
Coto Coil Company, Inc.	205
Cross Company, H.	119
Curtis Development & Mfg. Co.	190
Cutler-Hammer	40, 41, 55
Dale Electronics, Inc.	197
Damon Engineering, Inc.	23
Datapulse, Incorporated	2
Datex Division/Conrac Corporation	158
Deringer Metallurgical Corp.	191

Advertiser	Page
Deutsch Electronic Components Division	139
Digital Equipment Corporation	51
Digital Sensors, Inc.	202
Dranetz Engineering Laboratories, Inc.	218
Duncan Electronics, Inc.	20, 21
Dzus Fastener Co., Inc.	223
ESI/Electro Scientific Industries, Inc.	216
Eagle Signal, A Division E. W. Bliss Company	128
Electro/Data, Inc.	130
Electronic Controls, Incorporated	159
Electronic Research Associates, Inc.	46
Electrovert, Inc.	190
Ellis & Watts Company	182
Erie Technological Products, Inc.	9
Fairchild Instrumentation, A Division of Fairchild Camera and Instrument Corporation	43
Gardner-Denver Company	154
General Cable Corporation	135
General Electric Company	28, 177
General Precision Systems, Inc. Kearfott Division	136
General Radio Company	117
Gudebrod Bros. Silk Co., Inc.	32, 33
Guardian Electric Manufacturing Company	60
H P Associates	Cover III
Hankcraft Company	188
Harowe Servo Controls, Inc.	54
Hayden Book Company, Inc.	219, 222
Hewlett-Packard	1, 7, 111, 164
Honeywell, Computer Control Division	27
Hopkins Engineering Company	162
Hughes Aircraft Company	31
IBM Industrial Products	44, 45
IMC Magnetics Corporation	172
ITT Integrated Circuits	224
ITT Jennings, a subsidiary of Inter- national Telephone and Telegraph Corporation	61
International Electronic Research Corporation	167
JFD Electronics Co./Components Division	205
Johanson Manufacturing Corp.	138
Keithley Instruments	217
Kepeco, Inc.	186
Kester Solder Company	56, 57
Kistler Instrument Corporation	223
Krohn-Hite Corporation	209
LFE Electronics, Division of Laboratory of Electronics, Inc.	140
Lafayette Radio Electronics	198
Lambda Electronics Corp.	179
Leach Corporation	199
Lenox Fugle Electronics, Inc.	108
Line Electric Company	193
Little Falls Alloys, Inc.	166
Litton Industries, Winchester Division	34, 35
Litton Industries, Encoder Division	165
Lundy Associates, Inc.	197
Mac Panel Company	201
Magnetics, Inc.	187
Magtrol, Inc.	214
Melabs, Inc.	183
Metex Corporation	205
Method Electronics, Inc.	218
Microtran Company, Inc.	134
Microwave Expositions, Inc.	207

Advertiser	Page
Motorola Semiconductor Products, Inc.	8
National Semiconductor Corporation	4, 5
Notronics Company, Inc.	200
Ohmite Manufacturing Company	145
PEK Labs, Inc.	168
Pamotor, Inc.	50
Perfection Mica Company	213
Perkin Elmer Corporation	48
Phelps Dodge Electronic Products	152
Plastic Capacitors, Inc.	178
Princeton Applied Research Corp.	16
Pyrofilm Resistor Co., Inc.	156
RCA Electronic Components and Devices	88, 89, 109, 181, Cover IV
Raytheon Computer Raytheon Company, Semiconductor Operation	124 135
Reeves Hoffman Division of DCA	176
Scientific Atlanta, Inc.	127
Signalite, Incorporated	184
Signetics Integrated Circuits, A Sub- sidiary of Corning Glass Works	195
Siliconix Incorporated	155, 210
Simpson Electric Company	76, 77
Singer Metrics, The Singer Manufacturing Company	115
Solid State Electronics Corporation	223
Soliton Devices, Inc.	157
Sperry Rand Corporation, Microwave Components	129, 131
Sprague Electric Company	10, 12
Sweet's Industrial Information System	123
Switchcraft, Inc.	175
Sylvania Electric Products, Inc.	39
Syntronic Instruments, Inc.	180
TRW Capacitor Division, TRW, Inc.	64
Tektronix, Inc., Oscilloscopes	66
Telonic Engineering Co.	58
Tenney Engineering, Inc.	193
Texas Instruments Incorporated, Components Group	72, 73
Transistor Electronics Corporation	208
Tung Sol Division, Wagner Electric Corporation	221
Unholtz-Dickie Corp.	208
Union Carbide Corporation	19
United Transformer Co., Division of TRW, Inc.	Cover II
U.S. Capacitor Corporation	204
U.S. Components, Inc.	149
Unitrode Corporation	59
Varian Associates	151, 163
Varian Data Machines, A Varian Subsidiary	146
Varo, Inc.	192
Velonex, A Division of Pulse Engineering Inc.	189
Waldom Electronics, Inc.	150
Warlock Systems, Inc.	201
Waters Manufacturing, Inc.	132
Weckesser Company, Inc.	222
Weston Instruments, Inc.	153
White Instrument Laboratories Incorporated	188
Wood Electric Corporation	174
Career Advertising: Boeing Company, The	102
Delco Radio Division, General Motors	105
Lear Siegler, Inc.	108
Lockheed Aircraft Company	107
Univac Federal Systems Division	106



# TUNG-SOL 28 GP SERIES POWER SUPPLIES

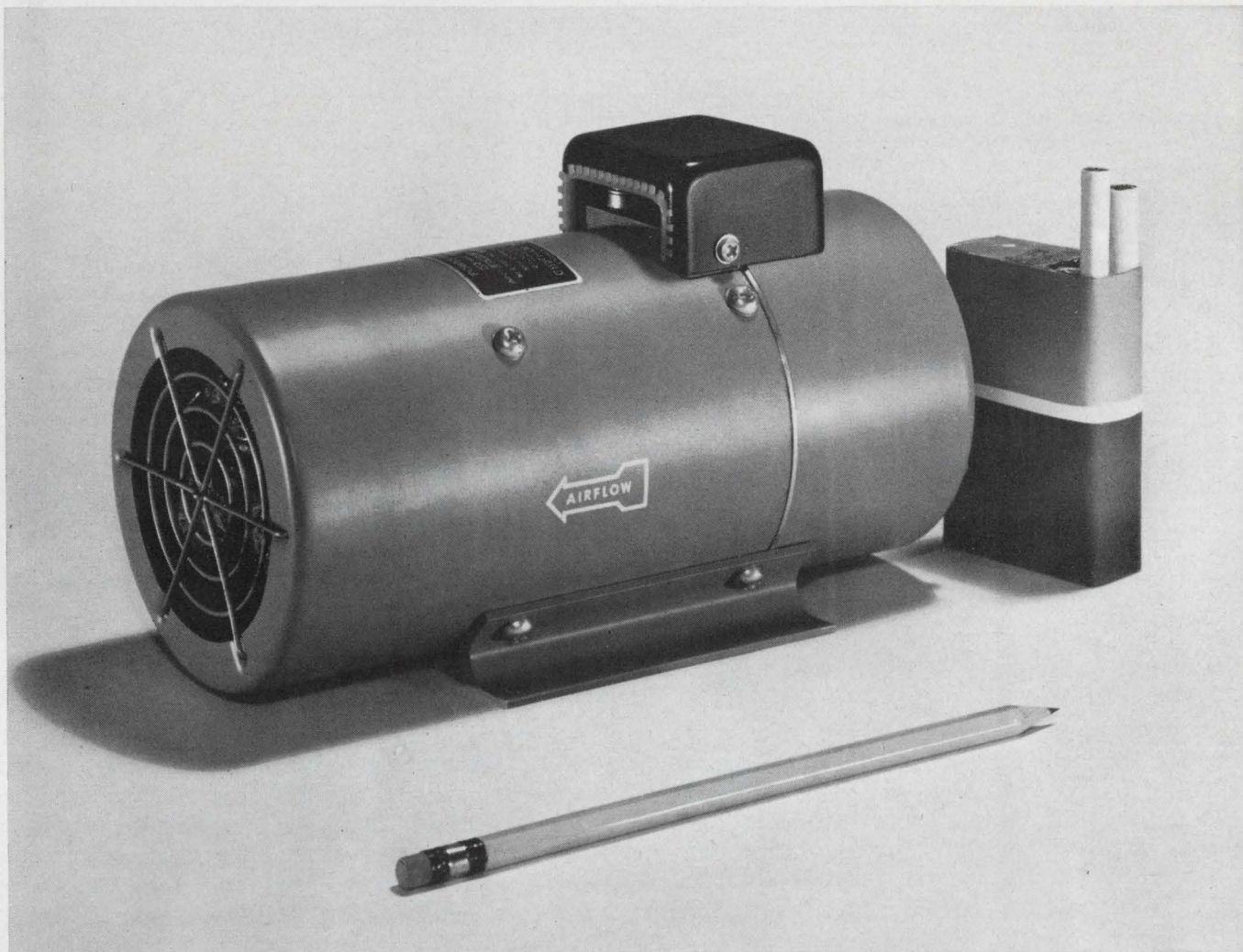

## up to 400 AMPS. D.C. in new weight-saving package

A tremendous break-through was achieved in space and weight reduction of air-borne power supplies when the Tung-Sol Y-series configuration was first developed. Now, this unique design has been adapted to the requirements of ground-based equipment, to provide the same advantages for applications in the 100 amp. to 400 amp. range.

The Tung-Sol 28 GP series consists of four standard units that supply 100, 200, 300 or 400 amps. at 28 volts D.C. from an input of 115 volts, three phase, 400 c.p.s. They are production items available on an off-the-shelf basis. All units embody high-performance characteristics. They have high environmental adaptability and are especially suited to seaborne installations. Important, also, is the fact that they can be mounted in any attitude. For air transportable equipment, the weight factor is an exceptional advantage.

<p><b>28 GP 100</b></p> <p>Output: 100 Amps. Size: 8½" L x 4" W x 5⅝" H Weight: 7.5 lbs.</p>	<p><b>28 GP 300</b></p> <p>Output: 300 Amps. Size: 10½" L x 6" W x 7½" H Weight: 19 lbs.</p>
<p><b>28 GP 200</b></p> <p>Output: 200 Amps. Size: 10½" L x 5" W x 6⅝" H Weight: 13 lbs.</p>	<p><b>28 GP 400</b></p> <p>Output: 400 Amps. Size: 13" L x 6" W x 7½" H Weight: 26 lbs.</p>

For full technical information write for Bulletin.

**TUNG-SOL DIVISION**  
**Wagner Electric Corporation**

630 West Mt. Pleasant Ave. • Livingston, N.J. 07039

ON READER-SERVICE CARD CIRCLE 197



ELECTRONIC DESIGN'S function is:

- To aid progress in the electronics manufacturing industry by promoting good design.
- To give the electronic design engineer concepts and ideas that make his job easier and more productive.
- To provide a central source of timely electronics information.
- To promote two-way communication between manufacturer and engineer.

**Want a subscription?** ELECTRONIC DESIGN is sent free to qualified engineers and engineering managers doing design work, supervising design or setting standards in the United States and Western Europe. For a free subscription, use the postfree application form inside the back cover. If none is included, write to us direct for an application form.

If you do not qualify, you may take out a paid subscription for \$25 a year in the U.S.A., \$35 a year elsewhere. Single copies are \$1.50 each.

**If you change your address,** send us an old mailing label and your new address; there is generally a prepaid postcard for this inside the back cover. You will have to requalify to continue receiving ELECTRONIC DESIGN free.

**The accuracy policy** of ELECTRONIC DESIGN is:

- To make reasonable efforts to ensure the accuracy of editorial matter.
- To publish prompt corrections whenever inaccuracies are brought to our attention. Corrections appear at the end of the Letters column.
- To refuse any advertisement deemed to be misleading or fraudulent.

**Microfilm copies** are available of complete issues of ELECTRONIC DESIGN and individual articles, published since the beginning of 1961. Complete issues cost 4¢ a page, articles cost 50¢ a page; shipping and handling charges are extra. The minimum charge is \$3. For further details and to place orders, contact University Microfilms, Inc., 300 N. Zeeb Road, Ann Arbor, Mich. 48106; telephone (313) 761-4700.

**Want to contact us?** If you have any comments or wish to submit a manuscript or article outline, address your correspondence to:

Howard Bierman, Editor,  
ELECTRONIC DESIGN,  
850 Third Avenue,  
New York, N.Y. 10022.

## New "Tape Lift" Printed Circuit Drafting Aids

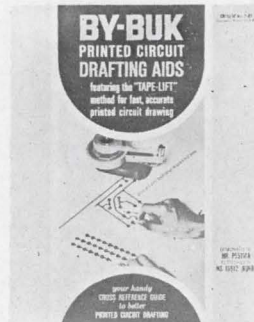

No engineer or draftsman should be without the most up-to-date cross-reference guide to better Printed Circuit Drafting Catalog. It is complete with prices and illustrations of over 1200 sizes of "Tape Lift" pads, shapes and other aids for faster, more accurate, distortion-free printed circuit master drawings. Write for FREE catalog.

**By-Buk Company**

4326 West Pico Blvd., Los Angeles, Calif. 90019  
Telephone: (213) 937-3511

# 174

## Self-Aligning Molded Nylon Clamps



These new cable clamps have self-aligning molded-in ribs that prevent slipping during installation. They hold their circular shape superbly, and cost considerably less than conventional clamps of the same size. New bulletin gives full details.

**Weckesser Company, Inc.**

4444 West Irving Park Road  
Chicago, Illinois 60641

# 175

## ELECTRONIC DESIGN TECHNIQUES

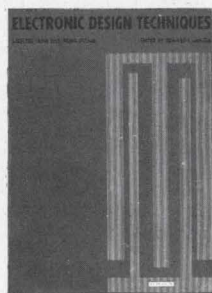

In this outstanding reference book, leaders in electronic design demonstrate for your immediate use new ideas and proven techniques that have solved difficult problems for themselves and their firms. Over 55 practical design studies selected from **Electronic Design** are presented. Vital sections of the book cover the use and design aspects of amplifiers, resistor networks, filters, control devices, power supplies, microwave systems, oscillators, and pulse and switching currents. Edited by Edward E. Grazda. Just published. 312 pages. 352 Illustrations. Large format, 8 1/2 x 11. \$12.75, clothbound. Examine for 15 days without obligation or ask for details.

**HAYDEN BOOK COMPANY, INC.**

116 W. 14 St.  
New York, N.Y. 10011

# 176



# Manufacturers

Advertisements of booklets, brochures, catalogs and data sheets. To order use Reader-ServiceCard. (Advertisement)

## New Force Links for Tensile Testing

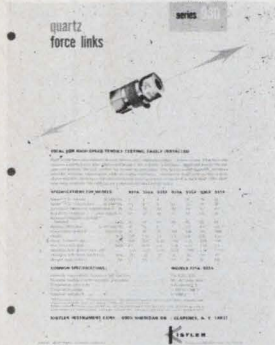

Bulletin 233-5/67 describes Series 930 quartz force links ideal for high speed measurement of dynamic tension and compression forces. Illustrated is the rigid factory-sealed assembly of a quartz load washer between two end nuts which minimizes precision mounting requirements while increasing installation convenience. Specifications are given for seven models with tension ranges to 25,000 lbs. and compression ranges to 45,000 lbs.

### Kistler Instrument Corporation

8969 Sheridan Drive  
Clarence, N. Y. 14031

177

## NEW SOLID STATE TELEMETERING CATALOG

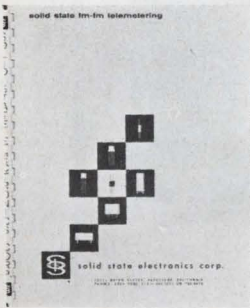

New 48 page catalog describes solid state telemeter modules including Freqmeters, Freqmeters Relays, Oscillators (Crystal, Tuning Fork, LC), DC Amplifiers, Mixers, Phase Detectors, Voltage-to-frequency Converters, DC Signal Isolators, Analog-To-Digital Converters, Pressure Transducers, FM Discriminators, and microminiature telemeter systems.

Data provides complete description of products. Includes electronic, mechanical-application data. Units are designed for aerospace, military and Industrial applications.

**Solid State Electronics Corporation**  
15321 Rayen St., Sepulveda, Cal. 91343  
(213) 894-2271

178

## Quality Fasteners For All Design Applications



This 8-page catalog provides design data on the complete group of DZUS 1/4-turn self-locking fasteners for standard, high speed and panel applications, as well as universal high strength multiple thread fasteners for high tensile and shear stresses. Dzus stud assemblies, wire forms and receptacles offer an exceptional, wide variety of combinations from stock to fit specific fastening requirements. Diagrams and tables give full details for rapid, unlimited design selection. Condensed Catalog No. S-2 or comprehensive Catalog No. D-3 are available on request.

### Dzus Fastener Co., Inc.

Division 32  
425 Union Boulevard  
West Islip, L. I., N. Y. 11795

179

# Designer's Datebook

NOVEMBER						
S	M	T	W	T	F	S
		1	2	3	4	
5	6	7	8	9	10	11
12	13	14	15	16	17	18
19	20	21	22	23	24	25
26	27	28	29	30		

DECEMBER						
S	M	T	W	T	F	S
					1	2
3	4	5	6	7	8	9
10	11	12	13	14	15	16
17	18	19	20	21	22	23
24	25	26	27	28	29	30

For further information on meetings, use Reader Service card.

### CIRCLE NO. 470

Nov. 13-16

**Engineering in Medicine & Biology Conference** (Boston) Sponsor: IEEE; T.B. Sheridan, Room 3-453A, MIT, 77 Massachusetts Ave., Cambridge, Mass. 02139.

### CIRCLE NO. 471

Nov. 14-16

**Fall Joint Computer Conference** Anaheim, Calif.) Sponsor: IEEE, AFIPS; AFIPS Headquarters, 345 E. 47 St., New York, N.Y. 10017.

### CIRCLE NO. 472

Nov. 14-18

**International Exhibition of Industrial Electronics** (Basel, Switzerland) Sponsor: INEL; Sekretariat INEL 67, Schweiz. Bankverein, Basel Switzerland (Konto Nr. 533 977.1).

### CIRCLE NO. 473

Dec. 4-6

**Data Communications Seminar** (New York City) Sponsor: Institute for Automation Research, Inc.; IAR, Inc., Tavern Square, 110 North Royal St., Alexandria, Va. 22314.

### CIRCLE NO. 474

Dec. 5-7

**Vehicular Communications Conference** (New York City) Sponsor: IEEE; A. Katz, Amperex Electronics Corp., 230 Duffy Ave., Hicksville, N. Y. 11802.



# The Predictables.



**When ITT people  
ship your Series 930 DTL order  
you get on-time delivery.**

More than 97% of your Series 930 DTL orders get delivered on time. How's that for predictability? We offer the same 15 circuit functions in the same packages as those people you've been having delivery problems with. Doesn't that justify a change?

To see how little trouble DTL buying can be, try the ITT "Predictables." Order off the shelf from your distributor or direct from your factory representative. Our shipping people may have to work late, but your receiving people won't.

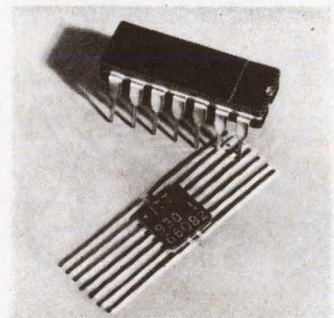

**Integrated circuits** **ITT**

FACTORIES IN WEST PALM BEACH, FLORIDA; PALO ALTO, CALIFORNIA; LAWRENCE, MASSACHUSETTS; HARLOW AND FOOTSCRAY, ENGLAND; FREIBURG AND NURENBERG, GERMANY

ON READER-SERVICE CARD CIRCLE 206



# SPEED WITH STABILITY IN PHOTOCELLS...

- Economy priced
- Proven reliability
- Hermetic TO-5 package
- Immediate delivery

...from HPA

Here's the answer to your sensitive, low-level chopping, switching and control circuit requirements—HPA's 4600 Series of Cadmium Sulfo-Selenide Photocells with optional integral electrostatic shield. You get fast switching time with high temperature stability. Order now directly from stock. Large quantity discounts are available. HP Associates, 620 Page Mill Road, Palo Alto, California 94304.

### Typical specifications at 25° C

Type	R <sub>LIT</sub> KΩ ± 50%	Price	
		1-9	10-99
4601	100	\$2.90	\$2.45
*4603	120	3.05	2.60
4602	4	2.90	2.45
*4604	5	3.05	2.60
4606	10	2.90	2.45
*4608	12	3.05	2.60

Temperature Coefficient ( $\frac{R_{LIT} @ 65^{\circ} C}{R_{LIT} @ 25^{\circ} C}$ ): 1.5 typical  
 Dark resistance: 500 MΩ typical  
 Decay time: 1.2 milliseconds typical

\*Electrostatic shield

HEWLETT  
PACKARD  HP  
ASSOCIATES

01707

ON READER-SERVICE CARD CIRCLE 243



# The "non-plastic" plastic transistors



So reliable you'd think they were hermetic

We're big enough to realize that with any plastic transistor, you're bound to have questions concerning reliability.

So...long before RCA announced this family of "Hometaxial-Base" silicon power plastic devices (10 transistors with ratings of 36W or 83W), our reliability engineers devised a most rigorous new-product testing program. RCA

subjected hundreds of units to stresses beyond device ratings and the results are so impressive that, frankly, you'd think the transistors were hermetic.

We thought it would be appropriate for you to see our reliability manager's comment on the tests to date.

Here's what he had to say: "...sure we've had failures to our end points. But take a close look at them. Out of 376 units totalling 410,000 device hours at 175°C (versus an actual transistor rating of 150°C) only 3 failed. There were 2 failures from 119 units subjected to 25 temperature cycles of -65°C to 175°C (device rating is 5 cycles of -65°C to 150°C). In all, our actual unit hours on all life tests, including storage, operating, and reverse bias, total over 1,600,000 with a failure rate of 1.7% per 1,000 hours. And if you adjust for the fact that all these tests were essentially at over-stress conditions, the result is an estimated failure rate of less than 0.1% per 1,000 hours."

Why not evaluate the facts behind RCA's "non-plastic" plastic transistors yourself? We documented all of the details in a no-nonsense brochure (HBT-600A) which we'll be glad to send you. Just write RCA Commercial Engineering, Section IG11-2, Harrison, N.J. 07029, or see your local RCA representative.

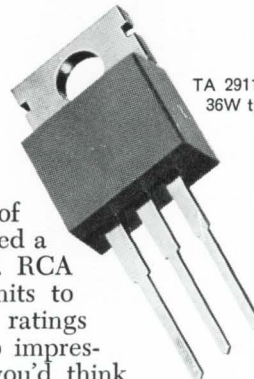

TA 2911  
36W type for printed-circuit boards

TA 7155  
36W type for TO-66 sockets

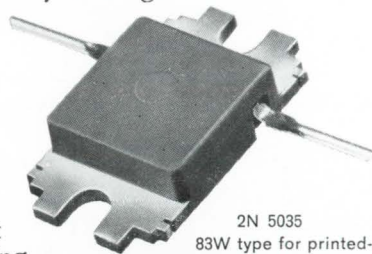
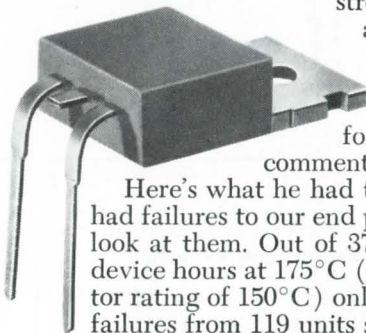

2N 5035  
83W type for printed-circuit boards



2N 5034  
83W type for TO-3 sockets

RCA Electronic Components and Devices



The Most Trusted Name in Electronics

ON READER-SERVICE CARD CIRCLE 244