

# Electronic Design

FOR ENGINEERS AND ENGINEERING MANAGERS

VOL. 16 NO.

# 2

JAN. 18, 1968

## Avionics propels the SST era:

Like today's space-flown craft, jets of the '70s will be steered by inertial navigation, tested for flight-readiness automatically, and

kept in touch with ground control by a satellite radio network. The new jumbos will haul more than 400 passengers. Pre-flight the speedy trend, starting on p. 49.



Here is the latest hp addition to the new generation of all-solid-state, high-performance oscilloscopes!

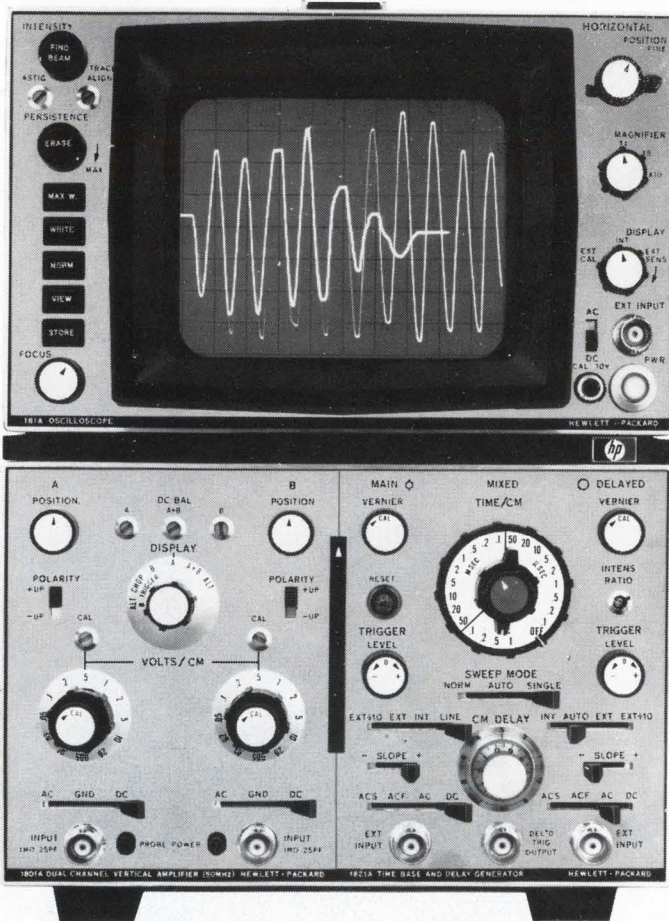

# Stop... Store...

## Vary Display Time!

*New hp 181A Oscilloscope... You control CRT display time with variable persistence and storage!*

Now for the first time you get the added dimension of variable persistence and storage in a high frequency scope—50 MHz bandwidth at 5 mV sensitivity now, and mainframe capabilities for 100 MHz. The new all-solid-state, 30-pound 181A Variable Persistence and Storage Oscilloscope lets you see even more—do even more!

**See more** with the new 181A's variable persistence—made possible by the extra-large rectangular CRT using hp's exclusive mesh storage design. Use it to see low rep rate pulses which brighten as each trace reinforces the previous one. Check signal trends by adjusting persistence so several traces are on CRT simultaneously. Vary persistence from 0.2 sec to more than a minute.

**Do more** with hp's new scope with a memory! Store traces for more than an hour—overnight or even weeks if scope is turned off. Catch and store single-shot transients with the 181A's fast writing rate of 1 cm/ $\mu$ sec. Use it to get a graphic display of critical parameters prior to system failure, activation of a safety device, or excursion beyond some predetermined limit.

**Get an extra measure of performance!** You get the same step-ahead electrical performance, lightweight

portability and rugged design that you have with the standard 180A. All the 180 Series Plug-ins give full performance in the 181A mainframe. You get 50 MHz bandwidth, 7 ns rise time, 5 mV/cm sensitivity, mixed sweep—and *variable persistence and storage!*

Get the full story on the new hp scope with a memory. Ask your hp field engineer for full specifications on the new hp 181A Oscilloscope. Or, write to Hewlett-Packard, Palo Alto, California 94304. Europe: 54 Route des Acacias, Geneva. Price: hp 181A Oscilloscope, \$1850; hp 181AR Oscilloscope (Rack Mount), \$1925; hp 1801A Dual Channel Amplifier, \$650; hp 1820A Time Base, \$475; hp 1821A Time Base and Delay Generator \$800.

HEWLETT  PACKARD

OSCILLOSCOPE SYSTEMS

# mark sensing with no trouble-gap

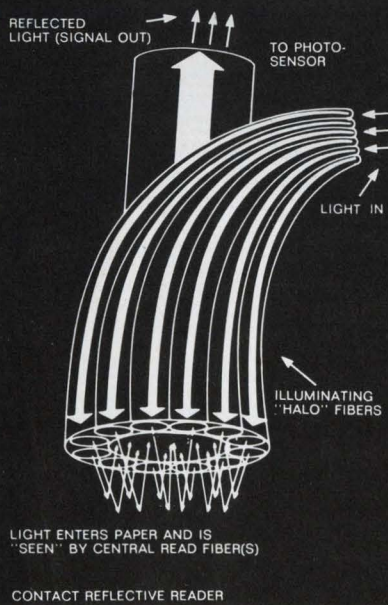

THE NEW BENDIX FIBER OPTIC CONTACT REFLECTIVE READER! Now you can achieve a new consistently reliable, extraordinarily high level of efficiency in your data processing mark-sensing, punch tape reading and magnetic tape monitoring. Efficiency in signal-to-noise ratio of 100:1. The answer: the unique, new fiber optic read head developed by Mosaic — it rides in contact with the paper!

The Mosaic fiber optic reflective reader components are based on a new discovery by Mosaic: that with certain fiber sizes and bundle configurations, very high signal-to-noise ratios can be achieved with the sensor head in contact with the paper. A special *fused flexible fiber bundle* was designed and fabricated to utilize the phenomenon: a central core of read fibers .008" in diameter, surrounded by a halo of thirteen .003" illuminating fibers. The result is the elimination of the trouble-gap in mark-sensing: the critical gap ordinary fiber optic readers need to angle light onto the work so it can reflect back into the pick-up fibers.

Gone with the gap is the troublesome collecting point for dirt carried by the paper: contaminants that cause rapid degeneration of signal-to-noise ratios and resultant sensor errors. Gone, too, are the clear epoxy or transparent plastic gap-fillers utilized with ordinary read heads — compromisers at best which do nothing to increase efficiency. Dramatic efficiency. Consistent, superior performance with signal-to-noise ratios of 100:1. Reliability never possible before. This is what you achieve with the new fiber optic contact reflective reader from Mosaic — the largest single source of fiber optic technology in the world. Contact Mosaic Fabrications Division, The Bendix Corporation, Galileo Park, Sturbridge, Massachusetts 01518. Telephone: 617/347-9191.

Write for complete descriptive literature, today!

**Bendix Electronics**

ON READER-SERVICE CARD CIRCLE 3

# Little plug-ins make the big difference in 50 MHz counters



When you look only at the main frame, it's hard to find important differences between 50 MHz counters. But when you compare plug-ins, you'll find great differences and decisive advantages. Only Systron-Donner plug-ins can give you:

## 1. Final-answer frequency readings to 40 GHz.

A single plug-in, our Model 1292 semi-automatic transfer oscillator, boosts the counter's frequency-measuring range to 15 GHz. Measures FM and pulsed RF above 50 MHz. And the complete dc to 15 GHz system (counter with plug-in) costs only \$3250. Our new Model 1298 semi-automatic T.O. now gives you final-answer readings up to 40 GHz—a new record.

Contact Systron-Donner Corporation, 888 Galindo Street, Concord, California. Phone (415) 682-6161.

## 2. Automatic frequency readings to 18 GHz.

Three Acto<sup>®</sup> plug-ins now produce fully-automatic microwave frequency readings: 50 MHz to 3 GHz (P, L & S band), 3 to 12.4 GHz (S & X band), and 12.4 to 18 GHz (K<sub>U</sub> band).



Find more unique measuring capability in this catalog

## 3. Time readings with 10-nano-second resolution.

Our latest time interval plug-in gives you time readings with 10-nanosecond resolution—greater precision than ever before possible with a standard counter.

All this unique measuring capability can be yours today—or tomorrow—when you buy your basic counter from Systron-Donner. Sixteen different plug-ins have been especially designed to give your Systron-Donner counter more measuring power at less cost than any other system.

**SYSTRON**  **DONNER**

## NEWS

- 21 News Scope  
25 **Shed Light: to hunt and kill in real time**  
Air Force seeks ways to find and strike foe at night, through rain and foliage.  
36 Hybrid microwave LSI to operate in K band.  
39 Washington Report  
44 Troposcatter radars run into bad weather  
49 **Special Report: Avionics in the SST era**  
Automatic checkout, inertial navigation and satellite radio nets are key features.  
65 Letters  
72 Sidelights of the Issue  
75 **Editorial: Come out of the clouds, get down to brass tacks.**

## TECHNOLOGY

- 78 **Op amps act as universal elements**—as voltage, transconductance, transresistance or current amplifiers—when a few simple formulas are applied.  
90 **Computers ease worst-case analysis** so long as the designer understands the program and so creates an efficient man-machine partnership.  
100 **Taut-band or pivot-and-jewel?** You're buying more than a suspension system, so specify your panel meter carefully.  
108 Test Your IC IQ  
112 **Advance by making your boss look good.** You'll find new challenge and opportunity for a career as manager when you practice "upward motivation."  
120 NASA Tech Briefs  
128 Ideas for Design

## PRODUCTS

- 140 **Components:** Fluidic elements have 8 functions.  
142 Hyperbola connector uses wire suspension.  
148 Microwaves  
150 **Test Equipment:** Signal detector for electromagnetics.  
150 Programmable supplies respond in 25  $\mu$ s.  
153 Transducer measurements made with microvoltmeter.  
154 1/2-W power amplifier spans 10 to 400 MHz.  
160 **Systems:** Magnetic computer tape withstands temperature extremes.  
162 **Materials:** Circuit cards aid R&D design.

## Departments

- |                        |                                    |
|------------------------|------------------------------------|
| 16 Designer's Datebook | 171 Reprints Available             |
| 164 Design Aids        | 172 About the Magazine             |
| 165 Application Notes  | 174 Advertisers' Index             |
| 166 New Literature     | 176 Information Retrieval Services |
- Reader Service card inside back cover

"Did you say there's  
a miniature switch  
available with  
shorting and  
non-shorting poles  
and positions  
on the same deck?"

"Yes . . . that's what  
I said".

**"UNBELIEVABLE!"**

"Not really . . .  
it's made by  
**RCL**".



ACTUAL SIZE  
1/2" MINIATURE  
ROTARY SWITCH

# RCL

ELECTRONICS, INC.

General Sales Office:  
700 South 21st Street  
Irvington, New Jersey 07111

# Reader's Choice

## IEE introduces 10-gun CRT Display Tube



### New readout offers 12 advantages over tubes now in use.

The state of the readout art took on a new dimension recently when IEE, world leader in rear-projection readouts, introduced the 10-gun CRT — an unparalleled method for electronic projection of numbers, letters, messages, etc. Observers report character brightness and clarity, viewed on a fluorescent screen, are optimum under any ambient light condition. Powerless control grid switching... extremely low power consumption... small grid control swing... exceptionally wide view angle... all are features which make the new device ideal for instrument applications. Now available in quantity, all it lacks is a name!

#### Name IEE's new display tube and win a portable TV set!

On your company letterhead, describe a particular application for the new tube. Then fill in the coupon, attach it to the letter and send them to:



ADVERTISING DEPARTMENT  
7720 Lemona Ave.,  
Van Nuys, Calif. 91405

Sirs:

My name for the new IEE 10-gun CRT display tube is \_\_\_\_\_

Name: \_\_\_\_\_

Firm: \_\_\_\_\_ Dept.: \_\_\_\_\_

Address: \_\_\_\_\_

City: \_\_\_\_\_ State: \_\_\_\_\_ Zone: \_\_\_\_\_

Entries must be in by Feb. 28, 1968. The judges' decision will be final.

## IEE bright, legible, wide-angle readouts:

Any characters desired  
Any colors or combinations  
Any input, BCD or decimal  
Any input signal level  
Any mounting, vertical or horizontal

Many sizes  
Many configurations  
Many lamp lives (to 100,000 hours)  
Many brightness choices  
Many options and accessories

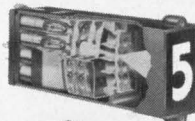

**Standard Readouts:** Rear projection principle, like all IEE readouts. A lamp in the rear of the unit illuminates one of the 12 film messages, and projects it to the front viewing screen. Unbeatable readability and versatility.

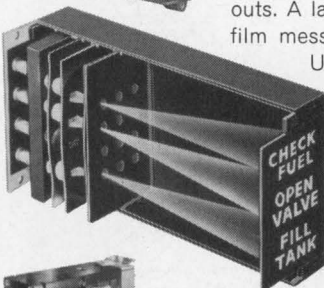

**Large Screen Readouts:** For reading distances up to 100 feet. Maximum character size 3 3/8".

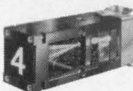

**Miniature Readouts:** Only 1" wide x 1-5/16" high, yet can be read at 30 feet because of clarity of one-plane projection. Character size: 5/8".



**Micro-Miniature Readouts:** Only 1/2" wide x 3/4" high, but 20 foot viewing distance and maximum 175° viewing angle because of front-plane display. Character size: 3/8".



**Hi-Brite Readouts:** Special lens system increases character brightness 50%. Particularly good when high ambient light conditions exist.

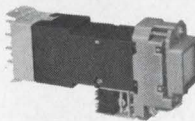

**Cue-Switch Readouts:** Rear projection readout with push-button viewing screen. Combination switch and display device.



**Bina-View Readout:** Accepts binary or teletype code, decodes, and displays the proper character.



**Status Indicator Readout:** Displays up to 12 different messages, individually or in combination. Viewing screen only 3 sq. in.



**Indicator Assemblies:** Available with up to 11 rear projection readouts, for indicating seconds, minutes, hours, days, etc.

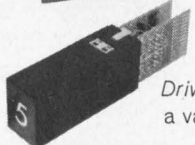

**Driver/Decoder Module:** Designed to work with IEE Readouts. Accepts a variety of binary codes for decimal conversion.

The new IEE Display Devices catalog gives complete information and specifications on these products, and their accessories. Ask for it.



"I-double-E", the world's largest manufacturer of rear projection readouts.  
Industrial Electronic Engineers, Inc. 7720 Lemona Avenue, Van Nuys, California

# The great LSI race.

**While the rest of the semiconductor industry tried to squeeze enough ICs on a chip to get into the MSI/LSI business, Fairchild turned systems inside out. We were looking for an intelligent alternative to component mentality. Our investigation led to a whole new set of design criteria for medium and large scale integration devices.**

## **A computer isn't a computer.**

It's a digital logic system. It has the same functional needs as any other digital system: control, memory, input/output and arithmetic. There's no logical reason to custom design a complex circuit for each system. That's why Fairchild MSIs and LSIs are designed to function as fundamental building blocks in any digital logic system. Even if it's a computer.

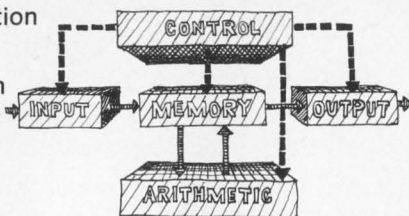

## **A little complexity goes a long way.**

Anybody can package a potpourri of circuitry and call it MSI or LSI. But, that's not the problem. Why multiply components, when you should divide the system? Like we did. We found that sub-systems have a common tendency toward functional overlap. There are too many devices performing similar functions. More stumbling blocks than building blocks. Our remedy is a family of MSIs and LSIs with multiple applications. The Fairchild 9300 universal register, for example, can also function as a modulo counter, shift register, binary to BCD shift converter, up/down counter, serial to parallel (and parallel to serial) converter, and a half-dozen other devices.

## **Watch out for that first step.**

There are all kinds of complex circuits. Some of them have a lot of headache potential. Especially if you want to interface them with next year's MSIs and LSIs. We decided to eliminate the problem before it got into your system. All Fairchild building blocks share the same compatible design characteristics.



We're also making the interface devices that tie them together. For example, our 9301 one-of-ten decoder can be used as an input/output between our universal register, dual full adder and memory cell.

(It could also get a job as an expandable digital demultiplexer, minterm generator or BCD decoder.)

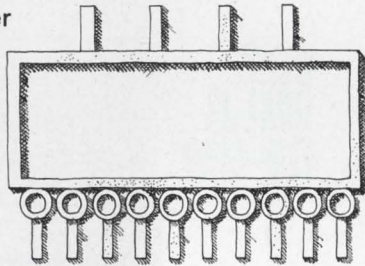

## **H**urry. Before the price goes down.

Gate for gate, today's complex circuits are about the same price as discrete ICs. But, by the time you're ready to order production quantities, the price should be a lot lower. At least ours will. The reason is simple: Fairchild devices are extremely versatile. There are fewer of them. But, they do more jobs. That means we'll be producing large quantities of each device. That also means low unit cost to you. And you'll have fewer devices to inventory. And fewer to assemble.

If you agree with our approach to medium and large scale integration, we'd like to tell you more about it. There are two ways you can get additional information. One is by mail. Simply write us on your company letterhead. You can also get more data by watching the trade press. Fairchild is introducing a new integrated circuit each week for 52 weeks. (We started on October 9, 1967.)

Many of them will be MSI and LSI. If you'd like to see the last few we've introduced, turn the page.

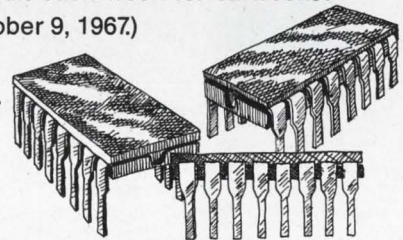

**FAIRCHILD SEMICONDUCTOR**  
A Division of Fairchild Camera and Instrument Corporation  
313 Fairchild Drive, Mountain View, California 94040  
(415) 962-5011, TWX: 910-379-6435

# RECAP:

## 9935 EXPANDABLE HEX INVERTER

**9.**  
Fairchild will introduce a new integrated circuit each week for 52 weeks. This is number

The Fairchild 9935 is a fundamental element in the CC5L family. It can serve as the nucleus of virtually any digital logic circuit. It consists of six 271<sub>1</sub> gates without input diodes. Each gate performs a single inversion operation. The device can be expanded to an unlimited number of inputs and, therefore, can be used in a great variety of functions. For example, it can serve as a matching circuit, a one-shot multivibrator, or as a flip-flop in address registers, counters, decoders, etc. It can be wired "or" connected to reduce overall system count. The 9935 comes in both a 14-pin hermetic DIP and Fairchild's popular 18-pin available in both military and industrial temperature ranges (-55°C to +125°C and 0°C to +70°C). Production delay is typically 30 nanoseconds. Typical power dissipation is 8 milliwatts per gate. The 9935 is available in volume quantities. Fairchild distributors have it in stock now. Write for complete specs and applications information. Ask about our other new products, too.

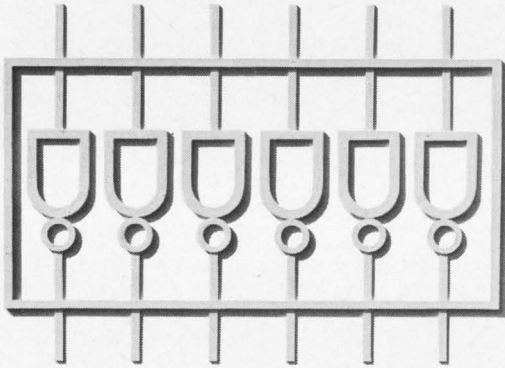

Fairchild Semiconductor • A Division of Fairchild Camera and Instrument Corporation  
**FAIRCHILD**  
 SEMICONDUCTOR 213 Fairchild Drive, Mountain View, California 94035 (415) 961-5011 • FAX: 910-270-9420

CIRCLE READER SERVICE NUMBER 109

## 3701 SIX-CHANNEL MULTIPLEX SWITCH

**10.**  
Fairchild will introduce a new integrated circuit each week for 52 weeks. This is number

The Fairchild 3701 is a P-channel enhancement mode MOS six-channel single output switch. It can be used in virtually any switching application. It's ideal for analog and digital data transmission, logic control in industrial systems, and remote line switching in memory systems. The 3701 incorporates a patented switch. It has very low "on" resistance (300 Ohms), extremely high "off" resistance (2 x 10<sup>10</sup> Ohms), and zero offset current. Output leakage current is typically as low as 0.1 nanomhos. Input gate protection minimizes handling problems. It can accept input signals up to 3 volts. Stability and reliability are assured by Plasma II<sup>®</sup> technology. The 3701 comes in a 14-pin package. It can operate over a temperature range of -55°C to +85°C. Volume quantities of this device are now available. Your Fairchild distributor has it in stock. Write for complete specs and applications information. Ask about our other new products, too.

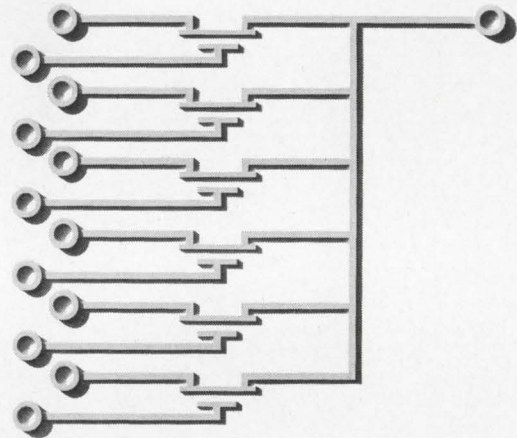

Fairchild Semiconductor • A Division of Fairchild Camera and Instrument Corporation  
**FAIRCHILD**  
 SEMICONDUCTOR 213 Fairchild Drive, Mountain View, California 94035 (415) 961-5011 • FAX: 910-270-9420

CIRCLE READER SERVICE NUMBER 110

## 9016 TTL HEX INVERTER

**11.**  
Fairchild will introduce a new integrated circuit each week for 52 weeks. This is number

The 9016 completes our 9000 series TTL family. It is a CC5L device designed primarily for high speed inverter applications. It consists of six inverting gates with input clamping diodes to prevent ringing. Active pull-up is provided in the output for high capacitive drive. It can also be used as a line driver. Propagation delay is 1 nanosecond maximum (typical) for the entire TTL family. Power dissipation per gate is typically 10mW. The 9016 comes in a 14-pin hermetic DIP and is available in both military and industrial temperature ranges (-55°C to +125°C and 0°C to +70°C). You can now order volume quantities of the 9016. Fairchild distributors have it in stock. Write for complete specs and applications information. Ask about our other new products, too.

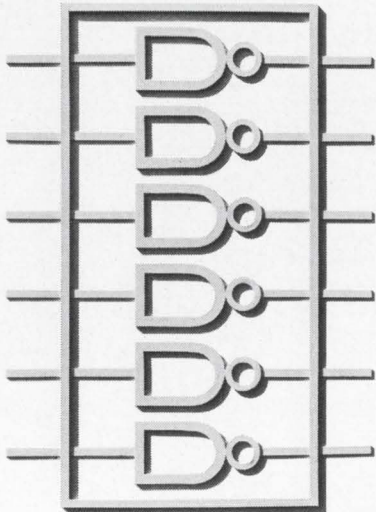

Fairchild Semiconductor • A Division of Fairchild Camera and Instrument Corporation  
**FAIRCHILD**  
 SEMICONDUCTOR 213 Fairchild Drive, Mountain View, California 94035 (415) 961-5011 • FAX: 910-270-9420

CIRCLE READER SERVICE NUMBER 111

## 9022 DUAL JK FLIP-FLOP

**12.**  
Fairchild will introduce a new integrated circuit each week for 52 weeks. This is number

The 9022 is a CC5L device in a 16-pin hermetic DIP. This TTL circuit consists of two JK flip-flops with a common clock input, common JK input, and separate J and K inputs. The J allows the 9022 to perform as a dual type D flip-flop by tying the J and K inputs together. The common JK input eliminates the need for gating clock systems and can resolve any race condition and minimized clock skew problems. The 9022 is fast (20nM) and flexible. It is a true DC sensitive monostable dual flip-flop. As a companion to our 9020 dual JK flip-flop, it provides additional logical flexibility because it has separate set-direct inputs in addition to clear-direct. Both types of inputs are truly asynchronous and overriding. A single clock further reduces clock fan-in and noise. The 9022 comes in both military and industrial temperature ranges (-55°C to +125°C and 0°C to +70°C). It is available in volume quantities. Your Fairchild distributor has it in stock. Write for complete specs and applications information. Ask about our other new products, too.

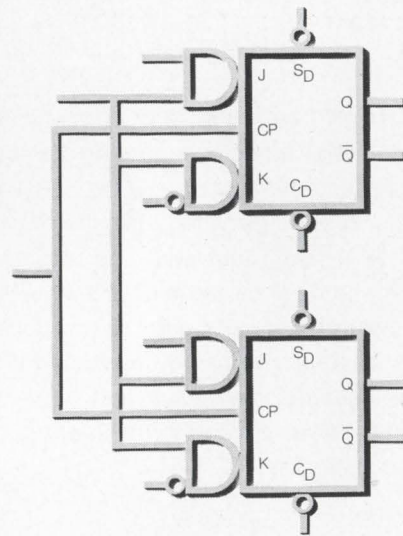

Fairchild Semiconductor • A Division of Fairchild Camera and Instrument Corporation  
**FAIRCHILD**  
 SEMICONDUCTOR 213 Fairchild Drive, Mountain View, California 94035 (415) 961-5011 • FAX: 910-270-9420

CIRCLE READER SERVICE NUMBER 112

Fairchild is introducing a new integrated circuit every week. The last two months look like this.

**FAIRCHILD**  
SEMICONDUCTOR

Starting October 9, 1967, Fairchild promised to introduce a new integrated circuit each week for 52 weeks. This is number **13.**

## 3102 MOS THREE-INPUT GATE

The 3102 is an extremely versatile three-input breadboard gate which can serve as the fundamental element in any MOS digital logic system. It can also function as an evaluation tool for determining the performance of Fairchild's line of MOS devices, or simply as a vehicle for gaining familiarity with MOS integrated circuitry. The 3102 comes in both TO-18 and TO-18A packages. The availability of all source and drain leads for each Fairchild device eases logic complexity, input protection reduces handling problems. Power consumption is typically as low as 5mW. Operating temperature ranges from -55°C to +85°C. Volume quantities of the 3102 are now available. Your Fairchild distributor has them in stock. Write us for complete specs and applications information. While you're at it, ask about our other new products, too.

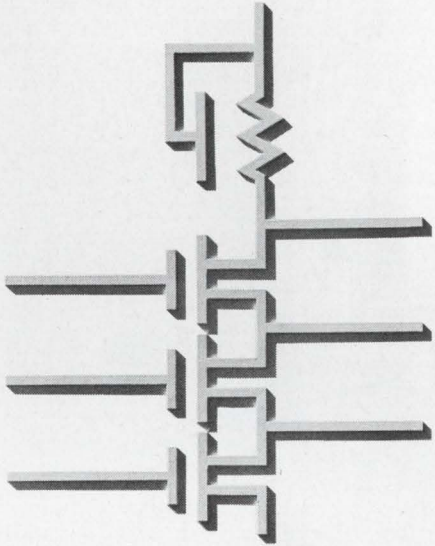

FAIRCHILD SEMICONDUCTOR / A Division of Fairchild Camera and Instrument Corporation  
FAIRCHILD SEMICONDUCTOR 310  
310 Fairchild Drive, Mountain View, California 94035, U.S.A. TEL: 916/274-8400

CIRCLE READER SERVICE NUMBER 113

Starting October 9, 1967, Fairchild promised to introduce a new integrated circuit each week for 52 weeks. This is number **14.**

## 3700 FOUR-CHANNEL MULTIPLEX SWITCH

Fairchild's 3700 is designed for use in A/D and D/A converters; multiplexing, analog or digital data transmission systems; and other airborne or ground instrumentation signal routing applications. It can be used in telemetry systems, computers, remote monitoring equipment and transmitter sensing equipment. Control logic has been included to make it Apollo compatible. It features Planar  $P^+P$  technology enhancement mode MOS technology and provides all channel blanking control. It also features built-in output high ON/OFF ratio and input gate protection. And, our 3712 high level fan inverter (new product number 13) can be used to directly interface the 3700 with CDS/L logic levels. The 3700 is available in two digital ranges: the 3700K4 for -55°C to +85°C, and the 3700K43 for ranges of 0 to +85°C. Both of the 3700 devices come in the gate and will operate over the entire temperature range from -55°C to +85°C. They're available in volume quantities. Your Fairchild distributor has them in stock. Write for complete specs and applications information. Ask about our other new products, too.

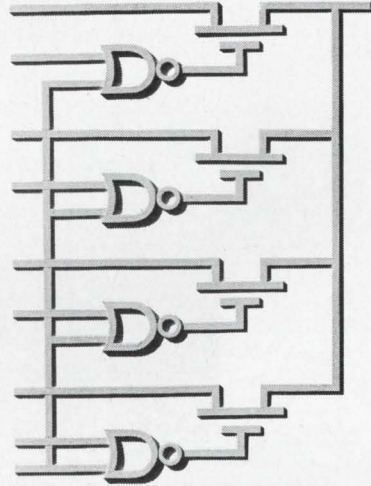

FAIRCHILD SEMICONDUCTOR / A Division of Fairchild Camera and Instrument Corporation  
FAIRCHILD SEMICONDUCTOR 310  
310 Fairchild Drive, Mountain View, California 94035, U.S.A. TEL: 916/274-8400

CIRCLE READER SERVICE NUMBER 114

Starting October 9, 1967, Fairchild promised to introduce a new integrated circuit each week for 52 weeks. This is number **15.**

## 3303 DUAL 25-BIT DYNAMIC SHIFT REGISTER

The 3303 is a product of Planar  $P^+P$  technology enhancement mode MOS technology. It contains two 25-bit shift register strings with two common clock lines. Output stages can be connected as either inverters or as source followers. It is applicable for digital delay lines in computers and radar systems (both ground and airborne). It can also be used as a serial memory in telemetry systems. The 3303 comes in a TO-18 case and will operate over the entire temperature range from -55°C to +85°C. It operates at 1 MHz typical. Power dissipation is typically less than 20mW per bit. Volume quantities of the 3303 are now available. Your Fairchild distributor has it in stock. Write for complete specs and applications information. Ask about our other new products, too.

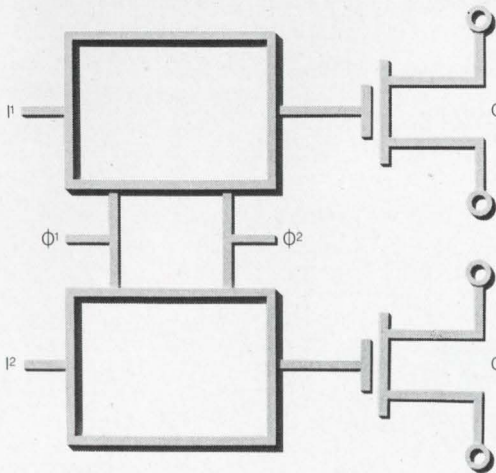

FAIRCHILD SEMICONDUCTOR / A Division of Fairchild Camera and Instrument Corporation  
FAIRCHILD SEMICONDUCTOR 310  
310 Fairchild Drive, Mountain View, California 94035, U.S.A. TEL: 916/274-8400

CIRCLE READER SERVICE NUMBER 115

Starting October 9, 1967, Fairchild promised to introduce a new integrated circuit each week for 52 weeks. This is number **16.**

## 9307 BCD TO SEVEN-SEGMENT DECODER

The Fairchild 9307 is designed to be used in any numeric display system which requires seven-segment information. This includes incandescent, electroluminescent, seven-segment neon, or CRT numeric displays. It is an MOS device. It accepts an input in 8421 BCD code and produces individual outputs to drive the seven-segment display system. It has an active low input lamp test which overrides all other input combinations and forces lamp operation. It also has active high outputs to blank the segments. It also has active low blanking inputs and outputs to provide leading edge zero suppression. It also has internal modulation capability. The 9307 is a CDS/L device in a 16-pin hermetic DIP. It operates from a single 5-volt power supply. It comes in both military and industrial temperature ranges (-55°C to +125°C and 0°C to +70°C). The 9307 is available in volume quantities. Your Fairchild distributor has it in stock. Write for complete specs and applications information. Ask about our other new products, too.

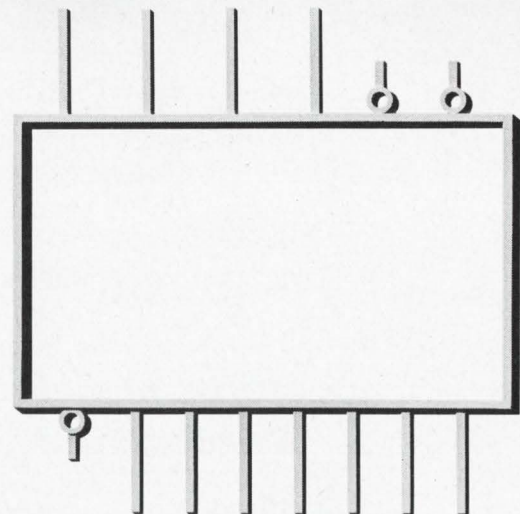

FAIRCHILD SEMICONDUCTOR / A Division of Fairchild Camera and Instrument Corporation  
FAIRCHILD SEMICONDUCTOR 310  
310 Fairchild Drive, Mountain View, California 94035, U.S.A. TEL: 916/274-8400

CIRCLE READER SERVICE NUMBER 116

# Keep ahead of your competition.

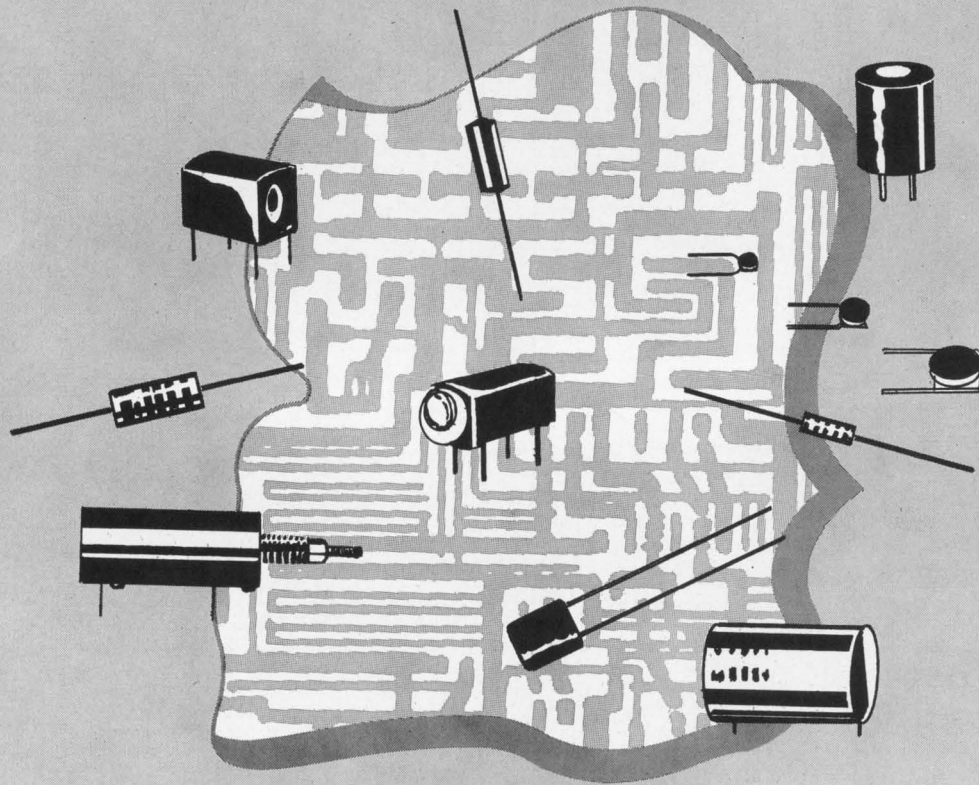

## We do.

Delevan is the most experienced coil and transformer manufacturer in the world. We got that way . . . by innovating . . . by packing high values into the smallest configurations known today.

Combine engineering talent with large volume production experience and you have a company you can depend on. Try us!

**Delevan Electronics  
Corporation / Division**



**AMERICAN  
PRECISION  
INDUSTRIES INC.**

270 QUAKER ROAD / EAST AURORA, NEW YORK 14052 / 716 652-3600

OTHER DIVISIONS OF AMERICAN PRECISION INDUSTRIES INC.: BASCO, INC. • ELECTRO-MECHANICAL PRODUCTS DIVISION

ON READER-SERVICE CARD CIRCLE 7

# 3 ways you can use the Raysistor® to improve your product, cut costs

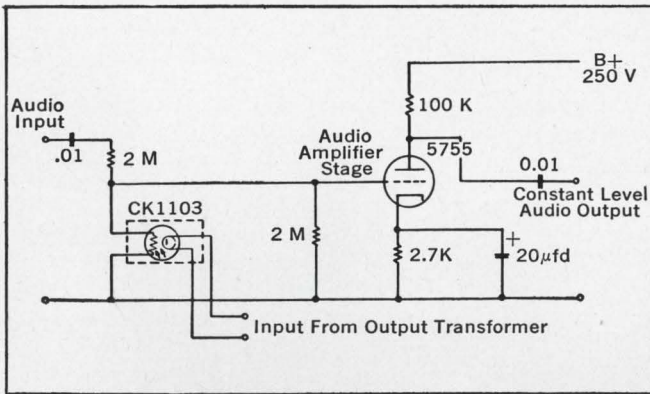

**1. Use the Raysistor®** as a simple remote or automatic volume control in SSB suppressed carrier receivers. Feeding part of the audio output into the control light source varies the resistance of the Raysistor's photocell, making it usable in place of a normal volume control.

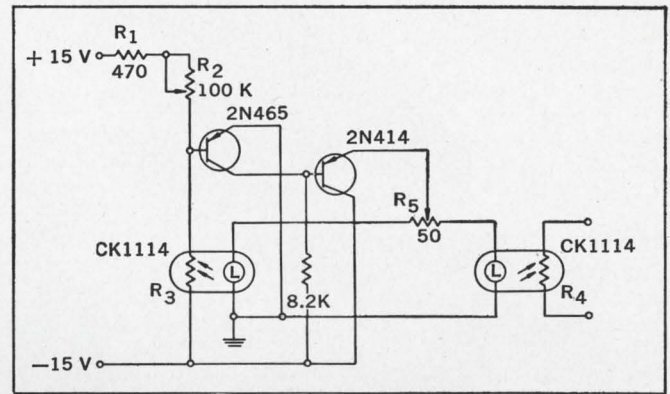

**2. As a remotely controlled linear potentiometer.** The Raysistor can be used as a remotely controlled linear potentiometer when used in the circuit shown above. Here the Raysistor forms a voltage divider between the positive and negative voltages.

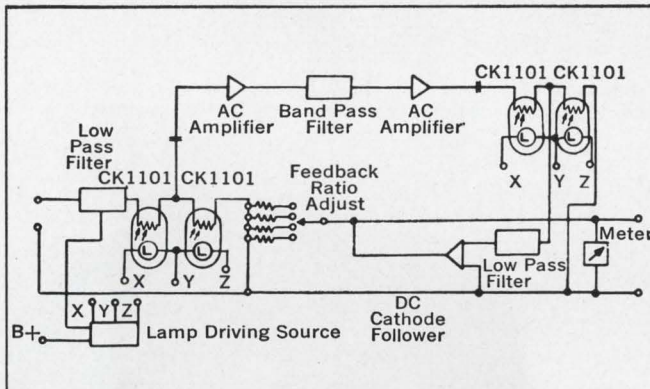

**3. As a photochopper stabilized D-C microvoltmeter.** Raysistors, used as photochoppers in both modulator and demodulator circuits, enable d-c levels to be measured to a fraction of a microvolt. They facilitate synchronous detection and demodulation with simple electrical coupling, have less noise than transistor choppers, while avoiding maintenance problems of mechanical choppers. Other photochopper applications: photochopper relay, series or shunt chopper, modulator circuit, and as a stabilizer to reduce long-term drift.

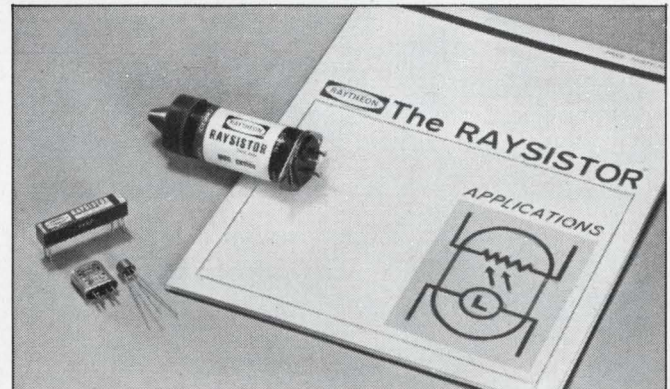

**Many more ways you can use the Raysistor.** Send for *The Raysistor Applications Manual* which describes ways you can use this unique optoelectronic component as a photochopper, variable resistor, solid-state switch, relay, voltage or signal isolator, nonlinear potentiometer, etc. For complete specifications and prices, call your Raytheon distributor or regional sales office. For a copy of this 28-page manual, circle the reader service card or write directly to *Raytheon Company, Components Division, Quincy, Massachusetts 02169.*



**Industrial Components Operation—A single source for Circuit Modules/Control Knobs/Display Devices/Filters/Hybrid Thick-Film Circuits/Industrial Tubes/Optoelectronic Devices/Panel Hardware**

ON READER-SERVICE CARD CIRCLE 8

# Cast center ring assures uniform air gap in Bodine motors. Now you know our secret of consistency.



A small, very accurate air gap between rotor and stator, or between armature and field, is all-important for Bodine motor quietness and efficiency. And using a cast, machined center ring as well as cast end shields makes air gap accuracy controllable and predictable.

A cast center ring assures the high degree of consistency in performance that Bodine motor users have come to expect.

Edges are machined with rabbets to mate perfectly with rabbeted end shields. And end shields are bored with great precision on a special, Bodine-designed machine.

Now you know why Bodine can maintain air gap to uncommonly close

tolerances—and keep it *consistent* from motor to motor, lot to lot.

Bodine motors have cast housings (except our K-type motors, which have laminated center rings . . . and type U-3 which have steel rings)—offer rigidity, accuracy, extra sound-muffling properties.

Whenever the type of motor permits, experience dictates that we use this kind of construction. It's a mark of Bodine quality. Doesn't your product deserve motors of such quality? Bulletin S describes over 275 stock types and sizes from 1/2000 to 1/6 hp. Write Bodine Electric Company, 2528 West Bradley Place, Chicago, Illinois 60618.

ON READER-SERVICE CARD CIRCLE 9

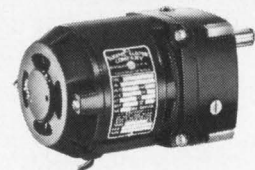

*Bodine motors wear out—  
it just takes longer*

**BODINE**  
fractional/horsepower  
**MOTORS**  
...the power behind the leading products

Miniature Devices at Miniature Prices\*

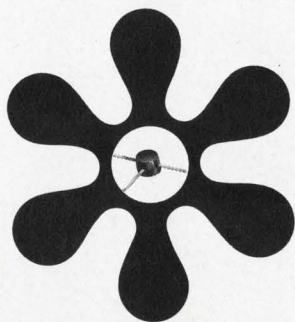

# MMT3904/6 PROTOTYPE PAIR: 2 FOR THE PRICE OF 1!

Turn the page for news of Motorola's new Micro-T HANDYPac special offer from these franchised distributors:

## EASTERN

ALABAMA, Huntsville 35805.....(205) 837-6101.....Airwork Gulf Electronics Corp.  
 CONNECTICUT, Hamden 06514.....(203) 288-7771.....Cramer Electronics, Inc.  
 D.C., Washington 20001.....(202) HUDson 3-5200.....Electronic Wholesalers, Inc.  
 FLORIDA, Miami 33148.....(305) 885-2401.....Airwork Gulf Electronics Corp.  
 FLORIDA, Orlando 32809.....(305) 855-4020.....Hall-Mark Electronics Corp.  
 GEORGIA, Atlanta 30318.....(404) 355-2223.....Jackson Electronic Supply Co., Inc.  
 MARYLAND, Baltimore 21230.....(301) 539-6525.....Pyttronic Industries, Inc.  
 MARYLAND, Silver Spring 20910.....(301) 587-2900.....Schweber Electronics  
 MASSACHUSETTS, Cambridge 02139.....(617) 864-0400.....R & D Electronic Supply Co., Inc.  
 MASSACHUSETTS, Newton 02164.....(617) WOODward 9-7700.....Cramer Electronics, Inc.  
 NEW JERSEY, Moorestown 08057.....(609) 235-1900.....Angus, Inc.  
 NEW YORK, Binghamton 13902.....(607) 748-8211.....Federal Electronics, Inc.  
 NEW YORK, Buffalo 14202.....(716) TT 4-3450.....Summit Distributors, Inc.  
 NEW YORK, Flushing 11369.....(212) GR 8-4000.....Cramer Electronics Inc  
 NEW YORK, Syracuse 13211.....(315) 454-9247.....Cramer/Eastern  
 NEW YORK, Westbury, L.I. 11591.....(516) ED 4-7474.....Schweber Electronics  
 NEW YORK, Woodbury, L.I. 11797.....(516) 921-8700.....Harvey Radio Co., Inc.  
 NORTH CAROLINA, Winston-Salem 27102.....(919) Park 5-8711.....Electronic Wholesalers, Inc.  
 PENNSYLVANIA, Philadelphia 19106.....(215) WA 5-6900.....Radio Electric Service Co. of Pa.  
 PENNSYLVANIA, Pittsburgh 15218.....(412) 351-3611.....Semiconductor Specialists, Inc.

## CENTRAL

ILLINOIS, Chicago 60680.....(312) TA 9-9121.....Allied Electronics Corp.  
 ILLINOIS, Chicago 60624.....(312) 638-4411.....Newark Electronics Corp.  
 ILLINOIS, Chicago 60666.....(312) 279-1000.....Semiconductor Specialists, Inc.  
 IOWA, Cedar Rapids 52406.....(319) 365-7551.....Deeco, Inc.  
 KANSAS, Kansas City 66103.....(913) AD 6-4343.....Hall-Mark Electronics Corp.  
 LOUISIANA, New Orleans 70112.....(504) 522-8726.....Sterling Electronics, Inc.  
 MICHIGAN, Detroit 48240.....(313) 255-0300.....Semiconductor Specialists, Inc.  
 MICHIGAN, Detroit 48227.....(313) BRoadway 2-4212.....Radio Specialties Co., Inc.  
 MINNESOTA, Edina 55424.....(612) 941-4680.....Lew Bonn Co.  
 MINNESOTA, Minneapolis 55423.....(612) 866-3434.....Semiconductor Specialists, Inc.  
 MISSOURI, St. Louis 63134.....(314) 423-6500.....Semiconductor Specialists, Inc.  
 OHIO, Cincinnati 45237.....(513) 761-5432.....Sheridan Sales Co.  
 OHIO, Cleveland 44103.....(216) 432-0010.....Pioneer-Standard Electronics, Inc.  
 OHIO, Cleveland 44133.....(216) 237-9145.....Sheridan Sales Co.  
 OKLAHOMA, Tulsa 74115.....(918) TE 5-8458.....Hall-Mark Electronics Corp.  
 TEXAS, Dallas 75220.....(214) Fleetwood 7-9131.....Sterling Electronics  
 TEXAS, El Paso 79903.....(915) 533-9555.....Midland Specialty Co.  
 TEXAS, Dallas 75231.....(214) AD 1-6111.....Hall-Mark Electronics Corp.  
 TEXAS, Houston 77042.....(713) SU 1-0011.....Hall-Mark Electronics Corp.  
 WISCONSIN, Milwaukee 53226.....(414) 476-1270.....Hall-Mark Electronics/Midwest

## WESTERN

ARIZONA, Phoenix 85009.....(602) 272-2601.....Hamilton Electro of Arizona  
 CALIFORNIA, Inglewood 90301.....(213) ORegon 8-8111.....Liberty Electronics Corp.  
 CALIFORNIA, Los Angeles 90230.....(213) UP 0-7171.....Hamilton Electro Sales  
 CALIFORNIA, Los Angeles 90022.....(213) OV 5-5888.....K-Tronics  
 CALIFORNIA, Oakland 94607.....(415) TEmplebar 4-3311.....Elmar Electronics  
 CALIFORNIA, Mountain View 94040.....(415) 961-3611.....Elmar Electronics  
 CALIFORNIA, Mountain View 94040.....(415) 961-7000.....Hamilton Electro Sales-North  
 CALIFORNIA, San Diego 92123.....(714) BRowning 8-2112.....Kierulff Electronics, Inc.  
 CALIFORNIA, San Diego 92109.....(714) 274-3131.....San Delcor, Inc.  
 COLORADO, Denver 80204.....(303) TABor 5-7033.....Kierulff Electronics Co., Inc.  
 NEW MEXICO, Albuquerque 87108.....(505) 268-3901.....Kierulff Electronics Co., Inc.  
 UTAH, Salt Lake City 84110.....(801) 363-5821.....W. H. Bintz Company  
 WASHINGTON, Seattle 98121.....(206) MA 4-5930.....Hamilton Electro of the Pacific Northwest

## CANADA

MONTREAL, P.Q.....(514) 861-2411.....Cesco Electronics Ltd.  
 MONTREAL, P.Q.....(514) 735-2471.....Zentronics (Quebec) Ltd.  
 OTTAWA, Ont.....(613) 729-5118.....Cesco Electronics Ltd.  
 QUEBEC CITY, P.Q.....(418) 524-3518.....Cesco Electronics Ltd.  
 TORONTO, Ont.....(416) 638-5250.....Cesco Electronics Ltd.  
 TORONTO 19, Ont.....(416) 787-1271.....Zentronics Ltd.  
 VANCOUVER, B.C.....(604) 685-4628.....Bowtek Electric Co. Ltd.  
 VANCOUVER, B.C.....(604) 736-6411.....L. A. Varah Ltd.  
 WINNIPEG, Man.....(204) 942-0901.....Cam Gard Supply Ltd.



# MOTOROLA Semiconductors

# HERE'S HOW TO MINIATURIZE YOUR

USE MOTOROLA MICRO-T TRANSISTORS!

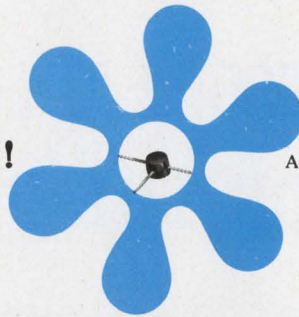

ACTUAL SIZE

**NOW... Miniaturize Your Amplifier And Switching Circuits!**

- Use them individually or in complementary circuitry
- Low than you need the volume of standard TO-18 or TO-32 packages
- High reliability "dielectric" vapor-hermetic case
- Low ohmic, stress on mounting. Gold-plated leads helps reduce stress on the unit.
- High power dissipation in relation to size—25 mW @  $T_A = 25^\circ\text{C}$ .



These working samples are typical of the many types of Micro-T transistors made by Motorola. They compare favorably with the standard TO-18 and TO-32 packages and their electrical performance is identical. However, the Micro-T packages "breakthrough" the high stress area for micro-miniature equipment applications.

**MOTOROLA**

**MMT3905**  
**MMT3906**

PNP SILICON ANNULAR\* TRANSISTORS

MICRO-MINIATURE

PNP SILICON SWITCHING & AMPLIFIER TRANSISTORS

201 290 — 25 5228

designed for general purpose switching and amplifier applications and for complementary circuitry with types MMT3903 and MMT3904 where high density packaging is required.

- Space Saving Micro-Miniature Package
- Current Gain Specified in Two Ranges for Design Flexibility
- High Voltage Ratings —  $BV_{CE0} = 40$  Volts min
- Low Capacitance —  $C_{cb} = 4.0$  pF max
- One-Facet, Injection-Molded Unibloc Package for High Reliability

| COLOR CODING       |          |                            |                     |
|--------------------|----------|----------------------------|---------------------|
| TYPE NO.           | POLARITY | POLARITY IDENTITY (BOTTOM) | TYPE IDENTITY (TOP) |
| MMT3903<br>MMT3904 | NPN      | BLUE                       | RED<br>GREEN        |
| MMT3905<br>MMT3906 | PNP      | WHITE                      | RED<br>GREEN        |

**MOTOROLA Semiconductor Products Inc.**

**\* (Order this Micro-T HANDYPac... Get two devices for the price of one!)**

*- where the priceless ingredient is care!*





# AMPLIFIER & SWITCHING DESIGNS!

## MMT3904/06 Prototype Pair Now Available in Micro-T HANDYPac!

How small can (complementary) discrete device circuitry get? Well, the fact that Motorola's new Micro-T<sup>†</sup> transistors are just one-tenth the volume of standard TO-18 and TO-92 types will give you some idea. And, now you can try them and see for yourself. Motorola's Micro-T HANDYPac offered here contains two sample devices, MMT3904 (NPN) and MMT3906 (PNP), plus their respective data sheets, prices and information on custom Micro-T types. It's yours for just \$3.00 (a \$6.00 value) when you complete and mail the coupon below to your nearby Motorola Semiconductor distributor.

MMT3904/06 utilize the same patented Annular\*\* die structure found in the popular 2N3904/06 . . . and the electrical characteristics are similar.

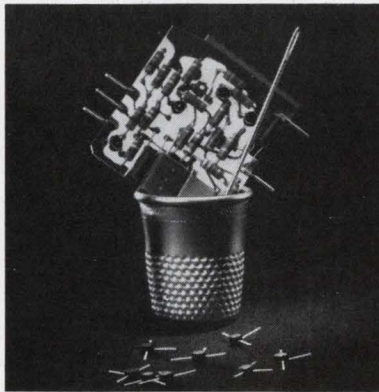

Major difference is the size of the package — it's almost an order of magnitude *smaller!* In addition, the Micro-T's gold-plated ribbon leads radiate from its center for easy, low-silhouette, drop-in mounting; and, the package itself is formed by Motorola's one-piece injection-molding process to achieve the same high reliability as other MIL-reliable Unibloc<sup>‡</sup> types.

<sup>‡</sup>Trademarks of Motorola Inc.

\*\*Annular Semiconductors are patented by Motorola Inc.

**MOTOROLA**  
**Semiconductor Products Inc.**

P.O. Box 955, Phoenix, Arizona 85001

ELECTRONIC DESIGN 2, January 18, 1968

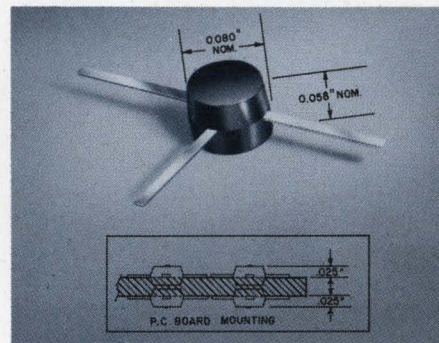

Use the coupon below to order your special \$3.00 Micro-T Prototype Pair HANDYPac. (Offer expires April 1, 1968.)

**YES!** I want to prove to myself that your Micro-T types MMT3904/06 are my best bet for miniaturized designs. Please send me \_\_\_\_\_ Micro-T HANDYPac(s) @ \$3.00 each. I am enclosing \$\_\_\_\_\_.

NAME \_\_\_\_\_

TITLE \_\_\_\_\_

COMPANY \_\_\_\_\_

DIV/DEPT \_\_\_\_\_

ADDRESS \_\_\_\_\_

CITY \_\_\_\_\_

STATE \_\_\_\_\_

ZIP \_\_\_\_\_

Complete and mail to your nearby Motorola distributor listed on the preceding page. (Offer expires April 1, 1968)

ON READER-SERVICE CARD CIRCLE 10

# The 747's designers chose this high-power basic size 23 servo motor\* for 2 reasons:

**Higher Torque**—Because its finned case dissipates more heat, it can run at higher power—and deliver more torque—than other size 23 servo motors. In the 747, it produces 12 oz-in to drive a 3 ft<sup>2</sup> butterfly valve.

**No Single-Phasing**—Special rotor design absolutely prevents single-phasing, even when the control phase is tuned and sees an open circuit from the servo amp. This lets 747 designers drive the motor with small, lightweight SCR controls—impossible with conventional servo motors.

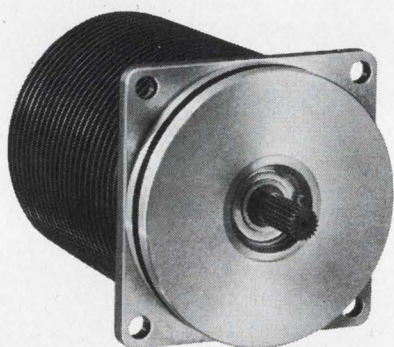

## You could choose it for at least 2 others:

**Still Higher Torque**—When single-phasing isn't a problem (as with conventional low source impedance servo amps), the motor can produce up to 16 oz-in torque—75% more than a conventional size 23.

**Longer Life**—Even if you don't need higher torque, you can use this motor like a conventional size 23 . . . and it will last far longer. Its heat-sink design lets it run cool in applications where ordinary 23's would push the limit of their heat-rise ratings.

Whatever your electro-mechanical actuation need, there's a Harowe servo motor to fill it—large and small sizes . . . with built-in brakes and generators . . . with 400 Hz windings for aerospace or 60 Hz windings for industrial control. Just let us know your application.

**\*P.S.:** They also chose Harowe standard synchros, pancake synchros, and limited-rotation brushless synchros.



**SERVO CONTROLS, INC.**

20 Westtown Road • West Chester, Pa. 19380

Servo, Stepper & Synchronous Motors • Motor Generators  
Synchros • Resolvers • Pancakes • Gearheads

ON READER-SERVICE CARD CIRCLE 12

## Designer's Datebook

| FEBRUARY |     |     |     |     |     |     |
|----------|-----|-----|-----|-----|-----|-----|
| Sun      | Mon | Tue | Wed | Thu | Fri | Sat |
|          | 4   | 5   | 6   | 7   | 8   | 9   |
| 11       | 12  | 13  | 14  | 15  | 16  | 17  |
| 18       | 19  | 20  | 21  | 22  | 23  | 24  |
| 25       | 26  | 27  | 28  | 29  |     |     |

| MARCH |     |     |     |     |     |     |
|-------|-----|-----|-----|-----|-----|-----|
| Sun   | Mon | Tue | Wed | Thu | Fri | Sat |
|       |     |     |     |     | 1   | 2   |
| 3     | 4   | 5   | 6   | 7   | 8   | 9   |
| 10    | 11  | 12  | 13  | 14  | 15  | 16  |
| 17    | 18  | 19  | 20  | 21  | 22  | 23  |
| 24    | 25  | 26  | 27  | 28  | 29  | 30  |
| 31    |     |     |     |     |     |     |

For further information on meetings, use Reader Service card.

### Jan. 28-Feb. 2

**Winter Power Meeting** (New York) Sponsor: IEEE; IEEE Headquarters, Technical Conference Services, 345 E. 47 St., New York, N.Y. 10017.

CIRCLE NO. 361

### Feb. 10

**Defense Contract Administration Forum** (Clearwater, Fla.) Sponsor: American Society for Quality Control; Lewis Rubin, General Electric Co., Neutron Devices Dept., P.O. Box 11508, St. Petersburg, Fla. 33730.

CIRCLE NO. 362

### Feb. 13-15

**Aerospace & Electronic Systems Winter Convention (WINCON)** (Los Angeles) Sponsor: IEEE; R. P. Lytle or K. F. Cates, 3370 Miraloma Ave., Anaheim, Calif. 92803.

CIRCLE NO. 363

### Feb. 14-16

**International Solid-State Circuits Conference** (Philadelphia) Sponsor: IEEE; Lewis Winner, 152 W. 42 St., New York, N.Y. 10036.

CIRCLE NO. 364

### Feb. 28-Mar. 1

**Scintillation and Semiconductor Counter Symposium** (Washington, D. C.) Sponsor: IEEE, NBS, Atomic Energy Commission; W. A. Higinbotham, Brookhaven National Laboratories, Upton, N.Y. 11973.

CIRCLE NO. 365

### Mar. 18-21

**IEEE International Convention and Exhibition** (New York) Sponsor: IEEE; J. M. Kinn, IEEE, 345 E. 47 St., New York, N.Y. 10017.

CIRCLE NO. 366

ON READER-SERVICE CARD CIRCLE 13 ▶

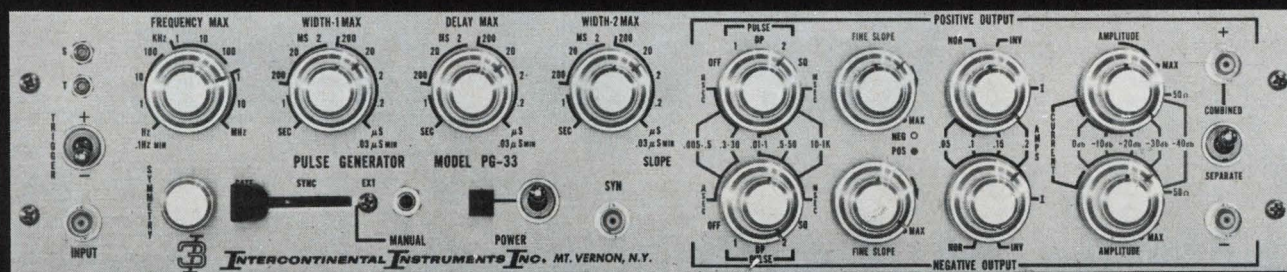
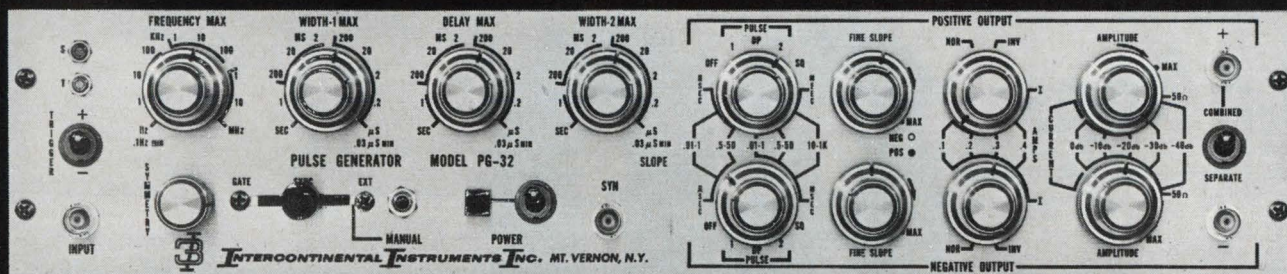
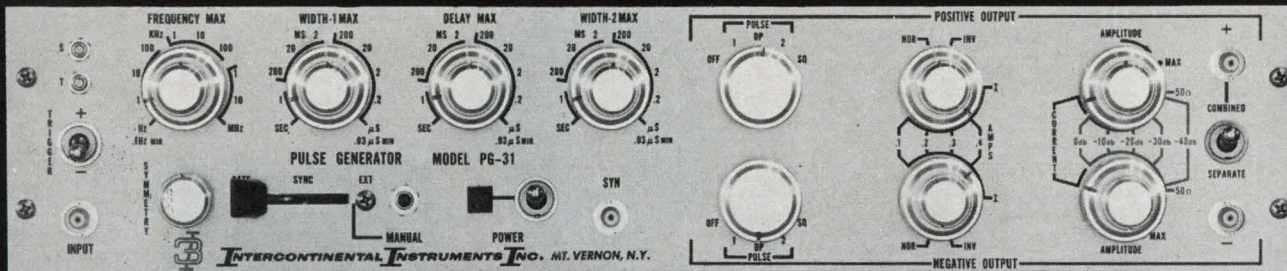
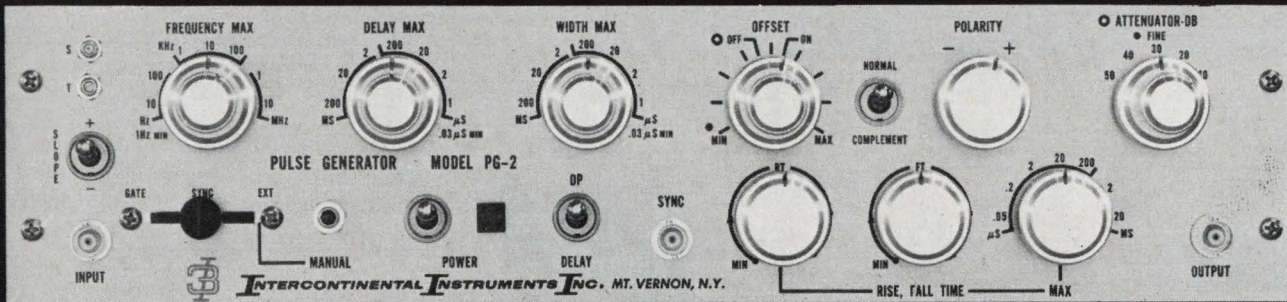

## THE *PLUS* PULSERS.

These four solid-state pulse generators offer you more in the 0.1 Hz to 20 MHz range than any others available at equivalent prices.

More range in prf, width, delay, rise and fall, and amplitude. More versatility: PG-31, PG-32, PG-33 are dual, independent channel bipolar pulsers voltage or current outputs, normal or complementary, single or double pulses, square waves plus sync and one-shot. PG-2 is a single

channel unit: positive or negative out, single or double pulse or square wave plus sync plus one-shot. All four are DC-coupled: no low frequency or duty cycle limitations.

The plus pulsers.

Compare specs — not nameplates.

Intercontinental Instruments, Inc., a Subsidiary of Chronetics, 500 Nuber Avenue, Mt. Vernon, New York (914) 699-4400. In Europe: 39 Rue Rothschild, Geneva, Switzerland (022) 31 81 80.

| MODEL | CLOCK PRF                                 | AMPLITUDE                                       | Z OUT                     | RISE / FALL TIME          | WIDTH                     | DELAY       | DUTY CYCLE (MAX) | DC OFFSET            | PRICE   |
|-------|---|---|---------------------------|---------------------------|---------------------------|-------------|------------------|----------------------|---------|
| PG-2  | 1 Hz-10 MHz<br>20 MHz Max. <sup>1</sup>   | 10 mv-10V<br>+ or -                             | 50 ohms                   | <10 ns-20 ms <sup>4</sup> | <35 ns-200 ms             | 0-200 ms    | 100%             | ± 5V                 | \$ 925. |
| PG-31 | 0.1 Hz-10 MHz<br>20 MHz Max. <sup>1</sup> | 20 mV-20V <sup>3</sup><br>+ and -<br>2 Channels | 50 ohms<br>or<br>500 ohms | 10 ns                     | <30 ns-1 sec <sup>5</sup> | 50 ns-1 sec | 100%             | To 10V<br>To 400 mA* | 1225.   |
| PG-32 | 0.1 Hz-10 MHz<br>20 MHz Max. <sup>1</sup> | 20 mV-20V <sup>3</sup><br>+ and -<br>2 Channels | 50 ohms<br>or<br>500 ohms | 10 ns-1 sec <sup>4</sup>  | <30 ns-1 sec <sup>5</sup> | 50 ns-1 sec | 100%             | To 10V<br>To 400 mA  | 1385.   |
| PG-33 | 0.1 Hz-10 MHz<br>20 MHz Max. <sup>1</sup> | 10 mV-10V <sup>3</sup><br>+ and -<br>2 Channels | 50 ohms<br>or<br>500 ohms | 5 ns-1 sec <sup>4</sup>   | <30 ns-1 sec <sup>5</sup> | 50 ns-1 sec | 100%             | To 10V<br>To 400 mA  | 1350.   |

### Notes:

- 1 Effective PRF in double pulse mode
- 2 Max. Range into 50-ohm loads
- 3 Separate or combined (bipolar) channels;

- 4 same polarity on Special Order  
Variable linearly — 100:1 dynamic range.  
Separate control of Rise and Fall Times

- 5 Independent control Pulse 1/Pulse 2 (double pulse mode)
- 6 f.o.b. Mt. Vernon, N. Y., domestic



**gates**

**5**

**nsec**

**flip-flops**

**60**

**MHz**

**Increase your system speed.  
Sprague SSL\* is the fastest saturated  
logic. And it's pin compatible  
with series 8000.**

**You should call us fast.**



*For additional information on  
Sprague SSL Super-Speed Logic, write to:  
Semiconductor Division  
Sprague Electric Company  
115 Northeast Cutoff  
Worcester, Mass. 01606*

★Trademark for Super-Speed Logic

**SPRAGUE WORCESTER... the world's finest microcircuit facility**



'Sprague' and '®' are registered trademarks of the Sprague Electric Co.

# News



Avionics in the SST era will demand advances in inertial navigation to keep the giants en

route, automatic checkout for equipment safety and satellite radio nets. Page 49



Project Shed Light aims to enable pilots to see at night, through rain, foliage. Lt. Col.

L. A. Tollman (left) and Maj. C. E. Waters are key figures in this Air Force effort. P. 25

## Also in this section:

Hybrid microwave LSI to operate in K band. Page 36

Troposcatter radars run into heavy weather. Page 44

# The connector THING

A periodical periodical designed, quite frankly, to further the sales of Microdot connectors and cables. Published entirely in the interest of profit.

## The 2 MINUTE (OR LESS) BRIBE

The two minute (or 120 second, whichever is shorter) "bribe" is about how long it should take a rank amateur (or even a good-smelling amateur) to prove to his satisfaction that Microdot does not speak with forked connector. (Affidavit: "This ain't a bribe in the true sense." Signed the management.)

The "bribe" centers around our high density, circular, multipin connectors. Microdot started this particular concept over four years ago with the MARC 53, the hit of the subminiature world. It's been right up there on the Gemini space walks and, as the world's smallest, high-performance connector has also been drafted for other military (meets MIL-C-38300A) and NASA projects. It heralded a new generation in submins. The Microdot high density design is coupled with two other exclusive features: (1) Posilock, the only advanced push-pull, lock coupling mechanism that guarantees proper engagement even under "blind mating" conditions and (2) Posiseal, a sandwich insert design using silicon interwafer seals.

## PRESS ON

Now that you are conversant with the MARC 53, let's try the MARC 53 RMD. Now this differs from the other much more than those three little letters on the end.

### HOW SO?

Because the RMD version has rear-insertable and removable pins and sockets!!!!

## BENEFITS PLEASE

No tools needed for assembly or disassembly. And tools, as every inspector knows, are oft cause of damage of a connector's rubber parts which in turn leads to insufficient sealing which in turn leads to all sorts of trouble. And the need for tools further makes field repair and/or maintenance a veritable "you're kidding" situation.

## AND EVEN MORE

All this means here's a submin connector that lends itself to real mass production assembly techniques because assemblers can use factory produced, pre-crimped wire.

## WHAT DOES THIS MEAN TO YOU?

Fame, fortune and undying gratitude when you tot up all the savings in time and money you'll be responsible for.

NOT ENOUGH  
WHAT ELSE?

**BÜZ** (a case in point is a Beefeater)  
If you're the fastest under the two minute barrier.

## WINNERS

The three best winners, those with the neatest times, will receive a choice case of their own choice of hard stuff; Smirnoff, J&B, Beefeater, Jack Daniels, COMPLETE with THEIR OWN PRIVATE LABELS WITH THEIR OWN CUSTOM DESIGNED NAMES, very effective for impressing folk at parties and/or other get togethers.

## TWO MINUTE BRIBE CONTEST RULES

You must use a Microdot RMD MARC 53 Connector. And you must use a Microdot Rep. (There are several used ones in your vicinity.)

### SMALL PRINT

1. You will be handed a MARC 53 RMD.
2. You will be told to unscrew the neatly machined rear nut and
3. Dismantle the back of the device and loosen all those metal things.
4. Then pull out 4 pins.
5. Put back those 4 pins. And
6. Put all that metal stuff back in the proper order. And tighten the rear nut.

## LOSERS AND OTHERS

Because, there are NO TOOLS NECESSARY WITH THE MARC 53 RMD, and to compensate you for that fact, you will receive a very tool tool. (Better than a connector tool, really.) You will receive ONE STERLING BAR SPOON. (This spoon is sterling in concept only, but it shouldn't rust.)

**HURRY!** For this remarkable contest closes sometime this spring o/a midnight February 28, 1968. Fill out the neat coupon below. All of this madness is, unfortunately, void where the legislature is a bit stuffy.



## NEAT COUPON



## MICRODOT INC.

220 Pasadena Ave., South Pasadena, Calif. 91030.

- Yes, I would like to take the two minutes "bribe," but I couldn't read your crumby contest rules.
- Yes, yes. I want to take the "bribe," rules or no rules.
- Enough of that. Just send me all the info on the MARC 53 RMD. I make my own stuff.

Name \_\_\_\_\_

Company \_\_\_\_\_

Position \_\_\_\_\_

Address \_\_\_\_\_

City \_\_\_\_\_

State \_\_\_\_\_ Zip \_\_\_\_\_

MARC 53, RMD, Posilock and Posiseal are trademarks of Microdot Inc.

{ What's happening in New York on March 18? Write in and tell us, and we'll send you a little surprise! }

ON READER-SERVICE CARD CIRCLE 15

ELECTRONIC DESIGN 2, January 18, 1968

## New ways to ease U.S. communications

While debate rages over the pros and cons of cables and satellites for international communications, the domestic problem—communications congestion—worsens by the day. To avoid a complete jam over the next 10 years, scientists and designers are going to have to come up with some good solutions.

"We're already hurting in a dozen frequency bands," says a spokesman for the Federal Communications Commission. "One of the most crowded are the frequencies allocated to land mobile services—32 to 50 MHz, 150.8 to 162 MHz, and 450 to 470 MHz. The services include the police and firemen, businesses, railroads, buses, and taxis.

"For maximum performance, these services should operate at frequencies below 1 GHz. The only solution is to move into another allocated band, which, of course, would crowd it."

Dr. Lee L. Davenport, president of General Telephone and Electronics Laboratories, New York, warns: "Microwave links will be saturated before 10 years—especially in high traffic-density areas near major cities."

In the next few years several solutions will be tried, including millimeter waves, lasers, cables and new modulations.

Davenport suggests millimeter-wave transmission in high-density areas to ease the microwave strain. A spokesman for American Telephone and Telegraph says cables will probably be the answer. The FCC says cables joined to a microwave loop around the cities have been suggested.

"The next extension is in the optical-frequency lasers," Davenport says. "Whether we transmit through a pipe or in the open air remains to be seen. The absorption problem with pipes is serious.

"We're not looking for transmitting lasers over long distances. Lasers, like millimeter-wave links, will be used for interchange trunks in cities with high-density traffic. They will probably operate in a 10-to-20-block area."

Transmitting without a pipe in the open atmosphere is another approach. "The Russians have done this, I believe, in an interexchange trunk in Moscow," Davenport says. To cut through the obscurity in the atmosphere, a high-power laser would have to be used, and this could create a hazard.

"But the laser has tremendous capacity for traffic on a single beam," he adds.

"A big mess will soon exist in the 4- and 6-GHz regions—the backbone of our domestic TV distribution network," according to the FCC. "The confusion will come with more traffic from communication satellites, which are assigned the same overcrowded frequencies."

To avoid this, Bell Telephone Laboratories, Holmdel, N.J., recently endorsed the use of millimeter waves for the down-link from satellites.

Because millimeter waves are easily attenuated in the atmosphere, ground terminals for satellites will be built in pairs, 10 miles or so apart; if a rainstorm blacks out one station, the other should still be effective.

"Besides the use of millimeter waves to provide more channels, large, highly directional antennas will be used on satellites," Davenport predicts. "Although antennas 30 to 40 feet in diameter seem large now, they will one day reach 300 feet."

These large antennas will provide pencil beams that can be directed accurately at a small area on the Earth. Two beams directed to different cities—Los Angeles

and St. Louis, for example—could be transmitted at the same time on the same frequency without interference with each other.

To add more channels to cables, the use of pulse-code modulation will be increased substantially. The present PCM carrier system converts voice into pulses and transmits 24 voice channels.

"The only unused portions of the spectrum," the FCC says, "lie between 17.7 to 19.7 GHz and above 40 GHz."

Otherwise, saturation has nearly been reached.

### Budget cuts overtake hypersonic aircraft

The X-15 rocket aircraft, the famous hypersonic test vehicle, has fallen victim to an economy measure. Originally financed jointly by the Navy, the Air Force and NASA, the air-launched experimental craft lost Air Force support in fiscal 1968. Now NASA, too, has withdrawn funds. Until Congress slashed the space agency's budget from \$4.6 billion to \$4.28 billion, NASA had planned to spend \$5.5 million in 1969 to test a new ramjet engine. Now, however, X-15 funds have been diverted to other research programs.

### Proxmire investigation may bring new controls

The allegation by Senator William Proxmire (D-Wis.) that defense contractors have been making improper use of Government-owned equipment may lead to "tighter control over inventories and more ownership by industry," according to staff members of the Joint Economic Committee, which Senator Proxmire heads.

The Senator, citing General Accounting Office reports, has listed 23 companies as "representative" of thousands that, in his estimation, are collectively wasting "hundreds of millions of dollars a year."

He charges that expensive capital equipment was turned over to industry so that companies could produce what the Government needed, only to have the companies use the equipment for commercial production without permission and

without the payment of rentals to the Government.

The companies involved, including such giants as Boeing, TRW and Sperry-Rand, deny the charges.

## All systems are go on TTS-1 satellite

NASA's Test and Training Satellite (TTS-1), launched Dec. 13, has been successfully used by all stations in the Manned Space Flight Network. Now circling the Earth once every 92 minutes in an elliptical orbit simulating that of an Apollo mission, the small transponder provides a means of simulating communications in duplex for each station at least several times a day.

Officials at Goddard Space Flight Center, Greenbelt, Md., said that the instrumented aircraft previously used for station exercise and training will still be used as well as TTS-1.

A second TTS is slated to be launched this summer. Goddard management also contemplates the use of a synchronous satellite for station exercise, although funds have not been set aside for it.

## Who has the urge to merge with ABC?

Who will merge with American Broadcasting Companies, Inc.?

This newest guessing game in financial and electronic circles began following the cancellation of a merger agreement by the International Telephone and Telegraph Corp. Among the companies mentioned as prospective buyers of ABC are Litton Industries and General Electric.

ITT said that the continuing delay in consummating the merger—first before the Federal Communications Commission and then in the courts—had prompted its board of directors to back out of the deal with ABC. ITT stock has nearly doubled in price since the proposed

merger was first announced in December, 1965. With the terms of the merger calling for 1.14 shares of ITT for every share of ABC, the pending cost to ITT had risen greatly—to about \$130 for each share of ABC, as against \$85.50 offered by ITT in 1965.

ABC, which needs capital for modernization of its television studios and fuller conversion to color, is now free to discuss a merger with other potential buyers. Those who speculate about Litton recall that the giant holding company, with heavy interests in electronics, approached ABC with an offer of \$80 a share in December, 1965, but was turned down when ITT topped its bid.

## FAA asks for bids for altitude device

The Federal Aviation Administration is soliciting proposals for an altitude warning device that would give visual and auditory warnings to pilots of civil turbojet aircraft when the aircraft are either approaching or deviating from a preselected altitude.

The warning signals are preset, so that when a plane approaches a certain altitude the warning device is activated. First the visual signal would come on at a point between 700 and 1500 feet from the preset altitude. It would be followed by an audible signal at a range of 200 to 800 feet. A minimum of 400 feet between the two types of signals would be required.

While the two preset signals would remain the same for any phase of operation, the preselected altitude would be changed by the pilot to adjust to the changing phases of flight.

The device is aimed primarily at installing "altitude awareness" in jet pilots particularly during high-speed climb and descent maneuvers, according to the FAA.

## Pentagon juggles funds to meet Vietnam costs

The Pentagon has found a new way to pay for its underestimated Vietnam war cost—remove money from its procurement pocket and place it in its war-expenditures

pocket. This approach, which has already been applied to fiscal year 1968 funds, is believed by Defense Dept. officials to be the only way to minimize their anticipated request to Congress for a supplementary appropriation.

No official figure has been released by the Pentagon, but Rep. Melvin R. Laird (R-Wis.) has predicted that at least \$2.5 billion will be shifted in that fashion to pay for Vietnam support. Cuts in the purchase of new tactical and strategic equipment are bound to be felt by most aerospace and military electronics manufacturers, informants say. Some new programs may be eliminated entirely, while others will be delayed or stretched out, industry experts assert.

Military officials will find it difficult to convince Congress that such hardware cuts will not seriously bend the defense posture, since their arguments for fiscal 1968 appropriations last year indicated that budget figures had been reduced to the minimum commensurate with national security.

## Communications users may use own equipment

The Federal Communications Commission has authorized ITT World Communications, Inc., a subsidiary of the International Telephone and Telegraph Corp., to allow customers to use their own equipment on cable and satellite communications channels. The FCC says it granted the authorization "to allow customers to achieve greater flexibility in meeting their communications service needs."

In operation, users of overseas voice-grade channels may subdivide them in order to produce additional circuits. The limits set for this service are:

- Not more than 22 telegraph circuits on a voice-grade cable channel.

- Not more than 24 telegraph circuits on a voice-grade satellite channel.

These additional channels may be used to accommodate alternating or simultaneous voice and non-voice communications.

Potential high-volume users for this service are said to be NASA, the airlines, press agencies and petroleum companies.



quality assurance • production test

## automatic resistor tester becomes more automatic

ESI's Model 500 Resistance Deviation Bridge—an automated resistor test system at 50 ppm accuracy for incoming quality assurance or production control—has a new sorting accessory which boosts speed still further and reduces operator error to nil.



It's an automatic sorter, which ejects the measured resistor without operator aid into one of 3 bins, which represent preset tolerance limits anywhere between plus or minus 10%. An accessory counter records quantity in each bin.

The Model 500 is a rugged but precisely made resistance measuring system designed for production line sorting of high accuracy resistors. Much more than a go-no-go unit, it checks values from 0.1 ohm to 111 megohms and has infinitely adjustable deviation settings from 0.01% to 10% full scale. The system includes a KELVIN KLAMP® holding jig, foot pedal and complete instruction manual for \$2,750. For more details circle No. 210 on the Reader Service Card.

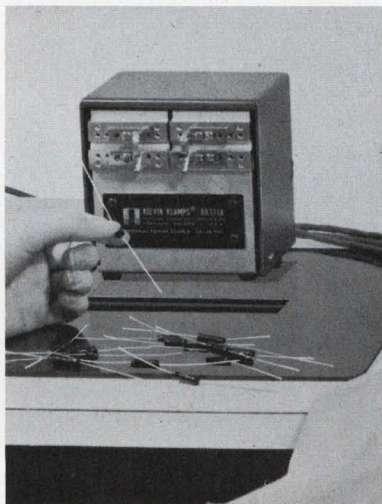

components for instrument designers

## dekapot's got a lot that's not in a multi-turn pot

What's a reasonable price for a 5-digit potentiometer with 0.002% linearity, has ultra stability, takes only one panel dial space and is set and read faster than any multi-turn pot?

If you and your customer want this kind of performance then price probably is not a big factor, but the fact that you can have this off-the-shelf from ESI for \$90-\$175 makes our patented DEKAPOT® decade potentiometer even more attractive.

They're built around our precision wirewound resistors and a patented coaxial dial system. The resistors are the same hand-crafted components that provide accuracy and reliability for ESI laboratory standards. The DEKADIAL® design allows three or four dials to be stacked and yet be dialed independently for fast, in-line readout. Circle No. 211 on your Reader Service Card.



Model DP1311

esi®

news and innovations in metrology

circuit designers

## new "lo-power" bridge best for selecting components

A new model of an old workhorse in precision measurement—ESI's 250DE Portable Impedance Bridge—is finding increasing application in the circuit and equipment design field.

Because of its "lo-power" characteristics, the 250DE is especially suited for selecting or checking sensitive circuit components. The small voltage applied to the device under test does not affect measurement accuracy. Solid-state circuit elements, transducers, sensors, etc., can be reliably measured, without effect from self-heating and voltage coefficients.

The 250DE's combined portability and near laboratory precision make it an ideal multipurpose test tool for measuring resistance, capacitance and inductance. It operates from four "D" size dry cell batteries and requires no external accessories. Its oversized panel meter and patented DEKADIAL® decade dials provide excellent readout display. Accuracy is as follows: Resistance to 12 MΩ at ± 0.1%, capacitance from 0.1 pF to 1200 μF ± 0.2% and inductance from 0.1 μH to 1200 H at ± 0.3%. Price: \$525. Circle No. 212 on your Reader Service Card.



Model 250DE

circuit designers

## little bridge with big name is components sorter of all sorts

A remarkable little bridge originally designed for fabricating wirewound resistors—ESI's new Model 261 Impedance Comparator—is rapidly finding its way into a variety of appli-

cations. It's an accurate (.05%) sorter-matcher on the circuit designer's bench and a fast, handy tester at incoming quality assurance stations.

Priced at only \$250 and measuring only 8½"x6"x6½", the Model 261 is a *simplified*, solid-state ac bridge which can check resistors, capacitors or inductors against a reference standard. Meter response on deviation ranges of 1%, 5% or 25% is virtually *instantaneous*. A sorting fixture facilitates testing of axial or radial lead components (optional).

In addition to simple value sorting, a prototype builder quickly finds components that match one another or one of specific value.

Resistance values from 10Ω to 2MΩ, capacitance from 0.001 μF to 100 μF and inductance between 30 mH and 5 kH may be efficiently and accurately compared. Resistance accuracies for the 1% deviation range are ± 0.05% for values between 10Ω and 500 kΩ and ± 0.2% between 500 kΩ and 2 MΩ. Equivalent accuracies can be expected on inductive or capacitive components. For further information, circle No. 213 on your Reader Service Card.

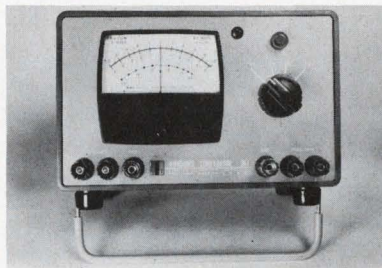

Electro Scientific Industries, Inc.

13900 N.W. SCIENCE PARK DRIVE  
PORTLAND, OREGON 97229



## intricate, close tolerance magnet shapes... economically

New G-E Lodex® permanent magnets can revolutionize your product

With G-E Lodex permanent magnets, you can forget about conventional magnet size and shape limitations and design your product the way you want it. Then we will produce the magnet to fit. Here's how:

Lodex permanent magnet material consists of elongated single-domain particles dispersed in a lead matrix.

This makes it possible to produce shapes with extremely close physical tolerances without expensive form grinding.

Lodex permanent magnets also have exceptionally high piece-to-piece magnetic uniformity, which virtually eliminates the need for individual testing and calibration of

the end product.

So, whatever your application, let your imagination soar. Call your G-E Sales Engineer and see how you can revolutionize your product. Or write to General Electric Company, Section 731-06, Edmore, Mich. 48829.

®Reg. Trademark of General Electric Co.

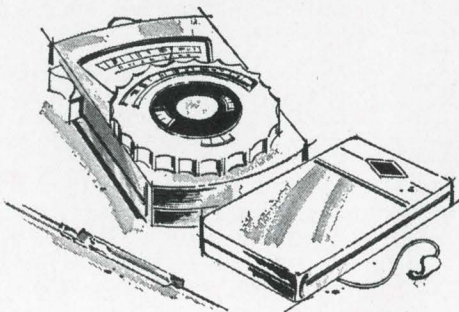

◀ **Exposure meters**—consistent fields with space and cost savings. **Hearing aids**—minute magnet for diaphragm movement contributes to miniaturization. **Reed Switches**—highly uniform magnetic fields with high-density packaging.

**GENERAL**  **ELECTRIC**

ON READER-SERVICE CARD CIRCLE 18

ELECTRONIC DESIGN 2, January 18, 1968

# Shed light: to hunt and kill in real time

## Air Force search for invisible foe pays off with new light intensifiers, infrared, radar, lasers

**John F. Mason**  
Military-Aerospace Editor

The Air Force's highly-guarded effort to develop ways for pilots to find and destroy the enemy at night, in bad weather and through foliage and camouflage, has reached its first major milestone: equipment for seeing at night has passed the development stage. Prototypes have been built and they are operating in Vietnam.

Solutions to the more difficult tasks of seeing through fog, rain, foliage, and earth have not reached this stage but these projects are moving and will be integrated into workable multi-sensor systems when they are ready.

Called Operation Shed Light, the two-year-old, top-priority program—guaranteed to move on, healthy and untouched by next year's budget cuts—consists of almost 100 projects, some of which are big multi-sensor aircraft systems while others are single sensors, components and even techniques.

Shed Light's objective—to pro-

vide real-time, or near real-time, find-and-kill capability under conditions of poor visibility—will be achieved by both self-contained systems and hunter-killer teams. The self-contained planes will carry sensors and weapons while the team approach will consist of one plane with sensors to find a target, mark it with flares, illuminate it with xenon lights, or transmit its position to an armed plane or to ground forces.

If the hunter plane is too crowded for sensor processors and cockpit readouts, raw target data may be data-linked to a ground station that will process and relay it to armed planes in near real time.

The only operational system that approaches this ultimate in quick response is the Army's Mohawk surveillance plane now in Vietnam. Equipped with infrared sensors and data-link, the Mohawk detects targets and relays their positions back to home base so fast that armed helicopters, fighters, and artillery can respond at once.

The Air Force reconnaissance

planes, on the other hand, designed for bigger and less immediate enemy maneuvers, must return to home base before their sensors' findings can be processed.

### The designer gets a job

Industry's job was, and is, a big one—to extend the capabilities of the eyeball.

The human eye, which requires at least partial moonlight to see at night, is particularly limited when looking at objects in motion, small targets against backgrounds of low contrast, and when viewing from a moving platform. Also, the eye can't see through fog, rain, foliage or beneath the surface of the earth.

Individual sensors can do all of these things but each has its specialty. Shed Light systems will therefore be multi-sensor combinations—when one is unable to "see," another is there to take over.

For dark nights, relatively free of precipitation, there are night glasses—a fairly straightforward device that uses a lens much larger than the pupil of the human eye that therefore captures a large quantity of photons.

Eyeglass, a night-glass device made by Electro-Optical Systems, Inc., a subsidiary of Xerox Corp., was tested with good results in an O-2A light plane. The pilot was able to spot targets on the ground with light from a quarter moon. With Eyeglass, the O-2A might be used for a forward air controller.

### Multiplying available light

To go beyond the capabilities of night glasses, image intensifiers using vacuum tubes are used. The three general kinds under development are those that convert an optical to an electron image to be observed or recorded directly, those that produce a fluorescent image, and those that yield a television signal.

To provide a gain in basic perception plus a gain in signal-to-noise ratio, the electron and



Typical North Vietnamese targets, like this mock-up of a SAM surface-to-air missile, are simulated at Eglin Air Force Base, Fla., and moved from range to range for Shed Light pilots to try out various sensors. To test foliage-penetrating radar, the SAM is moved to the underbrush range; planes equipped with infrared may fly over sampans on sluggish Florida bayous; and low-light-level TV looks for SAM under various degrees of darkness.

*(Shed light, continued)*

fluorescent image devices normally use a front objective lens which forms an image on a photocathode second element. The observer views the image formed on the screen face of the tube through a magnifying eyepiece. An initial gain in S/N ratio can be obtained by using an objective lens with a large diameter and a photocathode with good photon efficiency. The problems are to find ways to suppress background light within the tube and to prevent loss of resolution due to curvature of the electron-optical image plane.

The tube used in the two low-light-level TV cameras being tested in the Shed Light program is Westinghouse Electric Corp.'s SEC (Secondary Electron Conduction) tube. SEC won this favor because of its wide dynamic light range that enables it to operate satisfac-

torily over a wide latitude of light levels and because it has a quick response speed; unlike the human eye it adjusts quickly to changing light levels. Other tubes are more likely to "bloom" when subjected to a sudden increase in light—that is, halos appear around objects on the screen or the screen goes white.

The SEC tube converts light into an electrical signal, amplifies it hundreds of times and then changes it back to visible light. The tube operates with visible light, ultraviolet, X-rays, and other radiations.

An image focused on a fiber optic faceplate causes the emission of electrons which are accelerated and focused on the target. The target, a thin membrane about 10 microns thick, amplifies and stores the charge image which is then read out by a conventional direct-beam scanning section.

The Radio Corp. of America has a new tube, called the Isocon, being tested in the Shed Light program,

but says it is too classified to discuss. RCA does say the new tube is a departure from its previous work. RCA's earlier work consisted of using an orthicon that was essentially a TV pickup preceded by an image converter used as a pre-amplifier. The output was fed to video amplifiers for direct viewing or photo-recording.

**Seeing in the dark with TV**

TV cameras, installed in the nose of many planes in Vietnam are already helping pilots spot and identify targets they can't see with the naked eye. The cameras are tilted forward, rather than straight down, to give the pilot time to study what he's approaching rather than having to catch a fleeting glimpse of what's whizzing by directly below.

With improved light-intensifier tubes, TV systems are getting better and they are being installed in a variety of planes. But there are inherent limits to TV: it doesn't work in total darkness and it doesn't see through fog, rain or anything the human eye can't penetrate.

The problem of operating in total darkness is being tackled in several ways: TV systems sensitive to infrared can be used and planes are being equipped to provide their own light.

Westinghouse is developing a TV system to use light provided by a laser illuminator. A single pinpoint of laser light will scan the terrain in a raster pattern so quickly that the reflected return will paint a picture of the ground ahead on a cathode ray tube.

Other work under way on TV include a study by North American Aviation, Inc.'s Autonetics Div. on a new viewfinder that won't present a distorted, jittery picture when the plane is flying at high speed; Wright-Patterson is testing RCA's new Isocon intensifier tube; and Scripps Institution of Oceanography will send a team to Southeast Asia next year to test environmental factors that affect TV.

TV is no longer considered to be a slow-plane sensor. Under project Tropic Moon I, a TV set built by Dalmo Victor, Aerospace Product Group, a division of Textron, Inc., was tested on a Navy A-1E Sky-

**Light booster**

SEC (Secondary Electron Conduction) tube uses a two-step process to convert the invisible image to a charge image. In the image intensifier stage (left), light ejects electrons from a photoemitter. After re-imaging and amplification in the middle or imaging section the primary photoelectrons fall on the thin film face of the second-

ary target. This charge image modulates the scanning beam current from the reading section (far right). The electric field applied across the film causes a majority of the secondary electrons to be transported through a potassium-chloride low-density film layer to produce a secondary conduction current; the result is a sensitive TV tube.

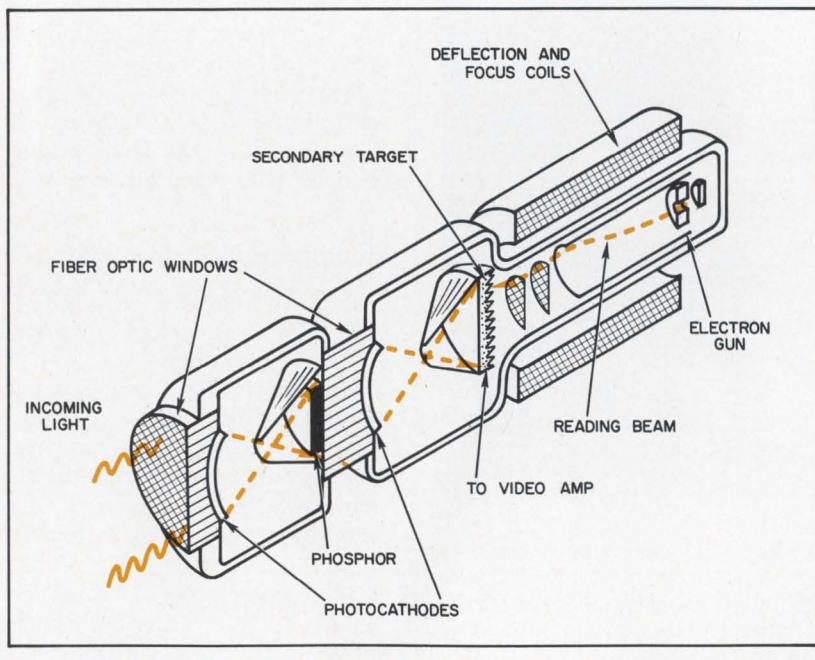

# FLUX'EM, SOAK'EM, CLEAN'EM

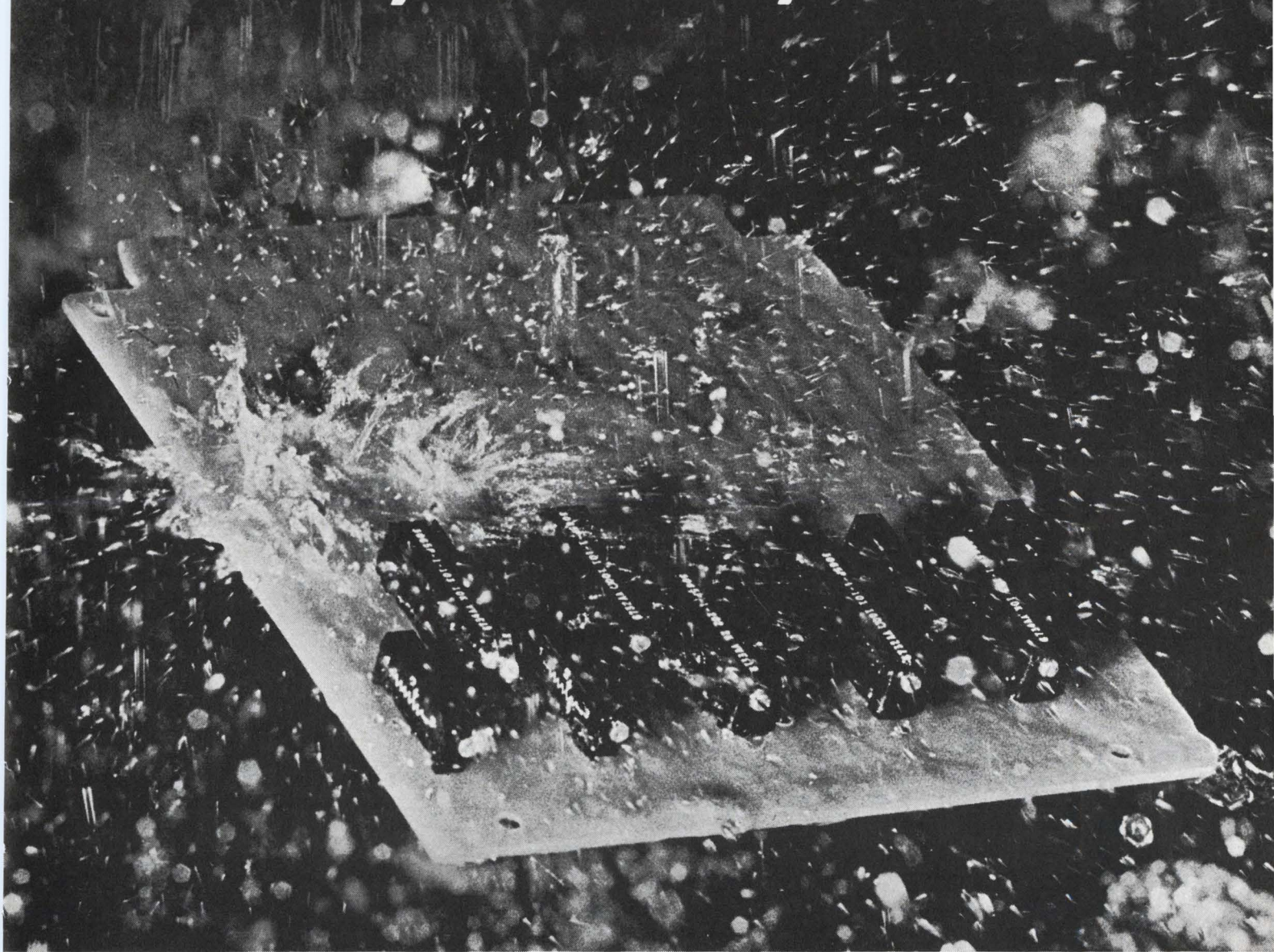

## BOURNS 3 NEW COMMERCIAL MODELS TAKE IT!

. . . that's right because the new E-Z-TRIM® potentiometers have been designed and built to meet today's production requirements. Sealed to prevent damage from fluxing, soldering and cleaning, the new Models 3005, 3065 and 3066 are available in two sizes . . . with wirewound or non-wirewound elements . . . yet the unit price is less than competitive models with lower specs.

Don't live with unnecessary production problems . . . when your design and production needs call for sealed, low-cost potentiometers, specify these E-Z-TRIM units . . . they're big in everything but size and price!

Write today for complete data or contact your nearest Bourns office or representative.



|                                 | Model 3005<br>Wirewound<br>Element | Model 3065<br>Wirewound<br>Element | Model 3066<br>Carbon<br>Element |
|---------------------------------|------------------------------------|------------------------------------|---------------------------------|
| Size (L, W, H)                  | .75 x .14 x .31                    | 1 x .29 x .36                      | 1 x .29 x .36                   |
| Standard Resistance Range       | 10Ω to 25K                         | 50Ω to 20K                         | 20K to 1 Meg                    |
| Resistance Tolerance (Standard) | ±10%                               | ±10%                               | ±20%                            |
| Resolution                      | 0.2 to 1.6%                        | 0.32 to 1.39%                      | Infinite                        |
| Power Rating                    | 1 watt                             | 0.5 watt                           | 0.2 watt                        |
| Temperature Range               | -65°C to +125°C                    | -55°C to +85°C                     | -55°C to +85°C                  |
| Seal                            | Immersion Proof                    | Immersion Proof                    | Immersion Proof                 |
| Price (500 piece)               | \$1.45                             | \$1.44                             | \$1.44                          |



BOURNS, INC., TRIMPOT DIVISION • 1200 COLUMBIA AVE., RIVERSIDE, CALIF.  
TELEPHONE (714) 684-1700 • TWX: 910 332-1252 • CABLE: BOURNSINC.

**(Shed light, continued)**

raider. The results were so good that Tropic Moon II successfully flew a Westinghouse TV in the faster B-57.

Badly needed is a fully solid-state, low-light-level TV unit. Those now available are too heavy for very light planes.

If the weight of the TV and the infrared unit can be brought down, the OV-10 counterinsurgency plane will probably be fitted out for a forward air controller. A study North American did on this project for Wright-Patterson is now with the Air Staff in the Pentagon.

**Seeing heat**

Detection of heat gradations on the ground can be displayed by a TV camera, on film that is developed in the plane or on the ground, or directly on a cathode ray tube.

Infrared takes over where night vision devices stop because they operate in total darkness and are good at detecting traces of the enemy, such as buried campfires. Also, metal from trucks under a thin canopy of leaves can be seen.

Except for these advantages, infrared is stymied by the same phenomena that block TV; it doesn't penetrate fog, clouds, or rain, heavy foliage, or any solid barrier. Also, keeping the detector cool requires a lot of equipment.

Both Hughes Aircraft Co. and Aerojet-General Corp. are trying to

improve resolution. Texas Instruments, Inc. is developing a sensor that operates at frequencies that can get through enough atmosphere for use at high altitudes, and the company is also working on a real-time raster display.

TI's sensor in the RF-4C reconnaissance plane looks straight down, but the company has been working on a forward-looking system. As with TV, the infrared operator also needs time to study the terrain.

The next step is to build a system with an array of detectors instead of just one. Whereas a single detector gets one look at a spot on the ground, a bank of detectors, lined up in several rows, would look more than once at each place. This would provide better resolution plus information that a heat source is moving. To know that an oblong object is moving may identify it as a truck or tank rather than a harmless shack.

With an array of indicators and a cockpit display, the pilot has a real-time, high-resolution infrared system with moving target indication. Avco Corp. is working on this. Wright-Patterson wants arrays of up to 100 detectors.

**Getting through rain and fog**

Great strides are being made with radar—still the best way to get through precipitation. Side-looking radar, for obtaining a map-like picture of almost photographic quality far to the side of the plane,

**Chain of command**

The Air Force Systems Command's Aeronautical Systems Div. at Wright-Patterson Air Force Base, Ohio, plans programs and carries out Shed Light research and development projects, and an office at Eglin Air Force Base, Fla., made up of members of the Tactical Air Warfare Center and the Air Proving Ground, is responsible for the operational tests and evaluation.

The Shed Light office at Eglin maintains liaison with the Air Force Logistics Command and the Air Training Command.

By July the program will have cost \$200 million.

is moving ahead on several fronts.

Goodyear Aerospace Corp., a subsidiary of the Goodyear Tire and Rubber Co., is trying to improve resolution, image stability and image retention of its AN/APQ-102A side-looking radar used on the RF-4C reconnaissance plane.

Regardless of improvements, however, the RF-4C's radar won't provide cockpit readout. It's a coherent radar, operating on the doppler principle, which provides a return that is meaningless to the eye. To get a picture, the returns are recorded on film in the plane, taken back to home base where they are fed into a processor correlator. This, in turn, must be printed on another film to provide an understandable radar image.

The Army's side-looking radar used in the Mohawk does provide a picture in the cockpit, processed in about one minute, but the enormous antenna it requires rules it out for supersonic planes.

Motorola, Inc. is trying to beat this problem by developing a coherent, nonfocused, synthetic aperture for side-looking radar with improved resolution, a smaller antenna, and a cockpit readout.

For better resolution, Goodyear will map the terrain with a number of frequencies with a "poly-frequency, side-looking radar."

Goodyear is also developing a low-frequency radar to look through foliage—the theory being that the long waves at these frequencies will be so much longer than any individual leaf that some

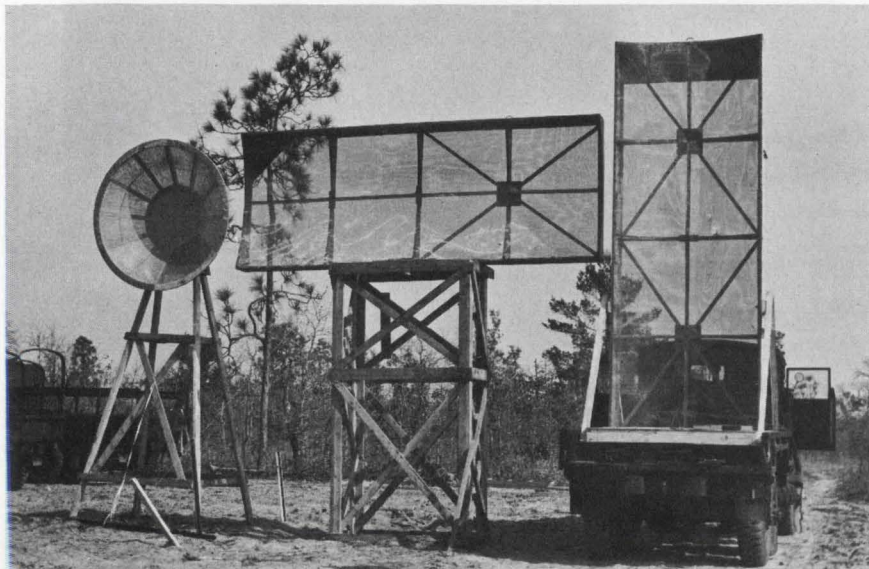

**Mock-up of North Vietnamese SAM site radar is moved to a new place for each test run by a new airborne sensor.**

# THIS POWER SUPPLY IS 3-WAYS\* **NEW!**

PANEL HEIGHT  
IN INCHES.

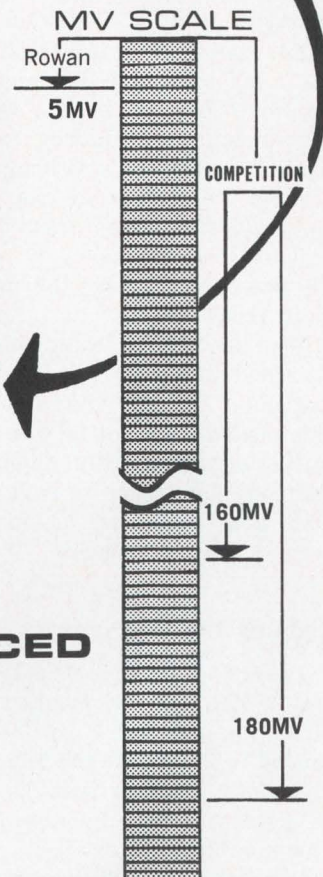
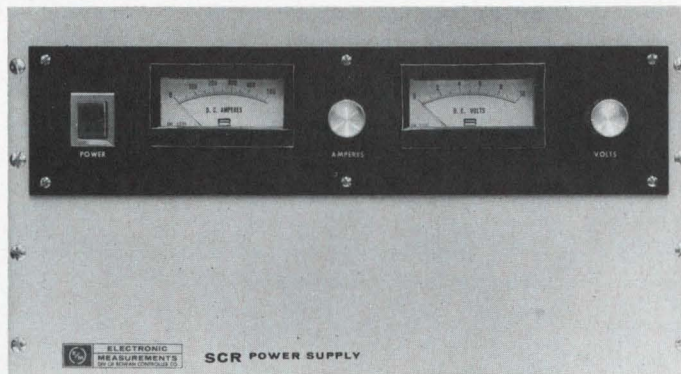
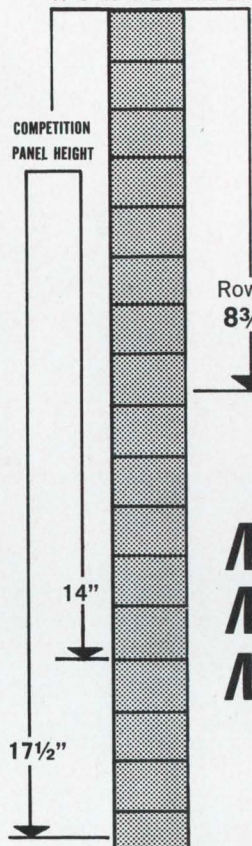

**NEW\*** **S**MALLER SIZE  
**NEW\*** **C**OMPETITIVELY PRICED  
**NEW\*** **R**EDUCED RIPPLE

| MODEL     | DC OUTPUT |      | REGULATION |     |         |      | RIPPLE<br>MV RMS | SIZE  |    |    | WEIGHT | PRICE     |
|-----------|-----------|------|------------|-----|---------|------|------------------|-------|----|----|--------|-----------|
|           | VOLTS     | AMPS | VOLTAGE    |     | CURRENT |      |                  | H     | W  | D  |        |           |
|           |           |      | %          | MV* | %       | MA** |                  |       |    |    |        |           |
| SCR10-500 | 0-10      | 500  | 0.1        | 3   | 0.1     | 150  | 5                | 8 3/4 | 19 | 20 | 195#   | \$1700.00 |
| SCR10-250 | 0-10      | 250  | 0.1        | 3   | 0.1     | 75   | 5                | 7     | 19 | 20 | 140#   | 1300.00   |
| SCR20-250 | 0-20      | 250  | 0.1        | 6   | 0.1     | 75   | 5                | 8 3/4 | 19 | 20 | 190#   | 1500.00   |
| SCR20-125 | 0-20      | 125  | 0.1        | 6   | 0.1     | 40   | 5                | 7     | 19 | 20 | 140#   | 1150.00   |
| SCR40-125 | 0-40      | 125  | 0.1        | 12  | 0.1     | 40   | 5                | 8 3/4 | 19 | 20 | 185#   | 1375.00   |
| SCR40-60  | 0-40      | 60   | 0.1        | 12  | 0.1     | 20   | 5                | 7     | 19 | 20 | 140#   | 925.00    |
| SCR80-30  | 0-80      | 30   | 0.1        | 30  | 0.1     | 10   | 10               | 7     | 19 | 20 | 140#   | 900.00    |
| SCR120-20 | 0-120     | 20   | 0.1        | 40  | 0.1     | 8    | 10               | 7     | 19 | 20 | 140#   | 900.00    |
| SCR160-30 | 0-160     | 30   | 0.1        | 50  | 0.1     | 10   | 10               | 8 3/4 | 19 | 20 | 185#   | 1500.00   |
| SCR160-15 | 0-160     | 15   | 0.1        | 50  | 0.1     | 5    | 10               | 7     | 19 | 20 | 140#   | 900.00    |
| SCR250-20 | 0-250     | 20   | 0.1        | 75  | 0.1     | 8    | 10               | 8 3/4 | 19 | 20 | 185#   | 1500.00   |
| SCR250-10 | 0-250     | 10   | 0.1        | 75  | 0.1     | 4    | 10               | 7     | 19 | 20 | 140#   | 900.00    |
| SCR500-10 | 25-500    | 10   | 0.1        | 150 | 0.1     | 4    | 10               | 8 3/4 | 19 | 20 | 185#   | 1700.00   |
| SCR500-5  | 25-500    | 5    | 0.1        | 150 | 0.1     | 2    | 10               | 7     | 19 | 20 | 140#   | 1300.00   |
| SCR120-40 | 0-120     | 40   | 0.1        | 40  | 0.1     | 12   | 10               | 8 3/4 | 19 | 20 | 185#   | 1500.00   |

\*Voltage regulation—% or MV, whichever is greater      \*\*Current regulation—% + MA total



**ELECTRONIC MEASUREMENTS**

2 CRESCENT PLACE | OCEANPORT, N.J. 07757

ON READER-SERVICE CARD CIRCLE 20

(Shed light, *continued*)

of each wave will spill past the leaves to the ground and up again to reveal what is concealed.

For zeroing in on small areas for a photographic-like picture in total darkness or in bad weather, extremely-high-frequency radar is being developed. Although the higher the frequency the better the resolution, there are limits. At a point, the frequency is so high the waves won't pass through precipitation.

The Air Force Cambridge Research Laboratory is working on "resonant region radar." Whether this means the resonance is created by the movement of an object or by its molecular structure isn't known. The goal, however, is to detect targets such as trucks.

### Lighting the way

Laser is light and therefore subject to the same elements that restrict the eye. But it can be transmitted to illuminate the terrain and it bounces back to paint a picture of what it strikes on film, cathode ray tubes, or TV.

A number of companies and university research centers are making tests to find the best frequencies to use in the visible and non-visible laser spectrum.

Infrared lasers haven't been too popular because the units are heavy and bulky. Ultraviolet lasers have been even less interesting because their range is limited and the power requirement is high.

Sometime this year, Hughes will test a laser line-scanner that will paint a picture on a video scope in real time. International Business Machines Corp., and TI are both working on gallium arsenide laser transmitters.

Two Shed Light projects will use lasers to determine the exact slant distance from a plane's bombing sight to the target—a vital measurement for dropping the bomb right on the spot. Because echos from precise, pencil-beam laser pulses can be timed and converted to distance, the laser makes an ideal device for determining range.

Republic Air Div. of Fairchild Hiller Corp. is building a slant-range laser-ranging device for the

F-105's radar bombing system. If the results are good, one will also be developed for the F-100 plane.

A slant-range laser-ranging device is also being built by Hughes for the visual-optical bombing system used on the F-4C.

### Seeing the invisible

Two other sensors that seem far out but are nevertheless active projects look for radiometric emissions and abrupt changes in the earth's magnetic field.

The Air Force is watching the Army's work on highly sensitive radiometers for detecting differences in the natural emission of electromagnetic radiation from objects well enough to see configurations. Definition of the faint emissions can apparently be received with enough strength to enable a missile to home on them.

And, an airborne magnetometry device to detect buried metal is being developed by Varian Associates.

### Building a system

Hunter I, a C-130 cargo plane that will find the target in the dark with sensors and illuminate it with xenon arc lamps, either visible or infrared, will use a variety of sensors. The results of three studies to select these sensors have been turned in to Wright-Patterson by Lockheed Aircraft Corp., Ling-Temco-Vought, Inc., and TI. The battlefield illumination airborne system, known as Bias, will be built by LTV.

An in-house study at Wright-Patterson has examined the problems in converting the RF-4C reconnaissance plane to a hunter plane. The RF-4C is equipped with a barrage of cameras, side-looking radar and infrared detectors. Data from all of them must be processed on the ground. Whether the study recommends in-plane processing and display or transmitting raw data to the ground station for processing isn't known. Since the RF-4C is already packed to the skin with electronic equipment, the decision will probably be data-link.

Project Black Spot is a C-123 cargo plane converted to a hunter-killer weapon. Already equipped with guns, LTV has put sensors in

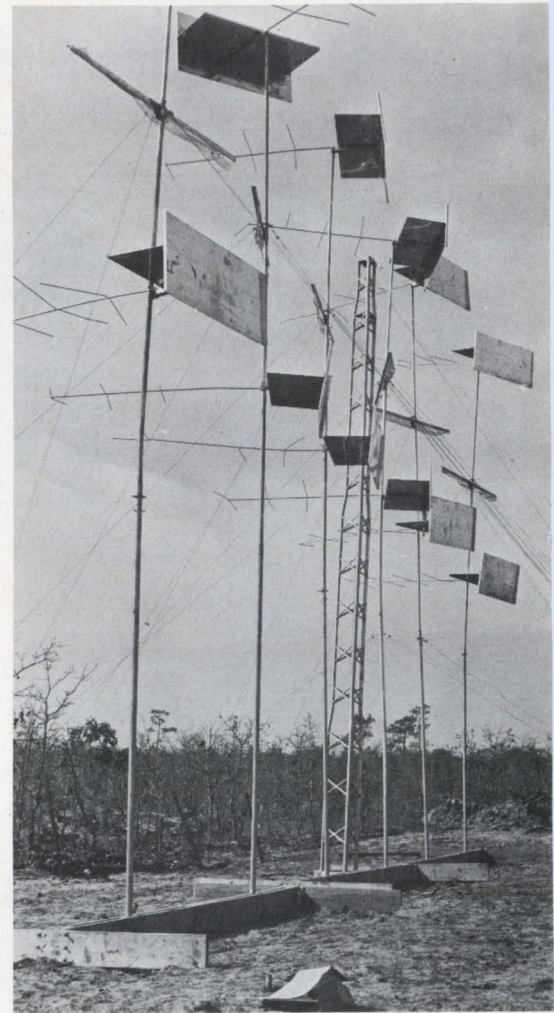

**Simulated microwave** communications site shows up on airborne radar like the real thing in North Vietnam.

the plane—probably TV and infrared detectors—so it can find its target at night.

A look into the future will be made in a six-month study, if the Defense Department approves, for the feasibility of designing a brand new NX plane—night sensor and fighter combination designed as such. The Air Force's Electronic Systems Div. is studying the plan.

"Puff the Magic Dragon," an old C-47 cargo plane with flares to mark the target and 7.62-mm Gatling guns to attack it, has been joined in Vietnam by Gun Ship II, a C-130 cargo plane with 7.62-mm and 20-mm miniguns. The new plane also uses a new computerized fire control system; the computer operates the pilot's displays and the fire control unit. The system was built in-house at Wright-Patterson. Production contracts for more will go out to industry.

A science-fiction type project will enable a pilot to look at a



target, press a button, and thereby inform his home base what he saw and where it is. The magic is in the helmet he wears; it will measure, via a reticle through which he looks, the azimuth and elevation of his head. This information fed into a computer along with the aircraft's altitude, true heading, and position, will tell the ground crew where the target is. The button the pilot presses will be coded to reveal the nature of the target. Honeywell, Inc. is working on this.

For ranging and homing, Hughes is developing a ground station to transmit off-set target homing information into the ADF (automatic direction finder) or Tacan (tactical air navigation system) of a strike aircraft for dropping troops or supplies.

Also, for finding a drop zone, Motorola will develop and flight test a wideband marker beacon for radar-equipped planes to use while the radar is in the ground-mapping or search mode rather than having to switch to the beacon mode. This way the pilot can watch for familiar landmarks while homing on the beacon.

### Finding the way

A proposal for the air transportable loran D navigation system to be used by both hunter and killer forces as a common reference has been presented by Sperry Gyroscope Co., a subsidiary of the Sperry Rand Corp. Instead of the hunter's telling the killer the target location in geographical coordinates, he would relay the numbers of the two loran D grid lines that intersect over the target.

An elaborate navigation system for weapons delivery consisting of three integrated navigation systems—doppler, inertial and loran D—are being developed in competition by Litton Industries, Inc., General Precision Inc., and Teledyne Corp.

Waiting for approval by the Air Staff is a proposal for a manpack loran D receiver built with integrated circuits.

Litton and Sperry have each developed a bombing system that uses a combination of an inertial navigation system and loran D. Litton's system has been tested. ■■

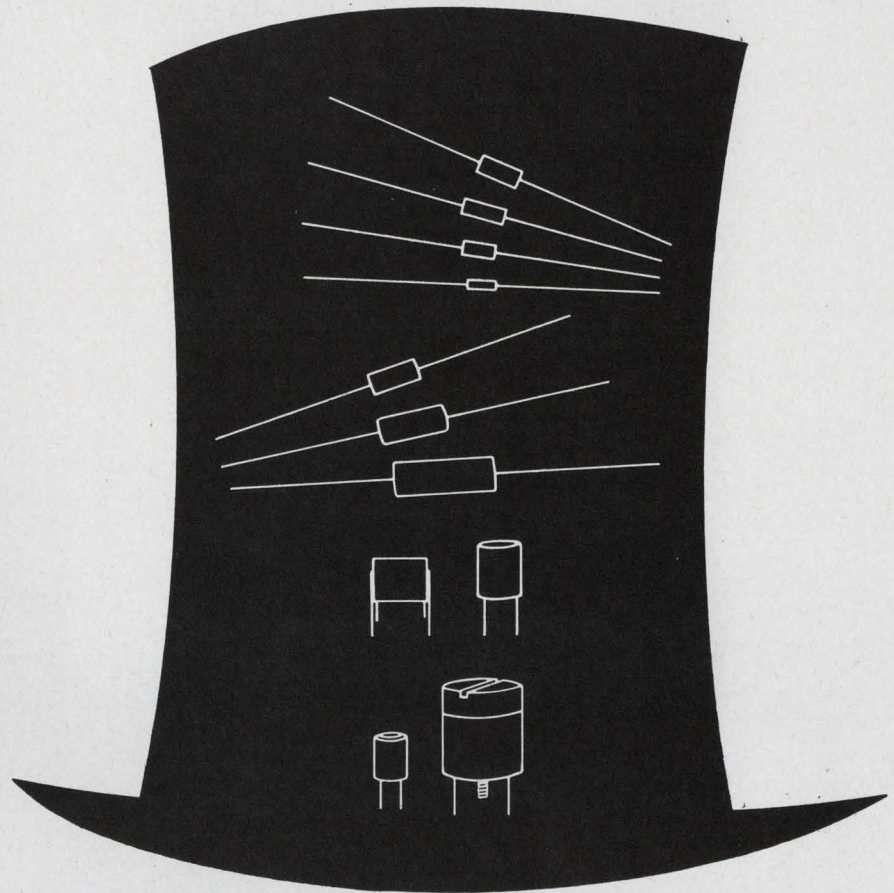

## If you think Nytronics Inductors are tops...you ought to try our Ceramic Capacitors!

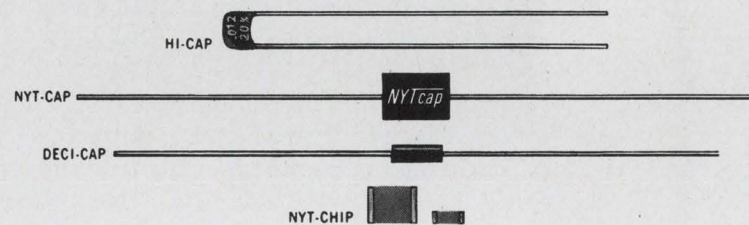

You'll find they're tops in quality and performance, too. Because they're the result of the very same unremitting research and development — and a standard line concept that links volume production with utmost precision. And you'll find the widest range of units with the greatest capacitance-to-unit size.

**HY-CAP:** .01 to 2.5 mfd.;  $\pm 20\%$  tolerance; 100 WVDC; no derating to 125°C; and meets MIL-C-11015.

**NYT-CAP:** Molded epoxy package 0.1" diameter by 0.250" long.... 4.7 to 220 pf; and 0.350" by 0.250" by 0.1"..... 270 to 4700 pf; T/C does not exceed  $\pm 40$

ppm/°C (−55°C to +125°C); and 200 WVDC.

**DECI-CAP:** Epoxy molded envelope 0.100" diameter by 0.250" long.... 4.7 to 27,000 pf; and  $\pm 10\%$  tolerance.

**NYT-CHIP:** 0.170" by 0.065" by 0.070" ...4.7 to 220 pf; and 0.280" by 0.195" by 0.070"....270 to 4700 pf; T/C does not exceed  $\pm 40$  ppm/°C (−55°C to +125°C); and 200 WVDC.

In addition to ceramic capacitors and inductors, we maintain inventories of high quality delay lines and resistors. Complete engineering data on all products will be sent on request.



# NYTRONICS®

...for Precision Electronic Components

550 Springfield Ave., Berkeley Heights, N. J. 07922 ■ (201) 464-9300 ■ TWX: 710-984-7977

ON READER-SERVICE CARD CIRCLE 21

FIVE GOOD WAYS TO LEARN ALL  
ABOUT THE LATEST IN MICROWAVES

- \*By visiting all the leading microwave plants and interviewing their best designers and researchers.
- \*By attending all major conferences on the subject.
- \*By developing and editing state-of-the-art articles covering latest design techniques.
- \*By writing extensively about new developments and trends.
- \*By working for Electronic Design... the magazine whose editors make it their business to know.

Good salary,  
excellent benefits, and  
association with top professional  
engineer-writers can be yours.  
If you are an engineer with  
experience in microwaves or  
communications systems, and are  
interested in the possibilities,  
call or write Robert Haavind,  
Managing Editor, Electronic  
Design, 850 Third Avenue,  
New York, New York 10022,  
(212) PL 1-5530

# this is the freshest relay design approach since 1956.

(or was it '37?)

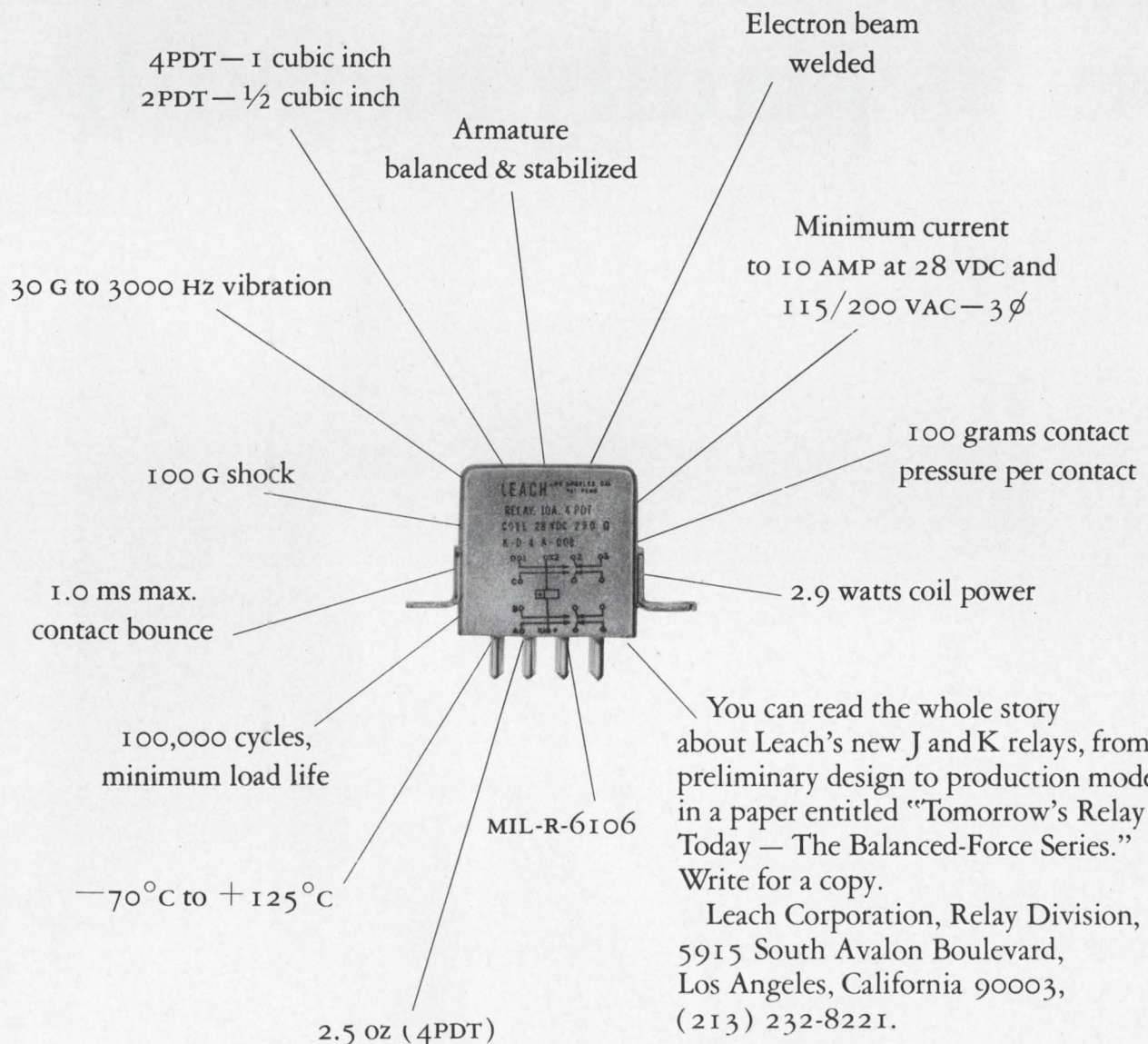

## LEACH

ON READER-SERVICE CARD CIRCLE 22

**Of the following 14 MOS devices, some are merely equal, a few are slightly superior, a couple are almost unbelievable, and one is plainly incredible.**

–55°C to +125°C

0°C to +70°C

|  | 100-999 |         | 100-999 |         |
|--|---------|---------|---------|---------|
| <b>Merely Equal:</b><br>DUAL 3-INPUT NOR GATE<br>DUAL EXCLUSIVE OR GATE  | MM 480  | \$12.00 | MM 580  | \$ 8.00 |
|  | MM 481  | 18.00   | MM 581  | 12.00   |
| <b>Slightly Superior:</b><br>DUAL 25-BIT DYNAMIC SHIFT REGISTER<br><i>Low power with 1MHz guaranteed.</i><br>DUAL DIGITAL MULTIPLEX SWITCH<br><i>Ideal for routing information in dynamic register memory.</i> | MM 400  | 25.00   | MM 500  | 9.85    |
|  | MM 482  | 12.00   | MM 582  | 8.00    |
| <b>Almost Unbelievable:</b><br>DUAL 50-BIT DYNAMIC SHIFT REGISTER<br><i>14.8¢/bit.</i><br>DUAL 16-BIT STATIC SHIFT REGISTER<br><i>Single clock, 1MHz operation up to 125°C.</i>                                | MM 402  | 40.00   | MM 502  | 14.80   |
|  | MM 404  | 30.00   | MM 504  | 12.00   |
| <b>Plainly Incredible:</b><br>DUAL 100-BIT DYNAMIC SHIFT REGISTER<br><i>200 register bit in a single package.</i>  | MM 406  | 60.00   | MM 506  | 30.00   |

Amazingly, they're all available now. For a list of stocking distributors and additional information, write: National Semiconductor Corporation, 2975 San Ysidro Way, Santa Clara, California 95051. (408) 245-4320.

# National Semiconductor

ON READER-SERVICE CARD CIRCLE 23

# A-to-D Converters

... up to 12 bits  
... loaded with options

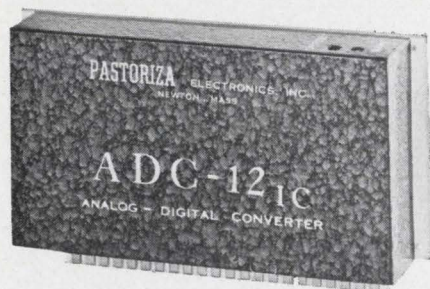

4½" x 2¾" x ¾"

- High-frequency FET input amplifier.
- Bipolar or unipolar input signals of varying ranges.
- Parallel and serial outputs of binary or BCD codes.
- TTL logic for high speed and fanout drive capability.
- Resolution up to one part in 4096 (12 bits)
- Extended temperature capability.

Get any of these options easily in the Pastoriza Model ADC-12<sub>1c</sub> analog-to-digital converter — without the usual delays and extra cost that "specials" always involve.

The 12-bit Model ADC-12<sub>1c</sub> is a single-card, general purpose, integrated circuit A-to-D converter that accepts input voltages on command and converts them to a 12-digit binary code in 25 microseconds. The single card contains an input amplifier, precision reference supply, logic, weighing network, switching, comparison, and internal clock. Only external DC power is needed.

The Model ADC-12<sub>1c</sub> 12-bit converter is just one of Pastoriza's many competitively priced A-to-D and D-to-A converters. All are available with a variety of different input options, resolutions, and output codes.

Write or call for more information  
on ADC TTL Series.



**PASTORIZA**  
ELECTRONICS, INC.

385 Elliot St., Newton, Mass. 02164 • 617-332-2131

ON READER-SERVICE CARD CIRCLE 24

## Hybrid microwave LSI to operate in K band

A module that may well be the first microwave large-scale integrated hybrid circuit is being designed. It is part of an Air Force effort to explore the feasibility of producing individual hybrid substrates that offer many circuit functions at higher microwave frequencies.

The Semiconductor Div. of Sylvania Electric Products, Inc., Woburn, Mass., is building a prototype integrated K-band Doppler navigator transceiver on a single substrate. The Avionics Laboratory at Wright-Patterson Air Force Base, Ohio, is sponsoring the project. The module, which is intended to operate at 13.3 GHz, will have its rf source and all rf and i-f stages set on the substrate. It will be fabricated with both thin- and thick-film hybrid techniques.

### Operating frequency increases

The Avionics Laboratory is also sponsoring Texas Instruments' MERA (molecular electronics for radar applications) program (see "Civilian markets beckon microwave ICs, ED 25, Dec. 6, 1967, pp. 34-36). The Sylvania program extends the objectives of MERA by calling for:

- Operation at 13.3 GHz (K band) instead of S and X band.
- Combination of thick- and thin-film techniques on a single substrate.

MERA modules are primarily assemblies of thin-film hybrids on alumina substrates. Module complexity is achieved by assembling groups of functional substrates in a mounting frame and making the necessary interconnections. The S-band rf source is outside the module. The Sylvania transceiver module, on the other hand, will convert dc to rf on the substrate.

Arthur Solomon, section head for solid-state components in Sylvania Semiconductor Div.'s Microwave Dept., says the experimental transceiver will include:

- A master oscillator using varactor-tuned avalanche diodes that is frequency-stabilized by means of

an integrated microwave discriminator. Both transmitter and local-oscillator signals are derived from the master oscillator.

- A chain of avalanche diodes in a power amplifier that increases the power level of the transmitter signal to 100 mW.

- A frequency shift-key modulator that uses beam-lead Schottky barrier diodes.

- A transmit-receive switch that uses beam-lead pin diodes.

- A mixer that uses beam-lead Schottky barrier diodes.

- An i-f amplifier that has as its design goal a 1-dB noise figure at 120 MHz.

### Group dynamics explored

"We will be developing analytic and experimental techniques for solving problems arising when a large number of components are put together on a single substrate," Solomon says.

He points out: "We won't be able to treat the components individually or in small groups, and therefore must consider the mutual influence of all the components on each stage. It is really an approach to microwave LSI.

"We will use thin-film technology to form the microwave circuitry. The lower-frequency circuits (i-f amplifier, synchronous detector, buffer amplifier and oscillator) are going to be done with thick-film (silk screen and fire) technology. We have to develop a compatible sequence of events to build on one ceramic substrate both thick- and thin-film hybrid circuitry. We will be using beam-lead semiconductor devices wherever possible."

The Sylvania Electronic Systems Div., Waltham, Mass., is furnishing technical guidance to the Semiconductor Div.

The program is an extension of previous Sylvania efforts described at the 1967 IEEE International Convention in New York. At that time the company demonstrated an X-band hybrid microwave integrated circuit that functioned as a Doppler radar. ■■



## Everything you want in a counter . . . and for only \$1340

This new 20-MHz, IC counter-timer has just about everything you have been asking for in a general-purpose counter: multiple-measurement capability, remote programmability, eight-digit readout, two input channels, choice of time base, low cost, and available complementary scalars to extend frequency range to 100 MHz and higher.

**Measurement Versatility.** Frequency: DC to 20 MHz; 1  $\mu$ s to 10 s counting gate times. Accuracy of  $\pm 1$  count  $\pm$  time-base accuracy.

Single Period: Up to  $10^9$ s (over 3 years); clock rate variable from 0.1  $\mu$ s to 10 s.

Multiple Period: 1 to  $10^8$  periods; clock rate 0.1  $\mu$ s.

Time Interval: 0.1  $\mu$ s to  $10^9$ s (full input-signal processing).

Frequency Ratio: 1 to  $10^8$ .

Count: Register capacity  $10^8$ .

**Programmability.** Measurement functions, ranges, and most of the secondary controls (such as display time and input-trigger level) can be programmed remotely. Most of the programming is controlled by simple contact closures to ground. Models are

available with high-speed, buffered BCD outputs from internal storage to drive auxiliary data-handling equipment.

**Readout.** Eight digits of high-contrast neon indicators, with automatic display of decimal point and units. Continuous display from storage provides rapidly corrected data without flicker.

**Input Circuits.** Two high-sensitivity input channels consisting of a high-impedance, low-noise FET circuit preceded by a 3-position step attenuator. Full controls for trigger level, slope, and polarity. The 1-megohm input impedance is constant for all control settings, permitting use of general-purpose, low-capacitance oscilloscope probes.

**Time Base.** Choice of time base to match needs and budget. Room-temperature oscillator has excellent stability, better than  $2 \times 10^{-7}/^\circ\text{C}$  from  $0^\circ$  to  $50^\circ\text{C}$ , which is adequate for most applications. A high-precision oscillator, in proportional-control oven, provides a stability of better than  $2 \times 10^{-10}/^\circ\text{C}$  from  $0^\circ$  to  $50^\circ\text{C}$  when operated continuously. Either time base can be locked to an external standard frequency of 0.1,

1.0, 2.5, 5, or 10 MHz. Because it has no warmup frequency transient, the room-temperature oscillator is specifically recommended for this application.

**Cost.** Prices\* range from \$1340 for the basic counter with a room-temperature crystal to \$1540 for the model with an oven-controlled crystal and BCD outputs. The basic model with only the BCD-output option costs \$1390. For large-volume users, in particular, the savings realized by specifying our new 1191 Counter is substantial.

**Higher Frequencies.** By using our 1156-A Decade Scaler with the 1191 Counter, you can extend the upper frequency limit of the 1191 to 100 MHz. A new scaler to be available soon will extend the limit to 500 MHz.

For complete information, write General Radio Company, W. Concord, Mass. 01781; telephone (617) 369-4400; TWX (710) 347-1051.

**GENERAL RADIO**

\*Prices apply only in the U.S.A.



**New I/C 500-600 nsec  
Memory System . . .**

**. . . Stores 1/4 million bits in  
single 5-1/4" high unit, features  
MTBF of 12 years under normal  
40-hour week operation**

Now you can get the new  $\mu$ -STORE ICM-500 in standard systems: 600 nanoseconds full cycle time. Special systems: cycle times as low as 500 nanoseconds. Up to 16,384 words with 54 bits/word; or up to 4096 words with 72 bits/word. (Over 3/4 of a million bits in little more than 15" of vertical rack space — including power supply). You also get I/C construction for all major functions including X-Y current drivers plus a choice of mechanical packaging.

Get the full story. And take advantage of our eight years' experience in solving core memory problems. Write today for our new brochure. Honeywell, Computer Control Division, Old Connecticut Path, Framingham, Massachusetts 01701.

\*Patent applied for.

**Honeywell**

 **COMPUTER CONTROL  
DIVISION**



Gunboat fires guns automatically



### Gunboats to use automatic fire control

The Mark 87 Gun Fire Control System is to be installed on all the Navy's new high-speed PG-84 patrol gunboats. Built by the Ford Instrument Div. of Sperry Rand, the Mark 87 was originally designed by the Dutch firm of Signaal. The fast-reaction 7200-pound system employs an integrated radar and high-speed data processor, to provide rapid acquisition and tracking of both high-speed aircraft and surface targets. The system automatically controls weapon firing. The system also includes a stabilized optical sight to track visible targets and to control weapon aiming and firing. Only three men are required to operate the system, as opposed to ten required for conventional systems.

The 250-ton-displacement PG-84 gunboat is made of aluminum and fiber glass. Measuring 165 feet in length with a 24-foot beam, the vessel carries a 3-inch, 50-caliber rapid-fire gun, a 40-mm gun and two twin-50-caliber machine guns.

### SST flight-control contract due soon

Proposals to Boeing for the automatic flight control system for the SST are due by the middle of this month. Principal contenders for what will be the most complex and precise aircraft flight control system ever designed are General Electric's Avionics Control Dept., Bendix Navigation and Control Div., and Sperry Flight Systems Div. Honeywell Aerospace Div. was in the running but dropped out last summer, informants say.

The contract, which ultimately could represent hundreds of millions of dollars to the winner, will probably be a cost-sharing effort initially. A contractor is scheduled to be selected by early April but this may be extended to early June because of the complexity of the technical proposals. The competition among the three participants will be extremely close. Bendix and Sperry have long histories in the provision of control systems for commercial aircraft. GE, however, has provided the automatic control systems

# Washington Report

CHARLES D. LAFOND  
WASHINGTON BUREAU

for all of the new F-111s and thus it is the only manufacturer who has heavy experience with a supersonic, high-altitude, swing-wing aircraft. Flight test of the first system will be in the first SST flight model in late 1970.

### Apollo net may extend to Moon

Goddard Space Flight Center has called for proposals for a feasibility study of flight dynamics for a communications relay satellite located between the Earth and the Moon. The vehicle would serve as a relay for Apollo Command Modules when on the farther swing of a lunar orbit, thus ensuring communication with Earth at all times. The study will be made with reference to the point in space that is now under consideration for locating the satellite—libration point number two ( $L_2$ ), some 65,000 kilometers off to the side of the Moon.

A libration point, one of five, is a spot in space where the attraction on a body from both the Moon and the Earth is exactly equal. A relay satellite at this point will always be in radio view of the Earth and will be nearly synchronous with the far side of the Moon. The vehicle would be provided with a small propulsion unit to ensure a maneuvering capability.

Requests for proposals have been sent by Goddard to nearly 40 firms with responses due January 31. The contractor will be selected by early spring for what is expected to be a six-month contract worth nearly \$100,000. A major element to be studied is the effect of perturbations of the sun on a vehicle located at a libration point.

### SST funds to be withheld

Despite congressional appropriation of the full \$142 million requested by the Administration for SST development, some of these funds will be withheld to conform with President Johnson's fiscal year 1968 budget reductions. The amount of the reduction in funds has not been revealed by Transportation

# Washington Report

CONTINUED

Secretary Alan S. Boyd. "There will be some delays and slow-downs," he said. He indicated that the effect on the program will be to slow down the rate of selecting subcontractors. Any delay in subcontracting will be felt later as the production schedule is stretched out.

## Entertainment subcontracts awarded

Two major subcontractors have been selected by Boeing for its 747 Jumbo Jet passenger-entertainment electrical systems: \$20 million goes to Instrument Systems Corp. for the entertainment and service multiplexing system, and a \$2.5 million award to North American Philips Co., Inc., for a highly advanced projection system.

The digital multiplexing system will provide ten audio channels for music or information with combinations of both stereo and monaural signals. The motion picture projection system, to be built in the Netherlands and delivered this summer, will employ a totally new concept, according to Dave Flexer, president of the parent company, Inflight Motion Pictures, Inc. With the new system, two or more full-length films can be shown with simultaneous dual-language capability. Film rewind is automatic.

## Contractors line up for ship program

The Navy will seek proposals from six industry teams by Feb. 15 for over-all system designs for the new DX/DXG-class destroyers. This will be the largest destroyer-building effort since World War II and will certainly lead to procurement of hundreds of millions of dollars of on-board electronic equipment. Estimates for the total program run as high as a billion dollars for up to 80 destroyers. The winner is expected to make use of automated ship design and introduce new methods of straight-line production to ensure maximum cost effectiveness.

The teaming arrangements now known indicate the integration problems expected in merging shipbuilding and electronics-systems capabilities necessary for a total-package-procurement contract. The

six shipyards asked to respond are Avondale Shipyards, Inc. (teamed with the Autonetics Div. of North American Rockwell), Newport News Shipbuilding & Drydock Co., Bath Ironworks Corp., Todd Shipyard Corp. (teamed with Sperry Rand Corp.), General Dynamics (probably teamed with its own GD-Electronics Div.), and Ingalls Shipbuilding Corp. (a division of Litton Industries and probably teamed with Litton Systems, Inc.).

The new vessels will be high-speed and will be larger than the present Gearing-class destroyers, since they will be required to carry a vastly larger amount of new radar, antisubmarine-warfare, sonar, and communications equipment. Another goal sought in the ship design is a high degree of automation to reduce the number of personnel required aboard ship, the Navy said.

## Burroughs wins final round

The selection by the Air Force of Burroughs Corp. for the largest electronic data-processing contract ever awarded ends another phase in what has to be considered a very questionable competition. It can also be assumed that the controversy is far from ended. With a bid of roughly \$60 million for 135 model-B3500 computers, Burroughs won out over the other contenders—RCA, IBM and Honeywell. The losers were reported to be in that order. Honeywell, believed to have submitted the highest bid, was the firm that led the fight resulting in the rebid for the program.

On May 2, 1967, IBM was selected originally under a \$114 million award. The losing contractors, led by Honeywell, contested the award claiming that IBM was, in fact, the highest bidder and that the Air Force had technically categorized the losers as nonresponsive. The pressure, applied through Congress, and the Senate in particular, forced a contract cancellation and a resubmission of the bids last July.

The new contract covers only equipment costs and includes an option for the Air Force to purchase up to 25 additional computers. Services for operation and maintenance could bring the initial contract value close to \$100 million. The computers will be employed for administrative and accounting functions. Since funds for the purchase are not immediately available, the Air Force is expected to lease the first units.



**When you want a relay that...**

*delivers billions of high speed  
bounce-free operations;  
has low profile for p.c. board mounting  
and is compatible with solid state circuits*

## **mercury's the answer**

In order of importance, how would you rate these advantages of P&B's mercury-wetted contact relays?

- no bounce
- constant low contact resistance
- long life (billions of operations)
- low profile for p.c. board mounting
- 1 ms operating speed
- contact isolation
- compatibility with solid state circuitry

You will find our JMF Series relays useful in computer logic circuits, high speed processing equipment, in sophisticated instrumentation . . . wherever you need crisp switching action, long life, solid state compatibility, and immunity from transient voltages.

Housed in a pressurized glass capsule, the contacts are renewed on every cycle through capillary action of the mercury. Hence, contact resistance remains constant and extremely long, maintenance-free life is assured.

P&B mercury-wetted relays are available in contact Forms C and D, as well as polarized and sensitive models. Up to four capsules in a single case are available. Call your P&B representative for full information today.

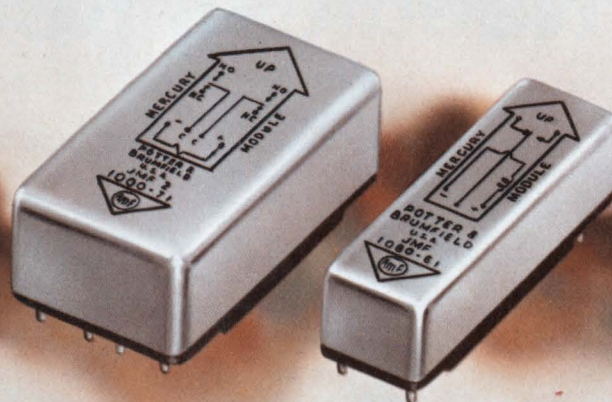

**POTTER & BRUMFIELD**

Division of American Machine & Foundry Company, Princeton, Ind. 47570  
Export: AMF International, 261 Madison Avenue, New York, N. Y. 10016

# \$695.00

(and at last)

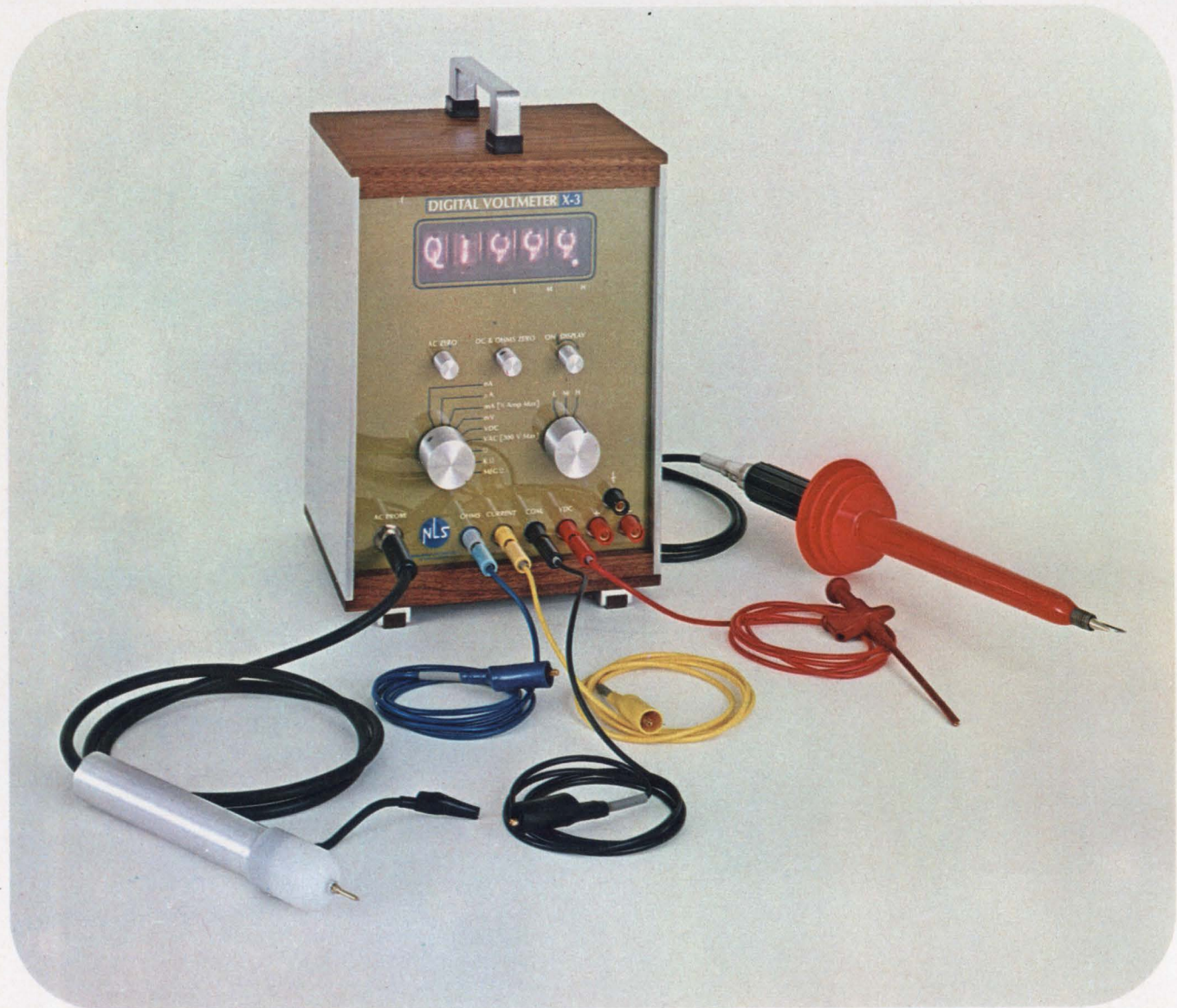

## No Needless Needles

### WHY?

Because Non-Linear Systems introduces (X-3), a solid-state integrated circuit DVM "(VTVM)" with extras for \$695.

### DC Volts:

10 mv to 10K v  
.1%  $\pm$  1 digit  
100 Megohm input impedance, entire range  
10 Microvolts resolution

### AC Volts:

200 Millivolts to 300 volts

10 Millivolts resolution  
3% Accuracy  
20 Hz to 500 MHz  
10 Megohms Input Impedance

### Resistance:

10 Ohms to  
2000 Megohms  
.1%  $\pm$  1 digit to 200K

### Current:

10 Nano Amps to  
200 Milliamps  
.1%  $\pm$  1 digit

Yes, all these extras for \$695 (including probes)

### LOOK AT THESE EXTRAS

100% Over-range Digit  
Over-load Indicator  
Over-load Protection  
Automatic Polarity  
Display Storage  
High CMR  
Unique Low, Medium, and High Range Selector



Originator of the Digital Voltmeter  
**NON-LINEAR SYSTEMS, INC.**  
DEL MAR, CALIFORNIA 92014  
[714] 755-1134/TWX: 910-322-1132

ON READER-SERVICE CARD CIRCLE 28

# Announcing AE's Class H relay. It's compact, versatile, low in cost.



The Class H relay is small in size—just about a 1.3 inch cube. It's a versatile "telephone-type" component that offers better than average quality at a low price.

You can use the Class H to reduce the physical dimensions and decrease the cost of your products. It's well suited for business machines, vending machines, communication equipment, computer peripheral equipment, aircraft and missile simulators. These applications take advantage of its small size, versatility of mounting, and large switching capacity (maximum of 6 form C or 4 C and 2 D contacts).

The Class H can be direct-mounted or socket-mounted to a PC card. Or it can be socketed into a panel. It also has a socket that mounts on a rack.

The Class H is made as a regular quick-acting relay (Series HQA). It's also available as a short or long pulse "latching relay." In this ver-

sion (Series HRM) it uses remanent magnetism—or controlled residual magnetism of the coil core—as its latching medium.

This little relay's rugged construction protects it from ordinary shock and vibration. Mechanical life expectancy exceeds 100 million operations. Molded pileup insulators provide high dielectric strength and dimensional stability. Contact actuation is by a lift-off card method—which eliminates the problem of contact sticking.

A clear heavy-duty plastic cover provides protection from contamination and abuse. Once this cover is snapped into place, it's not readily removed. This discourages tampering.

Want helpful, detailed specification and application data? Send for Circular No. 1100. Just write to the Director, Relay Control Equipment Sales, Automatic Electric, Northlake, Illinois 60164.

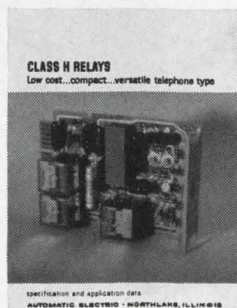

## **AUTOMATIC ELECTRIC**

SUBSIDIARY OF GENERAL TELEPHONE & ELECTRONICS

ON READER-SERVICE CARD CIRCLE 29

## Troposcatter radars run into bad weather

Rome Air Development Center has received a gloomy report from the Air Proving Ground test group at Eglin Air Force Base, Fla., on both of its highly regarded tropospheric-scatter communications units—the AN/TRC-105, built by Motorola Inc.'s Government Electronics Div., and the AN/TRC-104, by Textron Inc.'s Bell Aerosystems Div.

Although each unit weighs less than 500 pounds, compared with the 2000-pound AN/TRC-97A that the better of the two was to replace, both need to be redesigned, the report says.

"Motorola's AN/TRC-105 is too busy. By the time its frequency-scan diversity device samples 16 frequencies for determining the best one to use, the information is out of date," a test official said.

As for the AN/TRC-104, "Something in the basic design of the transmitter or receiver causes a weak signal," an official affirmed. "Also, error-correcting coding, which was its main claim to fame, didn't work well. The 8-by-16 diversity is little or no better than dual diversity.

"Once during a freak power condition when the AN/TRC-97A, against which the two new units were tested, dropped to a power output of 1 watt, the 97A was still better than the TRC-104 or 105 operating at 200 watts. When all three were operating at 200 watts, the 97A was consistently better."

On the brighter side, the AN/PRC-66 uhf radio, built for two-way voice communication between forward air controllers and aircraft, passed tests at Eglin with flying colors. The report to Rome gives full blessings to buy.

The radio weighs 4 pounds without battery, 9 pounds with, and has a 2-watt output. It has direction capability—making it useful in aircraft for homing on ground-based beacons. It can also provide line-of-sight, point-to-point communications. Integrated circuits are used throughout. The developer is Collins Radio Co. of Canada, Ltd., a subsidiary of Collins Radio Co., of Cedar Rapids, Iowa. ■■

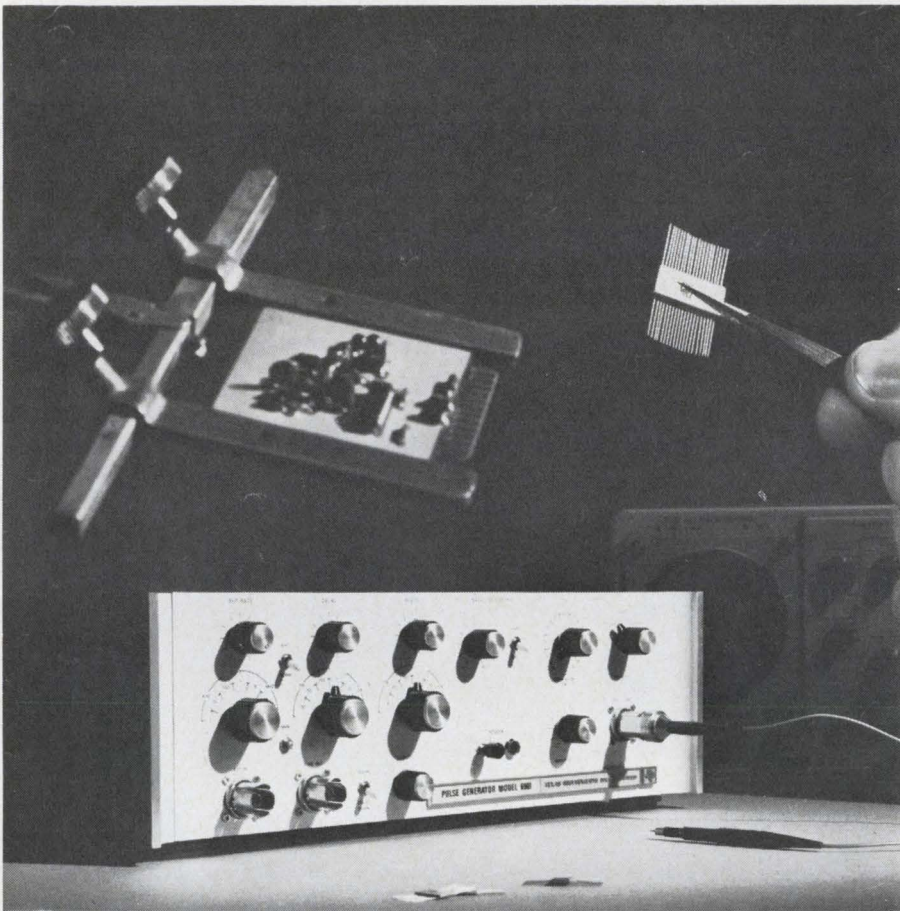

## Why You Need a Special Pulse Generator for State of the Art Circuit Design

With high speeds and critical design parameters, you need the best test instruments to be sure your designs will be optimum. The TI Model 6901 Pulse Generator gives outputs from 1 KHz to 0.1 GHz; independent amplitude and baseline controls; jitter less than 0.1% of period + 50 psec; and count-down synchronization output.

The 6901 makes your designing simpler, too. Because the pulse amplitude of the generator can be changed without affecting DC offset, you can use the offset instead of an external bias supply for your circuit.

For additional information, contact your TI Field Office, or the Industrial Products Division, Texas Instruments Incorporated, P. O. Box 66027, Houston, Texas 77006.

**TEXAS INSTRUMENTS**  
INCORPORATED

ON READER-SERVICE CARD CIRCLE 30

627A

- 7 STANDARD single, dual, and triple units, including units with concentric shaft and vernier operation.
- 16 STANDARD resistance values from 50 ohms to 5 meg.
- 2 STANDARD tolerances 10% and 20%.
- 5 STANDARD resistance tapers.
- 18 STANDARD electrical tap options.
- 46 STANDARD shaft lengths from 3/8" to 6.0".
- 3 STANDARD shaft endings.
- 9 STANDARD variations of bushings.
- 4 STANDARD locating lug options.
- 4 STANDARD switch options with single and double pole.

# Allen-Bradley offers a 1,000,001 standard variations of Type J Potentiometers

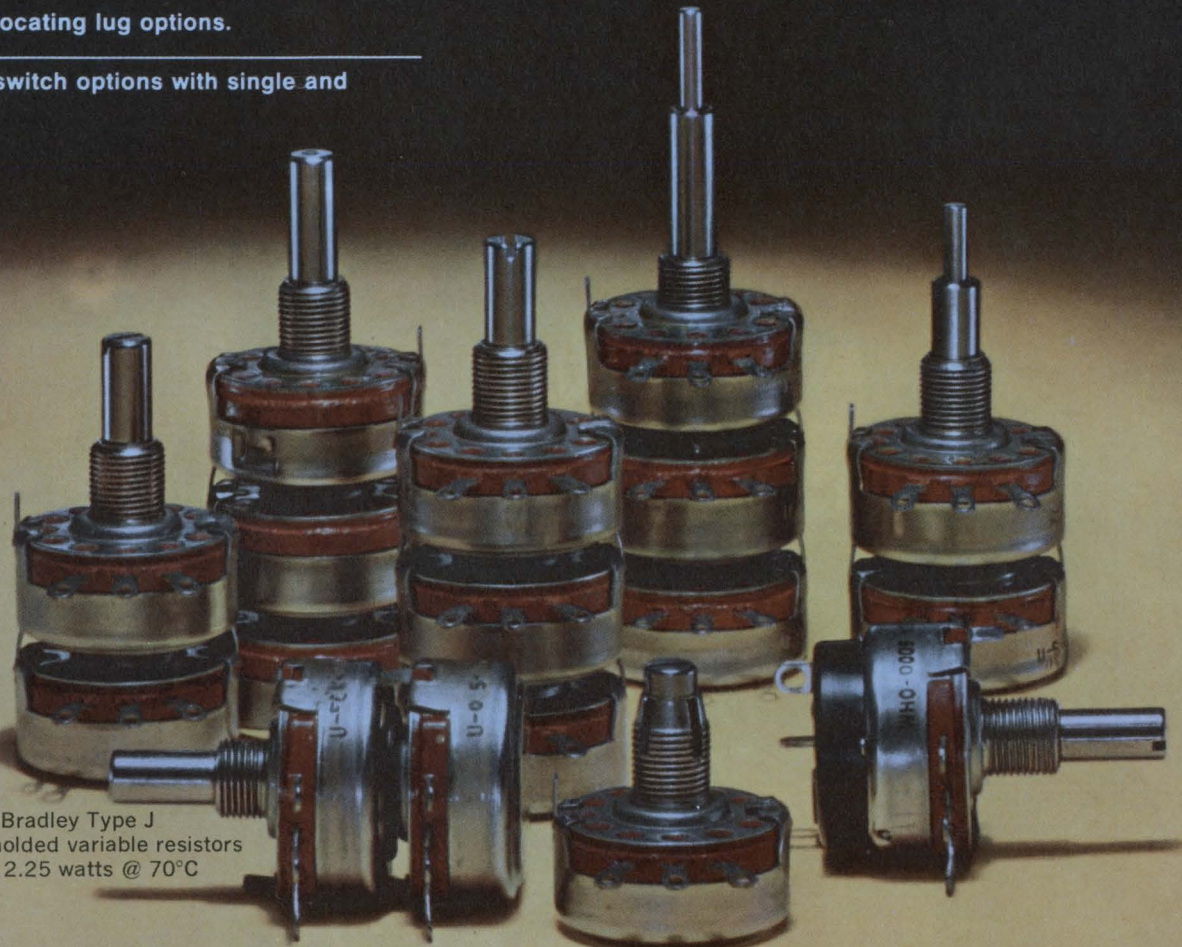

Allen-Bradley Type J hot molded variable resistors rated 2.25 watts @ 70°C

These *standard* variations in the Allen-Bradley Type J hot molded potentiometer line eliminate the need for a "special" control. When you include the numerous special resistance values and tapers in which the Type J can be supplied, the variations become virtually infinite.

Yet, all of these Type J variable resistors have one thing in common—each and every one is made by the same A-B hot molding process—your guarantee of "tops" in quality. The solid hot molded resistance track assures extremely long life—exceeding well beyond 100,000 complete operations on accelerated tests with less than 10% resistance change. Control is always smooth and free from the sudden turn-to-turn resistance changes of wire-

wound units. And being essentially noninductive, Type J controls can be used at the higher frequencies—where wire-wound units are totally impractical.

Let Allen-Bradley Type J variable resistors be the answer to your special requirements—it's almost certain there's a "standard" unit in the Type J line. And you *know* you're obtaining the ultimate in reliability and performance. For more complete information on Allen-Bradley Type J potentiometers, please write for Technical Bulletin 5200: Allen-Bradley Co., 222 W. Greenfield Ave., Milwaukee, Wis. 53204. In Canada: Allen-Bradley Canada Limited. Export Office: 630 Third Ave., New York, N.Y., U.S.A. 10017.



**ALLEN - BRADLEY**  
QUALITY ELECTRONIC COMPONENTS

# Inside Story

*on the  
newest way  
to terminate  
shielded  
wires*



Designed for the common grounding of individual shields used in wire and cable bundles, Glenair's new Terminating And Grounding (TAG) Ring assembly introduces a totally new concept to the termination of shielded wires.

Using a self-pigtailing technique, individual shields are entrapped in a castellated body by a spring member which also compensates for differences in the shield thickness.

Providing total repairability, Glenair TAG Rings can be assembled and disassembled completely by hand with no special tools required . . .

and they offer as much as a 60% reduction in weight over equivalent inner-outer crimp ring arrangements. These TAG Rings can be provided as part of an adapter for grounding shields to the connector shell, and they can be used with connector adapters or backshells for isolating or common grounding with over-all shielding.

For a closer look into the many advantages this new Terminating And Grounding Ring can provide for you, write or phone Glenair today.

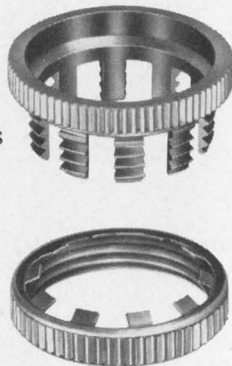

GLENAIR, INC. / 1211 AIR WAY  
GLENDALE, CALIFORNIA 91201

Phone: (213) 245-8587 • TWX: 910-497-2066

ON READER-SERVICE CARD CIRCLE 32

## NEWS

### Trackless trains at Houston airport

When Houston's new Intercontinental Airport goes into operation next year, passengers will be whisked from one part of the terminal area to another by electronically controlled passenger trains. The sleek driverless and trackless trains follow a 3000-foot-long underground concrete subway route between terminals and parking areas, pausing at programmed stops to pick up and discharge passengers. Tape-recorded announcements tell passengers of their location before each stop and before the doors close.

The four trains, built by Barrett Electronics Corp., Northbrook, Ill., are made of aluminum and light blue fiber glass and are designed to carry more than 200 passengers during a peak 10-minute period. They have a peak capacity of more than 23,000 passengers daily.

Officials expect this capacity to be needed less than 10 per cent of the day — during peak traffic periods.

The train will transport passengers and their hand baggage to and from the terminal, flight gates, ticket counters and escalators to inside parking areas. A typical trip, according to company officials, will cover one-third of a mile in less than four minutes.

The train consists of a power and guidance unit and three passenger cars. Two one-ton heavy industry storage batteries power dc motors that drive the train through the underground route. Sensors in the train's guidance unit, responding to instructions from a wire embedded in the tunnel's floor and from safety signals throughout the route, guide the train through the tunnel.

An automatic conveyor device replaces both batteries every eight hours in a 30-second operation.

According to airport officials, long-range plans call for expanding the underground route to nearly two miles as work on the airport progresses. They anticipate that 12 or more trains will be running constantly when Houston Intercontinental reaches full capacity in the next decade. ■■

ON READER SERVICE CARD CIRCLE 33 ►



# single source

“second source everything...except Allen-Bradley hot-molded resistors”

NEXUS RESEARCH LABORATORIES, INC.

NEXUS operational amplifiers showing use of Allen-Bradley hot-molded resistors

Management's instructions to Purchasing for exclusive use of Allen-Bradley hot-molded resistors is one of the precautions Nexus takes to insure the reliability of its products. A course more and more leading manufacturers of quality electronic gear are tending to follow.

There are sound reasons behind this trend. Years of accumulated experience have shown that Allen-Bradley hot-molded resistors are unequalled for uniformity, predictable performance, appearance, and freedom from catastrophic failure.

Allen-Bradley resistors are made by an exclusive hot-molding process on fully automatic machines—developed, built, and used *only* by Allen-Bradley. There is such complete uniformity from one resistor to the next—million after million—that long term in-circuit performance can be predicted with a high degree of accuracy.

Complete specifications for Allen-Bradley hot-molded resistors are contained in Technical Bulletin 5000. For your copy, please write: Allen-Bradley Co., 1344 South Second Street, Milwaukee, Wis. 53204. In Canada: Allen-Bradley Canada Ltd. Export Office: 630 Third Ave., New York, N. Y., U.S.A. 10017.

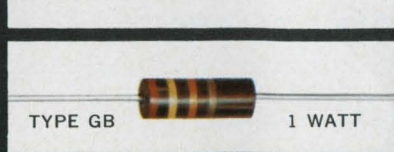
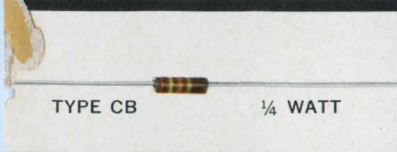
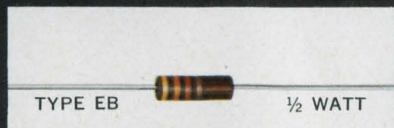
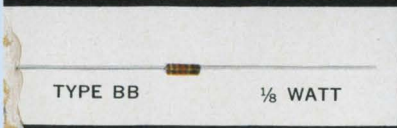

A-B hot-molded fixed resistors are available in all standard resistance values and tolerances, plus values above and below standard limits. A-B hot-molded resistors meet or exceed all applicable military specifications including the new Established Reliability Specification. Shown actual size.

QUALITY ELECTRONIC COMPONENTS



ALLEN - BRADLEY

1067E-1

# So You Think This Looks Like a Transistor

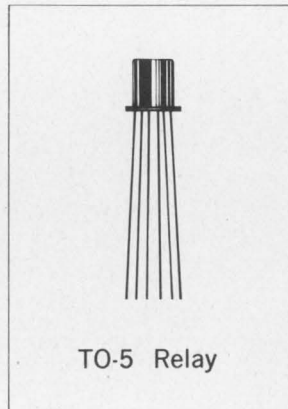

Every once in a while someone mistakes our TO-5 Relay for a transistor. They are not only surprised it is a Relay, they are usually overwhelmed with its capability. Things like resistance to vibration and shock, weight, size, isolation, and 1 amp current capability are a little hard to believe at first. Oh, yes, mag

atches, too! Now that we are putting IC chips into the TO-5 Relay, we have to admit it is beginning to look a little like a transistor. If you are not completely familiar with the TO-5, write for our data sheets — the most critical Design Engineers are impressed — even when they thought it was a transistor.

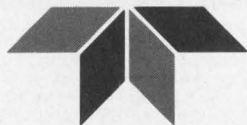

**TELEDYNE RELAYS**

A TELEDYNE COMPANY

3155 West El Segundo Boulevard • Hawthorne, California 90250

Telephone (213) 679-2205 • 772-4357

ON READER-SERVICE CARD CIRCLE 34

# Avionics in the SST era

**Charles D. LaFond**, Chief  
Washington News Bureau

In five years the American aviation industry will be turning out jetliners that will carry, conventionally, 350 to 490 passengers. It will build cargo jets that will haul up to 250,000 pounds (or 814 persons, if converted to passenger service). And increasingly, as the decade of the Seventies unfolds, the public will become aware of two booms: the ear-splitting, repugnant one created by supersonic transports thundering through the upper stratosphere, and the welcome one created by contracts to businesses with a stake in aviation equipment. Electronics will share heavily in the latter boom.

The cost of avionics systems and subsystems for each long-range commercial jet being built today is estimated at \$200,000. By the early nineteen-seventies, this figure is expected to climb to well over

\$500,000. Electronic advances will be under way in these major areas:

- Navigation equipment—Inertial systems will be routine for long-range flights. They will offer accuracy to within a mile for every hour of flying and triple redundancy for reliability.

- Automatic checkout equipment — The performance of mechanical and electronic systems aboard every new commercial aircraft will be monitored continuously as the plane flies. Aircraft integrated data systems will perform the checks, and the information will be processed and made available in two ways: on the spot, in real time, as the aircraft flies, and on the ground, after the plane has landed. Air and ground crews will perform maintenance on the basis of the readouts. (See "ACE: The ultimate in failure detection," ED 24, Nov. 22, 1967, pp. 49-67.)

- Communications equipment—

For transoceanic flights, now plagued by communication blackouts with hf equipment, vhf systems and automatic and semi-automatic digital techniques will provide full-range radio coverage via satellites.

The first new electronic systems will be installed in the jumbo jets: the Boeing 747 Superjet, designed to carry up to 490 passengers, and the Lockheed C-5A Galaxy designed to haul up to 265,000 pounds of military cargo. Improved versions of the avionics for these two planes, plus new systems, are scheduled to go into the British-French Concorde SST and the U.S.-Boeing 2707 SST.

It is impossible to consider these aircraft without using superlatives to describe their size, weight or velocity. Yet it is because of these superlative characteristics that new electronic systems are required to make

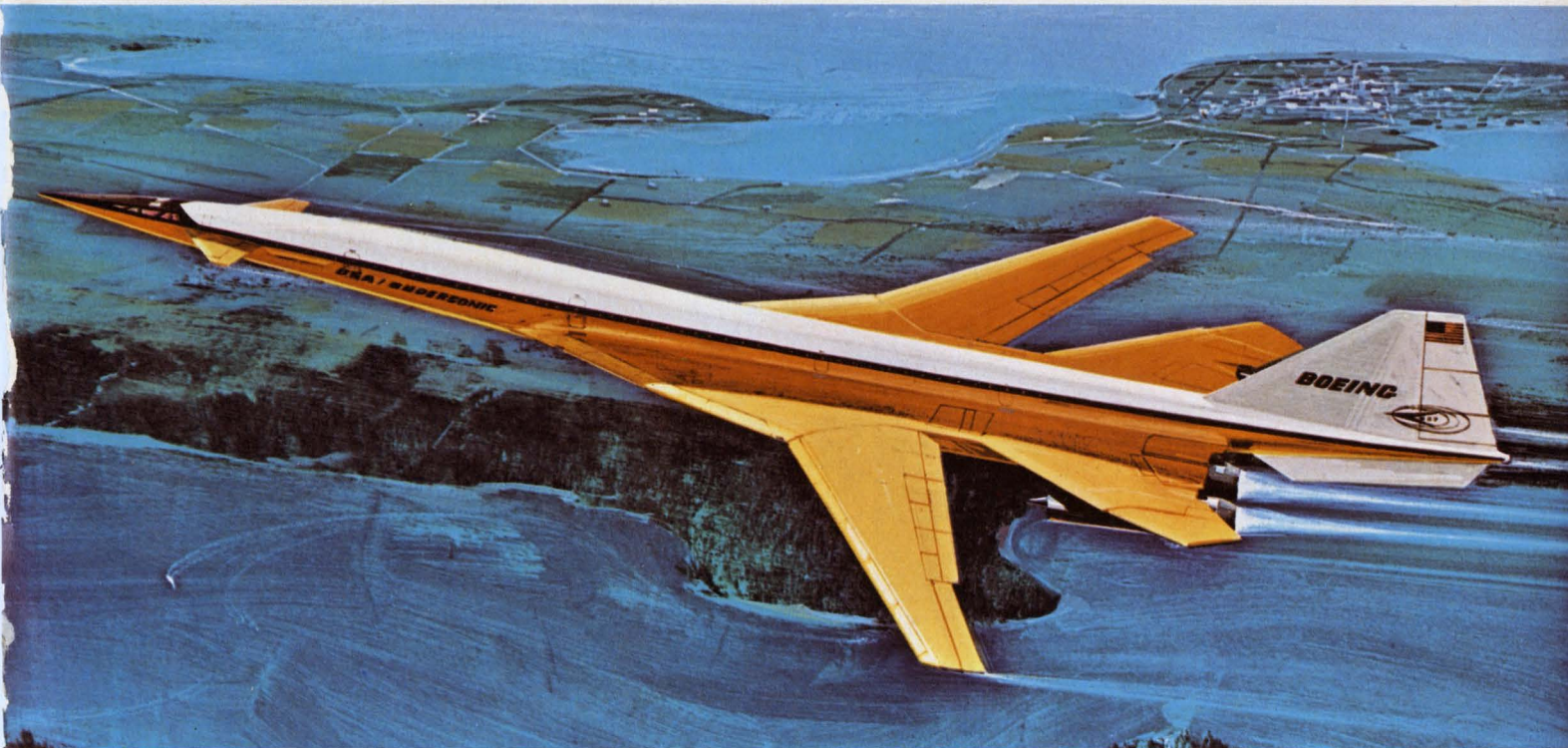

Revised design of Boeing's 2707 SST has a canard, or small wing, on the forward end of the fuselage for im-

proved longitudinal control. The aircraft will carry nearly \$700,000 worth of advanced avionics.

them safe to fly in the new era.

The Boeing 747 will be longer than an ice hockey rink (77 yards), with a wingspan of 65 yards. Its tail will rise six stories above the ground. It will be the largest airline jet when it takes to the air in 1972, and it will be able to fly 6000 miles at 45,000 feet at 625 miles an hour.

Boeing plans to produce 200 Superjets by the end of 1972 and 400 by late 1975. The price: \$20 million apiece. As of November, 1967, the company had firm orders for 134 aircraft, or a total of \$2.7 billion.

### Cargo for the battlefield

The C-5A cargo jet, being built by Lockheed for the Air Force, will be 82 yards long, with a wingspan of 74 yards and a tail six and a half stories high. It is designed to move heavy equipment for tactical ground forces into a battle zone. A typical payload could include two helicopters, a main battle tank, five armored personnel carriers, three trucks with trailers ranging from a quarter-ton to two and a half tons, 95

soldiers and a 12-man crew. (A multilevel airliner version of the C-5A being considered by Lockheed would carry up to 814 passengers). While designed for a maximum payload of 265,000 pounds, the Galaxy's basic mission is envisioned as carrying 100,000 pounds for 6300 miles at 500 miles an hour.

The C-5A is being developed under a \$1.4-billion contract by the Lockheed-Georgia Co. of Marietta, Ga. The program breaks down roughly into \$680 million for R&D and \$720 million for the production of 58 aircraft. The Air Force holds an option for 57 more planes, and Lockheed is tentatively planning the production of 85 on top of that.

Because of its great size and the fact that it can remain aloft for up to 20 hours, the C-5A is being considered by the Defense Dept. for auxiliary roles — for example, as an airborne command and control center or for the Airborne Warning and Control System.

As for the SSTs, they have a basic similarity in design and avionics subsystems. The major

differences between the Concorde and the Boeing 2707 relate to speed and the payload. The British-French craft (and the Soviet TU-144) are designed to operate at Mach 2.2, or about 1450 miles an hour, and the U.S. plane at Mach 2.7, or 1800 miles an hour. Accordingly the Concorde fuselage is being constructed of aluminum, while the Boeing will be of titanium. The Concorde is a fixed-wing design, the Boeing a swing-wing. Both will operate at up to 65,000 feet, the Concorde with 136 passengers and the Boeing with over 300.

### Operational SSTs by 1971

The Concorde is priced at \$21 million. The British Aircraft Corp. and Sud Aviation, comanufacturers of the plane, have orders for 74 from 16 airlines in the world. The first flight test is scheduled for next February, and the Concorde should be operational by 1971.

The operational target date for the Boeing 2707 is late 1974 or early 1975. The Federal Aviation Administration's SST program director, Maj. Gen. J. C. Maxwell, forecasts a \$20-billion market for the plane. This is based on anticipated sales of 500 aircraft at \$30 million each, plus spares, through 1990 and on expected operations only over oceans. Should the problem of sonic booms be solved so the craft could operate over land, the market estimates go wild — 1200 aircraft at \$31 billion. More than 110 Boeing SSTs have already been ordered by airlines.

### Computer designs debated

Besides the new major electronic systems that each of these new aircraft will need, avionics development will progress widely in peripheral areas. What is the best computer setup for the new planes, for example? Design debates now under way will continue over whether to use a large, general-purpose digital central processor (see Fig. 1) or many smaller special-purpose computers. The airlines traditionally shy away from dependence on a single processor. The first jumbo

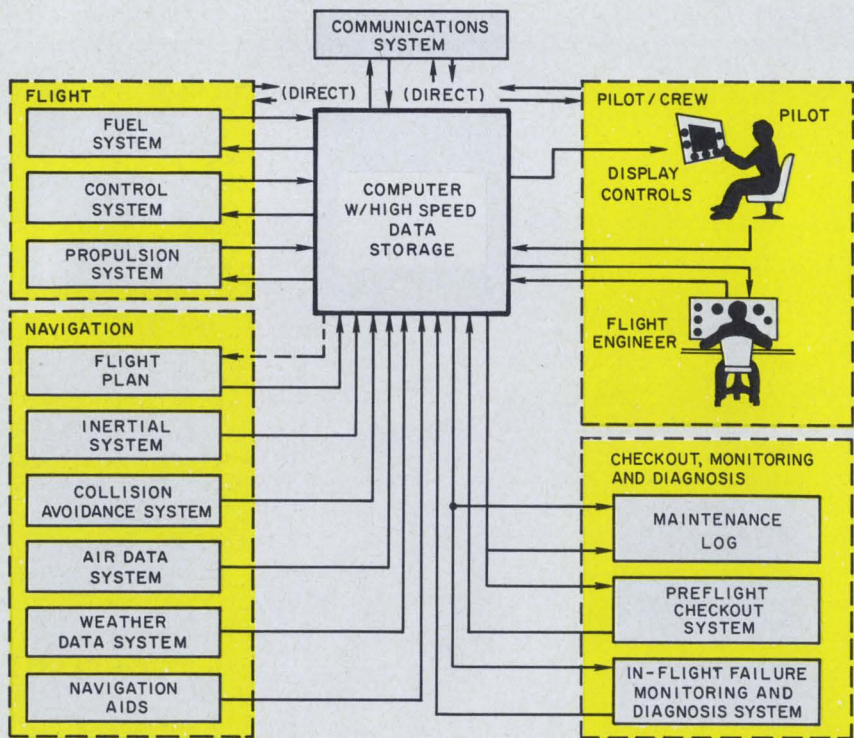

1. Centralized computer-controlled avionics systems, such as this NASA research concept, are being considered by some airline experts. Digital techniques would be used throughout for data-handling and for communications.

jets and SSTs will have multiple computers.

But other designers believe that the programming flexibility and greater storage capacity of a central computer far outweigh any disadvantage. A variety of standardization efforts are in progress, for instance, to further its use in digital communications. The Radio Technical Commission for Aeronautics has worked for some time to establish a standard format and digital system. At least three organizations, including Aeronautical Radio, Inc., are standardizing computer input-output language and format. The goal is to establish and obtain acceptance of worldwide standards, for without such agreement the entire concept would be near useless.

In addition solutions will be sought to such perennial problems as these:

- Better air traffic control to assure all-weather operation.

- Improved displays, especially pictorial ones in the cockpit.

- Collision-avoidance systems (see "CAS: Aid to traffic safety in crowded skies," ED 10, May 10, 1967, pp. 17-23).

- Detectors of the clear-air-turbulence menace (see "Super-sensitive radars spot perilous CAT," ED 17, July 19, 1966, p. 24).

- Automatic flight-control equipment to make the pilot's job largely one of monitoring the aircraft instead of actively flying it.

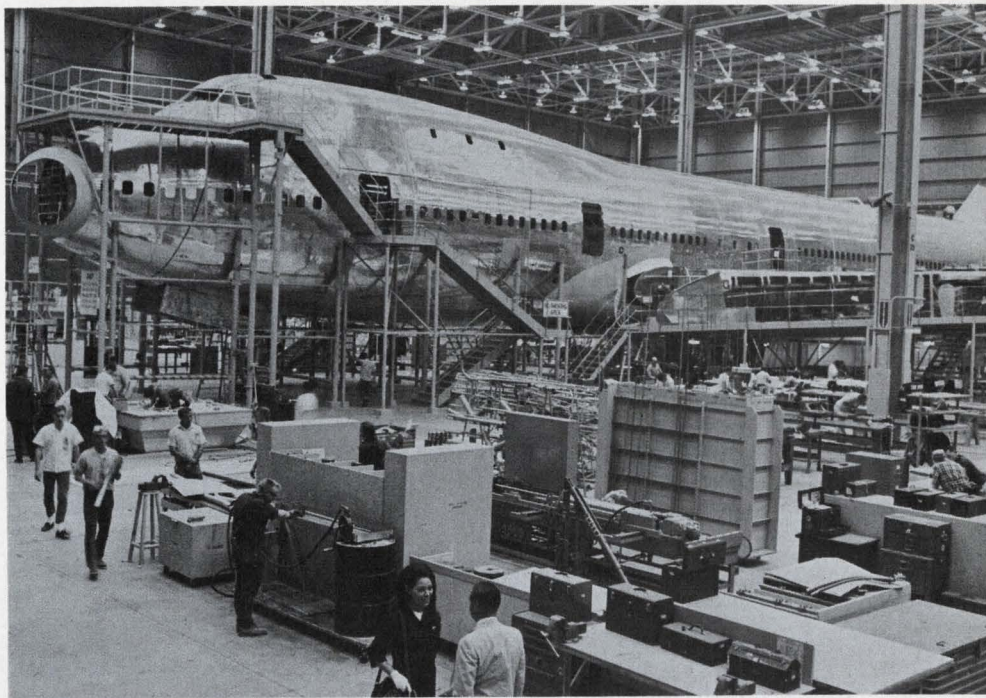

**Mock-up of Boeing's 747 Superjet** at the company's plant in Everett, Wash. The jumbo jet will seat up to 490 passengers.

NASA's Electronics Research Center in Cambridge, Mass., is looking beyond the first generation of SSTs to avionics needs for the 1975-1985 period. For advanced guidance and control, according to Dr. Richard M. Head, director of the center's Aeronautics Program Office, investigations are being made of concepts to combine directly VOR-DME and satellite inputs with inertial

navigators.

Another major NASA effort will be directed toward automatic flight control and management. An airline would employ a digital computer as a central controlling element. The computer would receive a wide variety of input signals from various sensors. It would handle the power plants and have control over the plane's altitudes and flight path.

## Inertial navigation to keep jets on course

The airliners of the nineteen-seventies will be navigated routinely the way ballistic missiles are today — by inertial guidance. Military and commercial aircraft users agree that such systems offer the greatest flexibility and accuracy for high-speed, long-range flights.

Electronics companies now leading in missile and spacecraft inertial technology are in the forefront of the competition to develop small, lightweight inertial systems for aircraft. These systems top the list today:

- The Carousel IV, developed by the AC Electronics Div. of the

General Motors Corp.

- The LTN-51, developed by Litton Industries, Inc.

- The Doppler-inertial guidance for the C-5A Galaxy cargo jet, developed by the Nortronics Div. of the Northrop Corp.

The Carousel IV and the LTN-51 have many basic similarities. The Carousel has been selected by Boeing for its 747 jetliner and for possible use in its SST, and both the Carousel IV and the LTN-51 will be tested by many airlines for possible installation in long-range jetliners now flying, such as the Boeing 707.

Boeing plans initial flight tests

this month, using a pair of Carousel IVs installed in a 707. It expects to accumulate at least 3000 flight hours before starting to test the system in the jumbo jet. The cost of each Carousel IV is expected to be about \$95,000 once production begins in earnest. The Litton system is reported priced competitively.

Precision navigation with inertial systems is important because in the nineteen-seventies a reduction is expected in the present 120-nautical-mile lateral separation between airliners flying the North Atlantic (this would have been reduced to 90 miles in 1966,

but objections by the International Federation of Airline Pilots reversed the decision). Increasing air traffic over the ocean will prompt the reduction.

The Carousel IV system is essentially four black boxes: a 47-pound inertial navigation unit, a small control-display unit, a mode selector unit and a 20-pound battery unit. The total system weighs less than 74 pounds, and it can be stored in an area of 0.87 cubic feet. The principal element is the inertial navigation unit, which contains the stable platform, electronics, a digital computer and the associated input-output sub-systems.

Boeing is looking for an MTBF of 2500 hours with the Carousel IV and an accuracy to one nautical mile in an hour's travel, with a 99 per cent probability of success. To achieve this, two inertial navigators will be employed, with an optional third unit recommended as a standby.

The Carousel platform employs two single-degree-of-freedom gyroscopes for sensors to measure platform rotations about the horizontal axis. Two accelerometers sense the horizontal components of aircraft acceleration. This AC Electronics technique differs from other approaches in that these components can be rotated as a single rigid unit, compared with the individual rotation of gyros in other systems.

### Error modulation provided

Accelerometer errors, instrument misalignment errors and gyro drifts are modulated in the Carousel; thus, the company says, a bias error in a horizontal instrument viewed in the Earth-fixed frame can be removed easily, because it appears as a zero mean sinusoidal error signal. Since the frequency is known, the bias error has negligible effect on the inertial subsystem.

The benefits of error modulation with platform rotation during initial alignment operations include a reduction in total alignment time (less than 30 minutes from  $-18^{\circ}\text{C}$ ), improved alignment accuracy, a confirmation of system accuracy during alignment, and the suppression of hori-

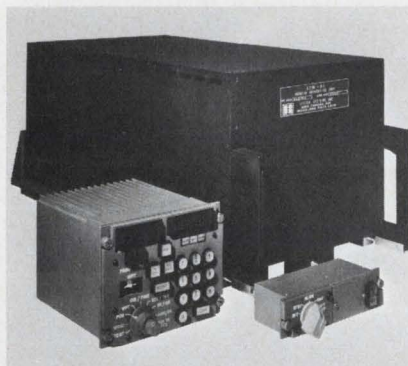

The Litton LTN-51 inertial-navigation units include, at left, the platform and computer system, a control display unit and a mode selector switch. On the right is the control display, as installed in the cockpit of an American Airlines plane during recent flight tests.

zontal-error effects that may develop in flight.

In operation, five modes are available in the Carousel, including "off" (all power removed from the system) and "stand-by" in which power is supplied to maintain thermal stabilization of critical elements and to permit computer programming). A third mode is for the automatic alignment of the system to the reference navigation coordinates. In the "navigate" mode the system computes the aircraft's position and feeds steering data to the instruments.

In the fifth mode, "attitude," the computer is disabled, the platform is slaved to the local vertical, and the system supplies attitude information only. This mode is used only when a malfunction has occurred in the system, so that the accuracy of navigational data might be in doubt, or following a computer failure.

Carousel IV performance is limited chiefly to three error sources: uncompensated azimuth gyro drift rate, uncertainty in the initial azimuth angle and uncertainty with the average horizontal gyro-torquer scale factor. On a long-term basis, the first error source is the most significant, for it varies with calibration time, latitude and system temperature when the system is energized.

High-latitude operation (above  $70^{\circ}$ ) can degrade the signal-to-noise ratio, as viewed by the gyrocompassing filters, and the result



is an increase in reaction time. Below  $70^{\circ}$  latitude, the gyrocompassing accuracy is unaffected.

The destination and waypoints along the plane's route are fed into the computer system through a 10-key telephone keyboard on the control-display unit. Each waypoint is inserted into a numbered location — from one to nine — in the computer. The data include the north or south latitude in degrees and minutes to the nearest tenth; comparable data are inserted for longitude. The data are displayed before insertion into the computer. Eighteen words must be loaded into the control display unit for nine destination-waypoint locations. Two additional words are required to indicate the present position. Waypoints also may be inserted, as required, in flight.

The output from the computer is transmitted digitally, in both serial binary and serial BCD, and analog, as two-wire and three-wire ac and two-wire dc. These outputs feed the cockpit flight instruments, the autopilot, the other inertial navigation systems (for accuracy comparison) and, in time, will provide digital air-to-ground data, probably through a communication satellite system for air traffic control.

The Litton LTN-51 inertial system is expected to be used in the Concorde SST through a licensing arrangement with Sagem-Ferranti in Europe. In testing to date by several airlines, and through sub-

sequent minor system modifications, Litton reports close to a one-nautical-mile error every hour in flights up to 10 hours and an MTBF of nearly 1200 hours. Automatic alignment by gyrocompassing can be accomplished under normal operating conditions within 15 minutes, the company said.

In the C-5A cargo-jet, Nortronics has received a \$20-million subcontract to produce its Doppler-inertial navigation equipment. Two digital computers are required for the guidance system. Although interchangeable, one computer is considered primary and the other standby.

The two digital computers used to support the navigation system

are identical, except for the memory. Additional memory blocks may be provided, as needed, for whichever computer is designated primary. The primary is designed for 12,288 words, and the auxiliary carries 8192 words in storage. Both computers and the monitor unit, plus the extra memory modules, are installed in a single 1-1/2 ATR case. The unit occupies 0.9 cubic feet, weighs 25 pounds and requires 250 watts.

The Doppler navigation subsystem is being built for Nortronics by General Precision, Inc. It provides damping for the inertial system and accurate altitude information up to 10,000 feet. There is also a coherent radar that operates in the Ku band (13 GHz) at 300 mW. The Doppler antenna is stabilized in attitude and azimuth, and it employs beam-lobing to assure accuracy over water. The fm continuous-wave transmission is operable from sea level to 50,000 feet. An all-solid-state system, it includes built-in test equipment.

The Nortronics platform is highly advanced, employing a gimballess stable sphere that can operate in any altitude. The outer sphere is strapped down in the aircraft. An inner sphere is floated within the outer sphere and may rotate in any of the three axes or in combinations of them. The inner sphere contains all the platform electronics and inertial elements. Data pick-offs are through three capacitive strips on the sphere. The inertial elements consist of orthogonally mounted gyroscopes and accelerometers for each of the three axes. Gyros are rate-integrating, single-degree-of-freedom, floated elements. The Air Force requires accuracy of one nautical mile an hour for long-term operation.

### Multimode radar planned

The Air Force also considers a multi-mode radar system being developed by the Norden Div. of United Aircraft under an \$18-million subcontract, as part of the C-5A guidance equipment. Norden, which will supply 65 systems initially, is providing paired radars for redundancy. The system will be used for high-resolution ground mapping; for automatic,

low-level maneuvering; weather warnings, and beacon operation.

The Air Force goal is to achieve accurate global, all-weather navigation and landings without any help from ground equipment. In addition the system should permit in-flight station-keeping in adverse weather, allowing for formations of up to 12 aircraft with 2000-foot separations.

Each multimode radar system is to consist of two units operating at X band and Ku band, each providing a backup capability to the other. The Ku-band radar is to be used for high-resolution, short-range ground-mapping (20-nautical-mile range) and for aircraft landings. The X-band radar has primary functions of terrain-following; terrain-avoidance and long-range ground mapping (250-nautical-mile range); ground-contour mapping; weather-contour mapping and beacon operation. Each function will be independently controlled from any of three operator positions.

### Weight-saving antenna design

Atop each antenna-receiver reflector will be a passive interferometer array, rigidly attached to the scan column and maintained in bore-sight coincidence with each antenna. The larger radar reflectors are to be employed for both transmitting and receiving; the interferometers, however, are to be used only passively. The interferometers will process radar returns to generate elevation profile data for terrain-following, contour mapping, and radar approach to landings. The arrangement of antennas is to permit 180° coverage in azimuth, yet save over 30 pounds in weight.

In normal operation, the pilot or copilot will control the X-band radar, with appropriate displays; the Ku band radar is to be used by the navigator. Should one radar fail, the remaining unit will provide terrain-following and ground-mapping functions.

A phase interferometer technique will be used for any radar modes of operation requiring vertical angle information. This approach was selected for the C-5A cargo jet because it provides extremely fast terrain data-ac-

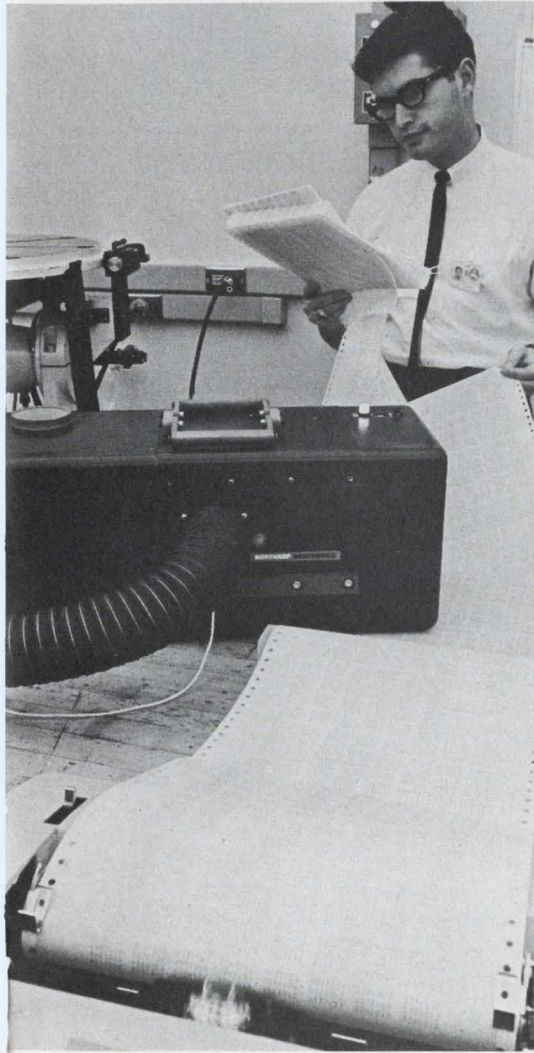

**Nortronics' C-5A navigation computer under test.** Two units are required to support the inertial system, one with a 12,000-word memory and the other with 8000 words (a modified version of the same unit is used in the C-5A MADAR system, described in part 3 of this report).



The Carousel IV inertial-guidance system, developed by AC Electronics, has been selected by Boeing for the 747 Superjet. All airlines are asking for triple-redundancy.

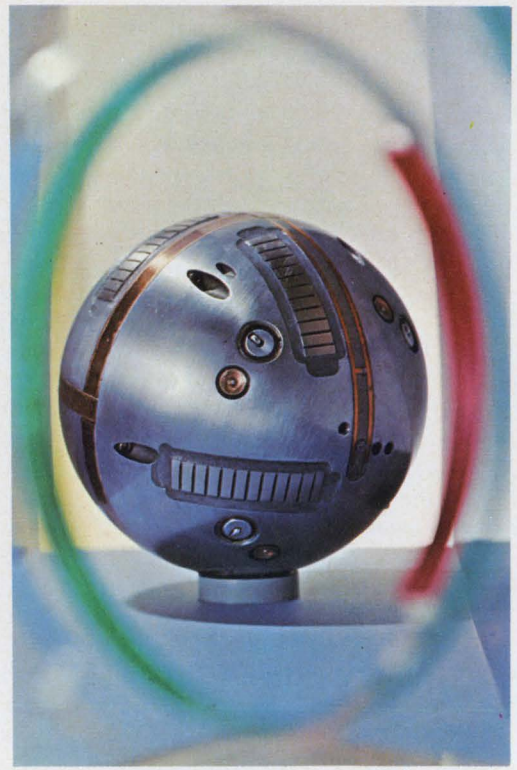

A gimballess stable sphere houses the electronics in the Nortronics inertial platform, which can operate at any altitude.

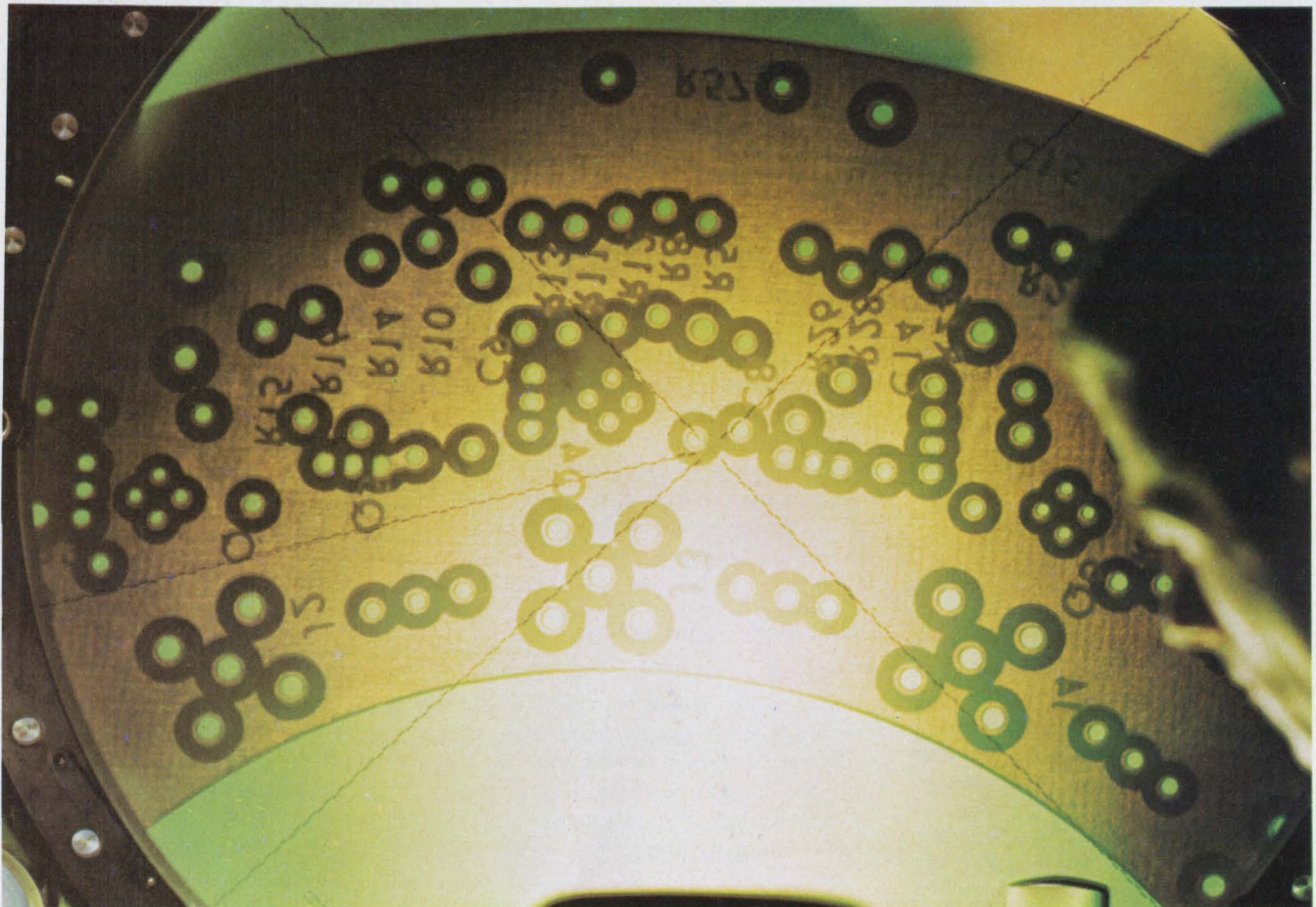

A printed-circuit board for the Doppler inertial navigation system to be used on board the C-5A cargo jet is checked

on an optical comparator by a Northrop Nortronics technician. The guidance system uses two computers.



quisition rates, wide elevation coverage, the ability to perform ground mapping concurrent with terrain following, and effectiveness at shallow grazing angles.

The radar subsystem will permit long-range operation at altitudes of 300 to 1500 feet. For air drops, it will work in conjunction with the Doppler navigation equipment to establish the aircraft's position and to determine the release point to within 325 feet of the target.

Finally, it will provide radar ability to land without ground assistance under a 500-foot ceiling and a mile visibility, or a 200-foot ceiling and a half-mile visibility if a beacon reflector is used on the ground.

When operating in the radar approach-to-landing mode, the multimode radar will measure the azimuth and elevation angles to the runway and provide synthetic ILS (instrument landing system) information. When the aircraft is lined up in azimuth, glide-path information.

For weather detection, the sys-

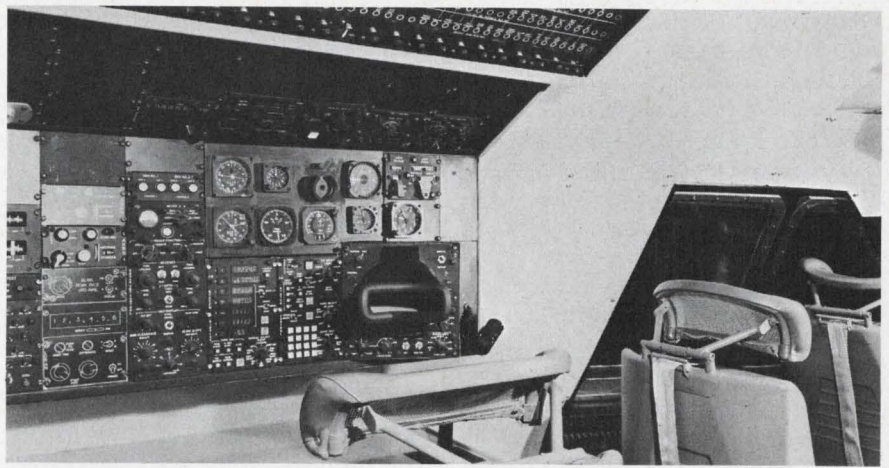

The navigator's instrument panel in the C-5A cargo jet provides all the controls for the Doppler inertial system, including the Ku-band scope for the multimode radar.

tem will provide a forward-looking range of 250 nautical miles with a contour weather display. An iso-echo processing is to be employed to provide a contour weather display.

The total installed weight of the multimode radar system is put at 706 pounds, and its volume will be about 52 cubic feet. The

required input power will be 2500 W. The beamwidth of the Ku-band dish is to be  $2.2^\circ$ , and for the X-band,  $0.85^\circ$ . The Ku-band search radar will use a 62-by-30-inch, doubly-curved reflector with a dual-polarized feedhorn. The X-band antenna will have a 43-by-34-inch dual reflective surface and a dual-polarized horn.

## Automatic checkout for flaw-free flying

Thirty-five years ago an airline passenger making a cross-country flight often found himself at a small airport in a small town where he never expected to go. Engine malfunctions forced such landings. Even today, airline flights may be canceled at the last minute because the equipment does not check out to the pilot's satisfaction. Automatic checkout systems should make such failures increasingly rare in the airlines of the seventies.

Aircraft integrated data systems are envisioned that will test and store information on 1024 performance points in a commercial plane while it is flying. The data will be available to ground crews immediately after the plane has landed, and it will be possible to replace worn equipment or to correct potentially hazardous flaws before a breakdown occurs. Checkout systems for the military are being designed to give the data on over 1000

test points in flight, both in real time and in stored form for later analysis.

Of the two approaches to automatic checkout equipment, the military's is the furthest advanced at this time. The MADAR (Malfunction Detection, Analysis and Recording) system being designed for the Air Force's giant C-5A cargo jet has no immediate counterpart in proposed airliners. A complex analog-digital system, MADAR will give flight engineers a real-time view of the C-5A's performance aloft and ground maintenance personnel a post-flight presentation. It will permit isolation of flaws down to the smallest unit of subsystems and their instant replacement with off-the-shelf modules.

On the commercial side of aviation, the approach is significantly more conservative. The airlines seem incapable of agreeing at present on standardized checkout parameters and equipment.

The majority agree that some form of integrated data system should be incorporated in the 747 jumbo jet being built by Boeing. Essentially it would monitor and provide a recording of engine performance for post-flight evaluation. The system would be expanded later for testing avionics subsystems.

The C-5A MADAR is being designed by the Lockheed Missiles and Space Co. with the help of the Lockheed Aircraft Service Co. It will have both an automatic mode, for continuous monitoring of the cargo plane's performance in flight, and a manual mode (semi-automatic), for detailed diagnosis by the flight engineer of a limited number of check points. The first flight test of the system in a C-5A is scheduled for 1970.

Malfunctions spotted by MADAR will be readily identifiable on a printout record, and there will be a visual indication of sub-

system malfunctions on a lighted annunciator panel.

A key part of the system that is shaping up is the central multiplexer adapter, the principal interface component (see Fig. 2). Connected to this unit are automatic and manual remote signal acquisition units, the control-display assembly, the digital computer, the manual multiplexer, a maintenance data recorder and the printout unit.

The system's Nortronics digital computer carries an 8000-word memory and is a modification of that used in the C-5A Doppler-inertial guidance system. It operates at 500 kHz, or on a two-microsecond time cycle. About 20,000 test points can be sampled each second. By contrast, the manual system can accommodate only four decisions a minute.

In the automatic mode, the computer program selects test points, encodes both printer and recorder information, compares measurements against stored criteria and determines malfunctions. After a

test point is selected, a 10-bit address is sent from the computer to the central multiplexer. It in turn routes five bits to all of the automatic remote acquisition units to select the same channel in each. Next, the acquisition unit selects the proper data gate and routes the data signal from the conditioning circuitry through the gate to a data amplifier for transmission back to the central multiplexer. The remaining five bits, retained at the central multiplexer, are employed to select the required acquisition unit output. After proper channel selection, the analog data are sampled and converted to a nine-bit digital word.

### Two kinds of data furnished

Subsequent handling of the word by the computer varies with the particular program. That is, it might either be trend data or data calling for replacement of an aircraft part. If trend data, the computer checks to see if any

deviation is in tolerance with a recorded value. If it is, the word is discarded. But if it exceeds the allowable deviation, both the test point number and a time reference is directed to the maintenance data recorder. Replaceable parts data are compared with a programmed tolerance range, and a "go" or "no go" condition is indicated.

In the manual mode, the operator replaces the computer and makes his own selection of channels through remote signal acquisition units. Having selected a particular subsystem for tests, he begins a pre-programmed interrogation of test points. As each particular waveform in the test appears on the operator's oscilloscope, a corresponding film frame is projected on a screen (see photo).

The capacity of the unit is 10,000 frames of film. Control data for a test sequence are stored as dots on the edge of each film and are read automatically into the system by a photocell matrix.

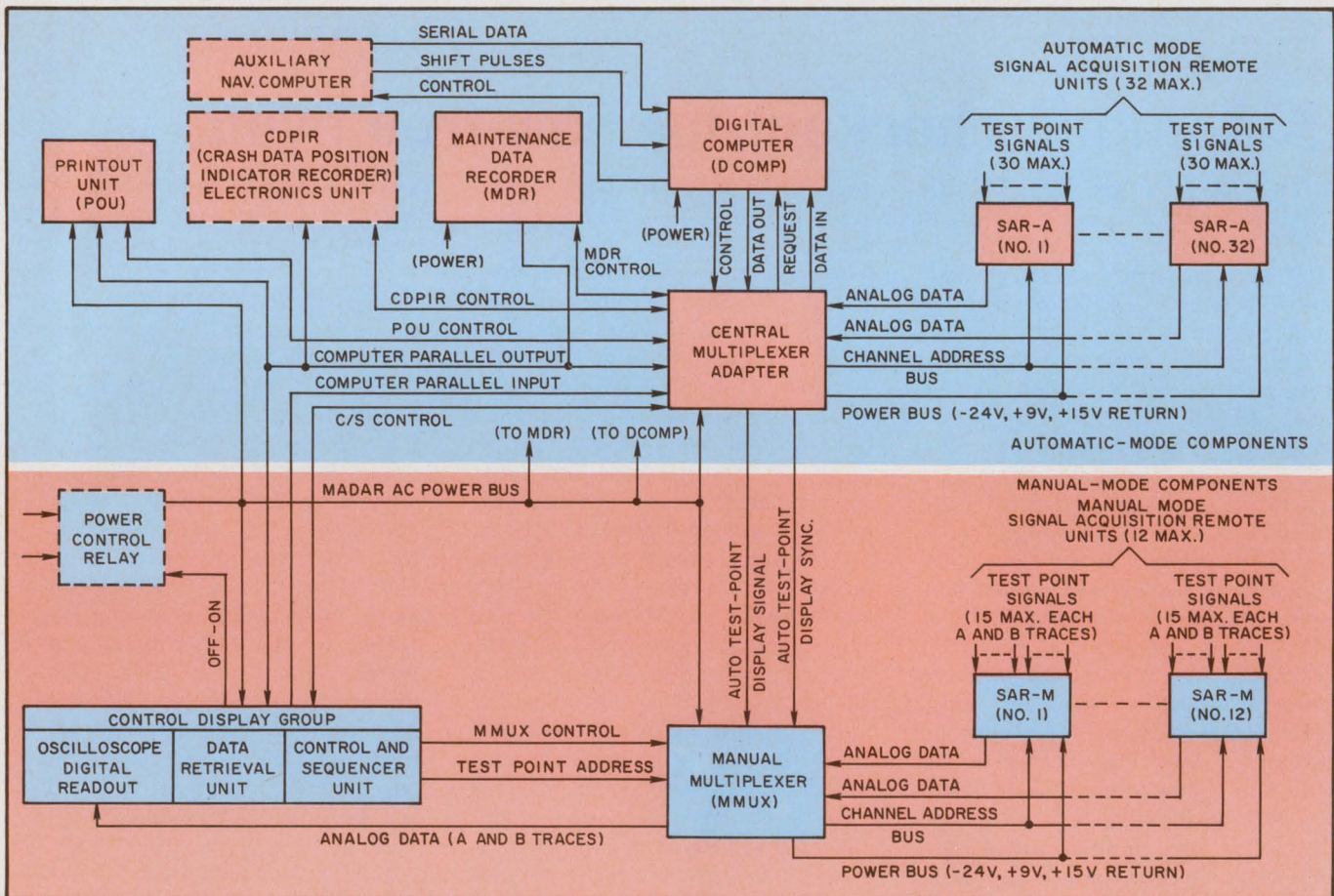

2. The C-5A Malfunction Detection Analysis and Recording System (MADAR), showing separation of automatic

and manual functions. It will continuously monitor the planes' electronic subsystems.

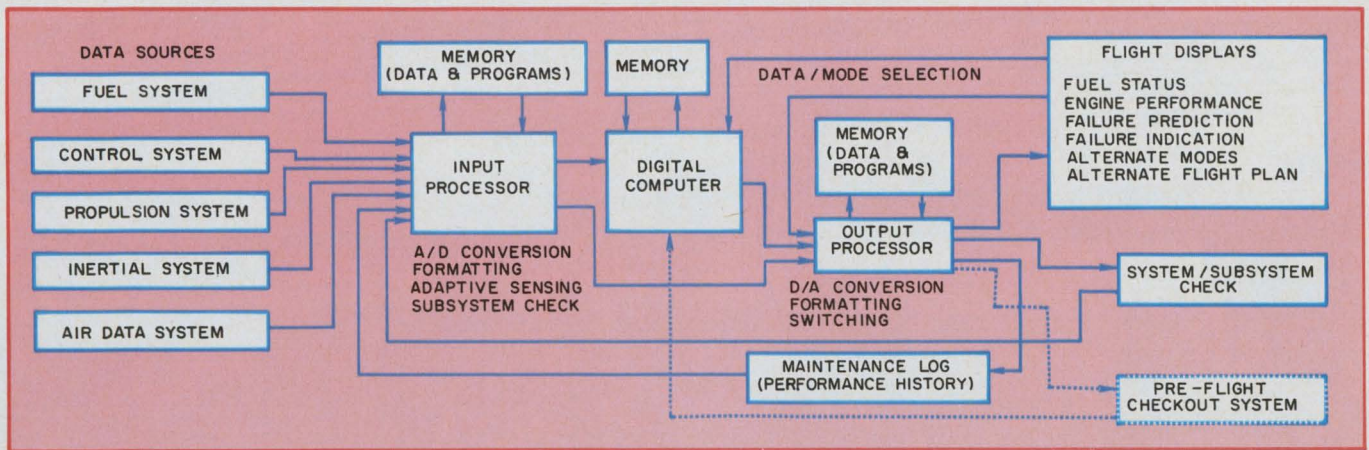

3. Typical of the approaches to on-board monitoring and failure diagnosis systems for the SST is this NASA Elec-

tronic Research Center concept. It would provide a maintenance log for ground crews after each flight.

Each frame carries up to 150 dots. Thus the total data capacity is 1.5 million bits. The system covers 250 test points, and the dots are employed to direct four functions:

- Automatic calibration and adjustment of the oscilloscope.
- Operation of a particular switch or gate in a particular remote signal acquisition unit.
- Provision for alternate answers to questions that may come up on the control-panel screen for the operator.
- Automatic sequencing of the next frame at the proper time.

### Control by the operator

The film used is unperforated, 16 mm, and it is driven by pressure wheels instead of conventional cogged wheels. The frame provides either information or waveforms, permitting the operator to make a determination as necessary for continued operation. And with each choice or comparison, the operator continues through a program diagnosis. Should an improper value or waveform be revealed, manual indication of malfunction by the operator produces an appropriate output to the maintenance data recorder and the printout unit, identifying the unit subsystem and the time.

Random access to a waveform from any manually monitored test point, can be obtained at will by the operator without regard to any set diagnostic subroutine. However, the latter approach would probably most often be applied by experienced maintenance personnel.

The MADAR's automatic mode would normally be employed during taxiing, take-offs, landings and other flight conditions that require the active participation of the flight engineer. During cruising, however, when the engineer is free to perform secondary functions, he may elect to employ the manual, or diagnostic, mode. The automatic mode is not interrupted during the manual diagnosis.

In the automatic mode, the system sequentially monitors up to 1024 data points at a rate of 20,000 per second. The manual system, however, is limited to a maximum of 384 data points.

The Boeing SST will, by order of the Federal Aviation Administration, have an integrated data system for automatic checkout when it takes to the skies in late 1974 or early 1975. But before then, a checkout system will in all likelihood be installed in the Boeing 747 Superjet. Boeing already has made allowances throughout the jumbo jet.

Most airlines favor a checkout system that will do the following:

- Determine long-term failure trends in aircraft subsystems. The extent of this determination is in question, some favoring only a limited "shotgun" approach.

- Monitor the pilot's flight performance for periodic evaluation (possibly as a substitute for the present FAA certification of pilots every six months).

Hardly anyone in commercial aviation sees a need for real-time surveillance of system operation other than the conventional panel warnings now in use.

Last September, Aeronautical Radio, Inc. (ARINC)—a private corporation owned by all the airlines to operate their communication system and to prepare specifications for electronic equipment—prepared an interim spec for space and wire bundles for an airliner checkout system. The spec, ARINC 307, provides for an avionics rack space to accommodate an electronic unit, a quick-access recorder, a long-term recorder and acquisition units where appropriate. ARINC says some of this space could be occupied by an appropriate digital computer.

It states further that each remote acquisition unit should be capable of handling 256 data-input circuits—for an average 2.7 circuits for each monitored parameter. The spec requires, by virtue of the termination points of its wiring bundles, that suitable multiplexers be located after and near the forward electronic equipment center. At the flight engineers' station, it requires that provision be made for a data entry panel, multiplexer and circuit breakers.

### Computer question undecided

The ARINC specification will have only minimal influence on the Boeing 747, but it will unquestionably be used in the Boeing SST and probably will affect the British-French Concorde design.

The extent of computer control, not only of checkout but of other subsystems for future aircraft, is at present in a state of confusion: Should one central computer (see Fig. 3) or many independent com-

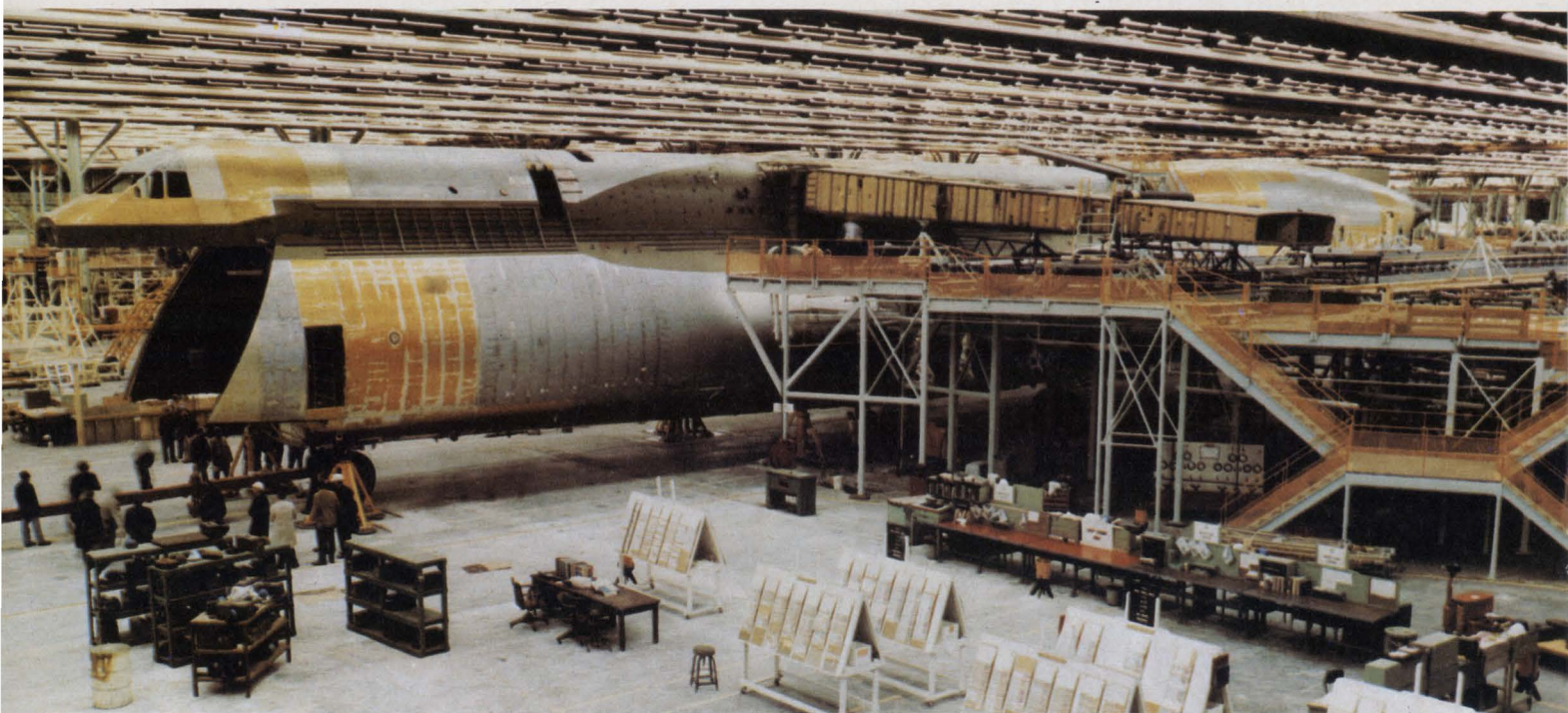

The Air Force C-5A Galaxy, under construction at the Lockheed-Georgia Co. plant in Marietta, Ga., will carry up

to 265,000 pounds of cargo. A planned commercial version would carry up to 814 passengers.

puters be used? The trend seems toward the use of many small, general-purpose digital computers, each programmed for a special purpose. This appears to be the approach favored by Boeing engineers, who are now attempting to determine the basic design of a

standardized digital computer. Reportedly they envision the use of as many as 22 like computers in a single aircraft to handle many specialized functions and to provide redundancy for critical operations.

Ultimately the supplier for Boeing's integrated data system will

build two prototypes, each capable of handling 1024 test points. The system will be digital and relate critical engine parameters of temperature, pressure, vibration, frequency, control positions, on-off functions, and some electrical and mechanical quantities.

## Satellites may end aviation radio blackouts

Airline crews flying the ocean routes of the world encounter a common problem with high-frequency radio communications: the signals black out or are so covered by noise as to be unreadable at times (Fig. 4). A remedy is being sought in new vhf systems that will relay their signals by way of communication satellites.

Tests are already under way with NASA's Applications Technology Satellite series. These experiments began in December, 1966, with ATS-1 and are continuing today with ATS-3. Pan American World Airways and other airlines are cooperating in the voice and data testing.

But there are arguments in the world airline industry over whether satellite communications are really essential. Last year, for example,

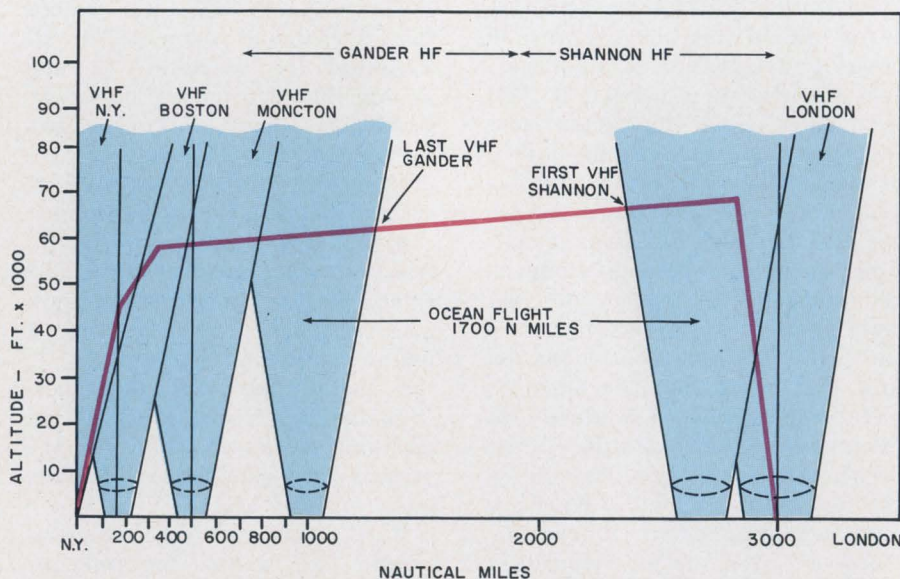

4. This communications profile of the New York-to-London route over the North Atlantic indicates the radio coverage by hf and vhf stations. The zone of poorest radio continuity is that served only by hf facilities.

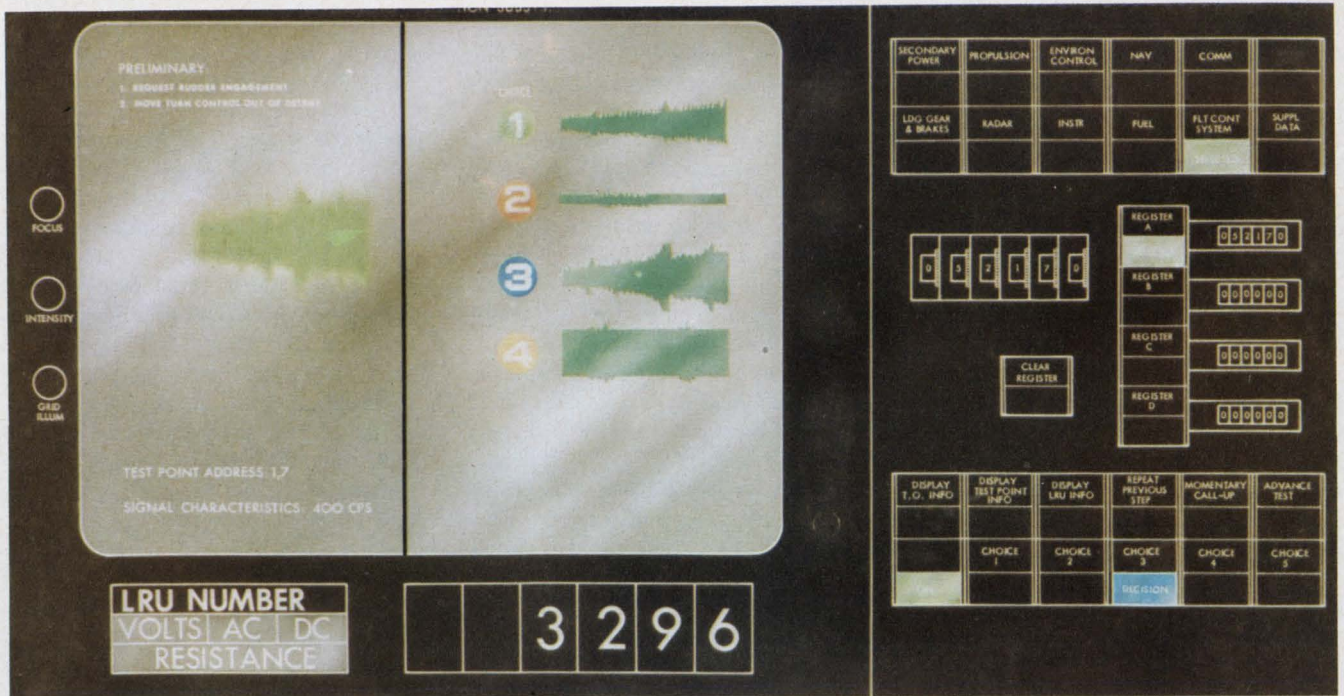

In MADAR's manual mode of subsystems testing, the measured waveforms are presented on a screen and may

be compared with a film display of possible variations in the waveform, to indicate malfunctions.

Sud Aviation and the British Aircraft Corp. organized a symposium for their Concorde SST customers to discuss the features they would like built into the supersonic jetliner. The consensus was that no imminent need existed for including a satellite communications capability in new vhf systems.

The airlines requested instead full provision for two standard vhf sets and continued use of two hf installations, until the availability of satellite communications justified reconsideration.

The European Electronics Committee, representing commercial operators overseas, has argued that equipment compatible with any future satellite system should be separate from standard vhf communications. They cited these points to support their stand:

- The increased complexity of an integrated vhf system could significantly reduce reliability.

- Although aimed at future jumbo and supersonic jets, the satellite communications specifications that have been proposed would be all-inclusive, thus subjecting short-range aircraft to a requirement for unnecessarily complex hardware.

- There is still uncertainty as to the frequency band to be employed for satellite communications.

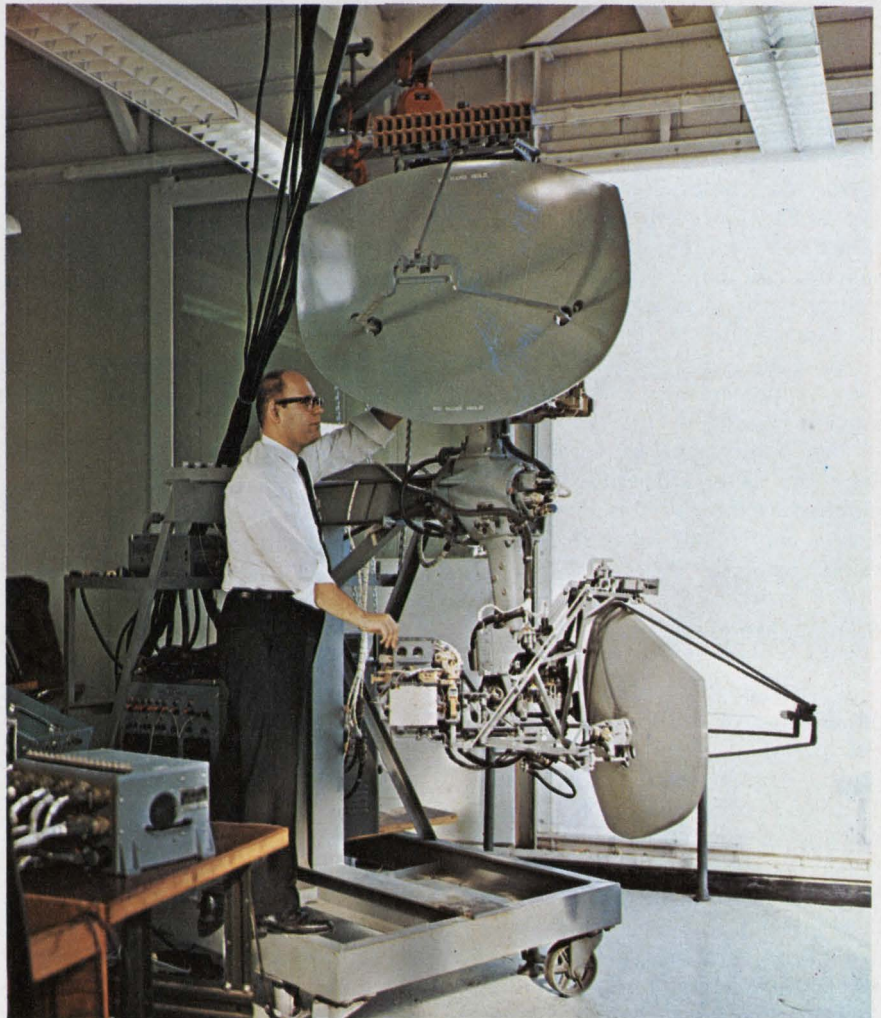

This eight-foot multimode radar for the C-5A navigation system has an X-band reflector (above) and a Ku-band radar (below) for redundancy.

■ There still has been no decision on whether to require the installation of new satellite equipment in existing aircraft.

The U.S. airlines have led the fight for inclusion of a satellite communications capability in standard vhf transceivers for aircraft. Seemingly they have won, for specifications for such systems have been included in an updated version of a recommendation issued by Aeronautical Radio, Inc. (ARINC), which handles communications affairs for the airlines in this country. European aircraft manufacturers who hope to sell their planes to U.S. operators are obliged to follow ARINC specifications.

### Automatic controls sought

In addition the Boeing Airplane Co. has committed itself to a five-year developmental effort to advance automatic flight controls. For an aircraft the size and speed of the Boeing SST, according to T. A. Wilson, executive vice president of the company, delays in traffic patterns, even if no worse than those of today, could cost \$1 million a year for each plane. Thus improved air traffic control is mandatory for the SST era. And to assist such improvement, Boeing is pressing for the installation of inertial guidance for navigation and the use of a satellite communications system.

Also, the Air Transport Association, representing U.S. airlines, supports the view that the relaying of communications by satellite offers the best immediate way to eliminate existing gaps in vhf coverage, particularly over the Atlantic Ocean.

### Standardization pressed

A variety of standardization efforts are in progress to further the use of a central processor and digital communication. The Radio Technical Commission for Aeronautics, a U.S. Government-industry group of users and suppliers, has worked for some time to establish a standard format and standard digital system. At least three other organizations, including ARINC, are standardizing computer input-output language and format. The goal is to establish

and obtain acceptance of worldwide standards; for without such agreement, the entire concept would be near useless.

By 1975, it is believed, full satellite communications coverage could be available for aircraft use. There also is a move to promote the use of a surveillance satellite system, functioning like a secondary radar, to assist in automatic air-traffic control. Both the communications and surveillance functions could be performed in a hybrid synchronous satellite system, many experts believe.

The new ARINC specifications for satellite communications provide for an "airborne vhf communications transceiver and Mark I vhf Satcom system." The details are contained in Project Paper No. 546A, prepared largely by the Satcom Subcommittee of the Airline Electronic Engineering Committee and ARINC and then modified in a second draft by Robert Bohannon of Pan American and the Collins Radio Co.

### Versatile transceiver needed

The paper calls for a transceiver that must include, or be capable of interfacing with, a modulation adapter/modem unit. The latter is intended to adapt the vhf transceiver to transmission and reception of angle-modulated signals. Other units called for in the specifications include a power amplifier for satellite use and for extended range, a preamplifier-switching unit, a control panel for frequency selection, and a remote frequency readout indicator. A standard vhf vertically polarized omnidirectional antenna is recommended for reception, plus a special satellite antenna. Excluding the antennas, the total system weight is given a broad range—from 54 to 105 pounds.

The ARINC system would have a frequency range covering all 25-kHz spaced channels (a total of 720) from 118.00 to 135.975 MHz. It also would have a maximum frequency channeling time of 60  $\mu$ s. It must accommodate a transmitter frequency offset by multi-megahertz increments—the frequency plans, so far, call for 6-MHz, 7-MHz and 10-MHz spacings. A standard 2-out-of-5 frequency se-

lection also is required.

In the receiver portion, the specifications call for a signal plus noise-to-noise ratio of 6 dB or better with a 3- $\mu$ V signal modulated 30 per cent at 1 kHz (with squelch positively opened) at all frequencies. All spurious responses must be down 80 dB, and between 108 to 136 MHz, they must be down 100 dB—preferably 120 dB. For receiver gain, the specifications require that a 3- $\mu$ V signal, modulated 30 per cent at 1 kHz, produce a minimum of 100 mW in a 200-to-500-ohm resistive load. A locking potentiometer type of audio gain control must be provided.

The maximum allowable transmitter carrier frequency deviation on any channel, under normal operating conditions, is to be  $\pm 0.004$  per cent, and for any satellite channel, the limit is  $\pm 0.001$  per cent. Spurious emissions between 108 to 136 MHz must be down at least -75 dBW, preferably -105 dBW.

The ARINC specifications offer considerable leeway for the satellite-communications antenna design and assume that it will vary considerably with the aircraft's global operating paths. Thus ARINC states that the antenna may vary from one radiating in all azimuths and from zenith to 10° above horizon to one that is only side-looking. The specifications do require, however, that the antenna provide a nominal 0-dB gain or more above isotropic at all elevation angles and azimuths applicable to the aircraft's operation. For multipath rejection and maximum link gain, the specifications call for lefthand circular polarization with minimum ellipticity.

Looking ahead to future requirements, ARINC includes provisions for use of an automatic data link system and for compatibility for a satcom data link mode.

For satellite operation, the ARINC specifications recommend that power radiated toward the satellite from the aircraft or from the ground provide a density of -143 dBW/m<sup>2</sup> at the satellite repeater on a 99.7 per cent probability basis. The effective radiated power from the satellite repeater should produce a density of -146 dBW/m<sup>2</sup> at the aircraft or groundstation on a 99.7 per cent probability basis. ■■

# Metal Glaze



Thick-film resistors outperform tin-oxides. And at MIL-R-11 prices.

IRC adds a two-watt unit to its Metal Glaze line. Now you can get stability, reliability, and economy in three popular sizes to fill a wide range of industrial and MIL-R-22684 applications.

These rugged, thick-film resistors defy failure. Performance, across the board is significantly better than MIL-R-11 types, yet they're available at the same prices. Under load or temperature stress, thin-film tin-oxides can't match their exceptional stability and mechanical ruggedness.

Metal Glaze resistors remain stable under 70°C loads exceeding specification requirements. On the ¼-watt, for example, there is little stability degradation under double load at 70°C. It has withstood 14 million unit hours of testing. Estimated failure rate is only .006%/1000 hrs., full load at 70°C, at 60% confidence.

The uniformly molded body is tough. Can't crack or craze during automated inserting. And it resists solvents and corrosion. Samples are immediately available. Write to: IRC, Inc., 401 N. Broad St., Philadelphia, Pa. 19108.

#### CAPSULE SPECIFICATIONS

|               |              |             |             |
|---------------|--------------|-------------|-------------|
| Power:        | ¼ W @ 70°C   | ½ W @ 70°C  | 2 W @ 70°C  |
| Size:         | RL07-RC07    | RL20        | RL42-RC42   |
| Resistance:   | 6.8Ω to 680K | 10Ω to 470K | 10Ω to 470K |
| Tolerances:   | ±2,5%        | ±2,5%       | ±2,5,10%    |
| Max. Voltage: | 250V         | 350V        | 500V        |
| IRC Type:     | RG07         | RG20        | RG2         |





Now! Cutler-Hammer  
puts up to six heavy-duty  
oiltight units...

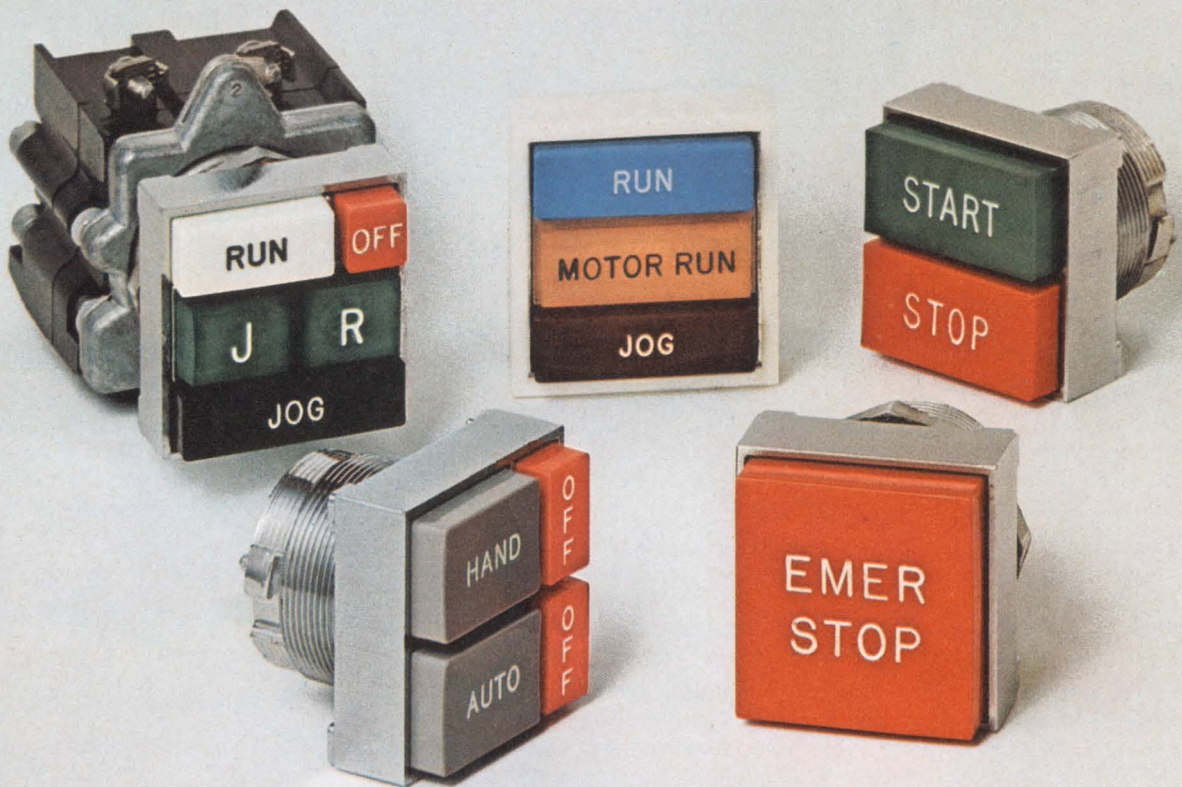

New Cutler-Hammer compact pushbuttons  
use the same  $\frac{1}{16}$ " round industry-standard  
mounting holes as your present  
full-size oiltight pushbuttons.





...in one  
compact pushbutton.  
(We' ve gone square!)

It took a little squeezing. Some pushing and pulling. And a lot of design savvy.

But we did it.

We developed a new compact oiltight pushbutton line with up to six heavy-duty control functions in the space of a single operator, only  $1\frac{7}{16}$ " square.

Think of the space you'll save on the panel!

But note we said "square." Why a new square shape? Some people simply reduce the size of their full-size pushbuttons and call them "miniature" pushbuttons. The result is: they're reduced in voltage ratings and limited in circuitry and terminal types. They can be difficult to operate, too.

Not so with our new compact pushbutton line.

By going to a new square shape, we not only give you more pushbuttons in less space. But you get full 600-volt construction. Unlimited circuit flexibility (you can stack the contact blocks in the field). Both screw type and quick connect terminals. And easier operation.

You also get a full selection of pushbuttons and indicating lights, in a wide range of sizes, shapes and colors of buttons and lenses.

And of course the same protection against oil, dust, dirt or coolants you've always had with Cutler-Hammer full-size oiltight pushbuttons.

Get the full story and start saving now! Your Cutler-Hammer Distributor or Sales Engineer will square you away.

*See your Cutler-Hammer Distributor—  
the man who has everything.*

**CUTLER-HAMMER**

Milwaukee, Wisconsin 53201



# For a clear picture of Centralab...

...keep an eye on our ripples

In our years of manufacturing miniature and subminiature components, we've made many ripples, and a few splashes, in the electronics industry:

**Centralab designed** and produced the world's first carbon composition potentiometer and for more than 40 years has been an industry leader. In 1936 we introduced the first temperature-compensating ceramic capacitor in America. We were first to offer dual controls and to add integral line switches to variable resistors. Our exclusive  integrated circuits have been key elements in the miniaturization of electronic equipment. During World War II days Centralab developed the ceramic disc capacitor design for military requirements. And our Ultra-Kap<sup>®</sup> ceramic disc capacitor has replaced millions of larger, more costly devices.

**Centralab sales** have increased substantially every year and our services have grown proportionately. Our products are sold, by separate sales groups and from separate warehouses, to original equipment and distributor markets.

**Centralab's tested and proven** products include capacitors, packaged circuits, rotary switches, potentiometers and technical ceramics. In October, 1966, we erected a push button switch manufacturing plant and in May, 1967, we acquired solar devices and semiconductor facilities.

Innovation, growth and stirring the waters are nothing new at Centralab; and we don't intend to stop. As technology advances and components become smaller, more complex and more sophisticated, we'll keep our feet wet.

To help keep abreast of Centralab developments, we'll be happy to send you complete product literature.



**CENTRALAB**

Electronics Division

GLOBE-UNION INC.

5757 NORTH GREEN BAY AVENUE  
MILWAUKEE, WISCONSIN 53201



ON READER-SERVICE CARD CIRCLE 37

# Letters

## Author finds serious inaccuracies in his research for his ED article

Sir:

It has come to my attention that some errors exist in my article "Counter designs swing without gates," ED 25, Dec. 6, 1967, pp. 82-88. Further investigation has revealed that some of the entries in Table 1 do not count properly. These are the straight 5, mixed 7 and straight 9 on p. 84, the straight 10, mixed 11, mixed 13, mixed 14 and mixed 15 on p. 85, the straight 17, mixed 17, mixed 19 and both mixed 20s on p. 86. The others in the table work in the form in which they are shown.

Now about these discrepancies—the general method works and has been thoroughly tested with Motorola MECL (emitter-coupled logic) and MHTL (high-threshold logic) J-K flip-flops. The error was not in the method for deriving frequency dividers of any integer divisor but in the adaptation of that method to the general J-K flip-flop. This was a somewhat hasty, last-minute innovation that I incorporated into my rough draft.

Until the adaptation can be further investigated, the method will work only with flip-flops that have the following properties *in addition* to the conditions that are set out in the article:

- With *C* input held at a logic 1, application of a pulse to *J* input causes the device to set regardless of its previous state.

- With *C* at logic 1, application of a pulse to *K* input causes the device to reset.

- With *C* at logic 1, application of a pulse to both *J* and *K* inputs simultaneously causes the device to change state regardless of its previous state.

- With *C* at logic 0, the *J* and *K* inputs are disabled.

A flip-flop of this type is easy to recognize from a manufacturer's schematic. Internally it really has two *J* inputs and two *K* inputs and *C* is formed by tying a *J* to a *K* and bringing it out of the case as one lead. If *C* is tied to a third point internally, it is likely that the device in question is unsuitable for this application. A number of suitable devices are available from various manufacturers, but certain popular types, such as master-slave, for example, cannot implement the method.

Another important change is necessary to make the counters work. On all ADD-ONE flip-flops, the *C* and *K* inputs must be interchanged. These ADD-ONE flip-flops are always at the right-hand end of a feedback loop. The example on p. 88 of the article is shown wired correctly. It is reproduced below with the ADD-ONE flip-flops shaded.

Some of the recovery factors cited in my article are in error by

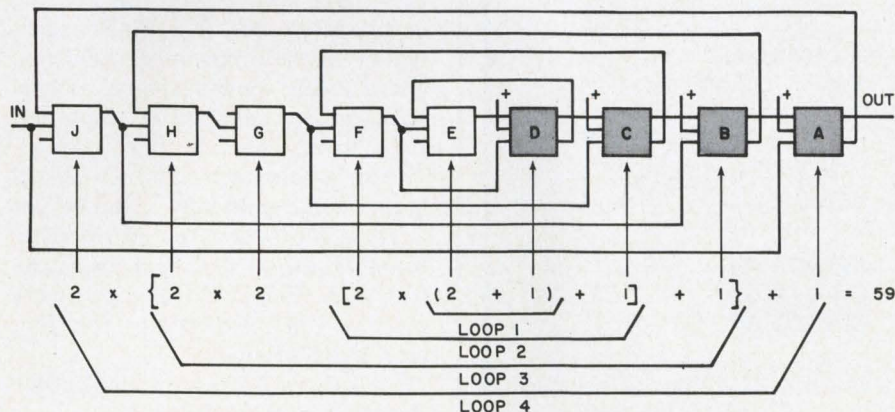

**A 59s counter is built entirely with flip-flops.** The ADD-ONE flip-flops (shaded) must have *C* and *K* inputs interchanged, as shown, for the counter to work.

# More than a CATALOG



## on VITREOSIL® PURE FUSED QUARTZ

More complete than most text books, the 48 pages cover Vitreosil pure fused quartz and Spectrosil, synthetic fused silica, the purest form of quartz known. Complete data on properties, applications, chemical behavior, and many others. Thermal American's full lines of products for industry, laboratory and special applications are illustrated and described. A 16 page list is pocketed in the rear cover.

If you use quartz—this book is a must for your library.

Write for your free copy today.

58



**THERMAL AMERICAN FUSED QUARTZ CO.**  
RT. 202 & CHANGE BRIDGE RD.  
MONTVILLE, NEW JERSEY  
ZIP CODE 07045

ON READER-SERVICE CARD CIRCLE 38

# Now you can get a miniature ceramic capacitor for AC applications

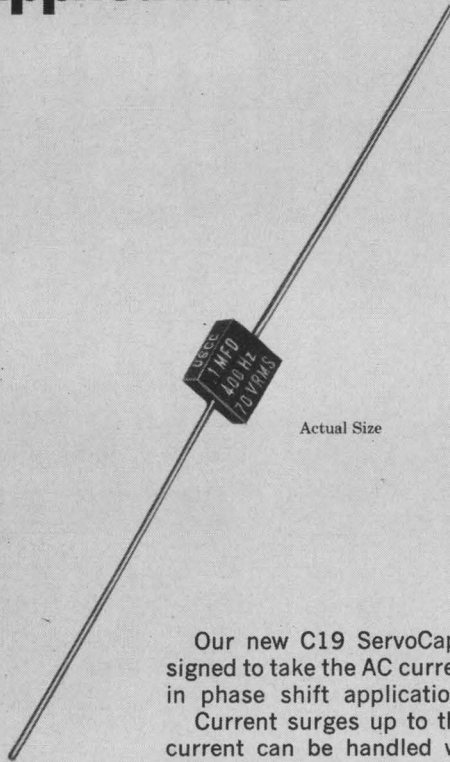

Our new C19 ServoCap® Series is designed to take the AC currents encountered in phase shift applications.

Current surges up to three times rated current can be handled with no appreciable degradation.

The low leakage factor will solve your isolation problems.

The small profile will solve your size problem.

If you design for small motor starters, power amplifiers, servo or pulsing applications for digital logic circuits, investigate the C19 ServoCap® Series from USCC.

#### GENERAL SPECIFICATIONS:

Capacitance range: .01 Mfd to 10 Mfd  
Voltage rating: 70 VRMS at 125°C  
Frequencies: 400 Hz and 1200 Hz  
Capacitance tolerances: ±5%, ±10% and ±20%

For current information, call or write



U.S. CAPACITOR CORPORATION  
2151 No. Lincoln Street • Burbank, California 91504  
(213) 843-4222 TWX: 910-498-2222

ON READER-SERVICE CARD CIRCLE 39

## LETTERS

1 or 2 as a result of these changes but the article otherwise reads correctly with the above supplemental information.

Peter S. Duryee  
Senior Electronics Engineer  
Motorola Govt. Electronics Div.  
Scottsdale, Ariz.

(Editor's note: *Peter Duryee has been asked to furnish correct data for all 13 incorrect entries in Table 1. These will be published as soon as they become available, so that readers may adjust the table. They will appear in a format that corresponds to the original table so that they may be pasted in.*

*In the right-hand column of p. 83, in the last paragraph before the subhead, a Table 2 was referred to. This was omitted from the published article on the grounds that it gave only supplemental information that was not really germane to Duryee's main theory. Readers who would like a copy, however, may obtain one by circling Reader Service No. 474.)*

## Credit where credit is due

Sir:

Please permit me to clarify a few points in your November 22 article ["Faraday effect gives new twist to laser memory," ED 24, pp. 22-23] about Honeywell's program on optical information storage.

The research discussed in the article was attributed to me, but actually represents the work of several Honeywell scientists. In particular, Dr. D. Chen, whose picture appeared on page 11 of that issue, has been responsible for the development of the MnBi technology in the program. In addition, John Ready and Enrique Bernal have made substantial contributions to it.

"Curie-point writing" on MnBi films was originally studied at General Mills, Inc., using electron-beam heating. The first measurements at Honeywell Research were made on films provided by the General Mills group.

M. D. Blue  
Research Section Head  
Honeywell, Inc.  
Hopkins, Minn.

ON READER-SERVICE CARD CIRCLE 40 ►



## A word to the do-it-yourself module builder:

### Don't.

Buy our J Series modules instead.

The J Series is our new family of general purpose, all integrated circuit logic modules. Their performance almost matches that of our famous T Series modules, but they cost about 25% less. They're made to the same dimensions as the T Series, with the same 52 pin connectors, so they're physically interchangeable. We make them for our own seismic recorder systems, so they're rugged and reliable. Now, as of January, you can buy them (com-

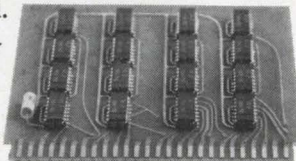

These will cost you less.

plete with mounting hardware, racks and power supplies, if you wish) in any of 25 different functions.

And save yourself the time and cost of making your own: designing, assembling, testing, new procedures, new equipment, new personnel, additional training, to say nothing of the added paper work.

If you're building systems, you must have better things to do than go into the module assembly business. Such as reading our J Series catalog.

It's free.

# SDS

Scientific Data Systems,  
Santa Monica, California



## Nearly everyone comes around to our YIG designs

PEL's YIG designs satisfy virtually any systems requirement. We pioneered this technology and now have a complete line of "black boxes." PEL developed the first dual channel YIG filter and the first YIG discriminators. And we were the first to produce them in volume for systems application.

We consistently design and build production models with specs that are superior to those of the prototype. And, when we transfer a device to production, its specs are guaranteed. You can depend on reliable, repeatable performance. You won't find a YIG filter with a lower insertion loss than a PEL YIG filter.

Technical acumen, emphasis on quality, reproducible performance . . . these are the things that make PEL designs the best available. Call PEL for the latest information on YIG devices in the 0.5 to 26 GHz frequency range.

Send for your copy of our latest short form catalog—soon.

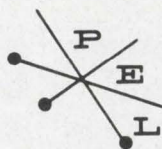

**Physical Electronics Laboratories**

1185 O'Brien Drive • Menlo Park, California 94025,  
(415) 323-9092

ON READER-SERVICE CARD CIRCLE 41

### LETTERS

#### Accuracy is our policy

In "Whiskered cathodes are cool emitters," in ED 21, Oct. 11, 1967, p. 36, in the illustration the labels "Vertically deflecting solenoid" and "Horizontally deflecting solenoid" should be reversed.

In "Regulate voltages with varistors," ED 24, Nov. 22, 1967, pp. 81-85, author Meyer Sapoff has indicated that the following corrections should be made.

On p. 82 in Fig. 2b, the label on the voltage source should read:

$$\frac{E_s R_L}{R_i + R_L}$$

On p. 83 in Fig. 3, the heavy black line referred to in the caption is the load that was erroneously printed in red. The shifted load line, which the caption erroneously states is shown in color, is the black line parallel to the load line wrongly printed in red.

On p. 83 in Fig. 4, the lower load line intercepts the ordinate at a point that should be labeled:

$$\frac{R_p}{R_L} E_s$$

On p. 84 in Fig. 5, the blue line showing the  $V-I$  curve has been moved by a printing error. It should be lowered so that it passes through the operating point. The label " $R_D \approx 35 \Omega$ " should read " $R_D \approx 40 \Omega$ ."

On p. 84 in Fig. 6,  $R_D$  should again be shown approximately equal to  $40 \Omega$ , not  $35 \Omega$  as printed.

In the News Scope section of ED 25, Dec. 6, 1967, p. 14, in the item "Radiation may announce new one-chip 709 unit," reference in the last paragraph should be to Union Carbide's dielectrically isolated monolithic operational amplifier UC4200 (not UC4000, as printed). Dielectric isolation in this unit, furthermore, is available only on special order.

In ED 25, Dec. 6, 1967, two pictures were exchanged by printer's error. In the Components listing of the Products section on p. 159, the illustration to "Adjustable coils span 1 to  $100 \mu\text{H}$ " belongs rightly in the New Literature listing on p. 177 with "Relay lamp driver," and vice versa.

ON READER-SERVICE CARD CIRCLE 42 ►

Simply connect your oscilloscope and sweep oscillator or signal generator to a new Polarad Model 2400 Spectrum Analyzer Converter, (cost: \$2990) and suddenly you have a spectrum measurement system which will out-perform other analyzers costing \$10,000 or more.

For example, it will provide a calibrated display with a **70 db** dynamic range on a large screen or storage oscilloscope, or any other inexpensive 'scope available.

Frequency range is 0.01 — 12.4 GHz into the first mixer; up to 90 GHz with external mixing.

Sensitivity is **-105 dbm (10 KHz: bandwidth)** with fundamental mixing, and, since you supply the i.o., you can retain the sensitivity of fundamental mixing anywhere in the frequency range.

Frequency sweeps (spectrum widths) can be varied from 10 KHz to 4 GHz, limited only by your oscillator's sweep-range. Image separation is 520 MHz.

You are afforded the best features of a front end swept, narrow band i.f. analyzer, with a swept i.f. for narrow spectrum widths.

For more information, or a demonstration — any i.o. or 'scope will do — call your local Polarad field engineering office or write Polarad Electronic Instruments, 34-02 Queens Boulevard, Long Island City, N. Y. 11101. Telephone: (212) EX 2-4500.



**now for only \$2990  
you can get  
\$10,000 spectrum analyzer performance**



CONTROLLED

PREREACTION



# **New** Kemet<sup>®</sup> Ceramic Capacitors.

## *They're with it.*

Controlled Prereaction is a method of carefully controlling and prereacting raw material to provide a more homogeneous and "cleaner" capacitor.

What this means to you is a superior ceramic capacitor which has less chance of failure due to dielectric breakdown, degradation of insulation resistance and high dissipation factor.

And there's more.

KEMET ceramics are most rugged. Case leads are attached with solder having a melting point in excess of 220°C. Hence, you get outstanding lead integrity.

KEMET ceramics meet or exceed the BX requirements of MIL-C-11015C and MIL-C-39014.

And to inhibit electrode oxidation and migration, KEMET ceramics use a superior

platinum alloy electrode material. Chances are the ones you've used have just a single metal by itself.

There are many additional benefits that go along with the new KEMET ceramic capacitors. To get the whole story, write to P.O. Box 5928, Greenville, South Carolina, 29606, or simply contact your local KEMET Representative.

From Union Carbide, The Discovery Company.



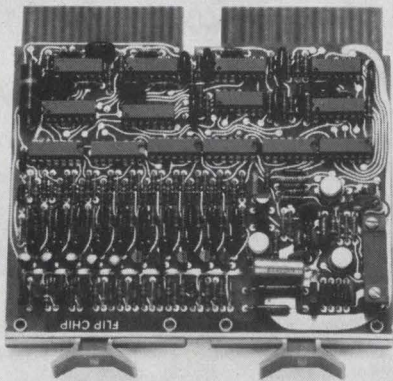

## New Complete High Speed A to D Converter: \$750

An analog to digital converter complete on one module and just 5 by 5 by 1/2 inch, including the control logic, digital register, comparator and internal precision reference supply, converts 100,000 samples per second with an accuracy of 0.1%.

The A801 converter, part of our A Series module line, is designed for industrial and scientific instrumentation applications with DIGITAL's range of small computers. It features the reliability, space savings and speed of the latest TTL integrated circuits coupled with the economies of mass production and machine assembly.

Digital is the world's leading producer of logic modules. Our dominance in this area, and our experience with interfacing between measuring systems and computing systems, resulted in the development of this converter.

Other converters, interfacing modules, modules for computer-speed instrumentation and industrial control modules are all described in our Industrial Control and Logic Handbooks. Write for free copies.

### A801 A to D Converter

#### Specifications

Input: Uni-polar

Voltage 0 to +10v

Impedance 1000 ohms

Output Format: Parallel Binary

Uni-polar

Digital Output: Logical "0" + 0.4v max.

Logical "1" + 2.4v min.

Resolution: 10 bits

Accuracy: 0.1% of full scale

Conversion rate: 100 kHz max.

**digital**  
MODULES · COMPUTERS

Maynard, Mass. Tele: (617) 897-8821

## Shedding light on Shed Light

While in Vietnam as a writer nearly two years ago, Military-Aerospace Editor John F. Mason vowed to investigate what was clearly one of the biggest problems of the war—how to employ electronics to find and attack the enemy at night. Since then he had probed the subject as much as security would permit on visits to Wright-Patterson Air Force Base in Ohio, the Tactical Air Reconnaissance Center, Shaw Air Force Base, S. C., and the Pentagon.

Then, in mid-December, he received permission to inspect the very heart of the work—the test and evaluation center for Operation Shed Light, the program at Eglin Air Force Base in Florida to develop aircraft sensors to find the enemy at night, in fog and rain, or amid camouflage. After a week at Eglin, Mason went to Air Force Systems Command Headquarters at Andrews Air Force Base, Md., to talk to officials who administer Shed Light.

Don't miss the full, exciting story, starting on page 25.



**Hon Cong Mountain, South Vietnam:** John F. Mason (right) with the U.S. First Air Cavalry Division in 1966. The importance of detecting the foe at night became apparent on this trip.

## Super reporting of supersonic trends

The comprehensive story of "Avionics in the SST era," starting on p. 49, began to take wings two months ago in sunny Anaheim, Calif., where the American Institute of Aeronautics and Astronautics was holding its annual meeting. Charles D. LaFond, chief of ELECTRONIC DESIGN's Washington News Bureau, attended the meeting, and by seeking out the knowledgeable people, he started to put together a broad word picture of the role of electronics in the future of aviation. Many field trips, phone calls and letters followed before LaFond was satisfied that the perspective was complete.

A technical writer since 1951, when he wrote instruction books for the Army, LaFond joined ELECTRONIC DESIGN last year after eight years as a senior editor for *Aerospace Technology* (formerly *Technology Week* and, before that, *Missiles and Rockets*).



# The F-111's Defense Penetration System

## has some nerve.

### Ours.

No ordinary coaxial cable can handle the black box-to-antenna (nose-to-tail) interconnect for this incredible avionics marvel.

Ordinary coaxial cable is too lossy and too heavy, won't hold high input powers above 60,000 feet and 350° F, and exhibits a large VSWR change with temperature cycling. And it can't be bent on a 2½" radius without a large VSWR increase. Ordinary connectors are too large, too heavy and create too much VSWR. Ordinary assemblies aren't pressure tight, and here the pressure really is on—to 15 psig.

Obviously, the F-111 is an extraordinary aircraft. Obviously its Enemy Defense Penetration System needed extraordinary cables and connectors.

Times developed and manufactured a complete ship set of prebent, and terminated interconnecting assemblies, each sweep-tested for VSWR and insertion loss across its bandwidth. We used High Temperature, Light Weight Alumispline® (seamless aluminum sheath) with a longitudinally extruded dielectric. And, despite one bend per foot needed to meet configurations of the aircraft, we achieve negligible motion of the cable axis and change in size during bending by a unique method developed for this type of cable.

For each F-111 we are now furnishing 45 assemblies, of cable lengths from 2 to 14 feet, joined by selected connectors and our own specially-designed low-profile Timatch® Type-N connectors (minimum VSWR and minimum space). Each assembly is completely terminated, three-dimensionally fit checked, and electrically tested, so all General Dynamics has to do is put them in. That makes field maintenance simple, too.

Have you a tough cable interconnect problem? Times has the nerve to solve it. Times Wire & Cable, Wallingford, Connecticut 06492. Phone (203) 269-3381. Contact the Engineering Services Department.

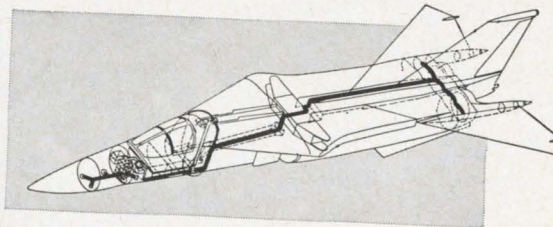
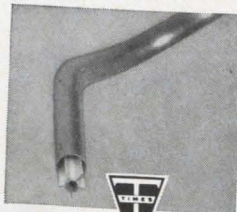

**TIMES  
WIRE & CABLE**  
DIVISION OF THE INTERNATIONAL SILVER CO.

# TRW D to A Converter

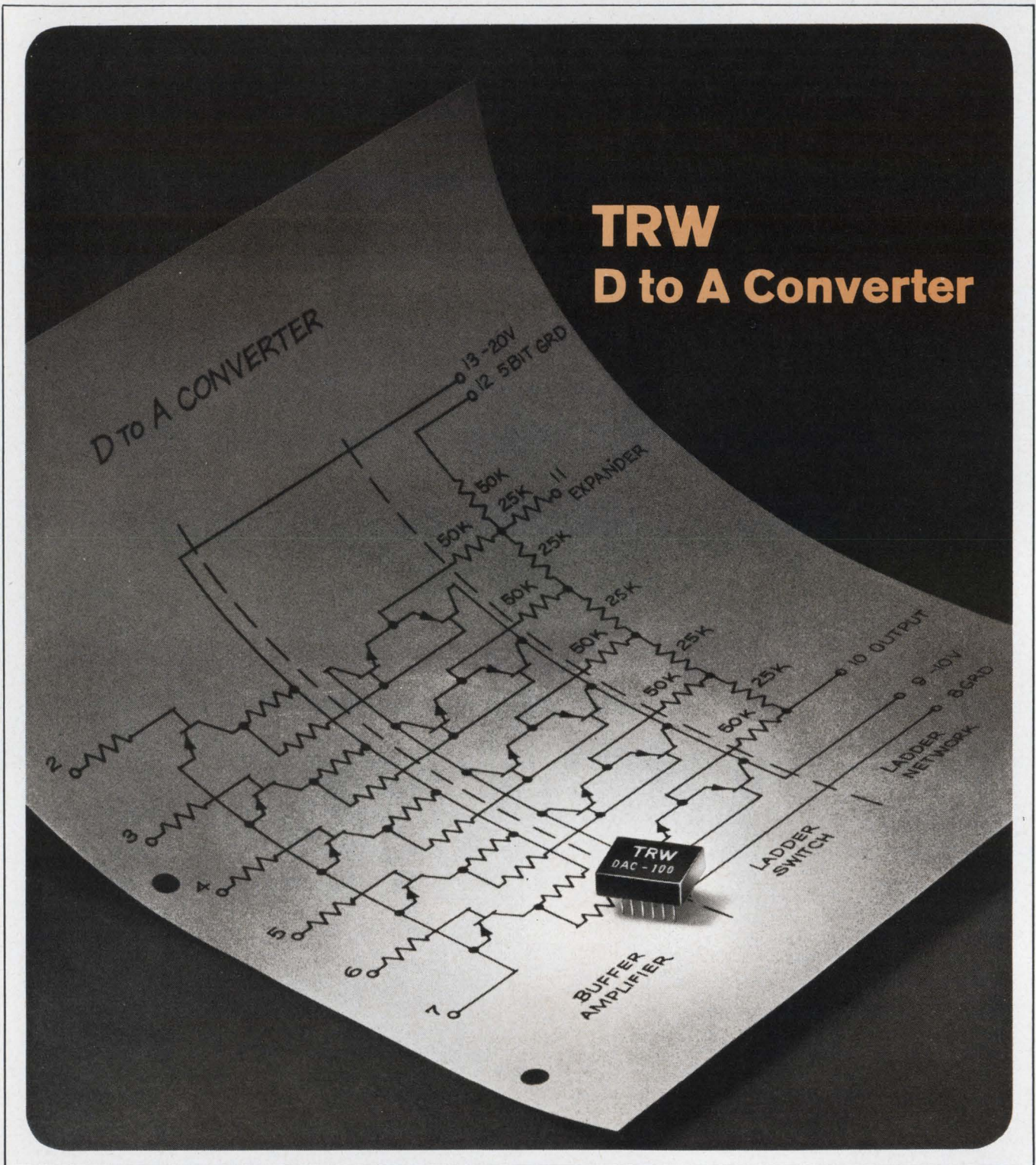

## ...complete in a single microcircuit

This new digital to analog converter takes up only 0.4 sq. in. on your PC board. Only 12 external connections are required.

TRW type DAC-100 is a complete five bit converter, expandable to 10 bits. Stabilized thin film resistors

guarantee accuracy over a wide temperature range.

Available now!

For detailed technical information contact any TRW distributor or TRW Semiconductors, 14520 Aviation Blvd., Lawndale, Calif.

ON READER-SERVICE CARD CIRCLE 46

90260. Phone (213) 679-4561; TWX: 910-325-6206. TRW Semiconductors Inc. is a subsidiary of TRW INC.

# TRW®

ELECTRONIC DESIGN 2, January 18, 1968

**Publisher**

Hugh R. Roome

**Editor**

Howard Bierman

**Managing Editor**

Robert C. Haavind

**Technical Editors**Jeffrey N. Bairstow  
Peter N. Budzilovich  
David H. Sorgan**Management and Careers Editor**

Howard S. Ravis

**News Editors**Ralph Dobriner, Chief  
Richard N. Einhorn**Washington News Bureau**

Charles D. LaFond, Chief

**Military/Aerospace Editor**

John F. Mason

**East Coast Editor**

Neil Sclater

**West Coast Editor**

Ron Gechman

**New Products Editor**

Steven B. Futterman

**Copy Editor**

Peter Beales

**Editorial Production**Dollie S. Viebig  
Phyllis Gura**Art Director**

Clifford M. Gardiner

**Art Assistant**

William Kelly

**Technical Illustrators**Cheh Nam Low  
Sheila F. Ward  
William Alvarez**Production Manager**

Thomas V. Sedita

**Asst. Production Manager**

Helen De Polo

**Production Assistants**Bernard Wolinsky  
Gregory A. Bannon**Circulation Manager**

Nancy L. Merritt

**Reader Service**

Diane Mandell

## EDITORIAL



## Come out of the clouds, get down to brass tacks

Zero defects, quality assurance, reliability, value engineering . . . Who are we kidding with all this double talk? Aren't we merely trying to make up for the loss of the basic ingredients of good engineering—common sense and pride in workmanship? Indeed, if everyone all down the line from prototype designer to assemblyman did his job well—that is, took pride in it—the quality-control function would disappear altogether. For in setting up QC and reliability departments, we are trying to cure the symptoms, not the causes of the disease.

Where did it all start? It may well have begun with an engineering graduate who was never taught that good soldering and wiring are just as important as his skill in manipulating Laplace transforms; an engineer who was never taught to respect a good technician or assembly-line worker, who came out of school with a chip on his shoulder, believing that the world owed him a living because he was able to pass a few quizzes.

The cure, in fact, must start in the engineering schools. They must teach students that people do not drive mathematical models, but prefer well-made cars at the least possible cost. Many schools offer courses on music appreciation, but few teach the practical side of engineering. Their graduates have seldom been exposed to the fact that the judicious use of standard, off-the-shelf components and subsystems can save days or weeks on deliveries as well as cut costs. In short, no stress is put on the fact that an engineering accomplishment should be judged on the performance and cost of the end product.

The engineer must also know how to deal with technicians, draftsmen, production workers, and others who turn his product from an idea to reality. Yet how many schools give any training in practical methods of management?

Some schools provide a partial solution to the problem by offering five-year cooperative courses leading, in certain cases, to an advanced degree. Participating students spend up to 16 months in industry learning the ropes. It is an approach worthy of emulation by more schools. The programs, moreover, might be oriented even more to turning out practical, well-rounded engineers. Developing a common-sense approach to problem solution should be a compulsory part of all engineering training.

Let's slow the trend toward poetry and flashy theorizing and add a strong dose of practicality.

PETER N. BUDZILOVICH

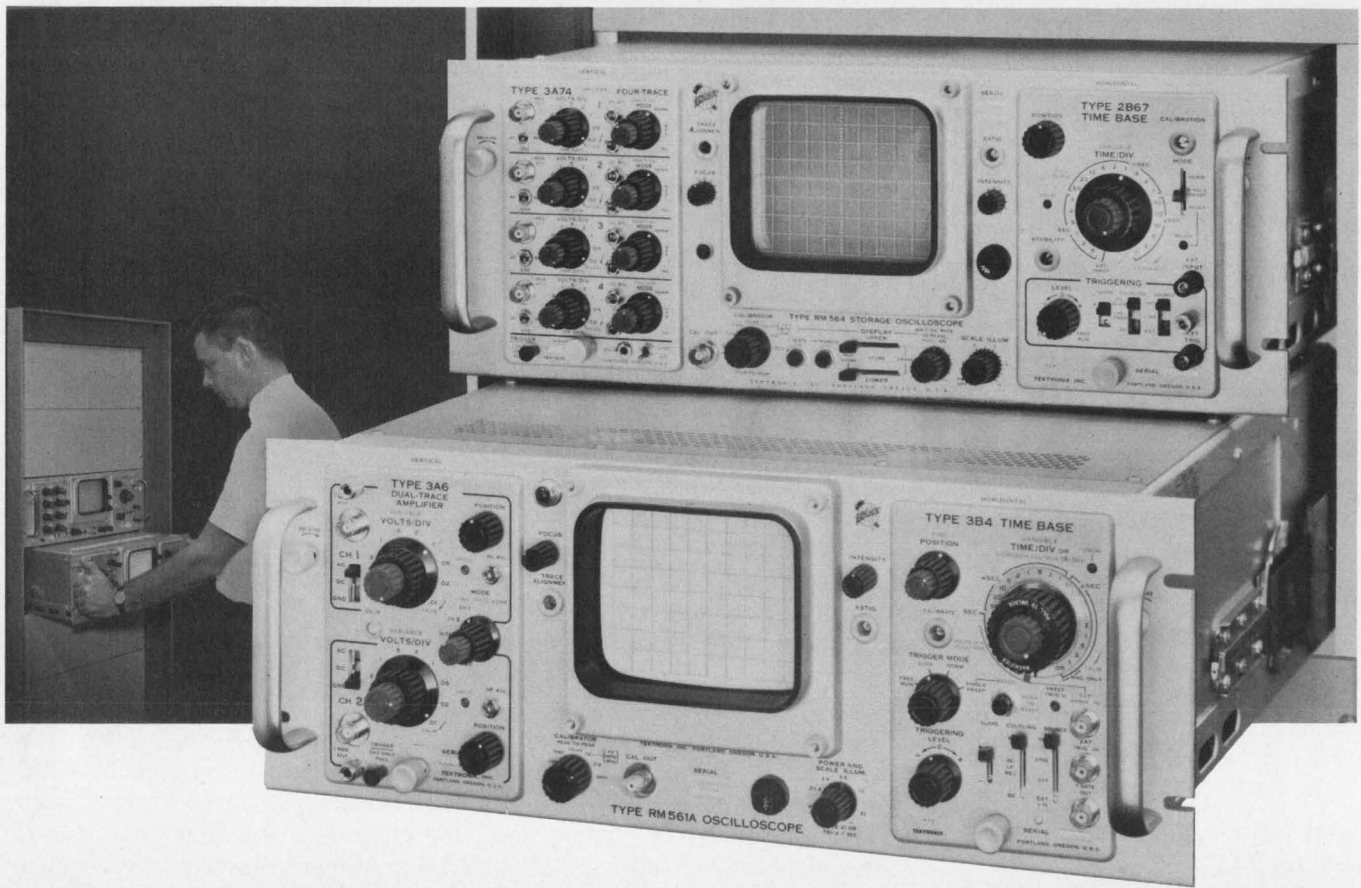

## plug in a Tektronix rack-mount oscilloscope

- Conventional or storage
- Multi-trace, differential, sampling and spectrum analyzer plug-ins
- 7 inches of rack height

The **Type RM561A** 7-inch high rack-mount oscilloscope provides conventional oscilloscope performance with measurement capabilities extending from DC through 1 GHz with appropriate plug-in units. It has an 8 by 10-cm CRT with a bright P31 phosphor and an illuminated, internal graticule.

The measurement system illustrated consists of the Type RM561A with the Type 3B4 Time-Base Plug-in and the Type 3A6 Dual-Trace Amplifier. The Type 3B4 provides versatile triggering and calibrated sweep speeds from 5 s/div to 50 ns/div. A direct-reading magnifier provides up to X50 magnification about the center of the CRT. The Type 3A6 Dual-Trace Amplifier has DC-to-10 MHz bandwidth and 35-ns risetime over its 10 mV/div to 10 V/div deflection range.

|  |        |
|--|--------|
| Type RM561A Oscilloscope . . . . .                         | \$ 580 |
| Type RM561A MOD 171A (Includes slide-out tracks) . . . . . | \$ 630 |
| Type 3B4 Time Base . . . . .                               | \$ 425 |
| Type 3A6 Dual Trace Amplifier . . . . .                    | \$ 525 |

The **Type RM564** split-screen storage oscilloscope is virtually two instruments in one. It offers all the advantages of a storage oscilloscope plus those of a conventional plug-in oscilloscope. The contrast ratio and brightness of stored displays are constant and independent of viewing time, writing and sweep speeds, and signal repetition rates. The entire screen or either half can be used for storage and/or conventional displays. In the stored mode, either half of the screen can be erased independently of the other half. A rear panel connector permits remote erasure of either or both halves of the display.

The plug-ins shown in the Type RM564 are the Type 2B67 Time-Base Unit that has calibrated sweep speeds from 5 s/div to 1  $\mu$ s/div extending to 200 ns/div with the X5 magnifier, and the Type 3A74 Four-Channel Amplifier that provides DC-to-2 MHz bandwidth over its 20 mV/div to 10 V/div calibrated deflection range.

|   |        |
|---|--------|
| Type RM564 Storage Oscilloscope . . . . .                 | \$1025 |
| Type RM564 MOD 171A (Includes slide-out tracks) . . . . . | \$1075 |
| Type 2B67 Time-Base . . . . .                             | \$ 225 |
| Type 3A74 Four-Channel Amplifier . . . . .                | \$ 625 |

U. S. Sales Prices FOB Beaverton, Oregon

For a demonstration, contact your nearby Tektronix Field Engineer or write: Tektronix, Inc., P. O. Box 500, Beaverton, Oregon 97005.



*Conventional or storage  
oscilloscopes*

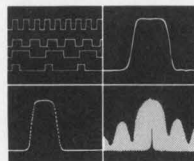

*...with multi-trace, differential,  
sampling and spectrum analyzer plug-ins*

ON READER-SERVICE CARD CIRCLE 47

# Technology

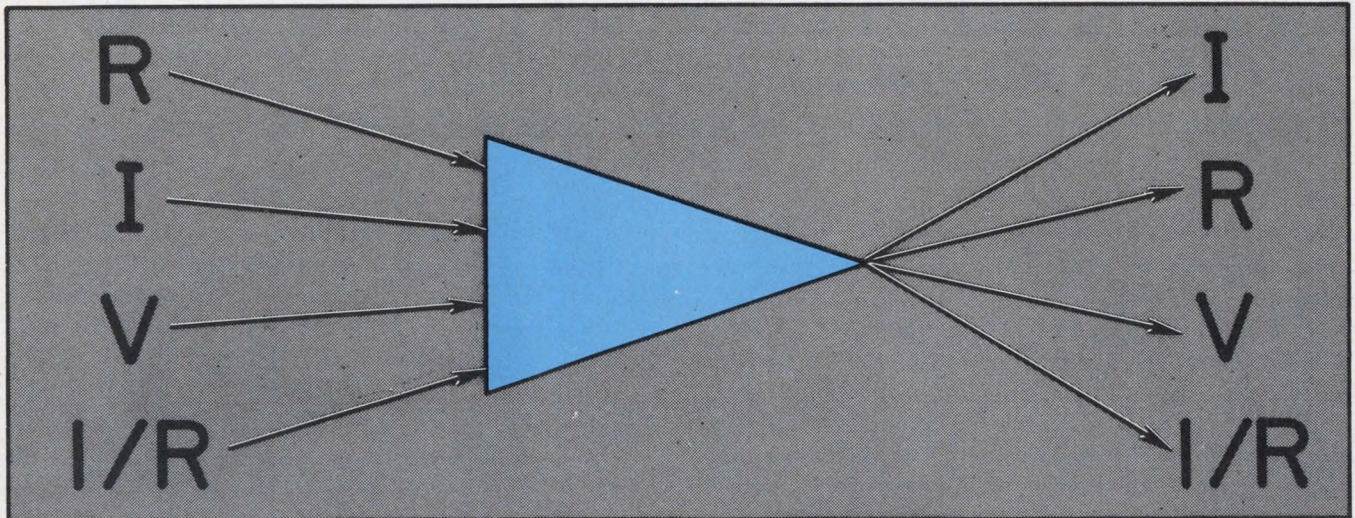

The versatility of the operational amplifier as a universal gain element is shown by its use

in four amplifiers—transconductance, transresistance, voltage and current. Page 78

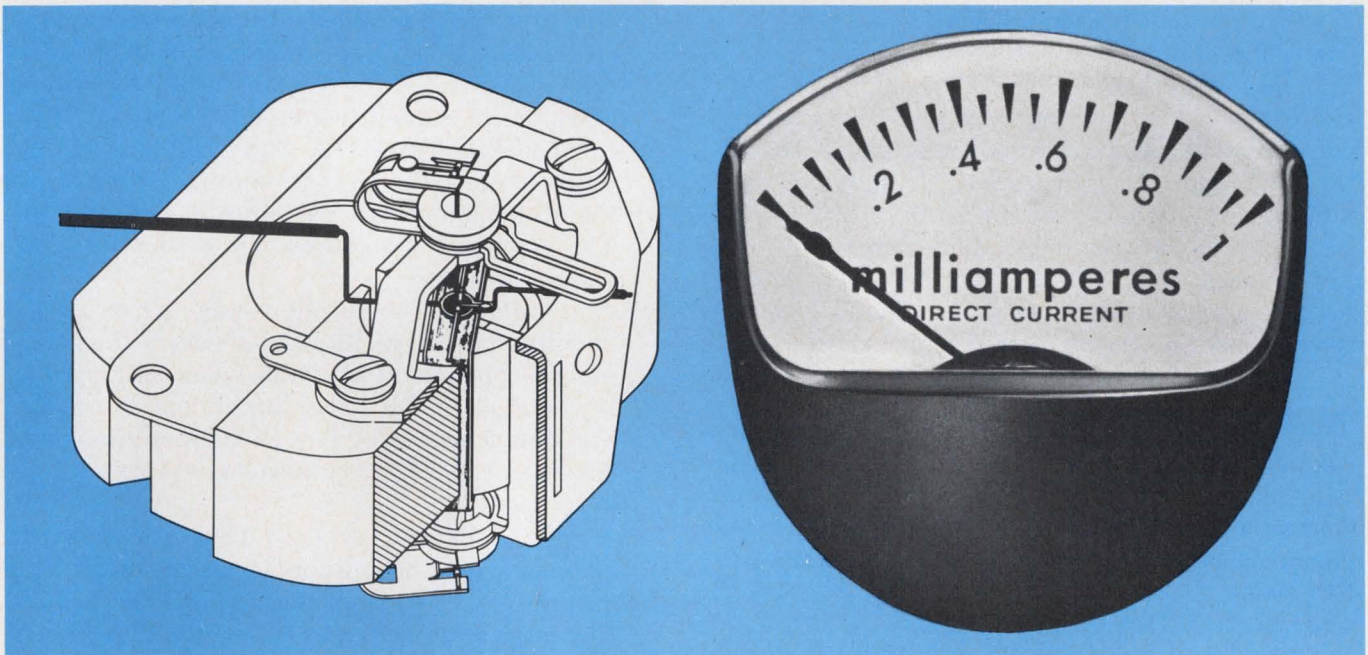

Panel meters are either of the pivot-and-jewel type or the taut-band type. Differences

show up in performance and sway choice of a unit for any particular application. Page 100

## Also in this section:

**Worst-case analysis by computer** is easy once the designer grasps the program. Page 90

**'Upward motivation'**—making the boss look good—is the key to advancement. Page 112

**Test your IC IQ.** Page 108

# Op amps act as universal gain elements

—as voltage, transconductance, transresistance or current amplifiers—when a few simple formulas are applied.

In face of the rapidly growing list of commercially available integrated and discrete operational amplifiers, it is important to know which is the most appropriate unit for each application. Selection is greatly simplified if an operational amplifier is understood for what it is—a versatile, universal gain element with transfer functions and input-output resistances that are easy to calculate from manufacturers' specifications.

The operational amplifier's versatility can be clearly demonstrated by its use in four applications:

- Voltage amplifier.
- Transconductance amplifier.
- Transresistance amplifier.
- Current amplifier.

In all four cases (see Table 1) both approximate and exact expressions are to be given for transfer functions and input and output resistances. To ease the evaluation of gain error, straight forward nomograms are included for each case, and key static parameters used by manufacturers to describe operational amplifiers are explained. Armed with this knowledge, a designer should have no trouble choosing the right device for his needs.

## Interpreting manufacturers' specifications

Operational amplifiers are advertised and sold to a "black box spec" of input, output and transfer characteristics. Table 2 shows the typical specified parameter values that are used in the equations in this article.

They can be interpreted as follows:

*Open-loop dc voltage gain*—This in an operational amplifier is very high, generally between 80 and 120 dB for nonchopper types, and as high as 180 dB for a chopper-stabilized device. The value given in the manufacturers' specification sheets is usually at the standard load of 10 k $\Omega$ , as shown under "Test condition" in Table 2. The value

under a no-load condition would be at least 6 dB higher for high output resistance amplifier.

*Differential input resistance*—This is the resistance between an amplifier's inverting and non-inverting input terminals. Present values range from several hundred kilohms to a million megohms. As shown in Table 2, the minimum value for the H6010 general-purpose amplifier is 150 k $\Omega$ , for the bipolar, high-input-impedance H6000 is 4 M $\Omega$ , and for the H7000 FET input stage is 100 G $\Omega$ . Since the differential input resistance has such a wide range, an appropriate value can always be selected.

*Dc output resistance*—Two kinds of output resistance are usually specified—the open-loop and the closed-loop. When the closed-loop output resistance is specified, a closed-loop condition is always given at the same time, as shown under "Test condition" in Table 2. A very low value of output resistance can thus be obtained, even when the open-loop output resistance is rather large. The open-loop resistance can be higher than several kilohms.

*Output voltage*—The output voltage given in the manufacturers' specification sheets is the maximum output voltage available when the amplifier is operated in the linear amplification region. The commonest value is  $\pm 10$  volts minimum, as shown in Table 2, but  $\pm 20$  volts or more are also available.

*Short-circuit output current*—This is the output current with the output terminal shorted to ground ( $R_L = 0$ ), and the amplifier saturated. The rated output current can be found by dividing the output voltage by the rated load given in Table 2 under "Test condition" for the output voltage. For an amplifier that is not short-circuit-proof, a time duration of short circuit is usually specified. This guarantees that the amplifier will not be damaged if the output terminal is shorted to ground within that time. Many operational amplifiers with current source type output stages are short-circuit-proof for "continuous" shorts.

*Common-mode input resistance*—This is the input resistance of both inverting and noninverting inputs with respect to ground. The values are

---

George Nieu, Senior Engineer, Fairchild Instrumentation, Sunnyvale, Calif. Work for this article was done when the author was with Union Carbide Corp., Mountain View, Calif.



**Table 1. Four op-amp applications and their general characteristics**

| Application<br>Parameter                         | Voltage amplifier  | Transconductance amplifier         | Transresistance amplifier                              | Current amplifier  |
|--|--|------------------------------------|--|--|
| Configuration                                    |  |                                    |  |  |
| *Closed-loop gain and conditions for small error | $A_{VC} = (R_i + R_f)/R_i$ ,<br>$R_{in} \geq 10 R_i$ ,<br>$R_f \geq R_{out}$ | $g_f = 1/R_s$ ,<br>$R_{in}$ large. | $R_F = -R_f$ ,<br>$R_{in}$ large,<br>$R_f \gg R_{out}$ | $A_{ic} = -(R_s + R_f)/R_s$ ,<br>$R_{in}$ large,<br>$R_s$ small. |
| *Closed-loop input resistance, $R_{ic}$          | High<br>$R_{in} (1 + A_V \beta)$   | High<br>$R_{in} (1 + A_V \beta)$   | Low<br>$R_f / (1 + A_V)$                               | Low<br>$R_f / (1 + A_V)$   |
| *Closed-loop output resistance, $R_{oc}$         | Low<br>$R_{out} / (1 + A_V \beta)$   | High<br>$R_s (1 + A_V)$            | Low<br>$R_{out} / (1 + A_V)$                           | High<br>$R_s (1 + A_V)$  |

\*The expressions for all the parameters are valid only when certain conditions are met. See text for exact expressions and nomographs 1 through 4 for error determination.

**Table 2. Typical specifications for three types of op-amp**

| Parameter                     | Symbol    | H6010/6010C<br>general-purpose,<br>low-cost |          |         | H6000/6000A<br>bipolar, high<br>input impedance |           |           | H7000/7000A<br>FET input stage |           |           | Unit       | Test conditions  |
|-------------------------------|-----------|---|----------|---------|---|-----------|-----------|--------------------------------|-----------|-----------|------------|--|
|                               |           | Min   | Typ.     | Max     | Min   | Typ.      | Max       | Min                            | Typ.      | Max       |            |  |
| Open-loop dc voltage gain     | $A_V$     | 86  | 90       | —       | 90  | 97        | —         | 86                             | 92        | —         | dB         | $R_L = 10 \text{ k}\Omega$ , $R_i = 0$ , $R_f = \infty$                    |
| Differential input resistance | $R_{in}$  | 150*  | 250*     | —       | 4   | 6         | —         | $10^5$                         | $10^6$    | —         | M $\Omega$ | $-10 \text{ V} < V_{out} < +10 \text{ V}$                                  |
| Dc output resistance          | $R_{out}$ | —   | 80       | 150     | —   | 35        | 100       | —                              | 75        | 135       | $\Omega$   | $R_i = 1 \text{ k}\Omega$ , $R_f = 100 \text{ k}\Omega$ , $ A_{VC}  = 100$ |
|                               | $R_{oc}$  | —   | 16       | 30      | —   | 25        | 27        | —                              | 15        | 27        | k $\Omega$ | $R_i = 0$ , $R_f = \infty^\dagger$ , $e_{out} < 1 \text{ V pk-pk}$         |
| Output voltage                | $V_{out}$ | $\pm 10$                                    | $\pm 11$ | —       | $\pm 10$  | $\pm 11$  | —         | $\pm 10$                       | $\pm 12$  | —         | V          | $R_L > 3.3 \text{ k}\Omega^\ddagger$                                       |
| Short-circuit output current  | $I_{out}$ | $\pm 3$                                     | $\pm 5$  | $\pm 8$ | $\pm 2.5$                                       | $\pm 3.3$ | $\pm 4.0$ | $\pm 2.5$                      | $\pm 3.3$ | $\pm 4.0$ | mA         | $R_L = 0$  |
| Common-mode input resistance  | $R_{cm}$  | 100   | 300      | —       | 300   | 400       | —         | $10^5$                         | $10^6$    | —         | M $\Omega$ | $V_{out} > -10 \text{ V}$ , $V_{cm} < +10 \text{ V}$                       |
| Common-mode voltage range     | $V_{cm}$  | $\pm 10$                                    | $\pm 12$ | —       | $\pm 10$  | $\pm 11$  | —         | $\pm 10$                       | $\pm 11$  | —         | V          | CM input, $R_f = \infty$   |

\*These values are in k $\Omega$ .

†For the H7000 use  $R_f = 100 \text{ k}\Omega$ .

‡For H6000 and H7000 use  $R_L \geq 5 \text{ k}\Omega$ .

**Glossary of symbols**

- |  |   |  |
|--|---|--|
| $A_V$ Open-loop dc voltage gain.       | $E_{out}$ Large-signal output voltage.  | $R_g$ Source resistance.                           |
| $A_{VC}$ Closed-loop dc voltage gain.  | $g_f$ Forward transconductance.         | $R_i$ Input resistor in closed-loop connection.    |
| $A_{ic}$ Closed-loop dc current gain.  | $R_f$ Feedback resistor.                | $R_f$ Feedback resistor in closed-loop connection. |
| $A_V \beta$ Loop gain.                 | $R_F$ Forward resistance.               | $R_L$ Load resistance.                             |
| $\beta$ Feedback attenuation.          | $R_{cm}$ Common-mode input resistance.  | $R_s$ Sensing resistor in closed-loop connection.  |
| $e_e$ Input error voltage.             | $R_{in}$ Differential input resistance. | $V_{out}$ Dc output voltage.                       |
| $e_{in}$ Small-signal input voltage.   | $R_{out}$ Open-loop output resistance.  | $I_{out}$ Short-circuit output current.            |
| $E_{in}$ Large-signal input voltage.   | $R_{ic}$ Closed-loop input resistance.  | $V_{cm}$ Common-mode voltage range.                |
| $e_{out}$ Small-signal output voltage. | $R_{oc}$ Closed-loop output resistance. |  |

extremely high, generally ranging from tens of megohms to a teraohm, as shown in Table 2. Since the common-mode resistance is usually much higher than the differential input resistance, the effect of the former is neglected in deriving the equations in this article.

**Common-mode voltage range**—This is the range of voltage that may be applied to both inputs without saturating the amplifier's input stage. The typical value is  $\pm 10$  volts minimum, as shown in Table 2. The value of the input voltage in the voltage and transconductance amplifiers should not exceed that of the common-mode voltage range given in the manufacturers' specifications, in order to avoid saturating the unit.

Once the manufacturers' specifications are understood, the four operational-amplifier applications listed in Table 1 can be examined in detail.

### Use it as a voltage amplifier

A voltage amplifier provides a voltage output proportional to a voltage input, and is probably the most commonly used configuration of operational amplifier. Variations of the configuration include adders, subtractors and inverters. Since modern operational amplifiers have high open-loop gain, high input impedance and low output impedance, accurate voltage transfer characteristics can be obtained. The typical noninverting voltage amplifier as shown in Figs. 1a and 1b will be used for analysis. The feedback is provided by a voltage divider formed by  $R_f$  and  $R_i$  connected back to the inverting (negative) input of the amplifier.

**Transfer function**—The exact equation for the transfer function (closed-loop gain) of the noninverting-voltage-amplifier configuration is:

$$A_{vc} = \frac{R_i R_{out} + R_{in} (R_i + R_f) A_v}{\left\{ (R_{out} + R_f) (R_i + R_{in} + R_g) \right\} + R_i (R_{in} + R_g) + R_i R_{in} A_v} \quad (1)$$

where all symbols are defined in the box and  $R_L$  and  $R_{cm}$  are assumed to be infinite.

Equation 1 can be simplified if input resistance  $R_{in}$  is much greater than input resistor  $R_i$  and feedback resistor  $R_f$ , and output resistance  $R_{out}$  is much lower than  $R_f$ :

$$A_{vc} = (R_i + R_f) A_v / (R_i + R_f + R_i A_v) = [(R_i + R_f) / R_i] 1 / [1 + (1 / A_v \beta)] \quad (2)$$

where  $\beta = R_i / (R_i + R_f)$ .  $A_v \beta$  is known as the "loop gain." If the loop gain is much greater than unity, Eq. 2 reduces to:

$$A_{vc} = (R_i + R_f) / R_i \quad (3)$$

Equation 3 is the classic, ideal expression for the closed-loop gain of a noninverting voltage amplifier and is entirely determined by  $R_i$  and  $R_f$ .

Since the open-loop gain is finite, however, a gain error is introduced when working with the classic equation. This gain error can be calculated either with Nomogram 1 or Eq. 2 and the manufacturers'

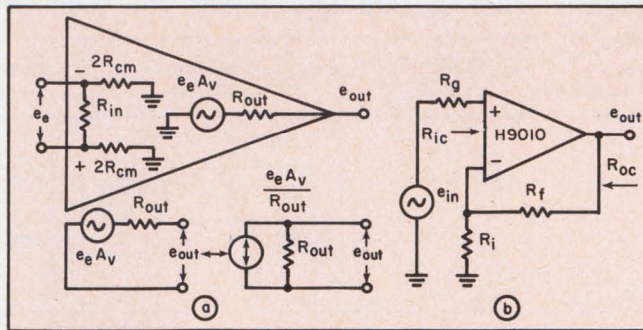

1. **Voltage amplifier** results when an operational amplifier is connected as shown in (b). The op-amp equivalent circuit is in (a).

data as follows.

Consider some typical operational-amplifier parameters:

|                                  |                                 |
|----------------------------------|---------------------------------|
| $R_{in} = 10 \text{ M}\Omega$ ,  | $R_i = 100 \text{ k}\Omega$ ,   |
| $R_{out} = 25 \text{ k}\Omega$ , | $R_f = 900 \text{ k}\Omega$ ,   |
| $R_g = 1 \text{ k}\Omega$ ,      | $A_v = 10^5 = 100 \text{ dB}$ . |

The ideal equation, Eq. 3, gives:

$$A_{vc} = (100 + 900) / 100 = 10.$$

With Eq. 2:

$$A_{vc} = 10 (1 / 1.0001) = 9.999.$$

The static gain error introduced by the simplified Eq. 3 compared with Eq. 2 is 0.01%. This is due to finite open-loop gain  $A_v$  ( $10^5$ ), which is included in Eq. 2 but is assumed to be infinite in Eq. 3. It can be seen that the higher the open-loop gain, the less the error between the two equations.

This static gain error for the same parameter values can as easily be obtained from Nomogram 1 in two steps:

Step 1—Draw line A from the value of  $R_i = 100 \text{ k}\Omega$  through  $R_i + R_f = 1 \text{ M}\Omega$  to obtain  $A_{vc} = 10$ .

Step 2—Draw line B from the value of  $A_{vc}$  to the given value of  $A_v = 10^5$ . The intersection of line B with the error column gives a gain error value of 0.01%.

Finally, the exact value of  $A_{vc}$  can be derived with Eq. 1. The result is the same as that obtained from Eq. 2. This is because  $R_{in}$  ( $10 \text{ M}\Omega$ ) is much greater than  $R_i$  ( $100 \text{ k}\Omega$ ) and  $R_f$  ( $900 \text{ k}\Omega$ ), and  $R_{out}$  ( $25 \text{ k}\Omega$ ) is much smaller than the  $R_f$  ( $900 \text{ k}\Omega$ ). The effect of  $R_{in}$  and  $R_{out}$  is thus negligible. To make the gain error small, then, the values of  $R_i$ ,  $R_{in}$ ,  $R_f$  and  $R_{out}$  should be such that  $R_{in} \geq 10 R_i$  and  $R_f \geq 10 R_{out}$ . Otherwise, gain error will be introduced by  $R_{in}$  and  $R_{out}$ . For instance, if  $R_{in} = 100 \text{ k}\Omega$  and the other parameter values are the same as before, the exact closed-loop gain calculated with Eq. 1 becomes 9.998. This means that a gain error of 0.01% is introduced between Eqs. 2 and 1.

If the value of  $R_{out}$  is little lower than  $R_f$ , then again there will be gain error. Suppose  $R_i = 1 \text{ k}\Omega$ ,  $R_f = 9 \text{ k}\Omega$ ,  $R_{in} = 100 \text{ k}\Omega$ ,  $R_{out} = 25 \text{ k}\Omega$ . In this case,  $R_{in}$  is much greater than  $R_i$ , but  $R_{out}$  is not smaller than  $R_f$ . Substituting the component values into

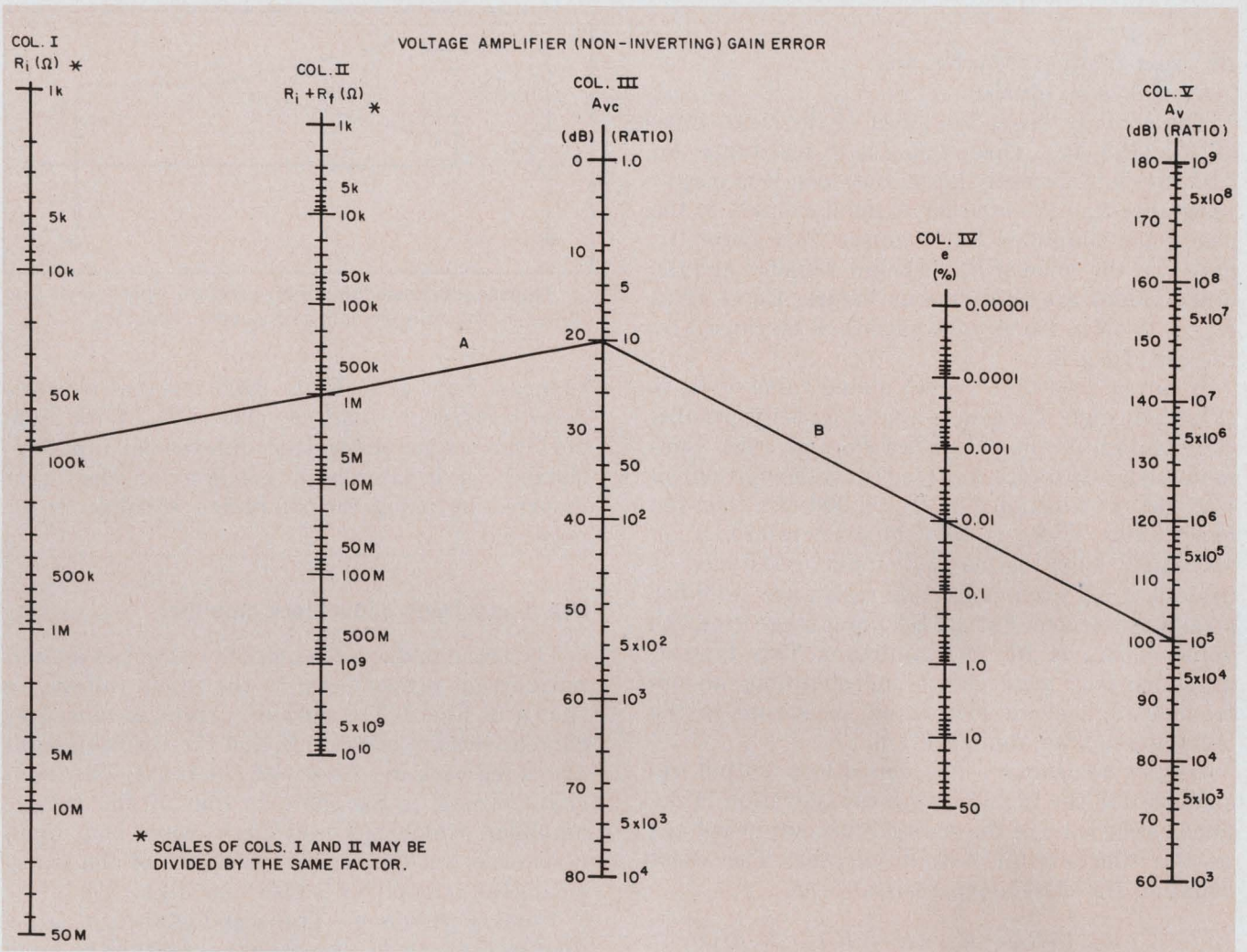

Eq. 1 yields  $A_{vc} = 9.962$ . This introduces a gain error of 0.47% between Eqs. 2 and 1, due to the effect of the large value of  $R_{out}$  (25 k $\Omega$ ).

Therefore for high gain accuracy a high-input-resistance and low-output-resistance amplifier should be selected. The values of  $R_{in}$  and  $R_{out}$  should be determined according to the values of  $R_i$  and  $R_f$  used in the closed-loop voltage-amplifier configuration. Otherwise gain error should be computed with Eq. 1.

Equation 1 is derived by assuming that  $R_L$  and  $R_{cm}$  are infinite. The common-mode resistance of the practical amplifiers available today ranges from several tens of megohms to several million megohms, so it is reasonable to neglect the effect of  $R_{cm}$  in the equations. For simplicity the amplifier is taken at a no-load condition, so that the effect of  $R_L$  is not included.

**Input resistance**—The feedback voltage from the voltage divider is returned to the inverting input in opposition to input voltage  $e_{in}$ . The error voltage across input resistance  $R_{in}$  is then much less than  $e_{in}$ . The resulting current flow into the closed-loop amplifier is much smaller than the current produced by the entire  $e_{in}$  applied across  $R_{in}$ ; there-

fore the closed-loop input resistance is increased. The precise expression for the closed-loop input resistance is:

$$R_{ic} = R_{in} + R_g + \frac{R_i (R_{out} + R_f + R_{in} A_v)}{R_i + R_f + R_{out}} \quad (4)$$

For the case where input resistance  $R_{in}$  is much greater than source resistor  $R_g$  and output resistance  $R_{out}$ , Eq. 4 reduces to:

$$R_{ic} = R_{in} [1 + R_i A_v / (R_i + R_f)] = R_{in} (1 + A_v \beta) \quad (5)$$

In Eq. 5 the value of  $R_{ic}$  is approximately equal to the value of loop gain times  $R_{in}$ , and is extremely high. The exact value of  $R_{ic}$ , however, is the value of the parallel combination of  $(A_v \beta) R_{in}$  and twice the common-mode input resistance,  $2R_{cm}$  (see equivalent circuit in Fig. 1a). Thus the closed-loop input resistance is limited by the value of common-mode resistance.

Take, for example, an operational amplifier with the parameter values:

$$\begin{aligned} R_{in} &= 10 \text{ M}\Omega, & R_i &= 100 \text{ k}\Omega, \\ R_{out} &= 25 \text{ k}\Omega, & R_f &= 900 \text{ k}\Omega, \\ R_g &= 1 \text{ k}\Omega & A_v &= 10^5. \end{aligned}$$

Calculating the closed-loop input resistance from Eq. 5 gives:

$$R_{ic} = 10^7 [1 + (100) 10^5 / (100 + 900)]$$

$$= 10^5 \text{ M}\Omega.$$

An exact solution from Eq. 4 is:

$$R_{ic} = 9.75 \times 10^4 \text{ M}\Omega.$$

The error is due to the effect of the large value of  $R_{out}$  (25 k $\Omega$ ). Open-loop input resistance  $R_{in}$  (10 M $\Omega$ ) is sufficiently large, but open-loop output resistance  $R_{out}$  (25 k $\Omega$ ) is not small enough, so the use of the simplified Eq. 5 causes 2.5% error. If, however, the value of  $R_{out}$  is below 1 kilohm and the other values are the same as before, Eq. 4 gives  $R_{ic} = 10^5 \text{ M}\Omega$ . No error would then be caused by the use of Eq. 5.

It can be seen that the calculated value of  $R_{ic}$  is extremely high. The exact value of  $R_{ic}$  is the parallel combination of the calculated  $R_{ic}$  and twice common-mode resistance  $R_{cm}$  (see equivalent circuit in Fig. 1a). For instance, if  $R_{cm} = 500 \text{ M}\Omega$ , then the exact value of  $R_{ic}$  is 1000 M $\Omega$ . Therefore, if an extremely high closed-loop input resistance is desired, a high common-mode-resistance amplifier should be selected. For a FET input stage type, the value of  $R_{cm}$  is  $10^5 \text{ M}\Omega$  minimum. This type of amplifier is a good choice for obtaining an extremely high closed-loop input resistance in the voltage-amplifier configuration.

**Output resistance**—The closed-loop output resistance for the noninverting configuration is defined as the ratio of the open-circuit output voltage to the short-circuit output current. The exact equation for closed-loop resistance is:

$$R_{oc} = \frac{\left\{ R_{out} [(R_{in} + R_g) (R_i + R_f) + R_i R_f] \right\}}{\left\{ [R_i R_{out} + R_{in} (R_i + R_f) A_v] \right\}} \cdot \frac{1}{\left\{ \begin{array}{l} R_{in} (R_i + R_f) A_v [(R_{out} + R_f) (R_i + R_{in}) \\ + R_g] + R_i (R_{in} + R_g) + R_i R_{in} A_v \end{array} \right\}} \quad (6)$$

If the open-loop gain  $A_v$  is high ( $10^5$  or larger) and input resistance  $R_{in}$  is also very high (10 M $\Omega$  and up), Eq. 6 may be simplified to:

$$R_{oc} = R_{out} / (1 + A_v \beta). \quad (7)$$

The output resistance is thus reduced by a factor of  $(1 + A_v \beta)$ . Therefore negative feedback improves the low-output-resistance characteristic of the voltage amplifier.

Assume an operational amplifier has three parameter values:

$$\begin{array}{ll} R_{in} = 10 \text{ M}\Omega, & R_i = 100 \text{ k}\Omega, \\ R_{out} = 25 \text{ k}\Omega, & R_f = 900 \text{ k}\Omega, \\ R_g = 1 \text{ k}\Omega, & A_v = 10^5. \end{array}$$

The closed-loop output resistance may be calculated from Eq. 7 to be:

$$R_{oc} = (25 \times 10^3) / (1 + 10^4) = 2.5 \Omega.$$

Substituting the component values into the exact Eq. 6 also yields 2.5  $\Omega$ . The value of  $R_{oc}$  calculated with either equation is the same, because the values of  $A_v$  and  $R_{in}$  are very high. The simplified equation thus gives an accurate value.

If the input resistance is 100 k $\Omega$  instead of 10 M $\Omega$  and the other component values are kept un-

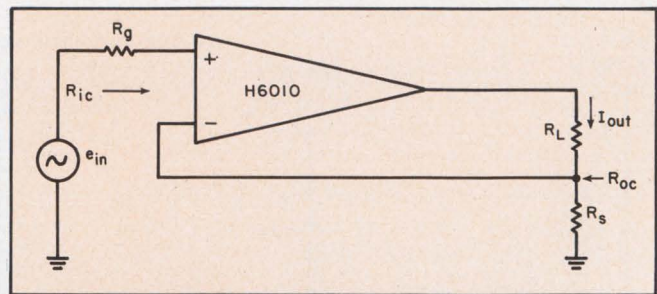

2. Transconductance amplifier uses an operational amplifier as the gain element and several resistors.

changed, Eq. 6 gives  $R_{oc} = 2.525 \Omega$ —that is, a 1% error is caused by a lower value of  $R_{in}$ . With high-performance amplifiers the differential input resistance is usually high enough for the error incurred by using the simplified equation to be neglected.

### Use it as a transconductance amplifier

The transconductance amplifier supplies an output current proportional to the input voltage, as shown in Fig. 2. The output current is sensed by current-sensing resistor  $R_s$  and the resulting voltage is fed back in series with the input. The input characteristic is the same as that of the voltage amplifier, which has very high closed-loop input resistance, but the output resistance of the transconductance amplifier is also very high.

**Transfer function**—Transconductance,  $g_f$ , is defined as the ratio of the output current to the input voltage. The exact transfer equation is:

$$g_f = \frac{R_{in} A_v - R_s}{\left\{ \begin{array}{l} (R_{out} + R_L) (R_s + R_{in} + R_g) \\ + R_s (R_{in} + R_g) + R_s R_{in} A_v \end{array} \right\}} \quad (8)$$

If input resistance  $R_{in}$  is large (100 k $\Omega$  or higher), Eq. 8 may be simplified to:

$$\begin{aligned} g_f &= A_v / (R_L + R_s + R_{out} + R_s A_v) \\ &= (1/R_s) / [1 + (1/A_v \beta)], \end{aligned} \quad (9)$$

where  $\beta = R_s / (R_s + R_L + R_{out})$ . If  $A_v \beta$  is much greater than unity, Eq. 9 can be further simplified to:

$$g_f = 1/R_s. \quad (10)$$

Equation 10 may be used in most operational-amplifier applications. The resultant transconductance error can be obtained either from Nomogram 2 or from Eqs. 8 and 9.

Assume an operational amplifier has three parameter values:

$$\begin{array}{ll} R_{in} = 100 \text{ k}\Omega, & R_L = 800 \Omega, \\ R_g = 1 \text{ k}\Omega, & R_s = 100 \Omega, \\ R_{out} = 100 \Omega, & A_v = 10^5. \end{array}$$

The transconductance can be calculated from Eqs. 8, 9 or 10. Equation 10 gives:

$$g_f = 1/R_s = 1/100 = 10^{-4} \mu\text{mhos}.$$

With the finite open-loop gain, Eq. 9 gives:

$$g_f = (1/100) / (1 + 0.0001) = 9.999 \times 10^{-3} \mu\text{mhos}.$$

Thus with the simplified equation, the finite  $A_v$

TRANSCONDUCTANCE AMPLIFIER GAIN ERROR

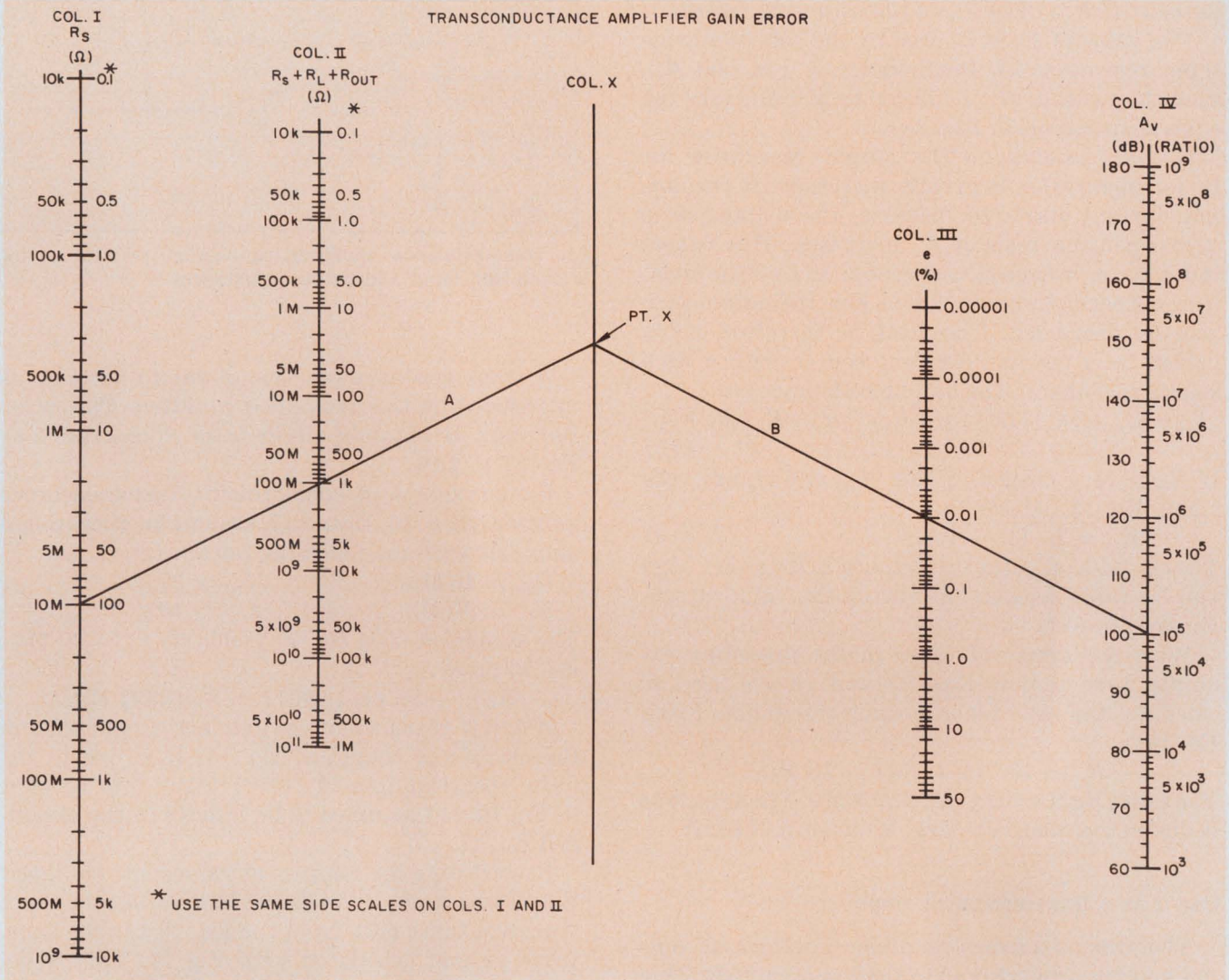

causes a 0.01% transconductance gain error. The higher the open-loop voltage gain is, the less the transconductance gain error, as Nomogram 2 also shows.

If the component values are substituted into Eq. 8,  $g_f$  is calculated to be  $9.999 \times 10^3 \mu\text{mhos}$ . The exact value of the transconductance calculated from Eq. 8, then, is the same as that from Eq. 9. This is because the value of  $R_{in}$  (100 k $\Omega$ ) is large compared with the other component values. If, on the other hand,  $R_{in} = 1 \text{ k}\Omega$  and the other component values are the same as before, Eq. 8 gives  $g_f = 9.998 \times 10^3 \mu\text{mhos}$ , so a 0.02% error is introduced by the simplified Eq. 10. The input resistance of solid-state operational amplifiers, however, is usually much higher than 10 k $\Omega$ , so Eqs. 9 and 10 can be used accurately.

To calculate the static transconductance gain error from Nomogram 2 on the basis of standard operational-amplifier to manufacturers' data, two simple steps are required (assuming the same values as above):

Step 1—Draw line A from the value of  $R_s = 100 \Omega$  through the value of  $R_s + R_L + R_{out} = 1 \text{ k}\Omega$ ,

to intersect the center vertical reference line at point x.

Step 2—Draw line B from point x to the value of  $A_v = 10^5$ ; its intersection with the error line gives the transconductance gain error: 0.01%.

*Input resistance*—For the same reason as in the voltage amplifier, input resistance is increased by closing the loop, and is given by:

$$R_{ic} = R_{in} + R_g + \frac{R_s (R_{out} + R_L + R_{in} A_v)}{R_s + R_L + R_{out}} \quad (11)$$

If  $R_{in}$  is large compared to  $R_g$ ,  $R_{out}$  and  $R_L$ , then:

$$R_{ic} = R_{in} [1 + R_s A_v / (R_s + R_L + R_{out})] = R_{in} (1 + A_v \beta) \quad (12)$$

To illustrate the use of Eqs. 11 and 12, assume an operational amplifier with the following parameter values:

$$\begin{aligned} R_{in} &= 100 \text{ k}\Omega, & R_L &= 800 \Omega, \\ R_g &= 1 \text{ k}\Omega, & R_s &= 100 \Omega, \\ R_{out} &= 100 \Omega, & A_v &= 10^5. \end{aligned}$$

From Eq. 12:

$$R_{ic} = 100 \times 10^3 (1 + 10^4) = 1000.1 \text{ M}\Omega.$$

From Eq. 11, the exact value of  $R_{ic}$  is also 1000.1 M $\Omega$ . This is because  $R_{in}$  (100 k $\Omega$ ) is large com-

pared with  $R_g$  (1 k $\Omega$ ),  $R_{out}$  (100  $\Omega$ ) and  $R_L$  (800 k $\Omega$ ).

The value of  $R_{ic}$  is limited by the common-mode input resistance. If, for instance,  $R_{cm} = 500$  M $\Omega$ , then the value of  $R_{ic}$  is limited to 500 M $\Omega$  (see the equivalent circuit in Fig. 1a).

**Output resistance**—The output resistance for this configuration is greatly increased. If the output current starts to increase, the voltage drop across sensing resistor  $R_s$  increases. This causes input error voltage  $e_e$  to decrease, so that the open-loop output voltage decreases and the output current is decreased. The load is therefore being driven by a constant-current source with a high source resistance. The output resistance is:

$$R_{oc} = R_{out} + [R_s / (R_s + R_{in} + R_g)] [R_{in} + R_g + R_{in}A_v]. \quad (13)$$

If  $R_{in}$  is very large and both  $R_{out}$  and  $R_g$  are very small, Eq. 13 reduces to:

$$R_{oc} = R_s (1 + A_v). \quad (14)$$

The closed-loop output resistance is thus very high and its value depends heavily on the value of sensing resistor  $R_s$ .

With the same values as in the preceding example, here is how Eqs. 13 and 14 are used to calculate the closed-loop output resistance. From Eq. 14:

$$R_{oc} = 100 (1 + 10^5) = 10 \text{ M}\Omega.$$

The exact Eq. 13 yields  $R_{oc} = 9.9$  M $\Omega$ . The 1% error is due to the relatively large value of  $R_g$  (1 k $\Omega$ ).

### Use it as a transresistance amplifier

The transresistance amplifier provides an output voltage proportional to the input current. This property is obtained by connecting a feedback resistor,  $R_f$ , to sense the output voltage and to feed back a current equal and opposite to the input current, as shown in Fig. 3. This configuration is the simplest of the four types of amplifiers. Only one feedback resistor is required and its maximum value is limited by the output voltage capability of the operational amplifier and the availability of the current source.

**Transfer function**—The transresistance transfer function,  $R_F$ , is the ratio of the output voltage to the input current. The exact equation for transresistance is:

$$R_F = \frac{\left\{ \begin{array}{l} -R_{in} (R_f + R_{in}) (R_f + R_{out}) A_v \\ -R_{out} (R_{in} + R_f + R_{out}) \end{array} \right\}}{\left\{ \begin{array}{l} (R_{in} + R_f + R_{out}) (R_{out}) \\ + R_f + R_{in} + R_{in} A_v \end{array} \right\}}, \quad (15)$$

assuming that the current source is ideal and there is no loading effect. If  $R_{in}$  is large and  $R_{out}$  is small in relation to  $R_f$ , Eq. 15 reduces to:

$$R_F = -R_f R_{in} A_v / (R_f + R_{in} + R_{in} A_v) = -R_f / (1 + 1/A_v \beta), \quad (16)$$

where  $\beta = R_{in} / (R_{in} + R_f)$ . If  $A_v \beta$  is much greater than unity, then Eq. 16 further reduces to:

$$R_F = -R_f. \quad (17)$$

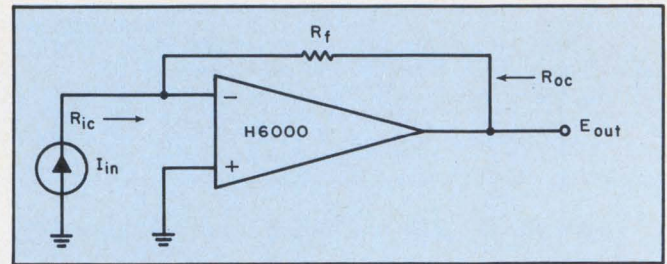

3. Transresistance amplifier connection results in low closed-loop input and output resistances.

A transresistance gain error due to finite  $A_v$  is introduced by this simplified equation. The error can easily be obtained either from Nomogram 3 or Eqs. 15 and 16.

For an example of calculating the transresistance gain with Eqs. 15, 16 and 17, assume an operational amplifier with the following parameter values:

$$R_{in} = 10 \text{ M}\Omega, \quad R_{out} = 25 \text{ k}\Omega, \\ R_f = 90 \text{ M}\Omega, \quad A_v = 10^5.$$

The simplified ideal Eq. 17 yields  $R_F = -90$  M $\Omega$ ; Eq. 16 gives:

$$R_F = -90 (1/1.0001) = -89.991 \text{ M}\Omega.$$

A 0.01% transresistance gain error results from the use of the simplified Eq. 17. It is due to the finite open-loop gain  $A_v$  ( $10^5$ ) taken into account in Eq. 16, but assumed to be infinite in the simplified Eq. 17.

Substituting the component values into the exact Eq. 15 leads to  $R_F = -89.991$  M $\Omega$ , so that the exact transresistance gain from the Eq. 15 has the same value as that calculated with Eq. 16. This is because the value of  $R_{in}$  (10 M $\Omega$ ) is very large and  $R_{out}$  (25 k $\Omega$ ) is very small in relation to  $R_f$  (90 M $\Omega$ ).

If  $R_{out}$  is not much smaller than  $R_f$ , transresistance gain error will result.

If, for instance,  $R_f = 10$  k $\Omega$  and the other values are unchanged, the simplified Eq. 17 yields a transresistance gain,  $R_F$ , of 10 k $\Omega$ . However, substituting the component values into the exact Eq. 15, shows  $R_F = 34.9$  k $\Omega$ . In this case, the transresistance gain error is about 250%. Therefore, in order to avoid gain error,  $R_f$  must be at least 10 times greater than  $R_{out}$ . The value of  $R_f$  is fixed by the output voltage capability of the amplifier, so a low-output-resistance amplifier must be selected such that  $R_f \geq 10R_{out}$ .

The nomogram for this configuration is used in the same manner as those for determining voltage and transconductance gain error.

**Input resistance**—Since here most of the input current is flowing through  $R_f$  instead of  $R_{in}$ , the effect of feedback resistor  $R_f$  is to reduce the closed loop input resistance. Thus:

$$R_{ic} = \frac{R_{in} (R_{out} + R_f)}{R_{out} + R_f + R_{in} + R_{in} A_v}. \quad (18)$$

For high  $R_{in}$  and low  $R_{out}$  in relation to  $R_f$ , Eq. 18

TRANSRESISTANCE AMPLIFIER GAIN ERROR

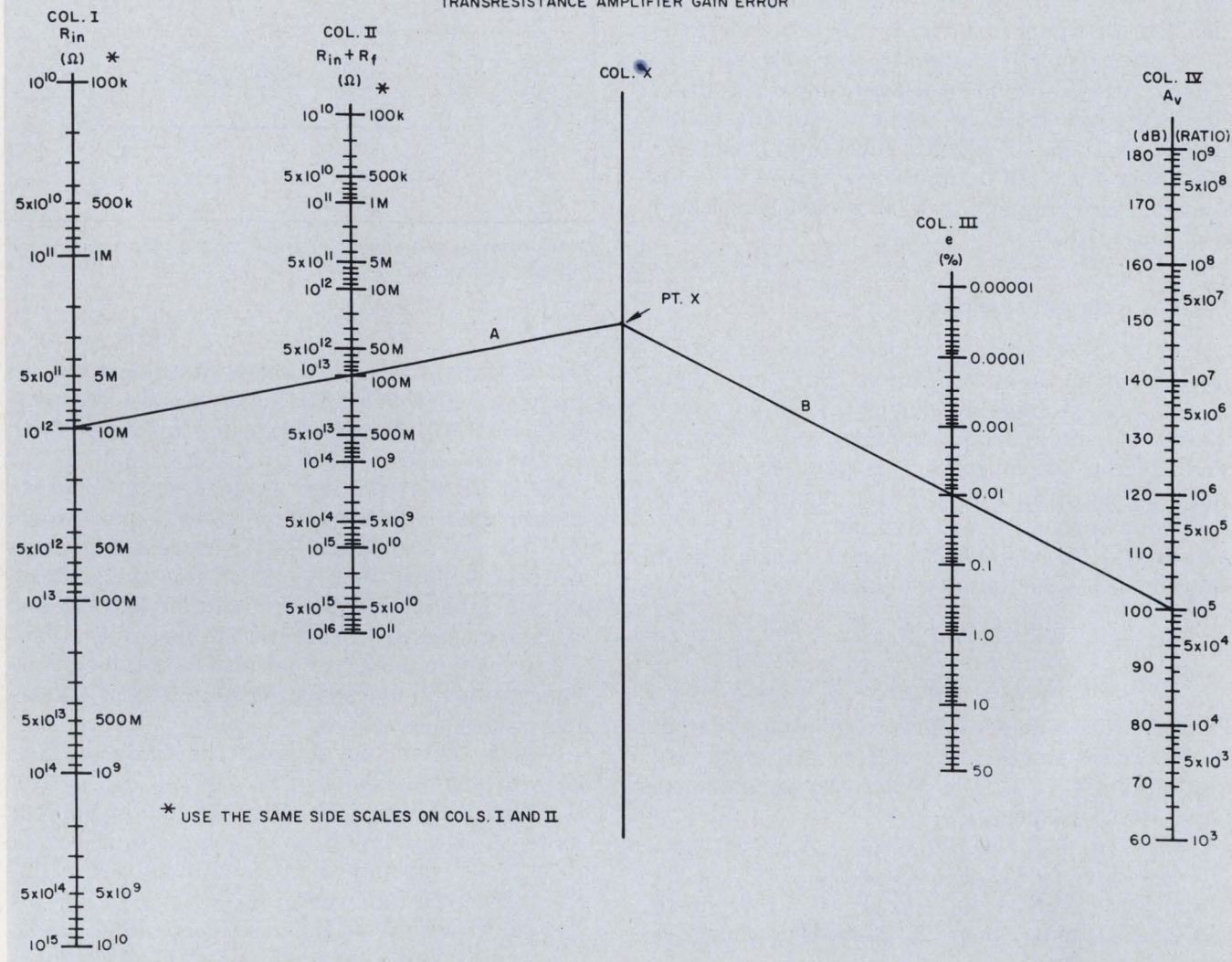

simplifies to:

$$R_{ic} = R_f / (1 + A_v) \tag{19}$$

Since the open-loop gain is usually very high ( $10^5$ ), the effective closed-loop input resistance is very low.

To demonstrate the use of the two foregoing equations, an operational amplifier is assumed to have the following parameter values:

$$\begin{aligned} R_f &= 90 \text{ M}\Omega, & R_{in} &= 10 \text{ M}\Omega, \\ R_{out} &= 25 \text{ k}\Omega, & A_v &= 10^5. \end{aligned}$$

Simplified Eq. 19 gives:

$$R_{ic} = 90 \times 10^6 / (1 + 10^5) = 900 \Omega;$$

but Eq. 18 yields  $R_{ic} = 900.16 \Omega$ . Thus the exact closed-loop input resistance is nearly equal to that obtained by the simplified equation. This is because  $R_{in}$  is very large and  $R_{out}$  very small in relation to  $R_f$ . If this were not so, Eq. 19 would introduce an error. If  $R_{out} = 25 \text{ k}\Omega$ ,  $R_f = 10 \text{ k}\Omega$  and  $R_{in} = 10 \text{ M}\Omega$ , for instance, from simplified Eq. 19  $R_{ic} = (10 \times 10^3) / 10^5 = 0.1 \Omega$ . The exact Eq. 18, however, yields:

$$\begin{aligned} R_{ic} &= 10 \times 10^6 (0.035) / (0.035 + 10 + 10 \times 10^5) \\ &= 0.35 \Omega. \end{aligned}$$

the error is 250%. However, if a low-output-resistance amplifier is selected, the simplified equation can be used accurately.

*Output resistance*—The closed-loop output resistance is derived by the same analysis as that used for the voltage amplifier. For low  $R_{out}$ , it is:

$$R_{oc} = R_{out} (R_f + R_{in}) / (R_{out} + R_f + R_{in} + R_{in}A_v) \tag{20}$$

If the input resistance,  $R_{in}$ , is large compared with  $R_{out}$  and  $R_f$ , Eq. 20 simplifies to:

$$R_{oc} = R_{out} / (1 + A_v), \tag{21}$$

reducing the closed-loop output resistance by a factor of  $(1 + A_v)$ .

To calculate output resistance with Eqs. 20 and 21, assume the following parameter values:

$$\begin{aligned} R_{in} &= 10 \text{ M}\Omega, & R_f &= 10 \text{ k}\Omega, \\ R_{out} &= 25 \text{ k}\Omega, & A_v &= 10^5. \end{aligned}$$

With simplified Eq. 21:

$$R_{oc} = 25 \times 10^3 / (1 + 10^5) = 0.25 \Omega,$$

and from exact Eq. 20, too,  $R_{oc} = 0.25 \Omega$ .

Since  $R_{in}$  (10 M $\Omega$ ) is large compared with  $R_{out}$  (25 k $\Omega$ ) and  $R_f$  (10 k $\Omega$ ), the result obtained from the simplified Eq. 21 is accurate. If  $R_{in}$  were not large,

say,  $R_{in} = R_f = 10 \text{ M}\Omega$ ,  $R_{out} = 25 \text{ k}\Omega$  and  $A_v = 10^5$ , then Eq. 20 would give  $R_{oc} = 0.5 \Omega$ . In this case, 100% error would be caused by using Eq. 21.

For a practical solid-state operational amplifier, the differential input resistance is usually better than several tens of kilohms (even up to the teraohm range for a FET-input-stage type). In order to avoid error, either  $R_{in}$  or  $R_f$  should be selected so that  $R_{in} \gg 10R_f$ .

### Use it as a current amplifier

A current amplifier provides a current output proportional to the current input. This can be done by forming a voltage divider at the output of the operational amplifier to feed back a signal proportional to the output current in parallel with the input, as shown in Fig. 4. This configuration has low input impedance and high output impedance.

*Transfer function*—The exact current gain equation of the current amplifier is:

$$A_{ic} = \frac{-R_{in} [(R_f + R_s) A_v + R_s]}{\left\{ (R_{in} + R_f) (R_s + R_L + R_{out}) \right\} + R_s (R_L + R_{out}) + R_s R_{in} A_v} \quad (22)$$

This equation is derived on the assumption that an ideal current source is applied to the input and  $R_{cm}$  is infinite. If  $A_v$  and  $R_{in}$  are large, and  $R_s$  is small, Eq. 22 reduces to:

$$A_{ic} = - (R_s + R_f) A_v / (R_s + R_L + R_{out} + R_s A_v) \\ = - [(R_s + R_f) / R_s] / (1 + 1/A_v \beta), \quad (23)$$

where  $\beta = R_s / (R_s + R_L + R_{out})$ . If  $A_v \beta$  is much greater than unity, then Eq. 23 further simplifies to the ideal form:

$$A_{ic} = - (R_s + R_f) / R_s. \quad (24)$$

Equation 24 shows that for a high-performance operational amplifier (that is, one where the stated assumptions are valid), the current gain depends only on the values of  $R_s$  and  $R_f$ . The negative sign indicates that the output current is out of phase with the input current. When Eq. 24 is used, the current gain error due to finite open-loop voltage gain can be obtained from Nomogram 4 or from Eqs. 22 and 23.

For an example of the calculation of current gain with Eqs. 22, 23 and 24, assume an operational amplifier has these values:

$$\begin{aligned} R_{in} &= 10 \text{ M}\Omega, & R_f &= 10 \text{ k}\Omega, \\ R_{out} &= 200 \Omega, & R_L &= 4.3 \text{ k}\Omega, \\ R_s &= 500 \Omega, & A_v &= 10^5. \end{aligned}$$

Simplified Eq. 24 yields:

$$A_{ic} = - (0.5 + 10) / 0.5 = - 21,$$

and from Eq. 23:

$$A_{ic} = - 21 (1/1.0001) = - 20.998.$$

Use of the simplified equation leads to a 0.01% current gain error, due to the finite open-loop gain, which is included in Eq. 23 but assumed to be infinite in Eq. 24.

Substituting the component values into the exact

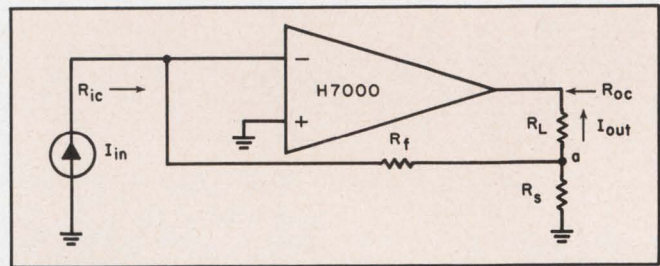

4. Current amplifier features low closed-loop input, high output resistances.

Eq. 22 gives  $A_{ic} = - 20.998$ —the same result as that obtained from Eq. 23. This is because the value of  $R_{in}$  ( $10 \text{ M}\Omega$ ) is very large in comparison with  $R_f$  ( $10 \text{ k}\Omega$ ), and  $R_s$  ( $500 \Omega$ ) is very small. If the value of  $R_{in}$  were not very large, say,  $R_{in} = 10 \text{ k}\Omega$ , and the other values were the same, Eq. 22 would give  $A_{ic} = - 20.996$ , that is, the current gain error would be doubled (0.02%). The value of  $R_{in}$  is usually much higher than  $10 \text{ k}\Omega$ , so that Eqs. 23 and 24 can be used very accurately in most situations.

The current gain error can also be obtained from Nomogram 4 in two steps. Assuming same component values, here is how:

Step 1—Draw line A from the value of  $R_s = 500 \Omega$  through the value of  $R_s + R_L + R_{out} = 5 \text{ k}\Omega$  to intersect the vertical reference line at point x.

Step 2—Draw line B from point x to the value of  $A_v = 10^5$ ; its intersection with the error line gives the current gain error: 0.01%.

*Input resistance*—The closed-loop input resistance is very low because of the effect of feedback resistor  $R_f$ . An increase in input current causes an increase in the input error voltage and in output current. Owing to the increase in output current, the current flowing through  $R_s$  must increase and cause a greater voltage drop across  $R_s$ . This causes most of the input current to flow through  $R_f$  instead of  $R_{in}$ , and a very low closed-loop input resistance results. This is given by:

$$R_{ic} = \frac{\left\{ R_{in} [R_f (R_s + R_L + R_{out})] \right\}}{\left\{ (R_{in} + R_f) (R_s + R_L + R_{out}) \right\} + R_s (R_L + R_{out}) + R_s R_{in} A_v} \quad (25)$$

If  $R_{in}$  is large and  $R_{out}$  and  $R_L$  are very small in relation to  $R_s$ , Eq. 25 reduces to:

$$R_{ic} = R_f / (1 + A_v). \quad (26)$$

This simplified form is the same as that for the transresistance amplifier. Since  $A_v$  is usually large, input resistance is very low.

To get some feel for the magnitudes of input resistance, take a look at an operational amplifier with these component values:

$$\begin{aligned} R_{in} &= 10 \text{ M}\Omega, & R_f &= 10 \text{ k}\Omega, \\ R_{out} &= 200 \Omega, & R_L &= 4.3 \text{ k}\Omega, \\ R_s &= 500 \Omega, & A_v &= 10^5. \end{aligned}$$

Simplified Eq. 26 gives:



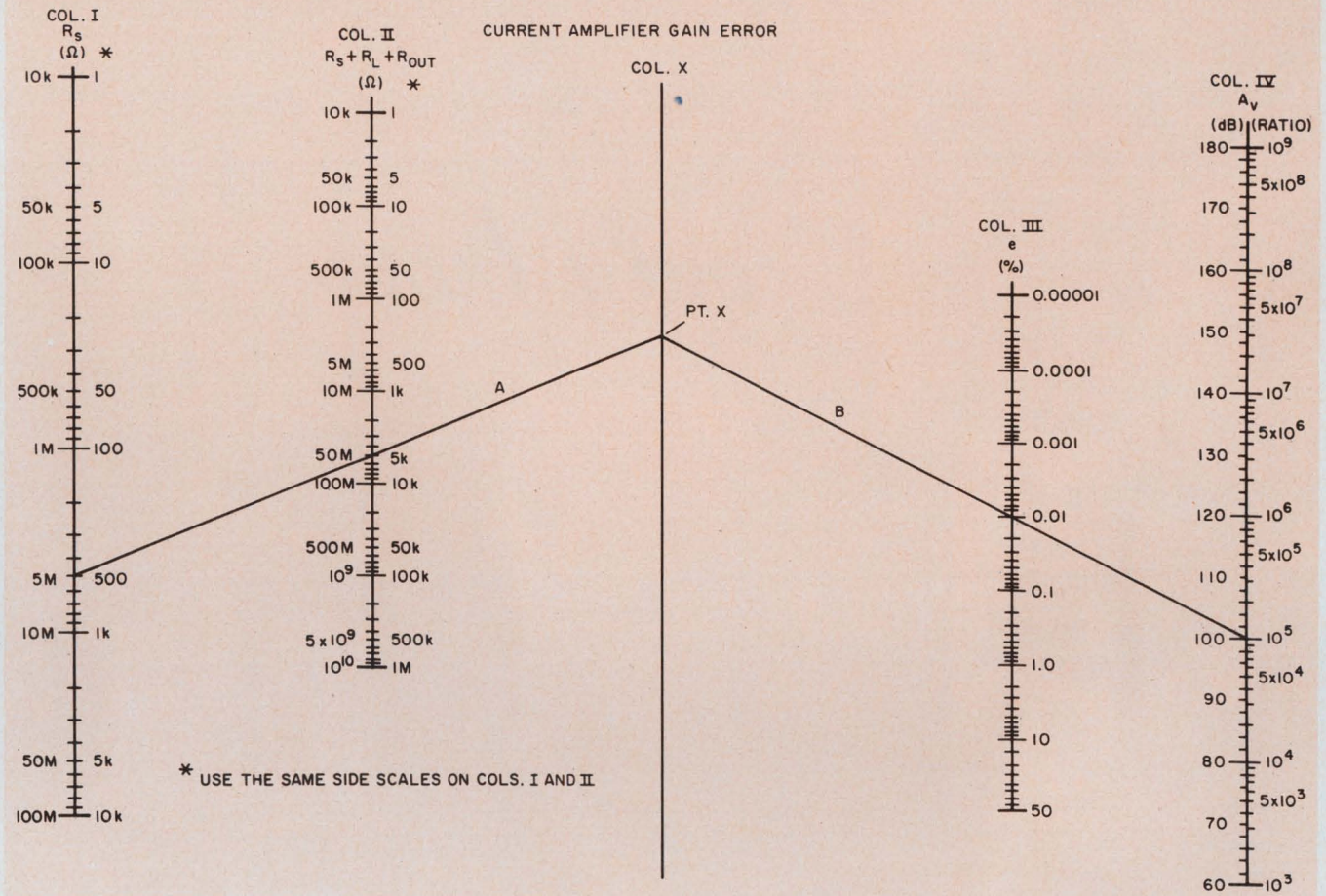

$$R_{ic} = 10^4 / (1 + 10^5) = 0.1 \Omega;$$

Eq. 25, however, gives  $R_{ic}$  a value of 1.04  $\Omega$ . These calculations demonstrate that use of the simplified equation induces a factor-of-10 error. This is because  $R_{out}$  and  $R_L$  are not small in relation to  $R_s$ . In this case, the exact equation must be used. If  $R_{out}$  and  $R_L$  were smaller than  $R_s$ , say,  $R_{out} = R_L = 100 \Omega$ ,  $R_s = 10 \Omega$  and the other values were the same as before, Eq. 25 would give  $R_{ic} = 0.102 \Omega$ , which is very close to the value of Eq. 26.

**Output resistance**—The closed-loop output resistance is very high for the same reason as that of the transconductance amplifier. It is given by:

$$R_{oc} = \frac{\left\{ (R_f + R_s) (R_{out} + R_s) [(R_{in} + R_f) (R_s) + R_{out}] + R_s R_{out} + R_s R_{in} A_v \right\}}{(R_{in} + R_f + R_s) (R_f R_s + R_f R_{out} + R_s R_{out})} \quad (27)$$

If  $R_{in}$  is large and  $R_s$  and  $R_{out}$  are small in comparison with  $R_f$ , Eq. 27 simplifies to:

$$R_{oc} = R_s (1 + A_v). \quad (28)$$

This simplified form is also the same as that for the transconductance amplifier. The closed-loop output resistance appears to be very high.

To calculate the output resistance, assume the following component values:

$$\begin{aligned} R_{in} &= 10 \text{ M}\Omega, & R_f &= 10 \text{ k}\Omega, \\ R_{out} &= 200 \Omega, & A_v &= 10^5, \\ R_s &= 500 \Omega, & & \end{aligned}$$

Simplified Eq. 28 yields:

$$R_{oc} = 500 (1 + 10^5) = 50 \text{ M}\Omega,$$

while from Eq. 27  $R_{oc} = 51.7 \text{ M}\Omega$ .

The error stemming from Eq. 28 is due to the fact that  $R_s$  (500  $\Omega$ ) is not small enough. If  $R_s = 100 \Omega$ , and the other component values stay the same, Eq. 27 gives  $R_{oc} = 50 \text{ M}\Omega$ . In this case, no error is introduced by the simplified equation. ■ ■

### Test your retention

Here are questions based on the main points of this article. They are to help you see if you have overlooked any important ideas. You'll find the answers in the article.

1. Can you define in words transfer functions for the four operational-amplifier configurations?
2. When can ideal gain equations be used in each of the four applications?
3. Qualitatively what are closed-loop input resistances in each of the four configurations (i.e., high or low)?

For a free reprint of this article circle number 343 on the Reader-Service Card.

only from



# INSTANT RESET THERMAL TIMING...

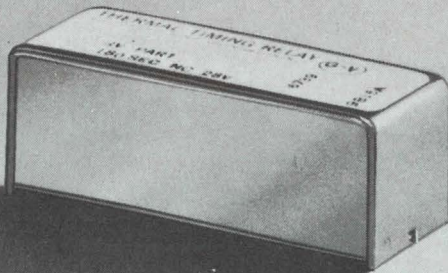

## QUICK CONNECT TYPE INDUSTRIAL THERMAL RELAY

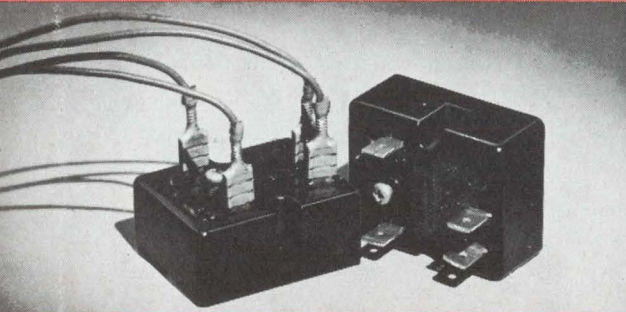

## SUBMINIATURE THERMAL TIMING RELAYS



## SOLID STATE TIME DELAY

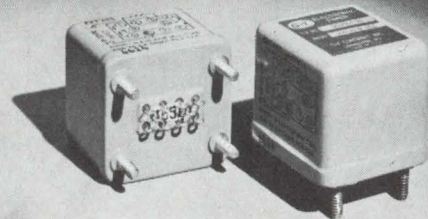

The Quick Connect thermal relays are designed to withstand the most demanding industrial applications. They reduce installation time and cost. Require only two mounting screws. Eliminates need for brackets, sockets, retainers. **Features:** time delays, 5 to 180 sec.; contacts, SPST, NO/NC; heater voltages, 6.3, 26, 115V AC or DC; resistive rating, 2A 115V AC or 1A 28V DC; mounts in any position.

Recognized Under The Components Program Of Underwriter's Laboratories, Inc.



ON READER-SERVICE CARD CIRCLE 162

The LT Series relays provide hi-level performance in a subminiature hermetically sealed housing — space saving without loss of performance. Meets military standards. **Features:** height above mounting panel 40% of standard relays (7 pin flange mount); time delays, 2 to 75 sec.; operating temp., -65°C to +85°C; operating voltages, 6.3 to 115V. AC or DC.



ON READER-SERVICE CARD CIRCLE 163

Series 900-064 has been accepted as a standard for many military and aerospace applications where high quality, reliability and cost are requirements. **Features:** hermetically sealed; fixed or adjustable time delays 0.1 to 60 sec.; solid state or relay output; vibration to 2000 Hz; shock, 50g.



ON READER-SERVICE CARD CIRCLE 164

# devices recycle automatically!

**RESETS WHENEVER POWER IS INTERRUPTED DURING OR AFTER DELAY . . .**

*it's from G-V*

G-V has designed its INSTANT RESET feature into two series of thermal timing devices: the JM Series pc board mount thermal timing relays and the Red Line thermal timing relays. The INSTANT RESET thermal element, when used with a small magnetic relay, provides instant reset time delay in a reliable and economical form. Delays from 5 seconds to 6 minutes can be supplied. Specifications include: Heater voltage from 6.3 to 115 volts, AC or DC, output circuits insulated from input circuits, temperature compensated, output: NO/NC.



**G-V CONTROLS INC.**

LIVINGSTON, NEW JERSEY 07039  
(201) 992-6200

ON READER-SERVICE CARD CIRCLE 161

## THERMETTE 9 PIN RELAY

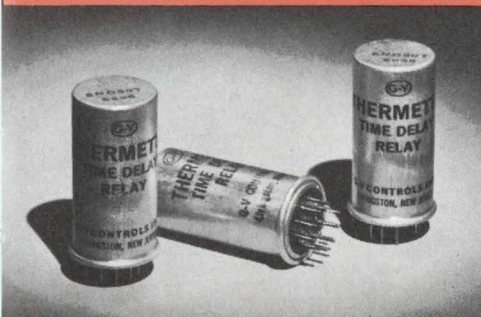

Metal enclosed thermal time delay is dust proof and shatter proof — designed for industrial applications requiring reliable operation and long life. **Features:** temp. compensated; time delays, 5 to 180 sec.; heater voltages, 6.3, 26, and 115V. AC or DC; contacts, SPST, NO or NC.

Recognized Under The Components Program Of Underwriter's Laboratories, Inc.



ON READER-SERVICE CARD CIRCLE 165

## AIR FLOW SENSING SWITCH

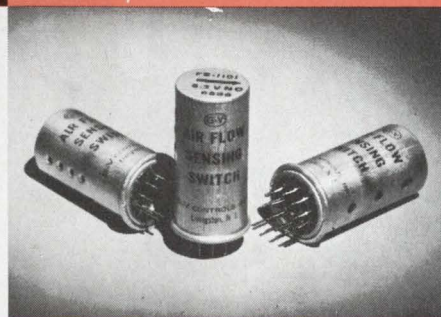

A new design concept and technique is utilized to monitor presence of air flow. When air flow drops below a safe level, it operates an alarm or automatic shut-off. Used in electronic equipment, cooling packages, air conditioners, computers, etc. **Features:** Operates in any plane, no moving parts. No special adjustments.

Recognized Under The Components Program Of Underwriter's Laboratories, Inc.

*only from* 

ON READER-SERVICE CARD CIRCLE 166

## DIRECT-LINE FIELD ENGINEERING SERVICE



G-V assistance is always available to help you design and produce a better product. G-V Regional Field Engineers in your area will assist you and your design group in new applications and proper selection of your controls. G-V Product Engineers will help you with special applications. When you require experience, products and services in electro-mechanical and solid-state controls . . . call your man from G-V.



ON READER-SERVICE CARD CIRCLE 167

# Computers ease worst-case analyses

so long as the designer understands the program and so creates an efficient man-machine partnership.

Over the last decade many circuit-analysis computer programs have appeared. Some of them have brought about profound changes in electronic circuit design. In particular, programs with parameter-variation and worst-case-analysis capabilities are now so comprehensive and easy to use that they make it possible to thoroughly evaluate large circuits that are nearly impossible to handle with breadboard tests.

To use these programs, the designer must understand what worst-case analysis is, how it can be used and how a computer program can perform it.

## What is worst-case analysis?

In a circuit there will be no single worst-case condition but rather different worst-case conditions for each circuit performance variable. Performance variables include such items as node voltages, resistor currents and transistor power dissipations. To determine the worst-case maxima and minima of a variable requires a knowledge of the effect of each circuit element on that variable. This sensitivity must be calculated for each variable in order to arrive at the values for worst-case conditions.

Use of a computer program with a parameter variation capability makes it easy to determine the sensitivity of each performance variable, and so to develop its worst-case maxima and minima. Even where these procedures are available automatically, however, the computer will do a great deal of work and produce large amounts of data. Some of these will be necessary for communication between computer and designer, but in order to have an efficient partnership the design engineer must fully understand how the computer performs automatic worst-case analysis. Even an engineer with previous experience of worst-case analysis in slide-rule designs needs to know some

of the special characteristics of computer-aided worst-case analysis.

## Worst-case analysis: some questions

Can worst-case analysis be done with little expenditure of engineering time? Yes, if the program to be used:

- Does automatic equation-writing with the circuit topology description.
- Uses nonlinear models.
- Has an automatic worst-case analysis capability.

Are data available to make the application of

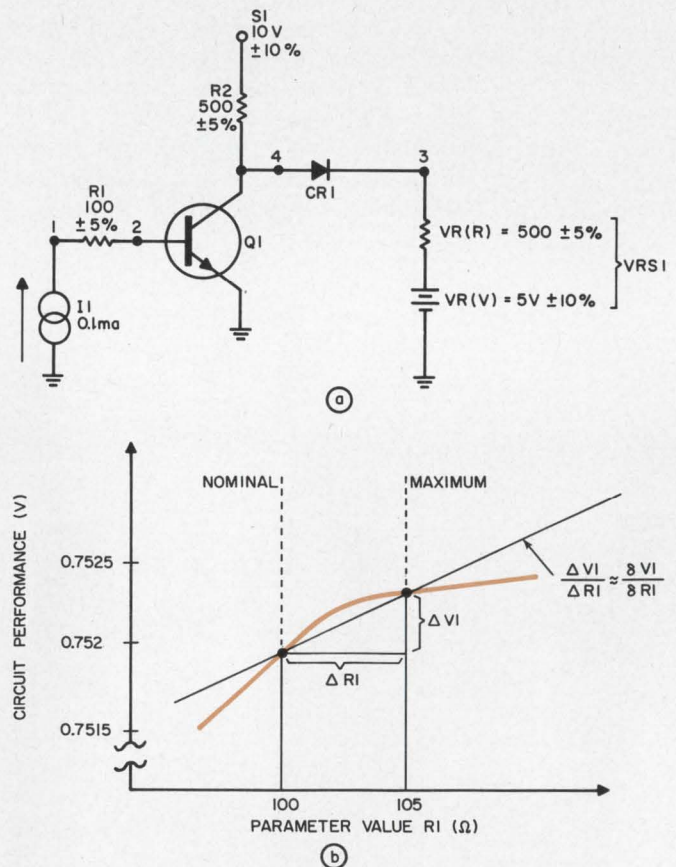

1. **Parameter tolerances** are entered on this simple transistor circuit (a). CIRC sensitivity analysis for node 1 with respect to R1 shows the differences used to obtain the partial derivatives (b).

Richard D. McNair, Staff Engineer, Scientific Data Systems, Inc., Santa Monica, Calif.

worst-case analysis practical? Yes, but the availability of data, particularly on transistors, is to some extent a function of the type of data that the models require. The transistor model in CIRC<sup>1</sup>, for example, has been intentionally set up to allow the necessary data to be obtained from manufacturers' data sheets.

Although adequate data for describing a component's worst-case performance limits may be available, it is seldom possible to obtain perfect data. The engineer, then, must generally make a pessimistic estimate of appropriate data values. If the circuit performs correctly, the circuit design is good. If the circuit does not perform properly under the conditions of the assumed parameters, the estimated parameter values should be made less pessimistic and the circuit's performance checked again. The engineer's judgment will be required to determine when the assumed parameter values are such that further improvement in them is unrealistic. If the circuit performance is still inadequate then, a design modification should be considered.

How large a circuit can be handled? The circuit size that is acceptable for worst-case analysis is a function of the program that does the analysis. For example, the CIRC program on the

SDS 900 series computers will handle circuits with 40 nodes. A version of the same program for the SDS 9300 computer will handle circuits with 100 or more nodes. The significant fact is that all the labor is performed by the computer so that large circuits can be worst-case analyzed.

### Derive parameter sensitivities

A simple single-transistor-circuit (Fig. 1a) worst-case analysis with the CIRC program will show the fundamental principles. The basic nature of worst-case analysis may be viewed as involving two tasks:

- To determine what parameter value conditions create worst-case performance.
- To set up these parameter value conditions and analyze the circuit to determine the resulting worst-case performance.

The first of these is implemented by having the circuit-analysis program determine "sensitivities." CIRC determines parameter sensitivities by comparing the circuit's nominal performance with the performance obtained when one parameter is changed from nominal. To do this, CIRC increases the parameter values to their maximum limits. The maximum values are specified by the designer and are fed in when CIRC calls for the parameter specifications (Tables 1 and 2). For example, CIRC increases resistor  $R1$  of Fig. 1a to 105 ohms and determines the performance of the circuit—or more specifically it determines the value of all the performance variables<sup>2</sup> are listed in Fig. 3.

Analysis of the circuit by CIRC shows that as  $R1$  is increased from 100 ohms to 105 ohms,  $V1$  increases from 0.7519026 volt to 0.7524026 volt. Thus the sensitivity of  $V1$  to resistor  $R1$  in the form of a partial derivative is:

$$\begin{aligned} \delta V1/\delta R1 &\approx \Delta V1/\Delta R1 \\ &= 0.0005/5 \\ &= +0.1 \times 10^{-3} \text{V}/\Omega. \end{aligned}$$

Figure 1b shows that node 1 voltage has a positive sensitivity to  $R1$ : that is, if  $R1$  increases,  $V1$  increases.

Once CIRC has determined the entire circuit performance with one parameter increased, it stores the algebraic sign of the change of all the circuit performance variables with respect to the one parameter that has been increased. A special solution of the circuit performance must be done for each parameter and all the sensitivities must be determined before any worst-case analysis can be automatically performed by the program.

### Know the sensitive areas in your circuit

The sensitivity data produced by a circuit analysis program is not only necessary for automatic

**Table 1. Transistor data at 25°C**

| Parameter | Condition parameters | Nominal | Minimum | Maximum |
|-----------|----------------------|---------|---------|---------|
| $V_{SAT}$ | —                    | 0.3 V   | 0.2 V   | 0.5 V   |
| —         | $I_{C(sat)}$         | 20 mA   | 20 mA   | 20 mA   |
| —         | $I_{B(sat)}$         | 1 mA    | 1 mA    | 1 mA    |
| $V_{BE}$  |                      | 0.7     | 0.6     | 0.8     |
| —         | $I_{E(act)}$         | 1 mA    | 1 mA    | 1 mA    |
| $\beta_N$ | —                    | 50      | 30      | 150     |
| $\beta_I$ | —                    | 1.0     | 1.0     | 1.0     |
| $I_{CBO}$ | —                    | 100 nA  | 0 nA    | 750 nA  |

**Table 2. Diode data at 25°C**

| Parameter | Condition parameters | Nominal | Minimum | Maximum |
|-----------|----------------------|---------|---------|---------|
| $V_D$     | —                    | 0.7     | 0.6     | 0.8     |
| —         | $I_D$                | 10 mA   | 10 mA   | 10 mA   |
| $I_R$     | —                    | 100 nA  | 0 nA    | 750 nA  |

**Table 3. Interpretation of sensitivity data for node one worst-case**

| Parameter numbers | Symbol                    | Units | Sensitivity results | Significant worst-case parameter values | Other parameter values |
|-------------------|---------------------------|-------|---------------------|---|------------------------|
| 1                 | <i>SUP1</i>               | V     | insignificant       |   | 11.0                   |
| 2                 | <i>TEMP</i>               | °C    | not treated         |   | 25.0                   |
| 3                 | <i>R1</i>                 | Ω     | positive +          | 105.0                                   |                        |
| 4                 | <i>R2</i>                 | Ω     | insignificant       |   | 525.0                  |
| 5                 | <i>VR (V)</i>             | V     | insignificant       |   | 5.5                    |
| 6                 | <i>VR (R)</i>             | Ω     | insignificant       |   | 525.0                  |
| 7                 | <i>I1</i>                 | mA    | not treated         |   | 0.1                    |
| 8                 | <i>V<sub>D</sub></i>      | V     | insignificant       |   | 0.8                    |
| 9                 | <i>I<sub>R</sub></i>      | mA    | insignificant       |   | 0.75                   |
| 10                | <i>V<sub>BE</sub></i>     | V     | positive +          | 0.8                                     |                        |
| 11                | <i>V<sub>SAT</sub></i>    | V     | insignificant       |   | 0.5                    |
| 12                | <i>β<sub>N</sub></i>      | —     | positive +          | 150.0                                   |                        |
| 13                | <i>β<sub>I</sub></i>      | —     | not treated         |   | 1.0                    |
| 14                | <i>I<sub>CBO</sub></i>    | μA    | positive +          | 0.75                                    |                        |
| 15                | <i>I<sub>D</sub></i>      | mA    | not treated         |   | 10.0                   |
| 16                | <i>I<sub>C(sat)</sub></i> | mA    | not treated         |   | 20.0                   |
| 17                | <i>I<sub>B(sat)</sub></i> | mA    | not treated         |   | 1.0                    |
| 18                | <i>I<sub>E(act)</sub></i> | mA    | not treated         |   | 1.0                    |

worst-case analysis, but is also information of general value to the engineer. Most worst-case analysis programs therefore print these data out. CIRC offers two output options—differences or partial derivatives. The difference option displays the actual change in the circuit performance variables caused by the parameter increase; for instance,  $\Delta V1 = 0.0005$  V in the previous example. The partial-derivative option shows the ratio of variable change to parameter change; for instance,  $\Delta V1/\Delta R1 = 0.0001$  V/Ω in the previous example.

The disadvantages of partial derivatives can best be appreciated when a parameter is either relatively large or relatively small. A hypothetical case involving  $I_{CBO}$  illustrates the point. Suppose a voltage is nominally 1.0 volt and the maximum value of  $I_{CBO}$  causes the voltage to become 1.005 volts. Then the difference is:

$$\Delta V = 0.005 \text{ V} = 0.5 \times 10^{-2} \text{ V.}$$

Suppose the  $I_{CBO}$  (nominal) =  $0.5 \times 10^{-6}$  A and  $I_{CBO}$  (maximum) =  $2.5 \times 10^{-6}$  A, then  $\Delta I_{CBO} = 2 \times 10^{-6}$  A. Therefore  $\delta V/\delta I = 0.5 \times 10^{-2}/2 \times 10^{-6} = 0.25 \times 10^4 = 2500$  volts/ampere.

The value of the partial derivative is quite large and this may mislead the engineer into thinking that  $I_{CBO}$  is a critical parameter. But the difference itself shows that  $I_{CBO}$  is not critical, for at its maxi-

imum limit it increases the voltage by only 5 mV.

Partial derivatives do, however, have the advantage that they can be used directly in estimating the magnitude of change that a parameter change will cause. Take, for example, the hypothetical  $I_{CBO}$  case. Suppose you wanted to know the effect of increasing  $I_{CBO}$  by  $200 \mu\text{A}$ . The change in the voltage would be:

$$\begin{aligned} \Delta V &\approx \delta V/\delta I \times \Delta I = \delta V/\delta I_{CBO} \times \Delta I_{CBO} \\ &\approx 2500 (200 \times 10^{-6}) \\ \Delta V &\approx 0.5 \text{ volts} \end{aligned}$$

#### The computer sets up worst-case conditions

Once the sensitivity data have been produced and stored, the analysis program can set up the appropriate parameter value conditions and analyze the circuit to determine worst-case performance. As an example, consider the determination of the worst-case maximum value of node 1 of the single transistor circuit (Fig. 1a). Table 3 summarizes the sensitivity data and resultant parameter selection. Columns 1, 2 and 3 describe all the parameters that contribute to the circuit's performance, column 4 summarizes sensitivity results, and columns 5 and 6 show the parameter selections made automatically by CIRC.

| W. C. MAX                   |                   | NODE     |               | 1        |               |           |               |   |       |
|-----------------------------|-------------------|----------|---------------|----------|---------------|-----------|---------------|---|-------|
| V                           | VALUE             | V        | VALUE         | V        | VALUE         | V         | VALUE         | V | VALUE |
| 1                           | .8804669E 00      | 2        | .8699669E 00  | 3        | .5499605E 01  | 4         | .3065806E 01  |   |       |
| D                           | VALUE             | D        | VALUE         | D        | VALUE         | D         | VALUE         | D | VALUE |
| Current                     |                   | Power    |               |          |               |           |               |   |       |
| Resistor 1                  | → 1 .1000000E-03  | 2        | .1050000E-05  |          |               |           |               |   |       |
| Resistor 2                  | → 3 -.1511275E-01 | 4        | .1199075E 00  |          |               |           |               |   |       |
| Voltage-resistance source 1 | → 5 .7524339E-06  | 6        | .4138089E-05  |          |               |           |               |   |       |
| Current source 1            | → 7 .8804669E-04  |          |               |          |               |           |               |   |       |
| Transistor 1                | → 8 -.7524338E-06 | 9        | .1831272E-05  | 10       | -.2433799E 01 |           |               |   |       |
| $I_B$                       |                   | $I_C$    |               | $I_E$    |               | P         |               |   |       |
| 11                          | .1000000E-03      | 12       | .1511425E-01  | 13       | .1521350E-01  | 14        | .4642437E-01  |   |       |
| 15                          | .8699669E 00      | 16       | -.2195839E 01 | 17       | .3065806E 01  | 18        | .1511425E 03  |   |       |
| $\bar{V}_{BE}$              |                   | $V_{BC}$ |               | $V_{CE}$ |               | $I_C/I_B$ |               |   |       |
| PARAMETERS                  |                   |          |               |          |               |           |               |   |       |
| 1                           | .11000000E 02     | 2        | .25000000E 02 | 3        | .10500000E 03 | 4         | .52500000E 03 |   |       |
| 5                           | .55000000E 01     | 6        | .52500000E 03 | 7        | .10000000E-03 | 8         | .80000000E 00 |   |       |
| 9                           | .75000000E-06     | 10       | .80000000E 00 | 11       | .50000000E 00 | 12        | .15000000E 03 |   |       |
| 13                          | .10000000E 01     | 14       | .75000000E-06 | 15       | .10000000E-01 | 16        | .20000000E-01 |   |       |
| 17                          | .10000000E-02     | 18       | .10000000E-02 |          |               |           |               |   |       |

2. For each worst case CIRC prints out the actual worst-case value, in this case node 1 voltage, and all the other

node voltages and dependent variables for this case to give the complete picture.

Each entry in column 4 is one of three phrases: NOT TREATED, INSIGNIFICANT or POSITIVE+. The different phrases are required because of the subtleties of parameter effect on the worst-case analysis. NOT TREATED is used to indicate that sensitivity data was not directly obtained for the associated parameter. Sensitivities are not obtained for parameters that have no variation or for "condition" parameters (15 through 18) which be explained later.

Within a circuit, some parameters will have little or no effect on some of the performance variables. For example, in the circuit of Fig. 1a,

the input resistance,  $R_1$  will have no effect on the output voltages because the base current is independent of  $R_1$ 's value. Furthermore, the supply voltage has very little effect on  $V_1$  because the only path between node 1 and  $S_1$  is through the very high impedance of the reverse-biased base-collector junction. CIRC defines "very little effect" as causing less than 0.001% change in a variable. Table 3 shows that many parameters have an insignificant effect upon node 1 voltage.

Only four of the parameters treated (3, 10, 12 and 14) have a significant effect on the worst-case performance of node 1. In the example, all

The one worst-case answer shown in Figure 2

| W. C. Results |                |                |                      | Node Voltages | Dependent Variables |                                |
|---------------|----------------|----------------|----------------------|---------------|---------------------|--------------------------------|
| Variable      | Minimum        | Nominal        | Maximum              |               |                     |                                |
| V 1           | .63858113E 00  | .75190255E 00  | <b>.88046711E 00</b> | Node 1        | Res. 1              | Current                        |
| V 2           | .62908113E 00  | .74190255E 00  | .86996711E 00        | Node 2        |                     | Power                          |
| V 3           | .44996421E 01  | .59204083E 01  | .73384825E 01        | Node 3        | Res. 2              | Current                        |
| V 4           | .10017080E 01  | .65769114E 01  | .80058056E 01        | Node 4        |                     | Power                          |
| D 1           | .10000000E-03  | .10000000E-03  | .10000000E-03        |               | Vrs                 | Current                        |
| D 2           | .95000000E-06  | .10000000E-05  | .10500000E-05        |               |                     | Power                          |
| D 3           | -.15235262E-01 | -.68461773E-02 | -.41249778E-02       |               | Cur                 | Power                          |
| D 4           | .88934186E-02  | .23435072E-01  | .12185271E 00        |               | Dio                 | Current                        |
| D 5           | -.47306850E-02 | -.18408165E-02 | .75443376E-06        |               |                     | Power                          |
| D 6           | -.31918288E-01 | -.10898385E-01 | .41490868E-05        |               | Tran                | Base Current                   |
| D 7           | .63858116E-04  | .75190255E-04  | .88046691E-04        |               |                     | Collector Cur.                 |
| D 8           | -.75443364E-06 | .18408165E-02  | .47306850E-02        |               |                     | Emitter Cur.                   |
| D 9           | .54333509E-09  | .12085018E-02  | .35248799E-02        |               |                     | Power                          |
| D10           | -.44982889E 01 | .65650310E 00  | .77960245E 00        |               |                     | Voltage                        |
| D11           | .10000000E-03  | .10000000E-03  | .10000000E-03        |               |                     |                                |
| D12           | .30001534E-02  | .50054608E-02  | .15236013E-01        |               |                     |                                |
| D13           | .31001534E-02  | .51053608E-02  | .15335263E-01        |               |                     |                                |
| D14           | .15328635E-01  | .32994662E-01  | .57844874E-01        |               |                     |                                |
| D15           | .62908113E 00  | .74190255E 00  | .86996711E 00        |               |                     | V <sub>BE</sub>                |
| D16           | -.73767182E 01 | -.58350088E 01 | -.19599908E 00       |               |                     | V <sub>BC</sub>                |
| D17           | .10017080E 01  | .65769114E 01  | .80058056E 01        |               |                     | V <sub>CE</sub>                |
| D18           | .30001534E 02  | .50054607E 02  | .15236012E 03        |               |                     | I <sub>C</sub> /I <sub>B</sub> |

3. The worst cases for each node and dependent variable are automatically summarized by CIRC and printed out

sensitivities were positive, but in general some of the sensitivities would normally be negative. Column 5 of Table 3 shows the four parameter values that are to control the worst-case performance of node 1. All values are at the parameter's upper limits because all sensitivities were positive.

The sixth column of Table 3 shows the other parameter values, selection of which was not directly based on sensitivity data. These parameters fall into three categories. The parameters that had insignificant sensitivities are set to maximum values, as shown in the table. When a worst-case minimum unknown is being calculated, these parameters are set to minimum parameter values. The parameter that has equal nominal, minimum and maximum values is set to its only existent value. Parameters 15 through 18 are in the third category, "condition" parameters. These will be explained shortly.

**Worst-case analysis gives large volumes**

Figure 2 shows the results of the actual worst-case analysis for the maximum value of the node 1 voltage. The parameter values used to create

as a table. For the single transistor example, this table summarized 44 pages of computer printout.

this worst-case analysis are shown at the bottom of the printout. All the other variable values that appear in Fig. 2 are those that apply to the parameter set that created the worst-case maximum for node 1. An entirely new analysis with the parameters at opposite limits should be needed to determine the worst-case minimum value of the node 1 voltage.

Furthermore, full worst-case analysis of all the variables would require two solutions (one minimum and one maximum) for all nodes and all dependent unknowns. Figure 2 shows that in the present instance full worst-case analysis would involve  $(4 + 18) \times 2 = 44$  individual solutions. Therefore even the simple problem of this example requires a large volume of calculation to perform a full worst-case analysis.

It is right to conclude that at times it is not desirable to worst-case-analyze all unknowns. CIRC therefore has the capability of selecting those unknowns that are to be worst-case and excluding other unknowns.

Figure 2 contains only one worst-case node voltage value and many data that are not worst-case results per se—namely, three node voltages, 18 dependent unknowns, and 18 parameter values.



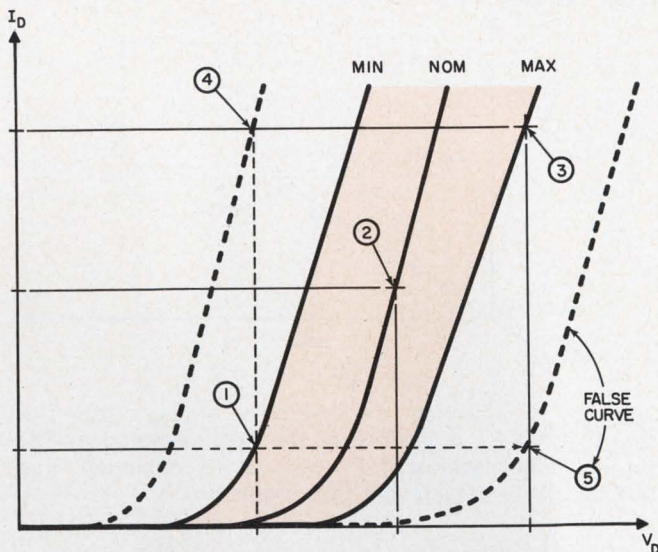

4. If independent parameter selection were allowed, then, by selecting a maximum value of voltage,  $V_D$ , and a minimum value of current,  $I_D$ , CIRC could create a false diode-performance curve. By making the current a "condition" parameter dependent on the voltage selected, this problem is avoided.

It is therefore very useful to have a summary of the worst-case analysis results (Fig. 3). For the example, Fig. 3 provides a summary of the data that could be obtained from the nominal solution output page plus 44 individual solution outputs of the form shown in Fig. 2.

CIRC offers three output options:

- Summary table only.
- Individual worst-case solutions.
- Individual worst-case solutions with parameters.

Option 1 means that no individual solutions are printed out during the analysis; only the summary table is obtained (this is automatically printed out at the end of a worst-case-analysis). The disadvantage of this is that the engineer obtains no data about the over-all conditions that exist when a particular worst-case result is obtained. On the other hand, when option 2 or 3 is used, it is possible to determine a great deal of data about over-all conditions. For example, all node voltages, device currents and transistor states, may be determined. Option 3 differs from option 2 only in having the parameters shown in Fig. 2.

#### Normal and 'condition' parameters

When a worst-case analysis program provides nonlinear component models such as the CIRC Ebers-Moll-type model, the program becomes responsible for handling component subtleties that are often overlooked when a component is modeled by the program user.

For example, with CIRC a diode is described primarily by a current and voltage point from the

### Description and availability

The general principles of worst-case analysis discussed in this article are applicable to any computer-aided analysis, but the analysis program used as an example is CIRC, a FORTRAN II-based program. It operates on any SDS-900-Series computer that has a minimum of 16,384 words of memory, and typewriter and paper-tape equipment. The program contains 29 FORTRAN and 17 SYMBOL machine-language sections.

At present the dc analysis section of CIRC is available to "installation members" of the SDS Users' Group. It is released in the form of a magnetic tape that contains both object versions ready for execution by the computer, and the major portion of CIRC in a card image of its original source-language form. CIRC is copyrighted by SDS. Non-SDS users interested in CIRC should contact Richard D. McNair, Scientific Data Systems, Inc., 1649 Seventeenth Street, Santa Monica, Calif. 90404.

nonlinear performance characteristics.

For worst-case analysis three classes of diode performance should be described—minimum, nominal and maximum (Fig. 4). In performing worst-case analysis, CIRC is normally allowed to select each parameter value independently. If CIRC selected a minimum value of current and a maximum value of voltage this could create an unacceptable false diode-performance curve, like point 5 in Fig. 4.

To avoid the false curve, CIRC does not treat the diode current and voltage data as independent data, but treats the diode voltage as an independent, or normal, parameter. The current is treated as a dependent parameter that specifies the "condition" under which the voltage is measured. Similarly the CIRC transistor model has three "condition" parameters:  $I_{E(act)}$  is the condition under which  $V_{BE}$  is obtained, and  $I_{B(sat)}$  and  $I_{C(sat)}$  are the conditions under which  $V_{(SAT)}$  is obtained.

In CIRC operation, if the normal parameter of a normal condition data set has a value during analysis that is less than nominal, then the condition parameter is set as a minimum value with data taken directly from its minimum data storage. The same type of procedure is used for maximum parameter value conditions. This means that the values of condition parameters are controlled by CIRC immediately after a specific analysis is begun.

#### Deficiencies of worst-case mechanism

A worst-case analysis may be imperfect if the worst-case parameter conditions are imperfectly

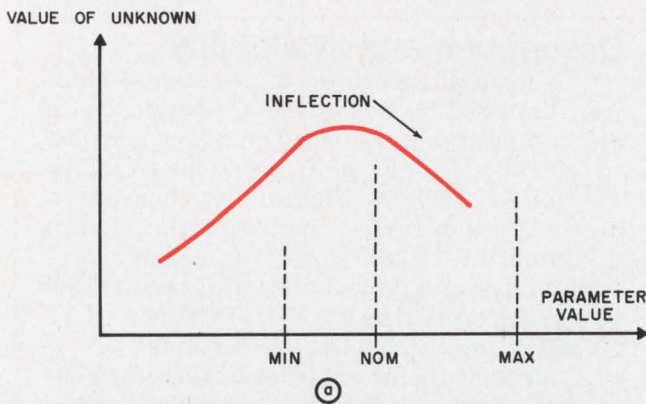

5. Two sources of error exist with the sign-only method of automatic worst-case analysis. First, the worst-case maximum (a) or minimum may lie between the minimum and maximum limits. The second error arises when an

determined or if an imperfect analysis is performed with the worst-case parameters selected. Some programs use linear models and approximation methods of worst-case analysis and so introduce error in the analysis itself. The procedure described in this article, however, has only the first type of deficiency—a deficiency in worst-case parameter selection.

There are two possible sources of error. Figure 5a shows a partial sensitivity that has an inflection between nominal and maximum parameter values. The worst-case maximum of the unknown therefore does not occur with the parameter at a maximum limit. When performing a worst-case analysis, CIRC selects a limit (maximum or minimum) value for each parameter and so may not actually find the absolute maximum for the unknown. An example of this type of performance is the power dissipation of a transistor (the unknown) versus the value of a resistor (the parameter) that determines the device drive. If the resistor variation changed the transistor operating point from below midrange active to above midrange active, the peak power dissipation would not be determined, since it occurs precisely at midrange active.

Figure 5b displays the characteristic that may result when an unknown actually depends on a number of parameters. The sensitivity data are obtained when one parameter is varied and the other parameters are nominal, a basic characteristic of partial derivatives. The curve shows a two-parameter, three-dimensional system in which the sensitivity of  $P1$  is influenced to go from positive to negative because of the secondary effect of parameter  $P2$ . Actual circuits have  $n + 1$  dimensions, where  $n$  may be a large number of parameters.

These two sources of error are not a matter of major concern for this reason: worst-case conditions should not normally cause devices to change bias states, for example, diodes should not change

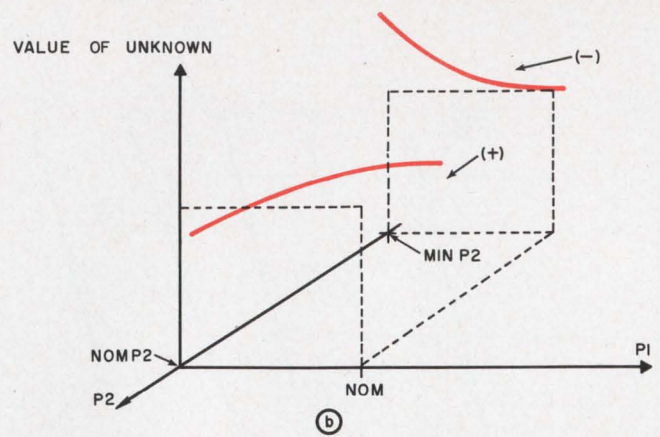

unknown is dependent on several parameters (b). The sensitivity of  $P1$  is positive at the nominal value of  $P2$ , yet would be negative if  $P2$  were at its minimum. See text for ways to overcome this problem.

from off to on. If bias states do not change, then the worst-case analysis is usually precise. If bias states do change, the parameter selection may fail slightly in creating an absolute worst case, but the fact that states change is sufficient to indicate a need for circuit redesign.

### Sorting improves worst-case analyses

Any procedures that would totally eliminate these two deficiencies would require a prohibitive amount of calculation. But CIRC has a simple feature that improves worst-case analysis with very little increase in analysis time. A sort is made every time a sensitivity evaluation is made or a worst case is calculated for a specific unknown.

The sort operates as follows. Each time a solution is completed, the resulting or present unknown values, all node voltages and all dependent unknowns, are individually compared with the previously recorded minimum and maximum values of that unknown. If the present value is less than the previous minimum, the present value replaces the previous minimum. If the present value is greater than the previous maximum, the previous maximum is replaced. This procedure makes maximum use of all the calculations that are performed.

The worst-case conditions for every unknown may be unique. That is to say, a different set of parameter value conditions may be required for each worst case of each unknown. However, there is often a strong similarity if not equality between the worst-case conditions for two different variables. The result is that each time a specific worst-case analysis is performed, a near worst case may be determined for other unknowns. Because sorting is used, all the near-worst-case values are recorded. Therefore performing specific worst-case analyses for a group of unknowns, for example, all node voltages, produces

a near worst case for other unknowns, for example, all the dependent unknowns.

Because of the extremely large volume of calculation required to worst-case-analyze all unknowns in large circuits, this near-worst-case feature is of considerable value.

### Message reports failure of worst-case mechanism

The sorting makes it possible to determine some of the times that the directly controlled worst-case analysis does not result in the absolute worst case. When CIRC is using the worst-case mechanism to determine the worst-case maximum of node 4, for example, the value obtained is checked to see if any sensitivity evaluation or the worst-case evaluation of nodes 1, 2 or 3 had produced a larger node 4 voltage value. If the value that had been sorted as the maximum of node 4 is larger than the present value, a special message is printed out:

```
MAX NODE 4 NOT WC, I.E. NOW = No.  
BEFORE = No.
```

This message reports the present value and the actual maximum value previously obtained. The actual maximum value remains as the worst-case maximum value. The same type of message appears if the worst-case mechanism does not produce an absolute minimum. These messages may also appear for dependent unknowns, abbreviated in the output message as D.EQ.

The error checking is done only at the time that a specific worst-case analysis is performed. After the specific worst-case evaluation of a given unknown is determined, additional values may be created. If these values are larger or smaller than previously determined, no message appears, but the actual worst-case value is sorted into the table that is put out as the worst-case summary output (Fig. 3).

### Analyze both analog and digital circuits

Without the aid of a computer, worst-case design procedures were normally applied only to digital circuits, primarily gating circuits with a very repetitive structure for the input and output portions of the circuit. With a general-purpose program available, however, worst-case analysis of both analog and digital circuits is equally possible and appropriate. This is because the sensitivity-determining procedure and worst-case parameter-setup-and-solution procedure are the same for both.

The circuit variables selected for worst-case analysis, however, are affected by the nature of the circuit. Consider a digital switching circuit. The states of the transistors within the circuit are normally the most critical characteristic of the circuit's performance. Suppose that for a true

input signal, the output device of the circuit is to be cut off. For the true case, then, an appropriate analysis would be to determine the worst-case maximum of the output devices  $V_{BE}$  or  $I_B$ . This would in effect try to force the output device on. If the worst-case parameter conditions were able to turn the device on, it would be a circuit failure.

This same circuit would typically have a false logical state in which the output device should be on. A program such as CIRC that has nonlinear mode's can be set up immediately to analyze the false condition by simply changing the logic state of the input. (This is not true of a linear analysis program). Once the logic state was set to false, the appropriate worst-case analysis would be one that tried to turn the output device off. The appropriate variable to maximize would be the ratio of  $I_C$  to  $I_B$  (this is one of the variables calculated by CIRC but not available in most other programs, and is calculated by SCAN.<sup>2</sup>) Worst-case analysis of this variable will simultaneously decrease base current and increase collector current to bring the output device out of saturation (the on condition).

Note that to analyze a switching circuit properly, two independent analyses are required—one for the true condition and one for the false, while an analog circuit will not normally require two independent analyses. ■■

### References:

1. R. D. McNair, "Computer talks to the circuit designer," *ELECTRONIC DESIGN*, XV, No. 21 (Oct. 11, 1967), 58-63.
2. C. T. Kleiner, E. D. Johnson and W. D. Ashcraft, "A General-Purpose System of Digital Computer Codes for Linear/Nonlinear Network and System Analysis," *IEEE International Convention Record*, XV (1967), Pt. 5, 136-148.

### Test your retention

*Here are questions based on the main point of this article. They are to help you see if you have overlooked any important ideas. You'll find the answers in the article.*

1. *What are the two principal tasks involved in worst-case analysis?*
2. *What are the dangers of obtaining sensitivity information in the form of partial derivatives?*
3. *How are condition parameters defined? What are they for the CIRC diode and transistor models?*
4. *What are the two possible sources of error in using the signs of the sensitivities for automatic worst-case analysis? Can they be avoided?*
5. *What is the effect of sorting on automatic worst-case analysis.*

**If you have power requirements\* in the 10 to 2900 mHz and up to 50 watt output range, there are twelve ways out (six singles, one with six plug-ins). All off the shelf.**

**You name it.**

*I'm interested in:*

**Single Units**

|                                      |               | <b>Power Output</b> |
|--------------------------------------|---------------|---------------------|
| <input type="checkbox"/> Model 404 A | 10-50 mHz     | 50 watts            |
| <input type="checkbox"/> Model 406 A | 50-200 mHz    | 50 watts            |
| <input type="checkbox"/> Model 408 B | 200-500 mHz   | 50 watts            |
| <input type="checkbox"/> Model 410 B | 500-1000 mHz  | 50 watts            |
| <input type="checkbox"/> Model 411 A | 900-1800 mHz  | 25 watts            |
| <input type="checkbox"/> Model 413   | 1800-2900 mHz | 5 watts             |
| <input type="checkbox"/> Model 445   | 10-2350 mHz   | 15-50 watts         |

(6 plug-in modules)

Name \_\_\_\_\_

Title \_\_\_\_\_

Company \_\_\_\_\_

Address \_\_\_\_\_

City \_\_\_\_\_

State \_\_\_\_\_ Zip \_\_\_\_\_

\*i.e. power meter calibration, antenna pattern measurements, power amplifier drive, varactor multiplier drive, susceptibility measurements, high attenuation measurements, testing filter characteristics, oscilloscope Rossi displays.



**Microdot Inc. Instrumentation Division**

220 Pasadena Avenue, South Pasadena, California 91030

ON READER-SERVICE CARD CIRCLE 156

**But, if you have some esoteric problems in transmitters, power sources or power amplifiers from 10 mHz to over 5 KmHz at power levels to over 1 kW, there's only one way out.**

**We name it.**  
(usually)

*Let's start some dialogue: I have:*

- Power Source
- Power Amplifier
- Transmitter

problems with these Parameters \_\_\_\_\_  
\_\_\_\_\_

For this application \_\_\_\_\_  
\_\_\_\_\_

Name \_\_\_\_\_

Title \_\_\_\_\_

Company \_\_\_\_\_

Address \_\_\_\_\_

City \_\_\_\_\_

State \_\_\_\_\_ Zip \_\_\_\_\_



**Microdot Inc. Instrumentation Division**  
220 Pasadena Avenue, South Pasadena, California 91030

ON READER-SERVICE CARD CIRCLE 156

# Taut-band or pivot-and-jewel?

You're buying more than a suspension system, so specify your panel meter carefully.

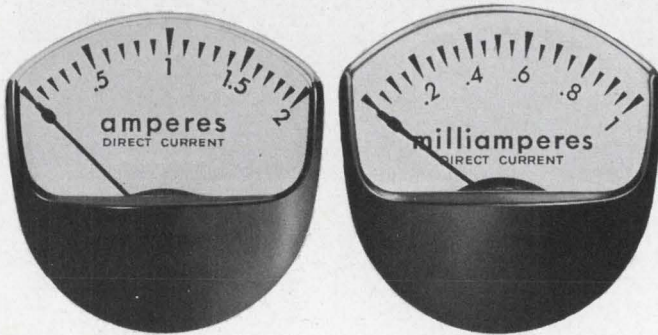

Which one has the taut band? One of these two is a taut-band panel meter; the other a pivot-and-jewel meter. Since there is no apparent difference between the two except that one is calibrated in amperes and the other in milliamperes, it is impossible to tell them apart simply by looking at them. However, there are major internal differences (see box) that show up only in performance. A knowledge of the basic characteristics of taut-band meters compared with pivot-and-jewel meters can help you make the best choice for your equipment.

## Lower power loss in taut bands

Since there is no pivot friction in taut-band meters, the restoring force required is considerably less than by the pivot-and-jewel meters, so that much less power is required to drive the pointer upscale. Sample calculations show the power loss difference between meters.

The restoring torque is equal to the torque developed by the current in the moving coil interacting with the permanent magnet, whenever the meter pointer is at equilibrium. The meter torque,  $T$ , is given by:

$$T = 2BerIN/10^4, \quad (1)$$

where:

- $T$  = meter torque in dyne·cm,
- $B$  = magnetic flux density in gauss,
- $e$  = length of active coil form in the air gap in cm,
- $r$  = radius of coil form in cm,
- $I$  = current moving through coil in mA,

**John H. Maislinger**, Chief Engineer, Honeywell, Precision Meter Division, Manchester, N.H.

$N$  = number of turns on coil form.

The power loss,  $P$ , of a meter is given by:

$$P = I^2R, \quad (2)$$

where:

$P$  = power loss in watts,

$I$  = current in amperes,

$R$  = terminal resistance in ohms.

The voltage drop,  $E$ , across a meter is given by Ohm's law:

$$E = IR, \quad (3)$$

where:

$E$  = voltage drop in volts,

$I$  = current through moving coil in amperes,

$R$  = the meter's terminal resistance in ohms (most of which is in the coil).

Thus for a pivot-and-jewel meter with a scale range from 0 to 50  $\mu$ A,  $B = 3800$  gauss,  $e = 1.3$  cm,  $r = 1.1$  cm,  $N = 1500$ , and  $R = 1650$  ohms, Eq. 1 shows the torque to be:

$$T = (3800)(2)(1.3)(1.1)(0.05)(1500)/10^4 \\ = 81.5 \text{ dyne}\cdot\text{cm}.$$

The meter's power loss from Eq. 2 is:

$$P = (0.00005)^2(1650) = 4.1 \mu\text{W}.$$

And its voltage drop is:

$$E = (0.00005)(1650) = 82.5 \text{ mV}.$$

It is feasible to build a taut-band meter with the same characteristics as this pivot-and-jewel meter. But what of a taut-band design with the same scale range, sensitivity and damping as the pivot-and-jewel unit? A taut-band meter with the same design constants can be built with 450 turns on the coil and a terminal resistance of 130 ohms. Equations 1 through 3 show that torque is 24.5 dyne·cm, power loss is 0.325  $\mu$ W, and the voltage drop is 6.5 mV.

## Response time depends on torque

Response time is defined by ASA Spec. C39.1 (1964) as the time required for a meter pointer to travel from zero to a new rest position. The pointer is at effective rest when it remains within a range equal to one-half of its accuracy rating on either side of its final position. In a meter with a 2% accuracy, for example, the pointer is considered to be at rest when it remains within 1% to either side of its rest position. The natural time period,  $t_0$ , for

## The evolution of a suspension system

For many years, the basic design of the permanent-magnet-moving-coil instrument has remained substantially unchanged. The principle of a current-carrying conductor moving in the field of a permanent magnet which deflects the pointer upscale is still being used much as it was decades ago. The method of suspending the moving parts, however, has changed. Figure 1 shows the suspension of the moving system used in the very early models built by Jacques d'Arsonval and others. The coil and pointer are suspended by a filament or wire, and the wire, which also provided the restoring force, is held under tension by a weight. These early instruments were position-sensitive and had to be leveled accurately before a reading could be taken. Erroneous readings due to hysteresis of the suspension wire were also a problem.

To overcome these difficulties, a pivot-and-jewel suspension (Fig. 2) was introduced. A

pair of pivots is attached to the coil and a pair of jewels provides the bearing surface for the pivots. Spiral hair springs were added later to provide the restoring torque. While this eliminated earlier difficulties, new problems, inherent in pivot-and-jewel suspension, were introduced. Pivot friction causes erroneous readings, and usually gets worse the more the meter is used. For that reason, pivot-and-jewel meters are tapped lightly before a reading is taken.

Suspending the moving coil as in the basic taut-band design of Fig. 3, eliminates most of the design disadvantages of Figs. 1 and 2. After World War II, this method of suspension came into wide use. The moving coil is suspended between two metal ribbons under tension provided by two cantilever springs. While the taut-band meter has many advantages, it also has drawbacks. A comparison of meter performance will bear this out.

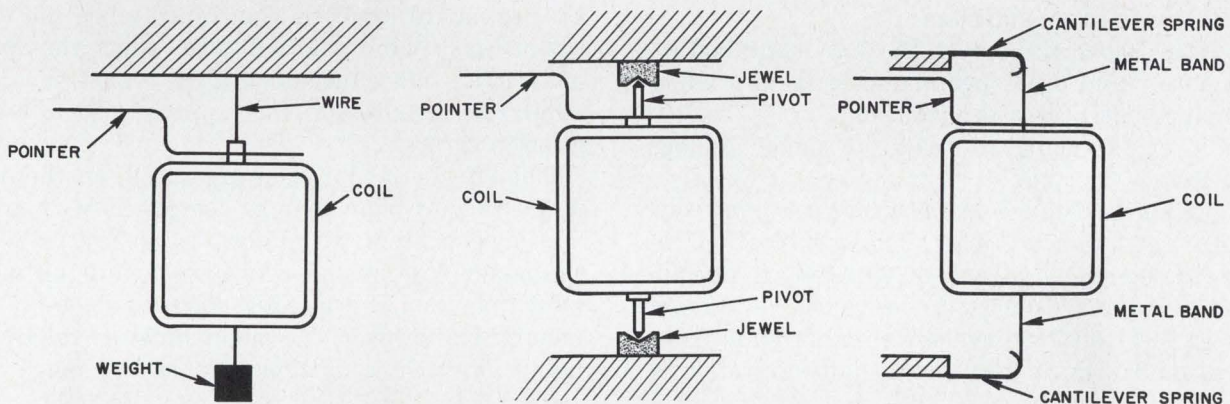

1. **Early meter design** basically parallels today's taut-band. A coil with a pointer is suspended by a wire held under tension by a weight. This design was obviously very position-sensitive and prone to hysteresis error.

2. **Pivot-and-jewel design** is practically insensitive to position. Pivots are attached to a coil with jewels providing the bearing surface. This eliminates many problems but introduces errors due to friction.

3. **Taut-band design** reverts to the earlier method of suspending the coil—now with a short metal band held under tension by the two cantilever springs. The band also provides restoring torque and electrical connection.

the moving element of a meter is given by:

$$t_0 = 2\pi(K/S)^{1/2}, \quad (4)$$

where:

- $t_0$  = natural time period in seconds,
- $K$  = moment of inertia of moving element in  $\text{gm} \cdot \text{cm}^2$ ,
- $S$  = meter torque per radian in  $\text{dyne} \cdot \text{cm}/\text{rad}$ .

The response time,  $\tau$ , of a meter is given by:

$$\tau = t_0 F \quad (5)$$

where  $t_0$  is the time period and  $F$  is a factor that depends on the damping of a meter.  $F$  is 1, for instance, for a meter with 5% overshoot and becomes 0.67 for near-critical damping.

For the same pivot-and-jewel meter, the moment of inertia is  $0.53 \text{ gm} \cdot \text{cm}^2$  and overshoot is 5%, so  $F = 1$ . The torque for  $100^\circ$  deflection was calcu-

lated as  $81.5 \text{ dyne} \cdot \text{cm}$ . The torque per radian,  $S$ , is then:

$$S = (81.5/100^\circ) (180^\circ/\pi) = 46.7 \text{ dyne} \cdot \text{cm}/\text{rad}.$$

From Eq. 3 the natural time period is:

$$t_0 = 2\pi(0.53/46.7)^{1/2} = 0.67 \text{ seconds},$$

And response time is:

$$\tau = (0.67)(1) = 0.67 \text{ seconds}.$$

The same taut-band meter as that used as an example previously has a torque per radian of  $14.04 \text{ dyne} \cdot \text{cm}/\text{rad}$ , and has both a natural time period and a response time of 1.22 seconds.

While the taut-band meter's power loss is lower by more than one order of magnitude than that of the pivot-and-jewel version, the response time is less than doubled. If this response time is not satis-

factory, the damping can be increased to near critical ( $F = 0.67$ ). The response time of the taut-band meter is then cut to 0.82 second.

As summarized in Table 1, the taut-band meter can be designed in a variety of forms to give a range of performance characteristics. The first version in Table 1 is a duplicate of the pivot-and-jewel meter except, obviously, for the suspension of the moving element. The second design is a minimum-power-loss version and the third offers a response time fairly close to that of the pivot-and-jewel meter but with power loss almost as low as that of the minimum-loss meter.

### Environment affects both types of meter

Vibration, shock, position and other environmental conditions affect both types of meter in different ways. The user should know the environmental extremes of his application before specifying.

The "vibration resistance" of meters can be defined under two conditions:

- The user is concerned with the detrimental effect on accuracy and other performance factors when the meter is subjected to vibration.
- The user is trying to read the meter during vibration.

Vibration resistance in the first case is set out in ASA Spec. C39.1 (1964). The specification requires the double amplitude of vibration to be 0.02 inches and the frequency to be varied uniformly between 500 and 2500 cycles per minute, or from 8.33 to 41.67 Hz. Meters are usually vibrated in

several planes for a total of three hours. The allowable additional error due to vibration is equal to the amount of the initial rated accuracy. For instance, a meter with an accuracy of  $\pm 2\%$  is allowed a total error of  $\pm 4\%$  after vibration. The gravity forces acting on the instrument are:

$$g = 0.051Df^2, \quad (6)$$

where:

$g$  = gravity units,

$D$  = double amplitude in inches,

$f$  = frequency in Hz.

Then the maximum  $g$  force to which a meter is subjected during the vibration spelled out in the specification is:

$$g = (0.051)(0.02)(41.67)^2 = 1.77 \text{ gravity units.}$$

No standards have been established for the second case since conditions are more complex and difficult to define.

The friction levels of a pivot-and-jewel meter usually show a marked increase after vibration. If a meter is to be read during vibration, only small deviations of the pointer from its true position are ordinarily observed. Continued vibration while the meter is being read will also reduce the apparent friction, since the effect of the vibration will be similar to the effect of the tapping used to reduce friction errors.

The effects of vibration are small, on the other hand, in taut-band meters compared with pivot-and-jewel meters. In almost all instances where the meter does not have to be read during actual vibration, then, it is advantageous to use taut-band meters. If, however, the meter must be read while being vibrated, conditions are rather more com-

**Table 1. Performance of four meter designs**

| Performance characteristics   | Pivot-&jewel | Taut-band                 |                    |  |
|-------------------------------|--------------|---------------------------|--------------------|--|
|                               |              | Duplicate of pivot-&jewel | Minimum power loss | Low power loss, response similar to pivot-&jewel |
| Scale range ( $\mu A$ )       | 0-50         | 0-50                      | 0-50               | 0-50   |
| Power loss ( $\mu W$ )        | 4.1          | 4.1                       | 0.325              | 0.354  |
| Voltage drop (mV)             | 82.5         | 82.5                      | 6.5                | 7.1  |
| Response time (seconds)       | 0.67         | 0.67                      | 1.22               | 0.82   |
| Full-scale torque (dyne · cm) | 46.7         | 46.7                      | 24.5               | 24.5   |
| Damping factor ( $d$ )        | 20           | 20                        | 20                 | 99   |
| Damping ratio ( $n$ )         | 0.7          | 0.7                       | 0.7                | 0.826  |



plex. While taut-band meters can absorb vibration for long periods of time, the pointer may at times deviate from its true position. A description of the taut-band suspension system (Fig. 4) helps to understand the meter's behavior under vibration.

Cantilever springs provide tension for the bands that suspend the moving element. This arrangement keeps the element free from frictional forces, except for negligible molecular friction within the band material when the bands are twisted during upscale movement of coil and pointer. This suspension system has a less rigid axis than pivot-and-jewel suspension. Under vibration the moving coil and the pointer are, within limits, free to travel in any direction, depending on the forces acting on the system. The cantilever springs deflect to protect the bands against breakage by shock during shipment or in use. However, this construction makes the system subject to oscillation. The type and amplitude of oscillation depends on external factors such as the direction and frequency of the exciting forces, and on internal factors such as band tension, band size, band lengths, the weight and configuration of the coil and pointer, and the spring rate of the cantilever springs.

The results of meter vibration tests help in predicting what can be expected of a taut-band meter under vibration. When an energized meter is being subjected to vibration with a constant  $g$  force of 0.5  $g$  through a frequency range of 5 to 500 Hz, the pointer will indicate the correct value over most of the frequency spectrum.

Over some narrow frequency bands, resonance of the moving parts of the system occurs. When

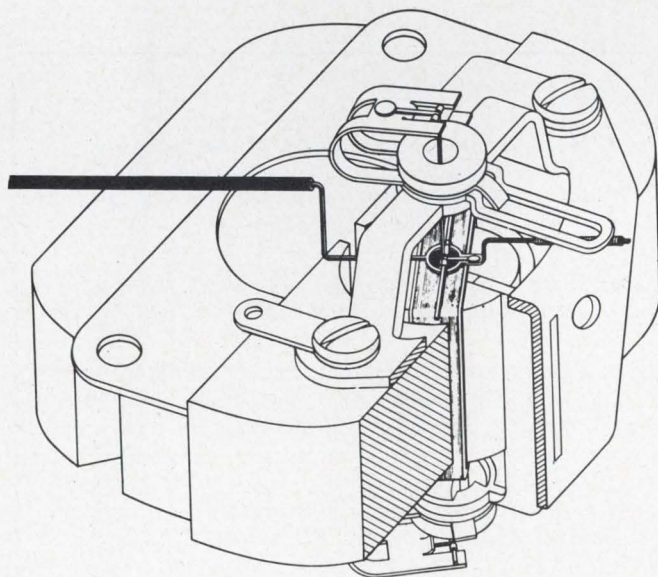

4. **Modern taut-band design** is susceptible to vibration. The type and amplitude of oscillation depend on the band tension, size and length, the weight and configuration of the coil and pointer assembly, and the spring rate of the cantilever springs.

this happens, the pointer may deviate from its true position anywhere from 1% to 5% of the scale length. The largest deviation will usually occur near the center of these frequency bands with fall-off on either side towards zero deviation. At this resonant peak, a reduction of the  $g$  force to 0.1  $g$  may not diminish pointer deviation much, but it will shrink the frequency bandwidth over which deviations occur. Increasing the  $g$  force to 1  $g$  or more sometimes accounts for additional resonant points within the given frequency spectrum. This indicates that the various components of the moving system resonate at different frequencies.

Panel meters are specified as withstanding 50- $g$  shocks with any additional error that is introduced not to exceed an amount equal to the rated accuracy. For instance, a meter with an accuracy rating of  $\pm 2\%$  is allowed a total error of  $\pm 4\%$  after the shock test. The accuracy of taut-band meters is usually less affected by shock than pivot-and-jewel meters. Excessive shock due to misuse may, however, cause band breakage, rendering the meter inoperative.

In accordance with the same ASA Spec. C39.1, panel meters are normally calibrated for use in a dial-vertical position. They can, however, be calibrated for use in a vertical or a horizontal position or any position in between. This applies to both pivot-and-jewel and taut-band meters.

Many users check the position influence by rotating the meter about the pivot axis of the mechanism. In some instances, this causes the pointer to change position and so arouses concern. Actually, however, there is no cause for alarm since this method of checking the influence of position on the meter does not represent the operating condition. As long as the meter reads accurately in the specified operating position or positions  $\pm 5^\circ$  tilt, there should be no concern.

The effects of temperature, overload and humidity are in general about the same for both taut-band and pivot-and-jewel meters. Table 2 summarizes the basic performance characteristics.

#### User specifies meter damping

If a meter is designed and applied correctly, there is no difference in the damping factors between taut-band meters and pivot-and-jewel meters. Underdamping, overdamping and near critical damping are obtainable in both designs.

To define the damping factor, let  $A$  be the zero position,  $B$  the position of furthest travel and  $C$  the steady-state position of the pointer. The distance between  $B$  and  $C$  is called overtravel or overshoot, expressed as a percentage of full scale. The damping factor,  $d$  is given by:

$$d = AC/CB. \quad (7)$$

For example, the pointer of a 50- $\mu$ A meter reaches

the end-scale mark when 40  $\mu\text{A}$  are suddenly applied. It then settles down at the 40- $\mu\text{A}$  point. The damping factor is then  $40/10 = 4$ .

A meter is considered to be critically damped when overshoot is present but does not exceed an amount equal to one-half the rated accuracy. For instance, a meter with  $\pm 2\%$  accuracy and an overshoot of no more than 1% is critically damped.

ASA Spec. C39.1 calls for a minimum damping factor of 2.5 for most moving-coil panel meters. So from Eq. 7, a meter with  $100^\circ$  deflection can have no more than  $28.5^\circ$  overshoot beyond the steady-state value when a signal is suddenly applied.

Equation 7 also says that the damping factor of an overdamped meter (no overshoot) is infinity. It does not, however, define the amount of overdamping. For this reason the damping ratio,  $n$ , is defined. The damping ratio is less than one for underdamping, more than one for overdamping and one for critical damping. The relationship between the damping factor,  $d$ , and ratio,  $n$ , is:

$$n = \left[ \frac{1}{(\pi/\ln d)^2 + 1} \right]^{1/2} \quad (8)$$

The meter designer usually works with this damping ratio rather than the damping factor. Since its value cannot be readily observed on a meter, however, the user may prefer to specify overshoot expressed as a percentage of full scale. In specifying, it should be remembered that special requirements for damping factor and response time (also called special ballistics) will usually add to the price of a meter.

With little damping, the pointer moves very quickly upscale when a signal is suddenly applied, but it takes a long time for it to come to rest. With overdamping, the pointer travels slowly upscale and no overshoot is observed. The amount of overdamping determines how long the pointer will take to come to rest. The fastest response time in a regular panel meter is obtained with near-critical damping. Table 3 shows the response time of a 50- $\mu\text{A}$  taut-band as the damping factor is varied. Unless otherwise specified, the damping factor and response time are checked according to ASA Spec. C39.1, which stipulates that the source impedance of the signal should be at least 100 times as great as the meter's terminal resistance.

Depending on the type of meter, the source impedance of the circuit to which the meter is connected can be of importance. The counter emf produced in the coil winding when the coil is moving through the permanent magnet field will cause a damping current to flow. Apart from the meter design constants, it is the source impedance that is the determining factor for the damping current. A low source impedance can cause certain types of meters to be very much overdamped; the response time will then be relatively long. ■ ■

**Table 2. Comparison checklist**

| Characteristic                         | Taut-band | Pivot-and-jewel |
|--|-----------|-----------------|
| Shorter response time                  |           | ✓               |
| Lower power loss                       | ✓         |                 |
| Lower voltage drop                     | ✓         |                 |
| Accuracy after shock                   | ✓         |                 |
| Resistance to breakage from shock      |           | ✓               |
| Accuracy during vibration              |           | ✓               |
| Maintains accuracy after vibration     | ✓         |                 |
| No errors due to friction              | ✓         |                 |
| No errors due to mechanical hysteresis |           | ✓               |
| Lower cost                             |           | ✓*              |

\*As a general rule, pivot-and-jewel meters cost the same as or less than taut-band meters. For example, Honeywell sells a 50- $\mu\text{A}$  3-1/2-inch pivot-and-jewel for \$9.99 each; a comparable taut-band costs \$12.05. Honeywell also sells a cheaper taut-band, the Auto-Torque, which has 50% fewer parts, for \$8.85 each. All prices are for 100-piece quantities.

**Table 3. Damping factor vs response**

| Damping factor ( $d$ ) | Damping ratio ( $n$ ) | Response time (seconds) |
|------------------------|-----------------------|-------------------------|
| 4                      | 0.4                   | 2                       |
| 10                     | 0.6                   | 1.6                     |
| 20                     | 0.7                   | 1.22                    |
| 99                     | 0.826                 | 0.82                    |
| very overdamped (>100) | 1.6                   | 2.5                     |

**Test your retention**

*Here are questions based on the main points of this article. They are to help you see if you have overlooked any important ideas. You'll find the answers in the article.*

- 1. Why is the response time of a pivot-and-jewel meter shorter than that of a taut-band?*
- 2. The damping ratio is a better measure than the damping factor in describing one meter parameter. Which one, and why?*
- 3. Taut-band meters survive vibration well, yet pivot-and-jewel meters yield a more accurate reading during vibration. Why?*
- 4. The pointer of a 100  $\mu\text{A}$  meter reaches the end-scale mark when 90  $\mu\text{A}$  are applied. It then settles down at 90  $\mu\text{A}$ . What is the meter's damping factor? Its damping ratio? Is it underdamped, overdamped or critically damped?*

# Now—the broadest line of convection-cooled, all silicon, .015% regulated power supplies

For test equipment and lab use 0-10,-20,-40,-60,-120 VDC, from 0-.5 amp to 0-66 amps

## Features and Data

- Rack or bench use
- Full five year guarantee on materials and labor
- Convection Cooled
- Remote Programming
- Regulation—.015% or 1 MV (Line or Load)
- Temp. Coef. .015%/°C
- Completely Protected—Short circuit proof—Continuously adjustable Automatic current limiting
- Remote Sensing
- Constant I./Constant V. by automatic crossover
- Series/Parallel Operation
- No Voltage Spikes or Overshoot on "turn on", "turn off" or power failure
- Ripple—LK models—500  $\mu$ V RMS  
LH models—250  $\mu$ V RMS, 1 MV P-P
- Meet MIL Environment Specs

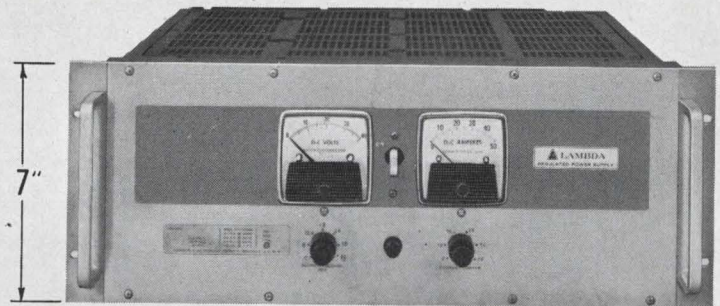

Full Rack 7" LK Series

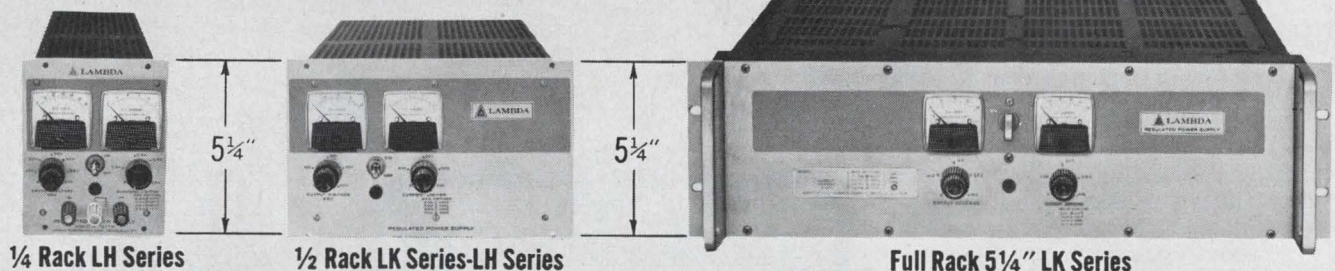

1/4 Rack LH Series

1/2 Rack LK Series-LH Series

Full Rack 5 1/4" LK Series

3 Full-rack Models — Size 7" x 19" x 18 1/2"

| Model <sup>2</sup> | Voltage Range | CURRENT RANGE AT AMBIENT OF: <sup>1</sup> |       |       |       | Price <sup>2</sup> |
|--------------------|---------------|---|-------|-------|-------|--------------------|
|                    |               | 40°C                                      | 50°C  | 60°C  | 71°C  |                    |
| LK 360 FM          | 0-20VDC       | 0-66A                                     | 0-59A | 0-50A | 0-40A | \$995              |
| LK 361 FM          | 0-36VDC       | 0-48A                                     | 0-43A | 0-36A | 0-30A | 950                |
| LK 362 FM          | 0-60VDC       | 0-25A                                     | 0-24A | 0-22A | 0-19A | 995                |

3 Full-rack Models — Size 5 1/4" x 19" x 16 1/2"

| Model <sup>2</sup> | Voltage Range | CURRENT RANGE AT AMBIENT OF: <sup>1</sup> |       |         |       | Price <sup>2</sup> |
|--------------------|---------------|---|-------|---------|-------|--------------------|
|                    |               | 40°C                                      | 50°C  | 60°C    | 71°C  |                    |
| LK 350             | 0-20VDC       | 0-35A                                     | 0-31A | 0-26A   | 0-20A | \$675              |
| LK 351             | 0-36VDC       | 0-25A                                     | 0-23A | 0-20A   | 0-15A | 640                |
| LK 352             | 0-60VDC       | 0-15A                                     | 0-14A | 0-12.5A | 0-10A | 650                |

5 Quarter-rack Models — Size 5 3/16" x 4 3/16" x 15 1/2"

| Model <sup>2</sup> | Voltage Range | CURRENT RANGE AT AMBIENT OF: <sup>1</sup> |         |         |         | Price <sup>2</sup> |
|--------------------|---------------|---|---------|---------|---------|--------------------|
|                    |               | 30°C                                      | 50°C    | 60°C    | 71°C    |                    |
| LH 118             | 0-10VDC       | 0-4.0A                                    | 0-3.5A  | 0-2.9A  | 0-2.3A  | \$175              |
| LH 121             | 0-20VDC       | 0-2.4A                                    | 0-2.2A  | 0-1.8A  | 0-1.5A  | 159                |
| LH 124             | 0-40VDC       | 0-1.3A                                    | 0-1.1A  | 0-0.9A  | 0-0.7A  | 154                |
| LH 127             | 0-60VDC       | 0-0.9A                                    | 0-0.7A  | 0-0.6A  | 0-0.5A  | 184                |
| LH 130             | 0-120VDC      | 0-0.50A                                   | 0-0.40A | 0-0.35A | 0-0.25A | 225                |

11 Half-rack Models — Size 5 3/16" x 8 3/8" x 15 1/2"

| Model <sup>2</sup> | Voltage Range | CURRENT RANGE AT AMBIENT OF: <sup>1</sup> |         |         |        | Price <sup>2</sup> |
|--------------------|---------------|---|---------|---------|--------|--------------------|
|                    |               | 40°C                                      | 50°C    | 60°C    | 71°C   |                    |
| LK 340             | 0-20VDC       | 0- 8.0A                                   | 0- 7.0A | 0- 6.1A | 0-4.9A | \$330              |
| LK 341             | 0-20VDC       | 0-13.5A                                   | 0-11.0A | 0-10.0A | 0-7.7A | 385                |
| LK 342             | 0-36VDC       | 0- 5.2A                                   | 0- 5.0A | 0- 4.5A | 0-3.7A | 335                |
| LK 343             | 0-36VDC       | 0- 9.0A                                   | 0- 8.5A | 0- 7.6A | 0-6.1A | 395                |
| LK 344             | 0-60VDC       | 0- 4.0A                                   | 0- 3.5A | 0- 3.0A | 0-2.5A | 340                |
| LK 345             | 0-60VDC       | 0- 6.0A                                   | 0- 5.2A | 0- 4.5A | 0-4.0A | 395                |

| Model <sup>2</sup> | Voltage Range | CURRENT RANGE AT AMBIENT OF: <sup>1</sup> |         |         |        | Price <sup>2</sup> |
|--------------------|---------------|---|---------|---------|--------|--------------------|
|                    |               | 30°C                                      | 50°C    | 60°C    | 71°C   |                    |
| LH 119             | 0-10VDC       | 0- 9.0A                                   | 0- 8.0A | 0- 6.9A | 0-5.8A | \$289              |
| LH 122             | 0-20VDC       | 0- 5.7A                                   | 0- 4.7A | 0- 4.0A | 0-3.3A | 260                |
| LH 125             | 0-40VDC       | 0- 3.0A                                   | 0- 2.7A | 0- 2.3A | 0-1.9A | 269                |
| LH 128             | 0-60VDC       | 0- 2.4A                                   | 0- 2.1A | 0- 1.8A | 0-1.5A | 315                |
| LH 131             | 0-120VDC      | 0- 1.2A                                   | 0- 0.9A | 0- 0.8A | 0-0.6A | 320                |

<sup>1</sup> Current rating applies over entire voltage range.

<sup>2</sup> Prices are for non-metered models (except for models LK360FM thru LK362FM which are not available without meters). For metered models, add suffix (FM) and add \$25 to price of LH models; add \$30 to price of LK models.

<sup>3</sup> Overvoltage Protection: add suffix (OV) to model number and add \$60 to the price of LH models; add \$70 to price of half-rack LK models; add \$90 to price of 5 1/4" full-rack LK models; add \$120 to price of 7" full-rack LK models.

<sup>4</sup> Chassis Slides for full rack models: Add suffix (CS) to model number and add \$60 to the price.



**LAMBDA** ELECTRONICS CORP.

TERMINAL DRIVE • PLAINVIEW, L.I., NEW YORK 11803 • 516-681-8300

A  SUBSIDIARY

LA-182A

Growth of good basic design makes **hp** oscillators

## YOUR BEST CHOICE FOR A WIDE VARIETY

Hewlett-Packard Oscillators are the progressive growth of the first successful Wien-bridge oscillator design introduced to the measurement industry by Hewlett-Packard in 1939. Now you can select from a variety of fifteen hp instruments using improved components and the well-known Hewlett-Packard RC oscillator design to give you the best price-to-performance ratio on the market! Choose from frequency ranges of 1 Hz to 10 MHz.

**General Purpose Oscillators.**—The *hp Model 200CD* is a direct descendant of the first Wien-bridge design. With its low price, high power, balanced output and low distortion, the 200CD is an ideal instrument for school, communications and military use.

You get a fully-transistorized and battery-powered signal source with easily-portable *hp Model 204B*. Amplitude and frequency control circuits give excellent stability over a range of 5 Hz to 560 kHz. You also get a completely floating output, isolated from chassis and ground. The 204B is ideal for field use.

**Test Oscillators.**—The *hp Model 651B* Test Oscillator is an advanced design, wide-band, solid state test oscillator! This line-operated instrument gives you a wide frequency range of 10 Hz to 10 MHz with highly stable amplitude and frequency. There are separate 50 $\Omega$  and 600 $\Omega$  calibrated outputs. A 75 $\Omega$  output is optional.

Battery-powered *hp Model 208A* Test Oscillator is a compact, lightweight, easily-carried laboratory or field source of 5 Hz to 560 kHz signals.

**Pushbutton Digital Oscillator.**—For your production line or wherever you have repetitive testing, the *hp Model 241A* Oscillator gives positive pushbutton frequency selection from 10 Hz to 1 MHz. You get repeatable test signals with three-digit frequency resolution. Set 4500 discrete frequencies!

### **A** Pick *hp Model 200CD* Oscillator For A Low-Cost, General Purpose Instrument

— When you need a low distortion signal independent of load—you'll get excellent results with *hp Model 200CD* Oscillator! Use it for generating subsonic to radio frequencies; testing servo and vibration systems; supplying medical and geophysical equipment; for checking audio circuits and systems.

The output of the 200CD is 600 $\Omega$  balanced, with a balanced accuracy of 0.1 to 1%, depending on frequency. Accurate frequency settings over a range of 5 Hz to 600 kHz are possible with the 85 dial divisions, effective scale length of 78 inches, and a vernier drive for precise adjustment. Frequency response is  $\pm 1$  dB over the entire range.

Distortion rating of sinewave output is less than 0.2% below 200 kHz. The modified *hp Model H20-200CD* provides a low distortion of 0.06% in the 60 Hz to 50 kHz range.

For excellence in design in a general purpose oscillator, pick *hp Model 200CD*. Price is only \$225.00

### **B** Pick *hp Model 204B* Oscillator for Portable, Highly-Stable Signal Source

Solid-state, battery-powered *hp Model 204B* Oscillator is an excellent choice for a source of stable, accurate signals in the field. You have an unusually low

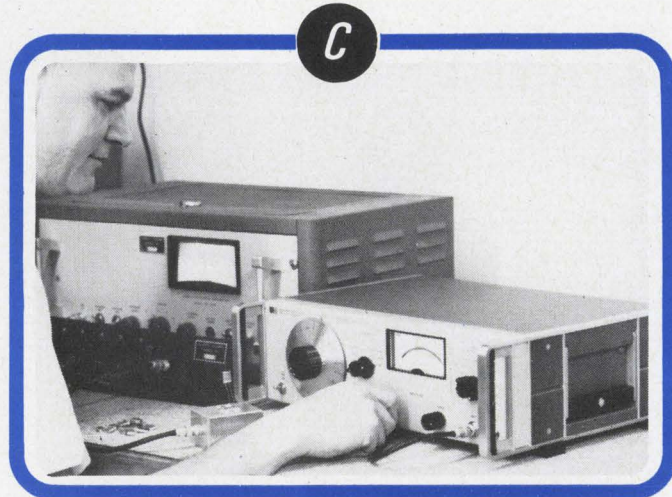
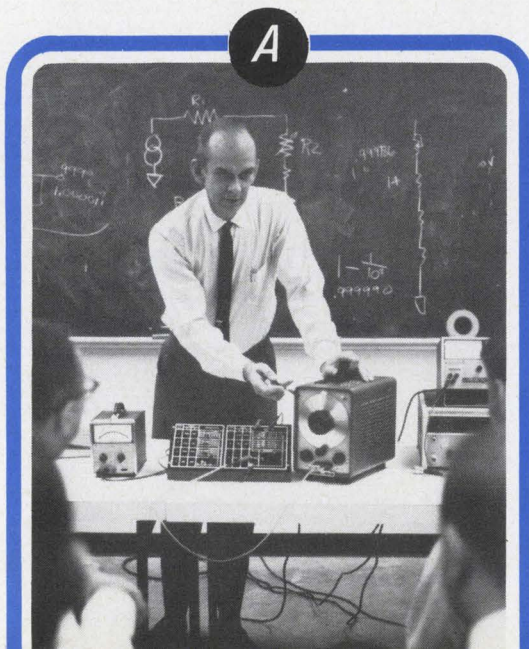
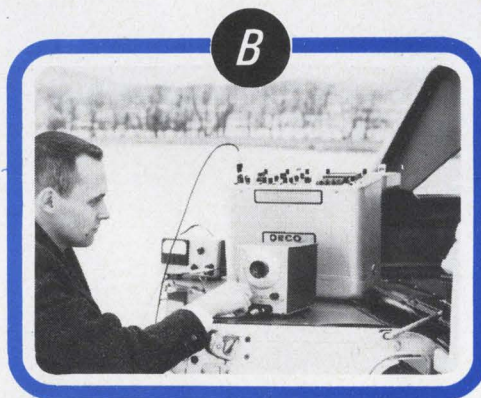

# OF LOW COST, SUPERIOR SIGNAL SOURCES

drift on warm-up; instantly available signals over a frequency range of 5 Hz to 560 kHz!

Stability is typically better than 5 parts in  $10^4$ —even at 560 kHz! Rapidly changing loads do not affect stability. Output is fully floating, flat within  $\pm 3\%$  at all settings of the dial and range switch.

Price of the hp Model 204B: Equipped with mercury batteries, \$315.00; with ac power supply in place of batteries (Option: 01), \$350.00; with rechargeable batteries and recharging circuit self-contained for ac or dc operation (Option: 02), \$390.00.

## C Pick hp Model 651B Test Oscillator for Accurate 10 MHz Frequency

**Range** — Outstanding flatness, stability and accuracy from 10 Hz to 10 MHz are yours with the hp Model 651B Test Oscillator. You get a typical  $\pm 0.1\%$  amplitude stability and  $\pm 0.02\%$  frequency stability, and a 1% accurate 90 dB output attenuator.

The 651B has two outputs: 200 mW into  $50\Omega$ , and 16 mW into  $600\Omega$ . Output attenuator has a 90 dB range in 10 dB steps, with a 20 dB coarse and fine amplitude controls for increased resolution in setting output voltage. Attenuator accuracy is  $\pm 0.1$  dB from  $-60$  dBm to  $+20$  dBm,  $\pm 0.2$  dB on  $-70$  dBm range. Output monitor is calibrated to read volts or dBm into a matched load. Price: hp Model 651B, \$590.00.

652A: The hp Model 652A is identical to 651A, with the additional ability to monitor output amplitudes within 0.25% over the entire frequency range of the instrument using the X20 expanded scale. Uppermost scale of the

652A reads in percent for quick reading of frequency response measurements. Price: hp Model 652A, \$725.00.

208A: Add a meter for accurate setting of output voltage and an attenuator to the 204B, and you have the hp Model 208A Test Oscillator. Model 208A is calibrated in volts, covering 0.01 mV to 1 V full scale with a 2.5 multiplier to extend range to 2.5 V. Model 208A (Option: 01) is calibrated in dBm for 0 to 110 dB in 1-dB steps. Output is constant within  $\pm 3\%$  at all attenuator settings over 5 Hz to 560 kHz range. Price: hp Model 208A, \$525.00; hp Model 208A (Option: 01), \$535.00.

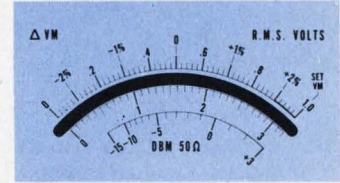

652A Expanded Scale Monitor

## D Pick hp Model 241A Oscillator for Pushbutton Repeatability

— Repeatability possible with the hp Model 241A digital oscillator makes it ideal for production line use—or in the laboratory where repetitive testing is a requirement. Set any frequency between 10 Hz and 999 kHz to three significant figures—simply by pushing buttons! This solid state instrument is designed with special hp precision resistors to provide typical frequency repeatability of 0.01%. Frequency accuracy is within  $\pm 1\%$  selected value on any range.

Infinite frequency resolution is provided by a vernier control, which also extends the upper frequency to 1 MHz. Output is flat within  $\pm 2\%$  over the entire range at any attenuator setting.

Use the 241A as a digital frequency source for filters and frequency sensitive circuits. Response test at audio and communication frequencies, or use it as a repeatable source in production testing. Price: hp Model 241A, \$490.00.

For full details on the wide variety of hp oscillators shown here and in our catalog, call your nearest hp field engineer. Or, write to Hewlett-Packard, Palo Alto, California 94304. Europe: 54 Route des Acacias, Geneva.

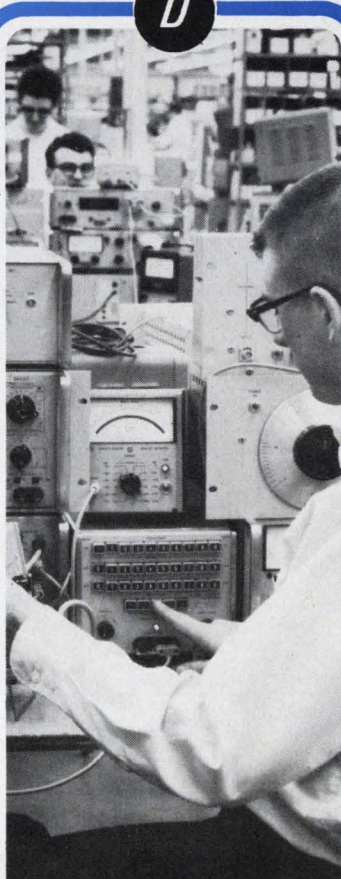

|                                 | 200CD   | 204B                                 | 208A   | 651B   | 241A  |
|---------------------------------|---|--------------------------------------|--|--|---|
| Frequency                       | 5 Hz to 600 kHz                                   | 5 Hz to 560 kHz                      | 5 Hz to 560 kHz  | 10 Hz to 10 MHz  | 10 Hz to 1 MHz                                    |
| Frequency Response (Rated load) | $\pm 1$ dB  | $\pm 3\%$                            | $\pm 3\%$  | $\pm 2\%$ to $\pm 4\%$   | $\pm 2\%$   |
| Accuracy                        | $\pm 2\%$   | $\pm 3\%$                            | $\pm 3\%$  | $\pm 2\%$ , $\pm 3\%$  | $\pm 1\%$   |
| Output                          | 10 V, 160 mW/600 $\Omega$ , balanced              | 2.5 V, 10 mW/600 $\Omega$ , floating | 10 mW, nominal 2.5 Vrms ( $+10$ dBm/600 $\Omega$ ), floating | 3.16 V, 200 mW into 50 $\Omega$ , 16 mW into 600 $\Omega$ , floating | 2.5 V, $+10$ to $-30$ dBm/600 $\Omega$ , floating |
| Distortion                      | 0.2% to 0.5% (200CD)<br>0.06% to 0.5% (H20-200CD) | <1%                                  | <1%  | <1% to 2% MHz, 2% at 10 MHz  | <1%   |
| Price                           | 200CD, \$225.00<br>H20-200CD, \$250.00            | 204B, \$315.00                       | 208A, \$525.00   | 651B, \$590.00<br>652A, \$725.00                                     | 241A, \$490.00                                    |

ON READER-SERVICE CARD CIRCLE 51

097/10R

# What reliability figures can I expect from ICs and how are they derived?

The figure commonly quoted at the present time is 0.01% per 1000 hours, or 0.1 failures per million hours. This failure rate is based on operating tests in the manufacturers' laboratories and is corroborated by controlled tests made by users. Though information on rates of failure in the field is sketchy, it seems to indicate that once ICs are placed in operation they remain so.

The low rate itself makes it difficult to obtain up-to-date information on failure rates. It takes between two and three years to accumulate enough meaningful data to calculate rates. Consequently, published figures usually describe circuits made with fabrication techniques that are at least two years old. These techniques, however, often become obsolete during the time it takes to ascertain reliability and, of course, as reliability improves, its proof becomes more difficult, expensive and time-consuming to obtain.

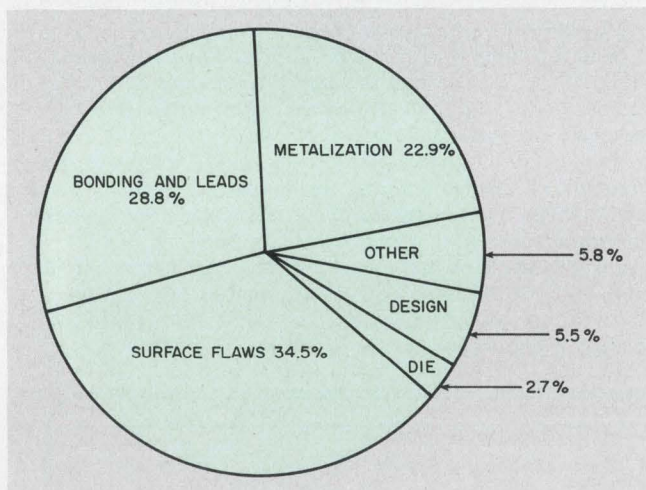

Integrated-circuit failures were distributed through these different portions of the chip, according to a four-year survey by Autonetics, Anaheim, Calif.

Test your IC IQ is a collaboration between the editors of ELECTRONIC DESIGN and the staff of the ICE (Integrated Circuit Engineering) Co., Phoenix, Ariz. Readers of this new column are invited to submit their questions to Test your IC IQ, ELECTRONIC DESIGN magazine, 850 Third Ave., New York, N.Y. 10022.

## What are the main differences between thin films and thick films?

Thin films normally range in thickness between 200 and 20,000 Å whereas thick films are invariably thicker than 20,000 Å. Beyond this simple definition, there is a distinct difference in the way each is made. Thin films are usually deposited in either a vacuum or a controlled-pressure enclosure by vacuum evaporation, sputtering, electron-beam bombardment or flash evaporation. Thick films, on the other hand, use a much cruder, cheaper process such as silk-screening. Thin films are usually patterned with photolithographic techniques whereas thick-film components are shaped by the pattern on the screen itself. Thin films are trimmed by heating in ovens or with lasers. Thick films are trimmed by scraping or sand-blasting.

## Will the prices of hybrid circuits drop at the same rate as monolithics?

No. In all likelihood, hybrid-circuit prices will decrease from their present levels as their production equipment and techniques are improved. Prices of monolithic circuits, however, will probably fall faster because of higher-volume production and better yields. The incremental price advantage of monolithic circuits increases rapidly as yield improves. They are also cheaper to produce because it requires more labor to assemble hybrid circuits. Thus hybrid circuits are now, and will continue to be, used either for prototype or small-quantity requirements or where monolithics are technically or economically not feasible.

## What are the major causes of manufacturers' low yields?

Low yields are most often due to the following problems:

- Subtle variations in the materials of the processes.
- Human errors, which cover a multitude of problems such as scratches and broken wafers or improper application of photo resist.
- Assembly problems.

The first group causes the spread of characteristics or tolerances. The latter two are the major causes of variation and field failure. And the most insidious problems don't appear until after a period of successful operation. A bad bond, for example, may make electrical contact until the circuit is jarred during use.

**What are the typical widths of monolithic resistors and what are normal spacings between components and elements of components?**

The minimum width of resistors for most commercially available integrated circuits is about 1 mil. Some of the more recent commercially available, state-of-the-art circuits boast 3/10-mil resistors. Laboratory techniques that are newer mask development methods claim better than 0.1-mil widths. The minimum spacings between the elements of a component (such as the emitter junction and the base junction of a transistor) are limited by the mask-making and alignment techniques. These are currently in the tolerance range of  $\pm 1/10$ -mil for state-of-the-art devices and approximately 1/4-mil for commercial or volume-production devices.

**What type of in-process electrical instruments can be made on integrated circuits?**

The in-process measurements made on integrated circuits are intended primarily for quality control. Most of them are dc measurements. They are done on a sample or statistical basis. During the in-process measurement, the only decision to make is whether to continue the processing or to reject the entire wafer. Special areas are usually set aside on the chip or in test patterns to avoid damage when making such tests, since sharp probes are necessary for making contact. The first set of complete electrical measurements is not possible until after the wafer has been completely processed and metalized. At this time, a 100% check is invariably made and the individual dice that are to be rejected are marked, so they will be identifiable after the wafer is separated into individual dice.

**Can a systems house save money by buying raw IC chips and wiring them?**

It is often profitable, for prototype or sample work, to purchase raw chips and wire them together. For high-production runs involving more than, say, 10,000 circuits, it is usually cheaper to turn to monolithic circuits packaged by their manufacturer.

There are unusual cases in which it pays for a systems house to buy raw chips in high volumes and wire them itself. A systems house might, for example, wish to buy monolithic operational amplifiers as raw chips and wire them to a thin-film

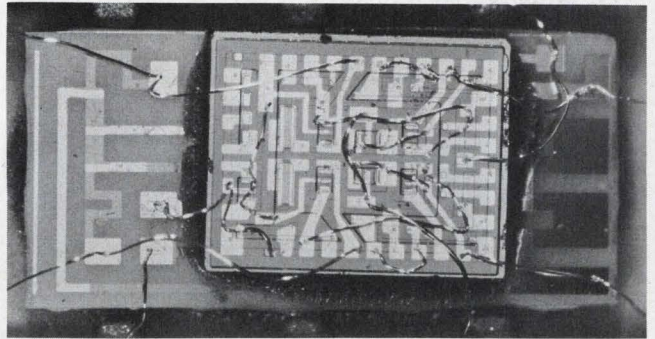
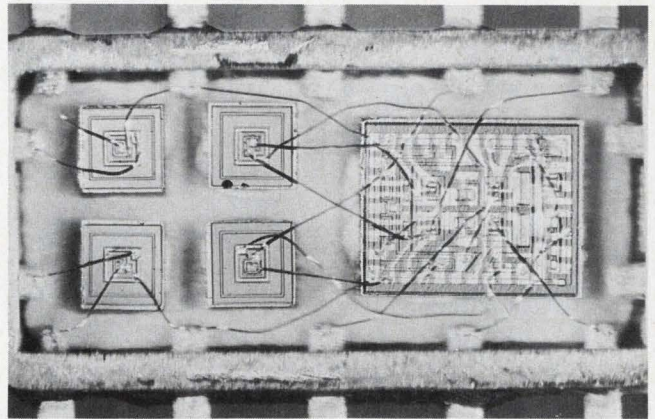

**A systems house may well purchase raw chips** if it wants to wire them either to other chips in a flat pack (top) or to passive components on a thick- or thin-film substrate (bottom). Here, a master chip is used by Autonetics in both configurations.

substrate that contains a passive compensation and feedback components. Some manufacturers make it easy to do this. They offer raw chips in sealed glass containers that are accompanied by small vials containing raw chip samples. Should a user wire and test the samples with disappointing results, he has the right to pay for them and reject the unopened large container.

**Can a test equipment manufacturer such as Hewlett-Packard expect profitably to operate an IC manufacturing operation that it builds for itself?**

Apparently Hewlett-Packard intends to provide an in-house integrated-circuit capability for limited production, research and development efforts by each of its operating divisions, and also to maintain and develop a high level of engineering capability in integrated-circuit technology. It may further intend to centralize its high-volume production capability within a central facility, which will be able to obtain the advantages that accrue from mass production. Hewlett-Packard apparently expects to maintain or improve its position in the test equipment business with the proprietary developments in its laboratories. It also intends to protect the proprietary nature of its developments.

# Celco

# STANDARD DEFLECTION YOKES

## AND CRT COMPONENTS

|   |  |   |
|---|--|---|
|  <p>Low cost stator type yoke for high grade commercial applications</p> <p><b>TYPE KY</b></p>                                 |  <p>Low LI<sup>2</sup>, high sensitivity for 42°, 52°, 70° and 90° 1 7/8" CRT neck</p> <p><b>TYPE FY</b></p>        |  <p>High quality general purpose, moderate resolution low residual, for 52°, 70° and 90° 1 7/8" CRT neck</p> <p><b>TYPE AY</b></p> |
|  <p>Fast core general purpose, moderate resolution, for 52°, 70° and 90° 1 7/8" CRT neck</p> <p><b>TYPE HY</b></p>             |  <p>Deflectron® general purpose for 42° 1 7/8" CRT neck</p> <p><b>TYPE HD</b></p>                                   |  <p>Fast core, low LI<sup>2</sup>, low distributed capacity for 52° 1 7/8" CRT neck</p> <p><b>TYPE GD</b></p>                      |
|  <p>Deflectron® for high resolution recording storage tubes Scan converter applications</p> <p><b>TYPE QD</b></p>              |  <p>Recording storage tube yoke Scan converter applications</p> <p><b>TYPE QY</b></p>                               |  <p>Writing yoke for high frequency beam modulation Celcaloy, ferrite and air core for 1 7/8" CRT neck</p> <p><b>TYPE AW</b></p>   |
|  <p>General purpose yokes for 7/8" CRT neck <b>BY</b><br/>1" storage tube <b>CY</b><br/>for 1 1/8" storage tube <b>CYT</b></p> |  <p>Miniature yoke for 7/8" CRT neck and special unit construction</p> <p><b>TYPE MY</b></p>                        |  <p>Rotating yoke for 52° and 70°, 1" and 1 1/8" CRT necks Includes bearings, gear and sliprings</p> <p><b>TYPE RY</b></p>         |
|  <p>Low resistance version of type BY Available for types CY and CYT</p> <p><b>TYPE YY</b></p>                               |  <p>Character and storage tube yoke for 2" CRT neck Type DY<br/>2 1/4" CRT neck Type DJ</p> <p><b>TYPE DY</b></p> |  <p>Coils for centering and beam alignment, aiming, flooding for 1 7/8" CRT neck</p> <p><b>TYPE KC</b></p>                       |
|  <p>Pincushion corrector, electromagnetic, low cost, general purpose</p> <p><b>TYPE L</b></p>                                |  <p>Pincushion corrector, permanent magnet Specials available</p> <p><b>TYPE M</b></p>                            |  <p>Focus coil, dynamic for high resolution Many other standard types available</p> <p><b>TYPE HLF</b></p>                       |
|  <p>Vidicon yoke, focus and alignment coils 1" For slow scan, high resolution</p> <p><b>TYPE WV</b></p>                      |  <p>Hybrid vidicon yoke, 1" Magnetic deflection coil with shielding</p> <p><b>TYPE HV</b></p>                     |  <p>Vidicon yoke, focus and alignment coil 1" For standard TV applications</p> <p><b>TYPE TV 129</b></p>                         |
|  <p>Image Orthicon yoke, focus and alignment coils 3" For high resolution, slow scans</p> <p><b>TYPE AV 172</b></p>          |  <p>Image Orthicon yoke, focus and alignment coils 3" For standard TV applications</p> <p><b>TYPE TV 172</b></p>  |  <p>Static astigmatic corrector and dynamic focus coil For high resolution 42° CRT</p> <p><b>TYPE NC</b></p>                     |

# Celco

Constantine Engineering Laboratories Company

MAHWAH, N. J.  
201-327-1123  
TWX 201-327-1435

UPLAND, CAL  
714-982-0215  
TWX 714-556-9550



# Another Reliable "Just Plug It In"

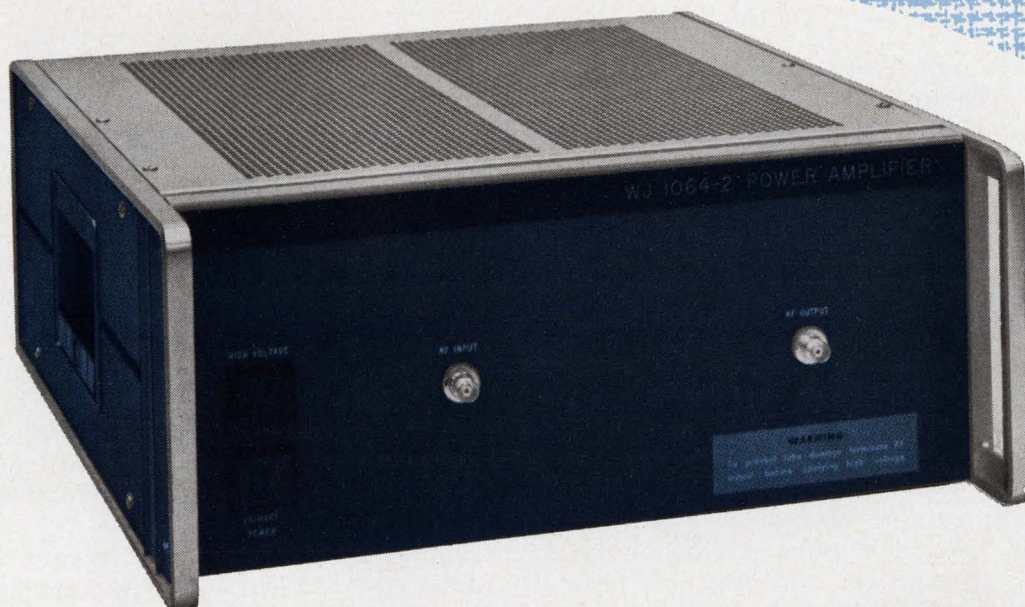

## POWER AMPLIFIER from W-J

Here's the ideal medium-power traveling-wave amplifier for satellite ground terminals! The WJ-1064-4 realizes a specified need for performance over the 5.9-6.45 GHz frequency range. Saturated power output is 35 watts and the noise figure is 35 dB maximum. The neat and compact package fits conveniently and is ready to work upon the simple act of plug-in connection. No trouble at all, this latest refinement of W-J's line of power amplifiers for space communications.

Information in more detail available  
from representative in your area,  
or from Applications Engineering.

WATKINS □ JOHNSON

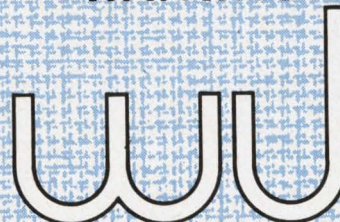

3333 HILLVIEW AVENUE  
STANFORD INDUSTRIAL PARK  
PALO ALTO, CALIFORNIA 94304

ON READER-SERVICE CARD CIRCLE 53

# Advance by making your boss look good

You'll find new challenge and opportunity for a career as manager when you practice 'upward motivation.'

There are two sides to motivation.

There is downward motivation, where the superior must provide the proper incentives for the subordinate to do a good job (see "Money is not the only motivator," ED 1, Jan. 4, 1968, pp. 126-130). Less clearly defined and understood, but equally as important, is upward motivation.

Part of the subordinate's role, especially if he desires to advance, is to motivate his superior. This upward motivation applies from the first-line supervisor-worker relationship on up.

Many men set up barriers to their advancement by letting their ambition show. They have the idea that if they can make themselves look good, advancement is inevitable. What they forget is that "good" involves a comparison; that making yourself look good involves, inevitably, making someone else look bad—and that "someone else" may be your superior.

When your superior has a lot to say about your advancement, making him look bad isn't going to enhance your career prospects. Instead, try this formula for success:

Don't try to make yourself look good at your boss's expense. Bend your efforts toward making the man in front of you look so good that he will be promoted and then, with all due modesty, you can step into the vacancy your efforts have helped to create.

Or, to put it another way:

Do all you can to promote the interests of your boss. Learn to think as he does, applying his measurements in judging results—exceeding his standards if you can, but meeting them at all costs.

Such an attitude is good for everyone concerned. As your boss comes to realize that all of your efforts are bent on furthering his programs, he will give you more and more opportunities with fewer and fewer controls.

In most cases, when you demonstrate to your boss how well you can carry out his programs,

he will pass down some of his responsibilities to you. The chief element he will watch is the appropriateness of your decisions.

## Does your boss qualify?

The assumption is, of course, that you are among the majority of engineers who work for qualified managers—persons whom you respect as superiors.

If your superior is a tyrant, a totally insensitive person and a failure at managing, no amount of advice will help your upward motivation. If you cannot respect your superior, the advice to you is:

First, be introspective. Ask yourself, "Is he at fault or am I?" If you are convinced after an honest appraisal that the fault lies with him, then start looking for another job, because you are at a dead end. But before taking this action, be sure that you have made an honest appraisal.

## Know your limitations

In your drive toward advancement, know your abilities, but also be aware of your limitations. When you need help or advice, ask for it—without hesitation and without embarrassment. And, remember, the easiest place to get help or advice is usually not from below but from above.

At the same time accentuate your strengths. If you have areas of special competence, show them. Become the man to whom others, especially your superiors, turn to for help. Become the acknowledged expert, not by trumpeting your abilities but by demonstrating them.

There is nothing that pleases an executive more than to be able to say at a conference when a knotty problem arises, "We can handle this, I have a man in mind . . ."

And it doesn't stop there. Other executives then begin to say to others, "George has a man

---

**Don Fuller**, Director, Engineering Div., Industrial Education Institute, New York.

Don Abel (center), manager, Optoelectronics Products Branch, Semiconductor-Components Div., Texas Instruments, Inc., Dallas, talks with his engineers at a project meeting.

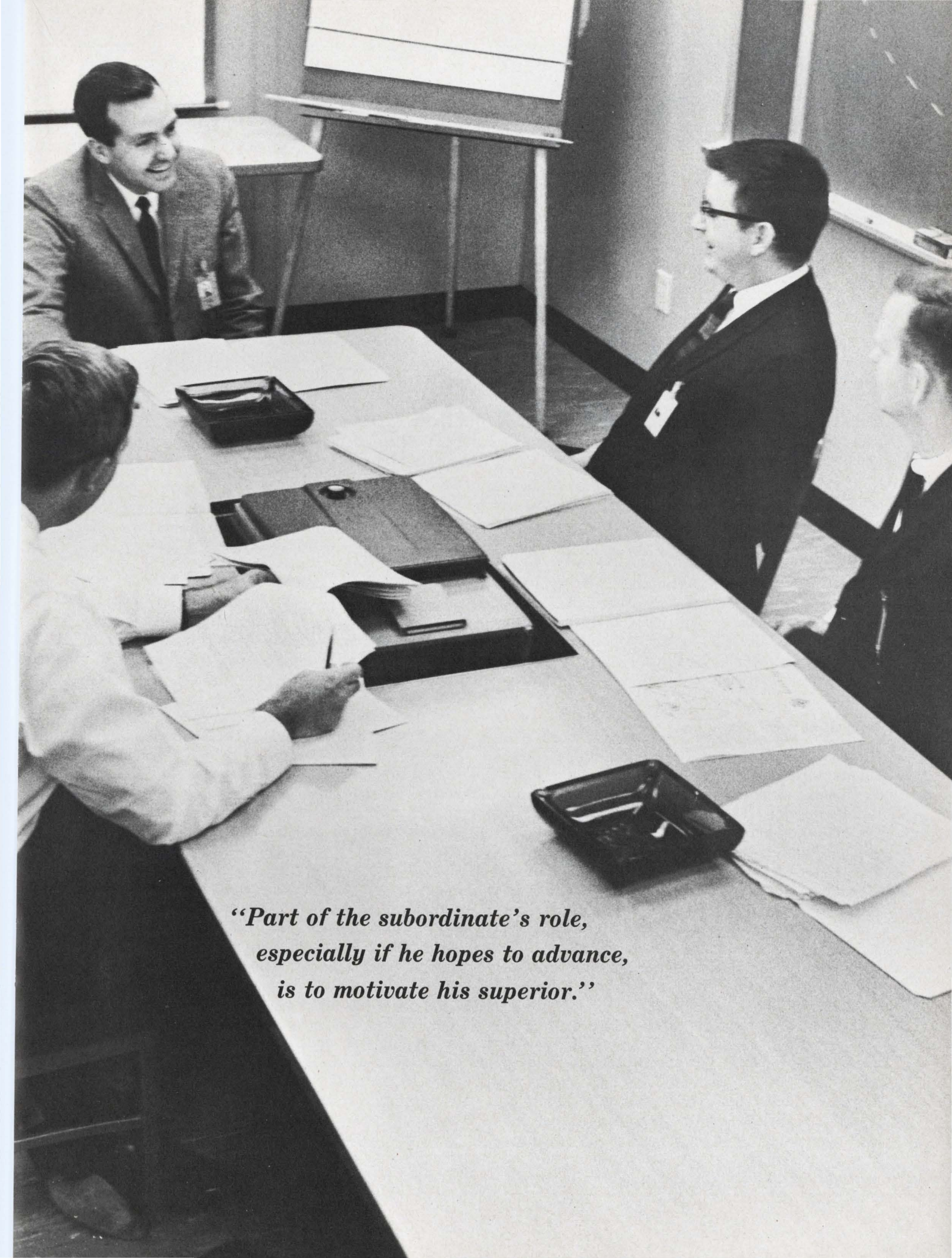
A black and white photograph of four men in a meeting around a conference table. The man on the left is wearing a light-colored suit and is writing in a notebook. The man on the right is wearing a dark suit and glasses, looking towards the man on the left. The man in the background is wearing a dark suit and glasses, looking towards the man on the left. The man on the far right is wearing a dark suit and glasses, looking towards the man on the left. The table is covered with papers, a calculator, and a pen. The background shows a whiteboard and a chalkboard.

*“Part of the subordinate’s role,  
especially if he hopes to advance,  
is to motivate his superior.”*



**Think as he does:** Use his measurements and not your own in judging results.

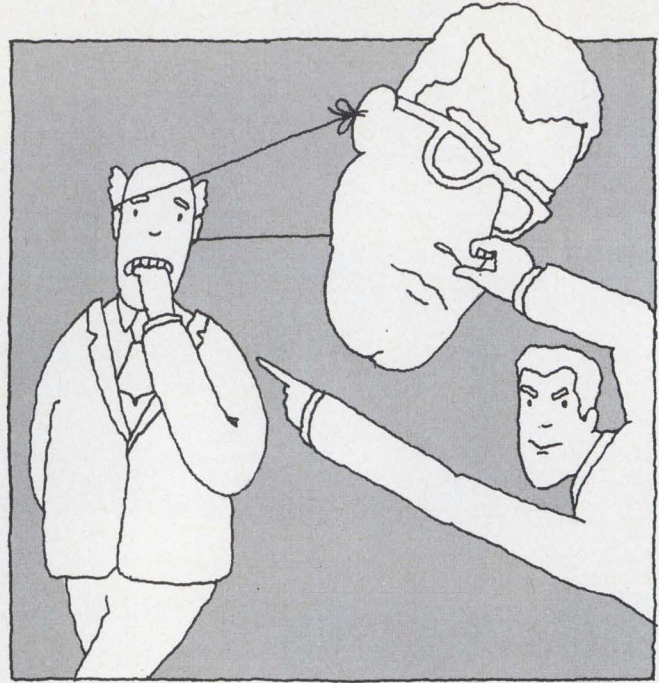

**Don't make your boss lose face:** It's an action that's intolerable in a subordinate.

... ." And the next step is for those others to ask, "George, can your man . . . ?"

But just as you must know and use your strengths, you must also be honest with yourself about your limitations. Identify these blind spots and, by self-study and other aids, strive to eliminate them. If you need an associate or a subordinate to "fill in" for you in the areas where you personally lack knowledge or experience, get the best help you can get.

### Think as he does

How far should you, as a subordinate, carry out your boss's program without troubling him? Your superior needs someone he can depend on, but he doesn't want to be bothered with trivia. On the other hand, he doesn't want his subordinates taking independent actions on important questions without consulting him. What is "trivial" and what is "important"? To decide, you must learn to think as he does.

This is a fine line to walk sometimes. The rule is: Know your boss's job, but don't try to do it. He wants you to do your job well so that his will be easier. Know his needs and try to anticipate what he will require of you.

Popping in on him every half hour or so to give him a running account of your activities is obviously overdoing it. When you begin to take up your boss's time needlessly, he may come out bluntly and tell you so. Or he may be devastatingly subtle. Learn to read his reactions. When his secretary interrupts a conversation to remind him an appointment, the interruption may be legitimate, but it may also be a device to protect

him against you. Does he seem to welcome an interruption of your story? Does he dismiss you in mid-sentence with unseemingly alacrity?

### Four roads to failure

Knowing what to do is important, but knowing what not to do is equally important. There are four things that are intolerable in a subordinate:

- Contradicting a superior.
- Making a superior lose face.
- Backing a superior into a corner.
- Trying to look good at the expense of your superior.

Contradicting is not the same as "disagreeing with." No good superior wants a string of "yes men" for subordinates. A subordinate may—and should, when the circumstances call for it—question information or disagree with conclusions. How does this differ from contradicting? Mainly it's a matter of degree. Contradiction is direct and total opposition. Contradiction says unequivocally, without any softening, that the other person is completely wrong—scarcely a way to win friends or to influence executives. The person who contradicts usually acts with an air of omnipotence that few of us are likely to have. Even when a superior is absolutely wrong and leaves himself open to direct contradictions, questioning or disagreement are better courses for a subordinate to take. The goal, after all, is to encourage a change in decision, not to antagonize the decision-maker.

As for the other sins that inept subordinates commit—making a superior lose face, trying to pressure him, or attempting to look good at his

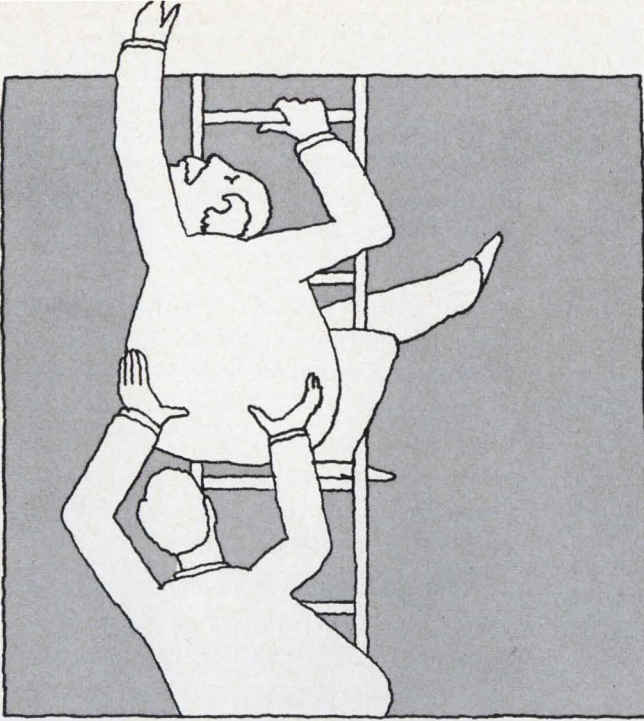

**Help your boss up the ladder:** The surest way for you to succeed is for your boss to succeed.

expense—they are not always obvious to the sinner, but they most certainly are to nearly everyone else. Let's examine a hypothetical case.

A company president wants a customer to talk with an engineering manager, whom we will call Edward Curtis. Walking down the corridor, the president says: "Ed may not be in yet. He's been doing some confidential work for me that he probably prefers to deal with at home."

As the two enter the department, an engineer subordinate bustles forward and eagerly thrusts himself upon the visitors.

"Is Mr. Curtis here?" the president asks Mr. Eager Beaver.

The correct response to such an inquiry should be, "No sir. May I be of help?" This is essentially the reply that Beaver gives, but he adds what a lawyer would call unsolicited testimony.

His full reply is: "I'm Eager Beaver, one of Mr. Curtis's assistants. No, sir, Mr. Curtis is not in. He usually arrives at the office quite late. May I be of help? If it's information you want, Mr. Curtis would probably come to me for assistance anyway."

In one brief statement, Eager Beaver attempts to make his superior lose face, to back him into a corner and to look good at the superior's expense.

"Thank you," says the president. "Have Mr. Curtis call me when he comes in."

Curtis does not call; he shows up in person. He is an easy going fellow, obviously accustomed to command and obviously held in high esteem by his president. When the introductions are over, the president blurts out: "Ed, you ought to fire that man Beaver. He's an idiot."

"Beaver? Of course, he's an idiot, replies

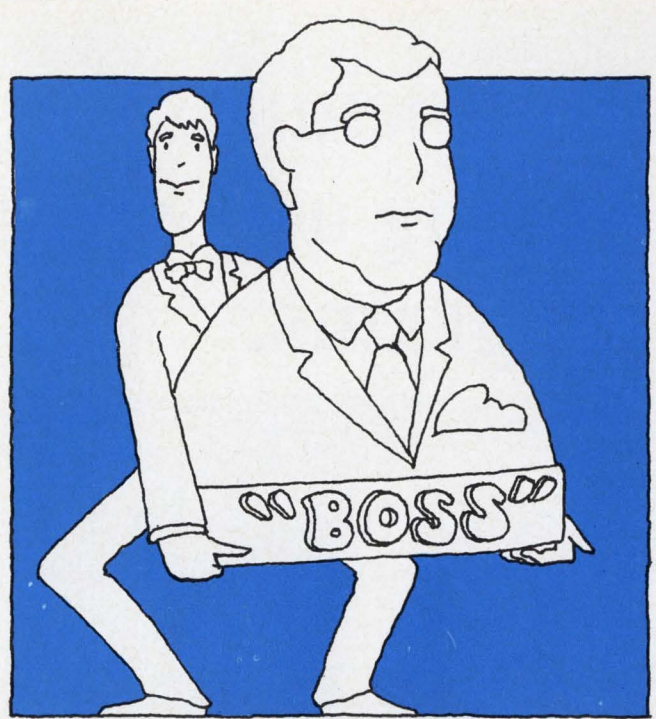

**Motivate your superior:** Bend all your efforts towards making the man in front of you look good.

Curtis. "But I'm not going to fire him, because he's a conscientious idiot with a fine memory for minor details."

Some day Curtis will be president of the company. Beaver probably will still be one of his assistants. He will always be an assistant, never given major responsibilities. Curtis will put him to good use—wherever there is a need for a conscientious idiot with a fine memory for minor details. ■■

*In addition to his post with the Industrial Education Institute, Don Fuller is an authority on training technical men to be effective managers. He is also the author of several books, including "Manage or be Managed! A Guide to Managerial Effectiveness."*

#### **Test your retention**

*Here are questions based on the main points of this article. They are to help you see if you have overlooked any important ideas. You'll find the answers in the article.*

- 1. Why is it wise to make your boss look good if you hope to advance on the job?*
- 2. Should you check with your superior before making a decision?*
- 3. What four actions are intolerable in a subordinate?*
- 4. What is the difference between "contradicting" and "disagreeing with" a superior?*

# EE openings on Boeing aerospace programs.

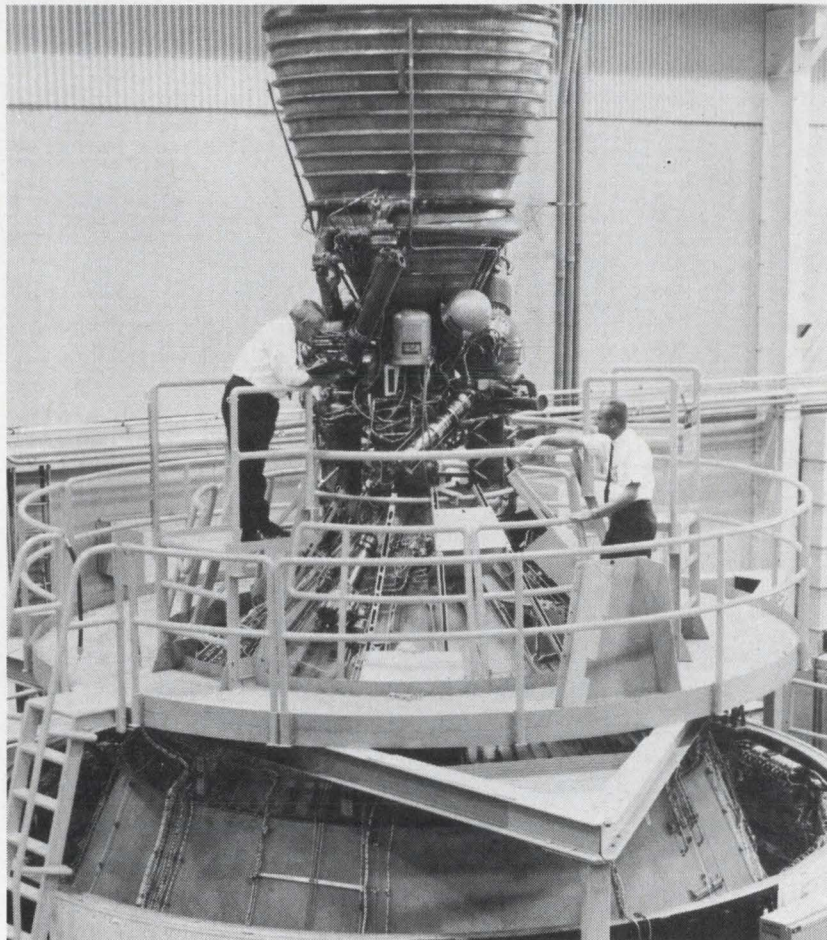

Electronic-mechanical simulator of the Kennedy Space Center's Saturn V launch control center. It is used by Boeing-Huntsville engineers and technicians to check out all components of Apollo/Saturn V vehicle.

The Boeing Company's deep involvement with the nation's major missile and space programs provides immediate career opportunities for electrical/electronic engineers at Seattle, Huntsville, and Kennedy Space Center.

At Seattle, Boeing is engaged in a number of company-funded and government-contracted programs which are advancing the technologies developed for such highly successful programs as NASA's Lunar Orbiter, U.S. Air Force's Minuteman II and Burner II, and U.S. Navy's PGH-2 (patrol gunboat hydrofoil).

Boeing is a major mission-support contractor to NASA on the Apollo/Saturn V program. At Huntsville, the company is performing systems engineering and integration functions on Saturn V. At Kennedy Space Center, Boeing is assisting NASA in systems analysis and basic modification and design of launch support equipment.

*Immediate electrical/electronic engineering openings at Seattle exist in test technology (data systems and instrumentation, test data handling and processing), flight technology (flight control, flight mechanics), developmental design (airborne control systems, ground system electrical power systems, environmental control), and electronic packaging.*

*Openings at Huntsville are immediately available in flight mechanics and flight evaluation (operational trajectories, mission analysis, trajectory analysis, post-flight trajectories, flight simulation development, flight dynamics). Other electrical/electronic assignments are open at Kennedy Space Center.*

Qualifications for these positions include a B.S., M.S., or Ph.D. in electrical engineering with two to five years experience. Salaries are commensurate with experience and educational background. Moving and travel allowances are paid to newly employed personnel. Boeing is an equal opportunity employer.

Please fill in and mail the coupon to the location of your choice and field of interest. A Boeing representative will get in touch with you.

**BOEING**  
AEROSPACE GROUP

Other Divisions: Commercial Airplane • Vertol  
Wichita • Also, Boeing Scientific Research Laboratories

*I'm interested in a Boeing aerospace career; please contact me with details.*

Name \_\_\_\_\_

Address \_\_\_\_\_

Phone (incl. area code) \_\_\_\_\_

City \_\_\_\_\_ State \_\_\_\_\_ Zip \_\_\_\_\_

I'm usually home between \_\_\_\_\_ and \_\_\_\_\_ (hours) on \_\_\_\_\_ (days)

Degree/Field of Interest \_\_\_\_\_

Please mail to the location of your choice and field of interest:  
SEATTLE: Mr. J. T. Cartwright, The Boeing Company, P.O. Box 3999-EDJ, Seattle, Washington 98124. HUNTSVILLE and KENNEDY SPACE CENTER: Southeast Staffing Manager, The Boeing Company, P.O. Box 1680-EDJ, Huntsville, Ala. 35807.

# Completely satisfied with your job?

## We can change all that.

If you're content just with a good salary, generous fringe benefits, pleasant working conditions and long vacations — watch out. You're in danger of becoming a well-satisfied non-entity.

But there's still time to save yourself.

Of course, your working conditions should be pleasant. Your compensation should be good.

But is that all you're working for?

A couple of years back weren't you more interested in making break-throughs in your chosen discipline?

Weren't you itching to do important things?

At Aerojet's Electronics Division you'll have your chance, working on our space satellite program. You'll rediscover excitement in your work. You'll get turned on working with some of the top engineers and scientists in the country. You'll have to do your best thinking. Isn't that what you want?

We need engineers and scientists — such as electronic circuit design and project engineers, optical engineers, infrared specialists — for work on some of the nation's most advanced programs. In such fields as sophisticated space surveillance, satellite pay-

loads, infrared and star sensing devices, data processing. And many more.

Incidentally, you'll make the mortgage payments. Your wife will be well dressed. Your kids will get a good education. We have all the frosting everybody else offers.

But at Aerojet, you get the cake.

Send your resume to Bob Smith, Aerojet-General Corporation, Box 303E, Azusa, California 91702.



AN EQUAL OPPORTUNITY EMPLOYER

ON CAREER-INQUIRY FORM CIRCLE 901

Electronic Engineers

# Can you design the circuits that make this pencil work?

If you can, IBM would like to hear from you.

We need electronic engineers for development work on sophisticated electromechanical applications. Including circuit design for input devices like our 1287 Optical Reader.

This is the first mass-produced machine to read hand-printed numbers (which explains the boastful message on our pencils). It's a whole new way of talking to computers.

And it's only one of many exciting projects you could work on at IBM Rochester (Minnesota).

## The outer limits

Join us, and you'll have a job that takes you to the outer limits of today's technology. You may, for example, get involved with sophisticated computer design techniques and new material applications.

And you'll be backed by specialists in mechanical design, metallurgy, plastics, computer-aided design, R&S, acoustics, dynamic analysis, electromagnetics, and all phases of manufacturing.

It's a rare opportunity to make a name for yourself in the development of data-processing devices.

## An ideal place to live

These openings are in our development lab in Rochester, Minnesota.

Don't jump to conclusions about this town (pop. 50,000). It has many advantages you'd normally find only in a big city. The Mayo Clinic and a major IBM facility help to give it an unusually high percentage of professional residents.

The school system is excellent (75 percent of Rochester's high school graduates go on to college), and there's an abundance of cultural and recreational facilities. You can enjoy the Minneapolis Symphony in the winter, for example, and three uncrowded golf courses in the summer.

Since Rochester sits in the southern tip of the state, it offers a wide variety of sports all year round. Typical commuting time is 5 to 10 minutes.

Look into it. If you're the kind of engineer we're looking for, you could catalyze your career here. Send a resume or outline of your experience to Robert Lewkowitz, IBM Corporation, Dept. QB5-N, Highway 52 and Northwest 37th Street, Rochester, Minnesota 55901.



**IBM**<sup>®</sup>

An Equal Opportunity Employer



# Free Career Inquiry Service

## Absolutely Confidential

Respond to the career opportunities advertised in this issue. Fill out and send us this handy resume. **Electronic Design** will do the rest – neatly typed copies of this form will be mailed to the companies of your choice, indicated by the circled Career Inquiry Numbers at the bottom of this page.

# 2

|                              |   |                           |                                |
|------------------------------|---|---------------------------|--------------------------------|
| <b>Name</b>                  |   | <b>Home Phone</b>         |                                |
| <b>Home Address (Street)</b> |   | <b>City</b>               | <b>State</b>   <b>ZIP Code</b> |
| <b>Age</b>                   | <b>U.S. Citizen</b><br><input type="checkbox"/> Yes <input type="checkbox"/> No | <b>Security Clearance</b> |                                |

| Prime Experience | Secondary Experience |
|------------------|----------------------|
|                  |                      |
|                  |                      |
|                  |                      |
|                  |                      |
|                  |                      |

|                       |                          |
|-----------------------|--------------------------|
| <b>Desired Salary</b> | <b>Availability Date</b> |
|-----------------------|--------------------------|

**Employment History – present and previous employers**

| Company | City, State | Dates | Title |
|---------|-------------|-------|-------|
|         |             | to    |       |
|         |             | to    |       |
|         |             | to    |       |
|         |             |       |       |
|         |             |       |       |

**Education – indicate major if degree is not self-explanatory**

| Degree | College | City, State | Dates |
|--------|---------|-------------|-------|
|        |         |             | to    |
|        |         |             | to    |
|        |         |             | to    |

**Additional Training – non-degree, industry, military, etc.**

---



---

**Professional Societies**

---

**Published Articles**

---

- Career Inquiry Numbers:**
- |     |     |     |     |     |     |     |     |     |     |
|-----|-----|-----|-----|-----|-----|-----|-----|-----|-----|
| 900 | 901 | 902 | 903 | 904 | 905 | 906 | 907 | 908 | 909 |
| 910 | 911 | 912 | 913 | 914 | 915 | 916 | 917 | 918 | 919 |

**ELECTRONIC DESIGN**  
850 Third Avenue  
New York, New York 10022

## Limit short-circuit amplifier current

**Problem:** To limit short-circuit currents in push-pull amplifiers. In many push-pull amplifiers, should the load be short-circuited for any reason, the amplifier will be destroyed.

**Solution:** An amplifier circuit that limits the current to a predetermined level and provides for overcurrent in one half of the push-pull amplifier to turn off the other half.

Consider the circuit as though diodes  $D1$  and  $D2$  were not included. A signal at the input is amplified by  $Q1$  and appears at junction points  $J1$  and  $J2$ . If  $Q2$  and  $Q3$  are biased class-B or class-AB, the positive portion of the signal at  $J1$  is amplified by  $Q2$  (an npn) and the negative portion at  $J2$  by  $Q3$  (a pnp). The negative portion of the signal at  $J1$  will turn  $Q2$  off and the positive portion at  $J2$  will turn  $Q3$  off.

The load is thus driven by  $Q2$  during one half and by  $Q3$  during the other half cycle—hence the term “push-pull amplifier.”

Now suppose  $D1$  and  $D2$  are included. Within the series circuit formed by  $R1$ ,  $D2$ ,  $D3$ ,  $D4$ ,  $D5$  and the emitter-base junction of  $Q2$ , all the voltage drops are fixed by nonlinear characteristics except for that of  $R1$ . The voltage across the emitter-base junction of  $Q2$  and the voltage across  $D2$  balance each other and can be disregarded. The remainder consists of equal and opposite voltage drops across  $D5$ ,  $D4$ ,  $D3$  and  $R1$ . Thus the instantaneous voltage across  $R1$  can be no greater than the voltage across the three diodes, otherwise insufficient bias on  $Q2$  results and it begins to turn off. So if an excess current through  $R1$  causes the voltage across it to equal the sum of the diode voltages, the circuit will start current-limiting, the level of which is set by the size of  $R1$ .

If  $Q2$  tends to draw excessive

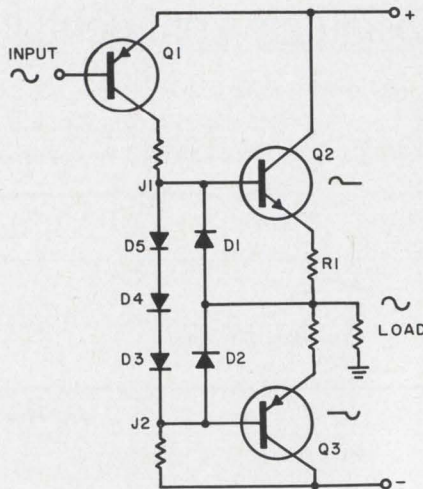

current,  $D2$  turns on and impresses across the emitter-base junction of  $Q3$  a voltage opposite in polarity to that required to maintain  $Q3$  in the conduction state. Conversely, should  $Q3$  tend to draw excessive current, equal and opposite action would take place in  $D1$  and the emitter-base junction of  $Q2$  to cause  $Q2$  to turn off. Thus no high-frequency oscillation or driving voltage can cause both  $Q2$  and  $Q3$  to conduct at the same time to short-circuit the two output terminals.

*Inquiries concerning this innovation may be directed to: Technology Utilization Officer, Manned Spacecraft Center, Houston, Texas 77058 (reference B67-10300).*

## Electronic shutter gates orthicon

**Problem:** Develop a sensitive TV camera to record images of diffuse light-scattering regions in the solar system.

**Solution:** Use an image orthicon photocathode tube and relate precisely the exposure time of the photocathode to the peak highlight in the scene under the investigation. To do this, an electronic shutter gates the image section on during expose time and off at all other times.

The shutter permits continu-

## Computer Systems/ Logic & Memory Designers



### Memory Engineer—

Requires minimum 5 years' experience with specialization in design of memories for airborne special purpose computers meeting MIL specs. Work will involve DRO and NDRO memories including exploration of esoteric techniques (e.g. plated wire, etc.). Opportunity exists to move into systems design.

### Systems Analyst/Engineer—

Supervisory level position requiring minimum 5 years' diversified experience with special purpose computers and ability to analyze overall computer requirements for specific applications and delineate systems specifications to meet them. Systems orientation is requisite as is an ability to program or communicate with programmers. Will direct systems formulation from concept through prototype and into manufacture.

### Logic Design Engineer—

Requires minimum 5 years' experience with ability to design logic circuits for special purpose digital computers for the aerospace environment. Will develop circuits with maximum density, flexibility and reliability using advanced techniques. Can move into interface work (A/D, D/A, I/O, etc.) as well as into technical management.

### Navigation Systems Engineer—

Experience on LORAN receiver and computer technology with consideration to interface or integration with other aircraft sensors and equipments. Some knowledge of inertial and Doppler technology desirable.

### Design Engineer—

5-7 years' experience in two or more of the following disciplines: Data Transmission and Communication in L and S Frequency Band, Multiplexing and Modulation on Secure Communications, Microwave and Radio Frequency Receiver Design, Aircraft Command and Control.

Please forward your resume to Mr. Wally Bieszard, ITT Avionics Division, Room 333-G, 390 Washington Avenue, Nutley, New Jersey 07110. All inquiries will be answered promptly.

AVIONICS **ITT**

**Compute position, ground speed, distance to go, cross track error to accuracies in tens of feet; operate ECM and fire control...all at up to 100,000 feet and Mach 3, from -60 to 125° C, in intense RFI.**

**Do it reliably. And economically. In a minimum of volume, with a minimum of weight.**

**That's just part of what you'll do here.**



Designing special-purpose digital navigational computers for the airborne (and spaceborne) environment isn't easy. But when you compound the difficulty by demanding logic and memory powerful enough to interface with and control virtually all a vehicle's critical systems, coupled with more stringent reliability requirements and a more hostile environment, you really take the measure of a computer specialist.

That's exactly what we're doing in the new Computer Group at ITT Avionics. Formulating an all-out proprietary design/development effort to refine our already significant navigation computer capability.

**To begin with, we're talking systems:**

Because the computers we're designing must interface with next-generation aircraft, you know we're thinking about the macro-picture (even though we'll talk microcircuits). With modern recon/weapons-delivery systems relying increasingly upon EDP techniques, the navigation-only computer is on its way out. And we're busily helping formulate its replacement.

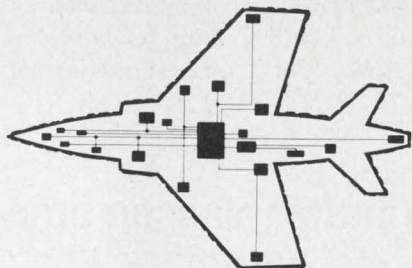

What does this mean to you? To begin with, an overview: a voice in setting systems objectives and trade-offs. And equally important, a chance to broaden your horizons. Into memory, if you're a logic expert...or vice versa. Into peripheral equipment for interfacing with the vehicle: A/D, D/A, servos and the like.

Or into display systems and human engineering, if you've a mind.

**We're talking concepts too:**

When we talk about formulating systems ideas, we're not talking 'formula' designs.

An example? Let's talk about the integration function, as applied to filtering a noisy signal in a LORAN receiver. Of course, the state of the art is beyond an analog integrator: we put the receiver output through an A/D converter and into an accumulator. Make the A/D interface sophisticated enough and you have effective filtering. But not effective enough, when you consider the real-time constraints of today's Mach 2+ aircraft.

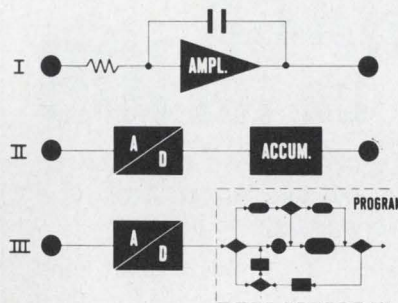

One of the approaches we're considering is combining receiver and computer. As soon as the signal is strong enough, we make a direct A/D conversion, and use the digital output as an operand in a program. Result? Theoretically, real-time adaptive filtering.

**We're also talking hardware:**

We're looking for hardware people with a conceptual bent. The reason? A belief that innovations proliferate only when lines between theory and practice are flexible or nonexistent. The kind of people we want see hardware from a systems

viewpoint. Memory people with enough savvy to talk about more than an improved NDRO memory—suggesting modification in systemwide word length if necessary. Logic people who can look beyond a 1 usec target unit add—insightful enough to show how T<sup>2</sup>L will yield faster process time, or CTL more powerful logic if system design is restructured accordingly.

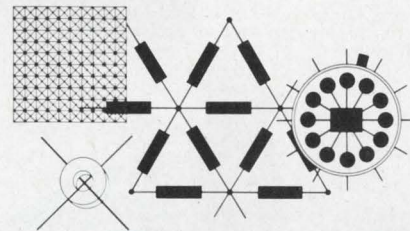

**Most important, we're talking futures:**

You're probably familiar with ITT's two-decade-plus history of accomplishment in the field of precision navigation, with basic and improved versions of LORAN, TACAN and OMEGA to our credit. But future implications derive from more than history. They're based on a firm management commitment to leadership in this field—a commitment with strong implications in the special-purpose computer area. But beyond this, there are the intrinsic implications of the computers themselves...where basic systems hardware techniques are readily transferable from aerospace to shipboard and land environments: areas where the Avionics Computer Group can provide substantial support for other ITT Divisions. What better implications are there for personal growth?

To find out how this growth can translate in terms of your personal advancement, why not investigate one of the positions outlined at the left.

**AVONICS DIVISION ITT**  
A Plans for Progress Equal Opportunity Employer (m/f)

Electrical / Electronic Engineer

# MICROELECTRONICS

To advance present state of microelectronics art. You'll

■ investigate various thin film deposition techniques used in fabricating microcircuit resistors and capacitors.

■ explore sophisticated packaging techniques needed in the application of integrated circuit technology.

■ initiate production processes for fabrication of thin film microcircuit components.

■ help design automated and computer-controlled test data entry and retrieval systems for microcircuits.

Requires knowledge of process variables and controls associated with high production rates of thin film components using different metal systems, including refractory types . . . and experience in fine line photolithographic work. Know-how in continuous process vacuum deposition equipment will make you even more valuable to our dynamically developing program. EE or Physics, preferably with advanced degree or innovative flair.

**Unique facility.** Separate engineering microelectronics laboratory for research. In addition, you'll have the opportunity to expand your technical background by teaming up with the widest range of professional competence and technological facilities in the U. S.

**Long-range development,** unaffected by contracts, proposals or fluctuations of the market place.

If you want individual responsibility and need not be shielded by red tape, please write today to Mr. W. H. Schaperkotter, Professional Placement Representative.

Box 303-GS, Kansas City, Missouri 64131

Bendix, Kansas City Division, is a prime contractor for the AEC and an equal opportunity employer.



ON CAREER-INQUIRY FORM CIRCLE 903

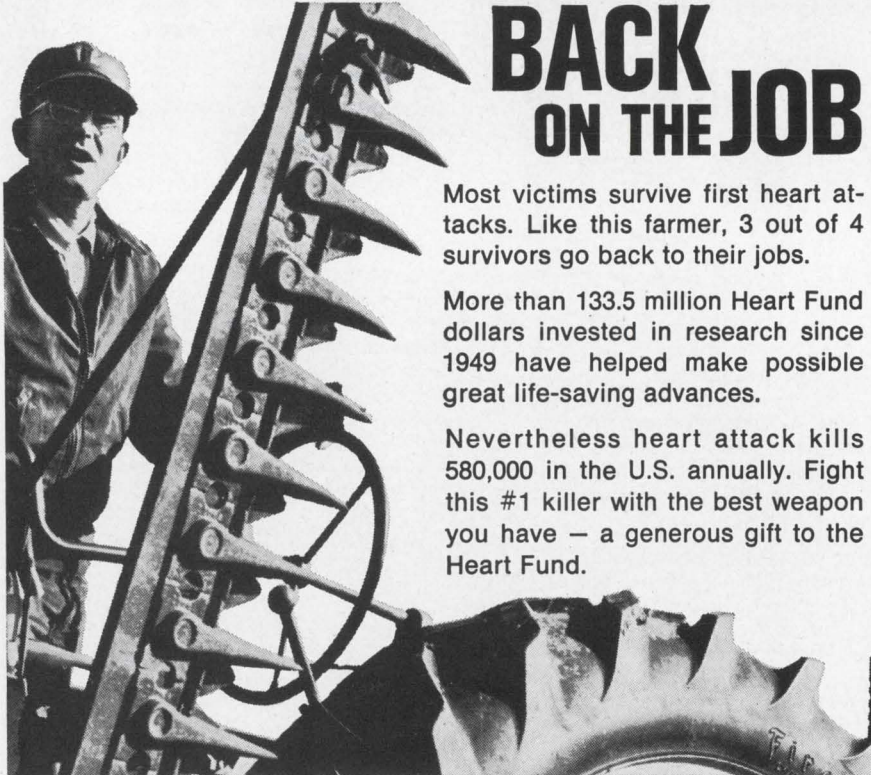

## BACK ON THE JOB

Most victims survive first heart attacks. Like this farmer, 3 out of 4 survivors go back to their jobs.

More than 133.5 million Heart Fund dollars invested in research since 1949 have helped make possible great life-saving advances.

Nevertheless heart attack kills 580,000 in the U.S. annually. Fight this #1 killer with the best weapon you have — a generous gift to the Heart Fund.

GIVE ... SO MORE WILL LIVE  
HEART FUND



Contributed by the Publisher

ously variable exposure times over a range from 125 ms to 16 s. The image section is gated on by applying approximately  $-550$  V to the photocathode and a negative potential that is approximately 85% of photocathode potential to the image section. To reduce image degradation, the combination rise and fall time of the on pulse should be a maximum of 0.01% of the shutter duration. To achieve the desired shutter durations, the maximum exposure time is set at 16 seconds and the minimum is determined by the rise and fall time limitation. Turn-on time of the electronic shutter is approximately  $900 \mu\text{s}$  and turn-off time approximately  $8 \mu\text{s}$ . Nominal shutter pulse width (exposure time) is manually adjustable (for tests) to values of 1/8, 1/4, 1/2, 1, 2, 4, 8, and 16 seconds; remote continuous adjustment (for mission operation) is possible from 0.07 to 17.4 seconds.

*Inquiries about this invention may be directed to: Technology Utilization Officer, Headquarters, National Aeronautics and Space Administration, Washington, D.C. 20546 (reference B67-10270).*

*Inquiries about obtaining rights for the commercial use of this invention may be made to NASA, Code GP, Washington, D.C. 20546.*

## Vibrator elapsed time fixed automatically

**Problem:** To determine elapsed operating time for vibrators (shaker tables) when three vibrators were located in one room and were powered by two amplifiers through either of two control systems. Additionally, two of the three vibrators could be operated in tandem from one or two control systems driving both amplifiers simultaneously.

**Solution:** A circuit that oper-

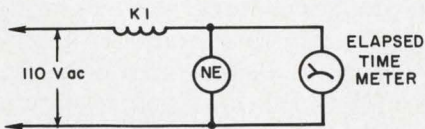
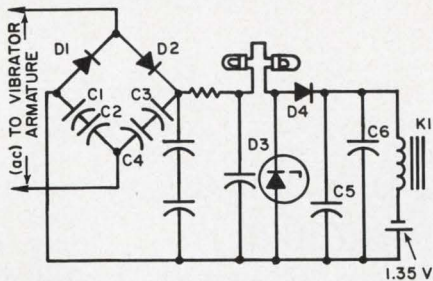

ates the control system elapsed-time clocks only when voltage is applied to the vibrator armatures.

Ac voltage is fed to the voltage doubler circuit  $D1$ ,  $D2$ ,  $C1$ ,  $C2$ ,  $C3$  and  $C4$ . This circuit and the pi filter system following it produce a dc voltage proportional to the ac voltage across the vibrator armature. Two light bulbs act as inexpensive nonlinear resistors, having negligible resistance at low input voltages and approximately  $8\text{ k}\Omega$  at 220 volts. Since  $K1$  requires 1 mA dc current at 10 volts for operation, potential across it is limited to 15 volts by  $D3$ . The two light bulbs protect  $D3$  and the balance of the circuit.

The  $K1$  relay springs are adjustable so that 3 volts rms will operate it. The 1.35-V mercury cell is used as a bias to increase  $K1$  sensitivity. The circuit of  $D4$ ,  $C5$ , and  $C6$  increases the shutoff time constant of the relay in order to hold it on during low voltage conditions due to resonances, but does not affect pull-in time which is essentially instantaneous with application of ac voltage to the doubler circuit. There is one clock (elapsed-time meter) with a neon indicator lamp for each vibrator.

*Inquiries concerning this invention may be directed to: Technology Utilization Officer, Marshall Space Flight Center, Huntsville, Ala. 35812 (reference B67-10284).*

*Inquiries about obtaining rights for the commercial use of this invention may be made to NASA, Code GP, Washington, D.C. 20546.*

Just because you work with hardware like this...

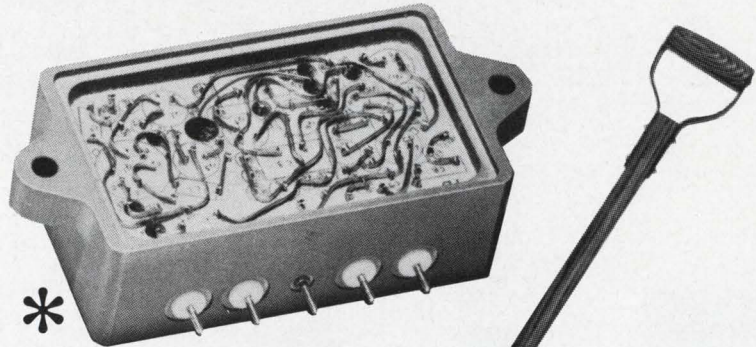

doesn't mean you have to work with hardware like this!

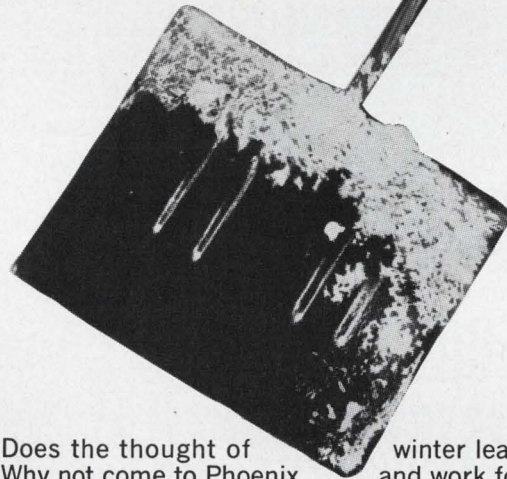

Does the thought of winter leave you cold? It does us. Why not come to Phoenix and work for Motorola's Aerospace Center? The work is important, the assignments are rewarding, the freedom is refreshing, the state-of-the-art is challenged, and, lest you forget, the weather's great. If you can qualify, send us a resume. You'll never feel snowbound again.

\*Motorola VCO shown actual size

#### Specific Opportunities:

- Space Communications ■ Radar Systems ■ Tracking & Telemetry ■ Fuzing ■ Digital Data Transmission ■ Guidance & Navigation ■ ECM & Elint ■ Checkout Systems ■ Coherent Transponders ■ Radar Transponders ■ Integrated Electronics ■ Antennas & Propagation ■ Reliability & Components ■ Advanced RF & Microwave Techniques



Government Electronics Division · Aerospace Center

Write: Paul Ahler, Recruitment Mgr., Dept. 62, Box 1417, Scottsdale, Arizona

MOTOROLA ALSO OFFERS OPPORTUNITIES AT CHICAGO, ILLINOIS — AN EQUAL OPPORTUNITY EMPLOYER



## EVER SEE THIS COLLECTION OF POWER RESISTORS BEFORE?

Don't feel left out because no one else has either. Each resistor or network illustrated is designed for custom fit and performance in some customer's special application.

If provided a few details of your extraordinary resistor needs perhaps SAGE can help you out too. Write or call industry's leading producer of miniature precision wire-wound resistors.



**SAGE ELECTRONICS CORP.**

Subsidiary of Gulton Industries, Inc.

BOX 3926 ROCHESTER, N. Y. 14610

Phone: (716) 586-8010

ON READER-SERVICE CARD CIRCLE 54

SEE OUR SPECIFICATIONS IN  
**VSMF**  
THE MICROFILM CATALOG FILE

## Self-starting procedure simplifies integration

**Problem:** Devise a self-starting, multistep procedure for the numerical integration of ordinary differential equations. Most multistep methods are not self-starting, and single-step methods, such as that of Runge-Kutta, are used to obtain starting values for the integration. This requires inessential tallying just to obtain starting values.

**Solution:** Generalize the classic, multistep, predictor-corrector procedures for the numerical solution of systems of ordinary differential equations, to produce all the required backward differences directly from the initial equations. Explicit algorithms and tables of numerical coefficients are given for starting and continuing the numerical integration of the equations.

The general problem is to devise algorithms for calculating  $X_n$ ,  $Y_n$ , and  $f_n$ —where  $X_n = x(t_n)$ ,  $Y_n = y(t_n)$ , and  $f_n = f(X_n, Y_n, t_n)$ —for  $n = 1, 2, 3, \dots$ , given the differential equations  $dx/dt = y$  and  $dy/dt = f(x, y, t)$  and the initial values  $X_0 = x(t_0)$  and  $Y_0 = y(t_0)$ . The theory for first-order systems is obtained by ignoring  $x$  in these equations. The procedure approximates the function ( $f$ ) by a polynomial  $t$  of degree  $q$ .

To achieve the best compromise between the speed, accuracy, and programing compactness, the following procedures are used in the integration:

- Fourth-order methods are used for first-order equations ( $q = 4$ ) and sixth-order methods are used for second-order equations ( $q = 6$ ).

- The iterated starter, which initializes the algorithms and then iterates the single set of equations, is used and iterated eight times. It is superior to a "bootstrap" starter, which is essentially an efficient way of obtaining first approximations in the right-hand side of the algorithms. This is because the "bootstrap" starter, although efficient in practice, is awkward and space-consuming when programed for automatic computers, owing to the multiplicity of algorithms and matrices required.

- The summed form of the predictor-corrector algorithm is used in backward-difference form. Backward differences in forward integration are preferable to backward ordinates for two reasons: The backward-ordinate formula tends to add nearly equal quantities of alternating sign, whereas the backward-difference formula adds monotonically decreasing quantities. And the availability of difference tables makes error estimation and automatic adjustment of the interval size a

straightforward procedure.

■ Four additional significant decimal digits are carried, in floating-point form, to control round-off errors.

*Inquiries may be directed to: Technology Utilization Officer, Ames Research Center, Moffett Field, Calif. 94035 (B67-10013).*

## Oscilloscope can be used as two-dimensional analyzer

**Problem:** To use a conventional oscilloscope as an X-Y plotter or two-dimensional analyzer with a capacity to tag each point with a yes or no, depending on a third parameter.

**Solution:** A square-wave pulse that would normally appear on the scope is replaced by a single dot which appears at a point related to the amplitude and horizontal position of the trailing edge of the input square wave. The information-bearing dot is designed to lengthen to a dash in response to a second, simultaneously occurring event.

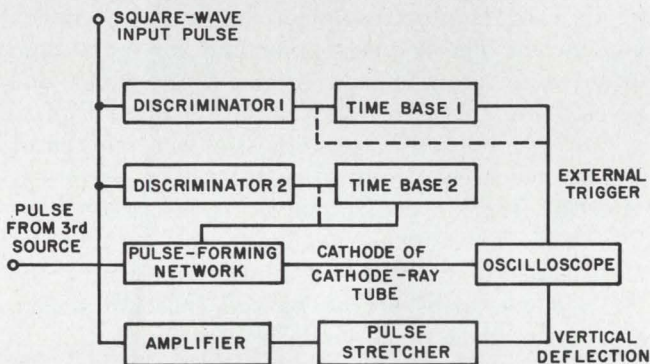

In operation, a square-wave pulse in a 50-ohm transmission line is applied to discriminator 1. The input to all the components in the diagram is of a much higher input impedance than 50 ohms. Discriminator 1 fires at a selected level on the leading edge of the input pulse and triggers time base 1. Discriminator 2 and time base 2 perform similarly but in response to a selected level on the trailing edge of the input pulse. The output of time base 1 triggers the oscilloscope sweep circuit while that of time base 2 triggers a pulse-forming network that pulses the oscilloscope tube cathode. Should a pulse from a third source appear at the second input to the pulse-forming network, the pulse applied to the cathode by time base 2 is lengthened by some adjustable amount. After being routed to the discriminators, the input pulse is applied to an amplifier and terminated in a 50-ohm load. The output of the amplifier is fed to a pulse stretcher with an appreciably longer time constant than the sweep rate. The stretched pulse is applied to the vertical deflection circuit of the oscilloscope.

*Inquiries concerning this innovation may be directed to: Technology Utilization Officer, Lewis Research Center, 21000 Brookpark Road, Cleveland, Ohio 44135 (reference B67-10269).*

DIALCO

# SUB-MINIATURE INDICATOR LIGHTS

make difficult display applications easier!

NEON  
OR  
INCANDESCENT

(Illus. approx. actual size)

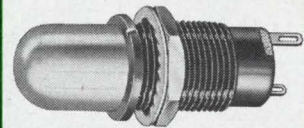

137-8836-0931-552



174-8430-0131-203



162-8430-0931-502



134-8430-0351-201

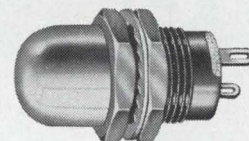

101-3830-0971-201

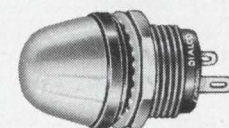

177-8430-0931-503

DIALCO®

Dialco has the widest selection of sub-miniature indicator lights to choose from ... off the shelf for quick delivery!

Designed to meet or exceed the environmental and operational requirements of MIL-L-6723 and MIL-L-3661, Dialco Incandescent units may be had for 1.35 to 28V circuits; Neon indicators for 105-125V AC-DC or 110-125V AC only. Units mount in 15/32" or 17/32" clearance hole—and lens caps unscrew from front of panel for easy lamp replacement.

Choose from a wide array of lens shapes and colors (with or without hot-stamped or engraved legends)—dimming or non-dimming features; assemblies with or without water-tight construction.



Ask for new 12 page catalog today. Get all the facts!

...and choose with the satisfaction of knowing you are getting the best. Dialco has been the standard of the industry for over a quarter of a century!

SAMPLES ON REQUEST—AT ONCE—NO CHARGE

Foremost Manufacturer of Indicator Lights

**DIALIGHT** CORPORATION

60 STEWART AVE., BROOKLYN, N.Y. 11237 • AREA CODE 212 497-7600

ON READER-SERVICE CARD CIRCLE 55

# MORE POWER IN LESS SPACE

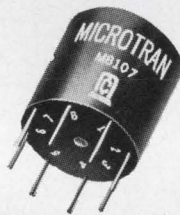

# NEW 400 Hz TOROIDAL TRANSFORMERS

Toroidal cores permit smaller height and package and greater efficiency. Size and savings up to 30%. Epoxy molded. Printed circuit pins can be bent for chassis mounting. Low phase shift.

For Applications Requiring Minimum Size and Weight  
Primary 115 Volts MIL Designation: TF5SX01ZZ

| Part No. | Secondary Volts | Secondary Current Ma. | V.A. | OD    | Dimension Height | Nominal Weight oz. |
|----------|-----------------|-----------------------|------|-------|------------------|--------------------|
| M8106    | 28 C.T.         | 320                   | 9    | 1 3/4 | 1 1/8            | 2                  |
| M8107    | 28 C.T.         | 710                   | 20   | 1 1/2 | 1 1/4            | 4                  |
| M8108    | 56 C.T.         | 160                   | 9    | 1 3/4 | 1 1/8            | 2                  |
| M8109    | 56 C.T.         | 356                   | 20   | 1 1/2 | 1 1/4            | 4                  |
| M8110    | 115 C.T.        | 78                    | 9    | 1 3/4 | 1 1/8            | 2                  |
| M8111    | 115 C.T.        | 170                   | 20   | 1 1/2 | 1 1/4            | 4                  |

IMMEDIATE DELIVERY FROM FRANCHISED DISTRIBUTORS  
Write for NEW 32 Page Catalog



## MICROTRAN

COMPANY, INC.

GARDENA, CALIF.

VALLEY STREAM, NEW YORK

## Computer program designed for sampled-data analysis

**Problem:** Design a computer program to accommodate  $S$  plane transfer functions of systems up to a limit of fiftieth order and to provide frequency response, step and ramp response, and root locus trajectories in either the  $W$  plane or the  $Z$  plane, as practicable. The program should have a direct  $S$ -to- $W$  and a  $W$ -to- $z$  transformation.

**Solution:** A program designed to perform transformations in the order  $S$  to  $W$  to  $Z$  which allows certain arithmetic to be completed in the  $W$  plane, rather than in the  $Z$  plane where computer resolution degrades the arithmetic. The new method is based on a direct transformation from the  $S$  plane to the  $W$  plane. The arithmetic required to get the  $W$  plane poles and zeros is not penalized noticeably by digital computer resolution, and great accuracy is achieved. The  $W$ -plane poles and zeros are then quite easily transformed into  $Z$ -plane poles and zeros using bilinear transformation algorithm.

*Partial Fraction Expansion* uses one method of simultaneous equations to calculate the constants (partial fraction coefficients) in the series.

*S-to-W Transformation* uses the method of algorithms to calculate  $W$ -plane substitutes for the  $S$ -plane terms of the partial fraction series, and the method of polynomial root extraction to obtain  $W$ -plane zeros. The algorithms give the  $W$ -plane poles directly.

*W-plane Root Locus* manipulates the  $W$ -plane numerator and denominator polynomials to generate the characteristic polynomial equations and uses polynomial root extraction to get the roots.

*W-plane Frequency Response* evaluates the  $W$ -plane numerator and denominator polynomials for real and imaginary parts for purely imaginary values of the argument.

*W-to-Z Transformation* uses the method of bilinear transformation, for each  $W$ -plane pole and zero.

The program is written in Fortran IV for an IBM 7094 computer. It can be used to obtain frequency response, step and ramp response, and root locus calculations of linear single-rate sampled-data systems up to a recommended limit of the fiftieth order. The complex  $W$  and  $Z$  planes are employed in the calculations. For practical reasons root locus calculations are performed only in the  $W$  plane, and step and ramp response calculations are performed only in the  $Z$  plane.

*Inquiries concerning this program may be directed to: COSMIC Computer Center, University of Georgia, Athens, Ga. 30601. Reference: B67-10287.*



# EECO's 970 synchronizes down range timing.....

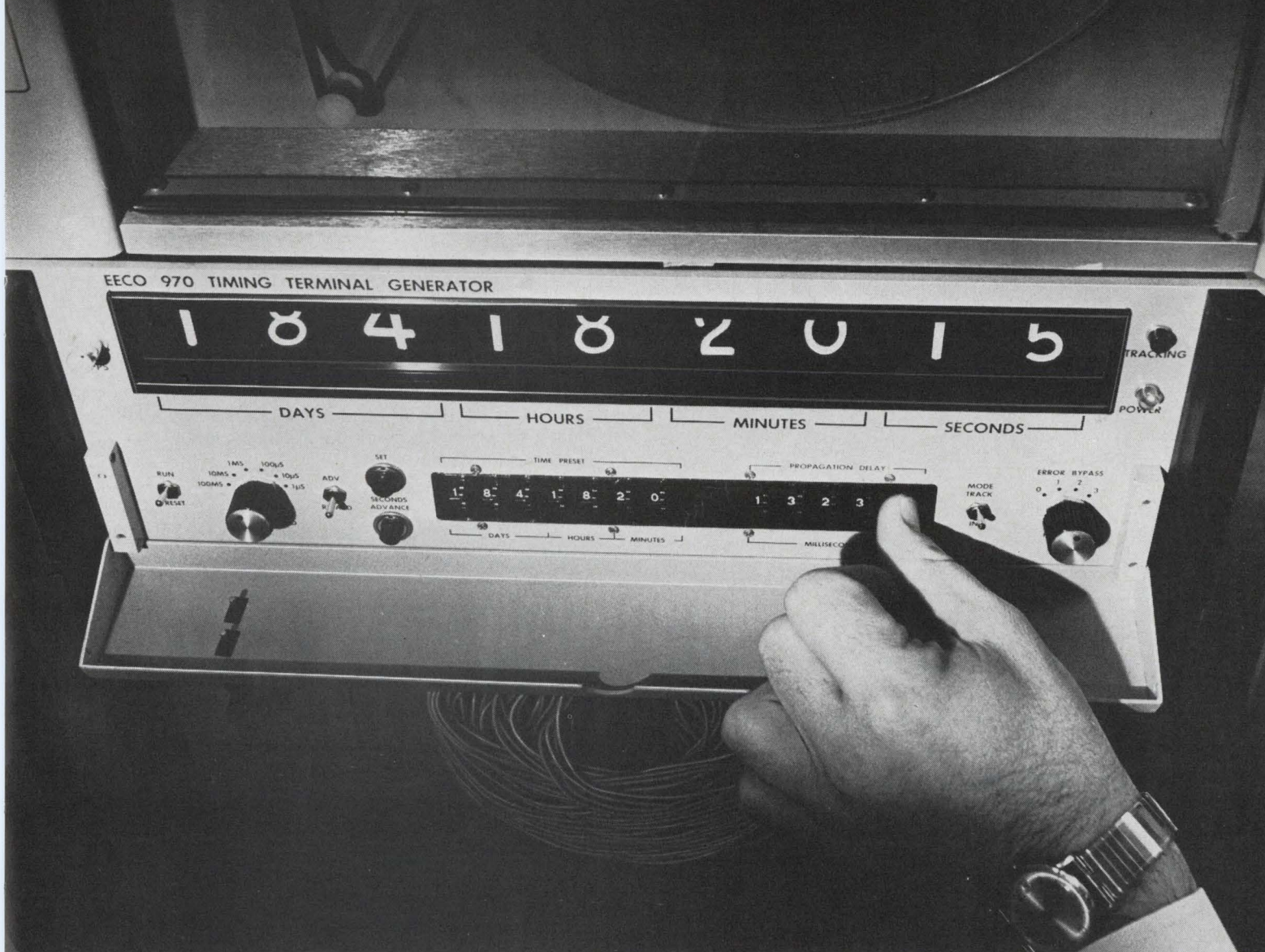

## and provides multiple code outputs

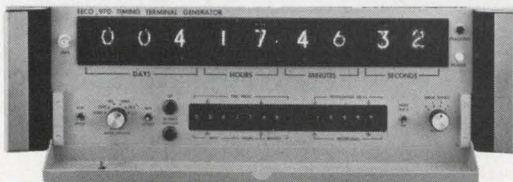

The new EECO Model 970 Timing Terminal Generator makes possible the synchronization of data recorded at remote sites with a central time code generator for later correlation and processing. The 970 accepts incoming 1 kHz carrier time codes in IRIG B, NASA 36-bit, or AMR D5 formats, and simultaneously generates up to five different output time codes. Unique propagation delay provisions, from 0 to 199.99 msec., permit output synchronization to within 5  $\mu$ sec; an error by-pass option allows reception of up to 3 erroneous time frames without effecting output. If the incoming signal is interrupted, codes are generated internally; when re-established, the unit automatically resynchronizes. Send for the data sheet covering the advanced Model 970.



### **INSTRUMENTS DIVISION**

ELECTRONIC ENGINEERING COMPANY OF CALIFORNIA

1601 EAST CHESTNUT AVENUE • SANTA ANA, CALIFORNIA 92701 • (714) 547-5651

# A stable voltage reference uses only six components

Highly regulated voltage for low-current applications that require an ultrastable reference can be achieved with the simple circuit shown in the accompanying figure. Circuits that might require such a reference are voltage-controlled oscillators in feedback loops and precision D/A converters.

The advantage of this regulator is that it provides good performance while occupying little space. The circuit contains only six components, and yet has the following specifications:

- Dc regulation: 0.01 mV/V
- Ripple suppression: 100 dB at 60 Hz  
60 dB at 20 kHz  
40 dB at 200 KHz
- Temperature stability:  $\pm 0.05\%$  from  $-55^\circ\text{C}$  to  $+125^\circ\text{C}$
- Input voltage range: 10.3 V to 22 V
- Short-circuit protection: at 13 mA  
10 mA
- Idle current: current limiting

The operation of this circuit is as follows. The operational amplifier senses the voltage difference between a precision resistance divider and the 1N827 temperature-compensated voltage reference diode. The full open-loop gain of the operational amplifier is then used to adjust this difference voltage to zero. Current for the reference diode is supplied from the regulated, rather than the unregulated, supply to minimize variations due to supply fluctuations. The resistance divider component values determine the ratio of the output

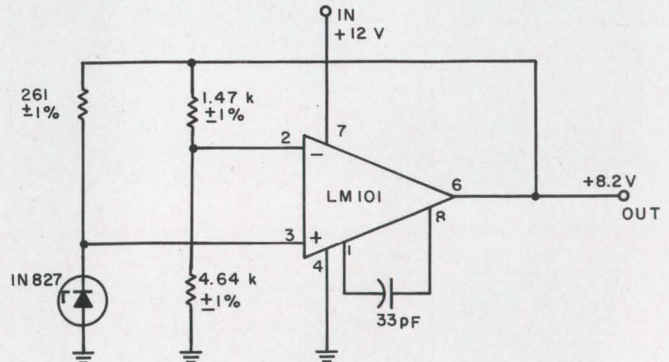

0.01 mV/V dc regulation is obtained in this simple voltage reference circuit. The output voltage can be adjusted to other values by changing the Zener diode and the precision resistor divider values.

voltage (8.2 V) to the reference voltage (6.2 V). A 200- $\Omega$  precision trimpot could be added at the center of the divider to adjust the output voltage to exactly 8.2 V over the  $\pm 5\%$  initial tolerance range of the 1N827 reference diode. The LM101 operational amplifier is ideally suited to this application because it is small, easy to stabilize, self-current-limiting, requires no ground connection, and has negligible current and voltage offset temperature coefficients (0.5 nA/ $^\circ\text{C}$  and 6  $\mu\text{V}/^\circ\text{C}$ ). The circuit can also be used to generate  $-8.2$  V from  $-12$  V by connecting pin 7 to ground, pin 4 to  $-12$  V, and reversing the polarity of the 1N827 diode.

*Frederick R. Shirley and L. Vanderlosk, Sanders Associates, Inc., Nashua, N.H.*

VOTE FOR 311



**VOTE!** Go through all Idea-for-Design entries, select the best, and circle the appropriate number on the Reader-Service-Card.

**SEND US YOUR IDEAS FOR DESIGN.** You may win a grand total of \$1050 (cash)! Here's how. Submit your IFD describing a new or important circuit or design technique, the clever use of a new component or test equipment, packaging tips, cost-saving ideas to our Ideas-for-Design editor. You will receive \$20 for each accepted idea, \$30 more if it is voted best-of-issue by our readers. The best-of-issue winners become eligible for the Idea Of the Year award of \$1000.

## Simple trick doubles sorting machine capacity

Electromechanical systems for sorting of articles at a high rate sooner or later approach their capacity limits. Specifically, a multistation sorting system, such as a letter sorter, where each station receives letters from a continuous stream at random, can fail to accept two letters for the same destination occurring one after the other. This is due to the fact that the electromechanical gate, after receiving a letter, will not have enough time to return to its ready state. Thus a system designed for such a worst case will be limited to a given

# The strong, silent one is now the faster, more compatible one.

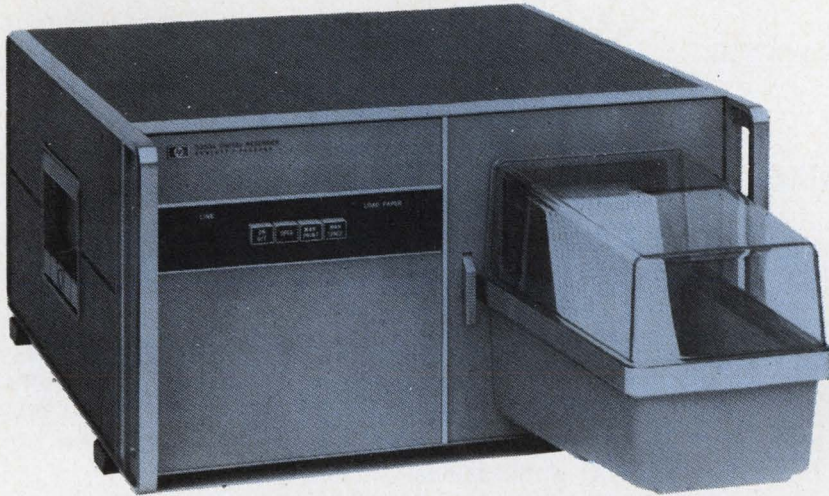

You've heard the Hewlett-Packard 5050A Digital Recorder called the "strong, silent one." That's because of its high reliability and noise-sealing paper hopper.

Now, data storage options are available to increase the overall speed of your data system. Adding storage reduces data transfer time to less than 100 microseconds. The storage options are highly compatible with inputs from integrated circuits since inputs of less than 1.3 volts are required. You can order storage with your new 5050A, or add it to your present 5050A.

With or without a storage option, the 5050A retains all its original advantages. It accepts 4-line BCD data from one or two sources and prints 20 lines/second with rugged but

quiet operation. Photoelectric decoding eliminates rotating electrical contacts. An ink roller provides greater reliability than start-stop mechanisms common to inked ribbon systems. Pressure-sensitive paper is also optional. The 5050A can print up to 18 columns, and you don't need expensive circuit boards to change formats or codes. Here is silent, dependable, durable and highly economical printing.

Price: 5050A Digital Printer: \$1750 (plus \$35 per column for driving electronics). Option 50, storage for 20 columns, \$400; Option 51, storage for 10 columns, \$200 (when ordered with printer). For more details, call your local HP field engineer or write Hewlett-Packard, Palo Alto, California 94304; Europe: 54 Route des Acacias, Geneva.

## Brief Specifications

**Print Cycle Time:**  
50 ms, asynchronous.

**Data Transfer Time:**  
<0.1 ms with storage options;  
50 ms without.

**Reference Voltage:**  $\pm 50$  V  
max. with storage options;  
 $\pm 150$  V without.

**Maximum Capacity:** 18  
columns, 16 characters each.

**Data Input:** Parallel entry,  
BCD (1-2-2-4, 1-2-4-8 or  
1-2-4-2); "1" must differ  
from "0" by 1.3 V minimum  
to 35 V maximum with  
storage options; 4.5 V to  
75 V without.

**Hold-Off Signals:** Both  
polarities diode coupled,  
simultaneously available (to  
inhibit input data sources  
while 5050A transfers data);  
10 mA load max.  $\pm 15$  V  
open circuit from 1 K source.

**Print Command Required:**  
Positive or negative pulse,  
2 to 20 V amplitude,  
 $1$  V/ $\mu$ s minimum rise time,  
 $6$   $\mu$ s or greater in width.  
AC coupled; without storage,  
4.5 to 20 V amplitude,  
 $20$   $\mu$ s minimum width.

HEWLETT  PACKARD

DIGITAL PRINTERS  
ON READER-SERVICE CARD CIRCLE 58

flow rate of letters.

A simple trick can effectively double the system's speed. It consists of "looking" at the letters as they are being placed into the main sorting machine, so that any letters with the same ZIP codes occurring are separated by at least one or more letters with different ZIP codes. In this fashion, the sorting speed can be roughly doubled without jamming up the machine.

Werner Hauer, Consultant, Sayre, Pa.

VOTE FOR 312

## Single-ended microwave mixer made in a rectangular box

A single-ended microwave mixer can be realized with a simple rectangular box (see Fig. 1a). This box resonates in the dominant  $TE_{101}$  mode and can be fabricated conveniently from sheet metal stock.

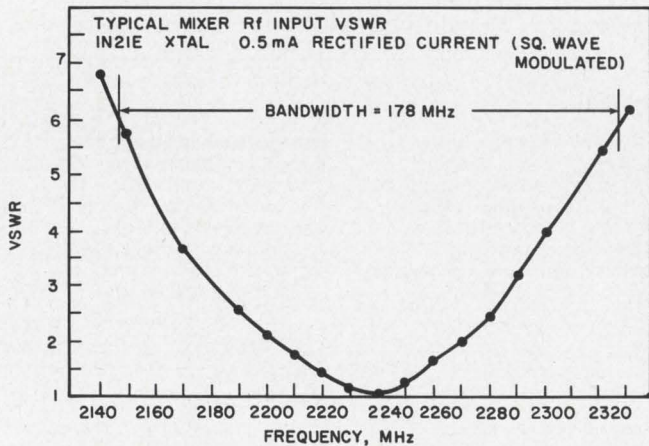
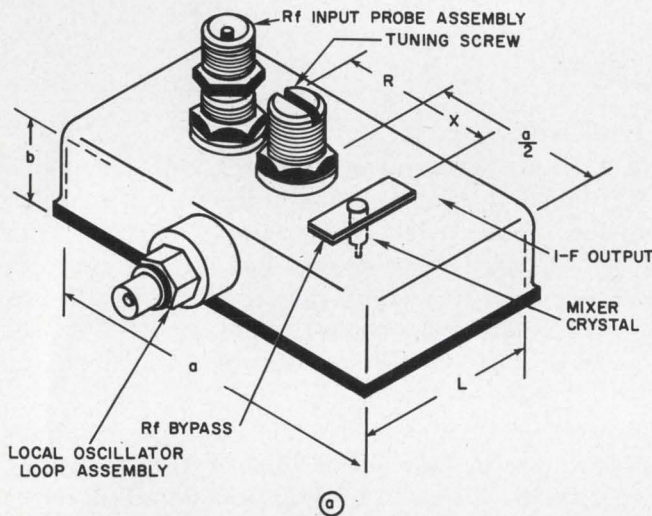

(b)

Single-ended mixer (a) can be built with sheet metal. Typical rf input vswr appears in (b).

Rf input is achieved with a coaxial probe, local oscillator injection with a coupling loop. The mixer crystal is mounted parallel to the cavity  $b$  dimension (waveguide height) in a position offset from the centerline of the  $a$  dimension (waveguide width). This offset (dimension  $x$ ) substantially determines the rf bandwidth of the mixer. A capacitive screw permits tuning of the box to resonance.

A single-ended mixer was built with a resonant box and  $a = 4.300$  inches (same as WR-430 waveguide). Adjusting the tuning screw and input probe assembly enabled the mixer to be tuned to any center frequency in the 1.7-to-2.4-GHz frequency range. Typical rf input vswr is shown in Fig. 1b.

The mixer is cheap and does not require use of a hybrid. The loosely coupled loop does not appreciably affect the cavity tuning; local oscillator power of about 20 milliwatts will, however, be required. Although this is an order of magnitude higher than that required with balanced mixers, recent advances in solid-state power generation make this level of local oscillator power quite feasible for many applications.

Richard M. Kurzrok, Consulting Engineer, New York.

VOTE FOR 313

## Old ball-point pens make handy test prods

Why throw away anything that might be useful? Used ball-point pens of the clear plastic type can be made into a set of test prods. With a pair of pliers pull the tips straight out, being careful not to break the plastic holders. Next, pull the empty ink tubes off the tips. Wash the tips with cleaning fluid, and then solder to them 3 ft of Belden 18.

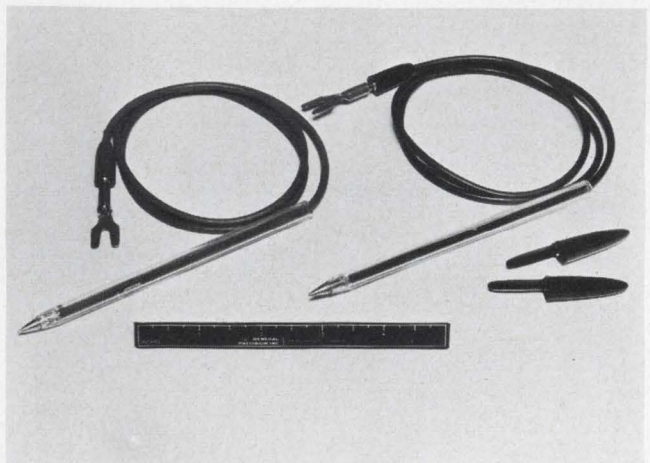

Handy test prods can be built from old ball-point pens, a few feet of insulated wire, and a couple of banana plugs.

# New complementary negative output series lets Helipot fill all your dc voltage regulator requirements — positive and negative.

## 12 Outstanding features on the negative:

- $\pm 0.05\%$  regulation
- short circuit proof models
- small size—0.5 sq. in.
- low profile—0.170"
- up to 5 amps load current
- fully sealed
- -3 to -21 volts output range fixed and adjustable
- hybrid cermet construction
- -55°C to +125°C
- up to 60 db ripple attenuation
- mil spec tested
- self-contained models, require no external components

| Voltage Range  | Positive               |                   | Negative               |                   |
|----------------|------------------------|-------------------|------------------------|-------------------|
|                | Fixed Output           | Adjustable Output | Fixed Output           | Adjustable Output |
| 3 to 9 volts   | Series 805             | Model 806         | Series 855             | Model 856         |
| 9 to 21 volts  | Series 801             | Model 802         | Series 851             | Model 852         |
| 21 to 32 volts | Series 803             | Model 804         |                        |                   |
|                | Reader Service No. 191 |                   | Reader Service No. 192 |                   |

### The price (1 to 9 quantity):

- \$30.00—fixed output models
- \$35.00—adjustable output models  
(delivery from factory stock)



### Positive or negative, Helipot fills your complete voltage regulator requirements.

Shown here is Model 851 Negative output DC Voltage Regulator — one of Helipot's four negative, hybrid cermet thick film units with outputs from -3 to -21 volts. Also available are 6 positive models with outputs from +3 to +32 volts.

For complete information on our unique *Negative* and *Positive* regulators, simply circle the appropriate number on the reader service card—or contact your local Helipot Sales Representative.

**Beckman®**

INSTRUMENTS, INC.  
HELIPOT DIVISION  
FULLERTON, CALIFORNIA • 92634

INTERNATIONAL SUBSIDIARIES: GENEVA; MUNICH; GLENROTHES, SCOTLAND; TOKYO; PARIS; CAPETOWN; LONDON; MEXICO CITY

AWG—Type 8899-100 test prod wire, black to some and red to the others. Pull the wires through the clear plastic pen holders and force the tips back into place. Solder banana plugs to the other ends of the wires. When the addition of spade lugs or alligator clips is required, you have a set of versatile test prods.

*George W. Pope, General Precision, Inc., Little Falls, N. J.*

VOTE FOR 314

## Capacitor leakage tester checks production units

Many capacitor acceptance specifications call for a minimum charge time at maximum surge voltage before leakage test can be made. When hundreds or thousands of capacitors must be checked for leakage, it is prohibitive to charge the capacitors indi-

vidually. The capacitor leakage tester shown increases the test rate substantially.

All the capacitors are charged simultaneously through *R1* when the charge switch, *S1*, is closed. Diodes *CR1* through *CR6* provide isolation for individual capacitor testing. When the capacitors are fully charged, *S1* is opened and *S2* is rotated to each capacitor position. This again places the full test voltage on the capacitor and monitors the leakage current. If one of the capacitors is shorted or partially shorted, relay *K1* opens to protect the meter. The "short" light comes on to indicate a circuit overload. When the capacitors have been tested, they are discharged through momentary toggle switch *S3* and *R2*. Diodes *CR7* through *CR12* provide a discharge path while maintaining isolation during testing.

*Fred W. Kear, Engineer, Sparton Southwest, Inc., a subsidiary of Sparton Corp., Albuquerque, N.M.*

VOTE FOR 315

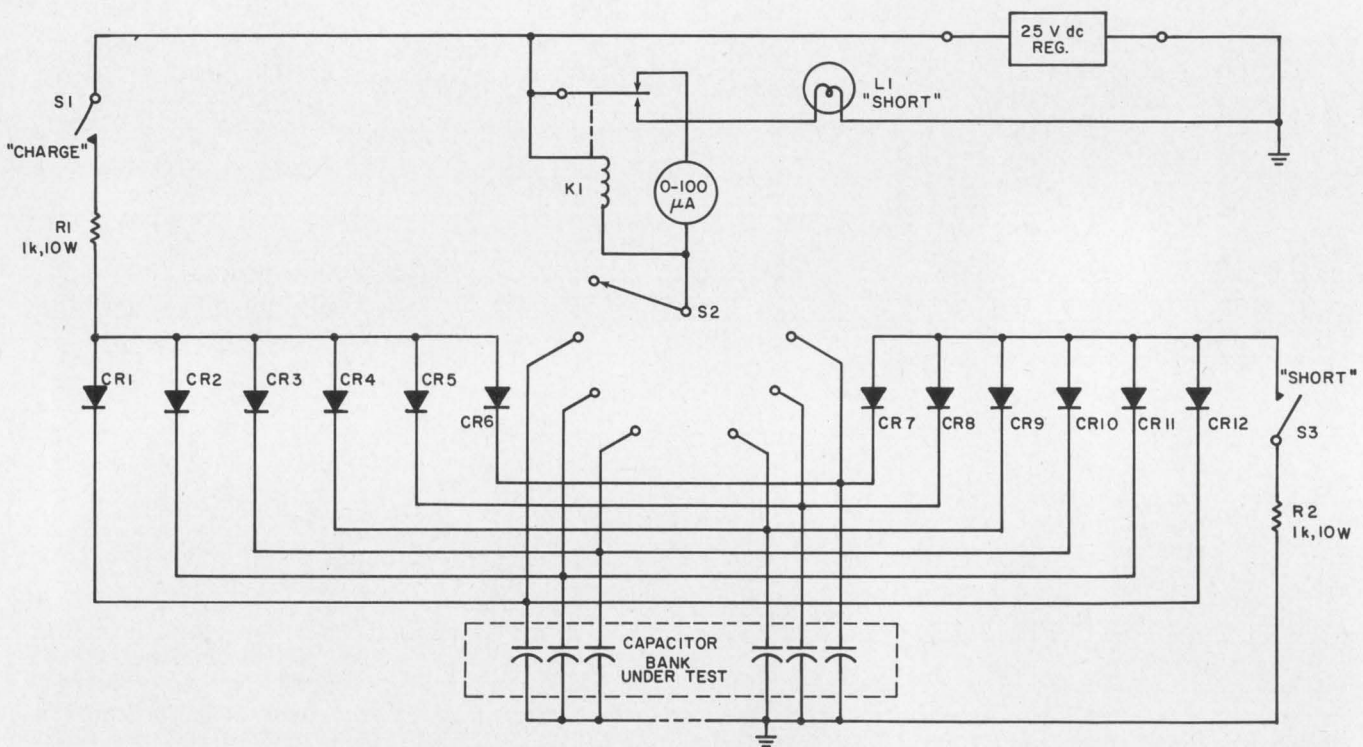

Fast testing of capacitor leakage currents is possible with this simple tester. Capacitors are charged in parallel, then

tested individually. Momentary on switch *S3* discharges all units after the test.

## Breakdown voltages found without curve-tracers

Although a curve-tracer or other special equipment is generally necessary to determine transistor or diode breakdown voltages, this can be done

easily with an ordinary oscilloscope, a voltmeter and a variable ac voltage source.

The circuit is shown in Fig. 1a. The load resistor may be any convenient value from 50 ohms to 5 kΩ, approximating the eventual circuit. Transistor junctions are tested individually.

# Microwave Test Equipment/ *waveguide and coaxial*

## Special Devices System Application Hardware

send for  
the most  
complete  
catalog  
of microwave  
components in  
the industry.

Waveline Inc., P.O. Box 718, West Caldwell, New Jersey,  
Phone: (201) 226-9100, TWX (201) 226-5558



### Attenuators

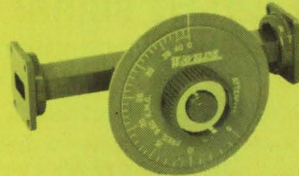

90 units are available to meet every requirement of attenuation, phase measurement and control in waveguide and coaxial lines.

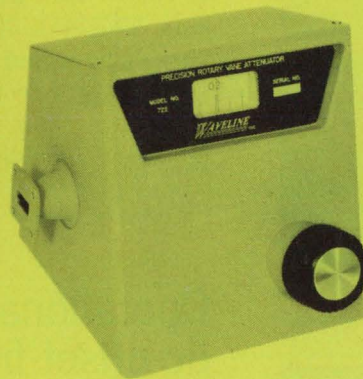

### Rotary Vane Attenuators

Ten units provide a 0.5 to 60.0 db range over the frequencies from 3.30 to 40.0 GHz at accuracy of  $\pm 2\%$  of dial reading or  $\pm 0.1$  db whichever is greater. Readout is spread over 30 inches of metal tape with parallax error correction. VSWR is less than 1.15. Three units cover the special common carrier bands.

### Special Devices

Waveline's capability to design and manufacture special components offers the widest range of engineering and production skills possible from one facility. Waveline is capable of generating basic designs in the form of a prototype or production of system components in strict compliance with your specifications.

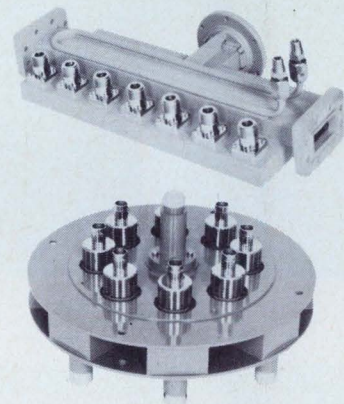

### Switches

These manually operated four way units in "E" and "H" planes provide switching in all bands from 3.95 to 40.0 GHz with Maximum VSWR's of 1.10. Power operated and other special units are also available.

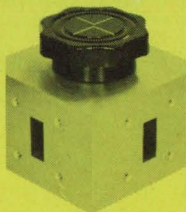

**WAVELINE** INC.

### Test Instruments

A complete line of instruments is available for all testing functions in bands from 2.60 to 40.0 GHz. Over 1200 standard units are shown in the generating catalog.



### Directional Couplers

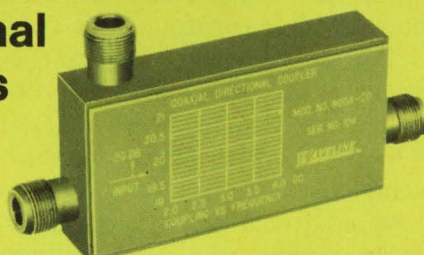

Couplers available for every application in any frequency band include broad wall, narrow wall, ultra-flat coupling, cross-guide and high directivity coaxial units. Hundreds of custom units have been produced to meet special requirements.

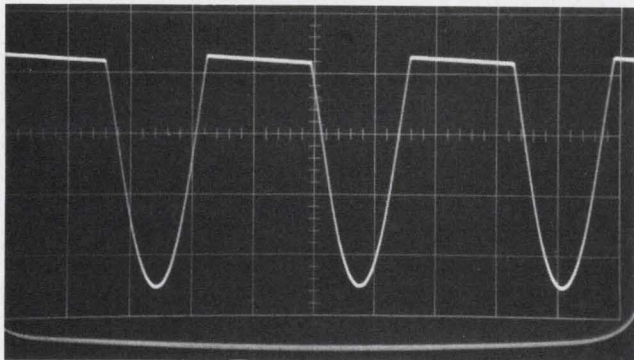
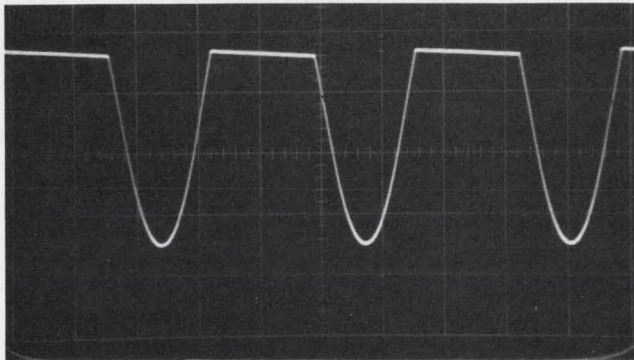
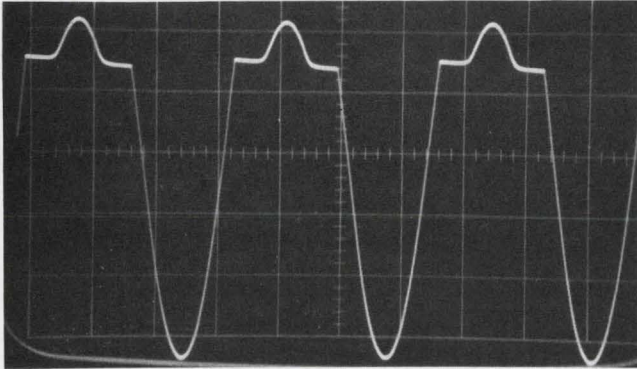
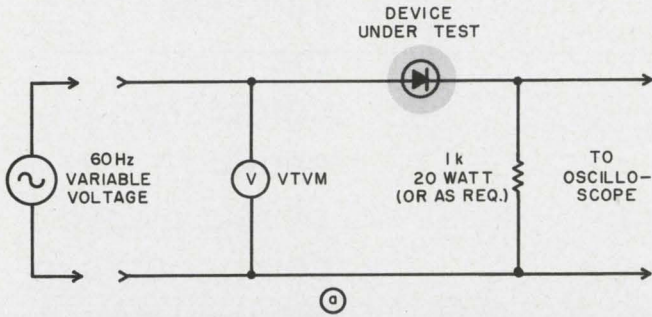

**Breakdown voltages** of transistors or diodes are determined with a simple circuit (a). Breakdown wave shape is in (b). Before (c) and after (d) tests show that the device was not damaged.

The test consists simply of increasing the voltage until the characteristic breakdown pattern (Fig. 1b) appears. Before and after test patterns (Figs. 1c and 1d, respectively) show that the device is not harmed in any way.

If a Variac or similar device with a two-prong ac plug is used for the voltage source, it is essential to determine which side of the line cord is grounded, otherwise at certain output voltages both output leads will be hot with respect to the oscilloscope chassis. Indeed it is highly recommended that any piece of test equipment with a two-prong ac plug be color-coded with a drop of nail-polish on the hot side. This will often produce a remarkable reduction of hum and noise, EMI, distortion, and leakage voltages from chassis to chassis.

*John H. Cone, General Manager, Electronic Enterprises, Pasadena, Calif.*

VOTE FOR 316

## Operational amplifier eliminates dc offset from 1/20-Hz signal

**Problem:** A piece of data-processing circuitry imposes a 1-volt dc offset onto its 1/20-Hz output. How can this dc offset be reduced to less than 1 mV without introducing phase shift if the working temperature ranges from  $-40^{\circ}$  to  $+55^{\circ}\text{C}$ ?

**Solution:** Theoretically, the offset can be removed by ac-coupling the 1/20-Hz signal to its subsequent stages. An electrolytic capacitor and resistor cost only a dollar or two . . . The phase-shift and temperature specifications, however, make this a major undertaking. To hold the offset below 1 mV without introducing phase shift requires a varactor-bridge operational temperature-stabilized oven.

The circuit in Fig. 1a eliminates an existing dc offset to enable low-frequency signals to vary about ground potential. The varactor bridge or parametric operational amplifier has 2-pA maximum initial bias current at  $25^{\circ}\text{C}$ , rising to 32 pA at  $65^{\circ}\text{C}$ . A temperature-controlled oven maintains the amplifier within  $\pm 5^{\circ}\text{C}$  of the nominal  $65^{\circ}\text{C}$  value for the full range of ambient variations, while an external offset control zeroes the amplifier at this  $65^{\circ}\text{C}$  point. Bias current at  $65^{\circ}\text{C}$  varies at an average drift rate of roughly  $2\text{ pA}/^{\circ}\text{C}$  (Fig. 1b), producing a voltage drop across  $R$  of only  $5^{\circ} \times 2 \times 10^{-12} \times 50 \times 10^6 = 500\text{ }\mu\text{V}$  for the  $5^{\circ}\text{C}$  temperature excursions.

An additional dc offset due to the varactor-bridge amplifier's  $50\text{ }\mu\text{V}/^{\circ}\text{C}$  voltage drift works out



Sperry has recently proved the performance of its X band klystron amplifiers through successful application in a military satellite communication terminal.

The system demanded a tube that is tunable across the entire military frequency allocation; a tube that is easy to install, operate and maintain; a lightweight tube that occupies a minimum of terminal space.

Sperry's answer is the SAX-4705, an 8 kW, 4-cavity klystron amplifier. The tube is tunable from 7.9 to 8.4 GHz. It delivers 48 db gain. It has a 1 db bandwidth of 40 MHz and is 36% efficient. Yet it occupies less than one cubic foot, including magnet, and the entire assembly weighs only 96 pounds. In addition, it has successfully passed testing to the most stringent military environmental specifications.

Other tubes in the SAX-4700 family include a 5-cavity version with 50 MHz, 1 db bandwidth, 53 db gain and 500 MHz mechanical tuning range; a 15 kW tube for operation from 10.0 to 10.5 GHz, and a 20 kW version for the 7.9 to 8.4 GHz band. For more details on any or all of these tubes, contact Cain and Co., or write Sperry Microwave Tube Division, Gainesville, Florida 32601.

**SPERRY**  
 MICROWAVE TUBE DIVISION  
 GAINESVILLE, FLORIDA

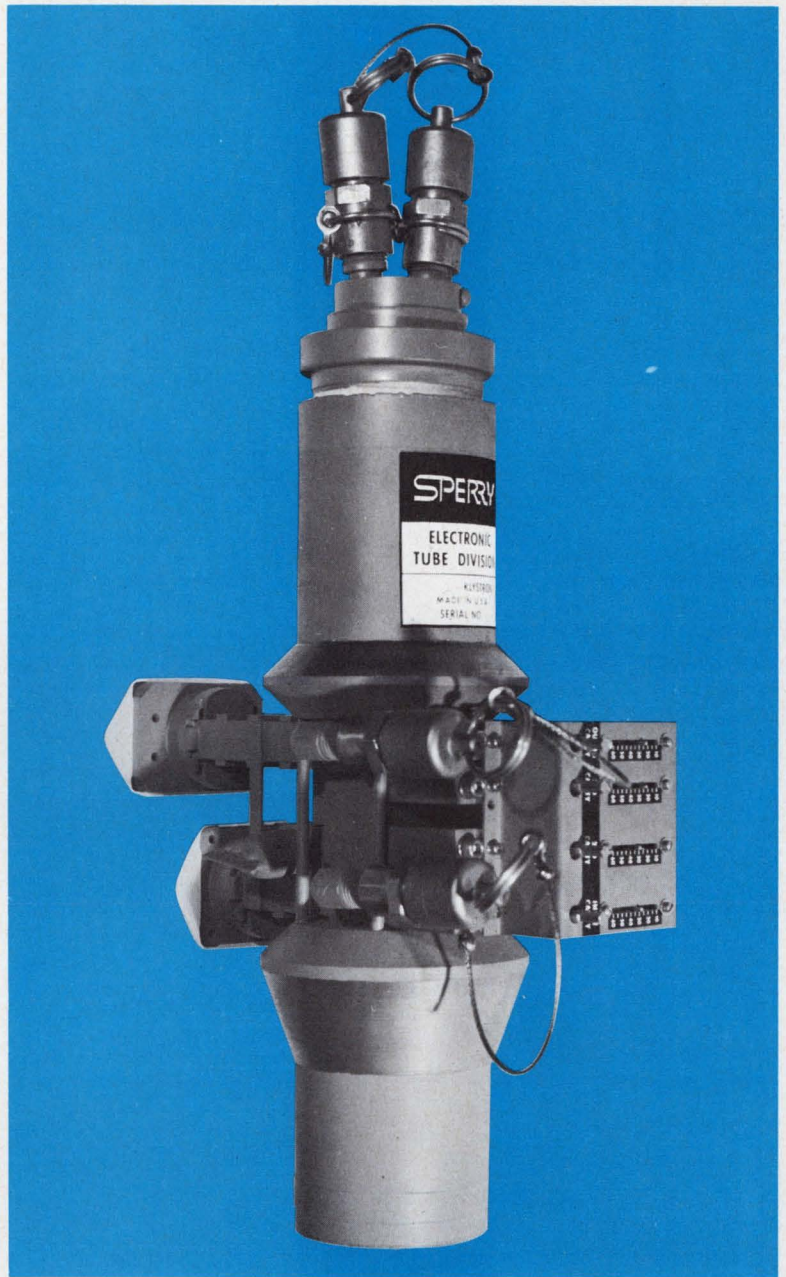

### **SAX-4700 Series Klystron Amplifier**

|                 |                 |
|-----------------|-----------------|
| Frequency range | 7.9-8.4 GHz     |
| Tuning range    | 500 MHz         |
| Power output    | 8.0-20.0 kW, CW |
| 1 db bandwidth  | 40-70 MHz       |
| Gain            | 45-54 db        |
| Efficiency      | 36-40%          |
| Weight          | 96 lbs          |

**Military communication satellite terminal application proves versatility of Sperry klystron amplifiers.**

ON READER-SERVICE CARD CIRCLE 61

## IDEAS FOR DESIGN

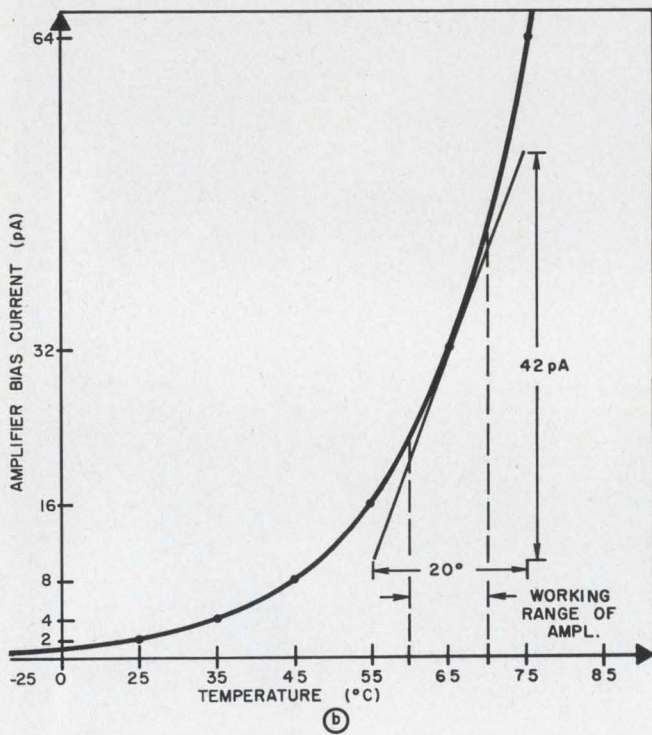
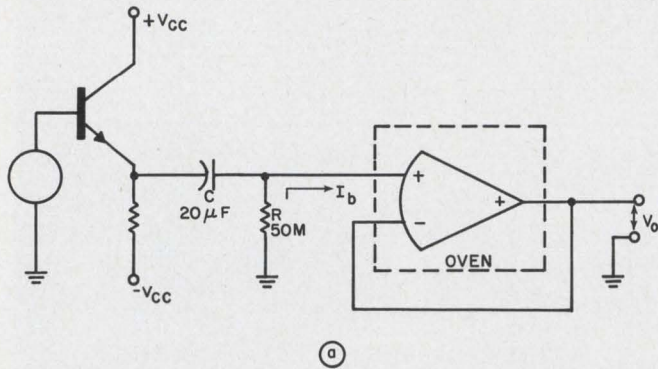

Dc offset of 1 V is reduced to less than 1 mV with a varactor operational amplifier in a temperature-controlled oven (a). Op-amp bias current vs temperature is in (b)

to  $5 \times 50 = 230 \mu\text{V}$ . Therefore, the worst-case over-all dc offset of  $(500 + 230) \mu\text{V}$  lies well within the specification.

Harvey Goldfarb, Application Engineer, Analog Devices, Inc., Cambridge, Mass.

VOTE FOR 317

## Simple tool removes plug-in modules

An annoying problem encountered with multi-lead plug-in modules is their removal from printed-circuit boards or chassis.

An easily constructed puller can be fabricated to fit modules of almost any size. The flexibility of its arms permits one puller to be used for a range of module sizes. Stainless steel 0.032 inch thick is used to make the tool.

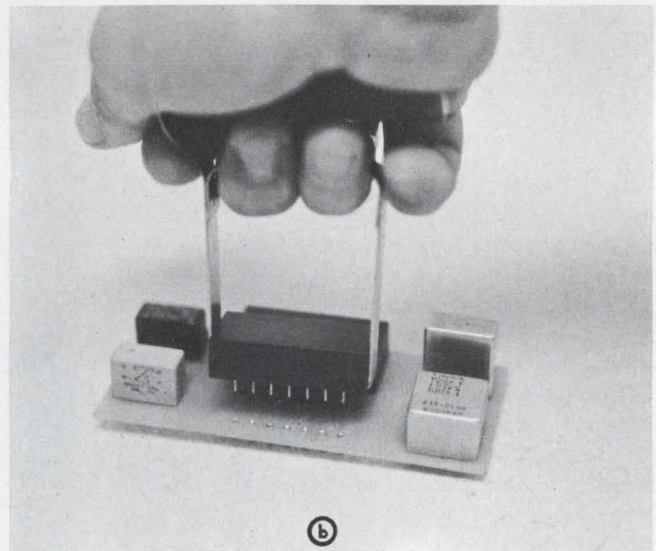
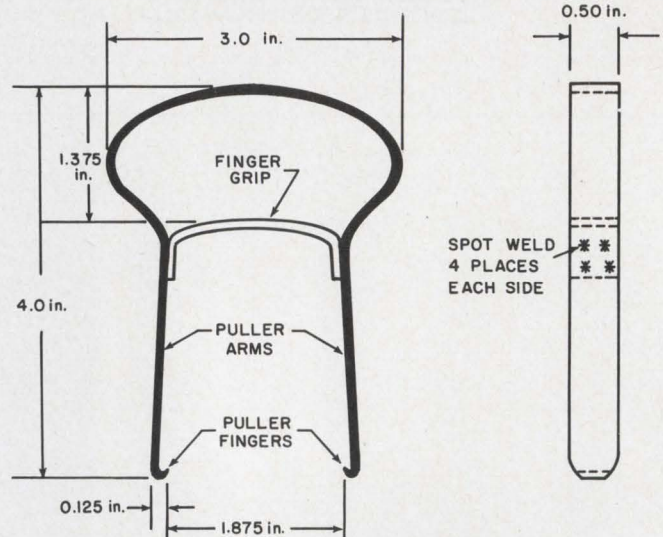

Plug-in modules are removed with ease (b) with a simple tool made out of few pieces of stainless steel scrap (a).

To remove a module, place the puller arms over the module body (Fig. 1b). When upward force is applied to the finger grip, the puller arms will be forced inward and the puller fingers will grip under the module. With steady pressure, pull the module.

Milton F. Dickfoss, Grumman Aircraft Engineering Corp., Bethpage, N.Y.

VOTE FOR 318

IFD Winner for October 11, 1967

Robert Billon, Design Engineer, Meylan, France.

His Idea, "Level detector has independently adjustable hysteresis and trip point," has been voted the \$50 Most Valuable of Issue Award.

Cast Your Vote for the Best Idea in this Issue.

**Design with  
confidence...**



**with  
Centralab's  
"Little Giant"  
Zeners  
up your sleeve**

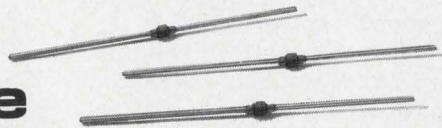

- Microminiature • High Rel
- High Wattage • Competitively priced

With Centralab Little Giant 1 watt zeners up your sleeve, regulators will be the least of your problems in circuit design. Though microminiature in size (actual size in above illustration), Centralab's Little Giant replaces larger zeners\*, in entertainment, industrial and high reliability applications. Rugged tests the Little Giant is subjected to and passes include acceleration,

mechanical shock, vibration, lead and body strength, temperature, thermal shock, humidity, salt spray and altitude. If you need a tough zener regulator, drop us a line on your letterhead and we'll send you complete specifications and a sample *free*, which is better than on-the-cuff.

*Centralab's Little Giant is available from the factory and through our Semiconductor Products Distributors. See your nearest distributor for your copy of the 1968 Centralab Condensed Semiconductor Catalog.*

\*The Centralab 1 watt zener regulator (HW6.8 through HW200.0) will replace any zener regulator that has a wattage rating of 1 watt or less within zener voltage breakdown of 6.8 to 200.0 volts, including aluminum can units, epoxies or other glass units. Here are some of the JEDEC types it will replace and outperform:

| 150mW   | ¼ watt  | ¼ watt  | 400mW   | 400mW   | 1 watt  | 1 watt  |
|---------|---------|---------|---------|---------|---------|---------|
| 1N1313  | 1N710   | 1N764   | 1N754   | 1N957   | 1N1767  | 1N3016  |
| through | through | through | through | through | through | through |
| 1N1327  | 1N745   | 1N769   | 1N759   | 1N992   | 1N1802  | 1N3051  |

**NOTE:** Also available in 1.5 watt, in solderable and weldable lead styles and in reel packaging for economical product assembly.



**CENTRALAB**

Electronics Division  
GLOBE-UNION INC.

5757 NORTH GREEN BAY AVENUE  
MILWAUKEE, WISCONSIN 53201

M-6722R

ON READER-SERVICE CARD CIRCLE 62

## ERA LC COMPACT MODULES

| Output Voltage (DC) | Current (71°C) | Model  | Price    |
|---------------------|----------------|--------|----------|
| 4-32                | 0-750 ma       | LC32P7 | \$ 89.00 |
| 4-32                | 0-2 amps       | LC322  | \$115.00 |
| 4-32                | 0-5 amps       | LC325  | \$179.00 |
| 4-32                | 0-10 amps      | LC3210 | \$215.00 |
| 30-60               | 0-1 amp        | LC601  | \$145.00 |

### SPECIFICATIONS

**Input:** 105-125 VAC, 50-400 cps  
**Ripple:** Less than 800 microvolts RMS  
**Line Regulation:** Better than  $\pm 0.01\%$   
**Load Regulation:** Better than 0.05% for 0-100% load change  
**Transient Response:** Less than 50 microseconds  
**Operating Temperature:**  $-20^{\circ}\text{C}$  to  $+71^{\circ}\text{C}$  free air, full ratings  
**Temperature Coefficient:** Less than 0.01% per degree C

Write Today for Catalog #147A

## ERA WR ULTRA-COMPACT MODULES

| Output Voltage (DC) | Current (71°C) | Model  | Price    |
|---------------------|----------------|--------|----------|
| 1-33                | 0-500 ma       | WR33P5 | \$120.00 |
| 1-33                | 0-1 amp        | WR331  | \$155.00 |
| 1-33                | 0-2 amps       | WR332  | \$185.00 |
| 1-33                | 0-4 amps       | WR334  | \$255.00 |
| 1-33                | 0-8 amps       | WR338  | \$305.00 |

### SPECIFICATIONS

**Input:** 105-125 VAC, 50-400 cps  
**Ripple:** Less than 800 microvolts RMS  
**Line Regulation:** Better than  $\pm 0.01\%$   
**Load Regulation:** Better than 0.05%  
**Transient Response:** Less than 50 microseconds  
**Operating Temperature:**  $-20^{\circ}\text{C}$  to  $+71^{\circ}\text{C}$  free air, full ratings  
**Temperature Coefficient:** Less than 0.01% per degree C

Write Today for Catalog #148A

## ERA ST SLIM PROFILE MODULES

| Output* Voltage (DC) | Current* (71°C) | Model    | Price    |
|----------------------|-----------------|----------|----------|
| 1-63                 | 0-1 amp         | ST1000   | \$155.00 |
| 1-33                 | 0-1 amp Dual    | ST1000-2 | \$195.00 |
| 1-33                 | 0-2 amps        | ST2000   | \$175.00 |

### SPECIFICATIONS

**Input:** 105-125 VAC, 50-400 cps  
**Ripple:** Less than 800 microvolts RMS  
**Line Regulation:** Less than 0.01%  
**Load Regulation:** Less than 0.05%  
**Transient Response:** Less than 50 microseconds  
**Operating Temperature:**  $-20^{\circ}\text{C}$  to  $+71^{\circ}\text{C}$  free air, full ratings  
**Temperature Coefficient:** Less than 0.01% per degree C

Write for Catalog #149

# With these power modules you get wide VDC ranges—and set your own slot!

Frustrated by the narrow voltage ranges of conventional power modules? Now you can specify *wide range* ERA Transpac® modules and *set any module to any voltage slot* within its range!

- You automatically eliminate power supply obsolescence while you simplify your stocking problem
  - Three repairable 71°C wide range lines to choose from—low cost (LC) types, ultra-compact (WR) types and slim profile Slim Tran® (ST) types
  - Same precision ERA specs throughout.
- Send for literature today.

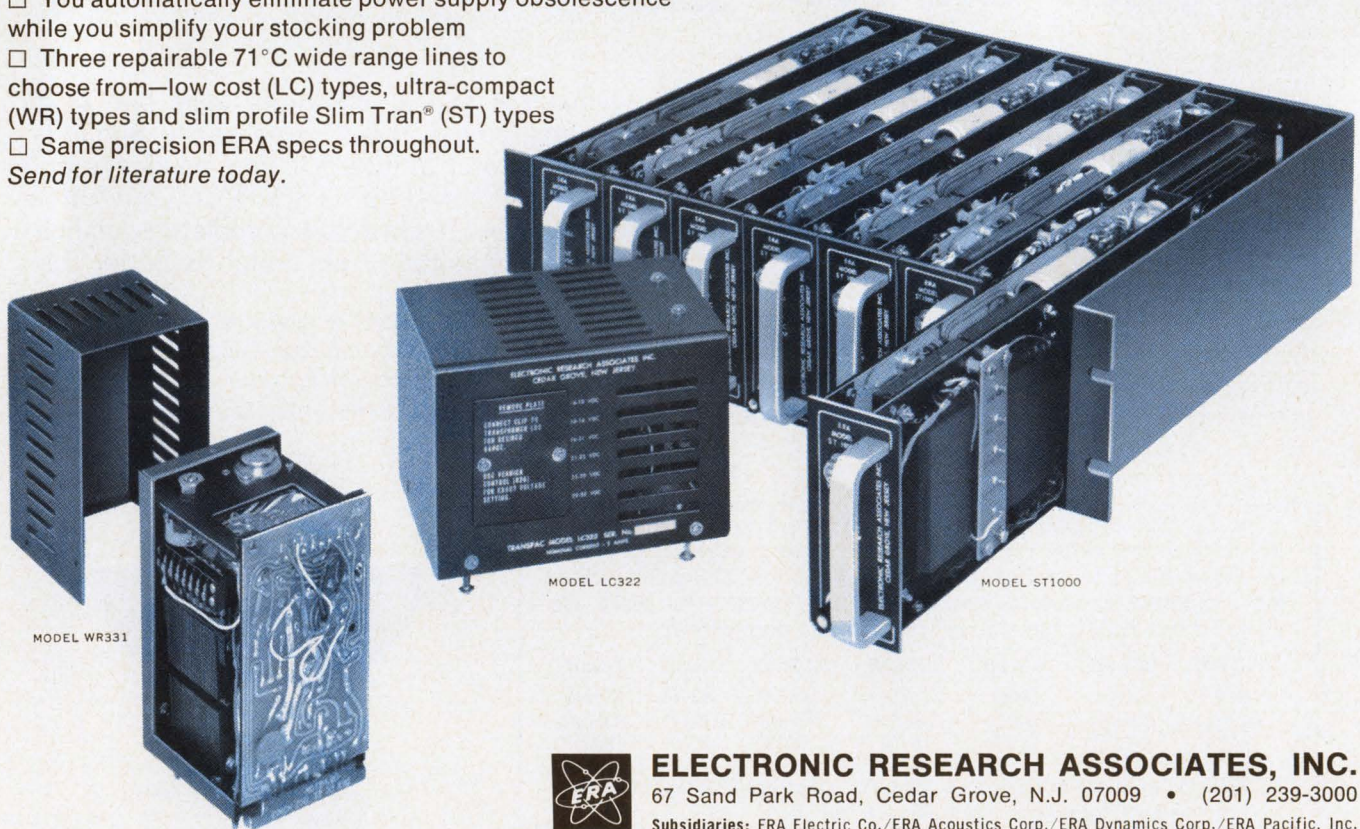

**ELECTRONIC RESEARCH ASSOCIATES, INC.**

67 Sand Park Road, Cedar Grove, N.J. 07009 • (201) 239-3000

Subsidiaries: ERA Electric Co./ERA Acoustics Corp./ERA Dynamics Corp./ERA Pacific, Inc.

ON READER-SERVICE CARD CIRCLE 63

# Products

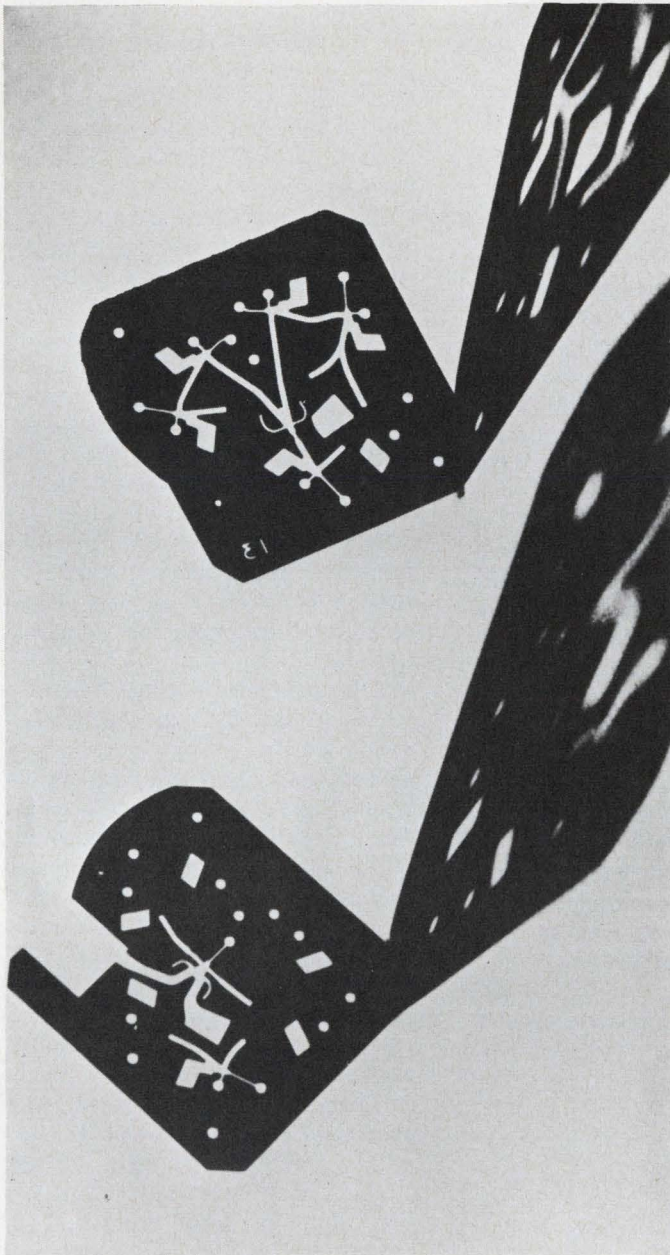

**Fluidic units** will from now on be listed as components. In this issue see page 140.

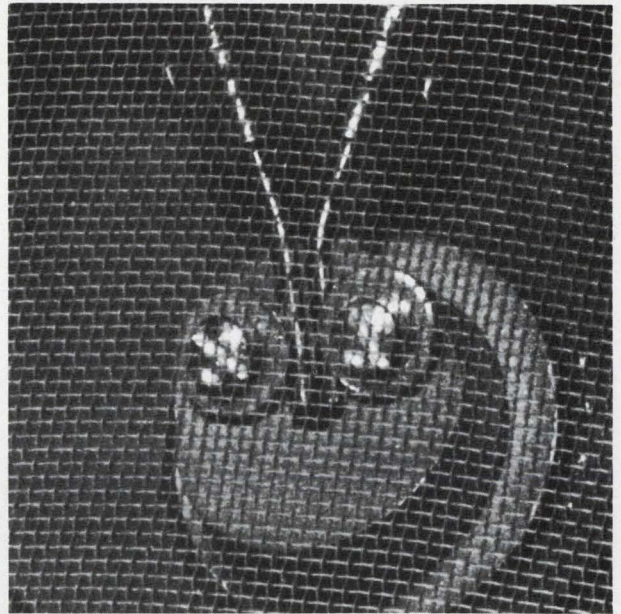

**Fluidic rate-sensor** provides a signal proportional to velocity sensed. Page 146

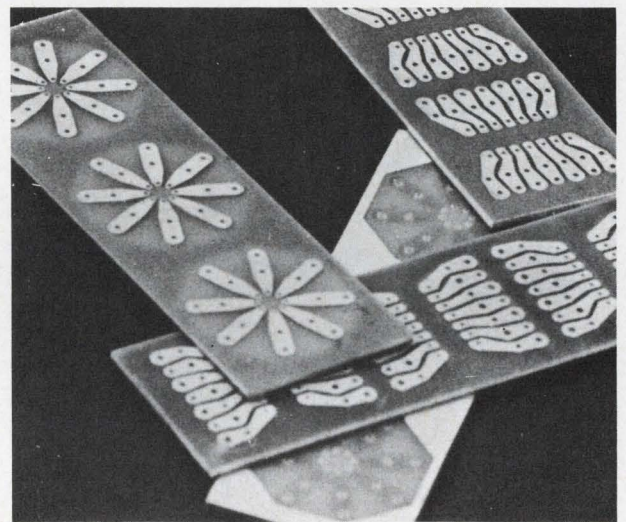

**Interchangeable card elements** help breadboarding in R&D work. Page 156

## Also in this section:

**Programmable power supply** has a slewing rate of 25  $\mu$ s. Page 150

**Linear transistor power amplifier** covers a range of 10 to 400 MHz. Page 154

**Design Aids**, Page 164 . . . **Application Notes**, Page 165 . . . **New Literature**, Page 166

# Fluidic control elements have eight functions

*General Electric General Purpose Control Dept., P.O. Box 913, Bloomington, Ill. Phone: (309) 967-9011.*

Six fluidic control elements and two fluidic control units have been put on the market. The control elements consist of a flip-flop, OR/NOT, digital amplifier, proportional amplifier, half adder and rectifier. The control units are a binary counter and a shift register or memory device.

Since fluidic units have no moving parts, they are durable and require no maintenance. They generate no electrical noise and their operating characteristics suit them particularly well to hazardous locations.

The fluidic elements are metal wafers sandwiched between two metal plates. The wafers are etched with channels which function as the inputs and outputs to produce the desired function.

The flip-flop element, or three-way valve, serves as the memory bank in a fluidic system. The output may be switched from one output port to the other by applying air pressure at the opposite control port, and will continue through this port even after the command signal has been removed. Minimum

control pressure to cause switching is about 10% of supply pressure. Max output flow is 50% of supply flow; max output pressure is 35% of supply pressure.

OR/NOT elements operate like three-way valves in parallel—a signal applied to any or all of the valves will allow the fluid to flow. This OR/NOT element is unique because when no command or control signal is present, output is always from the left port. A signal applied to any or all of the three control ports causes an output from the right output port. When the control signal is removed, output reverts to the left side. The OR/NOT is applicable to the functions of accepting and directing information between the sensors and actuation. Flow is changed to the right output port with a signal of 12% of the supply pressure; max pressure out is 45% of supply pressure; max flow out is 110% of supply flow.

The digital amplifier, or momentary three-way valve, is similar to the flip-flop except that it has no memory. Flow from an output port will continue only as long as there is a control signal present.

The half adder, or AND/EXCLUSIVE OR, is a passive element

that can replace 2 three-way valves connected in series. When a single signal is applied to either control port, the output is from the output port on the right side. If both signals are present, output is from the output port on the left. Max pressure out can be estimated at about 30% to 35% of the sum of control pressures. Max output flow is about 75% of the sum of control flows.

The proportional amplifier is a differential input and output device which provides pressure gains up to a max of 10. The fluid source is connected to the supply port and produces a jetstream that is divided between two output ports. The jet is deflected by the input signal pressure differential, which modulates the fraction of the jet flow that each output port receives.

The rectifier element provides full-wave rectification. Signal inversion is inherent in this device because of its operating principle. It is a differential input device with single-ended output. When the jet is centered, max output recovery occurs at the output port without control or balanced signals. When the jet is deflected to either side by an input signal or signal differential, the output decreases with no recognition of the input signal polarity. This provides full-wave rectification.

The shift register is assembled on the basis of information provided by the customer on the number of functions or exits to be performed. The assembled unit may have a max of 10 stages per unit. Each stage consists of two fluidic wafers, one the ready function and the other the shift or retentive function. Each wafer is a composite of a digital amplifier and a flip-flop.

The binary-counter can have a max of 20 stages per unit. The unit is similar in design to the shift register, but has two inputs, two major outputs and four major supply ports. It is particularly applicable when there is a need to count individual pieces to be packed in bulk, or for sorting in sequence control. When used in conjunction with a timed input it can also be an effective impulse counter.

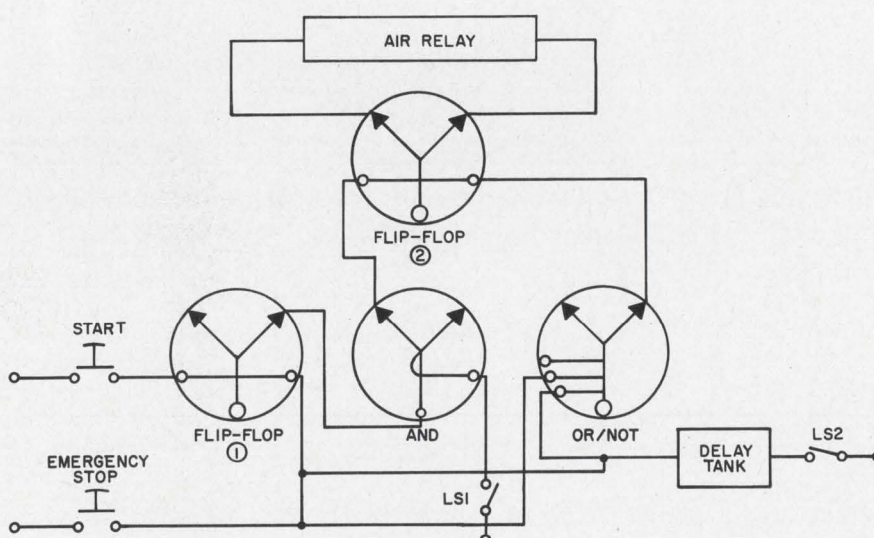

**Fluidic elements** being used in a control circuit. In this case an electric motor which is connected to a start/stop switch and a timer.

CIRCLE NO. 250

# Double Your Welding Production

→ in semi-conductor devices, IC modules and hermetically sealed enclosures with **weldPOWER<sup>®</sup>** Dual M-Head Welding Systems

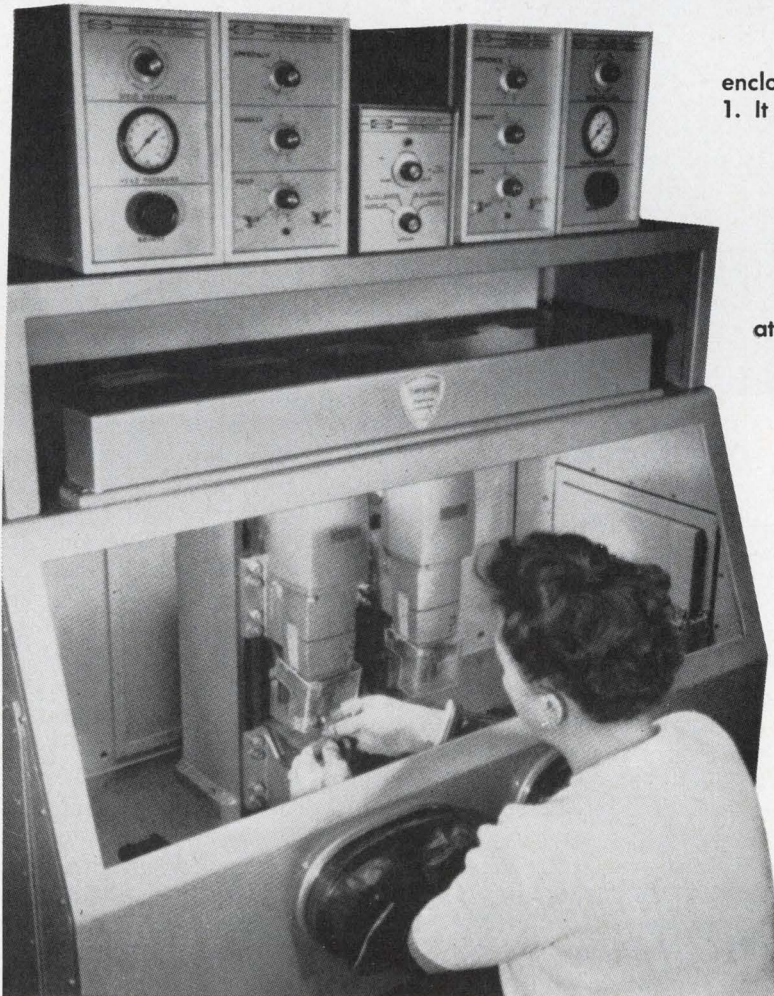

You can double your production rates, by the addition of a second welding head in a single atmosphere enclosure. This dual system offers four exclusive advantages.

1. It eliminates the need for a second atmosphere enclosure.
2. Saves on floor space needed for a second station.
3. Eliminates the need for a second operator.
4. Eliminates the need for a second power supply.

No other system is more ideally suited for quantity and quality production of semi-conductor devices or similar packages. Raytheon Model M Welding Heads are designed specifically to fit all standard atmosphere enclosures without any special modifications.

There is no need for special holes or space consuming protrusions. Pneumatic and electronic controls are conveniently located outside the unit. With the dual Model M Welding Heads, automatic ejectors and sequencing control this system, capable of producing up to 1,400 welds per hour and may be used with either AC or stored energy welding power supplies with maximum ratings up to 3,000 watt-seconds DC or 30 KVA AC.

The Model M Head design is compatible to atmosphere where the moisture content is as little as 3 ppm. It also has an adjustable anti-impact approach control that eliminates electrode impact damage to the work piece. Raytheon maintains facilities for analysis and evaluation of your particular welding problems.

For details on this and single head precision welding systems (DC and AC), or Ultrasonic Impact Grinders, contact

Raytheon Company, Sorensen Operation,  
Production Equipment Dept.,  
Richards Ave., Norwalk,  
Conn. 06856 Tel: 203-838-6571

**RAYTHEON**

## Miniature capacitors operate to 125°C

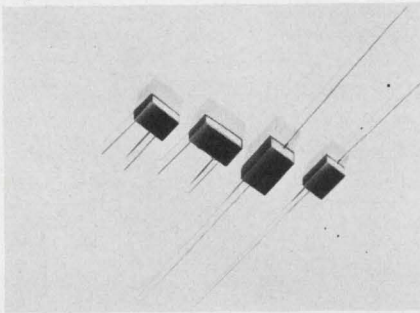

*Gulton Industries, Inc., 340 W. Huron St., Chicago. Phone: (312) 631-5073.*

Ultraminiature capacitors utilize a thin-film metalized polycarbonate dielectric. They are designed to operate within a temperature range of  $-55^{\circ}\text{C}$  to  $+125^{\circ}\text{C}$ . The low loss characteristic makes the series particularly suitable to tuned circuits, audio filters and both power and high-frequency ac circuits.

CIRCLE NO. 271

## Here's a tiny gang capacitor . . .

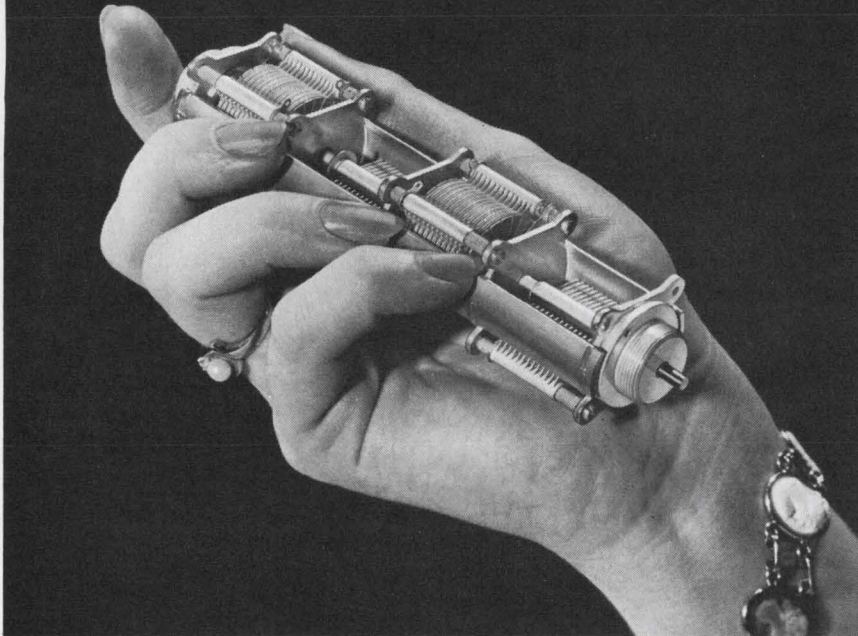

## that's rugged, precise, modular

True modular versatility permits a wider-than-ever range of applications for the new, ultra-compact Johanson Type 6100 gang capacitor. Specify from one to five sections . . . each section can be supplied in different capacitance ranges and in the following capacity variations: straight line capacity, straight line frequency, butterfly or split stator. Mounting versatility is another big feature — a special bearing mount permits easy direct panel mounting.

Functional simplicity is the keynote of the 6100. Exceptionally high shock and vibration resistance are the result of a new design utilizing an exclusive spring-type bearing and special alumina support of the rotor and stator. In addition the new 6100 series features low temperature coefficient, low torque and smooth tuning.

Save space . . . save cost. Get all the facts on the Johanson 6100 *before* you design your next project.

Write for full details, specifications

**Johanson** MANUFACTURING CORPORATION

400 Rockaway Valley Road, Boonton, N.J., Phone (201) 334-2676

ON READER-SERVICE CARD CIRCLE 65

## Hyperbola connector uses wire suspension

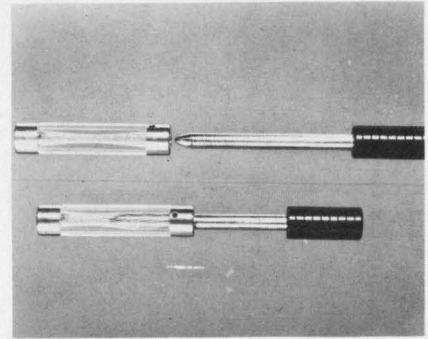

*Industrial Electronic Hardware Corp., 109 Prince St., New York. Phone: (212) 677-1881.*

The design of the connector is basically a hyperbolic linear generator achieved by stringing very fine wires inside a tube at an angle to the tube axis, and securing these wires to the tube ends. The tube then receives an outer sleeve with the appropriate terminal (solder cup, pin, turret, wire wrap, etc.) and the socket is complete.

The most commonly employed materials are the copper base alloys — brass, phosphor bronze, and beryllium copper. Also under investigation are high-temperature alloys such as Inconel, stainless steel and Kovar for high-temperature hermetic connector applications. Pin, socket and wire materials must be identical in each application to avoid corrosion from mating of dissimilar metals. The angle of inclination of the wires in the tube normally varies from  $6^{\circ}$  to  $10^{\circ}$  in all sizes. An increase in the angle increases the force required for insertion and extraction and decreases contact resistance. The number of wires employed varies from 5 to 12 according to the connector. Although wire gauge is normally constant for any given contact size, increasing the wire size results in slight increases in insertion and extraction forces but raises the working-current rating.

The units have been cycled 100,000 times without failure. The connectors have also withstood a test of 20,000 g without losing continuity. Models have been built that have carried 2000 A. Connectors are presently available in sizes 16, 20 and 26.

CIRCLE NO. 251



# FET analog switches & drivers

For commutators, choppers, digital filters - choose from dozens... here are some examples:

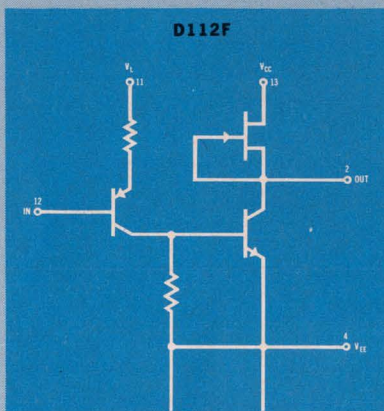

"D" Series FET Switch Drivers

These drivers are designed to couple between low-level logic and junction or MOS FET switches. Input thresholds are adjustable to your logic and you can preset the output voltage swing up to 30 volts peak-to-peak. The D series has as many as six drivers per package with a variety of electrical and logical options.

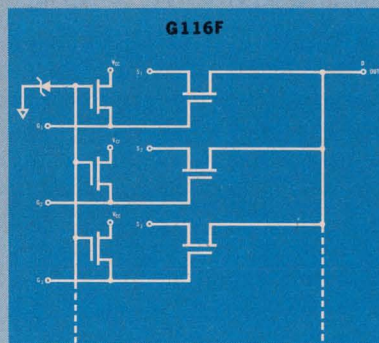

"G" Series MOS Switches

Here's a five-channel enhancement-mode MOS FET switch array that can be used directly with the Siliconix six-channel drivers. No external parts needed; just two IC packages and you've got five complete channels for multiplexing. The Zener diode protection is integrated, as are the FET pull-up elements that supply collector loads for the drivers. Other G-series circuits offer a wide choice of switching functions.

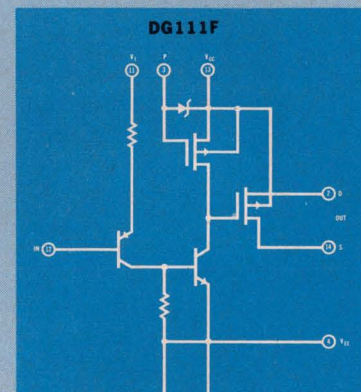

"DG" Series Drivers with FET Switches

Two complete channels—each with a driver and FET switch—are included in this one package. Connect the circuit directly to your low-level logic and it's ready to go. Each channel can control a millivolt whisper or a 20 volt roar. Driver gates (DG series) come in a variety of logical and electrical options.

Special requirements? Even 50 standard devices can't solve everybody's problem, so you're invited to write for a solution to your specific need.



**Siliconix incorporated**

1140 W. Evelyn Ave. • Sunnyvale, CA 94086  
Phone (408) 245-1000 • TWX: 910-339-9216

## ANALOG SWITCH/DRIVER DATA

Write for your FET switch data kit with information on all standard Siliconix switching products. If you have a current project that needs immediate attention, write or phone for applications assistance.

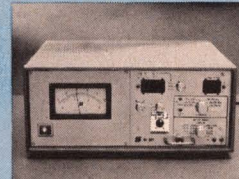
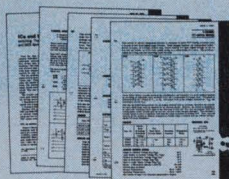

## NEW LOW COST FET TESTER

The S1200 Semiconductor Tester features plug-ins for expandable test capability, simplicity of operation, and low cost.

Price: S1200 Tester . . . \$960.  
Price: S1201 (DC &  $g_{fs}$ ) Plug in Module . . . \$1335.

Siliconix assumes no responsibility for the circuits shown, nor do they represent or warrant that they do not infringe any patents.

### Synchronous motor cycles in 1/100 s

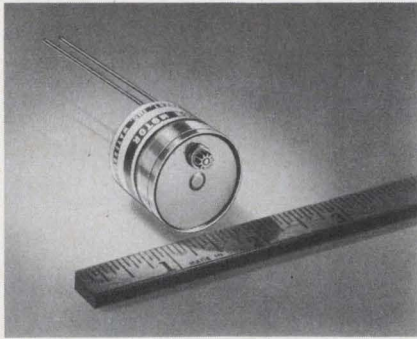

Haydon Switch, 1500 Meriden Rd., Waterbury, Conn. Phone: (203) 756-7441.

Single-phase synchronous integrating motors accelerate from stop to full speed at no load in 1/100 s. Starting torque at the 3600-rpm rotor shaft is 5 mm-g, and with a 60-rpm gear train, 10 in.-g. With a 3.6-rpm output speed, torque is 5 in.-oz. A low-inertia permanent-magnet rotor locks in on the first cycle of line frequency and stops instantly without coasting.

CIRCLE NO. 252

### Position detector analyzes angles

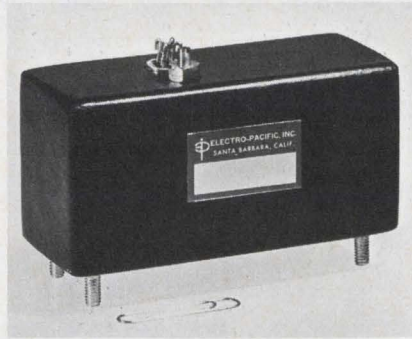

Electro Pacific, Inc., Box 30068, Santa Barbara, Calif. Phone: (805) 964-4878.

The model 9114 angular-position detector provides an electrical signal proportional to the angular displacement of the detector in a vertical plane. The detector does not contain moving parts or sliding contacts and relies completely on solid-state static-electronic components for operation. Resolution of the output voltage is infinite. The detector also provides a polarity reversing output.

CIRCLE NO. 253

### Power controls handle 120 or 220 V

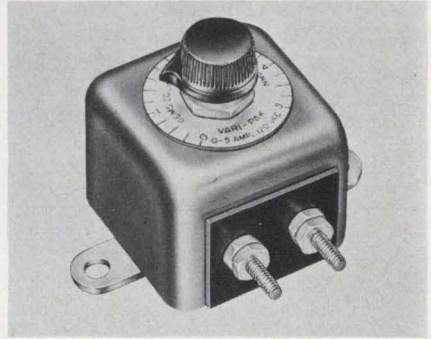

The Gems Co., Inc., Farmington, Conn. Phone: (202) 677-1311.

Solid-state power controls adjust input voltages to loads smoothly and arc-free from zero to max, for applications such as heater, lamp intensity, and universal motor control. The 120- and 220-V ac units regulate loads of 5, 10 and 15 A rms at 50 to 60 Hz. Only required power is drawn and the device sustains surge currents to 50 A. The unit is encapsulated in an aluminum housing measuring 1-3/4 in. square by 1-7/16 in. high.

CIRCLE NO. 254

#### UNEXCELLED QUALITY FOR LESS THAN 4¢

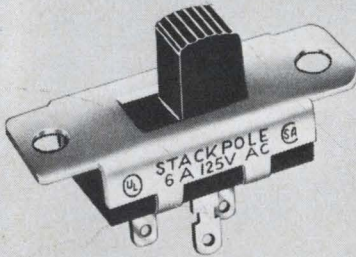

- Rated from 1 to 10 amps with full UL AND CSA approval.
- 7960 slide switch combinations — 23 basic types.
- New rugged solder lug terminal, designed for use with quick connectors.
- Uniform quality assured by automated assembly.
- Electro-silver plated terminals and contacts—shorting and non-shorting.
- Phenolic or nylon triggers in a variety of colors.
- Write for engineering bulletin.

**STACKPOLE**  
COMPONENTS COMPANY  
P. O. Box 14466  
Raleigh, N. C. 27610

ON READER-SERVICE CARD CIRCLE 66

#### UNIQUE DESIGN ADDS VALUE AND APPEAL

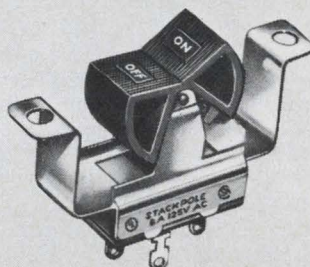

- 23 rocker switch configurations, including 2-3 positions, spring return and center-off.
- Variety of rocker designs available in a spectrum of colors and hot-stamped lettering.
- 1 to 10 amp UL AND CSA ratings at 125V and 250V.
- Solder lug, space saver, quick-connect or printed circuit terminals.
- Field-proven quality same as famous Stackpole slide switches.
- Prices start at less than 15¢.
- Write for engineering literature.

**STACKPOLE**  
COMPONENTS COMPANY  
P. O. Box 14466  
Raleigh, N. C. 27610

ON READER-SERVICE CARD CIRCLE 67

#### ENVIRONMENT PROOF ROTARY SWITCHES

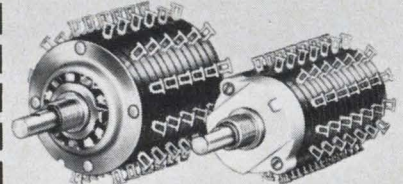

Series 600 1 5/8" Dia. — Series 100 1 1/8" Dia.

- Both index mechanism and electrical sections are completely enclosed.
- Corrosive atmospheres, dust, dirt and moisture are permanently sealed out, lubricants sealed in.
- Solder or quick-connect terminals molded permanently into position minimize production damage.
- Standard index angles include 15°, 30°, 36°, 60° and 90°, special angles available on request.
- Write for engineering bulletin.

**STACKPOLE**  
COMPONENTS COMPANY  
P. O. Box 14466  
Raleigh, N. C. 27610

ON READER-SERVICE CARD CIRCLE 68  
ELECTRONIC DESIGN 2, January 18, 1968

## Solid-state amplifier drives torque motors

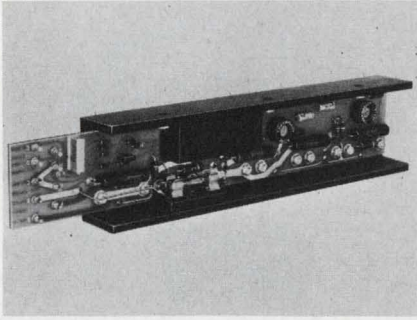

Magnedyne, Inc., 5580 El Camino Real, Carlsbad, Calif. Phone: (714) 720-7191. P&A: \$139 (1000 lots); stock.

A solid-state amplifier for driving torque motors is capable of operating up to 28 V and 25 A. The series 214 amplifiers can be used with a position servo or bidirectional velocity servo. The unit can be operated in either a voltage or current mode and with a gain of either 5 or 10. When used with a series 204 motor, the combination produces 1.5 ft-lb of torque.

CIRCLE NO. 255

## Photoelectric control uses fiber optics

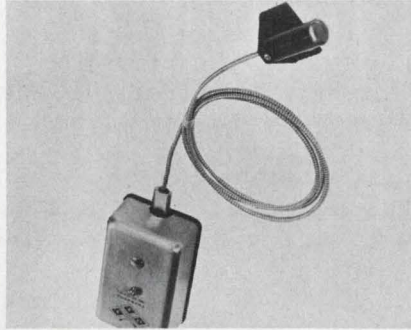

Dolan-Jenner Industries, Inc., 200 Ingalls Court, Melrose, Mass. Phone: (617) 662-8200. P&A: \$139 to \$182; 2 weeks.

Photoelectric and fiber-optic control utilizes a forked, high-temperature fiber-optic and lens assembly for retroreflective photoelectric detection up to 6 ft in ambient temperature ranges from  $-20^{\circ}$  to  $+600^{\circ}$ F. The fiber-optic scanner is sheathed in a rugged, flexible stainless-steel jacket. The control unit operates on 100-130 V ac.

CIRCLE NO. 256

## Miniature photo cells attain 150 $\mu$ A/lm

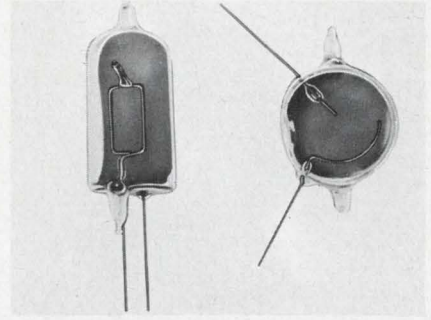

Calvert Electronics International Corp., 220 East 23 St., New York, N.Y. Phone: (212) 679-1340.

Six types of miniature photo cells can be used in movie projectors and spectrophotometers. Their size is less than  $1/2$  in.<sup>3</sup>. Gas-filled and vacuum cells are included in the range with min sensitivity ranging from 30 to 150  $\mu$ A/lumen. Caesium photocathodes are employed in order to give best response to tungsten illumination and their peak of spectral sensitivity occurs at 9600 Å.

CIRCLE NO. 257

### SOLVE NOISE AND FILTERING PROBLEMS WITH CERAMAG® FERRITE BEADS

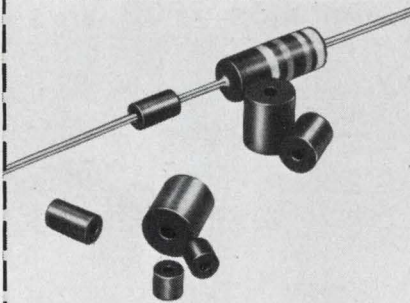

- Ceramag® ferrite beads are low cost, easy to install, and save space.
- Effective r.f. decoupling, shielding and parasitic suppression without sacrificing low-frequency power or signal level.
- Installed by simply sliding one or several over conductor leads.
- Beads can, but need not, be grounded.
- Sizes from .040" ID — .100" OD — 100" L.
- Sample quantities available.



**STACKPOLE**  
CARBON COMPANY  
Electronic Components Division  
St. Marys, Pa. 15857

### GUARANTEED UNIFORMITY IN ELECTRICAL, PHYSICAL CHARACTERISTICS

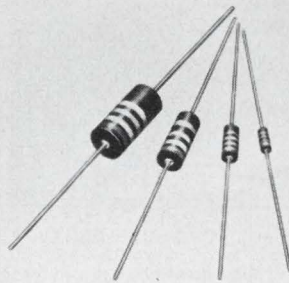

- Available in 2, 1,  $1/2$  and  $1/4$  watt sizes.
- Uniform from resistor to resistor, order to order.
- 100% tested for resistance value.
- Same day shipment on 9 orders out of 10.
- Solderability, load life and humidity-temperature characteristic checked.
- Impregnated to assure moisture resistance.
- Write for literature.



**STACKPOLE**  
CARBON COMPANY  
Electronic Components Division  
Kane, Pa. 16735

### NEW SPECIAL PURPOSE RESISTOR PROTECTION



- Currently in use on lightning arrestors, circuit breakers, spark plugs.
- Available in rods, sleeves, rings, special shapes, up to 15" in length and 5" in diameter.
- Ceramic composition favors high voltage applications with high surges.
- Organic Special Purpose Resistors are inexpensive solution where heat dissipation is necessary.
- Both ceramic and organic available in wide range of resistivity values.
- Write for technical assistance.



**STACKPOLE**  
CARBON COMPANY  
Electronic Components Division  
St. Marys, Pa. 15857

## Photoelectric pickup has own amplifier

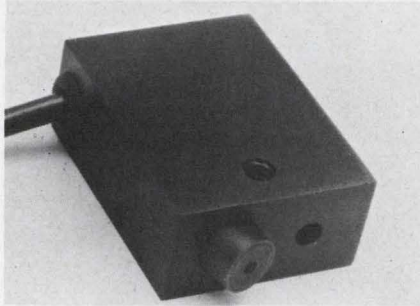

*Optronics, Inc., 51 Pleasant St., Newburyport, Mass. Phone: (617) 465-7568. P&A: \$79 (1-10); 2 wks.*

A light source, detector and amplifier circuit are contained in a small photoelectric pickup. The 201 is extremely sensitive to changes of reflected light and can respond up to 10,000 times per second. Applications include card reading, code detection, tape control, registration and inspection.

CIRCLE NO. 258

## Fluidic rate sensor reacts to velocity

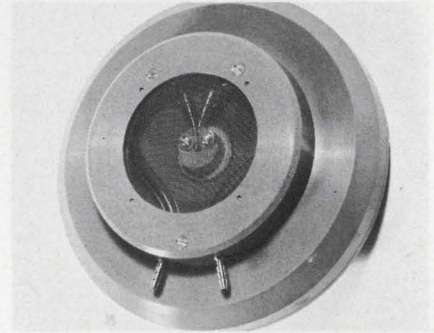

*Aviation Electric Ltd., 200 Laurentien Blvd., Montreal. Phone: (514) 744-2811.*

Fluidic rate sensor is a device capable of sensing angular velocity about its axis of sensitivity and provides a differential pressure signal proportional to that velocity. It has no moving parts and may be operated with air or most other commonly available gases. It is designed for operation under extreme conditions ranging from space-vehicle applications to aircraft autopilots and industrial speed-sensing applications. The rate sensor may be directly coupled to a proportional fluidic amplifier.

CIRCLE NO. 259

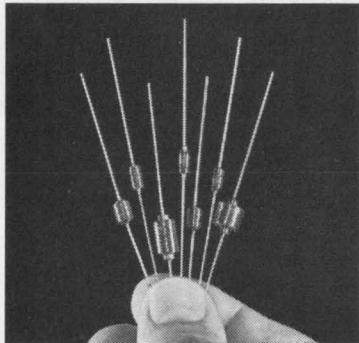

## Expanded Series (.01 uh to 100 mh) Subminiature RF Chokes

Ideal for network, filter, delay line and computer applications, 70F Series RF chokes give designers high reliability in a small package. Coils are impregnated with moisture resistant lacquer; can be fungus proofed or encapsulated on special order.

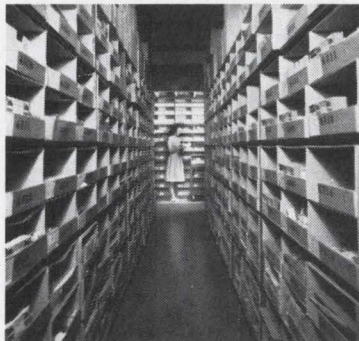

70F Series RF chokes are stocked in 88 standard inductance values to cover the .01 uh to 100 mh range completely. To insure fast delivery, J. W. Miller Company stocks the industry's widest line of RF chokes and RF & IF coils in depth. Virtually all orders are shipped on the same day the purchase order is received.

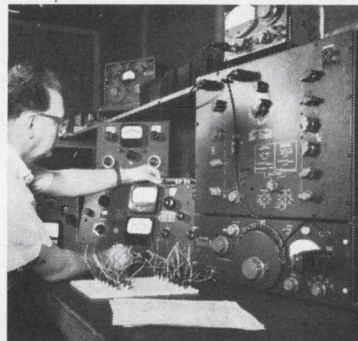

Screened room with precision test equipment assures close tolerance measurements for special coil characteristics. Special coil samples are shipped within 2 weeks; production coils are shipped within 3 weeks after sample approval.

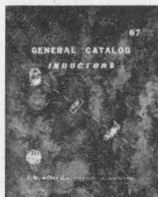

Catalog 67 gives specifications and prices for the full line of J. W. Miller RF chokes, RF and IF coils, transformers, filters, coil forms and components ... write for your copy today.

For your special coil requirements, call a Miller coil design specialist—(213) 233-4294.



## J. W. MILLER COMPANY

5917 SO. MAIN STREET • LOS ANGELES, CALIFORNIA 90003

GET FACTORY PRICES FROM YOUR LOCAL DISTRIBUTOR IN QUANTITIES TO 750

## Variable resistor withstands 7000 V

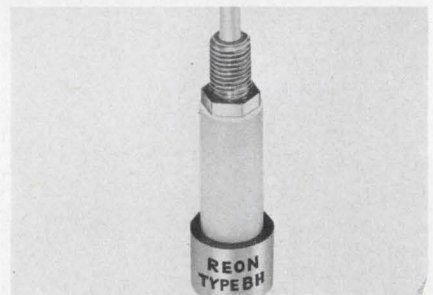

*Reon Resistor Corp., 155 Saw Mill River Rd., Yonkers, N.Y. Phone: (914) (965-9850).*

A variable resistor with a conductive plastic element that is 1/2 in. in dia is rated to withstand 7000 V. Featuring infinite resolution over a 50-Ω-to-5-MΩ range, the model BH is available as a completely sealed unit with a high-voltage bushing. A positive brush assembly reduces contact resistance and minimizes dynamic noise level to less than 2% initially.

CIRCLE NO. 260

# When you buy Continental's Series 2500 Center Screwlock Removable Contact Connectors...

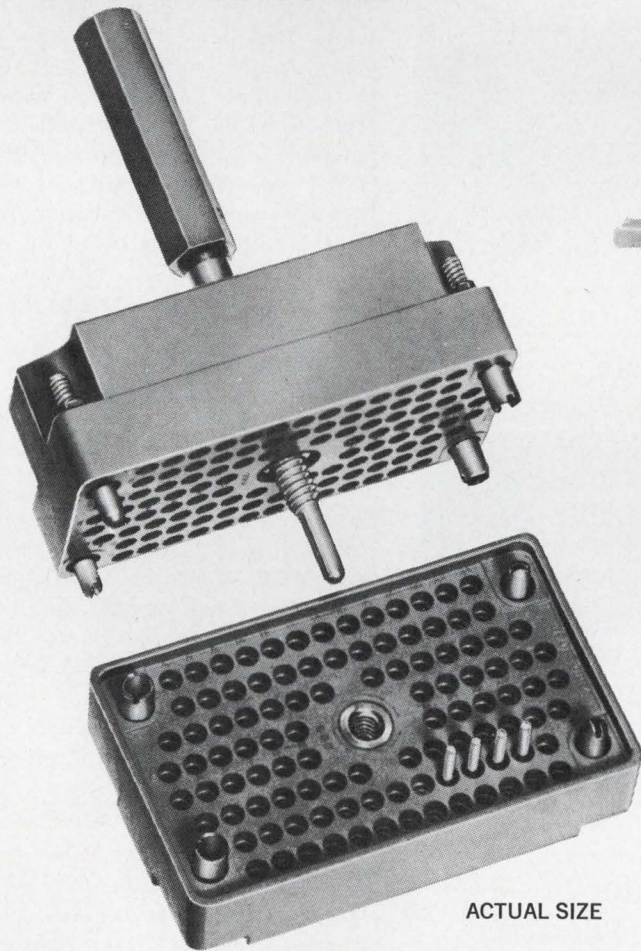

ACTUAL SIZE

# You can buy Continental's Removable Wire Crimp Termination Contacts for only 7¢ a set

(PIN AND SOCKET CONTACT)



Exclusive 3-Tine Tension Spring Clutch Conforms to MIL-C-22857

Now, high quality contacts you can depend on and still stay within your budget requirements. Only seven cents a contact set (in quantity) provides you with a choice of .0625 or .040 pin diameters, closed entry cartridge on socket and gold plated phosphor bronze material. Series 2500 center screwlock plug and socket connectors are available with 104 and 152 contacts. 7¢-per-set contacts are also available with miniature Series 25 and microminiature Series MMM plug and socket connectors.

*Write today for complete specifications on removable contact connectors. Phone sales department (212) 899-4422 for immediate action on quotations and catalogs.*

*For the Sales Representative Nearest You, See Our Listings in EEM and VSMF Directories.*

# CONTINENTAL CONNECTORS

CONTINENTAL CONNECTOR CORPORATION ■ WOODSIDE, NEW YORK 11377

ON READER-SERVICE CARD CIRCLE 73

### Source replenisher doesn't break vacuum

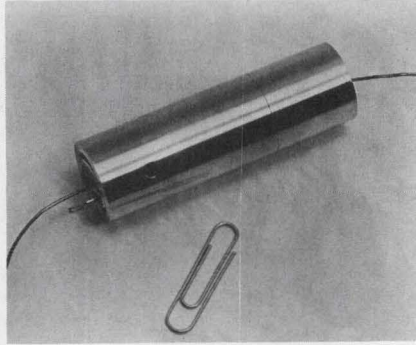

*Sloan Instruments, Box 4068, Santa Barbara, Calif. Phone: (805) 963-4431. P&A: \$195; 30 days.*

A source replenisher is a variable-pulse feeder for the continuous replenishment of electron-beam hearths without breaking vacuum. With an accessory power supply, this 7/8-in.-dia  $\times$  3-7/16-in.-long feeder can be made to pulse at any rate from 2/s to 6/min at up to 0.10 in. per pulse. It will accept a variety of source materials in wire form sizes up to 0.050 in. dia.

**CIRCLE NO. 261**

### Antenna feed horns are dual-polarized

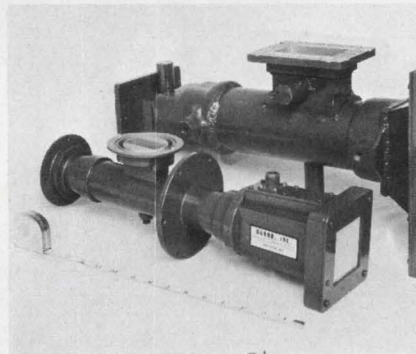

*Nurad, Inc., 2165 Druid Park Drive, Baltimore. Phone: (301) 664-8300. P&A: \$750 to \$1500; 45 days.*

This series of dual-polarized antenna feed horns covers the frequency range from  $-1$  to 12 GHz to illuminate reflectors varying from 4 to 60 ft in diameter. Its power is 10 kW cw and its VSWR is 1.2 max. This family of feed-horns is ideal for any communications systems where optimum gain is required from the reflector.

**CIRCLE NO. 262**

### Gain equalizer covers 4 to 8 GHz

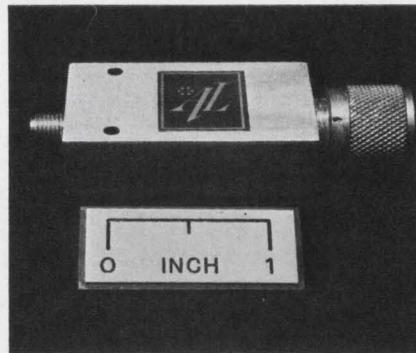

*Addington Labs., 157 San Lazaro, Sunnyvale, Calif. Phone: (408) 738-0200. P&G: \$200 to \$400; 3 wks.*

This gain equalizer for use on the output of a traveling-wave tube covers 4 to 8 GHz. The device is capable of operation at 70,000-ft altitude and withstands the additional environments imposed by MIL-T-5422 and MIL-E-5400. Its VSWR is 1.5 max and input power needed is 6 W cw. Designed on the basis of rf resonances, it employs no ferrite at all.

**CIRCLE NO. 263**

### Video detector spans 2 to 12 GHz

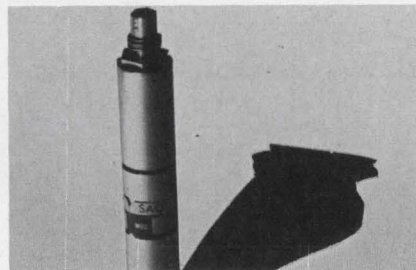

*Sage Laboratories, Inc., 3 Huron Dr., Natick, Mass. Phone: (617) 653-0844. P&A: \$125, 30 days.*

A miniature video detector covers 2 to 12 GHz and provides  $-48$ -dBm sensitivity with a 2-MHz video bandwidth. Typical voltage sensitivity is 700 mV/mW with a 1-k $\Omega$  load. The dc return is integral. Connectors are 1/4-36 miniature, male-in/female-out.

**CIRCLE NO. 264**

something's missing \*

see the ad on next page to find what it is... \*

## Microwave oscillator ranges to 1200 MHz

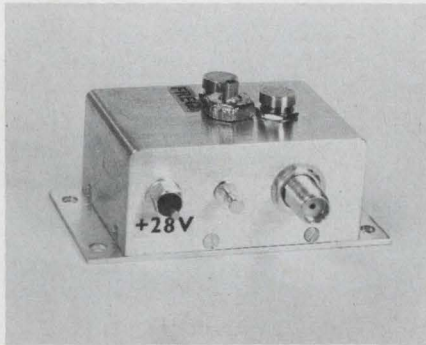

Advanced Technology Corp., 1830 York Rd., Timonium, Md. Phone: (301) 252-1400.

This solid-state oscillator can be manually tuned over one frequency octave with a single tuning adjustment. The input power is filtered to prevent radiation of the oscillator frequencies back into power supply and adjacent circuits. Its frequency range is 600 to 1200 MHz with an input voltage of 28 V dc. Input current needed is 250 mA max.

CIRCLE NO. 265

## Size-16 Kerr cells control pulse lasers

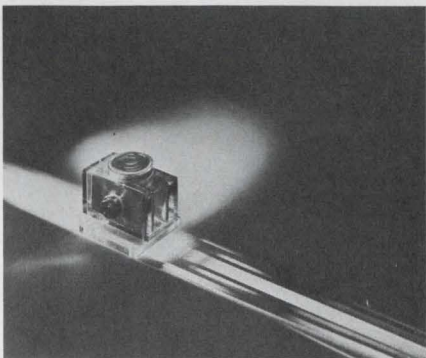

Kappa Scientific Corp., 5780 Thornwood Drive, Goleta, Calif. Phone: (805) 967-2396.

Laser Kerr cells have been designed and developed for the principal ruby wavelength of 6943 Å. High power densities of 100 to 250 mW can be achieved with pulses ranging from 5 to 20 ns. Total transmitting efficiency of the cell is typically 96%. The cell should be employed wherever synchronization of laser pulse with an external experiment is required.

CIRCLE NO. 266

## Energy modulator for radiant detection

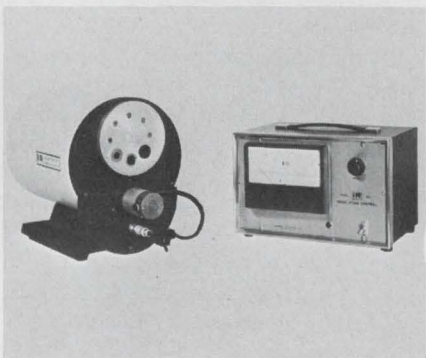

Infrared Industries, Inc., P.O. Box 989, Santa Barbara, Calif. Phone: (805) 684-4181.

This radiant energy modulator or chopper for use with infrared, visual, and ultraviolet detection systems has five ranges. Each range, obtained by interchangeable modulator blades, has a dynamic range of 100:1. Standard ranges directly on the meter are 2.5-250, 10-1000, 50-5000, 100-10,000, and 300-30,000 Hz. Modulators are available for direct mounting to a black-body radiation source.

CIRCLE NO. 267

## Light modulators filter gas lasers



Crystalab Products Corp., 19 Legion Pl., Rochelle Park, N.J. Phone: (201) 843-5780. P&A: \$265; stock.

This light modulator is designed to modulate the outputs of gas lasers from low audio (15 Hz) through ultrasonic frequencies (100 kHz). Low-beam distortion is achieved by using potassium dihydrogen phosphate crystals.

CIRCLE NO. 268



missing are the  
**CAPTIVE CONTACT**

# WEDGE-LOCK<sup>TM</sup> COAXIAL CONNECTORS from *Automatic*



Your assurance of  
**EFFICIENCY, RELIABILITY  
and ECONOMY!**

Outstanding electrical characteristics remain constant even under the extreme environmental conditions of vibration, shock and multiple flexing. Positive cable clamping allows the connector to withstand a "pull" greater than the inherent strength of the cable being used!

Only three parts to handle! Combing or trimming of the cable braid is no longer required!

Normal assembly times are reduced by more than 50%!

Virtually all of the popular cable connector styles in sizes from micro-miniature (TMM) up to large (HN) are available.

Literature and samples are available. Phone your nearest representative today!

**automatic**  
METAL PRODUCTS CORPORATION  
323 Berry St., B'klyn, N.Y. 11211 • Tel: (212) EV 8-6057

### REPRESENTATIVES

#### EASTERN

PAUL D. AARON  
Phone: (516) 767-8480

B. and W. ASSOCIATES  
Phone: (617) 275-9177

BOWSER and SAPECKY  
Phones: (716) 839-4170  
(315) 446-5920

JACK ONORE  
Phone: (201) EL 5-0474

THOMAS ASSOCIATES  
Phone: (609) UL 4-3011

SOUTHERN  
KIRKWOOD ASSOCIATES  
Phone: (813) 391-8452

MURPHY and COTA  
Phone: (919) 724-0750

WESTERN  
ARROWHEAD SALES CORP.  
Phone: (801) 298-2751

JAS. J. BACKER CO.  
Phone: (206) 283-6470

#### WESTERN (CONT'D)

BELL ELECTRONIC CORP.  
Phone: (415) 323-9431

MERCURY ENGINEERING SALES  
Phone: (602) 945-1927

WINTERS and COMPANY  
Phone: (213) 879-9045

#### MIDWESTERN

FRANK J. CAMPISANO  
Phone: (513) MD 2-1616

P. DAVID HALE  
Phone: (214) WH 6-7676

INLAND ASSOCIATES  
Phone: (913) EN 2-2366

R. C. NORDSTROM and CO.  
Phone: (313) 444-4417

PGM COMPONENT SALES  
Phone: (312) 622-8183

S.A.R.G.E. INC.  
Phone: (312) 237-9525

WEDGE-LOCK, U.S. PATENT NO. 3-107-135

ON READER-SERVICE CARD CIRCLE 74

Supplies that respond in 25  $\mu$ s



Model 220

**Budget Price!**

**\$540\*** buys this completely self-gaussmeter (with probe). Measures flux density from 0.2 gauss to 20,000 gauss; permanent magnet, DC and AC fields up to 50 kHz, allowing measurement of sine wave and pulsed magnetic fields with a time base down to the microsecond region. Better than  $\pm 3\%$  accuracy with self-calibrating feature which requires no reference magnets. Accuracy capabilities to  $\pm 1\%$ . Wide application in production, engineering, research and QC.



For detailed data and free Magnetic Application Booklet, write or call Herb Brumbach.

**RFL Industries, Inc.**

FORMERLY RADIO FREQUENCY LABORATORIES, INC.

Instrumentation Div. • Boonton, N. J. 07005

Tel.: 201-334-3100 / TWX: 710-987-8352 / CABLE: RADAIRCO, N. J.

ON READER-SERVICE CARD CIRCLE 75

TEST EQUIPMENT

**Programmable supplies respond in 25  $\mu$ s**



Raytheon Co., Sorensen Operation, Richards Ave., Norwalk, Conn. Phone: (203) 838-6571. P&A: \$178-\$285; stock.

Programmable power supplies which can respond to digital computer commands within 25  $\mu$ s are designated the QRD series. The series consists of seven units ranging from 30 to 90 W and from 15 to 60 V. The units are expected to find use in the automated testing of ICs, in servo system feedback loops, for component testing and for sequential instrumentation actuation.

Defined as the time for the output to move between 10% and 90% of max voltage, the programming time of the unit is 25  $\mu$ s for zero to max and 10  $\mu$ s for max to zero. The speed of the series is achieved by shunting out the normal input and output capacitors, whose stabilizing functions are taken over by control circuitry designed for the purpose. A rear terminal link is removed for high-speed operation. Regular operation is restored by replacing the terminal link.

Remote programming is accomplished by varying resistance, voltage or current to the control circuitry of the supply. At constant voltage, for instance, QRD units program at 100  $\Omega$ /V. At constant current for a 1-A supply, the program constant is 1 k $\Omega$ /A or 1 V/A. The supplies are fast enough to be used as amplifiers. A unit may be controlled by a 30-kHz programming signal at 8 V pk-pk. Drive at 10 mA under these conditions would result in a faithfully reproduced signal at 4 A at the same voltage, which is amplification by a factor of 400.

CIRCLE NO. 269

**Signal detector for electromagnetics**

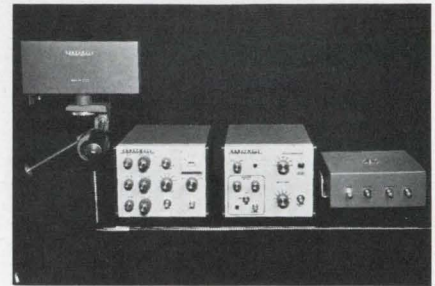

Honeywell Test Instruments Div., Box 391, Annapolis, Md. Phone: (301) 263-2661.

This system for detecting, amplifying and measuring extremely low-frequency, low-level electromagnetic fields that radiate from electronic and electromechanical equipment is intended for Federal Standard 222 testing purposes. It is designed to operate in the 1-to-1000-Hz frequency range, and can be battery-operated for portable use and power-line isolation.

It can be used to detect impulse-type signals such as those emitted by a relay when electrically activated. The model 1863 can also be used in study programs associated with electromagnetic interference problems and the investigation of electric or magnetic fields within its frequency range.

A typical application might involve reception of signals through the unit's vertical rod antenna or magnetic-loop antenna, amplification and filtering of the signals to eliminate power-line interference, and application of the amplified signals to a raster generator for processing and oscilloscope display.

Other operational design features include the system's ability independently to detect electric and magnetic fields, its built-in battery-monitoring and recharging circuits, its tunable band-reject filters to eliminate power line ambient effects and operation from 48-to-62-Hz power-line sources without modification. The detection system, is made up of three solid-state modules. These modules include a pre-amplifier, amplifier and accessory units. Also included in the system is a magnetic loop antenna and a vertical rod antenna.

CIRCLE NO. 270



# Deutsch-Filtors announces a new no-solder relay termination system.

We've made the best even better. We took a Deutsch-Filtors Blue Ribbon BRF 10-amp relay—each one is fully tested for total dependability—and added a unique, time-saving solderless termination system.

The key word, of course, is solderless. The results are the ultimate in simplicity. The best relay money can buy can be assembled into your system with savings in installation time of as much as 50%. The contact insertion—removal tool pictured right makes it all possible. It replaces forever the soldering iron and all its connected woes.

For example. Solderless terminations can't bend, break, bind or gall. Self-locking retainers defy vibration, shock, high pulling loads and mechanical damage. Shorting caused by moisture and contaminants is eliminated. In short, this no-solder integrated termination system eliminates *all* problems inherent in conventional relay

termination; whether soldering to hooked leads, relay sockets, or printed circuit boards.

Here's how. Just crimp the wire with a standard MIL-T-22520 crimping tool. Insert the wire into the insertion end of a NAS-type fail-safe insertion-removal tool. Tool and wire are pushed into connector until bottomed. Pull tool free and you're home free—with a firmly locked-in connection. To reverse the process, insert the other end of the tool and remove the wire with no risk of damage.

We could go on talking about it for pages. In fact, we have. Send for our brochure on the new BRF-TJ 10-amp relay with exclusive integrated termination system.\* Contact: Deutsch-Filtors Relay Division, East Northport, New York 11731 / (516) 266-1600.

\*This unique system is available on other Deutsch relays. Your Deutsch-Filtors salesman has all the details.

Copyright 1968 The Deutsch Company.

 **DEUTSCH**  
FILTORS RELAY DIVISION  
65 Daly Road · E. Northport, Long Island, New York

ON READER-SERVICE CARD CIRCLE 76

### Regulated dc supply puts out 0 to 36 V

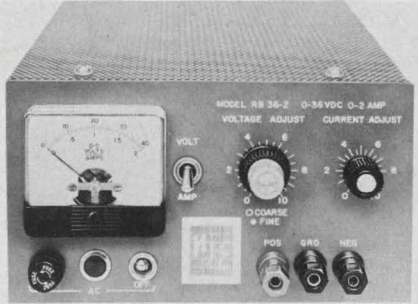

NJE Corp., 20 Boright Ave., Kenilworth, N.J. Phone: (201) 376-7300.

Voltage- and current-regulated dc power supplies have an output of 0 to 36 V, 0 to 2 A. The RB-36-2 can be used to obtain either constant voltage or constant current. When operated for constant voltage, the regulation for load and line changes is 0.01% or 1 mV, whichever is greater. When used as a source of constant current, the regulation is 1 mA/V change in output and 0.5 mA on the line.

CIRCLE NO. 272

### Silicon power supply spans 0 to 125 V

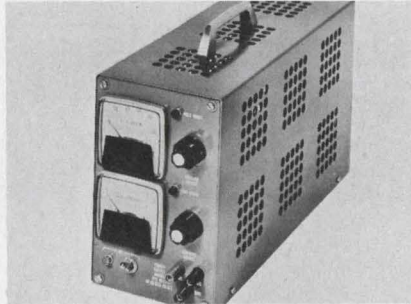

NJE Corp., 20 Boright Ave., Kenilworth, N.J. Phone: (201) 376-7300. Price: \$495.

A silicon high-temperature voltage current-regulated dc power supply has an output of from 0 to 125 V and 0 to 1.6 A. Voltage regulation for load and line changes is 0.01% or 1 mV, respectively, when operated as a voltage-regulated power supply. Current regulation is 0.1 mA/V change in output and 0.5 mA in constant-current mode.

CIRCLE NO. 273

### Oscillator sequencing 5 to 1500 MHz sweep



Telonic Instruments, 60 N. First Ave., Beech Grove, Ind. Phone: (317) 787-3231.

An oscillator for the 2003 sweep-signal generator system permits coverage of 5 to 1500 MHz in a single sweep. The oscillator has, in addition to its range, continuously variable sweep width from 200 kHz to 1500 MHz, linearity of 1.2 and an output of 0.35 V rms, flat within  $\pm 0.75$  dB. Two modes of operation, may be selected by a front panel switch.

CIRCLE NO. 274

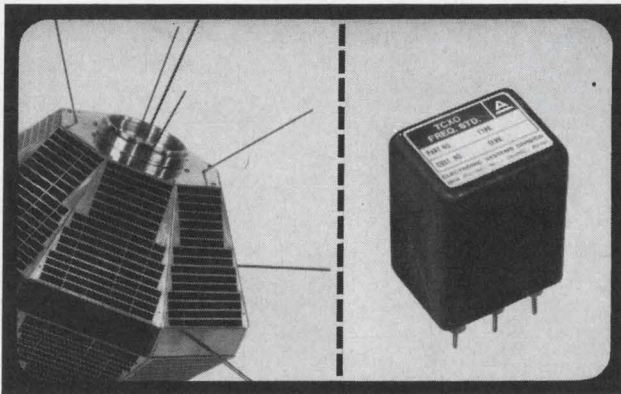

### TEMPERATURE COMPENSATED CRYSTAL OSCILLATORS

New Arvin TCXOs solve frequency management problems with oven-like accuracy in miniaturized communications and aerospace equipment.

- Volume, to one cubic inch
- No oven required
- 1 Hz to 200 MHz frequency
- Low power drain
- To  $\pm 5$  PP  $10^8$  stability
- Instant warm-up

All circuit values are computer optimized to provide precise, stable frequency standards. Units may be specified to conform to commercial, MIL, or NASA specifications. Write for Bulletin TCXO 101.

ARVIN FREQUENCY DEVICES



2505 North Salisbury Street, West Lafayette, Indiana 47906

ON READER-SERVICE CARD CIRCLE 77

## BERYLLIUM COPPER INTRICATE STAMPINGS

CUSTOM DESIGNS  
STANDARD RINGS,  
STRIPS, CLIPS,  
WASHERS, SHIELDS,  
CONTACTS,  
HOLDERS

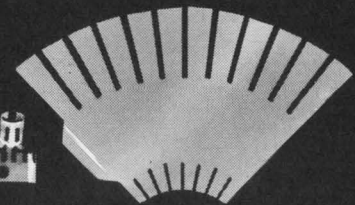
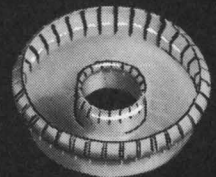

BRAUN's consulting engineers stand ready to evaluate and solve your beryllium copper stamping problems. They speak your language. They know the scope of BRAUN's technology and how to apply it to your problem, plus quote a price for the required stamping. This problem solving technique can be obtained by a simple phone call to our engineers. CALL TODAY!

**BTI** **BRAUN**

TOOL & INSTRUMENT CO., INC.

140 Fifth Avenue, Hawthorne, N. J. 07507  
Phone 201-427-1773 • TWX 710-988-4136

ON READER-SERVICE CARD CIRCLE 78

## Transducer measured with microvoltmeter



Doric Scientific Corp., 7969 Engineer Rd., San Diego, Calif. Phone: (714) 277-8421. Price: \$790 to \$1800.

This instrument, model DS-100, is an integrating digital microvoltmeter designed with a series of plug-in signal conditioners to allow direct use with transducers and other low-level sensors for physical and scientific measurements.

Research engineers can monitor physical parameters such as pressure, temperatures, and loads from transducers putting out electrical signals in the low-microvolt and millivolt region. Until now, the only suitable readout instrumentation has been analog indicators or recorders, portable or laboratory potentiometers, or servo-balance indicators.

A basic main-frame digital readout with about one dozen analog-signal-conditioning plug-ins are available. These plug-ins afford direct temperature measurements from thermocouples or platinum sensors; direct engineering readout from strain gauges and strain-gauge transducers for measurement of pressure, torque, load and strain; and dc voltage and ratio measurements from  $1 \mu\text{V}$ . A choice of accessory plug-in digital inputs and outputs and high-speed versions of 20 readings/s for automatic-tester or logging applications are also available.

The basic DVM design has  $1\text{-}\mu\text{V}$  basic sensitivity, a guarded differential input to allow floating, isolated measurements, true integration for max noise rejection and automatic zero drift correction. An AUTO-ZERO circuit makes the system dependent on the reference source for its accuracy.

CIRCLE NO. 275

# 10 Watts @ 1 GHz from one transistor!

**The S-1050 does it.** This silicon NPN epitaxial planar transistor delivers 10 Watts of power with 5 db gain . . . 30% efficiency . . .  $f_T$  of 1.5 GHz (typ.) . . . and  $\theta = 7^\circ \text{C/Watt}$ . Its modified stud-mounted power package gives optimum performance in high-frequency, high-power operation in grounded emitter configuration. And, best of all, *the S-1050 is available from stock.*

**Need 3 Watts @ 1 GHz from a single transistor? Our S-1000 amplifier transistor in the stripline package will do the job at 35% efficiency,  $f_T > 1 \text{ GHz}$ ,  $\theta < 10^\circ \text{C/Watt}$ .**

Get the full story on the S-1050 and the S-1000, as well as our complete line of RF power devices from Marketing Manager, (212) 355-5000, TWX 510-677-1717, or write direct.

**Electronic Components** DIVISION OF **United Aircraft**

TREVOSE, PENNSYLVANIA 19047

ON READER-SERVICE CARD CIRCLE 79

# PMG UNI-POWER Universal Power Supplies

**POWER/MATE CORP.**, is your one source for dependable, low cost, variable voltage, regulated power supplies. Our UNI-POWER universal power supply modules come in a range of voltage and current ratings, both single and dual outputs, that have been designed to cover your needs. Check the supplies below — any or all of them are available off-the-shelf.

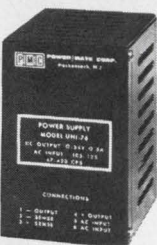

**UNI-76 • single output**  
Input — 105-125 V., 47-420 cps.  
Output — continuously adjustable from 0 to 34 volts at 0.5 amps.  
Regulation — Better than  $\pm 0.005\%$ .  
Ripple — Less than 250 microvolts.  
Overload and Short Circuit Protection — Solid state circuit, instantaneous recovery, automatic reset.  
Operating configuration — Series, Parallel or Series/Parallel.  
Price — \$76.00 f.o.b. Hackensack, N.J.

**UNI-88 • single output**  
Input — 105-125 V., 47-420 cps  
Output adjustable from 0 to 34 volts at 1.5 amps in 6 ranges with internal fine and coarse controls.  
Regulation — better than  $\pm 0.005\%$ .  
Ripple — less than 250 microvolts.  
Overload and Short Circuit Protection — solid state circuit, instantaneous recovery, automatic reset.  
Operating configuration — Series, Parallel or Series/Parallel.  
Price — \$88.00 f.o.b. Hackensack, N.J.

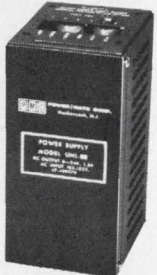
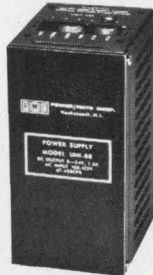

**UNI-128 • single output**  
Input — 105-125 V., 47-420 cps.  
Output — 0 to 26 V @ 4.5 amp; 26 to 31 V @ 4.0 amp; 31 to 34 V @ 3.5 amp.  
Regulation — better than  $\pm 0.005\%$ .  
Ripple — less than 250 microvolts.  
Overload and Short Circuit Protection — solid state instantaneous recovery; automatic reset.  
Operating configuration — Series, Parallel or Series/Parallel.  
Price — \$128.00 f.o.b. Hackensack, N.J.

**UNI-TWIN 164 • dual output**  
Input — 105-125 V., 47-420 cps  
Output adjustable 0 to 25 volts at 0.75 amps in four ranges with internal fine and coarse control.  
Regulation — better than  $\pm 0.01\%$ .  
Ripple — less than 500 microvolts.  
Overload and Short Circuit Protection — solid state, instantaneous recovery; auto-operating configuration — Series, Parallel or Series/Parallel.  
Price — \$164.00 f.o.b. Hackensack, N.J.



**FREE LITERATURE**

For complete specifications on these or any of the other 4,000 power supplies we manufacture, write today to:

**POWER/MATE CORP. PMG**  
163 Clay Street, Hackensack, N. J. 07601  
Telephone 201-343-6294

**TEST EQUIPMENT**

**1/2-W power amplifier spans 10 to 400 MHz**

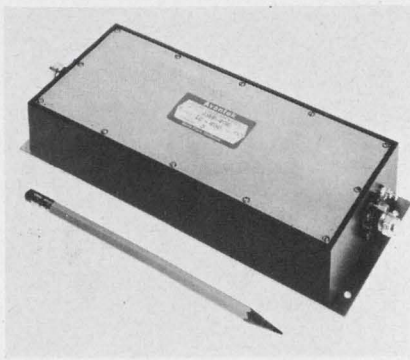

*Aventek, Inc., 3001 Copper Rd., Santa Clara, Calif. Phone: (408) 739-6170. P&A: \$1050; 30 days.*

This 1/2-W linear transistor power amplifier covers 10 to 400 MHz. The unit delivers +27 dBm minimum of linear class-A power into a 50- $\Omega$  load.

The wide dynamic range of the unit is achieved by using high-power transistors in a push-pull circuit arrangement. The push-pull arrangement also enhances even-order spurious performance.

The AWP 400 has applications in the laboratory with signal generators and power splitters, and applications in other instrumentation such as intermediate exciter driver stages for transmitters, wide-dynamic-range receiver systems, power stages in a local-oscillator or harmonic-generator chain, and for wide-band pulse devices.

Most manually tuned and swept-tuned signal generators operating up to 400 MHz deliver a linear output power of 0 to +20 dBm. Quite often laboratory experiments require power levels of 200 to 500 mW. The AWP 400 functions as a power amplifier for signal generators of limited output power. Thus, the linear amplifier extends the usefulness of signal generators.

**CIRCLE NO. 333**

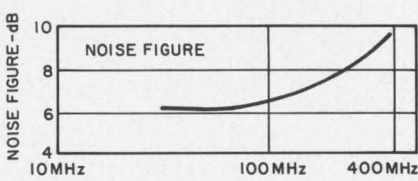

**Noise vs frequency curve covers amplifier in 10-to-400-MHz range.**

**Frequency converter gives 0.01% linearity**

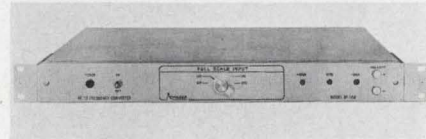

*Anadex Instruments Inc., 7833 Haskell Ave., Van Nuys, Calif. Phone: (213) 782-9527. Price: \$650.*

Bipolar dc-to-frequency converter offers a linearity of better than 0.01% full-scale. Applications include analog-to-digital conversion and data logging. It provides output frequency directly proportional to positive and negative input voltages. By means of a range switch, the user may select four input voltage ranges from 100 mV full-scale to 100 V full-scale with a 100-kHz full-scale output for each range. For 10-mV full-scale input, a 10-kHz output is provided. Front-panel zero control provides  $\pm 5\%$  of 100-kHz output frequency for zero input on any range. Line stability of the output changes less than  $\pm 0.01\%$  of full scale for  $\pm 10\%$  change of line voltage.

**CIRCLE NO. 293**

**Vhf signal simulator spans 225 to 260 MHz**

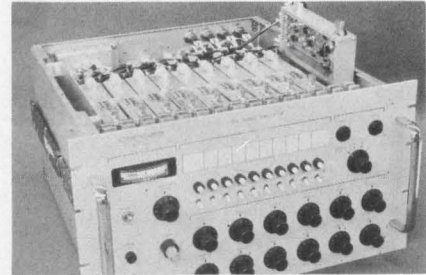

*Canoga Electronics Corp., 8966 Comanche Ave., Chatsworth, Calif. Phone: (213) 341-3010.*

A solid-state vhf signal simulator provides from 1 to 10 discrete frequency outputs in the IRIG telemetry frequency band of 225 to 260 MHz. Output levels are sequenced by a preset 7-level power programmer. Selection of the available vhf frequencies is accomplished by toggle switch selection of the desired crystal frequency output.

**CIRCLE NO. 294**

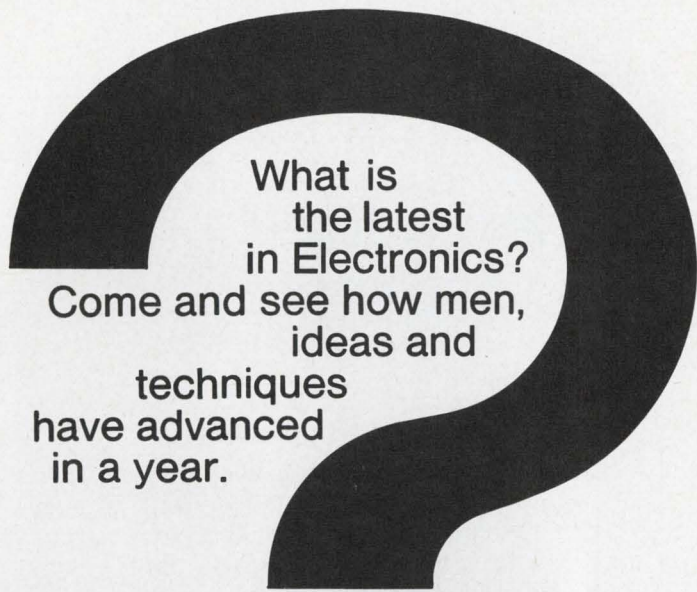

What is  
the latest  
in Electronics?

Come and see how men,  
ideas and

techniques  
have advanced  
in a year.



Be  
present  
at the

# INTERNATIONAL EXHIBITIONS OF ELECTRONIC COMPONENTS AND OF AUDIO-EQUIPMENT

FROM APRIL 1st TO 6th 1968 - PARIS  
PORTE DE VERSAILLES



## INTERNATIONAL CONFERENCE ON COLOUR TELEVISION

scientific and technical considerations  
FROM MARCH 25<sup>th</sup> TO 29<sup>th</sup> 1968 - PARIS

Programme and registration conditions on request

The oldest Components Exhibition held in **1934**, international since 1958, has seen its success confirmed every year by the presence of an ever increasing number of manufacturers and visitors.

**In 1968, the International Exhibition of Electronic Components promises to be more successful and on a larger scale than ever:** nearly a thousand exhibitors from 20 nations... more than 150,000 visitors from all over the world... are expected there.

It will be open in Paris from **April 1st to 6th** in the Exhibition Halls — Porte de Versailles.

### A double goal

The International Exhibition of Electronic Components has taken only a few years to become the greatest world-wide

intercomparison in the field of components, semiconductors, tubes, and electronic accessories. Exclusively open to manufacturers, it pursues - with constantly increasing success - two objectives:

- to present, every year, a **vast synthesis of the most recent world production**, giving manufacturers an opportunity to meet, discuss, exchange ideas, and prepare for the future ;

- to offer every year, to many specialists, engineers and technicians coming from all countries, a **technical information centre** where, in the most favourable conditions of rapidity, they can discover the latest novelties in their respective fields, obtain documentation and equipment... and make an appraisal of the evolution and prospects for the Electronic Components Industry.

ON READER-SERVICE CARD CIRCLE 86

S.D.S.A. - RELATIONS EXTERIEURES - 16, RUE DE PRESLES - 75 PARIS 15<sup>e</sup> - FRANCE

Official air-lines of the Exhibition, call for information: AIR FRANCE

UNMATCHED ACCURACY  
AND RELIABILITY WITH  
**MIDGI-TRIM**<sup>®</sup>  
1/2" and 3/8" SQUARE TRIMMERS



**MIDGI-TRIM** wirewound-square trimming potentiometers have acknowledged acceptance in the industry for accuracy and reliability. They meet or exceed the most demanding requirements of applicable missile and aerospace specs, including MIL-R-27208B.

**MIDGI-TRIM** trimming potentiometers are designed with fewer moving parts than most conventional square trimmers. A drive wheel replaces six parts or functions common to other square trimmers and functions as a mechanical actuator, slip ring, spring preload, slip clutch, and positive rotating stop.

**MIDGI-TRIM** trimming potentiometers feature a stainless steel adjustment screw insulated from the contact mechanism, which makes the case completely non-conductive.

**MIDGI-TRIM** trimming potentiometers contain precious metal alloys of platinum, silver, and gold, together with low-temperature coefficient resistance material, that provide minimum resistance change over wide temperature ranges.

**MIDGI-TRIM** trimming potentiometers offer many other features that can't be found in other square trimmers:

- Encapsulating problems are eliminated
- No loose lead screws
- No loose pins
- No open windings

A new four-page, two-color brochure details these features. Write for yours today — no obligation, of course.

**CONELCO COMPONENTS**

Subsidiary of **SYSTRON**  **DONNER**  
CORPORATION

wirewound/slidewire/multi-element/cermet/metalfilm trimming potentiometers

465 W. FIFTH ST., SAN BERNARDINO, CALIF. 92401  
PHONE: (714) 885-6847, TWX (910) 390-1157

ON READER-SERVICE CARD CIRCLE 83

TEST EQUIPMENT

**125-V amplifier  
operates to 1 MHz**



Optimization, Inc., 9421 Telfair Ave., Sun Valley, Calif. Phone: (213) 768-0830. P&A: \$1250; 30 days.

A direct-coupled amplifier delivers 125 V rms from dc to 1 MHz. This model PA-25 is a 25-V unit with a gain of 20 and slew rate of 3000 V $\mu$ s. The frequency range distortion is less than 0.03% to 100 kHz, gain stability is better than 0.01%, and short-term amplitude variation (assuming a stable input signal) is 10 ppm. The unit has a rise time of 150 ns for the 125-V rms output, which means it can deliver peak pulses of over 300 V. A parabolic reflector is used in conjunction with a transverse fan to dissipate radiated heat from the output tubes.

CIRCLE NO. 295

**Dc voltmeter recorder  
strip-chart-verified**

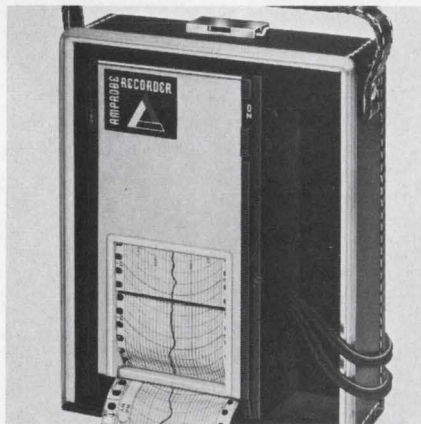

Amprobe Instrument, Div. of SOSS Manufacturing Co., 630 Merrick Rd., Lynbrook, N.Y. Phone: (516) 593-5600.

This strip-chart recorder is a 3-range dc voltmeter. The ranges are 0 to 150 V, 0 to 300 V and 0 to 600 V dc, with 20,000  $\Omega$ /V sensitivity. It comes in portable or flush-mount versions. By removing the chart, the recorder becomes an indication dc voltmeter.

CIRCLE NO. 296

# The most dangerous shift your employees can work

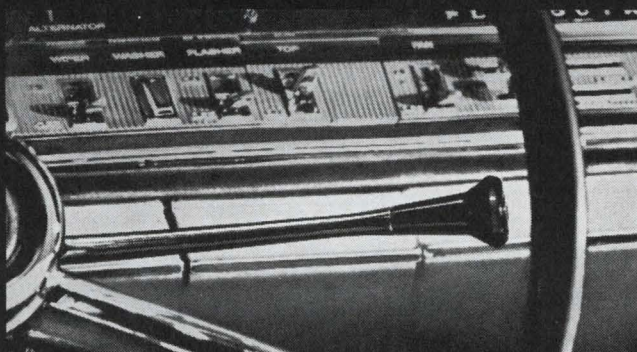

is this one.

In-plant safety records tell the smallest part of your plant safety record.

Look at what happens after your employees leave the plant.

During 1966, American industry lost more than one and one-half times as many employees killed in off-the-job traffic accidents as were killed in *all* on-the-job accidents. In addition, 800,000 workers were injured severely enough to keep them away from their jobs for periods of a day or more.

Many companies, like Western Electric, have done something about it. They teach the National Safety Council's Defensive Driving Course to their employees.

It's a short, interesting—and effective—course on defensive driving skills. The results are a significant drop in traffic accidents. And the cost is as low as a dollar per employee. It's a good investment. Shift into high gear and find out more with this coupon.

## Special Projects—Public Information

**National Safety Council**  
425 North Michigan Avenue  
Chicago, Illinois 60611



Please mail me full details on the  
Defensive Driving Program.

Name \_\_\_\_\_

Title \_\_\_\_\_

Firm Name \_\_\_\_\_

Street \_\_\_\_\_

City \_\_\_\_\_ State \_\_\_\_\_ Zip Code \_\_\_\_\_

**Pulse generator repeats 5 Hz to 50 MHz**

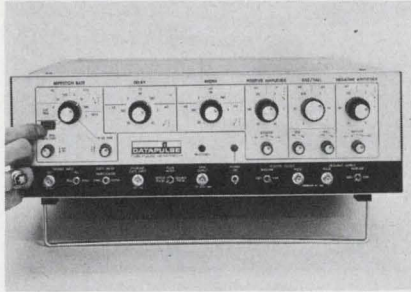

*Datapulse, Inc., 10150 W. Jefferson Blvd., Culver City, Calif. Phone: (213) 871-0410. P&A: \$1250; 2 wks.*

Variable rise time from 4 ns, repetition rates to 50 MHz and feedback-regulated dc baseline offset are features of this pulse generator. Repetition rates for the new unit are variable from 5 Hz to 50 MHz. Single- or double-pulse modes of operation are available. Rise and fall times are linear and independently variable.

CIRCLE NO. 322

**Temperature monitor surveys 20 points**

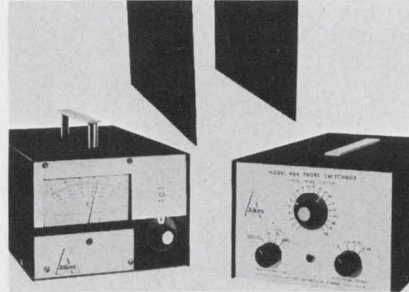

*Atkins Technical, Inc., Box 14405, University of Florida Station, Gainesville, Fla. Phone: (904) 372-3518.*

An electronic thermometer and switchbox monitor up to 20 points, displaying temperatures on 4-1/2-in. taut-band meter and providing a 0 to 50-mV signal to an optional recorder. The thermistor probe switchbox can be programmed for dwell time on each point from 10 s to 5 min, and for sweep through 3, 7, 12 or the full 20 probes.

CIRCLE NO. 323

**Thermocouple reference accurate to 0.2°F**

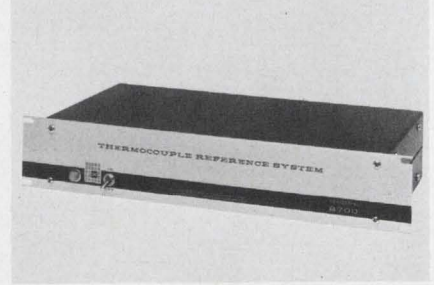

*Joseph Kaye & Co., Inc., 737 Concord Ave., Cambridge, Mass. Phone: (617) 868-7080. Price: \$299.*

Multichannel thermocouple oven-type reference systems with 24-channel capacity maintains a reference temperature of 150°F to an accuracy of  $\pm 0.2\%$  F and a stability of  $\pm 0.1^\circ$  F. They are 19-in.-panel-mounted and consume 3-1/2 in. of panel height. Other specifications include rear-mounted input and output terminals.

CIRCLE NO. 324

SOLID- **PRECISION** STATE

**ADJUSTABLE-SPEED DRIVES**

ALL MOTORS TOTALLY ENCLOSED, FAN-COOLED

**SPEED RANGE** Infinitely adjustable from less than 24 rpm to more than 3600 rpm (150:1) while delivering full rated torque. Continuous duty rating at all speeds.

**REGULATION** Temperature-compensated tachometer feedback provides both line and load regulation of better than 1/3 of 1% of rated speed.

**MAINTENANCE** Design eliminates vacuum tubes, selenium rectifiers, and time delays. Utilizes silicon diodes, transistors and a magnetic amplifier for exceptionally long service life. Modular plug-in construction requires only a screwdriver for servicing.

**REMOTE CONTROL** A 10-turn potentiometer provides precise adjustment and can be located at any convenient location. Meter monitors operation and continuously indicates speed.

**GEARED MOTORS** Motors are available with integral gear reducers.

**BRAKING-REVERSING** Relay controlled braking and reversing models available.

1 HP AS ILLUSTRATED  
**\$687<sup>00</sup>**

Other models from 1/8 hp to 1 1/2 hp proportionately priced.

Write for 500/600 series catalog:

**SERVO-TEK PRODUCTS COMPANY** 1086 ED Goffle Road, Hawthorne, N.J. 07506 • or call 201 427-3100

ON READER-SERVICE CARD CIRCLE 84

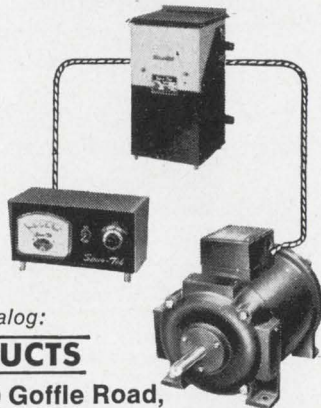

For Epoxy Encapsulating . . .

**VACUUM ENCAPSULATOR**

The NEW Vacuum Encapsulator eliminates *trapped air* — the most common cause of encapsulation failure with two-part epoxies. The complete operation is done within the vacuum chamber, therefore the mold and the epoxy is entirely evacuated of air, before and during pouring. For better flow, the epoxy is heated automatically. Work is easily accessible through the large transparent door. Contains built-in light. Clean-up is simple, with most of the feed system disposable. Supplied with an extra 10 disposable feed systems.

**Saves Time!**  
**Produces Superior Results!**

Only  
**\$57500\***  
Complete

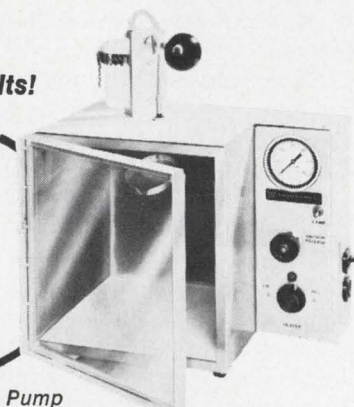

\*Includes Vacuum Pump

**WARLOCK SYSTEMS, INC.**  
81 Newtown Road, Danbury, Connecticut 06810  
Phone: (203) 744-5545

ON READER-SERVICE CARD CIRCLE 85



## Gate time generator uses a square wave



Nanosecond Systems, Inc., 176 Linwood Ave., Fairfield, Conn. Phone: (203) 255-1008. Price: \$825.

This gate time generator is a square-wave and dual-pulse generator developed for counter gating. A variable duty-cycle square wave is digitally generated, so that the period of each half cycle can be separately controlled. Two-ns pulses produced simultaneously with the rising and falling edges of the square-wave pulse are available at separate fixed-level outputs. The edges are locked to a 1-MHz oven-compensated oscillator. The wave emanates from the adjustable-level gate output with polarity selection, and the 1-MHz frequency standard (stability better than 1 part in  $10^7$  per day) is available on a separate output.

CIRCLE NO. 347

## Environmental tests possible to 204°C

Blue M Engineering Co., 138th & Chatham St., Blue Island, Ill. Phone: (312) 385-9000.

Available in six sizes from 1.14 to 27 ft<sup>3</sup>, the environmental cabinets have a temperature range of  $-18^{\circ}$  to  $+204^{\circ}\text{C}$ . The cooling coil of the refrigeration system is externally mounted and isolated from the work chamber, preventing condensation and keeping the chamber dry during rapid temperature transitions. A temperature uniformity of  $\pm 0.75^{\circ}\text{C}$  at  $+125^{\circ}\text{C}$  is maintained. The chambers have welded-steel housings with stainless interiors.

CIRCLE NO. 348

**CONTINUOUS PERFORMANCE**  
**POPULAR PRICES**

**PRESS-FIT® TEFLON\* TERMINALS**

You can depend on Sealectro "Press-Fit" Teflon\* insulated terminals for superior continuous performance at popular prices. "Press-Fit" Teflon terminals are designed for maximum operating efficiency minus hardware props such as nuts, washers and lockwashers. Tolerances of .001" ensure a positive fit. To make substantial savings in your next military or commercial production, send for the catalogue of stock Sealectro "Press-Fit" Teflon terminal performers. They include more than 10,000 Feed-Thrus, Stand-Offs, Jacks, Transistor Sockets and Holders, Probes, Bushings, and Taper-Pin receptacles. All available at popular prices and all available in the 10 EIA colors.

**SEALECTRO CORPORATION**  
CIRCUIT HARDWARE DIVISION  
HOYT STREET • MAMARONECK • NEW YORK  
PHONE: 914 698-5600 TWX: 710-566-1110  
Sealectro Ltd., Portsmouth, Hants, England

\*Registered Trademark E. I. DuPont De Nemours & Co.

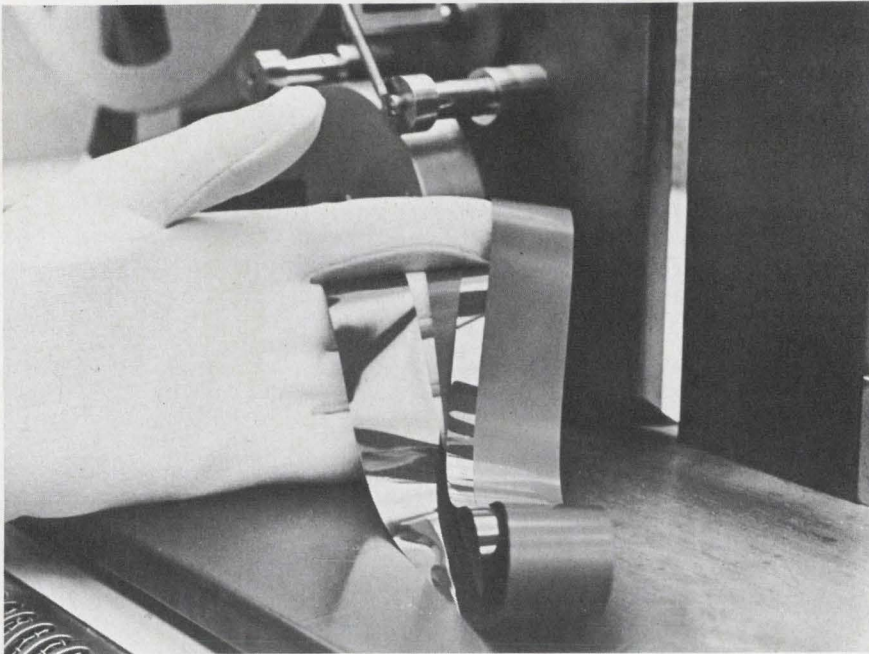

## Magnetic tape withstands extremes of temperature

*Wabash Magnetics, Inc., Wabash, Ind. Phone: (219) 563-2191. Price: \$1.00/ft. (up)*

Digital magnetic computer tape which can be used in extremes of hot or cold temperatures permits use of computers where it is not feasible to control environmental conditions. This tape performs at temperatures ranging from  $-55^{\circ}\text{F}$  to  $+180^{\circ}\text{F}$ . Rapid fluctuations between these temperature extremes—as might be encountered by a jet interceptor rising quickly to the stratosphere from a jungle airstrip—have no adverse effects on tape performance. It is also not affected by humidity extremes.

Computer applications have been restricted by the inherent temperature limitations of magnetic tape which consists of an iron oxide coating on a polyester base or substrate. This tape uses a polyimide substrate. Polyimide is stable at temperatures ranging from  $-100^{\circ}\text{F}$  to  $+400^{\circ}\text{F}$ . The tape has the capacity of 1600 b/in. The primary specification used as the keystone for the developmental work was that of the Goddard Space Flight Center—GSFC-X-534-67-195, especially section 4.3.8, dealing with thermal properties involving

temperatures of  $-50^{\circ}$  to  $+180^{\circ}\text{F}$ . Tape is offered in widths of 1/4 in. to 1 in. and in lengths of 200 to 1000 ft.

CIRCLE NO. 325

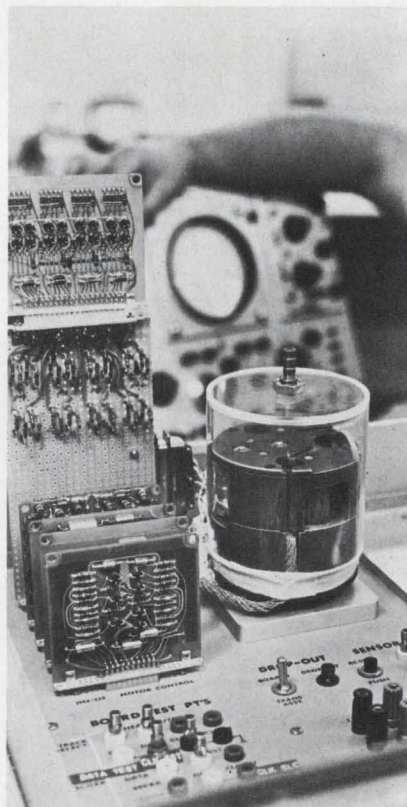

Magnetic computer tape undergoes simulated environmental tests.

**TECKNIT®**



... **NOW**

Lets you select from 72 standard EMI/RFI shielded enclosures . . .

Designed to conform to MIL-STD-189, NASA-SKD-KSC-153-F, EIA/STANDARD and RETMA SE-102.

**FREE**

**HERE IT IS!**  
**19" x 24" EMI / RFI SHIELDED ENCLOSURE TECHNICAL BULLETIN**

If you need more copies, or if someone has removed Data Sheet EMC-660 for their use, send coupon today and indicate quantity you require.

Please send ..... copies of EMI/RFI Shielded Enclosure Data Sheet EMC-660.

Name \_\_\_\_\_

Title \_\_\_\_\_

Company \_\_\_\_\_

Street \_\_\_\_\_

City \_\_\_\_\_

State \_\_\_\_\_ Zip \_\_\_\_\_

**Technical Wire Products, Inc.**

**TECKNIT®**

EAST DIVISION  
129 Dermody St.  
Cranford, N.J. 07016  
(201) 272-5500



**SHIELDED  
ENCLOSURES**

**DATA SHEET  
EMC-660**

## **EMI/RFI SHIELDED ENCLOSURES 19" AND 24" PANEL FOR CABINET RACK MOUNTING**

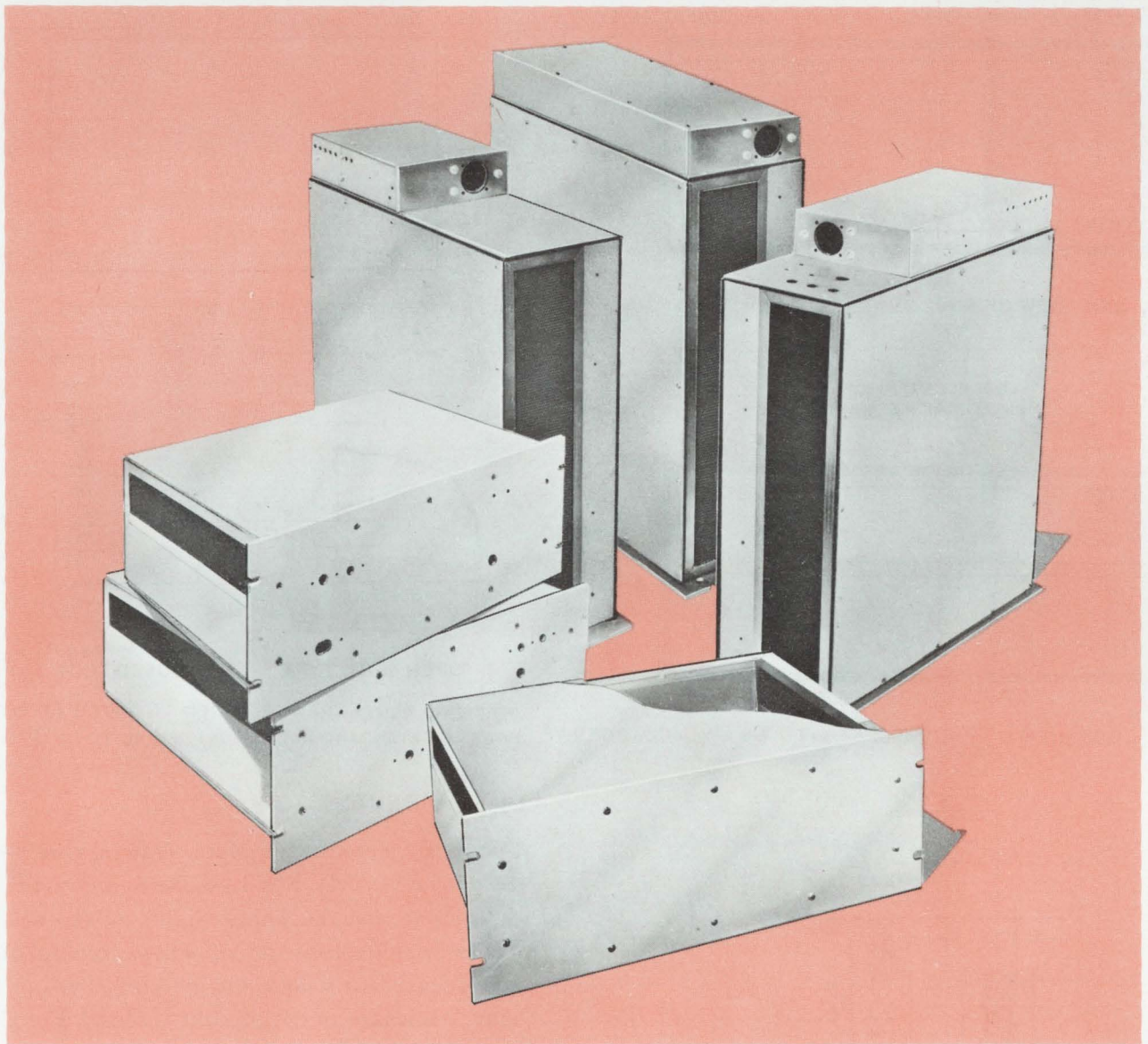

**CONFORMING TO MIL-STD-189,  
NASA KSC-153-F, RETMA SE-102 AND EIA STANDARD DESIGNS**

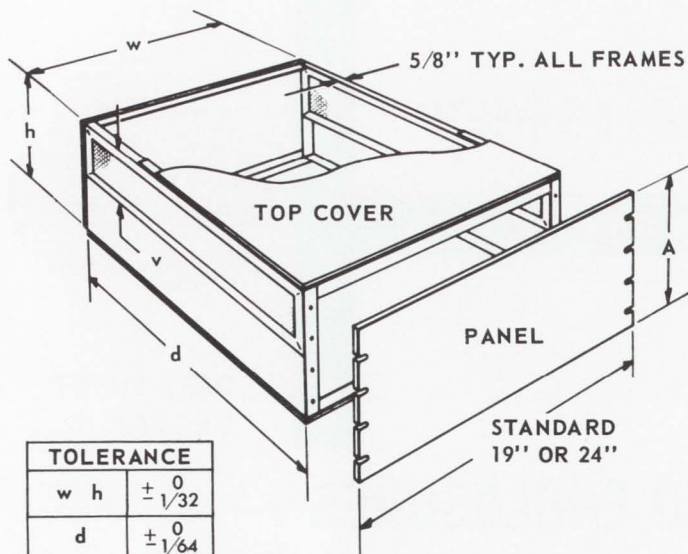

| TOLERANCE |   |                      |
|-----------|---|----------------------|
| w         | h | $\pm \frac{0}{1/32}$ |
| d         |   | $\pm \frac{0}{1/64}$ |

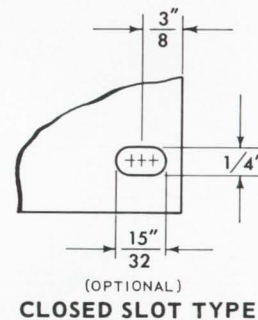
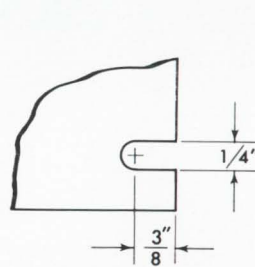
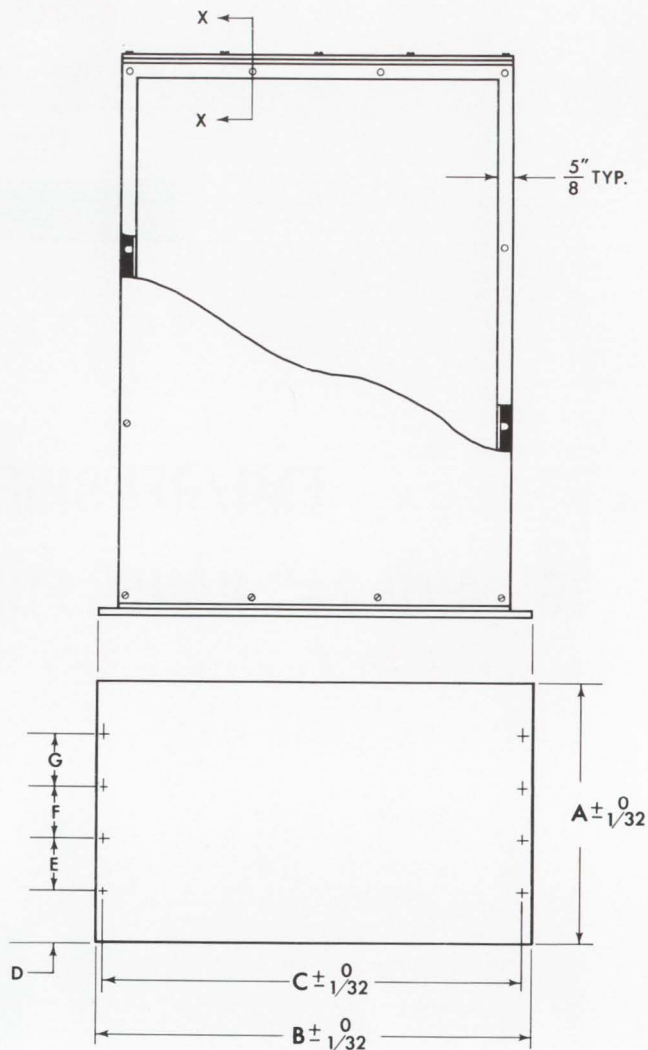
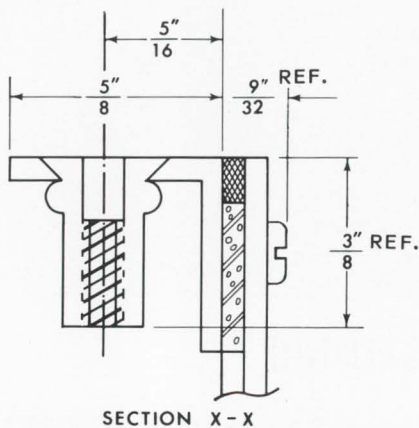
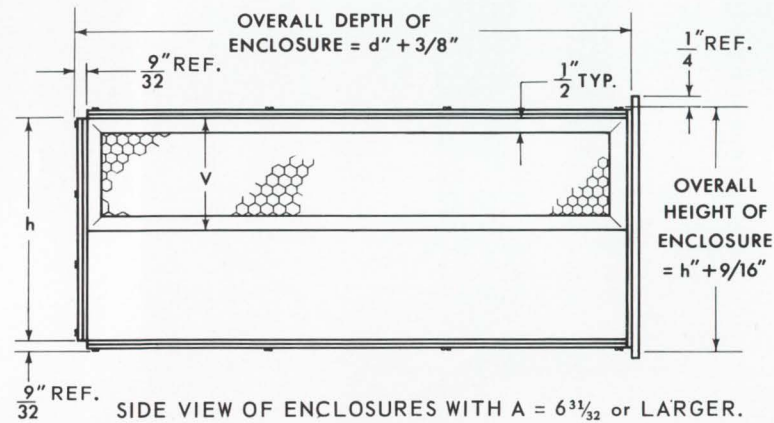
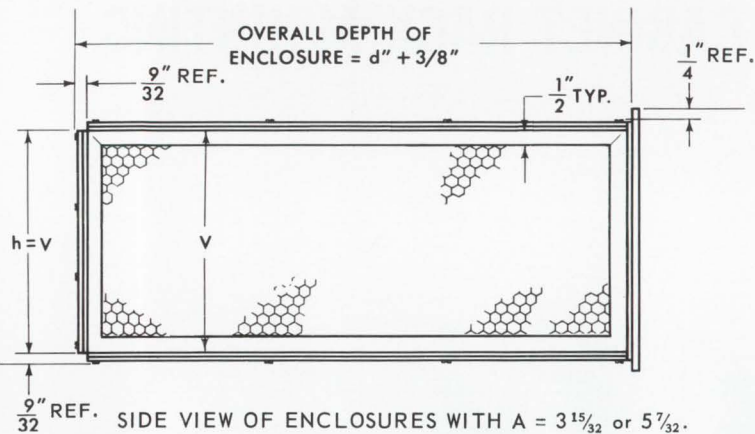

MOUNTING SLOTS ARE POSITIONED TO MATCH MOUNTING HOLES ON STANDARD RACKS CONFORMING TO MIL-STD-189.

## DETAIL DRAWINGS AVAILABLE

Complete, reproducible, form drawings of Tecknit's STANDARD ENCLOSURES are available on request from Tecknit's plants or through our Engineering Representative. These form drawings may be used to reduce engineering time, as the basic enclosure is completely detailed. For CUSTOMIZED ENCLOSURES only the custom details such as special holes, cutouts, handle locations, marking, painting and slide hardware need be added.

## EMI/RFI TEST DATA

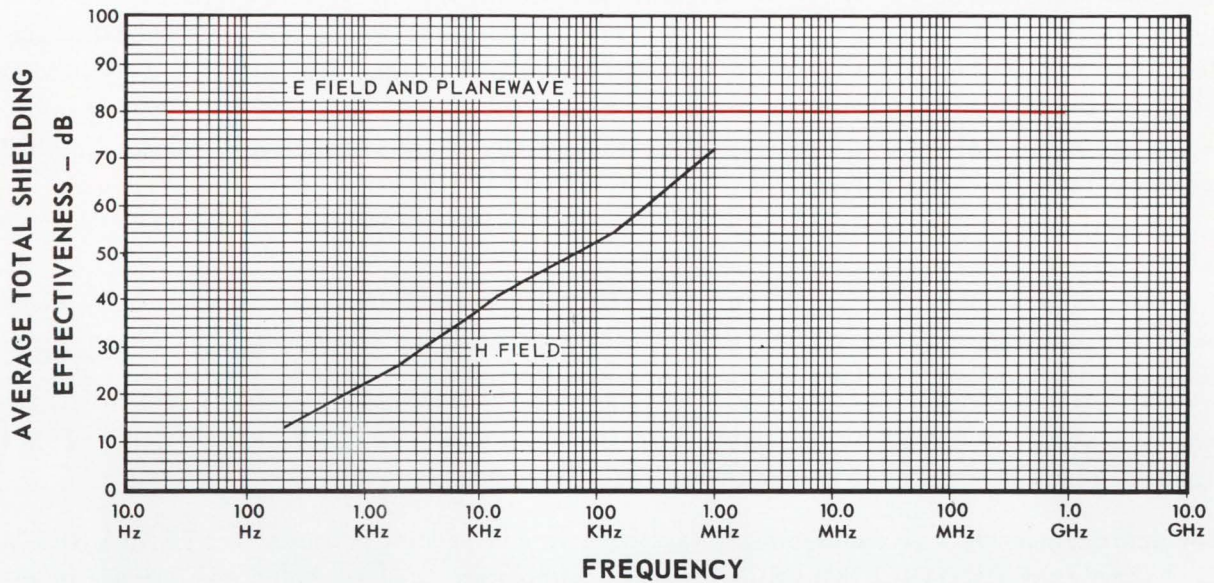

FOR DETAILED REPORT ON TEST PROCEDURES AND RESULTS OBTAINED FOR THE ABOVE GRAPH, SEND FOR ENGINEERING BULLETIN #66-1.

## MATERIAL SPECIFICATIONS

FRONT PANEL – 3/16", ALUMINUM, 5052-H32  
 FRONT PANEL SLOTS – OPEN TYPE.  
 ENCLOSURE SHELL – 1/16", ALUMINUM, 6063-T42 AND 5052-H32.  
 TOP, BOTTOM, REAR ENCLOSURE COVERS – 3/32", ALUMINUM, 5052-H32.  
 TECKCELL HONEYCOMB VENTS – ALUMINUM, MIL-C-7438, 1/8" CELL, 1/2" THICK.

### STANDARD

FASTENERS, CAPTIVE – 8-32, CAD PLATED STEEL, APPROX. 4" CENTER ALL FLANGES.  
 TECKNIT EMI/RFI GASKETS – SHIELD SN/CU/FE; RUBBER MIL-R-6130 TYPE II, GRADE A, COND. MED. FINISH, ALL PARTS – CADMIUM PLATING, QQ-P-416 AND CONDUCTIVE CHROMATE FINISH, MIL-C-5541.  
 COVER SCREWS – 8-32 PAN HEAD, CAD PLATED STEEL.

### FRONT PANEL OPTIONS

SUFFIX GF – GRAINED FINISH WITH PROTECTIVE MASKING.

SUFFIX CS – CLOSED SLOTS IN PANEL.

SUFFIX BP – NO HOLES OR SLOTS IN STANDARD PANEL.

## STANDARD ENCLOSURE PART NUMBERS

|                        | Tecknit Standard Enclosure Part Nos. |                      |          |          |          |          |          | Encl. Height | Encl. Width | Vent Frame Height | Standard Panel Dimensions Ref. MIL-STD-189. |        |       |       |       | Front Panel Options – To Order Add Suffix To Part No. |       |       |
|------------------------|--------------------------------------|----------------------|----------|----------|----------|----------|----------|--------------|-------------|-------------------|---|--------|-------|-------|-------|---|-------|-------|
|                        | Panel Height                         | Enclosure Depths = d |          |          |          |          |          |              |             |                   | C   | D      | E     | F     | G     | Finish  | Slots | Blank |
|                        |                                      | A                    | 12       | 15       | 18       | 21       | 24       |              |             |                   |   |        |       |       |       |   |       |       |
| Std. Panel Width B=19" | 3 15/32                              | 66-78602             | 66-78603 | 66-78604 | 66-78605 | 66-78606 | 66-78607 | 2 13/32      | 17          | 2 13/32           | 18 3/4                                      | 15/64  | 3     | –     | –     | GF  | CS    | BP    |
|                        | 5 7/32                               | 66-78612             | 66-78613 | 66-78614 | 66-78615 | 66-78616 | 66-78617 | 4 5/32       | 17          | 4 5/32            | 18 3/4                                      | 131/64 | 2 1/4 | –     | –     | GF  | CS    | BP    |
|                        | 6 31/32                              | 66-78622             | 66-78623 | 66-78624 | 66-78625 | 66-78626 | 66-78627 | 5 29/32      | 17          | 3 31/32           | 18 3/4                                      | 131/64 | 4     | –     | –     | GF  | CS    | BP    |
|                        | 8 23/32                              | 66-78632             | 66-78633 | 66-78634 | 66-78635 | 66-78636 | 66-78637 | 7 21/32      | 17          | 3 31/32           | 18 3/4                                      | 131/64 | 1 3/4 | 2 1/4 | 1 3/4 | GF  | CS    | BP    |
|                        | 10 15/32                             | 66-78642             | 66-78643 | 66-78644 | 66-78645 | 66-78646 | 66-78647 | 9 13/32      | 17          | 3 31/32           | 18 3/4                                      | 131/64 | 2 1/4 | 3     | 2 1/4 | GF  | CS    | BP    |
|                        | 12 7/32                              | 66-78702             | 66-78703 | 66-78704 | 66-78705 | 66-78706 | 66-78707 | 11 5/32      | 17          | 3 31/32           | 18 3/4                                      | 131/64 | 1 3/4 | 5 3/4 | 1 3/4 | GF  | CS    | BP    |
| Std. Panel Width B=24" | 3 15/32                              | 66-78652             | 66-78653 | 66-78654 | 66-78655 | 66-78656 | 66-78657 | 2 13/32      | 22          | 2 13/32           | 23 3/4                                      | 15/64  | 3     | –     | –     | GF  | CS    | BP    |
|                        | 5 7/32                               | 66-78662             | 66-78663 | 66-78664 | 66-78665 | 66-78666 | 66-78667 | 4 5/32       | 22          | 4 5/32            | 23 3/4                                      | 131/64 | 2 1/4 | –     | –     | GF  | CS    | BP    |
|                        | 6 31/32                              | 66-78672             | 66-78673 | 66-78674 | 66-78675 | 66-78676 | 66-78677 | 5 29/32      | 22          | 3 31/32           | 23 3/4                                      | 131/64 | 4     | –     | –     | GF  | CS    | BP    |
|                        | 8 23/32                              | 66-78682             | 66-78683 | 66-78684 | 66-78685 | 66-78686 | 66-78687 | 7 21/32      | 22          | 3 15/32           | 23 3/4                                      | 131/64 | 1 3/4 | 2 1/4 | 1 3/4 | GF  | CS    | BP    |
|                        | 10 15/32                             | 66-78692             | 66-78693 | 66-78694 | 66-78695 | 66-78696 | 66-78697 | 9 13/32      | 22          | 3 31/32           | 23 3/4                                      | 131/64 | 2 1/4 | 3     | 2 1/4 | GF  | CS    | BP    |
|                        | 12 7/32                              | 66-78712             | 66-78713 | 66-78714 | 66-78715 | 66-78716 | 66-78717 | 11 5/32      | 22          | 3 31/32           | 23 3/4                                      | 131/64 | 1 3/4 | 5 3/4 | 1 3/4 | GF  | CS    | BP    |

## DESCRIPTION

Designed to conform to MIL-STD-189, NASA-STD-KSC-153-F, EIA STANDARDS and RETMA SE-102. Tecknit's STANDARD ENCLOSURES for 19" or 24" rack mounting cabinet installation are all aluminum shielded electronic packages, with integral EMI/RFI honeycomb cooling panels. All 72 STANDARD ENCLOSURES feature EMI/RFI gasketed seams and have removable front, rear, top and bottom panels. The enclosures are of all welded construction, fully cadmium plated and conductive chromate finished to assure optimum Total Shielding Effectiveness and environmental compatibility.

## APPLICATION

Electronic packaging designers specify Tecknit STANDARD ENCLOSURES because they meet engineering and production requirements for EMI/RFI shielding performance, equipment ventilation, environmental compatibility, and are available quickly, at reasonable cost.

"Customizing" is easily achieved by beginning with the STANDARD ENCLOSURE design and then adding the special features required to suit individual packaging needs.

Tecknit provides engineering and manufacturing facilities to add special features to STANDARD ENCLOSURES. Examples of CUSTOM ENCLOSURE features offered are handles, holes and cutouts in any panels, chassis brackets or card racks, mounting holes for drawer slides, special painting, marking, etching or silk screening of panels.

## HOW TO SPECIFY AND ORDER STANDARD ENCLOSURES

To order or specify the STANDARD ENCLOSURES only the Tecknit STANDARD ENCLOSURE Part Number is needed. Price and delivery information on all standards are available from Tecknit's Engineering Representatives or direct from Tecknit's plants.

## HOW TO SPECIFY AND ORDER CUSTOM ENCLOSURES

To specify or obtain quotation on CUSTOM ENCLOSURES, Tecknit suggests the use of the STANDARD ENCLOSURE Form Drawings as a starting point. These drawings are reproducible and detail the basic enclosure. Only the custom features need be added to to show the desired special details and information. The STANDARD ENCLOSURE Form Drawings are available from Tecknit's plants or Engineering Representatives on request.

## TECKNIT EMI/RFI CABINET SHIELDING PRODUCTS

TECKNIT EMI/RFI  
VENT PANELS

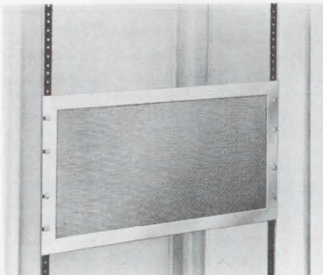

Shielded panels for cooling, filtering, Standards available for 19" or 24" rack mounting.

TECKNIT EMI/RFI STRIPS

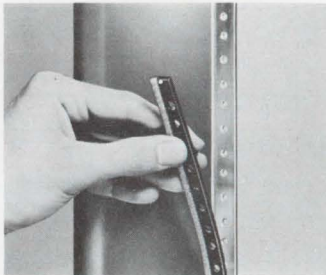

Hundreds of resilient, conductive gasket types for easy installation on all cabinet door and panel seams.

TECKNIT EMI/RFI  
INTERMEDIATE BARS

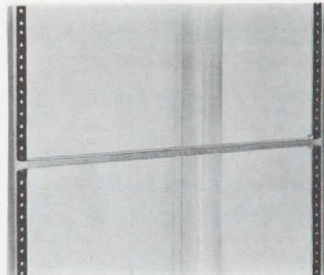

Easily installed, these shielded bars provide EMI/RFI gasketing between standard rack mounted panels.

TECKNIT EMI/RFI WINDOWS

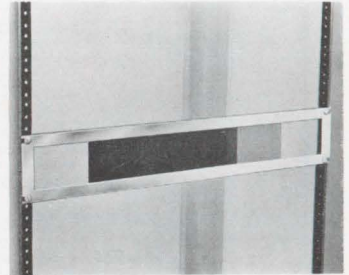

Standard for cabinet rack mounting, these EMI-GLAS panels are shielded viewing windows.



### Technical Wire Products Inc.

EASTERN-DIVISION  
129 DERMODY STREET  
CRANFORD, N. J. — 07016  
(201)272-5500 TWX(710)996-5951

WESTERN-DIVISION  
427 OLIVE STREET  
SANTA BARBARA, CALIF. — 93101  
(805)963-1867 TWX(910)334-1186

## Data recorder handles 2300-ft tape

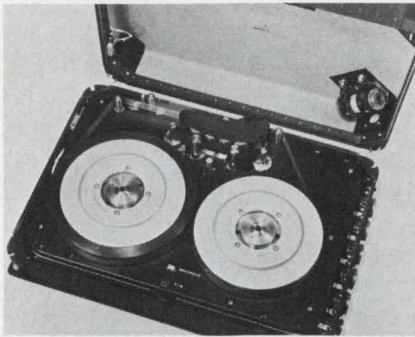

*Kinlogic Corp., 29 Pasadena Ave., Pasadena, Calif. Phone: (215) 449-8707.*

This digital or analog data recorder occupies 830 in.<sup>3</sup> and handles tape packs up to 2300 ft in length either 0.5- or 1-in. wide. It meets the requirements of MIL-E-5400, MIL-STD-704, and MIL-T-5422, so it is suited to airborne applications. The flutter content is less than 0.9% pk-pk over a bandwidth of 0.2 to 10,000 Hz at 30-in./s tape speed.

CIRCLE NO. 326

## 12-bit adder carries in 48 ns

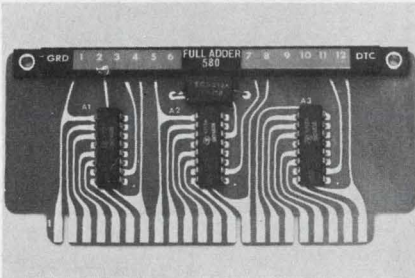

*Data Technology Corp., 2370 Charleston Rd., Mountain View, Calif. Phone: (415) 321-0551.*

A 12-bit adder consisting of three 4-bit circuits performs a 4-bit addition in 60 ns and a carry in 48 ns. Test points are provided on all circuit outputs, and color-coded test-point strip clearly identifies each test point without card removal. Power requirements are +5 V, 78 mA; the unit features a decoupling capacitor to minimize poise interference and is compatible with all DTL and TTL logic circuits. The module's size is 5.4 × 2.16 in. with a gold-plated 44-pin connector.

CIRCLE NO. 327

## Fluidic programmer accurate to 0.005%

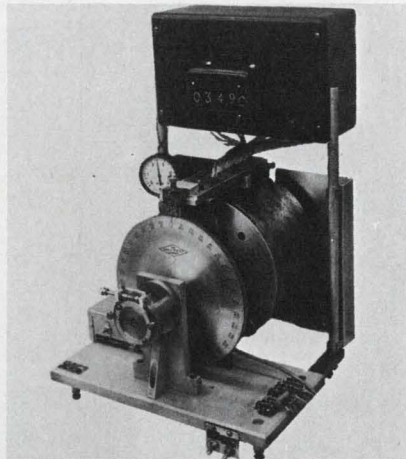

*Computer Instruments Corp., 92 Madison Ave., Hempstead, N.Y. Phone: (516) 483-8200.*

A digital drum programmer provides reference voltages accurate to 0.005% as a function of index wheel angle. The device consists of a punched coded metal drum, fluidic drum reader, and master resistive voltage divider with illuminated digital readout. When connected to a source of low-pressure air and dc or ac voltage, the generator will provide programmed voltage ratios at any shaft angle.

CIRCLE NO. 328

## Telemetry simulator offers PCM or PDM

*Electro-Mechanical Research, Inc., Box 3041, Sarasota, Fla. Phone: (609) 924-9100.*

Simulator of pulse-code modulation (PCM) signals provides all standard IRIG telemetry formats, and can also be programmed to simulate pulse-duration modulation (PDM) telemetry signals. Operating modes of the 2795 are selected by a switch. It can generate formats with up to 599 digital words in the main frame, and another 599 words in the sub-computed frame, at word lengths of 1 to 33 bits. Output is available in any of the seven codes. Signal disturbances such as dropout, baseline offset, bit-rate jitter and noise, can be introduced through an external input.

CIRCLE NO. 329

## PROVEN

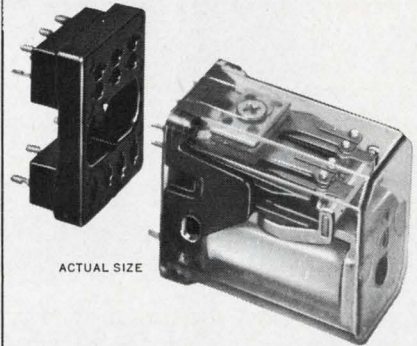

ACTUAL SIZE

## PERFORMER

American Zettler Series AZ-420 miniature relays, produced at the rate of 10,000 units per day, continue to lead the way in applications where space and long life are prime considerations. Computer systems, business machines and data processing equipment, and control and alarm systems are only a few of the many areas where AZ relays have successfully been field-proved.

AZ-420 relays require less than ONE CUBIC INCH of space. When installed with the AZ right-angle socket, their overall height is only 3/4". Life expectancy of AZ relays is up to 100 MILLION operations. Other outstanding features include:

- International standard-type relay
- Available with plug-in, solder or pc terminals
- Balanced spring-held armature allows same operating data in any mounting position
- Lower cost per unit from mass production techniques
- Available from stock.

AZ miniature relays are available in all common contact and coil configurations. Contacts are capable of carrying loads up to 5 amps, as well as low-level signals. For low-level, high-reliability switching, bifurcated contacts are available.

**Write today for complete technical information on the Series AZ-420. Find out why American Zettler can handle all of your relay requirements...from A to Z!**



**American Zettler, inc.**

697 RANDOLPH AVENUE  
COSTA MESA, CALIF. 92626  
PHONE (714) 540-4190

ON READER-SERVICE CARD CIRCLE 88

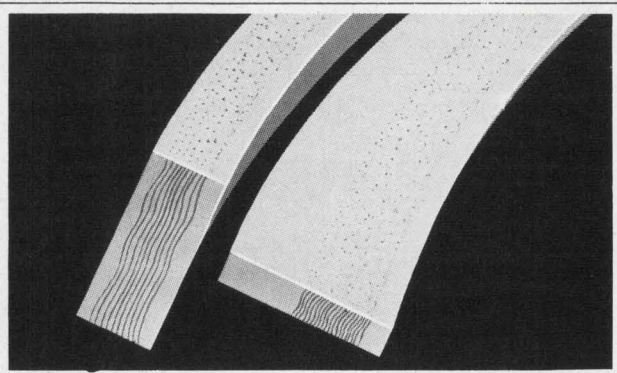

U. S. Patent #2,674,644

## POLASTRIP..

### seals and shields with a single material

Polastrip consists of oriented wire (typically monel or aluminum wire) imbedded in a matrix of silicone rubber. It is available as a standard item in several thousand cross-sections and types. Polastrip has proven itself

to be the most effective shielding material available for solving many difficult shielding problems. Cost is comparable to conventional, combination materials.

Write for free samples, prices, and literature!

### METEX Corporation

970 New Durham Road, Edison, N.J. 08817  
(201) 287-0800 • TWX 710-998-0578

West Coast: Cal-Metex Corp., 509 Hindry Ave., Inglewood, Calif.



ON READER-SERVICE CARD CIRCLE 89

### A NEW IDEA IN P-CLIPS!

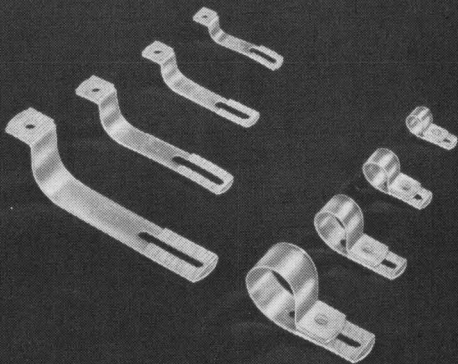

## ADJUSTABLE P-CLIPS

Only nine (9) sizes of P-Clips will fit all loop diameters from 1/8" through 2"; each size can be adjusted within a specified range. Does away with inventory problems, permits quantity purchases and controls the tension. Molded of non-corrosive, non-conductive, virgin nylon. Applications include: cables, bundles of wires, components, pipes, tubing—wherever a clamp, strain-relief or strap is required. Send for free samples.

**OTHER ELECTROVERT PRODUCTS:** Cradleclip; strapping; cable ties; spiroband; markers; grommet strip; wavesoldering systems.

Sold Coast-to-Coast through Authorized Distributors

**ELECTROVERT INC.**  
86 Hartford Ave., Mount Vernon, N. Y. 10553  
Burbank, California Milwaukee, Wisconsin

ON READER-SERVICE CARD CIRCLE 90

## MATERIALS

### Circuit-card elements permit IC mixing

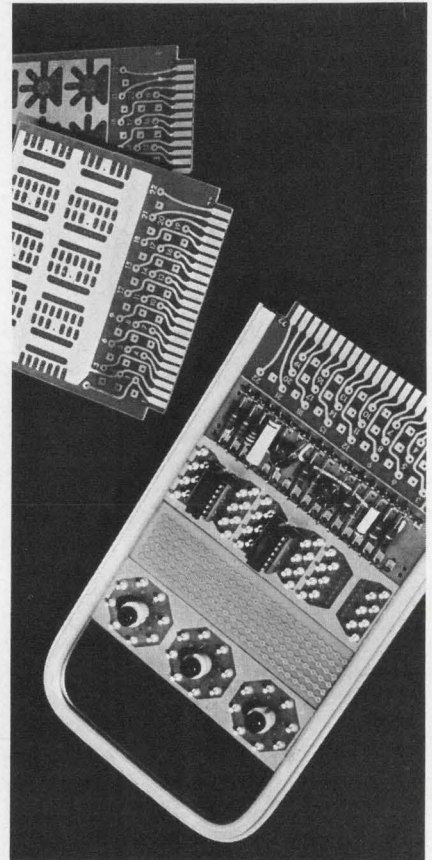

*Eglin Electronics, Inc., P.O. Box 1318, Erie, Pa. Phone: (814) 452-6773.*

Interchangeable modular card elements permit 8- and 10-pin TO-5s to be mixed with 14- and 16-pin dual-in-line ICs. They also permit the use of a strip pack to link ICs with discrete components, to increase versatility for breadboarding of design and prototype applications.

They feature 22-position, double-sided, gold-plated readout tabs with standard 0.156-in. spacing. The card elements accept standard sockets, edge connectors and terminals and plug into 4-1/2-in. card racks. When a design engineer determines his requirements, the desired pattern combinations slip together into a preformed aluminum rail which functions as a handle. A simple crimp of the rail locks the separate elements in place. The elements are without power connections and have a copper ground to minimize noise and cross talk.

CIRCLE NO. 321



## Trimetallic mesh acts as a shield

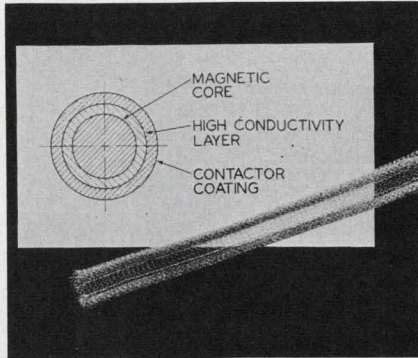

Metex Corp., Edison, N.J. Phone: (201) 381-7272.

Electromagnetic shielding material of trimetallic wire mesh can be used to manufacture electronic weatherstrip, combo strip, combo gaskets and compressed units. The trimetallic construction consists of a magnetic ferrous alloy core, a center section of high-conductivity metal, and an outer contactor coating.

CIRCLE NO. 330

## Square lead terminals ease wire wrapping

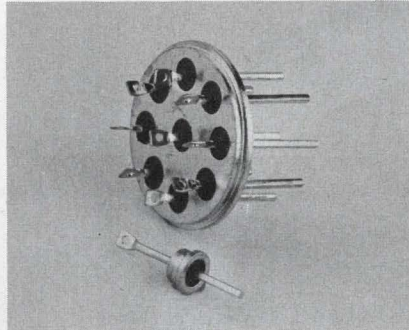

H. J. Electronic Seal Co., 366 Ely Ave., South Norwalk, Conn. Phone: (203) 838-8426.

Terminals with square leads for wrap-around applications on relays, transformers and filter operations are available. The square edges of these terminals provide the added gripping action required in wrap-around operations and eliminate slipping completely. The flat areas also provide a broader surface of contact for soldering.

CIRCLE NO. 331

## Aerosol varnish resists moisture



Industrial Supply Division, Spray-on Products, Inc., Bedford Heights, Ohio. Phone: (216) 292-7400.

A self-spraying varnish for use on electrical and electronic equipment is moisture- and fungus-proof. Its fungus-resistance and insulating effect is at least 10 times that of an untreated surface. Dielectric strength is 750 V/mil. The varnish may be safely applied directly to wires and insulation. It will neither crack nor splinter.

CIRCLE NO. 332

# NEW DERINGER PROCESSES CAN HELP YOU SAVE ON ELECTRICAL CONTACTS AND SUB-ASSEMBLIES

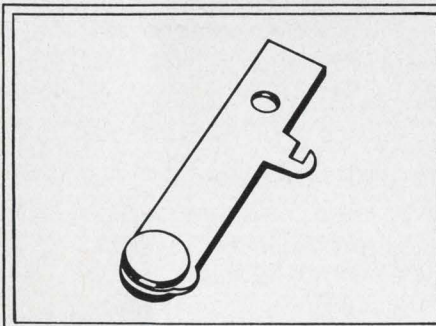

**DERINGER DUELL HEAD PROCESS REDUCES CONTACT SILVER USAGE UP TO 70%**

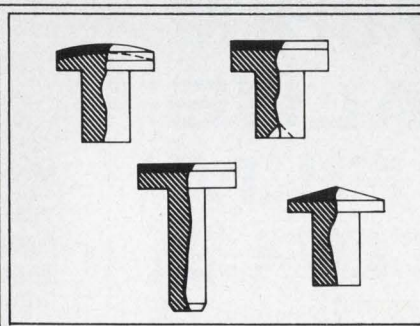

**DERINGER ECONOMET CONTACTS PROVIDE SAVINGS AND BENEFITS UNIQUE TO ECONOMET CONSTRUCTION**

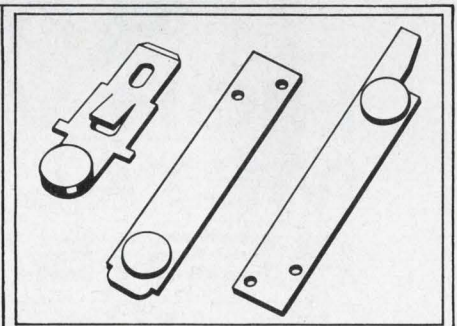

**EXCLUSIVE DERINGER MULTI-PURPOSE EQUIPMENT CUTS CONTACT SUB-ASSEMBLY LABOR COSTS UP TO 75%**

### DERINGER PRODUCTS INCLUDE

Rivets, discs, balls, rings, screws, gold treatment, silver cadmium oxide, composites, strip, sheet, laminated metals, silver and silver alloys, gold, platinum, palladium, etc.

### CONTACT ASSEMBLIES AND SUB-ASSEMBLIES

Welded, Riveted, Double Headed.

Interest in contact savings? Write for special data and complete catalog.



FOR CONTACTS—CONTACT

# DERINGER

METALLURGICAL CORPORATION

1250 Town Line Road - Mundelein, Illinois 60060

ON READER-SERVICE CARD CIRCLE 81

*if you don't like  
to compromise...*

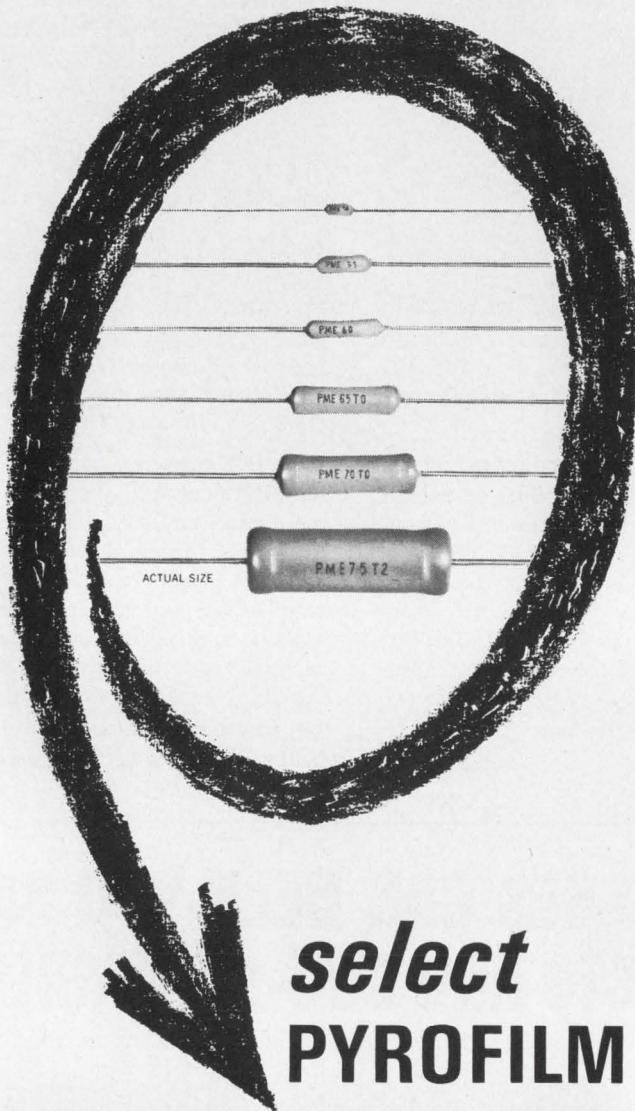

**select  
PYROFILM  
HIGH VALUE  
METAL FILM  
RESISTORS**

| Part No. | R/N | Power | Ohms | Temp. Coef.      |
|----------|-----|-------|------|------------------|
| PME 50   | 50  | 1/20W | 1M   | T-0<br>to<br>T-9 |
| PME 55   | 55  | 1/10W | 3M   |                  |
| PME 60   | 60  | 1/8W  | 8M   |                  |
| PME 65   | 65  | 1/4W  | 15M  |                  |
| PME 70   | 70  | 1/2W  | 30M  |                  |
| PME 75   | 75  | 1W    | 50M  |                  |

Send for fact-filled literature sheet

**PYROFILM RESISTOR  
COMPANY, INC.**

3 SADDLE ROAD • CEDAR KNOLLS, N. J. 07927 • 201-539-7110

ON READER-SERVICE CARD CIRCLE 91

## Application Notes

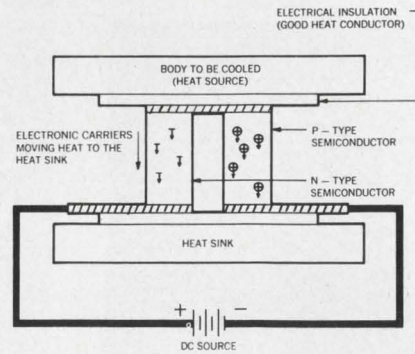

Cross-Section of a Typical Thermoelectric Cooler.

### Thermoelectrics

The principles, applications and design possibilities of thermoelectric cooling are discussed in this 48-page booklet. Like conventional refrigeration, thermoelectrics obeys the basic laws of thermodynamics. Both in result and principle, then, thermoelectric cooling has much in common with conventional refrigeration methods. In thermoelectric refrigeration the refrigerant in both liquid and vapor form is replaced by two dissimilar conductors. The freezer surface becomes cold through absorption of energy by the electrons as they pass from one semiconductor to another, instead of energy absorption by the refrigerant as it changes from liquid to vapor. Borg-Warner Corp.

CIRCLE NO. 335

### Motors and synchros

A revised text, *Technical Information for the Engineer, No. 1—Tenth Edition*, gives authoritative information about servomotors, inertial damped motors, synchronous motors, stepper motors, motor-tachometer generators, synchros, resolvers and servo electronics. The 80-page publication includes more than 200 illustrations in the form of block diagrams, curves, charts, graphs, tables, circuit drawings and wiring schematics complementing the text. Equations, formulas, expressions, and conversion factors are tabulated. General Precision Systems, Inc.

CIRCLE NO. 336

## Design Aids



### Thermistor kit

Positive - temperature - coefficient (PTC) thermistors for circuit compensation, time-delay current-limiting and thermostatic sensing, are available in a designer's kit. It contains sixteen PTC devices, curves and application notes, in a tabbed folder-type package for convenient reference.

Available for \$20 from the Carborundum Co., Electronic Devices, Bld. 1-1, P.O. Box 337, Niagara Falls, N.Y. 14302.

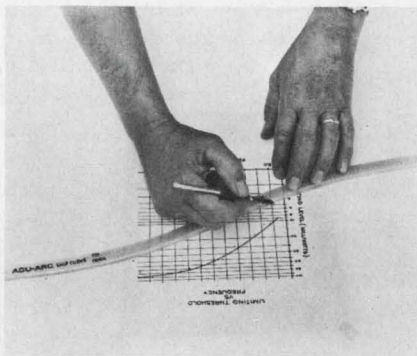

### Adjustable ship curve

An adjustable ship curve is a drawing instrument 18 in. long and replaces a complete set of ship curves. Segmented construction provides a smooth nonrippled fair line curve. Curves formed from the solid end will be tangential to the ruling edges at the solid end. It is useful for drawing a curved line between plotted points, and for template work transferring curves from one working surface to another. The ruling edge on one side is raised above the drawing surface for use with pen and ink. Both edges can be used for pencil work.

Available for \$3.50 from Rolatope Corp., 1301 Olympic Blvd., Santa Monica, Calif.

## reduce system size 7:1 with MicroVersaLOGIC IC Modules

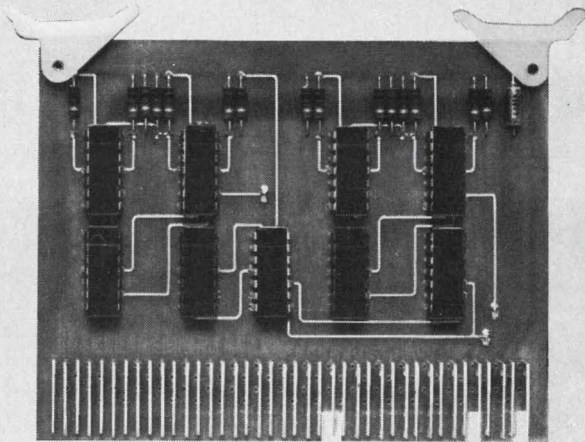

The complete MicroVersaLOGIC line gives you all the ready-made building blocks you need for anything from a register to an entire digital system—with a 7:1 size reduction because of MicroVersaLOGIC's high density IC packaging.

MicroVersaLOGIC also means increased reliability over discrete components, lower power requirements, greatly reduced costs. MicroVersaLOGIC features NAND, NOR logic with wired OR capacity at the collector, operates to 5v. logic levels, has excellent noise rejection of over 1v. There are over 20 basic module types, all meticulously designed and assembled to give you utmost reliability.

Our new MicroVersaLOGIC brochure will show you how easy and economical it is to design digital systems with MicroVersaLOGIC IC Modules. Write or call.



**varian data machines**  
a varian subsidiary

Formerly Decision Control, Inc.  
1590 Monrovia Ave., Newport Beach, Calif.  
(714) 646-9371 TWX (910) 596-1358

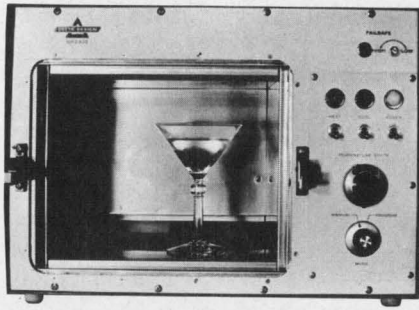

# This refrigerator heats to 1000 degrees.

It also cools to -300 degrees. It does both with remarkable accuracy, 0.1°.

Send for our latest catalog.



**Delta Design, Inc.**  
8000 Fletcher Parkway  
La Mesa, California 92042  
Telephone (714) 465-4141

ON READER-SERVICE CARD CIRCLE 93

## New Literature

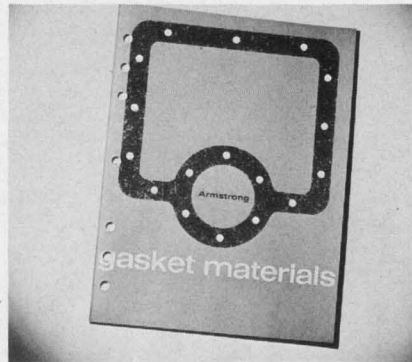

### Gasket materials

Entitled *Armstrong Gasket Materials*, the catalog contains a section on "Factors in gasket selection" and complete descriptions of Armstrong's line of gasket materials. These include asbestos fiber Accopac, cellulose fiber Accopac, Accobest, closed-cell Neoprene rubber, cork-rubber compositions, cork compositions, rubber compounds, and resilient frictional materials. A handy 2-page selector chart is included in the back. Armstrong Cork Co.

CIRCLE NO. 276

### Zener diode data

A 40-page catalog, covering a wide range of devices, contains a cross-reference listing of EIA Zener and temperature-compensated reference devices, a selection guide and a section devoted to dimension drawings. The manufacturer's zener, temperature-compensated and precision reference diodes, assemblies, current regulators, reference amplifiers, high-power transient suppressors, Meg-A-Life and MIL units are covered. Motorola Semiconductor Products, Inc.

CIRCLE NO. 277

### Measuring techniques

A primary phase-angle technique is discussed in a 10-page booklet that outlines the merits and shortcomings of the various methods of phase-angle measurements. Dytronics Co., Inc.

CIRCLE NO. 278

### Stock terminals

Designed to meet the needs of electronics and electrical users, a reference catalog gives information on the manufacturer's line of terminals. The publication also serves as a guide to proper terminal use and application. It describes plain and locking, solder lug and crimp types of terminals, which can be supplied in phosphor-bronze, brass, copper, beryllium copper or steel materials. Illinois Tool Works, Inc.

CIRCLE NO. 279

### Thermal cable wrapping

Technical information on a new cable wrap is offered in a 20-page bulletin which includes charts and illustrations. Topics covered are methods of measuring thermal properties, and the thermal barrier and thermal resistance of cable wraps. Electrical and mechanical properties are also discussed. Extrudo Film Corp.

CIRCLE NO. 280

### Motors booklet

Information on fractional and integral horsepower motors, motor speed controls, synchronous motors, gear motors, brakes, clutches, couplings, speed counters, tachometer systems, and timers and counters is included in a 64-page brochure. Tables, wiring diagrams and motor-frame sizes are given. B&B Motor Control Corp.

CIRCLE NO. 281

### Motor catalog

Descriptions and ordering information for fractional and integral horsepower motors are contained in a 16-page booklet. A broad line of small NEMA 48 and 56 frame motors for use in fans, blowers, compressors, pumps, machine tools, and general workshop equipment are discussed. Westinghouse Electric Corp.

CIRCLE NO. 282

# Special Introductory Offer to new members of the electronics and control engineers' book club

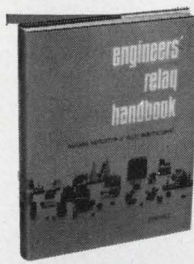

**Pub. Price**  
\$11.95  
**Club Price**  
\$10.15

Engineers' Relay Handbook by the National Association of Relay Manufacturers. Code #171

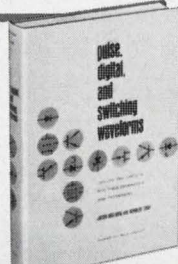

**Pub. Price**  
\$18.00  
**Club Price**  
\$15.30

Pulse, Digital, and Switching Waveforms by J. Millman and H. Taub. Code #381

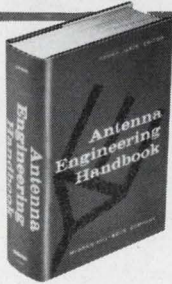

**Pub. Price**  
\$26.50  
**Club Price**  
\$18.95

Antenna Engineering Handbook by Henry Jasik. Code #290

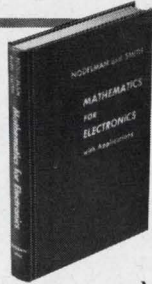

**Pub. Price**  
\$7.00  
**Club Price**  
\$5.95

Mathematics for Electronics with Applications by H. M. Nodelman. Code #850

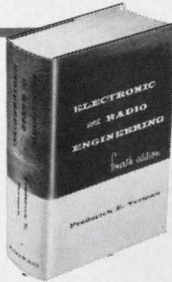

**Pub. Price**  
\$16.75  
**Club Price**  
\$14.25

Electronic and Radio Engineering by F. E. Terman. Code #509

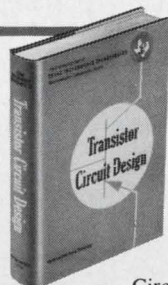

**Pub. Price**  
\$15.00  
**Club Price**  
\$12.75

Transistor Circuit Design by the Engineering Staff of Texas Instruments, Inc. Code #737

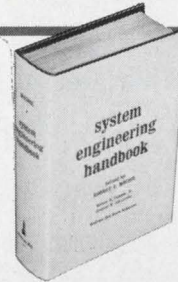

**Pub. Price**  
\$29.50  
**Club Price**  
\$25.00

System Engineering Handbook edited by R. E. Machol. Code #371

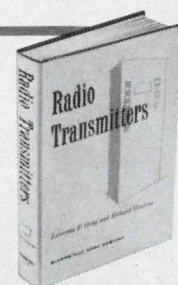

**Pub. Price**  
\$14.00  
**Club Price**  
\$11.90

Radio Transmitters by L. Gray and R. Graham. Code #240



Special \$1.00 bonus book comes to you with your first club selection

## SAVE TIME AND MONEY BY JOINING THE electronics and control engineers' book club

Here is a professional club designed specifically to meet your day-to-day engineering needs by providing practical books in your field on a regular basis at below publisher prices.

**HOW THE CLUB OPERATES.** Basic to the Club's service is its publication, the *Electronics and Control Engineers' Book Club Bulletin*, which brings you news of books in your field. Sent to members without cost, it announces and describes in detail the Club's featured book of the month as well as alternate selections which are available at special members' prices.

When you want to examine the Club's feature of the month, you do nothing. The book will be mailed to you as a regular part of your Club service. If you prefer one of the alternate selections — or if you want no book at all for that month — you notify the Club by returning the convenient card enclosed with each *Bulletin*.

As a Club member, you agree only to the purchase of four books over a two-year period. Considering the many books published annually in your field, there will surely be at least four that you would want to own anyway. By joining the Club, you save both money and the trouble of searching for the best books.

## MAIL THIS COUPON TODAY

**electronics and control engineers' book club**  
582 PRINCETON ROAD  
HIGHTSTOWN, N. J. 08520

Please enroll me as a member of the Electronics and Control Engineers' Book Club and send me the two books indicated below. You will bill me for my first selection at the special Club price and \$1 for my new membership book, plus local tax where applicable, and a few additional cents for delivery costs. These books are to be shipped on approval, and I may return them both without cost or further obligation. If I decide to keep the books, I agree to purchase as few as four additional books during the next two years at special Club prices (approximately 15% below list).

Write Code # of your \$1 bonus book

Write Code # of your first selection



NAME \_\_\_\_\_

ADDRESS \_\_\_\_\_

CITY \_\_\_\_\_

STATE \_\_\_\_\_ ZIP \_\_\_\_\_

COMPANY \_\_\_\_\_

(This offer good in United States only)

E33041

# Wedge-Action\*

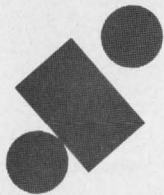

# Relays

Hermetically-sealed, electromagnetic relays that provide high performance and reliability under the most difficult operating conditions in dry-circuit to 2 amp applications.

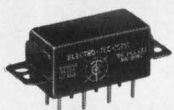

**2 PDT**  
MARK II, SERIES 500  
MIL-R-5757/9



**2 PDT**  
MARK II, SERIES 400  
(1.35" high)  
SERIES 410 (1" high)  
MIL-R-5757/8



**6PDT 4PDT**  
(1" x 1")  
MARK II, SERIES 300  
(6 PDT).  
SERIES 350 (4 PDT).  
MIL-R-5757/1 and  
MIL-R-5757/7



**6PDT**  
MARK II, SERIES 085  
(-55°C to +85°C)  
SERIES 100  
(-65°C to +125°C),  
SERIES 200  
(-65°C to +200°C).  
MIL-R-5757/1.

### \*Wedge-Action



The moving contacts are mounted between two stationary contacts. On actuation, they drive into the stationary contacts, creating high pressures and low

contact resistance at all current levels. In addition, wedge-action contact wipe provides self-cleaning of the precious-metal contacts.

\*Patent No. 2,866,046 and others pending.

For complete data write Relay Sales and Engineering Office, P. O. Box 667, Ormond Beach, Fla. 32074. Phone 904-677-1771, TWX 810-857-0305.

## Electro-Tec Corp.

SLIP RINGS • RELAYS • SWITCHES

ON READER-SERVICE CARD CIRCLE 94

## NEW LITERATURE

### Beryllium oxide

A guide to beryllium oxide powder and ceramics is contained in a 20-page manual that summarizes engineering properties and typical applications. Characteristics, properties and specifications are discussed with the aid of tables and graphs. A bibliography of technical references is included. Brush Beryllium Co.

CIRCLE NO. 334

### Miniature switches

Prices are given in a 52-page catalog for momentary-contact, push-button switches; multi-deck rotaries with up to 12 positions; test clips, binding posts, plastic cases and header boards, stand-off insulators and printed-circuit test jacks. Drawings, photographs, electrical ratings, and materials are also included. Grayhill, Inc.

CIRCLE NO. 283

### Thyristor guide

Those interested in thyristors may find this catalog helpful. It lists devices by 10 current choices from 800 mW to 35 amps, and in voltage categories from 25 to 1000 volts, pertinent to their needs. Data on plastic and metal unijunction transistors, plastic bilateral triggers, fast switching SCRs, four-layer diodes and case dimensions are included. Motorola Semiconductor Products, Inc.

CIRCLE NO. 284

### Ceramic substrates

High-alumina ceramic substrates for thick- and thin-film circuits are discussed in an illustrated booklet. Electrical, mechanical and thermal properties for two kinds of ceramic substrate material are given, along with information on surface finishes, shapes, sizes, and tolerances. Prescored sheets for substrate break-apart after circuit gang-printing are included. Coors Porcelain Co.

CIRCLE NO. 285

**VECTOR**  
"wire-them-yourself"  
plug-in cases save space,  
speed circuit building,  
and replacement.

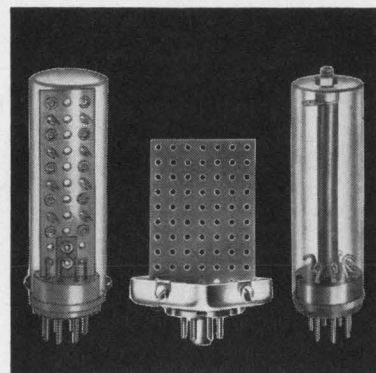

**56 standard models** — Vector's versatile, low-cost, plug-in cases facilitate quick fabrication of counters, oscillators, flip-flops, etc. in neat, compact packages. Plug-in base allows the entire circuit to be instantly removed for trouble-shooting, testing, repair, etc. Lock-in arrangements are available.

**Wide choice of internal structures** — Punched terminal cards for vertical or horizontal component placement, turrets, wafers, special designs, or models with no internal structure at all can be supplied to fit whatever circuit the user may wish to mount.

**Removable aluminum shells** — Provide shielding and accessibility. Both rectangular and round shapes are available in many sizes.

**Standard tube base plugs** — Furnished in 4-prong octal to 14-pin relay styles including 7- and 9-pin miniature, 8- and 11-pin octal.

**Larger plug-in modules are also available.**

Complete specifications and prices available from the factory.

**Vector**

ELECTRONIC CO., INC.  
1100 Flower Street, Glendale, California

ON READER-SERVICE CARD CIRCLE 95

ELECTRONIC DESIGN 2, January 18, 1968

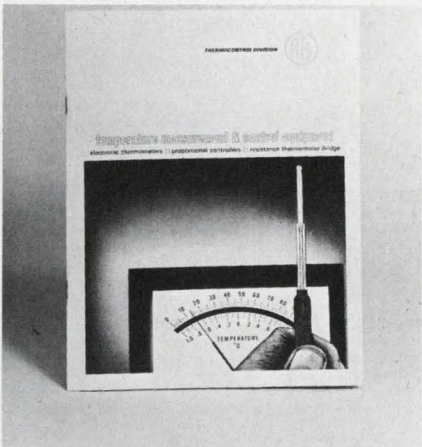

### Temperature control

A manufacturer's line of temperature measurement and control instruments is discussed in a 12-page booklet. It contains product descriptions and application information on electronic thermometers, and specifications and drawings for low-mass thermistor temperature sensors, which are shown in various configurations. RFL Industries, Inc.

CIRCLE NO. 286

### Plastics data

Design engineers and plastic processors may find this eight-page list of the properties of thermoplastics and thermosets helpful. Properties of plasticizers, including general-purpose, low-temperature, epoxy and special types are included. Union Carbide Corp.

CIRCLE NO. 287

### Microwave components

Airborne antennas, microwave components and microwave subsystems are discussed in a brochure. Specifications, photographs, outline drawings and features are given for antennas in L and S bands, as well as multiband types. Configurations include blades, stubs, sleeved dipoles, and cavity-back spirals. Details are given of various microwave components — stripline and coaxial switches, baluns, detector mounts, circulators, filters, and frequency translators. Raven Electronics, Inc.

CIRCLE NO. 288

# COSTS DOWN! WIRE FORMS PRECISION UP!

**BY ARTWIRE** Art Wire's high speed, automatic machines and production economies mean **BIG SAVINGS** for you... with guaranteed precision from the first to the millionth unit. Widest variety of wire components, made for today's automatic production lines, delivered on schedule to assure uninterrupted work flow.  
*Send a Sample or Blueprint for Estimates*

Write for catalog.

**ART WIRE AND STAMPING CO.**

17 Boyden Place, Newark, N. J. 07102

ON READER-SERVICE CARD CIRCLE 96

## Aircraft Flight Mechanisms: 4 weeks delivery. MIL-SPEC quality. The industry's lowest prices.

Nobody else but Ideal brings you *all* these benefits. Including high torque and sensitivities, up to 80° deflection, complete shielding, low weight, synchro or standard mounting, all shapes of pointers and flags — and customizing of all parameters.

American-made.

We're known for experience and promises *kept*. Write for free 32-page catalog. Ideal Precision Meter Co., Inc., 218 Franklin St., Brooklyn, N.Y. 11222. (212) EVergreen 3-6904.

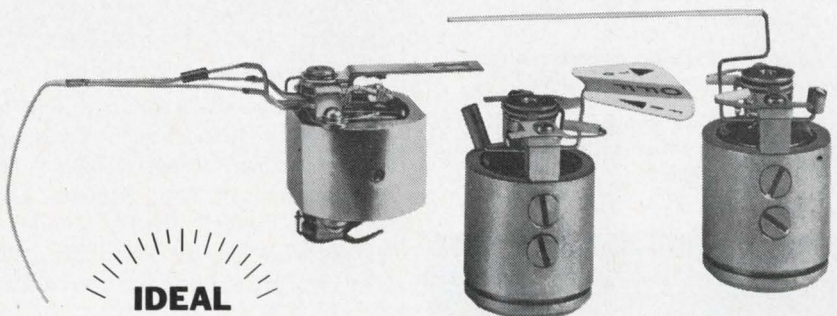

ON READER-SERVICE CARD CIRCLE 97

# THE UN-PRIVATE EYE.

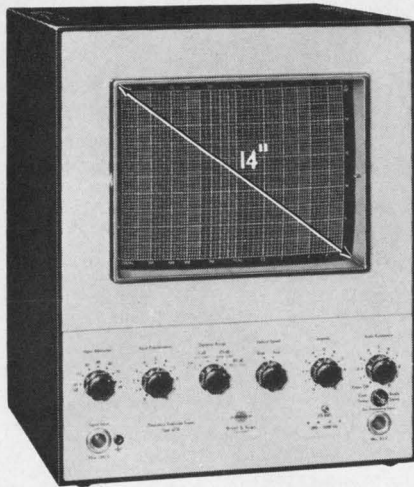

**For fast, large screen plots of audio and ultra-sonic frequency ranges.**

You won't need a magnifying glass with the B & K Model 4712 Frequency Response Tracer. 14"-diagonal screen gives you the big picture instantly. Team it up with B & K's 1022 Beat Frequency Oscillator for the most capable tracer duo going since Holmes met Watson.

- Specially designed for fast production testing and inspection: amplifiers, microphones, loudspeakers, hearing aids, tape recorders, audio-frequency filters and other electro-acoustic devices.

- Accurate response testing, from 20 Hz to 20 kHz, 200 to 500 kHz. Custom ranges down to 1 decade available.

- Vary sweep speeds from 1/3 octave/second to 3 octaves/second, or manual control for single sweeps.

- Selection of logarithmic and linear vertical sensitivities. Logarithmic: 50, 25, or 5 dB; linear range: 0-1 volt.

- Automatic trace brightness control, prevents picture tube spot burning.

- Irregular traces can be erased for low voltage signal investigation. Background noise is no problem.

- Write to Dept. 14.

**B & K INSTRUMENTS, INC.**  
Brüel & Kjær Precision Instruments  
5111 West 164th Street • Cleveland, Ohio 44142  
Telephone: (216) 267-4800 • TWX: (810) 421-8266

ON READER-SERVICE CARD CIRCLE 98

## NEW LITERATURE

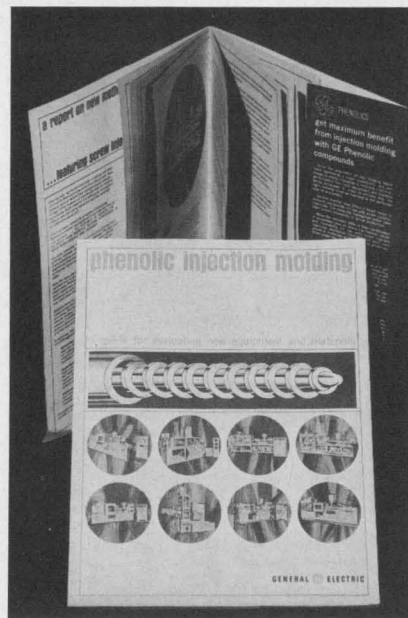

### Injection molding

*Phenolic Injection Molding* is the title of a 20-page brochure intended as a guide to evaluating new equipment and materials. It contains illustrations and descriptions of molding machines, most of which incorporate reciprocating screw plasticizing. In addition there is a discussion of points to consider in selecting a machine, plus selected properties data for phenolic grades recommended for injection molding. General Electric, Chemical Materials Dept.

CIRCLE NO. 289

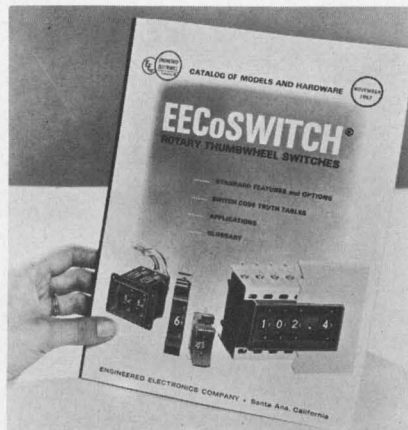

### Thumbwheel switches

A 54-page illustrated catalog has application information for selecting switches. Descriptions of the environmental and human engineering factors which should be considered for various applications are also included. Engineered Electronics Co.

CIRCLE NO. 290

**NEW, LOW COST,  
VOLTAGE-SENSITIVE RELAY DRIVER:  
WITH AN ADJUSTABLE  
TRIP POINT ( $\pm 20V$ .)!**

## VOLTSENSOR

VOLTSENSOR is a bistable voltage sensitive trip using all silicon transistors. Ideal for use as Seismic signal monitor, Power supply or battery monitor, Petro-chemical process alarm, Integrator reset and servo override, Nuclear reactor high speed alarm, Temperature controller, Strain gage alarm, etc.

Features: Input impedance 100,000 ohms. Operating time less than 25 microseconds. Resolution is infinite. Output +20v at 50-ma. Hysteresis less than 0.2% F.S. Operating temperature range -40°C to +75°C. Environmental MIL-E-5272.

The VOLTSENSOR contains an Emitter follower and a DC amplifier which drives a schmidt trigger. The trigger operates a transistor switch output stage. Tri-point adjustable by an external potentiometer.

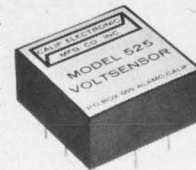

**CALIF. ELECTRONIC  
MFG. CO., INC.**

P.O. Box 555 • ALAMO, CAL. 94507  
• TEL. 415-932-3911

ON READER-SERVICE CARD CIRCLE 99

## 72 HOUR DELIVERY

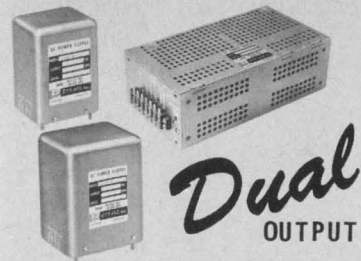

## POWER SUPPLIES

- Fully accessible, fully repairable
- Low Cost—large quantity discounts
- Dual 10, 12 and 15 standard voltages
- Current from 0.15 amps to 2.0 amps per output
- Tracking to 0.005%/°C
- Ideal for operational amplifier applications
- Special voltage combinations available on request
- Two year warranty

See EEM for power supplies and voltage references



**DYNAGE inc.**  
1331 Blue Hills Ave., Bloomfield  
Conn. 06002 • (203) 243-0315

ON READER-SERVICE CARD CIRCLE 100  
ELECTRONIC DESIGN 2, January 18, 1968



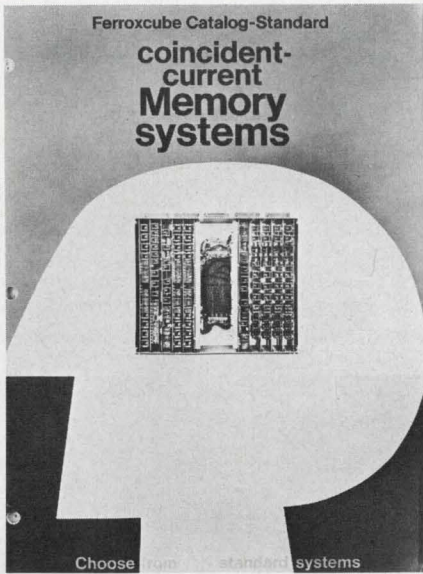

### Memory systems

A 22-page catalog of 500 memory systems contains specifications on standard systems with word and bit capacities from  $128 \times 8$  to  $4096 \times 32$  and a summary of the manufacturer's line of standard, coincident-current, magnetic-core memories. Operational theory, applications and packaging are discussed and illustrated in charts, graphs and diagrams. Ferroxcube Corp.

CIRCLE NO. 291

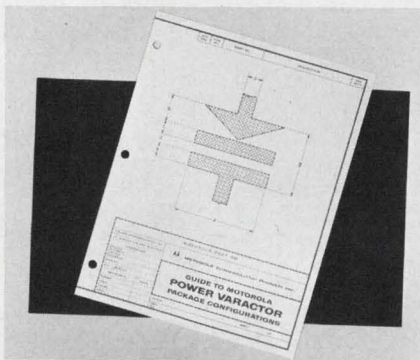

### Power varactors guide

The circuit design engineer concerned with obtaining a good varactor package to suit microwave or uhf space requirements will find this guide helpful. It contains a device and package selection chart, dimensions for each package, and a guide to the major electrical specifications for the manufacturer's standard and premium power varactor types. Motorola Semiconductor Products, Inc.

CIRCLE NO. 292

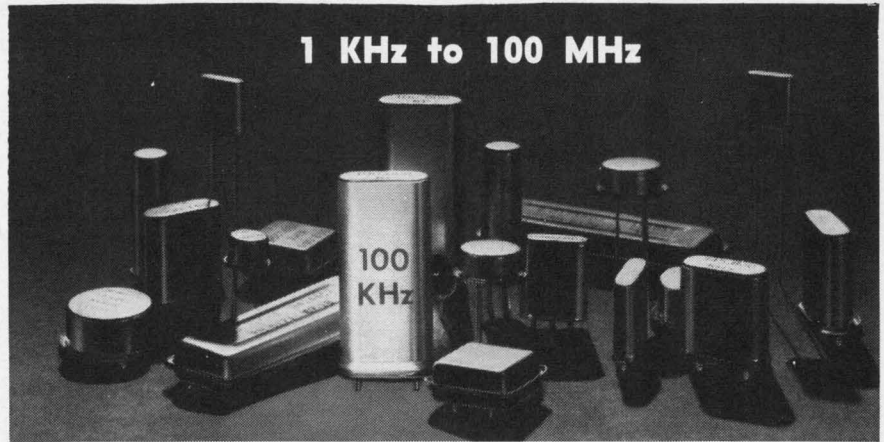

## 1 KHz to 100 MHz

### Can a 100 KHz crystal get lost in the field of frequencies?

Not if you look at Reeves-Hoffman! We are artists in ultra-precision crystals . . . but we're also experts and efficient at meeting less-demanding requirements. For example, the 100 KHz crystal shown above, and specified below, can be supplied in production quantities for less than \$2.50 each. How much less? Let us quote.

|                             |         |
|-----------------------------|---------|
| Frequency                   | 100 KHz |
| R <sub>1</sub> , ohms       | 1,800   |
| L <sub>1</sub> , henries    | 67      |
| C <sub>1</sub> , picofarads | 0.037   |
| C <sub>0</sub> , picofarads | 5.78    |
| Q                           | 24,000  |

5° X crystal for filter or oscillator applications, fundamental extensional mode.



400 WEST NORTH STREET, CARLISLE, PENNSYLVANIA 17013

ON READER-SERVICE CARD CIRCLE 101

**PROGRESS IN AN EXPLODING TECHNOLOGY**

**PROGRESS IN AN EXPLODING TECHNOLOGY**

**PROGRESS IN AN EXPLODING TECHNOLOGY**

**PROGRESS IN AN EXPLODING TECHNOLOGY**

**PROGRESS IN AN EXPLODING TECHNOLOGY**

**EXHIBITS**  
NEW YORK COLISEUM

**TECHNICAL SESSIONS**  
NEW YORK HILTON

Monday through Thursday

- 48 GENERAL SESSIONS at the New York Hilton. Hours: 10:00-12:30; 2:00-4:30.
- FOUR FLOORS OF EXHIBITS at the N. Y. Coliseum including over 750 firms. Hours: 10 a.m.-8 p.m. 4 Days.
- GALA ANNUAL BANQUET—Wednesday 7:15 p.m. N. Y. Hilton Grand Ballroom—\$16.00.
- FREE SHUTTLE BUSES between the Hilton and the Coliseum—every few minutes.
- REGISTRATION—Good all days—General Sessions and exhibits. In and out privileges.—IEEE Members \$3.00. Non-members \$6.00. Ladies \$1.00. High School Students \$3.00 if accompanied by an adult—One student per adult; Thursday only—limit of 3 students per adult.
- REG-IDENT CARD speeds request for exhibitors' literature. Ask for one when registering.
- ESCALATORS/EXPRESS ELEVATORS to the Fourth Floor.

# IEEE Exhibition MARCH 18-21, 1968

ON READER-SERVICE CARD CIRCLE 102

## Advertising Representatives

### New York 10022

Robert W. Gascoigne  
Thomas P. Barth  
Samuel M. Deitch  
Byron Adams  
850 Third Avenue  
(212) PLaza 1-5530  
TWX: 867-7866

### Philadelphia

William C. Repetto  
P. O. Box 206  
Merion Station, Pa. 19066  
(215) MO 4-1073

### Boston

Richard Parker  
40 Webb Street  
Salem, Mass. 01970  
(617) 742-0252

### Chicago 60611

Thomas P. Kavooras  
Berry Conner, Jr.  
720 N. Michigan  
(312) 337-0588

### Cleveland

(216) 247-7670

### Los Angeles 90303

Stanley I. Ehrenclou  
Terrence D. Buckley  
W. James Bischof  
2930 W. Imperial Highway  
Inglewood, Calif.  
(213) 757-0183

### San Francisco

Ashley P. Hartman  
175 South San Antonio Rd  
Ste. 243  
Los Altos, Calif. 94022  
(415) 941-3084

### Southwestern 75206

Tommy L. Wilson  
6200 North Central Express-  
way  
Dallas, Tex.  
(214) EMerson 1-2311

### London W. 1

Brayton C. Nichols  
44 Conduit Street

### Verviers, Belgium

Andre Jamar  
1, Rue Mallar, 1  
(037) 253.85

### Tokyo

Yoshihiro Takemura  
International Planning  
Service, Inc.  
Room 231 Tokyu-Mita Bldg.  
1, Shiba-Mita Koun-cho  
Minato-ku, Tokyo



## Thin-Wall Tubular Fabrications



To save material and labor costs, small parts often are fabricated best from thin-wall metal tubing rather than bar stock. This requires unique tooling and skills—developed over the years by Uniform Tubes. Data Sheet 1163 details their fabricating capabilities in over 80 metal alloys with O.D.'s from 0.625" to as small as 0.005". Wall thicknesses can be as thin as 0.0005" in some cases.

**Uniform Tubes, Inc.**  
Collegeville, Pa. 19426

# 174

## Clamp or Tie Wire Bundles In Seconds!

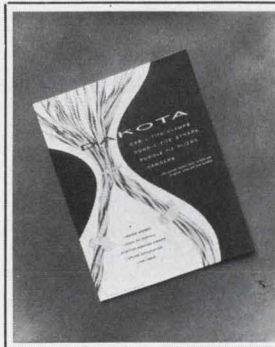

Six-page catalog contains complete ordering information for CAB-L-TITE® clamps and BUND-L-TITE® straps, devices which provide a fast and reliable means of securing wires and wire bundles. Units withstand loadings greater than 50 G's, are removable in seconds for re-routing wires, and are self-locking—no tying, no knots, no hitches to come loose. Lightweight Du Pont Zytel meets MIL-P-17091 and MIL-P-20693. Proved in aircraft and missiles. Photos, dimensional drawings, tables, physical properties, specifications, price list. Request catalog A.

**Dakota Engineering, Inc.**  
4315 Sepulveda Blvd.  
Culver City, California 90230

# 175

## ELECTRONIC DESIGN TECHNIQUES

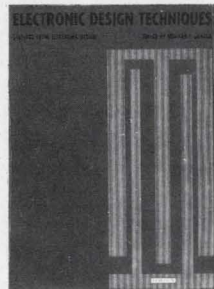

In this outstanding reference book, leaders in electronic design demonstrate for your immediate use new ideas and proven techniques that have solved difficult problems for themselves and their firms. Over 55 practical design studies selected from **Electronic Design** are presented. Vital sections of the book cover the use and design aspects of amplifiers, resistor networks, filters, control devices, power supplies, microwave systems, oscillators, and pulse and switching currents. Edited by Edward E. Grazda. Just published. 312 pages. 352 illustrations. Large format, 8 1/2 x 11. \$12.75, clothbound. Examine for 15 days without obligation or ask for details.

**HAYDEN BOOK COMPANY, INC.**  
116 W. 14 St.  
New York, N.Y. 10011

# 176

# Manufacturers

Advertisements of booklets, brochures, catalogs and data sheets. To order use Reader-ServiceCard.  
(Advertisement)

## New study compares free spinning fasteners



This comprehensive 48 page report, The Cost-Safe Story, compares the fastening effectiveness of free spinning locknuts (The M-F Flange Whiz-Lock) with split ring, external tooth, and internal tooth lock washers. These fasteners were tested for locking power, vibration resistance, and reusability. Complete test reports are offered as well as cost figures for the various fasteners. This book is the result of months of laboratory testing designed to show which system of fastening produces the maximum of safety, reliability and maintainability for the manufactured product.

**MacLean-Fogg Lock Nut Company**  
1060 Allanson Road  
Mundelein, Illinois 60060

**177**

## FREE REFERENCE LETTERS AND NUMBERS CATALOG

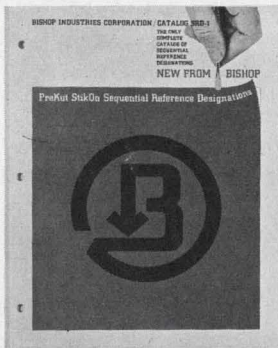

Bishop Industries now offers the only complete catalog of sequential reference designations, letters and numbers, especially developed for the electronics industry. The new 12-page Catalog No. SRD-1, features the time saving, easy to use, StikOn drafting aids in the most commonly used sizes for electronic circuit and assembly layouts. Individually precut symbols are available in opaque black, transparent red and blue. Also reverse black, red and blue for absolute registration on two sided boards from single art. Included are illustrations, range of sizes and complete price and ordering information. Send today for your free copy.

**BISHOP INDUSTRIES CORP.**  
11728 Vose Street  
North Hollywood, California 91605

**178**

## Terminal Block Selector

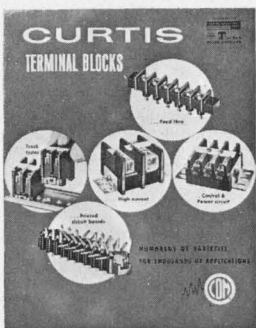

A new 24-page, completely illustrated catalog contains photos, descriptions, ratings, engineering drawings, and prices of the complete line of Curtis terminal blocks. Included are printed circuit, insulated feed-thru, quick disconnect, track type, and high current terminal blocks. Handy selection chart quickly locates the perfect block for your particular requirements. Send today for your free copy.

**Curtis Development & Mfg. Co.**  
3236 North 33rd Street  
Milwaukee, Wisconsin 53216

**179**

# Electronic Design

ELECTRONIC DESIGN's function is:

- To aid progress in the electronics manufacturing industry by promoting good design.
- To give the electronic design engineer concepts and ideas that make his job easier and more productive.
- To provide a central source of timely electronics information.
- To promote two-way communication between manufacturer and engineer.

**Want a subscription?** ELECTRONIC DESIGN is sent free to qualified engineers and engineering managers doing design work, supervising design or setting standards in the United States and Western Europe. For a free subscription, use the postfree application form inside the back cover. If none is included, write to us direct for an application form.

If you do not qualify, you may take out a paid subscription for \$25 a year in the U.S.A., \$35 a year elsewhere. Single copies are \$1.50 each.

**If you change your address,** send us an old mailing label and your new address; there is generally a prepaid postcard for this inside the back cover. You will have to requalify to continue receiving ELECTRONIC DESIGN free.

**The accuracy policy of ELECTRONIC DESIGN is:**

- To make reasonable efforts to ensure the accuracy of editorial matter.
- To publish prompt corrections whenever inaccuracies are brought to our attention. Corrections appear at the end of the Letters column.
- To refuse any advertisement deemed to be misleading or fraudulent.

**Microfilm copies are available** of complete issues of ELECTRONIC DESIGN and individual articles, published since the beginning of 1961. Complete issues cost 4¢ a page, articles cost 50¢ a page; shipping and handling charges are extra. The minimum charge is \$3. For further details and to place orders, contact University Microfilms, Inc., 300 N. Zeeb Road, Ann Arbor, Mich. 48106; telephone (313) 761-4700.

**Want to contact us?** If you have any comments or wish to submit a manuscript or article outline, address your correspondence to:

Howard Bierman, Editor,  
ELECTRONIC DESIGN,  
850 Third Avenue,  
New York, N.Y. 10022.



Please send me the latest Acopian catalog that lists

**62,000  
DIFFERENT  
POWER  
SUPPLIES**

available  
for shipment  
in 3 days.

Name \_\_\_\_\_

Title \_\_\_\_\_

Company \_\_\_\_\_

Address \_\_\_\_\_

City \_\_\_\_\_

State \_\_\_\_\_

ZIP \_\_\_\_\_

ACOPIAN CORP.  
EASTON, PENNSYLVANIA  
TEL: (215) 258-5441



ON READER-SERVICE CARD CIRCLE 103

## Advertisers' Index

| Advertiser   | Page                    | Advertiser   | Page            |
|--|-------------------------|--|-----------------|
| Acopian Corp. ....   | 174                     | Microdot, Inc. ....  | 20, 98, 99      |
| Advertising Council ....   | 157                     | Microtran Company, Inc. ....   | 126             |
| Allen-Bradley Co. ....   | 45, 47                  | Miller Company, J. W. ....   | 146             |
| American Zettler, Inc. ....  | 161                     | Mosaic Fabrications Division, The<br>Bendix Corporation ....               | 1               |
| Art Wire and Stamping Co. ....   | 169                     | Motorola Semiconductor Products,<br>Inc. ....                              | 13, 14, 15      |
| Arvin Frequency Devices ....   | 152                     | National Semiconductor Corporation ....                                    | 34, 35          |
| Automatic Electric, A Subsidiary of<br>General Telephone & Electronics ....                | 43                      | Non-Linear Systems, Inc. ....  | 42              |
| Automatic Metal Products Corporation ..  | 148, 149                | Nytronics, Inc. ....   | 31              |
| B & K Instruments, Inc. ....   | 170                     | Pastoriza Electronics, Inc. ....   | 36              |
| Beckman Instruments, Helipot Division ..   | 131                     | Physical Electronics Laboratories ....                                     | 68              |
| Bishop Industries ....   | 173                     | Polarad Electronic Instruments, Polarad<br>Electronics Corporation ....    | 69              |
| Bodine Electric Company ....   | 12                      | Potter & Brumfield Division of American<br>Machine & Foundry Company ....  | 41              |
| Bourns, Inc. ....  | 27                      | Power/Mate Corp. ....  | 154             |
| Braun Tool & Instrument Co. Inc. ....  | 152                     | Pyrofilm Resistor Co., Inc. ....   | 164             |
| Burr-Brown Research Corporation ....   | 175                     | RCA Electronic Components and<br>Devices ....                              | Cover IV        |
| CELCO Constantine Engineering<br>Laboratories Co. ....                                     | 110                     | RCL Electronics, Inc. ....   | 4               |
| Calif. Electronic Manufacturing Co., Inc. ..   | 170                     | RFL Industries, Inc. ....  | 150             |
| Centralab, the Electronics Division of<br>Globe-Union, Inc. ....                           | 64, 137                 | Raytheon Company, Components Division ..                                   | 11              |
| Conelco Components ....  | 156                     | Raytheon Company, Sorensen Operation ..                                    | 141             |
| Continental Connector Corporation ....   | 147                     | Reeves Hoffman Division of DCA ....  | 171             |
| Curtis Development & Mfg. Co. ....   | 173                     | Rowan Controller Co., The ....   | 29              |
| Cutler-Hammer ....   | 62, 63                  | Sage Electronics Corporation ....  | 124             |
| Dakota Engineering, Inc. ....  | 172                     | Salon International des Composants<br>Electroniques ....                   | 155             |
| Dale Electronics, Inc. ....  | Cover III               | Scientific Data Systems, Inc. ....   | 67              |
| Delevan Electronics, Inc. ....   | 10                      | Sealctro Corporation ....  | 159             |
| Delta Design, Inc. ....  | 166                     | Servo Tek Products Company, Inc. ....                                      | 158             |
| Deringer Metallurgical Corp. ....  | 163                     | Siliconix Incorporated ....  | 143             |
| Deutsch Filters Relay Division ....  | 151                     | Sperry Rand Corporation, Sperry<br>Microwave Electronics Division ....     | 135             |
| Dialight Corporation ....  | 125                     | Sprague Electric Company ....  | 18              |
| Digital Equipment Corporation ....   | 72                      | Stackpole Components Company ....  | 144, 145        |
| Dynage, Inc. ....  | 170                     | Systron-Donner Corporation ....  | 2               |
| ESI/Electro Scientific Industries, Inc. ....   | 23                      | TRW Semiconductors, Inc. ....  | 74              |
| Electro Tec Corp. ....   | 168                     | Technical Wire Products, Inc. ....   | 160, 160 A-B-CD |
| Electronic Design ....   | 32                      | Tektronix, Inc., Oscilloscopes ....  | 76              |
| Electronics & Control Engineers Book Club ..   | 167                     | Teledyne Relays, A Teledyne Company ....                                   | 48              |
| Electronic Engineering Co. of California ..  | 127                     | Texas Instruments Incorporated ....  | 44              |
| Electronic Research Associates, Inc. ....  | 138                     | Thermal American Fused Quartz Co., Inc. ..                                 | 65              |
| Electrovert, Inc. ....   | 162                     | Times Wire and Cable, Division of The<br>International Silver Company .... | 73              |
| Fairchild Semiconductor, A Division<br>Fairchild Camera and Instrument<br>Corporation .... | 6, 7, 8, 9              | U. S. Capacitor Corporation ....   | 66              |
| G-V Controls, Inc. ....  | 88, 89                  | Uniform Tubes, Inc. ....   | 172             |
| General Electric Company ....  | 24                      | Union Carbide Electronics ....   | 70, 71          |
| General Radio Company ....   | 37                      | United Aircraft, Electronic Components<br>Division ....                    | 153             |
| Glenaire, Inc. ....  | 46                      | Varian Data Machines,<br>A Varian Subsidiary ....                          | 165             |
| Harowe Servo Controls, Inc. ....   | 16                      | Vector Electronic Co. Inc. ....  | 168             |
| Hayden Book Company, Inc. ....   | 172                     | Warlock Systems Inc. ....  | 158             |
| Hewlett-Packard ....   | Cover II, 106, 107, 129 | Watkins-Johnson ....   | 111             |
| Honeywell, Computer Control Division ..  | 38                      | Waveline, Inc. ....  | 133             |
| IEEE ....  | 171                     | Career Advertising:<br>Aerojet-General ....                                | 117             |
| IRC, Inc. ....   | 61                      | Bendix Corporation, The ....   | 122             |
| Ideal Precision Meter Co. Inc. ....  | 169                     | Boeing Company, The ....   | 116             |
| Industrial Electronic Engineers, Inc. ....   | 5                       | IBM Corporation ....   | 118             |
| Intercontinental Instruments, Inc. ....  | 17                      | ITT Avionics Division ....   | 120, 121        |
| Johanson Manufacturing Corp. ....  | 142                     | Motorola Government Electronics<br>Division Aerospace Center ....          | 123             |
| Lambda Electronics Corp. ....  | 105                     |  |                 |
| Leach Corporation ....   | 33                      |  |                 |
| MacLean-Fogg Lock Nut Company ....   | 173                     |  |                 |
| Metex Corporation ....   | 162                     |  |                 |

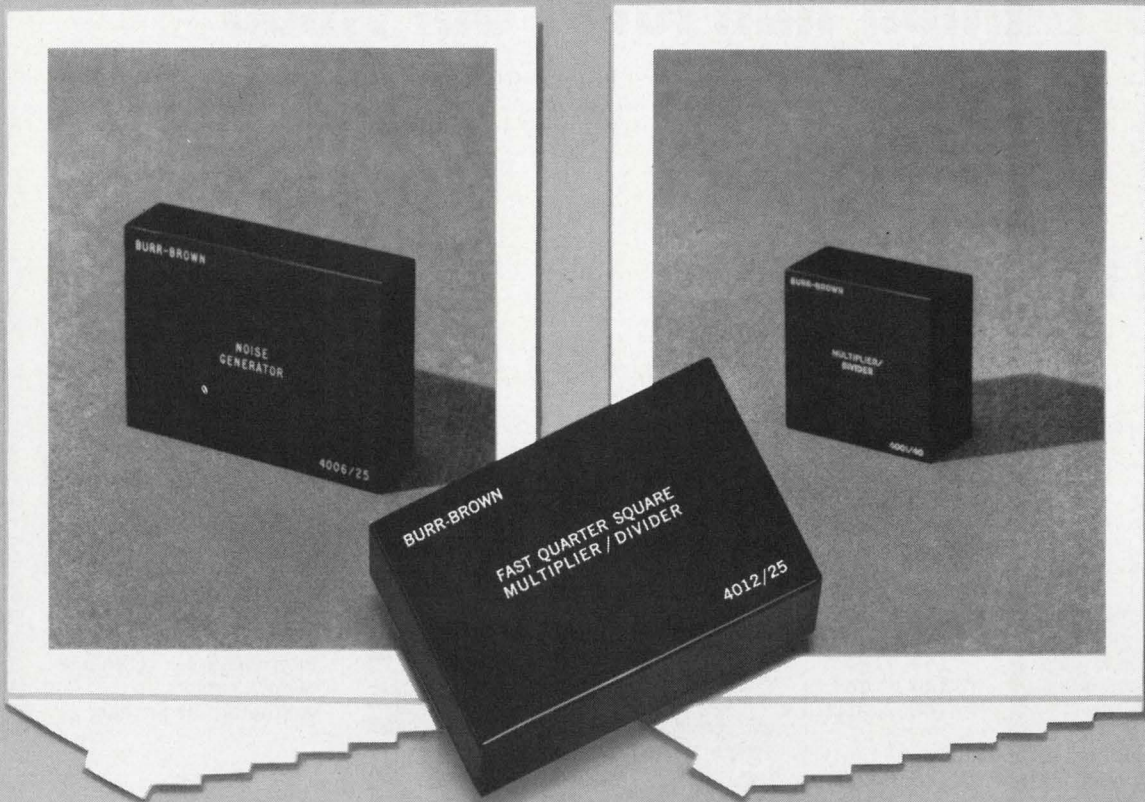

## for Instant Analog Systems

### Burr-Brown Encapsulated Function Modules

Cut costs, simplify design, and achieve maximum performance from your analog and hybrid circuits by utilizing Burr-Brown encapsulated function modules. These compatible sub-systems are designed to mount and work side by side with operational amplifiers. You save money on component and assembly costs, design time is reduced to an absolute minimum, and you gain the performance advantage of Burr-Brown's specialized experience in analog applications.

Currently, Burr-Brown is supplying fifteen 10V, encapsulated function modules from stock. Each one provides the type of performance you'd expect from the company that "wrote the book" on operational amplifier applications. Available units include:  Quarter Square Multiplier — Fast,  $E_o = -E_i E_2 / 10$ .  Squaring Modules —

Four separate units are offered.  Noise Generator — Random digital output.  Logarithmic Amplifiers — Both 40 db and 60 db log units.  Adaptive Analog Comparator — Switched hysteresis.  Electronic Switches — Including Fast Sample/Hold, Sample/Hold, Integrate/Hold, and Reset/Integrate/Hold units.

**Rack Mounting Units** — For your rack-mounting applications, Burr-Brown offers fourteen modules. These pre-engineered circuits are ready for you to plug in, wire together, and put to use immediately.

**FOR COMPLETE INFORMATION** on these maximum value units, contact your nearest Burr-Brown Engineering Representative and ask him for a copy of the new 20-page Burr-Brown catalog. He also has demonstrator units available for your immediate evaluation.

**BURR-BROWN**  
RESEARCH CORPORATION

International Airport Industrial Park • Tucson, Arizona 85706  
TELEPHONE: 602-294-1431 • TWX: 910-952-1111 • CABLE: BBRCORP



Operational Amplifiers  
Instrumentation Amplifiers  
Function Modules  
Analog Simulators  
Geophysical Instruments

ENGINEERING REPRESENTATIVES: ALABAMA, HUNTSVILLE (205) 534-1648 / ALASKA, ANCHORAGE (907) 272-5231 / ARIZONA, PHOENIX (602) 254-6085 / CALIF., LOS ANGELES (213) 665-5181, SAN FRANCISCO (408) 245-3321 / COLO., DENVER (303) 388-4391 / CONN., ENFIELD (203) 749-7888 / D.C., WASHINGTON (SEE MARYLAND) / FLORIDA, ORLANDO (305) 425-2764 ILLINOIS, CHICAGO (312) 286-6824 / LA., NEW ORLEANS (504) 888-2266 / MD., SILVER SPRING (301) 588-8134 / MASS., BOSTON (617) 245-4870 / MICH., DETROIT (313) 353-3822 / MINN., MINNEAPOLIS (612) 781-1611 / MO., ST. LOUIS (314) 524-4800 / N.C., GREENSBORO (919) 273-1918 / N.J., CAMDEN (215) 925-8711 / N.M., ALBUQUERQUE (505) 255-1638 / N.Y.,

ALBANY (518) 436-9649, BINGHAMTON (607) 723-9661, MT. VERNON (914) 968-2200, NEW HARTFORD (315) 732-3775, ROCHESTER (716) 473-2115 / OHIO, CINCINNATI (513) 761-5432, CLEVELAND (216) 237-9145, DAYTON (513) 277-8911 / OKLA., TULSA (918) 835-2481 / OREGON, PORTLAND (503) 292-8762 / PENN., PHILADELPHIA (SEE CAMDEN, N.J.), PITTSBURGH (412) 243-6655 / TEXAS, DALLAS (214) 363-1671, HOUSTON (713) 928-5251 / UTAH, SALT LAKE CITY (801) 466-3709 / VIRGINIA, (SEE MARYLAND) / WASH., SEATTLE (206) 767-4260 / CANADA, TORONTO (416) 293-7011, VANCOUVER (604) 736-6377

ON READER-SERVICE CARD CIRCLE 104

# Information Retrieval Services

All products, design aids(DA), application notes(AN), new literature(NL) and reprints(R) in this issue are listed here along with page numbers and Reader Service numbers. Reader Service requests will be promptly speed-processed by computer and mailed to the manufacturer within three days.

## New Products

| Category                        | Page | RSN†       | Category                       | Page | RSN†       | Category                   | Page | RSN†       |
|---------------------------------|------|------------|--------------------------------|------|------------|----------------------------|------|------------|
| <b>Amplifiers</b>               |      |            | cable wrapping (NL)            | 166  | <b>280</b> | microvoltmeter             | 153  | <b>275</b> |
| direct-coupled                  | 156  | <b>295</b> | ceramic substrates             | 168  | <b>285</b> | oscillator, sweep          | 152  | <b>274</b> |
| photoelectric                   | 146  | <b>258</b> | gasket materials (NL)          | 166  | <b>276</b> | phase measuring (NL)       | 166  | <b>278</b> |
| power, 1/2 W                    | 154  | <b>333</b> | plastics (NL)                  | 169  | <b>287</b> | power supply, 0 to 125 V   | 152  | <b>273</b> |
| resistance                      | 157  | <b>299</b> | shielding, electromagnetic     | 163  | <b>330</b> | power supply, lamp         | 157  | <b>297</b> |
| torque motor                    | 145  | <b>255</b> | terminals (NL)                 | 166  | <b>279</b> | power supply, programmable | 150  | <b>269</b> |
| <b>Circuit modules</b>          |      |            | varnish coating                | 163  | <b>332</b> | power supply, regulated dc | 152  | <b>272</b> |
| amplifier, 1/2 W                | 154  | <b>333</b> | <b>Microwave devices</b>       |      |            | pulse generator            | 158  | <b>322</b> |
| amplifier, motor                | 145  | <b>255</b> | antenna, 1 to 12 GHz           | 148  | <b>261</b> | telemetry simulator        | 161  | <b>329</b> |
| control, photoelectric          | 145  | <b>256</b> | detector, video                | 148  | <b>263</b> | temperature monitor        | 158  | <b>323</b> |
| control, power                  | 144  | <b>253</b> | Destroy your                   |      |            | thermocouple, reference    | 158  | <b>324</b> |
| detector, position              | 144  | <b>253</b> | microwave transistors (R)      | 171  | <b>338</b> | tester, cable              | 157  | <b>298</b> |
| fluidic controls                | 140  | <b>250</b> | gain equalizer                 | 148  | <b>263</b> | voltmeter, strip-chart     | 156  | <b>296</b> |
| <b>Communications equipment</b> |      |            | gasket materials               | 166  | <b>276</b> |                            |      |            |
| antenna, 1 to 12 GHz            | 148  | <b>262</b> | Kerr cells                     | 149  | <b>266</b> |                            |      |            |
| <b>Components</b>               |      |            | oscillator, 1.2 GHz            | 149  | <b>265</b> |                            |      |            |
| amplifier, motor                | 156  | <b>255</b> | source replenisher             | 148  | <b>261</b> |                            |      |            |
| amplifier, photoelectric        | 146  | <b>258</b> | varactors (NL)                 | 172  | <b>292</b> |                            |      |            |
| capacitors, miniature           | 142  | <b>271</b> | <b>Microwave equipment</b>     |      |            |                            |      |            |
| connector, hyperbola            | 142  | <b>251</b> | amplifier, 10 to 400 MHz       | 154  | <b>333</b> |                            |      |            |
| control, photoelectric          | 145  | <b>256</b> | antenna, 1 to 12 GHz           | 148  | <b>262</b> |                            |      |            |
| control, power                  | 144  | <b>254</b> | detector, video                | 148  | <b>264</b> |                            |      |            |
| detector, angle                 | 144  | <b>253</b> | energy modulator               | 149  | <b>267</b> |                            |      |            |
| fluidic controls                | 140  | <b>250</b> | gain equalizer                 | 148  | <b>263</b> |                            |      |            |
| fluidic rate sensor             | 146  | <b>259</b> | light modulator                | 149  | <b>268</b> |                            |      |            |
| gasket materials (NL)           | 166  | <b>276</b> | microwave components (NL)      | 169  | <b>288</b> |                            |      |            |
| miniature switches (NL)         | 168  | <b>283</b> | source replenisher             | 148  | <b>261</b> |                            |      |            |
| motors (NL)                     | 166  | <b>281</b> | telemetry simulator            | 161  | <b>329</b> |                            |      |            |
| motors (NL)                     | 166  | <b>282</b> | <b>Power supplies</b>          |      |            |                            |      |            |
| motors and synchros (AN)        | 164  | <b>336</b> | amplifier, 1/2 W               | 154  | <b>333</b> |                            |      |            |
| motor, single-phase             | 144  | <b>252</b> | lamp                           | 157  | <b>297</b> |                            |      |            |
| oscillator, 1200 MHz            | 149  | <b>265</b> | programmable, 25- $\mu$ s rise | 150  | <b>270</b> |                            |      |            |
| photocells                      | 145  | <b>257</b> | regulated, dc                  | 152  | <b>272</b> |                            |      |            |
| resistor, variable              | 146  | <b>260</b> | silicon, 0 to 125 V            | 152  | <b>273</b> |                            |      |            |
| terminals (NL)                  | 166  | <b>279</b> | <b>Production equipment</b>    |      |            |                            |      |            |
| thumbwheel switches (NL)        | 170  | <b>290</b> | injection molding (NL)         | 170  | <b>289</b> |                            |      |            |
| thyristors (NL)                 | 168  | <b>284</b> | <b>Semiconductors</b>          |      |            |                            |      |            |
| <b>Control devices</b>          |      |            | How, why and                   |      |            |                            |      |            |
| fluidic controls                | 140  | <b>250</b> | where to use FETs (R)          | 171  | <b>340</b> |                            |      |            |
| fluidic programmer              | 161  | <b>328</b> | Destroy your                   |      |            |                            |      |            |
| fluidic rate sensor             | 147  | <b>259</b> | microwave transistors (R)      | 171  | <b>338</b> |                            |      |            |
| Kerr cells                      | 149  | <b>266</b> | terminals, square              | 163  | <b>331</b> |                            |      |            |
| motor, single-phase             | 144  | <b>252</b> | thermistor kit (DA)            | 165  |            |                            |      |            |
| photoelectric control           | 145  | <b>256</b> | zener diodes (NL)              | 166  | <b>277</b> |                            |      |            |
| temperature control (NL)        | 169  | <b>286</b> | thyristors (NL)                | 168  | <b>284</b> |                            |      |            |
| <b>Data processing</b>          |      |            | <b>Test equipment</b>          |      |            |                            |      |            |
| adder, 12-bit                   | 161  | <b>326</b> | amplifier, 1/2 W               | 154  | <b>333</b> |                            |      |            |
| computer tape                   | 160  | <b>325</b> | amplifier, 125 V               | 156  | <b>295</b> |                            |      |            |
| memory systems (NL)             | 171  | <b>291</b> | amplifier, resistance          | 157  | <b>299</b> |                            |      |            |
| recorder, data                  | 161  | <b>326</b> | environmental tester           | 159  | <b>341</b> |                            |      |            |
| telemetry simulator             | 161  | <b>329</b> | detector, magnetic             | 150  | <b>269</b> |                            |      |            |
| <b>Hardware &amp; Packaging</b> |      |            | gate time generator            | 159  | <b>342</b> |                            |      |            |
| circuit cards                   | 162  | <b>321</b> |                                |      |            |                            |      |            |
| terminals, square               | 163  | <b>331</b> |                                |      |            |                            |      |            |
| <b>Materials</b>                |      |            |                                |      |            |                            |      |            |
| beryllium oxide (NL)            | 168  | <b>334</b> |                                |      |            |                            |      |            |

## Application Notes

|                     |     |            |
|---------------------|-----|------------|
| Motors and synchros | 164 | <b>336</b> |
| Thermoelectrics     | 164 | <b>335</b> |

## Design Aids

|                       |     |   |
|-----------------------|-----|---|
| Adjustable ship curve | 165 | — |
| Thermistor kit        | 165 | — |

## New Literature

|                      |     |            |
|----------------------|-----|------------|
| Beryllium oxide      | 168 | <b>334</b> |
| Cable wrapping       | 166 | <b>280</b> |
| Ceramic substrates   | 168 | <b>285</b> |
| Gasket materials     | 166 | <b>276</b> |
| Injection molding    | 170 | <b>289</b> |
| Memory systems       | 171 | <b>291</b> |
| Microwave components | 169 | <b>288</b> |
| Miniature switches   | 168 | <b>283</b> |
| Motors               | 166 | <b>281</b> |
| Motors               | 166 | <b>282</b> |
| Phase measuring      | 166 | <b>278</b> |
| Plastics             | 169 | <b>287</b> |
| Temperature control  | 169 | <b>286</b> |
| Terminals            | 166 | <b>279</b> |
| Thumbwheel switches  | 170 | <b>290</b> |
| Thyristors           | 168 | <b>284</b> |
| Varactors            | 172 | <b>292</b> |
| Zener diodes         | 166 | <b>277</b> |

## Reprints Available

|   |            |
|---|------------|
| Three-part series on cost analysis, budgeting and profit-volume analysis. | <b>338</b> |
| Destroy your microwave transistors.                                       | <b>339</b> |
| How, why and where to use FETs.   | <b>340</b> |



**From David—to Goliath...**  
 (5 watts) (250 watts)

## Dale RH Wirewounds have BONUS capacity to handle any power or stability problem.

Dale's RH Wirewound line offers 6 models, 5 to 250 watts. Each has bonus ability to dissipate heat beyond MIL-R-18546D requirements—see chart. In addition, you get an extra bonus of exceptional stability when RH models are derated to mil levels. To achieve this bonus performance, Dale combines precision wirewound elements with specially-conductive extruded aluminum housings and special molding compounds. The result is exceptional heat transfer ability matched by no other housed wirewound line.

### NEW HIGH-REL MODELS

The ARH, a high-rel version of the RH, is now available in four models: 5, 10, 15 and 30 watts. ARH resistors meet the requirements of MIL-R-39009 and are being produced on the same line as Dale's ARS and AGS—the world's most reliable wirewounds.

**For complete housed resistor information including non-inductive and thru-chassis models--write for Catalog A.**

| RH RESISTOR SPECIFICATIONS |                  |              |             |                         |                             |
|----------------------------|------------------|--------------|-------------|-------------------------|-----------------------------|
| DALE TYPE                  | EQUIV. MIL. TYPE | DALE RATING* | MIL. RATING | RESISTANCE RANGE (OHMS) | STANDARD HEAT SINK          |
| RH-5                       | RE-60            | 7.5 (5)      | 5           | .1–24K                  | 4x6x2x.040 Aluminum Chassis |
| RH-10                      | RE-65            | 12.5 (10)    | 10          | .1–47K                  | 5x7x2x.040 Aluminum Chassis |
| RH-25                      | RE-70            | 25           | 20          | .1–95K                  | 12x12x.059 Aluminum Panel   |
| RH-50                      | RE-75            | 50           | 30          | .1–273K                 | 12x12x.125 Aluminum Panel   |
| RH-100                     | RE-77            | 100          | 75          | .1–50K                  | 12x12x.125 Aluminum Panel   |
| RH-250                     | RE-80            | 250          | 120         | .1–75K                  | 12x12x.125 Aluminum Panel   |

### ELECTRICAL & ENVIRONMENTAL SPECIFICATIONS

**Tolerance:** .05%, .10%, .25%, .5%, 1%, 3%

**Load Life:** 1% max. Δ R (RH-5 – 50) 3% max. Δ R (RH-100 – 250) in 1000-hour load life.

**Operating Temp:** –55° C to +275° C

**Overload:** ±.5% max. Δ R per MIL-R-18546D

\*Power Rating based on 275° C max. internal hotspot temperature with resistor mounted on standard heat sink. Figures in parentheses indicate wattage printed on RH-5 and RH-10. New construction allows higher ratings as shown, but these resistors will be printed with the higher rating only on customer request.



**DALE ELECTRONICS, INC.**  
 1328 28th Avenue, Columbus, Nebraska  
 In Canada: Dale Electronics, Canada, Ltd.



# NOW...RCA tunnel diodes are "axially" wrapped in gold

It's true. But the real story of RCA's new tunnel diodes lies *inside* the practical, axial-lead package. There you'll find RCA-pioneered TD-II technology—a unique process of epitaxially-grown junctions that has brought to these devices a new standard of stability, performance, and reliability. Life tests exceeding 1 million hours prove it.

Leads are gold-plated for soldering efficiency. No pretinning is necessary. And the package lends itself well for high-volume PC-board mounting operations.

In all 14 types, the TD-II process assures low capacitance and mechanical ruggedness. Thermal resistance is improved. Because TD-II is a "batch" production process, you benefit further from low cost and uniform characteristics.

Designed for high-speed switching and high-frequency, signal-processing applications, these units are ideal as threshold detectors and in computer circuitry. Units are available through your RCA Distributor. See your RCA Representative for more information on these types or special selections. For technical data on specific types, write: RCA Commercial Engineering, Section SGI-5, Harrison, New Jersey 07029.

| Type  | $I_p$ (mA) |      | $I_p/I_V$ | C (pF) | tr (ps) |
|-------|------------|------|-----------|--------|---------|
|       | Min.       | Max. |           |        |         |
| 40561 | 4.5        | 5.5  | 6/1       | 25     | 1800    |
| 40562 | 9          | 11   | 6/1       | 25     | 900     |
| 40563 | 18         | 22   | 6/1       | 30     | 600     |
| 40564 | 45         | 55   | 6/1       | 40     | 350     |
| 40565 | 90         | 110  | 6/1       | 40     | 150     |
| 40566 | 4.75       | 5.25 | 8/1       | 15     | 1200    |
| 40567 | 9.5        | 10.5 | 8/1       | 15     | 600     |
| 40568 | 19         | 21   | 8/1       | 20     | 400     |
| 40569 | 47.5       | 52.5 | 8/1       | 25     | 200     |
| 40570 | 95         | 105  | 8/1       | 25     | 100     |
| 40571 | 4.75       | 5.25 | 8/1       | 8      | 600     |
| 40572 | 9.5        | 10.5 | 8/1       | 8      | 300     |
| 40573 | 19         | 21   | 8/1       | 10     | 200     |
| 40574 | 47.5       | 52.5 | 8/1       | 12     | 100     |

RCA Electronic Components & Devices



The Most Trusted Name in Electronics

ON READER-SERVICE CARD CIRCLE 244

