

# Electronic Design

FOR ENGINEERS AND ENGINEERING MANAGERS

VOL. 16 NO.

# 7

APRIL 1, 1968

**Memories are made of MOS** — like this random-access prototype. Experts see 256-bit arrays with 200-nanosecond cycle times by '69 and kilobit chips at a penny

a bit by 1972. Yields are high, dissipation low. MOSFETs will pack more bits to the inch than bipolars and cost less than cores. For details, see page 25.

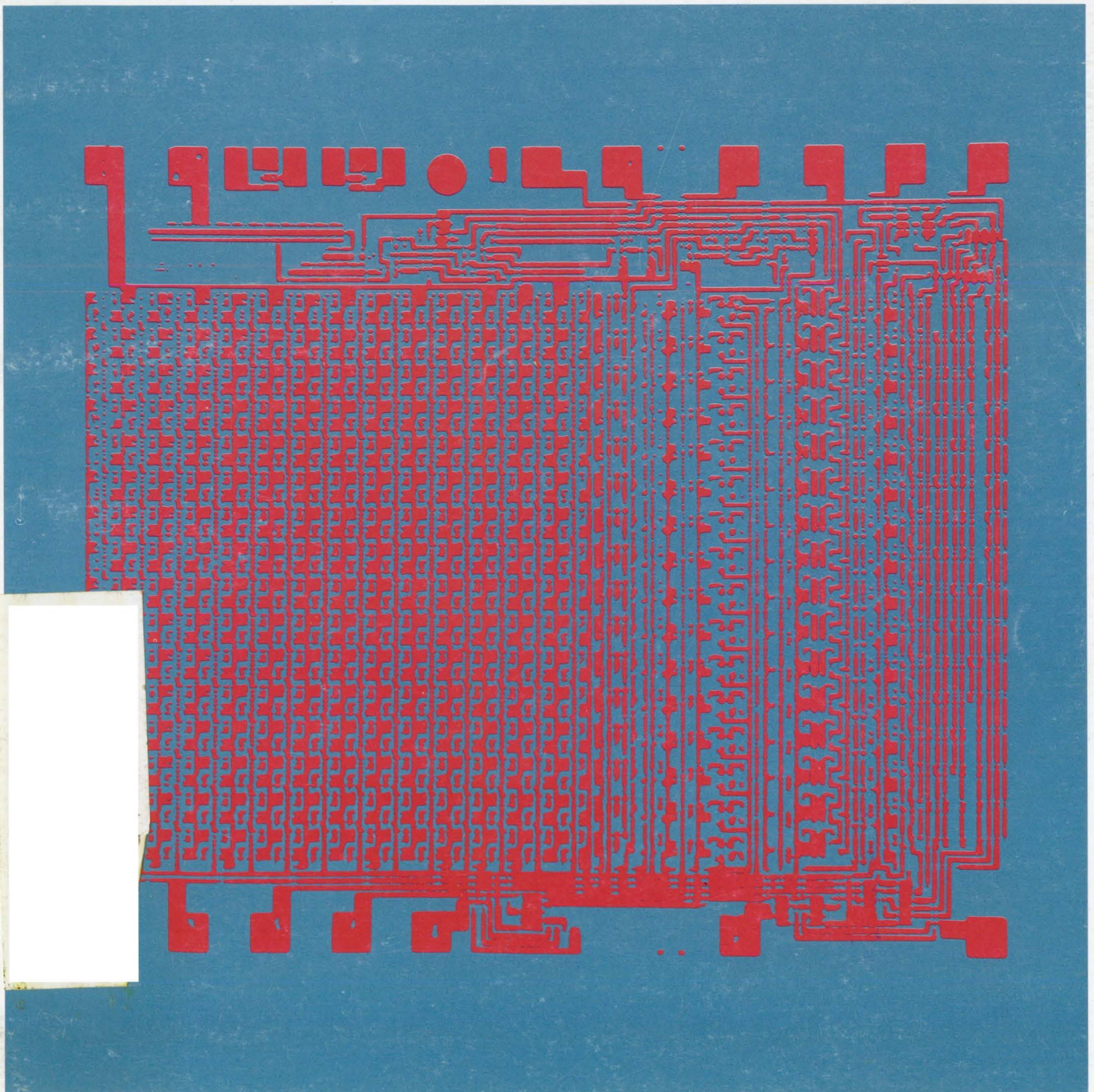

# TRW

## LVA diode...

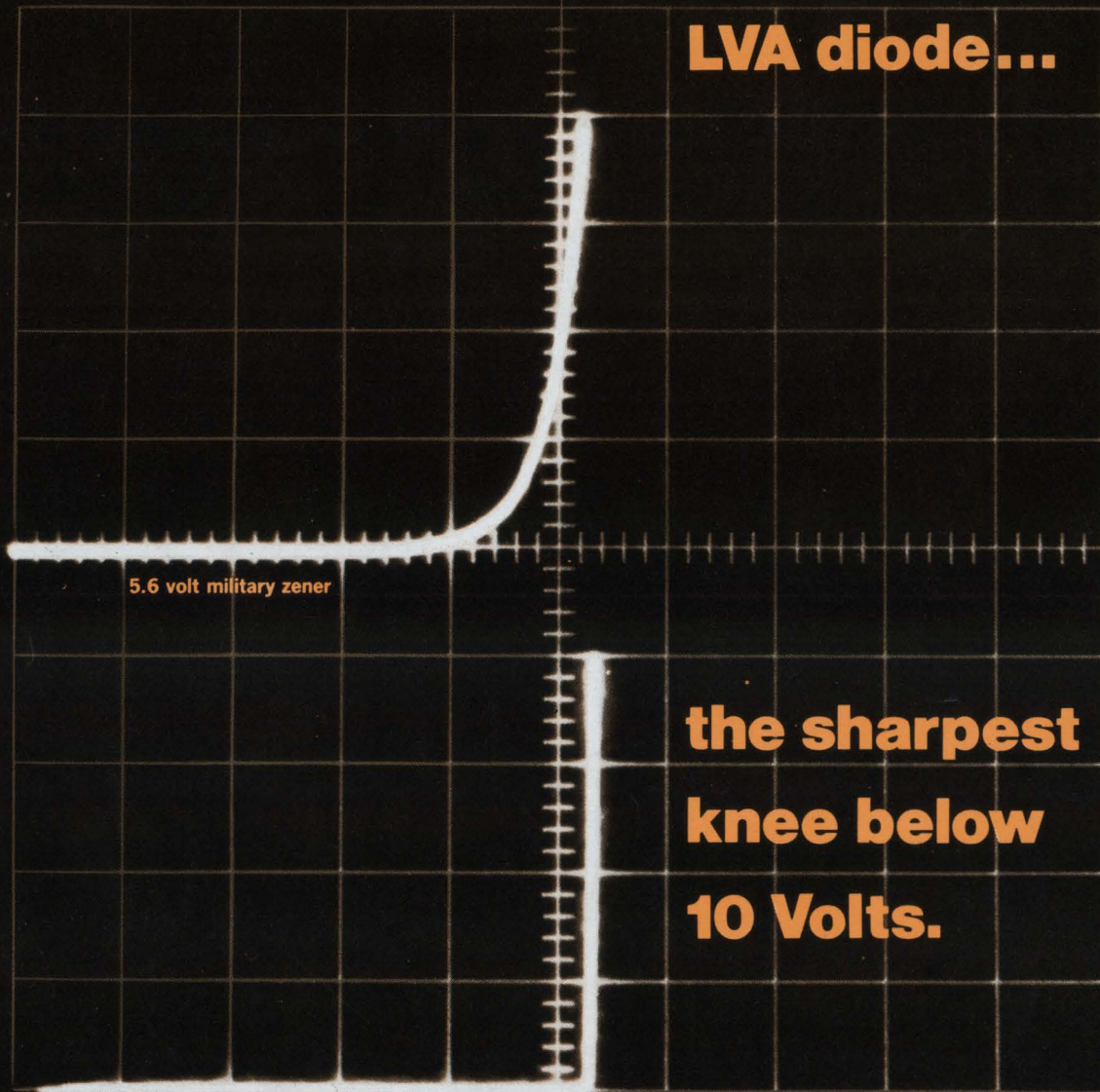

5.6 volt military zener

### the sharpest knee below 10 Volts.

New TRW 5.6 Volt LVA zener

Tektronix type 575. 1V/div. horizontal. 1mA/div. vertical.

## Low operating currents...ultra low leakage

Take a close look at the lower scope trace. The sharp knee comes from low field emission leakage all the way out to breakdown, and extremely tight regulation at low current levels after breakdown.

No other zener can approach the LVA performance below 10

volts. You get low operating currents plus ultra low leakage in a single device.

The Low Voltage Avalanche zener is available in 10 values from 4.3 volts to 10 volts. Delivery is off-the-shelf from authorized TRW distributors, or contact TRW Semiconductors, 14520 Aviation

Boulevard, Lawndale, Calif. 90260. Phone (213) 679-4561. TWX 910-325-6206. TRW Semiconductors is a subsidiary of TRW INC.

# TRW®

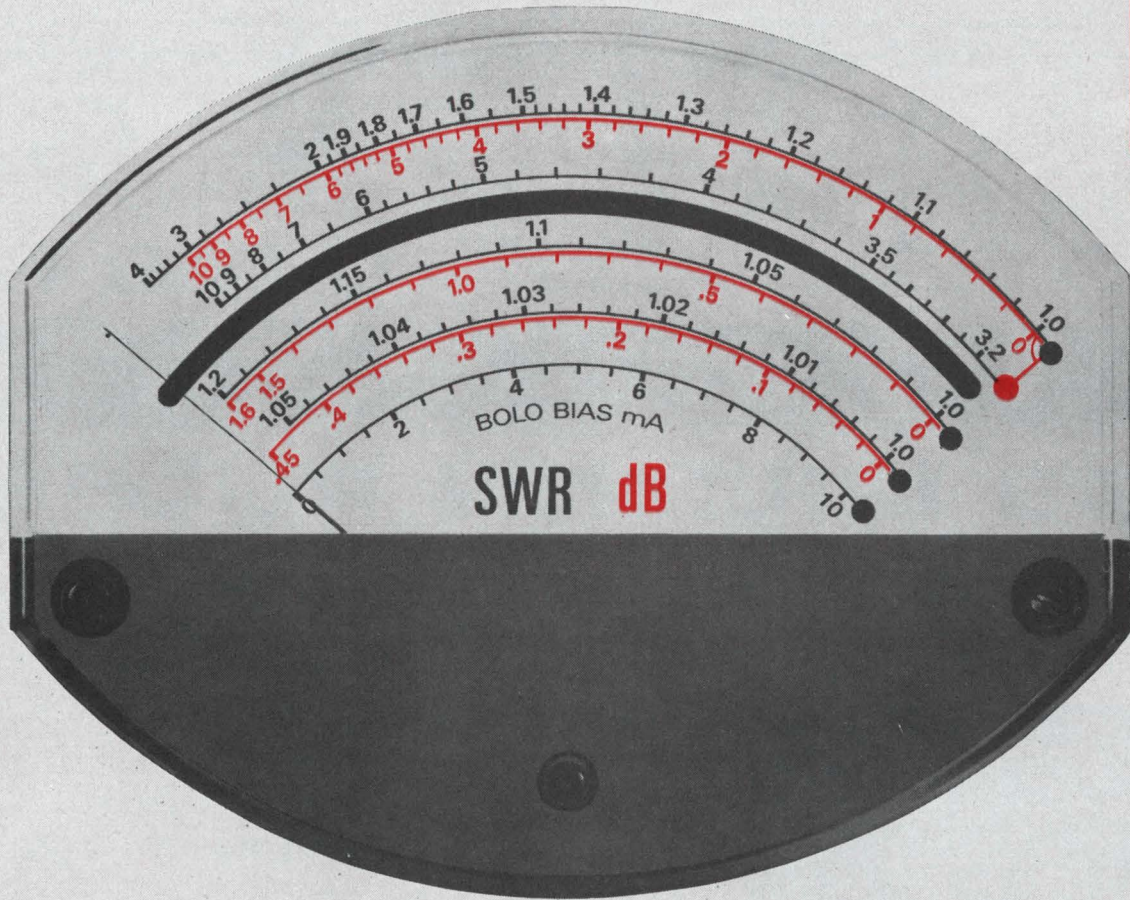

## You helped design this new SWR Meter

That's right. You're the one who has been asking for a meter that's large enough to read without getting on top of it . . . for a simple but foolproof way of knowing what scale you're supposed to be reading . . . for an expanded scale that provides high-resolution measurements of low-SWR values. In GR's new 1234 Standing-Wave Meter we've provided all these features plus many more we think you'll like.

The meter of the 1234 is shown here in actual size; as you can see, it is larger than the meter of any comparable instrument. The red dot at the end of the scale indicates an illuminated meter light. There are five lights in all, one for each scale, and they are controlled by the range switch. Hence, no fear of reading the wrong scale with this instrument.

On the meter face, the total 1-to-10 SWR range of the 1234 is spread out over four scales to give higher-resolution measurements. With the 1-to-1.05 expanded scale you can read increments of SWR as small as 0.0004. This sensitivity is commensurate with the needs of GR's 900-LB Precision Slotted Line, for which the 1234 is an important accessory.

a total range of 70 dB in steps of 1, 5, and 10 dB, and the 5 dB/step control features a sliding window that automatically displays incremental attenuation in substitution measurements. Three front-panel controls put band width adjustment (without change in gain), frequency detuning (centered at 1 kHz), and meter speed ("slow" or "fast") at your finger tips. Also included are protective circuitry for an external bolometer and a separate meter scale for reading the adjustable bolometer bias current.

For complete information on the 1234 Standing-Wave Meter and its companion GR874 and GR900 slotted lines and accessories, write General Radio Company, W. Concord, Massachusetts 01781.



Type 1234 Standing-Wave Meter, \$495 in U.S.A.

**GENERAL RADIO**

Convenience features in the 1234 don't end with its display. Three attenuators provide

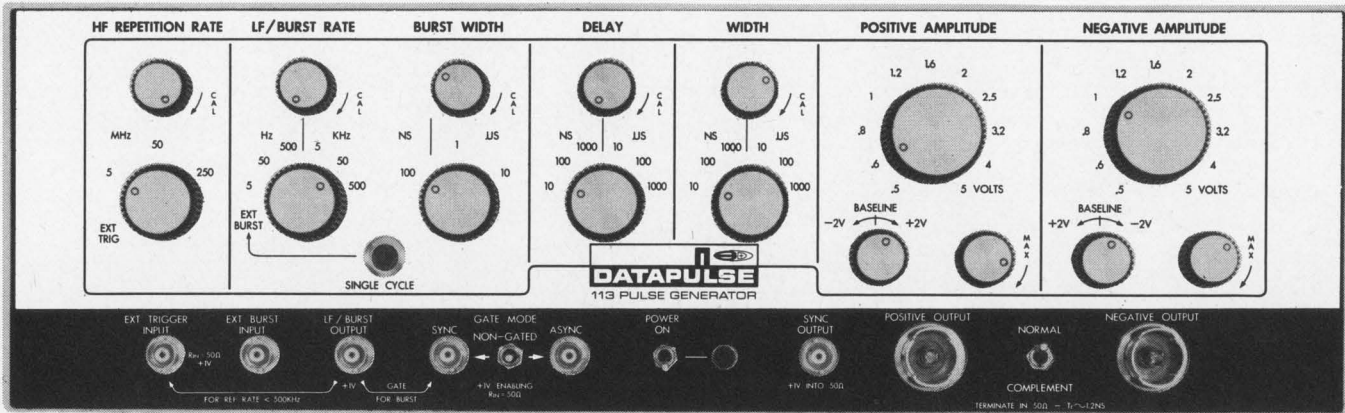

# 250 MILLION PULSES per second

A close check of the front panel on the new Datapulse 113 should convince you that it is the most versatile high frequency pulse generator yet designed.

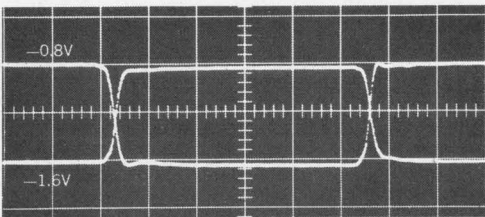

Complementary Output Simulates ECL F/F Output. 5 ns/cm, 500 mV/cm.

The 113 offers repetition rates from 0.5 Hz to 250 MHz, synchronous and asynchronous gating, simultaneous positive and negative outputs, and separate  $\pm 2V$  baseline offset (independent of high resolution amplitude controls). Both outputs may be complemented.

# with Built-in Burst Capability

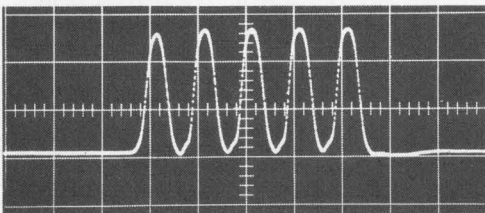

200 MHz Pulse Burst. 5 ns/cm, 0.5 V/cm

The built-in burst capability is there because the 113 is really two pulse generators in one. An HF oscillator provides rep rates from 500 KHz to 250 MHz. An LF oscillator (0.5 Hz to 500 KHz) gates pulse bursts from 10 ns to 10  $\mu$ s and is used to trigger the unit for low rep rates.

See what we're talking about even better by asking for a demonstration of the 113. Or, write for complete specifications. Price: \$3375.00

**Datapulse, Inc.**, A Subsidiary of Systron-Donner Corporation,  
 10150 W. Jefferson Blvd., Culver City, California 90230.  
 Telephone: 213-836-6100, 871-0410. TWX: 910-340-6766. Cable: Datapulse.  
 EXPORT SALES OFFICE: Systron-Donner International, 888 Galindo Street,  
 Concord, California. Telephone: 415-682-6161.  
 IN EUROPE: Systron-Donner International S.A., 447, Avenue de  
 Tervuren, Brussels 15, Belgium. Telephone: 71-76-84. Telex: 23606 (Belgium).

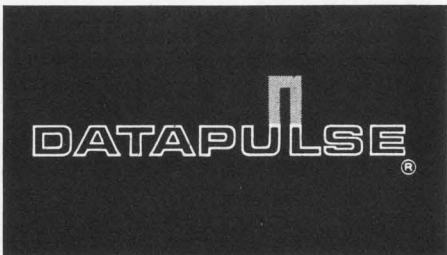

---

## NEWS

- 21' News Scope  
25 **LSI improves computer memory bit by bit**  
Groomed as contenders in the transistor race, MOS arrays may yet displace the ferrite core  
33 Laser tuned by cooling optical crystal  
34 Atlantic test center to get sonar range  
36 **'Flying radar' poses a design challenge**  
With 20 tons of airborne electronics, interference, reliability and flight maintenance will be problems.  
41 Washington Report  
44 Letters  
46 Sidelights of the Issue  
49 'Top Ten' prizewinning advertisements  
69 **Editorial: Question for the day: Who do you think you are?**

---

## TECHNOLOGY

- 72 **Simulate transfer functions with ECAP.** Digital programming and state variables are simpler than analog programming for linear and nonlinear systems.  
82 **Build a practical audio amplifier** with complementary transformerless output stages and stable active input circuits.  
90 **Don't lose pulses in long cables.** Get an accurate estimation of pulse degradation in long cables before your system is designed.  
94 **Find free-space attenuation at a glance.** If the antennas are close together, just plug their frequency and separation into this nomogram.  
96 **Do you like your job?** An attitude survey can pinpoint the causes of any discontent; then it's up to your company to resolve the problem.  
104 Ideas for Design  
114 NASA Tech Briefs

---

## PRODUCTS

- 120 **Components: Wafer speakers** occupy 1/5 the depth of a cone speaker handling the same power.  
130 **Test Equipment: Desk-top calculator** combines slide-rule simplicity with a computer's speed.  
134 **Materials: Inert fluorochemical liquids** test and cool.  
136 **Microelectronics: Hybrid microcircuit op amp** exhibits  $10^{11} \Omega$  impedance.  
124 Semiconductors  
126 Systems  
128 Microwaves

---

## Departments

- |                        |                                   |
|------------------------|-----------------------------------|
| 16 Designer's Datebook | 142 New Literature                |
| 116 Books              | 150 Advertisers' Index            |
| 138 Design Aids        | 152 Information Retrieval Service |
- Information Retrieval Service card inside back cover

# Will the greatest portable oscillograph please stand up?

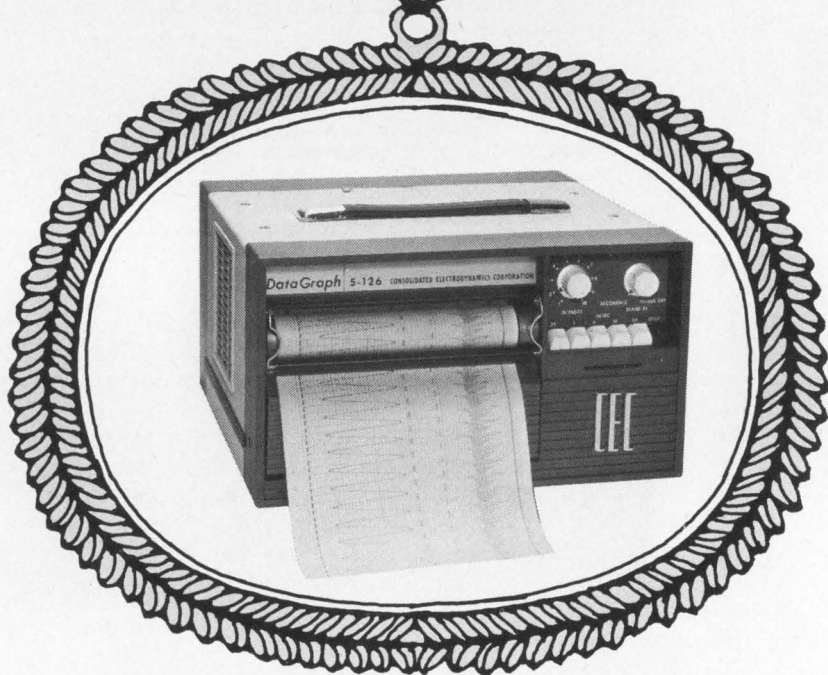

## You bet it will!

For this is CEC's portable 5-126—the only instrument that offers the basic advantages of a light beam oscillograph at a cost-per-channel approaching that of a direct writing recorder. With CEC's new 7-380 Galvanometer, the 5-126 will accurately record from dc to 1 KHz.

### Other advantages of the 5-126:

- *Direct print-out records* eliminate the need for chemical processing.
- *Nine channels* producing distinct data traces on 7-inch-wide paper.
- *A true portable* which may be easily moved from place to place for any application.
- *Simplicity of operation.* Due to CEC's automatic front-loading system, no spooling or threading is required.

### For other portable requirements:

CEC's portable DG 5511 is your logical choice. For this two-channel, low cost oscillograph is so versatile it matches the capability formerly achieved only through multiple instruments. Not only does it feature self-contained signal conditioning, but it may be converted from high-level signal inputs to low-level inputs by a simple change of plug-in attenuator/amplifier units.

Furthermore, the foolproof DG 5511 offers unique snap-in, front chart loading with pushbutton-selectable chart speeds.

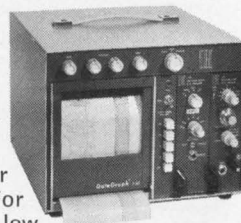

All in a rugged package weighing less than 40 pounds.

Why not call your nearest CEC Field Office now for a demonstration? Or write Consolidated ElectroDynamics, Pasadena, Calif. 91109. A subsidiary of Bell & Howell. Bulletin Kit 1703-X3.

**CEC/DATAGRAPH PRODUCTS**

 **BELL & HOWELL**

# THIS APPLICATIONS LIBRARY TELLS YOU HOW TO USE MOTOROLA LINEAR I/C's

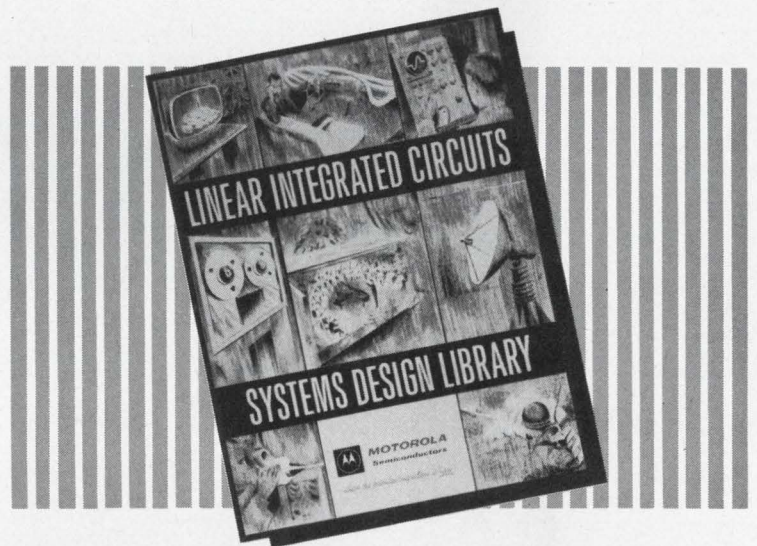

## The Circuits Speak for Themselves!

This Linear Systems Design Library is a compilation of valuable "How To" information about a wide spectrum of designs using linear integrated circuits. It includes the very latest ideas and information for designing-in the new dual operational amplifiers. And, it also examines, in depth, design ideas for the use of linear I/C's in single power supply, instrumentation, communication, data processing systems, analog computation and comparator applications, radar and PCM pulse applications, and, much, much, more!

Also included is practical information, such as "do-it-yourself" instructions for building an inexpensive integrated circuit operational amplifier tester; and, pertinent pointers on how to get the most information from an op amp data sheet. Finally, key parameters are specified for Motorola's broadest of all lines of commercially-usable linear I/C's.

For your copy, write us on your company letterhead at: P.O. Box 955, Phoenix, Arizona 85001.

*-where the priceless ingredient is care!*



**MOTOROLA**  
**Semiconductors**

# Why waste time on bypass/filter capacitors?

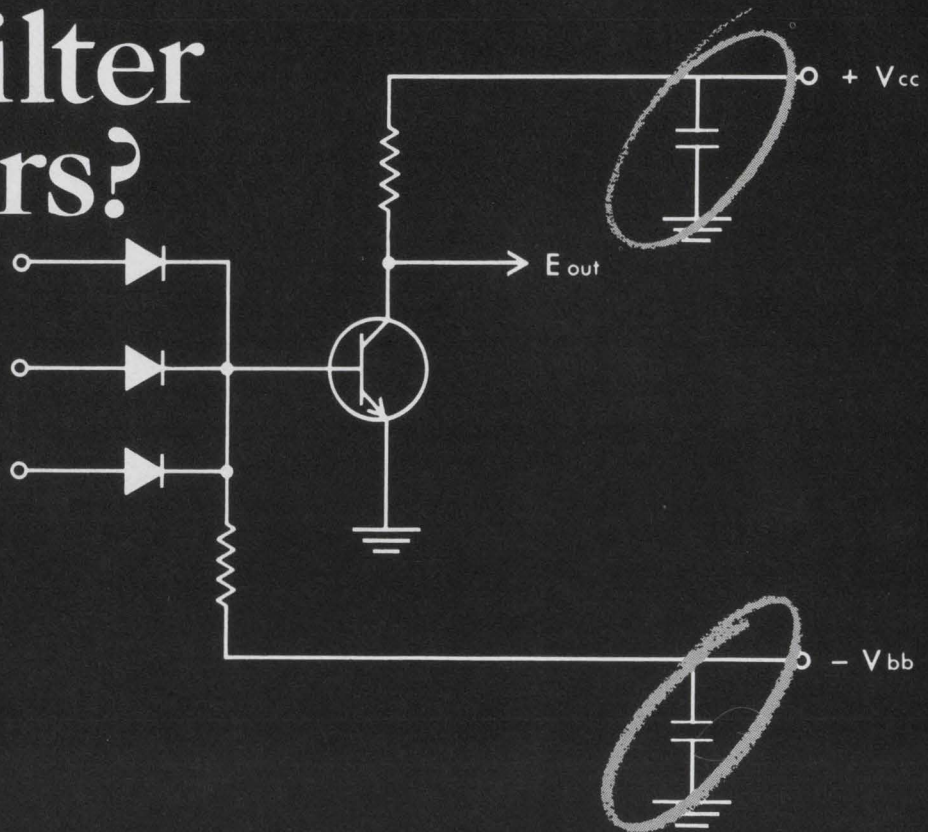

Specify CORNING® Glass-K Capacitors, and move on.

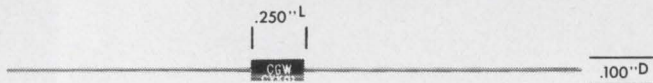

There's only one real concern with a bypass/filter capacitor. If it goes, your circuit will probably follow. Specify the guaranteed reliability of CORNING Glass-K Capacitors and forget it.

You can forget it for the same reason we can guarantee it:

1. Large capacitance in minimum case size, 1000 to 51,000  $\mu\text{f}$  in  $.250'' \times .100''$  or 12,000 to 100,000  $\mu\text{f}$  in  $.250'' \times .140''$ .
2. Low power factor and low DC leakage.
3. Adaptability to cordwood, printed circuit, and point-to-point packaging and automatic insertion.
4. Tight end-of-life design with guaranteed stability.

Get this confidence at a competitive price, and inside two weeks for standard items. Get complete data by writing to: Corning Glass Works, Electronic Products Division, Corning, New York 14830.

**CORNING**  
ELECTRONICS



# NEW DVM



## Dual Technique for 0.004% Accuracy

*hp 3460B Integrating/Potentiometric Voltmeter Has High Accuracy...  $>10^{10} \Omega$  Input Resistance... Systems Compatibility*

The new hp 3460B Digital Voltmeter is a dual-technique instrument that combines the best features of an integrating voltmeter with those of a potentiometric voltmeter—to give an accuracy of 0.004% of reading, superimposed noise immunity of integrating DVM's and a high common mode rejection of 160 dB at dc.

You get up to 15 readings per second with five full digits and 20% overranging indicated by a sixth digit. Polarity selection is automatic. The 3460B has 10  $\mu\text{V}$  sensitivity. Four ranges are selectable by pushbuttons on the front panel, or, range selection can be automatic or remote.

Floating and guarded input connectors are on both the front and back of the instrument. Input resistance is  $>10^{10} \Omega$  at balance on 1 V and 10 V ranges (minimum 10 M $\Omega$ ), and a constant 10 M $\Omega$  on 100 V and 1000 V ranges.

*Programmability.*—hp 3460B is designed for

fully automatic operation in a digital data acquisition system. A four-line BCD output (1-2-4-8) on the back of the instrument contains 6 digits of data, polarity, decimal location and overload information. Voltage range and two integration periods can be selected by external circuit closure to ground.

Get the full story on the new dual-technique hp 3460B Digital Voltmeter from your nearest hp field engineer. Or, write to Hewlett-Packard, Palo Alto, California 94304. Europe: 54 Route des Acacias, Geneva. Price: hp Model 3460B, \$3600.00.

097/13

**HEWLETT**  **PACKARD**  
An extra measure of quality

INFORMATION RETRIEVAL NUMBER 7

WHETHER  
or not you use  
Designer's Choice Logic,  
you have to admit that  
Signetics' idea of  
guaranteeing cross-  
family compatibility in  
integrated circuits can  
save you time and  
money in design.



PUBLISHED BY SIGNETICS: THE RESPONSE/ABILITY COMPANY

## NEW IC NIXIE DRIVER GETS UNGLOWING REPORT

### Guaranteed 67V Breakdown

Signetics Corporation today announced the first monolithic IC Nixie Driver that permits Nixie\* tube operation without excessive background glow and does not require any discrete external components for interfacing. "We've whipped the problem of getting a state-of-the-art 2.5-ohm centimeter process into production, so we can

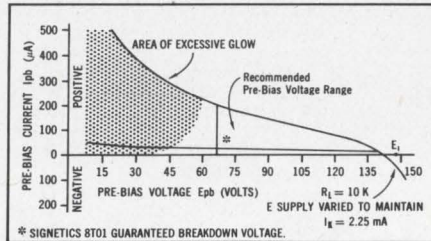

Pre-bias Voltage vs. Current Characteristics of a typical NIXIE Tube.

guarantee a 67V breakdown," a company spokesman said.

Officials also said that the new device, designated 8T01 Nixie Decoder/Driver, is the only one of its kind that will interface directly with all commonly used DTL and TTL circuits and drive Nixies directly. The new member of Signetics DCL family is offered in a 16-pin silicone DIP.

When told of this new device from Signetics, a competitive manufacturer stated, "Dammit."

\*Nixie is a registered trade mark of the Burroughs Corp.

## Big shift to new Shift Register

### Unique Device Announced

"Your new shift register is the answer to my prayers."

That quote, from a Dallas designer, is typical of the response to Signetics' introduction of a new 4-Bit Shift Register in the DCL line, according to Bill Slaymaker, a Signetics Product Marketer.

"This device has a unique organization and functional capability," Slaymaker commented.

The new 8270/8271 4-Bit Shift Register is fully synchronous and offers parallel or serial input and output. The device operates at clock rates up to 20 MHz and has a mass reset line (in the 8271, a 16-pin configuration) that is independent of the clock. A unique feature is separate load and shift controls that make it unnecessary to gate the clock to inhibit the shift, thus eliminating clock skew problems. Power consumption is 40mW per binary.

The 8270/8271 is supplied in 14 lead flat pak, and 14 or 16 lead silicone DIP in both full MIL and industrial temperature ranges.

### Signetics announces new publication

Signetics launched a new publication today, the DCL Bulletin. As you can see in the masthead the first issue is the 16th issue, the first fifteen issues having never been published. DCL has been famous and well-loved since 1966, so it would be just plain silly to call the first issue the first issue.

### TODAY'S BUZZ WORD

"Designer's Choice Logic"  
You didn't expect it to be "Fairchild"?

### FOR SPEC SHEETS

Specifications on our new Nixie Driver and Shift Register are now available. Send for information on our complete DCL line. Write: Signetics, 811 East Arques Ave., Sunnyvale, Calif. 94086.

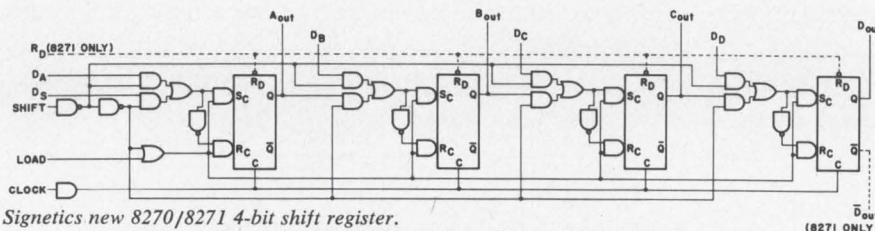

Comes in 14 lead flat pack or DIP and 16 lead DIP.

**SIGNETICS SALES OFFICES:** Fort Lee, New Jersey (201) 947-9870; Syracuse, New York (315) 469-1072; Richardson, Texas (214) 231-6344; Beverly Hills, California (213) 272-9421; Garden Grove, California (714) 636-4260; Wakefield, Massachusetts (617) 245-8200; Silver Springs, Maryland (301) 946-6030; Collingswood, New Jersey (609) 858-2864; Clearwater, Florida (813) 726-3734; Rolling Meadows, Illinois (312) 259-8300; Sunnyvale, California (408) 738-2710.

**DISTRIBUTORS:** Compar at all locations listed below. Semiconductor Specialists, Inc. (312) 279-1000; Terminal Hudson Electronics (212) 243-5200; Wesco Electronics (213) 684-0880; Wesco Electronics (405) 968-3475; Hammond Electronics (305) 241-6601; Avnet Electronics Corp. of Massachusetts (617) 272-3060; Pioneer Standard Electronics Inc. (301) 427-3300; Kieruluff Electronics (206) RO 3-5510; G. S. Marshall (213) 684-1530; Milgray Delaware Valley (215) 228-2000; Universal Electronics Inc. (713) 781-0421.

**DOMESTIC REPRESENTATIVES:** Jack Pyle Company (415) 349-1266. Compar Corporation at the following locations: Alabama (205) 539-8476; Arizona (602) 947-4336; California (213) 245-1172; California (415) 697-6244; Colorado (303) 781-0912; Connecticut (203) 288-9276; Florida (305) 855-3964; Illinois (312) 692-4125; Maryland (301) 484-5400; Massachusetts (617) 969-7140; Michigan (313) 357-5369; Minnesota (612) 922-7011; Missouri (314) 542-3399; New Jersey (609) 429-1526; New Mexico (505) 265-1020; New York (518) 436-8536; New York (607) 723-8743; New York (516) 921-9393; North Carolina (919) 724-0750; Ohio (216) 333-4120; Ohio (513) 878-2631; Texas (214) EM 3-1526; Texas (713) 667-3420; Washington (206) 763-1711.

**INTERNATIONAL SALES:** France, Germany, Italy, Belgium, Holland, Luxemburg, Spain - **Sovcor Electronique**, 11, Chemin de Ronde, Le Vesinet. (S.-&O.) France, United Kingdom, Ireland, Sweden, Denmark, Norway, Switzerland, Austria, Portugal - **Electrosil Ltd.**, Lakeside Estate, Colnbrook-Bypass Slough, Buckinghamshire, Great Britain. Australia - **Corning**, 1202 Plaza Building, Australia Square, Sydney, N.S.W. 27-4318. Canada - **Corning Glass Works of Canada, Ltd.**, Lakeside Plant, Ontario, Canada (416) 421-1500. Israel - **Optronix**, P.O. Box 195, Ramat-Gan, Israel 724-437. Japan - **ASAHI Glass Co., Ltd.**, Corning Products Sales Dept. No. 2, 3-Chome Marunouchi, Chiyoda-ku, Tokyo, Japan.

# This 50-volt silicon switch turns on an ampere in 30ns for only 98¢\*

**RCA's 2N5262 for high current switching features:**

$V_{(BR)CEO} = 50V$ ;  $t_{on} = 30ns$  max @  $I_c = 1A$ ;  $t_{off} = 60ns$  max @  $I_c = 1A$ ; plus freedom from second breakdown.

Controlled for safe operation without second breakdown under both forward-bias and reverse-bias conditions when operated within specified maximum ratings... very short turn-on and turn-off times... low saturation voltages... designed to meet the requirements of MIL-S-19500... hermetically sealed in a low profile TO-39 metal package to allow for high-density packaging... and yet the RCA 2N5262 sells for only 98¢ in 1,000-unit quantities!

Intended for use as a driver for "2½ D" coincident-current and word-organized magnetic memory systems, the 2N5262 is also ideally suited for other critical industrial applications requiring switching of large currents in inductive loads.

For complete information, including price and delivery, check with your RCA Field Representative. For Data, including Application Note AN-3608 "Operation of Memory-Core Driver Transistors in the Primary-Voltage Breakdown Region," write RCA Electronic Components, Commercial Engineering, Section CG4-1, Harrison, N.J. 07029. See your RCA Distributor for his price and delivery.

\*1000-unit quantities

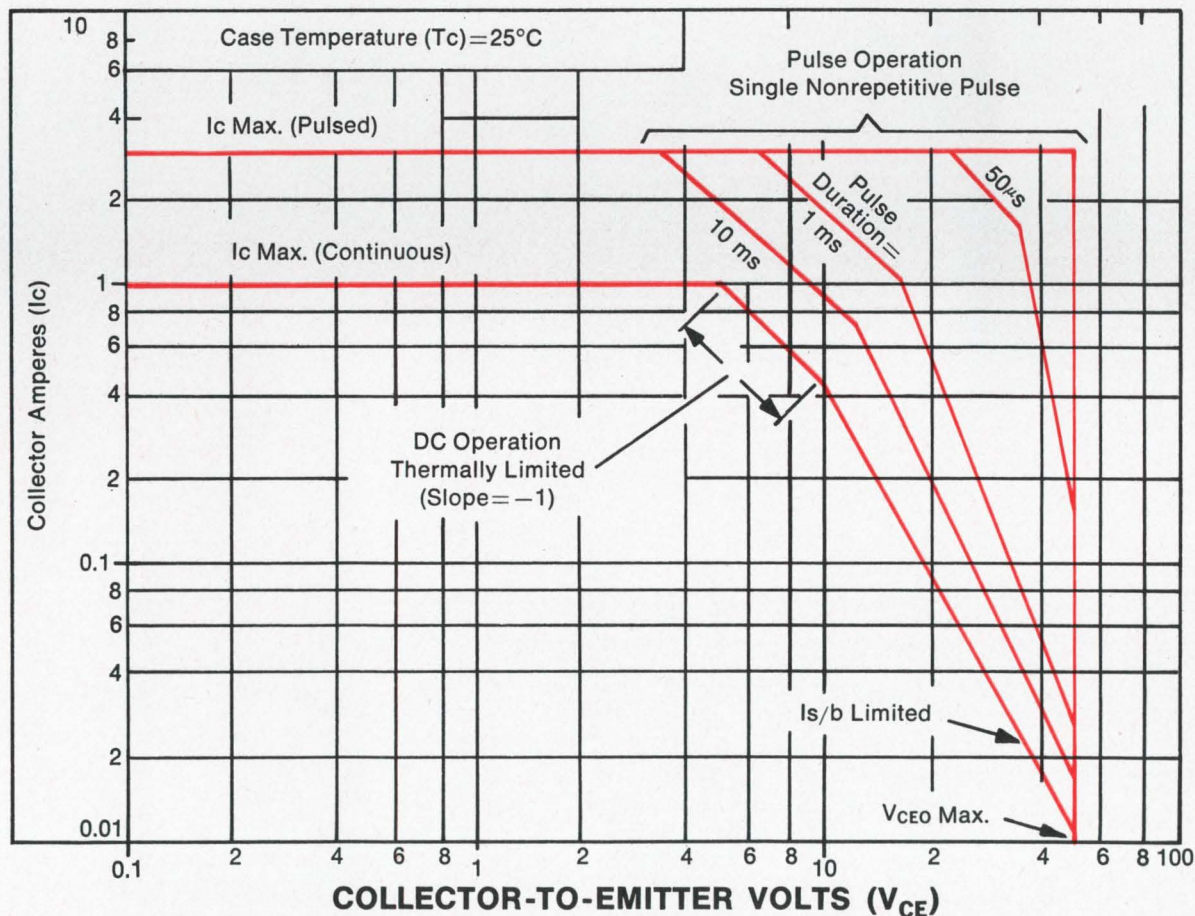

INFORMATION RETRIEVAL NUMBER 9

FIVE GOOD WAYS TO LEARN ALL  
ABOUT THE LATEST IN MICROWAVES

- \*By visiting all the leading microwave plants and interviewing their best designers and researchers.
- \*By attending all major conferences on the subject.
- \*By developing and editing state-of-the-art articles covering latest design techniques.
- \*By writing extensively about new developments and trends.
- \*By working for Electronic Design... the magazine whose editors make it their business to know.

Good salary,  
excellent benefits, and  
association with top professional  
engineer-writers can be yours.  
If you are an engineer with  
experience in microwaves or  
communications systems, and are  
interested in the possibilities,  
call or write Robert Haavind,  
Managing Editor, Electronic  
Design, 850 Third Avenue,  
New York, New York 10022,  
(212) PL 1-5530



## In composite insulations, the big plus is "Teflon\* plus..."

**In design**, composites of TEFLON plus one of several other materials provide the necessary electricals with a minimum of weight and space.

**In installation**, "TEFLON plus . . ." composites provide extra resistance to cut-through and abrasion.

**In operation**, "TEFLON plus . . ." composites offer the nonflammability of TEFLON, plus its resistance to heat aging, thermal stress cracking and embrittlement at low temperatures.

Whenever you need the extremes of performance that only a composite insulation can give, look for TEFLON plus such other materials as nylon, polyimide, glass, asbestos, mineral fillers, polyvinylidene fluoride—or you name it!

For more information on "TEFLON plus . . ." composites, send details of the application you have in mind to Du Pont Company, Room 5839C, Wilmington, Del. 19898.

\*Reg. U.S. Pat. Off. for Du Pont fluorocarbon resins and film.

**TEFLON...the sure one**



Better things for better living  
...through chemistry

# SWITCH CRAFT FORUM

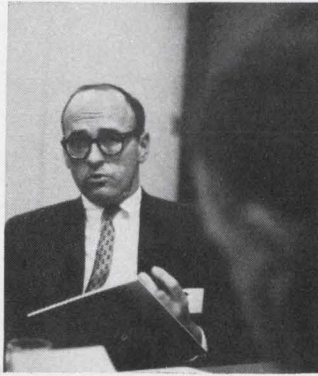

on the new  
DW  
"Multi-Switch"®\*

**A secret weapon, eh? I can tell you right now, if the new DW "Multi-Switch" doesn't save on space and cost, it's going to be a dud!**

That's the point. Switchcraft designed this compact pushbutton switch to do both. It's not just a scaled down version of an existing "Multi-Switch".

**I'll buy your design philosophy so long as you haven't sacrificed the versatility and quality we've been accustomed to on your larger switches. And, don't forget economy.**

Let's tackle your points one by one, and see how the new Series 65000 DW "Multi-Switch" shapes up!

We've guaranteed versatility by using simplified modular construction. Essentially, the switch consists of a frame up to 18 stations long, latch bar for function control and switching modules that provide up to 2C (DPDT) circuitry.

Fig. 1

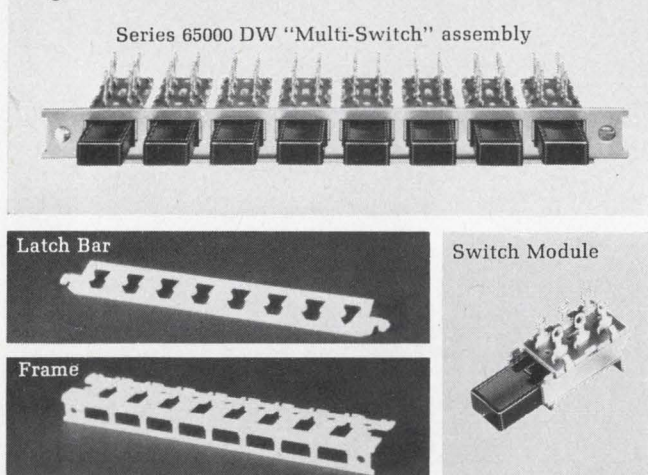
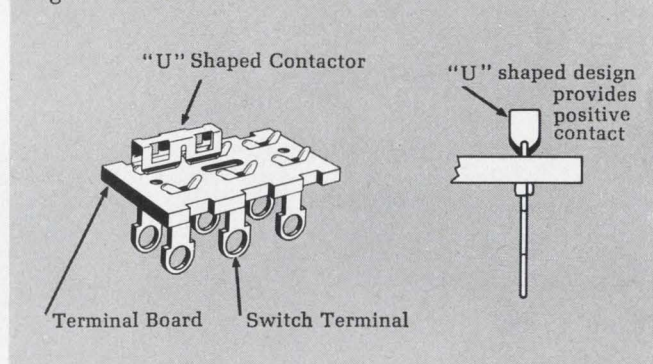

Fig. 1 shows how these elements are combined to complete the switch. The latch bar and mating actuator configuration determine the functional operation, such as: Interlock, All-lock, Non-lock and even special functions.

We don't have space to cover all the versatility details, such as, printed circuit terminals, pushbutton engraving, accommodation for mounting with Tinnerman nuts, etc. **JUST CIRCLE THE READER SERVICE NUMBER FOR NEW PRODUCT BULLETIN #174.**

An example of quality construction is the rigid frame, and double-wipe contactors used for extreme reliability. Fig. 2 shows how the "U" shaped contactor provides positive contact and minimizes "bounce". Also, the molded nylon pushbutton actuators are an integral part of the module. They can't be lost or pilfered. Our quality story ties right into economy. You can't buy a better made, compact multiple-station pushbutton switch for the money.

Fig. 2



**We'll accept the commercial, only because you have the reputation to back it up. The design looks great, but what about ratings and special circuit applications?**

Typical ratings for silver-plated contactors would be 3 amps. A.C., 0.5 amps. D.C. 125v. non-inductive. For dry circuit applications, gold flashed contactors and terminals could be furnished. As usual, we're glad to engineer specials to accommodate your volume requirements.

**I'll probably have more questions after we get a few samples on test. In the meantime, I'd like certain members of my staff to get complete engineering details on the DW "Multi-Switch" switch.**

Just have them drop us a request on your company letterhead for complete technical scoop. Also, we'll add their name to our TECH-TOPICS mailing list to receive this engineering-application magazine every-other month. Over 10,000 engineers find the application stories very interesting and useful in their work.

\*Patent applied for

**SWITCHCRAFT**  
INC.

5527 N. Elston Ave.  
Chicago, Ill. 60630

# INTRODUCING All new EECoLogIC<sup>®</sup> 2 with double density...

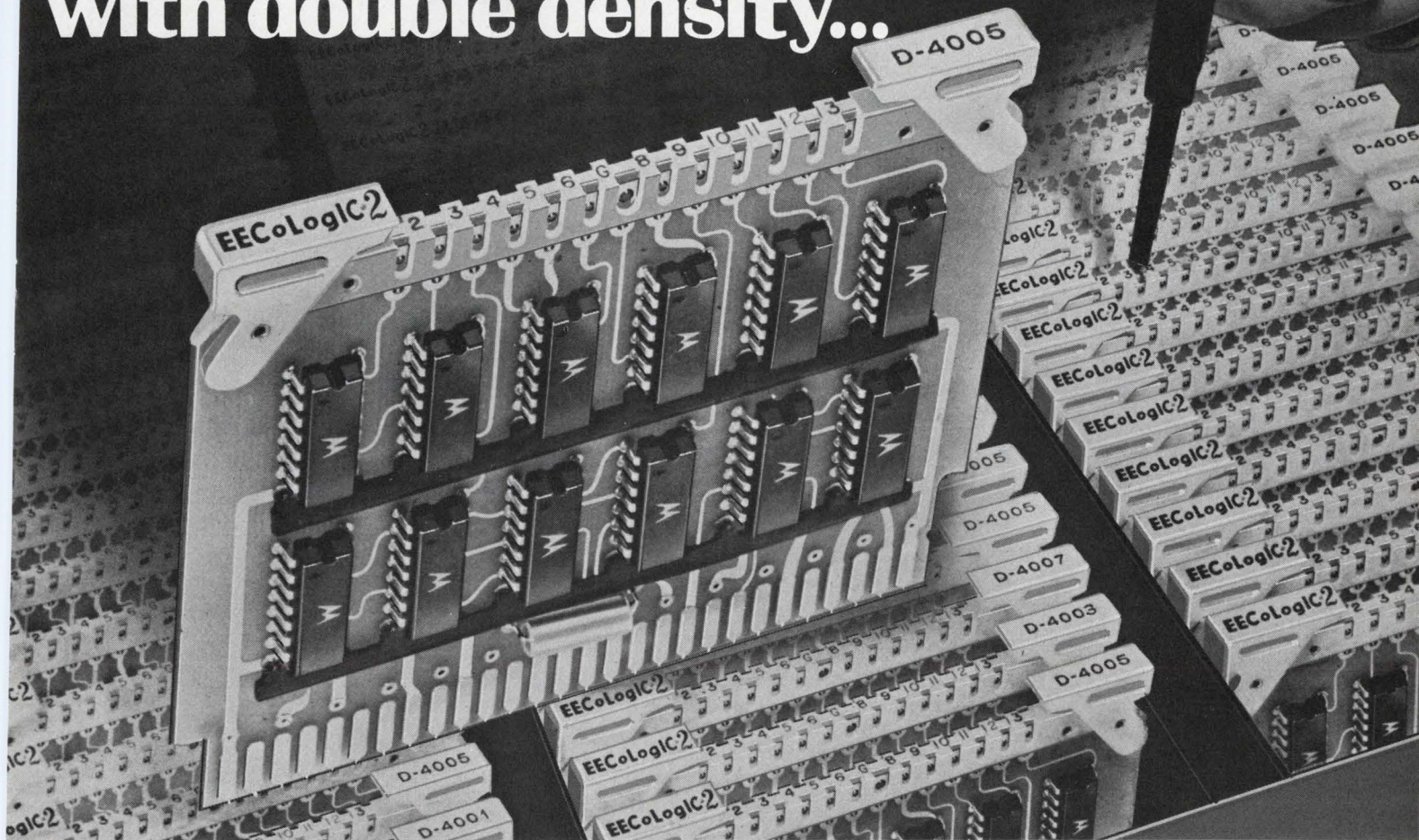

## to cut digital system costs

Digital system costs drop with EECoLogIC<sup>®</sup> 2 IC Digital Logic Cards because... prices per logic function are reduced about 10%... double density cards mean more of any system fits in a standard 19" drawer (up to 6240 pin connections/drawer)... the number of drawers required can be halved... wiring costs are minimized since fewer drawers mean less interface wiring and cabling.

### OTHER EECoLogIC<sup>®</sup> 2 ADVANTAGES:

- WIRE WRAP and TERMI-POINT wiring capability using manual or automatic machines, as well as soldering.
- 13 TEST POINTS accept probes, clips or hooks and make system check-out fast.
- INTEGRAL LOCKING/EXTRACTOR HANDLES hold each card securely in the card frame, identify the circuit and make card removal easy.
- LAMINATED POWER BUSES on each card and in the power wiring of each drawer reduce high frequency noise.

The EECoLogIC<sup>®</sup> 2 line of DTL logic modules with over 30 card types is available with a comprehensive selection of hardware and accessories. The new EECoLogIC<sup>®</sup> 2 catalog describes the entire line and includes practical application data. Send for your copy today.

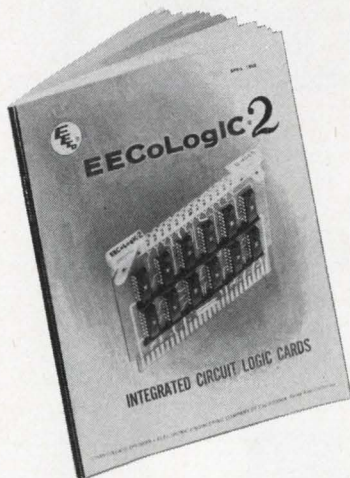

### COMPONENTS DIVISION

ELECTRONIC ENGINEERING COMPANY OF CALIFORNIA

1441 EAST CHESTNUT AVENUE • SANTA ANA, CALIFORNIA 92701 • (714) 547-5651

# circuit problems?

## Signalite Glow Lamps have solved problems in these areas:

- Voltage Regulation & References • Photo-Cell Drivers • SCR Triggering
- Timing • Photo Choppers • Oscillators • Indicator Lights • Counters
- Voltage Dividers • Surge Protectors • Logic Circuits • Flip-Flops
- Memory • Switching • Digital Readouts

Signalite glow lamps combine long life, close tolerance and economy, and are manufactured with a broad range of characteristics to meet individual application requirements. For a creative approach to your design problem . . . contact Signalite's Application Engineering Department.



**NUMERAL ONE REPLACEMENT FOR "NIXIE" TUBE.** The Signalite A261 neon lamp is designed to replace "Nixie" tubes in digital readouts which display only the numeral one. The lighted length is comparable to a "Nixie". It can also be used in the plus or minus display. A typical example is the over range position of a digital voltmeter.

SEE Signalite Application News for TYPICAL APPLICATIONS



**LOW COST ZENER REPLACEMENT** A new series of low cost voltage regulator tubes, Type V, are used for direct replacement of zeners. They are orders of magnitude better than zeners under transient conditions. Type V neon tubes feature temp. coef. less than 15 mv/°C with a life greater than 20,000 hours.

SEE Signalite Application News for TYPICAL APPLICATIONS

### SIGNALITE APPLICATION NEWS



is used to communicate new and proven techniques and applications of Signalite's neon lamps and gas discharge tubes. Signalite Application News provides a forum for an exchange of ideas to keep the design engineer aware of the versatility of neon lamps and their many applications. Copies are available from your Signalite representative or by contacting Signalite.

INFORMATION RETRIEVAL NUMBER 95



**NEON TIMERS** The bi-stable characteristics and high leakage resistance of Signalite's special glow lamps make them ideal as a component for timing circuits. The basic circuit resembles a relaxation oscillator network.

SEE Signalite Application News for TYPICAL APPLICATIONS



**TRIGGER LAMPS FOR OPERATION OF SCR'S AND TRIACS** The A230 lamp is recommended for use as a triggering device for both SCR'S and TRIACS in motor speed controls and light dimmer circuits. Its properties of stable operation and high current capabilities qualify it for this application.

See Signalite Application News for TYPICAL APPLICATIONS.

# Signalite

INCORPORATED  
NEPTUNE, NEW JERSEY 07753  
(201) 775-2490



A General Instrument Company

303



# THINKING RELAYS?

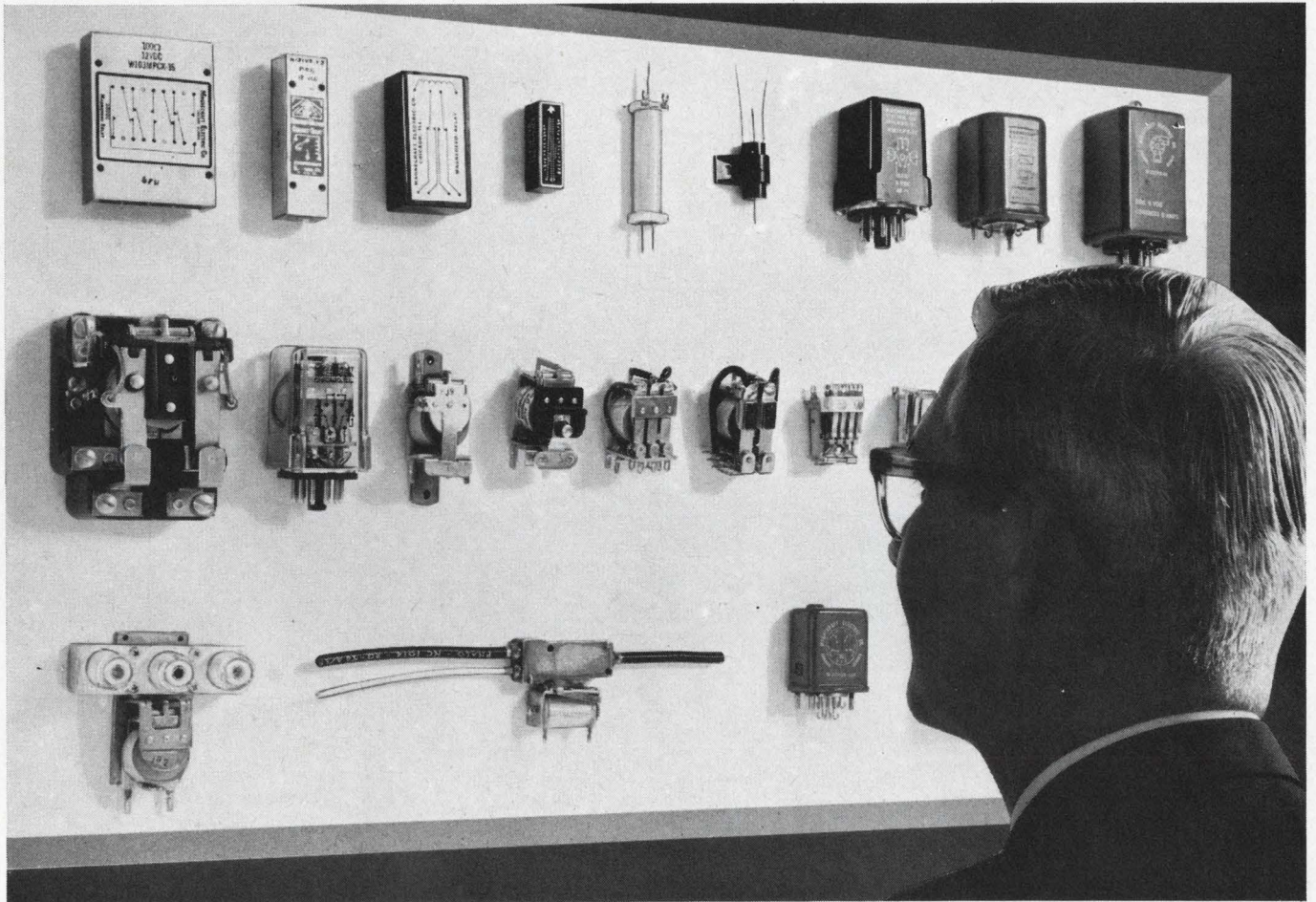

# THINK MAGNECRAFT!

**(that's all we think about, exclusively)**

We specialize in relays. Not only dry reed and mercury-wetted relays, but a full line of quality, long lasting relays. There are Magnecraft general purpose, telephone type, time delay and power relays, as well as coaxial relays for UHF switching.

All Magnecraft relays are built to provide reliable performance in any application. And to insure this reliability, our demanding quality control system puts every part and assembly through repeated inspections before any shipment leaves our plant.

Everyone at Magnecraft concentrates on relays to provide you with quality products, quickly delivered and at competitive cost. That's because all we think about is relays! Just ask our wives!

*See us in Booth No. 3J06 at the IEEE Show*

**Magnecraft**<sup>®</sup> ELECTRIC COMPANY

5575 NORTH LYNCH AVENUE • CHICAGO, ILLINOIS 60630 • 312 • 282-5500

INFORMATION RETRIEVAL NUMBER 15



**FREE! Product File —**  
Yours for the asking.  
Contains full details on  
all our stock relays.

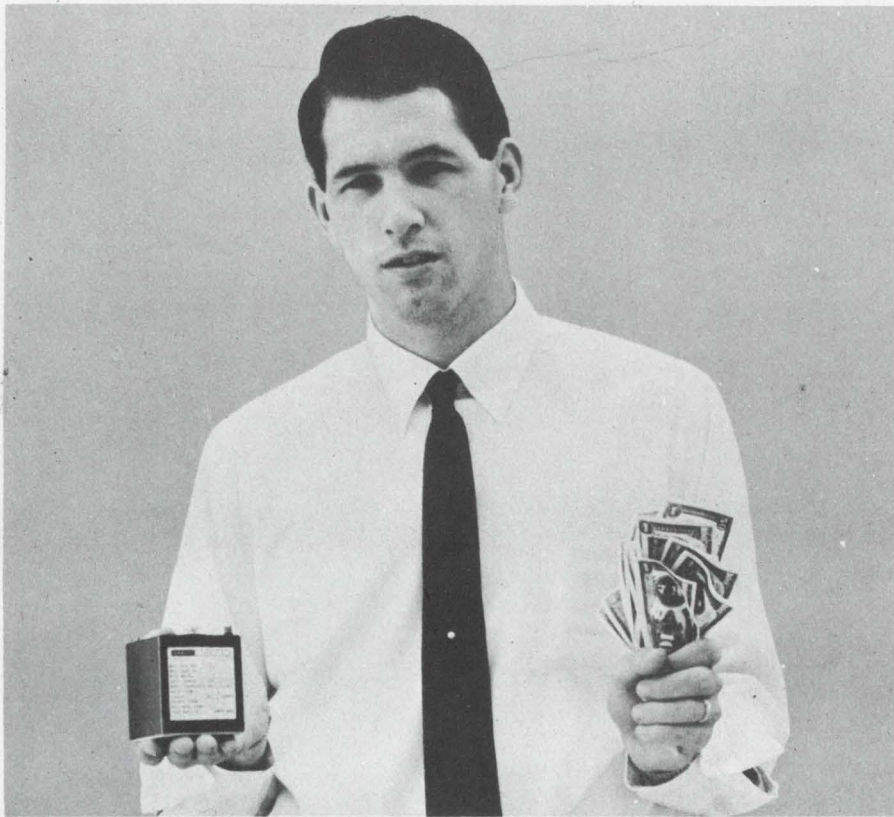

## How to Buy a Good Power Supply

### Without Spending a Bundle . . .

Take a long look at the Abbott line of over three thousand standard models *with their prices listed*. The unit shown above, for instance, is the Abbott Model AL6D-27.6A, a DC to DC converter which puts out 28 volts of regulated DC at two amps and sells for only \$220.00. Other power outputs from 5 to 240 watts are available with *any output voltage from 5 volts to 10,000 volts*, all listed as standard models in our catalog. These converters feature close regulation, short circuit protection, and hermetic sealing for rugged application found in military environment.

If you really want to save money in buying your power supply, why spend many hours writing a complicated specification? And why order a special custom-built unit which will cost a bundle — and may

Please write for your FREE copy of this new catalog or see **EEM** (1967-68 ELECTRONIC ENGINEERS MASTER Directory), Pages 1665 to 1678.

**abbott transistor**  
LABORATORIES, INCORPORATED  
5200 W. Jefferson Blvd./ Los Angeles 90016  
(213) WEBster 6-8185 Cable ABTLABS

bring a bundle of headaches. As soon as your power requirements are firmed up, check the Abbott Catalog or EEM (see below) and you may be pleasantly surprised to find that Abbott already has standard power supplies to meet your requirements — *and the prices are listed*. Merely phone, wire, or write to Abbott for an immediate delivery quotation. Many units are carried in stock.

Abbott manufactures a wide variety of different types of power supply modules including:

- 60 $\infty$  to DC, Regulated
- 400 $\infty$  to DC, Regulated
- 28 VDC to DC, Regulated
- 28 VDC to 400 $\infty$ , 1 $\phi$  or 3 $\phi$
- 60 $\infty$  to 400 $\infty$ , 1 $\phi$  or 3 $\phi$

TO: Abbott Transistor Labs., Inc., Dept. 87  
5200 West Jefferson Blvd.  
Los Angeles, California 90016

Sir:  
Please send me your latest catalog on power supply modules:

NAME \_\_\_\_\_ DEPT. \_\_\_\_\_  
COMPANY \_\_\_\_\_  
ADDRESS \_\_\_\_\_  
CITY & STATE \_\_\_\_\_

# Designer's Datebook

APRIL						
S	M	T	W	T	F	S
	1	2	3	4	5	6
7	8	9	10	11	12	13
14	15	16	17	18	19	20
21	22	23	24	25	26	27
28	29	30				

MAY						
S	M	T	W	T	F	S
		1	2	3	4	
5	6	7	8	9	10	11
12	13	14	15	16	17	18
19	20	21	22	23	24	25
26	27	28	29	30	31	

For further information on meetings, use Information Retrieval card.

### April 16-18

**National Symposium on Law Enforcement Science and Technology** (Chicago) Sponsor: U.S. Dept. of Justice: S. A. Yefsky, IITRI, 10 W. 35 St., Chicago, Ill. 06016.

CIRCLE NO. 464

### April 22-24

**Frequency Control Symposium** (Atlantic City, N.J.) Sponsor: U.S. Army Electronics Command; M. F. Timm AMSEL-KL-ST, Director Electronic Components Lab., U.S. Army Electronics Command, Fort Monmouth, N.J. 07703.

CIRCLE NO. 465

### April 23-24

**Relay Conference** (Stillwater, Okla.) Sponsor: National Association of Relay Manufacturers and Oklahoma State University; Dr. D. Lingelbach, School of Electrical Engineering, Oklahoma State University, Stillwater, Okla. 74074.

CIRCLE NO. 466

### April 29-May 1

**Process Automation Symposium** (Anaheim, Calif.) Sponsor: Beckman Instruments, Inc., and others; B. Stewart, Beckman Instruments, Inc., 2500 Harbor Blvd., Fullerton, Calif. 92634.

CIRCLE NO. 467

### April 29-May 1

**Institute of Environmental Sciences Meeting and Exposition** (St. Louis) Sponsor: D. N. Cerasuolo, Institute of Environmental Sciences, 940 E. Northwest Highway, Mt. Prospect, Ill. 60056.

CIRCLE NO. 468

### May 6-8

**Quality Control Technical Conference and Exhibit** (Philadelphia) Sponsor: American Society for Quality Control; J. Mehalek, General Chairman, ASQC, 161 W. Wisconsin Ave., Milwaukee, Wis. 53203.

CIRCLE NO. 469



In wirewound, axial lead resistors, Ohmite's answer is...

# tough:

Ohmite's series 99 wirewound axial lead resistors are designed to take it. To shrug off the stresses of toughest environments and deliver the performance you're looking for.

**Torture test . . .** The molded vitreous enamel coating used in the construction of the series 99 offers many advantages. In tests of 1500°F—red heat—these resistors show no deformation, markings remain legible. Thick, densely molded jacket insulates windings (1000 VAC hi pot), will not chip even where leads enter body. Markings are unaffected by degreasing and flux solvents, remain legible even after extreme overloads. They are fired into the molded vitreous enamel coating and become an integral part of the resistor.

**Extreme uniformity . . .** The series 99's exceptional size and shape uniformity make it ideal for mechanical feeds of automated assembly. Also facilitate metal clip mounting for heat-sink advantage of up to 100%.

Available in eight compact sizes from 1.5 to 15 watts at 25°C. Resistance range: 0.1 to 187K ohms. Tolerances: 0.25% to 5%.

Ohmite is continually developing new product answers for circuitry. In basic or special components . . . in solid state or electro-mechanical designs . . . you'll find no better source for products, ideas and answers. Ask for Ohmite Resistor Catalog 101. Write, Ohmite Manufacturing Company, 3643 Howard Street, Skokie, Illinois 60076.



## OHMITE

has the answer

in products for today's & tomorrow's circuitry

Relays • Variable Transformers • Tap Switches • Resistors • Rheostats • Capacitors • R. F. Chokes • Solid State Controls

# Here's a new digital IC from Sprague. The 54/74107A.

It's a single-chip  
replacement for the  
5473/7473 dual JK  
m-s flip-flop.

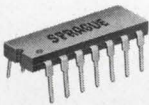
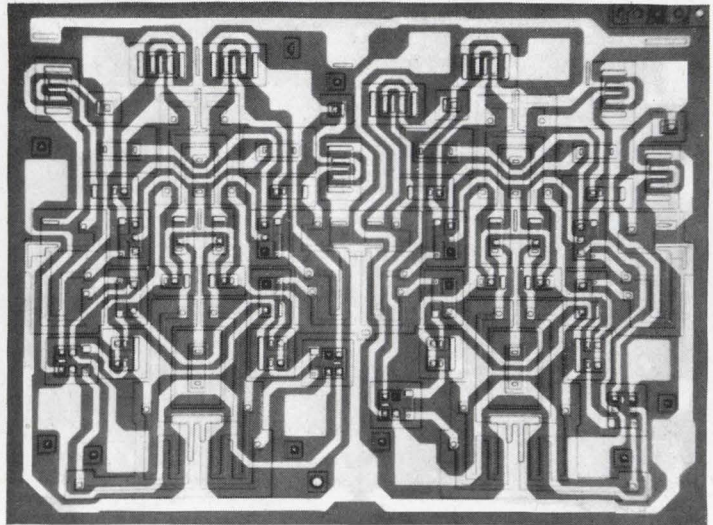

In DIP it has pin 7 GND,  
just like the rest of the Series 54/74 family.

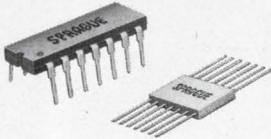

For existing designs,  
it's also offered in the "old"  
pinning in either DIP or flat pack.

Choose 0 to +70 or -55 to +125 C  
temperature range. Choose "old"  
or new compatible pinning.  
Choose Sprague for all Series 54/74.

## SPECIFICATIONS

Dual JK m-s Flip-Flop

	DIP PIN 7 GND	DIP PIN 11 GND	TO-88 PIN 11 GND
0 to +70 C	USN-74107A	USN-7473A	USN-7473J
-55 to +125 C	USS-54107A	USS-5473A	USS-5473J
Clock freq.	15 MHz	15 MHz	15 MHz
P <sub>diss</sub>	50 mW/ff	50 mW/ff	50 mW/ff
Fan Out	10	10	10

To request samples, call your Sprague representative.  
For further information, write to Technical Literature  
Service, 347 Marshall St., North Adams, Mass. 01247.

# SPRAGUE®

THE MARK OF RELIABILITY

SPRAGUE WORCESTER . . . the world's finest microcircuit facility.

# News

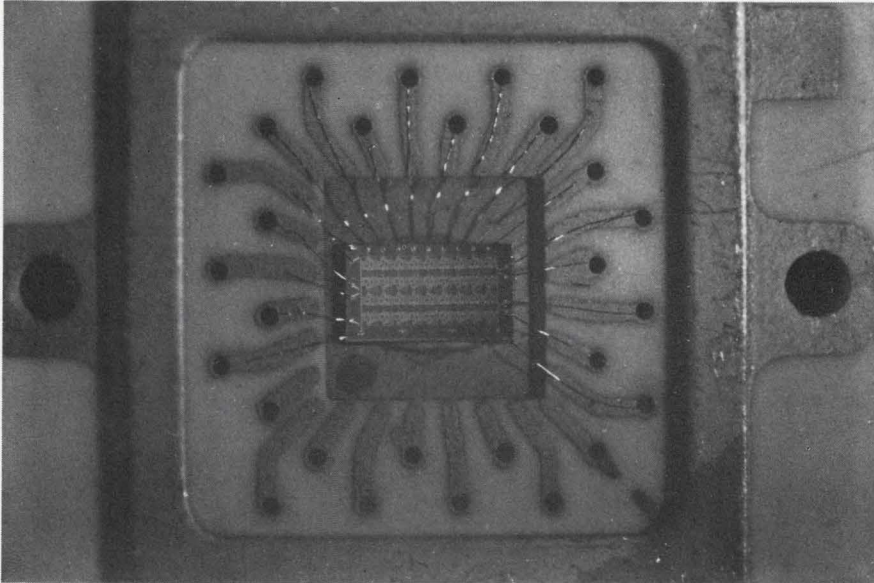

**MOS memories are challenging "King Core."** This 36-bit random-access array was made with complementary MOS. P. 25

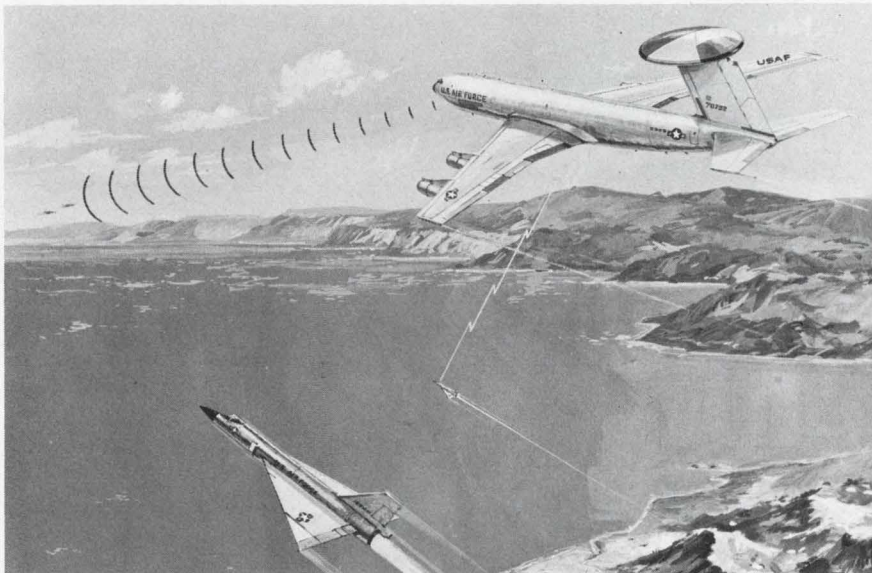

**'Flying radar' development studies** are under way at Boeing and McDonnell-Douglas for U.S. Air Force. Page 36

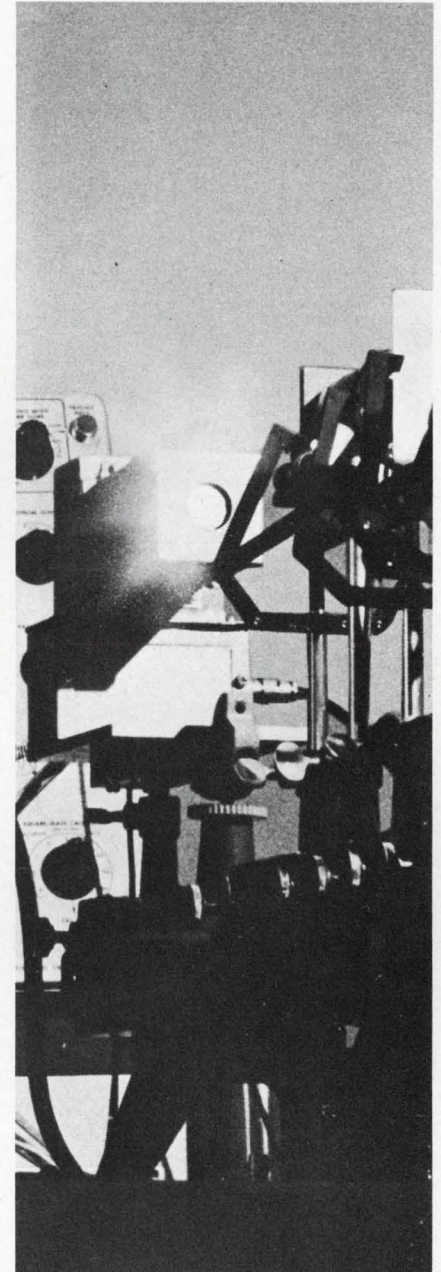

**A cw laser is tuned by cooling** optical crystal. Page 33

## Also in this section:

**Atlantic test center** to get sonar range. Page 34

**News Scope**, Page 21 . . . **Washington Report**, Page 41 . . . **Editorial**, Page 69

**Only from Sprague Electric!**

## TYPE 137D TANTALEX<sup>®</sup> SINTERED-ANODE TANTALUM CAPACITORS

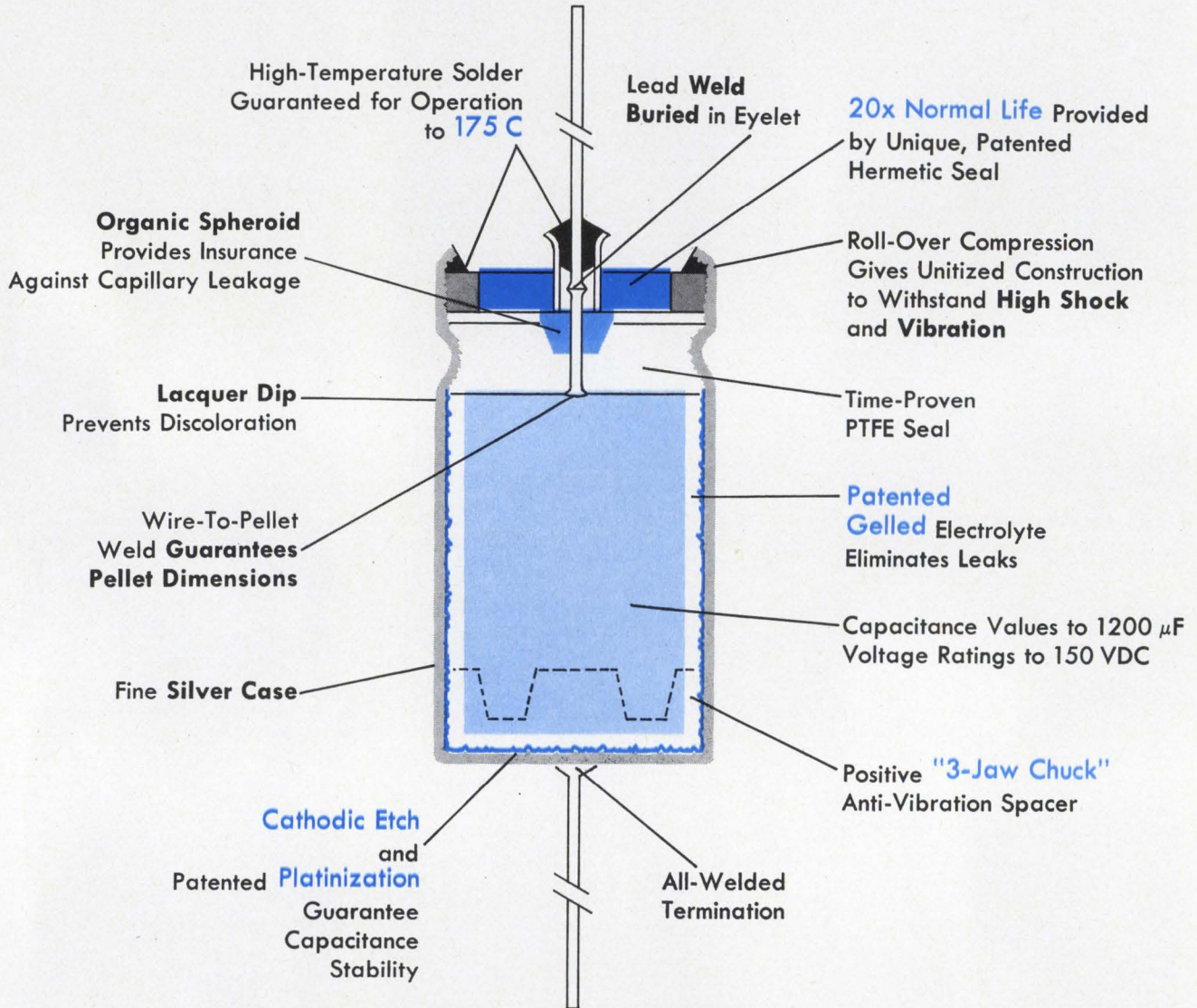

## WHY SETTLE FOR LESS?

For complete technical data, write for Engineering Bulletin  
3703A to Technical Literature Service, Sprague Electric Co.,  
347 Marshall St., North Adams, Massachusetts 01247.

### SPRAGUE COMPONENTS

CAPACITORS  
TRANSISTORS  
RESISTORS  
INTEGRATED CIRCUITS  
THIN-FILM MICROCIRCUITS

PULSE TRANSFORMERS  
INTERFERENCE FILTERS  
PULSE-FORMING NETWORKS  
TOROIDAL INDUCTORS  
ELECTRIC WAVE FILTERS

CERAMIC-BASE PRINTED NETWORKS  
PACKAGED COMPONENT ASSEMBLIES  
BOBBIN and TAPE WOUND MAGNETIC CORES  
SILICON RECTIFIER GATE CONTROLS  
FUNCTIONAL DIGITAL CIRCUITS



Sprague and ® are registered trademarks of the Sprague Electric Co.

INFORMATION RETRIEVAL NUMBER 19

## RF crowding in space reported nearing crisis

As the total of satellites in space increases, demands on the available radio frequency bands are approaching the danger point, a Government-sponsored report warns.

The report calls for sharing of bands between ground-based domestic users and satellite systems to avert a break-down in radio communications before 1980.

With 17 or 18 satellites being lofted into space each year, the report suggests that action be taken at once.

The fact-finding report, "Use of the Spectrum by Satellite Systems Through 1980," was written for the Office of Telecommunications Management by the Atlantic Research Corp. of Alexandria, Va. The findings and recommendations have been released by the Executive Office of the President.

The report sees the necessity of sharing the radio spectrum below 11 GHz between ground and space communications activities. It recognizes that some terrestrial frequency allocations are exclusively assigned, but suggests that both ground communications and space systems can share most of this region. It sees the necessity for planning and cooperation on all future spectrum use and calls for further

investigation of modulation and coding techniques to conserve frequencies.

In the region above 11 GHz, the report notes that more of the frequency spectrum is available for expansion. At first some of these allocations may be exclusive to satellite systems, but eventual sharing with terrestrial communications systems is anticipated.

Since spacecraft, even with highly directional antennas, transmit signals over bigger areas of the earth than are desired because of their altitude, they pose more severe interference problems than most earth-bound communication systems using the same frequency bands.

The report has classified all projected satellite systems according to function and orbital altitude. Three categories of orbit have been listed: near-earth and non-stationary near-earth and geo-stationary (synchronous orbit 22,300 miles up); and far-earth (lunar and planetary).

By 1980, one half of the projected space vehicles will be in geo-stationary orbit, the report says. Of these, about two thirds (one-third of the total) will be communications satellites. The vehicles in synchronous orbit pose the most severe frequency-sharing problems; if evenly distributed, the 130 vehicles would form a belt over the equator.

### Weather data on the economy plan

The savings are small by Washington standards—only \$180,000 a year—but the Environmental Sciences Services Administration (ESSA) is proud of the effort and of the cooperation from responsible citizens around the country that

makes it possible. Involved are ESSA's radiosonde instruments, which are sent aloft by balloon to sample temperature, humidity and air pressure and which float back to earth without damage after they have soared into the upper atmosphere. Tags on the instruments request finders to return them to a small Weather Bureau center in Joliet, Ill.

ESSA reports that over 25 per cent of the balloon-borne packages are returned each year, and each costs from \$15 to \$30. The Joliet center recently reconditioned its 400,000th radiosonde after return by a citizen. Established in 1945, the center employs 15 persons in the radiosonde section, and they handle 125 reconditioned instruments a day. Radiosondes are launched globally 300 times a day. Carried aloft by large balloons, they continue upward until the balloons burst, when they then parachute back to earth.

### Bill would let FCC control RFI at source

The Federal Communications Commission may soon win the authority to eliminate electromagnetic interference from electronic equipment—at the manufacturing plant or the unloading dock. A bill granting this authority over the design and manufacture of "gadgets" used in daily life has been passed by the House and awaits approval by the Senate.

The bill would give the FCC authority to prescribe "reasonable regulations" for the manufacture, importing, sale, shipment and use of devices that cause harmful radio interference. It would supplement regulations in effect since 1934. These regulations gave the FCC authority to enforce interference provisions only in cases where individual complaints were made.

Rep. William L. Springer (R., Ill.) said that his bill would affect such common consumer devices as electronic garage-door openers, electronic toys, medical diathermy sets, welders, and control equipment for motors.

Rep. Springer told the House that improved control of radio noise by regulating the emission characteristics of equipment at the

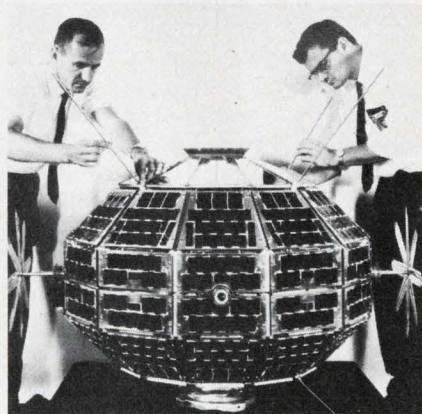

Satellite crowding may require expanded spectrum.

# News Scope

CONTINUED

factory or point of import would have these benefits, among others:

- Improvement of air safety by eliminating possible interference with aircraft navigational aids.
- Improvement of fire and police radio communications by suppressing unwanted emissions from such sources as welders.

## Magentic records vie with punch cards

Pocket-sized magnetic recording cards may some day replace the familiar punched-paper data-processing card. Machines employing air fluidic logic would record data on the cards, read and sort them at speeds up to 1200 per minute.

The new technique for processing and storing digital data has been developed by the UNIVAC Div. of Sperry Rand Corp., Philadelphia, for the U.S. Army Electronics Command, Fort Monmouth, N.J. It is still in the prototype stage. Use of the new cards and machines could alter present military and commercial practices by speeding up processing and decreasing record storage space.

"Computers have gotten ahead of input-output equipment," said the Army project officer. "The present punch cards are not fully suited to the environment in which the Army operates. They are vulnerable to sand, moisture and rough handling." The Army wants a system that will put more information in a smaller space and make fewer demands for machine maintenance.

The new data processing card is 2.5 in. wide and 4 in. long, of polyester plastic coated on both sides with a thin nickel-cobalt magnetic film, and capable of being erased and reused many times. Present recording techniques permit 4000 digital characters to be recorded on a side. The Army plans to limit storage to 1000 characters in a 1 by 2.5 in. space. This, however, is more than twelve times the information capacity of a standard punched paper card.

The present experimental card

handling system is limited to recording, reading and limited sorting ability but it can process cards at the rate of 300 per minute. Univac engineers state that it is now feasible to build a single fluidic controlled machine that would combine the functions of read, write, collate and update, handling the cards at speeds of 1200 per minute.

## Clock-like space pulses puzzle astronomers

Scientists and astronomers throughout the world are still speculating on the origin of regular and rapidly pulsating signals emanating from outer space.

First picked up at Cambridge University's Mullard Radio Astronomy Observatory, the signals are now being monitored three hours daily at Cornell University's giant radio telescope near Arecibo, Puerto Rico.

The signals are reported to occur at precise intervals of 1.337 seconds with a regularity "far greater than that of an ordinary timepiece." The intensity of each pulse varies considerably over a one-minute period. The emissions then disappear for three or four minutes, whereupon they reappear for another minute of variable intensity. The cycle is continuous.

The Arecibo observations have shown that, at a frequency of 111 MHz, the mean power is  $200 \times 10^{-26}$  watts per meter<sup>2</sup> per Hz—one of the strongest radio emissions yet discovered in the sky. The signals are inaudible below 40 MHz and above 200 MHz.

Observations by the Arecibo telescope have shown that the pulses are, in fact, really triple pulses, 12 thousandths of a second apart.

Some British astronomers ascribe the signals to pulsations of a "white dwarf" or neutron star; yet this explanation is now being questioned in view of the "coding" of the signals.

## Solitron's plans fuzzy after Amphenol bid fails

The board of directors of Solitron Devices is unsure of what their next step will be after having acquired only 25% interest in

Amphenol Corp., as a result of their tender offer.

Solitron had aggressively sought to gain control of Amphenol via a one-for-five exchange of its shares. Amphenol has just as aggressively opposed the offer and apparently has been successful.

According to a dispatch in the Wall Street Journal, Solitron's holding, although not a controlling interest, "is by far the largest block outstanding." One thing Solitron is sure of is that they will oppose Amphenol's pending merger with Bunker-Ramo Corp.

## New channels allocated for public-safety use

Following pressure by Congress and a direct request by President Johnson, the Federal Communications Commission finally has allocated 165 new radio channels for public-safety and business purposes.

Assigned to the 450-to-470-MHz band, 20 of the channels will be for the exclusive use of police departments. Five channels are for fire departments.

The new channels were obtained from the already heavily used band by ordering a reduction in bandwidth for existing channels from 50 kHz down to 25 kHz.

## Soviet's Lunar craft only a partial success

U.S. scientists now believe that the Zond-4 spacecraft launched by the Russians early last month was not intended to orbit the Moon, as first thought. The trip was intended to simulate a lunar orbit-and-return mission to achieve comparable reentry velocity and angle. The craft was first sent into a parking orbit 170 miles above the Earth. It was then directed outward into space to a point equivalent to lunar distance, some 240,000 miles, and then began its return to Earth.

The spacecraft was expected to return to Earth a week later, but since no information has been released by the Soviets, or by either NASA or the North American Air Defense Command, Zond-4 is believed to have crashed or burned in the Earth's atmosphere.



# bench accuracy at system speed

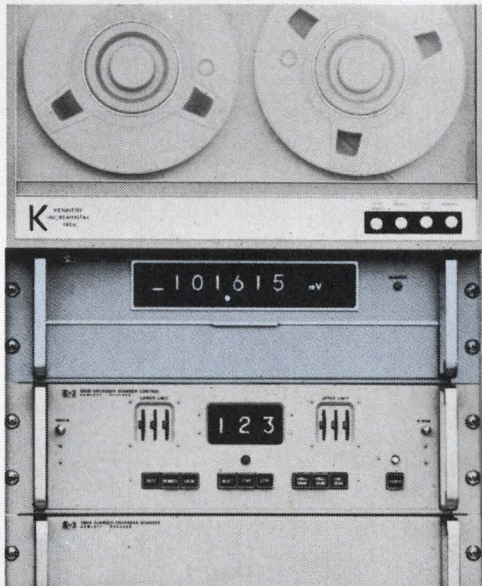

Cover protects 2402A controls for systems use.

Both in an  
integrating DVM  
with 1 microvolt  
resolution.

Take 40 readings per second, integrate and resolve the answers to a microvolt with the new Hewlett-Packard 2402A IDVM... get resolution never before available in this speed range. With the accuracy of a lab instrument (0.01% of reading  $\pm 0.003\%$  of full scale), the 2402A is excellent for system applications... with full programmability and all the features you'd expect from a systems voltmeter. (Of course, it's an excellent lab instrument, too.)

Guarding and integration permit accurate measurement of low-level signals in the presence of common mode and superimposed noise—over 120 dB effective common mode rejection... even at 40 readings per second. Designed for low-cost multimeter expandability: AC, resistance and frequency measurement capabilities can be added easily with optional plug-in circuit cards. Five ranges

to  $\pm 1000$  Volts, including a 0.1 Volt range for high-accuracy millivolt measurements.

The 2402A: \$4800. Plug-in options are reasonably priced—AC, for example, only \$450.

For more information, call your local HP field engineer or write Hewlett-Packard, Palo Alto, California 94304; Europe: 54 Route des Acacias, Geneva.

HEWLETT  PACKARD

DIGITAL VOLTMETERS

**Space heater, oven, furnace control problems? Try these 15A Triacs.**

RCA, the Triac leader, keeps the ball rolling with two more product advances! Now the industry's largest line-up of Triacs has been expanded to include two 15A devices. What really sets these Triacs apart from those now on the market is RCA's use of the inexpensive, practical TO-66 package. After all, why pay for the costly press-fit package when it doesn't buy you anything extra in electrical performance? Just compare the spec's on our devices. You get a full-rated 15A  $I_T$  (rms) at 70°C... surge current protection up to 100A... and thermal resistance of 1.3°C/W.

Actually, you shouldn't expect anything less from RCA... we're the Triac leader!

**Switching problems for ultrasonic generators, power supplies, and switching control circuits? Try these fast turn-off SCR's.**

Hold on world! RCA is extending its thyristor leadership ability into the marketplace of fast turn-off SCR's. We're proud to announce three 5A devices that are just right for a host of fast-switching circuits for which only higher current devices had been available. Again it's that old story of why pay for something you don't need. Prices on these types start at \$1.98\*, in case you hadn't noticed. And at that price, you get turn-off times of 6  $\mu$ s Max,

$dv/dt$  of 100 V/ $\mu$ s, and  $di/dt$  of 200 A/ $\mu$ s. Further, we have a unit rated up to 600 V, and there are not too many devices available with this combination of high voltage and fast switching speed.

For more technical data on specific types, including Application Notes, see your RCA Field Representative, or write RCA Electronic Components, Commercial Engineering Department, Harrison, N.J. 07029. Check your RCA Distributor for his price and delivery.

*\*Price for 1000 units*

**RCA**

**5 more Thyristors from RCA help solve your control problems**

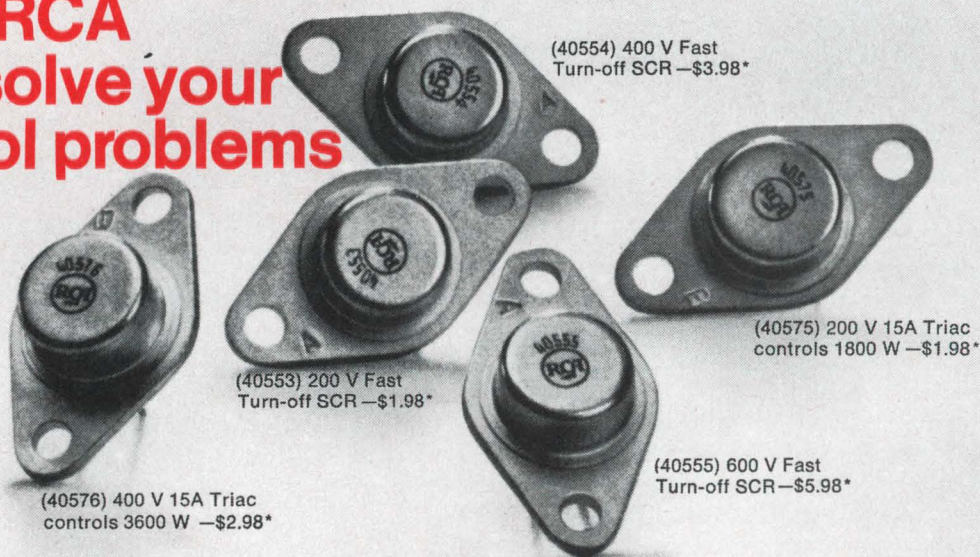

# LSI improves computer memory bit by bit

## Groomed as contenders in the transistor race, MOS arrays may yet displace the ferrite core

Richard N. Einhorn  
News Editor

Semiconductor memory arrays that are small enough, fast enough, dense enough and cheap enough to substitute for cores are nearing production status. They threaten to preempt every position in the computer hierarchical order, from the scratch pad to the small main memory of half a million bits. And the appearance of multimegabit semiconductor memories is just a matter of time, some experts say. (See "LSI impresses at solid-state conference," ED 5, March 1, p. 25).

In the forefront are MOS random-access read-write memory arrays, which by the end of the year should be available at 4 cents a bit—on a par with the cheapest cores.

Starting with packaging, it is easy to see why semiconductors are in the ascendancy. The development of flip-chips and beam-leads, and especially of plastic packaging, has resulted in a steady decline in packaging costs.

Chip size, on the other hand, is growing as more and more is learned about silicon processing. This is a decided advantage, since increasingly more complex devices—and even subsystems—can now be fabricated on silicon wafers.

While the chips get larger and larger—and therefore able to support more transistors than ever—the transistors themselves are getting smaller, because of improvements in mask-making and production equipment. This is particularly

true of MOS transistors, which always have been small anyway.

Packing, too, is getting denser. Improved mask layouts and multi-layer interconnects have permitted narrower spacing between components on a chip.

All of these technological advances have led to an exponential rise in device complexity per chip. This is even more important than the obvious improvements in yield: Either you get more circuits on a chip or you improve your yield. Since there is generally more profit in maintaining the same yield but increasing complexity, the manufacturers are likely to do just that.

MOS arrays can be fabricated in batches. Cores, on the other hand, have reached a point of diminishing returns in labor costs. In fact, the costs of cores may eventually rise as assemblers in Hong Kong and Taiwan and Brazil and Mexico demand, and receive, a higher standard of living.

MOS memory arrays, being intimately connected with semiconductor technology, are steadily decreasing in cost per bit. Ferrite cores, which are tied to hand labor, are at a bedrock position from which they can only rise in cost.

If MOS and core costs were plotted on a graph, their curves would eventually intersect, and MOS would take over from cores as the least expensive memory devices.

Judging from recent developments in the industry, one can predict that the crossover point should occur in late 1968 or early 1969. It is thus ironic that MOS devices, developed as a competitor for the bipolar transistor, should topple the core as the reigning monarch in the memory field.

### A generous slice of glory

Do the advantages claimed for MOS memory arrays really exist? And what about the disadvantages?

Memory arrays are repetitive devices. Individual cells line up like so many rows and columns of soldiers on parade. This is a natur-

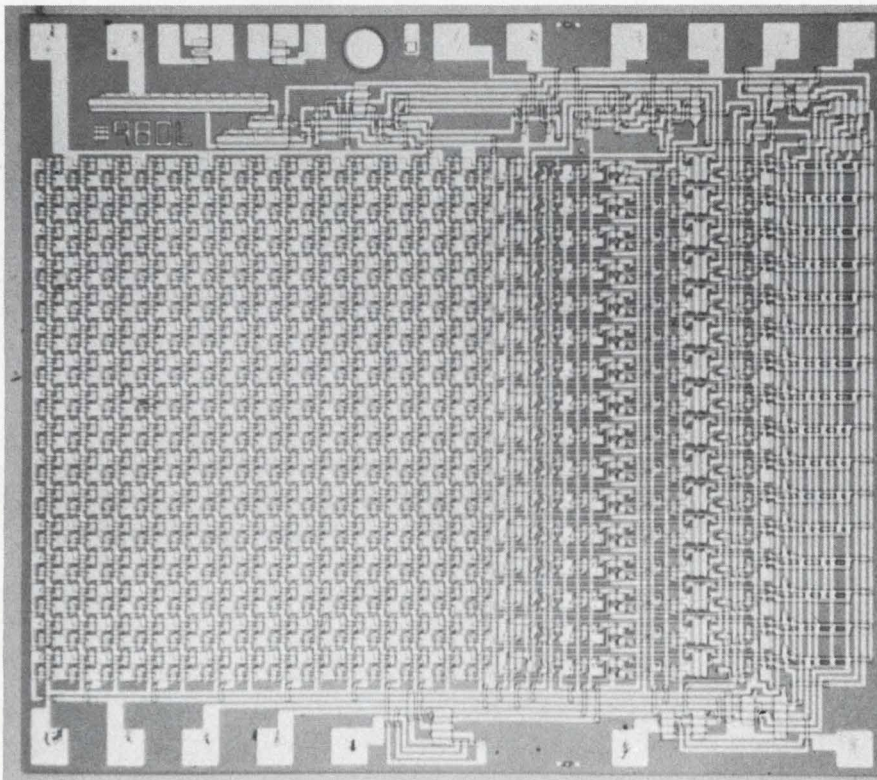

16-bit by 16-bit array on a chip is accessed randomly down to a channel. From that point on, it becomes a serial register. Decoding as well as storage functions are housed on the chip. Philco-Ford says that future arrays will be truly random access. Above 64 bits, sense amplifiers have to be included. At the present state of the technology, array size will level off at 512 bits.

**(MOS memories, continued)**

al application for large-scale integration, since the cost per bit tends to decline with the number of bits on the chip.

The sheer number of circuits that can be laid out on a silicon wafer with MOS technology means that, relative to other devices, fewer packages are required. This may not be crucial to the device manufacturer, but the computer designer is anxious to get equal or better performance from the fewest packages he can get away with.

As more and more bits are squeezed onto minute silicon chips, capacitance is reduced. With lowered capacitive reactance, each element dissipates less power—at no loss in speed. Thus chip temperature does not go up linearly with packing density. On the other hand, there is no point to making cores smaller. Heating becomes a problem. And they still have to be threaded by hand. Your wife would not appreciate it if manufacturers miniaturized her sewing needles.

Speeds—that is, complete memory cycle times—of 1 microsecond are reported as the rule for MOS arrays rather than the exception. For the 256-bit, random-access, read-write arrays that Philco-Ford Corp., Santa Clara, Calif., is bringing out later this year, cycle times will be about 0.2 microsecond. While this may be perhaps an order of magnitude slower than some of the ultra-high-speed bipolar scratch pads, it is highly competitive with magnetic devices. Even faster speeds are claimed for complementary MOS (both p-type and n-type on the same substrate) over single-channel MOS arrays.

MOS arrays lend themselves to distributed memories, a potential boon to the computer designer. Distributed core memories are prohibitively expensive because a good part of the economy of core storage comes from the fact that a large array can be driven with a limited amount of peripheral electronics. Breaking the huge core arrays into smaller units increases peripheral electronics drastically.

MOS permits nondestructive readout. This conserves cycle time, because it isn't necessary to erase data and write it back in, as with

cores. Moreover the signals are digital, hence compatible with semiconductor logic.

Because of the small size of the MOS transistors, decoders and amplifiers can be built right on the chip along with the storage cell.

It may turn out that MOS is the only road to truly associative memories. All of the elements can be processed onto the chip, including such logic as exclusive ORs. No other way of achieving this can match MOS in economy.

**Well, it's not quite perfect**

All of this sounds almost too good to be true. Can we really have a fast, versatile, reliable memory that costs less than any other type? There do seem to be a few drawbacks to MOS arrays.

For one thing, the use of off-the-chip drivers introduces a delay because of capacitance effects. This can reduce speed by a factor of 3 or 4. Capacitance effects also limit the fan-out capabilities.

Then, threshold voltages are higher than those of bipolars, so that levels must be adjusted when the two types interface.

The gates of MOS transistors can be damaged by the accumulation of static charge. Merely touching the leads can ruin the input gate. If that goes, the entire chip is knocked out. Zener diodes can protect the gates—at a sacrifice in speed.

All semiconductor memories provide volatile storage. The entire content may be lost if there is a power failure. However, the low power consumption of MOS permits the entire memory to be kept

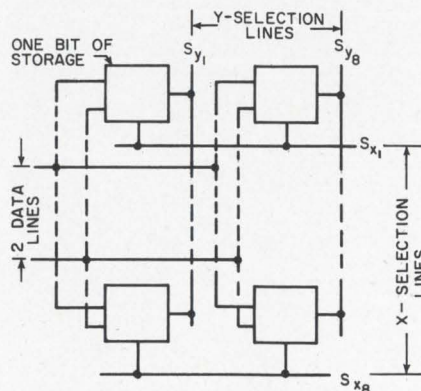

1. **64-bit random-access memory** is organized as 64 words by 1 bit for economy of bits. Device uses p-channel flip-flops in cells.

alive with small batteries.

The speeds, yields and reliabilities forecast for the larger (and therefore more economical) MOS arrays have not yet been proved. Only user experience will tell the tale.

**Who's gathering the MOS?**

The MOS memories are being developed both by device manufacturers, who intend to sell them virtually off the shelf, and by custom houses. Some particularly large arrays are used in Government systems.

Here's a thumbnail sketch of some of this activity:

- Philco-Ford is working on p-channel, random-access, read-write arrays of up to 256 bits on 9000-square-mil chips. The company has also done custom work, such as preparing the masks for a 64-bit array developed by Bunker-Ramo Corp., Canoga Park, Calif.

- General Instrument Corp., Hicksville, N.Y., has a 32-bit random-access memory module on the market. In addition the company has a contract with National Cash Register to develop 256-bit arrays, which will be ganged to provide 100,000 to 200,000 bits of storage.

- Fairchild Semiconductor Div., Palo Alto, Calif., has developed an experimental 64-bit, coincident-select memory array by using p-channel MOS. The company is looking forward to more complex arrays and the ganging of arrays to form large memories.

- American Microsystems, Inc., a small but well-regarded company in Santa Clara, Calif., is evaluating a 32-bit, random-access memory it

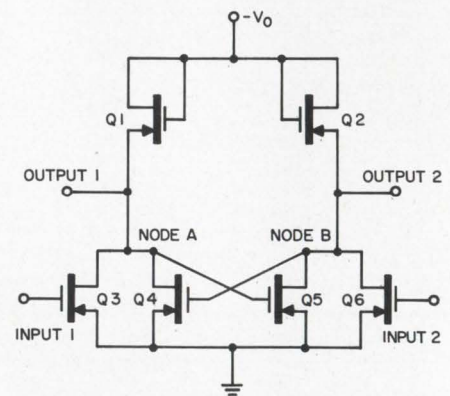

2. **Typical p-channel flip-flop** changes states only when negative pulses are applied to inputs. Q1 and Q2 serve as the loads.

# Our first new MOS switch is so good, it's almost embarrassing.

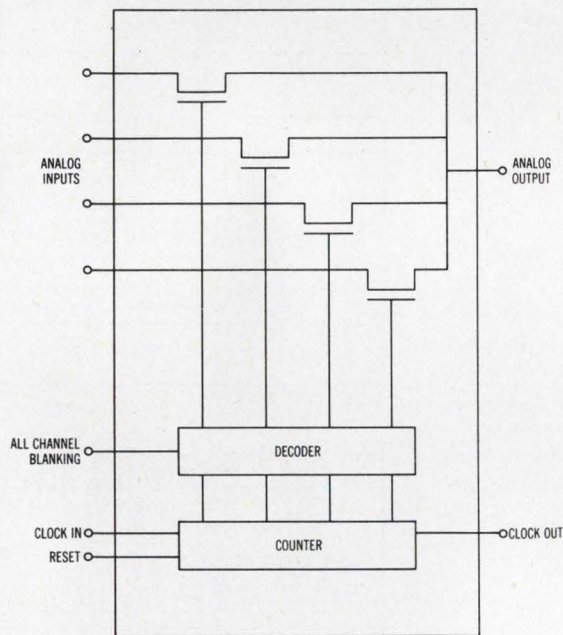

MM454 Commutator

It's the MM454, a monolithic, four-channel commutator, that's capable of handling  $\pm 10V$  analog signals. And it provides all driver and decode circuitry eliminating the need to construct a separate counter. All-channel blanking and a reset capability are a couple of bonus features.

We've also introduced four other new switches not quite so remarkable, but still worth crowing about. Our MM450 is a dual differential switch. Our MM451 is a four-channel unit. Then there's our MM452 which is comprised of four separate switch devices in a single flat pack with 14 leads. The last one, our MH453, is a dual differential analog switch with a built-in DTL/TTL interface circuit.

Not bad for openers. And these aren't just being designed. They're already stocked on your distributors' shelves complete with price tags:

	Quantity: 100-999
MM 450 Dual differential MOS switch . . . . .	\$20
MM 451 Four-channel MOS switch . . . . .	\$20
MM 452 Four MOS transistors . . . . .	\$30
MH 453 DTL/TTL compatible MOS switch . . . .	\$40
MM 454 Four-channel commutator . . . . .	\$50

Write for data. National Semiconductor Corporation, 2975 San Ysidro Way, Santa Clara, Calif. 95051. Phone (408) 245-4320.

## National Semiconductor

**(MOS memories, continued)**

has built. The company is said to be enthusiastic about the results.

■ Westinghouse Aerospace Div., Baltimore, has built a 288-bit, random-access, read-write array for the NASA Goddard Space Flight Center. The module, which is organized as a 16-word-by-18-bit matrix, uses complementary MOS. NASA favors complementary MOS exclusively because of the extremely low power consumption.

■ Westinghouse Molecular Electronics Div. has developed 16- and 32-bit complementary MOS arrays. The 32-bit unit has been delivered to the Army Electronics Laboratory, Fort Monmouth, N.J. This particular array is slow—2-microsecond cycle time—because of an Army requirement that the decoder be built on the chip. The memory cell itself is said to be an order of magnitude faster than the chip.

■ Radio Corp. of America is heavily committed to a program of complementary MOS. Development work is proceeding at Somerville, N.J., and Princeton, N.J. In addition to large arrays built for the Government, the company is making available for customer evaluation a 16-bit memory cell (see Products section, p. 136, of this issue). The device was unveiled at the recent IEEE show in New York.

The crystal ball is not altogether pellucid at this viewing. Assuming that MOS makes the scene—as many prophets assert it will—it is still not certain whether single-channel or complementary MOS will win out. And within single-channel technology, the n-type devices have not yet come into their own, despite their potentially superior performance.

In the foreseeable future, for ultra-high-speed scratch-pad operation, bipolars can't be touched by anything. All the experts seem agreed on that.

One specialist in systems designed for Government end-use, George Podraza of the Bunker-Ramo Corp., Canoga Park, Calif., concedes the point, but he qualifies it as follows:

"There's nothing exceptionally fast about MOS memories. Bipolars are 10 to 1000 times better in speed-power product figure of

merit." But Podraza adds that this is true only at high frequencies because capacitance is less critical as the frequency is lowered.

Dr. Friedolf Smits, scientist at Bell Telephone Laboratories, Murray Hill, N.J., predicted at the Solid-State Circuits Conference in Philadelphia in February that MOSFETs would never operate at 100 MHz.

**A capacity for sluggishness**

What is the basic mechanism that dooms MOS to second place in the semiconductor speed trials?

It's largely a matter of capacitance. MOS presents a high input-impedance relative to bipolars. Paul Richman, a senior engineer at General Telephone Laboratories, New York City, and the author of a book on MOS ("Characteristics and Operation of MOS Field-Effect Devices," McGraw-Hill Book Co.) said in a recent interview:

"When you look into the gate electrode, all you see basically is capacitance. But there's more to it than just the gate metal capacitance. Look at the structure of an MOS transistor. The output is taken at the drain, the input at the source. The gate electrode, which is separated from the drain by a thin insulating layer, slightly overlaps the drain. You can see that a capacitor is formed with the gate and drain as plates and the insulator between them as the dielectric.

"Basically it is a negative-feedback capacitance, because it goes directly from the drain back to the source. As speed increases, this capacitance becomes more significant and eventually it loads down the device. The negative gate-to-drain capacitance adds in parallel with the drain-to-substrate and channel-to-substrate capacitances. All of these combine to slow down the MOS device."

William McKinley, a microelectronics development engineer at Philco-Ford, adds that the resistance of the MOS device may be 1000 ohms and that of the bipolar device 50 ohms, so that RC charging is through a resistor that's 20 times as large.

"I foresee getting down to 200 nanoseconds on a 256-bit array," he says. "However, a larger array would probably be slower, because

**The basic MOS transistor**

The MOS field-effect transistor has been likened to an almost-perfect switch. Conduction between source and drain is controlled by the electrical potential applied to a gate electrode, which is separated from the doped inversion layer on the substrate by an insulating film.

There are two types of MOS transistors: the n-type, which conducts by means of electrons, and the p-type, which conducts by means of holes.

The device here is a complementary MOS structure, in which p+ material is diffused into n-type silicon. The n-type transistor (below, 8) is isolated, the p-type is not, when the substrate is n-silicon.

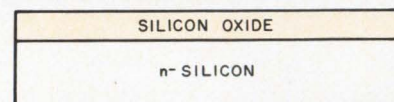

1. OXIDIZE WAFER

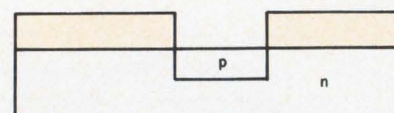

2. OPEN OXIDE AND DIFFUSE pWELL

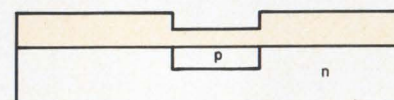

3. RE-OXIDIZE WAFER

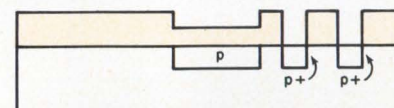

4. OPEN OXIDE AND DIFFUSE p+ SOURCE &amp; DRAIN

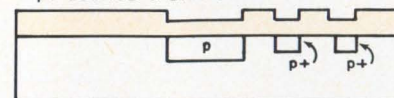

5. RE-OXIDIZE WAFER

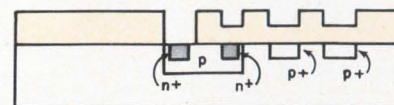

6. OPEN OXIDE AND DIFFUSE n+ SOURCE &amp; DRAIN

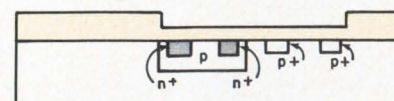

7. REMOVE OXIDE FROM ACTIVE REGIONS

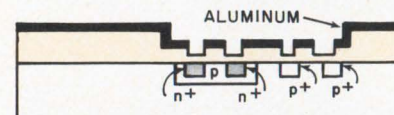

8. OPEN CONTACTS AND METALIZE

# a new low in op amps.

{ Our NH 0001 dissipates only }  
{ a puny 0.6mW at  $V_s \pm 6V$  }

Even the typical dissipation is only 1.8mW at  $V_s = \pm 15V$ , which must be some kind of record. Nevertheless, our mighty NH 0001 will deliver over  $\pm 10V$  into a 2K load from  $V_s = 15V$  supplies. That makes it a natural for space stuff.

A couple of other features of the NH 0001 are its low noise and maximum offset voltage of a mere 1mV at 25° C (only 2mV across the full temperature range). Power supply and common mode rejection are 90db. After that, there's

nothing left to say except that the NH 0001 is packaged in a TO-5 and priced at \$48.00 in 100 to 999 quantities.

If you need them now, call your National distributor. They're on the shelf. Or, if you would prefer to approach the matter more leisurely, write us for data sheets.

National Semiconductor Corporation,  
2975 San Ysidro Way, Santa Clara, California  
95051 (408) 245-4320.

**National Semiconductor**

INFORMATION RETRIEVAL NUMBER 23

**(MOS memories, continued)**

there would be greater capacitance on the chip."

**The battle of the channels**

Various gimmicks have been tried to increase the speed of MOS devices. One is the use of four-phase logic; another is complementary MOS. And other techniques have also been suggested.

Complementary MOS means the push-pull operation of p-channel and n-channel transistors on the same substrate. One unit is always off. Therefore a high impedance is always placed in series with the logic string. Thus little current flows to ground, and power dissipation is low.

Four-phase logic is an attempt to dissipate low power with p-channel devices. Clock inputs are deliberately applied to various transistors to keep them off, thereby opening the dc paths to ground.

Sound design techniques are just as important as the semiconductor technology used. Joseph H. Friedrich of Fairchild Semiconductor Div. presented a technical paper at the Solid-State Circuits Conference describing a 64-bit p-channel memory that employed coincident selection.

Coincident selection eliminates many of the peripheral drivers. The cost advantages become evident as the storage capacity increases. In a matrix type of array, the peripheral electronics increase by the square root of the storage locations.

Friedrich reports that by using high-speed peripheral drivers, he obtains memory cycle times of 200 to 300 nanoseconds. He says that by periodically interrupting the  $-V$  line, one can reduce standby power by a factor of 10 or more without disturbing normal memory operation.

The device is organized as 64 words by 1 bit (see Fig. 1). Flip-flops are the heart of each memory cell (see Fig. 2). Single words are selected by the coincidence of an  $S_x$  and  $S_y$  selection line. Two data lines provide high-speed read and write capability.

Typically, 16 packages can be

grouped to give a 1024-word-by-1-bit organization. Stacking in groups of 16 can increase the word length to any desired size.

Complementary MOS memory arrays are great in the estimation of many MOS and computer experts alike, with a big, qualifying "if"—if the processing technology can be mastered to give high yield, low cost and high packing density.

Podraza of Bunker-Ramo considered complementary MOS in the design of his prototype memory arrays, but decided against it.

"It's too recent a technology," he says. "It's still debatable whether complementary is economical. It requires more steps, and you need isolation. Therefore it takes up more area on a chip. You simply can't pack things as tightly as with four-phase."

Of course, it should be pointed out that four-phase is dynamic and is better suited to logic than to memory, where storage for a finite interval is often required.

David Lynch of Emerson Electric Co., St. Louis, a systems engineer who evaluates airborne and missile-borne computer subsystems, says:

"Complementary MOS is faster than p-channel because of the push-pull pn action, but it is questionable whether complementary MOS can match p-channel yields."

McKinley of Philco-Ford, a staunch supporter of p-channel MOS because of its high yield and small size, isn't overly sanguine over complementary's prospects.

"Complementary doesn't lend itself as well to large memory arrays, because it's generally larger," he says. "Even though complementary may be able to go somewhat faster, I don't think it will be applicable to a memory of 256 bits or more."

**Compliments for complementary**

Richman of General Telephone Laboratories thinks otherwise.

"Complementary MOS is really very simple. The only hard thing about it is its fabrication. But remember that it's in an early stage of its development. I think the problem of fabrication has been solved," he says.

"I've always looked upon four-phase clock operation as a substitute until complementary came of age. Complementary has every advantage of four-phase clock, and you can also use it at very low frequencies. You can put a one or zero in it and hold it forever, practically. You can use it at dc."

Joseph R. Burns and James J. Gibson, research engineers at RCA, Princeton, state the advantages of complementary MOS as follows:

- Microwatt standby power.
- Leakage in nanowatts.
- High speed (up to 10, and perhaps 20 MHz).
- Good noise immunity.

Burns and Gibson say that complementary MOS is relatively immune to noise and drift in device parameters. They cite the low output impedance of the devices. Noise

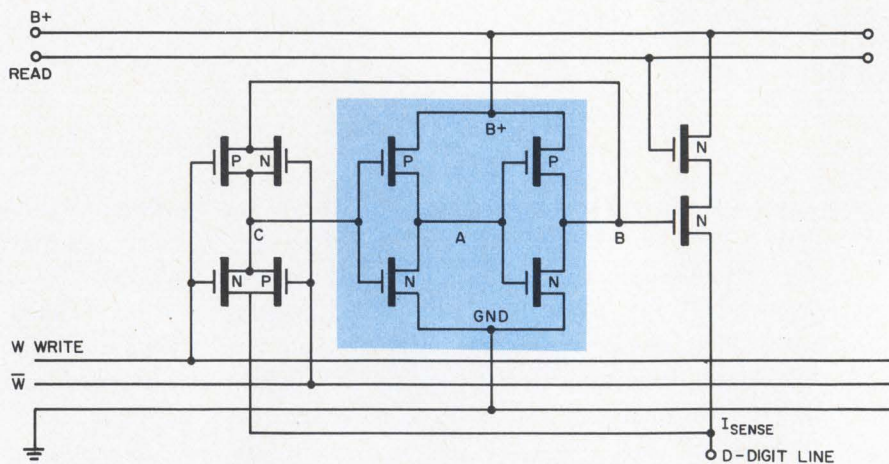

3. Complementary MOS memory cell reads and writes. The basic element is a bistable flip-flop (shaded area), which is formed by connecting two pairs of n-type and p-type MOS transistors in series and cross-connecting them symmetrically. There is no current flow, except for leakage current. Six transistors have been added to each cell to change the state of the flip-flop.



immunity is said to increase with the threshold voltages of the n- and p-transistors. However, beyond a certain point, increasing the threshold voltage retards the operation of the pn pairs. Therefore Burns and Gibson usually compromise on a threshold value of between 10 and 20 per cent of the supply voltage.

Sensing is done in nanoseconds, they say, because the sense signals don't need amplification. Many words can be connected to the same digit line. A typical cell is shown in Fig. 3.

The important question, still unanswered, Burns and Gibson say, is how well complementary scratch-pad memories, which would require special interface circuits, will compete with all-bipolar scratch-pad memories. In the final analysis this is going to depend on such device considerations as packing density, size, yield, speed, noise immunity and power consumption, as well as on such systems aspects as packaging, need for special-purpose circuits and maintenance.

### The power of negative thinking

Among the other techniques suggested for increased operating speed is the wider use of n-type transistors (instead of p-type or complementary).

Dale Critchlow, an expert on semiconductor memories at International Business Machines Corp., Yorktown Heights, N.Y., stated at the Solid-State Circuits Conference that "n-channel devices offer the potential of three to four times greater mobility, which can be translated into a desirable combination of higher speed and lower power."

McKinley of Philco-Ford estimates that n-channel should be two to three times faster than p-channel. However, he cites the difficulties in controlling the device threshold.

"An n-channel device inherently wants to be on," he says. "To make an enhancement-mode device, you have to have extreme control of processing. It isn't a production type process today, although I think that in two or three years it might be."

The prevalence of p-channel MOS over n-channel is perhaps best ex-

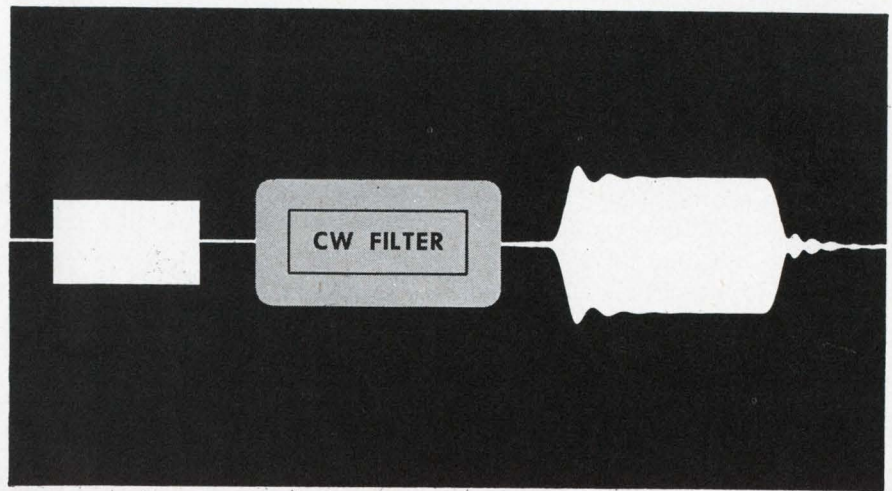

# SUPERIOR PULSE RESPONSE

with Matched Crystal Filters by DAMON



Matched Crystal Filter Model 5399A  
Center Frequency: Every 10 KHz  
from 5000 KHz to 5150 KHz  
Size: 3" L x 1" H x 7/8" W

Optimization of the signal-to-noise ratio of a pulse receiver is now possible with the Damon Matched Crystal Filter.

The illustration, above, compares the response of a conventional crystal filter with that of a Damon Matched Crystal Filter. The Damon Matched Crystal Filter not only minimizes overshoot and ringing, but since the filter is matched to the transform of the input pulse, maximum signal-to-noise ratio is also achieved.

Solutions to complex pulse modulation crystal filter designs cannot be "picked from a chart". Consultations between circuit designers and Damon engineers are the best route to proper filter selection. As a starter, may we invite you to write for our Technical Bulletin on Matched Crystal Filters. Damon Engineering, Inc., 115 Fourth Avenue, Needham Hts., Mass. 02194 (617) 449-0800.

## DAMON

**(MOS memories, continued)**

plained by Richman of General Telephone Laboratories:

"First, the stability of n-channel has never been as good as that of p-channel. Sodium tends to drift through n-type devices more than with p-type. This sodium drift lends itself to MOS device instability.

"Second, for logic applications you've got to use enhancement devices [defined as being off with zero gate voltages]. You can still perform switching with a depletion device, but you've got to have an extra power supply, and it's messy. Therefore you always want to operate digitally with enhancement-type devices. It is very easy to fabricate p-channel enhancement-type devices, but it's rather difficult to fabricate n-channel enhancement-type devices that still have the desired characteristics of high breakdown voltages, slow substrate modulation and all the rest."

**Take a big byte**

Some companies are considering byte, rather than bit, organization of random-access memory arrays to decrease memory cycle time.

Donald Richard, product marketing manager of American Microsystems, Inc., says that organization by bytes lowers the access times, because there are fewer word lines.

If a 256-bit memory were organized into 8-bit words, then it would be necessary to decode only 32 parts, instead of 256. Since the words would be tied in parallel, the capacitance would be 8 times as great for the 256-bit organization. And capacitive reactance is the enemy of speed.

Is there any laboratory development in the offing that could dramatically change the picture?

RCA, Autonetics and others are working on the silicon-on-sapphire technique. Because the sapphire substrate is an insulator, capacitances to the substrate are negligible, hence, slightly faster switching is possible. Burns of RCA has reported on complementary silicon-on-sapphire memory cells with standby power dissipations of 10 microwatts per bit and a pair delay time of 12 nanoseconds.

However, the chief benefit of depositing single-crystal silicon on sapphire lies in the convenience of fabricating LSI arrays. There is no diffusion, and junctionless p-channel MOSFETs can be fabricated if the silicon films are thin enough. Isolation is notably easy, and one thermal processing step is avoided.

**Mobilize for speed**

Dr. Richard Wegener of Sperry Research Laboratories, Sudbury, Mass., comments:

"A nice way of speeding up the devices is to use materials with greater mobility." Dr. Wegener suggests germanium, which is receiving renewed attention. Gallium arsenide, which has high mobility, theoretically could lead to an order-of-magnitude reduction in delay times in four or five years. The only fly in the ointment is the poor stability thus far exhibited by gallium arsenide. It may be possible to use indium antimonide, which has still higher mobility.

The problem with all of these substitutes is the difficulty of fabricating LSI. Right now, silicon has a clear edge.

Dr. Wegener has evolved a concept that he calls a slow-write, fast-read memory. He says that the voltage threshold on the gate is sensed logically, as a one or as a zero. Writing occurs only when the proper logic level is maintained for a specified interval.

Dr. Wegener says the arrays use metal-nitride-semiconductor (MNS) structures rather than MOS. He claims that MNS lends itself to LSI and is nonvolatile. Power can be interrupted without spilling the contents.

**Write not, want not**

Where writing into memory is not a requirement, read-only memories offer a transistor-to-bit ratio of almost one-to-one. Random-access, read-write memories will predominate in general-purpose computers, but permanent memory will definitely have a place, too, in such applications as calculators and decoders.

David Callan of General Instrument Co., Tarzana, Calif., says that his group is working on 500-bit arrays. Callan suggests using read-

only memories in character generation. It should easily be possible to store 35 or 40 alphanumeric characters within the confines of a single chip, assuming a code of six or seven bits per character.

David Schaefer of NASA's Goddard Space Flight Center says his organization is very much interested in complementary MOS read-only memories because they consume practically no power.

NASA has had favorable experiences with MOS devices, although not specifically with memory arrays. In the panel session on MOS devices at the Solid-State Circuits Conference, Schaefer reported that a satellite with MOSFET encoders aboard was launched with the intention of putting it into lunar orbit. Instead, it ended up on an earth orbit, whereupon NASA dispatched another satellite to the moon with an identical encoder.

One unintended benefit of the satellite that failed to reach escape velocity was the accumulation of 511 days' data.

"Thus," Schaefer chortled, "MOS is firmly in orbit around the earth and the moon."

**Memory through a pipe**

Before the advent of random-access MOS memory arrays, much of the design effort was directed toward shift registers. While it is obvious that random-access arrays will outstrip shift registers because the latter must drive all preceding bits through the register before the desired bits are reached, Richman of General Telephone Laboratories believes that shift registers, too, have their place.

"It depends on how computers of the future shape up," he says. "If you believe pipelining is the way to go, with data flowing through the computer like water through a pipe, then shift registers will prove very important."

Lynch of Emerson Electric contends that shift registers have serious drawbacks.

"Much work is being done on bipolar registers," he says. "American Microsystems has units that go to 10 MHz. However, they are not random access. They don't hold data—it's dynamic storage. The higher the temperature, the sooner you have to clock them." ■■

# Making magnetics work.

**Materials • Design • Production**  
**Basic technologies**  
**for applying the**  
**magnetic field.**

**Indiana General Corporation**

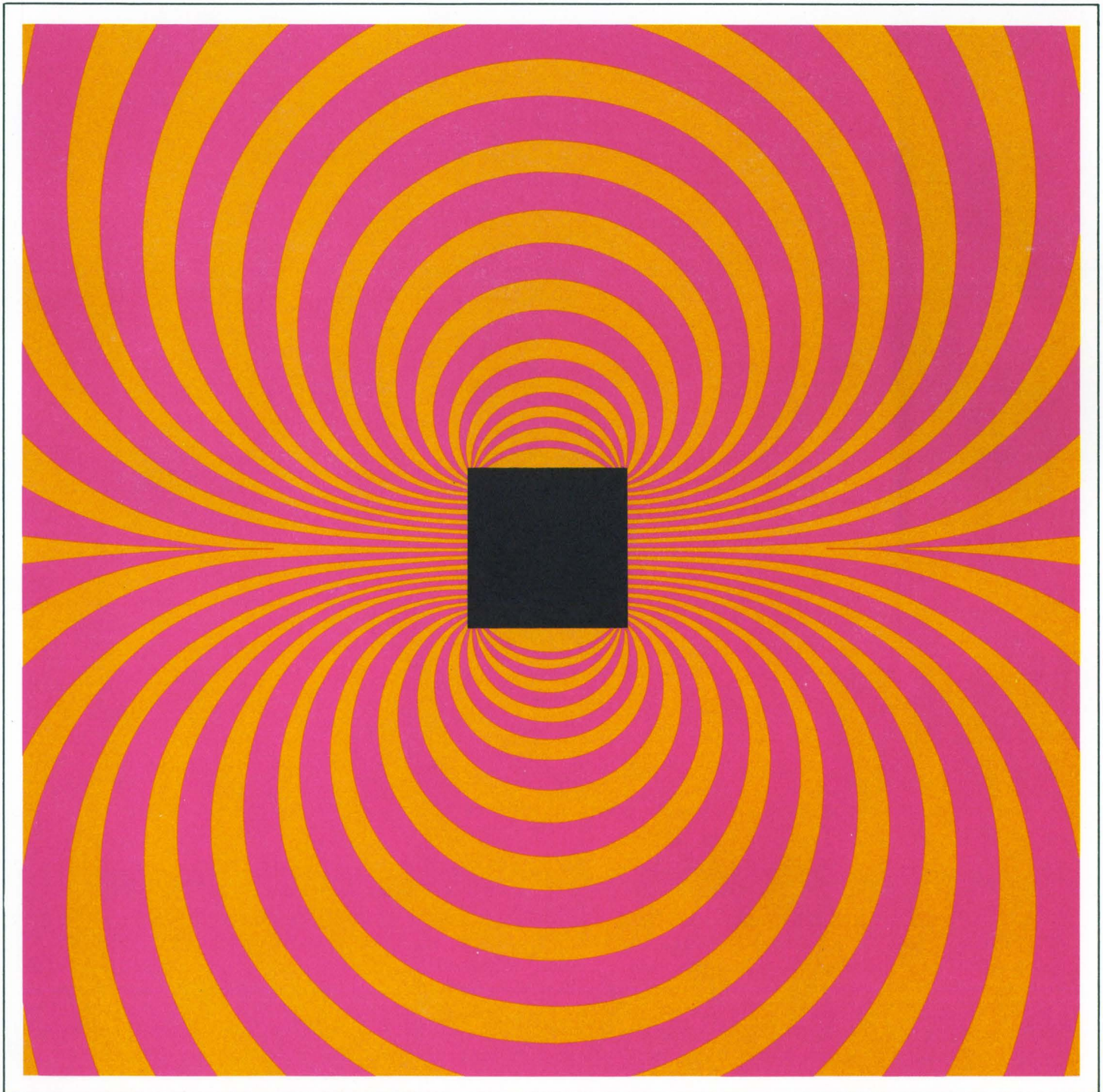

**A** lot of materials are magnetic. The trick is to make them work. From computers to PM motors, magnetic materials technology tailors coercive force, permeability, resistance, "Q" factors and many other characteristics to meet application needs.

Indiana General has a good batting average at solving problems through materials technology. The recording-head ferrite that made instant TV-Playback practical. The first computer memory core. The first ceramic magnet specifically for PM motors. And a nickel-free ferrite for color TV yokes. These are a few. On the next page are a few more. Altogether we've developed 22 permanent magnet materials (15 alloys & 7 ceramics), 19 ferrites and 16 memory cores. They are standards now. They'll soon be joined by new materials we're developing.

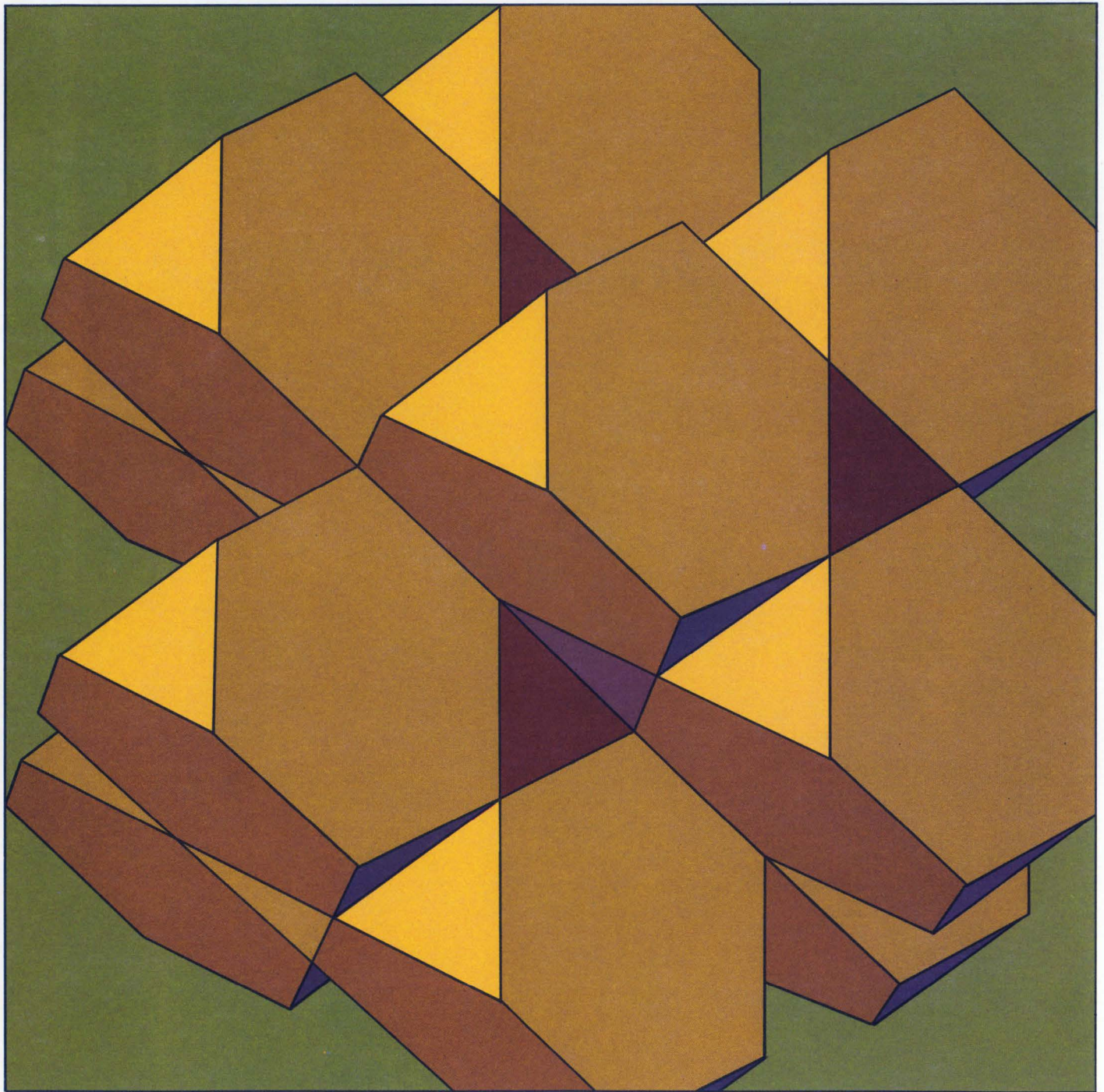

Magnets aren't fooled by external appearance. IGC-developed ceramic magnet separators helped make taconite ore separation a profitable reality.

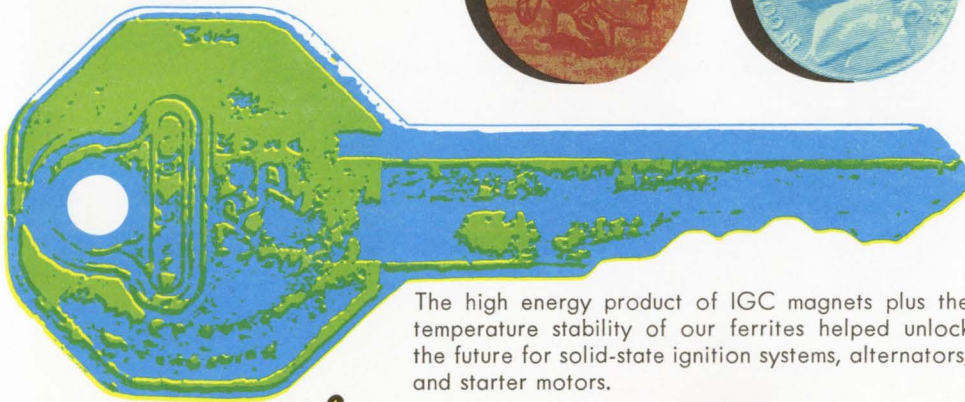

The high energy product of IGC magnets plus the temperature stability of our ferrites helped unlock the future for solid-state ignition systems, alternators, and starter motors.

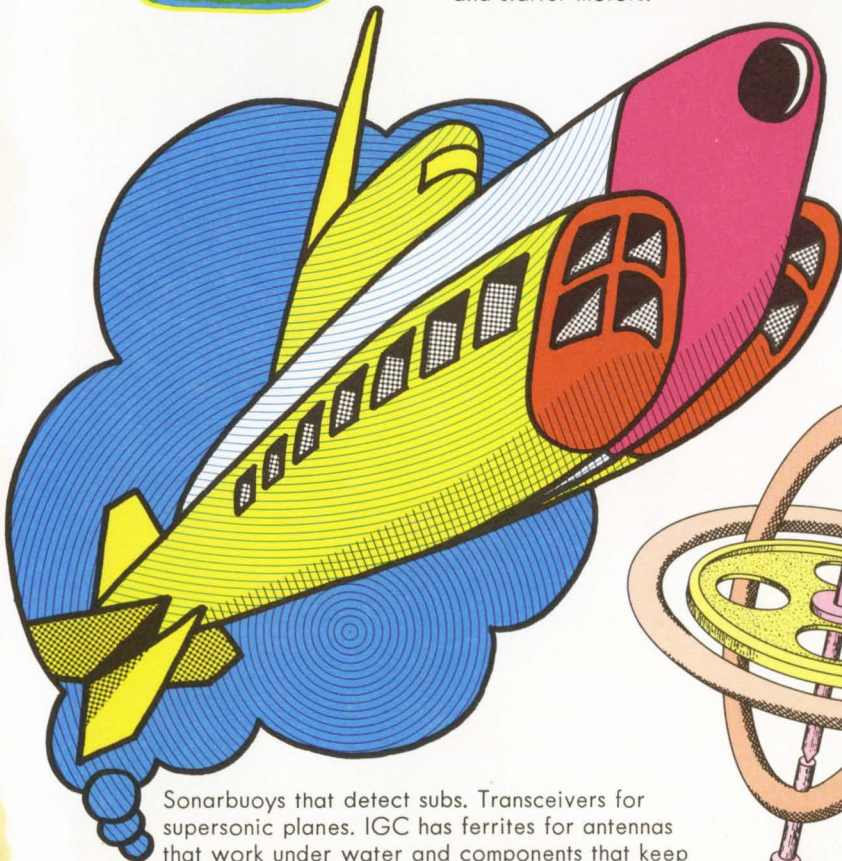

*Inertial guidance computers must interpret gyroscopes. Our Microstack memories meet size, weight and reliability demands in both the F-111 and commercial planes.*

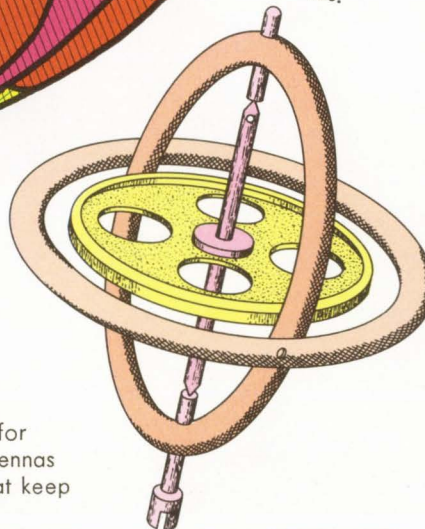

Sonarbuoys that detect subs. Transceivers for supersonic planes. IGC has ferrites for antennas that work under water and components that keep their cool as the temperature climbs.

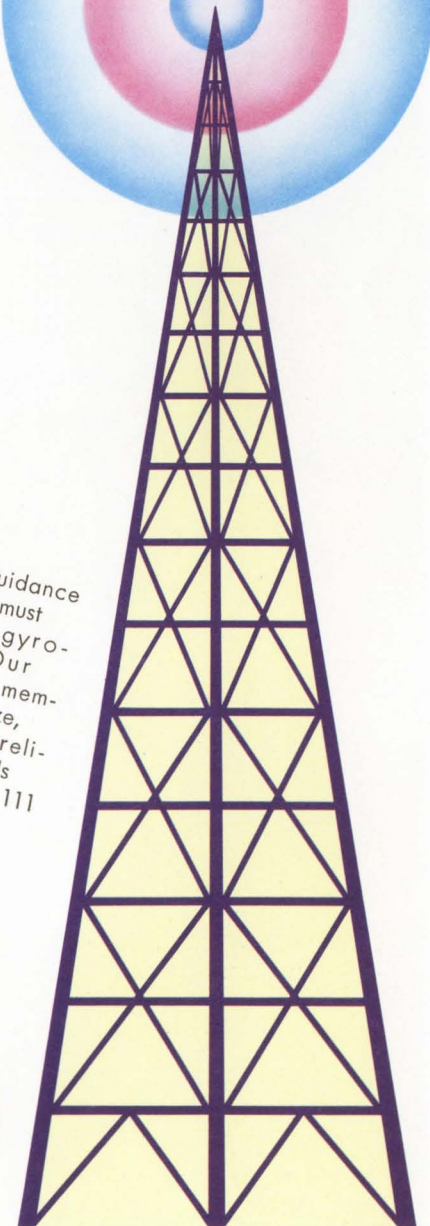

CATV provides TV for restricted areas. IGC ferrites provide unrestricted power and frequency for transformers, booster amplifiers, and baluns.

**F**orm follows function is a good rule for architects. And for magnet designers, too. The shape of the magnetic material affects the magnetic field and performance efficiency. The right design can make a new idea become a reality, or reduce the size, weight, and cost of existing parts. We've done it with magnetic couplings, speaker magnets, permanent suspended separation magnets and the applications shown at right. Just to name a few. And we not only helped make PM motors for cars practical, we also developed a whole new concept in precision f.h.p. motors we're now making ourselves. We do more in the field of magnetic design than anyone. We can do yours for you.

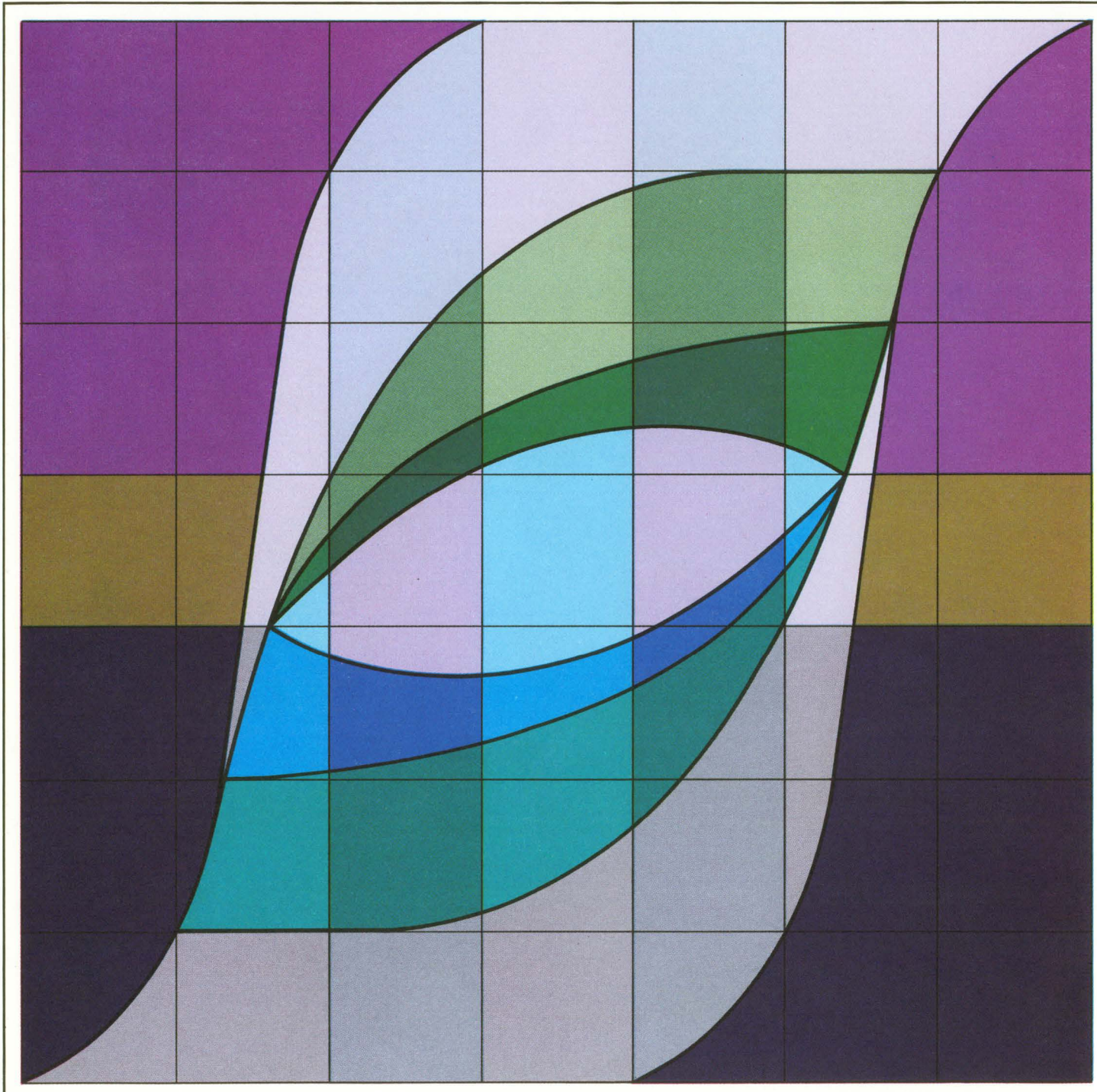

Nobody wants a rusty kiss. We keep ferrous and non-ferrous particles out of cosmetics (and practically every other product) with an electronic metal detector that catches particles as small as 0.03".



To protect fragile memory plane magnet wire terminations we've created a frame with no external wire terminations. It's called Cor-Gard.

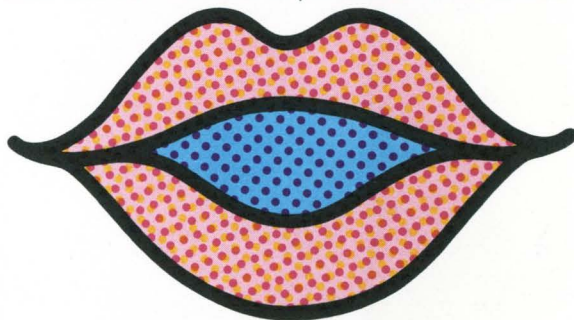

If this meter is wrong, somebody pays. IGC helped design a magnetic thrust bearing. No friction, no wear, no inaccuracy.

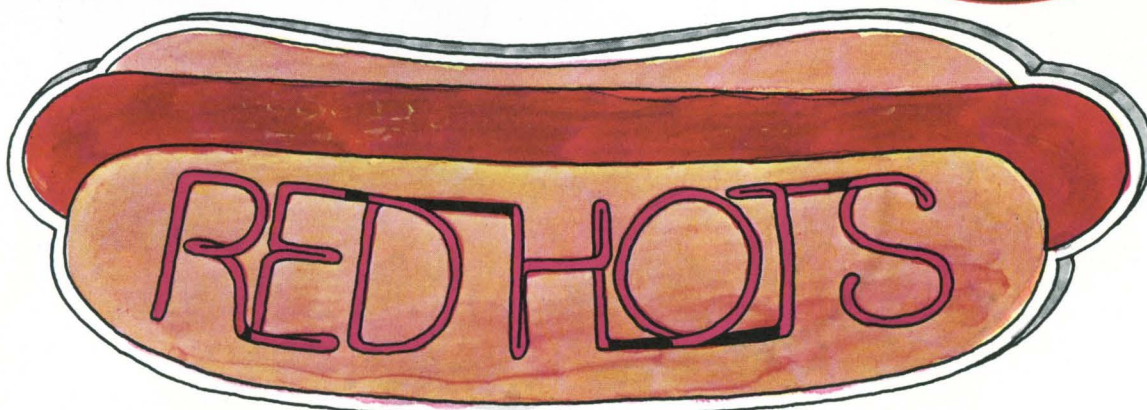

Magnetron magnets for "radar ranges" and TWT's for radar. IGC has cooked up more magnetron magnet and TWT stack designs, plus magnetizing, testing, and stabilization equipment, than anyone.

**M**agnetics starts with materials technology. Design gives it shape. But production is the pay-off. The ability to make a single item, or a million, with consistent reliability. It isn't easy. Cooling is as important to alnicos as heating. Ceramics must be pressed in a magnetic field. Controlled atmosphere, temperature and pressure are important to ferrites and memory cores. And since most magnetic materials are extremely difficult to machine, economy means holding tolerances exact. Whether it's 20-mil toroids, 55-ton electromagnets, ore separators, precision motors, memory cores and stacks, ceramic and metallic magnets, or magnetizing and test equipment, Indiana General has cemented its position as world leader in magnetic materials and equipment through production know-how.

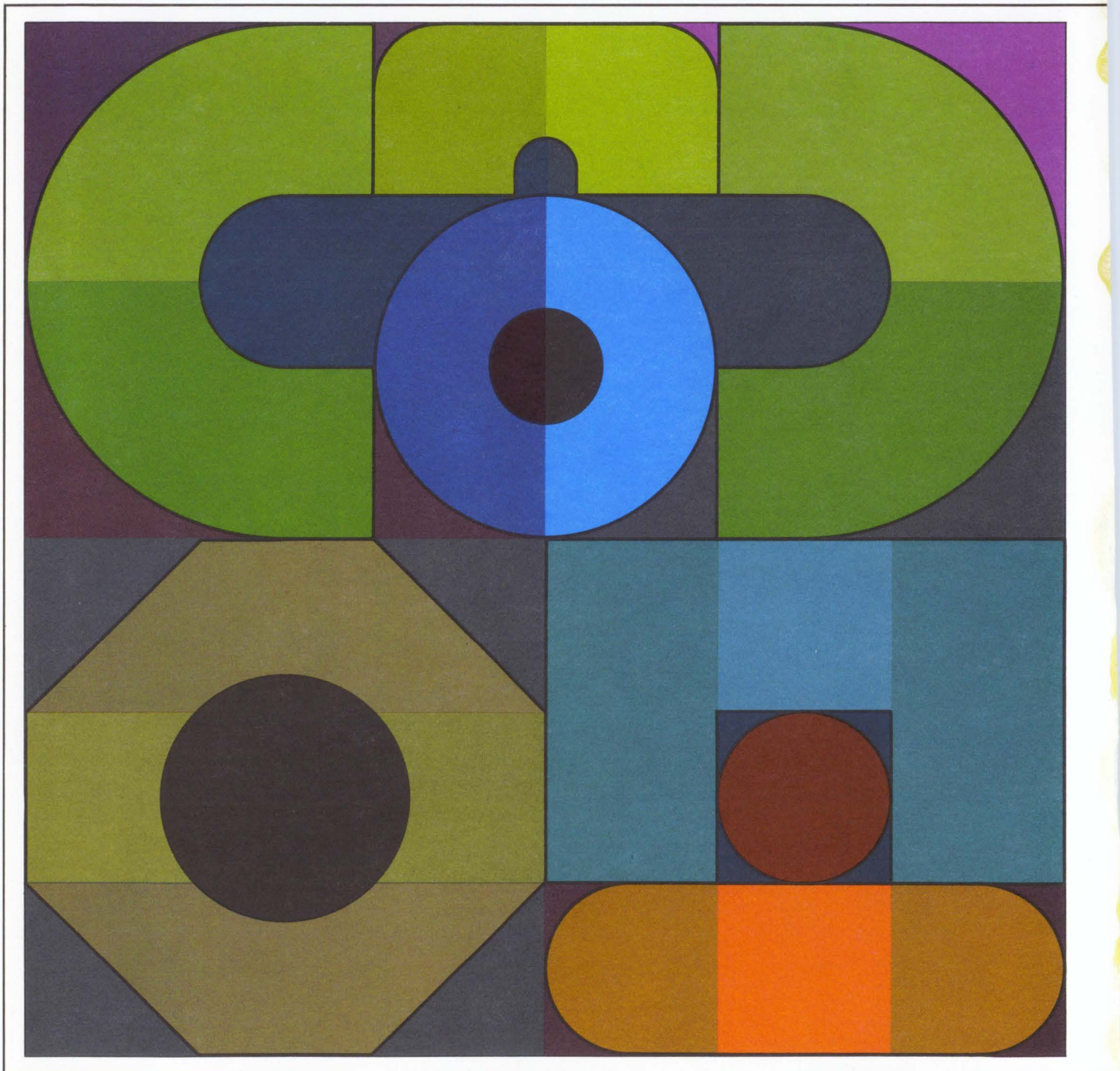



One of a kind or one of thousands. The Lunar Module won't use many of the special microminiature radar transformers we created. But other radar systems use IGC ferrite cup, cross and transformer cores by the millions. Neither quantity gives us trouble.

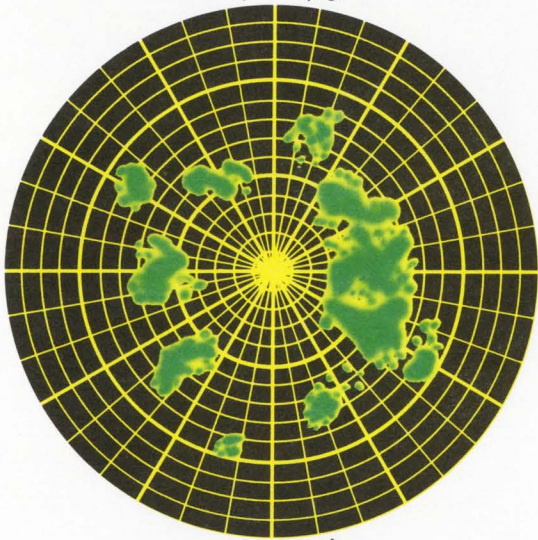

If it involves PM motors our Indox magnets make dreams come true. With 4 different magnet materials developed especially for motors, we make segments in huge quantities for appliances, tools, autos—practically every industry where motor designers are working.



Component combos are shrinking. We've developed the smallest ferrite cup core for IC's. Only 0.125" O.D. and 0.035" thick with 0.005" tolerances. And a new ferrite toroid only 0.08" O.D. and 0.05" I.D.

Small measurements often demand massive effort. Like the 1000-lb (or bigger) permanent magnet assemblies IGC makes for mass spectrometers and ion pumps. We not only make monsters but equipment to magnetize and stabilize them, too.

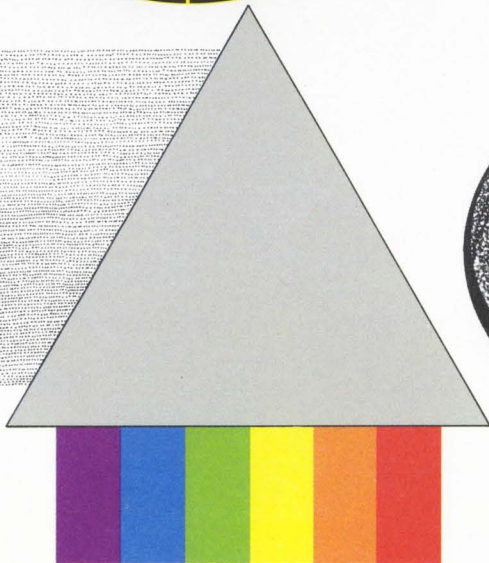

## Expanding the limits of the magnetic field.

**RESEARCH**—Making magnetics work requires looking ahead and behind at the same time. Rare earth alloys are opening new avenues for magnetic adventuring while present developments are making it profitable to re-examine the past. For example: one of our ferrites had been the preferred material for chokes and inductors for years. On a second and third look it turned out to be ideal for both low and high frequency antennas as well as an outstanding RFI attenuator. Indiana General engineers are leading the industry in developmental and applied magnetics research . . . making magnetics work by expanding the field for practical applications.

At present they are working in the areas of plated wire memories, ferrites for high frequency fluorescent lighting, new metallic and ceramic materials, as well as basic research into the nature of the magnetic phenomena. **EDUCATION**—How do you turn off a permanent magnet? What is the relation between configuration and the magnetic field? These are just a few of the basics engineers must know about magnetics. We'll tell anybody who asks. But we don't wait. Every year our top engineers hold seminars all over the country on the basics of magnetic design. It's just one more effort on the part of Indiana General to help make magnetics work, better.

INDIANA GENERAL CORPORATION, Valparaiso, Indiana 46383

I want to know more about the basic technologies of applied magnetics. Send the literature I have checked below.

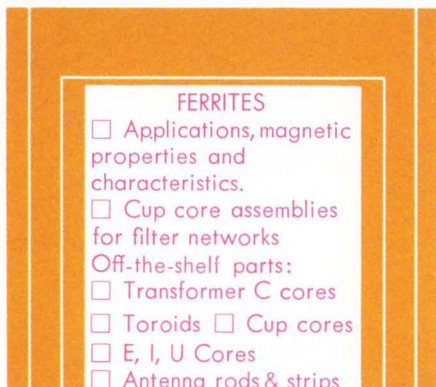
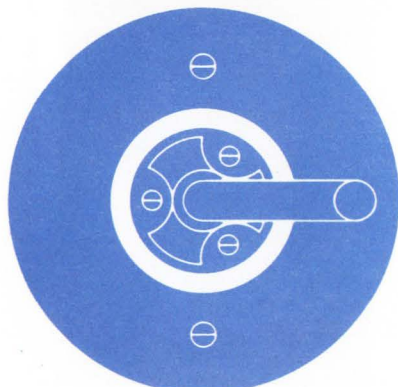
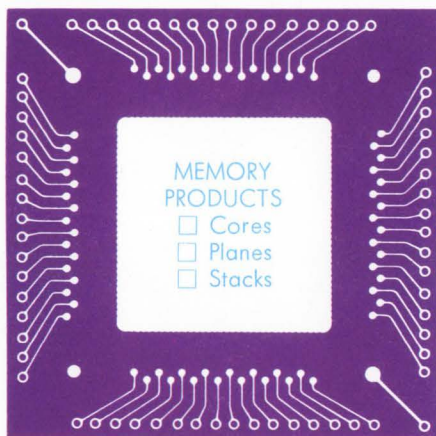
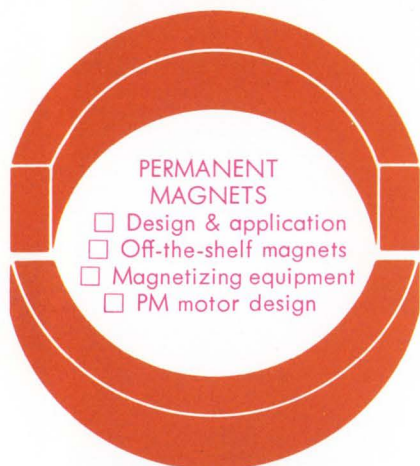

Name \_\_\_\_\_ Title \_\_\_\_\_

Company \_\_\_\_\_

Address \_\_\_\_\_

City \_\_\_\_\_ State \_\_\_\_\_ Zip \_\_\_\_\_

**INDIANA GENERAL**



**Making Magnetics Work**

Corporate Headquarters, Valparaiso, Ind.; Magnet Division, Valparaiso, Ind.; Electronics Division/Ferrites and Memory Products, Keasbey, N. J.; Electro-Mechanical Division, Ogleby, Ill.; Magnetic Equipment Division, Cudahy, Wis.; BMS Carbide Specialties Division, Boonton, N. J.; Indiana Steel Products of Canada Ltd., Kitchener Ontario; Ferromagnetica, S.A. Mixcoac, Mexico City and Calpulalpan, Mexico.

## Laser tuned by cooling optical crystal

A continuous-wave-laser parametric oscillator, tunable over a range of 1800 Å, produces light at useful power levels across this range.

The development is the result of experiments at Bell Telephone Laboratories, Murray Hill, N.J., with barium sodium niobate ( $\text{Ba}_2\text{Nb}_5\text{O}_{15}$ ), a new nonlinear optical crystal previously discovered at the laboratories.

Bell scientists say that the tunable laser oscillator concept can be applied to laser communications systems. It can increase the number of communications channels already possible with lasers at one frequency by making practical the frequency multiplexing of optical carriers.

The Bell research team was led by Dr. Joseph Geusic, head of the Solid State Optical Device Dept.

Two barium sodium niobate crystal blocks are used in the experimental parametric oscillator. One serves as a harmonic generator within a solid-state laser cavity to convert the infrared energy of the laser at 10,600 Å to green light at 5300 Å. The second with a polished outer face is combined with a separate, silvered mirror to form the tunable optical cavity.

The green light from the harmonic generator is used to pump the tunable optical cavity. By changing the temperature of the

tuning crystal, one can change the frequency of the output signal over the 9800 to 11,600 Å range.

Last year Bell Laboratories reported successful experiments in tuning the output of a helium-neon, continuously pulsed gas laser. Doppler shifts of  $\pm 45$  GHz were obtained by rapidly changing the refractive index of a stationary lithium niobate crystal (see Laser Beam Shifted  $\pm 45$  GHz by Crystal," ED 24, Nov. 26, 1967, p. 32).

An rf pulsed field applied to the crystal locks with optical pulses and changes the refractive index of the crystal. This shifts the frequency by varying the effective optical path length.

Lithium niobate, however, has only about half the nonlinear coefficient of the newer crystal and is more susceptible to damage by high laser powers because of its incomplete lattice structure.

A continuously pumped neodymium-doped yttrium aluminum garnet (Nd/YAG) crystal laser is used as the primary coherent light source. These lasers are capable of producing more than 25 watts of cw infrared light, but only enough power is used to assure reasonable output power after frequency conversion losses.

Green light generated within the cavity at power levels of only 45 milliwatts is used to pump the external cavity. ■■

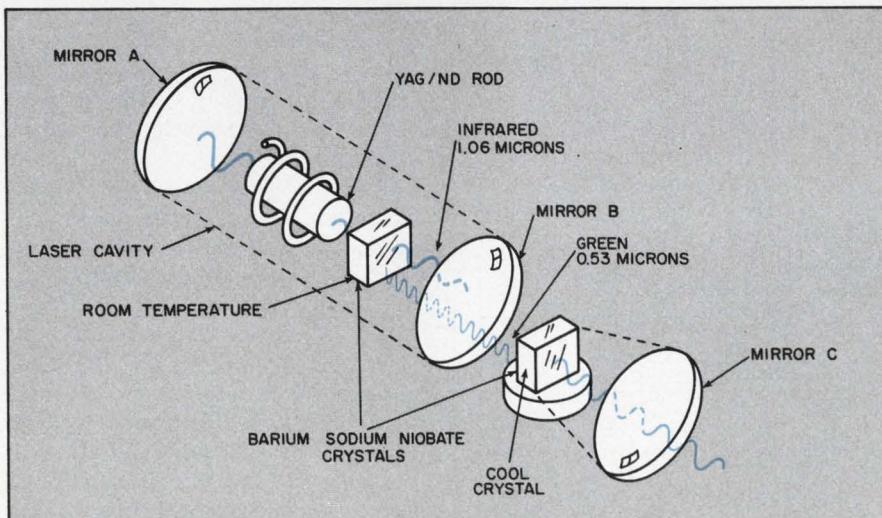

**Tunable optical parametric oscillator** uses two barium-sodium-niobate crystals. The unit in the laser cavity converts the infrared laser output to green light. With cooling, the external unit tunes the output over 0.18 micron in the infrared region between 0.98 to 1.16 microns.



**WHY SHOULD YOU  
SPECIFY  
MECATORN®  
SPUN  
REFLECTORS?**

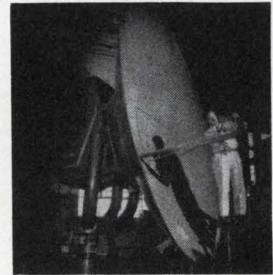

The exclusive Torngren Mecatorm® hydraulically controlled spinning process has produced thousands of spun-to-specification "dishes" in use today by both military and commercial communication networks — at substantial savings over other more costly fabricating methods.

If you have a requirement for parabolic reflectors from 4 inches to 16 feet in diameter call Torngren today for complete details on the cost saving and metallurgical advantages of the Mecatorm® process.

Send for a free copy of our new capabilities brochure today!



C. W.

**TORNGREN**

COMPANY, INC.

INFORMATION RETRIEVAL NUMBER 25

# Now you can get a miniature ceramic capacitor for AC applications

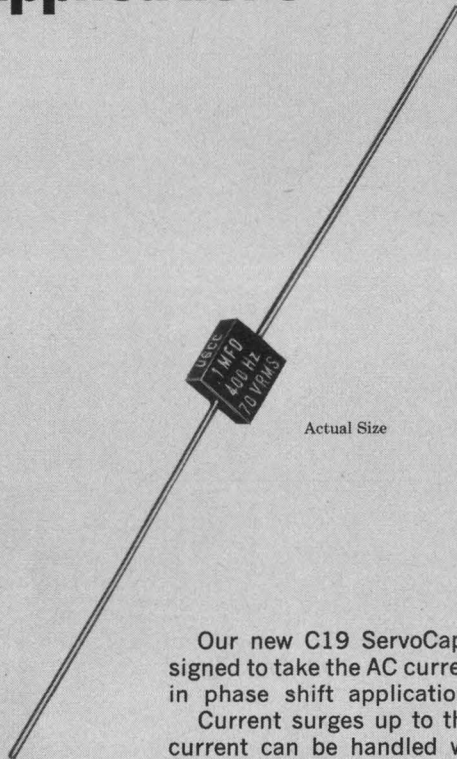

Our new C19 ServoCap® Series is designed to take the AC currents encountered in phase shift applications.

Current surges up to three times rated current can be handled with no appreciable degradation.

The low leakage factor will solve your isolation problems.

The small profile will solve your size problem.

If you design for small motor starters, power amplifiers, servo or pulsing applications for digital logic circuits, investigate the C19 ServoCap® Series from USCC.

#### GENERAL SPECIFICATIONS:

Capacitance range: .01 Mfd to 10 Mfd  
Voltage rating: 70 VRMS at 125°C  
Frequencies: 400 Hz and 1200 Hz  
Capacitance tolerances: ±5%, ±10% and ±20%

*For current information, call or write*



U.S. CAPACITOR CORPORATION  
2151 No. Lincoln Street • Burbank, California 91504  
(213) 843-4222 TWX: 910-498-2222

## NEWS

### Atlantic test center to get sonar range

The Navy is about to begin construction of an elaborate sonar range that will enable it to calibrate complex shipboard sonars.

One of six industry proposals will soon be selected for a five-year development project to equip the range. It will be part of the Navy's Atlantic Undersea Test and Evaluation Center (Autec) complex off Andros Island in the Bahamas.

The weapons range is already operational and equipment for its acoustical range is now being delivered. All three ranges are off the eastern edge of the island in a natural trough, called the Tongue of the Ocean, that is 6000 feet deep, 100 miles long, and 20 miles wide.

When completed, the sonar range will be equipped to calibrate sonars, both active and passive, on submarines and surface ships.

To calibrate active shipboard sonars, submerged arrays of hydrophones receive signals which are analyzed for beam patterns and power levels.

For the receiving sensitivity of the ship's sonars, active sonar arrays in the sea will send signals of known strength and characteristics.

A sonar's ability to locate targets can be tested by studying the main and side lobes of the sonar signal pattern. The effect of the ship's hull and the sonar dome on the sonar's accuracy in measuring the azimuth angle to the target will also be studied.

The sonar can be checked in its various depression modes—from horizontal transmission to almost straight down.

Two Control Data Corp. 3400 computers are used to process all data. By the time the sonar range is completed, more capability will be needed, the Navy says.

To determine the ship's precise position, three systems are used: submerged acoustic arrays to track both submarines and surface ships and optical theodolites and radio navigation systems, such as loran, Decca or others, for surface ships.

Information from the arrays is sent back to the data processing room by cable, land line, microwave links and vhf radio. ■■

# tricky tapers...

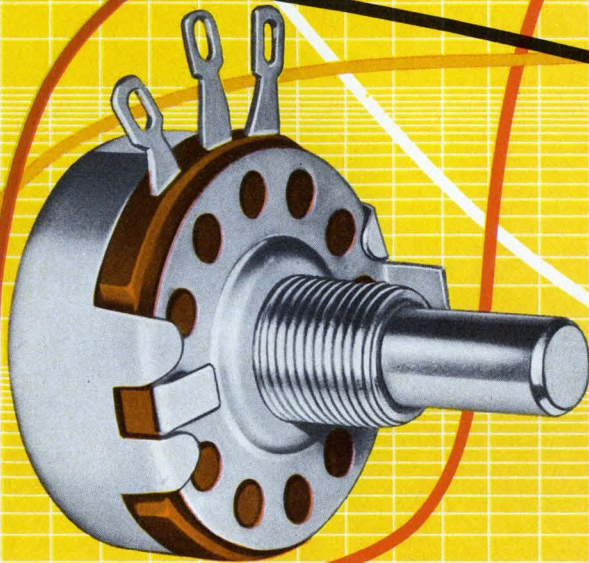

Allen-Bradley Type J  
hot molded variable resistor  
shown twice actual size

## Allen-Bradley Type J potentiometers offer tapers designed to your special needs!

■ When standard tapers fail to provide the control you desire, Allen-Bradley Type J potentiometers have the unique capability to provide a virtually limitless variety of curves to meet your specialized requirements. While not a precision device that is continuously taper-trimmed to very close tolerances, Allen-Bradley's control of the resistance-rotation characteristics during production assures a high degree of conformity.

Allen-Bradley Type J potentiometers have a solid hot molded resistance track made by an exclusive process which was pioneered and perfected by A-B. This solid resistance track assures smooth adjustment at all times—with none of the discrete changes in resistance that are encountered in wire-wound units. And being essentially noninductive, Type J controls can be applied in high frequency circuits where wire-wound units are useless.

Furthermore, A-B's solid molded resistance track assures low noise and long life. On accelerated tests, Type J potentiometers exceed 100,000 complete operations with less than 10% change in resistance.

For more complete details, please write: Allen-Bradley Co., 1344 South Second St., Milwaukee, Wis. 53204. In Canada: Allen-Bradley Canada Limited. Export Office: 630 Third Ave., New York, N.Y., U.S.A. 10017.

### ADDITIONAL ALLEN-BRADLEY HOT MOLDED VARIABLE RESISTORS

**TYPE G CONTROLS** are only  $\frac{1}{2}$ " in diameter. Quiet, stepless operation. Rated  $\frac{1}{2}$  watt at 70°C. Values to 5 megohms. Type L are similar in construction but rated  $\frac{1}{2}$  watt at 100°C.



**TYPE F TRIMMERS** are for mounting directly on printed wiring boards by means of their terminals. Rated  $\frac{1}{4}$  watt at 70°C. Values to 5 megohms. Type O are similar but rated 0.4 watt at 70°C.



**TYPE R ADJUSTABLE RESISTORS** for trimming applications are built to withstand environmental extremes. Only  $1\frac{1}{4}$ " in length. Have stepless adjustment. Watertight and can be encapsulated. Rated  $\frac{1}{4}$  watt at 70°C. Values to 2.5 megohms. Type N for less severe environments are rated  $\frac{1}{3}$  watt at 50°C.



**ALLEN-BRADLEY**  
QUALITY ELECTRONIC COMPONENTS



# 'Flying radar' poses a design challenge

**With 20 tons of airborne electronics, interference, reliability and flight maintenance are problems**

**John F. Mason**  
Military & Aerospace Editor

A promising solution to the problem of developing an airborne "overland" radar that can detect a low-flying enemy bomber has finally got the Airborne Warning and Control System (Awacs) program off the ground. The green light for contract-definition studies for the entire system is expected this month. The contractors will be the Boeing Co. in Seattle and McDonnell-Douglas, Inc., in Long Beach, Calif.

Although the precise radar technique to be used has not been determined, one will soon be selected. In January, Robert S. McNamara, then Defense Secretary, said: "At least two of the possible solutions I mentioned last year look extremely promising, and we will eventually have to choose between them."

One known way to detect a small target against a big background is to use a narrow beam to scan small sectors, memorizing the doppler shift of each. When a second look

at a sector reveals a different doppler shift, the presence of a moving object can be suspected.

The four companies that have worked on the radar project are the Raytheon Co.'s Space and Information Systems Div., Bedford, Mass.; Westinghouse Electric Corp.'s Air Arm Div., Baltimore; Hughes Aircraft Co.'s Ground Systems Group, Fullerton, Calif., and the General Electric Co.'s Heavy Military Electronics Dept., Syracuse, N.Y.

All four companies propose using a radar antenna inside a rotating radome (called a rotodome), mounted on the aft fuselage or tail of the plane. The rotodome will be approximately 6 by 30 feet.

Each company is using a different pulse repetition frequency. Raytheon and GE are using the low prf, Westinghouse the high prf, with Hughes in the middle.

Ground clutter problems are being studied by the Illinois Institute of Technology Research Institute in Chicago.

"Although the design of the radar display is still open, it will

probably be a cathode-ray tube," according to Alan Shoolman, the Airborne Warning and Control System's project leader at the Mitre Corp., which is providing systems engineering to the Air Force. "What form the presentation takes, however, is something else."

## A tactical role envisioned

Besides its antibomber defense role for the Air Defense Command, the warning system will serve the Tactical Air Command in brush-fire war situations. Until a tactical air control system is set up on the ground, the elaborately equipped planes will be able to run a war.

Command and control studies have been performed by International Business Machines Corp. and Litton Industries, Inc., under separate Air Force contracts.

The plane will be loaded with electronic equipment, close to 41,000 pounds of it.

With so many subsystems that must operate with each other, with systems on the ground and in the air, interface will be a problem.

For its tactical air control role, the aircraft must be able to operate with the Japanese air control system, the one in Europe, and the 407L system, now being developed (see "Air Force Getting War Network That Can Travel," ED 6, March 15, 1968, p. 25).

## Problems to solve

Whether to use one central computer or a number of smaller computers has not been determined. Regardless of this decision, Shoolman says, "the avionics system must be designed to minimize interface problems. The frequent practice of assuming that software can compensate for poor design of the avionics interface equipments must not be permitted. The result is usually over-commitment of the computer, which is an obstacle to operating in real time."

Some of the problems that designers will have to solve, Shool-

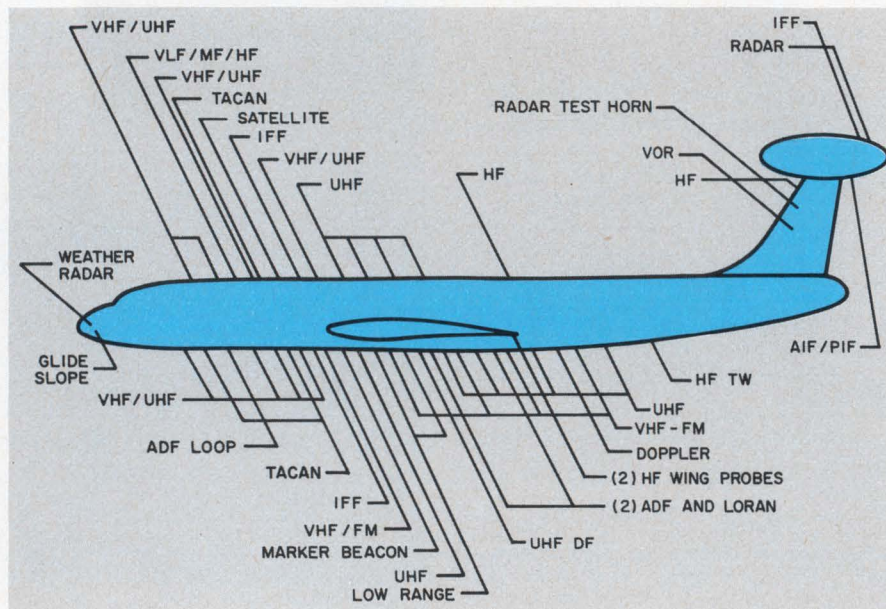

Awacs will bristle with more than 30 antennas plus big radome on the tail.

# single source

**"second source everything...except Allen-Bradley hot-molded resistors"**

NEXUS RESEARCH LABORATORIES, INC.

NEXUS operational amplifiers showing use of Allen-Bradley hot-molded resistors





Management's instructions to Purchasing for exclusive use of Allen-Bradley hot-molded resistors is one of the precautions Nexus takes to insure the reliability of its products. A course more and more leading manufacturers of quality electronic gear are tending to follow.

There are sound reasons behind this trend. Years of accumulated experience have shown that Allen-Bradley hot-molded resistors are unequalled for uniformity, predictable performance, appearance, and freedom from catastrophic failure.

Allen-Bradley resistors are made by an exclusive hot-molding process on fully automatic machines—developed, built, and used *only* by Allen-Bradley. There is such complete uniformity from one resistor to the next—million after million—that long term in-circuit performance can be predicted with a high degree of accuracy.

Complete specifications for Allen-Bradley hot-molded resistors are contained in Technical Bulletin 5000. For your copy, please write: Allen-Bradley Co., 1344 South Second Street, Milwaukee, Wis. 53204. In Canada: Allen-Bradley Canada Ltd. Export Office: 630 Third Ave., New York, N. Y., U.S.A. 10017.



 TYPE BB      1/8 WATT	 TYPE EB      1/2 WATT	 TYPE HB      2 WATTS
 TYPE CB      1/4 WATT	 TYPE GB      1 WATT	<p>A-B hot-molded fixed resistors are available in all standard resistance values and tolerances, plus values above and below standard limits. A-B hot-molded resistors meet or exceed all applicable military specifications including the new Established Reliability Specification. Shown actual size.</p>

QUALITY ELECTRONIC COMPONENTS



**ALLEN - BRADLEY**

1067E-1

# DOES YOUR DC VOLTMETER

*measure microvolts, millivolts,  
volts from any source resistance*

*detect currents from milliamps to femtoamps*

*provide a selectable choice of input resistances*

*furnish a recorder or scope output*

*measure resistance on linear scales  
from ohms to mega mega ohms*

*integrate current*

*employ all solid state circuitry*



## KEITHLEY ELECTROMETERS DO. CAN YOU AFFORD TO BUY LESS?

Measure mos fets or ordinary transistor and diode parameters. Detect capacitor leakage. Make in-circuit tests. Keithley electrometer multimeters handle these

and other tough-to-make measurements better and easier than any other dc multimeter ever made.

One easy-to-use Keithley electrometer allows fast, accurate measurements in lab, production and quality control. One like our line-operated 610B that makes more dc measurements over broader ranges than any other multimeter. For only \$585. Or one like our 602 model. It's battery-pow-

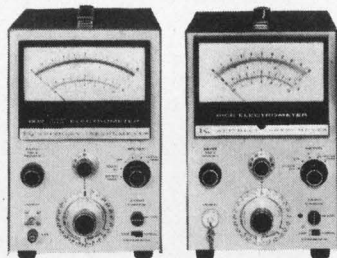

ered, all-solid state, uses mos fets for remarkably superior stability. Get one for \$675.

So why make-do with an ordinary voltmeter when you can do more

with a Keithley electrometer? Call your experienced Keithley Sales Engineer for demonstrations. Ask for technical information on the 610B, 602 and other Keithley electrometers, too.

Or, contact us direct. Keithley Instruments, Inc., 28775 Aurora Road, Cleveland, Ohio 44139.



Europe: 14 Ave. Villardin, 1009 Pully, Suisse. Prices slightly higher outside the U.S.A. and Canada.

**KEITHLEY**

See us at the **CECON Show--Booth #18**  
INFORMATION RETRIEVAL NUMBER 29

## NEWS

(AWACS, *continued*)

man says, include:

- Electromagnetic interference—there will be more than 30 antennas protruding from the plane.

- Long mission time—lengthy missions of 10 to 20 hours call for high reliability.

- In-flight maintenance. On-board automatic checking capability plus replaceable modules will be important.

- Commonality of modules to make repair and storage simple.

By fall, Boeing and McDonnell-Douglas will turn in complete contract definition packages with design details down to the subsystem level. Boeing will propose using a modified version of its commercial 707 airline plane, and McDonnell-Douglas, its DC-8. The contracting agency is the Air Force System Command's Electronic Systems Div., Hanscom Field, Mass.

### Contract will be big

By February, 1969, a total package procurement contract should be awarded to either Boeing or McDonnell-Douglas to provide production of an integrated command and control system; associated aircraft equipment; support and training equipment; all necessary facilities and data, computers, radar, and navigation and communications equipment. The contract will probably be fixed-price or fixed-price with incentives for performance, cost and schedule.

The cost of each aircraft, the Air Force says, will be in the neighborhood of \$10 million plus \$10 million more for electronics. For 50 planes, the bill would come to \$1 billion. Support equipment would cost \$500 million more.

Along with the Airborne Warning and Control System, the go-ahead will probably be given for the F-106X fighter, equipped with "look-down" radar for spotting low-flying targets, and for a new air-to-air missile. Also, radars operated by the Federal Aviation Administration will be improved for continental defense. The bill for this entire package over a 10-year period, McNamara said, would come to \$12.3 billion. ■■



Our new AC Designer Line switches come in an endless variety of colors, sizes and styles.

Sure, we know you'd never order a switch with a painted body. Or a style quite like this.

But our turned-on switch helps demonstrate the customizing possibilities these new Designer Line AC switches offer. The choices just don't quit.

Three types of terminals. In 1-, 2-, 3-, and 4-pole models. With special configurations like momentary-contact and center-off.

As for the lever, pick one to your liking and we'll deliver. Our unique design permits our Distributors to supply a broad array of sizes, shapes and colors. Or have our factory build them to your

own design at a truly modest tooling cost.

Select attractive new decorator nuts, too. Two smart styles, four stock colors. Dozens of other colors on request.

But we're not playing the numbers game. Just giving you unmatched flexibility to design our new AC switches into your products. Plus capacities from low-power dry circuits up to 25 amps, and Cutler-Hammer quality you know and expect.

Write for Brochure LA-136-G217, or call your Cutler-Hammer Sales Office or Stocking Distributor. Even our off-the-shelf delivery will turn you on.



These are the building blocks that provide new flexibility in designing with Cutler-Hammer AC Designer Line Switches.

# The switched-on switch



Switch  
to No.1

More than just switches:  
prompt availability,  
field help, innovation,  
quality assurance too.

INFORMATION RETRIEVAL NUMBER 30



**CUTLER-HAMMER**

Milwaukee, Wisconsin 53201

BUY A THYRISTOR . . . GET A TRIGGER FREE!

# Prototype your 1969

# power control designs with a 'T&T' Kit!

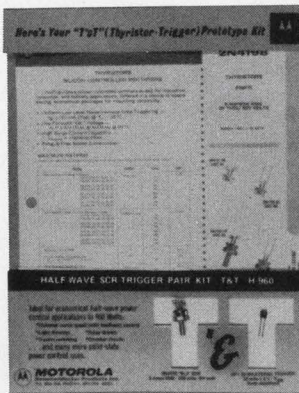

960 W Half-Wave Kit

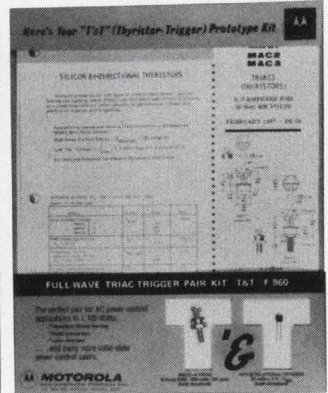

960 W Full-Wave Kit

If you're looking ahead to getting higher performance and more economy out of next year's power control designs than you realized from this year's circuits (and what designer isn't!) . . . you'll want one or both of these "T & T" — Thyristor and Trigger — prototype kits designed to introduce you to both application advantages — now!

Each kit is priced at the regular, 1-99 price for the thyristor alone — you get the 28 V, plastic trigger free together with performance data and circuits, ready for use right on your "new design" workbench!

Elf\* SCR's, long a popular, industry-standard for medium-powered, 50 to 600 V, commercial/industrial designs, furnish minimum power loss — low, 1.3-volt  $V_F$  @ 5 A, 25°C; immunity from false triggering due to noise with a realistic, 10 mA (typ) gate firing level;

100 A current surge protection and mounting versatility with 6 different hermetic cases.

Motorola's 960 W TRIAC takes the place of two conventional, back-to-back SCR's and has symmetrical gating and holding characteristics in all modes. In addition, 100 A peak surge capability, 50 to 400-volt  $V_{BOM}$  and built-in transient overvoltage protection make it a natural choice for a variety of cost-lowering, circuit-simplifying applications.

Both kits include one of the new, silicon Annular† plastic bilateral triggers offering symmetrical switching, low switching current, and higher-energy pulses-to-gate.

Prototype extra workpower into your continuous control circuits . . . fill in and mail the coupon today!

#### H-960 Half-Wave Kit

Ideal for prototyping universal motor speed control circuits with feedback control, crowbar, voltage regulators, battery charging, etc., circuits, the T & T H-960 kit consists of:

- 2N4170, 8 A, 200 V stud Elf SCR
- MPT28, 28 V, Bilateral Trigger
- Complete Technical Specifications
- "New Design" Circuits and "SCR Power Control Fundamentals"

PRICE \$2.10

#### F-960 Full-Wave Kit

The "power vs. price" design struggle in light dimmers, static contactors, capacitive motor starting and a host of other demanding AC applications can be won with the versatile, T & T F-960 kit of:

- MAC2-4, 8 A, 200 V stud TRIAC
- MPT28, 28 V, Bilateral Trigger
- Complete Technical Specifications
- "New Design" Circuits and "SCR Power Control Fundamentals"

PRICE \$3.45

Send me the following number of each special-offer Motorola T & T Kits:

- T & T H-960 Kits @ \$2.10 each for the SCR and Free Trigger
- T & T F-960 Kits @ \$3.45 each for the TRIAC and Free Trigger

Name \_\_\_\_\_ Title \_\_\_\_\_

Company \_\_\_\_\_ Div/Dept \_\_\_\_\_

Address \_\_\_\_\_

City \_\_\_\_\_ State \_\_\_\_\_ Zip \_\_\_\_\_

(Please enclose check for appropriate amount payable to Motorola Inc. Send to Box 955, Phoenix, Arizona 85001. Offer expires June 1, 1968.)

\*Trademark Motorola Inc.

†Annular semiconductors are patented by Motorola.

-where the priceless ingredient is care!



**MOTOROLA**  
Semiconductors

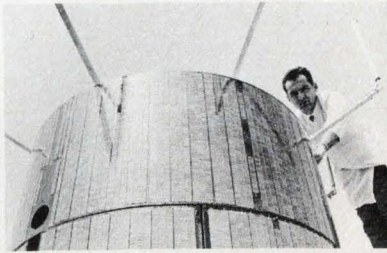

## R and D imbalance attacked

Representative Joseph E. Karth (D-Minn.) has clearly stated his intention to fight any NASA proposal that would deter progress in the unmanned Earth Resources Satellite program. During recent budget hearings, the Chairman of the House Subcommittee on Space Sciences and Applications deplored the conservatism shown by NASA in stretching out that particular satellite series. He questioned what he termed the needless insistence by NASA for continued repetitive paper studies. Karth's principle argument is that the Earth Resources Satellite program can provide an immediate economic payoff in the billions of dollars, while no similar return is obvious from the vastly more costly Apollo Program.

NASA's total space applications budget request is for \$112.2 million; for Earth Resources it is seeking only \$12.2 million and this will be applied to studies and aircraft flight tests of potential sensors. Speaking before the Sixth Goddard Memorial Symposium sponsored by the American Astronautical Society in Washington, D.C., Karth also deplored the Administration's attitude of "let technology wait," citing the ever decreasing percentage of Federal R&D funds. Since 1964, he pointed out, defense research and exploratory development expenditures have been reduced 30%. At the same time, an ever increasing portion of available R&D funds are being applied to projects for Southeast Asia. Total national R&D expenditures for 1968, he declared, will be about \$26 billion. The Government supports about 63% of this figure.

In terms of dollars, Karth stated, the U.S. spends "twice as much as the rest of the world combined."

However, the use of manpower may be a better measure of effort. The rest of the world devotes three times the manpower to R&D in comparison with that of the U.S., he said. Of greater significance,

# Washington Report

CHARLES D. LAFOND  
WASHINGTON BUREAU

said Karth, is the fact that foreign efforts are steadily increasing. The U.S. must continue to press technological advancement he urged, but at the same time it must achieve a better balance of R&D programs.

## Army presses digital communications

The Army has asked Martin Marietta's Orlando Div. to find out how the company's Random Access Discrete Address digital communications system can be used in MALLARD, the planned four-nation military digital communications system. The Material Command has given Martin an eight-month, \$300,000 study contract to conduct its investigations.

Earlier this year the Army announced award of an additional \$3.6 million to Martin to begin third-phase development of its system. In development for several years, the Random Access Discrete Address concept would provide fully automatic, high-capacity, dial-radiotelephone service for military tactical forces. The system also is capable of carrying high-speed data, teleprint, or facsimile transmissions within an Army division in the field.

A total of \$12.3 million has been authorized by the Army for development of the system. At the same time, Martin is working on three other MALLARD study contracts totaling over \$634,000.

## Pool of secondary frequencies proposed

The release of all currently unused primary frequency allocations for secondary use has been recommended by Transportation Secretary Alan S. Boyd. The move, he says, could provide many thousands of temporary radio channels for mobile land operations. In making his proposal to alleviate today's jammed portions of the spectrum, Boyd told the annual Government-industry conference of the Electronic Industries Association in Washington that one TV channel could support 240 mobile radio channels. He declared that Federal Aviation Administration experts have found that Los Angeles alone could obtain 450 channels

# Washington Report

CONTINUED

for immediate use, 300 more within 6 months with minor equipment modifications, and, over a longer time period, an eight-fold increase in channel capacity.

To implement such a nationwide mobile radio expansion, the Secretary proposed that radio-equipment leasing companies be formed. These would, in turn, establish equipment exchange agreements with one another to handle the problem of changing spectrum availability in a given area. Users would thus lease a communications service, and the rental companies would see to it that clients were provided with operable channels, either through exchange or modification of radio equipment, as required.

Secretary Boyd noted that in 1950 some 180,000 mobile land transmitters were in use in the U.S. This figure rose to over 2.5 million by June, 1967, and it excludes the millions of units operating on the Citizens Band.

## Multimillion Navy waste charged

The new Secretary of Defense, Clark Clifford, can expect to hear some fiery words from an agitated Congressman. In recent remarks before the House, Rep. Harold R. Gross (R-Iowa) presented a chronology of events in the Navy that, he said, could lead to a multimillion dollar waste. They involve the former Navy Radio Research Station at Sugar Grove, W. Va., a project that was cancelled in July, 1962, after expenditures of \$64 million. According to Congressman Gross, within seven days after cancellation of the gigantic radio-telescope project, some Navy officials invented a new use for the site. The plan was to move a Navy long-range radio station from Cheltenham, Md., to Sugar Grove because the existing station was experiencing electronic interference. In September, 1962, the then Secretary of the Navy, Fred Korth, recommended spending \$3.8 million to carry out the move, and approval was given two months later by the then Secretary of Defense, Robert S. McNamara. In the interim, studies have been made and reports submitted by the Navy Bureau of Ships (mid-1965), by a special Navy review board (late 1965), and by the Radio Corp.

of America and the Commerce Dept.'s Institute for Telecommunication Sciences and Aeronomy (mid-1966). All recommended against moving the radio station to Sugar Grove. Even the Defense Communications Agency stated in June 1966: ". . . no clearcut technical advantage for either site is apparent."

However, since the Secretary of Defense authorized the move in 1962, the present Secretary of the Navy supports the plan. At this point, according to Gross, the move has not been completed, but expenditures of \$5.6 million have been made and at least \$11 million more will be required over the next five years. In addition a General Accounting Office study has shown that operation of the radio station at Sugar Grove would cost \$1 million more to operate each year than at the Cheltenham site.

## More fire power for Navy missiles

The Navy has announced that a highly improved Mark 76 fire-control system, the first of 14 for surface-to-air missile defenses, has been delivered by the Sperry Gyroscope Div. of Sperry Rand. The Mark 76 is designed for use with Terrier anti-aircraft missiles and will be used with the Standard surface-to-air missile, now in development. Sperry's modernization effort is being performed under a \$17.2 million contract. The Leahy Destroyer will be the first vessel to receive the improved system. Each Mark 76 consists of two Sperry AN/SPG-55 radars, two Mark 119 Mod 5 fire-control computers (also Sperry), plus support electronics.

## Is defense business more profitable?

Taking issue with a recent study performed by the Logistics Management Institute for the Government, which showed profit rates declining on defense work, Professor Murray Weidenbaum told an Electronic Industries Association gathering here that his studies at Washington University, St. Louis reveal an opposite trend. "Large defense companies are more profitable than non-defense firms of similar size," he said. Further, Weidenbaum noted, the gap is widening in favor of defense-oriented firms. His estimates show that return on net worth over the period 1962-1965 for industrial firms was 10.6 per cent, for defense firms 17.5 per cent.

# New highs in IC Op Amp power...

with high gain and high voltage

RCA has these two monolithic OP AMP units for you—ready to meet your design requirements for high input impedance, high gain and high power output. Only the price isn't high! Ask your RCA Distributor for his price and delivery. Write RCA Electronic Components, Commercial Engineering Section, ICG4-1, Harrison, New Jersey 07029 for Data Sheet.

All characteristics below are typical

Power output (8% THD)  
Output swing voltage (P-P)  
Input impedance  
Open-loop Gain  
Input Offset Voltage  
Input Offset Current  
Input Bias Current  
Noise Figure  
Slew Rate

RCA-CA3033  
for  $\pm 12V$  Supply

122 mW  
21V  
1.5 M $\Omega$   
90 dB  
2.6 mV  
5 nA  
83 nA  
—  
1.2V/ $\mu$ s

RCA-CA3033A  
for  $\pm 18V$  Supply

255 mW  
32V  
1 M $\Omega$   
96 dB  
2.9 mV  
9 nA  
103 nA  
16 dB  
2.5V/ $\mu$ s

\$4.95(1000 units)    \$6.95(1000 units)

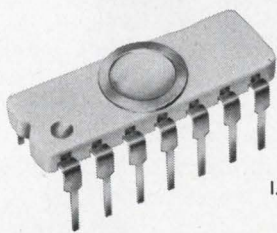
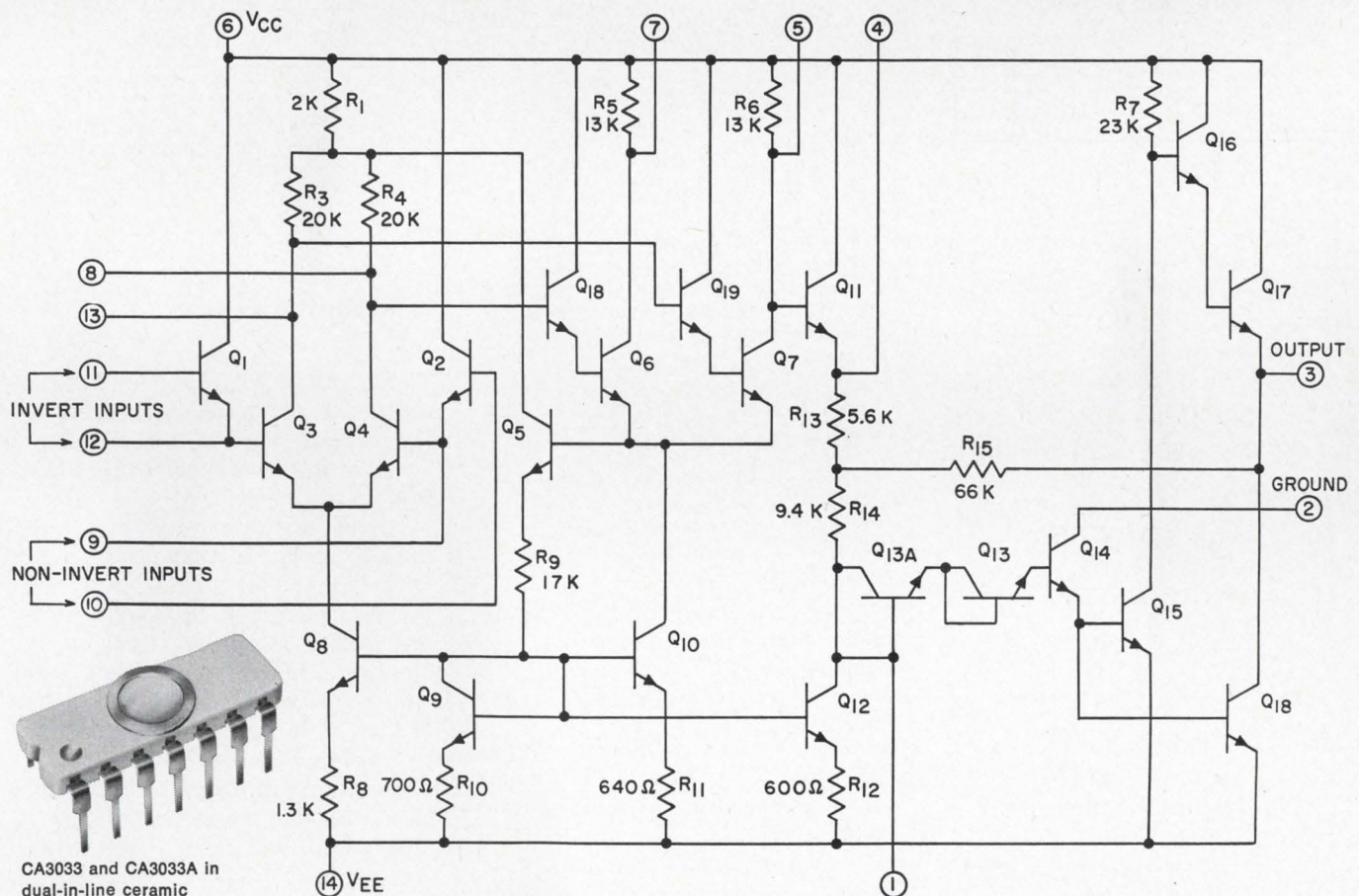

CA3033 and CA3033A in dual-in-line ceramic package ( $-55^{\circ}$  to  $+125^{\circ}$ C operating temperatures)

**RCA** Integrated Circuits

# Letters

## Parallel reactances with new technique

Sir:

I have read the very interesting article "Draw your network's impedance" by Richard E. Johnson in ED 1, Jan. 4, 1968, pp. 102-103.

I believe it is incorrect to say, as the author does, that capacitive and inductive reactances cannot be combined in parallel. It is easily done by extending the construction of Fig. 1 in the article, as shown below.

The proofs of the original techniques are relatively simple. If the nomenclature in Fig. 1 of the original article is used, then the following derivation can be made.

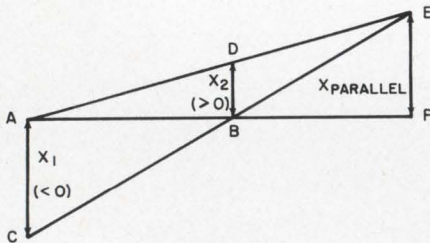

I. Proof of parallel R or X (same sign):

$$R_2/\overline{AB} = \tan \angle DAB; \quad (1)$$

$$R_1/\overline{AB} = \tan \angle CBA; \quad (2)$$

$$R = \overline{AP} \tan \angle DAB; \quad (3)$$

$$R = (\overline{AB} - \overline{AP}) \tan \angle CBA; \quad (4)$$

From Eq. 3:

$$\tan \angle DAB = R/\overline{AB},$$

so that, with Eq. 1:

$$R_2/\overline{AB} = R/\overline{AP}. \quad (5)$$

From Eq. 4:

$$\tan \angle CBA = R/(\overline{AB} - \overline{AP}),$$

so that, with Eq. 2:

$$R_1/\overline{AB} = R/(\overline{AB} - \overline{AP}). \quad (6)$$

Equation 5 may be rewritten:

$$\overline{AB} = (R_2/R)\overline{AP}.$$

Putting this into Eq. 6 yields:

$$R_1/[(R_2(\overline{AP}/R)] = R/[R_2(\overline{AP}/R) - \overline{AP}]$$

$$R(R_1)/[R_2(\overline{AP})] = R_2/[\overline{AP}(R_2 - R)]$$

$$R_1/R_2 = R/(R_2 - R)$$

$$R_1 R_2 - R_1 R = R R_2.$$

This gives:

$$R = R_1 R_2 / (R_1 + R_2)$$

II. Proof of parallel X (opposite sign). See figure above:

$$X_p = \overline{BP} \tan \angle EBP; \quad (7)$$

$$X_p = (\overline{AB} + \overline{BP}) \tan \angle DAB; \quad (8)$$

$$X_1 = -\overline{AB} \tan \angle EBP; \quad (9)$$

$$X_2 = \overline{AB} \tan \angle DAB. \quad (10)$$

From Eq. 7:

$$\tan \angle EBP = X_p/\overline{BP},$$

so that, with Eq. 9:

$$\overline{AB} = -X_1(\overline{BP}/X_p). \quad (11)$$

From Eq. 10:

$$\tan \angle DAB = X_2/\overline{AB},$$

so that, with Eq. 8:

$$X_p = (\overline{AB} + \overline{BP})(X_2/\overline{AB}). \quad (12)$$

Putting Eq. 11 into Eq. 12 yields:

$$\begin{aligned} X_p &= [-X_1(\overline{BP}/X_p) + \overline{BP}] \\ &\quad \times \{X_2/[-X_1(\overline{BP}/X_p)]\} \\ &= -[-(X_1/X_p) + 1] \\ &\quad \quad \quad [X_2 X_p / X_1] \\ &= (X_1 - X_p)(X_2/X_1). \end{aligned}$$

Then:

$$\begin{aligned} X_1 X_p &= X_1 X_2 - X_2 X_p \\ X_p (X_1 + X_2) &= X_1 X_2 \end{aligned}$$

This gives:

$$X_p = X_1 X_2 / (X_1 + X_2).$$

III. Proof of parallel-to-series conversion ( $R + jK = 1/(G + jB)$ ):

The following equivalences may be established by elementary ac circuit analysis:

$$R_s = R_p / (1 + R_p^2 / X_p^2);$$

$$X_s = X_p / (1 + X_p^2 / R_p^2);$$

$$R_p = (R_s^2 + X_s^2) / R_s;$$

$$X_p = (R_s^2 + X_s^2) / X_s.$$

Now referring to Fig. 2 in the original article:

$$\angle BOD = \angle CAO = \angle BCO \text{ } 90^\circ,$$

$$\angle OBC = \angle COA,$$

$$\angle OCA = \angle CDA.$$

Therefore  $\triangle BOD$ ,  $\triangle CAD$ ,  $\triangle COA$  and  $\triangle BCO$  are all similar.

Then:

$$\overline{AD}/\overline{AC} = \overline{OD}/\overline{BO} \quad (13)$$

and:

$$\overline{AC}/\overline{OA} = \overline{OD}/\overline{BO}. \quad (14)$$

Rewriting Eqs. 13 and 14 in terms of the appropriate circuit parameters gives:

$$(R_p - R_s)/X_s = R_p/X_p, \quad (15)$$

$$X_s/R_s = R_p/X_p. \quad (16)$$

From Eq. 16:

$$X_s = R_s R_p / X_p. \quad (17)$$

Putting Eq. 17 into Eq. 15 gives:

$$(R_p - R_s)X_p/R_s R_p = R_p/X_p,$$

$$X_p^2 R_p - X_p^2 R_s = R_p^2 R_s,$$

$$R_s = X_p^2 R_p / (R_p^2 + X_p^2)$$

$$R_s = R_p / (1 + R_p^2 / X_p^2)$$

Similarly:

$$R_s = X_s X_p / R_p,$$

$$R_p - X_s X_p / R_p = X_s R_p / X_p,$$

$$\begin{aligned} R_p &= X_s (X_p / R_p + R_p / X_p) \\ &= X_s (1 + X_p^2 / R_p^2) R_p / X_p \end{aligned}$$

$$X_s = X_p / (1 + X_p^2 / R_p^2)$$

The inverse is also true:

$$R_p = X_p X_s / R_s$$

$$(X_p X_s / R_s - R_s) X_s = X_s^2 / R_s$$

$$X_p = R_s (R_s + X_s^2 / R_s) / X_s$$

$$X_p = (R_s^2 + X_s^2) / X_s$$

and:

$$X_p = R_p R_s / X_s$$

$$(R_p - R_s) / X_s =$$

$$R_p X_s / R_p R_s = X_s / R_s$$

$$R_p = R_s + X_s^2 / R_s$$

$$R_p = (R_s^2 + X_s^2) / R_s$$

J. H. Horwitz

Staff Engineer

TRW Electronic Components Div.  
Camden, N.J.

## The author replies

Sir:

The proofs J. H. Horwitz has submitted for the techniques in my article are correct and illustrate some of the several ways these techniques can be proven.

After reviewing my text, I am unable to find a statement saying that capacitive and inductive reactances cannot be geometrically paralleled, as Horwitz indicated. I did state, however, that they could not be paralleled by the "leaning ladder" technique, which is correct.

Horwitz has described a new technique that will parallel a capacitive and an inductive reactance and so make the use of Eq. 1 in my article unnecessary. Like the techniques I described, the results obtained are not based on any approximations and will be as accurate as one cares to plot them. Horwitz has made a very useful design approach still more useful by his contribution.

Richard E. Johnson

Sylvania Metals and Chemicals  
Warren, Pa.

# Small wonder:



Our new "4th-generation" 12.5 MHz universal counter/timer. Wonderful versatility in a wonderfully small package — at an even more wonderfully small price.

With the new Model 100A you can measure average frequency, frequency ratio, single period or time interval, or count total events. It has a crystal-controlled clock, Monsanto integrated circuit construction, and built-in compatibility with a rapidly growing assemblage of accessory modules.

With its \$575\* price tag (accessory modules are pegged at comparably modest rates) you can have big-league counter/timer performance at

costs never before possible. Small wonder we are selling (and delivering) Model 100A's just as fast as we can build them.

Call your local Monsanto field engineering representative for full technical details, or contact us directly at: Monsanto Electronics Technical Ctr., 620 Passaic Avenue, West Caldwell, New Jersey 07006. Phone (201) 228-3800; TWX 710-734-4334.

\*U.S. Price, FOB West Caldwell, New Jersey.

  
ELECTRONICS<sup>®</sup>

## Anyone for spending money?

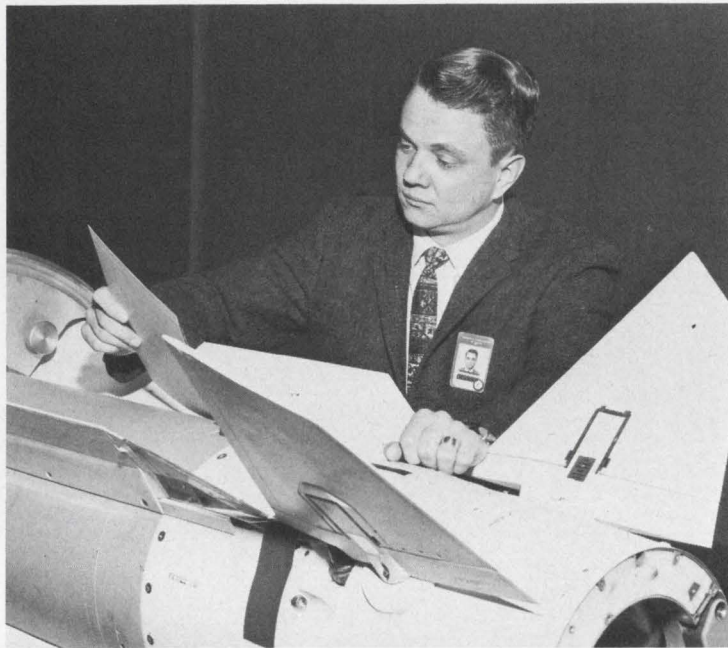

Don Herbert gathers the facts for his next article

### VITREOSIL<sup>®</sup> PURE FUSED QUARTZ CLOTH

offers the design engineer a combination of extreme heat resistance, exceptionally low coefficient of thermal expansion and excellent dielectric properties for plastic reinforcement, screening and filtration of molten, non-ferrous metals, high temperature gases and liquids. Also available are Vitreosil Quartz mat and wool of extremely fine diameter fibers which provide excellent thermal insulation barriers (to 2000° F. indefinitely with no degradation).



**THERMAL AMERICAN**  
FUSED QUARTZ CO.  
RT. 202 & CHANGE BRIDGE RD.  
MONTVILLE, NEW JERSEY  
ZIP CODE 07045

74

INFORMATION RETRIEVAL NUMBER 32

Author Don Herbert (p. 72) is going to buy his wife a new typewriter, and his company, General Dynamics, Pomona Div., is going to pay for it. Under General Dynamics Writing Award plan, Don will be paid \$150 for each of his two articles for *ELECTRONIC DESIGN*. Don says his wife typed hard for this two-part series; hence the new typewriter.

Not too many companies encourage their employees to put pen to paper, but those that do find their programs successful. Jack Sloan, staff assistant to the president of General Dynamics, feels that his company's scheme has encouraged an outflow of articles by employees. He sees this as beneficial to both author and company.

Although General Dynamics is unusual, in that it does not permit employees who qualify under its plan to accept a further fee from the magazine involved, authors ordinarily are paid by *ELECTRONIC DESIGN* for published articles. The rate depends of the length of the article and on the number of articles previously sold by the same author to *ELECTRONIC DESIGN*. The more articles you write and sell to us, the higher the fee. A payment of \$150 is not unusual.

This, however, is only part of the effort we make to help would-be authors get into print. You can get an Author's Guide by checking the box on the Editorgram (inside back cover). At intervals, *ELECTRONIC DESIGN* editors also visit plants to give a half-day writing seminar. Your public relations department can arrange for this by a call to our editor. And, of course, our entire editorial staff is ready to give individual assistance in person or by phone.



# 1Ω, 1%, 100 ppm

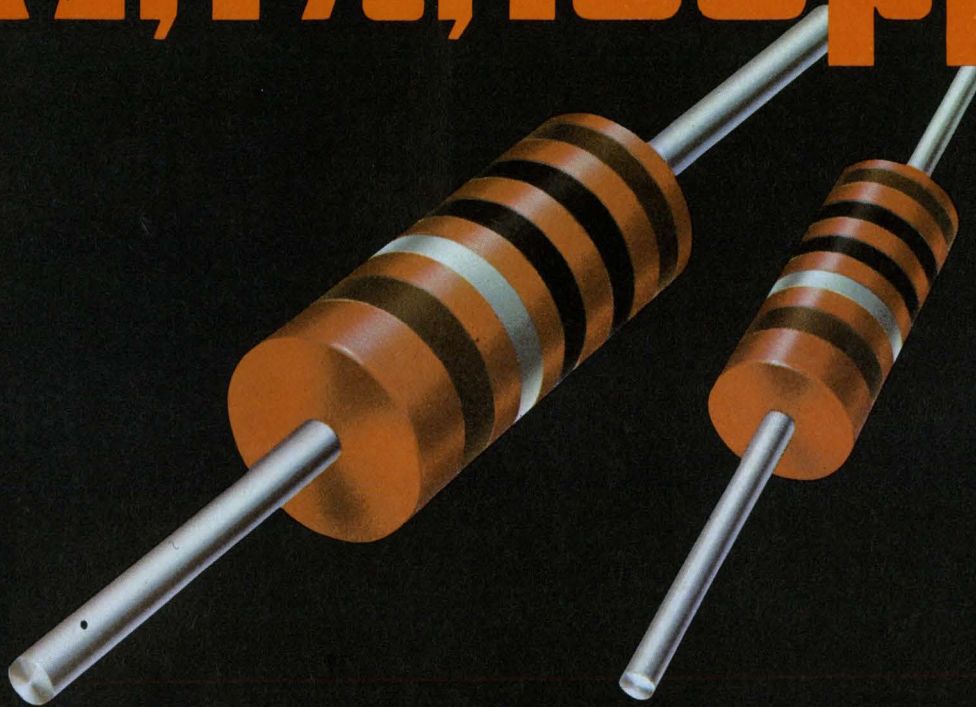

## First low-range, low-inductance thick-film resistors

These new IRC TF resistors have been designed specifically for your low-range, low-inductance needs. They provide precision performance, plus the added benefits of thick-film stability and reliability for a wide range of industrial and instrumentation applications.

Rugged Metal Glaze resistance element is inherently reliable. Tin-oxide types can't match its stability and ruggedness under severe load or elevated temperature conditions. Tough molded bodies of the TF07 and TF20 can't crack or craze during automated insertion. They resist solvents and corrosion. Write for samples, prices, and data on these new IRC low-range resistors. IRC, Inc., 401 N. Broad Street, Philadelphia, Pa. 19108.

**Resistor screening.** Does your low-range application require 100% burn-in? IRC is geared to perform meaningful screening tests on these new Type TF resistors on a production basis. Ask for data.

### CAPSULE SPECIFICATIONS

POWER:	¼ W @ 70°C	½ W @ 70°C
RESISTANCE:	1Ω to 10Ω	1Ω to 10Ω
TOLERANCES:	±1,2,5%	±1,2,5%
TEMP. COEF.:	±100ppm/°C	±100ppm/°C
SIZE:	RL07	RL20
IRC TYPE:	TF07	TF20





## UNDISPUTED LEADER in solving EMI problems

### ERIE subminiature EMI FILTERS

TODAY ... Erie EMI FILTERS are solving electro-magnetic interference problems in POSEIDON, F-111, MINUTEMAN, APOLLO, C-5A, PHANTOM II ... and even in sewing machines. .

### Why not tell us your EMI problem?

Our Filter performance, compactness and superior design ... plus Erie's volume production facilities are unique in the industry.

Look with confidence to ...

### ERIE'S IN-DEPTH EXPERIENCE



Write for complete specifications and  
Catalog 9000 ... or Call (814) 456-7084

ERIE

TECHNOLOGICAL

PRODUCTS, INC.



Erie, Pennsylvania

# Presenting the winning advertisements in 'Top Ten' contest

The following pages display the 10 outstanding advertisements that appeared in our Jan. 4 issue featuring the "Top Ten" contest. The contest attracted close to 4000 readers who attempted to match their ratings of the 10 most memorable advertisements with the "recall-seen" scores from ELECTRONIC DESIGN's regular Reader-Recall survey.

The winning advertisements combine attractive colors, tasteful design and well-written copy. The result: impact. The winners, in order of highest Reader-Recall score, are as follows:

1. Hewlett-Packard.
2. Paktron Division, Illinois Tool Works, Inc.
3. Sylvania Electric Products Inc.
4. Motorola Semiconductor Products.
5. Unitrode Corp.
6. Union Carbide Electronics.
7. Honeywell Precision Meter Div.
8. Dale Electronics, Inc.
9. Dow Corning Corp.
10. National Semiconductor Corp.

See the April 11 issue for names of the reader winners.

# The one-up op amp.

Since we announced the LM-101 op amp, our improvement on the 709, we've had great response: fan letters, purchase orders, and a new idea.

So now we have two 101's. The original LM-101 and the LH-101 which goes it one better by putting all required frequency compensation inside the package.

Operation guaranteed for supply voltages from  $\pm 5V$  to  $\pm 20V$ .

Low current drain—even with the output saturated. No latch-up when common-mode range is exceeded. Continuous short-circuit protection.

Input transistors protected from excessive input voltage.

Available now from our stocking distributors.

Prices (100 pcs.): LH-101, \$48.00. LH-201 (commercial unit), \$11.40. Write for details: National Semiconductor Corporation, 2975 San Ysidro Way, Santa Clara, California 95051, (408) 245-4320.

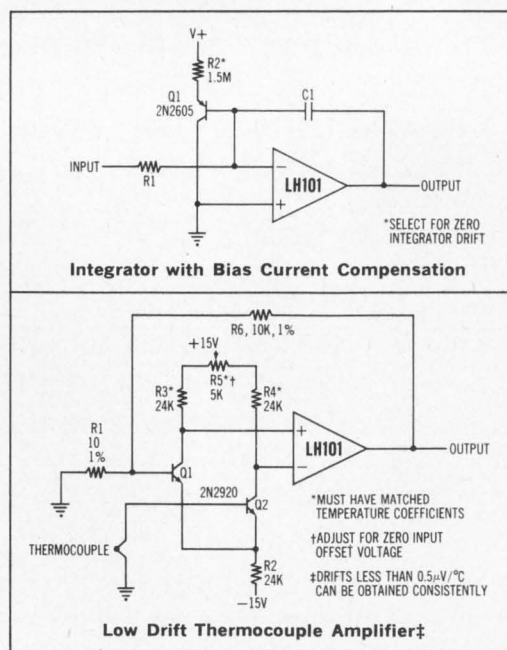

## National Semiconductor

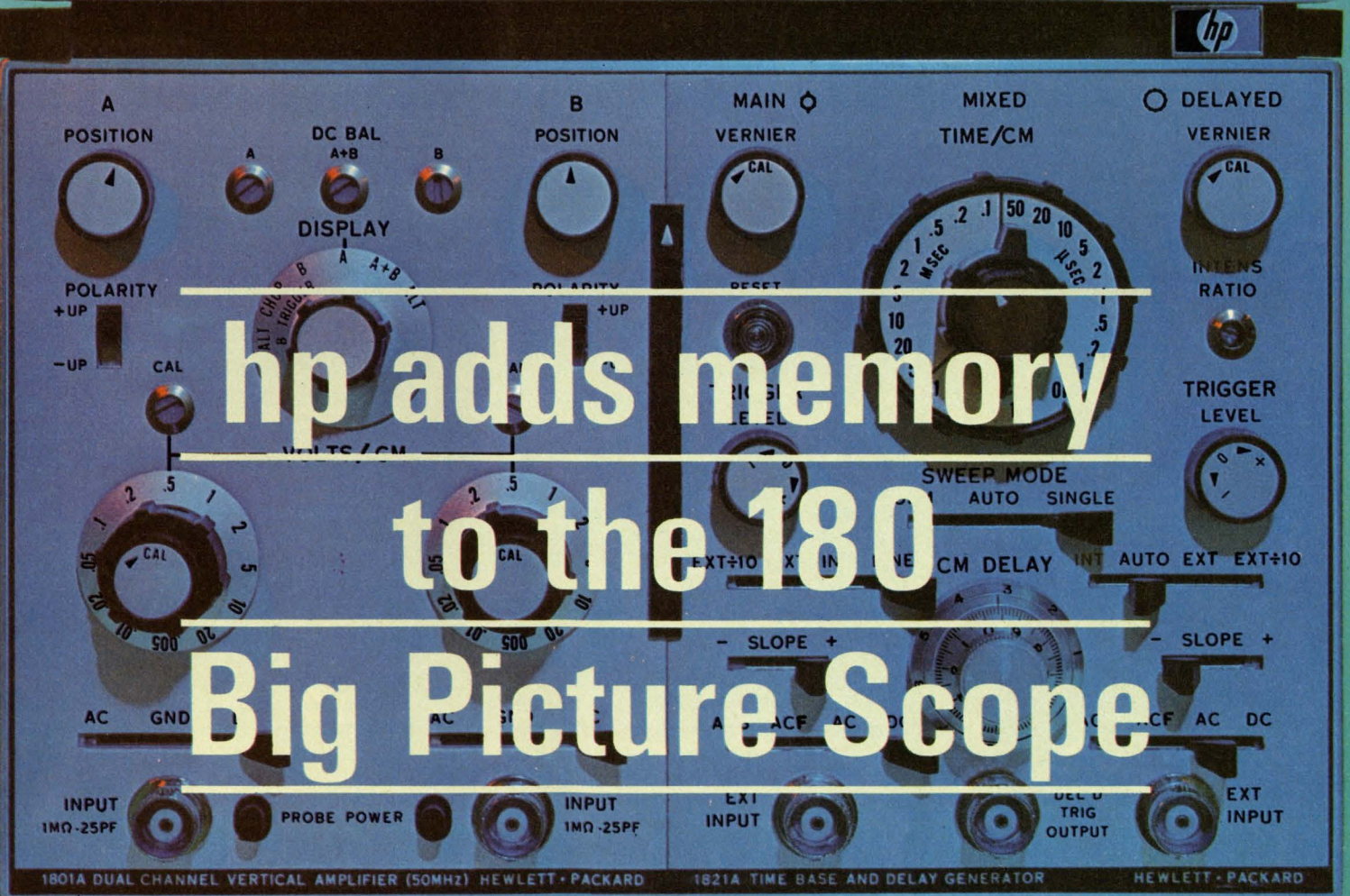
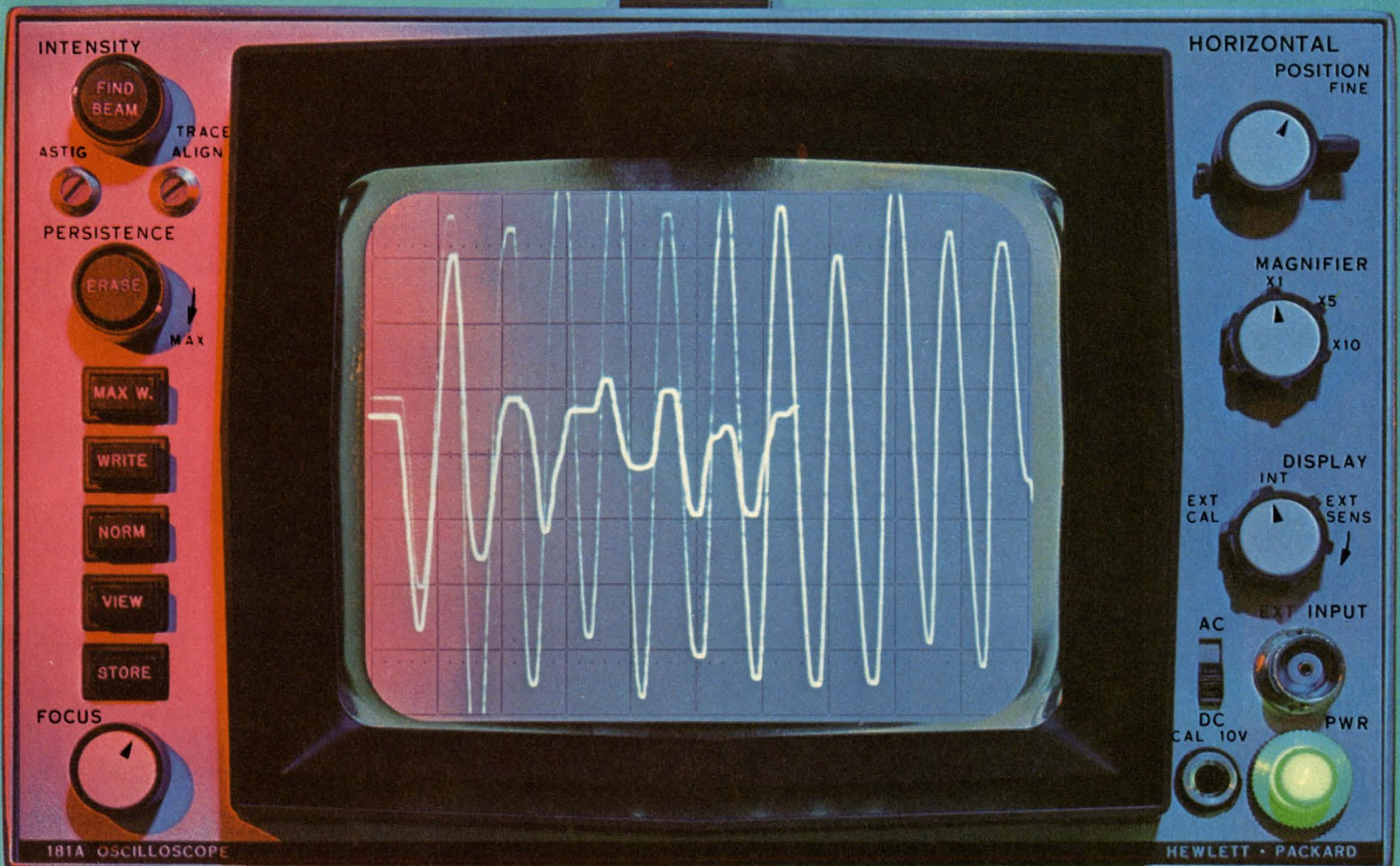

hp adds memory  
to the 180  
Big Picture Scope

ACTUAL SIZE

# PERSISTENCE



MAX



YOU  
CONTROL CRT  
PERSISTENCE!

# STOP • STORE •

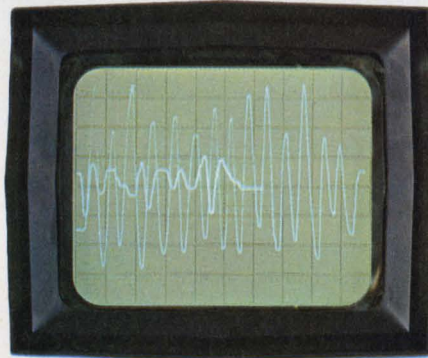

**VARIABLE PERSISTENCE**

See more with the new 181A's variable persistence—made possible by the special rectangular CRT using hp's exclusive mesh storage design! At the twist of a knob you can adjust the memory span from 0.2 second to more than a minute.

See clear, flicker-free displays of fast 7 ns rise time, low rep rate pulses. See signal trends while making circuit adjustments by simply adjusting persistence so several traces appear on the screen simultaneously. See slow traces such as transducer or biomedical waveforms by adjusting persistence so the old trace fades as the new one is being written.



**STORAGE**

Do more with the new 181A's storage capabilities! Catch and store single-shot transients with the 181A's fast writing rate of 1 cm/ $\mu$ sec. Store traces side by side for later comparison. Hold traces intact for later viewing for more than an hour. With the trace stored and the scope turned off, store as much as a full minute of information for days—or even weeks! Use this feature to get a graphic display of critical parameters prior to system failure, the activation of a safety device, or excursion beyond some predetermined limit.

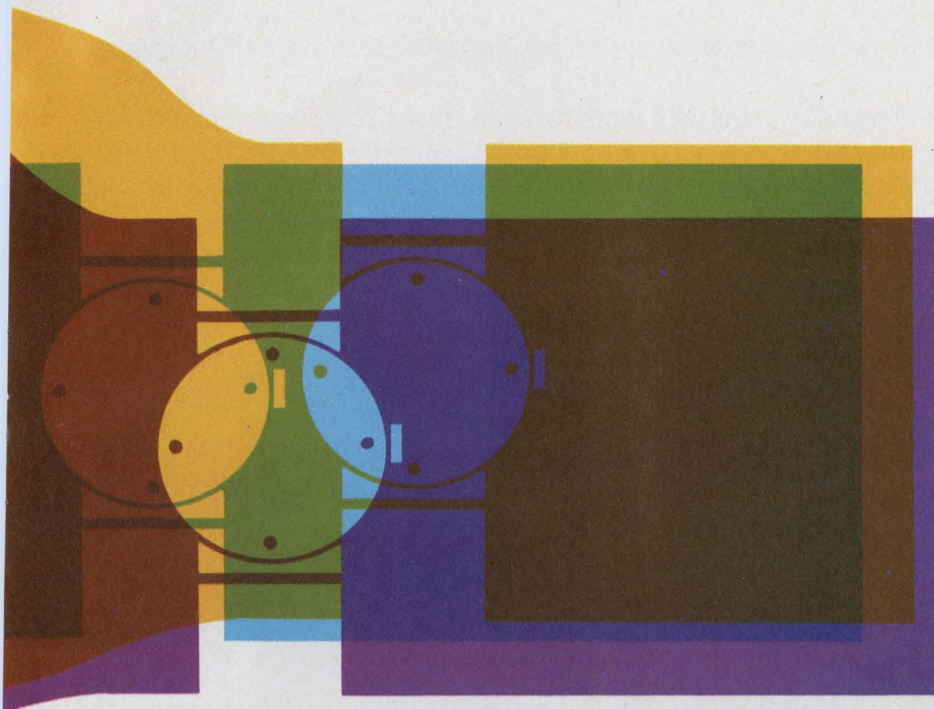

**New hp 181A Oscilloscope with Variable Persistence and Storage . . .**

For the first time you get the added dimension of variable persistence and storage in a high frequency scope—50 MHz bandwidth at 5 mV sensitivity now, and mainframe capabilities for 100 MHz.

With the 181A, you also have big picture displays, plug-in versatility, 100% solid-state circuitry, 30-pound portability, and superior performance for field, laboratory and production applications.

Get the complete story on the new hp 181A from your nearest hp field engineer. Or, write to Hewlett-Packard, Palo Alto, California 94304. Europe: 54 Route des Acacias, Geneva. Price: \$1,850.00 plus plug-ins.

# VARY DISPLAY TIME!

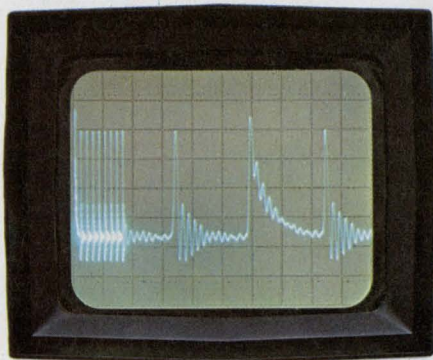

**CONVENTIONAL USE**

Use the new 181A as a conventional scope. You get the same high-frequency and high-sensitivity performance found in the other scopes in the hp 180 Series—50 MHz bandwidth at 5 mV sensitivity now, and mainframe capability for 100 MHz. All the hp 180 Series plug-ins give full performance in the 181A mainframe.

Use it anywhere. All-solid-state circuitry and aircraft frame construction give maximum ruggedness with minimum weight. Scope with plug-ins operates in temperatures from -28 to +65°C—and at altitudes up to 15,000 feet. It operates in a steaming 95% relative humidity up to 40°C!

It's rugged enough to take rough treatment in field, laboratory or production area without affecting electrical performance!

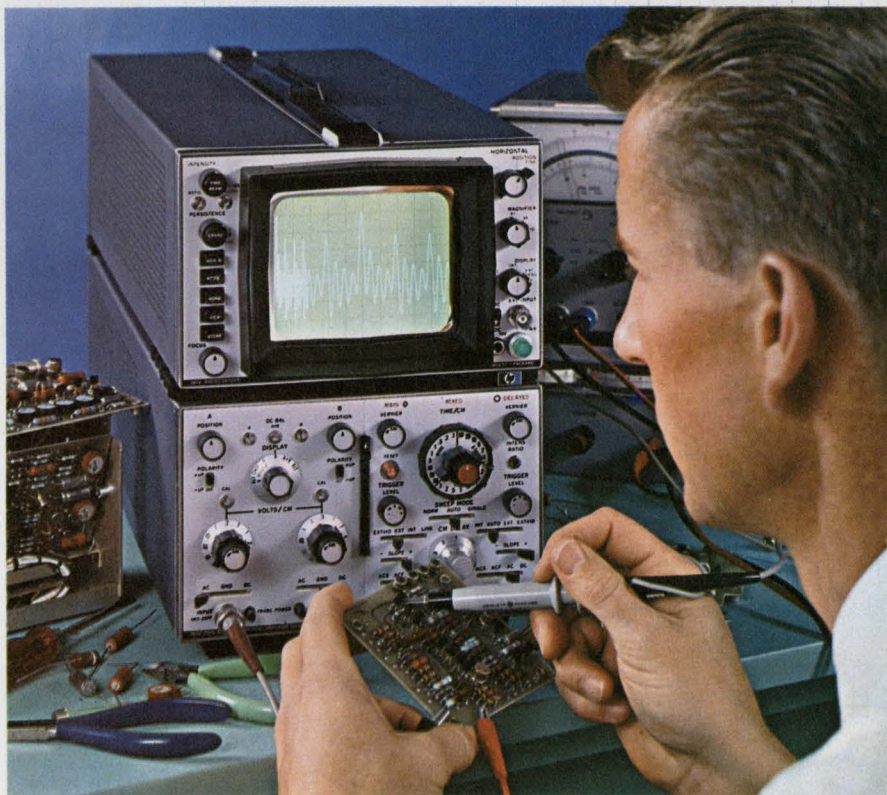

**HEWLETT *hp* PACKARD**

**OSCILLOSCOPE SYSTEMS**

# SEE MORE...

# DO MORE!

*with a scope from the growing, versatile hp 180 system.*

The hp 180 plug-in scope system has set the trend—for today and years to come. With an hp 180 scope, you get versatility previously possible only with a benchful of special purpose scopes. Hewlett-Packard now offers three mainframes—the 180A, 180E and the new 181A—plus three versatile plug-

ins with more to come, soon! You buy a scope to see with, so get the hp 180 mainframe with the *big picture* that meets your present requirements. It will continue to meet your growing requirements with new, fully compatible plug-ins in the future!

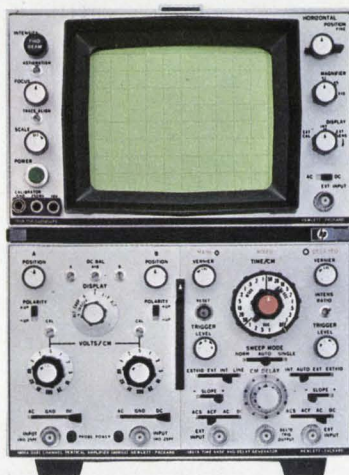

**Lab/Field 180A Oscilloscope**—First in the hp 180 Scope System, this scope has capability beyond 100 MHz, has horizontal amplifier sensitivity of 0.1 V/cm. X1, X5, X10 magnified sweep, accuracy  $\pm 5\%$ . Beam finder brings trace on CRT regardless of setting of horizontal, vertical or intensity controls. Power supplies and large 8 x 10 cm CRT are capable of handling existing and future plug-ins. Price: hp 180A, \$825; hp 180AR (rack mount), \$900.

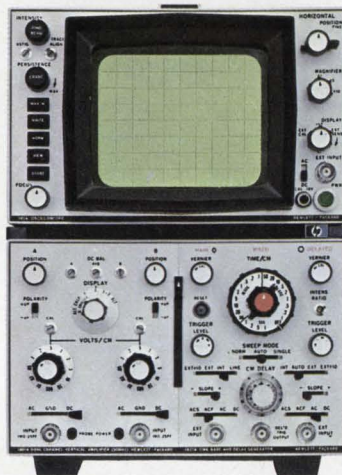

**Variable Persistence and Storage 181A Oscilloscope**—The new all-solid-state 181A scope expands the versatility of the 180 Scope System. The 181A operates as a conventional scope, or as a variable persistence scope, or as a storage scope. Persistence variable from 0.2 sec to more than a minute. Single shot writing rate is 1 cm/ $\mu$ sec. Standard 180 System plug-ins give full electrical performance in the 181A mainframe. Price: hp 181A, \$1850.

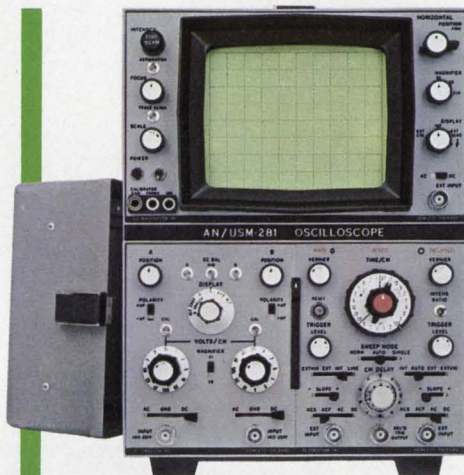

**Military Version 180E Oscilloscope**—Ruggedized version of hp 180A scope meets military requirements. Has same electrical performance specifications as 180A under such extreme environmental conditions as 95% humidity at 65°C. Passes MIL-S-910C for shock. Only 30 pounds including plug-ins for easy portability. Has proven MTBF of 5000 hours in accordance with MIL Hdbk. 217. Price: hp 180E, \$1215; hp 180ER (rack mount), \$1205.

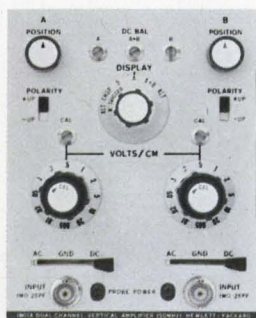

**1801A Dual Channel Vertical Amplifier**—Has dc to 50 MHz bandwidth (all ranges), 7 ns rise time, 5 mV/cm sensitivity, A + B and A - B operation, internal trigger on Channel B in ALT and CHOP modes. Price: hp 1801A, \$650; ruggedized hp 1801E with X5 amplifier for use with the 180E, \$800.

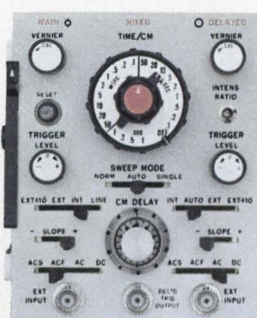

**18021A Time Base and Delay Generator**—Triggers to beyond 100 MHz, sweeps from 1 sec/cm to 10 ns/cm. Mixed sweep is provided for slow/fast sweep display. Delayed sweep is easy to use. Price: hp 18021A, \$800; ruggedized hp 18021E with added 2 sec/cm sweep to be used with the 180E, \$920.

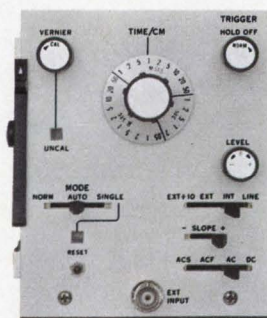

**18020A Time Base**—Triggers to beyond 100 MHz, sweeps from 2 sec/cm to 5 ns/cm. Variable holdoff locks-in complex waveforms. Has bright line automatic triggering. Gives you economy without sacrificing performance. Price: hp 18020A, \$475; ruggedized hp 18020E for use with the 180E, \$570.

**HEWLETT  PACKARD**

OSCILLOSCOPE SYSTEMS

INFORMATION RETRIEVAL NUMBER 36



Maybe it seems so.

In our thrifty, Scottish way, we've brought out a Honeywell taut-band meter that costs even less than a pivot-and-jewel meter. (About 10% less, on the average.)

Does that make you think we might be short-changing you? We are: We left all the unnecessary parts out of our taut-band meter. (Fewer parts: fewer things to go wrong.)

It's simple. Which is the whole idea.

It's self-shielded.

There's no friction in its moving parts. Which gives you better readout accuracy, better repeatability.

And it comes in just about any style you'd like.

Obviously, the low-cost taut-band meter from Honeywell has a brilliant future ahead of it.

But the question is: Will it ever replace the pivot-and-jewel meter?

We doubt it. We believe there are some sensitivities and applications that will always be

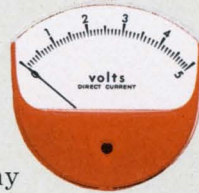

handled best by our good, old pivot-and-jewel meter.

But if you like the idea of our low-cost taut-band meter, by all means write us for our brochure. It'll tell you all the sizes, styles and prices.

Honeywell Precision Meter Division, Manchester, N.H. 03105.

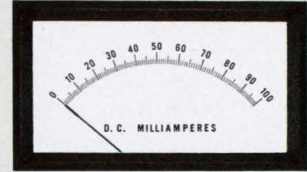
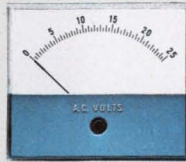

**Honeywell**

**Is the pivot-and-jewel meter going out of the picture?**

INFORMATION RETRIEVAL NUMBER 37

D.C. MILLIAMPERES

# Buy the Generation IC

UC4200 and UC709

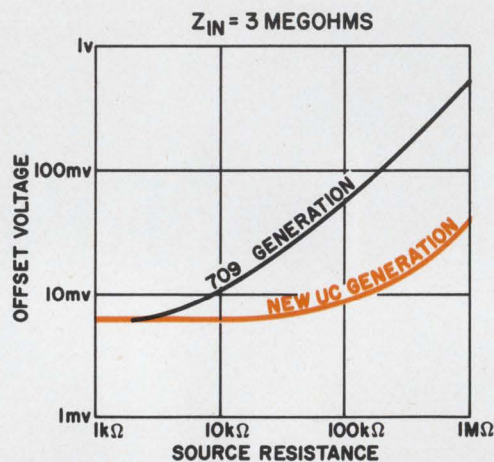

CHECK THE SPECIFICATIONS:

USE THEM IN: infra-red sensors, PM sensors, piezoelectric transducers, ionization gauges, EEG and EKG preamplifiers, analog integrators, and electrometric type voltage followers.

PRICES:	UC 4200	UC 709
1-24	\$34.00	\$15.00
25-99	28.00	12.75
100-249	22.50	9.50

Here's your Engineering Data Sheet; tear out and keep.

# New



ELECTRONICS

# op amps, now!

## MONOLITHIC OPERATIONAL AMPLIFIERS LINEAR INTEGRATED CIRCUITS UC4200

The UC4200 operational amplifier is constructed on a single silicon chip.

The amplifier has the following features:

- $\pm 24$  V operation for aerospace and airframe application
- High input impedance of 3 meg  $\Omega$
- Output is short-circuit proof
- TC of input offset voltage is 6  $\mu$ V per  $^{\circ}$ C typical
- Operating temperature range  $-55^{\circ}$ C to  $+125^{\circ}$ C

### MAXIMUM RATINGS

$T_A = 25^{\circ}$ C (UNLESS OTHERWISE NOTED)

Supply Voltage	$\pm 26$ V
Power Dissipation (125 $^{\circ}$ C Free Air)	300 mW
Differential Input Voltage	$\pm 5$ V
Total Input Voltage	$\pm 15$ V
Output Short Ckt. Duration	Indefinite
Op. Temp. Range	$-55^{\circ}$ C to $+125^{\circ}$ C
Storage Temp. Range	$-65^{\circ}$ C to $+200^{\circ}$ C

### ELECTRICAL CHARACTERISTICS

@ 25 $^{\circ}$ C and  $\pm 24$  V supply (UNLESS OTHERWISE NOTED)

SPECIFICATION	Sym.	Min.	Typ.	Max.	Units	CONDITIONS
Open Loop Voltage Gain	$A_{VOL}$	50K				$R_L = 5$ K
Differential Input Impedance	$Z_{in}$	1	3		Meg Ohm	$f = 1$ KHz
Output Impedance	$Z_{out}$		150		Ohms	$f = 1$ KHz
Input Bias Current	$I_B$		30	100	nA	$V_{out} = 0$
Input Offset Current	$I_{OS}$		5	35	nA	$V_{out} = 0$
Input Offset Voltage	$V_{OS}$			8	mV	$R_s = 10$ K $\Omega$
Power Dissipation	$P_D$		110	180	mW	$V_{out} = 0$
Supply Current (each supply)	$I_{SS}$		2.3		mA	$V_{out} = 0$
Com-Mode Rejection Ratio	CMR		90		dB	$V_{out} = 0$ VDC, $f = 1$ KHz
Transient Response						
Risetime	$t_r$			1.0	$\mu$ sec	(See Fig. 1)
Overshoot				30	%	(See Fig. 1)

## ELECTRICAL CHARACTERISTICS

@ -55 to +125°C (UNLESS OTHERWISE NOTED)

SPECIFICATION	Sym.	Min.	Typ.	Max.	Units	CONDITIONS
Open Loop Voltage Gain	$A_{VOL}$	50K				$R_L = 5 K$
Differential Input Impedance	$Z_{in}$	500K			Ohms	$f = 1 KHz$
Input Bias Current	$I_B$		80	300	nA	$V_{out} = 0$
Input Offset Current	$I_{OS}$		20	100	nA	$V_{out} = 0$
Av T.C. of Input Offset Voltage	$\Delta V_{OS(av)}$		6		$\mu V/^\circ C$	$R_s = 10 K\Omega$
Input Offset Voltage	$V_{OS}$			10	mV	$R_s = 10 K\Omega$
Com-Mode Voltage Range	CMV	$\pm 15$			Volts	$V_{out} = (0 VDC), f = 1 KHz$
Com-Mode Rejection Ratio	CMR	70	90		dB	$R_s = 10 K\Omega$
Output Voltage Swing	$V_{out}$	$\pm 20$			Volts	$R_L = 5 K\Omega$
Supply Sensitivity				150	$\mu V/V$	$R_s = 10 K\Omega$

## MECHANICAL DATA

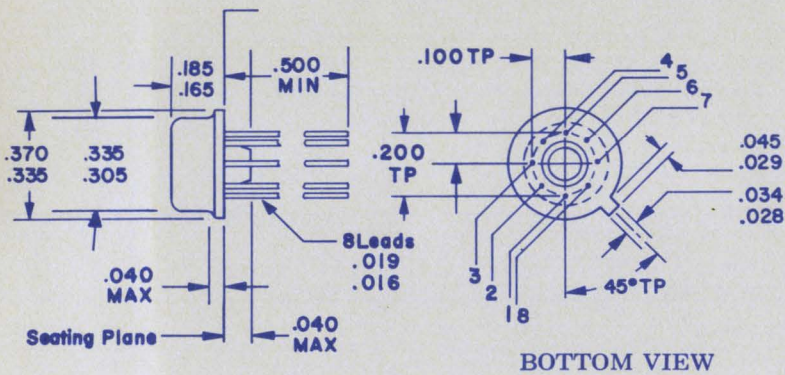

- (1) INPUT FREQUENCY COMPENSATION
- (2) INVERTING INPUT
- (3) NON-INVERTING INPUT
- (4) V- (PIN 4 CONNECTED TO CASE)
- (5) OUTPUT FREQUENCY COMPENSATION
- (6) OUTPUT
- (7) V+
- (8) INPUT FREQUENCY COMPENSATION

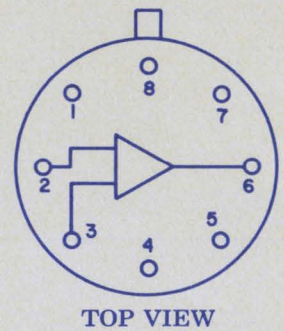

### TRANSIENT RESPONSE TEST

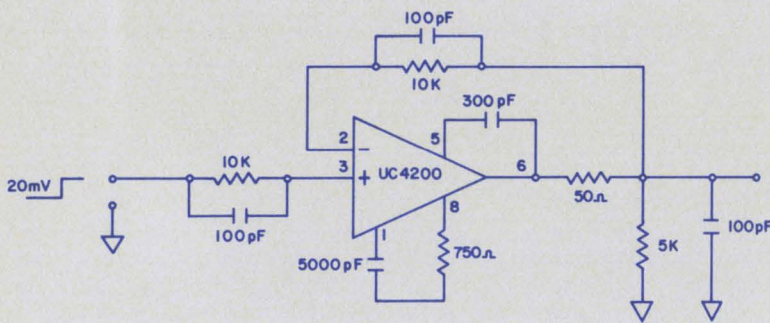
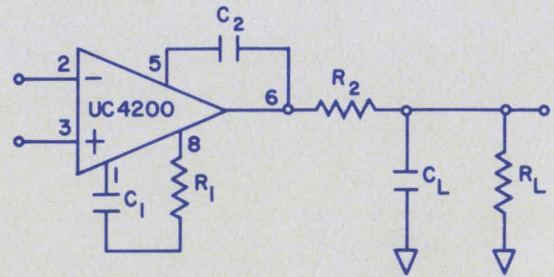

FIGURE 1

### RECOMMENDED COMPENSATION



Use  $R_2 = 50 \Omega$  when the amplifier is operated with heavy capacitive loading. A minimum value of 100 pF for  $C_L$  may be required for low values of  $R_L$ .

	$C_1$	$C_2$	$R_1$	$R_2$	$C_L$
$A_V = 1$	5000 pF	300 pF	750 $\Omega$	*	*
$A_V = 10$	3500 pF	50 pF	1.5K $\Omega$	*	*
$A_V = 100$	1000 pF	0	0	*	*
$A_V = 1000$	300 pF	0	0	*	*





ELECTRONICS

# MONOLITHIC OPERATIONAL AMPLIFIERS LINEAR INTEGRATED CIRCUITS UC709

The UC709 operational amplifier is constructed on a single silicon chip. The amplifier has the following features:

- Low power dissipation of 48 mW • High input impedance of 3 meg  $\Omega$  • Output is short-circuit proof • TC of input offset voltage is 6  $\mu\text{V}$  per  $^{\circ}\text{C}$  typical • Operating temperature range  $-55^{\circ}\text{C}$  to  $+125^{\circ}\text{C}$

### MAXIMUM RATINGS

@ 25 $^{\circ}\text{C}$  (UNLESS OTHERWISE NOTED)

Supply Voltage	$\pm 18\text{ V}$
Power Dissipation (125 $^{\circ}\text{C}$ Free Air)	300 mW
Differential Input Voltage	$\pm 5\text{ V}$
Total Input Voltage	$\pm 10\text{ V}$
Output Short Ckt. Duration	Indefinite
Op. Temp. Range	$-55^{\circ}\text{C}$ to $+125^{\circ}\text{C}$
Storage Temp. Range	$-65^{\circ}\text{C}$ to $+200^{\circ}\text{C}$

### ELECTRICAL CHARACTERISTICS

@ 25 $^{\circ}\text{C}$  and  $\pm 15\text{ V}$  supply (UNLESS OTHERWISE NOTED)

SPECIFICATION	Sym.	Min.	Typ.	Max.	Units	CONDITIONS
Open Loop Voltage Gain	$A_{VOL}$	25K		70K		$R_L = 2\text{ K}$
Differential Input Impedance	$Z_{in}$	1	3		Meg Ohms	$f = 1\text{ KHz}$
Output Impedance	$Z_{out}$		150		Ohms	$f = 1\text{ KHz}$
Input Bias Current	$I_B$		25	75	nA	$V_{out} = 0$
Input Offset Current	$I_{OS}$		5	25	nA	$V_{out} = 0$
Input Offset Voltage	$V_{OS}$			5	mV	$R_s = 10\text{ K}\Omega$
Power Dissipation	$P_D$		48	80	mW	$V_{out} = 0$
Supply Current (each supply)	$I_{SS}$		1.6		mA	$V_{out} = 0$
Com-Mode Rejection Ratio	CMR		90		dB	$V_{out} = 0\text{ VDC}, f = 1\text{ KHz}$
Transient Response						
Risetime	$t_r$			1.0	$\mu\text{sec}$	(See Fig. 1)
Overshoot				30	%	(See Fig. 1)

## ELECTRICAL CHARACTERISTICS

@ -55 to +125°C (UNLESS OTHERWISE NOTED)

SPECIFICATION	Sym.	Min.	Typ.	Max.	Units	CONDITIONS
Open Loop Voltage Gain	$A_{VOL}$	25K		70K		$R_L = 2\text{ K}$
Differential Input Impedance	$Z_{in}$	500K			Ohms	$f = 1\text{ KHz}$
Input Bias Current	$I_B$		75	225	nA	$V_{out} = 0$
Input Offset Current	$I_{OS}$		15	75	nA	$V_{out} = 0$
Av T.C. of Input Offset Voltage	$\Delta V_{OS(av)}$		6		$\mu\text{V}/^\circ\text{C}$	$R_s = 10\text{ K}\Omega$
Input Offset Voltage	$V_{OS}$			6	mV	$R_s = 10\text{ K}\Omega$
Com-Mode Voltage Range	CMV	$\pm 8$			Volts	$V_{out} = (0\text{ VDC}), f = 1\text{ KHz}$
Com-Mode Rejection Ratio	CMR	70	90		dB	$R_s = 10\text{ K}\Omega$
Output Voltage Swing	$V_{out}$	$\pm 12$			Volts p-p	$R_L = 10\text{ K}\Omega$
	$V_{out}$	$\pm 10$			Volts p-p	$R_L = 2\text{ K}\Omega$
Supply Sensitivity				150	$\mu\text{V}/\text{V}$	$R_s = 10\text{ K}\Omega$

## MECHANICAL DATA

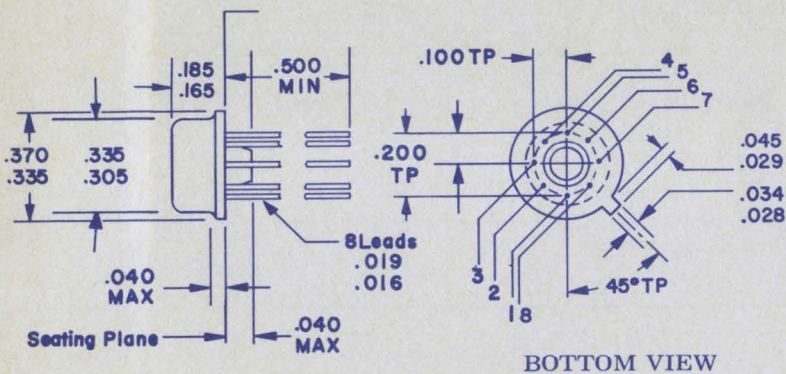

- (1) INPUT FREQUENCY COMPENSATION
- (2) INVERTING INPUT
- (3) NON-INVERTING INPUT
- (4) V- (PIN 4 CONNECTED TO CASE)
- (5) OUTPUT FREQUENCY COMPENSATION
- (6) OUTPUT
- (7) V+
- (8) INPUT FREQUENCY COMPENSATION

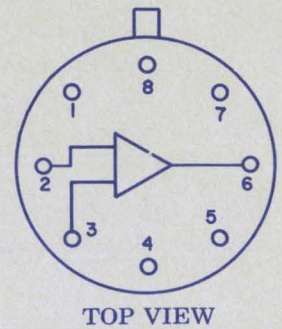

### TRANSIENT RESPONSE TEST

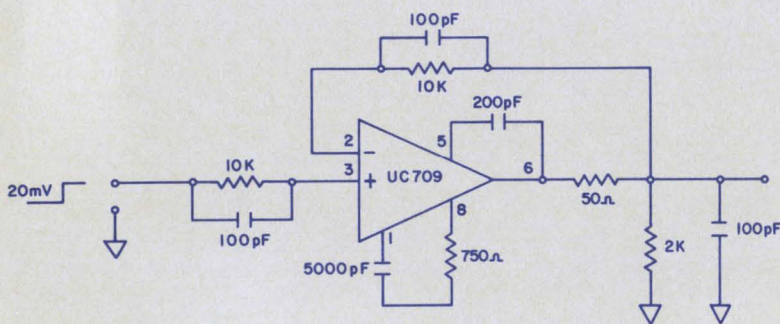
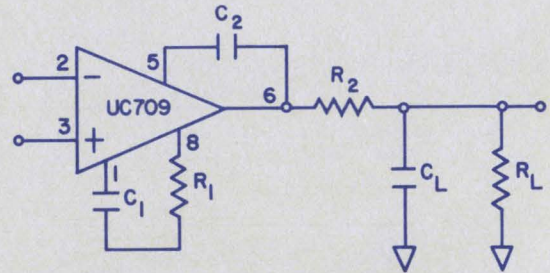

FIGURE 1

### RECOMMENDED COMPENSATION



\*Use  $R_2 = 50\ \Omega$  when the amplifier is operated with heavy capacitive loading. A minimum value of 100 pF for  $C_L$  may be required for low values of  $R_L$ .

$A_V = 1$	$C_1$	$C_2$	$R_1$	$R_2$	$C_L$
$A_V = 1$	5000 pF	200 pF	750 $\Omega$	*	*
$A_V = 10$	2500 pF	50 pF	3 K	*	*
$A_V = 100$	500 pF	0	0	*	*
$A_V = 1000$	150 pF	0	0	*	*



# New - Order samples by phone

## DISTRIBUTORS / EASTERN

**ALABAMA, Huntsville**  
Hall-Mark Electronics • (205) 536-9627

**ALABAMA, Huntsville**  
Schweber Electronics • (205) 539-2756

**FLORIDA, Orlando**  
Hall-Mark Electronics • (305) 855-4020

**MARYLAND, Silver Springs**  
Schweber Electronics • (301) 587-2900

**MASSACHUSETTS, Burlington**  
Avnet Electronics • (617) 272-3060

**MASSACHUSETTS, Waltham**  
Schweber Electronics • (617) 891-8484

**NEW JERSEY, Clifton**  
Eastern Radio • (201) 471-6600

**NEW YORK, Binghamton**  
Federal Electronics • (607) 748-8211

**NEW YORK, Buffalo**  
Summit Electronics • (716) 884-3450

**NEW YORK, New York**  
Eastern Radio • (212) 244-8930

**NEW YORK, Westbury, L.I.**  
Schweber Electronics • (516) 334-7474

**NORTH CAROLINA, Winston-Salem**  
Electronic Wholesalers  
(919) 725-8711

## CENTRAL

**ILLINOIS, Elk Grove Village**  
Arco Electronics • (312) 439-8100

**ILLINOIS, Schiller Park**  
Pace-Avnet • (312) 678-6310

**MINNESOTA, Minneapolis**  
Avnet Electronics • (612) 920-5866

**MISSOURI, St. Louis**  
Electronic Components for Industry  
(314) 647-5505

**OHIO, Cleveland**  
Schweber Electronics • (216) 333-7020

**OKLAHOMA, Tulsa**  
Hall-Mark Electronics • (918) 835-8458

**TEXAS, Dallas**  
Hall-Mark Electronics • (214) 231-6111

**TEXAS, Dallas**  
Sterling Electronics, Inc. • (214) FL 7-9133

**TEXAS, Houston**  
Hall-Mark Electronics • (713) SU 1-0011

**TEXAS, Houston**  
Sterling Electronics • (713) 666-3811

## WESTERN

**ARIZONA, Phoenix**  
Avnet Electronics • (602) 272-6821

**CALIFORNIA, Culver City**  
Avnet Electronics • (213) 870-6141

**CALIFORNIA, Los Angeles**  
K-Tronics • (213) 685-5888

**CALIFORNIA, Mountain View**  
Avnet Electronics • (415) 961-7700

**CALIFORNIA, Newport Beach**  
Western Electronic Components  
(714) 540-1322 • (213) 631-6119

**CALIFORNIA, Redwood City**  
Fortune Electronics • (415) 365-4000

**CALIFORNIA, San Diego**  
Avnet Electronics • (714) 279-1550

**CALIFORNIA, San Diego**  
Kierulff Electronics • (714) 278-2112

**COLORADO, Denver**  
Newark-Denver Electronics  
(303) 757-3351

**OREGON, Portland**  
Washington Electronics  
(206) 682-8981

**WASHINGTON, Seattle**  
Washington Electronics  
(206) 682-8981

## CANADA

**MONTREAL, Quebec**  
Avnet Electronics of Canada  
(514) 381-9126

**TORONTO, Ontario**  
Avnet Electronics of Canada  
(416) 789-2621

## FACTORY SALES ENGINEERS

**CALIFORNIA 92633, Fullerton**  
Fred Vogel, Fred Yingling  
(213) 691-0958 • (714) 871-5073  
TWX: 910-592-1255

**CALIFORNIA, Mountain View**  
Bill Geist  
(415) 969-9390 • TWX: 910-379-6444

**ILLINOIS 60068, Park Ridge**  
Buzz Potter, Dick Kolander  
(312) 825-7181 • TWX: 910-253-4081

**NEW YORK 11753, Jericho**  
Phil Cancelliere, Jim Blanchard  
(516) 433-8441 • TWX: 510-221-1840



Engineering Data Sheets: (If somebody beat you to them, circle No. 100  
For Applications Data, circle No. 101; Reliability Data, No. 102)

ORDER OFF THE SHELF FROM UNION CARBIDE ELECTRONICS DISTRIBUTORS.



Semiconductor Department / 365 Middlefield Road / Mountain View, California 94040 / Telephone: (415) 961-3300 / TWX: 910-379-6942

INFORMATION RETRIEVAL NUMBER 103

# Better Silicon Power Switch/Amplifier Ideas Are Available—Take It From The Authority!

All about designing with silicon power transistors with proven basic circuits acting as springboards for the designer's own requirements!

Chock-full of practical, comprehensive information every consumer and industrial circuit designer needs to know when using silicon power transistors, the just-released volume is highlighted by easy-to-understand, "how-to-do-it" topics like using direct coupling to eliminate amplifier transformers, outguessing the effects of damaging, secondary-breakdown transients, square wave forms and intermittent, irregular pulses, an exhaustive examination of AC to DC inverters, FET's and HV silicon in entertainment designs, and designing short-circuit-proof voltage regulators, to name a few.

Specific titled selections are:

- Low-Cost, High-Voltage Servo Amplifiers
- Complementary, Solid-State Audio Amplifiers
- Thermal Response of Semiconductors
- The ABC's of DC to AC Inverters
- A Method of Predicting Thermal Stability
- Solid-State Video Amplifiers
- New Solutions to Voltage Control Problems

... and much, much more that will make this a most-used design aid!

This more-than-120-page, 65-circuit edition is the latest Motorola-authored technical reference tool devoted to saving you time in design. It also incorporates the new Silicon Power Selector Guide... over 100 types — including the state-of-the-art Thermopad plastic devices — spanning collector currents from 30 mA to 30 A, collector-emitter voltages to 400 V, power dissipation ratings from 3.75 to 200 W and  $f_T$ 's from 1 to 60 MHz.

**Your technical library isn't complete without it and it's yours for the asking. Resolve to get it today!**

Write on your company letterhead to Box 955, Phoenix, Arizona 85001.



**MOTOROLA**  
Semiconductors

*— where the priceless ingredient is care!*

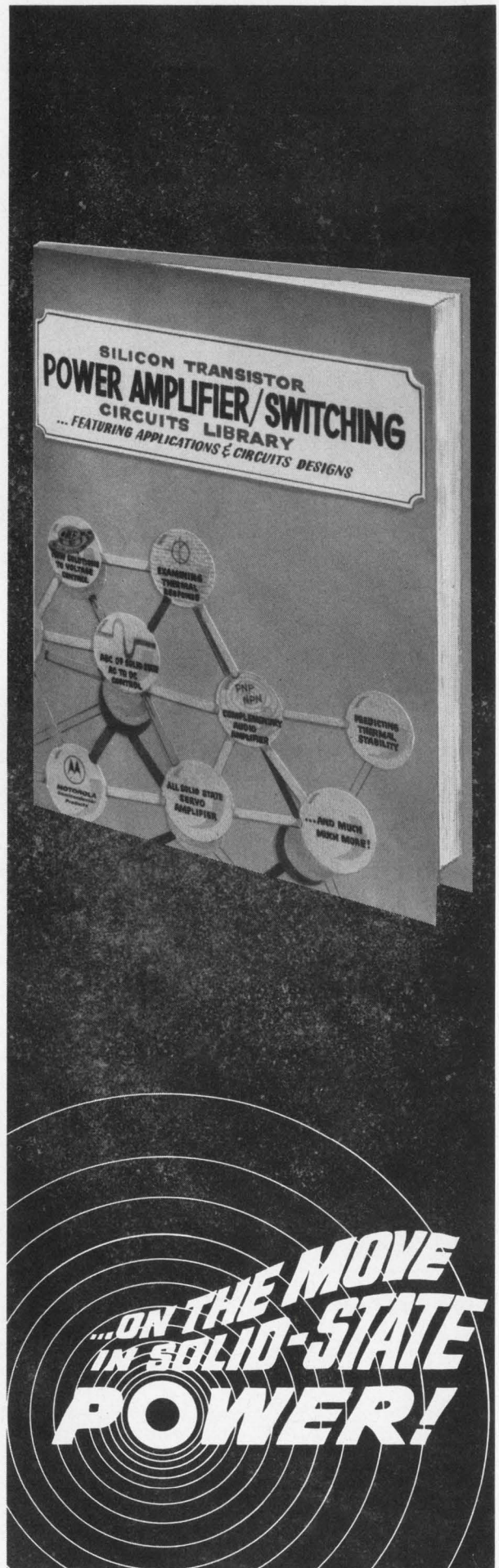



**PAKTRON**  
**THE**

**BIGGEST  
NAME  
IN FILM**

**CAPACITORS**

★ **PRESENTS** ★

THE FIRST

# PAKTRON FILM

INTRODUCING  
**LOLITA**  
IN METALIZED MYLAR



**SEE  
THE  
GREATEST  
COLLECTION  
OF FILM  
CAPACITORS  
EVER  
ASSEMBLED  
FOR A  
SINGLE  
PRODUCTION.**

Thrill as they match or exceed their guaranteed ratings. Chill as they find themselves in a maze of electronic equipment. Marvel as they slip into high reliability military applications.

THEY MAY  
SHOCK  
YOU.

THEY MAY  
STARTLE  
YOU.

BUT THEY'LL  
NEVER FAIL  
YOU.

"AN ELECTRIFYING PRODUCTION"  
... Chronicle Gazette

"HIGH VOLTAGE PERFORMANCE"  
... Globe Examiner

"...electrifying...totally new...a brilliant performance." *Globe Gazette*

You'll be dazzled by her resistance. Charmed by her size. Thrilled by her durability. You'll tremble at her volumetric efficiency. And you'll want to witness her tireless performance on the boards. Remember, Lolita is from Paktron, the company that brought you Theda and Greta—the biggest names in the radial capacitor biz. And, if you want to be alone with Lolita, just give us the word. Any capacitor named Lolita can't be all bad.

**LOLITA**  
ALL NEW RADIAL LEAD METALIZED  
MYLAR FILM CAPACITOR

Lolita—a character study:  
Working Voltage: 100, 200, and 400 WVDC  
Tolerance:  $\pm 5\%$ ,  $\pm 10\%$ ,  $\pm 20\%$  Standard  
Capacitance Values: .1 mfd.—10.0 mfd.  
Lead crimps to fit your printed  
circuit board applications

Marquee lights activated courtesy of Licon © Division Illinois Tool Works Inc.

ANNUAL

# FILM FESTIVAL

INTRODUCING  
**URSULA**  
IN WRAP AND FILL

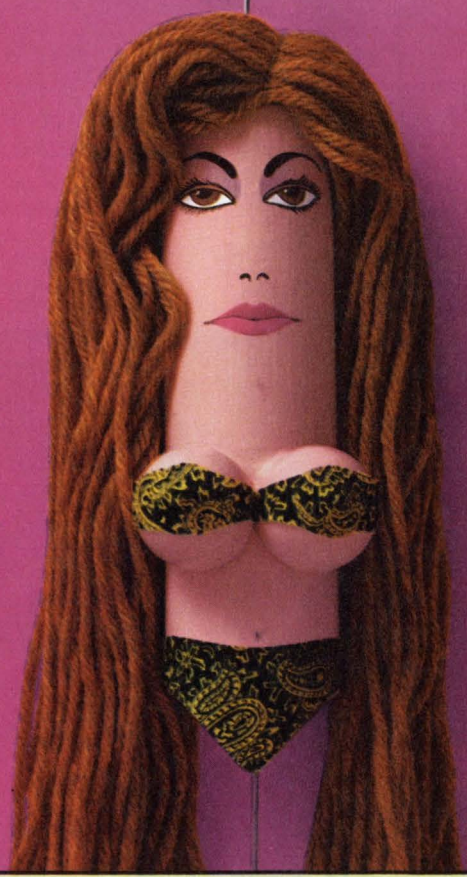

"...a really new film star...this one is destined for greatness." Chronicle Examiner  
You'll thrill to her high performance. You'll quiver as this trim little lovely exhibits her form in a skin type wrap. Your blood will run cold as she resists shock and vibration. Your palms will sweat when you see her axial leads in a point to point configuration. And remember, Ursula is from Paktron, the company that made radial lead capacitors the biggest hit of our time. Once you've seen Ursula in action, you'll have to see her in person. She's available for demonstrations. Just ask. Be honest with yourself. Would anyone name a capacitor Ursula if he didn't think it could stand the shock?

**URSULA**  
ALL NEW WRAP & FILL  
CAPACITOR

Here's how the critics describe Ursula:  
Capacitance Values: .001 mfd.-1.0 mfd.  
Tolerances:  $\pm 5\%$ ,  $\pm 10\%$ ,  $\pm 20\%$  Standard  
Working Voltage: 80, 100, 200, 400, and 600 WVDC

## COMING ATTRACTIONS

- In the months to come you'll see:
- One of the industry's brightest stars, Bridgette in **THE BATTLE OF CIRCUIT CITY**.
  - Rhonda, darling of the circuit, in **SHELL SHOCK**.
  - **RETURN TO PAKTRON PLACE** in which factory workers follow Sophia's Leads.
- You won't want to miss a single one of these film capacitors.

★ **SEND** ★  
**FOR A FREE  
PIN-UP  
CALENDAR.**

See all your film favorites, posed the way you like them, in shocking color. Write on your letterhead to:

**FLO ZIGFIELD**  
Paktron Division  
Illinois Tool Works Inc.  
1321 Leslie Avenue  
Alexandria, Virginia 22301

# EVER POPULAR FAVORITES

MEET  
**SOPHIA**  
MOLDED MYLAR CAPA-  
CITOR. GET TO KNOW  
HER BY HER  
FIRST NAME.



Working Voltage: 50WVDC  
Tolerance:  $\pm 1\%$ ,  $\pm 2\%$ ,  $\pm 5\%$ ,  $\pm 10\%$  Standard  
Capacitance Value: 220 mmfd.—.1 mfd.

THRILL AS  
TINY  
**THEDA**  
STRUGGLES TO  
PROTECT HER  
CAPACITY.



Ultra thin Mylar Film/Foil—the MW-50  
Capacitance Values: up to 0.47 mfd.  
Working Voltage: 50WVDC  
Tolerances:  $\pm 5\%$   $\pm 10\%$   $\pm 20\%$   
Operating Temperature Range:  
—55°C to +125°C

LEARN WHY  
**CLARA**  
ISOLATED HERSELF  
FROM THE REST  
OF THE  
CIRCUIT.



Flat Line—Mylar Film/Foil  
Capacitance Values: .01 mfd.—.5 mfd.  
Working Voltage: 100WVDC  
Tolerance:  $\pm 5\%$ ,  $\pm 10\%$ ,  $\pm 20\%$  Standard  
Operating Temperature Range:  
—55°C to +125°C

THE  
BEWITCHING  
**BRIGITTE**  
WILL LURE YOU  
WITH HER PRE-  
CISION FORM.



Classic molded polycarbonate  
Capacitance Values: 470 mmfd.—.056 mfd.  
Working Voltage: 50WVDC  
Tolerances:  $\pm 1\%$ ,  $\pm 2\%$ ,  $\pm 5\%$   $\pm 10\%$  Standard  
Operating Temperature Range: —65°C to 105°C  
(no Voltage derating)

THE GORGEOUS  
**GRETA**  
SEE THIS PROUD  
BEAUTY RESIST  
THE ADVANCES  
OF AGE.



<sup>TM</sup>  
Hi-Blu™ Mylar Film/Foil Epoxy Dip-coated  
Capacitance Values: to 0.5 mfd.  
Working Voltages: 100 to 600 WVDC  
Tolerance:  $\pm 5\%$  to  $\pm 20\%$   
Operating Temperature  
Range: —55°C to +125°C

THE TEMPTING  
**RHONDA**  
SAYS "WHY DON'T  
YOU PICK ME UP  
AND TRY ME  
SOMETIME?"



Epoxy dip coated Metalized Polycarbonate  
Capacitance Values: .068 mfd.—2.5 mfd.  
Working Voltage: 100 WVDC  
Tolerance:  $\pm 5\%$ ,  $\pm 10\%$ ,  $\pm 20\%$  Standard  
Operating Temperature Range: —55°C to  
+125°C (no Voltage derating)

**PAKTRON**  
Division Illinois Tool Works Inc.  
**itw**

These Paktron film stars are distributed exclusively by COMPAR.

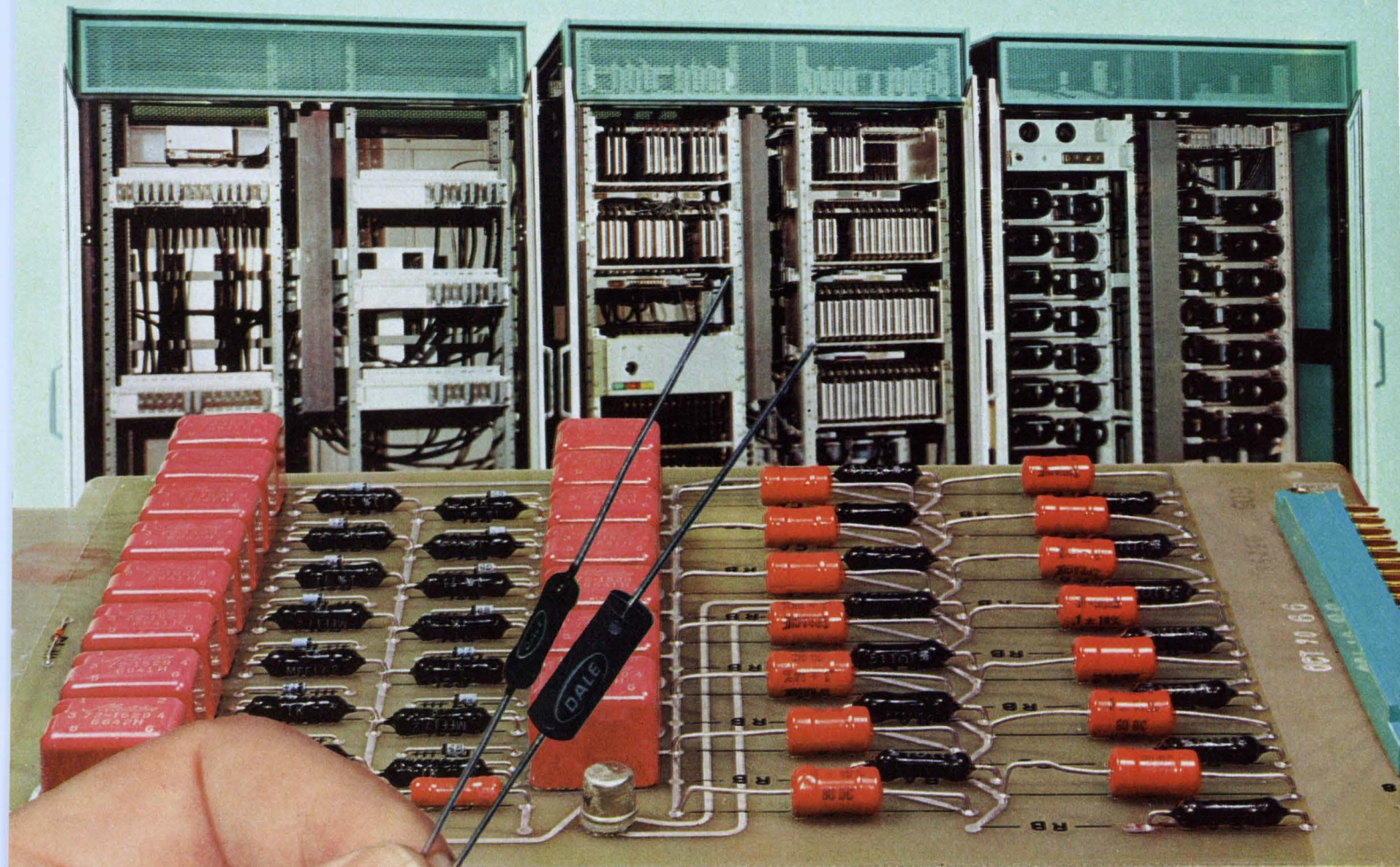

**DALE**

## Metal Film Resistors

...chosen for long life in the  
Westinghouse PRODAC System

### GENERAL SPECIFICATIONS TYPE MF\* MIL-R-10509F

DALE TYPE	MIL. TYPE	125°C RATING (Char. C & E)	70° C RATING (Char. D)	RESISTANCE RANGE (Ohms)
MF50	RN-50	1/20 w	1/10 w	30.1 to 80.6K
MF-1/10	RN-55	1/10 w	1/8 w	30.1 to 301K
MF-1/8	RN-60	1/8 w	1/4 w	10 to 1MΩ
MF-1/4	RN-65	1/4 w	1/2 w	10 to 1 MΩ
MFS-1/2	RN-70	1/2 w	3/4 w	10 to 1.5 MΩ
MF-1	RN-75	1 w	—	25 to 2.6 MΩ
MF-2	RN-80	—	2 w†	100 to 10 MΩ

\*Also available in conformal coated (MFF) styles. †Char. B.  
Tolerance: ±1%, ±5%, ±.25%, ±.10% standard.  
Characteristics D, C, or E apply depending on T.C. required.

Computers for industrial process control demand long resistor life. To insure this, Dale Metal Film resistors are used extensively in the versatile Westinghouse PRODAC System. Value analysis dictated the choice—with the long life characteristics of metal film winning over the lower price of carbon and carbon composition types. Dale verifies this reliability with long-term load life tests (see below). Delivery is reliable, too. Expanded production facilities can put quantities up to 50,000 in your plant in 2 weeks (1% tolerance units). We'll prove it—call 402-564-3131 today.

### NEW METAL FILM LOAD LIFE DATA

Dale MF resistors have undergone 16,320,000 hours of load life testing without a failure (100% rated power, 70°C; failure defined as  $\Delta R > 1\%$ ). Based on these tests, the MF resistor has a proven failure rate of .004% per 1,000 hours (60% confidence at 50% power, 70°C ambient). Write Dale for complete test data.

FOR COMPLETE INFORMATION CIRCLE NO. 181

**DALE**

for optimum value in industrial resistors

DALE ELECTRONICS, INC., 1300 28th Ave., Columbus, Nebr. 68601 In Canada: Dale Electronics Canada, Ltd.



**DALE**<sup>®</sup>

**G resistors need less space in outer space.**

*(and in down-to-earth circuits, too)*

Dale G resistors give you precision power in the smallest packages available. Test them with equivalent size wirewounds and you get 1.4 to 4 times more power. Run them at mil power levels and you get stability that can't be challenged. Dale's silicone-coated G Series combines the superior conductivity of beryllium oxide cores with the exclusive wire and wirewinding techniques perfected in the Minuteman High Reliability Development Program. When you need more precision power in less space, or more stability without increasing size—call Dale. Only the G Series gives you this freedom of choice.

**SURVEYOR RELIABILITY** demands are met by AGS wirewounds—the established reliability version of Dale's G Series. Supplied to Hughes Aircraft Company, builder of the Surveyor, AGS resistors have a proven failure rate of .000113% per thousand hours (60% confidence level, 50% rated power at 25° C ambient). They are the world's most reliable wirewounds. GARD TESTING is available to meet Established Reliability requirements at significant time/cost savings over typical 100 hr. burn in. Write for Test Report #19590.

#### G SERIES SPECIFICATIONS

DALE TYPE	MIL-R 26D TYPE	DALE RATING		RESISTANCE RANGES (OHMS)	
		U	V	.05%, .1%, .25%	.5%, 1%, 3%
G-1	RW-81	1.0 W	—	10 to 950	1 to 3.4K
G-2	—	1.5 W	—	10 to 1.3K	1 to 4.9K
G-3	RW-80	2.25 W	—	1 to 2.7K	.1 to 10.4K
G-5	—	4.0 W	5 W	1 to 6.5K	.1 to 24.5K
G-5A	—	4.5 W	6.5 W	1 to 11.4K	.1 to 42.1K
G-5C	—	5 W	7 W	1 to 8.6K	.1 to 32.3K
G-6	—	6 W	8 W	1 to 12.7K	.1 to 47.1K
G-10	—	7 W	10 W	.5 to 25.7K	.1 to 95.2K
G-12	—	10 W	12 W	.5 to 41.4K	.1 to 154K
G-15	—	15 W	18 W	.5 to 73.4K	.1 to 273K

**MIL SPEC:** G Series resistors meet the requirements of MIL-R-26D as well as the older MIL-R-26C and MIL-R-23379 specifications.

**STABILITY:** G Series resistance shift is less than 50% than that of conventional wirewounds of equivalent size (Dale RS) operated at the same ratings.

**STANDARD VARIATIONS:** G Series resistors are available with radial leads (Type GL) and with non-inductive (Aryton-Perry) winding (Types GN and GNL).

#### COMPARATIVE SIZE:



Dale G-5C resistance element (left) rated at 5 watts compared with conventional RS-5 watt wirewound element.

**For action, call Dale: 402-564-3131. For information, circle 181 for Catalog A.**



**DALE ELECTRONICS, INC.**

1300 28th Ave., Columbus, Nebraska 68601  
In Canada: Dale Electronics Canada, Ltd.

**DALE**<sup>®</sup>

Printed in U.S.A.

## IDEAS/CRTs

### Instantaneous display of computer-generated data, plus hard-copy prints in seconds.

How a Sylvania CRT lets you select and view computer data . . . and print out only the parts you want within seconds.

Here's another imaginative use for a Sylvania CRT: one-step viewing of computer-generated data and simultaneous hard-copy recording of it on Dry-Silver paper. The 3M "129" Display/Print Module also provides ready access, at many remote locations, to a single computer-memory storage bank.

In addition to electronic data processing applications, these CRT Display/Print Modules record medical data such as ECGs VCGs, and EEGs... duplicates sustained TV facsimile displays . . . and reproduces repeating waveforms displayed on CRT instrumentation recorders.

This is just one IDEA for use of a Sylvania CRT. (And we have dozens of different types—each for a specific application.)

Below are specifications for the CRT used in this 3M "129" Display/Print Module. How many ways can you use it?

#### SYLVANIA SC4639 CRT

Focusing Method	.....	Electrostatic
Deflection Method	.....	Electromagnetic
Deflection Angle	.....	.50 degrees
Phosphor	.....	.P1
Fluorescence	.....	Green
Persistence	.....	Short to medium
Faceplate	.....	7-inch diameter, flat (6-inch useful screen diameter)
Length	.....	.14 inches
Trace Width	.....	Better than 0.008 inch with light output in excess of 1,000 foot-lamberts
Anode Voltage	.....	20,000 VDC

CIRCLE NUMBER 300

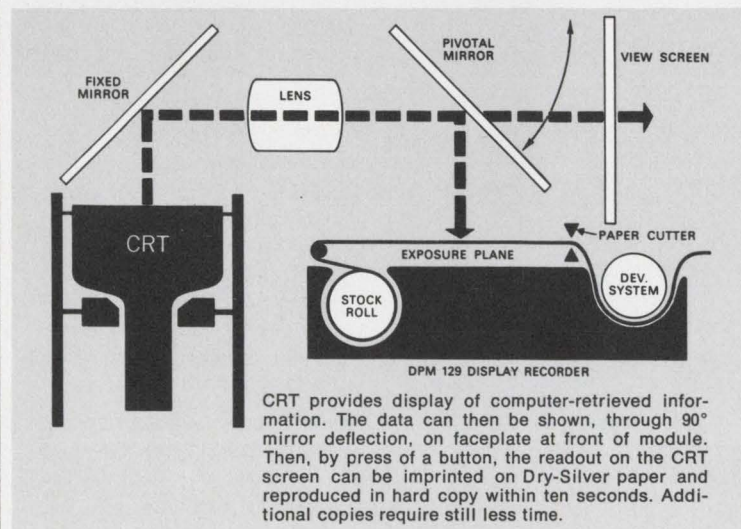

3M "129" Display CRT Print Module. Information retrieved from computer memory bank is displayed on screen at top. Press "print" button and information on screen will be reproduced on dry paper, below, within 10 seconds.

### This issue in capsule

#### Diodes

PIN microwave switching diodes with assured Quality ("Q") Factor

#### Rectifiers

1-amp glass rectifiers absorb 1000-watt reverse transients

#### Circuit Boards

Low-cost, laminated SYL-PAC boards increase IC switching speeds by 60%

#### B&W Picture Tubes

A black-and-white picture for less than 12¢ a square inch

#### Integrated Circuits

Designing a low-cost serial adder-subtractor subsystem

#### IC Systems

A 131,072-bit memory weighing less than 7 pounds

#### Manager's Corner

Why U.S.-made B&W TV receivers are still very much alive

## New PIN microwave switching diodes with assured R·C product (Quality or "Q" Factor).

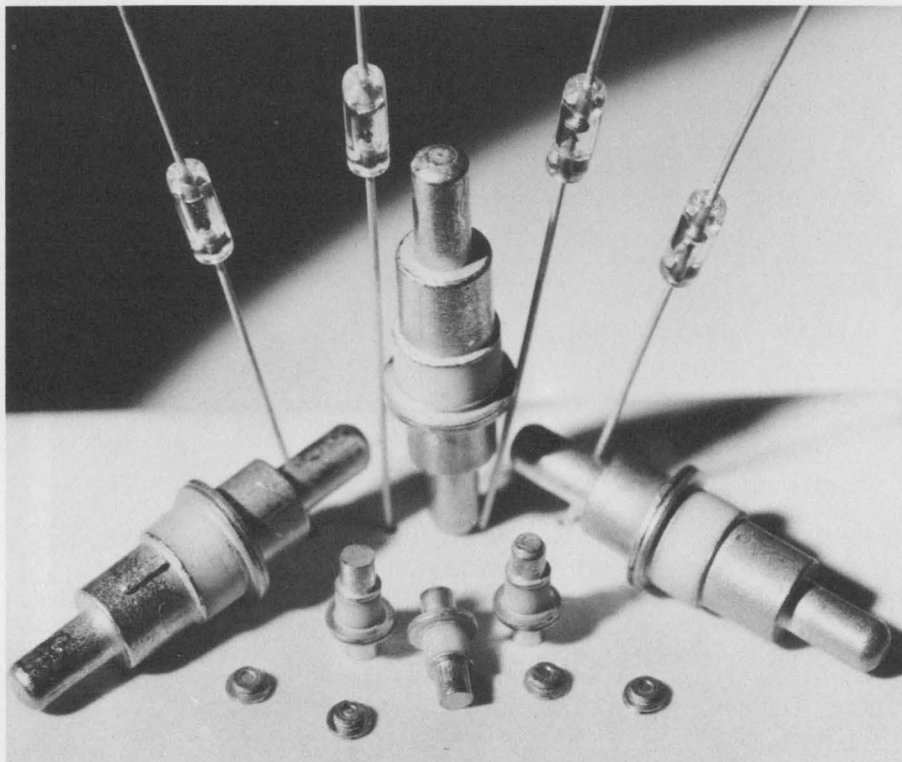

Available in a variety of package styles, both glass and ceramic-and-metal.

R·C curve for Sylvania PIN diodes. Broken line shows Q factor for standard units, solid line for premium units having slightly higher Q factor at slightly higher cost.

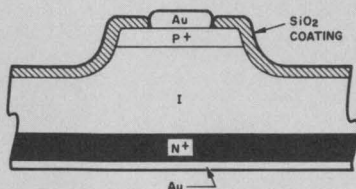
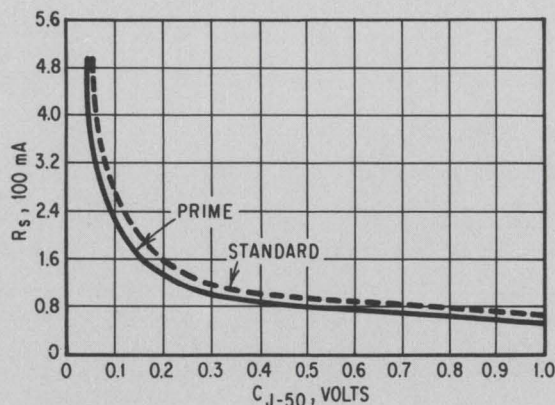

Diodes consist of a P+ type and N+ type region separated by an intrinsic layer, gold leads and a passivating layer of silicon dioxide which completely covers the junction area. Mesa construction provides high-voltage capability without sacrificing high-frequency switching performance.

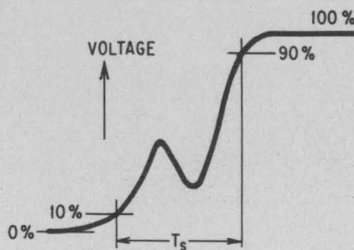

Switching time,  $T_s$ , measured between the 10% and 90% points of the wave form, is about 20 nanoseconds.

Now, PIN configuration assures customer-specified Resistance/Capacitance product—or Quality ("Q") Factor—in microwave switching diodes.

Sylvania now offers a line of PIN microwave switching diodes with an assured R·C (Quality Factor) product. In other words, you specify the maximum junction capacitance ( $C_J$ ) and the series resistance ( $R_S$ ) you want, and we'll provide that combination of characteristics on a unit-to-unit, lot-to-lot basis. Diodes are specified in two categories: low-cost standard and slightly higher-cost premium units so that you can obtain high performance when you need it, but don't have to pay extra for it when you don't.

Sylvania PIN microwave switching diodes are essentially voltage-dependent variable resistors, so that even at microwave frequencies they are capable of switching, limiting and controlling power from microwatts to kilowatts in cw or pulsed operation. To assure the most efficient device for operation at various power levels, these units are offered in voltage range of from 200-1000 volts.

A typical forward current bias of 50 to 100 ma is required for turn-on in switching applications. Zero bias is all that is necessary to "turn off" the diode in many applications. Under a reversed bias condition, the PIN diode exhibits a gradual decrease of series resistance because of the widening of depletion layer. This process continues until the reverse breakdown voltage of the device is reached and heavy conduction starts again.

### We recommend them for:

- Low power switching
- Higher power switching and multiplexing
- Limiting
- Voltage-controlled attenuators
- AGC systems
- High-frequency switching
- Phase shifters

**And we assure the R·C performance capability you specify.**

CIRCLE NUMBER 301



# One-amp glass rectifiers that absorb 1000-watt reverse transients.

Sylvania double-diffused silicon glass-encapsulated rectifiers meet all applicable commercial, industrial and military specifications within their performance range.

Our 1-amp glass-encapsulated silicon rectifiers easily take 50-amp forward surges and 1000-volt reverse transients in stride. They have extremely low reverse leakage current: 10 nA at 25°C. Sylvania's advanced glass-to-metal sealing techniques assure virtually complete hermetic seals: Radiflo leakage rates of less than  $1 \times 10^{-10}$  cc/sec typical. They operate over a temperature range of from -65°C to +175°C and exceed all standard life and design requirements of MIL-S-19500.

Heat dissipation in the units is increased by welding a solid, high-conduction power lead to an oversized heat conduction stud. This increases power handling capability, makes the device last longer and keeps it cooler. The glass package is electrically neutral and smaller than most metal rectifier cases, thus permitting greater stacking and card densities. The glass body also helps improve in-process quality control by allowing visual inspection during production.

CIRCLE NUMBER 302

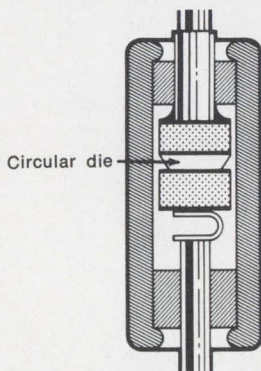

Sylvania's circular die with its truncated cross section provides better, more reliable breakdown characteristics than a straight-sided square die. This results from a uniform spreading of the field around the circular die as opposed to concentration at the corners of square ones. The truncated junction eliminates surface breakdown phenomena by controlling depletion-layer exposure at the die sides and its angle to the exposed edge. These units handle reverse power transients well over normal ratings with high immunity to catastrophic failure.

### Typical Characteristics

ABSOLUTE MAXIMUM RATINGS AT 25°C:						
	IN4383	IN4384	IN4385	IN4585	IN4586	
Breakdown Voltage, BV	200	400	600	800	1000	volts
Average Forward Current, $I_o$ (+50°C)	1.0	1.0	1.0	1.0	1.0	amp
Average Forward Current, $I_o$ (+100°C)	1.0	1.0	1.0	0.6	0.6	amp
Average Forward Current, $I_o$ (+150°C)	0.3	0.3	0.3	0.2	0.2	amp
Forward Surge Current, $I_F$ (surge) 1 cycle, F=60 cps	50	50	50	50	50	amps
Forward Surge Current, $I_F$ (surge) recurrent, F=60 cps	6	6	6	6	6	amps
Operating Temperature, $T_j$	(-65°C to +175°C, all types)					

ELECTRICAL CHARACTERISTICS:	TYPES	MAX.	UNIT
<b>Forward Voltage Drop, <math>V_F</math> (25°C)</b> $I_F=1.0$ amp	All	1.0	volt
<b>Reverse Current, <math>I_R</math> (25°C)</b> $V_R=200v$ , $V_R=400v$ , $V_R=600v$ , $V_R=800v$ , $V_R=1000v$ ,	1N4383 1N4384 1N4385 1N4585 1N4586	10 10 10 10 10	ua ua ua ua ua
<b>Reverse Current, <math>I_R</math> (+175°C)</b> $V_R=200v$ , $V_R=400v$ , $V_R=600v$ , $V_R=800v$ , $V_R=1000v$ ,	1N4383 1N4384 1N4385 1N4585 1N4586	500 500 500 500 500	ua ua ua ua ua
<b>Dynamic Reverse Current, <math>I_R</math> (full cycle average):</b> $I_o=1000ma$ , $V_R=200v$ , $T=100°C$ $I_o=1000ma$ , $V_R=400v$ , $T=100°C$ $I_o=1000ma$ , $V_R=600v$ , $T=100°C$ $I_o=1000ma$ , $V_R=800v$ , $T=50°C$ $I_o=1000ma$ , $V_R=1000v$ , $T=50°C$	1N4383 1N4384 1N4385 1N4585 1N4586	275 250 225 200 200	ua ua ua ua ua
<b>Dynamic Forward Voltage Drop, <math>V_F</math> (full cycle average):</b> $I_o=1000ma$ , $V_R=200v$ , $T=100°C$ $I_o=1000ma$ , $V_R=400v$ , $T=100°C$ $I_o=1000ma$ , $V_R=600v$ , $T=100°C$ $I_o=1000ma$ , $V_R=800v$ , $T=50°C$ $I_o=1000ma$ , $V_R=1000v$ , $T=50°C$	1N4383 1N4384 1N4385 1N4585 1N4586	1.3 1.3 1.3 1.3 1.3	v(pk) v(pk) v(pk) v(pk) v(pk)

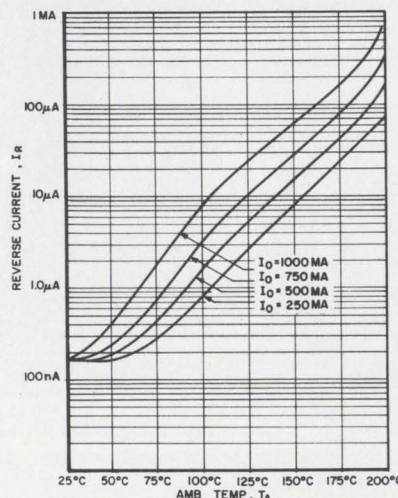

MAXIMUM PEAK REVERSE POWER DISSIPATION FOR A SINGLE PULSE. (25°C AMBIENT)

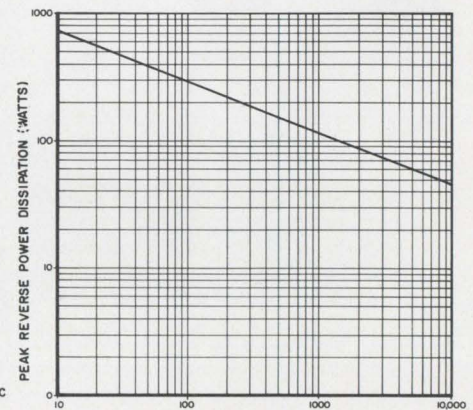

Reverse current vs ambient temperature.

PULSE TIME DURATION (MICROSECONDS)

# SYL-PAC: The circuit boards that are finally catching up to high-speed IC capabilities.

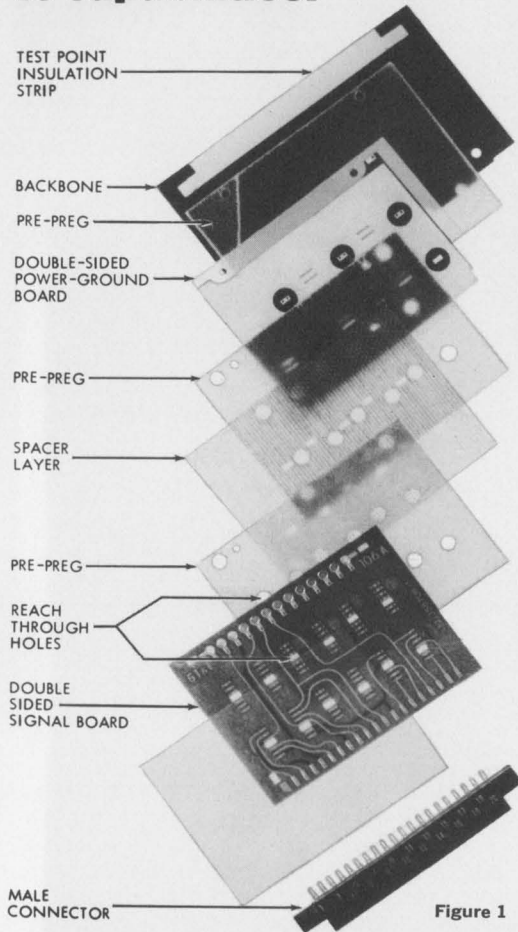

Figure 1

Exploded view, SYL-PAC laminated circuit board. Consists of a double-sided signal board, with two signal layers connected by plated reach-through holes, and a double-sided power-ground board. Any connection on either side of the board is always within 1/64" of the power-ground source.

How SYL-PAC circuit boards minimize  $L \frac{\Delta i}{\Delta t}$  noise at high-switching speeds.

Until now, high-speed integrated circuits mounted on conventional circuit boards have tended to be "noisy"...or to generate spurious signals...in direct proportion to the speed of operation and the length of the current paths connecting the terminals.

In fact, it had become almost pointless to design faster ICs since, up until now, circuit-board design had not kept pace with IC speeds. Heretofore, our 50 MHz SUHL™ II TTL ICs have been limited to about 20 MHz switching speed; anything faster on available boards would result in

extremely high noise levels.

But our new SYL-PAC circuit boards allow the same components to operate at about 33 MHz...and with  $L \frac{\Delta i}{\Delta t}$  noise levels as much as 8 times lower than other circuit boards...a 60% improvement.

### SYL-PAC board construction

SYL-PAC multi-plane laminated circuit boards are made up of two double-sided signal layers on either side of a "backbone." Signal layers are connected by plated reach-through holes, which allow the mounted ICs to contact a common power-ground plane, which carries the B+ voltage to all parts of the board (Fig. 1). With this construction, every IC lead is always within 1/64" of the power-ground source.

Such extremely short current

Adaptable to all forms of component mounting

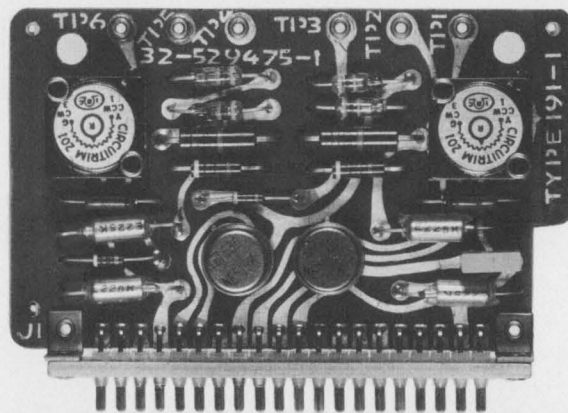

Discrete-component circuit logic card. This package uses the same male connector and configuration as the IC package; both types may be freely intermixed at chassis level.

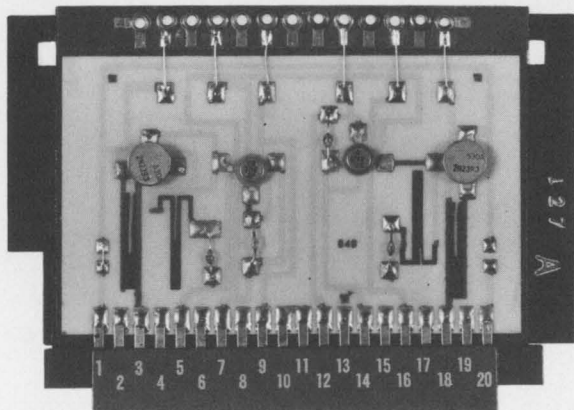

Thick-film/ceramic logic card. Here discrete components are mounted with thick-film/micro-electronic substrate components. Connectors are again the same as for the standard IC package.

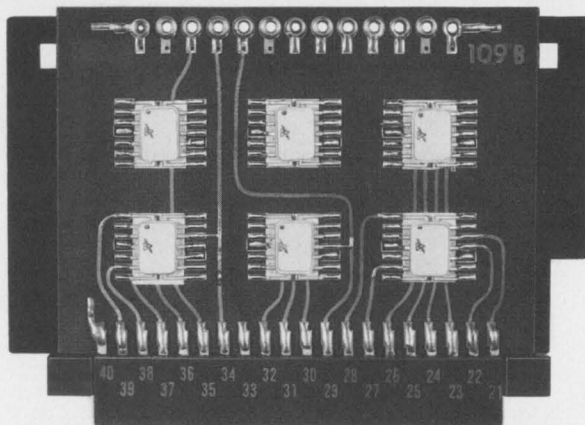

Integrated-circuit logic card. Double-sided board contains up to 12 IC flatpacks or dual in-line plug-in packs. Standard board has a 40-pin double-row male connector mounted at lower edge.

connections reduce noise sufficiently to let you approach the theoretical switching-speed limits of even the fastest ICs available today, such as SUHLII units.

**Reduce circuit noise**

Noise, or spurious signals in a high-speed switching circuit, can originate from four primary sources:

*Inherent IC noise.* For this problem, start out by using Sylvania SUHL TTL logic elements and monolithic arrays, the lowest-noise units available.

*Power-supply decoupling.* Problem is minimized by use of controlled distributed capacitance from the power-ground planes within the SYL-PAC board. This is achieved by precise control of the quality and thickness of the dielectric elements and the parallelism of the conductive layers. In our SYL-PAC boards, the capacitance between the power and ground layers, 1500 pF per package, provides adequate decoupling for any circuit configuration.

*Crosstalk, or intermodulation.* Directly proportional to switching circuit speed and number of interconnecting crossovers. The SYL-PAC common power-ground plane distributes power and ground voltages evenly, eliminates excess wiring and crossovers on the signal plane, and at the same time acts as an overall capacitor between connections.

*Self-induced noise.* Also known as  $L \frac{\Delta i}{\Delta t}$  noise, where L=inductance;  $\Delta i$  = pulse height, or change in current from "0" to "1" condition; and  $\Delta t$  = the rise time of the pulse.

This type of noise is *directly and linearly proportional* to the length of the circuit connection into which the signal is introduced. The extremely short connections characteristic of our SYL-PAC boards—particularly to the power-ground plane—can reduce  $L \frac{\Delta i}{\Delta t}$  noise by as much as 8 times in comparison with other board designs.

**Faster operating speed**

Because SYL-PAC boards with SUHL low-noise IC components reduce circuits noise so significantly, they let you operate your high-speed switching circuits at much higher speeds without fear of spurious signal interference.

CIRCLE NUMBER 303

## How about a 12-inch B&W picture tube for less than 12¢\* a square inch.

Modifications in basic design are one of the factors which can increase the cost of picture tubes. This new 12" B&W standard tube is designed to sell for an extremely low price, in large quantities and without modifications.

Black-and-white TV set manufacturers—particularly of small-sized sets—have run into increasing price competition in recent years from low-cost imported sets.

To meet the challenge, Sylvania has designed a new low-cost 12" picture tube which allows U.S. set manufacturers to be competitive again in the small-size B&W set market. Our new 12DEP4 incorporates all the quality components and engineering advances found in every Sylvania CRT. No performance characteristic is sacrificed... yet the tube costs less.

Sylvania has developed the tube to sell in OEM quantities for about \$9.00\*. We can deliver any changes you wish, of course, but each one will increase the cost per unit.

**Why was the 12" size selected?**

From the glassmaking standpoint, a major picture-tube bulb manufacturer recently conducted a survey to determine the most acceptable tube size for the small-screen, low-cost B&W set market. The survey solidly established the 12" size as the most popular.

From the electronics standpoint, Sylvania has determined just which focus and deflection voltages, gun-mount configurations, anode-button location and other design considerations are most desirable.

The result is a picture tube which incorporates all the most popular features manufacturers have requested in the past... in a single 12" size which we can now deliver in volume. Custom variations on the basic model... and other sizes such as 6", 9", 11" and 13"... will cost more, naturally.

But design this tube into your next portable model and you can market a "MADE IN U.S.A." TV set that's competitive in price with foreign imports of the same size. And you get all the service and delivery benefits that only a domestic manufacturer can offer.

We feel that you'll make up in unit volume what you miss in "uniqueness of screen size".

\*Determined in accordance with standard terms and conditions of sale.

CIRCLE NUMBER 304

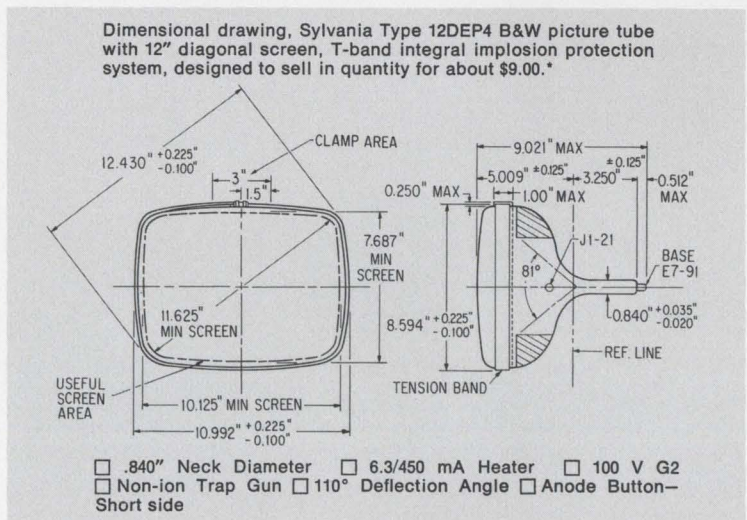

## How to make a low-cost TTL serial adder-subtractor.

Serial adder-subtractor subsystems are simpler than parallel subsystems to design and construct, and require fewer components. They cost less, and are ideal for medium-speed computers.

These diagrams (Figs. 1 and 2) indicate the packaging and interconnection economies permitted by serial adder subsystems.

In a *parallel* adder subsystem, the number of SM-10 adders must equal the number of bits being

processed simultaneously, i.e., a 64-bit storage register would require 64 full adders.

But in a *serial* adder subsystem, only one SM-10 adder is required regardless of the capacity of the storage register. A 64-bit serial system would require 64 storage registers but only one single SM-10 adder, greatly simplifying wiring and reducing component costs.

Such subsystems are recommended for what, today, we call "medium-speed computers." But today's SUHL and monolithic-array TTL ICs are so fast that these low-cost *serial* subsystems actually operate at speeds comparable to many *parallel* adder subsystems presently in operation: about 200 ns/bit. That means our serial adders can process a 24-bit number in 3 to 4 ms. If that's fast enough for you, systems like these can save you money.

The first subsystem (Fig. 1) will add or subtract two 4-digit binary numbers, depending on the logic levels applied to the mode control. A logic "0" level applied to the subtract control will produce a difference; to the add control it will produce a sum. For a sum or difference, the contents of the A and B registers are clocked into the SM-10 full adder, one bit at a time, and the result is stored in the B register.

If adding, the result in the B register is the sum. If subtracting, the Most Significant Digit (MSD) must be checked for "1" or "0". If the MSD is "1", the B register is complemented to obtain the difference, which will be a positive number. If the MSD is "0", the B register is shifted right four times to facilitate end-around carry and provide the difference, which in this case would be a negative number.

The second subsystem (Fig. 2) performs addition only, in the same manner as the first, with the final sum appearing in the B register. Both subsystems are open-ended, and can be expanded to handle numbers of any size merely by increasing the number of flip-flops in the A and B registers. No additional SM-10 fast adders would be required in either case.

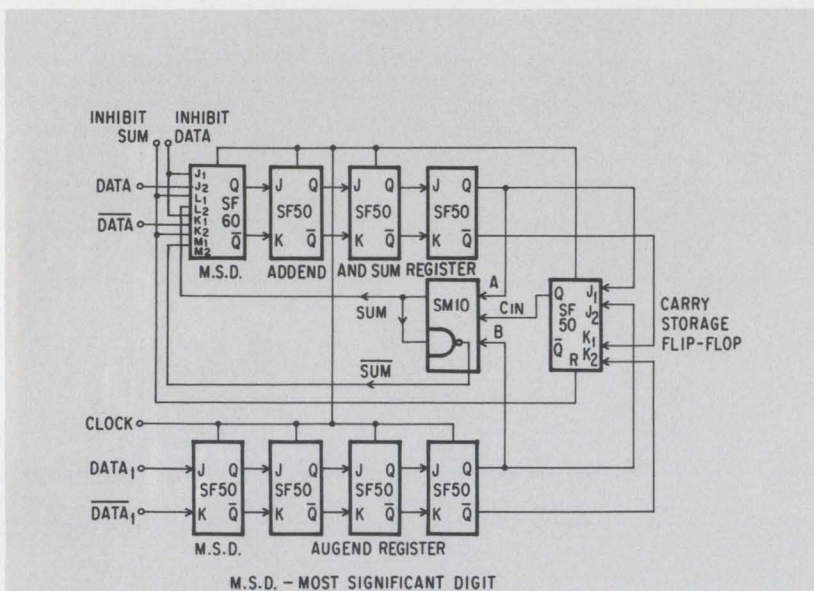

Fig. 1. Simpler subsystem performs addition only. Both subsystems can easily be expanded to handle larger numbers simply by increasing the number of flip-flops in the A and B registers.

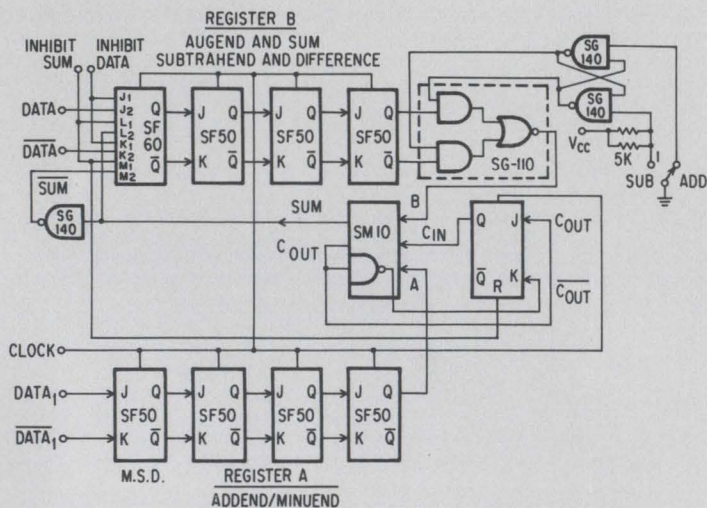

Fig. 2. Serial adder-subtractor subsystem uses SM-10 full adders, SF-60 OR J-K flip-flops, SK-50 AND J-K flip-flops, an SG-110 AND-NOR gate and SG-140 NAND-NOR gates. The full adders are monolithic arrays; the gates and flip-flops are standard SUHL integrated circuits.

## SUHL™ TTL ICs help create a 131,072-bit airborne memory weighing less than 7 pounds.

The new SEMS 5™—Severe Environment Memory System—to be demonstrated at April JCC. Miniature militarized unit was designed by Electronic Memories, Inc., of Hawthorne, California.

SEMS 5 is designed for aerospace applications where small size, low weight, high reliability, high speed and minimum power requirements are demanded. It can withstand 10G vibration, 30G shock over a temperature range from -55° to +85° C. It weighs 6.9 pounds and has a volume of only 132 cubic inches. It has a cycle time of 2 microseconds and an access time of 700 nanoseconds.

It can be built to custom specifications, with memory storage capacities of from 256 to 16,384 words from 8 to 32 bits each. Voltage requirements are +15 v, +5 v and -5 v.

The system uses SUHL TTL integrated circuits for logic, sense amplifiers, address decoders, data and address registers. Logic interface is TTL positive true. Both clear/write and read/restore are standard modes. Optional modes include split cycle (read/modify/write) and buffer cycle. Memory access is by initiate and read/write mode lines or by read/write pulse lines.

Use of SUHL ICs simplifies wiring to increase reliability. Each coincident-current memory plane contains eight bits instead of the usual one. Only three wires instead of the normal four are used, with a common line performing both sense and inhibit functions.

This eliminates a large number of electrical interconnections where many memory-stack failures can occur.

The unit uses approximately 50 Sylvania ICs: SG-40 and SG-140 dual 4-input NAND-NOR gates. Both are monolithic epitaxial saturated high-speed logic elements.

Electronic Memories naturally turned to SUHL TTL ICs to get the performance they wanted into the space available. They also inform us that: "Unfortunately, no failure data is available on the performance of your circuits, nor do (we) know when this would be available."

Because, obviously, none have failed yet . . . and none are likely to.

CIRCLE NUMBER 306

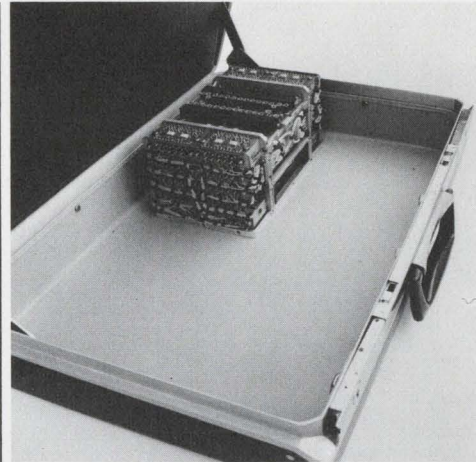

Tiny, rugged SEMS 5 militarized airborne memory system has memory storage capacity of 4096 words of 32 bits each. This extremely high packaging density is made possible by use of Sylvania SUHL TTL ICs.

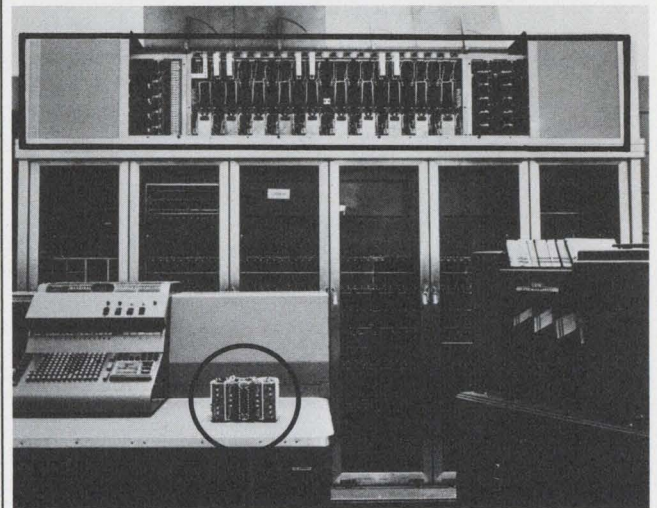

SEMS 5 (circled), on table in foreground, compared with an older, discrete-component memory system of comparable memory capacity (in rectangle). SEMS 5 was designed and produced by Electronic Memories, Inc., of Hawthorne, California.

SEE OUR SPECIFICATIONS IN  
**VSMF**  
MICROFILM CATALOG FILE

Use Sylvania's "Hot Line" inquiry service, especially if you require full particulars on any item in a hurry. It's easy and it's free. Circle the reader service number(s) you're most interested in; then fill in your name, title, company and address. We'll do the rest and see you get further information by return mail.

**BUSINESS REPLY MAIL**

No Postage Stamp Necessary if Mailed in the United States

FIRST CLASS  
Permit No. 2833  
Buffalo, N.Y.

POSTAGE WILL BE PAID BY

Sylvania Electric Products Inc.  
Sylvania Electronic Components  
1100 Main Street  
Buffalo, New York 14209

Dept. C111

---

---

---

---

---

---

---

---

## "Black and white TV receivers are dead."

How often have you heard this said?

Sylvania has a more positive approach. To paraphrase Mark Twain, we think that reports of the B&W set demise have been grossly exaggerated.

At present there are about 66 million B&W TV receivers in use in the United States, and about 7½ million were sold here in 1966. Hardly a dead market. People are still buying them for many reasons: low cost, small size and weight, portability, brightness, contrast, resolution and ease of servicing, just to name a few.

So the question is not whether to revive a dead market. It's to recapture a bigger share of a very "live" market which has been increasingly lost to foreign competition.

People buy foreign B&W sets—as opposed to domestic—on price. So to start with, you have to get the price down to compete.

One way is standardization. A decision to go with, and stick with, a standardized line of picture tubes, receiving tubes, circuitry and related components in a set that's standard except for external styling. Once this decision has been made, components can be designed into a marketable set at a very low cost.

As a start, we've developed a standard 12" B&W picture tube—the most expensive single component in a TV set—and designed it to sell, without variation, in OEM quantities for around \$9.00\*. (See article elsewhere in this issue.) Together with other standardization economies, this makes it possible to assemble, distribute and market a 12" set at a very low retail price.

\*Determined in accordance with standard terms and conditions of sale.

We didn't settle on the 12" size arbitrarily. As the companion article indicates, a recent survey conducted by a major picture-tube bulb manufacturer on consumer preferences in portable TV sets shows the 12" size to be the overwhelming favorite.

In deciding upon a standardized picture tube at such a low cost, you can offer the most popular features ever built into one picture tube without sacrificing any of the engineering leadership and quality assurance measures that have made Sylvania B&W picture tubes number one in the industry.

Our design and field-engineering staff still provide the full range of services and technical assistance you expect from Sylvania—and which you've probably learned *not* to expect from overseas manufacturers. With exception of the glass bulb, we still manufacture and process every component that goes into these tubes—and to our own unmatched quality standards.

The reason we can bring you a picture tube at such an extremely low price is volume production. That can be achieved only through wide acceptance of a standardized product.

Work with us and we'll help to show you that a market you may have considered "dead" is still very much "alive."

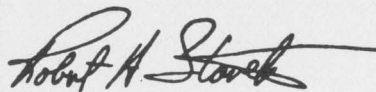

Robert A. Starek  
Product Marketing Manager  
Picture Tubes

This information in Sylvania Ideas is furnished without assuming any obligations.

# SYLVANIA

A SUBSIDIARY OF  
GENERAL TELEPHONE & ELECTRONICS

NEW CAPABILITIES IN: ELECTRONIC TUBES • SEMICONDUCTORS • MICROWAVE DEVICES • SPECIAL COMPONENTS • DISPLAY DEVICES

C1

NAME \_\_\_\_\_

TITLE \_\_\_\_\_

COMPANY \_\_\_\_\_

ADDRESS \_\_\_\_\_

CITY \_\_\_\_\_ STATE \_\_\_\_\_ ZIP \_\_\_\_\_

### Circle Numbers Corresponding to Product Item

300	301	302	303	304
305	306			

Please have a Sales Engineer call



### HOT LINE INQUIRY SERVICE

Need information in a hurry? Clip the card and mail it. Be sure to fill in all information requested. We'll rush you full particulars on any item indicated.

You can also get information using the publication's card elsewhere in this issue. Use of the card shown here will simplify handling and save time.

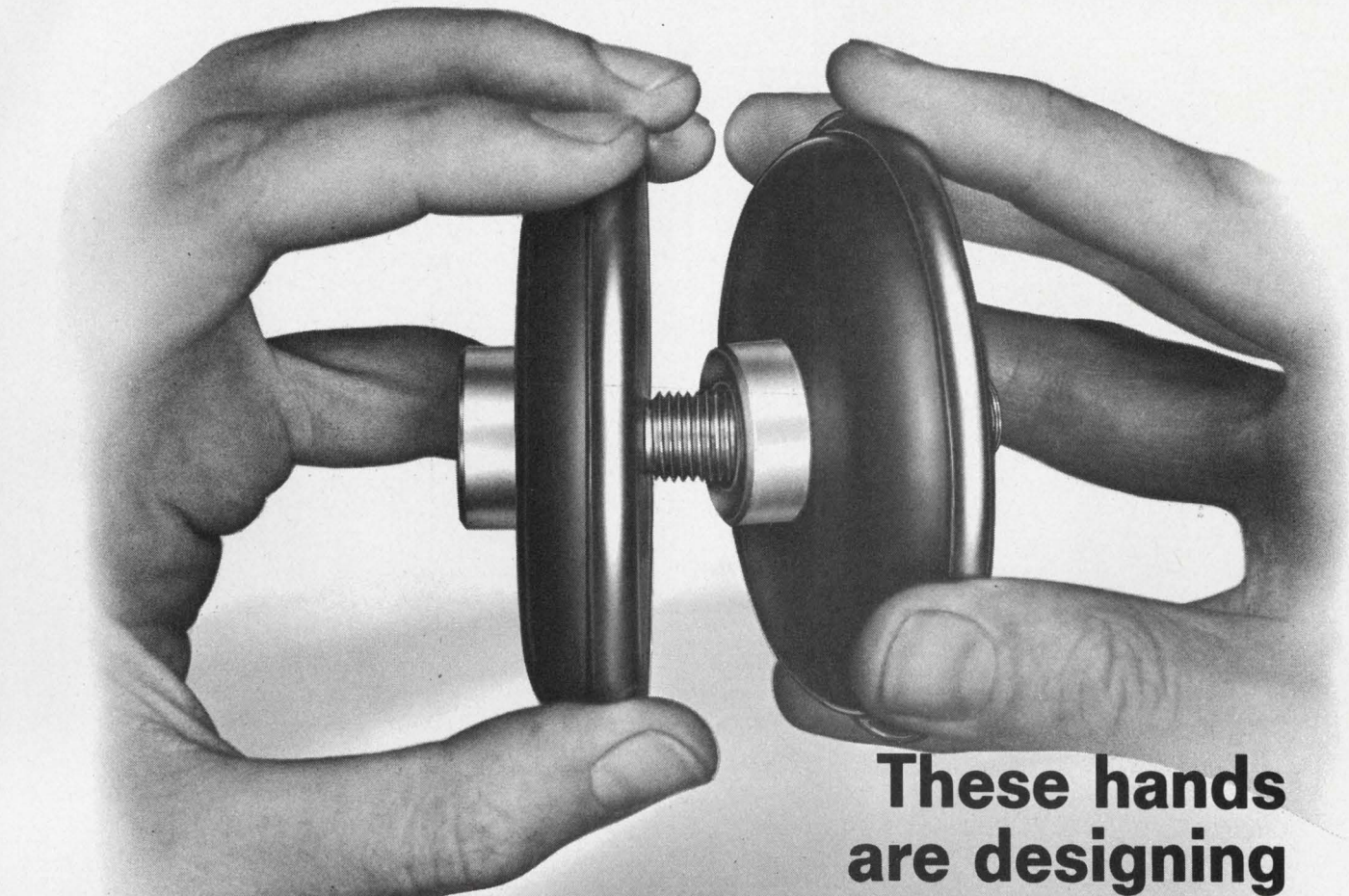

**These hands  
are designing  
a 50 KV–5 amp rectifier  
that is virtually fail-proof.**

It's no oversimplification. They do work, they don't fail, and you can screw together almost any assembly you need up to 600 KV from the 14 stackable modules we have on the shelf. PIV's from 2.5 KV to 15 KV and currents to 10 amps. The men who designed these modules were high-voltage engineers. They knew the high-voltage engineering had to be done in the module before you started stacking. That's why they built in protection against transient surges. That's why they built in things like an anti-corona ring, shunt capacitance and controlled gradients. And that's why we haven't seen a legitimate failure of one of these devices in 3 years. Look . . .

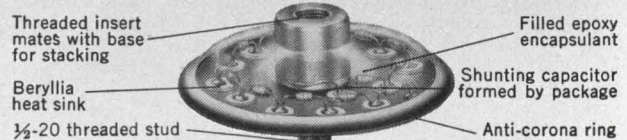

**THE DOORBELL RECTIFIER MODULE BY  
UNITRODE**

580 Pleasant St., Watertown, Mass. 02172, (617) 926-0404



Get yourself a complete set of specs that give you all kinds of information too detailed to put in this ad. Circle the reply card number now.

INFORMATION RETRIEVAL NUMBER 89.





# **T**est these new high-strength silicone resins before you specify!

Send for a cured sample of Sylgard® 186 or Sylgard® 187 silicone resin and test your own strength! These resins are *tough . . . flexible . . .* and highly tear resistant, even after being nicked.

Yet, they cure without danger of exothermic damage to delicate electronic parts . . . without damage due to stresses caused by shrinkage during cure. They are ideally suited for encapsulating, potting, filling, coating and embedding.

Sylgard 186 resin is transparent while Sylgard 187 resin is black. Both cure at room temperature . . . provide deep section cure . . . and have a service temperature range from -65 to 250 C with no post cure.

We will be happy to send you a sample of either Sylgard 186 or 187 silicone resin; plus complete technical data on both.

For the name of the Dow Corning representative in your area, write to: Dept. **A7432**, Electronic Products Division, Dow Corning Corporation, Midland, Michigan 48640.

**DOW CORNING**

DOW CORNING

*We're a materials producer exclusively. Let us tailor a material to your need.*

Circle No. **851**

# prove its mettle

## GENERAL INSTRUMENT'S NEW TYPE 974 INDUSTRIAL GRADE, ALL-WELDED, 85°C, METAL CASE ELECTROLYTIC CAPACITOR

To: General Instrument Corporation, Capacitor Group  
65 Gouverneur Street, Newark, N.J. 07104

Send me a working sample of your new Type 974 Aluminum  
Electrolytic Capacitor and a copy of your technical bulletin.

Name \_\_\_\_\_

Title \_\_\_\_\_

Company \_\_\_\_\_

Address \_\_\_\_\_

City \_\_\_\_\_ State \_\_\_\_\_ Zip \_\_\_\_\_

# test it!

What are **you** looking for in a tubular electrolytic? Industrial grade performance? All-welded construction? 85°C operation? Lots of capacitance in a small size? Low DCL? Low ESR? Extra surge protection? The added reliability of a metal case? You'll get them **all** in the Type 974! **And at only fractions of a cent more than plastic case capacitors.**

Why penalize your design with a plastic case capacitor? Why pay the size penalty? Or be satisfied with 65°C operation? You can now get the Type 974 in ratings from 1 to 800  $\mu$ F . . . in voltages from 3 to 150 WVDC. Prove its mettle. Fill out the coupon and we'll send you a sample.

General Instrument Corporation, Capacitor Group, 65 Gouverneur St., Newark, N.J.

# capacitors



**Publisher**

Hugh R. Roome

**Editor**

Howard Bierman

**Managing Editor**

Robert C. Haavind

**Technical Editors**

Jeffrey N. Bairstow  
 Peter N. Budzilovich  
 Raymond D. Speer  
 David H. Sorgan

**Management and Careers Editor**

Howard S. Ravis

**News Editors**

Ralph Dobriner, Chief  
 Richard N. Einhorn

**Washington News Bureau**

Charles D. LaFond, Chief

**Military/Aerospace Editor**

John F. Mason

**East Coast Editor**

Neil Sclater

**West Coast Editor**

Ron Gechman

**New Products Editors**

Steven B. Futterman  
 Robert Patton

**Editorial Production**

Dollie S. Viebig  
 Phyllis Gura

**Art Director**

Clifford M. Gardiner

**Art Assistant**

William Kelly

**Technical Illustrators**

Cheh Nam Low  
 Sheila F. Ward  
 William Alvarez

**Production Manager**

Thomas V. Sedita

**Asst. Production Manager**

Helen De Polo

**Production Assistants**

Bernard Wolinsky  
 Gregory A. Bannon

**Circulation Manager**

Nancy L. Merritt

**Information Retrieval**

Diane Mandell

## EDITORIAL



## Question for the day: Who do you think you are?

"Don't take yourself too seriously. Your job, yes. Your own importance, how you rate yourself, no."

You may have heard words like these before. They were repeated several times recently at the start of a management seminar given in New York by J. D. (Joe) Batten, author of "Tough-Minded Management" and "Developing a Tough-Minded Climate . . . for Results."\*

For openers, Batten says that 80 per cent of today's managers are obsolete. And you're a manager whether you are in charge of several technicians or a project team on a major development program. In this obsolete group are the "soft" and the "hard" managers. The "soft" managers hedge on decisions, stall, try to keep everyone happy and accept mediocre performance from potentially talented men.

The "hard" managers operate from weaknesses, says Batten, and are generally identified as belonging to the "old school" with its bully techniques. They use threats, tongue-lashings and frequent firings to keep the employees in line. They are quick to work on people's weaknesses and to ignore their strengths. They lack a positive attitude when reviewing suggestions by others, and invariably they have doubts about their own ability.

But what of "tough-minded" managers, as Batten calls them? How do they differ from "hard" managers? Tough-mindedness, Batten explains, means flexible not brittle, malleable but at the same time strong and tenacious. They are men who have the courage to follow Socrates' advice, "Know thyself." They know their strong points but they know their weaknesses, too.

From continual self-appraisal and from honest acceptance of feedback from others, they gain confidence that is reflected in sympathetic relationships with their employees. Tough-minded management is not merely a management tool; it's a positive way of life. And the process is unending—you never stop "knowing thyself."

What better day of the year for managers and would-be managers to learn this lesson than today—April Fool's Day. If you think you know all of the answers all of the time and that others on the job have nothing worthwhile to contribute, the odds are high that you qualify as a fool.

HOWARD BIERMAN

\*Recommended reading: "Tough-Minded Management," "Developing a Tough-Minded Climate . . . for Results," and "Beyond Management by Objectives"—all by J. D. Batten and available from the American Management Association, 135 W. 50 St., New York, N.Y. 10020.

# Tektronix simplifies reflectometry measurements

## Type 1S2 Sampling Unit for time domain reflectometry and general-purpose sampling

You can test transmission lines, cables, connectors, broad-band devices with ease and accuracy with the Type 1S2 Sampling Plug-In Unit. It can be used in any Tektronix oscilloscope that accepts letter and 1-series plug-ins.

The  $\leq 90$ -ps risetime of the vertical channel, and deflection factors to 5 mV/div make the Type 1S2 useful in many general-purpose sampling measurements. For this general-purpose use, a pretrigger or delay line is required. System risetime as a reflectometer is  $\leq 140$  ps.

The illustration shows a Type 1S2 in a Tektronix Type 549 Storage Oscilloscope being used to test a 50- $\Omega$  delay line. Information obtained from the upper trace includes electrical length of the line, nominal impedance, location and type of discontinuities. Lower trace is magnification of the discontinuity shown near the center of the upper trace. Deflection factors:

- Upper trace — Vertical 0.25 p/div  
Horizontal 20 ns/div
- Lower trace — Vertical 0.025 p/div  
Horizontal 5 ns/div

The Type 1S2 Manual Scan display mode was used in storing both traces to obtain optimum resolution.

With the Type 1S2, positions of discontinuities in a line under test can be read directly from a dial in units of time or distance. Accuracy of round-trip time readings is within  $\pm 1\%$  of full scale.

Dual, full-scale 10-division horizontal calibration is in distances of 10 m, 100 m, and 1 km, and in times of 0.1  $\mu$ s, 1  $\mu$ s, and 10  $\mu$ s. The display can be expanded by a 7-step, calibrated, X1 through X100 magnifier for detailed examination of any discontinuities.

Illuminated readout of the horizontal scale factor, including any magnification, adds to the operating ease. And testing of either short or long lines is facilitated by internal generators that provide a 50-ps, 250 mV pulse and a 1-ns, 1-V pulse.

A front-panel switch provides for matching the horizontal calibration to the types of lines most commonly tested—air, TFE, and polyethylene. A variable control permits matching the calibration to lines using other dielectrics.

Vertical calibration is in both  $\rho$  (rho) and in volts, from 0.005/div to 0.5/div, in 7 steps, with an accuracy within  $\pm 3\%$ . It is also variable between steps, uncalibrated. A  $\pm 2$ -V offset voltage, monitorable at the front panel, allows amplitude measurements, using slide-back techniques, with an accuracy within  $\pm 1\%$ .

Vertical and horizontal outputs of 1 V/div of displayed signal are available at front-panel connectors.

Type 1S2 . . . . . \$1375  
U. S. Sales Prices FOB Beaverton, Oregon

For a demonstration, contact your nearby Tektronix field engineer or write: Tektronix, Inc., P. O. Box 500, Beaverton, Oregon 97005.

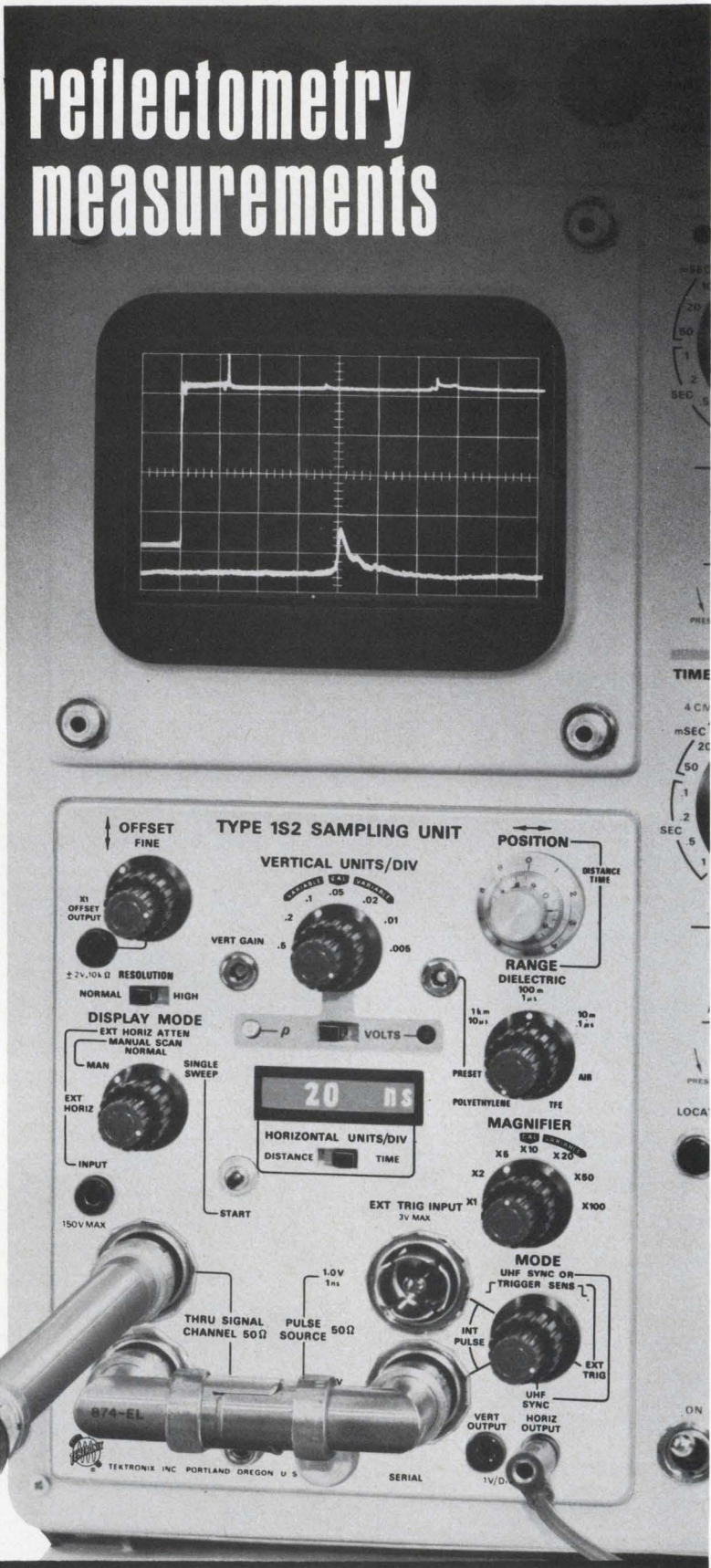

Research and development



... part of the Tektronix commitment  
to progress in the measurement sciences

# Technology

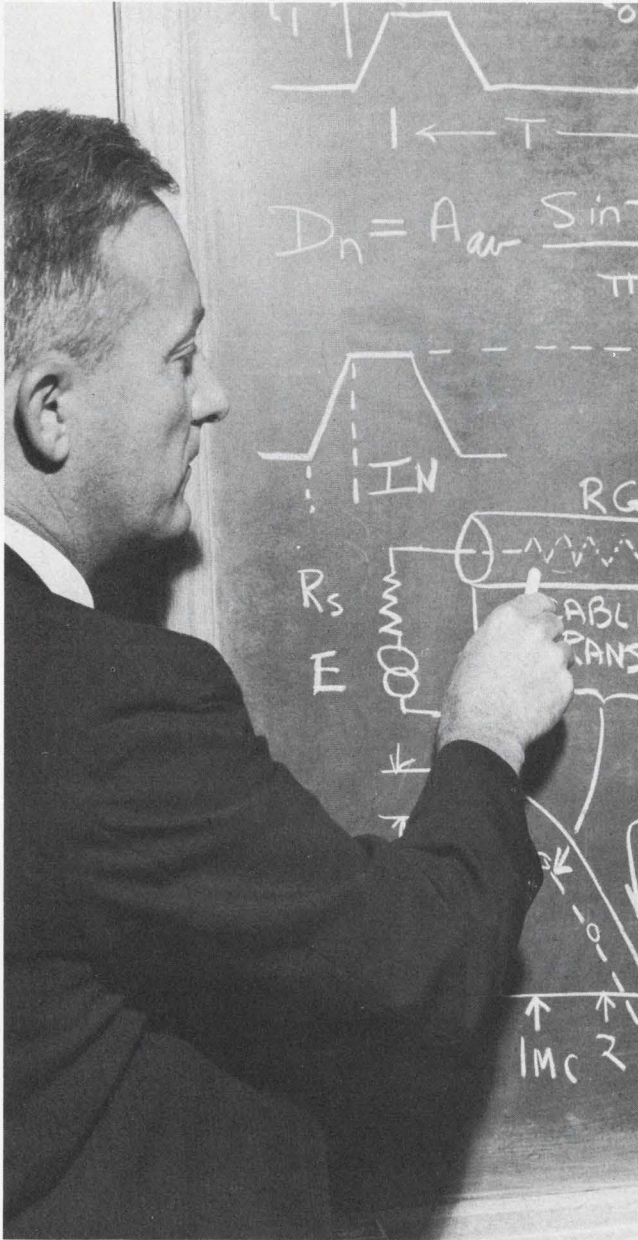

You can predict pulse degradation in a long cable simply and accurately. See page 90

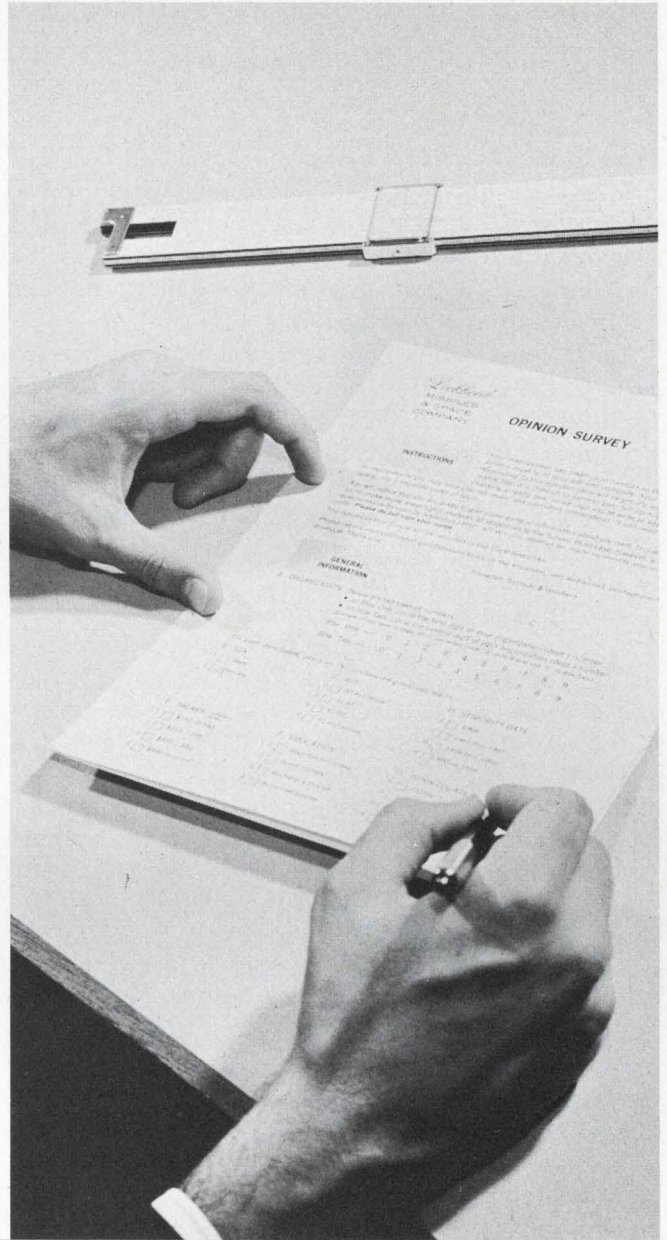

Rate your company, supervisor and job by taking part in an opinion survey. Page 96

## Also in this issue:

**Control system design** is simplified by using a digital computer. Page 72

**Complete design** of a 5-W complementary audio amplifier. Page 82

**Free-space attenuation** between closely spaced antennas is quickly found. Page 94

# Simulate transfer functions with ECAP.

Digital programming and state variables are simpler than analog programming for linear and nonlinear systems.

*Part 1 of a two-part series.*

Many control-system designers use analog computers to simulate system performance. The approach is satisfactory, but there's often a simpler way to do it: Use a digital computer and a suitable analysis program.<sup>1</sup>

Both linear and nonlinear transfer functions can be simulated by use of the standard branch parameters of the IBM Electronic Circuit Analysis Program (ECAP)\*. Not only does this offer all the advantages of computer-aided analysis; it makes use of ECAP's capability to provide steady-state frequency responses and transient responses to various forcing functions.

In addition ECAP programming is simpler than that for an analog computer, because amplitude scaling is not needed. The large dynamic range and the lack of bandwidth restrictions of a computer can accommodate wide ranges of variables.

Further, the ECAP user does not need to use standard element values, as the analog computer programmer does; this eliminates potentiometers.

Simulation of a transfer function by ECAP combines models of operational integrators and algebraic summers to model a particular problem. An ECAP user can become familiar with the characteristics of these models in a short time, and he can apply them to the analysis of a transfer function by using an analog computer diagram as an intermediate step. By a simple procedure, this diagram is transformed into an ECAP equivalent circuit, which in turn is used to derive the coding. The coding stems from the ECAP rules of format,<sup>2</sup> from which a data deck may be generated.

Three operations are required to simulate a transfer function with ECAP: multiplication by a constant, summing of two or more variables and integration.

The basic building block is a type of operational amplifier circuit, with the near-ideal characteristics of infinite input impedance, infinite open-loop

negative gain and infinite open-loop bandwidth, along with zero output impedance. The circuit of Fig. 1b is sufficient to simulate the significant properties of an operational amplifier. This network is easily simulated on the computer with the ECAP circuit-analysis program. The node equations for this circuit are:

$$\frac{V_{er} - V_i}{Z_i} + \frac{V_{er}}{R_i} + \frac{V_{er} - V_o}{Z_f} = 0,$$

and

$$\frac{V_o - V_{er}}{Z_f} + \frac{V_o}{Z_l} + \frac{V_o - KV_{er}}{R_o} = 0.$$

These equations reduce to:

$$V_{er} [1/Z_i + 1/R_i + 1/Z_f] - V_o/Z_f = V_i/Z_i$$

and  $V_{er} [1 - R_o/KZ_f]$

$$+ [V_o/K] [R_o/Z_f + R_o/Z_l + 1] = 0.$$

Elimination of  $V_{er}$  yields

$$\frac{V_o}{V_i} =$$

$$\frac{-Z_f/Z_i}{1 + \frac{Z_f^2}{KZ_f - R_o} \left[ 1 + \frac{R_o}{Z_l} + \frac{R_o}{Z_f} \right] \left[ \frac{1}{Z_i} + \frac{1}{R_i} + \frac{1}{Z_f} \right]}$$

which reduces to

$$V_o/V_i \approx -Z_f/Z_i$$

as  $K$  becomes large.

The value of  $K$  is dependent on the precision of the computer being used. For example, on the IBM 1620,  $K$  must be less than or equal to  $10^5$  (on the 7090,  $K$  must be less than or equal to  $10^6$ ). When ECAP is used on a CDC 3400 computer,  $K$  should be restricted to  $10^7$  or less. The dc gain and the frequency response of the circuit of Fig. 1b are set by the proper selection of  $Z_f$  and  $Z_i$ .

Care should be exercised when values are selected for  $R_i$ ,  $R_o$  and  $G_m = K/R_o$ . When  $G_m$  and  $R_i$  are large and  $R_o$  is small compared with the other parameters, the approximate desired relationship  $V_o = -KV_{er}$  will be more nearly correct. Since the circuit of Fig. 1b is a type of feedback amplifier circuit, the output impedance of the closed-loop amplifier is approximately the open-loop output impedance divided by the open-loop gain—this is,

\*©International Business Machines Corp., 1965

$$Z_o \approx R_o/K = 1/G_m.$$

Hence comparatively large values of  $R_o$  can be used in an equivalent circuit with little error when  $Z_o$  is insignificant.

From the author's tests, it seems that values for  $G_m$ ,  $R_i$  and  $R_o$  of  $10^5$  mhos,  $10^9$  ohms and 1 ohm, respectively, give results to a greater degree of accuracy than possible with the typical analog computer. Therefore it is not necessary to select extremely large values for  $G_m$  and  $R_i$ .

To ensure that the ECAP program will not exceed the precision accuracy of the CDC 3400 computer, two rules must be followed:

■ The selection of  $R_i$  and  $R_o$  is governed by the empirical rule that requires that the relationship between the two smallest impedances connected to a node be less than 6 or 7 orders of magnitude.

■ The selection of  $G_m$  requires that the relationship between  $1/G_m$  and the smallest resistance at a node also be less than 6 or 7 orders of magnitude when  $1/G_m$  is the second smallest "resistor."

Complicated transfer functions are constructed with a combination of integrators and algebraic summers. The real advantage of the use of operational amplifier feedback equivalent circuits is the capability for cascading them. This permits the simulation of complex transfer characteristics that would be difficult or impossible to model with just one circuit. Operational amplifier circuits can be cascaded without concern for loading effects in most instances, because the output impedance can usually be made insignificant ( $1/G_m$ ) and the input impedance can usually be made large (approximately  $Z_i$ ). Once a transfer function has been modeled by an analog computer type of diagram, developing an ECAP equivalent circuit is easy.

### Transfer functions as ECAP models

One significant advantage of working with the transfer function of a linear system is that the input-output relationship can be represented by a function of the Laplace operator,  $s$ , and the overall system may be described with a signal flow graph or a block diagram.<sup>3</sup> Often it is advantageous to use state variables (see box on p. 75) and a digital computer simulation to study a transfer function. The process of expressing a complex transfer function with state variables and a block diagram may also be used to develop an ECAP simulation.

The transfer function of a general system may be expressed implicitly in the following form:

$$\frac{Y(s)}{U(s)} = \frac{b_0 s^m + b_1 s^{m-1} + b_2 s^{m-2} + \dots + b_{m-1} s + b_m}{s^n + a_1 s^{n-1} + a_2 s^{n-2} + \dots + a_{n-1} s + a_n} \quad (1)$$

## Implementing transfer functions

Many linear relationships can be formed simply by choosing the correct elements for  $Z_i$  and  $Z_f$ .

**Sign change**—To change the polarity of a signal, let  $Z_i = Z_f = R$ , as shown below and obtain  $v_o = (R/R) v_i = -v_i$ .

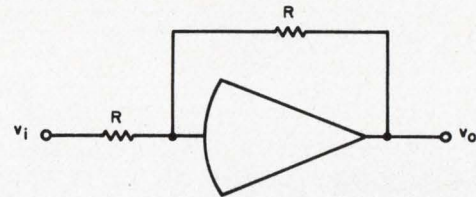

**Algebraic summation**—More than one input can be applied to the operational amplifier model. Let the first input have  $Z_i = 0.1/a$  MΩ, with  $Z_f = 0.1$  MΩ as below. The results is an adder, or summer, yielding

$$v_o = -(av_1 + av_2).$$

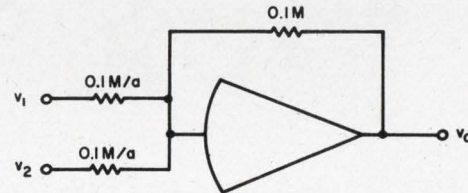

**Integration**—The operation of integration can be obtained in similar fashion. The impedance function of a resistor is  $R$ , whereas that of a perfect capacitor is  $1/Cs$ . Hence, the combination, below, results in an output equation of the form

$$v_o(s) = -[1/RCs] V_i(s) + 1/s V_o(0)$$

or

$$v_o(t) = -1/RC \int_0^t v_i(t) dt + v_o(0).$$

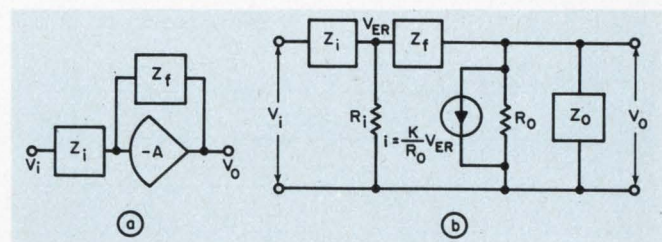
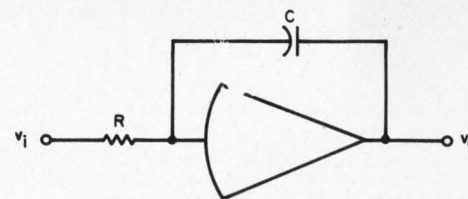

1. The basic unit of an analog computer is the operational amplifier with input and feedback impedances (a). A simple ECAP model (b) will simulate the significant properties of an operational amplifier.

where the order of the numerator is taken to be less than, or equal to, the order of the denominator. It is desirable to represent Eq. 1 in block-diagram form with the use only of integrator and constant multiplier blocks, in order to define the appropriate state variables. Thus, multiplying the numerator and the denominator of the right hand side of Eq. 1 by  $s^{-n}E(s)$ , where  $E(s)$  is defined to be an arbitrary function of  $s$ , we get:

$$\frac{Y(s)}{U(s)} = \frac{b_0 s^{m-n} + b_1 s^{m-n-1} + b_2 s^{m-n-2} + \dots + b_{m-1} s^{1-n} + b_m s^{-n}}{1 + a_1 s^{-1} + a_2 s^{-2} + \dots + a_{n-1} s^{1-n} + a_n s^{-n}} \cdot \frac{E(s)}{E(s)} \quad (2)$$

From Eq. 2, since  $E(s)$  is arbitrary, the following relationships may be derived by inspection:

$$Y(s) = b_0 s^{m-n} E(s) + b_1 s^{m-n-1} E(s) + b_2 s^{m-n-2} E(s) + \dots + b_{m-1} s^{1-n} E(s) + b_m s^{-n} E(s) \quad (3a)$$

and

$$U(s) = E(s) + a_1 s^{-1} E(s) + a_2 s^{-2} E(s) + \dots + a_{n-1} s^{1-n} E(s) + a_n s^{-n} E(s). \quad (3b)$$

Equation 3b can be written alternately as

$$E(s) = U(s) - a_1 s^{-1} E(s) - a_2 s^{-2} E(s) - \dots - a_{n-1} s^{1-n} E(s) - a_n s^{-n} E(s). \quad (4)$$

Using only integrator and constant multiplier blocks, a block diagram can portray Eqs. 3a and 4 (Fig. 2).<sup>4</sup> This figure was drawn for the case when  $m = n$ . When  $m < n$ ,  $b_i = 0$  for  $i < n-m$ .

An ECAP simulation of an explicit transfer function can be developed with the aid of a dia-

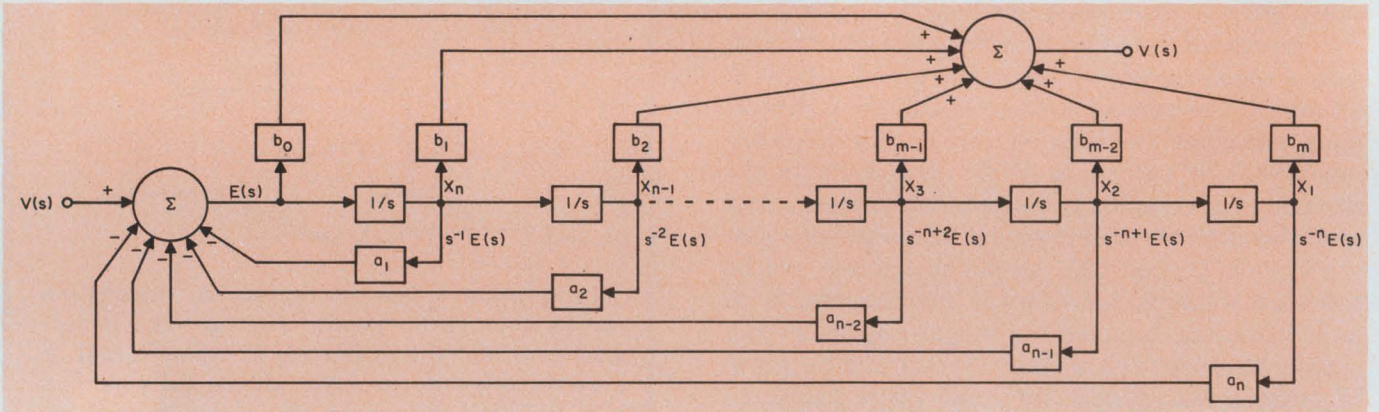

2. State variables lead directly to the block diagram of a transfer function. Each element of the block diagram

may be simulated by using the basic ECAP amplifier model as either a summer or an integrator.

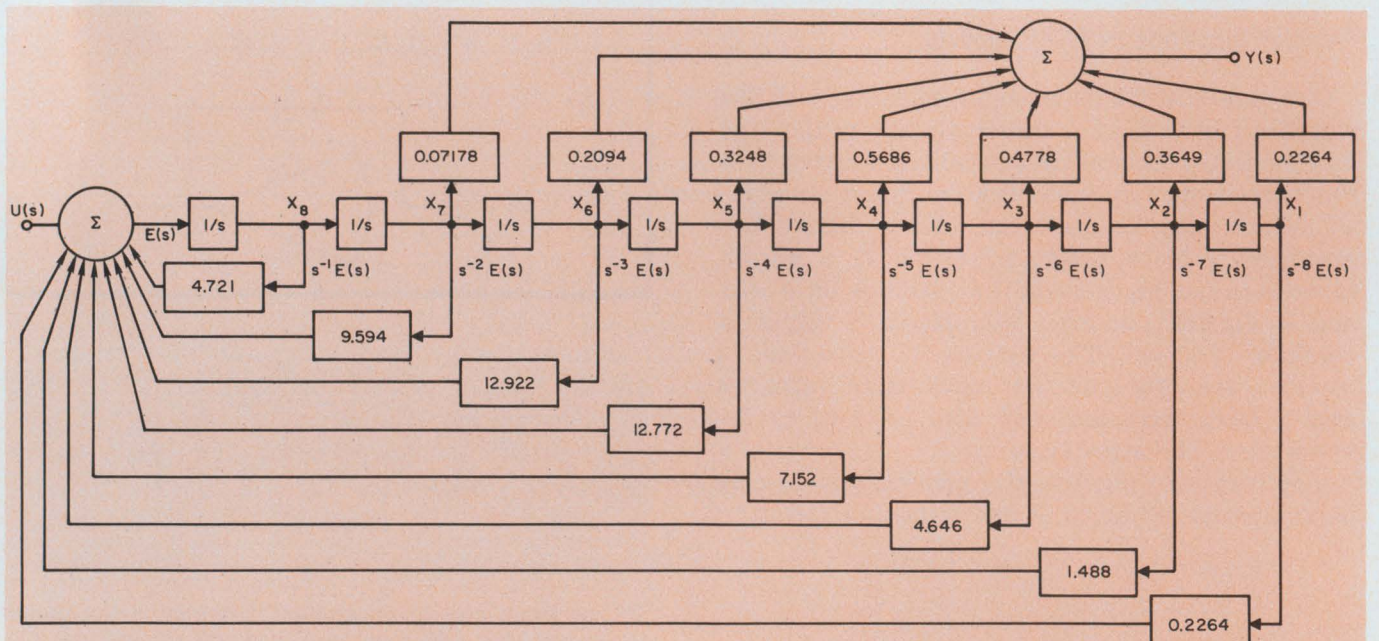

3. The first step in the ECAP analysis is to set up the block diagram from the transfer function. Using state

variables the numerator and denominator coefficients are inserted in the general block diagram of Fig. 2.



# State variables: The basic theory

The dynamic behavior of a system may be described by a set of physical or mathematic variables, called state variables. Properly defined, such a set of state variables contains, in general, as much information about the past history of the system as is required for the calculation of the future behavior of the system. When the signals in a system are all functions of the continuous time variable  $t$ , the system may be represented by a set of  $n$  first-order differential equations, rather than one  $n$ th-order differential equation, as in the classical approach. The  $n$  first-order differential equations may be characterized implicitly by:

$$\dot{x}_i(t) = f_i[x_1(t), x_2(t), \dots, x_n(t), u_1(t), u_2(t), \dots, u_m(t), t] \quad \text{where } i = 1, 2, \dots, n; x_1(t), x_2(t), \dots, x_n(t)$$

are the state variables of the system;  $u_1(t), u_2(t), \dots, u_m(t)$  are the input variables of the system; and  $f_i$  denotes the functional relationships. Since the state variables completely define the dynamic behavior of the system, it is possible to express the system output as

$$y_k(t) = g_k[x_1(t), x_2(t), \dots, x_n(t), u_1(t), u_2(t), \dots, u_m(t), t] \quad \text{where } k = 1, 2, \dots, p \text{ for } p \text{ output variables.}$$

When a dynamic system can be considered linear and time-invariant, the related state variable equations may be expressed as  $\dot{x}_i(t) = \sum_{j=1}^n a_{ij} x_j(t) + \sum_{n=1}^m b_{in} u_n(t)$ ,  $i = 1, 2, \dots, n$ ,

$$\text{and the system outputs are } y_k(t) = \sum_j c_{kj} x_j(t) + \sum_{n=1}^m d_{kn} u_n(t), \quad k = 1, 2, \dots, p. \quad (1)$$

With the use of matrix notation, the dynamic equations for the linear and time-invariant case become  $\dot{X}(t) = AX(t) + BU(t)$ ;  $Y(t) = CX(t) + DU(t)$ ,

where  $X(t)$  is an  $n \times 1$  column matrix on vector and  $y(t)$  and  $U(t)$  are  $m \times 1$  and  $P \times 1$  vectors, respectively.  $A$  is an  $n \times n$  matrix whose elements are denoted by  $a_{ij}$ ,  $B$  is an  $n \times m$  matrix, and its elements are given by  $b_{in}$ .  $C$  is a  $p \times n$  matrix, and  $D$  is a  $p \times m$  matrix.

Defining the state variables as the outputs of the integrators, we can write the state equations directly from the block diagram of Fig. 2. That is:

$$\begin{aligned} X_1 &= \frac{1}{s} X_2, \quad X_2 = \frac{1}{s} X_3, \quad \dots, \quad X_{n-1} = \frac{1}{s} X_n \\ X_n &= \frac{1}{s} [-a_n X_1 - a_{n-1} X_2 - a_{n-2} X_3 - \dots - a_2 X_{n-1} - a_1 X_n + U(s)] \end{aligned} \quad (3)$$

or in the time domain

$$\begin{aligned} \dot{x}_1 &= x_2, \quad \dot{x}_2 = x_3, \quad \dots, \quad \dot{x}_{n-1} = x_n \\ \dot{x}_n &= -a_n x_1 - a_{n-1} x_2 - a_{n-2} x_3 - \dots - a_2 x_{n-1} - a_1 x_n + u(t). \end{aligned} \quad (4)$$

In the matrix form these state variable equations become:

$$\begin{bmatrix} \dot{x}_1 \\ \dot{x}_2 \\ \vdots \\ \dot{x}_n \end{bmatrix} = \begin{bmatrix} 0 & 1 & 0 & 0 & \dots & 0 \\ 0 & 0 & 1 & 0 & \dots & 0 \\ \vdots & \vdots & \vdots & \vdots & \vdots & \vdots \\ -a_n & -a_{n-1} & -a_{n-2} & -a_{n-3} & \dots & -a_1 \end{bmatrix} \begin{bmatrix} x_1 \\ x_2 \\ \vdots \\ x_n \end{bmatrix} + \begin{bmatrix} 0 \\ 0 \\ \vdots \\ 1 \end{bmatrix} u(t). \quad (5)$$

From the same diagram the output equation may be written

$$y(s) = (b_n - b_0 a_n) X_1 + (b_{n-1} - b_0 a_{n-1}) X_2 + \dots + (b_2 - b_0 a_2) X_{n-1} + (b_1 - b_0 a_1) X_n + b_0 U(s).$$

In the time domain the matrix equation for  $y(t)$  may be written

$$y(t) = [(b_n - b_0 a_n) \quad (b_{n-1} - b_0 a_{n-1}) \quad \dots \quad (b_2 - b_0 a_2) \quad (b_1 - b_0 a_1)] \begin{bmatrix} x_1 \\ x_2 \\ \vdots \\ x_n \end{bmatrix} + b_0 u(t). \quad (6)$$

Using vector-matrix formulation, Eqs. 5 and 6 become  $\dot{X} = AX + Bu(t)$ ;  $Y = CX + Du(t)$ . (7)

The vectors and matrices in Eq. 7 may be defined by comparison with Eqs. 5 and 6. Taking the Laplace transform of Eq. 7, we get  $sX(s) = AX(s) + BU(s) + X(O)$ ;  $Y(s) = CX(s) + DU(s)$ . (8)

Elimination of  $X(s)$  in Eq. 8 for  $Y(s)$  yields:  $Y(s) = C(sI - A)^{-1}BU(s) + C(sI)^{-1}X(O) + DU(s)$ .

When the order of the numerator of the transfer function is less than the denominator ( $b_0 = C$ ), then the set of initial conditions that generates the same response as an impulse forcing function ( $U(s) = K$ ) is given by  $X(O) = KB$ , or

$$\begin{bmatrix} x_1(0) \\ x_2(0) \\ \vdots \\ x_n(0) \end{bmatrix} = \begin{bmatrix} 0 \\ 0 \\ \vdots \\ K \end{bmatrix}$$

where  $K$  is the strength of the impulse function. Hence, the only nonzero initial condition required is that associated with the  $n$ th state variable.

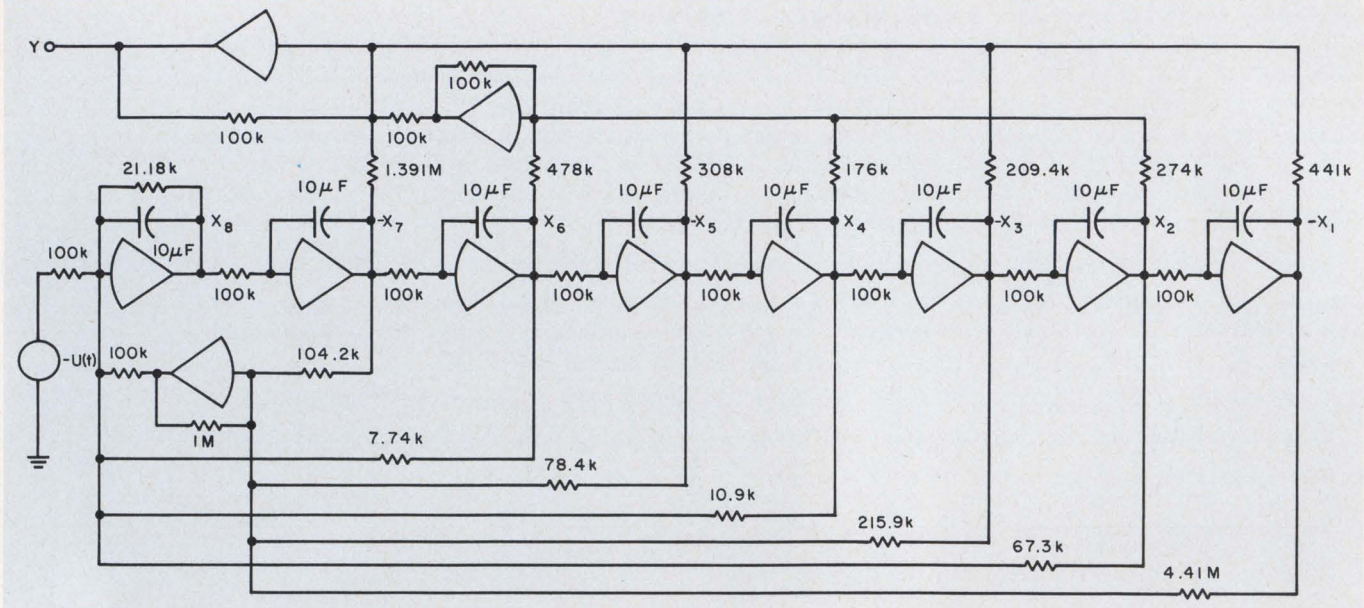

4. The second step in the analysis is the production of an analog computer schematic. Sign-change amplifiers

are used strategically to ensure the correct polarity of the feedback and output.

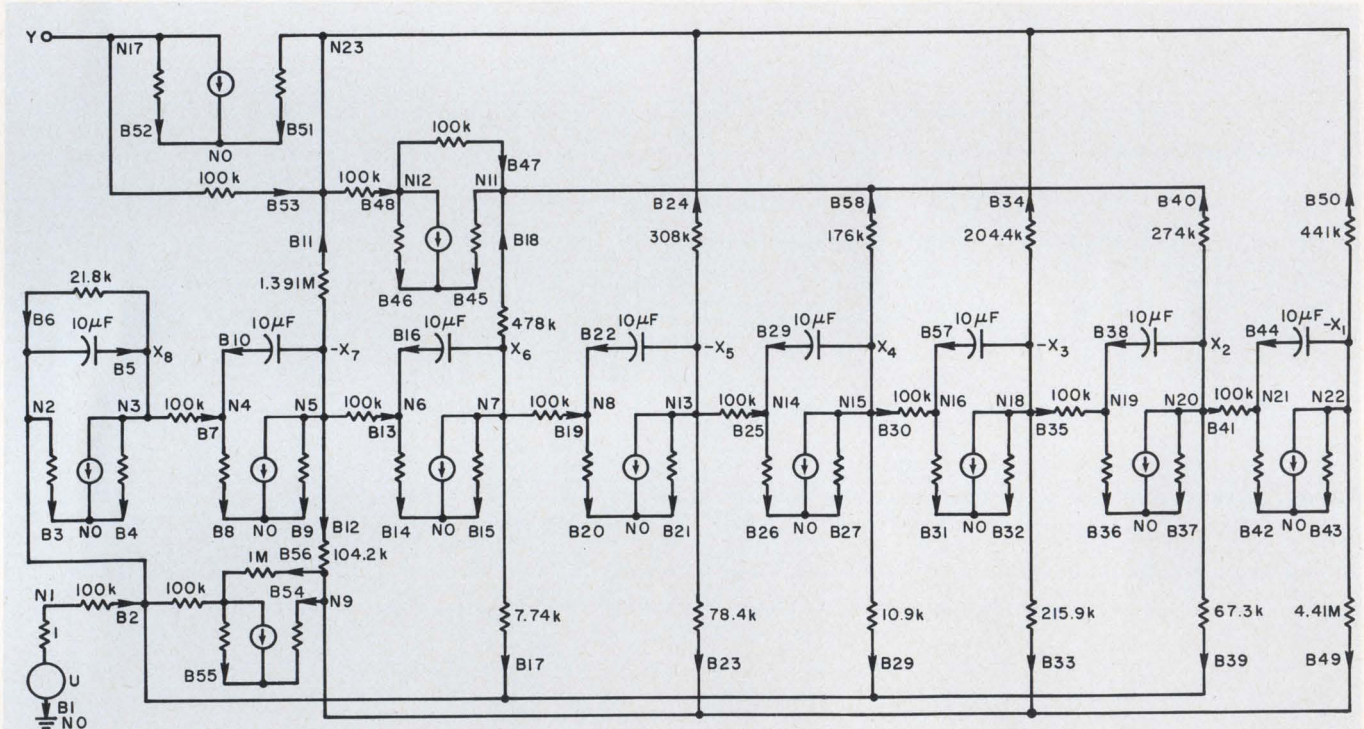

5. Step three in the analysis replaces the analog operational amplifiers with the ECAP model. After replacement

each node and branch is labeled so that the ECAP input data may be listed for computer input.

gram of the form of Fig. 2. Use the ECAP model of the operational amplifier for the integrator and constant multiplier blocks.

Using state variables (see box), we can select a set of initial conditions that will provide a duplicate of the impulse response of a system for the common case, in which the order of the numerator of a transfer function is less than that of the denominator ( $b_0 = 0$ ).<sup>5</sup> Such a set of initial conditions is useful, since there are no provisions in ECAP for generating an impulse function.

### Simulation of a linear transfer function

A complex linear transfer function, with eight poles and six zeros, illustrates the capabilities of the ECAP program for linear analysis<sup>6</sup>:

$$\frac{Y(s)}{U(s)} = \frac{0.07178s^6 + 0.2094s^5}{s^8 + 4.721s^7 + 9.5945s^6 + 12.922s^5 + 0.3248s^4 + 0.5686s^3 + 0.4778s^2 + 0.3649s + 0.2264 + 12.777s^4 + 9.152s^3 + 4.646s^2 + 1.488s + 0.2264}$$

```

C TRANSFER FUNCTION SIMULATION
C
AC ANALYSIS
B1 N( 1, 0), R=1.0 ,E=1.0
B2 N( 1, 2), R=1E5
B3 N( 2, 0), R=1E9
B4 N( 3, 0), R=1.0
B5 N( 2, 3), C=1E-5
B6 N( 3, 2), R=21180.
B7 N( 3, 4), R=1E5
B8 N( 4, 0), R=1E9
B9 N( 5, 0), R=1.0
B10 N( 5, 4), C=1E-5
B11 N( 5, 23), R=1391E3
B12 N( 5, 9), R=104200.
B13 N( 5, 6), R=1E5
B14 N( 6, 0), R=1E9
B15 N( 7, 0), R=1.0
B16 N( 7, 6), C=1E-5
B17 N( 7, 2), R=7.74E3
B18 N( 7, 11), R=478E3
B19 N( 7, 8), R=1E5
B20 N( 8, 0), R=1E9
B21 N(13, 0), R=1.0
B22 N(13, 8), C=1E-5
B23 N(13, 9), R=78.4E3
B24 N(13, 23), R=308E3
B25 N(13, 14), R=1E5
B26 N(14, 0), R=1E9
B27 N(15, 0), R=1.0
B28 N(15, 14), C=1E-5
B29 N(15, 2), R=109E2
B30 N(15, 16), R=1E5
B31 N(16, 0), R=1E9
B32 N(18, 0), R=1.0
B33 N(18, 9), R=215900.
B34 N(18, 23), R=209.4E3
B35 N(18, 19), R=1E5
B36 N(19, 0), R=1E9
B37 N(20, 0), R=1.0
B38 N(20, 19), C=1E-5
B39 N(20, 2), R=67.3E3
B40 N(20, 11), R=274E3
B41 N(20, 21), R=1E5
B42 N(21, 0), R=1E9
B43 N(22, 0), R=1.0
B44 N(22, 21), C=1E-5
B45 N(11, 0), R=1E9
B46 N(12, 0), R=1.0
B47 N(12, 11), R=1E5
B48 N(12, 23), R=1E5
B49 N(22, 9), R=4.41E6
B50 N(22, 23), R=441E3
B51 N(23, 0), R=1E9
B52 N(17, 0), R=1.0
B53 N(17, 23), R=1E5
B54 N( 9, 0), R=1E9
B55 N(10, 0), R=1.0
B56 N( 9, 10), R=1E6
B57 N(18, 16), C=1E-5
B58 N(15, 11), R=176E3
B59 N(10, 2), R=1E5
T1 B( 3, 4), GM=1E5
T2 B( 8, 9), GM=1E5
T3 B(14, 15), GM=1E5
T4 B(20, 21), GM=1E5
T5 B(26, 27), GM=1E5
T6 B(31, 32), GM=1E5
T7 B(36, 37), GM=1E5
T8 B(42, 43), GM=1E5
T9 B(51, 52), GM=1E5
T10 B(45, 46), GM=1E5
T11 B(54, 55), GM=1E5
FREQUENCY=0.0159
PRINT, V0
EXECUTE
MODIFY
FREQUENCY=0.0318(+18)0.318
EXECUTE
MODIFY
FREQUENCY=0.477(+7)1.59
EXECUTE

```

6. The ECAP input data for the example transfer function contains a list of branches indicating the node connections and the value of the element. The final section is a series of instructions for the particular analysis needed, in this case an ac analysis.

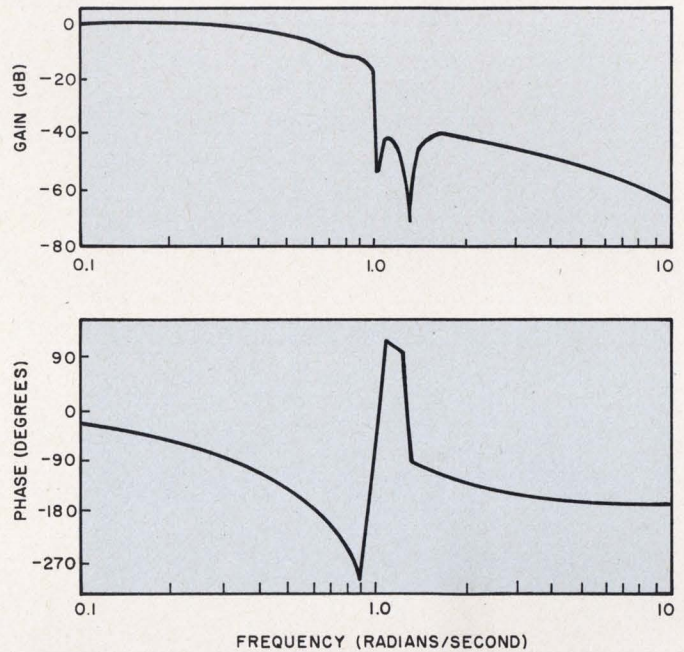

7. Gain and phase plots for the example function were plotted from the ECAP printout of the ac analysis results. The printout will give all the node voltages, in terms of magnitude, phase and dB.

```

TIME STEP=0.025
OUTPUT INTERVAL=40
FINISH TIME=40
SHORT=1.0
PLOT(V17)
PRINT, V0
EXECUTE

```

8. For a transient analysis solution the ECAP input data is modified by substituting a transient analysis command card for the ac analysis card and by substituting the time domain solution instructions shown here.

A block-diagram representation of the example transfer function (Fig. 3) was developed with the reduction method. The next step in the ECAP simulation procedure is to generate an analog computer diagram from the block diagram. Such a diagram, with element values, was devised with a combination of integrators and algebraic summers (Fig. 4). Since the coefficients of a transfer function are implemented with the closed-loop gain of op amps, it may often be necessary to replace  $s$  by  $10^N s$ .  $N$  is chosen to normalize the coefficients.

The last step in the simulation procedure is to generate an ECAP equivalent circuit (Fig. 5) from the analog computer diagram. This step consists simply of:

- Replacing the open-loop operational amplifier symbols in Fig. 4 with the model of Fig. 1b.
- Labeling the nodes and branches in accordance with the ECAP rules of format.<sup>7</sup>

The resultant circuit may then be used to derive coding for key-punching of an input data deck.

Following this procedure, an equivalent circuit of the transfer function was developed (Fig. 5).

SCALE MULTIPLIER = 10\*\* -2  
 MAJOR SCALE DIVISION = 20

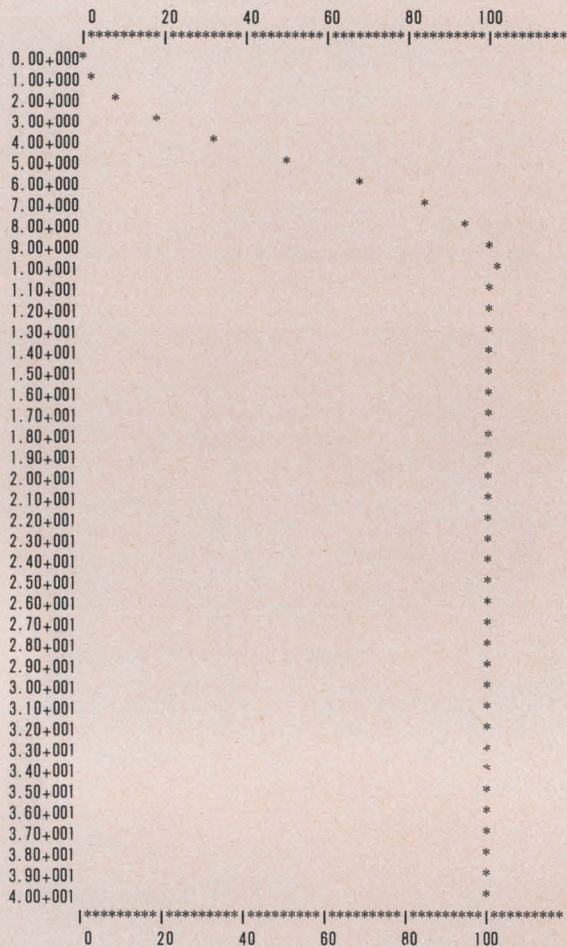

NODE 17 VOLTAGE

SCALE MULTIPLIER = 10\*\* -2  
 MAJOR SCALE DIVISION = 5

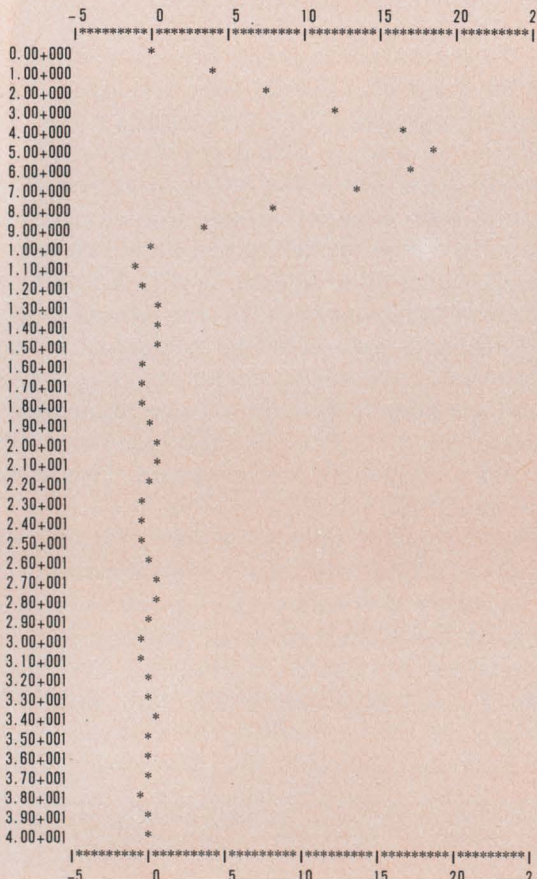

9. The transient analysis step function input gives a frequency response plot that shows an underdamped response with a dominant frequency of about one radian per second. The highest output frequency expected determines some of the transient analysis instructions.

10. The response to a unit impulse input is obtained by setting an initial condition on the highest order state variable, in this case the eighth variable. The response thus obtained is then identical to the impulse response under certain conditions.

An ac analysis was performed for a sequence of solutions in the range of 0.1 to 10.0 radians per second. The input coding (Fig. 6) is basically a list of the branch elements that shows the node connections and the value of each element. For example branch 1 is connected from node 1 to node 0 (the reference node) and has a resistance of 1  $\Omega$  in series with a 1-V independent voltage source.

A set of frequency-response solutions was obtained in one computer run by use of ECAP's modify-and-frequency-iteration capability. With each solution, ECAP provided a printout of all the node voltages in the equivalent circuit in terms of magnitude, phase and dB. Branch-current and branch-power solutions could also have been obtained, had they been desired. Gain and phase plots, as a function of frequency, were plotted directly from the ECAP printout (Fig. 7).

### Generate step and impulse responses

The unit impulse and step responses were obtained from the ECAP transient analysis program. The input data coding required only slight modifications to the ac analysis input data deck to convert the latter for use in the transient program. These modifications consisted of replacing the ac analysis command card with a transient analysis command card and substituting time-domain-solution control cards for the frequency-solution control cards (Fig. 8). The input to ECAP for a transient analysis requires control statements, based on the desired output interval and time step.

The TIME STEP and OUTPUT INTERVAL specifications of 0.025 second and 40 seconds, respectively (Fig. 8) were selected to achieve good numerical integration accuracy and to provide a sufficiently small solution printout interval to define the dominant response frequencies. Similarly the FINISH TIME specification of 40 seconds (Fig. 8) was chosen so as to obtain enough solutions to define the transient response. For this example, the frequency response plot (Fig. 9) indicates an underdamped response in the vicinity of one radian per second; hence, a solution OUTPUT INTERVAL of 1 second provides about 6.28 solutions per cycle at the frequency of interest. For systems or circuits possessing damping factors of much less than unity, it has been determined experimentally that the CDC 3400 version of ECAP often provides satisfactory numerical accuracy when between 200 and 300 solutions per cycle are obtained at the frequency of interest. The TIME STEP used in this example provides approximately 250 solutions per cycle at one radian per second. The FINISH TIME specification was selected to provide for about six complete cycles at the estimated dominant frequency. Quite often the above three specifications must be determined by trial and

error.<sup>8</sup> The ECAP model of a capacitor is a resistor and a battery in series. For initial conditions, ECAP sets the resistance to 0.01  $\Omega$  and the battery to 0 V. In this example, the initial condition — the SHORT specification was selected, on the basis of precision accuracy, to provide a minimum value of 1  $\Omega$  in the ECAP model of a capacitor for all initial condition solutions. This precludes the possibility of excessive node current unbalances for the solution at  $t = 0$ . ECAP assumes initial conditions of capacitor voltages and inductor currents to be zero unless otherwise specified.

An ECAP solution of the unit step response was provided by the computer (Fig. 9). The response of the transfer function to a unit impulse input was also provided by the computer (Fig. 10). The necessary changes to the input data coding for the solution consisted of setting the voltage source in branch 1 (B1) to zero and the addition of a 1-V initial condition in the capacitor in branch 5 (B5). The coding for branch 5 thus becomes

$$B5 N(2, 3), C = 1E - 5, EO = 1.0.$$

This initial condition simulates the initial condition of the eighth, or highest order, state variable. It has been shown that such an initial condition may be used to obtain a response that is identical to the impulse response, when the order of the numerator of a transfer function is less than the order of the denominator.

Each of the two transient response solutions required approximately two minutes of CDC 3400 computer time. The ECAP output included a printout of each node voltage at every output interval.

The graphical frequency and transient response solutions obtained with ECAP compare favorably with similar published solutions obtained with another, more specialized computer program.<sup>9</sup> Furthermore the step response solution at each output interval was within 1 per cent of a similar solution obtained with yet another computer program.<sup>10</sup> ■■

### References:

1. D. B. Herbert, "Simulate ICs With Analog Black Boxes," *ELECTRONIC DESIGN*, XV, No. 24, November 22, 1967, 75-79.
2. *1620 Electronic Circuit Analysis Program Users Manual, ECAP (1620-EE-02X)*, IBM Corp., White Plains, N.Y.
3. Benjamin C. Kuo, *Linear Networks and Systems* (New York: McGraw-Hill Book Co., 1967).
4. L. Hasdorf and W. Grosky, "Algorithms For The Numerical Computation Of The Time Responses Of A System From Its Transfer Function By State Variable Techniques," NASA Technical Report, ERC/CQ/66-659.
5. *Ibid.*
6. F. F. Kuo and J. F. Kaiser (editors), *System Analysis by Digital Computer* (New York: John Wiley and Sons, 1965).
7. *1620 Electronic Circuit Analysis Program Users Manual, ECAP (1620-EE-02X)*, IBM Corp., White Plains, N.Y.
8. *Ibid.*
9. F. F. Kuo and J. F. Kaiser, *ibid.*
10. L. Hasdorf and W. Grosky, *ibid.*

# Lockheed has in production the world's fastest 2½D memory system.



## And one even faster.

---

Lockheed's CD-65 completes a memory cycle in 650 nanoseconds. It's the world's fastest production 2½ D memory system... except for one that's 150 nanoseconds faster: the Lockheed CD-50. □ Speed is just one advantage you get with the CD-65 and CD-50. They both offer a wide range of standard storage capacities—from 8,192 to 65,536 words. Their 2½ D organization provides inherently high operating margins. Total modularity gives them highly flexible interface capability, timing and control, and storage capacities. Plus, both the CD-65 and CD-50, subjected to worst-case design analysis and review, perform with exceptional reliability. **For the world's fastest response with technical material—full details on the CD-65 and CD-50—write to: Memory Products, Lockheed Electronics Company, 6201 E. Randolph Street, Los Angeles, California 90022. Or even faster, call (213) 722-6810.**

---

### **LOCKHEED ELECTRONICS COMPANY**

A DIVISION OF LOCKHEED AIRCRAFT CORPORATION

# New! Solid state voltage sensors protect processes and equipment.

Positive response...plug-in convenience. P&B quality, too!

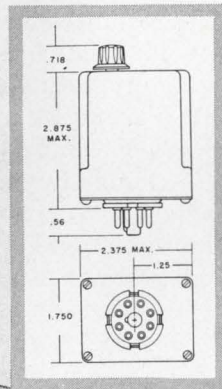

Sound an alarm, start or stop a motor, activate or cut off a system automatically with P&B's new series of voltage sensors. A sensitive solid state circuit "reads" changes in voltage. Over or under voltage deviations greater than predetermined levels cause an internal relay to operate . . . in 25 ms or less. Drop-out or pick-up is positive, and loads of 3 amperes at 120V AC resistive can be switched.

Three types are available: one with adjustable pick-up and drop-out; one with fixed pick-up and adjustable drop-out; one with fixed settings for both pick-up and drop-out. All models are available for either AC or DC operation. All have octal plugs.

Single lot prices for standard models, available from leading electronic parts distributors, range from \$22.70 to \$32.50. Today, call your P&B representative for complete information.

#### Specifications

- Sensing Current Drain: Maximum of 3 ma.
- Maximum Current Drain: After sensing: 30 ma.
- Accuracy of Set Point: 1% after initial setting.
- Reverse Polarity Protection: Yes, on DC types.
- Operating Temperature: -40°C to +55°C.
- Load Switching Relay Contacts:
  - 2 Form C (DPDT). Rating: 3 amps 28V DC resistive; 120V AC resistive.
- Mechanical Life: 10,000,000 operations.



Adjustable Pick-up and Drop-out

CS 38 Series

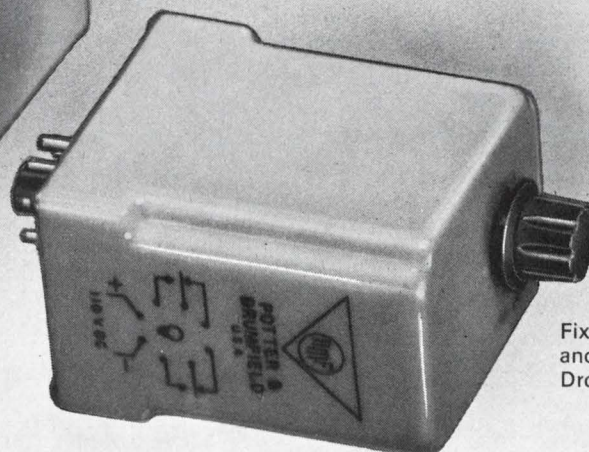

Fixed Pick-up and Adjustable Drop-out



**POTTER & BRUMFIELD**

Division of American Machine & Foundry Co., Princeton, Ind. 47570  
Export: AMF International, 261 Madison Ave., New York, N.Y. 10016

# Build a practical audio amplifier

with complementary transformerless output stages and stable active bias input circuits.

*Second of two articles.*

Limit-condition analysis—the examination of circuit performance under peak loads—can be used to design complementary, highly efficient, transformerless audio amplifiers. A 5-W audio amplifier, for example, will have low losses and low distortion with an unregulated power supply. And it will be feasible to build it with integrated circuits. The design equations used here were derived in Part I, ED 6, March 14, 1968. It covered theoretical aspects of the limit-condition analysis.

A number of such amplifiers have been constructed with the active bias technique (R7, R8, D3, Q6 in Fig. 1a) and with both silicon and germanium output devices. The circuit in Fig. 1a is presently providing satisfactory performance in an automobile radio, where it has been field-tested for several months. Germanium devices were used for Q5 and Q3 to reduce the associated  $V_{EB}$  losses. The undistorted power output is 5 W across 3.2  $\Omega$  when operated from a 14-V supply. The amplifier is driven to full output by an input signal of approximately 30 mW peak to peak.

Another amplifier, using a different output circuit, is shown in Figs. 1b and 1c. The Fairchild SE3030 had to be bypassed (as noted in the first of these two articles) to eliminate high-frequency oscillations. The performance was similar in all ways to that obtained from the circuit of Fig. 1a. The quiescent output-stage collector current in both cases was set at approximately 120 mA.

As can be seen, it is possible to mix germanium and silicon devices with excellent results when discrete components are employed. Slightly increased efficiency—that is, stretching the maximum unclipped output signal voltage swing almost to the full value of  $V_{CC}$ —can be obtained by such mixing. Q6, however, must always be silicon, to maintain thermal stability.

Amplifiers identical in all respects to the ones in Fig. 1b, except that they used complementary Motorola MJE370 pnp and MJE520 npn plastic-encapsulated silicon power transistors for Q2 and Q3, did not require Q3 bypassing because of the

lower  $f_T$  of the MJE520. The quiescent collector current in this case was approximately 200 mA. D1 and D2 (see Fig. 1b) were silicon diodes. R2 in the output circuit was 0.27  $\Omega$ .

The amplifiers maintained quiescent operating points within 5% of optimum for symmetrical clipping at all combinations of supply voltages (10 to 16 V) and at ambient temperatures of  $-30$  to  $+170^\circ\text{F}$ . (Failure of the electrolytics first used for C6 originally placed the lower limit at  $10^\circ\text{F}$ , but after the trouble was identified, a change of manufacturers extended the limit to  $-30^\circ\text{F}$ , the lowest temperature of interest.) Quiescent currents all remained within 30% of their  $75^\circ\text{F}$  values.

Figures 2a through 2d show typical waveforms that were obtained. While the pictures were taken with the circuit of Fig. 1b, with the use of a 2N2142-SE3030 output pair at a  $V_{CC}$  of 13V, they are completely representative of the results obtained with the other amplifiers.

A minimum of feedback, with the component values shown in Figs. 1a and 1b, was employed in all the circuits. The amount of feedback was determined experimentally by adjusting it to obtain maximum undistorted output. No attempt was made to obtain any particular response curve, since the primary purpose of this effort was to improve the amplifier's ability to swing the output within the full range of  $V_{CC}$  and operational environmental stability. In any specific design situation, the feedback would, of course, be tailored exactly to the intended application, with the use of conventional techniques. All of the circuits shown have low input impedances—typically 300 to 500  $\Omega$ —compatible with the automobile audio applications for which they were designed. If a higher input impedance is desired, it can be obtained by adding a series resistor, R9, or an additional stage.

## Integrated circuit applications

Any new circuit intended for high-volume production in today's market, must, to be competitive (or even practical), be so designed that it can eventually be reduced to an integrated circuit—or at least the majority of its functions must be included in one. Since the circuits presented here were origi-

David J. Bernays, Staff Engineer, Automatic Radio Manufacturing Co., Melrose, Mass.



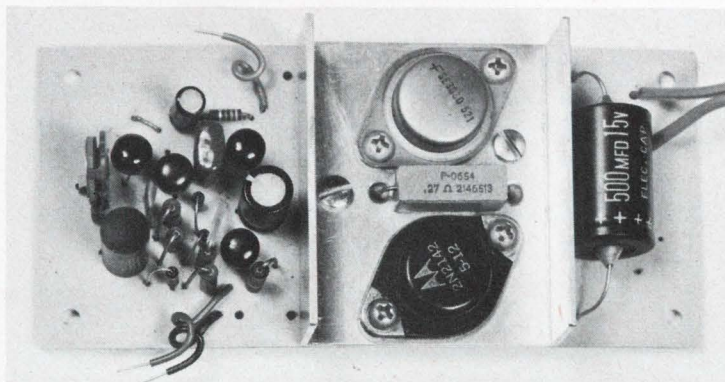
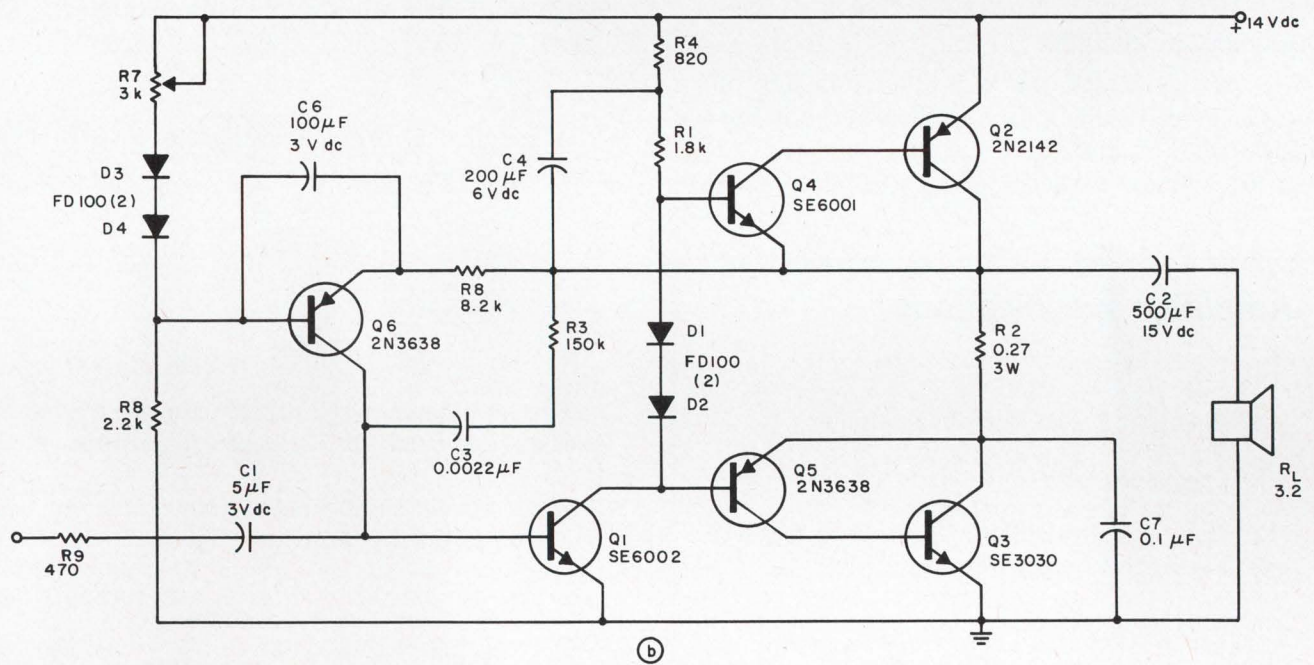
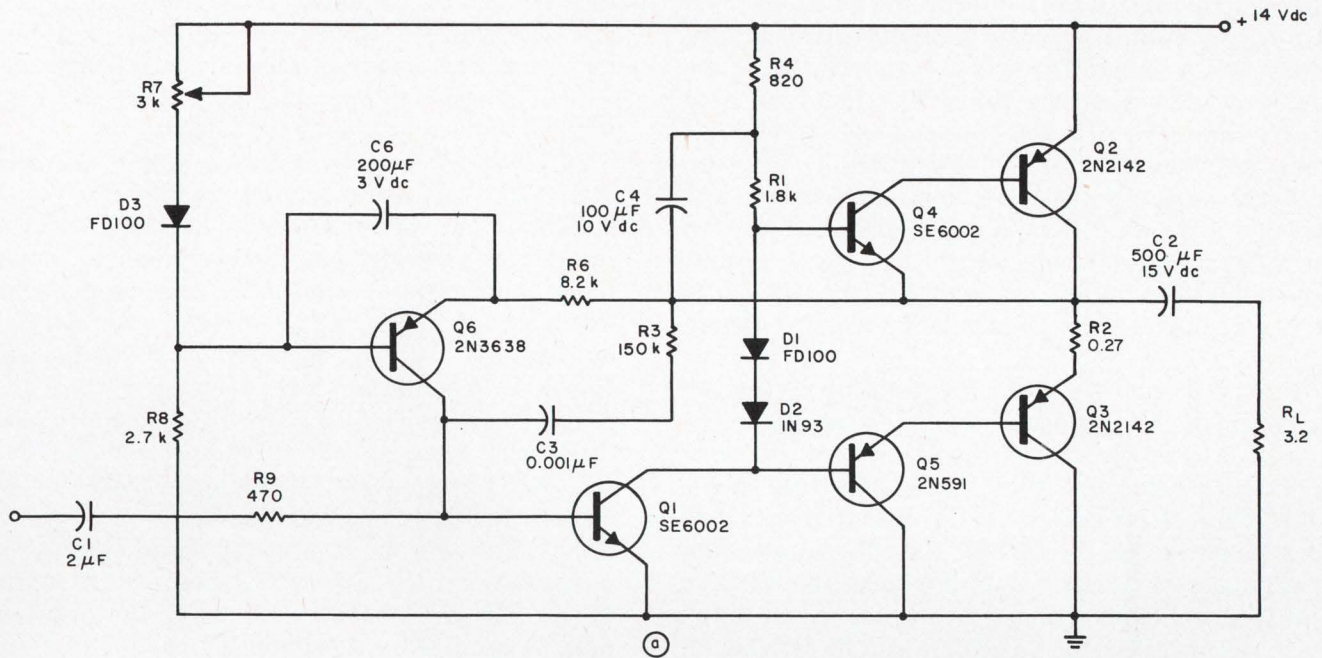

1. Several 5-W amplifiers that use active bias (R7, R8, D3 and Q6) were built and tested. The breadboard for (b) is shown in the photo. Quiescent current for both was set at 120 mA. The difference between (a) and (b) is primarily in the output stage: In (b) both the output transistor pairs are inverted Darlington, which gives better efficiency. High-frequency bypass, C7, can be eliminated with the use of transistors with lower  $f_T$  (see text).

nally designed for vehicular audio amplifiers—to be used in tape decks, entertainment radios and two-way communications equipment—IC compatibility was a primary consideration. All the active low-level devices, together with the associated diodes and resistors, are of types and values that lend themselves well to IC fabrication. Tolerances, in both the active bias and amplifier sections, are wide, due to the gain cushion provided by the various possible connections. The total circuit power dissipation, exclusive of  $R_2$ ,  $Q_2$  and  $Q_3$ , is well within the thermal capability of an economy IC package.

Figure 3 shows a division of circuit functions intended for 12-pin packaging in an arrangement designed to provide the optimum tradeoff between functions enclosed within the IC and user flexibility. The electrolytics, power-output transistors and the power resistor  $R_2$  are the only components that must necessarily be left outside of the IC. Bias and feedback connections are also taken out, however, so that the same basic chip can be tailored to a variety of applications.

### Designing an amplifier

Let's run through the step-by-step design of an actual circuit (see box for specifications), using the basic circuit of Fig. 1b.

Limit values corresponding to worst-case situa-

tions will be used wherever applicable, to develop a final circuit that can tolerate the transistor parameter variations normally encountered in production situations. The limit-analysis design approach, which focuses on boundary conditions to begin with, is an ideal technique for this purpose.

**Step 1. Choose the output configuration.** The basic circuit of Fig. 1b was chosen because it gives the largest output voltage swing and places the fewest limitations on device parameter spreads. Furthermore, appropriate transistors are economically available for all sockets.  $Q_1$  through  $Q_5$  must have minimum  $V_{CE} \rightarrow V_{CC}$ , since they all will experience full  $V_{CC}$ . The initial device selection (based on economics, suitable voltage ratings and appropriate dissipations) was as follows: Motorola MJE370 for  $Q_2$ , MJE520 for  $Q_3$ , Fairchild SE6002 for  $Q_1$ , SE6001 for  $Q_4$  and 2N3638 for  $Q_5$ .

**Step 2. Calculate the maximum signal output voltage swing,  $V_s$ .** Use Eq. 11 (see box). Since  $R_2$  and  $R_L$  are not yet known, a value for the last term must be assumed. Allowing 0.5 V for the last term will normally be sufficiently close to yield the accuracy required of this step. In this example:

$$\begin{aligned} V_s &= 14.0 - 0.2^* - 0.7^* - 0.2^* - 0.1^* - 0.8^* - 0.5 \\ &= 14.0 - 2.4 \\ &= 11.6 \text{ V.} \end{aligned}$$

**Step 3. Calculate the load resistance,  $R_L$ .** Rearrange Eq. 6 (see box) to get

$$R_L = \frac{V_s^2}{8P_{O_{max}}}, \quad (\text{A1})$$

and calculate  $R_L$ :

$$R_L = \frac{(11.6)^2}{8 \times 5} = 3.35 \Omega.$$

This will be changed to 3.2  $\Omega$  to use a standard speaker and used for  $R_L$  in the remaining calculations.

**Step 4. Calculate and check output transistor maximum collector current,  $i_{c_{max}}$ .**

$$i_{c_{max}} = \frac{(V_s)}{2R_L} = \frac{11.6}{2 \times 3.2} = 1.81 \text{ A.} \quad (\text{A2})$$

For the MJE520-370 series,  $I_{c_{peak}} = 4 \text{ A}$  dc and  $I_{c_{continuous}} = 3 \text{ A}$  dc. The calculated value is acceptable.

**Step 5. Calculate output transistor maximum base current,  $i_{b_{max}}$ , from results of step 4.** Use 1 A  $h_{FE}$  from MJE520-370 data sheets ( $h_{FE}$  of 25 at  $I_c$  of 1 ampere is the guaranteed minimum for the highest  $I_c$  specifically noted).

$$i_{b_{max}} = \frac{i_{c_{max}}}{h_{FE}} = \frac{1.8}{25} = 72 \text{ mA.}$$

**Step 6. Verify  $Q_4$  and  $Q_5$   $i_{c_{max}}$  device capability.**

### Amplifier specifications

1.  $V_{CC} = 14.0 \text{ V}$ .
2. Required  $P_{out}$ : 5 W without clipping.
3. Frequency range: 100 Hz to 4 kHz.
4. Input power available (at base of  $Q_1$ ): 80 mV peak-to-peak across 500 ohms.
5. Operating temperature range:  $-30^\circ\text{F}$  to  $+170^\circ\text{F}$ .

Design equations (from Part I):

$$\begin{aligned} V_s &= V_{CC} - V_{CEsatQ4} - V_{EBQ2} - \\ &V_{CEsatQ1} - V_{CEsatQ5} \\ &- V_{EBQ3} - (V_{s2}R_2/R_L) \end{aligned} \quad (11)$$

$$P_{O_{max}} = (V_s^2 R_2 / 8R_L) \quad (6)$$

$$i_{b_{max}Q4} = V_{s1} / R_L h_{FEQ2} h_{FEQ4} \quad (8)$$

The equation numbers are those used in Part I, ED 6, March 14, 1968.

\*Typical measured values at  $25^\circ\text{C}$ . A more conservative approach (although one that is misleading so far as typical performance is concerned) would be to use maximum data sheet values.

Check Fairchild SE6001 and 2N3638 data sheets to verify that this is a permissible value for  $i_{c_{max}}$  for  $Q_4$  and  $Q_5$ , respectively.

Step 7. Calculate  $i_{b_{max}Q_4}$ . Use Eq. 8 (see box) to solve for  $i_{b_{max}Q_4}$  using minimum  $h_{FE}$  of 50 from SE6001 data sheet ( $i_{b_{max}Q_5}$  can also be determined in a similar manner).

$$i_{b_{max}Q_4} = \frac{5.8}{3.2 \times 50 \times 25} = 1.6 \text{ mA.} \quad (\text{A3})$$

Step 8. Calculate minimum inverted Darlington input impedance.

$$Z_{inQ_4} = \frac{V_{S_2}}{i_{b_{max}Q_4}} = \frac{5.8}{1.6 \times 10^{-3}} = 3.62 \text{ k}\Omega. \quad (\text{A4})$$

The minimum input impedance of  $Q_5$  may be calculated in a similar manner.

The input impedances\* to  $Q_4$  and  $Q_5$  determine the ac collector load line for  $Q_1$  during positive and negative half cycles, respectively. Any differences between the  $Q_4$ - $Q_2$  and  $Q_5$ - $Q_3$   $h_{FE}$  products will therefore create a varying  $Q_1$  collector load, resulting in distortion. The degree of such mismatch that can be tolerated before distortion becomes unacceptable will depend upon the amount of feedback employed. The worst-case condition will occur when a low-limit  $h_{FE}$  pair of transistors are used for  $Q_4$  and  $Q_2$  and a high-limit pair for  $Q_5$  and  $Q_3$ . Satisfactory amplifier performance under these conditions should be verified empirically after the feedback network component values are chosen, by placing appropriate limit  $h_{FE}$  transistors in the inverted Darlington pairs. Such a check will insure trouble-free performance, insofar as the  $Q_2$ - $Q_5$   $h_{FE}$  variations are concerned, when the circuit reaches production.

Step 9. Determine values for  $R_1$  and  $R_4$ .  $R_1$  and  $R_4$  together determine the quiescent collector current of  $Q_1$ . Their summed value should be chosen to operate  $Q_1$  in a linear region under class A conditions. The necessary specific calculations are carried out in Step 10.

$R_1$  and  $R_4$ , in parallel, also provide the load for  $C_4$  in determining the bootstrap time constant (calculated in Step 11). The load will be minimum when  $R_1$  and  $R_4$  are equal, but, within a limit of approximately 2:1, the ratio is not critical.

Optimum  $I_{cQ_1}$  in the design example is slightly less than 3mA, indicating an  $R_1 + R_4$  total of 2.5 to 2.7 k $\Omega$ . Within these limits,  $R_1$  was chosen as 1.8 k and  $R_4$  820  $\Omega$  (total 2.62 k $\Omega$ ). The division between  $R_1$  and  $R_4$  was based primarily on the convenience of available stock.

Step 10. Calculate  $I_{cQ_1}$  and current swing.  $I_{cQ_1}$  can

\* $R_1$  is ignored, since, owing to the bootstrap capacitor  $C_4$ , it has no practical effect upon the ac load line.

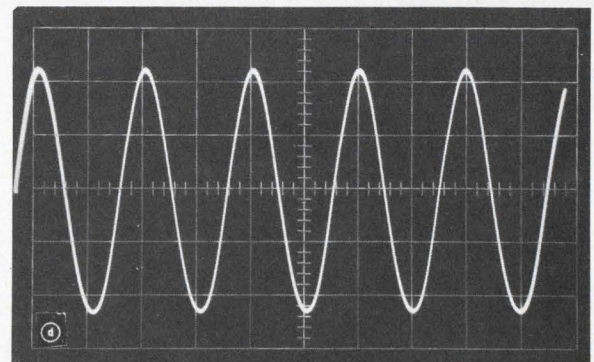
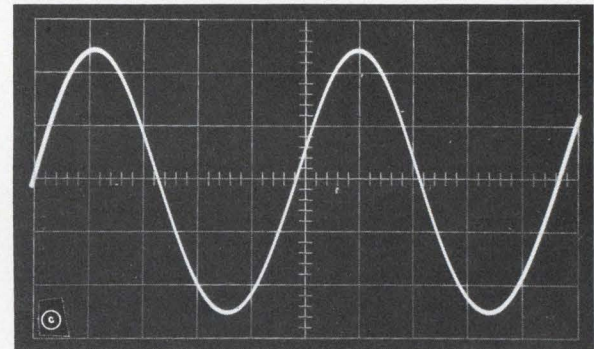
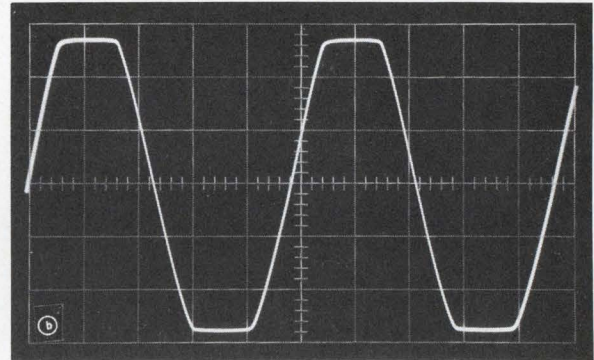
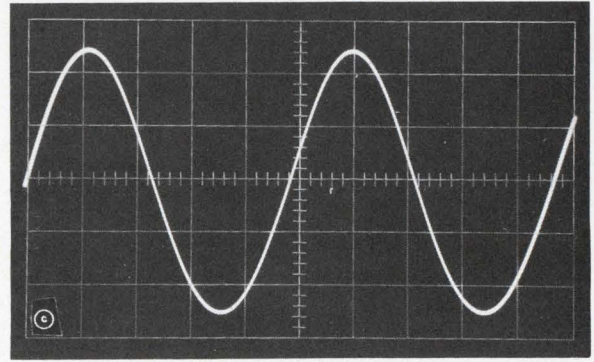

2. Maximum undistorted output at 1 kHz is shown in (a). Symmetrical clipping results with the increased drive (b). Waveforms of 100 Hz and 10 kHz are in (c) and (d), respectively. The conditions for all figures are: vertical scale = 2 V/cm,  $R_L = 3$  ohms,  $V_{CC} = 13$  Vdc. All were obtained with the circuit of Fig. 1b.

be found from

$$\begin{aligned} I_{cQ1} &= \frac{V_{CC}}{2(R1 + R4)} \\ &= \frac{14}{2(1.8 \times 10^3 + 820)} \\ &= 2.77 \text{ mA}, \end{aligned} \quad (A5)$$

and

$$i_{c_{max}Q1} = I_{cQ1} + i_{b_{max}Q5}, \quad (A6)$$

(assuming  $i_{b_{max}Q5} = i_{b_{max}Q3}$ , which will be true when  $h_{FE}$  products for  $Q4$ - $Q2$  and  $Q5$ - $Q3$  are equal),

$$\begin{aligned} i_{c_{max}Q1} &= 2.77 + 1.6 \\ &= 4.37 \text{ mA}. \end{aligned}$$

Likewise

$$\begin{aligned} i_{c_{min}Q1} &= I_{cQ1} - i_{b_{max}Q3} \\ &= 2.77 - 1.6 \\ &= 1.17 \text{ mA}. \end{aligned} \quad (A7)$$

Examination of the SE6002 collector data shows these values to be well within the linear operating region of  $Q1$ . The available drive is more than adequate to produce the  $Q1$  collector-current swing.

*Step 11. Select  $C4$ .* The bootstrap capacitor should have (1) a minimum voltage rating of

$$V_{C4} = \frac{V_{CC}}{2} \times \frac{R1}{(R1 + R4)} \quad (A8)$$

and (2) a time constant (when considered as being loaded by the parallel combination of  $R1$  and  $R4$ ) of at least 10 times the period of the lowest frequency of interest, here 100 Hz. So that

$$V_{C4} = \frac{14}{2} \times \frac{1.8 \times 10^3}{(1.8 \times 10^3 + 820)} = 4.85 \text{ V},$$

or, with the use of the nearest standard voltage value, 6 V.

The time constant,  $T$ , is given by

$$T = RC,$$

rearranging

$$\begin{aligned} C &= \frac{T}{R} \\ &= \frac{10^{-1}}{5.6 \times 10^{-4}} \\ &= 180 \text{ } \mu\text{F} \end{aligned} \quad (A9)$$

The nearest stock value is 200  $\mu\text{F}$ , and therefore  $C4$  is 200  $\mu\text{F}$  at 6 WVdc.

*Step 12. Calculate the value of  $R2$ .* Examination of Fig. 1b shows that the voltage appearing between the bases of  $Q4$  and  $Q5$  under quiescent conditions will be given by

$$V = V_{EBQ4} + R2 \cdot I_{cQ2,3} + V_{EBQ5}. \quad (A10)$$

From this equation it can be seen that the thermal-stability diodes  $D1$  and  $D2$  must, with  $Q1$  quiescent collector current flowing, present a slightly greater

combined contact potential than the combined emitter-base junctions of  $Q4$  and  $Q5$ , if quiescent current is to flow in the output transistors. The choice of two small signal silicon diodes similar to the Fairchild type FD-100 satisfied this condition. The determination was empirical and was verified by measurement of several different sets of components.  $R2$  was set at 0.27  $\Omega$ , on the basis of allowable crossover distortion, and yielded a quiescent current of slightly less than 200 mA. The power resistor actually used was selected for ease of obtaining 0.27 ohm, actual dissipation is less than 0.5 W. It should be mentioned that the choice of maximum allowable quiescent current is related to feedback requirements and amplifier gain, in that increasing feedback will minimize the apparent crossover distortion and hence the necessary quiescent current at the expense of amplifier gain. Since all of the designs described here were intended for automotive applications, where the availability of supply power is not a problem, the quiescent currents were intentionally set high to minimize feedback requirements and to maximize gain. Different considerations would have prevailed had the designs been intended for equipment with power problems.

It is now possible to calculate a value for the last term of Eq. 11 (see box), thus checking the value assumed in step 2 above,

$$V_{s2} \times R2 = 5.8 \times 0.27/3.2 = 0.49 \text{ V}.$$

*Step 13. Calculate output transistor thermal dissipation.* Thermal dissipation in the output transistors can be considered in two parts; a "class B" portion of the transistor dissipation in the output stage will be approximately 20% of the maximum available unclipped sine-wave power output, and will occur when the amplifier is delivering approximately 40% of maximum power output. Several references are available for further exploration of the derivation of these percentages (or those applicable to other waveforms)<sup>4,5</sup>. For the design example, the dissipation attributable to signal current is

$$20\% \times 5 = 1 \text{ W}.$$

The quiescent current dissipation is quiescent current times  $V_{CC}$  or:

$$(200 \text{ mA}) \times 14 = 2.8 \text{ W}.$$

The total output dissipation is therefore 3.8 W or 1.9 W per transistor. A very small heat sink is adequate. The actual size was determined empirically and verified by an oven check.

*Step 14. Calculate driver dissipation.* It is possible to take a shortcut in determining the dissipations of  $Q4$  and  $Q5$ . Since they experience essentially the same voltage swings as  $Q2$  and  $Q3$ , their dissipations can be estimated with sufficient accuracy for this analysis from the ratio of driver and output transistor peak currents—that is,

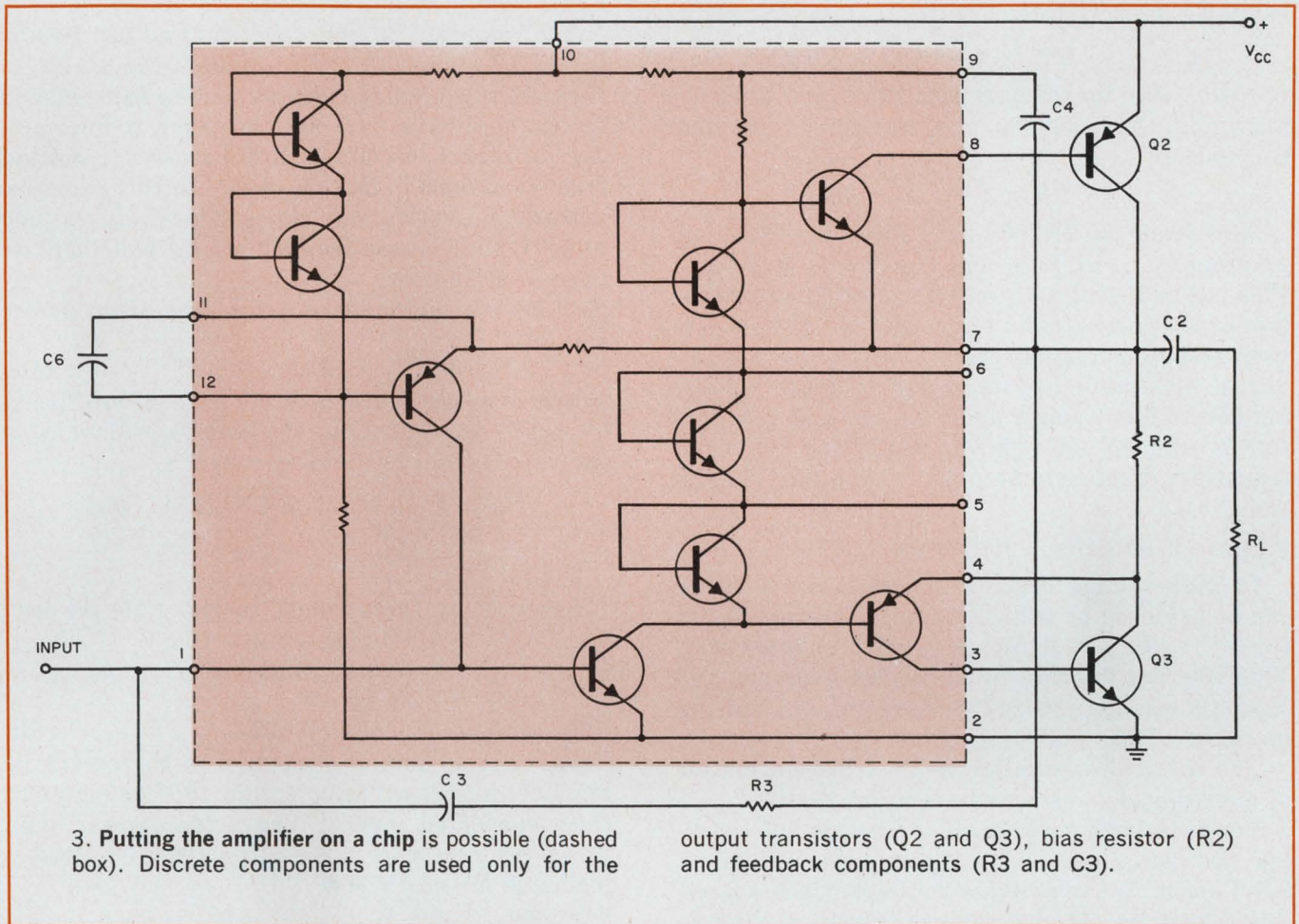

$(0.072 \text{ A}/1.8 \text{ A}) \times 1.9 = 76 \text{ mW/transistor}$ . This is well within the allowable  $25^\circ\text{C}$  ambient dissipations for  $Q_4$  and  $Q_5$  of  $300 \text{ mW/transistor}$ . Derating at  $3 \text{ mW}/^\circ\text{C}$  to  $170^\circ\text{F}$  (a change of  $50^\circ\text{C}$ ) still leaves an allowable dissipation of  $150 \text{ mW}$  at the highest design operating temperature.

**Step 15. Determine  $Q_1$  dissipation.** The dissipation of  $Q_1$  can be calculated in the standard manner for a class A amplifier, but in this instance inspection shows it to be so small that further calculation is unnecessary.

**Step 16. Design feedback network.** The feedback network must do two things: (1) Shape the amplifier audio response, and (2) Eliminate or minimize any distortion arising from the stages enclosed by the feedback loop. The values chosen for  $R_3$  and  $C_3$  ( $150 \text{ k}\Omega$  and  $0.0022 \mu\text{F}$ ) satisfy the first requirement by providing a bass boost beginning at approximately  $600 \text{ Hz}$ . Sufficient high-frequency feedback is provided to eliminate the residual cross-over distortion and any nonlinearity present in the output stage. The degree of high-frequency feedback is controlled by  $R_3$ . The value for  $R_3$  was determined empirically by waveform observation and distortion measurements (Figs. 2a through 2d).

**Step 17. Input to  $Q_1$ .** The  $470\text{-}\Omega$  resistor,  $R_9$ , in series with the input decoupling capacitor,  $C_1$ , is

( $I_{C_{BQ6}}$ ) that can be encountered at maximum operation an integral part of the basic circuit; it was selected experimentally and used in the prototypes to improve the input matching to existing signal sources. Input power loss due to the addition of  $R_9$  was  $3\text{dB}$ .

**Step 18. Calculate the value of the output coupling capacitor,  $C_2$ .** The impedance of a  $500\text{-}\mu\text{F}$  capacitor at  $100 \text{ Hz}$  is  $3.2 \text{ ohms}$ , and this determines the minimum possible value for  $C_2$ . A  $1000\text{-}\mu\text{F}$  capacitor would be better, but the added cost is not justified in this instance to eliminate the small amount of roll-off noted at  $100 \text{ Hz}$  with  $500 \mu\text{F}$ .

**Step 19. Choose  $Q_6$  and verify satisfactory operating conditions.**  $Q_6$  operates at an extremely low  $I_c$ , and thus two characteristics become the primary design considerations. The first is that  $Q_6$  must possess sufficient  $h_{FE}$  at the minimum possible  $I_c$  to function properly. Second, to insure temperature-stable active bias operation, the minimum possible base current for  $Q_6$  must be at least 10 times greater than the maximum possible leakage ating temperature.

Begin by calculating  $I_{c_{min}Q6}$  :

$$I_{c_{min}Q6} = I_{cQ1}/h_{FE_{max}Q1} \quad (\text{A11})$$

From the SE6002 data sheet  $h_{FE,maxQ1}$  is 600, hence:

$$I_{c_{min}Q6} = 2.77 \times 10^{-3}/600 = 4.6 \mu A.$$

Next, from the 2N2628 data sheet, note that the maximum  $Q6$   $h_{FE}$  is 120, and therefore, by similar calculation,

$$I_{c_{min}Q6} = 4.6 \times 10^{-6}/120 = 39 \text{ nA}.$$

Also from the 2N3638 data sheet, note that the maximum  $I_{CBO}$  at 75°F and  $V_{CE}$  of -10 is 3.4 nA. This is a sufficient margin to insure that the operation of  $Q6$  at maximum temperature will be stable with respect to  $I_{CBO}$  effects.

The maximum instantaneous collector voltage applied to  $Q6$  depends upon the ratio of resistors  $R6$ ,  $R7$  and  $R8$  and is given, neglecting diode and transistor junction losses, by the simplified expression:

$$V_{CEQ6} = V_{cc} R8/[R8 + R6R7/(R6 + R7)] \quad (A12)$$

In high-voltage designs, where some economy can be achieved by utilizing a lower-voltage device for  $Q6$ , it will be worthwhile to solve equation A12. This was not the case in the design example, and hence  $Q6$  was specified only to have a  $V_{CE(max)}$  rating in excess of  $V_{CC}$  (14V).

The thermal dissipation in  $Q6$  will be a matter of microwatts and so can be ignored.

Verify satisfactory low  $I_c$  operation by checking the data sheet, using the minimum  $I_c$  calculated above. When suitable data are not available, as in this example, satisfactory operation must be verified empirically with limit samples for  $Q6$  and  $Q1$  (low  $h_{FE}$  for  $Q6$ , high  $h_{FE}$  for  $Q1$ ).

*Step 20. Design the base circuit for  $Q6$ .*  $R7$  and  $R8$  are chosen to set the  $Q6$  base reference voltage, as well as to provide 2 to 3 mA of current through the temperature-compensating diodes used to control  $Q6$ .  $R7$  was made variable in the prototypes (Fig. 1) for convenience.

Two silicon temperature-compensating diodes are used, since the amplifier output is a completely symmetrical configuration. Diodes similar to the Fairchild FD100 were selected, since they track the emitter-base diode contact potential of  $Q6$  closely. They could be deleted, if a narrower operating temperature range were specified.

*Step 21. Determine the values of  $C6$  and  $R6$ .*  $C6$  serves to clamp  $Q6$  and should have, when considered in series with  $R6$  and the parallel combination of  $R7$  and  $R8$ , a time constant,  $T$ , of greater than 100 times the period of the lowest frequency of interest—here, 100 Hz.

$$T = [R6 + R7 \times R8/(R7 + R8)] \times C6 \geq 1 \text{ s} \quad (A13)$$

Rearranging,

$$\begin{aligned} C6 &= T/[R6 + R7 \times R8/(R7 + R8)] \\ &= 1/(8.2 \times 10^3 + 1.2 \times 10^3) \\ &= 106 \mu F. \end{aligned} \quad (A14)$$

100  $\mu F$  at 3 V—the nearest available stock value

is sufficiently close to be used.

The value for  $R6$  is not critical and can be any between 5 k $\Omega$  and 10 k $\Omega$ . The choice was 8.2 k $\Omega$ , in view of the preceding calculation. The value should be kept as small as practical, however, to minimize the variations in voltage drop across it resulting from variations in the  $h_{FE}$  of  $Q1$ . In this example, when  $Q1$   $h_{FE}$  varies from upper to lower limits (600 to 150), the voltage drop across  $R6$  will increase from 37 to 148 mV.

*Step 22. Calculate the required amplifier power gain,  $A$ .*

$$A \text{ (dB)} = 10 \log (P_{out}/P_{in}) \quad (A15)$$

where (see specifications in the box—80 mV peak-to-peak across 500 ohms; the peak-to-peak value is converted to rms by dividing it by 2.8)

$$\begin{aligned} P_{in} &= E^2/R = (80 \times 10^{-3}/2.8)^2/500 \\ &= 1.6 \mu W \end{aligned}$$

$$\text{and } P_{out} = 5 \text{ W}.$$

Substituting these values in Eq. A15, we get:

$$\begin{aligned} A &= 10 \log 5/1.6 \times 10^{-6} \\ &= 10 \log 3.12 \times 10^6 \\ &= 64.9 \text{ dB}. \end{aligned}$$

*Step 23. Evaluate the breadboard of the circuit.* Voltages and currents measured in the prototype amplifier all proved to be within 10% or better of their calculated values. The actual power gain (from the base of  $Q1$  to the output) was 66 dB—or, including  $R9$ , 63 dB. ■ ■

#### References:

1. Fisher, RCA Application Note AN-3185, June, 1966.
2. Amperex Electronic Corp. brochure, "Complementary Symmetry Circuits and Data."
3. Motorola Semiconductors, MJE370, 371 Preliminary Specification, September, 1966.
4. Blaser and Franco, "Push-Pull Class-AB Transformerless Power Amplifiers," Fairchild Application Note APP-51, February, 1963, and *IEEE Transactions on Audio*, January-February, 1963.
5. Hartz, "Power Dissipation in Complementary Symmetry Circuits," RCA Application Note AN-3505, June, 1967.

#### Test your retention

Here are questions based on the main points of this article. They are to help you see if you have overlooked any important ideas. You'll find the answers in the article.

1. Why do germanium transistors help to reduce losses?
2. Which transistor must be silicon to assure thermal stability?
3. What parameter of the output transistor permits elimination of the bypass capacitor?
4. What assures symmetrical output in all circuits?

# Do the Pavlovian Giants give you the Freudian slip?

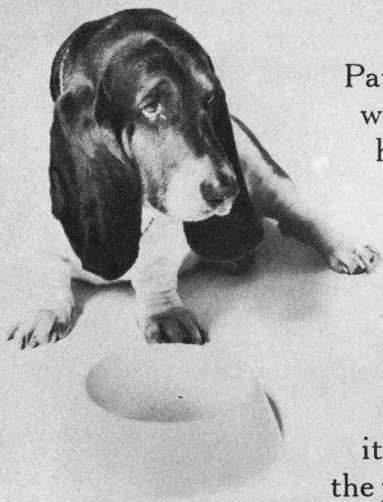

Pavlov, you know, was the guy who handed his hound the same old baloney day after day. Nothing extra. Nothing special. Just the same old baloney.

He got by with it because he was the pup's only source of supply. So sure of himself was this giant-like man that soon even his Freudian slip began to show . . . the baloney began to miss delivery dates! Finally, all the faithful friend got anymore was promises, promises and more promises from that stupid bell.

If you're tired of the standard Pavlovian

kind of baloney you get from some of the giants, think about little Midtex/AEMCO. For a long time people like Collins Radio, Bruning and Xerox have been getting what they want, when they want it . . . on a silver platter. If there is a relay or timer problem to solve, we

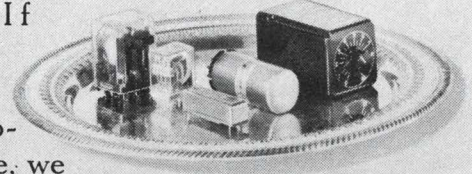

dive in head first and don't come up until we have an answer. We kinda feel that our customers like that attitude instead of some of the usual phoney baloney.

When you're a little company in Mankato, Minnesota, doing battle with the giants in the industry, you just have to think smarter, move quicker, and care a lot more.

We do. And we'd love to show you.

**MIDTEX**   
INCORPORATED

AEMCO DIVISION

10 STATE STREET

MANKATO, MINNESOTA 56001

PROGRAMMERS/TIME DELAY RELAYS/MINIATURE COAXIAL RELAYS/INDUSTRIAL RELAYS/MERCURY-WETTED CONTACT RELAYS

# Don't lose pulses in long cables.

Get an accurate estimate of pulse degradation in long cables before your system is designed.

Don't guess at the losses in long cables. If the low- and high-frequency components of pulses are treated separately, their degradation can be predicted accurately for most practical systems.

The basic assumption of the procedure is that the input and the output waveforms are symmetrical trapezoids. The duration of almost any pulse can be considered to consist of rise time, flat-top time and fall time. The signal during flat-top time has an amplitude that is predominantly attributable to dc or low-frequency components. During rise and fall times the signal can be ascribed mostly to higher-frequency components.

The estimate can be made by dealing with each of these two categories individually. The procedure reduces the flat-top portion in amplitude, according to dc and low-frequency losses, but keeps its time duration constant. At the same time, it increases the rise and fall times according to the attenuation of relevant higher-frequency components. This step can be done graphically.

The rise, flat-top and fall times are well defined in symmetrical trapezoidal pulses (Fig. 1a), which may be considered as inputs to a long cable. Their Fourier series expansion is:

$$y(t) = \sum D_n \exp jnt, \quad (1)$$

where the coefficients are given by:

$$D_n = A_{av} \frac{\sin(\pi n t_1 / T)}{\pi n t_1 / T} \frac{\sin[\pi n (t_1 + t_0) / T]}{\pi n (t_1 + t_0) / T}. \quad (2)$$

When  $t_1/T$  is small—less than 0.1—the second factor approaches unity. The factor therefore has an effect only near zero. The remainder of the equation is  $(\sin x)/x$  in character. The frequency (in rad/s) is given by  $2\pi/(t_1 + t_0)$ , so  $\omega T = 2\pi T/(t_1 + t_0)$ . The Fourier series (Eq. 1) is plotted in Fig. 1b as a function of  $\omega t$ .

The number of spectral lines that fall between the zero points of the plotted Fourier spectrum is given by  $[1/(t_1 + t_0)]/(1/T)$  or  $T/(t_1 + t_0)$ . For example, if  $t_1 + t_0 = 1 \mu\text{s}$  and  $T = 100 \mu\text{s}$ , the number of lines would be 100 and each line would be separated from its neighbors by  $10^4$  cycles. The

distance between zero points is  $100 \times 10^4$ , or  $10^6$ , cycles.

This brief calculation points up the fact that  $T$  signifies the separation of spectral lines, while  $1/(t_1 + t_0)$  indicates the frequency between crossover points in the spectrum. This means that the factor  $1/(t_1 + t_0)$  can be used as the frequency scale factor of the  $(\sin x)/x$  term, to estimate the losses during the rise and fall times.

At dc, the losses are predominantly due to the resistance of the cable,  $R_c$ . Its effect may be simulated by a voltage division between the condition when cable is present and when cable is not present, as shown in Fig. 2a. The inclusion of  $R_c$  (Fig. 2b) results in an output dc voltage of:

$$E_{dc} = \frac{R_L}{R_s + R_L + R_c} \bigg/ \frac{R_L}{R_L + R_s}. \quad (3)$$

## A practical situation proves the procedure

Now consider a practical situation where a pulse of the following dimensions is to be sent through 406 ft of RG 71U coaxial cable (Fig. 3):

$$t_0 = 280 \text{ ns}, t_1 + t_0 + t_1 = 350 \text{ ns}.$$

The cable's resistance is  $18 \Omega$ , the load is  $90 \Omega$  and the source is  $50 \Omega$ . What pulse shape can be expected from the cable?

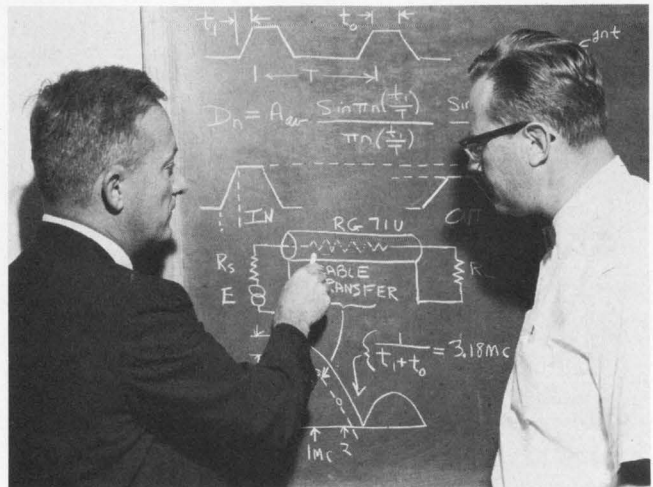

A few equations tell what happens to pulses in long cables, points out author Root.

**Henry G. Root**, Engineering Specialist, Sylvania Electronic Systems, Waltham, Mass.



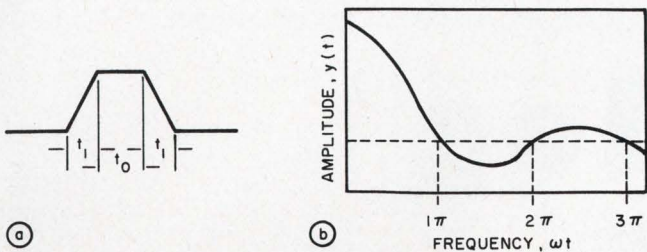

1. Input to a cable is assumed to be a **symmetrical trapezoidal pulse** (a), consisting of a flat section that takes care of dc components, and rise- and fall-time parts that include the high-frequency components. The Fourier transform of such a pulse approximates a  $(\sin x)/x$  function (b).

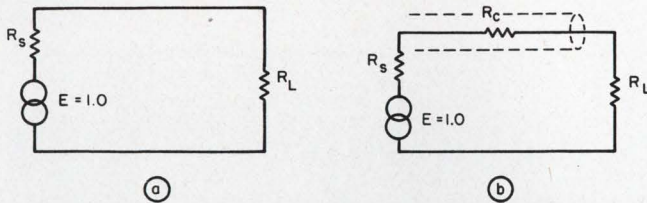

2. The losses at dc are due to the resistance of the cable,  $R_c$ . The change in the output dc voltage may be written in form of a voltage division, when the equivalent circuits without the cable (a) and with (b) the cable are considered.

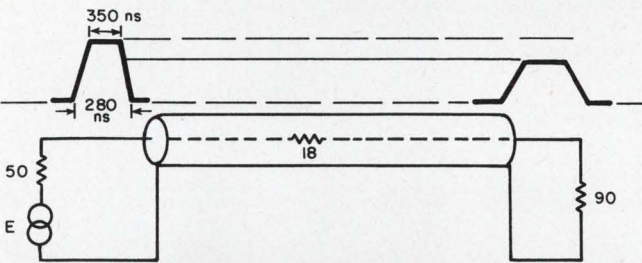

3. Case history involves 406 feet of RG 71U coaxial cable with a resistance of 18 ohms, a 50-ohm source and a 90-ohm load. The input trapezoidal pulse suffers some attenuation in the amplitude and increase in rise and fall times.

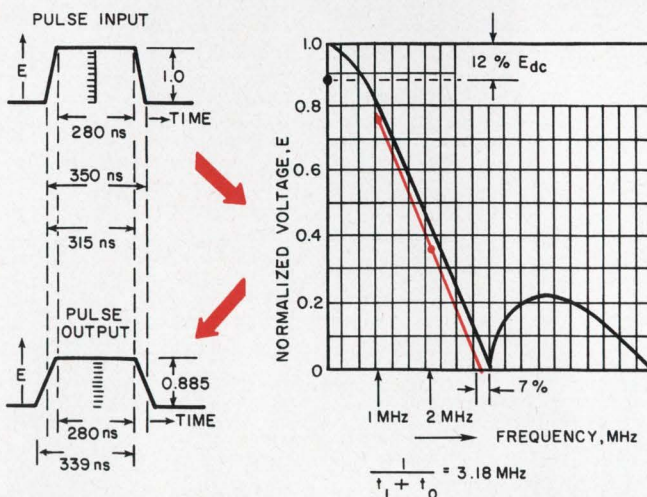

4. Estimate of degradation requires the plot of  $(\sin x)/x$  (heavy black line). The calculated amplitudes of the high-frequency components yield line in color, which helps predict changes in rise and fall times. The change in amplitude is found with Eq. 3 in the text.

The calculations are simple. The rise and fall times are found in a few steps:

$$\begin{aligned} 2t_1 + t_0 &= 350 \text{ ns}, \\ t_0 &= 280 \text{ ns}, \\ 2t_1 &= 70 \text{ ns}, \\ t_1 &= 35 \text{ ns}, \end{aligned}$$

Then  $t_0 + t_1 = 315 \text{ ns}$ .

The first crossover frequency (Fig. 4) is:

$$f_1 = 1/(t_1 + t_0) = 3.18 \text{ MHz}.$$

From cable specifications the expected voltage attenuation factors at three frequencies are:

$$\begin{aligned} \text{At 1 MHz} &-0.892, \\ \text{At 2 MHz} &-0.84, \\ \text{At 3 MHz} &-0.82. \end{aligned}$$

The 1-MHz point on the  $(\sin x)/x$  distribution curve is given by  $1/3.18 \times 10$  divisions, or 3.15 divisions (Fig. 4), the 2-MHz point by 6.3 divisions.

With an input of 1Vdc, the output becomes:

$$E_{dc} = \frac{90}{50 + 18 + 90} \bigg/ \frac{90}{90 + 50} = 0.885$$

The actual measured value was 0.9. This takes care of the attenuation of the dc part, or the flat-top section of the pulse.

Next, the changes in the rise and fall times should be found. The initial voltage at 1 MHz is shown in the graph as 0.82. Multiply this by the cable loss, 0.892, and place the product (0.78) on the chart. For 2 MHz, the initial value is 0.43. Multiply this by 0.84, the cable loss, to obtain the attenuated normalized output of 0.36. Mark this, too, on the chart.

Project a straight line connecting these two points to intercept the frequency axis (see line in color). This point of interception is 7% short of the first crossover. Thus  $t_1 + t_0$  can be expected to increase by 7%; or to  $1.07 \times (280 + 25) = 339 \text{ ns}$  (actual measured value was 340 ns).

If  $t_0$  is subtracted, the result is the new rise or fall time:  $t_1 = 339 - 280 = 59 \text{ ns}$ . The actual measured value was 62 ns, as shown at the bottom left of the time diagram in Fig. 4. The estimate was thus shown to be sufficiently accurate for most practical purposes. ■ ■

### Test your retention

Here are questions based on the main points of this article. They are to help you see if you have overlooked any important ideas. You'll find the answers in the article.

1. Why can the low- and high-frequency components of a pulse be separated?

2. What determines the separation of spectral lines, and what is the factor to find the crossover points in the spectrum?

# FET analog switches & drivers

For commutators, choppers, digital filters - choose from dozens ... here are some examples:

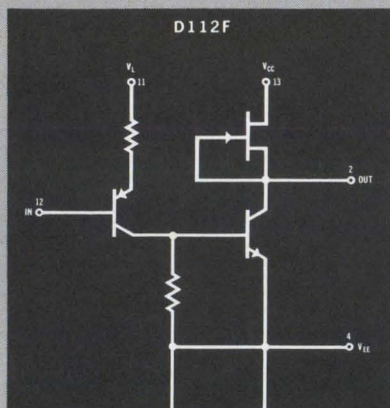

"D" Series FET Switch Drivers

These drivers are designed to couple between low-level logic and junction or MOS FET switches. Input thresholds are adjustable to your logic and you can preset the output voltage swing up to 30 volts peak-to-peak.

The D series has as many as six drivers per package with a variety of electrical and logical options.

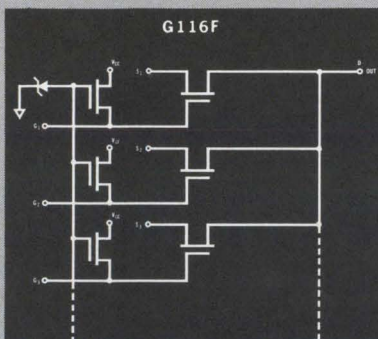

"G" Series MOS Switches

Here's a five-channel enhancement-mode MOS FET switch array that can be used directly with the Siliconix six-channel drivers. No external parts needed; just two IC packages and you've got five complete channels for multiplexing. The Zener diode protection is integrated, as are the FET pull-up elements that supply collector loads for the drivers. Other G-series circuits offer a wide choice of switching functions.

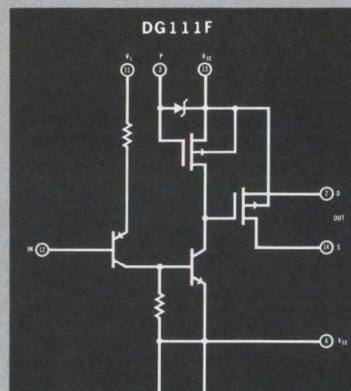

"DG" Series Drivers with FET Switches

Two complete channels—each with a driver and FET switch—are included in this one package. Connect the circuit directly to your low-level logic and it's ready to go. Each channel can control a millivolt whisper or a 20 volt roar. Driver gates (DG series) come in a variety of logical and electrical options.

Special requirements? Even 50 standard devices can't solve everybody's problem, so you're invited to write for a solution to your specific need.



**Siliconix incorporated**

1140 W. Evelyn Ave. • Sunnyvale, CA 94086  
Phone (408) 245-1000 • TWX: 910-339-9216

## ANALOG SWITCH/DRIVER DATA

Write for your FET switch data kit with information on all standard Siliconix switching products. If you have a current project that needs immediate attention, write or phone for applications assistance.

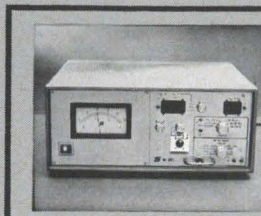
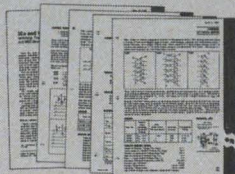

## NEW LOW COST FET TESTER

The SI200 Semiconductor Tester features plug-ins for expandable test capability, simplicity of operation, and low cost.

Price: SI200 Tester . . . \$960.  
Price: SI201 (DC &  $g_{fs}$ ) Plug in Module . . . \$1335.

# The newest "Vee Jem" capacitor has a 3-point lead over every other chip!

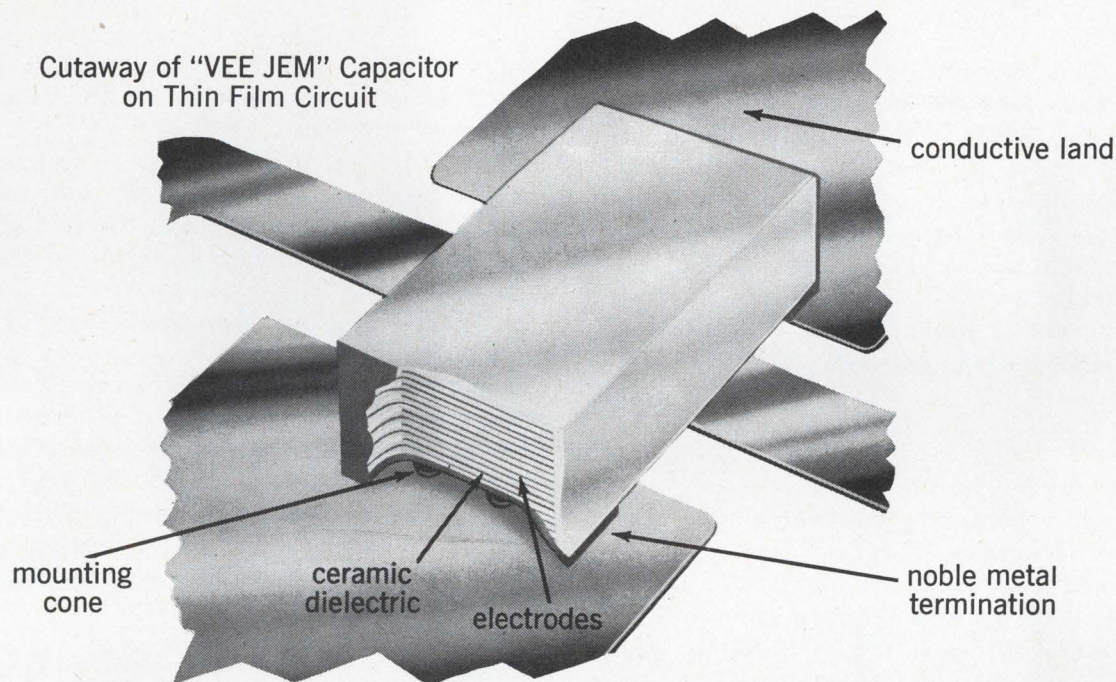

If your game is designing hybrid microcircuits, the newest "VEE JEM" Capacitor will immediately give you a three-point lead over every other chip you've used.

The three-point lead: a miniature (noble metal) termination featuring three mounting cones. The cones, barely visible to the naked eye, make component attachment a problem of the past.

The cones provide a superior bonding and mounting stability, and permit a concentration of pressure — vastly improving component attachment with ultrasonic and thermal-compression bonding methods.

This configuration also provides a solder flow path to the termination when bonded by reflow soldering techniques.

Extremely high solderability is assured because the termination's noble metal is free of surface oxides and frit (which inhibit soldering).

So make the design game easier — specify the new "VEE JEM" Chip. (Its new termination could be the 3-point lead you need to stay ahead in the microcircuit field.)

Write for Data Sheet C21

### "VeeJem" Chip Line-up

- Dimensions: .085" long x .055" wide x .040" thick (max.)
- Capacitance Values: 100 to 10,000 pf
- Voltage Ratings: 50 & 25 vdc
- Temperature Range: -55°C to +125°C
- Tolerances: ±10% & ±20%
- Temperature Characteristic: ±15% or better

## Vitramon

VITRAMON, INCORPORATED  
BOX 544  
BRIDGEPORT, CONN. 06601

In Greater Europe Contact:  
VITRAMON EUROPE  
Wooburn Green, Bucks, England

# Find free-space attenuation at a glance.

If the antennas are close together, just plug their frequency and separation into this nomogram.

Want to find the free-space attenuation between two relatively close antennas?

For example, what is the attenuation to be expected between a test generator antenna and a receiver antenna spaced 30 feet apart, both operating at 2 GHz? Instead of the usual calculations, a straight edge and a nomogram yield the solution quickly.

The nomogram is based on the equation for free-space attenuation between isotropic antennas:

$$P_r/P_t = \lambda^2 / (4\pi D)^2 \quad (1)$$

where:

- $P_r$  = power received in watts
- $P_t$  = power transmitted in watts
- $\lambda$  = wavelength in feet
- $D$  = separation in feet

The attenuation  $\alpha$  in dB is given by:

$$\alpha = 10 \log(P_r/P_t) = 10 \log[\lambda^2 / (4\pi D)^2] \quad (2)$$

At the  $D = \lambda$  point, the free-space attenuation is 22 dB. (This fact can be used to find frequency if wavelength is known, and wavelength if frequency is known.) For twice the separation, or  $2\lambda$ , the free-space attenuation is 6 dB additional, or 28 dB. An additional 6 dB arises every time the separation is doubled. This attenuation-separation relationship is shown in the table.

The following two problems illustrate the use of the nomogram.

1. What is the attenuation to be expected between a test generator antenna and a receiver antenna spaced 30 feet apart, both operating at 2 GHz and both assumed isotropic?

Referring to the nomogram, we see that the straight line connecting the 30-foot point on the

separation scale and the 2-GHz frequency point results in an intersection at 58 dB. This is the free-space attenuation.

If directive antennas are used in this problem, superposition is assumed, and the individual antenna gains in dB are added to the free-space attenuation in dB to obtain the over-all transmission loss.

2. What is the wavelength in feet for a frequency of 4 GHz?

From the table, note that when the wavelength equals the antenna separation, the free-space attenuation is 22 dB. Then connect the 22-dB point on the attenuation scale with the 4-GHz point on the center frequency scale. This dashed straight line intersects the separation (wavelength) scale at 0.25 ft. The wavelength then is one-quarter foot. ■■

**Table. Attenuation and separation**

Separation (ft)	$\lambda$	$2\lambda$	$4\lambda$	$8\lambda$	$16\lambda$	$32\lambda$	$64\lambda$
Attenuation (dB)	22	28	34	40	46	52	58

Irving Karmin, Research Scientist, Department of Meteorology and Oceanography, New York University, the Bronx, N.Y.

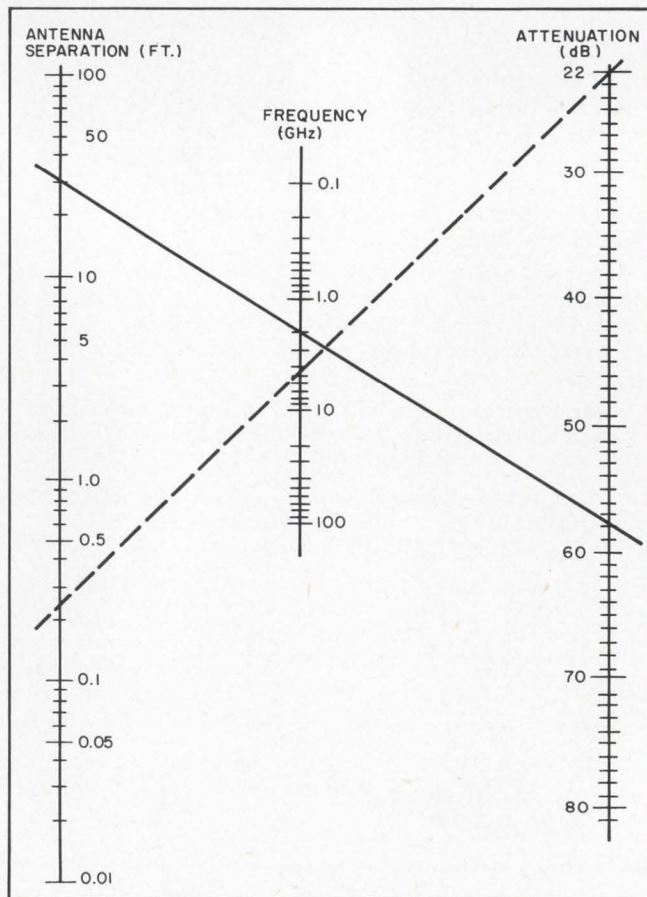

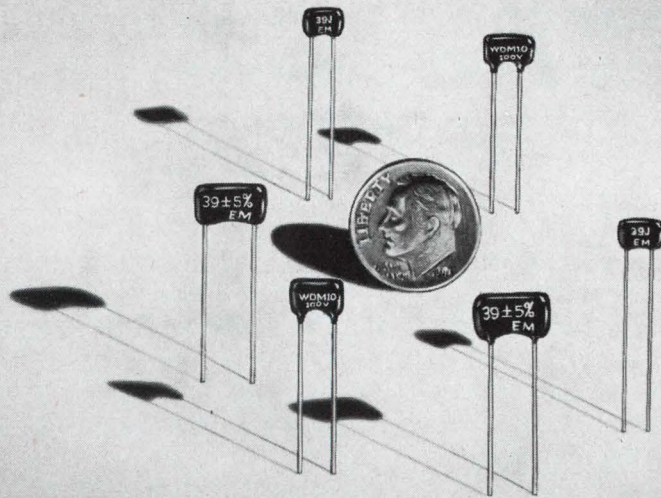

## They're Small and Reliable\*

### EL-MENCO DM5 — DM10 — DM15 — ONE COAT DIPPED MICA CAPACITORS

STYLE	WORKING VOLTAGE	CHARACTERISTIC	CAPACITANCE RANGE
DM5	50VDC	C	1pF thru 400pF
		D, E	27pF thru 400pF
		F	85pF thru 400pF
DM5	100VDC	C	1pF thru 200pF
		D, E	27pF thru 200pF
		F	85pF thru 200pF
C		1pF thru 400pF	
D, E		27pF thru 400pF	
F		85pF thru 400pF	
DM10	100VDC	C	1pF thru 1500pF
		D, E	27pF thru 1500pF
		F	85pF thru 1500pF
C		1pF thru 120pF	
D, E		27pF thru 120pF	
F		85pF thru 120pF	
DM15	100VDC	C	1pF thru 300pF
		D, E	27pF thru 300pF
		F	85pF thru 300pF
C		1pF thru 1200pF	
D, E		27pF thru 1200pF	
F		85pF thru 1200pF	
DM5	300VDC	C	1pF thru 250pF
		D, E	27pF thru 250pF
		F	85pF thru 250pF
C		1pF thru 750pF	
D, E		27pF thru 750pF	
F		85pF thru 750pF	
DM10	300VDC	C	1pF thru 250pF
		D, E	27pF thru 250pF
		F	85pF thru 250pF
C		1pF thru 750pF	
D, E		27pF thru 750pF	
F		85pF thru 750pF	
DM15	300VDC	C	1pF thru 250pF
		D, E	27pF thru 250pF
		F	85pF thru 250pF
C		1pF thru 750pF	
D, E		27pF thru 750pF	
F		85pF thru 750pF	
DM10	500VDC	C	1pF thru 250pF
		D, E	27pF thru 250pF
		F	85pF thru 250pF
C		1pF thru 750pF	
D, E		27pF thru 750pF	
F		85pF thru 750pF	
DM15	500VDC	C	1pF thru 250pF
		D, E	27pF thru 250pF
		F	85pF thru 250pF
C		1pF thru 750pF	
D, E		27pF thru 750pF	
F		85pF thru 750pF	

Where space and performance are critical, more and more manufacturers are finding that El-Menco miniaturized dipped mica capacitors are the reliable solution. The single coat is available in three sizes: 1-CRH, 1-CRT and 1-CE.

The 1-CRH DM "space savers" easily meet all the requirements of MIL and EIA specifications, including moisture resistance. The 1-CE and 1-CRT units also meet the requirements of MIL and EIA specifications, except that they have less moisture protection because of their thinner coating; these capacitors, therefore, are ideally suited where potting will be used. Note: DM10 and DM15 units are still available in the standard 4-CR size.

**Specify "El-Menco" and be sure . . .** the capacitors with proven reliability. Send for complete data and information.

\*Normally, El-Menco 39 pF capacitors will yield a failure rate of less than 0.001% per thousand hours at a 90% confidence level when operated with rated voltage and at a temperature of 85°C. Rating for specific applications depends on style, capacitance value, and operating conditions.

## THE ELECTRO MOTIVE MFG. CO., INC.

WILLIMANTIC, CONNECTICUT 06226

Dipped Mica • Molded Mica • Silvered Mica Films • Mica Trimmers & Padders  
Mylar-Paper Dipped • Paper Dipped • Mylar Dipped • Tubular Paper

West Coast Manufacturers contact: COLLINS & HYDE CO., 900 N. San Antonio Rd., Los Altos, California 94022  
5380 Whittier Blvd., Los Angeles, California 90022

ALSO SOLD NATIONALLY THROUGH ELECTRONIC PARTS DISTRIBUTORS  
INFORMATION RETRIEVAL NUMBER 50

## Do you like your job? An attitude survey can pinpoint the causes of any discontent; then it's up to your company to resolve the problem.

*"I could be doing so much more for my company if they would only let me."*

*"Any half-intelligent high school graduate could do the work I'm doing."*

*"How can I get management to understand that my skills are not being used?"*

Do any of these statements have a familiar ring? Or maybe you're a manager and seek the answers to these questions:

*"Am I realizing maximum productivity from my engineering manpower?"*

*"Are my engineers finding maximum job satisfaction?"*

*"Why is my manpower turnover so high?"*

Underlying all of these questions and statements is this fact: Some engineering managers and some companies do not know what their employees really think and want.

For the sake of convenience, let's restrict the discussion to engineers. The engineer, the manager and the company—all stand to benefit, if everyone knows whether the staff engineers are satisfied in their jobs. The assumption is that a smart company, once having learned the truth, will take steps to remove any employee dissatisfaction.

The truth is closely allied with whether or not the engineer is being properly motivated (see "Money Is Not the Only Motivator," ED 1, Jan. 4, 1968, pp. 126-130). How do you find out if an employee is properly motivated? It's simple—just ask him.

Yet very few companies do it. Relatively few conduct attitude surveys to find out what the employees think about their company, their supervisors, their jobs. This is unfortunate because such a survey can have many benefits, including the following:

- Providing a measure of over-all morale of employees.
- Identifying specific motivational problems.
- Indicating to employees that management is

concerned about their problems.

■ Giving employees a means of communicating their thoughts and feelings to management, perhaps even venting a little steam.

■ Showing the extent to which employees understand and support company policies.

### A stimulus to action

Some managers and companies may feel they already know what the morale level is and that nothing can be learned from an attitude survey. The experiences of most companies that have conducted surveys, however, do not bear this out. Even if major motivational problems are known to exist, a survey is still worthwhile, because it frequently is just the stimulus needed to trigger corrective action.

Top management at the Lockheed Missiles and Space Co. wanted to know if there were any serious morale problems. While the company turnover rate compared favorably with area industries, it felt it could be better. A company-wide attitude survey was prescribed to help find the remedies.

The opinion survey that the company conducted is shown on pages 99 and 100. Employees were asked to rate general management policies (Questions 1-8), the effectiveness of the company communications program (Questions 9-11), their own job (Questions 12-19), their working conditions (Questions 20-22) and their supervisors (Questions 23-27).

Employees also were asked to rate 13 of the company's special programs and services, such as the credit union, company newspaper, retirement plan, group insurance, cafeteria and vending-machine products.

### Corrective steps begin

As soon as the results were analyzed, action was taken on two fronts:

Author Tombrink discusses the results of an attitude survey of Lockheed employees with some of the company's engineering managers.

---

Dr. Keith Tombrink, Industrial Psychologist, Lockheed Missiles and Space Co., Sunnyvale, Calif.

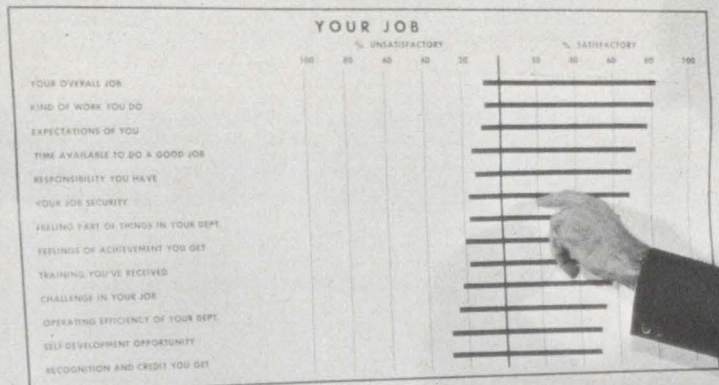

*“Unless sincere attempts are made to correct undesirable conditions, employees will likely become suspicious of management’s intentions, and an attitude survey will serve to worsen company morale rather than be a stimulus to improving conditions.”*

■ The results of the survey—from the most favorable to the most critical—were published and discussed at great length in the company newspaper for employees.

■ Corrective action was begun to eliminate or at least improve the greatest problem areas cited by the employees.

By publishing all the findings, top management showed the employees that they were interested in their welfare and were willing to admit that the staff had some legitimate complaints.

Corrective action began in the most easily correctable areas.

For example, there was a feeling among management that “we really took a beating” on Question 22, concerning “housekeeping.” (See Fig. 1). Immediate steps were taken to strengthen the janitorial staff and put it on an accelerated clean-up schedule. The company even changed the brand of floor wax that it was using when it received several individual complaints about the brand on the floor.

The cafeteria received a poor rating. The company got in touch with the concessionaire and action was taken to improve the food services.

Though the salary ratings (Question 20 and Fig. 1) were not as critical, improvements were initiated on this front. Managers and salary personnel were encouraged to look for inequities.

When the survey results showed significant employee dissatisfaction with company communications (Questions 9-11 and Fig. 2), managers at all levels were encouraged to expand their staff meetings and to have more of them. The company also increased its number of publications for employees. And managers were encouraged to attend meetings with other departments and sections. Finally, informal professional associations were encouraged.

When a high percentage of employees indicated they were dissatisfied with the amount of responsibility given them in their jobs (Question 16 and Fig. 3), superiors were asked to reassess their practices of delegating responsibility and to make certain that the work assigned was suited, as well as possible, to employee capabilities.

In short, steps were taken to improve employee morale. Follow-up random surveys, taken after the corrective actions, showed the company’s ratings had improved. The employees were more satisfied.

### Planning the survey

Is an attitude survey difficult to conduct?

One thing is apparent: It’s not a project for a do-it-yourselfer. Attitudes can be even more elusive to measure than electrons, and the techniques involved in assessing them are complex. Most companies turn to an outside professional consultant to do the job. Even if the capability is present

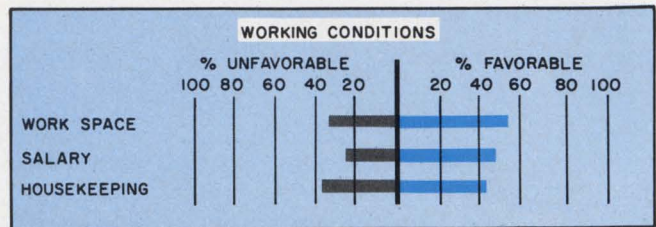

1. The company fared poorly in employees’ ratings of their working conditions. For example, nearly 40% of the sample was critical of the “housekeeping.” As a corrective measure, the company strengthened its janitorial staff and accelerated the clean-up schedule.

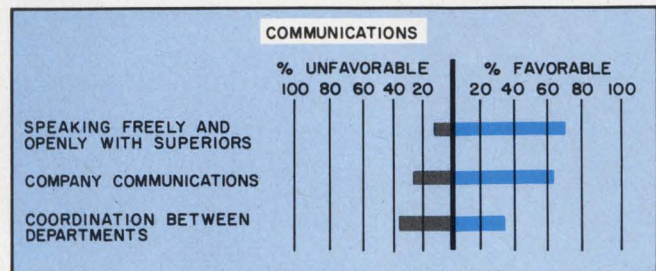

2. Coordination between departments received a low employee rating, with as many being critical as there were others reacting favorably. As a result, the company encouraged managers to expand their staff meetings and to conduct more of them.

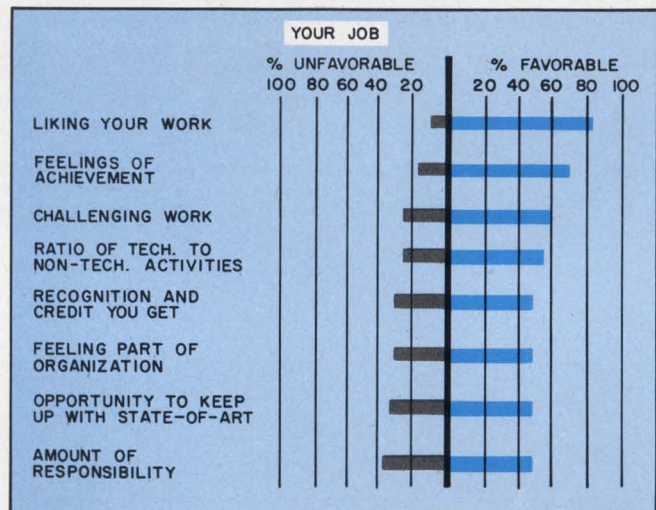

3. In rating their own jobs, employees gave the “amount of responsibility” the lowest rating. As a corrective measure, management urged supervisors to reassess their practice of delegating authority and make certain the work assigned is suited as well as possible to the capabilities of the employee.

within the company, it’s considered wiser to engage a consultant to give employees the assurance of complete anonymity. The ideal setup is to have a company man and the consultant work together on the survey. The former can provide an intimate knowledge of the company, and the latter can look at the company with fewer preconceived ideas.

(continued on p. 101)



## How would you rate your company, supervisor and job?

Here is the attitude questionnaire that Lockheed Missiles and Space Co. asked its employees to fill out.

Please show how you rate each of the following by placing an "X" in the appropriate box. Skip any item on which you don't have enough information to base an opinion.

- 1. How do you rate the company as a place to work for?  
 Very Good     Good     Neutral     Poor     Very Poor
- 2. How do you feel about our policies and procedures?  
 Very Satisfied     Satisfied     Neutral     Dissatisfied     Very Dissatisfied
- 3. How satisfied are you with your opportunity for advancement at the company?  
 Very Satisfied     Satisfied     Neutral     Dissatisfied     Very Dissatisfied
- 4. How do you rate the company's technical capability?  
 Very Good     Good     Neutral     Poor     Very Poor
- 5. How do you feel about management's concern for employees?  
 Very Satisfied     Satisfied     Neutral     Dissatisfied     Very Dissatisfied
- 6. How satisfied are you with self-development opportunities available through the company's training programs and courses?  
 Very Satisfied     Satisfied     Neutral     Dissatisfied     Very Dissatisfied
- 7. How do you rate management's overall operation of the company?  
 Very Good     Good     Neutral     Poor     Very Poor
- 8. I feel part of not just the company but the total corporation.  
 Strongly Agree     Agree     Neutral     Disagree     Strongly Disagree

COMMENTS

- 9. How good a job does management do in communicating about company activities and matters affecting your work?  
 Very Good     Good     Neutral     Poor     Very Poor
- 10. How good is the coordination between departments?  
 Very Good     Good     Neutral     Poor     Very Poor
- 11. Do you feel you can speak freely and openly with your superiors?  
 Almost Always     Often     Half-the-time     Occasionally     Almost Never

COMMENTS

- 12. Do you like the kind of work you do?

Strongly Like     Like     Neutral     Dislike     Strongly Dislike

- 13. I get a feeling of achievement from my work.

Strongly Agree     Agree     Neutral     Disagree     Strongly Disagree

- 14. How satisfied are you with the recognition and credit you get for your work?

Very Satisfied     Satisfied     Neutral     Dissatisfied     Very Dissatisfied

- 15. How satisfied are you with the ratio of technical to non-technical activities in your job?

Very Satisfied     Satisfied     Neutral     Dissatisfied     Very Dissatisfied

- 16. Under present conditions, I am satisfied with the amount of responsibility I have.

Strongly Agree     Agree     Neutral     Disagree     Strongly Disagree

- 17. My work is challenging.

Strongly Agree     Agree     Neutral     Disagree     Strongly Disagree

- 18. How satisfied are you with the opportunity to keep up with the state of the art in your field?

Very Satisfied     Satisfied     Neutral     Dissatisfied     Very Dissatisfied

- 19. I really feel part of things in my organization.

Strongly Agree     Agree     Neutral     Disagree     Strongly Disagree

COMMENTS

- 20. My present salary is appropriate for the work I do.

Strongly Agree     Agree     Neutral     Disagree     Strongly Disagree

- 21. How do you rate your work space?

Very Satisfactory     Satisfactory     Neutral     Unsatisfactory     Very Unsatisfactory

- 22. How do you rate the housekeeping?

Very Good     Good     Neutral     Poor     Very Poor

COMMENTS

No single survey can accomplish all things. Unless management's objectives are carefully determined in the beginning, the researcher may find himself trying to glean information from a survey that it was never intended to yield. Thus the question should be: "What conclusions do we want to draw from the survey, and what statistical tabulations will be required to make these conclusions?"

The two most common methods of collecting data in an attitude survey are the questionnaire and the interview. The easiest type of questionnaire consists of succinct questions and statements to which employes respond by making a simple check mark or by writing a number. It is relatively inexpensive; it can be administered to large groups at one time; it presents questions in exactly the same way to all respondents, and it permits direct comparisons to be made between groups of employes.

Its disadvantages are that it usually does not allow for personal introduction and hence may not achieve the best rapport with respondents; it does not permit freedom of expression available in less structured methods, and it usually suffers from relatively poor response rates.

Another type of questionnaire consists of open questions, to which the respondent is asked to write his opinions. This is more laborious for the employe and more laborious and costly to analyze the results.

The interview permits a richness of response beyond that achieved in questionnaires. It also ensures that the questions are properly understood, probes deeper into attitudinal areas as the need arises and generally establishes a level of rapport that elicits the willing cooperation of the respondent. On the other hand, interviewing is expensive and is subject to many difficulties and errors.

Lockheed attempted to combine the best parts of different methods. Its survey consisted of items to be rated on some continuum of satisfaction and favorableness (as shown on pages 99 and 100), coupled with interviews conducted on a small sampling basis.

Interviews at the beginning of the survey can be used to determine which items to include in the questionnaire. Interviews at the end of the survey can help verify and interpret the responses to the questionnaire.

### Preparing the questionnaire

Once management knows what it wants to ask, the questionnaire can be prepared. Professionals usually keep these guidelines in mind:

- Keep the questions short—less than 20 words, if possible.
- Use language that the employes understand.
- Avoid questions that contain more than one

concept. A respondent may agree with one part but not with the other.

- Avoid double negatives.
- Avoid leading questions—ones that indicate what the answer "should be."
- Avoid loaded questions—ones that create emotional tone or suggest feelings of approval or disapproval.

If comparisons are to be made between groups, individuals should be identifiable on pertinent characteristics. A good way to accomplish this and still maintain anonymity is to include questions about a person's age, level of education, sex and salary level.

It may also be desirable to ask questions about specific personnel policies or suspected problems.

Obviously, a survey should reflect specific conditions—possible morale problems—at your company. Other possible questions, in addition to those shown on pages 99 and 100, might include:

- How does the pay here compare with other companies in the area?
- How much encouragement does the company give for me to take outside courses?
- How effective is the company's management training program?
- How do you rate the company's attitude toward engineers who want to remain as "working engineers" rather than as managers?

Pre-testing is the only way to insure that questions are properly worded and that respondents can answer them in a reasonable period of time. Thus the questionnaire is administered to a small, representative sample. If substantial changes are made after this test, the survey should be pre-tested again.

### Conducting the survey

It is best, most professionals believe, to survey the entire work force, especially if a company is conducting one for the first time. This gives every employe the opportunity to participate, which in need to select a precise sample. Subsequent surveys are usually conducted on a sampling basis.

Questionnaire surveys frequently are sent directly to the employes' homes, accompanied by a letter of explanation and a self-addressed return envelope. To encourage a high rate of returns, a publicity campaign may be carried on in the company just prior to the mailing.

If it is still feared that the return rate will be too small or perhaps not representative, the questionnaire can be administered on company premises. The survey can then be introduced personally and the questionnaires collected immediately upon completion.

In all situations, participation must be on a *voluntary* basis.

Interviews usually are conducted on the company's premises.

### Analyzing the data

The statistics should be separate for each employe subgroup, as well as for the working force as a whole. This will permit between-group comparisons and possibly indicate where specific corrective action should be applied.

Processing write-in comments can be laborious. First, a sample of comments is selected and carefully studied. From these a classification system is derived, whose categories represent the different concepts contained in the responses. The remaining comments are then analyzed, either on a sampling basis or in full, by coding them according to the derived categories. Finally the number and percentage of comments are computed for each topical category.

### Reporting the results

It is the researcher's responsibility to interpret the findings as completely as possible and provide management with an appropriate verbal report.

Typical write-in comments and quotes from interviews should be sprinkled liberally throughout the report to illustrate the points of view. This gives management the feeling of reading the "real" opinions of employes. Care must be taken in using quotes, however, since it will be assumed by management that these attitudes are typical of the employe group in question.

There will always be some employes who do not believe that management will publish negative findings. Much is gained by making a full and forthright report to employes once the survey is complete. It will show management's sincerity, and will, in itself, be a form of corrective action towards improving communications.

Caution must be exercised in drawing conclusions from attitude surveys. It is important to avoid drawing cause and effect conclusions when the study design and the result data do not support them. Just because two factors are found to be related does not necessarily mean that one is the cause of the other. A particular survey may be good for identifying undesirable conditions, but it may be necessary to treat it only as the starting point for investigation to determine underlying causes.

### Taking corrective action

Unless sincere attempts are made to correct undesirable conditions, employes will likely become suspicious of management's intentions, and the ironic result will be that the attitude survey will

serve to worsen company morale rather than help to improve it. When employes have made a wrong conclusion because they had incomplete or erroneous information, the true, full facts should be explained. When it is impossible or impractical to correct a problem, this fact and the reasons for it should be known. Most employes realize that not all problems can be solved immediately and will accept logical explanations.

Factors to consider in setting priorities for corrective action include: the degree of unfavorable responses to an issue, the importance of the issue to employes, the extent to which the causes of the problem have been clearly identified and the difficulty and costs correcting the problem.

When a particular corrective action is taken, a way should be included to measure its effectiveness. Only through evaluation can management be sure that the action resulted in the greatest benefit to both employes and the company.

### Are surveys expensive?

The cost of a survey may run as low as \$2 an employe or as high as \$30 to \$40, depending on the methods used and the size of the company. The average is in the area of \$3 to \$5. In a large company, the total cost could easily exceed \$50,000.

But when evaluated against the outcome—a key to higher productivity—it can be a worthwhile investment. In an average company, an increase in productivity of just 1 or 2 per cent probably would offset the cost of both the survey and most of the follow-up corrective actions. ■ ■

### Test your retention

*Here are questions based on the main points of this article. They are to help you see if you have overlooked any important ideas. You'll find the answers in the article.*

1. *What are some of the key benefits of an attitude survey for management and employes?*

2. *Why is it incumbent on management to publish all the findings of the survey?*

3. *Should a company-wide attitude survey be done on a voluntary basis or should all employes be required to answer the questionnaire?*

4. *What would be the most damaging result if a company failed to take corrective action?*

The Hewlett-Packard 4204A Digital Oscillator in one instrument gives you an accurate frequency source of measured amplitude. It provides 0.2% frequency accuracy in highly stable test signals for both lab and production applications. Low distortion, 0.01% frequency repeatability and a flat frequency response of 0.3% variation add to your dollar value.

The 4204A allows you to select any frequency between 10.0 Hz and 999.9 kHz to four significant figures... 36,900 discrete frequencies are available. One vernier

control provides infinite resolution and extends the upper frequency limit of the 4204A Oscillator to 1 MHz.

This oscillator also has a built-in impedance voltmeter to measure output. It is calibrated to read volts or dBm into a matched 600 ohm load. The output attenuator has an 80 dB range and is adjustable in 10 dB steps with a 20 dB vernier. Price is \$695.

Call your local HP field engineer for more information, or write Hewlett-Packard, Palo Alto, California 94304. Europe: 54 Route des Acacias, Geneva.

## Stable and repeatable signal accuracy

HEWLETT  PACKARD  
S I G N A L   S O U R C E S

18701



INFORMATION RETRIEVAL NUMBER 52

# Breadboard circuits quickly and accurately without use of solder or other tools

This circuit breadboarding tool is based on a solderless connecting system that has been developed over the past six years. Its objectives are:

- Avoidance of solder in order to facilitate reuse of components and to eliminate damage to semiconductor elements.
- Rapidity of assembly and disassembly in order to maximize time available for experimentation.
- Accommodation for as large a range of wire sizes as possible at a single junction point.
- Tolerance of dirt and oxide films in order to eliminate the need for polishing lead wires prior to assembly.
- Low contact resistance relative to the smallest values of resistors encountered in electronic circuits.
- Compactness by spacing connection centers at distances comparable to the length of typical components.
- Low additional capacitance caused by the connection method in order to maximize the frequency range over which the system can be used.
- High reliability of connections both initially and over periods on the order of months.
- Reasonable cost.

Here is how the connecting system is used. The figure shows (top) a pair of panels that use the new\* solderless connecting system. The method of making the connections is shown below. The component lead wires and jumper wires that complete

\*U.S. Patent No. 3,235,830 (February 15, 1966)

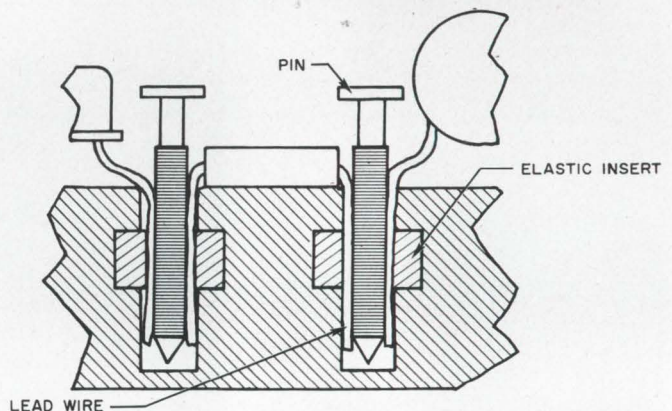
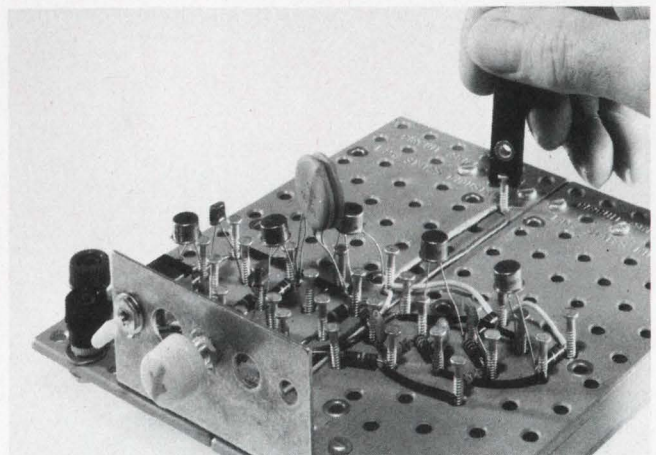

**Solderless breadboard** (top) uses simple pressure-type contact (bottom). The component leads and jumpers are pressed by a polychloroprene washer against an aluminum alloy pin to provide a good, low-resistance contact.

the circuit are bent for insertion into holes in the panels, to form the connection points. Serrated metal pins are inserted in the holes to complete the connections. Elastic circular inserts in the holes press the wires against the pins with sufficient force to produce low contact resistance.

During insertion the serration on the pins which are in the form of threads, perform a dual function. The crests of the threads scrape the component lead wires exposing clean surfaces. The bulk debris from the scraping is accommodated in the grooves between the crests. The cleaning action caused by inserting the pins produces a tolerance to dirt and oxide films and so helps to reduce contact resistance. Choice of pin material is also important. Empirically it has been found that soft aluminum alloys are the most successful for this



**VOTE!** Go through all Idea-for-Design entries, select the best, and circle the appropriate number on the Reader-Service-Card.

**SEND US YOUR IDEAS FOR DESIGN.** You may win a grand total of \$1050 (cash)! Here's how. Submit your IFD describing a new or important circuit or design technique, the clever use of a new component or test equipment, packaging tips, cost-saving ideas to our Ideas-for-Design editor. You will receive \$20 for each accepted idea, \$30 more if it is voted best-of-issue by our readers. The best-of-issue winners become eligible for the Idea Of the Year award of \$1000.

# Helipot rings up the twelve dollar C.P. pot.



The new Model 3351 conductive plastic potentiometer is our twelve dollar solution to your age-old budget problem. It's a new low price for a non-wirewound precision potentiometer, and yet performance and quality have not been sacrificed. This new model excels wherever high precision and long, trouble-free life are needed at minimum cost.

If you like the \$12.00 price, then check these specs. ■ Essentially infinite resolution. ■ Standard resistance range; 1K to 75K ohms. ■ Long life. ■ Linearity;  $\pm 0.5\%$ .

■ Power rating; 0.75 watts at 70°C. ■ Resistance tolerance;  $\pm 10\%$ . ■ Operating temperature range;  $-65^{\circ}\text{C}$  to  $+125^{\circ}\text{C}$ . ■ Factory stocked.

Also, Helipot has other all-new non-wirewound pots to satisfy most every application. Standard servo mount models with either conductive plastic or cermet resistance elements are available in 7/8" and 1-1/16" diameter. And they are priced under \$25.00.

Ask your local Helipot sales representative for the complete non-wirewound pot story...now.

**Beckman**

INSTRUMENTS, INC.

HELIPOT DIVISION

FULLERTON, CALIFORNIA • 92634

INTERNATIONAL SUBSIDIARIES: GENEVA; MUNICH; GLENROTHES, SCOTLAND; TOKYO; PARIS; CAPETOWN; LONDON; MEXICO CITY



\$12

type of application.

The ability to accommodate a range of wire sizes is due to the elastic insert in the panel holes. Experimentation has shown that elastomers such as a polychloroprene of moderate hardness enable wires from 20 through 30 AWG (0.032 through 0.010 inch diameter) to be handled by a fixed dimension for the pin, elastic insert and hole. For any particular contact, however, it is recommended that wire sizes should be limited to a mix of five adjacent AWG numbers. Sizes 20 through 24 AWG, for example, can be mixed in a single connection with no special precautions. If it is necessary to mix wire sizes over a large range, the smaller leads should be doubled back. That will avoid too low a force on the smallest lead if it happens to be located between two of the largest leads.

The elastic inserts are in the form of washers made from polychloroprene sheet stock. Three of these washers are inserted in each junction hole in the counterbore in the bottom of the panel.

The technique has been found extremely satisfactory during several years of laboratory use for frequencies up to  $10^7$  Hz.

*Dr. George C. Newton, Jr., Associate Director, Electronic Systems Laboratory, Massachusetts Institute of Technology, Cambridge, Mass.*

VOTE FOR 311

## Zero impedance current sink uses only two transistors

This current sink provides, within its limits of operation, essentially a zero impedance at or very close to zero voltage without use of an operational amplifier. The output voltage is a linear function of input current. The circuit's two transistors, a diode, and four resistors are less expensive than an integrated-circuit operational amplifier. It will also handle a larger input current than most operational amplifiers.

The applications of the circuit are generally related to use of reactive elements. A  $90^\circ$  phase shift can be obtained with a capacitor or inductor, but accurate only if series resistance is zero. The current sink circuit provides an effective output terminal. Its input impedance is so small it could not be measured. An emitter follower may be of low enough output impedance for a driver, depending on the desired degree of accuracy of phase shift.

A series resonant circuit can be used for band-pass coupling if it has a very low-impedance current source and sink. The bandwidth can be controlled by injecting series resistance. The cir-

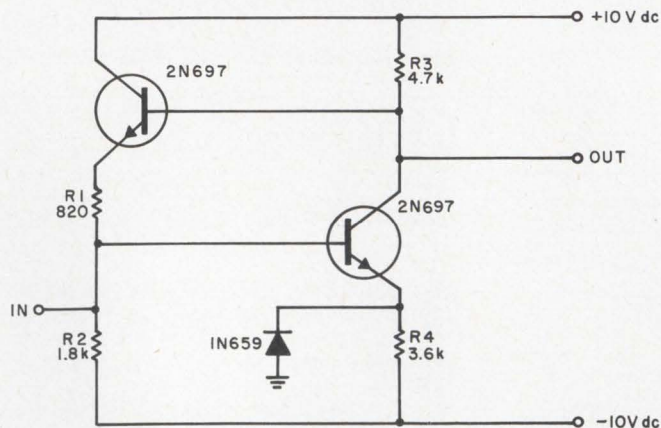

Zero impedance sink provides a linear voltage output with input current.

cuit is very satisfactory for this type of application.

The schematic gives values that were used. If zero voltage input is not an objective, the  $Q1$  emitter may be grounded with a reduction in components of one diode and one resistor. The amount of current that can be sunk depends on  $Q2$  and  $R1$ . Input signal current is very nearly balanced by out-of-phase signal current returning through  $R1$ ; the difference drives  $Q1$ .  $R1$  and  $R2$  form a voltage divider from  $Q2$  to the negative supply. The dc component establishes the operating point of  $Q1$ , working through the feedback loop.

*Harvey L. Morgan, Engineering Specialist, LTV Electrosystems, Inc., Dallas.*

VOTE FOR 312

## Matched transistor pair gives several circuits

Borrowing a biasing technique used in linear integrated circuits, a constant-current source can be implemented with a pair of matched transistors housed in single can and connected as shown in Fig. a. If the base-to-emitter voltages and the forward current gains of both transistors are identical then their collector currents will be equal, and if  $V_{BE} \ll V_{CC}$  and  $R_L \leq R1$ , the collector currents will be determined by  $I_C = (V_{CC} - V_{BE})/R1$ .

For a typical GE12A8 transistor pair  $I_{C2}$  will remain within 4% of  $I_{C1}$  over a current range of 50  $\mu A$  to 1 mA and a load change of zero ohms to  $R_L = R1$ .

Voltage-to-current converter is formed by connecting  $R1$  to an input voltage instead of  $V_{CC}$  as shown in Fig. b. The output current,  $I_{C2}$ , will be directly proportional to the input voltage as long





Forget me not

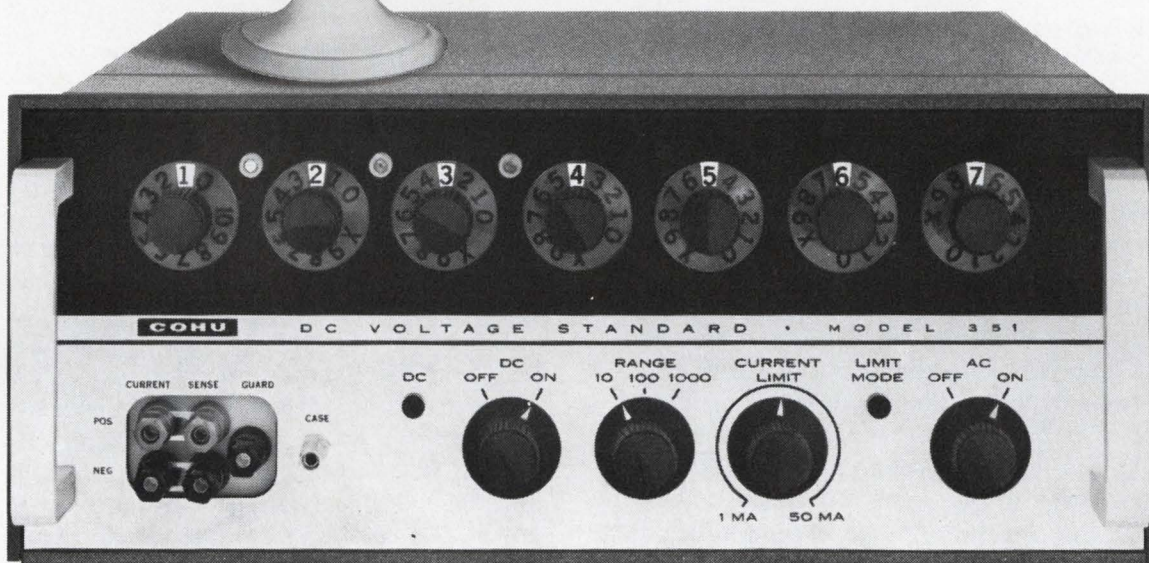

## Cohu's new 351 DC Voltage Standard

If it weren't so easy, you'd probably forget how to calibrate the new 351. It's only required once a year due to new, improved solid state circuit design. Major features include modular, plug-in construction, improved reliability with redundant switch sections, and a unique method of voltage preregulation that eliminates the need for series output stage transistors. Output voltages are provided from 0 to  $\pm 1100$  volts in three ranges with a basic accuracy within 0.003% of setting. RMS noise voltage less than 20  $\mu$ V on the lowest

range. Output current up to 50 mA at any voltage setting.

The 351 is a precision voltage source for the design, construction and control of accurate and stable electronic circuits and for certifying the characteristics of DC digital voltmeters, DC voltage amplifiers, voltage controlled oscillators and variable DC supplies. Price—an unforgettable \$1995—less than any other quality DC voltage standard available. For full details, contact your Cohu engineering representative.

**COHU**  
ELECTRONICS, INC.  
SAN DIEGO DIVISION

Box 623 • San Diego, Calif. 92112 • Phone: 714-277-6700

INFORMATION RETRIEVAL NUMBER 54

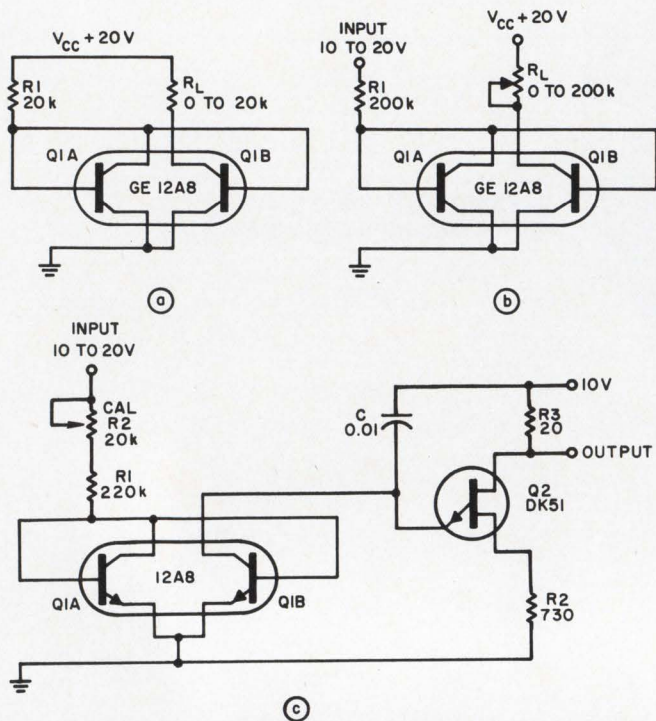

Constant-current source (a), voltage-to-current generator (b), and a linear voltage-to-frequency converter—all use a matched transistor pair, 12A80.

as  $V_{IN} \gg V_{BE}$ , and linearity will be better than  $\pm 2\%$  over a range of  $V_{IN}/R1 \leq 1$  mA.

A voltage-to-frequency converter with a linearity of  $\pm 0.4\%$ , a 24-hour frequency stability of  $0.1\%$  and a conversion accuracy of  $\pm 4$  Hz can be formed by combining the voltage-to-current converter of Fig. b with a complementary unijunction-transistor relaxation oscillator, as shown in Fig. c. Capacitor  $C$  is charged by the constant-current source of  $Q1B$  of which the current is controlled by the input voltage and  $R1$  plus  $R2$ . Since  $C$  is discharged through a resistance composed of  $R3$  and the negative resistance of  $Q2$ 's emitter-to-base-one junction, a finite, fixed discharge period, which does not change with frequency, is required for each cycle. That discharge period introduces an error that is proportional to the output frequency. By selecting the proper frequency range and the current-scaling factor to bias  $Q1$  on the upper portion of the  $V_{BE}$  logarithmic characteristic curve, the error from the discharged portion of the cycle will be canceled.

A voltage-to-frequency converter was constructed with the values shown in Fig. c. It was calibrated for a 1800-Hz output frequency with 18 volts applied to the input. Input voltage was measured with a Hewlett-Packard model 2410A digital voltmeter and the output frequency was measured with an HP model 5233L frequency counter. The

results are listed in the table below.

Voltage	Frequency Hz
10.000	922
11.004	1093
12.002	1195
13.005	1298
14.003	1399
15.000	1501
16.001	1600
17.006	1701
18.000	1800
19.008	1901
20.003	2000

An inexpensive digital voltmeter could be constructed by using an operational amplifier at the input of the converter and by connecting the output of the converter into a three-digit frequency counter, overranging the most significant digit.

*J. D. Reed, Electronic Design and Maintenance Shop Manager, University of Georgia, Athens, Ga.*  
VOTE FOR 313

## Gated 5-MHz amplifier has high gain

An ultrasonic fluid-velocity meter required a gated transducer driver amplifier with fixed gain, high isolation, no pedestal, low output impedance while on, and high output impedance while off. The amplifier shown in the accompanying figure meets these requirements.

The circuit is basically an operational amplifier connected in a noninverting mode. The amplifier is designed so that, when the current source,  $Q3$ , for the input differential amplifier stage,  $Q1, Q2$ , is gated off, all transistors in the circuit turn off. When gated off, the only way signals can pass from input to output or vice versa is through the stray capacitances of the unbiased base-emitter junctions of the input transistors, which are very small. Also, the output impedance becomes just  $R9$  and  $R10$ .

When gated on, the circuit becomes a powerful  $\times 20$  amplifier of relatively conventional design. The amplifier consists of two cascaded differential amplifiers with the output of the second differential amplifier made single-ended push-pull by the addition of a unity gain inverter stage,  $Q6$ .

It is necessary to have dc coupling and no frequency-compensation networks in this application, since the amplifier must be ready to amplify properly the instant it is turned on (with no time allowed for charging capacitors). For this reason, circuit layout must be done by rf tech-



# Careless

But only in the sense that a Nikon microscope doesn't care how specialized your needs are. Whether you're concerned with IC's or inks, transistors or turbines, papers or plastics—this ultra-precise instrument can play a vital role in inspection and quality control.

Here you see a Nikon S with trinocular head, equipped with Epi-Illuminator attachment and Auto-Microflex AFM with Polaroid film back. It is all set up for minutely studying any opaque specimens and making "instant" photomicrographs.

The Epi-Illuminator injects light into the microscope tube, providing shadowless surface illumination on the same axis as the microscope optics. The Auto-Microflex AFM is an automatic computer-controlled device that measures specimen brightness and times the exposure. It is shown with Polaroid M-100 film back, but can also be used with other photo equipment.

These are only a few of the many attachments which fit the Nikon microscope for a multitude of special uses. For details, write: Nikon Incorporated, Instrument Division, Garden City, N.Y. 11530. Subsidiary of Ehrenreich Photo-Optical Industries, Inc. (In Canada: Anglophoto Ltd., Instrument Division, Ont.)



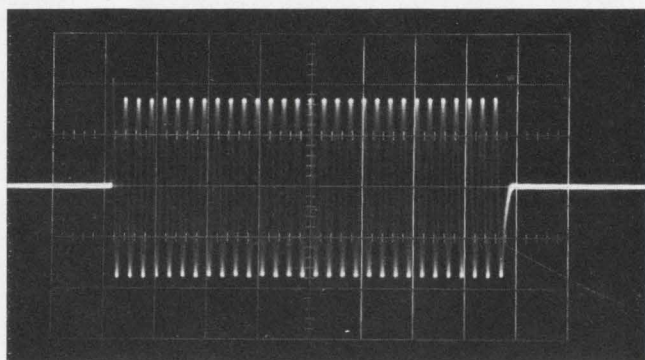
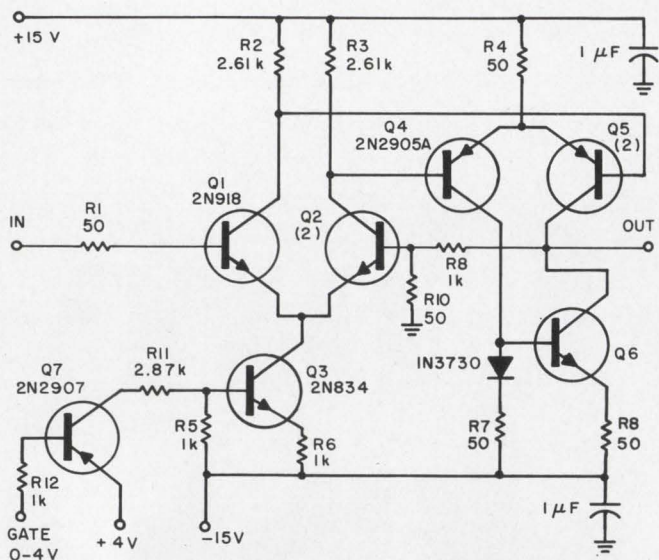

Low on and high off output impedances are obtained. Five-MHz signal gated on for 6.5 μs every 120 μs is shown in the photo.

niques to minimize stray coupling. Furthermore, the transistors must be selected so that the open-loop poles of the amplifier occur at the right frequencies.

The circuit will swing 15 volts peak to peak across a 100-Ω load at 5 MHz. It is capable of withstanding momentary short circuits on its output and can operate from a wide range of supply voltages.

The photo shows a 5-MHz signal gated on for 6.5 μs every 120 μs. Gating and signal are coherent.

*C. Andren, Design Engineer, Johns Hopkins University, Silver Spring, Md.*

VOTE FOR 314

## Single SCR can detect 0.1-Ω resistance change

In electrochemical machining it is necessary to be sure that the electrodes are not shorted when

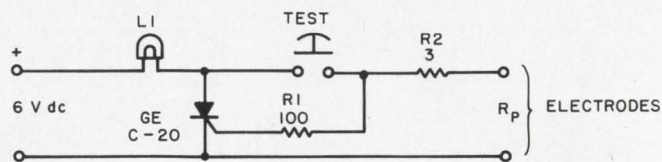

Change of 0.1 ohm is sensed with a simple single-SCR circuit. It is used to detect shorts in electrodes immersed in 0.1-ohm electrolyte.

the unit is turned on. The location of the electrodes does not permit visual examination, nor can an ohmmeter be used because of the low resistance of the chemical solution,  $R_p$ . The accompanying circuit provides a means to determine whether or not the electrodes are shorted.

Operation is based on the fact that when an SCR, with gate current applied, is shunted by a device that has a resistance less than the on resistance of the SCR, the SCR will not saturate. When the test pushbutton is depressed, current flows through  $L1$  and  $R1$ , turning on the SCR.  $R1$  limits the gate current. The current flowing through the SCR,  $R2$  and  $R_p$  lights lamp  $L1$ . On release of the pushbutton, the lamp will do one of two alternatives:

- Extinguish if  $R_p$  is less than 0.1 ohm (indicating shorted electrodes), since  $R2 + R_p$  is less than the on resistance of the SCR.

- Remain lit if  $R_p$  is greater than 0.1 ohm (no short), because the on resistance of the SCR is less than  $(R2 + R_p)$ .

The value of  $R2$  is determined experimentally, and is dependent upon the SCR, the electrodes, and the chemical solution being used.

The lamp could be replaced by a relay, and its contacts could be used as a safety control actuator.

*John J. Connelly, Engineer, International Harvester Manufacturing Research Div., Chicago.*

VOTE FOR 315

## Get long digital delays with a simple circuit

This active delay line is capable of providing fractional-bit delay times for digital waveform inputs. The circuit (see figure) has proved extremely useful in obtaining autocorrelation functions of complex digital sequences, compensating for propagation delays in digital circuits, and as a general wide-band digital delay line.

The main advantages of an active delay line over its passive counterpart are the ease with which the delay time can be varied and the length of delay. The circuit provides a fixed waveform delay regardless of the complexity or rate

# Coors Strate-Breaks™

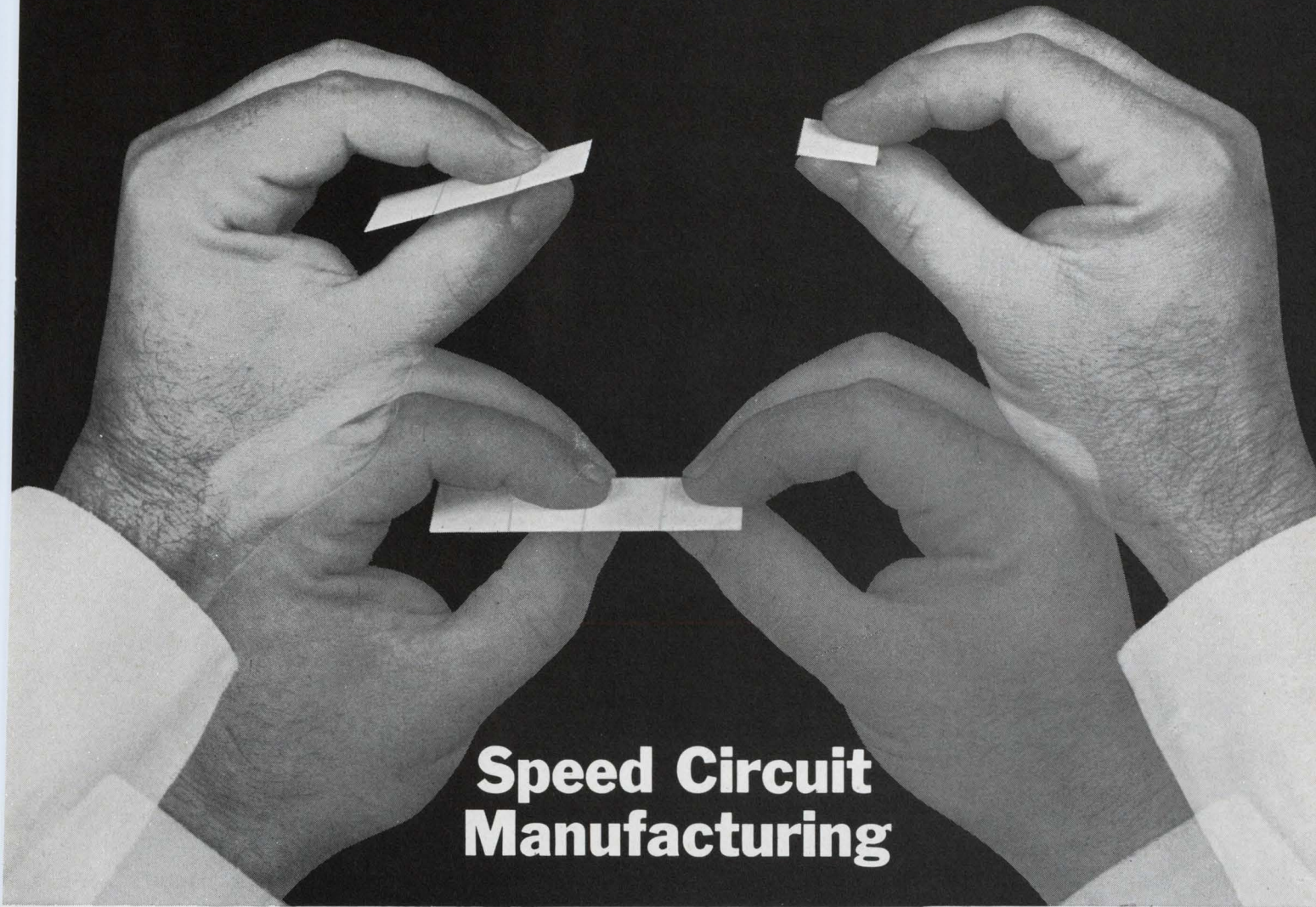

## Speed Circuit Manufacturing

High quantity production of integrated circuits with uniform quality, increased precision tolerances, greater economy in the production of micro-ceramic components—all these are yours by gang printing your circuits on Coors *Strate-Breaks*. No cutting apart, no multiple handling before assembly. Just SNAP!... and there are your individual components with a straight, smooth, precision edge.

Coors *Strate-Breaks* are made to your specifications in sizes from  $\frac{1}{2}'' \times \frac{1}{2}''$  to  $4'' \times 4''$ . They are available unglazed for thick-film circuits, and glazed or unglazed for thin-film circuits. Get on-the-spot answers. Dial Coors—303/279-6565, Ext. 361. For complete design criteria, write for Coors Alumina and Beryllia Properties Handbook No. 952.

Patent  
Pending

*consider  
Coors  
ceramics*

# Coors

## CERAMICS

ALUMINAS • BERYLLIAS • MAGNESIAS • SPECIAL OXIDES  
Coors Porcelain Co., Golden, Colo.

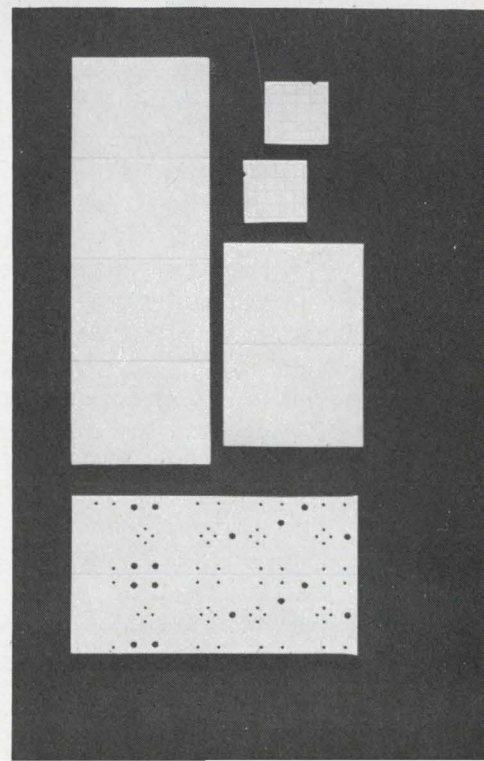

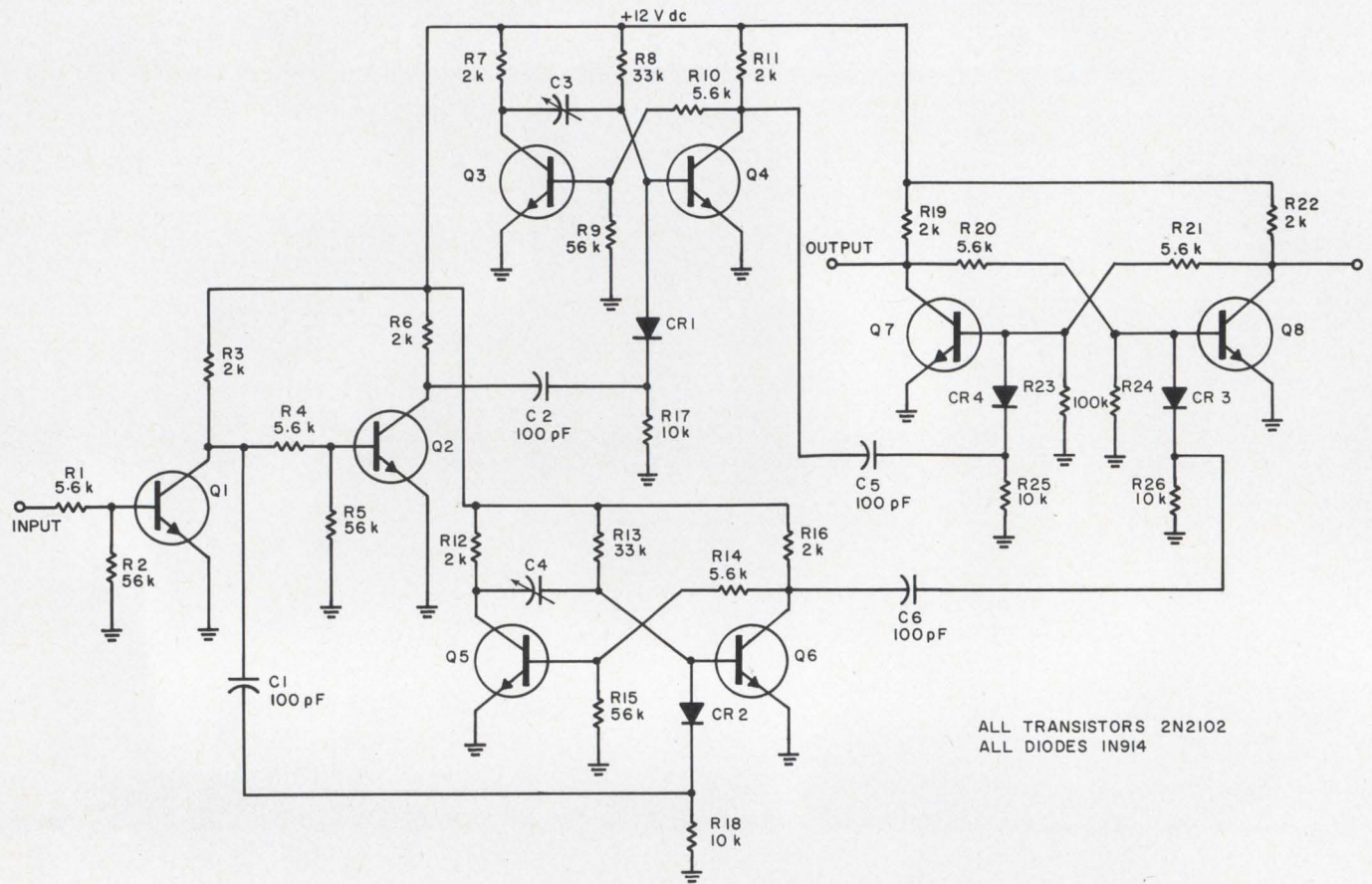

Up to one bit delays can be obtained, depending on the C3 and C4 values. When C3 = C4 = 2180 pF and the

input bit period is 100 μs, the delay will be 50 μs. Other delays can be easily obtained.

of the input binary sequence, and eliminates the necessity of wave-shaping after the delay. Delay time can be continuously varied from zero up to one bit period in length. Delays in excess of one bit are easily obtained by cascading identical delay circuits.

The operation of the circuit is based on triggering an R-S flip-flop, Q7 and Q8, from a delayed replica of the input pulse sequence. Two single-shot multivibrators are utilized to develop the appropriate trigger pulses. The first one-shot Q5 and Q6, develops trigger pulses from the leading edge of the input binary sequence. The second one-shot, Q3 and Q4, performs an identical function on the trailing edge of the input sequence. The input inverters, Q1 and Q2, simply serve to develop the proper triggering polarity for the leading-edge and trailing-edge one-shots.

The amount by which the input pulse sequence is delayed is determined by selection of C3 and C4. The values chosen for C3 and C4 should be equal, to avoid altering the pulse duration of the waveform. They can be selected and fixed for a constant waveform delay, or made variable to allow different delay increments to be obtained.

For example, if the input bit period is 100 μs, and a 50-μs delay is desired (0.5-fractional-bit delay time), then C3 = C4 = 2180 pF. The relationship between timing capacitor and delay time for the circuit is:

$$C3 = C4 = T/0.0229, \dots$$

where C3 = C4 = timing capacitor in pF, and T = delay time in μs.

Phil Salomon, Instructor in Engineering, Pasadena City College, Pasadena, Calif.

VOTE FOR 316

**IFD Winner for December 20, 1967**

A. G. Richardson, Supervisor Test Evaluation, Teledyne Automated Specialties, Charlottesville, Va. His Idea "Build a pulse generator with four components" has been voted the Most Valuable of Issue Award.

Cast your vote for Best Idea in this Issue.



EXAMPLE 1

The gold plating on these "hard-to-handle" female connector terminals cost \$3.78 per thousand . . .

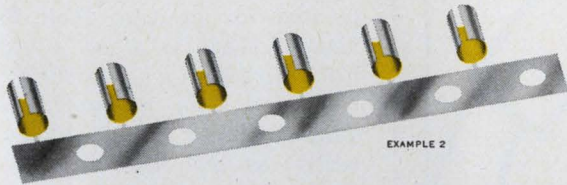

EXAMPLE 2

The gold plating on these female connector terminals . . . adaptable to automated assembly . . . cost only 83¢ per thousand and they are far better parts!

**ZCD\* Pre-plating of strip makes the difference...**

**And only Burton does it!**

Send for a sample strip. Write on your letterhead for a sample of strip demonstrating Burton's Zone Controlled Deposition. Gold at the center, no gold on the edges or opposite side of the strip.

**FREE TECHNICAL DATA.** Circle the Reader Service Card to receive "Burton Plating News" containing useful data pertaining to metal plating.



**\* Zone Controlled Deposition...** Burton's exclusive continuous plating technology reduces gold material and plating costs, produces better parts, speeds production in two important ways!

Both terminals shown were fabricated from the same strip base material. Both were gold plated with the same type of gold. The part with less gold costs approximately 80% less to produce, yet it is a far better part! The difference is Burton ZCD pre-plated strip!

**Example 1 was fabricated from strip and then barrel plated.** The surface that required gold (the inside) is the most difficult area to plate by barrel plating. To arrive at the specified thickness inside where contact is to be made, it was necessary to *overplate* the whole strip, depositing a *thicker layer where gold was not even needed.*

**Example 2 was fabricated after plating, using Burton ZCD Pre-Plated Strip.** Zone Controlled Deposition (ZCD), coupled with Burton's high-speed, continuous reel-to-reel plating technology, controls both the location and thickness of gold deposits on one or both sides of strip material of any width. Deposits can be held to zero where gold is not required, and the process assures a uniformity of thickness to within 10 micro inches within a reel and from reel-to-reel . . . for a thousand or a million feet of strip. By using Pre-Plate Strip with gold only on the side and area to be formed into the inside of the terminal, and deposited to the required thickness, 90% of the gold required by Example 1 was saved, and the part uniformity was greatly improved!

**Check these added advantages of Burton Pre-Plated Strip.** By using pre-plated strip, production and assembly sequences can be speeded. Drawing from an in-plant stock of pre-plated strip, the fabricator/plater/plant sequence can be reduced one step. More important, 500 to 1000 foot reels of formed parts are more readily adapted to automated assembly than short lengths of strip required to plate by barrel or rack techniques.

If you produce connector terminals or other parts fabricated from strip material, contact Burton for details on how you can achieve better parts in less time and at less cost with ZCD Pre-Plated Strip made to your specifications.

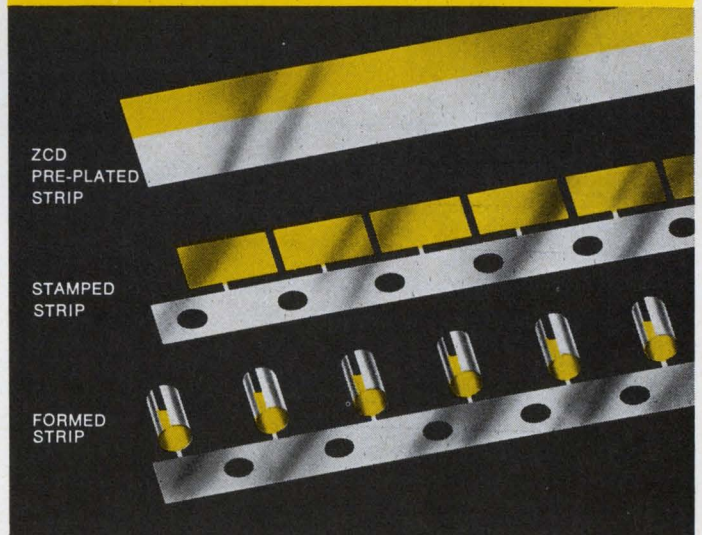

ZCD PRE-PLATED STRIP

STAMPED STRIP

FORMED STRIP

**BURTON RESEARCH LABORATORIES, INC.**



A DIVISION OF BURTON SILVER PLATING COMPANY

BURTON RESEARCH LABORATORIES, INC. • 11240 PLAYA COURT • CULVER CITY • CALIFORNIA 90230 • TELEPHONE (213) 391-6325

INFORMATION RETRIEVAL NUMBER 57

THINK SHRINK!



Motorola's growing leadership in state-of-the-art miniaturization of electronic fuzes is advancing the science of detonating explosives.

Fuzes designed and produced by Motorola — for the U.S. Army, Navy and Air Force — span the entire spectrum from small explosive packages to large missile systems — including free-fall devices and highly sophisticated surface-to-air, air-to-air, and air-to-surface systems.

To help us maintain our pace-setting competence in this vitally important field, Motorola needs Electronics Engineers with fuze experience. Ours is an engineering-oriented company where you'll be given freedom to exercise your own initiative — and by helping us "think shrink" about fuzes, you can make it big professionally. Send us your resume.

**Opportunities in Fuzing & Guidance:**

Electronics & Mechanical Design ■ Integrated Electronics ■ Advanced RF & Microwave Techniques ■ Antennas & Propagation ■ Fuzing ■ Missile Guidance ■ Checkout Systems ■ Reliability & Components ■ **OTHER OPPORTUNITIES:** Space Communications ■ Radar Systems ■ Tracking & Telemetry ■ Digital Data Transmission ■ ECM & Elint ■ Coherent Transponders ■ Radar Transponders

**in PHOENIX**  **MOTOROLA**

**Government Electronics Division • Aerospace Center**

Write: Paul Ahler, Recruitment Mgr., Dept. 62, Box 1417, Scottsdale, Arizona

MOTOROLA ALSO OFFERS OPPORTUNITIES AT CHICAGO, ILLINOIS — AN EQUAL OPPORTUNITY EMPLOYER

## Book Reviews

### Transistor analysis and design

*Modern Transistor Electronics Analysis and Design*, Fred K. Manasse, John A. Ekiss and Charles R. Gray ("Electrical Engineering Series," Prentice-Hall, Inc., Englewood Cliffs, N. J.), 55 pp. \$12.95.

The authors must be complimented for limiting their discussion of what is a pet subject of many writers on transistors—electron and hole movements—to a single, simple chapter. They correctly assume that the readers have seen enough of those descriptions to last them a lifetime.

Instead, they plunge right into examination of a variety of practical situations where transistors can be used. Chapter 2, for instance, covers  $h$ ,  $y$  and  $z$  parameters, chapter 3 presents transistor biasing techniques, chapter 4 analytical techniques for evaluating and designing low-frequency untuned amplifiers, chapter 5 tuned amplifiers, chapter 6 video or wide-band amplifiers, and chapter 7 choppers in comparison with electromechanical devices.

There is a whole chapter on tunnel diodes and the last chapter is devoted to practical discussion of integrated-circuit technology.

—Peter Budzilovich

CIRCLE NO. 321

### Laser technology

*Optical Lasers in Electronics*, Earl L. Steel (John Wiley & Sons, New York, N.Y.), 267 pp. \$11.95

A thorough, yet succinct, introduction to the optically pumped laser as oscillator and amplifier will impart a quantitative understanding to the reader who is familiar with the essentials of atomic physics and differential equations. Various chapters review basic principles and treat the topics of laser Q-switching, laser configurations and laser oscillators and amplifiers.

—Robert Patton

CIRCLE NO. 322



# Free Career Inquiry Service

## Absolutely Confidential

Respond to the career opportunities advertised in this issue. Fill out and send us this handy resume. **Electronic Design** will do the rest – neatly typed copies of this form will be mailed to the companies of your choice, indicated by the circled Career Inquiry Numbers at the bottom of this page.

7

<b>Name</b>				<b>Home Phone</b>			
<b>Home Address (Street)</b>			<b>City</b>		<b>State</b>		<b>ZIP Code</b>
<b>Age</b>	<b>U.S. Citizen</b>		<b>Security Clearance</b>				
	<input type="checkbox"/> Yes	<input type="checkbox"/> No					
<b>Prime Experience</b>			<b>Secondary Experience</b>				
<b>Desired Salary</b>			<b>Availability Date</b>				
<b>Employment History – present and previous employers</b>							
<b>Company</b>							
<b>City, State</b>							
<b>Dates</b>	to		to		to		
<b>Title</b>							
<b>Specialty</b>							
<b>Education – indicate major if degree is not self-explanatory</b>							
<b>Degree</b>							
<b>College</b>							
<b>City, State</b>							
<b>Dates</b>	to		to		to		
<b>Additional Training – non-degree, industry, military, etc.</b>							
<b>Professional Societies</b>							
<b>Published Articles</b>							

**Career Inquiry Numbers:**

- |     |     |     |     |     |     |     |     |     |     |
|-----|-----|-----|-----|-----|-----|-----|-----|-----|-----|
| 900 | 901 | 902 | 903 | 904 | 905 | 906 | 907 | 908 | 909 |
| 910 | 911 | 912 | 913 | 914 | 915 | 916 | 917 | 918 | 919 |

**ELECTRONIC DESIGN**  
 850 Third Avenue  
 New York, New York 10022

# vero

## Presents the **ULTIMATE PC CARD FRAME VERORACK SYSTEM 3**

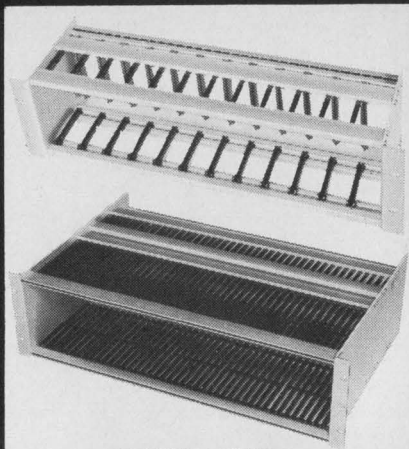

**MAKES THE  
USUAL BUCKET, BASKET  
CAGE OBSOLETE!**

The System 3 is shown in two of many versions. One with individual variable space polycarbonate guides available in a variety of lengths. The other with 4" blocks of guides on .5 spacings for fastest possible assembly.

All guides slide into precision aluminum extrusions which provide the greatest strength available, beauty of design, built in card identification and unique connector mounting.

Slotted end plate versions for prototypes available off the shelf. Card lengths from 3" short to 15" long and beyond are easily fitted. The low cost of the first product engineered card frame will surprise you. Verorack System 3 can improve your product and save you money.

WRITE FOR DETAILED  
INFORMATION

**VERO ELECTRONICS INC.**

176 Central Ave., Farmingdale, N. Y. 11703  
Tel.: 516 MY 4-6550 • TWX 510-224-6425

INFORMATION RETRIEVAL NUMBER 58

## Bonds improved in silicon ICs

**Problem:** To produce stable and reliable metallic systems for interconnections, contact pads, and bonded leads in silicon, planar integrated circuits. Metal-to-metal contact bonds are formed in conventional fabrication, which involves the use of vapor-deposited aluminum for interconnections, vapor-deposited gold on chromium for contact pads, and gold for bonded lead wires. The intermetallic compounds present at the interfaces degrade bond strength, increase ohmic contact resistance, and eventually suffer from open circuits caused by voids that arise from volumetric phase mismatch.

**Solution:** A method of fabrication based on substrate isolation of the interconnection metal from the contact pad and bonded wire.

The interconnections are separated from the contact pads by a barrier domain of bulk silicon substrate material that has been degenerately doped. The entire region—the interconnection metal (vapor-deposited aluminum), the degenerate substrate section and the contact pad (vapor-deposited gold on chromium)—is confined by a diffused isolation ring. Degradation is avoided because the only metal compatibility involved is between each of the land metals and the substrate material, not among the various metals themselves. The relatively thick substrate barrier prevents any phase reactions between the interconnection and pad-wire components of the metal assemblage.

*Inquiries about this innovation may be directed to: Technology Utilization Officer, Marshall Space Flight Center, Huntsville, Ala. 35812 (reference B67-10335).*

## How to synthesize passive networks

**Problem:** Design a program that can synthesize a passive network by minimizing the difference in desired frequency response and frequency response for the trial network.

**Solution:** A program that uses as a synthesis criterion a weighted last-squares fit between calculated and desired frequency response (called error function). The technique employed is to solve for the critical points of the error function by the multivariable Newton-Raphson method with components constrained to an admissible region. The program requirements are equations necessary in determining frequency response of prospective network and an initial estimate of component values.

For a given circuit configuration with a fixed input data, the error is a function of the variable components in the circuit. In other words, a change in any one of the variables will produce a related change in the error. Therefore the partial derivative of the error function with respect to a variable component may be expressed in order to obtain the critical points. The technique can displace the error function to a relative maximum or a relative minimum. The appropriate logic is internal to the iterative scheme so that the program may determine whether or not it is approaching a relative maximum or minimum, and if so, to provide a means for incrementing from that particular point.

*Inquiries concerning this program may be directed to: COSMIC Computer Center, University of Georgia, Athens, Ga. 3060 (B67-10406).*

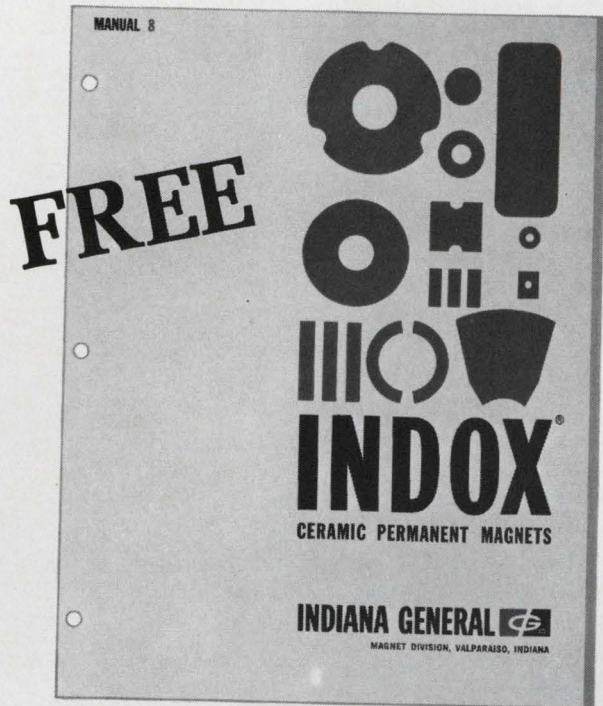

Write for bulletins detailing shapes, sizes, characteristics, and demagnetization and energy product curves for Indox 1, 2, 3, 4, 5 and 7. From IGC, world's largest producer of Indox ceramic permanent magnets. Indiana General Corporation, Magnet Division, Valparaiso, Indiana.

**INDIANA GENERAL** 

INFORMATION RETRIEVAL NUMBER 97

## Bi-DIRECTIONAL DIODE THYRISTOR

**SIDAC**

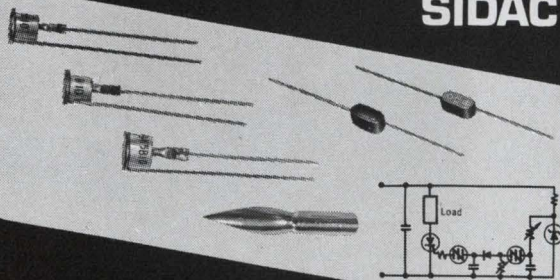

- Economy derived from the use of one Sidac unit to replace parallel silicon controlled rectifiers connected back-to-back. Sidac units offer bi-directional control characteristics.

- Low, low price plus top reliability.

Type	K3B10		K4B10		K5B10	
	R	L	R	L	R	L
V <sub>FROM</sub> (V)	170	250	170	250	170	250
I <sub>H</sub> (mA)	std 4		std 6		std 9	
I <sub>FO</sub> (A r.m.s)	1.3		2.5		5	
V <sub>I</sub> (V r.m.s)	120		120		120	

Type	K2C5		K2C6	
	V <sub>BO</sub> (V)	max 61	min 44	max 67
I <sub>BO</sub> (mA)	max 0.5		max 0.5	
I <sub>H</sub> (mA)	std 30		std 30	

 **SHINDENGEN ELECTRIC MFG. CO., LTD.**

New-Ohtemachi Buidg., 4, 2-chome, Ohtemachi, Chiyoda-ku, Tokyo, Japan  
Telephone: Tokyo (211) 2571 Cable Address: "SHINDENGEN TOKYO" Telex: 222-2539 (SHINDENGEN TOK)

INFORMATION RETRIEVAL NUMBER 98

ELECTRONIC DESIGN 7, April 1, 1968

# 10 reasons why we do faster, more precise aluminum fabricating.

- 1 We do our own engineering.
- 2 We do our own hydroforming.
- 3 We do our own deep drawing.
- 4 We do our own stamping.
- 5 We do our own spinning.
- 6 We do our own brake fabrication.
- 7 We do our own assembly.
- 8 We do our own heliarc work.
- 9 We do our own heat treating.
- 10 We do our own finishing.

Other aluminum fabricators do a lot of sub-contracting. Dealing with them can bring you lots of headaches—inconsistent quality, late deliveries, high prices. We have a fully integrated job shop. Engineering people who can work out correct production designs. Equipment needed to do every type of aluminum fabricating. And 50 years of know-how.

We also offer you a huge selection of standard aluminum cans, boxes and cases. All are available practically overnight. Call or write Dept. ED-4

 **AMERICAN ALUMINUM  
COMPANY**

Manufacturers of Aluminum Products for  
Industry Since 1910.

230 Sheffield St., Mountainside, N.J. 07092  
Phone (201) 233-3500

INFORMATION RETRIEVAL NUMBER 99

117

## Bolt a new METERMATE to any panel meter

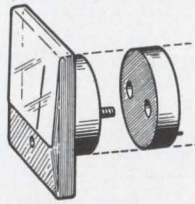

- ... it's a single-ended D.C. voltmeter
- ... it's a high impedance differential voltmeter
- ... it's a log scale D.C. voltmeter
- ... it's a log ratiometer D.C. voltmeter
- ... it's a "you-name-it-we've-got-it" meter

Now standard panel meters read voltage at high source impedances. METERMATES for various functions mount flush at the rear of the meter and fit within the length of the meter terminals — take no extra space, install easily. Ranges are altered simply by changing one external resistor value.

METERMATES are available as individual units or with companion meters in a complete selection of types and ranges. Call your Philbrick/Nexus sales representative for complete specifications, prices and applications assistance. Or write, Philbrick/Nexus Research, 46 Allied Drive at Route 128, Dedham, Massachusetts 02026.

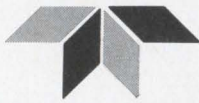

**PHILBRICK/NEXUS RESEARCH**

A TELEDYNE COMPANY

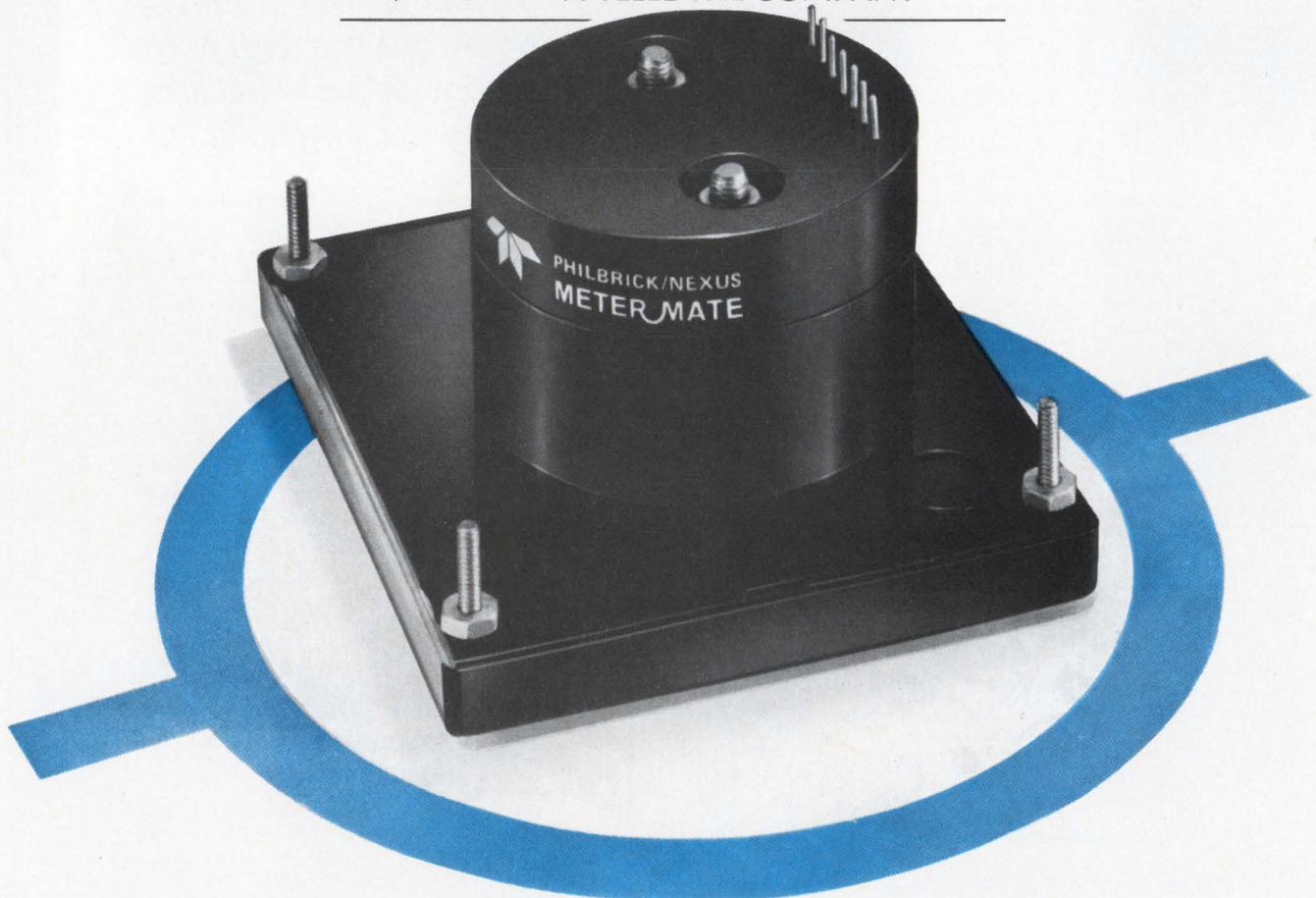

# Products

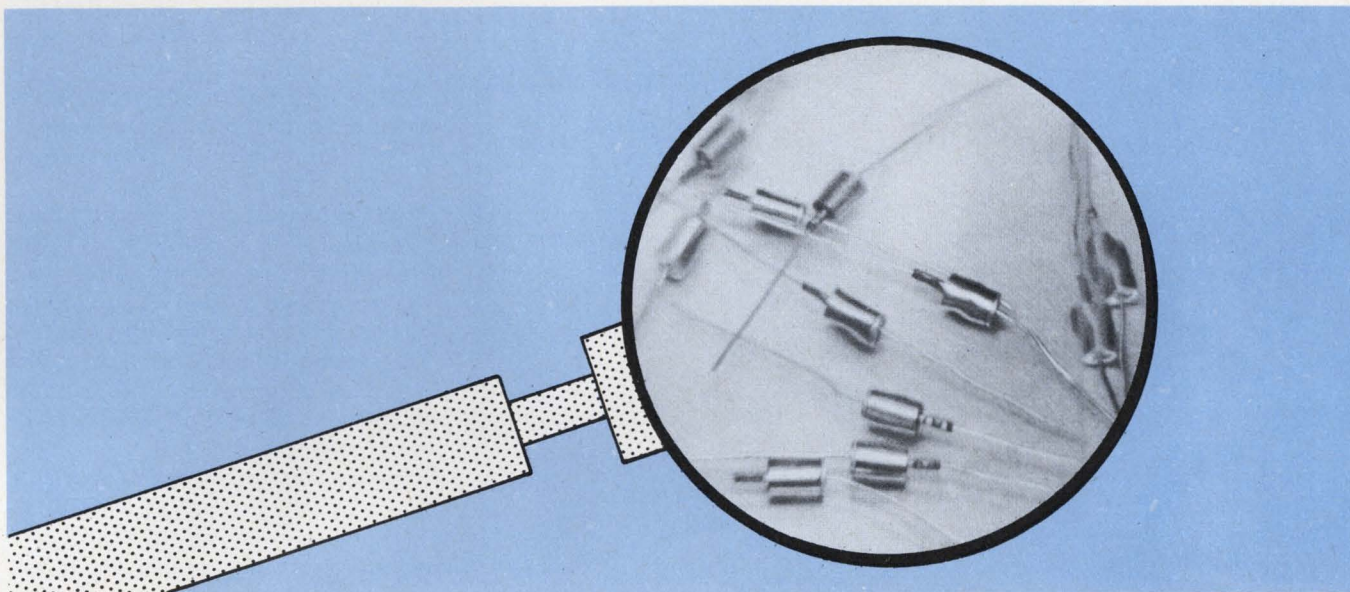

A family of inert fluorochemical liquids aids testing and cooling of electronic components.

The liquid boils at 155°C and will pour at 60°C leaving no residue. Page 134.

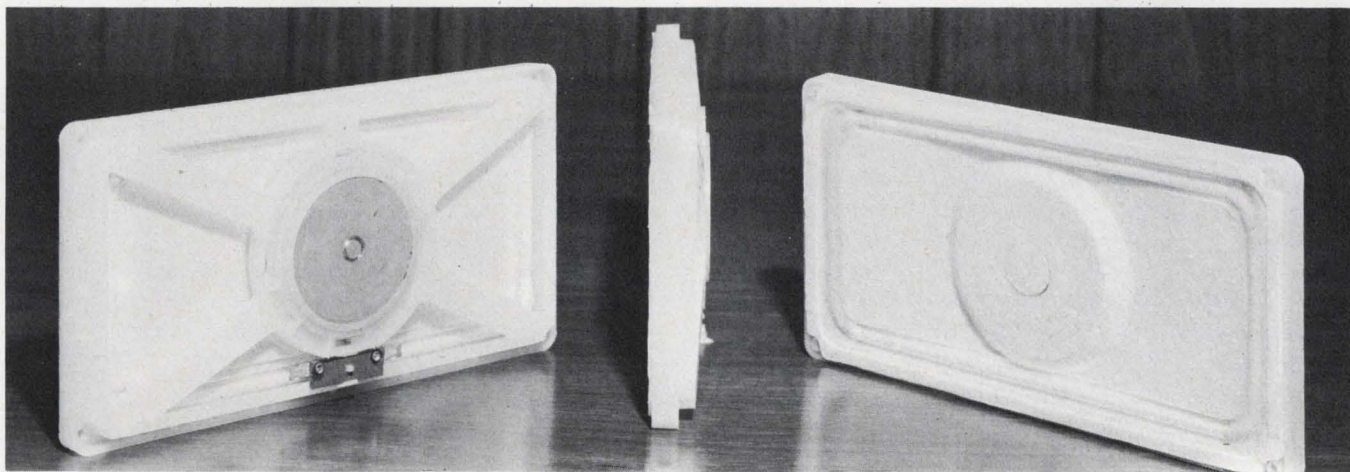

Wafer speakers designed to replace cone speakers reproduce from 40 Hz to 20 kHz.

The panel is 1/5 the depth of a cone speaker handling the same power. Page 120.

## Also in this section:

**Desk-top calculator** combines slide-rule simplicity with a high-speed computer. Page 130

**Lithium niobate** ( $\text{LiNbO}_3$ ) crystals are inclusion and striation free. Page 134

**Hybrid microcircuit operational amplifier** exhibits a  $10^{11} \Omega$  impedance. Page 136

**Design Aids**, Page 138 . . . **Application Notes**, Page 140 . . . **New Literature**, Page 142

## Ultra-thin wafer speakers cover a 40-Hz-to-20-kHz frequency range

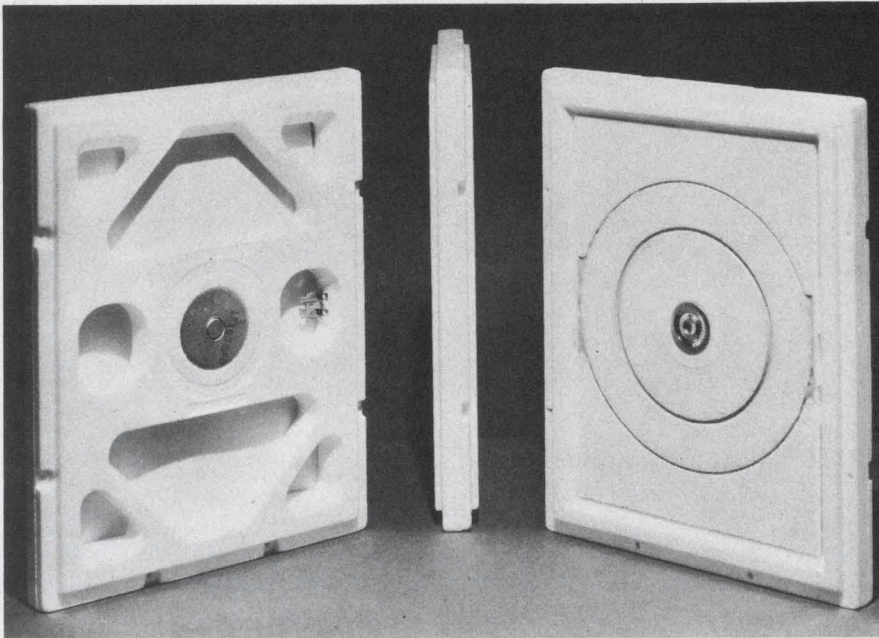

*ERA Acoustics Corp., 311 East Park St., Moonachie, N.J. Phone: (201) 746-8080. Price: \$4.05 (500 lots).*

Wafer speakers that are designed to replace cone speakers reproduce frequencies from 40 Hz to 20 kHz. The Poly-Planar speaker is a flat, lightweight, plastic acoustic panel, supported by a shallow plastic frame. It is approximately a fifth the depth of equivalent cone speakers that handle the same power range. For example, a Poly-Planar that is equivalent to a 20-W, 12-inch woofer and tweeter combination is 1-7/16 in. thick.

Basically the loudspeaker functions similar to the cone loudspeaker system. The latter reproduces sound by mechanical motion of the suspended cone piston. The degree to which a rigid piston of this type produces sound is determined by its size, how it is baffled and the magnitude of the electro-motive driving source. With its accompanying heavy magnet structure, the large cone speaker becomes excessively bulky, deep and heavy.

In the Poly-Planar speaker, there is a magnetic structure that pro-

duces a radial field within a closely spaced gap. A voice coil is immersed in the gap, and electrical signals are applied to the coil to produce motor action with resulting acoustical output. In place of the conventional paper cone, however, there is a flat plastic panel, only a fraction of the depth of the equivalent cone structure. This panel is made rigid with plastic materials and a special surface skin treatment.

The material for the diaphragm is expanded polystyrene in a compacted bead structure. Since the beads are largely air, the mass is extremely low. As an example, the density of a typical 1/8 in. acoustic panel is less than 0.2 grams/in.<sup>3</sup>. To obtain the desired acoustic properties, the panel incorporates a combination of circular grooves in conjunction with acoustic fill materials. This provides the proper balance of compliances and damping for wide response characteristics.

The acoustic panel is supported by a frame of similar polystyrene plastic that provides an identical coefficient of expansion. Since no supporting spiders or structures

are required, the composite unit can be assembled with a minimum of labor and time. The polystyrene plastic material makes the speaker completely waterproof and impervious to extremes of temperature, humidity, shock and vibration.

Manufacturing with automatic machinery is feasible. Both the acoustic panel and supporting frame can be molded at production rates. Magnetic assemblies can also be premodeled into the frame, and voice coils can be molded into the diaphragm. The Poly-Planar wafer speaker system has been under development for over five years.

Units may be used in all applications where conventional cone speakers are now employed. In addition their resistance to temperature, humidity and shock and their thin construction permit use in configurations with limited space and depth. Enclosures are feasible with thicknesses on the order of only 1-3/4 in., including cabinet and projecting grill. Since the units can operate under high temperature conditions, they may be placed adjacent to transistors, vacuum tubes, transformers or similar components.

A single unit is bidirectional; a number of units are needed for omnidirectional coverage.

CIRCLE NO. 250

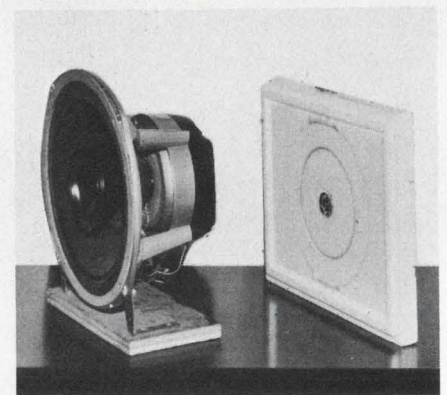

**Wafer speaker is a fifth the depth of a cone type, yet handles same power.**

## Look at a new half dollar (and let your imagination roam)

The materials concept represented by today's half dollar holds an interesting potential for imaginative designers.

The half dollar is a sandwich—a clad metal composite that looks, feels and wears like solid silver. But only 40% of it is silver. The rest is copper. (The outer layers of the sandwich are a high silver content alloy, the inner layer a high-copper, low silver alloy.)

Handy & Harman is a major supplier of the clad metal strip from which the half dollars are minted. This strip represents a specialized Handy & Harman capability—the capability of bonding precious metals to base metals, to form new materials that solve problems for industry.

The U.S. Mint uses the clad metal form to conserve silver. But the principle of using precious metals in clad, rather than solid form, is as valid for industry as it is for the Mint. These composites can often deliver the unique properties of precious metals at a fraction of the cost. Examples: silver-clad

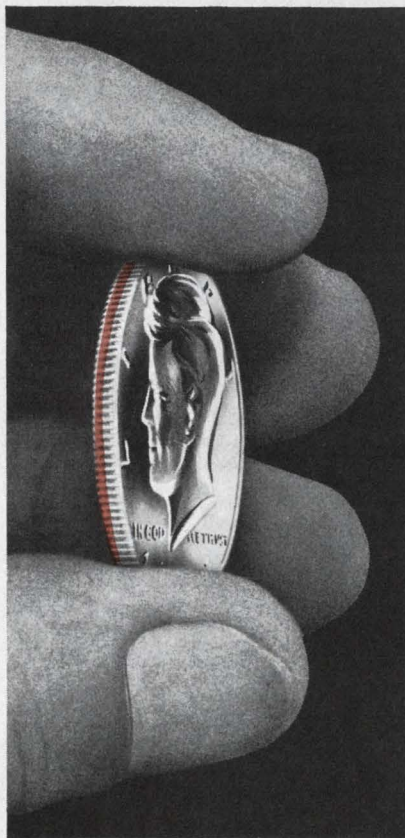

copper wire replaces solid silver for diode leads; low voltage relays are made of gold inlaid in copper; TV rotor switches are made of sterling silver clad to brass.

Clad precious metals can do more than simply conserve costly materials. They can reduce manufacturing costs by replacing fabricated-and-assembled components. And because they're tailored composites, combining the properties of two or more metals, they can frequently solve problems that can't be solved by monolithic metals.

If your company uses precious metals (or wishes it could afford to), Handy & Harman's cladding capabilities are worth exploring. If you'd like some easy reading on the subject, ask for our informative new booklet, "The Logic of Precious Metal Cladding." It has ideas that will stimulate your imagination.

**HANDY & HARMAN**  
**HH** 850 THIRD AVENUE, NEW YORK, N.Y. 10022  
100 Years of Leadership in Precious Metals

### Vacuum interrupters handle 200 A



Westinghouse Electric Corp., Box 2278, Pittsburgh. Phone: (412) 391-2800. P&A: \$75; 30 days.

Vacuum interrupters for disconnect switching, capacitor switching, and military power switching applications have ratings of 200 A continuous, 2000 A interrupting, and 15-kV rms. They are now available in four different styles including the basic interrupter with its unthreaded contact rods.

CIRCLE NO. 251

### Image orthicons have long life



Tokyo Shibaura Electric Co., Ltd., International Division, 1-1 Uchisaiwaicho, Chiyoda-ku, Tokyo, Japan.

Two image orthicon tubes have been developed for tv camera applications. An electron-conductive glass target and a multi-alkali photocathode in these tubes provides steady, high-grade sensitivity and long service life. Conventional image orthicons have a maximum service-life of 600 hours whereas the new orthicons are guaranteed to last 1000 hours.

CIRCLE NO. 255

### Diamond thermistors sense -200°C to +650°C

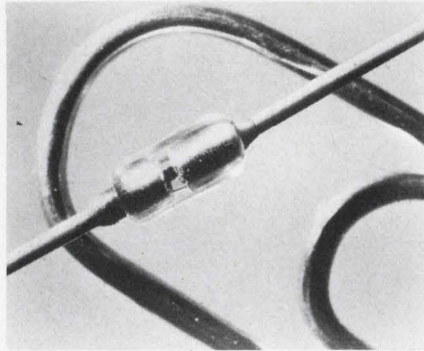

General Electric, 5504 S. Brainard Avenue, La Grange, Ill. Phone: (312) 354-8585.

Diamond thermistors are capable of continuous duty operation from -200° to +650°C. These hermetically sealed units utilize a synthetic diamond crystal as the temperature-sensitive resistance element. Resistance values from 3685 to 40,150 Ω (at 125°C) are available with tolerances of ±10%, ±20% and ±30%.

CIRCLE NO. 252

### Dial assembly reads out digitally

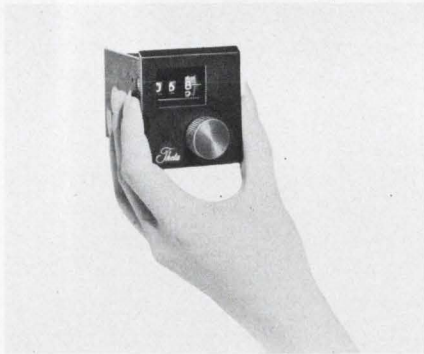

Theta Instrument Corp., 22 Spielman Road, Fairfield, N.J. Phone: (201) 227-1700. Price: \$300.

Measuring 2-1/2-in.<sup>2</sup> a dial assembly features a digital readout. Intended for use on test panels, the Midgi-Dial provides a calibrated rotary input for potentiometers, synchros, and tuning devices. It has a vernier dial with a 36-to-1 ratio. Provision is made for mounting any servo device including a flexible coupling for shaft connection.

CIRCLE NO. 253

### Data filters span 2 to 2000 Hz

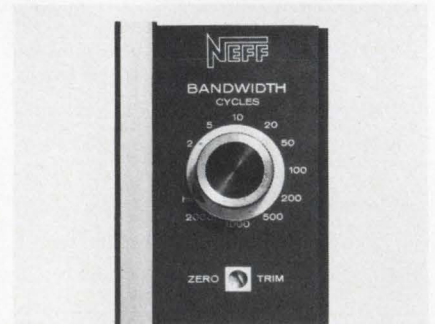

Neff Instrument Corporation, 1088 E. Hamilton Road, Duarte, Calif. Phone: (213) 357-2281. P&A: \$590; 60 days.

An active, low-pass filter having selectable filtering capabilities provides cutoff frequencies from 2 to 2000 Hz with Butterworth, Bessel, or Gaussian characteristics. In the unfiltered, wide-band position a 20-kHz response is provided. The unit, utilizing a FET input, has an impedance of greater than 100 MΩ and can operate from source impedances up to 1 MΩ.

CIRCLE NO. 256

### Miniature lamps use T-1 filaments



Industrial Electronic Engineers, Inc., 7720 Lemona Avenue, Van Nuys, Calif. Phone: (213) 787-0311.

Lamps are standard T-1-3/4 styles, but with T-1 filaments. The result is a long-life T-1-3/4 rated at 40,000 hours, or as much as 40 times the life of an average T-1-3/4 lamp. All B6 and BU6 lamps are aged for a minimum of 24 hours at rated voltage, and selected within mean spherical candle power range after aging.

CIRCLE NO. 254



## Dual-digital display accepts 4-line BCD

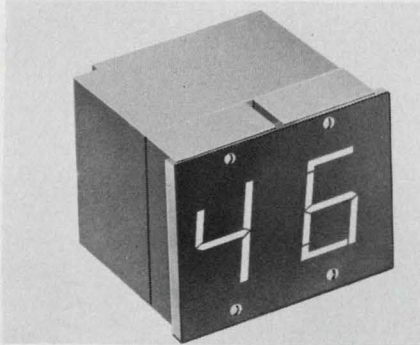

The Mesa Co., Inc., 220 Mill St., Bristol, Pa. Phone: (215) 788-5521. Price: \$19/decade.

A decoder-driver and display module is 1.97 in. high, 2.2 in. wide and 2 in. deep. It accepts 4-line BCD inputs at IC levels and requires a 105-125 V ac input. Bezels, sockets, mounting brackets, etc. are not necessary because the required number of displays are factory assembled as a single unit on a common mounting face to each customer's specification.

CIRCLE NO. 257

## Ceramic capacitors are glass-encased

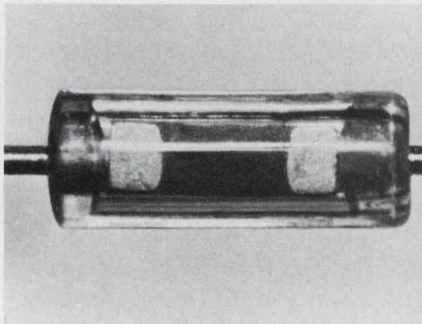

San Fernando Electric Manufacturing Co., 1509 First Street, San Fernando, Calif. Phone: (213) 365-9411.

Glass-encased ceramic capacitors offering 10 to 10,000 pF are in a case  $0.25 \times 0.095$  in. They are hermetically-sealed by brazing the ceramic slug to the lead-cap without flux and encapsulating the slug in an inert-gas atmosphere. The design allows the leads to be welded or soldered close to the capacitor body without affecting the mechanical or electrical integrity of the component.

CIRCLE NO. 258

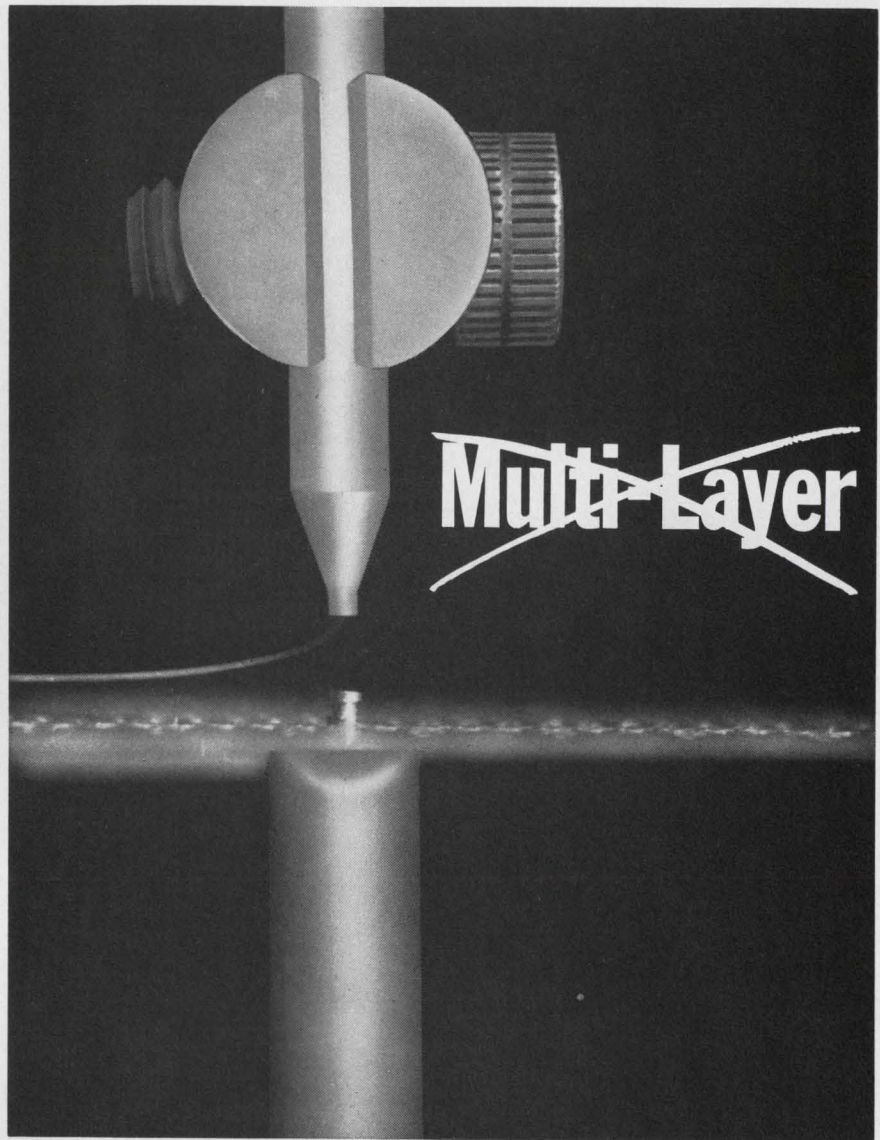

Would you consider an alternative to the use of multi-layer boards if you could lower the cost, improve the delivery and be able to easily modify your completed assemblies?

Our new "do-it-yourself" MICROPOINT system allows you to connect all points of a circuit mode with a single wire.

### MICROPOINT SYSTEM ADVANTAGES

- Cold electrode
- High temperature insulation
- wire welding
- Electrode fed wire for ease of routing
- Only one weld schedule required for production



write for further information

**MICRO TECHNOLOGY**

DIVISION OF STERLING ELECTRONICS

9722 Alpaca Street • So. El Monte, California 91733 • Phone: (213) 283-0241

INFORMATION RETRIEVAL NUMBER 62

### Transistor heat sinks cool TO-type packages

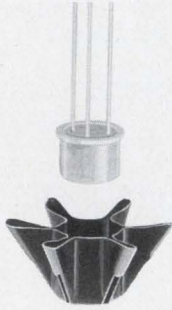

The Waterbury Pressed Metal Co., 407 Brookside Rd., Waterbury, Conn. Phone: (203) 756-8891.

A small lightweight heat dissipator fits transistors packaged in a variety of TO-type configurations. It is available in aluminum or beryllium copper with a choice of finishes. No tools are required for installation and a hole in the base of the heat sink permits direct attachment to a chassis.

CIRCLE NO. 259

### Silicon transistors withstand up to 250 V



Motorola Semiconductor Products Inc., P.O. Box 955, Phoenix, Ariz. Phone: (602) 273-6900. P&A: \$1.85 to \$4.50 (100 up); stock.

Npn 2N4924-27 and pnp 2N4928-31 high-voltage silicon transistors offer breakdown voltages of from 100 to 250 V with all devices measured at  $I_C = 10$  mA. Other features include a leakage current of  $I_{CBO} = 100$  nA, a saturation voltage of 0.25 to 1 V at 10 mA and a dc beta ( $h_{FE}$ ) to 200.

CIRCLE NO. 260

### Transistor heat sinks fit TO-5, TO-18 types

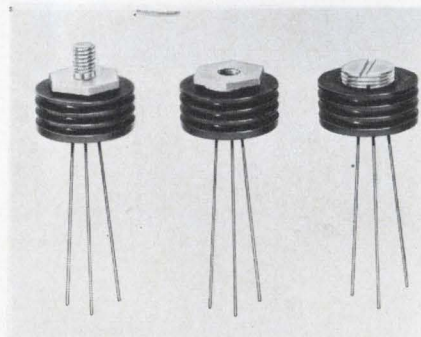

Horex Electronics, Inc., 1729 21st St., Santa Monica, Calif. Phone: (213) 451-0211.

Heat sinks feature a surface contact that assures a thermal conduction coefficient of 2 W/°C from the transistor case to the heat sink. The HA05R fits TO-5 cases, and the HA18R fits TO-18 cases. Both are lead-mounted. Secure mounting types in both sizes with taped holes or studs are also available, for use where shock and vibration is a problem.

CIRCLE NO. 261

### Switching diodes handle 200 or 500 V

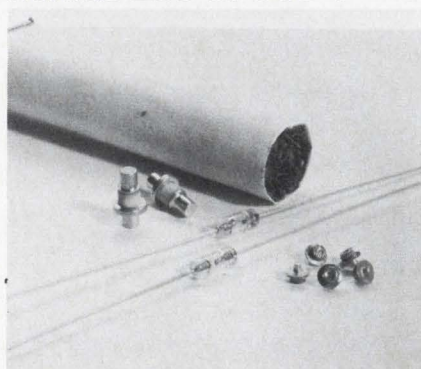

Alpha Industries, Inc., 381 Elliot St., Newton Upper Falls, Mass. Phone: (617) 969-6480.

Two series of PIN microwave switching diodes are designed for switching, limiting, duplexing, phase-shifting and variable-attenuation applications. The MO-111BL is a 200-V device. The type MO-120B1 is a 500-V diode with  $C_{total}$  at  $-50$  V of 0.4 pF max with a 1-W max rating. Both the 200 and 500 V series are available in three case styles: J, L and M.

CIRCLE NO. 262

### Silicon diodes switch in 50 ns

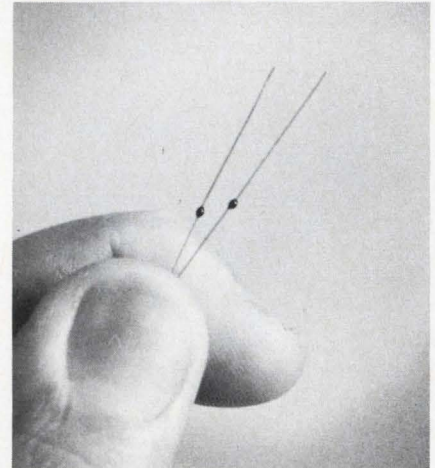

Computer Diode Corp., Pollitt Dr. South, Fair Lawn, N.J. Phone: (201) 797-3900.

Up to six matched silicon junctions are stacked and packaged in a micro epoxy form for switching applications up to 6000 in a new line of diodes. Switching speeds are as low as 50 ns for conditions of 10 mA, 100  $\Omega$ . These diodes measure only 0.075 in. dia by 0.125 in. long. Five separate units are offered in this line ranging from inverse working voltage ratings of 2000 to 6000 V in 1000-V steps. Peak surge current (8 ms) varies from 9 A to 3.5 A. Maximum reverse leakage at working voltage is 1  $\mu$ A.

CIRCLE NO. 263

### Epitaxial transistor switches 1 ampere

Radio Corp. of America, Electronic Components and Devices, Somerville, N.J. Phone: (201) 485-3900. P&A: 98¢ (1000 lots); stock.

This silicon npn epitaxial planar transistor will switch 1 A of current with a turn-on time of 30 ns and a turn-off time of 60 ns. The 2N5262 is controlled for freedom from second breakdown under both forward-bias and reverse-bias conditions when operated within specified maximum ratings. Another feature is its dc beta of 25 min at a collector current of 1 A. It meets the requirements of basic military specification MIL-S-19500 and is hermetically sealed in a metal low-profile TO-39 package.

CIRCLE NO. 264

# Ever need plug-in power supplies in a hurry?

## Send for our catalog.

### It lists 62,000 different types.

### The one you need will be shipped in 3 days.

(We've never failed to make good on this promise)

### DUAL OUTPUT SOLID STATE REGULATED POWER SUPPLIES (400 MA MAX.)

Ambient temperature rating 0 to 55°C.

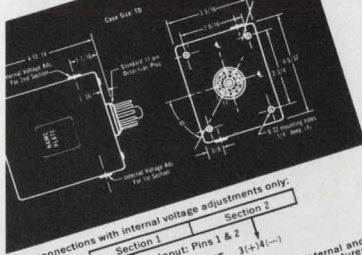

Pin connections with internal voltage adjustments only.

Section 1 Input: Pins 1 & 2  
Section 2 Output: 3(+), 4(-)  
10(+), 19(-) OUTPUT 3(+), 4(-)

Pin connections for models with provisions for both internal and remote output adjustment. (Models with prefix 'E'. See optional feature: Remote output adjustment.)

Section 1 Input: Pins 1 & 2  
Section 2 Output: 3(+), 4(-)  
10(+), 19(-) OUTPUT 3(+), 4(-)  
9 & 8 For Internal Pot. Short out pins  
9 & 7 For Remote Pot. Use pins

**SPECIFICATIONS**

INPUT VOLTAGE: 105-125V, AC, 50 to 400 cycle single phase.

OUTPUT VOLTAGE: SEE SPECIFIC SECTIONS

OUTPUT CURRENT: SEE SPECIFIC SECTIONS

REGULATION: SEE SPECIFIC SECTIONS

OUTPUT VOLTAGE ADJUSTMENT: ±1 volt adjustment provided for each section.

POLARITY: Outputs are floating. Each individual section may be connected as a separate power supply. Either negative or positive side of one section may be grounded irrespective of the other section.

IMPEDANCE: Approximately 2 ohm at 10Kc.

TEMPERATURE: Continuous duty at full load from 0 to 55°C ambient.

INSTALLATION: Plugs into standard 11-pin octal-type socket. Mount in holes (6-32) provided at each corner for installation in any position.

WEIGHT: 2½ to 3 lbs., depending on model.

**FEATURES**

Identical or different sections may be selected • Short circuit protection • No additional heat sinking required • May be used in series • Not encapsulated.

**HOW TO ORDER**

Select two sections desired. The Model Number is the combination of the two sections selected. Example: Section 6B10D and section 12A40D is Model 6B10D12A40D. Always specify the lower voltage section first.

For pricing purposes, add the cost of the individual sections selected. Example: Model 6B10D12A40D.

**OPTIONAL FEATURES**

**REMOTE OUTPUT ADJUSTMENT**—All standard dual power supplies are provided with accessible internal voltage adjustments. For remote external adjustments, add prefix "E" to model number and add \$2.00 to price. Example: 6B10D12E40D. "E" power supplies will have provisions for both internal and remote adjustments in both sections.

**REMOTE SENSING**—Provision for remote sensing of the output voltage so as to compensate for drops in the load lines can be furnished at an additional charge of \$30.00 per model. Add prefix "R" to model number when ordering. "R" power supplies will also have provisions for both internal and remote output adjustment.

**230 VOLT INPUT**—All standard units can be furnished to accept input of 210 to 250V. Add suffix "-230" to model number. Additional cost—\$10.00.

\* ±.5 volt adjustment from nominal.



### DUAL OUTPUT SOLID STATE REGULATED POWER SUPPLIES (400 MA MAX.)

Ambient temperature rating 0 to 55°C.

Model No.	Output Voltage	Output Current (Amps)	REGULATION (Line %)	Ripple (mV RMS)	Price per Section	Section (See Note 1)	REGULATION (Load %)	Output Current (Amps)	Price per Section
21	100	200	0.5	1	67	15B20D	0.5	1	67
22	100	200	0.5	1	67	15B40D	0.5	1	67
23	100	200	0.5	1	67	15B60D	0.5	1	67
24	100	200	0.5	1	67	15B80D	0.5	1	67
25	100	200	0.5	1	67	15B100D	0.5	1	67
26	100	200	0.5	1	67	15B120D	0.5	1	67
27	100	200	0.5	1	67	15B140D	0.5	1	67
28	100	200	0.5	1	67	15B160D	0.5	1	67
29	100	200	0.5	1	67	15B180D	0.5	1	67
30	100	200	0.5	1	67	15B200D	0.5	1	67
31	100	200	0.5	1	67	15B220D	0.5	1	67
32	100	200	0.5	1	67	15B240D	0.5	1	67
33	100	200	0.5	1	67	15B260D	0.5	1	67
34	100	200	0.5	1	67	15B280D	0.5	1	67
35	100	200	0.5	1	67	15B300D	0.5	1	67
36	100	200	0.5	1	67	15B320D	0.5	1	67
37	100	200	0.5	1	67	15B340D	0.5	1	67
38	100	200	0.5	1	67	15B360D	0.5	1	67
39	100	200	0.5	1	67	15B380D	0.5	1	67
40	100	200	0.5	1	67	15B400D	0.5	1	67
41	100	200	0.5	1	67	15B420D	0.5	1	67
42	100	200	0.5	1	67	15B440D	0.5	1	67
43	100	200	0.5	1	67	15B460D	0.5	1	67
44	100	200	0.5	1	67	15B480D	0.5	1	67
45	100	200	0.5	1	67	15B500D	0.5	1	67
46	100	200	0.5	1	67	15B520D	0.5	1	67
47	100	200	0.5	1	67	15B540D	0.5	1	67
48	100	200	0.5	1	67	15B560D	0.5	1	67
49	100	200	0.5	1	67	15B580D	0.5	1	67
50	100	200	0.5	1	67	15B600D	0.5	1	67
51	100	200	0.5	1	67	15B620D	0.5	1	67
52	100	200	0.5	1	67	15B640D	0.5	1	67
53	100	200	0.5	1	67	15B660D	0.5	1	67
54	100	200	0.5	1	67	15B680D	0.5	1	67
55	100	200	0.5	1	67	15B700D	0.5	1	67
56	100	200	0.5	1	67	15B720D	0.5	1	67
57	100	200	0.5	1	67	15B740D	0.5	1	67
58	100	200	0.5	1	67	15B760D	0.5	1	67
59	100	200	0.5	1	67	15B780D	0.5	1	67
60	100	200	0.5	1	67	15B800D	0.5	1	67
61	100	200	0.5	1	67	15B820D	0.5	1	67
62	100	200	0.5	1	67	15B840D	0.5	1	67
63	100	200	0.5	1	67	15B860D	0.5	1	67
64	100	200	0.5	1	67	15B880D	0.5	1	67
65	100	200	0.5	1	67	15B900D	0.5	1	67
66	100	200	0.5	1	67	15B920D	0.5	1	67
67	100	200	0.5	1	67	15B940D	0.5	1	67
68	100	200	0.5	1	67	15B960D	0.5	1	67
69	100	200	0.5	1	67	15B980D	0.5	1	67
70	100	200	0.5	1	67	15B1000D	0.5	1	67
71	100	200	0.5	1	67	15B1020D	0.5	1	67
72	100	200	0.5	1	67	15B1040D	0.5	1	67
73	100	200	0.5	1	67	15B1060D	0.5	1	67
74	100	200	0.5	1	67	15B1080D	0.5	1	67
75	100	200	0.5	1	67	15B1100D	0.5	1	67



Acopian Corp., Easton, Pennsylvania (215) 258-5441

### Resolver standard has direct readout

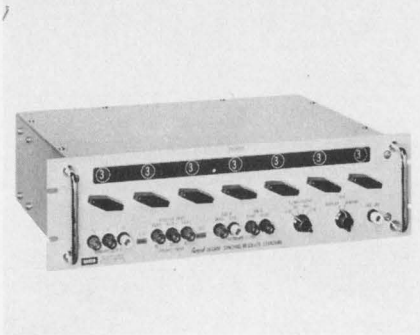

The Singer Co., 3211 S. La Cienega Blvd., Los Angeles. Phone: (213) 870-2761. P&A: \$2850; 4-6 wks.

A high-resolution synchro and resolver standard offers direct angular readout. The unit may be used in a system to provide precise inputs or to test components. Another application is converting magnetic heading data to X-Y coordinates for input to an analog computer. Angular accuracy is  $\pm 2$  s of arc at 400 Hz.

CIRCLE NO. 265

### Strip printer turns out 1500 characters/min

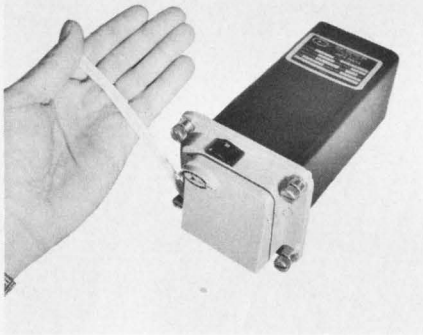

Clary Corp., San Gabriel, Calif. Phone: (213) 287-6111.

A 4-lb strip printer with only six moving parts measures  $3 \times 3 \times 6\frac{1}{4}$  in., including control circuitry. Printing up to 1500 characters/min, the device offers full 64-character alphanumeric selection. Front cartridge loading allows rapid paper change. Data input is 6-bit parallel binary code, and printout is on 5/16-in. pressure-sensitive tape.

CIRCLE NO. 266

### Electronic load cells feed NIXIE readout



Doric Scientific Corp., 7969 Engineer Rd., San Diego. Phone: (714) 277-8421.

An electronic load cell readout with summing reads directly in pounds, kilograms or other engineering units when connected to a load cell or other type of strain-gauge transducer. A NIXIE display plus IC design provides good readability, speed, reliability and accuracy. The instrument is particularly suited to weighing systems.

CIRCLE NO. 267

### Data storage unit has 64 registers

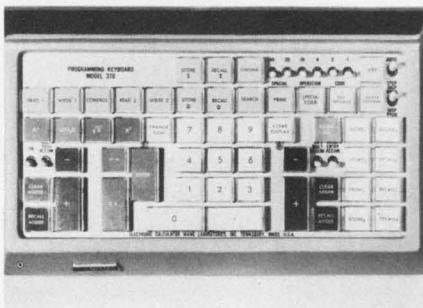

Wang Laboratories, Inc., 836 North St., Tewksbury, Mass. Phone: (617) 851-7311.

A data - storage unit consists of 64 registers and is provided with row- and column-counters to facilitate operation with systems of linear equations or matrices. The addition of this core storage device allows a 370 calculator to solve simultaneous equations with only two card readers.

CIRCLE NO. 268

### BCD to pulse converter accepts 1-2-4-8 code



AIC Instruments, 6214 Royalton St., Houston. Phone: (713) 664-0353. P&A: \$370; 45 days.

The Model 3100 BCD-to-pulse converter and printer adapter accepts inputs in 1-2-4-8 BCD code and converts them into decade serial solid-state switch closures. An input of 0010-0110-1000, corresponding to 268, is converted into 2 hundreds, 6 tens and 8 units position switch closures. The model is used as an interface between devices with BCD outputs and parallel entry, pulse-actuated printing mechanisms or display devices.

CIRCLE NO. 269

### Memory planes stack solidly

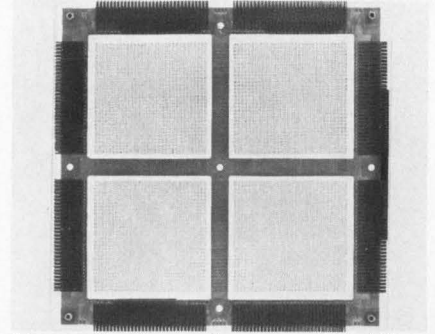

Magnetic Memories, Inc., 930 Piner Rd., Santa Rosa, Calif. Phone: (707) 544-8800.

Extended tabs, incorporated into the individual frames of memory planes, allow solid stacking with no spacer requirements. Each of these planes has a hard-coated aluminum distributive heat sink to which the cores are bonded by a silicon compound. Since the matrix wires do not support the cores nor exert any mechanical strain on the cores, the planes do not exhibit magnetostrictive effects.

CIRCLE NO. 270

## Computer disc pack records on 10 sides

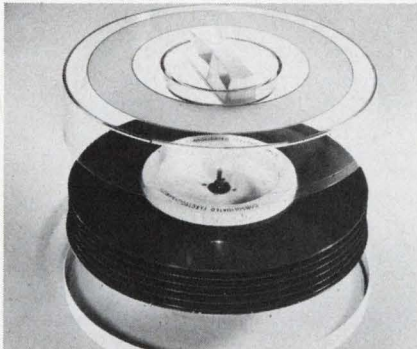

Consolidated Electrodynamics Corp., 360 Sierra Madre Villa, Pasadena, Calif. (213) 796-9381.

Designed for use in disc-drive computers, a precision assembly of six magnetic coated discs, providing 10 recording surfaces, is assembled in a heavy-duty, dust-proof container. The magnetic coating is compatible with the stainless steel flying heads ordinarily used in disc drivers, and it covers each disc evenly with a smooth, tough, durable recording surface designed not to chip or peel.

CIRCLE NO. 271

## Flying magnetic head has 8 reliable tracks

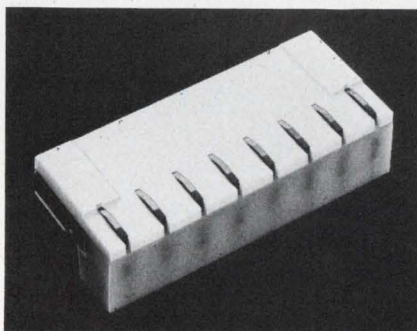

Applied Magnetics Corp., 75 Robin Hill Rd., Goleta, Calif. Phone: (805) 964-4881. P&A: \$160; 6 wks.

An eight-track flying magnetic head for disc memories provides reliable performance at packing densities up to 1300 bits/in. In a multiple interlace configuration, 30 tracks per inch can be recorded on a disc surface. The track width is 0.02 in., spaced on 0.0132 in. centers. Inductance is 20  $\mu$ H per winding leg, and the gap length is 250  $\mu$ m. The external dimensions are 1.052  $\times$  0.438  $\times$  0.3 in. max.

CIRCLE NO. 272

# MAKING THE RIGHT CONTACTS... for sequencing, data processing, programming, control and other industrial switching?

Ericsson offers an across-the-board selection of reliable, long-life and economical switching components for a broad spectrum of applications:

### 100-POINT PROGRAM BOARD

Multiple selection programmer for rapid circuit selection. 100 crosspoints in a 10 by 10 configuration, 2 $\frac{1}{4}$ " square, 1-1/16" deep. Contact springs beryllium — copper bronze, gold-plated. Shorting pins color-coded in five colors. Solder-type terminals at bottom of board. Boards can be multiplied either horizontally or vertically.

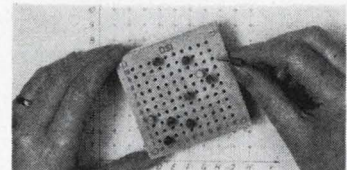

### 120-POINT SINGLE "CROSSBAR VERTICAL" MULTI-CONTACT RELAY

Replaces ten ordinary relays. Saves space, multiple wiring and complex wiring diagrams and circuitry. Silver alloy or gold bifurcated contacts. 8, 10 or 12 fixed contact strips, common to all ten (or split five and five) sub-relays and associated contact springs. 24 or 48 VDC coils. Special coils available. Life: 200 million operations.

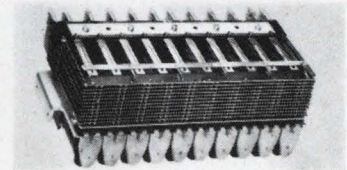

### 500 & 600-POINT CROSSBAR SWITCHES

Extremely high switching capacity, speed and reliability in an economical package. No rotary or sliding parts — minimum maintenance. Multipath selection by means of horizontal select bars and associated vertical contact strips. Silver alloy or gold contact strips and springs. 24 or 48 VDC coils. Special coils available.

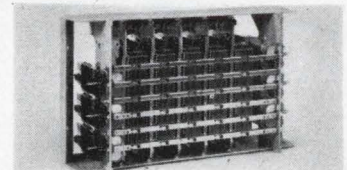

### 1,000 & 1,200-POINT CROSSBAR SWITCHES

Same superior features as small size switches, with up to 1,200-point switching capacity. Mechanical life of all switches 25 million operations per vertical, 60 million per horizontal select bar, without maintenance or adjustment. 70 million operations per contact. Operate times from select to hold 35 to 75 milliseconds.

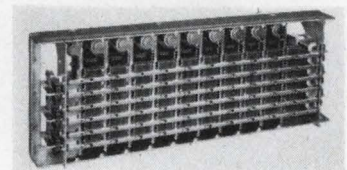

### 2,040-POINT BINARY CODE SWITCH

Compact switching matrix with wide range of input/output arrangements. Positive locked contacts — no sustaining power needed. Program will not change if power fails. New V-type positive-wipe copper/silver or silver/palladium contacts standard. Custom, built-in intermodular contact multiplying. Quick-connect plug-in wiring.

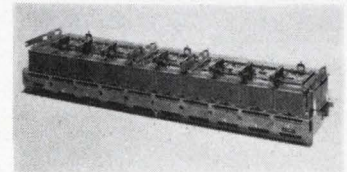

Ericsson also offers similar values in:

- Telephone-Type Relays
- Lighted Push-button Switches
- Rotary Switches
- Test Cords

You can rely upon the proven experience and continuing advanced capabilities of Ericsson — a leader in worldwide communications and switching technology for more than 81 years.



**ERICSSON CENTRUM, INC.**  
**Component Products**

16 E. 40th St., New York, N.Y. 10016



AVAILABLE IN CANADA — L. M. Ericsson Ltd., 2300 Laurentian Blvd., Montreal

### Microwave attenuators use rotary vanes

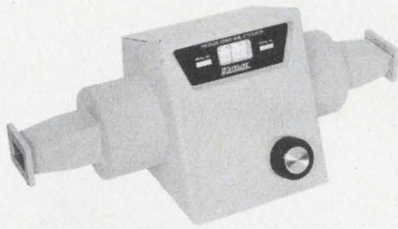

*Waveline Inc., Caldwell, N.J.  
Phone: (201) 226-9100.*

A series of rotary-vane attenuators is offered in three models covering 3.3 to 4.9 GHz, 4.9 to 7.05 GHz and 10 to 15 GHz respectively. These units have a range of 0 to 60 dB and a VSWR of 1.15 over their full bandwidth. Accuracy is  $\pm 0.1$  dB from 0 to 5 dB,  $\pm 2\%$  from 5 to 50 dB and  $\pm 3\%$  from 50 to 60 dB. Insertion loss is 1 dB max and typical loss is 1.5 dB.

CIRCLE NO. 273

### HeNe gas lasers radiate at 6328 Å

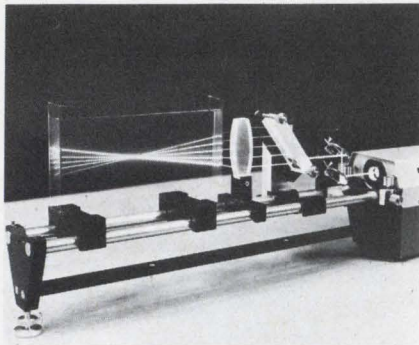

*AO Instrument Co., Buffalo, N.Y.  
Phone: (617) 764-3211. Price: \$645.*

A helium-neon gas laser and an accompanying kit of optical accessories provide 2 mW of visible red light at 6328 Å. This light is concentrated in the narrow beam, which is a well-known characteristic of the laser. It permits very bright displays of optical phenomena that are difficult to demonstrate with conventional light sources.

CIRCLE NO. 274

### Medium-power TWT is 24% efficient

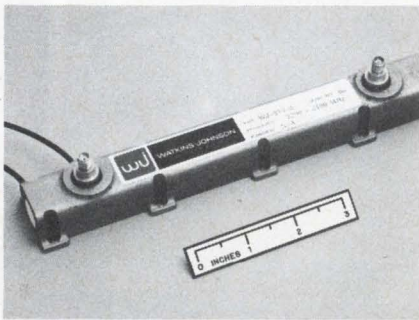

*Watkins-Johnson Co., 3333 Hillview Ave., Stanford Industrial Park, Palo Alto, Calif. Phone: (415) 326-8830.*

A medium-power traveling-wave tube is periodic-permanent-magnet focused and exhibits an overall efficiency, including heater power, above 24%. It will deliver 20 W of power over the frequency range of 2.2 to 2.4 GHz. Metal-ceramic construction ensures reliable performance.

CIRCLE NO. 275

### X-band noise source covers 8.9 to 9.1 GHz

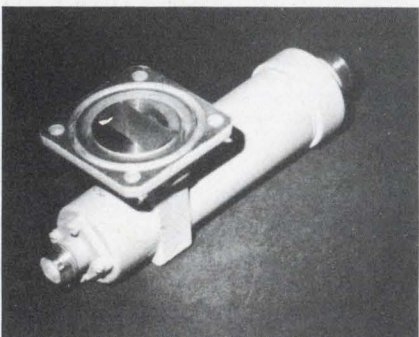

*Signalite Inc., Special Products Div., 1933 Heck Avenue, Neptune, N.J. Phone: (201) 775-2490.*

A 90° E-plane gas-discharge noise source for use at frequencies of 8.9 GHz to 9.1 GHz, is capable of supplying a high and uniform noise output with negligible insertion loss in the unfired condition. The unit is fired by a negative pulse of 950 V applied to the cathode. Operating voltage is 50 V dc nominal and operating current is 60 mA.

CIRCLE NO. 276

### Absorption wavemeters span 0.96 to 12.4 GHz

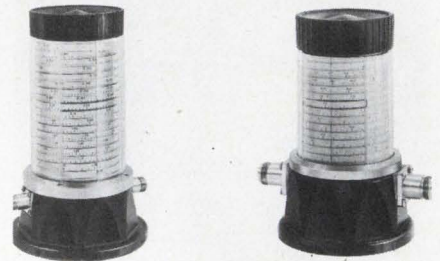

*Frequency Engineering Laboratories, Div. of Harvard Industries, Inc., Farmingdale, N.J. Phone: (201) 938-9221. Price: \$495.*

Covering a frequency range that usually requires up to 5 wavemeters, 2 direct-reading absorption-type instruments measure cw, a-m, fm or phase-modulated microwave signals from 0.96 to 12.4 GHz. These 5 W units can be used for measuring the frequency of transmitters, receivers, local oscillators and signal generators.

CIRCLE NO. 277

### Transistor amplifiers cover uhf and vhf

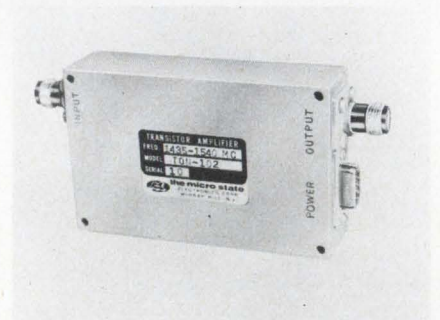

*Raytheon Co., Lexington, Mass. Phone: (617) 862-6600.*

A series of octave bandwidth transistor amplifiers and a group of telemetry band transistor amplifiers covers the uhf, vhf and microwave ranges. Typical of the octave amplifiers is the TQ0 101 covering 125 to 250 MHz, featuring a 25-dB gain and a noise figure of 4. The TQ0 104 operates at 1 to 2 GHz with a 20 dB gain and a 6.5 noise factor. The telemetry amplifiers range from 215 to 260 MHz with a 3 dB noise figure and 20 dB gain.

CIRCLE NO. 278



**You don't throw out  
the indicator light  
until you throw out the stereo.**

One of our biggest competitors in the stereo business gets the indicator lights for their equipment from Sylvania. (That's the miniature lamp that lights up when the power's on.)

They didn't choose one that screwed in. Nor one that plugged in, snapped in or slipped in.

They chose a miniature lamp that is wired directly into the circuit. Which makes it almost impossible to replace.

But that's our whole point. They're so sure our miniature lamp will last as long as their stereo that they don't have to worry about its ever having to be replaced.

We call this assured performance environmental reliability. Miniature lamps designed to operate better

under actual operating conditions.

And they're by no means our only customer with this much faith in us. A major computer manufacturer, for instance, directly wires our miniature indicator lamps into the computer circuits.

We'll be glad to tell you more about all the miniature lamps we produce. And even give you free technical advice on which to use and how to use it. Just write Dick Smith at Sylvania Miniature Lamp Products, Estes Street, Ipswich, Mass., or call him at 617-356-5612.

(If you're trying to figure out who made the stereo in the picture by looking at the cabinet, we apologize. It was made just for this ad. After all, nobody likes to see his product being thrown out.)

Miniature lamps by **SYLVANIA**  
A DIVISION OF  
GENERAL TELEPHONE & ELECTRONICS



STOP  
ERROR  
CONT

TEST PATTERN  
14 15 16

OPERATION MODE  
TEST MAN

MANUAL EXECUTE  
READ WRITE

STOP  
ERROR  
CONT

TEST PATTERN  
14 15 16

OPERATION MODE  
TEST MAN

MANUAL EXECUTE  
READ WRITE

AR  
RESET  
OR  
OR

28 27 26 25 24 23 22 21 20 19 18

14 13 12 11 10 9 8 7 6 5 4 3 2 1

HONEYWELL  ICM





3-week delivery...

**on the standard 1  $\mu$ -sec  
I/C memory system  
that packs 1/2 million  
bits in a single  
5 1/4" high unit.**

That's the ICM-40. A fast, highly reliable core memory system that's ready to meet your system requirement.

And when you say so, we'll give you 3-week CFS (Certified Fast Shipment) under our accelerated shipment plan.

What's more, the ICM-40 is a standard product . . . a proven performer with over 5,000 hours of life test without failure. Plus, some 400 actual installations; same success rate. What you'd expect from the most experienced memory maker.

**I/C Construction** — The ICM-40 is a 1 microsecond, full-cycle, magnetic core memory designed for operation as a high-speed random-access store. It is a basic system module that takes maximum advantage of the high reliability and low power consumption of integrated circuitry.

**Packaging** — Compactness and a high degree of maintainability are achieved in the ICM-40 design by packaging all of the circuitry on readily accessible, removable circuit modules.

**Capacity** — The ICM-40 packs nearly 1/2 million bits in a single 5 1/4" high module. The basic unit can be specified for up to 16K words, 4-26 bits per word. It's big brother, the ICM-40E with capacities of 32K words, 4-78 bits per word is available with 60-day CFS.

If you've drawn a block marked "core memory" recently, why not find out more about the ICM-40/40E. You'll be pleased by their versatility. And the standard-product pricing. And our Certified Fast Shipment commitment.

Now, don't you think it's about time you called us? Or, write Honeywell, Computer Control Division, Old Connecticut Path, Framingham, Massachusetts 01701.

**Honeywell**

 **COMPUTER CONTROL**  
DIVISION

INFORMATION RETRIEVAL NUMBER 192

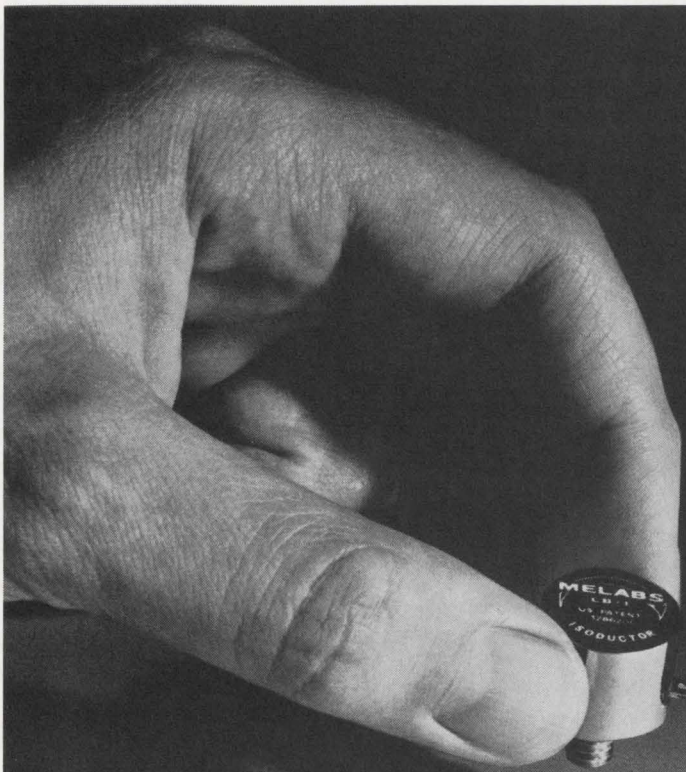

# The Melabs ISODUCTOR is practically a one-way pad.

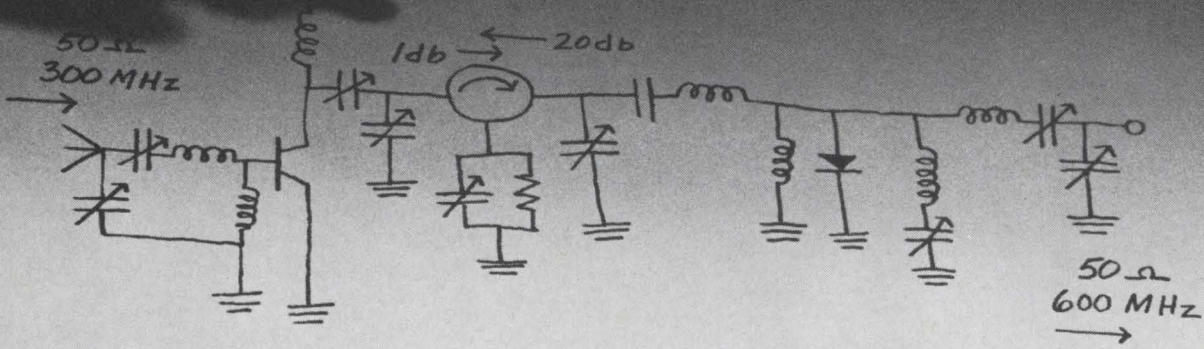

Why? Because **ISODUCTORS** have a high front-to-back, non-reciprocal attenuation characteristic. This makes them ideal for inter-stage decoupling, antenna duplexing, or as replacements for buffer amplifiers. **ISODUCTORS** are unique. They incorporate microwave ferrite techniques but operate in the 100 to 600 MHz range. When you use an **ISODUCTOR**, you eliminate most circuit stability design problems quickly. **ISODUCTORS** are designed to handle power comfortably, too. The spec and performance tables illustrate the characteristics of the standard models. For complete information, send for our 7 page application bulletin #7-182, or call your local Melabs representative for a demonstration.

Model	Freq. Range (MHz)	Average Power Dissipation (Watts)
LB-1	200 - 400	10
LB-3	300 - 600	10
LB-7	100 - 200	10

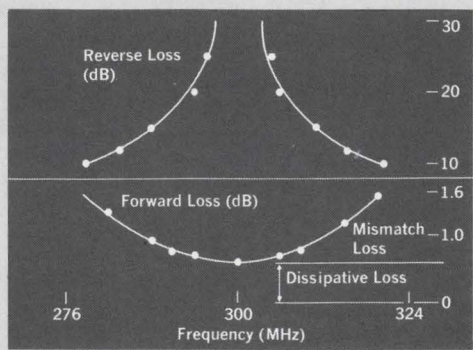

Insertion loss vs. frequency for ISODUCTOR terminated for 300 MHz operation.

Melabs, 3300 Hillview Avenue, Stanford Industrial Park, Palo Alto, California 94304. (415) 326-9500. TWX (910) 373-1777. Melabs, S. A. 393 Chaussee de Stockel, Brussels, 15, Belgium, Telephone 71-00-32. Telex MELABS BRU 23281.



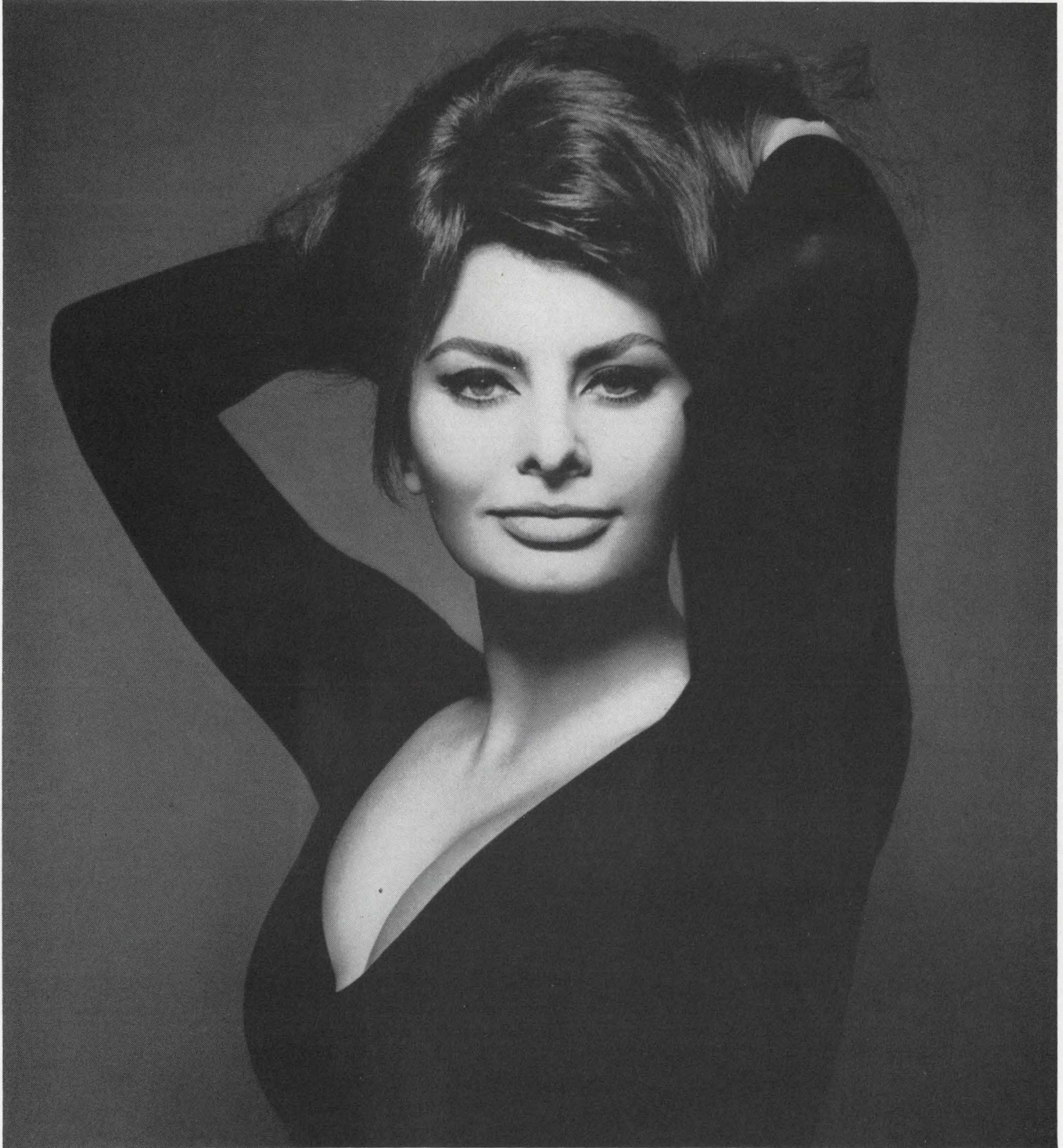

Photo by Richard Avedon

Miss Sophia Loren

## Learn the seven warning signals of cancer. You'll be in good company.

1. Unusual bleeding or discharge.
2. A lump or thickening in the breast or elsewhere.
3. A sore that does not heal.
4. Change in bowel or bladder habits.
5. Hoarseness or cough.

6. Indigestion or difficulty in swallowing.
7. Change in a wart or mole.

If a signal lasts longer than two weeks, see your doctor without delay.

It makes sense to know the seven warning signals of cancer.  
It makes sense to give to the American Cancer Society.



## ELECTRICAL & ELECTRONIC ENGINEERS

The harsh, forbidding undersea environment; a new world that poses as many problems for human existence as an alien planet. To help explore and exploit it, we're looking for engineers to design and interface the electrical and electronic building blocks for our submarines. Which means you'll be immersed in the most complex life support systems in the world, as it draws upon developments in just about every discipline from aerospace and biology to computer science and nuclear physics. ■ What's involved for you? New departures in solid state low frequency circuitry. Servo mechanism and computer circuit design. Military applications of digital computers. Design of low-voltage power plant systems and associated shipboard equipment. Integration and test development of shipborne radio, radar, sonar and ECM. Not to mention the management systems techniques that plan for their upkeep and performance for decades to come. ■ If you're qualified in any of these areas, let's talk futures...and careers. Send a resume now to Mr. James P. O'Brien.

**At Electric Boat  
you'll be throwing light  
on a world without sun.**

**GENERAL DYNAMICS**

*Electric Boat Division*

159D Eastern Point Road, Groton, Connecticut 06340

An Equal Opportunity Employer (M&F)

U. S. CITIZENSHIP IS REQUIRED

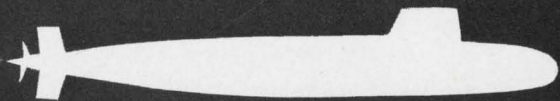

## Single beam splitters transmit laser light

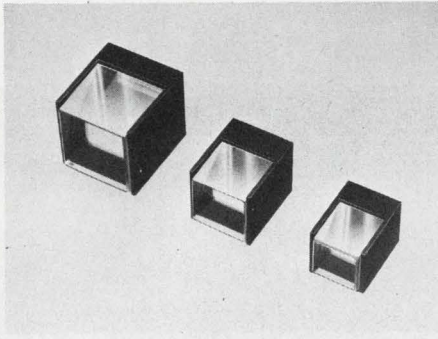

*Kappa Scientific Corp., 5780 Thornwood Dr., Goleta, Calif. Phone: (805) 967-2396.*

Single beam splitters have been designed for use with 6943 Å and 1.06 μm lasers. The beam splitter is placed in the laser cavity between the laser rod and Q-switching device. It may be supplied with low-reflection magnesium fluoride coating at the normal faces to provide peak transmission at either wavelength.

CIRCLE NO. 279

## X-band preamplifier has 50 MHz bandwidth

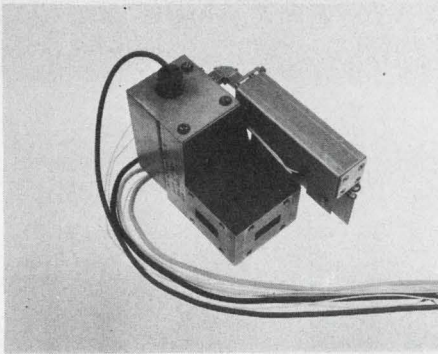

*Melabs, 3300 Hillview Ave., Stanford Industrial Park, Palo Alto, Calif. Phone: (415) 326-9500.*

A fixed-tuned parametric amplifier provides a 50-MHz bandwidth in the 8.5 to 12 GHz range. Its noise figure is 3.5 dB maximum for 16 dB gain. The amplifier operates over a temperature range of -40° to +70°C, and handles up to 200 mW cw input power. The small size (4 × 5 × 6 in.) and modular design allow packaging in a variety of configurations.

CIRCLE NO. 280

## C-band beacon antenna withstands 3000°F

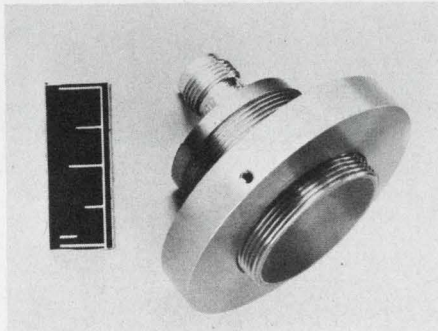

*Dorne and Margolin, Inc., 2950 Veteran's Memorial Highway, Bohemia, L.I., N.Y. Phone: (516) 585-4000.*

A C-band tracking antenna, designated DM AQ200-1, will survive heat pulses to 3000°F and operate for five minutes in a 1000°F environment. The antenna weighs 5 oz, is 1.5 in. long and has a 1.3-in. diameter. The frequency range is 5400 to 5800 MHz with a VSWR of less than 1.5:1.

CIRCLE NO. 281

## Laser mirror mount pivots on 2 axes

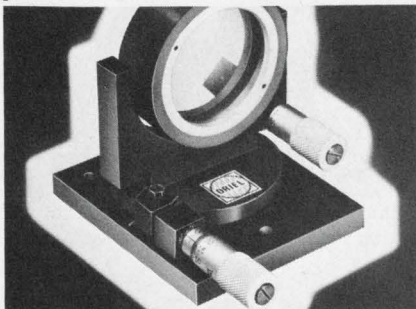

*Oriel Optics Corp., 1 Market St., Stamford, Conn. Phone: (203) 348-4247.*

A laser mirror mount provides precise adjustment of the mirror plane about the vertical and horizontal axes independently. The precision micrometer drives are spring loaded to prevent backlash. The mount holds 2-in. dia mirrors directly or 1-in. and 1-1/2 in. dia mirrors with adapters.

CIRCLE NO. 282

## Broadband antennas radiate to 12 GHz

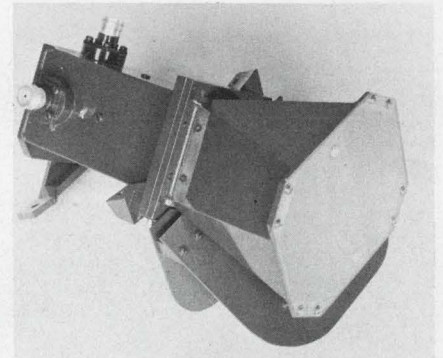

*Nurad, Inc., 2165 Druid Park Dr., Baltimore, Md. Phone: (301) 664-8300. P&A: \$600 to \$1500; 60 days.*

A series of broadband transmitting antennas are available in any specified octave frequency band in the 500 MHz-to-12-GHz frequency range. This group of two-port, dual, circularly polarized antennas is ideal for airborne electronic applications, where high gain, high-power handling and pattern control are required.

CIRCLE NO. 283

## Directional couplers range to 12.4 GHz

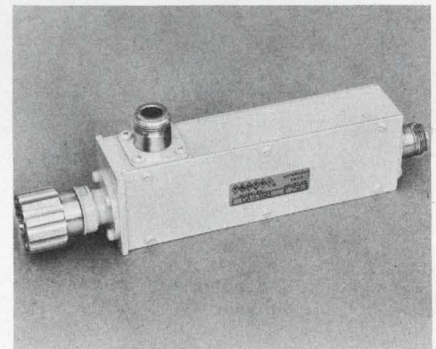

*Rantec, 24003 Ventura Blvd., Calabasas, Calif. Phone: (213) 347-5446.*

High-directivity directional couplers that provide coaxial measurement accuracy equal to that of a waveguide cover 200 MHz to 12.4 GHz. They are suited for broadband swept reflectometer setups or for constant VSWR monitoring systems. Minimum directivity for the five couplers ranges from greater than 40 dB to more than 30 dB.

CIRCLE NO. 284



## Desk-top electronic calculator speeds problem-solving

Hewlett-Packard Co., 1501 Page Mill Rd., Palo Alto, Calif. Phone: (415) 326-7000.

A wholly self-contained electronic calculator can perform an impressive variety of numerical calculations.

All ordinary calculator functions, such as add, subtract, multiply, divide and square root, are performed with ten-digit accuracy. At the touch of a finger, the machine computes the logarithm of a number, common or natural, as well as the full range of trigonometric functions in all quadrants including angular values exceeding  $360^\circ$ . An internal extended arithmetic unit enables the calculator to perform computations involving vectors or complex numbers. A single stroke

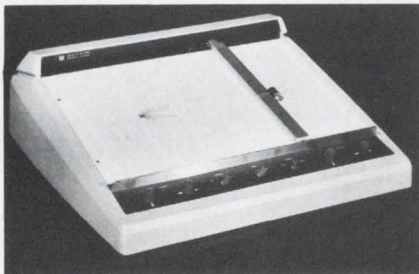

An accessory X-Y plotter will be available as a calculator option.

of a key makes the conversion between rectangular and polar coordinates. Hyperbolic functions are also on the keyboard. Lengthy program sequences required by other calculators for such operations are eliminated.

One of the more impressive features of the instrument is a range that reaches from  $1 \times 10^{-98}$  to  $9.999999999 \times 10^{99}$ . The user is not compelled to keep track of decimal points and is unlikely to overtax the machine's capacity.

Complete operating cycle for add or subtract manipulations is 2 ms. Multiplication averages 12 ms, division averages 18 ms and the trigonometric functions are typically computed in 280 ms. A complete polar-to-rectangular transformation or its inverse is a 300-ms operation.

Programming capability is such that as many as 196 key strokes may be fed into the built-in core memory using no accessories. All keys are labeled in English or standard mathematical symbols; no special computer language must be mastered. A stored program may also be recorded on a palm-sized card by means of which the program may be reentered at any time.

CIRCLE NO. 360

## Test instrument checks servos



Industrial Control Co., Central Ave. at Pinelawn, Farmingdale, L.I., N.Y. Phone: (516) 694-3000. P&A: \$1800; 6 wks.

One- and two-speed, 400-Hz synchro servos are quickly checked out by a rack-mounted test instrument. Three modes are provided for testing servos for static error, synchro zero alignment, direction of rotation, error constant, slewing rate and low-speed or creep performance.

CIRCLE NO. 285

## Programmable pulser varies rise and fall



Aerojet-General Corp., Aerometrics Div., P.O. Box 216, San Ramon, Calif. Phone: (415) 837-5343.

Offering linear variable rise and fall and dc base line offset, the model PG-300 pulse generator extends voltage programming capability to include linear rise and fall times from 5 ns to 1 ms. The dc base line offset is variable from +10 to -10 V into a  $50\text{-}\Omega$  load on both the positive and negative outputs. This particular feature allows duty cycles to 100%. Other programmable parameters include repetition rate, amplitude, delay and width. The unit is of solid-state construction and weighs approximately 10 lbs.

CIRCLE NO. 292

## Frequency counter covers up to 6.5 GHz

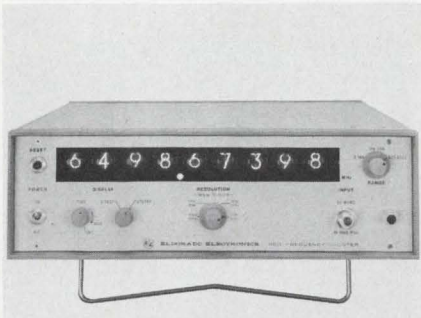

Eldorado Electronics, 601 Chalmar Rd., Concord, Calif. Phone: (415) 686-4200. Price: \$4250.

Microwave frequency measurements may be made, with few manual operations and no calculations, with a counter that covers the frequencies between 20 Hz and 6.5 GHz. The only manual operation necessary with this equipment is the setting of a three-position switch. In addition to a visual presentation, print-out data are provided for digits and decimal points.

CIRCLE NO. 287

## Stable potentiometer calibrates itself



RFL Industries, Inc., Boonton, N.J. Phone: (201) 334-3100. P&A: \$1700; 6 to 8 wks.

Self-calibration circuitry allows a direct-readout potentiometer to be recalibrated without the need for an external standard. Terminals permit the cell circuit to be monitored at all times. An internal zeroing circuit ensures a constant zero. The seven-digit, six-dial in-line readout provides a resolution of 1  $\mu$ V on the high range.

CIRCLE NO. 288

# Ballantine low-cost DVM's are small, easy-to-use... permit fast, highly accurate measurements in production with unskilled personnel... are ideal, too, for the lab and quality control. Compare their many useful features.

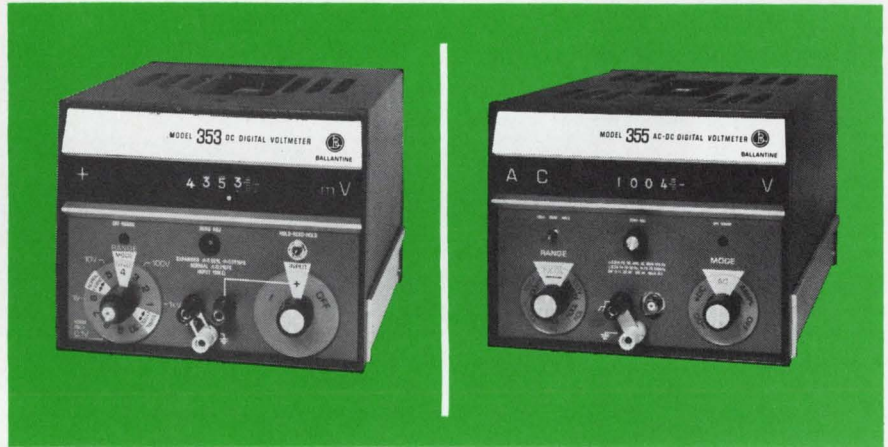

## BALLANTINE DC DVM

### Model 353

Designed to replace multi-knob manual vm's for speed and accuracy ■ 0 to 1100 V ■ High accuracy  $\pm 0.02\%$  of reading  $\pm 0.01\%$  f.s. ■ 4 digit with overranging to 5, plus interpolation of last digit ■ Resolution 0.002% ■ Reading retention or continuous observation of varying signals ■ All solid state ■ 10 megohms input resistance ■ Isolated signal ground with high common mode rejection ■ Small size ( $\frac{1}{2}$  rack module) and low weight (7.7 lbs.) ■ Power requirement 115/230 V, 50 to 60 Hz ■ Price: \$510

## BALLANTINE AC-DC DVM

### Model 355

Designed to increase accuracy and speed up readings compared to those made with analog instruments ■ 0 to 1000 V ac, 30 Hz to 250 kHz ■ 0 to 1000 V dc ■ Accuracy 0.25% f.s. ■ Full scale sensitivity of 10 mV on ac; 100 mV on dc ■ 3 digits with overranging to 4, plus interpolation of last digit ■ Single economical package ■ Small size ( $\frac{1}{2}$  rack module) ■ Reading retention, or continuous observation of varying signals ■ Isolated signal ground, with high common mode rejection ■ DC output for connection to recorder ■ Amplifier output, 60 dB gain ■ Zener reference ■ Power requirement 115/230 V, 50 to 60 Hz ■ Price: \$640

Write for brochures giving complete details



**BALLANTINE LABORATORIES INC.**

Boonton, New Jersey

CHECK WITH BALLANTINE FIRST FOR DC AND AC ELECTRONIC VOLTMETERS/AMMETERS/OHM METERS, REGARDLESS OF YOUR REQUIREMENTS. WE HAVE A LARGE LINE, WITH ADDITIONS EACH YEAR. ALSO AC/DC LINEAR CONVERTERS, AC/DC CALIBRATORS, WIDE BAND AMPLIFIERS, DIRECT-READING CAPACITANCE METERS, AND A LINE OF LABORATORY VOLTAGE STANDARDS FOR 0 TO 1,000 MHZ.

INFORMATION RETRIEVAL NUMBER 65

### Battery analyzer tests cell-by-cell

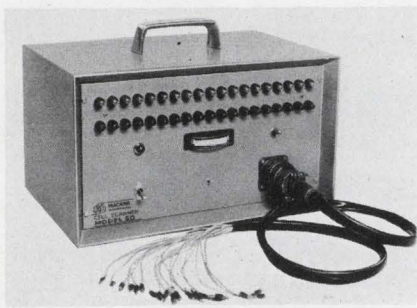

Macarr, Inc., 4360 Bullard Ave., New York. Phone: (212) 325-5510.

An instrument that automatically evaluates batteries by testing each cell's performance individually under load, permits as many as 19 cells to be monitored in only 5 s. During operation, white pilot lights indicate cells being scanned; a red light, which remains on until manually reset, indicates which cell is at fault.

CIRCLE NO. 293

### Bidirectional counter reverses in 1 $\mu$ s



Anadex Instruments Inc., 7833 Haskell Ave., Van Nuys, Calif. Phone: (213) 782-9527. P&A: \$1445; 4 wks.

A counter that will measure bidirectional-frequency signals at up to a 1-MHz rate can change count direction in less than 1  $\mu$ s. The unit features 5 input-signal modes which are selected by a front-panel switch. Input sensitivity is compatible with shaft transducer signals and is 100 mV at 1 M $\Omega$  input impedance.

CIRCLE NO. 294

### Test instrument measures phase

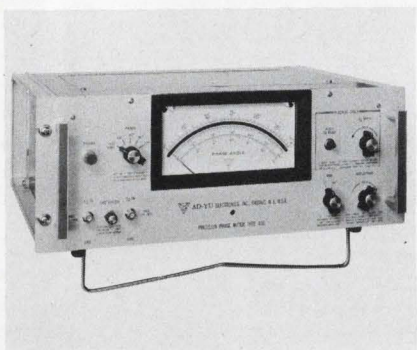

Ad-Yu Electronics, Inc. 249-259 Terhune Ave., Passaic, N.J. Phone: (201) 472-5622. P&A: \$845; stock.

A phase-measuring instrument that directly indicates phase angle has a frequency range from 1 Hz to 100 kHz, and it offers analog output for plotting phase curves over its entire frequency and amplitude range. A large panel meter with a 7.2-in. mirrored scale can be read to 0.1°. Amplitude variations from 0.05 to 90 V can be handled without switching.

CIRCLE NO. 295

### SCR testers come in 3 styles

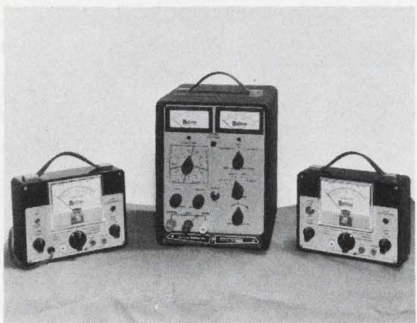

Solitron Devices, Inc., 256 Oak Tree Rd., Tappan, N.Y. Phone: (800) 431-1850.

The series includes a battery-powered unit, suitable for field testing; an ac-powered, 50-60 Hz, go-no-go device, valuable for quick inspections in the plant, and an all-solid-state laboratory instrument that gives accurate readings for such parameters as gate voltage and current, anode-to-cathode leakage and dc holding current.

CIRCLE NO. 296

### Microwave synthesizer resolves to 1 Hz



Frequency Engineering Laboratories, Farmingdale, N.J. Phone: (201) 938-9221. P&A: \$13,390; 6 wks.

A microwave synthesizer generates stable rf energy over a 1.2-to-2.4-GHz range in increments as small as 1 Hz. Stability is  $2 \times 10^{-3}$  ppm/day, and non-harmonically related spurious signals are held 70 dB below the desired frequency. Frequency selection is provided either by front-panel decade switches or electronically for remote operation.

CIRCLE NO. 297

### Briefcase laboratory breadboards fluidics



General Electric Co., Research & Development Center, P.O. Box 8, Schenectady, N.Y. Phone: (518) 346-8771. P&A: \$450; 2 wks.

A portable kit of materials and circuit ideas to familiarize engineers and designers with the field of fluidics includes everything needed to carry out experiments. The kit permits construction of a variety of circuits, such as frequency-to-analog, decoupling or differentiating, lead-lag and others. A comprehensive instruction manual is included.

CIRCLE NO. 298



## Matrix board programs testing



Lorlin Industries, Inc., 30 Padanaram Rd., Danbury, Conn. Phone: (203) 744-0096.

A 12 × 10 matrix board serves as a rapid front-panel sort programmer in an automatic tester for checking and classifying semiconductor devices. The instrument performs conventional dc and pulsed measurements, including leakage current, breakdown voltage, common-emitter current gain and saturation voltage.

CIRCLE NO. 299

## Five-lb oscilloscope covers dc to 10 MHz

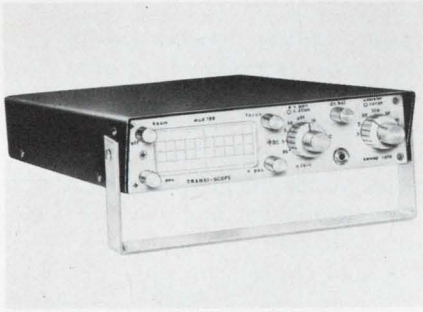

Measurement Control Devices, Inc., Philadelphia. Phone: (215) 426-8602.

Weighing 5 lb and measuring 1-3/4-in. high, 7-1/2-in. wide and 14-in. deep, this dc-to-10-MHz oscilloscope is small and light enough to slip into a briefcase for use on field trips. Constructed to withstand rough handling, it incorporates ICs. Input impedance is 1 MΩ at 75 pF. The CRT has a 1 × 2-1/2-in. face scaled in 0.25-in. squares.

CIRCLE NO. 323

## Frequency meter has digital display



Itron Corp., 8141 Engineer Rd., San Diego, Calif. Phone (714) 279-7200. P&A: \$1580; 60 days.

An automatic digital frequency meter continuously monitors and displays any test signal frequency between 15 MHz and 10 Hz. Resolution at 10 Hz is 0.001 Hz or better. Display is by five glow-indicators plus a dual-scale meter for sixth and seventh digits. The instrument also has automatic range selection and analog output for strip-chart or X-Y recording.

CIRCLE NO. 324

## Dc null detector offers 8 ranges

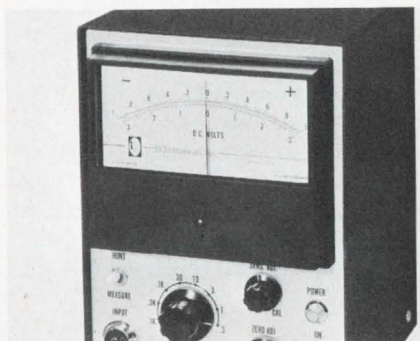

IB Instruments, Inc., 7016 Euclid Ave., Cleveland. Phone: (216) 431-4790. P&A: \$275; 4 wks.

A solid-state dc null detector uses a FET modulator-demodulator in its ac amplifier. Eight ranges, from 300 μV to 1 V full scale, have input resistances from 100 KΩ to 100 MΩ. Accuracy is ±2% of full scale. The detector is available as a line- or battery-operated instrument. It is housed in a cabinet 5.5 in. wide, 8 in. high and 5 in. deep.

CIRCLE NO. 325

# Bulova forks solve low frequency problems

Let the experience behind 300,000 forks per year help you!



American Time Products forks are now available up to 25 kc, thanks to years of experience plus new design techniques developed by Bulova. (Including the tiny forks for Accutron® electronic timepieces, Bulova made 300,000 last year alone!)

Result: ATP units provide lower cost, smaller size, lighter weight and greater long term stability in such applications as Computers, Navigation Systems, Doppler Radar, Motor Drives, Encoders and Timers. Accuracies of up to 0.001% are available.

Bulova fork oscillators offer the added advantage of simplicity of design and circuitry. Fewer components mean greater reliability. Finally, Bulova fork products are uniquely capable of withstanding severe shock and vibration environments.

No wonder Bulova sold 300,000 last year!

### FS-11 FORK FREQUENCY STANDARD

Standard Frequencies: Up to 10,000 cps

Accuracy: Up to ±.001%

Input: 28V DC (others on request)

Output: 5 volts p-to-p min. into 10K ohms

Temperature Range: As low as -55°C to as high as +85°C

Size: 1 1/2 in. sq. x 3/8"

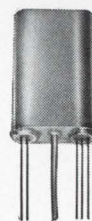

### SUB-MINIATURE TF-500 TUNING FORK

Standard Frequencies: Up to 2400 cps

Accuracy: Up to ±.001% at 25°C

Input: 28V DC (others on request)

Output: Up to 5V rms into 20K ohms

Temperature Range: As low as -55°C to as high as +85°C

Size: 3/8" x 3/4" x 1 1/2" max.

Write or call for specifications on Bulova's complete line of tuning fork products. Address: Dept. ED-16

# BULOVA

AMERICAN TIME PRODUCTS

ELECTRONICS DIVISION OF BULOVA WATCH COMPANY, INC.

61-20 WOODSIDE AVENUE WOODSIDE, N.Y. 11377, (212) DE 5-6000

INFORMATION RETRIEVAL NUMBER 66

## Three urethane foams mix when needed



Kerr Chemicals, Inc., 1001 North-West Highway, Des Plaines, Ill. Phone: (312) 827-4477. Price: \$3.98 (12 oz.)

A urethane foam package in aerosol form is available in three formulations. All three are pre-measured with exact amounts of catalyst and urethane that are mixed in the carton. This eliminates mess, waste and formula failures from faulty measuring.

To mix, push down on carton.

A self-extinguishing formulation meets the specifications of the American Society for Testing Materials (ASTM). While this is combustible in direct contact with flame, once the flame is removed, the cured foam extinguishes itself. With a density of 2 lb/ft<sup>3</sup>, this formulation has excellent dimensional stability and will not shrink—even at temperatures below zero.

A second urethane material will withstand temperatures of up to 280°F. It meets ASTM specifications for nonburning materials. It is suitable for use as thermal insulation in electronics equipment. The cured foam is light tan.

With sufficient free-rise space, a single aerosol can provide up to 1/2 ft<sup>3</sup> of rigid urethane foam.

All three formulations provide good thermal insulation characteristics and adhere to metal, wood, glass, fiberglass laminates, fabrics and most other non-waxy materials.

CIRCLE NO. 326

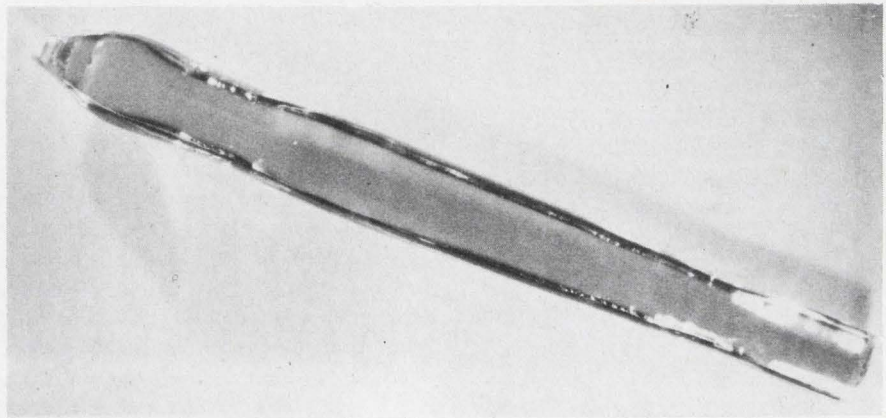

## Lithium niobate crystals are free of striation

Adolf Meller Co., P.O. Box 6001, Providence, R.I. Phone: (401) 331-3717.

Developed for a wide variety of electronic and optical applications, large lithium niobate (LiNbO<sub>3</sub>) single crystals are being offered commercially. The crystals are free of visible inclusions (Tyndall scattering) and are free of striation.

The important physical and electrical characteristics of the optically nonlinear crystals include: large electro-optic coefficients, large electromechanical coupling, extremely small acoustic transmission losses, transparency from 0.4 to 5 microns wavelength, a melting point of 1250°C, a Curie temperature of 1210°C, Moh hardness of 6, and insolubility in water.

Crystals are available from stock in sizes up to 1/2 in. dia and 6 in. length, with "a" or "c" axis orientation.

Larger crystals can be produced to user specifications.

The LiNbO<sub>3</sub> is fabricated into such configurations as rods, bars, cubes, prisms and optical flats. The applications include use as a frequency doubler and tunable laser, infrared detector, modulator, delay line and transducer.

For lithium niobate to function as a frequency doubler and tunable laser, advantage is taken of the material's large negative birefringence in the visible and near-infrared frequencies. Adjustment of the temperature of the crystal results in phase-matching of the fundamental and harmonic waves.

Because the material is piezoelectric, it can act as its own transducer, eliminating losses associated with bonded transducers. Its Q (10<sup>5</sup>) is equal to those of YIG and YAG.

CIRCLE NO. 327

## Inert fluorochemical tests and cools

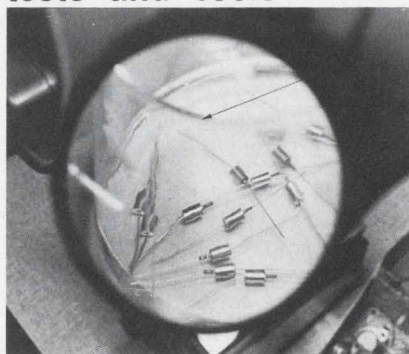

3M Co., 3M Center, 2501 Hudson Rd., St. Paul, Minn. Phone: (612) 733-1804.

A family of inert fluorochemical liquids is used for electric testing and cooling. FC-40 is a fluorinated liquid designed to help solve gross leak testing and IC performance testing problems. Typical properties of FC-40 include a nominal boiling point of 155°C and a pour point of -60°C. Its dielectric strength is greater than 350 V/mil.

CIRCLE NO. 328

## Etched lead wires of molybdenum foil

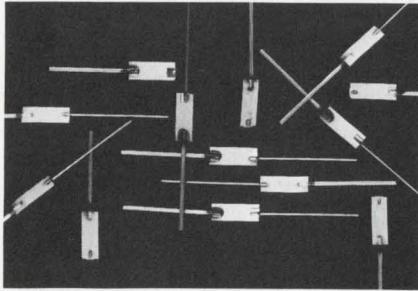

General Electric Co., Lamp Metals & Components Dept., 21800 Tungsten Rd., Cleveland. Phone: (216) 266-2121.

Etched molybdenum foil lead wires are for use in many types of hard glass or quartz encapsulated devices for high temperature applications. The welded assemblies provide internal and external electrical connections and mechanical support plus a hermetic sealing capability in such applications as mercury arc lamps, tungsten-halogen cycle lamps, and infrared heat lamps. They can also be used in electronic and instrumentation applications where electrical connections through quartz are necessary. Etched molybdenum foil leads are composed typically of an outer lead of KW molybdenum wire, an inner lead of Type 218 tungsten wire, with a center piece of etched molybdenum foil attached to each lead wire by a platinum clad molybdenum welt tab. The molybdenum foil that enables the hermetic pinch seal to be made has been etched to an approximately lenticular cross section. This cross-section minimizes the danger of forming a leak channel along the edge of the foil. The outer leads are furnished in standard diameters of 0.03 in. or 0.04 in. with tolerances of  $\pm 0.001$  in. Inner lead diameters are 0.01 in. or 0.02 in. with a tolerance limitation of  $\pm 0.0005$  in. Standard widths of the foil section are nominally 0.123, 0.065, 0.2 and 0.3 in. respectively. Foil thickness at the centerline is 0.001 in.  $\pm 0.0001$  in. Weld strength of these lead wire assemblies is good and passes the standard GE peel strength test with 40 grams applied force as a minimum requirement.

CIRCLE NO. 329

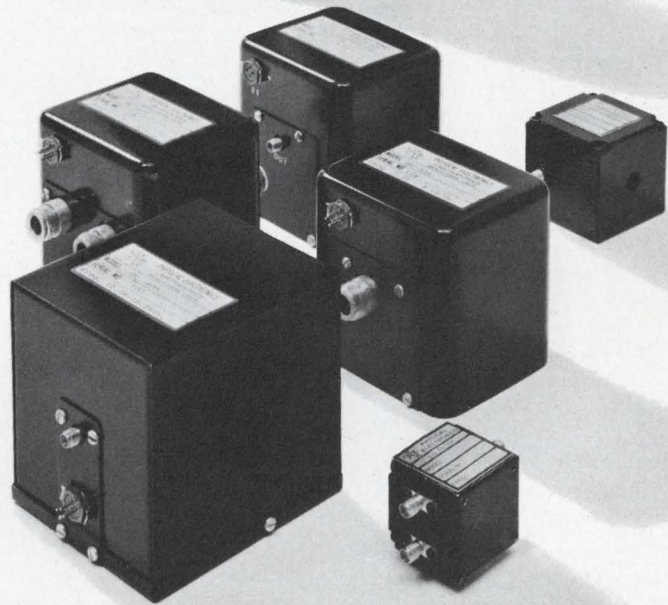

## Nearly everyone comes around to our YIG designs

PEL's YIG designs satisfy virtually any systems requirement. We pioneered this technology and now have a complete line of "black boxes." PEL developed the first dual channel YIG filter and the first YIG discriminators. And we were the first to produce them in volume for systems application.

We consistently design and build production models with specs that are superior to those of the prototype. And, when we transfer a device to production, its specs are guaranteed. You can depend on reliable, repeatable performance. You won't find a YIG filter with a lower insertion loss than a PEL YIG filter.

Technical acumen, emphasis on quality, reproducible performance . . . these are the things that make PEL designs the best available. Call PEL for the latest information on YIG devices in the 0.5 to 26 GHz frequency range.

Send for your copy of our latest short form catalog—soon.

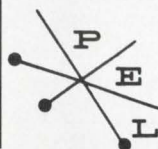

### Physical Electronics Laboratories

1185 O'Brien Drive • Menlo Park, California 94025,  
(415) 323-9092

INFORMATION RETRIEVAL NUMBER 67

## Multiplex switch has 4 channels

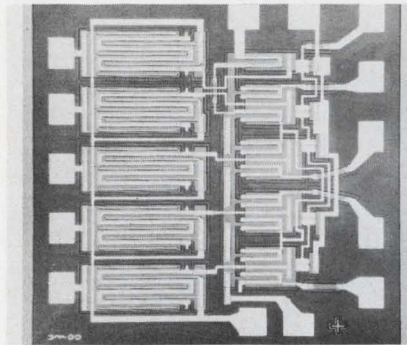

Fairchild Semiconductor, 313 Fairchild Dr., Mountain View, Calif. Phone: (415) 962-2530. Price: \$50 to \$62.50.

Four-channel multiplex switch provides compatibility with npn bipolar logic and features blanking control of all channels. The 3700 is a monolithic IC utilizing a P-channel enhancement mode MOS technology. On-chip control logic controls the output transistors and is used to shift MOS logic levels to npn bipolar logic levels. The output transistors approximate a perfect switch by incorporating an OFF impedance ( $10^{12} \Omega$ ), low ON impedance ( $270 \Omega$ ) and zero offset voltage. They serve as switches to channel four signal paths into a single output or summing point, with an OFF/ON ratio of  $10^{10}$  typically. MOS handling problems have been minimized by means of input gate protection.

CIRCLE NO. 330

## Voltage comparator built in 14-pin case

Fairchild Semiconductor, 313 Fairchild Dr., Mountain View, Calif. Phone: (415) 962-2530. Price: \$7.50.

The  $\mu A710C$ , a high-speed differential voltage comparator, is in a 14-pin plastic dual in-line package. It is available only in a low-profile, eight-lead TO-5 design and flatpack. The device is useful in such applications as pulse height discriminators, variable threshold Schmitt triggers, voltage comparators in high-speed A to D converters, memory-sense amplifiers, and high-noise immunity line receivers.

CIRCLE NO. 331

## MOS memory cell holds 16-bits

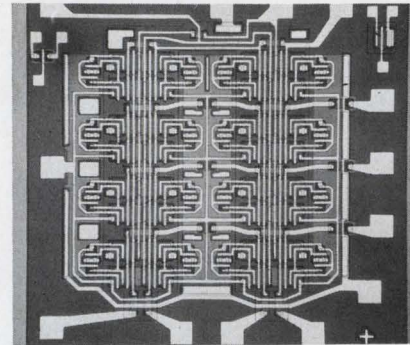

RCA, Industrial Tube & Semiconductor, Lancaster, Pa. Phone: (717) 393-3661. Price: \$25. (evaluation quantities.)

A 16-bit memory cell, type TA5406, employs n-channel and p-channel enhancement type MOS transistors connected in a complementary-symmetry circuit configuration, a coincident current address system, separate "0" and "1" SENSE/WRITE lines, and a primary sense line. The TA5406 operates at supply voltages up to 15V.

CIRCLE NO. 332

## Economy linear ICs available in 3 types

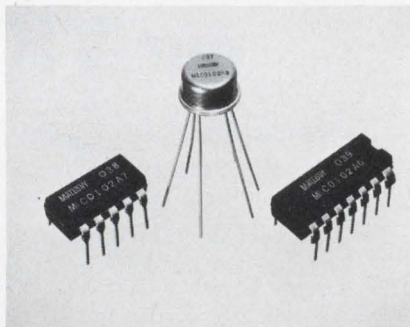

P. R. Mallory & Co., Inc., 3029 E. Washington St., Indianapolis. Phone: (317) 636-5353. Price: 80¢ to \$1.70.

Economy linear ICs are being offered for use as amplification devices in tape players and radios, and stereo sound systems. The preamplifier (MIC 0101) and dual preamplifier (MIC 0103) are designed for use with magnetic transducer inputs. The driver amplifier (MIC 0201) is designed for use with class-A single-ended pnp power stages.

CIRCLE NO. 333

## Hybrid IC op amp uses FET input

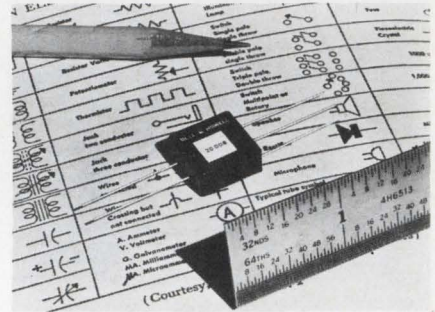

Control Products Div., Bell & Howell Co., 706 Bostwick Ave., Bridgeport, Conn. Phone: (203) 368-6751. Price: \$30-\$35.

A hybrid microcircuit FET-input operational amplifier measures 0.6 x 0.6 x 0.25 in. The device exhibits a  $10^{11} \Omega$  input impedance, 25-pA (max) leakage current (10-pA maximum version is available), large gain-bandwidth and a 5-mA output. The 008 has an internal voltage offset trim (guaranteed to be less than 1 mV), internal frequency compensation and internal short-circuit protection. The epoxy flat package has planar-positioned, gold-plated leads to match standard pin patterns.

CIRCLE NO. 334

## Dual flip-flop is JK or D circuit

Fairchild Semiconductor, 313 Fairchild Dr., Mountain View, Calif. Phone: (415) 962-2530. Price: \$10 to \$20.

A dual TTL flip-flop can function as a standard JK or Type D circuit. The T $T\mu$ L 9022 has a high-speed performance of 35 MHz and can be used in storage, shifting and counting registers. A companion to the 9020 JK flip-flop, the device provides separate direct clear and direct set inputs. These direct functions are asynchronous and take precedence over all other operations of the 9022. Packaged in a 16-pin hermetic, dual in-line, the device performs as a Type D flip-flop when the J and K inputs are tied together. Its common JK input feature eliminates the need for gating clock waveforms and minimizes clock skew problems.

CIRCLE NO. 335

# now-in-production

## HIGH RF VOLTAGE PISTON TRIMMER CAPACITORS

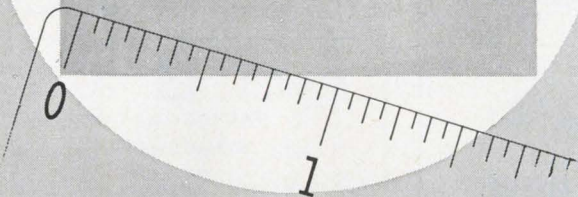
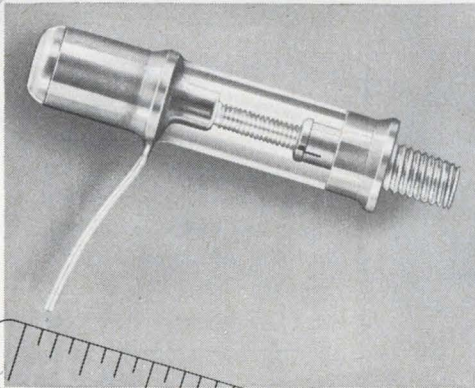

A new High RF Voltage Piston Trimmer Capacitor featuring high stability and small size is now available from JFD. The VCJ1616D is applicable in communications equipment and wherever a small trimmer capacitor is needed to handle large voltage peaks and high power at elevated temperatures. It operates over a frequency range of from 1 to 30 MHz.

This trimmer has an especially designed fused-quartz cylinder which yields an extremely low dissipation factor and temperature coefficient.

The operating RF voltage level of this unit is 3100 Volts peak at +25°C derated to 2500 Volts peak at +200°C. Its capacitance is variable from 0.5 to 5 pf, and its operating temperature range is from -55°C to +200°C. Its turning torque is 1-10 inch ounces in accordance with the Mil Spec.

The unit is furnished for panel mounting. It is 1 3/8" long and 5/16" in diameter.

Bulletin Hi RFV-67 will give you additional information. Write for your copy today.



"TODAY'S COMPONENTS BUILT FOR TOMORROW'S CHALLENGES"

JFD ELECTRONICS CO. / COMPONENTS DIVISION 15th Avenue at 62nd Street  
Brooklyn, New York 11219 / Phone 212-331-1000  
Offices and subsidiaries in principal cities, world-wide.

See us at Hannover Fair, Hannover, Germany"—April 27th-May 5th.

INFORMATION RETRIEVAL NUMBER 68



## 2-piece traps are out!

### Zenith uses Dale hybrid Series-Resonant Trap in FM circuitry

Zenith wanted a better way to bypass 10.7 MHz in its FM receivers. To replace the standard 2-component inductor-capacitor trap, Dale provided this unique hybrid.

Dale's Series-Resonant Trap has the electrical characteristics of an inductor and a capacitor in series and provides a method of controlling both functions. The result: Controlled self-resonance in a miniaturized circuit.

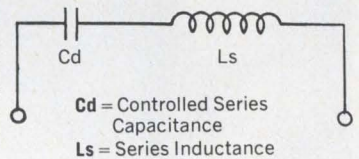

After four years of production use, Zenith says of the Series-Resonant Trap: "It saves space, saves time, works satisfactorily." Here are the basic specs:

- **Resonant Frequency:** 10.7 MHz  $\pm$  .5 MHz (Other frequencies available)
- **Impedance at Design Frequency:** 15 $\Omega$  or less
- **Impedance at  $\pm$ 50% of Design Frequency:** 1500 $\Omega$  min.

Space and money-saving components like this are a growing part of Dale's Sioux Division. Write for more information or call Dale at 605-665-9301.



**DALE ELECTRONICS, INC.**  
**SIoux DIVISION** Dept. ED  
Yankton, South Dakota 57078

Producers of: Toroids, Series Resonant Traps, Variable Pitch Inductors, Miniature High Frequency Inductors, Degaussing Coils, Industrial and Military Coils, Sub-Miniature Coils, Surge and Lightning Arresters, Custom Assemblies, Motor Driven Potentiometers.

# MIXERS

5 - 500 MHz

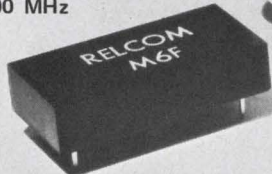

.05 - 200 MHz

ONLY 0.25 INCHES HIGH

Space problems? Here are double-balanced mixers that are compatible with the component height on your pc board. Only 0.25 inches high, these flat packets provide double-balanced performance at single-balanced prices. Isolation for M6F is typically > 45dB up to 500 MHz. Conversion loss typically 6dB up to 200 MHz... < 8dB up to 500 MHz.

Circle the reader-service card for complete information. Model M6A or M6F, \$38 in quantities 1 - 4, \$28 in quantities of 100.

## RELCOM

2329 Charleston Road, Mountain View, California 94040  
Telephone (415) 961-6265 TWX (910) 379-6979

INFORMATION RETRIEVAL NUMBER 70

# Design Aids

**D.A.T.A. Inc.**  
30 Lincoln Ave.  
Orange, N.J. 07066

**CONVERSION FACTORS**

WEIGHTS		LENGTHS		TEMPERATURES		PRESSURES		VOLUMES		DENSITIES	
Grain	8.81	Grain	0.001543	°C	°F	lb/ft <sup>2</sup>	kg/m <sup>2</sup>	cc	cm <sup>3</sup>	lb/ft <sup>3</sup>	kg/m <sup>3</sup>
...	...	...	...	...	...	...	...	...	...	...	...

## Conversion factors

A Conversion Factors chart gives the formula for converting one unit of measurement to another. It contains conversion formulas for more than 450 units of measurement, arranged alphabetically for easy reference. D.A.T.A., Inc.

CIRCLE NO. 336

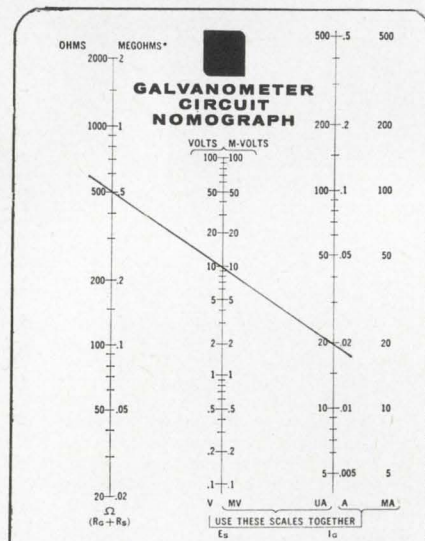

## Galvanometer aid

A pocket-size reference guide lists galvanometer characteristics and provides a nomograph to determine relationships between current, resistance and source voltages. When two values are known, the third can be found by intersecting the two known points by a straight line. Honeywell Test Instruments Division.

CIRCLE NO. 337



**PLAY IT SAFE:**  
Start now  
to save  
their hearts

Help your children form good health habits now to reduce risk of heart attack later:

- Encourage normal weight; obesity in youth may persist throughout life;
- Build body health through regular physical activity;
- Serve them foods low in saturated fats;
- Teach them that cigarette smoking is hazardous to health;
- Make medical check-ups a family routine.

Set a good example. Follow the rules yourself and guard *your* heart, too.

**GIVE...  
so more will live  
HEART  
FUND**

Contributed by the Publisher

# EASTMAN 910<sup>®</sup> Adhesive... bonds bronze to nylon in micro-dial assembly.

To obtain desired micro-dial gear ratios for use in their weighing equipment, Heltzel Steel Form and Iron Company, Warren, Ohio reassembles the gears on standard dials purchased by the company.



In the reassembly, a small naval bronze gear is quickly bonded to a white nylon gear and common bushing with a few drops of EASTMAN 910 Adhesive. The result is a fast setting bond with excellent joint strength and ability to withstand the vibration and torque of the variable, rotating, weight setting device. Not one bond failure has been reported in the three years EASTMAN 910 Adhesive has been used by Heltzel.

EASTMAN 910 Adhesive will form bonds with almost any kind of material without heat, solvent evaporation, catalysts, or more than contact pressure. Try it on your toughest bonding jobs.

For technical data and additional information, write to Chemicals Division, EASTMAN CHEMICAL PRODUCTS, INC., Kingsport, Tennessee. EASTMAN 910 Adhesive is distributed by Armstrong Cork Company, Industry Products Division, Lancaster, Pennsylvania.

## Here are some of the bonds that can be made with EASTMAN 910 Adhesive

Among the stronger: *steel, aluminum, brass, copper, vinyls, phenolics, cellulose, polyesters, polyurethanes, nylon; butyl, nitrile, SBR, natural rubber, most types of neoprene; some woods.*  
Among the weaker: *polystyrene, polyethylene (shear strengths up to 150 lb./sq. in.).*

INFORMATION RETRIEVAL NUMBER 71



# There is no adhesive like EASTMAN 910<sup>®</sup> Adhesive

**SETS FAST**—Makes firm bonds in seconds to minutes.

**VERSATILE**—Joins virtually any combination of materials.

**HIGH STRENGTH**—Up to 5000 lb./in.<sup>2</sup> depending on the materials being bonded.

**READY TO USE**—No catalyst or mixing necessary.

**CURES AT ROOM TEMPERATURE**—No heat required to initiate or accelerate setting.

**CONTACT PRESSURE SUFFICIENT.**

**LOW SHRINKAGE**—Virtually no shrinkage on setting as neither solvent nor heat is used.

**GOES FAR**—One-pound package contains about 30,000 one-drop applications. (Or in more specific terms, approximately 20 fast setting one-drop applications for a nickel.)

The use of EASTMAN 910 Adhesive is not suggested at temperatures continuously above 175°F., or in the presence of extreme moisture for prolonged periods.

See Sweet's 1968 Product Design File FAS-5/Ea.

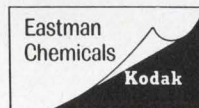

## For EMI/RFI APPLICATIONS

from SHIELDED ENCLOSURES

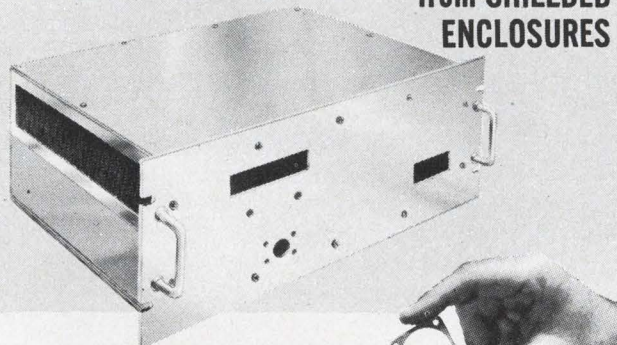

### ...To SHIELDING GASKETS

TECKNIT has a line of EMI/RFI Shielding devices that can help you.

### FREE

#### 80 PAGE PRODUCT CATALOG

contains complete technical details on shielding strips and gaskets; shielding & fluid seal gasketing; shielded air filters & vent panels; shielded cabinet components... meet EIA standards. Write or call today for catalog #8551.

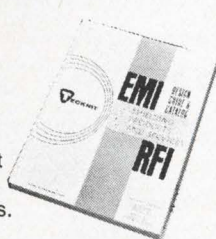

TECHNICAL WIRE PRODUCTS, INC.

East Division • 129 Dermody St.,  
Cranford, N. J. 07016 (201) 272-5500  
West Division • 427 Olive St.,  
Santa Barbara, Calif. 93101 (805) 963-1867



INFORMATION RETRIEVAL NUMBER 72

ELECTRONIC DESIGN 7, April 1, 1968

IEC

## 20 MHz COUNTER/TIMER

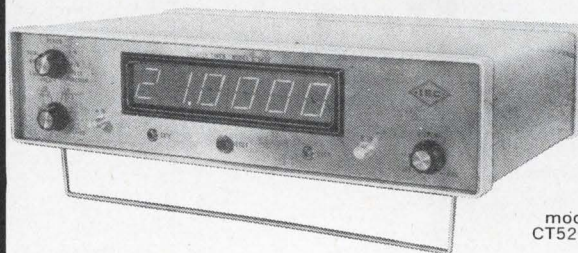

model  
CT520P

**\$1075.00**

#### FUNCTIONS:

Frequency, Period, Multiple Period, Elapsed Time, Ratio, Multiple Ratio, Manual Start/Stop, Totalize, Test.

#### ADDITIONAL FEATURES:

5 HZ-20MHz both channels, BCD Output, Clock Output (1 MHz). Power Requirements 115/230 V, 50-60 Cycle or 12 VDC, 35 Watts. Sensitivity 10mv rms. both channels.

#### TIME BASE:

1 MHz Oven controlled Crystal.

#### Other Products:

RF Signal  
Generators,  
Receivers,  
Preamps, Probes,  
Detectors,  
Custom Systems  
Phone  
716-377-5990

IEC

**INTERCONTINENTAL**  
*Electronics Corp.*

260 MACEDON CENTER ROAD  
FAIRPORT, NEW YORK 14450

"See us at the U.S. TRADE CENTER - London, England, May 15th through May 23rd".  
INFORMATION RETRIEVAL NUMBER 73

Evaluate these  
new Babcock Relays  
in your system.

You'll find them  
"ON THE SHELF"

at these  
distributors!

**AVNET ELECTRONICS CORPORATION**  
10916 Washington Boulevard  
Culver City, California  
Phone: (213) 870-0111, (213) 870-6141  
TLX 674-354

344 Middlefield Road  
Mountain View, California 94041  
Phone: (415) 961-7700; TLX 34-8441

First National Bank Building, East  
5301 Central Avenue N.E., Suite 1400E  
Albuquerque, New Mexico 87108  
Phone: (505) 265-7926; TLX 74-6459

2318 6th Avenue  
Seattle, Washington 98121  
Phone: (206) 623-8824; TLX 32-249

1729 North 28th Avenue  
Phoenix, Arizona 85009  
Phone: (602) 272-6821; TLX 66-750

1020 W. Ellsworth Avenue  
Denver, Colorado 80223  
Phone: (303) 623-6255; TLX 45-687

207 Cambridge Street  
Burlington, Massachusetts 02103  
Phone: (617) 272-3060

3901 Pace Court  
Schiller Park, Illinois 60176  
Phone: (312) 678-6310; TWX 312-678-2522

70 State Street  
Westbury, L.I., New York 11590  
Phone: (516) 333-8650; TLX 12-5928

4940 Viking Drive, Suite 208  
Minneapolis, Minnesota 55435  
Phone: (612) 920-5866; TWX 910-576-2784,  
TLX 029-5250

87 Wingold Avenue  
Toronto 19, Ontario, Canada  
Phone: (416) 789-1838; TLX 02-29195

1505 Louvain Street West  
Montreal 11, Quebec, Canada  
Phone: (514) 0381-9127; TLX 01-20678

**P. D. Q. ELECTRONICS CORPORATION**  
9559 Irontdale Avenue  
Chatsworth, California 91311  
Phone: (213) 882-0500; TWX 910-494-1235

**POWELL ELECTRONICS, INC.**  
S. Island Road, P. O. Box 18765  
Philadelphia, Pennsylvania 19101  
Phone: (215) 724-1900; TWX 710-670-0465

10728 Hanna Street  
Beltsville, Maryland 20705  
Phone: (301) 474-1030; TWX 710-828-9710

P. O. Box 488  
Fayetteville, Tennessee 37334  
Phone: (615) 433-5737; TWX 810-380-3890

2049 W. Central Boulevard  
Orlando, Florida 32805  
Phone: (305) 423-8586; TWX 810-850-0155

**Foreign Representation:**

**SWEDISH ELEKTROLINK AB**  
Stora Nygatan 39  
Stockholm C, Sweden  
Phone 114595; Cable Teletink

**A.E.M.G.P.**  
115 Avenue J. B. Clement  
Boulogne s/Seine, France  
Phone 825-96-20; Telex 842-27985

**BODAMER GmbH**  
8022 Grunwald Bei Munchen  
Keltenstr. 2a, West Germany  
Phone 471862

For price, delivery and application  
data call Babcock collect.  
Be sure to ask for Ext. 1000 when  
placing your call.



BABCOCK RELAYS

# Application Notes

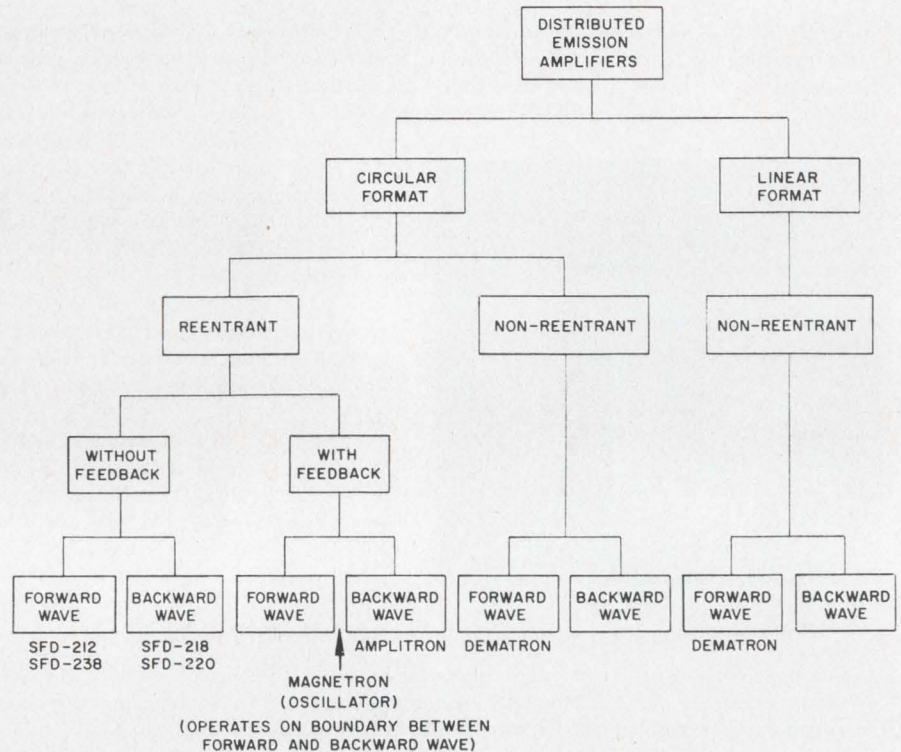

## Crossed-field amplifiers vs TWT

A 26-page booklet introducing pulsed crossed-field amplifiers provides a general and qualitative description of the behavior of crossed-field amplifier (CFA) tubes. Supported by 37 graphs, charts and illustrations, the text describes how the CFA, as a compact and lightweight microwave amplifier, provides bandwidth comparable with the TWT at low to moderate gain levels. Operating with high efficiency (40 to 75%), the CFA generates large amounts

of peak power with relatively low applied voltages, making these tubes particularly suited for applications in which the transmitter must be either airborne, spaceborne, transportable, mobile or portable. Chapters of the booklet present a discussion of the tube's transfer characteristics, the CFA as an rf and as a dc circuit element, the emission process of the cathode, typical performance characteristics with examples and limitation. SFD Laboratories, Inc.

CIRCLE NO. 338

## Time-series analysis

This monograph will attempt to impart a practical understanding of techniques for the development of the Fourier Transform and its methods, probability theory, correlation and spectral-density functions and optimum-filter theory. This note is devoted to the introduction of linear time-series analysis. Time/Data Corp.

CIRCLE NO. 339

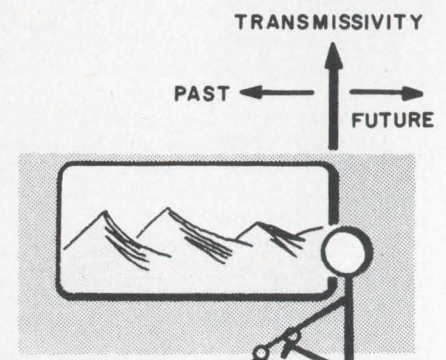

INFORMATION RETRIEVAL NUMBER 74 ►



**Four  
New  
Babcock  
Relays**

**BR42**

- Welded Crystal Can
- 2 Amp.—DPDT
- Single-Coil
- Universal Contacts
- To MIL-R-5757

**BR30**

- One-Inch Cube
- 4 PDT—10 Amp.
- Single-Coil
- All-Welded
- To MIL-R-6106

**BR24**

- Welded, Low-Profile
- 10 Amp.—DPDT
- Single Coil
- Universal Contacts
- To MIL-R-5757

**BR26**

- Welded Half-Size
- 2 Amp.—DPDT
- Single-Coil
- Universal Contacts
- To MIL-R-5757



**BABCOCK RELAYS**  
Babcock Electronics Corp.  
3501 Harbor Blvd.  
Costa Mesa, Calif. 92626  
Telephone: (714) 540-1234

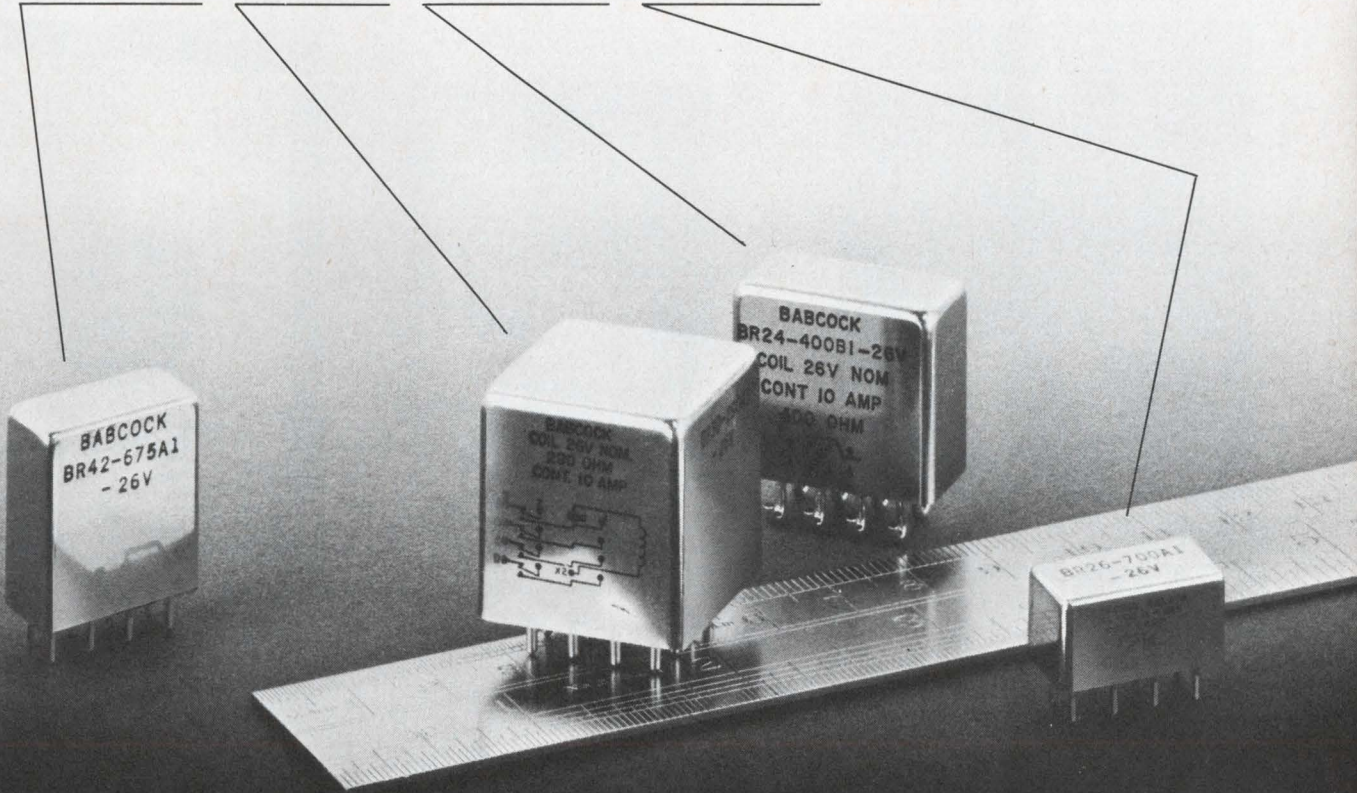

**New: At significantly lower prices!**

**Still the same: Babcock quality**

**Where: At your Babcock distributor When: Now!**

# New Literature

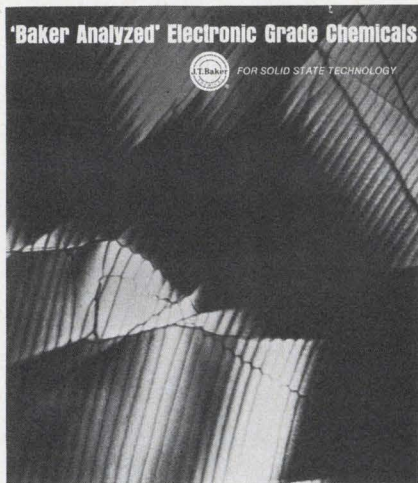

## Electronic chemicals

Data sheets describe a line of chemicals with high specifications that meet the needs of the electronics industry. More than 30 electronic-grade chemicals offer rigid specifications that ensure a high degree of product purity to provide high performance in electronic applications. The actual analysis of each lot is printed on each package label. These chemicals are used in the manufacture of transistors, integrated circuits and other semiconductor devices as well as in tube and capacitor manufacture. They are used in washing, stripping, cleaning and etching operations. J. T. Baker Chemical Company.

CIRCLE NO. 340

## Urethane encapsulant

A new color brochure describes the properties and uses of a new urethane elastomer. Formulated for room-temperature-cured potting and encapsulating, the material features low stress, low exotherm and excellent resistance to thermal cycling. The folder covers electrical and physical properties, moisture-sensitivity factors, production hints, recommended production equipment and plotted curves showing exotherm and gel-time relationships to mixed mass. Hardman, Inc.

CIRCLE NO. 346

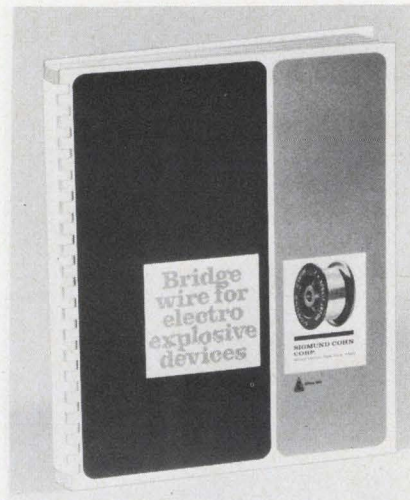

## Wire handbook

Featured in a 44-page wire-selection guide are five graphic charts plotting resistance vs. diameter for various metals and alloys, as well as a nomogram. A second section is a tabulation of 34 metals and alloys, identified numerically on the same resistivity basis as the graphs. Sigmund Cohn Corp.

CIRCLE NO. 342

## Fractional hp motors

A 17- by-22-in. wall chart lists over 1000 fractional horsepower motors from 1/2000 to 1/4 hp. Shaft rpm torque, electrical specifications, motor type, frame size and price are shown on one side. The reverse side gives motor dimensions and information on motor wiring and speed control. B & B Motor and Control Corp.

CIRCLE NO. 343

## Electronic components

A 100-page catalog, listing the components of all major manufacturers, features such items as accelerometers, counters, meters, motors, precision potentiometers, selsyns, servo-motors, test equipment and timers. Special sections are included on relays, pressure transducers and gyros. The brochure is illustrated with photos, drawings and diagrams. American Relays.

CIRCLE NO. 344

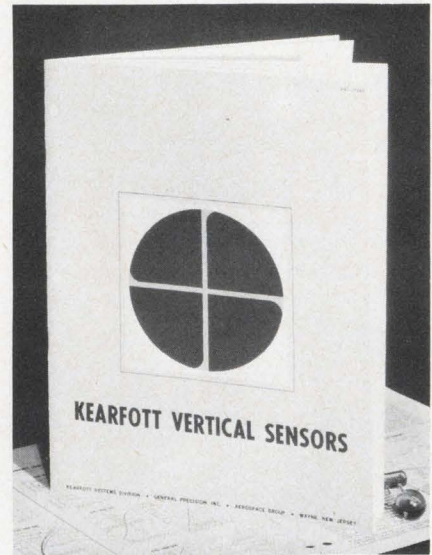

## Vertical sensors

Illustrated with performance curves, schematics, dimensional drawings and pictures, a 12-page booklet describes accurate electrolytic and electromagnetic, pendulous two-axis vertical sensors, used in such applications as vertical gyros, antenna or camera stabilization systems. Other missile, aircraft, ground vehicle and shipboard gyro reference systems are included. Tabulations of operating characteristics appear throughout, for both pendulous and bubble-type sensors. The latter, electrolytic in nature, are described in both single-axis and two-axis configurations, together with notes about typical applications. General Precision, Inc.

CIRCLE NO. 345

## Control knobs

A line of control knobs for electronic equipment is described in a 16-page catalog. Several series of knobs are described. These include military styles, a designer series topped with a burnished aluminum disk, and a group with pastel colors. There are also tactile knobs for use on military equipment. Offered in a variety of shapes and colors, they tell the user by day or night what electronic function the knob controls. Raytheon Co.

CIRCLE NO. 341

# new

## NIXIE® TUBE DRIVERS WITH INTEGRATED CIRCUITS MAKE "BUY" DECISIONS

- PRICED AS LOW AS \$26.00 INCLUDING THE NIXIE TUBE (100 QUANTITY) ■ SMALLEST, MOST CONVENIENT PACKAGES
- COMPATIBLE WITH TTL, DTL, & RTL ■ DECODER/DRIVERS WITH OR WITHOUT MEMORY
- COMPLETE ASSEMBLIES AVAILABLE OFF-THE-SHELF FROM BURROUGHS AND DISTRIBUTORS
- 0.6" CHARACTER HEIGHT OR 0.3" CHARACTER HEIGHT NIXIE TUBES
- MINIMAL NOISE PROBLEMS — DRIVERS ARE MOUNTED AS CLOSE TO TUBES AS POSSIBLE.



ACTUAL SIZE (even with memory).

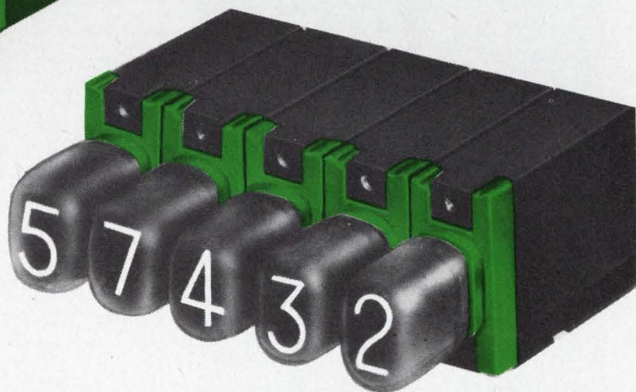

ACTUAL SIZE miniature drivers.\*

### SPECIFICATIONS OF IC NIXIE TUBE DRIVERS

Part Number	Tube Type	Character Height	Max. Overall Length (with tube)	Max. Height	Max. Width	Has Memory	Input Code	Price 100 quantity (includes NIXIE tube)
BIP-8806	Standard B-5991	0.6"	2.506"	1.583"	0.750"	Yes	4 line 8-4-2-1 BCD	30.00
BIP-8804	Standard B-5991	0.6"	2.506"	1.583"	0.750"	No	4 line 8-4-2-1 BCD	26.00
BIP-9801	Miniature B-4998	0.3"	2.648"*	0.960"	0.480"	No	4 line 8-4-2-1 BCD	42.00

\*Note new shorter overall length.

For additional information contact, Burroughs Corporation  
P.O. Box 1226, Department D2, Plainfield, N.J.



**Burroughs Corporation**

# IEC makes miniature electrolytic capacitors BETTER

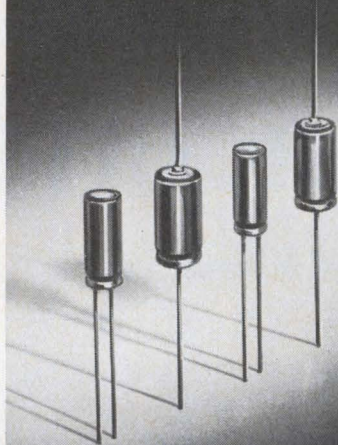

## ... and look at these features:

- Small size
- Aluminum can construction
- Welded lead connections
- Extremely low leakage current
- Meets stringent life and storage test requirements
- Available temperature range:  $-25^{\circ}\text{C}$  to  $+85^{\circ}\text{C}$

## ... and look at these prices\*:

- 5 mfd 15V @ 5¢  
( $-25^{\circ}\text{C}$  to  $+70^{\circ}\text{C}$ )  
IEC Part No. PCW 5A15  
(dimensions: 3/16" x .433")
- 10 mfd 15V @ 6¢  
( $-10^{\circ}\text{C}$  to  $+85^{\circ}\text{C}$ )  
IEC Part No. TAZ 10B15  
(dimensions: 1/4" x .472")

Send for general information and specifications on IEC's miniature electrolytic and miniature polyester capacitors for solid state equipment.



**INTERNATIONAL ELECTRONICS CORP.**  
Melville, Long Island, New York

ELECTRON TUBES • SEMICONDUCTORS • COMPONENTS

\*In production quantities

## NEW LITERATURE

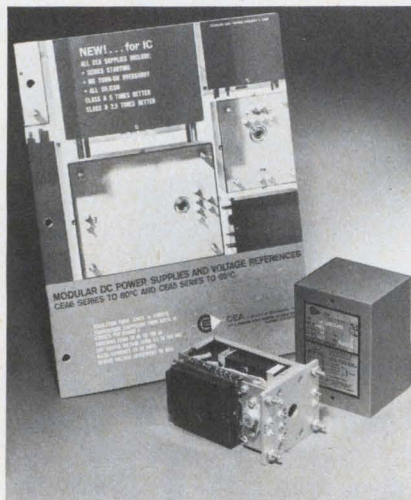

### Regulated dc supplies

Dc power supplies, described in a 20-page catalog, offer a choice of four regulations from 0.05% to 0.0005% to allow the engineer to specify any regulation that his system requires. All supplies include silicon semiconductors and shielded transformers. Selection can be made in any desired center voltage from 3.5 to 500 V with an adjustment range of  $\pm 1\%$ ,  $\pm 5\%$ ,  $\pm 10\%$ ,  $\pm 20\%$  or  $\pm 40\%$ . Current regulation is offered from 50 mA to 25 A. Additional options cover remote voltage control, input power, protection circuits and ruggedization. CEA, A Div. of Berkleonics, Inc.

CIRCLE NO. 347

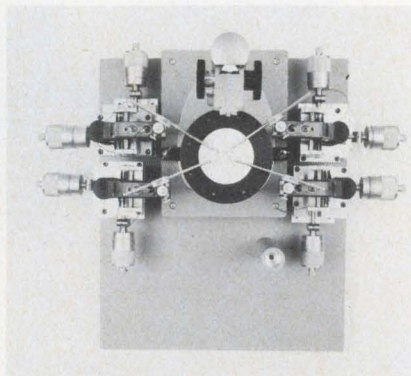

### Micro-manipulators

An assortment of micro-manipulators and positioners, including 42 basic models, are outlined in a 20-page catalog. New models feature high-sensitivity devices, compact designs and accessories for almost any mechanical manipulation. Brinkmann Instruments, Inc.

CIRCLE NO. 348

## DYNAMIC GEAR CO., INC.

CATALOG G-178

World's Largest Selection of

PRECISION STOCK GEARS

SPUR GEARS ALUMINUM & STEEL	48 D.P.
SPUR GEARS ALUMINUM & STEEL	64 D.P.
SPUR GEARS ALUMINUM & STEEL	72 D.P.
SPUR GEARS ALUMINUM & STEEL	96 D.P.
SPUR GEARS ALUMINUM & STEEL	120 D.P.
DELTRIN® GEARS	D.G.
COMPOUND GEARS	C.G.
ANTI-BACKLASH GEARS	A.B.
STANDARD SLIP CLUTCHES	S.S.C.
MINIATURE LINE GEARS	M.L.
DIFFERENTIALS	DIFF.
GEAR HEADS	G.H.
LIMIT STOPS	L.S.
CONTINUOUS SLIP CLUTCHES	C.S.C.
WORMS & HELICAL GEARS	W.H.
BEVEL GEARS	B.G.
BALL BEARINGS	B.B.
SHAFTING & SHIM SPACERS	Sh
CLAMPS & COLLARS	C.C.
COUPLINGS	COUP.

Precision  
Stock Gears  
and Allied  
Components

plus Complete  
Engineering Capabilities

### Gear catalog



A 176-page catalog describes 250,000 precision stock gears and related components. A variety of bevel, anti-backlash, compound, helical worm and spur gears, plus slip clutches, differentials, gear heads, speed reducers, ball bearings and limit stops are covered. The comprehensive handbook contains complete engineering drawings and related data on sizes, materials and tolerances. A special section is devoted to gear design and application data, including definitions and illustrations of basic terms, discussions of materials and details of design and tolerance calculation. Dynamic Gear Co.

CIRCLE NO. 349

### Electronics hardware

A 25-page catalog covers such product categories as jacks, plugs, switches, connectors, indicating devices and audio accessories. The information is condensed, and the electronic components are all stocked by industrial distributors. A postage-paid card is included, so that product specifications, drawings or other technical data can be obtained promptly. This catalog includes numerous electronic components for applications with computers, analyzers, transmitters, receivers, ground-support systems and scientific instruments. Switchcraft, Inc.

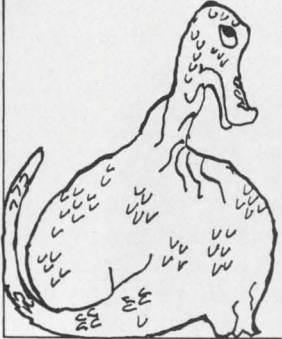
CIRCLE NO. 350

<p><b>NO BOUNCE NO BOUNCE</b></p>	<p>Hippopotamus*</p> 
<p>Trachodon*</p> 	<p>Gordos reed switch*</p> 

\*If you demand over 50,000,000 no bounce operations, a Gordos reed switch is your best wet beast. Send for color catalog.

**GORDOS CORPORATION**  
250 Glenwood Ave., Bloomfield, N.J. 07003 • 201-743-6800

INFORMATION RETRIEVAL NUMBER 80

**SPRING  
BUYERS  
DESIGN  
ENGINEERS  
MAINTENANCE  
ENGINEERS**

**FREE**

Our new Catalog has over 2500 spring designs. IMMEDIATE DELIVERY Compression — Extension — Torsion. Complete engineering data on each spring. All orders received by 2 pm EST will be shipped same day.

**LEE STOCK SPRINGS**  
OVER 2500 DIFFERENT DESIGNS  
MANUFACTURED TO  
ENGINEERED STANDARDS

COMPRESSOR    EXTENSION    TORSION

**MUSIC WIRE**  
Part Spn. 00-W-472

**STAINLESS STEEL**  
Part Spn. 00-W-443

**INCONEL**  
Part Spn. 00-W-396

**IMMEDIATE DELIVERY FROM STOCK**

ORDERS RECEIVED BEFORE 2 PM SHIPPED SAME DAY

**LEE SPRING COMPANY**  
DIVISION OF LEETRONICS, INC.

50 YEARS OF EXPERIENCE

**OVER 2500 STOCK SPRINGS with complete Engineering data on each spring.**

**LEE SPRING COMPANY**  
DIVISION OF LEETRONICS, INC.

30 MAIN STREET, BROOKLYN, N.Y. 11201    212-855-7163  
TWX 212-643-9349

**50 YEARS OF EXPERIENCE**

**SME**

INFORMATION RETRIEVAL NUMBER 81

ELECTRONIC DESIGN 7, April 1, 1968

**the last time you used a 'scope, did you really need more performance than these Heathkit® models provide?**

**Heathkit IO-17**  
... new 5 MHz  
3" 'scope ... only  
**\$79.95**



**IO-17 SPECIFICATIONS** — **VERTICAL CHANNEL:** Input impedance: 1 megohm shunted by 25 pF; x 50 attenuator position 1 megohm shunted by 15 pF. **Sensitivity:** 30mV P-P/div. (uncalibrated). **Frequency response:** 5Hz to 5MHz ±3 db. **HORIZONTAL CHANNEL:** Input impedance: 10 megohm shunted by 15 pF. **Sensitivity:** 300 mV P-P/div. **Frequency response:** 2Hz to 300 kHz ±3 db. **HORIZONTAL SWEEP GENERATOR:** Sweep generator: Recurrent type. **Frequency:** 20Hz to 200 kHz in four overlapping ranges. **Retrace:** Blanked by a pulse from blanking amplifier. **Synchronization:** Automatic type. **GENERAL: Tube complement:** (1) 3RP1 cathode ray tube, medium persistence, green trace; (3) 12AU7; (1) 12AX7; (1) 6GH8; (1) 6BH6; (1) 6BQ7. **Power requirements:** 105-125 volts 50/60 Hz or 210-250 volts 50/60 Hz. **Power consumption:** 60 watts. **Overall dimensions:** 9½" H x 5½" W x 14½" L. (Dimensions include handle, knobs, etc.). **Net weight:** 12 lbs.



**Heathkit IO-14**  
... DC to 8 MHz  
5" 'scope ...  
triggered sweep  
... 0.25 usec  
delay line input ...  
assembled  
**\$399.00**  
kit  
**\$259.00**

**IO-14 SPECIFICATIONS** — (VERTICAL) **Sensitivity:** 0.05 V/cm AC or DC. **Frequency Response:** DC to 5 MHz — 1 dB or less; DC to 8 MHz — 3 dB or less. **Rise time:** 40 nsec (0.04 microseconds) or less. **Input impedance:** 1 megohm shunted by 15 pF. **Signal delay:** 0.25 microsecond. **Attenuator:** 9-position, compensated, calibrated in 1, 2, 5 sequence from 0.05 V/cm to 20 V/cm. **Accuracy:** ±3% on each step with continuously variable control (uncalibrated) between each step. **Maximum input voltage:** 600 volts peak-to-peak; 120 volts provides full 6 cm pattern in least sensitive position. (HORIZONTAL) **Time base:** Triggered with 18 calibrated rates in 1, 2, 5 sequences from 0.5 sec/cm to 1 microsecond/cm with ±3% accuracy or continuously variable control position (uncalibrated). **Sweep magnifier:** X5, so that fastest sweep rate becomes 0.2 microseconds/cm with magnifier on. (Overall time-base accuracy ±5% when magnifier is on.) **Triggering capability:** Internal, external, or line signals may be switch selected. Switch selection of + or — slope. Variable control on slope level. Either AC or DC coupling. "Auto" position. **Triggering requirements:** Internal; 0.5 cm to 6 cm display. External; 0.5 volts to 120 volts peak-to-peak. **Triggering frequency response:** DC to 2.5 MHz approx. **Horizontal input:** 1.0 v/cm sensitivity (uncalibrated) continuous gain control. **Bandwidth:** DC to 200 kHz ±3 db. **Power requirements:** 285 watts. 115 or 230 VAC 50-60 Hz. **Cabinet dimensions:** 15" H x 10½" W x 22" D includes clearance for handle and knobs. **Net weight:** 40 lbs.



**FREE 1968 CATALOG**

Describes these and over 300 kits for stereo/hi-fi, color TV, amateur radio, shortwave, test, CB, marine, educational, home and hobby. Save up to 50% by doing the easy assembly yourself. Mail coupon or write Heath Company, Benton Harbor, Michigan 49022.

**HEATHKIT**

**HEATH COMPANY, Dept. 520-26**  
Benton Harbor, Michigan 49022

Enclosed is \$ \_\_\_\_\_, plus shipping

Please send model (s) \_\_\_\_\_

Please send FREE Heathkit Catalog.

Please send Credit Application.

Name \_\_\_\_\_  
(Please Print)

Address \_\_\_\_\_

City \_\_\_\_\_ State \_\_\_\_\_ Zip \_\_\_\_\_

Prices & specifications subject to change without notice.    TE-178

INFORMATION RETRIEVAL NUMBER 82

## ELECTRONICS ABSTRACTS JOURNAL

A QUARTERLY REFERENCE JOURNAL DEVOTED TO ELECTRONIC PHYSICS, DEVICES, CIRCUITS AND SYSTEMS

DESIGNED TO ASSIST THE ELECTRONICS SPECIALIST LOCATE INFORMATION

On a Specific Subject or Topic, in a Fraction of the Time required by a Conventional Literature Search.

PRESENTED IN ABSTRACT FORM, COMPLETELY INDEXED

By Subject, Topic, Source and Author and Thoroughly Cross-referenced.

15,000 ABSTRACTS PER YEAR

**CAMBRIDGE COMMUNICATIONS CORPORATION**

1612 K St. N.W.  
Washington, D.C. 20006  
(202) 393-1239

*Specialists in Scientific Information Retrieval for over 10 years*

INFORMATION RETRIEVAL NUMBER 83

# YOUR HEART FUND FIGHTS

HEART ATTACK  
STROKE  
HIGH BLOOD PRESSURE  
INBORN HEART DEFECTS

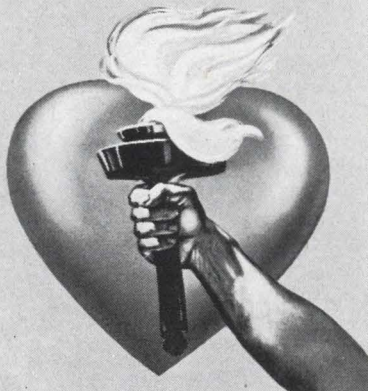

## NEW LITERATURE

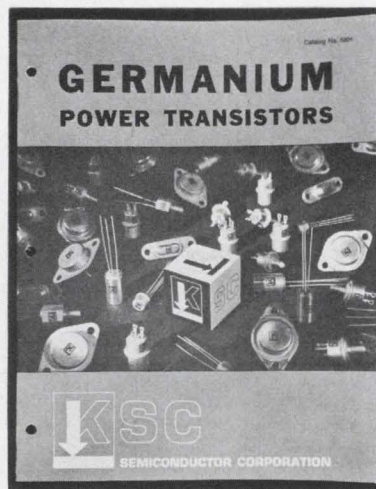

### Semiconductor catalog

A 16-page short-form catalog lists more than 1200 germanium power transistors. The two-color illustrated brochure lists many types formerly manufactured exclusively by CBS, Clevite, ITT, Sylvania and others. It gives electrical as well as mechanical specifications for types ranging in power from 0.4 W to 90 W in all popular package designs. KSC Semiconductor Corp.

CIRCLE NO. 351

### Filter specifications

This brochure, printed in 2 colors, describes standard and custom filters in the frequency range of 2 MHz to 18 GHz. Technical information on filter characteristics, terminology, design parameters and performance definitions are given. The profusely illustrated booklet includes filter specification charts and a comprehensive listing of various filters, detectors, diplexers, triplexers and quadraplexers. American Electronic Laboratories, Inc.

CIRCLE NO. 352

### Reflow soldering data

A paper describing single- and multiple-lead reflow soldering, was presented at the recent National Electronic Conference Show in Chicago. The paper describes the reflow soldering process, equipment and techniques. Reflow soldering equipment that is capable of connecting as many as 14 integrated circuit leads at once is discussed. The Sippican Corp.

CIRCLE NO. 353

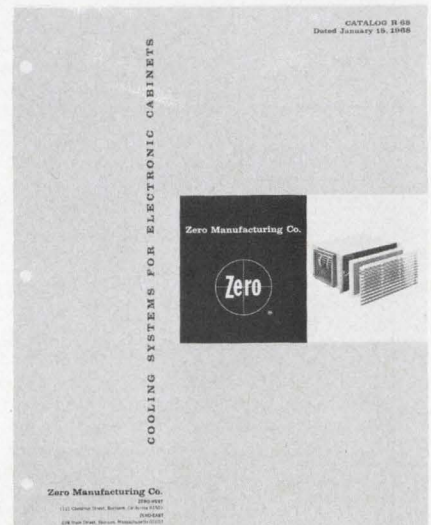

### Cooling systems

A 24-page catalog describes blowers and systems for cooling electronic cabinets. Designed to fit standard 19-in. racks per MIL-Std-189, the blowers are available in ranges from 200 to 1200 ft<sup>3</sup>/min and are provided with 50- or 60-Hz ball-bearing motors. Catalog pages list applicable government specifications, complete construction data, sizes, electrical properties and rfi shielding applications. In addition, detailed drawings and dimensional data are shown. The catalog features extensive engineering data for practical blower selection, including cooling formulas, air delivery and heat dissipation curves, horsepower requirements and noise criteria. Zero Manufacturing Co.

CIRCLE NO. 354

### Video disc memories

A comprehensive input-output manual contains details on digital video disc memories. Single disc memories with up to 72 completely independent tracks provide low-cost, high-density data buffer storage and are effectively used to store digital video data to refresh CRT displays. Each track has its own read-write and clock electronics so that tracks can be read or written in parallel. Tracks can be written without disturbing data on adjacent tracks. The manual includes diagrams of the timing, read-write circuits, input-output circuits, a brief applications section and photographs. Data Disc, Inc.

CIRCLE NO. 355

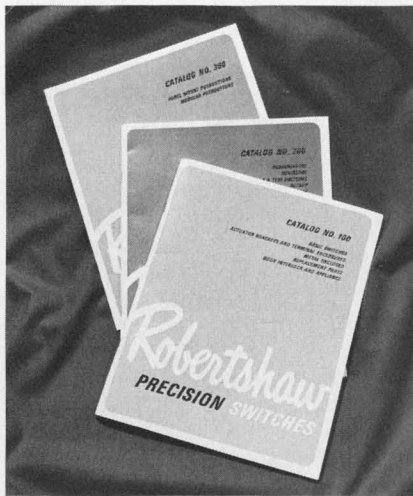

### Switch catalogs

Three catalogs cover a broad selection of electrical switches. An 84-page publication describes basic switches, actuator brackets and terminal enclosures. It also covers metal-enclosed, interlock and appliance switches. An additional section lists replacement parts and equivalents. The second catalog covers subminiature, rotary and open-blade switches. A third 20-page brochure describes panel mount and modular push-button switches. Robertshaw Controls Co.

CIRCLE NO. 356

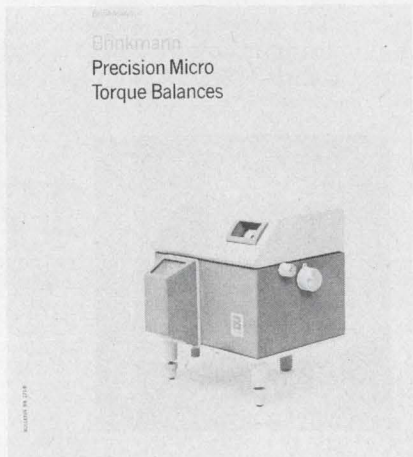

### Micro torque balance

An 8-page brochure describes a micro torque balance offered with an all-digital readout system. This balance has other unique features—single observation window, mechanical taring, uniwire design and separate coarse and fine controls. Fourteen models and their accessories are described. Brinkmann Instruments Inc.

CIRCLE NO. 357

### Silicone-rubber molding

Describing silicone-rubber molding techniques, a brochure details a full line of colored standard silicone-rubber lamp filters, imbedded lamps and sheet lenses. The brochure illustrates standard filter and lens colors conforming to applicable military specifications; it also covers compounding special filter colors. Master Dynamics Corp.

CIRCLE NO. 358

### Equipment service

A 12-page booklet contains color photographs that illustrate the comprehensive maintenance and repair capabilities of the Westinghouse Repair Division. The brochure gives the address and phone number of each repair plant where 24-hour service is offered on repair of all kinds of equipment. Westinghouse Electric Corp.

CIRCLE NO. 359

# Can you

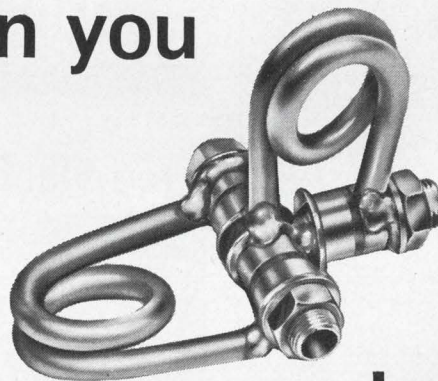

# do this?

These new Johanson glass *capacitors* are designed to bridge the gap between conventional trimmers and high frequency air capacitors. They have high Q—low inductance; they have high RF current characteristics, they can be soldered together with components to simplify circuitry and they are *strong*.

#### Models include:



7330

**Series II:** High RF voltage *low cost* units with  $Q > 1200$  and TC;  $0 \pm 50$  ppm.



7168

**Johanson 7168:** High voltage quartz capacitors which feature 7000 VDC; 2500 V peak RF at 30 mc and current capacity  $> 2$  amps.

#### Also available are:

- Tuners and ganged tuners; linear within  $\pm .3\%$
- Differential capacitors
- Mil spec capacitors
- Microminiature capacitors .075" diameter and .1-1 pf

Write today for full catalog.

**Johanson** MANUFACTURING CORPORATION

400 Rockaway Valley Road, Boonton, N. J. 07005 (201) 334-2676

Electronic Accuracy Through Mechanical Precision

INFORMATION RETRIEVAL NUMBER 84

# Electronic Design

ELECTRONIC DESIGN's function is:

- To aid progress in the electronics manufacturing industry by promoting good design.
- To give the electronic design engineer concepts and ideas that make his job easier and more productive.
- To provide a central source of timely electronics information.
- To promote two-way communication between manufacturer and engineer.

**Want a subscription?** ELECTRONIC DESIGN is sent free to qualified engineers and engineering managers doing design work, supervising design or setting standards in the United States and Western Europe. For a free subscription, use the postfree application form inside the back cover. If none is included, write to us direct for an application form.

If you do not qualify, you may take out a paid subscription for \$25 a year in the U.S.A., \$35 a year elsewhere. Single copies are \$1.50 each.

**If you change your address**, send us an old mailing label and your new address; there is generally a prepaid postcard for this inside the back cover. You will have to requalify to continue receiving ELECTRONIC DESIGN free.

**The accuracy policy** of ELECTRONIC DESIGN is:

- To make reasonable efforts to ensure the accuracy of editorial matter.
- To publish prompt corrections whenever inaccuracies are brought to our attention. Corrections appear at the end of the Letters column.
- To refuse any advertisement deemed to be misleading or fraudulent.

**Microfilm copies** are available of complete issues of ELECTRONIC DESIGN and individual articles, published since the beginning of 1961. Complete issues cost 4¢ a page, articles cost 50¢ a page; shipping and handling charges are extra. The minimum charge is \$3. For further details and to place orders, contact University Microfilms, Inc., 300 N. Zeeb Road, Ann Arbor, Mich. 48106; telephone (313) 761-4700.

**Want to contact us?** If you have any comments or wish to submit a manuscript or article outline, address your correspondence to:

Howard Bierman, Editor,  
ELECTRONIC DESIGN,  
850 Third Avenue,  
New York, N.Y. 10022.

# Design Data from

## TUBE REPLACEMENT SILICON MODULES



A 16 page application note has been prepared by Unitrode on direct and permanent replacement of high-voltage, high-current rectifier tubes with its self-stacking silicon "doorbell" rectifier modules mated with its tube-type bases and anode caps. Presented in this note are the advantages of using solid-state doorbell modules, details of the module's construction, and direct replacement data on over 50 high power rectifier tubes.

**Unitrode Corporation,**  
580 Pleasant Street  
Watertown, Mass. 02172

# 171

## Free Electronic Circuit Symbol Catalog

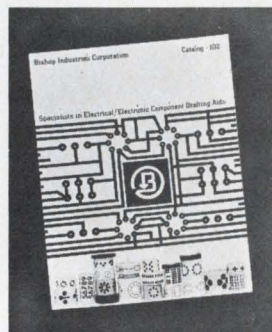

Save artwork and drafting time. Cut costs with thousands of electronic drafting aids and symbols featured in the new 28-page Catalog No. 102 from Bishop. In it is the industry's only complete selection of predrawn circuit component symbols: integrated circuits, logics, semiconductors, flat-packs, transistors, printed circuits, welded modules, etc. Also: tapes, pads, corners, connectors, schematic symbols, reference numbers and more. Included are illustrations, range of sizes and complete price information. Send today for your free copy.

**Bishop Industries Corp.**  
11728 Vose Street  
North Hollywood, California 91605

# 173

## A FREE Cross Reference Guide

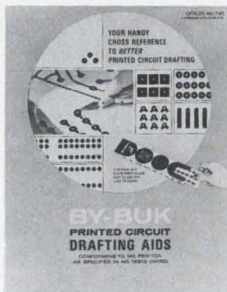

to better Printed Circuit drafting

No engineer or draftsman should be without the NEW 1968 By-Buk Printed Circuit Drafting Aids P-45 Catalog with color-coded MIL-SPEC sizes. Also contains over 2000 pads, shapes, tapes, transistor tri-pads, spaced integrated circuit terminal pad sets and many other drafting aids for faster, more accurate, distortion-free printed circuit master drawings. Send for your FREE catalog.

**By-Buk Company**  
4326 West Pico Blvd., Los Angeles, Calif. 90019  
Telephone: (213) 937-3511

# 175



# Manufacturers

Advertisements of booklets, brochures, catalogs and data sheets. To order use Reader-ServiceCard.  
(Advertisement)

## Equipment Under Test Sign



Bright red and white signs to attach to equipment while it is under test to forestall accidental interference are available from POWER/MATE CORP., Hackensack, N. J. The company is offering these heavy cardboard signs along with their new Power Supply Module Catalog No. 117. The Catalog lists all of the many supplies available from PMC. The package will also include information about their new Uni-88—a 0-34 volt, 1.5 amp. supply that sells for only \$88.00. Racks and other accessories are also available. Write today.

**Power/Mate Corp.**  
163 Clay St.  
Hackensack, N. J. 07601

# 172

## How To Write Technical Articles

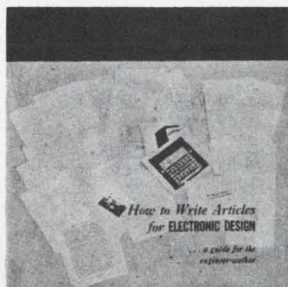

A guide for the engineer-author, "How to Write Articles for Electronic Design" shows how easy it is to write for publication—once the engineer knows what to write and how to write it. The Author's Guide includes a complete run-down of the types of articles published by Electronic Design—plus detailed instructions on how to prepare technical articles and short special features. A MUST for every "would-be-writer" in the electronics industry. Send for your complimentary copy by circling the number to the right.

**Electronic Design**  
850 Third Avenue  
New York, N.Y. 10022

# 174

## ELECTRONIC DESIGN TECHNIQUES

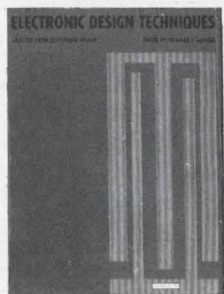

In this outstanding reference book, leaders in electronic design demonstrate for your immediate use new ideas and proven techniques that have solved difficult problems for themselves and their firms. Over 55 practical design studies selected from **Electronic Design** are presented. Vital sections of the book cover the use and design aspects of amplifiers, resistor networks, filters, control devices, power supplies, microwave systems, oscillators, and pulse and switching currents. Edited by Edward E. Grazda. Just published. 312 pages. 352 Illustrations. Large format, 8 1/2 x 11. \$12.75, clothbound. Examine for 15 days without obligation or ask for details.

**HAYDEN BOOK COMPANY, INC.**  
116 W. 14 St.  
New York, N.Y. 10011

# 176

# Electronic Design

## Advertising Representatives

**New York 10022**  
Robert W. Gascoigne  
Thomas P. Barth  
Samuel M. Deitch  
Byron Adams  
850 Third Avenue  
(212) PLaza 1-5530  
TWX: 867-7866

**Philadelphia**  
William C. Repetto  
P. O. Box 206  
Merion Station, Pa. 19066  
(215) MO 4-1073

**Boston**  
Richard Parker  
40 Webb Street  
Salem, Mass. 01970  
(617) 742-0252

**Chicago 60611**  
Thomas P. Kavooras  
Berry Conner, Jr.  
720 N. Michigan  
(312) 337-0588

**Cleveland**  
(216) 247-7670

**Los Angeles 90303**  
Stanley I. Ehrenclou  
Terrence D. Buckley  
W. James Bischof  
2930 W. Imperial Highway  
Inglewood, Calif.  
(213) 757-0183

**San Francisco**  
Ashley P. Hartman  
175 South San Antonio Rd  
Ste. 243  
Los Altos, Calif. 94022  
(415) 941-3084

**Southwestern 75206**  
Tommy L. Wilson  
6200 North Central Express-  
way  
Dallas, Tex.  
(214) EMerson 1-2311

**London W. 1**  
Brayton C. Nichols  
44 Conduit Street

**Verviers, Belgium**  
Andre Jamar  
1, Rue Mallar, 1  
(087) 253.85

**Tokyo**  
IPS Group Ltd.  
Box 36  
Ohsaki Post Office  
Tokyo  
Phone (431) 5804



# Buy Bonds where you work.

They do.



They work for freedom. And more than seven out of ten of them are supporting freedom with their dollars, too — through investment in U.S. Savings Bonds. When *you* buy Bonds, you can save up for a rainy day, a home, a free and comfortable future — and at the same time show these brave men you're on their side. Join the Payroll Savings Plan where you work or buy Bonds where you bank. You'll walk a bit taller.

## New Freedom Shares

Now, when you join the Payroll Savings Plan or the Bond-a-Month Plan, you are eligible to purchase new Freedom Shares. They pay 4.74% when held to maturity of just four-and-a-half years (redeemable after one year), and are available on a one-for-one basis with Savings Bonds. Get the facts where you work or bank.

Join up. America needs your help.



The U.S. Government does not pay for this advertisement. It is presented as a public service in cooperation with the Treasury Department and The Advertising Council.

# Advertisers' Index

Advertiser	Page	Advertiser	Page
Abbott Transistor Laboratories Incorporated	16	Keithley Instruments	38
Acopian Corporation	125	Lee Spring Company	145
Allen-Bradley Co.	35, 37	Lockheed Electronics Company	80
American Aluminum Company	117		
Babcock Relays, Division of Babcock Electronics Corporation	140, 141	Magnecraft Electric Company	15
Ballantine Laboratories, Inc.	131	Melabs, Inc.	128 D
Beckman Instruments, Inc., Helipot Division	105	Micro Technology, Division of Sterling Electronics	123
Bishop Industries Corp.	148	Midtex, Incorporated Aemco Division	89
Bulova Electronics Division of Bulova Watch Company	133	Monsanto Company	45
Burroughs Corporation	143	Motorola Semiconductor Products, Inc.	5, 40, 58
Burton Research Laboratories, Inc.	113		
By-Buk Company	148	National Semiconductor Corporation	27, 29, 50
Cambridge Communications Corp.	146	Ohmite Manufacturing Company	17
Cohu Electronics, Inc.	107		
Consolidated Electrodynamics, A Subsidiary of Bell & Howell	4, Cover III	Paktron Packaged Electronics Div., Illinois Tool Works	59, 60, 61, 62
Coors Porcelain Company	111	Philbrick/Nexus Research, A Teledyne Company	118
Corning Electronics, Division of Corning Glass Works	6	Phillips Electronic Measuring Instruments	10
Cutler-Hammer	39	Physical Electronics Laboratories	135
		Potter & Brumfield Division of American Machine & Foundry Company	81
Dale Electronics, Inc.	63, 64, 137	Power/Mate Corp.	149
Damon Engineering, Inc.	31		
Datapulse, Incorporated	2	RCA Electronic Components and Devices	9, 24, 43, Cover IV
Dow Corning Corporation	66, 67	Relcom	138
Du Pont Company	11		
		Shindengen Electric Mfg. Co., Ltd.	117
Eastman Chemical Products, Inc.	139	Signalite, Incorporated	14
Ehrenreich Photo Optical Industries, Inc.	109	Signetics	8
Electro-Motive Mfg. Co., Inc., The	95	Siliconix Incorporated	92
Electronic Design	10, 149	Sprague Electric Company	18, 20
Electronic Engineering Co. of California	13	Switchcraft, Inc.	12
Ericsson Centrum, Inc.	127	Sylvania, Subsidiary of General Telephone & Electronics	64 A—H, 128 A
Erie Technological Products, Inc.	48		
		TRW Semiconductors, A Subsidiary of TRW, Inc.	Cover II
General Instrument Corporation	68	Technical Wire Products, Inc.	139
General Radio Company	1	Tektronix, Inc., Oscilloscopes	70
Gordos Corporation	145	Thermal American Fused Quartz Co., Inc.	46
		Torngren Co., Inc., C. W.	33
Handy & Hårmon	121		
Hayden Book Company, Inc.	149, 151	Union Carbide Corporation	50, 56 A-B-C-D, 57
Heath Company	145	U. S. Capacitor Corporation	34
Hewlett-Packard	7, 23, 51, 52, 53, 54, 103	Unitrode Corporation	65, 148
Honeywell, Computer Control Division	128 B, 128 D		
Honeywell, Precision Meter Division	55	Vero Electronics, Incorporated	116
		Vitramon, Incorporated	93
IRC, Inc.	47		
Indiana General Corporation	32 A—H	<b>Career Advertising</b>	
Indiana General Corporation, Magnet Division	117	General Dynamics	128 F
Intercontinental Electronics Corp.	139	General Electric Company	128 E
International Electronics Corporation	144	Motorola Government Electronics Division Aerospace Center	114
JFD Electronics Co./Components Division	137		
Johanson Manufacturing Corp.	147		

# Test any of these books for 10 full days...FREE

## MEASURING METHODS & DEVICES IN ELECTRONICS A. J. C. Beerens.

Just Off Press — the definitive source on the why and how of measurement. The book describes instruments commonly used in laboratories, factories and workshops, compares different measuring methods, briefly sums up the sources of error, both human and mechanical. 5 $\frac{7}{8}$  x 8 $\frac{1}{4}$ , 182 pages, illustrated, clothbound.

#5832 ..... \$6.25

## CIRCUIT PROBLEMS & SOLUTIONS: VOL. I, ELEMENTARY METHODS Gerald Lippin.

A refresher and practical guide for electrical problem solving. Each chapter reviews a particular aspect of basic circuit theory, then applies it to numerous problems, showing step-by-step solutions. Nearly 300 problems are covered, including a wide range of a-c and d-c situations from simple series circuits to series-parallel RLC circuits. 208 pages 6 x 9, illustrated, paper cover.

#5754 ..... \$3.95

## PRINCIPLES OF TRANSISTOR CIRCUITS (3rd REVISED ED.) S. W. Amos.

Right in step with the rapid advance in transistor technology, this updated revision presents half again as much information as the previous edition. Contains new material on d-c stabilization of amplifiers by direct-coupled feedback, phase shift and Wien bridge oscillators, blocking oscillators and sawtooth generators, plus appendices on transistor parameters and manufacture. 293 pages 5 $\frac{1}{2}$  x 8 $\frac{1}{2}$ , illustrated, clothbound.

#5649 ..... \$7.95

## BASIC MICROWAVES Bernard Berkowitz.

Develops a clear, comprehensive understanding of the principles underlying modern microwave technology. Although complete in its survey of the field, it is non-rigorous. A knowledge of calculus is not required. Mathematical aids are introduced and explained where needed. Summaries and review questions reinforce each chapter. 169 pages, 6 x 9, illustrated, clothbound.

#5741 ..... \$5.95

## VIDEO TAPE RECORDING Julian Bernstein.

Of great value to everyone in cinematography and television broadcasting, this guide makes the theory and circuitry of video tape equipment completely understandable. It explains the advantages, characteristics and limitations of this medium so the everyone can use it more effectively. 280 pages, 6 x 9, illustrated, clothbound.

#0254 ..... \$8.95

## THE ELECTRONIC INVASION Robert M. Brown.

The best-selling detailed expose of electronic snooping gadgetry spells out do-it-yourself circuits for eavesdropping as well as effective de-bugging techniques. The book names major manufacturers and buyers of snooping devices, surveys the extent of bugging activity by government and corporations, fully covers legal restrictions. 188 pages, 5 $\frac{1}{2}$  x 8 $\frac{1}{2}$ , illustrated, paper cover.

#0779 ..... \$3.95

## SIMPLIFIED INDUSTRIAL TELEMETERING Jeff C. Campbell.

Presents the fundamental principles, techniques and practices of present-day industrial telemetering. Both Short Haul and Long Haul systems are fully discussed, and several chapters are devoted to communication systems between telemetering transmitters and receivers. Analog and digital telemetering equipment, conversion, coding and remote control techniques are also discussed. 138 pages, 5 $\frac{3}{8}$  x 8 $\frac{1}{4}$ , illustrated, paper cover.

#5542 ..... \$3.95

## THE PHYSICAL BASIS OF ELECTRONICS J. G. R. Van Dijk.

Systematically and thoroughly examines the physical phenomena underlying practical applications of electronics. After defining and discussing atomic structure and the basic forms of energy, the book introduces and interrelates the main electronic phenomena. Then, practical electronic functions and devices are explained. Summaries, surveys, glossaries, charts and tables clarify the text. 362 pages, 6 x 9, illustrated, clothbound.

#5706 ..... \$11.95

## UNDERSTANDING MICROWAVES Victor Young.

A basic yet rigorous discussion of the fundamentals of microwaves, their generation, transmission and applications. Book covers basics of waveguides, coaxial lines and resonant cavities as they function in connection with the magnetron, dynatron and klystron. The theory and design of antennas used in microwaves and electromagnetic and electrostatic fields are also covered. 304 pages, 5 $\frac{1}{2}$  x 8 $\frac{1}{2}$ , illustrated, paper cover.

#0107 ..... \$3.95

## MICROELECTRONIC DESIGN Edited by Howard Bierman.

A complete and concise survey of the entire field of microelectronics providing practical and professional ideas from the pages of *Electronic Design*. Almost 90 important studies cover all aspects of this rapidly expanding technology — basic integrated circuit components, thick and thin film, reliability, black-boxing, etc. Valuable data charts, a list of manufacturers, and a full bibliography insure the book's usefulness. 320 pages, 8 $\frac{1}{2}$  x 11, illustrated, clothbound.

#5762 ..... \$11.50

## MODERN NETWORK SYNTHESIS Donald A. Calahan.

Two volumes bound together. Volume I is an introduction to the literature of the approximation field, directed towards the worker in filter design who wants to up-date his knowledge and towards the student looking for more stimulating work in the network field. Volume II introduces the literature in the areas of multi-port passive and active networks and related topics. It contains brief introductions to passive n-ports, active networks, scattering matrices, sensitivity and equivalent networks. 240 pages, 6 x 9, illustrated, clothbound.

#5010 ..... \$8.50

## PLANNING & PREPARING DATA-FLOW DIAGRAMS J. J. DiCerto.

Here's a complete guide that begins with ground rules, covers definitions of terms and describes the entire procedure for laying out a data-flow diagram. Gives actual, step-by-step instructions for planning and laying out six different systems designs. 90 pages, 11 x 8 $\frac{1}{2}$ , illustrated, clothbound.

#5027 ..... \$10.50

## CLIP AND MAIL TODAY FOR FREE 10-DAY EXAMINATION

HAYDEN BOOK COMPANY, INC. Dept. MW-468, 116 W. 14 St., N.Y., N.Y. 10011

Please send me the books circled below, on a 10-day free examination. At the end of that time I will remit payment, plus postage, or return the books without obligation.

5832	0254	0107
5754	0779	5762
5649	5542	5010
5741	5706	5027

Payment enclosed (Hayden pays postage). Same return privilege.  
 Please send me a copy of your free 1968 catalog.

Name \_\_\_\_\_

Address \_\_\_\_\_

City \_\_\_\_\_ State \_\_\_\_\_ Zip \_\_\_\_\_

On all overseas orders, payment in U.S. dollars must be enclosed. Publisher pays postage with same return privilege.

# Information Retrieval Service

All products, design aids (DA), application notes (AN), new literature (NL), and reprints (R) in this issue are listed here with Page and Information Retrieval numbers. Reader requests will be promptly processed by computer and mailed to the manufacturer within three days.

Category	Page	IRN	Category	Page	IRN	Category	Page	IRN
<b>Amplifiers</b>			urethane foams	134	326	program? (R)		474
crossed-field amplifiers vs TWT (AN)	140	338	<b>Microwave Devices</b>			null detector, dc oscilloscope, dc to 10 MHz	133	325
<b>Components</b>			absorption wavemeters	128	277	phase tester	132	295
capacitors, ceramic-glass encased	123	258	beam splitters	129	279	potentiometer, self-calibrating	131	288
control knobs (NL)	142	341	broadband antennas	129	283	pulse generator, programmable	130	292
data filters, 2 to 2000 Hz	122	256	C-band beacon	129	281	SCR tester	132	296
dial assembly	122	253	directional couplers	129	284	servo tester	130	285
dual-digital display electronic	123	257	laser mirror mount	129	282	<b>Wire &amp; Cable</b>		
components (NL)	142	344	medium power TWT microwave attenuators	128	273	wire handbook (NL)	142	342
filters (NL)	146	352	transistor amplifier	128	278			
fractional hp motors (NL)	142	343	X-band noise source	128	276			
image orthicon	122	255	X-band preamplifier	129	280			
miniature lamps	122	254	<b>Microwave Equipment</b>					
speakers, wafer type	120	250	HeNe gas laser	128	274			
switch catalogs (NL)	147	356	<b>Power Supplies</b>					
thermistors, diamond	122	252	regulated dc supplies (NL)	144	347			
transistor, uhf-vhf	128	278	<b>Production Equipment</b>					
vacuum interruptors	122	251	micro-manipulators (NL)	144	348			
<b>Control Devices</b>			micro torque balance (NL)	147	357			
cooling systems (NL)	146	354	reflow soldering data (NL)	146	353			
vertical sensors (NL)	142	345	<b>Semiconductors</b>					
<b>Data Processing</b>			diodes, silicon to 6000 V	124	263			
time-series analysis (AN)	140	339	diodes, switching to 500 V	124	262			
video disc memories (NL)	146	355	heat sinks, transistor	124	259			
<b>Hardware &amp; Packaging</b>			heat sinks, transistor semiconductor catalog (NL)	146	357			
electronics hardware (NL)	144	350	transistors, silicon 250 V	124	260			
gear catalog (NL)	144	349	transistor, switch 1 A	124	264			
<b>IC Integrated Circuits</b>			<b>Systems</b>					
complementary MOS memory cell	136	332	BCD to pulse converter	126	269			
dual flip-flop, JK or D type	136	335	computer disc pack	127	271			
linear ICs, 3 types	136	333	data storage unit	126	268			
multiplex switch, 4 channel	136	330	load cell readout	126	267			
op amp, FET input	133	334	magnetic head, 8 track	127	272			
Ten steps to multilayer board design (R)		472	memory planes	126	270			
voltage comparator	136	331	strip printer	126	266			
<b>Materials</b>			synchro standard	126	265			
Don't fool with gold plate selection (R) electronic		473	<b>Test Equipment</b>					
chemicals (NL)	142	340	battery analyzer	132	293			
inert fluorochemical	134	328	calculator, desk-top conversion factors (DA)	130	360			
lithium niobate crystals	134	327	counter bidirectional equipment servicing (NL)	138	337			
molybdenum foil	135	329	fluidics kit	132	294			
silicon rubber molding (NL)	147	358	frequency counter, to 6.5 GHz	131	287			
urethane encapsulant (NL)	142	346	frequency meter	133	324			
			galvanometer aid (DA)	138	337			
			matrix programmer	133	299			
			microwave synthesizer	132	297			
			Need a circuit design					

## New Literature

cooling systems	146	354
control knobs	142	341
electronic chemicals	142	340
electronic components	142	344
electronics hardware	144	350
equipment servicing	147	359
filter specifications	146	352
fractional hp motors	142	343
gear catalog	144	349
micro-manipulators	144	348
micro torque balance	147	357
reflow soldering data	146	393
regulated dc supplies	144	347
semiconductor catalog	146	351
silicone-rubber molding	147	358
switch catalogs	147	356
urethane encapsulant	142	346
vertical sensors	142	345
video disc memories	146	355
wire handbook	142	342

## Design Aids

Conversion factors, It contains conversion formulas for more than 450 units of measurement	138	337
galvanometer aid, determines relationships between current, resistance and source voltages	138	337

## Application Notes

crossed-field amplifiers vs TWT	140	338
time-series analysis	140	339

## Reprints Available

Don't fool with gold plate selection.	473
Need a circuit design program?	474
Ten steps to multilayer board design.	472

# Fastest way to start a savings account



The data this unimpressive-looking little instrument can save you defies computation.

Because—CEC's new 1-366 Differential Amplifier has an **overload recovery time of less than 1 microsecond**. No DC amplifier known to us, or our customers, is able to match this achievement.

As a result, the solid-state, wideband 1-366 is proving invaluable in all signal conditioning applications where critical information must be recorded immediately upon cessation of the initial pulse. A current use is that of securing data 1 microsecond after shock waves, such as those encountered in mechanical and explosive shock testing.

#### Other significant advantages:

- *Frequency response*— $\pm 1$  db, DC to 1 MHz.
- *Common mode rejection at 1 MHz*—greater than 20 db, regardless of gain.

- *Input range*—up to  $\pm 5$  volts peak.
- *Output*— $\pm 5$  volts at  $\pm 50$  ma minimum.

For complete information about this advanced new transducer amplifier, call your nearest CEC Field Office. Or write Consolidated Electrodynamics, Pasadena, California 91109. A subsidiary of Bell & Howell. Ask for Bulletin 1366-X3.

## CEC/TRANSDUCER PRODUCTS

 **BELL & HOWELL**

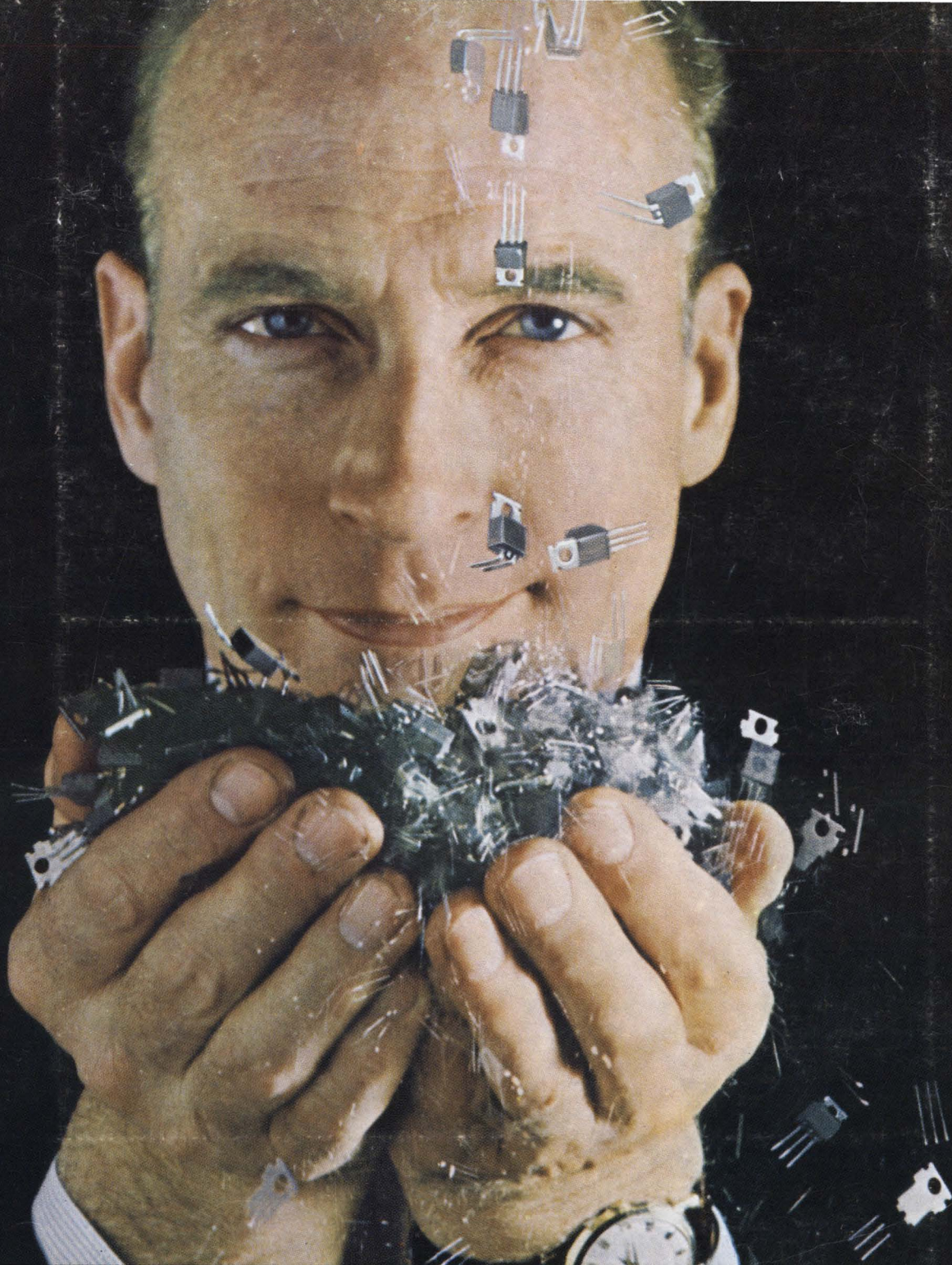

## Guess how many new RCA Plastic Power Transistors \$550 will buy

An even 1,000—if it's RCA-2N5294. That boils down to 55 cents\* each. Here are the facts:

- *55 cents buys* a plastic transistor having a brute power-dissipation capability of 36 watts—second only to RCA's already announced 83-watt family, the industry's highest power plastic devices.

- *55 cents buys* a straight-lead design for PC-board mounting or a formed-lead design that can be plugged into "TO-66" sockets.

- *55 cents buys* a plastic transistor with reliability so good that

we call the 2N5294 family the "non-plastic" plastic transistors!

- *55 cents buys* outstanding performance—an  $I_c$  max of 4A, excellent beta of 30-120 at 1A,  $V_{CB0}$  up to 80 volts, and thermal characteristics better than that of many hermetic units. Beside Homotaxial-Base construction for freedom from second breakdown, you get completely spec'd curves for safe area operation!

In all, RCA has 6 new types in its 36-watt family. And, there are no delivery "hang-ups"—all devices are available right now in

*production quantities.* Call your RCA representative today for information on pricing and delivery for large quantities, or for help on your special product requirements. For technical data on specific types, write: Commercial Engineering, RCA Electronic Components, Harrison, New Jersey 07029. See your RCA Distributor for his prices and delivery.

\*Price for 1000 units.

# RCA