

Electronic Design

FOR ENGINEERS AND ENGINEERING MANAGERS

VOL. 17 NO.

1

JAN. 4, 1969

Pondering his electronic future, this youngster will be taught by computer and closed-circuit TV. As an engineer he may design tomorrow's learning machine. He may even decide on a career in medical electronics, high-speed ground transportation systems or oceanography. For opportunities in these new areas, see p 54



Cornucopia



Get UTC's NEW 1969 Catalog—the quick-and-easy locator for transformers and filters.

UTC's 1969 Catalog is the most comprehensive in our history. Over 1350 standard parts, including audio, power and pulse transformers, inductors, electric wave filters, high Q inductors, magnetic amplifiers, saturable reactors, and similar iron-core inductance devices. Many of these new products are listed for the first time.

Eighty-eight clear pages make it easy to locate and specify the part you need: product lines categorized, product selection guide for each line, engineering specifications and applications, new

drawings, new curves, expanded charts.

Also included are: audio and power application circuitry, plus a lucid digest of the new MIL Specs (MIL-T-27C, MIL-F-18327C, MIL-T-21038B).

The "special" you need is probably a "standard" in the NEW UTC Catalog. All items are immediately available from your local distributor. For your copy of the catalog contact: United Transformer Company, Division of TRW INC., 150 Varick Street, New York, N.Y. 10013.

TRW
UNITED TRANSFORMER COMPANY

Here's One Place Where Your Dollar Is Worth A Dollar

Two new HP oscillators are teaching the old standard new tricks in performance and value. Both the new HP 204C and HP 209A Oscillators have exceptional spectral purity ($< 0.1\%$ -60dB). Both have FET's in the bridge for improved stability—balanced output—sync in/out. All this adds up to greatly improved performance. And, you get this extra value at only a modest increase in price over the old standard.

Both oscillators offer improvements that assure you of a consistent signal—test after test—time after time... whether you are testing on a production line, researching in a design lab, or instructing future engineers.

Portable, line or battery powered. The 204C is a clean, inexpensive oscillator with a frequency range of 5 Hz to 1.2 MHz. Power output is 2.5 Vrms into 600 Ω , 5 Vrms into open circuit. Choose interchangeable power packs—line, rechargeable or mercury battery. Price HP 204C, \$250 to \$285.

High power output, sine or square wave. The 209A generates simultaneous sine and square wave outputs over a frequency range of 4 Hz to 2 MHz. Amplitudes are independently adjustable. Power output for sine wave is double that of 204C—5 Vrms into 600 Ω , 10 Vrms into open circuit. Square wave output is 20 V peak-to-peak. Price HP 209A, \$320.

Get full value for your signal-source dollar. Consult your HP Instrumentation Catalog for full specifications and order your oscillator by calling your nearest HP telephone order desk. For additional data, write Hewlett-Packard, Palo Alto, California 94304. Europe: 1217 Meyrin-Geneva, Switzerland.

099/2

HEWLETT  PACKARD
SIGNAL SOURCES

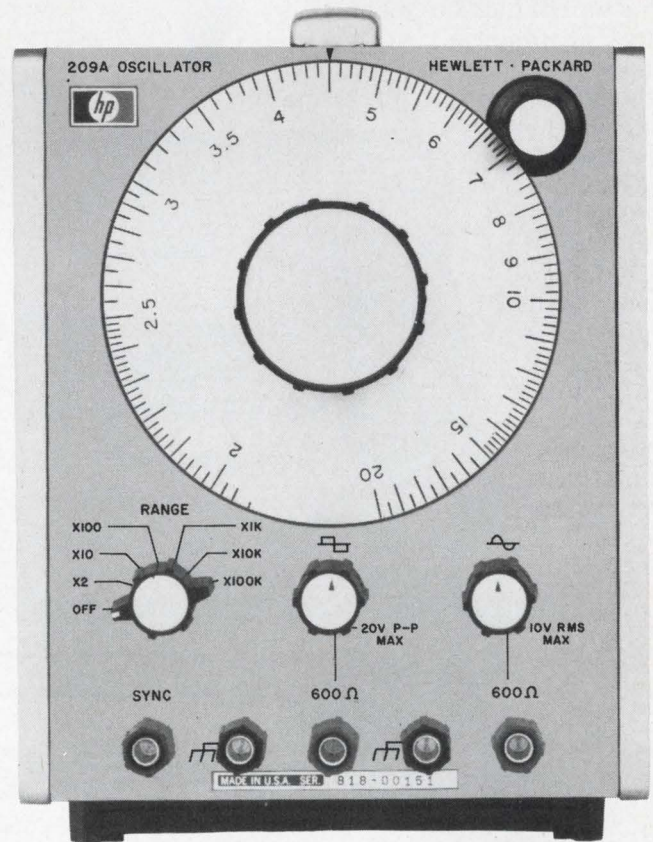
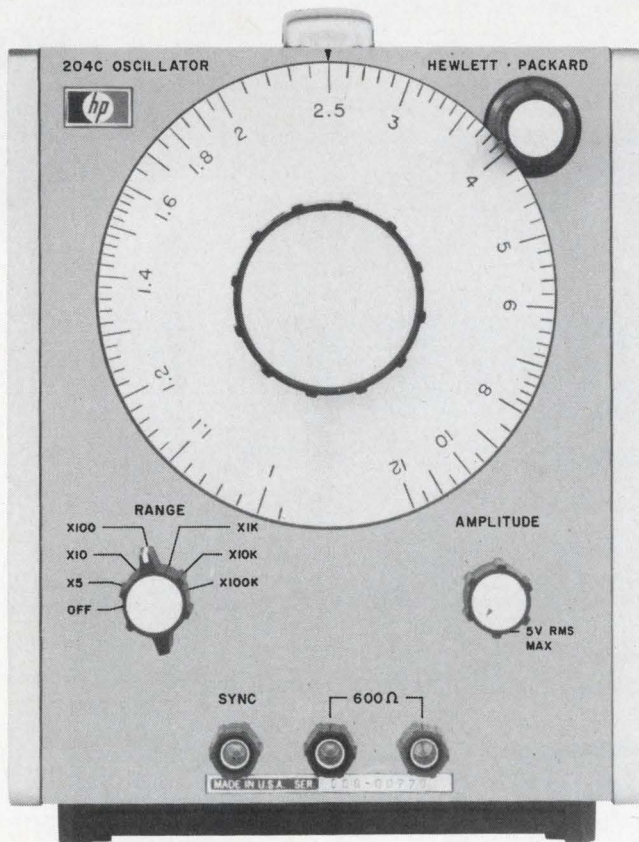

INFORMATION RETRIEVAL NUMBER 2

We put the
squeeze
on counter size
— and price.

Systron-Donner used modern integrated circuits to create a new breed of counters, smaller and less expensive than ever before.

**12.4
MHz
\$395**

Only \$395 buys the all-new Model 114, a simple digital frequency meter that anyone can operate. It displays frequency from 1 Hz to 12.4 MHz — complete with decimal point and unit of measurement. This tiny, handsomely styled instrument is designed for long, troublefree service with no maintenance attention. To use it as a panel meter you simply remove the tilt stand and insert the counter in a 3" x 7" hole. The sturdy faceplate supports the chassis.



For \$750 you can get Model 7014, a truly sophisticated instrument that packs extraordinary precision and versatility into an easily carried cabinet. This counter offers a 20-MHz range, crystal-controlled time base, 10 millivolt sensitivity, and precise determinations of very low frequencies by multiple period measurement. Optional extras include a super-stable oscillator with an aging rate of 3 parts in 10^{10} per 24 hours, and 8-digit or 9-digit readouts for ultra-high resolution.

**20
MHz
\$750**



SYSTRON  DONNER

888 Galindo Street, Concord, California 94520 Phone (415) 682-6161

NEWS

- 21 News Scope
- 25 **Electronic sales inch ahead—but hesitantly**
EIA predicts a \$24.6-billion market, up 4.1%,
with inflation and peace talks blurring the picture
- 30 **Making the world's fastest computer faster**
CDC 7600 design engineers took 5 years to top
the performance of the CDC 6600 by 4 to 8 times
- 34 **YIG echo effect promises new devices**
- 40 **People and computers have decided to get together**
- 47 Washington Report
- 54 **Emerging Technologies: Special Report**
- 56 Oceanography
- 60 Medical Electronics
- 64 Educational Electronics
- 68 Urban Transportation
- 76 Sidelights of the Issue
- 79 **Editorial: A plea for the human touch in information retrieval**

TECHNOLOGY

- 82 **Sectionalize your digital controller** in an adaptive control system
to simplify the logic and to increase system efficiency.
- 90 **Stop noise problems before they start** by suppressing transients at their
sources and designing your circuit to minimize undesired coupling.
- 97 Practical guide to a/d conversion, Part 3
- 97 Special types
- 104 Offset-correction
- 108 Time-sharing
- 114 **Management training for engineers.** Get things done through people.
Take an after-hours or part-time course listed in this roundup.
- 124 Ideas for Design

PRODUCTS

- 134 **Instrumentation:** Function generator spans 5-MHz range.
- 146 **ICs & Semiconductors:** MOS random-access memory chip stores 256 words.
- 162 **Components:** Stepping motor uses 5-disc rotor design.
- 170 Packaging & Materials
- 178 Modules & Subassemblies
- 184 Microwaves & Lasers
- 188 Data Processing
- 192 Production

Departments

- 14 Designer's Datebook
- 194 Design Aids
- 196 Application Notes
- 198 New Literature
- 208 Advertisers' Index
- 211 Information Retrieval Service

COVER CREDIT: Radio Corporation of America

Information Retrieval Service Card inside back cover

Capacitor problems?

General Electric has 1844 application-designed solutions

General Electric's application-designed capacitors are made to solve your problems. Whether you need aluminum, tantalum, or film units, GE has the right answer.

Circuit design problems? Many General Electric capacitors are designed by computer to optimize their electrical and mechanical characteristics. You get the highest capacitance in the least volume with electrical properties consistent to your own circuit designs. For example, if you know your installed capacitance requirements in a new power supply, our computers can quickly tell you the best capacitor combination and its electrical characteristics in your circuit.

Product application problems? General Electric has experienced capacitor application en-

gineers in Electronic Components Sales Offices throughout the country. These technical specialists are ready to help you select the capacitors you need and to provide specialized information about them.

Ordering or delivery problems? Your local Electronic Components Sales Office will be glad to furnish you price and delivery data for General Electric capacitors. We also have stocking distributors who can meet many of your immediate requirements for limited quantities of standard units.

You supply the capacitor problems. General Electric can supply 1844 application-designed solutions. Contact your local sales office, franchised distributor or **Capacitor Department, Irmo, South Carolina 29063.**

430-32

GENERAL  ELECTRIC

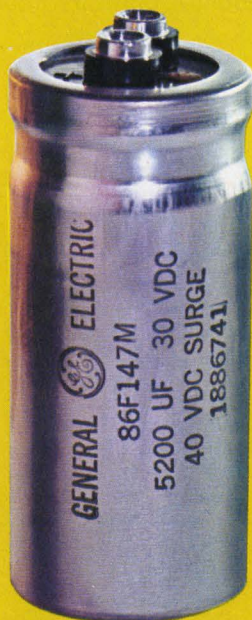

Aluminum High-performance Computer-grade Capacitors
236 standard ratings. 5 to 450 volts, 75 to 480,000 μf , -40 to 85C ambient temperature



Aluminum Miniature Tubular Capacitors
151 standard ratings. 3 to 150 volts, 1 to 790 μf , -40 to 85C ambient temperature



Aluminum Industrial Tubular Capacitors
102 standard ratings. 3 to 450 volts, 2 to 3500 μf , -20 to 85C ambient temperature



Tantalum Sub-miniature Wet-slug Capacitors
59 standard ratings. 6 to 60 volts, 0.01 to 450 μf , -40 to 85C ambient temperature

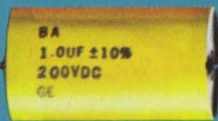

Metallized Film Flattened Oval Capacitors
102 standard ratings. 100 and 200 volts d-c, 0.01 to 10.0 μf , -55 to 85C



Metallized Polycarbonate Tubular Capacitors
57 standard ratings. 200 volts d-c, 0.010 to 10.0 μf , -55 to 125C



Aluminum Can-style Capacitors
43 case size and terminal combinations—thousands of ratings. 5 to 450 volts, 5 to 500 μf , 1, 2, 3, or 4 sections

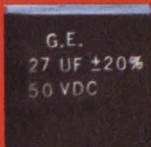

Micro-flat Polyester Capacitors
78 standard ratings. 50 volts d-c, 0.0010 to 1.50 μf , -55 to 85C



Polyester Tubular Capacitors (left)
296 standard ratings. 100 and 200 volts d-c, 0.0010 to 2.00 μf , -55 to 85C



Black Hawk Capacitors
483 standard ratings. 50 to 600 volts, 0.0010 to 1.00 μf , at 85C



Polycarbonate Tubular Capacitors (left)
64 standard ratings. 100 and 200 volts d-c, 0.001 to 1.0 μf , -55 to 85C

Blue Jay Capacitors
50 standard ratings. 100 and 200 volts d-c, 0.001 to 0.47 μf



Aluminum A-c Motor Start Capacitors
123 standard ratings. 110 to 330 volts a-c, 21 to 850 μf , -20 to 65C ambient temperature

**NOW!
FROM LAMBDA**

**1
1/4
rack**



high-performance Power Supplies

LR-SERIES

.0005% Regulation, 35 μ v Ripple

- 0.0005% plus 100 μ V regulation.
- 35 μ V rms, 100 μ V p-to-p ripple.
- **AC Input:** 105-132 VAC, 47-440 Hz (Ratings based on 55-65 Hz; derate current 10% at 50 Hz.) 205-265 VAC on request at no extra charge ("-V" option).
- **2 meters** monitor both voltage and current simultaneously and continuously.
- **With Remote Programing**
Accuracy—0.01% plus 1mV
Stability—0.001% plus 100 μ V for 8 hours
Temp. Coeff.—0.001% plus 10 μ V/ $^{\circ}$ C
- **Guaranteed for 5 years.** The only 5-year guarantee that includes labor as well as parts. Guarantee applies to operation at full published specifications at end of 5 years.
- **Multi-Current-Rated.**
- **Only 5 1/4" high.** Convenient 1/4 and 1/2 rack sizes for rack or bench use.
- **All-silicon** design for maximum reliability.
- **Convection cooled** for convenience and reliability... no blowers or heat sinks.
- **Remote programing** by changes in voltage or resistance for convenience in systems, test equipment and automatic equipment applications.
- **Auto Series/Auto Parallel** with Master-Slave tracking.
- **Constant I/Constant V** by automatic cross-over.
- **Completely protected:** short-circuit proof; continuously adjustable automatic current limiting.
- **Overvoltage protection** available as low cost add-on accessory.

FOUR 1/4-RACK MODELS

Model	Voltage Range	MAX. AMPS AT AMBIENT OF ¹				Price
		30 $^{\circ}$ C	40 $^{\circ}$ C	50 $^{\circ}$ C	60 $^{\circ}$ C	
LR-602-FM	0-20 VDC	1.1	.95	.80	.64	\$265
LR-603-FM	0-40 VDC	.60	.50	.42	.33	265
LR-605-FM	0-120 VDC	.23	.20	.17	.14	295
LR-606-FM	0-250 VDC	80ma	72ma	65ma	60ma	310

FOUR 1/2-RACK MODELS

Model	Voltage Range	MAX. AMPS AT AMBIENT OF ¹				Price ²
		30 $^{\circ}$ C	40 $^{\circ}$ C	50 $^{\circ}$ C	60 $^{\circ}$ C	
LR-612-FM	0-20 VDC	1.8A	1.6A	1.3A	1.1A	\$305
LR-613-FM	0-40 VDC	1.0A	0.9A	0.75A	0.6A	305
LR-615-FM	0-120 VDC	0.33A	0.29A	0.25A	0.21A	320
LR-616-FM	0-250 VDC	100ma	90ma	80ma	70ma	340

¹ Current rating applies over entire voltage range. Ratings based on 55-65 Hz operation. Derate current 10% for 50 Hz input.
² Prices are for metered models. LR Series models are not available without meters.

Prices F.O.B. factory, Melville, N. Y. All specifications and prices subject to change without notice.

OVERVOLTAGE PROTECTION

For Use With	Model	Adj. Volt. Range	Price
LR-602-FM, LR-612-FM	LH-OV-4	3-24 V	\$35
LR-603-FM, LR-613-FM	LH-OV-5	3-47 V	\$35

Write, wire, or call to order direct, for information, or for new Lambda Power Supplies catalog. LAMBDA Electronics Corp., 515 Broad Hollow Road, Melville, L. I., New York 11746, TEL. 516-694-4200, TWX 510-224-6484. Cable: VEECOVAC, Plainview, N. Y.

 **LAMBDA**

Being an HP Frequency Synthesizer is a tough life.

Using one is a snap.

The trouble with being a reliable instrument is that everyone is always asking you to prove it. Especially if you're a Hewlett-Packard Frequency Synthesizer, because many synthesizer users freeze them to -20°C, heat them to +65°C, engulf them in humid air, drop them 2½ feet (a 50G shock when they hit sand), and whack them with a 400 lb. hammer to prove conformance to military specification MIL-E-16400F. It is a tough life; that's why every HP synthesizer would much rather be the operator.

Look what *he* gets:

- Frequency change by pushbutton or remote command (20 μsec, typical).
- Frequency increments as small as 0.01 Hz.
- Search oscillator for continuous tuning or sweep capability.
- Low spurious signals, low phase noise, high spectral purity.
- Direct synthesis for best stability, fast switching, fail-safe operation.

MODEL	RANGE	MINIMUM INCREMENT	SPURIOUS SIGNALS	PRICE
5105A	100 kHz—500 MHz	0.1 Hz	70 dB	\$14,100.*
5100B	0.01 Hz—50 MHz	0.01 Hz	90 dB	\$12,500.*
5102A**	0.01 Hz—100 kHz 0.1 Hz—1 MHz	0.01 Hz 0.1 Hz	90 dB 70 dB	\$7200.
5103A**	0.1 Hz—1 MHz 1—10 MHz	0.1 Hz 1 Hz	70 dB 50 dB	\$7800.

*Includes required 5110B Driver (\$4350) which operates up to four synthesizers.

**Dual range unit; has internal driver.

Military-type reliability at commercial instrument prices is an extra benefit provided by HP synthesizers for commercial, scientific and military users.

It's easy to see why, after high and low temperature, humidity, jarring drops and fierce hammer blows, it's still the user of our frequency synthesizers who gets all the breaks.

Call your local HP field engineer or write Hewlett-Packard, Palo Alto, California 94304; Europe: 1217 Meyrin-Geneva, Switzerland.

HEWLETT  PACKARD
FREQUENCY SYNTHESIZERS

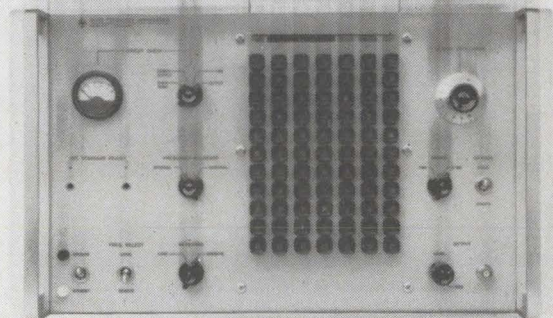

What's inside this little black box?

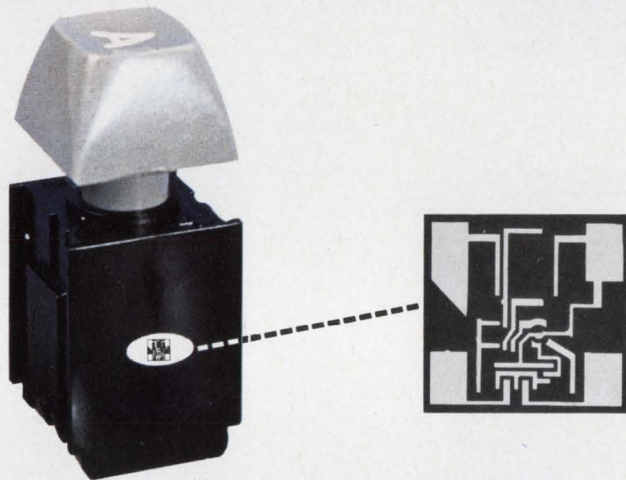

A breakthrough in keyboard technology from MICRO SWITCH

Inside this key is a new discovery. Using the Hall effect, MICRO SWITCH has developed the world's first practical application of an integrated circuit as a keyboard switching element. An integrated-circuit chip (only .040" square) is actuated with a magnet mounted on a plunger. Thus, MICRO SWITCH has combined integrated circuitry with manual actuation to bring you an all solid state keyboard, unlike any other ever made.

It is called SSK. A keyboard unmatched in reliability, flexibility and low cost!





It makes possible this all solid state keyboard... SSK... the first of its kind

SSK is a keyboard that is compatible with your present *and* next generation communications and data preparation equipment. Assembled, wired and encoded—ready to plug into your equipment.

A breakthrough in keyboard reliability

From key to connector, every unit of the new SSK keyboard is all solid state. The only moving mechanical part is the plunger. There are no mechanical linkages and no moving contacts to wear or fail. The result is unequalled reliability.

A breakthrough in keyboard economy

You get triple economy. First, the initial cost is less, tailored to your high production commitments. Second, the bounce-free output of SSK requires no special interface circuitry to adapt it to your equipment; just plug it in. Finally, being solid state, SSK is practically maintenance free; cuts your service costs to the bone.

All in a completely flexible package!

**For more facts on MICRO SWITCH SSK,
turn the page.**

SSK...a completely flexible package...

MICRO SWITCH solid state keyboard flexibility adapts to your format and encoding needs. All standard key arrays and custom arrays, block or offset. Encoding of any 8-bit code (or less); hexadecimal; Baudot; BCD; USASCII mono-mode, dual-mode and tri-function; plus EBCDIC and custom codes.

You may choose from a complete selection of customized legends and colors. Let us know the control functions you require—we'll match your needs to the letter. There's no reason anymore to compromise for any less—or pay for more—than what you want.

Featuring the latest human factors considerations...

- A. Two-Key Rollover permits typing at burst speeds without causing a system error output.
- B. Universally accepted truncated keys combined with standard typewriter offset arrangements between rows, permits accurate high-speed typing without hindering the natural flow of operation.
- C. SSK offers sloped key or stepped key rows.
- D. Custom molded-in legends are integral part of button, cannot be obscured by wear.

Backed by MICRO SWITCH Capabilities

Through advanced design concepts, complete engineering facilities, innovative assembly techniques, and unique quality assurance procedures, MICRO SWITCH is prepared to supply your every keyboard need. This means new reliability and flexibility in mass-production quantities with attractive customized appearance giving new sales appeal to your equipment.

Make no decisions on keyboards until you see what's happening at MICRO SWITCH. Send the coupon today.

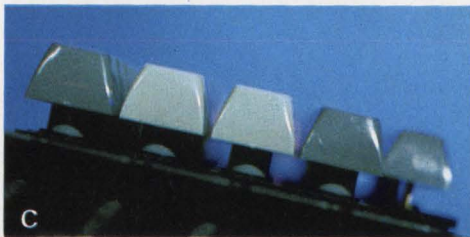
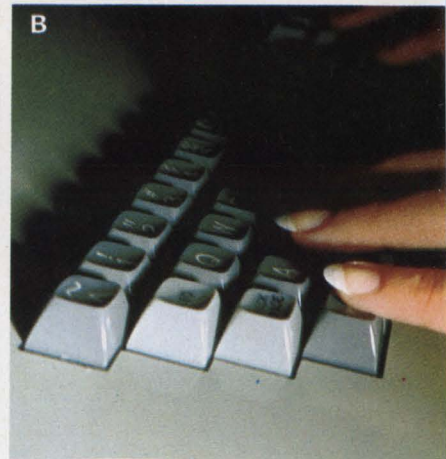
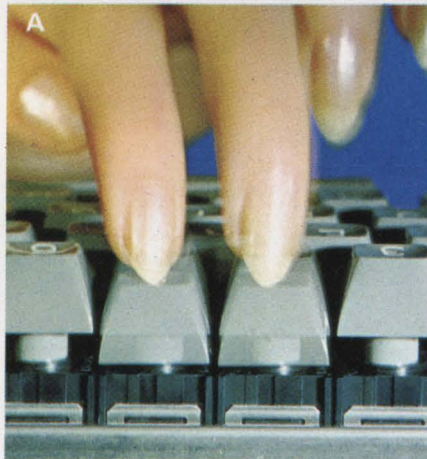

SSK MICRO SWITCH

Freeport, Illinois 61032

Dear Sir,

I would like further information about MICRO SWITCH SSK solid state keyboards.

Name & Title _____

Company _____

Address _____

City _____ State _____ Zip _____

Please have a field engineer call. Phone _____

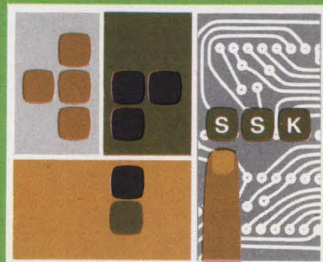

MICRO SWITCH

FREEPORT, ILLINOIS 61032

A DIVISION OF HONEYWELL
INFORMATION RETRIEVAL NUMBER 7

Our New MC1545 Is A Gated, Dual-Channel, Differential Inputs & Output DC Wideband Video Amplifier Integrated Circuit!

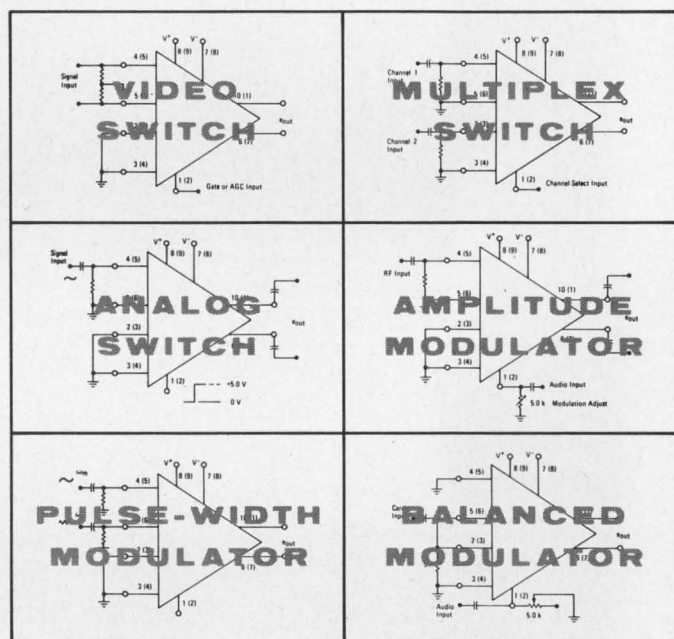

How versatile can one chip get?

So universally-usable is this new linear circuit, you can use it as a video switch, sense amplifier, multiplexer, modulator, FSK (frequency-shift-keying) circuit, limiter, AGC circuit, or pulse amplifier . . . to name just a few typical applications.

To make it even more universally usable, we've priced it at just \$5.50 (100-up). And, that's for a full-temperature-range device - in the 10-pin TO-5. It's also available in the dual in-line ceramic package and ceramic flat pack.

You can use the new MC1545 in a wide variety of equipment, too; like C.A.T.V. and Closed-Circuit TV, because of its excellent wideband characteristics (75 MHz, typ) and its gate-controlled, two-channel amplifier. Other uses include computer memory systems, communications systems and instrumentation.

Here are some of the features that make it all possible:

- 20 nSec (typ) channel-select time.
- Differential inputs and output.
- High Input Impedance - 10 K ohms (typ)
- Low output impedance - 25 ohms (typ)

To prove to yourself that MC1545 is the *Best Wide-band Amplifier Yet*, send for our data sheet.

- where the priceless ingredient is care!



MOTOROLA Integrated Circuits

MOTOROLA SEMICONDUCTOR PRODUCTS INC./P.O. BOX 20912/PHOENIX, ARIZONA 85036

INFORMATION RETRIEVAL NUMBER 8

Fairchild can make more hybrids in

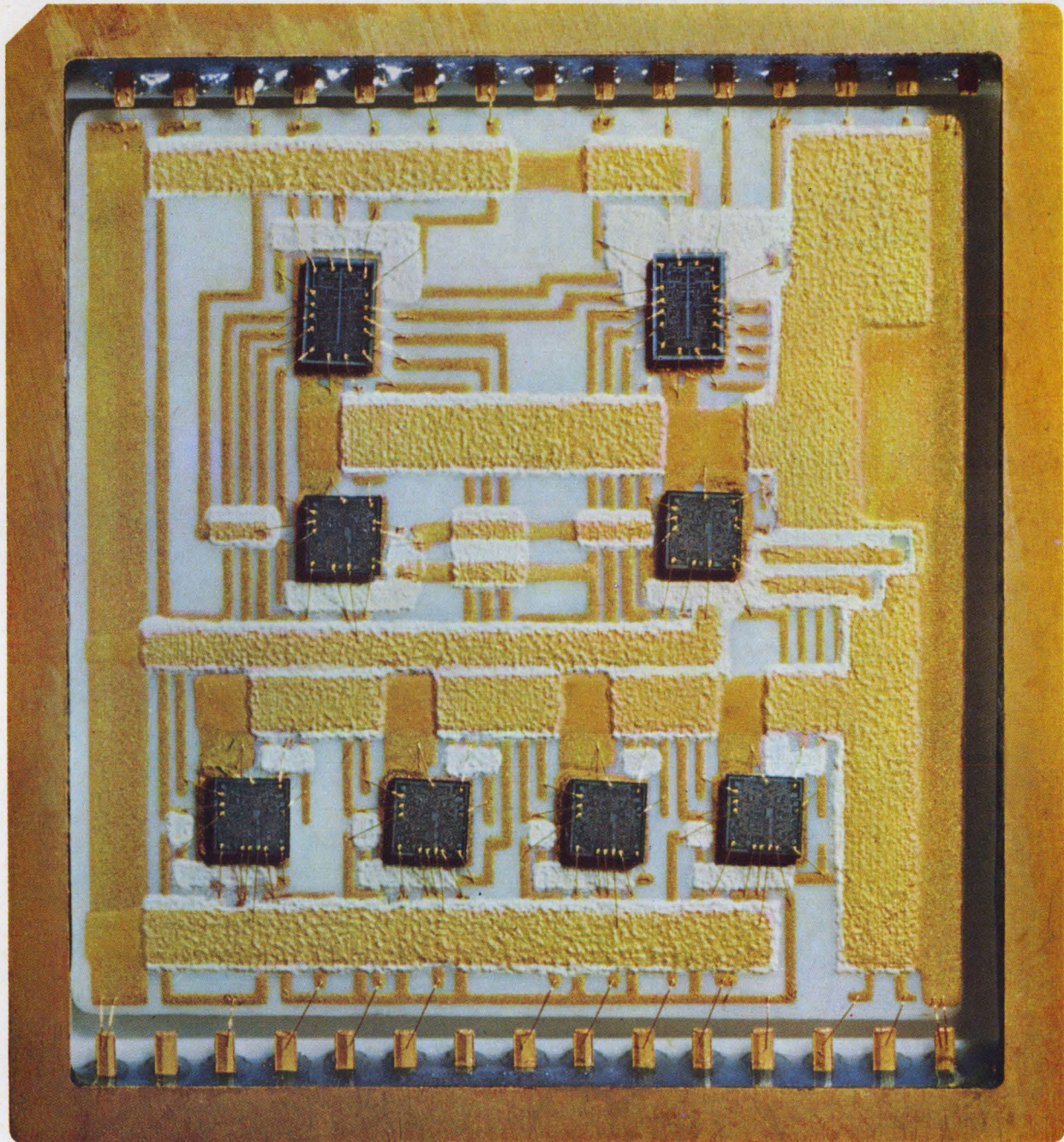

an hour than you can use in a month.



We can make any hybrid, in any quantity, using any method: Thick film. Thin film. Thin film on silicon.

We can make them faster than anyone in the industry. And deliver them quicker to anyone in the world.

We'll take any functions you need and package them any way you want. Our list of hybrid components has everything from a simple diode to a complex LSI array.

For your less complex applications, we have a line of off-the-shelf standard hybrids priced like discretes.

If this commitment makes sense in general, we'd like to send you the whole story in detail. Our brochure is called Fairchild Hybrid Microcircuits. It can give you more ideas in an hour than you could use in a year. Write for it.

Fairchild Semiconductor/A Division of Fairchild Camera and Instrument Corporation//313 Fairchild Drive, Mountain View, California 94040 (415) 962-5011 TWX: 910-379-6435

FAIRCHILD
SEMICONDUCTOR

INFORMATION RETRIEVAL NUMBER 9

A Smart Way to Beat Your Power Supply Size Problem



abbott

1½" thin, 2¾" short, yet this converter produces 1000 volts DC, regulated, from a battery input of 28 VDC! It weighs less than 15 ounces. This is only one of our wide variety of many small light weight converters, inverters and power supplies — there are over 3000 models listed in our newest catalog, including size, weight, and prices. If you have a size problem, why not send for an Abbott catalog?

MIL SPEC ENVIRONMENT — All of the power modules listed in our new catalog have been designed to meet the severe environmental conditions required by modern aerospace systems, including MIL-E-5272C and MIL-E-5400. They are hermetically sealed and encapsulated in heavy steel containers. New all silicon units will operate at 100°C.

Please write for your FREE copy of this new catalog or see EEM (1968-69 ELECTRONIC ENGINEERS MASTER Directory), Pages 1727 to 1740.

abbott transistor

LABORATORIES, INCORPORATED

5200 W. Jefferson Blvd./ Los Angeles 90016
(213) WEBster 6-8185 Cable ABTLABS

RELIABLE — Highest quality components are used in Abbott power modules to yield the high MTBF (mean time between failure) as calculated in the MIL-HDBK-217 handbook. Typical power modules have over 100,000 hours MTBF — proving that the quality was built in from the beginning.

WIDE RANGE OF OUTPUTS — Any voltage from 5 volts DC to 10,000 VDC is available by selecting the correct model you need from our catalog with any of a variety of inputs including:

- 60~ to DC, Regulated
- 400~ to DC, Regulated
- 28 VDC to DC, Regulated
- 28 VDC to 400~, 1φ or 3φ
- 60~ to 400~, 1φ or 3φ

T0: Abbott Transistor Labs., Inc., Dept. 57
5200 West Jefferson Blvd.
Los Angeles, California 90016

Sir:
Please send me your latest catalog on power supply modules:

NAME _____ DEPT. _____
COMPANY _____
ADDRESS _____
CITY & STATE _____

Designer's Datebook

FEBRUARY 1969						
Sun	Mon	Tue	Wed	Thu	Fri	Sat
						1
2	3	4	5	6	7	8
9	10	11	12	13	14	15
16	17	18	19	20	21	22
23	24	25	26	27	28	

MARCH 1969						
Sun	Mon	Tue	Wed	Thu	Fri	Sat
						1
2	3	4	5	6	7	8
9	10	11	12	13	14	15
16	17	18	19	20	21	22
23	24	25	26	27	28	29
30	31					

For further information on meetings, use Information Retrieval Card.

Feb. 10-11

Transducer Conference (Washington, D. C.). Sponsor: IEEE; H. P. Kalmus, Harry Diamond Labs., Dept. of the Army, Washington, D. C. 20438

CIRCLE NO. 430

Feb. 11-13

Aerospace and Electronic Systems Convention (WINCON) (Los Angeles). Sponsor: IEEE, G. D. Bagley, TRW Systems Inc., One Space Park, Redondo Beach, Calif. 90278

CIRCLE NO. 431

Feb. 13-14

Electrical Insulation Workshop, (Chicago). Sponsor: Society of Plastics Engineers; J. McCarthy, Workshop Publicity, c/o Insulation, Box 270, Libertyville, Ill. 60048

CIRCLE NO. 432

Feb. 19-21

Solid-State Circuits Conference (Philadelphia). Sponsor: IEEE, U. of Pennsylvania; L. Winner, 152 W. 42 St., New York, N. Y. 10036

CIRCLE NO. 433

Mar. 12-14

Microwave Technique Conference (Cologne, Germany). Sponsor: IEEE; H. H. Burghoff, Stresemann Allee 21, VDE-Haus, 6 Frankfurt/Main 70, West Germany.

CIRCLE NO. 434

Mar. 24-27

IEEE International Convention (New York City). Sponsor: IEEE. J. M. Kinn, IEEE, 345 E. 47 St., New York N. Y. 10017

CIRCLE NO. 435

Allen-Bradley's experience in resistor production reaches...

to the moon and back!



TYPE BB 1/8 WATT

TYPE EB 1/2 WATT

TYPE HB 2 WATTS

TYPE CB 1/4 WATT

TYPE GB 1 WATT

A-B hot-molded fixed resistors are available in all standard resistance values and tolerances, plus values above and below standard limits. **A-B hot-molded resistors meet or exceed all applicable military specifications including the new Established Reliability Specification at the S level.** Shown actual size.

After more than three decades and untold billions of hot-molded resistors, Allen-Bradley has accumulated manufacturing "know-how" which cannot be approached by anyone else. The fact that the resistors made by A-B over the years—if placed side by side—would more than reach to the moon and back, may be impressive. But "how" they are made is the key.

Allen-Bradley resistors are produced by an exclusive hot-molding technique—developed by A-B. They're made by completely automatic machines—also developed, built, and used only by Allen-Bradley. The human element of error is removed. Uniformity is so precise from one resistor to the next—year in and year out—that long-term resistor performance can be closely predicted.

And there has been no known incident of catastrophic failure of an A-B hot-molded resistor.

The reputation for quality and performance established by Allen-Bradley hot-molded resistors is reflected in the fact that they have been an integral part of virtually every U.S. space probe. And they are "on" the moon. No other resistor applications demand a higher measure of reliability.

For detailed specifications on this superior line of hot-molded resistors, please write Henry G. Rosenkranz and request a copy of Technical Bulletin 5000: Allen-Bradley Co., 1201 South Second Street, Milwaukee, Wisconsin 53204. Export Office: 630 Third Ave., New York, N.Y., U.S.A. 10017. In Canada: Allen-Bradley Canada Limited.

EC 6815

QUALITY ELECTRONIC COMPONENTS



ALLEN - BRADLEY

a standard line of

34 Dual FETs

tested and guaranteed!

With all this variety of matched-parameter dual FETs, the right spec/price tradeoff is not always obvious. Here are examples, however, of some of the specs you'll find on one or more of these 34 devices:

- GATE CURRENT, I_{GSS} ... 1 pA
- DIFFERENTIAL OFFSET VOLTAGE ... 5 mV
- DIFFERENTIAL GATE VOLTAGE DRIFT ... 5 $\mu\text{V}/^\circ\text{C}$
- OUTPUT CONDUCTANCE ... 1 μmho
- DIFFERENTIAL OUTPUT CONDUCTANCE ... 0.1 μmho
- COMMON MODE REJECTION ... 100 dB
- EQUIVALENT NOISE VOLTAGE @ 10 Hz ... 15 nV/ $\sqrt{\text{Hz}}$
- 100 QUANTITY PRICE ... as low as \$2.60

But this is just a sampling. What specs are most important to you? Do you have an application requiring new specs? Contact us if you have an applications question, or write today for complete information on the 34 standard Siliconix dual FETs.



Siliconix incorporated

1140 W. Evelyn Ave. • Sunnyvale, CA 94086
Phone (408) 245-1000 • TWX: 910-339-9216

INFORMATION RETRIEVAL NUMBER 12

INFORMATION RETRIEVAL NUMBER 300 THRU 305 ►

DIODES

Need Chip diodes? We'll slice them to your spec.

We'll design custom diodes for you, scribe and cut them to your needs and deliver them after a 100% DC test on each chip.

If you're working with hybrid circuits take a look at our capability to supply you with uncased diode chips. We can make them to order and test them to your electrical specs.

Right now, we are supplying chips similar to many popular finished diodes such as 1N3064, 1N3600, 1N4146, 1N4148 and 1N4448. All of these devices are 100% probe tested to DC specs and are checked for AC parameters on a sample

basis. After testing we'll scribe and cut them to your needs and we'll put a suitable backing material on the dice to be compatible with your method of welding or soldering the chips to your substrate.

Typical of the special treatment we can give is the quad N/P diode array we make for a large computer manufacturer. All four devices have a common anode with four separate cathode connections. We can also make quads in the P/N configuration if that's what you need.

Another way we can deliver diodes is as single or multiple chips in a channel pack. We'll give you common anode or common cathode configurations or even hook up some simple circuits such as bridges, ring modulators, etc. Again, all units are 100% tested to your specifications.

If you are looking at chip diodes as space savers in your circuit designs, talk to our sales engineers. You may be surprised at what they can offer you.

CIRCLE NUMBER 300

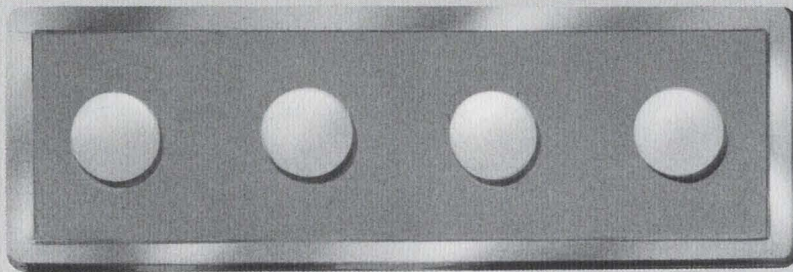

Quad diode array packs four diodes into a minimum of space.

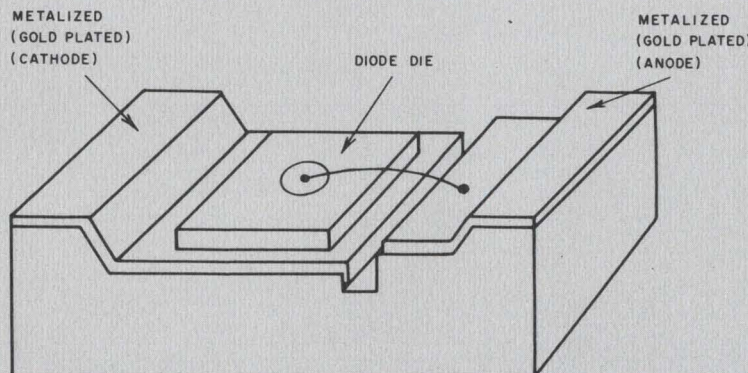

Diodes can be supplied in channel packs for ease of handling.

This issue in capsule

Integrated Circuits

Multiplexer/Demultiplexer arrays cut can count.

Microwave Devices

Beamlead and chip capacitors simplify hybrid circuit design.

Television

'Instant warm-up' heater speeds picture tube turn-on.

Manager's Corner

The path to LSI: Who goes first?

CRTs

Low drain heaters save portable power.

EL Readouts

How etched leads boost EL bar-graph resolution.

INTEGRATED CIRCUITS

Multiplexer/Demultiplexer arrays cut can count.

Two new functional arrays reduce number of gate packages in typical multiplex system from ten to two.

Lower can count, higher speed and less power dissipation are some of the benefits you get from two new functional arrays we have just introduced. The SM-210 is a dual 4-bit multiplexer and the SM-220 is its demultiplexing counterpart. Each replaces up to five gates used in a typical multiplexing operation.

By designing the internal gate structures for speed rather than drive capability we've obtained a high on-chip speed. As a result, propagation delays through several internal gates are comparable to those usually accepted for a single gate. Typically, outputs are produced in less than 12 nanoseconds after the input pulse.

Both devices have the type of inputs and outputs characteristic of SUHL circuits to assure top performance in fan-out, logic swing, capacitance drive, and noise immunity.

Logically speaking, the SM-210 (Fig. 1) is a dual four-bit multiplexer. In each section, two control lines select one of four inputs for presentation at the output. The control lines are common for each section and are buffered from their external connections to prevent excessive loading of drive stages. Data and selection variables are directed to either of two identical quad 3-input AND gates. The results of the "AND"ing are "OR"ed together and double inverted in the output driver stage. The resulting output is the true AND-OR form of the input logic. This means you can drive flip-flops, shift registers, adders and other functions directly, without extra gate inversions.

A typical application of the SM-210 is shown in Fig. 2. This parallel-to-serial converter multiplexes two 16-bit words onto two bus lines. All "A" inputs are bussed into F₀ and all "B" inputs are bussed into F₁. The selection variables are driven by a four-bit counter. The resultant outputs for each clock pulse are shown in the table. Propagation delay is about 24 nanoseconds from data input to data output and 29 nanoseconds from control input to final output.

This system could be expanded to multiplex two 32-bit words by constructing another identical system and directing its outputs along with F₀ and F₁ into another SM-210.

The SM-220 demultiplexer array performs the inverse operation of the SM-210. It consists of two separate decoding sections. In one section, incoming data may be steered to any one of four identical outputs under control of two selection variables. In the second section, another data input can be routed to either of two identical outputs determined by the state of the selection line.

The logic arrangement of the SM-220 is shown in Fig. 3. In the one-into-four section, four 3-input NAND gates are used, followed by output inverters. Each gate receives the data input along with one of the four possible combinations of the selection bits. The data can be steered to one output only for a particular selection input combination since the connections to each 3-input gate are unique. The output inverter/drivers provide the true states of the input data eliminating the need for extra gate inversions and allowing direct data entry into subsequent stages.

Used as a serial-to-parallel converter, as in Fig. 4, the SM-220 decodes 16 parallel bits onto two bus lines, F₀ and F₁. The one-to-two section is used in six of the eight SM-220s and the one-to-four section is used in all. The output bits appear in the chronological order of their subscripts, shifting one to the right with each clock pulse. The SG-130 drivers are used to satisfy the input current requirements of the control lines. Propagation delay is about 33 nanoseconds from input to any output. Delay from control input to any output is about 40 nanoseconds.

As you can see, the SM-210 and SM-220 make an ideal pair for multiplexing systems where high speed, low power consumption and a low package count are desired. And where aren't these features important?

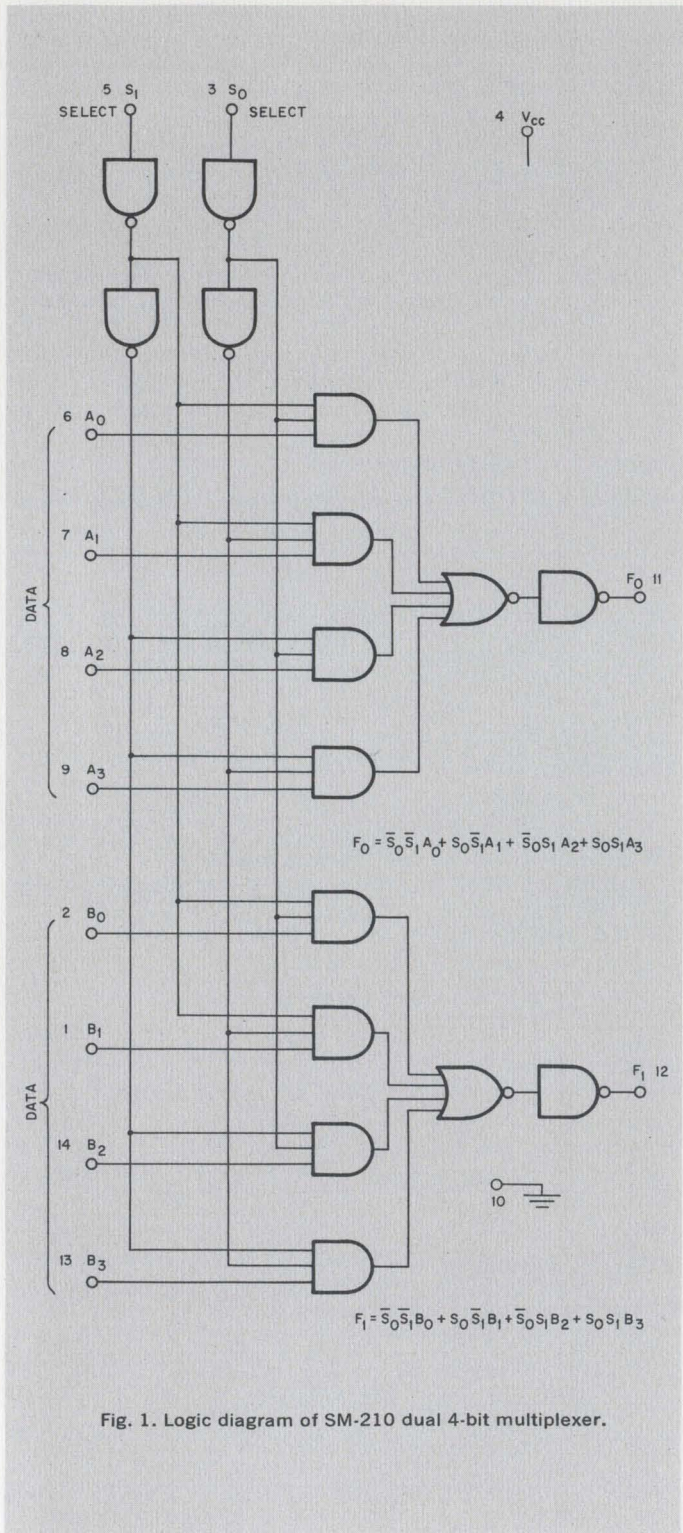
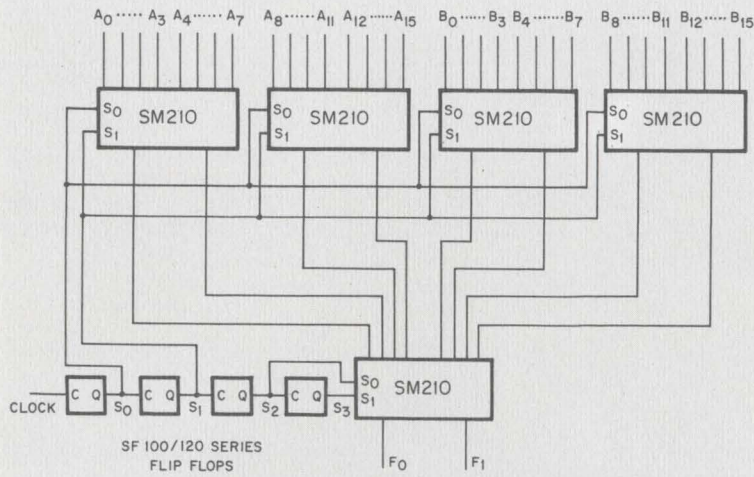

Fig. 1. Logic diagram of SM-210 dual 4-bit multiplexer.



TRUTH TABLE						
CONTROL		INPUTS			OUTPUT	
S ₀	S ₁	S ₂	S ₃	F ₀	F ₁	BITS
0	0	0	0	0	A ₀	B ₀
1	0	0	0	0	A ₁	B ₁
0	1	0	0	0	A ₂	B ₂
1	1	0	0	0	A ₃	B ₃
0	0	1	0	0	A ₄	B ₄
1	0	1	0	0	A ₅	B ₅
0	1	1	0	0	A ₆	B ₆
1	1	1	0	0	A ₇	B ₇
0	0	0	1	0	A ₈	B ₈
1	0	0	1	0	A ₉	B ₉
0	1	0	1	0	A ₁₀	B ₁₀
1	1	0	1	0	A ₁₁	B ₁₁
0	0	1	1	0	A ₁₂	B ₁₂
1	0	1	1	0	A ₁₃	B ₁₃
0	1	1	1	0	A ₁₄	B ₁₄
1	1	1	1	0	A ₁₅	B ₁₅

Fig. 2. Application of the SM-210 as a parallel-to-serial converter.

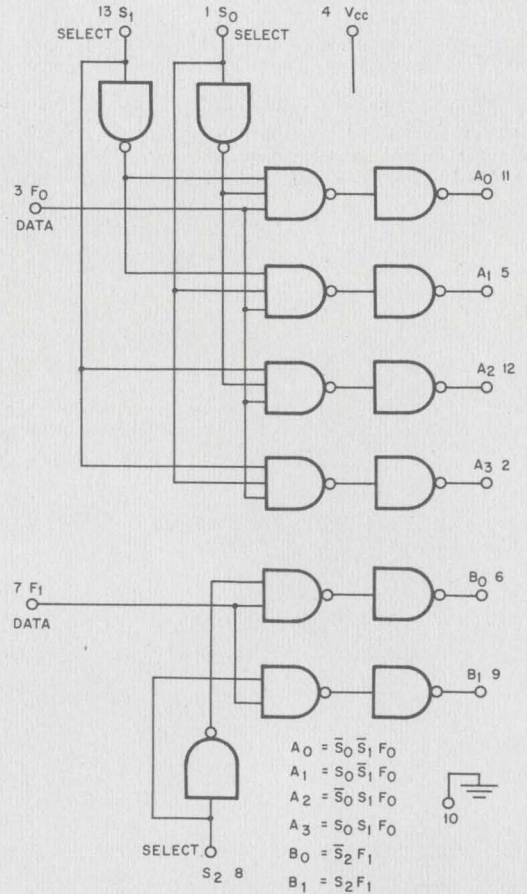

Fig. 3. Logic arrangement of SM-220 demultiplexer.

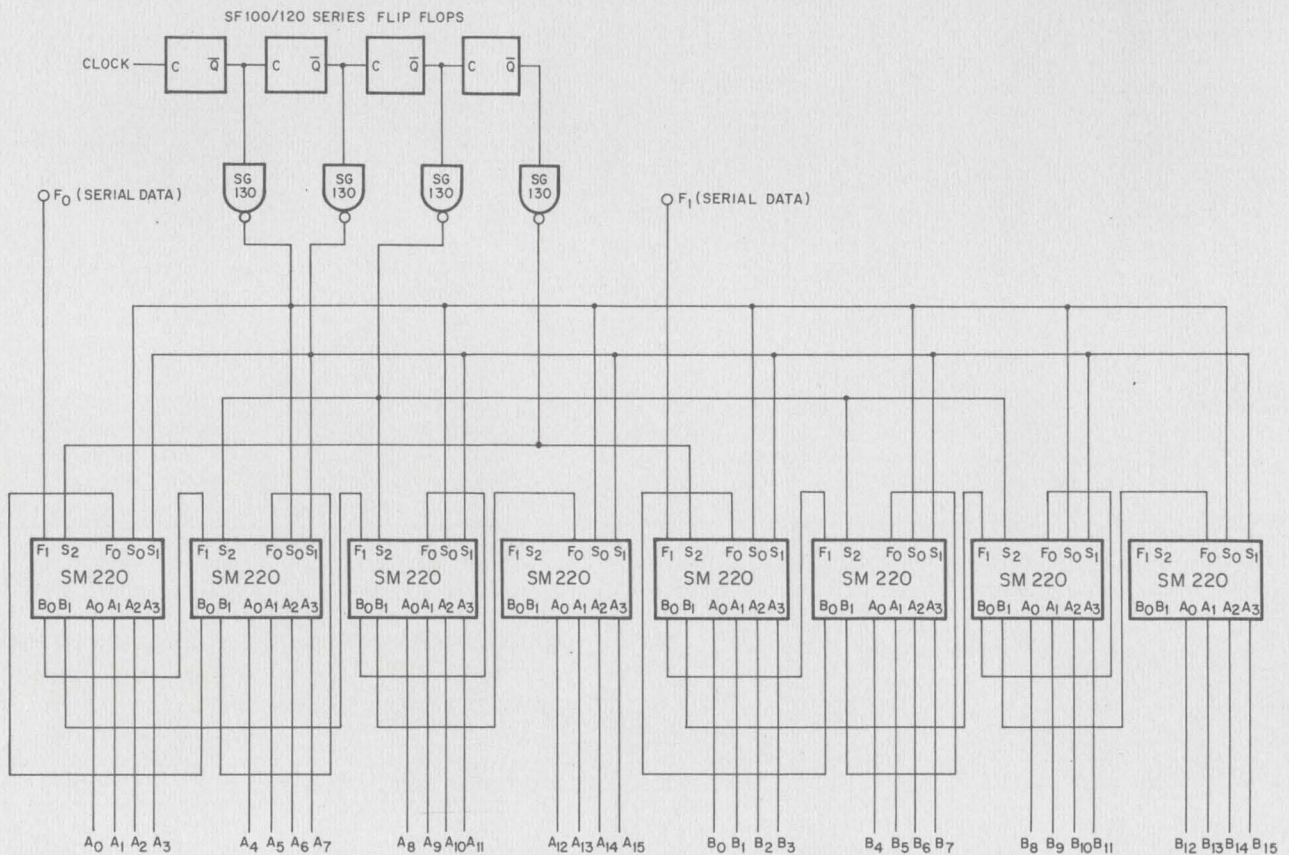

Fig. 4. SM-220 used as a serial-to-parallel converter.

MICROWAVE DEVICES

Beamlead and chip capacitors simplify hybrid circuit design.

New devices are ideally suited to use as series and bypass capacitors in microstrip applications.

Two new silicon-dioxide capacitor designs round out Sylvania's broad line of microwave components for microstrip systems.

The SC-9001 series are beamlead devices designed for series circuit applications such as coupling or blocking capacitors. Their mechanical design allows the gold beamleads to be spot-welded directly across a small gap in the microstrip line.

The SC-9002 series of chip capacitors is perfect for bypass applications. The base of the chip can be bonded directly to the ground plane and the other plate of the capacitor can be

connected to the microstrip line by a flying lead. These chip devices have gold metallization pads for ease of handling and bonding.

Both series of capacitors have an RF insertion loss equal to, or better than, microstrip line itself. Among the many applications for the two new capacitors are microwave switches, video detectors, RF and IF amplifiers and limiters.

Keep watching the pages of IDEAS for further developments in our microstrip components line. We expect to be telling you soon about a new resistor that will bring the benefits of beamlead devices to the microstrip world.

CIRCLE NUMBER 302

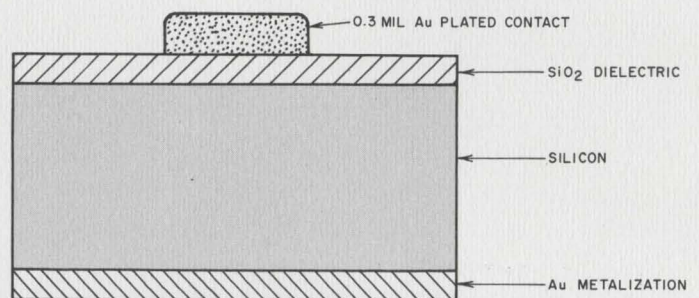

PACKAGE STYLE	CAPACITANCE RANGE
<p>BEAM LEAD</p> <p>PACKAGE 146</p>	0.5 TO 2.2 pF
<p>BEAM LEAD</p> <p>PACKAGE 147</p>	2.2 TO 4.7 pF
<p>BEAM LEAD</p> <p>PACKAGE 148</p>	5.6 TO 47 pF
<p>CHIP</p> <p>PACKAGE 149 - 152</p>	<p>* PACKAGE 149 0.020" x 0.020" = 6.8 TO 8.2 pF</p> <p>* PACKAGE 150 0.030" x 0.030" = 10 TO 22 pF</p> <p>* PACKAGE 151 0.040" x 0.040" = 33 TO 68 pF</p> <p>* PACKAGE 152 0.050" x 0.050" = 100 pF</p>

Electrical characteristics:	Beamlead	Chip
Capacitance Range @ 1 MHz	0.5 to 50 pf	6.8 to 100 pf
Temperature Coefficient	200 ppm/°C	200 ppm/°C
Capacitance Tolerance	± 20%	± 20%
Operating Temperature	-55°C to 150°C	-55°C to 150°C
Working Voltage	50 volts min	100 volts min

Characteristics of beamlead capacitors

Type number	Capacitance	Package number
SC-9001A	0.5 to 1.0	146
SC-9001B	1.0 to 2.2	146
SC-9001C	2.2 to 4.7	147
SC-9001DM	5.6 ± 20%	148
SC-9001EM	6.8 ± 20%	148
SC-9001FM	8.2 ± 20%	148
SC-9001GM	10.0 ± 20%	148
SC-9001HM	15.0 ± 20%	148
SC-9001JM	22.0 ± 20%	148
SC-9001KM	33.0 ± 20%	148
SC-9001LM	47.0 ± 20%	148

Characteristics of chip capacitors

Type number	Capacitance	Package number
SC-9002EM	6.8 ± 20%	149
SC-9002FM	8.2 ± 20%	149
SC-9002GM	10.0 ± 20%	150
SC-9002HM	15.0 ± 20%	150
SC-9002JM	22.0 ± 20%	150
SC-9002KM	33.0 ± 20%	151
SC-9002LM	47.0 ± 20%	151
SC-9002MM	68.0 ± 20%	151
SC-9002NM	100.0 ± 20%	152

TELEVISION

'Instant warm-up' heater speeds picture tube turn-on.

Two-second warm-up time more nearly matches CRT to the turn-on characteristics of solid-state TV receivers.

We've come up with a new directly heated cathode design for television picture tubes that approaches the "instant warm-up" characteristics of modern solid-state receivers. And what's more, it requires so little power that it can be driven by a simple link to the horizontal yoke current.

The construction of the new heater-cathode is shown in Fig. 1. The mounting is designed to give maximum thermal isolation for the cathode. The ceramic support is also carefully designed to act as a thermal sink for the cathode support structure. This maintains a relatively uniform thermal gradient along the length of the cathode ribbon. This is very important for long mechanical life of the cathode.

The cathode itself is a ribbon with an oxide-coated button at its center. Since power input requirements are proportional to the mass of the button, the button area is kept to a minimum.

We evaluated the new instant warm-up cathode in a type 12CSP4 monochrome tube and have come up with some remarkable results. Warm-up time, measured in terms of a

visible raster, was as little as 1½ to 2 seconds. The test tubes do not show any microphonic properties, nor does severe shock appear to change electrical characteristics. Emission levels are satisfactory with maximum currents in the range of 1 mA.

The low power requirements, 0.5 V at 0.800 A, enabled us to experiment with unusual sources of power. In a conventional arrangement, a portion of the DC power supply load current could provide the necessary heater current. But this approach would rule out use of the heater as the element by which the video signals are applied to the picture tube. This important feature can be retained if the heater is driven by means of a transformer in the yoke circuit as shown in Fig. 2.

In this circuit, a half-inch diameter ferrite toroid is used as a one-turn transformer. The primary is the ground return lead. The secondary is formed by passing the heater lead from the picture-tube socket through the core and connecting it to the other heater contact.

The result is a very low impedance source for powering the heater.

The toroidal transformer adds a minimum of capacitance to the video circuit, thus requiring no modification of the output stage peaking components. The low-impedance source is capable of supplying the higher-than-rated current needed when the cathode is cold. Measured warm-up time of the picture tube using this circuit was less than two seconds.

Although it's not yet an off-the-shelf item, our new instant warm-up cathode is definitely out of the experimental stage. We're ready to talk about designing it into your tubes. It can give you the selling feature you need for next year's models.

CIRCLE NUMBER 303

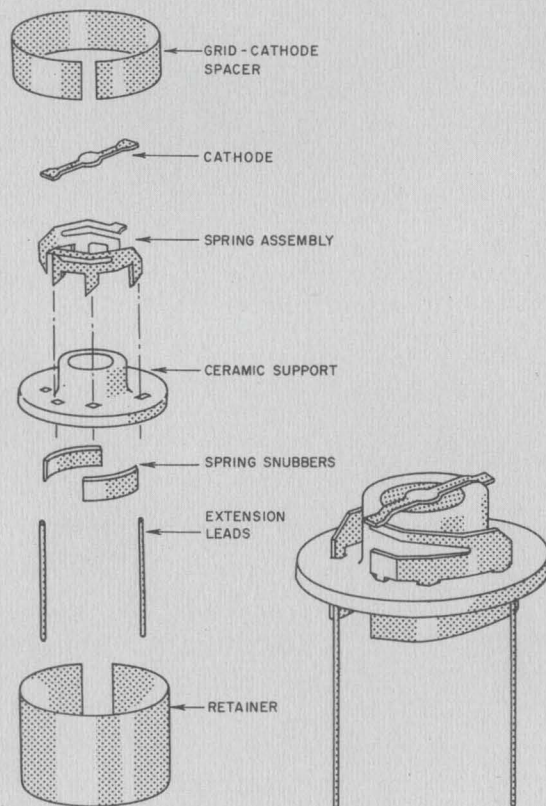

Fig. 1. Construction of the new instant warm-up picture tube cathode assembly.

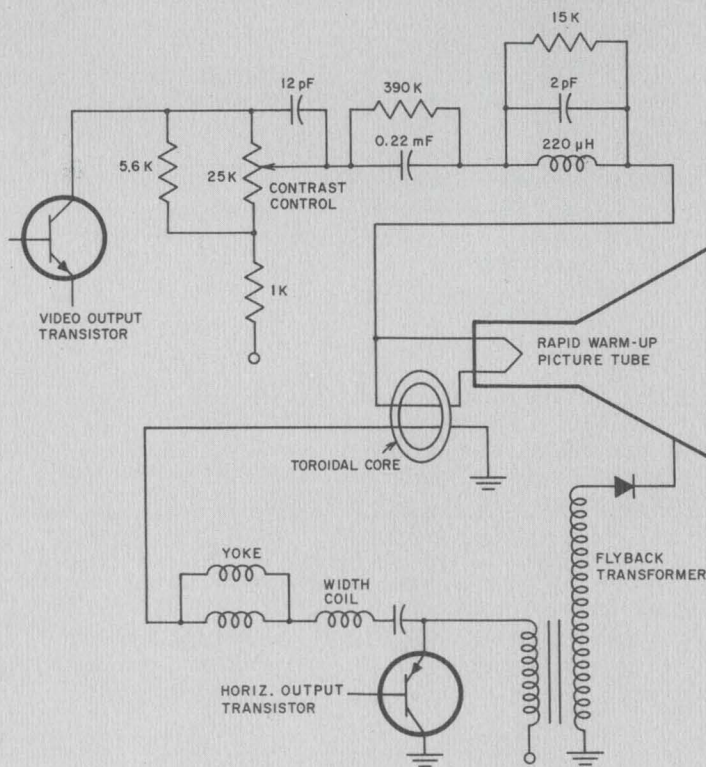

Fig. 2. New heater-cathode can be driven by single-turn transformer from yoke ground lead.

MANAGER'S CORNER

The path to LSI: Who goes first?

Perhaps the best analogy to illustrate the relationship between the design engineer and the integrated circuit manufacturer is that of two children daring each other to perform a certain adventurous act. Each one says "you go first."

As the semiconductor technology advances towards more highly complex circuits, the interface between the design engineer and the IC manufacturer becomes more critical. As the situation exists presently, the design engineer risks the design of a complex system based on the assumption that advanced circuit configurations can be fabricated by the integrated circuit manufacturer. The manufacturer, on the other hand, risks the production of a highly complex integrated circuit based on the assumption that the engineering community will use that package in their system design programs.

This could limit the advancement of LSI as a practical technology. The most apparent question is "who should take the first step." Should the design engineer be willing to take the gamble in hardening his design, hoping that the IC manufacturer can achieve the level of sophistication required to meet his IC specifications; or should the manufacturer go out on a limb and provide a more complex IC chip hoping that the engineering community can work with these more complex building blocks?

Actually, the relationship between the design engineer and the IC manufacturer is critical only if we are considering LSI as the immediate objective. If one looks back on the relationship as it has existed in the past, it is obvious that there is an evolutionary trend present. For example, in the past when an engineer intended to use a flip-flop in his system he merely designed the circuit using discrete components. With the introduction of the monolithic integrated circuit, the IC manufacturer decided to package the flip-flop configuration, thereby offering the design engineer a pre-tested building block.

In effect, the IC manufacturer made it possible for the engineering community to approach system designs on a higher level. They no longer were restricted to thinking in terms of discrete components since they now had available a wide assortment of functional blocks. The design engineer can now expand his thinking to a point where his general approach to system design assumes the use of these larger building blocks.

As the monolithic technology matured, the IC manufacturer, hoping to serve the engineering community, approached his packaging concept on a larger scale. If flip-flops could be packaged individually, why not complete shift registers and other similar complex circuit functions? Where once an engineer had to design a shift register by using individual IC flip-flops, he can now obtain this fundamental unit ready made.

Once again, the thinking of the design engineer was allowed to expand to a higher level. In approaching complex

system design, the engineer is now armed with larger and more sophisticated building blocks. This frees the engineer from the burden of having to design and test previously established circuit configurations. With larger, pretested building blocks available he can use his talent, experience and creative energies in the development of a more efficient and effective system.

It should be obvious at this point that the evolutionary trend has arrived, quite naturally, at the present state of semiconductor technology—namely, MSI (Medium Scale Integration). MSI is a natural extension of the monolithic technology, and is a stepping-stone on the path to LSI. It is this fact which lends so much importance to Sylvania's approach in satisfying the needs of the engineering community for more complex and sophisticated building blocks.

Rather than make an unrealistic leap into the production of extremely complex circuit configurations, which could possibly result in a retardation of semiconductor developments (i.e., trying to force the design engineer to work with building blocks far more advanced in sophistication than those which he is used to working with), Sylvania has followed the more natural line of evolution. We are providing the design engineer with integrated circuit configurations designed to allow him to expand his thinking at a more practical and realistic pace. In this way the same goals can be achieved. The level of LSI is approached for complex system design, while at the same time the design engineer can use practical building blocks to design and fabricate systems using present-day specifications.

What it all boils down to is the fact that the integrated circuit manufacturer serves as a high-level packager. He follows the activity of the system's design engineer, continuously observing system developments. The integrated circuit manufacturer then attempts to package larger portions of these systems, thereby freeing the design engineer to rise to higher levels of design approaches, and to think in bigger terms.

The relationship between the design engineering community and the integrated circuit manufacturer is, therefore, regenerative. As systems become more complex, the packaging of larger portions of these systems will follow. As these packages or building blocks are made more complex, the result will be the raising of the design engineer's level of thinking. This, of course, is a limitless process and will lead, in the future, to levels of design sophistication which today are unimaginable.

Harry Luhrs

H. M. Luhrs
Product Marketing Manager
Integrated Circuits

CRTs

Low-drain heaters save portable power.

High-efficiency heater-cathodes cut CRT power consumption to six percent of that of conventional units.

Our approach to heater-cathode design really takes the strain off battery-powered equipment. Wherever battery drain is a problem—spacecraft, military field equipment or industrial portable testers—our special design can reduce power requirements to 1/16 of that required by conventional CRTs.

These low-power heater-cathodes operate on as little as 0.21 watts (1.5 V, 140 mA) as compared to 3.78 watts (6.3 V, 600 mA) consumed by conventional heaters. The result is longer battery life (or smaller batteries), longer equipment life, and greater reliability. In addition, the lower power reduces equipment operating temperatures.

The low-power heater-cathode is a tiny pancake-like structure measuring 0.050" in diameter and 0.011" thick.

Compared with conventional units, the low-power assembly has an external radiating surface of 0.0054 square inches versus 0.136 square inches, a ratio of 25:1.

The extremely small mass enhances resistance to shock and vibration, upping reliability in severe environments.

One place where the low-power heater-cathode has been put to good use is in a lightweight, man-portable radar. This application uses two Sylvania low-power CRTs. Another application is in a portable industrial ultrasonic flaw detector. Here, the low-power heater-cathode is used in a CRT with helical-resistor post-deflection acceleration to achieve high writing rates and minimum pattern distortion. The table lists the characteristics of three tubes that make use of the low-power heater-cathode. These are just typical applications since the low-power design is adaptable to practically all present-day CRTs.

The 3BGP—offers high-deflection sensitivity, electrostatic deflection and focus with an optical-quality clear, pressed faceplate. It is a compact direct-view oscilloscope tube with face dimensions of 1½" x 3".

The 3BMP—is a 3" diameter tube with a flat, clear faceplate. It offers post-deflection acceleration, electrostatic deflection and focus.

The feature of the SC-3016 is compactness. It's only 6" long and offers a 1⅛" circular face. Deflection sensitivity is high with electrostatic focus and deflection.

CIRCLE NUMBER 304

Characteristics of low-heater power CRTs

Key Characteristics	3BGP-	3BMP-	SC-3016	Units
Heater Ratings	1.5V/140mA	1.5V/140mA	1.5V/140mA	Vdc
Anode No. 3 Voltage		6600*		Vdc
Anode No. 2 Voltage	2750*	2200*	2750*	Vdc
Anode No. 1 Voltage	1100*	1500*	1100*	inches
Face Dimension	1½ x 3/1/64	3	1⅛	inches
Over-all length	9¼	10	6	inches

*Absolute max. rating

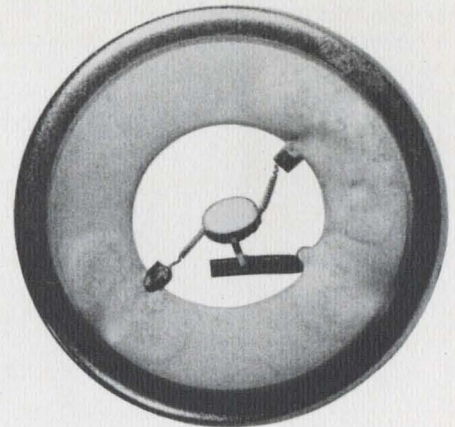

Low power heater-cathode operates on as little as 0.21 watt.

SEE OUR SPECIFICATIONS IN
VSMF
MICROFILM CATALOG FILE

Use Sylvania's "Hot Line" inquiry service, especially if you require full particulars on any item in a hurry. It's easy and it's free. Circle the reader service number(s) you're most interested in; then fill in your name, title, company and address. We'll do the rest and see you get further information by return mail.

BUSINESS REPLY MAIL
No Postage Stamp Necessary if Mailed in the United States

FIRST CLASS
Permit No. 2833
Buffalo, N. Y.

POSTAGE WILL BE PAID BY

Sylvania Electric Products Inc.
Sylvania Electronic Components
1100 Main Street
Buffalo, New York 14209

Dept. D 1 1 1 1

EL READOUTS

How etched leads boost EL bar graph resolution.

Chemical technique allows 50-line-per-inch spacing of bar graph segments, simplifies printed-circuit board connections.

Our recently developed chemical etch technique for making connections to electroluminescent (EL) devices improves the resulting device in two ways. By the use of this technique, we can now produce EL bar graphs with resolutions as high as 50 lines per inch. At the same time, the etched leads make an ideal way to connect the EL device directly to the necessary circuitry by soldering directly to a printed circuit board or to flex circuits.

The chemical etch method allows us to maintain tight control over lead spacing and lead dimensions. Because of this, we can vary the resolution along the length of a bar graph. This allows us to construct bar graphs having a logarithmic characteristic, or any other function desired. Elements of the bar graph can be as small as 0.050" in width.

Using this technique gives us better capability of stacking or making multiple bar graphs on a single substrate. Again, these can have the same or varying resolutions, widths, lengths, etc.

Chemical etch is just another flexibility added to the already high flexibility of EL display devices. In addition to bar graphs, EL devices are readily adaptable to the display of any type of information. For example letters, numbers,

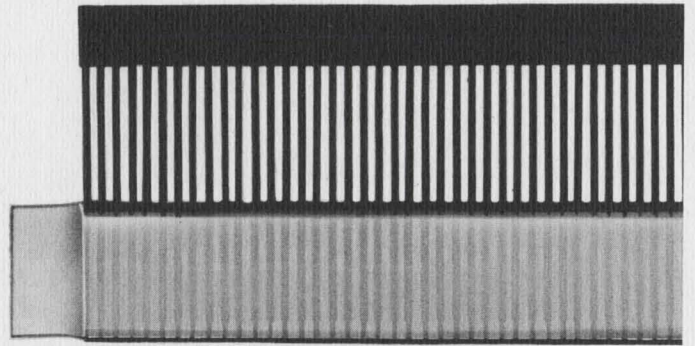

Chemical etch process allows accurate spacing of bar-graph divisions down to 50 lines per inch.

pictorial or analog data displays can be easily designed to meet your specific needs.

New developments in phosphors now enable us to offer EL devices with brightness levels up to 50 foot-lamberts at 250 V, 400 Hz and 25 foot-lamberts at 115 V, 400 Hz. Special glass faceplates allow contrast enhancement to permit viewing under the highest of ambient light conditions.

These features are in addition to the basic characteristics of EL that make it such an ideal display device. EL is a planar display; you don't have to look through a web of non-illuminated characters to see the one that's lit. It is practically immune to catastrophic failure and the spectral characteristic of EL devices closely matches the response of the human eye.

With all these features, isn't EL the best way to solve your display problems? Talk to Sylvania's applications engineers. They will be glad to show you how the flexibility of EL makes it practically certain that a display can be designed to match your exact requirements.

CIRCLE NUMBER 305

This information in Sylvania Ideas is furnished without assuming any obligations.

SYLVANIA

A SUBSIDIARY OF
GENERAL TELEPHONE & ELECTRONICS

NEW CAPABILITIES IN: ELECTRONIC TUBES • SEMICONDUCTORS • MICROWAVE DEVICES • SPECIAL COMPONENTS • DISPLAY DEVICES

D1

NAME _____

TITLE _____

COMPANY _____

ADDRESS _____

CITY _____ STATE _____ ZIP _____

Circle Numbers Corresponding to Product Item

300 301 302 303 304
305

Please have a Sales Engineer call



HOT LINE INQUIRY SERVICE

Need information in a hurry? Clip the card and mail it. Be sure to fill in all information requested. We'll rush you full particulars on any item indicated.

You can also get information using the publication's card elsewhere in this issue. Use of the card shown here will simplify handling and save time.

HAPPENINGS IN ELECTRONICS

January 1969

Extraordinary switching diodes made by extraordinary technology!

Why do we call these switching diodes from Isofilm International extraordinary? Because their Reverse Recovery Time (t_{rr}) is 3.0 nanoseconds, measured not at puny signal levels, but at real power levels such as 300 mils forward to 30 mils reverse; Forward Recovery Time (t_{fr}) 0.5 nsec. measured 10% to 10% above quiescent level.

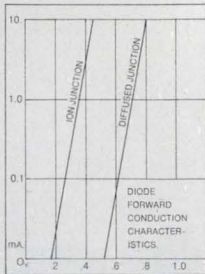

Why do we call the manufacturing process extraordinary? Because the junction of the diode is formed by ion implantation rather than conventional diffusion. This results in significant differences. The most important difference is the conduction turn-on point (illustrated in the figure). In conventional diffused junction silicon diodes, this point is widely known to be 0.55 volts; in the ion implanted junction silicon diode the forward turn-on point has been shifted toward the zero point by 0.4 volts! The low-voltage turn-on and the 3-nsec. reverse recovery time makes the Isofilm International HS series of diodes ideal for high-current, high-speed applications. Circle No. 221 for application note AN102. The HS series will be stocked by Schweber beginning Jan. 15th.

Second generation data sheets use computer-derived curves.

Up to now, design engineers looked for a table of raw electrical characteristics when they consulted semiconductor data sheets, and then out with the slide rule... Motorola has come up with a new idea in data sheets. Why not supply both device parameter data, and computer-derived solutions of circuit design equations preferably in the form of curves? The intention is to enable the designer to determine quickly the maximum power gain per degree of circuit stability for an unneutralized amplifier at any operating frequency. The 2N4957-8-9 series was selected for this purpose because it is state-of-the-art in small signal, UHF transistors. The eight pages of this data sheet contain 48 curves. To help you get started in the design of optimum UHF amplifiers using computer-derived curves, an eight-page application note (AN419) has been prepared in which a 1-GHz microstrip amplifier is used as a design example. The data sheet and the application note are yours by circling No. 222. The transistors are stocked by Schweber. Prices follow:

TYPE	1-99	100-999	Typ. NF	Min. Gpe
2N4957	20.25	13.50	2.6	17
2N4958	10.35	6.90	2.9	16
2N4959	6.75	4.50	3.2	15

Review of new catalogs:

Fairchild has enough MSI and LSI building blocks on the shelf to produce 60 to 80% of any digital logic system you have on the drawing board. Eleven versatile MSIs and nine unbelievable LSIs, designed specifically to work together, can do more jobs than a hundred discrete ICs. In addition to these fundamental building blocks, your whole 'thing' can be tied together by the interface circuitry of Fairchild's Micromatrix™ arrays. If you are planning a new generation of digital equipment, do yourself a favor and circle No. 223. You will receive a datapak with the whole story including four new second generation linears.

Wall chart for fixed film resistor users.

A cross reference selector chart of military fixed film resistors to MIL-R-55182-C prepared by Mepco, Inc. is available to those who circle No. 224. The chart is divided into Hermetic Seal Types RNR 55, 57, 60, 63, 65, 70 and Molded (Non-Hermetic Seal) Types RNC 50, 55, 60, 65. Electrical specs are listed including failure rate levels as well as information on lead materials, dimensions and methods of interconnecting.

Triac prevents arcing in relays.

Did you know that a triac can be used in a simple circuit to prevent contact arcing in relays? Not only will the triac reduce arcing, it will even reduce the size of the contacts required. A well-designed 5-ampere relay can be used in a 50-ampere load. This circuit is described in Motorola application note AN-444. Circle No. 225 to receive AN-444.

Hot Carrier Diodes in cartridge-type cases.

The Micro Optics Division of Alpha Industries is now in the business of making Hot Carrier Diodes with an important feature that should be of interest to the Microwave field. These hot carrier devices are being built in cartridge-type cases to make them directly interchangeable with the old 1N 21 and 1N 23 units so that little or no modification is necessary to the waveguide or coaxial mounts. This is your opportunity to try a state-of-the-art mixer in your microwave equipment with a minimum of effort. Circle No. 226.

Because most of the world is analog

2.8 MHz hybrid 10-bit D-to-A circuits are here to help.

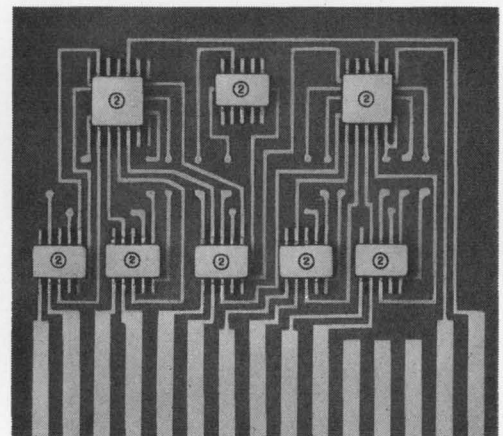

Get 10-bit accuracy at 2.8 MHz with only eight packages. You get ladder networks, ladder switches, and buffers. Just add a PC board and the fastest op amp you can find.

Only 240 mW. Save power. There's no hot speed/power trade-off with these new Sprague hybrids. And you save space, too. The D-to-A circuits are in $\frac{1}{4}'' \times \frac{1}{4}''$

and $\frac{1}{4}'' \times \frac{1}{8}''$ hermetically sealed ceramic flatpacks, rated for -55 to $+125^\circ\text{C}$ operation.

Three ways to go for these new D-to-A circuits. Call Dom Consorte at Sprague Worcester—(617) 853-5000, ext. 321. Or call your nearest Sprague industrial distributor. Or circle the inquiry card number for complete specification data.

THE BROAD-LINE PRODUCER OF ELECTRONIC PARTS

INFORMATION RETRIEVAL NUMBER 15



'Sprague' and '®' are registered trademarks of the Sprague Electric Co.

News

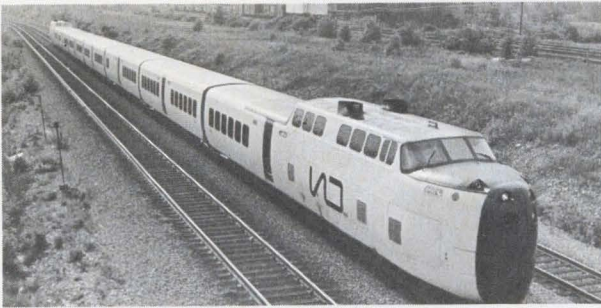

Thinking of a career in transportation, oceanography or education? See Page 54



Business prospects for 1969 look good despite inflation and Vietnam uncertainties. Page 25

Also in this section:

YIG echo effect promises new devices. Page 34

'Bargain' electronics for the Coast Guard. Page 36

People and computers have decided to get together. Page 40

News Scope, Page 21 . . . **Washington Report**, Page 47 . . . **Editorial**, Page 79

Something *New* Has Been Added!

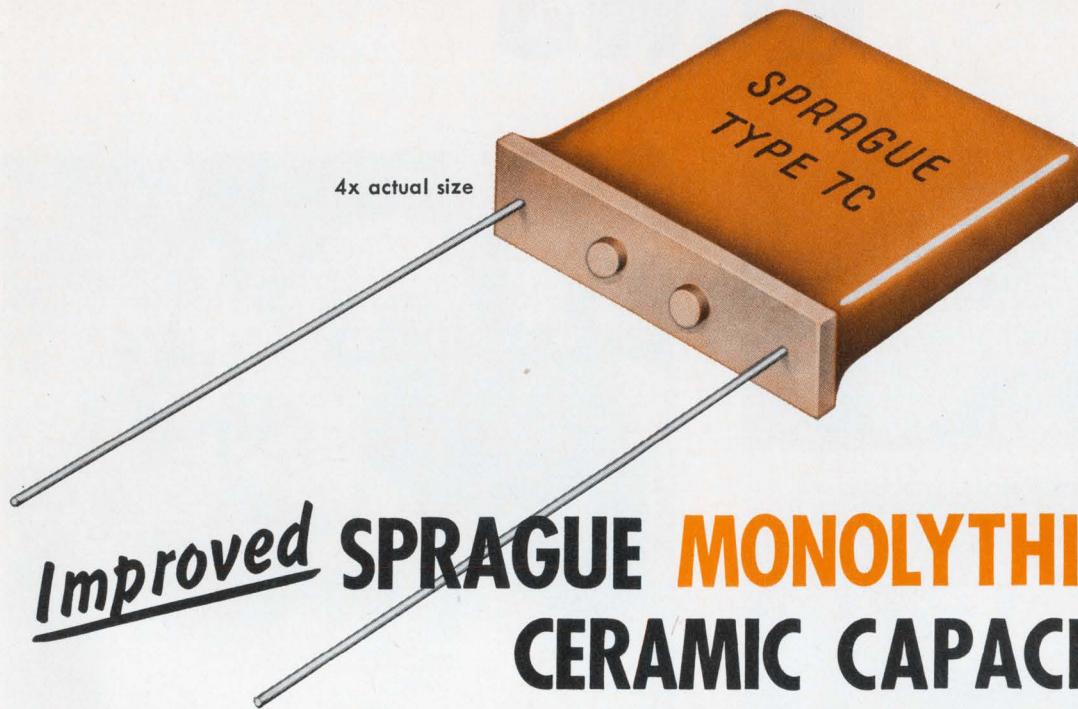

Improved SPRAGUE MONOLYTHIC[®] CERAMIC CAPACITORS

now have a phenolic terminal base

Type 7C Radial-lead Capacitors are made with alternate layers of sprayed ceramic dielectric material and screened metallic electrodes, fired into a solid homogeneous block and coated with a tough phenolic resin. Their new bossed terminal base construction provides these advantages: (1) No resin run-down on leads. (2) Uniform lead spacing is automatically maintained. (3) No dirt and moisture entrapment; degreasing fluid flows freely between capacitor and board.

Body Code	EIA Characteristic	Operating Temperature Range	Maximum Cap. Change over Temp. Range	WVDC	Capacitance Range	Capacitance Tolerance
082	N030	-55 C to +125 C	-30ppm/°C, ±30ppm/°C	50 100 200	51 pF to .024 μF	±20% ±10% ±5% ±2%
075	N750	+25 C to +85 C	Meets MIL-C-20 Char. UJ	50 100 200	.001 μF to .082 μF	±20% ±10% ±5% ±2%
		-55 C to +125 C	-750ppm/°C, ±120ppm/°C			
067	W5R	-55 C to +125 C	±15%	50 100	.0018 μF to 1.5 μF	±20% ±10%
023	Z5U	+10 C to +85 C	+22%, -56%	50	.01 μF to 3.3 μF	+80, -20% ±20%

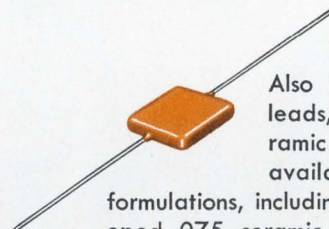

Also made with axial leads, Monolythic[®] Ceramic Capacitors are available in four body formulations, including a newly-developed 075 ceramic material, as described in the adjacent chart.

For complete technical data write for engineering bulletins on Monolythic Ceramic Capacitors to: Technical Literature Service, Sprague Electric Co., 347 Marshall St., North Adams, Mass. 01247.

SPRAGUE COMPONENTS

CAPACITORS
TRANSISTORS
RESISTORS
INTEGRATED CIRCUITS
THIN-FILM MICROCIRCUITS

PULSE TRANSFORMERS
INTERFERENCE FILTERS
PULSE-FORMING NETWORKS
TOROIDAL INDUCTORS
ELECTRIC WAVE FILTERS

CERAMIC-BASE PRINTED NETWORKS
PACKAGED COMPONENT ASSEMBLIES
BOBBIN and TAPE WOUND MAGNETIC CORES
SILICON RECTIFIER GATE CONTROLS
FUNCTIONAL DIGITAL CIRCUITS



[®]'Sprague' and '®' are registered trademarks of the Sprague Electric Co.

Computer industry girds for IBM-CDC 'battle'

The computer industry is all eyes and ears and quiet as a cat as it watches Control Data battle it out with IBM in the courts.

Control Data's suit has charged IBM with:

- Monopolizing domestic and foreign computer markets by conspiring with its own subsidiaries;
- Engaging "in overt acts and conduct with the specific intent to injure or destroy competition . . . ;"
- Having "power to control prices or exclude competition . . . ;" and
- "Misrepresenting the status of design, development, production, and performance of certain of its computers, and programs or software for certain computers . . . all for the purpose of depriving customers of the opportunity to accurately evaluate competitive computers." Control Data said that IBM began advertising its 360 series in 1964, long before the 360 was ready, and did so, then, just to lure prospective customers away from Control Data's then new 6000 series—just when the 6000 was ready for delivery.

The court battle is expected to take the disputants up and down many legal alleys.

Whether or not Control Data's complaint against IBM is motivated by fear that the computer giant was once again going to announce a new generation machine—well in advance of any availability—is open to speculation.

On Dec. 2, two days before the CDC complaint was made public, *DP Focus*—a data processing newsletter distributed at the Fall Joint Computer Conference in San Francisco—did, in fact, predict that IBM would soon announce just such a new generation series, one built with LSI.

IBM, which is no stranger to accusations of monopoly, says it plans to "vigorously defend itself"

against Control Data's action, on the grounds that the "allegations are unfounded and inconsistent."

IBM will claim that Control Data has contradicted itself by charging that "the data processing industry is not competitive," while in the same breath complaining "that there has been excessive competition."

IBM says the data processing industry "is highly competitive" and is open to any small computer manufacturer. Control Data, IBM says, started with less than \$1 million in capital and has assets now of "more than \$465 million." Control Data, IBM adds, has grown faster than IBM itself.

Opinion in the data processing community varies from glee, that IBM might get its comeuppance, to resentment that competitive practices might someday be regulated by law.

If IBM should be forced to divest itself of some of its operations, industry observers foresee a frantic scramble—by the rest of the community—to grab whatever IBM would turn loose.

Task Force urges new communications 'look'

Sufficient information has been leaked to the press by members of the Presidential Task Force on Communications Policy to make it possible to predict, with some accuracy, what the group's report will contain.

The forthcoming 450-page document is expected to recommend:

- Establishment of a new Presidential agency that will supervise all frequency allocations and advise the President on matters pertaining to communications.
- More personnel for the FCC, especially in technical positions.

- A merger of all existing U.S. international telecommunications into a "single entity."

- Establishment of a domestic communications satellite system for commercial broadcasting, on a pilot basis and under the management of Comsat Corp.

In urging establishment of the new executive agency, the Task Force will say it has no intention of eliminating or reducing the stature of the FCC. Instead, it will note that the FCC's heavy regulatory task prevents it from effectively expanding its efforts into other problem areas.

The report will strongly urge an end be made to divided control of frequency allocation.

At present, Federal use of the spectrum is controlled by the Interdepartment Radio Advisory Committee—the FCC controls all other frequency allocations. The present block-allocation procedure will be termed inadequate and inflexible in the report.

Autonetics introduces small LSI computer

If the advent of large scale integration in the commercial computer field is still some time off, in the military computer field the accent on LSI is on the here and now. (ED 24, Nov. 21, 1968, Special Report, p.C50).

One example that proves this is the case was displayed at the Fall

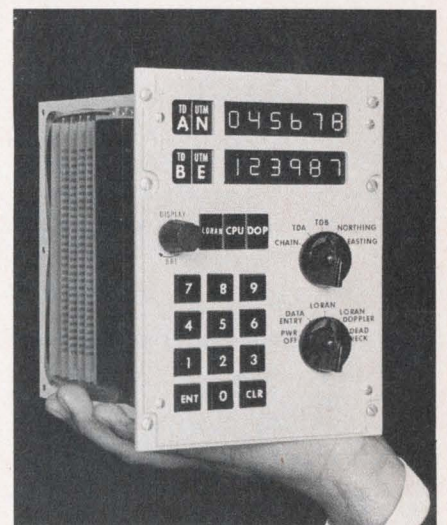

Autonetics D200 computer is shown in mock-up form.

Joint Computer Conference in San Francisco—in the form of Autonetics' new D200, a general-purpose, handheld computer designed with four-phase microcircuitry using automated techniques.

Although the D200 was designed for navigational use, the computer is, in fact, a general-purpose machine and can be adapted to a variety of commercial uses. So says R. M. Bukaty, vice president and general manager of Autonetics' Data Systems Div., Anaheim, Calif.

The fully operating breadboard version of the D200 was designed by R. K. Booher, who says it was designed to satisfy the general requirements of a navigational computer, and adds:

"Consequently, it is neither the world's fastest nor most versatile computer, but it does represent a quantum jump in the technology that produced it."

Asked for specifics, Booher says that 35 instructions are provided, and that these include a 108- μ s multiply, a 108- μ s sum-of-products multiply and a 112- μ s divide. Most of the other instructions require 8 μ s.

Booher explains that although the computer is designed to add a 32K word memory, it currently uses a 4K word memory. And while the clock rate, right now, is 250 kHz, the designer says that "in the not-too-distant future, we expect to operate at 1 MHz."

Bukaty states that although his division is not set up to handle commercial orders at the present time, he does not rule out the possibility that Autonetics might, in the future, put through an internal reorganization to accomplish just that.

Concerning the D200, as it now exists, he adds that the company is prepared to go into production at the rate of at least 8 computers per month, and to build up gradually, thereafter, to full-scale production of any desired quantity. He predicts that delivery of the D200 could be promised in 9 months from today, at an average

price of \$22,000 a machine for 100 units or \$15,000 a machine for orders of 1000 or more.

Canadian electronics in force at Chicago show

Canadian electronics has arrived, in force, on the American industrial scene.

This was signified by the presentation of a 14-exhibitor display at the National Electronics Conference and Exhibit held in Chicago.

Representing a good cross section of the fast-growing Canadian industry, the displays were produced in a cooperative effort between Canadian electronics firms and the Canadian Dept. of Trade and Commerce.

According to Douglas Dingwall, deputy director of Operation, Canadian Dept. of Trade and Commerce, electronic industry sales in his country have passed the \$1 billion mark, annually. Based on projected rates of increase, total sales for the next 10 years are expected to reach \$3 billion.

Although the industry, over-all, is located in areas as far apart as Nova Scotia and British Columbia, most of the firms are concentrated in the provinces of Ontario and Quebec.

Among products displayed were an auto-scan receiver system for coastal stations and an automatic direction finder by E.M.I.-Cossor Electronics Ltd., Dartmouth, Nova Scotia.

Waveguide components for the 1-18-GHz region, made by Desitron Company Ltd., Scarborough, Ontario, included low-and-high power rotary-helical coaxial phase shifters and a special polarization rotator that was developed for radio-astronomical observations.

Greek city found by new magnetometer

Covered by the ruins of Greek and Roman cities and by some 2500 years of flood deposits, the once wealthy Greek city of Sybaris, which long eluded all attempts to pinpoint its site, has now been found—by computer, in a plain some 80 times its size.

Detailed maps of the walls and buildings of the ancient capital—playhouse of the Sybarites—were first drawn by computer-aided data collected by a portable new magnetometer operated from above ground. These findings were then verified by spot drilling directly down into the called-out site.

The new cesium magnetometer was developed by Varian Associates, Palo Alto, Calif.

The newest model of this device, announced last May, weighs 22 pounds and sells for \$5750. It consists of a rod, as long as a broom with a cesium sensor at one end. An audio-readout unit and batteries are mounted on the operator's belt.

The sensor, which operates on the principal of atomic spin resonance, generates a radio frequency that is proportional to the magnetic field intensity, at a rate of exactly 3.5 Hz a gamma. This frequency is mixed with that of a variable reference oscillator in the belt-mounted audio-readout unit. The resultant difference frequency is used to drive a miniature speaker or earphones.

Thus, the device produces a continuous audible indication of changes in the magnetic field intensity near the sensor. The variable oscillator can also be adjusted until the difference frequency is zero; the field intensity, in gammas is then read off a digitally calibrated control dial.

The cesium magnetometer is at least 100 times more sensitive than the proton magnetometer—the only portable type previously available.

Seeks SST support

Boeing Company, prime contractor for this country's supersonic transport, is quietly but firmly pressuring many of its SST subcontractors to actively support continued Federal funding of the project. The firm apparently feels the extra support will be needed to counter impending Congressional attacks on the present SST program.

Boeing began its quest for industry assistance early last month. Informants say that Boeing has requested all subcontractors who hold contracts of over \$1 million to close ranks and show a solid front.

we've added another to the series

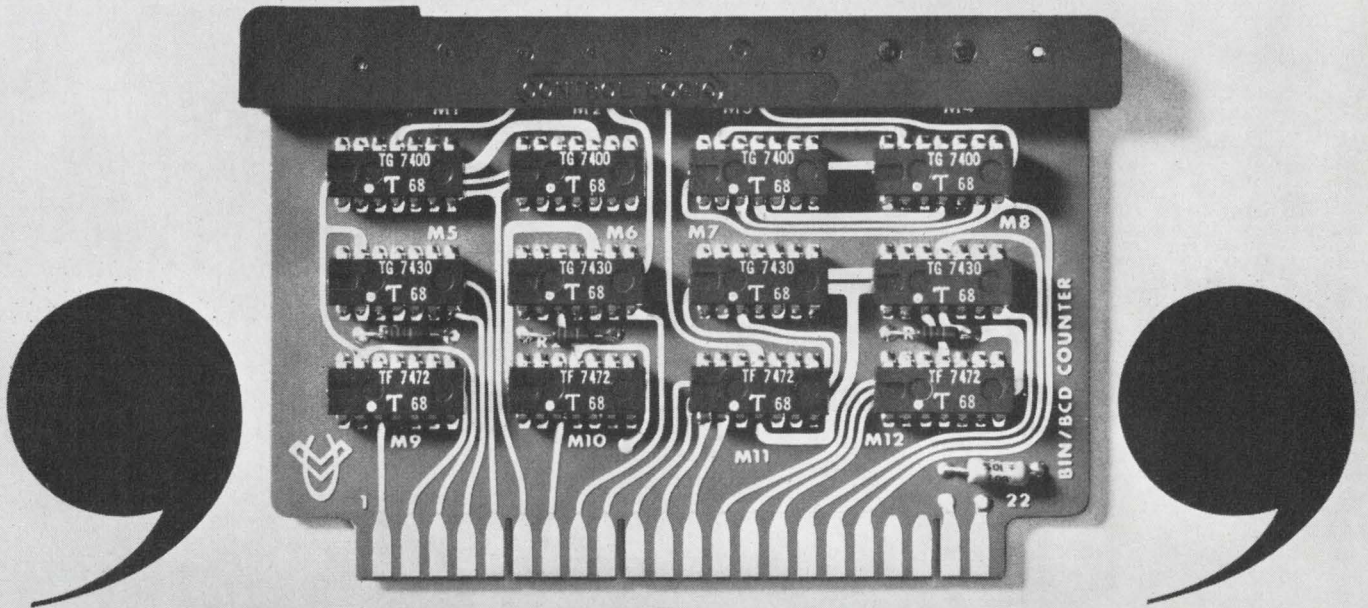

The 7400 T²L, our latest micro-logic circuit card. How did we do this? We just placed a comma after our last development, the automatic wire-wrap assembly. The series now looks something like this: T²L SUHL I, T²L SUHL II, DTL, AW, 7400 T²L, and . . . We've placed a comma after the 7400 because we're not done yet. Write or telephone for more information about our methods of punctuation.

 CONTROL LOGIC, INC., 3 Strathmore Rd., Natick, Mass. 01760 • 617/235-1865.

winning form

from the
form-factor
specialists
at Damon

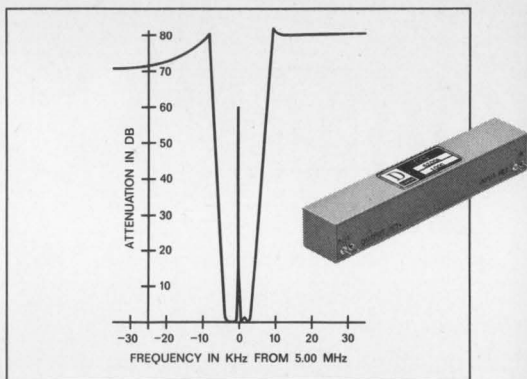

When it comes to rejecting clutter in a Doppler radar system, or the carrier in a suppressed-carrier communications system, the **Damon Model 5200A Bandpass-Notch Filter** gives you a double edge. It provides at least 50 db of clutter or carrier rejection — plus crystal bandpass filtering to eliminate unwanted sidebands.

Specifications: Notch frequency (f_r): 5.00 MHz. Reject bandwidth (>50 db): $f_r \pm 70$ Hz min. Passbands: Flat within ± 0.75 db from $f_r \pm 450$ Hz to $f_r \pm 3570$ Hz. Insertion loss: typically <5 db. Out-of-band rejection: 60 db min. Operating temperature range: -15°C to $+65^\circ\text{C}$.

Whatever your signal-shaping needs — from a sharp rejection notch to a broad bandpass — you can rely on the form-factor specialists at Damon. Write: Electronics Division, Damon Engineering, Inc., 115 Fourth Avenue, Needham, Mass. 02194, or call (617) 449-0800.

DAMON

INDUSTRY FORECAST FOR 1969

Electronic sales inch ahead—but hesitantly

EIA predicts a \$24.6-billion market, up 4.1%, with inflation and peace talks blurring the picture

Ralph Dobriner
Chief News Editor

By the accepted indicators, sales in the electronics industry should edge up slightly in 1969. But few prognosticators are willing to make more than cautious estimates.

The Electronics Industries Association predicts total sales will reach a new high of \$24.6 billion—up \$1 billion, or 4.1 per cent, over the figure for 1968.

Electronic suppliers are looking for increased spending under President Richard M. Nixon for military

and space programs, but the full effect, they say, probably will not be felt before fiscal 1971. For 1969, the EIA forecasts Government expenditures for electronics at \$12.7 billion—up only 4 per cent compared with an 8 per cent rise in 1968.

Other predictions, announced by Mark Shepherd Jr., the EIA's president and also the president of Texas Instruments, Inc., Dallas, include these:

- Consumer electronic product sales should show a 3.3 per cent

rise over the \$4.5 billion to \$4.65 billion of 1968. Last year's growth was 4.1 per cent.

- Industrial electronic product sales should climb 6.3 per cent to \$6.5 billion, the same increase as in 1968.

- Total sales of electronic components should increase about 1.5 per cent over last year's \$700-million level.

The two biggest questions that inject an element of doubt in the most confident predictions are: What will happen to the Government's investment in electronics as the Nixon Administration tries to combat runaway inflation? What will be the outcome of the Vietnam peace talks in Paris?

"Subject to international developments and the outcome of the peace negotiations over Vietnam," says EIA's president, "a renewed demand for increased military expenditures may expand Government procurement of electronics."

Shepherd says the second half of 1969 should be more active than the first, as "present uncertainties become more accepted as a way of life."

Aside from Government electronics spending, the major sectors of the industry can be broken down into these three: the consumer market, the component market and industrial electronics.



Regardless of the Vietnam peace talks, military spending is expected to climb under the Nixon Administration.

CONSUMER MARKET

Consumer electronics has been called both the oldest and the newest of the complex of industries that make up electronics—as old as the crystal radio set, as new as color television and the video tape recorder. It now constitutes about 20 per cent of the industry. Last year three major products—television, phonographs and radios—accounted for over \$3.5 billion in factory sales.

(Forecast '69, continued)

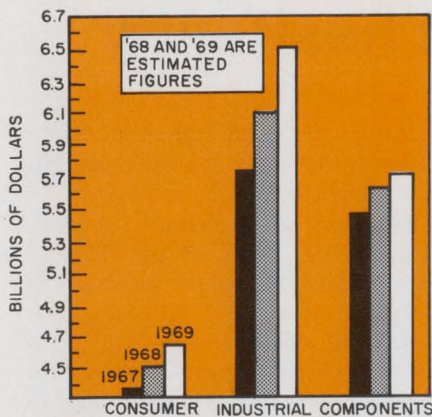

A slower growth rate is predicted for all areas of the electronics market this year.

Once again the hottest single item in the consumer market is color television. Factory sales this year, according to industry spokesmen, are expected to total some 6.2 million sets compared with an estimated 6 million sets sold in 1968. These figures include domestic and imported sets.

Last year may have been a milestone for television. When all the figures are in, it is expected that for the first time sales of domestic color TV sets may have exceeded those of black-and-white.

Nevertheless one surprise for manufacturers of consumer products last year, according to the EIA, was the rebound in industry sales of black-and-white television.

"Much of this success," according to Shepherd, "can be attributed to the rebirth of monochrome popularity in small-screen portable sets, many of which are battery operated, for ease of portability and use by young people."

Noting that acceptance of color TV has been adequately demonstrated, the EIA president sees a continuing trend toward smaller-screen, less-costly, portable sets, many of which are becoming a second or third color set in the home.

Magnetic tapes as a consumer recording and playback medium are now some 20 years old and stand on the threshold of possibly their biggest growth.

The versatile home audio record-

er crosses all price lines; it can be bought in versions that retail from \$10 to \$500 or more. U.S. sales of audio tape recorders including domestic label imports will reach a high in 1969, with the sale of an estimated 1.75 million units. Not included in this figure are the large and growing numbers of tape recorder decks, designed to play back through existing high-fidelity systems, or the popular playback-only tape cartridge systems.

The sharply increasing popularity of the easy-to-use cartridge (cassette) recorder and tape cartridge players is opening big new markets. In fact, according to the EIA, the size of the tape-recorder market is expected to more than double within a few years.

A newly evolving product, the video tape recorder is still too expensive (often around \$1000 for a monochromatic recorder and monitor without a camera) for general consumer use. Most are being purchased for professional or semi-professional use in industry or broadcasting studios.

COMPONENT MARKET

With an across-the-board slowdown in the growth rate of industrial, consumer and Government spending for electronics, components also are expected to show only a modest upturn. Sales this year are expected to be 1.5 per cent higher than in 1968.

Integrated circuits, color-TV picture tubes, power and special-purpose tubes and some of the newer semiconductor devices are expected to contribute to the relatively small increase.

Douglas O'Connor, director of Fairchild Semiconductor marketing, predicts that the total U. S. semiconductor market in 1969 will reach \$1.290 billion, compared to \$1.167 billion last year.

Tube sales of all types are expected to increase about 6 per cent over the estimated \$1.4 billion volume of 1968. This contrasts with a decline of approximately 4 per cent in 1967.

Demand for silicon transistors should be up in 1969, though the first half is expected to be better than the second because of an ex-

Predictions for 1969

Government: A modest 4 per cent increase to \$12.7 billion compared to last year's \$12.3 billion and 8 per cent rise.

Consumer: Color TV sales may surpass sales of monochrome sets. A huge market for "cassette" recorders of all types is forecast. Video tape recorders are still too expensive.

Components: Areas to watch: rf and power transistors as well as FETs. Demand for thick-film and hybrid circuits should exceed the supply.

Industrial: Continued rapid growth. Computers and data-processing equipment of all types lead the way.

pected slowing of the economy, according to Joseph Vielock, manager of silicon transistor marketing at Motorola Semiconductor, Phoenix, Ariz. Total sales are expected to reach \$311 million, compared with \$309 million in 1968.

Vielock predicts the following trends in 1969:

- Military demand for silicon transistors will be slightly stronger than in 1968—depending, of course, on the Vietnam conflict.

- No significant change in the industrial-commercial market.

- A strong consumer market should result as transistor TV receivers become more popular. This market will use large quantities of plastic small-signal and power transistors.

- Improved high-voltage and high-current devices will further penetrate the industrial market.

The greatest growth, according to Vielock, will be in power and rf transistors. FET sales will definitely increase, he adds.

Activity in plastic transistors

Plastic transistors will be in demand as new sockets are developed and as they replace germanium and metal-can transistors. Small-signal, metal-can devices will pick up as they are replaced by integrated circuits in many applications, Vielock says.

Demand for circuit assemblies

Remember When A Scope Had To Be Big To Be Good?

Not any more! No longer do you have to crowd your work area with overweight, two-handled monsters to provide the variety of measurements required by today's technology!

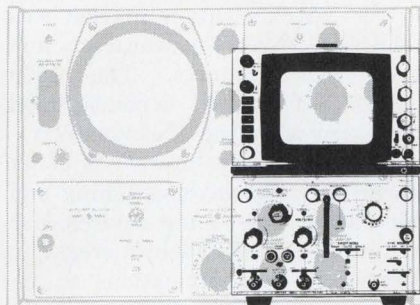

Now you can make accurate measurements from dc to 12.4 GHz with the mini-giant — the all-solid-state HP 180 Scope System. It fits nicely on your design bench, or in your production area—and it's so light it can be easily carried *wherever you need it*. No longer do you have to have a structural-steel cart to haul your scope around! The 180 cabinet models are only 8" x 11" x 22½" deep, and the rack mounts are only 5¼" high! With plug-ins, the 180 scopes weigh only 30 pounds.

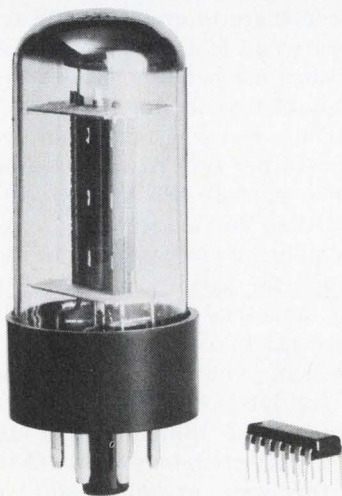

Vacuum tubes vs. all-solid-state: Not only does all-solid-state construction in the 180 scope system

give you compactness and light weight, it gives you many other advantages over outdated vacuum tube models. All-solid-state components eliminate the inherent high temperature and drift in vacuum tube scopes — and the resulting change in performance. Granted, vacuum tube scopes can be accurate—if they are frequently recalibrated—a procedure not necessary with the all-solid-state 180 system which makes consistent measurements time after time! And how many times have you had to wait for a vacuum tube scope to temperature stabilize—a frustrating delay eliminated with the 180 system.

Power consumption in the 180 scopes is a low 95 watts, convection cooled. Compare that with the more than 500 watts of some of the fan-cooled vacuum tube overweights. (And that says nothing about the noise and extra maintenance of a fan-cooled unit!)

Since the 180 scopes first appeared over two years ago, the all-solid-state concept has proved that service and maintenance required is minimized. The solid-state components are highly reliable and not subject to the matched tube replacement procedures that are mandatory for vacuum tube models.

All-solid-state and plug-in versatility: All-solid-state design lends itself well to the plug-in concept. Because solid-state components fit in smaller spaces, it was possible to design the 180 scopes with only the CRT and its power supply in the mainframe. You can choose a big, easy-to-read 8 x 10 cm conventional persistence, or a variable persistence and storage CRT—then expand your system to meet your requirements with the variety of 180 System plug-ins.

Packed in these small solid-state plug-in packages are such capabilities as dual channel, four-channel, 7 ns 50 MHz, 3.5 ns 100 MHz, 12.4 GHz sampling, 35 ps calibrated TDR, mixed sweep, delayed sweep, variable holdoff, differential/dc offset—to cover only a part of the list.

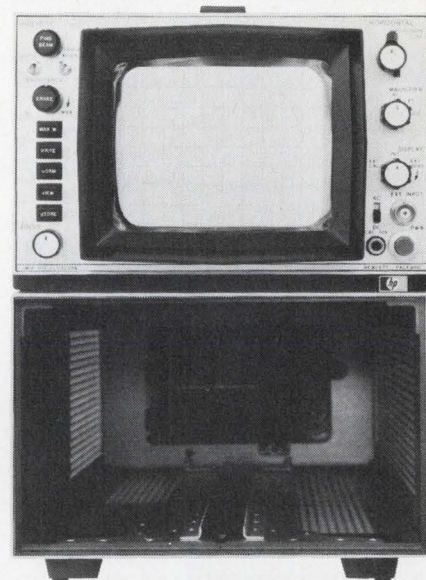

Where else can you get this performance and versatility? Only the HP 180 all-solid-state mini-giant provides you with a compact, lightweight system complete for accurate measurements from dc to 12.4 GHz. And the HP 180 scope system has been proven by more than two years of reliable service in the field!

Prove to yourself that good things do come in small packages. Contact your nearest HP field engineer (he's a broad spectrum measurement analyst) for complete specifications and prices on the HP 180 Scope System. Or, write to Hewlett-Packard, Palo Alto, California 94304. Europe: 1217 Meyrin-Geneva, Switzerland.

089/2

STEP FORWARD

HEWLETT  PACKARD

OSCILLOSCOPE SYSTEMS

INFORMATION RETRIEVAL NUMBER 19

(Forecast '69, continued)

and thick-film circuits should increase significantly. Sales this year are expected to reach \$400 million, compared with \$350 million last year. In fact, production of these largely custom parts will not be able to keep up with increased demand, according to Motorola. The rapid growth in hybrid circuits is expected to increase sales of unencapsulated transistors and transistor chips.

TTL spurs digital growth

Digital integrated circuit demand should continue at a high level, with total sales of about \$320 million, compared with some \$250 million in 1968, according to Motorola figures.

The largest single area accounting for this 31 per cent growth should be in TTL, with notable advances in such areas as memories, dielectrically isolated parts, complex MOS (non-consumer market) and emitter-coupled logic according to John Jordan, manager of digital IC marketing at Motorola.

Increased demand for digital ICs should be felt in the industrial and commercial markets spurred by

low-priced plastic integrated circuits and the advent of complex circuit functions.

"Complex functions, MOS and bipolar, with the added flexibility of second layer metal to optimize circuits to a particular customer need, will lead the development parade," Jordan says.

Linear IC upturn expected

The 1969 linear integrated circuit market should continue as in the last part of 1968—somewhat down from the year before. But it should experience an upswing in the last half of the year, when many new devices begin to stimulate the market.

Monolithic linear ICs are expected to compete ever more strongly with discrete devices, especially in the consumer area.

The 1968 linear IC dollar market is estimated at \$61 million and the 1969 market at \$78 million. The latter should be distributed as follows: military market, 50 per cent; industrial-commercial, 35 per cent, and consumer, 15 per cent.

There may not be any radically new technological developments in 1969, but much effort will be devoted to improving the characteristics of existing devices—higher

voltage capability, for example. In addition 1969 should see the introduction of linear devices that use dielectric isolation for radiation resistance.

"This technology will eventually be a factor in the military segment of the linear market, but the maximum effect will probably occur in post-1969—most likely with op amps with FET front ends," says James Burns, manager of linear IC marketing at Motorola.

In the discrete power device area, the demand for thyristors and related devices should continue up in 1969.

Last year's military market was relatively weak for varactor and microwave products. The 1969 outlook, of course, depends upon the outcome of the Vietnam War.

More and more interest is being shown in microwave switching and generating and tuning devices. Use of tuning diodes should increase in commercial communications equipment, such as aircraft receivers and transmitters.

A considerable increase in the use of tuning diodes in fm, TV and a-m receivers is expected. The availability of plastic diodes with extremely sharp tuning capabilities should make electronically tuned auto and table a-m receivers practical.

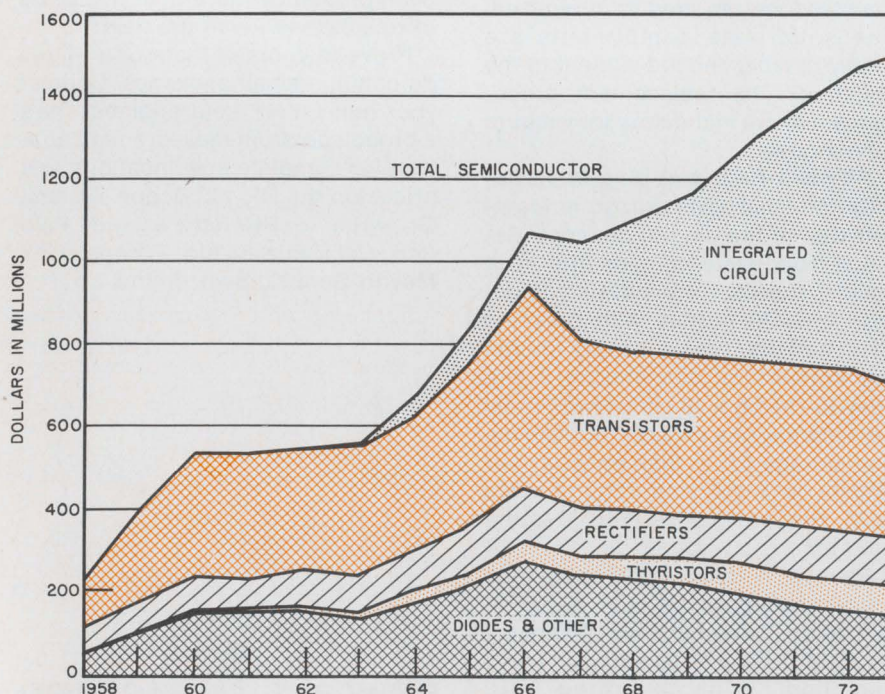

Integrated circuits will experience an almost explosive growth compared to the rest of the semiconductor industry, according to a Motorola Semiconductor survey.

INDUSTRIAL AREA

The industrial electronics market continues to grow at a substantial rate and is expected to register the same 6.3 per cent sales gain it scored last year. In 1957 the industrial sector comprised only about 16 per cent of the total electronics market; this year it will be more than 25 per cent.

Computing equipment sales alone account for about one-half of the total industrial electronics market. Shipments of computing and data-processing equipment to domestic and foreign users amounted to an estimated 3.5 billion during 1968 and is expected to exceed 3.5 billion this year, excluding software. Communications equipment, microwave, testing apparatus and control instrumentation should also share sizeably in the industrial market this year. ■■

Can you spare less than one gram to solve your MIL-STD-704 surge protection problems?

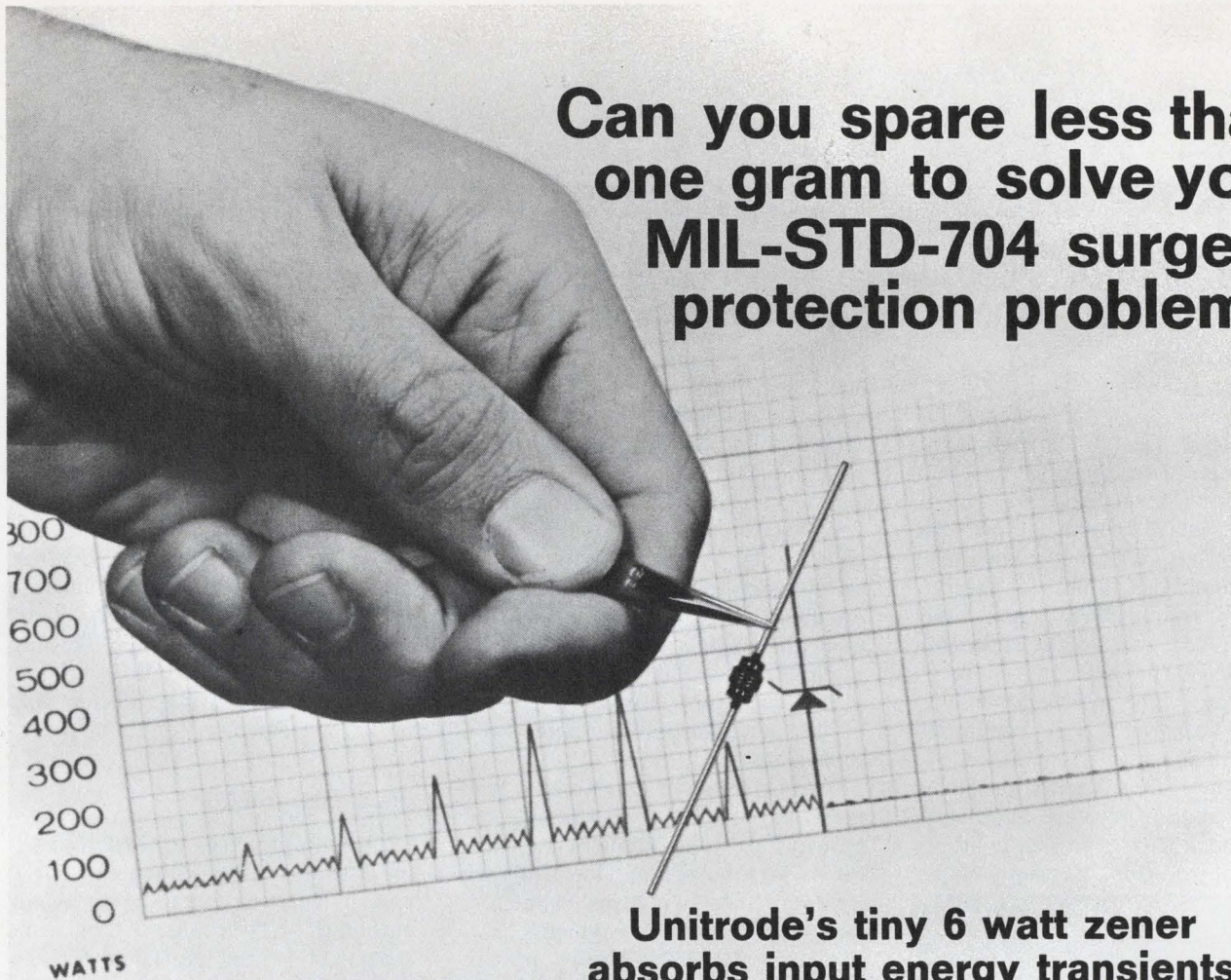

Unitrode's tiny 6 watt zener absorbs input energy transients up to 1000 watts for 1 microsecond.

- 350 watt surge capacity is 600% more than conventional 10 watt . . . 35% more than a 50 watt.
- Weighs less than 1 gram . . . 1/10th of a conventional 10 watt . . . 1/20th of a conventional 50 watt.
- Available in 10 watt rating, stud mounted.
- 6.8 to 100 volt range ■ low leakage current.
- Electrical characteristics remain stable throughout life, exceeding the environmental requirements of MIL-S-19500.

580 Pleasant St., Watertown, Mass. 02172 (617) 926-0404

UNITRODE

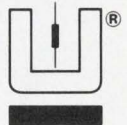

This one won't do it . . .

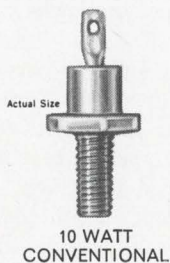

This one won't do it, either . . .

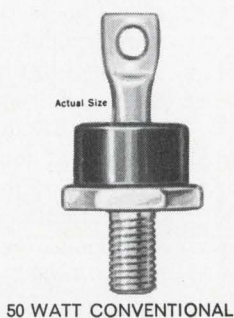

But this one will,



And so will this one . . .



Because it is built like this on the inside.

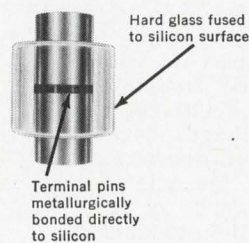

So . . . better get yourself a complete set of specs.



Check off the reply card number now or call Dave Green COLLECT at (617) 926-0404

INFORMATION RETRIEVAL NUMBER 20

Making the world's fastest computer faster

It took the CDC 7600 design engineers 5 years to top the CDC 6600 performance by 4 to 8 times

Robert Haavind
Managing Editor

Problem: Design a computing system able to operate at four times the instruction rate of the most powerful computer on the market—the CDC 6600, make it much more suitable for multi-terminal and general data processing jobs, and keep it within about twice the price.

Solution: The CDC 7600—the new most powerful computer available.

Designers faced with problems of lesser magnitude will appreciate why it took five years to come up with this solution. Seymour Cray,



Entire 7600 is made of modules like this, about the size of cigarette packs. Capacitance of probes coupled directly to emitter-coupled logic circuits would make accurate risetime measurements impossible — the values are around 1 ns. Therefore a signal-conditioning circuit takes the desired test voltage—base-emitter drop in the case of the emitter-coupled logic—and presents 1 volt of an output impedance of 50 ohms to the probe of the standard tester used. Each module holds about 500 transistors.

computer systems designer, and his associates at Control Data Corp.'s research laboratory in Chippewa Falls, Wis., had a tough act to follow.

The 6600, a \$4.5-million monster computer,¹ used a 100-ns logic clock cycle. It was heavily stocked with carry-save adders, and used advanced multiplication and division algorithms. The central arithmetic unit was isolated from any peripheral units by the inclusion of 10 peripheral processing units in the system.

The principle of concurrency was used throughout. For example, in multiplying two numbers with 48-bit characteristics, one number was split into two 24-bit segments, and each of these segments was further split into groups of six bits, which then rippled through multiple levels of carry-save adders. Two groups of carry-save adders were used for the two 24-bit segments, each being multiplied by the 48-bit multiplier. The partial products were then summed.

The whole multiplication operation took 10 cycles, or 1000 ns.

Many of the ideas used in the 6600 were simply extended in the 7600. But some new concepts had to be developed to meet the desired improvement.

Emitter-coupled logic circuits were chosen as the fastest available for logic or arithmetic operations.

And to obtain maximum speed and minimum tolerance variations, discrete transistors had to be favored over integrated devices. Cray feels that since integrated circuits must inherently compromise on these factors, compared with discretely, even the next step forward in computing speed and power will have to be based on transistors. However, in smaller computers not pushing the state of the art, the cost advantage of ICs

will naturally allow them to take over.

The transistor used in the emitter-coupled logic circuits is of special design. The circuits have risetimes on the order of a nano-second and allow the computer to operate on a 27.5-ns clock rate.

The capacitive loading of even a low-impedance probe would disturb circuit operation if voltage risetime were being measured across a base-emitter junction, according to Les Davis, engineering manager for the 7600 project. Thus a whole new testing scheme had to be developed.

It's similar to FIST

The maintenance approach closely resembles the Project FIST (Fault-Isolation through Semi-automatic Techniques)² concept developed at the National Bureau of Standards in the early 60s. Critical test points within a module are brought out to an external test pin through a signal conditioning circuit, which presents a uniform output voltage. The output test points in the 7600 modules present 1 volt across a 50-ohm output impedance. Variations within set tolerance limits are permitted, and the conditioning circuits translate whatever variations they see into the fixed limits selected for the standard testing instrument.

In addition, a maintenance console allows level variations to be introduced into various modules, so that drift in parameter values will show up. This level variation is programmed so that testing takes place in logical sequences across many modules.

Some circuits, such as core drivers and power-supply circuits, operate at such different voltage levels that some special testing devices are required for them.

Both multiplication and division operations were advanced further in the 7600, although the schemes still resemble 6600 operations.



**You thought you knew Darlington—
until you needed power.**

**Now see Bendix
for power IC Darlington.**

They're unique—our new BHF Power Darlington and our new BHB Power Driver integrated circuits.

Both offer major benefits over their discrete counterparts—including greater reliability, and lower cost of use. Result: a series of highly reliable, relatively low-cost modular packages that combine Bendix in-house power semiconductor capability with the latest in thick-film know-how.

All Bendix Darlington circuits include an integral commutating diode for load clamping and an emitter leakage-drain resistor. There are seven to choose from, and we're the only company that offers an 80-volt, 10-amp Darlington. Typical applications? In regulator circuits, in power amplifiers, in hammer driver circuits.

Our four new power driver modules complement Bendix Darlington by providing a TTL or DTL logic interface in the form of a 3-input gate, with an expander. Producing 5 amps output current at 60 volts. In typical applications, they are used as stepper motor drivers, as relay drivers and as servo motor drivers.

It's a lot of power for a lot of applications. All from the real power in power: Semiconductor Division, The Bendix Corporation, Holmdel, New Jersey 07733.

DARLINGTON CIRCUITS

Part Number	Breakdown Voltage (V)	Output Current (A)	Input Current (mA)
BHF0002	40	10	250
BHF0003	60	10	250
BHF0004	80	10	250
BHF0005	80	10	250
BHF0006	60	10	250
BHF0007	80	10	250
BHF0008	80	10	250

POWER DRIVER CIRCUITS

Part Number	Maximum Output Current (A)	Output Voltage (V)	Input Leakage Current (μ A)
BHB0005	5	60	300
BHB0005A	5	60	100
BHB0006	3	40	300
BHB0006A	3	40	100

Bendix **Electronics**

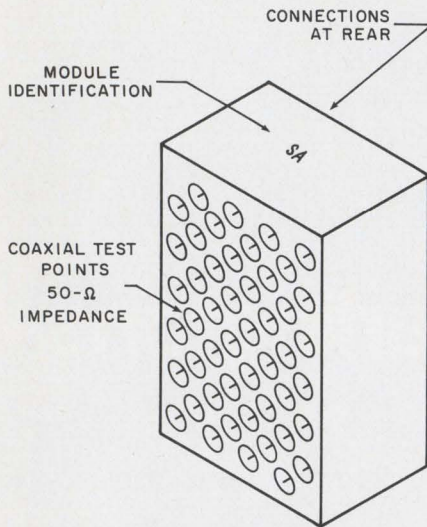
(CDC computer, *continued*)

A distinctive-looking computer, the 7600 has blue-tinted glass and walnut metal trim. Fourteen panels have test points forward and all wiring is in the rear. Wiring is by hand, rather than by wire-wrap machine, and there's lots of it.

Multiplication has been reduced to five cycles, and the pipeline concept has been introduced. Thus new operands can be entered into the lowest level of carry-save adders after two cycles have passed. The operation can be considered somewhat like a delay line, where new data are gated in or out at appropriate cycle times.

The division is similar to that used in the 6600, except that three bits are looked at simultaneously rather than two. Eight adders have been used instead of the four in the 6600, and since no segmenting is used, 20 clock cycles are needed for a division.

The packaging density is about five or six times greater in the 7600, and cooling is provided by Freon flowing through cross bars that hold the metal-encased modules. There is no air flow.

Again, in the 7600 no interaction with input-output devices is permitted. Twelve peripheral processing units are built into the sys-

tem, and 15 asynchronous, buffered channels have been provided for data entry or retrieval through peripheral processors.

The 7600 operates at about four times the instruction rate of the 6600 on scientific problems, but at about eight times faster on data-processing problems. This is because more character manipulation, branching and other data-processing features have been added.

One use of the 7600 beyond solving massive scientific, technical, or business problems might be as a central utility system for time-sharing. It can operate with thousands of remote terminals, according to Cray. ■■

References:

1. James E. Thornton, "Parallel Operation in the Control Data 6600," Proc., SJCC, 1964.
2. Gustav Shapiro, George J. Rogers, Owen B. Laug and P. Michael Fulcomer Jr., "Project FIST: Fault-Isolation through Semi-automatic Techniques" (Parts I and II), IEEE Spectrum, Aug. and Sept. 1964.

Radar beacon monitors 128 planes at a time

A radar beacon monitoring system has just gone into operation at the Peconic River Airport facility in Calverton, L. I., N. Y., that will enable Grumman Aircraft Engineering Corp. to monitor, with extreme precision, the flight characteristics of all aircraft it is testing in the area. Quick video playbacks permit test engineers to immediately determine the position of an airplane in trouble or to re-examine already-completed flight tests. The unit can handle 128 aircraft at one time. It can process and display the 4096 aircraft identity-codes and automatic altitude transmissions from transponders in the air-traffic-control radar beacon system, for 200 miles around.

Built for Grumman by the Airborne Instruments Laboratory, a division of Cutler-Hammer, Inc., the system is an offshoot of the beacon video digitizer built by Airborne for the FAA, and now in use in Atlanta. Additional "custom-built" variations of this new family of air-traffic monitoring

equipment include one for the Navy, now being tested in sea trials on the USS Constellation, and one for Canada's Dept. of Transportation.

The beacon video digitizer decodes and converts signals received from transponder-equipped aircraft into digital information that



Radar beacon system shows Grumman engineers alphanumeric flight data on planes under test.

shows the aircraft's position, altitude and identity-code number.

The information may be stored on conventional audio tape, to provide a permanent record of each flight test operation, or it can be immediately retrieved and played back into the displays. Using this feature, flight monitor personnel can locate the last-known position of an aircraft, if contact is lost.

Besides this unit, Grumman's new system consists of an interrogator-responder unit, a rotating antenna and associated display equipment.

An additional feature is the display of target trails that show aircraft position for several radar scans to indicate an aircraft's heading and its changes in heading.

By mid-summer, the Grumman system will be augmented by two new devices that will provide even more precise measurements of the location of planes under test: a laser range measuring station that works in conjunction with a theodolite. ■■

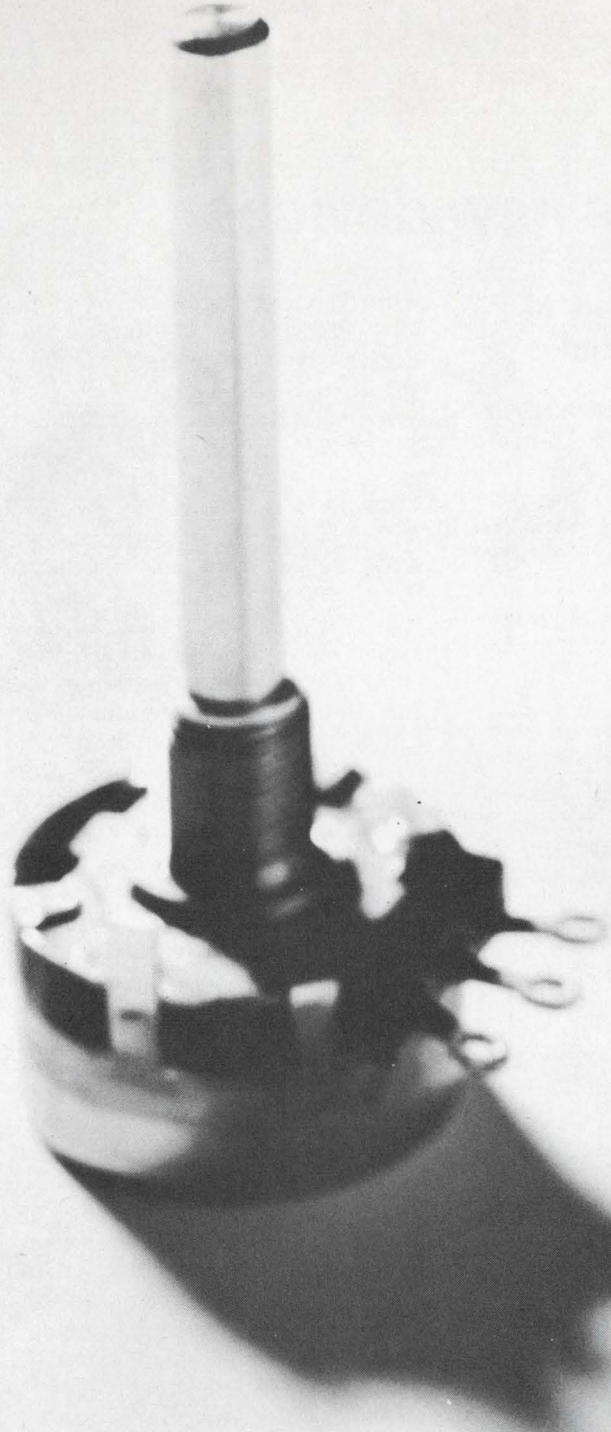

SON OF THE QUIET ONE

You know The Quiet One.
The potentiometer that's four times as
noise-free as the Allen Bradley Series J.
And twice as linear. And longer lasting.

Well, would you believe it?
The Quiet One has just fathered a
potentiometer with exactly the
same traits — except size.

Daddy: 1 1/16" diam., 2 watts.

Sonny: 5/8" diam., 1 watt.

Otherwise, like father like son.

Want to find out more?

Write Clarostat,
Dept. 102,
Dover, N.H. 03820.

It's pretty big news.
In a quiet, little way.

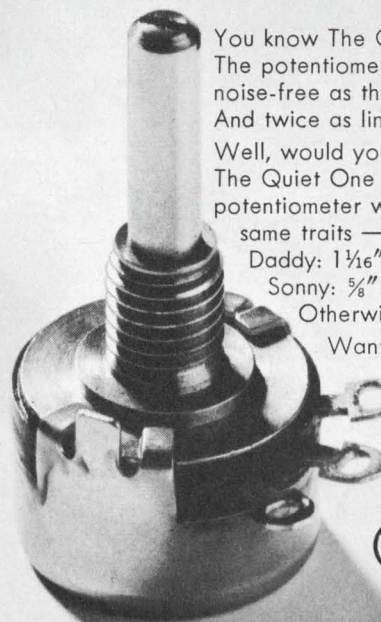

CLAROSTAT

YIG echo effect promises new devices

Room-temperature phenomenon can be used to squeeze, expand, delay and amplify at X band

Elizabeth deAtley
West Coast Editor

Three Lockheed scientists at Palo Alto, Calif., have discovered a physical effect, which, they feel, may lead to a new class of solid-state microwave devices that will offer many advantages over other echo systems used for microwave delay lines.

The phenomenon—called a ferrimagnetic echo—squeezes, expands and delays X-band pulses in time, amplifies them, and does all this at room temperature in a package the size of an alarm clock.

The ferrimagnetic echo is similar to the spin echo—first found to exist in paramagnetic resonance in 1950.

Dr. Daniel E. Kaplan, spokesman for the three-man Lockheed Research Laboratory team, told *ELECTRONIC DESIGN* that “no other device” in “a small configuration” combines these signal-processing features—delay of 12 μ s and gain to 53 dB at X band—at room temperature. Other such systems require a cryogenic environment.

How echo system works

As developed by Dr. Kaplan and his co-discoverers, Drs. Gabriel F. Hermann and Robert M. Hill, the scientific package contains surprisingly common laboratory items—a permanent magnet, a small and irregularly shaped crystal of YIG (yttrium iron garnet), and some

wire. The average dimension of the YIG is typically 0.2 inches (see Fig. 1.) And the more irregularly shaped it is, the better.

A small microwave pulse, P_1 , (see Fig. 2) at a given central frequency, f_c , is stored in the YIG (see Fig. 3) for a time τ . A recall pulse, P_2 , is then applied to the YIG. P_2 has the same frequency as P_1 and the same or a shorter time duration, but has a much larger amplitude (1 watt, compared with a few microwatts or less for P_1). The application of P_2 causes the YIG to put out an echo pulse exactly τ seconds later. This echo pulse is of the same frequency as P_1 and contains the same amplitude modulation (in mirror image), but it may be as much as 53-dB greater in power. The system thus acts as a delay line with high insertion gain. (P_1 and P_2 may be generated by a traveling-wave tube.)

The amplification is a function of the delay time τ . It is small for minimum delays, rises to a maximum for a period 2τ on the order of 1.5 μ s and then decreases. The delay can be extended by applying additional P_2 pulses, following the initial appearance of the echo. The YIG will produce an echo each time a P_2 pulse is applied. This way, Dr. Kaplan says, the total delay has been extended to as much as 12 μ s. He points out that with other amplifying delay line systems at these frequencies, the longest delays obtained would probably be on the order of a few microseconds, even at cryogenic temperatures. “To get a 12 μ s delay at room temperature,” with the systems, he explains, “the attenuation would be catastrophically high.”

To produce an amplified echo, the power level of P_2 should be on the order of 1 watt, he says, although amplified echoes have been obtained for P_2 as small as 25 microwatts. The range of signal powers that can be amplified extends from a minimum of a few picowatts to about 10 microwatts.

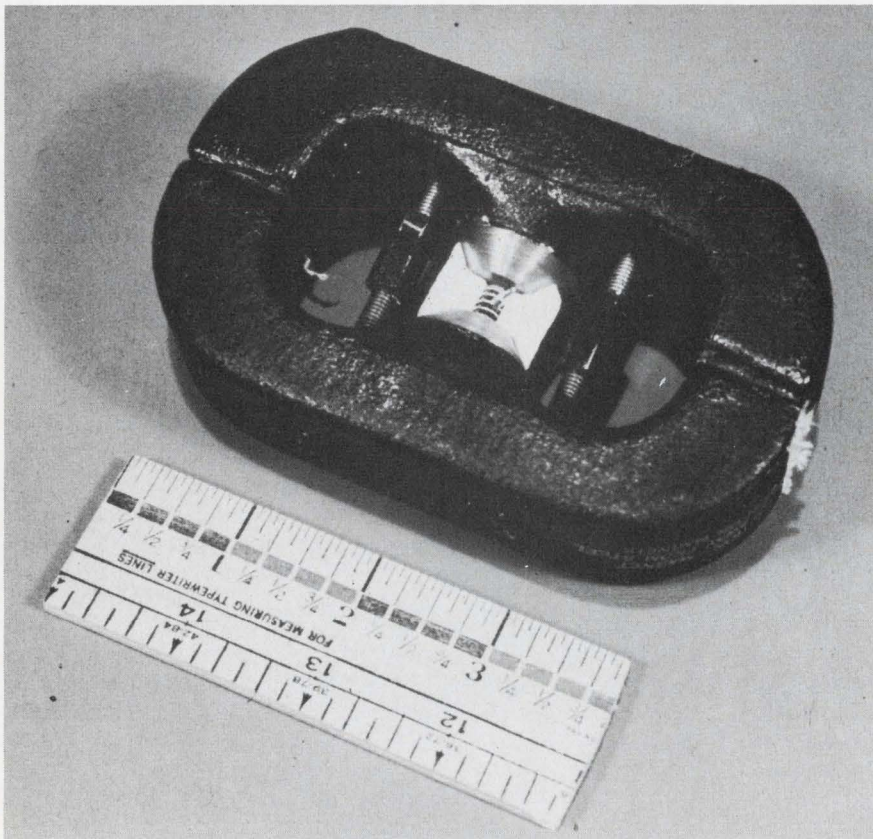

1. Lab model of ferrimagnetic echo system used by Lockheed scientists delays, amplifies, compresses and expands X-band microwave frequencies at room temperature.

Another unique feature of the system, Dr. Kaplan points out, is that it actually requires an inhomogeneous magnetic field to be present internally in the YIG for amplification. Thus a permanent magnet and a very irregular chip of YIG can be used.

"Other forms of magnetic delay lines that use YIG," he says, "require very carefully shaped and polished samples. This system, on the contrary, requires that the sample have many irregularities in its surface. The reason is that strongly inhomogeneous internal fields must exist in the sample, and in order to get these, the sample must have an irregular shape."

Pulse compression for radar

According to the researchers, the new ferrimagnetic echo system can be used for pulse compression.

The technique of pulse compression is widely used in radar systems to provide the very short pulses that are required for high spatial resolution. The feasibility of using the echo phenomenon for pulse compression was first demonstrated by Dr. W. B. Mims in 1963. The advantages of the new ferrimagnetic echo system for pulse compression are its amplification, the fact that it is not cryogenically cooled but functions at room temperature, and the fact that it has very high bandwidth capabilities extending to well over 1 GHz.

Pulse compression with the ferrimagnetic echo is accomplished in the following way (see Fig. 4): The signal pulse, P_1 , has a duration, T , and contains a band of frequencies that extend from f_1 to f_2 . It can be frequency-modulated linearly, parabolically or in any other more complex form so long as the modulation is monotonic (that is, no frequency is repeated). At a time, τ , after the leading edge of P_1 , the recall pulse, P_2 , is applied. This pulse contains the same frequency modulation as P_1 , but is squeezed into one-half the time. τ seconds after the leading edge of P_2 , a highly compressed and much amplified echo pulse, P_{echo} , appears. Its pulse width, t_{echo} , is approximately equal to $1/(f_2 - f_1)$, where f_1 and f_2 are the initial and final frequencies contained in P_1 , and it

contains all the information on type of frequency modulation and the width of P_1 .

In a lossless system, even without amplification, there should be a gain in peak power that is approximately equal to the time-bandwidth product of the system, or T/t_{echo} .

Thanks to the amplification inherent in the ferrimagnetic echo system, however, typical gains of 20-dB greater than the time-bandwidth product are obtained.

Another advantage of this system is the fact that the frequency modulation can be changed at will without affecting the amplitude or power of the echo pulse. This is attractive for a counter-measure device; an enemy would find it difficult to jam a radar whose frequency modulation is unknown.

The steps required to expand a pulse are the inverse of those described above for contracting it. For example, to reconvert P_{echo} in Fig. 4 back to the original signal P_1 of duration T , a recall pulse, P_2 , of duration $T/2$ is applied.

Dr. Kaplan points out that this technique can be used in pulse-time multiplexing. Here, a series of narrow pulses, (see Fig. 5), f_1 , f_2 , etc., up to f_n (where n is a large number as yet undetermined) is applied to the YIG over a time span of T . After a period of τ seconds from f_1 , a single recall pulse, P_2 , of duration $T/2$ and covering a frequency band $\Delta f = f_n - f_1$, is applied. The resulting echo pulse, P_{echo} , contains all the frequencies in the original pulses, as well as the information about the times and number of pulses. This echo pulse can be transmitted to a demultiplexer, where it is reconverted to the original frequencies in the reverse order, by applying the same recall pulse P_2 . The original order can be restored by application of a second recall pulse P_2 . ■■

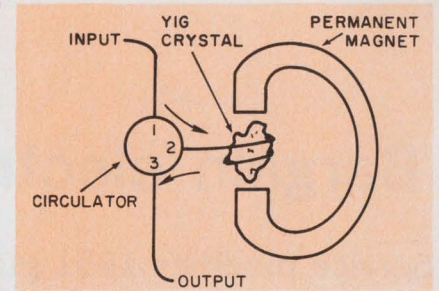

2. Ferrimagnetic echo system has signal and recall pulses applied to the input. After a delay, a much amplified echo pulse appears at the output.

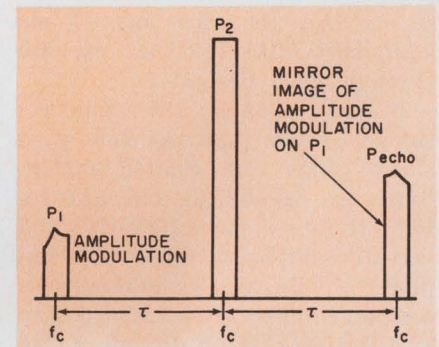

3. The magnetized YIG crystal in Fig. 2 produces an echo pulse P_{echo} at a time τ after application of a recall pulse P_2 and 2τ after the original signal pulse P_1 . P_{echo} contains a mirror image of the amplitude modulation that originally appeared on P_1 .

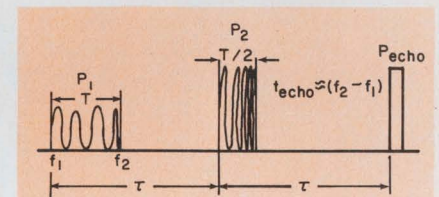

4. Pulse compression with amplification is achieved by applying a recall pulse P_2 , whose frequency modulation is identical to that of the signal pulse P_1 but compressed into half the time. The amplified echo pulse P_{echo} contains the frequency modulation information of P_1 .

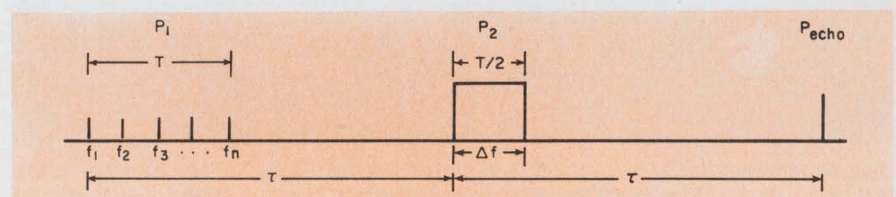

5. Pulse-Time multiplexing is one of several applications of the ferrimagnetic echo effect.

'Bargain' electronics for the Coast Guard

Service modifies 1951 gunfire-control system and gets the versatility of a general-purpose computer

Charles D. LaFond, Chief
Washington News Bureau

The Coast Guard, which has a history of strong electronics engineering and weak annual budgets, has again demonstrated that it can get the most out of old equipment with the least expense through good design.

It has taken a 1951 gunfire-control system that was slow, with short range and limited analog-computer capability, and has rebuilt it into a more powerful and versatile shipboard radar that employs a digital, general-purpose computer. The cost for design modifications and refitting of the systems on 39 Coast Guard cutters: \$5 million.

The redesigned system is sufficiently versatile to serve as a helicopter terminal control radar (each new cutter is being fitted with a copter landing platform on

the fantail). And the introduction of a general-purpose computer on the cutters will permit other important applications, including the reduction of raw oceanographic data and, ultimately, position determination with the help of the Navy Navigation Satellite System.

Civil and war roles

The Coast Guard's equipment problems derive, in part, from the varied roles that the service plays. During peacetime it is under the control of the Dept. of Transportation, and it performs such services as weather patrols—the gathering of meteorological data for the Weather Bureau and commercial ships and aircraft. During wartime it is under Navy direction, and it becomes an active military service.

Its shipboard equipment reflects

both civil and military roles, and by tradition it has been forced to operate largely with hand-me-downs from the Navy. With limited development funds, the Coast Guard has learned to modify the old to keep up with its expanding assignments.

Thus, confronted with the old General Electric MK-56 Gunfire Control System—used on cutters to track down high-speed aircraft and weather balloons—the service turned to Fairchild-Hiller for modification work. The result is the AN/SPQ-10 Shipboard Radar Set, and it fulfills a prime requirement for tracking at much longer slant ranges.

Better performance was achieved by the addition of a higher-powered transmitter, a low-sensitivity, low-noise receiver and a solid-state Honeywell DDP-516 computer. The latter is a military version of the commercial digital system.

Modular design for updating

Fairchild-Hiller's project engineer, Ralph L. Lee, stresses that modifications were made with an eye to future system updating or expansion. The new receiver-transmitter console, for example, was built as a separate unit, "isolating the gun director as a unit for future modification."

The Honeywell computer, which includes its own power regulation and self-checking capability, has a memory capacity of 8192 words, expandable to 32,768 in the future. The Combat Information Center console, says Lee, could, with slight modification, be used to perform all gunfire control functions.

Also, by integration of the console with the computer, all necessary calculations could be performed as well as gun direction. This, the project engineer says, would eliminate the need for two MK-56 subsystems—the oversized, power-consuming MK-4 console and MK-42 analog computer.



The Chincoteague is the first ocean-station Coast Guard cutter to receive the AN/SPQ-10 Shipboard Radar Set, a modernized version of the 1951 MK-56 Gun Fire Control Radar. Largely unchanged, the four-foot radar dish and pedestal are visible above and behind the bridge.

The MK-56 antenna and pedestal were modified by removal of the old receiver-transmitter subsystems and by the addition of new waveguide and rotary joints to handle increased rf power. The antenna is parabolic, has a four-foot diameter and operates with a 1.5-degree beamwidth and a 37-dB gain. It provides a spiral scan for searching and conical scan for tracking. The elevation-over-azimuth pedestal provides 360-degree azimuthal coverage and an elevation range from -20 to 82 degrees.

The modulator-transmitter operates in the X band (8.5 to 9.6 GHz) and provides a peak power of 200 kW, compared with previous peak power of 50 kW. Peak power output at the antenna is 175 kW. The radar pulse widths are either 0.1 or 1.0 μ s, and pulse repetition frequencies are 3.0 or 0.75 kHz.

Tunnel-diode amplifier used

To improve system performance and increase maximum range characteristics, the designers used a low-noise (7 dB maximum) solid-state receiver with a tunnel-diode amplifier. The old system used a standard crystal-mixer unit. The new receiver provides a sensitivity of -96 dBm (with the 0.1- μ s pulse width) or -106 dBm (with the 1.0- μ s pulse width).

New displays at the Combat Information Center console are designed to assist operators in rapid accurate interpretation of targets in both the searching and tracking modes. Four ranges are provided to obtain maximum resolution: 20,000, 40,000, 100,000 and 200,000 yards.

The Honeywell computer is a 16-bit binary computer with a 960-ns cycle time. The computer accepts 32 digital inputs and provides 24 outputs. Readouts are provided in seven separate Nixie-tube displays and on punched paper tape. The system is essentially the same as the commercial version, but it has been redesigned to permit front-access maintenance. Diagnostic routines are provided to permit a mean-time-to-repair of less than 20 minutes, the developers say; any logic card can be replaced in less than two minutes. ■■



Combat Information Center displays are driven by the Honeywell DDP-516 general-purpose computer. Target data appear in the Nixie-tube displays (above), in the 12-inch scope (plan position indicator and range-height indicator), and in the range gate (right).



Weather balloons are launched every six hours from Coast Guard weather ships to provide meteorological data to the Weather Bureau and to commercial ships and aircraft. The SPQ-10 will track these to 100,000 feet and provide immediate outputs for teleprinter transmission.

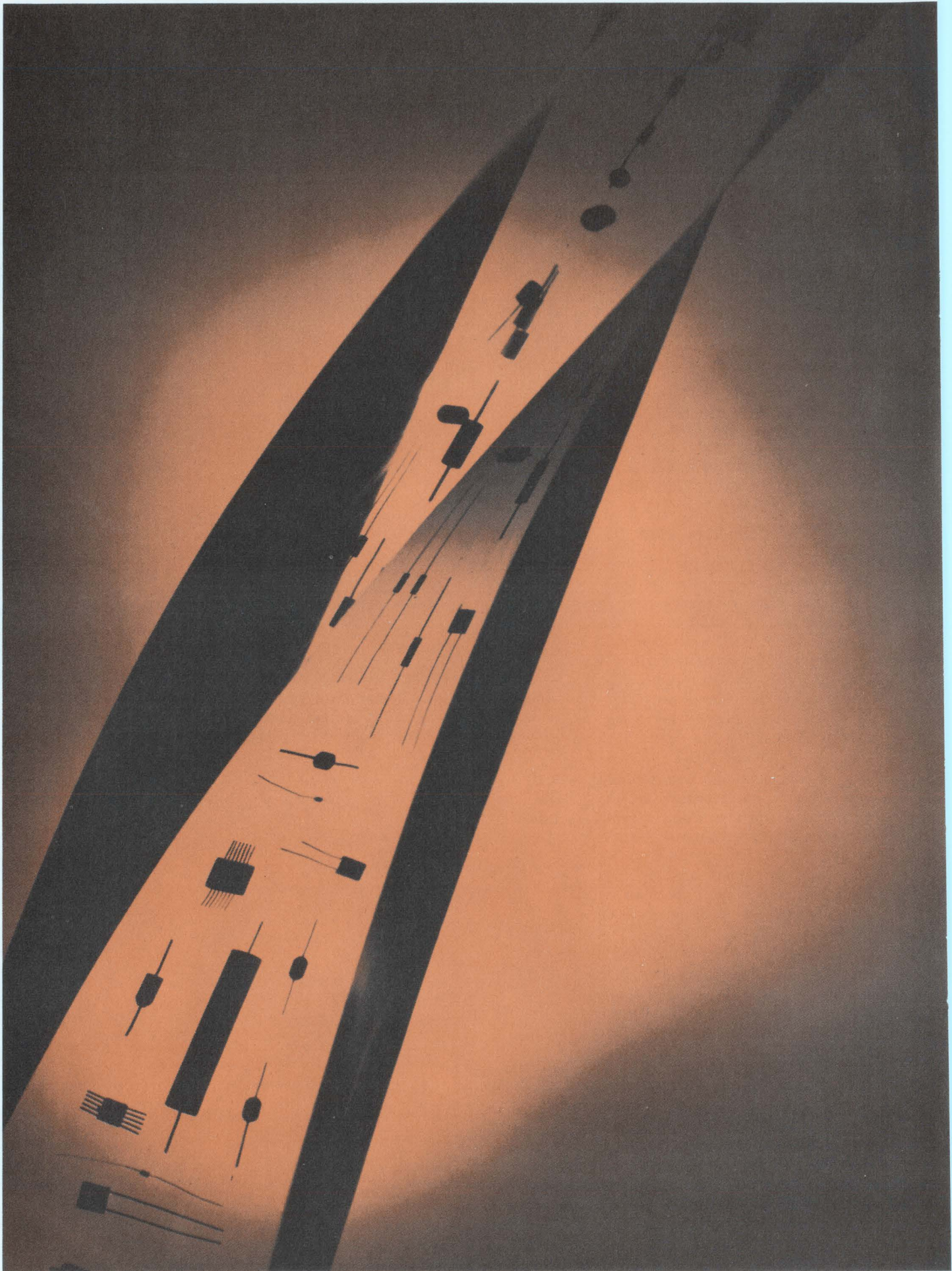

For environmental protection... silicone encapsulating resins

Whatever the operating conditions — heat, cold, moisture, or other harsh environments...there's a Dow Corning silicone encapsulating resin to provide protection for your electronic equipment.

Sylgard® brand encapsulating resins from Dow Corning are ideally suited for filling, potting, coating, impregnating and embedding. Processing flexibilities include room

temperature cure, heat accelerated cure, one-part and two-part systems. All provide these unique properties:

- cure in thick section without reversion
- no damaging exotherm during cure
- are self-extinguishing
- provide excellent dielectric strength
- have excellent resistance to moisture, ozone and oxygen

- maintain constant physical and electrical properties from —65 to 200 C or better
- excellent thermal shock resistance

Regardless of your encapsulating protection problems...Dow Corning offers a silicone resin to meet your needs. Find out by writing Dept. F-8474, Dow Corning Corporation, Midland, Michigan 48640, or call 517-636-8940.

DOW CORNING

DOW CORNING

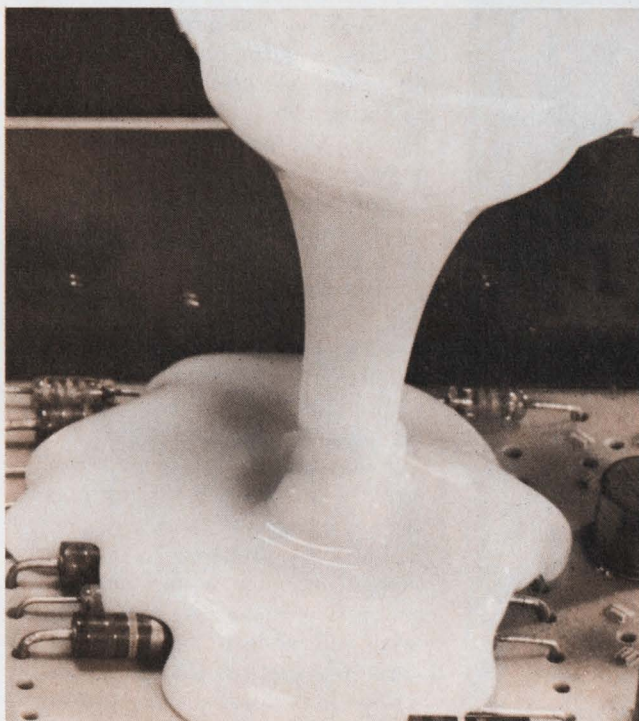

New premixed, ready-to-use white Sylgard silicone encapsulating resin flows freely around components and provides virtually unlimited working time at room temperature...cures in one hour at 135 C and in two hours at 100 C...no post cure required...no reversion...low water absorption...self-extinguishing.

New shock absorbing Sylgard silicone resins are ideal encapsulants for delicate electronic equipment subject to high G shock loads and continuous vibration. These low bayshore materials dampen out external forces with little internal reaction...available in either clear or black...deep section cure without reversion.



INFORMATION RETRIEVAL NUMBER 22

People and computers are getting together

Interactive computing couples the computer's speed and storage capacity with human insight

Interactive computing, in which human operators work on problems while directly linked to a powerful computing system, is bringing a revolution to computer design.

In days gone by it was enough for a designer to put together a computing box of good reliability and sufficient speed; it was then up to systems analysts and software specialists to figure out how dif-

ferent users could get the answers they wanted out of the box.

Today a number of developments are changing this concept. Time-sharing services are widespread, so that many users can tap in on the power of a single, large computing system. In many cases the interaction takes place over a simple teletype link, but the direction is toward graphical terminals.

There is an extreme mismatch between the computer and the human, however, and because of this the applications for interactive computing are still in the groping stage. This was evident in both the papers delivered and the exhibits shown at the Fall Joint Computer Conference in San Francisco.

Computers figure, people reason

Computers are adept at figuring with large numbers, keeping track of masses of data and repeatedly . . . or iteratively . . . solving the same problem, with slight variations, until a desired answer is found. People, by contrast, think and manipulate gross data rather slowly. Their memory capacity for details is quite limited. But when it comes to linking concepts—or applying insight and reasoning power—the man finds the machine simple-minded.

For years, man and computer have been satisfied to pursue their own brand of excellence separately. But the power promised by linking the two types of capability is becoming increasingly clear. Wherever large groups must coordinate their efforts on a large and complex problem, communication between all in the group can be greatly aided by working in such a fashion.

The main problems in interactive computing, now being tackled, are not just with hardware design, but with the mode of operation of interactive systems and software.

The psychological needs of someone working at a display console were thus the subject of an investigation by International Business Machines Corp., Poughkeepsie, N.Y., and reported by Robert B. Miller. People don't like to wait around for answers, IBM found—in fact, a wait as long as 15 seconds for a reply to a query to a computer was well-nigh intolerable. Miller found that as delays lengthened to over two seconds, a point was reached where the mental ef-

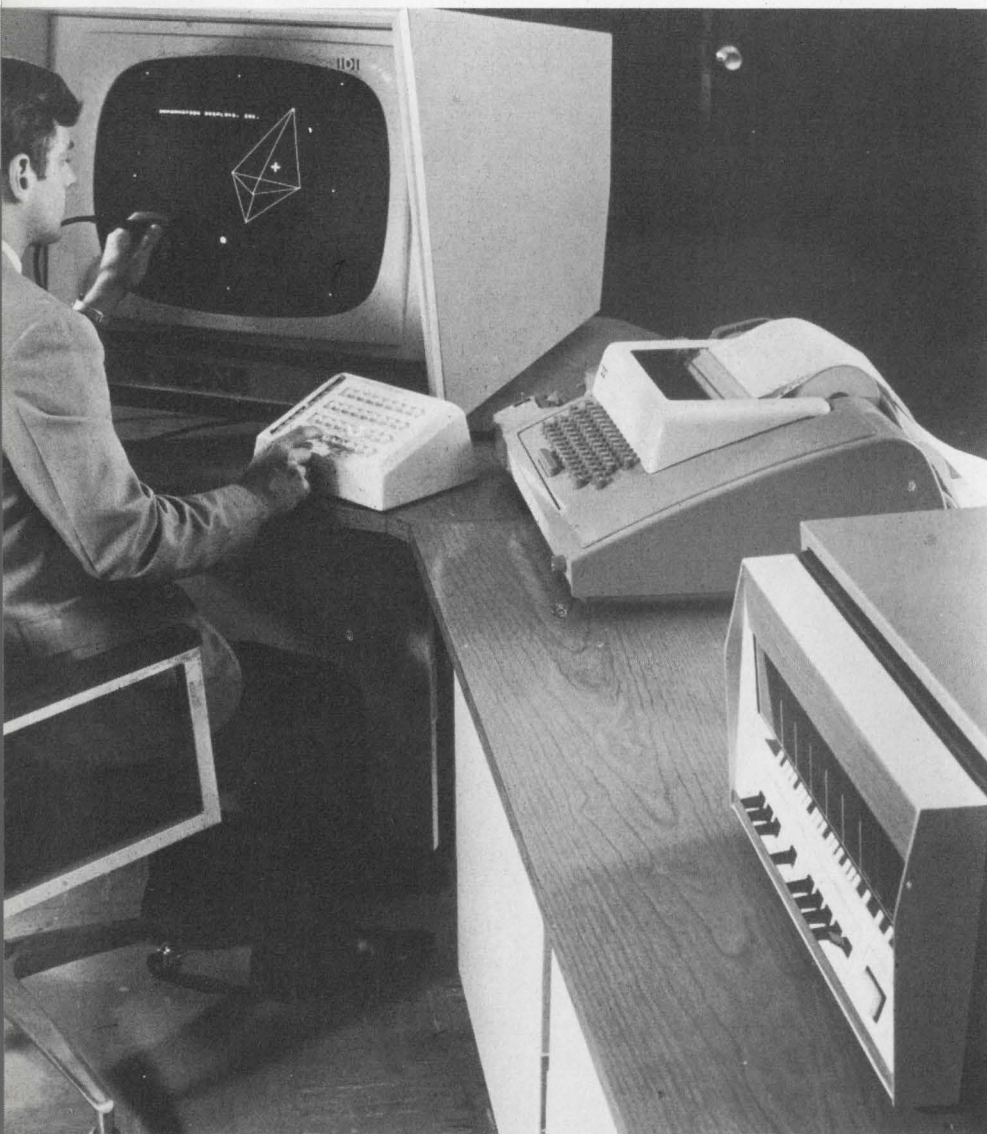

1. IDIOM graphics terminal has 32 function keys with changeable coded meanings. Informations Displays of Mt. Kisco, N.Y., sells it for \$79,000.

Looking for an All-Around Voltmeter?

Hewlett-Packard gives you a broad choice of multi-function meters that do not have to be pampered. Choose the versatility that fits your needs for ac volts, dc volts, current and resistance measurements. The exclusive individually calibrated taut-band meter used in these voltmeters gives you reliability, repeatability and high accuracy.

Make 90% of your day-to-day ac/dc measurements with laboratory precision using the hp model 410C Voltmeter. Measure dc from 15 mV to 1500 V full scale, current from 1.5 μ A full scale, resistances from 10 Ω to 10 M Ω , and ac volts to 700 MHz. The hp-developed photoconductor chopper amplifier gives the 410C high sensitivity, low drift, and low noise. Price of hp 410C is \$475. Vacuum tube version, hp 410B is \$275.

Low cost fully-portable multi-function meter—that's the all-solid-state, battery-operated hp model 427A Voltmeter. It costs only \$225. Option 01 gives both battery and line operation for an additional \$25. Measure dc voltages from 100 mV to 1 kV full scale; ac voltages from 10 mV to 300 V full scale at frequencies to 1 MHz (to 500 MHz with the 11096A High Frequency Probe, price \$45); resistance from 10 Ω to 10 M Ω . Ac and dc accuracy is \pm 2%. FET's in the input circuit give you 10 M Ω input impedance—minimal circuit loading.

Highly sensitive dc and resistance measurements are made with hp 412A DC Vacuum Tube Voltmeter. With its 1 mV full scale dc voltage sensitivity and 1 Ω midscale ohms sensitivity, and its simplicity of

operation, the 412A is ideal for production line testing. Measure dc with 1% full scale accuracy. Price of 412A is \$450.

Extreme accuracy and hands-free operation distinguish the "Touch and Read" 414A DC Autovoltmeter. Automatic ranging and polarity indication occurs in less than 300 ms. Measuring accuracy for dc voltage is \pm (0.5% of reading + 0.5% of full scale)—the best available in any analog voltmeter. Resistance accuracy is \pm (1% of reading + 0.5% of full scale) on an easy-to-read linear scale. Price is \$690.

For full details on these and other Hewlett-Packard Voltmeters, see your hp catalog or contact your nearest hp field engineer. Or, write to Hewlett-Packard, Palo Alto, California 94304. Europe: 1217 Meyrin-Geneva, Switzerland.



HEWLETT  PACKARD
ANALOG VOLTMETERS

098/15

(interactive, continued)

iciency of individuals suddenly started to drop off. He speculates that this is related to our short-term memory capability.

Because of this need for speed in changing displays, a research group at the Univ. of Michigan turned to an associative memory approach to overcome a major difficulty with graphics in time-sharing systems—that is, the long time it takes to transmit television pictures over ordinary voice telephone lines. A single TV picture of reasonable quality takes about 5 to 10 minutes. Therefore any communication that involves graphical information for an interactive user must be very high in information content. These instructions might involve positions for terminations of lines or figures, and designations of which one of a fixed number of figures is to be represented. A local DEC 338 computer presents a "menu" of possible actions to the user on one side of a CRT. He uses a light pen to select an item, and to indicate points where he wishes graphical elements to appear. This system, described by Edgar Sibley, Robert Taylor and David Gordon, is linked to an IBM 360/67, which does any of the more powerful computation.

In some of the graphical terminals, function keys allow the user to manipulate images. But in more recent systems the menu approach has been favored, allowing the number of functions possible to eventually be extended through software.

Program techniques are evolving for making use of images to perform useful work. Images can be changed in size, rotated, labelled, shown with or without hidden lines, cut off or "scissored," and formed either crudely by hand or from perfect straight line or curved segments stored by the computer and called up by the user. Other programs can be integrated with the image programs.

A survey of computer-driven displays and their control units by Arthur Hughes of Auerbach Corp., Philadelphia, indicated a price range from about \$2000 to over \$200,000. A typical, simple alphanumeric input-output device, priced

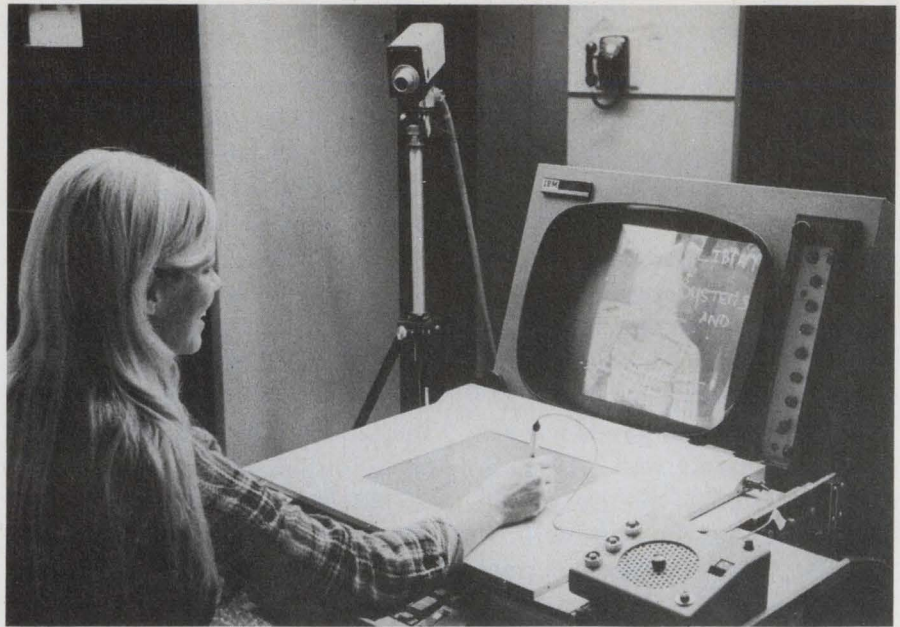

2. Rand Corp. and IBM will use this graphics terminal in a new experimental information network. Video disks store both written data and TV images.



3. Copies from a graphics terminal can be made in 15 to 38 seconds in this system that uses IBM's 2250 unit and a new 3M photosensitive paper copier.

at about \$6000 to \$7000, might include: an 8.5 × 6.5-inch monochrome CRT; the ability to display about 500 characters at a time; a 500-character memory used as an I/O buffer and to refresh the CRT; a character generator (for uppercase letters only) with 64 characters; a typewriter-like keyboard for data entry, plus special editing and control keys for insertions, deletions, etc.; and a method for computer interface, either a direct cable connection or a data communications link. If the user needs additional features, such as line-drawing capability, light-pen input,

hard-copy output and additional special function keys, the price quickly jumps to about \$100,000.

These prices are expected to begin to come down due to a number of factors.

Proceedings for the Fall Joint Computer Conference, held Dec. 9-11, may be ordered from Thompson Book Co., National Press Building, 14th and F Streets, N.W., Washington, D. C. 20005, at \$20.65 for members of any societies in the American Federation of Information Processing Societies (including the IEEE), or for \$41.30 by nonmembers. ■■



The most accurate multimeter in the world: try one free for ten days.

The Fluke 853A is the most accurate multimeter in the world and the most reliable. Once you've tried the 853A, we're willing to bet you won't let it go. Laying it on the line, try the 853A free for ten days with absolutely no obligation.

Here are the key specs and features. DC volts, 0.2%. AC volts, 0.5%. Range, 0 to 1.1 KV. DC amps, 0.2%. AC amps, 0.5%. Range, 0 to 11 amps. Ohms, 0.2%. Range, 0 to 110 megohms. All of these specifications are

guaranteed to hold for one full year without recalibration. Complete overload protection is featured. And the price is only \$445.

Available from local stock for fast delivery.

The Fluke 853A is now available off the shelf in major cities throughout the country. To painlessly arrange a free trial, simply call the nearest Fluke sales-engineering office (listed below) or, if you wish, drop us a line and we'll take care of all the details.

Call the number nearest you for a free trial.

Huntsville, Ala. (205) 534-1648	Chicago, Ill. (312) 825-1144
Phoenix, Ariz. (602) 959-2115	Indianapolis, Ind. (317) 244-2456
Los Angeles, Cal. (213) 245-9404	Baltimore, Md. (301) 744-7700
San Diego, Cal. (714) 232-2017	Boston, Mass. (617) 646-1034
San Francisco, Cal. (408) 244-1505	Detroit, Mich. (313) 838-7324
Denver, Colo. (303) 934-5505	Minneapolis, Minn. (612) 920-1022
Hartford, Conn. (203) 633-0777	St. Louis, Mo. (314) 423-1234
Orlando, Fla. (305) 425-2764	Newark, N.J. (201) 687-8737
Honolulu, Hawaii (808) 506-095	Albuquerque, N.M. (505) 265-7766

Long Island, N.Y. (516) 433-1421	Pittsburgh, Pa. (412) 371-1231
New York, N.Y. (914) 769-1811	Dallas, Tex. (214) AD 1-2573
Rochester, N.Y. (716) 381-8330	Houston, Tex. (713) NA 1-0040
Syracuse, N.Y. (315) 454-9377	Seattle, Wash. (206) 767-4260
Greensboro, N.C. (919) 273-1918	Washington, D.C. (301) 946-0300
Cleveland, Ohio (216) 734-0960	Vancouver, B.C. (604) 291-7161
Dayton, Ohio (513) 298-9964	Ottawa, Ont. (613) 725-1288
Portland, Ore. (206) 767-4260	Toronto, Ont. (416) 636-4910
Philadelphia, Pa. (215) 279-0377	Montreal, Que. (514) 747-9849

Fluke, Box 7428, Seattle, Washington 98133. Phone: (206) 744-2211. TWX: 910-449-2850. In Europe, address Fluke Nederland (N.V.), P.O. Box 5053, Tilburg, Holland. Telex: 844-50237. In the U.K., address Fluke International Corp., P.O. Box 102, Watford Herts, England. Telex: 851-934-583.



RCA Solid-State Data for Designers

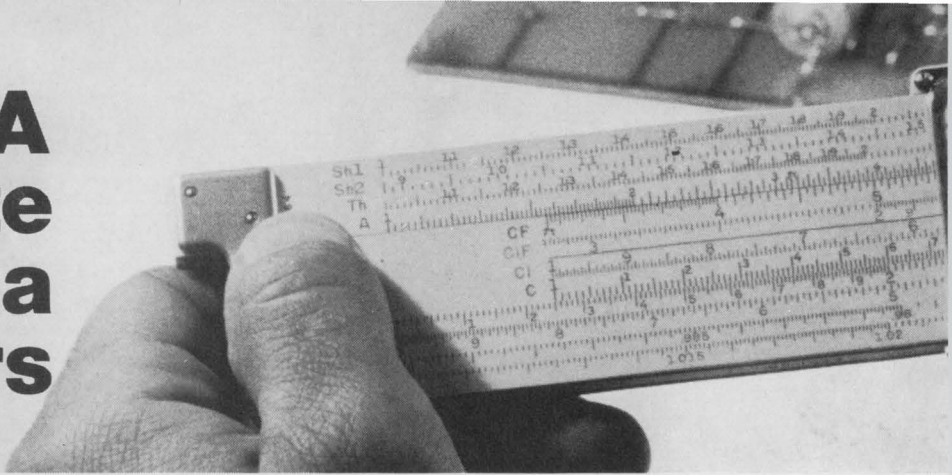

Build Stability and Long Life into Control Designs

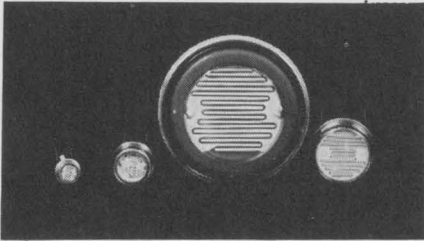

RCA has a selection of photocells that's one of the industry's widest... including cadmium-sulfide devices (with a maximum response of 5100 Å) and cadmium sulfo-selenide units (with maximum response of 6150 Å).

They're extensively used in a range of industrial applications such as counting, position and level indicators, pilot-flame monitoring, automatic lighting controls, burglar and other alarm systems. There's a comprehensive booklet—containing full information on RCA's line of photocells, and representative circuit schematics—plus technical data.

Circle Reader Service No. 191.

Turn On or Turn Up—High Speed Switching and Amplifier Applications in New Equipment Designs



Here are two new epitaxial silicon n-p-n transistors ready for your design evaluation. Both have high current and high power handling capacity plus fast switching speed, and are especially suited for use in switching-control amplifiers; power gates; switching regulators; converters; inverters and control circuits of many kinds. Use them, too, as DC-RF amplifiers and as power oscillators.

The units are RCA developmental types TA7323 and TA7323A—both mounted in JEDEC TO-3 package. The "A" version has higher voltage ratings [V_{CEO} (sus) of 120 V maximum compared with V_{CEO} (sus)=90 max.]

and lower leakage currents—making your selection of units for evaluation relatively simple. Both have turn-on times of 0.5 μ s maximum at 15 A I_C .

So if your designs can use such epitaxial silicon n-p-n devices to turn things on—or turn them up—circle Reader Service No. 192 for full details on these two transistors.

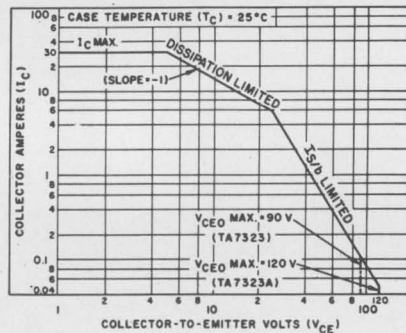

Pick Your Applications For This IC "Building Block"

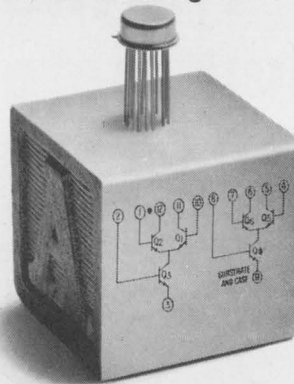

RCA-CA3026 is a true "building block" for all sorts of uses! Two matched differential-amplifier pairs on a single substrate offer uncommitted bases and collectors for broad input and output accessibility...and flexibility...for applications from dc to 120 MHz. Try it for dual Schmitt triggers; dual sense amplifiers; differential and/or cascode amplifiers; IF amplifiers; limiters; video amplifiers; doubly-balanced modulators and demodulators—just for a start!

RCA-CA3026 brings the advantages of monolithic IC devices to the most comprehensive range of solid-state circuit applications yet.

Circle Reader Service No. 193 for full details.

Keep Your Cool in Handling High-Power Control Problems

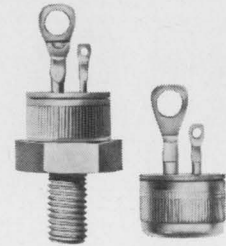

How's this for power-handling capability: 300-ampere peak surge (non-repetitive) on state current rating... 5 kW for 120 V line operation or 10 kW for 240 V? No point in getting heated up over control problems in such areas as furnace controls; arc welding controls; heater unit controls; motor controls; photocopying equipment controls; lighting controls; oven controls, and anywhere else you want to replace back-to-back SCR's with a single press-fit or stud type triac.

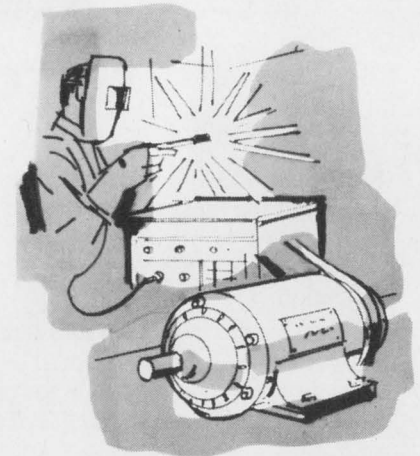

RCA-2N5441 and 2N5442 press-fit, as well as 2N5444 and 2N5445 stud-type triacs can replace virtually any two SCR's in circuits with voltage and current requirements comparable to those requirements for the 2N690 or 2N3899 SCR applications... and do the job with fewer components.

Circle Reader Service No. 194 for full details.

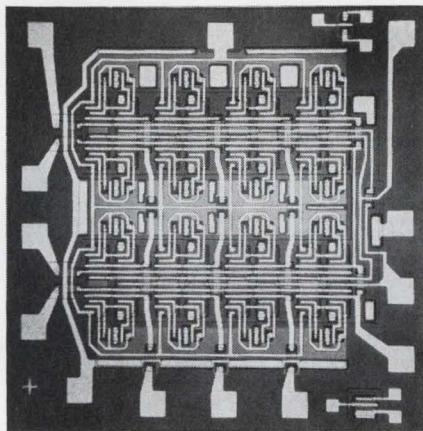
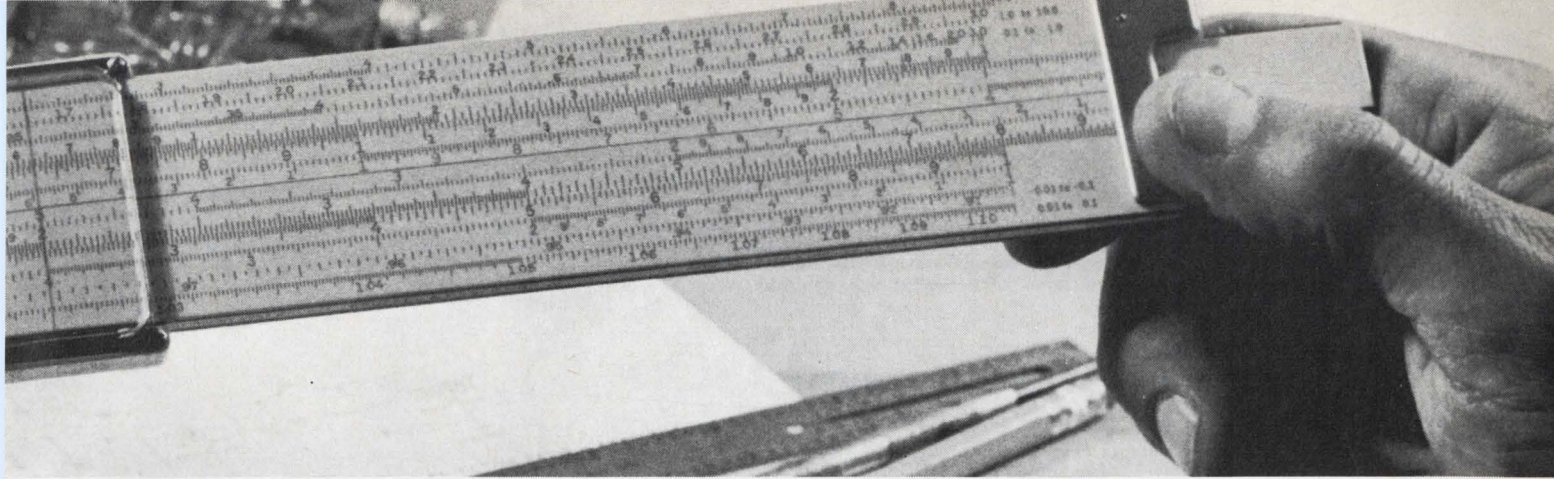

COS/MOS—RCA Breakthrough In Logic and Memory IC's

RCA COS/MOS—Complementary Symmetry MOS Integrated Circuits—now open the way to compact, ultra-low-power digital systems. RCA technology produces complementary pairs of "N" and "P" channel MOS transistors on the same substrate in high density circuit configurations that offer unique performance characteristics.

With COS/MOS, you can design for a 10-volt logic swing with a single 10-volt power supply, 4-volt noise immunity, fanouts up to 50, -55°C to +125°C operation and nanowatt quiescent dissipation. You get megacycle switching speeds, single phase clocks and freedom from tight tolerance power supplies.

COS/MOS is available to you in a growing range of circuits—from gates and flip-flops to MSI logic and memory. For technical data, circle Reader Service No. 195.

Here's General-Purpose Power for Small-Signal Applications

RCA types 2N5320 and 2N5321 are triple-diffused silicon n-p-n planar type transistors—differing only in voltage ratings, leakage current and beta-spread values. They have all the well-known desirable features of the 2N2102 type—and higher collector-current and dissipation ratings.

Use these units for medium-power small-signal applications in your mil-



itary, industrial and commercial equipment... wherever the design requires devices with low noise and low leakage characteristics, low saturation voltage, high beta, and fast switching speeds.

For detailed specifications data and complete characteristics, circle Reader Service No. 196.

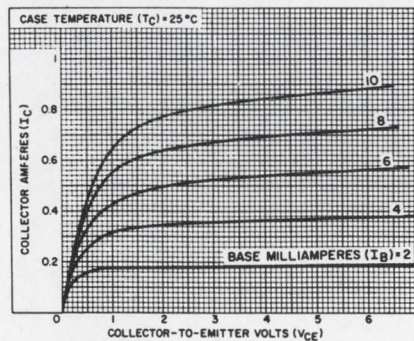

No Signaling and Detection Problem Too Tough for These GaAs Laser Diodes And IR Emitting Diodes

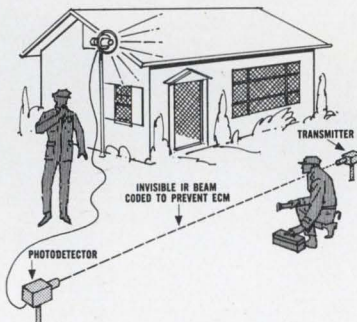

Need "light" beams invisible to the human eye for law enforcement, industrial safety, and military security applications? RCA optical devices can do the job. For your applications in communications, ranging, security systems, and fuse designs, RCA offers TA2930, TA2628, and 40598.

Developmental type TA2930 is a laser diode array capable of providing 50 W minimum peak output power at 30 A peak pulse forward current. TA2628, a single laser diode, can provide 1 W minimum peak output power at 30 A peak pulse forward current. 40598, an IR emitter, is rated at 0.3 milliwatt minimum radiant power output at 50 mA. For comprehensive technical data sheets, circle Reader Service No. 197.

High Beta Values, High Dissipation Ratings, High Voltage Capabilities...

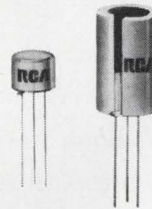

The characteristics you need for high-voltage, high-current amplifier and high-current switching applications are provided by RCA's 2N3241A family of silicon n-p-n, epitaxial, planar transistors. Fourteen types give you a broad selection of ratings and characteristics for audio pre-amplifier, audio and video amplifier, computer switching and instrumentation circuits. Included in the family are transistors with integral heat-radiators which provide 50% lower thermal resistance between junction and ambient and thus twice the dissipation capability of the prototypes at ambient temperatures up to 25°C.

Take advantage of these ratings for your circuit designs:

AUDIO PREAMPLIFIER—NF as low as 2 dB at 10 kHz, beta values as high as 165 min. at $I_C = 10$ mA.

AUDIO AMPLIFIER— P_T ratings as high as 2 W at T_C to 75°C for types with heat radiators, high current capabilities to 300 mA max.

HIGH-CURRENT SWITCHING applications including nixie and core drivers up to 300 mA max.

INSTRUMENTATION—high beta values; leakages as low as 10 nA max. at $V_{CB} = 25$ V; saturation voltages as low as 0.1 V typ., 0.2 V max. at $I_C = 100$ mA; breakdown voltages to 40 V.

Circle Reader Service No. 198 for detail specs.

See your RCA Representative for full information on all products shown. Ask your RCA Distributor for his price and delivery. Or write for data sheets to RCA Electronic Components, Commercial Engineering, Section No. QG-1-1, Harrison, N. J. 07029.

RCA

Meet a new kind of T²L. It's twice as fast.

Introducing Ray III. The fastest TTL on the market. Samples available now.

Ray III halves the best T²L speed-power product you previously could get. It has a 5½ nanosecond maximum propagation delay with only 22 mW dissipation per gate. Where older T²L flip flop frequencies reach about 50 MHz, Ray III hits 100 MHz. It's pin- and function-compatible with Ray I and Ray II, our standard T²L series. And we've added clamp diodes to all gates and active pull-down networks to improve noise immunity.

By April our distributors will be stocking 19 logic functions: expanders, inverters, gates, flip flops. All available in commercial or mil-type temperature ranges, in flatpacks and DIP cases. And by mid year we'll be producing even more functions as well as Ray III MSI. Send for data sheets, designer's handbook and list of distributors from the company that gets the ideas — and delivers them.

RAYTHEON

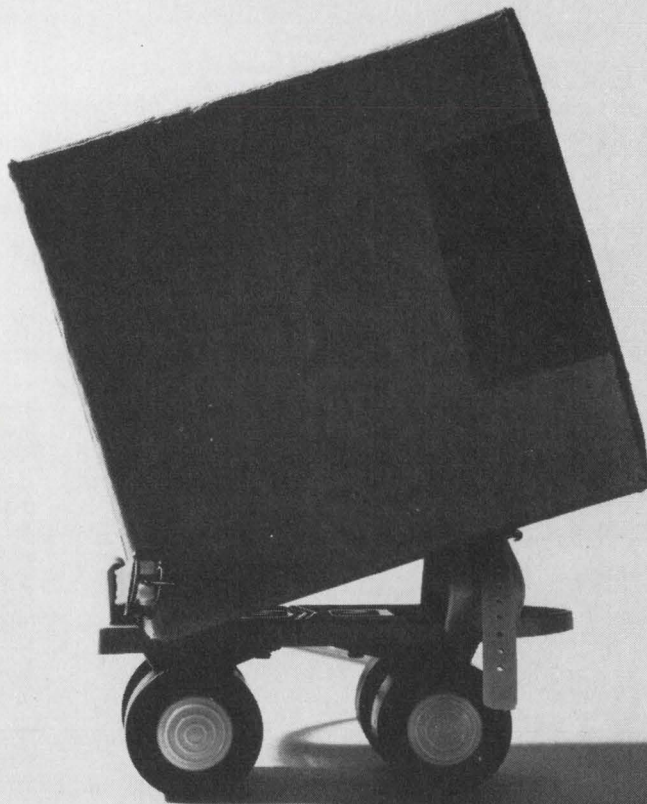

Samples available from distributors:

RG 3220/3222 Quad 2-Input NAND Gate. RF 3200/3202 AND-Input JK Flip Flop. RF 3210/3212 OR-Input JK Flip Flop.

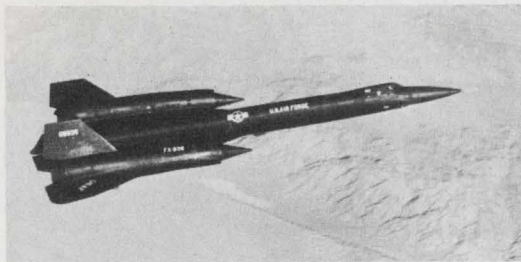

Washington Report

CHARLES D. LAFOND
WASHINGTON BUREAU

Four air programs await Nixon approval

At this time, only a prophet would dare predict to what extent the Nixon Administration will abide by the military development decisions instituted by the Johnson regime. Presumably, many military programs initiated by outgoing Defense Secretary Clark Clifford will be subject to intensive review—not only on the basis of their anticipated high costs but also for political and technical reasons. Prominent among these are the following aircraft programs.

The Navy F-14 fleet air-superiority fighter (VFX-1) has been approved to replace the cancelled F-111B. The Air Force has received an OK for its F-15 tactical fighter (FX), and for much-delayed Airborne Warning and Control System (Awacs). And a decision is imminent on the new Air Force bomber, the Advanced Manned Strategic Aircraft.

For the two fighters, RQD and procurement will probably take from 40% to 44% of final dollar costs; for Awacs, these preproduction costs may go as high as 50% to 55%—so say industry informants here. The multi-million dollar aircraft programs will provide fighters that will remain operational well into the 1980 time-frame.

The Navy F-14 is planned to be operational by 1973. Five contract-definition studies are under way by General Dynamics, Grumman, LTV, McDonnell Douglas and North American. The winning contractor may be selected this month.

An F-15 airframe contractor is also expected to be selected this month; all major subcontracts should be awarded by June. Westinghouse and Hughes Aircraft are now competing under

contract for the F-15 radar attack system.

Boeing and McDonnell Douglas were requested to submit proposals for the Awacs contract definition last week, with a single contractor due to be selected by April or May. GE, Hughes and Westinghouse have competitive contracts for the overland radar; two designs will be picked for competitive development. Other major electronics suppliers will be selected early next year.

Should the new manned strategic bomber be approved, it is believed that over-all development time normally required—five years—will be reduced to four, by skipping the conventional contract-definition phase. As now planned, the Air Force would like to contract two firms by July. These two would prepare designs and begin engineering development on a competitive basis.

Air Force to study auroral effects

For the first time, a meticulous effort has been made from the air to systematically study the effects of auroral activity on radio communications and navigation systems in the region surrounding the geomagnetic pole. Scientists from the Air Force Cambridge Research Center investigated the region for a seven-day period last month. Their research was conducted aboard a specially instrumented C-135 jet aircraft. More flights may be required after the present fund of data has been analyzed and evaluated.

The study concentrated on the auroral oval—the region above the pole

Washington Report

CONTINUED

that is the site of maximum auroral activity. The region is located at heights of from 100 to 300 km above the Earth's surface. The variety of instruments that were used in the measurement program included an ionospheric sounder, a four-barrel photometer, a flux-gate magnetometer, a gamma ray monitor, a series of infrared spectrometers and high-and-low frequency radio receivers.

The auroral region is of great interest to the Air Force because of the aurora's marked influence on radio equipment and radar surveillance systems. This influence is ascribed to the region's high concentration of charged particles and to the excitation these induce in the atmosphere. Through the present study the Air Force scientists hope to develop a reliable "barometer" for predicting the occurrence and the severity of auroral storms.

TV relays by manned satellite?

NASA is looking into the possibility of employing very large manned and automated satellites to relay color or black-and-white television programs from space into the home by the late 1970s. The agency's Marshall Space Flight Center has given General Dynamics' Convair Div. a \$200,000 contract to examine the feasibility of installing the extra-large satellites aboard the Saturn V booster. It is apparent that the effort, in part, is motivated by the need to determine future applications for Apollo-developed equipment and for the giant Saturn V launch vehicle.

Hughes Aircraft will serve as an electronics consultant to GD for the nine-month effort. The study will also seek to determine the practicality of beaming the relayed broadcasts

directly down to remote or isolated areas that are not now served by conventional broadcasting methods.

Frequencies under consideration extend from the existing 890-MHz UHF broadcast band up to 13 GHz. To reduce the need for elaborate receiving equipment on the ground, the broadcasting satellites would employ very large directional antennas and very powerful transmitters, which would draw their power from either a nuclear source or very large solar panel arrays, according to NASA.

The Marshall investigation will look into using both manned or unmanned craft in synchronous orbits. A parallel endeavor, centered on smaller, unmanned broadcasts satellites, is being directed by Lewis Research Center. Lewis has already issued contracts for this study to General Electric and TRW, Inc.

Oceanography support pledged

In a letter to Dr. Edward Wenk Jr., executive secretary of the President's Marine Council, President-elect Nixon pledged "first-priority" support for a coordinated Federal program to study and exploit the oceans. The Nixon letter reportedly was sent in response to an earlier communication by Rep. Charles A. Mosher (R-Ohio) in which the latter warned of a growing danger to this country's oceanographic programs, said to be caused by bureaucratic opposition to the efforts. Rep. Mosher warned that the Council, to guarantee its survival, urgently needed the new Administration's backing.

The President-elect is reported to have assured Dr. Wenk that the Council will continue, but that decisions on future programs must await the oceanographic study report, now pending, from the Commission on Marine Sciences.

While the Council may be continued, there is still no word on whether Dr. Wenk will stay on as executive secretary. The new Council chairman will be Vice President-elect Spiro Agnew.

THEY'RE
HERE!

Precision
TNC (PTNC[®])
High
Performance
Coaxial
Connectors
from GRFF

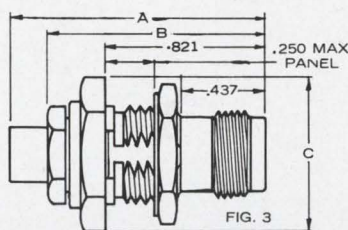
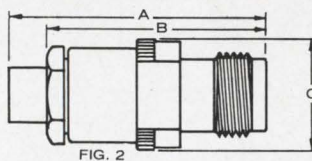
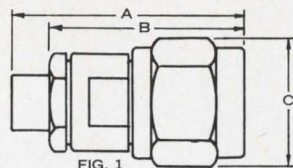

GRFF made the very first TNC coaxial connector . . . and now introduces the newest one, the PTNC[®].

This new series is the first and only line of precision TNC connectors with **VSWR less than 1.10 to 12.4 GHz!** These precision TNC's are gold plated for high conductivity and tarnish resistance, and feature hex coupling nuts for positive mating characteristics.

The new PTNC's exceed all parameters of the MIL-C-39012 TNC series, and are mateable with any TNC connector designed to this military specification. The units are ideal for wide band, phase sensitive applications requiring extremely low VSWR's.

CABLE PLUGS

GRFF No.	FIG.	REMARKS	A	B	C	CABLE
4501-0001	1	—	—	1.006	.562 Hex.	.141 Dia. Semi Rigid
4501-0002	1	Captive Contact	—	1.006	.562 Hex.	.141 Dia. Semi Rigid
4502-0001	1	—	1.202	1.006	.562 Hex.	.215 Dia. Semi Rigid
4503-0001	1	—	1.202	1.006	.562 Hex.	.250 Dia. Semi Rigid
4504-0001	1	—	—	1.077	.562 Hex.	.325 Dia. Semi Rigid
4505-0001	1	—	—	1.065	.562 Hex.	RG142 Series
4505-0002	1	Captive Contact	—	1.065	.562 Hex.	RG142 Series

CABLE JACKS

4521-0001	2	—	—	1.127	.562	.141 Dia. Semi Rigid
4521-0002	2	Captive Contact	—	1.127	.562	.141 Dia. Semi Rigid
4522-0001	2	—	1.323	1.127	.562	.215 Dia. Semi Rigid
4523-0001	2	—	1.323	1.127	.562	.250 Dia. Semi Rigid
4524-0001	2	—	—	1.231	.557	.325 Dia. Semi Rigid
4525-0001	2	—	—	1.167	.562	RG142 Series
4525-0002	2	Captive Contact	—	1.167	.562	RG142 Series

BULKHEAD CABLE JACKS

4541-0001	3	—	—	1.127	.688 Hex.	.141 Dia. Semi Rigid
4541-0002	3	Captive Contact	—	1.127	.688 Hex.	.141 Dia. Semi Rigid
4542-0001	3	—	1.323	1.127	.688 Hex.	.215 Dia. Semi Rigid
4543-0001	3	—	1.323	1.127	.688 Hex.	.250 Dia. Semi Rigid
4544-0001	3	—	—	1.231	.688 Hex.	.325 Dia. Semi Rigid
4545-0001	3	—	—	1.167	.688 Hex.	RG142 Series
4545-0002	3	Captive Contact	—	1.167	.688 Hex.	RG142 Series

So when you want connectors with precision engineering and high reliability performance, specify PTNC. Precision TNC connectors. From GRFF, of course.

A DIVISION OF SOLITRON DEVICES, INC.

**GENERAL
RF
FITTINGS**

COVE ROAD • PORT SALERNO, FLA. 33492
(305) 287-5000 • TWX: (510) 953-6010

Dial 1-800-327-3243 for a "No Charge" telephone call and further information.

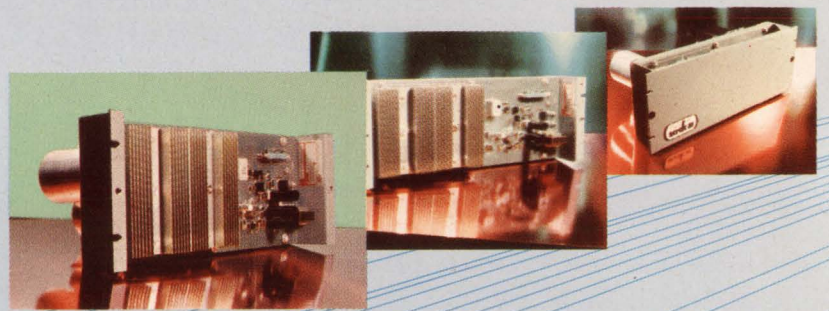

A THIRD

NOW, a power supply delivering overall static regulation of $\pm 3\%$. . . costing little more than a constant voltage transformer bulk supply delivering $\pm 10\%$ regulation . . . available "off-the-shelf" from your local electronic distributor.

Don't stop! There's more . . . like automatic current limiting, frequency insensi-

tivity, series connectability, three-phase operation, standard rack mounting, and remember . . . "off-the-shelf" from your local electronic distributor.

SCRDC-III is especially designed for use with logic circuitry and as a bulk power source for point-of-use Integrated Circuit regulators. It is an ideal design supply . . . a

scrdc-III

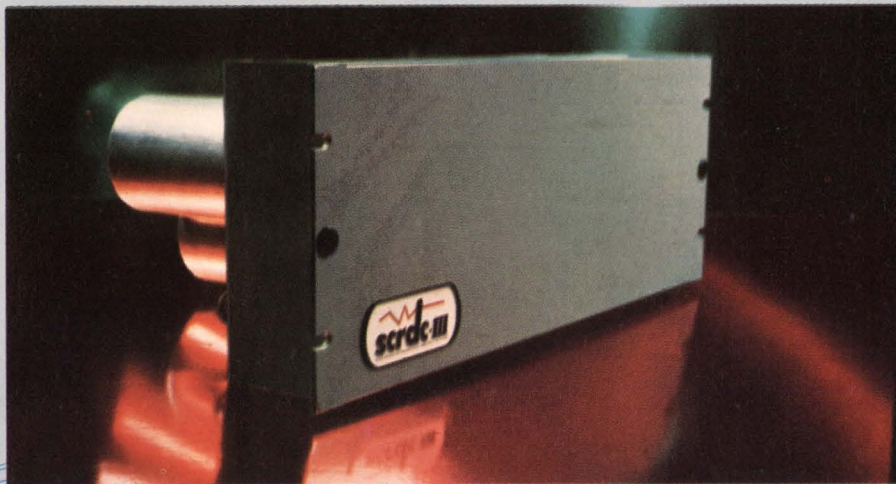

DIMENSION

IN POWER SUPPLIES

reliable production supply.

In plain and simple terms — if you need better overall regulation and performance than can be provided by an economical constant voltage transformer bulk supply but, do not need quite the regulation and performance provided by an expensive series regulated transistorized supply — your third

choice is your best choice — SCRDC-III.

Here is the true Third Dimension in Power Supplies.

For more information and technical data, contact your stocking Sola Electric electronic distributor or write or call today: **Sola Electric, 1717 Busse Road, Elk Grove Village, Illinois 60007.**



DIVISION OF SOLA BASIC INDUSTRIES

IN CANADA: SOLA BASIC LIMITED — IN MEXICO: SOLA ELECTRICA DE MEXICO, S.A.
SOLA BASIC DIVISIONS: ANCHOR ELECTRIC • DIELECTRIC COMMUNICATIONS • HEVI-DUTY ELECTRIC • SOLA ELECTRIC
LINDBERG HEVI-DUTY • NELSON ELECTRIC • SIERRA ELECTRIC • WARREN COMMUNICATIONS

INFORMATION RETRIEVAL NUMBER 28

He depends on choppers.



Astrodata is...



INSTRUMENTATION PRODUCTS
Tens of thousands of standard products doing very special jobs.

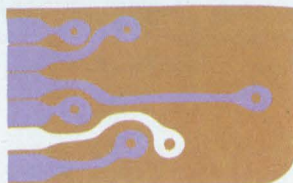

PRINTED CIRCUIT BOARDS
A high quality-high production operation using advanced equipment.



DIGITAL DATA DEVICES
The important peripherals for today's modern computers.



INFORMATION SERVICES
An advanced software capability just leaving the launch pad.

Astrodata's new amplifier doesn't.

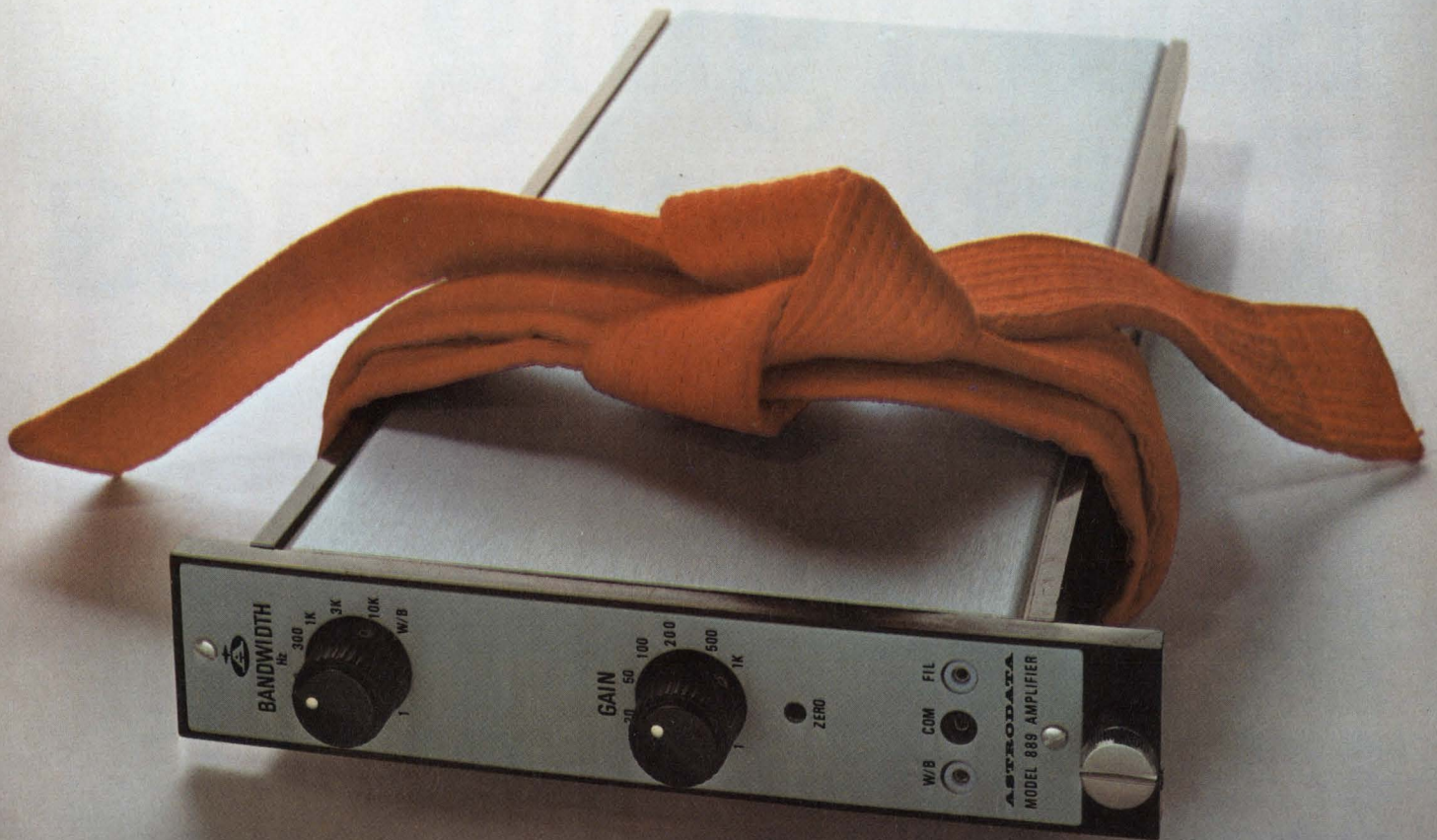

A Karate expert depends on choppers... his hard hands. High performance low level DC amplifiers used to depend on choppers too. But no longer.

Astrodata, by making use of the latest IC developments, has completely eliminated choppers in the new 889 amplifier with absolutely no reduction in accuracy or stability. No increase in drift.

The 889 is a real red belt champion. And you're the winner with lower initial and maintenance costs—smaller size—wider data bandwidth—lower noise—faster recovery and settling time.

Check these specs. No slew limiting to 40KHz. Settling time of less than 150 microseconds. Ideal for dynamic

applications. Gains to 2,500. Differential input current lower than a nano-amp. Perfect for use with low level transducers. Gain stability and linearity of 0.01%. Important in static tests.

Choppers chopped. Price and size chopped too. As low as \$330. And twelve 889 amplifiers fit snugly in just 7 inches of rack space. Even delivery is chop chop. Better than 30 days in quantity.

So chop an X on the reader card and get the full 889 story from Astrodata, who built industry's first all solid-state wideband DC amplifier 8 years ago and have delivered tens of thousands since then.

Astrodata—Space age technology on the industrial grow.



Astrodata, Inc. P.O. Box 3003 240 East Palais Road Anaheim, California 92803 Telephone (714) 772-1000



DATA AND TELEMTRY SYSTEMS
Over 350 systems delivered—more than 100 using digital computers.



ELECTRONIC SWITCHING SYSTEMS
To multiply the capability of the largest communication companies.



ANALOG AND HYBRID COMPUTERS
The largest hybrid systems in the world have been delivered by Comcor.



TIMING EQUIPMENT
Supplying the free world with more precision instrumentation than anyone.

An Electronic Design Special Report

Emerging Technologies

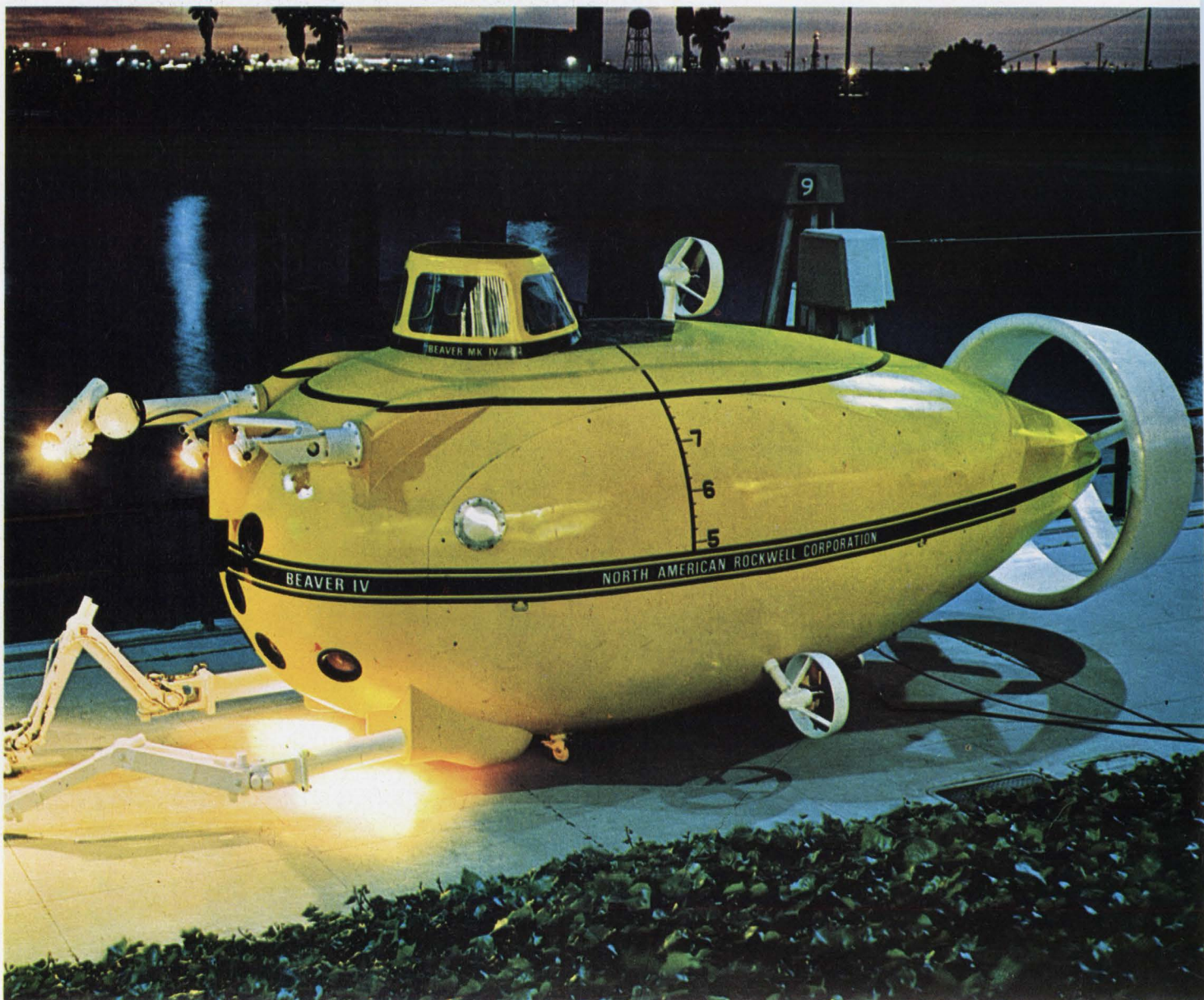

edited by Ralph Dobriner

Where is the electronics industry of the 1970s and 1980s headed? The major indicators point to expansion into four areas in particular:

- Oceanography.
- Medical electronics.
- Educational electronics.
- Urban transportation.

Engineers in these fields will be called on to uncover solutions for some of the nation's chronic social, economic and environmental ills. Their designs will lead to new methods for locating and extracting the ocean's resources . . . high-speed intercity transportation systems . . . huge health-care centers that employ the latest in electronic treatment systems . . . "electronic classrooms" to improve the quality of education.

Some say these will become the new glamour fields of electronics, now that space exploration is approaching the routine. What are the engineer's chances for a career here?

ELECTRONIC DESIGN has called on specialists in each field to evaluate the trends and to paint a broad picture. Some of the questions that these reports will answer are: How readily can today's engineer transfer his skills from one technology to another? What are the typical design problems he might be asked to solve? What new components and systems will have to be developed, and how do they differ from today's familiar equipment?

The reports are not intended to cover all contingencies in the finest detail. But they may stimulate your curiosity and start you on the path to new opportunity.

Beaver IV manned submersible will explore the sea floor down to 2000 feet.

Rich, untapped oceans beckon prospectors

Engineers face a harsh environment in designing equipment for the sea

Dr. Andreas B. Rechnitzer, Ocean Systems Operations, North American Rockwell Corp., Long Beach, Calif.

Many scientists contend that the oceans hold a key to man's future standard of living. The conquest of the seas, however, awaits a technology that will permit economic exploration and exploitation.

A start has been made. Already massive offshore platforms have been built to reach petroleum deposits deep beneath the sea floor. In several instances prototype electronic devices, such as hydrophones and undersea television, have contributed to the discovery of these resources and have served to whet industrial appetites for more electronic equipment that can help locate other ocean resources. For the interested electronics designer, there are many opportunities, not only in the offshore petroleum industry but in the growing field of oceanography.

Oceanography here is defined to include all pure and applied research in the basic sciences, exploration for and exploitation of natural resources, and environmental surveys and forecasts in support of military and commercial sea operations.

Why should today's electronic design engineer concern himself with oceanography? Foremost, there is a profitable market for his skills. Oceanography, as a business, is expanding in three prime areas:

- Over one-half billion dollars will be spent this year by the Government on various ocean programs.

- Hardware sales and services for ocean-oriented markets have increased significantly.

- Many companies in the ocean transportation, fishery, water purification fields and the like are being absorbed into what is identified as the new oceanography market.

There are strong indications that this business growth in oceanography will continue into the foreseeable future. As the military, social and natural-resource needs of the world grow, there will be more ambitious national programs of ocean research, exploration and development.

Electronics equipment to investigate the oceans, however, has not always met the challenge. Here are some typical user comments made in a recent random survey:

"Out of \$4 million of [oceanographic] instruments purchased, 37 per cent would not work when delivered."

"The only things that worked reliably during SeaLab II were the lead belts and swim fins."

Statements like these come after nearly two decades of effort to strengthen the use of electronics in oceanography.

Much credit for the early application of electronics to oceanography must go to the Woods Hole Oceanographic Institution in Woods Hole, Mass., where the study of acoustics in World War II military operations, particularly antisubmarine warfare, spurred a technology

that also permits measurement of ocean characteristics. Sound-travel phenomena in the oceans are intimately related to the physical properties of water, such as density, temperature and salinity.

These early attempts were plagued by failure after failure. The concepts were good, but the engineer did not properly understand the marine environment.

Today companies that produce both simple and sophisticated electronics equipment for the oceanography market are finding a growing demand. These devices range from relatively simple sensors that measure such parameters as water temperature turbidity and salinity to complex communications and sonar systems. However, the electronic design story is far from over.

Virtually every aspect of manufacturing, packaging, integration with other subsystems operations and maintenance is still a potential source of difficulty and a challenge to the electronics design engineer.

Oceanographic equipment failures, typically, are traceable to one or more of the following:

- Improper design for the environment.
- Inadequate connectors, splices and cables.
- Poor choice of materials.
- Loss or degradation of calibration.
- Inadequate environmental testing.



Hydrophones receive visual inspection before being lowered to the ocean floor from AC Electronics-Defense Research Laboratories' research vessel Swan.

There often is no single ideal approach to solving a particular design problem. Rather the designer must sacrifice one parameter—for example, weight—for another that is more important—pressure protection, say.

Here are some examples of inviolable rules and some not-so-obvious design decisions:

Don't let the electronics get wet. Slipping the electronic package into a pressure and water-resistant structure provides electrical isolation and physical protection.

"It's a solution, but not an entirely satisfactory one. Such containers possess certain inherent shortcomings. They are usually high-density structures with undesirable weight. Mechanical seals are generally unreliable, as are electrical connectors.

Counter the undesirable features of pressure protection. Effort has been directed to the design of pressure-equalized devices that is, electronics and electrical systems that can be exposed to the pressure of depth while receiving only electrical isolation from the sea waters.

Pressure equalization can be obtained by immersing the electronic package in an electrical-isolation liquid and mounting it in a light-weight container. A compliant membrane usually serves to transmit pressure if complete containerization of electronics and fluid is desired. All electronic components

operating at depth will then be at ambient sea pressure.

Such pressure-equalized devices have two advantages: minimal sealing problems and good heat dissipation. However, care must be taken to see that the pressure does not affect the components. Another possible problem is compressibility of many immersion liquids. Most hydrocarbons change volume by about 6 per cent at 20,000 psi (at the maximum known ocean depth of 35,800 feet, the pressure is approximately 16,000 psi). Silicone oil, a popular immersion oil, compresses approximately 12 per cent at 20,000 psi. Allowances must be made for these variations in volume. Another problem is that under hydrostatic pressure, electrical coatings may be permeated by the oil, due to pinholes or diffusion. On relaxation of pressure, the coating will likely be separated from its substrate if the liquid cannot pass back out.

Here are some other design problems that must be considered when operating electronic equipment at ambient pressures:

- Contaminates, such as water, in the immersion fluids, may cause serious problems. "Dust from dc motor brushes can nullify the effective dielectric usefulness of a fluid.

- Electronic components immersed and subjected to pressure must possess structural strength. Transistor cases, vacuum tubes and light-bulb strength may be ade-

quate, but are not necessarily immune to water vapor penetration.

- Pressure application will often produce a significant change in resistance of carbon composition types of resistors. Carbon film or tin oxide, by contrast, show no significant effect due to pressure. Wirewound resistors may or may not be affected, depending on how they are wound and impregnated. Bubbles in any casting or impregnation on resistors or other components can result in a change in performance or even component failure.

- Capacitors exposed to hydrostatic pressure may vary in performance. During initial exposure the capacity and leakage frequently increase. In fact, capacitors will often show some permanent change after being pressurized.

Electric power is fundamental to all electronic systems. Self-contained power is in use for disposable instruments, buoys, satellites and recoverable packages.

Available power sources are adequate for operating or testing most experimental or prototype developments. During long-term operation, it soon becomes obvious that most power supplies have shortcomings.

The packaging of primary batteries, secondary batteries, solar power, wave power converters, nuclear energy and fuel cells poses problems. For example, the design engineer must recognize that even sea gulls, perching on solar panels mounted on a buoy system, can cause problems. Mounting the panels low enough for a frequent cleansing by wave action will bring on marine fouling of another type.

Primary batteries are affected by low temperatures (25 per cent loss of nominal capacity at 0°C to 2°C). High-rate discharges are impracticable at such low temperatures. Dry cells packaged in solid imbedding or suitable liquid will show little direct pressure effect. Despite the surroundings, dry cells do lose moisture, with a resultant increase in void spaces—which, of course, will bring on physical distortions when pressure is applied.

The high-wattage-per-unit volume mercury battery looks promising for undersea applications. Although sensitive to low temperatures, it is possible to use some

of its own electric power to heat a protective jacket.

Nevertheless, for deep submergence applications, the reliable lead-acid cell leads all other power sources. It is amenable to ambient pressure packaging techniques, is relatively unaffected by ocean pressures, has long life, can be recharged many times, and can also serve as a deadweight, disposable anchor.

The more costly high ampere-hour, silver-zinc battery is a solution to many design problems. Nickel-cadmium batteries, too, may be employed successfully in the marine environment. Isotope power sources are slowly gaining acceptance in oceanographic buoys, primarily because of their long life and small size. Nuclear reactors will become more fashionable as future systems demand more power and their high cost can be justified.

Data on how continuous low temperature and high pressure affect the basic components of oceanographic instruments is not readily available from reference sources or manufacturers. Cyclical effects are also relatively unknown. Those who contemplate designing and fabricating electronic systems will require an environmental chamber, consisting of a temperature-controlled pressure vessel in which components or systems can be placed and subjected to electrical stress.

Electrical connectors is another component area where there is abundant opportunity for design and fabrication improvements. Underwater electrical connector technology took a great step forward when the molded rubber slip-fit connector appeared. This concept appears to make it possible to make waterproof, functionally reliable, quick make-break single or multiple wire connections manually and with ease, either above or below water. It was welcomed as a panacea for the frequent need for "quick splicing." Time and experience has revealed that the term "waterproof" has multiple meanings, like the waterproof watch you may have once bought. It may have been fine for the shower, but not for the swimming pool.

The most successful electrical connectors used for deep-sea equipment consist of a metal body, with electrical pins suspended in molded

rubber, which is bonded to the metal. Generally the metal body is custom-machined. Bonding of rubber and metal may not always take place or endure. In time the bonded interface will likely fail, resulting in electric leakage or even water penetration. Other material combinations, such as metal pins molded in plastic or ceramic, are also useful for certain applications. However, these, too, should be inspected and tested and retested. Inadvertent misalignment of pins and grooves, dirt, wire fatigue (particularly at the crimp of the pin to the connector) and metal corrosion—all have contributed to intermittent electrical connection.

In the effort to develop a highly reliable connector or splice, little concern has been given to reducing the bulk of each connector. Distribution panels also leave much to be desired. Pressure testing prior to use is recommended.

Besides the various components and subsystems that comprise a total underwater electronic system, the electronic designer will frequently be confronted by materials problems. Materials respond to the deep ocean environment in many unusual ways.

In addition to compressibility coefficients, the water, or absorption coefficients of liquids used for electronic immersion need to be known. Also, the effects of moisture loss, dielectric changes, alterations in chemical reactions, low-temperature performance, thermal shock, mechanical abuse, galvanic corrosion, and marine fouling confront the designer.

Materials that can serve as pressure protective housings for electronic equipment cannot be ignored. Metals continue to serve as the basic housing material. Mild steel, high-strength steel and certain stainless steels provide satisfactory characteristics for strength and fabrication. Titanium and aluminum offer improved strength-to-weight ratios, as do glass-reinforced plastics and bulk glass.

Since these are the principal materials for packaging electronic systems, interface problems must be considered when slipping electronic components in and out of such enclosures.

Seals and electrical penetrators must not only be watertight, but,

in some cases must be able to resist helium penetration, such as is found in manned undersea habitats or vehicles.

Electronic oceanographic instruments have stimulated a search for sensors that can be effectively used as transducers while exposed to a multitude of environmental stresses. To date, ocean current meters have appeared in a variety of electro-mechanical combinations. Temperature can be sensed in a number of different ways, as can depth.

No agreement on standards

Few oceanographers agree on any standard oceanographic instrument in terms of performance and data-output form. As oceanographic technology continues to grow, agreement on standards will have to be reached, especially regarding such factors as data output suitable for computer storage.

As instruments become more standardized, their employment will be more universal, and the customized units will be relegated to the market for exploratory activities. The expendable bathythermograph appears to be one of the first instruments to fill this description.

It should be obvious by now that oceanographic equipment design requires a careful systems analysis of materials and components. The designer should consider the following guidelines in his analysis:

- The instrument should be rugged.

- Operating procedures, maintenance and, if possible, repair should be simple. Sea-sick personnel have little interest in any mental gymnastics to nurse equipment back into action.

- Shipboard or self-calibration check should be incorporated in the design.

- The system most likely will have to tolerate moisture, temperature and pressure variations.

- The system should be small and amenable to easy handling on an unstable platform.

- A reliable communication link between sensing instrument and data readout storage must be available.

A recent example of a highly successful undersea instrument is described in the Oct. 4, 1968 issue of *Science*, pp. 78-87. In an article

entitled "Deep Sea Instrument Capsule," Frank Snodgrass, of Scripps Institution of Oceanography, discusses the measurement of deep-sea tides. The author developed a self-contained instrument capsule that could be dropped to the sea floor from a surface ship, where it would remain unattended for several months. The data are accumulated for computer analysis by compatible magnetic tape recorders in the capsule. The instrument capsule is later brought to the surface by acoustical commands from a surface ship. Separating itself from its deadweight ballast, its buoyancy propels it to the surface, whereupon its radio beacons and flashing lights are activated to facilitate recovery.

This instrument package is designed to perform at depths of 5.3 kilometers, where it can measure pressure to an accuracy of a millimeter, temperature changes to a few millionths of a degree, and water currents in the range of 0.1 to 10 centimeters a second.

For the design engineer who is contemplating entering this excit-

ing technology, the best advice is, first go to sea and observe equipment in service. Research organizations are most hospitable in this regard and can often arrange for a short and, what may turn out to be, a highly informative sea trip. The major oceanographic institutions have had the welcome mat out to the electronic engineer, but very few so far have taken advantage of the invitation. There is no substitute for seeing the entire show—equipment, installation, checkout and calibration—the way it is used and maintained and how data are recorded and handled.

Secondly, many academic institutions are showing interest in the Sea Grant Program Act. The program provides money to organizations that develop new technology for ocean engineering. For further information on this subject you are referred to University Curricula in Oceanography, Academic Year 1965-66, by the Interagency Committee on Oceanography, ICO Pamphlet No. 23, Washington, D.C., December 1965.

Formal education is becoming

more available as interest in ocean activities mount. Many universities are providing new courses (see References at end of this article).

Among the most active research institutions where new equipment requirements can be solicited are:

Scripps Institution of Oceanography, La Jolla, Calif.

Woods Hole Oceanographic Institution, Woods Hole, Mass.

Lamont Geological Observatory, Hudson, N.Y.

Miami Univ., Coral Gables, Fla.

Texas A&M College, College Station, Tex.

Univ. of Rhode Island, Kingston, R.I.

Johns Hopkins University, Baltimore, Md.

Univ. of Hawaii, Honolulu, Hawaii.

Univ. of Washington, Applied Physics Laboratory, Seattle, Wash.

Oregon State Univ., Eugene, Ore.

Battelle Memorial Institution, Columbus, Ohio.

Arthur D. Little, Boston, Mass.

Stanford Research, Palo Alto, Calif. ■■

Fisheye camera shows electronic controls in the pressure sphere of Electronics' - Defense Research Labora-

tories' ocean work boat. The vessel employs electronically controlled manipulator.

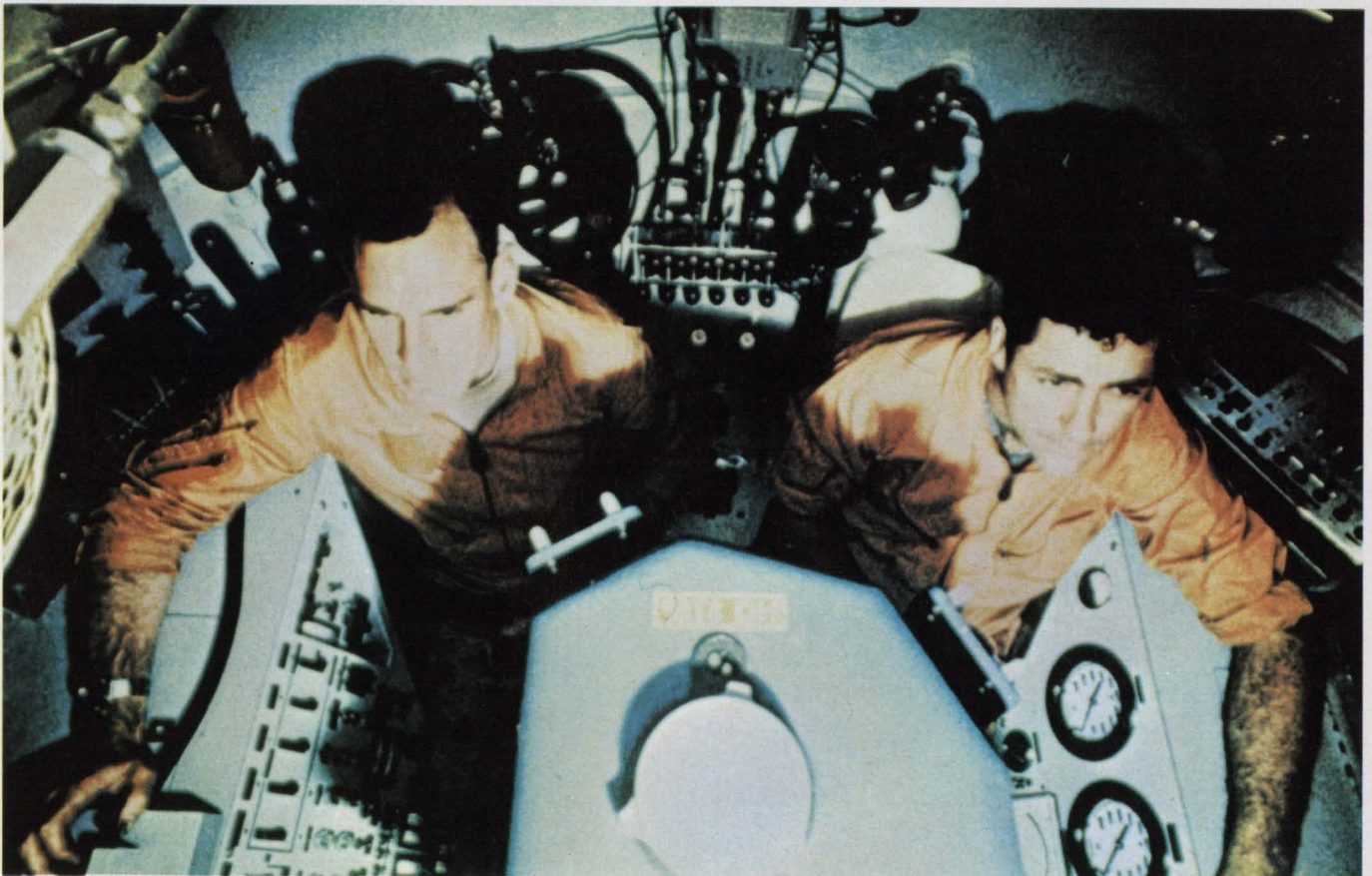

Medical electronics: Infant with promise

Industry is reorganizing for what could be a new era in diagnosis and treatment

Dr. Malcolm Ridgway, Systems Group of TRW, Inc., Redondo Beach, Calif.

If there were a glamour index of the emerging technologies, medical electronics would be high on the list. At least in the public view, the latest technical marvels of medical science have become popular symbols of this nation's growing affluence. This aura, plus the promises of what could become a multi-billion industry, is encouraging many engineers to consider careers in medical electronics.

Up to now, however, the potential bio-medical engineer has had little prospect of progressive opportunity in any area save that of

equipping a few of the nation's largest and most modern medical centers. In the last decade commercial successes in medical electronics have been rare and, perhaps as a result, the industry has failed to mature.

This failure can be partly attributed to a lack of total commitment to the market by most electronics companies. The philosophy has been to make minimal changes in nonmedical equipment and then try to sell it as a medical device. An even more serious cause has been the failure to develop skilled

product-line planners.

Industry-wide involvement in medical electronics came about first through a willingness on the part of some non-medical companies to provide technical assistance.

The first significant advances were made in the more sophisticated medical centers, where doctors received the assistance and advice of one or two engineers to solve particular technical problems.

Sometimes companies not involved in the medical field, entered into a business relationship with the medical researcher. They supplied the research and development facilities in exchange for marketing rights to the final product. What often resulted was a medical device that failed to meet the needs of the practitioner. Total system design was never considered.

At present the whole medical equipment industry is being reshaped because larger corporations are absorbing many smaller companies. This interest by the larger organizations, with their vast research and development capabilities and their potential for large capital investments, could signal the beginning of a new era in medical technology. A better structured industrial effort, with real growth prospect, would certainly open up career possibilities.

Recent budget cutbacks in the nation's space program and apparent Government concern at rising

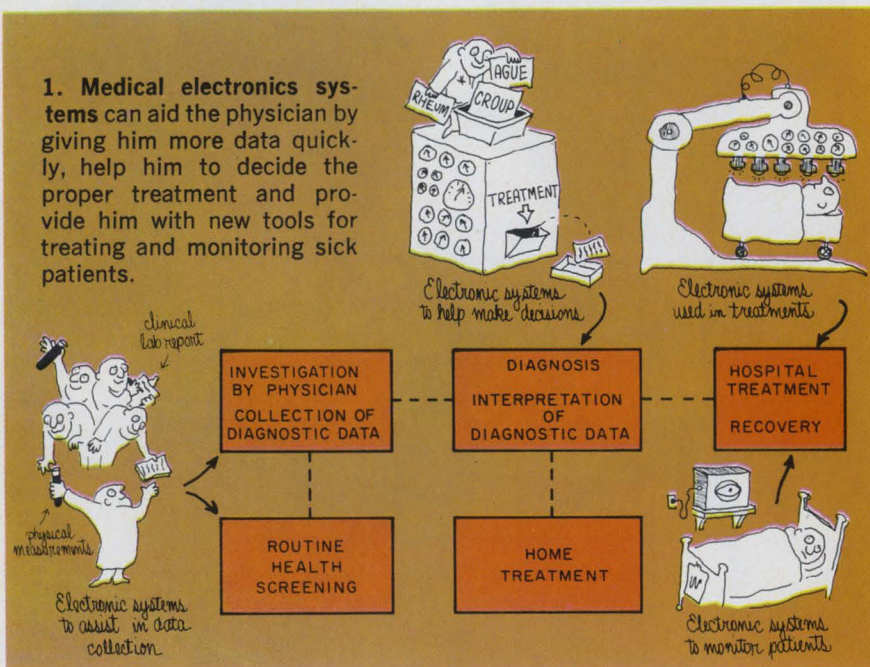



Coronary care units keep constant watch on patients' heart activities. It's made by Dallons Instruments Div. of International Rectifier Corp., El Segundo, Calif.

costs in health-care services are also factors that may have triggered an upsurge in business interest in the medical electronics field.

There is almost unanimous feeling among both supporters and critics of present health-care services that more extensive use must be made of technological aids as soon as possible.

Should assist not replace

The health-care field, despite its problems, treats medical electronics the same way it does any other seductively labeled, but improved, remedy: "What can it do for us that we can't do better ourselves?" Like other specialists, doctors urgently seek well-designed equipment that will assist them, but not supplant their skills, in diagnosis and treatment. Figure 1 shows how such electronics assistance systems can be applied to health care. They give the physician more data quickly, help him make decisions, offer him new tools for treating patients and monitor his sick patients.

There appears to be a widespread preoccupation among medical electronics designers with the question of doctor acceptance. This roadblock generally represents a failure on the part of the designer to appreciate the need for equipment that will link up with the doctor and his patient and function as a complete, definable system.

How is it possible to determine the requirements of such a system? By asking the user—the doctor or medical technician—to define exactly what he is trying to do, rather than asking him how he thinks he can improve what he is doing. This leaves the decision on which design approach to take where it should be—with the medical electronics designer.

Solving the problems

What then are the technical challenges? What problems can be clearly identified at present and what problems can be visualized for medical systems development?

Electronic assistance systems fall into two broad classes: aids to diagnosis and devices for some special treatment.

Electronic equipment is frequently used to take physical measurements of the patient during the screening, investigation and monitoring phases of treatment. A typical diagnostic system is shown in Fig. 2. For health screening, the requirement is simply to alert the physician to the fact that certain results lie outside what is accepted as the normal range. In routine diagnosis, the objective is to pinpoint a disease or disorder so that appropriate treatment can be started. In monitoring systems for critically sick patients, the requirement is to extend this diag-

nostic process to detect downward trends or poor response to treatment as rapidly as possible.

A designer must understand the functional requirements for the over-all system before he can proceed to design the smaller subsystems. The design of the sensor, for example, often determines the level of complexity and the effectiveness of the rest of the medical equipment. The use of sensors that imitate the manual approach usually throws an excessive load on the data-processing requirement, whereas it may be possible, through a new approach, to sense a variable that is more directly related to a particular physiological or anatomical function.

A good example is the electrocardiogram. By measuring at various points of the body, a doctor is able to obtain readings that he then mentally matches with established patterns to determine the normality or abnormality of the ECG readings.

Vast computer programs have developed for ECG recognition, but these have not significantly reduced the workload of the cardiologist.

The average heart beats 10,000 times a day, and computers today are not able to take more than two or three readings at any one time to determine an abnormal reading.

What is needed is a machine that does not duplicate what the doctor does in his mind. Rather than use the computer to analyze a single diagnostic signal as the doctor does, a better approach may be to simultaneously analyze two or more complementary pieces of information related to the same physiological function. For example, the ballistocardiograph which measures the pumping action of the heart could be correlated with the conventional electrocardiogram. The mind is easily confused by multiple inputs and this type of diagnosis has been neglected.

Another misdirected design effort has been the development of blood velocity computers to determine the gross circulation in the body. This information is almost irrelevant to most clinical conditions. The real circulation system is in the tissues. The only way to measure this microcirculation now is by a microscope or other optical

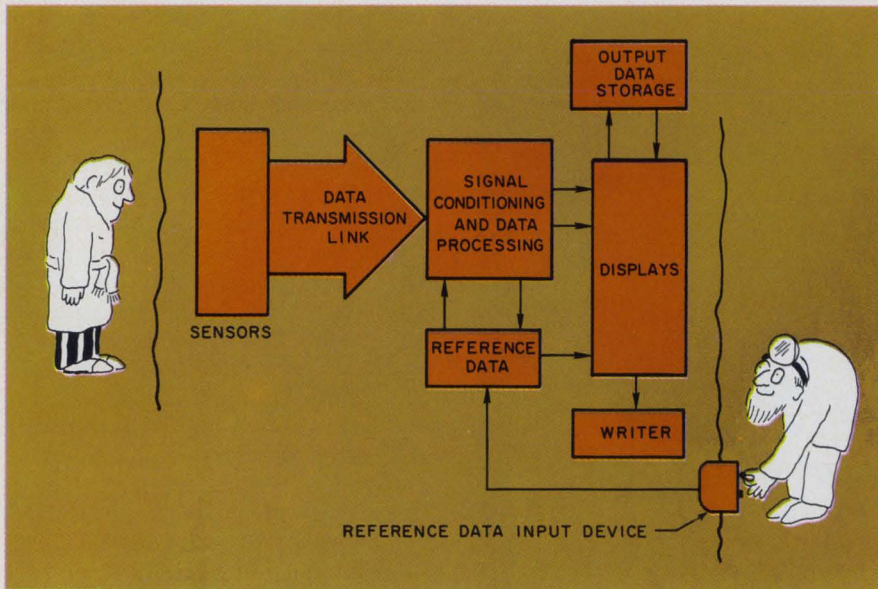

2. **Typical diagnostic system** alerts the physician to the fact that certain results lie outside the normal range.

methods in the laboratory.

Also, more should be done to determine those body parameters that are easiest to measure and that indicate reliably a particular physical condition. For example, the electrical impedance between a pair of electrodes positioned on one of the limbs is relatively easy to measure. Variations in impedance are related to changes in dimension of the blood vessels. It's not yet clear what this parameter means physiologically; it may even be irrelevant to any medical process. But if it isn't, then reliable and simple equipment can be readily designed.

Another simple-to-monitor parameter is pulse wave velocity. This is a measure of the actual velocity of pulse pressure as it travels between one point and another on the body. The velocity depends on two factors: blood pressure and the condition of the arterial wall. Since it is so easy to measure, it would be nice to relate pulse wave velocity directly to blood pressure.

There is also a need for more diverse sensing techniques. For example, in measuring blood pressure, the physician is usually interested in plus or minus 5 per cent accuracy—a figure completely adequate in establishing normal limits. Ideally then it might be preferable to have a remote sensing technique in which a button is pressed to record the patient's blood pressure. On the other hand,

such a relatively crude measurement would be inadequate if the doctor wanted to determine an instantaneous up or down trend—say plus or minus 1 per cent—as a result of the treatment just administered.

Here an implanted catheter might be needed. Between the two techniques there is a whole range of intermediate steps that require new sensing approaches—from the gross to the very refined.

One particularly neglected aspect of patient monitoring is the need for multifunction sensors. Why clutter a patient with a multitude of sensors to measure one parameter to endless accuracy points? Obtaining two or three sets of different parameters will often provide more information. Thus a single sensor could be designed to measure dc, ECG potentials and skin resistance. One example, is the occasional use of electrode arrays for simultaneous electrocardiogram and chest cavity impedance measurements. The significant reduction in hardware clutter about the patient could outweigh the less-than-optimum performance of such arrays in some less-critical monitoring situations.

Wanted: Better displays

Along with enhanced signal processing, there is a need for more effective ways of telling the physician what the machine has

found out. New ideas are badly needed to improve the display of slowly changing signals. The simple CRT and on-line numerical displays do not adequately cover the full range of requirements.

For example, important changes in a patient's condition can be determined by monitoring changes in the pH, pCO_2 content of the arterial blood. A peculiar combination or change in these values would indicate immediately whether a patient undergoing surgery was experiencing respiratory failure or loss of blood. A doctor should not have to view these values on say a multi-channel monitor, flicking his eyes back and forth to determine which value is going up and which down. He should be able to press a button and obtain instantly an index figure (resulting from a computed combination of pH, pCO_2) indicating the state of the acid-base balance of the patient.

It should not be necessary for the doctor to correlate outputs by eye anymore than he wishes, since this is more properly a machine function. In properly conceived systems, the computer analyzes and digests the data. It does not compete with the physician for his more proper function of interpreting the results.

New treatment methods sought

The physician's skill in treating is still linked closely to progress in pharmaceutical research. Drugs will probably remain the most effective weapon against ailments and disease, unless we give credit to the growing impact of the techniques of preventive medicine. However, the therapeutic actions of many drugs are still not completely understood, and there will probably always remain a small proportion of resistant disorders. For these cases we have to turn to other methods of treatment. This may be surgery or a special procedure, such as careful exposure to some form of physical irradiation. Electronic techniques have started to contribute, in a relatively small way at present, to that range of treatment procedures.

Implanted pulse generators are already an accepted treatment for muscle paralysis caused by electri-

cal conduction defects in the pathways between the body's control centers and the afflicted muscle area. The only problems which are treated this way on a routine basis at the moment are some heart disorders, but bladder, intestinal and breathing problems are also candidates.

Another possibility is the use of implanted electrical stimulators to trigger certain of the body's control circuits. Some success has been reported in treating drug-resistant hypertension by artificially stimulating the natural blood-pressure sensors in the carotid artery.

Development of the cardiac pacemaker, first used almost 10 years ago, has been disappointingly slow. Many technical problems still need attention, if these techniques are to be brought into wider application. Probably the best-known problem concerns the development of encapsulating materials that will not react with tissue fluids.

The size and shape of the package that is to be implanted in the body is also a very important design factor in achieving a reliable system. The volume of the hardware must be at a minimum. And, in general, primary power sources should not be part of the package. For implanted stimulators, for example, a radio-frequency coupled external source comes closest to the ideal.

The commercial potential of therapeutic assistance systems should not be underestimated. The annual sales volume in this country in artificial internal organs alone is expected to reach between a quarter and a half billion dollars within 10 years.

Specialized training needed

Whether the design engineer eager to enter medical electronics needs some form of specialized training depends largely on his personal leaning. Creative designers with sound, technical training will be needed to develop compact and reliable medical instruments. Engineers with additional physiological or psychological training would be much in demand. A good postgraduate bio-engineering course would help qualify engineers contemplating a career change. ■■



Bedside unit of patient-monitoring system contains an electrocardiogram channel, an oscilloscope display, a cardi tachometer, and an audio alarm. The unit was built by Honeywell, Inc., Denver.



Nurse touches light pen to the display portion of a medical management system. Up-to-the minute patient data is provided in the system, developed by Sanders Associates, Inc., Nashua, N.H.

Classroom electronics still in groping stage

Systems approach needed in a field where make-do has largely prevailed

A series of questions are listed on a panel to the left of the inquisitive child. At the right of the panel are multiple-choice answers.

The child holds up two metal-tipped probes and, casting his eyes over the questions, picks one:

"What country in the world has the tallest mountain?"

He places the lefthand probe on a metal contact at the question and the righthand probe on a contact alongside what he believes to be the correct answer. The panel makes a buzzing noise if he has picked the right reply—"Nepal."

An electronic teaching aid of the 1960s or 1970s? No, a battery-operated "game of knowledge," marketed by an educational toy manufacturer in the United States at least three decades ago.

Critics of the electronic industry's present efforts in education say that attempts to automate teaching have not progressed much beyond the "game of knowledge." Questions and multiple-choice responses are still the basic format in many so-called teaching machines. Only today solid-state circuitry and computers have replaced simple wiring and the dry-cell battery.

Totally lacking, critics say, is a systems engineering approach in which designers first determine the specific needs of the teaching profession and then design their

machines from the ground up. Many electronic companies in the education market have simply taken off-the-shelf products, designed for some other application, and have patched them together for the classroom with a minimum of redesign effort.

The developers of educational equipment blame the educators for failing to quantify their goals. "In this business you can't get at people's objectives," says Edward Katzenbach, former general manager of the Raytheon Education Co.

On the other hand, the electronics industry has failed to define how its machines can improve the quality of education.

But that is only the beginning of what is wrong with the attempt to use electronics as a teaching aid. Another thing is money—an unwillingness among both educational institutions and engineering companies to invest in R&D.

According to a report, "Innovation in Education: New Directions for the American School," compiled by the Committee for Economic Development, New York City, a small fraction of 1 per cent of the total investment in education is spent on educational R&D. No major industry would expect to progress satisfactorily, the report concludes, unless it invested many times that amount in re-

search and development.

It is estimated that some \$40 billion will be spent on elementary and secondary school education in the U. S. this year. This figure is expected to rise some \$3 billion annually, according to Government figures. About 3 per cent of this amount will go to purchase textbooks, furniture and school supplies. Only the tiniest fraction will be invested in audio-visual equipment or electronic teaching systems.

Nevertheless the perpetual dream of increased federal and state aid to education and a supreme confidence in their ability to solve all educational problems by technology has prompted such giants as IBM, Westinghouse, Raytheon and General Electric to plunge into the educational systems market. The results have been less than spectacular.

Raytheon: A case history

Educational technology as a distinctive market really began in the early 1960s, with IBM, Xerox, Raytheon and General Electric acquiring textbook publishers and hardware producers. One of the biggest jumps was taken by Raytheon Co. Between May, 1965, and June, 1966, it acquired Edex, Dage-Bell, Macalaster Scientific Corp. and C. C. Heath & Co.

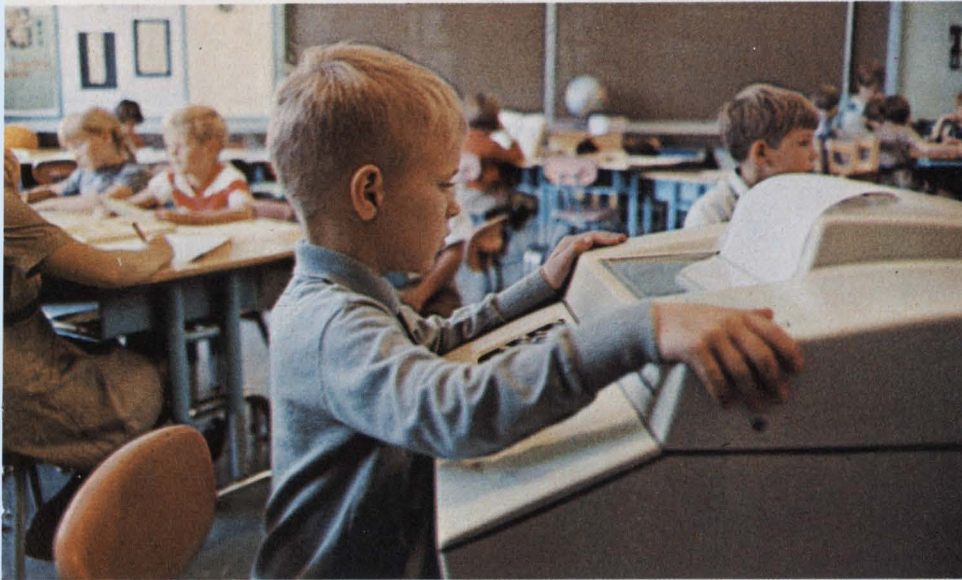

Tomorrow's data-processing systems for educational use require each member of the software and hardware design team to understand the needs, limitations and objectives of one another.

Raytheon entered education with a preconceived idea of what it thought was a model of the educational process. The equation was straightforward: Printed matter (textbooks) plus apparatus plus electronic communications systems equals learning. The formula has proved to be somewhat visionary. In the classrooms things are a lot simpler: Textbook plus teacher equals the daily lesson.

As one educator has noted, "You can make a pretty good case that teaching in most schools is simply turning textbook pages." True, motion-picture projectors, film-strip libraries and tape recorders are filling the schools, but they have hardly begun to change the method of teaching.

In many schools today hardware and software coexist; what is lacking, many educators feel, is a unifying thread. An attempt to capture this "thread" was made by Raytheon with its Student Response System.

The problem confronting a teacher is how to keep track of what each student in a class of 30 or 40 is getting out of a particular lesson. The teacher may have to wait a month or at least until the next test to know whether a point has sunk in or whether the student needs additional instruction. Could an instant feedback system help close this gap?

Raytheon's system, now operating in Northeastern University's Edex Room—a kind of classroom laboratory—consists of rows of narrow, plastic-topped desks, each containing a recessed compartment with four buttons: A, B, C, D. The desks are wired to a central console that has four dials, also A through D, with needle indicators.

At any moment, the dials record automatically what percentage of students is pressing each button.

Useful for multiple-choice

For example, Northeastern University uses the room to give an automated lecture on the subject of programmed instruction. Colored slides showing Skinner boxes, or teaching machines, are flashed on an overhead screen in front of the room. Periodically the monologue halts and the voice poses a question like: "Did Skinner evolve his learning theories from experiments with (a) snakes, (b) elephants, (c) hamsters, or (d) pigeons?"

Students then have about 10 seconds in which to depress one of the buttons in front of them. The central console in addition to recording the percentage of response for each choice, also keeps a running total of right answers for each desk, so that at the end of the lecture an instructor knows

each student's average for the day.

The advantages of this kind of system are obvious. A teacher monitoring the equipment knows at once when too high a percentage of the class does not understand the lesson, and he can interrupt the presentation to explain a point or hold a discussion. Also, a lesson that is repeated many times can be automated and presented to groups of several hundred students at a time.

But the limitations are even more important:

- The system permits student response in a multiple-choice format. The more sophisticated the material, the less useful the system.

- The device cannot be considered labor-saving, since it requires a full-time instructor to monitor it.

The system is 100 per cent hardware; before it can work, teaching programs are needed. The hardware itself, including slide and motion-picture projectors, costs \$12,500.

Thomas Wills, a member of Northeastern's Dept. of Educational Resources, estimated that it takes 40 hours to prepare a one-hour tape and slide lecture. A physics course that used 35 taped lectures in a year would require about 1440 hours of preparation. This would cost an estimated \$10,000 at professional rates.

Very few public schools at any level are willing to undertake such development courses on their own. Some question whether the advantage is worth the cost at any price.

The history of the Student Response System is a good example of what is plaguing not only Raytheon but most companies in the education systems market.

The problems are hardware cost and complexity of curriculum reform are joined by a third problem: computer-based instruction systems.

The key questions for the education industry are:

- How can computers help students to learn better?

- To what extent is their use in the schools economically feasible?

Companies such as IBM, General Electric and RCA have been looking for opportunities to tie

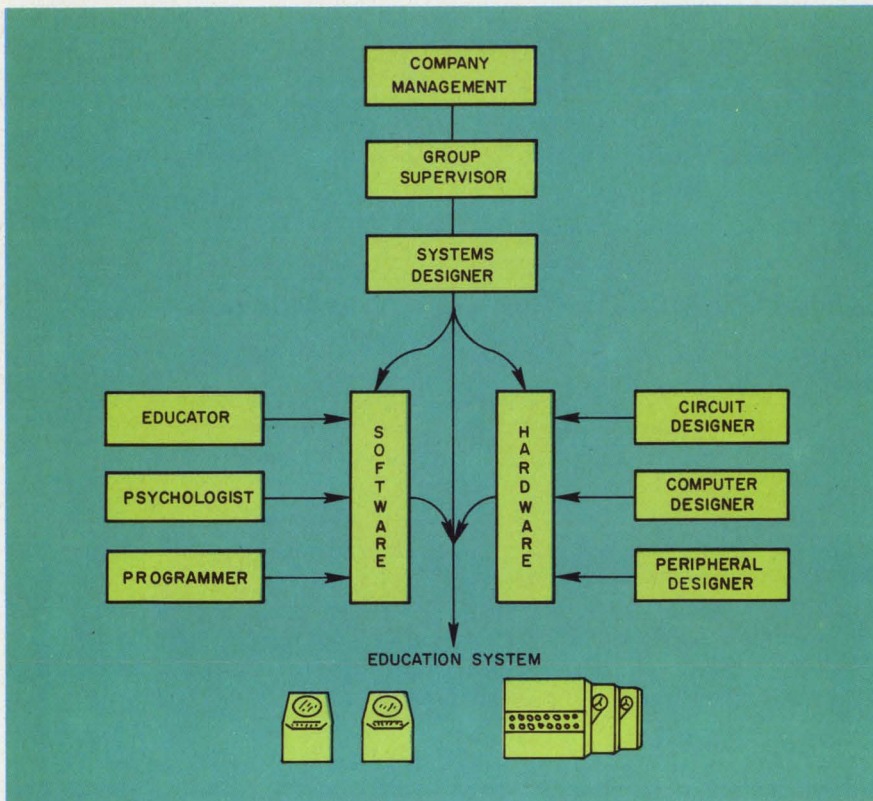

Developing tomorrow's automated education systems requires closer cooperation between software and hardware designers. Much of today's equipment is simply off the shelf and has been patched together with a minimum of redesign effort.

their sophisticated computer hardware into instruction programs for the schools.

The U. S. Office of Education has already spent \$34 million on projects that explore the applications of computer technology to education. At present some 178 efforts are under way. But despite the apparent activity, the use of computers in the public schools—except for a handful of pilot projects—is close to zero.

Computers have been used in two ways in education: Computer-assisted instruction, and computers for educational administration, scheduling and planning.

In a typical computer-instruction classroom, a pupil at a console responds to machine-generated questions either by typing or using a light pen and CRT display. One of the largest experiments has been at the Brentwood Elementary School in Palo Alto, Calif. Two Stanford University Professors, Patrick Suppes and Richard Atkinson, have been attempting to build elementary-school curricula there in reading, arithmetic and

logic.

The machine is considered most useful for teaching by repetition—multiplication drills or transformational grammar, for example. The child learns a basic pattern through repeated examples.

At present the cost of programming and the cost of computer time are considered prohibitive for most public-school systems. A course consisting of 35 one-hour sessions on the computer could take up to 7000 hours of professional time to prepare and the total cost might approach \$100,000.

Despite these costs, some computer experts have pushed ahead with the attempt to employ the computer for language lessons—notably IBM at Yorktown Heights, N. Y.

Among educators there is considerable doubt as to whether a computer can do a more efficient teaching job. As Judson Shaplin, dean of the Education School at Washington University notes: "The stress is on encoding and decoding processes in sequential order. Much of the present cur-

riculum is not amenable to such treatment; in fact, it is difficult to think of large segments of the elementary-school curriculum, other than in the areas of reading and arithmetic, which are subject to such an analysis, except in a fragmentary way."

The second application of computers appears more promising: The machine's ability to process large amounts of information and to keep track of many individuals suggests a solution to the problem of arranging classroom schedules so that individual pupils can learn at their own speed.

A step-by-step program

One such experiment known as Project PLAN (Program for Learning in Accordance with Needs) began last fall in the first and fifth grades of the Adams School in Suburban Quincy, Mass., in the ninth grade of an adjoining junior high and in 13 other school districts across the country.

A PLAN classroom at the Adams school has 29 youngsters at carrels or individual booths, each pursuing his own work project. The computer is in Palo Alto, Calif., with a terminal in Quincy. Its job is to correct the tests that pupils are given upon completion of a defined period of learning—usually every two weeks. On the basis of performance, the computer suggests the next step in the program to teacher and pupil.

PLAN costs less than computer-assisted instruction, since it does not call for large numbers of pupils to be on-line to the computer. And it has a better chance of acceptance by local school boards, since it provides a total curriculum, not just those bits and pieces that can be programmed for the computer.

Portions of this article have been extracted from "Business and the Schools: The Education Industry Today," a report completed by Efreem J. Sigel for the Harvard Business School, and "Innovation in Educators: New Directions for the American School," a statement on national policy by the Research and Policy Committee of the Committee for Economic Development, 477 Madison Ave., New York City. ■■



Computer-assisted instruction can be fun as well as educational, these young students are discovering. Prototype video instructional terminals at top and right were made by RCA, Princeton, N.J., while the computerized learning machine below is a product of IBM, Yorktown Heights, N.Y.

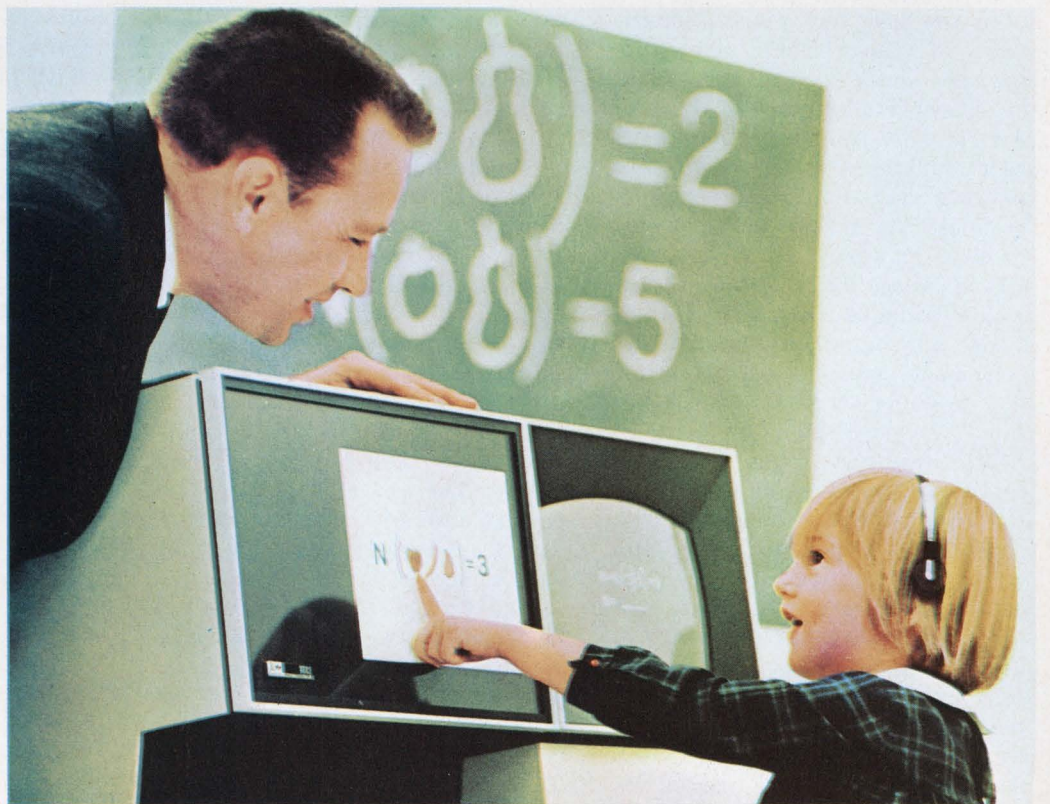

Cities seeking ways to 'fly' on the ground

Rapid-transit systems call for unique solutions to permit speeds to 450 mph

Richard K. Boyd, Systems Group of TRW, Inc., Redondo Beach, Calif.

Public and private ground transportation systems account for about one-seventh of the gross National Product. But they have benefited little from the enormous advances in electronics technology.

All of the nation's major transportation systems still rely on the human brain as the key control element. Until recently little, if any, thought was given to how electronics could improve safety, speed, communications and passenger comfort.

In the last few years a multitude of Government and state agencies—such as the U.S. Dept. of Transportation and the Federal Aviation Administration—have been studying a variety of ways to improve the nation's transportation systems. The impetus was provided in large part by the amended 1966 Urban Mass Transportation Act, which included among its provisions "a program of research, development, and demonstration of new systems of urban transportation."

Whatever the ground transportation systems evolve, it is clear that high-speed systems of the future will require complex electronic control systems, sophisticated microwave communication links and safety devices that will use the latest in laser and radar ranging techniques. It is the replacement of the human operator with electronics that will create new opportunities for electronics

designers in the transportation industry.

Several high-speed, inter-city ground transportation systems are now being studied. Among these are "vacuum tube," air-cushion, high-speed rail and automated highway systems.

The so-called vacuum tube system would consist of a sealed underground tube, hundreds of miles long, in which the air has been pumped out. With no aerodynamic drag, vehicles would be capable of attaining speeds of 300 to 450 mph. It suffers from a high initial cost, however. Air-cushion transportation offers relief from friction-limited wheels, but it requires powerful continuously operating motors to maintain levitation.

High-speed rail systems are limited because of wheel-rail slippage.

Safety, of course, is of paramount importance in civilian transportation systems; it transcends all other considerations and affects the design of the electronic equipment more than any other single factor. The concept of safety in civilian ground transportation differs from that found in the space or commercial aircraft industries. Public transportation systems are designed to operate for decades, rather than years or even days; they must run in all kinds of weather, under intermittent shock conditions and long-term vibration. The notion that an electronic safe-

ty system can be as safe as present mechanical control systems has yet to be proved.

The problem of cost of equipment will vary widely with the transportation system involved. In a railroad type of operation—with relatively large, high-speed vehicles that carry many passengers each—the absolute cost of the electronic equipment is a minimal part of the total cost of the system. No serious cost reduction efforts are required. On the other hand, in an automated highway system the cost of electronics for each automobile is obviously a far more serious issue.

Small obstructions a worry

A vexing problem in high-speed transportation systems is detecting obstructions.

In certain proposed systems an object larger than a cubic inch in the path of the vehicle could seriously damage or even derail a train. This situation, when coupled with a vehicle speed that requires several miles for stopping, dictates that the detection means not be carried on the vehicle but be installed virtually continuously along the vehicle guideway or highway. Such an installation could cost as much as 5 to 10 per cent of the total cost of the pathway.

The small size of the object just about rules out conventional radar for detection, since its wavelengths are too great to provide suitable



TurboTrains developed by United Aircraft's Sikorsky Div., will soon enter service between Boston and New York. Top speed will be about 120 mph.

resolution. If electromagnetic waves are to be employed, one is forced into regions where wavelengths are at least several times less than the smallest major dimension to be detected.

Thus laser systems are now being considered. Even so, some problems are worrisome. For instance, assume the obstruction is lying on the bottom of the guideway. The laser beam must be directed within an inch of the surface. Over a space of, say, a few hundred feet, beam refractions caused by thermal gradients resulting from solar and other heating of the guideway elements might raise serious false-alarm problems. Moreover precipitation (both falling and accumulated) would very possibly present problems.

The obstruction detection problem for automated highways is probably not so severe from a size standpoint because of lower speeds. Objects two to three cubic inches across can be tolerated. It becomes extremely costly, however, if one considers really ambitious installations involving thousands of lane miles.

The vehicle-spacing problem

Another problem is that of maintaining proper separation between vehicles. Generally the dominant cost element of ground transportation systems is the guideway, whether it be the railroad track,

the auto roadway or the subway tube. Consequently, with steadily increasing demands for transportation, the motivation to make more and more efficient use of guideway investment mounts. Policies of higher speeds and more closely spaced vehicles are fundamental to such increased use of expensive guideways. The electronics designer is expected to provide the means for maintaining close but safe separations. While spacing of but one second apart is nothing new to any veteran freeway driver, neither are the potential disasters when the vehicles are directly controlled by humans.

It is likely that one-second intervals can be obtained with current technology, depending upon the degree of "cooperativeness" from the preceding vehicle. The more fully automated a system is, the easier is the design of the control system.

As an example of trends, current railroad headways are measured in minutes. One rail system recently proposed would have separations of less than 100 milliseconds. Here is a clear challenge to the electronic designer to provide electronics for higher system capacity as an alternative to additional guideways.

Several techniques have been suggested, such as laser, radar and infrared ranging devices, to maintain vehicle separation in high-capacity traffic. Ranging systems,

however, begin to run into tracking problems when wide separations are encountered. Such systems would have to be capable of locking in on a single vehicle in heavy traffic. They would also have to compensate for rises, dips and turns in the highway.

Inductive loop detection systems operating in "blocks" similar to conventional railroad practice have also been proposed. They are potentially costly, since the wire loops must either be installed in the highway when it is built or placed laboriously in the existing pavement.

One idea demonstrated, but not adopted, for San Francisco's new rapid transit system used radar that could "see around corners." A metal guide, installed continuously along the side of the track, guided pulses of microwave energy emitted by a radar unit mounted on the front end of a train. The energy pulse is then reflected back to the radar along the guide by a passive reflector mounted on the preceding train. The distance of separation, of course, is then readily determined by the elapsed time required for the echo's return.

Another scheme suggested for a different type of transportation system employs a magnetic tape, also strung along the guideway. A train would first erase then record a repetitive signal of a constant repetition rate. A following train would then detect these pulses and, by adjusting its own speed to approximately the original, known recording repetition rate, it would theoretically not run into the first train. Such a scheme does not, of course, leave room for a sudden stop by the first train.

Still other ideas involve mounting radioactive material on the vehicle and detecting its response with wayside detectors; placing light sources and mating photo detectors on opposite sides of the guideway and then monitoring for a vehicle to interrupt the beams.

3-tier computer system studied

Computer technology will be well represented in the control subsystems of tomorrow's ground transportation systems. However, the popular vision of a single huge "centrally located computer," pre-

siding Big Brother-like over an entire network, appears unrealistic. Recent systems studies suggest strongly that a three-tiered hierarchy of computers is more practical.

The first set of computers would be in the vehicle itself. It will have the primary responsibility for both the immediate safety and rapid movement of the vehicle. In the case of futuristic railroad systems—meaning 80- to 150-passenger vehicles operating at speeds of more than 150 mph—the computer would probably be a small digital type, capable of control functions as well as communications. Systems employing numerous smaller vehicles operating closer together might well employ simpler, less costly analog units more advantageously.

The second tier of computers would be placed at intervals along the guideway—from a mile or two to 30 or 50 miles, according to the system. These would be responsible for functions in the vehicles as the latter passed over the guideway. Together with vehicle computers,

the guideway computers should be designed to maintain vehicular service in the event the functions of a third-tier computer are “lost” for any reason.

The third-tier computer would be a single, centrally located unit responsible for traffic management, surveillance and testing of the system, and control over operations during inclement weather or other situations that call for changes.

In general, safety responsibilities would be localized, while real-time planning of system facilities would be centralized. The middle tier of computers would couple the two major functions to form an integrated whole.

It is interesting to note that no technological breakthroughs are necessary for developing such a system. Current computer technology is adequate, although some progress is desirable in areas of reliability and—in the smaller units—cost.

The matter of reliability is intimately involved with that of safety, since computers would be

responsible for real-time direction of vehicles, switches and other critical functions.

It is not enough to build computers that provide either a right answer or none at all; they must give the right answer all the time within the limited time. Thus high accuracy *and* availability are required—a problem not unlike that facing the designers of telephone switching centers.

Communication advances needed

In communications, the problem is to provide a reliable and accurate link between fixed ground facilities and the system's vehicles; the remaining portions of the communication networks can easily be accommodated by existing technology.

Today's railway systems use either inductive loop communication techniques or fairly conventional radio techniques. The inductive systems utilize loops of wire, usually laid between the rails, which couple to coils mounted on the trains. Carrier frequencies of 15 to 80 kHz provide a very few voice channels. The radio links usually utilize uhf equipment for communications between the front and rear of a train and wayside personnel.

The communications requirements of advanced ground transportation systems are expected to be several magnitudes greater than those of current railroad or highway systems. The high-speed, closely-spaced vehicles will require, in general, many kilobits of data for control. In the case of futuristic railroad operations, the demand for passenger communications is expected to be very high. Several public telephone channels for each train are anticipated, as well as a TV channel or two and possibly channels for such services as electronic newspapers and stock reports.

Up to several hundred megahertz of bandwidth range may be required. Clearly neither inductive nor radio techniques will suffice—the first because of obvious bandwidth inadequacies, the second because the necessary spectrum frequency allocations would be unthinkable.

Accordingly several approaches



High-speed ground transportation in tomorrow's cities will require complex control systems and communication links.

are under study to meet the communications requirements without the need for additional Government frequency allocations. Various leaky transmission lines—coaxial, circular and rectangular—are possibilities. Surface wave guides, such as the Goubau Line (a single conductor waveguide where the microwave frequencies travel on the surface instead of the inside) are also being investigated. Spaced microwave repeaters along sections of the guideways are also possibilities, but they come very close to violating the "no allocation" restriction. Not a small problem is that of preventing undue amounts of noise from entering the system. Considering that continuous communications must be maintained over a network that is at least several hundred miles long, it can be seen that susceptibility considerations are most important.

Power-conversion competition

Power for propulsion raises other barriers that must be broken down. For the highway vehicle, a better battery is needed—a breakthrough to overcome present, obvious limitations. But when the better battery arrives, the need for reliable, relatively inexpensive electronics to perform the power transformations will keep a corps of designers in competing organizations busy indefinitely.

Similarly, in high-speed multi-passenger systems, the problem of converting power from the source to a form that can operate the motors will continue even after the first systems are in service. The big question of how best to furnish the frequencies and voltages—required by the rotary and linear ac induction motors that emerging as front runners for propulsion—is wide open.

If conversion is done on-board, current technology requires a sizable usurpation of space and weight on even a 100-passenger vehicle. Alternatively, conversion of the power along the guideway, before it is transmitted to the vehicle, introduces considerable control and synchronizing problems.

Virtually all existing ground transportation systems have "evolved," instead of being explicitly designed. It is clear that

future systems will never come into use in any reasonable length of time, or with any sensible economy, without the use of systems engineering principles in both design and management. Even today, system engineering opportunities are available to electronic designers. Organizations involved are as follows:

Systems engineers needed

On the Federal level, the Department of Transportation is the focus of activity. Within that department, the Federal Aviation Administration is seeking a cure to the well-publicized problem of traffic congestion at major airports. The Bureau of Public Roads is engaged in a number of efforts to assist the automobile driver. The Office of High Speed Ground Transportation is searching for intercity systems. The Urban Mass Transit Agency is promoting more and better transit systems.

Several states have also formed departments of transportation and

are planning for the future. New York, New Jersey and Pennsylvania are typical of these states.

Among the industrial concerns active are the traditional railway signaling companies: General-Railway Signal in Rochester, and Union Switch and Signal and the Westinghouse Electric Corp., both in the greater Pittsburgh area.

Both Philco-Ford, Newport, Calif., and General Motors, Detroit by their public announcements, are engaged in advanced electronic concepts for use on highway systems.

Several universities and research laboratories such as Rensselaer, MIT, Ohio State, University of Kentucky, Michigan University and Cornell Aeronautical Labs are involved in research for better ground transportation.

Wheeler Laboratories, Great Neck, N.Y., ESSA at Boulder, Colo., and Hughes Aircraft, Culver City, Calif., are among those working on vehicle communications.

TRW Systems, Washington D.C. and the MITRE Corp., are involved in systems engineering. ■■



Interior of the TurboTrain is similar to that in the first class section of jetliners. A typical car seats about 50 passengers.



25 winners in our collection of op art

nobody, but nobody makes more discrete op amps than Philbrick/Nexus

Philbrick/Nexus is avant-garde in operational amplifiers. Covers the spectrum of op amp capabilities — from mini-cost to maxi-performance. Standard products, as well as mixed products, match your needs economically. Use them. They'll color you bright. Op art masterpieces like these are but a few of the total Philbrick/Nexus exhibit:

Economy Grade

SQ-10A — MINI-PRICED, but a top performer in general purpose applications. Only \$10.50 each in hundred quantities.

QFT-5 — LOWEST PRICED FET. General-purpose performance, low leakage. Only \$15 each by the hundred.

1009 — LOW COST, HIGH PERFORMANCE FET. Input impedance 10^{12} ohms. Input bias current 5 pA. Priced at \$20.50 each in quantities of 100.

General Purpose

CIA-2 — LOW PROFILE, HIGH PERFORMANCE. Thick-film hybrid, 80,000 gain, $\pm 5\mu\text{V}/^\circ\text{C}$ input voltage offset.

SQ16 — HIGH PERFORMANCE. Gain 150,000, $\pm 5\text{mA}$ guaranteed minimum output at ± 11 volts. Low noise, $1\mu\text{V}$ rms broadband.

Q102A — ULTRA-HIGH PERFORMANCE. Gain 200,000, $\pm 2\mu\text{V}/^\circ\text{C}$ input voltage offset typical at -25 to $+85^\circ\text{C}$. Internally trimmed to 0.5mV max.

QFT-2 — TOP-GRADE PERFORMER. Gain 200,000, slew rate $10\text{V}/\mu\text{sec}$, 10 pA input bias current.

Q103A — HIGH INPUT IMPEDANCE, LOW BIAS CURRENT. Input voltage offset $\pm 2\mu\text{V}/^\circ\text{C}$. Only \$25.50 each by the hundred.

High Reliability

Q10A — ALL-PURPOSE TOP-GRADE. -55°C to 100°C operating temperature range.

P65A — PREMIUM GRADE. Wide application usage, proven performance, low broadband noise $1\mu\text{V}$.

CDA-3A — PROVEN PERFORMANCE. Input bias current 1nA, differential input resistance 2 megohms.

Q25AH — WIDEBAND FET HYBRID. 600,000 hours of operation with no failures. Small size TO-8 package, hermetically sealed.

Wide Band

PP45U — 100 MHz BANDWIDTH. Slew rate $200\text{V}/\mu\text{sec}$. Excellent for broadband inverter applications.

1016 — FAST, HIGH POWER. $f_p > 1$ MHz. Full output of $\pm 10\text{V}$, ± 100 mA to 1 MHz. CMRR 100,000. E_{os} T.C. is $10\mu\text{V}/^\circ\text{C}$. A_o at 750,000.

1011 — LOW PROFILE, FAST SETTLING TIME FET. 15 MHz bandwidth, slew rate $70\text{V}/\mu\text{sec}$. Delivers $\pm 11.5\text{V}$ output. Settles in 1.5 μsec to .01%, 0.4 inches high max.

Universal

ESL-1 — WIDE SUPPLY VOLTAGE RANGE, ± 8 to $\pm 16\text{V}$. CMRR 1,000,000:1, common mode input resistance 1.5 G ohms.

USL-1C — HIGH STABILITY. Wide range of supply voltages from ± 8 to $\pm 26\text{V}$. Input voltage offset $\pm 1\mu\text{V}/^\circ\text{C}$. Low drift.

High Voltage

MLF-100 — ± 100 VOLT OUTPUT at 10mA. FET input amplifier. Short circuit protected.

Micro-Power / Low Voltage

Q-200A — BATTERY OPERATED. $\pm 50\mu\text{A}$ quiescent drain. Ideal for OEM battery operated and airborne instrumentation.

1402 — MICROCIRCUIT FET HYBRID. Bias current 5pA. Input impedance 10^{12} ohms. Output $\pm 14\text{V}$, $\pm 5\text{mA}$. Supply voltage from ± 4 to $\pm 24\text{V}$. Quiescent current $\pm 0.5\text{mA}$. In TO-8 case, hermetically sealed.

High Performance

1003 — LOW-NOISE FET. 3,000,000:1 CMRR $\pm 1\mu\text{V}/^\circ\text{C}$ input offset voltage $+10^\circ\text{C}$ to $+60^\circ\text{C}$. Uses hermetically sealed active components.

1700 — LONG-TERM STABILITY. Input voltage offset $\pm 0.15\mu\text{V}/^\circ\text{C}$. Full output to 1.2 MHz. Gain 10^9 . Long-term stability .2 μV per day.

1018 — ULTRA-LOW DRIFT. Gain 1.5 meg E_{os} $0.5\mu\text{V}/^\circ\text{C}$ and I_{bias} .02nA/ $^\circ\text{C}$.

Monolithic IC's

S-52 — LOW, LOW COST IC. Easy to stabilize. Dual in-line package. \$5 each in quantity.

T-52 — A REAL BUY. Same as S-52, but in TO-5 package. Same low price.

Your Best-Of-Show selection brings with it, at no extra cost and available nowhere else — unequalled integrity resulting from superb artistry in things analog. For other op amp prize winners, too numerous to mention, contact your Philbrick/Nexus sales representative for complete specifications, prices and applications assistance. Or write, Philbrick/Nexus Research, 46 Allied Drive at Route 128, Dedham, Massachusetts 02026.

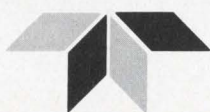

PHILBRICK/NEXUS RESEARCH

A TELEDYNE COMPANY

PICK THE TOP TEN!

WIN 2 ROUND-TRIP TICKETS BETWEEN

HERE'S ALL YOU HAVE TO DO Examine the January 4 issue of Electronic Design with extra care. Pick the ten advertisements that you think will be best remembered by your 69,000 fellow engineer-subscribers. List these advertisements (not necessarily in rank order) on the special entry blanks bound in the Jan. 4 issue, and mail to our Contest Editor. Your selections will be measured against the ten ads ranking highest in the "Recall Seen" category of Reader Recall—Electronic Design's method of measuring readership. Remember . . . in making your choices be sure to consider not only your own tastes and interests in the subject matter of each particular advertisement, but also those of the other engineer and engineering manager readers of this magazine. All Electronic Design subscribers may enter the contest (see rules in Jan. 4 issue). Good Luck! If you study the ads with care, you might wake up one morning in Paris!

FIRST PRIZE

Round-trip tickets for two between New York and Paris via AIR FRANCE. You can schedule your flight anytime you wish—stay up to 21 days before returning.

2ND PRIZE

DELUXE HEATHKIT®/THOMAS "PARAMOUNT" TRANSISTOR THEATER ORGAN

19 Organ Voices, 200 Watts Peak Power, Chimes, Color-Glo Key Lights, Rotating Leslie Speaker, Horseshoe-Shaped Console, Plus Many Other Features.

Here is a truly sophisticated organ with a wide variety of deluxe features to give professional playing versatility. Kit comes complete with all parts, step by step assembly instructions, and alignment tools.



Electronic Design 1969



NEW YORK AND PARIS VIA AIR FRANCE!

3RD PRIZE

DELUXE HEATHKIT® "180" COLOR TV WITH CONTEMPORARY WALNUT CABINET

Kit comes complete with all parts including chassis; hi-fi 90° 180 sq. in. rectangular color tube with anti-glare safety glass; 24,000 volt regulated picture power; rare earth phosphors; 27 tube, 10 diode, transistor circuit; automatic color control circuit; gated automatic gain control; extra B+ boost, etc. etc. All critical circuits are pre-wired and tested.



4TH THROUGH 10TH PRIZES

7 BULOVA ACCUTRON® "SPACEVIEW" ELECTRONIC TIMEPIECES

The "Spaceview" is an ideal timepiece for electronic engineers. Its clear-view dial reveals transistorized electronic circuit and tuning fork assembly. Accuracy guarantee is 99.9977% during actual wear on the wrist. Stainless steel case with luminous hands and dots.



PLUS 100 ADDITIONAL PRIZES

"ELECTRONIC DESIGN TECHNIQUES" edited by Edward E. Grazda

Contains a comprehensive collection of over 55 articles from Electronic Design covering almost all areas of interest to electronic design engineers. The articles are grouped in sections considering the use and design aspects of amplifiers, resistor networks, filters, control devices, power supplies, microwave systems, oscillators, and pulse and switching circuits. Hard cover, 312 pages.



TOP TEN CONTEST

WATCH FOR ENTRY BLANKS IN JAN. 4 ISSUE

There's a separate contest for electronic marketers. In addition to the valuable prizes listed at right, if you are a winner in the contest for marketers, and have an ad in the January 4 issue, that ad will receive a free re-run! Complete information, rules, and entry blanks will be bound in the January 4 issue of Electronic Design.

PRIZES—MARKETER CONTEST

- 1ST PRIZE: Round-trip tickets for two between New York and Paris via Air France.
- 2ND PRIZE: RCA "Carry-ette" portable 14" color TV set.
- 3RD PRIZE: Bulova Accutron® "Spaceview" electronic time-piece.

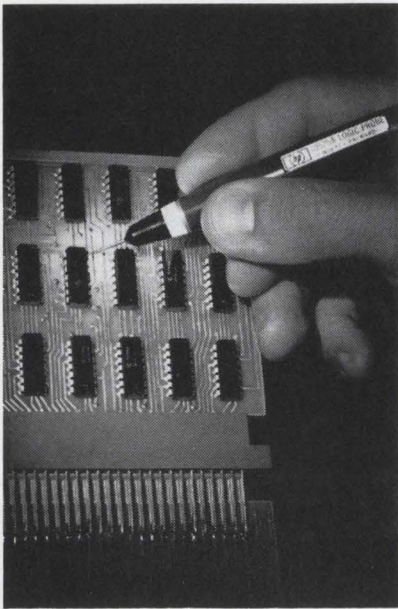

This probe lights up when a pulse goes by.

Even a pulse as short as 30 ns—positive or negative—will cause this logic indicator to flash a signal. You can trace pulses, or test the logic state of TTL or DTL integrated circuits, without taking your eyes off your work. In effect, the probes act like a second oscilloscope at your fingertips.

No adjustments of trigger level, slope or polarity are needed. A lamp in the tip will flash on 0.1 second for a positive pulse, momentarily extinguish for a negative pulse, come on low for a pulse train, burn brightly for a high logic state, and turn off for a low logic state.

The logic probe—with all circuits built into the handpiece—is rugged. Overload protection: -50 to +200 V continuous; 120 V ac for 10 s. Input impedance: 10 k Ω . Price of HP 10525A Logic Probe: \$95, quantity discounts available.

Ask your HP field engineer how you could put this new tool to work in logic circuit design or troubleshooting. Or write Hewlett-Packard, Palo Alto, Calif. 94304; Europe: 54 Route des Acacias, Geneva.

02825A

HEWLETT  **PACKARD**

INFORMATION RETRIEVAL NUMBER 31

The new 'glamour' electronics?

You might think that companies like North American Corp. and TRW, Inc., each with millions of dollars in Government contracts, would be tempted to feel self-satisfied. North American is heavily engaged in Minuteman III work and other military space and aviation projects. TRW is the nation's leading developer of scientific satellites. Yet both are looking quietly into the future, to the day when their present work may be largely passé. Should you be doing the same?

To give you a broad glimpse of some of the emerging technologies, *ELECTRONIC DESIGN* has chosen four fields and asked authorities in them to portray the prospects for design engineers. Starting on page 54, you can check the broad prospects for careers in Oceanography, Medical Electronics, Urban Transportation and Educational Electronics.

Trends in these fields are described by Dr. Andreas Rechnitzer, director of Ocean Systems Operations of North American Rockwell, Dr. Malcolm Ridgway, director of biomedical activities at TRW and Richard Boyd of TRW's Washington, D.C., operations.

ED's news chief, Ralph Dobriner, edited the entire special report—as well as, incidentally, writing the annual electronics industry forecast on page 25.



Ralph Dobriner discussing cover photo with Dr. John Wentworth, director of Educational Systems Engineering at Radio Corp. of American. RCA also supplied a number of other color photos in the educational electronics section of the report.

Putting a damper on circuit din

Noise caused by transients and the undesired coupling of signals—what circuit engineer hasn't been bothered by such problems? Instead of tearing the circuit apart, Tom Skopal, an applications engineer of Burrough Corp., Plainfield, N.J., sat down calmly and tore the problems apart. By the time he was finished, he had come up with two major ways to reduce the effects of transients and a handful of hints to overcome coupling interference. You may save yourself hours of anguish by checking Tom's article on page 90.

Who says relay specs are dull reading?

Not us. We're sure you'll find the specs of these two popular models positively fascinating. Want more info? Write: 1550 W. Carroll Ave., Chicago, Ill. 60607



GUARDIAN[®]

GUARDIAN ELECTRIC MANUFACTURING COMPANY

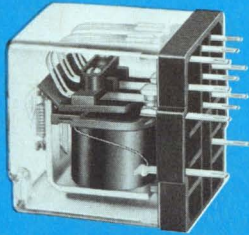

SERIES 1220

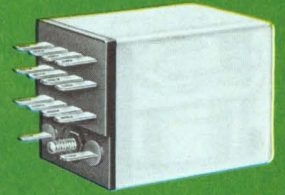

SERIES 1300



NO NEED FOR RADIO TYPE PINS
 ONE PIECE SWITCH

A.C. 10 AMP
 AVAILABLE WITH MANUAL RESET
 available with electrical reset
 AVAILABLE WITH TIME DELAY
 DPDT OR 3PDT
 UL RECOGNIZED
 ONLY \$1.55 IN QUANTITIES
 3 WAYS TO CONNECT

4PDT

ONE Cubic Inch
 RINGS 3 AMPS.
 120 WAT
 15 OUNCES
 TEMPERATURE RANGE
 -45° +70°c

500 MEGOHMS INSULATION RESISTANCE

ACCS
 PLUG-IN OR PRINTED CIRCUIT TERMINALS

DC
 LEXAN DUST COVER

TESTED FOR OVER 100 MILLION OPERATIONS

ERIE

TECHNOLOGICAL

PRODUCTS, INC.

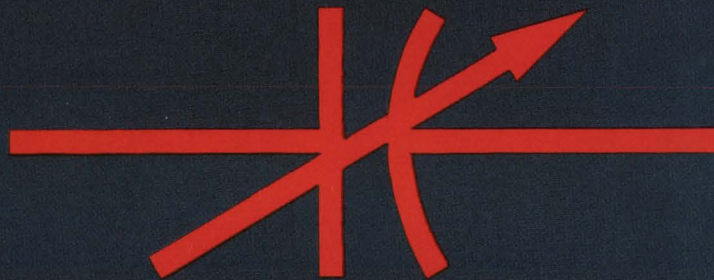

Quality **TRIMMER CAPACITORS** *by* **ERIE**

AIR • CERAMIC • GLASS • QUARTZ • PLASTIC



Call or wire **TODAY** for
complete new Trimmer data.

YOUR ERIE MAN HAS JUST THE RIGHT TRIMMER CAPACITOR... AT JUST THE RIGHT TIME

Your Erie Man won't sell you a particular type of trimmer capacitor... but he will help you choose the right trimmer from the world's most complete selection... AIR, CERAMIC, GLASS, QUARTZ, and PLASTIC — more than 1000 styles. With ERIE you save valuable time by talking with one expert rather than several representatives handling limited trimmer lines. And you know the trimmer you choose will be ideal for your application. So call in your ERIE man for your complete trimmer requirements.

ERIE is qualified to MIL-C-81 and MIL-C-14409

ERIE TECHNOLOGICAL PRODUCTS, INC.

644 WEST 12th STREET • ERIE, PENNSYLVANIA 16512 • PHONE (814) 456-8592

INFORMATION RETRIEVAL NUMBER 33

Publisher

Hugh R. Roome

Editor

Howard Bierman

Managing Editor

Robert C. Haavind

Technical EditorsFrank Egan
A. Craig Reynolds, Jr.
Michael J. Riezenman
Raymond D. Speer**Management and Careers Editor**

Bruce Trabue

News Editor

Ralph Dobriner, Chief

Washington News Bureau

Charles D. LaFond, Chief

Military/Aerospace Editor

John F. Mason

East Coast Editor

Jim McDermott

West Coast Editor

Elizabeth deAtley

New Products EditorsRobert Patton
Lucinda Mattera**Copy Editor**

Peter Irving

Editorial ProductionDollie S. Viebig
Phyllis Gura**Art Director**

Clifford M. Gardiner

Art Assistant

William Kelly

Technical IllustratorsWilliam Alvarez
Rita Jendrzejewski
Barney Krochek
Lynn E. Thompson**Production Manager**

Thomas V. Sedita

Asst. Production Manager

Helen De Polo

Production AssistantsBernard Wolinsky
Carl A. Merkin**Circulation Manager**

Nancy L. Merritt

Information Retrieval

Genate Pazmino

EDITORIAL



A plea for the human touch in information retrieval

Many professional librarians feel that engineers do not make adequate use of the services they provide. Thus when the prospects for massive computer-based information retrieval services became clear years ago, librarians decided to do a detailed study of how engineers *were* getting the information they needed.

They were startled to find that the primary source of information was personal interchange, whether by phone, letter or direct contact. On reflection, this is not surprising. Technology is changing quite rapidly. So fast, in fact, that despite a flood of literature, there are few areas where needed data has been presented as a coherent whole. Thus after searching through, and puzzling over, reams of articles, conference papers, books, and so on, the engineer may still not get the answers. In fact, he may find that what he seeks just hasn't been published yet. Or, even if it is available somewhere, he may fail to find it.

One solution is for the engineer simply to work out his problem without an exhaustive literature search. This is not an uncommon occurrence.

Another alternative is to call up some sharp engineer who you know is right on top of the technology. He may know the answers immediately. Or if he doesn't, he knows whether they have been published, and, if so, where. This is an extremely efficient approach *if* the engineer with the problem knows who such an expert is.

Despite these findings, information retrieval proceeds steadily in the direction of a completely machine-based system, modeled after the sorts of filing systems one finds in a conventional library. We believe that this is folly and that millions will be wasted on systems that will receive relatively little use.

What needs to be coupled into such a system are *brains*—the brains of the experts. A way should be found to compensate them for answering questions. Questioners should be charged for their queries, which would be taped, prescreened to eliminate cranks or long-winded, poorly phrased queries, and then sorted automatically to the proper expert.

The impact on our technical progress would be significant if such a scheme could be worked out economically. Machines *plus* brains can make a much more powerful and efficient approach to information-retrieval systems.

ROBERT HAAVIND

Our new AC Designer Line switches come in an endless variety of colors, sizes and styles.

Sure, we know you'd never order a switch with a painted body. Or a style quite like this.

But our turned-on switch helps demonstrate the customizing possibilities these new Designer Line AC switches offer. The choices just don't quit.

Three types of terminals. In 1-, 2-, 3-, and 4-pole models. With special configurations like momentary-contact and center-off.

As for the lever, pick one to your liking and we'll deliver. Our unique design permits our Distributors to supply a broad array of sizes, shapes and colors. Or have our factory build them to your

own design at a truly modest tooling cost.

Select attractive new decorator nuts, too. Two smart styles, four stock colors. Dozens of other colors on request.

But we're not playing the numbers game. Just giving you unmatched flexibility to design our new AC switches into your products. Plus capacities from low-power dry circuits up to 25 amps, and Cutler-Hammer quality you know and expect.

Write for Brochure LA-136-A217, or call your Cutler-Hammer Sales Office or Stocking Distributor. Even our off-the-shelf delivery will turn you on.



These are the building blocks that provide new flexibility in designing with Cutler-Hammer AC Designer Line Switches.

The switched-on switch



Switch
to No. 1

More than just switches:
prompt availability,
field help, innovation,
quality assurance too.

INFORMATION RETRIEVAL NUMBER 34



CUTLER-HAMMER

Milwaukee, Wisconsin 53201

Technology

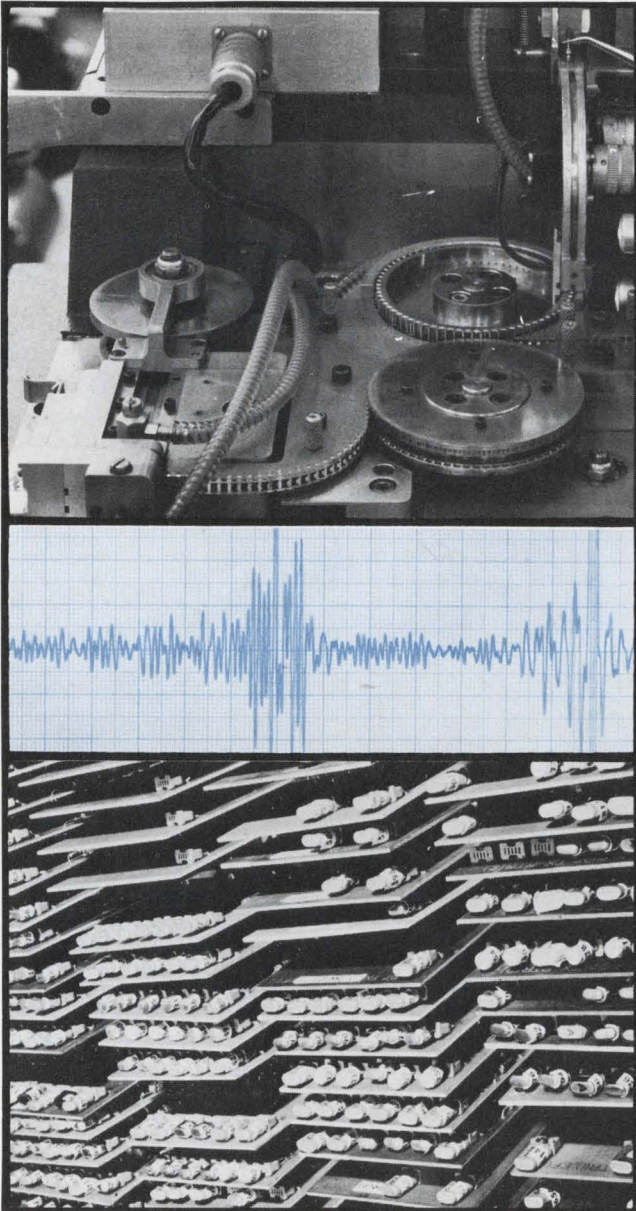

Stop noise problems before they start: cut coupling, kill transients. Page 90

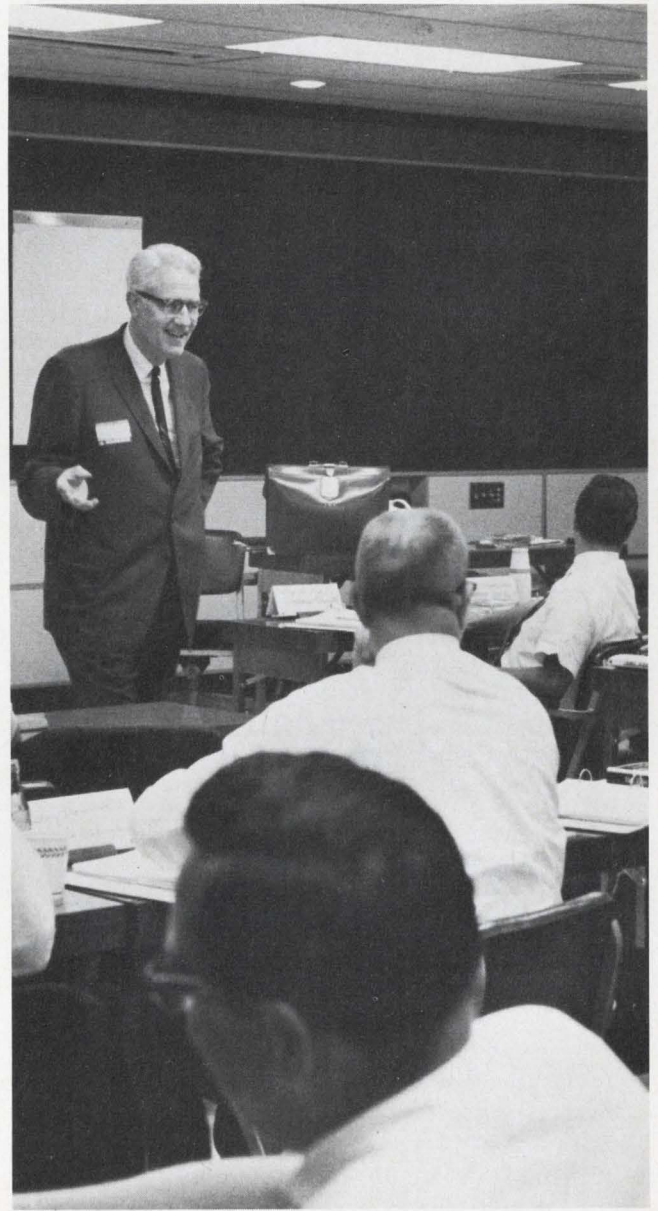

Management training courses help you get things done. Take one, part-time. Page 114

Also in this section:

Sectionalize your digital controller in an adaptive control system. Page 82

A practical guide to a/d conversion. Page 97

Ideas For Design. Page 124

Sectionalize your digital controller

in an adaptive control system to simplify the logic and to increase system efficiency.

Signal noise and crosstalk in performance-identifying channels can be major stumbling blocks to the development of practical adaptive control systems in either analog or digital form. The latter, however, is inherently more stable against drift. (An adaptive control system, as referred to in this article, is one in which a few system parameters change automatically to maintain invariant dynamic performance.)

The common way of designing a digital computer—by faithfully digitizing analog functions in every fine detail—leads to both complex and prohibitively expensive configurations. What is needed is a new approach to digital control system organization.

Such an approach is possible if the conventional primary controller is replaced by a new sectionalized digital controller. Further, the adaptive control loops will be designed with processing concepts instead of the conventional system analysis procedure to gain better insight into cross-talk and noise problems. Several simplified adaptive controllers will be used for illustration.

Develop a digital weighting function

In the design of a feedback control system, such as the one shown in Fig. 1, the controller is usually characterized by a weighting function—the response to a unit impulse input.

The shape of the weighting function is selected to make the closed-loop system stable and to have a desired dynamic behavior with frequency-response or root-locus procedures. As a rule, the weighting function of an analog controller is made up of several exponential functions with real or complex indexes.

One way to convert the analog controller to digital operation is to design a digital controller that produces a weighting function in the form of a pulse train with an envelope shaped like the analog weighting function. This is valid if the controller samples the information at a frequency that is five or more times faster than the highest effective

frequency of the system. The envelope of the pulse train is characterized by components of exponential functions so that a closed form (see box) exists and may be summarized as:

$$(a_0 + a_1Z^{-1} + a_2Z^{-2}) / (1 + b_1Z^{-1} + b_2Z^{-2} + b_3Z^{-3}) \\ = A(Z) / [1 + B(Z)]. \quad (1)$$

A controller with a closed-form Z-transform weighting function (see box) can be instrumented quite easily by simulating the pulse train of the numerator directly. Then it is followed by a scheme in which the pulse train corresponds to the “denominator minus unity” in the feedback branch. This latter scheme simulates the division operation following the standard rule that

$$G_c = G_f / (1 + G_f G_b), \quad (2)$$

where

G_c = closed-loop transfer or weighting function

$G_f = 1$ = forward loop transfer or weighting function

G_b = feedback loop transfer or weighting function.

This digital controller is shown as a block diagram in Fig. 2a while the corresponding schematic diagram is shown in Fig. 2b.

Sectionalize the weighting function

The configuration of Fig. 2b represents a typical digital controller scheme used in space-vehicle applications. Its results are identical to those of a scheme in which each component of an analog computer is digitized individually. This latter scheme would require n integrators for an n th order controller, and integration is just too complicated for a digital computer. This one reason why analog computers are frequently used in hybrid digital-analog computer systems to perform the integration. But, for a feedback controller, a hybrid system would appear to be impractical, since the basic problems of an analog system would still remain.

In the configuration of Fig. 2b an n th order controller would require about $2n$ multipliers (sometimes one or two less) to produce a func-

Prof. Y. T. Li, Department of Aeronautics and Astronautics, MIT, Cambridge, Mass.

What is a Z-transform?

A train of pulses in a digital control system is usually characterized by a Z-transform. Specifically a symbol Z^{-1} represents a pulse delayed by one sample period, Z^{-2} by two delays, etc. Thus a signal in the form of a train of pulses of various heights of a_n may be represented as

$$a_1 + a_2 Z^{-1} + a_3 Z^{-2} + \dots$$

An exponential function, e^{-t} if modulated by a pulse train spaced at one second apart, would become

$$1 + e^{-1} Z^{-1} + e^{-2} Z^{-2} + e^{-3} Z^{-3} + \dots$$

$$= 1 + 0.368Z^{-1} + 0.135Z^{-2} + 0.05Z^{-3} + \dots$$

The corresponding graphical representation is shown below:

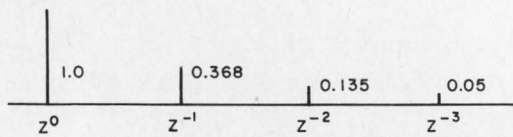

The infinite series of a pulse train of the exponential function can also be represented in a considerably simplified form (known as the closed form):

$$-1/(1 - 0.632Z^{-1}) = 1 + 0.368Z^{-1} + 0.135Z^{-2} + 0.05Z^{-3} + \dots$$

This can be verified quite readily if the division is carried out term by term and if one remembers that $Z^{-1} \times Z^{-1} = Z^{-2}$. This implies that if a system characterized by one delay is driven by a signal of another delay, the resultant output will be delayed by the sum of these two delays.

Any exponential function with a real or imaginary index or a combination of these functions has a corresponding closed-form Z-transform, such as may be found in most texts on sampled data systems.

tion in the form of a pulse train identical with that produced by the scheme involving the n integrators. In each case the result is an infinitely long pulse train with an exponential weighting function envelope.

One way to simplify the design of a digital controller even more is to modify the weighting function designed by Laplace transformation analysis. As you may recall, the weighting function of a conventional controller is built up from various types of exponential functions. Analytically this is easy to handle, and it is the natural property of an analog device.

But here is the crucial point: Why stick to the weighting function of an analog controller when a digital controller is to be designed? For example, suppose we have a plant with the characteristics of an integration plus some delay. In closed-loop operation a controller with some lead

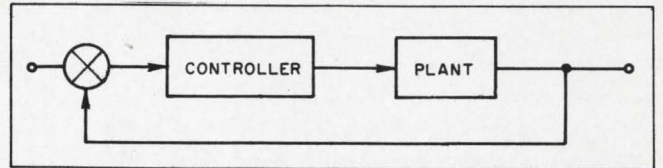

1. The first step in designing a typical feedback system is to obtain a weighting function (response to a unit impulse) for the controller.

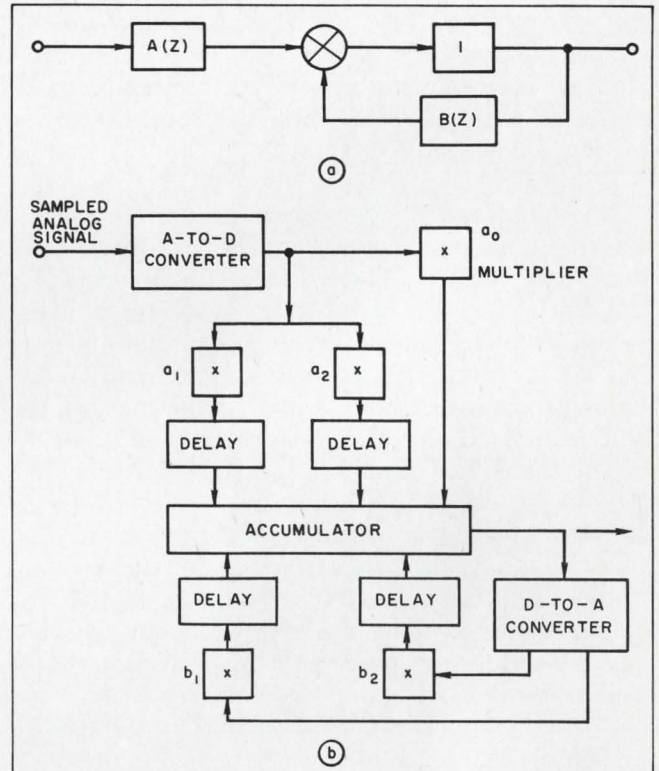

2. Digital controller can be represented either in a block-diagram form (a) or schematically (b). Standard use of analog-to-digital and digital-to-analog converters is made.

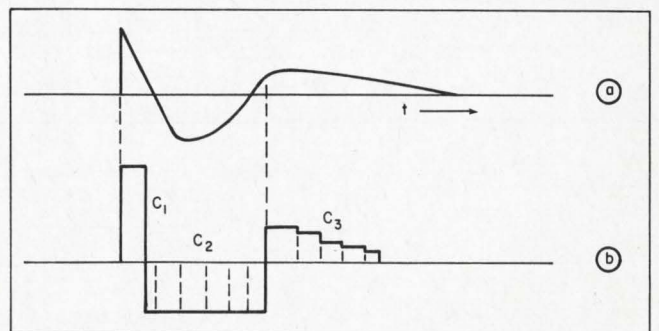

3. Analog weighting function (a) can be approximated closely by a train of pulses in a digital system (b) without precisely imitating the analog function. The tail of the analog weighting function can be omitted, since by the time it occurs, a fresh error signal is already present.

is required. The weighting function of this controller might appear as in Fig. 3a.

Now, suppose there were a human operator instead of the controller to operate the plant. After a little practice he would realize that while his first instinct was to push the control stick of the plant in a direction to null the error, and leave it there until the null occurs, he should instead give the stick a fast reversal just before nulling to prevent overshoot. If his weighting function were traced, it would agree with the weighting function of the analog controller in a general manner but deviate in many fine details.

Likewise for a digital controller, you need not follow the weighting function of an analog controller dogmatically in every fine detail. For instance, the weighting function of Fig. 3a can be matched quite well by three sections of conveniently shaped pulse trains, C_1 , C_2 and C_3 , shown in Fig. 3b.

These pulses are nonoverlapping time functions. Furthermore they are pulse trains of finite length instead of infinity. Indeed, in feedback operation the controller continuously receives fresh error signal from the output. Thus the infinitely long tail of the conventional weighting function can be discarded. A smooth roll-off is desired for the last section, to give bumpless response.

The weighting function of Fig. 3b is now sectionalized into three elementary pulse trains with simple characteristics to duplicate the main features of the weighting function of the conventional design. The required number of sections usually depends upon the complexity of the controller, and an n th order controller would require n sections or less.

The sampling period represented by the dashed lines in Fig. 3b is determined by the resolution requirement of the over-all system. A general guide

is a sampling period equal to $1/5$ of the fundamental period of the closed-loop system and a total weighting function length of four times this fundamental period. Thus a total of 20 sampling periods are required in the memory of the controller.

The sectionalized pulse train may be produced by several convenient digital schemes. A typical one is shown in Fig. 4.

In essence, the scheme of Fig. 4 is similar to that of Fig. 2b, with the feedback section eliminated. Simple feedback may be used for the last section to generate a smooth tail when needed. In that case a shorter memory section would be sufficient. The multiplier of the front end of Fig. 4 is replaced by a time-sharing analog-to-digital converter.

Matching the function of Fig. 3a with the sectionalized pulse trains of Fig. 3b is indeed an engineering approach. The adjustable parameters of the sectionalized pulse-train controller are the heights and widths of the pulse trains. Thus for a three-section controller there would be six adjustable parameters. Usually the response of a feedback control system is characterized by only about three engineering specification parameters, such as rise time, overshoot and solution time. The excessive number of adjustable parameters usually means additional freedom to improve the system performance. For example:

The total area and the mean delay time of each pulse train may have more dominant effects than either the height or width alone. Thus, it is possible to use the width of each pulse train as the secondary adjustment to permit the use of discrete pulse heights to simplify the design of the coefficient multipliers.

The height of the pulse may be designed in conjunction with the width to avoid saturation of the drive system of the plant.

A certain ratio of the width or height of the pulse trains may be used as the adjustable parameter to permit a more effective adaptive control system.

Defining adaptive control

Generally speaking, an ordinary feedback system is inherently adaptive over the static and low-frequency range. An adaptive control system, however, can maintain the desired dynamic performance over the entire useful frequency range, despite environmental disturbances. In an ordinary feedback system the adaptiveness over the low-frequency range is achieved by nulling the deviation of the static output with respect to a static reference.

Following the same principle, a dynamically adaptive control system would need additional loops to measure the deviation of the dynamic performance and to adjust the parameters of the controller, through high gain or integration, to null the deviation. Thus an adaptive control sys-

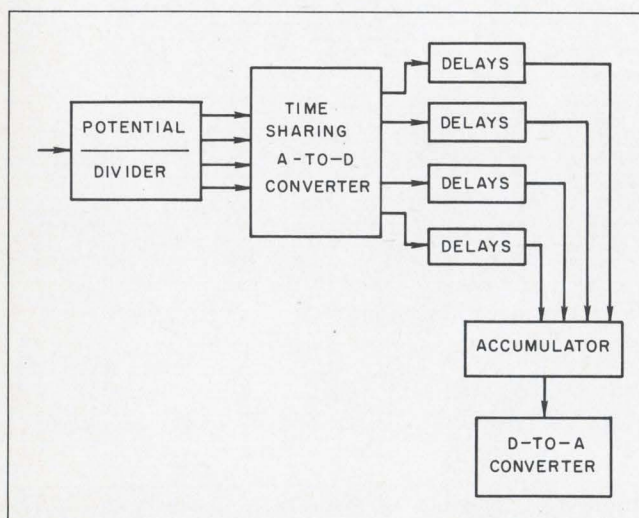

4. The sectionalized pulse train representing the weighting function of Fig. 3b can be generated by a simple digital system.

tem tends to be much more complicated than a simple feedback system. Consequently, simplicity in designing an adaptive system is even more important than in an ordinary feedback system.

For dynamic adaptive control, a dynamic model is usually used to provide the reference for generating the deviation signal. All schemes discussed in this article follow the same general pattern of using such a model as a reference, but the control logic is built upon the signal modulation concept instead of the conventional optimizing concept. This permits better understanding of the multi-channel information processing problem and yields simplified, practical configurations. One of the schemes that illustrates most of the pertinent problems is shown in Fig. 5.

In the lower part of this figure there is a feedback loop of the basic system. If we assume that this loop is invariant during the operation, it is possible to maintain the dynamic performance of the closed-loop system by making the forward loop between B and D adaptive to an open-loop model M . Thus, by definition, when the system is running near normal, we have

$$D = \beta * (C_1 + C_2 + C_3) G_p \simeq \beta * M, \quad (3)$$

where

β = the random signal at B serving as the excitation signal for the adaptive loops.

* = convolute multiplication

D = signal at D

C, G, M = weighting functions.

The symbol \simeq means best match. Furthermore, in this expression the notation for a system weighting function and its transfer function are used interchangeably. Also $\beta * G_p, C_1$ implies convolution of β with the weighting function of the combined system $G_p C_1$ and not $(\beta * G_p) C_1$.

Convolute multiplication, or convolution, means that if a given function (D in this case) is not the Laplace transform of a known function, it can be expressed as the product of two functions, each of which is the transform of a known function.

Now if the system is disturbed so that its output signal no longer matches that of the model, each section of the controller requires a small correction, $E C$, to regain the match. The deviation signal between the model and the system outputs is then

$$\begin{aligned} \delta &= (\beta * M) - [\beta * (C_1 + E_1 C_1 + C_2 + E_2 C_2 + \\ &\quad C_3 + E_3 C_3)] G_p \\ &\simeq \beta * (E_1 C_1 + E_2 C_2 + E_3 C_3) G_p \\ &\simeq (E \beta * C_1 G_p) + (E_2 \beta * C_2 G_p) + (E_3 \beta * C_3 G_p) \\ &\simeq (E_1 * \beta C_1 G_p) + (E_2 * \beta C_2 G_p) + (E_3 * \beta C_3 G_p). \end{aligned} \quad (4)$$

In principle, E_s vary with time as functions of

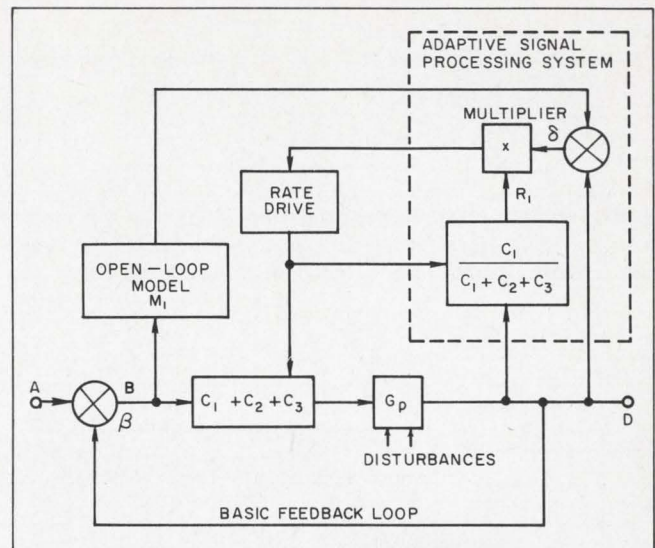

5. An adaptive control system uses a three-channel information processing system— C_1, C_2, C_3 . Deviation signals are generated by comparing the over-all system output with the three open loop models— M_1, M_2 , and M_3 , one model for each channel. In this figure only one channel is shown in detail. Note that the adaptive loop is in addition to the basic feedback loop and that it operates on the internal system parameters.

the environment changes. They reflect the effects due to the variations of G_p and may be treated as signals modulated by corresponding $\beta C G_p$.

The deviation signal, δ , is contributed by modulated deviations of all three channels. These deviations must be sorted out to permit effective feedback adjustments of the respective control channels. The scheme of Fig. 5 involves the generating of a reference signal due to each channel. This is done by taking the plant output and driving an analog-to-digital converter of the controller. The controller, in turn, drives its own three sections separately, as shown in the diagram. Thus the reference outputs of the three channels are

$$\begin{aligned} R_1 &\triangleq \beta * (\Sigma C) G_p (C_1 / \Sigma C) = \beta * C_1 G_p, \\ R_2 &\triangleq \beta * (\Sigma C) G_p (C_2 / \Sigma C) = \beta * C_2 G_p, \\ R_3 &\triangleq \beta * (\Sigma C) G_p (C_3 / \Sigma C) = \beta * C_3 G_p, \end{aligned} \quad (5)$$

where the symbol \triangleq stands for "corresponds to."

The deviation signal of Eq. 4 now appears to be the sum of the three error signals E_1, E_2, E_3 , each modulated by the respective reference signal. One conventional scheme for phase-sensitive demodulation of a signal is to multiply the modulated signal by the reference signal:

$$\begin{aligned} R_1 \times \delta &= E \times (\beta C_1 G_p)^2 + E_2 \beta G_p C_2 \times \\ &\quad \beta G_p C_1 + E_3 \beta G_p C_3 \times \beta G_p C_1 = \\ &\quad E_1 \mu_{11} + E_2 \mu_{21} + E_3 \mu_{31}. \end{aligned} \quad (6)$$

Similarly

$$R_2 \times \delta = E_1 \mu_{12} + E_2 \mu_{22} + E_3 \mu_{32}, \quad (7)$$

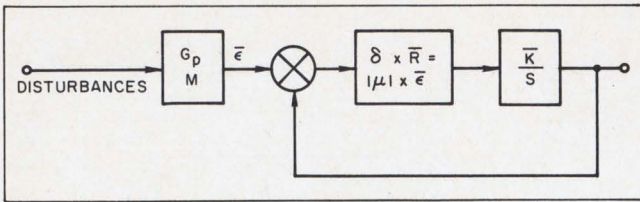

6. The adaptive parameter-adjusting loops can be summarized in a more convenient form with matrices. (See Eqs. 3 through 10 in the text.)

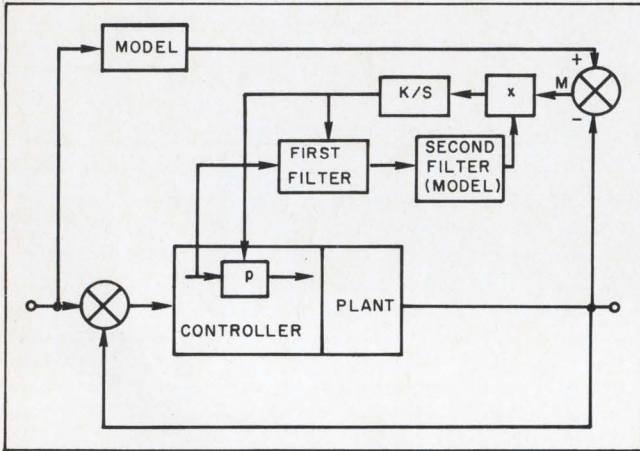

7. Input signal to the adjustable controller parameter, p , is multiplied by the deviation signal, m , and is fed back to modify the adjustable parameter. Essentially the controller parameters are adjusted in this fashion to minimize the mean-squared error between the system and the model outputs.

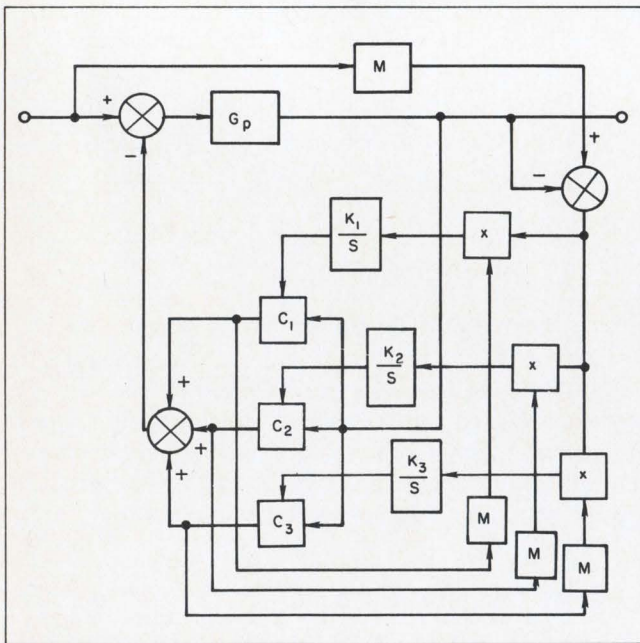

8. Three-channel sectionalized controller uses the basic scheme of Fig. 7. Filters are omitted here for simplicity. The three channels may handle separately such standard engineering parameters as rise time, overshoot and solution time.

$$R_3 \times \delta = E_1 \mu_{11} + E_2 \mu_{23} + E_3 \mu_{33}, \quad (8)$$

where

$$\begin{aligned} \mu_{11} &= (\beta C_1 G_p)^2 \\ \mu_{12} &= \beta C_1 G_p \times \beta C_2 G_p \end{aligned} \quad (9)$$

etc.

Equations 7, 8 and 9 can be summarized in a matrix equation as

$$\delta \bar{R} = |\mu| \times \bar{E}, \quad (10)$$

where \bar{R} and \bar{E} are vector notations of R_s and E_s , and $|\mu|$ is a matrix of μ_s .

The adaptive parameter adjusting loops of Fig. 5 are shown in matrix form in Fig. 6.

The inputs in this figure are the environmental disturbances applied to the plant referred to the model and generating a set of \bar{E}_s . The adaptive-signal-processing-system of Fig. 5 generates the signals $\delta \times \bar{R}$, which essentially are equal to $|\mu| \times \bar{E}$, as shown in the forward loop. This latter signal is then used to adjust the corresponding controller parameter through integration and a suitable gain K . All three sets of controller parameters are adjusted simultaneously.

In ideal situations, when $|\mu|$ is a diagonal matrix—that is, when all terms except μ_{11} , μ_{22} and μ_{33} are zero—the system can be reduced to three simple uncoupled feedback loops. The forward loop gain is then represented by $K_1 \mu_{11}$, $K_2 \mu_{22}$ and $K_3 \mu_{33}$. In Eqs. 7, 8 and 9 these diagonal μ_s are the instantaneous powers of the output signal of each channel and are the result of the phase-sensitive demodulation. Thus the close-loop performance of the three independent loops can be quite simple and unconditionally stable.

The integration operation used in the forward loop of this system serves two purposes:

1. To act as an averaging filter to smooth the ripples in μ_s and E_s .

2. To reduce the static error of the parameter adjustment to zero. For this type of noncoupled, multi-loop feedback system there is no stability problem to prevent the use of a very high value of K . This results in a high response speed, which is desired if the environmental effects change very fast.

In practical situations, all the elements in the μ -matrix are non-zero. For instance, $\mu_{12} = \beta G_p C_1 \times \beta G_p C_2$ is a product of two signals. They both come from the same source but are modified by different controller channels. If we assume βG_p is Fourier transformable while C_1 and C_2 modulate this signal with different amounts of phase shift, all the products of the unsimilar frequency terms in these two signals go to zero after integration. The components with 90° phase shift in similar frequency terms also go to zero. Thus, to achieve noncoupled operation, C_1 , C_2 and C_3 of the controller should

introduce phase shifts of 90° with respect to each other for all frequency components of the signal βG_p .

Adaptive control with closed-loop model

In an adaptive control system, controller parameters are adjusted to minimize the mean-square error between the system and the model outputs. Through some mathematical development advanced by Dr. Paul Osborn the net result of this procedure is the multiplication of the deviation signal by a weighted controller-parameter output signal. With reference to Fig. 7, this weighted signal can be defined briefly as follows:

Use the signal that comes directly from the adjustable controller parameter as an influence signal. A first filter is used to transfer this signal to the input station of the closed-loop system. A second filter is used to transfer it further to the output. From the block diagram of the system, determine the filter needed to do the first transferring. For the second transferring, the model is used as the filter, with the assumption that the adaptive loop is effective enough to track the model. This tracking is such that the input-output transfer function of the closed-loop system is effectively equal to that of the model.

The system of Fig. 7 can perform the phase-sensitive demodulation of the parameter deviation for any feedback control system configuration. One adaptive control system that uses this principle with a simple, sectionalized controller and a closed-loop model appears in Fig. 8.

Examine the multi-model adaptive system

Any simple feedback system can be considered a one-model adaptive control system in which its static performance, represented by unity (or another simple coefficient), is the model. In this sense the model-reference adaptive system presented before would be a two-model system. To further generalize this concept, we can establish an N-model adaptive system for an N-controller-adjustable parameter to satisfy N-engineering specification parameters. Ideally, if all these parameters are related by a series of diagonal matrices, the problem is simple. All the deviation signals involved must be generated and recovered through some excitation and modulation process. Only the outer loop, commonly reserved for the static performance, is excited by an externally regulated dc supply source (B + for an electrical amplifier, hydraulic pressure supply for a fluid drive, etc.) to yield a dc signal directly without demodulation. Other loops must operate with different excitation frequencies to allow for signal identification. The operating command signal and

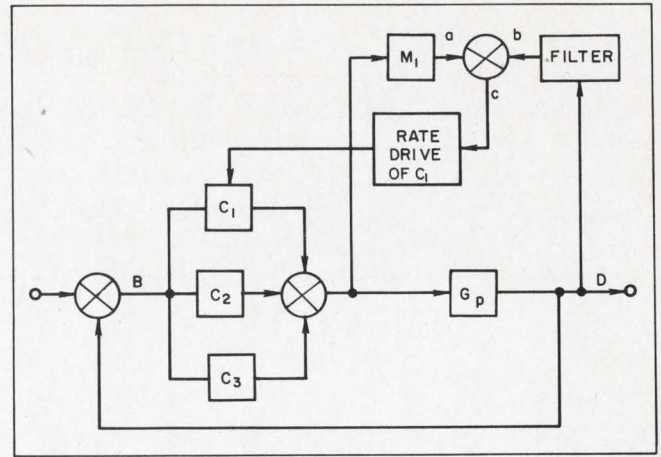

9. Separate open-loop models (one for each of the three channels) can be used to drive corresponding controller parameters. In this case the deviation signals are separated from the beginning and a phase-sensitive rectification (filter) is used. Note that only one channel is illustrated.

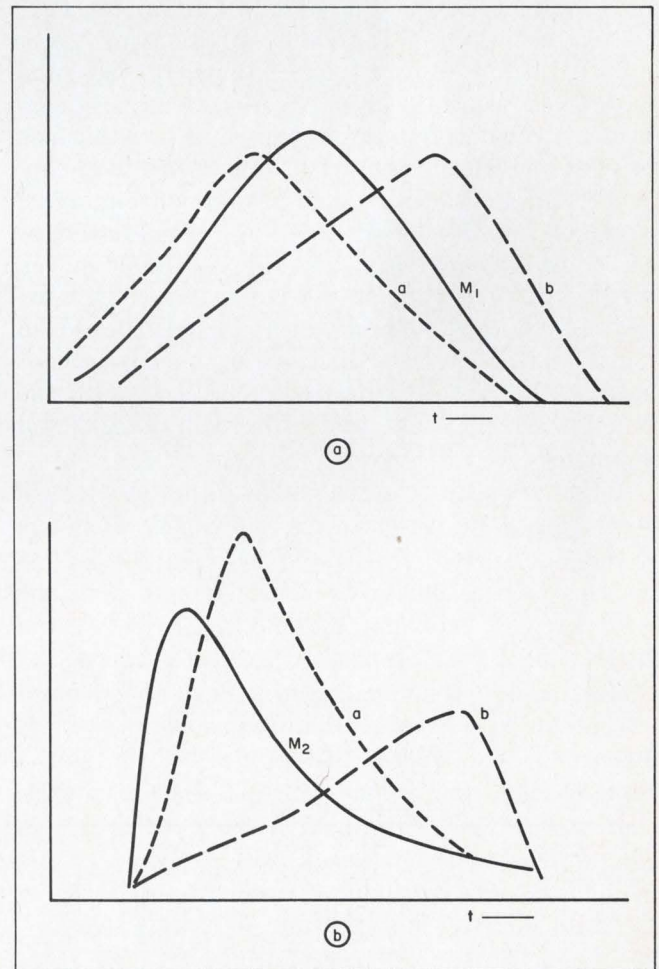

10. The multi-model concept provides additional freedom in the selection of the on-line reference models. In (a) for the two conditions, a and b, the model of the first channel, M_1 , would be used to get the best match on the first channel. In (b), a mismatch would result under the same two conditions on the channel associated with model M_2 .

its associated noise appears to be a natural and convenient source of excitation. Because such excitation is oscillatory, we need the phase-sensitive demodulation. Furthermore, in the case of only one model, the three components of the deviation still must be identified. This calls for a scheme to unscramble the over-all deviation signal, as illustrated by the multiplication of the respective reference signals discussed earlier (Eq. 5).

In a multi-model system the deviation signals of the various channels are separated from the beginning. Then simple phase-sensitive rectification may be used, as illustrated in Fig. 9.

In this figure only one adaptive loop is shown in detail. The object is to adjust the controller channels C_1 , C_2 and C_3 so that $C_1 G_p$, $C_2 G_p$ and $C_3 G_p$ would match the models M_1 , M_2 and M_3 . The assumption is that M_1 , M_2 and M_3 are selected so that the sum of the three yields a satisfactory total performance. The validity of this statement will be discussed later. For the time being, assume that each of the three C s has only one function—to match each $C G_p$ with its respective M . This is done by considering the signal at the point F as the excitation signal source. From this point, three models, M_1 , M_2 and M_3 , are coupled. In like manner three separate controller sections are connected to the output end of the plant. Comparison of the model output with the respective controller-channel output yields the deviation signal of each channel. Phase-sensitive demodulation is introduced by matching the sign of the deviation signal with the sign of the respective controller-channel output. These demodulated deviation signals are then used to control the adjustment rate of the respective parameter C s in both the primary controller and the reference-signal channels.

While accepting the feasibility of matching each controller-plant channel with the respective model, we may still question whether the result of the best match of three separate models would yield the best performance when one model is used. In the single-model case, compensating adjustments of the controller channels may achieve the desired effects. Now, with each channel tied down to its own model, the added constraint may prevent the best match. However, one must take into consideration that a model used as a reference for on-line comparison does not have to be the same as the model whose performance is to be duplicated. In fact, the on-line model itself is a designed configuration, and its characteristics are a function that has to be optimized during the design.

To be precise, this same logic also applies to the one-model scheme. But with a three-model scheme to match one conglomerated model, m , there is additional freedom in the selection of m_i on-line models and, consequently, more reason to use

model optimization for the multi-model system. Graphically this concept can be illustrated as in Figs. 10a and 10b.

In Fig. 10a the solid line is used to represent the weighting function of an on-line model M for a certain channel. The dashed lines represent the best matched weighting function of $C G_p$ at two G_p conditions. In this case M is chosen to represent the average of $C G_p$, and the result is the two $C G_p$ weighting function curves shown. Now, if another on-line model M_2 were used, as shown in Fig. 10b, we would have two different $C G_p$ curves under the same two G_p conditions, which might serve better in the over-all system. Thus M is indeed an extra degree of freedom to be optimized in the design stage.

Isolate high frequency plant disturbance

Generally speaking, a plant is subjected to two types of environmental effects: a parameter-modifying type of interference and a forcing-function disturbance. So far the primary objective of an adaptive control has been to minimize the effect of the modifying interferences. However, a satisfactory adaptive control system must also be insensitive to the disturbance. One good scheme is to place a low-pass filter into each signal channel before the demodulation. This will filter out most of the high-frequency noise. If the signal is excessively attenuated in this process, then a simple amplifying stage can be added to "pull up" the signal level. ■ ■

Test your retention

Here are questions based on the main points of this article. Their purpose is to help you make sure you have not overlooked any important ideas. You'll find the answers in the article.

1. *What are some of the major problems with analog adaptive control systems?*

2. *Why is it possible to represent an analog weighting function by a train of pulses that do not imitate it in every fine detail?*

3. *What is the advantage of the sectionalized, multi-channel digital controller over a single-channel one?*

4. *Why is it advantageous to use a multi-model adaptive loop in conjunction with the sectionalized digital controller?*

5. *How does one keep high noise disturbance from entering the plant?*

A Glowing report

... about the Drake "Glo-lite"

It's big.

In possibilities. In versatility.

In making your product look like tomorrow's product.

The "Glo-lite" has a hi-brightness, long life neon lamp. A simple encapsulation makes a one-piece lens and body. The lamp and termination are built-in which eliminates the need for a lampholder.

Versatility? Just change the lens to white, amber or red. Make it flush or protruding. Choose a plug button or Tinnerman nut for mounting. Select wire leads to your specs or the new solder-type "Faston" lugs.

Drake will match your specs and give you a price on a hundred . . . or a million. Write for a data sheet or check your local Drake distributor.

There are hundreds of other types, styles, shapes and sizes of neon or incandescent indicator lights, lenses and lampholders. You'll also receive assistance from prototype through production . . . It's the kind of personalized service you've come to expect from Drake over the last 35 years.

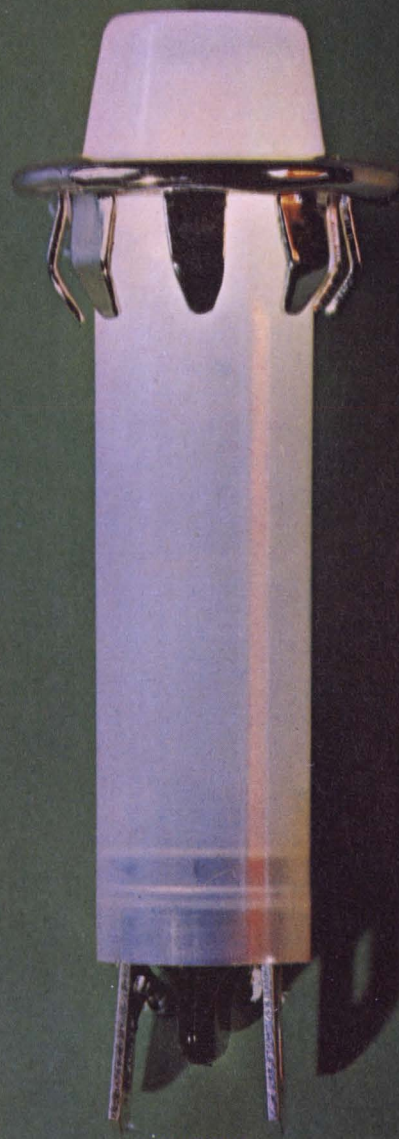

size approx.
2" high



Stop noise problems before they start

by suppressing transients at their sources and designing your circuit to minimize undesired coupling.

Often a breadboard or prototype circuit that functions flawlessly in the laboratory fails dismally when incorporated into a system. In production, some circuits may work and others may not. Or they may work intermittently. Why? In many cases the answer is noise.

Many engineers forget that their designs must operate in close proximity to—but without being affected by—other circuits that may or may not be generating interfering signals. While some of these interfering signals are generated intentionally, their coupling into adjacent circuits is not desired. Then again, where others—transients—are not wanted at all, too often precautions are not taken to forestall their generation and propagation. Although the amplitudes of these signals may be too low to disturb circuit and system operation, a healthy respect for “Murphy’s Law” teaches us that they most often are not. More likely, they will sneak in to cause intermittent and unreliable operation.

The time to prevent noise is before design and layout are frozen. Possible problems should be considered and steps taken to prevent them; this is neither difficult nor mysterious and it’s certainly a lot easier and less expensive than re-designing and rebuilding an entire system.

Let’s define noise

“Noise” is here defined to mean undesired signals that have been caused by inadequate physical layout and circuit design deficiencies. Such noise falls into two categories: that generated by either desired or undesired signals.

- Undesired signals (transients) externally or internally generated are most often caused by electromechanical components such as motors, relays, and switches. Signals of this type are best dealt with by reducing them at their source. Further improvement can then be realized by minimizing transient coupling to other circuits.
- Desired signals that appear in undesired loca-

tions, because of unintended coupling, can be kept where they belong by intelligent layout and by the addition of strategically placed shielding and filtering.

Here are two simple methods

A rather obvious but frequently neglected way to reduce all types of noise problems is: *Keep di/dt and dv/dt of all signals to the minimum consistent with proper circuit performance.* This rule cannot be overemphasized, because the amplitude of all types of noise is inversely proportional to the rise-time of the signal that causes it. Using faster signals than you need is an invitation to disaster. For the same reason, don’t use semiconductors that are inherently faster than required. They tend to add higher order harmonics to the signals they amplify. Don’t use a microwave transistor where a 2N706 will do, nor a 2N706 where a 2N1302 will suffice. A good case can often be made for using relatively slow integrated circuitry, such as RTL, in place of the newer and faster varieties. Besides saving a little money, you may save yourself a lot of grief and, by keeping rise and fall times as slow as possible, you will usually decrease logic “race” problems.

A second simple technique, applicable to digital systems, is to use very high logic threshold levels when operation in a noisy environment is unavoidable (for example, in electromechanical equipment such as a printer). The logic should be arranged with the most critical circuits either gated, or biased normally-off, so that noise amplitudes below the bias level will have no effect. Alternatively, unbiased diodes can be used in series with the input leads of critical circuits to effectively raise their threshold levels.

Suppress the intransigent transient

Most transients generated by electromechanical components are caused when the supply current to an inductor is abruptly switched off, thus generating a high-amplitude, back-voltage “kick” (in accordance with $V = L di/dt$). This high

Thomas E. Skopal, Applications Engineer, Burroughs Corp., Plainfield, N.J.

voltage often causes arcing which is an additional source of noise. To minimize the conducted noise of the transient itself; to prevent arcing with its radiated noise; and to protect semiconductors, coil insulation and contacts against overvoltage damage, all transients should be suppressed.

For dc circuits, the best way to suppress the transients is to connect a diode across each inductor, as shown in Fig. 1. When power is removed, the diode becomes forward-biased and limits the voltage amplitude to the forward drop of the diode. Bear in mind that the diode must have the same voltage and current ratings as the inductor. This method of suppression results in minimum backswing but, if the inductor is a relay coil, it will increase the relay dropout time in accordance with:

$$\text{Dropout time-constant} = L_1 / (R_1 + R_2),$$

where R_1 is the resistance of the inductor and R_2 is the forward resistance of the diode.

If dropout speed is critical, some suppression can be traded off for speed by adding an external resistor (50 to 500 ohms) in series with the diode. Alternatively, the diode can be connected to a pull-down voltage, which will decrease dropout time by permitting greater backswing.

It is imperative that the diode, and the resistor, if used, be mounted as closely as possible to the inductor so that the transient is not radiated from the interconnecting leads. Also, each driver circuit should have its own filter capacitor, C_f , mounted as close to the drive transistor as practical, to confine the damping current to the smallest possible area. Further isolation can be gained by inserting a small filter inductor, L_f , between the capacitor and the voltage buss, and by using separate voltage and ground busses for the electromechanical and logic circuitry in order to minimize conducted noise. If the electromechanical components draw a significant percentage of the total current, all of these measures must be taken. (The section on conducted noise will provide more detail on this point).

For ac circuits, diodes cannot be used and backswing is best suppressed with a series RC network across the inductance (Fig. 2). The current-limiting resistance is necessary to prevent the surge that otherwise would flow into C —when the switch is closed—from burning the switch contacts and causing noise of its own. By making $R_1 = R_2 = (L/C)^{1/2}$ the circuit appears purely resistive at all frequencies. This method of suppression also works well with dc circuits.

Reduce inductive coupling

Inductive coupling can exist between any two or more conductors in a group of conductors. Even when mutual coupling is slight, a signifi-

cant amplitude of noise can be induced in nearby conductors if di/dt is high. Consider Fig. 3. Current flowing in circuit A will cause a voltage, V_2 , to be induced in circuit B, where $V_2 = M di_1/dt$ and M is the mutual inductance between circuits A and B. Note that the induced voltage is a function of the di/dt of circuit A, and that the induced current is a function of R_2 . As we will see later, raising the impedance of circuit B is usually inadvisable, even if circuit parameters allow; by doing so we would only make the circuit more sensitive to capacitive coupling. If increasing the rise and fall times to their maximum permissible values is not sufficient to keep the noise at a tolerable level, steps must be taken to reduce or cancel the coupling that exists between each pair of circuits.

This is most effectively accomplished by re-

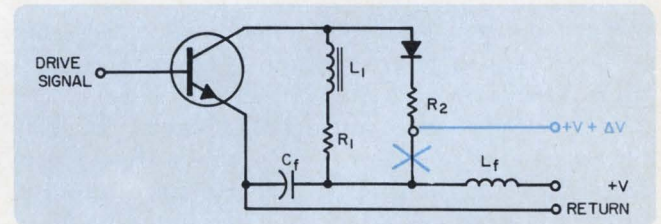

1. **Suppress transients in a dc circuit** by placing a diode across the inductor to provide a path for the inductor current after the drive is removed. R_1 is the coil resistance and R_2 is the forward resistance of the diode. A resistor can be placed in series with the diode to decrease the dropout time in relay circuits. Alternatively, the diode can be connected to a pull-down voltage as shown in color.

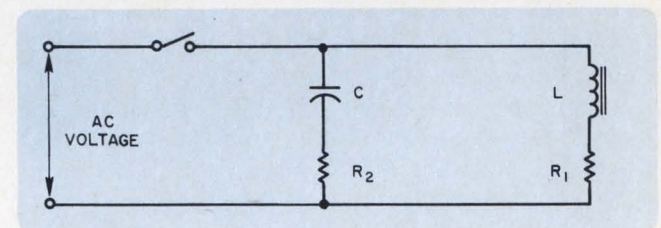

2. **This circuit will seem purely resistive** at all frequencies if $R_1 = R_2 = (L/C)^{1/2}$. The method is an excellent way to reduce transients in ac circuits where diodes can't be used. It works at dc, too.

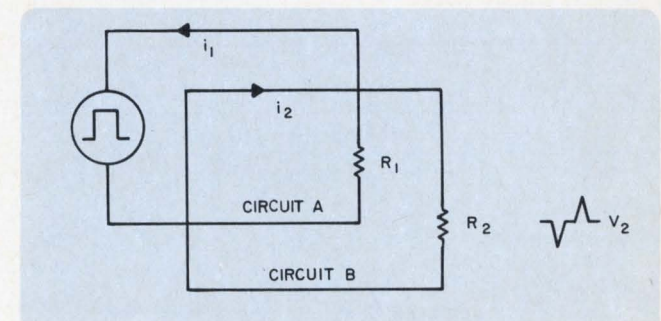

3. **The inductive coupling** between these two circuits is proportional to their common loop area and di/dt .

ducing the common loop area of the coupled circuits. One way to do this is to provide a separate return path for each signal lead, as shown in Fig. 4. This method has the advantage of not requiring any rearrangement of the circuit to be effective. Note that, although the pulse circuits see a lower impedance path through the signal returns, the dc will flow through the lower-resistance ground path, keeping the ohmic voltage-drop to a minimum.

The same end result can be obtained by physically arranging the circuits to minimize the actual loop area (by tightly wiring the circuits against a ground plane, used as the dc return path). Where a high wiring density exists, or where a large number of interconnections must be considered, the use of twisted pair wiring (or shielded wire, such as coaxial cable) is a more practical approach. Where only a few leads are involved, running the most critical ones perpendicular (or at least not parallel) to one another may sharply reduce common loop area and produce a significant reduction in noise.

If inductive coupling is unavoidable, consider the possibility of canceling its effect by deliberately inducing additional out-of-phase coupling. This can be accomplished most easily with a slug-tuned transformer (Fig. 5). If layout is closely controlled (as in a printed-circuit board-assembly), or if a gross reduction in effective coupling—rather than minimization—will satisfy requirements, the use of fixed transformers or strategic circuit layout may do an adequate job. With leads of a few inches, cancellation can typically reduce coupling by a factor of more than 1000:1, up to about 15 MHz. At higher frequencies, phase shift between the two coupling points will reduce its effectiveness.

When optimum layout by itself is not enough to reduce inductive coupling to a tolerable level, magnetic shielding may be required. A magnetic field will follow the path of least reluctance and can be effectively "shorted out" at low frequencies with one or more sheets of high-permeability metal. Such metals are made specifically for shielding purposes by a number of companies,

many of whom also offer extensive applications information free of charge. At higher frequencies, magnetic shielding can be obtained with nonmagnetic materials such as copper and brass; this is due to a secondary effect: Absorbed flux sets up voltage and current paths within the shield; these tend to cancel the primary field. The noise-rejection capability of coaxial cable and other transmission lines is partially due to this effect. At high frequencies, the circumference of the cable provides the necessary current path; at lower frequencies, an external path must be provided. This can be done by grounding the outer conductor at both ends.

Capacitive coupling can cause confusion

Voltage swings through a conductor will capacitively couple noise-signal currents into surrounding conductors. The induced current, I_2 , is given by $I_2 = C dv/dt$, where C is the capacitance between the two circuits and $v(t)$ is the voltage across the capacitance. The induced voltage is given by: $V_2 = I_2 R_2$, where R_2 is the resistance of the second circuit.

Unless the amount of capacitive coupling is unusually great, or the impedance into which the coupling exists is very high, the capacitive coupling will differentiate the driving pulse; the noise will then and typically appear as "spikes" during times of high dv/dt conditions.

Note that, with a fixed amount of capacitance, coupling is minimum at the impedance levels that maximize inductive coupling. The reverse is also true. Therefore, a compromise in impedance levels, within the limits of circuit parameters, is sometimes necessary to minimize total noise. However, the most effective way to prevent both capacitive and inductive noise is the same: thoughtful physical layout. Keeping signal lines separated and, running them at right angles to one another—when possible—is of help. Back-plane wiring should be point-to-point and slack, rather than tightly cabled. Signal lines, if they must be cabled, should preferably be shielded or,

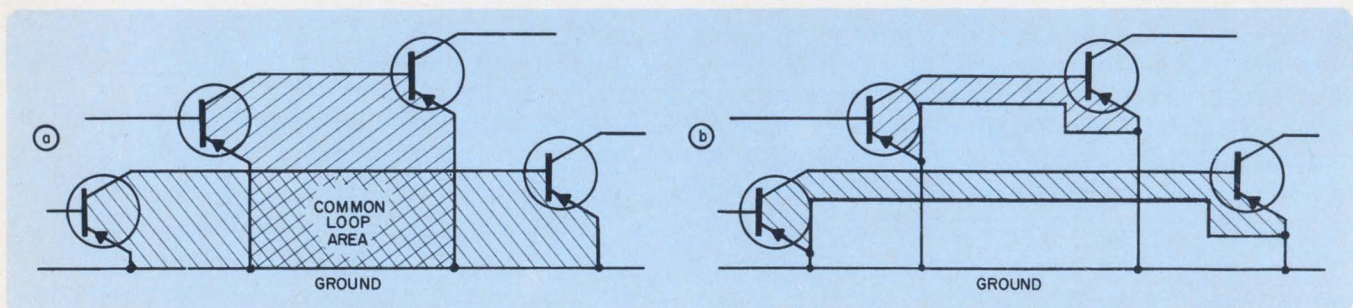

4. Reduce inductive coupling by using separate returns for each signal lead. Without these returns (a) the common loop area is large and a relatively high degree of coupling exists. By adding separate returns (b) the

common loop area, and hence the coupling, can be dramatically reduced. This method for reducing inductive coupling does not require physical rearrangement of the circuit.

at the least, should be twisted pairs. If connector pin availability or other mechanical reasons dictate that unshielded single-wire leads must be used to carry fast pulses, the use of wire with insulation that is very thick and that has a low dielectric constant (for example high-voltage cable) should be considered. This will reduce interconductor capacitance and inductance.

Electrostatic shielding, such as is provided by the braid of a coaxial cable, reduces capacitive coupling by providing a conductor at ground potential between two signal lines that have some impedance to ground (Fig. 6). This causes the capacitance between the signal lines to be divided into a pair of series capacitances with the center point grounded. Thus, voltage coupling into the shield from either signal line is bypassed to ground and cannot reach the other lead.

The same principle can be applied to printed circuits by including a grounded run between each pair of signal leads and by coating the other side of the board with metal to form a ground plane.

Sheet metal, wire screen and mesh, and the braid of coaxial cable make excellent electrostatic shields; a twisted pair is more susceptible to capacitive pickup than is coax, but is much better than a single lead. An electrostatic shield need not be grounded at more than one point (which, in the case of transmission lines, should be at the receiving end), unless the shield length is one quarter-wavelength or more at the highest signal frequency. Longer shields may rise above ground potential, unless grounded at several points along their length. A magnetic shield can usually double as an electrostatic shield. The converse, however, will not apply, unless the requirements unique to magnetic shielding—a high-permeability metal shield at low frequencies, or a complete current path at high frequencies—are satisfied.

Common impedances can conduct noise

The voltage developed across an impedance common to two or more circuits will appear in

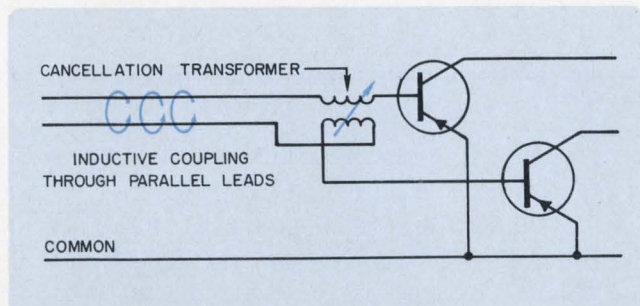

5. Inductive coupling can be sharply reduced by using a transformer to introduce additional coupling opposite in phase to the undesired coupling. The transformer can be adjusted for minimum net coupling.

each of the circuits. The result is that operation of one circuit may affect many others. The impedance of a piece of wire may be sufficient to cause problems of this type. For example, if 100 circuits are fed from a common power supply through a wire having a resistance of 0.2 ohms and if each circuit, when turned on, draws 50 mA, then turning on 90 of the circuits will cause a voltage drop of 0.9 V to be seen by all 100 circuits. This is sufficient to disrupt the operation of many low-voltage circuits.

But the problem can be worse: At frequencies above the audio range, the ac impedance of the line can be much higher than its dc resistance and must be considered.

Although most power distribution circuits are not made out of uniform transmission lines, and hence do not have a well-defined characteristic impedance, they do have series resistance and inductance and shunt capacitance. Therefore, the behavior of uniform lines suggests means for improving the characteristics of non-uniform ones. For example, the characteristic impedance, Z_0 , of a line is proportional to $(L/C)^{1/2}$, where L and C are the inductance and capacitance per unit length, respectively. Thus it is clear that to minimize the voltage transients caused by sudden current variations, L should be very small and C should be very large.

These considerations lead to three rules for reducing conducted noise:

- Increase C with bypass capacitors. Points having large current variations should have individual capacitors with a minimum value of $C = [∫i(t) dt]/V$, where the integral gives the total charge transferred during one transient pulse and V is the allowable voltage change. Clearly, the idea is to have the capacitor store the energy for the transients so that the energy does not have to come from the other circuits.

- Reduce L and the series resistance by using heavy wire or busses. A wide flat buss is better than a square one made of the same material and that has the same cross-sectional area. Although sometimes inconvenient, a buss meant to

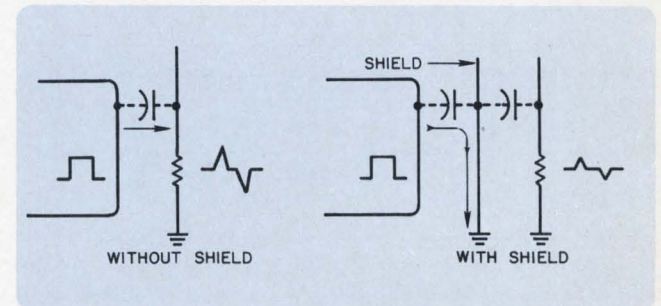

6. Reduce capacitive coupling with an electrostatic shield. The shield effectively divides the coupling capacitance into two series capacitances with their center point grounded.

have a low impedance must be continuous from the supply to the load, in order to be most effective.

■ Isolate sensitive circuits with separate supply and return lines. Reducing the common impedance also reduces coupling by the square of the ratio of the reduced and original impedances.

Although the suggestions outlined above were developed by considering a power-distribution system, they also apply to signal lines. Clock and reset lines, in particular, are very susceptible to conducted noise, since any appreciable distortion of a pulse may lead to a dropped or double count. The last point in the list given above—isolation of separate circuits—is particularly applicable to this situation. Fanning out individual leads from a central point will invariably provide better results than will one lead which is randomly snaked around a backplane.

Avoid ground loops

Voltage and signal return paths must also be considered as possible means for coupling voltage transitions from one circuit into others. A chassis, frame, or buss ground is not a zero impedance path, even though it might seem to be close enough at first glance. If many amperes flow through a frame or buss, the voltage drop can reach levels high enough to affect logic signals. However, a more common problem resulting from the use of a frame as a common ground occurs when the return-path voltage drop is conducted into the input circuit of an amplifier, as shown in Fig. 7. In this case, a conducted noise of less than a millivolt can cause

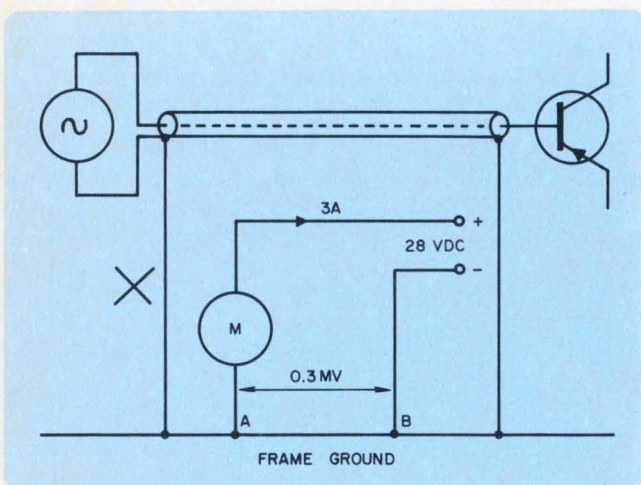

7. The ground loop formed by grounding the shield of the coaxial cable at both ends introduces noise into the low-level circuit, because part of the loop is shared with a noisy, high-current circuit. The cure: break the loop at X. Unfortunately, breaking the external current path will reduce the low-frequency magnetic isolation provided by the shield; the high-frequency isolation should not be significantly affected.

serious trouble. If the blower motor draws a current of three amperes, and the return path impedance is only 10^{-4} ohms or 100 microhms, the resulting voltage drop from A to B is $3 \times 10^{-4} = 0.3$ millivolt.

The noise amplitude would likely be greater than this, due to the inductive nature of the load. But even if best-case conditions are assumed, the 0.3 millivolt noise induced into the path of the low-level signal could mask it. This is easily avoided by isolating the two returns: breaking the connection at X prevents the voltage drop from being conducted into the low-level signal's path through the shield of its lead. This is an excellent example of incomplete engineering. The hypothetical designer may have purposely grounded both ends of the cable to provide low-frequency magnetic shielding without realizing that part of his ground path was being shared with a noisy, high-current device.

When frame grounds are used, special care must be taken to insure that impedance will not be increased in the future by the development of oxide film or corrosion in bolt-joined members. Joints should be welded, soldered, or plated with a precious metal if possible; if not, star washers should be specified in each joint to help insure a stable electrical path.

Determination of the optimum configuration and components may guarantee that a circuit *can* operate as intended, but not that it *will*. Only when steps have been taken to prevent all possibility of improper operation, because of unintended circuit interaction or the generation of undesired signals, is the design engineer's job complete. ■■

Test your retention

Here are questions based on the main points of this article. Their purpose is to help you make sure you have not overlooked any important ideas. You'll find the answers in the article.

1. Describe two ways of suppressing the back-voltage transient that occurs when the current in an inductor is abruptly shut off.
2. What is the principal approach to reducing inductive coupling between circuits?
3. How does shielded cable reduce capacitive coupling between circuits?
4. Under what circumstances would you ground the shield of a shielded cable at both ends?
5. If you decided to ground the shield of a cable at only one end, would you ground the transmitting or receiving end? Why?

CONDUCTIVE PLASTIC POTS

"From Duncan With Love"

(OR WHY EVERYONE SHOULD SPECIFY THE DUNCAN CP POTS
ENGINEERED AND QUALITY CONTROLLED WITH LOVING CARE)

DUNCAN CP POTS--
HOT OFF THE DRAWING
BOARD OF THE MOST
HIGHLY SKILLED
ENGINEERS IN
THE POT
INDUSTRY.

RESOLON®
CONDUCTIVE PLASTIC
PRECISION
POTENTIOMETERS

**ZERO
DEFECTS**

LINEAR OR NON-LINEAR FUNCTIONS

WHAT
REMARKABLE
LINEARITY AND
CONFORMITY
TOLERANCES
TO
 $\pm .05\%$

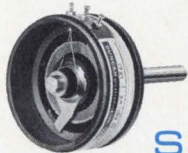

RESOLON® SPECIFICATIONS

State-of-the-art design and strict quality control provides Duncan Resolon potentiometers with these outstanding features:

- **Long Life:** 20 million shaft revolutions without significant change in characteristics
- **Low temperature coefficient:** -300 ppm/ $^{\circ}$ C max.
- **Wide temperature range:** -65° C to $+125^{\circ}$ C
- Conformance to all applicable MIL specs, including MIL-R-39023
- **Low output smoothness:** maximum of 0.1% of total applied voltage
- Linearity and conformity tolerance to $\pm .05\%$
- Single-turn/servo-mounted; available in $\frac{1}{8}$ " to 3" diameters
- Linear or non-linear functions may be provided

CALL OR WRITE TODAY FOR COMPLETE RESOLON BROCHURE

INFORMATION RETRIEVAL NUMBER 36



DUNCAN electronics, inc.

a division of Systron-Donner Corp.
2865 FAIRVIEW ROAD, COSTA MESA, CALIFORNIA 92626
TEL: (714) 545-8261 • TWX (910) 595-1128



EMCOR has lots of pretty models

Three are from our standard line, the other three . . . well, after all, even EMCOR doesn't have these in its line. But, we can offer "color engineered" EMCOR® Modular Enclosure Systems. ■ Apply the psychology of our new colors singly or in combination to create the atmosphere you want in your installation. For instance, for a relaxing and thoughtful mood use Blue or Olive Green; for a soft, warm feeling use Tan; for elegance, try Gold. Black is dignified, White pure and clean. ■ Our new colors also can be used functionally to codify operations as to input or output information, or to identify operator responsibilities. ■ "Human engineering" is another EMCOR asset. Our "people-watching" engineers studied the human form and have designed cabinets that cut down on mental and physical fatigue for that extra measure of efficiency. ■ Write for more details on EMCOR colors and "human engineering."

EMCOR Reg. U.S. Pat. Off.

EMCOR/colorful cabinetry

Ingersoll Products 1221 W. 120th St., Chicago, Ill. 60643 DIVISION OF BORG-WARNER CORPORATION



a/d

Part 3

Some applications require unique conversion techniques or special hardware.

In addition to the a/d conversion techniques described in Parts 1 and 2 of this design guide, there are several other techniques which are useful for special applications. These will be described here, although because of space limitations, not in the detail devoted to the previous types. Expanded information on these types can be found in the references.

1. Ultrahigh-speed a/d converters

Ultrahigh, or video, speed a/d converters have conversion rates in excess of 1,000,000 per second, but usually with low resolution and accuracy (usually 6 bits or less). They obtain this high conversion rate by trading accuracy for speed; that is, by using ultra-high-speed components.

For example, tunnel diodes are frequently employed in ultrahigh-speed converters as comparators, in place of differential amplifiers. This reduces the time required for one comparison to a fraction of a nanosecond instead of several tens of nanoseconds. But it also reduces the accuracy from 1 part in 10,000 to 1 part in a 100.

As one would expect, most of the problems with ultrahigh-speed a/d converters arise from the fact that the various circuits must operate with

high signal and clock frequencies. Accuracy problems, however, cannot be entirely discounted. The main problems common to all ultrahigh-speed converters are as follows:

- At very high frequencies every wire becomes a transmission line. If this transmission line is not properly terminated, distortions result from reflections bouncing back and forth.

- In lower-speed a/d converters, most emphasis is generally placed on static accuracy. In ultrahigh-speed a/d converters on the other hand, dynamic accuracy is more important. To predict the magnitude of the dynamic accuracy of a converter, the errors due to sampling, finite aperture time and transport delay must be added to the static error.

- If a converter operates at a very high clock frequency, the threshold devices must slew and settle to the correct value in the specified period. Therefore, the static accuracy is a function of how much time, T , or how many time constants, RC , are provided for this slew and settling process. If T is much larger than RC , then either RC must be very short or T very long. The first case means ultrahigh-speed components and the second case means fewer conversions. Only when T/RC is large enough (>4) can the static accuracy be better than ± 1 part in 100.

- The output signals of ultrahigh-speed a/d converters are generated either in parallel or in serial-binary form, usually with most-significant bit first. In most applications, however, the output signal is required in serial-binary form, but with least-significant bit first. Circuits must therefore be provided to convert these signals into the desired form: But this also requires time.

- Another problem with ultrahigh speed a/d converters is noise. At ultrahigh frequencies each wire is not only a transmission line but is also an antenna, transmitting and receiving electromagnetic waves. Clock signals are thus coupled into the data lines, and data frequencies on one wire are coupled into other data lines. To minimize this cross-coupling, or cross-talk, all wires not properly terminated must be as small as possible. Also, parallel routing of wires must be avoided, at least for those in close proximity.

In most of the previously discussed a/d converters, monolithic comparators, such as the $\mu A710$, are employed with positive feedback as the threshold detectors. Although the switching speed of the 710 is very high (50 ns) it is not high enough for some ultrahigh-speed a/d converters, and it is too complex and expensive for others. Simpler and faster threshold circuits are therefore required instead. Foremost among these is the tunnel-diode comparator.¹

In switching applications a tunnel diode offers two qualities of great merit. It switches extremely rapidly (<1 ns) and responds to a pulse of very

Hermann Schmid, Senior Engineer, General Electric Co., Binghamton, N.Y.

small energy. A pulse of 10^{-15} joules can move the tunnel diode past a critical point and initiate a transition. In comparison, a transistor may require a pulse of 10 times more energy in order to switch states. Moreover, a single tunnel diode may be used to construct a circuit with two stable states, whereas two transistors are required for this same purpose.

On the other hand, a transistor has the advantage over the tunnel diode in that the transistor operates at appreciably higher voltages. Additionally, the tunnel diode has the very disconcerting feature that, having only two terminals, the input and output ports are not isolated from each other. As a consequence, in circuits that involve cascades of tunnel diodes, it is difficult to ensure that the signal will proceed in one direction only. It is not surprising, then, that hybrid circuits which employ transistors and tunnel diodes often constitute the best solution for designing ultrahigh-speed comparator circuits.

All-serial, ultrahigh-speed a/d converter

The all-serial, ultrahigh-speed converter is similar to the cascade a/d converter previously described in Part 2. It is sometimes also referred to as the "bit-at-a-time" converter, because it requires one clock period for each bit to be converted.^{2,3}

Like the cascade a/d converter, an n -bit, all-serial unit is comprised of n single-stage converters. However, in the all-serial converter, only one of these is activated at any one time. This greatly simplifies generation of the fractional increments of the reference voltage because the same reference voltage can be connected to all conversion stages.

The 6-bit all-serial a/d converter shown in Fig. 1 is comprised of a 7-bit ring counter, an intermediate storage circuit and six single-state converters. Each single-stage converter consists of a triggered threshold detector, an analog switch and a weighted bias resistor.

The operation of the converter starts at t_1 , when the ring counter enables the first converter stage. It is assumed that in t_1 of the previous conversion cycle all triggered threshold detectors, $TD-1$ to $TD-6$, have been reset, so that their inputs are logical ZEROES. At the beginning of t_1 , threshold detector $TD-1$ is set to ONE. So $S1$ connects resistor $2R$ to $-V_R$, although all other switches connect their resistors to ground. The voltage at the inputs of all threshold detectors during t_1 is, therefore,

$$V_{I_1} = K (V_x - V_R/2).$$

This, of course, only holds true if the input impedance of the threshold detectors is infinite. If this is not so, a buffer amplifier must be connected between the summing point and all the

threshold detector inputs. For a 6-bit converter the value of K is $64/127$.

If V_{I_1} is positive, indicating that V_x is larger than $V_R/2$, the output of $TD-1$ remains unchanged. If, however, V_{I_1} is negative, $TD-1$ is reset to ZERO.

At the beginning of t_2 , threshold detector $TD-2$ is set to ONE. $S2$ connects its associated $4R$ resistor to $-V_R$, and if the output of $TD-1$ is still ONE, the voltage to all threshold detectors is:

$$V_{I_2} = K [V_x - (V_R/2) - (V_R/4)].$$

But if the output of $TD-1$ was reset to ZERO, then

$$V_{I_2} = K [V_x - (V_R/4)].$$

If V_{I_2} is positive, the output of $TD-2$ remains a ONE; and if it is negative, $TD-2$ will reset to ZERO.

The operation is similar for t_3 to t_6 , during which the outputs of $TD-3$ to $TD-6$ are determined. Obviously the outputs of the threshold detectors are the desired digital information, where the output of $TD-1$ represents the most-significant digit, 2^{-1} , and the output of $TD-6$ the least-significant digit, 2^{-6} . For the general case, the analog input voltage to the threshold detectors can be expressed as

$$V_I = K [V_x - a_1 (V_R/2) - a_2 (V_R/4) - \dots - a_6 (V_R/64)].$$

It can be seen from this that the operation of the all-serial a/d converter is very similar to that of the successive approximation a/d converter. The difference between the two lies only in the circuitry. The all-serial encoder uses one threshold detector for each bit, whereas the successive approximation converter time-shares one threshold detector between all bits.

The all-serial a/d converter of Fig. 1 can be implemented with a variety of basic circuit elements, the final choice of which depends primarily on the desired speed of conversion. Assuming that the conversion frequency must be in excess of 8 MHz, then the clock frequency, f_c , has to be at least 56 MHz. One conversion period is reserved for reset. In other words, the time available for a one-bit conversion is less than 18 ns.

For the 7-stage ring counter, several integrated logic lines that are available today have counting capabilities of up to several hundred megahertz. All of these logic circuits are of the nonsaturating, current-steered or emitter-coupled type. The most widely known of these lines is MECL, Motorola's Emitter-Coupled Logic. With MECL 300, it is now possible to count at clock rates up to 300 MHz.

The threshold detectors for the circuit of Fig. 1 must have the following capability:

- Common reset to ZERO
- Individual SET to ONE at the start of t_1
- Hold ONE if V_i is positive
- Reset to ZERO if V_i is negative.

The need for the common reset can be eliminated

if the input signal to all threshold detectors is made negative during t_7 .

The analog switches are shown in Fig. 1 as separate series-shunt switches connecting either $-V_R$ or ground to the summing resistors. However, in an actual converter of this type there are no switches as such. Instead, constant current generators that can be switched ON and OFF—or the output voltage of the threshold detector itself—are used. Both of these approaches offer sufficient accuracy in a 6-bit converter.

All-parallel, ultrahigh-speed a/d converter

Using the same type of threshold detector, an all-parallel, ultrahigh-speed converter can operate at a higher conversion speed than an all-serial converter. Similarly, the all-parallel converter can operate at the same conversion speed as an all-serial converter while using slower threshold detectors. The penalty for this reduction in threshold detector speed, however, is increased complexity. One threshold detector is needed for each level of resolution.

Assuming again that a 6-bit converter is required to operate with a conversion frequency of 8 MHz, then an all-parallel unit will require 64 threshold detectors and a conversion time of 125 ns. Although the number of threshold detectors required is very high, much simpler comparison-circuits can be used, because of the relatively long time that is available to perform a 1-bit conversion. Besides, no timing circuits are needed.

The operation of a conventional 3-bit all-parallel a/d converter using seven comparators was described in Part 2 of this design guide. The comparators in that converter had differential inputs. In the all-parallel, ultrahigh-speed converter of Fig. 2, single-input threshold detectors are used instead. The reference and input voltages must, therefore, be summed before being applied to the detectors. For this, each detector requires a different resistor divider (R_1 , R_2) to generate a voltage

$$V_1 = K [V_X + (m/8) V_R], \quad (1)$$

where m is 1, 2, 3, . . . 8, and K is a constant to be specified later.

The output voltage of an unloaded voltage divider consisting of R_1 and R_2 , in which the input voltage V_X is connected to R_1 and the reference voltage V_R is connected to R_2 , is

$$V_o = V_R + [(V_X - V_R)/(R_1 + R_2)] R_2,$$

or

$$V_o = [(R_2/R_1) + R_2] [V_X + (R_1/R_2) V_R].$$

Comparing this equation with Eq. 1 yields

$$K = R_2/(R_1 + R_2),$$

and

$$m/8 = R_1/R_2.$$

The simplest way to satisfy these two equa-

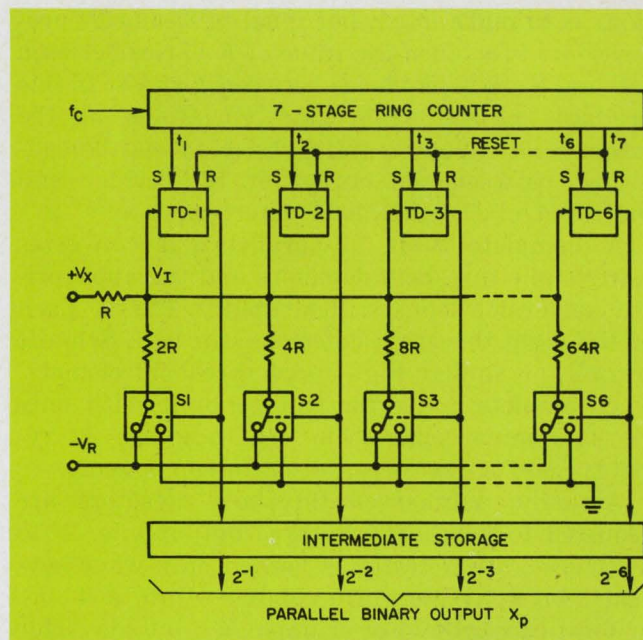

1. The all-serial, ultrahigh-speed a/d converter converts one bit during each clock period. It requires one comparator for each bit to be converted.

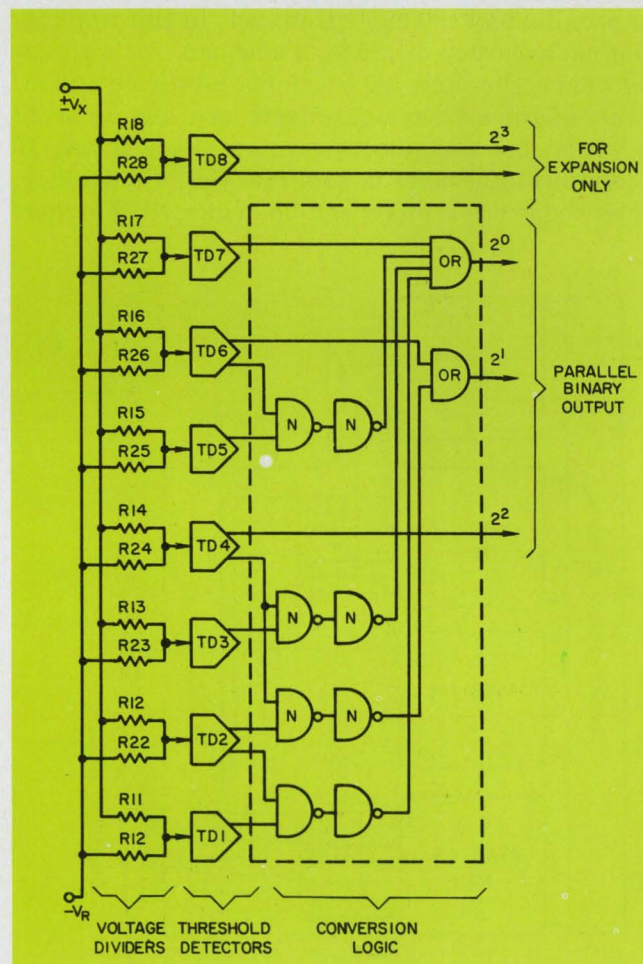

2. The all-parallel, ultrahigh-speed a/d converter requires a separate threshold detector for each level of resolution.

tions is to make R_1 proportional to m and R_2 proportional to 8. Then the value of K varies between $1/9$ and $8/16$ as m varies between 1 and 8. If this produces objectionable gain variations at the comparator inputs, a third resistor must be connected between the output of the divider and the input of the threshold detector.

A complete 3-bit all-parallel a/d converter using eight threshold detectors and the appropriate conversion logic is illustrated in Fig. 2. Each of the eight threshold detectors can be a Schmitt trigger, or similar high-speed threshold element. The complete converter can be built with only eleven standard Motorola MECL gates, 32 resistors and a few other discrete components.

Actually, only seven threshold detectors are required to generate the three output bits, 2^0 to 2^2 . The eighth detector is needed only when several 3-bit converters are combined into a 4-, 5-, or 6-bit converter. For example, a 5-bit converter would consist of four 3-bit converters whose outputs would be decoded into the 5-bit digital signal by the output logic circuits (see Fig. 3).

The accuracy of the all-parallel converter depends on the precision of the resistor voltage dividers, and the voltage and current offsets of each threshold detector. The resistor ratio can be made as accurate as desired, up to a limit of approximately $\pm 0.01\%$. However, in this application an accuracy of $\pm 5\%$ is adequate for a three-bit conversion and $\pm 0.5\%$ for a 6-bit conversion. State-of-the-art voltage offsets are less than 20 mV and current offsets are less than $1 \mu\text{A}$. If the input impedance is kept low (less than $1 \text{ k}\Omega$), then the current offset can be neglected. Further,

if the reference voltage, V_R , and the maximum value of the input voltage, $V_{X_{\text{max}}}$, are 10 V, then the offset errors of the threshold detector are small compared with the $\pm 5\%$ or $\pm 0.5\%$ tolerances of the resistors.

MECL 300 logic gates have a propagation delay of less than 10 ns. Since there are a maximum of four stages cascaded, the total delay through the converter is less than 40 ns. Allowing 40 ns for the delay in the sample-and-hold circuit at the input, and 20 ns for loading the output buffer, a complete conversion can be performed in less than 100 ns. Therefore, the maximum conversion rate is higher than 10,000,000 per second.

Problems with all-parallel converters arise from the fact that higher resolution requires not only more voltage dividers, threshold detectors and conversion logic, but also higher precision. To minimize the effects of current offset, the impedance of the voltage dividers must be kept low. But if there are many of these low-impedance dividers, the input signal source requires a very high driving capability. Compromises must thus be made, which sacrifice both accuracy and speed.

Serial-parallel, ultrahigh-speed a/d converter

The all-serial and the all-parallel a/d converters represent the extremes, as far as parts-count and number of operations per conversion are concerned. Both extremes have significant disadvantages: the serial converters in speed, and the parallel converters in parts-count. Serial-parallel a/d converters have therefore been developed to overcome these disadvantages and to provide a better or more economical solution to ultrahigh speed a/d conversion.⁴⁻⁶

The principle of serial-parallel a/d conversion has been described earlier in Part 2 of this design guide (see "partially-cascaded converters"). A $m \times n$ serial-parallel converter was described as being comprised of m stages, each containing an n -bit parallel a/d converter, an n -bit parallel d/a converter, and a means for subtracting the output of the d/a converter from the input signal V_x . Differences between those serial-parallel a/d converters and the ones used for ultrahigh-speed applications exist in the speed and accuracy required. In other words, the reduced accuracy and the increased speed of the ultrahigh-speed converters dictate an entirely new set of circuits. Moreover, the circuits of each stage of the previous serial-parallel converters were clearly divided into a parallel a/d converter, a parallel d/a converter and a subtractor. In the ultrahigh-speed converters the three functions are all combined in one circuit.

A 6-bit serial-parallel converter can be implemented either as a 2-bit parallel and 3-bit serial

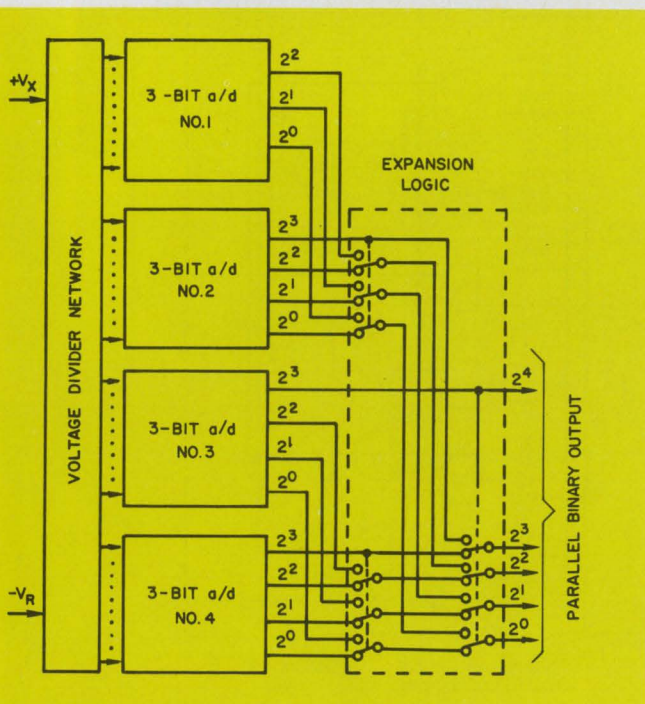

3. A 5-bit all-parallel converter uses four 3-bit converters. Output logic circuits then decode the outputs of the converters into the 5-bit digital signal.

encoder, or as a 3-bit parallel and 2-bit serial encoder. Of these, a 2-bit parallel and a 3-bit serial unit is shown in Fig. 4. For convenience, separate blocks are used on the diagram for the summing network, the voltage dividers and the weighting network. In practice, however, they are all combined in the over-all conversion circuit.

The timing of the converter operation is as follows: The input signal, V_x , is sampled during the short time interval t_1 ; during t_2 and t_3 , V_x is held constant by a sample-and-hold circuit at the input. The time t_2 is equal to the maximum propagation delay through the converter, while during

t_3 the digital output signal is read out or transferred into some intermediate storage circuit.

Propagation a/d converter

Another type of all-parallel, ultrahigh speed a/d converter is the propagation converter. An n -bit propagation a/d converter can be regarded as an n -stage shift register, where each stage performs a single-bit a/d conversion. The n stages are not identical; they increase in complexity as they are located further along the line from the input. The reason for this is that the i^{th} stage

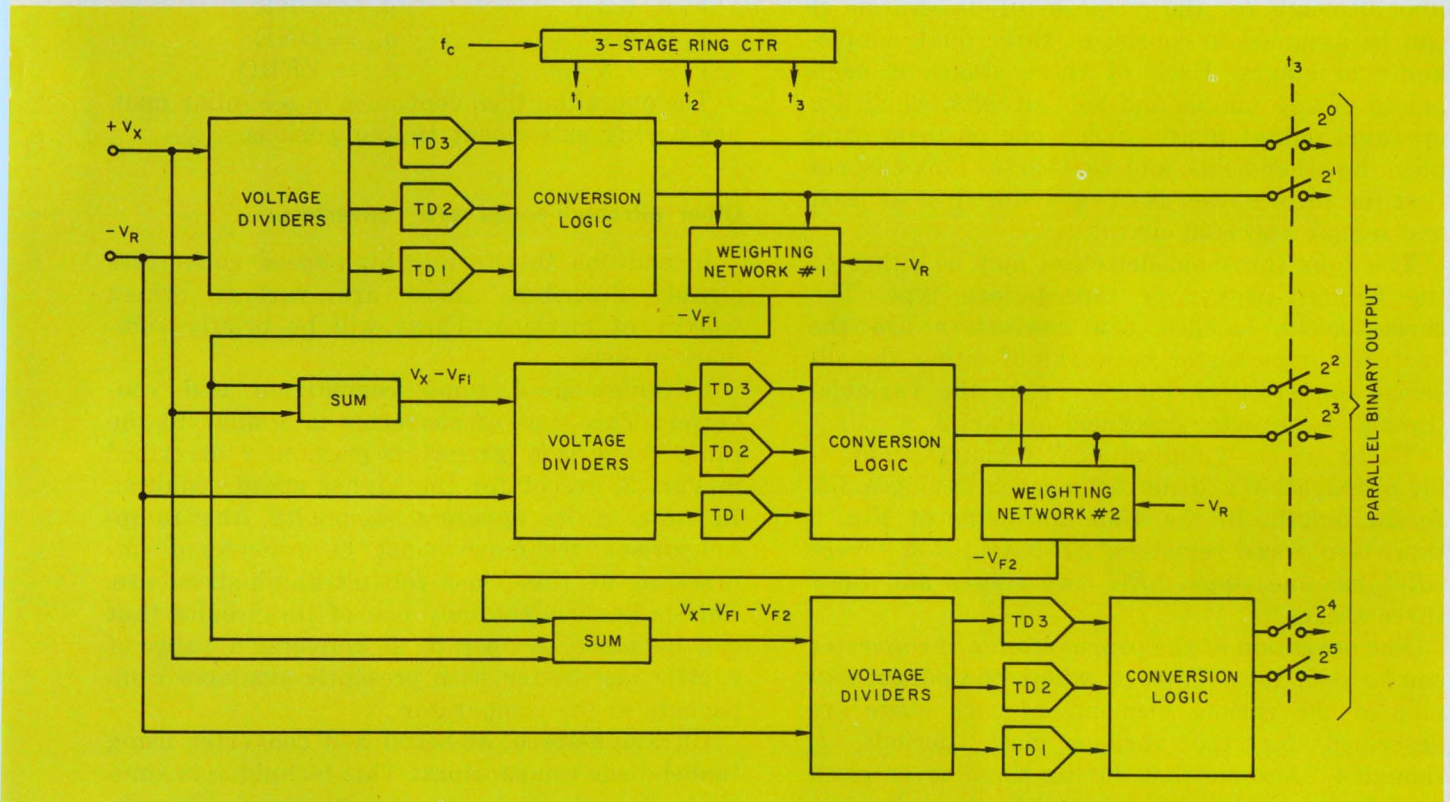

4. A serial-parallel a/d converter, such as this 2-bit parallel, 3-bit serial unit compromises between the speed

of an all-parallel converter and the more modest parts count of an all-serial converter.

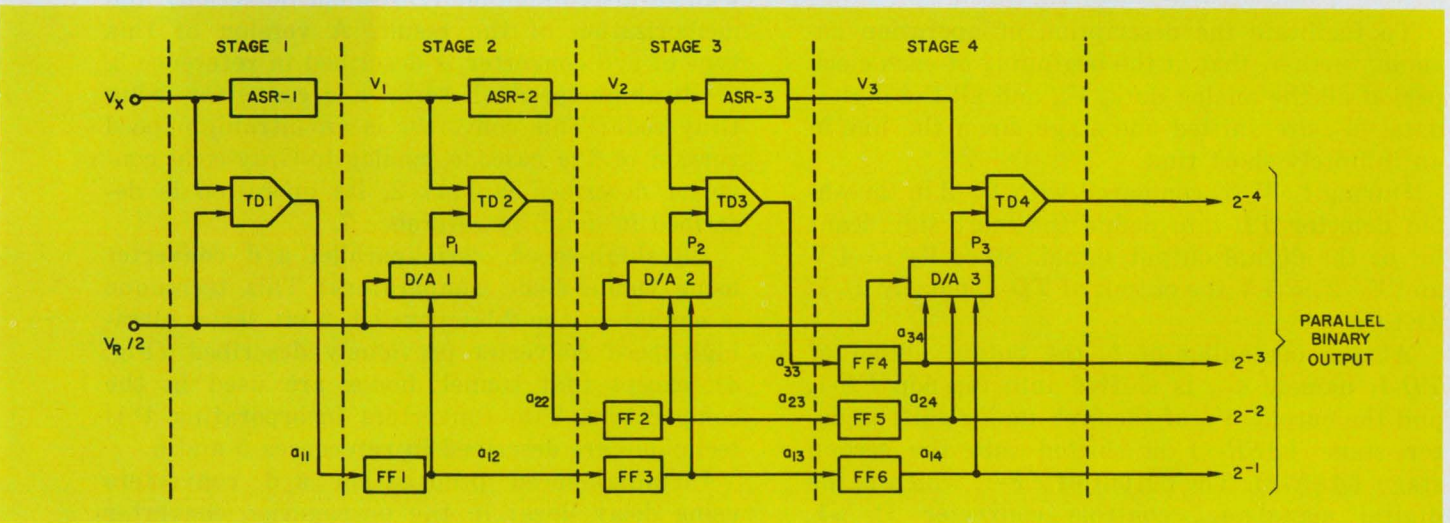

5. A 4-bit propagation a/d converter operates like a 4-stage shift register, with each stage performing a

single-bit a/d conversion. The stages increase in complexity the further they are from the input.

must store all the results of the decisions made in the previous ($i - 1$) stages.

The diagram of Fig. 5 shows that a 4-bit propagation a/d converter is comprised of a 3-stage analog shift register, *ASR-1* to *ASR-3*; four threshold detectors, *TD-1* to *TD-4*; three d/a converters, and three digital shift registers. Without the analog and digital shift registers the converter is almost identical to the all-serial a/d converter of Fig. 1, or to the variable-threshold converter described in Part 2. It is thus the addition of these shift registers that makes the propagation a/d converter different.

The analog shift register is usually a delay line, although for the purposes of illustration it can be assumed to consist of three dual sample-and-hold stages. Each of these stages is comprised of two sample and hold circuits, which are operated out of phase—when one of them samples, the other holds, and vice versa. This ensures that the information is always stored in at least one sample and hold circuit.

The four threshold detectors may be either of the Schmitt-trigger or tunnel-diode type. The three blocks labelled d/a converters are the switches and resistor networks of either the all-serial converter of Fig. 1, or of the variable-threshold converter described in Part 2.

There are $n-1$ digital shift registers in an n -bit propagation a/d converter, each having a different length. In the 4-bit converter of Fig. 5 there are three registers, *SR-1* to *SR-3*, where *SR-1* has one stage, *SR-2* two stages and *SR-3* three stages.

The operation of the propagation a/d converter can be seen from Table 1, where the output signals of the various elements of each stage are described for the various clock periods, t_1 through t_7 . Assume that during these seven clock periods the analog input signal to the converter, V_x , changes from 4 V in t_1 , to 5.1 V in t_2 , to 6.2 V in t_3 and so on. The reference voltage, $V_R/2$, is 5 V.

To facilitate the description of operation assume, further, that at the beginning of each clock period all the analog data, V_i , and all the digital data, a_{ij} , are shifted one stage down the line in an infinitely short time.

During t_1 , V_x is compared with $V_R/2$ in threshold detector *TD-1* to define the most significant bit of the digital output signal. Since $V_x = 4$ V and $V_R/2 = 5$ V the output of *TD-1*, namely a_{11} is ZERO.

At the beginning of t_2 the output signal of *TD-1*, namely a_{11} , is shifted into flip-flop *FF-1*, and the output, V_1 , of the first analog shift register stage (*ASR-1*) is shifted into the second stage (*ASR-2*). The output of *FF-1*, which is the digital signal a_{12} , controls converter D/A-1, whose output potential is generally

$$P_1 = V_R/4 + a_{12} V_R/2.$$

With a_{12} being ZERO, $P_1 = 2.5$ V. Threshold detector *TD-2* compares V_1 , which is 4 V during t_1 , with P_1 . Since V_1 is larger than P_1 , the output of *TD-2*, namely a_{22} , is ONE.

However, input signal V_x is 5.1 V during t_2 ; since *TD-1* compares V_x with $V_R/2$, its output, a_{11} , becomes a ONE. Therefore, at the end of t_2 , the following digital signals are present:

$a_{11} = \text{ONE}$, indicating that 5.1 V is larger than $V_R/2$

$a_{12} = \text{ZERO}$ } indicating that 4 V is smaller
 $a_{22} = \text{ONE}$ } than $V_R/2$ but larger than $V_R/4$.

At the beginning of t_3 , all analog and digital signals are shifted down the line to make

$V_x = 6.2$ V $a_{12} = \text{ONE}$
 $V_1 = 5.1$ V $a_{23} = \text{ONE}$
 $V_2 = 4$ V $a_{13} = \text{ZERO}$

The operation then continues in a similar manner during subsequent timing periods.

Other ultrahigh-speed a/d converters

In addition to the ultrahigh-speed converters already described, there are various others worthy of mention. These will be briefly summarized here.

Ultrahigh-speed ramp comparison a/d converter: This type of converter is similar to the ramp-comparison converters previously described in Part 2, except for the higher speed required. In spite of its apparent simplicity, the ramp-comparison technique must be considered impractical at this time for ultrahigh-speed use. This is because the only one of its circuits that can be made to operate at conversion rates of 8 MHz and better with presently-available components is the comparator.

Ultrahigh-speed, all-serial a/d converter using tunnel-diode comparators: This technique is similar to the all-serial converter previously described, except that the comparators, or threshold detectors, use tunnel diodes in pairs to perform voltage discrimination (threshold detection) and memorization of the result. A version of this type of a/d converter is described in reference 2.

Ultrahigh-speed, all serial a/d converter using Gray code: This converter is an ultrahigh-speed version of the cascade, analog-to-Gray-code converter described in Part 2. Its operation is described in detail in reference 7.

Ultrahigh-speed, serial-parallel a/d converter using tunnel-diode comparators: This technique is similar to the 2-bit parallel, 3-bit serial ultrahigh-speed converter previously described (Fig. 4), except that tunnel diodes are used in the comparators. Two converters incorporating this technique are described in references 5 and 6.

Ultrahigh-speed propagation a/d converters using delay lines: In the propagation converter of Fig. 5, the analog shift register was assumed to consist of sample-and-hold circuits. Usually,

though, this function is performed with delay lines. A 6-bit, 10-MHz converter of this type is described in reference 8. The converter employs a precisely-tapped delay line to provide the same value of the analog input signal to the various comparators sequentially in time.

Another commercial converter of this type,⁹ performs up to 5 million 8-bit conversions per second. Unlike the above converter, which delays the analog input signal in a single delay line having $(n-1)$ taps, this converter uses $(n-1)$ separate delay lines having delays of Δt , $2\Delta t$, $3\Delta t$, etc. In addition, this converter also uses delay lines for storing the digital output signal as well as generating timing pulses for the threshold detectors.

2. Logarithmic a/d converters

Some digital control or computation problems are considerably simplified if the digital signals represent the logarithm of a variable, rather than the variable itself. Consequently, a/d converters have been built which perform a logarithmic function.¹⁰⁻¹²

The operation of one type of logarithmic a/d converter is based on the logarithmic discharge curve of a capacitor, which in mathematical terms is expressed as

$$V(t) = V_R e^{-t/RC},$$

where V_R is the reference voltage with which the capacitor was charged prior to $t=0$, and $V(t)$ is the voltage left on the capacitor at any specific time.

If the voltage across the capacitor is compared with an input voltage, V_x , and if they are equal at time, $t=t_A$, then

$$V_x = V_R e^{-t_A/RC}.$$

Solving for t_A gives

$$t_A = RC \ln V_x/V_R.$$

But this equation would yield $t_A = 0$ for $V_x = V_R$, and $t_A = \infty$ for $V_x = 0$. What is really desired is the complementary function, which gives $t_A = 0$ for $V_x = 0$, and $t_A = T$ for $V_x = V_R$. This can be achieved easily by replacing V_x with $V_R - V_{IN}$.

One implementation of a capacitive-discharge logarithmic a/d converter is shown in Fig. 6. The capacitor, C , is charged at the time T to V_R and is discharged to zero during \bar{T} . The series analog switch, $S1$, is turned ON and OFF with T , which is the square-wave output signal of the most-significant stage of the 11-bit master counter. Consequently, the maximum time allowed for C to discharge is 1024 clock periods of duration, t_p , where $t_p = 1/f_c$.

The signal V_x is generated by connecting $+V_R$ and $-V_{IN}$ to a voltage divider, the output of which is the input to a noninverting amplifier having a gain of two. The output of this amplifier, $V_x = V_R - V_{IN}$, is then compared with the

Table 1. Propagation converter

	t_1	t_2	t_3	t_4	t_5	t_6	t_7		
V_x	4	5.1	6.2	4.5	-	-	-	Stage 1	
a_{11}	0	1	1	0	-	-	-		
a_{12}	-	0	1	1	0	-	-	Stage 2	
V_1	-	4	5.1	6.2	4.5	-	-		
P_1	-	2.5	7.5	7.5	2.5	-	-		
a_{22}	-	1	0	0	1	-	-		
a_{13}	-	-	0	1	1	0	-	Stage 3	
a_{23}	-	-	1	0	0	1	-		
V_2	-	-	4	5.1	6.2	4.5	-		
P_2	-	-	3.75	6.25	6.25	3.75	-		
a_{33}	-	-	1	0	0	1	-		
a_{14}	-	-	-	0	1	1	0		2^{-1}
a_{24}	-	-	-	1	0	0	1	2^{-2}	
a_{34}	-	-	-	1	0	0	1	2^{-3}	
V_3	-	-	-	4	5.1	6.2	4.5	Output	
P_3	-	-	-	4.375	5.625	5.625	4.375		
a_{44}	-	-	-	0	0	1	1		2^{-4}

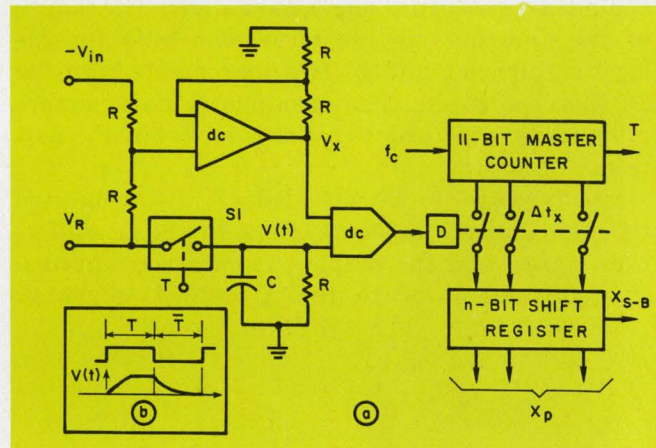

6. Logarithmic a/d converter (a) compares capacitive discharge voltage with input voltage and reads out the digital contents of the master counter when the comparator output changes. The capacitor is charged to V_R at time T , and discharges during \bar{T} (b).

voltage across the capacitor, $V(t)$. When $V(t)$ is larger than V_x , the output of the comparator is a logical ONE, and when $V(t)$ is smaller than V_x the output is a logical ZERO. A digital differentiator, D , generates a narrow pulse, Δt_x , at the ONE to ZERO transitions of the comparator output signal.

The 10-bit parallel output of the master counter represents the time elapsed since the start of the discharge. At the instant the comparator switches, that is, when $V_x = V(t)$, the contents of the master counter are transferred into the shift register, from which they can be read out

in either serial or parallel form.

With available components, a clock frequency of 1 MHz and trimming of the time constant, the converter of Fig. 6 should be capable of approaching an accuracy of 1 part in 1000 at room temperature.

Other types of logarithmic a/d converters are described in detail in the references. One of these,¹² uses the charge transfer technique, described under the charge-equalizing a/d converter (see Part 1).

3. Cathode-ray-tube a/d converters

The cathode-ray-tube (CRT) converter was yesterday's answer to high-speed encoding.¹³⁻¹⁵ Today, with high-speed integrated circuits and other high-speed semiconductor components, much higher conversion speeds are obtainable at smaller size, weight and cost. Nevertheless, the CRT conversion technique warrants description.

Essentially, the CRT a/d converter is a special type of cathode ray tube, in which an aperture and a segmented output plate have been added to the conventional electron gun and deflection plates (Fig. 7). The openings in the aperture plate are arranged in several columns, with each column representing one binary digit. The length of the apertures is one increment high for the least-significant bit, 2^0 , two increments high for 2^1 , four for 2^2 , etc. The openings in the aperture plate thus conform to a standard binary pattern.

The voltage to be encoded, V_{in} , is connected through appropriate amplifiers to the Y deflection plates, and the outputs from a conventional sawtooth generator to the X deflection plates.

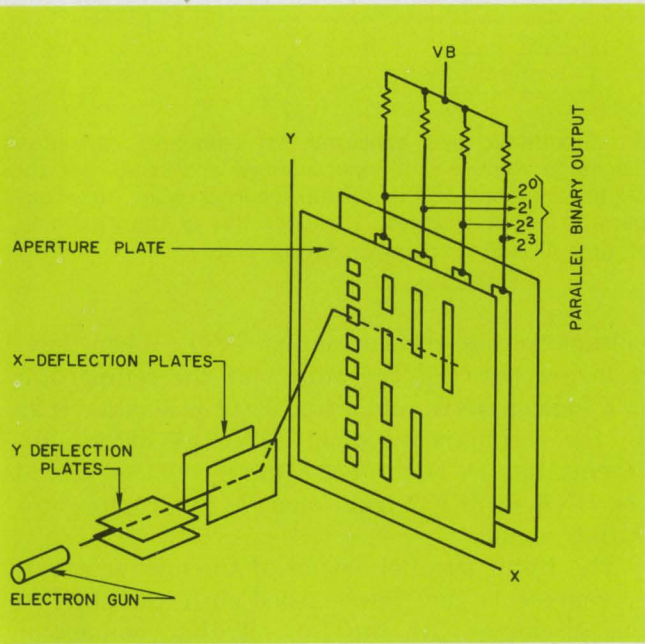

7. Cathode-ray-tube a/d converter produces a digital output as the electron beam is moved across the aperture plate by the analog voltage.

The sawtooth deflection causes a horizontal line across the aperture plate, the vertical position of which is determined by the voltage to be encoded, V_{in} .

The output plate is divided into n vertical strips, one for each bit of the parallel binary word to be generated. Whenever the electron beam scans horizontally, it will hit some of the strips of the output plate, depending on whether there is an opening in the aperture plate. ON-OFF voltage levels are thus generated across the load resistors, which are connected between the output strips and a power supply.

With the binary pattern shown in Fig. 7, the voltages across the load resistors will read

- 1 1 1 1 for $V_x = +$ full scale
- 1 0 0 0 for $V_x =$ zero
- 0 0 0 0 for $V_x = -$ full scale

This means that the output signal is in the offset binary code.

As in shaft encoders and cascaded a/d converters, ambiguities occur in the CRT converter output signals when V_{in} is such that the horizontal line made by the electron beam is at the edge of several apertures. For example, when the digital output signal should change from 0111 to 1000 it first may read 1111 before it finally changes to 1000. These ambiguities can be avoided by using cyclic or other suitable codes in place of the pure binary code. ■■

Automatic offset correction can boost a/d converter performance considerably.

Zero offsets and their variation with time and temperature have long been an annoying problem in a/d converters. They are caused primarily by analog circuits, and occur in even the most sophisticated designs.

In the past, these offsets in a/d converters have been minimized by reducing the individual offsets in the amplifiers, comparators, etc. This often resulted, though, in large converters that required many adjustments. With new offset-correction techniques there is no longer any need for individual offset correction. Instead, all offsets are corrected for simultaneously and, what is even better, are corrected automatically.

The automatic offset correction techniques require only a few additional components. But because they eliminate the need for low-drift amplifiers, comparators, and zero-output-trim potentiometers, the additional components are well justified from a cost standpoint.

Along with its many advantages, automatic offset correction brings one penalty—longer con-

version time. This is because one extra conversion period is needed to perform the offset correction. With time-shared a/d converters, however, this is no handicap because the offset correction period can be considered as just one more conversion period.

The total offset error of any converter is the sum of the individual offset errors generated by various circuits. Possible sources of offset are:

- Voltage and current offsets of amplifiers
- Voltage and current offsets of comparators
- Voltage offsets of bipolar junction transistor switches
- Leakage current from turned-OFF analog switches
- Capacitive feedthrough transients from analog switches
- Turn-ON and turn-OFF delays in analog switches
- Time delays through logic circuits
- Errors in reference voltages
- Errors in biasing resistors.

Automatic offset correction circuits provide a means for compensating for all of these.

Basically, the offset correction operation of a converter with automatic offset correction is as follows: A voltage representing zero analog input signal is converted into digital form and compared with a digital number that represents zero. The resulting error signal is then converted back into a corresponding analog voltage, which is fed back to the converter summing point. If there is any offset in the system, the voltage fed back is non-zero and compensates for the offset.

There are two basic techniques for achieving automatic offset correction in a/d converters. These are:

- The direct-storage method
- The integrating method.

The basic circuit arrangement for both of these methods is the same, and is shown in Fig. 8 for a converter that is being time shared between "n" channels. In the diagram, P_1 through P_n are the conversion periods for the data channels, and P_o is the offset correction period.

In the direct-storage method, X_{D_o} is subtracted from a digital number, designated REF, which represents zero in the specific code used in the converter. X_{D_o} is the digital output produced by the converter during period P_o when ground, or zero volts, is applied to the converter input. The difference, ΔX_o , between X_{D_o} and REF is then stored in a digital storage circuit, the output of which is labelled X_o .

During period P_o , the input to the d/a converter is made zero, forcing the output also to zero. ΔX_o is thus produced, which is exactly equal to the total offset in the converter. During all other periods, the input to the converter is the constant value X_o , so that a constant value

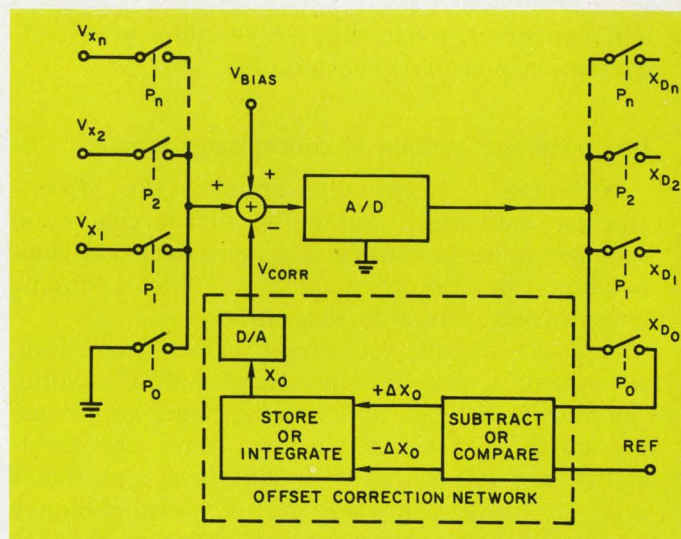

8. Offset correction takes place during timing period P_o , when a voltage representing zero analog signal is applied to the input of the a/d converter.

of V_{corr} is applied to the summing point.

In the integrating method, X_{D_o} is either subtracted from or compared with the REF signal. In the first case, ΔX_o represents the exact difference between X_{D_o} and REF; whereas in the second case, ΔX_o represents only +1 or -1, indicating if X_{D_o} is larger or smaller than REF. In either case, ΔX_o is added to the value already present in the integrator to update X_o and to make it a closer approximation to the actual offset in the converter.

In the integrating method, X_o is permanently connected to the d/a converter, so V_{corr} is present at all times. However, X_o is updated only during period P_o . Hence only during P_o does V_{corr} change values. During P_1 to P_n , V_{corr} remains constant.

In Fig. 8, the offset-correction network is shown to consist of a digital subtractor or comparator, a digital storage or integrator circuit and a d/a converter. This may seem like considerable circuitry. But in actuality it is not, since only a few binary digits must be carried.

With present-day monolithic amplifiers and comparators, and reasonably low impedances present at the input of these devices, the total offset of an a/d converter is less than $\pm 1\%$ (equivalent to a 7-bit accuracy) over the temperature range, if no offset correction is used. Another ± 5 bits are necessary to reduce this error to less than 1 part in 4096 and thus make a 12-bit conversion possible.

This means that either the offset-correction network needs a dynamic range of ± 5 bits, or that the comparator, integrator and d/a converter require a 5-bit capacity. With so few stages, these circuits become extremely simple. All of them, for example, could be built in monolithic form on a single chip, regardless of whether X_D is a serial or a parallel binary signal. As will be shown later for the case of the pulse-width

a/d converter, even simpler versions of offset-correction circuitry are possible.

Direct-storage method is conceptually simple

Although conceptually simple, the direct-storage method of automatic offset correction requires more hardware and more accurate components than do other methods. The technique nevertheless warrants description.

A 5-bit circuit for direct offset correction, as shown in Fig. 9, consists of a 6-bit holding register, a 6-bit d/a converter, and six transfer gates $A1$ to $A6$. In operation, the most-significant bit, 2^{-1} , and the five least-significant bits, 2^{-8} to 2^{-12} , of the output parallel-binary number X_p are preset into six latches, $FF-1$ to $FF-6$ during the P_o period. Each of the latches is comprised of two cross-coupled NAND gates. The outputs of the six latches are connected to the d/a converter switches, $A7$ to $A12$, during all periods except P_o .

The d/a converter is extremely simple. It can use lamp drivers for shunt switches, $A7$ to $A12$, and an inexpensive thin- or thick-film resistor ladder network.

If there is any chance that the a/d converter offset error exceeds the ± 5 bit limit, then additional stages must be added.

Integrating method can use bang-bang approach

One version of the integrating method of automatic offset correction for converters having parallel digital outputs is shown in Fig. 10. In this circuit, the digital output signal X_{D_o} , which is produced during offset-correction period P_o , is examined only to determine whether it is larger or smaller than zero. As a result, the circuit is referred to as the "bang-bang" offset-correction circuit.

The offset-binary code used in the converter has the following signal presentation:

```

+2 = 1000 . . . 010
+1 = 1000 . . . 001
  0 = 1000 . . . 000
-1 = 0111 . . . 111
-2 = 0111 . . . 110

```

To determine if X_{D_o} is larger than zero, all that is required is that the magnitude bits be examined for ONES, whenever the sign bit is ONE. Negative values of X_{D_o} can be detected simply by checking whether the sign bit is ZERO. The resulting information can then be used to increase or decrease the content of a 6-bit binary counter, the outputs of which drive a d/a converter.

Instead of applying the output of the comparator to a counter and then to a d/a converter, a much simpler method is to have the output of the comparator change the voltage across a ca-

pacitor, C .

As shown in Fig. 10, this type of circuit consists of four MOS gates, three MOS transistors, one resistor and one capacitor. When digital output signal X_{D_o} is positive, one of the magnitude bits, 2^{-8} to 2^{-12} , and the sign bit, 2^{-1} , will be ONE, enabling pulse t_p to pass AND gate $A1$. This turns ON transistor $Q1$ for the duration of t_p , causing capacitor C to charge toward ground. When X_{D_o} is negative, inverted sign bit 2^{-1} is ONE, thus permitting t_p to pass $A2$. Accordingly, $Q2$ turns ON for the duration of t_p , and capacitor C charges negatively.

If the voltage across capacitor C can be maintained between -5 and -7 V, if t_p is relatively short and if the ON-resistance of $Q1$ and $Q2$ are relatively high, then the charge on C will increase or decrease by approximately the same amount with each pulse, t_p , that is passed through $A1$ or $A2$, respectively. In other words, the voltage across C will be proportional to the number of positive or negative pulses, $+t_p$ or $-t_p$, passed through the gates, and hence the capacitor will function like an integrator.

For example, with $t_p = 1 \mu\text{s}$, $R_{ON} = 10 \text{ k}\Omega$ for $Q1$ and $Q2$, $C = 0.02 \mu\text{F}$ and $V_{corr} = -6 \text{ V}$, the voltage across the capacitor will increase with each clock period by:

$$\Delta V = \frac{It}{C} = \frac{(6\text{V}/10 \text{ k}\Omega) \times 10^{-6}\text{s}}{2 \times 10^{-8} \mu\text{F}} = 30 \text{ mV} \quad (1)$$

So with a maximum offset of ± 32 units as represented by five magnitude bits, the voltage across the capacitor will vary approximately $\pm 1 \text{ V}$, or from -5 V to -7 V .

The source follower, consisting of $Q3$ and R_s , provides a high load impedance to the storage capacitor and a level-shift equivalent to the threshold voltage, V_{th} . If V_{th} is 6 V, the output voltage of the source follower, V_{corr} , will vary between $+1 \text{ V}$ and -1 V . By using a resistor of proper value, the correction signal can be scaled so that 30 mV of V_{corr} corresponds to one unit of the input voltage to the a/d converter.

The disadvantage of this method is that it can correct only for one least-significant bit during each iteration. Care must be exercised that capacitor C does not discharge by a voltage corresponding to more than 1/2 bit. Otherwise, the correct value of V_{corr} can never be reached, or reached only after a very long time.

To assure a very small capacitor discharge, the total impedance, R_T , across C must be high and the total leakage current, I_{LT} , into C must be small. With the sample values used above, this means that the capacitor voltage, V_C , cannot change more than 15 mV during "n" offset-correction periods. Assuming further that in a parallel a/d converter, "n" offset-correction periods are no longer than 1 ms, then the total shunt impedance R_T should be larger than 40 M Ω . This means that the parallel combination of the

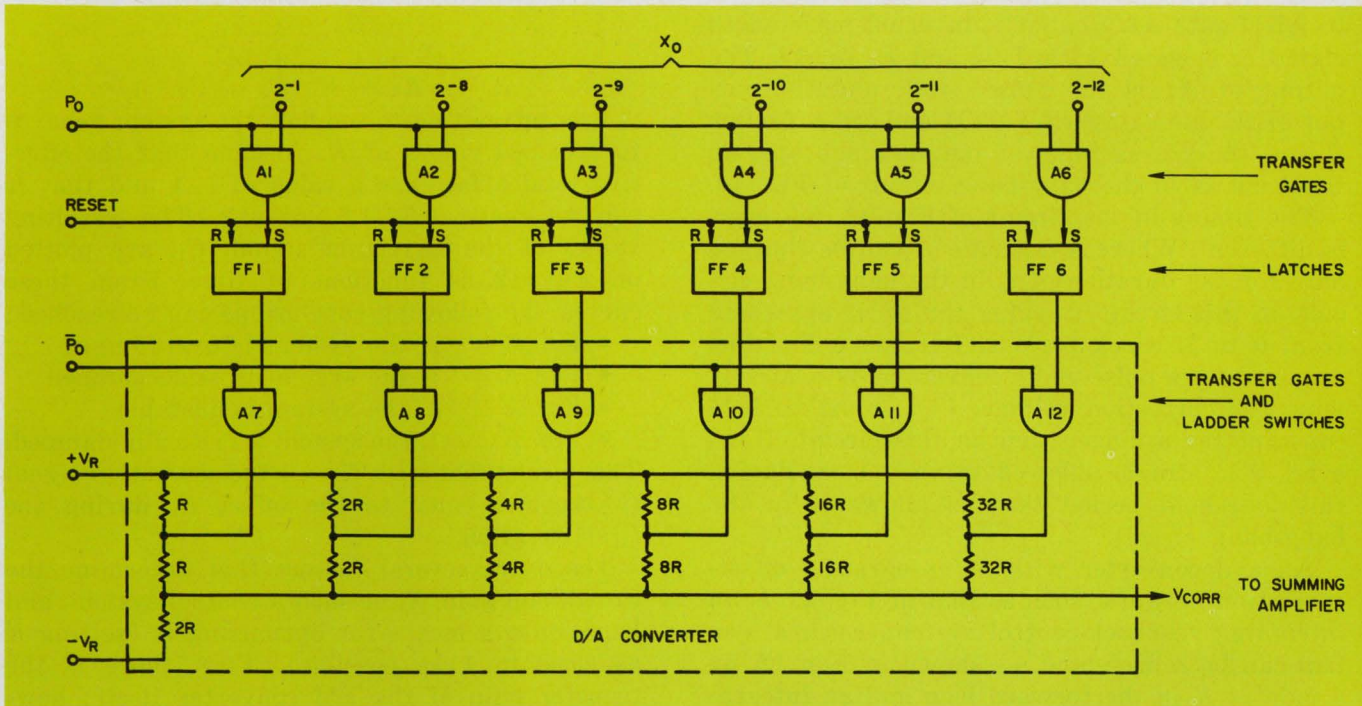

9. In the direct offset-correction method, a 6-bit holding register drives the d/a converter directly.

source-follower input impedance, the capacitor shunt-resistance and the OFF-resistance of both $Q1$ and $Q2$ must be higher than $40\text{ M}\Omega$. This is a stiff requirement, even for state-of-the-art components.

Similarly, the total leakage current, I_{LT} , must be less than 150 nA if ΔV_c is to change less than 15 mV . This is quite feasible with present MOS transistors.

Pulse-width technique offers advantages

Offset-correction networks for pulse-width a/d converters avoid all the disadvantages of the bang-bang circuit, previously described, and are even simpler. These networks operate with a pulse-width signal, t_x , and not with a pure digital signal. The width of t_x is directly proportional to the input voltage V_x .

An offset-correction network of this type is shown in Fig. 11. The circuit differs from that of Fig. 10 only in the digital input stage. Instead of detecting the polarity of a parallel-binary number, the pulse width signal, t_x , is compared with a reference pulse, T_{REF} , during the conversion period, P_o . The difference in duration between t_x and T_{REF} is another pulse-width signal, Δt , the width of which is proportional to the total offset in the system.

Since Δt is continuously variable, this technique permits faster slewing to a desired error voltage and to much smaller increments, or finer control, than does the bang-bang method.

In operation, pulse-width signal t_x is gated with the inverted reference pulse, $\overline{T_{REF}}$, and P_o

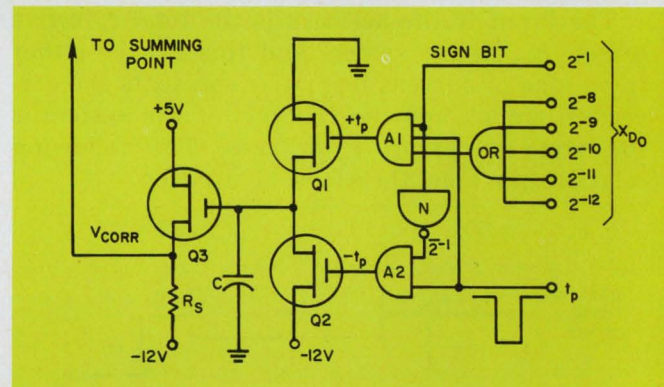

10. Circuit for bang-bang offset-correction method determines whether correction voltage X_{D0} is larger or smaller than zero, and then changes the voltage across capacitor C accordingly. This technique can correct for only one least-significant bit during each iteration.

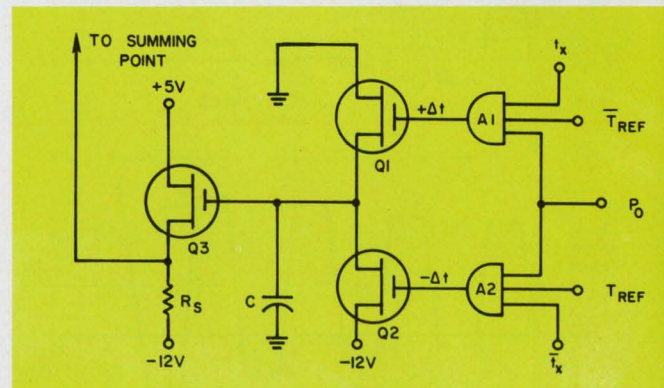

11. Offset-correction circuit for pulse-width converters compares a pulse-width signal, t_x , with a reference pulse-width in two AND gates.

in AND gate $A1$. Similarly, inverted pulse-width signal \bar{t}_x is gated with T_{REF} and P_o in $A2$. The output of $A1$ is the pulse, $+\Delta t$, and the output of $A2$ is $-\Delta t$. Switches $Q1$ and $Q2$, capacitor C and the source follower output stage operate the same as in the bang-bang circuit of Fig. 10.

The timing in the circuit of Fig. 11, however, is different. Whereas capacitor C can be charged only for the duration of t_p in the bang-bang circuit, in this circuit charging can occur anywhere from 0 to 32 clock periods. But, since the time required for a pulse-width conversion is relatively long, the correction voltage, V_{corr} , must be held constant for a longer time in this circuit. However, V_{corr} can be allowed to vary more during this long-hold period than is allowable in the bang-bang circuit.

An a/d converter with an integrating offset-correction network, such as that of Fig. 11, is an intriguing feedback-control system. Such a system can be represented, as shown in Fig. 12, by a gain of K in the forward loop and an integrator, or accumulator, in the feedback path. In this representation, information is connected to the accumulator only during predetermined periods of time: P_{o1} , P_{o2} , P_{o3} , etc.

The input to the network is the total effective offset, E_o , in the system and this can be either in voltage or current form. C_i represents the correction signal, and the function of the system is to drive the error, ϵ , to zero. The following relationships can therefore be written:

$$\begin{aligned}\epsilon &= E_o - C_{i-1} \\ C_i &= C_{i-1} + \Delta C_i \\ \Delta C_i &= K\epsilon = K(E_o - C_{i-1})\end{aligned}$$

It is interesting to see how the system behaves for various values of K . Assume that the effective total offset has a value of $+1$ and that K can be made 0.5, 1.5, or 2.2. The resulting values of the correction signal, C_i , are plotted on Fig. 12 as functions of time. From these curves, the following conclusions can be reached:

- For $K < 1$, the system is overdamped
- For $K > 1$, the system is underdamped
- For $K > 2$, the system is unstable
- For $K = 1$, the system is critically-damped.

This means that with $K = 1$ the correction signal C_i becomes equal to the offset E_o during the first iteration.

There are several factors that determine the closed loop gain, K , of such a control system, and hence offer a means for optimizing it (setting K as close to 1 as possible). First there is the transfer gain of the a/d converter itself; however this is usually fixed and cannot be altered.

Then there is the gain of the offset-correction network, which can be altered in several ways by varying circuit parameters. These parameters are capacitor C , the ON-resistance R_{ON} of $Q1$ and $Q2$ and the supply voltages. Another parameter is the scaling resistor that connects the correction voltage, V_{corr} , back into the summing point. Although these four parameters can be varied in many different ways, they are subject to the following restrictions:

- The supply voltages should be 0 V and -12 V.
- The ON-resistances of $Q1$ and $Q2$ should be between 1 k Ω and 10 k Ω
- The value of the capacitor should be less than 0.1 μ F
- The scaling resistor, R_c , should be $R_i < R_c < 10 R_i$, where R_i is the normal input resistor to the a/d converter
- The voltage across the capacitor should not vary more than ± 1 V.

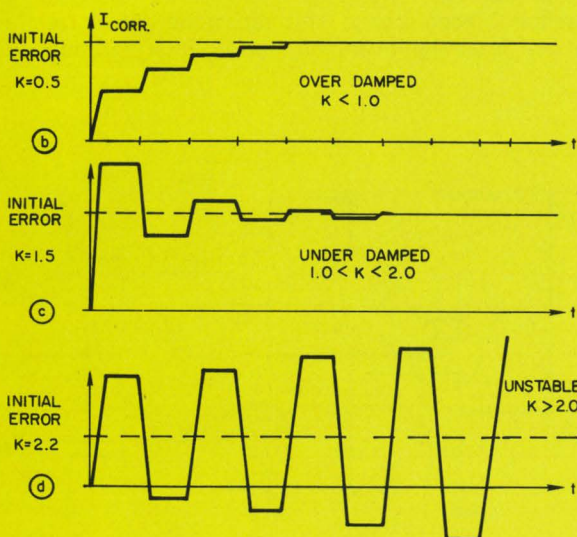
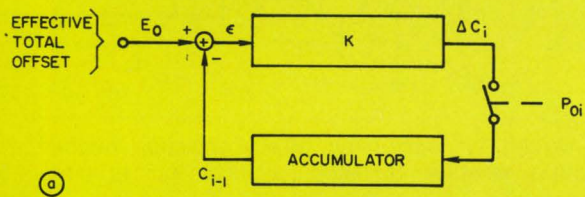

12. An a/d converter with automatic offset-correction can be treated as a feedback control system.

Time-sharing saves hardware, but may result in lower over-all performance.

Often, not one, but several analog signals must be converted into digital form. The question then arises whether one a/d converter should be used for each analog signal, or whether one a/d converter should be time-shared—or multiplexed—between several analog input signals.

If, for example, there is a control system in

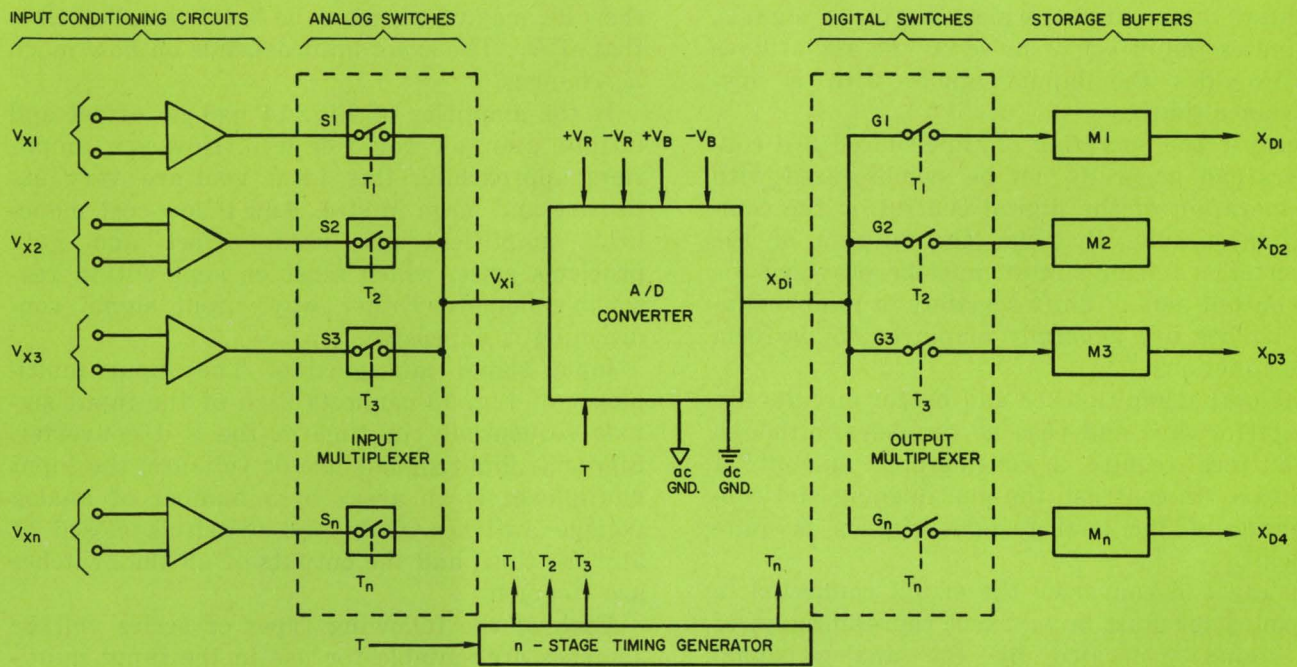

13. Time-shared a/d converter has one analog input, V_{xi} , connected to its input and one storage buffer, M_n ,

connected to its output during each conversion period, T_n . Switching is controlled by a timing generator.

which 16 dc voltages must be converted into digital signals, several possibilities exist. These include using 16 converters, one for each input; using 8 converters, each time-shared between two inputs, etc.

With the complexity, size, weight and cost of most presently available a/d converters, the most economical approach is to use one converter and time-share it between all 16 inputs. But this holds true only for most presently available hardware. With small and inexpensive monolithic converters, the economics are quite different.

Economics, however, is not the only consideration in deciding whether or not to time-share. Over-all performance must also be considered.

Every time an analog signal is processed by some circuit, no matter how simple, an error is introduced. Such is the case with time-sharing, where analog signals are connected sequentially in time to the a/d converter. Time-sharing deteriorates the over-all conversion accuracy: errors due to time-sharing generally increase with the number of signals being multiplexed.

There is another penalty paid for time-sharing; namely, conversion rate. When "n" analog signals are sequentially converted in time, each signal is converted only at a conversion rate of $1/n$. Using the example of 16 inputs again, and assuming that the maximum conversion rate is 16,000 per second, then each of the 16 inputs can be converted only at a rate of 1000 per second. Obviously, any economy in hardware through time-sharing can be achieved only by sacrificing conversion speed.

Time-sharing of a/d converters can, therefore, be employed only if the over-all system will permit reductions in accuracy and speed.

Only when the a/d converter is much more complex than the circuitry needed to multiplex one channel will time sharing offer a reduction in hardware. But only when the error and reduction in conversion rate introduced by the multiplexing circuitry can be tolerated is time sharing desirable.

General organization is same for all

The general organization of a time-shared a/d converter, including all peripheral circuits, is shown in Fig. 13. To time-share any a/d converter, no matter what type, requires a set of analog switches, $S1$ to S_n , at the input and a set of logic gates, $G1$ to G_n , at the output. Only one switch and one gate are closed at any one time, so that only one input signal is connected to the input of the converter and only one buffer circuit connected to its output.

The switches and gates are controlled by the outputs, T_1 to T_n , of an n-stage timing generator. These timing pulses have an ON-time equal to one conversion period of the particular a/d converter used. Often the timing generator is an n-bit ring counter.

Frequently, there is a need in time-shared a/d converters to provide a special conditioning circuit for each input signal. Such an input signal-conditioning circuit is also needed for an a/d converter that is not time-shared; in this case,

it is usually part of the converter itself. The input signal conditioning compensates for ground potential differentials, scales the input signals, eliminates the effect of noise on the signal lines and provides the input signals with a low-impedance source.

Because the operation of time-shared a/d converters can generally not be synchronized with the operation of the digital control or the computation circuits that use the outputs of the converter, a buffer circuit must be provided for each output signal. Shift registers or simple flip-flop latches are generally employed to perform these functions.

The output multiplexer and buffer circuits are straightforward and pose no problems, although the buffers require a considerable amount of hardware. In contrast, the multiplexing and conditioning of the analog input signals is quite difficult.

In any a/d converter the signal connected to the converter must be an exact representation of the signal generated by the analog signal source. Often, however, the signal at the converter is quite different from that at the source. Noise induced into the signal lines and the differences in ground potentials may completely distort the analog signal. Besides, the full scale output of the transducer may be greatly different from that required by the converter. And in another case, the impedance of the analog source may be too high.

To eliminate the effects of noise on the signal and the effect of ground-potential differences, to provide a capability of scaling, and to provide a low-impedance signal, the differential amplifier circuit in Fig. 14 is frequently employed. Assuming zero offset and infinite gain, the output voltage of the amplifier is

$$V_o = \frac{R_2}{R_1} (E_1 - E_2).$$

Any difference in scale factor between the sensor output and the converter input can be corrected by proper choice of resistors R_1 and R_2 , where for the sake of simplicity, R_1 , R_2 , R_1' and R_2' are assumed to be the same. Any difference in ground potential, ΔV_G , between the sensor and the a/d converter has no effect on the output of the differential amplifier, since V_o is proportional only to the difference voltage ($E_1 - E_2$). In addition, any induced noise, V_n , has equal amplitudes on both the signal line and the signal-return line and therefore will cancel, if the common-mode rejection of the amplifier is sufficiently high.

The output impedance, Z_o , of the differential amplifier is very low (less than 1 ohm) and is usually much lower than that required by the input multiplexer. In the circuit of Fig. 14, R_s may have any value, provided that the sum of R_s and R_1 is smaller than R_2/K , and that R_s remains

constant. (K = the desired closed-loop gain of the differential amplifier circuit.) If R_s varies, then its magnitude must be much smaller than that of R_1 : The exact limit depends on how much R_s changes.

If the amplifier of Fig. 14 had no offset and infinite gain, all would be well. However, amplifiers approaching this ideal goal are very expensive and large in size. And if low-cost monolithic amplifiers are used, offset and gain problems arise, which must be kept within reasonable bounds. Either way, input signal conditioning is expensive.

Input signal multiplexing. The input multiplexer of Fig. 13 connects each of the input signals sequentially in time to the a/d converter. Since the input signals are dc voltages, the input multiplexer is an array of a number of analog voltage switches. Only one switch is closed at any one time, and the outputs of all the switches are common.

Each of the following types of series voltage switches are suitable for use in the input multiplexer.¹⁶ However, each has particular advantages and disadvantages, which must be evaluated.

- Direct-coupled bipolar junction transistor switches
- Transformer-coupled bipolar junction transistor switches
- J-FET switches
- MOSFET switches.

Errors in the input multiplexer can be caused by leakage current through the OFF switches and capacitance feedthrough transients. The error produced by leakage current is very small. This may be surprising, as there are always $(n-1)$ switches turned OFF. Since, however, one switch is always closed, the total leakage current, I_{LT} , flows into the ON-resistance of the closed switch. The resulting error voltage is therefore the product of R_{ON} times I_{LT} , which is usually very small. This is shown in Fig. 15 for a multiplexer made of J-FET switches.

Whenever an analog switch operates, the change in control voltage is fed through the parasitic capacitances to the signal current. The resulting feedthrough transients can often cause problems. These problems are very much reduced in an analog multiplexer, where only the control signal to one switch changes while all others remain constant.

This statement is only valid, however, when the control voltages come from drivers that have a low impedance when they generate the turn-OFF signal. The situation is illustrated in Fig. 16a for a J-FET multiplexer, where a changing control signal is connected to $Q1$ and where constant and low-impedance turn-OFF signals are connected to $Q2$ through $Q9$. The transient equivalent for this multiplier is shown in Fig.

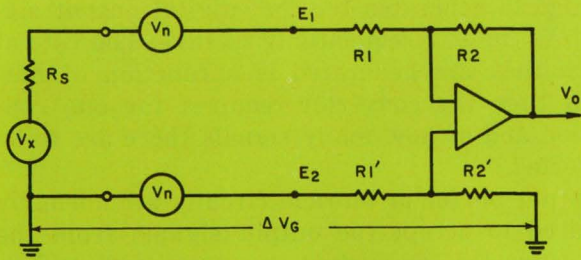

14. **Differential amplifier circuit** provides input signal conditioning for each channel of a time-shared a/d converter. One amplifier is used for each channel.

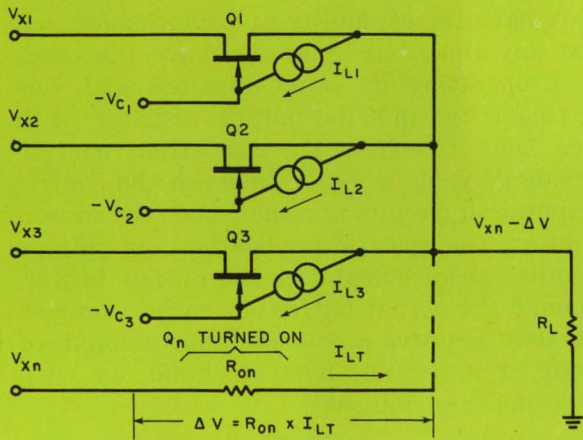

15. **Leakage current causes only small error** in input multiplexer, because total leakage current of all OFF switches flows into ON-resistance of closed switch.

16b. If $C_1 = C_2 = C_3 = \dots = C_n$, the circuit can further be simplified to that shown in Fig. 16c. From these equivalent circuits it is evident that any transient introduced through one capacitor is reduced by a factor of $1/(n - 1)$.

Switching speed is generally no problem in multiplexers used with a/d converters. This is because the multiplexer switches generally operate an order of magnitude slower than the switches inside the converter.

The impact of integrated circuits, and especially of MOS circuits, can nowhere be seen better than with analog multiplexers. It is more than ironic to see how present-day multiplexers are offered both as 19-inch rack modules and in IC flat-packs. Granted that the 19-inch rack model outperforms the present monolithic versions by far—that it still, to this day, represents a masterpiece of engineering—but for how much longer will this hold true? The MOS technique has come a long way; so has the engineer's ability to design around any deficiencies inherent in MOS circuits. The MOS current multiplexer shown in Fig. 17 is a good example of this.

In the 16-channel multiplexer of Fig. 17, MOSFETs are employed as current switches.

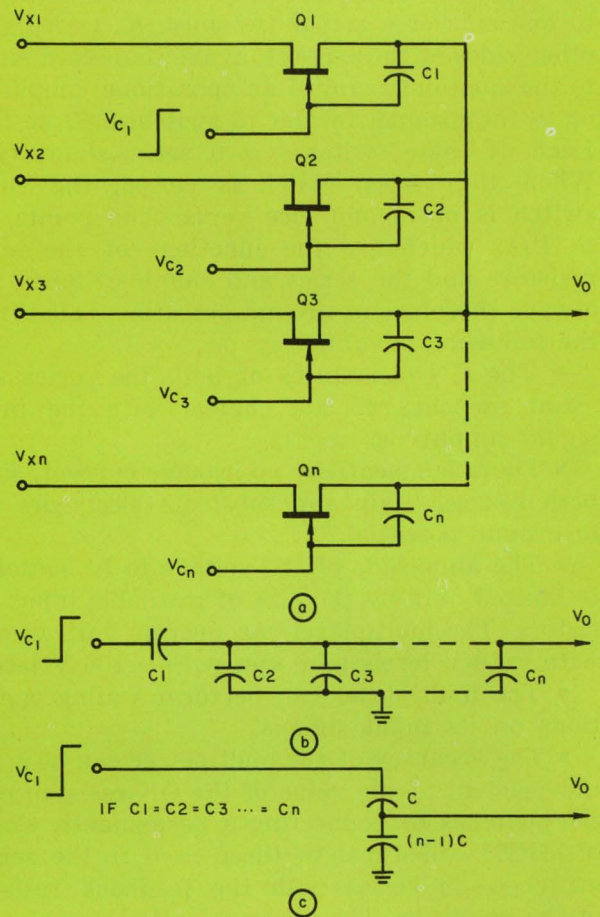

16. **Capacitive feedthrough transients** in the input multiplexer are generally small. This is because the actual parasitic capacitances (a) reduce to the equivalent of (c).

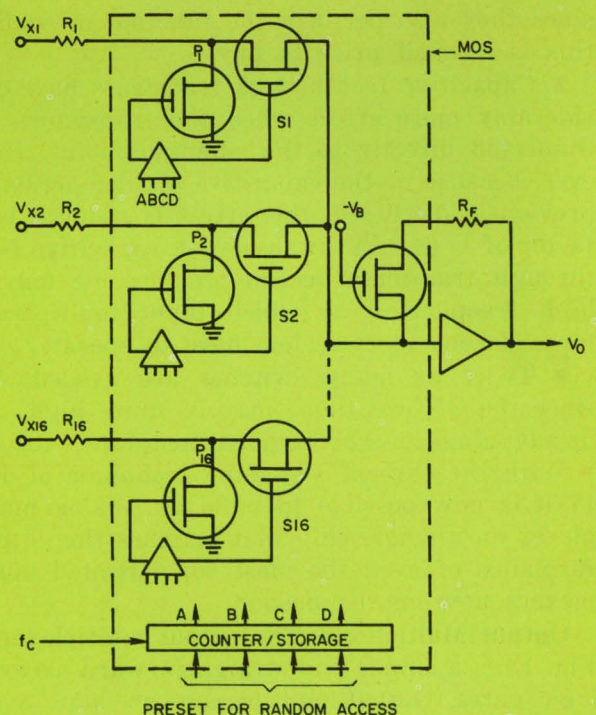

17. **Series-shunt current switches** are used in this all-MOSFET input multiplexer.

The 16-input voltages, V_{x1} to V_{x16} , are connected to one side of a set of resistors, R_1 to R_{16} . The other sides of these resistors are connected either to the summing point of an operational amplifier, or to the ground, by the 16 switches, $S1$ to $S16$. Each of these switches is a series-shunt type. When the series switch is closed, the shunt switch is open, and vice versa. The points, $P1$ to $P16$, which are the junctions of the input resistors and the series and shunt switches, are always therefore at ground potential. This offers the following advantages:

- The ON-resistances of both the series and shunt switches do not change with the input signal amplitude.

- There is essentially no leakage current, since both source, drain and substrate electrodes are at ground potential.

- The amplitude of the voltage to be switched is limited only by the size of available input resistors. The multiplexer can operate just as well with ± 10 -V levels as it can with ± 100 -V levels.

- The multiplexer can perform scaling operations on its input signals.

- The accuracy of the multiplexer can be made independent of the value of the ON-resistance of the switches by connecting a permanently-closed MOSFET—identical to those used in the series switches—in series with the feedback resistor of the amplifier. The accuracy and the maximum value of the ON-resistance of the switches is, therefore, only a function of how well R_{ON} can be matched.

The disadvantages of MOFSET current switches in the arrangement are:

- Additional precision resistors are needed. But since they also perform the function of scaling, this is a small price to pay.

- Capacitive feedthrough transients have considerably more effect when the transistors are connected directly to the summing point. However, because of the capacitive divider action, as previously discussed, this effect is reduced by a factor of $1/(n-1)$. In any event, capacitive feedthrough transients become troublesome only at high frequencies, at which input multiplexers for a/d converters seldom have to operate.

- Twice as many switches are needed. But since the ON-resistance may be quite high, this disadvantage is well compensated for.

With the current switching technique of Fig. 17 it is now possible to build an analog multiplexer on a single chip that matches the dc performance of even the most sophisticated multiplexers now on the market.

Output Multiplexer. The output multiplexer of Fig. 13 is a simple and straightforward array of logic gates. Output multiplexers are now available in all-monolithic form as binary-to-decimal, or binary to "1 in 4", to "1 in 8", or to "1 in 16" decoders.

Output Buffers. The time-shared a/d converter of Fig. 13 generates the "n" digital output signals, X_{D1} to X_{Dn} , sequentially in time. The rate at which they are generated is a function of how much time the converter requires for one conversion and of how many signals there are to be converted.

Output buffer or storage circuits are normally required to accept the output signals from the a/d converter when they are generated, and to hold them until they are needed by the digital control or computation circuits. The buffer circuits should also be able to handle any required serial-parallel or parallel-serial conversion.

The most convenient and widely used of these is the serial-in, serial-out type. This buffer must not only have the capability of being loaded and read at any time, but must also have the capability of operating its input register with one clock frequency and its output register with another. Output buffers are also often required to provide galvanic isolation between the control or computation circuits and the converter circuit. In addition, the specific application can impose many other requirements on the output buffer.

Although the output buffer is a rather complex circuit that requires a considerable amount of hardware, it is possible today to build one on a single monolithic chip. ■■

Reprints

To obtain reprints of this Guide, see p. 206.

References:

1. J. Millman, *Pulse, Digital and Switching Waveforms*, Chapter 10, McGraw-Hill, N.Y., 1965.
2. R. A. Kaenel, "High-Speed Analog to Digital Converters Using Tunnel Diodes," *IRE Transactions on Electronic Computers*, June 1961, pp 273-283.
3. F. D. Waldhauer, *Analog to Digital Converter*, U.S. Patent 3-187-325, 1965.
4. H. R. Schindler, "Using the Latest Semiconductor Circuits in a UHF Digital Converter," *Electronics*, Aug. 30, 1963, pp 37-40.
5. Y. C. Huang, "Approaches to Critical Problems of Ultra-High-Speed Analog to Digital Conversion," *Digest of Technical Papers, International Solid State Circuit Conference*, Feb. 1966.
6. J. Asin, "Goto Circuit TDs Give Rapid A/D Conversion," *Electronic Design*, April 1962, pp 77-78.
7. "Experimental 224 MB/S PCM System," *Bell Telephone Monograph 5057*, Bell Telephone Laboratories, Murray Hill, N.J., 1965.
8. "10 MHz Traveling Wave Videoverter, Model TWV-744," *Technical Bulletin 126402*, EPSCO, Inc., Westwood, Mass.
9. "Analog to Digital Converter Model A/D-50B," *Instruction Manual*, Raytheon Equipment Div., Norwood, Mass.
10. E. M. Glaser, "A Logarithmic Voltage Quantizer," *IRE Transactions on Electronic Computers*, Dec. 1955, pp. 150-155.
11. D. K. William, "Logarithmic Analog to Digital Converters," *Electronic Design*, Feb. 1, 1962, p. 36-41.
12. "The Logarithmic Capcoder," Internal Report, Towson Laboratories, Baltimore, Md., June 1964.
13. A. J. Rack, *Vernier Pulse Code Communication System*, U.S. Patent 2,530,538, Nov. 21, 1950.
14. W. M. Goodall, *Cathode Ray Coding Tube*, U.S. Patent 2,616,060, Oct. 28, 1952.
15. C. W. Hoover, *Beam Position System*, U.S. Patent 2,855,540, Oct. 7, 1958.
16. Hermann Schmid, "Electronic Analog Switches," *Electro-Technology*, June 1968, pp. 35-50.

Dale wirewounds can improve your memory.



The computer: General Electric's versatile GE/PAC[®] 4020 Process Control Computer...shown at left.

Resistor assignment: Establish line current values in the GE/PAC[®] 4020 core memory system.

The part used: Dale's Type NS...silicone coated, non-inductively wound.

Reason: Low inductance (less than 1 μ h) and unvarying stability (less than .5%/ 2000 hours).

Dale wirewounds give you unequalled design freedom in tailoring resistance, power, size and stability to your exact needs. Industrial.... precision.... established reliability.... standard or special....there's always a Dale resistor that can do the job better. Call 402-564-3131 for fast action, or circle 181 for Catalog A.



for optimum value in wirewound resistors

DALE ELECTRONICS, INC. 1300 28th Avenue, Columbus, Nebraska 68601

In Canada: Dale Electronics Canada, Ltd.

Printed in U.S.A.

Gard Testing is available to meet Established Reliability requirements at significant time/cost savings over typical 100 hr. burn in. Write for Test Report #19590.

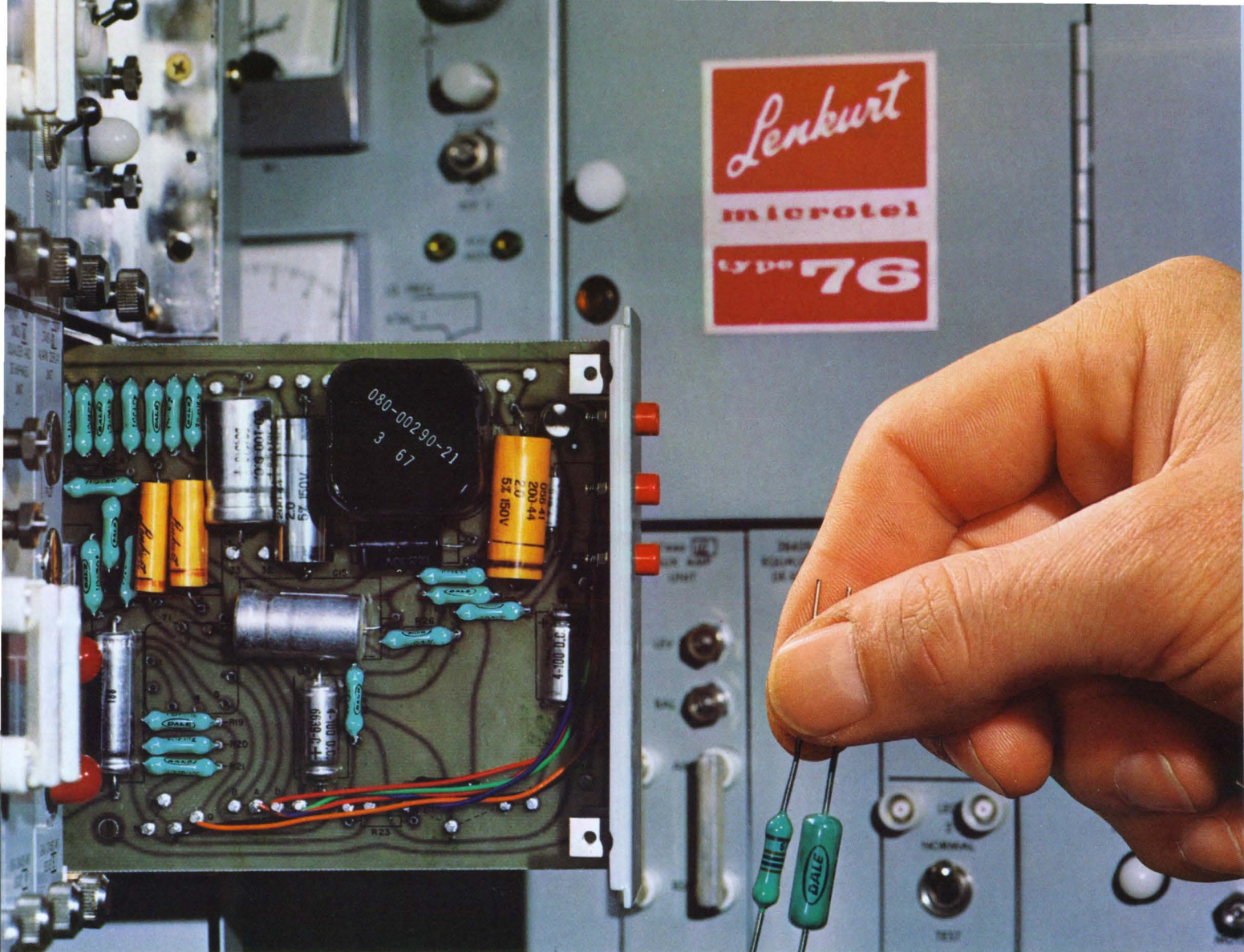

20 years of stability

...a job for DALE Metal Film Resistors

Twenty years—the design life of Lenkurt's versatile "76" Microwave Systems—puts stringent demands on a resistor. To meet them, Lenkurt uses Dale MFF Metal Film Resistors to maintain bias stability in critical amplification circuits. Their evaluation: "Good performance."

Here's how Dale multiplies the advantages of metal film for your application: **Broader design choice**—From subminiature 1/20 watt through 12 watts of housed power plus microresistive package and networks to your specification. **Proven failure rate**—See data at right. **Faster delivery**—Expanded production facilities let you call the shots on shipment of both MF and MFF types.

Call Dale today...402-564-3131 or circle 181 for complete Resistor Catalog A



for optimum value in metal film resistors

GENERAL SPECIFICATIONS TYPE MF* MIL-R-10509F				
DALE TYPE	MIL. TYPE	125° C RATING (Char. C & E)	70° C RATING (Char. D)	RESISTANCE RANGE (Ohms)
MF50	RN-50	1/20 w	1/10 w	30.1 to 80.6K
MF-1/10	RN-55	1/10 w	1/8 w	30.1 to 301K
MF-1/8	RN-60	1/8 w	1/4 w	10 to 1 MΩ
MF-1/4	RN-65	1/4 w	1/2 w	10 to 1 MΩ
MFS-1/2	RN-70	1/2 w	3/4 w	10 to 1.5 MΩ
MF-1	RN-75	1 w	—	25 to 2.6 MΩ
MF-2	RN-80	—	2 w†	100 to 10 MΩ

*Also available in conformal coated (MFF) and housed chassis mount (D) styles with power to 12 watts. †Char. B.
Tolerance: ±1%, ±.5%, ±.25%, ±.10% standard. Characteristics D, C, or E apply depending on T.C. required.
Proven Failure Rate: .004% per 1,000 hrs. (60% confidence at 50% power, 70° C ambient). Based on 16,320,000 hrs. of load life testing without a failure (100% rated power, 70° C, failure defined as ΔR > 1%).
Gard Testing is available to meet Established Reliability requirements at significant time/cost savings over typical 100 hr burn in. Write for Test Report #19590.

DALE ELECTRONICS, INC., 1300 28th Ave. Columbus, Nebraska 68601
 In Canada: Dale Electronics, Canada, Ltd.



The revolutionary PhotoSCR

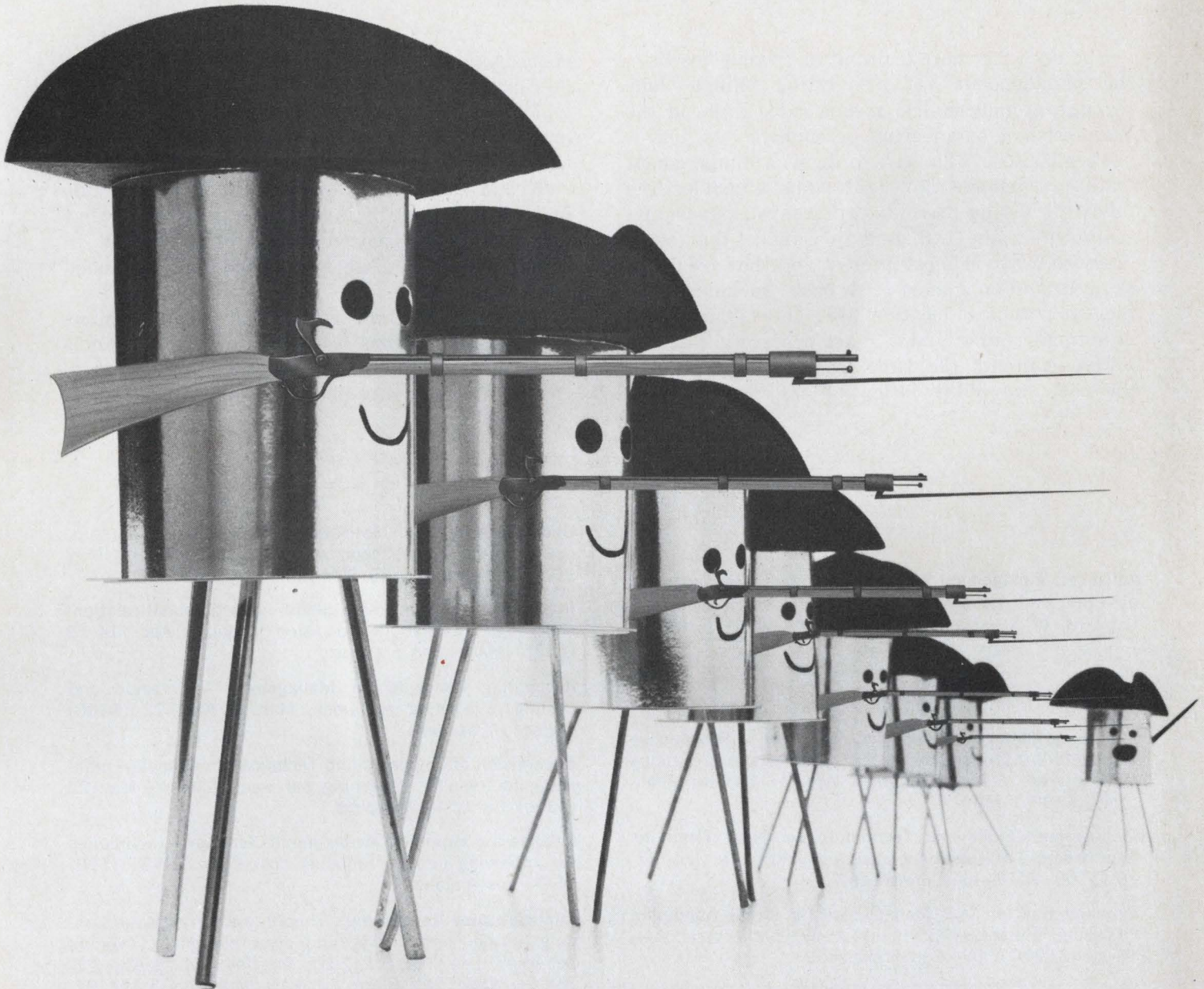

Will fire when it sees the whites of their eyes.

That much light is all the command this ultra-sensitive SCR needs to fire. Maximum light sensitivity is ten foot candles. Yet, its adherence to orders is so strict that you won't find a more stable device anywhere in the field. Even under charging currents that would overpower most other devices, it will hold its ground. Because its outputs are high, its gains are high, with peak currents up to one hundred times above those of other photosensitive semiconductors. You won't have to call in amplifiers for reinforcements. Watch how SSPI's Photo SCR performs when it sees action in tape and card readers, level controls, optional encoders, meter relays, and watt-hour meters. SSPI has started a revolution. A call to Howard Wasserman now could mobilize SSPI's standing army of PhotoSCR's to join forces with you.

SOLID STATE PRODUCTS **SSPI** DIVISION OF UNITRODE CORPORATION

One Pingree Street, Salem, Massachusetts 01970 / Tel. (617) 745-2900

Management training for engineers. Learn how to get things done through people. Take an after-hours or part-time course listed in this roundup.

The need for more training in "people" skills—the management art of getting things done through nonmechanical means rates high on the Want List of engineering personnel.

To aid those who seek to fit such management training sessions into tight work schedules, the following listing presents courses, workshops and seminars in the U.S. and in Canada that seem likely to prove of most interest and that are given at night and on a short-term basis. Included after the geographical location are: the name of the individual course and a short description of the course content; the time element involved and the cost; an abbreviation of the name of the

sponsoring institution or organization that must be contacted in order to register and the city in which the training will be conducted. The full name and address of each sponsoring organization is listed on page 120.

Within each state and for Canada as a whole, individual course listings range from those that give the most basic management training to those that offer more specialized and advanced instruction.

Listings cover 1969 winter and spring sessions only. No attempt has been made to evaluate individual course content. The editors of ELECTRONIC DESIGN welcome any pertinent additions. ■■

Arizona

Advanced Management Skills for Engineers—management of time and people. 1 evening per week, Jan.-Mar. (\$10) U. of A.—Tucson

California

Improving Managerial Skills for Your New or Prospective Managers—responsibility, authority, delegation, decision making. Feb. 5-7, Los Angeles; Apr. 16-18, San Francisco (\$190) AMA

Management Skills and Techniques for New, First-Line Supervisors—management tools and know-how. Jan. 27-29 (\$190) AMA—San Francisco

Fundamentals of R&D Management for Newly Appointed First-Line Managers—planning, motivation, control. Apr. 16-18 (\$190) AMA—San Francisco

How to Work Smarter Instead of Harder—techniques for getting ideas across, motivation. Mar. 11-12 (\$135) IEI—Los Angeles

Practicing Supervision—elements of management. 1 evening per week, Mar. 17-May 19 (\$300) Caltech—Pasadena

Personnel Aspects of Supervision—training, development, industrial relations. 1 evening per week, Mar. 19-May 21 (\$300) Caltech—Pasadena

Technical Writing and Editing—proposals, reports, correspondence. Mar. 31-Apr. 4 (\$275) UCLA—Los Angeles

Understanding and Motivating Employees—leadership, use of authority and control, results management. May 28, San Diego; May 29, Los Angeles (\$65) MCC

Improving Your Leadership Skills—interpersonal relationships, communications, decision making. Apr. 14-18 (\$325) AMA—San Francisco

Accounting Concepts for Management—allocation and costing. 1 evening per week, Mar. 20-May 22 (\$300) Caltech—Pasadena

Supervision of Engineers and Technical Personnel—managing for results. 1 evening per week, Mar. 20-May 22 (\$300) Caltech—Pasadena

Engineering Graphics Management Seminar—techniques for improving quality, reducing costs. Jan. 30-31 (\$90) USC—Los Angeles

Administrative Leadership, Theory and Practice—planning and decision making, employee relations. 1 evening per week. Feb. 3-Apr. 21, Los Angeles; Feb. 3-Apr. 21, San Fernando; Feb. 5-Apr. 23, Pasadena; Feb. 3-Apr. 21, Buena Park; Feb. 4-Apr. 22, Long Beach; Feb. 3-Apr. 21, Thousand Oaks; Feb. 3-Apr. 21, Lancaster; Feb. 3-Apr. 21, Hawthorne; Feb. 3-Apr. 21, Glendale; Feb. 3-Apr. 21, Oxnard. (\$140)—ASTD

Managing Management Time—Feb. 17-18; May 12-13 (\$200) Caltech—Pasadena

Developing and Installing Standards of Managerial Performance—Feb. 19-20; May 14-15 (\$200) Caltech—Pasadena

Management by Objectives and Results—Feb. 26-27; Apr. 29-30 (\$200) Caltech—Pasadena



"Engineers can fit management training into working schedules, at night or on a short-term basis."

Workshop—Advanced Techniques Management by Objectives and Results—Feb. 25 (\$200) Caltech-Pasadena

Management Information Systems—May 1-2 (\$200) Caltech—Pasadena

The Management Function in Research and Development—Mar. 2-7 (\$300) Caltech—Pasadena

Developing and Maintaining Effective Management—Apr. 20-25 (\$300) Caltech—Pasadena

Management Techniques for Technical Supervisors—May 18-23 (\$300) Caltech—Pasadena

Managerial Grid Seminar—team skills, intergroup relations. Mar. 16-21 (\$325) SMI—Los Angeles

Implementing Management by Objectives Workshop—job enlargement, staff and departmental coordination, planning and negotiations. Apr. 13-17 (\$300) INSTAD—Los Angeles

Management Information Systems—to bridge the communication gap between top management and the technical staff. Mar. 10-14 (\$475) RCAI—San Francisco

Engineering and Management Course—Mar. 24-29 (\$450) UCLA—Los Angeles

Methods of Instruction—development of instructional materials for industrial and government training. Mar. 14-18 (\$250) ETC—Los Angeles

Basic Systems and Procedures Course—systems management and operations. Jan. 27-31 (\$325) AMA—San Francisco

Estimating and Controlling Engineering Costs—factors effecting cost estimates and performance. Jan. 16, San Francisco; Jan. 17, Los Angeles (\$65) MCC

Fundamentals of Program and Project Management for Prime and Subcontractor Project Managers in Aircraft, Aerospace, Electronic and Missile Companies. Feb. 10-14 (\$325) AMA—Los Angeles

Executive Action Course—executive development and problem solving. 3 weeks, all-day duration, starting date Jan. 6 (\$1000) AMA—Carmel

Canada

Improving Managerial Skills for Your New or Prospective Managers—responsibility, authority, delegation decision making. Apr. 14-16 (\$190) AMA—Toronto, Ont.

Understanding and Motivating Employees—leadership, use of authority and control, results management. May 2, Toronto; May 8, Montreal (\$65) MCC

Perspective on Management—planning, organizing, decision making, innovating. May 11-16 (\$375) Queen's—Kingston, Ont.

Explorations in Management—concepts, business policy, decision making, industrial relations. May 25-June 7 (\$650) Queen's—Kingston, Ont.

Managerial Grid Seminar—team skills, intergroup relationships. Mar. 16-21 (\$325) SMI—Toronto, Ont.

Executive Action Course—executive development and problem solving. 3 weeks, all-day duration; starting date Apr. 21 (\$1000) AMA—Scarborough, Ont.

Connecticut

Management Concepts for Engineers and Scientists—modern organization, self development. Apr. 7-11 (\$150) RPI—Hartford

Management Development Program—financial, research and engineering management. Eight-week course, meets mornings every other week. Starts Jan. 13 (\$900) RPI—Hartford

Introduction to Technological Forecasting—workshop in trend analysis, mathematical models, nonlinear methods. Mar. 3-7 (\$150) RPI—Hartford

Corporate Long-Range Planning—concepts, steps, tools, resources, aids. Apr. 14-18 (\$150) RPI—Hartford

Advanced Workshop in Research and Engineering Management—project planning and controls, motivations, coordination. Feb. 24-28 (\$150) RPI—Hartford

District of Columbia

Understanding and Motivating Employees—leadership, use of authority and control, results management. Jan. 28 (\$65) MCC—Washington

Cost Effectiveness—management, control, planning. Feb. 3-7 (\$275) GWU—Washington

Management of Research and Development—management principles as applied to human factors in R & D. 1 evening per week, Jan. 27-Mar. 17 (\$175) GWU—Washington

Management of Research and Development—human factors, creativeness, cost controls, reports. Apr. 14-18 (\$275) GWU—Washington

Systems Analysis—systems and planning as applied to problems of management. 1 evening per week, Mar. 25-May 13 (\$175) GWU—Washington

PERT/Critical Path Scheduling and Network Analysis Techniques—fundamentals, application as a management tool. 1 evening per week, Jan. 23-Mar. 20 (\$175) GWU—Washington

Florida

Managerial Grid Seminar—team skills, intergroup relationships. Mar. 16-21 (\$325) SMI—Ft. Lauderdale

Georgia

Understanding and Motivating Employees—leadership, use of authority and control, results management. Jan. 29 (\$65) MCC—Atlanta

Talking and Working with People—predicting behavior, leadership style, motivation. Jan. 24 (\$65) MCC—Atlanta

Management for Engineers—fundamentals for the engineer being groomed to move up. Jan. 13-17; Apr. 7-11 (\$175) Ga. Tech—Atlanta

Management Dynamics and Effective Decision Making—planning, organizing, controlling. Mar. 3-7 (\$175) Ga. Tech—Atlanta

A Practical System for Managing by Objectives—performance measurement, motivation, creativity development. Mar. 1 (\$65) IEI—Atlanta

Project Management with CPM and PERT—network planning and scheduling. Feb. 24-28 (\$175) Ga. Tech—Atlanta

Managerial Economics—resource allocation, developing and evaluating proposals. Mar. 10-14 (\$175) Ga. Tech—Atlanta

Advanced Management Seminar—planning, organizing, communications. Jan. 12-17 (\$350) ESD—Pine Mountain

Statistical Analysis for Management—use of new formulas and technology. Jan. 20-24 (\$175) Ga. Tech—Atlanta

Cost Analysis for Management—costs as the implementing medium for decision making. Feb. 24-28 (\$175) Ga. Tech—Atlanta

Budgeting and Accounting for Industrial Managers—concepts of financial management for decision makers. May 26-30 (\$175) Ga. Tech—Atlanta

Creativity in Engineering—existing approaches and their application to practical problems. May 5-9 (\$150) Ga. Tech—Atlanta

Configuration Management—establishment and implementation of an effective program. Apr. 28-May 2 (\$175) Ga. Tech—Atlanta

Executive Action Course—executive development and problem solving. 3 weeks, all-day duration; Feb. 3 (\$1000) AMA—Pine Mountain

Illinois

Managing Your Time More Effectively—techniques and methods of saving time. Jan. 13 (\$65) IEI—Chicago

How to Work Smarter Instead of Harder—techniques for getting ideas across, motivation. Feb. 24-25 (\$135) IEI—Chicago

Improving Managerial Skills of Your New or Prospective Managers—responsibility, authority, delegation, decision making. Jan. 20-22, Mar. 17-19, May 14-16 (\$190) AMA—Chicago

A Practical System for Managing by Objectives—performance measurement, motivation, creativity development. Apr. 3 (\$65) IEI—Chicago

Managing and Measuring Engineering Effort—goals, staffing, controls. Jan. 29-31 (\$190) AMA—Chicago

Managing Research and Engineering in the Smaller Company—how to capitalize on the advantages, solve the unique problems. May 19-21 (\$190) AMA—Chicago

Managerial Grid Seminar—team skills, intergroup relationships. Jan. 19-24 (\$325) SMI—Chicago

Creating and Evaluating Research Projects—controls, work loads, performance evaluation. Jan. 27-29 (\$190) AMA—Chicago

Financial Management of Research and Development—scheduling, budgeting, accounting, controls, evaluation. Jan. 29-31 (\$190) AMA—Chicago

A learning resources directory

The Engineers Joint Council has developed a cross-indexed reference directory to continuing education opportunities that are available to engineers, scientists and managers.

In the new directory, "Learning Resources," to be issued three times a year, EJC compiles information on technical and nontechnical courses, seminars, workshops and other educational activities for engineers.

Information is drawn from colleges and universities, professional societies and trade associations, educational entrepreneurs and specialists, and from government and industry. Many of the listings on management training that appear on these pages have been excerpted from the first issue.

Annual subscriptions to "Learning Resources" are available on a single or a multiple basis; the latter include added services. Further information may be obtained from Learning Resources Information Center, Engineers Joint Council, 345 E. 47th St., New York, N.Y. 10017. For descriptive literature, Information Retrieval Number 250.

Basic Systems and Procedures Course—systems management and operation. Feb. 24-28 (\$325) AMA—Chicago

PERT and CPM Course—methodology of program evaluation techniques. Mar. 10-14 (\$325) AMA—Chicago

Kansas

Basic Principles of Supervision—administration, planning, controlling. Feb. 4-5 (\$25) U. of K.—Kansas City

Human Relations for Supervisors—motives, aptitudes, personality, leadership. Mar. 18-19 (\$25) U. of K.—Kansas City

Executive Leadership Techniques—problem solving, group direction, personal leadership. Feb. 10-12 (\$150) U. of K.—Shawnee Mission

Louisiana

Written Communications in Industry—planning and organizing letters, memos, reports. Mar. 14-15 (\$125) AICE—New Orleans

Management Science for Managers of Technical Activities—programming, analysis, planning, decision-making. May 12-16 (\$200) L.S.U.—Baton Rouge

Maryland

Introduction to EDP for Managers—systems principles, computer characteristics, management planning. Jan. 8-10 (\$210) CEIR—Silver Spring

Massachusetts

Managing Your Time More Effectively—techniques and method of saving time. Mar. 25 (\$65) IEI—Boston

Talking and Working with People—predicting behavior, leadership style, motivation. Jan. 20 (\$65) MCC—Boston

Understanding and Motivating Employees—leadership, use of authority and controls, results management. Mar. 20 (\$65) MCC—Boston

A Practical System for Managing by Objectives—performance measurements, motivation, creativity development. Jan. 29 (\$65) IEI—Boston

Michigan

Managing Your Time More Effectively—techniques and methods of saving time. Jan. 17 (\$65) IEI—Detroit

A Practical System for Managing by Objectives—performance measurement, motivation, creativity development. Apr. 1 (\$65) IEI—Detroit

New Frontiers of Management—dynamics, economics, decision-making, change. Feb. 9-14 (\$425) U. of M.—Ann Arbor

Missouri

Human Behavior in Industrial Situations—attitudes, testing and evaluation, counseling and interviewing. 1 evening per week, Feb.-June (\$115) Washington U.—St. Louis

Presentation of Technical Information—speeches, visual aid, technical presentation. 1 evening per week, Feb.-June (\$115) Washington U.—St. Louis

Scientific Decision Techniques—resource allocation, capital investment, project management. May 20-23 (on request) Washington U.—St. Louis

Economic Analysis for Engineering Executives—accounting, budgeting, and control of R & D. 1 evening per week, Feb.-June (\$115) Washington U.—St. Louis

Operations Research Models in Business and Industry—probability and games theory, programming, matrix operations. 1 evening per week, Feb.-June (\$115) Washington U.—St. Louis

Legal Problems for Scientists and Engineers—responsibilities in laboratory, manufacturing and consulting activities. Mar. 17-21 (price on request) Washington U.—St. Louis

New Jersey

Management Development Seminar—human factors in management, communications, leadership. 1 evening per week, Mar. 5-Apr. 23 (\$90) Rutgers—New Brunswick

Creative Problem Solving for Engineers—improvement of creative ability. 1 evening per week, Feb. 6-Apr. 10 (\$100) Rutgers—New Brunswick

Current Legal Practices for the Technical Manager—in management, finances, recruitment, patents. Feb. 17-19 (\$175) CPA—Hopatcong

New York

Understanding and Motivating Employees—leadership, use of authority and control, results management. Feb. 26 (\$65) MCC—New York City

How to Work Smarter Instead of Harder—techniques for getting ideas across, motivation. Jan. 20-21 (\$135) IEI—New York City

Managing Your Time More Effectively—techniques and methods of saving time. Mar. 24, Buffalo; Mar. 26, New York City (\$65) IEI

Talking and Working with People—predicting behavior, leadership style, motivation. Jan. 21 (\$65) MCC—New York City

Effective Engineering Writing—organizing and presenting materials. Mar. 24-27 (\$100) IEEE—New York City

Improving Managerial Skills for Your New or Prospective Managers—responsibility, authority, delegation, decision making. Jan. 15-17, Mar. 3-5, May 21-23 (\$190) AMA—New York City

New Techniques and Methodology for Improving Supervisory Performance—ways to achieve greater efficiency at lower cost. Feb. 12-14 (\$190) AMA—New York City

Organization Planning and Control—delegation and decision-making, line and staff relationships. Mar. 3-7 (\$325) AMA—New York City

Improving Your Leadership Skills—interpersonal relationships, communications, decision making. Mar. 3-7 (\$325) AMA—New York City

Fundamentals of R&D Management for Newly Appointed First-Line Managers—planning, motivation, control. Jan. 13-15, May 26-28 (\$190) AMA—New York City

First-Line Supervision of Scientists, Engineers and the Technical Staff—management and motivation. Mar. 10-14 (\$325) AMA—New York City

Fundamentals of Research and Engineering Management—planning to satisfy company requirements. Mar. 24-28 (\$325) AMA—New York City

Successful Engineering Management—organizing, negotiating, estimating and controlling costs. Feb. 3-4 (\$200) ICPD—New York City

Design Engineering Management—translation of prototypes into profitable products. Apr. 7-9 (\$190) AMA—New York City

A Practical System for Managing by Objectives—performance measurement, motivation, creativity development. Jan. 28 (\$65) IEI—New York City

Implementing Management by Objectives Workshop—job enlargement, staff and departmental coordination, planning and negotiations. May 18-22 (\$300) INSTAD—New York City

Management Information Systems—to bridge the communications gap between top management and the technical staff. May 12-15 (\$475) RCA—New York City

Managerial Grid Seminar—skills, intergroup relationships. Feb. 16-21 (\$325) SMI—Tarrytown

Creating and Evaluating Research Projects—goals, initiation, capacity, controls. Jan. 13-15 (\$190) AMA—New York City

Basic Systems and Procedures Course—systems management and operation. May 12-16 (\$325) AMA—New York City

Management Course—study of management as a profession. 4 weeks, all-day duration; starting dates Feb. 3, Mar. 3, Mar. 31 and Apr. 28 (\$950) AMA—New York City

Executive Action Course—executive development and problem solving. 3-weeks, all-day duration; starting date Mar. 3 (\$1000) AMA—Hamilton, N.Y.

Cope Training—development of sensitivity and adaptability in business contacts. 1 evening per week, Feb. 3-Mar. 17 (\$120) DAA—New York City

Utilizing the Techno-Economic Appraisal—profit-oriented decision making. Feb. 19-21 (\$190) AMA—New York City

Finding, Screening and Appraising New Products—analyzing needs, objectives and sources. Feb. 17-19 (\$190) AMA—New York City

Fundamentals of New Product Planning and Development—from product idea to production. May 5-9 (\$325) AMA—New York City

Fundamentals of Technical Planning—getting the money's worth out of R & D. Feb. 17-21 (\$325) AMA—New York City

Recruiting Experienced Engineers and Scientists—objectives, plans and procedures. Feb. 17-19 (\$190) AMA—New York City

North Carolina

Supervisory Development Seminar—effective organization and methods. Feb. 12-14 (\$75) N.C. State—Raleigh

How to Meet Every Engineering Deadline—budgets, estimates, schedules, manpower and money performance. Feb. 4-5 (\$100) N.C. State—Raleigh

Critical Path Methods—as used in planning, managing and controlling projects. Jan. 27-28 (\$70) N.C. State—Raleigh

Ohio

Managing Your Time Effectively—techniques and methods of saving time. Jan. 15 (\$65) IEI—Cleveland

Written Communications in Industry—planning and organizing letters, memos, reports. May 3-4 (\$125) AICE—Cleveland

A Practical System for Managing by Objectives—performance measurement, motivation, creativity development. Apr. 1 (\$65) IEI—Cleveland

Oregon

Managerial Grid Seminar—team skills, intergroup relationships. Jan. 26-31 (\$325) SMI—Portland

Pennsylvania

Talking and Working with People—predicting behavior, leadership style, motivation. Jan. 23 (\$65) MCC—Philadelphia

Basic Workshop for Supervisors—fundamentals of organization, communications, problem solving, decision making. Jan. 14-19, Philadelphia; Feb. 2-7, Beaver (\$150) Penn State

Oral Reporting in Business and Industry—preparation and delivery. 1 evening per week, Jan. 23-June 12 (\$120) Drexel—Philadelphia

Understanding and Motivating Employees—leadership, use of authority and control, results management. Feb. 27 (\$65) MCC—Philadelphia

Managing Your Time More Effectively—techniques and the methods of saving time. Mar. 19, Pittsburgh, Mar. 21, Philadelphia (\$65) IEI

Management Workshop for Middle Management Personnel—communications, leadership, employee training. May 11-16 (\$150) Penn State—Allentown

Tennessee

Management Development Seminar—new concepts, ideas and regulations in management. 1 evening per week, Jan. 20-Mar. 24 (\$75) U. of C.—Chattanooga

Texas

Understanding and Motivating Employees—leadership, use of authority and control, results management. Apr. 2, Dallas; Apr. 3, Houston. (\$65) MCC

Improving Managerial Skills for Your New or Prospective Managers—responsibility, authority, delegation, decision making. Feb. 5-7. (\$190) AMA—Dallas

A Practical System for Managing by Objectives—performance measurement, motivation, creativity development. Feb. 28 (\$65) IEI—Houston

Management Science for Engineering Managers—statistics, programming, systems, cost, industrial simulation. Mar. 31-Apr. 4 (\$500) U. of Texas—Austin

Management Information Systems—theory and encoding, decision risks, programming. Mar. 10-14 (\$500) U. of Texas—Austin

CPM/PERT—network theory, time-cost trade-off, computer vs. non-computer applications. Mar. 10-11 (\$100) U. of Texas—Austin

Managerial Grid Seminar—team skills, intergroup relationships. Mar. 2-7 (\$325) SMI—Dallas

Engineering Projects Investment Analysis—fund sources, depreciation, tax considerations, evaluation. Feb. 17-18 (\$100) U. of Texas—Austin

Basic Systems and Procedures Course—systems management and operation. Apr. 14-18 (\$325) AMA—Houston

Virginia

Managerial Grid Seminar—team skills, intergroup relationships. Mar. 9-14 (\$325) SMI—Alexandria

For more information . . . write or return Information Retrieval Card.

AICE—American Institute of Chemical Engineers; 345 E. 47th St., New York, N.Y. 10017 Information Retrieval Number **252**.

AMA—American Management Association; Registrar, 135 W. 50th St., New York, N.Y. 10020 (Fees shown are for non-members.) Information Retrieval Number **251**.

ASTD—American Society for Training and Development; P.O. Box 5307, Madison, Wis. 53705 Information Retrieval Number **253**.

ASTME—American Society of Tool and Manufacturing Engineers; Education Director, 20501 Ford Road, Dearborn, Mich. 48128 Information Retrieval Number **254**.

CALTECH—California Institute of Technology; Management Development Section, Industrial Relations Center, Pasadena, Calif. 91109 Information Retrieval Number **256**.

CEIR—C-E-I-R Institute for Advanced Technology; 5272 River Road, Washington, D.C. 20016 Information Retrieval Number **255**.

CPA—Center for Professional Advancement; P.O. Box 66, Hopatcong, N.J. 07843 Information Retrieval Number **257**.

DAA—Data Analysis Associates, 310 Madison Ave., New York, N.Y. 10017 Information Retrieval Number **258**.

DREXEL—Drexel Institute of Technology; Dean of Evening College, 32nd and Chestnut, Philadelphia, Pa. 19104 Information Retrieval Number **259**.

ETC—Education & Training Consultants Co.; 815 Moraga Drive, Los Angeles, Calif. 90049 Information Retrieval Number **260**.

GA. TECH—Georgia Institute of Technology; Department of Continuing Education, Atlanta, Ga. 30332 Information Retrieval Number **263**.

GWU—George Washington University; Coordinator of Continuing Engineering Education, School of Engineering & Applied Science, Washington, D.C. 20006 Information Retrieval Number **262**.

ICPD—International Center for Professional Development; Box 1-E, 235 E. 46th St., New York, N.Y. 10017 Information Retrieval Number **264**.

IEEE—Institute of Electrical & Electronics Engineers; 345 E. 47th St., New York, N.Y. 10017 Information Retrieval Number **265**.

IEI—Industrial Education Institute; Director of Operations, 221 Columbus Ave., Boston, Mass. 02116 Information Retrieval Number **266**.

INSTAD—Institute for Training and Development; Box 9650, Midtown Plaza Station, Rochester, N.Y. 14604 Information Retrieval Number **267**.

LSU—Louisiana State University; Associate Dean, College of Engineering, Baton Rouge, La. 70803 Information Retrieval Number **268**.

MCC—Management Center of Cambridge, P.O. Box 185, Harvard Square, Cambridge, Mass. 02138 Information Retrieval Number **269**.

N.C. STATE—North Carolina State University; Supervisor of Extended Education, School of Engineering, Raleigh, N.C. 27607 Information Retrieval Number **271**.

PENN STATE—Pennsylvania State University; Director of Continuing Education, J. Orvis Keller Building, University Park, Pa. 16802 Information Retrieval Number **272**.

QUEEN'S—Queen's University, School of Business, Kingston, Ont., Canada. Information Retrieval Number **273**.

RCAI—RCA Institutes; 49th. W, 45th St., New York, N.Y. 10036 Information Retrieval Number **274**.

RPI—Rensselaer Polytechnic Institute; Head of Special Programs, Hartford Graduate Center, E. Windsor Hill, Conn. 06028 Information Retrieval Number **276**.

RUTGERS—Rutgers State University; Director, Center for Continuing Engineering Studies, University Heights, New Brunswick, N.J. 08903 Information Retrieval Number **277**.

SMI—Scientific Methods, Inc., Box 195, Austin, Tex. Information Retrieval Number **278**.

UCLA—University of California at Los Angeles; University Extension, 10851 Le Conte Ave., Los Angeles, Calif. 90024 Information Retrieval Number **279**.

U OF A.—University of Arizona; Assistant to the Dean, College Of Engineering, Tucson, Ariz. Information Retrieval Number **280**.

U. OF C.—University of Chattanooga; Dean, Chattanooga College, Chattanooga, Tenn. 37403 Information Retrieval Number **281**.

U. OF K.—University of Kansas Extension; Registrar, The Kansas City Center, 39th & Rainbow Blvd., Kansas City, Kan. 61003 Information Retrieval Number **282**.

U. OF M.—University of Michigan; Programs Registrar, Bureau of Industrial Relations, Graduate School of Business Administration, 703 Haven St., Ann Arbor, Mich. 48104 Information Retrieval Number **283**.

USC—University of Southern California; Noncredit Program Coordinator, University Park, Los Angeles, Calif. 90007 Information Retrieval Number **284**.

U. OF TEXAS—University of Texas; Engineering Program Director, Room 153 Taylor Hall, Austin, Tex. 78712 Information Retrieval Number **285**.

WASHINGTON U.—Washington University; Director, Institute for Continuing Education in Engineering and Applied Science, St. Louis, Mo. 63130 Information Retrieval Number **286**.

missile engineers

Launch your new career at HUGHES Missile Systems Division.

The Missile Systems Division combines the technical and business functions associated with missile analysis, design, engineering, fabrication and checkout. Located at Canoga Park in Southern California on an 85-acre, campus-like complex, the new Division is responsible for all phases of missile development—from advanced conceptual studies through systems analysis, systems engineering, hardware design, prototype construction and testing of a wide variety of air-to-air, air-to-ground and tactical missiles. Current programs include Walleye, TOW, Maverick and Phoenix.

The Missile Systems Division now employs more than 1400 engineers, scientists, technicians and administrative personnel. New and expanding programs have created hundreds of openings for additional experienced people. Now is the ideal time to launch your new career with a dynamically expanding new organization.

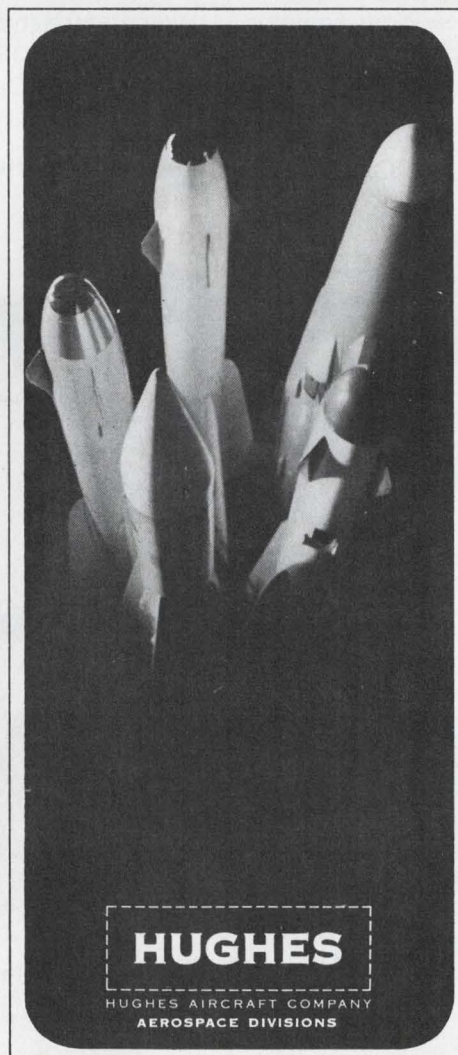

Some of our openings include:

Stress Analysts
Test Engineers
Systems Engineers
Preliminary Design Engineers
Guidance Systems Engineers
Circuit Design Engineers
Mechanical Product Design Engineers
Electronic Product Design Engineers
Aerodynamic Engineers
Servo Systems Design Engineers

Most assignments require accredited Engineering or Scientific degrees and applicable professional experience. Some openings are available for recent engineering graduates. U.S. citizenship is required.

For prompt consideration, please airmail your resume to:

Mr. Robert A. Martin
Head of Employment
Dept. 33
Hughes Aerospace Divisions
11940 W. Jefferson Blvd.,
Culver City, Calif. 90230

An equal opportunity employer

Logic Designers:

Help IBM develop large-scale data processing systems.

We need Logic Designers to develop the hardware for large-scale scientific systems, designed to solve complex problems having extremely large computational loads. Loads that are found in such areas as weather forecasting, radiation burst effects, or signal processing.

Imaginative new concepts.

Advanced concepts in system architecture are being explored to achieve exceptionally high data processing rates.

You would work on the design and development of systems hardware and its integration into the overall system.

If you qualify, you could get in on the ground floor of important advances in large-scale computation.

You should have an E.E. degree (or its equivalent) and two years' experience in large-scale scientific or commercial data processing systems, including logic design.

Grow with IBM.

This development program is just one of the many we have at IBM's Federal Systems Division, located near Washington, D.C.

For example, we are deeply involved with the manned space program. Working on systems to analyze delicate seismological disturbances. And designing many new real-time, on-line information systems.

It has been these kinds of advanced programs that have kept IBM a leader in the information processing industry.

Call or write.

Learn more details. Call Jim Dunn at (301) 921-7724 any weekday between 9 and 4.30. Or, if you prefer, send a brief letter or resume to him at IBM Corporation, Federal Systems Division Headquarters, Dept. CA1023, 18100 Frederick Pike, Gaithersburg, Maryland 20760.

An Equal Opportunity Employer

IBM



Free Career Inquiry Service

Absolutely Confidential

Respond to the career opportunities advertised in this issue. Fill out and send us this handy resume. **Electronic Design** will do the rest – neatly typed copies of this form will be mailed to the companies of your choice, indicated by the circled Career Inquiry Numbers at the bottom of this page.

1

Name		Home Phone	
Home Address (Street)		City	State
			ZIP Code
Age	U.S. Citizen	Security Clearance	
	<input type="checkbox"/> Yes <input type="checkbox"/> No		

Prime Experience	Secondary Experience

Desired Salary	Availability Date
-----------------------	--------------------------

Employment History – present and previous employers

Company	City, State	Dates	Title
		to	
		to	
		to	

Education – indicate major if degree is not self-explanatory

Degree	College	City, State	Dates
			to
			to
			to

Additional Training – non-degree, industry, military, etc.

Professional Societies

Published Articles

Career Inquiry Numbers:

900	901	902	903	904	905	906	907	908	909
910	911	912	913	914	915	916	917	918	919

ELECTRONIC DESIGN
850 Third Avenue
New York, New York 10022

Single SCR forms a simple, dual-polarity pulse generator

Only one silicon-controlled rectifier is needed to generate a pulser circuit that produces a positive and negative output pulse simultaneously. The amplitude of the two pulses may be varied merely by the choice of resistor values.

In this circuit, the SCR is initially in the OFF state and C is charged to the full supply voltage. The value of resistor R_h is such that less than the holding current will flow through the SCR when it is fired. Resistor R_k is used to stabilize the gate-to-cathode triggering point.

When a small positive pulse is placed on the gate terminal, G , the SCR switches to the conducting state. Capacitor C discharges through the now low-impedance SCR anode-to-cathode terminals, as well as through resistors R_p and R_n . With respect to ground, therefore, a positive pulse appears across R_p and a negative pulse across R_n . If $R_p = R_n$, these pulse amplitudes are virtually equal and are each one-half the supply level.

The pulses are also in synchronization with each other, and their time constant is determined by $C (R_p + R_n + R_{scr})$. Either pulse may be

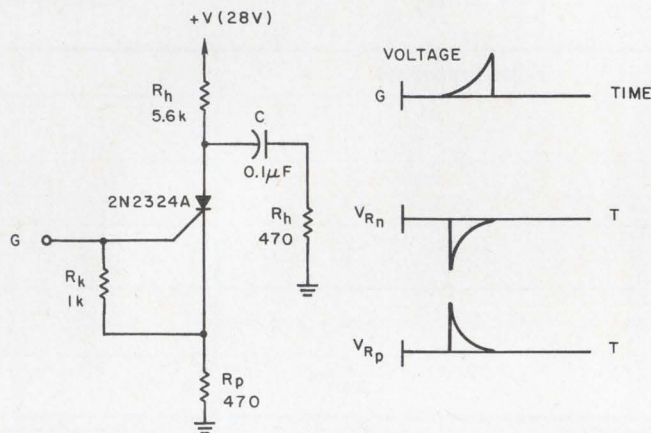

Opposite polarity pulses are developed across resistors R_n and R_p each time the SCR fires.

made larger or smaller by appropriate choice of the relative R_p and R_n values.

Component values shown on the diagram are for equal-amplitude pulses, 50 μ s wide.

A. Steuer, Electronics Consultant, Rego Park, N.Y.

VOTE FOR 311

IC op amp simplifies design of crystal-controlled oscillator

In the design of a crystal-controlled oscillator, various parameters of the crystal itself significantly affect the design and performance of the oscillator. These effects can be controlled easily if an integrated circuit operational amplifier is used in the oscillator.

The use of an IC operational amplifier allows the designer to control the power dissipation of the crystal by the selection of a resistor. It allows him to control and eliminate the spurious modes of oscillation with the selection of a single capacitor. And it allows him to match, by selection of specific temperature-coefficient components, the crystal impedance characteristics, so that wide-temperature operation can be obtained.

In a design of this type, the maximum crystal, series-resonant impedance at the desired frequency, as well as the series impedance of the spurious frequencies, must be known. For wide-temperature operation the temperature coefficient of this impedance must also be known.

The crystal (Fig. 1) may be replaced by a resistor for design purposes, since it has zero phase shift at the resonant frequency. The criterion for oscillation is that the equation, also shown in Fig. 1, be satisfied. If R_2 and R_3 are the same value, then it is only necessary to make the resonant impedance of the parallel combination of R_1 and C_1 slightly greater than the series-resonant impedance of the crystal.

The selection criteria for each component are as follows:

- Resistor R_3 is chosen so that the maximum allowed power dissipation of the crystal is not exceeded.
- Resistor R_2 is usually chosen to equal resistor R_3 . The important thing is that the ratios of R_1 to R_2 and crystal impedance to R_3 are maintained.
- Resistor R_1 is chosen so that the parallel combination of R_1 and C_1 results in an impedance that is greater than the crystal impedance.
- C_1 is chosen in this particular configuration

The endless line

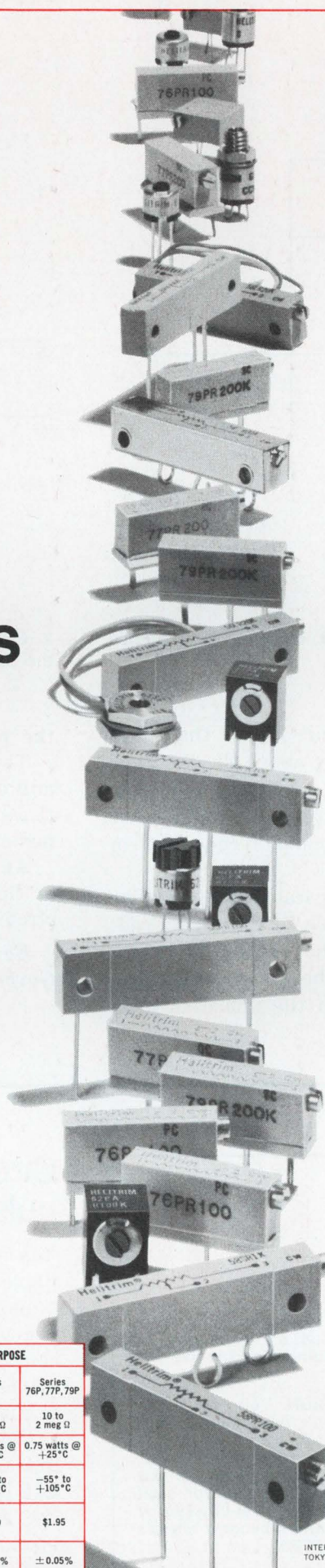

It's a complete line – an endless line of Helitrim® cermet trimming potentiometers with a current field failure rate of only 0.08%.

And all have essentially infinite resolution. Plus a wide range of standard resistance values. And excellent setting and total resistance stability under a wide range of environmental extremes. Helipot stocks almost 2 million trimmers in a wide range of models and values at 13 stocking locations. All to fit your every need—whatever it is. To fit your budget—list prices from \$1.75. And to assure you immediate delivery—anywhere in the U.S. and in Canada.

For more details on “the endless line” of cermet trimmers, contact your local Helipot sales representative. He'll tell you all about cermet reliability, fill you in with all available test data and personally handle your Helitrim orders.

	MILITARY			HIGH TEMP.	GENERAL PURPOSE		
	Series 55, 56, 58 (RJ11 & RJ12)	Series 61 (RJ50)	Series 63 (RJ24)	Series 50	Series 62	Series 78	Series 76P, 77P, 79P
Resistance Range	10 to 2 meg Ω	10 to 1 meg Ω	10 to 2 meg Ω	10 to 2 meg Ω	10 to 1 meg Ω	10 to 2 meg Ω	10 to 2 meg Ω
Power Rating	1 watt @ +85°C	0.5 watts @ +85°C	0.5 watts @ +85°C	1.5 watts @ +125°C	0.5 watts @ +70°C	0.75 watts @ +70°C	0.75 watts @ +25°C
Operating Temperature Range	-65° to +175°C	-65° to +150°C	-65° to +150°C	-65° to +200°C	-25° to +125°C	-25° to +125°C	-55° to +105°C
Price (List 1 to 9)	\$5.50	\$5.50 (61P) \$6.50 (all others)	\$6.50	\$8.00 (50) \$7.50 (53, 54)	\$1.75 (62P) \$2.00 (62PF) \$2.50 (all others)	\$3.00	\$1.95
Typical Setting Ability	±0.01%	±0.05%	±0.01%	±0.01%	±0.05%	±0.05%	±0.05%

Beckman

INSTRUMENTS, INC.
HELIPOT DIVISION
FULLERTON, CALIFORNIA • 92634

INTERNATIONAL SUBSIDIARIES: GENEVA; MUNICH; GLENROTHES, SCOTLAND; TOKYO; PARIS; CAPE TOWN; LONDON; MEXICO CITY; STOCKHOLM; VIENNA

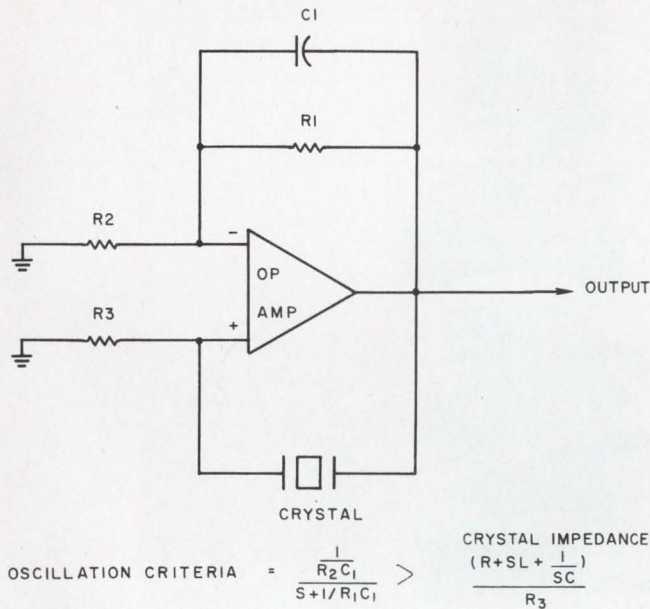

1. IC op amp serves as active element in a simple crystal-controlled oscillator.

so that the gain of the circuit is less than 1 at the closest spurious frequency above the designed frequency. Therefore C_1 is a control over the higher spurs. A capacitor across R_2 would serve as a control over lower spurious frequencies in the same manner.

By making resistor R_1 adjustable, the designer gives the circuit some degree of frequency adjustment. This is due to the ability to "pull" the crystal by controlling the point where the gain exceeds 1 in relation to the phase shift in

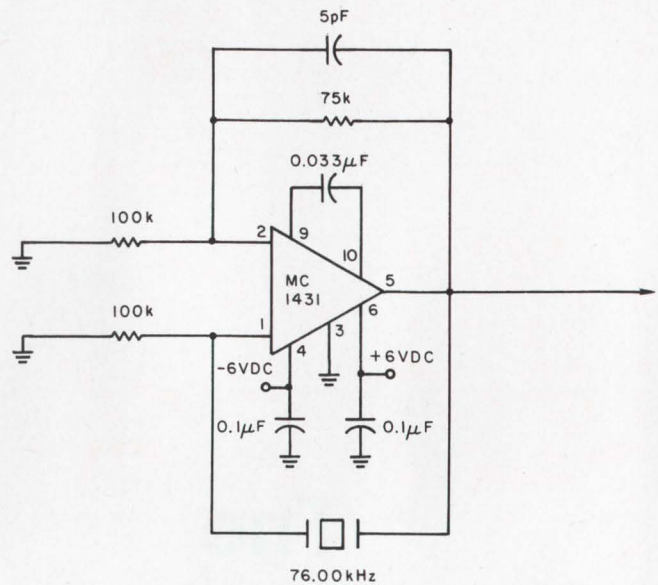

2. Clock generator for logic circuits can be adapted from the basic crystal-controlled oscillator circuit of Fig. 1.

the positive feedback loop.

The temperature coefficients of the resistors and capacitors can be selected so that the ratios track when temperature causes the crystal impedance to change.

An example of a crystal-controlled oscillator of this type, used as a clock generator for logic circuits, is shown in Fig. 2.

Earl F. Carlow, Design Engineer, Motorola, Government Electronics Div., Scottsdale, Ariz.

VOTE FOR 312

VOTE

VOTE! Go through all Idea-for-Design entries, select the best, and circle the appropriate number on the Reader-Service-Card.

SEND US YOUR IDEAS FOR DESIGN. You may win a grand total of \$1050 (cash)! Here's how. Submit your IFD describing a new or important circuit or design technique, the clever use of a new component or test equipment, packaging tips, cost-saving ideas to our Ideas-for-Design editor. You will receive \$20 for each accepted idea, \$30 more if it is voted best-of-issue by our readers. The best-of-issue winners become eligible for the Idea Of the Year award of \$1000.

Circuit provides IC trigger pulses on contact closure

A simple unijunction circuit can provide a reliable trigger pulse for a variety of the RTL economy microcircuit flip-flops. The circuit shown was designed for an application where flip-flop counter chains were to be triggered by manual or cam-operated microswitches, with their consequent contact-bounce problem.

Operation of the circuit is as follows: The unijunction transistor is provided with an inductive load and damping diode ($L1, D1$) to provide the required fast fall-time. When switch $S1$ is open, the emitter voltage of $Q1$ is just $0.5 V_{bb}$, and $Q1$ does not fire. Capacitor C_1 is charged to



DMM (Digital Multimeter)

GR's new 1820 Digital Voltmeter is far more than just another DVM . . . it's really a new breed of digital multimeter. Why? Because with it you can measure:

ac volts, 200 mV to 200 V, up to 1.5 GHz
ac volts, 10 μ V to 200 V, up to 2 MHz
dc volts, 5 μ V to 1000 V
dc current to picoamperes
ac current to nanoamperes
resistance, milliohms to 50 M Ω

Only two plug-ins are required to make all these measurements, but you certainly don't need both to have a very useful multifunction instrument. Which plug-in you select depends basically upon whether your need is for ultra sensitivity (1 μ V) or ultrahigh frequency (1.5 GHz). Compare this broad capability with that of an ordinary DVM.

There's much more. Voltage measurements can be read out directly in either volts or dB. Do you know of any other DVM that does this? High input impedance on all ranges, at least 100,000 megohms or 1000 megohms depending on plug-in, virtually eliminates voltmeter loading errors and ensures a true 0.1% measurement because there's no input attenuator to get in the way. The high input impedance also permits direct-reading resistance measurements to 50 M Ω . Since the ranges and polarity are automatically selected and no external

preamp is needed, a wide variety of voltage measurements can be made rapidly without manual switching or any fussing. This autoranging feature combined with BCD output also permits rapid printout of data that's always measured on the most appropriate range. The 1820-P2 plug-in provides six ranges each for voltage and current, and its picoampere resolution allows the measurement of leakage current in capacitors and semiconductors.

DC Multimeter/UHF Voltmeter (1820 with 1820-P1 Plug-in)

DC Voltage

± 220.0 mV full scale to ± 220.0 V full scale;
 ± 1000 V with attenuator. Measures to 0.1 mV on last digit.

AC Voltage

2.200 V full scale to 220.0 V full scale; 1000 V with attenuator; above 200 MHz, max voltage varies inversely with frequency. Resolution is 1 mV on last digit. Operates as peak voltmeter calibrated to read rms value of sine wave or 0.707 of peak value of a complex wave. Frequency response down 3 dB at 10 Hz and 1.5 GHz.

Log Voltage Function

AC: 6 to 62 dB (re 100 mV).

Resistance

0.220 k Ω full scale to 50 M Ω full scale
(8 overlapping ranges).

AC/DC Millivoltmeter (1820 with 1820-P2 Plug-in)

AC/DC Voltage

2.200 mV full scale to 220.0 V full scale;

1000 V with attenuator. Resolution is 1 μ V on last digit.

Log Voltage Function

60 to 122 dB (re 100 μ V).

Current

DC: 2.200 nA full scale to 220.0 μ A full scale; resolution is to 1 pA on last digit (with 1-M Ω internal shunt); 2.200 μ A full scale to 2.200 mA full scale (with 1-k Ω internal shunt). AC current can be measured with Tektronix clip-on current probe.

Resistance

2.200 Ω full scale to 22 M Ω full scale
(10 overlapping ranges).

Prices in U.S.A.

1820-A only, \$1985; 1820-P1 Plug-in, \$525;
1820-P2 Plug-in, \$550.

Also available . . . 1820-P3 Differential Adaptor (\$90) can be added to either plug-in to convert the 1820 to a fully-balanced differential voltmeter with better than 100-dB common-mode rejection.

For complete information, write General Radio Company, West Concord, Massachusetts 01781; telephone (617) 369-4400. In Europe: Postfach 124, CH 8034 Zurich 34, Switzerland.

GENERAL RADIO

INFORMATION RETRIEVAL NUMBER 40

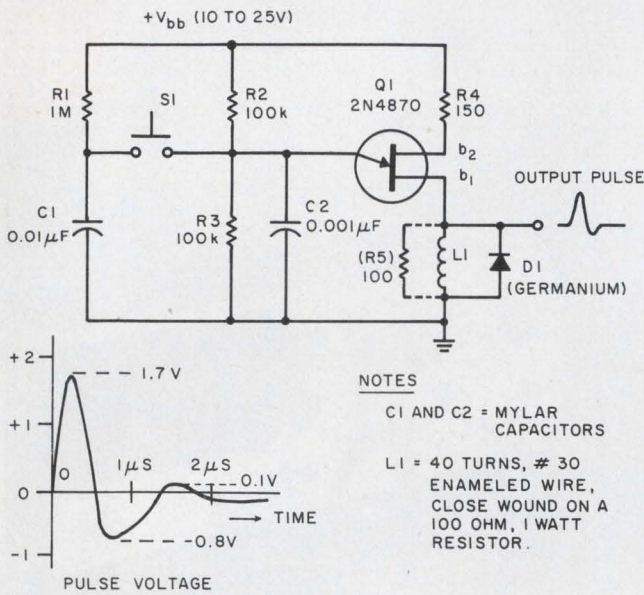

One output pulse is produced by the unijunction for each closure of switch S1.

V_{bb} . When S1 is closed, C_1 raises the emitter of Q1 to the firing point, and both C_1 and C_2 discharge into L_1 . If S1 is held closed, the emitter voltage rises to only about $0.6 V_{bb}$, and no additional firings of Q1 can occur.

For unijunctions with lower values of intrinsic standoff ratios, R_1 and/or R_2 can be increased in order to guarantee only one output pulse per switch closure. With the values shown, the switching rate can be somewhat higher than 25 cycles per second (or 20 ms on time). Typical RTL modules can be triggered by this circuit with V_{bb} values from 10 to 25 V.

The output pulse waveform delivered by the circuit is shown in the illustration. The pulse amplitude is about 1.7 V, at a 15-V supply voltage, and its duration (at the baseline) is $0.5 \mu s$.

Emerson M. Hoyt, Senior Systems Engineer, Industrial Systems Operation, Philco-Ford Corp., Dearborn, Mich.

VOTE FOR 313

Unusual astable multivibrator generates unusual waveforms

Extremely linear triangular waveforms can be generated by an astable multivibrator circuit that uses pnpn four-layer diodes and field-effect current generators. In the circuit, CR1 and CR2 are the field-effect current generators, and CR3 and CR4 are four-layer Shockley diodes.

CR1 and CR2 charge capacitor C in alternating directions with a constant current, I, and CR3 and CR4 establish the negative resistance necessary for oscillation.

Basically the operating cycle is as follows: Assume CR3 has just switched to the ON state. When CR3 turns ON, CR4 is turned OFF by coupling capacitor C. The capacitor then charges through CR2 until the firing point of CR4 is reached. When CR4 turns ON, CR3 is turned OFF and the process then repeats.

The time for one-half cycle can be computed from

$$T = 2C (V_{(BR)F} - V_F) / I,$$

where

$V_{(BR)F}$ = forward breakover-voltage of the four-layer diode

V_F = forward voltage of the four-layer diode in the ON state

and I = current generated by the field-effect device.

For the four-layer diodes and current generators shown in the illustration, nominal parameter values are

$$V_{(BR)F} = 11 \text{ V}$$

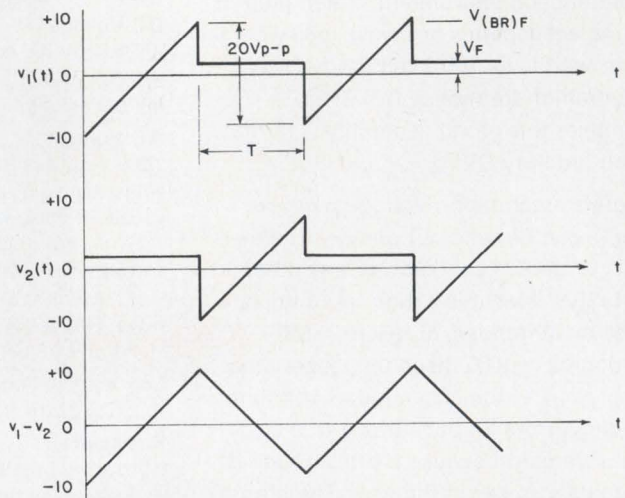
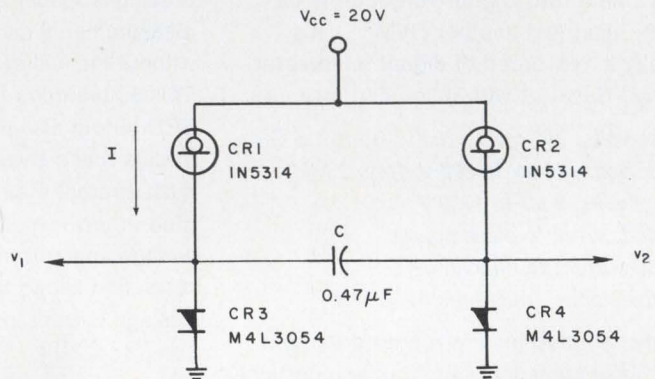

Unusual multivibrator is made from four-layer diodes, current generators and a single capacitor.

RF SILICON POWER TRANSISTORS

NOW...
from **Soliton**

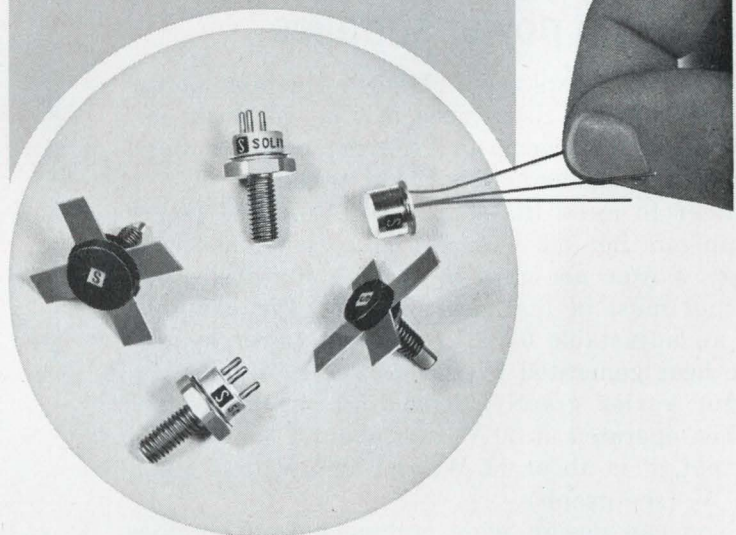

RF power transistors are NOW immediately available from Soliton in TO-5, TO-60 and plastic stripline cases. These high reliability silicon devices include the popular 2N3375, 2N3632, 2N4440, 2N5090 and 2N5108. The operating frequency is 100MHz to 1.0GHz, power ratings from 13.5W @ 175 MHz to 1.0W @ 1.0 GHz.

Typical applications include Class A, B and C RF amplifiers, telemetry systems, mobile and airborne communications equipment, commercial and high reliability communications equipment, CATV operations and as RF power oscillators.

THE RF KITS SHOWN ON RIGHT ARE AVAILABLE FOR 175 MHz and 400 MHz OPERATION:

Dial 1-800-327-3243 for a "No Charge" telephone call and further information.

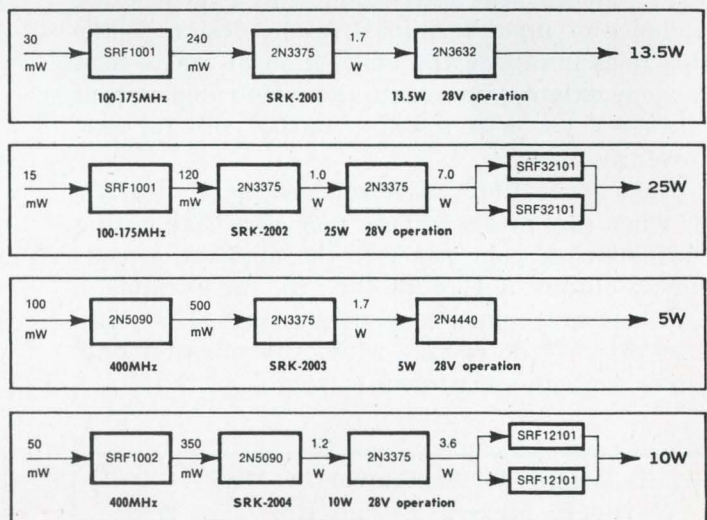

SEMICONDUCTOR DIVISION
Soliton **DEVICES, INC.**
1177 BLUE HERON BLVD. / RIVIERA BEACH, FLORIDA / TWX: (510) 952-6676

INFORMATION RETRIEVAL NUMBER 41

$$V_F = 1 \text{ V}$$

$$I = 4.7 \text{ mA.}$$

With $C = 0.47 \mu\text{F}$, a value of $T = 2.0 \text{ ms}$ is then realized.

Due to the constant-current feature of the charging devices, the supply voltage can be varied over a wide range without significantly changing the frequency.

Resistors can, of course, be substituted for $CR1$ and $CR2$, although with a sacrifice in linearity of the waveform. In this case the half-period

can be calculated as

$$T = RC \ln \frac{V_{CC} - 2V_F + V_{(BR)F}}{V_{CC} - V_{(BR)F}}$$

Applications for the circuit include sweep circuits and other waveform generation systems. An attractive feature for certain applications is the differential output, which is a perfect triangular wave (see waveforms).

Dennis R. Morgan, Electrical Engineer, General Electric Co., Syracuse, N. Y.

VOTE FOR 314

Avoid unnecessary heat in picking power supplies

Many designers use a voltage-adjustable power supply when it isn't needed. The result is unnecessary heat generated by the power supply, which can damage other components.

Bear in mind that the ac/dc regulated power supply is not efficient, since the portion of the input power not used to furnish the desired dc output must be dissipated as heat. For example, in an adjustable 0-30 V, 400-mA power supply, the heat generated by the series regulator transistor varies greatly, depending on the output. When operated at 30 V, it is about 4 W. At 15 V output, it is about 11 W, and at 5 V it is about 15 W (see graph).

You can generate wide voltage output supplies with reduced heat generation if you incorporate a choice of input terminals in the design. While this does minimize the generation of waste heat to some extent, you negate the wide-range output feature if you wire a 0-30 V output unit for narrower voltages.

Heat generation can be reduced more effectively when the power supply has a voltage rating that matches your need. If the application calls for an output of 15 V at 400 mA, for example, a "slot" power supply should be specified. ("Slot" here means a dc voltage with provisions for only minor voltage adjustment—usually $\pm 1 \text{ V}$).

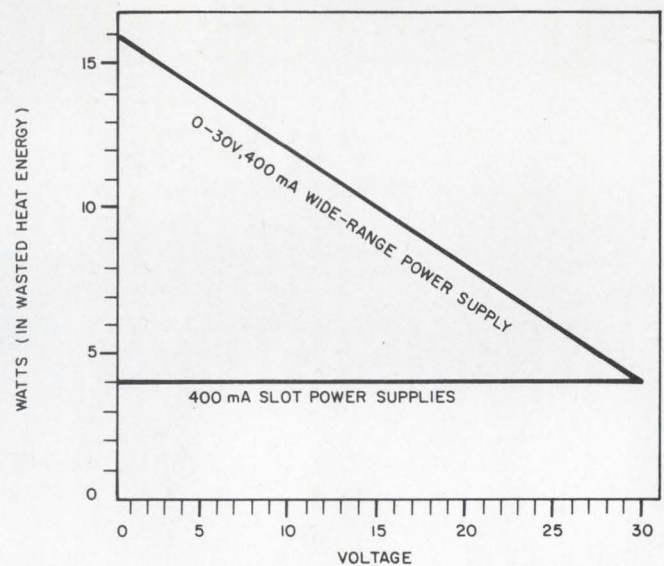

Unused output-voltage capability in a wide-range power supply results in unwanted heat energy.

The slot power supply runs cooler, since more of the input power goes into output power. A slot power supply rated at 400 mA, for example, will dissipate about 4 W of heat regardless of output voltage. This wattage is less than half that dissipated when a 0-30 V, 400-mA supply is used at 15 V.

J. Volk, Acopian Corp., Easton, Pa.

VOTE FOR 315

IFD Winner for September 12, 1968

Wayne H. Meyers, Design Engineer, Westinghouse Electric Co., Semiconductor Div., Youngwood, Pa. His Idea "Build a 117-V ac source from a 12-V battery" has been voted the most Valuable of Issue Award.

Vote for the Best Idea in this Issue.

IFD Winner for September 26, 1968

I. Lecis, Design Engineer, Monash University, Clayton, Victoria, Australia. His Idea "Decade counter uses no decoding matrix" has been voted the most Valuable of Issue Award.

Vote for the Best Idea in this Issue.

Pick the
BEST IC
for the job

Problem: Four DC to 30 kHz signals from high impedance sources must be summed into a $2k\Omega$, 100 pF load. The output is to be a guaranteed minimum ± 12 volts over the full frequency and military temperature range. The logical choice would be a Radiation RA-909. But amplifier offset current drift must not exceed $2 \text{ nA}/^\circ\text{C}$. Pick the Best IC for the job.

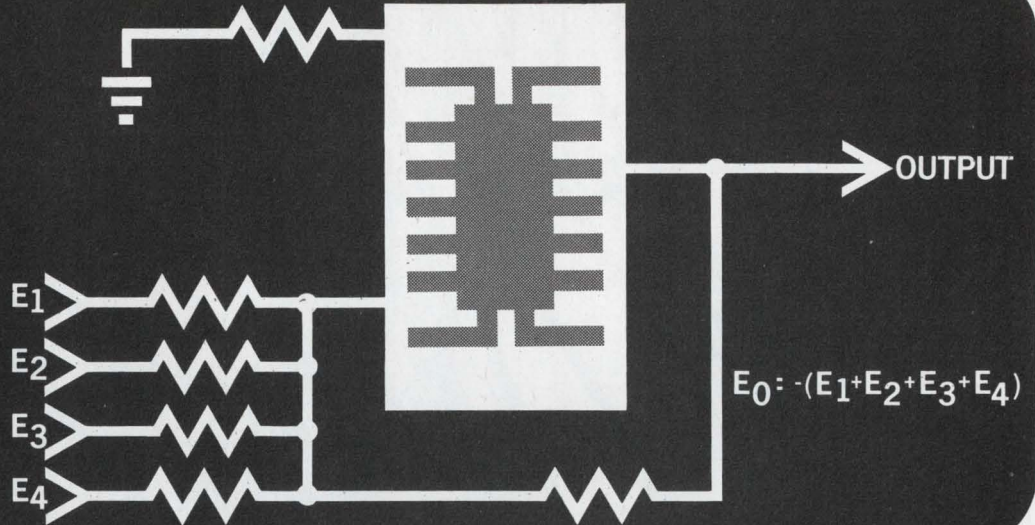

the **BEST** Solution:

THE NEW RA-909A COMPENSATIONLESS OPERATIONAL AMPLIFIER

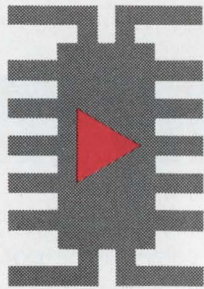

Drift error is very low in the new dielectrically isolated compensationless RA-909A. Between -55°C and $+25^\circ\text{C}$ offset current drift is a low $2 \text{ nA}/^\circ\text{C}$. From $+25^\circ\text{C}$ to $+125^\circ\text{C}$... an even lower $0.5 \text{ nA}/^\circ\text{C}$! And Radiation guarantees less than $15 \mu\text{V}/^\circ\text{C}$ offset voltage drift over the military temperature range. Compare this performance with any 709 type op amp over this extremely wide operating frequency range. You'll pick the Best op amp for the job. The RA-909A.

Like the RA-909, no external compensation is needed. Dielectric isolation and good circuit design eliminates the need for compensation. The RA-909A is in both a TO-99 package and a TO-86 flatpack configuration. A direct replacement for 709 type op amps.

Contact your nearest Radiation sales office. Let us help you pick the Best IC for the job.

WE MAKE THE **BEST** IC FOR THE JOB

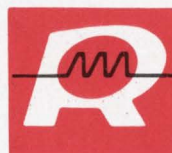

RADIATION
INCORPORATED
SUBSIDIARY OF HARRIS-INTERTYPE CORPORATION
MICROELECTRONICS DIVISION

RADIATION SALES OFFICES: P.O. Box 476, Lexington, Mass. 02173, (617) 682-1055 • 600 Old Country Road, Garden City, N.Y. 11530, (516) 747-3730 • 2600 Virginia Avenue N.W., Washington, D.C. 20037, (202) 337-4914 • 6151 W. Century Boulevard, Los Angeles, California 90045, (213) 670-5432 • P.O. Box 37, Melbourne, Florida 32901, (305) 727-5430 • International Sales: Marketing Department, P.O. Box 37, Melbourne, Florida 32901, (305) 727-5412

INFORMATION RETRIEVAL NUMBER 42



Our economy model

It's our 8B Series. Made to Winchester standards of quality and reliability—but at an easy-on-the-pocketbook commercial price.

Frankly, you'd look long and hard for a better buy than our 8B Series connectors for computers, memory systems, process control systems—or just about any industrial or commercial application.

We offer them in single and double row termination. You have a choice of eight different contacts—with from six to thirty positions. And contacts are removable. Easily. With a simple hand tool. Polarizing pins are available, too.

Let us send you the facts about how the Winchester 8B Series gives you more for your money. Isn't that a nice thought? Write: Winchester Electronics, Main St. and Hillside Ave., Oakville, Connecticut 06779.

WINCHESTER ELECTRONICS 
LITTON INDUSTRIES

The "MINI" power supply with the "MINI" price. \$124

SINGLE OUTPUT, 1/4 RACK

3 Models with ranges up to 0-50V plus:

- Three-range voltmeter
- Dual-range ammeter
- Coarse/fine voltage adjust
(3, 5, 7 mv resolution)
- Master slave series/parallel
- Adjustable current regulation
- Mil-T-27A grade transformers
- All-silicon construction
- Dual-tracking outputs



Model	Voltage	Current	Resolution	Weight	Size (Inches)	Price (4)
LVC10-2	0-10V	0-2A	3 mv	11 lbs.	4¾ (H) 4 (W) 12 (D)	\$124.00
LVC20-1	0-20V	0-1A	5 mv			
LVC50-.5	0-50V	0-.5A	7 mv			
2LVC10-2	0-10V Dual (1)	0-2A Dual	3 mv	22 lbs.	4¾ (H) 8¼ (W) 12 (D)	\$248.00
	0-20V (2)	0-2A				
	0-10V (3)	0-4A				
2LVC20-1	0-20V Dual (1)	0-1A Dual	5 mv	22 lbs.	4¾ (H) 8¼ (W) 12 (D)	\$248.00
	0-40V (2)	0-1A				
	0-20V (3)	0-2A				
2LVC50-.5	0-50V Dual (1)	0-.5A Dual	7 mv	22 lbs.	4¾ (H) 8¼ (W) 12 (D)	\$248.00
	0-100V (2)	0-.5A				
	0-50V (3)	0-1A				

(1) Dual outputs consist of (2) separate isolated power supplies.
 (2) Series outputs by connecting units in series.
 (3) Parallel outputs by connecting outputs and single master unit.
 (4) Effective Sept. 1, 1968.

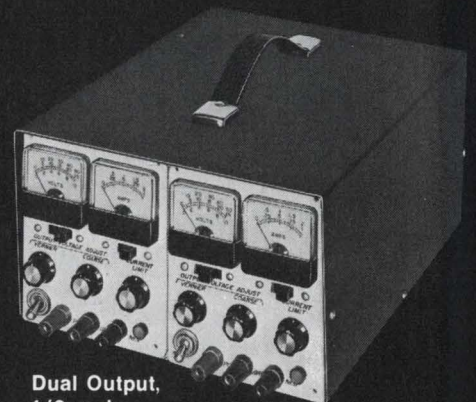

Dual Output,
1/2 rack,
\$248.

IMMEDIATE DELIVERY • 10 YEAR WARRANTY

Write for new catalog.

NJE CORPORATION
Electronic Development & Manufacturing

Kenilworth, New Jersey 07033 / (201) 272-6000

TELEFAX: FFP • TWX: (710) 996-5967

A subsidiary of  Corporation

HYBRID POWER

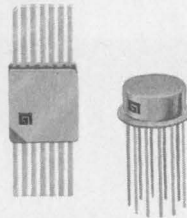

General Instrument, the “#1 Power” in hybrid microcircuitry adds the NC/PC-260 Hybrid Power Amplifier to the industry’s original and broadest line of hybrid ICs. The NC/PC-260 does more and costs less* than any other hybrid power amplifier.

The NC/PC-260 Hybrid Linear/Pulse Power Amplifier is a complementary symmetrical current amplifier exhibiting exceptional linearity in the entire output voltage range without crossover distortions; power efficiency approaching theoretical maximum; high output current; high input impedance; low output impedance and wide bandwidth. This unique combination of performance characteristics is made possible by the V_{BE} pairing and thermal feedback of the four transistors which keep the bias current constant, thereby preventing thermal runaway.

The NC/PC-260s are designed for use as linear, T^2L , and MOS buffers. They are immediately available from your authorized General Instrument distributor in TO-5 (NC-260) and $\frac{3}{8}$ " square flat packs (PC-260).

TYPICAL CIRCUIT PERFORMANCE RATINGS:

$V_{CC} = V_{EE} = 12V$, $R_L = R_S = 1K$
 $T_{OP} = -55^\circ C$ to $+125^\circ C$

Voltage Gain	0.99
Bandwidth (3 dB), $R_S = 100\Omega$, $V_{IN} = 1V_{PP,DC}$ to	40 MHz
Input Resistance	1 M Ω
Output Impedance	12 Ω
Total Harmonic Distortion $V_{in}(1-5 V_{rms})$	0.2 %
Power Efficiency ($R_L = 240\Omega$, 18V _{PP} Swing)	53%

*at quantities 1-24, NC-260 @ \$17.50 ea.; PC-260 @ \$20.30 ea.

Write for complete information. (In Europe, to General Instrument Europe S.P.A., Piazza Amendola 9, 20149 Milano, Italy.)



GENERAL INSTRUMENT CORPORATION • 600 WEST JOHN STREET, HICKSVILLE, L. I., NEW YORK

Interface accidents are on the rise.
And maybe we can help.

We've set up a new department
at Hughes. Our R F Sub-Systems
Department.

We did it to develop microwave
generation and amplification equipment
that can be integrated into transmitters
without incident.

To overcome the perils of interface.
Our winning ways with tubes
have led to several microwave packages
guaranteed to be "face-free."

Like the 10 mW multi-channel

crystal controlled solid-state source and
the 20 W medium power CW TWTA
package below.

Designs are available which cover
the power range from milliwatts to

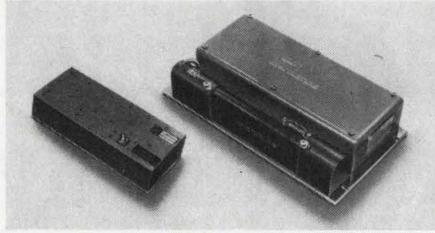

kilowatts. Frequency ranges from L through
Ku-band.

We specialize in such diverse fields
as low noise sources, space environment
TWT's, pulsed and CW TWT's,
solid-state power converters and
modulators, and special cooling methods
involving air, liquid and heat pipe
techniques.

Tell us your specifics. We believe
in saving face.

Write Electron Dynamics Division
of Hughes, 3100 West Lomita Boulevard,
Torrance, California 90509.

A word of caution to microwave engineers.

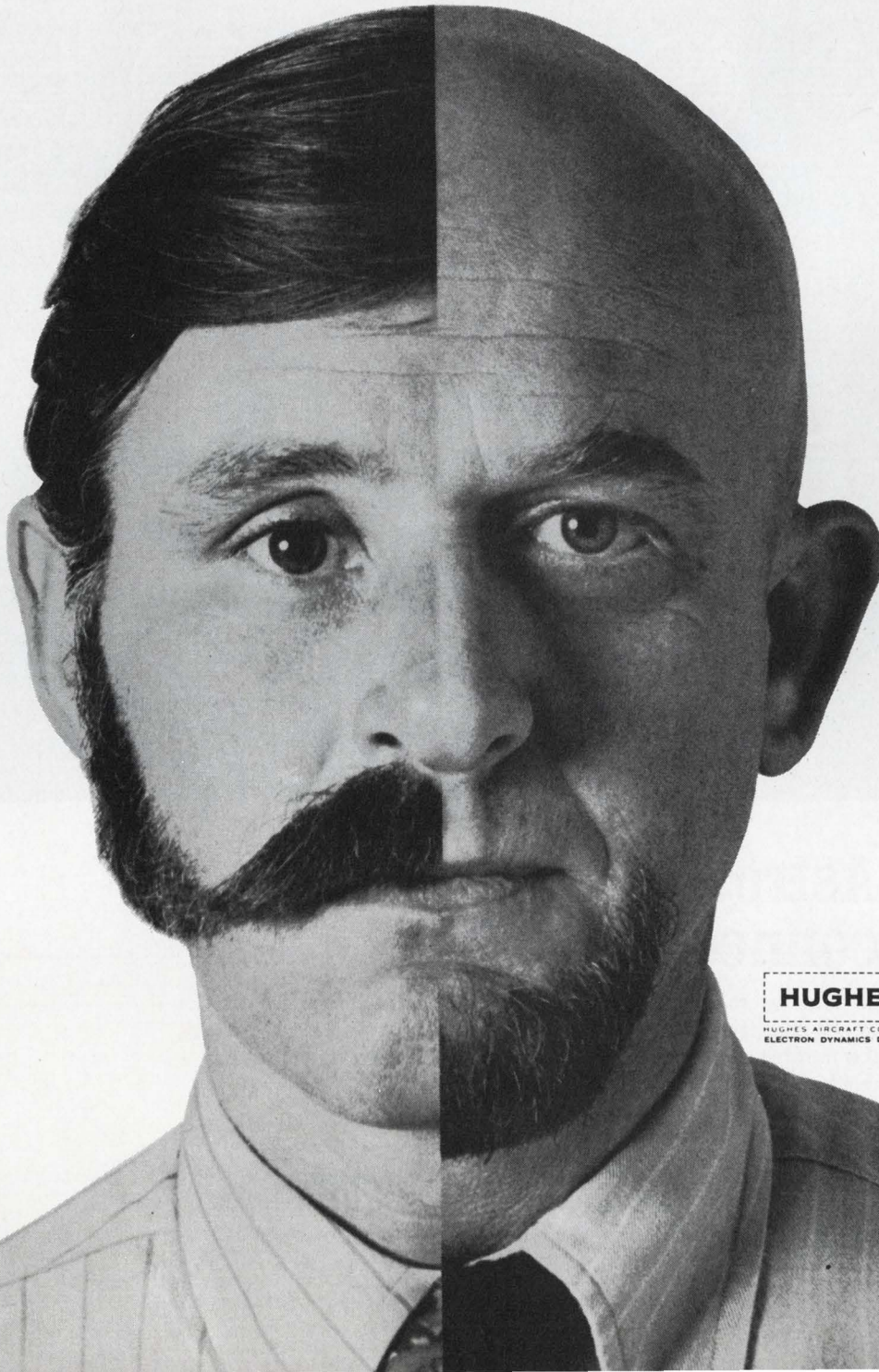

HUGHES
HUGHES AIRCRAFT COMPANY
ELECTRON DYNAMICS DIVISION

Meet the standard connector family for the next decade

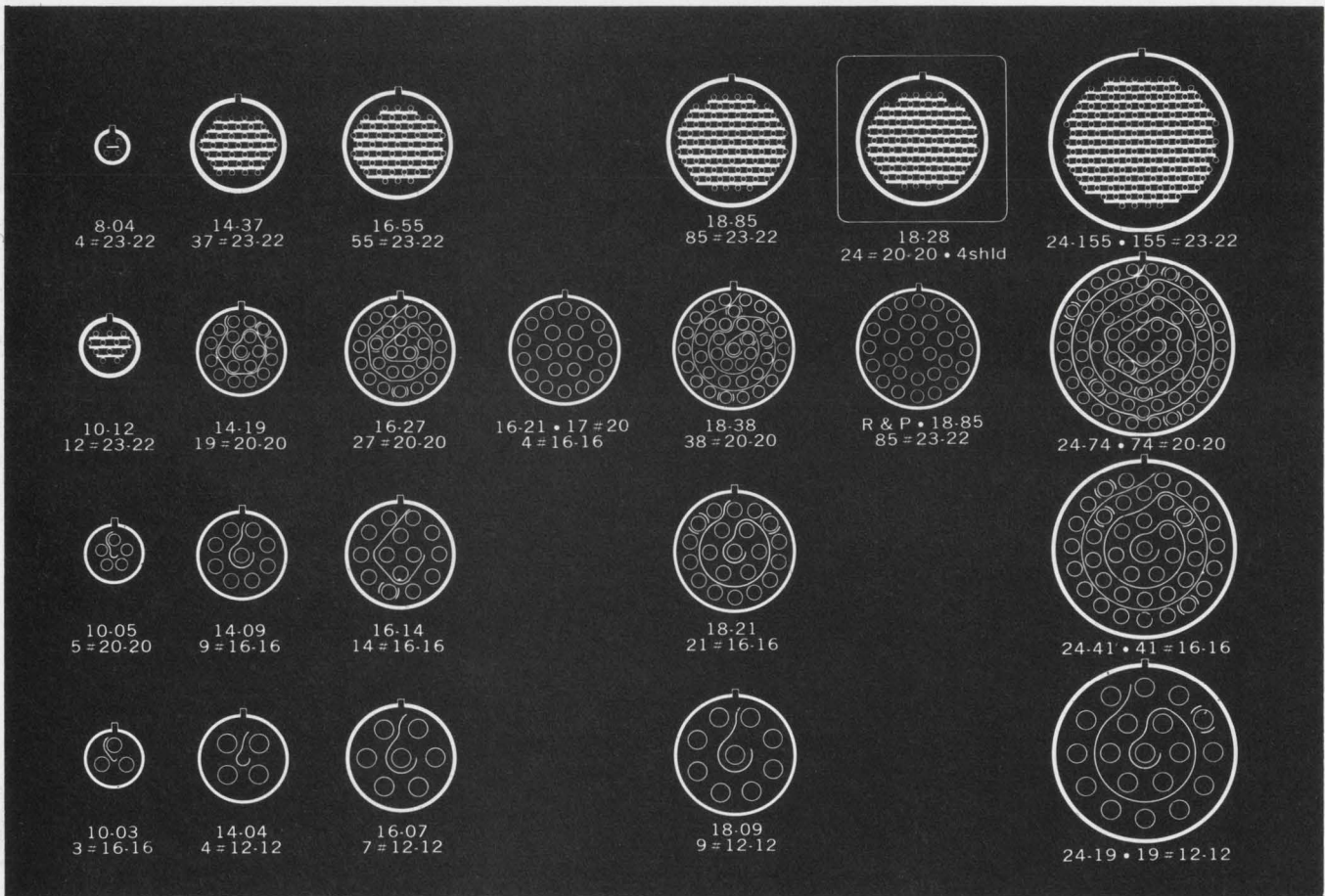

Astro/348[®] high-density connectors to MIL-C-81511

20-page insert tells the whole story—For complete details, refer to our 20-page insert in this issue. If the insert is missing, circle the number shown on this page on the reader service card and we'll send you a copy.



AMPHENOL

THE BUNKER-RAMO CORPORATION

Products

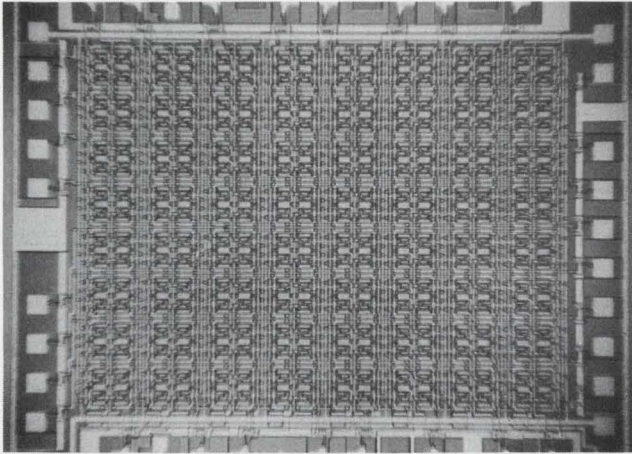

Monolithic random-access memory, a thick-oxide MOS IC, stores 256 words. P. 146

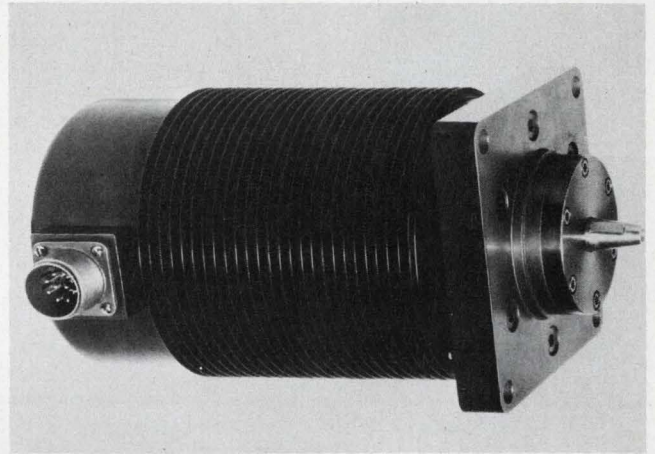

Digital stepping motor simplifies interface problems in numerical control. P. 162

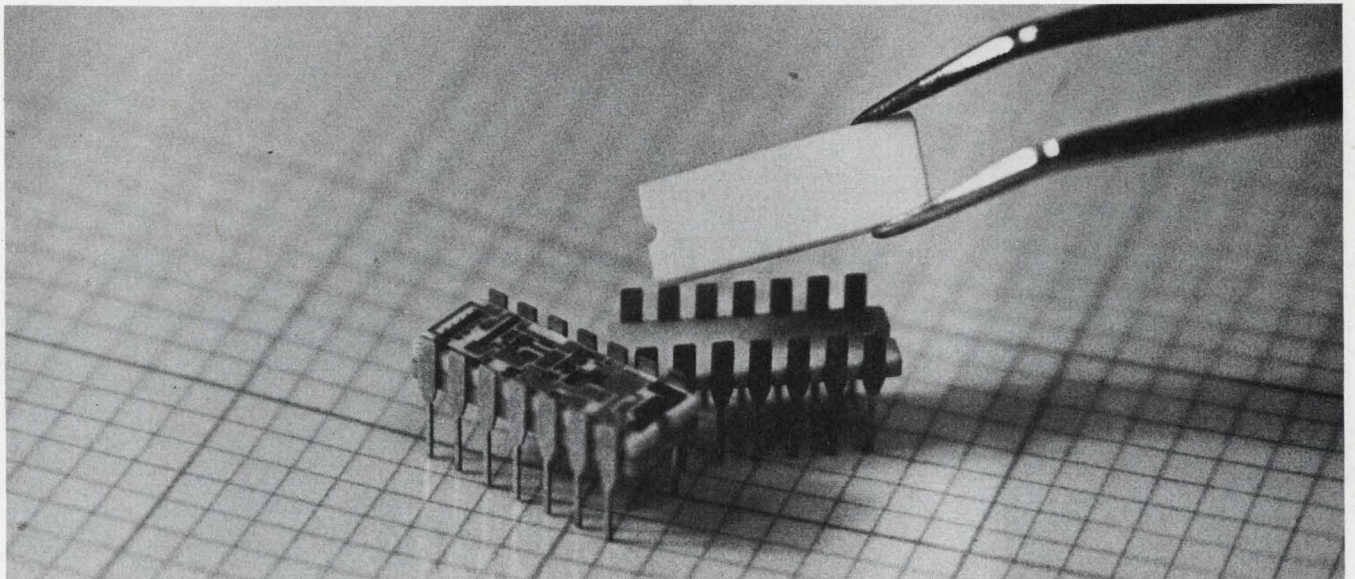

New hybrid package brings dual-in-line convenience to thick-film circuits. Two-piece

construction permits attachment of brazed lead frames before circuit mounting. P. 170

Also in this section:

Function generator delivers 3 simultaneous outputs over 5-MHz range. Page 134

LSI random-access memory with 285 gates features 25-ns write time. Page 149

Compact high-voltage supplies use encased modular circuit blocks. Page 178

Design Aids, Page 194 . . . **Application Notes**, Page 196 . . . **New Literature**, Page 198

Low-energy dosimeter monitors radiation



Bendix Corp., Scientific Instruments Div., 3625 Hauck Rd., Cincinnati. Phone: (513) 772-1600.

Gamma and X-rays in the energy range between 30 and 225 KeV can be measured with a low-energy dosimeter. It contains a quartz fiber electrometer and a compound microscope. When the user looks through the eyepiece toward a light, the fiber image appears as a hairline on a graduated scale.

CIRCLE NO. 287

Three pulse generators use ac or batteries

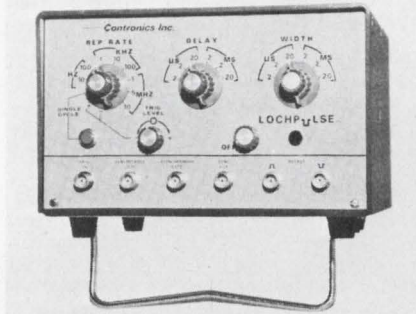

Contronics, Inc., 1061 Terra Bella Ave., Mountain View, Calif. Phone: (415) 969-0793. Price: \$310.

Ac-and-battery-operated pulse generators, designated the CPG 200 series, were designed for use with integrated circuits or field situations. The CPG 200 series currently has three models; all are easily portable and make extensive use of ICs. The repetition rate for the series is 1 Hz to 10 MHz in 8 ranges, with pulse width variable for 50 ns to 20 ms in 6 ranges.

CIRCLE NO. 288

Function generator spans 5-MHz range



Philips Electronic Instruments, 750 S. Fulton Ave., Mt. Vernon, N.Y. Phone: (914) 664-4500. P&A: \$550; stock.

Offering three simultaneous, fixed-amplitude waveform outputs over seven frequency ranges—from 0.0005 Hz to 5 kHz—an all-solid-state function generator has a fourth output that can be switched to provide any of three waveforms with adjustable amplitude and a dc reference level. Open circuit pk-pk amplitudes are: square wave, 20 V; triangle, 10 V; sinewave, 6 V.

CIRCLE NO. 289

Digital panel meter monitors ac voltage



Data Technology Corp., 1050 E. Meadow Circle, Palo Alto, Calif. Phone: (415) 964-2600. P&A: \$275; 30 days.

The DT342, an ac digital panel meter, is available in three ranges: 0 to 750 V rms, 200 V rms, and 20 V rms. The case is constructed of cycloc plastic and the unit is hermetically sealed. Accuracy is 0.2% ±2 digits on the two highest ranges and 0.5% on the 2-to-20-V scale. Frequency response is 45 Hz to 10 kHz and input impedance 1 MΩ.

CIRCLE NO. 290

Low-cost oscilloscope displays 10 MHz band



Leader Instruments Corp., 24-20 Jackson Ave., L.I.C., N.Y. Phone: (212) 729-7411. P&A: \$199; stock.

Model LBO-52B is a 5-in. oscilloscope with a bandwidth of dc to 10 MHz that features hybrid circuitry. The 10 mV/cm sensitivity is suitable for examination of low-level signals, such as tuners and i-f amplifiers.

CIRCLE NO. 291

Digital test probe checks pulse polarity

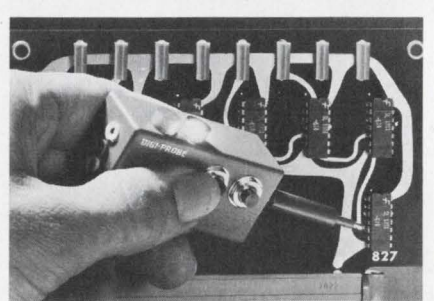

Pulse Monitors, Inc. Moorestown, N.J. Phone: (215) 735-0814. P&A: \$89; stock.

The presence and polarity of pulses in digital circuits can be determined with a hand-held test probe. Model 1210 uses integrated circuits and operates from a 5-V, 75-mA source. It can also be connected directly to the power leads of the digital circuits under test. A red and green indicator light in the probe allows engineers to troubleshoot their circuits quickly.

CIRCLE NO. 292



TRANS-SYLVANIA

The unbeatable charm and excitement of San Francisco is but one of the fringe benefits of Sylvania. You can enjoy this city of old-world charm and its way of life just minutes away from where you work. And what better way to get there than on The King's Highway, El Camino Real.

There's a Sylvania way of life, as well. It involves living and working in pleasant Mountain View (site of our laboratory facilities), or the resort city of Santa Cruz (site of our manufacturing facilities), or making your home in one of the many delightful communities in between. Today in this area there are

over 4100 families enjoying the Sylvania way of life.

Let us tell you about Sylvania and what we have to offer the qualified engineer. Your inquiry will receive confidential consideration including our "Trans-Sylvania" kit. This kit tells you in detail, and in full color, just what Sylvania has to offer you and your family. Sylvania's newly chartered Electro-Optics Organization currently has openings for:

SYSTEMS ENGINEERS/PHYSICISTS

Managers — Provide technical leadership to systems engineers in the laser electro-optical systems or LLLTV fields.

Requires BS in Electrical Engineering or Physics, MS or PhD preferred.

Engineers — EW Systems Analysis, Mechanical Design and EO Systems and Components Design.

EQUIPMENT DESIGN

Managers — Responsible for organizing, directing and participating in the design and development of a variety of electronic equipment for use in electro-optical systems. BSEE required, MSEE preferred. Must have recent experience directly applicable to LLLTV camera design.

Engineers — Electrical, Optical and Mechanical.

Sylvania is an equal opportunity employer.

SYLVANIA
A SUBSIDIARY OF
GENERAL TELEPHONE & ELECTRONICS

Please address your inquiry to: Ernest Olson, P.O. Box 188-1E, Mountain View, Calif.

step up!



to perfect performance

—with Bodine fhp motors and D.C. Motor Controls Now...precise control of speed, torque and power for every fractional horsepower need. Motor controls perfectly matched to characteristics of Bodine's NSH line of D.C. shunt-wound motors. Or, for just reliable fractional horsepower, Bodine motors available in over 3,500 standard catalogued specifications. Plus numerous specials. Virtually any type, size or rating: 1.45 milli-hp. to ¼ hp., torques from 0.18 oz.-in. to 350 lb.-in., speeds from 0.6 to 10,000 rpm. Also more than 330 stock types and sizes. Write for Bulletin. Bodine Electric Company, 2500 W. Bradley Place, Chicago, Illinois 60618.

Power/controls for office machines
■ machine tools ■ electronic equipment
■ electrical control devices
■ medical apparatus ■ communications equipment
■ data processing equipment ■ laboratory equipment
■ recording instruments
■ inspection and testing equipment
■ musical instruments ■ scientific apparatus ■ many other applications.

Bodine Motors Wear Out—It Just Takes Longer



BODINE MOTORS/CONTROLS

INFORMATION RETRIEVAL NUMBER 49



Wheelock QUALIFIES...

Again...

Lunar Excursion
Module ALSEP

And Again...

Nimbus Satellite

INSTRUMENTATION

Low-cost oscilloscope
is usable at 50 MHz

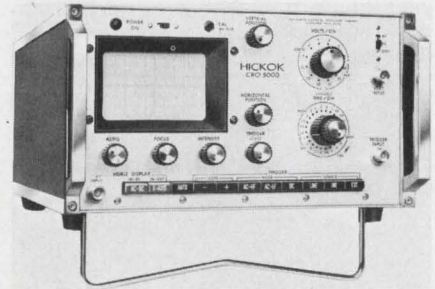

Hickok Electrical Instrument Co.,
10514 Dupont Ave., Cleveland.
Phone: (216) 541-8060. P&A:
\$650; stock.

Featuring all-solid-state design and 25-MHz bandwidth, the CRO 5000 oscilloscope is usable to 50 MHz. A built-in vertical delay line permits viewing of the leading edge of pulse displays when triggered internally. Vertical sensitivity is adjustable in 12 steps.

CIRCLE NO. 293

Low-cost VOM
has FET input

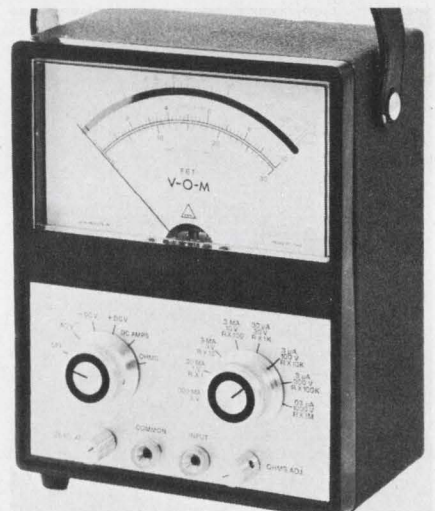

Delta Products, Inc., P.O. Box
1147, Grand Junction, Colo. Phone:
(303) 242-9000. Price: \$74.95
(\$59.95, kit).

Model 3000 FET-VOM is an efficient instrument that is priced at \$100 less than instruments of comparable sensitivity and performance. The portable meter weighs 3-3/4 lb and has a carrying strap. Accuracy is $\pm 2\%$ of full scale (8 ranges) for both dc volts and amperes, $\pm 3\%$ for ac volts.

CIRCLE NO. 294

Here are Three Good Reasons Why...

ULTRA MINIATURE REED RELAY



Series 442

- Smallest multi-pole relays in industry (1-4 poles Form A)
- PC Board Mount
- Operates on 90 mw
- Contacts rated at a full 7 watts
- Occupies 0.055 cu. in. per pole

MINIATURE REED RELAY

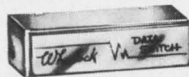

Series 262

- Meets crystal can relay standards for shock & vibration
- Single pole unit weighs only .2 oz.
- Coil ratings: 125 to 600 mw
- Contact rating: 10 watts
- Coil voltages: 6 to 48 VDC

STANDARD REED RELAYS



Series 3002

- 100% tested
- Coil ratings: 60 to 1500 mw
- Contact ratings: to 50 watts inductive
- Operating time: 2 ms (typical)
- Coil voltages: 6 to 120 VDC

Wheelock

WHEELOCK SIGNALS, INC.
273 Branchport Avenue
Long Branch, N. J.
(201) 222-6880

INFORMATION RETRIEVAL NUMBER 50

Small wonder:



**Our new "4th generation"
12.5 MHz universal counter/timer**
Wonderful versatility.
Wonderful small package.
Wonderful small price.

With the new Model 100A you can measure average frequency, frequency ratio, single period or time interval, or count total events. It has a crystal-controlled clock, Monsanto integrated circuit construction, and built-in compatibility with a rapidly growing assemblage of accessory modules.

With its \$575 price tag, FOB West Caldwell, New Jersey, you can have big-league counter/timer performance at costs never before possible. Small wonder we are selling and delivering Model 100A's just as fast as we can build them. Accessory modules are also comparably modestly priced.

For a demonstration of our "Small Wonder," the Model 100A universal counter/timer, or for full technical details call your local Monsanto Field Engineer, or contact us directly at: Monsanto Company, Electronic Instruments, West Caldwell, New Jersey 07006, (201) 228-3800.

Monsanto

**Reliability is a spring, a wheel
and two thingamajigs.**

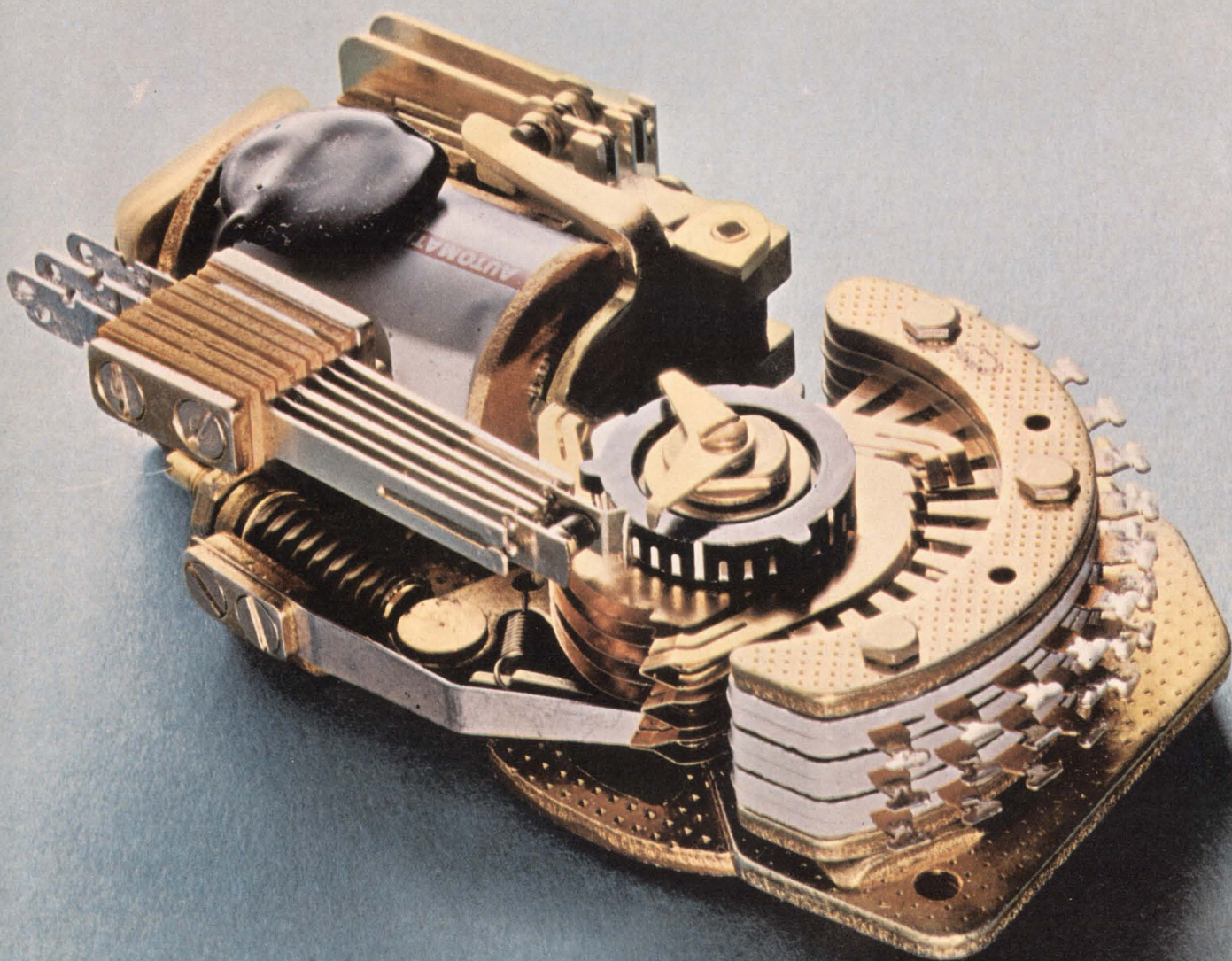



Every AE Type 44 stepping switch comes with them.

One-spring power.

The drive spring is a coil. What it does is store up power. When it comes time to switch, the spring lets loose and moves the wiper assembly forward. Each time using precisely the same pressure.

Notice our spring is tapered at one end. It's designed to perfectly match the power input. That's why you always get the best possible transfer of energy.

At one end of the drive spring is an adjusting screw. We turn it a little this way or a little that way and the tension is always perfect.

Try that with a flat spring.

We re-invented the wheel.

The ratchet wheel is a little different. The way it's made, for one thing. First, we blank it. Next, shave it. And finally, case-harden it. Then it's super strong.

Notice the big, square teeth that always provide a sure bite.

A thingamajig with teeth.

That thingamajig next to the wheel is the armature assembly. When the teeth on the end of it mesh with the teeth on the ratchet wheel, they stop the wiper assembly and position it precisely on the contact bank. Smooth as silk, every time. No jarring, no jamming, no banging.

No adjustments, either. As the teeth wear, they just drop further into the wheel. So nothing ever gets out of whack.

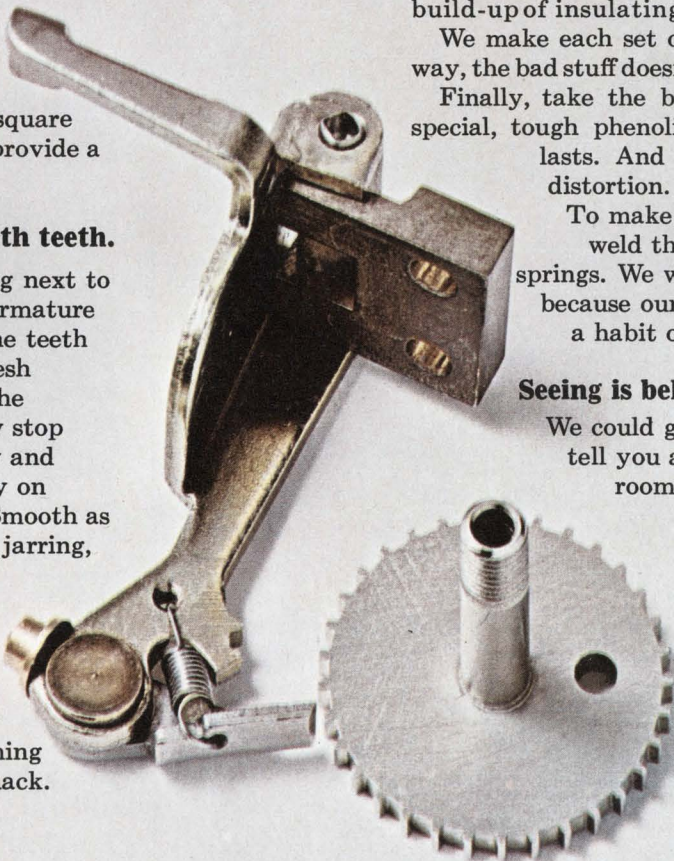

A pawl that floats.

On the end of the armature is the pawl. We made it "free floating" to eliminate the jamming and binding that go with the old style pawl stop block. And while we were at it, we stopped pawl breakage and put an end to double-stepping or overthrow.

Don't bother looking for this special set-up anywhere else. It's patented.

The other thingamajig.

It's called a contact spring. We've got some strong feelings as to what makes a contact spring strong.

In the first place, we believe there's strength in numbers. So we put two sets of contacts on each spring. This means you get a completed circuit every time. Without fail.

But some of the credit for this has to go to our solving the most common cause of contact failure—the build-up of insulating films on the contact points.

We make each set of points self-cleaning. That way, the bad stuff doesn't have a chance to build up.

Finally, take the buffers. We make ours of a special, tough phenolic material that lasts. And lasts. And lasts. All without wear or distortion.

To make sure they stay in place, we weld the buffer cups to the contact springs. We weld, rather than use rivets, because our lab found that rivets have a habit of falling off or wearing out.

Seeing is believing.

We could go on talking reliability and tell you about our testing and run-in room. There's a lot more to tell.

But we'd rather have our Sales Representative show you. And let you see first hand the reliability

that's built into every AE stepping switch.

Just call or write.

Automatic Electric Company, Northlake, Illinois 60164.



AUTOMATIC ELECTRIC

SUBSIDIARY OF GENERAL TELEPHONE & ELECTRONICS



The left side
had 500% higher
production.

He sputtered 5000
Angstroms per minute.

In the process, he hit a $\pm 1\%$ uniformity. You too can sputter 500% faster. Note that we're not saying, "as much as 500% faster." Fact is, for some materials you can sputter 600% faster than before. With MRC's new Plazmatomic process, nearly all materials can now be deposited at rates of 2000 to 5000 Angstroms per minute, compared to 200 to 1100 A.p.m. levels of a few months ago. And we've achieved these faster rates and higher uniformity with no sacrifice in bonding or structural quality. □ How did we do it? By moving the cathode and anode closer together (plus making a lot of other refinements in plasma physics that remain our secret), we've increased the ionization intensity and energy. □ Does this new process make your present MRC sputtering system obsolete? Not necessarily. Although most of our systems have been custom-made to client requirements, we've done everything we can to make Plazmatomic deposition adaptable to existing installations. Of course, if you don't have an MRC sputtering system, maybe it's time you looked into one. □ To find out how you can increase production and uniformity through Plazmatomic sputtering, write to MRC, Route 303, Orangeburg, New York 10962. Or phone us at (914) 359-4200. Cable: MATRESCO. **MATERIALS RESEARCH CORPORATION.**



INFORMATION RETRIEVAL NUMBER 53

INSTRUMENTATION

Wide range curve tracer eliminates overloading

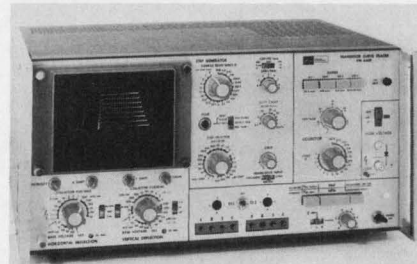

Philips Electronic Instruments, Div. of Philips Electronics and Pharmaceutical Industries Corp., 750 S. Fulton Ave., Mount Vernon, N.Y. Phone: (914) 664-4500.

Model PM6507 wide range transistor curve tracer can display two to eight characteristic curves from any four-terminal semiconductor without overloading the device. A variable-duty-cycle pulsed circuit controls input power to the device under test so that the device is loaded only during that part of the cycle which coincides with the portion of the curve being displayed (the beginning, end, or both).

CIRCLE NO. 295

Ohmmeter attachment gauges milliohms



Amphenol Distributor Div., The Bunker-Ramo Corp., 2875 S. 25th Ave., Broadview, Ill. Phone: (312) 329-9292. P&A: \$14.95; stock.

Capable of converting 10- Ω center-scale ohmmeters to read resistances of one ohm and less, a low-cost meter attachment is useful for checking voltage dropping resistors in solid-state power supplies, as well as for testing transformerless transistorized audio power amplifiers where the output is normally in 0.4-to-0.6 Ω range. The Amphenol 870-3 also features negligible in-circuit lead resistance.

CIRCLE NO. 296

INFORMATION RETRIEVAL NUMBER 54 ►

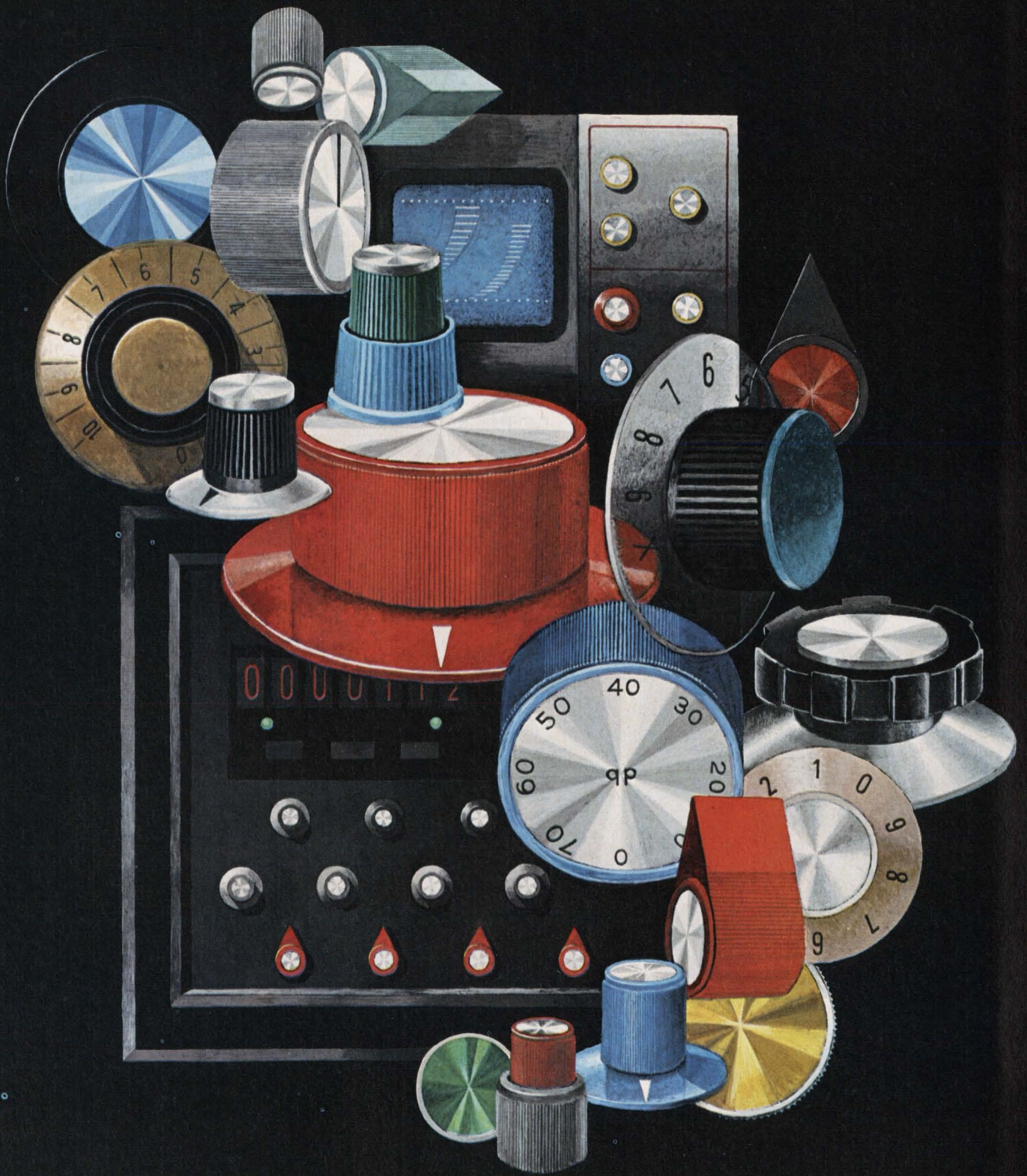

Rogan control knobs... tastefully complementary to your product

Modern in style ... classical in appearance—that's important in a knob. Attractive in color ... versatile in performance—that's important in a knob, too. These and many more features are found in the number one name in knobs—ROGAN—Rogan Control Knobs—knobs that add that "extra touch of taste" to your product.

Write today for new general color catalog or see us in Sweets or Thomas register.

Rogan
BROTHERS, INC.

8019 N. Monticello Ave. Skokie, Illinois 60076
Phone: (312) 675-1233

Logical 2nd source

SN5400/7400	Quad 2 gate
SN5410/7410	Triple 3 gate
SN5420/7420	Dual 4 gate
SN5440/7440	Dual 4 buffer
SN5441/7441	BCD decoder and Nixie* driver
SN5442/7442	BCD to decimal decoder
SN5473/7473	Dual J-K FlipFlop
SN5474/7474	Dual D FlipFlop
SN5475/7475	Quad Latch
SN5476/7476	Dual J-K FlipFlop with pre-set & clear inputs
SN5490/7490	Decade counter
SN5492/7492	Divide by 12 counter
SN5493/7493	4 bit binary counter

*Trademark of Burroughs Corporation

Second to none

DM7200/8200	4 bit digital comparator
DM7210/8210	8 channel digital switch
DM7220/8220	Parity generator & checker
DM7520/8520	Modulo N divider
DM7560/8560	Up-Down decade counter
DM7563/8563	Up-Down 4 Bit binary counter
DM7570/8570	8 bit serial in parallel out shift register
DM7590/8590	8 bit parallel in serial out shift register
DM7800/8800	Dual TTL/MOS translator
DM7820/8820	Line receiver
DM7830/8830	Line driver
NH0006/0006C	Hi current driver
NH0008/0008C	Hi current driver

In total TTL, National is second to none for the more complex functions. Prime source for a growing series of imaginative MSI circuits.

We'll send you full specifications, prices and local distributors at the drop of a reader service card. Write for MSI Data Pak. National Semiconductor, 2975 San Ysidro Way, Santa Clara, California 95051. (408) 245-4320. TWX: 910-339-9240
Cables: NATSEMICON.

National

TTL

MOS memory chip stores 256 words

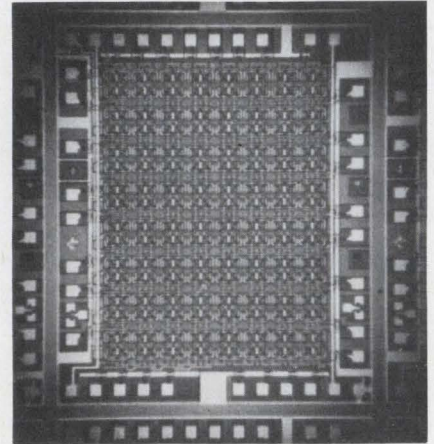

Texas Instruments, Inc., Semiconductor Div., P.O. Box 5012, Dallas, Tex. Phone: (214) 238-2011. P&A: 12¢/bit; 8 wks.

Organized as a 16×16 matrix of 256 one-bit words, a monolithic random-access memory has only final-level decoding circuitry. Designated the TMS 7A4003AC, the new memory is a p-channel enhancement-mode MOS IC that uses thick-oxide technology.

A given bit is selected by grounding one of the 16 X address lines and one of the 16 Y address lines. This chooses a single storage flip-flop, out of the 256 available, for reading or writing.

Reading of the memory is accomplished by externally addressing the desired cell and holding both the digit line and its complement at ground. Since addressing each bit reinforces its existing state, reading is nondestructive. Writing is accomplished by addressing a cell as if to read, while holding one digit line at ground and bringing the other digit line to the positive power-supply voltage.

The maximum speed of the circuit is limited by the propagation delay of the X addressing voltage through a series of p-diffused tunnels. This delay is about 40 ns at the far end of the line for an input step voltage, and about 30 ns for a ramp input with a 25-ns risetime.

The new memory chip, which is compatible with TTL circuits, is packaged in an hermetically sealed 40-pin dual-in-line ceramic housing.

CIRCLE NO. 297

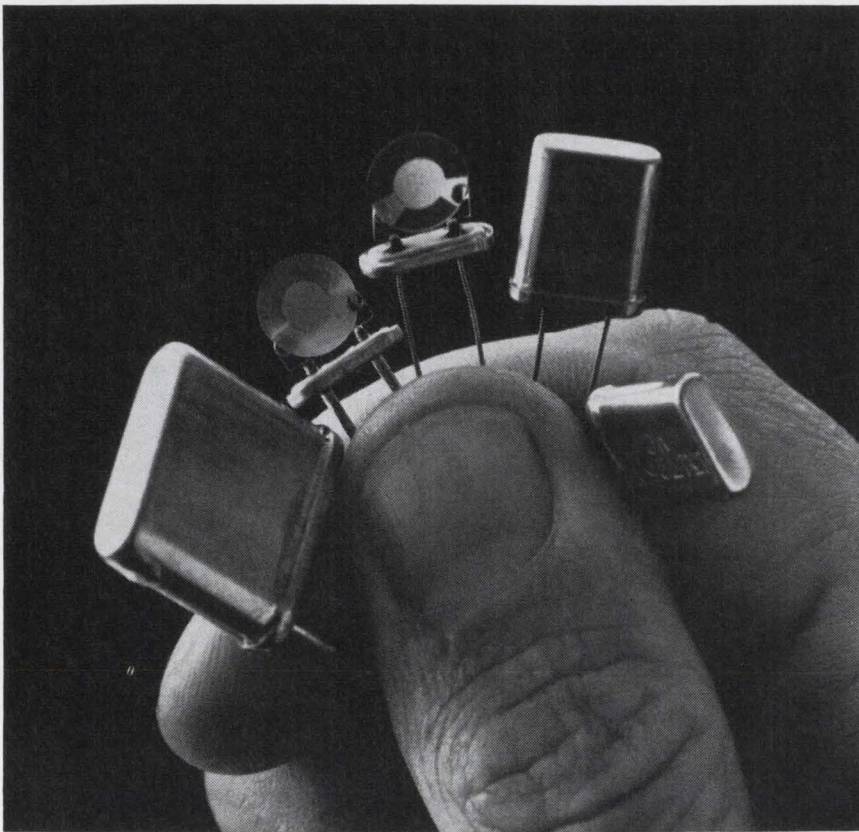

How are Sherold crystals a cut above the competition?

With frequency.

The right frequency. Consistently and with the low-cost quantity production that comes from top-quality crystal technology. Whether you order a few hundred or a few hundred thousand crystals from Sherold, you know you'll get exactly what you ordered — fast and accurate right down to the last MIL spec on the last crystal. We manufacture a variety of crystals from 4 kHz to 175 megaHz in numerous packages, as well as crystal filters and discriminators. In prototypes, short orders and long runs. In addition, Sherold has several plants geographically located to give you specialized local crystal technology assistance. Each has in-house facilities to meet and beat high shock and vibration MIL specs. Whether you're looking for a high-volume, off-the-shelf crystal or a prototype design, tell us about it. We'll give you a quote. With speed. Write Sherold Crystal Products Group, Tyco Laboratories, Inc., 1510 McGee Trafficway, Kansas City, Mo. 64108. Or phone (816) 842-9792. TWX 910-771-2181.

TYCO

INFORMATION RETRIEVAL NUMBER 56

PRINCIPLES OF FEEDBACK DESIGN. G. Edwin and Thomas Roddam. A practical guide for the designer of feedback amplifiers and similar systems, which brings together the fundamentals and advanced considerations. Book presents a thorough examination of negative feedback to simple amplifiers for both tube and transistor types, general problems, the analytical approach, use of feedback amplifiers as filters. Many signal flow diagrams and illustrations are included. 220 pages, 5½ x 8½, illus., cloth cover. #5533\$8.75

DESIGN OF COMMUNICATION SYSTEMS. Keats A. Pullen. This practical book brings together basic physical and theoretical data and subjects them to practical evaluation based on the latest signal theory. Consideration is given to design limitations of electronic communication systems and the variations resulting from controlled change of the parameters. Related information-engineering problems are examined and show how simple changes can significantly improve sensitivity and effectiveness of existing systems. 108 pages, 6 x 9, illustrated, cloth cover. #5012\$4.75

SIMPLIFIED MODERN FILTER DESIGN. Phillip R. Geffe. Bringing together the various modern, or network-synthesis methods in filter design, this book enables the engineer to achieve practical designs more easily. Extensive tables of numerical data preclude much of the difficulties in design. Covers lowpass, highpass, simplified and refined designs, bandstop, attenuation, equalizers, linear-phase and delay equalizers, measurement techniques, etc. 182 pages, 5½ x 8½, illustrated, cloth cover. #0317\$9.95

ELECTRONIC DESIGN TECHNIQUES. Edward E. Grazda. A vital new reference presenting reports of fresh ideas and proven techniques culled from Electronic Design magazine. Grouped in sections, they cover the use and design of amplifiers, resistor networks, filters, control devices, power supplies, microwave systems, oscillators, and pulse and switching circuits. Tables, nomographs, performance charts and guidelines for techniques in many areas make this an extremely valuable tool for the engineer. 312 pages, 8½ x 11, illustrated, cloth cover. #5648\$12.75

SYNTHESIS OF RC NETWORKS. Hun H. Sun. A convenient reference for faculty and research personnel which deals with the fundamentals of both active and passive networks. The book includes new and original contributions by the author. Such as the algorithm for ladder development and the criteria for determining the negative real roots of a polynomial. These class-tested materials are backed up by problems and suggested readings. 150 pages, 6 x 9 illustrated, cloth cover. #5676\$7.50

400 IDEAS FOR DESIGN. Selected from Electronic Design. Here are over 400 tested ideas written by engineers and selected from the popular "Ideas for Design" column of Electronic Design magazine. These ideas proved useful as parts of larger designs and aids in measuring the parameters or testing the effectiveness of designs. Arranged in convenient categories for handy reference, they provide valuable tips on improving equipment performance, developing versatile designs, saving on materials and time, etc. 232 pages 8½ x 11¼, illustrated, cloth cover. #5537\$9.95

Idea books Practical guides

prove them in your work for 10 full days—FREE

Please send me examination copies of the books checked to test in my work. If after 10 days I am not satisfied, I may return the books without obligation. Otherwise, I will remit payment, plus postage.

Check here if payment enclosed. Publisher pays postage with same return guarantee. (On all overseas orders, payment in \$ U.S. must be enclosed).

Name _____

Firm _____

Address _____

City _____ State _____ Zip _____

Send FREE 1968 catalog of electronics references. ED-169

HAYDEN BOOK COMPANY, INC. 116 W. 14 ST., NEW YORK, N. Y. 10011

MICROWAVE SYSTEMS PLANNING. Kenneth L. Dumas and Leo G. Sands. Designed for managers and engineers, this book defines and explains in a semi-technical manner the important criteria involved in the planning, engineering and installation of microwave equipment used for communications. Covers point-to-point FM systems beginning with frequency, wave theory and propagation, and following through to hardware theory and the practical aspects of establishing a microwave path with a high probability of good performance. 152 pages, 6 x 9 illustrated, cloth cover. #5696\$8.00

MATRIX ALGEBRA FOR ELECTRONIC ENGINEERS. Paul Hlawiczka. A basic course for the student and practicing engineer, for whom matrix algebra is often an indispensable tool for solving certain problems in physics and electronics. Gives a general orientation and shows the solutions of simple problems. Part I covers the essentials of matrix methods and their applications, requiring only a basic algebra background. Part II treats more complex methods, applying them to differential equations of linear networks. 224 pages, 5¾ x 8¾, illustrated, cloth cover. #5629\$8.75

NONDESTRUCTIVE HIGH POTENTIAL TESTING. Harold N. Miller. Now in one volume, all the information necessary for understanding, performing, and evaluating the results of high potential testing. Presents the entire field of nondestructive electrical testing from general principles to specific how-to instructions. Stresses important techniques for determining the ability of solid, gas, and liquid insulation to withstand predetermined amounts of over-voltage without failure. Guides to proper selection of test sets and mechanical features also included. 160 pages, 5½ x 8½, illustrated, cloth cover. #5028\$7.95

CIRCUIT THEORY ANALYSIS. Joseph Mittleman. An amply illustrated, clear-cut discussion ranging from fundamentals to more complex electronic circuits. The book includes step-by-step mathematical examples necessary for circuit analysis, and backs up each chapter with helpful problem sections. Cover page includes configurations of circuit elements, complex algebra and single element response, complete response of RL and RC networks, source-free response networks, and steady-state sinusoidal response. 461 pages, 6 x 9, illustrated, cloth cover. #5525\$9.50

ENGINEERS' RELAY HANDBOOK. NARM. An indispensable reference bringing together the knowledge of 31 experts in an all-encompassing work on electromagnetic and thermal relays and their characteristics. Complete basic relay information, inspection testing, life test information, military specification requirements and standardized definitions accumulated in an elementary yet comprehensive form. Diagrams, charts, tables and guidelines clarify and illustrate the text and a complete bibliography is included. 312 pages, 7¾ x 10¾, illustrated, cloth cover. #5665\$11.95

ELECTRICAL INTERFERENCE. Rocco Ficchi. Provides the designer, field engineer, program manager and technician a broad view of interference in modern electronics systems. This volume shows the entire field as a unified discipline and makes it possible to solve problems encountered in small radio receivers on up to large missile systems. Includes material on how interference control is introduced in design and the best practices to contain interference. 256 pages, 6 x 9, illustrated, cloth cover. #5512\$9.95

7 HOW TO PICK A RELAY

Relay
coil suppression
or
How to keep
an airline pilot
on the
straight and narrow.

Relays have been around for many decades, yet have survived evolving technologies and still retain a significant position in today's electrical and electronic systems. There have been changes in materials and changes in design, but the relay is still essentially a simple electro-mechanical switch. With today's ever-increasing need for the switching function, the relay offers advantages over other switching techniques. It can be used singly without auxiliary circuits (aside from a power supply); it exhibits very high isolation between controlling and controlled circuits; it can result in a simple, inexpensive circuit fast enough even for today's high speed world; and it can be compatible with semiconductors.

On the other hand, this compatibility is sometimes not achieved because one relay parameter or another is not considered. A relay is a very simple device — how much engineering time *should* be spent on it? Let's find out. **THE HIGH AND THE MIGHTY**

The cockpit of a commercial airliner witnessed the results of a lack of consideration for relays. The flight was on schedule, at cruising altitude and making good time. On autopilot and smooth — when all at once the stories of the last layover were interrupted by bells, buzzers and flashing red lights. Not Christmas —

autopilot failure. The rest of the flight was on instruments and the seat of the pants. A safe flight, but a busy one.

What happened? Several transistors in the autopilot computer and controller had been burned out, and this was traced to negative, high voltage spikes on the 28-volt DC line. The cause? Transients generated by relay coils in the system. The solution? Transient suppression. The reason for problems? Overlooking the fact that the relay coil is an inductor.

System designers usually take into account the problems associated with the making and breaking of currents by the relay contacts. In this case, arc suppression had been included on the load side of the relay to extend contact

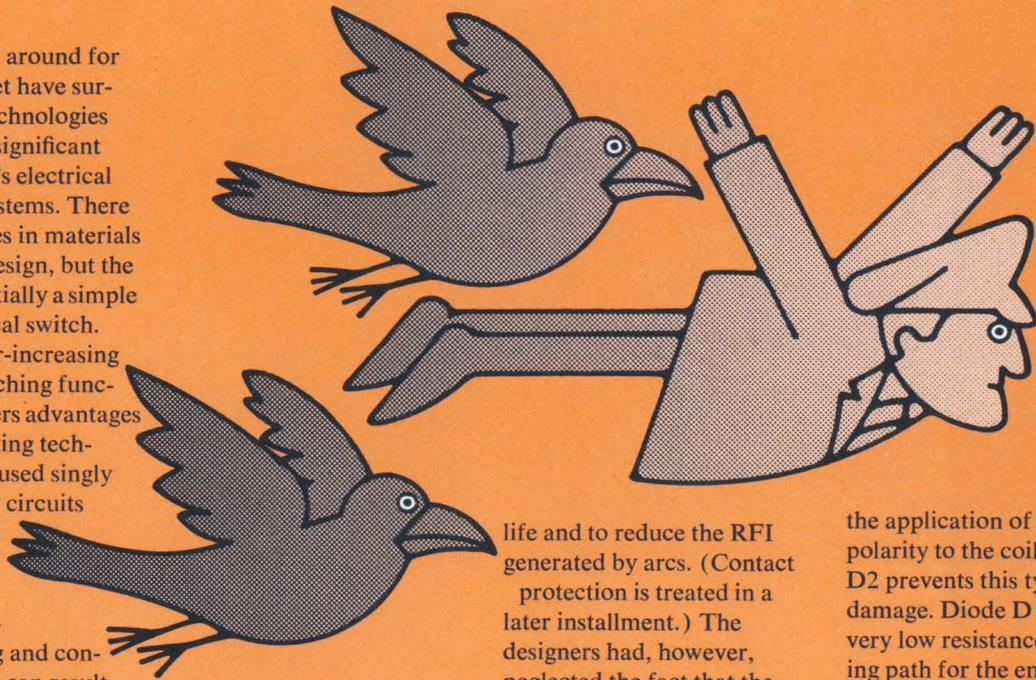

life and to reduce the RFI generated by arcs. (Contact protection is treated in a later installment.) The designers had, however, neglected the fact that the relay coil, too, is a non-resistive load and is thus capable of generating interference. The energy stored in the coil inductance is seen as a back EMF across the coil when the drive is removed. This voltage is usually greater than 750 volts and can be as large as 3000 volts in a 28-volt circuit. Few components are designed to withstand voltages of this magnitude. **WHAT TO DO**

The first step in curing circuit interference is to limit the magnitude of the coil-generated spike. Any of the circuits shown will do this.

The diode in Figure 1 is probably the most popular form of voltage suppression used today. A single diode (D1) can be used, but this is frequently burned out by

the application of the wrong polarity to the coil. Diode D2 prevents this type of damage. Diode D1 provides a very low resistance re-circulating path for the energy in the coil, and thus offers the highest degree of suppression available. Because of the low resistance, however, the time constant for energy decay is quite high, and the dropout time of the relay with a diode across the coil is increased at least 2 times — and often 10 times — the normal value for the unsuppressed relay. This slows the rate of separation of the relay contacts, and can increase arcing damage to the contacts. This actuation delay can also be very critical when several circuits are operating interdependently.

One method of suppression frequently used by relay manufacturers, the bifilar coil, is shown in Figure 2. This is manufactured by winding two

LEACH

coils in parallel simultaneously, then shorting the secondary coil inside the case. The resistance of this secondary coil determines the effectiveness of the suppression. The maximum back EMF generated is approximately equal to the applied coil voltage times the ratio of the coil resistances ($EMF = V \times R_{\text{bifilar}} / R_{\text{coil}}$).

This last equation seems to point up the bifilar method of suppression as one that can deliver an extreme amount of back EMF limiting. This is true, but you never get something for nothing. The bifilar coil in a relay has a considerable effect on relay performance. For instance, the smaller the resistance of the bifilar coil, the smaller the back EMF, but also the longer the dropout delay. The transfer time of the relay contacts may increase as much as 5 times.

In addition to this, because a current flows in the secondary coil, a magnetic field is generated by it. As the armature moves, the air gap changes and causes a change in the magnetic flux, which in turn causes an increase in self-induced current in the

secondary winding. This increase not only slows down the motion of the armature, but may even reverse its direction. If this is the case, break bounce occurs. This of course can cause arcing, which damages the contacts and shortens contact life.

BUT ZENERS ARE BETTER

A better method of suppression is shown in Figure 3. The zener diode can be placed in series with the shunt diode (D1) shown in Figure 1. Or, two zener diodes can be used back-to-back instead. This latter arrangement has the advantage that it is not polarized. The peak back EMF from the coil is now limited to the breakdown voltage of the zener diode. The breakdown voltage obviously should be chosen to be greater than the applied voltage on the coil. The increase in the dropout time when using this technique is negligible. In essence, the zener diode affects the relay performance only when that performance is out of its normal range; the rest of the time the relay behaves as if

the zener were not there. (This is not the case with the bifilar coil, which affects the relay's performance at all times.)

The series RC circuit of Figure 4 is effective for voltage limiting, but is usually used only with coil currents under 100 mA because of the voltage drop through the series resistors. This voltage drop can be eliminated by placing the resistance and capacitance both in the shunt path.

Figure 5 represents a common relay interface — the transistor driver. Because of the low currents required by relay coils, economical drive circuits can be readily designed. The transistor eliminates the possibility of arcing that exists when a switch activates the coil directly. Even if a switch is used to turn the transistor on, the transistor serves as a buffer amplifier so that a much lower (and hence less troublesome) current is being interrupted. Operate time can be tailored by varying the value of the capacitor. The zener shown prevents transistor burn-out when the coil is de-energized. The ground side of the relay coil

is the preferred location for this type of circuit to make it "fail-safe."

IF YOU NEED MORE

No component values have been given for any of the suppression circuits because these are dependent on circuit and relay coil parameters and choices will have to be made on that basis. The aim of suppression is voltage spike reduction, but contact life can be reduced if the techniques are improperly applied. If you have a specific application with which you would like some assistance, don't hesitate to contact us. We have an application group with years of experience at applying these techniques to practical, reliable circuits and would be happy to help you.

This is the seventh in a series of application stories. However, not all of these stories will appear in trade publications. If you would like to receive a copy of #6, write Leach Corporation, Relay Division, Department A, 5915 Avalon Boulevard, Los Angeles, California 90003 (213) 232-8221.

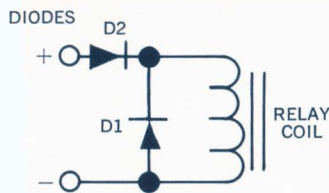

Figure 1



Figure 2

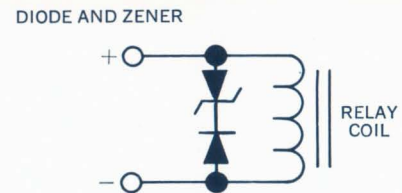

Figure 3

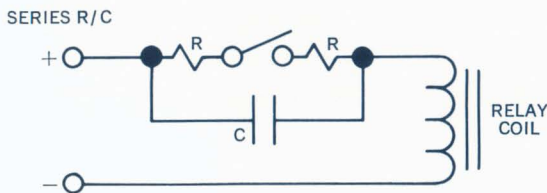

Figure 4

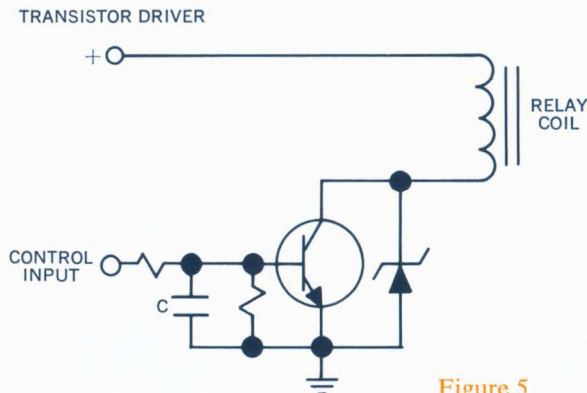
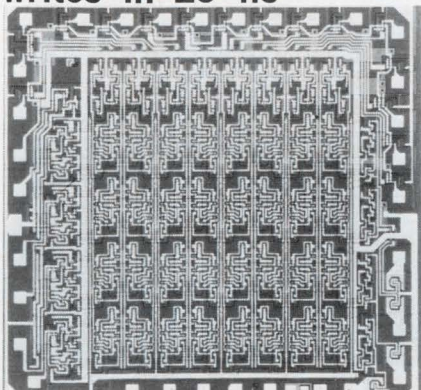

Figure 5

(LEACH)

Sponsored by Leach Corporation, Relay Division, Los Angeles, California

LSI memory writes in 25 ns



Fairchild Semiconductor, 313 Fairchild Dr., Mountain View, Calif. Phone: (415) 962-2530. Price: \$64 or \$128.

Featuring a read access time of 35 ns and a 25-ns write time, model 9035 64-bit random-access memory is a high-speed TTL LSI circuit with a 285-gate complexity organized in a 16-word-by-4-bit format. Simple memory expansion is made possible by internal buffering of the address lines.

CIRCLE NO. 298

Power transistors dissipate 350 W

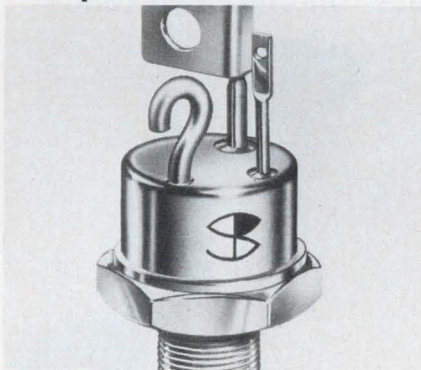

Solid Power Corp., 440 Eastern Pky, Farmingdale, N.Y. Phone: (212) 755-0845.

New silicon power transistors handle currents of 70 A and dissipate 350 W of power at a case temperature of 60°C. In addition to providing collector-emitter voltages as high as 150 V, types 2N4950, 2N3149, 2N3150 and 2N3151 also minimize leakage currents and saturation resistance. The collector of each unit is electrically connected to the case, a TO-114 package.

CIRCLE NO. 299



this is Simpson's 2700 digital system...

- 4 1/2 digits
- 0.05% accuracy
- 5 plug-in function modules



- Automatic Polarity Selection
- Built-in Self Calibration
- 100 Microvolt Resolution
- Optional BCD output
- IC Modular Design for reliability

Standard single and dual rack mount kits available.

2700 DIGITAL SYSTEM \$615⁰⁰
complete with DC voltage range module, test leads, and operator's manual

AVAILABLE "OFF-THE-SHELF" AT ELECTRONIC DISTRIBUTORS STOCKING SIMPSON INSTRUMENTATION PRODUCTS.

Simpson ELECTRIC COMPANY



5200 W. Kinzie Street, Chicago, Illinois 60644 • Phone (312) 379-1121
Export Dept: 400 W. Madison Street, Chicago, Illinois 60606. Cable Simelco
IN CANADA: Bach-Simpson Ltd., London, Ontario • IN INDIA: Ruttonsha-Simpson Private Ltd., International House, Bombay-Agra Road, Vikhroli, Bombay

INFORMATION RETRIEVAL NUMBER 58

less than \$180 per function...



HEATH Universal Digital Instrument

Now you only need one instrument, the Heath EU-805A, to perform all these functions: Frequency, Period, Time Interval, Events count, Ratio, Integrating DVM, and Voltage Integrator. Combining in one package a DC-12.5 MHz Multi-Purpose Counter/Timer with a 0.05% accuracy Digital Voltmeter, the new Heath/Malmstadt-Enke UDI offers you unmatched versatility at less than \$180 per function! An original modular design based on TTL IC's plug-in cards protects the instrument from obsolescence.

The UDI features convenient fast cycling on slow time bases, continuous summing function, memory, 0.1 s to 30 s display time, 6 digit readout plus over-range.

The identical high-sensitivity (10 mV) input comparators provide 1 M Ω impedance, complete range of trigger controls (including Automatic Mode), oscilloscope monitoring of triggering point and four levels of input attenuation. Input pulse resolution is better than 50 ns. Time bases range from 1 μ s to 10 s and short term stability is better than 5 in 10^9 . Accuracy ± 1 count.

DVM section has Automatic Polarity, $5 \times 10^9 \Omega$ input impedance on separate 1 V range (10 M Ω on the others), four ranges from 1 V to 1000 V, 10 μ V resolution, 0.1 s to 10 s integrating time and V-F output available at rear panel.

The UDI is obviously the instrument you need and it is obviously priced right: \$1250. Less DVM order EU-805D at \$940. DVM conversion pack costs \$340.

Many cards from the UDI may be used in the Heath/Malmstadt-Enke Analog Digital Designer EU-801A:

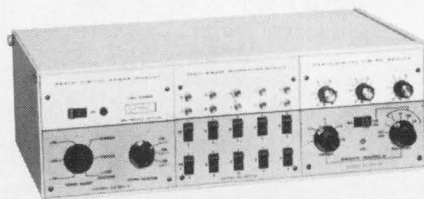

The ADD permits the design of various analog and digital circuits and instruments, by plugging-in logic cards into its power, binary and timing modules. Solderless connections are made with ordinary wire and component leads.



HEATH COMPANY, Dept. 580-21
Benton Harbor, Michigan 49022
In Canada, Daystrom Ltd.

- Please send Free New Scientific Instrumentation Catalog.
- Please send Manual EUA-800A, a special 250 pg. condensation of the manuals which accompany Heath Digital equipment ... \$3.50.

Name _____

Address _____

City _____ State _____ Zip _____

Prices & specifications subject to change without notice. EK-264

For full information send for the FREE NEW Scientific Instrumentation Catalog. An abridged Manual is available for \$3.50.

INFORMATION RETRIEVAL NUMBER 59

ICs & SEMICONDUCTORS

Video amplifier expands bandwidth

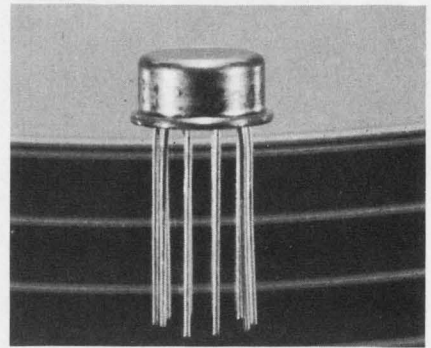

Fairchild Semiconductor, 313 Fairchild Dr., Mountain View, Calif. Phone: (415) 962-2530. P&A: \$10 or \$20; stock.

Model μ A733, two-stage differential video amplifier uses shunt-series feedback to achieve the combined advantages of wide bandwidth, low phase distortion and excellent gain stability. The unit has a 120-MHz bandwidth at a closed-loop gain of 10, and a 90-MHz bandwidth at a closed loop gain of 100.

CIRCLE NO. 323

Monolithic regulators use on-chip reference

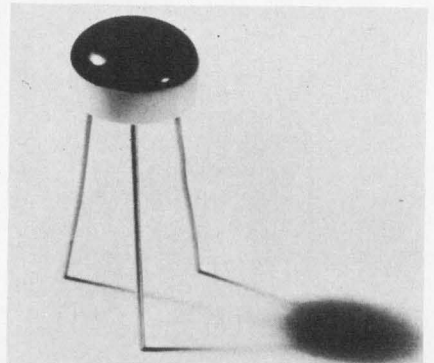

Philbrick/Nexus Research, A Teledyne Co., Allied Drive at Route 128, Dedham, Mass. Phone: (617) 329-1600. Price: \$3 to \$11.25.

Designed for a positive regulated output of 15 V, three new silicon monolithic voltage regulators contain an internal voltage reference element for regulation to 0.1%. Types 2103, 2104 and 2105 also feature internal short-circuit protection; this includes a thermal feedback circuit to prevent excessive operating temperature.

CIRCLE NO. 324

INFORMATION RETRIEVAL NUMBER 60 ►

What would you call this new Microwave instrument?



Our project engineer calls it a "microwave multimeter."

Our marketing people call it a "universal microwave test set."

Our catalog calls it the HP 8410A Network Analyzer.

You'll call it the answer to your measurement problems. Here's why—

First, "it" measures all these microwave parameters: gain/attenuation and phase shift, i.e., complete transmission coefficients; magnitude and angle of reflection coefficient with polar or Smith Chart plots of impedance/admittance. With "it," you can characterize active and passive components or systems at single or swept frequencies.

Second, "it" features all these advantages: broad frequency coverage from 110 MHz to 12.4 GHz; more than 60 dB dynamic range with less than ten milliwatts drive signal; swept frequency operation over octave bands with automatic tuning; high accuracy and resolution; unparalleled ease of operation.

"It" is actually a modular system: a signal-processing mainframe with choice of two readout plug-ins; a wideband RF

converter unit; a full-range transmission test unit; and two reflection test units for 0.11 to 12.4 GHz coverage.

Whatever you measure with "it," you can do the job more accurately, more completely, in less time, with less work and fewer pieces of equipment at lower cost than ever before. "It" is a designer's dream.

The modules for transmission measurements, 0.11 to 12.4 GHz, cost \$6450. Add the capability for polar and Smith Chart displays of reflection characteristics, 0.11 to 12.4 GHz, for \$4100.

Ask your HP field engineer how the 8410A "microwave multimeter, universal test set, network analyzer" can answer your problems. Or write Hewlett-Packard, Palo Alto, Calif. 94304; Europe: 1217 Meyrin-Geneva, Switzerland.

04804A

HEWLETT  PACKARD

MICROWAVE NETWORK ANALYZERS

microtopics

product news from Philco-Ford Microelectronics

Our Hybrid Hunters are looking for you!

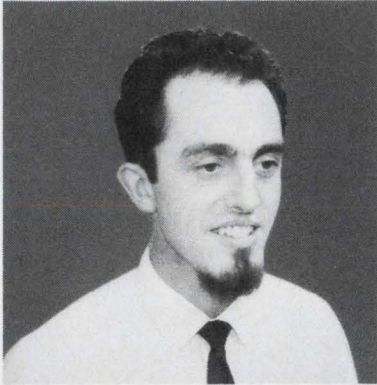

W. Peter Dean: Department Manager, Hybrid Circuits. More than 10 years' semiconductor and hybrid circuit experience.



Mal Gilbert: Engineering Supervisor, Circuit Design, Hybrid Circuits. 10 years' system design and hybrid circuit experience.

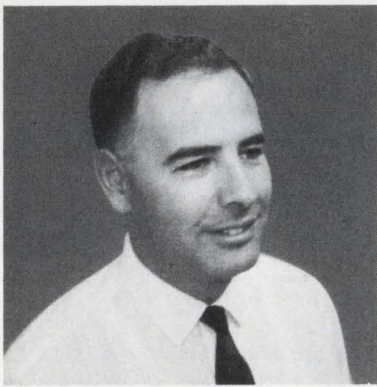

Hal Molyneux: Engineering Supervisor, Prototype Group, Hybrid Circuits. More than 10 years' semiconductor and hybrid experience.



Shawki Ibrahim: Circuit Design Engineer, Hybrid Circuits. More than three years' circuit design experience.



Bob Simon: Marketing Manager, Hybrid Circuits. Approximately 10 years' experience in semiconductors and hybrid circuits.

INFORMATION RETRIEVAL NUMBER 217

Lockheed Awards Philco-Ford Contract for Poseidon IC's

A multi-million dollar agreement calling for manufacture of seven types of integrated circuits (IC's), for use in the United States Navy's Poseidon program, has been awarded to Philco-Ford Corporation's Microelectronics Division by the Lockheed Missiles and Space Company, Sunnyvale, California.

"The contract's value is expected to exceed \$5 million over an 18-month

period," said Howard T. Steller, Microelectronics Division General Manager, in announcing the award.

Poseidon is the newest missile being developed for the United States Navy Fleet Ballistics Missile System. Lockheed is prime contractor.

The seven types of IC devices Philco-Ford will supply are five IC's with diode-transistor logic (DTL), a Model 709 operational amplifier, and

a Lockheed-designed IC.

Mr. Steller pointed out that this award, expected to exceed \$5 million, is the second major order recently received by the Microelectronics Division. The Division was selected to be one of three firms to share in a Burroughs Corporation order for IC's, believed to be the largest order ever placed in the semiconductor industry for standard devices.

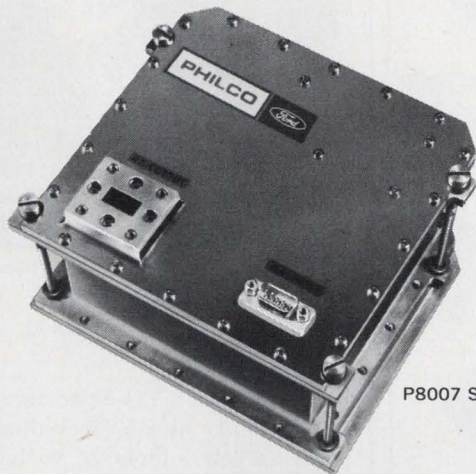

P8007 Solid-State Power Source

Take the solid-state route to >1 watt CW output in Ku band!

Cash in on the simplicity and compact size of the Philco P8007 Solid-State Power Source. It delivers more than 1 watt of spectrally clean, stable CW power at 13.3 GHz.

What's the secret of its success? Philco L8500 Series Silicon Integrated Varactors do the job of frequency multiplication. Their unique design, using series-connected silicon varactor chips bonded to a high thermal conductivity substrate, produces power handling capability nearly an order of magnitude greater than conventional varactors.

Supplied in standard microwave packages, they only need heat sinking at one end. Use of the single substrate technique results in the lowest thermal resistance values available in the industry. Cutoff frequencies up to 300 GHz can be provided.

We can supply proven Silicon Integrated Varactors to assemble into your own microwave power source. Or, we can take on the entire job and deliver the best high-power, solid-state power source you've ever seen.

INFORMATION RETRIEVAL NUMBER 218



Package Style 4

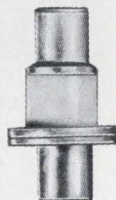

Package Style 5

Philco Integrated Varactors

Capability of Philco Silicon Integrated Varactors:

Type	Band	CW Watts Output
L8505	L	35
L8504	S	25
L8503	C	12
L8512	X	3
L8513	Ku	1.5

Spectral Characteristics of Philco P8007

Frequency stability: ± 10 ppm long term
 Spurious outputs: more than 40 db below carrier
 AM noise: -120 db typical at 1 KHz (100 Hz bw)
 FM noise: 6 Hz at 10 KHz (100 Hz bw)

Dielectrically Isolated IC's Now Available

The conventional technique for isolating components of an integrated circuit—reverse biased P-N junctions—has some inherent shortcomings, one of which is high sensitivity to transient radiation.

The urgent need for radiation tolerant systems has spurred development of dielectrically isolated integrated circuits in recent years. Philco-Ford is a leader in this technology. We have developed a reliable process for making IC's in which isolation is obtained by fabricating each component in a "tub" of silicon dioxide. Radiation-induced currents of catastrophic magnitude are thereby prevented from flowing throughout the die.

We are currently in position to supply prototype quantities of a selection of dielectrically isolated DTL devices, including gates, buffers and flip-flops. We're ready to consult with you on your specific application.

INFORMATION RETRIEVAL NUMBER 219

Industrial Cerdip DTL with MIL hermeticity... at new low prices

Performance. Economy. Immediate delivery. These are good reasons to put Philco-Ford Cerdip DTL to work in your equipment.

If you're using flat packs now, consider this: Cerdips are far more convenient to stock, handle and connect. They're ideally suited for automatic insertion and soldering techniques.

And when you buy from Philco-Ford, you can be confident that quality and reliability are proved by exhaustive qualification testing, and assured by the most painstakingly thorough inspection procedures in the IC business.

If you've looked on Cerdip as the high-priced package, turn your thinking around. Our industrial Cerdips carry new low price tags. They're immediately available for quantity shipments.

And they're ideal for MIL breadboards.

INFORMATION RETRIEVAL NUMBER 220

Wide-area photodiode minimizes lens effects

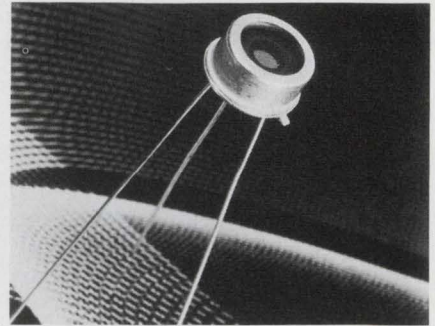

EG&G, Inc., Electronic Products Div., 160 Brookline Ave., Boston. Phone: (617) 267-9700. P&A: \$400; stock.

Housed in a TO-5 package, model SGD-100A silicon photodiode provides a low silhouette with a wide entrance window. This results in wider field of view, minimum lensing effects due to the window, and closer location of the active element to the window surface. In addition, a circular aperture is located near the surface of the diode to insure that only the active region of the photodiode is illuminated.

CIRCLE NO. 321

Compensated op amp costs only \$3.25

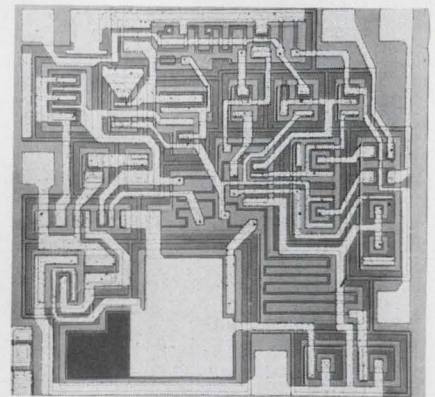

Fairchild Semiconductor, 313 Fairchild Drive, Mountain View, Calif. Phone: (415) 962-5011. Price: \$3.25.

To broaden its marketing position in linear circuits, Fairchild has reduced the price of its second-generation 709 operational amplifier, the $\mu A741$, by more than 50%. The frequency-compensated 741 will now cost as little as \$3.25 each in quantities of 100 or more.

CIRCLE NO. 322

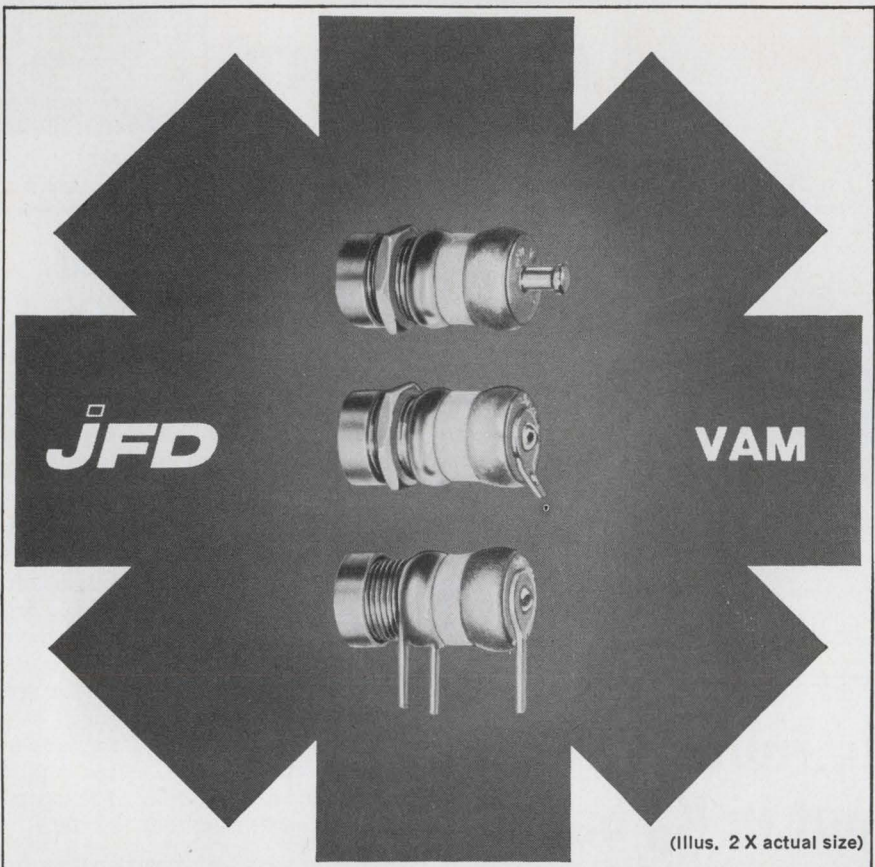

AIR VARIABLES FROM JFD SOLVE YOUR HIGH Q, HIGH FREQUENCY PROBLEMS

The JFD air variable miniature capacitor series — VAM — is specifically designed for high frequency applications that demand extreme stability, small size and high Q (greater than 2,000 measured at 10 pf and 100 MHz). VAM's have rugged construction, measure approx. 1/2" in length and are completely interchangeable with competitive devices.

ELECTRICAL DATA — ALL VAM MODELS

Cap. Range at 1 MHz...0.8 to 10.0 pf
 Q at 10 pf & 100 MHz... >2,000
 Insulation Res. at 25°C... 10⁶ megs. at 500 VDC
 Temp. Coeff. of Cap. (−55°C to +125°C)... 0 ±20 PPM/°C
 WVDC... 250 VDC
 Test Voltage... 500 VDC

ACTUAL SIZES

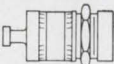
VAM 010* 
 Panel Mount w/Turret Terminal

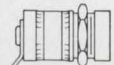
VAM 010M 
 Panel Mount w/Lug Terminal

VAM 010W 
 Printed Circuit

*VAM 010 also available as VAM 010H with 4-40 threaded stud replacing turret terminal.

Write for catalog VAM-67-B

"TODAY'S COMPONENTS BUILT FOR TOMORROW'S CHALLENGES"

JFD JFD ELECTRONICS CO. / COMPONENTS DIVISION
 15th Ave. at 62nd St. • Brooklyn, N.Y. 11219 / Phone 212-331-1000

Offices and subsidiaries in principal cities, world-wide.

INFORMATION RETRIEVAL NUMBER 61

SCOPE SAVER

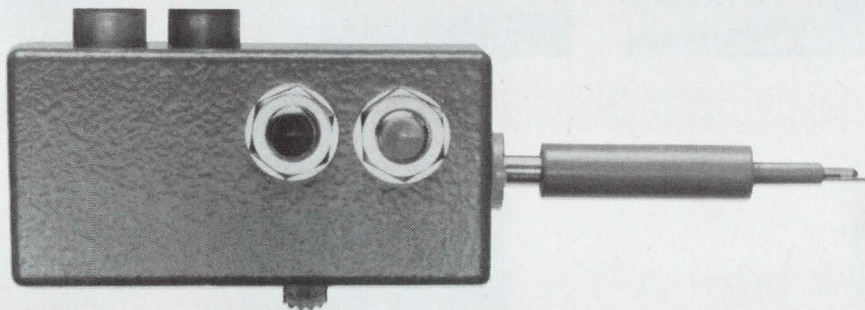

DIGI-PROBE*

New Test Probe Replaces Expensive Oscilloscopes For Simple Production Tests on Digital Circuits

This little test probe is a real money saver on the production line. Performs most checks on digital circuits now being done with costly oscilloscopes. Simple-to-interpret red/green indicator lights determine presence and polarity of pulses as fast as 25 ns. Speeds testing and debugging. Reduces skill level of testers. Send for our brochure describing how the Digi-Probe works to save you time and money.

*Trademark, Pat. Pend.

Available from stock \$89.

INFORMATION RETRIEVAL NUMBER 62

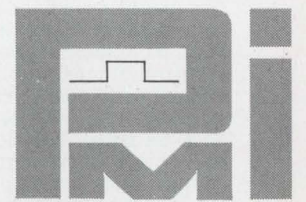

**PULSE
MONITORS, INC.**

351 New Albany Road
Moorestown, N.J. 08057
(609) 234-0556
A SUBSIDIARY OF
TELEPRODUCTS, INC.

automatic resistor tester becomes more automatic

ESI's Model 500 Resistance Deviation Bridge—an automated resistor test system at 50 ppm accuracy for incoming quality assurance or production control—has a new sorting accessory which boosts speed still further and reduces operator error to nil.

It's an automatic sorter, which ejects the measured resistor without operator aid into one of 3 bins, which



represent preset tolerance limits anywhere between plus or minus 10%. An accessory counter records quantity in each bin.

The Model 500 is a rugged but precisely made resistance measuring system designed for production line sorting of high accuracy resistors. Much more than a go-no-go unit, it checks values from 0.1 ohm to 111 megohms and has infinitely adjustable deviation settings from 0.01% to 10% full scale. The system includes a KELVIN KLAMP® holding jig, foot pedal and complete instruction manual for \$2,750. For more details circle No. 230 on the Reader Service Card.

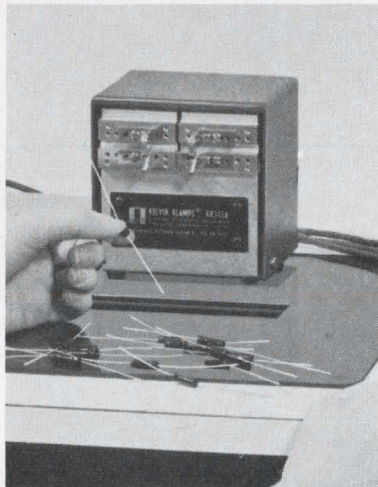

dekapot's got a lot that's not in a multi-turn pot

What's a reasonable price for a 5-digit potentiometer with 0.002% linearity, has ultra stability, takes only one panel dial space and is set and read faster than any multi-turn pot?

If you and your customer want this kind of performance then price probably is not a big factor, but the fact that you can have this off-the-shelf from ESI for \$90-\$175 makes our patented DEKAPOT® decade potentiometer even more attractive.

They're built around our precision wirewound resistors and a patented coaxial dial system. The resistors are the same hand-crafted components that provide accuracy and reliability for ESI laboratory standards. The DEKADIAL® design allows three or four dials to be stacked and yet be dialed independently for fast, in-line readout. Circle No. 231 on your Reader Service Card.

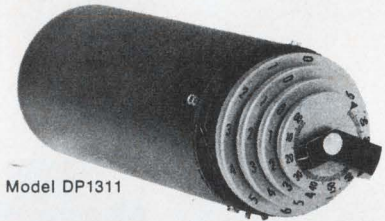

Model DP1311



news and innovations in metrology

circuit designers

new "lo-power" bridge best for selecting components

A new model of an old workhorse in precision measurement—ESI's 250DE Portable Impedance Bridge—is finding increasing application in the circuit and equipment design field.

Because of its "lo-power" characteristics, the 250DE is especially suited for selecting or checking sensitive circuit components. The small voltage applied to the device under test does not affect measurement accuracy. Solid-state circuit elements, transducers, sensors, etc., can be reliably measured, without effect from self-heating and voltage coefficients.

The 250DE's combined portability and near laboratory precision make it an ideal multipurpose test tool for measuring resistance, capacitance and inductance. It operates from four "D" size dry cell batteries and requires no external accessories. Its oversized panel meter and patented DEKADIAL® decade dials provide excellent readout display. Accuracy is as follows: Resistance to 12 MΩ at ± 0.1%, capacitance from 0.1 pF to 1200 μF ± 0.2% and inductance from 0.1 μH to 1200 H at ± 0.3%. Price: \$525. Circle No. 232 on your Reader Service Card.



circuit designers

little bridge with big name is components sorter of all sorts

A remarkable little bridge originally designed for fabricating wirewound resistors—ESI's new Model 261 Impedance Comparator—is rapidly finding its way into a variety of appli-

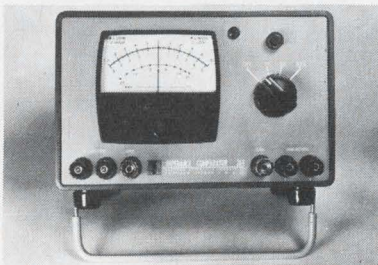

cations. It's an accurate (.05%) sorter-matcher on the circuit designer's bench and a fast, handy tester at incoming quality assurance stations.

Priced at only \$250 and measuring only 8½"x6"x6½", the Model 261 is a *simplified*, solid-state ac bridge which can check resistors, capacitors or inductors against a reference standard. Meter response on deviation ranges of 1%, 5% or 25% is virtually *instantaneous*. A sorting fixture facilitates testing of axial or radial lead components.

In addition to simple value sorting, a prototype builder quickly finds components that match one another or one of specific value.

Resistance values from 10Ω to 2MΩ, capacitance from 0.001 μF to 100 μF and inductance between 30 mH and 5 kH may be efficiently and accurately compared. Resistance accuracies for the 1% deviation range are ± 0.05% for values between 10Ω and 500 kΩ and ± 0.2% between 500 kΩ and 2 MΩ. Equivalent accuracies can be expected on inductive or capacitive components. For further information, circle No. 233 on your Reader Service Card.



Electro Scientific Industries, Inc.

13900 N.W. SCIENCE PARK DRIVE
PORTLAND, OREGON 97229

calibration/maintenance

now it's a recorder calibrator... 300 PVB®

The little black box we refer to as our *portable calibration laboratory* — the Model 300 PVB (Potentiometric Voltmeter Bridge) — continues to extend its versatility and usefulness with the addition of an adapter to *calibrate recorders* on the spot.

With the Model 1310 Precision Voltage Source — which becomes a small permanent attachment on the inside lid of the PVB — you can rapidly and easily check recording accuracy to 0.05% without taking the recorder off the job.

The 1310 adapter is a follower amplifier which converts the high output impedance of the PVB to a low output impedance for calibrating voltmeters, recorders, vacuum tube voltmeters, panel meters, etc.

Anything in the range of 5 volts to 50 nanovolts can be calibrated. The system is battery operated.

The 1310 is priced at \$300, while the 300 PVB delivers its own 0.02% accuracy and all-purpose measuring potential for just \$940. (The PVB can be used as a five-range potentiometric voltmeter, 10-range Kelvin resistance bridge, 3-range precision voltage source, 8-range ammeter, ratiometer or sensitive electronic null detector.) For more information, circle No. 234 on your reader card.

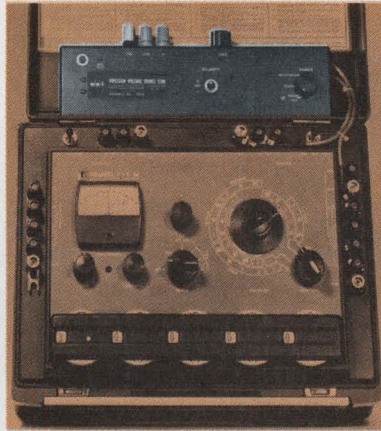

components for designers

sport that compact look with ESI DEKASTATS® and get 0.01% accuracy

Calibration, test and control instruments that used to have a half-dozen or more decade resistor switches are now sporting the compact look with ESI DEKASTATS. Up to four decades of precision wirewound resistors are coaxially mounted in a single 3" diameter panel space. Readout is simplified and each decade is independently adjusted, so dialing is rapid. Initial accuracy is 0.01% in any number of resistance values. All units are covered by a two-year warranty.

If you'd like to update your instrument, increase accuracy, make it more saleable, while saving on production time and costs, investigate our DEKASTATS by circling No. 235 on your reader card.

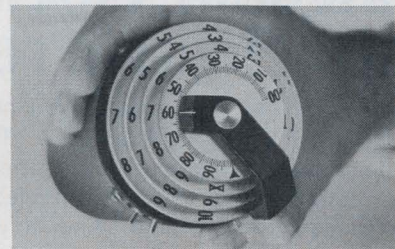

design engineers

capacitance bridge acquires new accuracy in high value range



Now comes our new solid-state Capacitance Bridge, the Model 273, designed to measure "direct" capacitance over a wide range with special capability for high values.

The new unit is far more compact than previous models, yet it operates on 9 ranges — from zero through 120 pF to zero through 12,000 μ F. Accuracy is $\pm 0.1%$ on middle ranges, $\pm 0.3%$ at the highest. It's priced at \$875.

Effects of lead resistance are eliminated through a four-terminal Kelvin connection and a high value internal standard reduces the effects of shunt capacitance. The Model 273 therefore is ideal for measuring electro-

lytics. The instrument also features a maximum voltage across the unknown of 0.5 volts, allowing measurements of tantalum capacitors with specified accuracy.

Features include two built-in frequencies of 120 Hz and 1kHz, log-linear meter response, and added terminals for DC bias, range extension, or external generator and detector. Circle No. 236 on your reader card.

meter calibration

automated tester saves big money for big calibration labs

Any 0.1% instrument can be tested and calibrated automatically with our new Model 70 Meter Calibration System — typically, a Simpson 260 in less than 10 minutes.

Complete calibration procedure for each of your meters is programmed onto a punched card — operator instructions, error limits, frequency, ranges, etc. Upon instruction from the operator, the Model 70 advances through each checkpoint while printing results on the typewriter. If the meter is out of tolerance, the system tells you how much and where.

Any technician can operate the Model 70 after a half hour demonstration. Repair time is cut, because the trouble area is shown on the readout.

Labor savings justify the \$25,000 price tag within a short time, so if your calibration lab faces the kind of pressure that makes this system attractive, circle No. 237 on your reader card.



esi.

Electro Scientific Industries, Inc.

13900 N.W. SCIENCE PARK DRIVE
PORTLAND, OREGON 97229

Time control for all data systems



Durant Calendar clock with electric readout

Whatever kind of time control you need, chances are the Durant 59005 Digital Clock will provide it. This versatile clock gives you a wide choice of models which supply visual and electrical readout in combinations of hours, minutes, seconds, tenths of minutes and thousandths of hours. And, if you wish, days of the month or calendar year.

Simple connections, made on the Digital Clock's back panel, provide remote electrical readout for computers, printers, and controls. For visual readout, a command signal holds all figures motionless; time pulses generated during readout are stored in the input circuit and recorded later. No guesswork, no lost counts.

Durant's 59005 Digital Clock has several desk, cabinet or relay rack mounting arrangements available. Operates on 115 or 230 volt AC, 50-60 cycle, or from your own system's time base generator.

For full information write for catalog 90-J, 622 North Cass Street, Milwaukee, Wisconsin 53201.

Digital Clock and EDP

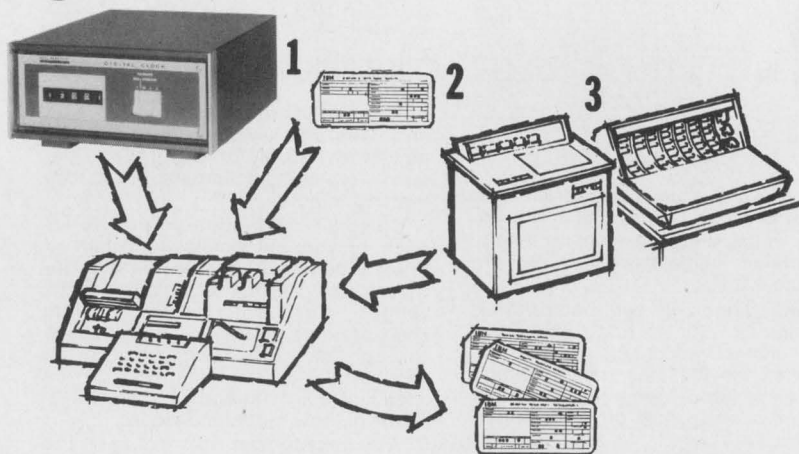

In a typical Digital Clock application, automatic keypunch assembles information from these sources: 1. Time, day and year from Durant Digital Clock. 2. Job and routing from prepunched worker's time card. 3. Production count for time period from worker, using input station. Simultaneously, instantly, keypunch enters this total input on a single computer card for EDP use.

ICs & SEMICONDUCTORS

Optoelectronic devices can be custom arrays

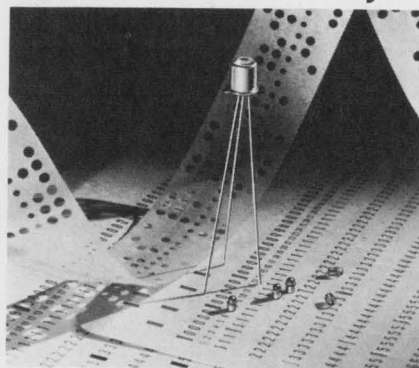

Motorola Semiconductor Products Inc., P.O. Box 20924, Phoenix, Ariz. Phone: (602) 273-8466. Price: \$6.25 to \$6.75.

Three new optoelectronic products—the MRD 210 and 250 sub-miniature photodetectors and the MRD 310 phototransistor—are now available in custom-designed arrays or matrices, as well as in discrete form. Minimum collector-emitter radiation sensitivities are 0.05, 0.1, and 0.2 mA/mW/cm², respectively. Maximum risetimes are in the order of 2.5 μ s; maximum falltimes are about 4 μ s.

CIRCLE NO. 325

Thick-film photo arrays isolate chip sensors

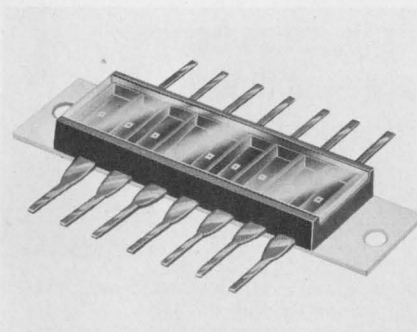

Hybrid Electronics, Inc., Jonathan Industrial Center, Chaska, Minn. Phone: (612) 926-2721.

Containing from 5 to 12 sensors, series LA-800 thick-film photo arrays minimize cross-talk by shielding adjacent sensors. All chips have common collectors and individual emitters. The package and lead frame is similar to a standard 14-lead dual-in-line IC type. The arrays can be mounted directly to a fiber-optic head or on a PC board.

CIRCLE NO. 326

DURANT
MANUFACTURING COMPANY
COUNT/CONTROL INSTRUMENTS
MECHANICAL/ELECTROMECHANICAL/ELECTRONIC
In Europe: Durant (Europa) N.V. Barneveld, Netherlands

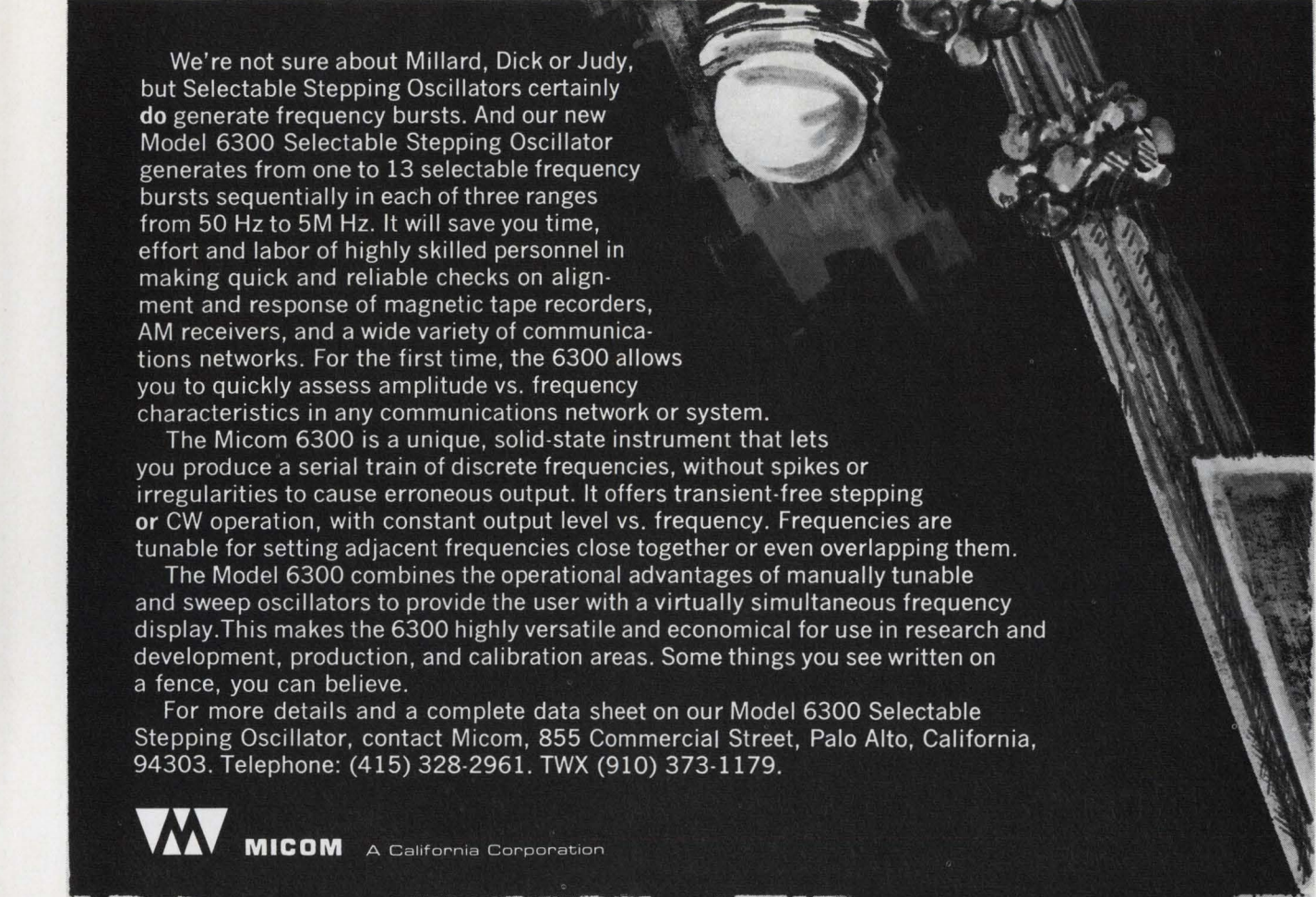

We're not sure about Millard, Dick or Judy, but Selectable Stepping Oscillators certainly **do** generate frequency bursts. And our new Model 6300 Selectable Stepping Oscillator generates from one to 13 selectable frequency bursts sequentially in each of three ranges from 50 Hz to 5M Hz. It will save you time, effort and labor of highly skilled personnel in making quick and reliable checks on alignment and response of magnetic tape recorders, AM receivers, and a wide variety of communications networks. For the first time, the 6300 allows you to quickly assess amplitude vs. frequency characteristics in any communications network or system.

The Micom 6300 is a unique, solid-state instrument that lets you produce a serial train of discrete frequencies, without spikes or irregularities to cause erroneous output. It offers transient-free stepping or CW operation, with constant output level vs. frequency. Frequencies are tunable for setting adjacent frequencies close together or even overlapping them.

The Model 6300 combines the operational advantages of manually tunable and sweep oscillators to provide the user with a virtually simultaneous frequency display. This makes the 6300 highly versatile and economical for use in research and development, production, and calibration areas. Some things you see written on a fence, you can believe.

For more details and a complete data sheet on our Model 6300 Selectable Stepping Oscillator, contact Micom, 855 Commercial Street, Palo Alto, California, 94303. Telephone: (415) 328-2961. TWX (910) 373-1179.



MICOM A California Corporation

MILLARD FILLMORE
IS ALIVE
AND
ORGANIZING
A POLITICAL
PARTY
IN
SOUTH
CAROLINA

JUDY W.
HAS A CRUSH
ON
TINY TIM

DICK TRACY
SLEEPS
WITH A
NIGHT LIGHT

**SELECTABLE STEPPING
OSCILLATORS
GENERATE FREQUENCY
BURSTS**

SWITCH CRAFT FORUM

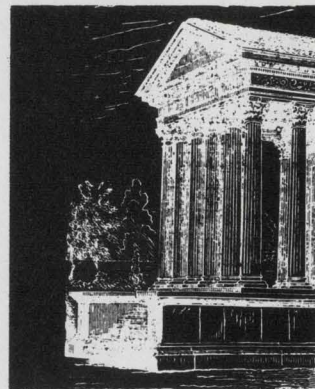

Ho-hum, another Forum. What have you got to say about "Multi-Switch"[®] switches that's new and exciting? Frankly, I get tired of just rehashing old product specs.

So do we. But, just the other day we discovered that a long standing customer of ours didn't know about our "Multi-Lite" pushbuttons that can couple two adjacent stations on a "Multi-Switch" switch.

Two stations?

Right. But, maybe we ought to start from the beginning. A single station can accommodate up to 6PDT circuitry. The "Multi-Lite" arrangement mechanically interlocks two adjacent stations for twice the switching capability without adding to the overall height of the switch stack. And, each station has a total of four lamps for sectionalized or redundant lighting, since we have combined two, dual lighted pushbuttons. Fig. 1. gives a good example of the flexibility we're talking about.

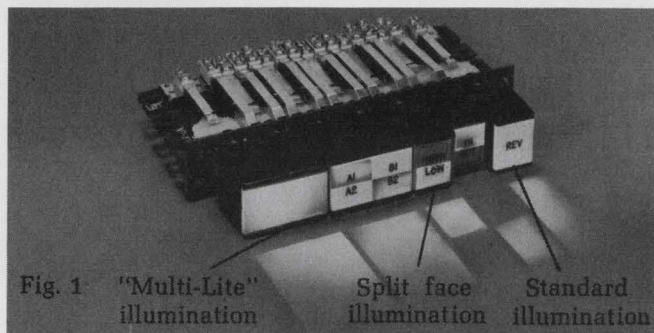

How does the "Multi-Lite" arrangement tie into the mechanics of your switch? I'm talking about lighting circuitry and switch functions.

Lighting circuitry on the Series 37000 & 38000 little "Multi-Switch" switches is accomplished by means of a lighting stack of the type shown in Fig. 2. The extra-long lighting springs extends the lighting circuit from the lamp terminal to the rear of the switch for convenient wiring to the N.O. or N.C. contacts on the lighting switch stack. Naturally, direct wiring to the pushbutton lights is another alternate.

Regarding switch functions, the coupled stations can be furnished for interlock, momentary, push-to-lock,

Fig. 2

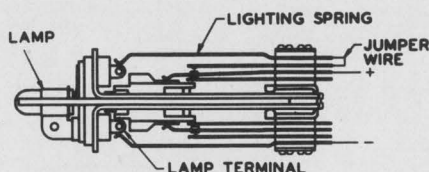

push-to-release, and all-lock operation. Of course, the all-lock arrangement will require a single button for a release station. (Forum readers may obtain complete info on switch functions from our engineering specification catalog. Just circle the reader service number below.)

"Multi-Switch" REGD. T.M.

The increased size of the "Multi-Lite" pushbutton would be ideal for a cancel bar on our new check-writer, but we'll need smaller pushbuttons for most of the other functions. How much legend information can I get on either type? And what about display screen colors and lamps?

The "Multi-Lite" pushbuttons will accept up to 4 lines of 11, 1/8" high characters per line. The smaller pushbuttons provide a 3 1/2" x 1 9/32" rectangular area for hot stamping or engraving. This should accommodate any of your legend requirements for each station. We have nine standard display screen colors plus color inserts to give you unlimited color flexibility.

As a convenience, Switchcraft has available, standard industry lamps #328 (6v.), #718 (6v.) or #327 (28v.). Or if you need zero power consumption on an "illuminated" switch, why not use the Switchcraft "Glo-Button." Available on certain switches, the "Glo-Button" produces a highly visible illumination change by strictly mechanical means without consuming any power.

I must admit we've learned something, but I suspect the Forum won't be dismissed until we've heard a "life & versatility" pitch.

Our catalog tells all about "life & versatility" and how you can specify a "Multi-Switch" switch anywhere from 1 to 18 stations in a row or up to 100 stations in ganged and coupled matrixes. The almost unlimited adaptability of this switch to countless applications is difficult to express. When we sit down to discuss your requirements in detail, the value of a "Multi-Switch" switch will become more apparent. We've dwelled on lighting pretty much, but the total versatility of these units doesn't begin to "shine" until you can see it solving your particular application problems.

Forum dismissed, but but don't forget that we have extra bound copies of "FORUM FACTS on 'Multi-Switch' Switches", that describes these units, their accessories and applications. Just have your engineers drop us a line on your company letterhead, asking for this handbook. We'll also place their name on our mailing list for TECH-TOPICS, our semi-monthly application engineering magazine. Ten-thousand engineers already receive TECH-TOPICS and tell us that the technical stories are interesting and useful.

SWITCHCRAFT[®]
INC.

5529 North Elston Avenue • Chicago, Illinois 60630

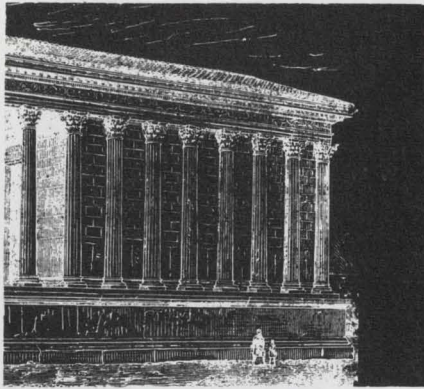

for computer and data processing engineers

Now that we're getting down to specifics in my field, I'd like to know if your "Multi-Switch" can handle a power range from "dry" circuits to line power?

No problem. The interchangeable spring stacks are available with gold contacts for micro-power circuits or with snap-act modules that will handle up to 15 amps.

What if I need a different switch function due to programming changes?

Then you'll want our Series 7000 non-illuminated or Series 21000 illuminated "Multi-Switch". Simple mechanical adjustments in the field permit these switches to be changed from interlock to non-lock or all-lock to non-lock for mixed functions on the same switch frame.

Do I need separate indicator lights to display a changed condition on any of my data retrieval channel selectors?

Save your money. Use a Series 38000 "Multi-Switch" with split face, dual color pushbuttons. Color changes can be achieved by remote signalling or pushbutton actuation.

When my stop-function relay operates, it's a whole new ball game. How do I tie this operation into the keyboard using your "Multi-Switches"?

Just use a solenoid release "Multi-Switch." When energized, it restores all the pushbuttons to the non-operated position. It can be easily attached to the 38000 switch frame for electrical release of up to 18 interlock stations.

YOU CAN GET COMPLETE FACTS ON "MULTI-SWITCH" SWITCHES FOR YOUR COMPUTER APPLICATIONS BY SENDING FOR THE "FORUM FACTS" HANDBOOK. JUST CIRCLE THE READER SERVICE NUMBER SHOWN BELOW.

INFORMATION RETRIEVAL NUMBER 66

ELECTRONIC DESIGN 1, January 4, 1969

ICs & SEMICONDUCTORS

MSI digital decoder has 16 active outputs

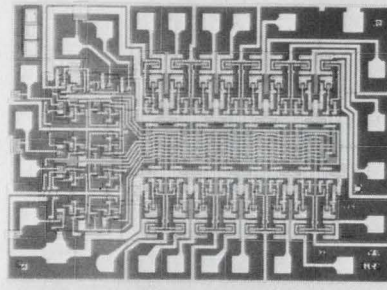

Fairchild Semiconductor, 313 Fairchild Dr., Mountain View, Calif. Phone: (415) 962-2530. P&A: \$15.50 to \$34; stock.

Representing an industry first, an MSI one-of-16 digital decoder converts four digital inputs into one of 16 mutually exclusive digital low-level active outputs. Replacing more than 10 discrete IC packages, model 9311 features a built-in, enabling capability and high-speed performance (20 nanoseconds) through delay.

CIRCLE NO. 327

Read-only memory chip performs custom logic

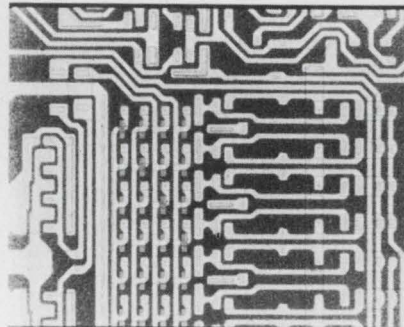

Motorola Semiconductor Products Inc., P.O. Box 20924, Phoenix, Ariz. Phone: (602) 273-6900. Price: \$9.95 plus setup (from \$50).

Supplying logic functions without the large development costs that are usually associated with custom devices, a bipolar read-only memory provides 16 custom 8-bit words. The customer programs the XC170 (determines the array-bit pattern) by punching the necessary information on a standard EDP card. The card is then used to control the automatic mask generation.

CIRCLE NO. 328

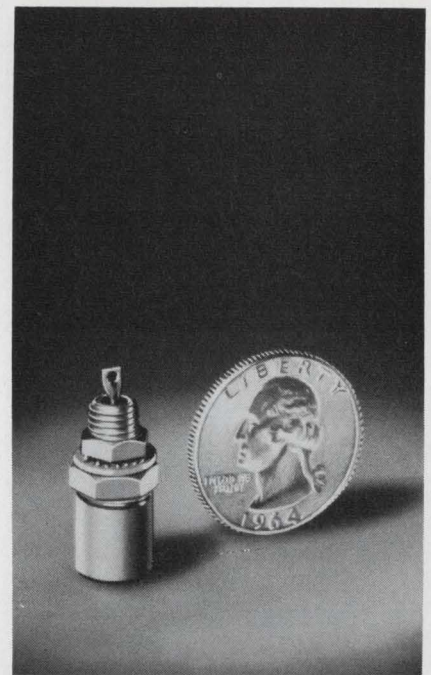

By George... Captor sure makes small EMC Filters!

Captor subminiature EMC filters are the industry's smallest... 25% to 37% more compact than other popular miniatures. Volumes and weights are correspondingly reduced... as light as 4.9 grams for many units. Captor EMC filters maintain high published performance over full temperature range to 125° C. Their performance is equal to or better than the competition's, yet they truthfully cost less! Let Captor bid on your next EMC filter or filter assembly requirement, by George! Write for Catalog F-104 and prices today.

Captor Corporation manufactures miniature filters... communications and security filters... custom-design filters, and other electronic components.

CAPTOR
CORPORATION

APPLICATION ENGINEERING DEPT.

5040 Dixie Highway, Tipp City, Ohio 45371

INFORMATION RETRIEVAL NUMBER 67

12.5GHz

with
-TR-3016
Frequency
Converter
Plug-in

250 MHz
-TR-5589L
Universal
Counter

3
8
3
4
4
3

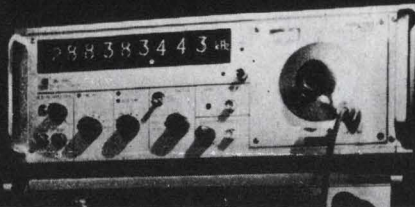

- Counts directly up to 250 MHz in decimal form, up to 500 MHz with prescaler plug-in, covers 10 Hz to 12.5 GHz with plug-ins.
- Interchangeable plug-ins increase versatility.
- Timing resolution of 10 nanosec.
- High input sensitivity—10mV rms. with ANS(Automatic Noise Suppressor) mode.
- 5 parts in 10¹⁰ per day time base stability.
- 9-digit storage display.
- BCD (8-4-2-1) code output is available.

Plug-ins for -TR- 5589L

-TR- 3083

Range: 10 Hz to 500 MHz/Input Voltage: 10mV rms. /Input Impedance: Approximately 50 ohms

-TR- 3015

Range: 500 MHz to 4.5 GHz, covering in 200 MHz steps/Input Voltage: 100mV rms. min./Input Impedance: Approximately 50 ohms.

-TR- 3016

Range: 4 to 12.5 GHz/Input Voltage: —7 dBm/Input Impedance: Approximately 50 ohms.

For details, write, _____



**Takeda Riken
Industry Co., Ltd.**

285, Asahi-cho, Nerima-ku, Tokyo 176, Japan
Tel: Tokyo 930-4111
Cables: TRITRONICS TOKYO

COMPONENTS

High-power stepper boosts speed, torque

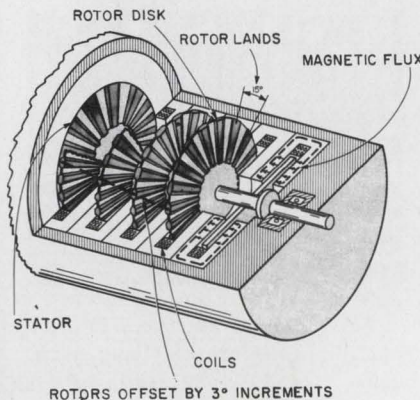

Icon Corp., 156 Sixth St., Cambridge, Mass. Phone: (617) 868-5400. P&A: \$760; stock.

Model 110 stepping motor features improvements in speed, torque, horsepower, and response that can increase the range of numerical control applications that benefit from open-loop digital control rather than closed-loop and log servo positioning. Using stepping-motor control eliminates the need for d/a converters while dispensing with feedback elements.

Although previous stepping motor designs have been limited in speed and power, the 110 boasts a slewing rate of 8000 steps per minute and develops one-third horsepower. Several innovations have been incorporated into the new stepping motor. Basic to the design is a five-disc rotor with each disc running within its own independent electromagnetic stator assembly. As magnetic flux passes parallel to the shaft each disc is pulled into alignment with the stator.

Since the discs are mounted on the shaft with 3° angular offset from each other, they will be pulled one-by-one into alignment with their respective stator when the magnetic coils are energized in sequence.

In operation the coil excitation scheme provides an excitation frequency that is one-tenth of the motor's stepping rate. This low coil frequency overcomes the effect of coil inductance that limits the drive rate of many competitive stepping motors.

CIRCLE NO. 329

Numeric readouts require only 0.1 A

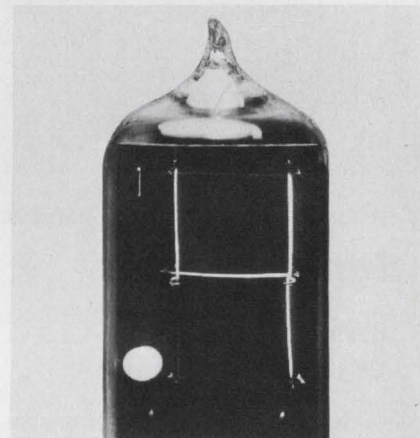

Los Angeles Miniature Products, 17000 South Western Ave., Gardena, Calif. Phone: (213) 323-7578. Price: \$3.

Interfacing directly with low-amperage ICs, low-cost numerical readout tubes are rated at 3 to 4 V, 0.1 to 0.15 A. Called Numerals, the new tubes produce numerals 0 through 9 on a seven-bar frame, with a decimal point available as an option.

CIRCLE NO. 330

Subminiature switch seals out environment

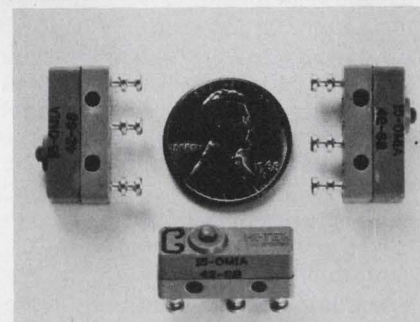

Hi-Tek Corp. Switch Div., 2220 S. Anne St., Santa Ana, Calif. Phone: (714) 540-3520.

Designed for use in both military and industrial applications, a sealed subminiature switch cannot be damaged by water, oil, flux or other harmful elements within its environment. Having a long life of five million operations, it is actuated by a force of 150 grams maximum. The 10-A unit is directly interchangeable with all existing subminiature switches meeting MIL-S-8805/2.

CIRCLE NO. 331

WAFERPOT™

Maximum outputs in minimum space.

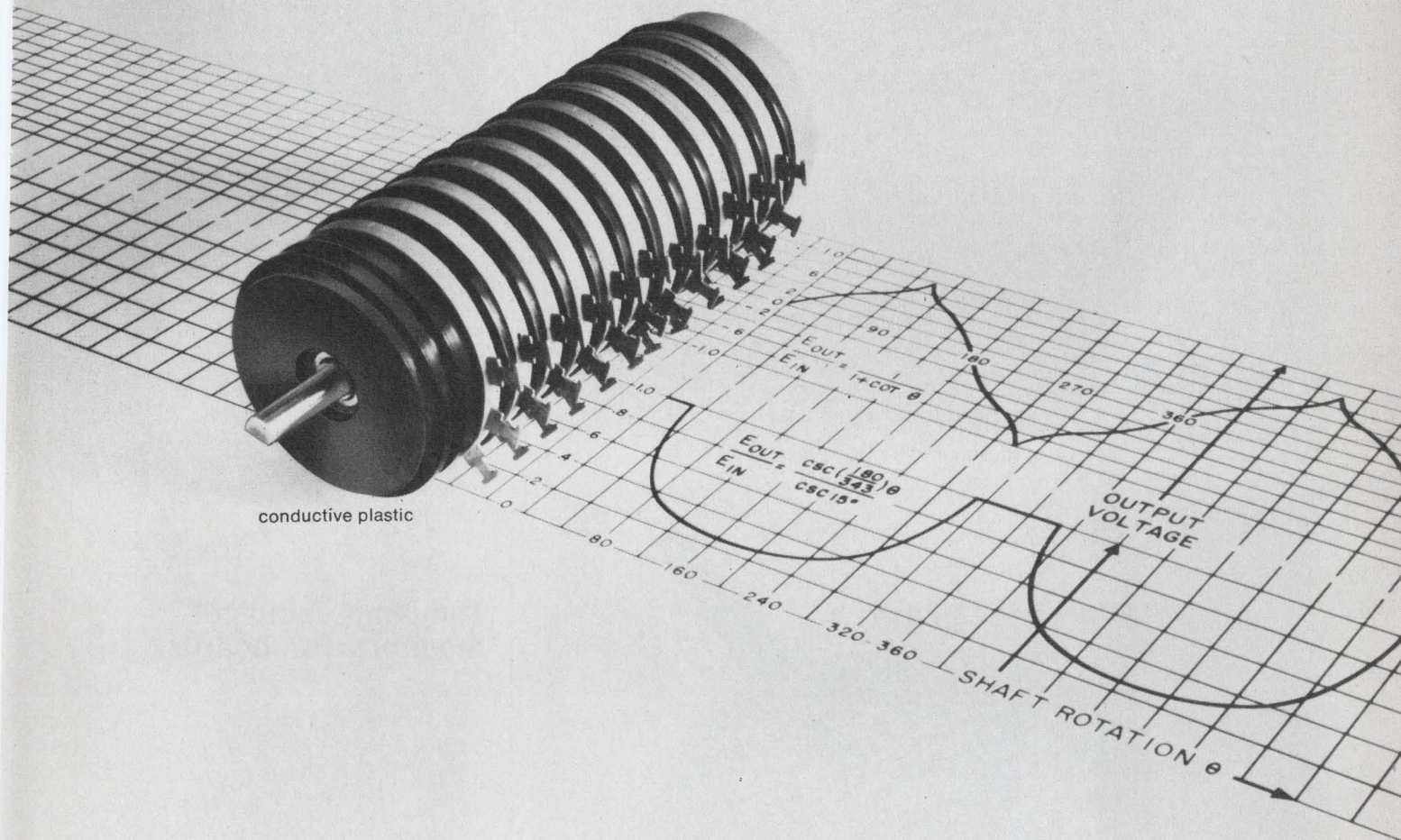

Your potentiometer requirement is complex
 ... single-shaft control of many circuits ... linearities as close as 0.05%
 ... complex nonlinearities demanding tight conformities ... per-cup depth of 0.200".
 Your potentiometer solution is simple.

NEI's compact, reliable WAFERPOT™ designs can meet your most stringent requirements. Our engineers couple more precise design techniques with a higher order of mathematics, through computer assisted design, to arrive at the optimum function with minimum error. You receive the ultimate in quality & reliability with faster response at the lowest possible cost.

If you need precision pots or elements, conductive plastic or wirewound, custom or standard, turn to NEI ... innovators in the potentiometer industry since 1957.

new england instrument company

The only manufacturer with equal capability in single turn conductive plastic & wirewound precision potentiometers

281 Billerica Road • Chelmsford, Mass. 01824 • Tel. 617-256-3711
 STANDARDS DIVISION



14 Kendall Lane • Natick, Mass. 01760 • Tel. 617-873-9711
 GENERAL OFFICES & CUSTOM DIVISION

**This is our 3 step.
Give us a call and see all
the steps in our routine.**

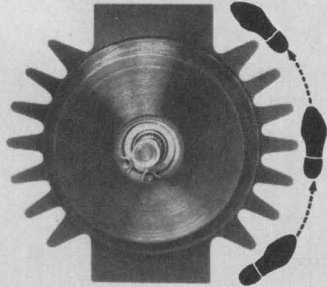

If you really want to swing you can also step 4, 8, 12, 24, 48, and 200 increments without gears.

Or to Indicate, Measure and Control using flag and remote angle indicators, synchros, resolvers, steppers, or solenoids. They are in stock at IMC Magnetics Corp., Western Division. For quick service contact the Applications Section at Western Division, 6058 Walker Ave., Maywood, Calif. 90270. Phone 213 583 4785 or TWX 910 321 3089.

If you need data sheets for references or consideration for future projects, write IMC's Marketing Division at 570 Main Street, Westbury, New York 11591.



INFORMATION RETRIEVAL NUMBER 70

A specialty of the house...



cooking up new ideas in electric motors.

Like the GT1612 that runs up to 60,000 rpm on hydrostatic air bearings. Extreme accuracy in locating the beryllium shaft helps make this possible. Other specialties to help you serve up exactly what's needed include induction, hysteresis, torque, synchronous, AC drive, DC drive and servo motors, in the milli- to integral-horsepower range, and without the compromise of run-of-mill

mass-produced motors. For motors for spacecraft, avionics, control, computer peripherals and other systems, contact IMC Magnetics Corp., Eastern Division, 570 Main St., Westbury, N.Y. Phone (516) 334-7070 or TWX 516 333 3319. If you need information for future projects write IMC's Marketing Div., at the same address, or circle the bingo number at the bottom of this ad.



INFORMATION RETRIEVAL NUMBER 71

COMPONENTS

**Digital indicators
light with 3 volts**

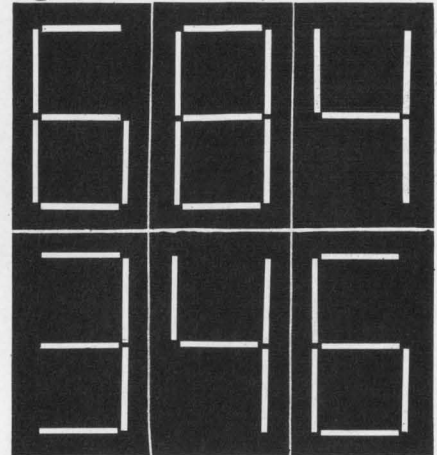

*Pinlites, Inc., 1275 Bloomfield Ave.,
Fairfield, N.J. Phone: (201) 226-
7724. Price: \$13.*

Series M digital display heads are seven-segment incandescent indicators that operate at power levels as low as 3 V at 8 mA. Six of the compact units, which measure only 3/16-in. deep, can be stacked in less than one square inch. Character brightness, which can be varied with applied voltage, ranges from 200 to 1000 ft-L, depending on the model.

CIRCLE NO. 332

**Ten-lamp indicator
monitors PC boards**

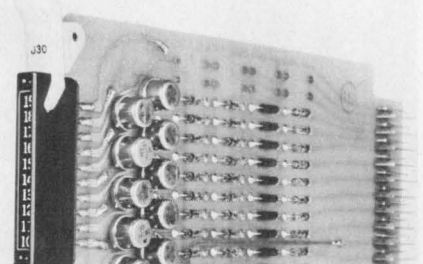

*Display Devices, Inc., 2928 Nebraska
Ave., Santa Monica, Calif.
Phone: (213) 393-0385.*

An edge-mounted, multiple-circuit module indicates the status of printed-circuit boards by selectively illuminating 10 internal T-1 lamps. Letters, symbols, words and/or colors can be utilized to signal board status, and integral light baffles can be removed to provide fewer than 10 lighted windows. Digistrip status indicator relamps from the front.

CIRCLE NO. 333

INFORMATION RETRIEVAL NUMBER 248 ►

Celco

solves CRT display problems
every day, and here's the reason why.

Just when you have CELCO pegged as the leader in the design and manufacture of deflection coils, we turn up in all areas of CRT displays with new products... newer and better ways of solving display problems than you thought possible.

In fact, nobody offers more opportunities for improving your display than CELCO. That's because CELCO experience includes every type of display system. Chances are we've worked on your problem and can help you.

Call now. We're ready.

CELCO, Mahwah, N. J. 07430 201-327-1123

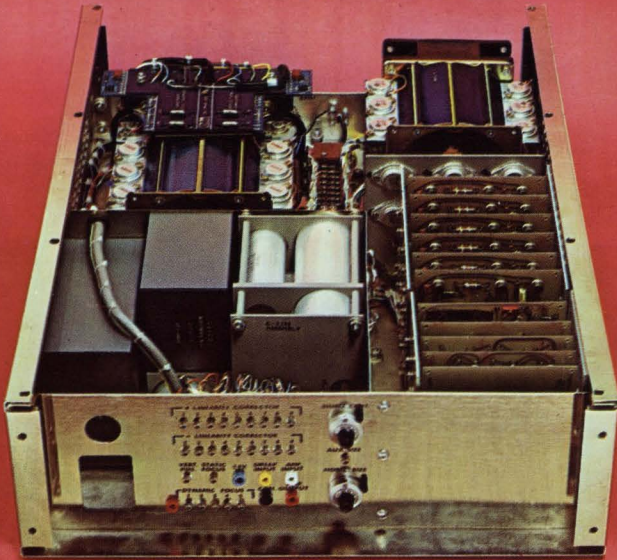

Planning a line scan system? Our versatile LSS unit provides all functions for deflection, focus, positioning, centering and linearity. It's completely self-contained and may be ordered in a wide flexible range of options.

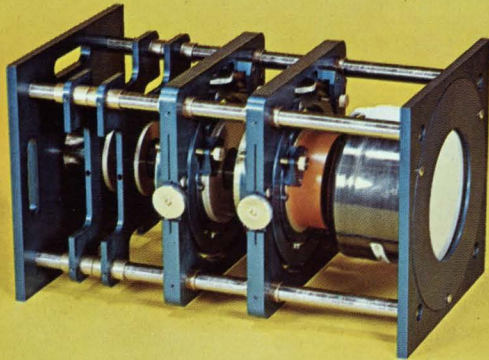

This Low Cost Positioner holds coils and tube, has six degrees of freedom without backlash. Permits accurate alignment of the electron beam for optimum resolution, linearity and spot stability.



The CELCO variable rate Raster Generator provides linear dual sweeps plus the convenience of phosphor protection and blanking. Sweeps from 10 μ sec. to 100 ms; specials to seconds. 10% to 90% duty cycle, linearity to 0.5%.

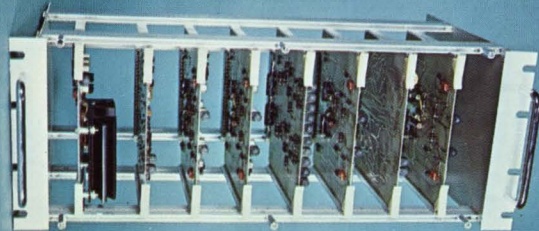

CRT Control Circuit Cards in standard 19" rack offer any desired display function and any geometric distortion correction.



CELCO Deflection Amplifiers provide from ± 0.25 Amps to ± 60 Amps to the yoke with up to 0.02% dc and 0.04% ramp linearities. Simplifies the problems of fast, accurate deflection.

Celco

DISPLAY COMPONENTS

Celco

CRT CONTROL CIRCUIT CARDS

FG100	Dual Axis Dynamic Focus Function Generator
FG101	Single Axis Dynamic Focus Function Generator
DA-PP025	Dynamic Focus Amplifier or Single Axis Deflection ($\pm .25A$)
DA-PP05	Dynamic Focus Amplifier or Single Axis Deflection ($\pm .5A$)
FA1000	Dynamic Focus Amplifier (1.0A p-p)
SR1000	Static Focus Current Regulator
CR200	Centering Alignment Coil Regulator
BA100	Blanking Amplifier
PP100	Phosphor Protection
BA-PP-30	Blanking Amplifier and Phosphor Protection
BR1000	Blanking Amplifier and Static Focus Current Regulator
VA110	Video Amplifier dc to 10 MHz
VA120	Video Amplifier dc to 20 MHz
VA130	Video Amplifier dc to 30 MHz
VA140	Video Amplifier dc to 40 MHz
LC101A	Linearity Correction On-Axis (X)
LC1234	Linearity Correction Off-Axis (X, Y)
2SG-3	Sawtooth Generator Two Axis Fixed Rates
CS/L1	Centering, Size, Linearity (Line Scan)
CCE	Circuit Card Extender
CCR	Circuit Card Rack with Receptacles

YOKE and FOCUS COIL POSITIONING MECHANISMS

P1	for 4" dia. coils
P2	for 3½" dia. coils
P3	for 3" dia. coils
P4	Special diameters
P100	Precision

MAGNETIC SHIELDS

B5M10	10db attenuation at 60Hz
B7M10	10db attenuation at 60Hz
B10M10	10db attenuation at 60Hz
D6M10	10db attenuation at 60Hz
BP5M60	60db attenuation at 60Hz

CENTERING and ALIGNMENT COIL HOLDERS

F1	for CELCO Type Coils (2-84 O.D.)
F2	for CELCO Type Coils (2-09 O.D.)
F3	for Special O.D. Coils (Special)
F4	Fixed Yoke and Focus Servo Mount
F5	Cylindrical Coil Mounts
F100	Adjustable

CRT and POSITIONER HOLDERS

C1	for 5" CRT
C2	for 7" CRT
C3	for 10" CRT
C4	for Dual Recording Storage
C100	Precision Mount for P100 Positioners

WIDE BAND DEFLECTION AMPLIFIERS

	Without Power Supply	With Unregulated Power Supply	With Regulated Quadru-Power Supply
±20 VOLTS ALL SILICON (250 kHz small signal bandwidth)			
±1.5 Amps	DA-PP2N-3	PDA-PP2N-3	RDA-PP2N-3
±3.0 Amps	DA-PP3N-3	PDA-PP3N-3	RDA-PP3N-3
±6.0 Amps	DA-PP6N-3	PDA-PP6N-3	RDA-PP6N-3
±35 VOLTS ALL SILICON (1 MHz small signal bandwidth)			
±2.0 Amps	DA-PP2N-5	PDA-PP2N-5	RDA-PP2N-5
±4.0 Amps	DA-PP4N-5	PDA-PP4N-5	RDA-PP4N-5
±6.0 Amps	DA-PP6N-5	PDA-PP6N-5	RDA-PP6N-5
±8.0 Amps	DA-PP8N-5	PDA-PP8N-5	RDA-PP8N-5
±40 VOLTS ALL SILICON (250 kHz small signal bandwidth)			
±2.0 Amps	DA-PP2N-4	PDA-PP2N-4	RDA-PP2N-4
±4.0 Amps	DA-PP4N-4	PDA-PP4N-4	RDA-PP4N-4
±6.0 Amps	DA-PP6N-4	PDA-PP6N-4	RDA-PP6N-4
±8.0 Amps	DA-PP8N-4	PDA-PP8N-4	RDA-PP8N-4
±45 VOLTS HIGH SPEED (2 MHz small signal bandwidth)			
±2.0 Amps	DA-PP2N-6	PDA-PP2N-6	RDA-PP2N-6
±4.0 Amps	DA-PP4N-6	PDA-PP4N-6	RDA-PP4N-6
±6.0 Amps	DA-PP6N-6	PDA-PP6N-6	RDA-PP6N-6
±8.0 Amps	DA-PP8N-6	PDA-PP8N-6	RDA-PP8N-6

Celco*Constantine Engineering Laboratories Company**"For the latest in the science of Electron Beam Control"*

Mahwah, New Jersey

Tel. 201-327-1123

TWX 710-988-1018

**Do you have
the question
to this**

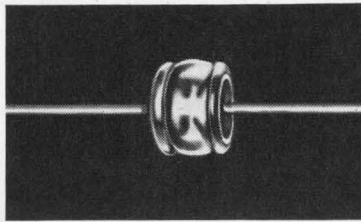

answer?

The only limits to the questions answered by the Siemens Gas-filled Surge Voltage Protector are your needs, and your imagination.

Tiny, lightweight, a handful can protect a ton of sensitive electronic equipment, especially supersensitive solid state circuits. They give you tailor-made protection in hundreds of places throughout circuitry. With current carrying capacities up to 5,000 amps. With DC striking voltages from 90V to 1000V. With reaction speeds in the nanosecond range. And with a cost of less than \$1 in quantity.

Lightning strokes, static charges, internal switching, short circuits—all these transient dangers are guarded against by these tiny, tireless sentries—Siemens Gas-filled Surge Voltage Protectors. If you've got a protection question, call Siemens America Incorporated for immediate protection delivery.

Send us your questions!

SIEMENS AMERICA INCORPORATED
350 Fifth Ave., New York, N.Y. 10001 • (212) 564-7674

Delay Lines

MAGNETOSTRICTIVE
DELAY LINES

SOLID
DELAY LINES
(Glass or Quartz)

LC and DC
DELAY LINES

DISPERSIVE
DELAY LINES

DIGITAL
DELAY LINES

for proven
reliability in
Delay Lines and
Serial Memory Systems
for military and
commercial
applications, it's...



MICROSONICS
60 Winter Street
Weymouth, Mass. 02188
Tel: 617 337-4200

A division of the Sangamo Electric Company

INFORMATION RETRIEVAL NUMBER 73

COMPONENTS

Trimmer capacitors have Q of 4000

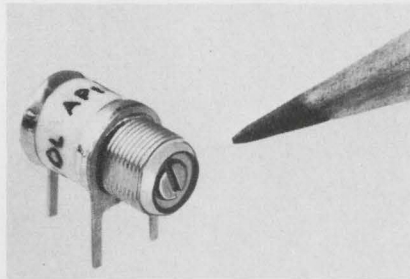

Voltronics Corp., West St., Hanover, N.J. Phone: (201) 887-1517.

Using a new design concept, precision air-dielectric trimmer capacitors boast a Q of 4000 at 100 MHz. They are available with two tuning ranges: 0.8 to 10 pF, and 0.8 to 14 pF. Their temperature coefficient is $+50/\pm 50$ ppm/ $^{\circ}$ C, and capacitance drift is 0.01 pF maximum. Operating temperature ranges from -55 to $+150^{\circ}$ C. Both printed-circuit and panel-mounting units are available.

CIRCLE NO. 334

Lighted rocker switch conserves panel space

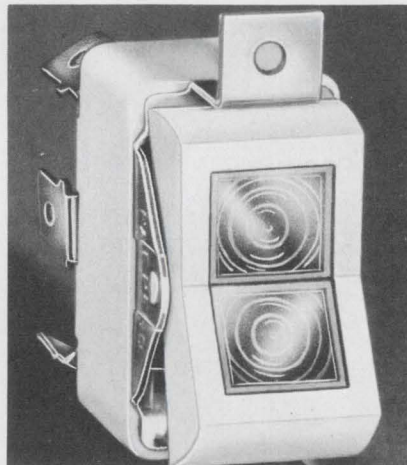

Leviton Mfg. Co., Inc., 236 Greenpoint Ave., Brooklyn, N.Y. Phone: (212) 383-4500.

Designed to enhance the eye appeal of instrument and computer panels, new lighted rocker switches save mounting space by eliminating the need for separate indicator lights. All series 15700, 15800 and 15900 switches indicate whether a circuit is on or off. They are available in a variety of colors, lamp types and ratings.

CIRCLE NO. 335

Fluidic amplifiers vary gain externally

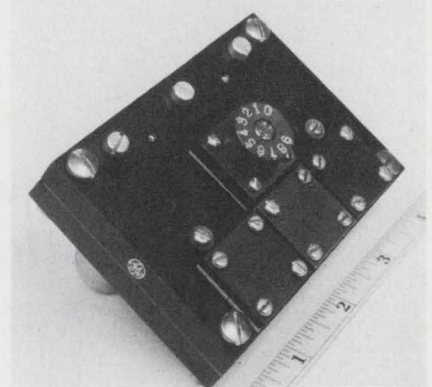

General Electric Co., Specialty Fluidics Operation, 1 River Rd., Schenectady, N.Y. Phone: (518) 374-2211.

Housed in a 3-by-4-in. module, Mark 50 fluidic operational amplifiers feature externally adjustable gain characteristics. They are available in several functions, including a three-input summing amplifier with a gain range from 5 to 50, a two-input summing integrator, and a two-input summing/derivative and lag circuit.

CIRCLE NO. 336

Tiny transformers fit in 0.5-in. cube

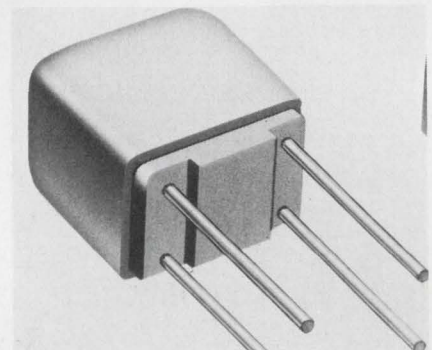

Nytronics, Inc., Transformer Div., Philipsburg, N.J. Phone: (201) 454-1143. P&A: \$4 to \$10; 2 wks.

Especially designed for PC boards, a new series of input, output and interstage transformers, and audio chokes is now available in a tiny 0.31-by-0.41 by 0.465-in. package. Useful operating range for these Nytran transformers is 100 Hz to 100 kHz, and normal frequency response is ± 2 dB from 300 Hz to 100 kHz.

CIRCLE NO. 337

Ice maker
control circuit
courtesy
of Gibson
Refrigerator Div.

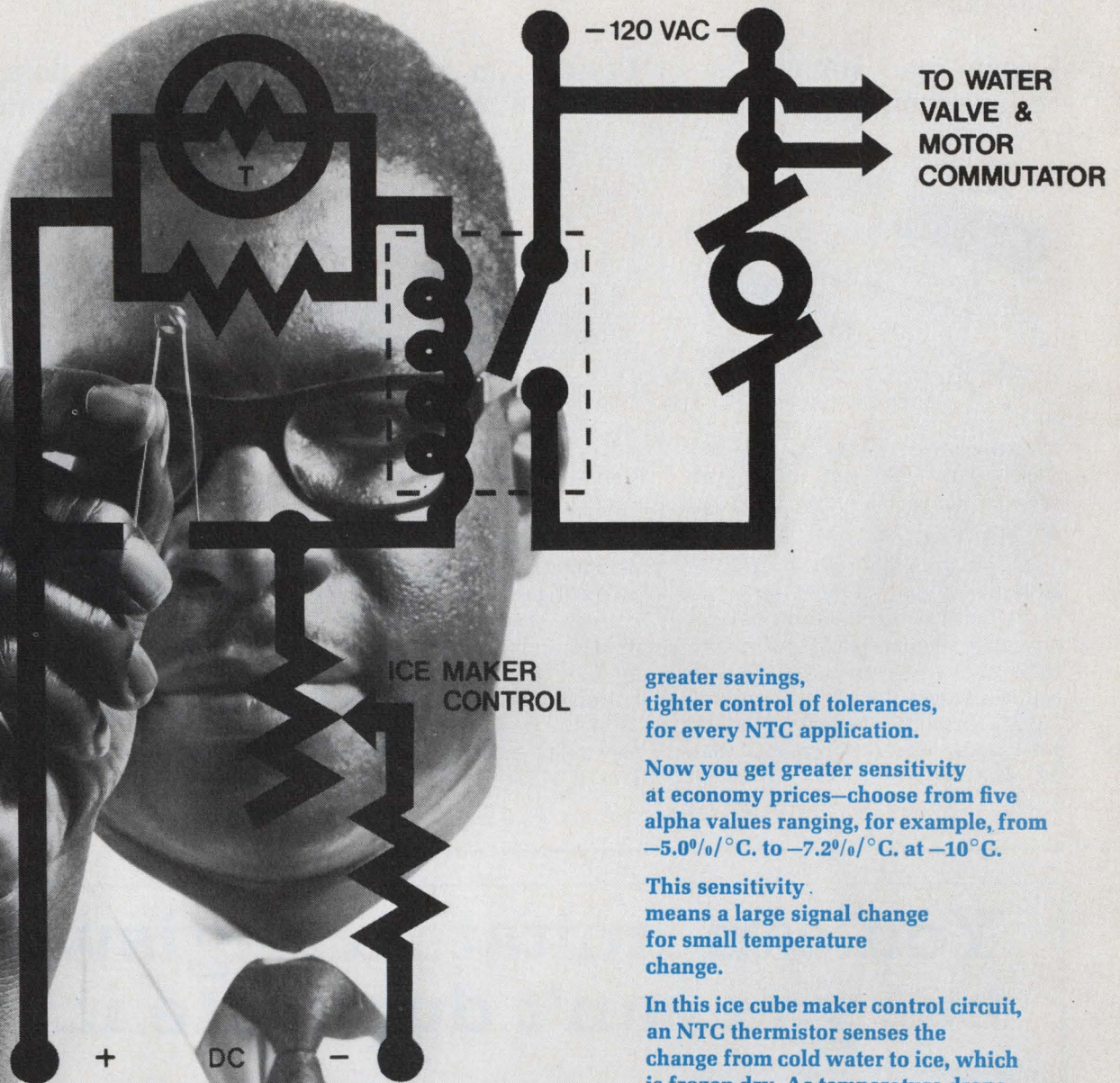

**Design in
precise solid-state
temperature sensing**

**... now for
just pennies**

Carborundum®
Negative Temperature Coefficient
Thermistors with resistance
tolerances to $\pm 5\%$ are now
available for as little
as 5c per unit.

Our new automated
thermistor production line means

greater savings,
tighter control of tolerances,
for every NTC application.

Now you get greater sensitivity
at economy prices—choose from five
alpha values ranging, for example, from
 $-5.0\%/^{\circ}\text{C}$. to $-7.2\%/^{\circ}\text{C}$. at -10°C .

This sensitivity
means a large signal change
for small temperature
change.

In this ice cube maker control circuit,
an NTC thermistor senses the
change from cold water to ice, which
is frozen dry. As temperature drops,
resistance across the thermistor
increases. At the required
temperature, the thermistor
activates the unit's ice cube harvest/
refill cycle. A second thermistor
compensates the reed relay for
ambient-temperature changes.

You too can simplify circuit design,
cut costs, and improve temperature-
sensing reliability in your solid-state
design with Carborundum NTC
thermistors.

For detailed information, or
assistance on specific applications,
write to Mr. James Battle,
The Carborundum Company,
Electronics Plant,
Niagara Falls, N.Y. 14302.

Precisely yours ...

CARBORUNDUM



Epoxy reed relays reduce coil power

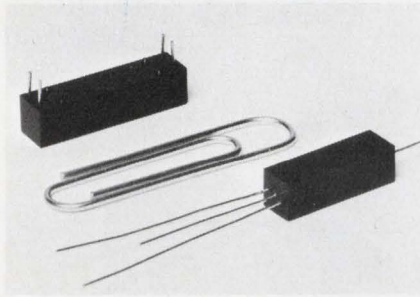

Electronic Instrument & Specialty Corp., P.O. Box 24, Winchester, Mass. Phone: (617) 729-1202. Availability: stock.

Available in both PC-board and axial-lead types, a new series of epoxy-encapsulated reed relays minimize required coil powers with their high coil resistances. Typical coil resistance for a 12-V unit is 1.9 k Ω . Insulation resistance is also very high; generally greater than 10⁶ M Ω .

CIRCLE NO 338

Crystal-can relay switches 2-A load

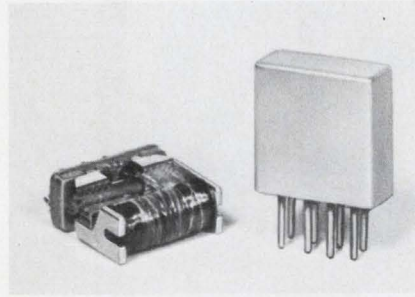

Allied Control Co., Inc., 2 East End Ave., New York City. Phone: (212) 288-7403.

Designated WA, a one-sixth size crystal-can relay can dissipate 100 mW of power and can switch a 2-A resistive load at 28 V dc. The all-welded unit measures only 0.505 by 0.5 by 0.23 in. Intended for military and industrial applications involving severe environments, the new relay meets specifications for MIL-R-5757D/19 and -/30.

CIRCLE NO. 339

Trimmer potentiometer contains cermet element

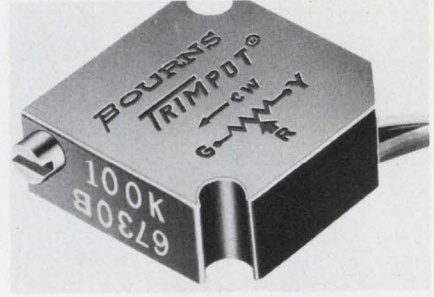

Bourns Inc., Trimpot Products Div., 1200 Columbia Ave., Riverside, Calif. Phone: (714) 684-1700. P&A: \$4.86; stock to 4 wks.

Using a cermet element to achieve infinite resolution, model 3292 trimmer potentiometer meets or exceeds all requirements of MIL-R-22097, Characteristic C. It has a resistance range of 10 Ω to 1 M Ω , an operating temperature range of -65° to +175 °C, and a power rating of 0.5 W at 70°C. Resistance tolerance is $\pm 10\%$.

CIRCLE NO. 340

You can imitate a Digiswitch but you can't duplicate it.

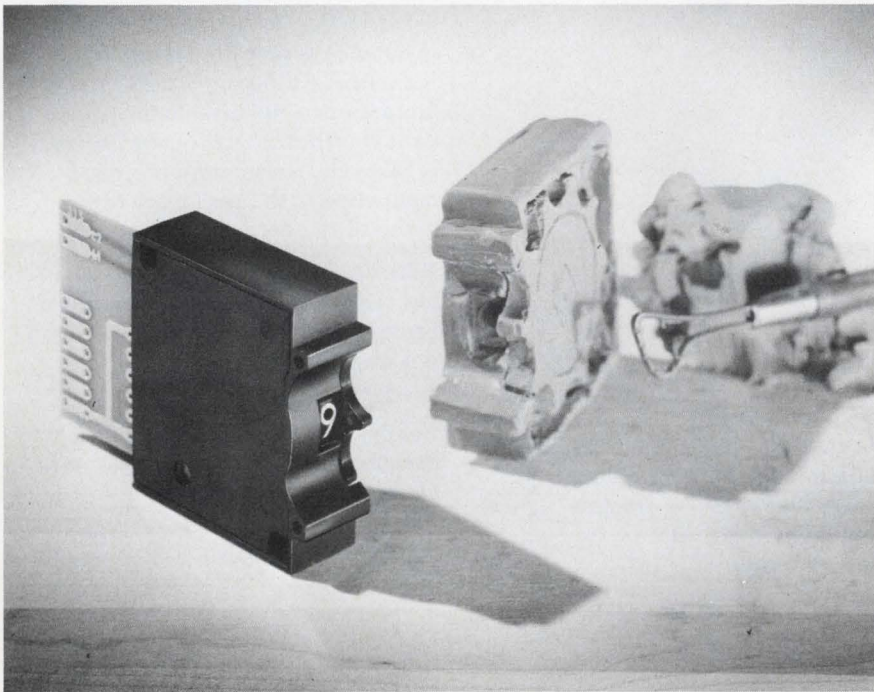

You can't duplicate a Digiswitch® any more than you could duplicate a sculpture by Rodin.

Make a fair copy? Sure, but the knowledge, experience and skill that went into the original would be missing.

Digitran pioneered thumbwheel switches, and years of experience and improvement have established Digiswitch as the industry standard. And, nobody comes close to duplicating our service organization, application library or scope of product.

Insist on an original. Digiswitch. The switch you can count on. More information about the original is yours for the asking.

THE DIGITRAN COMPANY
Subsidiary of Becton, Dickinson and Company 
855 S. Arroyo Pkwy./Pasadena, Cal. 91105
Tel: (213) 449-3110/TWX 910-588-3794

THREE NEW BROADBAND QUADRATURE HYBRIDS

Merrimac's new lineup of broadband quadrature hybrids are unsurpassed in performance, quality and price. The QH-7-17 covers the full bandwidth over 2-to-32 MHz with 23 db minimum isolation. This four-port hybrid network exhibits less than 0.75 db insertion loss and output equality of 0.5 db. Phase quadrature is $90^\circ \pm 3^\circ$. Other new broadband quadrature hybrids include the QH-4-53 covering 30-to-76 MHz and the QH-5-30 covering 10-to-50 MHz. Their low prices will surprise you! These broadband networks are extremely useful for imageless mixing, single sideband modulation, radio direction finding, phasing of antenna systems, and homing systems. Also available are a variety of reduced bandwidth and miniature quadrature hybrids from audio to microwave. For more details, write or phone Merrimac.

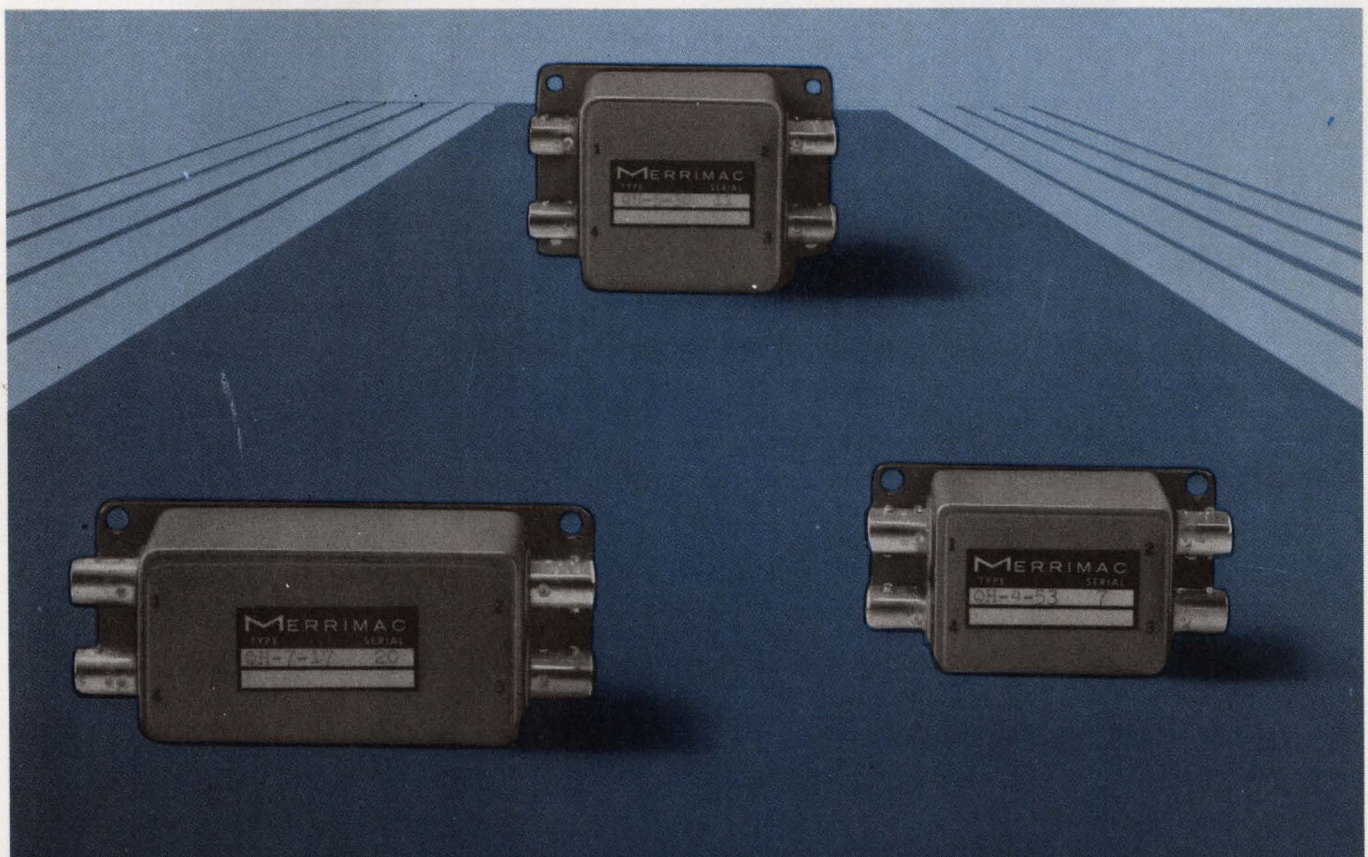

The image shows three Merrimac quadrature hybrids. The top one is a QH-7-17, the bottom left is a QH-5-30, and the bottom right is a QH-4-53. They are all rectangular metal boxes with four ports on each side. The background is a dark blue surface with perspective lines receding into the distance.

MERRIMAC RESEARCH AND DEVELOPMENT, INC.
41 FAIRFIELD PLACE, WEST CALDWELL, N. J. 07006 • 201-228-3890

High RF power, low distortion



The Hewlett-Packard 230A Signal Generator Power Amplifier delivers up to 4.5 watts of low distortion power from 10 to 500 MHz. It is ideal for meeting your high RF power requirements for applications such as receiver testing, wattmeter calibration, antenna testing, filter and component testing and attenuation measurements. The amplifier may be driven with any conventional signal source and will reproduce AM, FM and pulse modulation characteristics of the driver generator with minimum distortion. The instrument employs three tuned, cascaded stages of grounded-grid amplification fed from a regulated power supply. Price: \$1350. Application Note 76 discusses high and low-level applications. For your copy of this application note or more information about the amplifier, contact your local Hewlett-Packard field engineer or write: Hewlett-Packard, Rockaway Division, Green Pond Road, Rockaway, New Jersey 07866. In Europe: 1217 Meyrin-Geneva, Switzerland.

HEWLETT *hp* PACKARD

SIGNAL SOURCES

1082A

INFORMATION RETRIEVAL NUMBER 77

PACKAGING & MATERIALS

Hybrid package is dual in-line

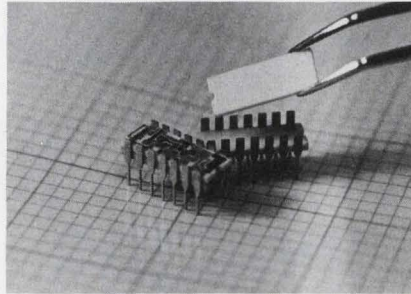

Cermex Division, Frenchtown/CFI Inc., Frenchtown, N.J. Phone: (201) 996-2121.

The advantages of dual in-line geometry and brazed lead-frame attachment can now be applied to thick-film hybrid circuits. This has been achieved by a new packaging concept that combines a dual in-line carrier with a mating thick film circuit. The lead frame is brazed to the base ceramic without subjecting the thick film circuit to high temperatures. The manufacturer offers the package either alone or with a substrate.

CIRCLE NO. 341

Insulating tubing shields against rfi

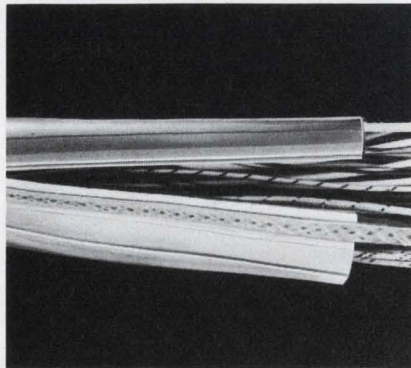

The Zippertubing Co., 13000 S. Broadway, Los Angeles. Phone: (213) 321-3901.

Offering cable protection at temperature extremes of -400°F to $+425^{\circ}\text{F}$, while shielding for rfi, a new sleeving material is designated as FEP5/SH3. It is Teflon tubing 5 mils thick, lined with 3-mil aluminum foil, with a tinned copper grounding braid that runs full length to provide a solderable termination point. An inside overlap of aluminum foil encloses cable snugly.

CIRCLE NO. 342

Self-locking fastener withstands vibration

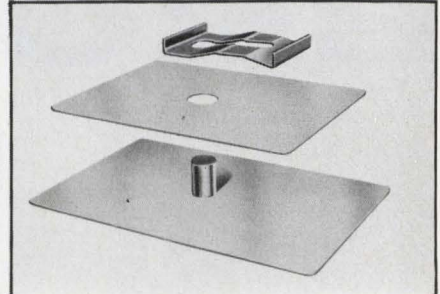

Warren Fastener Corp., 26750 E. 23 Mile Rd, Mt. Clemens, Mich.

A new type of self-locking fastener assures positive locking under extreme vibration conditions, because of its clip design. It cuts its own self-locking retaining groove and exceeds other push-on fasteners in over-all strength. In use, a soft wire stud of any length is welded to the base metal. The nonstructural portion is placed over the stud, and the fastener is then locked onto the stud.

CIRCLE NO. 343

Plastic press-clips clamp wire bundles

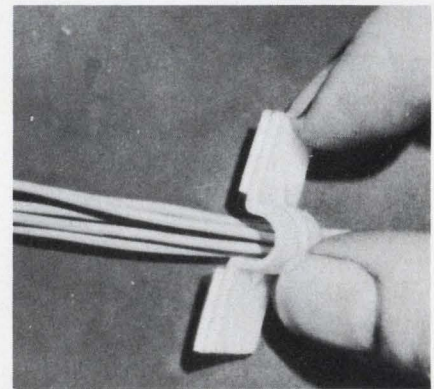

Weckesser Co., Inc., 4444 W. Irving Park Rd., Chicago. Phone: (312) 282-8626.

Plastic clips press into place for clamping and holding wire bundles or cables. Backed with foam adhesive on two sides, they permit permanent bonding, even to irregular surfaces. Four sizes, available in strips, serve bundles or cables from 1/8 to 1/2 in. in diameter. The clips are made of ABS resin, for good dielectric strength, high chemical resistance and long wear.

CIRCLE NO. 344

EVERY BLACK BOX SHOULD HAVE A DJINNI.

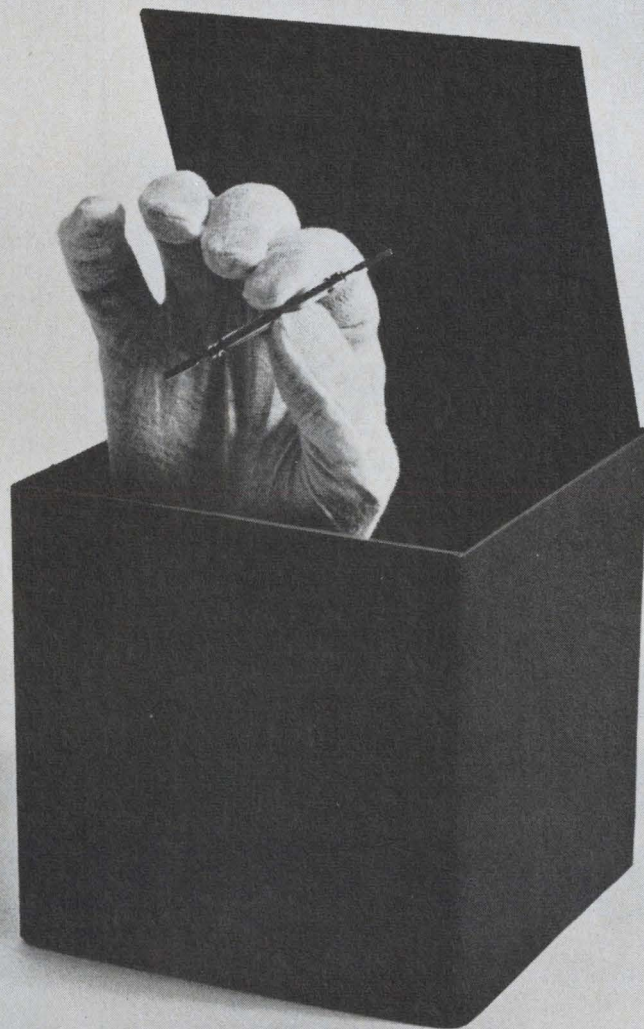

The reed switch is the greatest thing that's happened to electronic control devices since the Arabian Nights. It's encased in a little glass bottle you don't even have to rub. A coil turns it into a relay. A bar magnet makes it the most versatile electro-mechanical switch yet invented.

The reed switch is isolated in its glass container with a controlled atmosphere. It stays free of dust, damp and corrosion. There are no

armatures, springs or pivots to wear. Life can easily exceed 100 million operations. Sensitivity is readily controlled. Speed is the next best thing to transistorized logic at a mere wisp of the circuit cost. Even RF switching is practical.

If you're not as familiar with reed switches as you should be, ask Hamlin. We sell more reed switches to more people than anyone else.

Send for our free switch lab. No big deal, just a reed switch and a magnet and a couple of catalog sheets. But with them, you may come up with machine, flow or systems control uses no other engineer has conjured up yet. Just write Hamlin, Inc. "Baghdad on the Lake," Lake Mills, Wisconsin 53551.

HAMLIN INC.



If this isn't magic what is?

Faster, easier set-ups with



advanced "AGREE" chambers

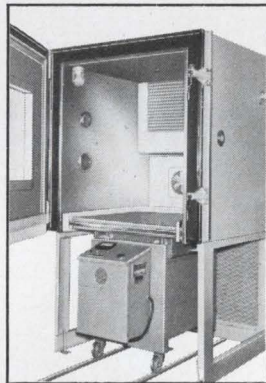

Tenney's "AGREE" Chambers have always offered the utmost in performance to meet and exceed all test levels of MIL-Std-781A. Now you also get the utmost in operator convenience. Tenney's exclusive "Redi-Seal" (patent applied for) provides a soft cushion of foam to seal between the chamber and L.A.B. or comparable vibration

testing machines. No more cumbersome diaphragms... no removable chamber sections... just roll the table in place. Save set-up time. Fully automatic operation of chamber, vibrator, and test item. Make it easy for yourself. For complete information on the latest in "AGREE" testing, write or call

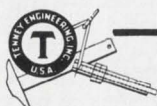

Tenney
ENGINEERING, INC.

1090 Springfield Rd., Union, New Jersey 07083 • (201) 686-7870
Western Division: 15721 Texaco St., Paramount, Calif. 90723

488

PACKAGING & MATERIALS

Teflon insulating tapes minimize elongation

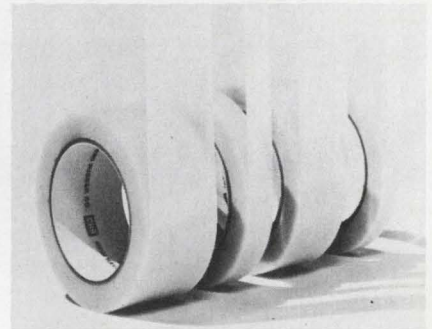

Connecticut Hard Rubber Co., 407 East St., New Haven, Conn. Phone: (203) 677-1351.

Four self-adhering Teflon insulating tapes exhibit lower elongation and higher breaking strength than those previously available. Manufactured from skived Teflon TFE film with a silicone polymer pressure-sensitive adhesive, the new tapes are easy to handle and will not curl when unwound from the roll. Their thicknesses are: HM 225 (2-1/4-mils), HM 350 and 352 (3-1/2 mils), and HM 650 (6-1/2 mils).

CIRCLE NO. 345

Conductive calk seals out rfi



Emerson & Cuming, Inc., Canton, Mass. Phone: (617) 828-3300. Price: \$11/lb.

An electrically conductive sealing calk is designed to provide electromagnetic shielding for shielded rooms, black boxes, electronic components and transmission lines. Proper calking with Eccoshield VY-G yields insertion losses greater than 100 dB over the entire radio-frequency range and the microwave band. Volume resistivity is less than 0.001 Ω -cm.

CIRCLE NO. 346

LET FUSITE SOLVE YOUR COMPLEX TERMINAL DESIGN PUZZLE

For over 25 years Fusite has been engineering customers out of trouble on highly complex hermetic terminal and header designs. Our more than 40 engineers and technicians have broad experience in sealing applications, including those of a highly unconventional nature. If your terminal design is *really* special, try us first. Call (513) 731-2020 or write Fusite Corporation, 6000 Fernview Ave., Cincinnati, Ohio 45212; overseas plants in Puerto Rico, Holland, West Germany, and Japan.

FUSITE
GLASS-TO-METAL HERMETIC TERMINALS
GLASS/GLASS-CERAMIC PREFORMS & SUBSTRATES

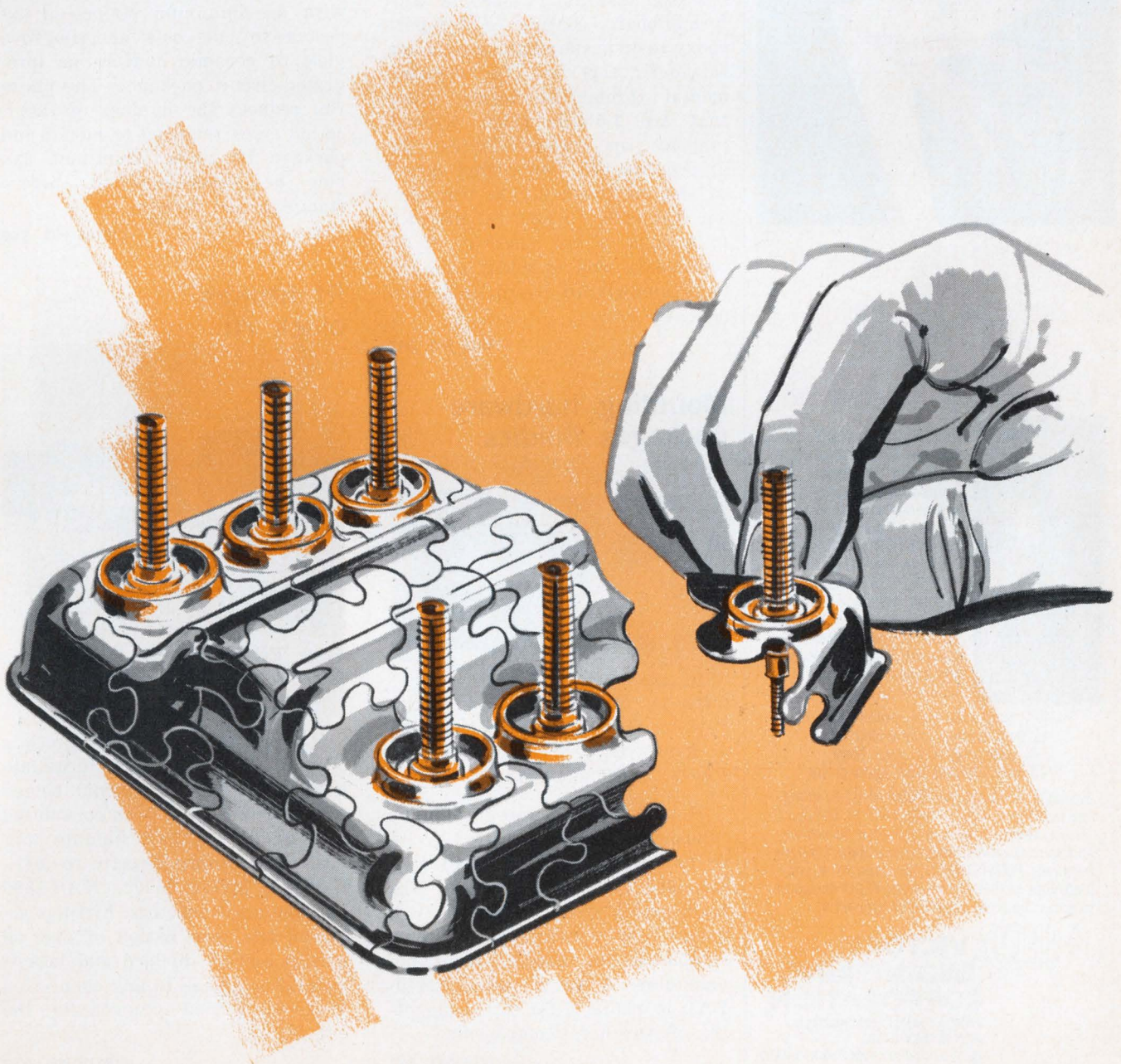

Introducing PLUSISTOR VECO®



slayer of dragon-size heat regulation problems

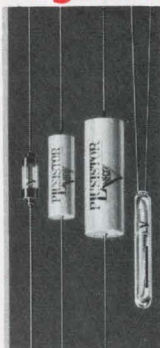

PLUSISTOR® is VECO's all-new positive temperature coefficient thermistor for temperature measurement and compensation. A solid state silicon resistor, PLUSISTOR features an average coefficient of $+0.7\%/^{\circ}\text{C}$ which remains virtually constant through the range of -60°C to $+150^{\circ}\text{C}$. These small-but-stalwart heat defenders are available to you in a variety of designs—

- 1/8 & 1/4 watt axial lead, molded design
- 1/8 watt, hermetically sealed can
- 1/8 watt axial lead, glass body
- 1/10 watt adjacent lead, glass probe

Available in decade multiples of E.I.A. standard resistance values from 10Ω to $10\text{K}\Omega$... 10% standard tolerance or tighter tolerances and special values other than standard where required. PLUSISTOR is just one of a complete line of thermistors from VECO designed to solve the most gigantic of problems.

VECO
**VICTORY
ENGINEERING
CORPORATION**
VICTORY ROAD, SPRINGFIELD,
NEW JERSEY 07081
(201) 379-5900 • TWX 710-983-4430

INFORMATION RETRIEVAL NUMBER 81

PACKAGING & MATERIALS

Conformal coating forms no pinholes

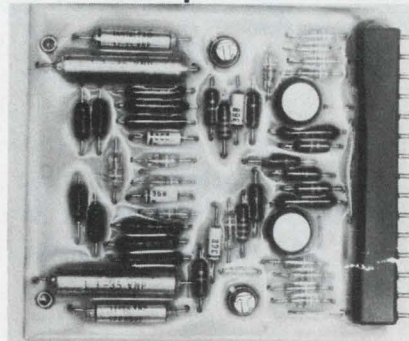

EPD Laboratories, div. of EPD Industries Inc., 2055 E. 223rd St., Long Beach, Calif. Phone: (213) 775-7141.

Designated as TC-3285, a conformal-board coating—a two-part epoxy resin system having complete flow-out properties for environmental protection—forms films that are 1.5-mils thick, without pinholes or craters. It can be dipped, brushed, flow coated, sprayed and air brushed. The transparent film offers a long pot life of 3 to 5 days, a low viscosity of 32 centipoises, and excellent adhesion to printed-circuit boards and components.

CIRCLE NO. 347

Mounting hardware packages fluidics

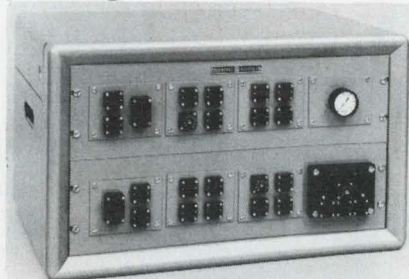

General Electric Co., Specialty Fluidics Operation, Section 37-209, 1 River Rd., Schenectady, N.Y. Phone: (518) 374-2211.

Mounting hardware for fluidic components comes in 5-1/4-by-19-in. panels that can be installed on standard 19-in. cabinet racks. The main panel, model PM19AA, will mount any combination of four sub-panels for fluidic operational amplifiers. A blank panel, PM40-BA1, is available for cutout mounting of peripheral components.

CIRCLE NO. 348

Alloy lead frames increase IC yield

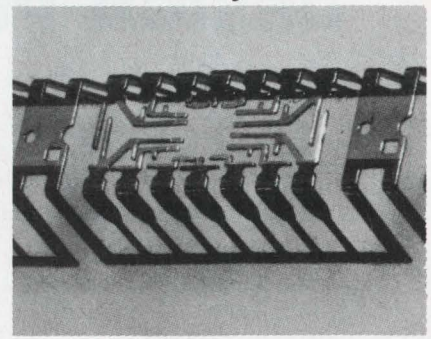

Texas Instruments, Inc., Materials Div., 34 Forest St., Attleboro, Mass. Phone: (617) 222-2800.

A new lead frame material—ASTM F-15 alloy, selectively clad with an aluminum stripe—is expected to cut costs and improve yield of ceramic dual-in-line integrated-circuit packages. The material reduces the number of fabrication steps required to mount and package IC chips. Aluminum can now be vapor-deposited, before stamping and forming.

CIRCLE NO. 349

Rf fittings block rfi

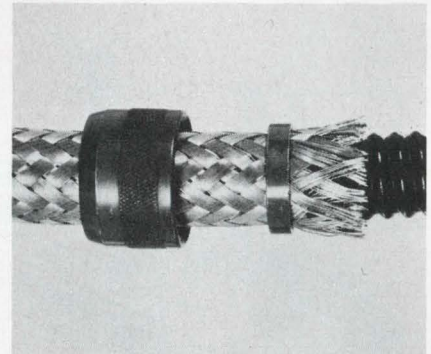

Icore Electro-Plastics, 1050 Kifer Rd., Sunnyvale, Calif. Phone: (408) 739-2395.

Rfi shielding over 360 degrees is offered by fittings that terminate both internal and external tinned copper braid. Used with convoluted tubing, the fittings terminate both braid and tubing directly to MIL-C-26482, MIL-C-26500, NAS-1599 and similar connectors. Fittings accommodate termination of over-all shields and of shielded and jacketed cables. Access to any connection is quickly gained by uncoupling the end-fitting.

CIRCLE NO. 350

MICROWAVE IC
PROGRESS
REPORT #5

PACT proves microstrip is compatible for MIC mixers, filters, hybrids

Before microwave integrated circuits can become a reality this important question must be answered—can present stripline technology be converted to microstrip without a prohibitive performance penalty? Engineers and scientists engaged in Sperry's PACT (Progress in Advanced Component Technology) Program have found the answer, and the answer is yes!

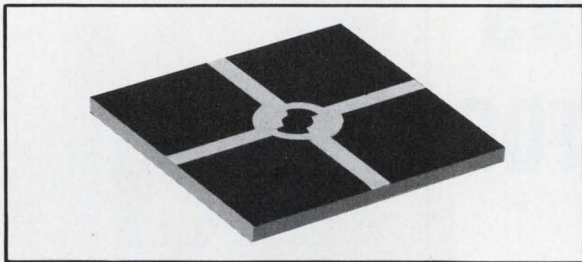

TWO-BRANCH MICROSTRIP 3 DB COUPLER

PACT investigations have already produced couplers, balanced mixers and a number of hybrid circuits, all utilizing the basic microstrip technology. Performance penalties have been negligible, and all indicators point to production availability of entire subsystems deposited on a single substrate.

Like other PACT activities, this effort has depended heavily on the proper selection of materials. For multi-function substrates, such as those capable of carrying entire subsystems, Sperry's choice is a composite of ferrimagnetic and alumina substrates. In some cases all-ferrimagnetic substrates are recommended.

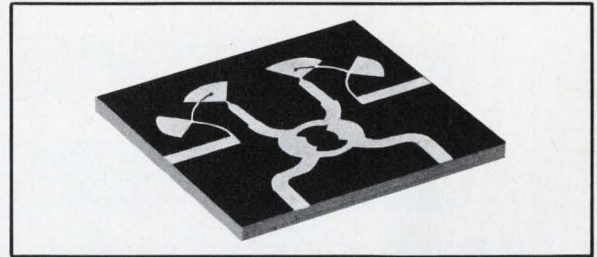

MICROSTRIP BALANCED MIXER CIRCUIT

This approach provides maximum size, weight and cost savings, along with significant increases in thermal and mechanical stability.

PACT has also benefited from the use of the computer as a design aid. For example, the computer was programmed to calculate the electrostatic potentials around a microstrip circuit and determine its impedance. Options were then added to the program to obtain a print-out of actual potentials around the microstrip and to plot equal potential lines.

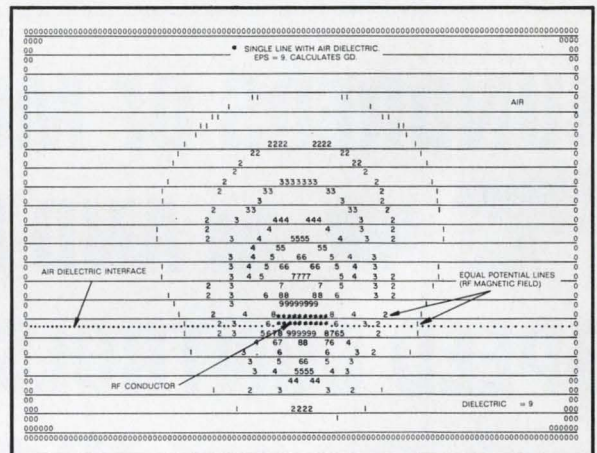

COMPUTER PLOT OF EQUAL-POTENTIAL SURFACES
(RF MAGNETIC FIELD) AROUND MICROSTRIP LINE
WITH $\epsilon = 9$

The result is optimum configuration for microstrip circuits prior to their fabrication.

To learn more about Sperry progress in design and fabrication of multi-function MICs for your applications, ask your Cain & Co. representative or write Sperry Microwave Electronics Division, Sperry Rand Corporation, Clearwater, Florida.

*For faster microwave progress,
make a PACT with people
who know microwaves.*

SPERRY
MICROWAVE ELECTRONICS DIVISION
CLEARWATER, FLORIDA

BUS BARS

...FOR PC CARDS

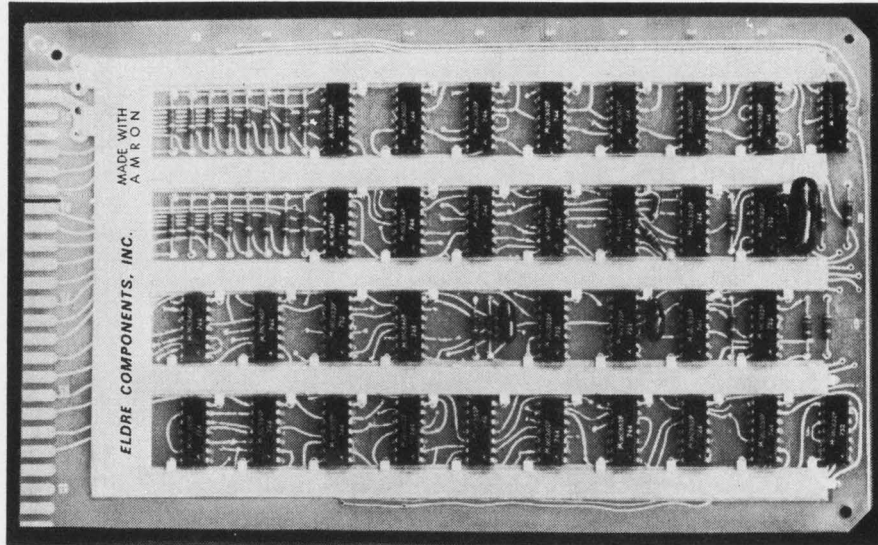

A laminated bus bar with distributed capacitance on a printed circuit card for power and ground distribution, eliminating the need for a multilayer card.



COMPONENTS, INC.
1239 University Ave.
Rochester, N. Y. 14607

INFORMATION RETRIEVAL NUMBER 83

HUNDREDS OF MOTORS AND MOTOR SPEED CONTROLS... IN STOCK!

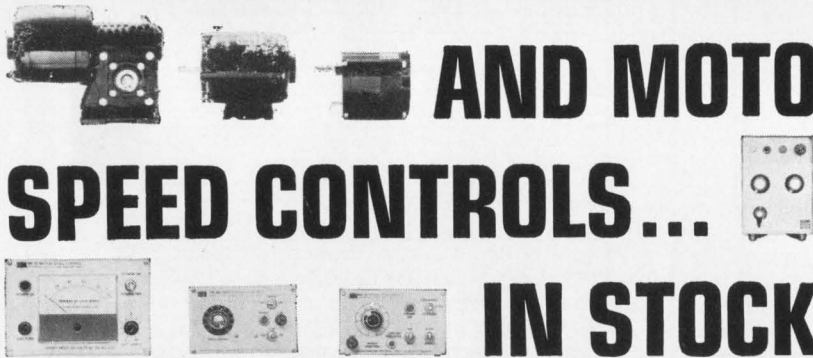

Any Motor, Variable Speed Motor, or Motor Speed Control that you can possibly need is available from one responsible source at B & B Motor and Control Corp. for off-the-shelf delivery at lowest prices. Motors range from 1/1000 to 150 H.P. and there are over 30 models of speed controls. Some are simple, effective, and inexpensive — some are sophisticated beauties with meter speed readout, 1% regulation, braking, and reversing. There are in-between models too. If in the slim event you need something we don't have we'll modify or build a control or motor for you. Our new 28 page catalog covering motor speed controls will give you the whole story.

We have Bodine Motors and Controls, Reliance Motors and Controls, Slo-syn Motors and Drive Controls, Apcor Multi-speed Gearmotors, Electroid Clutches and Brakes, ATC Timers and Vis-Count Speed Indicating Systems. Available as components, or as systems with one source responsibility.



B & B MOTOR AND CONTROL CORP. FREE NEW CATALOG
96 Spring St. New York N.Y. 10012 • Tel. (212) 966-5777

INFORMATION RETRIEVAL NUMBER 84

PACKAGING & MATERIALS

Printed circuit kit contains all hardware



Injectorall Electronics Corp., Great Neck, N.Y. Phone: (516) 487-6015. P&A: \$5.95; stock.

PC kit #500 contains printed-circuit boards and all chemicals and supplies needed to manufacture printed circuits. Each kit contains two printed-circuit boards, 4-3/4 by 3-3/4-in. in size; a resist-ink pen, one 6-oz bottle of resist-ink solvent and one 1/16-in. drill bit. The kit is packed in an acrylic box which serves as a developing tray.

CIRCLE NO. 351

Aerosol adhesive adjusts its spray



Adhesives, Coatings and Sealers Div., 3M Co., 3M Center, St. Paul, Minn.

Multi-purpose aerosol adhesives have an adjustable spray-tip that controls spray patterns. The translucent adhesive is designed to provide strong, permanent bonds for joining a large variety of materials. The heavy-bodied, quick-tack, adhesive does not wrinkle, strain, soak-in or bleed when used to bond thin materials.

CIRCLE NO. 352

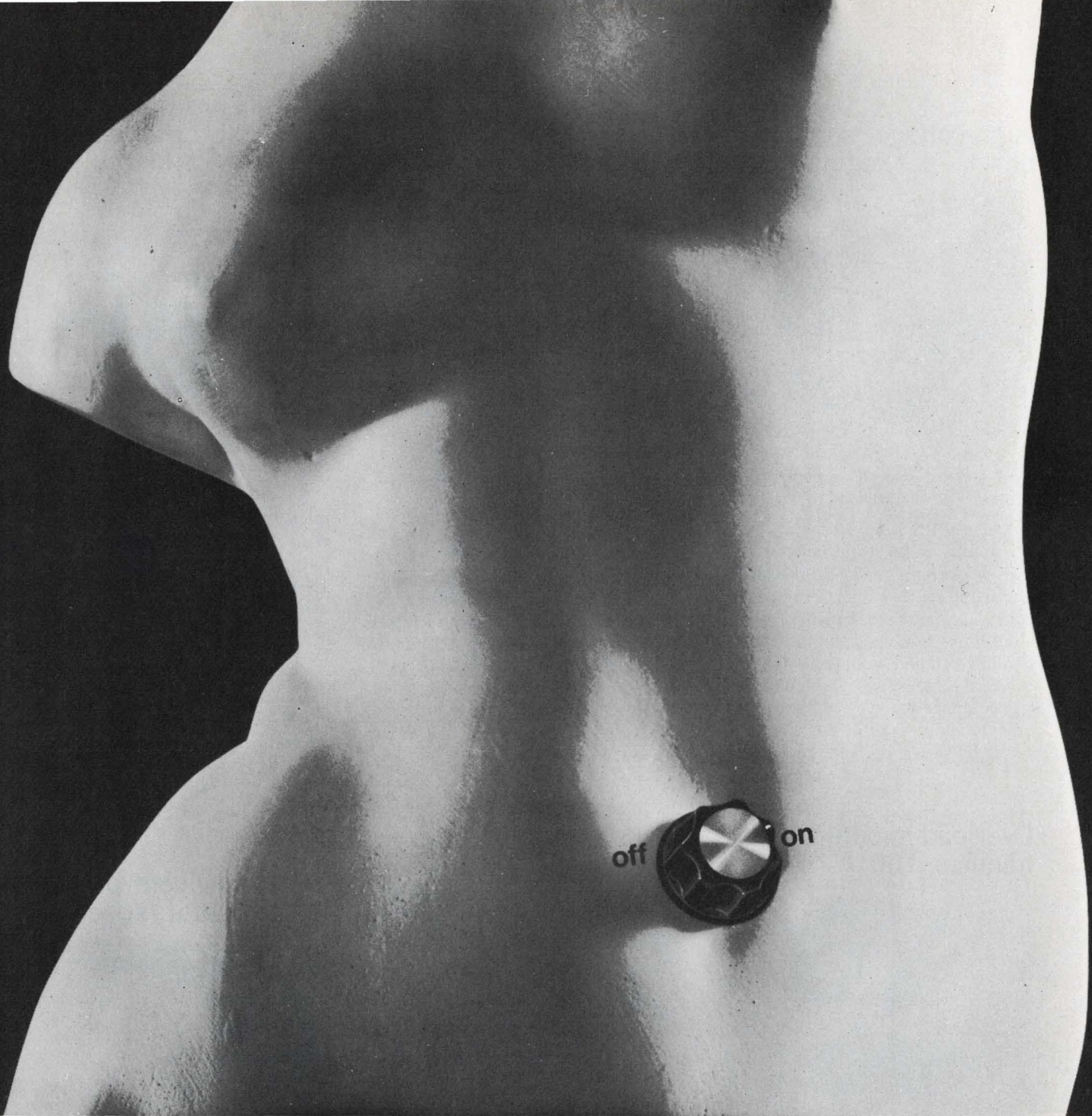

Kurz-Kasch instrument knobs turn the action on!

A knob is to start something. Or stop it. Or make it faster or or slower. Or more or less.

But a well designed knob on a well designed piece of equipment (electronic or otherwise) does more than this. It not only turns the equipment on—it turns the user on!

After all, the knobs are what an equipment user (and buyer) sees first, last, and most often. If they don't do more for him than turn the equipment on, the whole design leaves him cold.

Kurz-Kasch knob designers know this. They've put together a line of 347 instrument knobs in a variety of sizes, colors and thermosetting plastic materials. Each one is calculated to turn the action on—with *your* equipment, *your* users, *your* buyers.

You can join 4,000 action oriented original equipment manufacturers who already turn on with KK Knobs. Write today for free Kurz-Kasch Designer Catalog.



Write for new catalog
and free knob samples.



Kurz-Kasch, Inc.

Standard Parts Division • Dayton, Ohio 45401

High-voltage supplies shrink package size



Computer Power Systems, Inc., 722 East Evelyn Ave., Sunnyvale, Calif. Phone: (408) 738-0530.

Series CPS-1000 solid-state power supplies achieve miniaturization by packaging all high-voltage circuitry in four interlocking epoxy-encapsulated blocks. This eliminates space-consuming point-to-point wiring, and enhances mechanical reliability. Primarily designed to power CRT displays, the units supply 10 to 30 kV in a 4-1/2 by 4-5/8 by 9-in. package.

CIRCLE NO. 353

Overload module handles 100 A

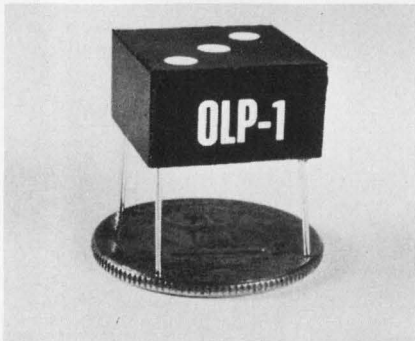

Space Age Microcircuits, P.O. Box 426, Chatham, N.J. Phone: (201) 635-8484. P&A: \$15; stock.

Without the use of wasteful series-dropping resistors, an overload module, model OLP-1, protects any regulated power supply in case of an overload or short circuit for currents as high as 100 A. When an overload occurs, the OLP-1 causes the regulating circuit to shut down. Interrupting the input power allows recovery. The unit has a volume of 0.17 in.³ (0.68 by 0.68 by 0.368 in.) and weighs less than 0.5 oz.

CIRCLE NO. 356

Waveform monitor detects Hz and V

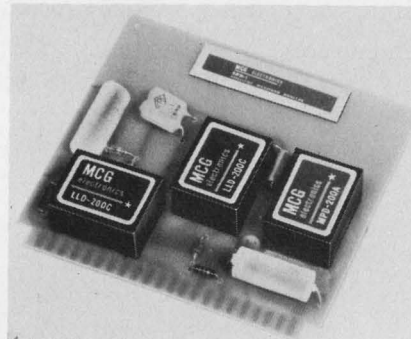

MCG Electronics, 279 Skidmore Rd., Deer Park, N.Y. Phone: (516) 586-5125. P&A: \$176; 2 wks.

A repetitive waveform-monitor detects and indicates when a repetitive signal, such as a sine wave or pulse, drops lower in frequency. In addition, the RWM-1 monitors the input waveform amplitude to assure that it does not drop below some preselected voltage threshold. Mounted on a printed-circuit card, the unit measures 4 by 3.75 by 0.75 in.

CIRCLE NO. 357

Differential op amp drifts only 0.5 nA/°C

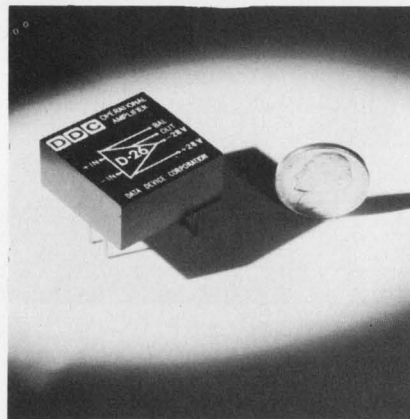

Data Device Corp., 100 Tec St., Hicksville, N.Y. Phone: (516) 433-5330. P&A: \$60; stock to 3 wks.

A differential operational amplifier with a minimum output of ± 20 V at 5 mA holds voltage drift to $10 \mu\text{V}/^\circ\text{C}$ and current drift to $0.5 \text{ nA}/^\circ\text{C}$. Model D-26 has input impedances of $500 \text{ k}\Omega$ differential, $50 \text{ M}\Omega$ common-mode. Its common-mode rejection ratio is 100 dB. Slewing-rate response is the same at both inputs.

CIRCLE NO. 358

Low-cost op amp spans 125 kHz

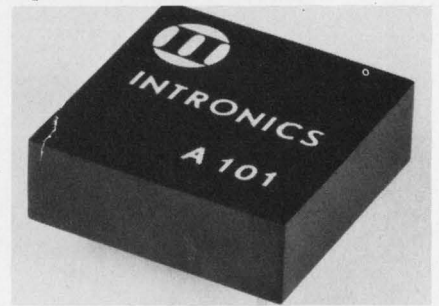

Intronics, Inc., 57 Chapel St., Newton, Mass. Phone: (617) 332-7350. P&A: \$13.50; stock.

Capable of delivering 10-V common-mode voltage, a low-cost operational amplifier supplies 5-mA output current over a bandwidth of 125 kHz. Other model A101 operating parameters are: an input offset drift of $20 \mu\text{V}/^\circ\text{C}$, an input current of $20 \text{ nA}/^\circ\text{C}$, a common-mode input impedance of $50 \text{ M}\Omega$ and a common-mode rejection ratio of 90 dB. The unit is supplied in a low-profile package, 0.385-in. high.

CIRCLE NO. 359

Electronic control reads motor speed

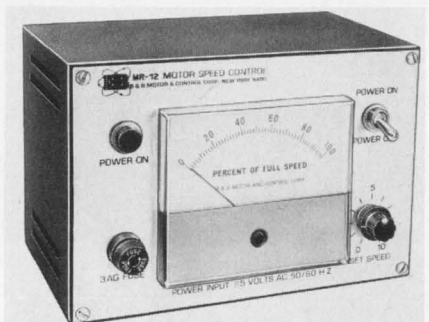

B & B Motor and Control Corp., 96 Spring St., New York City. Phone: (212) 966-5777. Price: \$175.

Operating from the variations in back emf generated by a running motor, an electronic control directly indicates motor speed on its built-in meter. Unlike other systems, the MR-12 controller does not use a tachometer sender mounted on the motor to provide the speed feedback signal. Its regulation accuracy is as low as 0.5% for motors rated up to 1/4 hp.

CIRCLE NO. 360

MAC is a good deal of computer.

72 instructions including: byte handling, 3-way nondestruct compare, test and skip up to 15 instructions, fast shifts, and optional multiply/divide.

1- μ sec memory cycle time. 16-bit parallel word, 2- μ sec add time. 4K words standard.

Three data channels: Programmed data channel, up to 90KHz. Optional multiplexed data channel up to 333KHz. Optional direct-memory-access up to 800 KHz.

Expansion to 8K words in mainframe. Up to 65K available.

True-nested priority interrupts: 4 levels standard. Expansion to 64 levels. Automatic register save-and-restore, 6- μ sec response.

Third-generation software: LEAP, a two-pass, macro-handling assembler, linking relocatable loader with automatic depaging, debug and edit programs, utility routines, I/O drivers, and diagnostics. LEAP-FORT and MACSIM: Program assembly and simulation on big computers. USASA Standard FORTRAN IV with math library.

MAC 16, with 4K memory, ASR 33, 4 priority interrupts. Ready to operate. . . . \$11,950.

Mainframe space for options. Swing-out front panel, relocatable to remote position. Control-panel programmer aids.

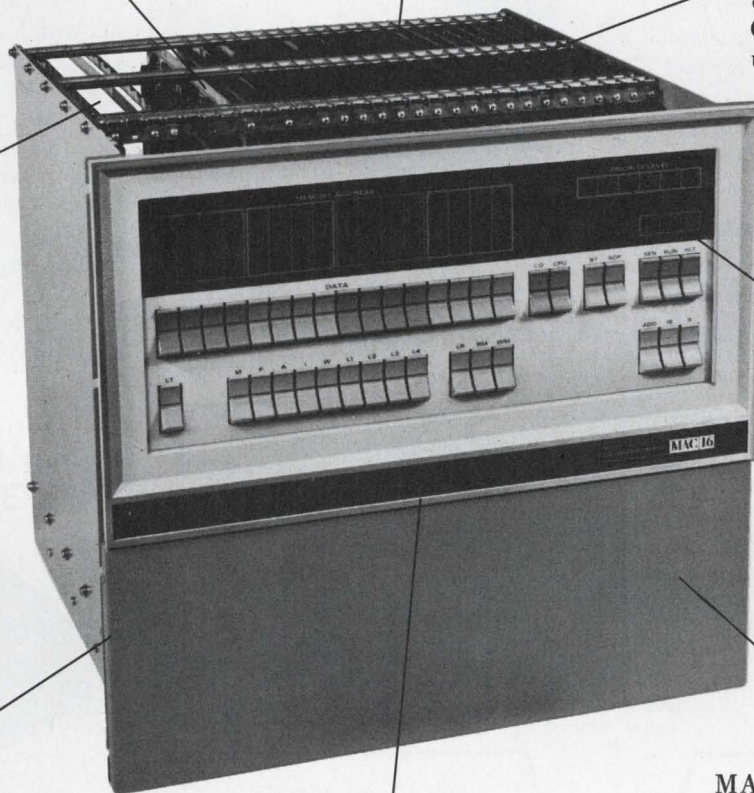

Let MAC do it.

For technical data, write: MAC, Lockheed Electronics Company, Data Products Division, 6201 East Randolph Street, Los Angeles, California 90022.

YOKE SPECIALISTS

FOR INFORMATION DISPLAYS

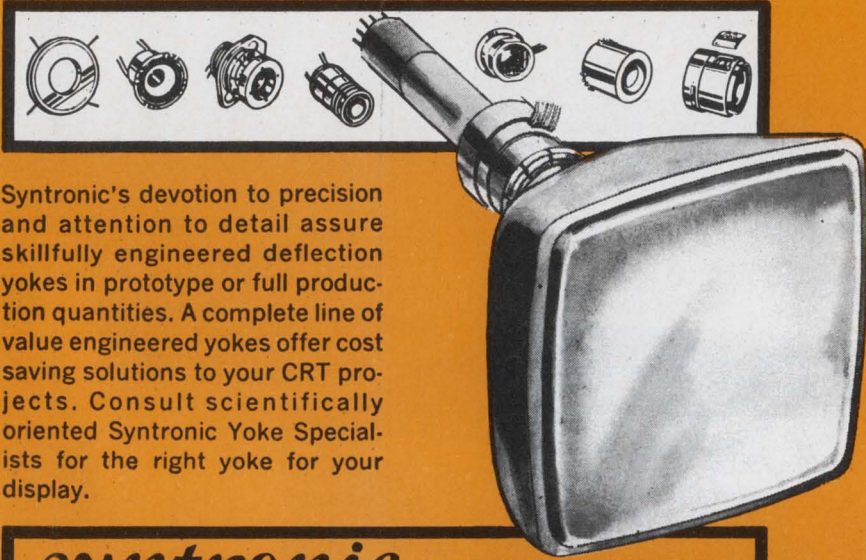

Syntronic's devotion to precision and attention to detail assure skillfully engineered deflection yokes in prototype or full production quantities. A complete line of value engineered yokes offer cost saving solutions to your CRT projects. Consult scientifically oriented Syntronic Yoke Specialists for the right yoke for your display.

Syntronic INSTRUMENTS, INC.
100 Industrial Road, Addison, Ill.
Phone: Area 312, 543-6444

INFORMATION RETRIEVAL NUMBER 87

FIRST TRULY LOW-COST CARD READER... READS 200 CARDS/MINUTE IN 2 SQ. FT. OF SPACE

Reading in excess of 200 cards per minute and requiring less than 2 square feet of space (little more than a typewriter), this low-cost MDS Series 6002 Card Reader offers many plus features common to more expensive models.

Input and output hoppers each hold 500 cards face-up and can be replenished during operation. The 6002 80-column Card Reader uses the same reliable, proven picker/reader head used in larger MDS readers and is available with or without logic circuitry (Series 6001 is without), and with options accommodating 51-column cards.

Highly accurate column registration ($\pm 0.0054''$) is possible with this low-cost Card Reader with the built-in "plus" features.

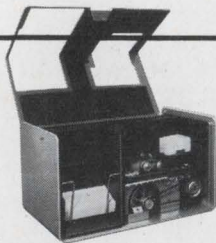

Compactness of reader mechanism is shown — unit is 12½" high, 12½" wide, 23" long.

Ask for the MDS folder-file — or
MEET YOUR MAN FROM MDS

MOHAWK MDS
DATA SCIENCES CORPORATION
OEM MARKETING
122 E. Ridgewood Ave. • Paramus, N.J. 07652

Telephone 201/265-7333
Every MDS Office is an OEM Marketing Office
Digital Strip Printers • Buffered Tape Units
High-Speed and Low-Speed Line Printers
Card Punches and Readers

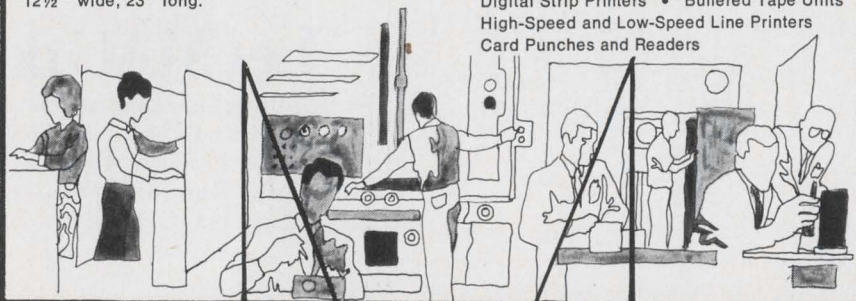

INFORMATION RETRIEVAL NUMBER 88

SUBASSEMBLIES & MODULES

Thick-film hybrid drives lamps directly

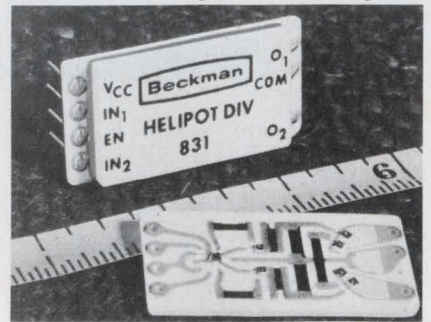

Beckman Instruments, Inc., Helipot Div., 2500 Harbor Blvd., Fullerton, Calif. Phone: (714) 871-4848.

A miniature lamp-and-relay driver, which is a hybrid cermet thick-film circuit, steps up power from digital IC levels without requiring external pass transistors. Model 831 features a 0-to-60-V operating range, two circuits per package, a 0-to-1-A current capability, standard DTL input levels, and an operating temperature range of -55 to $+125^\circ\text{C}$. Completely self-contained, the solid-state unit occupies just 0.5 square inches of board space.

CIRCLE NO. 361

Vector-function module finds 3 signal values

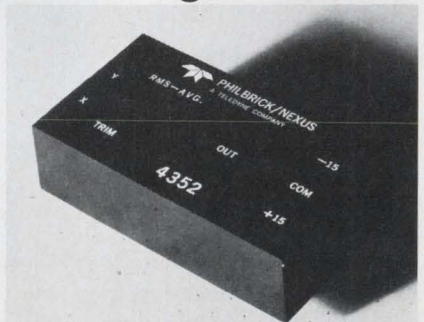

Philbrick/Nexus Research, A Teledyne Co., Allied Drive at Route 128, Dedham, Mass. Phone: (617) 329-1600. P&A: \$195.

Replacing complicated servo mechanisms, type 4352 vector-function module can find the average or the rms values of a signal, or calculate the square root of the sum the squares of two signals. This small encapsulated unit, which measures 2.7 by 1.5 by 0.75 in., delivers a $\pm 3\%$ accurate output to a 5000- Ω load without need of external circuitry.

CIRCLE NO. 362



Portables with Performance

50 MHz

7-ns Risetime, Dual-trace

150 MHz

2.4-ns Risetime, Dual-trace

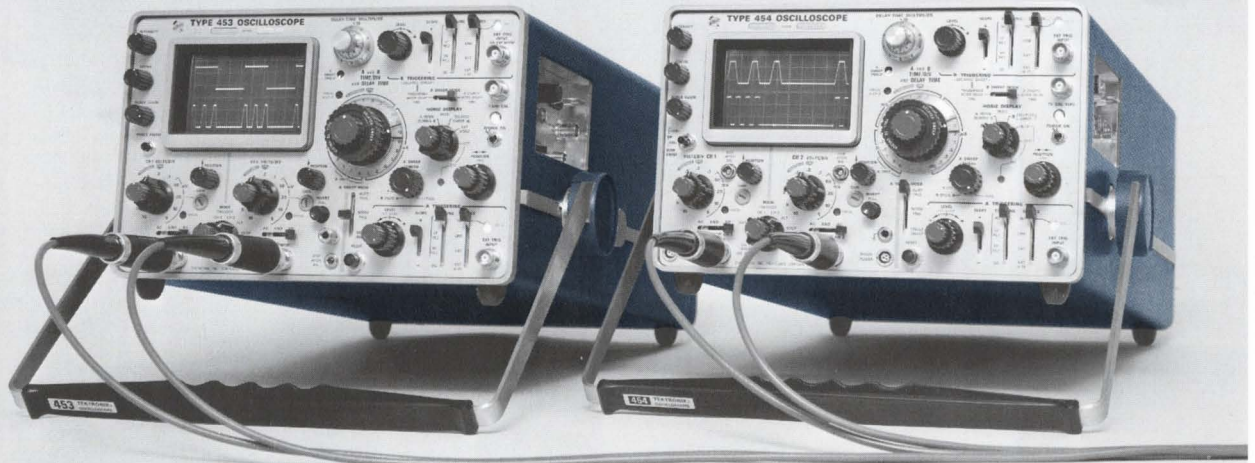

The Tektronix Type 453

Dual-trace, DC-to-50 MHz bandwidth with sweep delay in a compact 30-pound instrument. Rugged environmental capabilities are combined with performance features normally found only in multiple plug-in instruments. Vertical amplifiers provide 7-ns risetime, DC-to-50 MHz bandwidth, from 20 mV/div to 10 V/div deflection factor. At 5 mV/div deflection factor, risetime is 8.75 ns and bandwidth is DC to 40 MHz. Cascading Channel 1 and Channel 2 provides 1 mV/div deflection factor, DC-to-25 MHz bandwidth. The included Type P6010 miniature 10X probes preserve system bandwidth and risetime performance right to the probe tip. Front panel switching logic permits making 5 mV/div X-Y measurements. Jitter, time coincidence, pulse width and other measurements are easily made utilizing the calibrated sweep delay. Sweep rates are 5 s/div to 0.1 μ s/div, extending to 10 ns/div with the X10 magnifier. Solid-state design, with FET vertical inputs, provides low drift and fast stabilization time. AC powered.

Type 453 Oscilloscope \$1950

The Tektronix Type 454

DC-to-150 MHz bandwidth, 2.4-ns risetime! This oscilloscope is currently the fastest real-time, general-purpose instrument available. Dual-trace amplifiers provide 150-MHz bandwidth at 20 mV/div deflection factor. At 5 mV/div, risetime and bandwidth are 5.9 ns and 60 MHz respectively. Single-trace displays at 1 mV/div deflection factor permit viewing low level signals. The supplied P6047 10X probes preserve the 150-MHz bandwidth right to the tip of the probe. Sweep rates are 5 s/div to 50 ns/div, extending to 5 ns/div with the X10 magnifier. Calibrated sweep delay permits expanding specific portions of your waveform display for examination in detail. A photographic writing speed of 3200 div/ μ s (>2500 cm/ μ s) is provided by the Type 454 Oscilloscope, C-31 Camera, and 10,000 ASA film, without employing film-fogging techniques! X-Y displays, with calibrated deflection factors to 5 mV/div, are possible with the flick of two front panel switches. The Type 454 is mechanically designed to withstand environmental extremes and rough handling. AC powered.

Type 454 Oscilloscope \$2600

U.S. Sales Prices FOB Beaverton, Oregon

please turn page for additional information

Making the Measurement . . . with Tektronix Type 453 and Type 454 Portable Oscilloscopes

Portable Oscilloscopes

Portability

The Type 453 and Type 454 Oscilloscopes are designed to be easily transported. With the adjustable handle locked in the "carry" position, these instruments present a vertical form factor which enables them to be carried at the side using only one hand. The handle rotates to other fixed positions, providing a convenient tilt-stand for bench applications. A front cover prevents accidental damage to the operating controls and seals out dust and moisture while in transit. The cover also provides convenient storage for standard accessories. These compact high-performance instruments are lightweight—the Type 453 weighs 30 pounds and the Type 454 weighs 31 ¼ pounds, including panel cover and standard accessories. Both instruments are designed to withstand environmental extremes and rough handling. Specifications are valid over an operating temperature range of -15°C to +55°C.

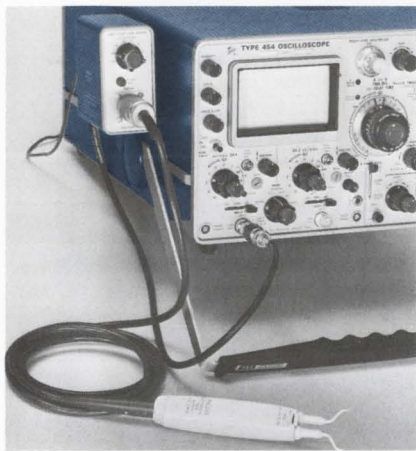
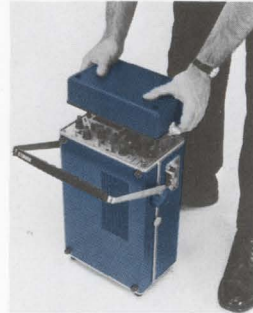
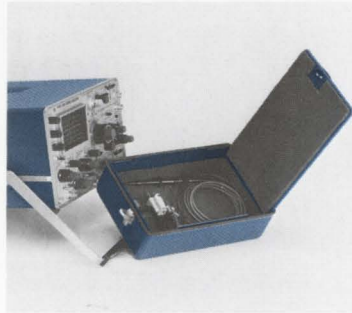

The P6046 Differential Probe and Amplifier provide a CMRR of 1000:1 at 50 MHz with 1 mV/div deflection factor. When used with the Type 454, this same probe/amplifier combination provides 1 mV/div deflection factor at ≈70-MHz bandwidth!



The Type 200-1 Scope-Mobile® Cart is specifically designed for the Type 453 and Type 454 Portable Oscilloscopes. This cart occupies less than 18 inches of aisle space and provides storage at the base for accessories or associated instruments.

Extra Performance

Dual-trace vertical amplifiers, calibrated delaying sweep, full-bandwidth triggering, and probe-tip performance are standard features offered by both the Type 453 and Type 454 Portable Oscilloscopes. To enhance these performance features and provide additional measurement value, a complete line of compatible optional accessories are available.



The new P6042 DC Current Probe permits measuring current flow with bandwidth from DC to 50 MHz and deflection factors to 1 mA/div.

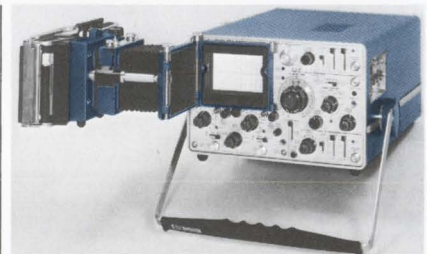

Repetitive or single-event waveform phenomena may be photographically recorded using the Type C-30A or C-31 Trace-Recording Camera. A minimum photographic writing speed of 3200 div/μs is provided by the Type 454 Oscilloscope with P11 phosphor, C-31R Camera and 10,000 ASA film—without employing film-fogging techniques!

Type 453 Portable Oscilloscope	\$1950
Type 454 Portable Oscilloscope	\$2600
Type C-31 Camera	\$ 550
P6042 Current Probe	\$ 600
P6046 Differential Probe and Amplifier	\$ 690
Type 200-1 Scope-Mobile® Cart	\$ 75
<small>U.S. Sales Prices FOB Beaverton, Oregon</small>	

Your Tektronix Field Engineer will demonstrate these products on your premises at your convenience. Please call him, or write Tektronix, Inc., Box 500, Beaverton, Oregon 97005.



Tektronix, Inc.
committed to progress in waveform measurement

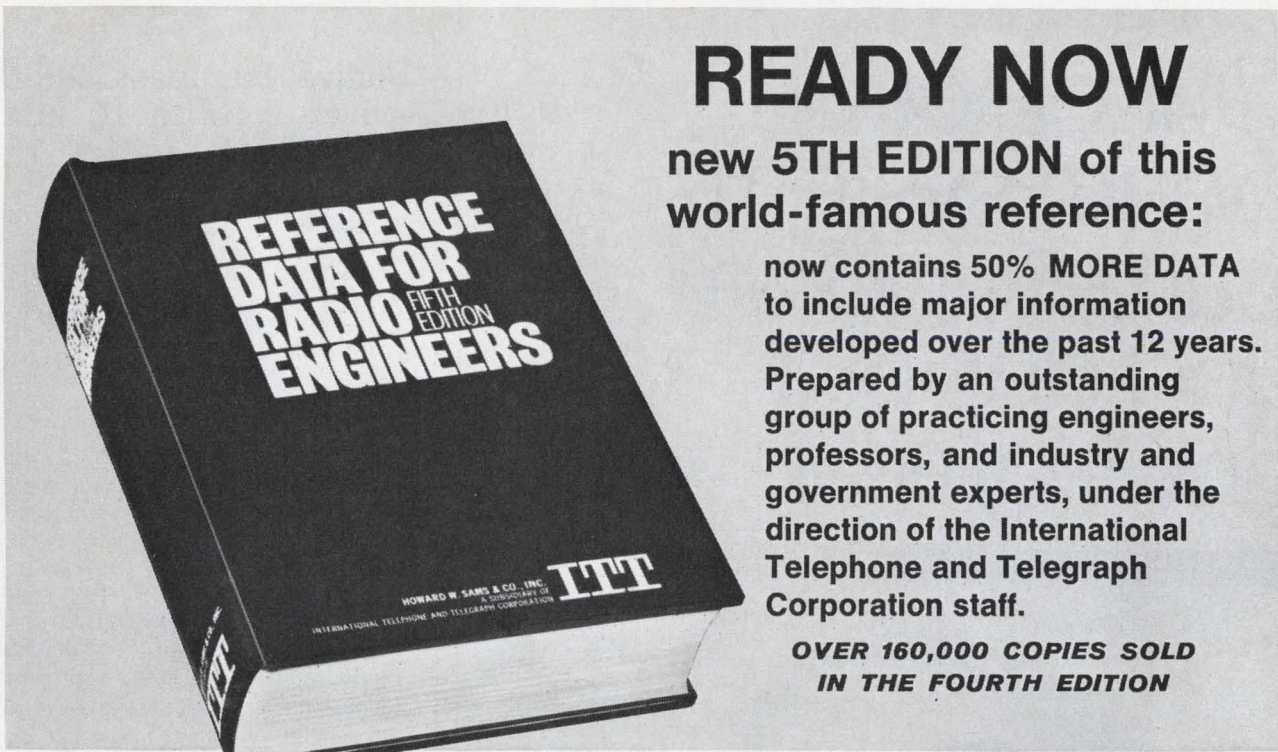

READY NOW

new 5TH EDITION of this world-famous reference:

now contains 50% MORE DATA to include major information developed over the past 12 years. Prepared by an outstanding group of practicing engineers, professors, and industry and government experts, under the direction of the International Telephone and Telegraph Corporation staff.

OVER 160,000 COPIES SOLD IN THE FOURTH EDITION

Reference Data for Radio Engineers

CHAPTER CONTENTS

- | | |
|--|--|
| Frequency Data | Transmission Lines |
| *International Telecommunication Recommendations | Waveguides and Resonators |
| Units, Constants, and Conversion Factors | Scattering Matrices |
| Properties of Materials | Antennas |
| Components or Parts | Electromagnetic-Wave Propagation |
| Fundamentals of Networks | Radio Noise and Interference |
| Filters, Image-Parameter Design | Broadcasting and Recording |
| Filters, Modern-Network-Theory Design | Radar Fundamentals |
| Filters, Simple Bandpass Design | Wire Transmission |
| Attenuators | *Switching Networks and Traffic Concepts |
| Bridges and Impedance Measurements | Digital Computers |
| Magnetic-Core Transformers and Reactors | *Navigation Aids |
| Rectifiers and Filters | *Space Communications |
| Magnetic Amplifiers | Electroacoustics |
| Feedback Control Systems | Nuclear Physics |
| Electron Tubes | *Quantum Electronics |
| Electron-Tube Circuits | Information Theory |
| Semiconductors and Transistors | Probability and Statistics |
| Transistor Circuits | *Reliability and Life Testing |
| *Microminiature Electronics | Miscellaneous Data |
| Modulation | Fourier Waveform Analysis |
| | Maxwell's Equations |
| | Mathematical Equations |
| | Mathematical Tables |

*New chapters on subjects not covered in 4th Edition

1138 PAGES • 1350 ILLUSTRATIONS
plus 41 page index

The new FIFTH EDITION of this widely used reference work has been completely revised and updated. It provides in a single volume comprehensive data on all basic phases of electronics, including tables, formulas, standards, and circuit information—PLUS—all-new data on microminiature electronics, space communications, navigation aids, reliability and life testing, international telecommunication recommendations, switching networks and traffic concepts, and quantum electronics. Includes over 1300 charts, nomographs, diagrams, tables, and illustrations. 45 data-packed chapters. 1138 pages of invaluable information for practicing radio and electronics engineers.

10-Day Free Examination

HOWARD W. SAMS & CO., INC., Dept. ED-1
A Subsidiary of International Telephone and Telegraph Corporation
4300 West 62nd Street, Indianapolis, Ind. 46268

Send me REFERENCE DATA FOR RADIO ENGINEERS for 10-day examination, without cost or obligation.

If I decide to keep the volume, I will send: \$20.00 (plus postage), or \$7.00 (plus postage) in 10 days, and \$6.50 per month for 2 months. Otherwise, I will return the book postpaid within 10 days.

\$20 payment enclosed. Send my copy postpaid with full 10-day refund privilege. (Include sales tax where applicable.)

Name _____

Company Name _____

Address _____

City _____ State _____ Zip _____

Our electron-beam systems can evaporate and deposit any material

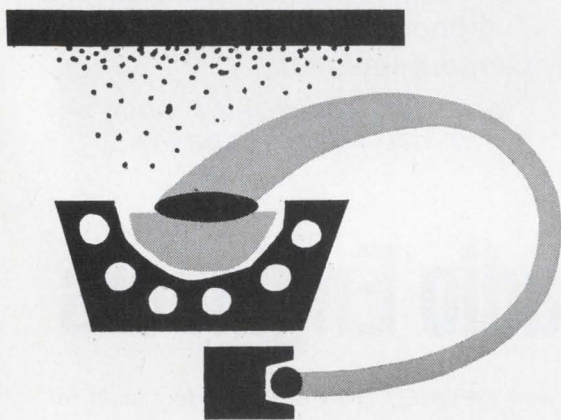

Including elements, alloys, refractory metals, compounds and mutually insoluble materials.

When it comes to physical vapor deposition, electron-beam technology has proved itself superior to any other evaporation method in the most critical areas: controllability, reliability, capacity to provide high evaporation rates and ability to cope with any material to be evaporated.

- Only the surface area is heated to evaporation temperature.
- Crucibles are made of water-cooled copper.
- Evaporation rates are 100 to 10,000 times higher than are attainable by older evaporation methods.
- Rapid rates yield high-purity coatings at pressures as high as 10^{-5} Torr.
- Newly designed source-feeding systems permit continuous operation.
- Alloy deposition can be controlled precisely in either single- or multiple-gun operations.
- Self-accelerating electron-beam guns are available with 180° and 270° beam-deflection systems, in sizes from 3 KW upward.
- Solid-state power supplies are available from 3 KW upward.

Why settle for less? Write for your free copy of our new 12-page brochure, "The Electron Beam and Evaporation."

AIRCO Temescal

A DIVISION OF AIR REDUCTION COMPANY, INCORPORATED
2850 Seventh Street, Berkeley, California 94710 Telephone 415 841-5720

SUBASSEMBLIES & MODULES

Active bandpass filters cover 1 Hz to 10 kHz

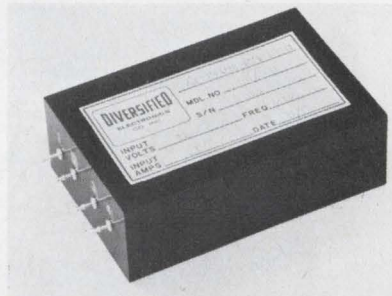

*Diversified Electronics Co., Inc.,
154 San Lazaro Ave., Sunnyvale,
Calif. Phone: (408) 738-3911.
Price: \$150.*

The DE500 series of active bandpass filters cover the 1-Hz to 10-kHz frequency range. Fast detector response time makes these units ideal for all tone-burst control applications such as: voice coding, acoustical coupling, facsimile, and frequency shift keying. As a tone filter-detector, a DE500 unit recognizes a frequency after one cycle of the input is applied.

CIRCLE NO. 376

FET amplifier has 0.2-pA bias



*Fairchild Controls, 225 Park Ave.,
Hicksville, N.Y. Phone: (415) 962-
3833. P&A: \$110; stock.*

Using a junction-FET differential input stage, model ADO-32 operational amplifier holds input bias currents to 0.2 pA typical, 0.5 pA maximum. The unit also features gain of 140,000, drift of $10 \mu\text{V}/^\circ\text{C}$, common-mode rejection of 20,000, and power-supply rejection of $200 \mu\text{V}/\text{V}$. It is suitable for sample-and-hold circuits, integrators, charge amplifiers, as well as many applications that previously required electrometer tubes.

CIRCLE NO. 377

Code and Program Your Attenuation As You Go Along *...in Milliseconds*

You can switch attenuation while operating . . . as you need it . . . for fast signal sampling and measurement. Switch in less than 100 milliseconds over a frequency range of DC to 1 GHz in 1 db steps from 0 to 139 db.

DC TO 1 GHz PROGRAMMABLE ATTENUATOR MODEL 2163/1M2

AUTOMATICALLY SETS attenuation levels in response to 9-line binary coded decimal input signals . . . 1-2-4-8 . . . 10-20-40-80 . . . 100. Make before break logic ensures that at no time while switching is the attenuation less than the starting or final programmed value.

DYNAMIC RANGE covers from 0 to 139 db in 1 db increments. At 1 KHz, the programmer is accurate to $\pm 0.5\%$ ± 0.1 db up to 120 db (± 1 db up to 130 db) . . . at 1 GHz, it's accurate to $\pm 1\%$ and ± 0.2 db up to 100 db (with additional 0.5% at 130 db).

VSWR does not exceed 1.10 below 100 MHz . . . 1.25 below 500 MHz . . . or 1.50 below 1 GHz. Insertion loss 0.35 db per 100 MHz.



MARCONI INSTRUMENTS
Division of English Electric Corporation

111 CEDAR LANE • ENGLEWOOD • NEW JERSEY 07631 • TELEPHONE: 201-567-0607

Stripline termination handles 15 W at 5 GHz

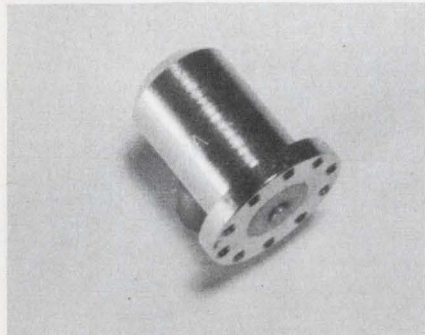

ESCA, 1426 West Front St., Plainfield, N.J. Phone: (201) 756-1252.

A right-angle stripline termination, covering the dc to 5-GHz frequency range, handles 15 W at room temperature and 3.5 W at 125°C. VSWR is 1.05 max., from dc to 2 GHz, and 1.1 max. at 2 to 5 GHz. Environmental performance to MIL-STD 202 is achieved. The unit measures 1 by 7/8-in. A button contact for mounting in a stripline circuit is provided.

CIRCLE NO. 378

Tunable filters work in S band

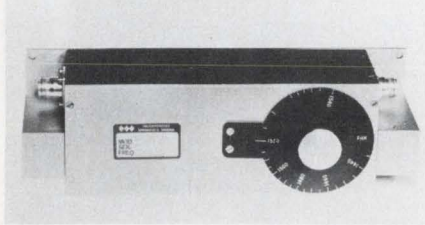

TRF, Inc., subsidiary of Quanta Systems Corp., 6627 Backlick Road, Springfield, Va. Phone: (703) 451-5131. Availability: stock to 30 days.

Tunable filters for L- and S-band telemetry applications can be frequency-calibrated directly, while low insertion loss and high selectivity is retained. Series TBP-400H units are available with bands from 1.435 to 1.540 GHz, or from 2.2 to 2.3 GHz. Bandwidths are 30 MHz at 0.5 dB; 33 MHz at 3 dB, and 76 MHz at 50 dB. Maximum insertion loss is 1 dB, and nominal VSWR is 1.5.

CIRCLE NO. 379

Attenuator cartridges connect in stripline

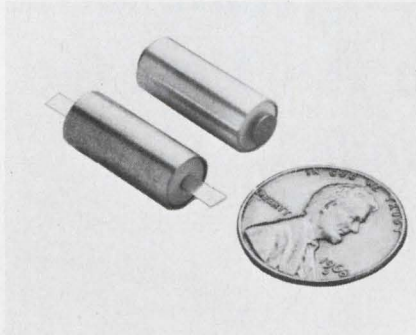

Microlab/FXR, Ten Microlab Rd., Livingston, N.J. Phone: (212) 721-9000. P&A: \$40; 4 wks.

Connectorless attenuator cartridges for direct inclusion in stripline modules and transmission lines are available in attenuation values up to 30 dB. The cartridges operate from dc to 10 GHz and can be provided with stripline, disc, or other mating configurations. Applications include incorporation into coaxial components such as switches, power dividers and detectors.

CIRCLE NO. 380

Uhf wattmeter measures and matches

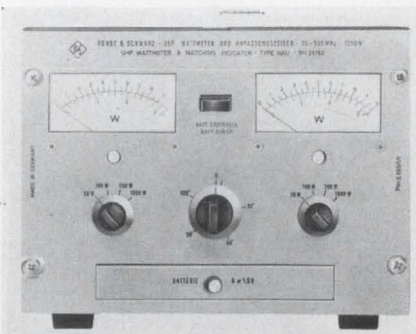

Rohde & Schwarz, 111 Lexington Ave., Passaic, N.J. P&A: \$1295; stock.

A uhf wattmeter and matching indicator permits simultaneous measurement of incident and reflected power on two meters. Simultaneous measurement eliminates any need for switching or replacing plug-in elements. Type NAU, with a frequency range of 25 to 500 MHz, is available in two models: 50 mW to 31.6 W; 2-to-1000 W.

CIRCLE NO. 381

Photodetector senses infrared

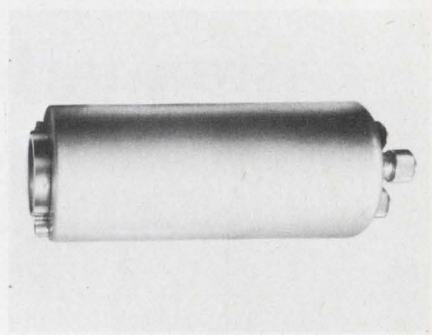

Raytheon Co., Foundry Ave., Waltham, Mass. Phone: (617) 688-7148.

A photoconductive detector for CO₂ laser and other infrared radiation features short response time—three nanoseconds or less—and is sensitive over the 2-to-30-micron range. The QKN1574 is available with special modifications, such as infrared filters to narrow bandwidth sensitivity and various transmission windows for handling specific wavebands.

CIRCLE NO. 382

Schottky photodiodes have standard lengths

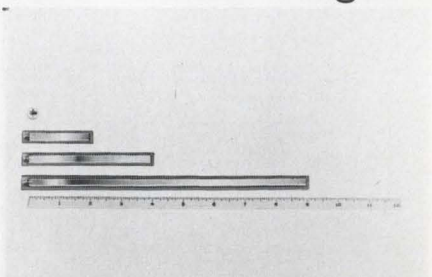

United Detector Technology, 1732 21st St., Santa Monica, Calif. Phone: (213) 393-3785.

Schottky-barrier photodiodes are designed for precise, single-axis position-sensing along standard available lengths. All models in the PIN-LSC series resolve position within one part in 10⁻⁵ in. Position sensitivity is 0.2 μA/mW/mil. Employment of the Schottky-barrier technique results in a spectral width that is three times wider than that given by photo-multipliers.

CIRCLE NO. 383

General Electric introduces a faster, more convenient and less costly technique for production line encapsulating and potting. And the RTV's used in the process are as tough as any previously available.

Called the RTV-800 series, the new liquid silicone rubbers do not need a catalyst to activate them, so no premixing is needed.

They cure at temperatures ranging from 200°F to 450°F, so pot life is far longer than is customary with RTV's. A typical deep section cure would be one hour at 300°F. For really rapid cure, components can be preheated and dipped into the RTV.

These three new products are supplied in both opaque and clear grades, with viscosities ranging from very pourable to pourable. They can be blended with one another to suit your particular encapsulating job.

For more information about these new encapsulating RTV silicones (they also make good short-run molding-

materials), write Section 300, Silicone Products Dept., General Electric Company, Waterford, N.Y. 12188.

TYPICAL PROPERTIES

Uncured	RTV-815	RTV-830	RTV-835
Color	Clear	Beige	Beige
Consistency	Easily pourable	Pourable	Easily pourable
Viscosity, cps	3500	200,000	8000
Specific Gravity	1.02	1.28	1.18
Solids, %	100	100	100
Shelf Life, months	4	4	4
Cured, ± 1 hr. @ 150°C	RTV-815	RTV-830	RTV-835
Hardness, Shore A durometer	35	50	35
Tensile Strength, psi	700	800	500
Elongation, %	150	250	200
Tear Strength, lb/in.	15	100	20

GENERAL  ELECTRIC

Now. Heat-curing,
no-mixing, high-strength
RTV silicones.

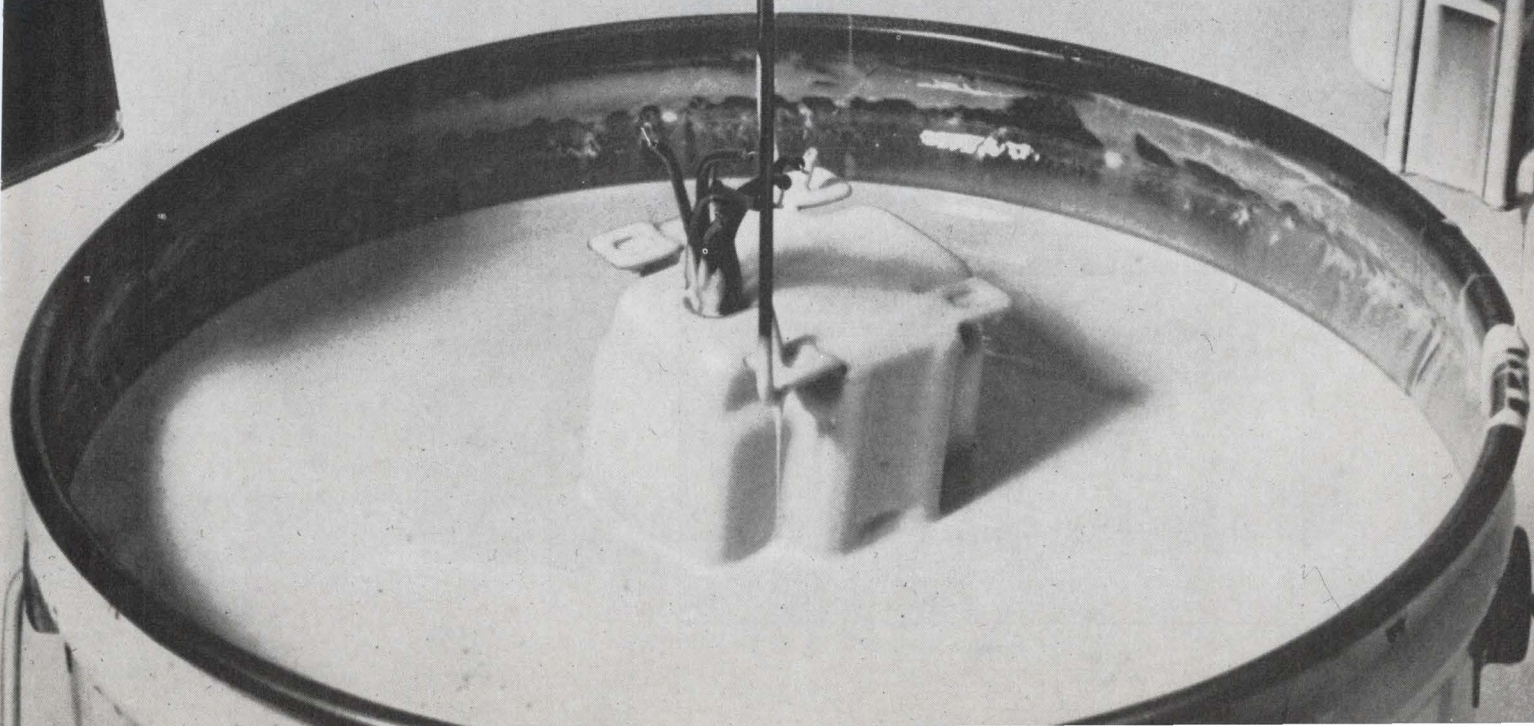

Tri-glycine sulphate bolometer with microsecond response time

Another state of the art infrared detector from Mullard. Replaces Golay cell for high speed spectroscopy. Response from 2 microns to microwave frequencies with NEP down to 10^{-9} at 1000Hz. Suitable for interference measuring techniques in machine tool control etc. Very rugged. *Samples now available from stock. Sensible prices.*

Other products available now: Cadmium mercury telluride detectors; Yttrium iron garnet modulator; Indium antimonide labyrinths and arrays; Filtered lead sulphide and doped germanium photo-conductive detectors. Also custom building. Send us your spec. for quotation.

Write today:
U.S. enquiries to Mullard Inc.,
100 Finn Court, Farmingdale,
Long Island, New York.
11735 U.S.A. Telephone:
(516) 694-8989. Telex: 961455.
Other enquiries to Mullard Ltd.,
Mullard House,
Torrington Place, London,
W.C.1, England.



INFORMATION RETRIEVAL NUMBER 93

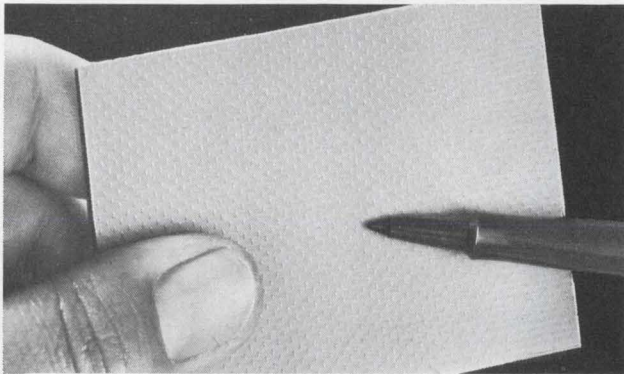

Porcupine Metalastic™

...best RF characteristics of any flat material

Hundreds of tiny contact points per square inch give Porcupine Metalastic exceptional RF shielding characteristics. Consisting of distorted solid Monel sheeting in silicone rubber, Porcupine is ideal in vacuum, atmosphere or moisture seal

applications. For high temperatures, it's available without silicone rubber. Standard widths: 8" & 10". Thickness: .020" and .030". Other sizes, too. About 6¢ per sq. in. Write for free samples, prices and literature.

METEX Corporation

970 New Durham Road, Edison, N.J. 08817
(201) 287-0800 • TWX 710-998-0578

West Coast: Cal-Metex Corp., 509 Hindry Ave., Inglewood, Calif.



INFORMATION RETRIEVAL NUMBER 94

MICROWAVES

Transistor amplifiers cover 225 to 400 MHz

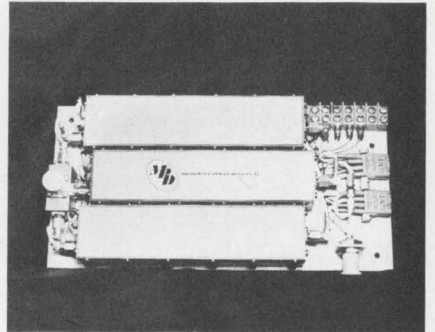

*Microwave Power Devices, Inc.,
556 Peninsula Blvd., Hempstead,
N.Y. Phone: (516) 538-7520.
Availability: 4 to 8 wks.*

Transistor amplifiers, covering the instantaneous bandwidths of 225 to 400 MHz, achieve third-order intermodulation of -35 dB at a power output of 1 W. The amplifiers are fully protected against open- or short-circuit load conditions. They operate indefinitely, into load VSWRs of 2.5 at any phase, with no change in intermodulation.

CIRCLE NO. 363

Coaxial switch spans 1 to 18 GHz

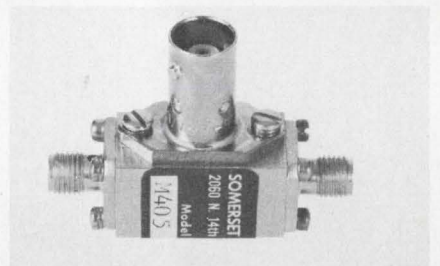

*Somerset Radiation Laboratory,
Inc., 2060 N. 14th St., Arlington,
Va. Phone: (703) 525-4255. P&A:
\$230; 20 days.*

Model M405 coaxial switch gives over 40-dB isolation in the 1-to-18-GHz range, with 0.5 to 2.5 dB insertion loss, and 2-W cw and 100-W peak power. Wide range is achieved by functionally integrating silicon p-i-n diodes into a low-pass filter, along with a shunt-bias circuit. With zero bias, minimum-signal attenuation is attained; with forward bias, the diodes prevent signal flow by spoiling the filter.

CIRCLE NO. 364

MEET MIDTEX



Midtex
Slayer of
giant problems



Midtex
Faithful
friend

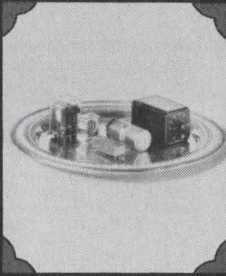

Midtex
The "service on a
silver tray" people



Midtex
The "we'll tackle
anything" people



Midtex
Cracker of
tough nuts

INDUSTRIAL RELAYS	TYPE 155	TYPE 156	TYPE 157	TYPE 48 Single Coil Latching Action
CONTACTS	U/L Recognized 1, 2, & 3 PDT 5 & 10 amp	U/L Recognized 1, 2, 3 & 4 PDT Low Level to 3 amp	1, 2, & 3 PDT 5 & 10 amp	1 & 2 PDT 10 amp
COILS	6 to 240 VAC 5 to 110 VDC	6 to 240 VAC 6 to 110 VDC	6 to 240 VAC 6 to 110 VDC	6 to 240 VAC 6 to 110 VDC
ENCLOSURES	Open and Dust Cover	Dust Cover and Hermetically Sealed	Open and Dust Cover	Open
TERMINALS	Solder, Plug-in, Wire-wrap, 3/16" Quick Connect	Solder/Plug-in, Printed Circuit, #78 Taper Tab	Solder/Plug-in/ 3/16" Quick Connect	Solder, 3/16" Quick Connect

MERCURY-WETTED CONTACT RELAYS	TYPE 159	TYPE 160	TYPE 161	TYPE 168
CONTACTS	1PDT	Mercury-Wetted, 2 amp max, 500 V max, 100 VA max 1PDT		1PDT
SENSITIVITY—Bistable Single-Side-Stable	20 mw 40 mw	20 mw 40 mw	30 mw 60 mw	2 mw 5 mw
TERMINALS	PCB pins	PCB pins	PCB pins	Octal plug

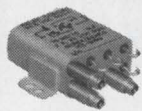

TYPE
153

COAXIAL CRYSTAL CAN

CHARACTERISTIC IMPEDANCES 50 and 75 ohms

RF CHARACTERISTICS:

Frequency	VSWR	Crosstalk
50 MHz	1.05/1	-62 DB
200 MHz	1.06/1	-50 DB
1000 MHz	1.15/1	-35 DB

CONTACTS 2C coaxial or 1C coaxial and 1C auxiliary, 100 watts RF, 2 amp 28 VDC

COILS 6 to 48 VDC

ENCLOSURE Hermetically sealed

TERMINALS RG188/AU Cable or ultra-miniature connectors, Solder hook for auxiliary

MOUNTING Standard varieties of crystal can relay stud, brackets, etc.

ENVIRONMENTAL Mil-R-5757



TYPE
615

ELECTRONIC TIME DELAY

DELAY TYPES Delay on operate Delay on release

DELAY RANGES

0.1 to 1 sec.	1 to 300 sec.
1 to 10 sec.	1 to 60 sec.
1 to 100 sec.	1 to 180 sec.

RESET TIME 25 MS max

REPEATABILITY ±2% at nominal voltage and +77°F

TOTAL TIMING VARIATION ±10% over voltage and temperature range

VOLTAGES AC 120 VAC (105 to 125 VAC) DC 12, 24, 48 VDC ±25%

TEMPERATURE RANGE -40°F to +150°F

CONTACTS 2PDT, 10 amp, 120/240 VAC or 24 VDC

TERMINALS Octal style plug-in, solder, screw

Midtex/AEMCO also designs and manufactures a wide variety of programmers, both standardized and to handle special customer requirements.

Midtex—The broad range relay and timer supplier

MIDTEX

INCORPORATED

AEMCO DIVISION

10 STATE STREET MANKATO, MINNESOTA 56001
PHONE 507-388-6286
TWX 910-565-2244

Diaphragm logic kit simplifies design

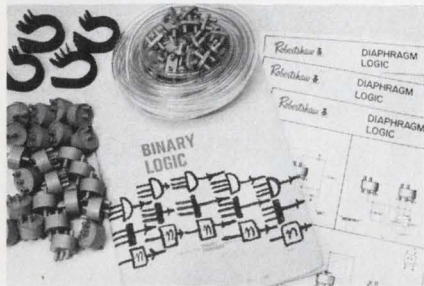

Robertshaw Controls Co., 1026 N. Main, Goshen, Ind. Phone: (219) 533-4111. Price: \$150.

Building digital logic circuits can now be simplified with a new diaphragm logic kit that includes logic valves, mounting brackets, tees, tubing, restrictors, a course in binary logic, and a set of logic circuit diagrams. The valves, which operate with pressures of 10 to 25 psi, can be used singly or in multiples to perform any logic function. They can operate as AND, OR, NOT, NAND, memory, differentiator, flip-flop or binary units.

CIRCLE NO. 365

Self-adhering patches ease tape correction

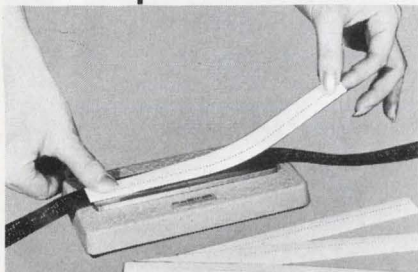

Robins Data Devices, Sub. of Robins Industries Corp., 15-58 127th St., College Point, N.Y. Phone: (212) 445-7200. Price: \$9 to \$58.50.

For quick and easy updating or changing of data on paper and mylar perforated tape, new self-adhering correction patches are now available. The correction patches, which come in packets of 100, 500 and 1000, are 9-in. long and are feedhole perforated. Made of the same quality material as the tape itself, they cover the area to be corrected or amended so that new data can be punched.

CIRCLE NO. 366

Digital computer uses MSI circuits

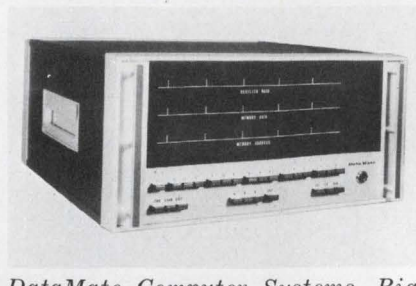

DataMate Computer Systems, Big Spring, Texas. Price: \$13,900.

Using standard ICs as well as MSI circuits, model 16 digital computer features a 4096-word 1- μ s memory that is modularly expandable to 32,724 words. The 16-bit arithmetic fully-parallel processor also includes hardware multiply and divide, eight I/O channels with priority interrupts, and hardware index registers. Its flexible I/O bus accommodates up to 64 peripheral devices.

CIRCLE NO. 367

D/A converter module keeps output monotonic



Pastoriza Electronics, Inc., 385 Elliot St., Newton Upper Falls, Mass. Phone: (617) 332-2131. P&A: \$1050; 30 to 60 days.

Besides featuring a conversion time of less than 2- μ s, a 14-bit d/a converter features a controlled transition output that insures monotonic output signal changes with negligible pre-shoot and over-shoot from one value to the other. The DAC 14T plug-in contains a reference supply, switches, storage registers, output amplifier, and gain and offset adjustments.

CIRCLE NO. 368

Acoustic coupler weighs only 5 lb



Digi-Data Corp., 4315 Baltimore Ave., Bladensburg, Md. Phone: (301) 277-9378.

Weighing only 5 lb, a streamlined acoustic data coupler provides data communications over the dial network using a standard voice handset. Model 103AC, which converts logic-level inputs to bit serial tones for transmission, is compatible with the Western Electric 103A. It is available with transmit or receive options for asynchronous data up to 300 bits/s. The unit measures 10-1/2 by 11-1/2 by 3-3/4 in.

CIRCLE NO. 369

Graphic digitizer tapes pictures

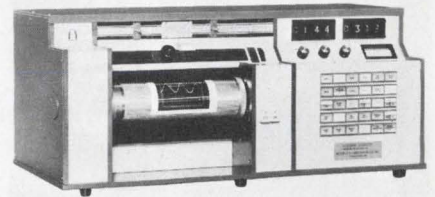

Aeroflex Laboratories, Inc., South Service Rd., Plainview, L.I., N.Y. Phone: (516) 694-6700.

A pictorial/graphic digitizer translates pictorial source material into computer language and records it directly on computer tape for subsequent data processing. The unit accommodates both graphic and photographic materials, either positive or negative, up to 8 by 10 in. in size. It has a resolution of 1000 lines per inch, an adjustable scanning aperture, bandwidth compression for graphic inputs, and a keyboard entry to record alphanumeric heading information.

CIRCLE NO. 370

Far Superior

TO ANY VTVM OR VOM

A NEW STANDARD OF THE INDUSTRY...

- Only Sencore makes a true field effect meter
- Less circuit loading than VTVM/obsoletes VOM
- Zero warm-up time — instant stability
- Complete circuit and meter protection
- Complete portability
- Greater frequency responses than most scopes

FE149 SENIOR FET METER

The only true Senior FET meter available today with outstanding accuracy and unbelievable ease of operation.

- **Unmatched Accuracy.** 1.5% on DC, 3% on AC, plus large 7-in. meter and mirrored scale, assure the most accurate tests possible.
- **Eight AC and DC ranges** .5V to 1500V full scale.
- **Zero center scale** with .25 v. either side assures measurements to less than .1 v. for transistor bias measurements.
- **AC peak to peak readings** to 4500V maximum with freq. response of 10HZ to 10MHZ \pm 3DB.
- **Eight resistance ranges** to R x 10 megohms with 6 OHMS center scale.
- **Nine DC and nine AC current ranges** 150ma to 5 amps.
- **Eight decibel ranges** for audio measurements.
- **Three HI-Voltage ranges**, 5 KV, 15 KV, 50KV with 39A21 high voltage probe. \$14.95
- **Absolute meter and circuit protection** against circuit overload.
- **Non-breakable, scuff-proof, vinyl-clad steel case.**
- **Three-way power.** Operates on AC, on self-contained rechargeable batteries, or on AC with batteries plugged in. Same readings all three ways.

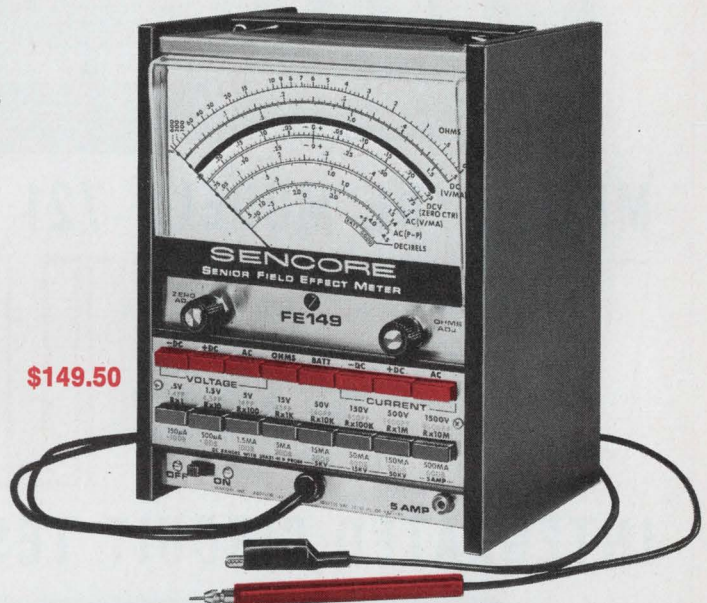

Exclusive push-button design. Just push two buttons for any test — top row selects function, bottom row selects range. Action is instant and automatic.



\$69.95

FE14 — STANDARD FET METER

ACCURACY DC \pm 2.5%
AC \pm 4.5%

- 4½-inch meter, vinyl-clad steel case.

FE14 and FE16 popular 4 1/2 inch FET Meters

- **Hi Accuracy.** For unsurpassed measurements. Mirrored scales prevent parallax errors.
- **Minimum circuit loading.** 15 megohm input resistance on DC; 10 megohm on AC.
- **Zero center scale** \pm 0.5 v. readings for transistor bias measurement.
- **Full meter & circuit protection** against possible circuit overload.
- **7 DC & AC voltage ranges** 1 to 1000 volts full scale.
- **AC peak to peak readings** 2800 v. maximum with freq. response of 10HZ to 10MHZ \pm 3DB.
- **5 resistance ranges** to 1000 megohms.
- **5 DC current ranges** 100ma to 1 amp.
- **3 Hi-Voltage ranges**, 3 KV, 10 KV, 30 KV, extended with 39A19 (\$9.95) high voltage probe.

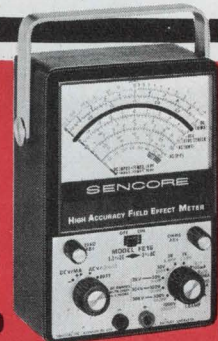

\$84.50

FE16 HI ACCURACY FET METER

ACCURACY DC \pm 1.5%
AC \pm 3%

- 4½-inch high-styled meter, high-styled knobs, and special meter-tilting metal handle. Vinyl-clad steel case.

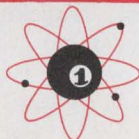

See your Sencore distributor today or write factory for complete line catalog.

SENCORE
STANDARD OF THE ELECTRONIC INDUSTRY

426 SOUTH WESTGATE DRIVE,
ADDISON, ILLINOIS 60101

INFORMATION RETRIEVAL NUMBER 96

MODEL 721 Fully Automatic
for high speed production testing.
Performs both **PARAMETRIC** and **FUNCTIONAL**
tests simultaneously

priced from **\$3490**

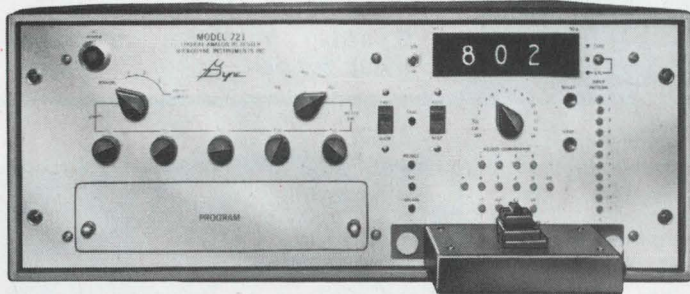

MICRODYNE MODELS 721 & 716

VERSATILES
THE

INTEGRATED CIRCUIT TESTERS



MODEL 716 Manual/Semi-Automatic for
engineering evaluation. Quality control and
small quantity production testing. Capable
of testing both **LINEAR** and **DIGITAL** circuits.

priced from **\$1890**

Microdyne

MICRODYNE INSTRUMENTS, INC.

203 MIDDLESEX TURNPIKE • BURLINGTON • MASSACHUSETTS 01803 • (617) 272-5691

DATA PROCESSING

Miniature memory
stores 1300 bits

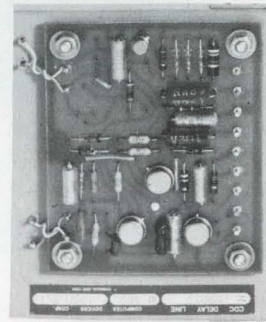

*Computer Devices Corp., 63 Austin
Blvd., Commack, N.Y. Phone: (516)
543-4220. P&A: \$150; stock.*

Designed for use in small electronic computers, calculators and digital interface devices, a miniature magnetostriuctive memory features a storage capacity of 1300 bits and a bit rate of 2.6 MHz. Model MS 2219, which measures 4-by-3-1/4 by 1-in. is supplied complete with all input and output circuitry. Its input and output is compatible with DTL and TTL logic.

CIRCLE NO. 371

Digital data coupler
links 8 recorders

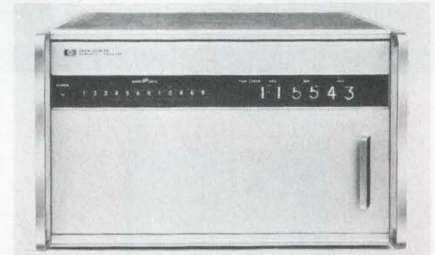

*Hewlett-Packard Co., 1501 Page
Mill Rd., Palo Alto, Calif. Phone:
(415) 326-7000. P&A: from \$4150
(including recorder); 8 wks.*

Economically automating data recording and analysis, a digital coupler records data from digital instruments on any one of eight different output recorders. Previously, each such output device required a separate coupler. The new coupler adapts to any standard output device with plug-in circuit cards. With model 2547A digital data are first translated from parallel to serial form; then transferred to the output recorder, in the code required by that device.

CIRCLE NO. 372

THINKING RELAYS?

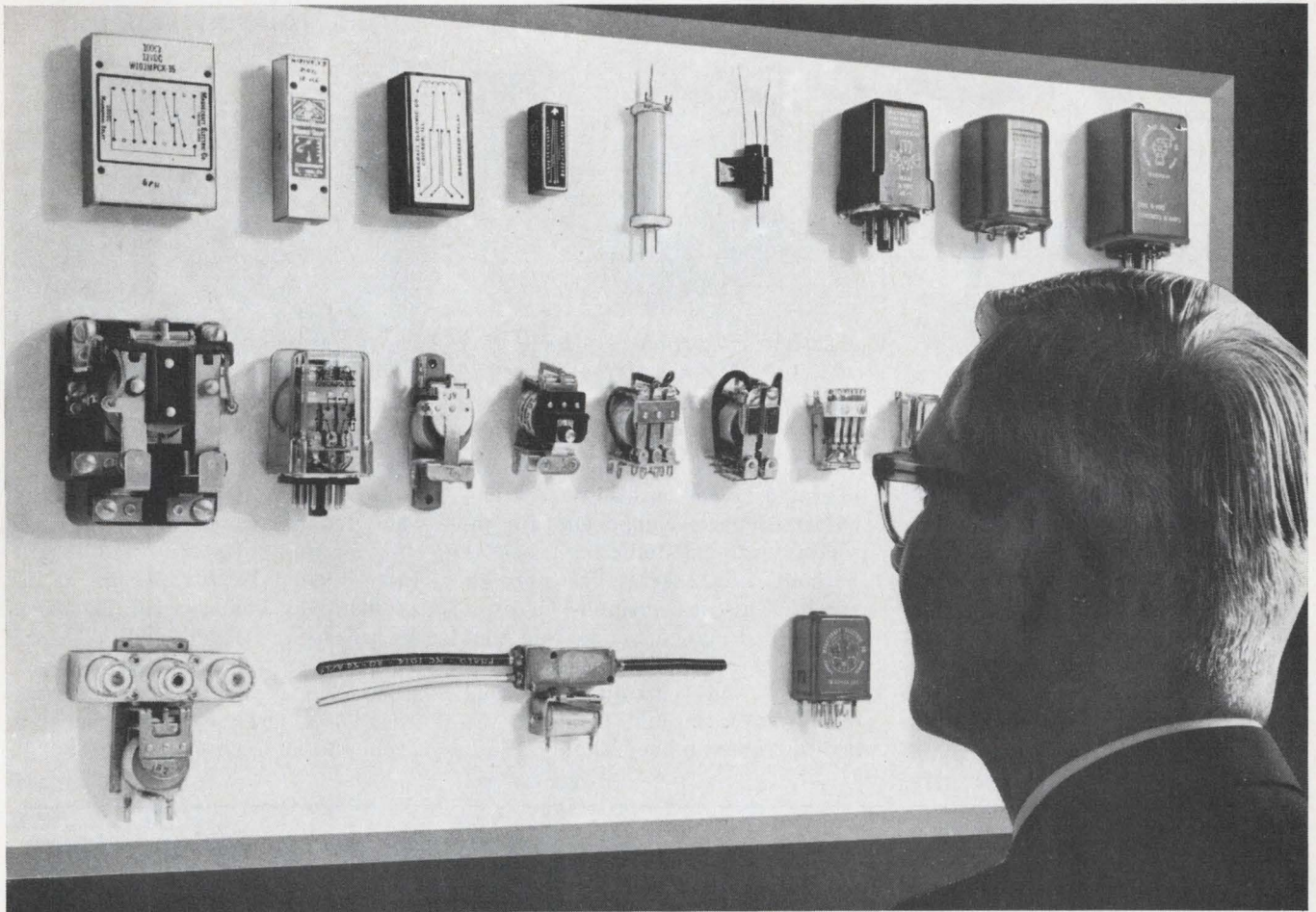

THINK MAGNECRAFT!

(that's all we think about, exclusively)

We specialize in relays. Not only dry reed and mercury-wetted relays, but a full line of quality, long lasting relays. There are Magnecraft general purpose, telephone type, time delay and power relays, as well as coaxial relays for UHF switching.

All Magnecraft relays are built to provide reliable performance in any application. And to insure this reliability, our demanding quality control system puts every part and assembly through repeated inspections before any shipment leaves our plant.

Everyone at Magnecraft concentrates on relays to provide you with quality products, quickly delivered and at competitive cost. That's because all we think about is relays! Just ask our wives!



FREE! Product File — Yours for the asking. Contains full details on all our stock relays.

Magnecraft[®] ELECTRIC COMPANY

5575 NORTH LYNCH AVENUE • CHICAGO, ILLINOIS 60630 • 312 • 282-5500

INFORMATION RETRIEVAL NUMBER 98

Wire insertion tool saves rework time

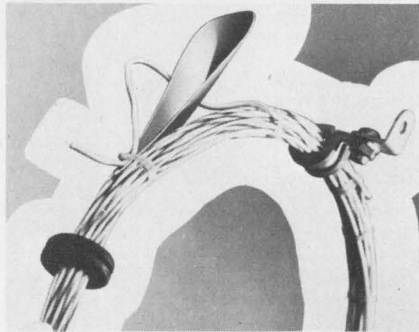

Macdonald & Co., 213 S. Brand Blvd., Glendale, Calif. Phone: (213) 241-4131. Price: \$1.65.

Anyone who has constructed a prototype with laced wire harnesses has undergone the frustrating experience of adding an extra wire to the original design. To eliminate frayed tempers and wires, a small handtool has been manufactured to allow the addition of extra wires without removing ties or clamps. Rounded edges will not mark wires or ties.

CIRCLE NO. 373

Lead bender and cutter does not strain parts

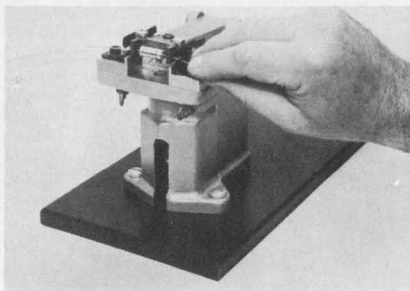

Western Electronic Products Co., 107 Los Molinos, San Clemente, Calif. Phone: (714) 492-4677. Price: \$84.50 or \$119.50.

Available in both hand- and air-operated models, a lead bender and cutter prepares components for insertion into printed-circuit boards without engendering tension or strain. This is accomplished by a uniquely designed bender die that clamps the lead firmly before the bending and cutting operation, thereby avoiding any strain on the body of the component.

CIRCLE NO. 374

Laser plus microscope drills micron holes

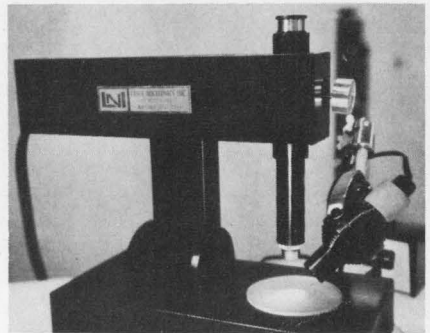

Laser Nucleonics, Inc., 123 Moody St., Waltham, Mass. Phone: (617) 891-7880. P&A: \$2869; stock.

A solid-state laser has been mounted in a microscope for making micron holes or slits. Target sizes from 1 to 10 microns in increments of 1 micron can be dialed by the user. Larger holes from 11 to 25 microns, or larger, can be selected in increments of 2 microns each. The laser can be separated from the microscope.

CIRCLE NO. 375

When Only Excellent is Adequate TURN to Grayhill

for TOTALLY ENCLOSED ROTARY SWITCHES. TEMPERATURE TO 125°C. MULTI-POLE. 30°, 36°, 45°, 60°, and 90° ANGLE OF THROW. 100,000 OPERATIONS.

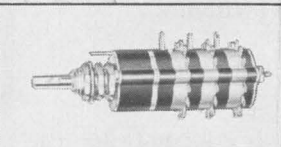
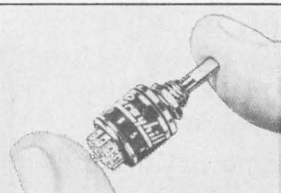
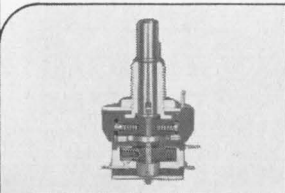

Typical Specifications

- Explosion Proof
- Contact Resistance 10 Milliohms
- Make or Break 1/4 Amp. to 15 Amps., 115 VAC Resistive
- 1 to 6 Poles per Deck
- 2 to 12 Positions per Pole
- 1 to 12 Decks

Send for Engineering Catalog G-304-A



575 Hillgrove Avenue
LaGrange, Illinois 60525
Area Code 312, Phone 354-1040

INFORMATION RETRIEVAL NUMBER 99

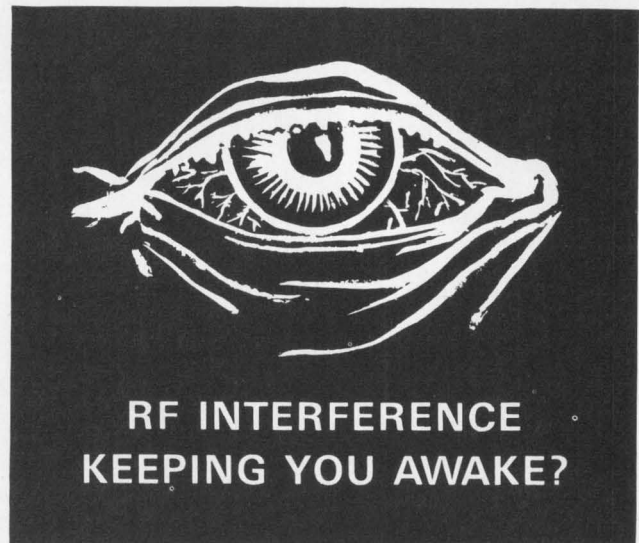

Rest easy with reliable Littelfuse RFI shielded fuse posts. Wide range available for military and commercial applications.

LITTELFUSE
DES PLAINES, ILLINOIS

INFORMATION RETRIEVAL NUMBER 100

ELECTRONIC DESIGN 1, January 4, 1969

BUY THE *FULLY* AUTOMATIC RFI/EMI DATA ACQUISITION SYSTEM...

GET A SPECTRUM ANALYZER FREE

Only Stoddart's Series VII System gives you **fully** automatic RFI/EMI data acquisition. Only the **modular** Series VII cuts your initial cost, gives you greater utilization. Start with the NM-37/57 now to cover the popular 30 MHz - 1 GHz range, add other receivers later. Each is lightweight, self-powered, usable independently in lab or field. A single R/O-7 digitizes and displays the output of one or all, one P-7 electronically programs all or any.

And we do mean program: receiver selection, tuning, bandwidth, sweeping, bandswitching, detector function, sweep speed, and peak hold-time. With 3-millisecond switching!

Plug in, turn on, and the Series VII gives you highly visible meter readings, feeds your X-Y plotter or strip-chart recorder. Tap its digital output, and generate a set of cards enabling automatic search for image and harmonic relationships. Or let your computer make real-time spectrum

signature comparisons, calculating total energies of broadband emissions. Or tape your RFI/EMI data for off-line processing.

But don't stop there. Hook up the Series VII to your standard scope, and what have you got? A spectrum analyzer with up to four stages of r-f preselection for superior rejection qualities and overload protection.

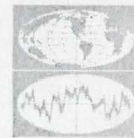

To reserve your free spectrum analyzer, write, wire or phone today!

The NM-37/57 RECEIVER (30 MHz to 1 GHz), the R/O-7 DIGITAL READOUT MODULE, and the P-7 STORED LOGIC PROGRAMMER may all be ordered now, the other receivers soon. Leading specs for the NM-37/57:

- 60 dB instantaneous dynamic range
- -17 dB sensitivity at 100 kHz bandwidth
- 160 MHz i.f. for high image rejection
- >60 dB spurious response rejection
- >100 dB shielding effectiveness

STODDART ELECTRO SYSTEMS

A Division of Tamar Electronics, Inc.

2045 WEST ROSECRANS AVE., GARDENA, CALIF.
TELEPHONE (213) 770-0270

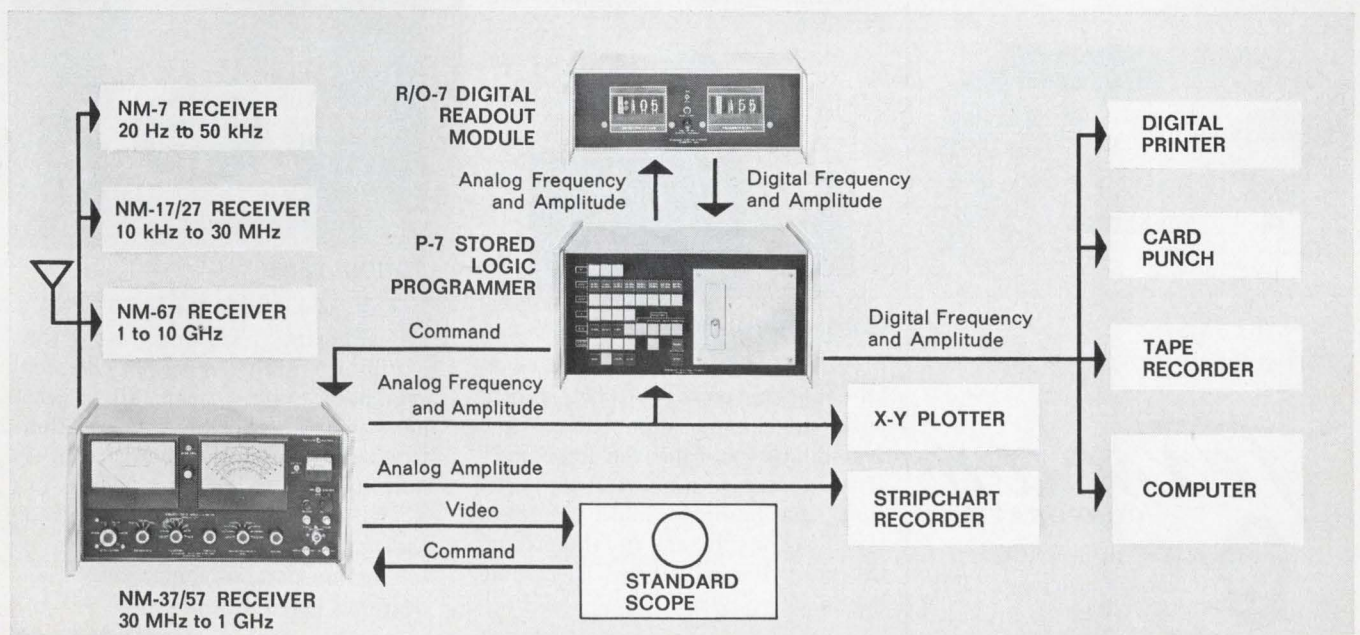

Video Sweep Generator

One Unit Covers 500 Hz to 25 MHz

The VS-20 solid state sweep signal generator can be centered at any frequency between 500 HZ and 25 MHz and can sweep anywhere within this range. The sweep width is continuously adjustable from 500 HZ to 25 MHz. It is also provided with a CW output mode. RF output is at least 1.0v rms into a 50 ohm load. Flatness is ± 0.25 db at maximum sweep width. Four sweep rate modes are provided: variable from 5 HZ to 60 HZ, 50/60 HZ line rate, manual sweep and external. Options available are a calibrated variable marker which covers the complete frequency range of the unit and the option of changing sweep rate range to 0.1 HZ to 10 HZ. Price: **\$1095.00**

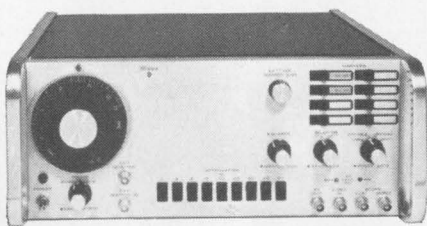

Specialists In Electronic Instrumentation

Texscan CORPORATION
 2446 N. Shadeland Ave.
 Indianapolis, Indiana 46219
 Ph. (317) 357-8781
 TWX. 810-341-3184

INFORMATION RETRIEVAL NUMBER 102

Design Aids



Captive floating nuts

A kit of self-locking, captive floating fasteners, designed to correct hole misalignments in chassis and panels, is offered as an aid to electronic packaging. Locking effect is achieved by distortion of a round extension, situated above the base of the fasteners. A dry, Teflon-type lubricant is applied to the thread to facilitate insertion and removal of the screws. Precision Metal Products Co.

CIRCLE NO. 384

Emi/rfi shielding kit

A sample kit of emi/rfi shielding material used on electronic enclosures is now offered free to assist qualified engineers in making the proper selection. Each reusable polyethylene bag contains a wide variety of knitted wire mesh gaskets, conductive silver/silicone, conductive tapes and see-through shielding glass. Technical Wire Products.

CIRCLE NO. 385

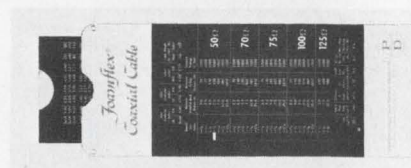

Coax calculator

Characteristics of Foamflex coaxial cable can be quickly determined with this handy slide rule. When over-all size and desired impedance are set opposite a pointer, all pertinent mechanical and electrical specifications appear in windows on the rule. Phelps Dodge Electronic Products.

CIRCLE NO. 386

FRACTION OR DRILL SIZE		DECIMAL EQUIVALENT	TAP SIZE	FRACTION OR DRILL SIZE		DECIMAL EQUIVALENT	TAP SIZE
15/64		.2344		19/64		.2969	3/16-11
	LETTER DRILL SIZES	.2380		39/64		.6094	3/16-16
	B	.2420		41/64		.6406	3/16-18
	C	.2460		43/64		.6719	3/16-20
	D	.2500	5/16-18	45/64		.7031	3/16-22
	E	.2540		47/64		.7344	
	F	.2580		49/64		.7656	7/16-9
	G	.2620		51/64		.7969	
17/64	H	.2660	5/16-24	53/64		.8281	7/16-14
	I	.2700		55/64		.8594	
	J	.2740		57/64		.8906	1-8
	K	.2780		59/64		.9219	
9/32	L	.2820	5/16-24	61/64		.9531	1-12-14
	M	.2860		63/64		.9844	1 1/2-7
	N	.2900		64		1.0000	1 1/2-12
	O	.2940		1 1/4	1	1.1250	1 1/2-12
	P	.2980		1 1/4	1 1/8	1.2500	1 1/2-8
19/64	Q	.3020	3/8-16	1 1/4	1 1/4	1.3750	1 1/2-6
	R	.3060		1 1/2	1 1/2	1.5000	1 1/2-12
	S	.3100		1 1/2	1 1/2	1.6250	1 1/2-12
	T	.3140		1 3/4	1 3/4	1.7500	1 1/2-12
23/64	U	.3180	7/16-14	1 3/4	1 3/4	1.8750	1 1/2-12
	V	.3220		1 3/4	1 3/4	2.0000	1 1/2-12
	W	.3260		2	2	2.1250	1 1/2-12
25/64	X	.3300	7/16-20	2	2	2.2500	1 1/2-12
	Y	.3340		2	2	2.3750	1 1/2-12
	Z	.3380		2 1/4	2 1/4	2.5000	1 1/2-12
27/64		.3420	1/2-13	2 1/4	2 1/4	2.6250	1 1/2-12
29/64		.3460		2 1/4	2 1/4	2.7500	1 1/2-12
31/32		.3500	1/2-20	2 1/2	2 1/2	2.8750	1 1/2-12
33/64		.3540		2 1/2	2 1/2	3.0000	1 1/2-12
35/32		.3580	1/2-20	2 1/2	2 1/2	3.1250	1 1/2-12
37/64		.3620		2 1/2	2 1/2	3.2500	1 1/2-12
		.3660		2 1/2	2 1/2	3.3750	1 1/2-12
		.3700		2 1/2	2 1/2	3.5000	1 1/2-12
		.3740		2 1/2	2 1/2	3.6250	1 1/2-12
		.3780		2 1/2	2 1/2	3.7500	1 1/2-12

Tap drill card

A pocket-sized plastic chart converts fractions or drill sizes to decimal equivalents and tap sizes. L. S. Starrett Co.

CIRCLE NO. 387



Teflon tape

Test the ruggedness of a new self-adhering Teflon tape that exhibits a high degree of chemical inertness and essentially zero-moisture absorption. An evaluation sample of the 2-mil film is now made available to design engineers. The new tape can be thermoset for greater resistance to commercial solvents. The Connecticut Hard Rubber Co.

CIRCLE NO. 388

Model LAT-100

The \$6,000* Resistor Trimming System

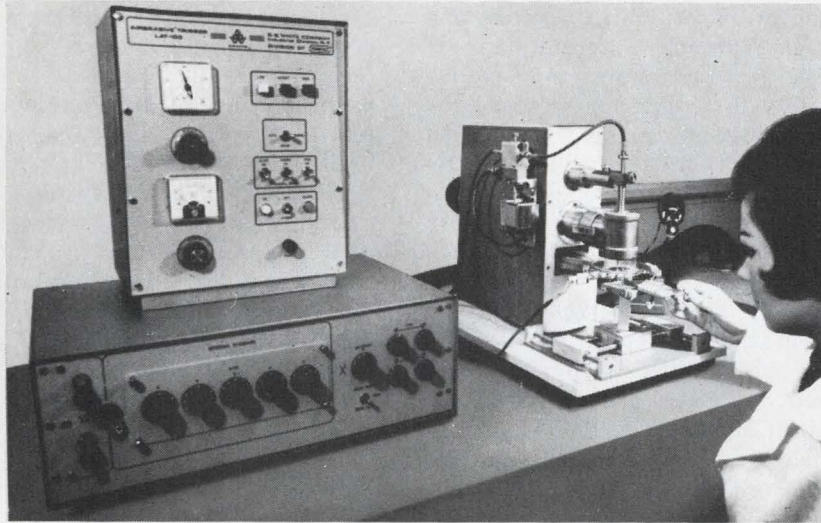

The number to call is 212-661-3320 for a demonstration like this—and you can bring your wife along if you like.

CALL us collect or write to arrange for a demonstration of S. S. White's new LAT-100, the complete, low-cost resistor trimming system for R & D and prototyping.

The LAT-100 automatically trims, monitors, and inspects PAF resistors to tolerances within 1%. That's guaranteed. In tests, 0.5% is often achieved. A precise 4-wire Kelvin bridge is integral to the system, which, with the optional plug-in decade box, permits the system to be programmed through five digits and three multipliers—from 0 to 10K and from 0 to 1M. Tolerances may be programmed from 0 to $\pm 11\%$. Panel controls permit operator to override the automatic cycle at will.

A holding fixture takes substrates up to 2x2 inches. A precise X-Y stage has 4"x4" movement. The trim slide has an automatic fast-return to place it exactly for the start of each trim. Tungsten carbide probes are mounted in a 14-position mounting ring. An efficient dust-removal system permits the LAT-100 to be operated in clean rooms. Installation requires a 110 VAC outlet and a level spot.

*Base price, \$5,950.00 each. With optional decade box, illuminator, foot-switch operation, \$6,350.00.

Without further detail, the LAT-100 does everything its bigger brothers the AT-701 and AT-704 do—a little less accurately, to be sure, and not nearly as fast—but what can you expect for a trifling \$6,000?

A step up from the LAT-100 is the AT-701, a no-nonsense production machine. The AT-701 can produce 600 trims per hour with guaranteed accuracy of 0.5% and attainable accuracy of 0.1% when



Model AT-701 garners accolades at IEEE show—top scientist says "Gee whiz."

things are going your way. The AT-701 with a decent amount of employment (say 1000 hours per year) produces trims at about $\frac{1}{2}\text{¢}$ each—including labor, materials, maintenance, and amortization. How about *that*?

But say you're big. Really big. We've got our big Bertha model for you, otherwise called the AT-704, which produces 4,000 trims per hour with accuracy and cost similar to those of the AT-701.

S. S. White resistor trimming systems are based on the proven Airbrasive® concept, controlled by precision electronics. The Airbrasive method of removing resistance material produces neither heat nor shock, does not alter substrate—yields of 100% can be attained with any of the S. S. White resistor trimming systems at some sacrifice of speed and tolerance. Each of the systems trims and monitors simultaneously and inspects after each trim.

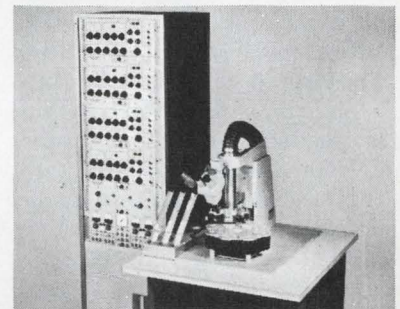

Big Bertha: Model AT 704 trims at 4,000/hour pace for high volume producers.

Up to now we've been able to offer fast delivery on all systems; however the enthusiasm we've encountered over the LAT-100 suggests that you'll be wise to place your order early for this model.

Call us or write to arrange for a demonstration of the LAT-100, the AT-701, or (if you're really big) the AT-704. Or ask for bulletin RT-14—it's great to read on planes.

Inquire, S.S. White Industrial, Dept. 28R 201 East 42nd Street, New York, N.Y. 10017. Telephone 212-661-3320.

S. S. WHITE INDUSTRIAL
A DIVISION OF PENNSALT CHEMICALS CORPORATION

INFORMATION RETRIEVAL NUMBER 103

Application Notes

Discharge lamps

A 28-page publication covers high-intensity discharge lamps, detailing the physical, electrical and performance characteristics of three principal categories of lamps. The booklet discusses the history of light output improvements, bulb shapes and sizes, designations, operating characteristics, lamp life, factors affecting lamp performance and spectral energy distribution data. General Electric Co.

CIRCLE NO. 417

Electroluminescence

Describing the theory, types and applications of electroluminescent light sources, a 20-page technical brochure explains how an electric field stimulates light emission from certain layered materials to produce electroluminescence. It includes sections on metal-ceramic panel lamps, other electroluminescent products, and their applications. Photographs and illustrations complement the text. Sylvania Electric Products Inc., Special Products Div.

CIRCLE NO. 418

Emi measurements

A 26-page application note discusses the principles of electromagnetic interference measurements. It describes how calibrated spectrum analyzers can be used as tuned rf microvoltmeters, with visual display to make these measurements with substantial savings in time. The note begins with a general summary of emi principles. It describes techniques for making standardized emi measurements and tells how these measurements can be made during the design stage, so that electromagnetic compatibility can be designed into the equipment. Hewlett-Packard Co.

CIRCLE NO. 419

PC soldering

Providing a thorough explanation of solderability problems and their solutions, a technical report discusses the restoration of solderability to copper surfaces and the damage that can be done to surfaces by abrasive particles. Also explained is how, after good solderability is attained, the surfaces can be protected against recontamination. Also covered is the application of fluxes, the advantage of preheating, pointers on cleaning and maintaining cleanliness of the work surfaces after soldering. Alpha Metals, Inc.

CIRCLE NO. 420

P-i-n diode data

An eight-page brochure has been prepared on the application of high-power p-i-n switching diodes in duplexers operating at megawatt peak power levels at frequencies through C-band. Included are a comparison of various types of duplexers, the relative advantages and disadvantages of each type, solid-state duplexer design analysis and operation, and typical solid-state duplexer performance parameters. Unित्रode Corp.

CIRCLE NO. 421

Static switching handbook

An illustrated, 66-page handbook on the subject of industrial static switching techniques and applications provides the control-logic circuit designer with the fundamental concepts involved in solid-state switching. The general logic described in the handbook is sink logic; the specific logic is English logic. Covered in the manual are parallel switching (sink logic), auxiliary (signal and power level) switching elements, truth tables, Boolean algebra, five conversion techniques, and applications of static logic. Jordan Controls, Inc.

CIRCLE NO. 422

MOS shift registers

MOS shift registers and how to use them in bipolar logic systems are described in a 20-page application report. The power requirements of a line of MOS static shift registers, ranging from dual 16-bit to dual 100-bit units, are given. Basic clocking requirements and clock drivers are discussed, along with requirements for interfacing with TTL and DTL systems. Basic input and output data on MOS static shift registers is also provided. Texas Instruments, Inc.

CIRCLE NO. 423

S-parameter techniques

Seven articles on high-frequency (>100 MHz) circuit design with S-parameters are presented in an 86-page application note. Techniques are described for measuring the S-parameters of transistors and networks, and for designing with the parameters. The articles are illustrated with charts and diagrams and include comprehensive bibliographies. Hewlett-Packard Co.

CIRCLE NO. 424

Ultrastable thyatrons

A series of hydrogen thyatrons employing an advanced design that significantly reduces power and circuit requirements as well as component replacement in high-energy systems is described in a 16-page booklet. The 4-color booklet gives a systematic description of the new tubes and their advantages. It makes extensive use of charts and diagrams to illustrate the principles and applications. The booklet discusses the effects of drift and jitter, the design of a new thyatron and its theoretical advantages, the empirical verification of these advantages, and specifications of the new tubes. Tung-Sol.

CIRCLE NO. 425

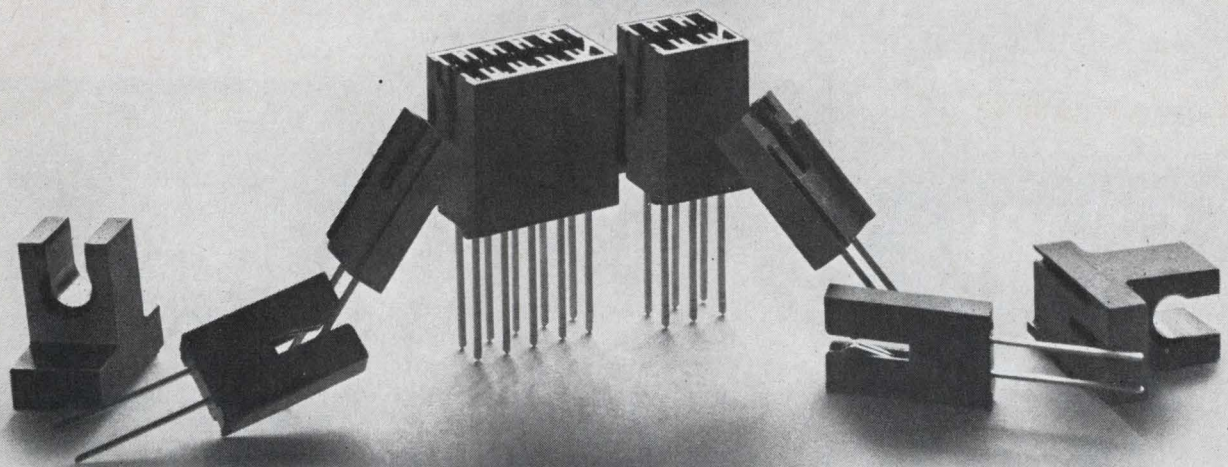

When you make a connector like this, it pays to give it away.

That's exactly what we are doing because it's such a handy design tool.

Sylvania's segmented connector gives you a building block approach to breadboarding and prototyping.

It allows you to build up exactly the single-position circuit-board connector to fit your job.

Just put together as many segments as you need.

Use it for actual circuit wiring and for mechanical layout.

When you have your final design, call Sylvania for fast production on connectors that will meet your exact specifications.

That way, you will get the benefits of Sylvania's long experience in custom connectors. Such benefits as our special gold-dot contact design that minimizes contact resistance and lowers cost.

You also get Sylvania's precision construction that puts connector terminals exactly where they're needed for programmed wiring systems.

For your own do-it-yourself connector design kit write on your letterhead to M. Gustafson, Product Manager, 12 Second Ave., Warren, Pa. 16365. Your kit will be sent by return mail. As a bonus, we'll throw in data sheets on our new off-the-shelf connector line.

CONNECTORS BY
SYLVANIA
A DIVISION OF
GENERAL TELEPHONE & ELECTRONICS

NPL

BINARY TO DECIMAL CONVERTER

The Northern Precision Laboratories' Binary To Decimal Converter converts Gray Code, V-Scan or True Binary Inputs into a decimal display thru the use of a fixed program computer. Upon receipt of an update pulse the computer samples the input information and processes it via shift registers and control logic. At the end of the conversion process, the resulting BCD number is stored in registers until the next update pulse is received. The BCD data is then used to drive a Nixie™ Display and/or is fed directly to output buffers. A complete conversion of 16 bit data is attained in approximately 50 microseconds; visual tracking of the input information is accomplished by utilizing an automatic internal update period of less than 5 milliseconds.

APPLICATIONS . . .

Peripheral Equipment Interfacing
Binary Format System Monitoring
Digital Test Equipment

SEND FOR NEW CATALOG . . .

NPL

**NORTHERN PRECISION
LABORATORIES INC.**

202 FAIRFIELD ROAD
FAIRFIELD, NEW JERSEY 07006
area code (201) 227-4800
TWX 710-734-4301

INFORMATION RETRIEVAL NUMBER 105

New Literature

Crossbar basics

Crossbar fundamentals are given in a 16-page illustrated bulletin. Capabilities, operational characteristics, and components of this general-purpose, high-performance, signal-switching device are covered. The bulletin provides information on details of actuating assemblies and contact matrix, with data on circuits and bussed-select and independent-select matrix and level selection. Also covered are design considerations, electrical characteristics, and complete specifying data. Cunningham Corp., Sub. of Gleason Works.

CIRCLE NO. 389

Air-moving devices

Propeller and vane-axial fans, squirrel-cage and centraxial blowers, low-speed and spiral blowers, and coolant panels are described in a 24-page quick-reference catalog. Other product information given includes airflow interlock switches, and solid-state converters and inverters. Operating data, photographs and outline drawings are given for all products. Rotron, Inc.

CIRCLE NO. 390

Epoxies for electronics

An epoxy molding-powder chart has been revised to include two new types and to eliminate outdated types. Application data includes molding temperatures and pressures, suggestions for mold design, an application selector table and processing notes. The properties of cured materials are given, including operating temperature limits, specific gravity, hardness, mechanical strength, water absorption, thermal expansion coefficient, thermal conductivity, flammability, dielectric constant, loss tangent, volume resistivity, dielectric strength and arc resistance. Emerson & Cuming, Inc.

CIRCLE NO. 391

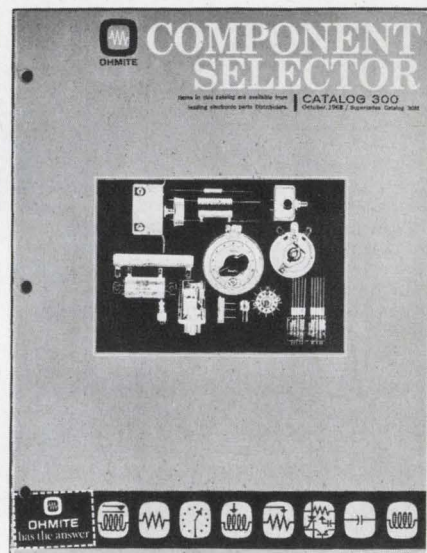

Electronic components

A 35-page condensed catalog gives complete details on a variety of resistors, potentiometers, transformers, capacitors, solid-state power controls, rf chokes and relays. The relay section includes dimensional drawings and mounting illustrations. The most popular component values are indicated in bold print. Ohmite Mfg. Co.

CIRCLE NO. 392

Shaft hardware

A line of shaft hardware is described in an eight-page bulletin that lists both standard and miniature items. The catalog includes such items as knobs, dials, couplings, gear drives, as well as shaft locks and bearings. James Millen Manufacturing Co.

CIRCLE NO. 393

Microwave components

A 20-page microwave component catalog includes solid-state switches, miniature coaxial hybrids, couplers and mixers. The catalog lists over 350 standard microwave components with emphasis on miniature, solid-state devices designed to meet requirements for broad bandwidth performance. Kevlin Mfg. Co.

CIRCLE NO. 394

TRW SPACE SAVING SOLID TANTALUM CAPACITORS

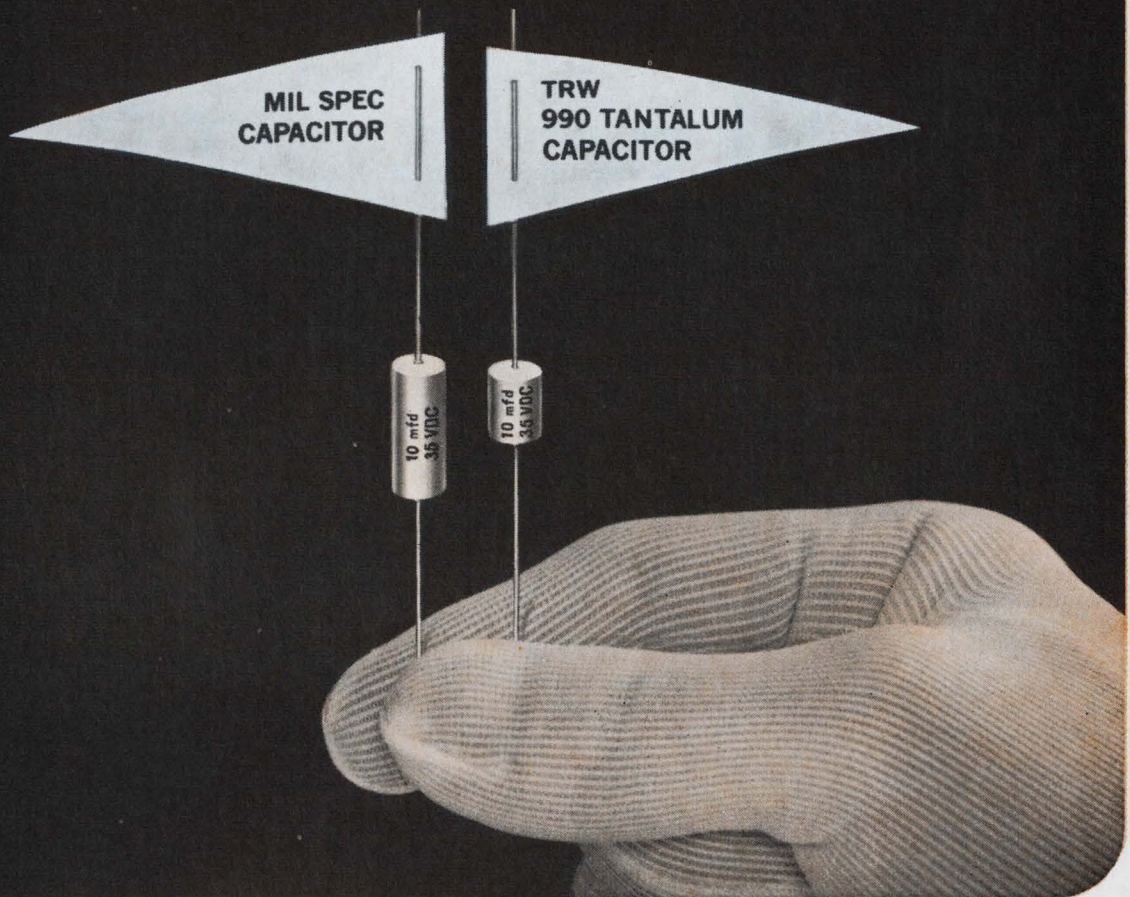

MIL spec performance...in half the space!

Type 990 miniature solid tantalums typify TRW's creative engineering. They're *designed* to fit in half the space. *Designed* to give better shock and vibration resistance. *Designed* to MIL

specs. They're *designed* to be the best hermetically sealed tantalums you can buy. Values from 8.2 to 330 mfd, 6 to 35 V.

Get the TRW tantalum story on space-savers like the 990,

on standard MIL types and tantalum hi rel capability. Contact TRW Capacitor Division, TRW INC., Box 1000, Ogallala, Nebraska. Phone (308) 284-3611. TWX: 910-620-0321.

TRW®

INFORMATION RETRIEVAL NUMBER 106

They said it couldn't be done!

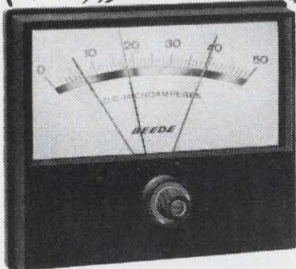
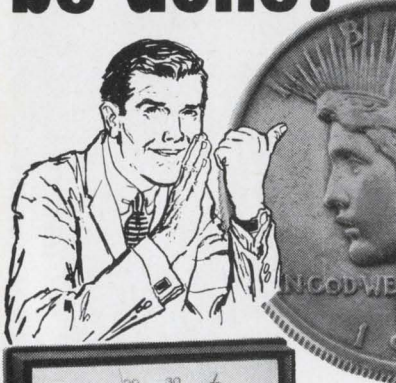

**a CONTROL METER RELAY
with 50% savings and
high performance**

WELL, THEY WERE WRONG! After a year of customer use in the field, our customers report that our units are consistently providing high accuracy and high reliability — and they must be right because they are re-ordering and pocketing cost savings of up to 50%. Why not join our increasing list of satisfied customers now?

Beede's Non-Contacting Control Meter Relay was initially designed to offer a wide choice of design options for the greatest application versatility. For instance:-

- 8 or more choices of power supply
- 4 choices of fail-safe configuration
- 10 or more choices of output mode
- 9 choices of alarm lights and reset switches
- Many special features such as tamper-proof units, fixed set pointer stops, etc.
- Pyrometers and resistance thermometers

Write for complete literature today!

BUY VALUE / BUY BEEDE

BEEDE

ELECTRICAL INSTRUMENT CO., INC.
PENACOOK, NEW HAMPSHIRE
Area Code: 603-753-6362

NEW LITERATURE

Capacitors

A 40-page short-form catalog lists the general characteristics of many capacitor types. Included are ceramic, film, paper-and-foil, polystyrene, polycarbonate, fluorocarbon and electrolytic capacitors. The specifications cover size, configuration, temperature range and coefficient, capacitance, tolerance, types of leads, and electrical parameters. West-Cap Div., San Fernando Electric Mfg. Co.

CIRCLE NO. 395

Lights and switches

Illuminated pushbutton switches an matching indicator lights, featuring a more versatile range of mounting hardware and improved styling, are described in a new catalog. The 14-page, 2-color catalog gives complete specifications, drawings, circuit details, and ordering information. Also included is a lamp selection guide. Marco-Oak, Div. of Oak Electro/Netics Corp.

CIRCLE NO. 396

Wire and cable catalog

A 48-page business machine wire and catalog is available at no charge. For quick location of individual items, the illustrated data are grouped into main categories—single wire, coaxial cable and multi-conductor cable. American Enka Corp., Brand-Rex Div.

CIRCLE NO. 397

Brushless dc motors

A four-page brochure describes a line of miniature brushless dc motors with solid-state controls. The booklet covers precision motors from 1.6 to 3.5 inches in length with diameters ranging from 0.8 to 2 in. and torques from 0.18 to 7 in.-oz. These brushless units minimize acoustical, conductive and rf noise. Siemens America, Inc., Power Equipment Div.

CIRCLE NO. 398



IC hardware

A new catalog describes a complete line of sockets, carriers, contactors and breadboards for integrated circuits, MSI and LSI devices, transistors, relays and operational amplifiers. Profusely illustrated with photographs and dimensional drawings, the catalog covers the full range of components offered for various devices. Barnes Corp.

CIRCLE NO. 399

IC audio amp

The operation and applications of an IC audio driver amplifier for communications equipment is described in an eight-page booklet. Circuit diagrams and equations are shown, as well as several class A amplifier circuits that deliver powers from 1 to 6 W. P. R. Mallory & Co., Inc.

CIRCLE NO. 400

Submicron filters

Industrial submicron filters are the subject of a 28-page bulletin that details the characteristics and applications of the new M-780 filters. Included in the technical data is a listing of nine maximum pore sizes, from 0.2 to 10 microns, for varying degrees of micro-organism and particulate filtration. A comparison of the new medium with film-type membranes is also given. Separate sections are devoted to applications that include drug manufacture, the aerospace program, electronic micro-circuit cleaning, chemical processing, and clinical-lab routine filtration. Cox Instrument, Div. of Lynch Corp.

CIRCLE NO. 401

40,000 pf IN **1** SQUARE INCH

with SANGAMO

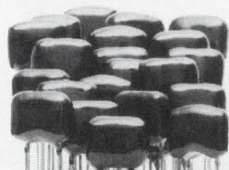

D-7 and D-10
Dipped Mica Capacitors

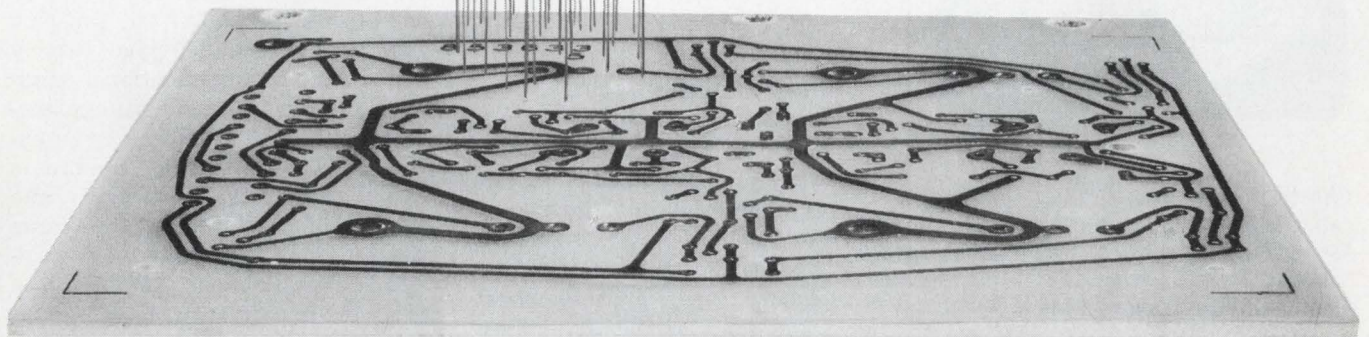

Sangamo makes these miniature dipped micas with up to 1500 pf—smallest in the industry with this much capacitance. Performance and stability are outstanding:

- T.C. retraceability as low as $\pm .05\% + .1$ pf.
- Temperature coefficient as low as $.007\%^\circ\text{C}$ (70 ppm).
- Q 1350 and higher above 82 pf.

These space-saving designs are the result of Sangamo's 45 years of experience in manufacturing dipped micas. We design and make them for every application—ask us for a quote!

NEW, FASTER DELIVERY SCHEDULES
Improved shipping and handling efficiency plus new production facilities assure fast delivery.

Dimensions as small as:

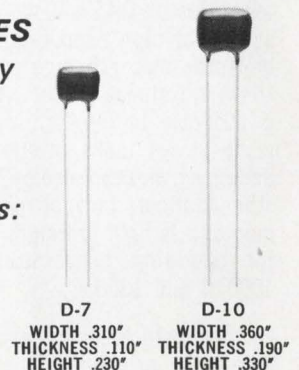

For samples and catalog, contact:

SANGAMO ELECTRIC COMPANY

Marketing Manager
Capacitor Division
Pickens, South Carolina 29671

Phone: 803-878-6311



INFORMATION RETRIEVAL NUMBER 108

VITREOSIL[®] INDUSTRIAL WARE

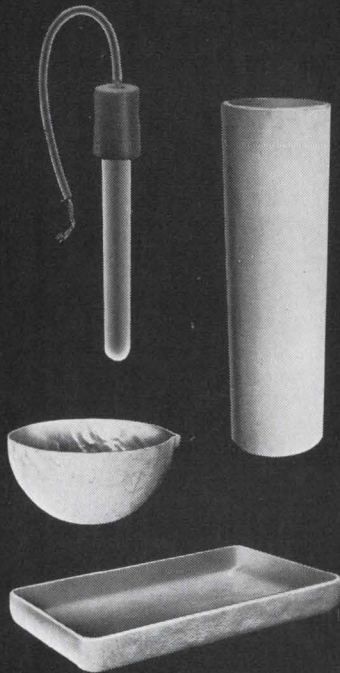

Whether you're concentrating, evaporating, or crystallizing acid solutions . . . or melting, sintering, or heat treating metals, Thermal American VITREOSIL Industrial Ware is your best bet.

VITREOSIL is exceptionally resistant to thermal shock (having a coefficient of expansion of: 0.45×10^{-6}), chemical reactions at high temperatures, has high dielectric strength, high purity, and extreme resistance to catalytic action. It is available in the forms of crucibles, dishes, trays, tanks, retorts, pots, tubes and pipes, and can also be fabricated in other configurations for specific requirements. It is light in weight and suitable for operating temperatures between 1000°C and 1300°C.

For complete technical and application data, write or phone.

79

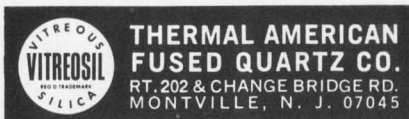

INFORMATION RETRIEVAL NUMBER 109

NEW LITERATURE

Rectifiers and zeners

Specifications and performance charts are shown in a 16-page catalog for a complete line of fused-in-glass silicon diodes, rectifiers, zeners and high-voltage assemblies. Covered are rectifiers (up to 9 A) with recovery times from 15 to 500 ns. Other sections describe high-surge 3-, 5- and 10-W zener diodes, MIL-type rectifiers and zeners, and high-voltage stack bridges and rectifier modules. Unitrode Corp.

CIRCLE NO. 402

Linear-motion pots

Fully described in a 4-page bulletin is a new design concept for a functional, yet economical, linear-motion potentiometer. The product advantages are illustrated, together with complete electrical characteristics and physical specifications. Also listed are application suggestions and cost reduction benefits. Stackpole Components Co.

CIRCLE NO. 403

Solid-state displays

A 4-color 12-page bulletin discusses the three solid-state-display technologies of magneto-optics, electroluminescence, and light-emitting semiconductor devices. These technologies, the state of their development, their prime applications, and some of the advantages of using solid-state displays are presented. General Electric Co.

CIRCLE NO. 404

Instrumentation

Covering a broad range of instrumentation products, an 11-page catalog gives specifications in short-form for system and spectrum analyzers, metrology instruments, and noise and field intensity meters. Analyzer/surveillance receivers, ac/dc voltmeters and ammeters, synchro-resolver test instruments, and d/a converters are also described. The Singer Co., Metrics Div.

CIRCLE NO. 405

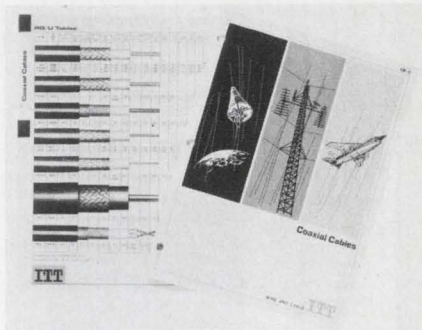

Coaxial cable

To assist in the selection of coaxial cables for specific electronic applications, a new 16-page catalog details the design considerations, conductor selection, and properties of dielectric insulating materials. An RG/U/table illustrates cable constructions and gives complete attenuation information. Indexed are all commonly used military and governmental wire specifications. ITT Wire and Cable Division.

CIRCLE NO. 406

Antennas and rf lines

Containing a comprehensive listing of antenna and rf transmission line products, a 200-page catalog has complete specifications, engineering data and installation procedures in military and industrial antennas. They include aluminum elliptical waveguide, rigid and semi-rigid copper and aluminum coaxial transmission line, and communication antennas. Also featured is a new line of ocean telemetering buoy systems. Prodelin, Inc.

CIRCLE NO. 407

Precision resistors

Precision wirewound resistors for both military and commercial applications are discussed in a 44-page illustrated brochure. Included are specifications on high-reliability, high-accuracy, printed-circuit, and power resistors. There is also a chart of minimum resistance value versus tolerance. In addition, curves indicate wattage versus tolerance derating with temperature rise and wattage versus ambient-temperature derating. Cutler-Hammer, Shallcross Div.

CIRCLE NO. 408

Precision tube parts

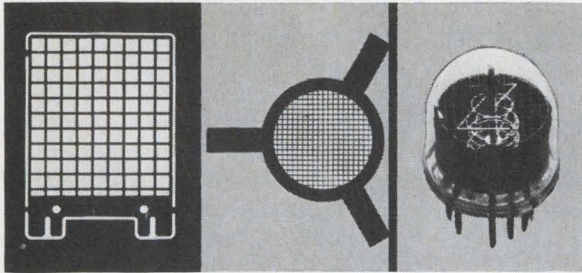

Grids, Nixie characters and other precision parts for electronic tubes are a specialty at Buckbee-Mears. We photoetch or electroform a wide variety of metals to production tolerances as close as ± 2 microns. We deliver on time, and our prices are fair.

May we tell you more? See your Buckbee-Mears technical representative, or call or write Bill Amundson, our industrial sales manager.

**BUCKBEE-MEARS
COMPANY**



245 E. 6th St., St. Paul, Minn. 55101 / (612) 227-6371

INFORMATION RETRIEVAL NUMBER 110

free engineers' fact file

on all-purpose Ebert "Hi-power" Mercury Relays!

Up-date your relay know-how with this comprehensive manual on Ebert mercury-to-mercury relays.

FEATURING: Ratings to 60 kW • 1, 2 and 3-pole models • Hermetically sealed metal tube construction • Silent and Service-free operation.



SEND FOR YOUR FREE COPY TODAY.
EBERT ELECTRONICS CORP.

130-10 JERICHO TPKE., FLORAL PARK, N.Y. 11002

INFORMATION RETRIEVAL NUMBER 111

ELECTRONIC DESIGN 1, January 4, 1969

5 days can do a lot for your next 5 years.

If you're involved in systems and equipment design, research, production or management . . . five days at one of our Seminars may make your next five years—and many more after that—much more productive.

More and more key management and high-level technical personnel from top companies all over the United States are attending RCA Institutes Seminars. Just as they are doing, you'll acquire information and techniques of immediate value in your work. You will also gain the kind of knowledge that can help build your professional standing in the years just ahead.

We believe we can increase your productivity by providing you with a firm grasp of many of the latest engineering techniques. Our experienced staff maintains constant contact with "what's happening" in industry. The texts and audio-visual materials are prepared exclusively by us for each seminar.

You can attend RCA Institutes Seminars around the country the year-round. Check your subject and send along the coupon for your brochure. Now—while you're thinking about it.

RCA

RCA Institutes, Inc. Dept. ELD-19

Institute for Professional Development
132 West 31st Street
New York, New York 10001

For FREE descriptive brochure, check the Seminar in which you are interested:

- | | |
|--|---|
| <input type="checkbox"/> Logic Design | <input type="checkbox"/> Management Information Systems |
| <input type="checkbox"/> Digital Systems Engineering | <input type="checkbox"/> Digital Communications |
| <input type="checkbox"/> Modern Optics | <input type="checkbox"/> Digital Electronics |
| <input type="checkbox"/> Integrated Circuits | <input type="checkbox"/> Numerical Control Systems |
| <input type="checkbox"/> Reliability of Integrated Systems | |

Name _____

Title _____

Company _____

Address _____

City _____ State _____ Zip _____

INFORMATION RETRIEVAL NUMBER 112

Our D servomotor is mad with power.

That's our SU-680D-29 permanent-magnet D-C servomotor. We call it our D motor for short. It's small, rugged and powerful. It delivers 12.7 watts of continuous power output at 8600 rpm and is a natural for any servomechanism that requires a prime mover. It has a high repeatability-to-time ratio which makes it immensely stable, a 0-10,000 rpm speed range and a high acceleration Torque/Inertia. Torque peaks at 15 oz-in., 2 oz-in. continuous at 8600 rpm. It measures only 1 1/8 inches in diameter and weighs just 8 1/4 ounces.

SERVO-TEK PRODUCTS COMPANY
1086 Goffle Road, Hawthorne, New Jersey 07506.

SERVO-TEK

PRODUCTS COMPANY

For full details write for our interesting technical sheets and get mad with power yourself.



NEW LITERATURE

Thermoplastic resins

A revised, 20-page two-color bulletin describes glass-filled grades of thermoplastic resin. Noted for their resistance to temperatures of up to 310°F, the materials feature high tensile strength and low water absorption. Bulletin CDX-38B covers characteristics and includes comparisons between glass-filled and standard grades. Typical metal replacement applications are described. General Electric, Plastics Dept.

CIRCLE NO. 409

DIP packaging

A new concept in high-density packaging of dual-in-line integrated circuit modules is described in a 20-page designer's catalog. Constituting a high-density modular method of mounting IC modules that uses a new type of receptacle, the system offers complete design and flexibility in three dimensions and features maximum component-packing densities. Scanbe Manufacturing Corp.

CIRCLE NO. 410

Oscilloscopes

Presenting a complete profile of scope data, a 30-page short-form catalog contains information on low-frequency and high-frequency oscilloscopes. Included are general-purpose, dual-trace, high-gain, and large-screen scopes, as well as amplifier and time-base plug-ins. Also described is a line of signal generators and oscilloscope cameras and accessories. Dumont Oscilloscope Laboratories, Inc.

CIRCLE NO. 411

Power supplies

More than 300 power supplies, including modular, high-voltage and frequency converters, are detailed in a new loose-leaf catalog. Page references and convenient charts for cross-indexing aid in selecting the appropriate power supply for such needs as voltage and current range, regulation, ripple and size. Prices are included for the full line. NJE Corp.

CIRCLE NO. 412

Control and telemetry

An 8-page catalog describes control, telemetry, and power conversion components. Specifications, features, applications, outline drawings and photographs are given for each unit. Among the components shown are an IC-logic power supply, rf circuitry, traveling-wave tubes, and a 50- to 400-Hz frequency converter with a 0.00001% frequency tolerance. Raven Electronics, Inc.

CIRCLE NO. 413

Transistor heat sinks

Heat sinks for all basic types of transistor cases, as well as custom heat sinks for power semiconductors, are described in a 31-page catalog. Several new designs are introduced, including new lines of forced-air heat exchangers, liquid-cooled heat sinks and heat sinks for disc semiconductors that come with mounting hardware in either single or double side configurations. Thermalloy Co.

CIRCLE NO. 414

Production aerosols

Industrial aerosol products are covered in a 12-page catalog featuring anti-rust compounds, cutting oils, industrial paints, mold releases, varnish removers, die makers layout inks and a variety of other specialty products. The catalog has been designed to give adequate application data. It is scored, punched and slotted for easy insertion into permanent binders. Percy Harms Corp.

CIRCLE NO. 415

Connector catalog

An expanded series of rectangular pin and socket connectors for rack-and-panel cable applications is fully described in a 52-page catalog. Completely updated specifications, plus application and dimensional data for nearly 900 items are included. Semi-automatic machinery for large-volume production wiring and hand tools for maintenance and production use are also described. AMP Inc.

CIRCLE NO. 416

SOCKET TO ME! RELAY SOCKET ASSEMBLIES

CURTIS

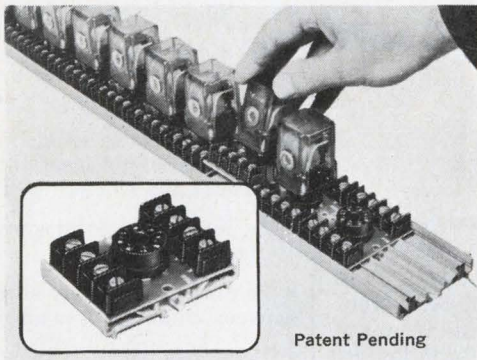

TYPE RS8 PRINTED CIRCUIT, SNAP-IN, TRACK MOUNT

The new RS8 octal relay socket assemblies offer compact mounting of up to 24 2 P.D.T. relays in a 4' prepunched vinyl track requiring only 2 or 3 mounting screws. Features Curtis GB-type terminal blocks and recessed octal relay socket. P.C. construction, rated 10 amps, 250 volts.



Models RS15 and RS11 also available for 15 pin 4 P.D.T. relays and 11 pin 3 P.D.T. relays.

Send today for further information.

CURTIS DEVELOPMENT & MFG. CO.
3236 N. 33rd St. • Milwaukee, Wis. 53216



INFORMATION RETRIEVAL NUMBER 121

TRUE SOLID-STATE RELAY



Opening New Relay Applications in Multiplexing, Isolated Sensing, High Speed Isolated Control, etc. Offered in A - B - C Contact Configurations for Direct Replacement of Mechanical Types.

- Switching Time less than 65 μ sec
- Contact Open Resistance 10⁹ ohms
- Contacts Capable of switching D C to 4 M HZ
- Non-Polarized Effective Coil
- Effective Coil Accuate/Release Voltage Hysteresis . . . less than 10 mV . . .
- Non-Polarized Contacts
- No Reference Required Between Effective Coil and Effective Contacts
- Life Expectancy—tested to 10¹⁰ operations with no failure.

SHAFFSTALL-BALL CORPORATION

5149 E. 65th Street, Indianapolis, Indiana 46220
Phone: 317-257-6296

INFORMATION RETRIEVAL NUMBER 122

Your inductor sources aren't complete without Dale's new catalog

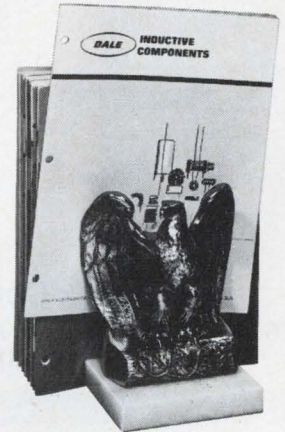

Think Dale—if you design or specify for circuits using inductive components. Long a source of custom-built inductors, Dale's Sioux Division has expanded its production to include a broad line of standard inductors and transformers. This rapidly growing line is described in our new catalog. It includes:

MINIATURE SHIELDED TUNABLE $\frac{3}{8}$ " round and $\frac{1}{2}$ " square models meet MIL-C-15305C, Grade 2, Class O.

MINIATURE UNSHIELDED TUNABLE Vertically and horizontally tuned models meet MIL-C-15305C, Grade 2, Class B and O.

MINIATURE UNSHIELDED FIXED Toroidal and bobbin versions meet MIL-C-15305C, Grade 2, Class O.

TRANSFORMERS • INDUCTORS Hermetically sealed versions meet MIL-T-27B, Grades 1 and 4, Class Q, R, S, V. Encapsulated versions for Grades 2 and 5, Class Q, R, S, V.

SERIES RESONANT TRAPS Combining the electrical characteristics of an inductor and a capacitor in series. Standard models: 10.7, 12, 14, 18 MHz.

Send for new Dale Inductor Catalog today — for price, delivery and custom design information phone 605-665-9301 or write:

DALE ELECTRONICS, INC.
SIoux DIVISION Dept. ED
Yankton, South Dakota 57078

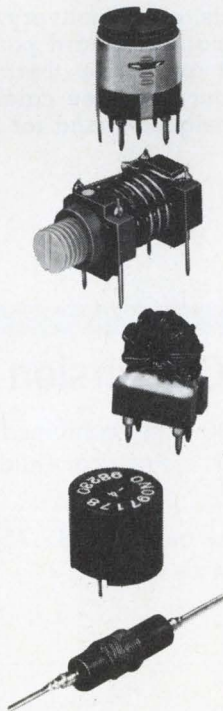

INFORMATION RETRIEVAL NUMBER 123

Design Data from Manufacturers

Advertisements of booklets, brochures, catalogs and data sheets. To order use Reader-Service Card. (Advertisement)

Electronic Design

A FREE Cross Reference Guide

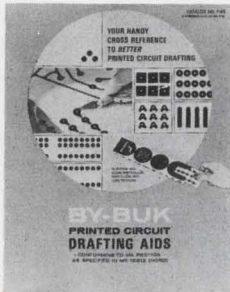

to better Printed Circuit drafting
No engineer or draftsman should be without the NEW By-Buk Printed Circuit Drafting Aids P-45 Catalog with color-coded MIL-SPEC sizes. Also contains over 2000 pads, shapes, tapes, transistor tri-pads, spaced integrated circuit terminal pad sets and many other drafting aids for faster, more accurate, distortion-free printed circuit master drawings. Send for your FREE catalog.

By-Buk Company

4326 West Pico Blvd., Los Angeles, Calif. 90019
Telephone: (213) 937-3511

171

Free: 2,500 Plastic Parts Catalog



New from Nylomatic, molders and fabricators of mechanical plastic components, a highly informative 48-page catalog of more than 2,500 standard parts. It can help you save time and money in design, test and production. Advantages of Nylomatic standard parts: no tooling charges, low unit costs, quick delivery, complete range of sizes. Nylomatic standard parts are made of Nylon, Delrin® and other thermoplastic materials. You'll find our new free catalog a real problem solver for designers, send for it today.

Nylomatic Corporation

Dept. P

Nolan Ave., Morrisville, Pa. 19067

172

REPRINTS a/d and d/a Conversion Guides

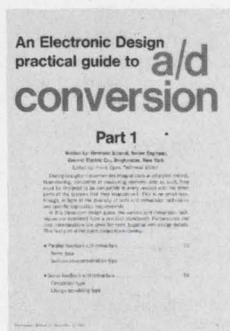

Order your 100-page combined reprint of ELECTRONIC DESIGN's Practical Guides to a/d and d/a Conversion.

Check or money order for \$2.75 must be enclosed for each reprint desired.

No. of reprints

Name

Address

Electronic Design, Reader Service Dept.
850 Third Avenue
New York, N.Y. 10022

ELECTRONIC DESIGN's function is:

- To aid progress in the electronics manufacturing industry by promoting good design.
- To give the electronic design engineer concepts and ideas that make his job easier and more productive.
- To provide a central source of timely electronics information.
- To promote two-way communication between manufacturer and engineer.

Want a subscription? ELECTRONIC DESIGN is sent free to qualified engineers and engineering managers doing design work, supervising design or setting standards in the United States and Western Europe. For a free subscription, use the postfree application form inside the back cover. If none is included, write to us direct for an application form.

If you do not qualify, you may take out a paid subscription for \$25 a year in the U.S.A., \$35 a year elsewhere. Single copies are \$1.50 each.

If you change your address, send us an old mailing label and your new address; there is generally a prepaid postcard for this inside the back cover. You will have to requalify to continue receiving ELECTRONIC DESIGN free.

The accuracy policy of ELECTRONIC DESIGN is:

- To make reasonable efforts to ensure the accuracy of editorial matter.
- To publish prompt corrections whenever inaccuracies are brought to our attention. Corrections appear at the end of the Letters column.
- To refuse any advertisement deemed to be misleading or fraudulent.

Microfilm copies are available of complete issues of ELECTRONIC DESIGN and individual articles, published since the beginning of 1961. Complete issues cost 4¢ a page, articles cost 50¢ a page; shipping and handling charges are extra. The minimum charge is \$3. For further details and to place orders, contact University Microfilms, Inc., 300 N. Zeeb Road, Ann Arbor, Mich. 48106; telephone (313) 761-4700.

Want to contact us? If you have any comments or wish to submit a manuscript or article outline, address your correspondence to:

Howard Bierman, Editor,
ELECTRONIC DESIGN,
850 Third Avenue,
New York, N.Y. 10022.

**EXTREME STABILITY
OVER A WIDE
TEMPERATURE RANGE**

Synthar CAPACITORS

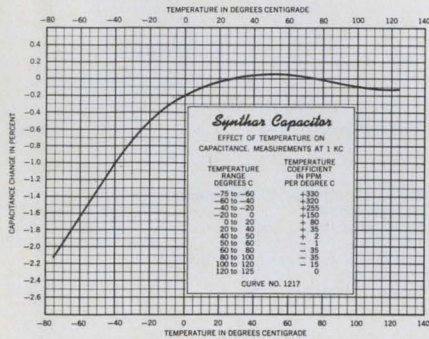
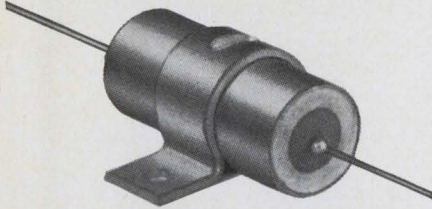

As indicated in the curve above, the total change in capacitance of Synthar Capacitors over a wide range of operating temperatures (10°C—125°C) is only $\pm 0.12\%$. This makes them suitable for use in all types of circuitry requiring a high degree of capacitance stability. Extremely high insulation resistance, low dielectric absorption and low power factor, all are outstanding characteristics of Synthar Capacitors. They offer the performance of costly laboratory built capacitors at commercial prices.

SPECIFICATIONS

- Rated from -75°C to $+125^{\circ}\text{C}$.
- Temperature Coefficient— $\pm 35\text{PPM}$, from $+20^{\circ}\text{C}$ to $+125^{\circ}\text{C}$.
- Standard DC Working voltages—up to 600 VDC.
- AC Voltage ratings available—up to radio frequency.
- Insulation Resistance—At 25°C 3.5×10^4 Megohm/Mfd.
At 125°C 2×10^4 Megohm/Mfd.
- Outstanding long time capacitance stability.
- Available in matched pairs—within $\pm 0.1\%$ of each other.

For complete performance characteristics send for free catalog No. 1212.

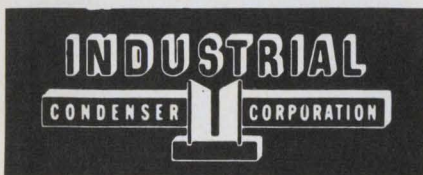

3243 No. California Ave.
Chicago, Illinois 60618

INFORMATION RETRIEVAL NUMBER 114

ELECTRONIC DESIGN 1, January 4, 1969

Electronic Design

Advertising Sales Staff

New York 10022

Robert G. Drake
Sales Manager
Edward F. Clancy
Sales Service Manager
Robert W. Gascoigne
Thomas P. Barth
Samuel M. Deitch
Byron Adams
850 Third Avenue
(212) Plaza 1-5530
TWX: 867-7866

Philadelphia 19066

William C. Repetto
P. O. Box 206
Merion Station, Pa.
(215) MA-3-5888

Boston 01945

Richard Parker
P.O. Box 645
Clifton Station
Marblehead, Mass.
(617) 742-0252

Chicago 60611

Thomas P. Kavooras
Berry Conner, Jr.
200 East Ontario
(312) 337-0588

Cleveland

(216) 247-7670

Los Angeles 90303

Stanley I. Ehrenclou
John V. Quillman
W. James Bischof
2930 Imperial Highway
Inglewood, Calif.
(213) 757-0183

San Francisco 94022

Arthur R. Shields, Jr.
175 San Antonio Rd., S 243
Los Altos, Calif.
(415) 941-3084

London W. 1

For United Kingdom & Holland
Brayton C. Nichols
44 Conduit Street
Tel: REGent 4714

Verviers, Belgium

For Continental Europe
Andre Jamar
1, Rue Mallar, 1
(087) 253.83 Telex 41563

Tokyo

Yoshihiro Takemura
IPS Group Ltd.
Box 36, Ohsaki Post Office
Phone (431) 5804



INFORMATION RETRIEVAL NUMBER 115 ▶

Another
Sigmund Cohn
Corp.
Exclusive...



(Matched Expansion)

Spools for Total Quality Control of Gold Bonding Wire...

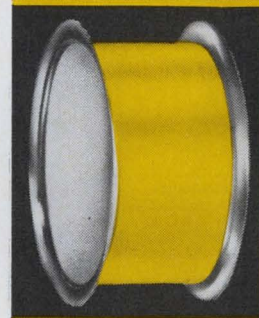

**Result:
always
like this...**

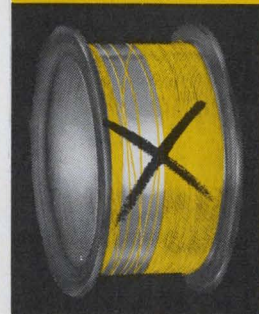

**not
this.**

Most efficient way to deliver Gold Bonding Wire is on Stainless Steel Spools... Some time ago, our engineers came up with the concept of Matched Expansion Spools, exclusively designed for this purpose... The spools have an expansion coefficient closely conforming to the Gold Wire...

When the wire is wound on our M.E. spools tension and pitch are fully controlled so that It always stays put — cannot shift or slip. This assures extra economy by substantial reduction of scrap... We check every production step to be sure that each foot of Gold Bonding Wire meets our high standards.



Wound in single or multi-layer

Write for engineering data.

Sigmund Cohn Corp.

121 So. Columbus Ave.
Mt. Vernon, N.Y. 10553

Since 1901



Advertisers' Index

Advertiser	Page	Advertiser	Page	Advertiser	Page
Abbott Transistor Laboratories Incorporated	14	General R. F. Fittings Inc.	49	RCA Electronic Components and Devices	44, 45 Cover IV
Airco Temescal, A Division of Air Reduction Company	182	General Radio Company	127	RCA Institutes, Inc.	203
Allen-Bradley Co.	15	Grayhill, Inc.	192	Radiation, Incorporated	131
Amphenol Connector Division, The Bunker-Ramo Corporation	132D, 132E-X	Guardian Electric Manufacturing Company ..	77	Raytheon Company, Semiconductor Operation	46
Astrodata, Inc.	52, 53			Rogan Brothers, Inc.	143
Automatic Electric Company	140, 141				
		Hamlin, Inc.	171	Sams & Co., Howard W.	181
B & B Motor & Control Corp.	176	Hayden Book Company, Inc.	148	Schweber Electronics	17
Babcock Relays, Division of Babcock Electronics Corporation	210	Heath Company	150	Sangamo Electric Company	201
Beckman Instruments, Inc., Helipot Division	125	Hewlett-Packard	1, 7, 27, 41, 76, 151, 170	Senore	189
Beede Electrical Instrument Co., Inc.	200	Hughes Aircraft Company, Electronic Dynamics Division	132C	Servo-Tek Products Company, Inc.	204
Bendix Corporation, The, Semiconductor Division	31			Shaffstall-Ball Corporation	205
Bodine Electric Company	136, 137	IMC Magnetics Corporation	164	Siemens America Incorporated	165
Buckbee Mears Co.	203	Industrial Condenser Corp.	207	Siliconix Incorporated	16
By-Buk Company	206	Ingersoll Products, Division of Borg Warner Corporation	96	Simpson Electric Company	149
				Sola Electric, Division of Sola Basic Industries	50, 51
Captor Corporation	161	JFD Electronics Co./Components Division ..	154	Solid State Products	113
Carborundum Company, The	167			Solitron Devices, Inc.	129
CELCO (Constantine Engineering Laboratories Co.)	164A-B	Kurz-Kasch, Inc.	177	Sperry Rand Corporation, Sperry Microwave Electronics Division	175
Clarostat Mfg. Co., Inc.	33			Sprague Electric Company	18, 20
Cohn Corp., Sigmund	207	Lambda Electronics Corp.	6	Stackpole Components Company	Cover III
Control Logic, Inc.	23	Leach Corporation	148 A-B	Stoddart ElectroSystems, A Division of Tamar Electronics, Inc.	193
Curtis Development & Mfg. Co.	205	Littelfuse	192	Switchcraft, Inc.	160, 161
Cutler-Hammer	80	Lockheed Electronics Company	179, 209	Sylvania Electric Products, Inc.	16 A-B, 197
				Syntronic Instruments, Inc.	180
Dale Electronics, Inc.	112 A-B, 205	Magnecraft Electric Company	191	Systron-Donner Corporation	2
Damon Engineering, Inc.	24	Marconi Instruments, Division of English Electric Corporation	183	TRW Inc., Capacitor Division	199
Digitran Company, The	168	Materials Research Corporation	142	Takeda Riken Industry Co. Ltd.	162
Dow Corning Corporation	38, 39	Merrimac Research and Development, Inc.	169	Tektronix, Inc., Oscilloscopes	180 A-B
Drake Manufacturing Company	89	Metex Corporation	186	Tenney Engineering, Inc.	172
Duncan Electronics, Inc.	95	Micon, A California Company	159	Texas Instruments Incorporated Components Group	48A-F
Durant Manufacturing Co.	158	Microdyne Instruments, Inc.	190	Texscan Corporation	194
		Microsonics, Inc.	166	Thermal American Fused Quartz Co., Inc.	202
ESI/Electro Scientific Industries, Inc.	156, 157	MicroSwitch, A Division of Honeywell 8, 9, 10 Midtex, Incorporated Aemco Division	187	Tyco Laboratories, Inc.	146
Ebert Electronics Corp.	203	Mohawk Data Sciences Co.	180		
Eldre Components, Inc.	176	Monsanto Company	139	United Transformer Co., Division of TRW, Inc.	Cover II
Electronic Design	74, 75, 212	Motorola Semiconductor Products, Inc.	11	Unitrode Corporation	29
Erie Technological Products, Inc.	78	Mullard, Inc.	186		
				Victory Engineering Corporation	174
Fairchild Semiconductor, A Division Fairchild Camera and Instrument Corporation	12, 13	NJE Corporation	132A		
Fluke Mfg. Co., Inc., John	43	National Semiconductor Corporation	144, 145, 147	Wheelock Signals, Inc.	138
Fusite Corporation, The	173	New England Instrument Company	163	White Industrial, S. S., A Division of Pennsalt Chemicals Corporation	195
		Northern Precision Laboratories, Inc.	198	Winchester Electronics, Litton Industries	132
General Electric Company, Capacitor Department	4, 5	Nylomatic Corporation	206		
General Electric Company, Silicone Products Department	185			Career Advertising	
General Instrument Corporation	132B	Philbrick/Nexus Research, A Teledyne Company	72, 73	Hughes Aircraft Company	121
		Philco-Ford Corporation	152, 153	IBM Corporation	122
		Pulse Monitors, Inc.	155	Sylvania Electric Products, Inc.	135

Lockheed has been making multilayer circuits by the thousands. For years. With the most advanced laminating techniques.

You'll probably want from 3 to 6 layers, but we can make 15 or more layers if you need them. And we'll give you precision flatness—well above industry standards. With all layers perfectly registered. The quality of our lamination will equal or exceed the 2-sided boards you might now be using.

Another comfort. We can provide you with sophisticated multilayer circuits for little more than you're now paying for the standard 2-layer board.

Which means you can get the Lockheed Sandwich for very little bread.

Write for your "Designer's Guide to Multilayer": Printed Circuits, Lockheed Electronics Company, Data Products Division, 6201 East Randolph Street, Los Angeles, California 90022.

Presenting: The Lockheed Sandwich

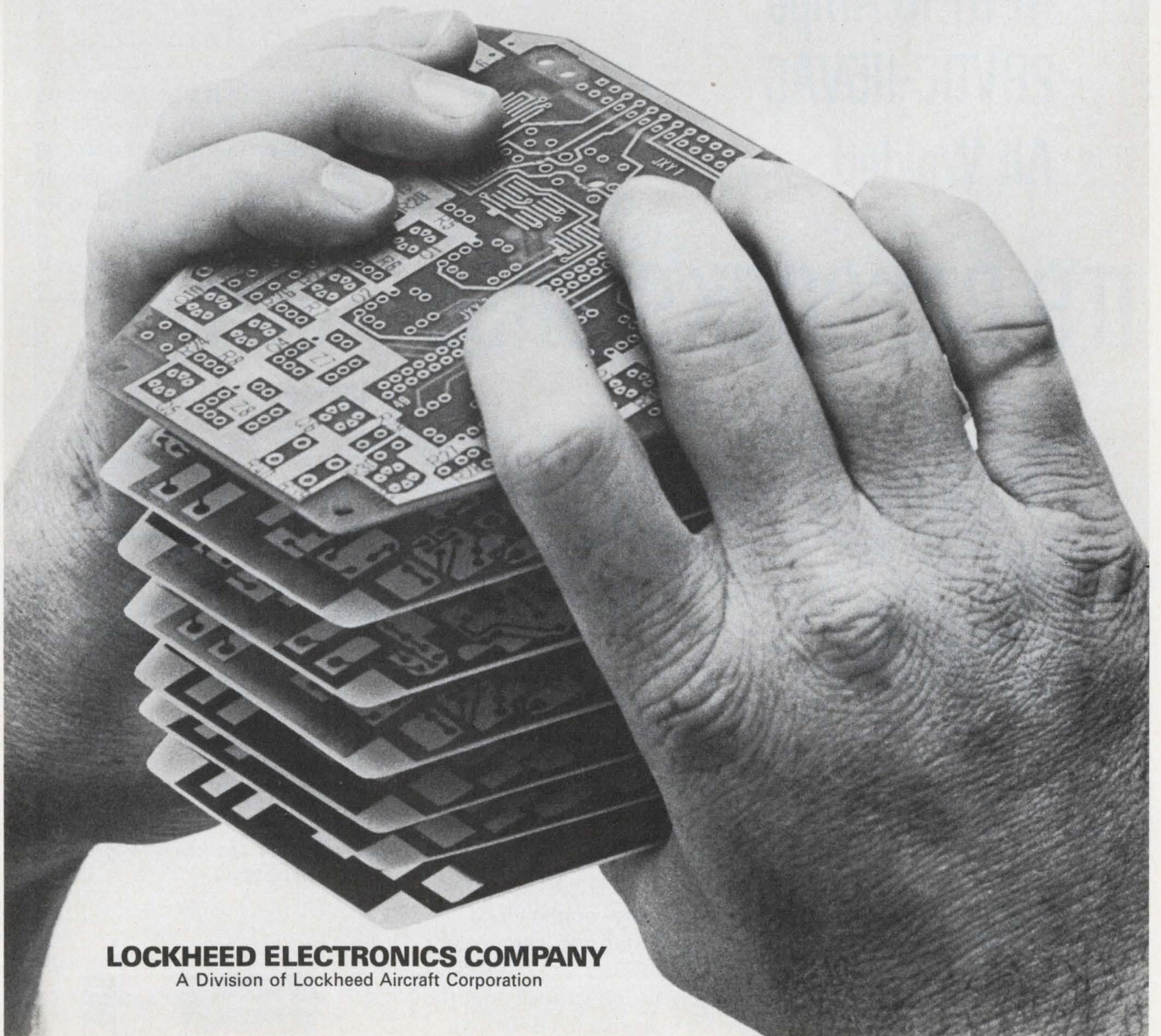

LOCKHEED ELECTRONICS COMPANY
A Division of Lockheed Aircraft Corporation

INFORMATION RETRIEVAL NUMBER 117

RELAYS

NEW MIL-R-6106

- One-Inch Cube
- 4PDT-10 Amps
- 28VDC-115VAC
- All Welded

IT'S BABCOCK'S BR30

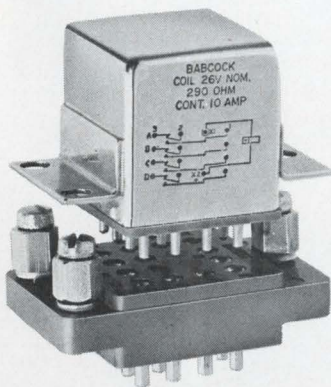

Babcock's new Model BR30 is a miniature, all-welded, 4PDT relay . . . designed specifically to meet the requirements of MIL-R-6106 (MS-27400)—and to be completely interchangeable with other models of this type. Characterized by reliable op-

eration in environmental extremes, this new relay is the first developed by Babcock to meet the needs of airframe applications. Performance is outstanding . . . to 200g's shock, 30g's vibration, over a temperature range of -70°C to $+125^{\circ}\text{C}$, for a minimum of 100,000 operations. All welded construction, inside and out, assures a contaminant-free unit. Plug-in and solder-hook versions are offered; qualified relay sockets also available.

The Model BR30 is a new relay for new applications . . . and it carries the same mark of proven Babcock dependability. Your assurance that it's better because it's Babcock.

The Babcock Model BR30 is a brand new MIL-R-6106 relay . . . featuring a new symmetrical magnetic circuit. Utilizing two permanent magnets, this system provides a positive holding force, undisturbed by shock and vibration extremes . . . and

dependable switching action throughout the life of the relay.

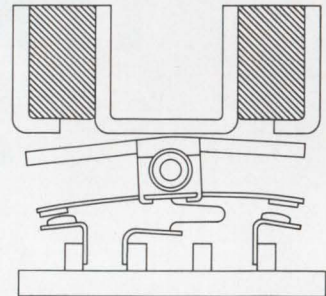

Coil design has also undergone some innovation. AC versions have been fabricated such that coil frequency is operational from 60 Hz to 400Hz, without degradation of ratings.

SPECIFICATIONS

Contact Rating (@ 28VDC, 115/208VAC 400Hz)	Resistive: 10 amps. Inductive: 8 amps.
Overload	D.C. 40 amps. A.C. 60 amps.
Rupture	D.C. 50 amps. A.C. 80 amps.
Coil Voltages	6, 12 and 28VDC, 115VAC
Shock	200g's (6ms.)
Vibration	30g's, 70-3000Hz
Operation Temp.	-70°C to $+125^{\circ}\text{C}$
Pull-In Power	600mw
Operate/Release Time	15ms, max.
Bounce Time	1ms, max.
Life	100,000 operation, min.

Get complete information on the new Model BR30 . . . contact Babcock Electronics Corp., Relays Division, Subsidiary of Esterline Corp., 3501 Harbor Blvd., Costa Mesa, Calif. 92626. CALL COLLECT (714) 540-1234 or TWX 910-595-1517.

Challenging opportunities for relay-switch engineers.



Information Retrieval Service

All products, design aids (DA), application notes (AN), new literature (NL), and reprints (R) in this issue are listed here with Page and Information Retrieval numbers. Reader requests will be promptly processed by computer and mailed to the manufacturer within three days.

Category	Page	IRN	Category	Page	IRN	Category	Page	IRN
Components			emi measurements (AN) 196 419			tubing, rf-shield 170 342		
antennas			generator, function 134 287			wire and cable (NL) 200 397		
and rf lines (NL) 202 407			generators, pulse 134 288			Production		
capacitors (NL) 200 395			low-ohm attachment 142 296			drill, laser 192 375		
capacitors, trimmer 166 334			meter, digital panel 134 290			lead bender and cutter 192 374		
components (NL) 198 392			oscilloscope, 10-MHz 134 291			soldering, PC (AN) 196 420		
crossbars (NL) 198 389			oscilloscope, 25-MHz 138 293			tap drill card (DA) 194 387		
displays,			oscilloscopes (NL) 204 411			tool, wiring 192 373		
solid-state (NL) 202 404			probe, digital 134 292			New Literature		
fans and blowers (NL) 198 390			VOM, FET-input 138 294			aerosols, production 204 415		
filters, submicron (NL) 200 401			Microwaves & Lasers			antennas and rf lines 202 407		
indicator, circuit 164 333			amplifiers, vhf 186 363			audio amp, IC 200 400		
indicators, digital 164 332			attenuator, cartridges 184 380			cable, coaxial 202 406		
lamps, discharge (AN) 196 417			components,			capacitors 200 395		
lights			microwave (NL) 198 394			components, control 204 413		
and switches (NL) 200 396			detector, infrared 184 382			components, electronic 198 392		
motor, stepping 162 329			diodes, p-i-n (AN) 196 421			components, microwave 198 394		
motors, dc (NL) 200 398			filters, tunable 184 379			connectors 204 416		
op amps, fluidic 166 336			photodiodes, Schottky 184 383			crossbar basics 198 389		
pots, linear (NL) 202 403			S-parameters (AN) 196 424			displays, solid-state 202 404		
relay, crystal-can 168 339			stripline termination 184 378			epoxies 198 391		
relays, reed 168 338			switch, coax 186 364			fans and blowers 198 390		
resistors (NL) 202 408			thyratrons (AN) 196 425			filters, submicron 200 401		
switch, sealed 162 331			wattmeter, uhf 184 387			hardware, IC 200 399		
switches, rocker 166 335			Modules & Subassemblies			hardware, shaft 198 393		
switching, static (AN) 196 422			components,			heat sinks 204 414		
transformers, PC 166 337			control (NL) 204 413			lights and switches 200 396		
trimmer potentiometer 168 340			control, motor speed 178 360			motors, dc 200 398		
tubes, readout 162 330			driver, lamp/relay 180 361			oscilloscopes 204 411		
Data Processing			filters, active 182 376			packaging, DIP 204 410		
computer, digital 188 367			module, vector-function 180 362			pots, linear-motion 202 403		
converter, d/a 188 368			monitor, waveform 178 357			power supplies 204 412		
coupler, acoustic 188 369			op amp, differential 178 358			rectifiers and zeners 202 402		
coupler, digital 190 372			op amp, FET 182 377			resins, thermoplastic 204 409		
digitizer, graphic 188 370			op amp, low-cost 178 359			resistors 202 408		
logic kit, diaphragm 188 365			overload module 178 356			wire and cable 200 397		
memory, 1300-bit 190 371			power supplies (NL) 204 412			Application Notes		
patches, tape 188 366			supplies, high-voltage 178 353			diodes, p-i-n 196 421		
ICs & Semiconductors			Packaging & Materials			electroluminescence 196 418		
amplifier, video 150 323			adhesive, aerosol 176 352			emi measurements 196 419		
arrays, photo 158 326			aerosols (NL) 204 415			lamps, discharge 196 417		
audio amp, IC (NL) 200 400			cable, coaxial (NL) 202 406			S-parameters 196 424		
decoder, MSI 161 327			clips, wire and cable 170 344			shift registers, MOS 196 423		
displays,			coating, conformal 174 347			soldering, PC 196 420		
solid-state (NL) 202 404			coax calculator (DA) 194 386			switching, static 196 422		
electroluminescence (AN) 196 418			connectors (NL) 204 416			thyratrons 196 425		
hardware, IC (NL) 200 399			epoxies (NL) 198 391			Design Aids		
memory, random-access 146 297			fastener, self-lock 170 343			coax calculator 194 386		
memory, random access 149 298			hardware, fluidic 174 348			nuts, floating 194 384		
memory, read-only 161 328			hardware, IC (NL) 200 399			shielding kit 194 385		
op amp, compensated 154 322			hardware, shaft (NL) 198 393			tap drill card 194 387		
packaging, DIP (NL) 204 410			heat sinks (NL) 204 414			tape, teflon 194 388		
photo devices 158 325			hybrid package, DIP 170 341					
photodiode, Si 154 321			kit, PC-fabrication 176 351					
rectifiers			lead frames, IC 174 349					
and zeners (NL) 202 402			nuts, floating (DA) 194 384					
regulators, voltage 150 324			packaging, DIP (NL) 204 410					
shift registers (AN) 196 423			resins (NL) 204 409					
transistors, power 149 299			seal, rfi 172 346					
Instrumentation			shielding kit (DA) 194 385					
curve tracer 142 295			tape, teflon (DA) 194 388					
dosimeter, radiation 134 287			tapes, insulating 172 345					
			terminations, rf shield 174 350					

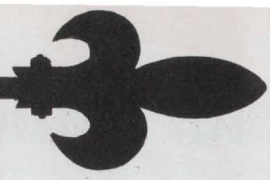

Electronic Design

1969 TOP TEN

CONTEST

PICK THE TOP TEN ADVERTISEMENTS IN THIS ISSUE...WIN A FLIGHT TO PARIS OR ONE OF 109 OTHER VALUABLE PRIZES

Examine this issue of Electronic Design with extra care. Pick the ten advertisements that you think will be best remembered by your fellow engineer-subscribers. List these advertisements (not necessarily in rank order) on the special entry form included on Electronic Design's *Information Retrieval Card*, bound in at right. Your selections will be measured against the ten ads ranking highest in the "Recall Seen" category of Reader Recall—Electronic Design's method of measuring readership. In making your choices *do not* include "house" advertisements placed by Electronic Design or Hayden Publishing Company, Inc. (such as this ad describing the contest). Don't miss your chance to be a TOP TEN winner! All entries must be postmarked no later than midnight, February 28, 1969. Winners will be notified by March 21, 1969.

MARKETER CONTEST—There's a separate contest open to all personnel at companies and agencies. Use the entry blank included on the *Information Retrieval Card* bound in this issue. In addition to valuable prizes, all ads that place in the Top Ten will be given free re-runs. If you are a winner, and if you ran an ad in the January 4 issue that did not place in the Top Ten, that advertisement will also be given a free re-run.

PRIZES—READER CONTEST

- 1ST PRIZE**—Round trip tickets for two between N.Y. and Paris via Air France
- 2ND PRIZE**—Deluxe Heathkit®/Thomas "Paramount" Transistor Theater Organ
- 3RD PRIZE**—Deluxe Heathkit® "180" Color TV With Contemporary Walnut Cabinet
- 4TH TO 10TH PRIZES**—7 Bulova Accutron® "Spaceview" Electronic Timepieces
- 11TH TO 110TH PRIZES**—"Electronic Design Techniques" Edited by Edward E. Grazda

PRIZES—MARKETER CONTEST

- 1ST PRIZE**—Round trip tickets for two between N.Y. and Paris via Air France
- 2ND PRIZE**—RCA "Carry-ette" Portable 14" Color TV Set
- 3RD PRIZE**—Bulova Accutron® "Spaceview" Electronic Timepiece Plus free re-runs (see information at left)

USE ENTRY BLANK ON INFORMATION RETRIEVAL CARD AT RIGHT

ELECTRONIC DESIGN 1969 TOP TEN CONTEST RULES

READER CONTEST RULES

1. Enter your top ten selections on the entry blank provided, or on any reasonable facsimile. Be sure to indicate the name of the advertiser and page number for each of your choices. These choices need not be placed in rank order. (Ads placed by Hayden Publishing Company in Electronic Design *should not* be considered in this contest.)
2. No more than one entry may be submitted by any one individual. Entry blank must be filled in completely, or it will not be considered. Electronic Design will pay postage for official entry blanks only.
3. To enter, readers must be engaged in electronic design engineering work, either by carrying out or supervising design engineering or by setting standards for design components and materials.
4. First prize is two tourist class, round-trip tickets between New York and Paris via Air France. Transportation to and from point of embarkation in NY or Paris, and any other expenses incurred as part of this trip, are not included in the prize. No cash payments, or other substitutes, will be made in lieu of any prize.
5. Contest void where prohibited or taxed by law. Liability for any taxes on prizes is the sole responsibility of the winners.
6. In case of a tie, the entry with earliest postmark will determine the winner.
7. Decisions of Top Ten Contest judges will be final.

MANUFACTURER (COMPANY) / ADVERTISING AGENCY CONTEST RULES

1. All rules for the Reader Contest will similarly apply for this contest, with one exception: readers engaged in electronic design engineering work, as defined in the reader contest rules, are *not* eligible to participate in this special contest.
2. Entrants in this contest may use the official reader contest entry blanks or any reasonable facsimile. Blanks may also be obtained from your Electronic Design representative.
3. This special contest is open to marketing personnel only at all manufacturing companies and advertising agencies whether or not their companies or agencies have an advertisement in the Jan. 4, 1969 issue. However, only those companies (or divisions thereof) advertising in the Jan. 4 issue, and the advertising agencies placing such advertisements, are eligible for a free re-run of their advertisement should a member of their organization win. Entrants from such companies and advertising agencies must clearly indicate the specific advertisement to be re-run (including page number) in the space at the bottom of the entry blank.
4. Free re-runs of any advertisement will be made only from existing plates or negatives. If the advertisement qualifying for a free re-run is an insert, Electronic Design will bind and run the insert, but furnishing the inserts is again the responsibility of the winner.
5. Hayden Publishing Company, Inc., reserves the right to schedule re-runs at its discretion.

The Straight Line

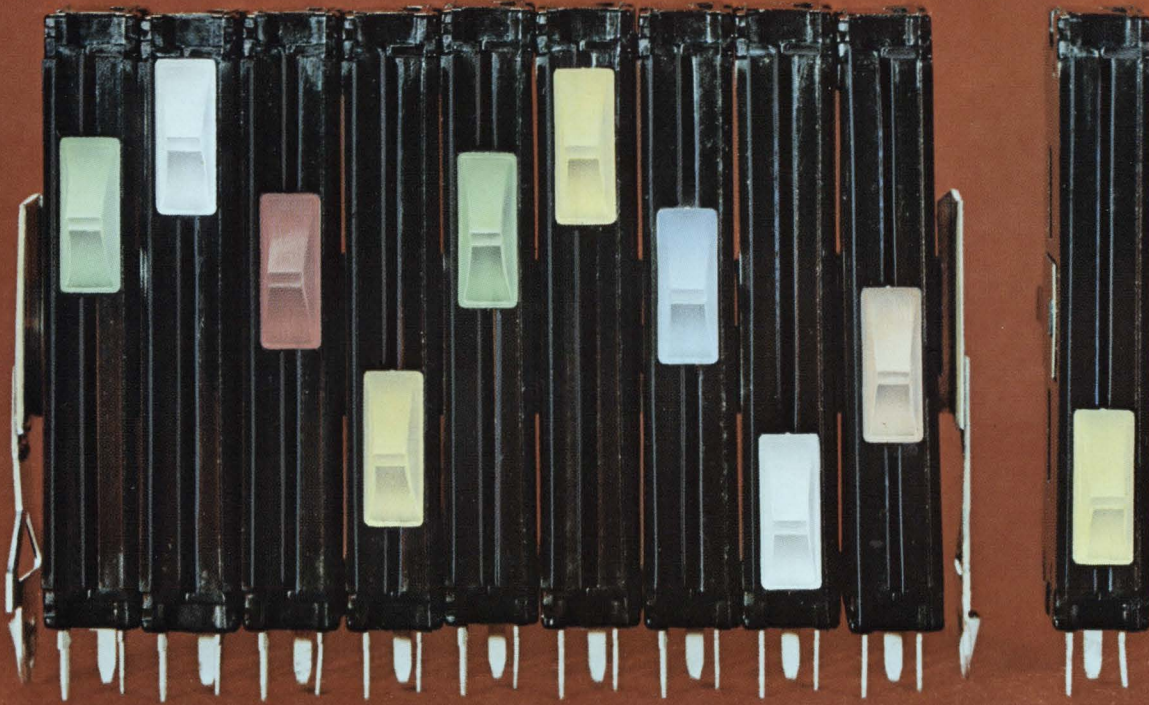

Covered under Patent No. 3,362,004 and others pending.

Functional new concept in Potentiometer design

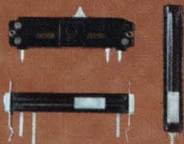

Horizontal, vertical or side mounting available.

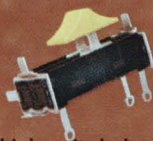

Multiple units lock and actuate with single knob.



Preliminary adjustment with template possible.



Needs only 1/3 mounting area of standard control.



Standard solder lug, wire-wrap or printed circuit terminals supplied.



Forward or rear facing twist-tab mountings. Snap-in mounts also available.

Variable resistors have been going in circles for years. Now Stackpole straightens them out. Using linear motion, Stackpole engineers created a potentiometer that conserves circuit board and panel space and offers a host of design advantages. Stackpole calls it SLIDE-TROL®. You'll call it ingenious! Utter simplicity, yet with all the quality and features of devices costing much more. SLIDE-TROL® is available in values of 40 ohms to 15 meg. ohms and since the element is rectangular and provides more area to dissipate heat, higher wattage ratings are possible. Phenolic housings eliminate shock hazards. Low noise and low contact resistance are assured by a patented 9-point movable spring contact. Only imagination limits the applications for SLIDE-TROL®. If you're looking for performance, economy and appeal in variable resistors, get the facts on SLIDE-TROL®. Write for samples and brochure: Stackpole Components Co., P.O. Box 14466 Raleigh, N. Carolina 27610. PH: 919-828-6201 TWX: 510-928-0520

STACKPOLE
COMPONENTS COMPANY

INFORMATION RETRIEVAL NUMBER 243

Also a leading producer of quality slide, rocker and rotary switches.

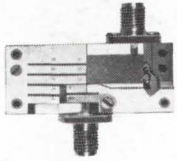

Frequency Multipliers—
High power—up to 5
watts output; up to
10% bandwidth;
from L- to S-, C-, and
X-band.



Transistor Oscillators—
Small size—less than
1"; rugged—50,000 g;
0.25-watt output in
L-band.



Transistor Amplifiers—
High power—up to
10 watts in L-band;
up to 10% bandwidth.

The name of the game is microwave integrated circuits. RCA has them under development. From L- through X-band. Pulsed and CW. Your choice of frequency and power level. We use transistors and transferred electron oscillators (TEO's). We have hybrid circuits using active "chips" plus thin-film microstrip.

With this broad capability in MIC's, we can "customize" amplifiers, oscillators, and multipliers for your particular integrated circuit function and sub-system. RCA units offer ceramic-microstrip construction, dimensional stability, ruggedness, reliability, a high degree of uniformity, and the advantages of mass production including low cost.

Call RCA. We'll be glad to help turn on your system by reducing concepts to immediate application. For more details, see your RCA Representative. For technical data, write: RCA Electronic Components, Commercial Engineering, Section No. Q-18A-2 Harrison, N. J. 07029.

RCA

**Research...to turn your system on by
reducing concepts to practical product**

