

Electronic Design

FOR ENGINEERS AND ENGINEERING MANAGERS

VOL. 17 NO.

4

FEB. 15, 1969

Holography reveals dynamic stress and strain, vibration anomalies, heat flow and material changes, all in real time and three dimensions. Opaque and transparent objects can be tested, page 25.

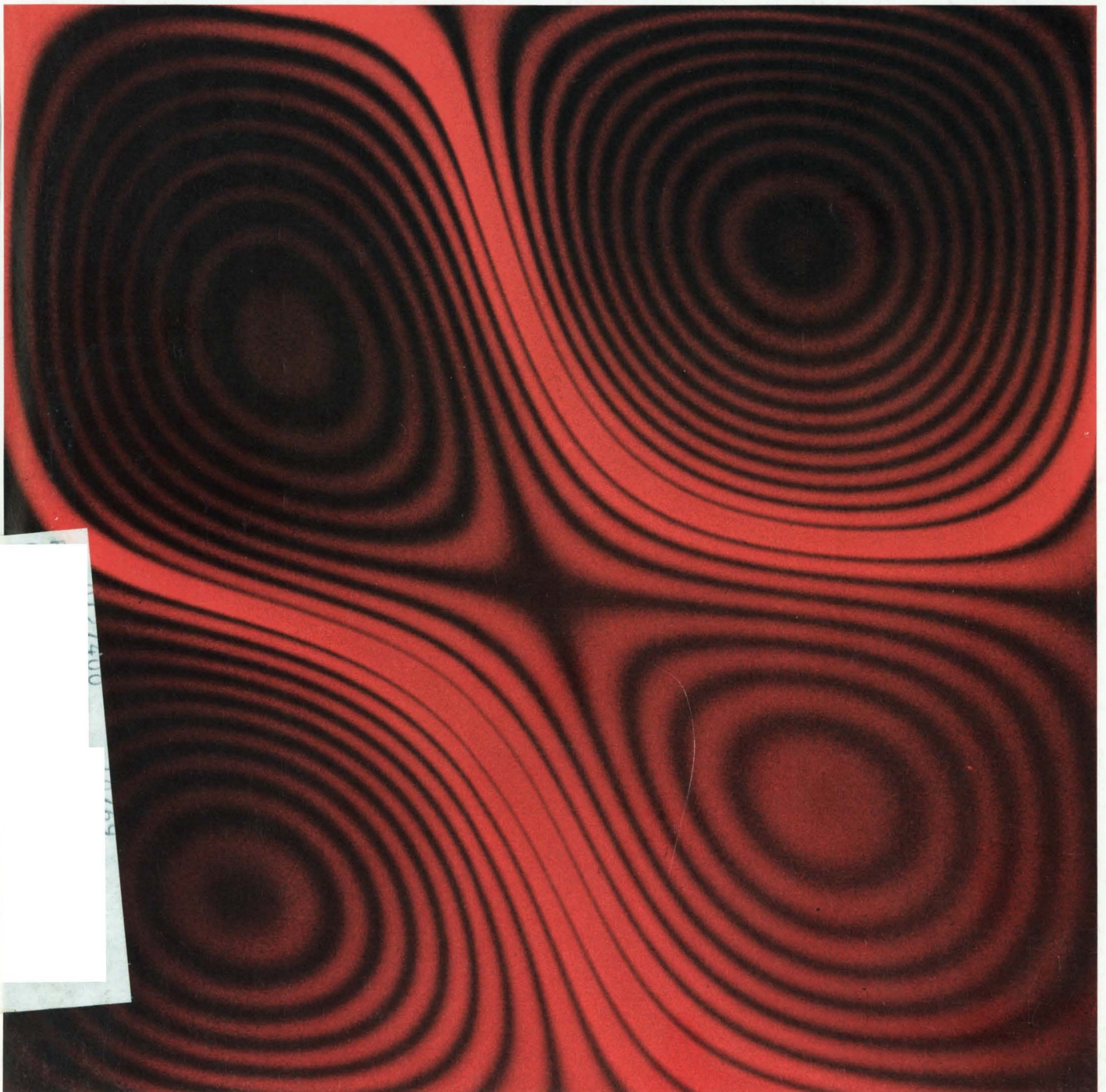

For the first time you have the added dimension of variable persistence **and** storage in a low frequency scope for your dc to 500 kHz measurements. And, *only* variable persistence gives you completely flicker-free displays of all your low frequency measurements.

Four new models in the HP 1200 series have pushbuttons allowing selection of conventional, variable persistence and storage modes. Having one of these new all-solid-state scopes is like having three scopes in one!

You can select storage writing speed by pressing the STD pushbutton for >20 cm/ms. Press the FAST pushbutton for $>1/2$ cm/ μ s writing speed. Persistence is continuously variable from 0.2 second to 1 minute or longer in STD mode and

0.2 second to 15 seconds in FAST mode.

In STD mode, you can vary storage time from 1 minute to 8 hours—in FAST mode, from 15 seconds to 1 hour. And, because of the mesh storage technique used in the 8 x 10 cm internal graticule CRTs, you get bright displays without the loss of trace brightness caused by phosphor deterioration. The 1200 storage CRTs have a life expectancy comparable to HP conventional CRTs.

The new HP 1201A (cabinet) and 1201B (rack) models are dual trace storage scopes with 100 μ V/cm deflection factor. Models 1207A and 1207B are single trace storage scopes with 5 mV/cm deflection factor. These new scopes have single-ended or differential input on all ranges, high common mode rejection ratio,

complete triggering versatility, external horizontal input, dc-coupled Z-axis, beam finder — many of the features normally associated only with high frequency scopes.

For full details on the new HP dc to 500 kHz variable persistence and storage scopes in the 1200 series, contact your nearest HP field engineer. Or, write to Hewlett-Packard, Palo Alto, California 94304. In Europe: 1217 Meyrin-Geneva, Switzerland.

Prices: HP 1201A or 1201B 100 μ V storage scopes, \$1800; HP 1207A or 1207B 5 mV storage scopes, \$1475.



HEWLETT *hp* PACKARD

 OSCILLOSCOPE SYSTEMS

089/9

Now You Can Get Flicker-Free Variable Persistence and Storage In A Low-Cost, Low Frequency Scope!

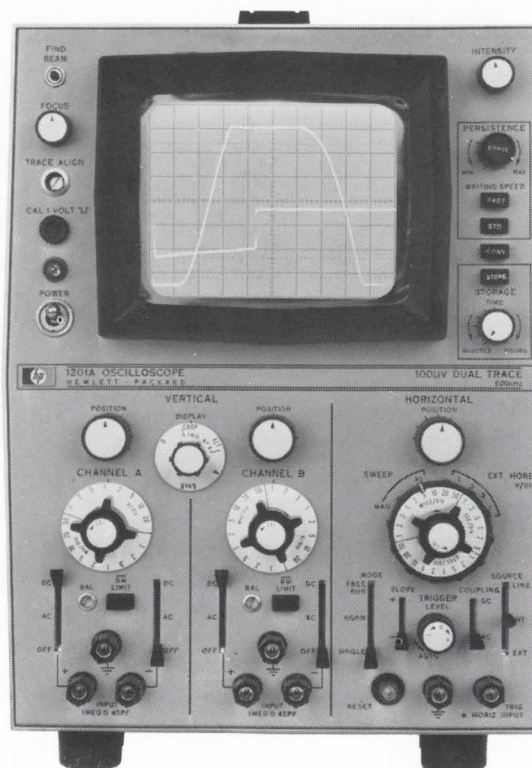
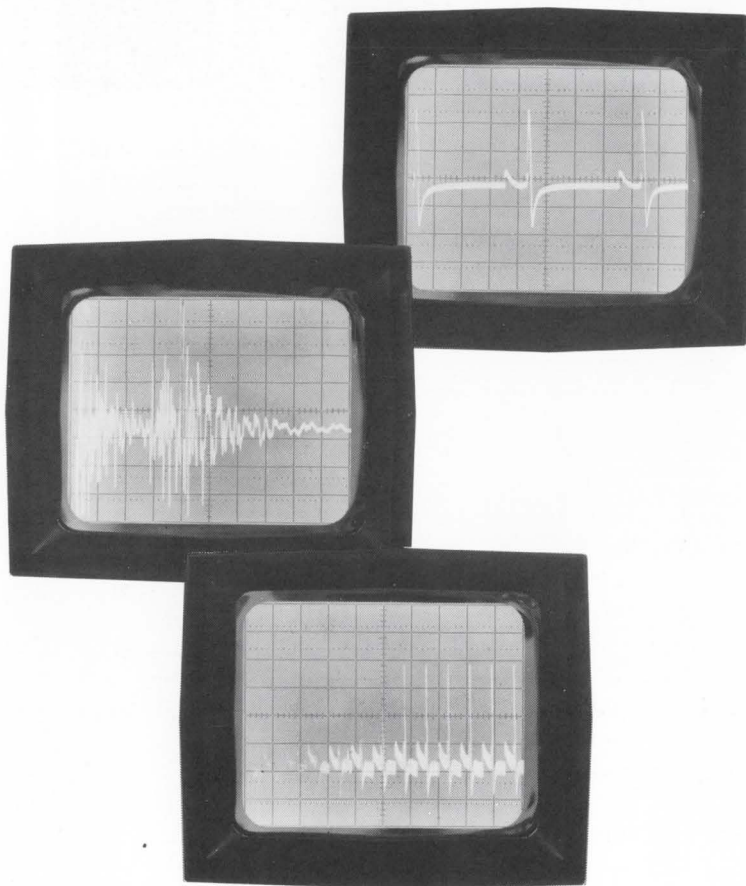

On display at IEEE Show

INFORMATION RETRIEVAL NUMBER 202

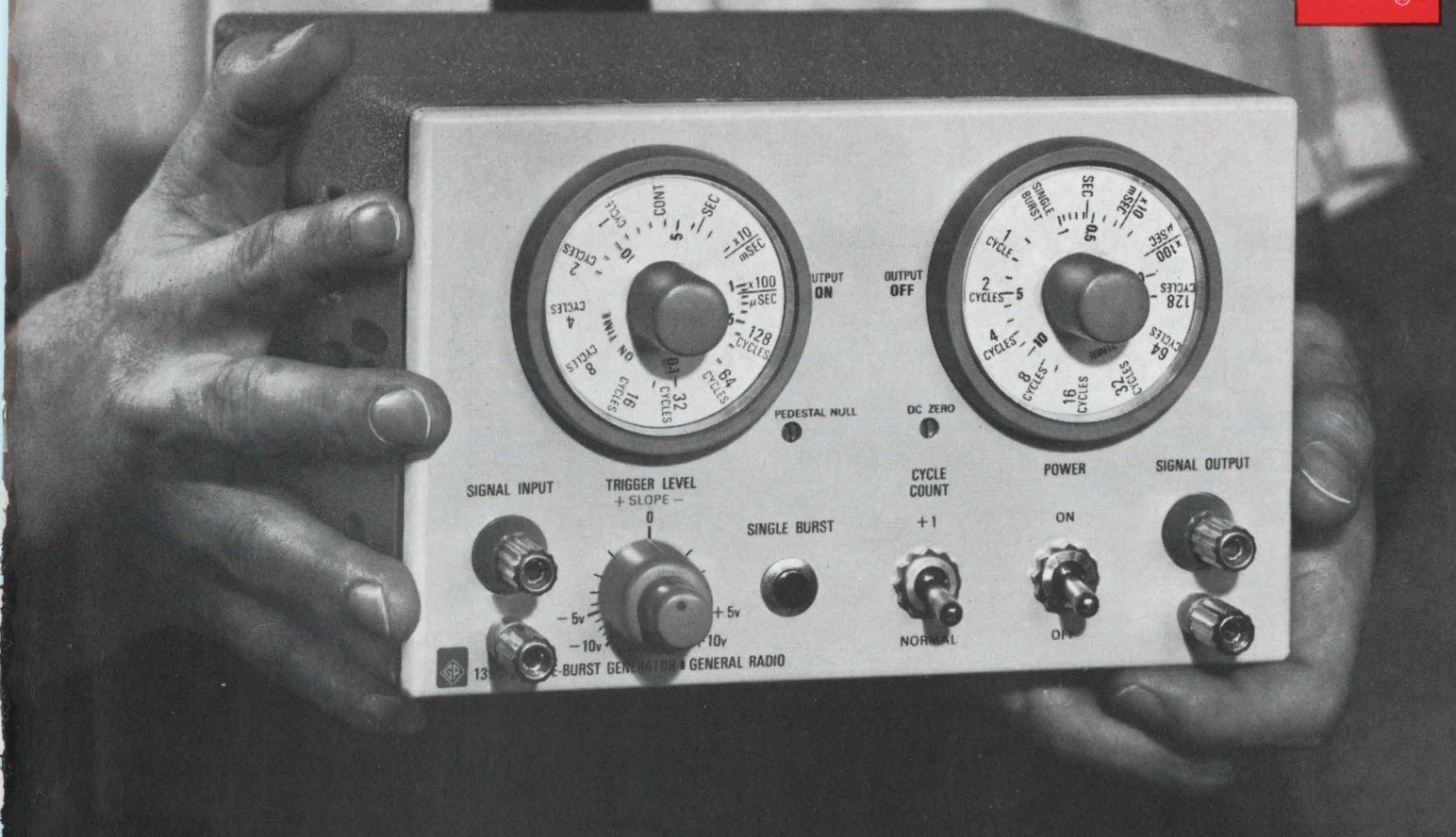

The tone-burst generator you designed

Tone-burst testing created a mild revolution when we introduced our first tone-burst generator in 1965. With properties of both continuous tones and pulses, tone-bursts quickly reveal important information about response curves.

You soon recognized the value of tone bursts in sonar and psychoacoustic testing, and the original 1396-A Tone-Burst Generator became an overnight success. Not only did you buy the instrument, but you told us how to improve it.

- You said, "Increase the upper frequency limit," and we did — to 2 MHz.
- In sonar and psychoacoustic testing, very long bursts are often required, so you said, "Provide for an analog ON as well as an analog OFF," and we did.
- You said, "Increase the signal suppression between bursts," and we did — to -60 dB.
- You said, "Add a single-burst button," and we did.

Furthermore, we increased the output voltage to 20 V and the output current to 50 mA; we reduced the output impedance to 25 Ω , and we increased the input impedance to 50 k Ω . Then we added convenience features like switch-selection of timing source, provision for direct drive of gate, and provision for nulling the DC output.

When we got through, we had the 1396-B — a completely new instrument — designed with *you* in mind because we minded *you* when we designed it.

For more information, write General Radio Company, West Concord, Massachusetts 01781; telephone (617) 369-4400. In Europe: Postfach 124, CH 8034 Zurich 34, Switzerland.

GENERAL RADIO

RECEIVED
FEB 14 1969
CALMA CO.

New Datapulse 112 gives you higher rep rates (to 125 MHz), faster rise times (1.3ns) and narrower pulses (to 3ns)—yet it costs you hundreds of dollars less.

What's more it has all the pulse parameter control you need to test high-speed circuits: simultaneous $\pm 5V$ outputs, single or double pulses, independent dc offset to $\pm 2V$, widths from 3ns to 5 ms, and delays to 5 ms.

You can control the pulse train with external gating pulses, produce complementary outputs for duty cycles approaching 100%, set the baseline at exact ground with a switch, and reduce rep rate to 10 Hz for low-speed testing.

No other high-speed pulser offers so much for just \$1595.00 . . . and the 112 is being delivered now. For a demo contact Datapulse Division, Systron-Donner Corporation, 10150 W. Jefferson Blvd., Culver City, Calif. 90230 213-836-6100.

Why buy a high-priced 100 MHz pulser? Here's 125 MHz for \$1595!



Oscilloscope photo. 2ns/div, 2v/div.

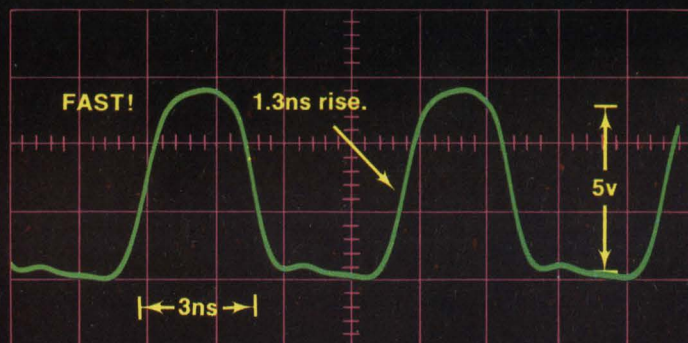

Another first. One of 135 Systron-Donner instruments

Electronic counters	Analog computers
Pulse generators	Digital panel meters
Microwave frequency indicators	Microwave signal generators
Digital clocks	Laboratory magnets
Memory testers	Data acquisition systems
Digital voltmeters	Microwave test sets
Time code generators	
Data generators	

SYSTRON  DONNER

NEWS

- 21 News Scope
- 25 **Finally: A practical application for holography**
A new, nondestructive test technique combines holography with laser interferometry to picture stress and strain in real time
- 38 Will the military accept plastic ICs?
- 42 Computer service turns logic into packages
- 47 Washington Report
- 52 **1970 U.S. budget is Nixon's problem now**
\$83 billion DOD package may get thorough overhaul; modest rise in electronics procurement seen over last year
- 58 Letters
- 60 Sidelights of the Issue
- 63 **Editorial: Technology and politics: better support needed**

TECHNOLOGY

- 66 **Slash ROM sizes with equivalent functions.** Use trigonometric or arithmetic manipulation to greatly reduce bit requirements for a look-up table memory.
- 78 **Will radiation wreck your IC design?** Not if you know the effects of radiation on IC parameters and design your circuits to tolerate them.
- 86 **Measure MOSFET parameters with ease** by using circuits and techniques that accurately determine their important characteristics.
- 96 **Get the best one-shot for your money** by combining NAND gates and discrete components. Temperature stability is as good as 0.027%/°C.
- 102 **Don't wait for brainstorming,** but organize for creativity with structured 'idea sessions' that can lead to new thinking—and new, successful products, too.
- 108 **Semiannual Index of Articles:** June through December 1968
- 124 Ideas for Design

PRODUCTS

- 136 **Data Processing:** Plated wire is offered for OEM memories.
- 152 **ICs and Semiconductors:** Solid-state isolators use optical coupling.
- 162 **Components:** Miniature lamps are only the size of a dot.
- 170 Instrumentation
- 178 Microwaves and Lasers
- 184 Modules and Subassemblies
- 190 Packaging and Materials
- 196 Production

Departments

- | | | | |
|-----|-------------------------------|-----|--------------------|
| 14 | Designer's Datebook | 206 | Application Notes |
| 202 | Evaluation Samples | 210 | New Literature |
| 204 | Design Aids | 222 | Advertisers' Index |
| 224 | Information Retrieval Service | | |

Information Retrieval Service Card inside back cover

COVER CREDIT: General Electric Electronics Laboratory, Syracuse, N.Y.

Fairchild told everyone what MSI could do.

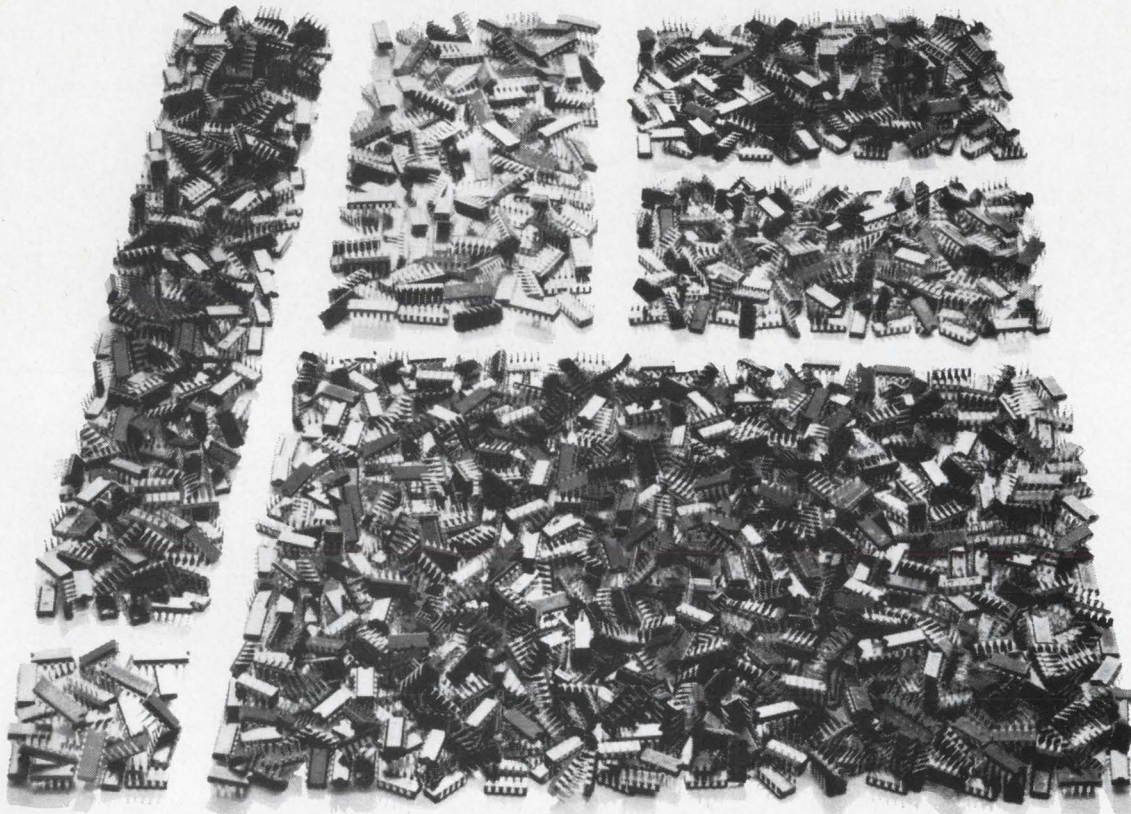

Ever since we introduced medium scale integration in 1967, we've been talking about the systems approach to computer design. Basic, compatible fundamental building blocks that do more jobs than a hundred Integrated Circuits.

Versatile circuits that function like shift

registers, counters, decoders, latching circuits, storage elements, comparators, function generators, etc. We said we had enough MSI device types to build more than half of any digital system you could design. An imaginative company in Boston took us up on it.

We're glad someone was listening.

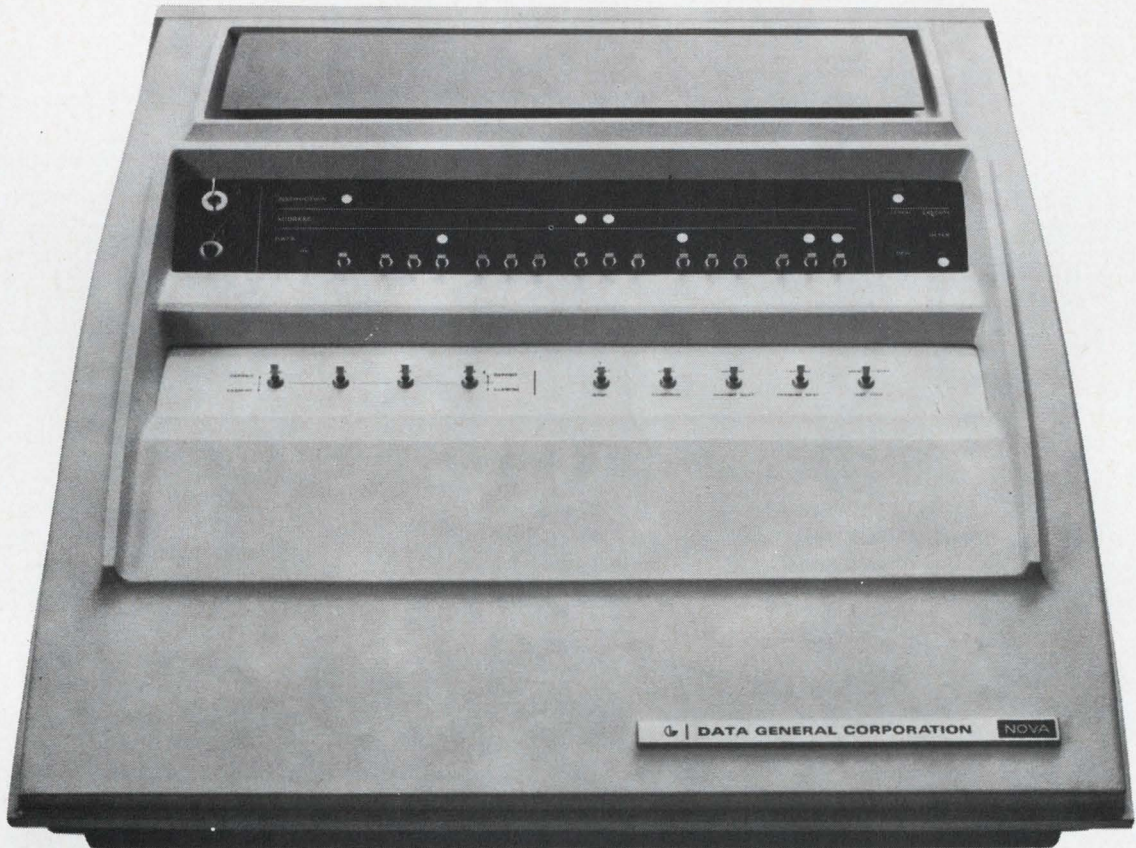

Data General Corporation built a revolutionary computer with Fairchild MSI circuits. The building block approach allowed them to design and build the whole system in six months. And put it in either a desk top console (shown above) or a 5¼-inch high standard 19-inch rack mount package. The central processor fits on two 15-inch by 15-inch plug-in circuit boards.

Another board houses a 4,096-word core memory. A fourth board provides enough space for eight I/O devices. And there's still enough room left for boards that expand the memory capability up to 16K. Any circuit board can be changed in seconds, so the computer has zero down

time. The NOVA is the world's first computer built around medium scale integration. The first general-purpose computer with multi-accumulator/index register organization. The first with a read-only memory you can program like core. The first low-cost computer that allows you to expand memory or build interfaces within the basic configuration. And the first to prove the price/performance economy of MSI circuitry: The NOVA 16-bit, 4K word memory computer with Teletype interface costs less than \$8,000.

If you'd like more information on MSI, use the reader service number on the opposite page. For specs on the NOVA, use the reader service number below.

FAIRCHILD
SEMICONDUCTOR

FAIRCHILD SEMICONDUCTOR / A Division of Fairchild Camera and Instrument Corporation ■ 313 Fairchild Drive, Mountain View, California 94040, (415) 962-5011 ■ TWX: 910-379-6435

INFORMATION RETRIEVAL NUMBER 4

MystR[®]



(Waters Own Conductive Plastic)

Potentiometers

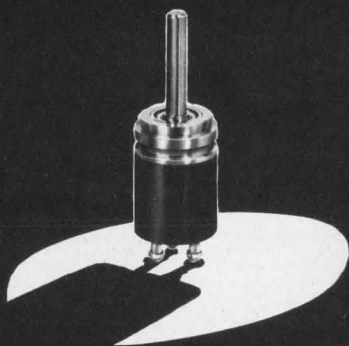

"PERFORMANCE *PLUS*"

MystR[®] Potentiometers offer widest versatility with such performance-plus factors as: Resistance Ranges from 10 ohms to 5 megohms; Linearity as low as 0.25%; Output Smoothness less than 0.1%; Rotational Life well beyond 5,000,000 cycles; Dither Life in excess of 400,000,000 cycles; Operational Temperatures to 150°C; Infinite Resolution. And what's more they're even quiet!



WATERS
MANUFACTURING INC.
WAYLAND, MASS. 01778



Cimron leapfrogs the DVM industry —and there's a reason!

A number of reasons, to be exact! The all-IC Model 6753 is the next generation in digital multimeters—the lowest-priced autoranging instrument that will read DC from 100 nanovolts to 1099.9 volts and DC ratios. A fast-tracker, too—ideal for systems work. The closed loop tracking logic continually samples output at the rate of 14 readings a second, with accuracies of $\pm 0.001\%$ full scale $+0.005\%$ of reading. Like to learn about automatic desensitization? repetitive mode? out-of-range indication? Just ask how they can

help you. Important to you is the basic design, featuring optional IC plug-ins to extend capability which you can install yourself without technical service! Options include a 4-range AC converter with 10 microvolt sensitivity, a 5-range ohms converter, remote programmability, five print-out options. You can't beat the base price of \$2990! Cimron's **customer concern** continues to provide what you really need at the lowest possible price. Write Cimron, Dept. C-127, 1152 Morena, San Diego, Calif. 92110.

LEAR SIEGLER, INC.



CIMRON DIVISION



INFORMATION RETRIEVAL NUMBER 6

You don't need a degree to test op amps.



Signetics' new Model 1410 is the most comprehensive, definitive, easy-to-use op amp tester on the market. And we can prove it.

Rather than shout about its many features, let us just tell you how it works and what it does:

First, you simply insert a program board (manufacturer's spec or your own) for the op amp to be tested. Plug in the device. All operations are now performed by pushing illuminated test buttons. Push the top left button and the lights immediately indicate what tests will be performed. Next, push the "Test" button. If all tests are passed all button lights go out and the "PASS" indicator lights up. If any test is failed, the button corresponding to that test stays lit and the fail light comes on.

Now, if you want to know to what degree a given parameter passed or failed its test, just push the button corresponding to that specific test. The

answer is read out immediately as a percentage of the specified test limit.

We call this real "decision language."

There are fourteen tests: power consumption overrange (greater than 200%), power consumption (less than 200%), offset voltage (source resistance zero ohms), offset voltage (source resistance programmed), + supply sensitivity, - supply sensitivity, common mode rejection, bias current, offset current, gain (programmed light load), gain (programmed heavy load), noise and oscillation. And for the first time there are tests you won't find on testers selling for ten times our price: + slew rate, - slew rate.

The Model 1410 has no knobs to turn or meters to interpret. Your secretary could learn to use it in about one minute. Optional input/output boards allow you print-out or data log complete

parameter measurement.

And there's more. But suffice it to say for now that we believe the 1410 represents a major breakthrough in linear testing. Many who have wanted to test op amps can now afford to do so because the 1410 makes op amp testing practical and cost-efficient.

We know that there are some prospects out there who could profit by paying eighty or ninety thousand for this tester.

We're happy to say that the price will not be more than a tenth of that. Plus tax.

See us at IEEE, booth number 3A01 to 3A04.

SIGNETICS CORPORATION
MEASUREMENT/DATA
A subsidiary of Corning Glass Works

For detailed information or a demonstration write Signetics, Measurement/Data, 811 E. Arques Ave., Sunnyvale, Calif. 94086, or contact one of the following:

AUTHORIZED SIGNETICS REPRESENTATIVES (Measurement/Data) □ Alabama and Tennessee Col-Ins.-Co., Inc., Huntsville (205) 539-1771 □ California L and M Engineering, Inc., Inglewood (213) 678-5409; Santa Clara (408) 243-6661 □ Connecticut Datech Associates, Inc., New Haven (203) 624-7291 □ District of Columbia (see Silver Spring, Maryland) □ Florida Col-Ins.-Co., Inc., Orlando (305) 423-7615 □ Georgia Col-Ins.-Co., Inc., Marietta (404) 422-8327 □ Illinois Carter Electronics, Inc., Chicago (312) 776-1601 □ Indiana Carter Electronics, Inc., Indianapolis (317) 293-0696 □ Maryland QED Electronics, Inc., Silver Spring (301) 588-8134 □ Massachusetts Datech Associates, Inc., Newtonville (617) 959-9710 □ Minnesota Carter Electronics, Inc., Minneapolis (612) 869-3261 □ Mississippi/Louisiana Col-Ins.-Co., Inc., St. Louis (504) 833-1116 □ New Jersey QED Electronics, Inc., Camden (215) 925-8711 □ New York QED Electronics, Inc., Mt. Vernon (914) 664-0080 □ J. A. Reagan Co., Inc., Albany (518) 489-4777; Binghamton (607) 723-9661; Newburgh (914) 561-4510; Syracuse (315) 471-7274; Utica (315) 732-3775; Rochester (716) 473-2115 □ North Carolina Col-Ins.-Co., Inc., Winston-Salem (919) 765-3650 □ Ohio WKM Associates, Inc., Cleveland (216) 885-5616; Dayton (513) 434-7500 □ Pennsylvania WKM Associates, Inc., Pittsburgh (412) 892-2953 □ Michigan WKM Associates, Inc., Detroit (313) 892-2500 □

A new lead to a 300 W, 100 A silicon power transistor in a TO-3 case

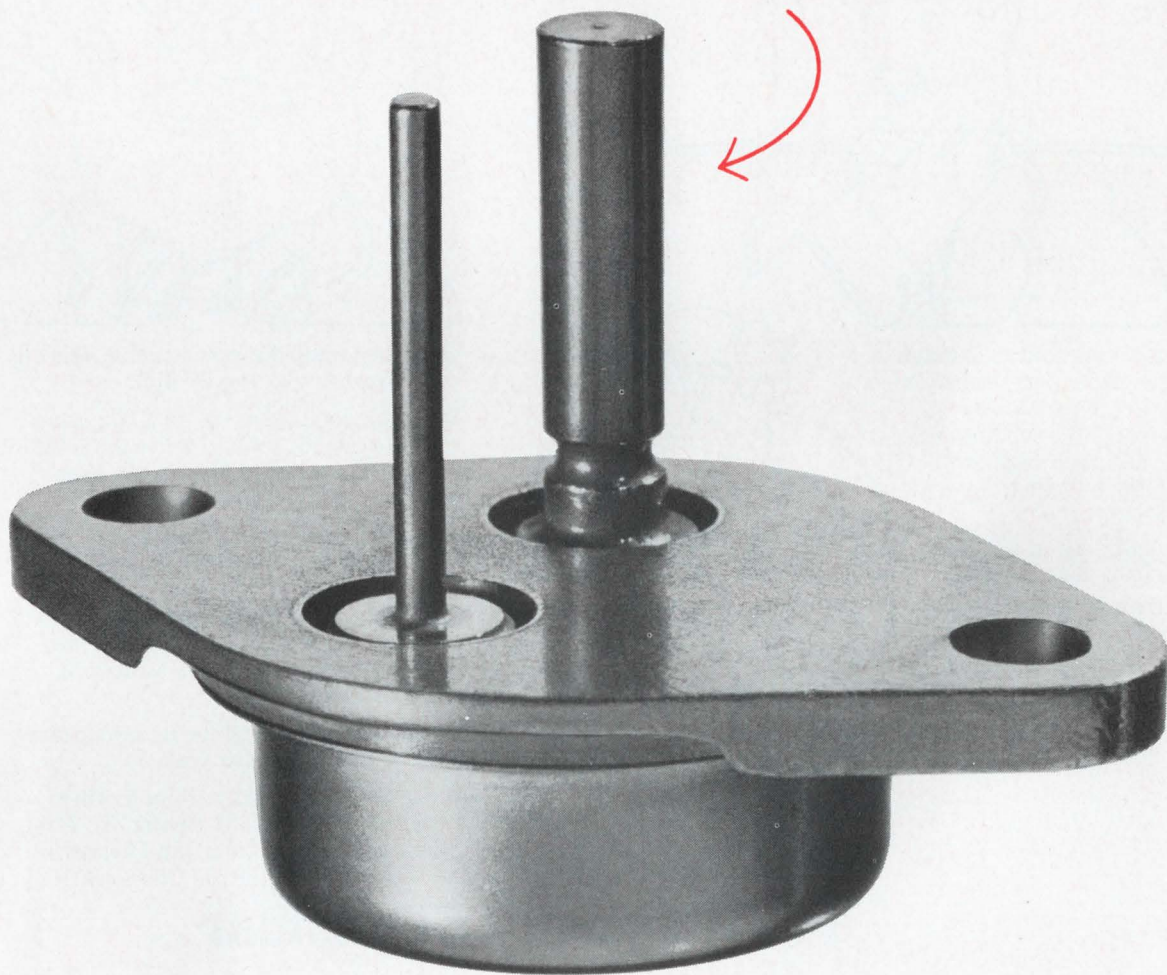

2N5578 showing new, heavy pin terminal design.

What are you looking for in your linear and switching applications? 100 ampere pulsed current capability? 300 watts power dissipation? The highest second breakdown capability of any device on the market in a modified TO-3 package?

Look no further. Here's another first from the silicon power leader—RCA's new 2N5578 family...six high-power, high-current Hometaxial-base silicon n-p-n transistors designed for applications in military, industrial, and commercial equipment.

2N5575, for example, has a pulsed collector current of 100 A. Dissipation

is 300 watts at 25°C with V_{CEX} (sus) of 70 V. The useful beta range is 10-40 at 60 A.

For complete design flexibility, there are three terminal variations: 2N5575 and 2N5578 have heavy pins; 2N5576 and 2N5579 have soldering lugs; and 2N5577 and 2N5580 have flexible leads with solderless connectors.

This family of types all adds up to circuit cost savings in inverters, regulators, motor controls, and other linear and switching applications. Check the chart. For more information, see your RCA Representative or

your RCA Distributor. For technical data, write: RCA Electronic Components, Commercial Engineering, Section No. IG-2-2, Harrison, N. J. 07029.

Characteristic	Test Conditions				2N5575 2N5576 2N5577		2N5578 2N5579 2N5580		Units
	V_{CE} V	V_{BE} V	I_C A	Min.	Max.	Min.	Max.		
h_{FE}	4	4	40	—	—	10	40		
V_{CEX} (sus)	—	—	60	10	40	—	—	V	
$I_{S/ST}$ †	25	—	0.2	50	—	70	—	A	
$E_{S/ST}$ * H _{J.C}	—	-1.5	7	12	—	12	—	J	
	—	—	—	0.8	0.5	0.8	0.5	°C/W	

†With base forward biased

*With base reverse biased and $R_{BE}=10\Omega$, $L=33mH$

We want our Scotchpar[®] film reviewed by every critic in the country.

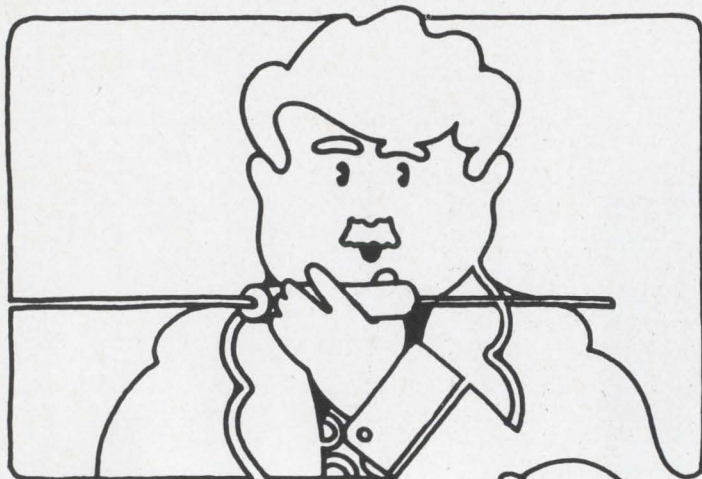

Many important "critics"—manufacturers of capacitors, transformers, motors, wire and cable—have already given 3M's SCOTCHPAR polyester film their highest praise: They bought it for insulation.

They bought a lot of it for capacitors, because 3M is in the capacitor business with thin films.

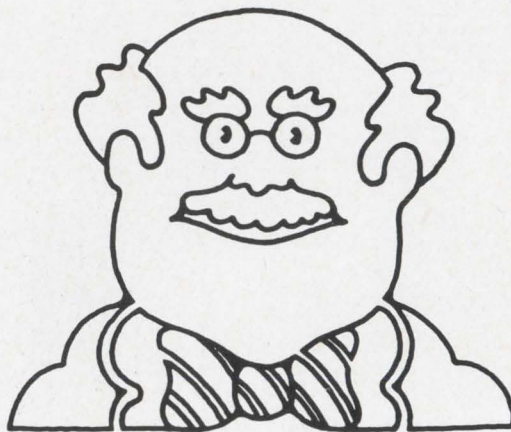

Or if they wanted a heat sealable version, they bought SCOTCHPAK[®] film.

We hope you'll give our film the same critical acclaim, because we've put a lot into our polyester film to help it win over some of the followers of the "big name" film.

SCOTCHPAR film combines excellent electrical strength and steel-like tensile strength with resistance to moisture and solvents. It's thin, tough, flexible and durable. And it comes in a variety of thicknesses and types.

With that much going for it, SCOTCHPAR may be the film of the year.

Write to 3M Company, Film & Allied Products Division, 3M Center, St. Paul, Minnesota 55101 . . . or the Dielectric Materials Desk at the 3M Office nearest you.

Scotchpar[®]
BRAND POLYESTER FILM

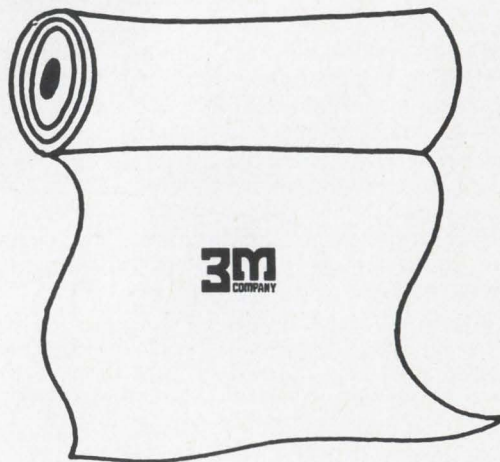

Hybrids from United Aircraft?

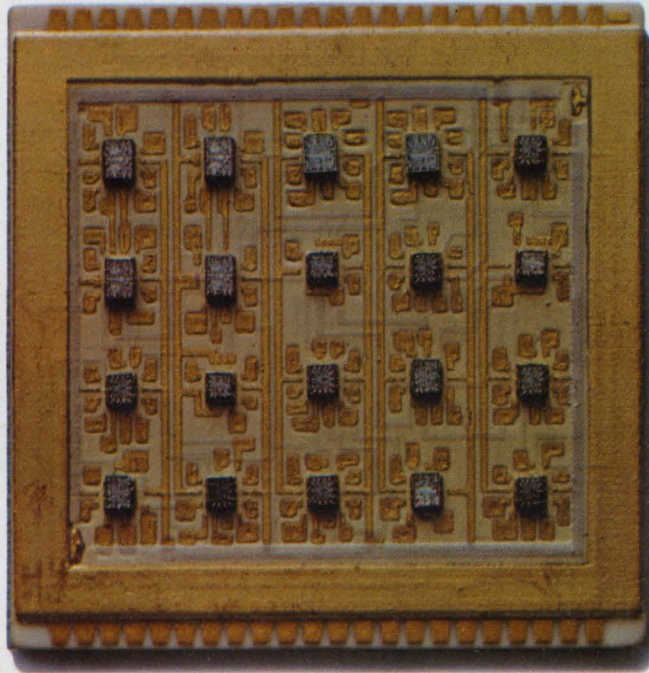

Unretouched photograph of a typical 1/4" square Multilayer MSI Module.

You'd better believe it!

Thin film. Thick film. Single layer. Multilayer. Hermetic and nonhermetic packages. Whatever you need in custom hybrid microcircuits, you can get it from us. Because—beyond engineering skills—we have proven capability in every major hybrid production and

packaging technique.

And we have a pilot line that lets you prove out designs before committing to full production.

Call our Hybrid Microcircuit Marketing Manager at (215) 355-5000. TWX 510-677-1717. Or write direct.

Electronic Components DIVISION OF **United Aircraft**

TREVOSE, PENNSYLVANIA 19047

In the West: 128 E. Katella Ave., Orange, Calif. (714) 639-4030

INFORMATION RETRIEVAL NUMBER 10

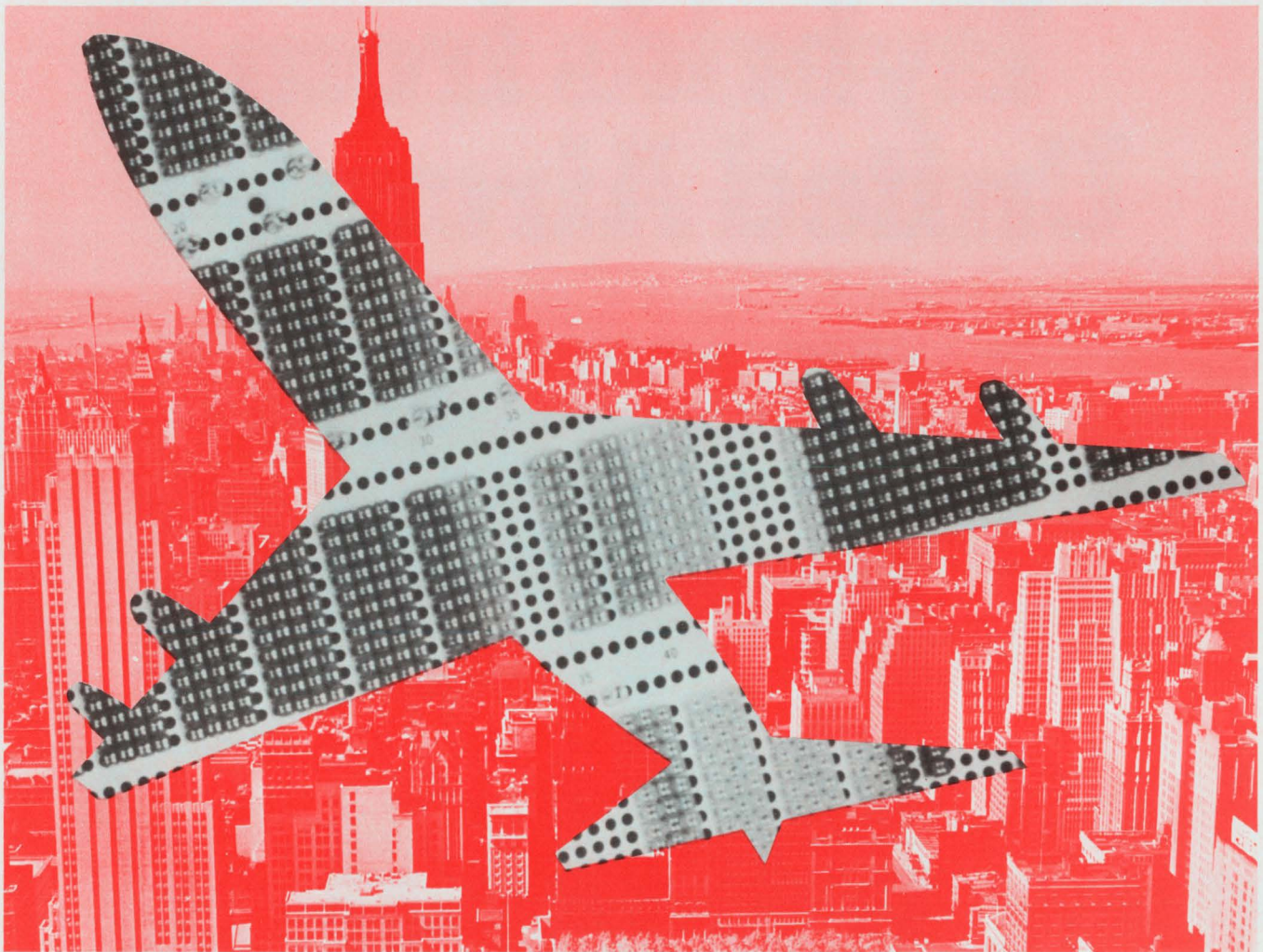

We're not afraid to say it out loud: 'Delivery.'

(WHILE "YOU KNOW WHO" MAY NOT EVEN WANT

TO WHISPER ABOUT THEIR METAL PLATE CONNECTOR PUNCTUALITY)

And it's what we deliver when we deliver on-time that counts. The packaging flexibility to convert from p.c. connectors to plates without changing cards. Any possible contact nose. Stranded or solid wire terminations. Grid spacing at .100", .150", .200", .250". Any practicable size or shape plate. From less than 1" x 1" to 30" x 48". Wiring density up to 25,000. Back panel automatic wire wrap up to 550 per hour. Test our delivery claims by asking us to rush you our Metal Plate Connector Guide. It'll help increase your reliability and put you in a more competitive market position, too. Write, wire, call or TWX Elco Corporation, Willow Grove, Pa. 19090; 215-659-7000; TWX 510-665-5573.

P.S.—FREE SAMPLE? Let us know after you read our literature. We'll be delighted to send you one.



As a metals fabricator, Cross makes a great tailor.



In fact, we spend every working day tailoring ribbon and strip metal production to our customers' needs. We've become known as the custom shop—the one you can hand any job to and expect to get it back perfect. Big, medium or small.

Naturally, we get some pretty tough assignments thrown at us, with that kind of reputation. But we've developed some pretty special techniques for handling them. Take tolerances. We'll roll tungsten or molybdenum down to $\pm .0001$ " and hold that tolerance. There's not another shop around that can do that. With rhenium tungsten, rhenium moly, columbium, zirconium, titanium, vanadium,

copper, nickel, alloys and other metals, we'll hold a tolerance of $\pm .00005$ ".

No wonder we're called the custom shop. Isn't it time you came to Cross and had your ribbon and strip metal requirements custom-manufactured, with zero defects? And we don't care how mean and ornery a job you hand us. After all, would a good tailor tell a customer he couldn't fit him?

For further information write H. Cross Co., 363 Park Avenue, Weehawken, New Jersey, or call (201) 863-1134.

H. Cross Co. "The Master Rollers"

Tungsten — for filaments, heaters, grids, etc. **Rhenium Tungsten** — Tungsten containing 3% Rhenium. Used in application where resistance to recrystallization, room temperature, elongation, and pliability, after heating, are needed. **Thoriated Tungsten** — Tungsten containing 1% or 2% thorium. Used where relatively high electron emission is required. **Molybdenum** — Used as support for lamps and electron tube mandrels, for tungsten coil winding, traveling wave tube helices, furnace windings, tube grids, etc. **Molybdenum Rhenium** — 50% Molybdenum and 50% Rhenium used for grids, heaters, supports etc. where high electrical resistivity and low thermal conductivity, ductility, weldability are of importance. **Rhenium** — Used for filaments in mass spectrometers, ion gauges and other electronic components where electrical resistivity, electron emission weldability and ductility are important. **Tantalum** — Used for heat exchanges. Electron tube capacitors, filaments, grid wires and getters. **Columbium** — Used for getters in electron tubes and electrical rectifiers.

INFORMATION RETRIEVAL NUMBER 12

The 100,000,000,000 ohm Nanosecond Switch

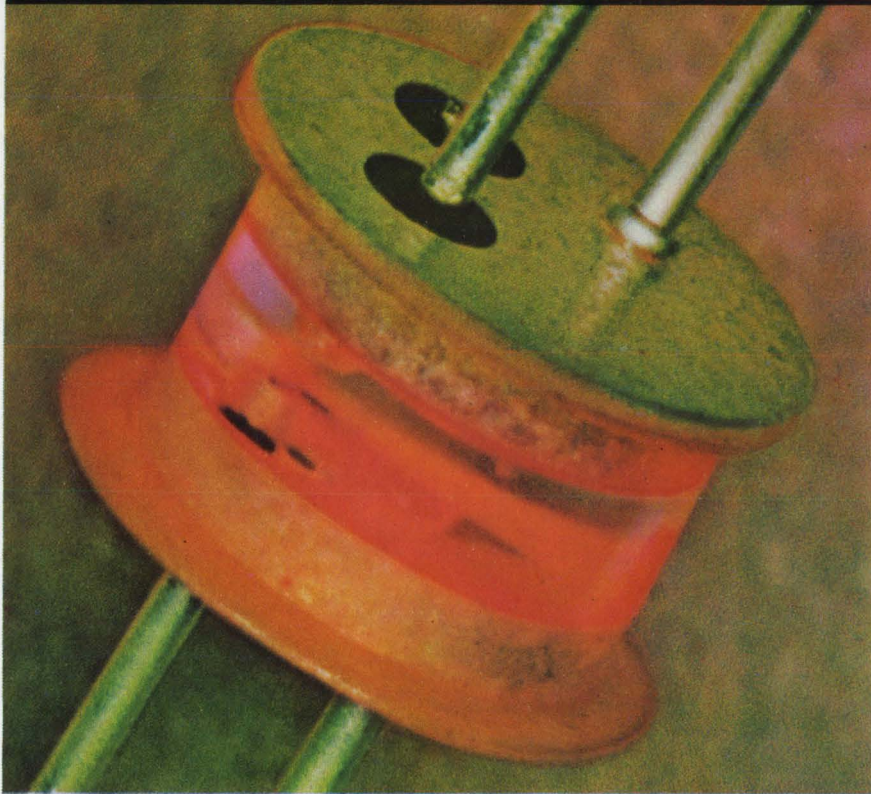

This new photodiode coupled pair offers the designer 5 ns rise and fall times together with over 3,000 volts isolation between input and output. The IR emitter and companion detector are optically coupled through clear epoxy—as seen here. The unit is then encased in opaque epoxy for

maximum dark resistance. It's ideal for high speed isolated switching and high voltage isolation

For additional information and applications write or call Monsanto Electronic Special Products, 10131 Bubb Road, Cupertino, Ca. 95014 (408) 257-2140.

Monsanto

Designer's Datebook

MARCH 1969						
Sun	Mon	Tue	Wed	Thu	Fri	Sat
	2	3	4	5	6	7
8	9	10	11	12	13	14
15	16	17	18	19	20	21
22	23	24	25	26	27	28
29	30	31				

APRIL 1969						
Sun	Mon	Tue	Wed	Thu	Fri	Sat
			1	2	3	4
5	6	7	8	9	10	11
12	13	14	15	16	17	18
19	20	21	22	23	24	25
26	27	28	29	30		

For further information on meetings, use Information Retrieval Card.

Mar. 12-14

Microwave Technique Conference (Cologne, Germany) Sponsor: IEEE; H. H. Burghoff, Stresemann Allee 21, VDE-Haus, 6 Frankfurt/Main 70, Federal Republic.

CIRCLE NO. 434

Mar. 24-27

IEEE International Convention (New York City) Sponsor: IEEE; J. M. Kinn, 345 E. 47 St., New York, N. Y. 10017

CIRCLE NO. 435

Mar. 25-27

Conference on Lasers and Optoelectronics (Southampton, England) Sponsor: IEE; IEE, Savoy Place, London W. C. 2, England.

CIRCLE NO. 436

Apr. 15-18

International Magnetism Conference (Amsterdam, the Netherlands) Sponsor: G-MAG; U.F. Gianola, Bell Telephone Labs., Murray Hill, N.J. 07971

CIRCLE NO. 437

Apr. 16-18

Geoscience Electronics Symposium (Washington, D. C.) Sponsor: G-GE; Maurice Ringenback, Weather Bureau, ESSA, Gramax Bldg., Silver Spring, Md. 20910

CIRCLE NO. 438

Apr. 23-25

Southwestern IEEE Conference and Exhibit (San Antonio, Texas) W. H. Hartwig, Univ. of Texas, EE Dept., Austin, Texas 78712

CIRCLE NO. 439

◀ INFORMATION RETRIEVAL NUMBER 13

INFORMATION RETRIEVAL NUMBER 14 ▶

The Incredible Dodecameter...

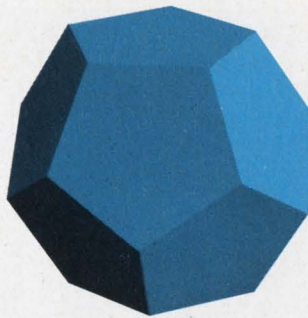

Adds twelve programmable measurement functions to your system.

You start with the basic dc unit and add options to fit your systems needs. You can use the new HP 3450A Multi-Function Meter for dc, ac and ohms measurements — ratio, limit tests, and ratio limit tests. The 3450A has autoranging on all functions—and all functions are fully programmable. This broad capability is contained in a 3½" high rack mount — ideal for systems.

The basic dc unit is integrating and fully guarded for excellent noise immunity. You can make 15 readings per second with a sensitivity of 1 μ V. Add the AC Voltage and AC Ratio Option to your basic dc unit and you can make true RMS ac measure-

ments from 45 Hz to 1 MHz—without the errors due to harmonic distortion.

Add the Ohms and Ohms Ratio Option for ohms measurements with 1 m Ω sensitivity. The four-wire ohms input provides sense and signal leads to reduce errors due to lead resistance.

Put in the Limit Test Option and you can preset two four-digit limits. Your system then can make simple comparisons without using a computer or digital comparator. Use the Digital Output Option with the Limit Test Option for nine columns of information including HI, GO, LO limit test decisions.

The Rear Input Terminal Option provides a set of guarded rear input terminals and a FRONT/REAR INPUT selector switch on the front panel.

If your requirements change, any of the options are field-installable (except rear input terminals). Call your nearest HP field engineer to learn how easily "the incredible dodecameter" adapts to your measurement system. For full specifications, write to Hewlett-Packard, Palo Alto, California 94304. Europe: 1217 Meyrin-Geneva, Switzerland.

Prices: Basic 3450A, \$3150; AC Option 001, \$1250; Ohms Option 002, \$400; Limit Test Option 003, \$350; Digital Output Option 004, \$175; Remote Control Option 005, \$225; Rear Input Terminal Option 006, \$50.

099/4

HEWLETT  PACKARD

DIGITAL VOLTMETERS

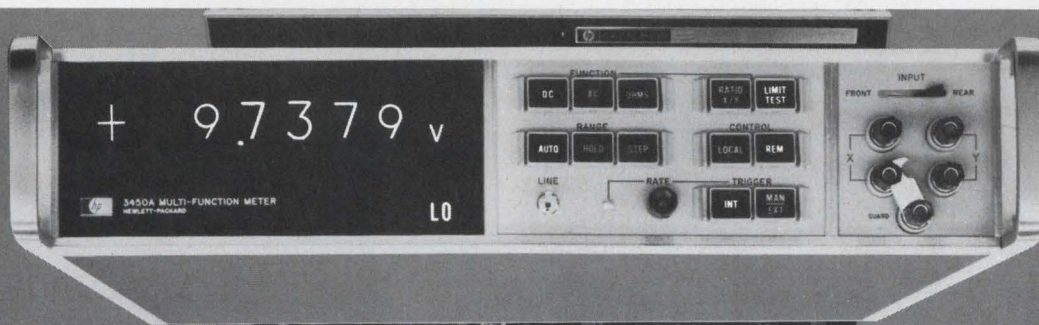

THINK

SMALL

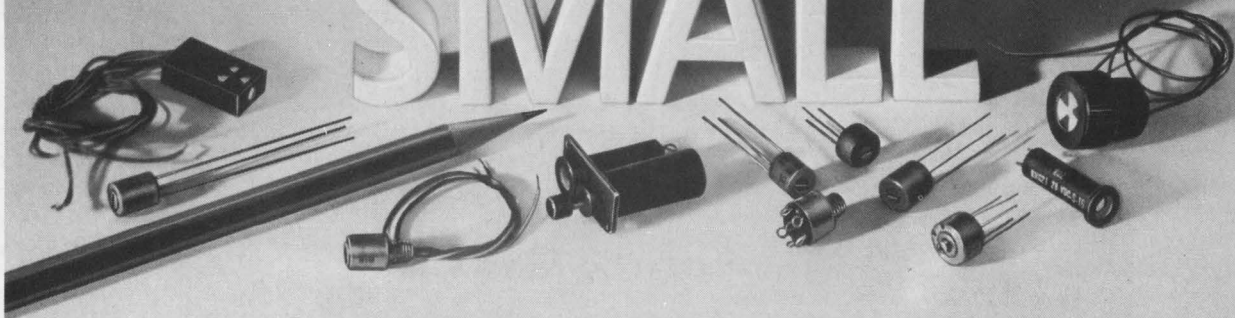

The Minelco family of small components that solve big problems. Small? **Miniature!** Trimmer Potentiometers... Rotary Selector Switches... BITE (built in test equipment) Indicators. A size, a configuration, a type for every requirement. Name your specifications, we'll supply the component. We keep it in the family.

...THINK MINELCO!

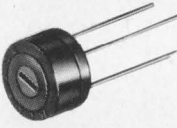
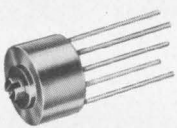
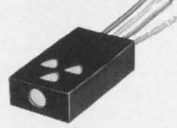
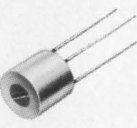
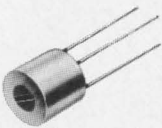
 <p>NEW1 MP32 5/16" dia. Pancake Trimmer Potentiometer</p>	 <p>Microminiature! MS1 1/4" dia. Trimmer Potentiometer</p>	 <p>For printed circuits! SW32 .350" dia. Rotary Selector Switch</p>	 <p>For panel mounting! SW37 .350" dia. Rotary Selector Switch</p>	 <p>Manual reset! BHGM 1/2" wide BITE Indicator</p>
 <p>Internal switching! M170 .2" x .4" x .7" BITE Indicator</p>	 <p>Electrical or mechanical reset! M151SMS 1/2" dia. BITE Indicator</p>	 <p>Tiny... bistable... highly visible! BHG21 1/4" dia. BITE Indicator</p>	 <p>Low-cost! MP2 .290" dia. Trimmer Potentiometer</p>	 <p>Infinite resolution! MF2 1/4" dia. Trimmer Potentiometer</p>

For additional information, contact:

MINELCO

a subsidiary of

GENERAL TIME
Progress in the World of Time

600 SOUTH STREET, HOLBROOK, MASS. 02343 / (617) 963-7717

BITE INDICATORS • ROTARY SWITCHES • TRIMMER POTENTIOMETERS • ELAPSED TIME INDICATORS • EVENTS COUNTERS



In the power tetrode field we're defining the state of the art by demonstrating intermodulation distortion better than any other known tubes. In 1966 we introduced the 4CX1500B, a 1.5 kW tetrode with the highest linearity then known: better than -40 dB 3rd order IM distortion. Since then we produced the 4CX600J, a 600 watt tube with -45 dB 3rd order IM products—without feedback—and later a 5 kW tetrode with the same figure. Now the latest tetrode in our program, a 15 kW tube, exhibits -40 dB 3rd order IM products. We can show IM distortion improvements from 10 to 20 dB in a practical quiescent plate current range.

Other tetrodes now under development will deliver up to 40 kW with linearity as high as -45 dB IMD, according to preliminary data. Such performance advances are part of a long range program employing computer-assisted design studies to optimize internal tube geometry—all part of our plan to insure you get state of the art products every time you buy from Eimac.



Contact your nearest Varian/Eimac distributor or ask Information Operator for Varian Electron Tube and Device Group.

**No tetrodes
with higher
linearity.**

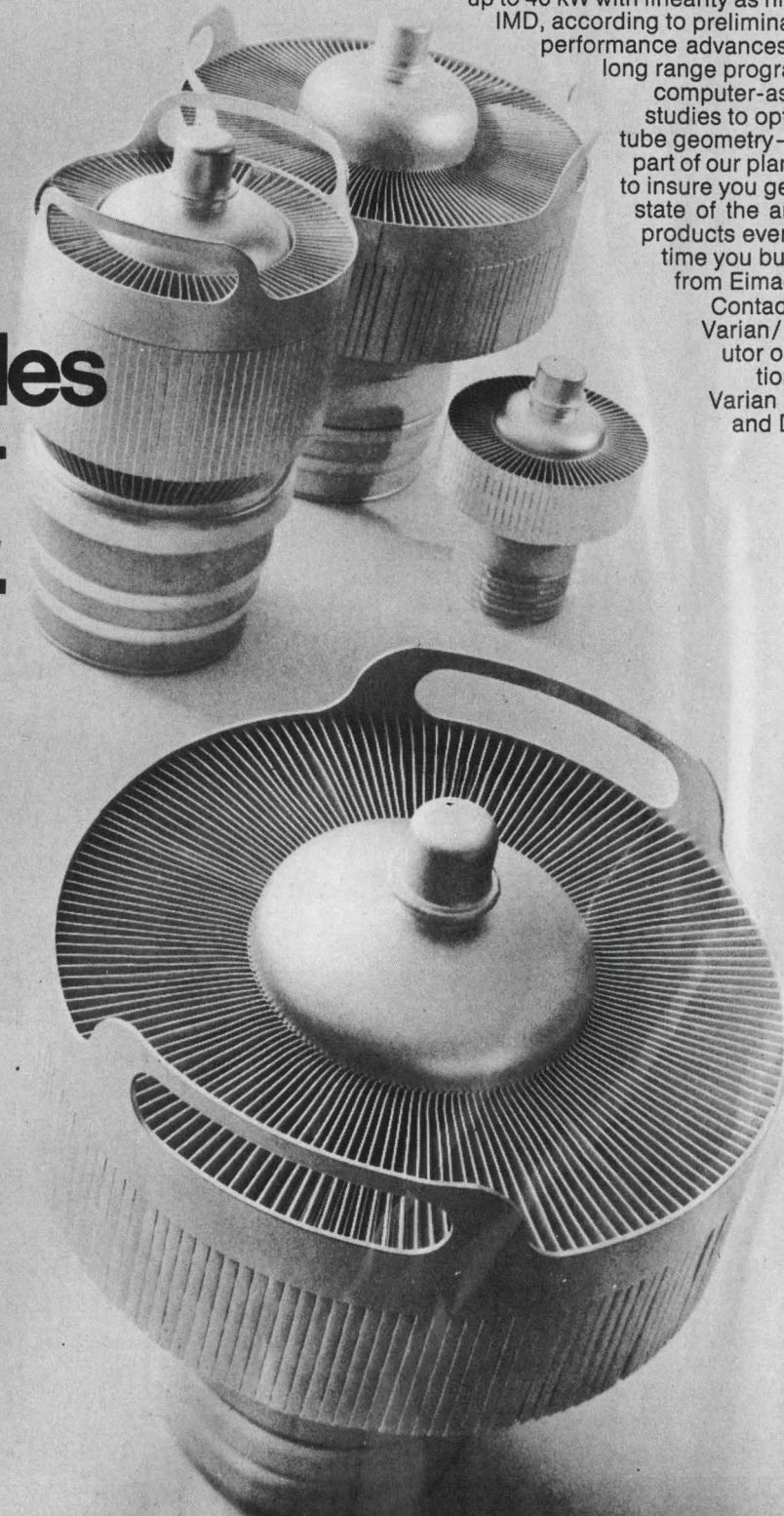

Three Series 54/74 circuits that really count.

Decade Counter

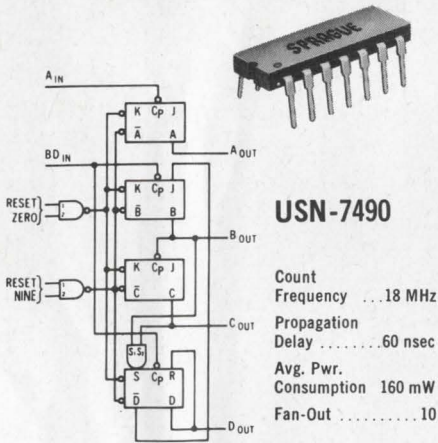

Divide-By-Twelve

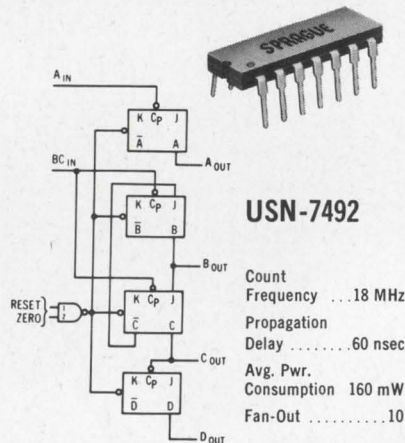

4-Bit Binary

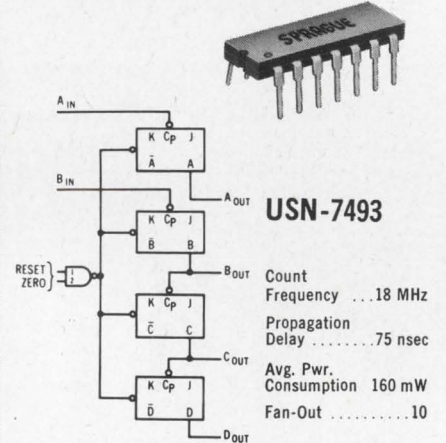

GET ANY OF THESE COUNT MODES

Type Number	Count Mode								
	÷2	÷3	÷4	÷5	÷6	÷8	÷10	÷12	÷16
USN-7490	✓			✓			✓		
USN-7492	✓	✓			✓			✓	
USN-7493	✓		✓			✓			✓

Twenty-one standard circuits and nine complex arrays... available now from Sprague, your broad line source for Series 54/74.

Call your distributor, your Sprague representative, or the Semiconductor Div., Sprague Electric Co., Worcester, Mass. Tel. 617-853-5000, Ext. 316. For descriptive data, write: Technical Literature Service, Sprague Electric Co., 347 Marshall St., North Adams, Mass. 01247.

THE BROAD-LINE PRODUCER OF ELECTRONIC PARTS



'Sprague' and '®' are registered trademarks of the Sprague Electric Co.

News

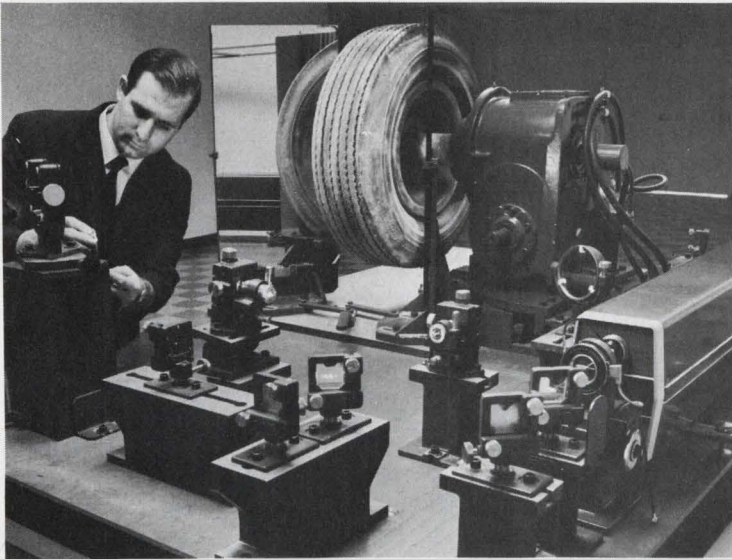

Holographic interferometry, powerful new nondestructive test technique, pinpoints hidden defects in automobile tires. Details on page 25



Plastic devices, despite limitations, find growing military use, says Chris Goodman of Motorola. See page 38

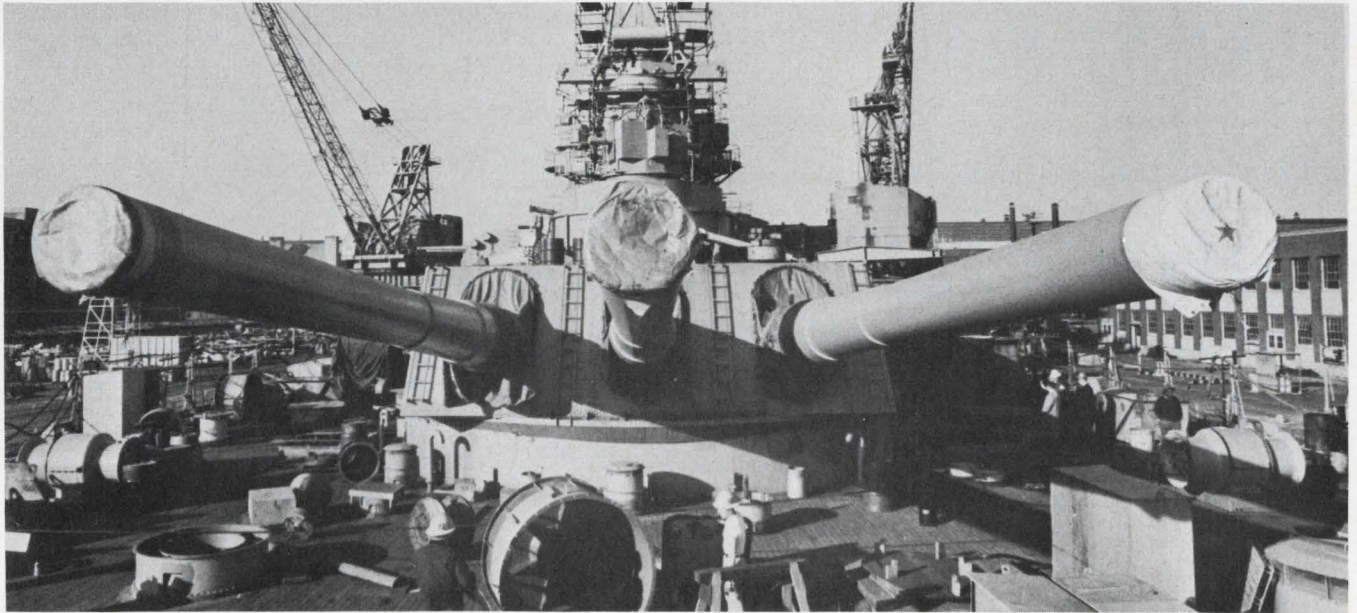

The Navy has requested funds in the fiscal 1970 budget that could lead to a major ship-

building program involving 19 warships. The request totals \$9.7 billion. See page 52

Also in this section:

New computer service turns logic into packages. Page 42

News Scope. Page 21 . . . **Washington Report.** Page 47 . . . **Editorial.** Page 63

hybrid microcircuits from the “total capability” source

There's a reason why Burroughs is a preferred source for hybrid microcircuits. It's TOTAL CAPABILITY. TOTAL CAPABILITY is the unique ingredient that keeps Burroughs ahead in hybrid circuit leadership and enables you to reduce system size with increased reliability.

Burroughs now offers the entire circuit package* and its components — all designed and fabricated under the eyes of experts in one complete in-house operation, providing economy, high reliability, quality control and prompt delivery.

■ Hermetic Packaging ■ MSI Capability ■ Computer Test Facility ■ Fully Documented to MIL-Q-9858A and MIL-I-45208

Buy your hybrid microcircuits NOW from Burroughs, and discover what Burroughs Total Capability can do for you.

Call or write Burroughs Corporation, Electronic Components Division,
P.O. Box 1226, Dept. H1, Plainfield, New Jersey 07061.
Tel. (201) 757-5000, or contact your nearest Burroughs
representative or sales engineer.

*Circuits are available in various configurations with resistors, capacitors, and discrete IC and MSI chips, mounted.

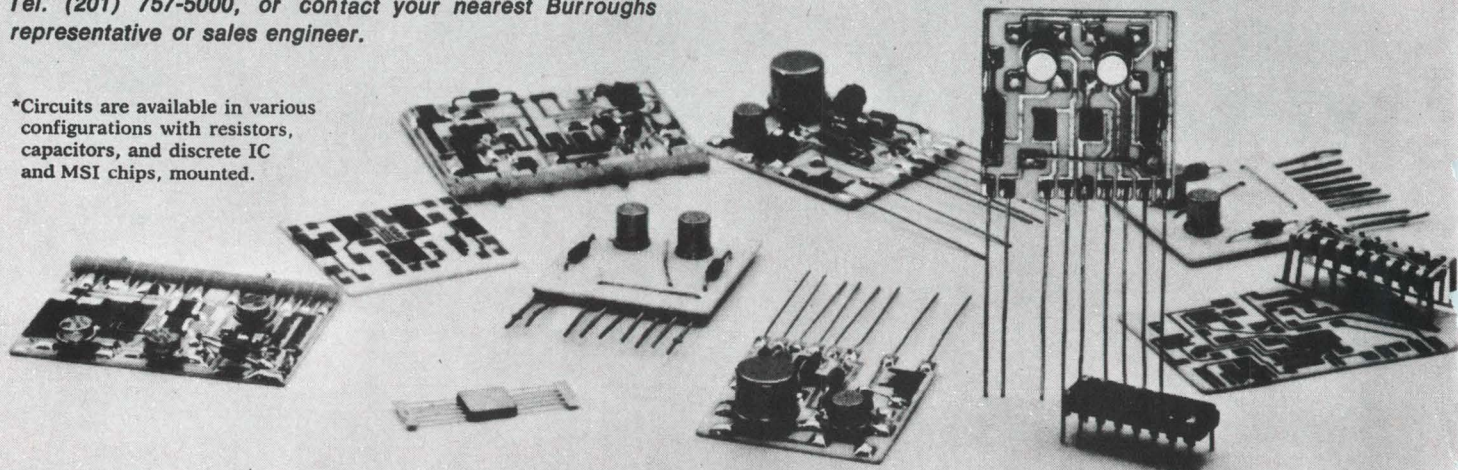

Burroughs 

5-year buildup forecast in electronics for Navy

During last year's Presidential campaign, Richard M. Nixon accused the Johnson Administration of complacency in the face of a Soviet naval buildup that, he said, threatened American superiority on the seas. He pledged that his Administration would "restore the goal of a Navy second to none."

A study about to be released by Frost & Sullivan, a defense and space market research organization in New York, predicts that President Nixon will begin to strengthen the Navy's shipbuilding program, with particular emphasis on shipboard electronic systems (see p. 52). The buildup, the report says, will take at least five years.

Among the Frost & Sullivan forecasts are these:

- A change in bidding procedures for the next generation of DX destroyers. Bidding will be by "teams" of shipbuilding and electronics contractors. Heretofore a shipyard has built the warship and various other contractors have sup-

plied the electronics equipment separately—a wasteful procedure. Since half the cost of the new destroyers will be for on-board electronics equipment, team bidding is expected to result in savings.

- A considerable increase in funds for development of an advanced solar detection system for the next generation of Poseidon-missile attack submarines.

- A major modernization program to upgrade fire-control radars to be used with the Navy's Standard surface-to-air missile next year. Sperry Gyroscope and Raytheon are the major contractors. Some of the Navy's radars have been in use since 1950.

- An even larger modernization program will adapt the Navy's fire-control system for the Advanced Surface Missile, which won't be deployed until the late 1970s. The phased-array radars will have increased capabilities, and will be very expensive items.

- Continued heavy funding of Project Sanguine, a very-low-frequency communications network that, by the mid-1970s, will enable the Navy to communicate with all of its vessels above and below water, anywhere in the world. In the next six years, about \$1.5 billion will be spent on the program. In the interim the Navy will continue to fund development of a vlf communications system that would be used in case of attack.

- An effort to develop a countermeasures system to jam the Russian's Styx ship-to-ship missile—the missile that sank an Israeli destroyer two years ago.

- High priority in the next five years for Shortstop, an integrated electronic countermeasures system for ships. The program aims at developing a complete shipboard electronic-warfare system, including detection, real-time threat analysis

and jamming. ITT Avionics Div., Nutley, N.J. is prime contractor and RCA is participating.

Finally, as a result of the Pueblo incident, the U.S. is expected to rush development of a new generation of electronic surveillance equipment for ships.

Russians will attend Intelsat meeting in U.S.

In a surprise move, the Soviet Union has announced its intention to send a delegation to "observe" the month-long meeting in Washington, D.C., of the International Telecommunications Satellite Consortium. N. V. Talyzin, Deputy Minister of Soviet Communications, will head the visiting group.

Bulgaria and Yugoslavia have also stated they will send observers to the meeting, which opens Feb. 24 and has as one of its goals the establishment of a single, permanent world communications satellite system. It appears now that over 80 nations will attend the conference.

The Soviet has an experimental communications system, using the Molniya satellite, and has proposed a competing global network dubbed Intersputnik. The Russian spacecraft are in random orbits and migrate continuously, compared with the Comsat vehicles which are in synchronous equatorial orbits.

The need for a single satellite communications system is obvious, if costs are to be minimized and best operating efficiency attained. However, past political problems between the East and the West have created many obstacles.

Blind-landing system sold—after 14 years

Patience has paid off for one long-suffering manufacturer of "all-weather" landing systems. After receiving a study contract from the Air Force in 1955 and eventually providing model systems for the Federal Aviation Administration, National Aeronautics and Space Administration, the U. S. Navy and the French Government, Airborne Instruments Laboratory at Deer Park, N. Y., has found three customers: Sweden, the U. S. Navy

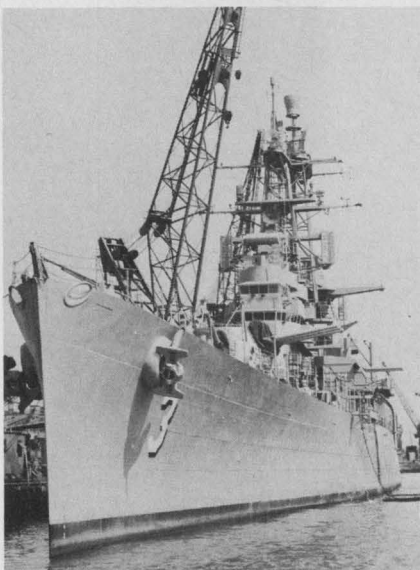

On-board electronics will account for half the cost of new warships.

and the FAA.

The FAA, which some manufacturers have said makes a career of testing instrument-landing systems without ever selecting one, will use its new purchase in further tests.

Sweden has bought one prototype package from Airborne Instruments. It consists of a ground terminal and its airborne companion, Flarescan. The latter will be installed in the Saab Viggen jet fighter. The package is called TILS (Tactical Instrument Landing System). Later, Sweden will either buy production models from Airborne Instruments or try to get a license to manufacture the system in Sweden.

The U. S. Navy is negotiating a contract for the C-Scan systems (the airborne portions of the system), to be installed in 1000 jet fighters. Ground terminals will be placed on 13 carriers and at 10 shore sites.

The FAA has contracted for installation of a scaled-down version of TILS on a truck. It will be driven to 19 airports where the terrain makes instrument landings difficult. FAA wants to see if the system will improve the situation. If it does, these 19 airports, plus about 40 more with "sitting" problems, might eventually benefit.

The TILS ground station transmits guidance landing signals to a receiver in the aircraft. The output signals of the receiver are processed in the plane's digital computer and displayed as steering commands on a special read-up display.

Major IC program underway at GE?

General Electric executives are unwilling to affirm or deny the existence of project IC²—a multimillion dollar program that, informed sources say, could result in GE becoming a major supplier of low-cost integrated circuits for the mass consumer market.

Under a top priority project, GE Syracuse is reported to be moving

rapidly to set up a production facility that would employ a degree of automation not previously associated with microcircuit manufacture.

The integrated circuits, mostly linear, but also including digital, will reportedly be manufactured using a type of stripline assembly technique, similar to that which GE developed for its line of low power semiconductors, but considerably more complex.

The system is said to involve a conveyor belt approach in which IC substrates are taken through all stages of production with virtually no manual operations required.

The importance of the program, according to market observers, is that GE, with a highly mechanized in-house IC operation, could greatly increase the penetration of such devices in consumer markets.

These include color and monochrome TVs, phonographs, tape players and other entertainment products.

Light air-traffic tower turns strip into airport

A portable air-traffic tower that can convert a remote airstrip, a level stretch of ground or a highway into a relatively high-capacity military airfield in an hour is under test at the RCA Defense Products Div., Burlington, Mass.

The 4000-pound tower (AN/TSW-70), being built for the Air Force, is light enough to be carried by aircraft, ship or truck, yet it contains sophisticated communications and fair-weather (VFR) traffic-control capabilities not found at major jetports.

Only 12 feet long by 7 feet wide by 7.5 feet high, the tower can accommodate three controllers. Its equipment includes four vhf transceivers (116.000 to 149.975 MHz), and five solid-state uhf transceivers (225.000 to 399.995 MHz) to permit the tower to be set up on any one of 1360 vhf and 3500 uhf channels.

The most significant feature of the tower is its antenna, which combines both transmitting and receiving antennas in one vertical mast, in contrast with the usual spacing of these antennas by hun-

dreds of feet. The unique antenna and feed design provides enough isolation so that the tower radios can operate within 2 MHz of each other without cross-talk.

Included in the design is a new solid-state vhf/uhf radio direction finder with an accuracy of one degree. A valuable feature of this set is a digital bearing-display that appears the instant an aircraft calls. The display vanishes in 10 seconds, but it remains stored, to be recalled at the touch of a button. The direction is updated each time a call comes in.

Honeywell takes aim at software, services

The burgeoning software and services business is the target of Honeywell, Inc., Minneapolis, as it announced a new time-sharing system and formed an Information Services Division.

Software services for any computer, in the form of systems analysis, special programs and proprietary packages, will be sold by the new division. The other big computer companies have steered clear of this type of work except for their own equipment. This left the field wide open to many small companies, and to software houses.

Service centers and time-sharing services are also part of the new division. Ten Honeywell Service Centers already exist, and an eleventh will be added in 1970. Honeywell's new H-1648 time-sharing system will be used in seven time-sharing centers to be in operation by the end of 1969.

Use of a multiprocessor approach to the time-sharing system design greatly reduced software problems for the H-1648, according to John Gilson, marketing support manager. A DDP416 handles incoming communications channels, and two DDP556 computers act as a control processor and a job processor.

Honeywell's estimates of expected growth in various services are, in millions of dollars:

	1967	1968	1972
Service centers	\$450	—	\$900
Time-sharing	—	\$110	\$850
Software services	\$300	—	\$750

**MOST
RESISTORS ARE
PRETTY MUCH
ALIKE
IT'S THE NAME
BEHIND THEM
THAT COUNTS**

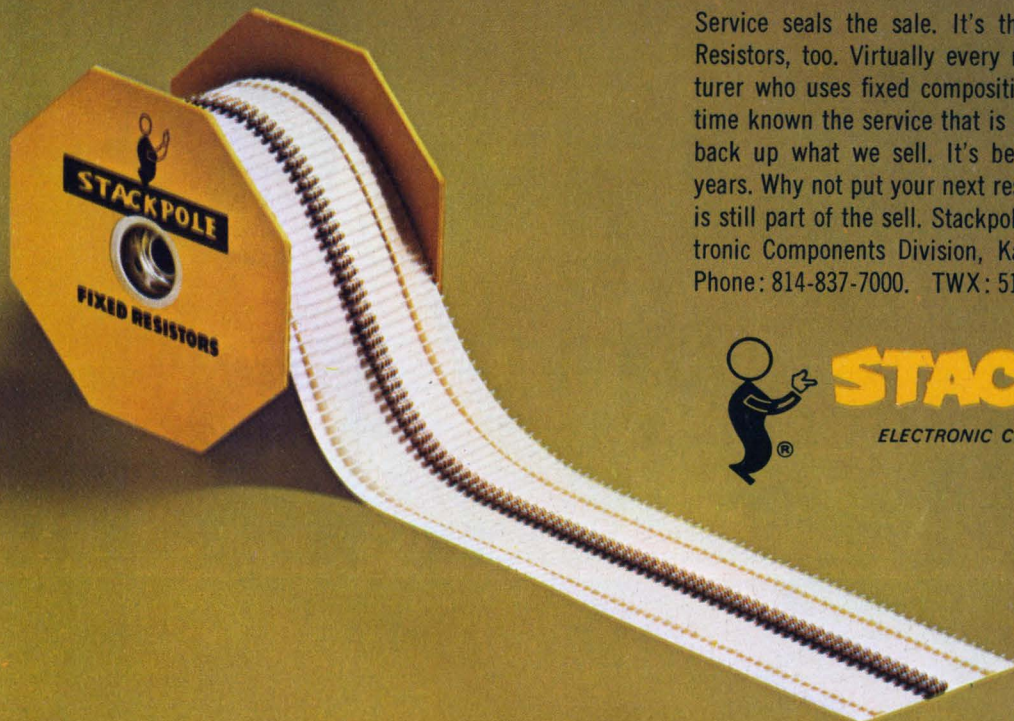

Service seals the sale. It's that way with everything. Resistors, too. Virtually every major domestic manufacturer who uses fixed composition resistors has at some time known the service that is distinctly Stackpole's. We back up what we sell. It's been that way for over 35 years. Why not put your next resistor order where service is still part of the sell. Stackpole Carbon Company, Electronic Components Division, Kane, Pennsylvania 16735. Phone: 814-837-7000. TWX: 510-695-8404.



STACKPOLE

ELECTRONIC COMPONENTS DIVISION

New from Damon...

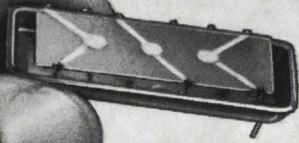

MONOLITHIC CRYSTAL FILTERS

Significantly smaller.
Far more reliable.
Lower in price.

You'll find no maze of capacitors, coils, or multiple soldered joints in the new Damon Monolithic Crystal Filter. Instead, a single crystal substrate with coupled resonators provides far more reliable performance in far less space than conventional multicomponent filters — *and at a significantly lower price.* Failure rate is nearly zero.

Since all resonators are on a single AT-cut quartz plate, you get superior temperature characteristics. And the coldweld enclosure assures improved aging. Damon monolithic filters are available in a variety of computer-assisted designs from Chebyshev to Gaussian characteristics — with minimum delivery time.

Specifications: Center frequency (f_0): 3 MHz to 30 MHz. Bandwidth at -3 dB (B_3): 300 Hz to 30 KHz. Coupled resonators (N): 2 to 8. Insertion loss: 1 to 6 dB (determined by f_0 , B_3 , and N). Termination impedance: 50 ohms to 5 kilohms (determined by f_0 and B_3). Ripple: 0.5 dB max.

For a detailed technical brochure on new Damon Monolithic Crystal Filters, write:
Electronics Division,
Damon Engineering, Inc.,
115 Fourth Ave.,
Needham, Mass. 02194.
Or call (617) 449-0800.

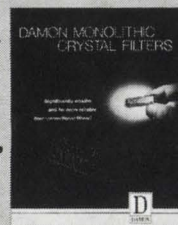

DAMON

Finally: A practical application for holography

Photographic technique, combined with laser, is being applied in nondestructive testing

Jim McDermott
East Coast Editor

Holography—lensless photography that produces three-dimensional images of objects—is emerging as a widely applicable nondestructive test method after more than 20 years in the laboratory.

The new technique combines laser interferometry and holography. The result: holographic interferometry testing.

Here's how it works: A hologram is made of the object to be tested. Then the object's surface is wrinkled, or otherwise distorted, by vibration, heat, strain, pressure, vacuum or some other testing force. The distortions are on the order of microinches—dimensions close to the wavelengths of laser light. Laser beams are then directed at both the distorted object and the hologram of the original object, and the resulting interference patterns—map-like contours of dark and light—are compared visually and interpreted. In such tests, fringe patterns indicate to the trained eye any tiny flaws, stress or movement.

The new method promises an almost unlimited potential for locating defects in materials, components and assemblies heretofore regarded as difficult or impossible to spot.

Predict unlimited applications

Holographic interferometry testing is being used, for example, to check automobile tires for hidden voids or cracks that frequently escape standard X-ray examination. It is under study in aerospace industry as a way of running contour-mapping, deflection-measurement, vibration-analysis, flaw-detection and photo-elasticity checks on objects and materials. Laboratories are finding the method helpful in conducting fracture studies and

optical accuracy tests. It even works under water—as an aid in evaluating sonar transducers under load conditions.

Major companies in the United States—among them, General Electric, Bell Telephone, Hughes Aircraft and TRW—have been exploring holographic interferometry testing in the last couple of years.

One company—G. C. Optronics, Inc., of Ann Arbor, Mich.—is selling a commercial testing unit, now being used by the Uniroyal Tire Co. of Detroit to check passenger-car tires.

How holograms are made

Holograms are made with a laser setup like that shown in Fig. 1a. Laser light is a coherent electromagnetic radiation, just like micro-

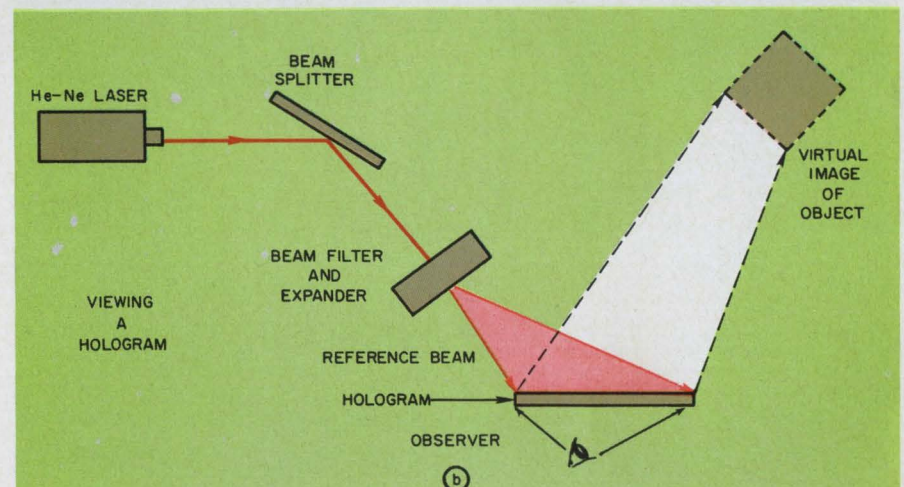
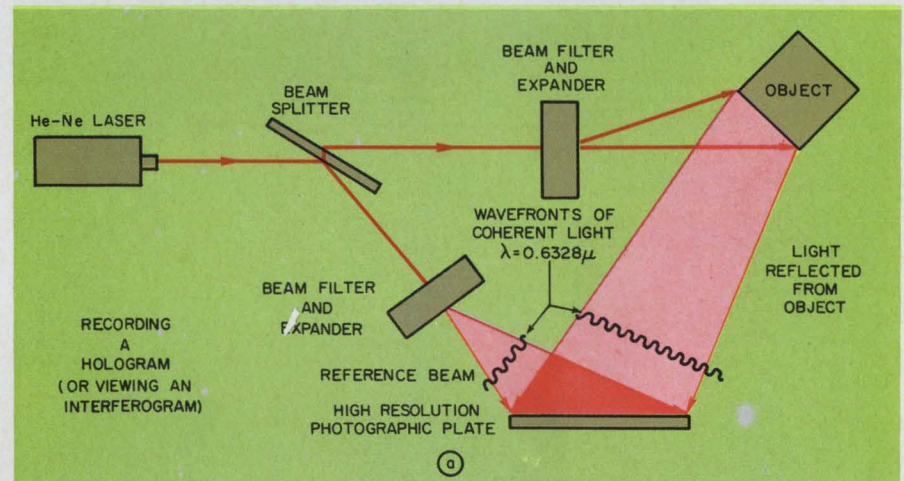

1. Essentials in hologram-making and viewing include a laser for coherent light; a beam splitter for obtaining one beam (the reference) to illuminate the hologram plate and another beam to illuminate the object; expanders to spread the beams; and a stable mount for the hologram plate. The finished hologram is a diffraction grating through which 3-D reconstruction of the object can be seen.

(holography, continued):

waves. If two helium-neon laser beams are mixed on a plane surface, a standing wave pattern is obtained, due to the alternate interference and reinforcement of the wavefronts. Because the wavelength of the laser light is about 25 micro-inches (≈ 0.633 microns) such a pattern can be stored in the emulsion of a high-resolution photographic plate as a complicated series of alternate light and dark areas, separated by 12 microinches or one-half wavelength.

This pattern constitutes a diffraction grating which has the property of bending light that passes through it. As a result, a grating with the proper photo-

graphic pattern can be used to form an image in space. This is just what we have in a hologram.

The hologram plate is sensitized with a high-resolution (3,000 lines per mm) photographic emulsion of the type used by astronomers for spectrographic work. The pattern recorded in the emulsion is a very fine interference pattern that normally is discernible only under a microscope. The developed hologram is, therefore, a diffraction grating, unique to the "picture" taken.

When the hologram is illuminated by the reference beam used in the original exposure, as in Fig. 1b, the observer who looks in the proper direction sees a "reconstructed," three dimensional, image of the object—a replica of the

original in size and at the precise position in space in which the object was, when the hologram was taken.

Because the reconstructed wavefront contains phase information, two or more simultaneously reconstructed wavefronts can be compared. The reconstructed image is thus useful for measuring changes in, or motion of, an object's surfaces.

There are three main types of holographic interferometer testing: real-time, double-exposure, and time-average.

Real-time approach

In the real-time approach, a hologram is made of the object. The object is left unmoved, and the hologram is developed and repositioned precisely so that the virtual image coincides with the real object. No discernible difference is yet apparent.

However, by displacing or distorting the object a few micro-inches, the length of the light path from the object changes and interference occurs between the wavefronts of the image and the object. This produces the interferometric fringe pattern. The fringe contours are superimposed on the object. The distances between fringes can be interpreted to provide a precise measure of object distortion because the light areas represent successive elevation differences of half a wavelength of illuminating laser light (with known exceptions).

Should the object be moved or distorted slightly while under observation, the fringes move. Consequently the observer sees the interferometric motion in real time. The interference effects can be observed directly or photographed with a movie camera.

Real-time interferometry is particularly useful for analyzing any phenomenon that changes with time. While generally applied in the analysis of vibrating objects, such as sonar transducers, loudspeakers or turbine blades, it can also be used to examine air-and gas-flow patterns, as well as changes in the refractive index of a gas, liquid or transparent material caused by temperature or pressure.

The big advantage in vibration studies is that intricate mode pat-

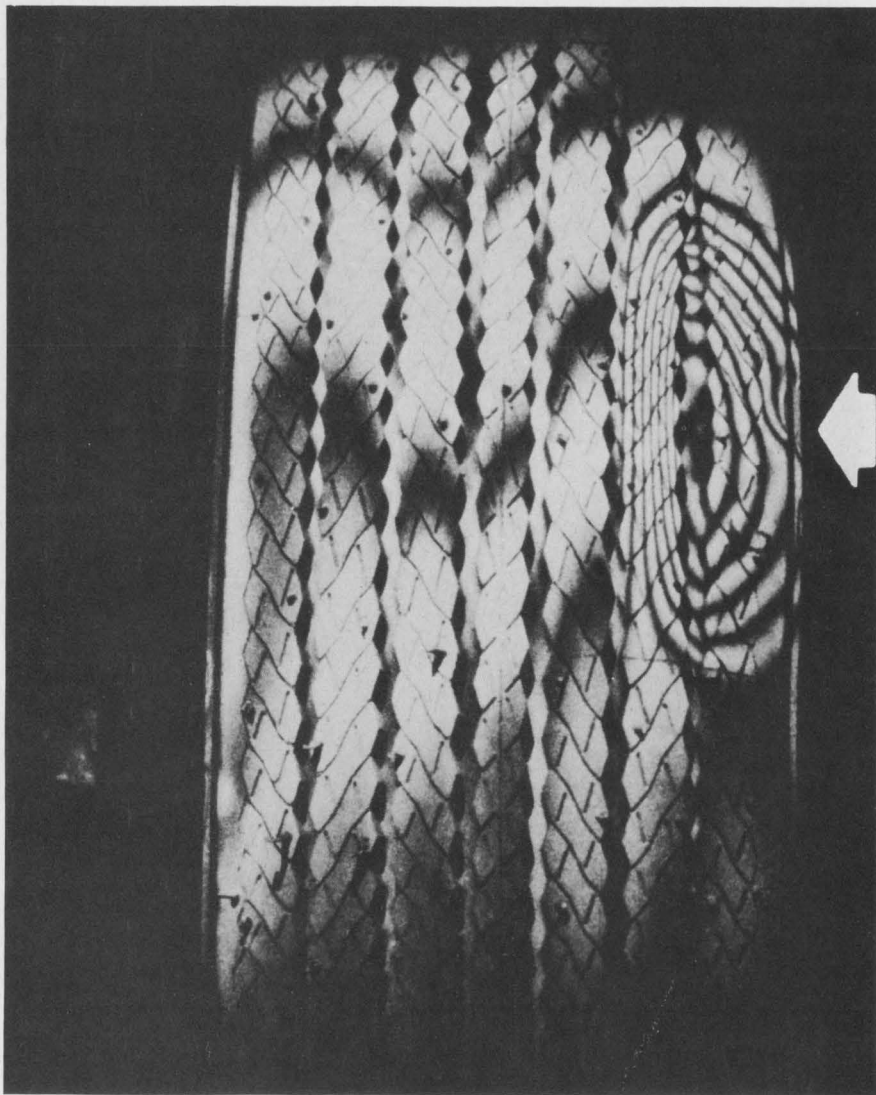

2. A separation at the tread edge of an 8.25 x 14, two-ply tubeless tire is clearly revealed by real-time holographic interferometry unit built by G. C. Optronics. The tire was inflated to 30 psi and stressed by natural tire creep. The separation is between the tread and the outer-ply.

terns are displayed, which permit rapid evaluation of what is happening as the driving frequencies are changed.

A limitation of the real-time approach is the time-consuming effort required to superimpose the holograph image precisely on the object.

Double-exposure approach

Double-exposure holography eliminates the repositioning effort by leaving the hologram plate in its holder and exposing it twice: once, for the undisturbed object and a second time after the object moves or is distorted.

When the double-exposure hologram is illuminated by the reference beam, both images of the object are reconstructed. Where two

reconstructed wavefronts interfere, they produce a related fringe pattern (Fig. 2). One drawback is that a separate double-exposure hologram must be made for each pattern to be viewed. Another effect observed with the double-exposure is a typical shift of the fringes when the observer changes his perspective as he looks through the hologram.

Time-average approach

A time-averaging hologram provides a wealth of information on vibrating surface states, and consequently it is one of the most useful approaches to holographic interferometry testing.

The time-average hologram is exposed for a short period while, say a transducer diaphragm is in

Background

Holography was discovered in 1948 by Dr. Dennis Gabor in the Dept. of Electron Physics at the Imperial College of London. It remained a laboratory curiosity until the fall of 1962. By December of 1963 Dr. Earnest Leith, head of the optics group at the Radar and Optics Laboratory, at the University of Michigan, together with Prof. Juris Upatnicks, had demonstrated the first three-dimensional holograms. In March of 1965 Karl Stetson and Robert Powell, research engineers at the university, developed the first practical application of time-averaging holographic interferometry for vibration studies.



3. **Holographic fringe patterns** of deflection modes on the face of a 10 kHz sonar transducer element that was excited at 88 kHz. Made by the time-averaging method at the GE Electronics Laboratory, the bright areas are

stationary nodes, while the dark areas are surface excursions. The fringe pattern portrays contours of constant vibration amplitudes, each dark area representing successive elevation differences of one-half wavelength.

(holography, continued)

motion. When developed, this provides a contour picture of the standing-wave patterns set up on the vibrating surface. For small displacements, a few fringes appear, whereas for larger displacements, more fringes are present. The nodes appear as the bright spots. By counting the fringes, and evaluating them with respect to the manner in which the surface is vibrating, surface displacement can be accurately calculated (Fig. 3).

Hidden tire flaws revealed

After several months of studying both real-time and double exposure approaches the Uniroyal Tire Co. reports it has been able to program tests that can plainly disclose tire flaws that formerly were concealed.

"X-rays are excellent for examining such things as tire beads," says H. D. Tarpinian, manager of test development and laboratories at Uniroyal, "because of the dif-

ference in transmissibility of steel and rubber. But such things as weakly bonded areas may not be discovered. The holographic interferometry testing method detects these areas."

Dr. Robert H. Snyder, manager of product engineering at Uniroyal who spearheaded adoption of the new technique by buying a basic testing setup from C. G. Optronics, calls it a \$74,000 investment to prove feasibility. At present Uniroyal is concentrating on passenger tires, simply because they're faster to work with in developing a catalog of test patterns.

To make a test, Snyder explains, a tire is inflated, and a hologram is taken immediately. But the tire continues to expand slightly by itself for a few moments, a characteristic of all tires. "If the tire has no defects," Snyder says, "normal expansion is distributed evenly. But any hidden crack, flaw, separation, blister, or deformity is seen as a plainly identifiable concentric contour pattern of light and shadow, even though the defect lies

deep within the tire."

With more experience and as techniques improve, Uniroyal plans to use the method to test more complex, multiply aircraft and construction-machine tires. The company has invested over \$450,000 for research and development on holographic interferometer testing.

The market looks good

At present G. C. Optronics is the sole supplier of such tire analyzer systems here and abroad. The company is headed by Dr. Ralph Grant, a former faculty researcher at the University of Michigan holographic center in Ann Arbor, where major contributions to holography have been made in the last few years.

Holographic interferometry testing is proving to be a real challenge to competitive methods. Dr. Grant says, "The market looks excellent. We're taking over a field which, two years ago, was exclusive to ultrasound, X-rays and crack-penetrant techniques."

The Uniroyal tire-test method is

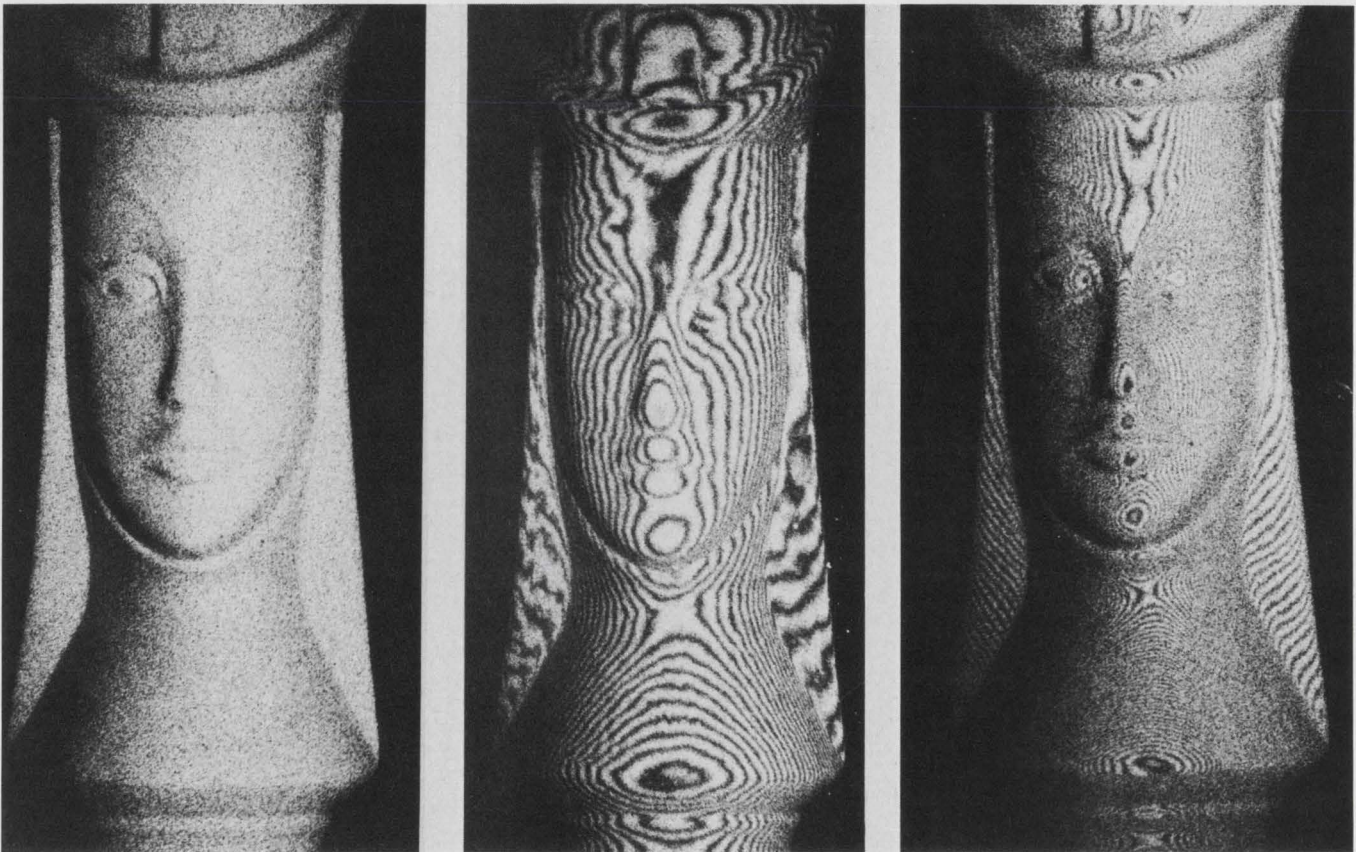

4. Contour mapping, done at Aerojet-General by changing the refractive index of surrounding liquid or gas. At left, the hologram of a chess queen immersed in liquid. At center, the same queen, observed through the first

hologram, when the refractive index was changed by 0.0006. At right, the queen is again observed through the hologram, showing the fringe gradient obtained with an index change of 0.0020.

based on an accidental discovery at G. C. Optronics that came to light during a vibration analysis of a steel plate, which happened to contain a rubber grommet. The grommet seemed sound, but anomalous fringe patterns indicated something was wrong, and further investigation turned up hidden cracks in the rubber.

With evidence that concealed rubber flaws could be detected. Optronics investigated and, in collaboration with R. H. Snyder of Uniroyal, developed the tire test method.

Besides supplying Uniroyal, Optronics has installed holographic test units at Aerojet General Corp., Sacramento, Calif.; the Navy Underwater Sound Laboratories, New London, Conn., and Rohr Corp., Chula Vista, Calif.

Study proves worth

Aerojet-General installed its system early in 1968 "to explore the full potential" of holographic interferometry testing, according to R. G. Sampson, manager of the photo-mechanics laboratory. A 10-month study, completed last December, ran the gamut of applications, including contour mapping, deflection measurement, vibration analysis, flaw detection and photoelasticity and the results have made Sampson enthusiastic about the potential for evaluating the structural behavior of materials.

"The usefulness of holographic interferometry testing in problems of vibration analysis would be difficult to exaggerate," he reports. "The complete description of complex mode shapes obtainable by this technique is unrivaled by any other experimental procedure."

As an example, Sampson points to the study of a small, serrated washer that was causing the turbo-pump in an Aerojet liquid rocket motor to fail when the washer tangs (fingers) broke off and traveled through the lubrication system. Vibration analysis of this small part by ordinary means was virtually impossible, but holographic testing provided the solution. The washer was bonded to a test fixture and subjected to a range of vibrations. At 12,250 Hz the washer tangs vibrated wildly in resonance. This, Sampson ex-

plains, proved to be close enough to the forcing frequency of the turbo pump—12,800 to 13,000 Hz—to cause eventual tang failure. The washer design was changed to shift the tang resonant frequency away from the pump frequencies, and no further failures have occurred.

Vibration analysis of turbine blades and rotors and of aluminum honeycomb plates have also proved valuable at Aerojet. Honeycomb-bond flaws were readily disclosed by applying a transducer to the honeycomb plate and vibrating the panel surface (see Fig. 5).

Cw lasers favored

Some companies that are looking at holographic interferometer testing have designed their own systems. A Spectra Physics 50-milliwatt helium-neon laser, the Model 125, appears to be favored by many.

This basic type of cw laser provides excellent results for the over-

whelming majority of holographic interferometry testing. A primary advantage is its small size and relatively low cost, about \$250.

For example, Rohr Corp. has a specially designed low-power system for scanning a large honeycomb panel for bond-flaw detection. GE's plant in Syracuse, N.Y., has a helium-neon setup that is being used in component vibration and heat-stress studies. The Navy Underwater Sound Laboratory and the Navy Electronics Laboratory are using gas lasers for transducer tests. Bell Laboratories at Whippany, N.J., has a comparable system for material fracture studies and other laboratory investigations.

Dr. Jose Pastor, supervisor of the Optical Physics Group, Perkin-Elmer Corp., Norwalk, Conn., recently told ELECTRONIC DESIGN of optical tests using low-power gas lasers.

"Our interest," he said, "is centered in utilizing hologram interferometry for testing of aspheric



5. Clear indications of subsurface bonding flaws and voids in honeycomb panels can be seen by these fringe-pattern anomalies. At Aerojet General, the aluminum honeycomb surface was vibrated by the round transducer (in clamps). Flaws appear at 11,700 Hz, and stand out in marked contrast at 17,200 Hz.

(holography, continued)

[optical] surfaces that cannot be tested otherwise with interferometric accuracy. Aspheric surfaces are of extreme importance in generating optical systems for space and other applications. With holography, not only any surface deformation produced by polishing or other causes can be detected or compared, but different optical pieces can be compared with each other. Further, aspheric surfaces identical to a master can be gener-

ated by hologram interferometry."

Considerable work in transducer testing has been done at the GE laboratory and at two Navy installations: the Underwater Sound Laboratory in New London and the Naval Electronics Laboratory in San Diego.

Holographic interferometry testing is particularly useful for underwater sound work, because the holograms can be made through clear water as well as air. This permits evaluating the transducer under load, in its normal environment.

For certain types of investigations, primarily gas-flow and shock-wave visualization for wind-tunnel models, high-power pulsed lasers are a must for holographic interferograms of such phenomena. At the Hughes Research Laboratory, Malibu, Calif., Alexander Jacobson heads a company pulse holography program that uses a giant pulse laser.

Jacobson declines to give details of the work at present, but if the expected results materialize, he told ELECTRONIC DESIGN, "it will have a major effect on the instrumen-

Holographic interferometer setup

Coherent light is provided by a Spectra-Physics 125 laser (1). The laser beam is reflected from the mirror (2) onto the first beam-splitter (3), which divides the beam into two parts: a reference beam that is reflected and an object beam that is transmitted through the beam-splitter.

The diverted reference beam passes first through a neutral density wedge (4), which adjusts the relative intensities

of the reference and object beams on the holographic plate. The reference beam now passes onto a mirror (5) on the optical rail, the movement of which permits the reference beam to be adjusted to exactly the same length as the object beam. From the mirror, the reference beam is reflected back onto another mirror (6), which reflects the beam to the reference spatial filter (7). The spatial filter consists of a microscope-objective

lens, which spreads the beam, and a pinhole, which passes only the center-most portion of the beam, thereby eliminating the incoherent light that is invariably present. From the pinhole, a spreading beam passes through the collimating lens (8), which keeps the edges of the beam parallel and produces a one-inch spot on the hologram plate (10), after being reflected from the large mirror (9).

The object beam, upon leaving mirror (3) passes through its own spatial filter (11) and then goes on to a large beamsplitter (12) which divides the beam into reflected and transmitted beams. The transmitted beam simply goes off into space. But the reflected beam illuminates the transducer head (13) with light which is then reflected from the head (13), back through beamsplitter (12), and onto the hologram plate (10), where a portion of it is superimposed on the reference-beam spot. This spot acts as a type of mask. Now, because the plate-holder (14) has a three-position indexing mount, the plate can be inverted after three exposures are made. Thus, a total of six holograms can be made on the same plate. However, with other setups the reference and object beams are expanded to cover the full hologram plate area for a single picture.

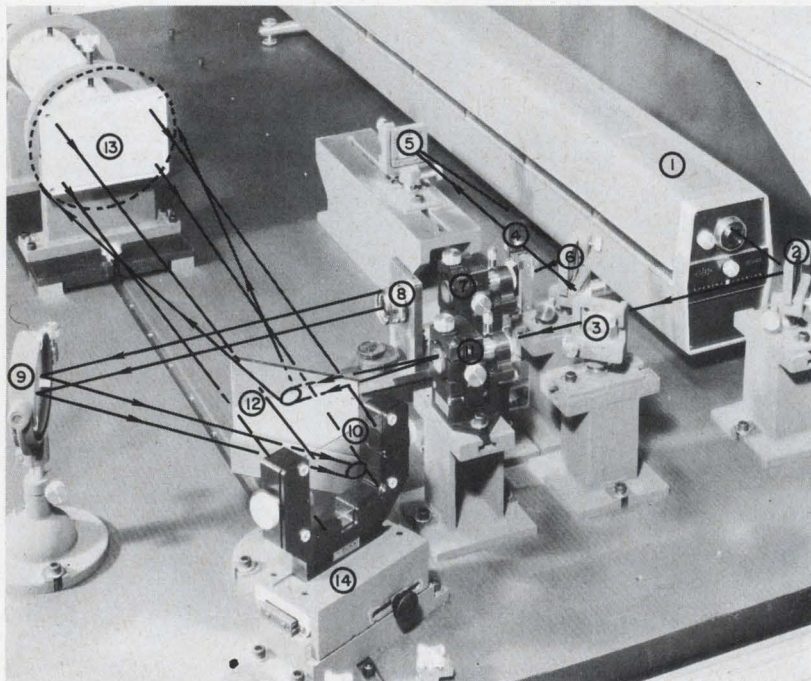

The representative holographic interferometry testing setup, shown here, is made by Optronics, for vibration analysis of rectangular sonar transducers.

tation of wind tunnels."

At the Boeing Aerospace Systems Div., Kent, Washington, Dr. Russell Hanks says that the division has been "investigating the validity and usefulness of both cw and pulsed laser systems for two years." The unit is being used in surface studies, honeycomb bond detection, crack detection and vibration analysis.

"For pulsed lasers," he says, "we're looking at the diagnostics of noise processes in sonic and supersonic flows, by analyzing the density of turbulent flows. The ultimate aim is, of course, reduction of in-flight noise."

Analyzes turbine blades

At the United Aircraft Research Laboratories in East Hartford, Conn., a spokesman confirms that cw lasers have been used in investigations there for three years and pulsed lasers for the last year. The principal application of cw has been in pressure testing and the vibration analysis of turbine blades for stress.

The spokesman also discloses that these studies have produced a special method of mounting ferroelectric transducers at turbine blade roots, permitting them to drive the blades in either flexure or torsion. And based on an original proposal, United Aircraft is attempting to get a contract from the Naval Air Systems Command for holographic stress and strain analysis.

For pulsed laser tests, the laboratory has developed a special, single-mode, bleachable dye laser with a 20-nanosecond pulse duration and 1.5-meter coherence length. It permits observations at about a 3-meter depth of field. The application is to wind-tunnel and high-speed air flow work.

Dr. Lee Heffliner of the TRW Physical Research Laboratories, Redondo Beach, Calif., says that the potential of holographic interferometry testing for TRW was discovered accidentally when pulse-laser holograms were made of bullets in flight. Fringes appeared.

"We found out the laser had accidentally pulsed twice, instead of once," he told ELECTRONIC DESIGN.

TRW is using its own lasers with a typical 50-to-100-nanosecond pulse length to examine air and

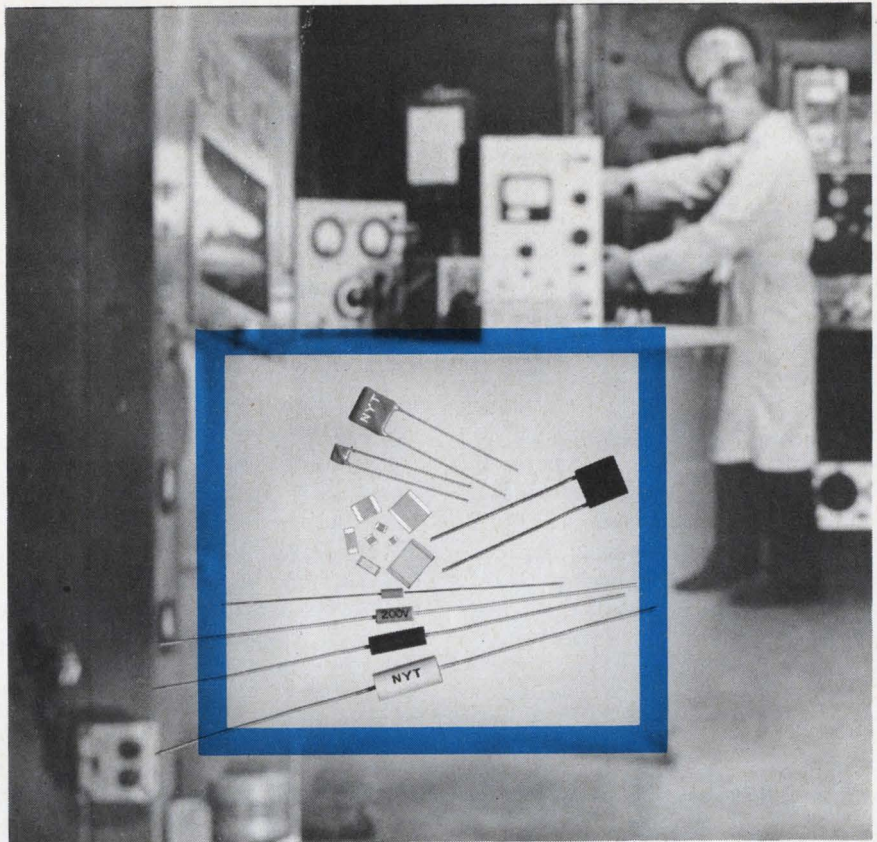

NYT-CAP

The better Ceramic Capacitor that Nytronics R&D built

Nytronics NYT-CAP ceramic capacitors are different. They had to be, because we wanted to make them better. That's why we did not use the same old standard formula. Our R&D people developed our own new formula and methods for a better capacitor—and in the process they eliminated failure modes others don't even know exist.

NYT-CAPS are the most perfect capacitors, designed to meet applicable requirements of MIL-C-11015, 39014 and MIL-C-20. Outstanding K1200 and NPO characteristics, superior humidity resistance, highest insulation resistance, low dissipation factor.

NYT-CHIPS: Uncased for hybrid microcircuit applications. Series of 9 sizes with capacitance up to 1 micro-farad in K-1200 (Type B) dielectric. NPO also available.

DECI-CAPS: 4.7pf. to 27,000pf. in 46 off-the-shelf values. Standard molded axial lead size of .100 inch diameter x .250 inch length for high density cordwood packaging.

MILI-CAPS: Natural outgrowth of Deci-Cap molded series. 10pf. to 3.3ufd. in the 5 molded axial lead sizes of Mil-C-11015 D/20B. Highest

electrical and environmental performance over the entire capacitance range.

HK-CAPS: Newly expanded radial lead, high-gloss, epoxy conformal coated line offers higher capacitance density than equivalent molded case units, with no sacrifice in performance. Capacitance range of 4.7pf. to 2.5ufd. in K-1200. Also available in NPO dielectric.

NK 05/06: Encapsulated radial lead Nyt-Cap with 0.200 inch lead spacing for all values is ideal for printed circuit and other automatic insertion applications.

Write today for complete engineering data.



NYTRONICS®

Essex Electronics Division

550 Springfield Ave., Berkeley Heights, N.J. 07922 ■ (201) 464-9300 ■ TWX: 710-984-7977

INFORMATION RETRIEVAL NUMBER 21

shock-wave flow at the laboratory's range for hypervelocity studies.

System limitations

Amid all the promise for holographic interferometry testing, however, the fact that object displacements on the order of micro-inches can be readily observed poses a difficulty in making the holograms. For example, any vibration, shift or thermal expansion of the object, the photographic plate, or any of the optical components of the testing unit shows up in the hologram as a fringe pattern. These unwanted patterns are superimposed on the reconstructed image as "noise."

Vibration in buildings is a principal source of ambient disturbances that can produce spurious fringes. For practical reasons, few testing setups can be placed in super-quiet sites—such as those used for earthquake studies, say. For this reason, the optical systems frequently are mounted on heavy, granite or metal slabs that are floated on some sort of air platform.

At the Naval Electronics Laboratory in San Diego, for instance, a two-ton granite slab is used, supported by eight inflated scooter innertubes. In addition, to eliminate thermal room gradients and to allow all air currents to subside, five minutes is generally allowed before the shutter in front of the hologram plate is tripped remotely, from an adjoining room.

Interpretation of the patterns in holographic interferometry testing can also be troublesome because what is recorded is a net change of optical path length rather than physical displacement of the object.

William E. Penn, manager of optical processing at GE's Electronics Laboratory, has devoted considerable study to the problem.

"Fringe interpretation," he says, "is in the state where the theory is understood completely. But complexities are such that a well-qualified user finds it difficult to take the theory and apply it directly to a real case.

"However, in 95 per cent of the cases looked at, the worker has had enough *a priori* knowledge so that he can make a reasonably close evaluation without resorting to the theoretical analysis." ■■

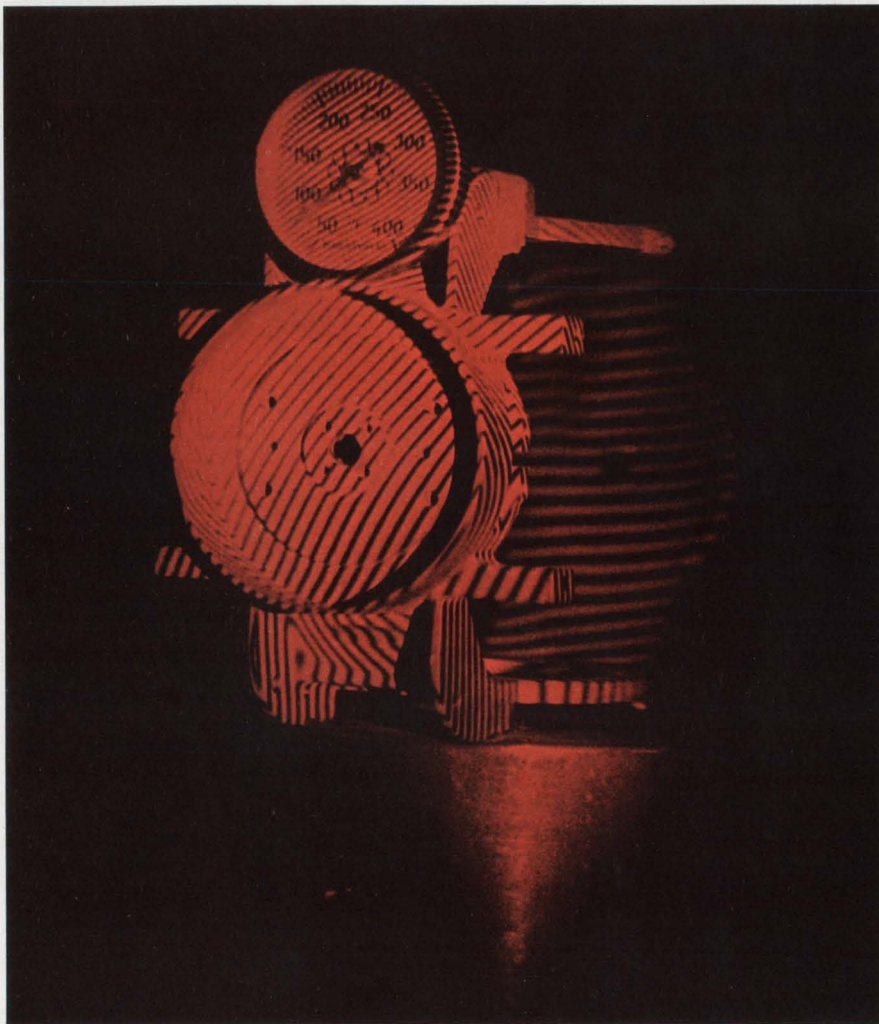

6. Expansion of gyro gimbal from increase in temperature is disclosed by holographic interferometry. This photo was made by the double-exposure method. A hologram plate was exposed with the gimbal at room temperature, then re-exposed after a temperature increase of 5 degrees F.



7. Holographic tests of metal toughness conducted by T. D. Dudderar of Bell Telephone Laboratories, show 12 microinch strain contours.

Integrated Circuit **IDEAS** FROM SYLVANIA

Oakland Athletics score with Sylvania MSI.

Million-dollar scoreboards driven by over 7,000 medium-scale integrated circuits.

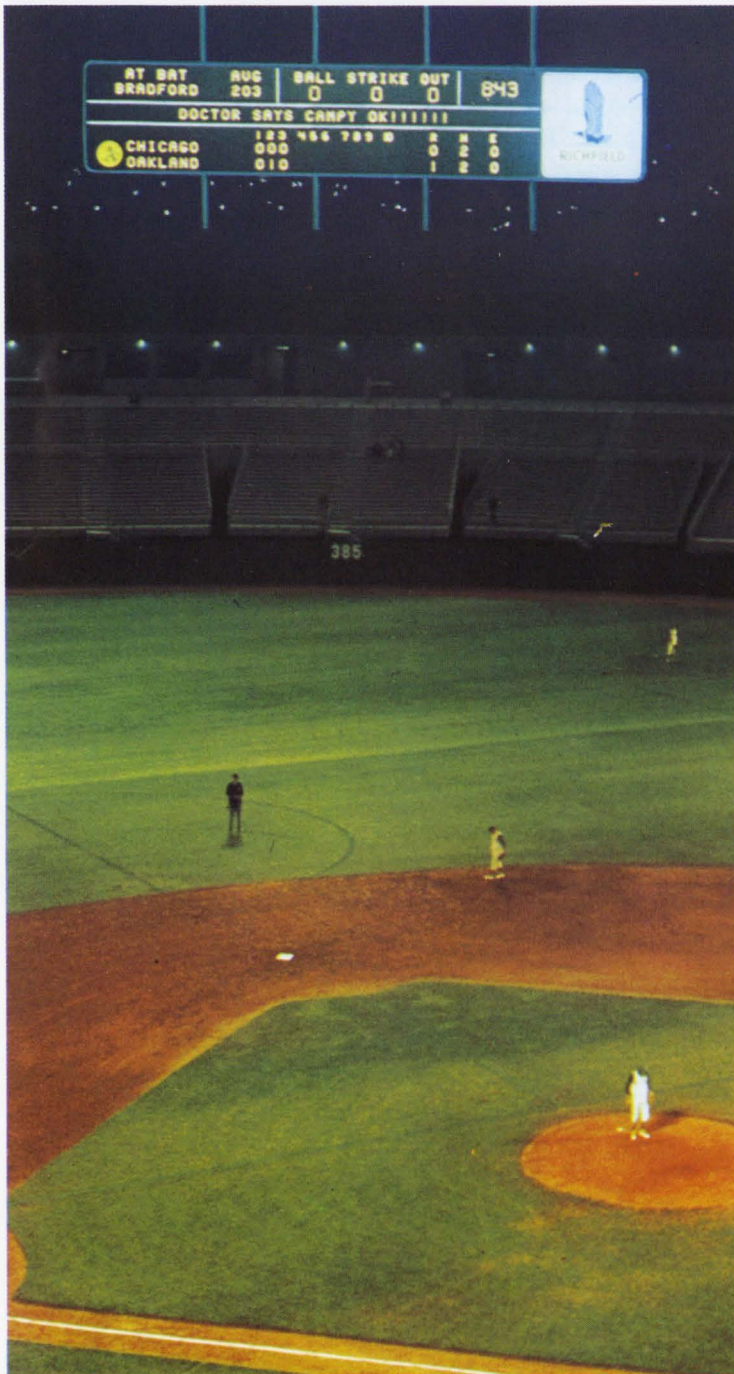

Scoreboards at Oakland Athletics' new stadium are under the control of 7,000 Sylvania integrated circuits.

When California sports fans get the score at the Oakland Athletics' new ballpark in Alameda County Coliseum, they'll be watching 7,000 Sylvania SM-70 4-bit storage registers at work. These medium-scale integrated circuits play an important role in controlling two separate scoreboards that give up-to-the-minute player and team statistics as the game progresses.

Sylvania's SM-70s are the information storage elements for the complex system. The entire scoreboard complex is under the control of an IBM 1130 computer. The output of the computer drives the SM-70s which in turn control triacs which turn the proper lamps on and off.

There were several reasons for selecting the SM-70 for this important function. One was its storage capability. Triacs, when used in an AC system, do not have the ability to store information. Thus, flip-flops or gated latch circuits were required to drive the triacs. There was also a problem of environment. The devices used had to operate as a free ambient temperature as high as 100°F, with minimum protection from high humidity and other extremes of the elements. Sylvania's hermetically sealed package solved these problems.

Another important problem lay in the drive requirements. The SM-70s had to be capable of driving anywhere from 30 to 80 feet of unshielded line having a common ground return. This required a circuit that would not be affected by noise, crosstalk, ringing or reflections. The SM-70s high noise immunity and buffered high-level output solved the problem.

Before using the SM-70s in the scoreboard the manufacturer, Datex Division of Conrac Corp., put them through a grinding test to assure their reliability. A hundred SM-70s were put under an accelerated testing program with a high power supply voltage of 6 to 6.5 volts. In the 17,000 device hours accumulated, not a single failure occurred.

It's this sort of reliability and dependability that makes Sylvania's SUHL logic system so popular for a wide variety of applications, both military and industrial.

CIRCLE NUMBER 300

This issue in capsule

IC Applications

Single-chip shift register replaces eight cans.

IC Types

The growing SUHL integrated circuit line keeps on growing.

MSI Applications

Scratchpad memory gives high-speed access.

Manager's Corner

The most often asked questions about SUHL logic.

Hybrid Circuits

High-speed clock driver matches SUHL integrated circuit speed.

Single-chip shift register replaces eight cans.

High speed and low power consumption make the SM-110 an ideal replacement for a whole set of integrated circuits.

We've packed a lot of function and a lot of flexibility into our new SM-110 4-bit shift register. It can be used for parallel and serial storage and data shifting in any type of digital system. In addition, it can be used for parallel-to-serial or serial-to-parallel conversion, storage, delay and shifting operations, and can be used as a system building block to perform key arithmetic operations such as multiplication and division.

The result is a truly universal logic element that can simplify the design of digital systems. Each SM-110 contains the equivalent of eight conventional SUHL packages. These include: two dual J-K flip-flops, two dual AND-NOR gates, one quad inverter, one dual inverter, and one AND-OR gate.

In addition to replacing eight devices, the SM-110 requires lower power (160 mW), substantially less board wiring, less board space and less clock loading than individual packages, and shift frequency can be as high as 20 MHz.

The SM-110 is designed for serial shift right. All four outputs have SUHL integrated circuit drive and logic capability. In addition, there is a mode control line which will permit parallel entry into all four bits. This data can then be shifted serially upon command. By simple wiring at the package terminals, the SM-110 can be converted to a shift register that can shift left.

As you can see from Fig. 1, each flip-flop in the SM-110 has an inverter between the J and K inputs. This means that you don't need the complement of the data. Only the data itself is required. This single data input has an AND-OR structure which permits feeding in the output of a preceding flip-flop or data from external terminals, depending on the state of the mode control. The external data terminals can be used for parallel transfer into the four bits or they can be connected to the outputs of following flip-flop to permit shifting left.

The SM-110 can perform a shift right and parallel storage operation or a shift left and a shift right, depending on the state of the mode control. However, it can't perform a shift left and store operation in conjunction with each other.

A typical application of the SM-110 as a parallel-to-serial converter is shown in Fig. 2. Here, the register is initially loaded through the parallel inputs by supplying a start pulse during the first clock period.

The start pulse raises the mode control to a high level, allowing the data on the parallel inputs to be entered into the register. By grounding the D_{p1} input in the first register, a "0" bit is placed in this position which will follow the last bit in the word being shifted. The "0" bit is followed by all "1" bits since the D_s input is maintained at the "1" level while the data is being shifted. After six pulses, all inputs of the decoder gate will be high. This raises the mode control input to a "1" level and allows new data to be transferred into the register on the following clock pulse while the last bit is being shifted out.

The SM-110 can also be used to perform the reverse operation, serial-to-parallel conversion. This is shown in Fig. 3. The initial loading of the register is accomplished by supplying a start pulse during the first clock period. This preconditions the register with a single "1" bit at B_2 and "0" bits at B_3 through B_7 . The serial data is fed into the D_s and D_{p1} inputs of the first stage during the same clock pulse. Six clock pulses later the first data bit will appear at output B_7 . The "1" bit that was set into the second stage during the first clock pulse is now at the output of the last stage.

The last stage is not used for data conversion since it is used to produce an output signal when all preceding stages of the register are filled with data bits.

This signal automatically preconditions the register again on the next clock pulse and can also be used as a control signal for parallel transfer.

By adding a two-input NAND gate, as shown in Fig. 3, the signal bit can be ANDed with an external control pulse to store the information in the register until the control pulse is removed.

CIRCLE NUMBER 301

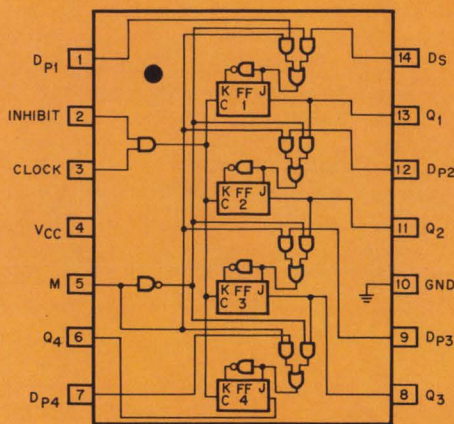

Fig. 1. Logic diagram of SM-110 4-bit shift register.

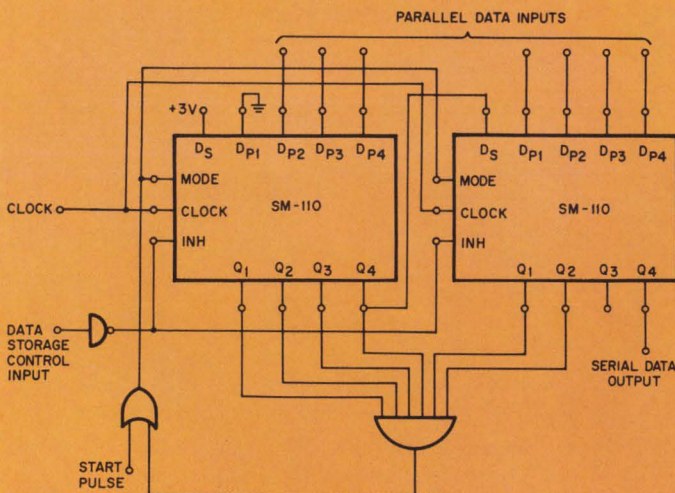
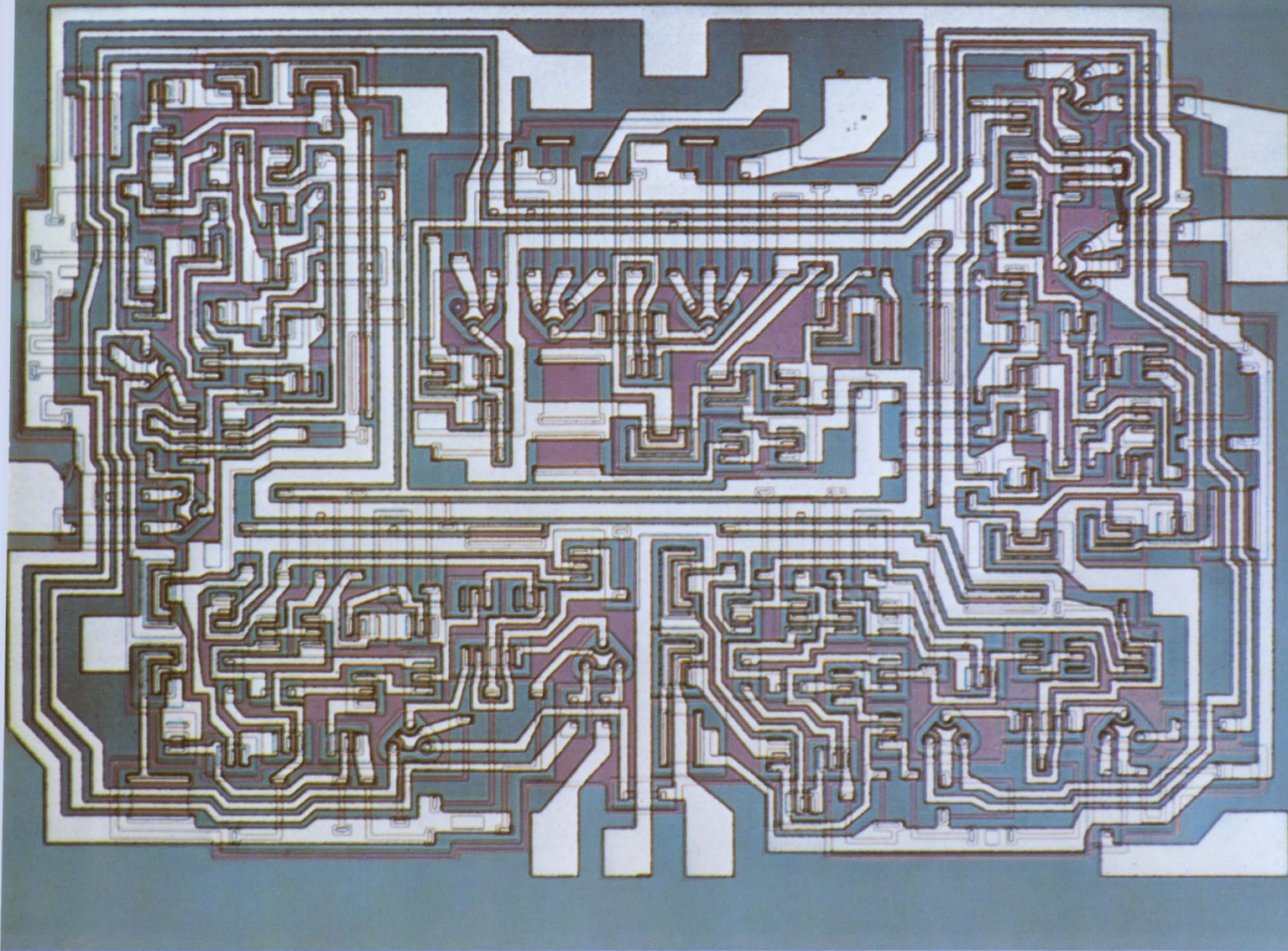

Fig. 2. Application of SM-110 as a 7-bit parallel-to-serial converter.



SM-110 four-bit shift register.

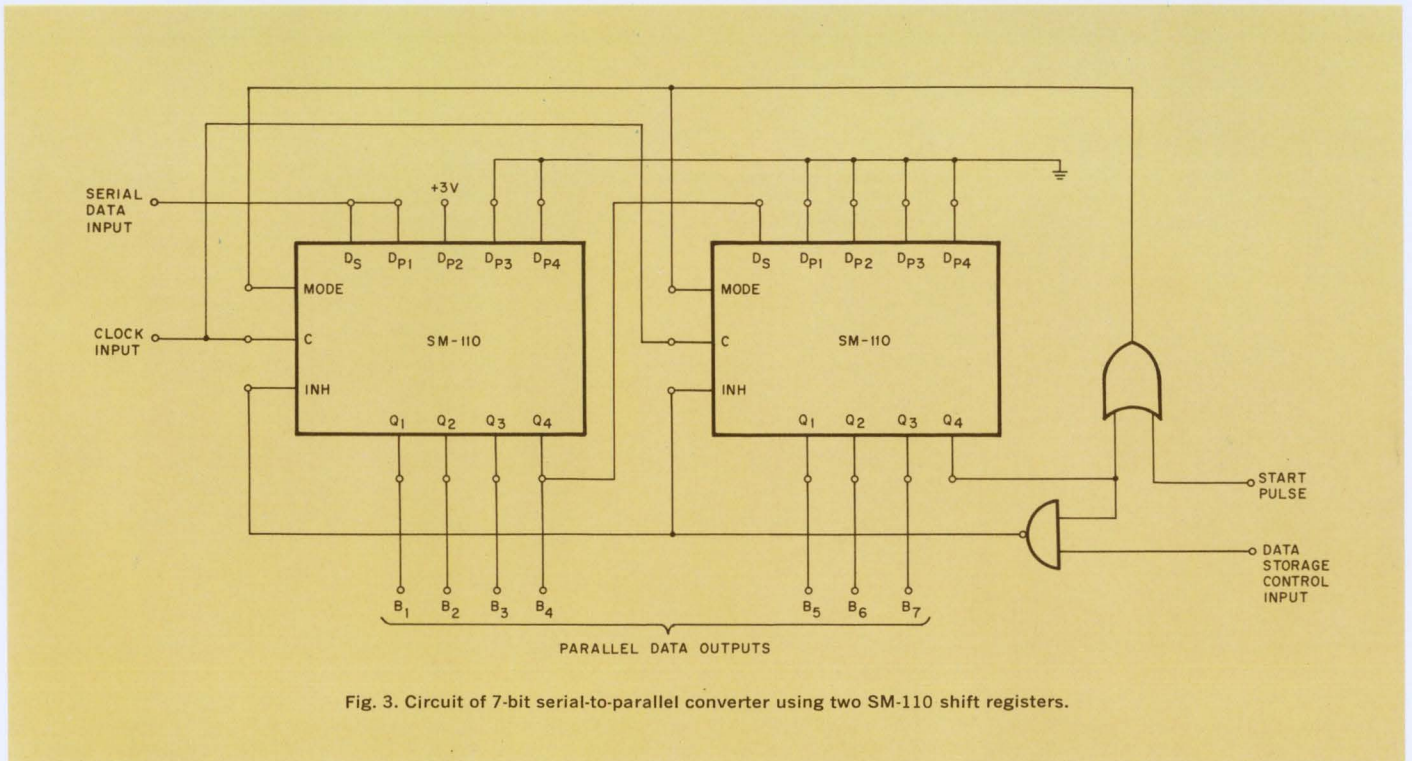
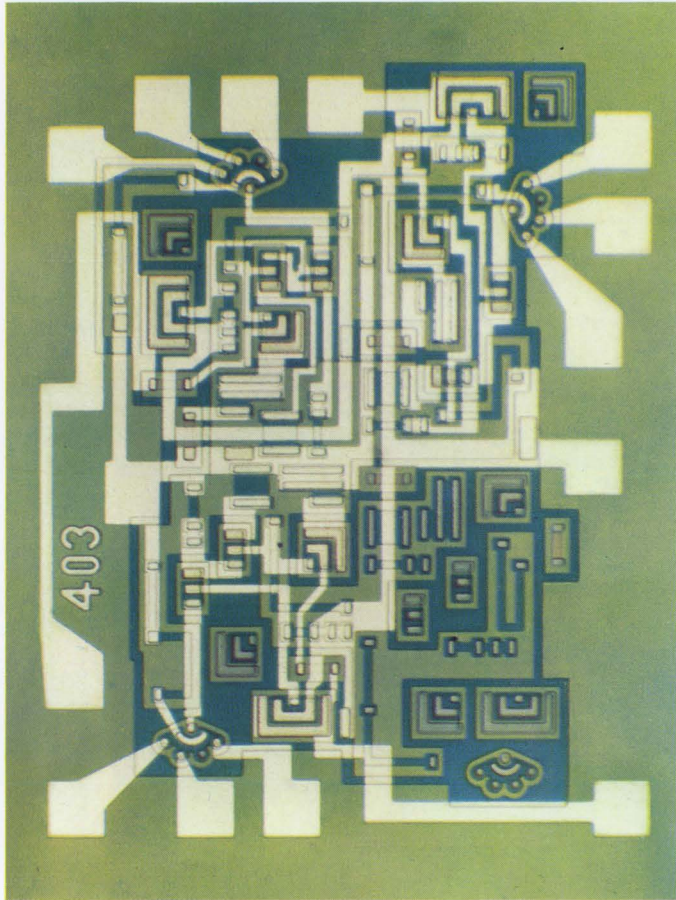

Fig. 3. Circuit of 7-bit serial-to-parallel converter using two SM-110 shift registers.

The growing SUHL line keeps on growing.

New additions to chart include a delay flip-flop and a triple 3-input NAND/NOR gate.



Logic Layout of SF-80, SF-90 dual "D" flip-flop.

Sylvania continues to add to the most complete TTL line in the industry. Two new circuits, making their appearance on the chart for the first time, are the SF-80 dual "D" flip-flop and the SG-320 series triple 3-input NAND/NOR gate.

The SF-80 flip-flop is ideally suited to the design of simple storage registers with minimum input requirements. Only a single input line is required, eliminating the need for complementary inputs. Another feature of this flip-flop is the inclusion of a clamp diode on the input line. This provides damping action to prevent ringing and allows higher system operating speeds.

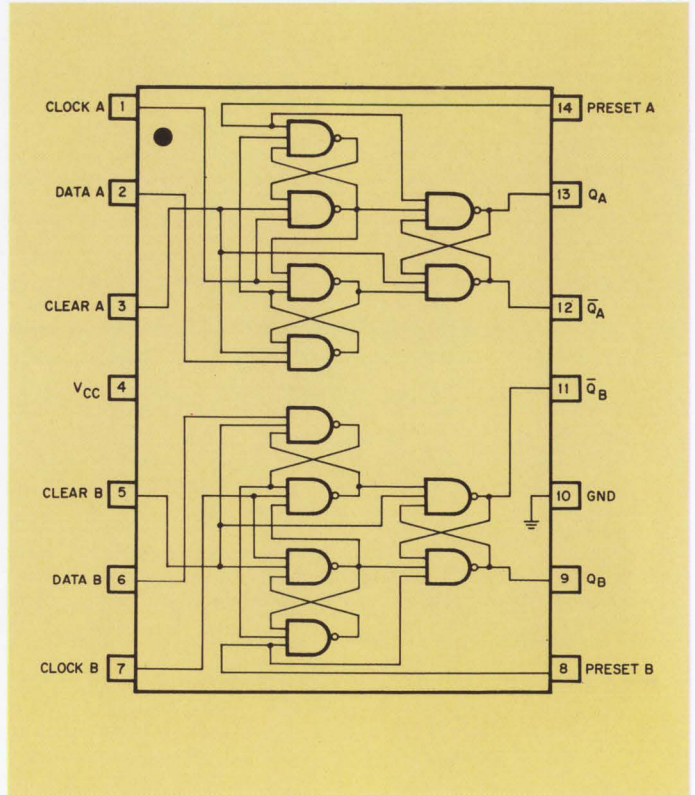

Circuit arrangement of SG-320 triple 3-input NAND/NOR gate.

Digital Functional Arrays

FUNCTIONAL ARRAYS, TYPICAL CHARACTERISTICS (+25°C, +5.0 Volts)						
Function	Type Nos.	t_{pd} (nsec)	Avg. Power (mw)	Noise Immunity +(Volts)-	Fanout	
Full Adder	SM10 Series	Sum 22 Carry 10	90	1.0 1.0		These arrays are available in fanouts up to 15 and are completely compatible with SUHL I and SUHL II integrated circuits.
Dependent Carry Fast Adder	SM20 Series	Sum 22 Carry 10	125	1.0 1.0		
Independent Carry Fast Adder	SM30 Series	Sum 22 Carry 10	125	1.0 1.0		
Carry Decoder	SM40 Series	2	25	1.0 1.0		
4-Bit Storage Register	SM60 Series	20	30/bit	1.0 1.0		
Bus Transfer Output 4-Bit Storage Register	SM70 Series	20	30/bit	1.0 1.0		
Cascade Pullup Output 16-Bit Scratch Pad Memory	SM80 Series	25	250	1.0 1.0		
Decade Frequency Divider	SM90/92 Series SM91/93 Series	35MHz 30MHz	125 85	1.0 1.0		
4-Bit Shift Register	SM110 Series	25MHz	120	1.0 1.0		
Parity Generator/Checker	SM120 Series	22	125	1.0 1.0		
Comparator	SM130 Series	17	120	1.0 1.0		
Programmable Binary Divider	SM140 Series	25MHz	150	1.0 1.0		
Programmable Decade Divider	SM150 Series	25MHz	150	1.0 1.0		
Binary Counter	SM160 Series	25MHz	135	1.0 1.0		
Decade Counter	SM170 Series	25MHz	135	1.0 1.0		
Binary Up/Down Counter	SM180 Series	25MHz	205	1.0 1.0		
Decade Up/Down Counter	SM190 Series	25MHz	205	1.0 1.0		
BCD to 7-Segment Translator	SM200 Series	85	280	1.0 1.0		
Dual 4-Bit Multiplexer	SM210 Series	10-20	130	1.0 1.0		
Demultiplexer	SM220 Series	9-14	225	1.0 1.0		

The SF-80 operates at 20 MHz. And coming soon is the SF-90 which will run at a 30 MHz rate. Both devices are single-chip monolithic silicon units.

The SG-320 triple 3-input NAND/NOR gate is the SUHL II version of our popular SG-190 SUHL I gate. That means you get high-speed operation—6 ns propagation delay is typical—along with the usual advantages of SUHL circuitry. And power consumption is low, too—typically 22 mW per gate.

The SG-320 contains three 3-input AND gates each followed by an inverting amplifier and a cascade pull-up output

network. Each gate operates as a NAND element in positive logic or a NOR element in negative logic.

Both of these new circuits are completely compatible with the entire SUHL logic line and they share all of the benefits inherent in the SUHL design. These include: high noise immunity, high logic swings and operation from a single 5-volt power supply. Both devices are available in either 14-lead flat packs or dual in-line plug-in ceramic packages.

CIRCLE NUMBER 302

SUHL Integrated Circuits

SUHL I TYPICAL CHARACTERISTICS (+25°C, +5.0 Volts)										
Function	Type Nos.	t _{pd} (nsec)	Avg. Power (mw)	Noise Immunity +(volts)-		**Military (-55°C to +125°C) Prime FO Std. FO		**Industrial (0°C to +75°C) Prime FO Std. FO		
NAND/NOR Gates										
Dual 4-Input NAND/NOR Gate	SG-40, SG-41, SG-42, SG-43	10	15	1.1	1.5	15	7	12	6	
Single 8-Input NAND/NOR Gate	SG-60, SG-61, SG-62, SG-63	12	15	1.1	1.5	15	7	12	6	
Expandable Single 8-Input NAND/NOR Gate	SG-120, SG-121, SG-122, SG-123	18	15	1.1	1.5	15	7	12	6	
Dual 4-Input Line Driver	SG-130, SG-131, SG-132, SG-133	25	30	1.1	1.5	30	15	24	12	
Quad 2-Input NAND/NOR Gate	SG-140, SG-141, SG-142, SG-143	10	15	1.1	1.5	15	7	12	6	
Triple 2-Input Bus Driver	SG-160, SG-161, SG-162, SG-163	15	15	1.1	1.5	15	7	12	6	
Triple 3-Input NAND/NOR Gate	SG-190, SG-191, SG-192, SG-193	10	15	1.1	1.5	15	7	12	6	
AND-NOR Gates										
Expandable Quad 2-Input OR Gate	SG-50, SG-51, SG-52, SG-53	12	30	1.1	1.5	15	7	12	6	
Expandable Dual Output, Dual 2-Input OR Gate	SG-70, SG-71, SG-72, SG-73	12	20/gate	1.1	1.5	15	7	12	6	
Exclusive-OR with Complement	SG-90, SG-91, SG-92, SG-93	11	35	1.1	1.5	15	7	12	6	
Expandable Triple 3-Input OR Gate	SG-100, SG-101, SG-102, SG-103	12	25	1.1	1.5	15	7	12	6	
Expandable Dual 4-Input OR Gate	SG-110, SG-111, SG-112, SG-113	12	20	1.1	1.5	15	7	12	6	
Non-Inverting Gates										
Dual Pulse Shaper/Delay-AND Gate	SG-80, SG-81, SG-82, SG-83	11	30/gate	1.1	1.5	15	7	12	6	
Dual 4-Input AND/OR Gate	SG-280, SG-281, SG-282, SG-283	11	38/gate	1.0	1.5	10	5	8	4	
AND Expanders										
Dual 4-Input AND Expander	SG-180, SG-181, SG-182, SG-183	< 1	0.9/gate	1.1	1.5					
OR Expanders										
Quad 2-Input OR Expander	SG-150, SG-151, SG-152, SG-153	4	20	1.1	1.5					
Dual 4-Input OR Expander	SG-170, SG-171, SG-172, SG-173	3	5	1.1	1.5					
Flip-Flops										
Single Phase SRT Flip-Flop	SF-30, SF-31, SF-32, SF-33	15MHz*	30	1.1	1.5	15	7	12	6	
J-K Flip-Flop (AND Inputs)	SF-50, SF-51, SF-52, SF-53	20MHz*	50	1.1	1.5	15	7	12	6	
J-K Flip-Flops (OR Inputs)	SF-60, SF-61, SF-62, SF-63	20MHz*	55	1.1	1.5	15	7	12	6	
Dual D Flip-Flop	SF-80, SF-81, SF-82, SF-83	20MHz*	48	1.0	1.5		10		10	
Dual 35MHz Flip-Flop (Separate Clock)	SF-100, SF-101, SF-102, SF-103	35MHz*	55/FF	1.0	1.5	11	6	9	5	
Dual 35MHz J-K Flip-Flop (Common Clock)	SF-110, SF-111, SF-112, SF-113	35MHz*	55/FF	1.0	1.5	11	6	9	5	
Lamp Driver										
Quad 2-Input Lamp Driver	SG-350 series	10	37	1.0	1.5	22	12	18	10	
SUHL II TYPICAL CHARACTERISTICS (+25°C, +5.0 Volts)										
NAND/NOR Gates										
Expandable Single 8-Input NAND/NOR Gate	SG-200, SG-201, SG-202, SG-203	8	22	1.0	1.5	11	6	9	5	
Quad 2-Input NAND/NOR Gate	SG-220, SG-221, SG-222, SG-223	6	22	1.0	1.5	11	6	9	5	
Dual 4-Input NAND/NOR Gate	SG-240, SG-241, SG-242, SG-243	6	22	1.0	1.5	11	6	9	5	
Single 8-Input NAND/NOR Gate	SG-260, SG-261, SG-262, SG-263	8	22	1.0	1.5	11	6	9	5	
Triple 3-Input NAND/NOR Gate	SG-320, SG-321, SG-322, SG-323	6	22	1.0	1.5	11	6	9	5	
AND-NOR Gates										
Expandable Dual 4-Input OR Gate	SG-210, SG-211, SG-212, SG-213	7	30	1.0	1.5	11	6	9	5	
Expandable Quad 2-Input OR Gate	SG-250, SG-251, SG-252, SG-253	7.5	43	1.0	1.5	11	6	9	5	
Expandable Triple 3-Input OR Gate	SG-300, SG-301, SG-302, SG-303	7	36	1.0	1.5	11	6	9	5	
Expandable Dual Output Dual 2-Input OR Gate	SG-310, SG-311, SG-312, SG-313	7	30/gate	1.0	1.5	11	6	9	5	
AND/OR Expander										
Dual 2 & 3 Input AND/OR Expander	SG-290, SG-291, SG-292, SG-293	7	15/gate	1.0	1.5					
OR Expanders										
Quad 2-Input OR Expander	SG-230, SG-231, SG-232, SG-233	2	28	1.0						
Dual 4-Input OR Expander	SG-270, SG-271, SG-272, SG-273	2	6.7	1.0	1.5					
Flip-Flops										
Dual D Flip-Flop	SF-90, SF-91, SF-92, SF-93	30MHz*	75	1.0	1.5		7		7	
Dual 50MHz J-K Flip-Flop (Separate Clock)	SF-120, SF-121, SF-122, SF-123	50MHz*	55/FF	1.0	1.5	11	6	9	5	
Dual 50MHz J-K Flip-Flop (Common Clock)	SF-130, SF-131, SF-132, SF-133	50MHz*	55/FF	1.0	1.5	11	6	9	5	
50MHz J-K Flip-Flop (AND Inputs)	SF-200, SF-201, SF-202, SF-203	50MHz*	55	1.0	1.5	11	6	9	5	
50MHz J-K Flip-Flop (OR Inputs)	SF-210, SF-211, SF-212, SF-213	50MHz*	55	1.0	1.5	11	6	9	5	

*Minimum toggle frequency **Minimum fan-out

Scratchpad memory gives high-speed access.

Sixteen-bit functional array is designed for memory systems with cycle times in the 100 ns range.

Here's a functional array that makes good use of Sylvania's ability to pack more functions into a single chip. The SM-180 16-bit memory, with an access time of 25 ns, has been designed specifically for high-speed scratchpad memory applications.

The single-chip circuit consists of sixteen set/reset flip-flops forming a four-by-four addressable memory matrix (Fig. 1). Read or write addressing is done through four X and four Y lines brought out to external terminals. Four internal amplifiers take care of the read and write functions on the chip. Two of these are sense amplifiers for "0" and "1" reading and the other two are write amplifiers for "0" and "1" writing. Each flip-flop in the four-by-four matrix is logically connected to its own unique address combination, and to the sense and write amplifiers. This design permits nondestructive readout of all sixteen bits.

When a readout command is received, the dual sense amplifiers indicate the state of the selected bit. If a "1" is stored, the sense "1" amplifier gives an output at the proper logic level, and the sense "0" amplifier remains in the unselected state.

Since the SM-80 is word organized, it is relatively simple to expand memory systems in both the word and bit direction.

Figure 2 shows examples of how the SM-80 can be used to form a 16-word parallel memory and a 64-bit memory unit. The sense outputs of the SM-80 are from a single

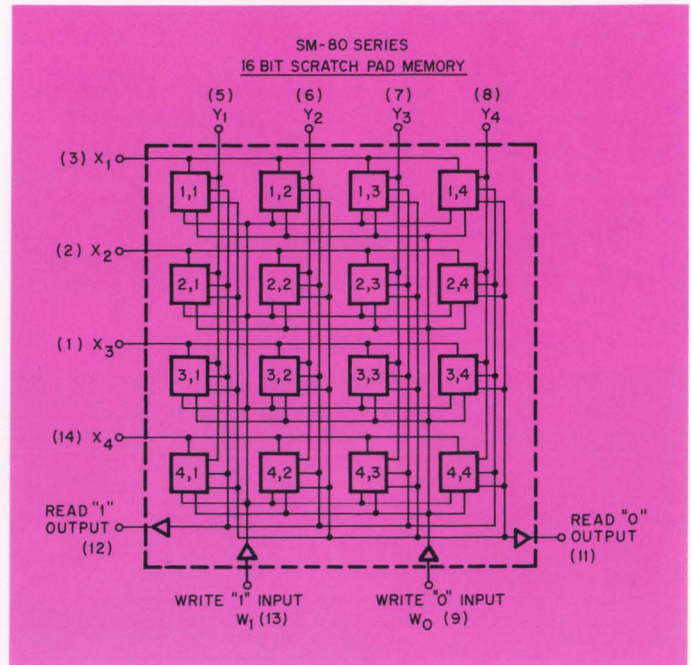

Fig. 1. Logic layout of SM-80 16-bit scratchpad memory.

transistor with no pull-up network. This means word expansion is simplified, since it permits the use of the "wired-OR" function. Such an application requires that an external resistor be used to pull up the "OR"ed collectors. The pull-up resistor can be returned to any V_{cc} less than 6 volts.

The SM-80 comes in both military and commercial temperature ranges. It is available in Sylvania TO-85 hermetically sealed ceramic flat packs or dual in-line packages.

CIRCLE NUMBER 303

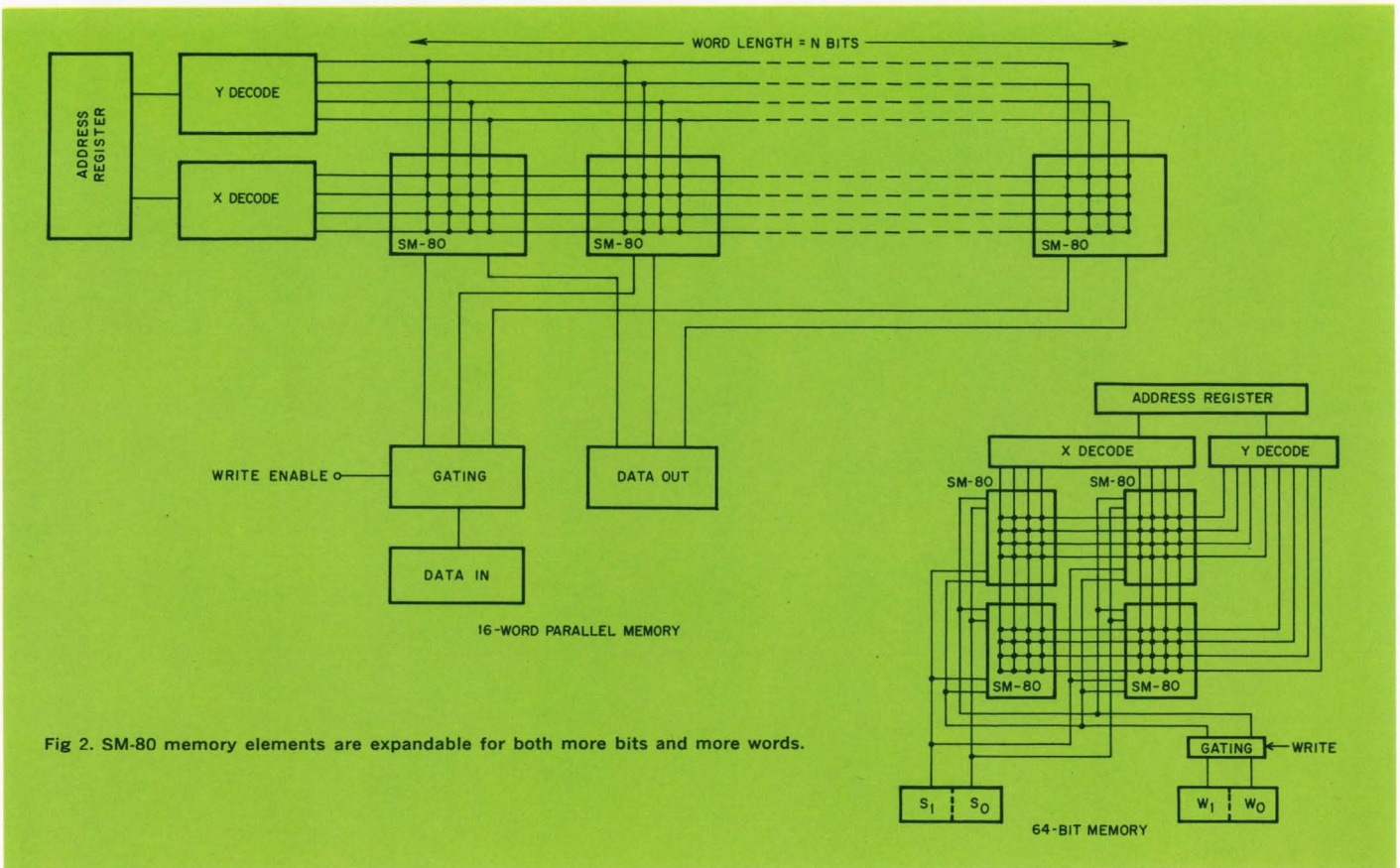

Fig 2. SM-80 memory elements are expandable for both more bits and more words.

MANAGER'S CORNER

The most often asked questions about SUHL logic circuits.

Sylvania's SUHL logic circuits have been around for over five years. However, we still get questions about the general characteristics of our circuit. Most of these questions deal with what the user can and cannot do with SUHL circuits beyond the information given in the data sheets. Here are some of the most commonly asked questions and our answers.

Can a SUHL I circuit drive a SUHL II circuit and vice versa?

Yes. These circuits are completely compatible with regard to signal level, power supply and pin basing. Individual data sheets define the input unit loads and output current sinking capability of each device.

Will a SUHL circuit drive a DTL?

Yes. Signal swings are compatible. You can compute the number of DTL inputs that can be driven by referring to the DTL input unit load and the output current sinking capability of the SUHL circuit.

Will DTL drive a SUHL circuit?

Yes. Signal levels are compatible. When DTL is driving SUHL circuit inputs, you should keep in mind that TTL inputs have greater input leakage current than DTL inputs. This current must be allowed for when computing the DTL output logic "1" voltage level.

Can a SUHL circuit drive MECL, and conversely will MECL drive a SUHL circuit?

No. MECL requires two power supplies and the signal swing starts below ground. MECL is not compatible with either DTL or TTL.

Does Sylvania have an interface circuit?

Yes. The SG-130 and SG-160 line drivers can be used as interface circuits in many applications. The SG-170 dual 4-input OR expander can be used to translate levels compatible with RTL logic.

Can I drive long lengths of line with SUHL circuits?

Emphatically yes. One of the major features of a SUHL circuit is its ability to drive heavy capacitive loads. SUHL circuit outputs present a low impedance in the output "0" and output "1" states. SUHL circuit inputs tend to clamp at about 0.7 Volts below ground if ringing should occur and attempt to pull the input below ground. Furthermore, the SG-130 and SG-350 series can be used to drive terminated lines where the termination consists of resistors tied to B+, ground or to both. The high output capability of these devices provides the needed drive to supply these terminations.

I want to buy industrial standard for price advantage but want to use it in the military temperature range. Will this work? Will you guarantee it?

The devices will probably work. However, there are definite tradeoffs in parameter performance. You can expect threshold changes and the possibility of running out of drive capability in the output "0" state. Therefore, we can make no guarantees beyond the specifications shown on the data sheets.

Is the industrial grade circuit less reliable than the military grade circuit?

No. Sylvania circuits are made by the same process at the same time. A device is classified as industrial or military based on its resistor tolerance, primarily. Reliability does not vary from one grade to another. For example, the 10,000-hour life test results reported in our Technical Bulletin No. 7 are based on industrial grade circuits.

Do you guarantee switching times at temperature extremes?

No. There is no practical way to make 100% tests of switching times at temperature extremes on high-speed test equipment. To guarantee switching times at other than room temperature, even on a sampling basis, means special programming. And that means extra cost.

These questions and answers may take care of some of your thoughts about SUHL circuits. If you have further questions, feel free to submit them to us. We'll be glad to give you the straight answers.



John Rienzo
Manager, Applications Engineering



HOT LINE INQUIRY SERVICE

Need information in a hurry? Use Sylvania's "Hot Line" inquiry service. It's easy and it's free. Just circle the reader service number(s) you're most interested in. Then fill in your name, title, company and address. We'll do the rest and see that you get further information by return mail.

You can also get information by using the publication's inquiry card elsewhere in this issue. However, using the card shown here will simplify handling and save time.



Fold and seal with tape or glue. (Do not staple.)

Fold here.

FIRST CLASS
Permit No. 2833
Buffalo, N. Y.

BUSINESS REPLY MAIL
No Postage Stamp Necessary if
Mailed in the United States

POSTAGE WILL BE PAID BY

Sylvania Electric Products Inc.
Sylvania Electronic Components
1100 Main Street
Buffalo, New York 14209

Dept. D 2 2 2 2

High-speed clock driver matches SUHL integrated circuit speed.

Hybrid integrated circuit clock driver is designed to drive SUHL and other TTL circuits at speeds up to 50 MHz.

Here's the only 50 MHz clock driver compatible with the size and electrical characteristics of high-speed TTL circuitry. Designed in hybrid form by Sylvania, this power amplifier is capable of driving up to twenty flip-flops at speeds up to 50 MHz. Multiple ground leads, internally connected bypass capacitors, and a carefully determined pin arrangement make it easy to mount this clock driver on printed circuit boards to achieve the low-noise level clock distribution that high-speed circuitry requires.

Because the unit is self-contained (except for one power resistor), it can be conveniently mounted close to the flip-flops to be driven. Also, clock drivers can be cascaded to drive systems containing a large number of flip-flops. Two inhibit inputs, compatible with SUHL I and II logic circuits, are provided to allow for a gated clock system.

The small size of the clock driver package (0.82" x 1.70") makes it physically compatible with the use of flat packs and dual-inline packages.

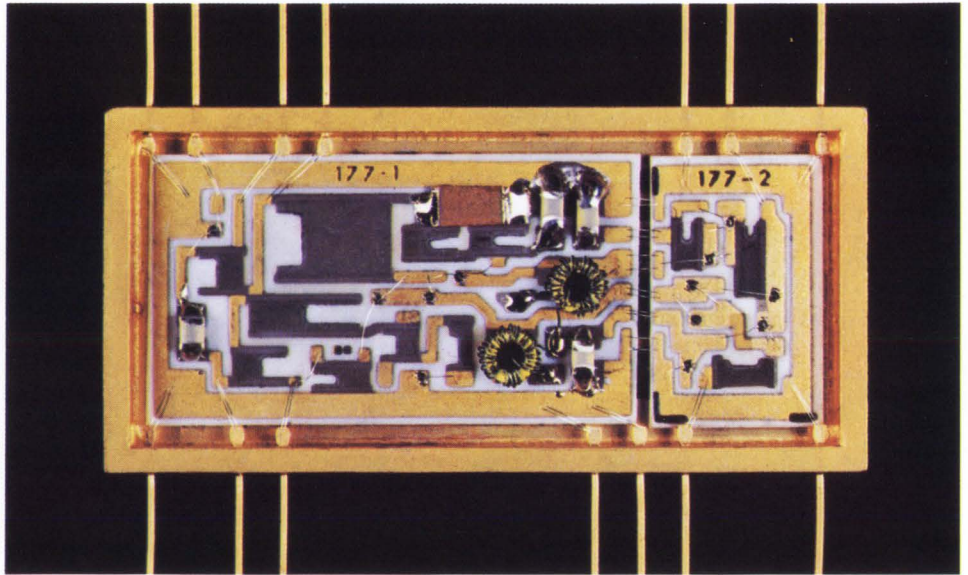

Hybrid construction of high-speed clock driver makes it compatible in size with integrated circuits.

Use of this new clock driver package brings with it a lot of extra advantages. First, its availability relieves you of the problem of designing a high-speed, fast fall time, low-noise clock source. Because we have the circuit in mass production, we can offer this driver at a cost lower than you would pay for a conventional discrete component clock driver card. Our expertise with hybrid circuits makes it easy for us to modify the clock driver to your specs at minimum additional cost. With all these advantages going for you, why not look into Sylvania's clock driver for your systems application.

CIRCLE NUMBER 304

This information in Sylvania Ideas is furnished without assuming any obligations.

SYLVANIA

A SUBSIDIARY OF
GENERAL TELEPHONE & ELECTRONICS

NEW CAPABILITIES IN: ELECTRONIC TUBES • SEMICONDUCTORS • MICROWAVE DEVICES • SPECIAL COMPONENTS • DISPLAY DEVICES

I am especially interested in ICs for following application(s) _____

NAME _____

TITLE _____

COMPANY _____

ADDRESS _____

CITY _____ STATE _____ ZIP _____

Circle Numbers Corresponding to Product Item

300

301

302

303

304

Please have a Sales Engineer call

Standardizing a military memory has its ups and downs.

The ups:

Apollo
Airborne navigation computer
X-15 computer
Missile re-entry
Supersonic aircraft
Side-looking radar

The downs:

Counter-mortar radar
Counter-measures computer
Deep-submergence vehicle
Underground bomb tests
Ground-mobile marine radar

Let's face it—there's no way to standardize on a single configuration for a product that goes into as many diverse applications as our military memories do, so we've built two types that fit a wide variety of requirements. Maybe yours? Our SEMS-5 has a cycle time of $2\mu\text{sec}$, storage capacity to 131,062 bits, and meets all the specs to qualify it as an airborne system, but you'll find it in ground-based and oceanographic applications. Our SEMS-7 has a cycle time of $2\mu\text{sec}$, storage capacity to 327,680 bits and was designed for ground-based applications, but it's also designed into a supersonic aircraft.

Delivery is fast for almost any application, and to help you choose the right configuration, we're offering a paper entitled "How to Specify a Special-Purpose Memory" as well as product literature. Just ask.

EM electronic memories

12621 Chadron Ave., Hawthorne, California 90250 • (213) 772-5201

BELDEN...new ideas for moving electrical energy

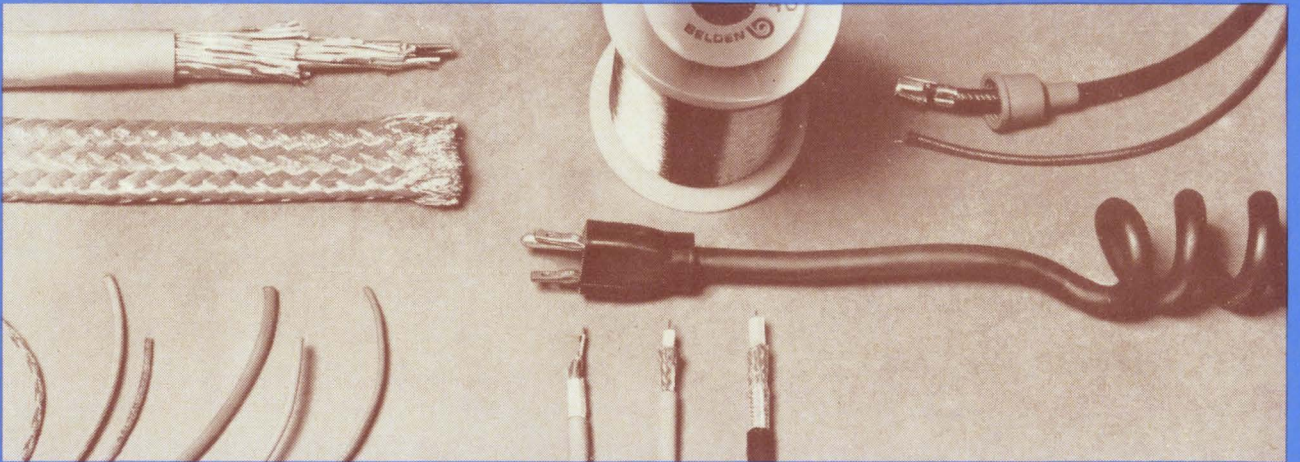
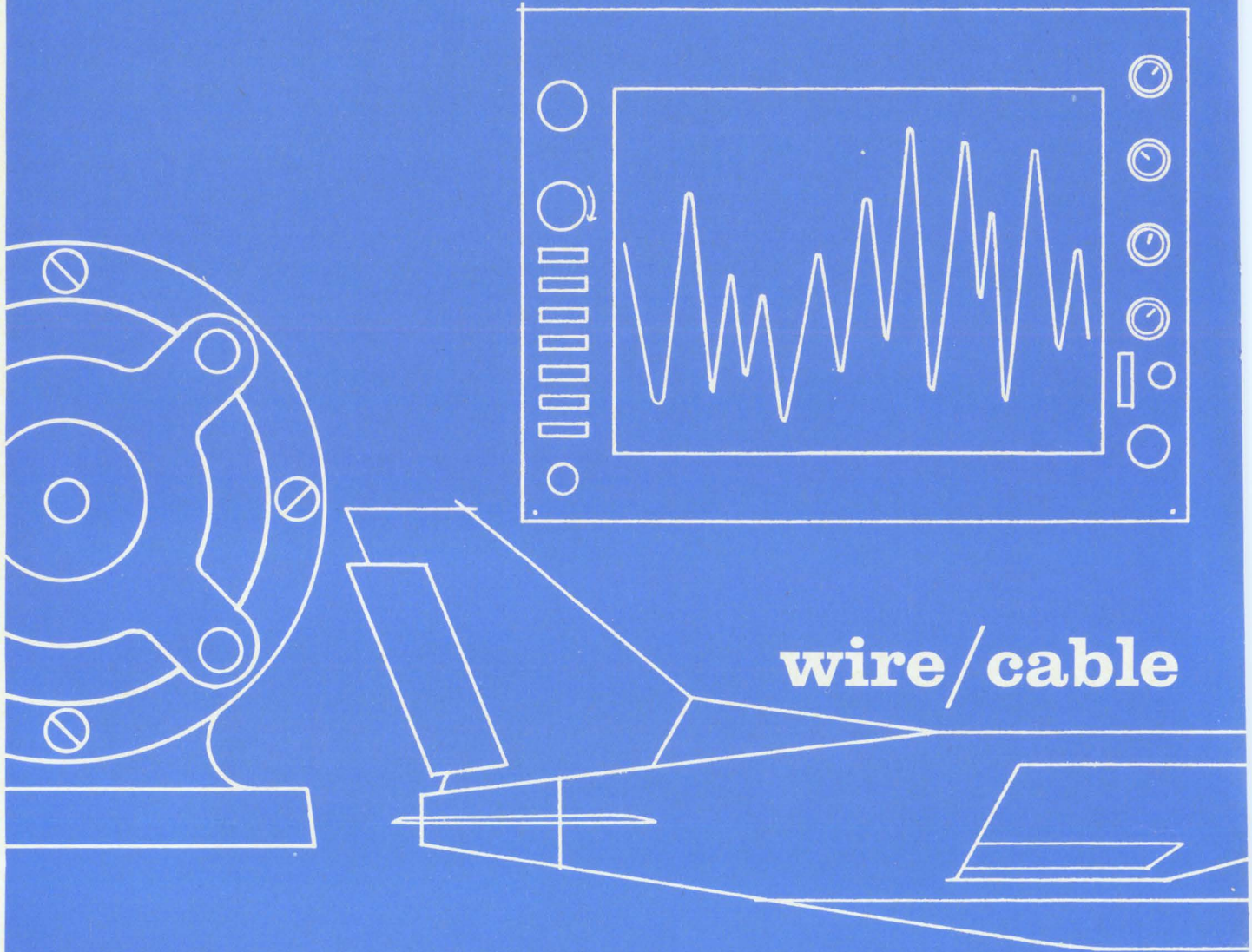

BELDEN

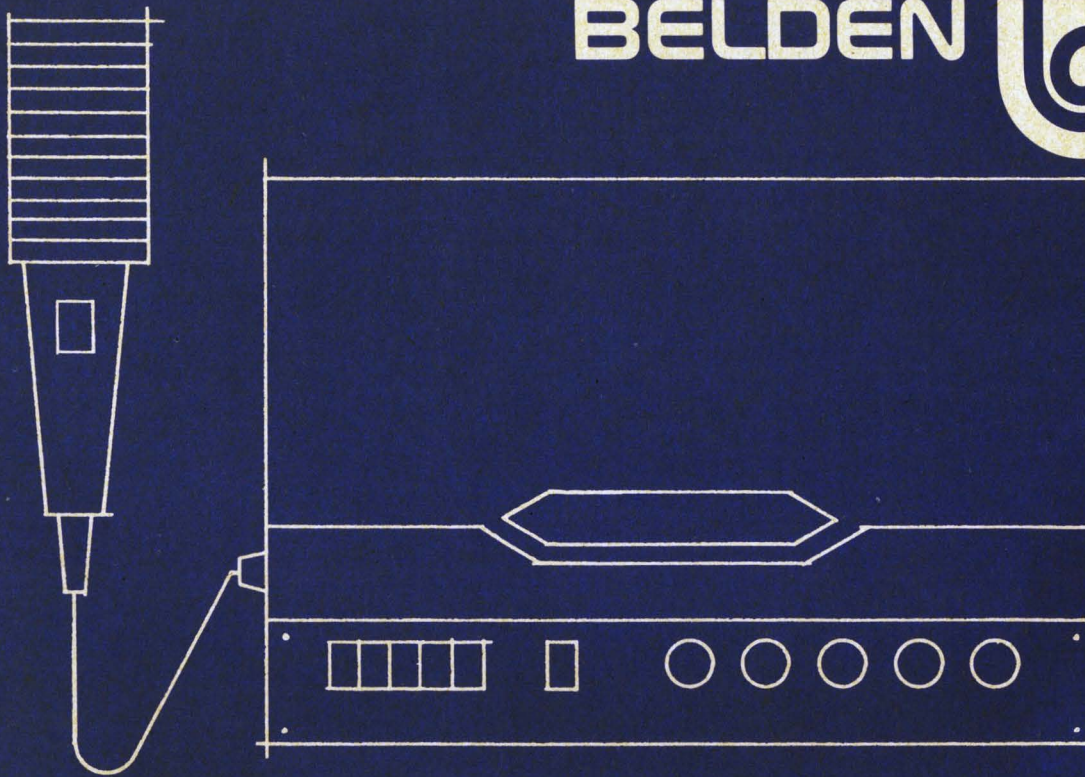

systems turn us on

We have an active imagination when it comes to wiring. Because it's sparked by a lot of savvy about wire and cable and its capabilities. With applied imagination we can create fresh ideas that help a customer get a better value for his dollar. Our Wire Systems Specialists are trained to explore every wire-related aspect of a product—compatibility, production, packaging, operating environment . . . the entire system. And then put their imaginations to work. To eliminate a shielding or stripping problem*. Or save money. Or enhance the product's reliability. And whatever type of wire or cable it takes to turn an

idea into reality . . . well, we make all kinds of wire for all kinds of systems. Why not see what we can imagine for your product? Call or write: Belden Corporation, P.O. Box 5070-A, Chicago, Illinois 60680. And ask for our catalog, and the reprint article, "Key Questions and Answers on Specifying Electronic Cable."

*For example: We've insulated some of our lead wire with silicone. So no glass braid protection is needed. This means that stripper blades will last much, much longer. And a potential health hazard to stripper operators is eliminated.

G-1-8

FOR HIGH DENSITY PANEL WIRING,
THE MOST DEPENDABLE, EFFICIENT,
FLEXIBLE SYSTEM IS RIGHT HERE,

THE P/2/P!
DOUBT IT?

THEN
ASK:

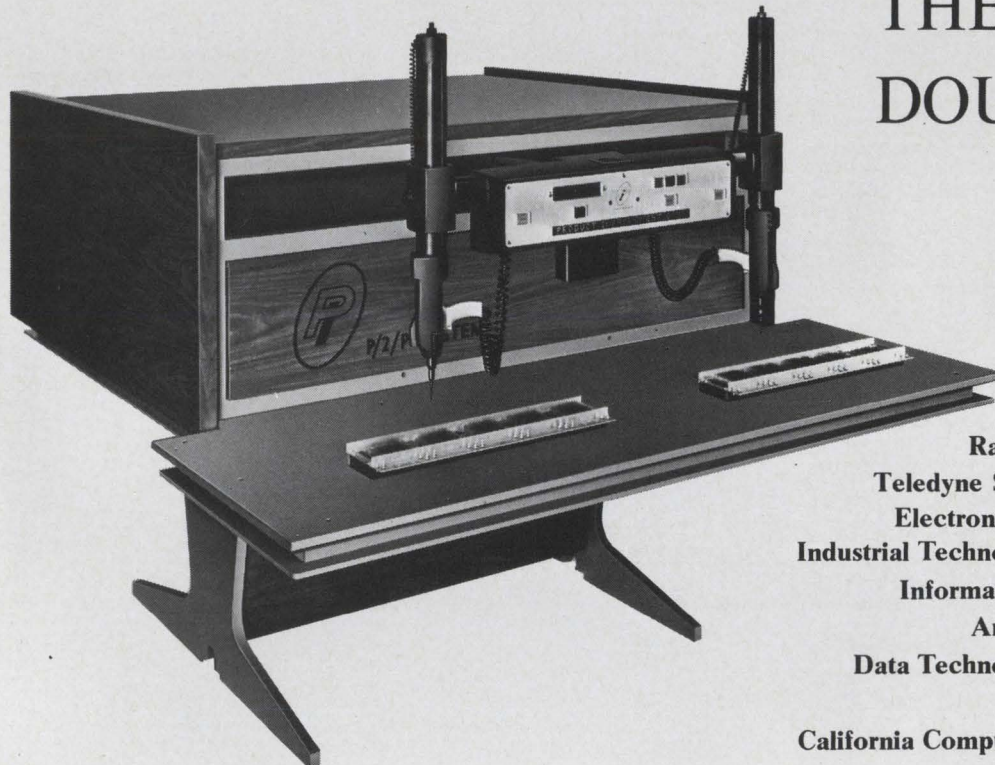

Model No. 2302
Dual-Head
Two 22" X 36" Wiring Areas

Raytheon Computer
Teledyne Systems Company
Electronic Associates, Inc.
Industrial Technology Corporation
Information Displays, Inc.
Ampex Corporation
Data Technology Corporation
Astrodata, Inc.
California Computer Products Inc.
Compat Corporation
Elco Corporation

And many other users, names on request.

Before **you** make any investment in automatic or semiautomatic wiring equipment, consider the benefits that a P/2/P System delivers—

Production Increases—Up to 250 wires per hour from a single head machine, twice that with a dual head system.

Low or No Investment—A fraction the cost of an automatic wiring system, the P/2/P can be purchased, or if more convenient, **leased**.

The Most Flexibility—Can be used for wire wrapping, clip-on or insertion wiring with a 5-minute tool change. Accepts color coded wires, stranded or twisted pairs—virtually no limitation.

Fits Your Application—P/2/P **field-proven** Wiring Systems are available in several sizes, in moving head and moving table versions, to suit your application.

Write for P/2/P Data File.

PRODUCT IMPROVEMENT CORPORATION
A SUBSIDIARY OF CAVITRON CORPORATION



150 STEVENS AVE., SANTA ANA, CALIF. 92707
ORIGINATOR OF SEMI-AUTOMATIC WIRING SYSTEMS

©1968. Product Improvement Corp.

have you met...

the saver

The OmniTester™ 1000 will save you more time and money faster than any other automatic circuit tester ever made.

Circuit-testing time is money. And that makes the OmniTester a real money saver. When it comes to high speed automatic test capability, you can match the OmniTester's time-saving credentials against anything else in the field: it whizzes through as many as 100,000 termination points in a single test sequence. And it's self-programming. And it tests dynamically for required voltages, currents or impedances. And it prints out the results in permanent record form.

What would such a machine be worth in your production program? Much more than its cost.

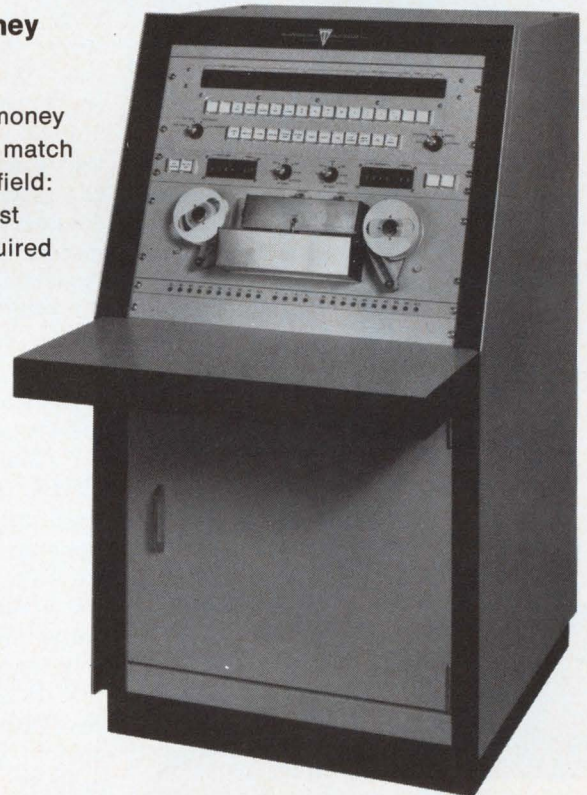

OMNITESTER™ 1000 CIRCUIT TESTER

TeleSciences INC. 351 NEW ALBANY RD., MOORESTOWN, N.J. 08057
FORMERLY TELEPRODUCTS INC. (609) 235-6227

INFORMATION RETRIEVAL NUMBER 25

Will the military accept plastic ICs?

Edited by Raymond D. Speer
Microelectronics Editor

Reliability? Hermeticity? Qualification tests?—the debate over the acceptability of plastic-packaged integrated circuits rages on. To answer some of these questions, **ELECTRONIC DESIGN** invited engineers in the industry and in the military to state their views. Here they are:

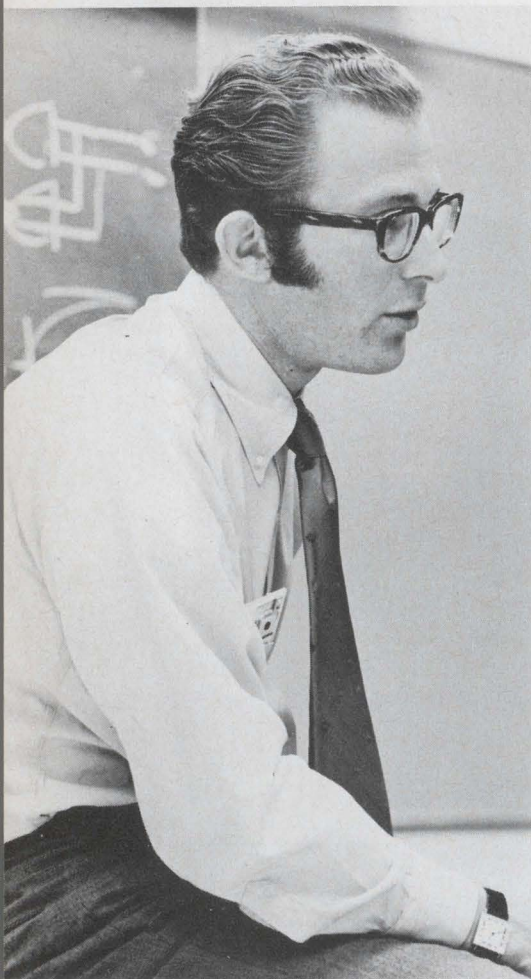

"No! Because of their basic limitations, transfer-molded plastic semiconductors should not be considered for military or defense-oriented use."—Anixter

Ben Anixter, Integrated Circuit Product Manager, Fairchild Semiconductor, Mountain View, Calif.:

Transfer molded plastic semiconductors should not be used in military or defense-oriented applications: They offer questionable reliability and little, if any, true cost savings.

Although Fairchild does produce RTL devices in epoxy, these are cast-molded: no release agent is used; degradation of the lead-to-package adhesion is therefore avoided. The devices are recommended for use only in those commercial applications where temperatures do not go below 0°C or above 70°C.

Originally, plastic transistors were developed to serve the consumer market. The thinking, then, was that because specifications could be loose and because reliability would not be a problem, the consumer marketplace would be receptive to low-cost plastic devices. At that time (approximately 1965), when metal-can transistors were selling in volume for over \$2 each, plastic units were selling for 20 cents.

Today, some metal-packaged transistors that meet military specifications can be bought in volume for from 15 to 25 cents each. But plastic devices that meet similar specifications—not the "loose" parameters of the past—still sell for between 10 and 20 cents each. The old highly attractive price differential has been reduced to one of pennies.

With regard to reliability, investigations by Fairchild Semiconductor into plastic-molded dual-in-lines (DIPs) have uncovered significant hermeticity problems. Basically, water plus epoxy plus aluminum produces a galvanic action that attacks the aluminum metalization on the chip. That's

why gold leads are used in plastic packages. ICs are most susceptible to this failure mode, due to the large number of critical aluminum paths and the narrow metal-runs commonly used. The water-barriers used to protect the chip merely postpone this galvanic action. Test results indicate that under the common life-test conditions, it is only a question of time (usually less than 1500 hours) before a significant percentage of devices (20 to 35 per cent) fail.

Two other reasons for using plastic packaging—high shock/vibration resistance and form flexibility—have to be evaluated in light of inherent weaknesses. The combination of questionable reliability and lack of any substantial cost advantage has led Fairchild to decide against putting its logic circuits into DIP packages.

Chris Goodman, Vice President and Marketing Manager—USA, Motorola Semiconductor Products, Inc., Phoenix, Ariz.:

Yes. Plastic ICs are now being used successfully in military applications—in artillery and bomb fuses, for example—and have been for some time.

Plastic packaged ICs offer high shock and vibration resistance at low cost, and perform admirably when operated within their electrical and environmental limits. They should be thoroughly evaluated by all potential users, including the military, and used, in the interests of economy, when environmental conditions permit. Plastics have their place in the sun.

Plastic packages are being continually improved. A designer who evaluated plastic ICs a year ago may not know what is available today, and he is definitely being pessimistic if he's using year-old data. Moisture resistance is better now, chip surface passivation tech-



"Yes. Plastic ICs are now being used successfully by the military, and have been for some time."—Goodman

niques are more advanced and the plastic materials and molding techniques have been improved. Designers must update their impression of plastic packages, or they'll sell plastic short.

Plastic ICs are not less reliable, less efficient, or less functional than their hermetically sealed counterparts. They do have a limited operating temperature range, but operated within this range they are as reliable, efficient, and functional as any other type. Several manufacturers have a good deal of data to prove this. Customers, military and civilian, are gaining confidence in the major suppliers of plastic ICs—and in good products proved out by testing programs—and are taking advantage of the low cost wherever they can.

Plastics are not suited for use over the full military environmental range, of course, but not all military equipment is exposed to the rigors of jungle fighting. Computing and control equipment housed in permanent installations see conditions no worse than those encountered in civilian industry. Where the expected environmental conditions will be within a satis-

factory range, plastic ICs can be used at no sacrifice in performance, and at a significant saving in cost. Surely the potential cost saving dictates their use in these instances. There is nothing to be gained by paying for full military temperature range parts for equipment that will never operate outside of a narrow and predictable range. The computer industry understands this very well, and computer manufacturers use plastic ICs. If the large-scale computer manufacturers didn't use plastic, as a matter of fact, they wouldn't be in business. Their cost would be too high.

We argue with the outmoded policy that military approved devices must meet the standard military environmental specs. The specs are unnecessarily harsh for a lot of military equipment, especially in the temperature-range and humidity areas. Why not classify military equipment into end-use categories, with differing environmental requirements? Reclassification of the components used in groundbased, permanently installed systems would result in significant cost savings in active devices alone.

Whether for military or indus-

trial use, however, Motorola recommends that each type of IC package be evaluated on its own merit for the particular application in which it is to be used. The potential cost saving that plastic offers—on the order of 25%—cannot be ignored. This cost saving is greatest for plastic transistors, in which package cost is a large portion of the total cost, and is least for complex MSI or LSI products in which the chip cost predominates.

A word of caution: Plastic products vary in quality among the various manufacturers. Processes and materials differ, with a marked effect on the environmental and electrical characteristics of the ICs. No fixed specification exists for testing plastic ICs, and each manufacturer is free to set up his own tests. The tests chosen may not truly reflect the capabilities and limitations of the products, and the customer must avoid freely comparing data received from various manufacturers without first checking in detail the test methods used.

Opponents of the plastic package are quick to point out that the price differential between plastic and metal-packaged transistors has shrunk. Initially an order of magnitude, the difference is now 25 to 35 per cent. Opponents suggest that the new differential of 25% is insignificant, but we cannot share this view. Any saving in cost is an advantage.

Don Winstead, Manager, Sales Department, Signetics Corp., Sunnyvale, Calif.:

Yes, the military will accept plastic packaged ICs—if they are properly designed and manufactured. And vendors will soon prove, with adequate documentation, the hermeticity of plastic packages. This is the only area of question.

A combination of the right plastic, a good device design, and a rigidly-controlled manufacturing process can produce plastic-packaged devices that equal or exceed the reliability of glass-metal or ceramic-metal units.

With the exception of one standard test, plastic ICs have repeatedly met or exceeded all existing military reliability requirements for semiconductor devices.

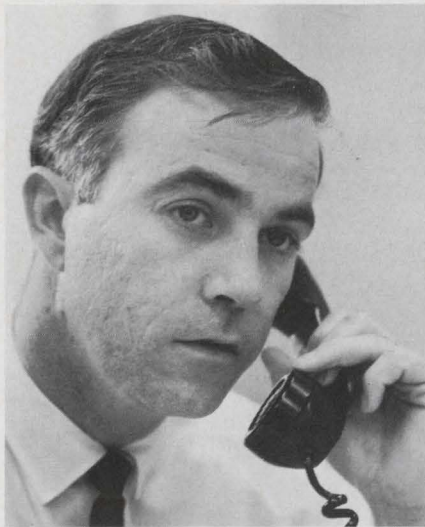

“Yes. Vendors will soon prove the hermeticity of plastic packages, and this is the only area in question.”—Winstead

That one test, covered by MIL-STD 202, Method 112, is a seal integrity test to establish package hermeticity. Since the test depends on the package having an internal cavity (the test consists of detecting leakage of gas, previously injected into the cavity through a poor seal) it cannot be rationally applied to solid packages such as the plastic dual-inline.

Several alternate tests that have been advanced by the military and by the industry are not suitable for use, either as 100% screens or for lot-by-lot acceptance; they are potentially destructive or they take too much time for practical lot-conformance procurement purposes.

We have accumulated data on over 2.5-million plastic-package device-hours in such tests. We are continuing, in constant consultation with the military, to try to establish a meaningful environmental test-matrix.

In the course of developing our DIP we have used a variety of plastic materials. For the last few years we have been molding our packages out of silicone rather than epoxy. Independently-obtained materials test data, as well as that obtained from our own test program, indicate that silicone is superior to epoxy for IC packages. Silicone is nonhygroscopic, has no free ions, and does not deteriorate

at high temperatures.

The current reluctance of the military to permit across-the-board use of plastic-packaged devices is justified. Variations in materials used, in production processes, and in process control—even among the three leading producers of plastic-packaged ICs—demand caution and the establishment of standards. The question of what these standards should be generates a lot of argument. We need a realistic set of qualification tests that are acceptable to both the military and the IC industry.

We believe, however, that there is sufficient data now available to permit selective use of plastic packaged ICs in a variety of military applications.

Alfred Tamburrino, Acting Chief, Reliability Physics Section, Rome Air Development Center, Griffiss Air Force Base, Rome, New York:

Ultimately, plastic-packaged ICs will be approved and accepted by the military. But just when this will happen will depend to a large degree on the actions of the IC manufacturers.

The plastic IC products which have been tested to date have not shown acceptable failure rates under military environmental requirements. Vendors must become more concerned with improving the reliability of their devices. It is possible that, within three years, plastic ICs can be produced that will be satisfactory for military use, but the responsibility for improving the product lies with the manufacturer.

We've been under considerable pressure from vendors who want to know why they can't sell plastic ICs to the military. We need more reliability data, and it's hard to get.

We have asked the vendors to cooperate, and we have sent copies of a proposed test program to all manufacturers of plastic semiconductors. Tests outlined in the program will help them to prove their devices, to obtain the necessary data to develop adequate qualifications and screening tests, and to establish at least an eligibility for qualification—the tests involve some 7500 hours of moisture stress.

These tests were not advanced as a minimum qualification procedure, but rather as a source of information from which answers could be derived on device capability, economical and effective screening techniques, and effective qualification or acceptance test requirements.

Yet only three or four manufacturers have, so far, undertaken to do the tests. While these three or four are sincerely trying to improve their products, many, many others still prefer sales promotions to device improvement.

We expect to see great improvements in some lines of plastic, from some vendors, in the next few years. The vendors who ignore the proposed reliability tests and who do not make an effort to improve their plastic packages are really going to be left behind.

MIL Standard 883 and Notice #1 now include procedures for qualification screening and testing of ICs, but contain no good hermeticity test for plastic ICs. This lack of a good hermeticity test has led to a large number of proposals—high-humidity-with-bias tests; pressure-cooker tests; boiling water tests, and dye-penetration tests—all proposed as checks on the moisture-penetration resistance of plastic packaged devices.

So far, our tests have resulted in serious failure rates on plastic ICs. The failure rates for an 85/85 test—85°C and 85% relative humidity, with reverse bias on the IC for 2000 hours or so—runs between 4% and 50% of small (about 50 devices) sample lots!

Erwin Herr, Manager, Reliability Engineering, Semiconductor Products Department, General Electric Company, Syracuse, New York:

Yes. Recent advances in plastic devices should allow them to be qualified for increased military use in 1969-70. We expect that specifications will be generated for a number of new applications in military and NASA systems in the near future.

Since the introduction of epoxy-encapsulated transistors in 1962, many improvements have been made in both the packages and the

transistor pellets:

■ Operating life conditions have increased, from 200-mW dissipation rating to 400-mW, for a TO18-size package. Successful performance under accelerated tests—up to 800 mW—has been demonstrated on these small signal devices.

■ Storage life temperature has been increased, from 125° to 150°C.

■ Humidity life stress has been increased, from 40°C/90% RH to 85°C/85% RH.

■ The initial I_{CBO} limit has been decreased, from 500 nA to 50 nA.

Plastic devices, first used in consumer and automotive applications, were introduced into general industrial and computer equipment in 1964. The successful performance of millions of devices in these applications led to their introduction into military systems in 1966-67.

The application of plastic devices in industrial and military systems can result in savings in testing and evaluation, as well as in initial cost. Because the devices have been strengthened mechanically, the possibility of failure due to loose internal "foreign particles" (that cause intermittent operation), and to failure from shock and vibration fatigue, has been eliminated. Constant-acceleration, mechanical-shock, vibration-variable-frequency, particle-visual-inspection, and particle-detection tests are therefore no longer needed in military lot-type inspections.

There is considerable interest in the industry in improving the pellet-surface stability and the sealed-junction integrity. Development of new passivation techniques that use silicon nitride, glassivation and films are in progress. When these improvements in sealed junctions are accomplished, the cost and mechanical advantages of plastic encapsulation will become even more significant.

Plastic IC failure rates have been found to fit the Arrhenius Model—the log of failure rate decreases linearly with the reciprocal of absolute temperature. Derating power dissipation, a common practice for circuit designers, will enable users to obtain lower than specified failure rates.

C. Gordon Peattie, Manager, Quality and Reliability Assurance, Components Group, Texas Instruments Inc., Dallas, Texas:

Yes. We expect the military to include plastic ICs in more and more applications as reliability information becomes available. Armed Forces of the United Kingdom, for instance, are currently qualifying plastic transistors and ICs for use in some systems designed to operate in controlled environments.

We introduced our first Silect transistors in 1965. Realizing that detailed reliability information would be required by users, we launched a 30-million transistor-hour reliability program. The program was completed in 1967, and the results proved that these transistors are as reliable as their metal-case equivalents (when tested under conditions specified by MIL-STD-202C and MIL-STD-750A). Similar tests conducted with ICs indicate equally encouraging results. Our work is now directed toward improving the resistance of the plastic-encapsulated devices to accelerated stresses of temperature and humidity (for example, to back-bias conditions at 85°C and 85% relative humidity).

Texas Instruments makes the following recommendations to the users of plastic-encapsulated ICs:

■ Plastic ICs can be used in those systems where environment and use fall within test conditions set forth in MIL-STD-883. In other words, if the system operates below 65°C and 95% relative humidity, and the design derates the devices by at least a factor of two, plastic may be employed. Benign environments, such as those associated with main-frame computers and related peripheral equipment, certainly offer opportunities for the use of plastic devices.

■ Plastic-encapsulated devices should be used in preference to hermetic devices where the mechanical environment requires high acceleration, shock or vibration resistance. The military has already recognized this advantage for many of its fuze programs. Other situations in which plastic-encapsulated semiconductors offer benefits are those that require high-

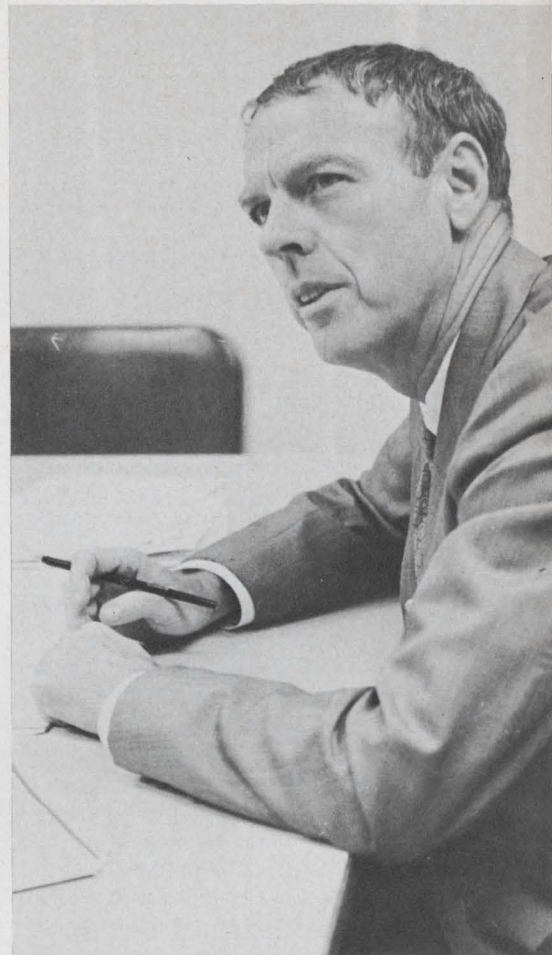

"We expect the military to apply plastic in more and more applications, as reliability information becomes available."—Peattie

frequency or high-power operation: plastic encapsulation avoids glass-to-metal seals that increase lead inductance and provides better conduction of heat away from the chip than does air.

Semiconductor manufacturers are continuing their investigations into the development of better plastic-encapsulated devices. There presently exists, in fact, a real danger that the imposition of stringent specifications on plastic devices will increase their cost and erase the price differential between them and their hermetic equivalents. Plastic devices should not be forced to meet specifications that are more harsh than those for their hermetic equivalents. Rather they should be regarded as complementary to the hermetic devices, and should be used where their particular advantages—low cost and high shock resistance—make them the best choice for a given system. ■■

Computer service turns logic into packages

A boon for designers of data systems, it can slash time for final design from months to weeks

Robert Haavind
Managing Editor

Turning a set of logic equations into a packaged system can be a tedious design procedure. After years of painstaking effort, most computer manufacturers have managed to automate the process. But for designers in small companies, or those in companies without the necessary computer programs, the answer still is drudgery.

Now at least two manufacturers are offering to do major portions of the logic-equation-to-final package-design by computer as a service. Both Data Technology Corp., Mountain View, Calif., and Litton's Inter/Pak Electronics Div., Beverly Hills, Calif., are expecting to achieve six-to-eight-week cycles for the process. With conventional methods, it could take months to develop a final package.

The total market in such packaged logic systems in the United States is about \$530-million to \$580-million, according to a detailed study by Peter Dietz, vice presi-

dent-marketing for Data Technology. Dietz and Charles Russ, vice president and general manager of Inter/Pak, believe that a large part of the work will soon be done by services such as theirs because of the increased accuracy, short turn-around time and cost advantages that can be achieved. Their programs are not nearly as sophisticated as some being used by some commercial and military computer design facilities. However, they do represent a type of service that should become common in the industry for logic as well as other types of design.

The 'Total Logic Solution'

Data Technology is using a program developed by Stanford Research Institute, Menlo Park, Calif., under a \$180,000 contract. The service is called Total Logic Solution, or TLS. The logic designer must develop the logic diagrams for his system. Characteristics and pin numbers for both logic modules

of various types and widely used DTL and TTL integrated-circuit families (830, 930, 7400) are stored. The initial computer output is suitable for checking the logic design to see if it will work.

After checking, the computer prepares a master term list, a punched-paper tape for driving a numerically controlled wire-wrap machine, and a component location chart. The system documentation and testing data are produced.

The program works with the language and mnemonics normally used by logic designers. Thus FF stands for flip-flop and N stands for NAND gate.

Typical price for a system design involving 1000 ICs is in the range of \$7000 a system when five to 10 systems are to be produced, according to Dietz.

Inter/Pak is still developing software for its system, although the wire-wrap portion is completed. Various programs are under development by Computer Usage Development Corp., Palo Alto, Calif., and two other Litton groups in California: the data systems division in Van Nuys and the guidance and controls section in Woodland Hills.

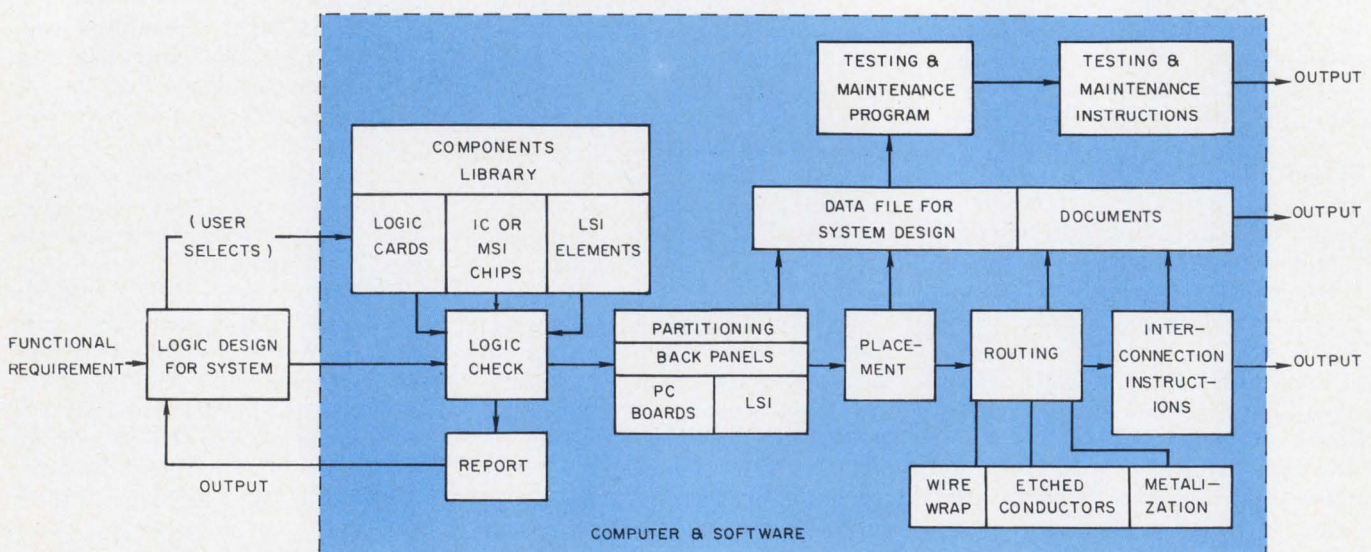

1. Logic system design computer programs throughout the industry are approaching the degree of automation

indicated by this generalized flow diagram. Various systems automate parts of the process.

These programs are only fore-runners of more comprehensive ones, according to Charels King, formerly an engineer-programmer with Computer Usage and now with Burroughs Corp., Pasadena, Calif. He visualizes more extensive programs (like the type in Fig. 1) in wide use soon. He points out that once such a program has been developed, it can be readily adapted to various packaging approaches. Thus the library of elements can store characteristics of logic cards, IC or MSI (medium-scale integration) chips or LSI (large-scale integration) elements. Also, routing routines can be stored for wire-wrapping large systems, producing printed-circuit-board art work or making integrated-circuit metalization patterns.

The rules for placement are not too different for LSI or for printed-circuit boards, King says. They involve such things as minimum spacing between gates for isolation or for connections. The gates themselves, however, are not being designed by the program.

The maintenance procedure will be a deck of computer cards that can be run through the logic system once every week so as to see that everything is working properly. If a fault turns up, the testing program will allow the user of the logic system to pin down the specific trouble.

Computer feeds CRTs

An example of the use of this type of computer-aided logic system design is the work being done by the Univac Div. of Sperry Rand Corp., Minneapolis. In the Univac approach (Fig. 2), the computer starts with the Boolean logic expressions and works through the total process to the design of PC board wiring and a numerically controlled wire-wrap tape. Logic diagrams are generated on a five-inch CRT screen and microfilmed. Then drafting plates are automatically produced from the films according to MIL 806 A, C or D.

The designer specifies the node placement on the PC boards to be used to implement the system, and the computer "massages" his design to decrease lead lengths or to correct loading violations. Then interconnection networks are auto-

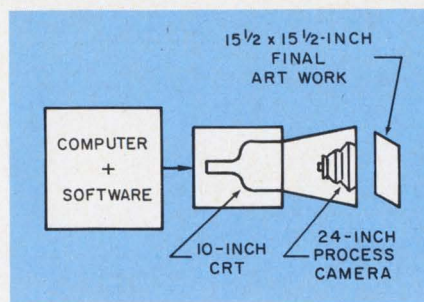

2. Univac photographs a CRT face to produce the art work used for printed-circuit logic boards.

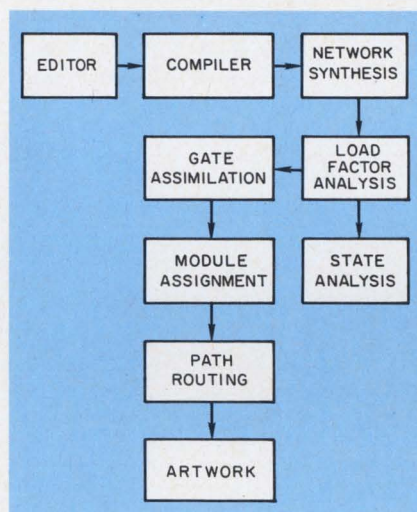

3. General Electric uses a series of programs in its ACCLAIM system for Boolean expression-to-logic system package design.

matically generated.

The art work for the PC boards is produced again on a CRT, but this time a 10-inch tube is used to increase precision. The tube can display 100 lines of 10-mil line width that can be spaced down to 10 mils apart. The final art work produced by the process camera has ± 0.002 -inch precision.

Univac is now working on the addition of display units capable of allowing a designer to interact with the computer system during this design process, according to Wayne Leverkus, senior design engineer. Thus errors in the work that were diagnosed by the computer at various stages of the operation could be shown to the designer, and he could correct them and allow the process to proceed immediately to the next step.

Among several programs developed by IBM for automating logic packaging is the WRAP program (Wire Routing And Packaging). IBM's 4-Pi aerospace com-

puter line was wired in this fashion. One algorithm places ICs on a multilayer board randomly and then moves them around to see if wiring lengths are decreased. Eventually all lengths are minimized. Wire routing is then done by a special "mazerunning" program.¹

General Electric's Aerospace Electronics Dept., Utica, N.Y., has also developed programs to generate packaging designs from Boolean expressions. Its ACCLAIM (Automated Circuit Card Layout and Implementation) set of programs is written in Fortran IV. Boolean expressions are converted to logical elements, which are then translated into a gate design. The gates are then arranged into a switching network, and placement of the gates on the printed-circuit cards is automatically determined.

One program in ACCLAIM, called the editor (Fig. 3), checks to see that the Boolean equations have been written properly for computer entry. The compiler translates corrected equations into text lists useful for computer manipulation.

In the Network Synthesis program, the compiled text lists are converted from AND/OR diode logic form to NAND transistor logic. The logical elements used are flip-flops, 2-legged and 4-legged gates, 4-legged expanders, terminal connectors, 4-legged line drivers and monostable flip-flops. The design is checked for fan-in and fan-out loading by a Load Factor Analysis program, and if necessary, extra gates are added.

After this the process can be carried on to the steps needed to produce printed-circuit board designs, or a State Analysis program can be used to verify that the logic will work as desired. The PC-board art work in the GE approach is drawn on a Calcomp plotter.

Many more programs are under various stages of evolution in the industry. Although the cost of software development is quite high, many of the basic techniques are now becoming widely known, and because of the potential for cost and time savings, greater use of such programs seems inevitable. ■■

Reference:

1. *Proceedings of Design Automation Workshop*, July 15-18, IEEE Cat. 68C36CPR, (available for \$10 from Sales Desk, 9th Floor, IEEE, 345 E. 47th, New York, N.Y. 10017).

HEARD THE LATEST?

As an engineering editor for Electronic Design you will be sure to learn about the latest developments in technology as they happen. An editor:

- *Attends the major conferences in his specialty.
- *Talks to top design engineers and scientists about their work.
- *Solicits and edits articles describing new design techniques.
- *Writes by-lined articles about new developments in electronics.

Interested?

If your background is in computers, circuit design or systems work we are especially interested in you. Even if your expertise is in other areas, but you enjoy writing, we may have a good spot for you.

Call or send resume to Robert Haavind,
Managing Editor, Electronic Design,
850 Third Avenue, New York,
New York 10022. (212) PL 1-5530.

Teledyne TO-5 Relays quality & experience

(right...today and tomorrow)

TELEDYNE



TO-5 Relay



Teledyne's reputation for quality demands adherence to the right specifications, the right delivery schedule, the right experience and facilities and the right Q.C. system to eliminate human error.

Right you are, that Teledyne, the originator and world's most experienced producer of quality TO-5 Relays, can meet the needs and standards of tomorrow's designs.

The price is right.

Send for further information and complete catalog.



TELEDYNE RELAYS
A TELEDYNE COMPANY

3155 West El Segundo Boulevard Hawthorne, California
90250 Telephone: (213) 679-2205

HONEYWELL

SERIES 16

Tomorrow computer systems today...

**that you'll want to live with a long,
long time**

Some computers come and go. And when they go, you're out of luck if you own one and want to extend the system to keep pace with your expanding needs.

No problem when you own a member of the Honeywell Series 16 family of real-time integrated-circuit computer systems. This prolific brood includes standard computer mainframes like the DDP-516 and DDP-416, many peripherals, a mature and expanding software library plus support services tailored to stretch the life of your investment. Special systems, functional application packages and new configurations like our Ruggedized and Ruggedized/EMI suppressed models give you even greater flexibility. No wonder Series 16 systems are being used so much in applications

like communications, research, medicine, industrial control and flight simulation.

And Honeywell's Series 16 family will continue to grow — investment today in time, money and effort will not go down the drain because of sudden obsolescence tomorrow.

For more information about the Series 16 family and some of the ways Honeywell computers are being used, write:
Honeywell, Computer Control Division, Framingham, Massachusetts 01701.

Honeywell
AUTOMATION



Aerospace electronics found wanting

A classified military report says the electronics being turned out by aerospace contractors for major U. S. weapons systems are largely unreliable. They were bad in the 1950s, the document charges, and are even worse in the 1960s. Details in the report, titled "Improving the Acquisition Process for High Risk Military Electronic Systems," were disclosed in an exclusive story by the Washington Post. The author of the document was unidentified, described by the Post only as a "key Government official."

The report is being reviewed by Government officials, the paper said, and is believed to be the first systematic effort to measure the performance of costly weapons over a long period of time.

Evaluations are made in the document of the Mean Time Between Failure of weapons systems, and a marked decline is noted over the last decade.

The document asserts, according to the Post, that 13 major aircraft and missile programs, all carrying highly sophisticated electronics, were built in the mid-1950s at a cost of \$40 billion. Of these, it says, only five equaled or exceeded the reliability requirements. (Two of these, however, far exceeded MTBF specs: One was the Sidewinder infrared homing air-to-air missile, and the other an unidentified missile.) Rated low on the list were the B-47, B-58, F-102 and F-104 aircraft and three other missile systems.

Of 11 major systems developed in the '60s, however—none of them identified—only two are said to meet MTFB requirements. According to the Post account, these 11 systems account for over half of the aerospace programs started in the 1960s, and their electronic content totals

Washington Report

CHARLES D. LAFOND
WASHINGTON BUREAU

well over a billion dollars. Of even greater significance, a majority of the 1960 systems were reported as achieving an MTFB of only 25% of the spec.

Nuclear research sub launched

The Navy has launched what is believed to be the first nuclear-reactor-driven research submarine—the NR-1. Only 140 feet long, the deep-diving submersible can carry seven men and remain submerged for several weeks at a time. While designed as a multi-purpose research craft, it is (nevertheless) a highly classified vehicle about which few details have been released by either the Navy or the builder, the Electronic Boat Division of General Dynamics Corp.

Most observers at the launching in Groton, Conn., noted the absence of Vice Admiral Hyman G. Rickover, who directed the development program for the NR-1. Many have pointed out here in Washington that while the acid-tongued nuclear specialist was deriding the Pentagon for its improper handling and waste in military contracts, his own program more than tripled in cost. In 1965, when the program began, the cost of the NR-1 was estimated at \$30 million; the present estimate is in excess of \$99 million, and may go higher.

Among the costs are \$11.8 million for R&D, plus just under \$20 million for special equipment and electronic instrumentation. A major effort in the development of the craft was the need to design the nuclear power plant and shielding so it could fit into a hull measuring only 12 feet in diameter at its maximum point.

The vessel has an external manipulator, capable of picking up outside objects;

an external TV camera system, and viewing ports. It also has wheels under its hull to permit movement on the ocean bottom.

Apollo 9 to test 3 ranging systems

The Apollo 9 launching, scheduled for Feb. 28, will provide the first manned test of three key systems in the lunar module: the rendezvous radar, landing radar and a vhf transceiver—all provided to Grumman by RCA.

Seattle seethes over Sentinel site

The controversy grows in the nation over Army selections for Sentinel antiballistic missile sites. Three early choices—Boston, San Francisco and Seattle—have each drawn opposition from area residents. Seattle is typical.

The fight in Seattle is being led by its Rep. Thomas M. Pelley. He is an early supporter of the decision to deploy the Sentinel and has indicated his constituents are willing to accommodate an ABM facility in the Seattle area. They recognize the need for placing the massive Perimeter Array Radar and associated missiles on the Northwest Coastline. But at issue is the site selected—an expensive section of Bainbridge Island, five miles across Puget Sound from Seattle and surrounded by 8,800 residents.

The schools there are overcrowded, there is no rail transportation, and the only access to the island is by a single bridge. In addition, a water shortage exists, and the Sentinel facility will require 300 gallons of water a minute to cool the massive electronics, says Congressman Pelley.

Last month, in a statement before the military construction subcommittee of

the House Committee on Appropriations, Pelley argued that the Army had reneged on its previously declared intention to pick sites away from residential areas, wherever possible, or on Government-owned property. Yet, he said, last December the Army held a meeting with Bainbridge Island officials and residents to inform them of its plans and to state a policy of locating sites as close as possible to cities.

Rep. Pelley says he has offered several alternative sites for Army consideration, including the Bangor Ammunition Depot, a Government-owned station. But he fears the Army has already made up its mind.

Army to get helmet gunsight?

If anyone doubts the impact of electronic warfare on today's battlefield, he might consider a recent contract awarded to the Honeywell Aerospace Div. for helmet sights—\$4 million worth.

They will be used by pilots in the Army's new AH-56A Cheyenne attack helicopter to aim all of its weapons automatically. The contract, let by Lockheed-California Co., which is building the Cheyenne copter, involves a total of 375 units, with deliveries to begin late this year.

The Honeywell-built helmet permits hands-free fire direction by providing automatic input to a computer in the fire-control system for both target elevation and azimuth. The system consists of a helmet sight and sensor assembly that uses two pairs of helmet-mounted photosensors. (The photosensors are aligned to a collimated sight piece that projects a reticle in front the the eye of the wearer.) A light source assembly generates a pair of rotating light beams that sweep across the helmet photosensors, and a sensor electronics assembly converts pulses from the photo sensors into line-of-sight elevation and azimuth angles.

Honeywell reports a 5000-hour Mean Time Between Failure for the helmet system. It also claims an accuracy of ± 4 milliradians in elevation and ± 7 milliradians in azimuth. The helmet unit adds about 11 ounces to the standard aviation helmet weight. The other subsystems add about 12 pounds to the Cheyenne.

Microwave Associates (West) now offers standard circulators at UHF so small that you'd think they were at X-Band. □ 1.25 x 1.13 x .80. Just 1.13 cubic inches. That's the larger one. □ For isolation in the output of solid-state transmitters. Interstage isolation in solid-state sources and power amplifiers. Anywhere in fact, where size and weight are critical design factors and where excellent electrical characteristics are a must. □ Standard miniature coaxial circulators from Microwave Associates (West) now from UHF to K-Bands. Call Microwave Associates (West), (408) 736-9330, or a letter to 999 East Arques Avenue, Sunnyvale, California 94086, to get full specifications on these and others.

MODEL NUMBER	CENTER FREQ. (MHz)	SIZE (INCHES)
MA-7K311	450	1.25 x 1.13 x .80
MA-7K314	600	1.25 x 1.13 x .80
MA-7K317	800	1.25 x 1.13 x .80
MA-7K320	1060	1.0 x .80 x .80
MA-7K322	1200	1.0 x .80 x .80
MA-7K324	1400	1.0 x .80 x .80

Bandwidth: 6% min. Isolation: 20 dB min.
 Insertion Loss: .75 dB max. Av. Power: 5W VSWR: 1.25:1
 Connectors: OSM or TNC Female.

UHF Miniature Ferrite Circulators, MA—West Style.



MICROWAVE ASSOCIATES

Burlington, Massachusetts

Offices: Northwest Industrial Park, Burlington, Mass.
 3605 Long Beach Blvd., Long Beach, Cal.

Subsidiaries: Microwave Associates (West) Inc.,
 Sunnyvale, Cal.

Microwave Associates, Ltd., Luton, Beds, England.

Flexibility?



Astrodata is...



INSTRUMENTATION PRODUCTS
Tens of thousands of standard products doing very special jobs.

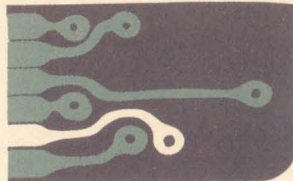

PRINTED CIRCUIT BOARDS
A high quality-high production operation using advanced equipment.



DIGITAL DATA DEVICES
The important peripherals for today's modern computers.



INFORMATION SERVICES
An advanced software capability just leaving the launch pad.

System Flexibility. The 100 KHz Astroverter!

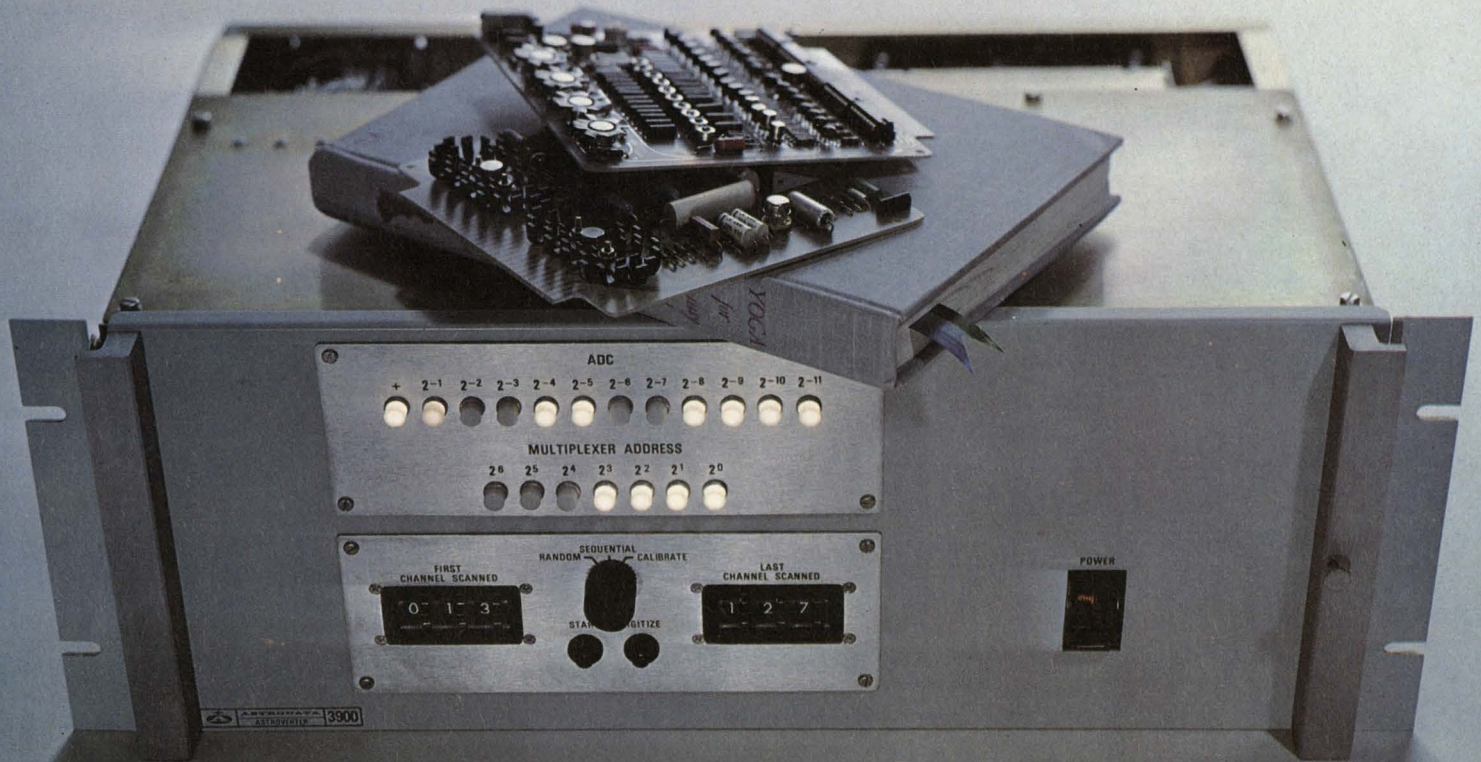

Flexible. That's the word for the Astroverter—an entirely new concept in data system packaging.

It consists of a 7-inch high rack adapter, built-in power supply, 16 card slots, and a whole family of high speed plug-in cards including multiplexers, ADCs, sample and hold amplifiers, buffers, and DACs.

A 12-bit ADC takes only two cards. Add sample and hold with one more card. 16 channels of multiplex fills 1 card slot with expandability to 128 channels. And you still have room for "quick look" DACs. Or fill the card slots with amplifiers or DACs. The combination you need. Configurations are unlimited.

Astroverter is fast, too. 5 microsecond digitizing. Less

than 5 microseconds for multiplexer switching and settling, including sample and hold. A true thru-put rate of 100 KHz!

The price is surprisingly low, too. Like a 16 channel multiplexed ADC system with sample and hold for only \$1,825 including power supply and rack.

No other system combines this flexibility, speed, and economy. No wonder. Astrodata has more systems experience than anyone. Over 350 systems in the field—more than 100 with digital computers.

Circle the reader card for the Astroverter brochure. With it you can specify just the system you need.

Astrodata—Space age technology on the industrial grow.

ASTRODATA

P.O. Box 3003 Anaheim, California 92803 Telephone (714) 772-1000



DATA AND TELEMETRY SYSTEMS
Over 350 systems delivered—more than 100 using digital computers.



ELECTRONIC SWITCHING SYSTEMS
To multiply the capability of the largest communication companies.



ANALOG AND HYBRID COMPUTERS
The largest hybrid systems in the world have been delivered by Comcor.



TIMING EQUIPMENT
Supplying the free world with more precision instrumentation than anyone.

1970 U.S. budget is Nixon's problem now

\$83 billion DOD package may get thorough overhaul; modest rise seen in electronics spending

Charles D. LaFond
Chief, Washington News Bureau

Regarding President Johnson's final budget, three certainties exist: total expenditures will show a very small increase over those made last year; Congress must approve it, and President Nixon's people are going to give it a thorough going over.

For the electronics industry, the money allocated for product purchases and contracted research and development falls between \$11 and \$12 billion. Most of this will go to the Defense Dept. NASA funding will remain at about last year's level, while budgets for the Environmental Science Services Administration, the Coast Guard, the Atomic Energy Commission and the Federal Aviation Administration have all been increased.

The big question is what Nixon will do to Johnson's final figures. According to a Washington consensus, the answer will be: not much—not until the new President

makes fiscal 1971 requests, all on his own, next year. Capital informants hedge this forecast, however, by saying there may be one clue to watch out for: Although President Johnson estimated his handover budget would produce a surplus of \$3.4 billion, President Nixon, for his part and in the name of necessity, could beef up some inherited programs to produce a budget deficit. If Nixon actually did do this, these informants point out, Johnson would get the blame and Nixon would automatically get the benefit of a budgetary surplus in fiscal 1971—the first such monetary spill-over since the last Republican administration.

No matter how you look at it, whether by total obligational authority or by expenditures anticipated, defense spending requested for the new year—\$83 billion—is up about \$2 billion over last year. Procurement requests exceed \$25 billion, and the money

asked for Research, Development, Test and Evaluation (RDT&E) comes to more than \$8 billion.

In summary, the DOD budget increase can be ascribed to cost-push inflation, to Navy requests for a very large shipbuilding program involving 19 ships, and to greatly expanded expenditures for the Sentinel ABM system, the Poseidon and Minuteman III missile programs.

Navy leads in procurement

For the first time in years, the Navy is asking more than the Air Force with a procurement request for nearly \$9.7 billion. The Navy's RDT&E request—\$2.2 billion—is also up slightly over last year.

Top procurement needs are shown in its ship and aircraft categories—\$2.8 and \$2.6 billion, respectively. The Navy hopes to convert six submarines to accommodate the new Poseidon missile (\$459 million); to construct one nuclear attack aircraft carrier (\$377 million); and to begin procurement on long-leadtime items



Large C-5A expenditures continue despite Congressional criticism of rising costs. The budget requests over \$1 billion to begin procurement of the second batch of 57 transports.



Navy shipbuilding and conversion program will require \$2.8 billion in fiscal 1970.

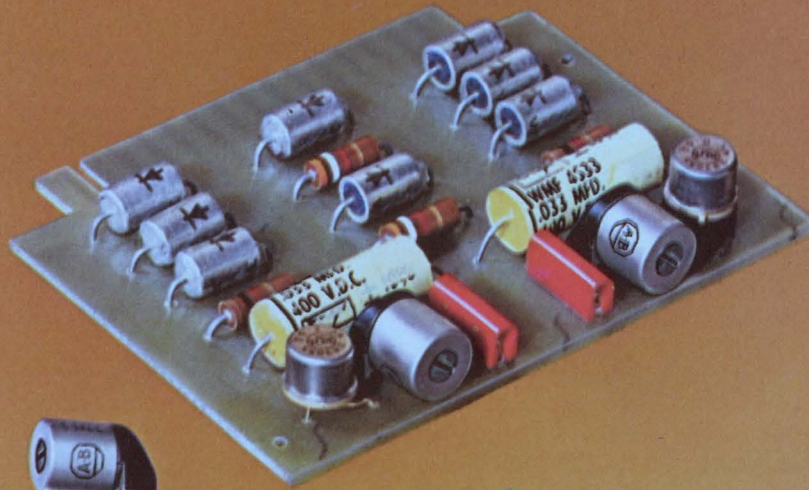

All components shown actual size



Only the new Allen-Bradley Type S cermet trimming resistors have all these features

Type S

shown twice actual size

for side adjustment



for top adjustment

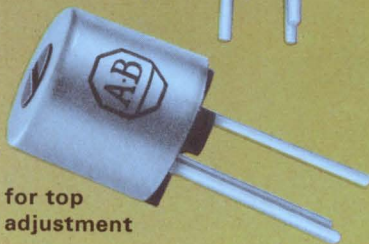

The Allen-Bradley Type S is a one turn cermet trimmer in which you will find incorporated a wider range of features than in any other trimmer now on the market. Here are a few of the more important features.

- **COMPACT**—body is $\frac{3}{8}$ " dia.
- **BUILT FOR EITHER TOP OR SIDE ADJUSTMENT**
- **50 OHMS THRU 1 MEGOHM**
- **THE SEALED UNIT** is immersion-proof
- **TEMPERATURE COEFFICIENT** less than 250 ppm/°C over all resistance values and complete temperature range
- **UNIQUE ROTOR DESIGN** provides exceptional stability of setting under shock and vibration
- **SMOOTH CONTROL**, approaches infinite resolution
- **PIN TYPE TERMINALS** for use on printed circuit boards with a 1/10" pattern

- **VIRTUALLY NO BACKLASH**
- **WIDE TEMPERATURE RANGE** from -65°C to +150°C
- **RATED $\frac{1}{2}$ watt @ 85°C**
- **EXCEPTIONAL STABILITY** under high temperature or high humidity
- **MEETS OR EXCEEDS ALL APPLICABLE MIL SPECS**
- **COMPETITIVELY PRICED!**

You'll find the new Type S trimmer equal to the traditional Allen-Bradley quality. You really ought to know more about the Type S. Won't you write for detailed specifications? Allen-Bradley Co., 222 W. Greenfield Ave., Milwaukee, Wis. 53204. In Canada: Allen-Bradley Canada Limited. Export Office: 630 Third Ave., New York, N. Y., U.S.A. 10017.



ALLEN - BRADLEY
QUALITY ELECTRONIC COMPONENTS

(budget, continued)

for additional frigates (\$196 million): Also asked is money to start construction of five DX-type advanced conventionally-powered destroyers and long-leadtime procurement for eight more DX ships. (\$343 million); for three high-speed submarines (\$505 million); and three fast deployment logistic vessels (\$187 million).

In its aircraft program, the Navy is seeking large amounts for the new F-14A fleet air-superiority fighter (\$239 million), and is moving to full production on its EA-6B electronic warfare aircraft (\$248 million). Funding is sought to continue production of the F-4J (\$207 million) and the A-7E tactical fighter (\$104 million). Among the large number of other aircraft to be purchased are the VSX anti-submarine warfare aircraft, the A-6A (\$65 million), and the KA-6B (\$70 million).

The major Navy missile program continues to be the Poseidon (\$1.2 billion), with missile procurement alone totaling \$492 million. Other missile purchases include Sparrow (\$42 million) and Sidewinder (\$32 million).

Navy procurement spending for electronics and communications will drop slightly to \$462 million. An additional \$109 million will be required for the Marine Corps.

Heaviest Navy RDT&E expenditures will go for aircraft (\$577 million) and missiles (\$552 million). A strong effort will be made to improve both airborne and ship

ASW detection systems. Research studies into the feasibility of a sea-based antiballistic missile system (Sabmis) are expected to continue.

Army stays about even

The Army procurement request—\$6.3 billion—is down \$500 million. This is countered somewhat by a \$200-million rise for RDT&E for a total of \$1.8 billion.

Army requirements for electronics and communications total \$432 million. Emphasis continues for the Mallard program (multi-nation digital field communications for the 1970's), for mobile and lightweight tactical communications equipment, for ground terminal equipment associated with the strategic and tactical defense communications satellite programs, and for long-haul communications required by the global Defense Communications System.

Electronics requirements in some missile and aircraft programs will be high—varying from 30% to 50% of total costs. While purchases of the venerable UH-1A helicopter have dropped to only \$49 million, the big buy begins this year for the highly advanced AH-56A Cheyenne armed attack helicopter, which will add up to \$302 million.

The expanding Sentinel ABM system will require \$173 million for missiles \$33 million for Sprint and \$140 million for Spartan), and close to \$500 million for long-leadtime purchase of Sentinel radar systems and for RDT&E largely associated with radars and data processing for targeting and fire control.

Other significant missile purchases include the infrared homing surface-to-air Redeye (\$23 million) and Chaparral (\$100 million) missiles, and continued procurement of the radio-controlled Hawk (\$99 million) and Nike-Hercules systems. Large procurements continue for the wire-guided Shillelagh \$51 million) and TOW (\$156 million) anti-tank missile systems. Limited funding is available for the continued improvement of heavily electronic support systems for the Pershing long-range nuclear missile.

In addition to the Sentinel R&D funds, major Army efforts to be continued include the Sam-D surface-to-air missile system, advanced digital field-communications systems, tactical data-processing systems, and night vision and imaging devices.

Air Force electronics needs rise

Air Force procurement and R&D expenditures follow a trend similar to that of the Army; that is, procurement is down somewhat to \$9 billion and RDT&E is up to \$3.6 billion. On closer study, however, it appears that Air Force spending will be directed more to the electronics industry than in the previous year.

For example, Air Force needs for electronics and communications are up nearly \$100 million for a total of \$466 million. While aircraft procurement dropped slightly to \$4.6 billion, missile expenditures are up to nearly \$1.9 billion.

Much of the Air Force aircraft money is concentrated in a few

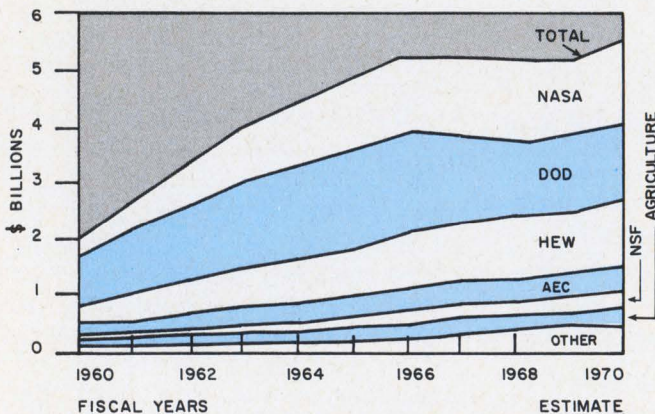

Total obligations for Federal research and development will be \$17.1 billion. Expenditures will be \$16.7 billion. Note the rise in research (left) compared with nearly flat development curve (right).

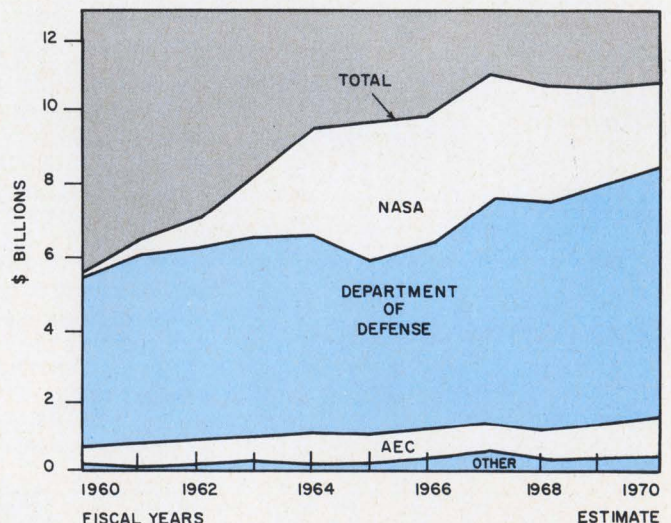

Foxboro engineers select A-B hot molded potentiometers
**"Best repeatability—component-to-component
 and setting-to-setting"**



Foxboro Model 62H electronic controller for process regulation. The control mode adjustments use Allen-Bradley Type J hot molded variable resistors with values of 10, 100, and 200 megohms.

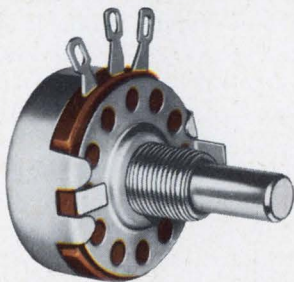

A-B Type J hot molded variable resistor rated 2.25 watts @ 70°C. Available in single, dual, and triple units. Standard total resistance values from 50 ohms to 5 megohms. Special resistance values and tapers can be supplied.

Widely used throughout the process industries, the Foxboro Model 62H Universal Controller is a highly dependable precision instrument. During the years of painstaking development, Allen-Bradley engineers worked closely with Foxboro to provide a potentiometer having unusually high resistance values, which would provide the precise performance required.

Allen-Bradley Type J potentiometers were the answer. They have a solid hot molded resistance track which is produced by an exclusive A-B molding technique that assures extremely long operating life. Accelerated tests—exceeding 100,000 revolutions—show very slight resistance change. Control is smooth at all times with adjustment approaching infinite resolution. There are none of the abrupt turn-to-turn resistance vari-

ations inherent in wirewound controls. Furthermore, Allen-Bradley Type J potentiometers are—for all practical purposes—noninductive, permitting their use throughout the frequency spectrum.

Whether your particular circuit design can be best satisfied with one of the millions of standard Type J variations or whether it calls for unusual resistance characteristics, it will pay you to look first to A-B Type J potentiometers. Their more than 25-year history of providing superior performance is your guarantee of complete satisfaction. For full details, please write for Technical Bulletin 5200: Allen-Bradley Co., 1201 South Second Street, Milwaukee, Wisconsin 53204. Export Office: 1293 Broad St., Bloomfield, New Jersey, U.S.A. 07003. In Canada: Allen-Bradley Canada Limited.



ALLEN - BRADLEY
 QUALITY ELECTRONIC COMPONENTS

(budget, continued)

procurement programs. These include: the F-111A and D, \$518 million; the FB-111A, \$294 million; the C-5A, \$1048 million and the A-7D, \$375 million. Remaining aircraft purchases are largely represented by the F-4, F-5, A-37, the new O-X air-controller aircraft, trainers, and helicopters, along with aircraft spares and support equipment.

Air Force missile system procurement totals \$1.9 billion, centering heavily on Minuteman III, which alone totals \$814 million (the full Minuteman program adds up to \$1.6 billion). Other Air Force missile purchases include the Shrike and Standard ARM antiradiation missiles, the short-range attack missile (Sram), and Sparrow and Sidewinder air-to-air missiles.

Air Force RDT&E money asked for space activities comes to \$1.11 billion. Next highest expenditures are for missiles, nearly \$1 billion, and for aircraft, \$645 million. The Manned Orbiting Laboratory program has been increased to \$576 million.

While R&D phases out this year for the massive C-5A transport, new funds should be available to continue definition studies for the Advanced Manned Strategic Aircraft (\$77 million), for the Airborne Warning and Control System (\$75 million), and for the F-15 tactical air-superiority fighter (\$175 million). Continued funding is requested for the advanced Bullpup and for Maverick air-to-surface missiles. Minuteman III R&D funds total \$350 million, (an additional \$430 million will be asked for silos and missile support electronics).

NASA budget termed austere

In the words of acting NASA Administrator Dr. Thomas O. Paine, his agency's fiscal 1970 budget of \$3.878 billion "is austere, and does not make full use of the aerospace capabilities that the Nation has developed in Government, in industry, and in universities." Nevertheless, the NASA chief asserts that "the budget

permits a balanced program of useful work in critical areas."

Others in NASA declare flatly that this year's budget supports a "starvation diet" and virtually assures the demise of manned programs by the mid-1970s.

Total NASA expenditures for R&D, of which nearly 90% are spent externally, approach \$3.2 billion. Slightly over \$2 billion of this is for manned space flight, over \$500 million is for science and applications, and over \$250 million is for advanced research and technology. Nearly \$300 million will be applied for tracking and data acquisition.

For its manned programs, NASA is seeking \$1.65 billion to continue the Apollo program. For the so-called Apollo Applications Program, \$354 million is sought. The money breaks down to \$138 million for space vehicles, \$170 million for the required instrumentation, with the remainder going to support research.

For unmanned planetary probes, principal efforts will include hardware for the Mariner flights to Mars planned for 1969, 1971 and 1973, and for Pioneer spacecraft ordered for flights to Jupiter in 1972 and 1973. Also, a new class of planetary Explorers will begin development for flyby trips to Mars and Venus. Development will start on an additional Mariner-class vehicle in time for a launch to Mercury in 1973, and on a new class of planetary Explorers for

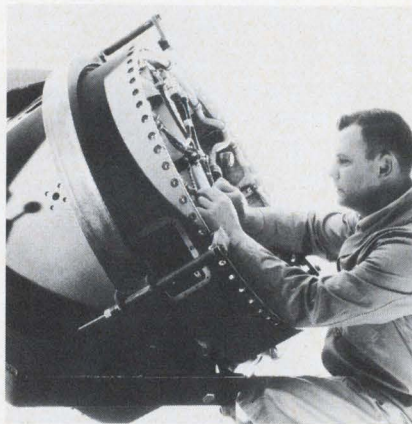

Research and development continues for advanced penetration aids (shown above is the Mk I being developed by Avco for Minuteman III ICBM), multiple independently targeted re-entry vehicles, and radar detection and discrimination technology.

flyby trips to Mars and Venus.

Launches are planned this year for a Nimbus experimental weather satellite, another Orbiting Astronomical Observatory (OAO-III), an Orbiting Geophysical Observatory, and an Applications Technology Satellite.

The bulk of expenditures for tracking and data acquisition will go for contractor operation of the global NASA communications and tracking systems. In addition, some \$46 million will go for new electronic equipment at the various stations and \$12.5 million will be used for supporting research and technology.

ESSA gets in-house funds

The big spender in the Commerce Dept. budget request will be the Environmental Science Services Administration (ESSA), with relatively small amounts asked for the Maritime Administration for R&D (about \$10.8 million) and for the National Bureau of Standards.

The bulk of ESSA expenditures are spent in house. R&D funding has risen very slightly to a total of \$27.4 million; facilities and new equipment expenditures will be up somewhat for a total of \$10 million, and total program costs for weather satellite operation and procurement will be \$21 million.

ESSA's request, however, in the latter category for new obligational authority to procure satellite and launch vehicles is down by over 50% (about \$9 million), because of the unexpected long-operating life of its operational satellites.

The largest funds available to industry in the Dept. of Transportation originate with the U.S. Coast Guard, the Federal Aviation Administration and the Urban Mass Transportation Administration. Overall the Dept's budget is up slightly, but its total R&D program has increased nearly \$70 million for a total of \$264 million.

In an attempt to improve the Federal Airways System, the FAA will procure more traffic control and navigation instrumentation and expand its R&D effort for new systems. Of its total procurement budget of \$173 million, \$134 million will be required for automation equipment to update traffic control centers. ■■

1st DUAL IN-LINE CERMET POTENTIOMETER

TRIMPOT® MODEL 3099

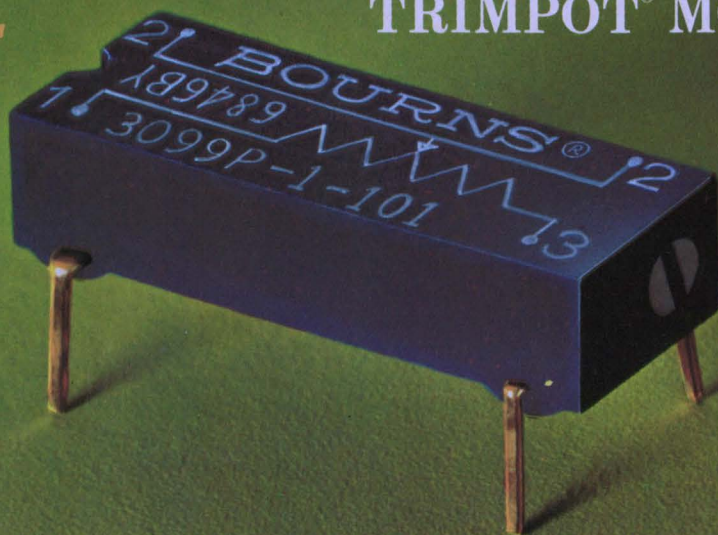

**Designed for Automated Insertion . . . TC 150 PPM/°C*
over entire resistance range of 10 ohms to 1 megohm!**

The new Trimpot Model 3099 dual in-line cermet element potentiometer has standard DIP construction with a TO-116 case. Today's ever-accelerating computer industry requires dual in-line components for socket or modern state-of-the-art automated assembly. The Model 3099 utilizes this mounting and is completely compatible with manual or automatic insertion equipment.

Let us tell you the complete technical story on this newest potentiometer innovation in the industry! For full details on the Model 3099, please contact the factory, your local field office or representative!

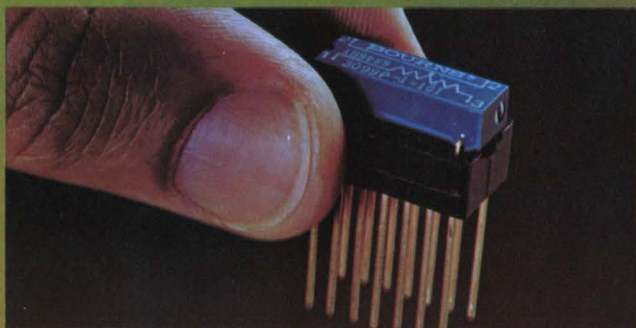

Model 3099 in standard 14 pin DIP socket.

* 100 PPM/°C available

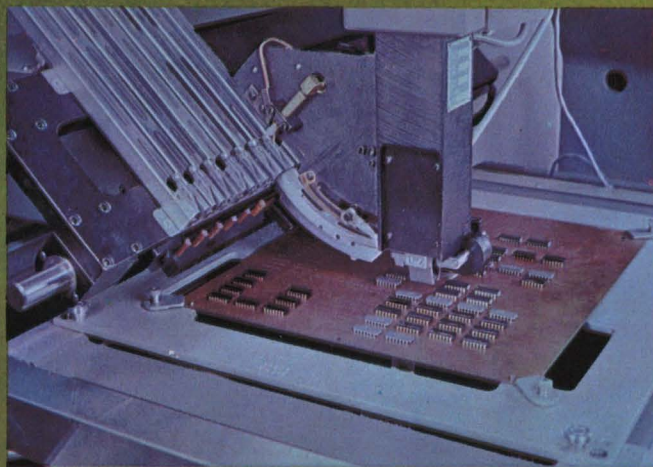

Model 3099 is designed for use with DIP automatic insertion equipment.



BOURNS, INC., TRIMPOT PRODUCTS DIVISION
1200 COLUMBIA AVENUE, RIVERSIDE, CALIFORNIA 92507
714 684-1700 • TWX: 910 332-1252 • CABLE: BOURNSINC

Military Power

ERA supplies it off the shelf!

ERA CERTIFIED MIL SPEC POWER MODULES FULLY MEET OR EXCEED:

MIL-E-4158, MIL-E-5400, MIL-E-16400,
MIL-E-5272, MIL-T-21200, MIL-E-4158

- no engineering or prototype costs
- checked, approved and certified
- minimum cost for single or quantity orders
- fast delivery
- 77 proven and tested models
- repairable 75°C silicon types
- encapsulated types
- hundreds of variations in each group

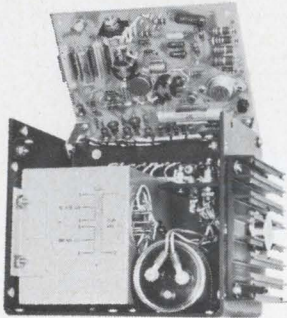

Satisfy your most exacting military requirements with off-the-shelf certified ERA Mil Spec DC power modules. Choose from 77 stock models. Proven designs ... no engineering or prototype costs AND, you get certification from one of America's leading independent testing laboratories.

Write for free informative booklet describing tests and results along with the ERA catalog.

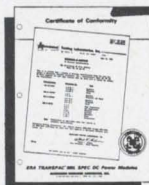

ELECTRONIC RESEARCH ASSOCIATES, INC.

67 Sand Park Road, Cedar Grove, N.J. 07009 • (201) 239-3000

SUBSIDIARIES:

ERA Acoustics Corp. • ERA Dynamics Corp.
Astrocom Inc. • The Magitran Company

INFORMATION RETRIEVAL NUMBER 33

Letters

A word on electronics in new British liner

Sir:

We refer to your East Coast Editor's article "Computers Build and Run New Cruise Ship" in your Sept. 1, 1968 issue, (ED 18, p. 25):

By inference, your readers are misled into believing that the Lincompex equipment and hf receivers supplied to Cunard for the Queen Elizabeth 2 are of International Telephone and Telegraph manufacture. In fact, this equipment is produced by GEC-AEI (Electronics) Ltd., Coventry.

Furthermore, all development work and the "extensive successful testing" mentioned by your man was done by our company. We assigned engineers to sail in the Cunard ships mentioned, and the first live demonstration to the press of the effectiveness of GEC Lincompex was supervised by our senior project engineer, who was on board the Carmania for this very exercise.

The British G.P.O. is responsible for the basic conception of Lincompex. They gave our company the contract for complete design and development, based on their ideas, resulting in two six-foot cabinets. These were considered by our engineers to be too large, and the equipment on the Cunard ships is GEC Lincompex Mk. II, which has been reduced in size through the extensive use of miniaturization techniques to a mere 8-3/4 inches high.

GEC Lincompex equipment sales have topped the £ 1M mark, and the equipment is receiving worldwide acclaim. GEC Lincompex equipment is being operated by international broadcasting telegraph and telephone authorities, government agencies and public commercial companies in India, South Africa, West and East Africa, South America, U.S.A., U.K. and Europe.

M. Luscott-Evans

Publicity Manager
General Electric Co. Ltd.
GEC-AEI (Electronics) Ltd.
Coventry, England

Accuracy is our policy

Sir:

Accuracy is *our* policy. ED 6, Mar. 14, 1968, p. 58, has our electronic thermometer. The 1 k in the Q2 emitter circuit should be present in Fig. 2 as in Fig. 1. I hope this printer's error did not frustrate too many people.

John L. Menke

National Bureau of Standards
Washington, D.C.

In the article "Move Toward Automated Circuit Design" (ED 17, Aug. 15, 1968, pp. 184-189), Fig. 2 should have appeared as follows, the author says:

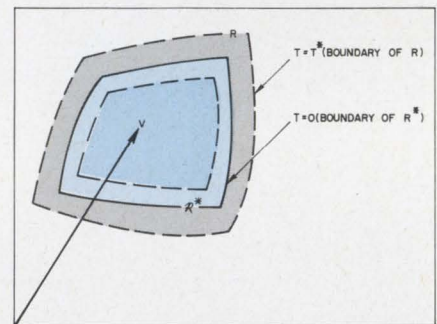

The paragraph following the sub-head "Include tolerance interaction effects" should begin: "The method described thus far does not differentiate . . ."

The following references can be added:

8. A. Brown and H. C. Yang, "Optimal Worst Case Circuit Design," *Proceedings of the NEC*, Vol. XXI, 1965, pp. 737-742.

9. A. Brown and H. C. Yang, "Optimal Worst Case Circuit Design, Part 2," IBM Tech. Report TR00.1345, (Oct. 14, 1965).

In the second article of the series, "Evaluate Digital Circuits Automatically" (ED 18, Sept. 1, 1968, pp. 78-83), the following references can be added:

1. W. Bell, P. Holub and J. Keran, "Computer Aided Analysis of a Silicon Monolithic Integrated Circuit Switch Gate," Ninth Midwest Symposium on Circuit Theory, May 1965, p. 18-0.

2. R. Seeds and W. Bridwell, "The Design of Integrated Current Switching Logic Elements having Propagation Delays from 1 to 2 Nanoseconds," *Proceedings NEC*, Vol. XXI, Oct. 1965, pp. 101-105.



all fhp motors are alike?

Now that you're surprised at how different this Howard fhp motor looks on the *outside*, let's talk about *output*:

When Howard rates a motor 1/20 hp, we're not about to underpower your system with a 1/25 hp motor. We've always True Rated our fhp motors this way.

Now engineers and designers are finding that a carelessly overrated or underrated motor can cause system problems. And they want no part of either. That's why engineers look to Howard for True Rated fractional horsepower motors. . . .

and they get them. Our computer guarantees it. And your products benefit.

Next time you look at the outside of a Howard motor, you won't find mod painting. You will find that if the label says 1/20 hp, we don't mean 1/25 hp. Or 1/15 hp, either.

Get the complete Howard True Rated story. Find out in detail why it makes no difference that all fhp motors *look* alike. It's the output that counts. Write or call Howard for Fractional Horsepower Motor Information Packet ED-29.



HOWARD

HOWARD INDUSTRIES
MSL INDUSTRIES, INC./MOTOR GROUP
2420 18th STREET, RACINE, WISCONSIN 53403
414-632-2731 TWX 910-271-2387

INFORMATION RETRIEVAL NUMBER 34

PROGRAM VOLTAGE OR PROGRAM CURRENT WITH KEPCO AUTO-CROSSOVER POWER SUPPLIES

by PROGRAM, we mean the exercise of intentional control over the output of your power supply — a regulated supply that remains quiescent — unmoving, stable until it receives your command signal.

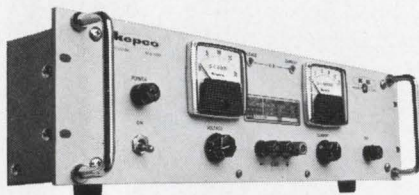

Model KS 18—15M voltage/current regulator showing Kepco's exclusive mode indicator lights — VIX®. This 5 1/4" x 19" rack mounting power supply delivers 0—18V@0—15A.

You can signal with analog voltage or current or resistance or conductance. Or, you can get fancy and use digital control. Kepco's 20 KS models offer complete control over both voltage (0—8V to 0—120V) and current (0—1A to 0—100A) in four basic panel heights — 3 1/2", 5 1/4", 7" and 8 3/4". Write Dept. AD-5 and we'll tell you about the 16 programming terminals available on all models.

**with KEPCO
IT'S CONTROL!**



131-38 SANFORD AVE. • FLUSHING, N.Y. 11352
(212) 461-7000 • TWX # 710-582-2631

INFORMATION RETRIEVAL NUMBER 35

Holography leaves the lab

After 20 years in the laboratory, largely as a photographic curiosity, holography has been joined to laser interferometry to form a new, nondestructive test technique. With it, quality controllers in the aircraft, tire and other industries are able to determine exactly what is happening inside a manufactured product while it is being subjected to severe environmental stresses: They compare a 3-D image of the object under stress to the object when it sits unstressed. Small dimensional changes that are stress-induced are the telltale clues to trouble. Just how the new technique sees the flaws and what the testing breakthrough means for producers is spelled out by East Coast Editor Jim McDermott, who interviewed major users. Begin on p. 25.

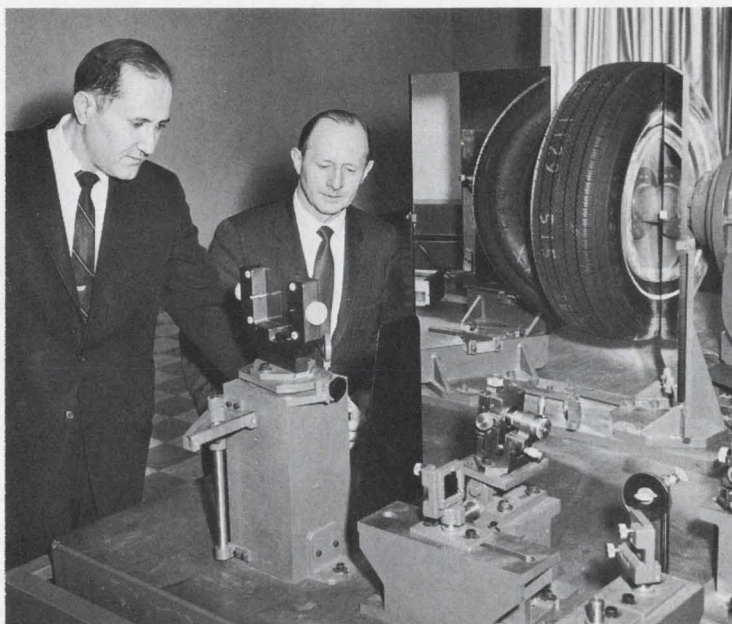

ED's East Coast Editor, Jim McDermott (right), examines the new holographic testing setup at the Uniroyal Tire Co. plant in Detroit. H. D. Tarpinian, manager of test development at Uniroyal, is demonstrating.

Our Reader Service now brings you samples

Every engineer has, at one time or another, found himself unable to evaluate a component or a material adequately from raw specs or photos alone. With this issue, ELECTRONIC DESIGN adds a new Evaluation Samples department (p. 202). Readers who wish samples of any component or material described on that page have only to circle the appropriate number on the Information Retrieval Card inside the back cover. Requests will be forwarded to the cooperating manufacturers within three days.



*The
Standard of
Excellence*

S/D D/S converters by CLIFTON

Excellent means — "first class, of great worth, eminently good." Definite qualities of our ADverter S/D, D/S converters. But we should add one other feature: *not expensive!* (Model SD12A1, \$795 qty. 1-9.)

In fact, their low cost, combined with such other features as: reliable, all solid state circuitry, easily interchangeable

encapsulated sub-modules, no calibration or adjustments, multi-channel capability, wide variety of options, make them superior in many ways to brush encoders.

Although designed especially for the process control and machine tool fields, this system can easily be modified for military applications.

So take advantage of our

application engineering know-how which is yours for the asking. Call our DITRAN division in Burlington, Mass. (617) 272-6210, or your local Clifton sales office. When you consider Litton, Clifton, Ditrans quality, you couldn't do better!

CLIFTON 
DIVISION OF LITTON INDUSTRIES

Pearls by J. E. Caldwell Co., Philadelphia—\$5,600

Three new A version linear ICs. Tightest specs you can get.

Raytheon is coaxing record performances from three veteran circuits with new advanced A versions. Compare these key maximum specifications, rated over the full military -55 to 125°C temperature range.

RM709A High Gain Op Amp. Offset voltage 2.0 mV, drift $6.0\mu\text{V}/^{\circ}\text{C}$. Low temp (-55°C to 25°C) offset current drift is $1.0\text{ nA}/^{\circ}\text{C}$, high temp drift only $0.3\text{ nA}/^{\circ}\text{C}$. (Best competitive specs: V_{os} 3.0 mV, drift $10.0\mu\text{V}/^{\circ}\text{C}$, $2.8\text{ nA}/^{\circ}\text{C}$.)

RM710A Differential Voltage Comparator. V_{os} is 1.5 mV, drift $5.0\mu\text{V}/^{\circ}\text{C}$. Low and high temperature offset current drift only 50 and $10\text{ nA}/^{\circ}\text{C}$, respectively. (Competition: V_{os} 3.0 mV, drift $10.0\mu\text{V}/^{\circ}\text{C}$ and $75\text{ nA}/^{\circ}\text{C}$.)

RM711A Dual Differential Voltage Comparator. Offset voltage is 1.5 mV. Low temp offset current drift $25\text{ nA}/^{\circ}\text{C}$, high temp drift $10\text{ nA}/^{\circ}\text{C}$. (Best elsewhere: V_{os} 4.5 mV, current drift N/A.)

And price? Surprisingly low. Only 10% over costs of standard mil-temp versions. Available now from Raytheon distributors across the nation. Send for data sheets and distributor list from the company that gets the ideas and delivers the goods. Raytheon Semiconductor, Mountain View, California, (415) 968-9211.

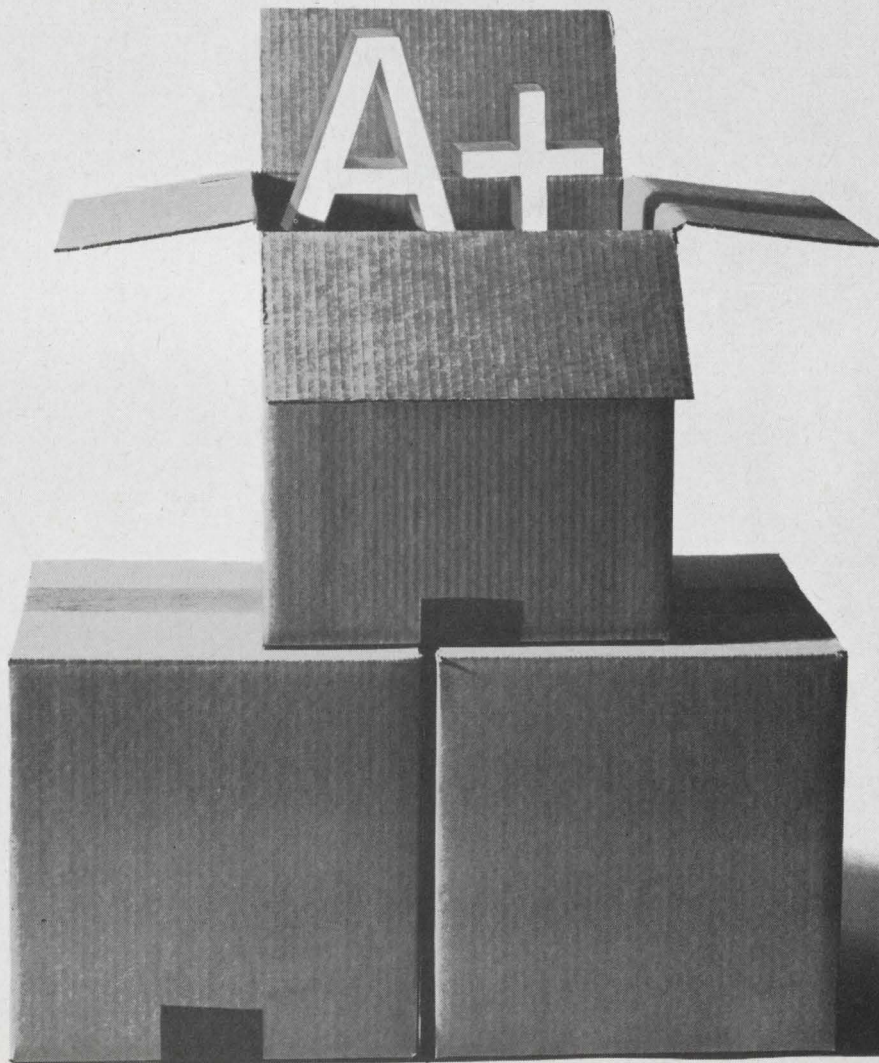

Publisher

Hugh R. Roome

Editor

Howard Bierman

Managing Editor

Robert C. Haavind

Technical EditorsFrank Egan
Michael J. Riezenman
Raymond D. Speer**Management and Careers Editor**

Lawrence Locke

News Editor

Ralph Dobriner, Chief

Washington News Bureau

Charles D. LaFond, Chief

Military/Aerospace Editor

John F. Mason

East Coast Editor

Jim McDermott

West Coast Editor

Elizabeth deAtley

New Products EditorsRobert Patton
Lucinda Mattera**Copy Editor**

Peter Irving

Editorial ProductionDollie S. Viebig
Phyllis Gura**Art Director**

Clifford M. Gardiner

Art Assistant

William Kelly

Technical IllustratorsWilliam Alvarez
Rita Jendrzewski
Lynn E. Thompson**Production Manager**

Thomas V. Sedita

Asst. Production Manager

Helen De Polo

Production AssistantsBernard Wolinsky
Carl A. Merkin**Circulation Manager**

Nancy L. Merritt

Information Retrieval

Genate Pazmino

EDITORIAL



Technology and politics: Better rapport needed

Is the nation beginning to go sour on technology?

There are signs that it is. Despite the lift to our technical prestige provided by the circumnavigation of the moon, there is more and more public questioning of the billions spent on research and development. There is good reason for many of the complaints. Jet noise *is* increasing. Technologically generated pollutants *are* contaminating our waters and atmosphere. Television *is* feeding large doses of violence to our children. But the fault is not technology's; it is our *use* of technology.

Today we are hearing that technology and science can cure our problems. It will be unfortunate if our products continue to be peddled to the public as a panacea. No human problem can be cured by statistical distributions or machines.

Yet the tools of scientists and engineers are essential to an intelligent attack on many of the new problems that are besetting us. But too few of those in high office have had a valid sense of the role they should play.

For example, electronic noise-monitoring instruments are available to measure the din at urban construction sites. Medical researchers can prove that such loud noises cause permanent damage to membranes of the inner ear. Mechanical engineers can demonstrate how easily the sound can be damped, muffled or designed out of construction equipment.

But as long as public officials fail to develop and pass solid, technologically based laws to curb offenders, scientific and technical efforts are of little help. Measuring water pollution can provide loads of data. But as long as lumber mills and sewage plants upstream continue to dump untreated wastes into clear water without penalty, pollution will continue.

Many of the problems that are most disturbing to our citizens are of little interest to the science and technology establishment that has grown up in recent years, however. Too often R & D peddlers have seen that larger and larger sums were provided for their own pet projects.

The resulting distortion of needs is beginning to give the public the feeling that technology is creating more problems than it is solving. Technology may be viewed some day in the same negative way that "big business" sometimes is today.

More intelligent use of the fruits of technology, and an effort to inform the public better of the part it can play in solving our problems, are two areas where the new Administration in Washington can make real progress. Otherwise public antipathy may hinder even the most worthwhile programs.

ROBERT HAAVIND

variable viewing time 5 cm/ μ s stored writing speed

split-screen displays

all in the Tektronix Type 549 Storage Oscilloscope

Waveform display showing train of pulses. Upper screen in the stored mode shows three pulses with falltime of the pulse trailing edge showing system deficiency. Lower screen in conventional display mode shows the same pulse train with corrections applied to provide a well formed pulse shape. Pulse width shown is 8 μ s with risetime of 0.1 μ s. Vertical deflection factor is 0.5 volts/cm. Horizontal deflection factor is 10 μ s/cm. Repetitive sweep used for both displays.

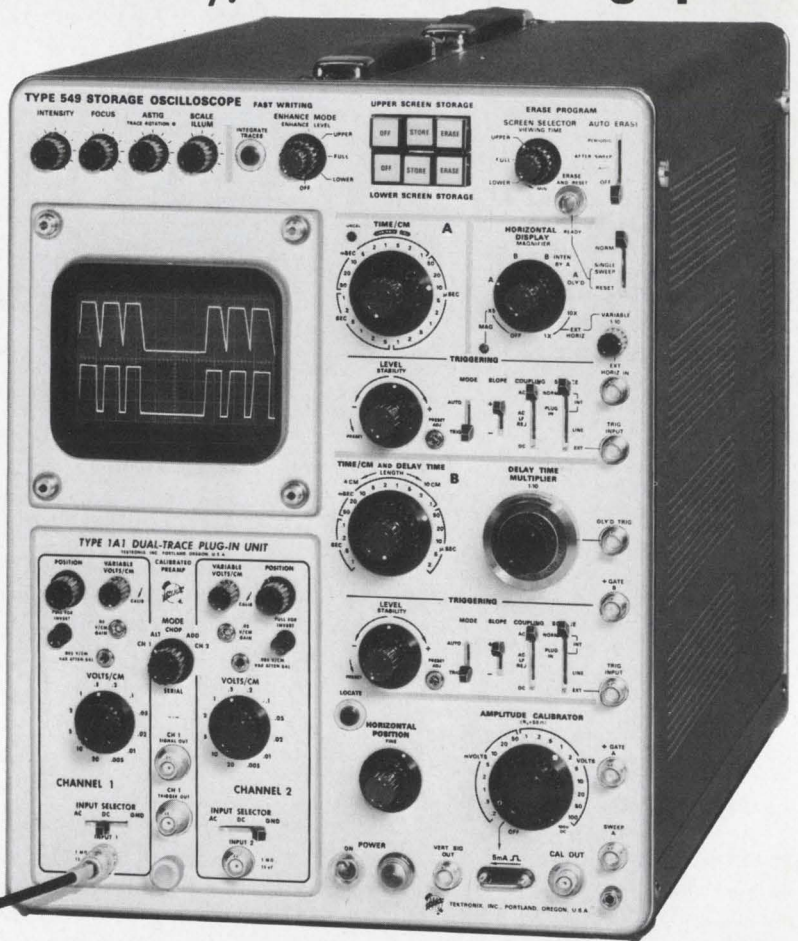

The Type 549 allows up to one hour of continuous visual storage, giving you ample time in most applications to measure and analyze stored waveforms. Stored displays can be erased in less than one-quarter of a second.

Split-screen displays

Unique with Tektronix storage oscilloscopes, split-screen displays bring you many advantages in waveform-comparison applications. You can use either half of the 6 cm by 10 cm display area for stored displays, the other half for nonstored displays, with independent control of each half. You can also use the entire screen for either type of display.

Variable viewing time

Variable viewing time — an outstanding feature of the Type 549 — allows you to automatically store displays, view them for a selected time, then automatically erase them on either or both halves of the screen. Two modes of operation are possible. In the After-Sweep Automatic Erase Mode, the selectable viewing time of 0.5 s to 5 s begins at the end of each complete sweep. After the viewing time, the display is automatically erased and the cycle begins again when the next sweep is triggered by a signal.

In the Periodic Automatic Erase Mode, the sequence of storing, viewing time and erasure is continuous and independent of the sweep or signal. In this mode, the viewing time can also be varied from 0.5 s to 5 s.

There is no degradation of stored traces during the selected viewing time, in either mode, and you can retain or erase displays manually whenever desired.

For a demonstration, contact your nearby Tektronix field engineer or write: Tektronix, Inc., P.O. Box 500, Beaverton, Oregon 97005.

Bistable storage advantages

With bistable storage oscilloscopes, such as the Type 564 and Type 549, the contrast ratio and brightness of stored displays are constant and independent of the viewing time, writing and sweep speeds, or signal repetition rates. This also simplifies waveform photography. Once initial camera settings are made for photographs of one stored display, no further adjustments are needed for photographs of subsequent stored displays.

Tektronix bistable storage cathode ray tubes are not inherently susceptible to burn-damage and require only the ordinary precautions taken in operating conventional oscilloscopes.

Plug-in unit adaptability

Vertical deflection characteristics of the Type 549 are extremely flexible through use of any of the Tektronix letter- or 1-series plug-in units. These include multi-trace, differential, sampling, and spectrum analyzer units. Depending upon the plug-in being used, bandwidth of nonstored displays extends from DC to 30 MHz.

Among other features of the Type 549 are 5 cm/ μ s stored writing speed, calibrated sweep delay from 1 μ s to 10 s, sweep speeds to 20 ns/cm, amplitude calibrator from 0.2 mV to 100 V and a locate zone for easy positioning of stored traces.

Type 549, without plug-in units \$2575

Type 1A1 Dual-Trace Plug-In Unit \$ 625

DC to 30 MHz at 50 mV/cm; DC to 23 MHz at 5 mV/cm.
2 Hz to 14 MHz at 500 μ V/cm, single-channel.

U.S. Sales Prices, FOB Beaverton, Oregon



Tektronix, Inc.
committed to progress in waveform measurement

Technology

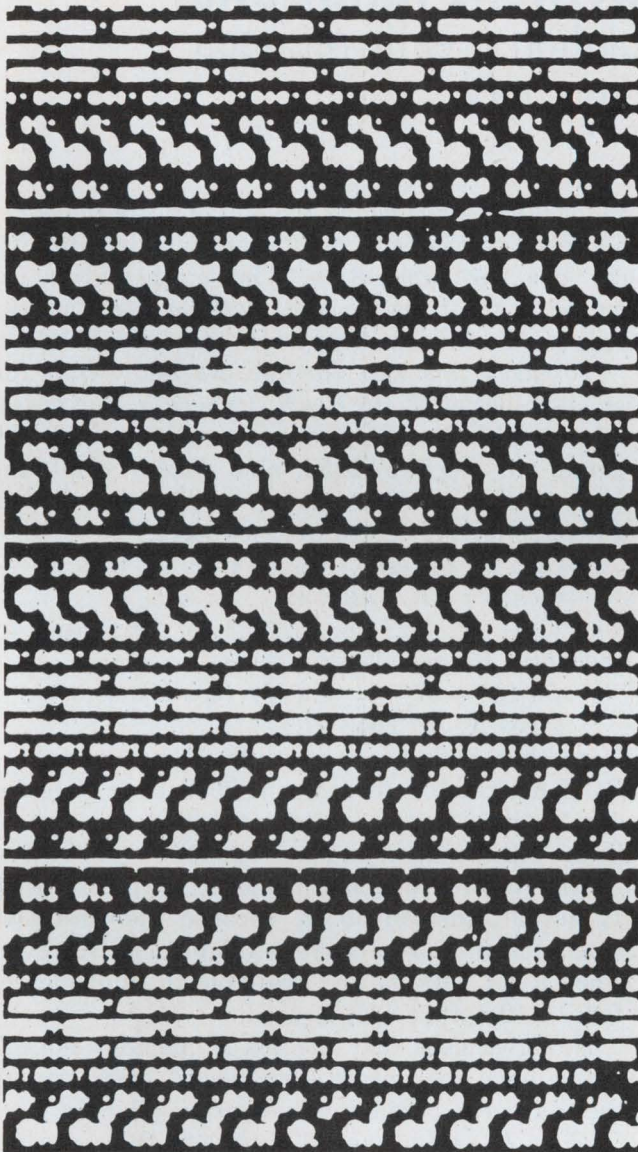

Math manipulation cuts bit requirements for a look-up table memory, p. 66.



Asking "What is time?" led to new products in General Time's idea sessions, p. 102.

Also in this section:

Will radiation wreck your IC design? Not if you design your circuits properly, p. 78.

To measure MOSFET parameters with ease, here is all you need, p. 86.

Best one-shot for your money: NAND gates and discrete components, p. 96.

Semiannual index of articles for June through December 1968, p. 108.

Ideas for Design, p. 124.

Slash ROM sizes with equivalent functions.

Trigonometric or arithmetic manipulation greatly reduces bit requirements for a look-up table memory.

A major problem in using read-only memories for high-resolution functions is keeping the size small enough to be practical in fabrication. A simple look-up table for $\sin x$, for example, can require 144,000 bits of memory (9000 words at 16 bits each), if x is accurate to hundredths of a degree and $\sin x$ is accurate to 16 bits.

A ROM chip this complex is not economically feasible and is not expected to be for some years. Production yields drop off rapidly with increasing chip size, and mask-resolution imposes an upper limit of about 1300 MOS transistors on a 100 by 100-mil chip. To contain 144,000 bits of memory, such a chip would have to be at least one inch square; the yield on such a device would be miniscule, and the cost correspondingly high. A practical ROM size at present is 2500 bits.

An obvious alternative, of course, is to use many smaller memories in parallel, but this, too, gets expensive. And it's unnecessary. The proper use of trigonometric and other equivalent functions can vastly reduce the required bit count.

Trigonometric identities save bits

Consider the ROM $\sin x$ generator. If we let $x = N + H$, where N is the number of whole degrees and H is the fractional degree in hundredths (if $x = 36.81^\circ$, for example, $N = 36$ and $H = 0.81$), then we can write

$$\begin{aligned}\sin(N+H) &= (\sin N) (\cos H) \\ &+ (\cos N) (\sin H)\end{aligned}$$

Now, instead of one large memory, we need four smaller ones. Since N has only 90 possible values, and H has 100, the four memories required would be limited in size:

$$\begin{aligned}\sin N &= 90 \text{ words @ } 16 \text{ bits} = 1440 \text{ bits} \\ \cos H &= 100 \text{ words @ } 16 \text{ bits} = 1600 \text{ bits} \\ \cos N &= 90 \text{ words @ } 16 \text{ bits} = 1440 \text{ bits} \\ \sin H &= 100 \text{ words @ } 16 \text{ bits} = 1600 \text{ bits}\end{aligned}$$

The total memory requirement is now only 6080 bits. This memory is much smaller than the

144,000 bits required by the single large memory, and each of the four small memories is a practical size for fabrication. The mathematics required in the formula is straightforward, and it, too, can be implemented with standard ROMs.¹⁻⁶

To carry this idea further, we know that for small values of H , $\sin H \rightarrow H$, (where H is expressed in radians). Since we are working with degrees, $\sin H \rightarrow H/57.2958$, and since $H < 1.0$, the error in this approximation is negligible (see box 2). Substituting, therefore, we have

$$\begin{aligned}\sin x = \sin(N + H) &= (\sin N) (\cos H) + \\ &(\cos N) (H/57.2958)\end{aligned}$$

The division of H by 57.2958 is eliminated by rewriting the equation:

$$\begin{aligned}\sin(N + H) &= (\sin N) (\cos H) + \\ &[(\cos N)/57.2958]H.\end{aligned}$$

Note that it is no more difficult to create the ROM matrix for $(\cos N)/57.2958$ than it is for $\cos N$ (it is just a matter of which crosspoints in the ROM matrix to leave open).

The $(\cos N)/57.2958$ memory can get by with 11 outputs instead of 16, because the first five fractional bits are always 0 (Table 1). However, since ROM outputs are available in multiples of four, a 12-output unit is used.

Now, we note that the $\cos H$ memory doesn't really have to contain 100 words, even though there are 100 possible values of H (Table 2).

Since H varies over slightly less than one degree, $\cos H$ stays very close to unity. The first 4 bits of H are found—by inspection of the $\cos H$ table—to be sufficient to provide the required resolution. If we use only the first 4 bits of H as inputs to a 16-word $\cos H$ memory, the error in the $\cos H$ output is always less than 1 bit in the 16th binary position (this estimate can be verified easily by direct comparison of true $\cos H$ values and those in Table 2).

The representation of unity for $\cos H$, as shown in the first four lines of the table, would normally require a 17th output, since 16 are required for the fractional bits. However, it is possible to get by with only six outputs, instead of 17, by taking advantage of the repetition in the first 12 fractional bits (2^{-1} to 2^{-12}). The first out-

Albert Hemel, Senior Engineering Specialist, Philco Ford WDL, GIO Defense Control Systems Activity, Palo Alto, Calif.

MOS ROM Basics

MOS read-only memories (ROMs) are cheap—and their prices continue to drop. Substituting a ROM for an equivalent diode matrix now reduces memory cost by approximately two thirds. A 1024-bit memory, rated for operation from 0° to +75° C, can currently be bought for about \$40—four cents per bit—in quantities of 100 or more, and manufacturers predict that this cost will drop to less than 0.4 cents per bit in the next few years.

The low cost of the MOS ROM can be traced to the ease with which it can be custom designed. Manufacturers start with an assortment of common memory functions; from these, they are able to custom design new and complex functions—at customers' requests—with a single mask change. Extensive redesign for customer-requested functions therefore becomes unnecessary.

The ease with which ROMs can be redesigned grows out of the memory's basic structure: conducting crosspoints, which are three-terminal MOS devices, can be included or eliminated—as required—by modification of the gate metallization mask alone.

If the gate for a crosspoint is provided in the mask, that element conducts when it is interrogated; if the gate has been omitted, it does not conduct. The pattern of conducting and non-conducting gates at a particular address determines the pattern of output bits.

The signal input to a ROM comprises a number of bits whose quantity depends on the memory size and organization; the signal input serves to define and interrogate an address. The bits of data stored at that address appear automatically on the output leads.

When a function is stored in a ROM in look-up table form, the input bits describe the value of the variable in the function (an address). The quantity permanently stored in memory (at that address) is the corresponding value of the function.

The active-element crosspoints provide one other advantage—they require far less power to operate than diode matrices. A 1024-bit ROM presently available from Philco-Ford (see photo), for example, operates as a 128-word 8-bit memory with a power dissipation of only 150 mW. An equivalent diode matrix would normally consume 5 W.

put represents the whole number 1 or 0; the second output represents the next 12 bits, and the last four outputs are the last 4 bits shown in the table. Again, since outputs in multiples of four are convenient, an eight-output ROM unit is used, and provides 2 more bits of accuracy (in the 2^{-17} and 2^{-18} positions). Hence, the $\cos H$ memory need consist only of four inputs, 16 words, and eight outputs, for a total of 128 bits.

The final score, then, is:

$\sin H = 90 \text{ words @ } 16 \text{ bits/word} = 1440 \text{ bits.}$

$(\cos N)/57.2958 = 90 \text{ words @ } 12/\text{bits/word} = 1080 \text{ bits}$

$\cos H = 16 \text{ words @ } 8 \text{ bits/word} = 128 \text{ bits}$

The total memory requirement: 2648 bits.

Our objective was to generate $\sin x$ for $0.00^\circ \leq x \leq 89.99^\circ$. A straightforward memory table would have required 144,000 bits, but:

(1) Using the equivalent function,

$$\sin x = \sin(N + H) = (\sin N)(\cos H) + (\cos N)(\sin H)$$

we reduced the memory to 6080 bits;

(2) Then applying the relationship,

$$\sin H = H/57.2958 \text{ for } H \leq 0.99^\circ$$

we reduced the function to

$$\sin x = \sin(N + H) = (\sin N)(\cos H) + [(\cos N)/57.2958]H,$$

and the memory to 4120 bits;

(3) The first 5 bits of the $(\cos N)/57.2958$ memory output were always 0, so we reduced this memory to 12 outputs;

(4) And since the $\cos H$ memory output stayed so close to unity, (a) the first 4 bits of H were sufficient input for the required resolution, and we reduced the memory to 2^4 or 16 words, instead of 100, and (b) the first 12 output-bits were always the same, permitting a reduction to 8 outputs. The result: a total memory requirement of only 2648 bits—a reduction of 98%.

In the $\sin x$ generator that results from this

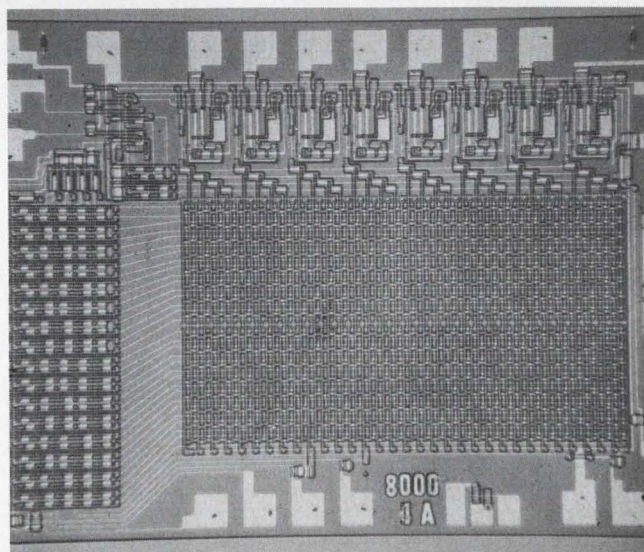

The Philco PM1024 is a typical read-only memory containing 1250 transistors on a 70 by 100-mil chip. Its output of 128 words of 8 bits or 256 words of 4 bits is compatible with either MOS or bipolar circuitry. Cycle times are as low as one microsecond.

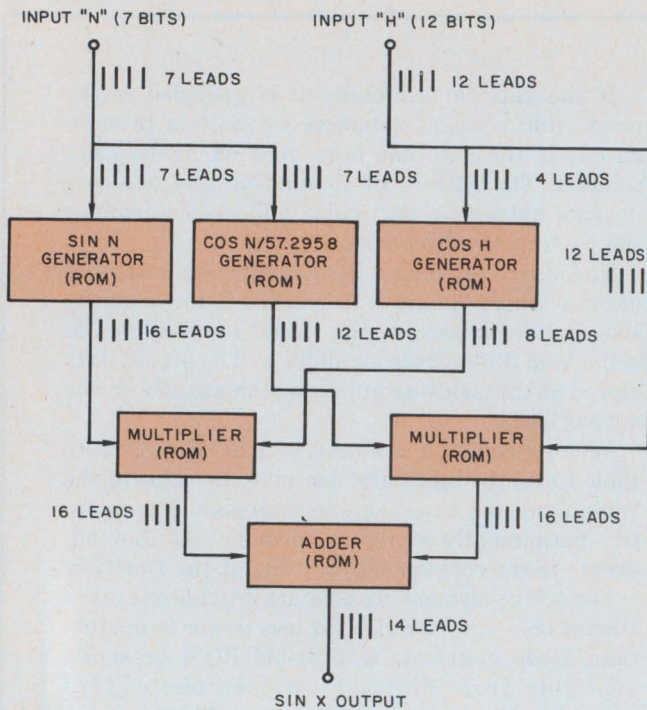

1. A $\sin x$ generator, built completely of MOS read-only memories, provides the sine function to 14 binary-place (4 decimal-place) accuracy for inputs to within 0.01 degree. The generator uses only 2648 bits of memory, a vast reduction from the 144,000 bits required by an equivalent simple look-up table memory.

analysis (Fig. 1), N is represented for the range $0 \leq N \leq 89$ by 7 bits. Only 12 bits are required in H to ensure 14-bit accuracy at the output (only the 16 most-significant bits are taken out of the multipliers).

Detailed error analysis is often required in ROM generators, especially if equivalent functions are used extensively. A typical analysis for the $\sin x$ case is shown in the box. It indicates that the output is good to the 14th binary position, better than fourth-place decimal accuracy.

Taylor series also valuable

Nontrigonometric functions are also reducible to equivalent functions, generally to a Taylor series. (The reasons for some of the choices made here may not be obvious and will be discussed at the end of the example.) To determine $\log_e x$ for $1000 \leq x \leq 4999$, we apply the Taylor series,

$$F(x) = F(x_0 + \Delta x) = F(x_0) + \Delta x F'(x_0) + (\Delta x^2/2!) F''(x_0) + \dots,$$

and let

$$x = 10T + U, \text{ where } 100 \leq T \leq 499 \text{ and } 0 \leq U \leq 9.$$

This enables a saving in memory, since the range of T now is only one-tenth the range of x .

Table 1. $(\cos X)/57.2958$ look-up

Cos X/57.2958	Binary representation																
	2 ⁰	2 ⁻¹	2 ⁻²	2 ⁻³	2 ⁻⁴	2 ⁻⁵	2 ⁻⁶	2 ⁻⁷	2 ⁻⁸	2 ⁻⁹	2 ⁻¹⁰	2 ⁻¹¹	2 ⁻¹²	2 ⁻¹³	2 ⁻¹⁴	2 ⁻¹⁵	2 ⁻¹⁶
Cos 0°/57.2958	0	0	0	0	0	0	1	0	0	0	1	1	1	1	0	0	0
Cos 1°/57.2958	0	0	0	0	0	0	—	—	—	—	—	—	—	—	—	—	—
Cos 2°/57.2958	0	0	0	0	0	0	—	—	—	—	—	—	—	—	—	—	—
Cos 89°/57.2958	0	0	0	0	0	0	0	0	0	0	0	0	1	0	1	0	0

Table 2. Cos H look-up

H (binary)				Cos H (binary)																
2 ⁻¹	2 ⁻²	2 ⁻³	2 ⁻⁴	2 ⁰	2 ⁻¹	2 ⁻²	2 ⁻³	2 ⁻⁴	2 ⁻⁵	2 ⁻⁶	2 ⁻⁷	2 ⁻⁸	2 ⁻⁹	2 ⁻¹⁰	2 ⁻¹¹	2 ⁻¹²	2 ⁻¹³	2 ⁻¹⁴	2 ⁻¹⁵	2 ⁻¹⁶
0	0	0	0	1	0	0	0	0	0	0	0	0	0	0	0	0	0	0	0	0
0	0	0	1	1	0	0	0	0	0	0	0	0	0	0	0	0	0	0	0	0
0	0	1	0	1	0	0	0	0	0	0	0	0	0	0	0	0	0	0	0	0
0	0	1	1	1	0	0	0	0	0	0	0	0	0	0	0	0	0	0	0	0
0	1	0	0	0	1	1	1	1	1	1	1	1	1	1	1	1	1	1	1	1
0	1	0	1	0	1	1	1	1	1	1	1	1	1	1	1	1	1	1	1	1
0	1	1	0	0	1	1	1	1	1	1	1	1	1	1	1	1	1	1	1	1
0	1	1	1	0	1	1	1	1	1	1	1	1	1	1	1	1	1	1	1	0
1	0	0	0	0	1	1	1	1	1	1	1	1	1	1	1	1	1	1	1	0
1	0	0	1	0	1	1	1	1	1	1	1	1	1	1	1	1	1	1	0	1
1	0	1	0	0	1	1	1	1	1	1	1	1	1	1	1	1	1	1	0	0
1	0	1	1	0	1	1	1	1	1	1	1	1	1	1	1	1	1	1	0	1
1	0	1	1	1	1	1	1	1	1	1	1	1	1	1	1	1	1	1	0	1
1	1	0	0	0	1	1	1	1	1	1	1	1	1	1	1	1	1	1	0	0
1	1	0	1	0	1	1	1	1	1	1	1	1	1	1	1	1	1	1	0	1
1	1	1	0	0	1	1	1	1	1	1	1	1	1	1	1	1	1	1	0	0
1	1	1	1	0	1	1	1	1	1	1	1	1	1	1	1	1	1	1	0	0
1	1	1	1	1	0	1	1	1	1	1	1	1	1	1	1	1	1	1	0	1
1	1	1	1	1	1	1	1	1	1	1	1	1	1	1	1	1	1	1	1	1

Table 3. $\log_e X$ look-up

X	$\log_e X$	$\log_e X$ (binary)															
		2 ³	2 ²	2 ¹	2 ⁰	2 ⁻¹	2 ⁻²	2 ⁻³	2 ⁻⁴	2 ⁻⁵	2 ⁻⁶	2 ⁻⁷	2 ⁻⁸	2 ⁻⁹	2 ⁻¹⁰	2 ⁻¹¹	2 ⁻¹²
1000	6.90776	0	1	1	0	1	1	1	0	1	0	0	0	0	1	1	0
4998	8.51680	1	0	0	0	1	0	0	0	0	1	0	0	0	1	0	1
4999	8.51700	1	0	0	0	1	0	0	0	0	0	1	0	0	0	1	0

Then, in the series

$$x_0 = 10T,$$

$$\Delta x = U,$$

$$F(x_0) = \log_e 10T,$$

$$F'(x_0) = 1/x_0 = 1/10T,$$

and

$$F''(x_0) = -1/x_0^2 = -1/100T^2.$$

The Taylor series becomes,

$$\begin{aligned} \log_e x &= \log_e (10T + U) \\ &= \log_e 10T + (U/10T) - (U^2/200T^2) + \dots \end{aligned}$$

It is convenient to make the substitution

$$\begin{aligned} \log_e 10T &= \log_e 10 + \log_e T \\ &= 2.302585 + \log_e T. \end{aligned}$$

Also, the maximum value of the last term in the series is

$$\begin{aligned} U^2_{\max}/200T^2_{\min} &= 9^2/200 (100)^2 \\ &= 40.5 \times 10^{-6}. \end{aligned}$$

If the last term is replaced by one-half of this maximum value, then the maximum error that can be introduced is:

$$\begin{aligned} E_{\max} &= \pm 1/2 (40.5 \times 10^{-6}) \\ &= \pm 20 \times 10^{-6} \end{aligned}$$

since the Taylor series is convergent.

So, the Taylor series becomes

$$\begin{aligned} \log_e x &= 2.302585 + \log_e T + U/10T - 0.000020 \\ &= 2.302565 + \log_e T + (1/10T)U, \end{aligned}$$

which, in binary form, is

$$\log_e x = [1001001101011101] + \log_e T + (1/10T)U.$$

If we had used a straightforward \log_e table memory for $\log_e x$, it would have contained 4000 words, ranging from $x = 1000$ to $x = 4999$. Sixteen output bits would have been required for 2^{-12} place binary accuracy, since 4 bits (2^0 to 2^3) would be needed for the whole numbers (Table 3). This memory would have required 4000×16 , or 64,000 bits.

In the above $\log_e x$ formula, two ROMs are required, one for $\log_e T$ and the other for $1/10T$. Each contains 400 words, for $100 \leq T \leq 499$ (Tables 4 and 5).

Since the first binary bit is always 1 over the full range of T , this output bit is excluded from the $\log_e T$ memory and is wired in separately. This memory, then, has 16 outputs (two whole-number and 14 fraction bits) for a total of 16×400 , or 6400 bits.

Since the first 9 bits are always 0's, only the last 8 bits need to be obtained from the $1/10T$ memory; it thus contains 400×8 , or 3200 bits.

The multiplication of the 8-bit $1/10T$ output by the 4-bit U value is fairly simple and can also be done with ROMs.¹⁻⁶ The range of the product is shown in Table 6. The last 3 bits can be dropped,

Table 4. $\log_e T$ look-up

T	$\log_e T$	$\log_e T$ (binary)																
		2^2	2^1	2^0	2^{-1}	2^{-2}	2^{-3}	2^{-4}	2^{-5}	2^{-6}	2^{-7}	2^{-8}	2^{-9}	2^{-10}	2^{-11}	2^{-12}	2^{-13}	2^{-14}
100	4.60517	1	0	0	1	0	0	1	1	0	1	0	1	1	1	0	1	1
499	6.21261	1	1	0	0	1	1	1	0	1	1	0	0	1	1	1	0	0

Table 5. $1/10T$ look-up

T	$1/10T$	$1/10T$ (binary)																	
		2^0	2^{-1}	2^{-2}	2^{-3}	2^{-4}	2^{-5}	2^{-6}	2^{-7}	2^{-8}	2^{-9}	2^{-10}	2^{-11}	2^{-12}	2^{-13}	2^{-14}	2^{-15}	2^{-16}	2^{-17}
100	1/1000	0	0	0	0	0	0	0	0	0	0	1	0	0	0	0	0	1	1
499	1/4990	0	0	0	0	0	0	0	0	0	0	0	0	0	1	1	0	1	0

Table 6. $(1/10T)U$ look-up

T	U	$(1/10T)U$	$(1/10T)U$ (binary)																	
			2^0	2^{-1}	2^{-2}	2^{-3}	2^{-4}	2^{-5}	2^{-6}	2^{-7}	2^{-8}	2^{-9}	2^{-10}	2^{-11}	2^{-12}	2^{-13}	2^{-14}	2^{-15}	2^{-16}	2^{-17}
100	9	(max)	0	0	0	0	0	0	0	1	0	0	1	0	0	1	1	0	1	1
499	0	(min)	0	0	0	0	0	0	0	0	0	0	0	0	0	0	0	0	0	0

Table 7. Summation for $\log_e X$

Summation	Summation in binary																
	2^2	2^1	2^0	2^{-1}	2^{-2}	2^{-3}	2^{-4}	2^{-5}	2^{-6}	2^{-7}	2^{-8}	2^{-9}	2^{-10}	2^{-11}	2^{-12}	2^{-13}	2^{-14}
2.302565	0	1	0	0	1	0	0	1	1	0	1	0	1	1	1	0	1
+ $\log_e T$	1	-	-	-	-	-	-	-	-	-	-	-	-	-	-	-	-
+ $(1/10T)U$	0	0	0	0	0	0	0	0	-	-	-	-	-	-	-	-	-
= $\log_e (10T + U)$	-	-	-	-	-	-	-	-	-	-	-	-	-	-	-	-	-

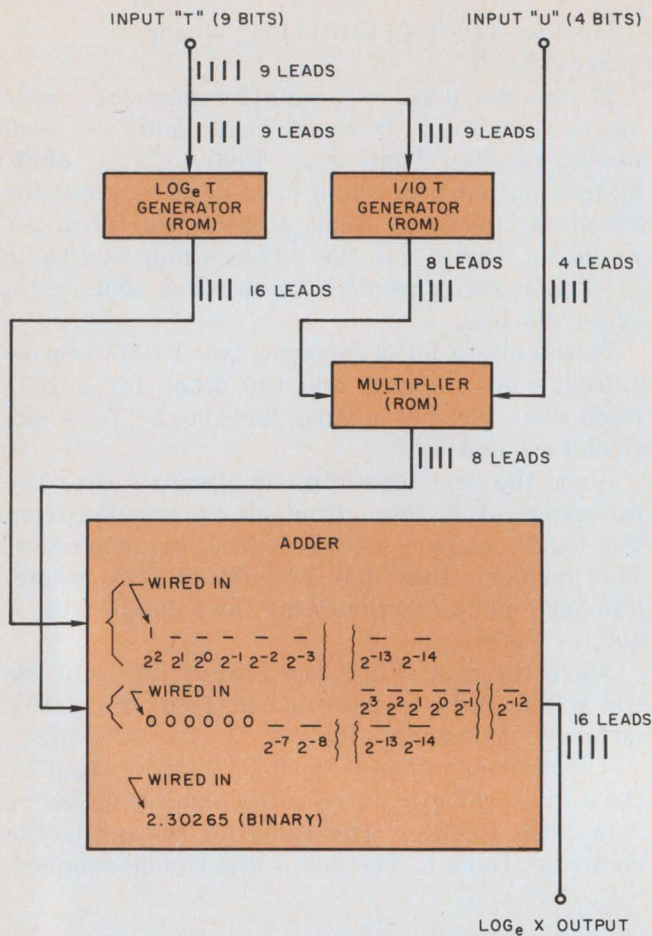

2. A $\log_e X$ generator, again exclusively MOS, provides \log_e to $\pm 2^{-12}$ accuracy. The variable X is inserted as the equivalent function $X = 10T + U$. This generator uses 9600 bits of memory, against 64,000 bits for a simple table look-up scheme.

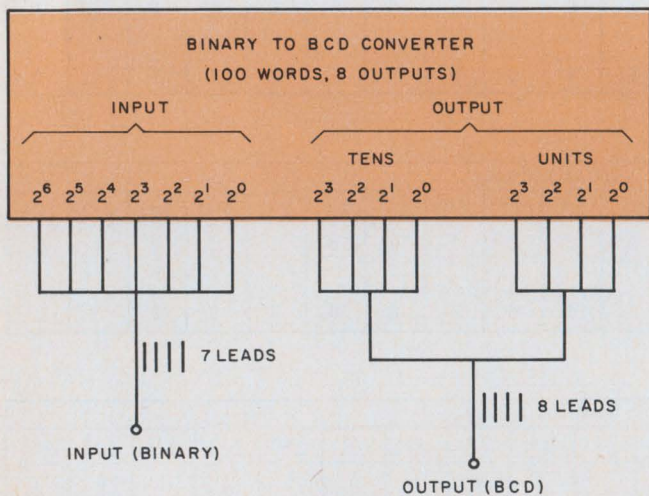

3. A binary-to-BCD converter will require 800 bits of memory if it is to cover the decimal range of 0 to 99, if the straightforward look-up approach is used. A similar look-up table memory for the range 0 to .9999 would require 160,000 bits.

since 14-place accuracy is sufficient.

The summation for $\log_e x$, then, is as shown in Table 7, where the blanks on the $\log_e T$ line are the outputs of that memory, and the blanks on the $(1/10T)U$ line are the product of the $1/10T$ memory outputs and U (see Fig. 2).

The total memory requirement is 400×16 for $\log_e T$, plus 400×8 for $1/10T$, for a total of 9600 bits, as compared to the 4000×16 , or 64,000 bits, required for a straightforward $\log_e x$ memory. The reduction accomplished is over 84%. Allowing for truncation error, the final $\log_e x$ output is accurate to the 2^{-12} binary place (see box).

A postmortem is now in order, to reveal some of the more subtle features of the preceding operation:

(1) The reason for letting

$$\begin{aligned} \log_e 10T &= \log_e 10 + \log_e T = 2.302585 \\ &+ \log_e T \text{ was that with } 100 < T < 499, \\ \log_e 499 &= 6.21262, \end{aligned}$$

and the "6" could be represented with 3 bits; namely, 110.

If the term had been left as $\log_e 10T$, then

$\log_e 10T_{\max} = \log_e 4990 = 8.515$, which would have required 4 whole-number bits, leaving one less place-accuracy in the memory output.

(2) The first bit of $\log_e T$ is always 1, over the full range of T , as shown in the 2^2 column of Table 4. This first bit could then be wired in, and the extra bit would then be used for still greater accuracy. There is no such repetition in the $\log_e 10/T$ case.

(3) It was noticed that the first 6 bits of the $1/10T$ output were always 0, so an 8-bit output was sufficient to give 14-place accuracy.

(4) The reader may wonder why x was split up as $x = 10T + U$, with $100 \leq T \leq 499$ and $0 \leq U \leq 9$; this required 400-word memories for both $\log_e T$ and $1/10T$. If it had been split up as $x = 100A + B$, with $10 \leq A \leq 49$ and $0 \leq B \leq 99$,

it would have required only 40-word memories for $\log_e A$ and $1/100A$. The reason for choosing $x = 10T + U$ was that in the initial equation,

$$\begin{aligned} \log_e x &= \log_e (10T + U) \\ &= \log_e (10T) + (U/10T) - (U^2/2(10T)^2), \end{aligned}$$

it was shown that $U^2/200T^2$ had a maximum value of 40.5×10^{-6} . By incorporating half of this into the equation, the term was dropped with only a 20×10^{-6} maximum error.

If the equation had been of the form,

$$\begin{aligned} \log_e x &= \log_e (100A + B) \\ &= \log_e (100A) + (B/100A) \\ &\quad - (B^2/2(100A)^2) + \dots, \end{aligned}$$

then the term $B^2/2(100A)^2$ could have been dropped. Its maximum value is

$$\begin{aligned} (B^2/2(100A)^2)_{\max} &= (B^2_{\max}/2(100A_{\min})^2) \\ &= (99^2/2(100 \times 10)^2) \\ &= 4.9 \times 10^{-3}, \end{aligned}$$

which is 120 times as great as the $U^2/2(10T)^2$ term. This would have permitted only 2^{-8} place accuracy in the final output display of $\log_e x$.

Simple reduction formulas effective

At this point, you may have the impression that all memory reductions have to be accomplished with involved trigonometric or Taylor series equivalents. To show that this is not so, consider the following example—one devoid of lengthy manipulations and error analysis.

A binary-to-BCD converter, ranging from 0 to 99, can be obtained from a 100-word, seven-input memory, as shown in Fig. 3. If a 0-to-9999 input range is required, it is apparent that the straightforward approach would require 10,000 words with 16-bits output. However, using the equivalence

$$x = x_0 + \Delta x,$$

where x_0 is the first 7 bits of x followed by 7 zero's, and Δx is the last 7 bits, then

$$\begin{array}{r} x_0 = \text{-----} 0000000 \\ + \Delta x = \quad \quad \quad \text{-----} \\ \hline x = \text{-----} \end{array}$$

The schematic for the generator is shown in Fig. 4.

Two comments here are worthy of note:

(1) The first memory requires only 79 words because the upper limit of x is 9999, for which

$$\begin{array}{r} x_0 = 78 \times 2^7 = 9984 \\ + \Delta x = \quad \quad \quad 15 \\ \hline x = \quad \quad \quad \quad \quad 9999 \end{array}$$

Note that $x_0 = 0$ is the 79th word.

(2) The second memory requires only one output for H (see Fig. 4). Since the upper limit of Δx is 127, H cannot exceed 1. Thus, a 98% reduction in memory is obtained from an equivalence as simple as $x = x_0 + \Delta x$.

One more manipulation is in order. The 9 output leads of the second memory are incongruous with the convenient multiple-of-four rule. But since the least significant bit of any binary value is the same as its BCD equivalent, only the first 8 of these leads are required. The 2^0 output can be obtained by direct connection to the $2^0 \Delta x$ input. Note that the 2^0 output of the 79 word converter can also be dropped since it will be 0 for all values of x_0 .

A few helpful hints for implementing equivalent functions haven't been discussed yet: They are common to all types—trigonometric, Taylor series, and simple equivalents.

The equivalents shown so far were all split into two parts. In cases where the memory must be very large, a split into three or more parts may be necessary. In the $\sin x$ generator, for example, where x was split into $x = N + H$,

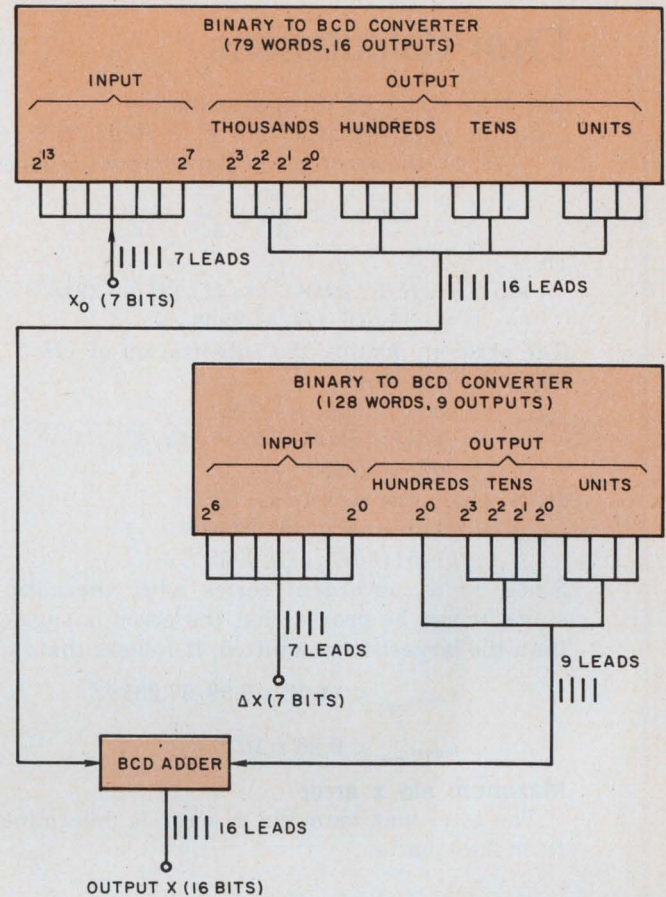

4. An optimized binary-to-BCD converter needs only 2416 bits of memory to cover the decimal range 0 to 9999. This represents a 98% reduction in memory from an equivalence as simple as $x = x_0 + \Delta x$.

further splitting such that $N = N_0 + \Delta N$, would reduce the total memory size again by slightly more than one-half. It would also complicate the formula to:

$$\sin x = [\sin N_0 \cos (\Delta N) + \cos N_0 \sin (\Delta N)] \cos H + [\cos N_0 \cos (\Delta N) - \sin N_0 \sin (\Delta N)] (H/57.2958).$$

Similarly, letting $T = 10T_0 + \Delta T$ in the Taylor series would further reduce the total memory by 90%; but the added computation involved in

$$\log_e x = 4.60517 + \log_e T_0 + (1/10T_0) \Delta T + (U/10) [(1/10T_0) - (1/10T_0)^2] \Delta T$$

requires added ROM components. The point of this manipulation, after all, is to save cost. If the quantity of x -values was large enough, however, the computation would be worth doing both for $\sin x$ and $\log_e x$.

The binary-to-BCD converter for a 0 to 99,999, 999 range provides a clear example of the value of four-part splitting. The previous equivalence of $x = x_0 + \Delta x$ would now involve two memories of 10,000 words each. This can be reduced by letting

$$x = A_7 + B_7 + C_7 + D_6,$$

where A is the first 7 bits of the 27-bit binary input, x , followed by 20 zeros,

Error Calculations

Sin H → H/57.2958 approximation

In the approximation $\sin H \rightarrow H/57.2958$ for $0^\circ \leq H < 1^\circ$, the error is calculated from the series

$$\sin x = x - \frac{x^3}{3!} + \frac{x^5}{5!} - \dots,$$

so

$$\sin H = (H/57.2958) - (1/3!) (H/57.2958)^3 + (1/5!) (H/57.2958)^5 - \dots$$

The error in making the substitution of $(H/57.2958)$ for $\sin H$ is

$$\begin{aligned} \epsilon_{\text{subst}} &= (H/57.2958) - \sin H \\ &= (1/3!) (H/57.2958)^3 - (1/5!) (H/57.2958)^5 + \dots, \end{aligned}$$

from which the worst-case error

$$\epsilon_{\text{subst}} = (1/3!) (H_{\text{max}}/57.2958)^3 - (1/5!) (H_{\text{max}}/57.2958)^5 + \dots$$

Since, in a convergent series with alternating signs, it can be proved that the error is smaller than the largest term omitted, it follows that:

$$\epsilon_{\text{subst max}} < (1/3!) (0.99/57.2958)^3$$

$$\epsilon_{\text{subst max}} < 0.86 \times 10^{-6}$$

Maximum sin x error

The total maximum $\sin x$ error is determined from the equation,

$$\begin{aligned} |\epsilon_{\sin x}|_{\text{max}} &= |\epsilon_{\sin(N+H)}|_{\text{max}} \\ &= \left(\sin(N+H) + |\epsilon_{\sin(N+H)}|_{\text{max}} \right) \\ &\quad - \sin(N+H), \end{aligned}$$

where

$$\sin(N+H) = (\sin N)(\cos H) + [(\cos N)/57.2958] H$$

and

$$\begin{aligned} & \left(\sin(N+H) + |\epsilon_{\sin(N+H)}|_{\text{max}} \right) \leq \\ & \left(\sin N + |\epsilon_{\sin N}|_{\text{max}} \right) \left(\cos H + |\epsilon_{\cos H}|_{\text{max}} \right) \\ & + \left[\left((\cos N)/57.2958 \right) + |\epsilon_{(\cos N)/57.2958}|_{\text{max}} \right] \\ & \quad \left[H + |\epsilon_H|_{\text{max}} \right] \end{aligned}$$

Multiplying out the terms, dropping the error-term products

$$\left[|\epsilon_{\sin N}|_{\text{max}} \right] \left[|\epsilon_{\cos H}|_{\text{max}} \right]$$

and

$$\left[\epsilon_{(\cos N)/57.2958} \right] \left[|\epsilon_H|_{\text{max}} \right]$$

as negligible, and subtracting, then

$$\begin{aligned} & |\epsilon_{\sin x}|_{\text{max}} \leq \\ & (\sin N) \left(|\epsilon_{\cos H}|_{\text{max}} \right) + (\cos H) \left[|\epsilon_{\sin N}|_{\text{max}} \right] \\ & + \left[(\cos N)/57.2958 \right] |\epsilon_H|_{\text{max}} \\ & + H \left[\epsilon_{(\cos N)/57.2958} \right]_{\text{max}} \end{aligned}$$

Evaluating the error terms,

$$|\epsilon_{\cos H}|_{\text{max}} < 2^{-16}.$$

This error is caused by using only the first 4 bits of H for the $(\cos H)$ memory input. As can be seen from Table 2, the change between successive values of H never causes a change in $\cos H$ of more than 2^{-16} ;

$$|\epsilon_{\sin N}|_{\text{max}} = 2^{-17}.$$

This error is caused by truncation of the $(\sin N)$ memory output beyond the 12^{-16} bit position. Ordinarily, this truncation would result in a maximum error of 2^{-16} . But since the 2^{-16} bit can be set to result in minimum error when the ROM is designed, maximum error is $\pm 2^{-17}$.

$$|\epsilon_H|_{\text{max}} = 2^{-13}$$

is similarly caused by truncation of H (.00 to .99) beyond the 2^{-12} bit; and

$$\left| \left(\epsilon_{\cos N} \right) / 57.2958 \right|_{\text{max}} = 2^{-18}$$

is caused by truncation of the $(\cos N)/57.2958$ memory output beyond the 2^{-17} bit.

Inserting all 4 error values,

$$\begin{aligned} |\epsilon_{\sin x}|_{\text{max}} &< (2^{-16}) (\sin N) + (2^{-17}) \\ & (\cos H) + 2^{-13} (\cos N/57.2958) + (2^{-18}) H. \end{aligned}$$

The remaining question is: what values of N and H maximize this error? Rather than go into an involved exercise in partial differentiation, we can simplify this with some ball-park estimating, as follows: H varies from 0 to 0.99. It is clear that $H = 0.99$ maximizes the last term. Then $\cos H = 0.99^{\circ} = 0.9998$. Approximating these to $H = 1$ and $\cos H = 1$ increases the inequality, so

$$\begin{aligned} |\epsilon_{\sin x}|_{\text{max}} &< (2^{-16}) (\sin N) \\ & + (2^{-17}) + (2^{-13}) (\cos N/57.2958) + (2^{-18}). \end{aligned}$$

Now to find the value of N for the maximum error. Differentiating the equation and setting this to 0,

$$\begin{aligned} \frac{d \left(|\epsilon_{\sin x}|_{\text{max}} \right)}{dN} &= (2^{-16}) (\cos N) + 0 - (2^{-18}) \\ & (\sin N/57.2958) + 0 \\ & = 0. \end{aligned}$$

Thus

$$\cos N = (2^3) (\sin N/57.2958).$$

or

$$\begin{aligned} \tan N &= (57.2958/8) \\ N &\approx 82^\circ \end{aligned}$$

Substituting this back into the error equation,

$$\begin{aligned} |\epsilon_{\sin x}|_{\text{max}} &< 2^{-16} (\sin 82^\circ) + (2^{-17}) \\ & + (2^{-13}) (\cos 82^\circ/57.2958) + 2^{-18} \\ & < (2^{-16}) (0.9903 + 0.5000 + 0.0243 + 0.2500) \end{aligned}$$

Error calculations continued

Where, in binary form,

N_7 is: X X X X X X 0 0 0 0 0 0 0

(Xs denote either 0 or 1) and

$(\Delta N)_7$ is: X X X X X X X

Each term within the bracket is positive since $N_7 > (\Delta N)_7 \geq 0$.

Therefore

$$\epsilon_{\text{trunc}_{\text{max}}} \leq \epsilon_{\text{third term}_{\text{max}}} + \epsilon_{\text{fourth term}_{\text{max}}} + \dots$$

To find the maximum value of the third term, it is first necessary to find the values of N_7 and $(\Delta N)_7$. It is convenient to let $N_7 = X$, $(\Delta N)_7 = Z$ and the total value of the third term error = Y . Then

$$Y = (Z^2/16X^{3/2}) [Z - (Z/X)]$$

$$Y = (Z^2/8X^{3/2}) - (Z^3/16X^{5/2})$$

Differentiating with respect to Z ,

$$\left. \frac{dY}{dZ} \right|_{z=\text{const}} = (2Z/8X^{3/2}) - (3Z^2/16X^{5/2}) \\ = (Z/X^{3/2}) ((1/4) - (3/16) (Z/X))$$

Since $Z_{\text{max}} = 127$ and $X_{\text{min}} = 128$, (Z/X) is always less than 1 and the slope is always positive. Therefore the maximum error, Y , is obtained when Z is maximum i.e. $Z = 1111111 = 127$.

Now differentiating Y with respect to X , with Z at its maximum,

$$Y = [(127)^2/8X^{3/2}] - [(127)^3/16X^{5/2}]$$

$$Y = [(127)^2 X^{-3/2}/8] - [(127)^3 X^{-5/2}/16]$$

$$\frac{dY}{dX} = \left[\frac{(127)^2}{8} \left(-\frac{3}{2} X^{-5/2} \right) \right] - \left[\frac{(127)^3}{16} \left(-\frac{5}{2} X^{-7/2} \right) \right]$$

$$\frac{dY}{dX} = \frac{(127)^2}{X^{5/2}} \left(-\frac{3}{16} + \frac{5}{32} \left(\frac{127}{X} \right) \right)$$

$$\frac{dY}{dX} < 0, \text{ since } X \geq 128.$$

Since this slope is always negative, the maximum error, Y , is obtained when X is minimum i.e. $X = 10000000 = 128$. And so, having established that the maximum third term error occurs when $(\Delta N)_7 = 127$ and $N_7 = 128$, this error is evaluated at

$$\epsilon_{\text{third term}_{\text{max}}} = [(127)^2/16(128)^{3/2}] [2 - (127/128)] \\ = 0.702$$

The same procedure can be applied to the other terms, but rather than evaluate all of these and sum them up, we take a simple short cut. It was just shown that the third term error was maximum at $N_7 = 128$ and $(\Delta N)_7 = 127$. It can also be shown in the same manner that this is true for the fourth term and for the series as a whole. Then the maximum error occurs when

$$N_{14} = N_7 + (\Delta N)_7 = 128 + 127 = 255$$

By the formula,

$$\sqrt{N_{14}} = \sqrt{N_7} + (\Delta N)_7 / 2\sqrt{N_7}$$

$$\sqrt{255} = \sqrt{128} + (127/2\sqrt{128})$$

$$= 16.93$$

Actually,

$$\sqrt{255} = 15.97$$

Therefore, the maximum convergent sum of the truncated terms is $15.97 - 16.93 = -0.96$. Adding half of this to the formula ensures that the truncation error will be within ± 0.48 , and so the square root formula becomes

$$R_7 = \sqrt{N_{14}} = \sqrt{N_7} + ((\Delta N)_7 / 2\sqrt{N_7}) - 0.48$$

B_7 is the next 7 bits of the binary input, x , followed by 13 zeros,

C_7 is the next 7 bits of the binary input, x , followed by 6 zeros,

D_6 is the last 6 bits of the binary input x .

Note that a total of 27 bits is required for x to reach the value 99,999,999. This four-part split reduces the total memory by about 98%, when compared to the two-part split, $x = x_o + \Delta x$. ■■

References:

1. G. A. Maley and J. Earle, *The Logic Design of Transistor Digital Computers*, Prentice Hall, Englewood Cliffs, N.J., 1963.
2. Y. Chu, *Digital Computer Design Fundamentals*, McGraw Hill, New York, 1962.
3. I. Flores, *The Logic of Computer Arithmetic*, Prentice Hall, Englewood Cliffs, N.J., 1963.
4. *Applications of the CCSL 9304 Dual Adder*, Application Bulletin #163, Fairchild Semiconductor, Dec., 1967.
5. *Four-bit Binary Full Adder*, SN7483N Data Sheet, Texas Instruments, Feb., 1967.
6. *Parallel Multiplier*, Standard Logic Function #18, Philco-Ford Designers Manual, March, 1968.

Test your retention

Here are questions based on the main points of this article. Their purpose is to help you make sure you have not overlooked any important ideas. You'll find the answers in the article.

1. Why is the practical ROM size at present limited to roughly 500 bits?
2. What percentage reduction in bit requirement resulted from the substitution $\sin(N + H) = \sin N \cos H + \cos N \sin H$?
3. What equivalent function was used in the Taylor series example for $\log_e X$?
4. Why is four-part splitting advised for the binary-to-BCD converter with range 0 to 99,999,999, but not for the converter with lesser range? What is the deciding factor?

**Rectifiers, diodes, SCRs and Zeners
from Power House distributors.**

For those commercial and industrial applications where both performance and price are critical parameters, International Rectifier offers the industry's most complete line of high reliability power rectification components in low cost, rugged plastic packages.

For instance, our proprietary 21PT half-wave rectifier unit: only about ¼-inch square, it replaces stud-mounted DO-4 rectifier packages up to 15 amps, at a fraction of their size and cost.

And we have rectifier bridges from 1 through 10 amperes. We offer diodes, SCRs, zeners. Even plastic Klip-Sels, our handy surge arrestors for use with our other power components. Everything you need, at the price and performance you want, and available now from your Power House distributor's shelves.

INTERNATIONAL RECTIFIER

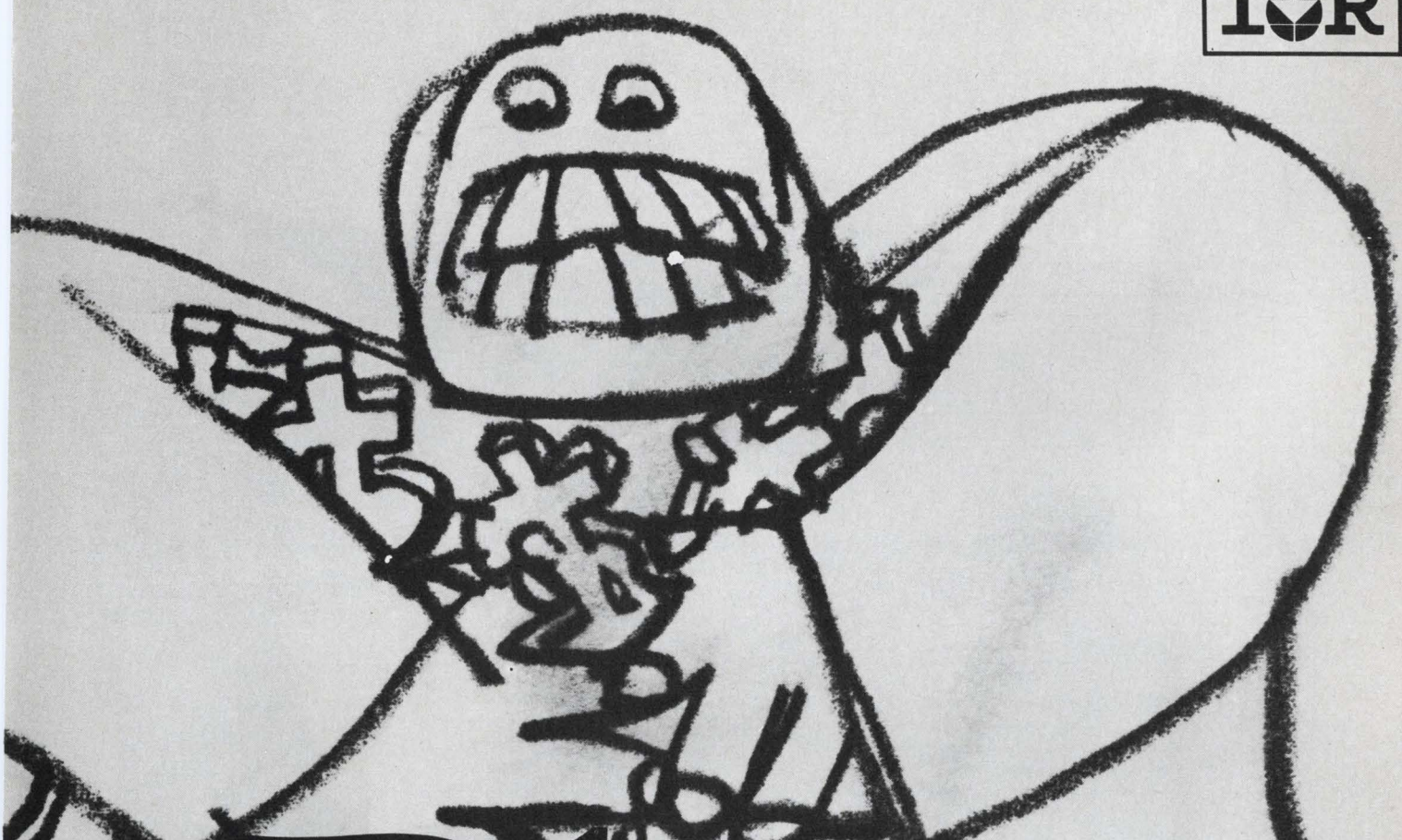

**Plastic
power.**

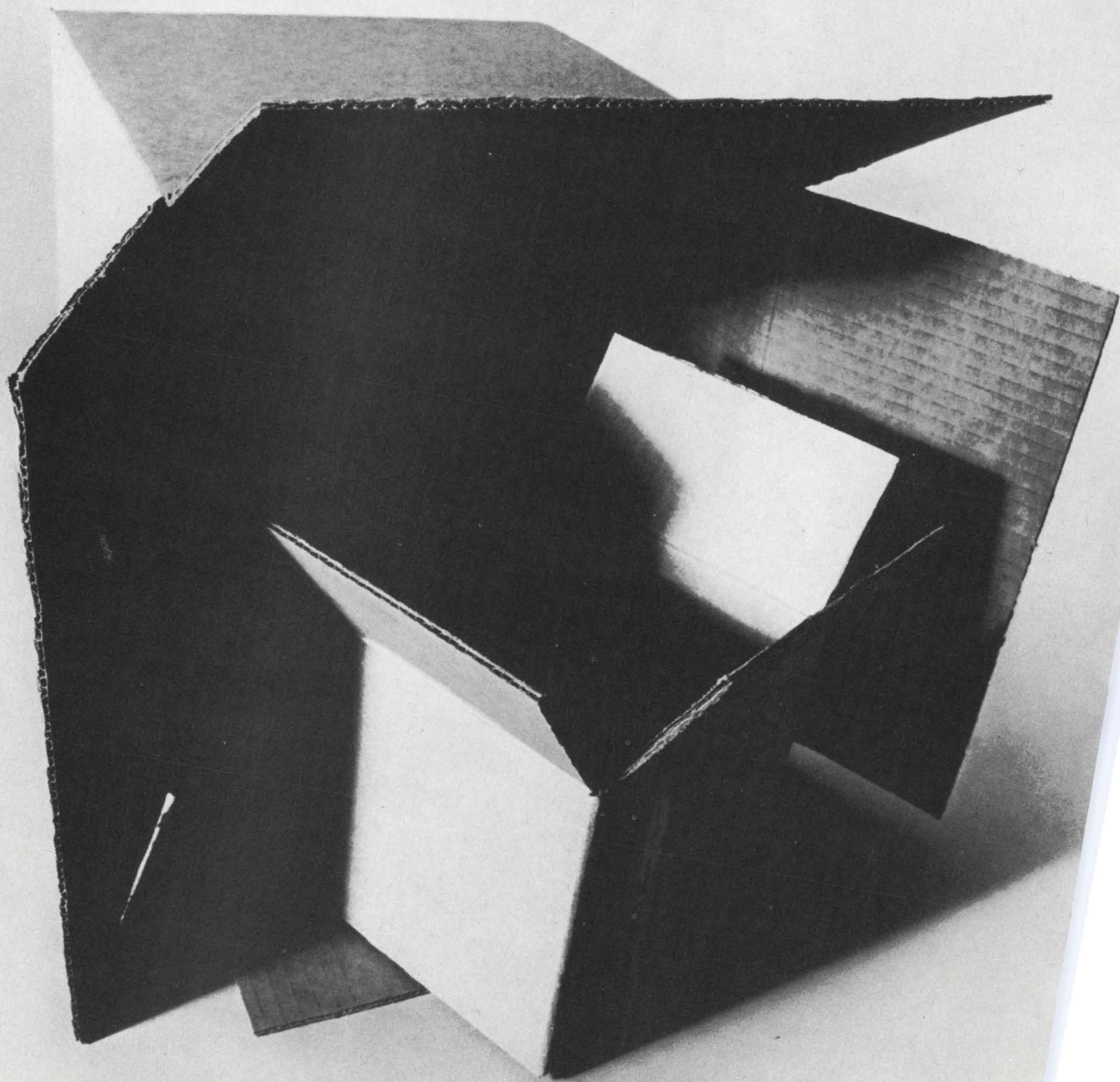

We made TTL half as big. And half as big is twice as good.

We had an idea you weren't getting all you could from T²L. If it were smaller we knew it would be better. And we figured we could make it smaller.

So we added a few circuit improvements, reduced our active chip area over 50%, and turned the problem over to our production line.

The result is Ray III. With no increase in power and far less parasitic capacitance, it's the fastest T²L available. Flip flops toggle up to 100 MHz. Gate propagation delay is only 5½ nsec maximum. Improved transfer characteristics and input clamp diodes guarantee more noise immunity than before. And it's in production now.

All because we had an idea how to squeeze the fat out of a T²L chip . . . and delivered!



Will radiation wreck your IC design?

Know the effects of radiation on IC parameters and design your circuits to tolerate them.

The design of the ICs and IC systems for radiation tolerance is not simply a matter of shielding. Adequate shields are bulky and necessarily heavy, and for this reason can be used in very few systems.

A far better approach is to design the ICs so that even though they are affected by radiation, they continue to operate in a satisfactory manner. This is the direction that the industry is taking.

Most IC designers today understand the mechanisms of radiation effects. Armed with this knowledge, they are designing circuits that remain functional even in the face of intense radiation. Circuit and system designers also must understand radiation effects, if they are to properly apply these ICs and recognize their limitations.

Radiation effects on bulk silicon must be divided into two categories: the temporary and the permanent. Temporary effects, such as surface damage to the crystal and hole-electron pair-generation, occur during irradiation and fade away when the radiation ceases. Permanent lattice damage, caused by fast neutrons (with energies of 0.5 to 1.0 million electron volts) is an accumulative process that ultimately limits the radiation resistance of an IC.

Temporary surface-damage effects disappear with time constants ranging from milliseconds to days. Electron-hole pair generation is completely analogous to the ionization that takes place in photodiodes and phototransistors. Carrier pairs recover with time constants that are roughly equal to the minority-carrier lifetime of the semiconductor material. Although the effect is temporary, the current available to all reverse-biased junctions must be limited, because they may conduct quite heavily during irradiation.

Lattice damage permanently changes the electrical properties of the semiconductor material. Both n- and p-type materials tend to behave more and more like intrinsic (undoped) material as they are exposed to successive doses of radiation.

tion—the impurity concentration appears to diminish, and the minority-carrier lifetime decreases rapidly with radiation, as does the mobility of holes and electrons. These changes in material properties result in changes in the parameters of an IC formed of the material.

Because our concern is mainly with the question of whether or not the irradiated IC will operate, consideration of radiation effects can be limited here to the effects on the functioning of the IC itself. The following discussion is limited to monolithic epitaxial ICs, with all circuit elements being diffused (this type of construction is not necessarily the most tolerant of radiation, but it does yield economical and reliable circuits).

Digital circuits offer the greatest promise in radiation environments because they can be made very insensitive to changes in the parameters of individual devices. As a general rule, the transistors used should be low-voltage switches—the low saturation voltage of a good transistor switch tends to offset the increase of $V_{CE\text{ sat}}$ which results from irradiation.

Because h_{FE} is degraded by the reduced minority-carrier lifetime that results from irradiation, it is important that the base transit-times of the transistors be as low as possible. This can be achieved simply by making the base regions very thin, since the gain-bandwidth product of a transistor is a measure of the base transit-time—as the transit time decreases, the gain-bandwidth product increases. Thus, transistors for use in radiation environments should have a high gain-bandwidth product.

Understand the mechanisms

But these are rules of thumb. For a good understanding of the mechanisms involved, we must examine in detail the changes that occur in the IC:

Resistors: Integrated resistors, normally formed by diffusing long strips of p-material into an n-type epitaxial layer, increase in value with radiation. The percentage increase is dependent on the amount of radiation received, as well as on the concentration of the original impurity. Low values of resistivity or high im-

J. J. Kubinec, Senior Application Engineer, National Semiconductor Corp., Santa Clara, Calif.

purity concentrations are less affected by fast neutrons (Fig. 1). Ordinary diffused resistors change by less than their starting tolerance (about $\pm 20\%$), after receiving 10^{15} nvt of fast neutron radiation. (The total integrated neutron flux, or fluence, is expressed as the product of the number of neutrons per square centimeter, their average velocity, and the length of time of exposure—thus the abbreviation nvt).

Capacitors: The only data available on integrated capacitors describes the behavior of the back-biased diode used as a capacitor. Because both n- and p-type silicon tend to revert to the electrical properties of their intrinsic materials under fast-neutron radiation, the pn junction

The reverse-biased junction leakage-currents of planar transistors, whether they be discrete or integrated, tend to increase during radiation. The percentage change in leakage current may be quite large, but the initial leakage for planar devices is so small that it is unlikely that leakage currents could ever limit the operation of a digital circuit. In fact, if the primary contribution to leakage current is surface leakage, the leakage current may actually decrease with increasing radiation dosage. (The radiation may tend to anneal surface damage and reduce its contribution to leakage current).

The avalanche voltage of all pn junctions in an IC increases with fast-neutron radiation, pri-

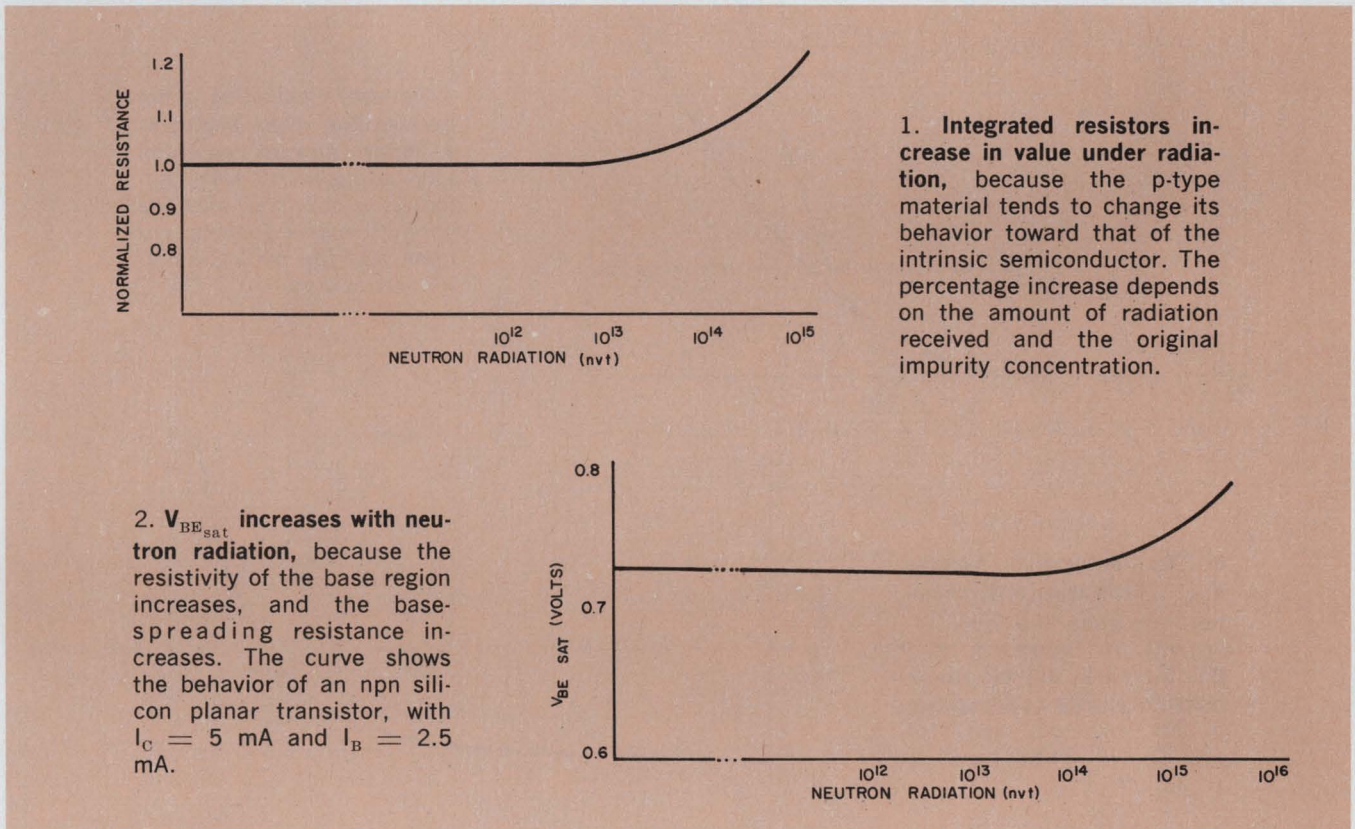

capacity decreases. Again, the percentage decrease in capacitance will usually be less than the original tolerance after 10^{15} nvt of fast neutron radiation, for both emitter-base and collector-base diodes.

Transistors: The transistor is the component most sensitive to nuclear radiation. Transistors used in monolithic circuits are basically the same as the discrete planar epitaxial transistors available today, and the vast amount of data and theory available on the degradation of irradiated transistors can be applied to transistors diffused into ICs. Existing theory may be used to design a radiation-resistant transistor and to predict its behavior once it is made.

marily because of the reduction in impurity gradient that occurs at the junctions. It is very important to make sure that the breakdown mechanism of the transistors on the chip is the avalanche mechanism. If the breakdown is actually punchthrough, the breakdown voltage will decrease with fast-neutron radiation, due to the reduced impurity concentration in the base region.

The saturation voltages $V_{BE\text{sat}}$ and $V_{CE\text{sat}}$ are of considerable importance in digital circuits, whether discrete or integrated. (Quite often the difference of the two is a measure of the noise immunity). $V_{BE\text{sat}}$ increases with neutron radiation (Fig. 2). This increase is caused by the

increase in resistivity in the base region; more specifically by an increase in base spreading-resistance r_b . Forward conduction in the base-emitter diode begins at a lower forward potential after the diode has been exposed to fast neutrons (Fig. 3). This is a result of the reduction in impurity concentrations on both sides of the junction, which lowers their built-in potential barrier. At higher currents, the voltage produced across the junction is higher, following radiation, because of the increased bulk resistivity.

The collector-to-emitter saturation voltage ($V_{CE_{sat}}$) of a planar transistor is a direct meas-

and BV_{CEO} ; low-voltage transistor switches should, therefore, be used in radiation-resistant circuits.

Since both $V_{BE_{sat}}$ and $V_{CE_{sat}}$ increase with fast neutron irradiation, their difference will be a function which varies more slowly than does either term singly. This fact enables digital ICs to maintain respectable noise immunities in a radiation environment.

h_{FE} is quickly degraded

Because the current gain of transistors is de-

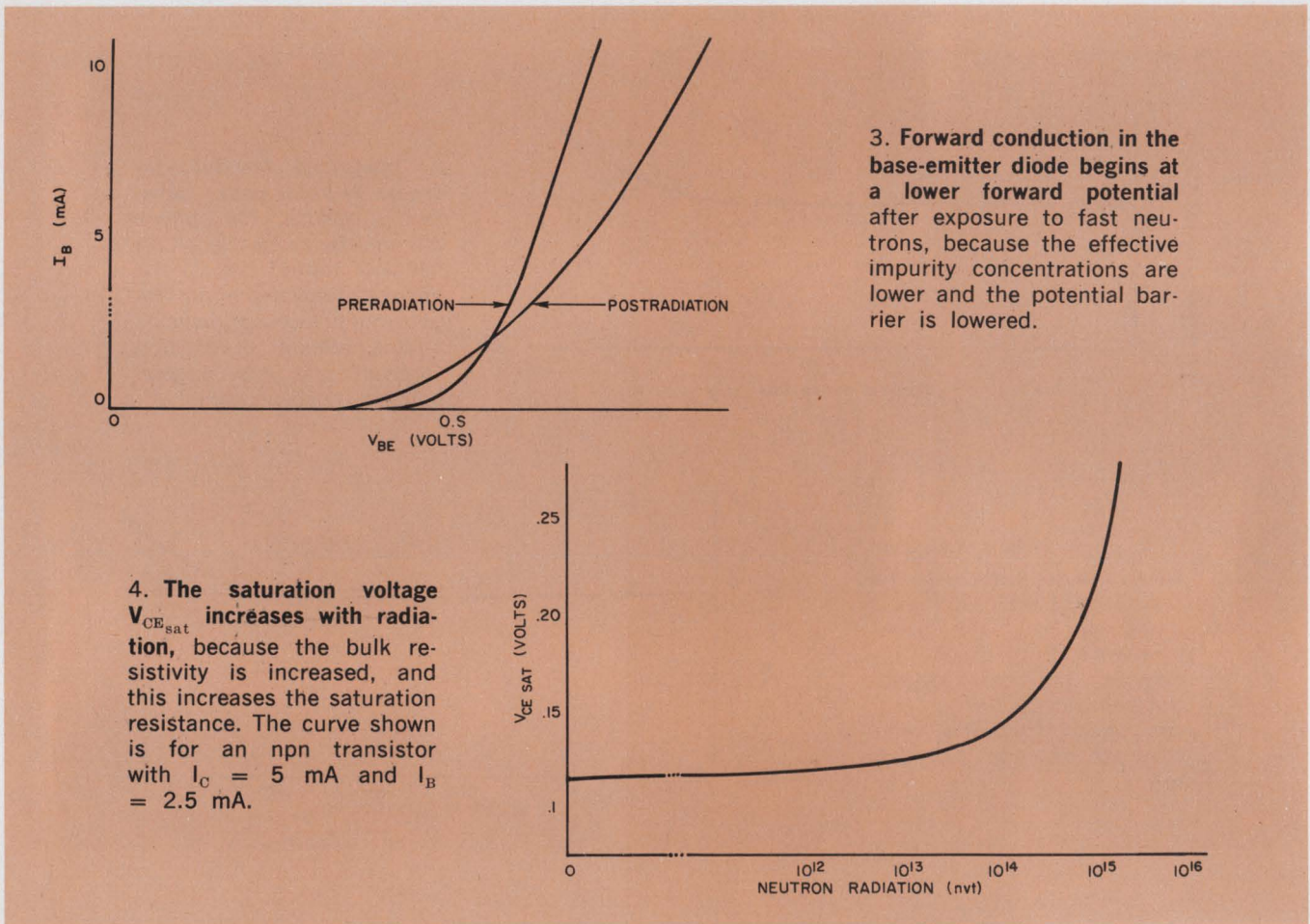

ure of its efficiency when operated as a switch. This saturation voltage increases with radiation (Fig. 4). The primary factor involved in the increase of $V_{CE_{sat}}$ is the saturation resistance, which is a function of the collector bulk-resistivity. Furthermore, the percentage change in saturation resistance is greatly dependent on its starting value; low-resistivity material is less affected by irradiation. This implies that the better the saturation characteristics of a transistor switch before irradiation, the more well-behaved it will be in a radiation environment. Low collector resistivity implies a lower LV_{CEO}

pendent upon the minority carrier lifetime, it degrades in fast-neutron radiation at a much faster rate than any of the other parameters discussed. It is, therefore, the paramount limiting factor in most circuits and will eventually render the circuit inoperative after successive doses of radiation.

Recall that:

$$h_{FE} = \frac{\alpha}{1 - \alpha}$$

where α is the grounded-base current-gain. If we neglect collector avalanche multiplication, we may write:

$$\alpha = \gamma\beta^*$$

where γ is the emitter efficiency and β^* is the base transport factor. The emitter efficiency is a function of the doping levels at the emitter-base junction, and since the transistors in an IC are planar double-diffused the impurity densities at this junction are quite high. As a result, the emitter efficiency is a slowly varying function of radiation relative to the base transport factor. For an npn transistor, we write β^{*1} as

$$\beta^* = \operatorname{sech}(\omega/L_{nb}),$$

for a uniform base where W is the effective base-width and L_{nb} is the diffusion length of electrons in the base. Using the power series expansion for

electrons in the base. Note that the above result was derived using a uniform base. A graded-base structure such as a planar transistor simply has the base transit-time T_B reduced for a given base-width, because of the built-in drift field associated with the impurity gradient in the base.

Since the minority carrier lifetime T_{nb} is reduced as the device receives fast neutron radiation, and since we wish β^* to remain as large as possible, we should make all the transistors with thin-base structures to achieve very small base transit times. In an IC, all transistors are diffused simultaneously; if the process used pro-

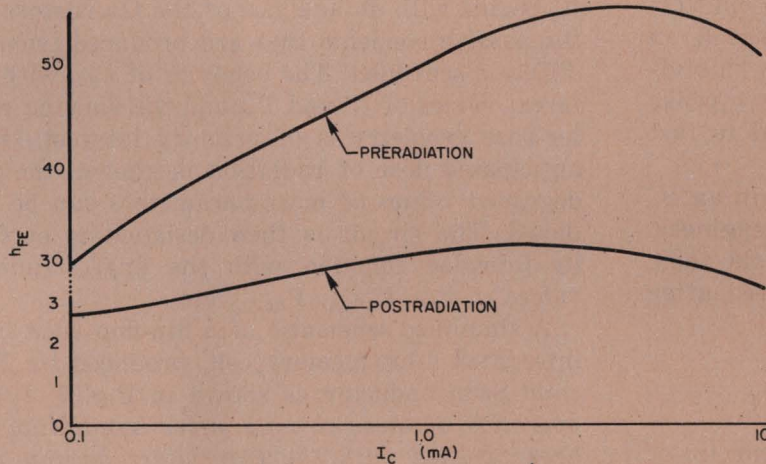

5. h_{FE} is reduced by fast neutron radiation, and the collector current at which h_{FE} has its peak value is decreased. The post-radiation curve is the result of a 10^{15} nvt dosage on a silicon npn planar transistor.

6. The gain-bandwidth product of an npn silicon planar transistor is a linear function of the emitter current over a limited range. If measurements are made at two points which fall on the straight line, f_t' (the gain-bandwidth product due only to T_B) and T_B (the basic transit-time) can be obtained graphically.

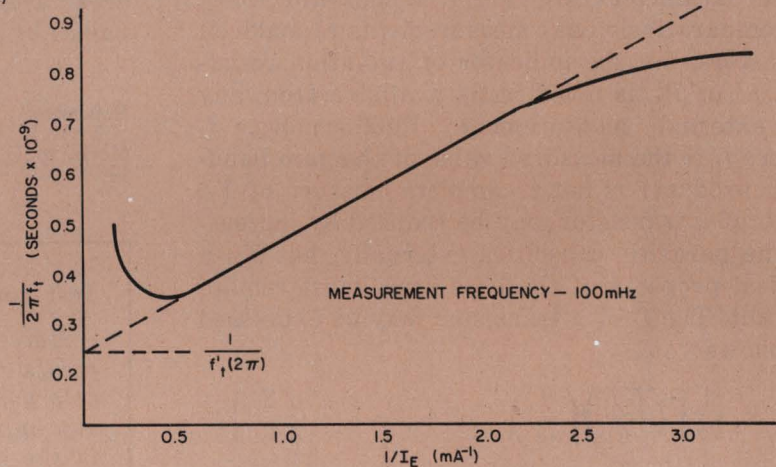

the hyperbolic secant, we have¹:

$$\beta^* \approx 1 - (1/2)(\omega/L_{nb})^2$$

Using the two equations¹:

$$L_{nb} = \sqrt{D_{nb} T_{nb}}$$

and

$$T_B = \omega^2/D_{nb}$$

where D_{nb} is the diffusion constant for electrons in the base, and T_{nb} is the base transit time for an electron injected by the emitter. We finally write:

$$\beta^* \approx 1 - (1/2)(T_B/T_{nb})$$

From this expression, we can see the dependence of β^* on T_{nb} , the minority carrier lifetime of

duces thin-base devices, they will all necessarily have thin bases. A measure of T_B will be discussed in more detail later. It is important here to note that devices with high f_t' (where f_t' is the gain bandwidth product due only to T_B) should behave better under radiation than devices having lower f_t' .

After a planar transistor receives a dose of fast neutron radiation, the r_b' of the device increases due to increased resistivity in the base region. This causes the emitter current to fringe around the periphery of the emitter-base junction to a greater extent than before the transistor was

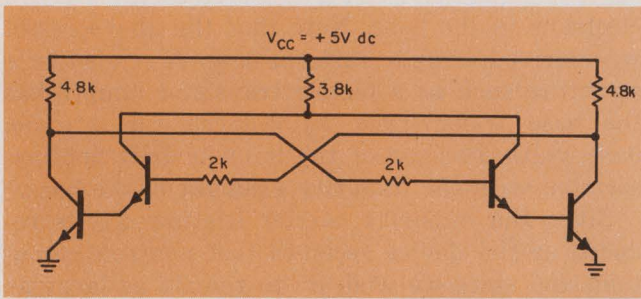

7. A radiation-resistant IC flip-flop (with triggering logic omitted) uses a pseudo-Darlington arrangement to overcome radiation-degraded h_{FE} . Proper operation of this circuit has been verified after the h_{FE} of the transistors was lowered to two by radiation.

irradiated. The result is a loss of active emitter-base junction area. A curve of h_{FE} versus I_C on an irradiated transistor (Fig. 5) shows this effect. The collector current at which h_{FE} peaks is reduced when the device is subjected to fast neutrons.

The geometry and size of the devices in an IC are variables at the command of the IC engineer. The transistors can be designed to yield their maximum h_{FE} at the current levels involved, after exposure to fast-neutron radiation.

Radiation resistance is easily predicted

The parameters h_{FE} , $V_{CE_{sat}}$, BV_{CBO} and $V_{BE_{sat}}$ are comparatively easy measurements to make on transistors, but the indicator of radiation resistance, f_t' or T_B , is not directly available from any one external measurement. Furthermore, f_t (where f_t is the measured value of the gain bandwidth product) is not a complete measure of T_B . The f_t of a transistor may be reduced by increasing the parasitic capacities externally, but T_B , a physical property of the base area, must remain constant. The f_t of a transistor may be expressed as follows:¹

$$\frac{1}{2\pi f_t} = \frac{1}{k\theta} \left[\left(\frac{KT}{q} \right) \left(\frac{1}{I_E} \right) (C_{TE} + C_{TC}) + \frac{TB}{2.43} \right],$$

where C_{TE} and C_{TC} are the respective emitter and collector junction capacities, $k\theta$ is a constant (0.82 for graded base transistors), K is the Boltzman constant, q is the electron charge, and T is the temperature in degrees Kelvin. (The assumptions in the above equation are: the delay time for carriers to cross the collector space-charge region is negligible, and $r_e = (KT/qI_E)$, at the emitter current used, is much larger than the collector bulk resistance.

We notice from the expression that $1/f_t$ is a linear function of $1/I_E$, and further that when I_E is infinite, f_t' is simply a function of T_B . A typical plot of $1/f_t$ versus $1/I_E$ for an npn silicon planar transistor is shown in Fig. 6. When the

emitter current is increased to high values (or small values of $1/I_E$), the performance deviates from the straight line because electrons in the base swamp out the drift field and the base-widening effects. The deviation from the straight line at low values of emitter current (large values of $1/I_E$) is due to the shunting of the emitter resistance r_e by the emitter capacity at the frequency of measurement. Of course, if two measurements of f_t are made on the straight-line portion of the curve, f_t' and T_B may be obtained by graphical means.

ICs for radiation resistance

The design procedure for a radiation-resistant IC begins with an analysis of the transistors and the passive elements that are produced from the diffusion schedules. The behavior of h_{FE} , with different values of f_t' and T_B , and the varying emitter-base geometry is of primary interest. If the anticipated dose of radiation is known, the final degraded values of most parameters can be predicted. The circuit is then designed to perform its intended function with the final irradiated values of h_{FE} , $V_{CE_{sat}}$, $V_{BE_{sat}}$, etc.

A simplified schematic of a flip-flop used in an integrated 4-bit memory cell, produced by Fairchild Semiconductor, is shown in Fig. 7. Proper operation of these circuits, after irradiation, has been verified with the transistors having final values of h_{FE} as low as 2.

Reference:

1. A. B. Phillips, *Transistor Engineering*, New York: McGraw-Hill Book Company, Inc., 1962, chapters 8 and 14.

Test your retention

Here are questions based on the main points of this article. Their purpose is to help you make sure you have not overlooked any important ideas. You'll find the answers in the article.

1. What are the two prominent temporary effects of radiation on bulk silicon?
2. Why must the current available to reversed-bias junctions be limited in ICs exposed to radiation?
3. What effect does lattice damage have on the electrical properties of bulk silicon?
4. What happens to diffused resistors under radiation?
5. What happens to the transistor saturation voltages $V_{CE_{sat}}$ and $V_{BE_{sat}}$ under radiation?

Would a 15W power IC audio amplifier be music to your ears?

Listen to what the new Bendix Model BHA-0002 audio amplifier can do for you.

This 1" x 2" x 5/16" package actually costs less to use than discrete components—and outperforms them as well. It has 25Hz-20KHz frequency response, a voltage range of 14 to 40 volts, power gain of 55db, THD less than 1%, high-power operation to 100°C case temperature, and 350 mV input for $P_o = 15$ watts.

The BHA-0002 offers some exciting possibilities for stereo amplifiers, trancivers, PA systems, phonographs, musical instrument amplifiers, intercoms and movie projector/sound systems.

It's one of a whole new family of thick-film power circuits from Bendix. These additions include two more audio amplifiers, 2W and 5W (see chart), plus a new Darlington, bridge rectifier and power driver module for industrial applications.

It's a lot of power for a lot of applications. From the real power in power: Semiconductor Division, The Bendix Corporation, Holmdel, New Jersey 07733.

POWER AUDIO AMPLIFIER CIRCUITS

Part Number	Maximum Power Output (W)	Voltage Range (V)	Input Voltage (mV)	Frequency Response (Hz)
BHA0001	2	11 to 16	5	40 to 10K
BHA0004	5	11 to 20	20	25 to 20K
BHA0002	15	14 to 40	350	25 to 20K

Bendix **Electronics**

Chicago—(312) 637-6929; Dallas—(214) 357-1972; Detroit—(313) 548-2120; Great Neck, N.Y.—H. V. Sales Co. (516) HU 7-1142; Greenwich, Conn.—(203) 869-7797; Holmdel, N.J.—(201) 946-9400; Lexington, Mass.—(617) 861-8350; Los Angeles—(213) 776-4100; Minneapolis—(612) 926-4633; Orlando, Fla.—(304) 241-6559; Rochester, N.Y.—(716) 266-5550; Runnemede, N.J.—(609) 933-2550; Seattle—Ray Johnston Co., Inc. (206) LA 4-5170; Export—Cable: "Bendixint," 605 Third Avenue, New York, (212) 973-2121; Ottawa, Ont.—Computing Devices of Canada, P.O. Box 508 (613) 829-1800; San Juan, Puerto Rico—Southern International Sales Co. 723-3879.

twice twist

Twist in. Twist out.

It's that simple to insert or remove terminal posts of our HW Series of Wire-Wrap printed circuit connectors.

Here's how it works. Our HW Series contacts are .025" square posts retained in the connector block by a simple 90° twist. Firmly. Because the hole in the block is also square, the contacts are rigidly retained by the resulting diagonal dimension of the post. It's a twist that gives far less breakage. And, because the posts twist out almost as easily as they went in, you don't have to discard a good connector if a contact should break.

Contacts are extracted with a simple hand tool by untwisting the terminal post to its original position, then sliding it out from the connector. And there are no adverse effects on the thermoset plastic material of the connector from the first or repeated twistings.

Let us tell you more about this new twist in wire-wrap printed circuit connectors. Descriptive literature is yours for the asking. Ask: Winchester Electronics, Main St. and Hillside Avenue, Oakville, Connecticut 06779.

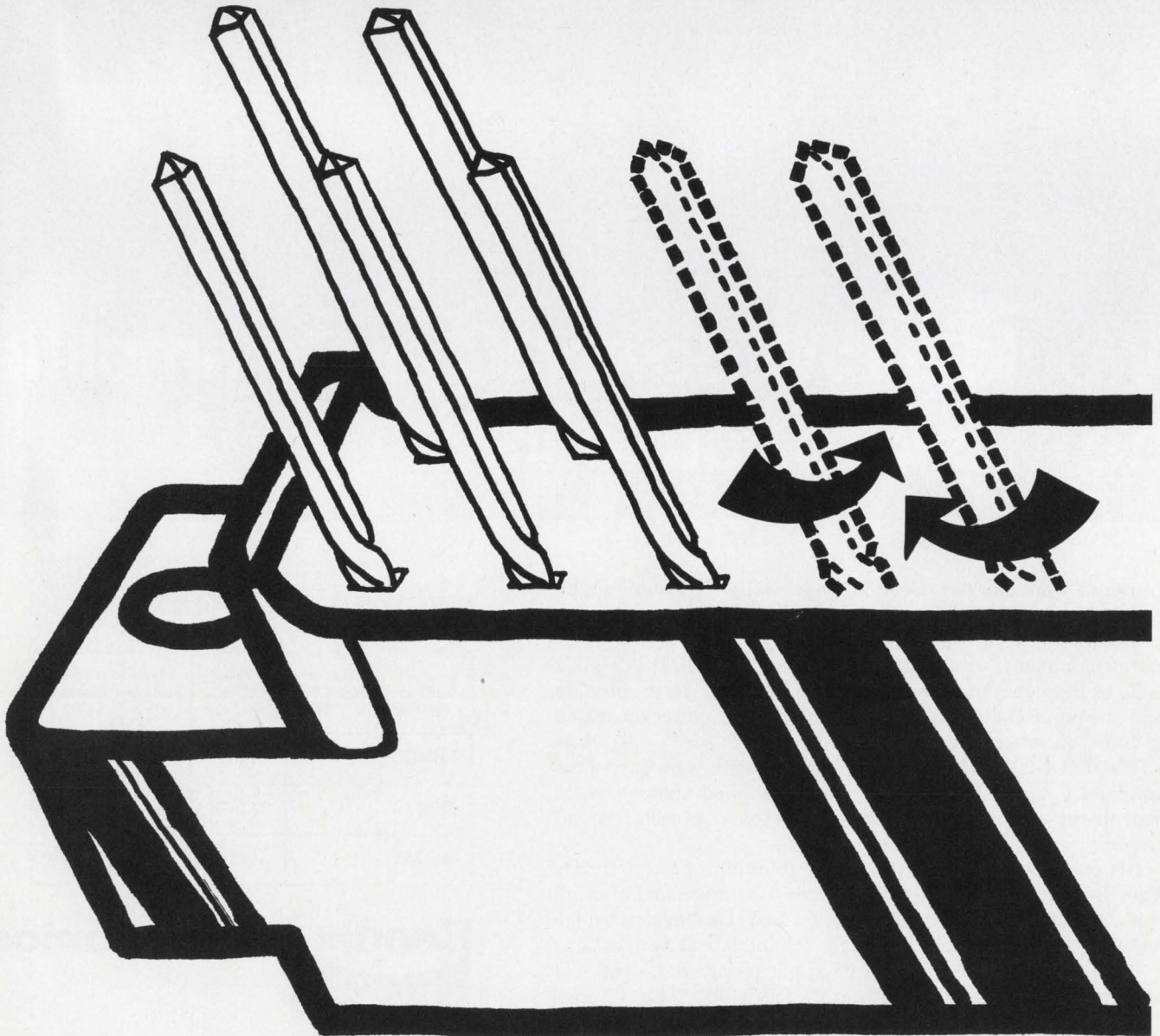

WINCHESTER ELECTRONICS 
LITTON INDUSTRIES

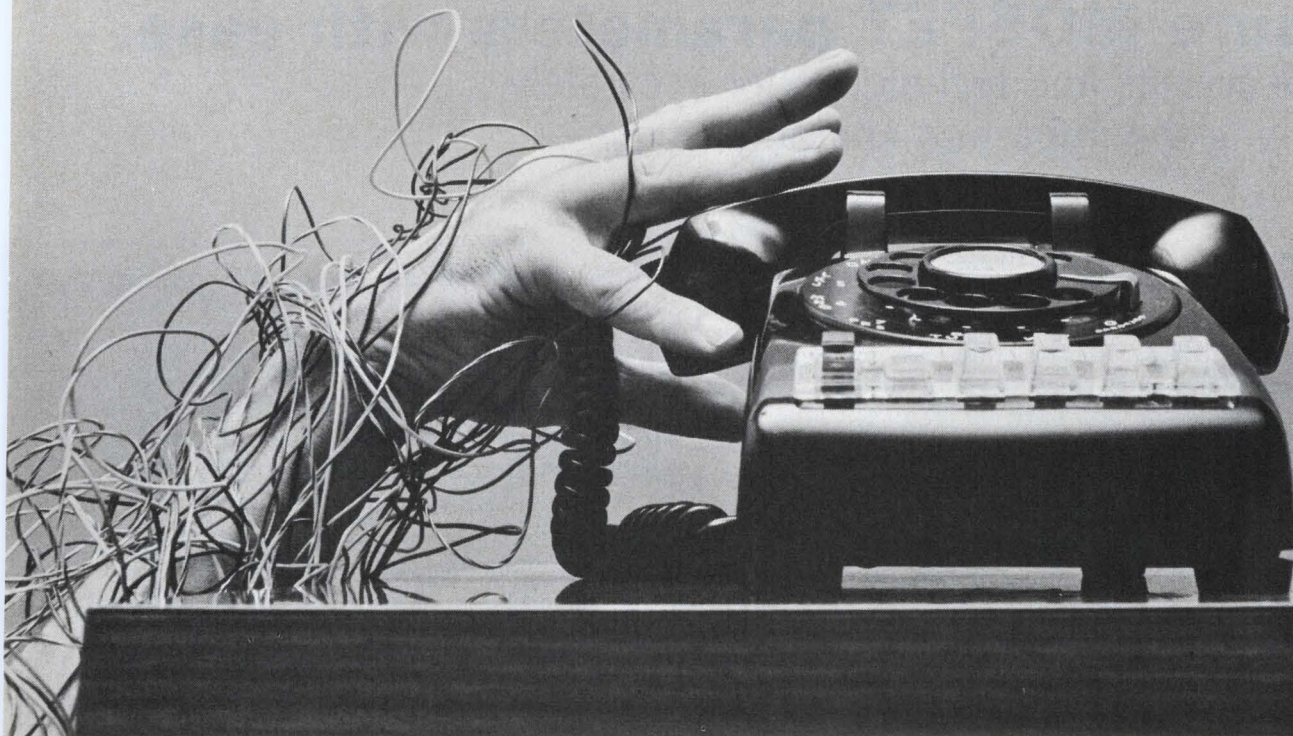

Call your logic module supplier for automated wire listing and wrapping.

Lots of luck if it isn't us.

No one else has a standard module line plus both automated services: wire listing and wire wrapping. So we're your sole source for a new way to save time, money, and trouble in building digital systems.

Fill in some simple forms defining your system. Our computerized design service will convert your design into an error-free, optimized wire list.

The computer will also program our automatic wire wrapping machines. These will lower your wiring costs at least 40% on any job worth doing. And once again you'll save a large chunk of time and money, because our computerized wiring verifier checks every connection. Finally, every board will be neatly wired, with multiple copies exactly alike — unlike the spaghetti bowl effect of hand wiring.

This is a proven system . . . not a flight of fancy. It was used for the entire family of Sigma computer products. And because we developed it for ourselves,

you'll only buy computer time, not development. Ask for our Application Bulletin No. 8 on "Automated Wire Listing."

All this and more modules too.

Our expanded J Series now has 123 low cost ways to solve digital system problems. You can choose among 76 logic modules, four power supplies, 33 cabinets and mounting cases, plus 10 solutions to cabling problems. There's even an edge lamp test assembly that lets you instantly check key points in your system. But our high performance T Series isn't a slouch. There are 73 modules to choose from plus all the hardware the J Series has to offer.

So call your logic module supplier, and if he isn't us tell him goodbye.

SDS
Scientific Data Systems,
El Segundo, California

Measure MOSFET parameters with ease.

Here are circuits and techniques for accurately determining the important characteristics.

How do you measure the characteristics of an MOS transistor or MOSFET? More and more designers use these devices today, but in the process they are finding out that they cannot use the same test techniques they have been using for bipolar transistors. An entirely new set of techniques—aimed specifically at the unique properties of the MOS device—is required.

What is the transfer characteristic, or V_{GS} vs I_P curve, of a particular device? At what gate-to-source voltage will a particular device cut off? Or, in an MOS switch, what is the drain-to-source ON-resistance, $r_{DS(on)}$, when the transistor is biased fully ON? These are only some of the parameters that are frequently of interest in MOS circuit design.

Complete data on all MOS parameters can best be determined by the combined use of a curve tracer and special measurement circuits. If a curve tracer is not available, an X-Y oscilloscope can be used instead.

The curve tracer or oscilloscope provides a sweep display of the transistor static characteristics, from which some of the important electrical parameters are either read off directly or calculated. Although this sweep method provides reasonably accurate results, it is limited to dc or low-frequency measurements. For very accurate results, as well as for high-frequency measurements, special measurement circuits are required. These test circuits are designed specifically for each transistor or family of transistors.

MOS parameters covered in this article include:

I_{DSS}	g_{fs}
$I_{D(off)}$	r_{os}
I_{GSS}	short-circuit
V_P	capacitances
V_T	power gain
$V_{DS(max)}$	noise figure
$V_{GS(max)}$	cross modulation
$r_{DS(on)}$	

F. M. Carlson, Engineer, RCA, Electronic Components, Somerville, N.J.

Sweep method shows curves

The approximate value of a number of MOS-transistor electrical parameters can be obtained conveniently from a display of the corresponding static characteristics as shown on an oscilloscope or curve tracer. A commercial curve tracer, such as the Tektronix 575, is specifically designed to display a complete family of characteristics. Although designed for use with bipolar transistors (current amplifiers), this equipment can be used with MOS transistors (voltage amplifiers) when the base-step generator is modified to provide voltage steps instead of current steps.

The modification involves the connection of a 1000-ohm resistor between the base and emitter terminals of the curve tracer. The adjustment of the base-step generator to 1 mA per step (negative steps for n-channel devices) results in an incremental voltage of -1 V per step being applied to the gate of the MOS transistor.

When a commercial curve tracer is not available, any low-frequency oscilloscope that has X and Y inputs and a vertical sensitivity of at least 10 mV per division may be adapted to curve tracing by use of the special adapter circuit shown in Fig. 1. Although this method does not result in the complete family of curves being presented on the oscilloscope simultaneously, each curve may be displayed sequentially by turning the gate-bias switch, $S1$, on the adapter. This switch provides 10 different gate voltages, from zero to -10 V, in increments of -1 V per step.

The drain-current/drain-voltage family of curves and the drain-current/gate-voltage curve obtained by use of the curve-tracer is shown in Fig. 2. Pinchoff voltage, V_p (depletion-type MOS transistors), and zero-bias drain current, I_{DSS} , are read off the

High accuracy requires special test circuits

For accurate measurements on MOS devices, test circuits are required. Figure 1 shows a circuit suitable for measuring the following dc electrical parameters: zero-bias drain current, I_{DSS} , drain-to-source cut-off current, $I_{D(off)}$, gate-to-source cutoff voltage, $V_{GS(off)}$ for depletion-type devices (approximately equal to the pinch-off voltage, V_P), and threshold voltage, V_T , for enhancement-type devices.

These parameters are measured under specific operating conditions of current and/or voltage, which are derived from the specifications for the transistor being tested. The operating conditions for the 3N128 single-gate MOS transistor, which is used in these examples, is shown in the Table.

The value of resistor R in Fig. 1 is chosen, in conjunction with voltage V_{DS} , to limit the drain current to a safe level in order to protect the transistor and ammeter.

The parameters, I_{DSS} , $I_{D(off)}$ and I_{GSS} are measured by first adjusting the variable circuit elements to obtain the specified gate-to-source and drain-to-source voltage conditions, then reading the current flowing through the ammeter. For measuring $I_{D(off)}$, a picoammeter should be used. Gate leakage current, I_{GSS} , can also be measured if the drain and source terminals are tied together and resistor R is removed (Fig. 2).

$V_{GS(off)}$ (for depletion-type transistors) is measured by first setting the drain-to-source voltage to the specified value, then adjusting the gate-to-source potential, V_{GS} , until the drain current equals the manufacturer's specified value. For the 3N128, I_D is specified at $50 \mu A$. The gate-to-source potential at this drain current is the pinchoff voltage.

The threshold voltage, V_T , for an n-channel, enhancement-type MOS transistor is measured by first setting the circuit for the specified drain-to-source voltage, then increasing the positive gate-to-source potential until the drain current reads the value specified on the data sheet. Usually this value is $10 \mu A$. The gate-to-source potential at this drain current is the threshold voltage.

The drain-to-source voltage, $V_{DS(max)}$, and gate-to-source voltage, $V_{GS(max)}$, at breakdown are not measured directly. Instead, the transistor's capability to withstand the specified maximum ratings is evaluated.

$V_{DS(max)}$ is measured at zero gate-bias under pulse conditions. The measurement is performed by tying the gate terminal to the

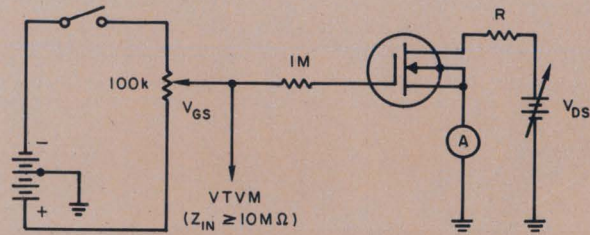

1. I_{DSS} and $I_{D(off)}$, as well as $V_{GS(off)}$ for depletion-type devices and V_T for enhancement-type devices, are measured with this test circuit.

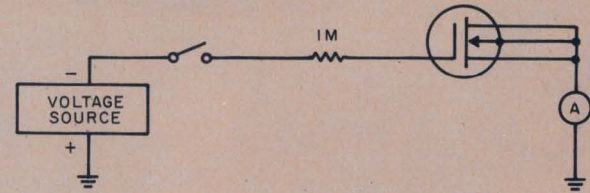

2. Gate leakage current, I_{GSS} , measurements.

Table 1. 3N128 operating conditions

Parameter	Symbol	Operating conditions	Limits		
			Min.	Typ.	Max.
Zero-bias drain current, mA	I_{DSS}	$V_{DS} = 15 V$, $V_{GS} = 0$	5	15	25
Drain-to-source cutoff-current, μA	$I_{D(off)}$	$V_{DS} = 15 V$, $V_{GS} = -8 V$	-	-	50
Gate-leakage current, pA	I_{GSS}	$V_{DS} = 0$, $V_{GS} = -8 V$, $T_A = 25^\circ C$	-	0.1	50
Maximum drain-to-source voltage, V	$V_{DS(max)}$		-	-	20
Pinchoff voltage, V	V_P	$V_{DS} = 15 V$	-	-3	-

source, placing the ammeter into the drain circuit, briefly applying the rated maximum drain-to-source potential and noting the drain current. Drain current less than $I_{D(max)}$ indicates proper transistor operation.

$V_{GS(max)}$ is measured by applying the maximum rated gate-to-source voltage, with the drain and substrate terminals tied to the source, and measuring the resulting gate current. If this value is less than the maximum specified gate leakage current, I_{GSS} , it means that the insulating oxide is not damaged; the transistor, therefore, can withstand the rated value of $V_{GS(max)}$. Since any voltage spikes generated can damage the oxide, $V_{GS(max)}$ measurements should be avoided unless conditions are carefully controlled.

In addition to the dc parameters just described, special test circuits are required for measuring the other MOS parameters of interest.

Channel resistance $r_{DS(on)}$

The channel resistance, $r_{DS(on)}$, also called the drain-to-source ON-resistance, represents the resistance of the conducting channel when the MOS transistor is biased fully ON; that is, when $V_{GS} = 0$ and $V_{DS} = 0$. For choppers, such as the 3N138, $r_{DS(on)}$ is also measured when V_{GS} is specified at some positive potential. A circuit that can be used to measure $r_{DS(on)}$ is shown in the illustration. The voltage source and the 100-k Ω resistor make up a constant-current generator that is connected to a low-value resistance, namely, $r_{DS(on)}$, across which the voltage is measured.

With the transistor removed from the test socket and switch $S1$ in the "Calibrate" po-

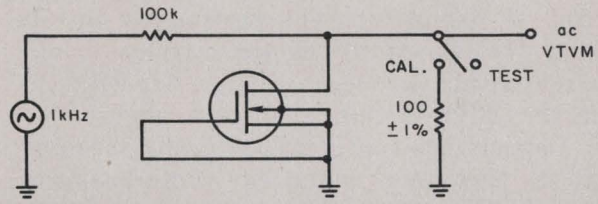

sition, the amplitude of the 1-kHz signal is adjusted until the indicator of the ac vacuum-tube voltmeter points to unity on some convenient scale between 0.1 and 10 mV. The MOS transistor is then inserted into the test socket, the switch is turned to the "Test" position, and the channel resistance is read directly (except for the decimal point) from the voltmeter. The maximum error of the test circuit is 1 per cent when channel resistance $r_{DS} \leq 1000$ ohms.

Transconductance, g_{fs}

A circuit for measuring the low-frequency transconductance, g_{fs} , of an MOS transistor is shown here. The transconductance is read directly from the ac vacuum-tube voltmeter. The theory behind the operation of this circuit is as follows:

Low-frequency transconductance, g_{fs} , is defined as the change in drain-to-source current as a function of a change in gate-to-source voltage. If the source voltage is constant, then

$$g_{fs} = i_D / e_G; \quad (1)$$

where e_G is the instantaneous change in gate voltage.

For the circuit shown, the drain current is the ratio of the output voltage to the load resistance, or

$$i_D = v_o / 50. \quad (2)$$

By substituting Eq. 2 into Eq. 1, the transconductance becomes

$$g_{fs} = v_o / 50 e_G. \quad (3)$$

Then, if the gate voltage is adjusted to 20 mV, the transconductance (in mhos) becomes the equivalent of the output voltage (in volts), or

$$g_{fs} = v_o / 50 (0.02) = v_o / 1 = v_o. \quad (4)$$

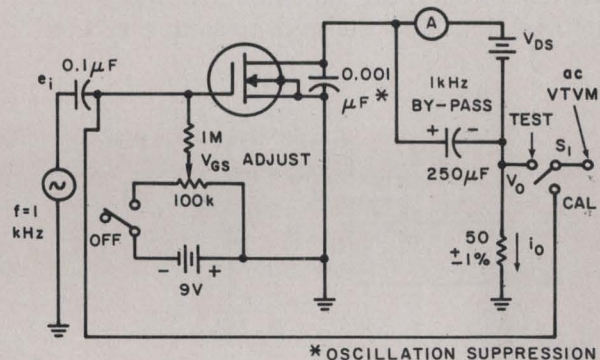

The procedure for measuring the transconductance, therefore, involves setting switch $S1$ to the "Calibrate" position (with the transistor removed from the test socket), and adjusting the amplitude of the 1-kHz signal until the ac voltmeter reads 20 mV. Next, switch $S1$ is turned to the "Test" position, the specified gate bias indicated on the manufacturer's data sheet is then applied, and the transistor is inserted into the test socket. The transconductance is then read directly from the voltmeter. A reading of 7 mV, for example, corresponds to a transconductance of 7 millimhos (7000 micromhos).

Small-signal short-circuit capacitances

The input, and reverse-transfer capacitances of an MOS transistor are commonly measured in the medium-frequency range (0.3 to 3.0 MHz). The reason for this is that the sensitivity of the various bridge circuits used to measure these capacitances is very high in this frequency range.

Capacitance values are generally specified at a particular value of drain-to-source voltage, V_{DS} , and either some value of gate bias, V_{GS} , or drain current, I_D . Figures 1 and 2 show the special test circuits that can be used to measure the specified input and reverse-transfer capacitances of most single-gate and dual-gate MOS transistors. The circuits are designed for use with the Boonton Model 75D-S8 (or equivalent) capacitance bridge, which has an operating frequency of 1 MHz.

To make a capacitance measurement, the test circuit, with the transistor removed, is connected to the capacitance bridge. The bridge is then balanced-out to eliminate all capacitances external to the transistor. Next, the MOS transistor is inserted into the test circuit; the specified drain-to-source voltage, V_{DS} , and the gate-to-source voltage,

V_{GS} , for proper drain current, I_D , are applied, and the capacitance value is then read directly from the bridge when it is nulled again.

The following points concerning the test circuits of Figs. 1 and 2 should be mentioned here.

- Internal dc bias is available from the capacitance bridge, between the HIGH terminal and the LOW plus GUARD (ground) terminals.

- The gate of the MOS transistor is normally connected to the ac HIGH post (which is the dc LOW post).

- The capacitance between the HIGH and/or LOW terminals and the GUARD terminal of the bridge is effectively excluded from the capacitance measured between the HIGH and LOW terminals.

- All capacitors used as ac bypass or coupling elements are chosen to be series resonant with their own leads at 1 MHz; all inductors used as ac blocking elements are chosen to be approximately parallel resonant with their own internal winding capacitance at 1 MHz.

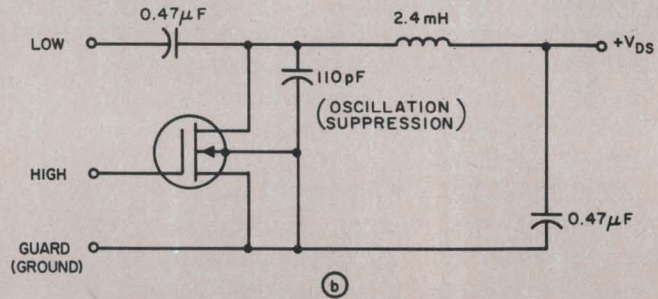
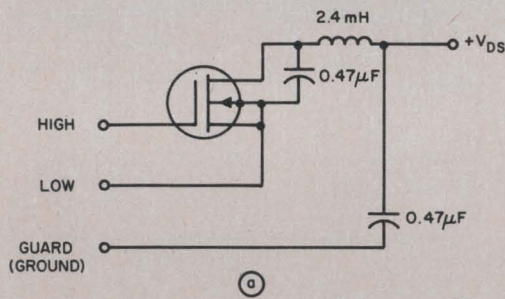

1. Input capacitance (a) and reverse transfer capacitance (b) of single-gate MOS transistors are

measured with these test circuits. A 1-MHz capacitance bridge is used for the measurements.

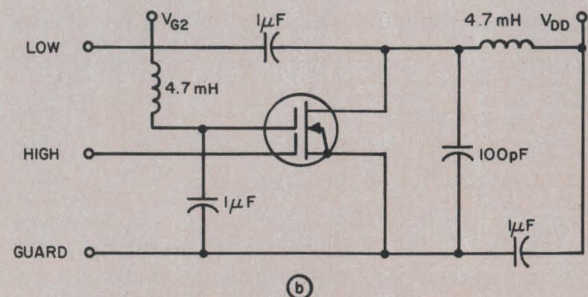
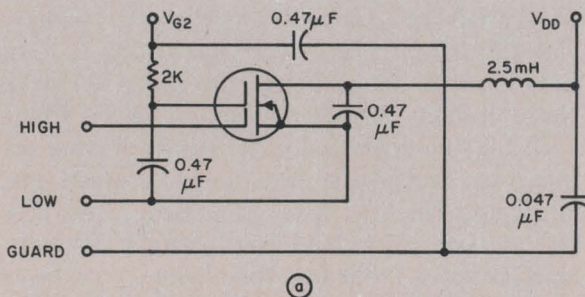

2. Capacitances of dual-gate MOS transistors are measured with these test circuits. Input capaci-

tance is measured with the circuit of (a), and reverse transfer capacitance with that of (b).

Output resistance, r_{os}

Output resistance, r_{os} , can be measured with the circuit shown in the illustration. The circuit, including the MOS transistor, is basically a constant-current generator connected to a low-value calibrating resistor (10 ohms), across which the ac voltage is measured.

The procedure for making a measurement is as follows: Prior to inserting the transistor into the test socket, switch $S1$ is turned to the "Calibrate" position and the amplitude of the 1-kHz signal is adjusted to provide a unity reading (either 0.1 or

1.0 mV) on the ac voltmeter. Switch $S1$ is then turned to the "Test" position, the transistor is inserted into the test socket, the specified bias is applied, and the output voltage is read from the voltmeter. This voltage reading, then, is actually a conductance reading, $1/r_{os}$, from which the output resistance can be calculated. When the voltmeter is calibrated to 0.1 mV, a test reading of 0.1 mV corresponds to an output resistance of (1/0.0001), or 10,000 ohms. Similarly, a test reading of 0.2 mV corresponds to an output resistance of 5000 ohms.

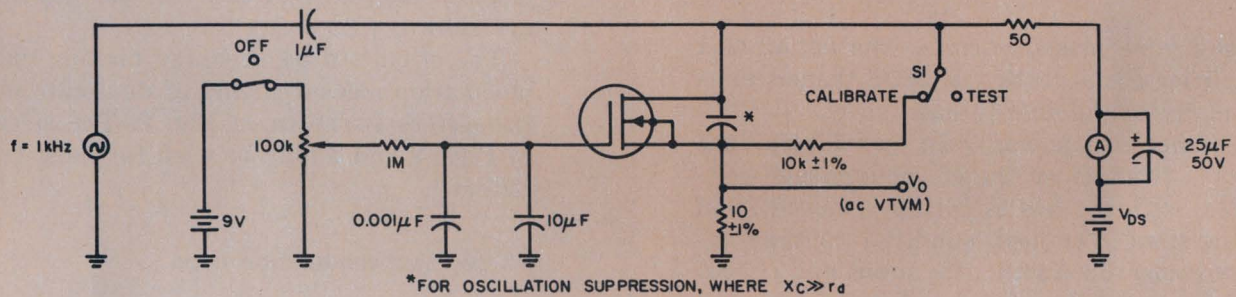

Power gain and noise figure

The power gain and noise figure of MOS transistors are measured in the very-high-frequency range (30 to 300 MHz) and are generally specified at 100 or 200 MHz. For dual-gate MOS transistors, power gain and noise figures are also measured at 400 MHz. A block diagram of the complete test setup used to measure power gain is shown in Fig.

1. Figure 2 shows the test apparatus for measuring noise figure. The test amplifier shown in these illustrations contains the MOS transistor to be tested. Although the amplifier configuration is specific for each MOS transistor or family of transistors, it is generally used for both power-gain and

(Continued on next page)

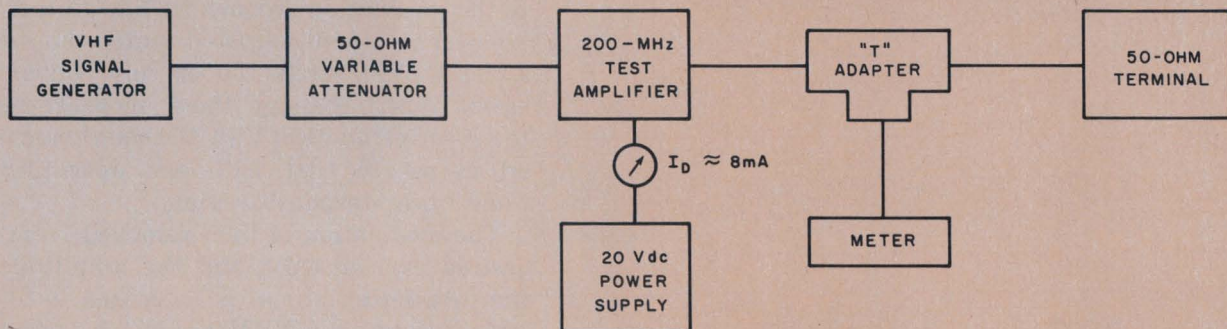

1. Power gain measurements.

Power gain, continued

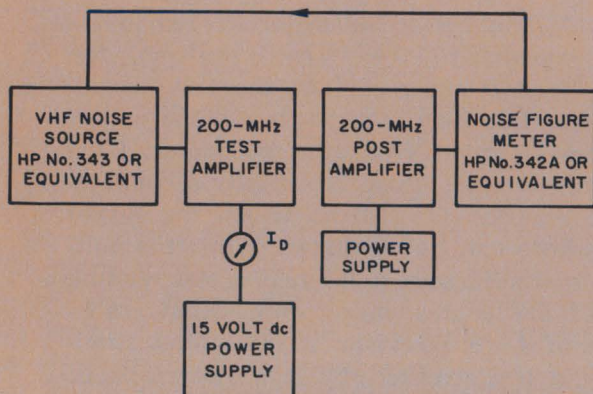

2. Noise figure measurements.

noise-figure measurements. The actual test amplifier for a particular MOS transistor is normally found in the data sheet.

To measure power gain, some reference level is first set on the rf vacuum-tube voltmeter, with the test amplifier removed from the system. The test amplifier is then inserted into the system; the input and output circuits are tuned for maximum gain, and the attenuation is increased until the voltmeter again reads the reference level. Power gain is then read directly from the attenuator.

For measurement of noise figure (Fig. 2), the MOS transistor is inserted into the test amplifier, the test amplifier power supply is then turned on, and the specified drain-to-source voltage is applied. The noise-figure meter should be calibrated at "Zero" and "Infinity," and the noise-source output current should be adjusted to 3.31 mA. Then, when the input and output circuits of the test amplifier have been tuned for minimum noise, the value of noise figure is read directly from the meter.

Cross-modulation distortion

Cross modulation in an rf amplifier is the transfer of information from an undesired carrier to the desired carrier. The block diagram of a test setup for measuring cross-modulation distortion in an MOS amplifier is shown in Fig. 1. This arrangement measures the amount of undesired signal that is required to cause 1 per cent (or some other percentage value) cross modulation of a desired signal at various levels of gain reduction caused by a dc voltage. The MOS amplifier circuits to be used for making these measurements on single-gate MOS transistors are shown in Fig. 2. Unneutralized, neutralized and cascode configurations are shown.

The circuit to be used for making cross-modulation measurements of dual-gate MOS transistors is shown in Fig. 3. The circuits of Figs. 2 and 3 may be used for most transistors.

30 per cent modulation used

The procedure for measuring cross-modulation distortion (Fig. 1) begins with setting the amplitude of the desired signal to the required signal level (one to 10 mV is the normal range for MOS transistors). The interfering signal, obtained from the interfering-frequency generator, is adjusted to zero volts and both rf carriers are modulated with an audio signal. A frequency of 400 to 1000 Hz at 30 per cent modulation is generally used.

Next, the MOS transistor is inserted into the test circuit, the proper bias specified in the data sheet is applied, and the amplifier circuit is tuned to the desired carrier frequency, as indicated by the rf vacuum-tube voltmeter. The radio-receiver is tuned to the desired carrier frequency, and the audio-frequency vacuum-tube voltmeter is tuned to the modulation frequency. The gain of the receiver is then adjusted until the tuned audio VTVM reads 100 on any convenient scale. When making these measurements, the receiver and the VTVM should be checked to assure that both are operating in their linear-response region.

The modulation is then removed from the desired carrier only, and the amplitude of the interfering signal is increased until the audio-frequency VTVM reads 1.0 (one per cent of its original reading). The value of

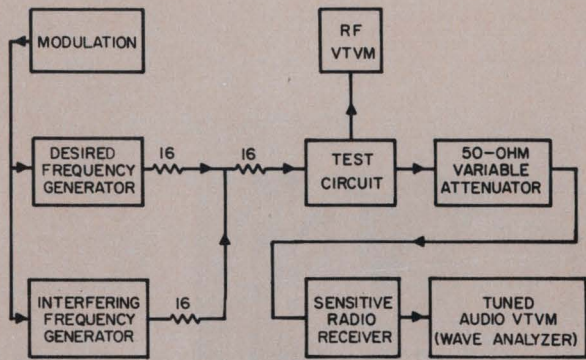

1. Cross modulation in an MOS transistor amplifier is measured with this test arrangement.

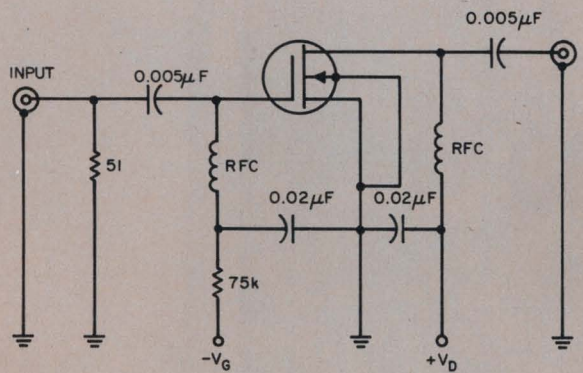

(a)

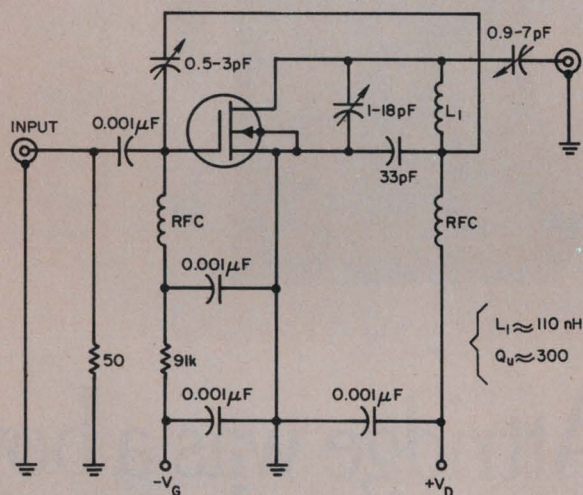

(b)

the interfering-frequency rf carrier at that point is the signal level required to cause 1 per cent cross modulation.

In like manner, the level of interfering signal is measured in desired increments of gain reduction from zero to 50 dB. Throughout this procedure the attenuator is adjusted to maintain a constant level of input

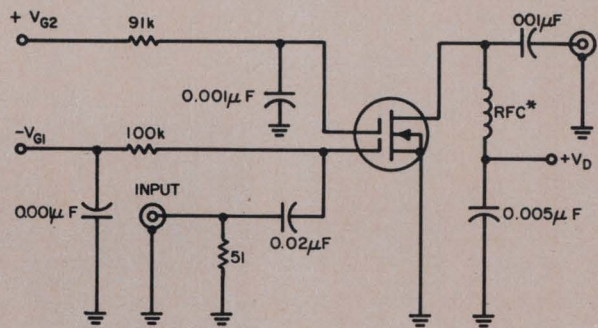

* CHOKE SHOULD BE PARALLEL RESONANT WITH rf INPUT FREQUENCY

3. Cross-modulation measurements of dual-gate MOS devices are made with this test circuit.

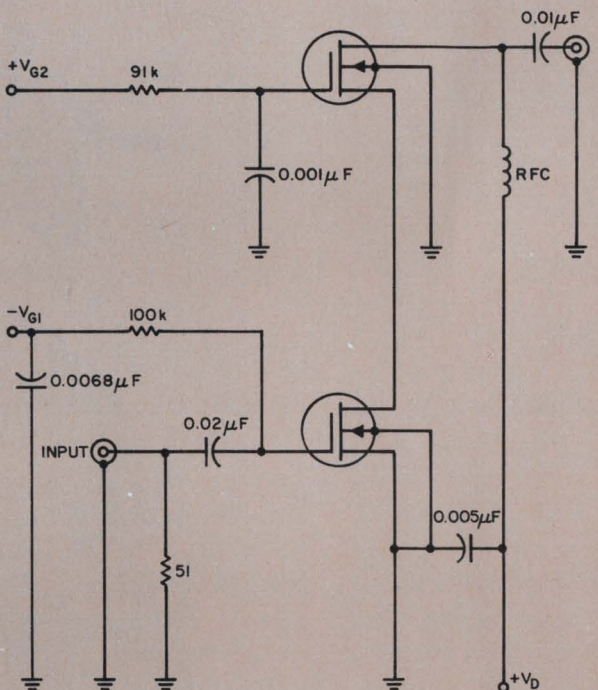

(c)

NOTE: CHOKE SHOULD BE PARALLEL RESONANT WITH rf INPUT FREQUENCY.

2. Test circuits for cross-modulation measurements of single-gate MOS transistors are shown for unneutralized (a), neutralized (b) and cascode configurations (c).

signal to the receiver. The initial setting of the attenuator should be 20 to 50 dB, depending on the amount of gain reduction expected.

The results of the cross-modulation distortion measurements are normally given in graphic form showing gain reduction as a function of the interfering-signal level. ■■



When Bill Attridge was a boy,
training production people was
no big deal.

There was no electronics elite when Bill Attridge was growing up in Boston. Designers of industrial tools were simple, practical men. Their brilliance was established on the production line, not in the laboratory.

Bill Attridge's dad was a toolmaker. A perfectionist. Bill is more of the same. At Teradyne he designs extraordinarily complex instruments to test electronic components. But he designs them to be used by mortal men and women.

To reduce costly training time and lessen human errors in production, Teradyne removes the mysteries from instrument operation. Simplicity is the keynote.

Programming controls are thoughtfully arranged. Panel markings are self-explanatory. Simple line drawings of the front panels describe accurately and completely each instrument's function. Anyone familiar with the nomenclature of component testing can use Teradyne equipment with only minimum instruction. Even the computer-operated systems built by Teradyne to test complex IC's are relatively simple to use.

Bill Attridge and his associates are succeeding in lowering the high cost of errors in testing; first, by building machines to spot rejects automatically and reliably, and second, by making these machines easy to use without long, costly training.

Outsiders may still think you're in a glamorous, blue sky business. But you know better, don't you. It's the same old story. You get good people and you give them good tools.

By making automatic test equipment easier to use, Teradyne makes your good people better. And you save a barrel of training time and money in the bargain. It's that simple at Teradyne, 183 Essex Street, Boston, Massachusetts 02111.

Teradyne makes sense.

Get the best one-shot for your money

by combining NAND gates and discrete components.

Temperature stability is as good as 0.027%/°C.

Why pay a higher price than necessary for a monostable mil spec? The integrated one-shots now available are expensive to begin with—on the order of \$20—and they still need external RC timing networks. A one-shot built with discrete components is cheaper—about \$5 for parts alone—but it requires at least 11 components, and more than twice this number of interconnections. Keeping track of all these parts and assembling them can be a headache—and it means more expense.

A good alternative—cheaper than the integrated version and simpler than the discrete component unit—uses NAND gates and a suitable feedback path. Only five readily available components are used, and total parts cost is in the neighborhood of \$10 (see Table). The circuit lends itself to simple analysis, and its operating parameters can be easily controlled by variation of the few discrete components used. The temperature stability of this circuit is typically better than 0.027% per degree centigrade.

RC network controls pulsewidth

The circuit (Fig. 1) closely resembles more conventional monostables. The timing cycle begins with an input trigger pulse, pulling point 1 toward ground potential. The coupling through C_T turns off $T1$ and therefore turns gate ($G1$) on. Positive feedback from $G1$ will hold point 1 at saturation voltage (approximately 0.1) whether the trigger pulse remains or not.

This condition is sustained while point 2, which was pulled to -3 V, charges through R_T toward $+4$ V (Fig. 2). When $+0.6$ V is reached, the base voltage is sufficient to turn on $T1$ and conclude the pulse output. The time necessary for this to occur is easily derived from the capacitor discharge relation:

$$\begin{aligned} 0.6 \text{ V} &= 7 (1 - e^{-T_{OUT}/R_T C_T}) - 3\text{V} \\ T_{OUT} &= 0.726 R_T C_T \text{ seconds.} \end{aligned} \quad (1)$$

The timing cycle is terminated when $T1$ returns to the on state and $G1$, in turn, releases

point 1 from ground. Point 1 must charge to V_{CC} ($+4$ V), primarily through R_p (510 ohms), before the monostable is fired again. If point 1 is not allowed to reach V_{CC} before the circuit is fired, the period of the output pulse will be affected. Since, in normal applications of the circuit, an error in the output period of 1% or so can be easily tolerated, the voltage at point 1 need only reach 99% of V_{CC} . This is equivalent to an error in output period of 0.7%. The recovery time (Fig. 3) is thus the time required for the voltage at point 1 to reach 99% of V_{CC} , or:

$$0.99 = 1 - e^{-T_{RE}/R_p C_T}$$

and

$$T_{RE} = 1.87 \times 10^3 C_T \text{ seconds.} \quad (2)$$

R_T must supply sufficient base current to saturate $T1$ for whatever fan-out is required. For the 2N2501, a β of 20 at -55°C is assumed as the worst case. Since a DTL gate requires about 1.6 mA to insure a "zero" state, R_T must supply this current (divided by β) for the positive fan-out (N) as well as the NAND gate in the monostable circuit. This can be expressed:

$$(N + 1) (1.6 \times 10^{-3}) = (3.3/R_T) \beta \text{ amps.}$$

Then

$$R_T \leq (40.2/N + 1) \times 10^3 \text{ ohms.} \quad (3)$$

When the additional gates available in the quad package are connected as shown in Fig. 4, a great deal of flexibility is obtained for DTL logic design. Two sources of input can trigger the "one shot" when "enabled." Both positive and negative outputs are available (an inhibit can be used with the negative output) and the monostable timing can be "reset."

Design for required performance

The first step in design is to define the required performance in terms of the parameters given by Eqs. 1 and 2. The output pulse width T_{OUT} and the maximum permissible recovery time T_{RE} are assigned target values, and the necessary fan-out capability is decided upon. These values are then used to determine the resistance R_T and capacitance C_T .

Generally, R_T should be chosen at the upper limit given by Eq. 3 to ensure the smallest pos-

Table. Cost comparison for one-shot designs

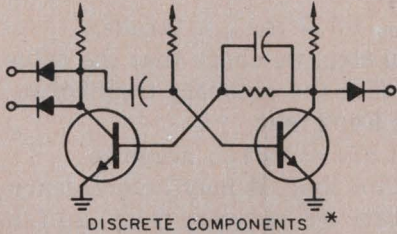
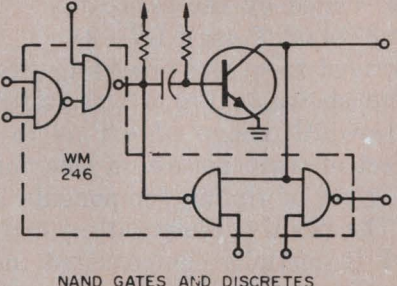
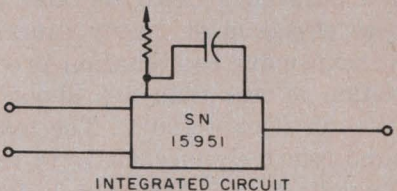
Circuits	Parts	Cost	Number of parts	Temperature stability
 <p>DISCRETE COMPONENTS *</p>	(4) Thin film resistor (2) Capacitors – DM (2) Transistors (3) Diodes	.60 1.50 2.00 .30 <hr/> \$4.40	11	-55 to 100 °C* 0.18%/°C*
 <p>NAND GATES AND DISCRETES</p>	(2) Thin film resistor (1) Capacitors – DM (1) 4 Nand gates (see note) (1) Transistor	.30 .75 7.30 <hr/> 1.00 \$9.35	5	0.025%/°C (Tested)
 <p>INTEGRATED CIRCUIT</p>	(1) Thin film resistor (1) Capacitor – DM (1) Monostable IC (see note)	.15 .75 <hr/> 20.40 \$21.30	3	0.02%/°C (estimated by author)

*Pulse, Digital, and Switching Waveforms – Millman and Taub, McGraw Hill 1965, p. 417

Note: Prices for below listed components are those of December 1, 1968, for quantities of 1 to 10. (all are MIL SPEC ICs)

- DTL Quad Nand Gate, -55 to +125 °C

WM 246G	\$7.30	Westinghouse
MC 946	\$6.50	Motorola
SN 15946	\$4.12	Texas Instruments

- DTL Monostable Multivibrator, -55 to +125 °C

MC 951F	\$20.25	Motorola
WM 841Q	\$32.25	Westinghouse
SN 15951	\$12.37	Texas Instruments

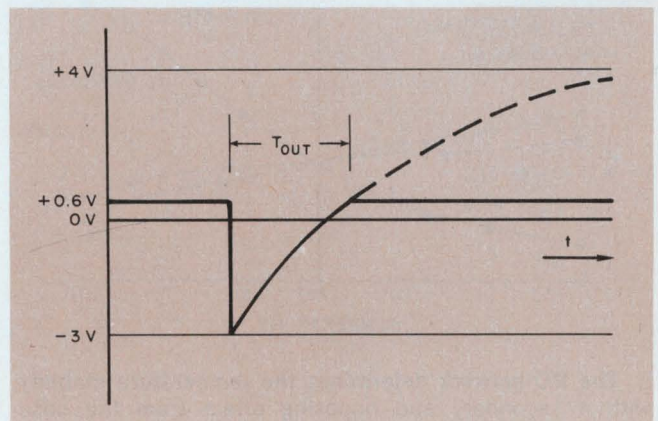
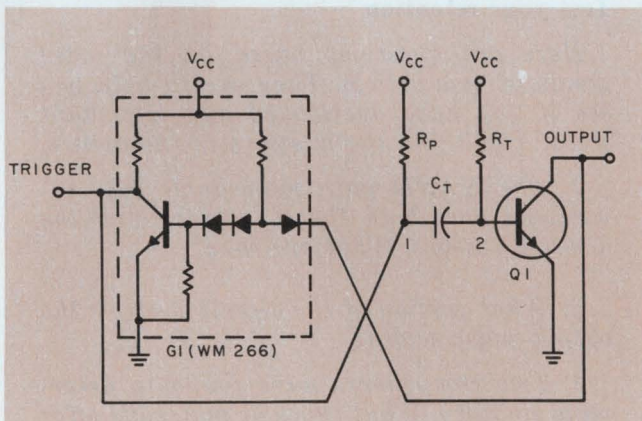

1. The basic monostable circuit uses four discrete components and a NAND gate, with the output pulse duration controlled by the values of R_T and C_T . If a duramica capacitor and a tin-oxide resistor are used, the temperature coefficient can be as low as 0.027%/°C.

2. The voltage at the base of transistor T1 is pulled to -3V on application of a trigger pulse, and then rises as C_T is charged through R_T . When the voltage on C_T reaches +0.6 V, the base voltage is sufficient to turn on Q1 and conclude the pulse output.

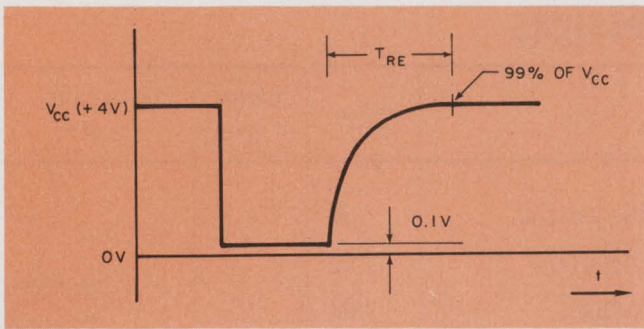

3. The recovery time of the circuit (T_{RE}) is the time required for the voltage at point 1 (Fig. 1) to reach 99 per cent of V_{CC} . If the circuit is retriggered after only T_{RE} seconds, the error caused in the output period will be less than 0.7 per cent.

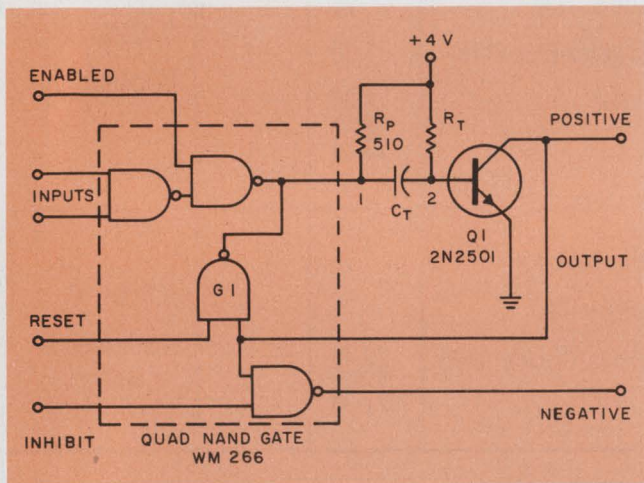

4. The quad NAND gate gives added flexibility. Two sources of input pulses can trigger the one-shot, but only when "enabled." Both positive and negative outputs are available, with an "inhibit" on the negative output. The monostable timing can be "reset" at any time by means of G1.

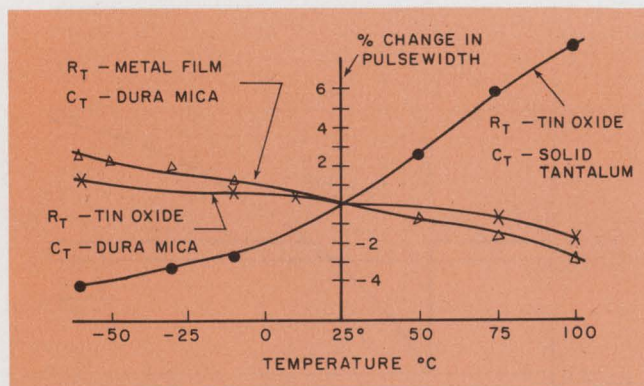

5. The RC network determines the temperature stability, with a secondary and opposing effect from the base-emitter temperature coefficient of the transistor. The variation of output pulsewidth was less than 2 per cent over the range -55°C to $+100^{\circ}\text{C}$ when a dura-mica capacitor and tin-oxide resistor were used in the network ($R_T = 47\text{K}$, $C_T = 0.001 \mu\text{F}$, output pulsewidth = $35 \mu\text{s}$).

sible capacitor is used and fastest recovery time is attained.

Capacitor C_T and resistor R_T determine the output pulse width, of course, and since we know the required pulse width and the value of R_T , from Eq. 1:

$$C_T = T_{OUT}/0.727 R_T (\text{max}) \text{ farads.} \quad (4)$$

As a final step, we check that the value selected for C_T satisfies the recovery-time constraint. We know from Eq. 2 that

$$T_{RE} = (1.87 \times 10^3) C_T \text{ seconds.}$$

If T_{RE} is too long, it may be necessary to make a tradeoff between recovery time and fan-out, and begin the design cycle again. Recovery time and fan-out are related by the expression

$$T_{RE} = (1.87/4.02 T_{(OUT)}) (N+2),$$

which is derived from the preceding equations.

The circuit shown in Fig. 4 was tested for an output pulse-width range of $0.3 \mu\text{s}$ to 140 ms , and the effect of temperature on this "one shot" for several types of timing components is shown in Fig. 5. The positive temperature drift of the RC network is partially compensated for by the base-emitter temperature coefficient of $T1$. In the case of a dura-mica capacitor and tin-oxide resistor, these effects most nearly canceled each other. This inexpensive combination produces an output variation of less than 2% about the ambient output -55°C to $+100^{\circ}\text{C}$. The monostable was also found relatively insensitive to variations in the supply voltage. A 5% change in the supply voltage caused only 1.4% variation in the output pulse width. ■■

References:

1. J. Millman and H. Taub, *Pulse, Digital and Switching Waveforms*, New York: McGraw-Hill Book Co., 1965.
2. J. M. Pettit, *Electronic Switching, Timing and Pulse Circuits*, New York: McGraw-Hill Book Co., 1959.

Test your retention

Here are questions based on the main points of this article. They are to help you see if you have overlooked any important ideas. You'll find the answers in the article.

1. The NAND gate monostable has advantages over both the IC version and the discrete version. What are they?
2. What portion of the circuit controls the output pulse width?
3. Two components were found to determine stability. What types of materials offer the best stability?
4. Does the pulsewidth decrease with increasing temperature, regardless of the timing components used?

3530 64-BIT STATIC RANDOM ACCESS MEMORY

The 3530 is an MOS non-destructive read-out (NDRO) random access memory organized as 64, 1-bit words. Addressing of any selected bit is through a 6-line decoder included on the chip, and access time is under 2 μ sec. Several 3530's may be stacked for longer words.

The need for external gates is reduced by a built-in wired-OR capability. And system power needs are less (under 3mW/bit) because the chip is built with p-channel enhancement mode MOS.

The 3530 was designed to be used in military or commercial airborne, space, or ground-based systems. It is easily integrated into any data storage system, from computer peripherals and calculators to scratch pad and process control memories.

The 3530 comes in a 16-pin DIP. Write for complete specs and application notes. Or order it from stock from your Fairchild distributor.

To order the 3530, ask for:

Part No.	Temperature Range	Price		
		(1-24)	(25-99)	(100-999)
A6J353014X	-55°C to +85°C	\$36.00	\$32.00	\$24.00

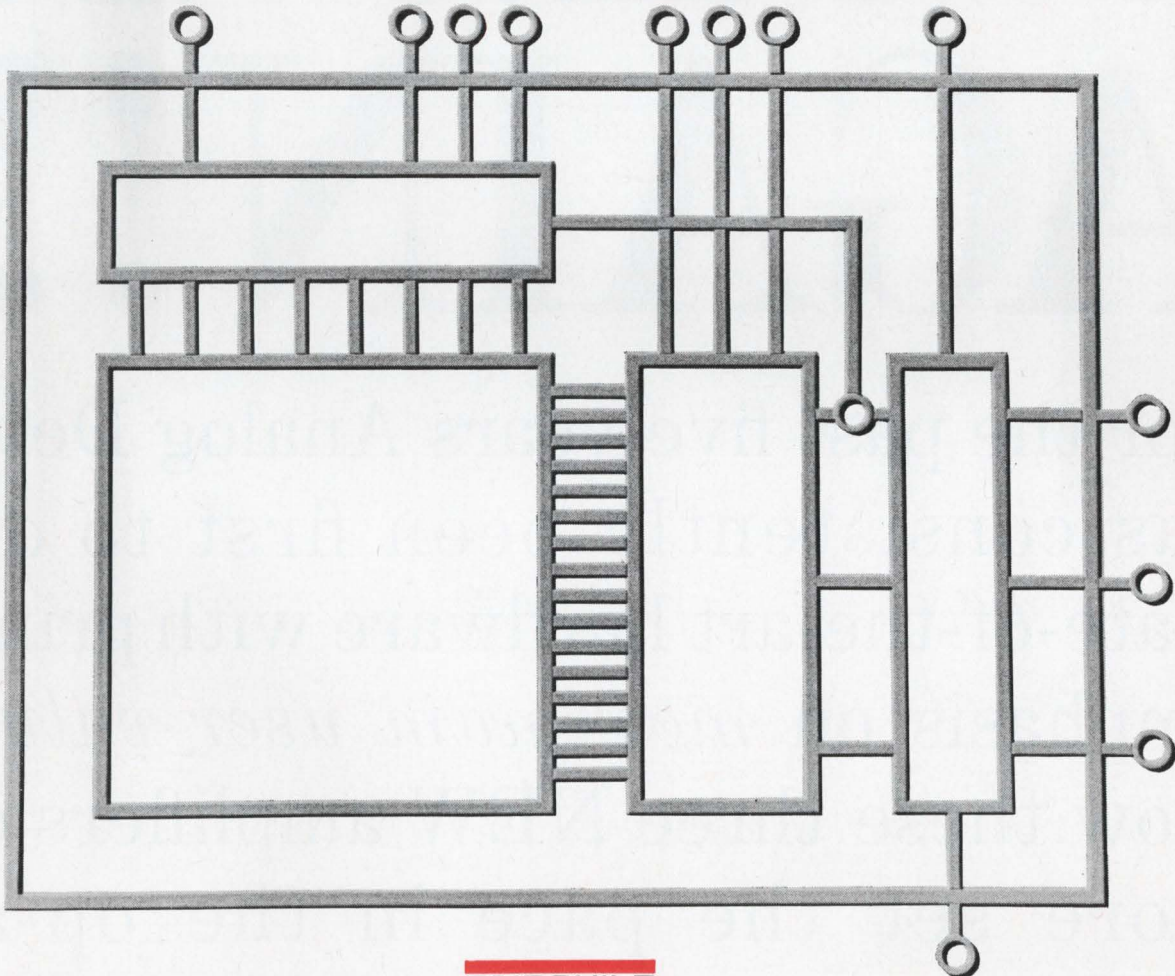

ANALOG DEVICES DOES IT AGAIN!!!

For the past five years Analog Devices has consistently been first to offer state-of-the-art hardware with primary emphasis on *maximum user value*... Now these three NEW amplifiers once more set the pace in the op-amp performance per dollar competition...

LOW COST/GENERAL PURPOSE—\$11

Maximized user value really shows up in this new low cost series. The Model 118 offers performance that was simply unheard of just a few months ago. With every spec "one up" from I.C. types, the 118 is the best value available for literally hundreds of general purpose applications. Not even the spec table tells the whole story. . . A dual input transistor stage, usually found in much higher priced amplifiers, means immunity from "thermal gradient" errors and low noise. Other important advantages are high open loop gain, fast slew rate and low bias current.

Models with 20 volt output swing and 20mA output currents are also available under \$25.

SPECIFICATIONS	118A/K
Open Loop Gain, min	2.5×10^5
Rated Output, min	$\pm 10V @ 5mA$
Full Power Resp. min	100kHz
Slew Rate, min	$6V/\mu sec$
Voltage Drift, max	$\pm 20/5\mu V/^\circ C$
Bias Current, max	$\pm .6/.5nA/^\circ C$
Price (1-9)	\$11
(10-24)	\$10.50

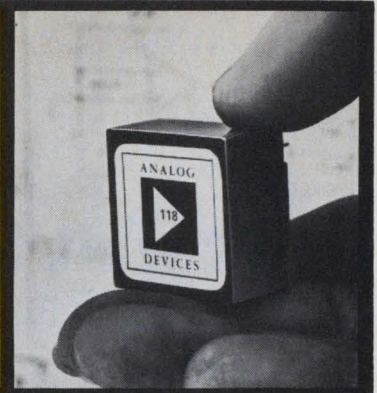

CHOPPER STABILIZED OP-AMP—\$64

This new series sets the price standard for sophisticated chopper stabilized op-amps. At \$64 unit price, the 232J is less than half the cost of comparable units available just last year. Performance has also been improved over previous types. . . long term drift tests indicate that initial offset voltage will stay within $5\mu V$ indefinitely and low frequency "flicker" noise has been reduced. Package size is only 0.4" high for card rack mounting.

A selected high performance version designated 232K is available at \$99 unit cost. The units are identical except for initial offset voltage and drift rates ($10\mu V$, $0.1\mu V/^\circ C$) and initial bias current and drift rate (50pA, $0.5pA/^\circ C$).

SPECIFICATIONS	232J
Open Loop Gain, min	10^7
Initial Offset, max	$15\mu V$
Voltage Drift, max	$0.25\mu V/^\circ C$
Long Term Stability	$1\mu V/month$
Noise, dc to 1Hz	$1.5\mu V, p-p$
Bias Current, max	100pA
Current Drift, max	$1pA/^\circ C$
Rated Output, min	$\pm 10V @ 4mA$
Price (1-9)	\$64
(10-24)	\$58



ELECTROMETER AMPLIFIER

The Models 310 and 311 are varactor bridge input amplifiers with ultra low bias currents. . . typically $10^{-14}A$. These new amplifiers offer for the first time a realistic, solid-state alternative to vacuum electrometer tubes. In addition, voltage drift of only $10\mu V/^\circ C$ is 10 times less, and \$50 in hundred lots is highly competitive.

The 310 is for inverting operation and is useful where tiny currents measure as is typified by photo-multiplier tubes and gas chromatograph flame detectors. The 311 is essentially identical but is optimized for non-inverting circuits. It is the best choice where voltages from high source impedances are found (pH cells, chemical transducers, etc.)

SPECIFICATIONS	310/311
Open Loop Gain	10^5
Rated Output	$\pm 10V @ 5mA$
Voltage Drift	$30\mu V/^\circ C$
Signal Input	
Input Bias Current	.01pA
Differential Input	$3 \times 10^{11}\Omega$
Noise (.01-1Hz)	.001pA
Price (1-9)	\$75
(10-24)	\$70

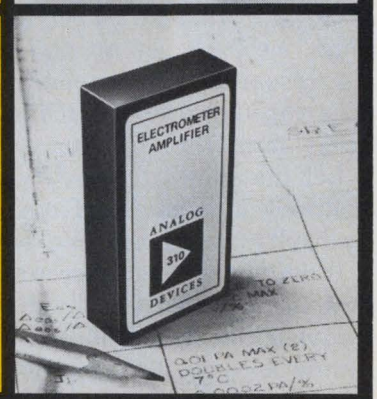

These are just three examples of the 19 brand new products which appear for the first time in our new comprehensive catalog for 1969. All have been specifically designed for *maximum user value* . . . get your FREE copy today, available from any sales office or use the Reader Service Card.

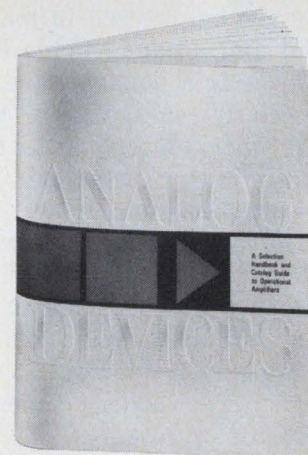

SEE US AT IEEE BOOTH 4E-26, 4E-28

Two Twenty One Fifth Street
Cambridge • Massachusetts 02142
Tel: (617) 492-6000 • TWX: (710) 320-0326

Don't wait for brainstorming. Organize for creativity. Structured 'idea sessions' can lead to new thinking — and new, successful products.

Second of two articles

New product ideas pop up in many places—sales, the engineering department, the customer's imagination. Most of these ideas, however, are usually one-shot affairs that do not lead to a new product line.

Is there a way to organize the creative talents of your staff to insure a steady flow of new, successful products? At General Time Corp., we have found the "idea session" to be of valuable assistance. Instead of relying on random inspirations, we have set up planned sessions at which our research staff attempts to create new products through the interchange of ideas. Such a program might work for you.

Let me show you how two important products emerged at General Time from this organized creativity: Incremag and Mu-Chron.

Incremag is an electronic/magnetic counter that can be used for dividing or multiplying the frequency of an oscillator into a fixed number of counts to provide specific pulse output. Incremag products were used in some Ranger moon probes, in the first six Tiros weather satellites and they are being used in many other military, industrial and oceanographic devices.

Mu-Chron is a square-wave, magnetic oscillator, especially valuable in the low-frequency range. It operates on the saturating-core-magnetic-multivibrator principle. The unit's advantages lie in the square wave, its small size and low cost for the frequency range involved. Optimum frequency range is 10 Hz to 1 kHz. Mu-Chron is accurate in the first cycle after power turn-on; first half-cycle polarity can be controlled. Output frequency is a function of the transformer's saturating time.

As director of research at General Time, I am helmsman and catalyst of the on-going innovation program in which we developed these products. We start with idea sessions—not to be confused with brainstorming, which is different in form and content (see "Yes, You Can Develop Your

Creativity," ED 3, Feb. 1, 1968, p. 66). We have tried brainstorming, but with little success. In an idea session:

- We discuss only one major topic—thoroughly and fully—including technical aspects.
- We notify participants of the topic at least two weeks in advance of the meeting, so they can read and think about it.
- We choose participants carefully from all levels, using their demonstrated creativity as the criterion.
- We mix as many different disciplines as possible, to cross-pollinate the thinking.

An idea session in action

Here's how an idea session operates in practice. You have just come to work for General Time. As the name implies, the company makes timepieces and is interested in new and improved methods of timekeeping and related matters. With this background, what could be more appropriate for the first idea session than the topic of time? So, among other points, we discuss (1) What is time? (2) How is it measured? (3) What are its uses? The session begins:

Although all of us speak of time in some form every day, nobody can say what time actually is. Yet we use it. Just as we do not know what electric, magnetic or gravitational fields are, yet we use them in thousands of products.

For our second session, we decide to concentrate on the second question—How is time measured?

Man has probably been conscious of time passing from his earliest intelligent moment. Even the cavemen knew that after so many moons the seasons would change. Or that the stars would look different in the night sky. The first men might even have used a "timepiece" by watching the shadow of a tree as the sun appeared to pass overhead.

Getting back to business, we start the second session with the four major categories in which time can be measured: astronomical, physical, chemical and biological. Each can be a whole topic for discussion. Briefly though, astronomical

Dr. Wilmer C. Anderson, Director of Research, General Time Corp., Stamford, Conn.

"Mixing disciplines in idea sessions widens and cross-pollinates the thinking."

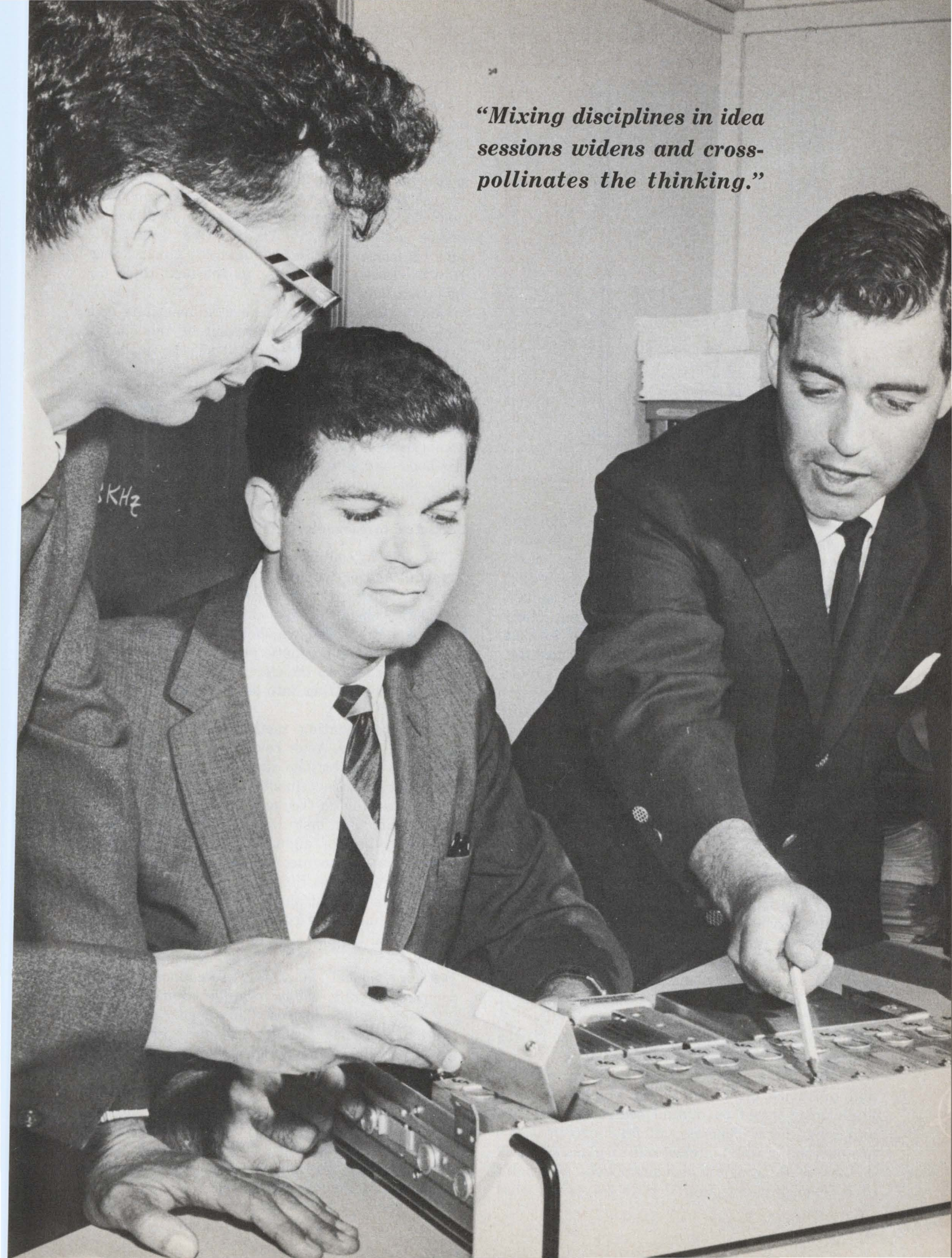

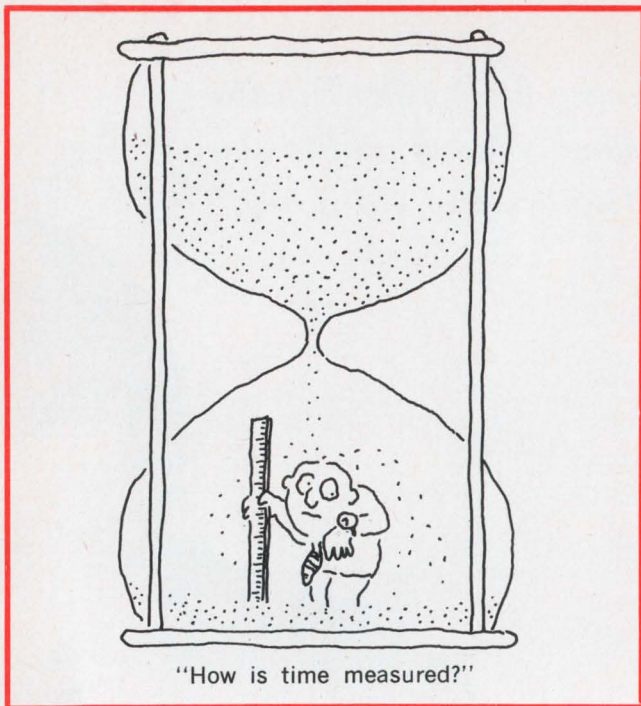

methods would include such things as sun and moon cycles and the earth's rotation. Chemical methods might include chemical reactions, burning ropes or candles, or electroplating. Biological methods—say, incubation or gestation periods—are known to be accurate within 5 per cent. Many people have internal "alarm clocks" that awaken them at almost the same time each morning. Further, we all can estimate time intervals more or less accurately.

In our second session, we discard these major categories—except for the physical. We choose it for the next session. And in doing so, we open a Pandora's box. To mention a few major sub-categories: fluid flow, mechanical methods, electrical methods, atomic methods. Again, any one is material for another study.

Don't junk old ideas—update them

Under fluid flow, there's the old water wheel and Chinese water clock, and the hourglass. Just to prove you should never discard old ideas, we look at this last principle. I passed a store window recently and saw an hourglass advertised. About 30 inches high, built of plastic, with plastic beads in place of sand, it served as a table on which individual drinks could be placed. It was sold as the "Cocktail Hour"—for \$50.

Similarly the latest thinking in fuzing missiles and ordnance pieces, and even computers, is a fluid timer based on a fluid oscillator, flip-flops and other logic elements, all fluid driven. Some are extremely small, etched out of glass. A stack of them is about as big as a sugar cube. The point of both examples is that it pays to review what

has been done and to update it for modern needs.

On to mechanical methods. They include many common vibrating or oscillating devices. For example: tuning forks, pendulums, a watch's hair-spring balance wheel.

We decide to postpone discussion of electrical methods. We go on to atomic methods. How can we use the atom to keep time? Four rather obvious ways are atomic, molecular, crystalline or lattice oscillations, and radioactive decay. We pick radioactive decay (incidentally, this was before the maser-laser days) as the next topic for investigation.

Among the many ways to use radioactivity as a time source are: the integration of the charge from released particles; counting the particles given off; collecting the derived products, such as radon gas, lead or Carbon 14 concentration. We choose to discuss counting of disintegrated particles at the third session. When we do, the topic leads to possible detectors to use, counting methods and alternate ways to display the results that would indicate time.

Attracted to magnets

We select "counting methods" for the fourth session. Again, we break this topic down into several categories: electrochemical, electronic, magnetic, chemical. We choose two: electronic and magnetic. Later we shelve the electronic approach when the magnetic proves very successful. We hope to pick up the electronic approach again, since we are getting into several rather unusual concepts.

Magnetic counting methods open up several possible avenues. After reviewing each briefly, we decide to consider the idea of a multiple-count core that uses incremental magnetization. This means counting on frequency-dividing with fewer components. For instance, we can use two transistors instead of eight to get a binary count-down. Also, of course, we do not have a power drain, because the magnetic core remains in a stable state without any power input. This seems unique to us, and besides, it offers considerable appeal and potential for proprietary developments.

After normal laboratory breadboarding of counting circuits, we go to applications in counting and timing devices. This leads us to our present Incremag product line and gives us our first entry into the space program that was born after Sputnik I.

Now you may ask what would have happened if we had chosen a path other than the one that led to Incremag? We did just that—after Incremag was fully launched. We went back to the point at which we were discussing how time can be measured by physical means.

'Exercises' in creative thinking: Test yourself

Here are three simple exercises that the research director of General Time Corp. has found useful in helping to evaluate the mental acuity and potential creativity of engineers (the answers appear on p. 200):

1. The following is a description of an "ideal" consumer product: It depreciates to practically zero in 48 hours, and new ones are purchased as soon as they are available. It is flexible, lightweight, absorbent, has low heat and electrical conductivity, is readily combustible, easily torn and disintegrates slowly in water. It has a low price. What is it?

2. Picture these three items, each in a container: milk, ink and pineapple juice. Compare the three.

3. Imagine that an archeologist has just dug up what seems to be an ancient mathematics

book. It is made of woven fabric pages, with twigs of equal size interwoven for symbols. One page has seven twigs, but only six are still woven securely in place. Like this:

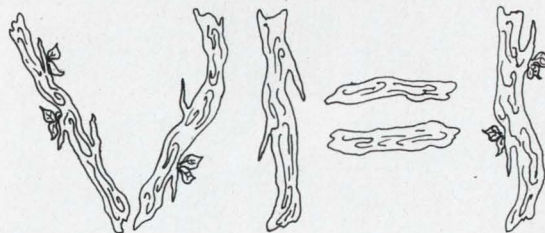

The seventh twig is loose, and there is no clue to its position. How would you place the loose twig to produce a correct mathematical statement?

This time we pick the road labeled "electrical methods." First, we subdivide the subject, listing electrolysis, oscillators, ionization and many electromagnetic devices, such as motors and steppers. We look more closely at oscillators.

Here again we have a wide range. We happen to like the "magnetic saturation type"—probably because of our prior work with Incremag systems. The same magnetic core that makes the Incremag a stable counting device is used to make a stable oscillator. We see a lot of flexibility in this circuit. It provides oscillators with variable-duty cycle and frequency (voltage controlled).

The choice again is a happy one, since it leads us directly to another product line—Mu-Chron. We have only begun to scratch the surface of Mu-Chron's numerous variations and uses.

Random creativity won't work

The value of Incremag and Mu-Chron has been tremendous. With them, we have been able to do such formerly impossible things as:

- Obtain a count of 50 per stage over a military environment; formerly only a count of 2 per stage was practical.

- Divide a 5-MHz frequency down to 200 Hz in two stages; or drive a 50-Hz synchronous clock from a 1-MHz source with only two dividing stages. By other methods, this normally takes six to ten stages.

- Have frequency discrimination over any given bandwidth with extremely sharp edges—and without the use of any resonant circuits.

- Divide a frequency by as much as 1000:1 in

a single stage. Even our own Incremag group considered this impossible to achieve.

Our idea sessions taught us a lot, particularly about imagination and how to stimulate it to produce practical products. But perhaps the most important general concept we learned about innovating is that the random method won't work in the long haul. Often not even in the short haul.

You must work in a disciplined, though flexible, structure. For us, that structure is the idea sessions, which have proved themselves an outstanding way to spur creativity—and to produce successful new products. ■■

A third article, by a different author, will discuss various "creative types" among engineers and how managers can best direct their efforts.

Test your retention

Here are questions based on the main points of this article. Their purpose is to help you make sure you have not overlooked any important ideas. You'll find the answers in the article.

1. *What are the four ground rules for idea sessions?*

2. *Who organizes and leads the discussions?*

3. *Can outdated ideas be turned into new ones? How?*



THESE G-V AIR FLOW SWITCHES...

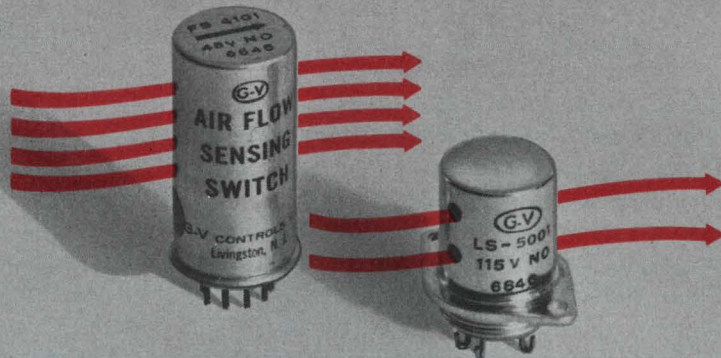

SEALED THERMAL TIME DELAY RELAYS

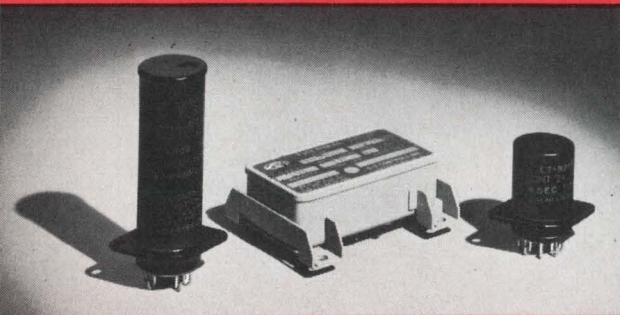

G-V is the largest source and offers the widest variety. Several types are hermetically sealed and still adjustable. All meet requirements of Mil-R-19648. Available in a wide variety including: sub-miniature, miniature, octal and missile types. **Features:** delay time, 0.1 sec. to 3 min.; heater voltages to 230 V; ambient operating temp., -55°C to $+125^{\circ}\text{C}$; vibration to 2000 Hz; shock to 50g.



INFORMATION RETRIEVAL NUMBER 231

SOLID STATE TIME DELAY

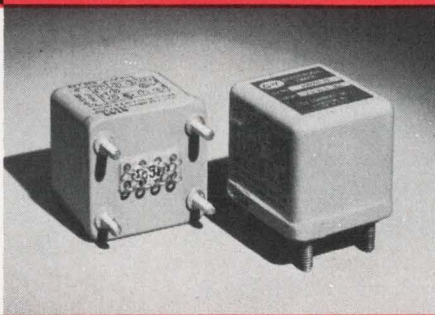

Series 900-064 has been accepted as a standard for many military and aerospace applications where high quality, reliability and cost are requirements. **Features:** hermetically sealed; fixed or adjustable time delays 0.1 to 60 sec.; solid state or relay output; vibration to 2000 Hz; shock, 50g.



INFORMATION RETRIEVAL NUMBER 232

SEALED ELECTRICAL THERMOSTATS



Cartridge Type: Series C8 hermetically sealed and still adjustable. Contact rating up to 5 amps. **Crystal Can Size:** Series VE-2 hermetically sealed. Contact rating up to 3 amps. **Features:** Rapid rate of response; minimal differential; operating range, -65° to $+300^{\circ}\text{F}$; vibration to 2000 Hz; shock to 50g.



INFORMATION RETRIEVAL NUMBER 233

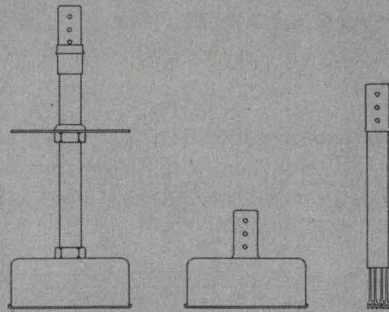

Specially designed mounting arrangements available.

work when air flow stops!

UNIQUE APPROACH TO AIR FLOW SENSING OFFERS POSITIVE PROTECTION...

only from G-V

These G-V Air Flow Sensing Switches provide a positive way to constantly monitor the presence of air flow. They operate an alarm or automatic shut-down if the air flow drops below a safe level. These devices, which utilize a thermal principle, eliminate the need for sensitive adjustment and reduce maintenance to a minimum. Operation in any plane is possible. Two models are available to cover a wide range of applications in electronic equipment, cooling packages, air conditioning ducts, computers or wherever an air flow system is used. The FS Series is designed for industrial applications. The sub-miniature LS Series is designed to operate under rugged military environmental conditions.



G-V CONTROLS INC.

LIVINGSTON, NEW JERSEY 07039

(201) 992-6200

INFORMATION RETRIEVAL NUMBER 230

THERMETTE 9 PIN RELAY



Metal enclosed thermal time delay is dust proof and shatter proof — designed for industrial applications requiring reliable operation and long life. **Features:** temp. compensated; time delays, 2 to 180 sec.; heater voltages, 6.3, 26, and 115V. AC or DC; contacts, SPST, NO or NC.

Recognized Under The Components Program Of Underwriter's Laboratories, Inc.



INFORMATION RETRIEVAL NUMBER 231

INSTANT RESET THERMAL TIMING DEVICES

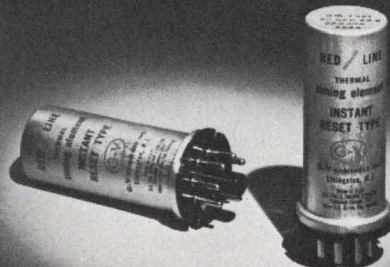

Instant reset during or after timing is available by combining G-V's unique instant reset timing element with a magnetic relay. Widely used in communication systems and data processing equipment. **Features:** delay time, 2 sec. to 5 min.; ambient operating temp., 32°F to 185°F.

only from 

INFORMATION RETRIEVAL NUMBER 232

DIRECT-LINE FIELD ENGINEERING SERVICE



G-V assistance is always available to help you design and produce a better product. G-V Regional Field Engineers in your area will assist you and your design group in new applications and proper selection of your controls. G-V Product Engineers will help you with special applications. When you require experience, products and services in electro-mechanical and solid-state controls . . . call your man from G-V.



INFORMATION RETRIEVAL NUMBER 233

ELECTRONIC DESIGN

semiannual index of articles

The articles in the various sections of this index are grouped under key words that indicate their general topics. Articles are listed more than once if they have to do with more than one general topic.

Automatic Controls & Servos

- DIGITAL CONTROLS: Digital process control stars at exhibition NEWS, ED 24, p. 30
- FLUIDICS: First fluidics exhibit held and the stress is on use NEWS, ED 25, p. 22
- TACHOMETERS: Simple resistor network eliminates dc tachometer IFD, ED 26, p. 100
- THERMAL CONTROL: Thermoelectric cells check Intelstat III NEWS, ED 14, p. 48

Avionics

- ANTICOLLISION SYSTEMS: 2 electronic aids urged to ease air traffic jams NEWS, ED 22, p. 21
- Warning system features equipment capability NEWS, ED 17, p. 22
- COMMUNICATIONS: Air Force plans integrated avionics network NEWS, ED 18, p. 30
- MIT modem enhances air-land communications NEWS, ED 16, p. 34
- Tackle noise variations at video ART, ED 20, p. 54
- LANDING AIDS: Gemini guidance system tested for V/STOL use NEWS, ED 16, p. 22
- NAVIGATION: Digital system standards are adopted for aircraft NEWS, ED 16, p. 22
- RADARS: ICs cut radar logic to one-tenth NEWS, ED 24, p. 32
- New E-2A radar to take less for granted NEWS, ED 17, p. 46
- Radar redesign slated for E-2A spotter plane NEWS, ED 14, p. 21
- WIRING CONCEPTS: MUXing slices tons of weight from aircraft NEWS, ED 22, p. 25

Circuits

- AMPLIFIERS: A wideband amplifier

Departments Key

- ART Technical Article
- EDIT Editorial
- IFD Idea for Design
- M&C Management and Careers
- NASA NASA Tech Brief
- PF Product Feature
- SR Special Report

- uses a single DTL gate IFD, ED 21, p. 106
- Adjust amplifier gain with an op-amp IFD, ED 23, p. 90
- Complementary audio amplifier has low distortion, high output IFD, ED 22, p. 118
- Electroacoustic amplifier has separate element NEWS, ED 23, p. 22
- Eliminate dead zone in a complementary stage IFD, ED 20, p. 70
- Infinite input impedance circuit uses one op amp IFD, ED 24, p. 74
- Stable analog buffer has 0.005% linearity NASA, ED 17, p. 246
- AMPLIFIERS, HIGH-FREQUENCY: Combine parameters with time sharing ART, ED 16, p. 62
- AMPLIFIERS, LOGARITHMIC: Get approximate logarithmic response ART, ED 17, p. 192
- A/D CONVERSION: Practical design guide to a/d conversion SR, ED 25, p. 49
- Automatic offset correction techniques in a/d converters SR, ED 1, Jan. 4, 1969, p. 104
- Cathode-ray-tube a/d converters SR, ED 1, Jan. 4, 1969, p. 104

- High-speed, high-accuracy a/d converters SR, ED 26, p. 67
- Indirect a/d converters SR, ED 26, p. 58
- Logarithmic a/d converters SR, ED, Jan. 4, 1969, p. 103
- Parallel-feedback a/d converters SR, ED 25, p. 50
- Propagation a/d converter SR, ED 1, Jan. 4, 1969, p. 101
- Serial-feedback a/d converters SR, ED 25, p. 58
- Time sharing a/d converters SR, ED 1, Jan. 4, 1969, p. 109
- Ultrahigh-speed a/d converters SR, ED 1, Jan. 4, 1969, p. 97
- A/D CONVERTERS: A/d angle converter slews at 20,000°/s PF, ED 22, p. 142
- ANALOG GATE: High-level analog gate uses an inexpensive J-FET IFD, ED 20, p. 71
- AUTOCORRELATORS: Indirect design piercing celestial 'barriers' NEWS, ED 26, p. 25
- CHOPPERS: Cure voltage and temperature ills in inverted chopper switches IFD, ED 23, p. 92
- COMPARATORS: Design digital comparators logically ART, ED 23, p. 52
- Here are more digital comparators ART, ED 24, p. 56
- CONTROL SYSTEMS: Boost reliability in your op-amp circuit—Part I of a two-part article ART, ED 14, p. 62
- Dodge transducer failures with a RAMP ART, ED 15, p. 70
- CONVERTERS: Convert binary data to a three-level output IFD, ED 17, p. 234
- COUNTERS, MULTI-STAGE: Speed your multi-stage counter designs ART, ED 17, p. 212
- CURRENT INTEGRATORS: Calibrate your current integrator with a simple setup IFD, ED 16, p. 84
- CURRENT SOURCES: Double the output of your sensors ART, ED 17, p. 166

- D/A CONVERSION: Practical design guide to d/a conversion SR, ED 22, p. 49
- Digital-to-ac d/a converters SR, ED 22, p. 78
- Indirect d/a converters SR, ED 22, p. 70
- Parallel d/a converters SR, ED 22, p. 50
- Multiplexing d/a converters SR, ED 22, p. 84
- Serial d/a converters SR, ED 22, p. 60
- D/A CONVERTER: Low-level inputs operate digital-to-analog converter NASA, ED 14, p. 108
- DELAY CIRCUITS: Delay circuit needs no internal clock IFD, ED 18, p. 106
- A long delay one-shot uses inexpensive components IFD, ED 21, p. 112
- DELAY LINE: Inexpensive delay line is built with plastic tubing IFD, ED 19, p. 106
- Ultrasonic delay line needs no power supply IFD, ED 17, p. 230
- DETECTORS, FREQUENCY: Simple solid-state circuit detects frequency IFD, ED 23, p. 94
- DIGITAL CONTROLLERS: Step-recovery diode specified for pulse and digital circuits PF, ED 16, p. 116
- A variable-gain circuit is controlled digitally IFD, ED 18, p. 102
- DIVIDE-BY-TWO circuit uses an inexpensive IC IFD, ED 15, p. 92
- FLOATING OUTPUT: Two op amps provide floating output circuit IFD, ED 23, p. 98
- FREQUENCY DIVIDER generates two exclusive waveforms IFD, ED 15, p. 86
- Simple frequency divider uses four-layer diodes IFD, ED 14, p. 94
- FREQUENCY SYNTHESIZERS: Cut synthesizer current consumption ART, ED 25, p. 80
- GENERATORS: An op amp and a chopper give precision ramp generator IFD, ED 15, p. 90
- IC ramp generator is simple and fast IFD, ED 25, p. 94
- Leading-edge synchronization provided by pulse generator IFD, ED 25, p. 96
- Saw-tooth generator provides millivolt discharge level IFD, ED 23, p. 90
- Use DDA techniques for arc sine/cosine generation IFD, ED 26, p. 98
- HIGH FREQUENCIES: Simplify high-frequency circuit design ART, ED 14, p. 70
- HYBRID CIRCUITS: Microcircuit engineer: Hybrids, linear ICs dominate the scene SR, ED 17, p. U82
- HYBRID, POWER-COMBINATION: Use hybrid junctions for more VHF power ART, ED 16, p. 54
- INDICATOR CIRCUITS: 400-Hz phase-sequence indicator is small and inexpensive IFD, ED 22, p. 120
- IC SYSTEMS: Monitor IC supply voltage with a simple circuit IFD, ED 14, p. 98
- IC TESTING: IC tester checks each element NASA, ED 14, p. 106
- LAMP DRIVERS: Series resistors protect transistorized lamp drivers IFD, ED 19, p. 110
- SCR lamp driver indicates IC outputs NASA, ED 17, p. 242
- LIMITERS: Variable threshold limiting circuit uses 2 current sources IFD, ED 18, p. 104
- LOGIC CIRCUITS: Design better sequential circuits ART, ED 26, p. 80
- LOGIC CLOCKS: Build an IC logic clock with a couple of NAND gates IFD, ED 16, p. 82
- LOGIC, EMITTER-COUPLED: Power your oscillator with ECL ART, ED 16, p. 70
- Delayed feedback improves ECL speed and noise immunity IFD, ED 24, p. 72
- LOGIC SYSTEMS: Divide-by-60 counter uses dual flip-flops IFD, ED 18, p. 100
- Convert binary to BCD without flip-flops ART, ED 21, p. 58
- MIXERS: Replace bipolars with FETs in rf and mixer stages IFD, ED 17, p. 230
- MULTIPLIER-DIVIDER: Electronic multiplier-divider uses one or two ICs IFD, ED 21, p. 106
- MULTIVIBRATORS: A few IC gates add to a monostable IFD, ED 14, p. 102
- A* monostable multivibrator has zero recovery time IFD, ED 17, p. 238
- Astable multivibrator has high ON-OFF ratios IFD, ED 22, p. 120
- Emitter-coupled multi boosts variable-frequency performance IFD, ED 26, p. 102
- One-shot uses a single IC chip IFD, ED 15, p. 86
- Simple one-shot circuit uses half a quad gate module IFD, ED 24, p. 78

Subject Listing

- | | | |
|-------------------------------|-------------------------|------------------------------|
| Automatic Controls and Servos | General Industry | Packaging and Cooling |
| Avionics | Industrial Electronics | Physics |
| Circuits | Infrared | Power Sources |
| Circuit Theory and Analysis | Lasers | Production Processes |
| Communications | Management and Careers | Radio Frequency Interference |
| Components | Materials | Reliability |
| Computer-Aided Design | Medical Electronics | Research and Development |
| Computers and Data Processing | Microelectronics | Semiconductors |
| Consumer Electronics | Microwaves | Space |
| Displays | Military Electronics | System Design |
| Editorials | Missiles | Telemetry |
| Fluidics | Navigation and Guidance | Test Equipment and Measuring |
| | Oceanology | Tubes |
| | Optoelectronics | |

OSCILLATORS: Build an oscillator using a single IC... IFD, ED 20, p. 71
 Blocking oscillator uses negative feedback... IFD, ED 15, p. 94
 Build a phase-lock stabilized VCO... ART, ED 21, p. 68
 Cascode blocking oscillator yields improved performance... IFD, ED 25, p. 98
 Lower an oscillator's frequency drift... ART, ED 24, p. 50
 Power your oscillator with ECL... ART, ED 16, p. 70

PHASE DETECTORS: IC digital phase detector locks a square wave... IFD, ED 16, p. 86

PROTECTION CIRCUITS: Circuit protects line driver against inadvertent shorts... IFD, ED 21, p. 110
 Flip-flop provides inhibit pulse during power turn-on... IFD, ED 22, p. 120
 Inexpensive IC logic overvoltage protection... IFD, ED 14, p. 100

PULSE CIRCUITS: TEMPERATURE-STABLE: Step-recovery diode pulser is stable with temperature... IFD, ED 19, p. 104

PULSE DELAYS: Step-recovery diode specified for pulse and digital circuits... PF, ED 16, p. 116

REGULATORS: Get better performance from a parallel-transistor stage... IFD, ED 16, p. 88

RELAYS: Test relay parameters with a simple circuit... IFD, ED 20, p. 72

RESISTOR SELECTION: Simplify selection of the critical resistor... ART, ED 23, p. 80

SAMPLE-AND-HOLD circuit has accurate memory of 0.5 s... IFD, ED 19, p. 108
 Sample-and-hold circuit is inexpensive and stable... IFD, ED 14, p. 94

SAMPLING CIRCUITS: Sampling gate has high rejection and an adjustable pedestal... IFD, ED 22, p. 122

SUPPLY VOLTAGES: Monitor IC supply voltage with a simple circuit... IFD, ED 14, p. 98

SWITCHES: Bilateral semiconductor switch has zero impedance... NASA, ED 14, p. 112
 Solid-state switch has zero bias... NASA, ED 14, p. 106

SWITCHING CIRCUITS: Eliminate contact bounce in your IC system... IFD, ED 18, p. 100
 Magnetic CRT driver switches during retrace... NASA, ED 16, p. 100

SYNCHRONIZATION: ICs synchronize asynchronous inputs... IFD, ED 17, p. 236

TANK CIRCUITS: Speed up design

of rf tank circuit... ART, ED 14, p. 88

THERMISTORS: Give your thermistor a helping hand... ART, ED 19, p. 86

THIN-FILM DESIGN: Understand thin-film circuit design... ART, ED 21, p. 78

TIMING & CONTROL: Flip-flop latch adds versatility to unijunction circuit... IFD, ED 25, p. 92

TIMING CIRCUITS: FET and UJT provide timing over wide temperature range... IFD, ED 26, p. 98

TRIGGER CIRCUITS: Line synchronized pulse unit triggers microcircuits... IFD, ED 23, p. 98
 Microwave synthesizer has extended range; generates stable signals at 1 to 12.4 GHz... PF, ED 23, p. 102
 MOSFETs reduce power loss in a Schmitt trigger... IFD, ED 19, p. 106
 Schmitt trigger provides variable low-rep-rate pulses... IFD, ED 21, p. 112

UP/DOWN COUNTER: Choose a number, any number, with a variable modulo counter... IFD, ED 25, p. 92

VECTOR ANALYSIS: Move toward automated circuit design... ART, ED 17, p. 184

VOLTAGE CALIBRATION: TC zener + FET chopper = ac-dc calibrator... IFD, ED 16, p. 82

VOLTAGE MULTIPLIERS: Eliminate pulse transformer with a voltage multiplier... IFD, ED 17, p. 234

VOLTAGE REGULATORS: MOSFET improves voltage regulator... NASA, ED 15, p. 96
 Proportional dc motor control requires low-level inputs... IFD, ED 17, p. 236

ZERO CROSSING: Cross zero with a tunnel-diode switch... ART, ED 14, p. 82

Circuit Theory & Analysis

AUTOMATED: Evaluate digital circuits automatically... ART, ED 18, p. 78
 Move toward automatic circuit design... ART, ED 17, p. 184
 Save time and effort in transient analysis... ART, ED 20, p. 58

CHARGE CONTROL: Check your circuit's switching times using charge control theory... ART, ED 18, p. 94
 Switching-circuit analysis can be a snap... ART, ED 17, p. 174

FREQUENCY STABILIZATION: NBS device makes rf stabilization easy... NEWS, ED 14, p. 44

HIGH-FREQUENCY DESIGN: Simplify high-frequency circuit design... ART, ED 14, p. 70

HIGH IMPEDANCE: Double the output of your sensors... ART, ED 17, p. 166

LOGIC DESIGN: Design digital comparators logically... ART, ED 23, p. 52
 Here are more digital comparators... ART, ED 24, p. 56

NETWORK ANALYSIS: Combines parameters with time sharing... ART, ED 16, p. 62

NUMERICAL ANALYSIS: Arithmetic techniques are often handy... ART, ED 19, p. 92
 Interpolate data for your computer... ART, ED 17, p. 198
 Nonlinear algebraic equations yield to a number of computer techniques... ART, ED 18, p. 86

SIMULTANEOUS EQUATIONS: Solve simultaneous equations deftly... ART, ED 16, p. 74

SWITCHES: Hall effect is used in new switch design... NEWS, ED 20, p. 21

WORST-CASE ANALYSIS: Nonlinear programing is essential... ART, ED 22, p. 90

Communications

CABLES: MUXing slices tons of weight from aircraft... NEWS, ED 22, p. 25

COMMON CARRIERS: FCC overrules itself: phone devices get O.K... NEWS, ED 15, p. 22
 System uses phones to read utility meters... NEWS, ED 14, p. 22

COMPATIBILITY, COMPONENTS: Communications products: In communications it's components, packages... SR, ED 17, p. U77

COMPUTERS: Computers build and run new cruise ship... NEWS, ED 18, p. 25

COMSAT: Comsat 'makes do' after Intelsat failure... NEWS, ED 21, p. 21
 Gates modem sends 50 megabits/sec... NEWS, ED 15, p. 33

DIGITAL: Communications engineer: digitize and cut redundancy... SR, ED 17, p. U75
 Digital system speeds jetliner communications... NEWS, ED 26, p. 22

LASER: Harnessing the laser to electronic systems... SR, ED 19, p. 59
 The laser: Science's unruly 'whiz kid'... SR, ED 19, p. 50

PUBLIC SAFETY: Computers will link California crime net... NEWS, ED 26, p. 22
 Electronics in the public sector—Air-traffic controllers look at automation... SR, ED 15, p. 35
 Rocks over your head? Use this beacon... NEWS, ED 17, p. 33

RFI: Four-year study urges new spectrum allocation... NEWS, ED 16, p. 21
 Nose-cone antenna aids ionospheric research... NEWS, ED 23, p. 32
 Satellite overcomes low-frequency barrier... NEWS, ED 17, p. 25

SATELLITES: Astronomy craft orbited, to map outer space. . . . NEWS, ED 15, p. 22
 Gated modem sends 50 megabits/sec. . . . NEWS, ED 15, p. 33
 Life support for moon landing ready for test. . . . NEWS, ED 14, p. 30
 MIT modem enhances air-land communications. . . . NEWS, ED 16, p. 34
 Pioneer IX transmits finer, faster, farther. . . . NEWS, ED 24, p. 21
SPECTRUM CROWDING: Electronics in the public sector—Crowding in spectrum nears a crisis. . . . SR, ED 15, p. 42
 Four-year study urges new spectrum allocation. . . . NEWS, ED 16, p. 21
 Goal of the '70s: A trouble-free spectrum. . . . NEWS, ED 17, p. 30

Components

BATTERIES, PAPER: "Paper power" may run cordless appliances. . . . NEWS, ED 17, p. 21
CHIP KITS: Chip component kits assemble 113 RC values. . . . PF, ED 20, p. 78
COMMUNICATIONS PACKAGES: In communications it's components, packages. . . . SR, ED 17, p. U77
COUNTER: Decade counter uses no decoding matrix. . . . IFD, ED 20, p. 68
DISPLAYS: Solid-state numeric displays operate from 5-V IC levels. . . . PF, ED 24, p. 94
 Tiny CRT display package slashes cost per digit. . . . PF, ED 15, p. 100
FILTER: Stable hybrid active filter varies mode, Q , f_0 and band. . . . PF, ED 21, p. 120
METER, POWER: Microwave thermistor power meter sets zero automatically, holds accuracy. . . . PF, ED 17, p. U106
MILITARY STANDARDS: Connector standards remain doubtful. . . . NEWS, ED 24, p. 22
OSCILLOSCOPES: Internal 8-hour battery powers 7-lb oscilloscope. . . . PF, ED 14, p. 140
SWITCHES: Broadband coax switch stops spurious modes. . . . PF, ED 22, p. 126
TV TUBES: Camera tube waxes when light wanes. . . . PF, ED 15, p. 102

Computer-Aided Design

ANTENNA DESIGN: Computer program designs antenna. . . . NASA, ED 17, p. 240D
AUTOMATED DESIGN: Computers build and run new cruise ship. . . . NEWS, ED 18, p. 25
CIRCUIT ANALYSIS: Apply computer analysis accurately. . . . ART, ED 14, p. 76

CIRCUIT DESIGN: Digital logic in one; from design to package. . . . NEWS, ED 21, p. 22
 Move toward automated circuit design. . . . ART, ED 17, p. 184
DESIGNERS LAG IN USAGE: Survey finds lag in use of computers for design. . . . NEWS, ED 20, p. 21
DIGITAL FILTER SYNTHESIS: Synthesize digital filters by computer. . . . NASA, ED 17, p. 240B
IMMITTANCE CALCULATIONS: Speed immittance calculations. . . . ART, ED 25, p. 74
LANGUAGE: FORTRAN—the language for engineers. . . . ART, ED 15, p. 64
NUMERICAL ANALYSIS: Arithmetic techniques are often handy. . . . ART, ED 19, p. 92
 Interpolate data for your computer. . . . ART, ED 17, p. 198
 Learn about linear programing. . . . ART, ED 21, p. 86
 Nonlinear algebraic equations yield to a number of computer techniques. . . . ART, ED 18, p. 86
SIMULTANEOUS EQUATIONS: Solve simultaneous equations deftly. . . . ART, ED 16, p. 74
TIME SHARING: Combine s parameters with time sharing. . . . ART, ED 16, p. 62
TRANSIENT ANALYSIS: Save time and effort in transient analysis. . . . ART, ED 20, p. 58
WIRING LISTS: Unsnarl your complex wiring problems. . . . ART, ED 23, p. 72
WIRING: LSI: Computer-aids speed discretionary wiring. . . . SR, ED 24, p. C10
WORST-CASE ANALYSIS: Nonlinear programing is essential. . . . ART, ED 22, p. 90

Computers & Data Processing

AUTOMATED SHIP: Computers build and run new cruise ship. . . . NEWS, ED 18, p. 25
CDC-7600: New king of computers unveiled in Wisconsin. . . . NEWS, ED 26, p. 21
CODE CONVERTERS: Fast code converters deliver any output. . . . PF, ED 26, p. 122
COMMUNICATIONS: Redesign strengthens air defense backup. . . . NEWS, ED 19, p. 25
 Southeast Asia to get new control center gear. . . . NEWS, ED 17, p. 22
COMPATIBILITY: Warning system features equipment compatibility. . . . NEWS, ED 17, p. 22
DATA TRANSMISSION: AT&T eases policy on phone attachments. . . . NEWS, ED 19, p. 22
 Digital system speeds jetliner communications. . . . NEWS, ED 26, p. 22
 Retime digital data with a simple circuit. . . . IFD, ED 18, p. 104

DESK CALCULATORS: Computer products: After desktop computers there's little that's new. . . . SR, ED 17, p. U78
DISPLAYS: CRT storage displays stop flicker and fade. . . . PF, ED 24, p. C66
ELECTRO-OPTICS: Computer engineer: Optics is no illusion for computer designers. . . . SR, ED 17, p. U77
EMPLOYMENT SURVEY: Who's who, what's what in data-processing field? . . . NEWS, ED 23, p. 21
KEYBOARD: Solid-state keyboard actuates ICs magnetically. . . . PF, ED 21, p. 140
FJCC DEVELOPMENTS: Computer parley to explore new design goals. . . . SR, ED 24, p. C36
FORTRAN: The language for engineers. . . . ART, ED 15, p. 64
INTERFACING: MOS shift registers eliminate interfacing. . . . PF, ED 24, p. 120
LSI: Attractive, feasible, but still a question mark. . . . NEWS, ED 15, p. 21
 Computer makers proceed with caution. . . . SR, ED 24, p. C50
 LSI and Computer design. . . . SR, ED 24, p. C1
MEDICAL ELECTRONICS: Nondestructive testing—a new diagnostic tool. . . . SR, ED 17, p. U80
MEMORIES: Disc-pack family revealed by Honeywell. . . . NEWS, ED 21, p. 33
 LSI memories change computer design. . . . SR, ED 24, p. C4
 Monolithic read-only memory puts control logic on chip. . . . PF, ED 19, p. 114
 Optical memory acts like a kaleidoscope. . . . NEWS, ED 17, p. 52
 Plated-wire memories have 200-ns cycle time. . . . PF, ED 24, p. 84
 Three-wire 3-D memory cycles in only 750 ns. . . . PF, ED 24, p. C68
MSI: Small-scale digital computer gets accumulators via MSI. . . . PF, ED 24, p. C66
NONIMPACT PRINTER: 1200-wpm printer due for computer users. . . . NEWS, ED 19, p. 21
OPTICAL COMPUTERS: Do computations at the speed of light. . . . ART, ED 23, p. 60
PATENT RIGHTS: Court upholds patents for computer software. . . . NEWS, ED 25, p. 21
 Software patent debate rages despite guidelines. . . . NEWS, ED 23, p. 21
TIME SHARING: Computers will link California crime net. . . . NEWS, ED 26, p. 22
 IBM faces trust action on time-sharing service. . . . NEWS, ED 21, p. 21
 Travel agents may hook into airline computer net. . . . NEWS, ED 16, p. 22
WEATHER DATA: Digital systems

standards are adopted for aircraft
NEWS, ED 16, p. 22

Consumer Electronics

BATTERIES, PAPER: "Paper power" may run cordless appliances...
NEWS, ED 17, p. 21

COLOR TELEVISION: IC demodulators improve color-TV picture...
NEWS, ED 14, p. 32

ELECTRIC CARS: MIT, CalTech to send electric cars across U.S....
NEWS, ED 17, p. 22

PUBLIC SAFETY: Computers will link California crime net...
NEWS, ED 26, p. 22

Rocks over your head? Use this beacon...
NEWS, ED 17, p. 33

TAPE CASSETTES: Improved tape is challenging the disk...
NEWS, ED 17, p. 36

TRANSISTOR RADIOS: FTC on transistor sets: watch deceptive claims...
NEWS, ED 14, p. 21

TV MARKETS: Electronics is leading U.S. industry in growth...
NEWS, ED 24, p. 22

Displays

ASW: Navy's new sub hunter relies on digital displays...
NEWS, ED 21, p. 22

COCKPIT: Military intensifies its surveillance contracting...
NEWS, ED 18, p. 21

Military moving to buy low-light-level TV...
NEWS, ED 21, p. 25

CRTs: Magnetic CRT driver switches during retrace...
NASA, ED 16, p. 100

Optical memory acts like a kaleidoscope...
NEWS, ED 17, p. 52

Tiny CRT display package slashes cost per digit...
PF, ED 15, p. 100

DISPLAYS, DIGITAL: Electroluminescence displays digital data...
PF, ED 16, p. 108

Printed-circuit board contains 10-MHz counter...
PF, ED 14, p. 126

Two digital displays count on microcircuits for a stability of 2 ppm...
PF, ED 14, p. 116

SOLID-STATE displays and fluidics advance...
SR, ED 17, p. U74

Editorials

All is not well in the electronic classroom...
EDIT, ED 19, p. 77

Are all designers business boos? We, for one, don't think so...
EDIT, ED 23, p. 49

For the international patent crises—help is on the way...
EDIT, ED 18, p. 45

It's time we repaired our mad invention system...
EDIT, ED 16, p. 51

Let's come to grips with the grippers...
EDIT, ED 22, p. 45

Memo to the IEEE: Can you use these ideas?...
EDIT, ED 14, p. 59

Research on education: A pressing national need...
EDIT, ED 17, p. 163

Tell it like it is, or risk consumer ad controls...
EDIT, ED 20, p. 43

The radio can be mightier than the armored column...
EDIT, ED 21, p. 55

Trend toward obfuscation breeds 'irreproducible results'...
EDIT, ED 25, p. 45

Users to phone companies: 'Thanks. Now about that 3-minute charge...?'...
EDIT, ED 24, p. 47

Vietnam lesson: Better feedback and focus on design needed...
EDIT, ED 15, p. 61

Who does a man really work for?...
EDIT, ED 26, p. 53

Fluidics

FIRST FLUIDICS exhibit held and the stress is on use...
NEWS, ED 25, p. 22

General Industry

EIA-IEEE, SPECTRUM REPORT: Goal of the 1970s: A trouble-free spectrum...
NEWS, ED 17, p. 30

ELECTRONICS MARKET: Electronics is leading U.S. industry in growth...
NEWS, ED 24, p. 22

Electronics officials see expansion under Nixon...
NEWS, ED 24, p. 21

Industry outlook for '69 looks 'thin,' EIA says...
NEWS, ED 22, p. 21

ELECTRONIC WATCHES: \$75 electronic watches predicted under pact...
NEWS, ED 24, p. 22

FCC overrules itself: phone devices get O.K....
NEWS, ED 15, p. 22

INDUSTRIAL DESIGN AWARDS: The best in product design...
SR, ED 17, p. U152

LAW SUITS: Minuteman 3 set to go; Poseidon may be held...
NEWS, ED 17, p. 21

Motorola sues Fairchild, charging raid on staff...
NEWS, ED 19, p. 21

NATIONAL BUDGET: U.S. belt-tightening backed by industry...
NEWS, ED 15, p. 22

PATENTS: GE offers companies rights to processes...
NEWS, ED 25, p. 21

PATENTS, SOFTWARE: Court upholds patents for computer software...
NEWS, ED 25, p. 21

Software patent debate rages despite guidelines...
NEWS, ED 23, p. 21

RELATIONS WITH THE GOVERNMENT: Government and the electronics industry: A changing partnership—Part II: The hidden ace in the U.S. space effort—Military projects grow despite NASA cuts...
SR, ED 14, p. 36

Government and the electronics industry: A changing partnership. Part III: Electronics in the public sector—Air-traffic controllers look at automation—SR, ED 15, p. 35

WESCON 1968—A GUIDE TO THE 1968 WESCON SHOW...
SR, ED 17, p. U67

The Wescon scene: More companies jump on digital bandwagon...
NEWS, ED 19, p. 32

Industrial Electronics

A/D CONVERSION: Practical design guide to a/d conversion...
SR, ED 25, p. 49

Automatic offset correction techniques in a/d converters...
SR, ED 1, Jan. 4, 1969, p. 104

High-speed, high-accuracy a/d converters...
SR, ED 26, p. 67

Indirect a/d converters...
SR, ED 26, p. 58

Logarithmic a/d converters...
SR, ED 1, Jan. 4, 1969, p. 103

Parallel-feedback a/d converters...
SR, ED 25, p. 50

Propagation a/d converter...
SR, ED 1, Jan. 4, 1969, p. 101

Serial-feedback a/d converters...
SR, ED 25, p. 58

Time sharing...
SR, ED 1, Jan. 4, 1969, p. 109

Ultrahigh-speed a/d converters...
SR, ED 1, Jan. 4, 1969, p. 97

A/D CONVERTERS: A/d angle converter slews at 20,000°/s...
PF, ED 22, p. 142

AIR-WATER POLLUTION: Government and the electronics industry: A changing partnership...**PART III:** Electronics in the public sector—Engineers asked to stem air-water pollution...
SR, ED 15, p. 46

COMMON CARRIERS: System uses phones to read utility meters...
NEWS, ED 14, p. 22

COMPARATORS: Design digital comparators logically...
ART, ED 23, p. 52

Here are more digital comparators...
ART, ED 24, p. 56

CONTROL SYSTEMS: Boost reliability in your op-amp circuit—Part I of a two-part article...
ART, ED 14, p. 62

Dodge transducer failures with a RAMP...
ART, ED 15, p. 70

D/A CONVERSION: Practical design guide to d/a conversion...
SR, ED 22, p. 49

Digital-to-ac d/a converters...

SR, ED 22, p. 78
 Indirect d/a converters SR, ED 22, p. 70
 Parallel d/a converters SR, ED 22, p. 50
 Multiplexing d/a converters SR, ED 22, p. 84
 Serial d/a converters SR, ED 22, p. 60
D/A CONVERTER: Low-level inputs operate digital-to-analog converter NASA, ED 14, p. 108
IC TESTING: What approach should the industrial user take?
INDUSTRIAL DESIGN AWARDS: The best in product design SR, ED 17, p. U152
INFRARED TESTING: New infrared camera slashes costs in half NEWS, ED 19, p. 22
LASERS: The laser: Science's unruly 'whiz' kid SR, ED 19, p. 50
MICROSCOPES: Interference microscopy shows detail in relief PF, ED 17, p. U148
PROCESS CONTROLS: Digital process control stars at exhibition NEWS, E D24, p. 30
SENSORS: Double the output of your sensors ART, ED 17, p. 166
SWITCHES: Hall effect is used in new switch design NEWS, ED 20, p. 21

Infrared

INFRARED array camera developed for satellites NEWS, ED 25, p. 32

Lasers

ADVANCES IN LASERS SR, ED 19, p. 49
APPLICATIONS: Harnessing the laser to electronic systems SR, ED 19, p. 59
HOLOGRAMS: Light-sensitive flip-flops read holograms NEWS, ED 25, p. 28
LARGE-APERTURE DISCS: Glass discs lase at high outputs NEWS, ED 14, p. 33
LASER COMPUTERS: Do computations at the speed of light ART, ED 23, p. 60
SEISMOLOGY: Laser technique reduces problem in seismology NEWS, ED 14, p. 22
STRUCTURE ANALYSIS: Optical spectrum analyzer reveals laser-mode structure PF, ED 15, p. 112
TRACKING: Laser faster than radar, tracking Mach 4.5 sled NEWS, ED 23, p. 36

Management & Careers

COACHING: How to upgrade job performance M&C, ED 24, p. 66
COMMUNICATION: Here's how to get

word to the top M&C, ED 17, p. 220
MOTIVATION: Stop the revolt in the labs! M&C, ED 26, p. 88
RECRUIT TRAINING: How to train new engineers M&C, ED 19, p. 96
RESUMES: Call your shots when you change jobs M&C, ED 21, p. 92
SHORT-INTERVAL SCHEDULING: Design more in less time at less cost M&C, ED 22, p. 106

Materials

AMORPHOUS SEMICONDUCTORS prove workable NEWS, ED 22, p. 33
CERAMICS: Ceramic 'filter' generates color images NEWS, ED 24, p. 28
CRYSTALS: C-axis flipping lifts transducer power NEWS, ED 20, p. 33
FLEXIBLE SUBSTRATES: Transistors deposited on flexible tapes NEWS, ED 18, p. 21
 Transistors on tape NEWS, ED 19, p. 38
GLASS: Glass bonded to metal at low temperature NEWS, ED 18, p. 22
 Glass discs lase at high outputs NEWS, ED 14, p. 33
 New process upgrades monolithic pnps NEWS, ED 24, p. 25
HOLOGRAPH PLATES: New holograph plate uses low laser power NEWS, ED 18, p. 33
LASERS: Advances in Lasers SR, ED 19, p. 49
MAGNETIC TAPES: Improved tape is challenging the disc NEWS, ED 17, p. 36
THICK FILMS: Thick films headed for wide use in 1970s NEWS, ED 16, p. 25
THIN FILMS: Investigate thin-film hybrid assembly ART, ED 22, p. 98
 Know your thin-film materials ART, ED 19, p. 80

Medical Electronics

ARTIFICIAL HEART: Problem: How to power the artificial heart? NEWS, ED 25, p. 25
DIAGNOSTIC TOOLS: Medical electronics: Nondestructive testing—a new diagnostic tool SR, ED 17, p. U80
LIFE SUPPORT for moon landing ready for test NEWS, ED 14, p. 30
PROSTHETICS: Artificial arm senses muscular movement NEWS, ED 20, p. 22

Microelectronics

AMPLIFIERS: Device delivers kW output in picoseconds NEWS, ED 22, p. 30

COLOR TV: IC demodulators improve color-TV picture NEWS, ED 14, p. 32
HYBRID ASSEMBLY: Investigate thin-film hybrid assembly ART, ED 22, p. 98
HYBRID ICs: Microcircuit engineer: Hybrids, linear ICs dominate the scene SR, ED 17, p. U82
 Miniature IC hybrid shrinks attenuator size PF, ED 23, p. 104
 Parley analyzes 3 paths to world of MICs NEWS, ED 23, p. 25
IC DIRECTORY: 1968 Integrated Circuit Directory SR, ED 20, p. IC3
IEEE PAPERS: IEEE parley to reveal IC and IMPATT gains NEWS, ED 21, p. 21
IC-IQ: Is the master-slice approach practical? IC-IQ, ED 15, p. 84
 Why blame sample testing? IC-IQ, ED 14, p. 92
 Will systems houses take over IC design? IC-IQ, ED 20, p. 64
IC PACKAGES: Thick films headed for wide use in the 1970s NEWS, ED 16, p. 25
IC PROCESSING labeled a sophisticated industry NEWS, ED 14, p. 22
IC TESTER checks each element NASA, ED 14, p. 106
IC TESTING SR, ED 18, p. 49
 Aerospace users test to ensure system reliability SR, ED 18, p. 58
 Are high-speed automatic test systems the answers? SR, ED 18, p. 62
 New concept may bridge tester price-gap SR, ED 18, p. 68
 Testing begins with the IC manufacturer SR, ED 18, p. 54
 What approach should the industrial user take? SR, ED 18, p. 74
LOGIC CARDS: Universal IC logic cards allow system flexibility PF, ED 14, p. 164
LSI: LSI and computer design SR, ED 24, p. C1
 LSI: Attractive, feasible, but still a question mark NEWS, ED 15, p. 21
 LSI: Computer-aids speed discretionary wiring SR, ED 24, p. C10
 LSI: Computer makers proceed with caution SR, ED 24, p. C50
 LSI offers high logic speeds SR, ED 24, p. C18
 Must the vendor bear development costs? SR, ED 24, p. C24
LSI MEMORIES: LSI memories change computer design SR, ED 24, p. C4
MEMORIES: Monolithic read-only memory puts control logic on chip PF, ED 19, p. 114
 Tunnel diodes can boost performance ART, ED 20, p. 46
MONOLITHIC PROCESS: New proc-

- ess upgrades monolithic pnps...
NEWS, ED 24, p. 25
- RADAR LOGIC:** ICs cut radar logic to one-tenth. NEWS, ED 24, p. 32
- SHIFT REGISTERS:** Half-chip shift register accepts 8 bits at 20 MHz...
PF, ED 17, p. 252
- MOS shift registers eliminate interfacing...
PF, ED 24, p. 120
- THICK FILMS:** Thick films headed for wide use in the 1970s...
NEWS, ED 16, p. 25
- Microwaves**
- AIR TRAFFIC** designers turning to microwaves... NEWS, ED 20, p. 30
- DEVICES:** IMPATT gains in solid-state derby...
NEWS, ED 14, p. 25
- Microwave diodes reach for higher power... NEWS, ED 20, p. 25
- Microwave products: Next for microwaves: search for best uses...
SR, ED 17, p. U86
- TWT device interest grows...
NEWS, ED 25, p. 33
- IMPATT:** IEEE parley to reveal IC and IMPATT gains...
NEWS, ED 21, p. 21
- INTEGRATED CIRCUITS:** NEREM parley analyzes 3 paths to world of MICs... NEWS, ED 23, p. 25
- MINIATURIZATION:** Miniaturized devices are reaching maturity...
SR, ED 17, p. U84
- PRETERSONICS:** Microwaves of the future?... NEWS, ED 15, p. 25
- WAVEGUIDE COUPLING:** Cut waveguide filter length with sidewall couplings...
IFD, ED 17, p. 238
- Military Electronics**
- CONTRACTS** are awarded for new AF fighter... NEWS, ED 25, p. 22
- Military intensifies its surveillance contracting... NEWS, ED 18, p. 21
- U.S. to award contracts for computer interfaces...
NEWS, ED 23, p. 22
- ELECTRONIC WARFARE:** Byrd warns against lag in electronic warfare...
NEWS, ED 25, p. 22
- MARKETS:** Industry outlook for '69 looks 'thin', EIA says...
NEWS, ED 22, p. 21
- MIL-STANDARDS:** Connector standards remain doubtful...
NEWS, ED 24, p. 32
- MISSILES:** ABM vs. disarmament: what will be the result?...
- NEWS, ED 15, p. 21
- NEWS, ED 15, p. 21
- Minuteman 3 set to go; Posidon may be held. NEWS, ED 17, p. 21
- Senate gives Sentinel an immediate go-ahead. NEWS, ED 14, p. 21
- NATIONAL BUDGET:** Senator Stennis predicts boost in military R&D...
NEWS, ED 26, p. 21
- NAVY:** Award sonar contract for Bahamas range...
NEWS, ED 21, p. 22
- Navy's new sub hunter relies on digital displays...
NEWS, ED 21, p. 22
- New carrier Kennedy is tops in electronics... NEWS, ED 20, p. 21
- Oceanographers reach toward 21st century...
SR, ED 15, p. 49
- RADARS:** Air Force equipment spots foe's radar 1-2-3...
NEWS, ED 22, p. 22
- New E-2A radar to take less for granted... NEWS, ED 17, p. 46
- Radar redesign slated for E-2A spotter plane...
NEWS, ED 14, p. 21
- Mortar-locating radar readied for Vietnam...
NEWS, ED 22, p. 22
- Redesign strenghtens air defense backup... NEWS, ED 19, p. 25
- RELATIONS WITH THE GOVERNMENT:** Military projects grow despite NASA cuts. SR, ED 14, p. 36
- SOVIET-USA:** ABM vs. disarmament: what will be the result?...
NEWS, ED 15, p. 21
- Soviet air fighter threat worrying U.S. military...
NEWS, ED 16, p. 21
- Soviet fleet buildup to spur ASW effort... NEWS, ED 25, p. 21
- TRACKING & CONTROL:** Southeast Asia to get new control center gear...
NEWS, ED 17, p. 22
- Missiles**
- MULTIPLE WARHEADS:** Minuteman 3 set to go; Poseidon may be held...
NEWS, ED 17, p. 21
- SENTINEL:** Senate gives Sentinel an immediate go-ahead...
NEWS, ED 14, p. 21
- SOVIET:** ABM vs. disarmament: what will be the result?...
NEWS, ED 15, p. 21
- Navigation & Guidance**
- AIR TRAFFIC CONTROL:** Air-traffic controllers look at automation...
SR, ED 15, p. 35
- BEACONS:** 2 electronic aids urged to ease air traffic jams...
NEWS, ED 22, p. 21
- CIVILIAN AIRCRAFT:** RCA equipment enters private plane market...
NEWS, ED 21, p. 22
- DIGITAL SYSTEMS:** Digital system standards are adopted for aircraft...
NEWS, ED 16, p. 22
- MARITIME:** Computers build and run new cruise ship...
NEWS, ED 18, p. 25
- MICROWAVE SYSTEMS:** Air traffic designers turning to microwaves...
NEWS, ED 20, p. 30
- Oceanology**
- EXPLORATION:** Oceanographers reach toward 21st century...
SR, ED 15, p. 49
- RESEARCH:** U.S. oceanograph needs to be surveyed...
NEWS, ED 18, p. 22
- SEAMOUNT:** Survey undersea volcano for manned research site...
NEWS, ED 22, p. 22
- Optoelectronics**
- CAMERAS:** Step-and-repeat camera promised for IC makers...
NEWS, ED 20, p. 22
- COLOR GENERATION:** Ceramic 'filter' generates color images...
NEWS, ED 24, p. 28
- ELECTROLUMINESCENCE** displays digital data... PF, ED 16, p. 108
- HOLOGRAMS:** Largest hologram goes on display... NEWS, ED 21, p. 22
- Light-sensitive flip-flops read holograms... NEWS, ED 25, p. 28
- LASERS:** Harnessing the laser to electronic systems...
SR, ED 19, p. 59
- Laser faster than radar, tracking Mach 4.5 sled...
NEWS, ED 23, p. 36
- OPTICAL COMPUTERS:** Do computations at the speed of light...
ART, ED 23, p. 60
- Optics is no illusion for computer designers... SR, ED 17, p. U77
- OPTICAL MEMORY** acts like a kaleidoscope... NEWS, ED 17, p. 52
- PHOTOCONDUCTOR** arrays are custom designed...
PF, ED 23, p. 116
- PHOTODEVICES:** Count your footcandles with photodiodes...
ART, ED 17, p. 206
- Make your own phototransistor out of almost any silicon unit...
IFD, ED 15, p. 92
- SPECTRUM ANALYZERS:** Optical spectrum analyzer reveals laser-mode structure...
PF, ED 15, p. 112
- TV:** Military moving to buy low-light-level TV... NEWS, ED, p. 25
- Packaging & Cooling**
- COMMUNICATIONS** products: In communications, it's components, packages... SR, ED 17, p. U77
- HIGH-STRENGTH SANDWICH:** Glass bonded to metal at low temperature...
NEWS, ED 18, p. 22

MODULAR ASSEMBLY: Modular circuit package makes discretés of ICs. PF, ED 14, p. 122

PARTS PACKAGES: Keep a data package of common parts. ART, ED 15, p. 78

POWER TRANSISTORS: Mount power transistors integrally with printed circuit. NASA, ED 14, p. 108

THERMAL CONTROL: Thermoelectric cells check Intelsat III. NEWS, ED 14, p. 48

THICK FILMS headed for wide use in the 1970s. . . NEWS, ED 18, p. 21

Physics

LASERS: Advances in Lasers. SR, ED 19, p. 49

PRETERSONICS: Microwaves of the future? NEWS, ED 15, p. 25

RADIO ASTRONOMY: Indirect design piercing celestial 'barriers'. NEWS, ED 26, p. 25

RELATIVITY THEORY TEST: Old satellite to test Einstein theory. NEWS, ED 25, p. 32

SOLAR FLARES: Satellite overcomes low-frequency barrier. NEWS, ED 17, p. 25

Power Sources

BATTERIES, PAPER: "Paper power" may run cordless appliances. NEWS, ED 17, p. 21

ELECTRIC CARS: MIT, CalTech to send electric cars across U.S. NEWS, ED 17, p. 22

FUEL CELL: Problem: How to power the artificial heart? NEWS, ED 25, p. 25

INVERTERS: Build a 117-V ac source from a 12-V battery. IFD, ED 19, p. 104

POWER SUPPLIES: Auxiliary power supply uses IC gates. IFD, ED 26, p. 104

REGULATORS: Get better performance from a parallel-transistor stage. IFD, ED 16, p. 88

Production Processes

AUTOMATIC LETTERING machine speeds production drawings. PF, ED 20, p. 92

AUTOMATIC TESTING: IC Testing: Are high-speed automatic test systems the answer? SR, ED 18, p. 62

GRAPHIC AID: Tool helps design first-order systems. NASA, ED 17, p. 240D

IC PROCESSING labeled a sophisticated industry. NEWS, ED 14, p. 22

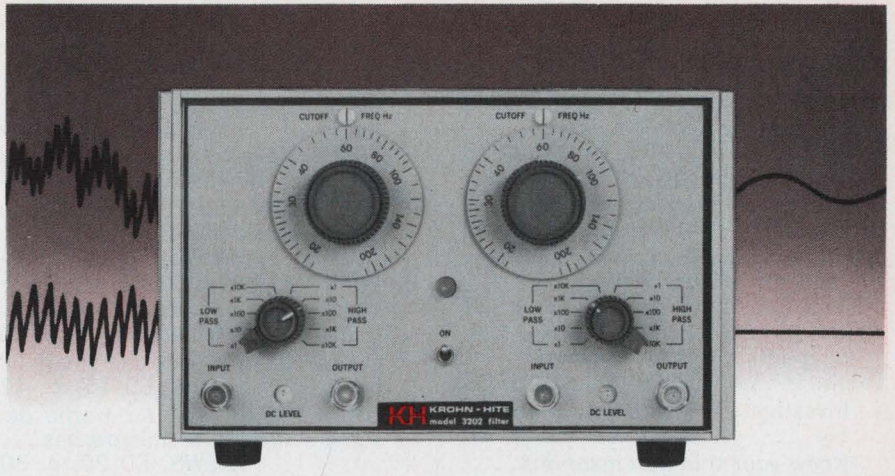

**Best way
to get rid of
unwanted
signals**

K-H multifunction filter.

Model 3202 all solid state filter with two independent channels gives you continuously adjustable high-pass, low-pass, bandpass or band reject functions over a 20 Hz to 2 MHz frequency range; provides the flexibility essential for complex frequency or time domain measurements.

Check these exclusive features. See for yourself why the Krohn-Hite Model 3202 is such an exceptional value at \$795.

FUNCTIONS: Low-pass — direct coupled with low drift. High-pass — upper 3 db at 10 MHz. Bandpass — continuously variable. Band rejection — variable broad band or sharp null.

TWO RESPONSE CHARACTERISTICS: (1) Fourth-order Butterworth or (2) simple R-C (transient free).

ZERO-db INSERTION LOSS: All-silicon amplifiers provide unity gain passband response. 24 db per octave slopes per channel extend to at least 80 db.

90-db DYNAMIC RANGE: Low hum and noise (100 micro-volts) eliminate costly preamplifiers.

There's more. Write for complete data. Contact your Krohn-Hite Representative for an eye-opening demonstration.

OVERSEAS SALES OFFICES: BELGIUM, C. N. Rood s. a.; DENMARK, SC Metric A/S; FRANCE, Antares; GERMANY, Nucletron Vertriebs-GMBH; HOLLAND, C. N. Rood n. v.; ITALY, Dott. Ing. Mario Vianello; SWEDEN, Teletinstrument; ISRAEL, R.D.T. Elect. Eng. Ltd.; JAPAN, Shoshin Shoji Kaisha, Ltd.; AUSTRALIA, Sample Electronics (Vic.) Pty., Ltd.



580 Massachusetts Ave., Cambridge, Mass. 02139, U.S.A.
Phone: (617) 491-3211 TWX: 710-320-6583

Oscillators / Filters / AC Power Sources / DC Power Supplies / Amplifiers
INFORMATION RETRIEVAL NUMBER 47

PARTS PACKAGES: Keep a data package of common parts. ART, ED 15, p. 78

PROCESS CONTROLS: Digital process control stars at exhibition. NEWS, ED 24, p. 30

SILICON WAFERS: Lower costs foreseen for silicon devices. NEWS, ED 23, p. 21

THIN & THICK FILMS: C-axis flipping lifts transducer power. NEWS, ED 20, p. 33

Investigate thin-film hybrid assembly. ART, ED 22, p. 98

Know your thin-film materials. ART, ED 19, p. 80

Parley analyzes 3 paths to world of MICs. NEWS, ED 23, p. 25

Thick films headed for wide use in the 1970s. NEWS, ED 16, p. 25

Transistors deposited on flexible tapes. NEWS, ED 18, p. 21

Understand thin-film circuit design. ART, ED 21, p. 78

WET Chemical: New holographic plates uses low laser power. NEWS, ED 18, p. 33

tions at video. ART, ED 20, p. 54

SATELLITE overcomes low-frequency barrier. NEWS, ED 17, p. 25

SIGNAL STABILIZERS: NBS device makes rf stabilization easy. NEWS, ED 14, p. 44

SPECTRUM CROWDING: Four-year study urges new spectrum allocation. NEWS, ED 16, p. 21

Crowding in spectrum nears a crisis. SR, ED 15, p. 42

SPURIOUS SIGNALS: Air traffic designers turning to microwaves. NEWS, ED 20, p. 30

Reliability

AVIONICS: Apollo 7 good in space; trouble is on the ground. NEWS, ED 22, p. 22

New E-2A radar to take less for granted. NEWS, ED 17, p. 46

CONTROL SYSTEMS: Boost reliability in your op-amp circuit. ART, ED 14, p. 62

Dodge transducer failures with a RAMP. ART, ED 15, p. 70

IC-USER STANDARDS: IC testing. SR, ED 18, p. 49

Radio Frequency Interference:

NOISE AT VIDEO: Tackle noise varia-

Research & Development

AMORPHOUS SEMICONDUCTORS prove workable. NEWS, ED 22, p. 33

ASTRONOMY: 11 telescopes in space offer new view of stars. NEWS, ED 26, p. 22

ASTRONOMY, RADIO: Indirect design piercing celestial 'barriers'. NEWS, ED 26, p. 25

BIOMEDICAL: Problem: How to power the artificial heart? NEWS, ED 25, p. 25

IONOSPHERE: Nose-cone antenna aids ionospheric research. NEWS, ED 23, p. 32

LASERS: Glass discs lase at high outputs. NEWS, ED 14, p. 33

The laser: Science's unruly 'whiz kid'. SR, ED 19, p. 50

MILITARY: Senator Stennis predicts boost in military R&D. NEWS, ED 26, p. 21

NATIONAL SCIENCE FOUNDATION gets wider powers. NEWS, ED 16, p. 22

OCEANOGRAPHIC: Oceanographers reach toward 21st century. SR, ED 15, p. 49

U.S. oceanographic needs to be surveyed. NEWS, ED 18, p. 22

YEARS AHEAD

ENGINEERS

PUT TIME AND TECHNOLOGY ON YOUR SIDE

L-1011 The largest airliner order in history—over \$2 billion—demands extensive engineering work. First L-1011 deliveries are not until late 1971. And that's only the beginning.

VS(X) A new carrier-based, state-of-the-art U.S. Navy ASW plane, the VS(X) is now in final phases of contract definition. This \$2-billion program will run well into the 1980's—not to mention possible VS(X) derivatives.

AH-56A The U.S. Army's initial AH-56A production contract calls for 375 vehicles. So engineering opportunities are great. This is merely the first compound helicopter to use the new Lockheed-developed Rigid Rotor.

If long-term projects are what you've been waiting for, act now. Lockheed-California Company has immediate openings in structural design and design of avionics, flight controls, real-time computers, digital displays, EMI, and tooling. Analysis assignments in human engineering, acoustics, aerodynamics, structural dynamics, thermodynamics, propulsion, weights, and reliability.

Write: Mr. C. R. Alexander, Professional Placement Manager, Dept. 1702, 3415 Empire Avenue, Burbank, California 91503. An equal opportunity employer.

LOCKHEED-CALIFORNIA COMPANY

A Division of Lockheed Aircraft Corporation

INFORMATION RETRIEVAL NUMBER 901

Semiconductors

AMORPHOUS semiconductors prove workable. NEWS, ED 22, p. 33

DIODES: Air-isolated diode array minimizes lead bonds. PF, ED 15, p. 126

Chip zeners take 400 mW. PF, ED 26, p. 116

Count your foot-candles with photodiodes. ART, ED 17, p. 206

Step-recovery diode specified for pulse and digital circuits. PF, ED 16, p. 116

Tunnel diodes can boost performance. ART, ED 20, p. 46

DIODES, BEAM: Device delivers kW output in picoseconds. NEWS, ED 22, p. 30

MOSFETS: Amplifier/switching MOSFET is passivated with nitride. PF, ED 14, p. 148

POWER TRANSISTORS: Mount power transistors integrally with printed circuit. NASA, ED 14, p. 108

Use hybrid junctions for more VHF power. ART, ED 16, p. 54

TRANSISTORS, THIN-FILM: Transistors on tape. NEWS, ED 19, p. 38

Space

APOLLO network is ready for the Moon. NEWS, ED 19, p. 28

- Apollo 7 good in space; trouble is on the ground. . . . NEWS, ED 22, p. 22
- Life support for Moon landing ready for test. . . . NEWS, ED 14, p. 30
- 2nd Apollo manned flight may go around the Moon. . . . NEWS, ED 19, p. 21
- COMSAT 'makes do' after Intelsat failure. . . . NEWS, ED 21, p. 21
- MICROMINIATURIZATION: A new gyro sought for future vehicles. . . . NEWS, ED 20, p. 22
- OAO: 11 telescopes in space offer new view of stars. . . . NEWS, ED 26, p. 22
- RADARS: ICs cut radar logic to one-tenth. . . . NEWS, ED 24, p. 32
- SATELLITES: Air Force plans integrated avionics network. . . . NEWS, ED 18, p. 30
- Astronomy craft orbited, to map outer space. . . . NEWS, ED 15, p. 22
- Infrared array camera developed for satellites. NEWS, ED 25, p. 32
- MIT modem enhances air-land communications. . . . NEWS, ED 16, p. 34
- New satcom system urged for defense. . . . NEWS, ED 20, p. 22
- Old satellite to test Einstein theory. . . . NEWS, ED 25, p. 32
- Pioneer IX transmits finer, faster, farther. . . . NEWS, ED 24, p. 21
- Satellite overcomes low-frequency barrier. . . . NEWS, ED 17, p. 25
- Spaceborne instrument may monitor pollution. . . . NEWS, ED 23, p. 22
- SOVIET: Is Russia waiting for us to ease off after Apollo? NEWS, ED 18, p. 22
- Three ways to put a Russian on the Moon. . . NEWS, ED 26, p. 36
- SPACE BUDGET: The hidden ace in the U.S. space effort. . . . SR, ED 14, p. 36

System Design

- AIRCRAFT: MUXing slices tons of weight from aircraft. . . . NEWS, ED 22, p. 25
- AIR TRAFFIC CONTROL: Government and the electronics industry, Part III: Air-traffic controllers look at automation. . . . SR, ED 15, p. 35
- AIR-WATER POLLUTION: Government and the electronics industry, Part III: Engineers asked to stem air-water pollution. . . . SR, ED 15, p. 46
- ANTENNAS: Computer program designs antenna. . . . NASA, ED 17, p. 240D
- New E-2A radar to take less for granted. . . . NEWS, ED 17, p. 46
- Nose-cone antenna aids ionospheric research. . . . NEWS, ED 23, p. 32

Check out your opportunities

In minutes, this Conductron suitcase-size Controller / Programmer / Evaluator can check out the electronic systems of most commercial or military jet aircraft.

In minutes, you can check out our excellent career opportunities in electronics.

Engineers and technicians can begin a new career—and a lasting one—in these areas: **Logic and circuit design • Electrical and electronic systems • Math modeling • Scientific programming • Aerodynamics • Reliability and maintainability engineering • Communications • Optics • Mechanical and manufacturing engineering • Microcircuitry • Value engineering • Environmental testing.**

Send us your resume today. Write: Mr. D. H. Besgrove, Professional Employment, Conductron Corporation, P.O. Box 426, St. Charles, (near St. Louis), Mo. 63301

CONDUCTRON CORPORATION



An equal opportunity employer

SEMIANNUAL INDEX

- Satellite overcomes low-frequency barrier. . . . NEWS, ED 17, p. 25
- AUTOCORRELATION: Indirect design piercing celestial 'barriers' NEWS, ED 26, p. 25
- COMPUTERS: Apply computer analysis accurately ART, ED 14, p. 76
- Learn about linear programming. ART, ED 21, p. 86
- DIGITAL CIRCUITS: Evaluate digital circuits automatically ART, ED 18, p. 78
- Universal IC logic cards allow system flexibility. PF, ED 14, p. 164
- MARITIME: Computers build and run new cruise ship. NEWS, ED 18, p. 25
- NUMERICAL ANALYSIS: Save time and effort in transient analysis. ART, ED 20, p. 58
- URBAN AFFAIRS: Down-to-earth aerospace work. Systems approach being used to unsnarl a range of social problems in country. SR, ED 17, p. U68
- Urban systems engineer: Systems approach gives answer to urban crises. SR, ED 17, p. U87
- WIRING LISTS: Unsnarl your complex wiring problems. ART, ED 23, p. 72

Telemetry

- CONVOLUTIONAL CODER: Pioneer IX transmits finer, faster, farther NEWS, ED 24, p. 21
- FREQUENCY CHANGES: Vhf-to-uhf conversion starts at 3 test ranges NEWS, ED 19, p. 21
- LIFE-SUPPORT SYSTEM for Moon landing ready for test. NEWS, ED 14, p. 30
- SOVIET SYSTEMS: Three ways to put a Russian on the Moon. NEWS, ED 26, p. 36

Test Equipment & Measurement

- CONTINUITY TESTING: Simplify continuity testing of low dc-resistance circuits. IFD, ED 20, p. 71
- COUNTERS: Count your foot-candles with photodiodes. ART, ED 17, p. 206
- Counter divides by either 3 or 4. IFD, ED 21, p. 114
- Printed-circuit board contains 10-MHz counter. PF, ED 14, p. 126
- Reciprocal-taking counter reads rf carrier frequency. PF, ED 26, p. 110
- Universal 200-MHz counter performs without plug-ins. PF, ED 17, p. 258
- GENERATORS, PULSE: Wide-range pulse generator varies rise and fall times. PF, ED 15, p. 108
- GENERATORS, WAVEFORM: Multi-

- function generator has triggered sweep. PF, ED 17, p. 262
- INFRARED TESTING: New infrared camera slashes costs in half. NEWS, ED 19, p. 22
- IC TESTER checks each element. NASA, ED 14, p. 106
- THERMAL CONTROL: Thermoelectric cells check Intelsat III. NEWS, ED 14, p. 48
- LIGHT: Count your foot-candles with photodiodes. ART, ED 17, p. 206
- MEGOhmmeters: A wide range megohmmeter uses a single FET. IFD, ED 17, p. 240
- METERS: Carrier removed by S/N meter. NASA, ED 17, p. 249
- Compact panel meters display D/A data. PF, ED 23, p. 110
- Digital multifunction meter performs 12 measurements. PF, ED 19, p. 120
- Rack-type digital meter has a low price tag. PF, ED 17, p. U116
- Two digital displays count on microcircuits for a stability of 2 ppm. PF, ED 14, p. 116
- MICROSCOPES: Interference microscopy shows detail in relief. PF, ED 17, p. U148
- OSCILLOSCOPES: Internal 8-hour battery powers 7-lb oscilloscope. PF, ED 14, p. 140
- Storage scope displays characteristic curves. IFD, ED 24, p. 76
- PLOTTERS: Low-cost X-Y recorder features high-price extras. PF, ED 17, p. 282

- PROBES AND COUPLINGS: Shaped probe boosts filter input-output couplings. IFD, ED 15, p. 88
- SEISMOLOGY: Laser technique reduces problem in seismology. NEWS, ED 14, p. 22
- SIGNAL STABILIZERS: NBS device makes rf stabilization easy. NEWS, ED 14, p. 44
- SPECTRUM ANALYZERS: Indirect design piercing celestial 'barriers'. NEWS, ED 26, p. 25
- TEMPERATURE SENSORS: Linear differential temperature sensor is accurate and simple. IFD, ED 22, p. 116
- THERMISTORS: Give your thermistor a helping hand. ART, ED 19, p. 86

Tubes

- CRT DISPLAYS: Tiny CRT display package slashes cost per digit. PF, ED 15, p. 100
- PHOTOMULTIPLIER accuracy raised tenfold by RCA. NEWS, ED 23, p. 22
- TV TUBES: Camera tube waxes when light wanes. PF, ED 15, p. 102
- Military moving to buy low-light-level TV. NEWS, ED 21, p. 25
- TV camera offers resolution of 2200 lines. NEWS, ED 24, p. 33
- Vidicon tube doubles as an X-ray display. NEWS, ED 19, p. 33

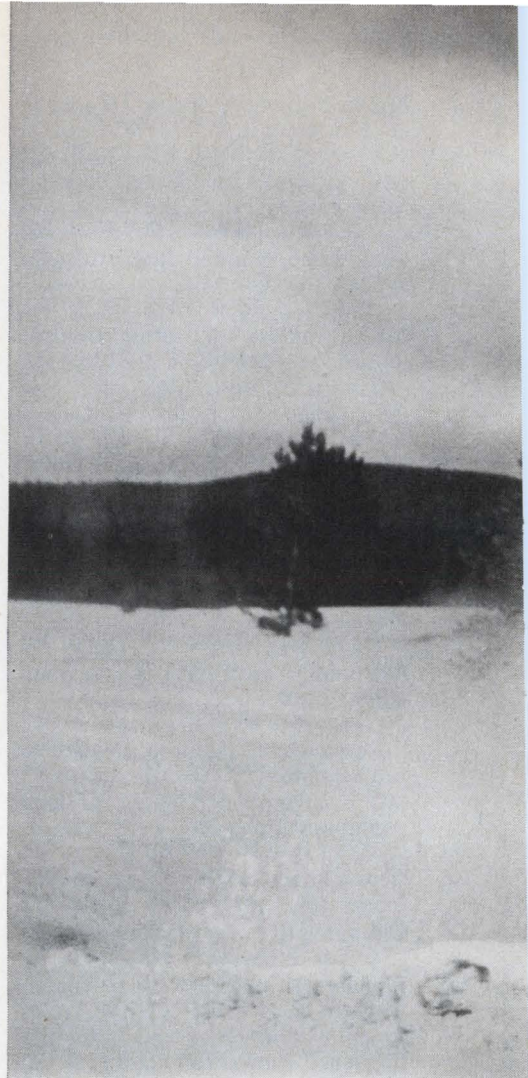

ELECTRICAL ENGINEERS—Will deal with a wide variety of solid state devices, laboratory test equipment, using basic logic theory to design control logic. Responsibilities include all phases of electrical layout, packaging and documentation such as: system power, interconnector, circuit layout, component specification, and liaison with vendors, drafting and manufacturing. BSEE required with a minimum of 4 years' related experience.

MECHANICAL & ELECTRICAL DESIGNERS—Generate original and creative machine design concepts. Prepare complete and accurate design layouts to resolve design or redesign problems identified by Engineers, Scientists, Sr. Designers and Managers. Mechanical design in areas of complex mechanisms, castings, cams, gears, drive systems, optics, sheet metal and plastics. Electrical design in areas of schematics, printed circuit boards, integrated circuits, cable harnesses and wire lists; familiarity with controls logic, etc. At least 8-10 years' experience in mechanical and electrical development practices. Good working knowledge in applying geometric dimensioning including true positioning desirable, for both development and production programs.

MECHANICAL DEVELOPMENT ENGINEERS—Will generate novel approaches in the development of new products; develop and prove product concepts through design, test and evaluation of appropriate models of products for quantity production. Previous design and development experience of consumer products such as business machines, appliances, photographic equipment, printing machines, instruments, light machinery, or automotive equipment. BS or MS in ME, EE, or Engineering Sciences.

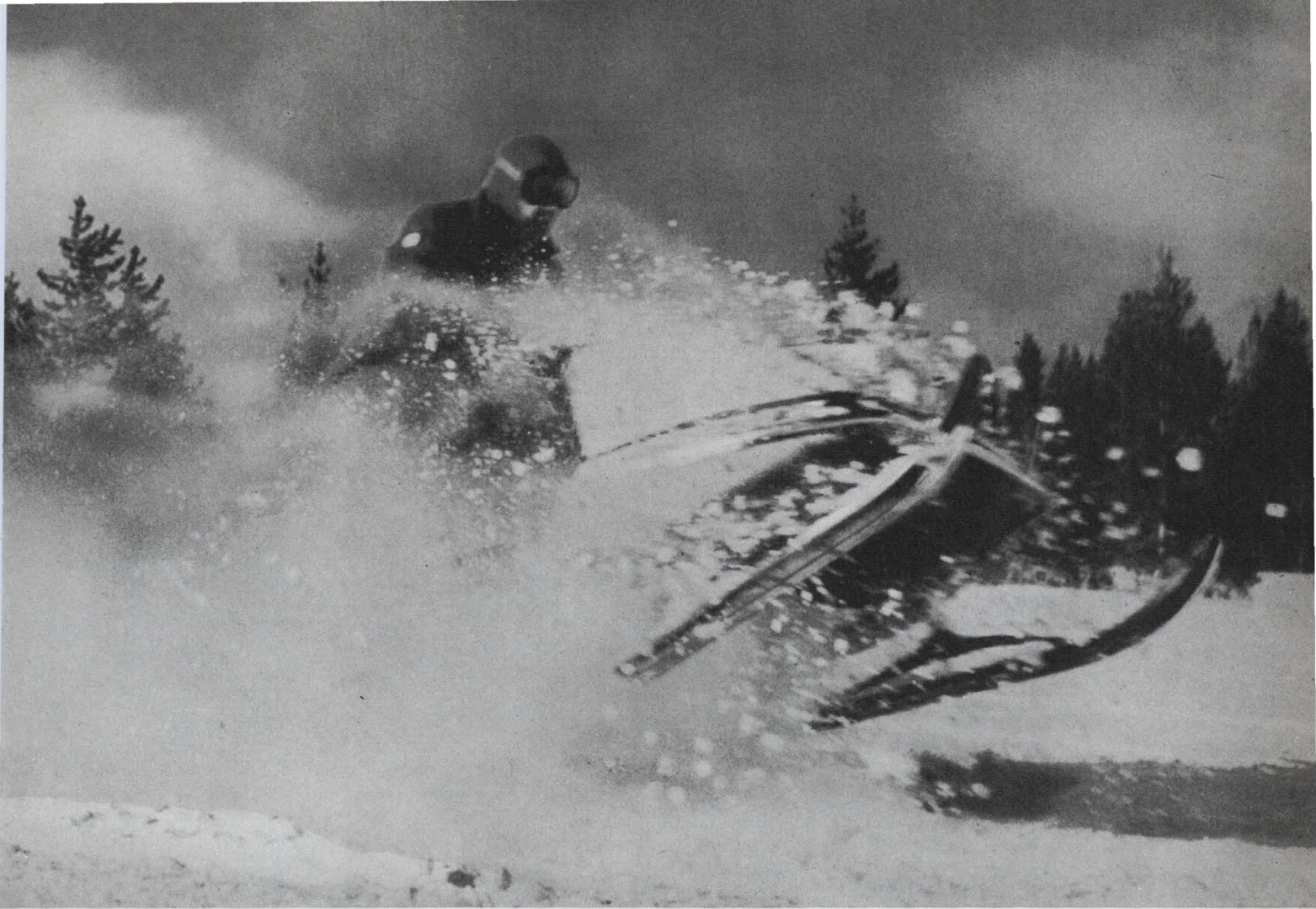

Can there be this kind of excitement in engineering?

An Adirondack day . . . still, crisp and glittering. From knee-height, the speed seems tremendous as your momentum builds down the long, sloping flat. Then—ridge ahead! A touch of throttle . . . a muted howl from the engine . . . and you lift suddenly—burst up and over in a whirl of powdery snow.

Try Xerox and see



A Xerox scientist employs X-ray fluorescence in studying photoreceptors for current and future product use.

This is part of a new excitement . . . snowmobiling* . . . that has added a new dimension to the winter scene. When we say you can find engineering excitement at Xerox, snowmobiling makes a good analogy: fast action, wide-ranging freedom, in a new kind of setting. Hard to believe, if you're conditioned to a more routine definition of professional work.

To spur this excitement, we've put over \$100 million into research and engineering in the past three years alone. That's why we say, look into what Xerox offers. See for yourself.

Specific positions available at our suburban Rochester, New York facilities are outlined at the left.

Please forward your resume to Mr. Richard L. Melnotte, Dept. MZ-32-B2, Xerox Corporation, P.O. Box 1995, Rochester, New York 14603.

XEROX

An Equal Opportunity Employer (m/f)

* Snowmobile buffs and snowmobiles abound in the Rochester area.

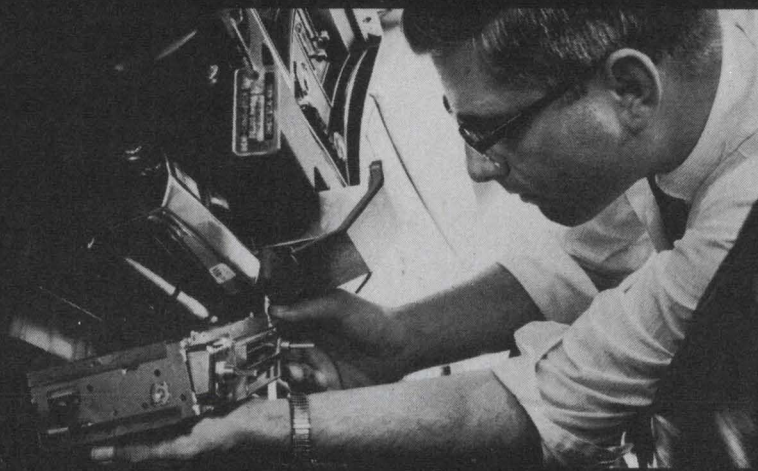

Mondays never look the same to Bob Byse

When you're breaking ground on a new idea at Delco, you don't see a lot of your own desk. For Bob Byse, design engineering means work with two dozen solid professionals . . . people whose specialties range from microelectronics to model making to production. Wherever the project leads, Bob Byse is on his way. And every skill is at his disposal. Right through full production. And beyond. If there's trouble shooting under dealer warranty three years from now, Bob Byse is still the man we'll call for. That's why no two Mondays ever look alike to Bob Byse and his colleagues at Delco.

The question is . . . can you say the same? Take a good hard look at how your responsibility shapes up, compared with Bob's. In fact, why not discuss it with us. By letter or telephone. Collect. Area Code 317/459-2808.

Contact: Mr. C. D. Longshore, Supervisor, Salaried Employment,
Dept. 302, Delco Radio Division of General Motors, Kokomo, Indiana.

**DELCO
RADIO**



AN EQUAL OPPORTUNITY EMPLOYER
DIVISION OF GENERAL MOTORS
KOKOMO, INDIANA

INFORMATION RETRIEVAL NUMBER 903

Free Career Inquiry Service

Absolutely Confidential

Respond to the career opportunities advertised in this issue. Fill out and send us this handy resume. **Electronic Design** will do the rest – neatly typed copies of this form will be mailed to the companies of your choice, indicated by the circled Career Inquiry Numbers at the bottom of this page.

4

Name		Home Phone	
Home Address (Street)		City	State
			ZIP Code
Age	U.S. Citizen <input type="checkbox"/> Yes <input type="checkbox"/> No	Security Clearance	

Prime Experience	Secondary Experience

Desired Salary	Availability Date
-----------------------	--------------------------

Employment History – present and previous employers

Company	City, State	Dates	Title
		to	
		to	
		to	

Education – indicate major if degree is not self-explanatory

Degree	College	City, State	Dates
			to
			to
			to

Additional Training – non-degree, industry, military, etc.

Professional Societies

Published Articles

Career Inquiry Numbers:

900	901	902	903	904	905	906	907	908	909
910	911	912	913	914	915	916	917	918	919

ELECTRONIC DESIGN
850 Third Avenue
New York, New York 10022

Radar signal processing engineers:

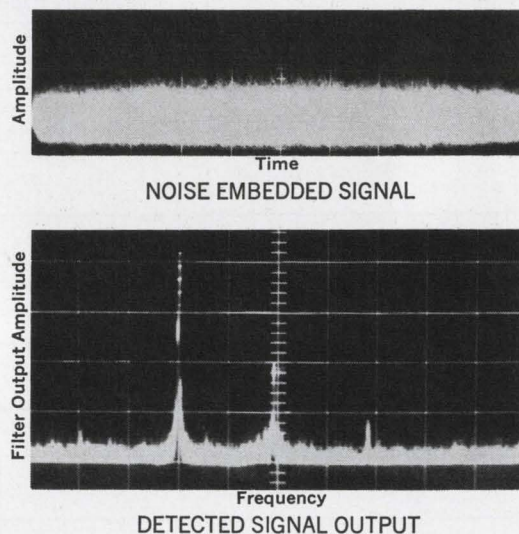

Our expansion can be your opportunity.

Today at Hughes, we're developing digital radar signal processors for a variety of important airborne applications.

An engineering model of one of these processors has been developed for real-time operation. It uses the Cooley Tukey, or fast Fourier transform algorithm, to form a bank of 512 narrowband doppler filters, together with their associated detectors and threshold circuits.

The scope photographs show a processor input signal 12 db

below wideband input noise, and the resulting processor output signal 15 db above rms noise in one digital filter output.

Several programs are now starting to carry this technique and others further toward operational radar systems.

It's a rapidly expanding field. And Hughes wants to grow with it. That's why qualified engineers and scientists are needed now. Particularly those with digital circuit design experience, signal processing analysis and

subsystem design experience, and microelectronic circuit applications background.

Interested? Please airmail resume today to:

Mr. Robert A. Martin
Head of Employment
Hughes Aerospace Divisions
Dept. 55
11940 W. Jefferson Blvd.
Culver City, Calif. 90230

An equal-opportunity employer
— M & F

U.S. citizenship is required

HUGHES

HUGHES AIRCRAFT COMPANY
AEROSPACE DIVISIONS

Florida opportunities

for a special breed of communication engineer

If you're going to enjoy your job, you might as well enjoy where you're living! At Electronic Communications, Inc., you can have both: professional challenge and career opportunity plus the advantages of living in St. Petersburg on Florida's subtropical Gulf Coast.

We don't offer comfortable grooves where you can get lost . . . and your work overlooked. At ECI you'll work on projects that push the state-of-the-art in satellite communications, multiplexing, electronic switching and advanced radio communications to supply systems advanced and equipment for many of the nation's key military and space programs. You'll work on projects beginning with applied research and advance development through prototype and product design. In fact, two-thirds of all advanced development at ECI is done in regular engineering development areas.

CHECK THESE OPPORTUNITIES IN ENGINEERING AT ECI

RF Circuit Engineers
Systems Analysis Engineers
Systems Integration Engineers
Industrial Engineers
Digital Engineers
Reliability Engineers

CHALLENGE, GROWTH . . . AND LOCATION TOO!

If you'd like a challenging engineering position, growth instead of a groove, and stimulating, comfortable living in sunny St. Petersburg, send your resume — in confidence — to P. D. Jordan, Supervisor of Professional Placement, Electronic Communications, Inc., Box 12248, St. Petersburg, Florida 33733.

(An equal opportunity employer, M/F.)



ELECTRONIC COMMUNICATIONS, INC.
St. Petersburg Division a subsidiary of NCR



Build a direct-reading phase detector with ICs

A phase-measuring system takes a long time to design and in the end may be quite complex. Here is a circuit (see figure) that provides a direct reading of a phase shift between two signals. It requires two input signals, a reference sinusoid and a phase-shifted sinusoid. The output signal is a varying duty-cycle pulse-width waveform that has twice the frequency of the input signals. The output signal is averaged by a zero-center microammeter that can be calibrated to read phase angles directly via the selected resistor.

Referring to the schematic, the R_1 - R_2 - C_1 - C_2 combination provides unity gain for all frequencies of e_{R1} if $R_1 = R_2$ and $C_1 = C_2$. The phase shift between e_{R1} and e_{R2} is given by:

$$\phi_{R1-R2} = \text{ARCTAN} [2\omega R_1 C_1 / (R_1^2 C_1^2 \omega^2 - 1)].$$

$R_1 = R_2 = 800$ ohms and $C_1 = C_2 = 0.5 \mu\text{F}$ were chosen to make $\phi_{R1-R2} = 90^\circ$ for $f = 400$ Hz operation. Q_1, Q_3 and Q_5 are normally in the satu-

rated state due to the full-wave rectifiers in their respective base circuits. Only near the zero crossings of their respective ac-signal inputs are they allowed to cut off and generate a narrow, positive-going pulse. Q_2 generates a square wave in phase with e_S . Q_4 generates a square wave 180° out of phase with e_{R2} .

The phase-angle measurement is made by the E_{1C} and E_{1D} flip-flop. V sets this flip-flop in the $A=1$ state. Z resets the flip-flop to the $A=0$ state. The duty cycle of the A and B waveforms are directly proportional to the phase shift between e_S and e_{R1} .

The A and B waveforms are gated to the output as follows. $X \cdot Y$ is a narrow positive-going pulse each time e_{R1} goes through zero with a positive slope. If $X \cdot Y=1$ occurs when W is a logic 1, the phase angle is leading. If $X \cdot Y=1$ when W is a logic 0, the phase angle is lagging. The E_{3A} - E_{3B}

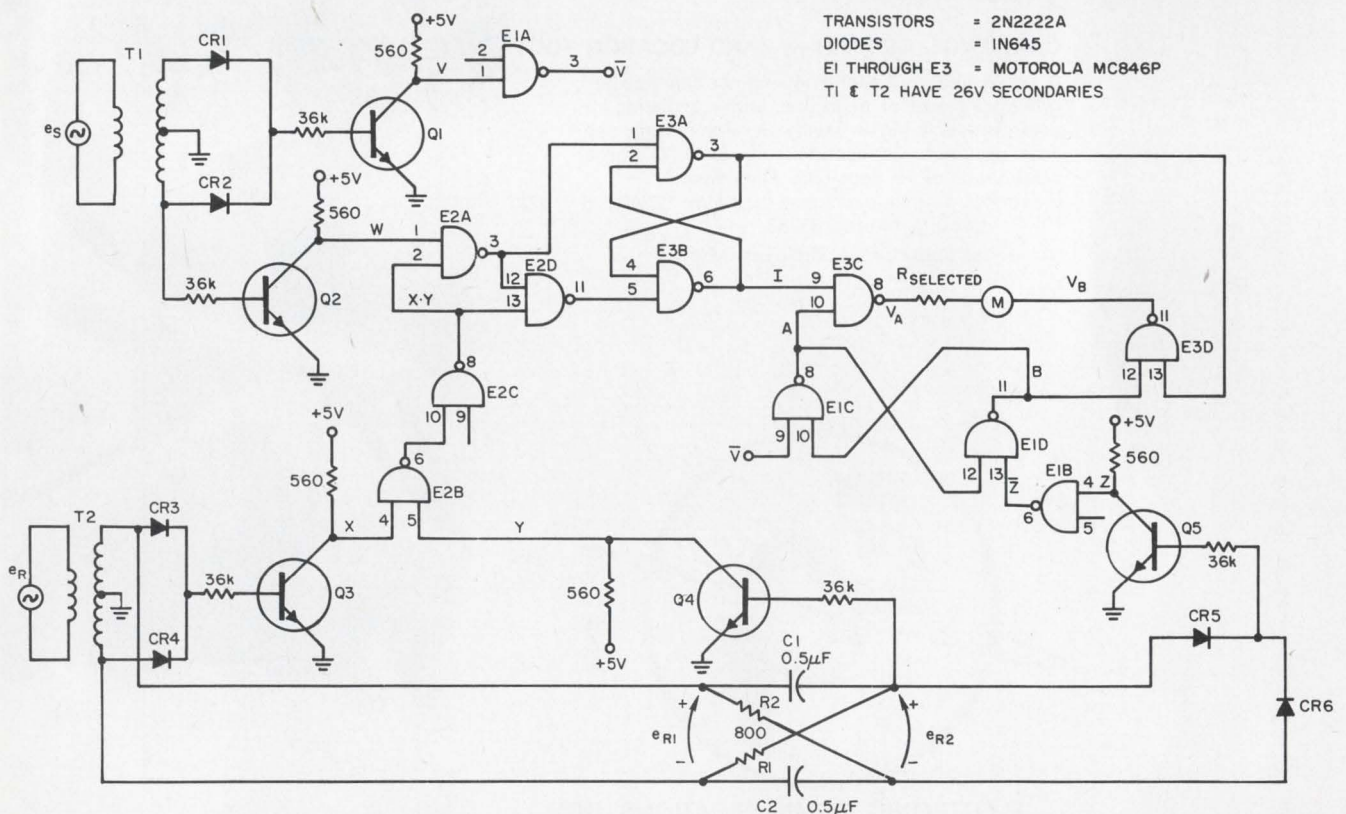

1. Phase shift between two sinewaves is read out directly on the microammeter, M, which can be calibrated to

read phase angles directly. Excellent linearity and reasonable cost highlight the circuit.

2 amp switching and 100mw sensitivity in 1/6 crystal can

Allied's new WA relay packs a lot of value in a tiny package. Consider these specifications: switching capability, 2.0 amps resistive and 0.5 amp inductive load at 28 VDC; sensitivity, 100 mw. That combination is hard to find anywhere

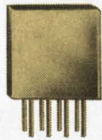

else. Add the hermetically sealed (by welding) construction of the WA, and you have an ideal relay for military or industrial applications. Finally, the WA is designed to meet MIL-R-5757D/19 and /30. For complete information, call or write...THE RELAY PEOPLE.



ALLIED CONTROL COMPANY, INC.
2 EAST END AVENUE, NEW YORK 10021

INFORMATION RETRIEVAL NUMBER 48

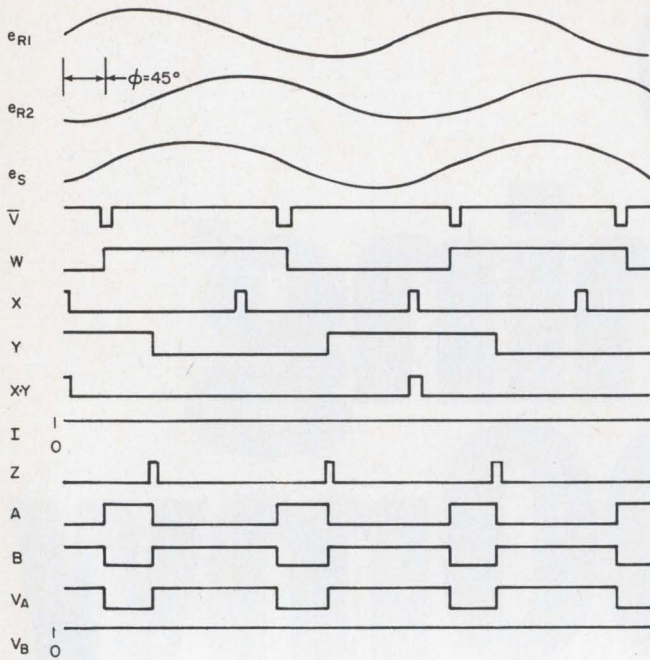

2. Waveforms throughout the circuit are shown for a phase lag of 45 degrees.

flip-flop is then set to the $I=1$ state for a lag and to the $I=0$ state for a lead. Thus only waveform A is gated to the meter for a lagging phase angle and only waveform B is gated to the meter for a leading phase angle. The meter then indicates the difference between the logic level and the average dc voltage of the gated waveform.

This circuit has been breadboarded and exhibits excellent linear characteristics with rather inexpensive components.

William M. Floyd, Product Service Engineer, Avionic Controls Dept., General Electric Co., Binghamton, N.Y.

VOTE FOR 311

Bandpass filter has independent gain and selectivity controls

Tuned amplifiers are often used as variable-gain, variable-selectivity filters. Difficulties arise in these circuits, though, in minimizing interaction between the gain and selectivity controls. In the circuit shown, the two controls are truly independent of each other over a wide range—much wider, in fact, than is obtainable with the component values shown.

The frequency of maximum gain for the circuit is given by:

$$f_o = 1/(2\pi RC).$$

If the input impedance of Q4 is much larger than

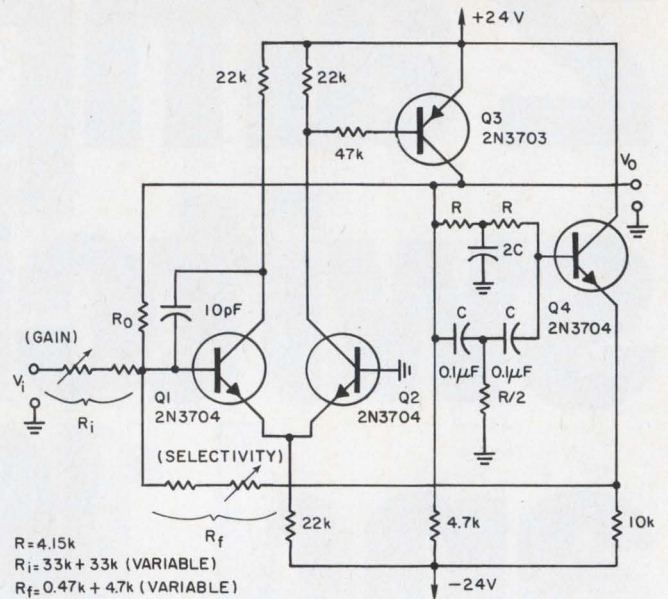

Independence of the gain and selectivity controls is achieved in this active bandpass filter circuit.

$2R$, and the ratio of R_o/R_i is much smaller than the open-loop gain of the amplifier, then the transfer function of the device is:

$$V_o/V_i = \frac{-R_o/R_i}{1 + (R_o/R_f) \frac{[(f_o/f) - (f/f_o)]}{[f_o/f - (f/f_o)] + 4j}} \quad (1)$$

This shows that the gain can be controlled by varying R_i ; the feedback term in the denominator that determines the selectivity can be controlled by varying R_f . Under the conditions of validity of Eq. 1, the two controls act completely independently.

If the selectivity of the circuit is high, the -3 dB bandwidth is approximately:

$$B = 8f_o R_f / R_o.$$

For moderate and low selectivities, the calculation of B is difficult; it is best done by graphical methods.

The above expression for the transfer function also shows that if f_1 and f_2 are the upper and lower frequencies giving the same gain, then:

$$f_1 f_2 = f_o^2.$$

With the values shown in the diagram, the following results have been obtained for the circuit:

- $f_o = 381$ Hz
- Max gain = $+3$ dB
- Min gain = -3 dB
- Max bandwidth (-3 dB) = 153 Hz
- Min bandwidth (-3 dB) = 17 Hz

The 10-pF capacitor is required to suppress parasitic oscillations in the megahertz range.

G. Gelato, Design Engineer, European Space Technology Centre, The Netherlands.

VOTE FOR 312

Now, METAL GLAZE resistors for MIL-R-10509

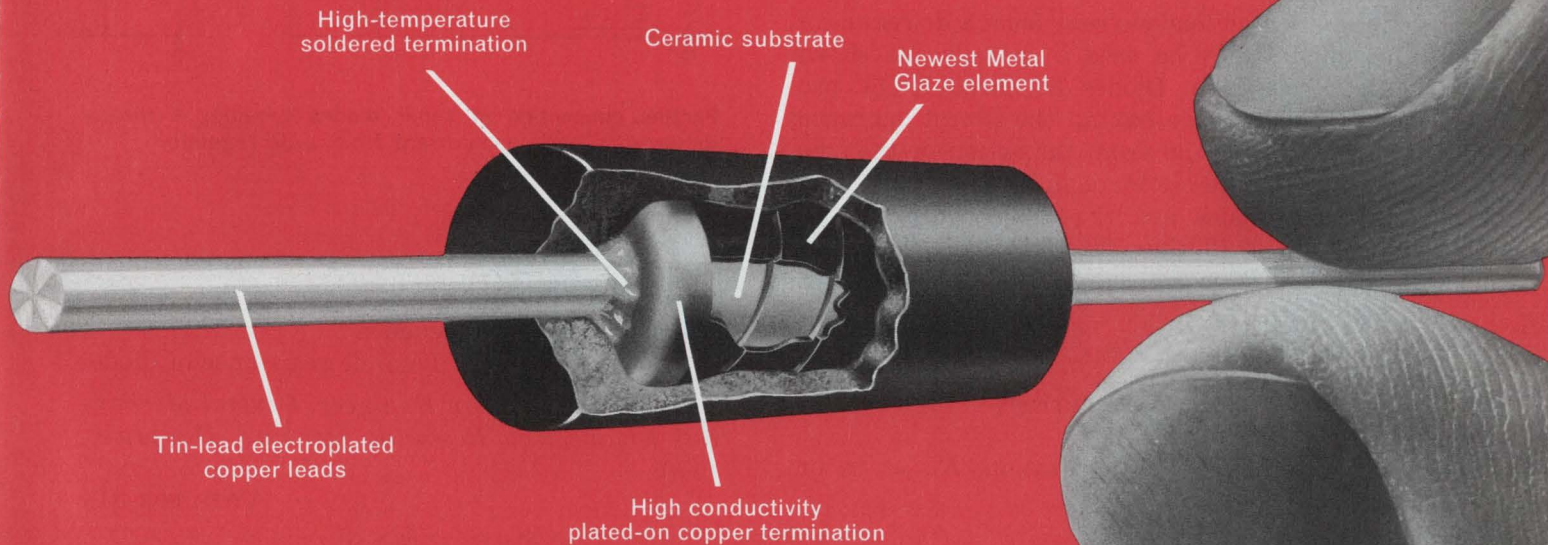

100ppm, 1% plus thick-film stability

IRC's newest Metal Glaze resistors offer the most economical approach to MIL-R-10509 requirements. They have precision performance, plus the added benefits of thick-film stability and reliability.

These resistors feature IRC's latest generation of Metal Glaze resistance material. This improved thick-film element provides the electrical stability and mechanical ruggedness that tin oxide types can't achieve. And, their tough molded bodies resist solvents and the pounding of automated inserting equipment.

Metal Glaze resistors have withstood over 15 million unit hours of testing. In addition to MIL-R-10509, they also meet or exceed MIL-R-22684 and MIL-R-39017. For complete data and prices see your IRC Qualified Industrial Distributor. Or, write IRC, 401 North Broad Street, Philadelphia, Pa. 19108.

CAPSULE SPECIFICATIONS

MIL STYLE	Type T-55	Type T-60
RESISTANCE	RN55	RN60
TOLERANCE	10 Ω thru 90K	10 Ω thru 200K
TEMP. COEFF.	$\pm 1\%$	$\pm 1\%$
POWER	$\pm 100\text{ppm}/^\circ\text{C}$	$\pm 100\text{ppm}/^\circ\text{C}$
	$\frac{1}{2}$ watt @70°C	$\frac{1}{2}$ watt @70°C
	$\frac{1}{4}$ watt @125°C	$\frac{1}{4}$ watt @125°C
	(derate to zero at 165°C, no load)	



DIVISION OF TRW INC.

Parallel-connected zener diodes answer load-current problems

It is well-known that zener diodes may be used in series to provide higher regulated voltage than is possible with a single diode. It is also generally known that zeners should not be used in parallel, as only the diode with the lowest breakdown voltage would carry any current. As will be shown, though, this second point is not necessarily true.

To draw high load-current from a dc regulator, zener diodes may be used in parallel, as shown in the illustration. Diodes *DI* through *DN* protect the zener diode having the lowest operating breakdown potential from the action of the common current flowing through the load-resistance, R_L . These diodes are chosen according to the current that will flow through them. The value of resistors R_s is determined for the worst condition from:

$$R_s = \frac{E_{in(min)} - E_{out(min)}}{I_{z(min)} + I_{L(max)}}$$

where I_z = zener diode current
 I_L = load-current

The coefficient of stabilization, K_s , as in ordinary circuits, is

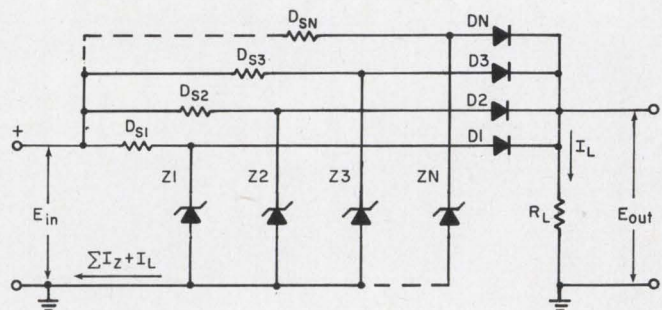

Parallel connection of zener diodes provides a means for drawing high load-current from a dc regulator.

$$K_s = E_{out}/E_{in} = \frac{r_z R_L + r_{fd}}{R_s + r_z R_L + r_{fd}} = \frac{r_z}{R_s}$$

where r_z = zener impedance

r_{fd} = forward dynamic resistance of diode.

L. Bhaduri, Design Engineer, Central Mechanical Engineering Research Institute, Durgapur, India

VOTE FOR 313

Triggered sawtooth generator has constant amplitude

A triggered sawtooth generator can be built that delivers a constant-amplitude sawtooth waveform over a wide operating frequency range. The sawtooth is developed from an ac input signal that varies in frequency and amplitude.

The circuit can be separated into four sections: Section A consists of a transistor switch, a differentiator, and a half-wave rectifier. This circuitry processes the input signal to trigger section B, which is a monostable multivibrator. The

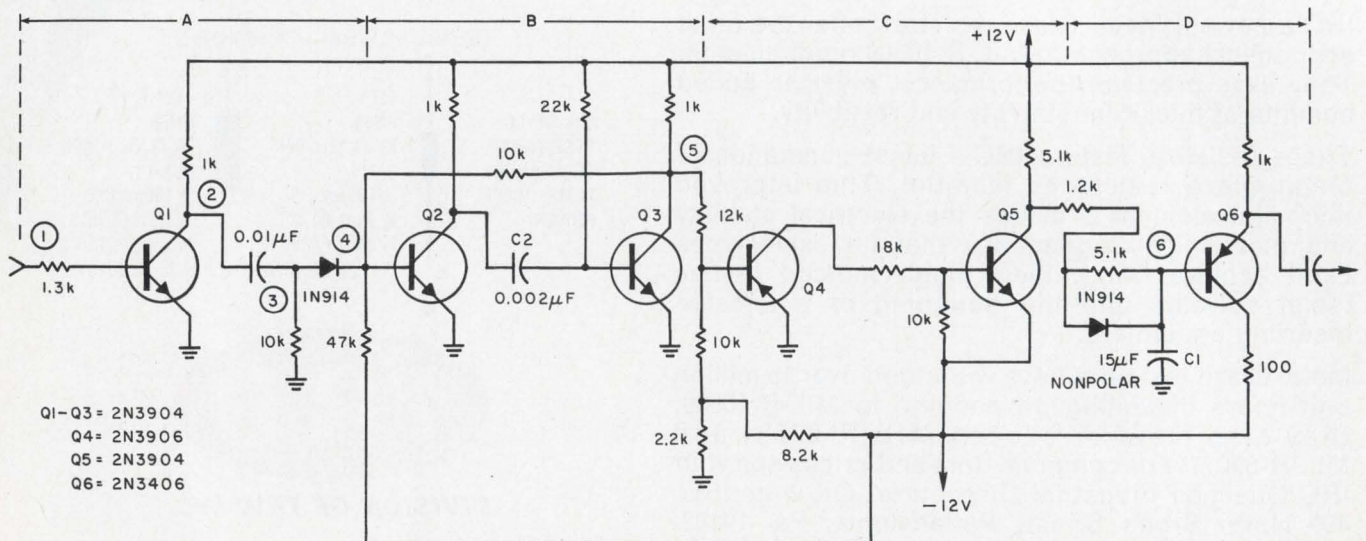

- Q1-Q3 = 2N3904
- Q4 = 2N3906
- Q5 = 2N3904
- Q6 = 2N3406

1. Triggered sawtooth generator circuit develops a sawtooth output that has the same frequency as the input

but a constant amplitude. The sawtooth has excellent linearity over the range of 300 Hz to about 10 kHz.

The deflection plate aligner

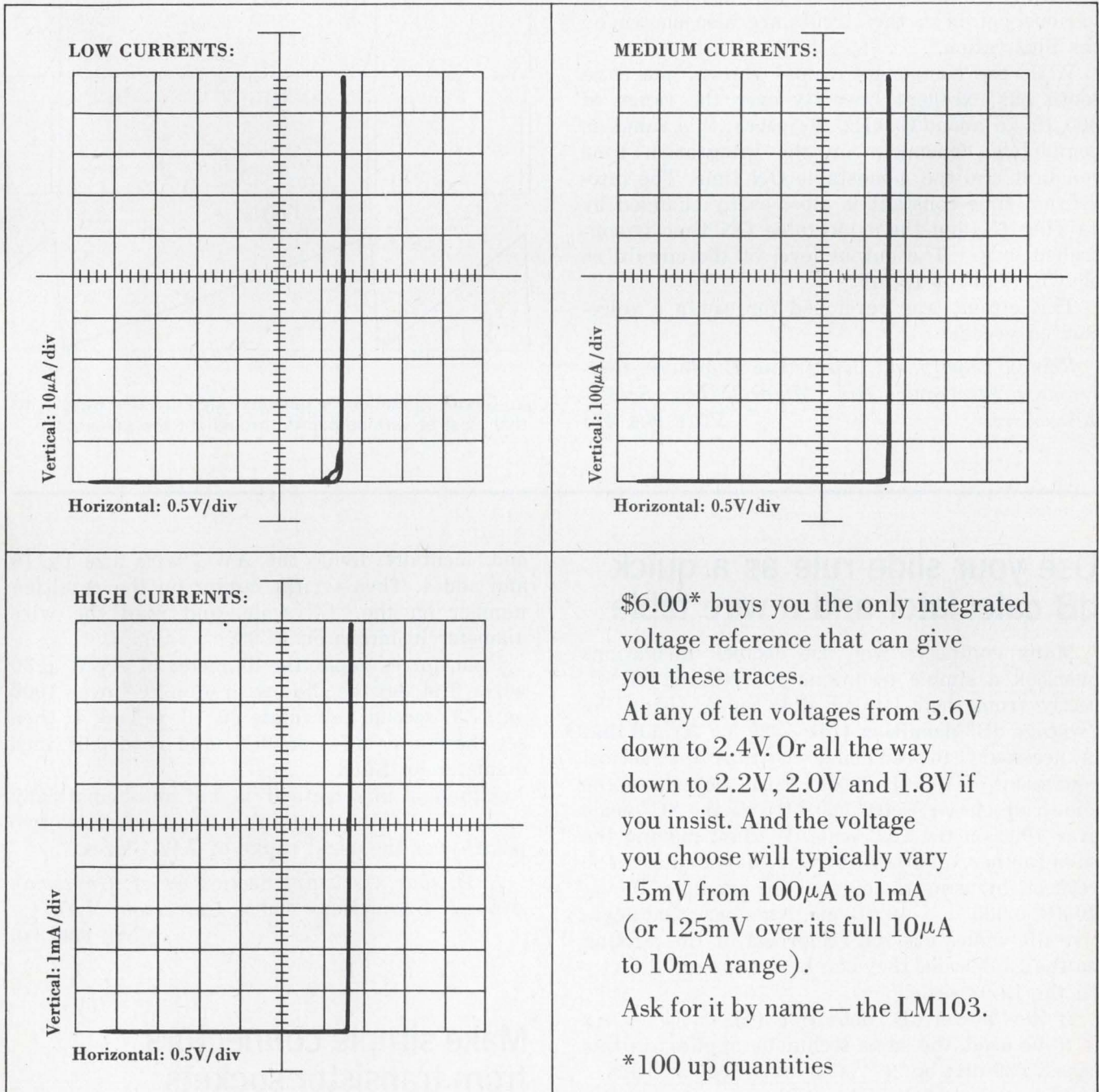

National/Linear

National Semiconductor, 2975 San Ysidro Way, Santa Clara, California 95051 • (408) 245-4320 • TWX 910-339-9240 • Cables: NATSEMICON

INFORMATION RETRIEVAL NUMBER 50

monostable is triggered on positive-going zero crossings of the input signal.

Section C is a pulse amplifier, and section D consists of an integrator and an emitter-follower output. The output amplitude is kept constant over frequency by operating the emitter follower near saturation. The dc level on the base of the emitter follower changes with the pulse input frequency, which, in turn, changes the base-emitter diode resistance of the transistor. Thus, the sawtooth amplitude remains constant over the operating-frequency range. The waveforms at various points in the circuit are also shown on the illustration.

With the component values shown, the sawtooth has excellent linearity over the range of 300 Hz to about 10 kHz. However, this range is completely dependent on the integration time constant and the monostable ON time. The integration time constant is most easily changed by varying C_1 , and the monostable ON time is controlled by C_2 . The output level of the circuit, as shown, is about 10 mV.

This circuit was developed for use in a voice-excited vocoder.

Roman Lopatynski, Electronic Engineer, Government Electronics Div., Motorola Inc., Scottsdale, Ariz.

VOTE FOR 314

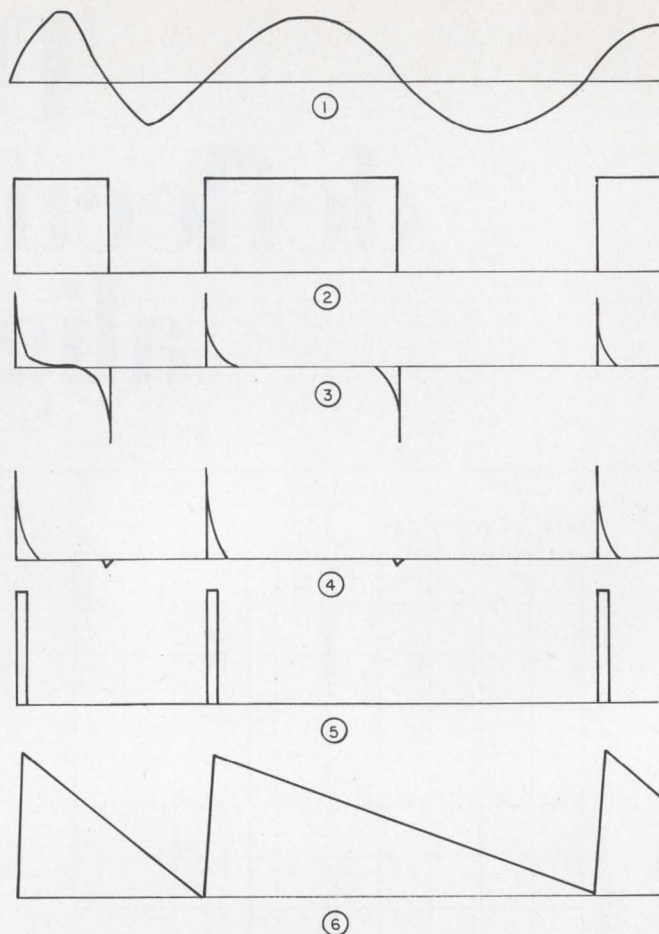

2. Circuit operation is demonstrated by the waveforms that exist at various points throughout the generator.

Use your slide rule as a quick dB calculator and a wire table

Many engineers who use decibel calculations overlook a simple technique for reading dB directly from their log-log slide rules. Using the "voltage dB" definition ($\text{dB} = 20 \log A$), all that is necessary to remember is that the decibel equivalent of 1000 is 60 dB. With the help of the slide rule cursor, set 6 (60 dB) on the "C" scale over 1000 on the LL3 scale. Without moving the slide further, all other dB-ratio equivalents can be read off by using the cursor; for example, 100 = 40 dB, 0.005 = -40 dB, etc. Note here that negative dB values are the reciprocal of the reading on the LL3 scale; they can be set or read directly on the LL03 scale.

If the "power dB" definition ($\text{dB} = 10 \log A$) is to be used, the same technique applies; in this case 3 (30 dB) on "C" is set over 1000 on LL3.

A second useful trick enables the engineer to use his log-log rule as a wire table. First, set the slide as described above for "voltage dB" calculations; that is, 6 on "C" over 1000 on LL3. Sec-

ond, mentally divide the AWG wire size by 10 and add 1. Then set the cursor on the resulting number on the "C" scale, and read the wire diameter in inches on LL03.

Find, for example, the diameter of AWG #30 wire: first, set the slide with 6 on "C" over 1000 on LL3; second, calculate $30/10 + 1 = 4$; then set the cursor on 4 on "C", and read 0.01 inch diameter on LL03.

Although this method is not mathematically exact, it provides results that are accurate to two places over the usual range of AWG sizes.

L. Dunbar, Assistant Section Chief, Grumman Aircraft Engineering Corp., Calverton, N.Y.

VOTE FOR 315

Make simple connectors from transistor sockets

A very simple four-pin connector for breadboard applications can be constructed from two inexpensive transistor sockets and a short length

Our new LM 106 is the 710 and then some.

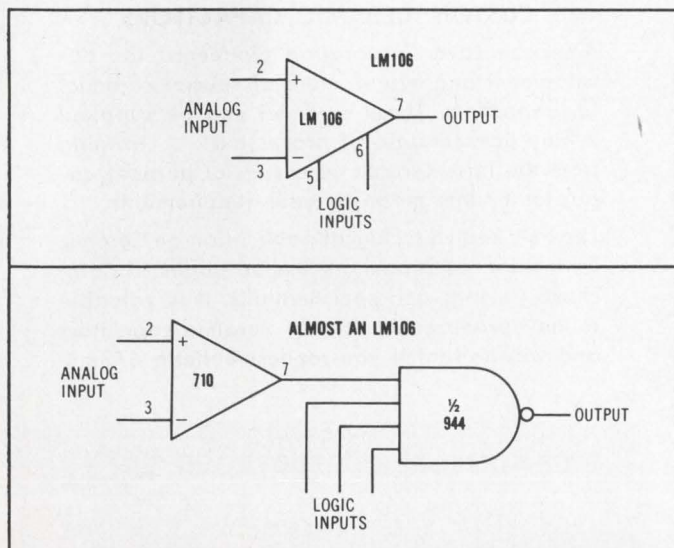

Our LM106 is a clever brute. It's a high-speed voltage comparator that is a direct plug-in replacement for the 710 in practically every application. What's more, on two pins the 710 doesn't even use, the LM106 accepts logic signals to strobe an output that drives up to 10 DTL or TTL loads. Or it switches up to 18V at 100mA to drive relays or lamps directly. The 25,000 gain makes gain error insignificant compared to the 2mV maximum offset. And it operates over a wide range of supply voltages even with symmetrical supplies. In quantities of 100 to 999, the military version LM106 is \$18.00, the LM206 for instrumentation (-25 to +85°C) is \$11.50, and the LM306 for industrial uses (0 to +70°C) is \$6.80. Write us for other clever things about the LM106. National Semiconductor, 2975 San Ysidro Way, Santa Clara, California 95051. (408) 245-4320.

National/Linear

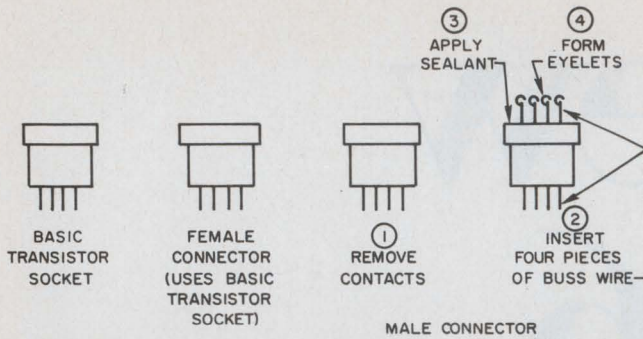

1. Two inexpensive transistor sockets can be quickly converted into a versatile mini-connector.

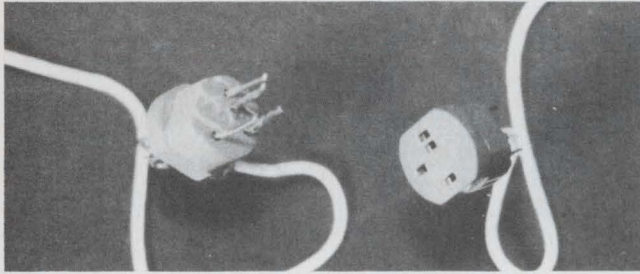

2. Photo shows actual connector made by authors.

of AWG 22 buss wire.

As shown in Fig. 1, simply remove the contacts from one of the sockets and insert four one-inch pieces of buss wire into the socket holes. Apply a small amount of epoxy or other sealant, such as RTV, to the top of the socket to secure the wires. Form solder eyelets, as shown, and trim the connector pins to a length of about 0.25 in. Although not very elegant, the finished product can adequately serve many applications. An actual connector made in this way is shown in Fig. 2.

Jack L. Shagena, Jr. and Tom H. Miller, Design Engineers, Bendix Corp., Bendix Communications Div., Towson, Maryland.

VOTE FOR 316

VOTE! Go through all Idea-for-Design entries, select the best, and circle the appropriate number on the Reader-Service-Card.

SEND US YOUR IDEAS FOR DESIGN. You may win a grand total of \$1050 (cash)! Here's how. Submit your IFD describing a new or important circuit or design technique, the clever use of a new component or test equipment, packaging tips, cost-saving ideas to our Ideas-for-Design editor. You will receive \$20 for each accepted idea, \$30 more if it is voted best-of-issue by our readers. The best-of-issue winners become eligible for the Idea Of the Year award of \$1000.

IFD Winner for October 24, 1968

Melvin William Kyle Jr., Design Engineer, Los Angeles, Calif. His Idea "Complementary audio amplifier has low distortion, high output" has been voted the Most Valuable of Issue Award.

Vote for the Best Idea in this Issue.

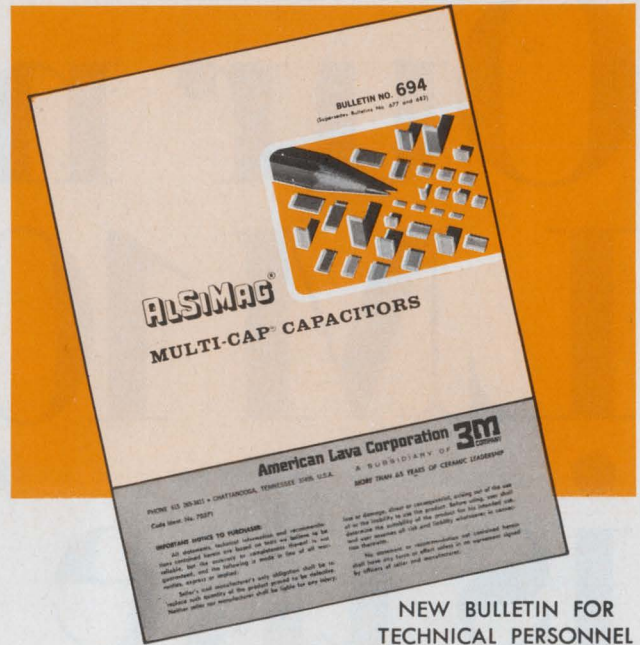

NEW BULLETIN FOR
TECHNICAL PERSONNEL

ALSIMAG[®] MULTI-CAP[®] CERAMIC DIELECTRIC CAPACITORS FROM STOCK

This Bulletin gives specifications, physical properties and graphs of typical characteristics of space saving and money saving Multi-Cap Ceramic Capacitors carried in stock. Details are given on a wide range of capacitances and working voltages in both NPO, Low Loss, High Stability capacitors and in K-1300 Temperature Stable capacitors. Sizes from .085 x .055 to .380 x .157 cover most requirements for high capacitance-to-volume ratio units. The range of stock sizes is expanded as the need for specific additional sizes becomes established.

Please request Bulletin 694 on business letter-head giving your title or work assignment.

CUSTOM CERAMIC CAPACITORS

American Lava Corporation pioneered the development and manufacture of special ceramics for capacitors. These ceramics can be supplied in any desired state of processing . . . ranging from the base ceramic to a special purpose capacitor custom made to your requirements.

The only known technical publication on Ceramic Dielectrics for Capacitors has 36 pages of data, charts, graphs and specifications. It is valuable to any producer or user of ceramic capacitors and will be sent if you request Bulletin 673.

American Lava Corporation **3M**
A SUBSIDIARY OF COMPANY

PHONE 265-3411 (Area 615), CHATTANOOGA, TENN. 37405

.....YOU ASKED FOR IT.....HERE IT IS!.....

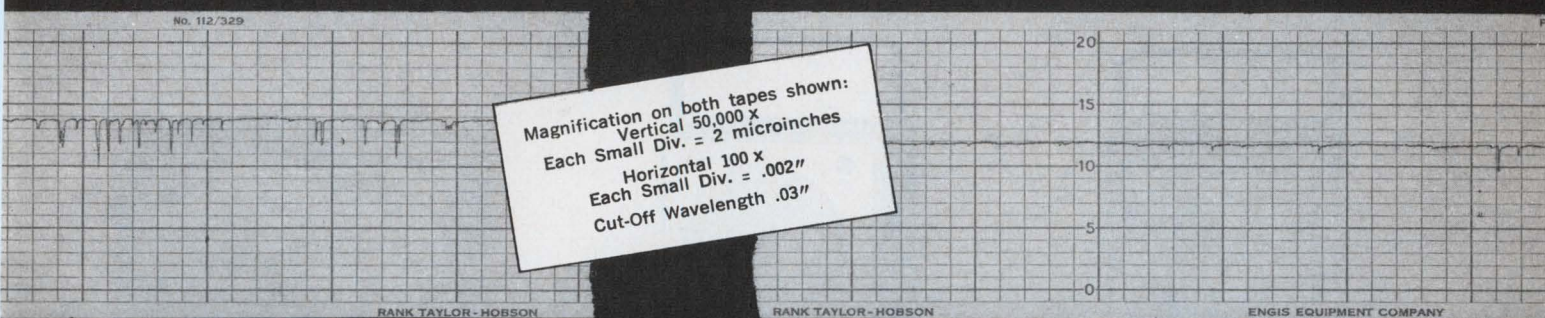

Magnification on both tapes shown:
 Vertical 50,000 x
 Each Small Div. = 2 microinches
 Horizontal 100 x
 Each Small Div. = .002"
 Cut-Off Wavelength .03"

This Talysurf trace shows a 2.5 microinch surface.

A more polished ceramic shows a .3 microinch surface.



POLISHED CERAMIC SUBSTRATES

Especially processed ALSiBase substrates are now being produced up to 5" x 8" with a ground surface of 10 microinches CLA or better. Smaller substrates on the order of 1" x 3" with surface of 2 or better and substrates of 1" x 1" with surface of 1 microinch CLA or better are now practical. The surface is remarkably uniform with a minimum of voids. These substrates are produced, ground for flatness and thickness control and polished for surface finish under one responsibility.

The basic ceramic is ALSiMag 772, a 99½ % alumina ceramic composition of extraordinary strength and superior electrical characteristics.

PROTOTYPES normally can be hand made at no tooling cost. Consultation is suggested to arrive at the design most desirable for your application.



CODE IDENT. NO. 70371

American Lava Corporation **3M**
 A SUBSIDIARY OF COMPANY

PHONE 615 265-3411, CHATTANOOGA, TENN. 37405

For service, contact American Lava representatives in Offices of Minnesota Mining and Manufacturing Company in these cities (see your local telephone directory): Boston: Needham Heights, Mass. • Chagrin Falls, Ohio • Chicago: Elmhurst, Ill. • Dallas, Tex. Indianapolis, Ind. • Laurens, S. C. • Los Angeles, Calif. • Metropolitan New York: Ridgefield, N. J. • Up-State New York and Canada: Phoenix, New York • Orange, Conn. • Philadelphia, Penna. • Roanoke, Virginia • St. Louis: Lee's Summit, Mo. So. San Francisco, Calif. • 3M International: c/o American Lava Corporation, Chattanooga, Tenn. 37405, U.S.A., 615/265-3411.



generate



The RCA WR-50B RF Signal Generator with sweep features is versatile, portable, and exceptionally well suited for alignment and signal tracing of AM, FM, hi-fi and citizen's band receivers and trouble-shooting in nearly all sections of TV receivers. IT'S ONLY \$65.00.* Also available in an easy to assemble kit, WR-50B(K).



The RCA WA-504A Transistorized Sine/Square Wave Audio Signal Generator covers a frequency range from 20 Hz to 200,000 Hz with exceptional frequency stability. For use in audio, hi-fi and general electronics applications, as well as in electronics training, demonstrations and lab work. ONLY \$95.00*

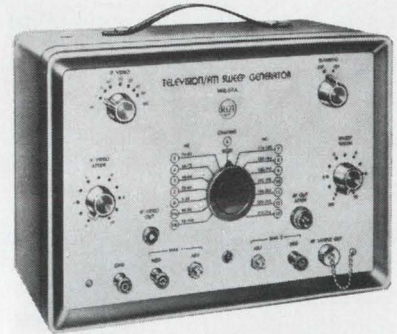

The RCA WR-69A Television/FM Sweep Generator is designed for lab, service, and production applications for sweep-frequency alignment of color and black and white TV receivers and broadcast FM receivers. It's also used to align VHF tuners, picture-and-sound IF amplifiers, video amplifiers and chrominance circuitry in color TV receivers. AND IT'S ONLY \$295.00.*



The RCA WP-700A and WP-702A Power Supplies are extremely reliable, solid-state, constant voltage DC power supplies that provide 0 to 20 volts dc at current levels up to 200mA. WP-702A is actually identical to WP-700A, except it is a dual unit with two complete power supply sections. WP-700A IS ONLY \$40.00* in quantities over five, and WP-702A IS ONLY \$73.00* in quantities over five. Prices on less than five units are \$48.00* and \$87.00* respectively.



The RCA WR-70A RF/IF/VF Marker Adder is designed for use with conventional markers and sweep generators such as the RCA WR-39, WR-89 and WR-99 series calibrators and the WR-59 and WR-69 series sweep generators to produce clean, narrow markers on the sweep-response curve on an oscilloscope. AND IT'S ONLY \$96.00.*



The RCA WR-99A Crystal-Calibrated Marker Generator combines in one compact, accurate, and stable instrument the functions of a multiple-marker generator, crystal calibrator and a heterodyne frequency meter. Ideal for servicing and aligning color and black and white TV receivers, communications and other equipment in the frequency range of 19 to 260 MHz. ONLY \$256.50.*

*Optional Distributor resale price.

For a complete catalog of descriptions and specifications for all RCA test equipment see your RCA Test Equipment distributor or write RCA Electronic Components, Commercial Engineering, Department No. B-18W, Harrison, N. J. 07029.

LOOK TO RCA FOR INSTRUMENTS TO TEST/MEASURE/VIEW/MONITOR/GENERATE

INFORMATION RETRIEVAL NUMBER 54

Products

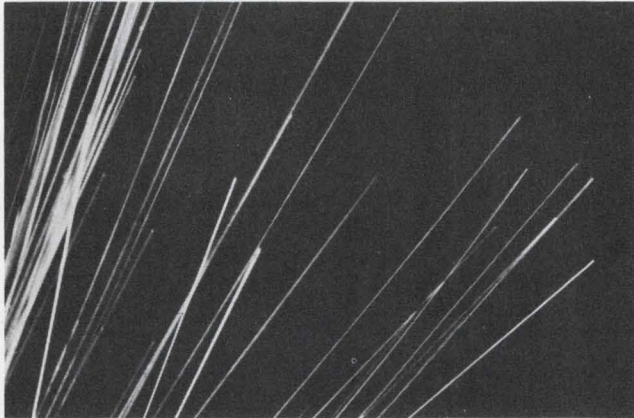

Plated wire for fabricating high-speed memories challenges ferrite cores, p. 136.

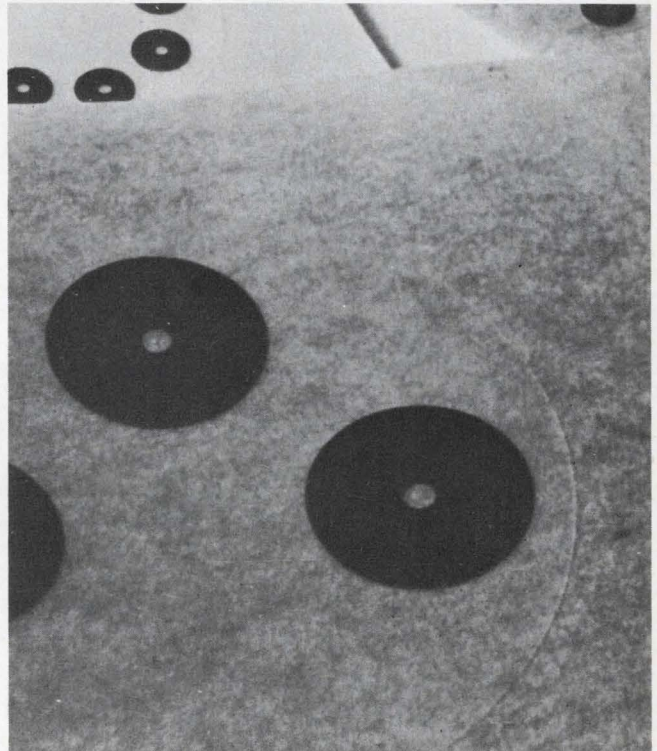

Samples of die-cut TO-5 and -18 symbols are offered for engineering evaluation, p. 202.

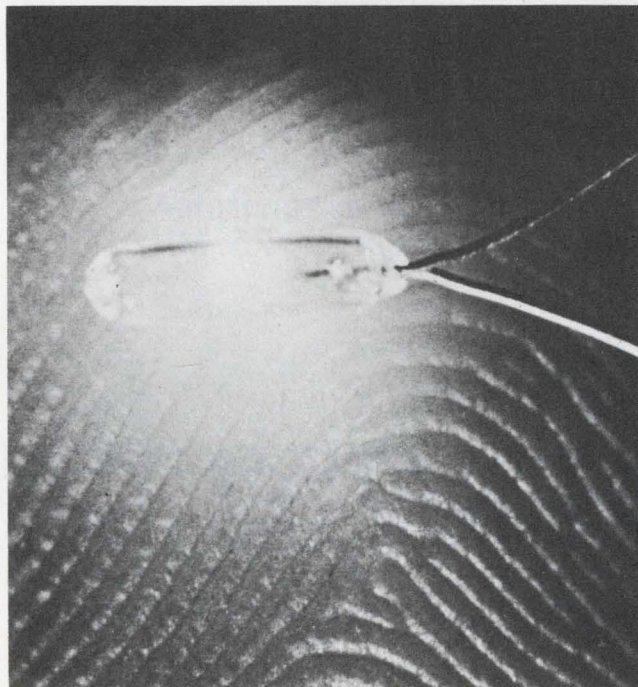

Dot-sized high-density lamps feature 0.054-in. diameter and 0.176-in. length, p. 162.

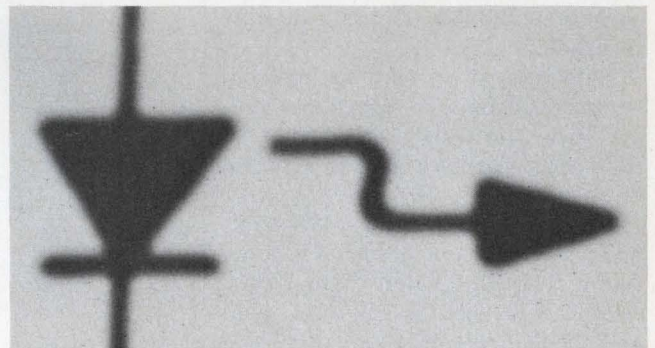

Optically coupled solid-state isolators can replace relays and transformers, p. 152.

Also in this section:

Quad transformer is packaged like dual-in-line IC, p. 164.

Modular op amp supply with 3/4-in. volume delivers 1-W output, p. 184.

Ribbon cable assemblies terminate in 14-pin DIP connectors, p. 190.

Design Aids, p. 204 . . . **Application Notes**, p. 206 . . . **New Literature**, p. 210

Now-plated wire challenges cores

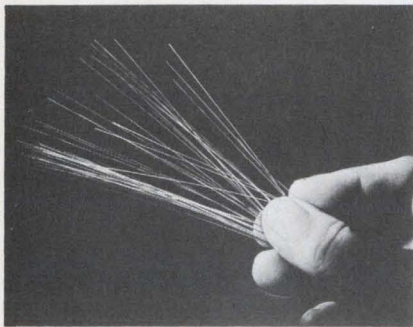

Indiana General Corp., Crows Mill Rd., Keasbey, N. J. 08832. Phone: (201) 826-5100. Price: \$15.25 per 16-in. piece in 500-1000 quantity; minimum order, \$200.

Plated wire has been touted as a potential competitor to ferrite cores for memories because it promises lower assembly cost, faster switching, higher density, and non-destructive readout. Up to now most designers couldn't try plated wire because developers used the materials only for proprietary projects.

Now, two types of plated wire suitable for memory fabrication are on the market. Indalloy I has a bit-write threshold of about 43 mA, and its low creep properties make it suitable for high-density packing and for unipolar pulse operation. Indalloy II has a 30-mA threshold.

Both consist of thin nickel-iron layers deposited on beryllium-copper wire with a 0.005-in. diameter. Resistance for both grades of wire is $1.6 \Omega \pm 10\%$ per foot.

Switching speed is 15 to 20 ns at 800-mA word and 50-mA bit currents for this plated wire. This compares to about 80 ns with read and write drive currents of about 800 mA for 12-mil OD ferrite cores.

Bits are stored in the plated wire by magnetization in the clockwise or counterclockwise directions. Reading is done by pulsing the word line in a word-organized memory. Then, in bipolar operation, 1 or 0 is represented by pulses of opposite polarity.

The wire is stress-sensitive so that careful assembly design is essential. Each piece has a 16-in. working length in addition to a 1/2-in. margin on each end for connection use.

CIRCLE NO. 250

Data input system uses disc storage



Logic Corp., Haddonfield, N.J. Price: \$6800/month rental.

The LC-720 data entry system is the computer industry's first data input system to use a direct keyboard-to-magnetic disc storage file. It consists of standard keyboard input terminals, a central processor that will simultaneously accept data from as many as 120 keyboards, and an IBM 2311 disc-pack drive. The addition of a magnetic disc gives the system the advantages of bulk storage and high-speed data access for computer entry.

CIRCLE NO. 251

Miniature memory stores 1300 bits

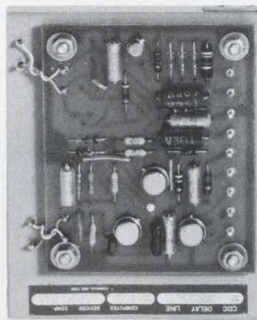

Computer Devices Corp., 63 Austin Blvd., Commack, N.Y. Phone: (516) 543-4220. P&A: \$150 ;stock.

Designed for use in small, electronic computers, calculators and digital interface devices, a miniature magnetostrictive memory features a storage capacity of 1300 bits and a bit rate of 1.6 MHz. Model MS 2119, which measures 4-by-3-1/4 by 1-in. is supplied complete with all input and output circuitry. Its input and output is compatible with DTL and TTL logic.

CIRCLE NO. 252

Digital computer uses MSI circuits

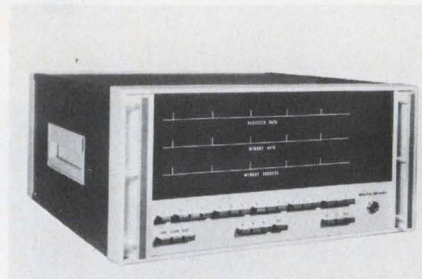

DataMate Computer Systems, Big Spring, Texas. Price: \$13,900.

Using standard ICs as well as MSI circuits, model 16 digital computer features a 4096-word $1\text{-}\mu\text{s}$ memory that is modularly expandable to 32,724 words. The 16-bit arithmetic fully-parallel processor also includes hardware multiply and divide, eight I/O channels with priority interrupts, and hardware index registers. Its flexible I/O bus accommodates up to 64 peripheral devices.

CIRCLE NO. 253

Data generator reps to 75 MHz

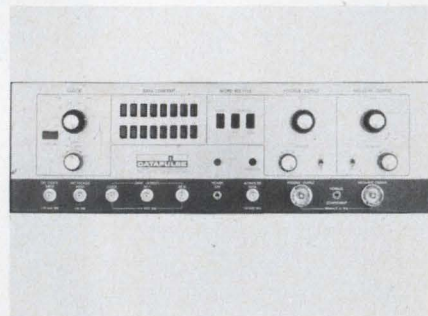

Systron-Donner Corp., Datapulse Div., 10150 W. Jefferson Blvd., Culver City, Calif. Phone: (213) 836-6100. P&A: \$2715; 4 wks.

With an internal clock rate as fast as 75 MHz, model 212 data generator provides narrow pulses with risetimes and falltimes of 1.3 ns. Data length for the unit is fixed at 16 bits, and the data content of each bit is determined by front-panel pushbuttons. There are simultaneous $\pm 5\text{-V}$ outputs and an independent dc offset that is variable from +2 to -2 V. Normal/complementary output functions are also selected from the front panel.

CIRCLE NO. 254

Sorensen modular power supplies

± 0.005% regulation **\$89⁰⁰**

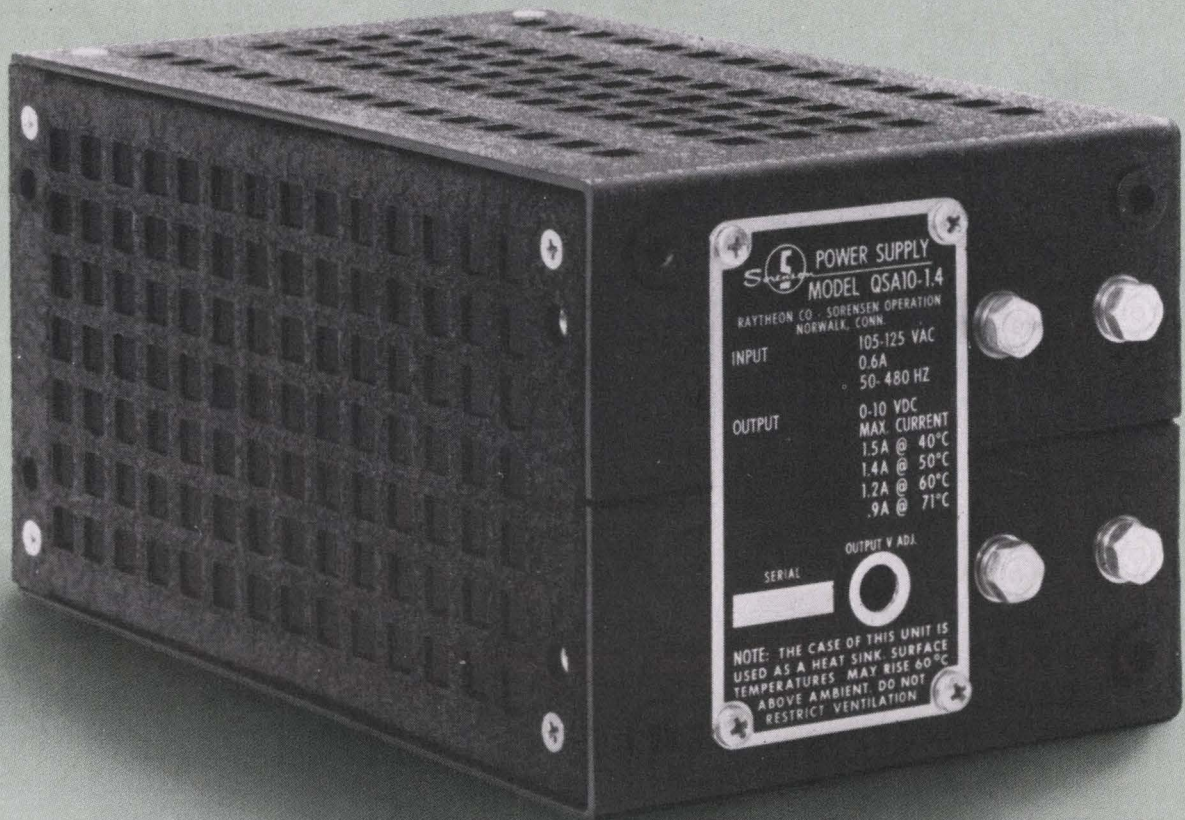

- Optional 10 μ sec. overvoltage protection.
- Requires no external heat sink in ambients to 71° C.
- 29 models—voltages to 330 Vdc at power levels to 300 watts.
- Remote programming—remote sensing—series/parallel operation.
- Overload and short circuit protection.
- Meets military specifications.

Model QSA 10-1.4, shown actual size, illustrates the compactness of the Sorensen QSA Series. These laboratory-grade, precision power sources are designed for OEM or system applications and utilize the latest solid-state regulating technology to provide a high degree of regulation and stability.

Sorensen produces 29 wide-range models, each with optional overvoltage protection. Other manufacturers require more than 100 models to cover the same area. By producing and stocking fewer models, Sorensen is able to provide better specifications, higher reliability, lower prices and "same-day shipments."

For more information contact your local Sorensen representative or; Raytheon Company, Sorensen Operation, Richards Ave., Norwalk, Conn. 06856. Tel.: 203-838-6571; TWX: 710-468-2940; TELEX: 96-5953.



Binary code converter handles 16 bits in 50 μ s



Northern Precision Labs., 202 Fairfield Rd., Fairfield, N.J. Phone: (201) 227-4800.

A binary-to-decimal converter translates 16-bit Gray code, V-scan or true binary inputs into decimal display within 50 μ s. A fixed-program computer, upon receipt of an update pulse, samples the input information and processes it via shift registers and control logic. At the end of the conversion process, the resulting BCD data can be used to drive a Nixie display and/or directly feed output buffers.

CIRCLE NO. 255

Graphic digitizer tapes pictures

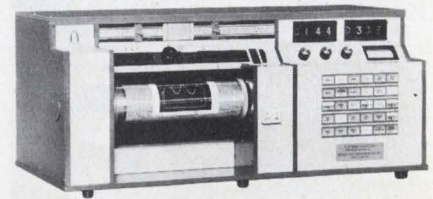

Aeroflex Laboratories, Inc., South Service Rd., Plainview, L.I., N.Y. Phone: (516) 694-6700.

A pictorial/graphic digitizer translates pictorial source material into computer language and records it directly on computer tape for subsequent data processing. The unit accommodates both graphic and photographic materials, either positive or negative, up to 8 by 10 in. in size. It has a resolution of 1000 lines per inch, an adjustable scanning aperture, bandwidth compression for graphic inputs, and a keyboard entry to record alphanumeric heading information.

CIRCLE NO. 256

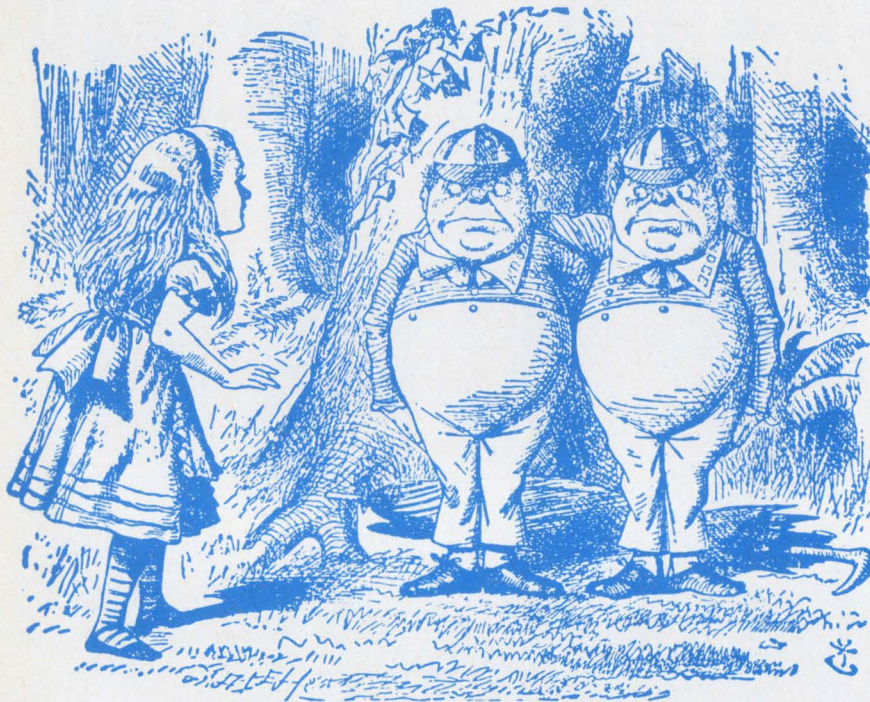

HOW to tell Tweedledum from Tweedledee.

We doubt that even "Alice" could distinguish our VR-3700 from our VR-3400. They each immodestly claim to be the best laboratory recorder for the money. But they look exactly alike. And they both offer the same fat advantages. Well, almost.

For example, their mutual reliability is unmatched by any competitive tape transport. Their recording heads are guaranteed to exceed 1000 hours. A failsafe capstan drive assures dramatically improved flutter and TDE



performance. Unsurpassed tape handling is realized by the use of linear, wide range servo controls. Plus—they share a host of other performance advantages unrivaled by any recorders in their class.

Then what's the difference between the two? The slightly costlier VR-3700 has a frequency range to 2.0 MHz. However, you may convert a VR-3400 to a VR-3700 by a simple exchange of electronics and heads.

Be it Tweedledum or Tweedledee—for further information, call or write Bell & Howell, Pasadena, California 91109. Ask for Bulletin Kit 3304-X1.

CEC/DATA INSTRUMENTS DIVISION



BELL & HOWELL

INFORMATION RETRIEVAL NUMBER 56



micro-pak™

Short on size, but long on life. The dot on the "i" is a life-sized picture of our newest transistor package, the Fairchild Micro-Pak. Just 80mils on a side, our Micro-Pak is the only plastic transistor in this size that passes rigid military reliability tests. Plastic, but with all the reliability of a metal can.

The high degree of shock resistance inherent in its inert single-block construction makes it ideal for warhead fuzes or missiles. Small, light and reliable, the Micro-Pak is the best way to go for applications from missiles to computers, submarines to satellites. And anything in-between.

Listed on the right are 26 popular transistor types available in the Micro-Pak. Electrical characteristics are similar to those of metal can equivalents. The transistors can operate with junction temperatures up to 175°C and dissipate up to 300mW doing it. Three radial ribbon leads make it easy to incorporate into PC board layouts, hybrid modules and other high density configurations. Write for full specifications.

Or, if you already know what you want, see your Fairchild distributor. He's got them in stock, in quantity.

FAIRCHILD
SEMICONDUCTOR

PART NUMBER	PRICE (100-999)	PART NUMBER	PRICE (100-999)
FX3299	1.60	FX2894A	3.00
FX3300	2.00	FX4960	6.00
FX3962	2.40	FX918	2.20
FX3963	3.20	FX2483	2.00
FX3964	3.20	FX2484	2.40
FX3965	3.70	FX709	2.00
FX3724	4.00	FX2368	1.20
FX3725	5.00	FX914	1.20
FX4046	3.00	FX2894	2.00
FX4047	4.00	FX4034	1.60
FX3013	5.00	FX4207	3.00
FX3014	3.00	FX3502	3.00
FX2369A	1.30	FX3503	5.00

FAIRCHILD SEMICONDUCTOR / A Division of Fairchild Camera and Instrument Corporation ■ 313 Fairchild Drive, Mountain View, California 94040, (415) 962-5011 ■ TWX: 910-379-6435

INFORMATION RETRIEVAL NUMBER 57

Ultimeter! *

A new building block for electronic derring-do

(it's not a meter-relay)

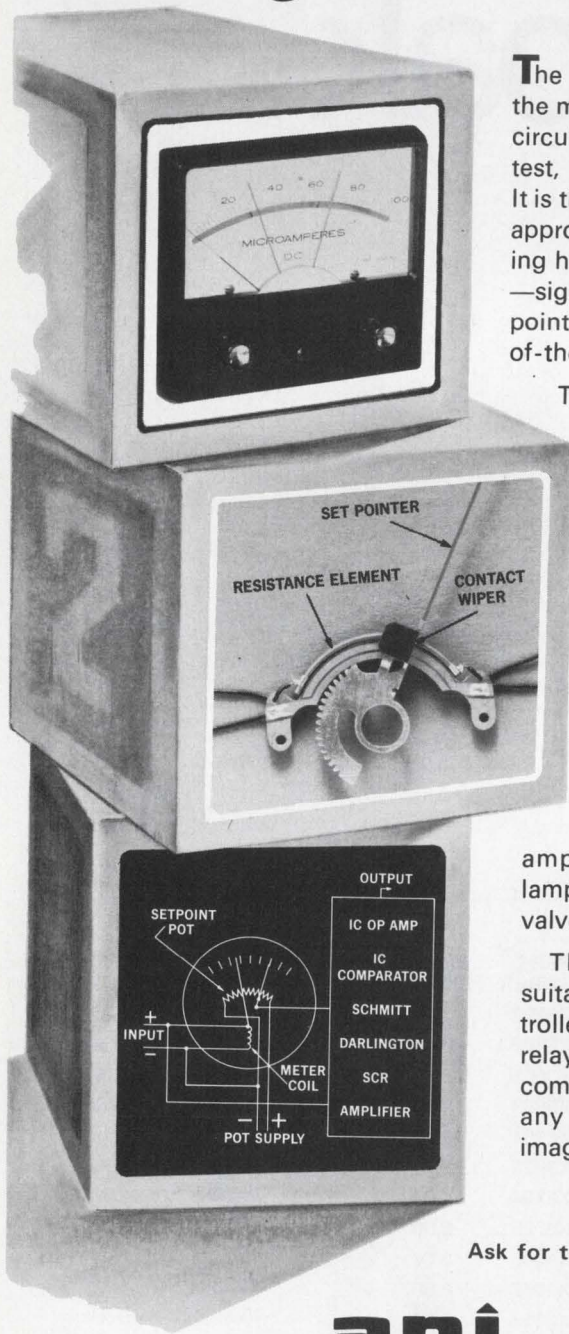

The Ultimeter helps you make the most of the latest integrated circuit techniques in control, test, or monitoring apparatus. It is the best and least expensive approach yet known for melding human engineering features—signal indication, easy set point adjustment—with state-of-the-art electronics.

The Ultimeter contains a 1 per cent linear meter movement and a 0.5 per cent linear potentiometer, both precisely calibrated to the same meter dial. Red set pointers actually operate the potentiometer contact wipers. You can readily team the Ultimeter with IC op amps, IC comparators, Schmitt triggers, Darlington's, SCR's or amplifiers. They can drive lamps, alarms, relays, motors, valves, power SCR's, etc.

These combinations are suitable for proportional controllers, indicating solid-state relays, simple panel loaders, component testing bridges, or any other application your imagination comes up with.

Ask for the full story in Bulletin 64.

IEEE Show Booth No. 2G-34

api INSTRUMENTS CO.

Chesterland, Ohio 44026 | (216) 729-1611

Incidentally, if all you need is simple On/Off control, API has pre-packaged relay output circuitry to go with the Ultimeter. This circuitry comes in an integral controller called Compact IV.

INFORMATION RETRIEVAL NUMBER 58

DATA PROCESSING

Wideband recorders operate at 2 MHz

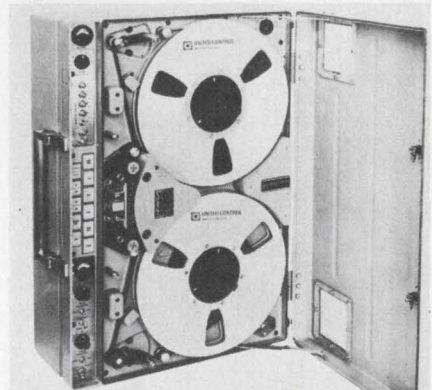

United Control Corp., Overlake Industrial Park, Redmond, Wash. Phone: (206) 885-3711.

Completely solid-state, series P-8000 portable wideband instrumentation recorders perform at frequencies of 2 MHz with tape speeds of 120 in./s. They use ferrite-core magnetic heads to achieve signal-to-noise ratios that are greater than 22 dB. Two configurations are available: the P-8007, a 7-channel recorder for 0.5-in. tape; and the P-8014, a 14-channel unit for 1-in. tape.

CIRCLE NO. 257

Digital intercouplers interface directly

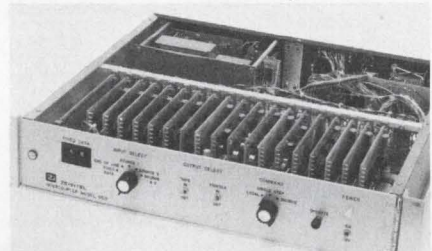

Zehntel, Inc., 1450 Sixth St., Berkeley, Calif. Phone: (415) 527-5440.

Designed to communicate with computer-compatible media such as punch cards, magnetic tape, punched tape and printers, a new line of intercouplers allows almost any digital measurement device to communicate directly or indirectly with a computer. The intercouplers can be assembled to permit more than one instrument or device to be multiplexed. In addition, the output format can be changed for manually introducing data.

CIRCLE NO. 258

*Pat. Pending

Flame retardancy!

that's not all you get
with **GE Silicone
Rubber Insulation**

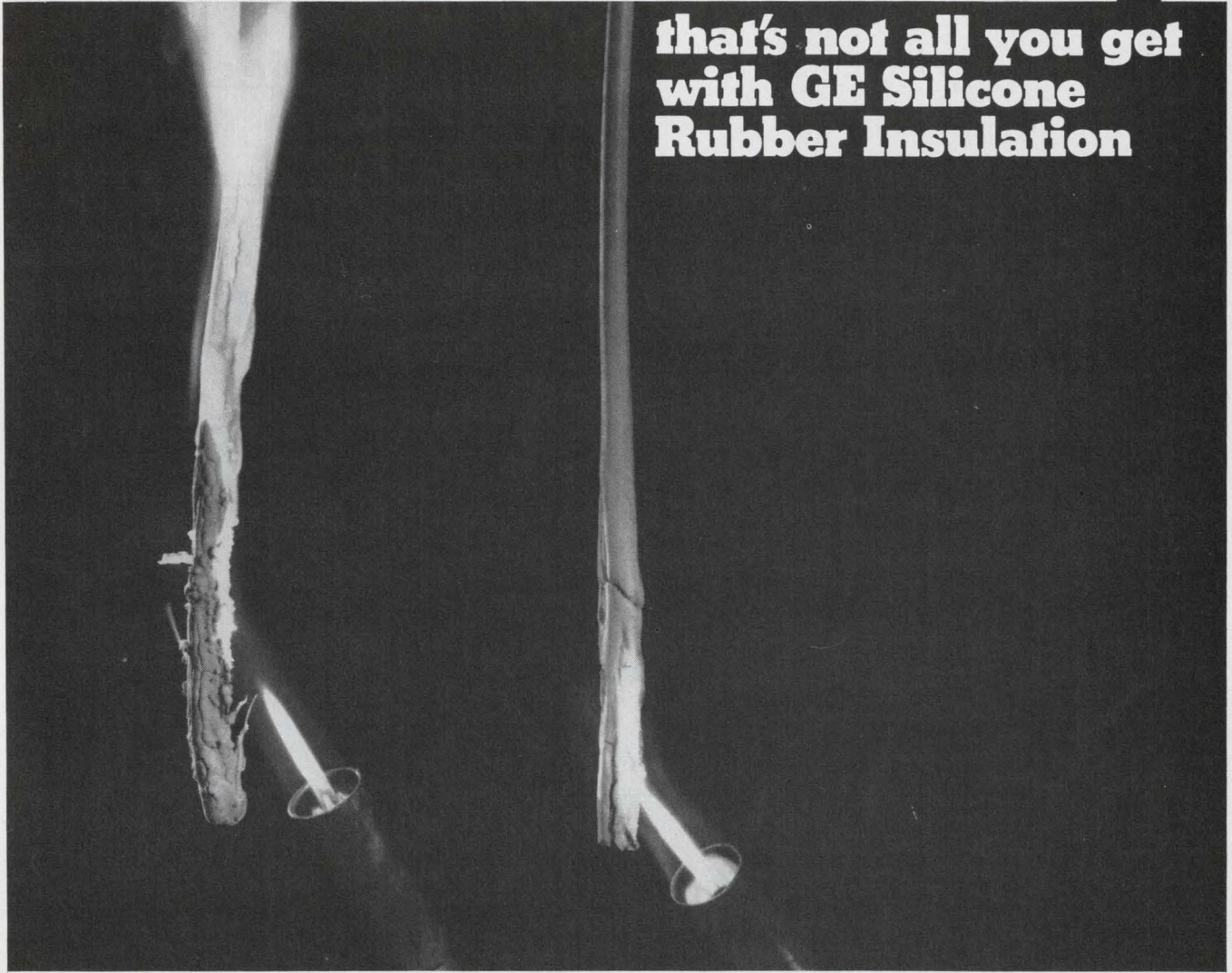

New ultra-tough SE-9090 braidless wire and cable insulation (right) doesn't support combustion like conventional insulation. It's shown here passing the UL vertical flame test. SE-9090 has both outstanding insulation resistance and dielectric strength.

The big news in silicone rubber this year is flame retardancy *plus* high physical strength.

But don't overlook the other design advantages of GE silicones: radiation, ozone, corona, and fungus resistance ... reliable performance from -150F to 600F ... and the proved dependability of silicones for the most demanding dielectric requirements. Weigh them all and you'll find that GE silicones offer the best combination of desirable values in insulation.

Versatile silicones take many shapes and forms to adapt to your specific problems. For a new booklet illustrating electronic applications for GE silicones, write Section L2294, General Electric Company, Waterford, N.Y. 12188.

GENERAL  **ELECTRIC**

Use GE flame-retardant silicones for...

Potting applications

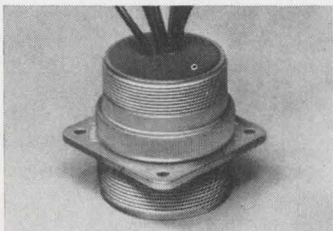

Conformal coatings



Wire & cable insulation

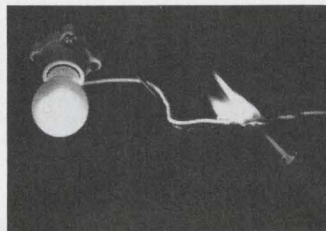

Fabricated parts

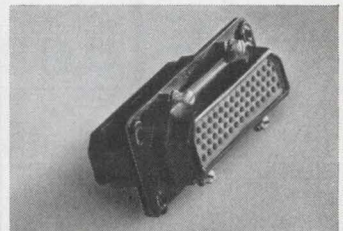

INFORMATION RETRIEVAL NUMBER 59

Using spot ties for
wire harnessing?

HERE IS THE
**GUDEBROD
SYSTEM "S"**

—SPEEDS THE WORK—SAVES MONEY, TOO!

GUDE-TIES CUT LENGTHS—Specifically produced for spot knotting these handy cut lengths of Gudebrod Flat Braided Lacing Tape are dispenser packaged for one hand, speedy withdrawal. Available in 6", 8", 10", 12", 15", 18", 20" and 22" lengths (other lengths on order). Meet or exceed MIL-T Specs, no-slip knots hold firmly without cutting insulation.

GUDE-SNIPS—These palm-of-the-hand snips cut cleanly, easily. For right or left hand use, spring action, DuPont Teflon bearing. Allow operator to have free use of fingers without constant reaching for knife or shears. Save motion, save time.

GUDEBROD SWIVEL-TILT HARNESS BOARD MOUNT—Balanced, two dimensional action brings every section of the harness within easy reach. No stretching, no straining. Knots are tied in an easy, natural position. Cuts fatigue—speeds work.

Here you have the Gudebrod System "S" for spot tie lacing, based on the high quality, high speed Gudebrod Lacing Tape—if you're interested in saving money while speeding the harness work, get in touch with us. (For continuous tying, ask about System "C".)



Available also in other types
of Gudebrod Lacing Tapes

GUDEBROD
Electronics Division

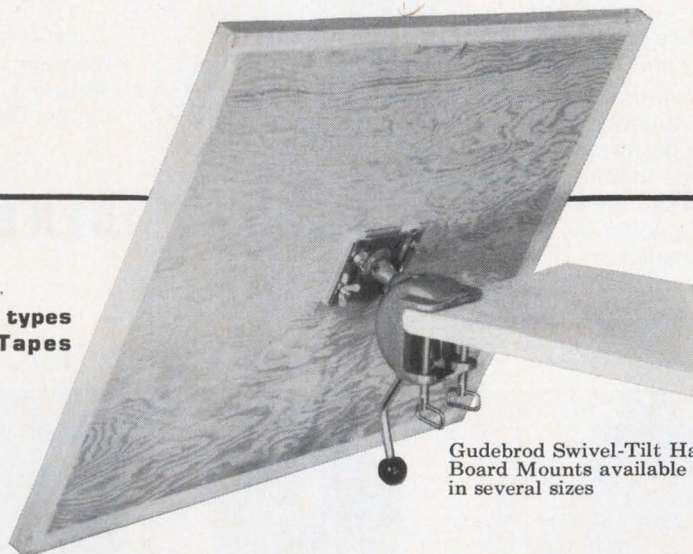

Gudebrod Swivel-Tilt Harness
Board Mounts available
in several sizes

GUDEBROD BROS. SILK CO., INC. Founded 1870, 12 South 12th Street, Philadelphia, Pa. 19107

INFORMATION RETRIEVAL NUMBER 60

Surgeons needed a battery for a "periscope"* that looks inside you.

Mallory made it.

What can we do for you?

Surgeons needed a battery. A battery to power an amazing instrument—a fiberoptics "periscope" that lets the surgeon's eye explore deep inside you by the light of a small power pack. A battery that could last through an operation. A battery that could be sealed in a power pack and autoclaved, sterilized by steam and pressure.

Mallory made it. The battery—a Mallory mercury battery. It packs enough power for hours of operation into a cylinder less than an inch wide and not much more than two inches tall. It is completely sealed and spark-free. And in the power pack it can be steam-sterilized at 320° F for a period of 30 minutes without harm.



4.05 volt 3-cell Mallory mercury battery made for MPC power packs.

SEALED POWER

Not too long ago the thought of a "battery" in an operating instrument would have given surgeons the shudders. "Batteries" were unreliable for use inside the body. They couldn't be sterilized. They were too bulky. All that changed. As you can see from the cutaway, a Mallory

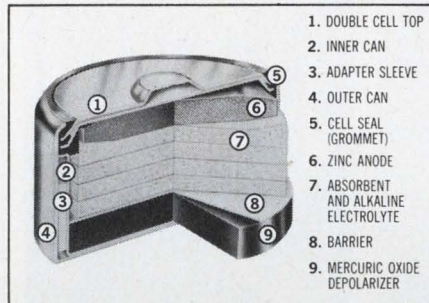

mercury cell has a double steel jacket, and a grommet that can withstand internal pressures up to 300 psi. Potted in epoxy, these cells have performed reliably powering heart pace-makers and other medical-electronic devices actually implanted in the body for years. Ordinary batteries may have no place in the operating room. It's clear that Mallory mercury batteries do.

OVER 1000 DIFFERENT TYPES

Chances are Mallory has the battery you need already in production. Right now we're making over 1000 different types and sizes. And if we're not actually producing the one you need, we'll be glad to sit down with you to design one to your specifications.

For more information, please write Technical Sales Department, Mallory Battery Company, a division of P. R. Mallory & Co. Inc., South Broadway, Tarrytown, New York 10591. Telephone: 914-591-7000. (In Canada: Mallory Battery Company of Canada Limited, Sheridan Park, Ontario.)

It's good business to do business with Mallory

MALLORY



*Goldberg Mediastinoscope by Medical Products Corporation, Skokie, Illinois

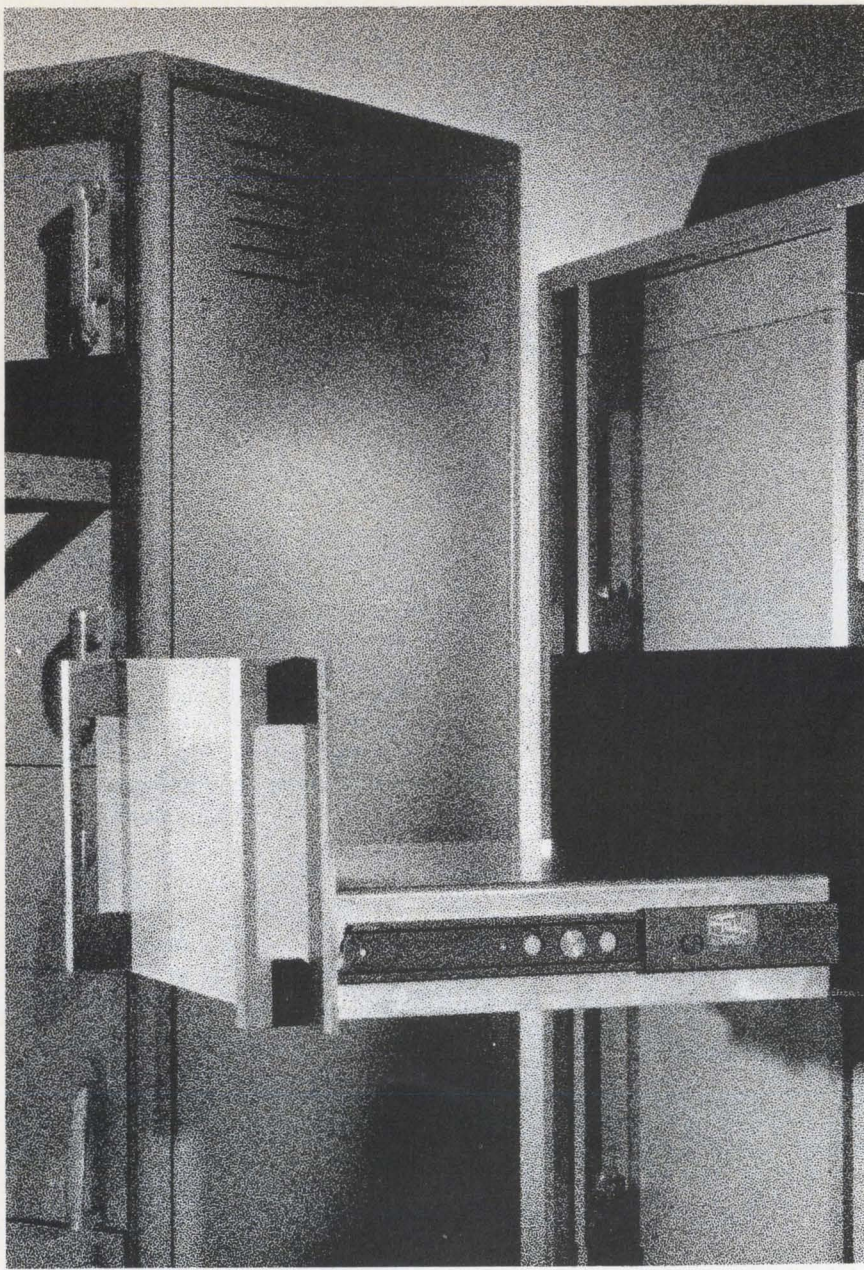

This slide is a real steel

See us at **NepCon**
BOOTH 144

Chassis-Trak Slides are made of hard, cold-rolled steel for maximum strength and cadmium-plated for extra corrosion resistance. Smooth operation is possible because it is coated with Poxylube 75 dry-film lubricant that actually works better the more you use it.

Chassis-Trak Slides are available in 16 models with weight capacities up to

1000 lbs. in non-tilt, tilt, and tilt-dependent designs. Pencil-thin Chassis-Trak design permits installation of standard 17" chassis in standard 19" panel racks without modification. Chassis-Trak steel slides are available from stock for fast delivery at quotations that are something of a steal also. Let Chassis-Trak quote on your job.

A package for every Major Missile Project from . . .
525 South Webster Ave., Indianapolis, Indiana

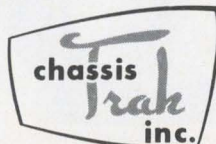

INFORMATION RETRIEVAL NUMBER 62

DATA PROCESSING

Digital system monitors computer



Heuristic Systems Div., Allied Computer Technology, P.O. Box 3262, Santa Monica, Calif. Phone: (213) 884-9741.

Primarily designed for use with IBM System/360, 1130 and 1800 computers, a computer performance monitor identifies system imbalances, monitors system utilization, locates performance bottlenecks and provides the information necessary to improve and maintain the efficiency of a data processing system. This general-purpose digital measurement unit features plug-board Boolean logic capability and an integrated magnetic-tape data recording system.

CIRCLE NO. 259

Diaphragm logic kit simplifies design

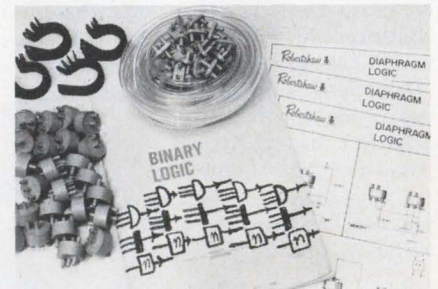

Robertshaw Controls Co., 1026 N. Main, Gashen, Ind. Phone: (219) 533-4111. Price: \$150.

Building digital logic circuits can now be simplified with a new diaphragm logic kit that includes logic valves, mounting brackets, tees, tubing, restrictors, a course in binary logic, and a set of logic circuit diagrams. The valves, which operate with pressures of 10 to 25 psi, can be used singly or in multiples to perform any logic function.

CIRCLE NO. 260

~~Now \$3.97~~ **NOW \$3.47**
The biggest little \$3.97 precision 10-turn wirewound pot in the world!

The Duncan "PIXIEPOT" potentiometer gives you the big features at a little price. It is the one and only precision 10-turn miniature pot for under \$4 that has all these features: □ Length: ONLY 3/4" □ Diameter: ONLY 7/8" □ Linearity: ±0.25% □ Resistance Range: 100 ohms to 100K ohms □ Power Rating: 2 watts @ +20°C □ Temperature Range: -25°C to +85°C □ Resolution: Better than ANY wirewound pot TWICE its size □ Slotted Stainless Steel Shaft/C ring □ Now you can save big dollars on your instrument and system requirements. Specify Model 3253 "PIXIEPOT" for as low as \$3.97 each in production quantities and only \$5.95 each for 1-9 units. In-stock delivery, of course. Call, write or wire Duncan today for complete specifications and the name of your nearest distributor.

~~Now \$4.95~~
NOW \$4.95

SAVE EVEN MORE!
 Buy Pixiepots in a combination package with Model 61 miniature turns-counting dials at one super-budget price!
under \$7.00
 production quantities



"PIXIEPOT"
TM

**little price,
 big features**



  
DUNCAN electronics, inc.
 A DIVISION OF SYSTRON-DONNER CORPORATION
 2865 FAIRVIEW ROAD,
 COSTA MESA, CALIFORNIA 92626
 Phone: (714) 545-8261

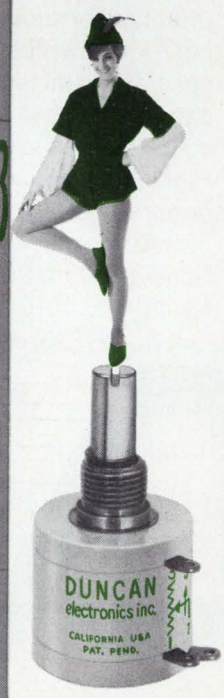

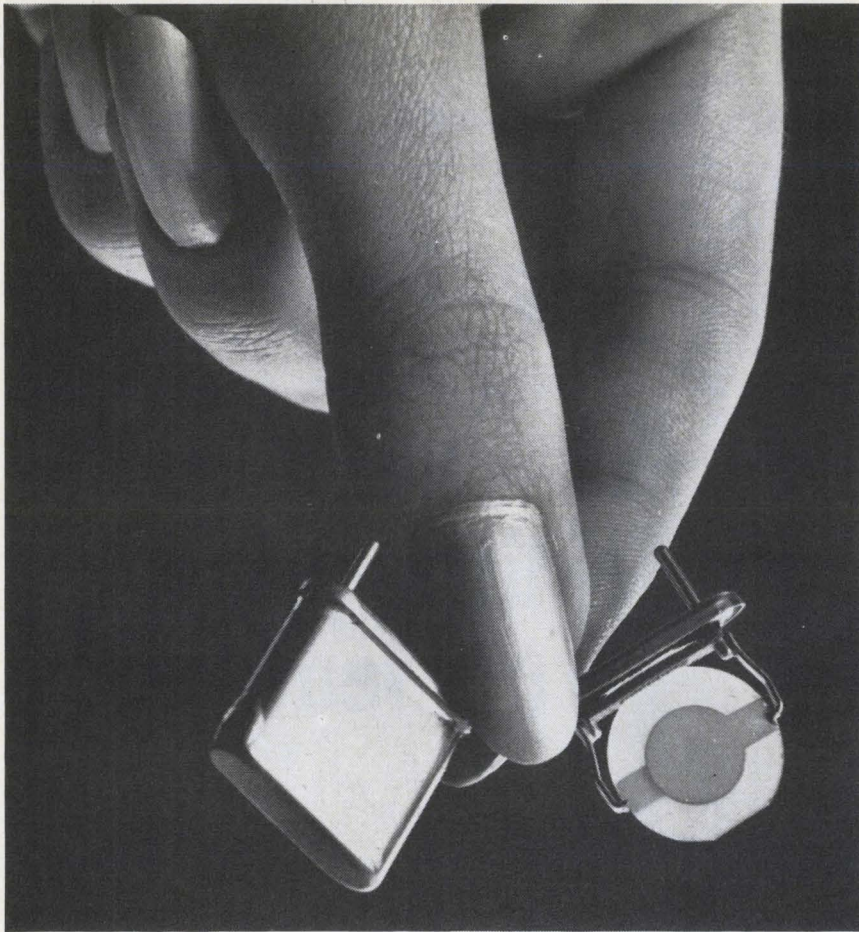

How do you get fast service on special, short-order or prototype crystals?

Tune Sherold in.

We've got the advanced crystal technology to analyze your unique crystal problems, design the solution, and manufacture a prototype or short order — quickly. And we have the facilities to put it into low-cost quantity production, too. No matter what special crystal techniques your application requires, Sherold can produce it in the 4 kHz to 175 megaHz range. Solder seal, cold weld, resistance weld or glass fusing. Custom packaging. High shock and vibration MIL specs. And we have several plants geographically located to give you this special crystal technology assistance quickly and locally. Tune us in on your problem. Send details to Sherold Crystal Products Group, Tyco Laboratories, Inc., 1510 McGee Trafficway, Kansas City, Missouri 64108. Or phone (816) 842-9792. TWX 910-771-2181.

TYCO

INFORMATION RETRIEVAL NUMBER 64

DATA PROCESSING

Tape transport records 9 tracks

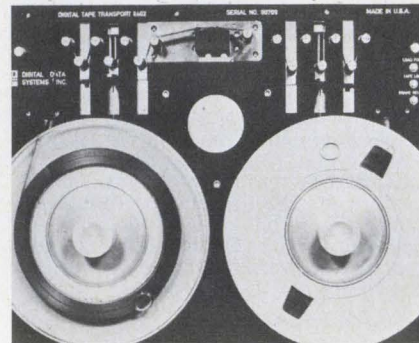

Digital Data Systems, Inc., 7415 Hillcroft Ave., Houston, Tex. Phone: (713) 771-3583. Price: from \$7500.

The 640 capstan-drive tape transport records digital data on 0.5-in. tape in seven- or nine-track IBM-compatible format. It is light enough to be carried easily by one person; for fixed installations, it mounts readily into standard 19-in. equipment racks. Precise speed control is maintained by a servo system that allows manual or programmed speed changes without pulleys, gears, or belts.

CIRCLE NO. 261

Calculating system cuts analysis time

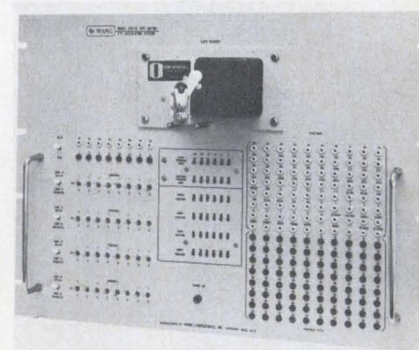

Wang Laboratories, Inc., 836 North St., Tewksbury, Mass. Phone: (617) 851-7311.

Model 379-19 is a new calculating system for the off-line reduction of data from analytical instruments. Using a patch-panel input arrangement, it has abundant computing power for long programs and extra data storage capacity, and accepts a variety of output devices.

CIRCLE NO. 262

INFORMATION RETRIEVAL NUMBER 65 ►

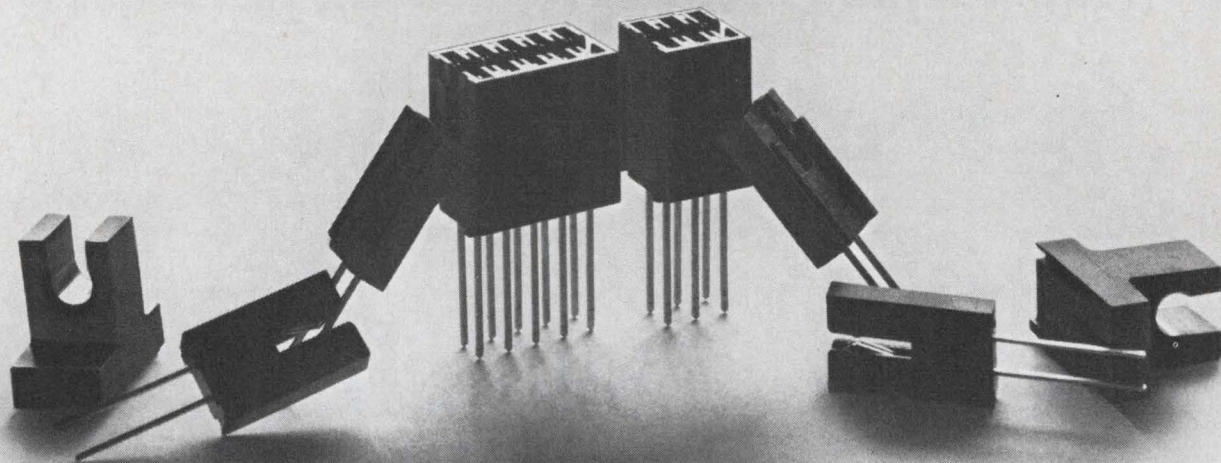

When you make a connector like this, it pays to give it away.

That's exactly what we are doing because it's such a handy design tool.

Sylvania's segmented connector gives you a building block approach to breadboarding and prototyping.

It allows you to build up exactly the single-position circuit-board connector to fit your job.

Just put together as many segments as you need.

Use it for actual circuit wiring and for mechanical layout.

When you have your final design, call Sylvania for fast production on connectors that will meet your exact specifications.

That way, you will get the benefits of Sylvania's long experience in custom connectors. Such benefits as our special gold-dot contact design that minimizes contact resistance and lowers cost.

You also get Sylvania's precision construction that puts connector terminals exactly where they're needed for programmed wiring systems.

For your own connector kit write on letterhead to M. Gustafson, Sylvania Metals and Chemicals, Parts Div., 12 Second Ave., Warren, Pa. 16365. Your kit will be sent by return mail. As a bonus, we'll throw in data sheets on our new off-the-shelf connector line.

CONNECTORS BY
SYLVANIA
A DIVISION OF
GENERAL TELEPHONE & ELECTRONICS

Why does Sealectro make such a wide variety of programming devices?

Just so we can give you the little things that count and switch and control and read and program and...

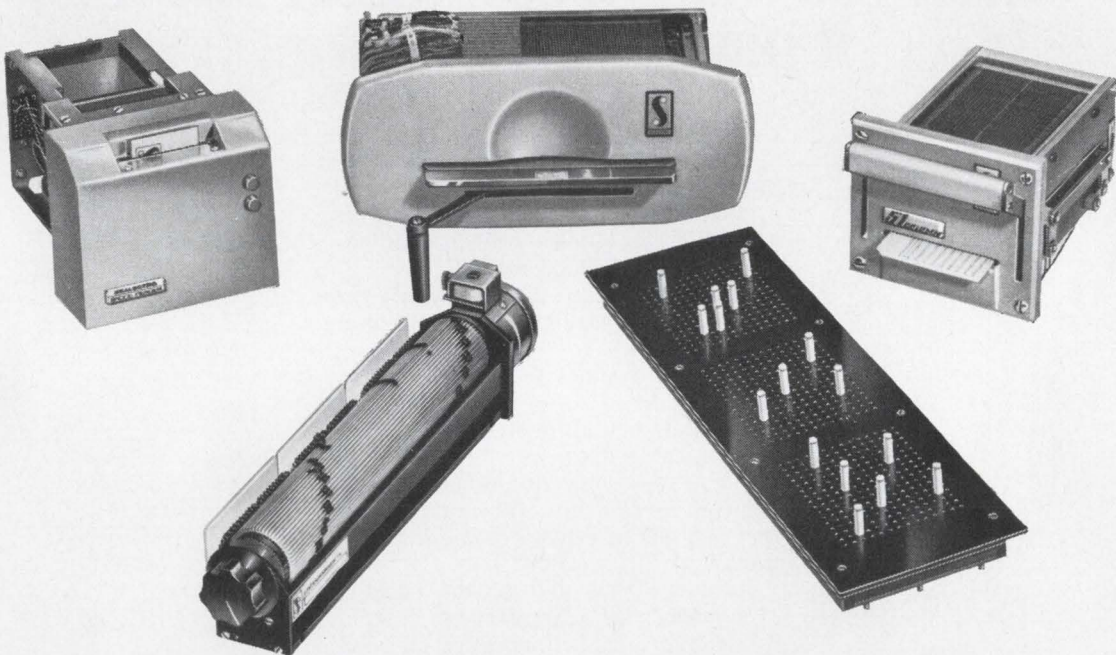

meet every programming requirement. Sealectrocard™ 10 x 10 Badge Readers, 51 x 12 Tab Readers and 80 x 12 Card Readers designed for maximum versatility... they just work and work and work. Sealectroboard™ programming boards for all types of programming, switching,

and program display — in any conceivable configuration. Sealectroswitch™ field-adjustable programming switches for timing and control or just plain switching.

It's the little things that count in programming and Sealectro provides every one of them.

Write or call to hear about our complete line.



PROGRAMMING DEVICES DIVISION

SEALECTRO
CORPORATION

MAMARONECK • NEW YORK

PHONE: 914 698-5600 TWX: 710-566-1110

Sealectro Ltd. Portsmouth, Hants, England

Sealectro S.A. Villiers-le-Bel, Paris, France

INFORMATION RETRIEVAL NUMBER 66

TRW 5-WATT - 2 GIGAHERTZ MICROWAVE TRANSISTOR

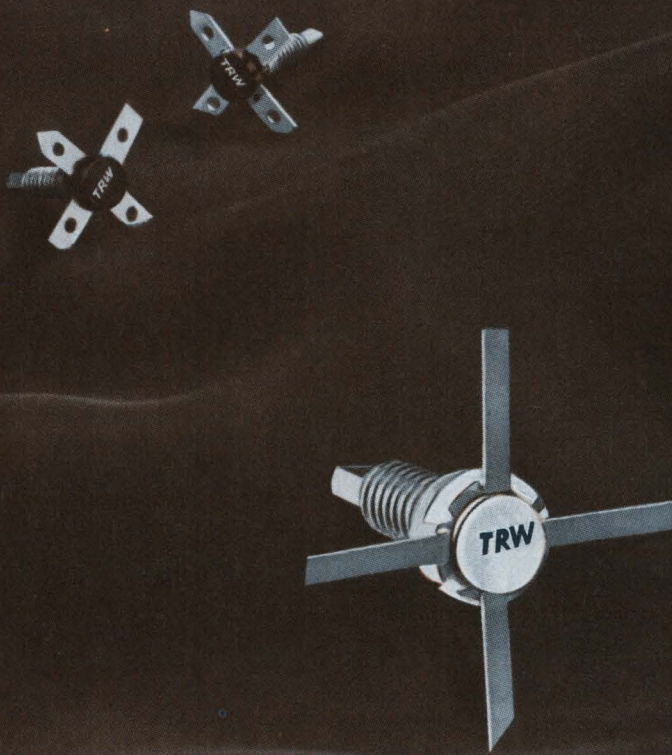

28 volts...33% efficiency...stripline design

A 5 watt 2 GHz microwave transistor in a hermetically sealed ultra-ceramic stripline package!

The new TRW 2N5483 provides 4 db gain at 2 GHz with 33% efficiency in simple, straightforward circuits. Two new companion transistors for input and driver stages deliver 1 watt at 6dB and 2.5 watts

at 5 dB. All operate from a 28V source.

Delivery is immediate... in production quantities. Order from the factory or any TRW distributor.

For complete information and applications assistance contact TRW Semiconductors, 14520 Aviation Blvd., Lawndale, California

90260. Phone: (213) 679-4561. TWX: 910-325-6206. TRW Semiconductors Inc. is a subsidiary of TRW INC.

TRW[®]

INFORMATION RETRIEVAL NUMBER 67

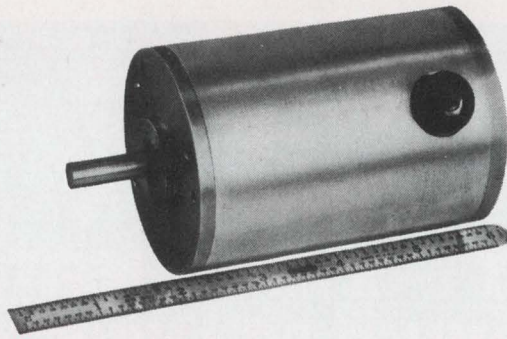

Now that we've cut the cost, size and weight of landing gear motors...

what can we do for you?

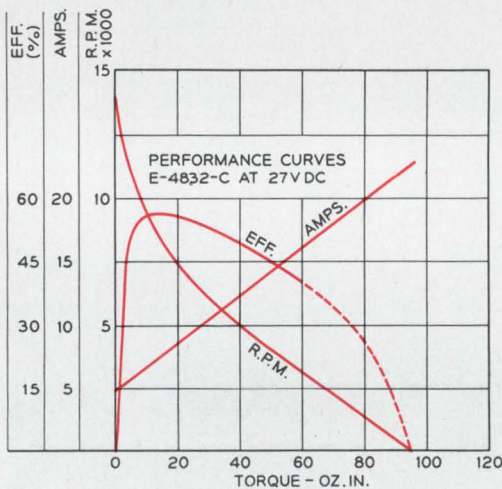

By making an engineering analysis of the customer's application Lamb Electric was able to design a complete gearmotor assembly (utilizing the motor described above) for an aircraft manufacturer who previously purchased and assembled motors, gear reducers, couplings, and base plates. In this way Lamb was able to reduce the size, the weight, the cost, and, more importantly, the chance of failure, of the total landing gear assembly.

This extremely successful design solution was made possible by Lamb's extensive engineering and manufacturing capability! Besides our complete line of fractional horsepower DC motors designed to meet commercial and MIL spec requirements and our line of gear reducers, an extensive stock of standard modular components is maintained. In addition, Lamb has an applications engineering group set up to work closely with the customer in analyzing his needs and applying the existing modular devices whenever possible.

Very few motor designers and manufacturers can match Lamb's success because few have Lamb's extensive capabilities. If you have a "need" may we assist you in solving it by evaluating the applicational requirements through an engineering analysis? Call us at (216) 673-3451 or write: Ametek, Inc., Lamb Electric Division, Kent, Ohio 44240.

AMETEK / Lamb Electric



INFORMATION RETRIEVAL NUMBER 68

DATA PROCESSING

Graphic digitizer scans lines and points



Calma Co., 707 Kifer Road, Sunnyvale, Calif. Phone: (408) 244-0960. Price: \$39,500.

Designed for transferring graphic data directly to magnetic tape for computer processing and analysis, an analog-to-digital system is capable of digitizing both lines and points simultaneously. Model 485 offers effortless data reduction from such graphic presentations as motion analysis films, templates, and X-ray patterns.

CIRCLE NO. 263

Computer cables link 50 channels

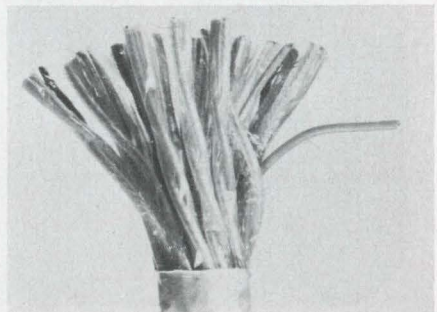

Dynatronic Engineering Corp., 128 San Fernando Road, Los Angeles. Phone: (213) 255-5611.

Designed for connecting computers with their peripheral equipment, series D-200 cables provide up to 50 simultaneous channels for transmitting pulsed digital signals with fast risetimes and extremely low crosstalk. The multiple-pair cables can be used for both balanced and single-ended systems without individual shields on each cabled pair.

CIRCLE NO. 264

Eight good reasons for specifying Sperry C and X band traveling wave amplifiers

If you're working on radar, communications or ECM systems at C or X band frequencies, investigate Sperry's newest developments — the STC-5210 (4 to 7 GHz) and the STX-5220 (7 to 11 GHz). Here are eight good reasons why these tubes belong in your system:

1. Output Power: These tubes deliver 200 watts CW minimum across their entire bandwidth and 250 watts CW minimum across any 25% of the band.

2. Extended Bandwidth: The STX-5224 delivers 200 watts minimum from 7 to 11 GHz, 100 watts minimum to 12.4 GHz and 50 watts minimum to 13.4 GHz.

3. Efficiency: The STC-5210 and STX-5220 have a minimum beam efficiency of 21%.

4. Pulse Performance: More than 350 watts of output across C band and 300 watts across X band. Both at 5% duty cycle.

5. Matched Power Supplies: Simplify your applications task — take delivery with the tube/power supply interface already made. Sperry's power supply comes in a 4" x 7" x 15" package weighing just 22 lbs. It's all solid-state, 82% efficient, and qualified to MIL-E-5400, Class II. Your choice of 400 cycle AC or 28 VDC input.

6. Weight: Tubes weigh 6 lbs.; power supplies weigh 22 lbs., maximum.

7. Cooling: Specify conduction or forced air cooling at no additional cost.

8. Environmental Qualification: Tubes and power supplies are designed to meet the most stringent MIL requirements.

Get more information on these outstanding TWT amplifiers. Contact your Cain & Co. man or write Sperry Electronic Tube Division, Gainesville, Florida.



SPERRY
ELECTRONIC TUBE DIVISION
GAINESVILLE, FLORIDA



MICROWAVE PROS!



Tell us about your engineering degree(s) and your five or more years of microwave tube experience. Let us tell you about exciting work, educational opportunity and pleasant living in one of America's most attractive university cities. Resume, please, to Walt Thomas, Director of Industrial Relations. (An equal opportunity employer, M&F.)

INFORMATION RETRIEVAL NUMBER 69

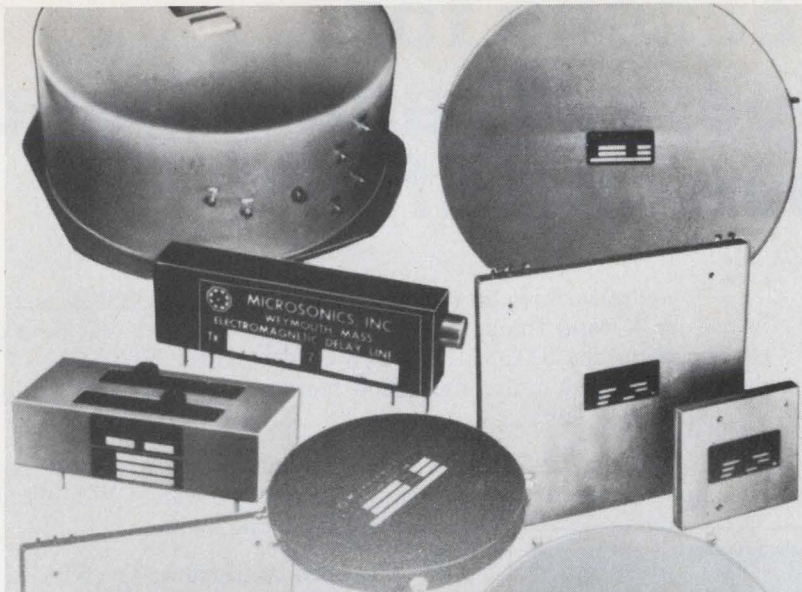

LC & DC • DISPERSIVE • DIGITAL
 MAGNETOSTRICTIVE • QUARTZ
 GLASS • VARIABLE • TAPPED
 LC & DC • DISPERSIVE • DIGITAL
 MAGNETOSTRICTIVE • QUARTZ
 GLASS • VARIABLE • TAPPED
 LC & DC • DISPERSIVE • DIGITAL
 MAGNETOSTRICTIVE • QUARTZ
 GLASS • VARIABLE • TAPPED
 LC & DC • DISPERSIVE • DIGITAL
 MAGNETOSTRICTIVE • QUARTZ
 GLASS • VARIABLE • TAPPED
 LC & DC • DISPERSIVE • DIGITAL

MICROSONICS

*for proven design, reliability &
 performance in*

DELAY LINES

Serial Memories



Write for Bulletins today

MICROSONICS

60 Winter Street, Weymouth, Mass. 02188

Tel: 617 337-4200

A division of the Sangamo Electric Company

ICS & SEMICONDUCTORS

Solid-state isolators couple optically

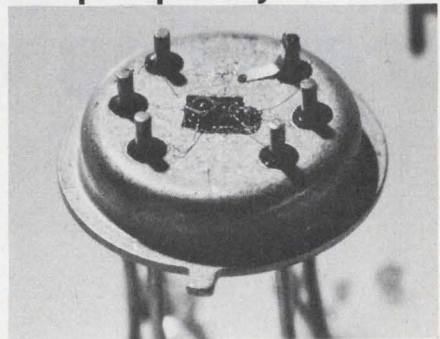

Texas Instruments Inc., Components Group, 13500 N. Central Expressway, Dallas. Phone: (214) 238-3741. P&A: \$40 or \$75; stock.

Capable of replacing low-power relays and transformers, two new, high-gain, solid-state isolators use optical coupling to achieve high reliability and long device life by eliminating moving parts and fragile wiring. They operate 1000 times faster than mechanical relays and, unlike transformers, have a low-frequency response that extends to dc.

Designated TIXL102 and TIXL103, the new isolators can often reduce the need for other circuitry in such applications as voltage regulators, actuator switches and logic arrangements. In addition, they are useful in linear circuits because of their linear response to input current.

Functionally, these optically coupled isolators are similar to relays and transformers because they offer a pair of input and output terminals with a high degree of electrical isolation, ± 100 V. Instead of using a magnetic field for signal transfer, however, these devices operate through internal light coupling.

They contain gallium-arsenide light-emitting diodes that operate in the near-infrared region, with wavelengths of about 0.9 microns. Emitted light is absorbed by a photo-transistor, thereby providing conduction between output leads.

The new devices have an internal resistance of greater than 10^6 M Ω and a capacitance of 4 pF. Typical over-all current gains are 0.6 for the TIXL102 and 1.4 for the TIXL103. Both units are packaged in 6-lead TO-5 metal cans.

CIRCLE NO. 265

Helipot building blocks stack up to more convenience and economy.

Helipot's wide and expanding selection of *standard hybrid cermet microcircuits*—locally stocked throughout the country—give you reliable, inexpensive, off-the-shelf solutions to your complex design problems. In addition, Helipot building blocks help eliminate expensive design time and reduce purchasing, stocking, and production to their minimums. Whatever your need, you'll be interested in the new 48-page *Helipot Microcircuits Catalog*. For your copy, simply send a request on your company letterhead.

Beckman®

INSTRUMENTS, INC.
HELIPOT DIVISION

2500 HARBOR BOULEVARD
FULLERTON, CALIFORNIA • 92634

INTERNATIONAL SUBSIDIARIES: AMSTERDAM; CAPE TOWN; GENEVA; GLENROTHES, SCOTLAND;
LONDON; MEXICO CITY; MUNICH; PARIS; STOCKHOLM; TOKYO; VIENNA

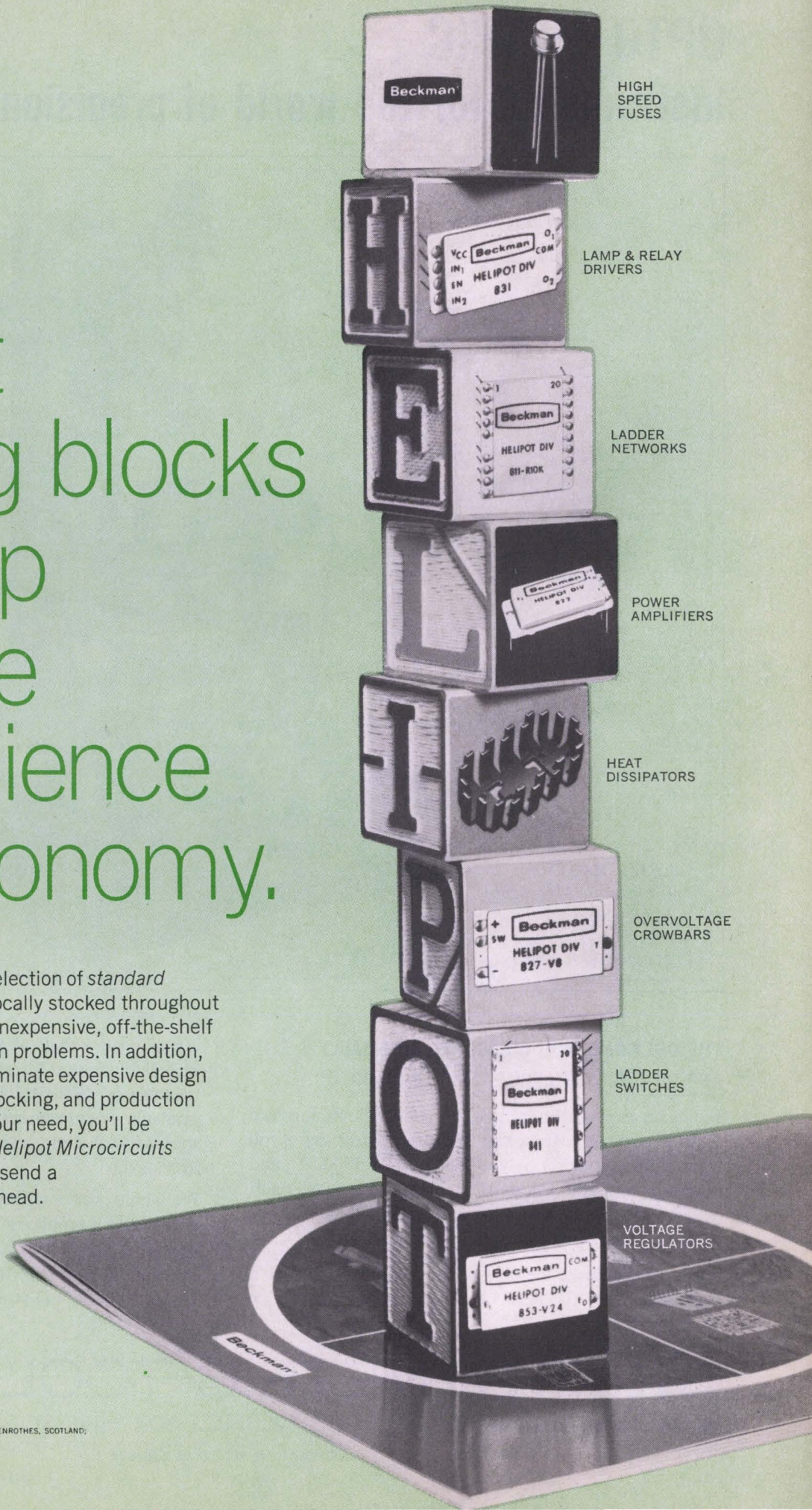

OPTO-METRIC

Instruments for the world of precision measurement

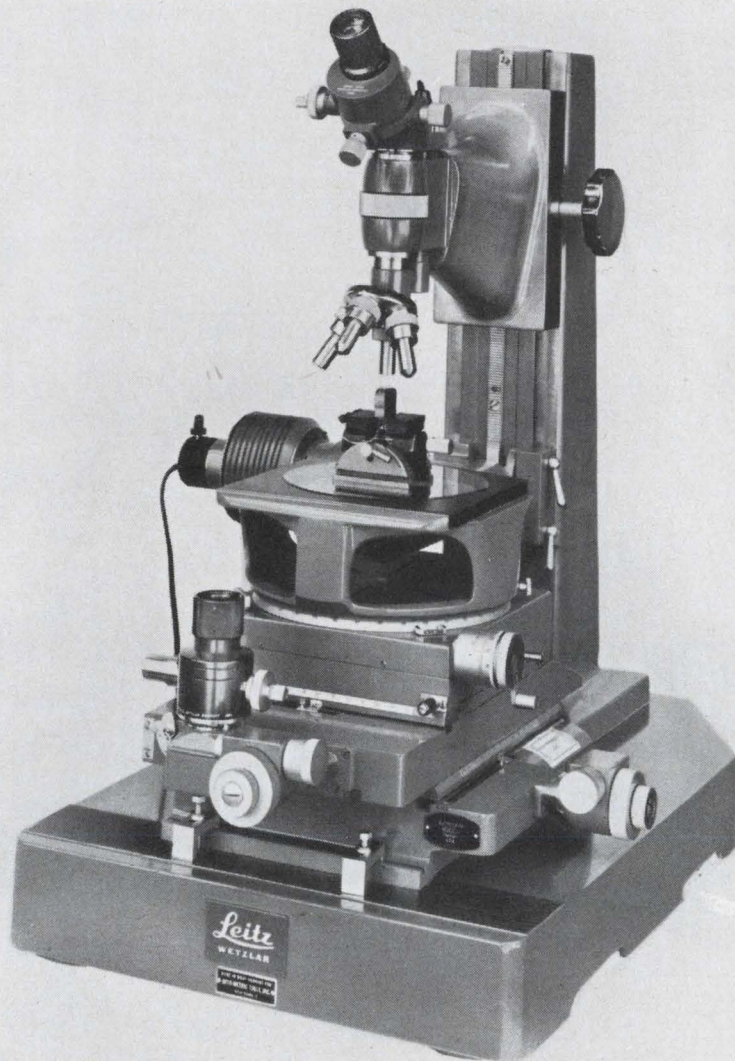

*LEITZ KM-150
Coordinate Measuring
Microscope
with 6" x 6"
Measuring Range*

THE ONLY ONE THAT MEASURES SO SMALL... AND SO BIG...SO ACCURATELY IN .000020"

Filling an important need in today's technology, this new Leitz Coordinate Measuring Microscope features a full 6" x 6" measuring range, with readings in .000020", and microscope magnifications up to 600 diameters. All readings are from illuminated, wear-free optical glass scales for simplified observations and permanent accuracy.

Both coordinates of the 6" x 6" stage are read through a single eyepiece—.000020" graduations can actually be

interpolated to half of this. The microscope tube has a completely optical Micrometer Measuring Eyepiece, with readings in .00005", .000025" and .000016" for the available magnifications of 200X, 400X and 600X, respectively. A certificate of accuracy accompanies each instrument.

We would welcome the opportunity to help with your measurement problems. Whether for R&D or production control, Opto-Metric has an instrument to meet your exacting needs. Write for an Opto-Metric Catalog, c/o Technical Service Division.

01266

OPTO-METRIC TOOLS, INC. 
A SUBSIDIARY OF E. LEITZ, INC., 304 HUDSON ST., N.Y., N.Y. 10013

INFORMATION RETRIEVAL NUMBER 72

these BURR-BROWN op amps out-perform look-alike units

You can put Burr-Brown quality in your economy-minded applications for as little as \$11.25. In fact, there's a whole series of Burr-Brown operational amplifiers which includes units specifically designed for engineers facing tight budget restrictions as well as premium units for more critical applications.

Each amplifier has been carefully engineered from the leads up to give you maximum performance at competitive prices . . . without sacrificing Burr-Brown's usual high quality standards. Even the 7-pin and 9-pin encapsulated packages are new.

MODEL NO.	KEY SPECIFICATIONS	100 UNIT PRICE
3077/12C	Lowest Price — a general purpose ± 10 V, ± 5 mA, 7-pin unit. Drift: $\pm 10 \mu\text{V}/^\circ\text{C}$ and $0.5 \text{ nA}/^\circ\text{C}$.	\$11.25
3119/12C	General Purpose — ± 10 V, ± 10 mA output. Drift: $\pm 10 \mu\text{V}/^\circ\text{C}$ and $\pm 0.5 \text{ nA}/^\circ\text{C}$. 7-pin package.	\$14.25
3118/12C	General Purpose — ± 10 V, ± 10 mA output. Drift: $\pm 5 \mu\text{V}/^\circ\text{C}$ and $\pm 0.4 \text{ nA}/^\circ\text{C}$. 7-pin package.	\$18.75
3117/12C	General Purpose — ± 10 V, ± 10 mA output. Drift: $\pm 2 \mu\text{V}/^\circ\text{C}$ and $\pm 0.2 \text{ nA}/^\circ\text{C}$. 7-pin package.	\$26.25
3104A/12C	FET Input — ± 10 V, ± 5 mA output. $\pm 10 \mu\text{V}/^\circ\text{C}$ drift. Input bias current: $\pm 0.01 \text{ nA}$. 7-pin package.	\$21.75
3116/12C	FET Input — ± 10 V, ± 10 mA output. $\pm 15 \mu\text{V}/^\circ\text{C}$ drift. Input bias current: $\pm 0.01 \text{ nA}$. 9-pin package.	\$26.25
3064/12C	FET Input, Wideband — ± 10 V, ± 10 mA output. $\pm 15 \mu\text{V}/^\circ\text{C}$ drift. 5 MHz bandwidth. 9-pin package.	\$33.75
3115/12C	FET Input — ± 10 V, ± 10 mA output. $\pm 8 \mu\text{V}/^\circ\text{C}$ drift. Input bias current: $\pm 0.01 \text{ nA}$. 9-pin package.	\$45.00
3114/12C	FET Input, Low Drift — ± 10 V, ± 10 mA output. $\pm 2 \mu\text{V}/^\circ\text{C}$ drift. Input bias current: $\pm 0.01 \text{ nA}$. 9-pin package.	\$63.75

Demonstrator units are available on all of these models. Contact your Burr-Brown Representative. Most of these units are in Burr-Brown Jet Stock for immediate shipment from your local representative's office.

For Complete Information. To get your copy of the 4-page Product Bulletin describing these Burr-Brown op amps, simply use this publication's reader service card or call your local Burr-Brown Representative. For immediate applications assistance, phone (602) 294-1431, and ask to talk to your Burr-Brown Application's Engineer.

BURR-BROWN

RESEARCH CORPORATION

International Airport Industrial Park • Tucson, Arizona 85706
TELEPHONE: 602-294-1431 • TWX: 910-952-1111 • CABLE: BBRCORP



Operational Amplifiers
Instrumentation Amplifiers
Function Modules
Active Filters
Analog Simulators
Geophysical Instruments

ENGINEERING REPRESENTATIVES: ALABAMA, HUNTSVILLE (205) 534-1648 / ARIZONA, PHOENIX (602) 254-6085 / CALIF., LOS ANGELES (213) 665-5181, SAN DIEGO (714) 232-2017, SAN FRANCISCO (408) 244-1505 / COLO., DENVER (303) 399-4391 / CONN., EAST HARTFORD (203) 874-9222 / D.C., WASHINGTON (SEE MARYLAND) / FLORIDA, ORLANDO (305) 425-2764 / ILLINOIS, CHICAGO (312) 286-6824 / LA., NEW ORLEANS (504) 888-2266 / MD., SILVER SPRING (301) 588-8134 / MASS., BOSTON (617) 245-4870 / MICH., DETROIT (313) 358-3333 / MINN., MINNEAPOLIS (612) 781-1611 / MO., ST. LOUIS (314) 524-4800 / N.C., GREENSBORO (919) 273-1918 / N.J., CAMDEN (215) 925-8711 / N.M., ALBUQUERQUE (505) 255-1638 / N.Y., ALBANY

(518) 489-4777, BINGHAMTON (607) 723-9661, MT. VERNON (914) 664-0080, NEWBURGH (914) 561-4510, NEW HARTFORD (315) 732-3775, ROCHESTER (716) 473-2115 / OHIO, CINCINNATI (513) 761-5432, CLEVELAND (216) 237-9145, DAYTON (513) 277-8911 / PENN., PHILADELPHIA (SEE CAMDEN, N.J.), PITTSBURGH (412) 243-6655 / TEXAS, DALLAS (214) 357-6451, HOUSTON (713) 774-2568 / UTAH, SALT LAKE CITY (801) 466-8709 / VIRGINIA, (SEE MARYLAND) / WASH., SEATTLE (206) 767-4260 / CANADA, DOWNSVIEW, ONT. (416) 636-4910, MONTREAL, QUE. (514) 739-6776, OTTAWA, ONT. (613) 725-1288, VANCOUVER B.C. (604) 291-7161

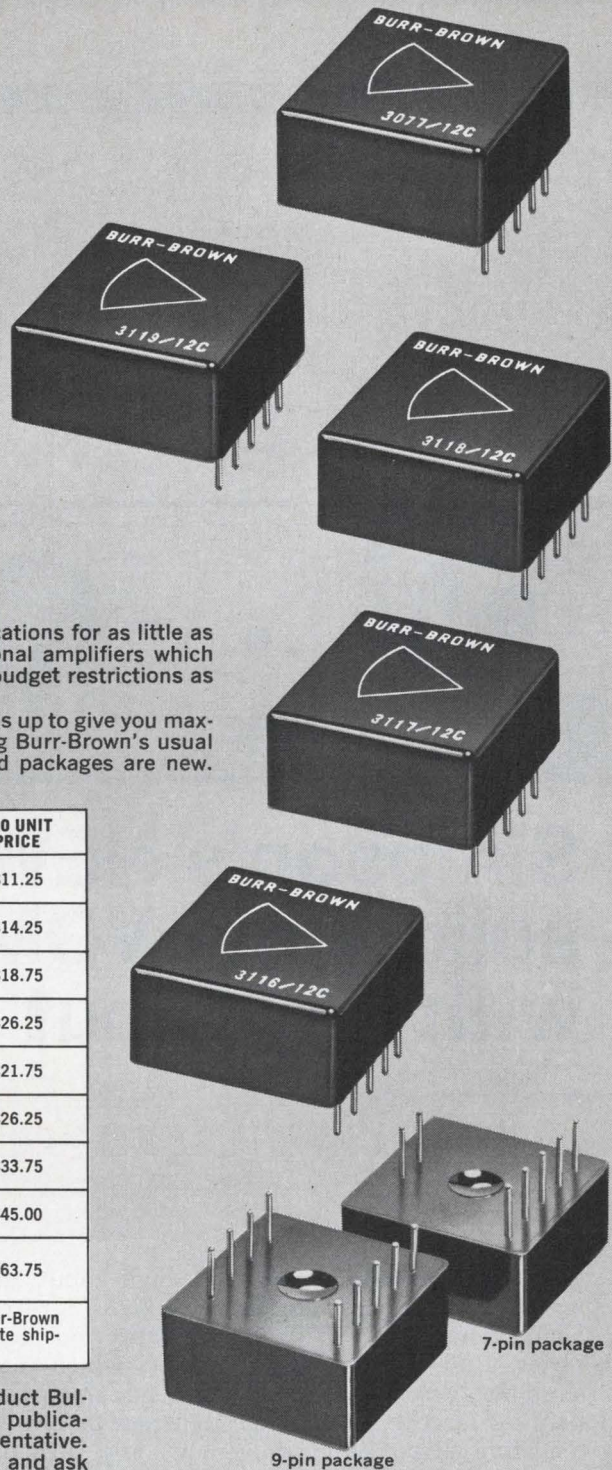

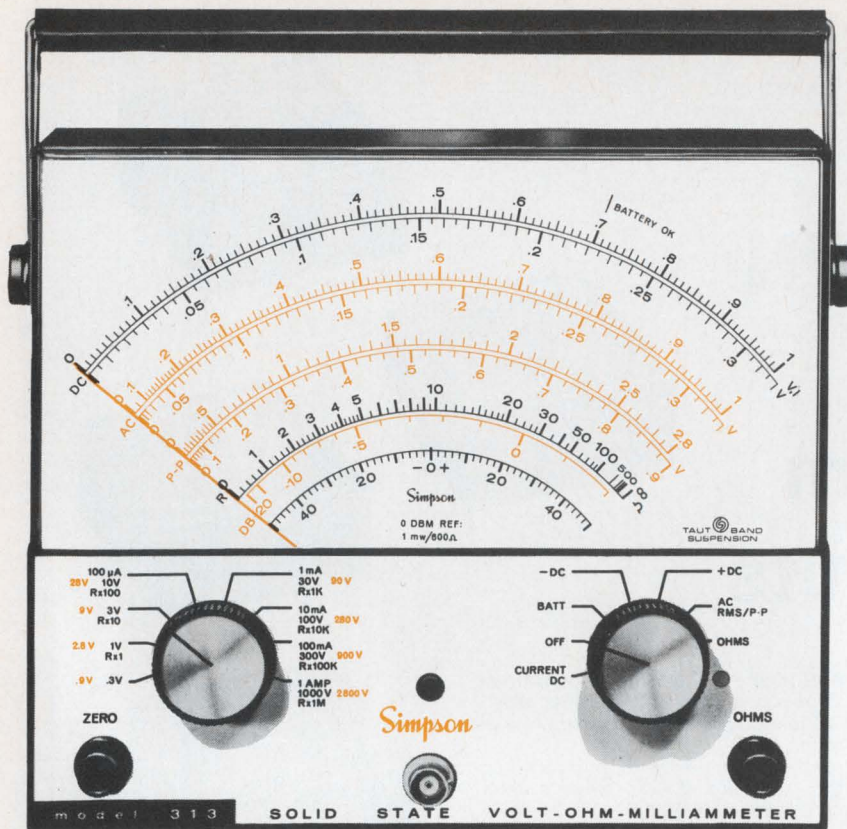

Simpson's NEW solid-state VOM with FET-Input

- **HIGH INPUT IMPEDANCE...**
11 Meg Ω DC 10 Meg Ω AC
- **PORTABLE..... battery operated**
- **7-INCH METER..... overload protected**

Simpson's new 313 gives you high input impedance for accurate testing of latest circuit designs . . . free of line cord connections. Over 300 hours operation on inexpensive batteries. And the new 313 is *stable*, which means positive, simplified zero and ohms adjustments. Protected FET-input handles large overloads. DC current ranges to 1000 mA. Sensitive Taut Band movement and 7-inch meter scale provide superior resolution down to 5 millivolts. Write today for complete specifications.

Complete with batteries, 3-way AC-DC-Ohms probe, and operator's manual **\$100⁰⁰**

Simpson ELECTRIC COMPANY

GET "OFF-THE-SHELF" DELIVERY FROM
YOUR LOCAL ELECTRONIC DISTRIBUTOR



5200 W. Kinzie Street, Chicago, Illinois 60644 • Phone (312) 379-1121

EXPORT DEPT.: 400 W. Madison Street, Chicago, Illinois 60606. Cable Simelco
IN CANADA: Bach-Simpson Ltd., London, Ontario • IN INDIA: Ruttonsha-Simpson Private Ltd., International House, Bombay-Agra Road, Vikhroli, Bombay

INFORMATION RETRIEVAL NUMBER 74

ICS & SEMICONDUCTORS

Pnp transistors carry up to 10 A

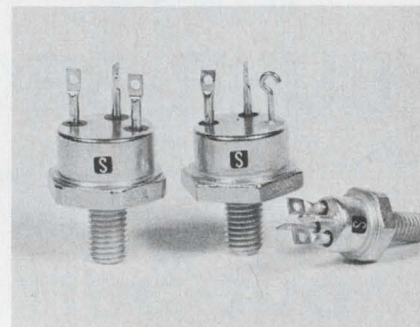

Solitron Devices, Inc., Transistor Div., 1177 Blue Heron Blvd., Riviera Beach, Fla. Phone: (305) 848-4311.

Pnp silicon power transistors with breakdown voltages that range from 40 to 120 V can carry continuous currents as high as 10 A. Types SDT 3105 to 3109 are supplied in isolated TO-61 packages; types SDT 3115 to 3119 in grounded-collector TO-61 packages; and types SDT 3125 to 3129 in isolated TO-111 packages. All transistors have a minimum gain-bandwidth product of 30 MHz.

CIRCLE NO. 266

Silicon rectifiers recover in 300 ns

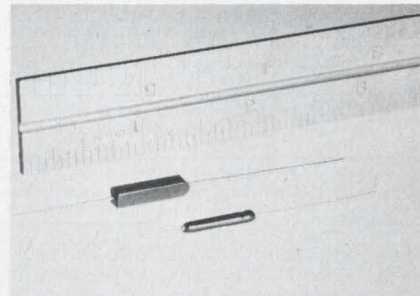

Atlantic Semiconductor, div. of Aerological Research, 905 Mattison Ave., Asbury Park, N.J. Phone: (201) 775-1827.

Rated at 3-mA continuous current for voltages from 7.5 to 50 kV, series FR silicon rectifiers have a typical recovery time of 300 ns. The hermetically sealed devices are supplied in miniaturized packages. They are designed primarily for applications such as voltage multiplier assemblies, cathode ray tube and electrostatic power supplies.

CIRCLE NO. 267

INFORMATION RETRIEVAL NUMBER 75 ▶

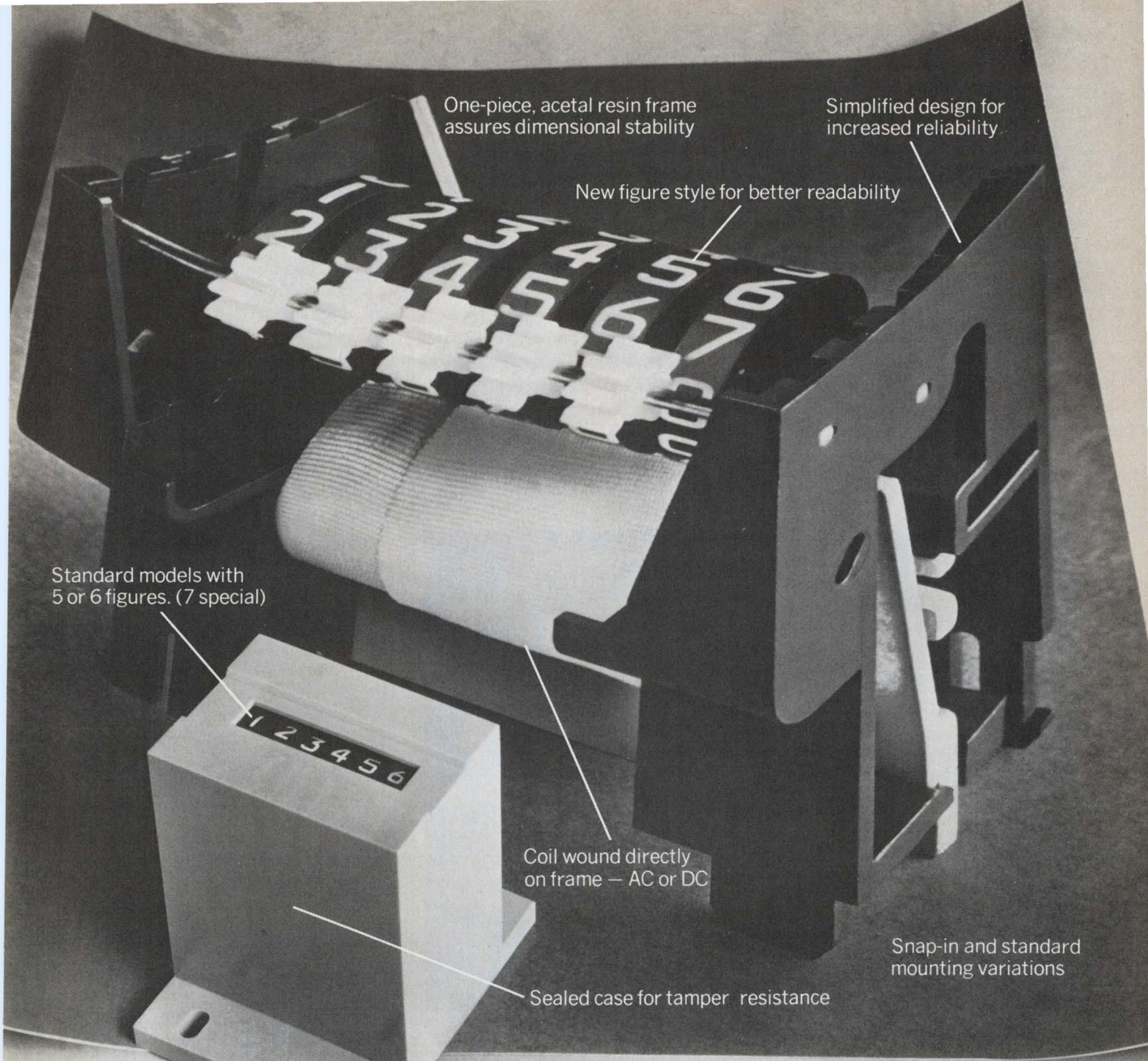

Take a good look at the first new idea in counter design in years

It's the Series 7437 counter.* The first of a new MOD 7400 line coming to you from Veeder-Root. What's so new about it? *Total Engineering*. From a multi-purpose frame to a new figure style, pretested for highest readability. The dimensionally stable, acetal resin frame in one piece. All working parts affix to it. From the coil, which is wound directly on the frame, to the verge clapper and wheel shaft which seat in molded receptacles.

Close tolerances are assured because the frame serves as the reference point for all components in assembly operations. The end result is exceptional reliability. Yet, because

of the simplicity of design, the price of this counter is surprisingly low.

Add a variety of mounting configurations and you have some of the reasons why it would make sense for you to test this counter. It's a natural for office machines, coin-operated equipment or in applications where reliability and low cost are vital considerations.

The Series 7437 is just one of a full line of Veeder-Root counters and controls for data acquisition—mechanical, electrical and electronic. For complete information, write: Veeder-Root, Hartford, Conn. 06102. *Patent applied for.

V E E D E R - R O O T

INNOVATORS IN NUMERICS: COUNTING/RECORDING/CONTROLLING

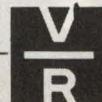

Diversified Glass-to-Metal Hermetic Seals like these...

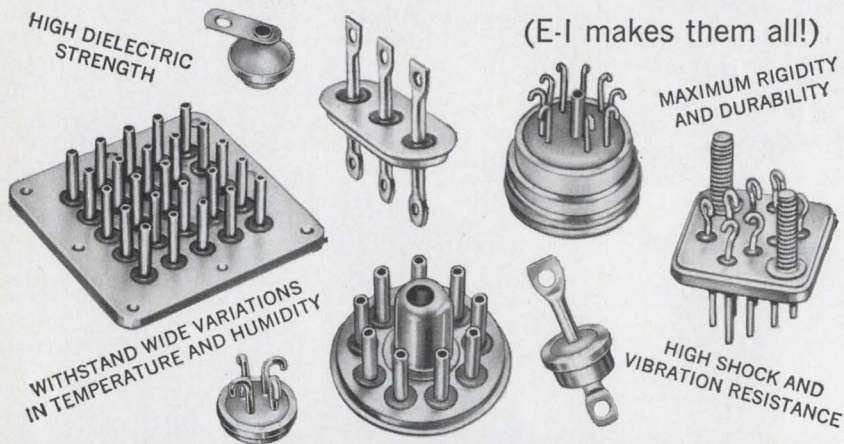

Require Highly Specialized Engineering Capabilities...

(E-I has the know-how!)



Specify E-I Sealed Terminations for Unusual Service Applications!

How does E. I. produce a quality line of hermetic seals? The answer is simple. A stringent program of testing and control! Above is shown an optical comparator being utilized to measure wire terminals for use in a hermetic seal. Testing in this manner assures that the finished hermetic seal will comply with all your requirements.

Available in thousands of standard types, E-I seals can be produced in 'specials' to meet particular component or equipment requirements.

Technical literature edited for the engineer/designer/specifier, and containing complete data and information, is available on request.

- Sealed Terminations
- Multiple Headers
- Transistor and Diode Bases
- Semiconductor Bases
- Compression-type Threaded End Seals
- Plug-in Connectors
- Vibrator Plug-in Connectors
- High Voltage Glass-bonded Ceramic Seals
- Hermetically-sealed Relay Headers
- Special Application Custom Seals
- Custom Sealing to Specifications



Electrical Industries

A Division of Philips Electronics and Pharmaceutical Industries Corp.
Murray Hill, N. J. 07971 — Tel. (201) 464-3200

Patented in U.S.A., No. 3,035,372; in Canada, No. 523,390; in United Kingdom, 734,583; other patents pending.

INFORMATION RETRIEVAL NUMBER 76

ICS & SEMICONDUCTORS

Multiple transistors drive at 200 MHz

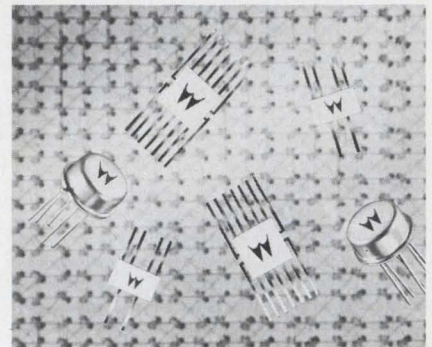

Motorola Semiconductor Products, Inc., P.O. Box 955, Phoenix. Phone: (602) 273-6900. Price: \$7.50 to \$31.75.

Compatible with ICs in size and construction, six new multiple transistors perform tasks that present ICs cannot handle well—fast high-current core driving and rf driving at frequencies up to 200 MHz. There are three pnp devices and three npn complements. The MD3467, MD3467F, MD3725 and MD3725F are dual transistors; the MQ3467 and MQ3725 are quad transistors.

CIRCLE NO. 268

Silicon transistors withstand 200 V

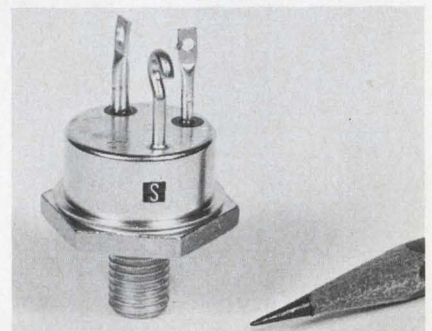

Solitron Devices, Inc., Transistor Div., 1177 Blue Heron Blvd., Riviera Beach, Fla. Phone: (305) 848-4311.

A new series of 20-A npn silicon power transistors feature voltage ratings from 100 to 200 V. Types SDT 8751 through SDT 8758 are packaged in a TO-63 case. Their current gain ranges from 15 to 90 at collector currents of 10 A; collector saturation voltages are lower than 0.5 V. The unity-gain crossover frequency is typically 30 MHz.

CIRCLE NO. 269

Unique anode design reduces dissipation factor and ESR.

By designing anodes with holes through them and risers welded separately to their tops, Mallory has reduced the physical electrical loss paths of its tantalum capacitors, particularly at higher frequencies (up to 1 MHz).

This greatly improves the electrical characteristics and performance of the Mallory capacitors, making them better than conventional electrolytic tantalum capacitors in the following ways:

- Lower dissipation factors
- Lower impedance at higher frequencies
- Larger permissible ripple voltages
- Less capacitance change with frequency
- Less capacitance change with temperature

These superior characteristics are in addition to the usual features of solid electrolyte tantalum capacitors.

Designated THF by Mallory, the new capacitors are available in the large and intermediate CV product range where improvements in the electrical characteristics are most significant.

THF capacitors are enclosed in standard Mallory F and G cases which correspond to Military C and D case sizes. They meet the requirements of Style CS12 and CS13 of MIL-C-26655B.

For data, write Mallory Capacitor Company, a division of P. R. Mallory & Co. Inc., Indianapolis, Indiana 46206.

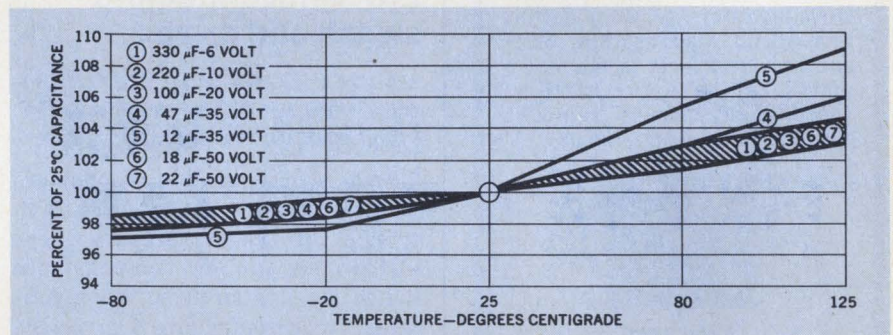
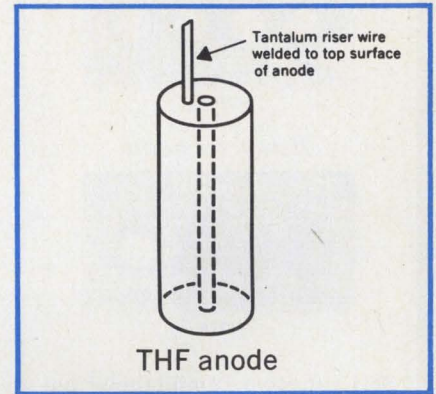
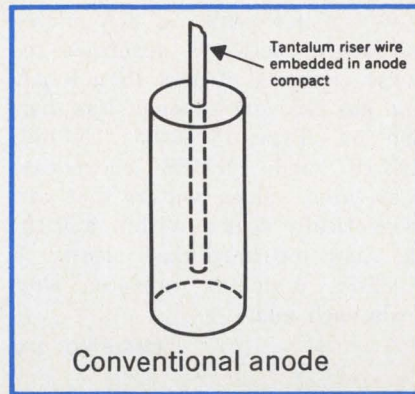

1 KHz capacitance change at four temperatures

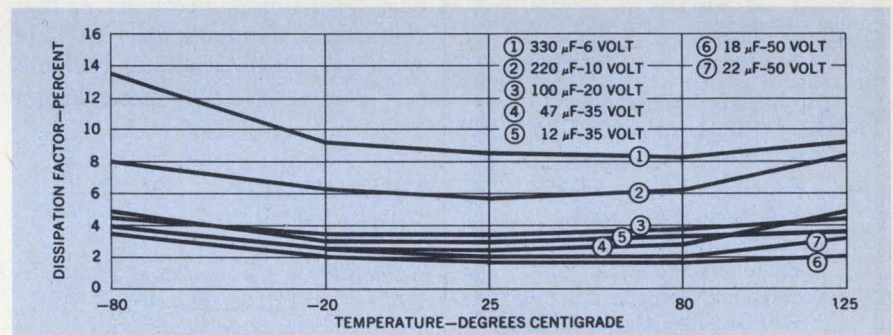

1 KHz dissipation factor at five temperatures

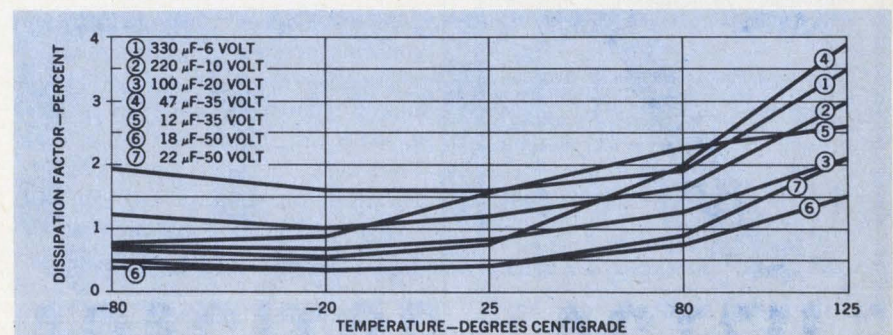

120 Hz dissipation factor at five temperatures

For a true record
of temperature
in service...

Tempilabel

Easy to use . . .

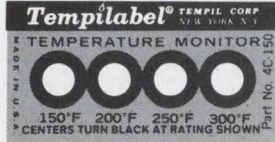

Easy to read



Self-adhesive Tempilabels[®] assure dependable monitoring of attained temperatures. Heat-sensitive indicators, sealed under the little round windows, turn black and provide a permanent record of the temperature history. Tempilabel[®] can be removed easily to document a report.



AVAILABLE

Within the range 100° to 500°F Tempilabels[®] are available to indicate a single temperature rating each — and also in a wide choice of four-temperature combinations per Tempilabel[®].

JUST A FEW OF THE TYPICAL APPLICATIONS

- Electrical Apparatus
- Electronic Assemblies
- Appliance Warranties
- Aircraft and Rockets
- Machinery and Equipment
- Storage and Transportation of Heat Sensitive Materials.

For descriptive literature and a sample Tempilabel[®] for evaluation . . . (please state temperature range of interest).

Write to: SPECIAL APPLICATIONS DIVISION

TEMPILABEL[®] INDICATING PRODUCTS
Tempilabel CORPORATION
132 WEST 22nd St.
NEW YORK, N. Y. 10011
Phone: (212) 675-6610
TWX 212-640-5478

ICS & SEMICONDUCTORS

Micro rectifiers hold I_R to 5 μA

Centralab, Semiconductor Div., 4501 N. Arden Dr., El Monte, Calif. Phone: (213) 686-0567. P&A: from \$2.50; 2 wks.

Available in peak reverse working voltages of 50, 100, 200 and 400 V, a new series of 3-A micro-miniature rectifiers generates reverse currents of less than 5 μA and has recovery times of less than 300 ns. Types 1N5185, 1N5186, 1N5187 and 1N5188 incorporate passivated silicon wafers that are hermetically sealed within a 0.12-in. diameter hard-glass sleeve. A 0.087-in. diameter tungsten slug seals each end.

CIRCLE NO. 270

LID semiconductors switch and drive

Amperex Electronic Corp., Providence Pike, Slatersville, R. I. Phone: (401) 762-9000.

Two new npn semiconductors come in LID packages for use in hybrid integrated circuits. Type LDS207 is a low on-resistance switch for d/a circuits. When activated, it presents only 4 Ω resistance. Type LDS210 is a medium-current switch-and-core driver that features a minimum current gain of 30 for 300-mA collector currents.

CIRCLE NO. 271

Pnp switch costs 42¢

Fairchild Semiconductor, 313 Fairchild Dr., Mountain View, Calif. Phone: (415) 962-2530. P&A: 42¢; stock.

A high-speed pnp switch and general-purpose amplifier, which is capable of operating at frequencies of 400 MHz, sells for as little as 42¢ in single-unit quantities. The new device, type 2N4389, comes in an epoxy TO-18 package and is electrically equivalent to the 2N2894 metal can. It combines fast switching (20 ns maximum on-time and 90 ns maximum off-time) with a 0.3-V saturation voltage.

CIRCLE NO. 272

TTL IC logic family approach speed limit

Raytheon Co., Semiconductor Operation, 350 Ellis St., Mountain View, Calif. Phone: (415) 968-9211. Price: from \$3.25.

Known as Ray III, a new line of TTL integrated circuits operate at speeds approaching the limits of saturated logic, use clamping diodes on all inputs to suppress ringing and offer high noise immunity. The 19 basic circuit types include NAND gates, AND gates, AND-OR-INVERT gates, a hex inverter, and single and dual flip-flops.

CIRCLE NO. 273

Power transistors cut cost in half

Motorola Semiconductor Products, Inc., P.O. Box 20924, Phoenix, Arizona. Phone: (602) 273-6900. Price: \$3.25 to \$11.75.

Prices of nine popular diffused-base germanium power transistors have been reduced up to 53%. Types 2N1651 through 2N1653, 2N2285 through 2N2287, and 2N2357 through 2N2359 are designed for high current switching applications that require low saturation voltages, fast switching times and stable collector-emitter sustaining voltages.

CIRCLE NO. 274

COS/MOS ICs lower price

RCA Electronic Components, 415 S. Fifth St., Harrison, N. J. Phone: (201) 485-3900. Price: \$4.20 to \$17.80.

Reflecting improvements in production efficiency, fourteen COS/MOS (complementary symmetry metal oxide semiconductor) integrated circuits offer price reductions as large as 35%. The circuits with the new low price tag include: dual-in-line ceramic packages (CD4000D through CD4007-D); ceramic flatpacks (CD4000 through CD4007); and a TO-5 package (CD4004T). Prices now range from \$4.20 to \$17.80, rather than \$6 to \$25.40.

CIRCLE NO. 275

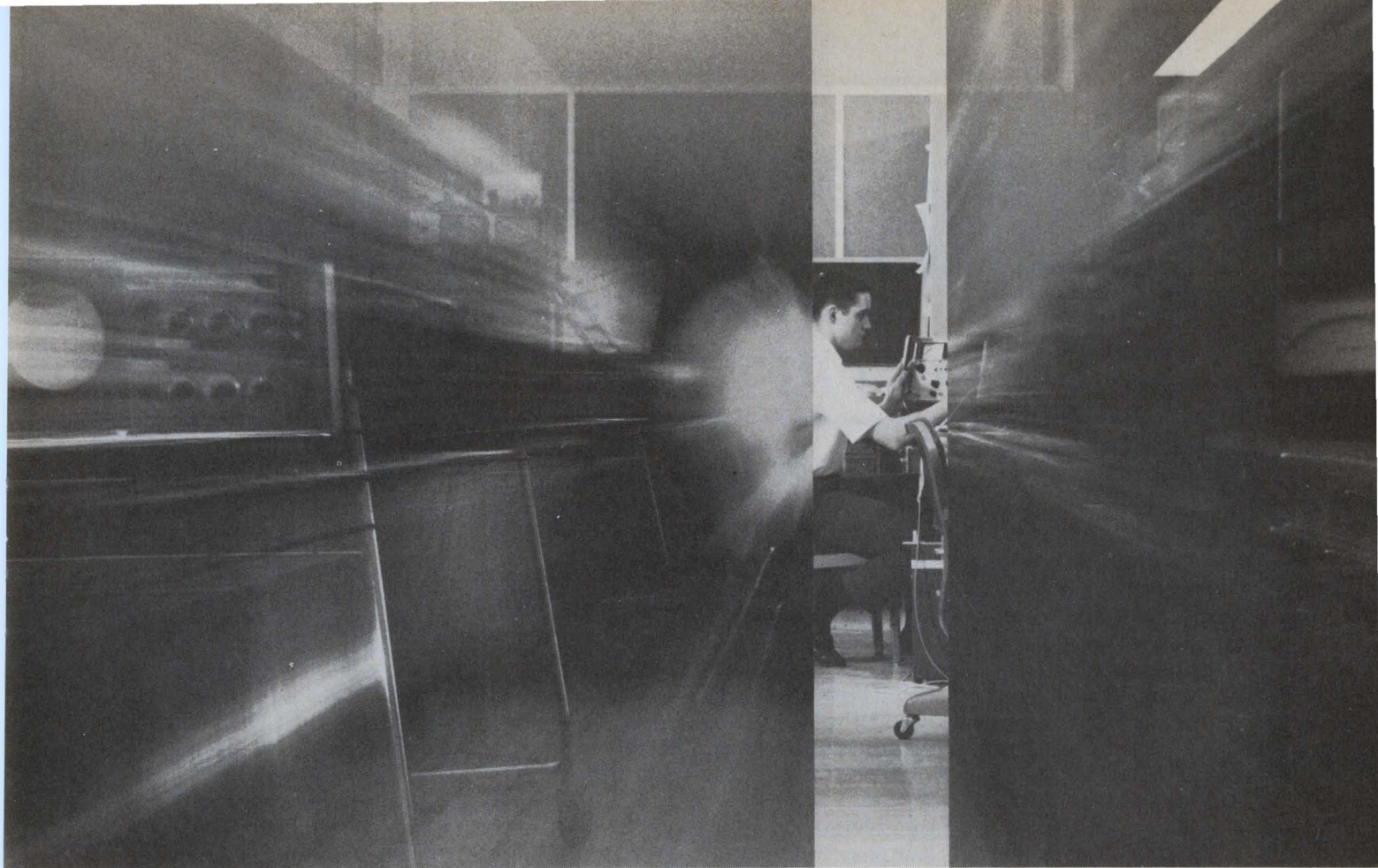

The Narrow Point-Of-View for Broad-Minded Engineers

When someone keeps telling you to be broad-minded and to get the "big-picture," aren't you often tempted to reply that sometimes a narrow point-of-view can be even more valuable? For example, one of the greatest race horses that ever lived, parlayed a narrow point-of-view into a fortune. By placing blinders on this horse, all extraneous objects were eliminated and he could concentrate on the immediate problem — the finish line and getting there first.

Hewlett-Packard has their own set of "blinders" for engineers who want to take a "narrow look" at individual signals over a wide range of frequencies. We call them wave analyzers.

Let's start with the HP 302A. When a very narrow point-of-view is required, a special 1 Hz bandpass is available. This bandpass, combined with a sensitivity of 3 μ V to 300 V,

is ideal for differentiating closely spaced signals with wide variations in amplitude. This wave analyzer can be battery operated and covers the frequency range of 20 Hz to 50 kHz. The price, \$1900.

Next in line is the HP 310A, a highly selective wave analyzer for the 1 kHz to 1.5 MHz range, 1 μ V to 100V. With selectable bandwidths of 200, 1000 and 3000 Hz, it is well suited for tape transport harmonic measurements, or frequency response and level measurements on carrier and radio systems up to 300 channels. Get direct readouts in volts or dB. All this capability for \$2500.

And finally, the HP 3590A — the most automated wave analyzer you can get today. Covering a frequency range of 20 Hz to 620 kHz with built-in autoranging and electronic sweeping, the HP 3590A almost operates

itself. With 85 dB dynamic range and 4 selectable bandwidths of 10, 100, 1000 and 3100 Hz you can separate closely spaced signals, characterize distortion, or analyze a frequency spectrum. With its plug-ins the HP 3590A runs from \$3280 to \$4800.

When a balanced input and selectable impedances are required, just add \$150 to the price of a 3590A and get the HP 3591A.

So, if the "big-picture" has become a big pain then it's time to quit "horsing-around" and call your local HP field engineer for more information. Or, write to Hewlett-Packard, Palo Alto, California 94304. Europe: 1217 Meyrin-Geneva, Switzerland.

099/10

HEWLETT  **PACKARD**
SIGNAL ANALYZERS

USCC

announces:
a dependable

50 WVdc RFI Filter

Don't design trouble in. USCC's new Low Pass L Section filter is a beefed-up miniature built tough to stay reliable. It's designed to give extremely high attenuation with minimal power loss and negligible heat buildup—and to do it for a long, long time.

This is a unit engineered to reduce interference from conducted noise in dc power lines. Hermetically sealed, these filters are available off the shelf in 60 models in 6 current ratings. Operating range is from 10 kHz to 10 GHz, at -55° to $+125^{\circ}\text{C}$. Line transients can be accommodated up to 100 Vdc.

Design trouble out by specifying USCC L2000 Series filters. For evaluation samples and complete technical data, contact: U.S. Capacitor Corporation, 2151 North Lincoln Street, Burbank, California 91504. Telephone: (213) 843-4222. TWX: 910-498-2222.

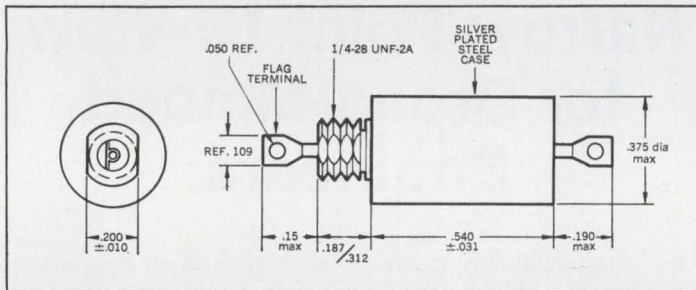

TYPICAL ATTENUATION CURVE AT 25°C

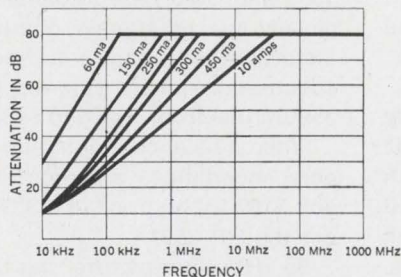

SCHEMATIC

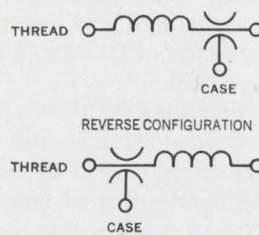

STOCKED AND DISTRIBUTED BY:

JACO

ELECTRONICS, INC.

ENGINEERS ROAD • HAUPPAUGE, L.I., NEW YORK 11787 • TEL: 516-273-5500 • TWX: 510-227-6232
20723 DEARBORN ST. • CHATSWORTH, CALIFORNIA 91311 • TEL: 213-341-6020 • TWX: 910-494-1923

INFORMATION RETRIEVAL NUMBER 80

COMPONENTS

Miniature lamps light in dash

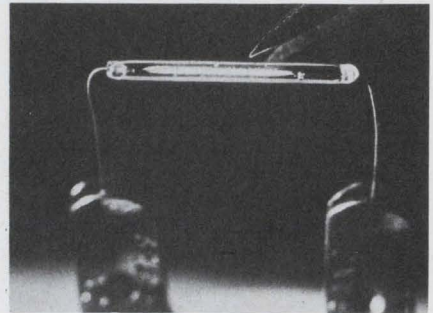

Lamps, Inc., 17000 South Western Ave., Gardena, Calif. Price: \$3.50.

Nine new line-filament lamps provide strip illumination for data processing card and tape readers, instrument dials and panels, encoding devices, roll charts, and applications involving photosensitive detectors. The filament is attached to a lead-in wire at one end and a coilspring at the other to offset thermal changes in length. Voltage ratings range from 2.5 to 48 V; current, from 40 to 200 mA. The lamps are available in over-all lengths of 0.88 to 12.9 in.

CIRCLE NO. 276

Microminiature lamps have 0.05-in. dia

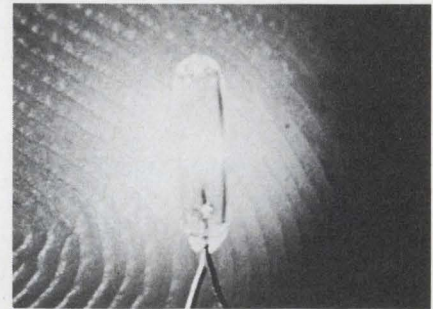

Los Angeles Miniature Products, Inc., 17000 S. Western Ave., Gardena, Calif. Phone: (213) 323-7578. Price: from 89¢.

High-density microminiature lamps feature a maximum diameter of 0.054 in. and a bulb length of only 0.176 in. They are unsupported-filament, unbased, T-3/8 units designed for use in electronic circuit exciters, pointer indicators and readout lamps. Three ratings are available: 1.5 V, 0.051 A; 3 V, 0.029 A; and 1.5 V, 0.015 A. Each rating has an average life of 5000 hours.

CIRCLE NO. 277

how fine is a fine screen?

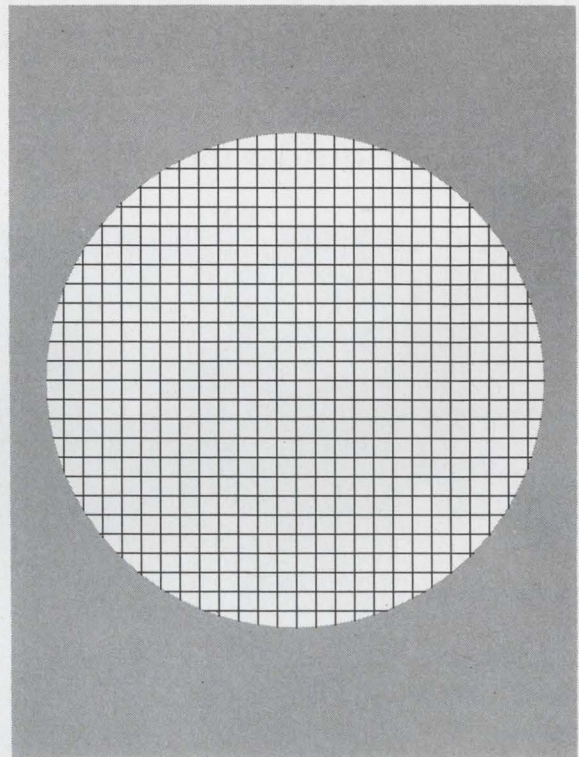

(INSET ENLARGED 200 TIMES)

***At Buckbee-Mears it can have
4,000,000 holes per square inch***

Whether your requirements for fine mesh screens are electronic, optical, or purely mechanical, you will find what you want at Buckbee-Mears.

The 4,000,000 holes per square inch we illustrate above is a standard product, the finest of our electroformed mesh. Buckbee-Mears electroforming produces screens with 5 to 2000 lines per inch in nickel, copper, gold or silver. They are used as sieves in various kinds of fine particle sizing and as parts of many electronic tubes.

Other screens to almost the same degree

of fineness are made by automatic photo-etching on continuous rolls of stainless steel up to 24 inches wide. Applications include centrifuges used in food processing, fine filtering of canned draft beer, synthetic fiber production, automatic coffee makers and aperture masks for all color TV sets.

Make us prove our capabilities. Ask us to have a trained technical representative tell how we would solve your problems. Call or write Bill Amundson, industrial sales manager.



BUCKBEE-MEARS CO.

245 E. 6th St., St. Paul, Minnesota 55101 / (612) 227-6371

The world leader in precision photomechanical reproduction

INFORMATION RETRIEVAL NUMBER 81

Lectrohm knows Resistors...

We should, they're our only business!

Fixed or Adjustable
Standard or Custom

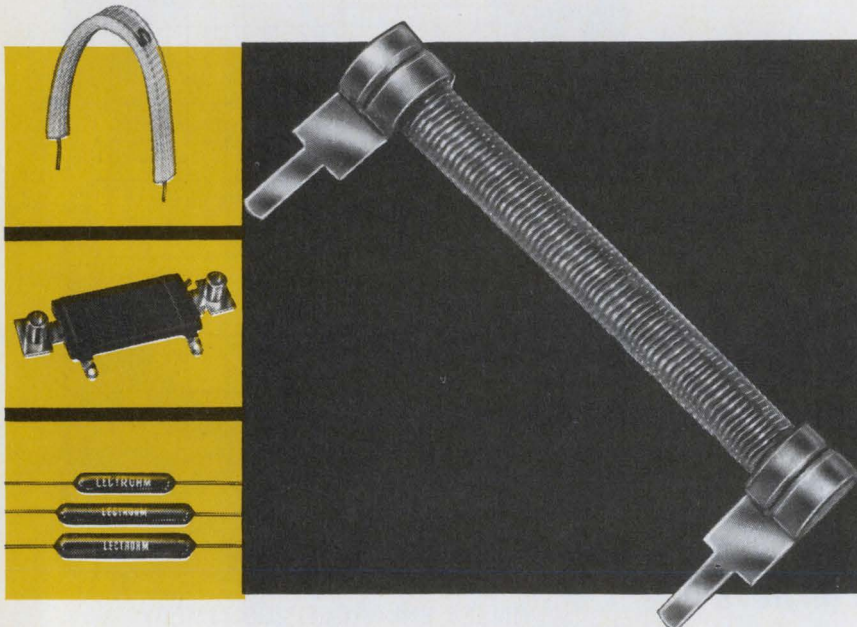

Specialization in the design and production of wire-wound resistors has established LECTROHM'S leader in the resistor field.

For example, LECTROHM type FP and XFP is one of the lowest cost power resistors available for P-C board applications. They can be inserted in 0.050" or 0.070" diameter holes. Center-to-center distance of prongs on terminals are variable from 0.5" to 2.5". Power rating is 4 watts per inch and resistance range is from 0.2 ohms per inch to 1,000 ohms per inch.

Check your resistor needs today... send specifications, prints or requirements, no obligation... you can trust LECTROHM to match those needs quickly and economically.



FREE!

Full line
LECTROHM
catalog.

Send for your
copy today!

Lectrohm, Inc.

A subsidiary of



COOK ELECTRIC

5562 Northwest Highway, Chicago, Ill. 60630

INFORMATION RETRIEVAL NUMBER 82

COMPONENTS

Quad transformer has DIP housing

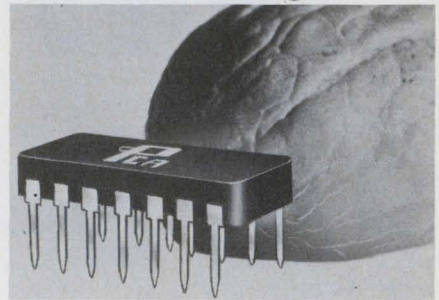

PCA Electronics, Inc., 16799
Schoenborn St., Sepulveda, Calif.
Phone: (213) 892-0761. P&A:
\$2.50; 3 wks.

Designed for impedance matching and dc isolation in computer memory cores, a dual-in-line quad transformer is packaged like a standard integrated circuit. The new miniature configuration houses four transformers with a primary sine wave inductance of 400 μ H minimum and a maximum risetime of only 8 ns. The unit measures 0.125-in. high by 0.25-in. wide by 0.75-in. long.

CIRCLE NO. 278

PC reed switch complements DIPs

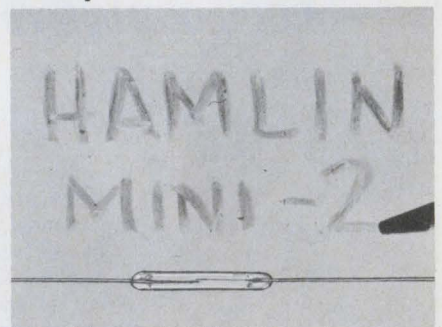

Hamlin, Inc., Lake & Grove Sts.,
Lake Mills, Wis. Phone: (414)
648-2361.

Designated as Mini-2, a PC-board form A reed switch has dimensions that are compatible with low-profile reed relays and DIP ICs. It operates with only 100 mW of power in an actuate time of 200 μ s and has a sensitivity range of 7.5 to 32.5 ampere turns. The unit can handle up to 3 W of power at 110 mA, 28 V dc. Its breakdown voltage is 200 V dc, and life expectancy is five million operations.

CIRCLE NO. 279

Miniature toggles have 3 positions

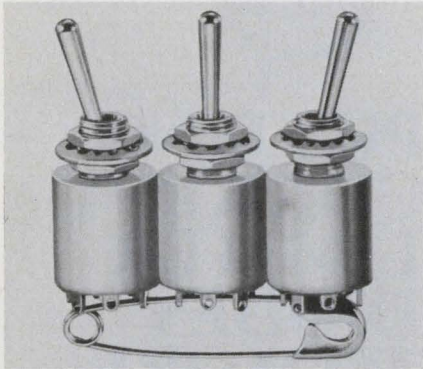

Controls Co. of America, Control Switch Div., 1420 Delmar Dr., Folcroft, Pa. Phone: (215) 583-4044.

Cylindrical two- and three-position toggle switches are only 0.515 in. in diameter by 1.447 in. in over-all length. The switches, which mount in 1/4-in. panel holes, meet the requirements of MIL-S-3950. Series T9100 and T9200 units include spdt and dpdt contact configurations.

CIRCLE NO. 280

Thin flexible sensor expands surface area

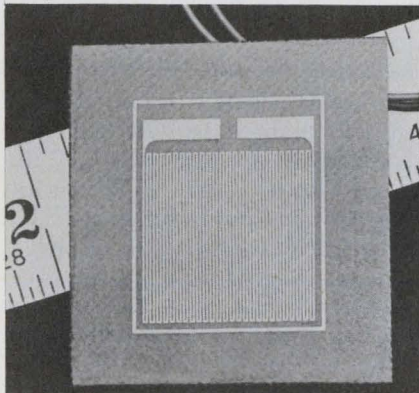

Thermal Systems, Inc., 13920 S. Broadway, Los Angeles. Phone: (213) 321-4350. P&A: \$10; 2 wks.

Using PC-type etching on highly flexible silicon rubber, an ultra-thin temperature sensor holds self-heating measurement errors to less than 1% with 150-mW dissipation. Because its flat configuration and low thermal mass provide greater surface exposure than conventional wire sensors, model 5004-1 has a response time which is equal to that of the surface being measured.

CIRCLE NO. 281

Automatic Controls' Industrial Relays

provide:

- * Advance Design
- * More Switching Capability
- * Mounting Versatility

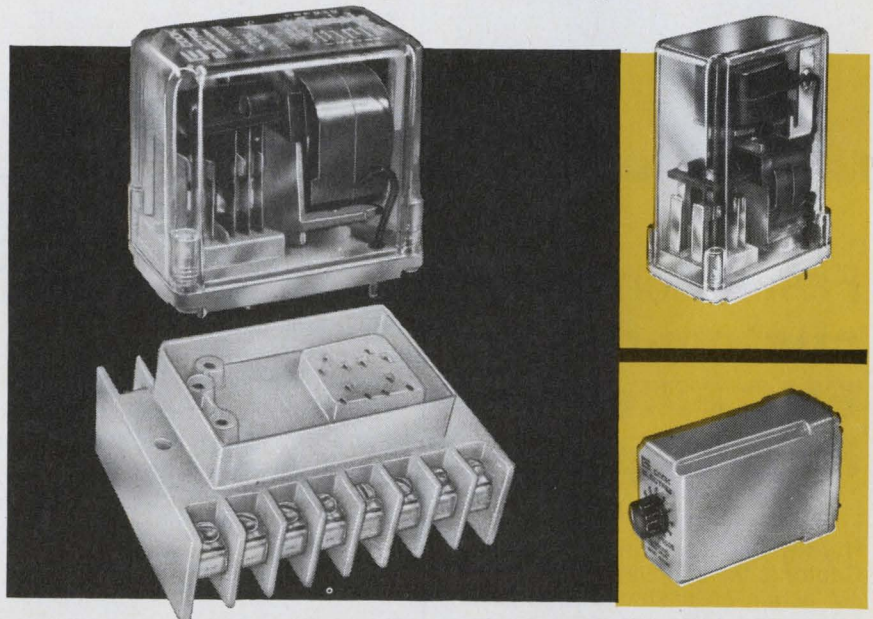

Automatic Controls' "Family" of industrial relays now available with front-connected screw terminal sockets, with nylon construction, wiring without removal of relay, terminals accommodate up to 2-#14 AWG wires — captive pressure plates.

Weigh the advantages of front-connected, behind panel, or quick disconnect termination with 4 PDT 10 Amp capacity; silver cadmium oxide contacts; epoxy encapsulated coil; and sturdy, dust-proof lexan bases and covers. Remember too, the improved design of these relays requires 1/3 less volume, 20 percent less mounting space.

Match specific product needs with the industrial mechanical latch and time delay relays . . . Automatic Controls stocks them all to meet immediate needs!

Automatic Controls

Division



COOK ELECTRIC

200 East Daniels Rd., Palatine, Ill. 60067



FREE!

Automatic Controls
Industrial
Relay Booklet.
Send for your copy
today!

INFORMATION RETRIEVAL NUMBER 83



Fast action on custom-design EMC Filters from Captor!

If your EMC problem is unique, Captor is the supplier with the fastest action on custom-design EMC filters and filter assemblies. Our application engineers will go to work immediately to evolve a prototype that fulfills your mechanical and electrical requirements and conforms to applicable MIL specifications. Captor has the manufacturing capability to produce in volume economically — cylindrical or rectangular electromagnetic interference filters for all commercial or military compliances. Also Captor offers many cataloged EMC filters ready for immediate delivery. Contact Captor today on your EMC problem!

Captor Corporation manufactures miniature filters . . . communications and security filters . . . custom-design filters, and other electronic components.

CAPTOR CORPORATION

APPLICATION ENGINEERING DEPT.

5040 Dixie Highway, Tipp City, Ohio 45371

COMPONENTS

I-f crystal filters integrate thin films

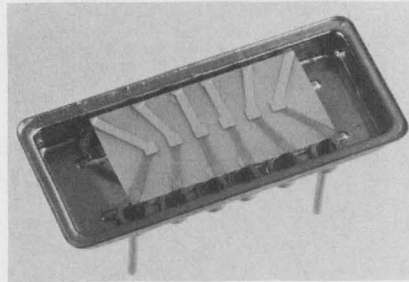

General Electric Co., Ltd., Salford Electrical Instruments Ltd., Hirst Research Centre, East Lane, Wembley, Middlesex, England.

Integrated crystal filters for use in i-f circuits use either a monolithic construction (a single quartz wafer with an array of thin-film electrodes) or a bilithic structure (two multi-electrode wafers connected in series). In both cases, mechanical rather than electrical coupling is used between the resonant sections. It is expected that integrated crystal filters will eventually replace conventional crystal filters in many applications for frequencies from 5 to 100 MHz.

CIRCLE NO. 282

Rectangular neon lamp expands lens by 50%

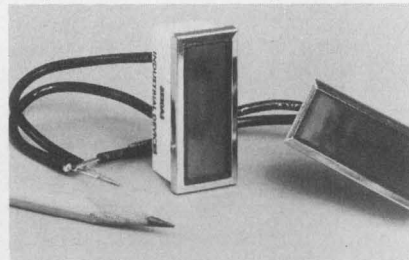

Industrial Devices, Inc., Edgewater, N.J. Phone: (201) 943-4084.

Providing approximately three times as much lens area as other lamps, a rectangular neon pilot light with a 9/16 by 1-1/2-in. illumination area allows longer and larger messages to be displayed. Available in a wide variety of lens colors and bezel finishes, series 3500 lamps are rated for 10,000 hours of operation. Each unit is supplied with a resistor to limit current to less than 2 mA in 115- or 230-V service.

CIRCLE NO. 283

Applications Power*



PUTTING CURRENT-LIMITER DIODES TO WORK

Problem: How to provide a linear voltage sweep?

Solution: Provide a constant charging current to a capacitor . . . with a Siliconix CL diode.

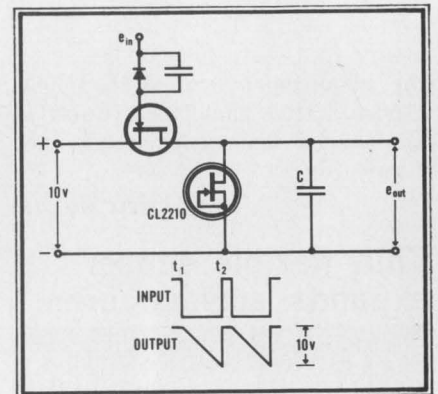

The FET switch is initially closed with C charged to +10v. At t_1 a -10v opens the FET switch. C discharges linearly, due to the constant current characteristic of the CL diode. At t_2 the switch is closed; C is again charged. Sweep time is determined by the values of C and the CL diode. Flyback time depends on C and the FET switch R_{ON} . FET switches are available with R_{ON} as low as 5 ohms!

For immediate applications assistance call the number below; ask for extension 19.

Siliconix Incorporated

1140 W. Evelyn Ave. • Sunnyvale, CA 94086
Phone (408) 245-1000 • TWX: 910-339-9216

***Applications Power: A wide product line and an in-depth applications team to help you over new design hurdles.**

NOW... the IC regulator you've been waiting for

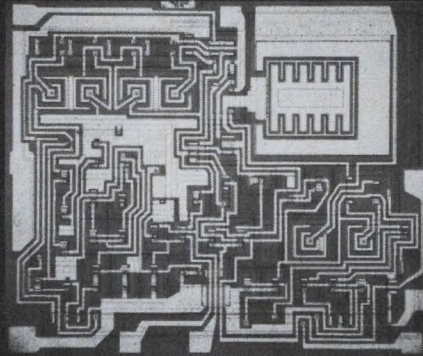

The TVR-2000 – Highest efficiency ... independent, programmable foldback ... 8-40V input range ... output to 200mA ... internal temperature compensated reference.

PROGRAMMABLE FOLDBACK — Exclusive, built-in circuit permits full control of foldback slope and short circuit current through selection of external resistors.

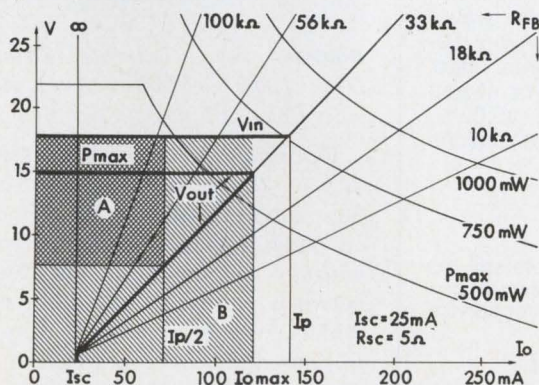

Peak power prediction for typical output characteristics. Programmable foldback permits maximum power dissipation ("A" above) only $\frac{1}{3}$ that resulting from conventional current limiting ("B" above) or optionally, 3x greater output current with the same power dissipation.

LOWEST MINIMUM ΔV — Minimum input/output voltage differential is 2.2V ... lowest of all available IC regulators.

LOWEST MINIMUM INPUT VOLTAGE / BROADEST OPERATING RANGE — Input Voltages from 8V to 40V. Output voltages from 3V to 38V.

Minimum input-output voltage differential, output impedance, bandwidth, are constant over full output voltage range and not degraded by current limiting.

EXPANDABILITY — Current may be expanded, with external output transistor under full control of foldback circuit.

The TVR-2000 is designed for -55°C to $+125^{\circ}\text{C}$ operation. A commercial version, the TVR-2001, is available for 0°C to 70°C , with generally equivalent characteristics. Both available for immediate delivery in TO-100 (10 lead TO-5) packages.

Send for complete specifications

Transitron
electronic corporation
168 Albion Street Wakefield, Massachusetts 01880

make an
EXACT
comparison

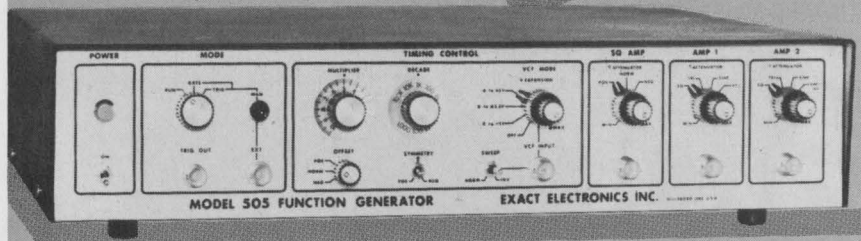
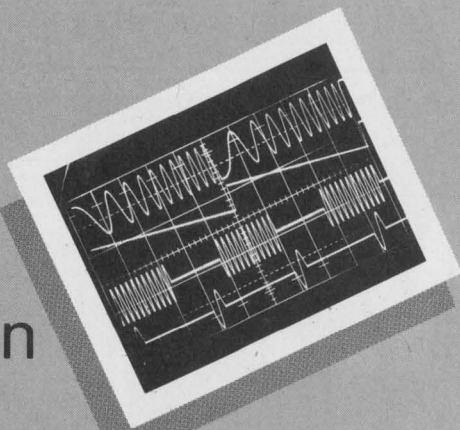

*You'll find the model 505 the best
function generator buy on the market
in price, performance and dependability.*

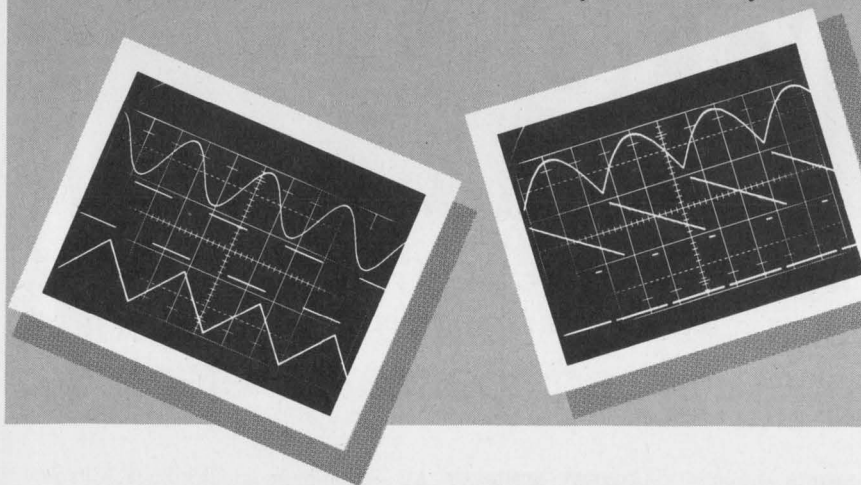

Don't let the low price of only \$595.00 fool you when you compare Exact's Model 505 Function Generator to others. At a flick of the switch you can have sine, triangle, square, ramp, pulse, reverse ramp, or sync-pulse waveforms from 0.0001 Hz to 1.0 MHz. Three separate amplifiers give you dissimilar or identical waveforms, with individual amplitude adjustments. Gate, trigger (single-shot), variable offset or push-pull any waveform—or sweep with voltage-controlled frequency (VCF). Frequency stability to $\pm 0.02\%$, long-life, solid-state construction and integrated circuitry are more reasons for comparing and buying the 505.



\$385.00

Exact makes other function generators too (such as the Model 502 shown here for just \$385.00), with slightly different performance features and prices. Call, write, or circle the number on the reader service card for complete information on Exact's line of function generators.

See us at the IEEE Show — booth 3A31

EXACT electronics, inc.



Box 160, Hillsboro, Oregon 97123
Telephone (503) 648-6661

INFORMATION RETRIEVAL NUMBER 86

COMPONENTS

**Miniature switch
indicates position**

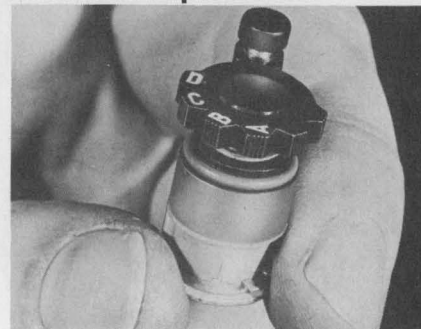

*Janco Corp., 3111 Winona Ave.,
Burbank, Calif. Phone: (213) 845-
7473. Availability: 4 to 6 wks.*

Totally enclosed for protection against explosion, corrosion, humidity, and contaminants, a miniature rotary switch provides four positions with a visual indicator, in addition to an instant release button. Model 1-2516 exceeds the requirements of MIL-S-3786 and has an electrical rating of 6 V dc at 100 mA. The unit uses silver alloys for its contacts and glass-filled alkyd for insulation.

CIRCLE NO. 284

**Latching relay
stops emi**

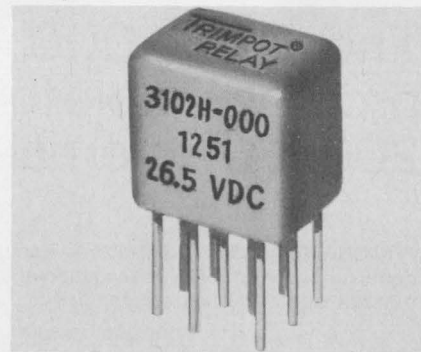

*Bourns, Inc., Trimpot Products
Div., 1200 Columbia Ave., River-
side, Calif. Phone: (714) 684-1700.*

Featuring a latch/reset sensitivity of 160 mW, model 3102 magnetic latching relays can be mounted side by side on PC boards without any magnetic interference between units. The new relay, which measures 0.43 by 0.4 by 0.33 in., has dpdt contacts rated at 1 A, 28 V dc. Its performance exceeds the requirements of MIL-R-5757, and its operating temperature range is -65 to $+125^{\circ}\text{C}$.

CIRCLE NO. 285

A PORTRAIT OF YOUR NEXT DVM FOR OEM



If you don't see anything, it's only because we haven't made **your** Digital Voltmeter yet. Don't get us wrong—we've made thousands of them. But they're unique in appearance and performance . . . **tailored to specific requirements at off-the-shelf prices.**

* appearance, dimensions and functional characteristics predicated by your specific requirements.

*If you can use a minimum of 100 DVM's in a twelve month period, we'll custom **design** and **build** units for you with the following features:*

1. Customized to your exact specifications (no need to repackage or to kluge.)
2. Accuracy as required. DATASCAN DVM's can give you 0.1% ± 1 digit on 3-decade unit and 0.03% ± 1 digit on 4-decade unit. (But, if you can use less, we'll give it to you—along with the savings.)
3. Input voltage range and input impedance to suit your specific needs. (Another money saving customized feature.)
4. Units can be furnished with automatic polarity . . . over-range capability . . . 3 or 4 decade (nixie® type display) . . . decimal points where you need them . . . or wired for remote operation.
5. Speed lets you multiplex and measure several variables by adding storage and display units, instead of additional DVM's. Up to 30 encodes/second!
6. Save by sharing power supplies—we use yours, or you utilize our power. Full electrical outputs provided.
7. Meet your needs for digital zero offset to improve accuracy, rather than a voltage offset with narrow range use of the DVM.

All this quality and flexibility in a true *economy* line of DVM's for OEM applications, thanks to our unmatched integrated circuits know-how (we manufacture a complete line of IC Logic Cards).

Put **Datascan** in your OEM DVM picture . . . we'll even personalize them with your signature at no extra charge.



Datascan, Inc. 1111 Paulison Ave., Clifton, New Jersey 07013

Put the Op Amp you're now using on this square.

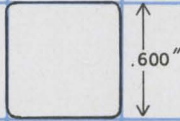

If it doesn't fit, call Data Device.

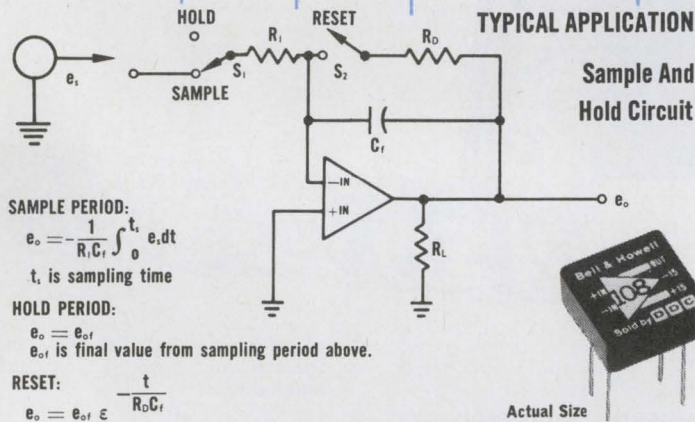

We have two new FET and bipolar series of microminiature hybrid operational amplifiers. They do everything the old fat ones did, cost about the same, and can even be inserted into existing holes on your cards.

They're internally compensated and trimmed so you don't need a lot of peripheral components. These op amps will be among the smallest devices on your board and, at 0.25" high, among the flattest.

Priced to meet your budget — in several grades of voltage and current stability; radial leads optional.

SPECIFICATION LIMITS	MODEL 008/108 FET INPUT	MODEL 009/109 COMPLEMENTARY INPUT
VOLTAGE GAIN, OPEN LOOP, DC At rated load (2K)	88 db min	83 db min
INPUT VOLTAGE CHARACTERISTICS Initial offset Drift vs. temperature	1 mV max * 5 μ V/ $^{\circ}$ C max *	0.2 mV max * 1 μ V/ $^{\circ}$ C max *
INPUT CURRENT CHARACTERISTICS Initial offset, either terminal	5 pA max *	2 nA max
RATED OUTPUT Voltage-peak at rated load Current-peak	\pm 10 V min \pm 5 mA min	\pm 10 V min \pm 5 mA min
SUPPLY VOLTAGES	\pm 10 to \pm 22 V	\pm 6V to \pm 22V
SHORT-CIRCUIT PROTECTION	Inputs & outputs	Inputs & outputs
WEIGHT	0.125 ounce	0.125 ounce
PRICE (10-25)	\$28-70	\$15-90

(*) Available with less stringent specifications

All specifications at 25 C and \pm 15 V supplies unless otherwise noted. Specifications subject to change without notice.

THE 008 & 009 HYBRID SERIES ARE MANUFACTURED FOR DDC BY BELL & HOWELL AND ARE NOW IN STOCK FOR IMMEDIATE DELIVERY



DDC has a better design

DATA DEVICE CORPORATION

100 Tec Street / Hicksville, N.Y. 11801 / (516) 433-5330

INFORMATION RETRIEVAL NUMBER 88

INSTRUMENTATION

In-circuit tester checks DIP ICs

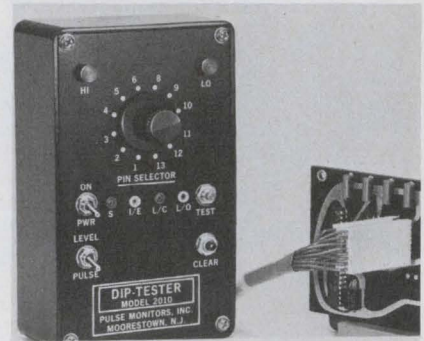

Pulse Monitors, Inc., Moorestown, N.J. P&A: \$98; stock.

Model 2010 DIP tester can check dual-in-line ICs without removing them from their circuit boards. Using an integrated circuit clip, the unit selects an active pin and a red or green light indicates the level (high or low) or polarity of pulses at that point. The tester contains integrated circuits itself and obtains its nominal 5-V 75-mA power directly from the leads of the DIP under test. It is packaged in a 6 by 3-1/2 by 2-in. plastic case.

CIRCLE NO. 286

Pressure transducer contains IC amplifier

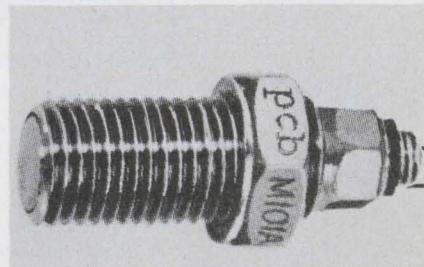

Piezotronics, Inc., 3311 Walden Ave., Depew, N.Y. Phone: (716) 684-0001. P&A: \$245; 2 wks.

With a built-in IC amplifier, model 101A pressure transducer lowers the output impedance of its quartz element by more than ten orders of magnitude to less than 100 Ω . The piezoelectric device has a resonant frequency of 400 kHz and a 1- μ s risetime. It supplies a high-voltage low-impedance output signal that may be connected directly into scopes, meters or recorders without the use of charge or voltage amplifiers.

CIRCLE NO. 287

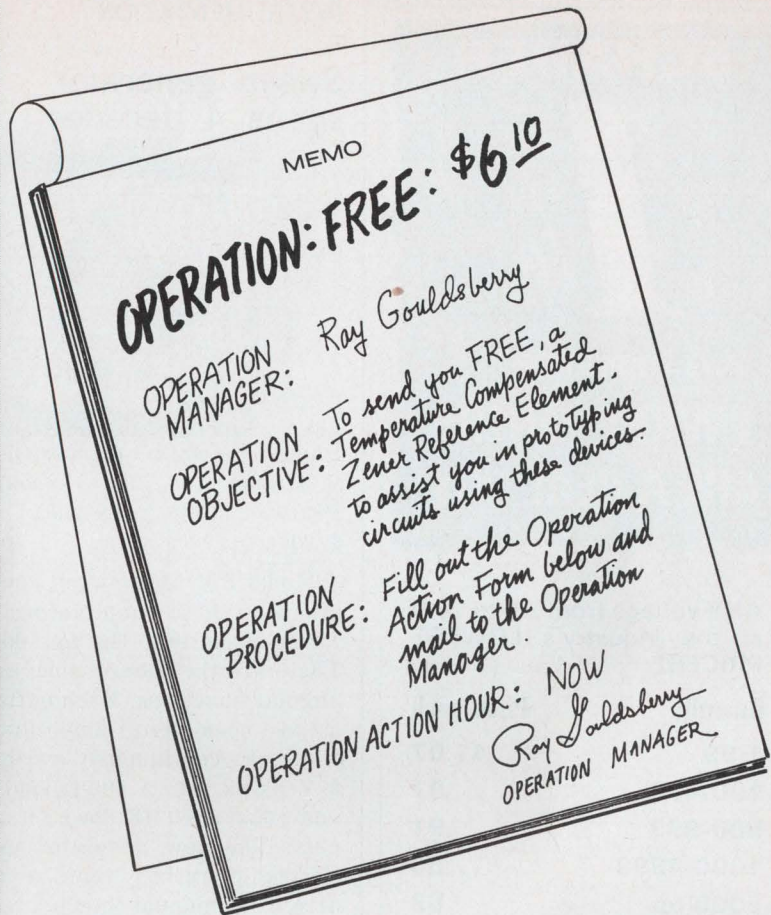
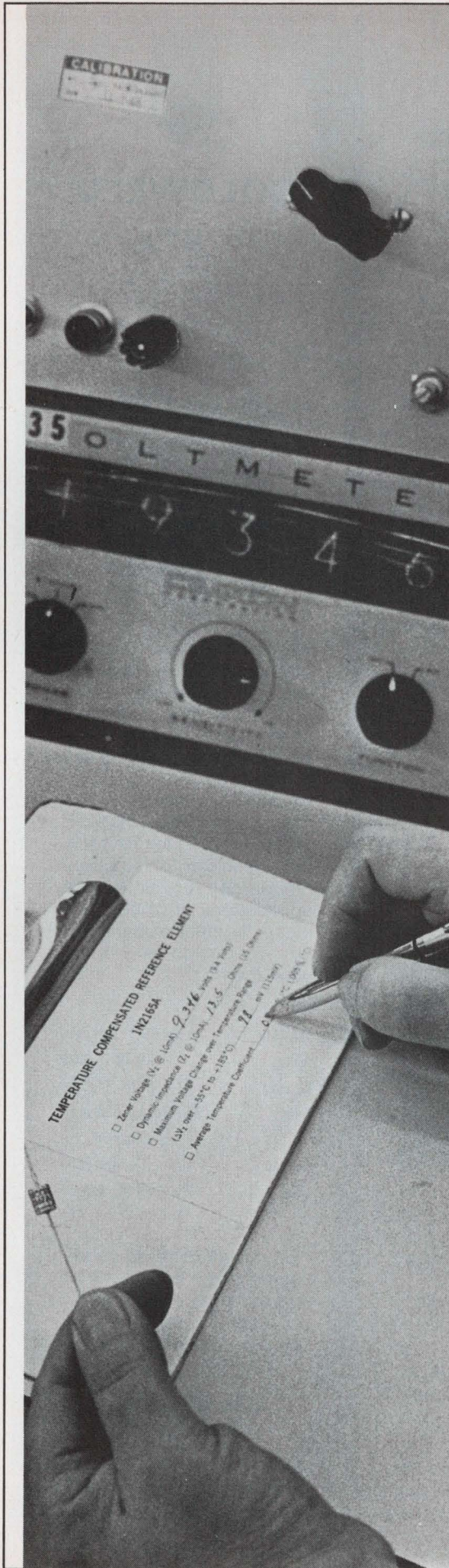

This high quality device selling for \$6.10 has these standard specifications:

- Zener Voltage (V_z): 9.4 Volts $\pm 2\%$
- Maximum Dynamic Impedance (Z_z): 15 Ohms
- Maximum Voltage Change Over Temperature Range (ΔV_z over -55°C to $+185^\circ\text{C}$): 115 mV
- Average Temperature Coefficient: .005%/°C

It will be sent to you free attached to card on which all critical parameters of your device have been recorded for you.

Operation Action Form

In what project will this device be used? _____

If this is a production project what quantity of Zener Reference Elements do you anticipate using? _____

Name: _____ Position: _____

Company: _____ M/S: _____

Street: _____

City: _____ State: _____ Zip: _____

Phone: _____ Ext: _____



3540 W. OSBORN RD. / PHOENIX, ARIZONA 85019
PHONE 602-272-7671 / TWX 910-951-1381

SCHAUER

1%

tolerance

1 WATT ZENERS ARE A REAL BUY!

ANY voltage from 2.0 to 16.0 at the industry's **LOWEST PRICES!**

Quantity	Price each
1-99	\$1.07
100-499	.97
500-999	.91
1000-4999	.86
5000 up	.82



THE HI-RELIABLE!

No fragile nail heads.
Silicon junction aligned between two, parallel, offset tantalum heat sinks . . . great lead tension strength.
All welded and brazed assembly.
High pressure molded package.
Gold plated nickel-clad copper leads.
Write or phone for Form 68-4 for complete rating data and other tolerance prices.

Semiconductor Division

**SCHAUER
MANUFACTURING
CORP.** 4511 Alpine Avenue
Cincinnati, O. 45242
Ph. (513) 791-3030

INFORMATION RETRIEVAL NUMBER 90

INSTRUMENTATION

Sweep generator spans 4 decades



Philips Electronic Instruments, 750 S. Fulton Ave., Mt. Vernon, N.Y. Phone: (914) 664-4500. Price: \$720.

Model PM 5162 sweep generator produces three simultaneous waveforms from 0.1 Hz to 100 kHz. These are the square, sine, and triangular functions. Each output has a fixed open-circuit amplitude of 10 V pk-pk, continuously variable to 3 V pk-pk into a 600-Ω load. Hum and noise is 60 dB down on all outputs. The new generator uses an electronic rather than a motor-driven or manual sweep.

CIRCLE NO. 288

Digital panel meter measures to 0.1%



Digital Instruments Co., Inc., P.O. Box 8130, Prairie Village, Kan. Phone: (913) 236-8717. P&A: \$200; 10 days.

With an accuracy of 0.1%, a digital panel meter measures dc millivolts, dc volts, ac volts, microamperes, milliamperes and ohms. Model 170 has a standard-sized face of 4-3/4 by 3 in. and weighs 1.75 lb. Custom features include choice of labels, BCD output, decimal place, plus-and-minus indicator and overrange.

CIRCLE NO. 289



COLDWELD CRYSTALS set the stage for economical high-precision Frequency Standards

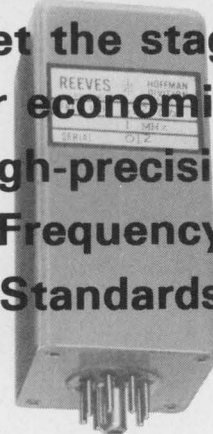

Reeves-Hoffman coldweld crystals assure superior aging; proportional oven-control provides high precision; our standardized design gives you price benefits.

The result: Model S12206 1MHz and 2 to 10 MHz high-precision frequency standards for time-base applications at prices that make it uneconomical for you to design and build your own.

Stability 1×10^{-9} rms/sec
Aging $.5 \times 10^{-9}$ /day
Range -55° to $+65^{\circ}$ C
Input 23-30 v dc, .65A max during warm-up
Output 1 v rms, 1K-ohm load
Size 2 x 2 x 4 in., seated

Government tests show aging of cold-weld crystals-superior to crystals in any other holder, including glass.

Write for additional specifications and prices.

REEVES-HOFFMAN

DIVISION, DYNAMICS CORPORATION OF AMERICA
400 WEST NORTH ST., CARLISLE, PENNSYLVANIA 17013 • 717/243-5929

INFORMATION RETRIEVAL NUMBER 91
ELECTRONIC DESIGN 4, February 15, 1969

The wreckless rechargeable.

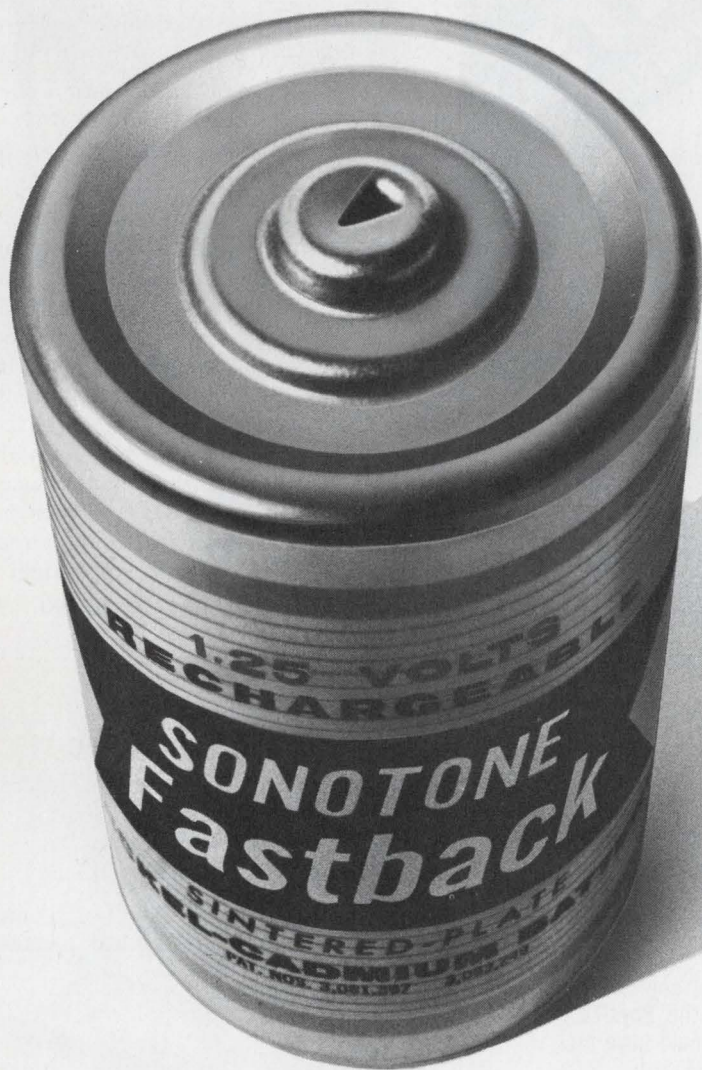

Sonotone's Fastback[®] battery won't wreck itself. Even under fast charging. Over and over and over again.

Sonotone's new nickel-cadmium sealed cell is called the Fastback because it gets back into action *fast*. In just five minutes, it gets enough charge to start a lawn mower or to operate a camera. So your product goes to work today... not tomorrow.

The Fastback's safe, too. In laboratory tests, it's been deliberately overcharged for months at the 3-hour rate. Without overheating or blowing its top. Even after that, it delivers full rated output under load.

And there's no need for expensive, bulky external charging apparatus. All

the charging capability is built right into the Fastback. Already, the Fastback's found its place in many consumer products. Should it be in yours? Find out by writing for full specifications and performance charts. Sonotone Corporation, Battery Division, Elmsford, New York 10523.

CLEVITE SONOTONE

INFORMATION RETRIEVAL NUMBER 92

YOU'RE MEASURING PHYSICAL DISPLACEMENTS

... Movement is extremely fast, slow, great or small.
... You're ascertaining position, velocity, strain, acceleration or motion.
... Conditions are extreme cold, heat, rapid motion or radio activity.

YOU CAN DO IT!
EASIER, FASTER, MORE ACCURATELY WITH PHYSITECH'S MODEL 39-A
COMPLETELY NON-CONTACTING ELECTRO-OPTICAL TRACKING SYSTEM

Simple to set up! The 39-A electronically displays the position of the target relative to the field of view. Total time from start of "set-up" to read-out of data is less than five minutes.

Multiple use 3-WAY OPERATION! Single switch changes modes from vertical to horizontal to biaxial.

Versatile lens system! Lenses are interchangeable, any one can focus from a minimum distance to infinity. With the **PhysiTech Reflex Viewer**, one lens can now do the job that would have previously taken three or four.

Unaffected by ambient light! Data is completely reliable and repetitive.

WANT TO KNOW MORE? ASK!

... For more information, a demonstration on your application by a **PhysiTech Engineer**.

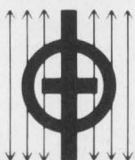

PhysiTech, Inc.

WILLOW GROVE, PA. 19090

Offices in Philadelphia, Atlanta, Chicago, Dallas, Los Angeles, through our subsidiary, PhysiTech Field Corporation.

INSTRUMENTATION

Digital counter/timer uses MSI circuits

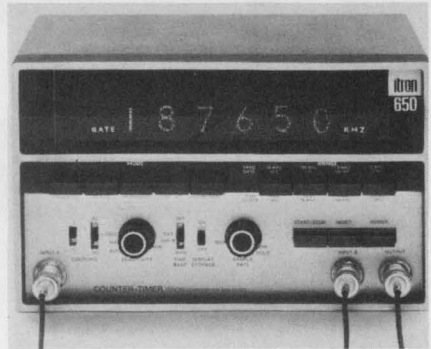

Itron Corp., 11675 Sorrento Valley Rd., San Diego, Calif. Phone: (714) 453-5300. P&A: \$595; 30 days.

By incorporating MSI circuits, a new counter/timer is able to measure frequency to 15 MHz and period to 200 seconds. Model 650 can also measure multiple period, time interval, cumulative time interval, ratio, multiple ratio, events per external gate, and cumulative events per external gate. In addition, the 6-digit instrument totalizes, scales (divides), generates reference frequencies, and can be used as an electronic stopwatch.

CIRCLE NO. 290

Circuit tester handles dc and ac

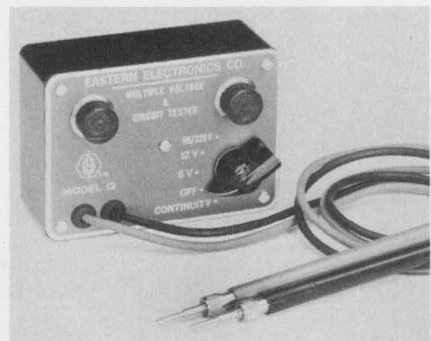

Eastern Electronics Mfg. Corp., 2 Cedar St., East Hartford, Conn. Price: \$12.95.

A compact battery-operated tester checks voltages and circuits for both ac and dc currents. Its large ruby lamps indicate shorts, opens and continuity of circuits in all types of equipment. Supplied with 36-in. leads, the tester is packaged in an unbreakable case that measures 2-7/8 by 4 by 1-5/8 in.

CIRCLE NO. 291

Centralab has a **ZENER** with your number on it!

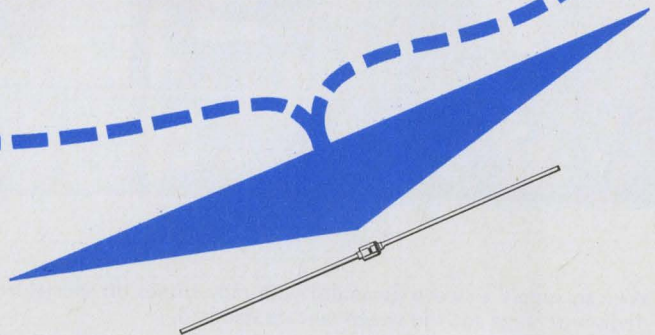

The odds are good that no matter what microglass zener regulator you need, we make it . . . with the industry's shortest (and most reliable) delivery.

If we *don't* presently make it, just give us your specs, then relax and watch your Zener Task Force go to work. We'll come back to you with a zener to meet or exceed your high rel military specs or demanding industrial requirements — one that offers highest performance . . . plus stable, effective surface passivation . . . in a case style to fit your application.

Or our name isn't Centralab*, "the zener specialists" — the originators of microglass zeners!

But, either way — when you design a Centralab silicon zener regulator with either *your* JEDEC number or *your* part number on it into *your* product — we'll lay *our* reputation on the line right along with yours.

Have we got your number?

Dial ours — (213) 686-0567 — and find out.

*On May 1, 1967, Centralab acquired the Semiconductor Division of Hoffman Electronics Corporation.

THE
ZENER
SPECIALISTS



CENTRALAB

Semiconductor Division
GLOBE-UNION INC.
4501 NORTH ARDEN DRIVE
EL MONTE, CALIFORNIA 91734

M-6836

INFORMATION RETRIEVAL NUMBER 94



sweeps
5 to 1500 MHz
in 7.5 milliseconds
flat!



We can supply a sweep generator with rally stripes on special order, but the frequency range and the sweep rate are standard.

Telonic's 2003 Sweep Generator will cover that entire band—14.5 MHz—in a single sweep, or in any segment down to 0.02 Hz wide. You can instantly see response characteristics over all, or any portion, of a circuit's operating frequencies.

And don't overlook that word "instantly." If you're still in the habit of using a signal generator for point-to-point testing, it's time to upshift into swept techniques. Let your local Telonic rep show you the '69 floor models.

Model 2003 Sweep/Signal Generator System

Frequency Range (Seven different plug-in oscillators available)..... 0.02 Hz-1500 MHz
Sweep Width (F_1-F_2 or $F_C/\Delta F$)..... 0.02 Hz-1495 MHz
Frequency Marking (Four different marker plug-ins available)..... Fixed or variable
Attenuation (Eight attenuator plug-ins available)..... 1 db to 109 db (50 or 75 Ω)
Sweep Rate (Select from two rate plug-ins)..... 0.001 to 60 sweeps/sec.
Log Amplification (One plug-in does it all)..... 105 dB dynamic range
Detection (Two detector plug-ins available)..... P-P passive, 50 and 75 Ω
Display (Two display processing plug-ins)..... Amplitude and marker tilt control

Catalog 70-A and Supplements contain complete descriptions on all Telonic Sweep Generators plus a full section devoted to "how-to" applications. Get your copy today.



TELONIC INSTRUMENTS
 A Division of Telonic Industries, Inc.
 60 N. First Avenue
 Beech Grove, Indiana 46107
 TEL (317) 787-3231 • TWX-810-341-3202

INFORMATION RETRIEVAL NUMBER 95

INSTRUMENTATION

Low-priced IC tester cuts checking costs

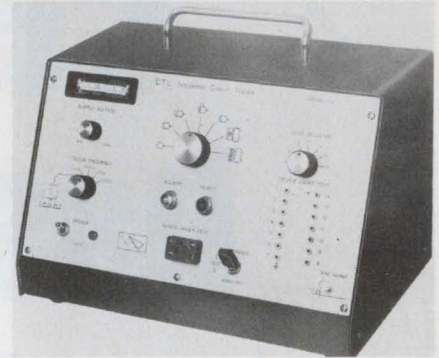

E&L Instruments, Inc., 61 First St., Derby, Conn. Phone: (203) 735-8774. Price: \$850.

Designed for volume testing of integrated circuits, a low-cost DTL IC tester automatically performs dynamic functional tests for less than 0.5¢ per module. Model 714 operates by comparing an internally generated standard signal with the combined outputs of the device under test. By performing all tests on a go/no-go basis, the unit can test up to 3600 modules a day—450 an hour, 7 or 8 a minute.

CIRCLE NO. 292

Universal test clamp prevents shorting

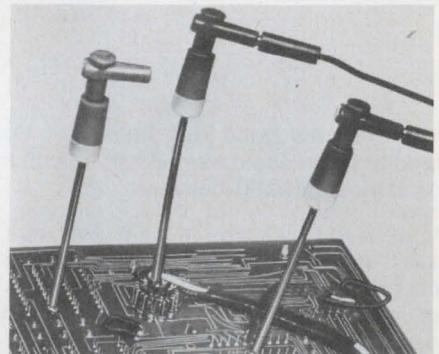

Hunter Associates, 182 Clairmont Terrace, Orange, N.J. Phone: (201) 672-0423. Price: \$2.35.

Able to grip the finest wire or PC-board etching and then retract into its insulating sleeve, a universal test clamp checks high-density circuitry without the danger of shorts. The retractable spring clamp of type P-1 is activated by light pressure on the head. A standard banana jack allows rapid interconnection.

CIRCLE NO. 293

life of a STACOSWITCH

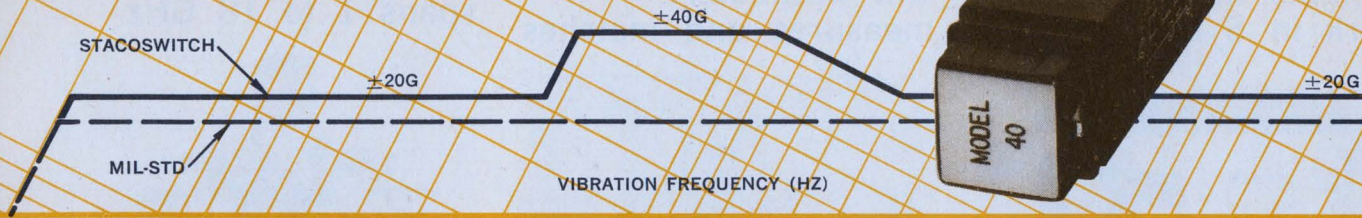

Series 40 four-lamp, word indicator switch (Actual Size)

STACOSWITCH Series 40 switches are functioning efficiently on aircraft throughout the world. Currently, they're installed on the A7D/E, EC-121, A-4, P3C, LORAN D, and other major programs. But, if you think they get "shook-up" in flight, you should see what we do to them in our own testing lab! □ STACOSWITCH laboratory is approved by the Defense Electronics Supply Center to conduct testing to meet the requirements of MIL-S-22885, for switch, pushbutton and illumi-

nated devices. □ Series 40 switches are recommended for many types of switching. They are life rated to handle currents in the full range of "dry circuit," logic level, intermediate current (50ma), high current levels, even inductive loads (per MIL-I-81023A) up to 5 amperes @ 28 volts d.c. □ The Series 40 Lighted Switch meets test requirements in addition to MIL-S-22885—such as explosion, acceleration, sand and dust, and high altitude, 20g vibration. RFI/EMI shield-

ing is also a standard option on the Series 40; screen mesh size has been optimized for attenuation and light output. □ There's no extra charge for this performance, in fact, you'll find that our switches, such as the Series 40, cost you less. For complete information on the Series 40, request Catalog SF-3 from:

STACOSWITCH, 1139 Baker Street
COSTA MESA, CALIFORNIA 92626
(714) 543-3041

INFORMATION RETRIEVAL NUMBER 96



Tunable filters work in S band

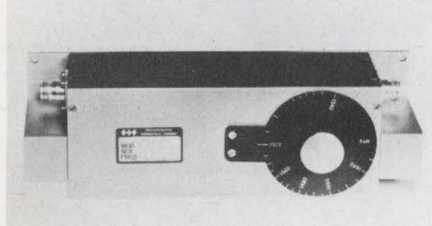

TRF, Inc., subsidiary of Quanta Systems Corp., 6627 Backlick Road, Springfield, Va. Phone: (703) 451-5131. Availability: stock to 30 days.

Tunable filters for L- and S-band telemetry applications can be frequency-calibrated directly, while low insertion loss and high selectivity is retained. Series TBP-400H units are available with bands from 1.435 to 1.540 GHz, or from 2.2 to 2.3 GHz. Bandwidths are 30 MHz at 0.5 dB; 33 MHz at 3 dB, and 76 MHz at 50 dB. Maximum insertion loss is 1 dB, and nominal VSWR is 1.5.

CIRCLE NO. 294

Uhf wattmeter measures and matches

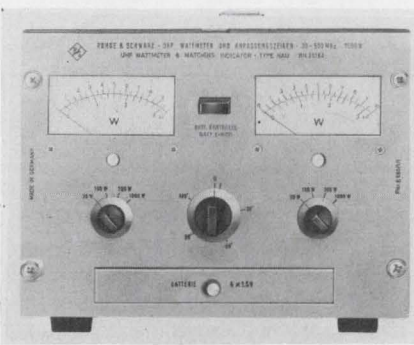

Rohde & Schwarz, 111 Lexington Ave., Passaic, N.J. P&A: \$1295; stock.

A uhf wattmeter and matching indicator permits simultaneous measurement of incident and reflected power on two meters. Simultaneous measurement eliminates any need for switching or replacing plug-in elements. Type NAU, with a frequency range of 25 to 500 MHz, is available in two models: 50 mW to 31.6 W; 2-to-1000 W.

CIRCLE NO. 295

Coaxial switch spans 1 to 18 GHz

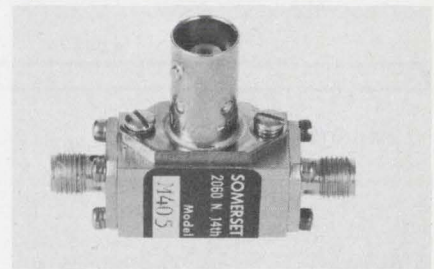

Somerset Radiation Laboratory, Inc., 2060 N. 14th St., Arlington, Va. Phone: (703) 525-4255. P&A: \$230; 20 days.

Model M405 coaxial switch gives over 40-dB isolation in the 1-to-18-GHz range, with 0.5 to 2.5 dB insertion loss, and 2-W cw and 100-W peak power. Wide range is achieved by functionally integrating silicon p-i-n diodes into a low-pass filter, along with a shunt-bias circuit. With zero bias, minimum-signal attenuation is attained; with forward bias, the diodes prevent signal flow from spoiling the filter.

CIRCLE NO. 296

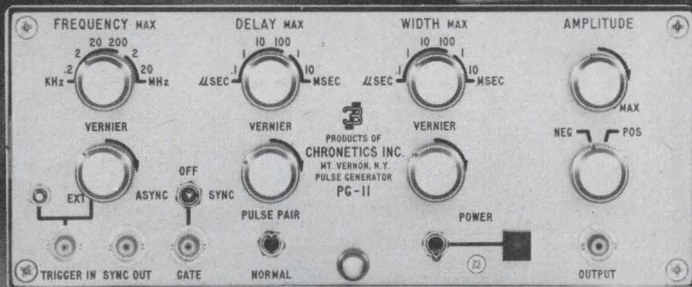

The PG-11 Costs \$375. Don't Tell It. It Thinks It Costs A Lot More.

We designed the PG-11 to be the best all-around low cost pulser available for general purpose test, development and production use. It is. It can do just about anything it does extremely well and with complete reliability.

For example, it provides ± 15 volt pulses, single or double, pulse bursts when suitably gated, or one-shot pulses via a front panel pushbutton. Rep rate is continuously variable from 10 Hz to 20 MHz and amplitude, width and delay are continuously

variable, too: width 25 ns to 10 ms; delay 20 ns to 10 ms; amplitude 0 to ± 15 volts at any rep rate including 20 MHz. Rise time is typically 4 ns although we spec it at 5 ns; fall time is 5 ns or better and both of them are this good at full amplitude or any other amplitude.

So, even if it's small (4" h x 8-1/2" wd x 9-1/2" d) and even if you can get two of them in 3-1/2" of rack height with our rack adapter, the PG-11 acts like it ought to cost a lot more than \$375. But don't tell it and it will never know.

Write or 'phone your nearest Chronetics representative (eem) for full data and/or a very prompt demonstration.

Chronetics, Inc., 500 Nuber Avenue, Mt. Vernon, N.Y. (914) 699-4400. In Europe: 39 Rue Rothschild, Geneva, Switzerland (022) 31 81 80.

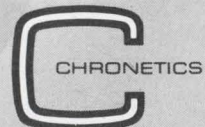

Only Magnetics Inc. gives you all three of these advantages in photo-etched parts:

1. Metals processed to your specification
2. Guaranteed magnetic performance properties
3. Total quality control, raw metal to finished part

There is nothing new about chemically milling small, thin metal parts. Dozens of companies can photo-etch any part that can be drawn. What sets Magnetics Inc. apart in photo-etching is our capability of processing the metal to close tolerances.

Magnetics' completely integrated

production system for Photofab® parts is all-inclusive. We can custom blend basic metals into special alloys, or we can start with stock metal. We follow through with whatever it takes to match your specifications—precision rolling or flattening or strip annealing. As long-time specialists in magnetic materials, we have the facilities and the expertise needed to provide the ultimate in dimensional accuracies, at the same time guaranteeing the magnetic properties of your parts.

We augment our production capa-

bilities with uptight quality control. This means the most advanced laboratory and test equipment, manned by a staff of nit-picking experts. When you take delivery on Photofab parts, you can be sure that they've passed our constant surveillance, from basic metal through shipment in custom-designed packaging.

If you've been looking for a supplier who can offer single-source responsibility on photo-etched parts, you've found us. For more information, write Magnetics Inc., Dept. ED-110, Butler, Pa. 16001.



Photofab example—
words photo-etched
in a sheet of .001
beryllium copper.

MAGNETICS inc.

TAPE, POWDER, BOBBIN, FERRITE CORES • LAMINATIONS • PHOTO-ETCHED PARTS • SPECIALTY METALS • ENGINEERED CONTROL SYSTEMS

INFORMATION RETRIEVAL NUMBER 98

san fernando

electric manufacturing company

Electronic components
of proven reliability

INTRODUCES AN OUTSTANDING RFI FILTER



Actual Size

TYPE CF MINIATURE RFI LOW PASS
FILTER SERIES DEVELOPED BY WEST-CAP®

▶ PACKS MORE INSERTION LOSS IN A
SMALLER UNIT THAN EVER BEFORE

Plus all these features:

MINIATURE SIZE • LOW WEIGHT • LOW D.C. RESISTANCE • HIGH ATTENUATION • HERMETICALLY SEALED • BROADER RANGE OF VALUES • GOLD OR SILVER PLATED, STEEL CASE • HIGHER CURRENT RATINGS (TO 15 AMPS.)

Dimensions (inches)

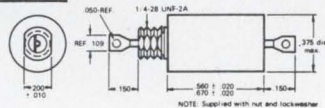

Ordering information

CF	4	A	PO6	- 1	G
TYPE	CIRCUIT	VOLTAGE	CURRENT	MOUNTING STYLE	TERMINAL STYLE

Voltage

A	50 VDC
B	100 VDC
C	200 VDC (115 VAC)

Circuit

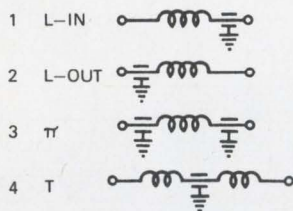

Mounting Style

1	.312	NO FLATS
2	.312	2 FLATS
3	.190	NO FLATS
4	.190	2 FLATS

Terminal Style

G	90° LUG
L	LEADS

Current in Amperes

PO6	.06 Amps.
P15	.15 Amps.
P25	.25 Amps.
P50	.50 Amps.
1P0	1.0 Amps.
2P0	2.0 Amps.
3P0	3.0 Amps.
5P0	5.0 Amps.
10P	10.0 Amps.
15P	15.0 Amps.

Call your representative of West-Cap high-reliability products or contact West-Cap Division—where service and quality count.



WEST-CAP DIVISION

1501 First Street, San Fernando, California
Telephones: (213) 365-9411 TWX (213) 764-5963

STANWYCK WINDING
NEWBURGH, NEW YORK

• WEST-CAP ARIZONA
TUCSON, ARIZONA

• GENERAL SCIENTIFIC
SAN FERNANDO, CALIFORNIA

INFORMATION RETRIEVAL NUMBER 101

MICROWAVES & LASERS

Stripline termination handles 15 W at 5 GHz

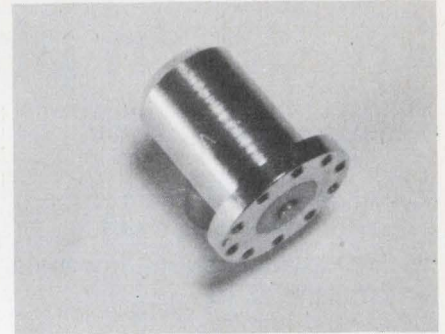

ESCA, 1426 West Front St., Plainfield, N.J. Phone: (201) 756-1252.

A right-angle stripline termination, covering the dc to 5-GHz frequency range, handles 15 W at room temperature and 3.5 W at 125°C. VSWR is 1.05 max., from dc to 2 GHz, and 1.1 max. at 2 to 5 GHz. Environmental performance to MIL-STD 202 is achieved. The unit measures 1 by 7/8-in. A button contact for mounting in a stripline circuit is provided.

CIRCLE NO. 297

Transistor amplifiers cover 225 to 400 MHz

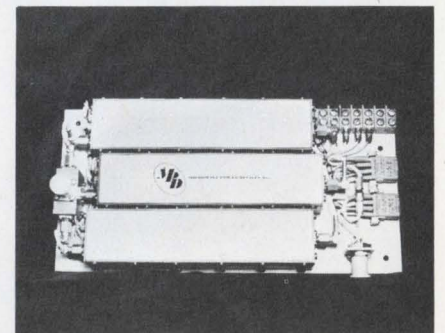

Microwave Power Devices, Inc.,
556 Peninsula Blvd., Hempstead,
N.Y. Phone: (516) 538-7520.
Availability: 4 to 8 wks.

Transistor amplifiers, covering the instantaneous bandwidths of 225 to 400 MHz, achieve third-order intermodulation of -35 dB at a power output of 1 W. The amplifiers are fully protected against open- or short-circuit load conditions. They operate indefinitely, into load VSWRs of 2.5 at any phase, with no change in intermodulation.

CIRCLE NO. 298

Soliton announces

300 VOLTS

5-AMP, PLANAR TRIPLE DIFFUSED TRANSISTORS

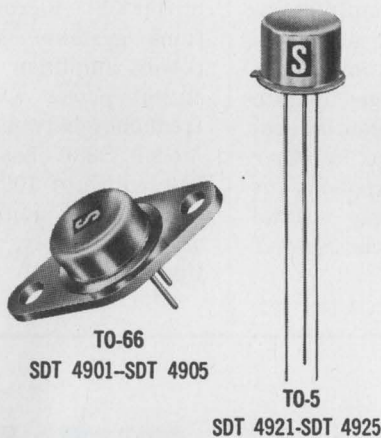

Soliton expands its line of high-rel, high voltage planar devices with new 5-Amp NPN Triple Diffused Transistors having voltages up to 300V. These transistors, the SDT 4901-5 and SDT 4921-5 Series, have the same construction technique as Soliton's popular 20-Amp SDT 8800 and 10-Amp SDT 7900 Series. This advanced planar construction results in stable performance at high temperature under reverse bias conditions. Available in the TO-66 and TO-5 case, they are designed for high voltage, fast switching applications such as telemetry, radar systems, high speed data transmissions, sweep circuits and TV deflection circuits.

Type Number TO-66	Type Number TO-5	RATED BREAKDOWN VOLTAGES			PERFORMANCE SPECIFICATIONS						
		BV _{CBO}	BV _{CEO} (SUS)	BV _{EBO}	h _{FE}		V _{CE} (sat) Volts	V _{BE} (sat) Volts	I _{CBO}		f _T
					@ I _C = 1.0A V _{CE} = 5.0V	@ I _C = 1.0A I _B = 0.1A	@ I _C = 1.0A I _B = 0.1A	μA		MHz	
		Min.	Min.	Min.	Min.	Max.	Max.	Max.	Max.	@ V _{CB}	Typ.
SDT 4901	SDT 4921	225	200	8	20	60	0.4	1.2	1.0	100	40
SDT 4902	SDT 4922	250	225	8	20	60	0.4	1.2	1.0	100	40
SDT 4903	SDT 4923	275	250	8	20	60	0.4	1.2	1.0	100	40
SDT 4904	SDT 4924	300	275	8	20	60	0.4	1.2	1.0	100	40
SDT 4905	SDT 4925	325	300	8	20	60	0.4	1.2	1.0	100	40

To obtain additional information on these devices, Dial 1-800-327-3245 for a "No Charge" telephone call.

SEMICONDUCTOR DIVISION

Soliton
DEVICES, INC.

1177 BLUE HERON BLVD. / RIVIERA BEACH, FLA / TWX: (510) 952-6676

INFORMATION RETRIEVAL NUMBER 102

Solid state amplifiers span 1 MHz to 1 GHz



Locus, Inc., P.O. Box 740, 906 West College Ave., State College, Pa. Phone: (814) 237-0301. Price: \$400 to \$800.

Designed to provide excellent electrical performance in a small package, series 2A and series 2B solid-state rf amplifiers cover the frequency range of 1 MHz to 1 GHz in bandwidths of 0.5 MHz or several octaves. The units achieve power outputs of 20 dBm with gains as large as 25 dB, while holding noise figures between 2 and 7 dB. They meet the environmental requirements of Mil-E-5400 and Mil-I-6181.

CIRCLE NO. 321

Attenuator cartridges connect in stripline

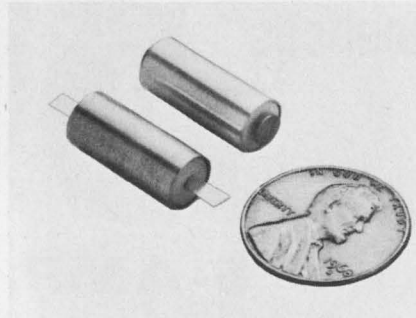

Microlab/FXR, Ten Microlab Rd., Livingston, N.J. Phone: (212) 721-9000. P&A: \$40; 4 wks.

Connectorless attenuator cartridges for direct inclusion in stripline modules and transmission lines are available in attenuation values up to 30 dB. The cartridges operate from dc to 10 GHz and can be provided with stripline, disc, or other mating configurations. Applications include incorporation into coaxial components such as switches, power dividers and detectors.

CIRCLE NO. 322

S-band amplifier delivers 2 watts

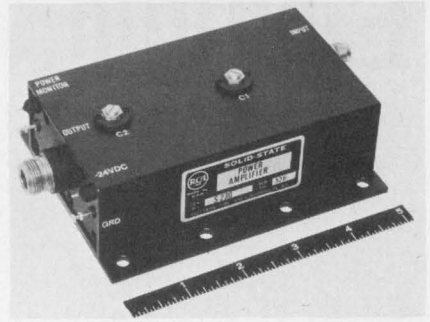

RCA/Electronic Components, 415 South Fifth St., Harrison, N. J. Phone: (201) 485-3900. P&A: \$695; 60 days.

Designed to function as a transmitter in microwave communications systems, a new transistor power amplifier supplies 2 W of output power when tuned to any frequency between 1.85 and 2 GHz. Model S230 has a typical 3-dB bandwidth of 100 MHz. It operates as a class C amplifier, from a 24- or 28-V supply, for alarm indication.

CIRCLE NO. 323

POWER/MATE CORP. UNI-76

UNIVERSAL POWER SUPPLY

- * 0 to 34 volts at 0.5 AMPS.
- * .005% regulation
- * 250 Microvolts ripple
- * Meets MIL-E-5272 specs
- * 100,000 hours MTBF
- * 5 year warranty

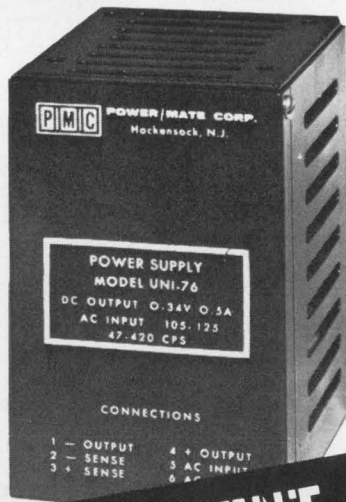

SAME DAY SHIPMENT
\$76.00



POWER/MATE CORPORATION

163 Clay St. ■ Hackensack, N. J. 07601
(201) 343-6294 ■ TWX (710) 990-5023

INFORMATION RETRIEVAL NUMBER 103

FREE

Model S1301A

Get technical literature on the only *totally* portable, solid state oscilloscope. Operates from optional internal battery or from 110/220 vac, 50 to 400 Hz line voltage. Features include: 20 MHz bandwidth; 17 nsec rise time; 18 ranges of calibrated sweep speeds; internal voltage calibrator; and triggering stability in excess of 30 MHz.

Write for Bulletin TIC 3316 to Motorola Communications & Electronics Inc., 4501 W. Augusta Blvd., Chicago, Ill. 60651



MOTOROLA
Precision Instrument Products

INFORMATION RETRIEVAL NUMBER 104

SILICON RECTIFIER ASSEMBLIES

YOUR SPECIAL REQUIREMENTS
MAY BE A TUNG-SOL STANDARD

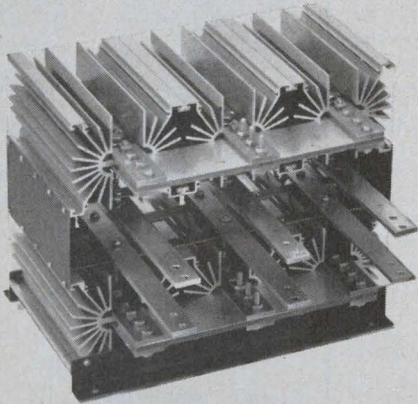

High current, three phase bridge. 1400 amps continuous.

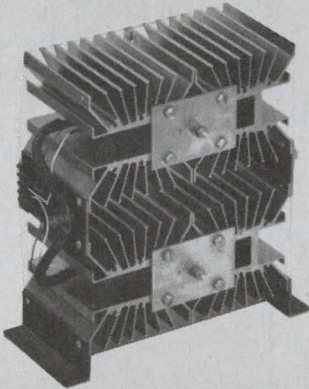

Silicon rectifier and SCR hybrid. Up to 270 amps continuous.



Single phase or three phase bridge. Up to 31 amps D.C. and PVR's up to 1KV.

Controlled avalanche. Available to 150KV at 3 amps, single phase, halfwave.

Tung-Sol design capability encompasses wide power range. Write, describing requirements. No obligation. Tung-Sol Division, Wagner Electric Corporation, One Summer Ave., Newark, New Jersey 07104.

TUNG-SOL[®]

SILICON RECTIFIER ASSEMBLIES

© REG. T.M. WAGNER ELECTRIC CORPORATION

INFORMATION RETRIEVAL NUMBER 105

ELECTRONIC DESIGN 4, February 15, 1969

New 510 Series Laser Light Modulators Only 75 volts for 100% modulation @ 632.8nm

Suggested Applications: Laser Printing and Display Systems

- Optical Storage and Readout
- High Bit Rate Data Links
- High Resolution Laser Ranging Systems
- Atmospheric Propagation Studies
- Ultra High Speed Laser Stroboscopy

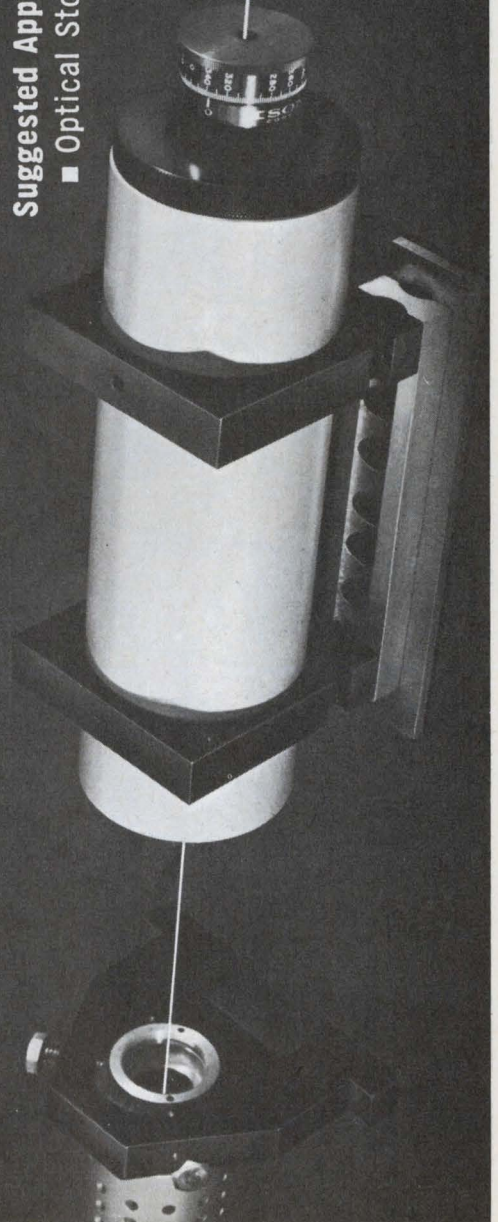

For additional information write: Isomet Corp.,
433 Commercial Ave., Palisades Park, N. J. 07650,
or call (201) 944-4100

ISOMET
CORPORATION

INFORMATION RETRIEVAL NUMBER 106

Hickok

DMS 3200 DIGITAL MEASURING SYSTEM (Fully solid state with IC's)

MODULES & SUBASSEMBLIES



This all-solid-state precision measurement system offers unlimited expansion capability through plug-in additions, resulting in a specialized instrument for each type of measurement. New plug-ins now broaden the measurement capability of this field-proven unit. Over 10,000 are in use at present.

Scaling controls make possible resolution of up to seven digits on the three-digit display by utilizing the overrange capability of many of the plug-ins, thus providing high resolution and accuracy with minimum investment. Companion devices such as the PR 4900 Digital Printer and 1050 Digital Set-Point Controller further extend the utility of the DMS 3200 System.



- DC VOLTMETER PLUG-IN DP 100 \$175
00.1 mv to 999. volts
± 0.1% rdg ± 1 digit
- DC MICROVOLTMETER PLUG-IN DP 110 \$450
0.001 mv to 999.9 volts
± 0.05% rdg ± 1 digit
4-digit resolution
- AC VOLTMETER PLUG-IN DP 130 \$375
0.01 mv to 999. volts
± 0.1% rdg ± 1 digit
22 Hz to 1.0 MHz
- EVENT COUNTER/SLAVE PLUG-IN DP 140 \$90
Up to 1,000,000 counts/sec
Cascade with second DMS to
obtain 6-digit display
- 1 MHz COUNTER PLUG-IN DP 150A \$230
00.1 Hz to 999. kHz
± 0.0005% rdg ± 1 digit
7-digit resolution
- 80 MHz COUNTER PLUG-IN DP 160 \$395
00.1 Hz to 80.0 MHz
± 0.00005% rdg ± 1 digit
7-digit resolution
- OHMMETER PLUG-IN DP 170 \$275
.001 ohm to 999. megohms
± 0.1% rdg ± 1 digit
Microamp test current
- CAPACITY METER PLUG-IN DP 200 \$275
.001 picofarad to 9,999 mfd
± 0.1% rdg ± 1 digit
Low DC test voltage
- TIME INTERVAL METER PLUG-IN DP 210 \$230
0.01 ms to 999. seconds
± 0.0005% rdg ± 1 digit
Period or time interval
- DC CURRENT METER ADAPTER D 310 \$90
.0001 microamp to 9.99 amps
± 0.15% rdg ± 1 digit

Op amp supply occupies 3/4 in.³

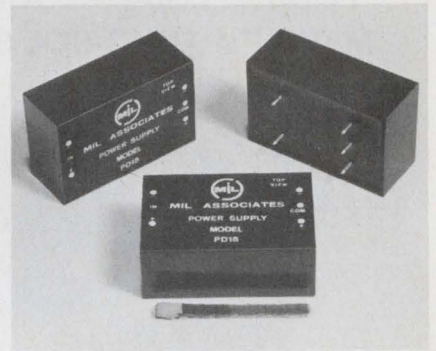

Mil Associates, Dracut Rd., Hudson, N.H. Phone (603) 889-6671. P&A: \$49; two days.

Designed especially for operational amplifiers and integrated circuits, a modular ±15 V power supply packs a 1-W output into a volume of 3/4 in.³ Ideal for plug-in PC-card applications, model PD-15 provides 150-V isolation and operates from a 28-V dc source. Its line regulation for a ±4 V change is better than ±0.5%, and its output ripple is less than 0.3%. The unit has reverse polarity protection up to 100 V.

CIRCLE NO. 324

Low-cost op amp spans 125 kHz

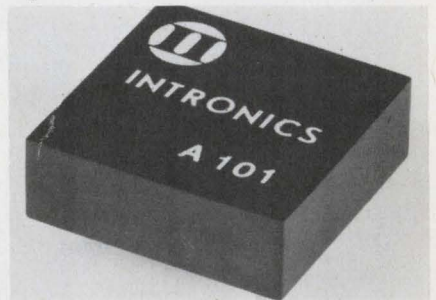

intronics, Inc., 57 Chapel St., Newton, Mass. Phone: (617) 332-7350. P&A: \$13.50; stock.

Capable of delivering 10-V common-mode voltage, a low-cost operational amplifier supplies 5-mA output current over a bandwidth of 125 kHz. Other model A101 operating parameters are: an input-offset drift of 20 μV/°C, an input current of 20 nA/°C, a common-mode input impedance of 50 MΩ and a common-mode rejection ratio of 90 dB.

CIRCLE NO. 325

HICKOK ELECTRICAL INSTRUMENT COMPANY, 10514 Dupont Ave., Cleveland, Ohio 44108

INFORMATION RETRIEVAL NUMBER 107

The chips are down.

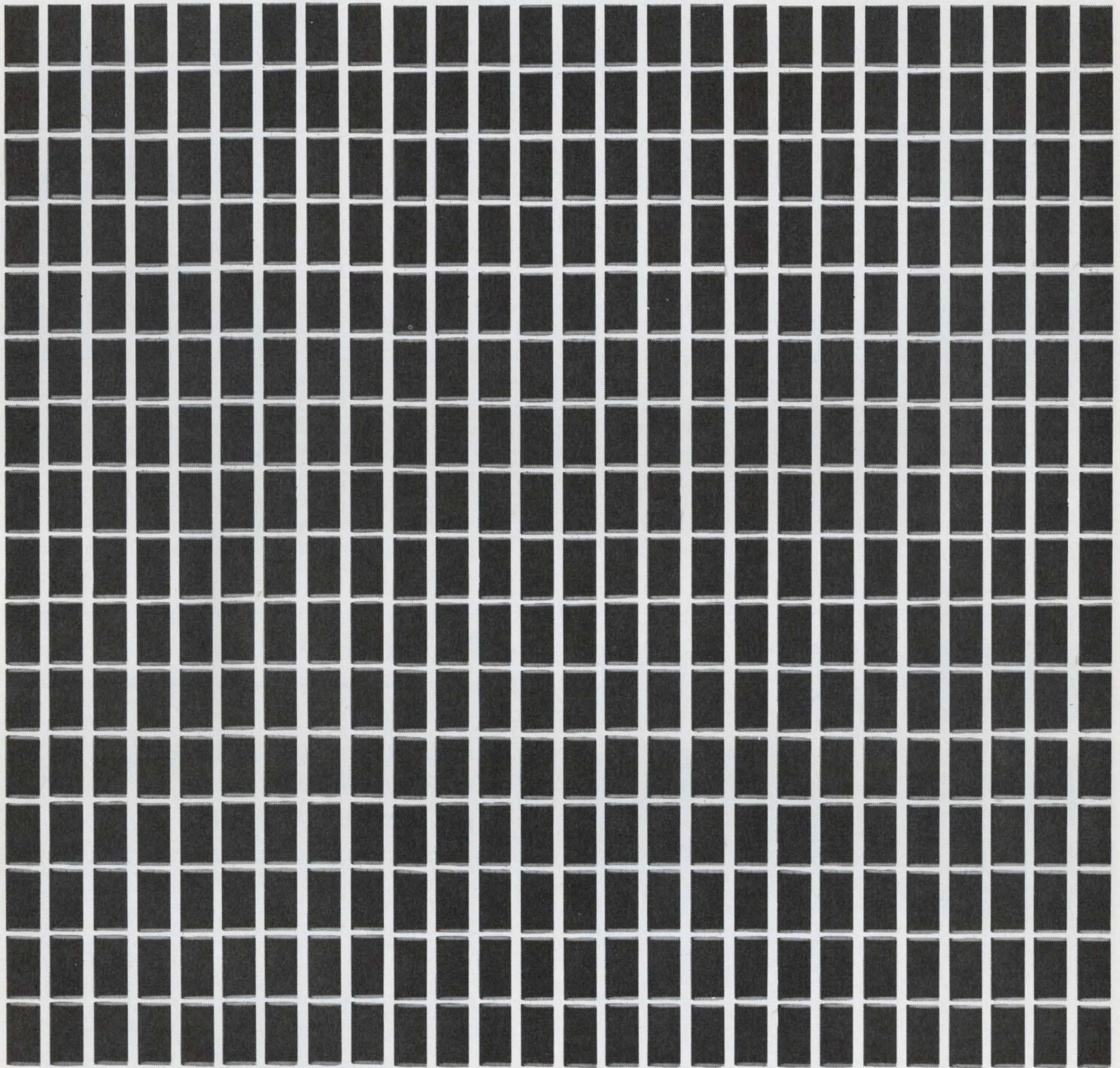

Some designers think that if you've seen one chip capacitor, you've seen 'em all. Negative.

EMC Metamorphic® chip capacitors are something else. Like semiconductor chip devices, these high-quality components can be attached to substrates, headers, or

printed circuit boards.

In terms of lumped capacitance per unit area, EMC chip capacitors have it all over single-layer devices. That's because they're made up of as many as 30 layers of high-K ceramics. And they come in a variety of sizes in rectangular

and near-square types with 50, 100 and 200-volt ratings.

While our standard terminations are silver, we can give you gold or nickel. Our free catalog will tell you we also build a healthy range of axial and radial-lead capacitors.

But mainly, we're in the chips.

Electro Materials 

11620 Sorrento Valley Road, San Diego, California 92121, Phone (714) 459-4355, TWX 910 322-1130
Electro Materials, A Division of Illinois Tool Works Inc., Represented by COMPAR

INFORMATION RETRIEVAL NUMBER 108

Overload module handles 100 A

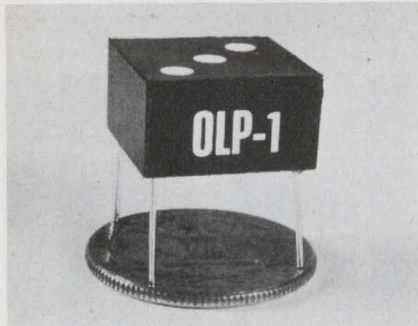

Space Age Microcircuits, P.O. Box 426, Chatham, N.J. Phone: (201) 635-8484. P&A: \$15; stock.

Without the use of wasteful series-dropping resistors, an overload module, model OLP-1, protects any regulated power supply in case of an overload or short circuit for currents as high as 100 A. When an overload occurs, the OLP-1 causes the regulating circuit to shut down. Interrupting the input power allows recovery. The unit has a volume of 0.17 in.³

CIRCLE NO. 326

Counter/display kit operates at 18 GHz

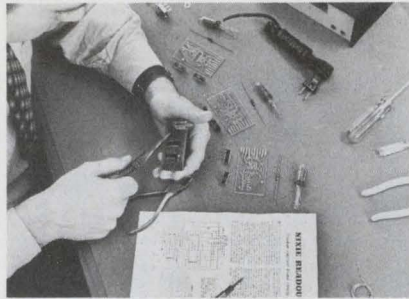

Southwest Technical Products Corp., 219 West Rhapsody, San Antonio, Tex. Price: \$30.

A new counter/display card in kit form operates at 18-MHz rates and displays the total count on its integral readout tube. It is designed to reduce costs for low-voltage component users in such applications as low-cost displays, prototypes, and experiments. Using two ICs, the palm-sized kit reduces to just five the number of components for a single-digit counter/readout.

CIRCLE NO. 327

High-voltage supplies shrink package size



Computer Power Systems, Inc., 722 East Evelyn Ave., Sunnyvale, Calif. Phone: (408) 738-0530.

Series CPS-1000 solid-state power supplies achieve miniaturization by packaging all high-voltage circuitry in four interlocking epoxy-encapsulated blocks. This eliminates space-consuming point-to-point wiring, and enhances mechanical reliability. Primarily designed to power CRT displays, the units supply 10 to 30 kV in a 4-1/2 by 4-5/8 by 9-in. package.

CIRCLE NO. 328

POWER/MATE CORP.
UNI-88

UNIVERSAL POWER SUPPLY

- * 0 to 34 volts at 1.5 AMPS.
- * .005% Regulation
- * 250 Microvolts ripple
- * Meets MIL-E-5272 specs
- * 100,000 hours MTBF
- * 5 year warranty

\$99.⁰⁰

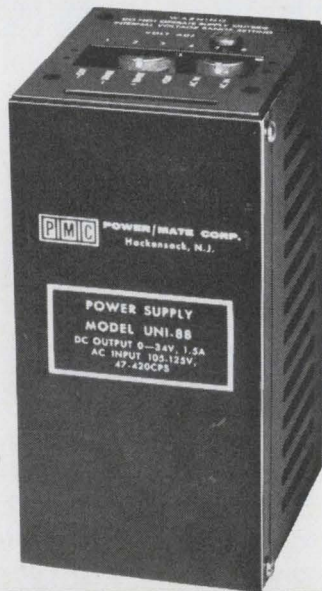

SAME DAY SHIPMENT



POWER/MATE CORPORATION
163 Clay St. ■ Hackensack, N. J. 07601
(201) 343-6294 ■ TWX (710) 990-5023

INFORMATION RETRIEVAL NUMBER 109

TURN to Grayhill

for EXCELLENCE IN
MINIATURE... SUB-MINIATURE...
ULTRA-MINIATURE
ELECTRONIC COMPONENTS

 Test Clips	 PUSH POSTS	 Stand-Off Insulators	 Binding Posts	 Insulated Test Clips
				 Lamp Sockets
... the Difference Between Excellent and Adequate				 Transistor Sockets
Grayhill Components are only fabricated from select materials . . . in designs long proven to fully satisfy applications demanding long life and high reliability under extreme environmental and operating conditions. Here is Excellence, competitively priced.				 Module Cases
Ask for Catalog G-304-A for full details				
				565 Hillgrove Avenue LaGrange, Illinois 60525 Area Code 312, Phone 354-1040
"PIONEERS IN MINIATURIZATION"				

When Only Excellent is Adequate

INFORMATION RETRIEVAL NUMBER 110

New, smaller air variable capacitor

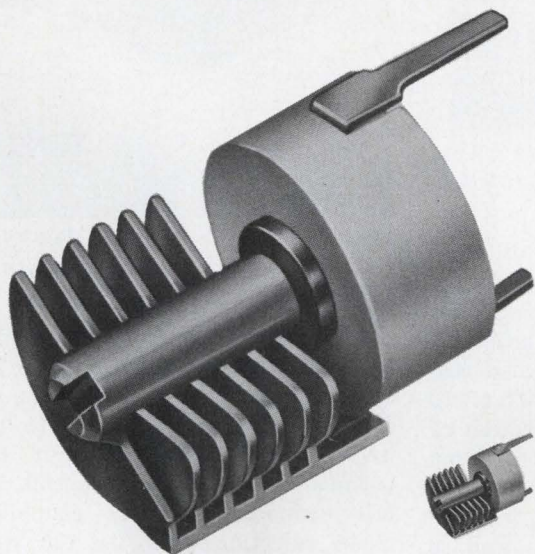

ACTUAL SIZE

**1.7 to 11 pf machined plate capacitor
for PC mounting is only .310" in diameter**

This new, sub-miniature Type "T" air dielectric trimmer capacitor from E. F. Johnson fits the limited space requirements of modern design. It is designed for VHF and UHF applications where small size (.310" diameter), high Q (greater than 1500 at 1 MHz), low TC and low cost are important considerations.

The Type "T" mounts interchangeably with widely used 3/8" printed-circuit-type ceramic disc trimmers in two .050" diameter holes on .300" centers.

Nominal capacity is 1.7 pf minimum, 11.0 pf maximum. Peak voltage breakdown is 250 VDC. End frame is 95% alumina, grade L624 or better, DC200 treated. Metal parts are silver plated and Iridited.

Johnson machined plate construction provides exceptional stability, including minimum drift over extremes of temperature and humidity.

MAY WE TELL YOU MORE? Write for detailed specs and prices on Type "T" capacitors. And ask for Components Catalog 701 covering the entire E. F. Johnson component line.



E. F. JOHNSON COMPANY

3378 Tenth Ave. S.W., Waseca, Minnesota 56093

Providing nearly a half-century of communications leadership

ON READER SERVICE CARD CIRCLE 111

ELECTRONIC DESIGN 4, February 15, 1969

PULL PUSH

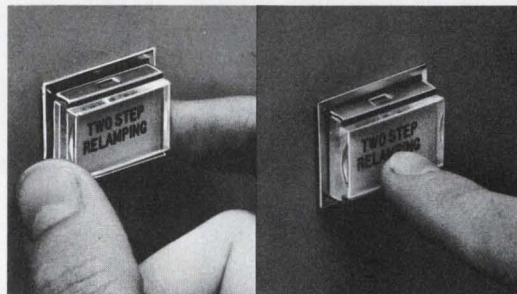

REMOVE

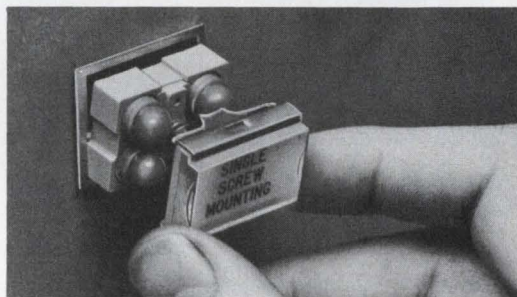

The easiest relamp since
lighted push button
controls were invented.

Easiest installation too—front mounting with a single captive screw, no costly wiring because we buss our lamps internally at the factory.

Unimax Series 9 LPB's are four-lamp pushbutton panel controls designed to meet the requirements of MIL-S-22885/9-12. You have a wide choice of display screen styles, color coding and customized messages which can be modified or replaced in the field. Features include multi-pole switching and holding coil capabilities, and each of the four lamps can be illuminated independently. Switch guards, spacer barriers, RF shielding and drip-proof seals are available.

Unimax LPB's have a lot going for you. Contact our representative or write for Catalog 50-2. See a lively demonstration of our LPB capabilities—ask our rep to bring his demonstrator.

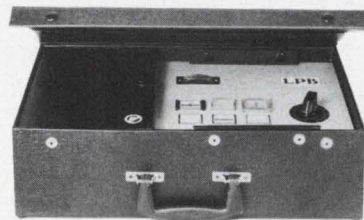

Illuminated Push-Button Controls by

Unimax Switch

Division of Maxson Electronics Corp.
IVES ROAD, WALLINGFORD, CONN. 06492



ON READER SERVICE CARD CIRCLE 112

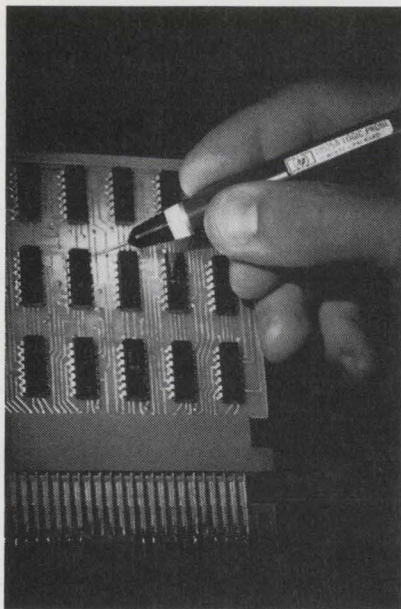

This probe lights up when a pulse goes by.

Even a pulse as short as 30 ns—positive or negative—will cause this logic indicator to flash a signal. You can trace pulses, or test the logic state of TTL or DTL integrated circuits, without taking your eyes off your work. In effect, the probes act like a second oscilloscope at your fingertips.

No adjustments of trigger level, slope or polarity are needed. A lamp in the tip will flash on 0.1 second for a positive pulse, momentarily extinguish for a negative pulse, come on low for a pulse train, burn brightly for a high logic state, and turn off for a low logic state.

The logic probe—with all circuits built into the handpiece—is rugged. Overload protection: -50 to +200 V continuous; 120 V ac for 10 s. Input impedance: 10 k Ω . Price of HP 10525A Logic Probe: \$95, quantity discounts available.

Ask your HP field engineer how you could put this new tool to work in logic circuit design or troubleshooting. Or write Hewlett-Packard, Palo Alto, Calif. 94304; Europe: 54 Route des Acacias, Geneva.

02825A

HEWLETT  **PACKARD**

INFORMATION RETRIEVAL NUMBER 113

MODULES & SUBASSEMBLIES

FET amplifier has 0.2-pA bias



Fairchild Controls, 225 Park Ave., Hicksville, N.Y. Phone: (415) 962-3833. P&A: \$110; stock.

Using a junction-FET differential input stage, model ADO-32 operational amplifier holds input bias currents to 0.2 pA typical, 0.5 pA maximum. The unit also features gain of 140,000, drift of 10 $\mu\text{V}/^\circ\text{C}$, common-mode rejection of 20,000, and power-supply rejection of 200 $\mu\text{V}/\text{V}$. It is suitable for sample-and-hold circuits, integrators, charge amplifiers, as well as many applications that previously required electrometer tubes.

CIRCLE NO. 329

Thick-film hybrid drives lamps directly

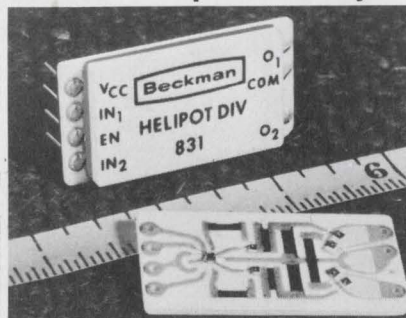

Beckman Instruments, Inc., Helipot Div., 2500 Harbor Blvd., Fullerton, Calif. Phone: (714) 871-4848.

A miniature lamp-and-relay driver, which is a hybrid cermet thick-film circuit, steps up power from digital IC levels without requiring external pass transistors. Model 831 features a 0-to-60-V operating range, two circuits per package, a 0-to-1-A current capability, standard DTL input levels, and an operating temperature range of -55 to +125 $^\circ\text{C}$. Completely self-contained, the solid-state unit occupies just 0.5 square inches of board space.

CIRCLE NO. 330

Differential op amp drifts only 0.5 nA/ $^\circ\text{C}$

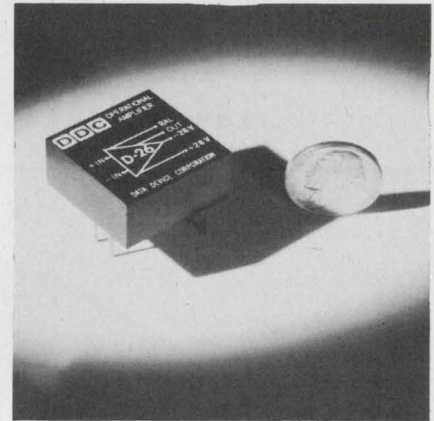

Data Device Corp., 100 Tec St., Hicksville, N.Y. Phone: (516) 433-5330. P&A: \$60; stock to 3 wks.

A differential operational amplifier with a minimum output of ± 20 V at 5 mA holds voltage drift to 10 $\mu\text{V}/^\circ\text{C}$ and current drift to 0.5 nA/ $^\circ\text{C}$. Model D-26 has input impedances of 500 k Ω differential, 50 M Ω common-mode. Its common-mode rejection ratio is 100 dB. Slewing-rate response is the same at both inputs.

CIRCLE NO. 331

Vector-function module finds 3 signal values



Philbrick/Nexus Research, A Tele-dyne Co., Allied Drive at Route 128, Dedham, Mass. Phone: (617) 329-1600. P&A: \$195.

Replacing complicated servo mechanisms, type 4352 vector-function module can find the average or the rms values of a signal, or calculate the square root of the sum of the squares of two signals. This small encapsulated unit, which measures 2.7 by 1.5 by 0.75 in., delivers a $\pm 3\%$ accurate output to a 5000- Ω load without need of external circuitry.

CIRCLE NO. 332

Introducing the no-nonsense counter.

Built to be used. Five digits plus over-ranging and overflow bits. With no frills, just functions. Instructions and control settings for 14 types of measurements in a pocket built right into the counter. Frequency (up to 15MHz), period, multiple period, time interval, totals, ratios, multiple ratios, and more.

We've put all the controls on the front so you can get to them and made them big enough so you can use them. We've included conveniences like ac/dc coupling, storage, automatic triggering, and our own ASC high noise-rejection circuitry. And deep down inside where it really counts, we've made it reliable but it's maintainable anyhow.

The no-nonsense price of the model 650 is \$595. Send for our brochure today.

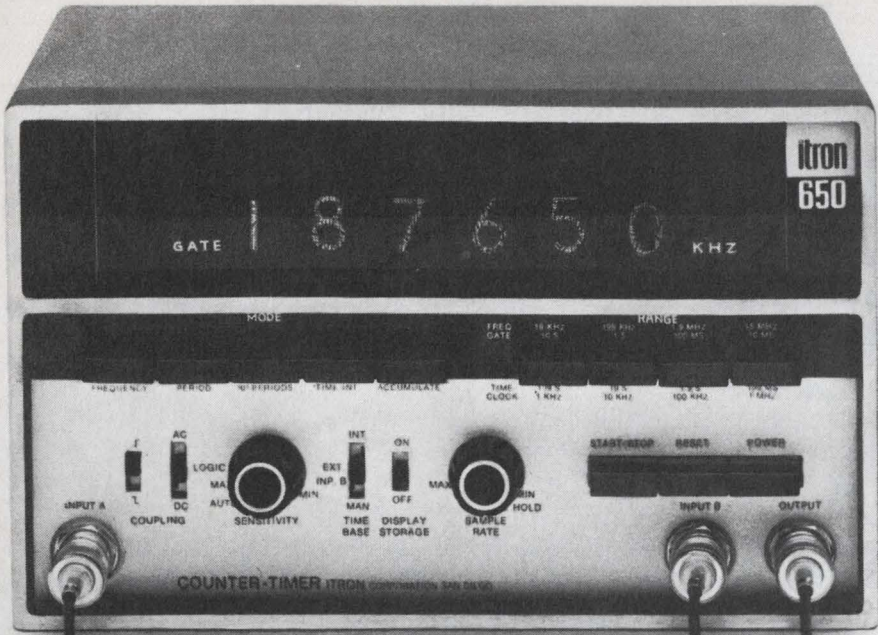

ITRON Corporation 11675 Sorrento Valley Road
San Diego, California 92121 Telephone (714) 453-5300

Cable sheath stops moisture

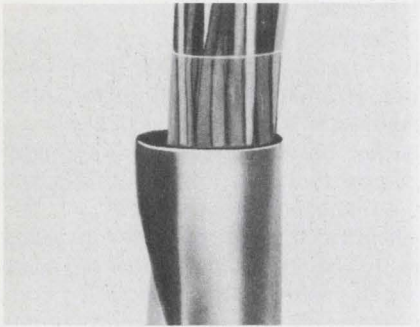

General Cable Corp., 730 3rd Ave., New York City. Phone: (212) 986-3800.

Preventing moisture from penetrating a cable core, the V/I cable sheath envelopes a cable core with aluminum foil. The foil is supported by plastic that is parallel to and formed about the core. The edges of the plastic form a tab that is heat sealed along the length of the cable. The sheath component adds only 90 to 150 mils to the over-all cable diameter.

CIRCLE NO. 333

Custom cabinets slide together

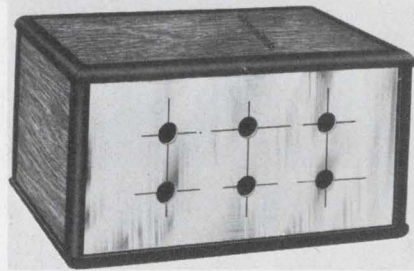

Beltronix Systems, Inc., Bell Educational Labs Div., 123 Marcus Blvd., Hauppauge, N.Y. Phone: (516) 231-8100. Price: from \$2.98

Ideally suited for designers and engineers who want a sturdy as well as attractive housing for their products, a new line of custom cabinets cuts assembly time to minutes. Each Flexi-Cab unit consists of six panels and 12 vise-grip slides that assemble quickly by merely joining the panels with the slides. The cabinets are supplied with pressure-sensitive labels for identifying controls and functions.

CIRCLE NO. 334

Sexless connectors use female modules

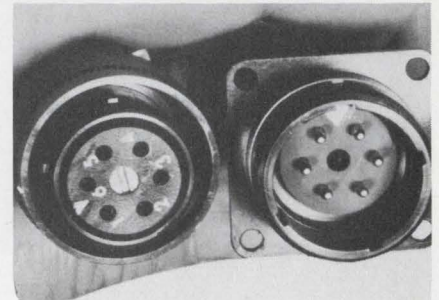







Appleton Electric Co., 1701 Wellington Ave., Chicago. Phone: (312) 327-7200.

Multiple-pin type ICM connectors with removable, female-contact modules allows plugs and receptacles to be used interchangeably. This means that either shell can house the male or female contact without disturbing the wiring end of the connector. The female-contact module, which has replaceable contacts, uses a coined wrap to attain stringent industrial connector specifications.

CIRCLE NO. 335

Wherever Non-Contamination is Essential

MICRO-CLEANING FOR PRODUCT RELIABILITY

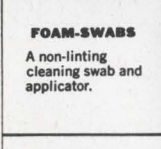
	TEXWIPE™ A disposable 100% cellulose LINT-FREE CLOTH.		OPTIC-CLOTH for scratch-free cleaning and polishing coated optics.
	FOAMWIPE A three dimensional polyurethane clean room wiper.		"FREON" TF Aerosol Solvent Cleaner — A selective, precision cleaning agent. <small>*Reg. Trade Mark of E. I. duPont Company</small>
	MICRO-DUSTER™ A compressed gas precision cleaning instrument.		PRECISION CLEANING KIT For critical cleaning of magnetic tape equipment
	FOAM-SWABS A non-linting cleaning swab and applicator.	THE TEXWIPE COMPANY	
HILLSDALE, NEW JERSEY 07642			
CATALOG AVAILABLE UPON REQUEST			

INFORMATION RETRIEVAL NUMBER 115



Pledged

SYNCRO makes quality dry electrolytic capacitors for OEM customers exclusively.

Please furnish complete specifications when requesting quotations and/or samples.

WRITE FOR CATALOG!



1081

SYNCRO Capacitor Corporation

HICKSVILLE, OHIO 43526 • (419) 542-2711 • TWX 810-490-2550

INFORMATION RETRIEVAL NUMBER 116

ELECTRONIC DESIGN 4, February 15, 1969

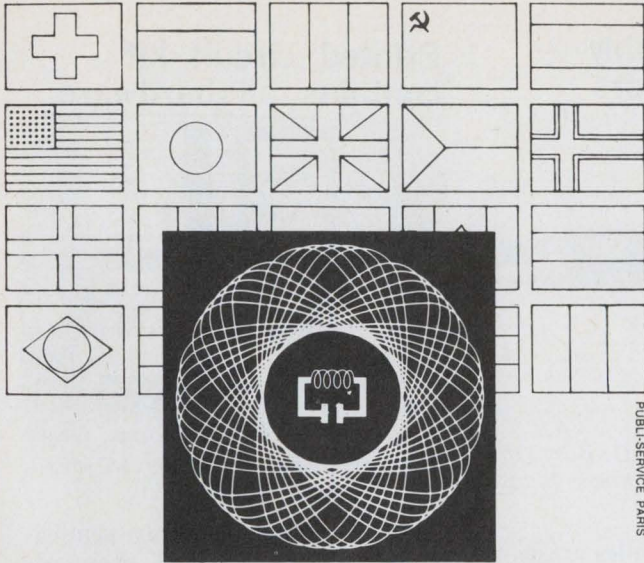

PUBLI-SERVICE PARIS

**150.000
electronic engineers
in Paris**

**This concerns
YOU DIRECTLY !**

SALONS INTERNATIONAUX DES
**COMPOSANTS
ELECTRONIQUES**

ET DE L'ÉLECTROACOUSTIQUE

FROM MARCH 28th TO APRIL 2nd 1969
PORTE DE VERSAILLES - PARIS



**INTERNATIONAL CONFERENCE ON
REMOTE DATA PROCESSING**

Scientific, technical and economic aspects
Program and registration conditions on request
FROM MARCH 24th TO 28th 1969 - PARIS

S. D. S. A. - RELATIONS EXTERIEURES 16, RUE DE PRESLES - 75 PARIS 15^e - FRANCE
CALL FOR INFORMATION : FRENCH TRADE SHOWS - NEW YORK - PHONE : (212) 582-4960-1

INFORMATION RETRIEVAL NUMBER 117
ELECTRONIC DESIGN 4, February 15, 1969

**Just right for
two-way radio!**

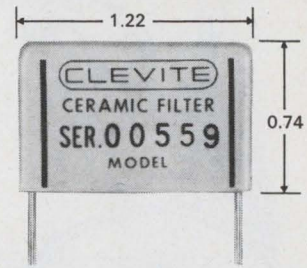

**Clevite's
computer-designed
TCF ceramic filter.**

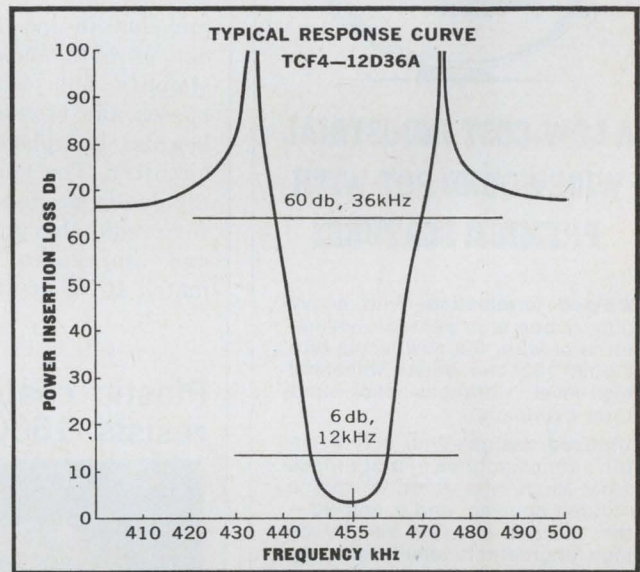

TCF — a hybrid combination of a tuned transformer and ceramic resonators . . . in less than 0.6 cu. in.!

Designed specifically for use in two-way communication sets including mobile two-way, aircraft communication, aircraft navigation SSB receiver applications and CB. The TCF combines the input advantages of a tuned transformer with the stability and high performance of a ceramic filter. Result: manufacturers of quality FM receiving equipment (and AM as well) get greater selectivity at a lower cost. TCF filters are free of unwanted responses, and input impedances are suitable for both transistor and vacuum tube circuits.

Model Number	Bandwidth	
	6 db (Min.)	60 db (Max.)
TCF4-4D10A	4kHz	10kHz
TCF4-8D20A	8kHz	20kHz
TCF4-12D36A	12kHz	36kHz
TCF4-18G38A	18kHz	38kHz
TCF6-30D55A	30kHz	55kHz
TCF6-35D60A	35kHz	60kHz
TCF6-12F36A	12kHz	36kHz (90 db)

PRICES: TCF-4 models: 1—\$15 ea; 25—\$10 ea; 100—\$8.50 ea; 500—\$6.75 ea; 1000—\$6.00 ea; 2500—\$5.45 ea. TCF-6 models slightly higher.

(Prices subject to change without notice)

Send order or request for Bulletin 94026 to: Clevite Corporation, Piezoelectric Division, 232 Forbes Rd., Bedford, Ohio 44146, U.S.A. Or: Brush Clevite Company, Ltd., Southampton, England.

CLEVITE

INFORMATION RETRIEVAL NUMBER 118

New from the **SPEC-TROLL!**



A LOW-COST INDUSTRIAL WIREWOUND POT WITH PREMIUM FEATURES

Welded termination—With heavy-duty ribbon taps welded to several turns of wire, the new single-turn Model 132 can better withstand high-level vibrations and short-term overloads.

Unitized design—With only 4 major subassemblies—a stainless-steel shaft and rotor, a coil, a molded housing, and a rear lid—the 132 offers a new simpler design for greater reliability, with rear terminals for better packaging.

Rugged construction—The materials used in the 132 have been selected for their ability to withstand impacts and abrasions during assembly or maintenance to assure the customer a trouble-free, serviceable pot.

Low cost—For less than \$6 (in quantity)—you can buy this precision industrial pot! Also, heavy-duty stops (8 in. lb. static) are optional at no extra cost.

For full specs, circle the reader service card. Qualified respondents requesting a sample will receive a Model 132 *free of charge* from their local Spectrol representative.



Spectrol Electronics Corporation
A subsidiary of Carrier Corporation
17070 East Gale Avenue
City of Industry, Calif. 91745
Phone: (213) 964-6565
TWX: (910) 584-1314

PACKAGING & MATERIALS

Flat cable assembly has DIP connectors

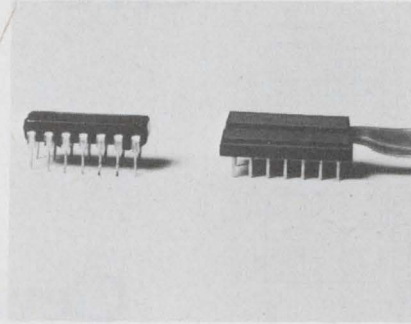

Spectra-Strip Corp., P.O. Box 415, Garden Grove, Calif. Phone: (714) 892-3361.

Ribbon cable assemblies are now available with new low-profile 14-pin dual-in-line IC connectors at one or both ends. The assemblies simplify and reduce the cost of busses and crossovers between PC boards, backplanes and other IC circuitry. The ribbon cable has individually bonded round conductors for predictable uniform capacitance and impedance. The connectors match IC elements in height.

CIRCLE NO. 336

Plastic coating resists 1500°F

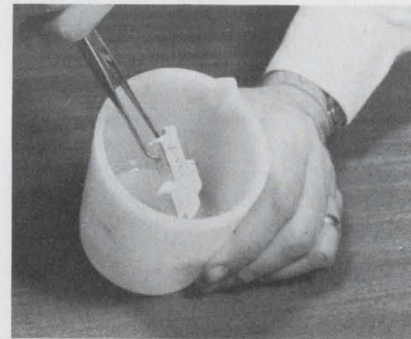

Aremco Products, Inc., P.O. Box 145, Briarcliff Manor, N.Y. Phone: (914) 762-0685. Price: \$20 or \$22/pint.

Available in liquid or paste form, a single-component plastic/ceramic coating withstands continuous temperatures up to 600°F and intermittent temperatures as high as 1500°F. The clear liquid version of Aremco-Seal 529 can be used for applications that require penetration, such as moisture-proofing a porous ceramic. The black paste version provides a thixotropic coating for such uses as end seals.

CIRCLE NO. 337

Printed circuit kit contains all hardware



Injectorall Electronics Corp., Great Neck, N.Y. Phone: (516) 487-6015. P&A: \$5.95; stock.

PC kit #500 contains printed-circuit boards and all chemicals and supplies needed to manufacture printed circuits. Each kit contains two printed-circuit boards, 4-3/4 by 3-3/4-in. in size; a resist-ink pen, one 6-oz bottle of resist-ink solvent and one 1/16-in. drill bit.

CIRCLE NO. 338

Metal circuit board acts as heat sink

American Enka Corp., Brand-Rex Div., Willimantic, Conn. Phone: (203) 423-7771.

Possessing the structural properties of a metal, a new printed-circuit board dissipates heat just like a heat sink, and yet can be etched by standard processing techniques. Called Rexotherm A, the board consists of an aluminum sheet that is laminated with copper through a special film of chemically crosslinked polyethylene.

CIRCLE NO. 339

Contact cement is nonflammable

3M Co., Adhesives, Coatings and Sealers Div., 3M Center, St. Paul, Minn.

A nonflammable synthetic rubber adhesive requires only contact pressure to effect a high-strength bond. It can hold down the edges of warped plastic laminates, and it permits routing or trimming of laminate edges immediately after the bond is completed. Scotch-Grip 5034 is a water-resistant cement.

CIRCLE NO. 340

The best swept frequency measurements between 100 kHz and 40GHz start here:

REFLECTOMETRY

GAIN/ATTENUATION

NETWORK ANALYSIS

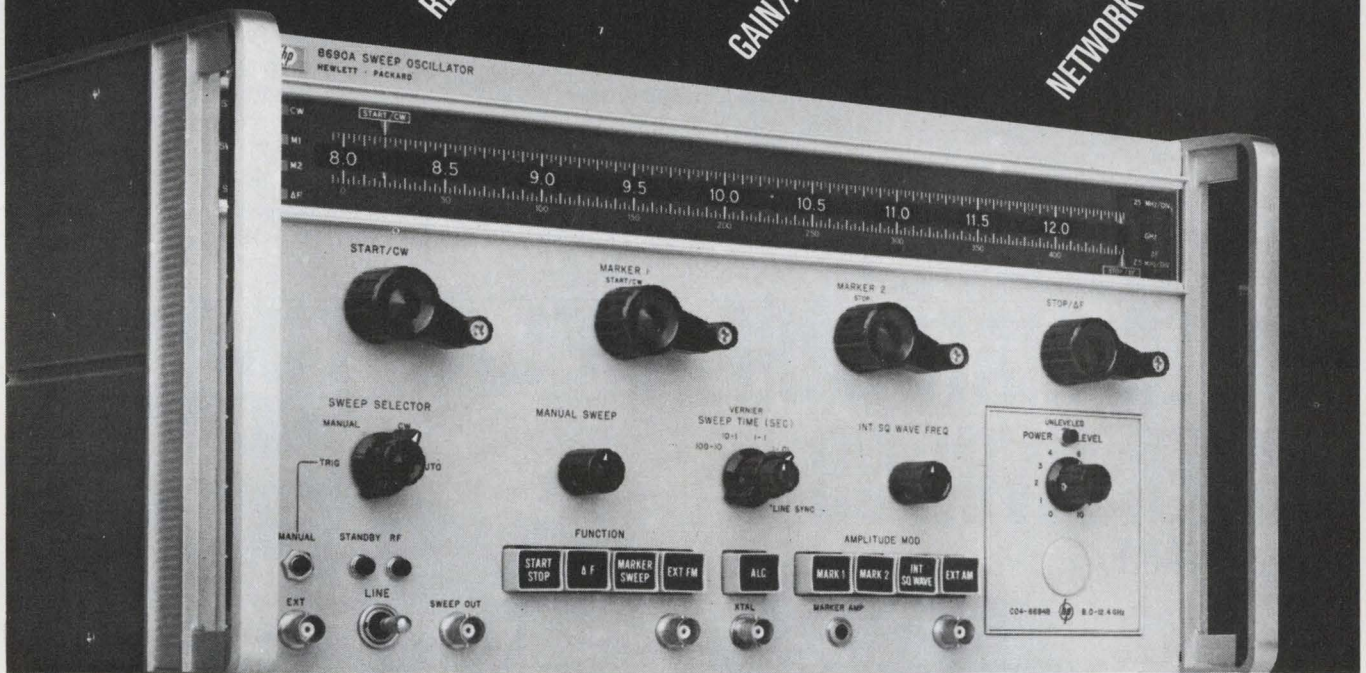

The measurements you get out of a circuit are only as good as the signals you put in. Consequently, the HP 8690B Sweep Oscillator—and each of its RF plug-ins—are designed to give excellent frequency accuracy and linearity with low residual FM. The result is superior overall performance. And you can be sure the measurements you get represent the device your testing.

In addition, controls on the 8690 are designed to eliminate human error. Pushbuttons select the desired function and modulation. Start and Stop pointers set end points for sweeping, up or down, anywhere in the band. Two independent frequency markers, also set anywhere in the band, expand a sweep segment or establish a second sweep range. You can switch to a calibrated narrow-band sweep symmetrical about a center frequency.

The HP 8690B mainframe costs \$1600. Plug-in RF Units range from \$1300 to \$4300, depending on the frequency range. The 8690 is also the starting point for multiband and phase-locked systems used in production and systems applications. For complete information, call your HP field engineer. Or write Hewlett-Packard, Palo Alto, California 94304; Europe: 1217 Meyrin-Geneva, Switzerland.

04811

HEWLETT  PACKARD
SWEEP OSCILLATORS

INFORMATION RETRIEVAL NUMBER 120

Conductive epoxy withstands 350°F

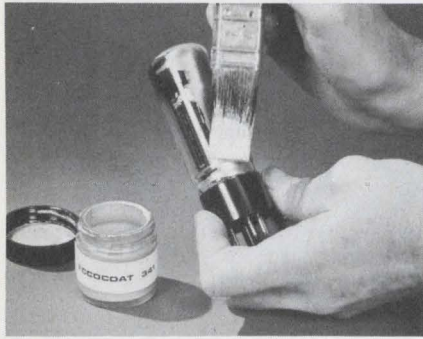

Emerson & Cuming, Inc., Dielectric Materials Div., Canton, Mass. Phone: (617) 828-3300. Price: \$14.50/lb.

Useful in various rf shielding applications, a single-component conductive epoxy coating operates over the temperature range of -65 to +350°F. Eccocoat 341 can be applied to plastics, metal and ceramic by brushing, spraying or dipping. An 8-mil coating has a surface resistivity of 0.3 ohms per square. The material can be used as a ground plane.

CIRCLE NO. 370

Modular connector adjusts its length

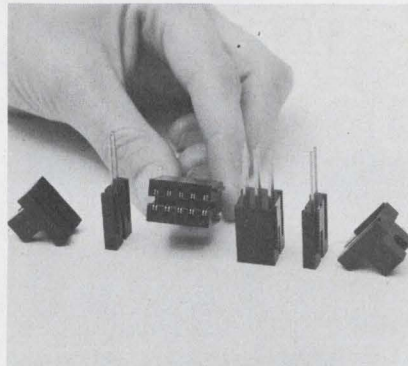

Sylvania Electric Products, Inc., Parts Div., 12 Second Ave., Warren, Pa. Phone: (814) 723-2000.

A four-part segmented connector that allows a building-block approach in fabricating breadboard circuits can be assembled to any desired length with up to 50 contact positions. The interlocking segments can be joined by bonding with adhesive film. There are four basic connector segments: an end block; and one-position, three-position and five-position blocks.

CIRCLE NO. 341

Gold-epoxy compound stabilizes conductivity

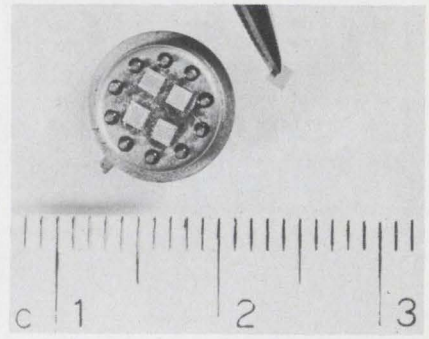

Epoxy Technology, Inc., 65 Grove St., Watertown, Mass. Phone: (617) 926-1949.

A new single-component epoxy compound, which contains pure gold powder for uniform and highly reproducible conductivity, holds its volume resistivity between 0.0001 and 0.0005 Ω-cm. Epo-Tek 441 is a smooth paste that can be used directly from the jar. Its shelf life is at least six months at room temperature, and its curing schedule ranges from 15 minutes at 150°C to two hours at 100°C.

CIRCLE NO. 342

POWER/MATE CORP. POWER TWIN-99

DUAL OP AMP SUPPLY

- * Dual output 12.0 to 18.0 VDC at 400 ma.
- * ± 0.05% regulation
- * 1.0 Mv rms ripple
- * Overload and Short Circuit protected
- * Meets MIL-E-5272 specs

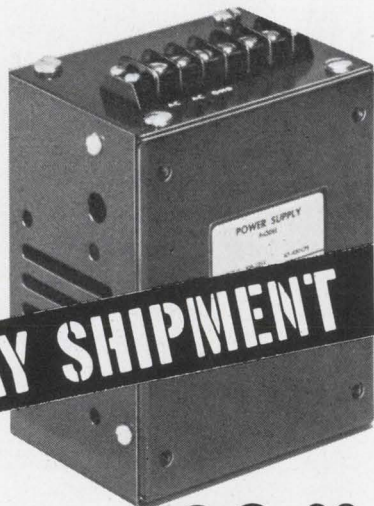

SAME DAY SHIPMENT

Send for Literature describing thousands of Power Supplies to 400 Volts and to 50 Amps.

\$99.00



POWER/MATE CORPORATION

163 Clay St. ■ Hackensack, N. J. 07601
(201) 343-6294 ■ TWX (710) 990-5023

INFORMATION RETRIEVAL NUMBER 121

DELAY TIMERS



Any mounting style; voltage specification; time cycle; operational method. No special engineering required. Good delivery schedules. Our stock is ample.

**INDUSTRIAL
TIMER**
CORPORATION

U. S. Highway 305, Parsippany, N. J.

Subsidiary of the Singer Company

INFORMATION RETRIEVAL NUMBER 122

ELECTRONIC DESIGN 4, February 15, 1969

**HERE'S HELP FOR YOUR
COST-REDUCTION PROGRAM**

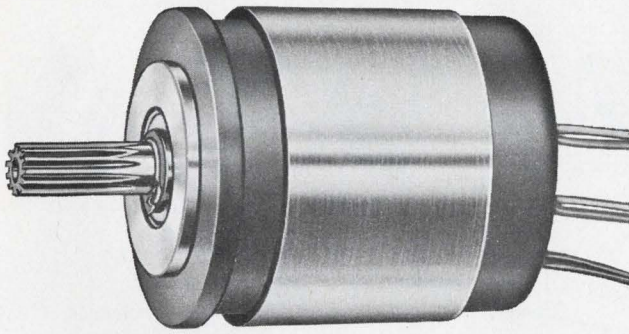

**Cedar's new
JETLINE
Servo Motor**

**With Cedar's traditional high
quality and performance but
at far less cost
than conventional motors**

The new Jetline motors are a family of standard motors available from stock for quick delivery. Modifications and special designs on request. Size 8, 10 and 11 servo motors and Size 8 and 10 motor-tachs are available for both 26-volt and 115-volt applications.

These new motors are an extension of Cedar's more than 10 years experience in the transfer-molding of stators. Molded plastic replaces the case and end cap resulting in fewer parts. Efficiency is maximized through the use of larger stator laminations. The larger flanged bearings fit against the molded plastic, run cooler and provide greater reliability.

Thorough testing of these motors has proven them to meet traditional Cedar quality standards. Our normal warranty applies. Jetline motors have, however, demonstrated over 3500 hours at 100°C ambient.

The important difference to you when you specify Cedar's Jetline motors is that they cost less. For example, a standard Size 10 Servo Motor costs only \$16.50 in quantities up to 1000. To get all the facts on how Cedar's new Jetline servo motors can help in your cost-reduction efforts, write or call today.

**CEDAR CONTROL DATA
DIVISION CORPORATION**

5806 West 36th Street, Minneapolis, Minnesota 55416
Phone: 612/929-1681

INFORMATION RETRIEVAL NUMBER 123

**5 days
can do a lot for your next 5 years.**

If you're involved in systems and equipment design, research, production or management . . . five days at one of our Seminars may make your next five years—and many more after that—much more productive.

More and more key management and high-level technical personnel from top companies all over the United States are attending RCA Institutes Seminars. Just as they are doing, you'll acquire information and techniques of immediate value in your work. You will also gain the kind of knowledge that can help build your professional standing in the years just ahead.

We believe we can increase your productivity by providing you with a firm grasp of many of the latest engineering techniques. Our experienced staff maintains constant contact with "what's happening" in industry. The texts and audio-visual materials are prepared exclusively by us for each seminar.

You can attend RCA Institutes Seminars around the country the year-round. Check your subject and send along the coupon for your brochure. Now—while you're thinking about it.



RCA Institutes, Inc. Dept. ELD-29A

Institute for Professional Development
132 West 31st Street
New York, New York 10001

For FREE descriptive brochure, check the Seminar in which you are interested:

- | | |
|--|---|
| <input type="checkbox"/> Logic Design | <input type="checkbox"/> Management Information Systems |
| <input type="checkbox"/> Digital Systems Engineering | <input type="checkbox"/> Digital Communications |
| <input type="checkbox"/> Modern Optics | <input type="checkbox"/> Digital Electronics |
| <input type="checkbox"/> Integrated Circuits | <input type="checkbox"/> Numerical Control Systems |
| <input type="checkbox"/> Reliability of Integrated Systems | |

Name _____

Title _____

Company _____

Address _____

City _____ State _____ Zip _____

INFORMATION RETRIEVAL NUMBER 124

Bulova can supply the crystal you need



to match your specs!

Many years of supplying crystal control units for the most advanced military and space programs enable Bulova to offer a full line encompassing virtually the entire frequency spectrum—2 kc to 125 Mc for oscillator and filter applications. We can supply every type of packaging—including koldweld and glass sealed. Our military crystals meet latest MIL-C-3098D specifications. All reasons why you should make Bulova your single source of supply.

HIGH PRECISION GLASS SEALED CRYSTALS 1 Mc to 125Mc. Available in vacuum sealed, glass enclosures of the HC-26/U and HC-27/U type.

Example: Precision SSB Crystals

Frequency: 1 Mc to 5 Mc
Holder: HC-27/U
Tolerance: $\pm .0025\%$ from -55°C to $+90^{\circ}\text{C}$, or to specification
Aging: 3×10^{-8} per week after one week stabilization at 75°C

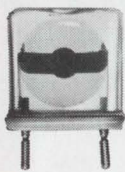

KOLDWELD SEALED CRYSTALS—low aging, high reliability, 1 Mc to 125 Mc. Now available in TO-5, HC-6/U and HC-18/U type cans sealed by the koldweld process to eliminate effects of heat and to reduce contamination.

Example: TO-5

Frequency: 15 Mc to 125 Mc
Tolerance: $\pm .0025\%$ from -55°C to $+105^{\circ}\text{C}$, or to specification
Aging: 1×10^{-7} per week after one week stabilization at 75°C



Write or call for specifications on Bulova's complete line of crystals. Address: Dept. ED-17

BULOVA

FREQUENCY CONTROL PRODUCTS

ELECTRONICS DIVISION
OF BULOVA WATCH COMPANY, INC.
61-20 WOODSIDE AVENUE
WOODSIDE, N.Y. 11377, (212) DE 5-6000

PRODUCTION

Ultrasonic cleaner delivers 100 watts



Blackstone Ultrasonics, Inc., Ctr./Horton Sts., Sheffield, Pa. Phone: (814) 968-3221.

Providing an average output of 100 W, a portable ultrasonic cleaner is able to remove grease and contaminants with a high-intensity uniform action. Operating at frequencies of approximately 34 kHz, model SP-100 assures maximum cleaning efficiency at any given liquid level, temperature or load. Its self-contained generator is completely solid state and is automatically tuned.

CIRCLE NO. 343

Wire insertion tool saves rework time

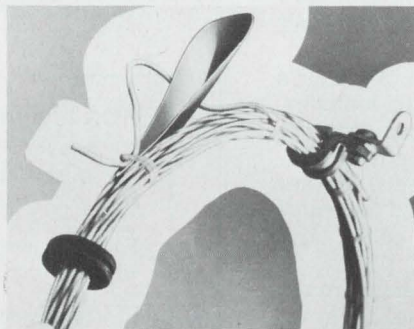

Macdonald & Co., 213 S. Brand Blvd., Glendale, Calif. Phone: (213) 241-4131. Price: \$1.65.

Anyone who has constructed a prototype with laced wire harnesses has undergone the frustrating experience of adding an extra wire to the original design. To eliminate frayed tempers and wires, a small handtool has been manufactured to allow the addition of extra wires without removing ties or clamps. Rounded edges will not mark wires or ties.

CIRCLE NO. 344

PC-board holder tilts and rotates

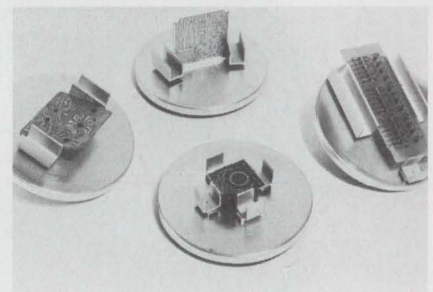

Western Electronic Products Co., 107 Los Molinos, San Clemente, Calif. Phone: (714) 492-4677. Price: \$14 to \$23.75.

Representing a new concept in holding circuit boards during assembly, model MH PC-board holder consists of a series of movable magnetic blocks mounted on a 10-in. diameter rotatable steel disc. Slots in the magnetic blocks allow circuit boards to be held horizontally, vertically, or at some intermediate angle. The circular base can be set horizontally or at a 30° angle and can be rotated.

CIRCLE NO. 345

Lightweight iron puts out 100 W

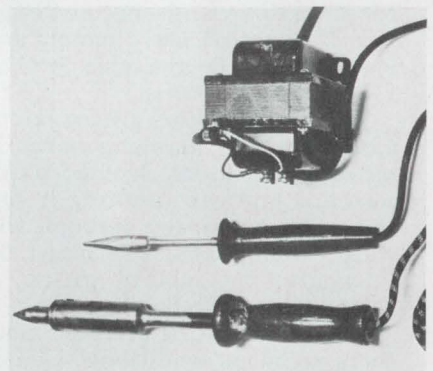

General Electric, Industrial Heating Dept., Shelbyville, Ind.

Called Mighty Midget, a seven-ounce 100-W soldering iron does the work of larger irons that are twice as heavy, while operating from a 12-V supply. To offset the cost of the new iron's 115-V step-down transformer, the company offers a tip-reprocessing program, under which new ironclad tips are rebrazed to the heater unit at the factory. Ratings include 60, 80 and 100 W.

CIRCLE NO. 346

Thou shalt not invert.

Not when you have AND, OR, NAND and NOR functions available in one logic family.

With the recent addition of seven new

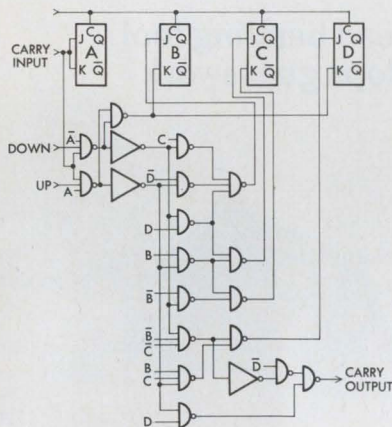

DTL implemented up-down counter

gates to the line, Utilogic II now allows you to implement functions simply, any way you choose — with AND, OR, NAND or NOR elements. No other logic family permits this flexibility.

It's possible to eliminate inverters, commonly required in DTL designs. The Utilogic II implementation of the Up-Down Counter shown below requires 11% fewer packages than the typical DTL version. In terms of comparative system costs based on 1000-up pricing, the Utilogic II implementation saves you 30% in parts cost alone.

The new circuits include dual 4-input expandable, triple 3-input and quad gates in both OR and NAND logic functions, plus a triple 2-input expandable OR gate and a diode expander.

All the new circuits are immediately available in volume in a 14-pin dual-in-line silicone package in the SP (0°C to 75°C) and LU (10°C to 55°C) operating temperature

ranges. Utilogic II, as you recall, has three times greater noise margins and double the fan-out of any other available logic family. And its performance has been proven by over 15 million elements in the field. For our Utilogic II Handbook write Signetics, 811 East Arques Avenue, Sunnyvale, California 94086. Bless you.

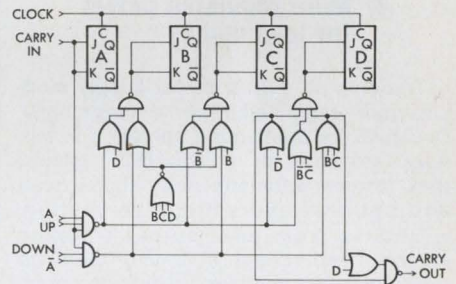

UTILOGIC II implemented up-down counter

Signetics Integrated Circuits 
A SUBSIDIARY OF CORNING GLASS WORKS

SIGNETICS SALES OFFICES: Wakefield, Massachusetts (617) 245-8200; Trumbull, Connecticut (203) 268-8010; Poughkeepsie, New York (914) 471-3292; Syracuse, New York (315) 469-1072; Fort Lee, New Jersey (201) 947-9870; Radnor, Pennsylvania (215) 687-2660; Silver Spring, Maryland (301) 946-6030; Clearwater, Florida (813) 726-3734; Winter Park, Florida (305) 671-5350; Dayton, Ohio (513) 433-4133; Minneapolis, Minnesota (612) 920-3256; Rolling Meadows, Illinois (312) 259-8300; Richardson, Texas (214) 231-6344; Garden Grove, California (714) 636-4260; Burbank, California (213) 846-1020; Redwood City, California (415) 369-0333.

DISTRIBUTORS: Avnet Electronics Corp., Burlington, Mass. (617) 272-3060; Cesco Electronics, Ltd., Montreal, Quebec, Canada (514) 735-5511. **Compar Corporation at the following locations:** Huntsville, Alabama (205) 539-8476; Los Angeles, California (213) 245-1172; Burlingame, California (415) 347-8244; Hamden, Connecticut (203) 288-9276; Clearwater, Florida (813) 446-2991; Orlando, Florida (305) 855-3964; Park Ridge, Illinois (312) 692-4125; Baltimore, Maryland (301) 484-5400; Newton Highlands, Mass. (617) 969-7140; Minneapolis, Minnesota (612) 922-7011; St. Louis, Missouri (314) 542-3399; Albany, New York (518) 489-7408; Endwell, New York (607) 723-8743; Woodbury, New York (516) 921-9393; Fairport, New York (716) 271-2230; Syracuse, New York (315) 471-3356; Winston-Salem, North Carolina (919) 723-1002; Seattle, Washington (206) 763-1711. **Hamilton Electro Sales,** Culver City, Calif. (213) 870-7171; Cherry Hill, N.J. (609) 662-9337; **Hammond Electronics,** Orlando, Florida (305) 241-6601; **Kierulff Electronics,** Seattle, Wash. (206) 763-1550; **G. S. Marshall,** San Marino, Calif. (213) 684-1530; **Milgray-Delaware Valley, Inc.,** Philadelphia, Pa. (215) 228-2000; **Pioneer Standard Electronics,** Rockville, Maryland (301) 427-3300; **Schley Electronics,** Watertown, Mass. (617) 926-0235; **Semiconductor Specialists, Inc.,** Elmhurst, Illinois (312) 279-1000; **Terminal-Hudson Electronics,** New York, New York (212) 243-5200; **Universal Electronics, Inc.,** Houston, Texas (713) 781-0421; **Wesco Electronics, Inc.,** Los Angeles, Calif. (213) 685-9525; Palo Alto, Calif. (405) 968-3475.

DOMESTIC REPRESENTATIVES: Compar Corporation at the following locations: Scottsdale, Arizona (602) 947-4336; Denver, Colorado (303) 781-0912; Southfield, Michigan (313) 357-5369; Haddonfield, New Jersey (609) 429-1526; Albuquerque, New Mexico (505) 265-1020; Albany, New York (518) 489-7408; Endwell, New York (607) 723-8743; Fairport, New York (716) 271-2230; Syracuse, New York (315) 471-3356; Rocky River, Ohio (216) 333-4120; Fairborn, Ohio (513) 878-2631; Dallas, Texas (214) 363-1526; Houston, Texas (713) 667-3420. **Ozark Electronic Marketing, Inc.,** St. Louis, Missouri (314) 423-7200.

INTERNATIONAL SALES: France, Germany, Italy, Belgium, Holland, Luxembourg, Spain—**Sovcor Electronique**, 11, Chemin de Ronde, Le Vesinet, (S.-&O.) France. United Kingdom, Ireland, Sweden, Denmark, Norway, Switzerland, Austria, Portugal—**Electrosil Ltd.**, Lakeside Estate, Colnbrook-Bypass Slough, Buckinghamshire, Great Britain. Australia—**Corning**, 1202 Plaza Building, Australia Square, Sydney, N.S.W. 27-4318. Canada—**Corning Glass Works of Canada, Ltd.**, Leaside Plant, Ontario, Canada (416) 421-1500. Israel—**Talviton**, P.O. Box 3282, Tel-Aviv, Israel 236-666. Japan—**ASAHI Glass Co., Ltd.**, Corning Products Sales Dept. No 14, 2-Chome Marunouchi, Chiyoda-ku, Tokyo, Japan 211-0411.

INFORMATION RETRIEVAL NUMBER 126

TRYGON HAS THE POWER

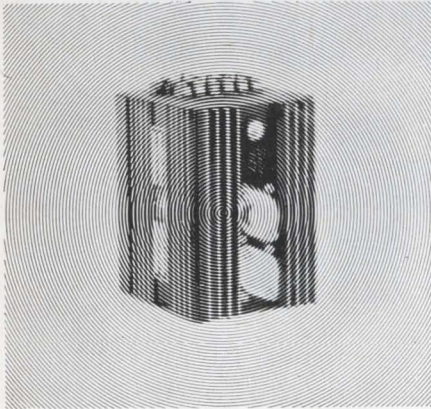

**to deliver systems
power modules
with all these features:**

- All silicon circuitry
- 71°C rating/no derating
- Independent of external heat sinks
- More regulated power for less money

Trygon's all silicon power supply modules: more regulated power for less money. Designed for unattended operation in military, industrial or commercial systems, they feature automatic reset short-circuit and optional overvoltage protection.

Choose from dual output tracking models, fixed voltage units and full-range programmable modules to provide versatile combinations for your multiple output system requirements.

Highest quality components: generously derated and aged power transistors—hermetically sealed rectifiers—temperature stabilized zener diodes—computer grade capacitors.

0.01% line regulation; temperature range from 0° to +71° C; remote programming; remote sensing; and more.

Compact 3¼" modules with ratings from 0 to 210 V, 0 to 1 amp, from as little as \$99. Ratings to 160 V in 4⅝" size (0 to 2 amps, from \$167); 5" size (0 to 5 amps, from \$182).



TRYGON POWER SUPPLIES

111 Pleasant Avenue, Roosevelt, L.I., N.Y. 11575
Trygon GmbH 8 Munchen 60, Haidelweg 20, Germany
Write for Trygon 1968 Power Supply Handbook.

INFORMATION RETRIEVAL NUMBER 127

PRODUCTION

Soldering machines work without pallet



Dee Electric Co., 2501 N. Wayne Ave., Chicago. Phone: (312) 337-8188.

Series 5000 palletless wave soldering machines function automatically by consolidating the following manufacturing operations: power conveyors, precise solder wave-height control and accurate positioning of PC boards in the conveyor. The potentiometer wave-height control permits adjustments up to 0.5-in. high, ± 0.005 in.

CIRCLE NO. 347

Welding machines seam 1-mil materials



William A. Jones Research Corp., 161 North St., Newtonville, Mass. Phone: (617) 332-3532.

High-speed automatic welding machines use tungsten-inert gas techniques for linear, circular, and nonlinear seam welding of materials from 0.001 to 0.125 in. thick. With an output range of 0.5 to 120 A, the Micro-TIG machines feature high stability of both current and voltage for improved weld quality. They permit rapid, automatic welding of diaphragms, closures, precision hermetic assemblies and lightweight structural elements.

CIRCLE NO. 348

Insulation stripper stops cable damage

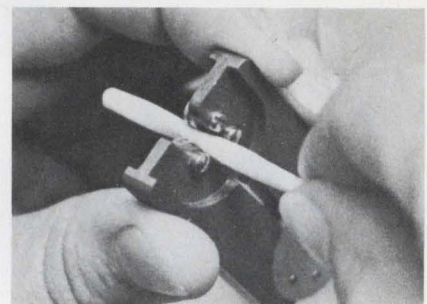

MacDonald & Co., 213 S. Brand Blvd., Glendale, Calif. Phone: (213) 241-4131. Price: \$19.80.

Designed for multiconductor cables with diameters of 0.06 to 0.25 in., model 40 stripping tool is guaranteed to remove outer insulations without damaging the inner shielding or a single conductor. It is ideal for Kynar, Tedlar and other high-temperature insulations—except Teflon—that meet the requirements of MIL-80144.

CIRCLE NO. 349

Lead bending tool stops guesswork

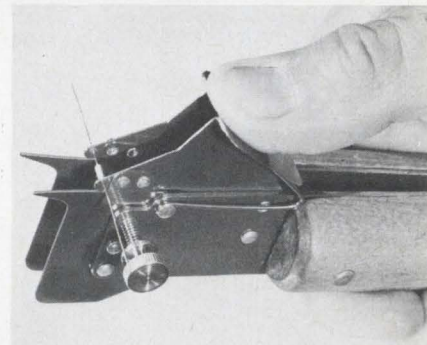

Harwil Co., 1009 Montana Ave., Santa Monica, Calif. Phone: (213) 394-4710. P&A: \$19.50; stock.

Model N-400 lead bender for micro-sized components eliminates trial-and-error bending, while providing fast, continuous adjustment of the space between lead bends. Matching the tool's pointers with eyelet holes in the circuit board automatically spaces lead bends for component insertion. Bends are formed by pressing the component leads against the sides of the pointers with the thumb and forefinger.

CIRCLE NO. 350

Our New Frequency Extender Wears 2 Hats . . .



. . . It's Also A Signal Monitor!

Connect the new FE-26 Frequency Extender to any of W-J's 900 Series receivers (or to any other receiver of sufficient bandwidth) and triple the frequency range. The FE-26 not only tunes the 235 to 1000 MHz range and converts the signals to a 60 MHz output, but also provides a visual display of signals throughout the entire combined range of the receiver and the extender.

Other outstanding features of the FE-26 include: ability to place in or out of operation without changing inter-connecting cables, 3 antenna inputs and 1 output, switchable automatic or manual gain control,

variable sweep rate control, MOS FET first mixer, digital automatic frequency control capability (when used with an ancillary counter), and standard 19-inch rack size.

CEI DIVISION



WATKINS-JOHNSON

6006 Executive Blvd., Rockville, Md. 20852

World's largest selection of receiving equipment for surveillance, direction finding and countermeasures.

INFORMATION RETRIEVAL NUMBER 128

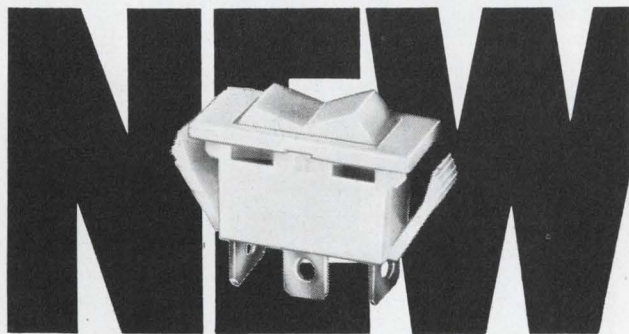

New Snap-in Snap Action ROCKER SWITCH

Here's a good looking, rugged, practical idea in compact rocker switches. It snaps-in, instantly . . . holds secure, permanently . . . and costs less! You'll find it ideal for appliances, electronic and electrical equipment. Field tested and proven, the unique snap-in holding clips remove assembly-line guess-work, step-up production.

Where the advantages of rocker actuation are desired, everything you need in a reliable switch is here: silver contacts; colored nylon case bezel and button; numbered terminals; smooth actuation—snaps with authority. On-off, or momentary plus a variety of single pole, double throw and 3 position circuit arrangements. Rated at 10 Amps. 120 V.A.C. Send for Technical Bulletin and free sample. Dept.

CS
CHICAGO SWITCH DIVISION • F & F ENTERPRISES, INC.
2035 Wabansia Avenue • Chicago, Illinois 60647 • 312/489-5500

INFORMATION RETRIEVAL NUMBER 129

ELECTRONIC DESIGN 4, February 15, 1969

LAFAYETTE RADIO ELECTRONICS FREE!



LAFAYETTE 1969 CATALOG 690 500 Pages

Lists Lafayette's Own Value Engineered Components plus Quality Designed Equipment From Many Leading Manufacturers for

- HOME • INDUSTRY
- LABORATORY

Semiconductors • Capacitors • Connectors • Controls • Fuses and Circuit Breakers • Relays • Resistors • Wire and Cable • Transformers • Test Equipment

All Components Are Immediately Available From Stock!

LAFAYETTE Radio ELECTRONICS Dept. 45039 P.O. Box 10
Syosset, L.I., N.Y. 11791

Send me the Free 1969 Lafayette Catalog 690 45039

Name

Address

City State Zip

(Please Give Your Zip Code No.)

INFORMATION RETRIEVAL NUMBER 130

199

Complete aluminum fabrication facilities

...all under one roof

A completely integrated job shop for deep drawing, hydroforming, spinning, stamping, heliarc welding, spot welding, sheet metal, heat treating, assembly, engineering and tool design.

Plus—Complete finishing facilities for anodizing, Iriditing, painting, polishing, silk screening.

We comply with all military specs.

For free estimates and engineering advice write or call Mr. C. W. Hunter or Mr. B. M. Jenkins at 201-233-3500.



Dept. 4

AMERICAN ALUMINUM COMPANY

Manufacturers of Aluminum Products for Industry Since 1910.

230 Sheffield St., Mountainside, N.J. 07092
Phone (201) 233-3500

29

INFORMATION RETRIEVAL NUMBER 131

Answers to 'exercises' on p. 104

1. A newspaper. Now try to come up with some uses for it besides its obvious purpose of supplying news (General Time got over 100 alternatives in a few minutes).

2. If you compared the objects' *similarities* rather than their differences, you have a creative bent. Three-quarters of the engineers at General Time compared the similarities, and the company then correlated their known creativity (demonstrated in new products and patents) and found an almost 100% correlation between creative engineers and those who view objects in terms of similarities. Analogous thinking appears to be a basic trait of creative people—at least in industry.

3. Engineers came up with two answers, both correct: $VI \neq I$ and $VI = II$. The last is a statement of numerical equivalents between Roman numeral 6 and the notation for modulo 5 (base 5 instead of 10).

Step on it!



Send for your **FREE** Catalog of Amalco deep drawn aluminum cases today!

Amalco carrying cases for industrial or commercial applications give you:

- immediate delivery on 8 standard sizes up to 8½" W x 12" L x 8½" H
- light weight with protective strength
- full protection against dust, sprays and rust
- special sizes to comply with MIL-C-4150F

Get all the facts now by writing:



Dept. 1

AMERICAN ALUMINUM COMPANY

Manufacturers of Aluminum Products for Industry Since 1910.

230 Sheffield St., Mountainside, N.J. 07092
Phone (201) 233-3500

26

INFORMATION RETRIEVAL NUMBER 132

Don't go 'round & 'round



Go straight to American Aluminum's Catalog of drawn aluminum cans to fit your needs.

You'll find we have round (and rectangular) cans available in standard sizes directly from stock ranging in diameter from less than 1" to 24" and up to 24" deep.

Get the information straight from:



Dept. 3

AMERICAN ALUMINUM COMPANY

Manufacturers of Aluminum Products for Industry Since 1910.

230 Sheffield St., Mountainside, N.J. 07092
Phone (201) 233-3500

27

INFORMATION RETRIEVAL NUMBER 133

The Air France guide to European markets

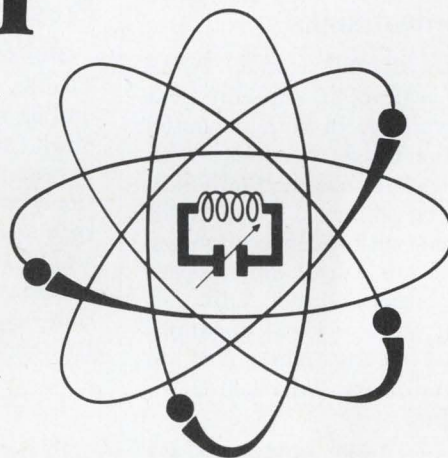

The International Exhibition of Electronic Components

Paris March 28-April 2, 1969

Once again Air France is happy to be the official carrier for the Show, with a ticket reservation and Welcome Service counter on the Show grounds for overseas visitors.

Fly to Paris on Air France 707 Intercontinental jets and enjoy the finest in French food and wines, and unexcelled service.

Direct service from New York, Chicago, Los Angeles, Washington and Boston.

For information and reservations, see your travel agent or call the Air France office nearest to you.

AIR FRANCE

We know where you're going.

Evaluation Samples

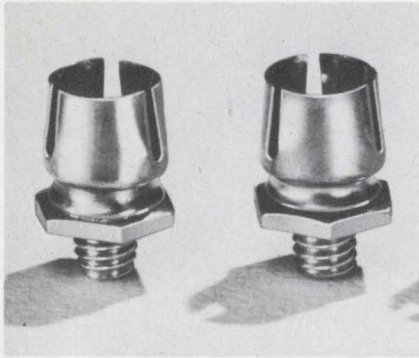

Cup-clip heat sinks

Sized to fit TO-5 and TO-18 packages, a line of cup-clip heat sinks is available in both insulated and noninsulated versions with three types of bases. Plain-base units can be soldered, epoxy-bonded, or used with panhead screws. The two other types are tapped-base and stud-mounted units. A sample kit that includes an application tool is available free to qualified engineers. Wakefield Engineering, Inc.

CIRCLE NO. 353

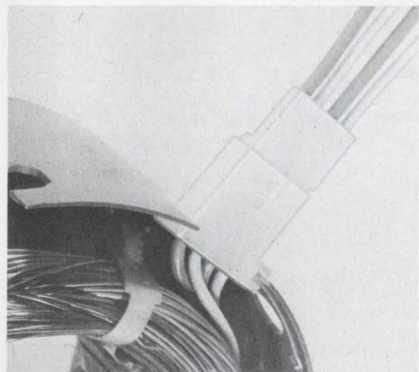

Motor-control connector

A cost-saving approach to motor/control termination, the 1292P motor connector, mounts directly to a motor frame. Service leads can be connected directly into it and no additional strain relief or clamping is needed. Due to the method of mounting, the need to clamp service leads and connectors away from fans and gears is eliminated. Single samples are available without charge. Molex Products Co.

CIRCLE NO. 354

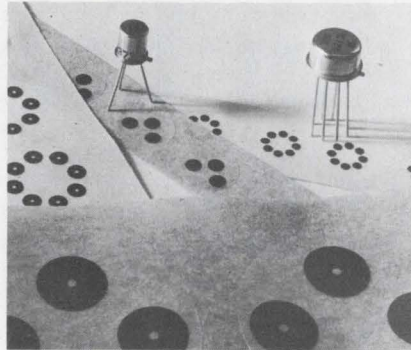

Press-on die-cut symbols

Die-cut symbols for TO-5s and TO-18s are available in 1x, 2x, 4x and 5x scales, in a choice of opaque black, transparent red and transparent blue tints. The configurations are printed on rolls of pressure-sensitive and dimensionally stable 1.5-mil acetate film with an accuracy to ± 0.002 in. An evaluation sample kit is offered free. Bishop Industries Corp.

CIRCLE NO. 351

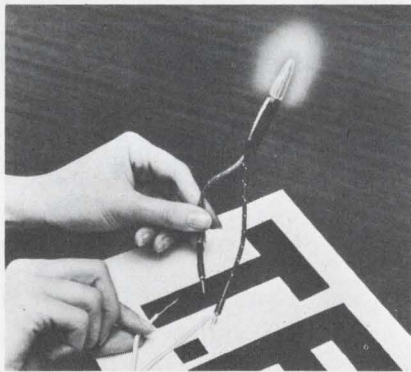

Conductive plastic film

Originally intended to bleed static electricity, a fluorocarbon film has an electrical resistance of only 2000 Ω compared to the 90,000 Ω of similar silicone materials when both were tested on a low-voltage meter. The film is supplied in thicknesses of 0.002 to 0.060 in., in widths up to 30 in. Resistance tests of 0.005-in. film, sandwiched between metal strips held firmly with C-clamps, gave readings as low as 180 Ω . Evaluation samples are available. T.F.E. Inc.

CIRCLE NO. 352



Tamper-proof labels

An opaque white film has been combined with a high-strength adhesive to form a new label that is virtually tamper-proof. The holding power of the adhesive far exceeds the tear strength of the face material. The labels are suitable for use both indoors and outdoors. Free samples are available for evaluation. Avery Label Co.

CIRCLE NO. 355

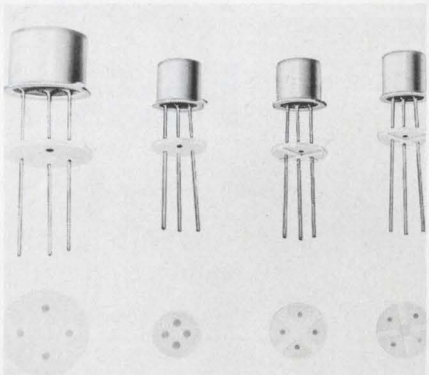

Insulating spacers

Electrically insulating spacers for use with TO-5 and TO-18 semiconductors are available in Thermofilm, Mylar, Teflon and nylon in thicknesses from 0.001 to 0.020 in. Dielectric strengths range from 7000 V/mil for the one-mil spacers down to 350 V/mil for the 20-mil type. Nearly four dozen samples are included with a brochure that covers the complete line. Thermalloy Co.

CIRCLE NO. 356

You Don't Have to See the Light... Just Look at the Data

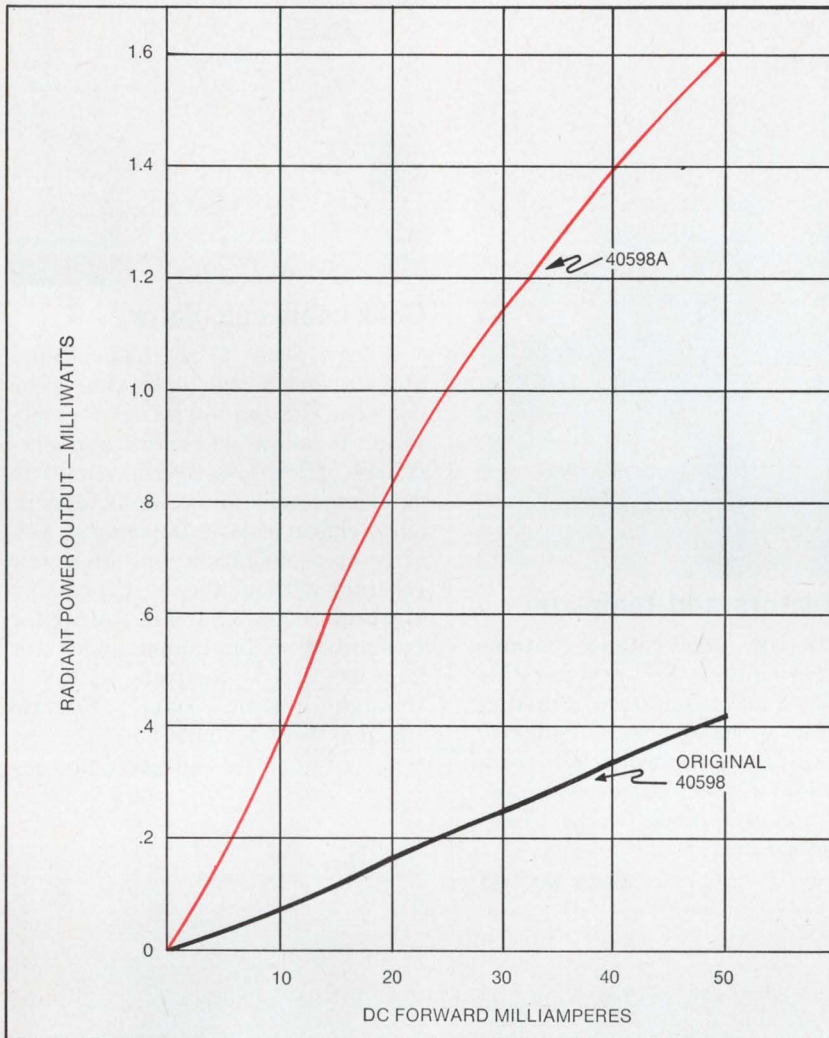

40598A — INFRARED EMITTER

- 3 X More Power Than Original 40598
- Same Drive Current—50 mA
- Same Small Package
- Same Low Price

Typical Irradiance on Photodetector

Distance from Photodetector to Emitting Diode	Punched Card	Punched Paper Tape
0.150" Separation	15 mW/cm ²	14 mW/cm ²
0.200" Separation	10.5 mW/cm ²	10 mW/cm ²

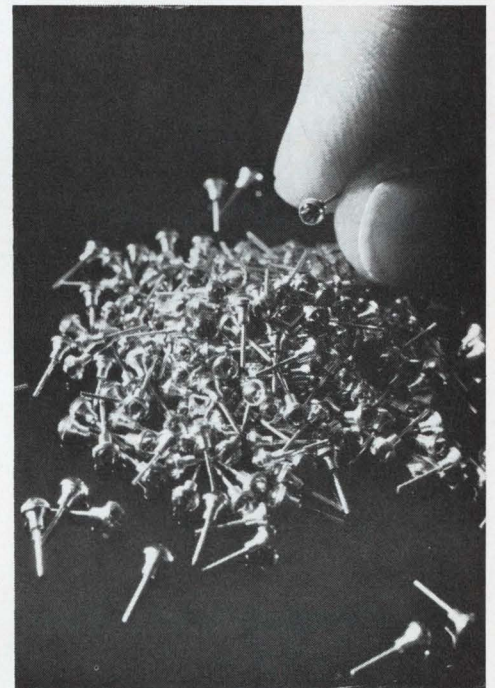

ROOM TEMPERATURE LASERS

<p>New! TA2628 and TA2628R* Single Laser Diodes</p> <ul style="list-style-type: none"> • 1 W (Min.) Peak Output • 30 A Drive Current • Pulse rate to 4 kHz <p>*Reverse Polarity</p>	<p>New! TA7438 10 Diode Series Array</p> <ul style="list-style-type: none"> • 10 W (Min.) Peak Output • 30 A Drive Current • Pulse rate to 500 Hz 	<p>Now Declassified! TA2930 Available for Industrial Use</p> <ul style="list-style-type: none"> • 50 W (Min.) Peak Output • 30 A Drive Current • Pulse rate to 1 kHz 	<p>Custom Arrays</p> <p>Devices from a few diodes to hundreds can be designed to your specifications.</p>
---	---	--	--

Immediate availability in quantity. That's the story of RCA's line of solid-state GaAs Lasers and our exceptional IR emitter. Each of these invisible light devices offers important electro-optic opportunities in secure communications, intrusion alarms, traffic control, instrumentation, ranging, and field illumination.

Call your local RCA Representative today for more information. Or see your RCA Distributor. For technical data on the new 40598A, and the developmental TA2628, TA7438 and TA2930 GaAs Lasers, write: RCA Electronic Components, Commercial Engineering, Section No. SG-2-2C, Harrison, New Jersey 07029.

INFORMATION RETRIEVAL NUMBER 135

**FREE SAMPLE
RFI GASKET
ECCOSHIELD® SV**

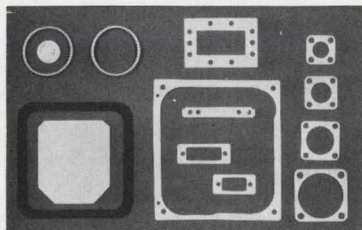

Eccoshield® SV is the flexible, compressible plastic with the conductivity of metal—available in many physical forms—for RF and hermetic seals. Insertion loss has exceeded 100 db.

INFORMATION RETRIEVAL NUMBER 161

**ECCOMOLD®
EPOXY MOLDING
COMPOUNDS**

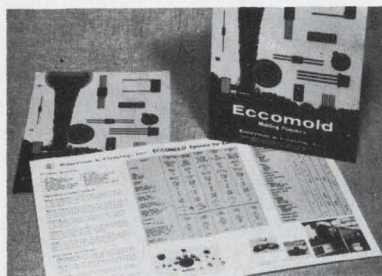

Comparative physical, electrical and processing properties of Eccomold transfer molding compounds are in colorful chart. Typical applications are indicated.

INFORMATION RETRIEVAL NUMBER 162

**ECCOMAX HI-Q
LOW-LOSS
DIELECTRICS**

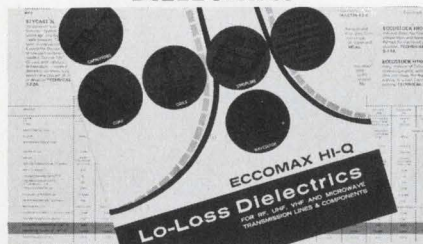

18 low loss systems are described in new folder and chart. Casting resins, impregnants, coatings, adhesives, rod & sheet — some foams — some Hi K — all with dissipation factors below 0.001. For RF, UHF, VHF and microwaves — capacitors, coils, etc.

INFORMATION RETRIEVAL NUMBER 163

Emerson & Cuming, Inc.



**CANTON, MASS.
GARDENA, CALIF.
NORTHBROOK, ILL.**
Sales Offices
in Principal Cities

EMERSON & CUMING EUROPE N.V., Oevel, Belgium

Design Aids

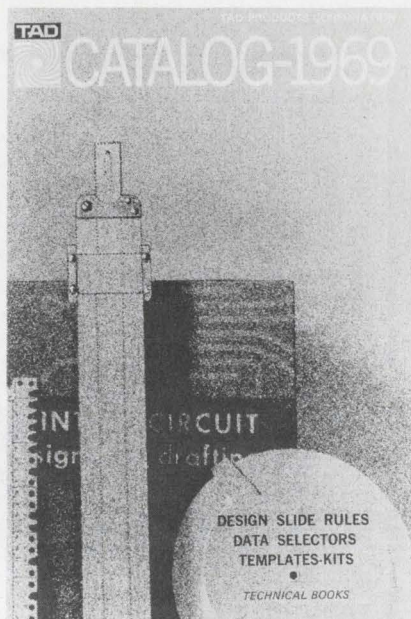

Calculators and templates

A 32-page, 1969 catalog contains full descriptions of design slide rules and data selectors, drafting templates, handbooks, manuals, technical books, curves, kits, converters and other time-saving devices and reference works. TAD Products Corp.

CIRCLE NO. 357



Thermistor calculator

A slide rule, 6.5 × 9 in., speeds thermistor selection. Once thermistor shape and resistance at 25°C have been selected, it is possible to read resistance directly opposite all temperature points on the characteristic curve of the thermistor. Also included are complete dimensions, dissipation, time constants and maximum temperature limits for each of several hundred thermistors. Fenwal Electronics Inc.

CIRCLE NO. 358

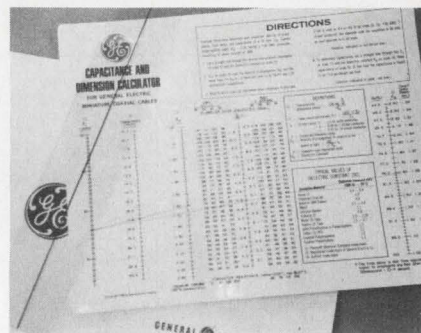

Coax cable calculator

A new, easy to use capacitance and dimension calculator has been designed in the form of a nomogram to allow designers and specifiers of low-loss coaxial cables to determine cable dimensions, capacitance, characteristic impedance, velocity of propagation, and dielectric constant without the need for using algebraic equations. The calculator is printed on laminated paper for long use and is complete with see-through plastic ruler. General Electric Wire & Cable Dept.

CIRCLE NO. 359

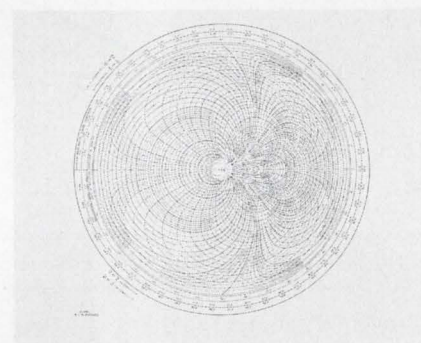

Inverted Smith chart

Known as the Blanchard chart, a new microwave transmission line chart is offered at \$25 per M. This chart gives an increased plotting area for smaller values of VSWR and allows the presentation of the phase length of a line. An application sheet that shows how the chart may be used to solve a variety of microwave problems is included with the charts. This application sheet with a free sample of the chart will be sent to interested readers on request. Greencastle Electronics.

CIRCLE NO. 360

INFORMATION RETRIEVAL NUMBER 136 ▶

TRIPLET

EXTRA QUALITY IS HIDDEN*

MODEL 630 V-O-M PRICE † \$61.00

Standard Of The Industry



USES UNLIMITED:

- Field Engineers
- Application Engineers
- Electrical, Radio, TV, and Appliance Servicemen
- Electrical Contractors
- Factory Maintenance Men
- Industrial Electronic Maintenance Technicians
- Home Owners, Hobbyists

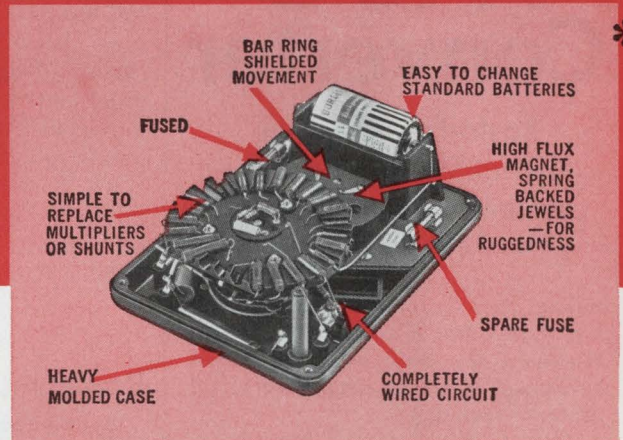

FACTS MAKE FEATURES:

- 1** One selector switch minimizes chance of incorrect settings and burnouts.
- 2** 4.4 ohm center scale, reads from 0.1 ohm up to 100 megohms resistance in 4 ranges.
- 3** 20,000 ohms per volt DC sensitivity: 5,000 AC.

Attention to detail makes the Triplet Model 630 V-O-M a lifetime investment. It has an outstanding ohm scale; four ranges—low readings .1 ohm, high 100 megs. Fuse affords extra protection to the resistors in the ohmmeter circuit, especially the X1 setting, should too high a voltage be applied. Accuracy 2% DC to 1200V. Heavy molded case.

†630A same as 630 plus 1½% accuracy and mirror scale only \$71.00
TRIPLET ELECTRICAL INSTRUMENT COMPANY, BLUFFTON, OHIO

RANGES

DC VOLTS	0-3-12-60-300-1,200-6,000 at 20,000 ohms per volt.
AC VOLTS	0-3-12-60-300-1,200-6000 at 5,000 ohms per volt.
OHMS	0-1,000-10,000.
MEG OHMS	0-1-100.
DC MICRO-AMPERES	0-60 at 250 millivolts.
DC MILLI-AMPERES	0-1-2-12-120 at 250 millivolts.
DC AMPERES	0-12.

DB: -20 to +77 (600 ohm line at 1 MW).

OUTPUT VOLTS: 0-3-12-60-300-1,200; jack with condenser in series with AC ranges.

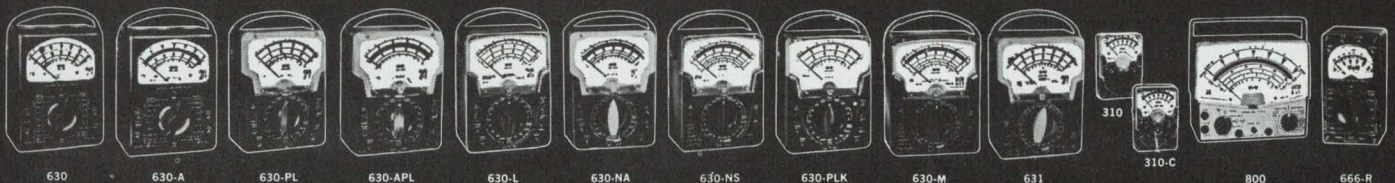

THE WORLD'S MOST COMPLETE LINE OF V-O-M'S. AVAILABLE FROM YOUR TRIPLET DISTRIBUTOR'S STOCK.

NEW O.E.M.

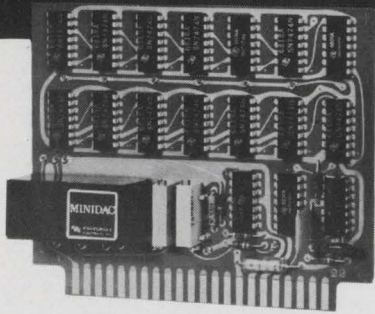

3 3/4" x 4 1/2" x 1/2"

A-to-D Converter

Pastoriza offers the
first utility converter for
systems applications . . .
priced for quantity sales.

Having first introduced the modular A-to-D and D-to-A converter, Pastoriza Electronics now offers an unprecedented innovation: A printed circuit card A-to-D converter featuring . . .

High Performance

- 12 bits conversion in 8 microseconds.
- 10 bits conversion in 4 microseconds.
- 8 bits conversion in 2 microseconds.

Low Cost

Priced competitively with any ADC available today, and designed for volume production.

Open Book Concept

No black magic in the design — circuitry is accessible and repairable.

User Confidence

Design and component information is supplied to insure ease and confidence in customer application.

This complete single-card A-to-D converter includes reference supply and comparison amplifier, using dual in-line integrated circuit logic with a MINIDAC D-to-A module. It accepts 0 to +10 volts input range, and provides up to 12 bits resolution.

Write for eye-opening facts on this newest modular A-to-D utility converter.

PASTORIZA
ELECTRONICS, INC.

385 Elliot St., Newton, Mass. 02164 • 617-332-2131

INFORMATION RETRIEVAL NUMBER 137

Application Notes

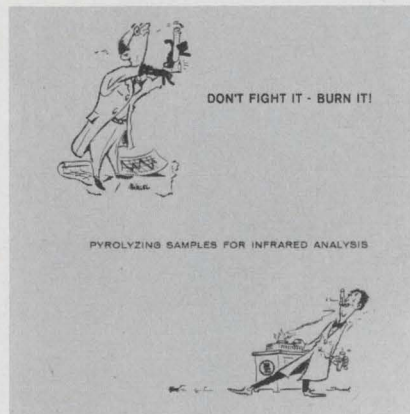

Infrared analysis

Time-saving techniques for pyrolyzing obstinate samples for infrared analysis are discussed in a six-page booklet, which shows how carbon-filled rubber, polymers and other intractable samples are reduced in seconds by pyrolysis to obtain quick and reproducible results. Spectra of ATR and transmission condensates and gases are reproduced to illustrate results. Barnes Engineering Co.

CIRCLE NO. 381

Pneumatic circuits

A 36-page handbook offers more than 70 illustrations and diagrams that cover basic air circuitry, typical control and logic systems that can be used as basic guides when developing new circuits, and a complete symbols comparison chart. Also included are basic references and helpful hints on circuit design plus a complete treatment of modular control valves, fittings and accessories. Pneucon, Inc.

CIRCLE NO. 382

Ferrite magnets

Describing a complete line of ferrite permanent magnets, an 18-page catalog also introduces three new grades of magnets. Shown for each grade is the normal and intrinsic demagnetization curve and other pertinent information to aid the engineer in materials selection. The catalog also contains a glossary of magnetic terms. The Arnold Engineering Co.

CIRCLE NO. 383

P-i-n diode data

An eight-page brochure has been prepared on the application of high-power p-i-n switching diodes in duplexers operating at megawatt peak power levels at frequencies through C-band. Included are a comparison of various types of duplexers, the relative advantages and disadvantages of each type, solid-state duplexer design analysis and operation, and typical solid-state duplexer performance parameters. Unitrode Corp.

CIRCLE NO. 384

Pressure switch notes

Available for immediate distribution is a new set of application notes for pressure switches and a pressure-switch/solid-state relay combinations. The 23 applications range from the counting of objects to the automatic retraction of a plane's landing gear. Fairchild Controls.

CIRCLE NO. 385

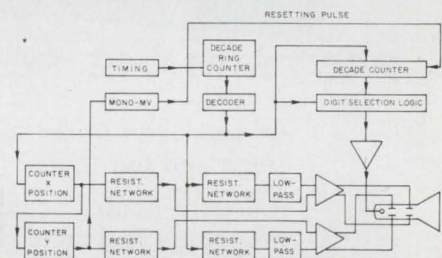

Digital CRT readouts

A method of achieving digital indication in four 16-digit lines, without recourse to special purpose tubes or overly complex circuitry is described in an 8-page application note. The block diagram shown above depicts one unit that was developed for this purpose. The pamphlet discusses the system in general and examines in detail the individual circuits involved. The note also describes the basic methods of character presentation on cathode-ray tubes and discusses the problems that led to development of the unit shown. AEG-Telefunken.

CIRCLE NO. 386

Far Superior

TO ANY VTVM OR VOM

A NEW STANDARD OF THE INDUSTRY...

- Only Sencore makes a true field effect meter
- Less circuit loading than VTVM/obsoletes VOM
- Zero warm-up time — instant stability
- Complete circuit and meter protection
- Complete portability
- Greater frequency responses than most scopes

FE149 SENIOR FET METER

The only true Senior FET meter available today with outstanding accuracy and unbelievable ease of operation.

- **Unmatched Accuracy.** 1.5% on DC, 3% on AC, plus large 7-in. meter and mirrored scale, assure the most accurate tests possible.
- **Eight AC and DC ranges** .5V to 1500V full scale.
- **Zero center scale** with .25 v. either side assures measurements to less than .1 v. for transistor bias measurements.
- **AC peak to peak** readings to 4500V maximum with freq. response of 10HZ to 10MHZ \pm 3DB.
- **Eight resistance ranges** to R x 10 megohms with 6 OHMS center scale.
- **Nine DC and nine AC current ranges** 150ma to 5 amps.
- **Eight decibel ranges** for audio measurements.
- **Three HI-Voltage ranges**, 5 KV, 15 KV, 50KV with 39A21 high voltage probe. **\$14.95**
- **Absolute meter and circuit protection** against circuit overload.
- Non-breakable, scuff-proof, vinyl-clad steel case.
- **Three-way power.** Operates on AC, on self-contained rechargeable batteries, or on AC with batteries plugged in. Same readings all three ways.



\$149.50

Exclusive push-button design. Just push two buttons for any test — top row selects function, bottom row selects range. Action is instant and automatic.



\$69.95

FE14 — STANDARD FET METER

ACCURACY DC \pm 2.5%
AC \pm 4.5%

- 4½-inch meter, vinyl-clad steel case.

FE14 and FE16 popular 4 1/2 inch FET Meters

- **Hi Accuracy.** For unsurpassed measurements. Mirrored scales prevent parallax errors.
- **Minimum circuit loading.** 15 megohm input resistance on DC; 10 megohm on AC.
- **Zero center scale** \pm 0.5 v. readings for transistor bias measurement.
- **Full meter & circuit protection** against possible circuit overload.
- **7 DC & AC voltage ranges** 1 to 1000 volts full scale.
- **AC peak to peak readings** 2800 v. maximum with freq. response of 10HZ to 10MHZ \pm 3DB.
- **5 resistance ranges** to 1000 megohms.
- **5 DC current ranges** 100ma to 1 amp.
- **3 Hi-Voltage ranges**, 3 KV, 10 KV, 30 KV, extended with 39A19 (\$9.95) high voltage probe.



\$84.50

FE16 HI ACCURACY FET METER

ACCURACY DC \pm 1.5%
AC \pm 3%

- 4½-inch high-styled meter, high-styled knobs, and special meter-tilting metal handle. Vinyl-clad steel case.



See your Sencore distributor today or write factory for complete line catalog.

SENCORE
STANDARD OF THE ELECTRONIC INDUSTRY

426 SOUTH WESTGATE DRIVE,
ADDISON, ILLINOIS 60101

INFORMATION RETRIEVAL NUMBER 138

Gain an extra stockroom at no additional cost! Let a P&B distributor carry your relay inventory.

Authorized distributors will deliver your choice of 822 standard P&B relays. In almost any quantity, daily, weekly or monthly. Isn't that like having another stockroom?

In addition to the convenience, you actually save in several ways. The cost of owning inventory, for example. Factory shipping charges. You also save the time required for factory scheduling and production.

Often an order for P&B relays can be combined with one for other electronic components. That's another saving.

Order standard relays from your Potter & Brumfield distributor. Prototype or production quantities. He's in business to save you time and money.

Potter & Brumfield Division American Machine & Foundry Company, Princeton, Indiana 47570.



Select from 822
standard P&B relays

AMF | POTTER & BRUMFIELD

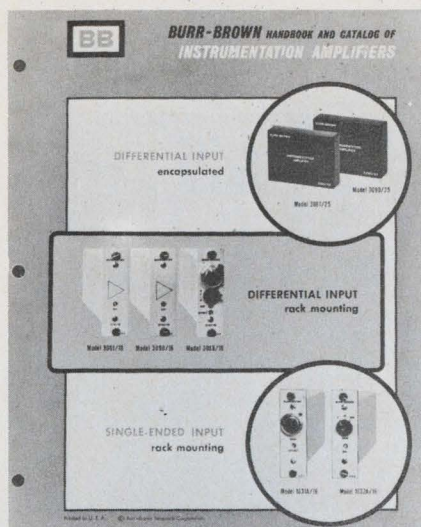

Instrumentation amps

Providing a valuable reference on instrumentation amplifiers, this 32-page publication begins with a discussion on the various parameters for choosing such an amplifier, and follows up with data on instrumentation design and applications. Burr-Brown Research Corp.

CIRCLE NO. 387

Coating brochure

A new brochure describing capabilities for coating products with Teflon and other plastic-based materials. Applied to parts that range from miniature components to bulk steel fabrications, the coatings provide various combinations of nonstick properties, chemical inertness, low coefficient of friction, high or low temperature resistance, corrosion protection and electrical insulation. The Fluorocarbon Co.

CIRCLE NO. 388

Oceanography

An eight-page, two-color treatise on underwater television has been reprinted. The brochure includes an original painting that depicts the sea from surface to below 35,000 feet, 18 photographs, and discussions of such subjects as industry in the sea, oceanographic research, undersea food sources and government/defense programs. Cohu Electronics, Inc.

CIRCLE NO. 389

PC soldering

Providing a thorough explanation of solderability problems and their solutions, a technical report discusses the restoration of solderability to copper surfaces and the damage that can be done to surfaces by abrasive particles. Also explained is how, after good solderability is attained, the surfaces can be protected against recontamination. Also covered is the application of fluxes, the advantage of preheating, pointers on cleaning and maintaining cleanliness of the work surfaces after soldering. Alpha Metals, Inc.

CIRCLE NO. 390

Static switching handbook

An illustrated, 66-page handbook on the subject of industrial static switching techniques and applications provides the control-logic circuit designer with the fundamental concepts involved in solid-state switching. The general logic described in the handbook is sink logic; the specific logic is English logic. Covered in the manual are parallel switching (sink logic), auxiliary (signal and power level) switching elements, truth tables, Boolean algebra, five conversion techniques, and applications of static logic. Jordan Controls, Inc.

CIRCLE NO. 391

Emi measurements

A 26-page application note discusses the principles of electromagnetic interference measurements. It describes how calibrated spectrum analyzers can be used as tuned rf microvoltmeters, with visual display to make these measurements with substantial savings in time. The note begins with a general summary of emi principles. It describes techniques for making standardized emi measurements and tells how these measurements can be made during the design stage, so that electromagnetic compatibility can be designed into the equipment. Hewlett-Packard Co.

CIRCLE NO. 392



RUGGED LOW COST GENERAL PURPOSE RELAY

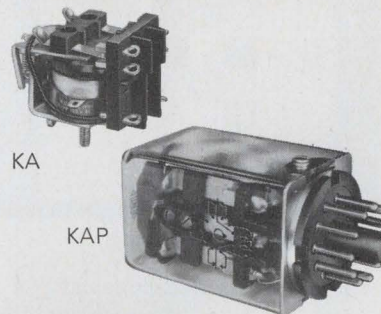

Although low in price, this small rugged relay is highly efficient for handling light power loads such as small motors, solenoids and general automation applications. It is available in a wide variety of AC and DC coil voltages, contact arrangements and ratings. A broad selection of mountings, including terminals for printed circuits, is offered. Many standard models are U/L recognized and CSA listed.

The KA is the open version of this series. The KAP is enclosed in a transparent, high impact plastic dust cover, with 8 or 11-pin octal type plugs for socket mounting.

PLUS P&B Capabilities and Facilities that insure

- **Controlled Quality**
- **Reliability**
- **Long Life**
- **On Time Deliveries**

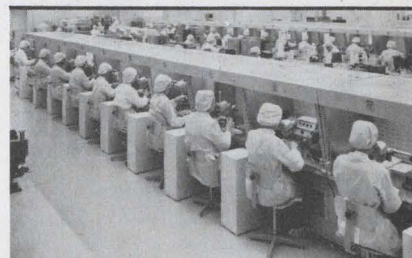

P&B also produces aero-space and military relays which are assembled, tested and sealed in a spacious clean room where all production is under our Intensified Control and Reliability Program.

AMF
POTTER & BRUMFIELD
 Division of American Machine & Foundry Co.
 Princeton, Indiana 47570

INFORMATION RETRIEVAL NUMBER 140

New Literature

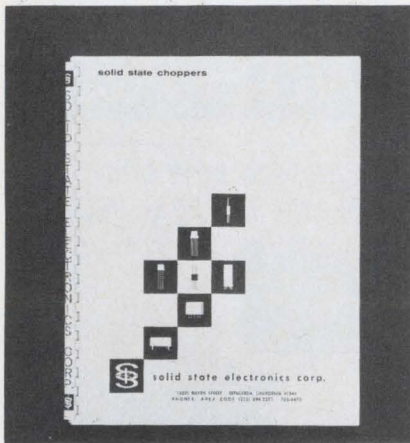

Solid-state choppers

Described in a 62-page catalog is a complete line of choppers that includes 30 types. All units are of completely solid state miniature design and have been widely utilized for military, industrial, and research applications. Solid State Electronics Corp.

CIRCLE NO. 393

IC audio amp

The operation and applications of an IC audio driver amplifier for communications equipment is described in an eight-page booklet. Circuit diagrams and equations are shown, as well as several class A amplifier circuits that deliver powers from 1 to 6 W. P. R. Mallory & Co., Inc.

CIRCLE NO. 394

Precision resistors

Precision wirewound resistors for both military and commercial applications are discussed in a 44-page illustrated brochure. Included are specifications on high-reliability, high-accuracy, printed-circuit, and power resistors. There is also a chart of minimum resistance value versus tolerance. In addition, curves indicate wattage versus tolerance derating with temperature rise and wattage versus ambient-temperature derating. Cutler-Hammer, Shallcross Div.

CIRCLE NO. 395

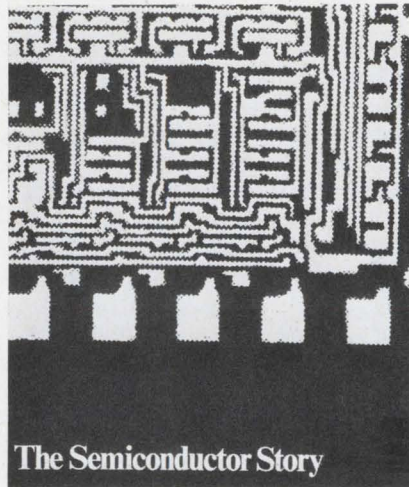

The Semiconductor Story

Semiconductor facts

Single copies of a 28-page booklet, *The Semiconductor Story*, are offered at no charge to electronics engineers. The booklet includes seven articles that trace the history of solid-state electronics. The heroes of the great adventure are all here, from Faraday to Shockley. The theory behind modern solid-state devices is also explained in the four articles that follow the historical introduction. Schweber Electronics.

CIRCLE NO. 396

Mo and W threaded rods

A technical information bulletin on threaded molybdenum and tungsten rods is now available. The bulletin lists tables that show typical tensile strength of the rods and their thermal expansion and electrical resistivity. Sylvania Electronic Products, Inc.

CIRCLE NO. 397

Shaft hardware

A line of shaft hardware is described in an eight-page bulletin that lists both standard and miniature items. The catalog includes such items as knobs, dials, couplings, gear drives, as well as shaft locks and bearings. James Millen Manufacturing Co.

CIRCLE NO. 398

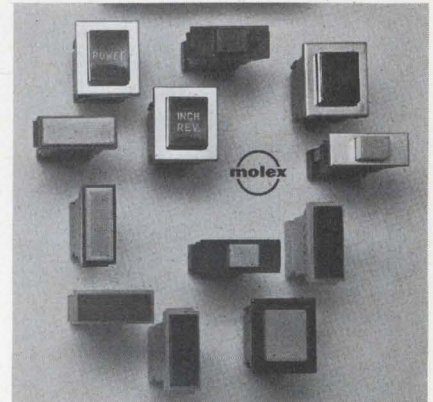

Switch catalog

A new, four-color, six-page catalog describes five versatile lighted and unlighted pushbutton switches. Illustrations and specifications describe the application flexibility for two models of lighted pushbutton switches with colored buttons and bezels, a combination switch and receptacle, a pushbutton receptacle switch and a uniquely designed record-changer switch. Molex Products Co.

CIRCLE NO. 399

Indicators and actuators

Five technical bulletins describe a wide variety of miniature fail-safe indicators. The literature includes descriptions, specifications, dimensional drawings, photographs and ordering information. DACO Instruments Co., Inc.

CIRCLE NO. 401

Thin-film technology

Residual gas analyzers are finding increased use with the widening application of sputtering and evaporation systems for thin-film integrated circuit production. A new 20-page brochure on a residual gas analyzer contains specifications, outline drawings, a theoretical background, and detailed descriptions of operation and operating controls. Shown, too, are 26 actual scope and chart recorder scans, and resolution specifications for five currently used definitions of resolution. Veeco Instruments.

CIRCLE NO. 402

Pick the
BEST IC
for the job

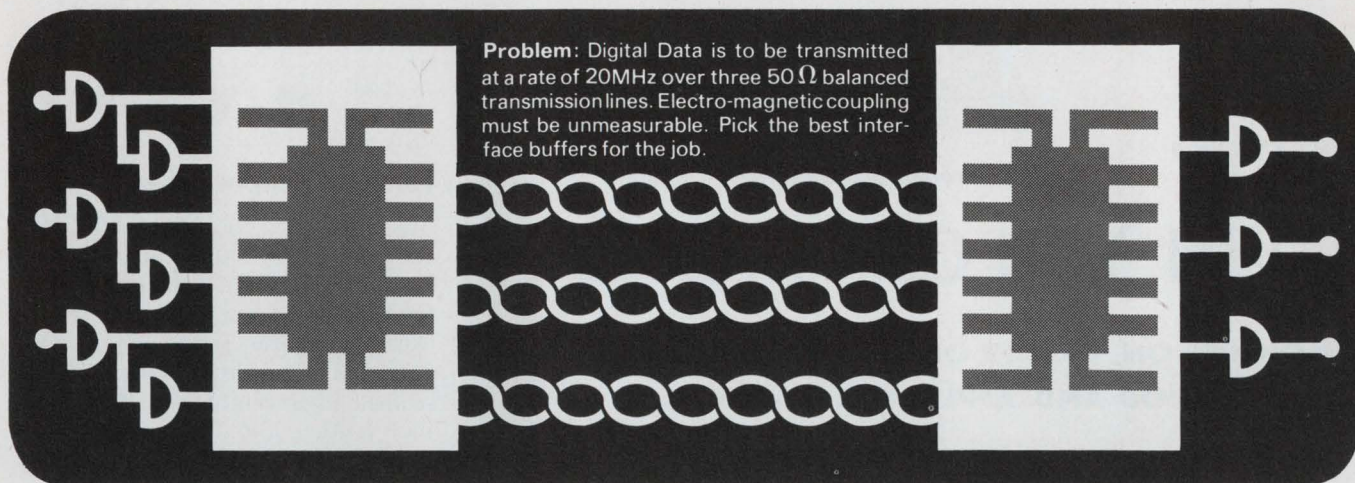

Problem: Digital Data is to be transmitted at a rate of 20MHz over three 50Ω balanced transmission lines. Electro-magnetic coupling must be unmeasurable. Pick the best interface buffers for the job.

the **BEST** Solution:

THE NEW RA-245 LINE TRANSMITTER



The best IC to use at the sending end is Radiation's dielectrically isolated RA-245. This line transmitter converts digital voltage pulses to current pulses. The high speed CML circuits assure data transfer rates in excess of 30MHz. Power dissipation is a constant, independent of data rate. The balanced system virtually eliminates the adverse effects of line capacity. Electro-magnetic coupling and susceptibility is greatly reduced. RA-245 is available in both the TO-84 flatpack and the ceramic dual inline package. Three voltage-to-current converters are in each package. Power dissipation is negligible when converters are not being used. So use only one or all three. RA-245 is the Best IC for the job.

THE NEW RA-246 LINE RECEIVER



For best results, use Radiation's dielectrically isolated RA-246 at the receiving end. This 3-element buffer faithfully restores the current pulses to digital voltage pulses. The RA-246 current-to-voltage converter has built-in input terminations for balanced 50Ω lines. Outputs from each element are suitable to drive all standard saturated logic circuits (such as DTL, TTL, etc.).

Like the RA-245, the RA-246 is available in both the TO-84 flatpack and the ceramic dual inline package. And you can use any or all of the converters. The Best IC for the job.

Contact your nearest Radiation sales office for further information. Ask how the RA-245 can be used as a level shifter. And how to use the RA-246 as a threshold detector. We will help you pick the Best IC for the job.

WE MAKE THE **BEST** IC FOR THE JOB



RADIATION
INCORPORATED

SUBSIDIARY OF HARRIS-INTERTYPE CORPORATION
MICROELECTRONICS DIVISION

RADIATION SALES OFFICES: P.O. Box 476, Lexington, Mass. 02173, (617) 682-1055 • 600 Old Country Road, Garden City, N.Y. 11530, (516) 747-3730 • 2600 Virginia Avenue N.W., Washington, D.C. 20037, (202) 337-4914 • 6151 W. Century Boulevard, Los Angeles, California 90045, (213) 670-5432 • P.O. Box 37, Melbourne, Florida 32901, (305) 727-5430 • International Sales: Marketing Department, P.O. Box 37, Melbourne, Florida 32901, (305) 727-5412

INFORMATION RETRIEVAL NUMBER 141

The PARKER model ER 35

will
really

TURN YOU ON . . . or OFF,

OR ON OFF ON, OR OFF ON OFF, OR WHATEVER YOUR
MOOD AND APPLICATION MAY BE !

- Completely Self-Contained Indicating and Control Meter.
- Matching Noncontrolling Indicator (Model E-35)



PARKER INSTRUMENT CORP.

200 HARVARD AVE. STAMFORD, CONN. 06904 tel-203 325-4361 TWX 710-474-2277

INFORMATION RETRIEVAL NUMBER 142

**Chart-Pak[®]
short cuts
get printed
circuit
masters
off the
board fast!**

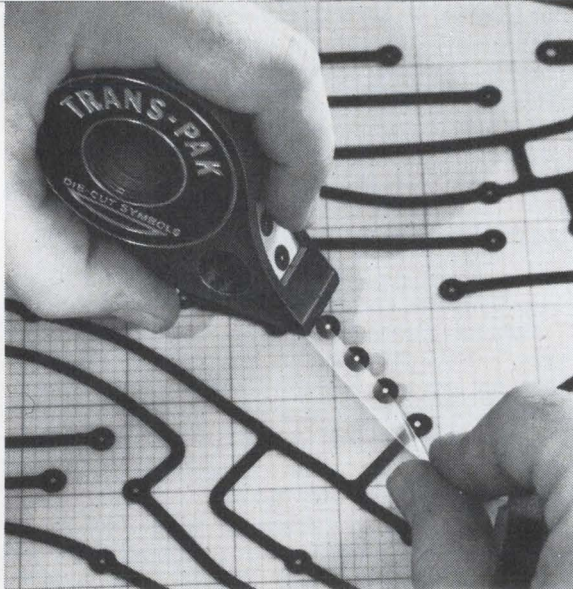

- Trans-Pak die-cut symbols and Chart-Pak pressure sensitive tapes cut time, cut cost.
- Trans-Pak's unique patented "position, press and peel" method permits fast application of distortion-free symbols.
- Chart-Pak crepe paper tapes precision-slit guaranteed to $\pm .002$ " accuracy.
- Finished masters reproduce with maximum sharpness . . . require minimum opaquing.
- Chart-Pak's Precision Grids guarantee master accuracy.

Using is believing . . . write for free catalog showing complete line of printed circuit materials.

CHARTPAK ROTEX

A Division of Avery Products Corp.
Santa Ana, Calif. & Leeds, Mass.
Look in The Yellow Pages under Drafting Supplies.
Art Tapes, Charts/Business for your dealer's name.

Look In The Yellow Pages under Charts/Business, Drafting Supplies, Tapes or
Art Supplies for your dealer's name.

INFORMATION RETRIEVAL NUMBER 143

NEW LITERATURE

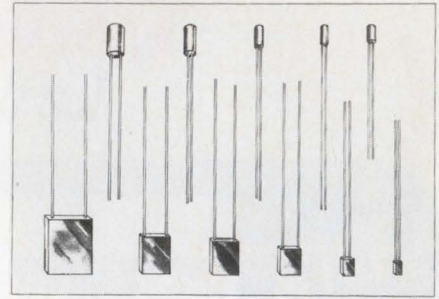

Tantalum capacitors

A complete line of microminiature solid tantalum capacitors is designed to provide maximum electrical performance and capacitance-to-volume ratio for hybrid, thick film and integrated circuits. Described in an eight-page brochure, they feature a wide variety of case styles, sizes and lead configuration for modular, cordwood and other applications requiring minimum packaging density. Union Carbide Corp.

CIRCLE NO. 403

Control and telemetry

An 8-page catalog describes control, telemetry, and power conversion components. Specifications, features, applications, outline drawings and photographs are given for each unit. Among the components shown are an IC-logic power supply, rf circuitry, traveling-wave tubes, and a 50- to 400-Hz frequency converter with a 0.00001% frequency tolerance. Raven Electronics, Inc.

CIRCLE NO. 404

Industrial sealants

A four-page, two-color, 8-1/2 by 11-in. illustrated catalog describes six industrial sealants for sealing gaps between mating surfaces to prevent the passage of liquids, gases or minute particles. The catalog lists the various types of sealants together with information on end uses, physical properties, application methods, color, solids content, consistency, coverage, drying time, and outstanding features of each. 3M Co. Adhesives, Coatings and Sealers Div.

CIRCLE NO. 405

NITINEWS

for coating,
encapsulating, potting,
casting, sealing

Nitine NR Frozen Epoxies

High density alumina filled epoxies which provide superior high temperature performance and excellent thermal conductivity.

Nitine NR "electronic grade" frozen epoxies have been developed to meet the specialized requirements of makers and users of semiconductors. These resins represent the latest developments in the use of high thermal conductivity aluminas, and are specially formulated systems fully compatible with semiconductor materials.

Low viscosities and rapid cure cycles

Rigid quality control to eliminate trace impurities

Superior electrical properties:

arc & tracking resistance
corona resistance

When refrigerated storage is impractical, Nitine NR epoxies are available as conventional, two-part mixes.

Write or call for Product Data Sheets. Details of proprietary epoxies and special packaging capabilities on request.

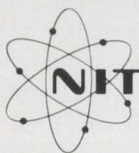

NITINE, INC.
SUBSIDIARY OF SHULTON, INC.
Route 46, Clifton, N. J. 07015
(201) 779-4800

INFORMATION RETRIEVAL NUMBER 144

ELECTRONIC DESIGN 4, February 15, 1969

Solid-state chopper

A four-page, 2-color brochure describes a solid-state chopper that incorporates a pair of balanced silicon field effect transistors and a unique magnetic drive system. The brochure contains application and specification information for eight models in the 6100 series. A variety of package designs for direct plug-in or PC-board installation as direct replacements for mechanical choppers are illustrated. James Electronics, Inc.

CIRCLE NO. 406

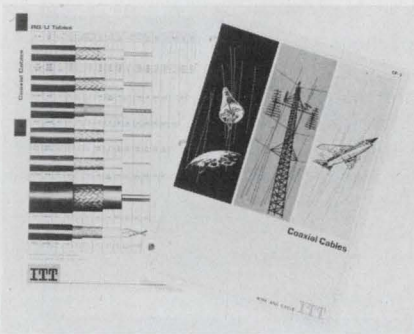

Coaxial cable

To assist in the selection of coaxial cables for specific electronic applications, a new 16-page catalog details the design considerations, conductor selection, and properties of dielectric insulating materials. An RG/U/table illustrates cable constructions and gives complete attenuation information. Indexed are all commonly used military and governmental wire specifications. ITT Wire and Cable Division.

CIRCLE NO. 407

Component encapsulation

How costs can be cut drastically in standardized and custom injection molding of electrical components is detailed in a new brochure. It covers the savings achieved through newly developed techniques; charts cost per thousand pieces of toroids, cylinders, and through terminals; and presents production requirements, quote prerequisites, and specifications of thermoplastic and thermosetting encapsulating materials. Capsonic Group, Inc.

CIRCLE NO. 408

think digital

ELFIN®
2.99*



MS-4000-B
3.85*

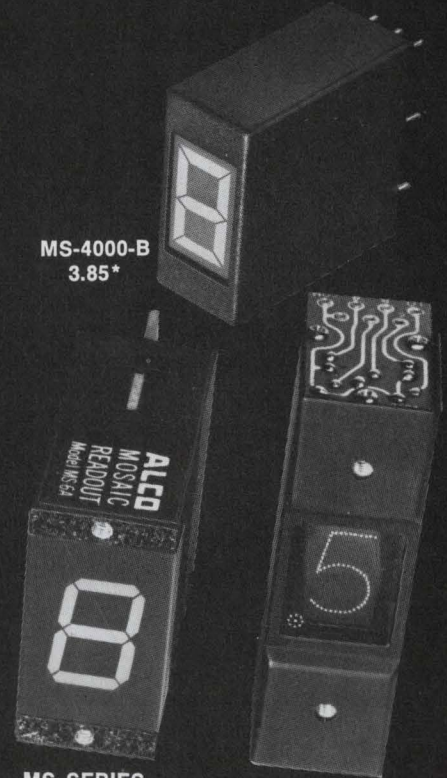

MS SERIES
4.97*

RK SERIES
4.97*

Think ELFIN® — the new single plane, segmented neon readout indicator that provides brighter displays and wider viewing. Only 0.41" dia. ELFIN® displays 0-9, + and -, some alpha symbols and decimal.

MS-4000-B miniature encased readout with the flat single-plane viewing, uses 100,000 hr. #683 T-1 subminiature incandescent lamps. Plug-in feature expedites replacement.

ALCO's RK numeric and symbol readouts have a unique in-line design to provide clear displays without focusing problems. The precision machined 1-piece aluminum case also serves as a heat sink.

The MS Mosaic numeric segmented indicators are available in 2 sizes and use either 6, 14 or 24V lamps for flexibility in design.

*1000 Lot prices

ALCO

ELECTRONIC PRODUCTS, INC.

Lawrence, Massachusetts 01843

INFORMATION RETRIEVAL NUMBER 145 ►

IC BREADBOARD AND TEST PANELS

TIME SAVING • FLEXIBLE

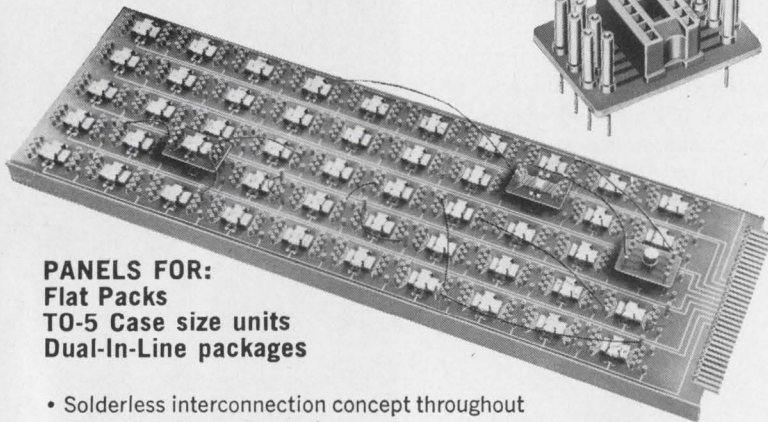

PANELS FOR:
Flat Packs
TO-5 Case size units
Dual-In-Line packages

- Solderless interconnection concept throughout
- 10 to 50 patterns standard
- Fast loading and operation — easy IC interchangeability
- Single pattern units provide interchangeability of all three packages
- Power and ground connection at each pattern
- Panel plugs into 36 position edge connector with contacts spaced on .156 centers
- 6" x 17" panels (50 patterns)

Request IC Folder
Tel: 617/222-2202

AUGAT inc.

31 PERRY AVE., ATTLEBORO, MASS. 02703

INFORMATION RETRIEVAL NUMBER 146

*Unlocking
the Future*

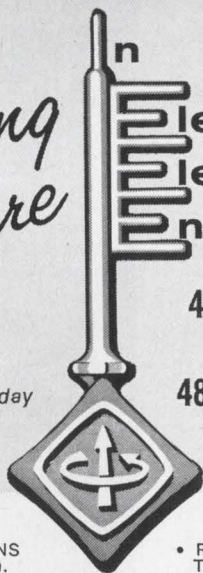

4 FLOORS OF EXHIBITS
NEW YORK COLISEUM
48 TECHNICAL SESSIONS
NEW YORK HILTON

Monday through Thursday

- 48 TECHNICAL SESSIONS at the New York Hilton. Hours: 10:00-12:30; 2:00-4:30.
- FOUR FLOORS OF EXHIBITS at the N. Y. Coliseum including over 600 firms. Hours: 10 a.m.-8 p.m. 4 Days.
- GALA ANNUAL BANQUET—Wednesday 7:15 p.m. N. Y. Hilton Grand Ballroom — \$18.00.
- FREE SHUTTLE BUSES between the Hilton and the Coliseum — every few minutes.

- REGISTRATION — Good all days — Technical Sessions and exhibits. In and out privileges. — IEEE Members \$3.00. Non-members \$6.00. Ladies \$1.00. High School Students \$3.00 if accompanied by an adult — One student per adult; Thursday only — limit of 3 students per adult.
- REG-IDENT CARD speeds request for exhibitors' literature. Ask for one when registering.
- ESCALATORS/EXPRESS ELEVATORS to the Fourth Floor.

IEEE '69  **INTERNATIONAL CONVENTION & EXHIBITION MARCH 24-27, 1969**

INFORMATION RETRIEVAL NUMBER 147

NEW LITERATURE

Thermoplastic resins

A revised, 20-page two-color bulletin describes glass-filled grades of thermoplastic resin. Noted for their resistance to temperatures of up to 310° F, the materials feature high tensile strength and low water absorption. Bulletin CDX-38B covers characteristics and includes comparisons between glass-filled and standard grades. Typical metal replacement applications are described. General Electric, Plastics Dept.

CIRCLE NO. 409

Submicron filters

Industrial submicron filters are the subject of a 28-page bulletin that details the characteristics and applications of the new M-780 filters. Included in the technical data is a listing of nine maximum pore sizes, from 0.2 to 10 microns, for varying degrees of micro-organism and particulate filtration. A comparison of the new medium with film-type membranes is also given. Separate sections are devoted to applications that include drug manufacture, the aerospace program, electronic micro-circuit cleaning, chemical processing, and clinical-lab routine filtration. Cox Instrument, Div. of Lynch Corp.

CIRCLE NO. 410

Epoxies for electronics

An epoxy molding-powder chart has been revised to include two new types and to eliminate outdated types. Application data includes molding temperatures and pressures, suggestions for mold design, an application selector table and processing notes. The properties of cured materials are given, including operating temperature limits, specific gravity, hardness, mechanical strength, water absorption, thermal expansion coefficient, thermal conductivity, flammability, dielectric constant, loss tangent, volume resistivity, dielectric strength and arc resistance. Emerson & Cuming, Inc.

CIRCLE NO. 411

High Voltage Rectifiers

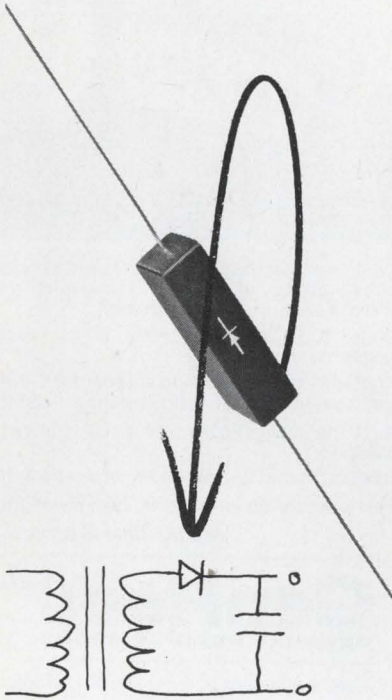

New! From Varo.

Silicon Rectifiers At Selenium Prices!

At last, economical high voltage silicon rectifiers. Ideal for use in all high voltage, low current applications.

- 5,000-40,000 Volts
- 5, 10, 25 milliamp ratings
- Standard and Fast Recovery
- In 1/4" square package.

These are the high voltage rectifiers that make completely solid state television circuits possible. Equally well suited for use in other cathode ray tube applications, electrostatic power supplies and voltage multipliers.

Only \$1.32

10,000V, 5mA rating. Quantity of 1,000. Complete details, applications, and price list available.



SEMICONDUCTOR DIVISION
2203 WALNUT STREET, GARLAND, TEXAS 75040
(214) 272-3561

INFORMATION RETRIEVAL NUMBER 148

ELECTRONIC DESIGN 4, February 15, 1969

Air-moving devices

Propeller and vane-axial fans, squirrel-cage and centraxial blowers, low-speed and spiral blowers, and coolant panels are described in a 24-page quick-reference catalog. Other product information given includes airflow interlock switches, and solid-state converters and inverters. Operating data, photographs and outline drawings are given for all products. Rotron, Inc.

CIRCLE NO. 412

Transistor heat sinks

Heat sinks for all basic types of transistor cases, as well as custom heat sinks for power semiconductors, are described in a 31-page catalog. Several new designs are introduced, including new lines of forced-air heat exchangers, liquid-cooled heat sinks and heat sinks for disc semiconductors that come with mounting hardware in either single or double side configurations. Thermalloy Co.

CIRCLE NO. 413

CCTV applications

Use of closed-circuit television to provide close-up observation of airborne test activity in real time is the subject of a technical application bulletin. Eight photographs and a story describe one such television system in operation. Cohu Electronics, Inc.

CIRCLE NO. 414

Aluminum oxide tapes

A data sheet on hybrid aluminum oxide tapes describes the properties of this new dielectric material. The sheet also describes typical applications, including substrates, high-temperature current boards, microcircuit packages and package lids, relay and crystal header preforms, as well as connector preforms. The data sheet provides a comparison of physical and electrical properties of glass and the new hybrid aluminum oxide. Hani-bal Glass, Inc.

CIRCLE NO. 415

brite glo[®]



BNE SERIES



BNF SERIES



BND SERIES

MINI
NEON
PILOTS

Modern design series has a 1-piece body ideal for display configurations. BNE SERIES features a compact lens system protruding slightly above the panel. BNF SERIES' lens system extends more for greater illumination. BND SERIES' pilot assembly protrudes beyond panel to provide maximum light intensity. All units have one-nut mounting, and are available with or without built-in series resistors.

L. to R.
Short leads, 10" lead
metal base & 10" lead



T-1 3/8 NEON LAMPS

An unusual ring-electrode construction glows on the entire surface for maximum brightness. The unobstructed glass allows the illuminated elements to be placed close to the top where it may be viewed to advantage.

For 75V to 95V operation.

PANEL INDICATORS

A new advent to ultra-miniaturization is this ALCO Series that mounts in a 3/16" hole. Available only in the most popular 5 volt 60 ma. rating having an exceptionally high 100,000-hr. lamp life. The sealed high temperature plastic assembly contains a standard #680 or #683 T-1 lamp. Choose from a variety of colors. Supplied either with long wire leads (Type ME-680L), with pin contacts (Type ME-680).

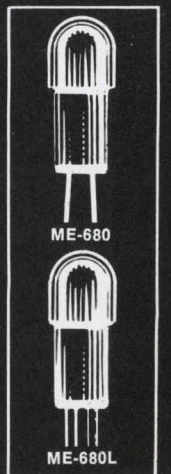

ALCO

ELECTRONIC PRODUCTS, INC.

Lawrence, Massachusetts 01843

INFORMATION RETRIEVAL NUMBER 149 ►

NEW HIGHLY SELECTIVE CONSTANT DELAY FILTERS

CONSTANT DELAY OVER 100%
of PASS BAND COUPLED with
HIGH SELECTIVITY
and LOW RIPPLE

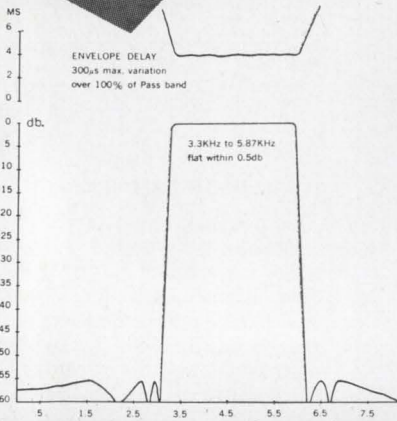
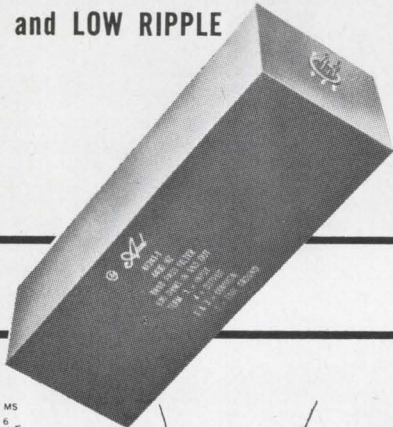

Check These Specifications

- 300 μ sec max. delay distortion from 3300Hz to 5920Hz
- ± 0.25 db max. amplitude variation from 3300Hz to 5870Hz
- 55db or greater below 3070Hz and above 6160Hz
- Size: 3x9x2 $\frac{3}{4}$ high
- Manufactured to meet Govt. Specifications: MIL-F-18327C

Axel

AXEL ELECTRONICS, INC.

A UNIT OF GENERAL SIGNAL CORPORATION

134-20 Jamaica Avenue

Jamaica, N.Y. 11418

Manufacturers of:

Capacitors • Precision Wave Filters • R.F.I. Filters • Pulse Networks • Pulse Transformers • Pulse Modulators.

INFORMATION RETRIEVAL NUMBER 150

216

NEW LITERATURE

Panel-mounted counters

A line of electrical and mechanical counting devices are described in a new four-page catalog. It illustrates seven separate and distinct panel-mounted counters—including resettable and non-resettable counters, key-lock types and hour indicators. Complete specifications, dimensional diagrams and application suggestions are included in the two-color catalog. ENM Co.

CIRCLE NO. 416

Brushless dc motors

A four-page brochure describes a line of miniature brushless dc motors with solid-state controls. The booklet covers precision motors from 1.6 to 3.5 inches in length with diameters ranging from 0.8 to 2 in. and torques from 0.18 to 7 in.-oz. These brushless units minimize acoustical, conductive and rf noise. Siemens America, Inc., Power Equipment Div.

CIRCLE NO. 417

Power supplies

More than 300 power supplies, including modular, high-voltage and frequency converters, are detailed in a new loose-leaf catalog. Page references and convenient charts for cross-indexing aid in selecting the appropriate power supply for such needs as voltage and current range, regulation, ripple and size. Prices are included for the full line. NJE Corp.

CIRCLE NO. 418

Capacitors

A 40-page short-form catalog lists the general characteristics of many capacitor types. Included are ceramic, film, paper-and-foil, polystyrene, polycarbonate, fluorocarbon and electrolytic capacitors. The specifications cover size, configuration, temperature range and coefficient, capacitance, tolerance, types of leads, and electrical parameters. West-Cap Div., San Fernando Electric Mfg. Co.

CIRCLE NO. 419

REED RELAYS

Certifiable to
MIL-R-5757/29B

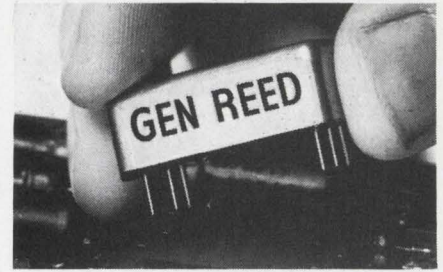

- Choice of 14 basic Form A, Form C, and combinations of A and C capsules in three standard-size metal cases.
- Coils: 6, 12, and 26.5 volts, or to specifications.
- Printed circuit type pin on standard 0.1-inch grid spacing, in standoff insulating header.
- All units magnetically and electrostatically shielded.
- Resists humidity, vibration, and shock.
- Fast operate time; long life; high reliability.

Ask for Bulletin GR-5.



19 Walnut Ave. (Box 858), Clark, N.J. 07066

Tel. 201-382-7373

INFORMATION RETRIEVAL NUMBER 152

YOUR HEART FUND FIGHTS

HEART ATTACK
STROKE
HIGH BLOOD
PRESSURE
INBORN HEART
DEFECTS

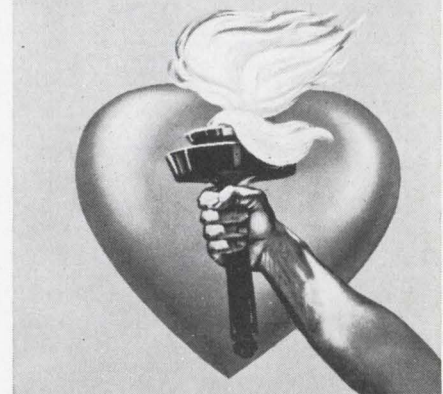

Design Brochure Cable Assemblies & Coaxial Delay Lines

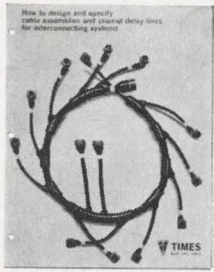

This 4-page brochure details specifications and multiple design possibilities of cable assemblies and coaxial delay lines. It also follows through with evaluation, production and test procedure info.

For your copy write or phone:
Times Wire & Cable, Wallingford,
Conn. (203) CO 9-3381

INFORMATION RETRIEVAL NUMBER 191

Seamless Metal Tube Sheathed Coaxial Cable

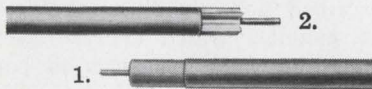

Times' new semiflexible coaxial cable with seamless aluminum tube sheath conductor is available in two standard versions:

1. ALUMIFOAM® — Foam polyethylene dielectric where pressurizing isn't practical.
2. ALUMISPLINE® — Air dielectric where pressurizing is practical. These cables offer more isolation—at 80 < db more than ordinary coax. Uniformity average — VSWR 1.1 or less. Stability — 10 times better. Lower loss — 30% less. Pulse reflection — less than 1%. Less distortion. Also avail. in solid dielectric and high temp. constructions.

For prices & data write or phone:
Times Wire & Cable, Wallingford,
Conn. (203) CO 9-3381

INFORMATION RETRIEVAL NUMBER 192

Connectors for Solid Sheathed Cable

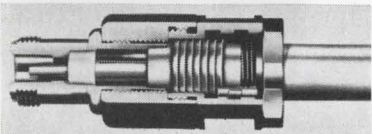

Only one step required to use the new one-piece TIMATCH® Connector with its own pat. CoilGrip® clamp—just unpack it. Its reusable and repeated assembly and disassembly does not impair either the RF or physical characteristics of the connector or the cable. Available in all popular sizes and fits all metal tube sheathed coaxial cables.

For prices & data write or phone:
Times Wire & Cable, Wallingford,
Conn. (203) CO 9-3381

INFORMATION RETRIEVAL NUMBER 193

Current probes

Current probes for applications that range from the emi-rfi field to detectors for all types of electronic instrumentation are described in an eight-page brochure. The illustrated booklet provides major specifications including frequency range, transfer impedance, and relevant dimensions. The brochure also features an introductory discussion of current probe applications as rfi accessories, general monitoring devices, and pickup devices or sensors for signal conditioning equipment. Genisco Technology Corp.

CIRCLE NO. 420

Data acquisition

A four-page application bulletin discusses computer-based data acquisition systems. The material presented covers the basic concepts behind computer-based systems, clarifies some of the terms and concepts germane to a discussion of such systems, and attempts to give some insight into devising economical and practical data acquisition programs. Quindar Electronics, Inc.

CIRCLE NO. 421

Linear-motion pots

Fully described in a 4-page bulletin is a new design concept for a functional, yet economical, linear-motion potentiometer. The product advantages are illustrated, together with complete electrical characteristics and physical specifications. Also listed are application suggestions and cost reduction benefits. Stackpole Components Co.

CIRCLE NO. 422

Wire and cable catalog

A 48-page business machine wire and catalog is available at no charge. For quick location of individual items, the illustrated data are grouped into main categories—single wire, coaxial cable and multi-conductor cable. American Enka Corp., Brand-Rex Div.

CIRCLE NO. 423

small power



"SNAP-ON" BUTTON



LONG BUTTON



MUSHROOM HEAD

ALCO Power Switches combine compact size, modern appearance, and functional flexibility to meet today's control needs, and mount in a 1" hole.

New, snap-on push buttons simplify selection of colors, shapes and legends.

These versatile switches allow "add on" contact sections for maximum flexibility in switching.

Manufactured from approved materials for stringent requirements. Rated 6 amps @ 230 VAC to handle most power applications.

The low cost of these space-saving power devices will surprise you!

ALCO

ELECTRONIC PRODUCTS, INC.

Lawrence, Massachusetts 01843

Mission: Protection

Skydyne A.B.S. Cases

There's a time on every project when delicate equipment must be packaged and protected for shipping and transportation. Skydyne A.B.S. thermoformed cases provide the means. Over 35 standard sizes are included in the line . . . from about 8"x6"x4" to 67"x26"x5". Custom interiors of polyurethane or polyethylene provide maximum protection against vibration and shock. For special applications, custom molded A.B.S. cases are available with the lowest possible tooling costs and lead time. Write for our complete set of A.B.S., Fiberglass and Sandwich panel case catalogs.

Skydyne, Inc.

RIVER ROAD, PORT JERVIS, N. Y. 12771
Telephone (914) 856-5241



INFORMATION RETRIEVAL NUMBER 155



APT-1; 1 cu. in.,
3.15 oz. (actual size)

More torque, Less weight in moving coil mechanism

Highly stable, linear and accurate mechanism for indicating, control or recording systems. 18-0-18° linearity is 1%. Coil design with over 75% of winding "working" in high energy, uniform field air gap assures greater accuracy. Coil system weighs 0.85 gm, develops 26.4 mmg of torque; 31:1 T/W. Mechanism offers negligible vibration pivots and jewels — custom damping — wide range of sensitivities.

AMMON

AMMON INSTRUMENTS, INC.
345 Kelley St., Manchester, N.H. 03105

INFORMATION RETRIEVAL NUMBER 156

Specify KEYSTONE BATTERY HOLDERS

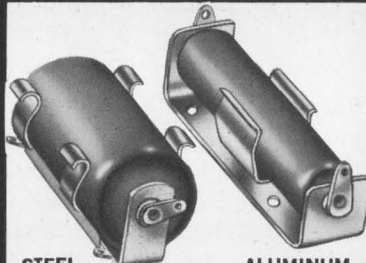

STEEL

ALUMINUM

A complete standard line of battery holders for use with all type batteries. Available for immediate shipment from stock, single or multiple holders.

- LOW COST
- STURDILY CONSTRUCTED
- LIGHTWEIGHT

Free engineering service for your special custom built holders.

A holder for every application. Also a complete line of Standardized Components or Modification of our Standard Line.

- TERMINAL BOARDS • TERMINALS
- PLUG-IN HOUSING • STAKING TOOLS
- PRE-PUNCHED BOARDS • BUSHINGS

NEW FREE CATALOG ON REQUEST

KEYSTONE ELECTRONICS CORP.

49 Bleecker St., New York, N.Y. 10012

INFORMATION RETRIEVAL NUMBER 157

NEW LITERATURE

Brushless dc motors

A four-page brochure describes a line of brushless dc motors. The motors are of a new and unique design that utilize Hall-effect devices and offer many advantages over conventional dc motors. The brochure explains theory and operation and describes a family of four motors that cover a range of torques from 0.5 to 7 in.-oz. Brushless Motors Electronics, Inc.

CIRCLE NO. 424

Shaft encoder bulletin

An eight-page bulletin describes 27 shaft encoder types as well as 16 solid-state modular accessories. Described and illustrated are circuit modules which operate as a system with the encoders to perform such tasks as digital display, data logging, set-point control, ON-OFF motor control, and computer interfacing. Theta Instrument Corp.

CIRCLE NO. 425

Fastener data

Technical Report No. 94 concerns the tightening and loosening of small screws used to fasten thin, flexible sheet metal. Described are the various groups of locking and non-locking washers that prevent loosening. General characteristics of selected lock washers are examined and appropriate schematic representations of basic types are given. Shakeproof.

CIRCLE NO. 426

Antennas and rf lines

Containing a comprehensive listing of antenna and rf transmission line products, a 200-page catalog has complete specifications, engineering data and installation procedures in military and industrial antennas. They include aluminum elliptical waveguide, rigid and semi-rigid copper and aluminum coaxial transmission line, and communication antennas. Also featured is a new line of ocean telemetering buoy systems. Prodelin, Inc.

CIRCLE NO. 427

Snowflakes Look Alike...

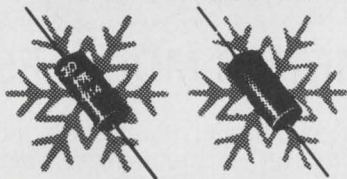

...So Do Resistors! But One Is 6 Ways Better!

Like snowflakes, precision wire-wound and metal film resistors only look alike.

Kelvin precision wire-wound resistors offer:

1. **Lower Noise** (db's quieter — no current noise).
2. **Better Long Term Stability** (.003% /year).
3. **Lower Temperature Coefficients** (to ± 1 ppm) at much less cost.

Metal films are good but, Kelvin precision wire-wounds are **6 ways better**. Want the other 3 ways? Please call us!

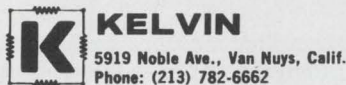

INFORMATION RETRIEVAL NUMBER 158

FOR Cable Ties

Think

GC

Tie into greater production, bigger profits... with GC Government-Accepted Cable Ties.

Choose from nylon or plastic in sizes from 4 1/4" to 12", all color coded with GC patented "Snap-In" button terminals. All available in stock for immediate shipment. Remember too, on special cable problems, check with GC... we're tooled to save you time and money.

Write today on your Company letterhead for the big **FREE** GC Electronic Components Catalog —

FREE! FR-66-1... it's your pass book to greater production and profits.



GC Electronics

400 South Wyman Street
Rockford, Ill. 61101

A Division of
GC-Hydrometals, Inc.
Shipping warehouses in:
Hicksville, L.I., N.Y.
Los Angeles, California



INFORMATION RETRIEVAL NUMBER 159

ELECTRONIC DESIGN 4, February 15, 1969

Thermistor thermometers

New technical literature that describes a line of linear thermistor thermometers is now ready. These thermometers employ a unique thermistor development that provides a linear voltage output with temperature. Details and specifications are available as are reprints of publications that describe the new development. Yellow Springs Instrument Co., Inc.

CIRCLE NO. 428

TTL logic cards

A 64-page brochure describing a new line of TTL logic cards is now available. The catalog contains complete technical information on thirty-four TTL logic cards and includes schematics, manufacturer's IC specifications and specifications of associated hardware and power supplies. A price list is included. A brief description of a compatible DTL logic-card series is provided. Wyle Laboratories.

CIRCLE NO. 429

Microwave components

A 20-page microwave component catalog includes solid-state switches, miniature coaxial hybrids, couplers and mixers. The catalog lists over 350 standard microwave components with emphasis on miniature, solid-state devices designed to meet requirements for broad bandwidth performance. Kevlin Mfg. Co.

CIRCLE NO. 430

Instrumentation

Covering a broad range of instrumentation products, an 11-page catalog gives specifications in short-form for system and spectrum analyzers, metrology instruments, and noise and field intensity meters. Analyzer/surveillance receivers, ac/dc voltmeters and ammeters, synchro-resolver test instruments, and d/a converters are also described. The Singer Co., Metrics Div.

CIRCLE NO. 431



If You Still Pay "PREVAILING PRICES" for STEPPING MOTORS ... YOU SHOULD BE CRYING BY NOW!!!

YOU CAN GET OUR INSTANT RESPONSE

RAPID SYN

STEPPING MOTORS FOR A LOT LESS!!!

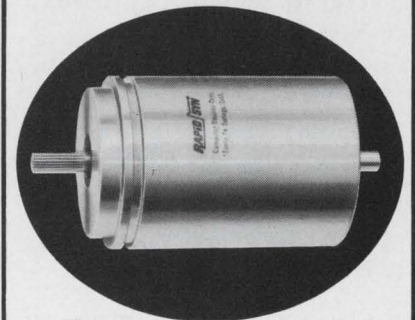

Look at these quality features:

- Class H insulation
- Precision 5 shielded bearings
- Corrosion resistant construction
- Sizes 5-20
- Step angles 15°-90°

Isn't this a good reason to contact us—immediately?



11925 Burke Street, Santa Fe Springs,
Calif. 90670 • (213) 698-2595 • 723-6593

"The only real home stepping motors ever had"

INFORMATION RETRIEVAL NUMBER 160

ELECTRONIC DESIGN's function is:

- To aid progress in the electronics manufacturing industry by promoting good design.
- To give the electronic design engineer concepts and ideas that make his job easier and more productive.
- To provide a central source of timely electronics information.
- To promote two-way communication between manufacturer and engineer.

Want a subscription? ELECTRONIC DESIGN is sent free to qualified engineers and engineering managers doing design work, supervising design or setting standards in the United States and Western Europe. For a free subscription, use the postfree application form inside the back cover. If none is included, write to us direct for an application form.

If you do not qualify, you may take out a paid subscription for \$25 a year in the U.S.A., \$35 a year elsewhere. Single copies are \$1.50 each.

If you change your address, send us an old mailing label and your new address; there is generally a prepaid postcard for this inside the back cover. You will have to requalify to continue receiving ELECTRONIC DESIGN free.

The accuracy policy of ELECTRONIC DESIGN is:

- To make reasonable efforts to ensure the accuracy of editorial matter.
- To publish prompt corrections whenever inaccuracies are brought to our attention. Corrections appear at the end of the Letters column.
- To refuse any advertisement deemed to be misleading or fraudulent.

Microfilm copies are available of complete volumes of ELECTRONIC DESIGN at \$19.00 per volume, beginning with Volume 9, 1961. Work is now in process to complete the microfilm edition of Volumes 1-8. Reprints of individual articles may be obtained for \$2.00 each, prepaid (\$.50 for each additional copy of the same article) no matter how long the article. For further details and to place orders, contact the Customer Services Department, University Microfilms, 300 North Zeeb Road, Ann Arbor, Michigan 48106; telephone (313) 761-4700.

Want to contact us? If you have any comments or wish to submit a manuscript or article outline, address your correspondence to:

Howard Bierman, Editor,
ELECTRONIC DESIGN,
850 Third Avenue,
New York, N.Y. 10022.

MANUAL ON TRIGONOMETRIC MODULES

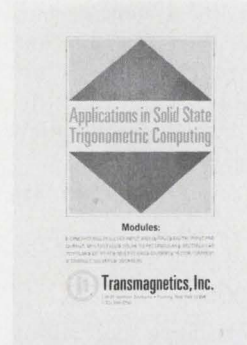

A new design manual, illustrating more than 45 applications for trigonometric modules, is available free for engineers.

The "building block" modules, around which the manual is based, allow designers to develop all solid state computing systems. The devices replace synchro or resolver servos or provide interfacing with them.

The manual contains nearly two dozen applications, complete with drawings and diagrams, for analog systems and subsystems and digital applications.

Transmagnetics, Inc.

134-25 Northern Blvd.
Flushing, New York 11354

174

Free: 2,500 Plastic Parts Catalog



New from Nylomatic, molders and fabricators of mechanical plastic components, a highly informative 48-page catalog of more than 2,500 standard parts. It can help you save time and money in design, test and production. Advantages of Nylomatic standard parts: no tooling charges, low unit costs, quick delivery, complete range of sizes. Nylomatic standard parts are made of Nylon, Delrin® and other thermoplastic materials. You'll find our new free catalog a real problem solver for designers, send for it today.

Nylomatic Corporation

Dept. P

Nolan Ave., Morrisville, Pa. 19067

175

FUNDAMENTALS OF INTEGRATED CIRCUITS

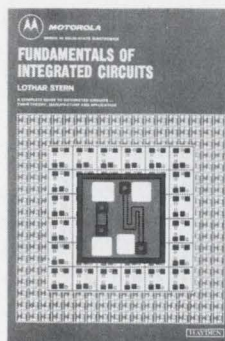

A practical guide to integrated circuits, their theory, manufacture, and applications. This new guide by Lothar Stern offers complete, highly readable coverage of the various techniques of circuit fabrication, and their effect on circuit design and performance. As to marketing considerations, it compares the characteristics of the numerous IC structures devised to date in terms of economics and logistics. A volume in the **Motorola Series in Solid-State Electronics**. 198 pages, 7 x 10, illustrated. \$8.95, clothbound. Send for 15-day examination copies.

Hayden Book Company, Inc.

116 West 14th Street
New York, N.Y. 10011

176

Manufacturers

Advertisements of booklets, brochures, catalogs and data sheets. To order use Reader-ServiceCard.
(Advertisement)

NEW 68-PAGE DRAFTING CATALOG — FREE

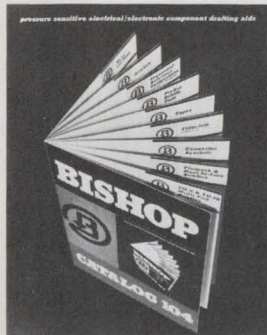

Bishop Catalog 104 — the most comprehensive manual type catalog of pressure-sensitive electrical/electronic component drafting aids ever assembled. Filled with thousands of printed wiring symbols and patterns to speed artwork preparation time and cut drafting costs. Featuring the latest information on printed wiring drafting techniques. Contains multi-pad component symbols, including flatpacs and dual in-lines. Also, general purpose wiring symbols, logics, schematics, reference designations, tapes, pads, shapes and many, many more. Send today for your free copy and samples.

Bishop Industries Corp.

7300 Radford Ave.
North Hollywood, California 91605
Phone: (213) 982-2000

177

NON-FADING LAMP COLOR BOOTS.



SiliKromes® are silicon rubber colored filters that instantly change the color of clear miniature lamps. Capable of operating in extremely difficult environmental conditions, SiliKromes serve, for example, at 500°F for 1000 hours or more with out color fade or degradation of the elastomer properties. Interchangeable and reusable, the filters come in any color, meets MIL-S-22885 and other applicable Mil-Specs, and are ideally suited for switch indicators, lighting panels, instrument lighting, automotive radios and dash panels and many other military and commercial applications. Write today for free SiliKrome samples, and detailed information.

APM Hexseal Corporation

44 Honeck Street, Englewood
New Jersey 07631 (201) 569-5700

178

Terminal Block Selector



A new 24-page, completely illustrated catalog contains photos, descriptions, ratings, engineering drawings, and prices of the complete line of Curtis terminal blocks. Included are printed circuit, insulated feed-thru, quick disconnect, track type, and high current terminal blocks. Handy selection chart quickly locates the perfect block for your particular requirements. Send today for your free copy.

See us at IEEE Show-Booth 4E12

Curtis Development & Mfg. Co.

3236 North 33rd Street
Milwaukee, Wisconsin 53216

179

Electronic Design

Advertising Sales Staff

New York 10022

Robert G. Drake
Sales Manager
Edward F. Clancy
Sales Service Manager
Robert W. Gascoigne
Thomas P. Barth
Samuel M. Deitch
Byron Adams
850 Third Avenue
(212) Plaza 1-5530
TWX: 867-7866

Philadelphia 19066

William C. Repetto
P. O. Box 206
Merion Station, Pa.
(215) MA-3-5888

Boston 01945

Richard Parker
P.O. Box 645
Clifton Station
Marblehead, Mass.
(617) 742-0252

Chicago 60611

Thomas P. Kavooras
Berry Conner, Jr.
200 East Ontario
(312) 337-0588

Cleveland

(216) 247-7670

Los Angeles 90303

Stanley I. Ehrenclou
John V. Quillman
W. James Bischof
2930 Imperial Highway
Inglewood, Calif.
(213) 757-0183

San Francisco 94022

Arthur R. Shields, Jr.
175 San Antonio Rd., S 243
Los Altos, Calif.
(415) 941-3084

London W. 1

For United Kingdom & Holland
Brayton C. Nichols
44 Conduit Street
Tel: REGent 4714

Verviers, Belgium

For Continental Europe
Andre Jamar
1, Rue Mallar, 1
(087) 253.83 Telex 41563

Tokyo

Yoshihiro Takemura
IPS Group Ltd.
Box 36, Ohsaki Post Office
Phone (431) 5804



Advertisers' Index

Advertiser	Page	Advertiser	Page	Advertiser	Page
API Instruments Co.	140	General Electric Company, Silicone Products Department	141	Radiation, Inc.	211
APM-Hexseal Corporation	221	General Radio Company	1	Raytheon/Semiconductor	62, 76, 77
Air France	201	General Reed Company	216	Reeves Hoffman Division of Dynamics Corporation of America	172
Alco Electronic Products, Inc.	215, 217, 219	Grayhill, Inc.	186	S.D.S.A.	191
Allen-Bradley Co.	53, 55	Gudebrod Bros., Silk Co., Inc.	142	San Fernando Electric Mfg. Company	180
Allied Control Company, Inc.	125	Hayden Book Company, Inc.	220	Scientific Data Systems, Inc.	85
American Aluminum Company	200	Hewlett-Packard	Cover II, 15, 161, 188, 193	Sealectro Corporation	148
American Lava Corporation	132, 133	Hickok Electrical Instruments Co., Inc. The	184	Sencore	207
Ametek/Lamb Electric	150	Honeywell Computer Control Division	46	Shauer Manufacturing Corp.	172
Ammon Instruments, Inc.	218	Howard Industries, MSL Industries, Inc./Motor Group	59	Signetics Corporation, Measurement/Data	8
Analog Devices, Inc.	100, 101	IEEE	214	Signetics Integrated Circuits, A subsidiary of Corning Glass Works	197
Astrodata, Inc.	50, 51	IRC, Division of TRW Inc.	127	Siliconix Incorporated	166
Automatic Controls Division, Cook Electric	165	Industrial Timer Corporation	194	Simpson Electric Company	156
Augat, Inc.	214	International Rectifier	75	Skydyne, Inc.	218
Axel Electronics, Inc.	216	Isomet Corporation	183	S.O.G.I.E.	44
Beckman Instruments, Inc., Helipot Division	153	Itron Corporation	189	Solitron Devices, Inc.	181
Belden Corporation	34, 35	Jaco Electronics, Inc.	162	Sorenson Operation, Raytheon Company	137
Bell & Howell	138	Johnson Company, E. F.	187	Spectrol Electronics Corporation	192
Bendix Corporation, The Semiconductor Division	83	Kelvin Electric Co.	219	Sperry Rand Corporation, Electronic Tube Division	151
Bishop Industries Corp.	221	Kepeco, Inc.	60	Sprague Electric Company	18
Bourns, Inc.	57	Keystone Electronics Corp.	218	Stackpole Carbon Company	23
Buckbee Mears Co.	163	Krohn-Hite Corporation	115	Stacosevitch	177
Bulova Electronics Division of Bulova Watch Company	196	Lafayette Radio Electronics	199	Sylvania Electric Products, Inc. 32A-H	147
Burr-Brown Research Corporation	155	Lear Siegler Inc., Cimron Division	7	Syncro Capacitor Corporation	190
Burroughs Corporation	20	Lectrohm Inc., A Subsidiary of Cook Electric	164	Systron-Donner Corporation, Data Pulse Division	2
CEI, A Subsidiary of Watkins-Johnson	199	Magnetics, Inc.	179	TRW Semiconductors, Inc.	149
Captor Corporation	166	Mallory Capacitor Company	159	Tektronix Inc., Oscilloscopes	64
Cedar Engineering Division, Data Control Corporation	195	Mallory Battery Company	143	Teledyne Relays, A Teledyne Company	45
Centralab, The Semiconductor Division of Globe Union, Inc.	175	Microsonics, Inc.	152	Tele Sciences, Inc.	37
Chartpak Rotex, A division of Avery Products Corp.	212	Microwave Associates, Inc.	49	Telonic Instruments, A Division of Telonic Industries, Inc.	176
Chassis-Trak Inc.	144	Minelco, Division of General Time	16	Tempil Corporation	160
Chicago Switch Division, F & F Enterprises, Inc.	199	Monsanto Company	14	Teradyne	94, 95
Chronetics, Inc.	178	Motorola Communications & Electronics, Inc.	182	Texwipe Company, The	190
Clevite Corporation	191	National Semiconductor Corporation	129, 131	Times Wire and Cable, Division of The International Silver Company	217
Clifton, Division of Litton Industries	61	Nitine, Inc.	213	The International Silver Corporation	167
Clevite/Sonotone	173	Nylomatic Corporation	220	Transmagetics, Inc.	220
Components, Inc., Semiconductor Division	171	Nytronics, Inc.	31	Triplett Electrical Instrument Company	205
Computer Devices	219	Opto Metric Tools, Inc.	154	Trygon Power Supplies	198
Cross Co., H.	13	Parker Instrument Corporation	212	Tyco Laboratories, Inc.	146
Curtis Development & Mfg. Co.	221	Pastoriza Electronics, Inc.	206	Tung Sol Division, Wagner Electric Corporation	183
Dale Electronics, Inc.	Cover III	Physitech, Inc.	174	U. S. Capacitor Corporation	162
Damon Engineerings, Inc.	24	Potter & Brumfield Division of American Machine & Foundry Company	208, 209	Unimax Switch, Division Maxon Electronics Corporation	187
Data Device Corporation	170	Power/Mate Corp.	182, 186, 194	United Aircraft Corporation, Electronic Components Division	11
Datscan, Inc.	169	Product Improvement Corporation	36	Varo Inc.	215
Duncan Electronics, Inc.	145	RCA Electronic Components and Devices	9, 134, 203, Cover IV	Veeder-Root	157
Eimac, A Division of Varian	17	RCA Institutes, Inc.	195	Waters Manufacturing, Inc.	6
Elco Corporation	12	Waters Manufacturing, Inc., Litton Industries	84	Winchester Electronics, Litton Industries	84
Electrical Industries	158	Career Advertising		Conduction Corporation	117
Electro Materials Corp.	185	Conduction Corporation	117	Delco Radio Division, General Motors	120
Electronic Design	44	Delco Radio Division, General Motors	120	Electronic Communications, Inc.	123
Electronic Memories, Inc.	33	Hughes Aircraft Company, Aerospace Divisions	122	Lockheed-California Company	116
Electronic Research Associates, Inc.	58	Lockheed-California Company	116	Lockheed Electronics Company	223
Emerson & Cuming, Inc.	204	Lockheed Electronics Company	223	Xerox Corporation	118, 119
Exact Electronics, Inc.	168	Xerox Corporation	118, 119		
Fairchild Semiconductor, A Division Fairchild Camera and Instrument Corporation	4, 5, 99, 139				
G-V Controls, Inc.	106, 107				
G C Electronics	219				

You probably aren't our kind of engineer.

No offense intended. We just know what we want.

We're computer memory specialists. If you know our products, you know we're good.

Not surprisingly, we're growing fast.

So we need engineers. Good minds. Good technical backgrounds. But that's not all.

You see, back when we were small we learned an important lesson. Each of our engineers had to get involved in everything: research, design, costing, marketing, production — you name it. Being involved, they became committed. And worked better for it.

That's how we got our reputation for doing what we do better than anyone else. We intend to keep it.

That's why we take such a close look at all applicants for our engineering positions. We'll talk to you about interests and aspirations and experience. And, at some point along the line, we'll draw this diagram:

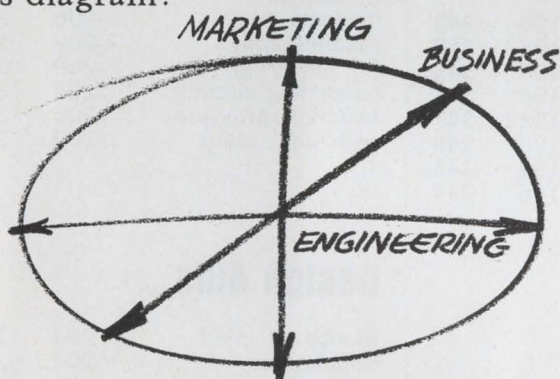

It's the essence of what we mean by our kind of engineer. An interest in and understanding of all aspects of our com-

pany's activities. You could call it balance. Whatever it is, it works for us.

* * *

What can we offer you?

First, a good salary. (We want the best and we're willing to pay for it.) Second, the opportunity to advance rapidly along either engineering or administrative lines. (Lots of outfits will tell you this, then stick you in an isolation ward. We mean what we say.) Third, the opportunity to grow with the best engineering staff in the industry. Fourth, the satisfaction and pride of seeing the products you work on produced and sold.

* * *

We make memory systems and stacks and planes and printed circuits. We're looking to the future with research in plated wire and films. And we're in the process of introducing a brand new product: MAC 16, a compact, inexpensive Multi-Application Computer. Our division is going to keep right on growing. And we'll need even more of our kind of engineers.

If we sound like your kind of company and if you have an M.E. or E.E. degree and computer-related experience, let's get together.

Write me a letter: Mr. E. E. Gage, 6201 E. Randolph Street, Los Angeles, California 90022. Or, call me collect at (213) 722-6810.

Naturally, we're an equal opportunity employer.

LOCKHEED ELECTRONICS COMPANY

Data Products Division • Lockheed Aircraft Corporation

ON CAREER INQUIRY FORM, p 121, CIRCLE INFORMATION RETRIEVAL NUMBER 909

Information Retrieval Service

All products, design aids (DA), application notes (AN), new literature (NL), and reprints (R) in this issue are listed here with Page and Information Retrieval numbers. Reader requests will be promptly processed by computer and mailed to the manufacturer within three days.

Category	Page	IRN	Category	Page	IRN	Category	Page	IRN
Components			terminal, stripline	180	297	epoxies	214	411
filters, monolithic	166	282	wattmeter, uhf	178	295	fasteners	218	426
lamp, neon	166	283	Modules & Subassemblies			filters, submicron	214	410
lamps, line	162	276	air circuits (AN)	206	382	hardware, shaft	210	398
lamps, microminiature	162	277	amplifier, FET	188	329	heat sinks	215	413
relay, latching	168	285	amplifiers (AN)	209	387	indicators	210	401
sensor, temperature	165	281	counter/display	186	327	instrumentation	219	431
switch, reed	164	279	driver, lamp	188	330	logic cards, TTL	219	429
switch, rotary	168	284	op amp, 125-KHz	184	325	motors	216	417
switches, toggle	165	280	op amp, differential	188	331	motors	218	424
thermistor rule (DA)	204	358	overload module	186	326	pots, linear-motion	217	422
transformer, DIP	164	278	supplies, HV	186	328	power supplies	216	418
Data Processing			supply, op amp	184	324	probes, current	217	420
cable, computer	150	264	vector-function module	188	332	resins, thermoplastic	214	409
computer, digital	136	253	Packaging & Materials			resistors	210	395
computer, monitor	144	259	adhesive, contact	192	340	rods, threaded	210	397
converter, 16-bit	138	255	cabinets, custom	190	334	sealants	212	405
data input system	136	251	cable, DIP	192	336	semiconductors	210	396
data reduction system	146	262	cable sheath	190	333	switches	210	399
digitizer, graphic	138	256	coating, high-temp	192	337	tape, Al ₂ O ₃	215	415
digitizer, graphic	150	263	coatings (AN)	209	388	thermometers	219	428
display, digital (AN)	206	386	coax calculator (DA)	204	359	thin-film production	210	402
generator, data	136	254	connector, modulator	194	341	wire and cable	217	423
intercouplers	140	258	connectors	190	335			
logic kit	144	260	die-cut symbols (ES)	202	351			
memory, 1300-bit	136	252	epoxy, conductive	194	340			
recorders, wideband	140	257	epoxy, gold	194	342			
transport, tape	146	261	film, conductive (ES)	202	352			
wire, plated	136	250	heat sinks (ES)	202	353			
ICs & Semiconductors			PC board, metal	192	339			
ICs, COS/MOS	160	275	PC-board kit	192	338			
ICs, TTL	160	273	spacers (ES)	202	356			
isolators, optical	152	265	Production					
rectifiers, 3-A	160	270	cleaner, ultrasonic	196	343			
rectifiers, Si	156	267	lead bender	198	350			
semiconductors, LID	160	271	PC-board holder	196	345			
switch pnp	160	272	soldering iron	196	346			
transistors, multiple	158	268	soldering machines	198	347			
transistors, power	156	266	stripper, insulation	198	349			
transistors, power	158	269	welding machines	198	348			
transistors, power	160	274	wire inserter	196	344			
Instrumentation								
counter/timer	174	290						
emi measurements (AN)	209	392						
generator, sweep	172	288						
IR analysis (AN)	206	381						
meter, digital panel	172	289						
oceanography (AN)	209	389						
test clamp	176	293						
tester, circuit	174	291						
tester, DIP	170	286						
tester, IC	176	292						
transducer, pressure	170	287						
Microwaves & Lasers								
amplifier, S-band	182	323						
amplifiers, rf	182	321						
amplifiers, uhf	180	298						
attenuators	182	322						
Blanchard chart (DA)	204	360						
diodes, p-i-n (AN)	206	384						
filters, S-band	178	294						
switch, coaxial	178	296						

Application Notes

amplifiers	209	387
coatings	209	388
diodes, p-i-n	206	384
display, digital	206	386
emi measurements	209	392
IR analysis	206	381
magnets	206	383
oceanography	209	389
PC soldering	209	390
pneumatic circuits	206	382
switches, pressure	206	385
switching, static	209	391

Design Aids

Blanchard chart	204	360
calculators	204	357
coax calculator	204	359
thermistor calculator	204	358

Evaluation Samples

connector	202	354
die-cut symbols	202	351
film, conductive	202	352
heat sinks	202	353
labels	202	355
spacers, insulating	202	356

Dual Darlington diff amp array

RCA-CA3050 and CA3051 now offer the circuit designer another significant opportunity to work with the inherent device match of monolithic construction PLUS the flexibility of RCA building-block arrays. On a single chip, in a dual-in-line package, each type offers:

- independently accessible inputs and outputs
- diode temperature compensation of constant-current-transistor bias
- high input impedance—460 K Ω typ
- low input offset current—70 nA max
- low offset voltage—5 mV max
- low input bias current—500 nA max

Get the feel of real design freedom with CA3050 or CA3051 for matched dual amplifiers, dual sense amplifiers, dual Schmitt triggers, doubly balanced detectors and modulators, and a multitude of applications that call for matched device performance from DC to 20 MHz.

For more information, contact your local RCA Representative or your RCA Distributor. For technical data, write RCA Electronic Components, Commercial Engineering, Section ICG-2-2, Harrison, New Jersey 07029.

Ask About These Linear Transistor Arrays from RCA

CA3018	Darlington pair, plus 2 independent transistors	\$.98 (1,000 units)
CA3018A	Tight-spec version of CA3018	\$1.35 (1,000 units)
CA3026	High gain dual diff ampl array for DC to 120 MHz	\$1.25 (1,000 units)
CA3036	Dual Darlington array	\$.89 (1,000 units)
CA3045	Darlington pair plus 3 transistors in dual-in-line ceramic package	\$1.50 (1,000 units)
CA3046	Dual-in-line plastic package version of CA3045	\$.98 (1,000 units)

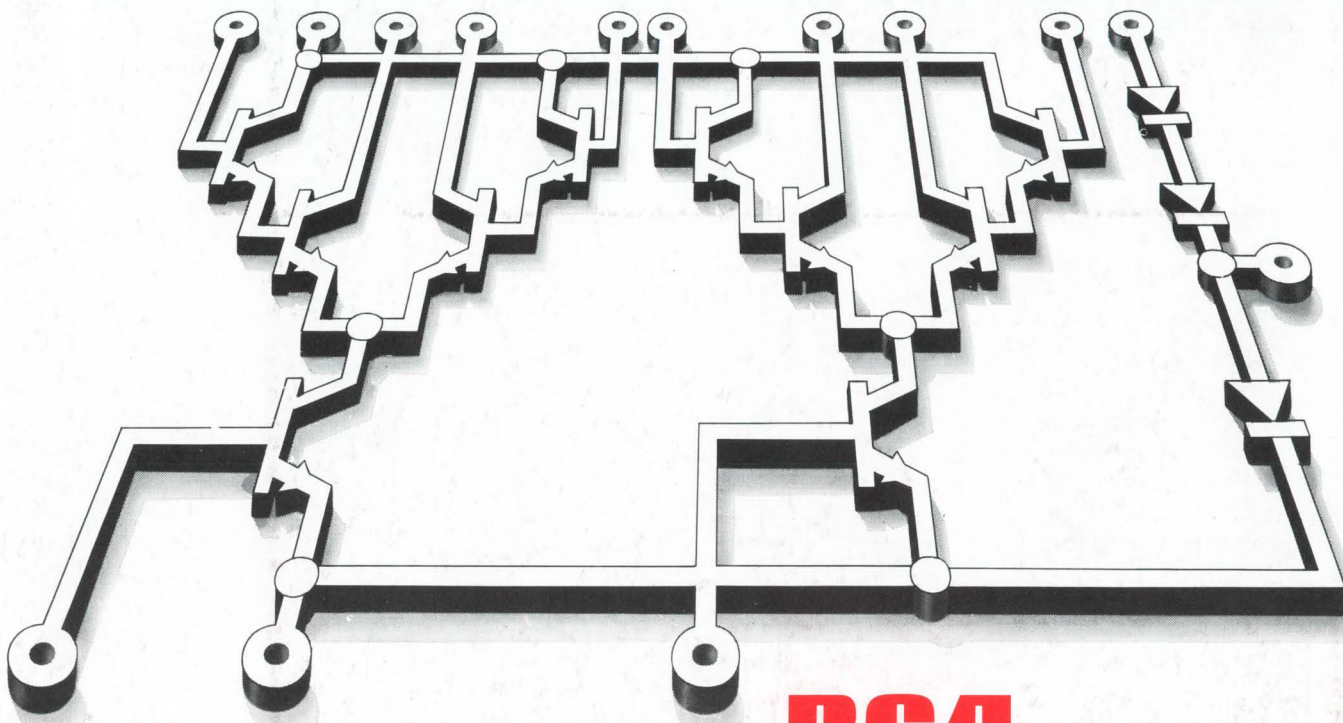

RCA-CA3050 in 14-lead dual-in-line ceramic pkg \$2.25 (1000 units)

RCA-CA3051 in 14-lead dual-in-line plastic pkg \$1.65 (1000 units)

RCA
Integrated
Circuits