

# Electronic Design 18

VOL. 17 NO.

FOR ENGINEERS AND ENGINEERING MANAGERS

SEPT. 1, 1969

**MOS wafers leave the furnaces** as production volume mounts. But designers face some critical decisions. Where should they use MOS? It imposes entirely

new design restrictions. For a look at system design problems, bipolar compatibility, and the new customer-vendor relationship in MOS procurement, turn to p. 65.

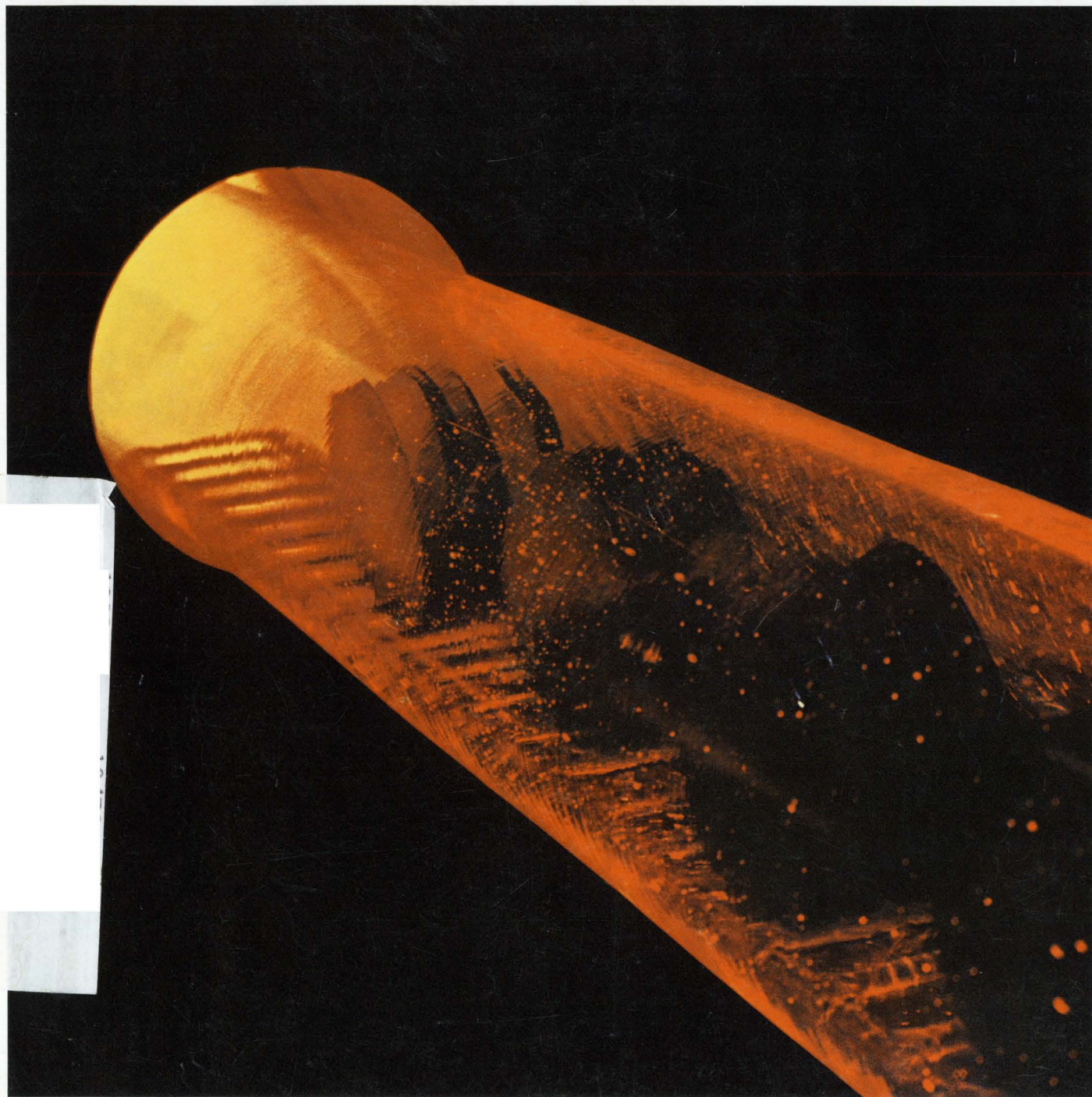

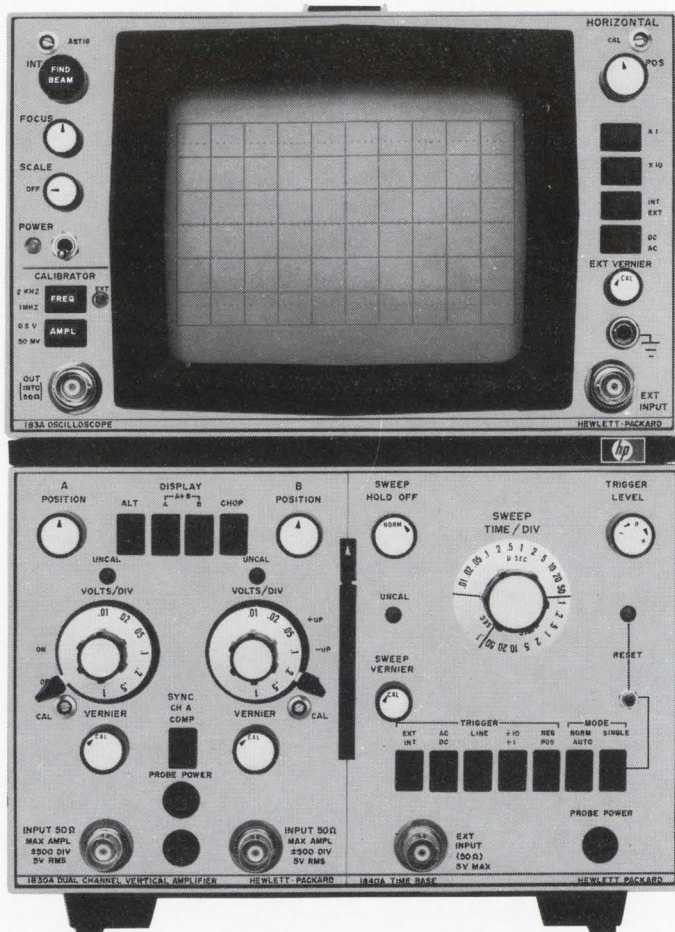

# 250 MHz Real Time With 10 mV Input

**New to the 180 System**—for the first time you can get a 6 centimeter vertical display of repetitive wave-forms or single-shot transients in frequencies from dc to 250 MHz. And, you can see these displays with only 10 mV/division input.

A major breakthrough in CRT technology provides the 183A with a high sensitivity CRT compatible with solid-state circuitry and bandwidths above 500 MHz. This capability will prevent the mainframe from limiting future advances in vertical plug-ins. The new CRT design also gives you a fast writing rate of 4 cm/ns, so you can have bright displays of low rep-rate, narrow pulses.

With the HP resistive dividers or active probes and the 50  $\Omega$  inputs you can make accurate measurements, regardless of your source impedances. Capacitive effects on rise time and CW amplitude have been minimized—VSWR is < 1.35:1 at 250 MHz, 10 mV/cm.

Since the 180 scopes first appeared in 1966, the all-solid-state concept has proved that service and maintenance are minimized. All-solid-state design also lends itself well to the versatile plug-in concept. Packed in small plug-in modules are such capabilities as dual-channel,

four-channel, 7 ns 50 MHz, 3.5 ns 100 MHz, 12.4 GHz sampling, 35 ps calibrated TDR, mixed sweep, delayed sweep, variable holdoff, differential/dc offset—to cover only part of the growing list of field-proven plug-ins, all of which are compatible with the new 183A. This versatility is possible because all 180 scope mainframes contain only the CRT and its power supply—you will not be mainframe-limited in the future selection of advanced plug-ins.

When your job depends on your measurements, when your reputation rests on your purchases, when you want maximum performance per dollar invested, **step forward with the growing HP 180 Scope System.**

For price and availability of the HP 183A 250 MHz Oscilloscope (cabinet or rack model), and other mainframes and plug-ins in the HP 180 Scope System, call your nearest HP field engineer. Or, write Hewlett-Packard, Palo Alto, California 94304. Europe: 1217 Meyrin-Geneva, Switzerland.

HEWLETT  PACKARD

OSCILLOSCOPE SYSTEMS

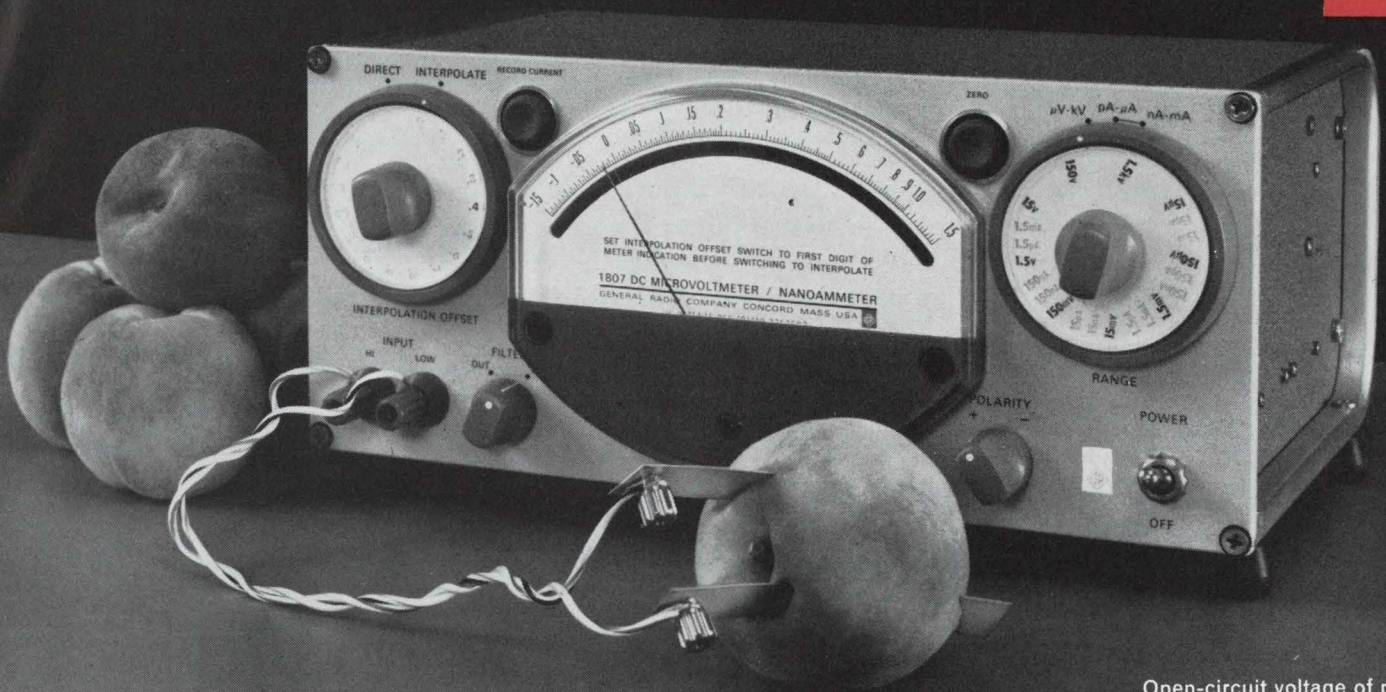

Open-circuit voltage of peach is 0.398V (0.4V on switch dial minus 0.002V on meter).

## A Peach of a Reading, $\pm 0.2\%$ , at a Peach of a Price, \$695.

Is a low-level dc voltmeter essential to your measurements work? You'd probably like one as accurate as the economies of your measurement allow. How about one that's  $\pm 0.2\%$  accurate, measures below  $1\mu\text{V}$  and costs only \$695?

Need more than just a voltmeter? Besides being a microvoltmeter, the GR 1807 also is a nanoammeter, null detector, and differential voltmeter at the same  $\pm 0.2\%$  accuracy . . . as a microvoltmeter the 1807 offers nine decade ranges from  $15\mu\text{V}$  full scale to  $1500\text{V}$  . . . as a nanoammeter, currents can be measured from  $15\text{ pA}$  full-scale to  $10\text{ mA}$  . . . as a null detector the 1807 has a common mode rejection of greater than  $160\text{ dB}$  plus a 3-second recovery speed for overloads up to  $1,000,000:1$ ; and, used as a differential voltmeter, this 1807 offers accuracies 10 times better than conventional voltmeters. You might say that the GR 1807 fills in

the accuracy gap that's been created between analog and digital voltmeters.

What's the secret? Nothing really. By using differential techniques, the first one or two digits can be moved off the meter and put on a switch. This allows the meter to do just the fine work — the interpolating. You can do this by setting the interpolation-offset switch to subtract from the input a calibrated voltage equal to the most significant figure of the unknown, and then read the difference directly from a meter. Thus, the 1807 achieves digital accuracies but still preserves the versatility of an analog device.

Other features . . .

High input impedance, greater than  $500\text{M}\Omega$  on most ranges, eliminates practically all loading errors . . . The use of a photochopper modulator minimizes noise, drift, and offset problems . . . Excellent common-mode rejection is achieved by using Teflon throughout the 1807 to isolate high and low terminals from ground. The meter readout is also unique — it is logarithmic above 10% of full scale and linear below 10% of full scale. The meter zero is offset upscale

by about  $20^\circ$  to permit easy reading around zero . . . D-C amplified output is provided to drive chart recorders . . . Problems arising from thermoelectric voltages generated by junctions of dissimilar metals have been eliminated by copper-to-copper junctions at all points in the input circuitry . . . a built-in switchable RC low-pass filter with a 1.5-Hz cut-off is provided to eliminate any ac hash that might be superimposed on the input dc signal . . . And, you have a choice of either battery or line-voltage operation.

For complete information, write General Radio Company, West Concord, Massachusetts 01781; telephone (617) 369-4400. In Europe: Postfach 124, CH8034 Zurich 34, Switzerland.

## GENERAL RADIO

INFORMATION RETRIEVAL NUMBER 2

Input filtering PLUS dual-slope integration form a unique double barrier against noise in these fast-reading DVM's. This new idea from S-D gives you more accuracy for less money than any other .01% DVM.

The portable Model 9200 and the Thin-Line, rack-mounting Model 9300 come with all the popular ranges, functions and interfacing options. Prices start at \$1175.

Send for the complete, proven specs and see for yourself. Contact Measurements Division, Systron-Donner Corporation, 888 Galindo Street, Concord, Calif. 94520. Phone (415) 682-6161.

## Newest DVM idea: double noise barrier boosts accuracy!

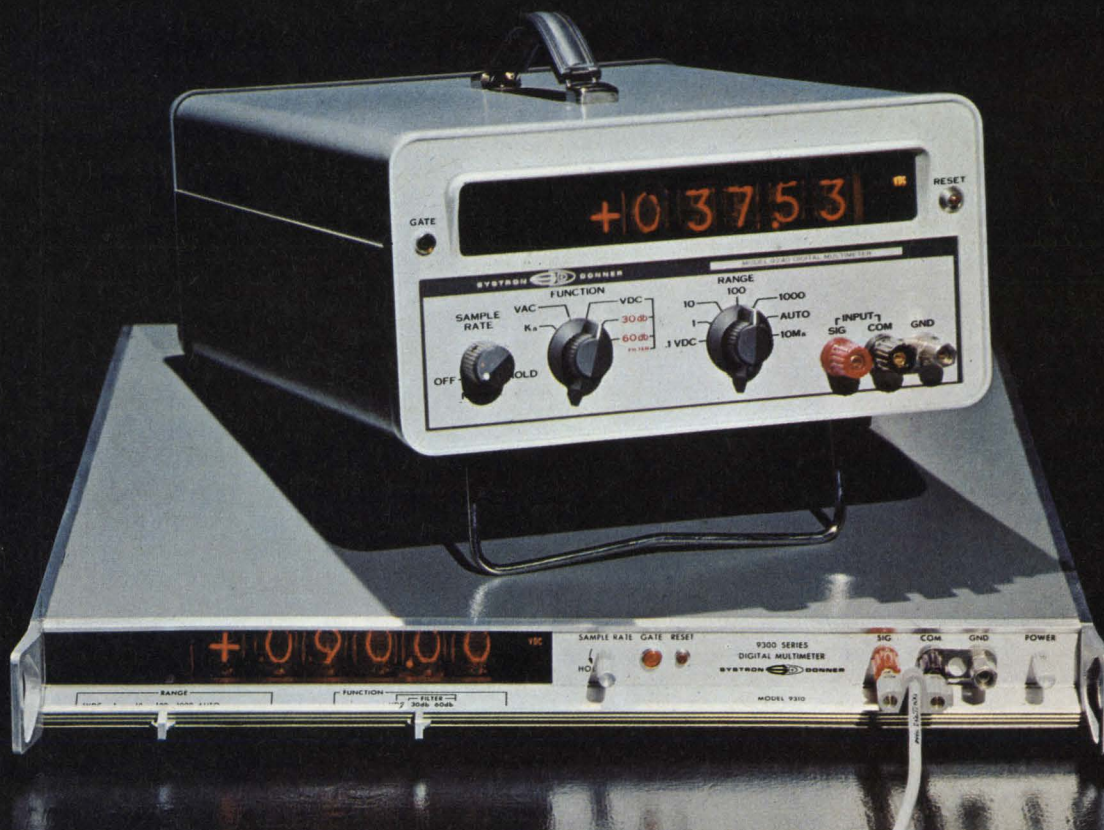

### More firsts. Two of 145 Systron-Donner instruments

Electronic counters	Digital voltmeters
Pulse generators	Spectrum analyzers
Microwave frequency indicators	Digital panel meters
Digital clocks	Microwave signal generators
Memory testers	Laboratory magnets
Analog computers	Data acquisition systems
Time code generators	Microwave test sets
Data generators	

SYSTRON  DONNER

# Electronic Design 18

VOL. 17 NO.

FOR ENGINEERS AND ENGINEERING MANAGERS

SEPT. 1, 1969

---

## NEWS

- 21 **News Scope**
- 25 **Megabit 'bubble' memory? In 5 years, maybe**  
Bell Labs' magnetic-domain technology shows high promise, but must be adapted for mass production
- 30 **The shake, rattle and roll test for electronics**  
Martin Marietta devises an obstacle course with economy fm telemetry to check out the Pershing guided-missile system
- 36 **We could put astronauts on Mars in 1982, if . . .**  
Propulsion, electronic and physiological problems are big—and then there's the matter of money, too
- 45 **Washington Report**
- 50 **Sidelights**
- 53 **Editorial: Are you a crybaby—or a mistreated engineer?**

---

## TECHNOLOGY

- 65 **MOS: A Critical Review**
- 66 Problems for the designer
- 70 TTL compatibility is here
- 74 Partitioning is a challenge
- 78 Single-sourcing causes changes
- 82 **Just how tight a tolerance does your circuit require?** You may be using more expensive components than you need.
- 86 **Talk it out with your computer.** Use conversational FORTRAN and achieve optimum designs quickly and easily.
- 94 **No engineer wants to be a crybaby!** But sometimes the EE has a legitimate gripe, and one concerned designer comments on six of them.
- 100 **Ideas for Design**

---

## PRODUCTS

- 110 **Modules & Subassemblies:** Analog multiplier with 1% accuracy sells for \$39.
- 112D **ICs & Semiconductors:** Op amp gives gains greater than 600 at 1  $\mu$ A.
- |                     |                           |
|---------------------|---------------------------|
| 115 Instrumentation | 124 Production            |
| 118 Components      | 125 Packaging & Materials |
| 121 Data Processing | 128 Microwaves & Lasers   |

---

## Departments

- |                        |                                   |
|------------------------|-----------------------------------|
| 14 Designer's Datebook | 133 Application Notes             |
| 130 Evaluation Samples | 134 New Literature                |
| 131 Design Aids        | 142 Advertisers' Index            |
| 132 Annual Reports     | 144 Information Retrieval Service |

Information Retrieval Service Card inside back cover

**Cover Credit:** Fairchild Semiconductor, Mountain View, Calif.

MOS wafers come hot from the diffusion furnace.

---

ELECTRONIC DESIGN is published biweekly by Hayden Publishing Company, Inc., 850 Third Avenue, New York, N.Y. 10022. James S. Mulholland, Jr., President. Printed at Brown Printing Co., Inc., Waseca, Minn. Controlled circulation postage paid at Waseca, Minn., and New York, N.Y. Copyright © 1969, Hayden Publishing Company, Inc. 77,523 copies this issue.

# RCA Solid-State Data for Designers

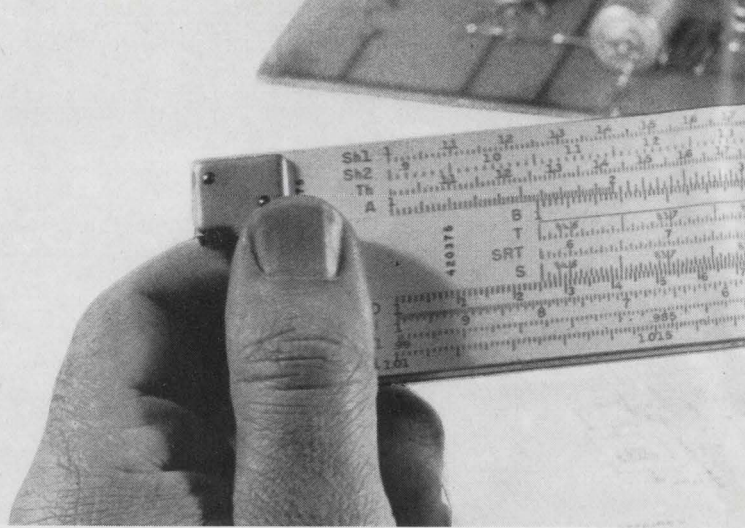

## IR Injection Lasers with Double the Output at Half the Threshold Current

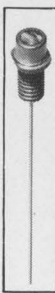

Here's your answer to designing compact IR laser range finders; line-of-sight communications systems; aircraft altimeters; proximity fuzes, and intrusion alarms: RCA's new Close Confinement ("CC") GaAs infrared injection laser diodes in RCA's OP-3 coaxial-lead, stud-type package. "Close Confinement" means that the radiation is confined strictly in the junction area.

Choose from 1 to 10 watts (minimum); 2 to 13 W (typical). Peak current ratings:  $I_{th}$  from 4 amperes to 10 A;  $I_{FM}$  from 10 A to 40 A.

For technical data on RCA's new Close-Confinement GaAs lasers, circle Reader Response No. 141

RCA OP-3 Pkg.	TA7606	TA7608	TA7610
Peak Power Output (Watts)			
Min.	1	5	10*
Typ.	2	6	13
Largest Emitting Area Dimension	3 mils	6 mils	9 mils
Amps Peak Current			
$I_{th}$	4	7	10
$I_{FM}$	10	25	40

\*Selections offering power output up to 5 W at 70°C are available.

## High Beta Values, High Dissipation Ratings, High Voltage Capabilities...

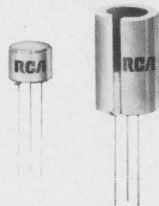

The characteristics you need for high-voltage, high-current amplifier and high-current switching applications are provided by RCA's 2N3241A family of silicon n-p-n, epitaxial, planar transistors. Fourteen types give you a

broad selection of ratings and characteristics for audio preamplifier, audio and video amplifier, computer switching and instrumentation circuits. Included in the family are transistors with integral heat-radiators which provide 50% lower thermal resistance between junction and ambient and thus twice the dissipation capability of the prototypes at ambient temperatures up to 25°C.

Take advantage of these ratings for your circuit designs:

**AUDIO PREAMPLIFIER**—NF as low as 2 dB at 10 kHz, beta values as high as 165 (min.) at  $I_C=10$  mA.

**AUDIO AMPLIFIER**— $P_T$  ratings as high as 2 W at  $T_C$  to 75°C for types with heat radiators, high current capabilities to 300 mA max.

**HIGH CURRENT SWITCHING** applications including core drivers up to 300 mA max.

**INSTRUMENTATION**—high beta values; leakages as low as 10 nA max. at  $V_{CB}=25$  V; saturation voltages as low as 0.1 V typ., 0.2 V max. at  $I_C=100$  mA; breakdown voltages to 40 V.

Circle Reader Response No. 142 for detailed specs.

## "All Purpose" Economy For Linear IC Users

Wherever your designs call for economy—without sacrificing performance—look at the RCA-CA3053 Linear IC. CA3053 is specified to bring you important savings in a high-performance IF and general-purpose integrated circuit. It's designed to fit your plans for differential and cascode amplifiers, for limiters, detectors, mixers, modulators, converters and oscillators. You can figure on 40 dB typical cascode voltage gain, 30 dB typical differential voltage gain at 10.7 MHz.

RCA-CA3053 is offered in the hermetic TO-5 package at a 1,000 unit price of 49¢ per unit.

Circle Reader Response No. 143 for full details.

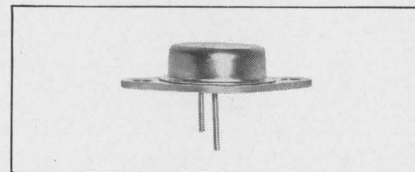
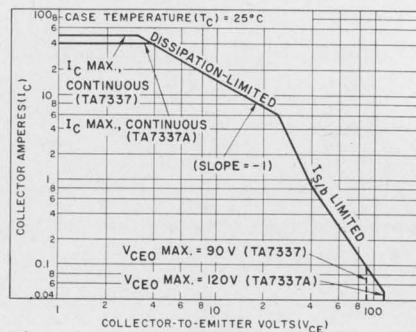
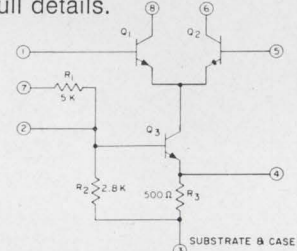

## 40 A to 50 A Performance For Your High-Speed Switching

Whatever you want to switch—control amplifiers, power gates, switching regulators, converters, or inverters—investigate RCA's new high-speed, high-current switching transistors. Other recommended applications include DC-RF amplifiers and power oscillators.

For instance, RCA developmental types TA7337 and TA7337A—silicon n-p-n types—both in modified TO-3 package (two 60-mil pins)—offer parameters like those listed below.

Additional benefit: These units have enhanced second breakdown capability under forward and reverse-bias conditions.

Circle Reader Response No. 144 for full details.

Type	$V_{CEO}$ (sus) (V)	$I_C$ (A)	$V_{CE}$ (sat)	$f_T$ (MHz)	$t_{on}$
TA7337A	120	40	1.2 V (max.) @ 40 A	50	1 $\mu$ s (max.) @ 40 A
TA7337	90	50	1.5 V (max.) @ 50-A	30	1 $\mu$ s (max.) @ 40 A

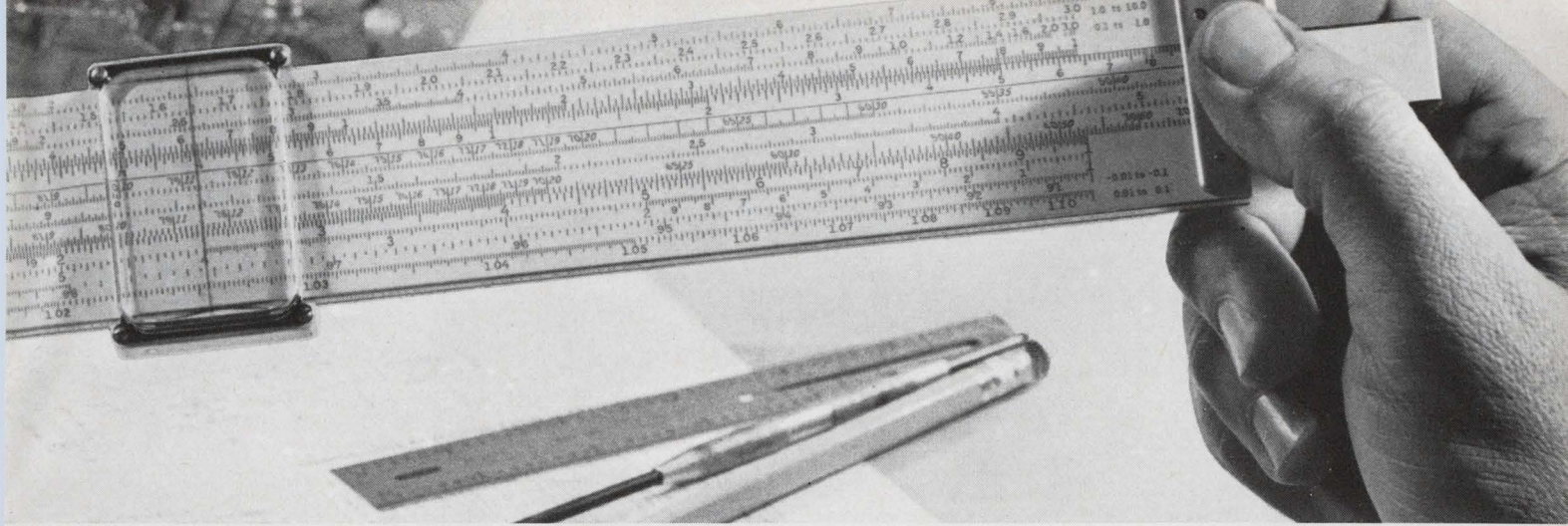

### 400 Hz 120-V Line Operation for Triacs

You can turn to triacs for all your airborne controls that you now design with electro-mechanical relays or switches!

RCA offers a cross-section of triacs—all rated at 400 Hz, with RMS currents from 0.5 A to 40 A and repetitive peak off-state blocking voltages of 200 V and 400 V. Units are available in two- and three-lead modified TO-5, press-fit and stud-type packages.

Plan around these triacs for such aircraft applications as: lighting controls for cabins and running lights; heater controls; motor controls, and hydraulic valve controls. Circle Reader Response No. 145 for help in your designs

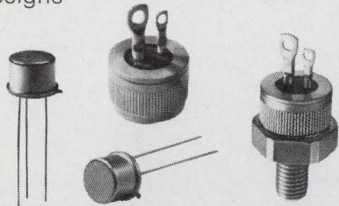

### Optimize RF Amplifier Designs to 400 MHz... And Protect Against Handling and In-Circuit Transients

RCA's new 40673 Dual-Gate MOSFET gives you all the inherent, superior performance characteristics of an MOS Field-Effect Transistor *and* transient voltage protection for each gate. Integrated "Transient Trappers" (back-to-back zener diodes) guard each gate of the 40673 against static discharge during handling operations and in-circuit transients. Now, you

have new assurance of dependable, high performance when you take advantage of these outstanding characteristics of the RCA-40673 to optimize your RF amplifier designs:

- Power Gain (MAG) = 20 dB @ 200 MHz
- Noise Figure (NF) = 3.5 dB @ 200 MHz
- Superior Cross-Modulation Characteristics
- Wide Dynamic Range Without Diode Current Loading
- Reduced Spurious Response
- Extremely Low Feedback Capacitance = 0.02 pF
- Excellent Gain-Reduction Characteristics
- Simplified AGC Circuitry
- Reduced Oscillator Feed-through

Furthermore, the dual-gate design of the 40673 makes it possible for you to reduce feedback capacitance by operating in the common-source configuration and AC-grounding gate No. 2. Result: Maximum gain without neutralization and reduced local oscillator feed-through to the antenna.

So, before initiating new designs for RF amplifiers, mixers or IF amplifiers (to be used in industrial, military and consumer communications equipment; aircraft and marine vehicular receivers; CATV and MATV equipment or telemetry and multiplex systems) get complete technical data on the RCA-40673 MOSFET. Circle Reader Response No. 146

### TA7205—World's Highest Power, Gain, Efficiency Transistor For Operation at 2 GHz



The RCA-TA7205 is the latest RF power transistor featuring RCA's patented multiple-emitter "overlay" construction in a coaxial package. You can rely on its dependable performance in microwave communications, L- and S-band telemetry, microwave relay link, phased-array radar, distance-measuring equipment and collision-avoidance systems.

Packaged in a hermetically-sealed, ceramic-metal, coaxial configuration, this silicon n-p-n device is ideal for large signal applications in coaxial, stripline and lumped-constant circuits.

Specifically, the TA7205 provides a 5.8-W (typ.) output, 7.6-dB (typ.) gain and 45% (typ.) efficiency at 2 GHz in a common-base circuit. At 1.2 GHz, it offers 11-W output with 11.5-dB (typ.) gain and 60% (typ.) efficiency.

Circle Reader Response No. 147 for further details.

### High Performance At New Low Prices from RCA's COS/MOS Logic—COS/MOS Memory

Now, take advantage of the many opportunities for innovations in design, performance and application offered by RCA's unique monolithic integrated circuits using Complementary Symmetry MOS construction. These new COS/MOS integrated circuits provide:

- Nanowatt quiescent power dissipation
- Frequency capability—from DC to 5 MHz
- Noise immunity—4 V (typ.) @  $V_{DD} = 10$  V
- Fanout capability up to 50
- Operation from a single power supply (6–15 V)
- Full military temperature range
- Operation with single-phase clocking

RCA has a package of bulletins for you on COS/MOS. Included in this package is a new product-line catalog which provides data on commercial and developmental COS/MOS types.

For your package of bulletins, circle Reader Response No. 148

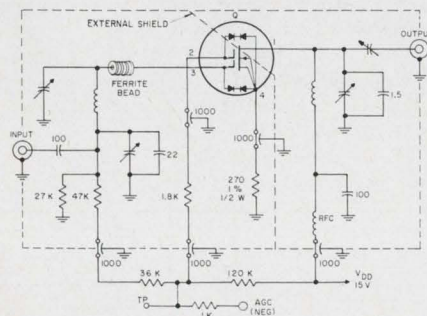

For price and availability information on all solid-state devices, see your local RCA Representative or your RCA Distributor. For specific technical data, write RCA Electronic Components, Commercial Engineering, Section IQG9-1Harrison, N. J. 07029.

# RCA

Oh, you'll put it together, all right, and after a while, it'll work, more or less. Then you'll take the prototype to engineering for board design, get it back, attach the components, test it, make a few compromises, try it again. What you have then is an engineering model. Then the manufacturing design. Back to engineering for debugging. More testing. Parts procurement. Incoming inspection. Telephone calls. Late deliveries. More testing. Heartache. Final release and the module is ready for manufacture. Maybe.

All this time, an already designed, fully debugged, guaranteed, computer-tested, solid state module sits on Digital's shelf. Fifty engineers in offices around the country wait for your call to help. Application notes, installation drawings, catalogs sit in our mail room. Power supplies, hardware, racks are piled high in the stock room.

M Series modules are the most complete, fully compatible, fast, all IC, TTL, inexpensive solid state logic available anywhere. With a few million modules in our recent history, and a few million dollars worth of test equipment, we really know how to put them out. Read all about them in the new Logic Handbook. Free.

**digital**  
COMPUTERS · MODULES



# Hold it, right there.

DIGITAL EQUIPMENT CORPORATION,  
Maynard, Massachusetts 01754. Telephone:  
(617) 897-5111 / Cambridge, Mass. / New  
Haven / Washington, D.C. / Parsippany, Palisades  
Park, N.J. / Princeton, N.J. / Rochester, N.Y. / Long  
Island, N.Y. / Philadelphia / Pittsburgh / Cleveland /  
Dayton / Huntsville / Cocoa, Fla. / Chicago / Denver /  
Ann Arbor / Salt Lake City / Houston / Albuquerque /  
Los Angeles / Palo Alto / Seattle. INTERNATIONAL,  
Carleton Place and Toronto, Ont. / Montreal,  
Quebec / Edmonton, Alberta, Canada / Reading and  
Manchester, England / Paris, France / Munich and  
Cologne, Germany / Oslo, Norway / Stockholm,  
Sweden / Sydney and West Perth, Australia.

INFORMATION RETRIEVAL NUMBER 5



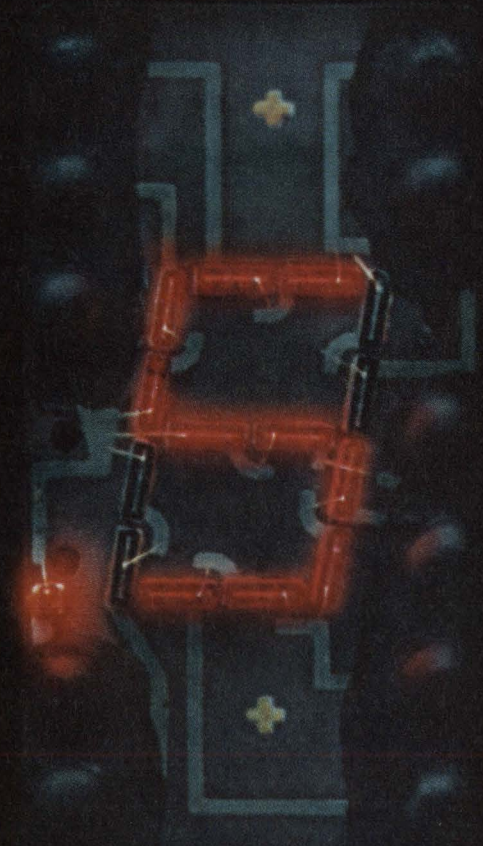

The solid state numeric  
is ready at Monsanto.

So are 19 other LED's.

## Send a P.O.

MAN 1 shown 6 X actual size.

You know we've been working on the MAN 1 visible diode numeric for several years. Well, now we're ready to take orders.

It offers all the good things you expect from microcircuits. Low power drain. Shock resistance. Happy interface with your solid-state circuitry. Plus it gives you design flexibility you've never had before. And the multi-segmented construction avoids the danger of a number being altered by a small circuit failure.

Send a P.O. and be the first designer on your block to give your

digital readout the look of the 70's.

The 19 other low-cost, long-lived LED's? Four are bright red light-emitting semiconductors that have ns switching time, diode reliability and million-hour\* life.

One of our LED's emits amber light, one green light. Five put out frequencies in the infrared. One is a coupled pair, with detector and emitter in the same package to give you a light-quick switch (5 ns rise and fall) with 3 kV isolation.

Six are room temperature lasers in a variety of miniaturized configurations. Number 19 is a bunch of new

CO<sub>2</sub> laser modulator components.

So there's the whole line. They're all currently available from Schweber, Kierulff, K-Tronics, or Semiconductor Specialists. Or from us: Monsanto Electronic Special Products, 10131 Bubb Road, Cupertino, California 95014. Phone (415) 257-2140.

Want more information on our new numeric, the MAN 1? Circle reader service #215.

For specs on the other 19 LED's, circle #216.

\* T<sub>A</sub> = 25°C, I<sub>F</sub> = 50ma. Result of step-stress testing with end of life projections.

On the left you see the HP 5323A Automatic Counter at work in a system. On the right is our HP 5325B Universal Counter, making a hard test easy.

The counters could easily be reversed. Because both are programmable and with either of them you can count up to 20 MHz in a system or on your bench. The one you choose depends on what you need.

**The Automatic Counter** has automatic range selection from 0.125 Hz to 20 MHz. And it needs no switching from frequency measuring mode for high frequency measurements to period measuring mode for accurate low frequency measurements. That's because all measurements are made in the period mode, and internal

computing circuits invert the period measurements to frequency. Thus you get the speed and accuracy benefits of period measurements at low frequencies coupled with the convenience of direct readout in frequency at all frequencies. There's no accuracy penalty at any frequency. The 5323A has a score of other advantages built in. For instance, it can automatically measure the carrier frequency of pulsed signals. Some people buy the 5323A for bench and production line use because its simple, automatic operation and direct readout in frequency reduce errors, even with untrained users. It even keeps tabs on the user by refusing to display more digits than it should for a given measurement speed. For easy use in systems, it's programmable, of course.

## These two counters make systems run smoother.

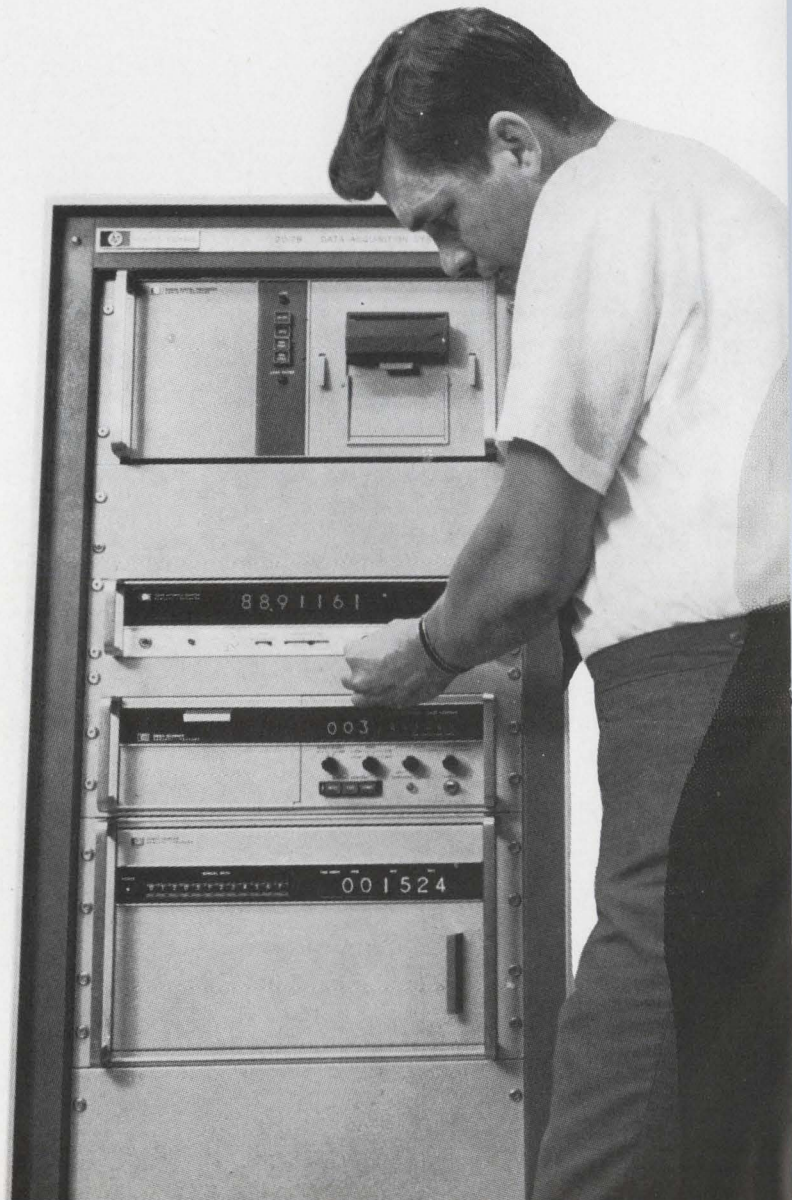

The Universal Counter is even more versatile but is less automatic. It will measure frequency to 20 MHz, time intervals from 100 ns to 10<sup>8</sup>s, and period, multiple period, ratio and multiple ratio. It will totalize input events or scale an input frequency. Time interval stop and start signals can be from common or separate inputs, with separate trigger-level, slope and polarity controls for each. And its very narrow trigger-level threshold band, less than 1.0 mV, prevents false counts when the trigger level setting is marginal. In addition, the Universal Counter generates two types of oscilloscope markers. These not only mark the start and stop points of a measured interval, but can also intensify the entire measured segment. For easy use in systems, it's

programmable, of course. The cost of this versatility for either system or bench use is \$2150 for the 5323A and \$1300 for the 5325B. Your local HP field engineer has all the details. So give him a call. Or write to Hewlett-Packard, Palo Alto, California 94304; Europe: 1217 Meyrin-Geneva, Switzerland.

HEWLETT  PACKARD

ELECTRONIC COUNTERS  
INFORMATION RETRIEVAL NUMBER 7

## And tests run faster.

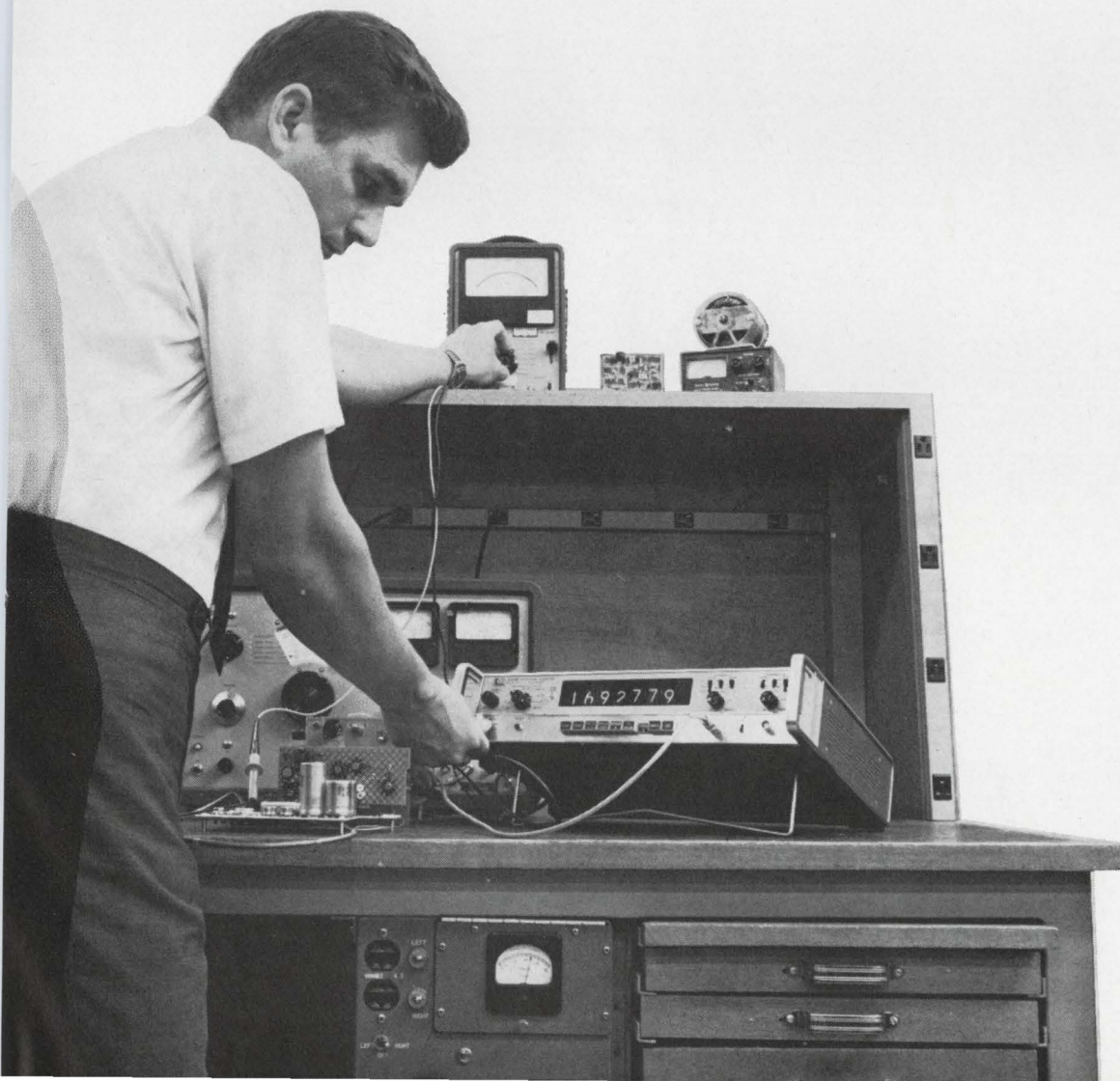



# Flight Companion

## 417—the lightweight recorder you carry on the plane

It's the one data recorder you don't have to waste time crating and shipping, or possibly having damaged by baggage-style handling. The compact 417 flies with you, safely under the seat, ready to work when you step off the plane.

Only 6"x14"x15", the rugged 417 weighs just 28 pounds—50 pounds less than any comparable recorder. Works in any position, under roughest vibration conditions, for dependable data gathering in plants, labs, on and under the seas, or out in the wilds.

Maintenance-free mechanism has exclusive low-mass differential capstan drive for precision opera-



**LOCKHEED ELECTRONICS COMPANY**  
A Division of Lockheed Aircraft Corporation.

tion. Phaselock servo for precise speed control, with accuracy matching large rack machines. Records on 7 channels, IRIG compatible. Runs on 110/220v AC/DC or internal battery. Power consumption as low as 10w. Frequency response: 100 kc direct, 10 kc FM.

Priced as low as \$7,000.

Send for our catalog containing full details on the 417, one of a family of precision data recorders for land, ocean, air and space applications. Write: Boyd McKnight, Dept. ED-9F, Lockheed Electronics Company, Plainfield, New Jersey.

Have questions on data recording? Call us at (201) 757-1600.

# New complementary NPN/PNP power transistors from GE

Color-molded to end assembly mix-up

Now available in volume from General Electric . . . two new 1-amp and 3-amp pairs of low-cost complementary power transistors. These NPN/PNP pairs feature low saturation voltage, excellent gain linearity and fast switching . . . all in a sensible package, at a sensible price. GE's flat silicone-encapsulated power tab package is rugged enough to withstand hard use, and *with the new narrow leads (25 mils), can easily be formed to either TO-66 or TO-5 configurations.* To help eliminate NPN/PNP confusion during your assembly, each type is molded in distinctive color. No need for separate storage and production facilities for each type.

GE's new complementary power transistors are ideal for any class B audio application—everything from auto radios, tape players to televisions and stereo phonographs—from 3 to 20 watts output. These new NPN/PNP pairs are also well suited for use as drivers for higher power transistors, regulators, inverters, motor controls, lamp controls, solid-state relays, core drivers and many other applications. The 2.1W P<sub>r</sub> free air rating allows simple printed circuit board assembly with no additional heat sinking. With added heat sinking, as much as 12W power

dissipation can be achieved. Performance at these levels is everything you'd expect from General Electric, leader in power semiconductors.

TYPE NUMBER new	D40D (NPN)	D41D (PNP)	D42C (NPN)	D43C (PNP)
previous	D28D	D31B	D27C	D27D
I <sub>c</sub> (continuous)	1A		3A	
(peak)	1.5A		5A	
V <sub>CE</sub> (sat.) Max.	0.5V @ 0.5A		0.5V @ 1A	
V <sub>CEO</sub> (sus.)	30V, 45V and 60V		30V, 45V and 60V	
Total Power Dissipation				
Free air @ 25 C	1.25W		2.1W	
Tab @ 25 C	6.0W		12.0W	
h <sub>FE</sub> (min.)	50 @ 0.1A/2V 10 @ 1A/2V		40 @ 0.2A/1V 20 @ 1A/1V*	
f <sub>T</sub> (typ.)	60MHz		45MHz	

\*Types available with h<sub>FE</sub>=20 min. @ 2A/1V

For more information on these and other General Electric semiconductor products, call or write your GE sales engineer or distributor, or write General Electric Company, Section 220-72, 1 River Road, Schenectady, N.Y. 12305. In Canada: Canadian General Electric, 189 Dufferin Street, Toronto, Ont. Export: Electronic Component Sales, IGE Export Division, 159 Madison Avenue, New York, N.Y. 10016.

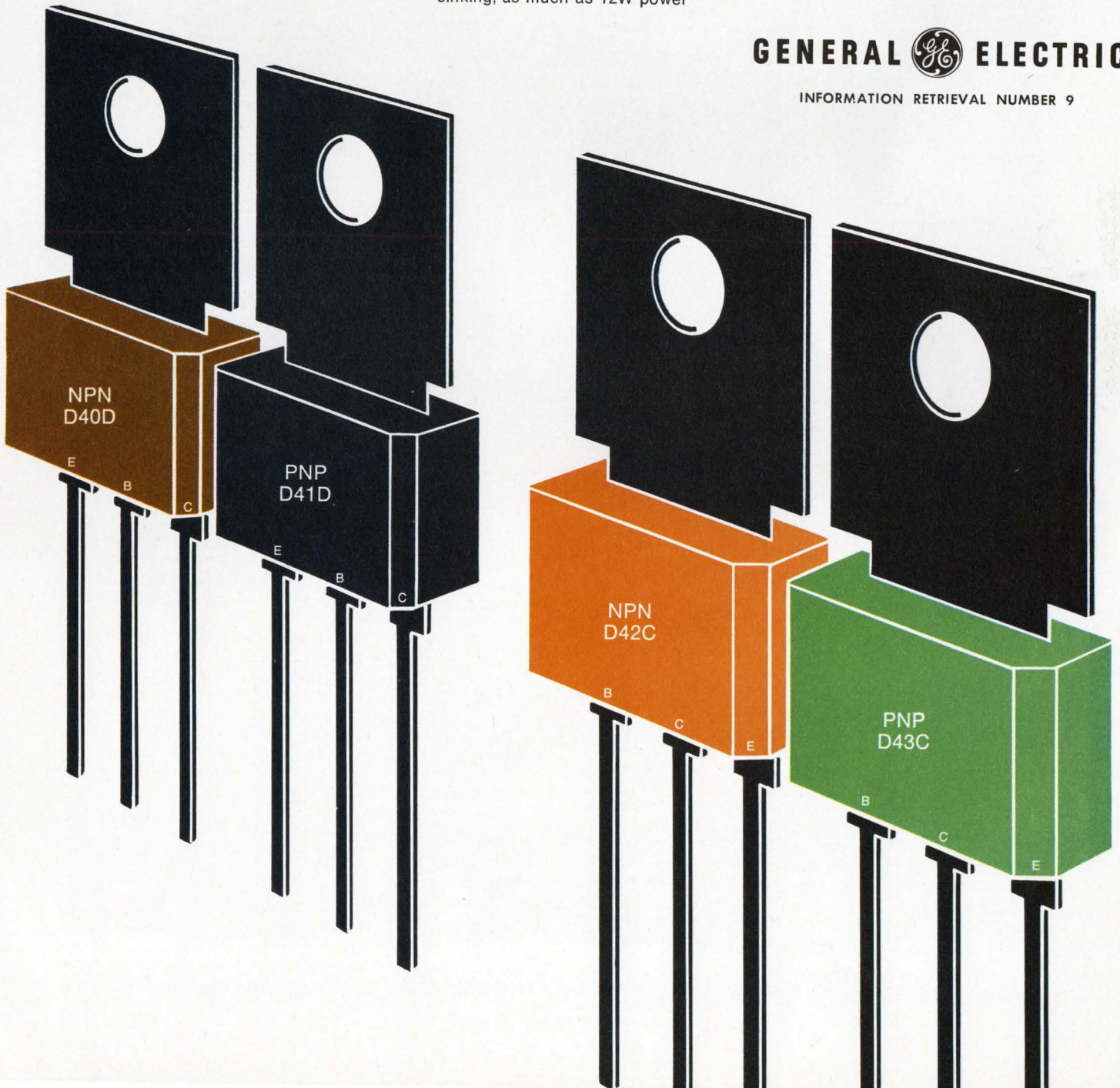

**GENERAL ELECTRIC**

INFORMATION RETRIEVAL NUMBER 9

Model  
LD-2 System

# Automatic



*the Solution for End-to-End*

## *on Data Transmission Circuits . . .*

Group Delay plays an important role in high speed data transmission where maximum system capacity is to be utilized.

Measurement of Group Delay (as a function of measuring frequency) in the laboratory poses no problem as transmission of the reference phase is easily accomplished.

But how do you solve the problem if the circuit under test is hundreds of miles long and cannot be looped? Even the best crystal oscillator has a drift which superimposes itself on the measurement if transmitting and receiving ends are not synchronized. Can you afford a two hour wait while the crystal temperature reaches its assigned value? Will you tolerate constant phase readjustments to compensate for instability in your measuring instrumentation or for the changing value of the absolute delay of the measured circuit (as in the case of a satellite transmission)?

You have more important things to do. You can insist that your group delay measuring instrumentation

be operable immediately upon turn-on and that it yield reproducible, stable results. You can because W & G has now developed a measurement technique which eliminates the drawbacks of all former methods of measurement.

Based on the measuring set to 14 MHz (Model LD-1) which has proven itself as the only instrument available for measurements on video tape recorders, a group delay measuring instrument was developed for the frequency range from 200 Hz to 600 kHz. Only one, fixed, modulation frequency of 40 Hz is used for the entire frequency range — in spite of this the instrument attains the remarkable sensitivity of 1  $\mu$ s at all measuring frequencies.

You can sweep or measure point by point; the result is always exactly reproducible.

The results are displayed on three meters simultaneously: Frequency; Attenuation; and Group Delay. You can connect an X-Y-Recorder and immediately have a permanent record of the test results. Obviously solid state — Naturally 19" Rack Mountable.

**Wandel & Goltermann**

W. Germany

• Represented in U.S.A. by

# Phase Control

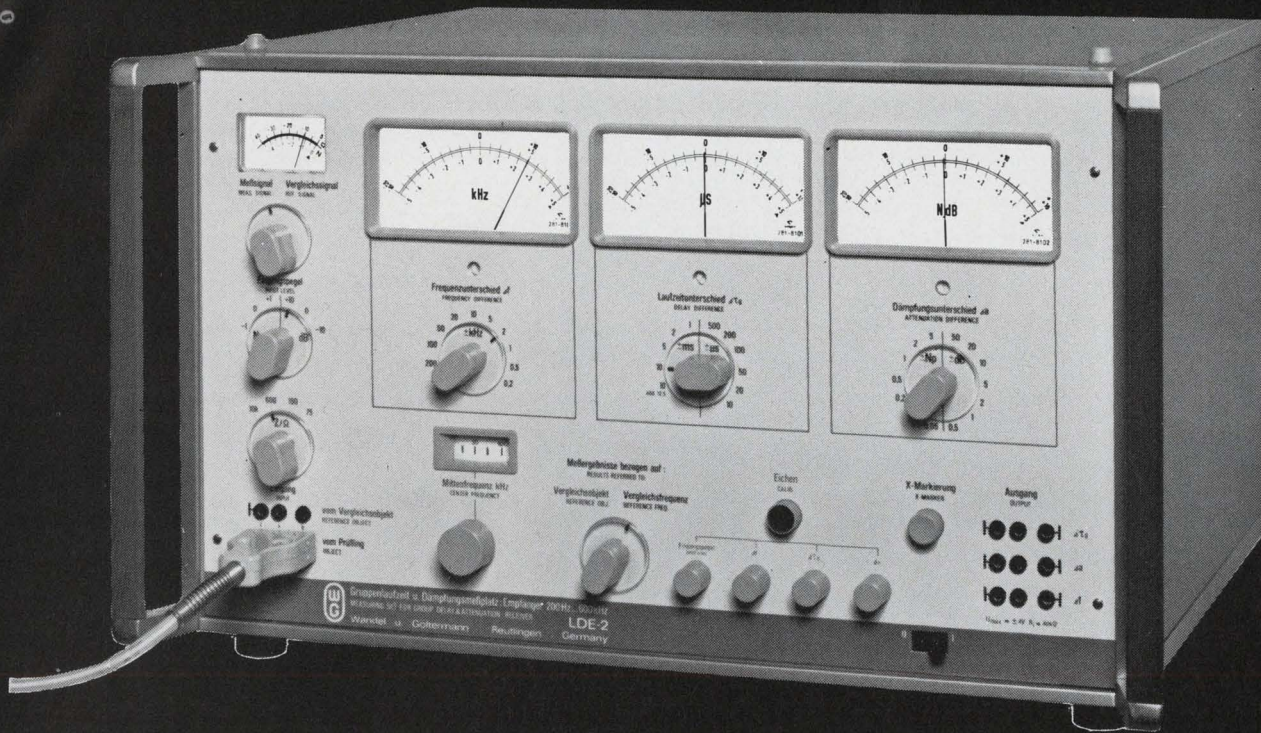

## Measurements of Envelope Delay

### PRINCIPLE:

Nyquist principle, modulation frequency 40 Hz, therefore, no beat with the line frequency.

### READOUT:

Simultaneous, separate, meter displays of frequency and group delay and attenuation distortion; or frequency and absolute group delay and attenuation—for either point by point or sweep measurement. Output for X-Y-Recorder available.

### DIAL TONE ELIMINATION:

Provisions are incorporated in the generator to avoid unwanted actuation of dial tone receivers within a system under test.

### FREQUENCY RANGE:

200 Hz to 600 kHz. Accurate frequency adjustment assured by an 8 foot long projection scale with sub-ranges 200 Hz to 60 kHz and 10 kHz to 600 kHz.

### PHASE CONTROL:

The receiver is automatically phase synchronized to the generator via a phase reference transmitted through the circuit under test, thus assuring repeatable measurements without warmup or preliminary phase adjustments.

### RESOLUTION:

1  $\mu$ s for group delay measurements; 0.05 dB for attenuation.

### SENSITIVITY:

Transmitter output level +10 to -35 dB. Receiver sensitivity +10 to -50 dB. Dynamic range of the receiver 40 dB.

### IMPEDANCES:

75, 150, 600 ohms; plus 0 $\Omega$  (generator) and 10 k $\Omega$  (receiver).

### SWEEP:

Sweep width from 400 Hz to 600 kHz continuously adjustable. Sweep time from 0.3 second to 1 hour.

### POWER SUPPLY:

Operation from AC line or a 24 volt battery.

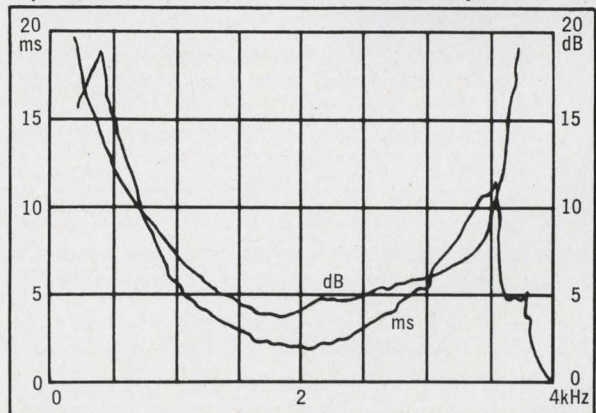

Typical diagram of a telephone connection recorded by an X-Y Recorder connected to the output.



**W&G INSTRUMENTS, INC.** 6 Great Meadow Lane, Hanover, N.J. 07936 • (201) 887-8700

INFORMATION RETRIEVAL NUMBER 10



Meet the "Mite".  
Only .218" diameter. The toughest ceramic disc trimmer capacitor its size.

New from E. F. Johnson. And it's this small:   
Designed for printed circuit applications where space is at a premium. Stator of High Alumina for greater shock and vibration resistance. The rotor plate is encapsulated in ceramic for environmental stability and long life. The Q factor at 1 MHz is 500 minimum. Precision lapped bearing surfaces give you smooth linear tuning. Pick from a wide capacitance range: 1.0-3.0 pF, 2.5-9.0 pF, 3.5-20.0 pF, 5.0-25.0 pF. Designed to meet or exceed applicable requirements of MIL-C-81A.

Return the coupon today for information on Johnson's new Micro-J.<sup>™</sup> And if you have a special capacitor need, we'd like to work with you. The same engineering that made our air variable capacitors the standard of excellence goes into every new Johnson product.

E. F. JOHNSON COMPANY/3308 Tenth Ave. S.W./Waseca, Minnesota 56093

- Send product specification information on new Micro-J capacitor.
- Include information about your full capacitor line and other Johnson components.

NAME \_\_\_\_\_ TITLE \_\_\_\_\_

FIRM \_\_\_\_\_ ADDRESS \_\_\_\_\_

CITY \_\_\_\_\_ STATE \_\_\_\_\_ ZIP \_\_\_\_\_



**E. F. JOHNSON COMPANY**

INFORMATION RETRIEVAL NUMBER 11

# Designer's Datebook

SEPTEMBER 1969						
Sun	Mon	Tue	Wed	Thu	Fri	Sat
	1	2	3	4	5	6
7	8	9	10	11	12	13
14	15	16	17	18	19	20
21	22	23	24	25	26	27
28	29	30				

OCTOBER 1969						
Sun	Mon	Tue	Wed	Thu	Fri	Sat
			1	2	3	4
5	6	7	8	9	10	11
12	13	14	15	16	17	18
19	20	21	22	23	24	25
26	27	28	29	30	31	

For further information on meetings, use Information Retrieval Card.

## Sept. 21-26

**Intersociety Energy Conversion Engineering Conference** (Washington, D.C.) Sponsor: IEEE, ASME, AIAA et al, T. G. Kirkland, U. S. Army R&D Center, Fort Belvoir, Va. 22060

CIRCLE NO. 410

## Sept. 24-26

**Ultrasonics Symposium** (St. Louis, Mo.) Sponsor: IEEE, C. K. Jones, Westinghouse R&D Div., Churchill Boro, Pittsburgh, Pa. 15235

CIRCLE NO. 411

## Oct. 6-8

**Canadian Electronics Conference and Exposition** (Toronto) Sponsor: IEEE, R. DeBuda, International Electronics Conf., 1819 Yonge St., Toronto 7, Ontario.

CIRCLE NO. 412

## Oct. 13-19

**International Astronautical Federation Congress** (New York City) Sponsor: AIAA, American Institute of Aeronautics and Astronautics, 1290 Avenue of the Americas, New York, N. Y. 10019

CIRCLE NO. 413

## Oct. 21-23

**Thermionic Energy Conversion Conference** (Carmel, Calif.) Sponsor: IEEE, W. E. Harbaugh, RCA, Electronic Components, Lancaster, Pa. 17604

CIRCLE NO. 414

## Oct. 27-29

**Electronic & Aerospace Systems Convention (EASCON)** (Washington, D.C.) Sponsor: IEEE, H. P. Gates, Jr., Sect. of Army for Southeast Asia Matters, The Pentagon, Washington, D.C. 20310

CIRCLE NO. 415



**Buy a Polycarbonate capacitor today and six months from now you won't recognize it.**

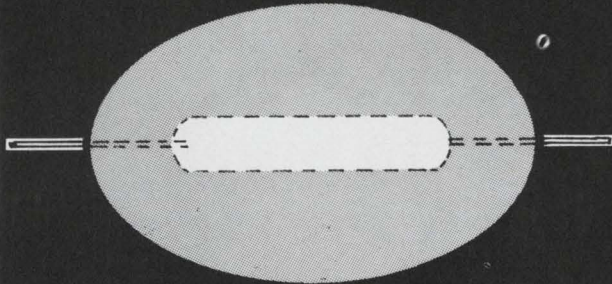

**It'll change that much.**

**On the other hand, the KEMET® Flat-Kap remains electrically stable indefinitely—for years and years.**

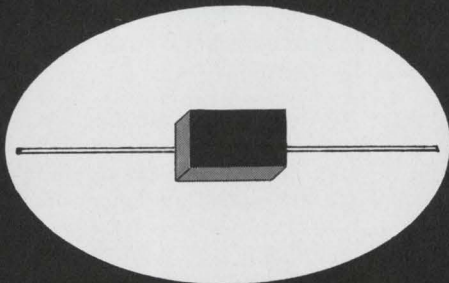

**WITH KEMET FLAT-KAPS TIME IS ON YOUR SIDE.** Because they're made with Union Carbide developed Parylene. That's why they can eliminate production problems frequently experienced with Polycarbonate capacitors. Examples: variations in temperature coefficient, instability on-shelf life, shorts, or even *delayed deliveries*.

<b>Capacitance range:</b>	<b>.001 <math>\mu</math>F to .1 <math>\mu</math>F</b>
<b>Voltage rating:</b>	<b>50 VDC</b>
<b>Standard tolerances:</b>	<b><math>\pm 10\%</math>, <math>\pm 5\%</math>, and <math>\pm 1\%</math></b>
(Custom tolerances available on special order)	
<b>Temperature range:</b>	<b><math>-55^{\circ}\text{C}</math> to <math>+125^{\circ}\text{C}</math></b>
<b>Insulation resistance:</b>	<b>100,000 megohms at <math>25^{\circ}\text{C}</math></b>
<b>Dissipation factor:</b>	<b>.35% max. at <math>25^{\circ}\text{C}</math>, 1KHz</b>
Environmental test performance per MIL-C-55514	

Stability is the key...it's built-in...because Parylene is not subject to the dimensional changes and capacitance changes caused by stress-oriented plastic film (like Polycarbonate). And Union Carbide makes Parylene right here in the U.S.A. . . . so you don't have to worry about long lead-time foreign deliveries.

Available off-the-shelf in three temperature coefficients,  $0 \pm 50$  PPM,  $0 \pm 100$  PPM, and  $-200 \pm 30$  PPM, in space saving epoxy cases with either radial or axial leads for your filter and tuned circuit applications. For complete information see your local Union Carbide representative, or write to P. O. Box 5928, Greenville, S. C. 29606.

**ELECTRONICS DIVISION  
COMPONENTS DEPARTMENT**

P.O. Box 5928, Greenville, South Carolina 29606 • Tel: (803) 963-7421/TWX: 810-287-2536



THE DISCOVERY COMPANY

Union Carbide's Electronics Division is a total supplier to the Electronics Community through its Semiconductor Department, Components Department, Crystal Products Department, KORAD® Department, and Instrument Department.

# When your IC bugs out, chances are the heat's on!

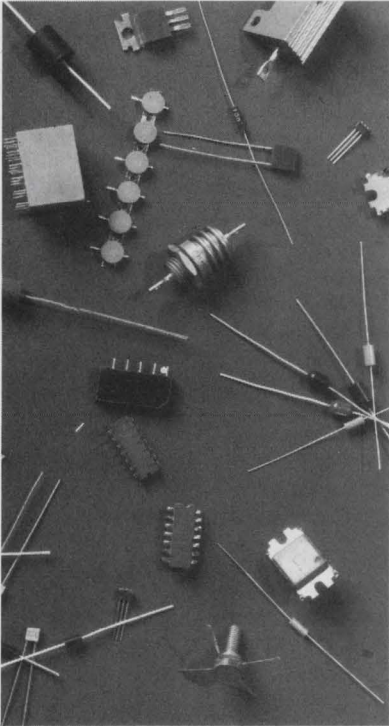

Devices packaged in Dow Corning® silicone molding compound are physically and electrically stable—even after long term exposure to both high heat and humidity. Derating, a practice common with organic packaging, is not necessary. In fact, you can design for high device and component density by using silicone molding compound. One manufacturer of glass package power diodes reduced the part to 1/30th of its former volume. Sizes from 1/5th to 1/3rd smaller can be obtained by using silicone molding compound in place of other plastics.

**Little moisture absorption.** Silicone molding compounds when exposed for 1000 hours to 93% RH at 70 C showed an average weight increase of 0.32% with the greatest increase being 0.5% and the least being 0.17%. Five organic plastics had average weight increases ranging from 1.0 to 2.1%—an average of nearly five times greater than silicone molding compounds under the same test conditions.

**No cracking.** Unlike other thermal setting plastics, Dow Corning silicone molding compounds are virtually unaffected by thermal shock. For example, a power resistor molded in Dow Corning® 307 compound was cycled repeatedly from -65 to 350 C without damaging the packaging material or the component.

**Will not burn.** Silicone molding compounds are

inherently nonburning. Thus, components and devices packaged in silicone molding compound do not constitute a fire hazard. No flame snuffers are used—a source of ionic contamination for devices packaged in organic materials.

**Corrosion free.** These silicone molding compounds are free of ionic contaminants which may contribute to metallic corrosion when operating in high humidity and influenced by voltage bias.

**Competitive price.** Costing only a fraction of a cent per device, Dow Corning silicone molding compounds enjoy a substantial price advantage over metal cans . . . glass packages.

**Manufacturing economies.** Transfer molding enables manufacturers to package devices and components with a minimum of manual labor and supervision. Good mold release and minimum flash assure high production rates . . . reduced deflashing costs. These manufacturing advantages make silicone molding compounds totally competitive with organic plastics.

So why be bugged by device failures because of a cheap plastic package? Specify Dow Corning® brand silicone molding compound, and get the best package protection in your electronic equipment . . . lets you keep your cool. For technical data, write: Dept. D-8472, Dow Corning Corporation, Midland, Michigan 48640.

**DOW CORNING**

DOW CORNING

# The non-catalog connector.

If you can't buy it. We'll make it. Any kind of printed circuit connector.

Tell us how many positions, how many contacts. And what kind of shape it ought to be in.

We'll take it from there, and turn out a connector for you, at a price that's probably the lowest in the business.

The biggest reason is our contacts—because they're the biggest single factor in the price of connectors.

We put more gold at the contact area than any plater does. But we weld it there instead of plating it. So we use less gold overall.

As a result, our contacts are the best you can buy. (Maybe that's why many of our competi-

tors use them.)

We also do our own wire drawing, coining, forming, bending, and solder plating. We design our own tooling and mold our own plastic bodies. And we assemble and test the whole connector ourselves.

If you're looking for ordinary connectors look in ordinary catalogs.

But if you want something a little special, now you know where you can go.

Sylvania Metals & Chemicals, Parts Division, Warren, Pennsylvania 16365.

**SYLVANIA**  
GENERAL TELEPHONE & ELECTRONICS

INFORMATION RETRIEVAL NUMBER 14

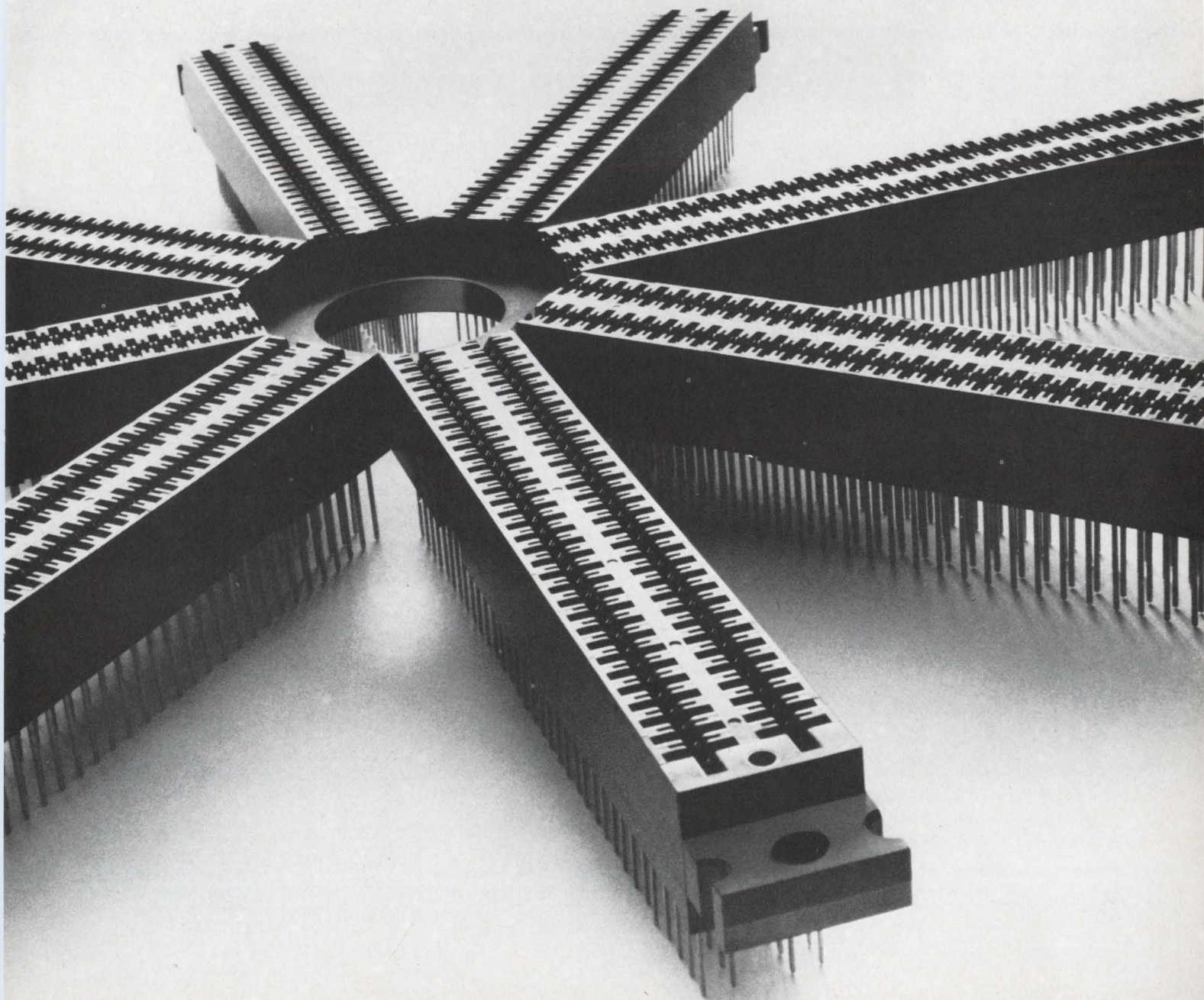

**Buy resistors with built-in dependability...**

# Vitreous-enamel **BLUE JACKET<sup>®</sup>** **POWER WIREWOUND RESISTORS**

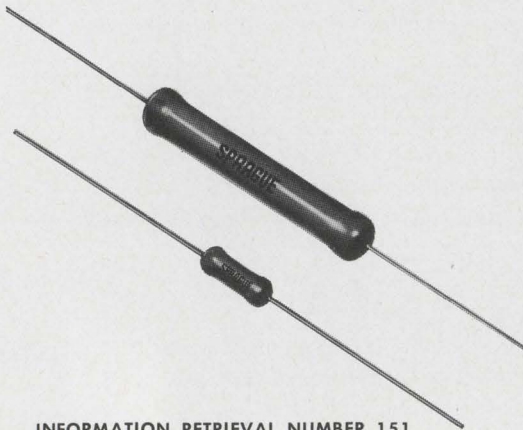

INFORMATION RETRIEVAL NUMBER 151

All-welded end-cap construction eliminates moisture along the leads, also anchors leads securely to resistor body. Expansion coefficients of vitreous enamel coating, ceramic core, and end caps are closely matched. Standard wattage ratings include 1, 2, 2.5, 3, 5, 7, 10, and 11 watts. Also available with radial tab terminals in ratings from 8 to 230 watts.

48R-9145

**Tiny in size...Giants in volume efficiency!**

# Type 160D, 161D Solid-Electrolyte Tantalex<sup>®</sup> Capacitors for hearing aids and ultra-miniature circuits

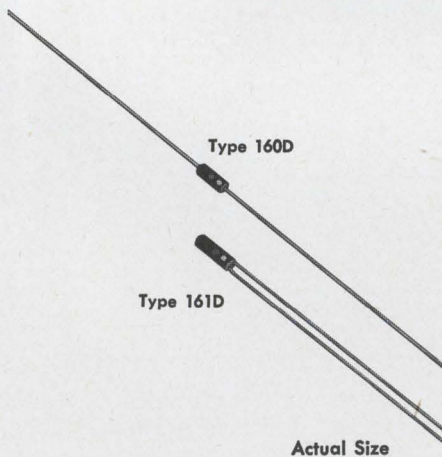

INFORMATION RETRIEVAL NUMBER 152

Tiny Type 160D/161D Tantalex Capacitors are sealed within a polyester film tube with tightly-bonded epoxy fill, so the assembly is both electrically insulated and highly resistant to moisture. They are available with axial leads as well as in single-ended construction.

Offering extremely high capacitance per unit volume (for example: 0.25  $\mu\text{F}$  @ 20 VDC in a case only .065" D. x .125" L.), Tantalex Hearing-aid Capacitors let you select from a broad range of ratings in five different case sizes.

For information on Blue Jacket Resistors, request Engineering Bulletin 7410D. For the full story on Type 160D/161D Capacitors, write for Engineering Bulletin 3515D. Address Technical Literature Service, Sprague Electric Co., 347 Marshall St., North Adams, Mass. 01247.



Sprague' and '®' are registered trademarks of the Sprague Electric Co.

**THE BROAD-LINE PRODUCER OF ELECTRONIC PARTS**

# News

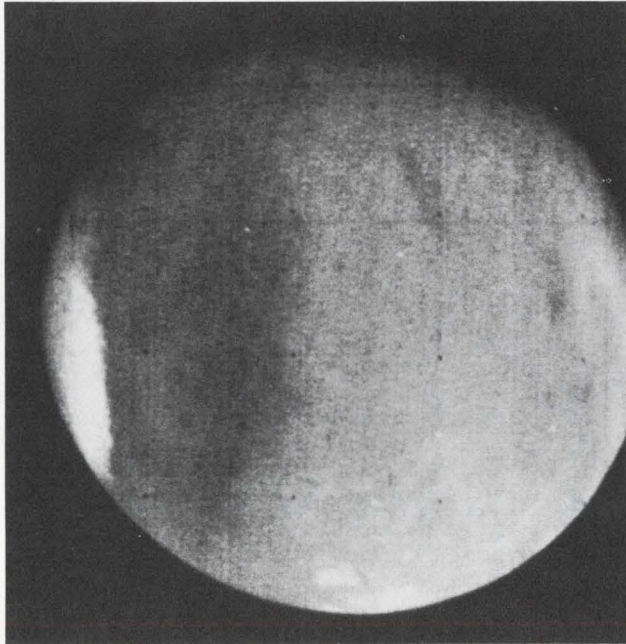

**Landing men on Mars** by 1982 is possible according to a NASA study, but many technological advances are needed in electronics, propulsion and physiology. p. 36

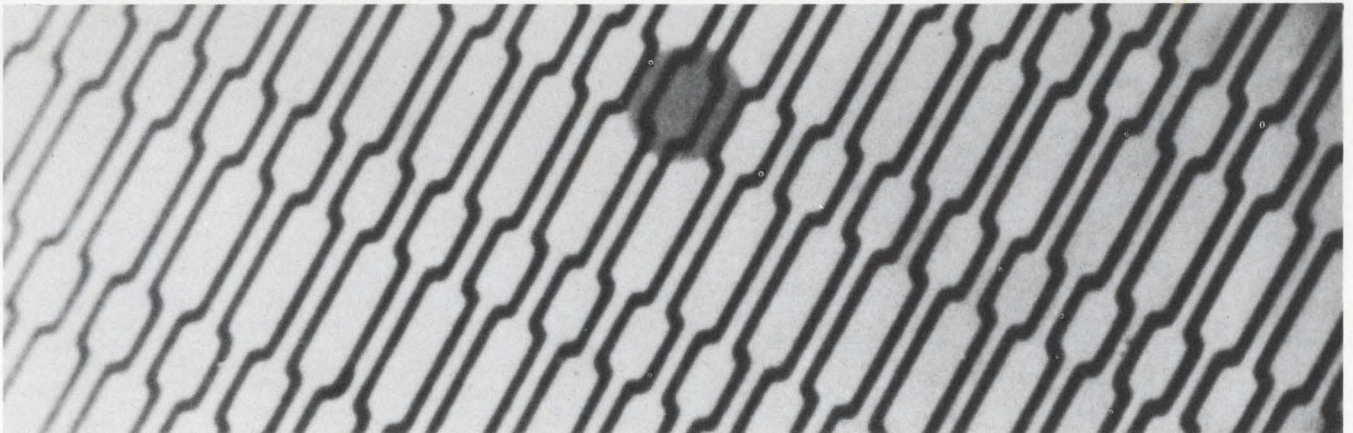

**Tiny magnetic "bubbles"** moving through a sheet of thulium orthoferrite may, within five

years, lead to miniature computers the size of a wrist watch. p. 25

## Also in this section:

**The shake, rattle and roll test** for electronics. p. 30

**News Scope**, p. 21 . . . **Washington Report**, p. 45 . . . **Editorial**, p. 53

# BURROUGHS DEVELOPS... SELF-SCAN<sup>TM</sup> PANEL DISPLAY

## the most significant development in electronic display

Burroughs, the originator of NIXIE<sup>®</sup> tubes, now revolutionizes display technology with the first commercially practical dot matrix display system. It took SELF-SCAN panel display, the remarkable Burroughs invention that takes the electronics out of the present electronic display ... reducing costly drive circuitry up to 90%.

With a minimum number of leads and drivers, Burroughs' system automatically scans data input into in-plane readout characters formed by glowing dots ... making possible a totally new combination of readability, minimal packaging and cost advantages.

The new flat-panel display is basically a matrix of small gas discharge cells hermetically sealed between heavy glass plates in a sandwich configuration. The matrix itself, formed of insulating material, has small grooves on its top surface to allow positioning of information anode wires which intersect each hole. Cathode conductors behind the center sheet intersect at each cavity with a second set of anode wires.



By utilizing the phenomena of preferential glow transfer and glow shifting, the initial glow caused by cathode ionization in the dot matrix may be moved through selected holes to a visible position on the top surface. A sequential flow of light is thus achieved without separate drivers for individual columns and rows.

Burroughs' alphanumeric SELF-SCAN panel displays are available with or without memory for any application requiring 16 or 18 readout.

Write today for descriptive brochure, Burroughs Corporation, Electronic Components Division, P. O. Box 1226, Plainfield, New Jersey 07061. Tel.: (201) 757-5000.

**Burroughs**



INFORMATION RETRIEVAL NUMBER 16

## U.S. aerospace firms bloody but unbowed

"The whole industry is coming under fire these days. We're no longer the defense industry or the aerospace industry. Now it seems we're part of the military-industrial complex."

In these words, Lockheed's chairman of the board, Daniel J. Haughton, summed up for a group of the corporation's stockholders the less-than-attractive new image that the aerospace-defense industry is trying to live with.

Haughton offered a partial explanation: "A lot of the criticism that has been directed at us in Lockheed has just been a reflection of the general dissatisfaction with our whole society—the war in Vietnam, social problems here at home, inflation and high taxes, and all the rest."

Lockheed, as well as other giant aerospace-defense companies queried by ELECTRONIC DESIGN, are far from discouraged, however. The nation will have to maintain a strong defense, they point out, despite the criticisms of doves in Congress. All are pursuing new military and space contracts aggressively. And they are looking for ways to strengthen their civilian markets, both at home and abroad.

One spokesman for a big electronics corporation who requested anonymity, said he was glad for today's soul-searching, even though it was clouding the market-research department's crystal ball.

"No one knows for sure how to plan defense work until we know how our foreign policy will change," he said. "Our foreign commitments are being examined with widely divergent points of view. And within the country, Congress is agonizing over a new priority list for home-grown ills. All industry can do is to watch and wait and be responsive to new

requirements when they emerge.

"We do believe we can predict certain things," he continued. "The U.S. will maintain its strong strategic deterrence—land- and sea-based missiles. We will keep our general purpose forces strong—whether this means we will be able to carry on two wars at once, one and a half, or just one, I don't know. But we will continue to have fighter planes, and land armies and navies—particularly aircraft carriers, because of the dwindling hospitality our overseas forces enjoy."

In looking for new civilian business, Lockheed would like to be a 50:50 company, although it is still 95:5.

With the possibility of reduced government spending, design will have to be more competitive. Lockheed, for example, hopes to develop a land vehicle to replace the tank.

The overseas market also looks good. McDonnell-Douglas says if procurement falls off here, it will still sell 1500 Phantom jets to foreign governments.

As for space, McDonnell-Douglas says it is actually having "an upswing." It has a contract for a 3-man orbiting workshop, a study award for an ambitious 50-man space base, and it hopes to build logistics vehicles to support both.

In addition, the company hopes to get the F-15 Air Force fighter award. "This would keep us in the fighter business for the next 15 years."

General Dynamics hopes to get the Navy's Advanced Surface Missile System award this year, and the gigantic order for a whole new class of destroyers, the DD 963 (formerly called the DX).

Although Boeing's Government sales are only 12 per cent of its total, this portion of its business is uncertain—\$6 million a month is going into the supersonic trans-

port, for example, but the project is considerably behind Russia's TU-144 and the French and British Concorde.

Boeing would like the Advanced Manned Strategic bomber award, but movement on this program is also slow.

Meanwhile, Boeing says, "We're still building half the jet airliners in the non-communist world."

## Small microwave firm wins decision from FCC

Round 1 has been fought between the David and Goliath of communication carriers, and it looks as if the small guy won. Microwave Communications, Inc., Washington, D.C., has won from the Federal Communications Commission a decision that has been contested for six years by the Bell System.

For the first time, the FCC has permitted a company to supply private-line microwave communications and compete with regulated companies like the American Telephone and Telegraph Co. MCI is now, in effect, a common carrier.

President John D. Goeken says his company will install a \$560,000 microwave link for interoffice and interplant communications between Chicago and St. Louis next July.

Goeken sees the formation of three areas of domestic common carriers: switched network communications, such as AT&T, public record carriers, such as Western Union, and point-to-point communications carriers, like MCI, for firms that don't require switched network facilities.

The FCC decision was handed down August 14, and AT&T has 30 days to appeal or ask for a reconsideration. But Goeken says, "With all the publicity AT&T is getting about its not being able to handle the business it already has, I think it would be poor timing for them to go ahead with a reconsideration." He referred specifically to telephone problems in New York City.

MCI will also permit a customer to have different bandwidths in each direction. For example, a company can transmit low-speed data and receive information back on a picture tube.

According to Goeken, during the

FCC hearings, "AT&T said it would not voluntarily interconnect" the MCI network to the Bell System. But, he says, the commission will order them to do so.

A spokesman for AT&T said that the company has "not yet reached a conclusion on whether to petition for reconsideration."

According to the spokesman, AT&T, Illinois Bell and Southwestern Bell have opposed the MCI proposal on the basis that it would:

- result in wasteful use of limited common carrier radio frequencies
- wastefully duplicate facilities already existing
- begin to undermine the existing policy of uniform interstate rates.

On the matter of interconnection, AT&T says that MCI's proposal "will not provide a complete communications service to its customers. It would be left to each user to find a way to get from his location to the MCI microwave terminal."

## There's a computer in the car of the future

In the car of the future—and not-so-distant future, at that—a computer the size of a kitchen match box will control all of the wiring. And more: Multiplexing will eliminate 80 per cent of the connectors and wiring in the car.

That's the picture painted by Paul W. O'Malley, president of Essex International, Inc., Fort Wayne, Ind., which is putting together such a system. Called Computerized Energy Distribution and Automated Control, the system is under development at the Mellon Institute in Pittsburgh, under the sponsorship of Essex, one of the nation's leading suppliers of automotive wiring harnesses.

The new method uses PCM time-division multiplexing, together with redundancy techniques, for noise rejection. The small digital-control computer gives commands

and receives monitoring signals over a single energy distribution and control harness of three wires and one pneumatic tube.

In sending and receiving information to and from actuators and sensors, the logic unit controls such functions as lighting, power assist, air conditioning, transmission shifting, ignition, air-fuel mixture, and antiskid braking. The harness carries both control-signal data and electric and pneumatic power to the elements or devices being operated.

The system's continuous monitoring functions give alarms—as, for example, when a tail light fails. Like other conventional multiplexing (see "MUXing Slices Tons of Weight From Aircraft," ED 22, Oct. 24, 1968, p. 25) integrated circuits are used for multiplexing and control functions.

Essex International is setting up a pilot plant in Pittsburgh, to be operable this fall.

Hopefully, the full-system placement in new cars will take place in the mid-1970's, O'Malley says.

## Rapid battery charger uses 'burping' method

A new principle for recharging electric storage batteries is said to be 100 times faster than currently available methods. The technique is reported to be particularly advantageous in the case of sealed nickel-cadmium batteries, which are difficult to control under rapid charging.

Developed by McCulloch Corp., Los Angeles, the principle is described by the company as comparable "to the way a mother burps her baby to prevent indigestion." The McCulloch charger sends a series of high-current pulses into the battery, and then applies a reverse current pulse to remove accumulated gases and other products of polarization that cause cells to heat and can lead to failure.

The rapid-charge device has three major elements: a pulsing charge, an extremely accurate sensor that determines when the cell is fully charged, and a system to apply brief (as short as millionths of a second), reverse-current pulses that condition the plates to continue to accept high charge rates.

The charger does the job, typically, in 10 to 15 minutes, compared with the 12 to 15 hours that most battery charging systems require.

A patent on the principle is pending, McCulloch says. But it is licensing other companies for commercial applications. The first licensee is Honeywell, Inc., which has been granted rights in the photographic field.

## Systron Donner to make sales reps 'partners'

Systron Donner Corp. of Concord, Calif., plans to enter into a unique cooperative venture with its sales representatives. It will permit them to establish their own franchise corporations and to share in Systron Donner profits.

This arrangement, says James Cunningham, marketing manager for the instruments group, will make all parties to the agreement richer. The traditional relationship between manufacturer and representative, he says, gives no one the profit or corporate equity his abilities would otherwise yield. The traditional representative company, he points out, has no equity in the parent company. Its most valuable possessions are the contracts it holds from the parent organization and these can be terminated on 30 days' notice.

Cunningham expects the franchise system being set up by Systron-Donner to enable all parties to make more profit and build more equity.

The income of salesmen will be based not only on their volume of sales but also on the percentage of stock they own in the representative corporation. They will have a lifetime contract to sell Systron-Donner products and will be free to sell non-competing products of other companies.

In addition, they will own an interest in Systron-Donner itself, through part ownership of a national sales corporation now being set up. This national organization will distribute 60 per cent of its stock to Systron-Donner and 40 per cent to all the franchises. In exchange, it will hold shares of the stock of Systron-Donner and of the franchise corporations.



# With Film-Met, only the case is the same.

**Inside, it's a  
whole new trimmer.**

The element\* is made by an exclusive Amphenol patented process. We use a vacuum deposition chamber to evaporate 100% metal alloys onto insulating substrates—then protect them against oxidation with noble metal overlays.

The result is trimmer performance neither wirewounds nor cermets can match. Only Film-Met™ offers both infinite resolution and a low temperature coefficient of 100 ppm/°C. (50 ppm/°C is available on request.)

Film-Met trimmers have excellent high frequency and pulse characteristics and low contact resistance variation. Their low thermal and current noise features are comparable to metal film fixed resistors.

The new Amphenol Film-Met trimmer line isn't designed to replace wirewounds and cermets in every application. What

Film-Met performance does is eliminate circuit design compromise. By adding these trimmers to our line of cermets and wirewounds, we can now match your performance needs perfectly.

To see how Film-Met trimmers perform, contact your local Amphenol distributor or sales engineer. Or write to Amphenol Controls Division, Janesville, Wisconsin.

This could be what you've been waiting for. A whole new trimmer!

Film-Met™ by Amphenol

\*U.S. Patent No. 3,353,134; also foreign patents.

**Film-Met**  **AMPHENOL**  
THE BUNKER-RAMO CORPORATION



# HP Test Oscillators... the step-savers!

Dollar for dollar, HP's 650 series of test oscillators provides the best performance in the 10 Hz to 10 MHz range—and saves you steps while doing it.

This series matches your performance requirements with the right price to give you the test oscillator that best suits your needs.

In the 650 series, you get test-quality amplitude and frequency stability. Once you have these oscillators set up you don't have to waste steps constantly checking them!

With the 652A, a X20 expanded scale lets you monitor output amplitudes to within 0.25% over the entire 10 Hz to 10 MHz frequency range. The readings on the upper-most expanded scale are in percent. This added convenience lets you get a quick reading of % deviation for frequency response of the device under test—in one easy step. (Price HP 651B, \$590; HP 652A, \$725)

The next big step-saver is for people who are tired of tweaking up their oscillator level every time they change frequency. The HP 654A has automatically controlled 0.5% level flatness from 10 Hz to 10 MHz. Eliminates the need to verify and adjust the oscillator output after each frequency change. You are free to concentrate on system performance instead of system input.

But that's not all, with the 654A you get pushbutton selection of 135, 150, or 600  $\Omega$  balanced outputs—or 50 or 75  $\Omega$  unbalanced. The combination of an expanded meter scale and a sensitive output level control assures you of extremely accurate output resolution. Add it all up and you have the 654A—the best general purpose test oscillator available today. (Price \$875).

Anyone have a special television application? Well, that's where the step-saving HP 653A comes in. It has

the inherent accuracy and ease of operation of the 654A. It also has many special built-in video capabilities for A2 type television system measurements. Too many to cover here—but if you want more information, just ask. (Price \$990)

If you want to put your test oscillator dollar to the best use, and save steps at the same time—call your local HP Field Engineer or consult your HP catalog. For data sheets, write Hewlett-Packard, Palo Alto, California 94304. Europe: 1217 Meyrin-Geneva, Switzerland.

099/22

**HEWLETT  PACKARD**  
S I G N A L S O U R C E S

INFORMATION RETRIEVAL NUMBER 18

# Megabit bubble memory? In 5 years, maybe

## Bell Labs' magnetic-domain technology shows high promise, but must be adapted for mass production

John N. Kessler  
News Editor

Millions of data bits in teaspoon-sized memories are promised with a new magnetic "bubble" technology that is being compared in importance with the discovery of the transistor. But don't expect delivery of such memories tomorrow. Bell Telephone Laboratories, the developer, says it probably will be five years before its megabit bubble devices are available to designers.

The biggest problem, according to Jack A. Morton, vice president in the Materials and Components Div, is materials: How can orthoferrite crystals that contain the oval-shaped bubbles, or domains, be grown for production runs? The problem, as Morton puts it, is one of "exchanging macroscopic complexity for microscopic complexity."

The bubbles are actually magnetic domains that can be cycled and positioned to perform logic, memory, switching, and counting function. Bell Labs has made a hundred bit shift register on a chip 1/4-inch square and it has plans for fabricating a 1.5-million-bit shift register on a one-inch chip.

### 100 megabits the limit

What is the theoretical limit to the density of magnetic bubbles? Probably about 100 million bits per square inch, says Andrew H. Bobeck, a Bell engineer who played a prominent role in developing the new technology. But before you can put a million bits on a square inch, you've got to have the square inch. So far, Bell crystallographers have grown crystals that are about 0.25-inch square. But they are working on a number of techniques. Morton says a single crystal film is the most desirable material, but he expects a bulk crystal, sliced into wafers, to be the most feasible.

Eugene R. Reed, executive director of the Solid State Device Division at Bell Laboratories, says the bubble devices are the result of a "partnership between device physicists and materials scientists." Morton, who directed the development of the transistor at Bell Labs in the late 1940's describes the new development as "an entirely new approach to the architecture of computers."

For the electronic designer, this new technology provides a basic building block for compact and inexpensive computers and switching systems. Exploratory devices somewhat larger than a pinhead were shown at a Bell Labs press conference last month. Under magnification, one could watch as the bubbles "cruised" around the circuit.

The bubbles can be created, erased and moved anywhere in thin sheets of magnetic material

without interconnection. They may interact with one another in a controlled fashion, and their presence or absence can be detected. With a permanent magnet to provide a stabilizing field, the information in a bubble memory cannot be "lost," even if power is turned off.

The energy to manipulate the bubbles can be applied either by current-carrying conductors or picked up from a surrounding magnetic field by microscopic ferro-magnetic antennae in a printed pattern distributed over the surface of the material.

In either case, the power needed to move the bubbles is two to three times less than that needed to power the smallest transistor.

Reaction to the bubble concept by other electronic laboratories has been either non-committal or favorable so far. A sampling by ELECTRONIC DESIGN turned up the following:

A spokesman for IBM said, "Our technical people are aware of

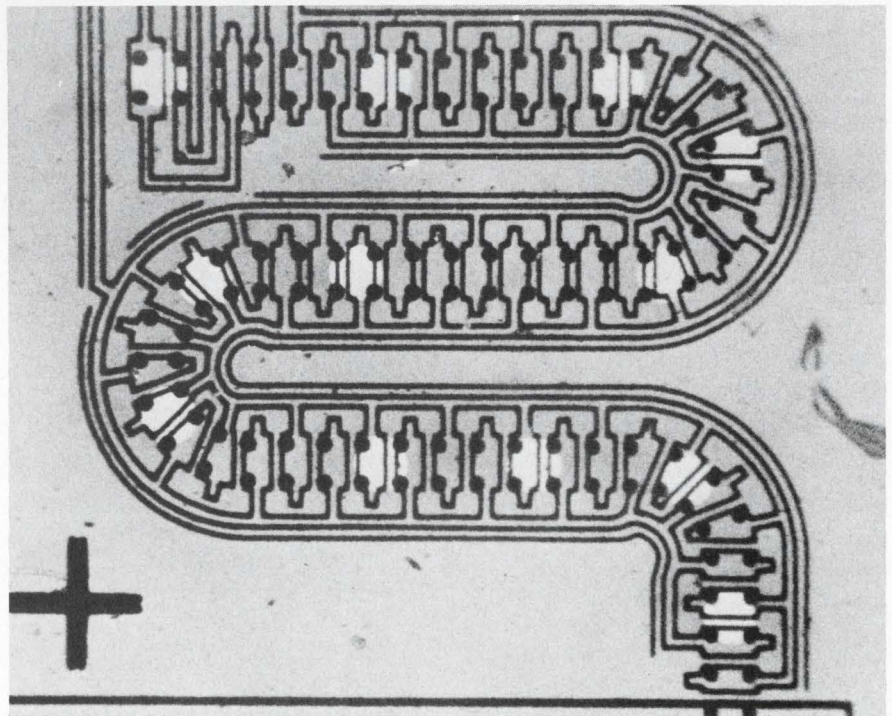

Travelling bubbles (the white dots) can move through conductor circuits at data rates of three megahertz.

**(Megabit memory, continued)**

it, but it would be premature to comment on the development at this time."

General Electric had no comment.

Robert J. Spain, senior engineering specialist at Sylvania's Applied Research Laboratories in Waltham, Mass., was enthusiastic. Spain, who also developed a thin-film technique for propagating magnetic domains, said that the bubble technology, requiring "minimal electronics, conductors, and processing steps, can lead to low-cost distributed memories that can be run asynchronously."

For example, the speed of a bubble memory can be matched to the speed of a computer terminal. Spain said that the materials developed at Bell Laboratories have been improved over those he worked with—in terms of the density and stability of the magnetic domains. But, like Bell, Spain also mentioned the materials problems that remain to be solved.

Dr. Jan A. Rajchman, staff vice president for information sciences at RCA Laboratories, Princeton, N.J., called the bubbles, "a most markable piece of research that looks very promising." "However," he cautioned, "it is at an early stage of development, and a great deal of work must be done to bring it to a useful product."

The Bell Laboratories bubbles are controlled either by programming electric currents in an overlaid pattern of conductors or (with no connecting wires) by controlling the surrounding magnetic field.

The bubbles are inherent to a group of magnetic materials composed of rare-earth iron oxides: the orthoferrites. These were grown as crystals first at Bell Laboratories. When these crystals are sliced into wafers, a circuit pattern is laid down through conventional photolithographic or vacuum deposition techniques.

Under a microscope, strip magnetic domains—typically 3.5 thousandths of an inch wide—can be seen by means of polarized light. Because it is possible actually to watch the bubbles propagate, the devices can be designed with opti-

cal readouts. Or Hall effect devices can be used to sense voltage outputs. Bell Labs says it can manipulate bubbles with diameters of a few microns.

When a 50-oersted bias field is applied perpendicular to a sheet of terbium orthoferrite 3.2 thousandths of an inch thick, the strip domains change to bubbles, with diameters about the size of a human hair. (1.4 thousandth of an inch).

Bell Labs engineers now use an electronic probe to position a bubble at a specific spot on the circuits where new bubbles are to be formed. This would be done electronically when production circuits are manufactured, according to Bell Labs.

A motion picture of an experimental circuit taken through a microscope shows how a bubble is placed in a "cutter." When the proper current is applied, these pairs of parallel conductors "cut" the original bubble in half. This operation looks much like the fission of one-celled animals.

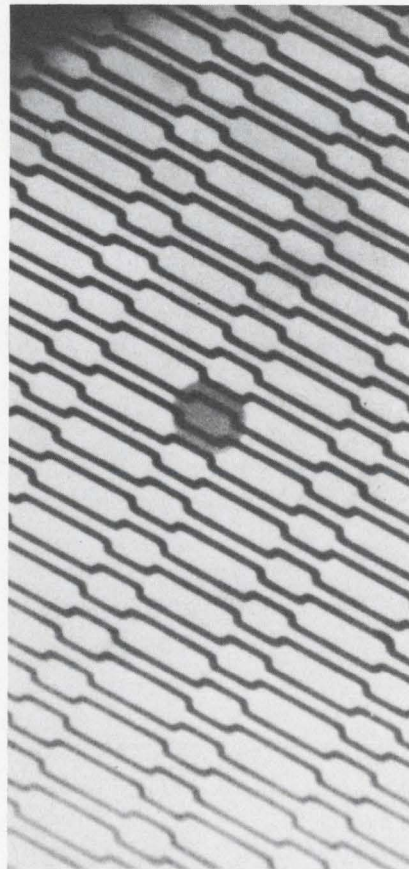

**Barbell conductor pattern** can be used to make megabit bubble memories. Magnetic field is generated by current pulses.

One bubble goes into the circuit, the other goes into the reset" position and is cut again and again, depending on how many bubbles are desired for the circuit. The surplus bubbles are eliminated by what Bobeck calls a "bubble eater" at the output of the circuit.

Three types of conductive patterns are being used by Bell to propagate the bubbles: a barbell pattern, an "angel fish" design, and T's and bars. The bubbles behave much like charged particles. In the barbell circuits, applied magnetic fields generated by current pulsed through the printed conductors can move the bubbles to any location within the plane of an orthoferrite chip. The bubble moves rapidly along the bars and slows up or is made to rest at a bell.

**Like an electronic inch worm**

The angel-fish shift register takes advantage of the expansion and contraction of the bubbles that occurs when a bias field is increased or decreased. A mag-

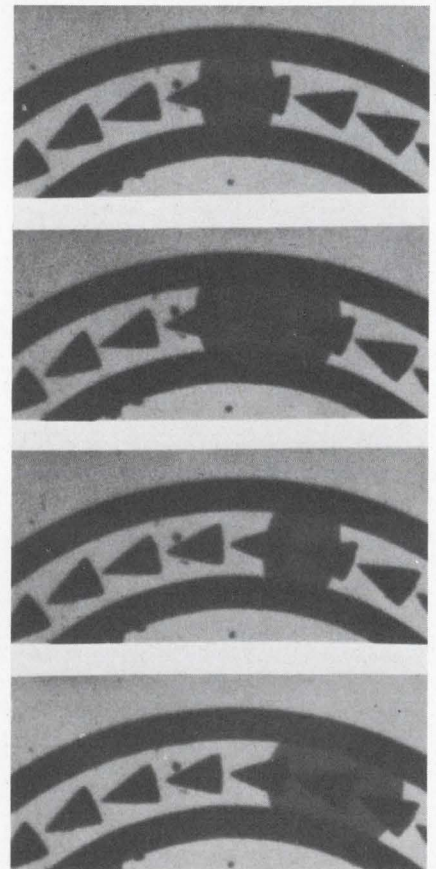

**Angelfish conductor pattern.** Magnetic bubbles moving through such circuits resemble inch worms as they expand and contract.

**Good heavens. If we still haven't mesmerized you with all the magic arrays Signetics makes, what do we have to do? Conjure up a picture?**

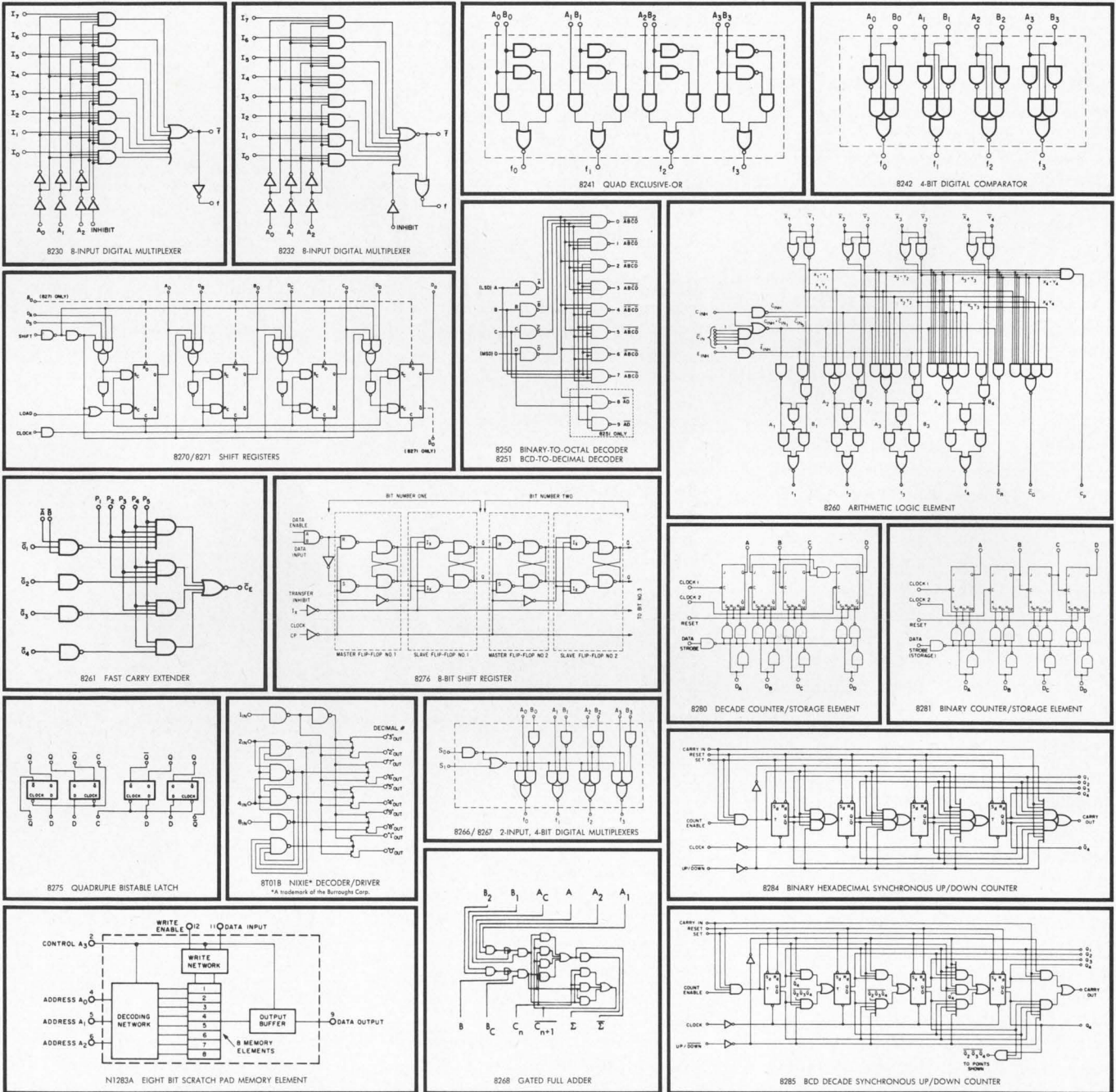

P.S. To keep you posted on our whole array of arrays, we've made a king-sized poster of this ad. (Just the thing for your rumpus room—or your purchasing agent's wall.) Offer limited; send today. And please: stop squinting!

More complex magic from **Signetics** **MSI**  
 Signetics Corporation / 811 E. Arques Ave., Sunnyvale, Calif. 94086 / A subsidiary of Corning Glass Works

INFORMATION RETRIEVAL NUMBER 19

**(Megabit memory, continued)**

netically soft material (easily magnetized or demagnetized), such as Permalloy, is deposited as a wedge-shaped film over an orthoferrite sheet. Bobeck says that the bubble will change its diameter by about 3 to 1 as the bias is varied. As each domain expands, it latches on to the blunt edge of the next wedge. When the field is decreased, the forward edge of the bubble moves ahead. When the bias is increased, the other end slips off the point of the trailing wedge. The motion approximates that of a very-fast-moving inch worm.

If Permalloy is deposited on an orthoferrite chip in a T and bar pattern, a rotating in-plane field will generate traveling positive and negative poles. While this field has little effect on the orthoferrite itself, it produces magnetic poles in the Permalloy and the bubbles move in the direction of the rotating field.

Bubbles have been propagated using barbell conductors at data rates of 3 million bits per second. Bell Labs engineers expect that the angelfish and T-bar circuits will have data rates of better than 1 million bits per second. The power required to move an 8-micron domain 3 diameters in a microsecond is  $4 \times 10^{-14}$  joules. The total systems requirement for a 15-million bit memory is 5 to 10 watts. The same capacity memory in today's computers requires 1000 watts.

According to Bell Labs, bubble devices can be made that will perform "logic, memory, switching, and counting—all with a single magnetic material." This eliminates costly interfaces and opens the possibility for distributing both logic and memory in switching and computer system—a radical change in these electronic machines.

In speaking of the simplicity of bubble memories, Reed noted that present memory and logic system—ferrite core, twistors, magnetic film, and semiconductor memories—involve intricate geometries. He emphasized that bubble memories require much fewer process steps. The two factors that must be controlled are the composition of the orthoferrite and its thickness.

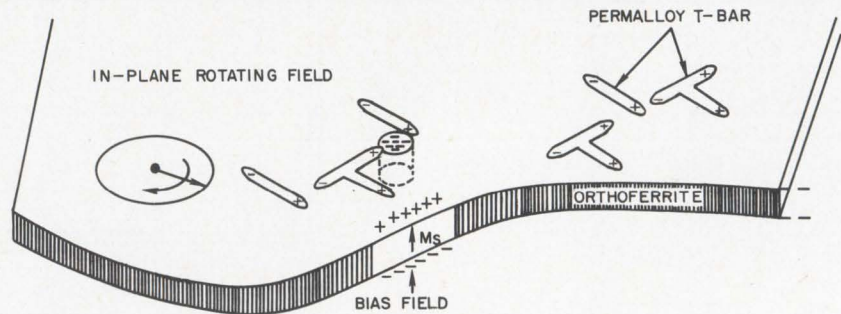
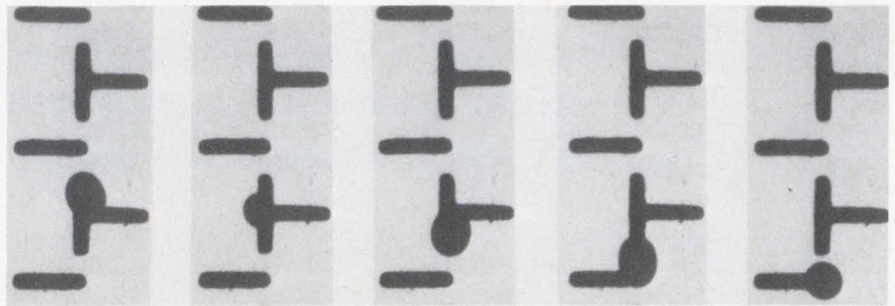

**A pattern of T's and bars form a maze that controls the path of magnetic bubbles cruising through a circuit. (Bottom) An in-plane field rotating through 360 degrees generates positive and negative poles that moves bubbles.**

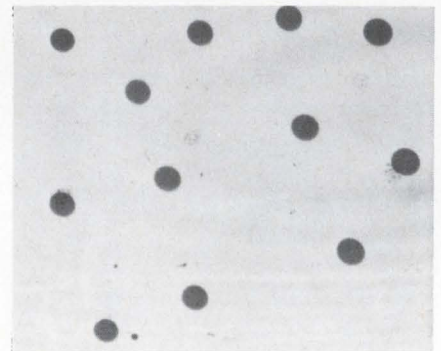

**Before the bubbles are formed the magnetic domains look like fingerprint ridges and valleys. Domains shrink and bubbles appear (right). Bubbles shown above are about 1.4 mils in diameter.**

The device applications of cylindrical magnetic domains were first reported by Bobeck in October 1967 ("Properties and Device Applications of Magnetic Domains," in the Bell System Technical Journal, Vol. XLVI, Part II, No. 8, pp. 1901-25.) and jointly credited to Umberto F. Gianola, Richard C. Sherwood, and William Shockley. The technique takes advantage of long-known domain-wall-motion theory.

Earlier, Paul C. Michaelis of Bell Labs had announced the discovery of a technique for two-dimensional propagation and interaction of isolated magnetic domains in anisotropic ferromagnetic thin films.

Michaelis was able to control the motion of magnetic domains along the hard as well as the orthogonal easy axis. This suggested that it would be possible to store information in the form of magnetic domains which could be moved anywhere within the bounds of the film.

Bobeck and his associates found that orthoferrites offered a more practical material. When grown as single crystals and sliced into thin sheets, the potential bit capacity is huge. The results of present research suggest that computers with megabit memories the size of a wristwatch may one day be practical. ■■

# $\pm 50 \text{ ppm}/^\circ\text{C}$

## in all Helipot Cermet Trimmers

This significant advance in Helipot's cermet technology is now available at only a dime/unit more . . . 100 ohms thru 2 megohms. In addition, you get essentially infinite resolution, environmental stability, reliability, no catastrophic failures — all superior to wirewound trimmers. We'll also deliver off-the-shelf, locally stocked trimmers with a standard tempco of  $\pm 100 \text{ ppm}/^\circ\text{C}$  in the 100 ohm thru 2 megohm range.



INSTRUMENTS, INC.

HELIPOT DIVISION

FULLERTON, CALIFORNIA • 92634

INTERNATIONAL SUBSIDIARIES: AMSTERDAM; CAPE TOWN; GENEVA; GLENROTHES, SCOTLAND; LONDON; MEXICO CITY; MUNICH; PARIS; STOCKHOLM; TOKYO; VIENNA

# The shake, rattle and roll test for electronics



## Martin devises an obstacle course with economy fm telemetry to check out Pershing missile system

Charles D. LaFond, Chief  
Washington News Bureau

Unlike the Big Berthas of World War I, modern mobile surface-to-surface missile systems have highly complex electronics. How can the designers be sure that such a system will withstand the dusty, jolting, vibrating field conditions in which it must ultimately operate?

Martin Marietta Corp., prime contractor for the Army's new Pershing 1-A, a 400-mile-range, surface-to-surface missile system, found a way: It built a mile-long rugged outdoor road course at its center in Orlando, Fla., and then spent two years shaking, bouncing and rattling the new hardware until it was sure it could withstand the worst operational conditions in Europe, where the nuclear-tipped Pershing 1-A is now being deployed.

### Recording the bounce

To make sure that test engineers could monitor the results of this tooth-jarring mayhem in real time and provide a faithful record of all these data, the company also introduced an fm telemetry system into its test program. Previously it had been common under rugged, mobile testing to employ an umbilical connection between a test vehicle and the equipment. The

monitoring vehicle would then follow the new mobile system as it bounced down the road—an approach that at best was inconvenient and limiting.

Martin built the Pershing 1-A road course in two months and began initial tests in October, 1966. The cost of the course and the associated telemetry system was only \$93,000, Martin officials estimate. The telemetry setup was assembled from subsystems left over from previous missile programs.

### P-band telemetry used

Essentially the telemetry consists of a P-band transmitter with sensors and signal-processing equipment and a one-quarter-wavelength aircraft stub antenna that is carried by the vehicle under test.

Shock and vibration data were transmitted at 5 to 40 watts output power over the fm link to the Martin-Orlando main plant and were received through a 7 1/2-turn helical antenna at what the company calls its MADRE (Martin Automatic Data Reduction Equipment) Control Center.

There, part of the information was read out in real time, so that monitoring engineers could follow what was happening out on the road and could, if necessary instruct the test vehicle operator over a radio link to perform additional or different tests. At the same time

all telemetered data was recorded on magnetic tape for subsequent analysis.

Not only has the telemetry system proved its worth on the Pershing road course, but it has found application for other purposes. For example, Martin recently used it during an air transportability test, in which the Pershing system was carried aboard a C-130 aircraft. Data was transmitted from the airborne equipment to the MADRE Center and read out immediately.

Also, Martin officials have revealed that the same equipment has been employed to record pre-flight and flight test data in Pershing firing exercises down the Eastern Test Range from Cape Kennedy, Fla.

Although originally designed to employ the P-band for operation, the telemetry system is now being modified in accordance with a recent Federal Communications Commission decision to shift to a higher frequency band. Both transmitters and receivers will be altered to operate within the S-band by next Jan. 1, company officials say.

### Running the obstacle course

The road course is a cyclic obstacle track, with a half dozen phases of rough and erratic roadbed designed to bring out the worst in any piece of equipment.

As the driver of the Pershing 1-A five-ton vehicle, carrying 35-foot, two-stage missiles, rolled along the course, here's what he



encountered at approximately 200-foot intervals.

- A series of three-inch bumps created by oak planking mounted on movable rails. By shifting the bumps, the test supervisor could vary their frequency.

- A strip of two-inch-high concrete ridges laid at a 45-degree angle to the roadway. The result here was a twist-and-jolt action that would reduce an average automobile to junk well before the end of its warranty period.

- A radial washboard with two-to-four-inch concrete risers.

- A stretch of steady, two-inch washboard to produce the ultimate in chatterbumps.

- A two-foot-deep quagmire—the mud stretch.

- A water-fording basin more than three feet deep.

### Flexible measuring of data

The adaptation of telemetry for recording the test data, without the awkward tag-along and cables of a "mother" vehicle, was the creation of Charles B. Whitmore, a Pershing instrumentation engineer. He designed and installed the system.

The portable telemetry packages in the Pershing test vehicles, Whitmore says, provided 88 high- and low-frequency fm channels for measuring and recording obstacle reaction. The higher frequency channels were necessary for the more sensitive vibration tests—those demanding high-quality transmission for accurate data reduction. The only external attachments to the vehicle being tested were the transmitting antennas.

Through the use of a vibration analysis system, a conventional wave analyzer was employed to determine the frequency distribution (power spectral density) of the vibrations.

Time increments as short as 50  $\mu$ s could be examined with a variable-speed, wideband fm recorder that provided time expansion on the order of 32:1. A parallel array of one-third octave filters allowed rapid analysis of complex vibration data. The latter was printed out in real-time, hard-copy form.

The system has an analog-to-digital conversion capability of 20,000 twelve-bit BCD conversions

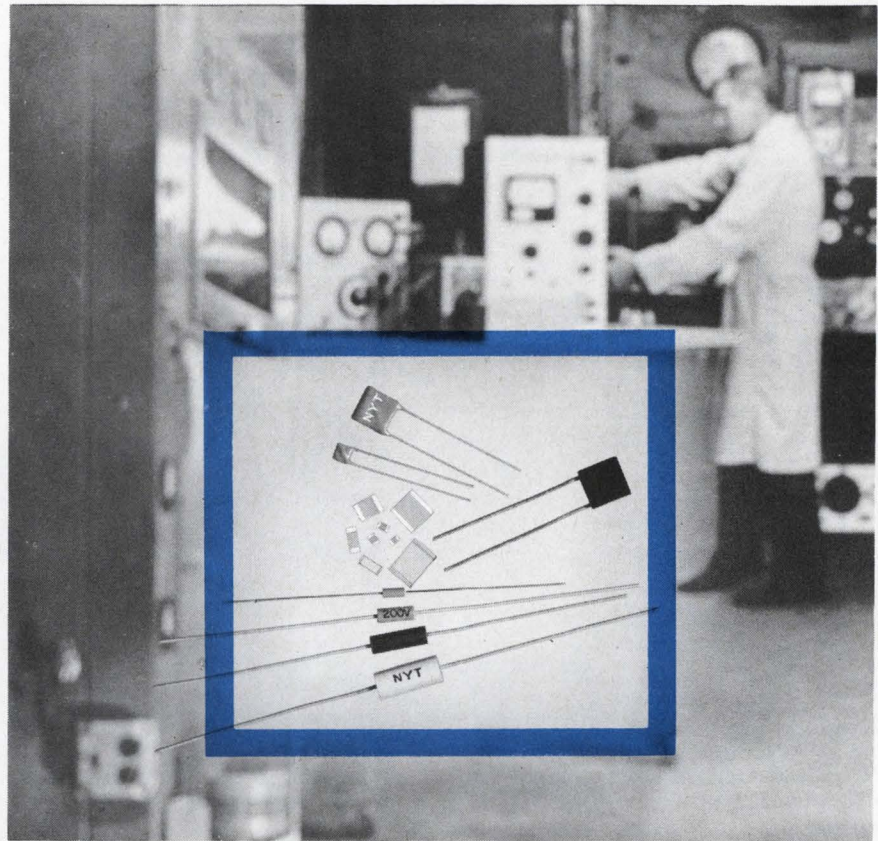

# NYT-CAP

## The better Ceramic Capacitor that Nytronics R&D built

Nytronics NYT-CAP ceramic capacitors are different. They had to be, because we wanted to make them *better*. That's why we did *not* use the old standard formulas. Our R&D people developed our own new formulas and methods to build a better capacitor — and in the process they eliminated failure modes others don't even know exist.

NYT-CAP "State-of-the-art" ceramic capacitors are designed to meet applicable requirements of MIL-C-11015, 39014 and MIL-C-20. Outstanding BX and NPO characteristics, superior humidity resistance, highest insulation resistance, low dissipation factor and long life are assured.

### NEW!

**FLAT-CAPS**—New radial lead hi-gloss epoxy conformal coated line offers higher capacitance density than molded case units, with no sacrifice in performance. Capacitance range of 2.2pf. to 1.0ufd.

**NYT-CHIPS**—For hybrid microcircuit application. This Series features capacitance up to 1 microfarad in BX dielectric and 10,000pf. in NPO.

**DECI-CAPS**—4.7pf. to 27,000pf. in 49 off-the-shelf values. Standard molded axial lead size of .100 inch diameter x .250 inch length for high density cordwood packaging.

**MILI-CAPS**—Natural outgrowth of Deci-Cap molded series. 10pf. to 3.3ufd. in the 5 molded axial lead sizes of MIL-C-11015 D/20B. Highest electrical and environmental performance over the entire capacitance range.

**HY-CAPS**—Similar to Flat-Caps but slightly larger package with capacitance range to 2.5uf.

**NPO NYT-CAPS**—4.7 to 10,000pf. Axial leads, molded.  $0 \pm 25$  ppm/ $^{\circ}$ C TC.

■ NEW CATALOG NOW AVAILABLE!



## NYTRONICS, INC.

*The quality line of standard components*

550 Springfield Ave., Berkeley Heights, N.J. 07922 ■ (201) 464-9300 ■ TWX: 710-984-7977

INFORMATION RETRIEVAL NUMBER 21

# Clare announces a new treat in General Purpose Relays

## *It's called the GP1.*

If you haven't heard the name before, it's because we haven't made it before.

You see, we didn't want to make just another general purpose relay. We wanted to make the best. Now we have it.

The new GP1 gives you everything standard 4 PDT, 3 amp relays do. Plus a lot more. Contacts rated at 1/10 horsepower, 240 volts AC. Opposite polarity capability. Largest selection of contact types.

And you can buy it at a price competitive enough to make you the company hero.

With every order of Clare General Purpose Relays, you get something no other company can offer. The Clare guarantee of outstanding service. The new GP1. Only from Clare.

The first of a complete line of Clare General Purpose Relays—all fully interchangeable with existing types.

For full information, circle Reader Service number, call your local Clare Distributor, or write C. P. Clare & Co., Chicago, Illinois 60645... and worldwide.

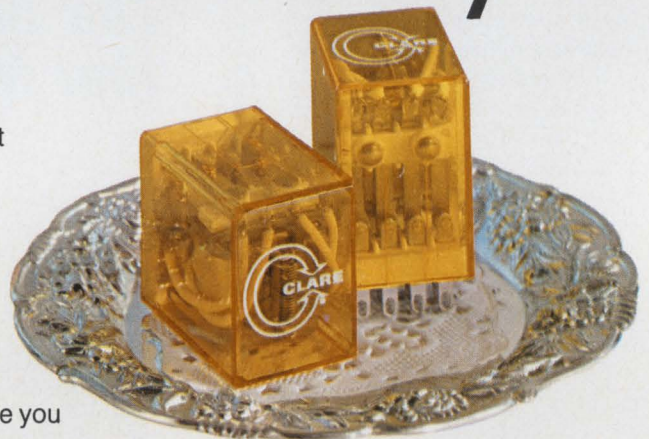

### **FREE SAMPLE**

A free sample of the new Clare GP1 General Purpose Relay is available to qualifying purchasing agents and engineers. For details, see reply card insert above.

LOOK FOR



**CLARE**

ON GENERAL PURPOSE RELAYS

a GENERAL INSTRUMENT company

INFORMATION RETRIEVAL NUMBER 192

(Pershing, continued)

a second, or 100 variables at 200 samples a second.

This flexibility, says Whitmore, combined with the time expansion technique, allows a maximum effective conversion rate of 640,000 samples a second.

Because of the limited number of fm frequencies available, the system uses time-shared telemetering. At the transmitter, a solid-state commutator, synchronized with a similar decommutator at the receiver, divides the pulse amplitude modulated signal into as many as 45 segments. Two of these segments are synchronization pulses for the paired commutators. The resulting signal is transmitted and then reconstructed at the receiver into meaningful data. ■■

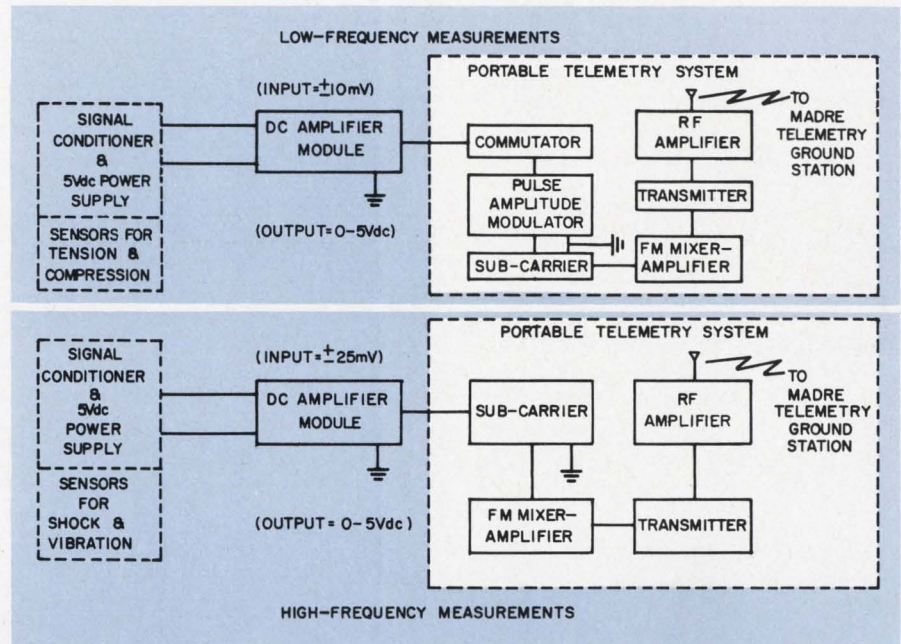

Fm telemetry system on Pershing missile system undergoing road tests transmits shock and vibration data to data reduction center.

## Pershing 1-A: A 400% greater wallop

The Pershing 1-A is a highly improved version of the original Army 400-mile-range, surface-to-surface missile system. With more missiles carried in each battery and with automatic self-testing and rapid countdown procedures in the new system, Col. Edwin A. Rudd, until recently the Pershing project manager, estimates a "better than 400 per cent increase in missile delivery capability."

Built by the Orlando, Fla., division of Martin Marietta Corp. under a \$31.1-million contract from the Army Missile Command, the weapon system has completely redesigned electronic ground-support equipment, and tracked transporters have been replaced by faster, softer-riding 5-ton vehicles. The two-stage, inertially guided nuclear missile itself remains unchanged, except for replacement of a few interface connectors for checkout and firing cables, Colonel Rudd says.

A typical U.S. Army Pershing battalion or West German "gruppe" includes one headquarters battery, one service battery and four firing batteries. Each battalion is self-sustaining tactically and administratively. Also, each firing battery is staffed to permit independent operations, separate from the

battalion headquarters, Colonel Rudd says.

The Pershing I-A battery structure is somewhat different. A new family of vehicles has been developed by the Ford Motor Co. Several (more than two but the exact number is classified) M757 prime movers (missile carriers) draw wheeled

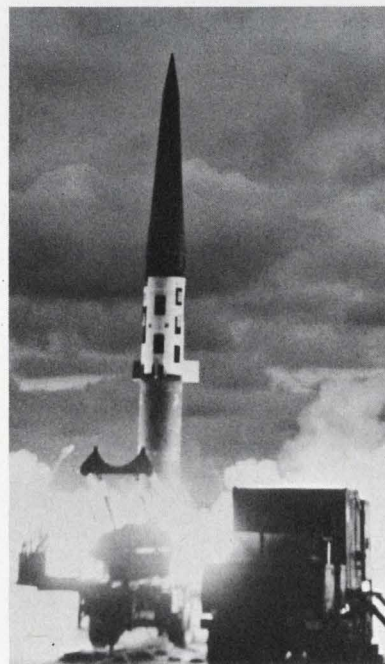

Pershing 1-A blasts off from mobile launch vehicle.

erector-launchers, each carrying a cradled missile first stage and a detached second-stage warhead. Three differently configured Ford M656 cargo trucks carry the supporting ground stations.

One of the ground-station trucks, the programmer-test van, has all the computer equipment for missile checkout and pre-launch and launch countdown. This van also carries the primary electrical power distribution system.

The second ground station provides the central radio terminal. It is equipped to provide either line-of-sight or troposcatter voice and teleprinter links. An inflatable paraboloidal-reflector antenna is carried, stowed, during road travel and is installed atop the van when ready for use.

The third ground station, a new unit added to the Pershing I-A battery, is called the battery control central. It is housed in an "expando-van" and is intended to provide the battery commander with a mobile command post. From this station, he can monitor system status and direct all firing activities. The station is connected with the central radio terminal to provide direct communications with the next higher headquarters.



# We make components for guys who can't stand failures.

You can't court-martial a capacitor or a resistor for refusing to carry out orders. But at Corning we make our capacitors and resistors for guys who are demanding enough to wish that they could.

We make components that give you an extra measure of performance. Components that let you make sure your system will deliver all you designed into it. Because like you and the guys who use your equipment, we can't stand failures either.

Take our glass capacitors, for instance. There's only one reason why they've been designed into the Surveyor, Minuteman, Gemini, Apollo, Saturn, Titan, Syncom, Sparrow, Hawk and a number of other major aerospace and missile projects. With our glass capacitors, their circuit designers could get the proven stability and reliability that these important systems demanded.

U.S. Air Force tests have established that our glass capacitors deliver much better stability and much higher insulation resistance than ceramic and mica capacitors.

And take our precision tin

oxide resistors. They're the best of the metal film class. Because the resistive tin film is completely oxidized and molecularly bonded to the glass substrate, our tin oxide resistors are impervious to moisture and environmental degradation. No other resistor can deliver the same stability and reliability over load life. They offer guaranteed moisture resistance across all ohmic values to set a standard of reliability that can't be matched by metal film, wire wounds, carbon comps or metal glaze resistors. After a 56-day-long heat test in an environment of extremely high humidity, our tin oxide resistors showed a resistance change of just 0.2 per cent. And in an ambient temperature test—now in its ninth year—not one of the 600 tin oxide resistors being tested has exceeded a resistance change of 1.5 per cent.

But don't only think of Corning for military and other precision applications. We've got something to offer when economy and value are the prime considerations. At Corning we've been active in improving these important capacitor

and resistor characteristics, too.

We've developed the Glass-K™ capacitor to give you the volumetric efficiency and economy of monolithic ceramic capacitors, but with the much improved stability and reliability that a glass dielectric can add.

In resistors, our tin oxide resistors already offer long-term economy over metal film, precision wire wound and metal glaze resistors. And our new C3 resistors, in addition to giving you a small case size, compete costwise with carbon comps.

At Corning we make components for guys who can't stand failures. Guys like your most important customers. Guys like you. So, next time you're designing a system, reach for your CORNING® capacitor and resistor catalogs and call your local Corning authorized distributor for off-the-shelf delivery. They'll help you design-in that extra measure of performance.

If you don't have our catalogs, ask your Corning distributor for copies or drop us a line at: Corning Glass Works, Electronic Products Division, Corning, New York 14830.

**CORNING**  
ELECTRONICS

# We could put astronauts on Mars in '82, if . . .

## Propulsion, electronic and physiological problems are big—and then there's the matter of money

Elizabeth deAtley  
West Coast Editor

Men on Mars in the summer of 1982? The obstacles would be great, but NASA is prepared to undertake the mission, if the nation is prepared to foot the bill. The space agency's administrator, Dr. Thomas O. Paine, estimates the round trip would take about two years (allowing three months to explore Mars) and would cost about the same that it took to put men on the moon—some \$24-billion. An optimum starting date for the mission, he points out, would be Nov. 12, 1981.

What technological advances would be needed between now and then to make such a trip possible? Scientists at NASA's Ames Research Center, Mountain View, Calif., have completed a preliminary study of the feasibility of a manned Mars flight and have informed views on the subject. As Harold Hornby, assistant director of special projects in the Office of Advanced Research and Technology, sees it, eight to 12 men could be sent to Mars as early as 1981, but it would require advances in the following fields:

- Propulsion systems. Nuclear rockets using hydrogen for fuel would be necessary to launch the mission.

- Electronics—particularly in the area of computers and power distribution systems. "Electronics will have to do an awful lot of work," Hornby says, "to make up for the fact that there are only a few people around."

- Physiology and psychology. Greater understanding is needed of human reactions under prolonged periods of weightlessness.

To launch a Mars mission into earth orbit," says Hornby, "you will probably have to build a much bigger rocket than the Saturn V. Not only would you have to have

much larger living quarters for a trip to Mars than to the moon but the larger spaceship would require far more fuel to take it out of earth orbit. The total payload that must be launched into near-earth orbit is about 1000 tons—and most of this is liquid hydrogen for the nuclear rocket that will boost the spacecraft out of earth orbit and head it on the journey to Mars.

### Rendezvous not feasible

"Of course, you could send up several separate tanks of hydrogen with Saturn Vs and rendezvous the tanks in space. Our calculations show it would take about 12 launchings to do this. We have had considerable experience with rendezvous maneuvers, and we know they can be done."

But a multiple rendezvous of liquid hydrogen fuel tanks, Hornby continues, is simply not feasible with the two launch pads present-

ly available at Cape Kennedy—and it would be very costly to build more. With two launch pads, it would take about a year to get 12 tanks up, and liquid hydrogen can't be stored that long in near-earth orbit—its boiling point is too low.

"Not only do you get heat from sunlight directly impinging on the rocketship in space," says Hornby, "but also you have the earth's atmosphere reradiating the sun's energy outward. So even with the good insulating systems we have today, it really wouldn't be very long before all the hydrogen had boiled off and you had, in effect, just a bunch of empty tanks in orbit."

Even if the problem of fuel boil-off did not exist, Hornby points out, "you would still have the problem of checking the systems out. After all, you've intercoupled so many fuel lines, electronic actuator systems, attitude control systems and so forth that you can't just assume 'all systems are go' and head for Mars. You'd want to

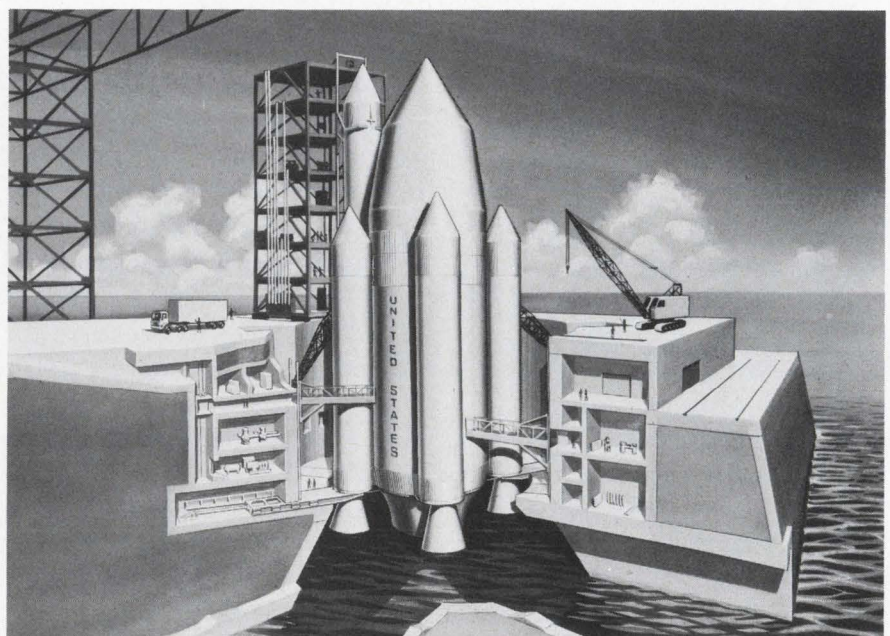

**Blockbuster rocket** would put an eight-to-12-man mission into earth orbit for a trip to Mars as early as 1981.



less  
than  
\$1.00\*

for new high performance  
A-B solid hot-molded  
variable resistor...

A-B Type W  
variable resistor  
shown about 5 times  
actual size

The QUALITY is Allen-Bradley—the price is COMPETITIVE! This new Type W variable resistor is a commercial version of the Type G control.

This Type W variable resistor features a solid, hot-molded resistance track for long operating life. Life tests show less than 10% resistance change after 50,000 complete cycles. Noise level is low initially and actually becomes less after normal use. Furthermore, the resolution is essentially infinite, and the low inductance permits operation at high frequencies where wirewound controls are useless.

The Type W control, while only  $\frac{1}{2}$  inch in diameter, is immersion-proof. The shaft is sealed with an "O" ring, making it watertight at that point.

Rated  $\frac{1}{2}$  watt at 70°C, the Type W can be operated at 120°C ambient with zero load. Nominal resistance values are from 100 ohms to 5.0 megohms.

For complete specifications on tolerances, tapers, and options, please write Henry G. Rosenkranz and request Publication 5212. Allen-Bradley Co., 1201 S. Second St., Milwaukee, Wis. 53204. Export Office: 1293 Broad St., Bloomfield, N.J. U.S.A. 07003. In Canada: Allen-Bradley Canada Ltd.

EC69-1



**ALLEN-BRADLEY**  
QUALITY ELECTRONIC COMPONENTS

*(Mars in '82, continued)*

check it out pretty carefully first, and for that you'd need some kind of space station to house all the mechanics you'd need for the job. After all, you can't very well have several hundred mechanics crawling around over a bunch of fuel tanks in space."

Because of these difficulties with the multi-rocket booster concept, Hornby says, he and his associates envision a single "blockbuster" rocket (see figure). The rough design allows for different numbers of strap-on rockets surrounding a large center rocket. This would make it possible to boost into orbit varying amounts of fuel. The distance to Mars varies by nearly 30 million miles, depending on how it lies with respect to earth at a particular time.

**Four men per MEM**

The lower cylindrical portion of the main rocket in NASA's concept would contain a hydrogen-oxygen fuel to boost the payload in the upper, cone-shaped portion of the rocket into near-earth orbit. In addition to the bulky hydrogen fuel container, the payload would consist of the main spaceship, one or two Mars Excursion Modules (MEMs) and the propulsion stages for entry into Mars orbit, landing and takeoff from Mars and for return to earth. Each MEM would be able to land four men on Mars, while the other four would remain behind in the main spaceship, or Manned Mars Module (MMM).

All systems for the Mars mission would be launched by the blockbuster rocket, except for the men and their earth re-entry vehicle. These would be launched separately by a smaller rocket—possibly a Saturn V—and would rendezvous with the apex of the main rocket.

NASA's Administrator envisions sending two side-by-side "space trains" to Mars. One would rescue the other in case trouble develops.

One of the big unanswered problems in the blockbuster-rocket concept is that of onboard checkout. "Even if you have checked out the entire system in earth orbit and know it is in good working order," Hornby notes, can you be sure, af-

ter a six or seven-month trip to Mars, that it is in condition to undergo entry into Mars orbit and descend to the Martian surface?" The only way to check out the system at such a distance from earth is to employ an onboard checkout system.

Edward Gomersall, technical manager of the blockbuster concept, agrees.

"We like to think in terms of an integral unit within the vehicle which actually has its own brains to check itself out," he says. "We see two different ways of doing this: (1) A centralized computer with wires to all the different parts of the vehicle, so you could ask for checkout of different parts, and this would all be centrally processed in one large central computer on board; and (2) Isolated smaller, less sophisticated computers. With each component or each system in the vehicle, you would have a self-checkout system that could only be connected to a sequencer and some sort of communications link with the ground. Each component would check itself out and then tell some central communicating device, 'I'm all right.' That eliminates a lot of wiring and complexity in the vehicle."

**Self-checking computer needed**

Of course, the logical extension of a computer that can check out a system is a computer that can check out itself. It would sense when one of its own circuits was out of order and "repair" itself by rerouting messages through different circuits.

This calls for much larger arrays of circuits, says Gomersall, and thus it would push the trend toward microminiaturization and the use of atomic phenomena for memory. It would also push the demand for more accurate sensors, which could detect incipient failures—in the form of very slight pressure changes, for example.

There would also have to be some means of on-board repair of equipment. "There will probably be whole series of instructions stored in computer memory or perhaps telemetered from the earth relative to something that is not functioning well," Gomersall says.

The power requirements of a

Mars trip would be enormous, Hornby points out. Not only would the computer itself eat up large amounts of power, but the communication system over the vast reaches of space would require many kilowatts of power at the final stage of amplification.

**More power for life systems**

Perhaps the largest power consumption would come from the life-support systems for the astronauts. Not only would this system have to supply living space, oxygen and storage for food, says Hornby. It would very likely also have to manufacture some of the astronaut's food and water for them out of their own waste materials.

The big elusive question mark in any interplanetary mission, Hornby feels, is the ability of man to survive in space for prolonged periods.

"I would suggest," he says, "that before we attempt such a mission, we must demonstrate that we can reliably build life-support systems that will last for several years. We will also have to demonstrate that we can keep man in a healthy and happy state of eating algae and being weightless. Maybe we will have to give him some periods of artificial gravity. Maybe we will have to put him on a centrifuge for an hour or so every day, or maybe we will have to introduce some spin into the spacecraft. We don't really know the answers to all these questions, and until we do, we really can't know the design of a spaceship that would take men to Mars and back."

These are some of the problems NASA would hope to solve by Nov. 12, 1981.

Hornby estimates that the total cost of developing the blockbuster and building a pad to accommodate it would be about \$4-billion. Some parts of the system have already been checked out, he says. The Air Force has fired nine 156-inch solid-fuel rockets of the type that would be strapped on the center rocket, and NASA has fired three 260-inch rockets of the same type. A single 260-inch rocket produced 5.5 million pounds of thrust—almost 3.5 times as much as that of each of the F-1 engines on the Saturn V booster. ■■



# Allen-Bradley cuts space requirements with new sealed type Z cermet trimmers

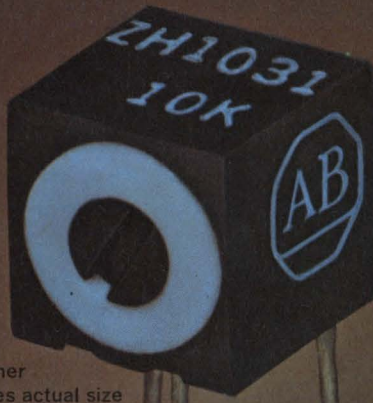

Type Z  
½-watt trimmer  
shown 5 times actual size

this latest addition to the Allen-Bradley line of cermet trimmers...the type Z...affords high performance in an especially compact package

The cermet material—an exclusive formulation developed by Allen-Bradley—provides superior load life, operating life, and electrical performance. For example, the full load operation (½ watt) for 1000 hours at 70°C produces less than 3% total resistance change. And the temperature coefficient is less than  $\pm 250$  PPM/°C for all resistance values and throughout the complete temperature range (-55°C to +125°C).

The Type Z is ruggedly constructed to withstand shock and vibration. The unique rotor design ensures smooth adjustment and complete stability under severe environments. The leads are permanently anchored and bonded. The connection exceeds the lead strength—opens cannot occur. Leads are weldable.

The enclosure is *SEALED*. It is both dust-tight as well as watertight, and can be potted. Mounting pads prevent moisture migration and also post-solder washout. For full specifications on this new spacesaving cermet trimmer, please write Henry G. Rosenkranz, Allen-Bradley Co., 1201 S. Second St., Milwaukee, Wis. 53204. Export Office: 1293 Broad Street, Bloomfield, N.J., U.S.A. 07003. In Canada: Allen-Bradley Canada Ltd.

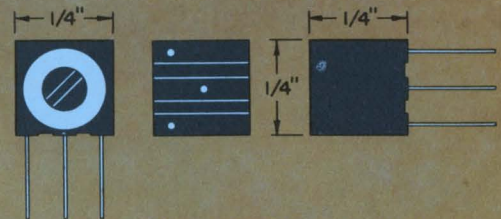

#### SPECIFICATIONS SUMMARY

- Adjustment:** Horizontal or vertical.
- Temperature Range:** -55°C to +125°C.
- Resistances:** 50 ohms through 1 megohm.  
Lower resistances available.
- Tolerances:**  $\pm 20\%$  standard,  $\pm 10\%$  available.
- Resolution:** Essentially infinite.
- Rotational Life:** Less than 2% total resistance change after 200 cycles.
- Rotation:** 300° single turn.
- End Resistance:** Less than 3 ohms.



 **The  
Trend  
is TTL.**

 6917A  
SN74150M

 6917A  
SN74151N

 6917A  
SN74151J

 6917A  
SN74152L

*To help you cut the cost of multiplexing...*

## TI announces a new 16-bit and two new 8-bit MSI data selectors.

Here are three new ways to cut the cost of multiplexing and related operations. Each of these data selectors/multiplexers selects one of sixteen (or eight) data sources determined by the binary address inputs.

Each contains both inverter-drivers and AND-OR-INVERT gates in a single package.

This reduces your design time, inventory requirements and circuit costs. In addition, manufacturing costs are reduced and reliability is improved.

Applications include:

- Boolean function generation
- Random or sequential parallel-to-serial conversion
- Multiplexing from N-lines to one line (or N lines to M lines)
- Read-only memory or pulse-pattern generation.

SN54150/SN74150 are 16-bit data selectors in 24-pin plastic packages (left). SN54151/SN74151 are 8-bit circuits in either the 16-pin plastic or ceramic dual-in-line packages

shown at the left. SN54152/SN74152 are 8-bit selectors available in the 14 pin  $\frac{1}{4}$ " x  $\frac{1}{8}$ " flatpacks.

An SN7493 4-bit binary counter may be used as the select register to perform sequential selection. Or a register with parallel load capability—such as the SN7495—will provide flexibility to perform random selection and/or pulse pattern generation.

Any Boolean function of up to five variables can be implemented with the SN74150 without any external gating.

Any number of bits—and any word length—may be multiplexed by paralleling and cascading circuits. Decoding may be accomplished with SN7442 BCD-to-decimal decoders.

Propagation delay is only 10 ns from data input to output, and 20 ns total through three select levels.

Power dissipation is low...only 200 mW typical for the SN74150.

The SN54151/SN74151 features complementary outputs, while

SN54150/SN74150 and SN54152/SN74152 have inverted outputs.

SN54150/SN74150 and SN54151/SN74151 have strobe inputs to enable the data selectors. This provides maximum flexibility when cascading the circuits.

### New TTL Design Aid

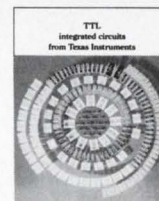

These new data selectors/multiplexers take their places in industry's broadest line of TTL/MSI circuits. To tell you

the full story, we have just completed a new 80-page brochure that gives valuable design information on all Series 54/74 circuits including the data selectors. Circle 195 on the Reader Service card for your copy...or write Texas Instruments Incorporated, P. O. Box 5012, MS 308, Dallas, Texas 75222.



**TEXAS INSTRUMENTS**  
INCORPORATED

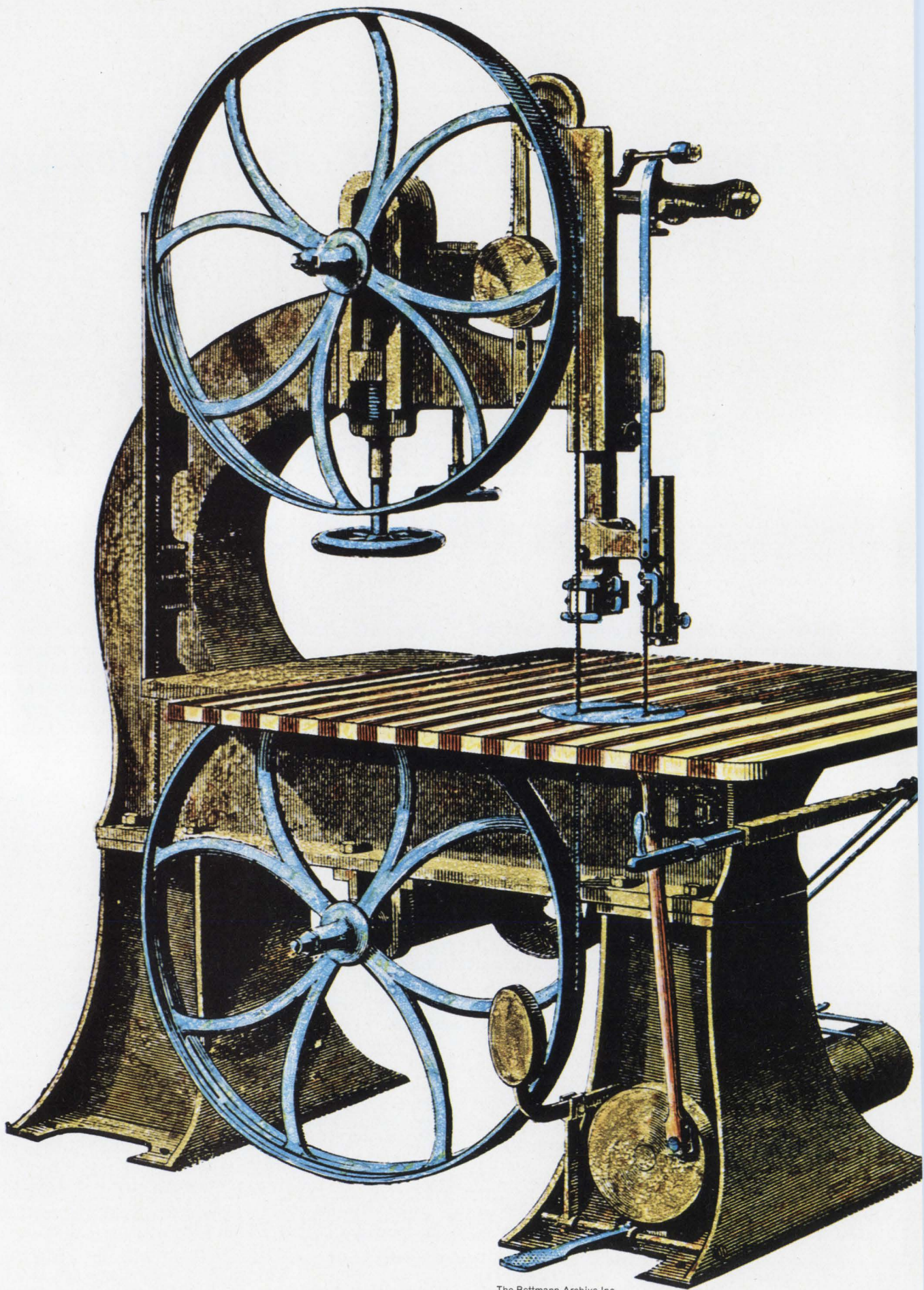

# MAGNETICS BY ARNOLD



**CUT SOME FANCY CURVES!** Operating an old-time bandsaw was no push-over. Today, it's a snap of the switch and a motor does it for you...easily, smoothly, steadily. A motor that's probably actuated by an Arnox® hard ferrite permanent magnet. What's more, Arnold's magnetic materials perform a similarly efficient job for a lot of other machine tools—including the computer-driven ones.

Forward-looking manufacturers always look to Arnold for high-quality magnetic materials, design, technology, components. Magnetic cores. Powder cores. Laminations. You ask. We'll supply. The best in magnetic materials.



**ARNOLD**  
SPECIALISTS IN MAGNETIC MATERIALS

The Arnold Engineering Company, Main Office: Marengo, Ill.  
Branch Offices and Representatives in Principal Cities.

Other Arnold products offer a lot of potential both in machine tool operation and control: MPP and powdered iron cores • Tape and Bobbin cores • Alnico and Arnox® permanent magnets • Supermendur transformer cores.



Write for your free guide to the only complete line of magnetic materials.

Whether you *build* or *buy* many *Hi-Rel* semiconductors, do you ever wonder how you can get hold of them faster, at less cost?

Don't hire yourself a High Production Pyromaniac. Ogden's new BURN-EZE custom semiconductor burn-in systems are a much better idea.

It's really economical to own and operate BURN-EZE systems because we've overcome the problems associated with other makes — low density, costly maintenance, and high operating costs.

Others use a large PC board for socket mounting. Expensive, easy to break. — Forget them! — Taped over and dummy sockets filled with broken leads? — Forget them too! — We've devised a unique, little, inexpensive PC board for each socket. Broken lead sockets are simply replaced with new ones.

The unusual way we mount these little boards in BURN-EZE system trays also permits dollar saving densities of up to 1000 devices per cubic foot. More output per oven means fewer ovens and less of that expensive floor space. Lower fuel bills too!

More savings. — An external cable and parallel tray connector arrangement permits devices to cool *outside the oven under bias*. Reduced heat loss means more devices processed per hour, less fuel. Meets bias/cooling Mil Specs too.

BURN-EZE systems are made for TO-5 and TO-18 Transistors, TO-5 ICs, Dual In-Lines and Flat Paks. They operate from 20° to 200° C. We'll supply the oven or install our systems in your old one. All easily programmable. With or without power supplies.

Ask for our new BURN-EZE brochure from any of our facilities.

#### Ogden Technology Laboratories, Inc.

Facility locations:

Deer Park, New York  
(516) 667-7200

Oklahoma City, Oklahoma  
(405) 946-9986

Sunnyvale, California  
(408) 739-5900

Beaumont, California  
(714) 845-1103

Woodside, New York  
(212) 478-2010

Monterey Park, California  
(213) 289-4425

Fullerton, California  
(714) 879-6110



## High Production Pyromania?

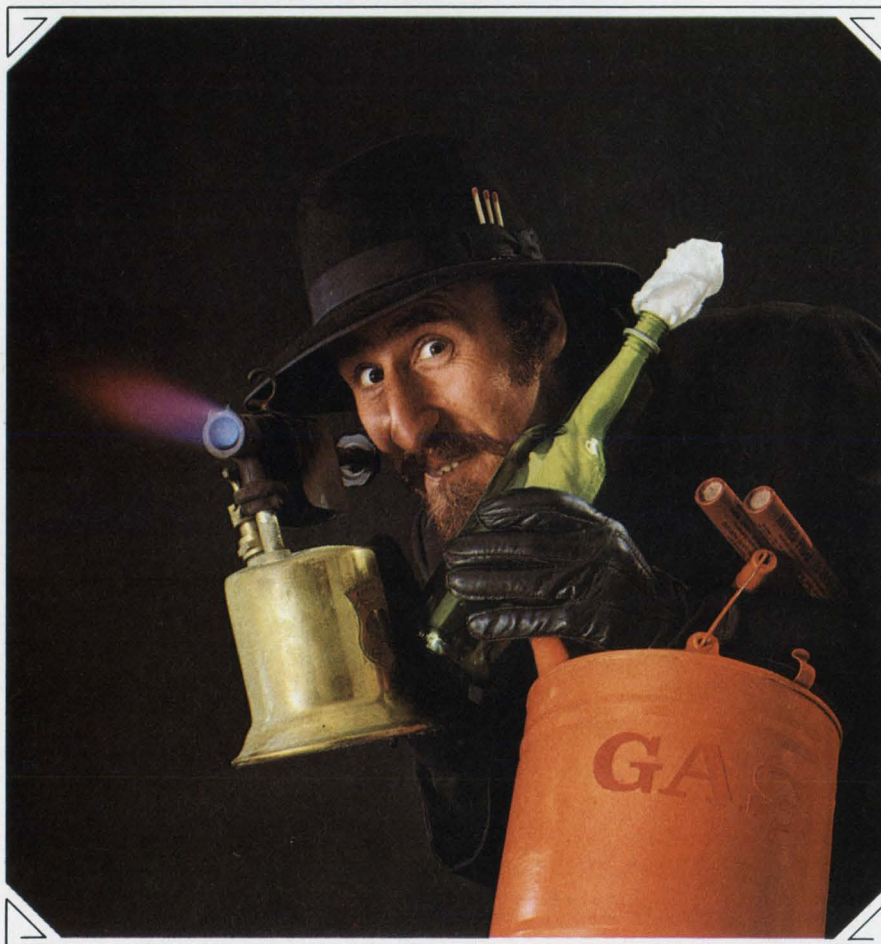

After ABM: MIRV

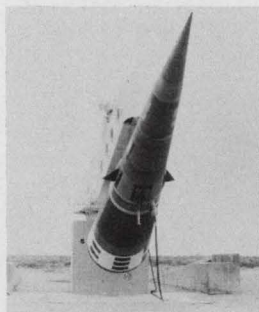

# Washington Report

CHARLES D. LAFOND  
WASHINGTON BUREAU

## Next: The Battle of MIRV

With the battle for deployment of the Safeguard ABM system won in Congress, the next missile entanglement on Capitol Hill will revolve around MIRV (Multiple Independently Targetable Re-entry Vehicles). The MIRV concept calls for dispersal of a group of warheads from a single strategic missile. Each warhead has its own guidance system. Those in Congress who are for MIRV argue it is necessary for our second-strike force to assure circumvention of any Soviet ABM system. Critics declare that any move toward deployment of MIRV will start another round of nuclear weapons escalation (the same argument used against ABM).

The Dept. of Defense has indicated that it has already deployed multiple re-entry missiles—only they are not individually guided. On release they fall downward in a predictably spaced pattern, due to both the release mechanism and the individually designed flight dynamics of the warheads. Such vehicles are believed to have been installed in clusters of three atop Minuteman II and Polaris A-3 missiles.

That the Pentagon is continuing with MIRV development is becoming more and more apparent. For example, last month, in the military's normal announcement of contract awards, there were two contracts for over \$1-million each to General Electric and LTV Aerospace Corp. for studies of "advanced post boost" systems for missiles. Also, there was an announcement of a \$3.87-million award to Singer-General Precision, Inc., for study of an "inertial instrument development of the Advanced Ballistic Re-entry System." The latter is the so-called ABRES program, long known as the development effort leading to MIRV. Other contract awards associated with the Minuteman III program,

involving North American-Rockwell and General Electric, also give indication of continued MIRV research.

The contracts mentioned deal with either the study of actual production of prototype hardware, as in the Singer award. Congressional opponents are now expected to wage a strong fight to block any move to large-scale production and subsequent deployment—at least in the near future. However, the current Pentagon belief is that the Soviet Union, like the U.S., has developed multiple re-entry vehicles without individual guidance and is working hard on MIRVs.

Dr. John S. Foster Jr., director of Defense Research and Engineering, says: "We need a more reliable method of delivering our deception devices and our warheads. We need, essentially, to be able to spread them out in space, so that one Soviet defensive nuclear burst cannot destroy several American warheads or a whole cloud of decoys."

## Mars landing called premature

Quickly quashing hopes of many top NASA officials, Rep. George P. Miller (D-Calif.), chairman of the House Science and Astronautics Committee, declares he is "not against going to Mars or elsewhere," but he does believe that now is not the time. He suggests that such a goal might be more opportune in 5 to 10 years because the nation needs more experience in long-duration manned space flight and more extensive unmanned space exploration. Rep. Miller also says that more fundamental knowledge of Mars is necessary before we can determine the importance of landing a man on that planet within the century. He appears to agree with NASA officials

in striving for a more "balanced" program. For manned operations he supports continued lunar exploration and the presently planned manned Earth orbital operations during the next decade. But he also believes there should be more emphasis on applications-type satellites that offer an obvious economic return—such as the Earth Resources Survey satellites.

The budget should be increased, he declares, on a proportional basis for unmanned planetary exploration and he also calls for continued R&D on nuclear rocket engines. The latter may well be a requisite for a manned Mars exploration program.

## Splashdown detector goes 'splash!'

The Air Force's experimental Interim Buoy System, being deployed to help pinpoint the impact point of missiles fired down the Eastern Test Range from Cape Kennedy, has got off to an unlucky start. The first buoy, housing a \$70,000 acoustic detecting device, was lost in deep water off Antigua in the Caribbean.

The instrument was being lowered into the sea by the crew of the Coast Guard cutter Sagebrush, when, according to one official, "the whole thing just kept right on going down." The buoy was attached to a cable, intended to anchor the instrumented package in a permanent position. Observers indicated that the instrument got fouled with the cable and that this combined with high wind and waves, prevented correction of the problem.

The Interim Buoy System will consist of at least four buoys, each carrying two or three wideband hydrophones, deployed in a 10-mile-diameter circle. The experimental array is intended to provide the instruments and techniques that, hopefully by next year, will be embodied in an

Advanced Impact Location System. The Air Force is seeking a system that will spot and identify multiple warhead impacts that are closely spaced.

The instrumented buoy lost is one of 10 prototypes being built for the Air Force by the AC Electronics Div. of General Motors.

## Are the new tanks worth the cost?

Some Congressmen are shaking grave heads over further authorization of development funds for the Main Battle Tank (MBT-70). The armored vehicle was conceived and initiated as a joint venture with West Germany in 1963 to produce a weapons system that could operate in the event of a Western European tactical nuclear war. But the project has been refined to the point where development costs for the tank "have risen from \$86-million to over \$300-million," according to Sen. William Proxmire (D-Wis.)

The prime contractor, General Motors, was practically given carte blanche to develop the tank. GM even included an automatic laser range-finding instrument in the fire-control system, built by its AC Electronics Div. But it now appears that, even if all the bugs are worked out of the MBT-70, the projected production cost for each tank will be between \$600,000 and \$700,000, or nearly three times the cost of the M-60 tank it is supposed to replace.

The MBT-70 is considered the most advanced weapon of its type. It has an unusually powerful engine and special protective steel that is resistant to nuclear weapons under some conditions. It also uses a highly advanced computer-driven and gyroscopically controlled fire-control system for its multifunction cannon, which is capable of firing both 152-mm artillery shells and the Shillelagh missile through the same barrel.

The current military authorization bill seeks only about \$55-million to continue development of the tank. This part of the program has been recommended by the Senate Armed Services Committee, but with a reduction of \$11.7 million. Opponents, who would like to scrap the whole project, say the performance of the present M-60 tank is only marginally below the MBT-70.



# Our 5-band carbon comps are cats of a different stripe



Okay, so the other leading brand is also great on military specs. But our Speer resistors have still more to offer. □ They provide superior soldering characteristics. They're backed by the first and most sophisticated on-line computerized resistor quality control system. They're delivered in an exclusive foil pack. □ And they're accompanied by written documentation. □ Another helpful note—both our ½-watt and ¼-watt types qualify under the new Established Reliability Specification at the S level. □ Our 4-band carbon comps are something special, too—particularly now. They offer all of our traditional quality features—plus competitive prices. □ To learn more about our resistors—and the reliable customer service that backs them up—write AIRCO SPEER ELECTRONIC COMPONENTS, St. Marys, Pennsylvania 15857. □ Five "stripes" or four—you may even decide we're a whole new breed.

The passive innovators at **AIRCO** Speer

Speer resistors □ Resistor and conductor paste □ Jeffers JC precision resistors □ Jeffers JXP precision resistors and networks □ Jeffers inductors □ Jeffers capacitors □ PEC variable resistors and trimmer potentiometers.

# PROTOTYPES

We'll ship them immediately—toroids and oscillators\* right out of stock—at far below competitive prices.

At Allen Electronics Division, we manufacture these, and other components, in quantity for the world's finest electronic organs. So we constantly maintain a complete stock of high quality frequency sources, and over 150 sizes of toroids. We'll send you the few you need to start your idea; the many you'll need to produce it.

All Allen components are made under the most rigid quality controls, including thorough inspection and testing, at one of the most modern and efficient plants in the country.

Send for complete information on the "Prototypes". Then, when you have an application that requires quality components immediately, at no-penalty prices, you'll know where to get them. Pronto.

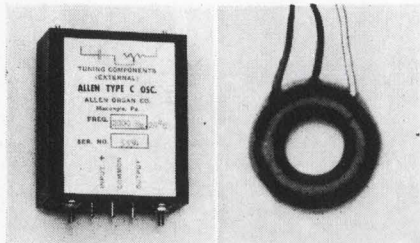

**Type C Oscillator**  
Range: 15 Hz to 10 kHz  
Use: Designed for applications having moderate requirements for stability in respect to temperature and frequency drift.

**Toroids**  
Over 150 sizes available from stock include Permalloy, Ferrite and Powdered iron types. Some no-center-tap. Inductance tolerance  $\pm 2\%$ .

\*Allow several extra days for packaging.

## ALLEN electronics division



Dept. ED969  
Macungie, Pa. 18062

INFORMATION RETRIEVAL NUMBER 35

## Pardon us while we catch our breath

So you're just back from Wescon, and maybe ELECTRONIC DESIGN helped you plan your visit to the show a little better than you might have on your own. Or possibly ELECTRONIC DESIGN filled in for you in San Francisco, and you took the grand tour at home or at your engineering desk, simply by turning the pages of the special sections we ran Aug. 2 and Aug. 16. In either case, you can be sure of one thing: No other magazine gave you more coverage of the event than ELECTRONIC DESIGN did.

We had six editors at Wescon. We printed roughly 85 pages, or nearly 40,000 words of copy, about the show. We ran dozens of photos in four colors and black and white. And we do the same each year for the IEEE Convention and Exposition in New York.

Extra sweat for our staff? You bet it is. For instance: Our New Products Editor writes letters to the hundreds of exhibitors at the show *before the show opens*, requesting details on the products they plan to display. Hundreds of follow-up letters and more than a hundred phone calls later, and the significant details begin to take shape. Our technical editors get in touch with the authors of papers *before they deliver them*. The big hangup here, though, is that many engineers don't get around to completing the final drafts of their papers until the night before the show opens—or so it seems at times. But we get the significant. Extra sweat does it.

When the show opens, the rat race really begins. At Wescon, for instance, the editors met each morning to compare notes and then rarely saw one another again all day. They were too busy using their eyes and ears for you—talking with the experts and picking up new ideas for future stories.

There are other annual shows in the electronics industry. Wescon and IEEE are the biggest and get the fullest treatment. But the others are reported, too, in detail.



When the show opens in the Cow Palace the rat race really begins. The editors are on the job early.

# It's time for a change in your digital displays! Increase versatility, decrease costs — with RCA's new NUMITRON Digital Display Devices

Compare these RCA product advantages:

- Sharper, cleaner displays
- Controllable high brightness
- Up-front planar numerals for wider viewing angle
- Unlimited filter-color selection
- Low voltage operation—designed for 4½ V
- Fully compatible with RCA's new Integrated Circuit Decoder/Drivers

- Rugged construction
- Long life—high reliability
- Designed for low-cost 9-pin miniature sockets

Interested? For more information on the new RCA NUMITRON Digital Display Devices, contact your local RCA Representative or write to RCA Electronic Components, Commercial Engineering, Section ICG-9, Harrison, N.J. 07029. Also ask for

data on the new RCA Integrated Circuit Decoder/Drivers, especially designed for use with RCA's Digital Display Devices. Type Numbers of NUMITRON Digital Display Devices:

RCA-DR-2000—Numerals 0 through 9  
RCA-DR-2010—Numerals 0 through 9, with decimal  
RCA-DR-2020—Plus-Minus and Numeral 1  
RCA-DR-2030—Plus-Minus

Unretouched photograph of operating NUMITRON devices mounted on plastic tubing.

**RCA**  
Digital Display Devices



Behind the new versatility and lower costs of digital displays...

# RCA's New 7-Segment Decoder-Drivers

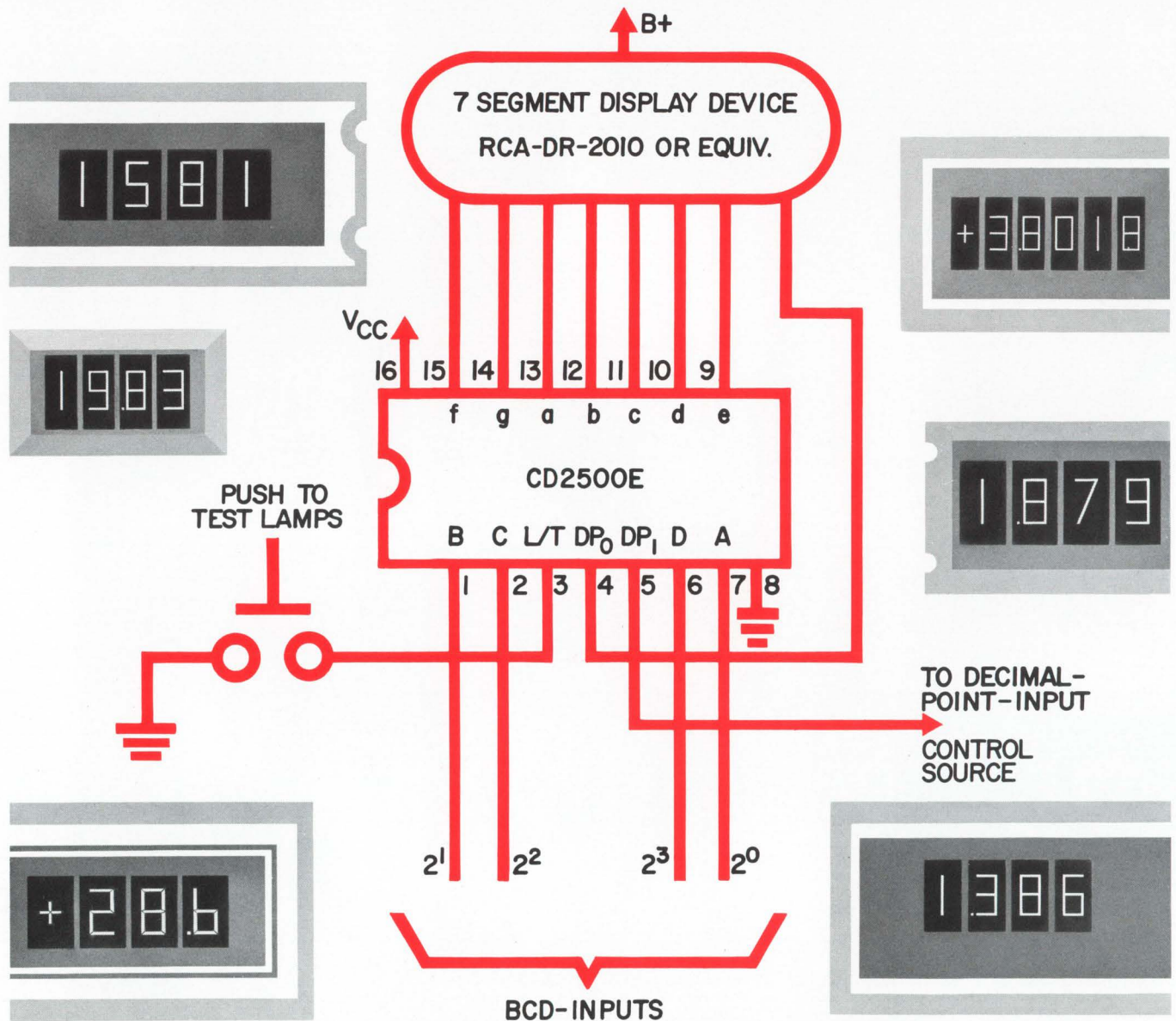

Whether you drive your digital displays with low current or high current, your drive circuits can now be more versatile—simpler—lower in cost. RCA's new CD2500E series of 16-lead DIP 7-segment Decoder Driver MSI integrated circuits includes both 30 mA devices for driving RCA's new NUMITRON 7-segment Digital Display Units and 80 mA devices to drive miniature low-voltage lamps or relays.

Look at the tabulation of the new CD2500E devices. Compare their prices and their advantages with present decoder-drivers and decoder and driver combinations. Then contact your local RCA Representative for details. For technical data, write to RCA Electronic Components, Commercial Engineering, Section ICG 8-3, Harrison, N. J. 07029.

RCA's 7-segment Decoder-Drivers		
Operating Current per Segment	Type Number	Price (1,000 units)
30 mA 80 mA	CD2500E CD2502E	\$6.75 \$8.00 with decimal point
30 mA 80 mA	CD2501E CD2503E	\$6.75 \$8.00 with ripple blanking
<b>ADVANTAGES</b>		
<ul style="list-style-type: none"> <li>* Power supply and input voltages compatible with DTL and TTL devices</li> <li>* Lamp test provision</li> <li>* High current sinking capability for direct display driving</li> </ul>		<ul style="list-style-type: none"> <li>* Clamp diodes on all inputs</li> <li>* Intensity control capability</li> <li>* Over-range detection</li> <li>* 0° to 75°C temperature range</li> <li>* Lamp supply voltage up to 8 V</li> </ul>

**RCA** Integrated Circuits

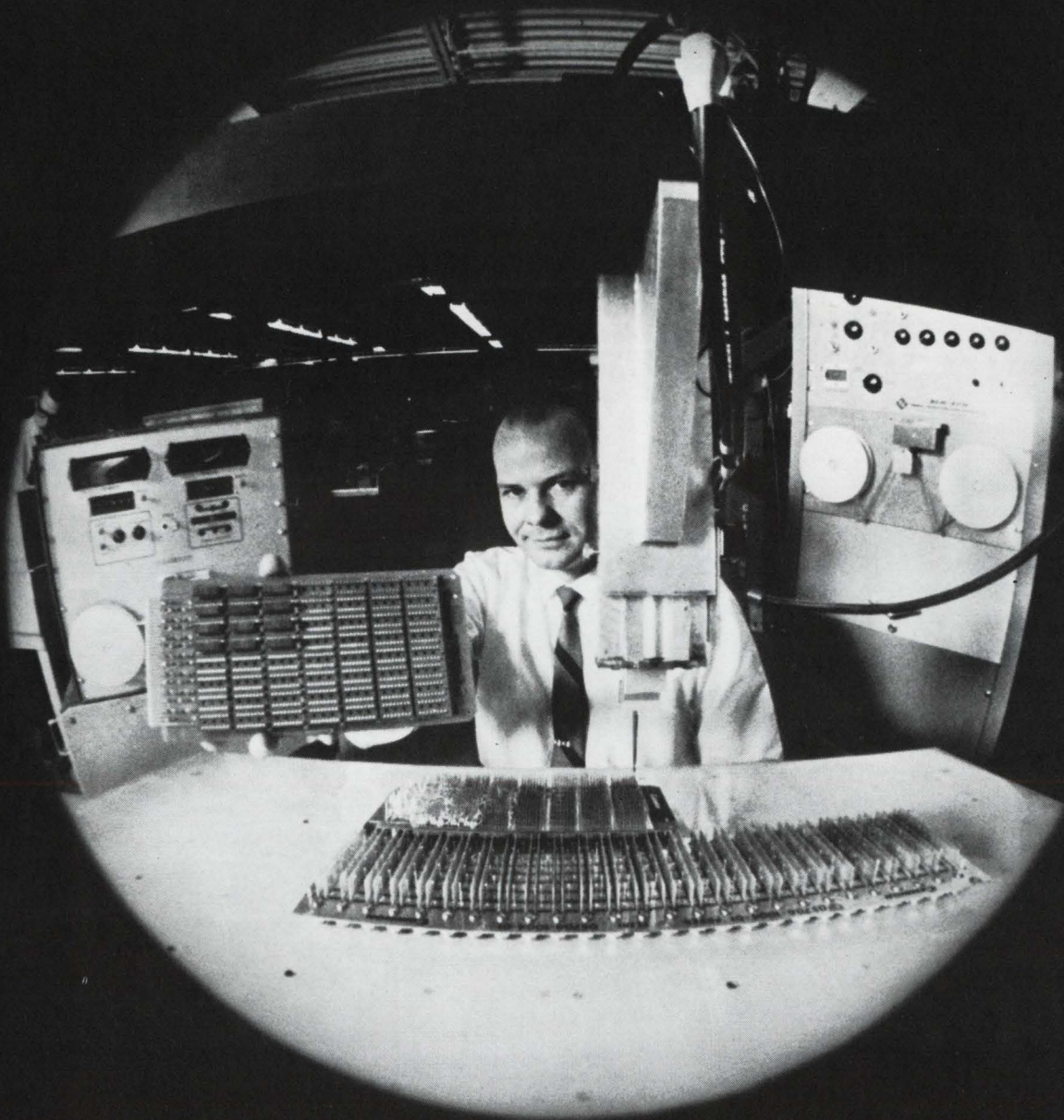

## Do you or don't you?

Whether you're a budget-minded do-it-yourselfer or a guy who needs to save time, CAMBION's high density Wire-Wrap\* system components let you have it your way. Quality 14, 16, 24 or 36-pin Wire-Wrap sockets, cards, card files, power planes . . . you save time and money when you build your systems with the new CAMBION line.

Whether you're building a sub-system or a full logic complex, with CAMBION Wire-Wrap components, you'll have a modular technique that provides maximum flexibility of design, high density packaging and noise immunity.

Is our automated production facility working for you? If not, let's get together!

If you want to start your design further along, we will wire-wrap our cards and package sub-systems for you.

To get the big picture of what CAMBION can do for **you**, ask for our latest literature on CAMBION Wire-Wrap products and facilities. We'll include your Logic Manual as well. They're both fact-packed to save you time and money. Free, too. Cambridge Thermionic Corporation, 457 Concord Avenue, Cambridge, Massachusetts 02138. Phone: (617) 491-5400. In Los Angeles, 8703 La Tijera Boulevard 90045. Phone: (213) 776-0472.

Standardize on

**CAMBION**<sup>®</sup>

*the guaranteed electronic components*

\*Registered Trademark of Gardner-Denver Co.

INFORMATION RETRIEVAL NUMBER 29

# The Emancipator Becomes a Show-off!



The HP 9100A Calculator gave you

**Freedom from waiting** to get on the BIG computer;

**Freedom from translating** your problems into foreign computer languages;

**Freedom from starvation-level computing** with under-developed calculators;

**Freedom from the drudgery of manual computation**—  
All for the one-time price of \$4400.

## **NOW — EVEN GREATER COMPUTING FREEDOM IS YOURS. GRAPHIC DISPLAY**

Add the new HP 9125A X-Y Recorder. Make your HP 9100A desk-top computing calculator a show-off. You will be liberated from the tediousness of hand-plotting, from the

omnipresent human errors and from inundating reams of data that go with point-to-point hand plotting.

Think back! Would a picture be worth a thousand figures, to you? ... to your company? Be an innovator ... be a producer ... a picture producer.

The 9125A recorder automatically draws the answers as the calculator solves your problems—such as network response (photo shows Tchebysheff filter response expanded around  $f_c$ ), differential equations, roots of polynomials and curve-fitting. It shows you the results of your calculations faster, easier, and more accurately than you can get with hand plots! It ends the gnawing frustration of interpreting the limbo between data points. And ... it gives you a calibrated plot so you can read your units directly!

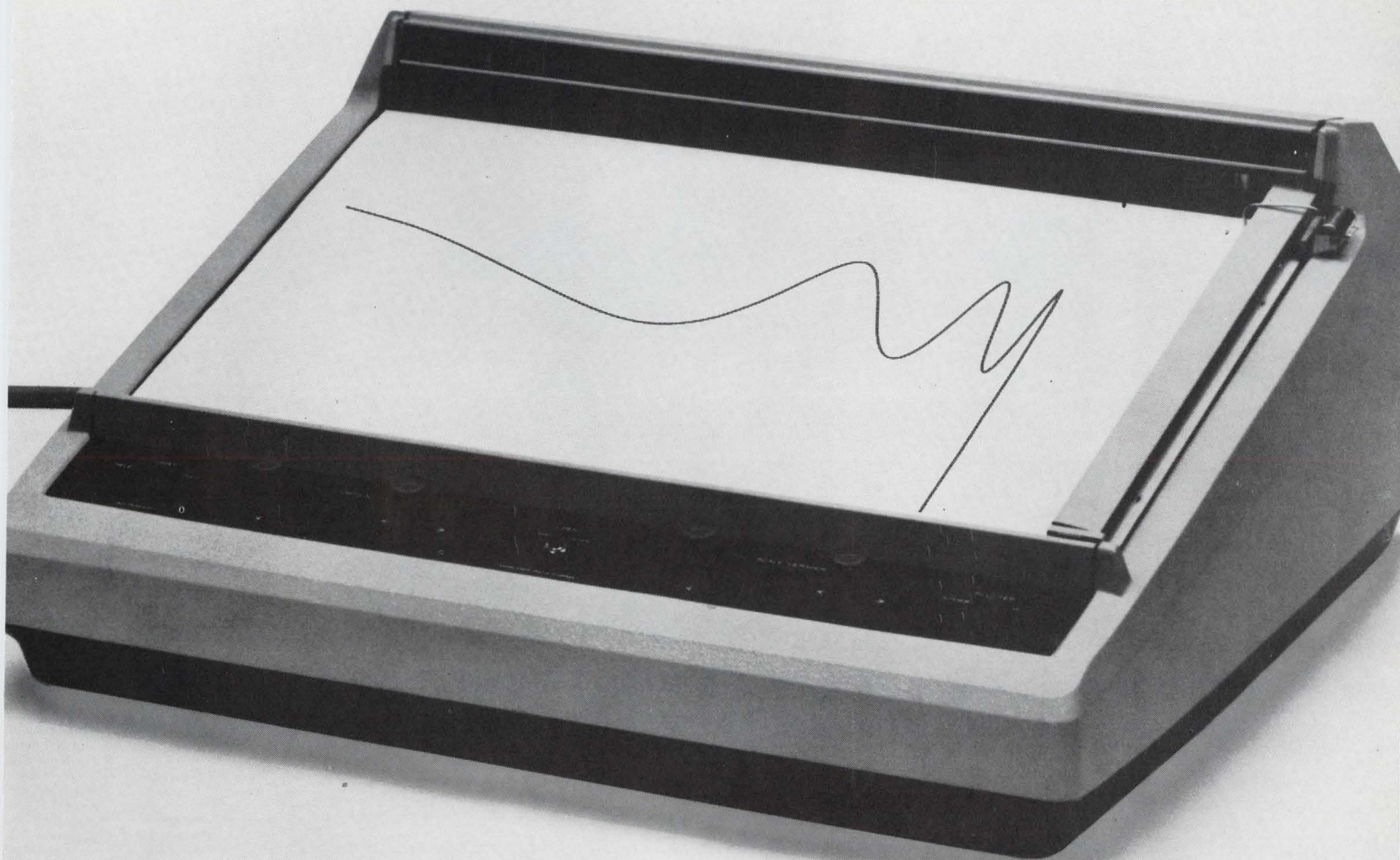

What's more, once the 9125A has given you a permanent graphic presentation, you can modify the input data, plot again, and immediately see the changes you have made. Nuances in areas of critical importance can be readily identified because of the pin-point resolution of the calculator/recorder combination—a resolution made possible by the four-digit calculator output that locates coordinate points with hair-splitting accuracy.

Completely documented programs for use with the HP 9100A Calculator and the HP 9125A X-Y Recorder are supplied with your instrument.

Show off with the 9125A for only \$2475. Add \$4400 if you don't already have the 9100A. Both are ready for immediate delivery.

Start your new liberation today. Call for a demonstration or send your purchase order to any Hewlett-Packard Sales and Service office (located in principal cities throughout the world). For a 22-page brochure, write Hewlett-Packard, P.O. Box 301, Loveland, Colorado 80537. Europe: 1217 Meyrin-Geneva, Switzerland.

*9100A/9125A puts answers just a glance away!*



INFORMATION RETRIEVAL NUMBER 30

# Maintainability<sup>3</sup>



Systems maintainability is assured by Minelco's power of 3: BITE (Built in test equipment) indicators that pinpoint circuit faults, say GO or NO GO. Elapsed Time indicators that tell you how long things have been going on. Events Counters that tell you how often they've happened. And Minelco is the exponent of the maintainability component. Miniature and subminiature—in a size, configuration, and type for every requirement—for *your* requirement. Minimize downtime... get up with the Big Time.



## **MINELCO®**

SPACE AND SYSTEMS DIVISION



GENERAL TIME

High Ridge Park, Stamford, Connecticut 06904

*For information and specifications, contact our local representative:*

Huntsville, Ala. (205) 883-0244 / Phoenix, Ariz. (602) 267-3916 / Palo Alto, Calif. (415) 326-4186 / San Diego, Calif. (714) 298-1121 / Orlando, Fla. (305) 851-1210 / Marietta, Ga. (404) 422-8242 / Berkeley, Ill. (312) 544-7400 / Indianapolis, Ind. (317) 925-3528 / Santa Monica, Calif. (213) 451-5711 / Wichita, Kans. (316) 683-7518 / Waltham, Mass. (617) 894-9165 / Bridgeton, Mo. (314) 731-3011 / Plainview, N.Y. (516) 681-8710 / Utica, N.Y. (315) 735-8341 / Columbus, Ohio (614) 231-4571 / Dayton, Ohio (531) 224-0728 / Devon, Pa. (215) 688-5157 / Fort Worth, Tex. (817) 335-4541 / Arlington, Va. (703) 525-1191 / Bellevue, Wash. (206) 454-7922.

**BITE INDICATORS • ELAPSED TIME INDICATORS • EVENTS COUNTERS • ROTARY SWITCHES • TRIMMER POTENTIOMETERS**

INFORMATION RETRIEVAL NUMBER 31



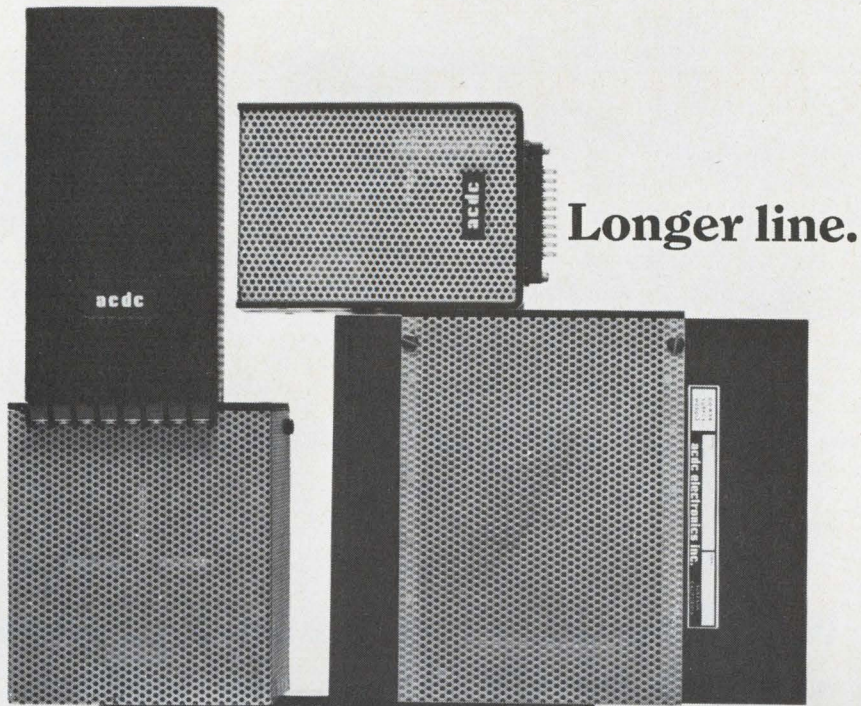

Longer line.

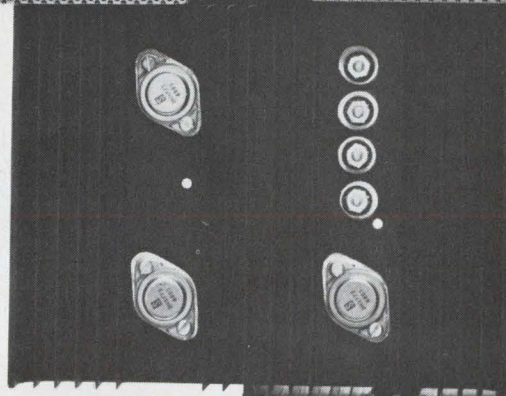

Shorter delivery.

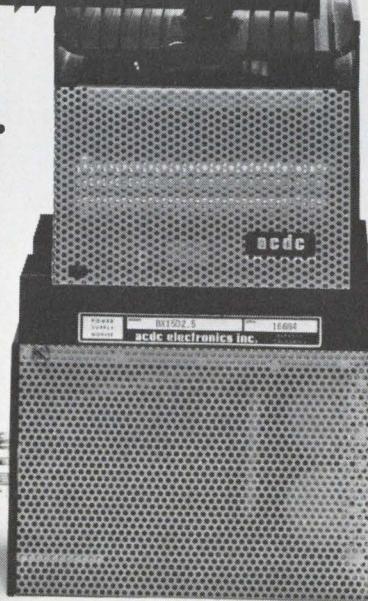

We've added more power supplies. And put more of them on the shelf. So now you get a wider selection and faster delivery. Write for our complete catalog. (It includes the new miniaturized JR.) **acdc electronics, inc.** 2979 N. Ontario St., Burbank, Calif. 91504.

# PRE-ENGINEERED POWER!

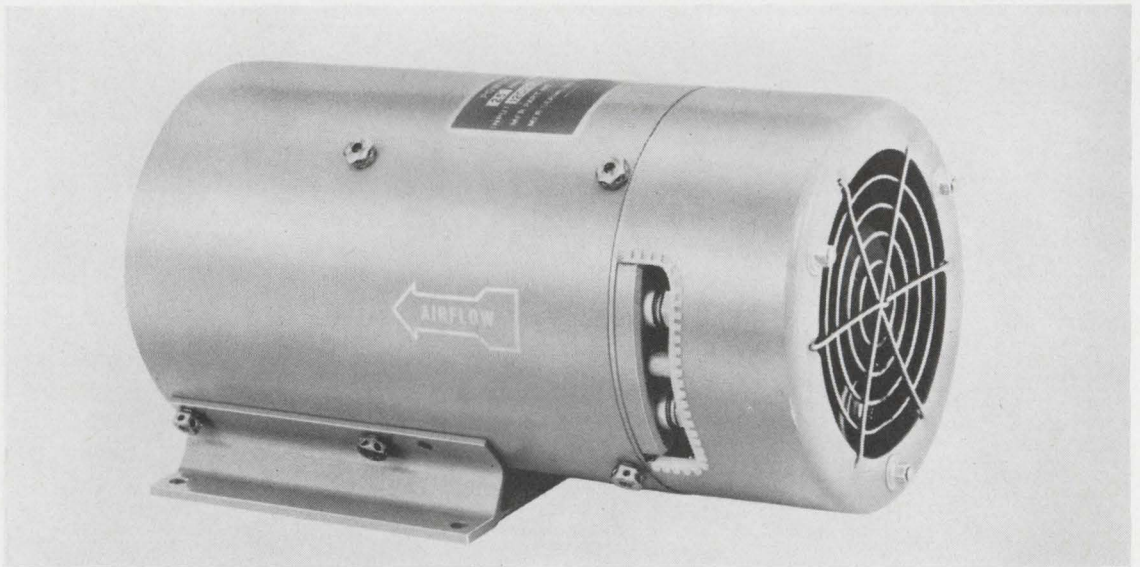

**28G5P** 47-65 Hz input (also style 28GP for 400 Hz), high-efficiency 28 V.D.C. output; lightest, most compact static unit.

**Here are two readily available ways to get dependable 28 V. D. C. high-current power**

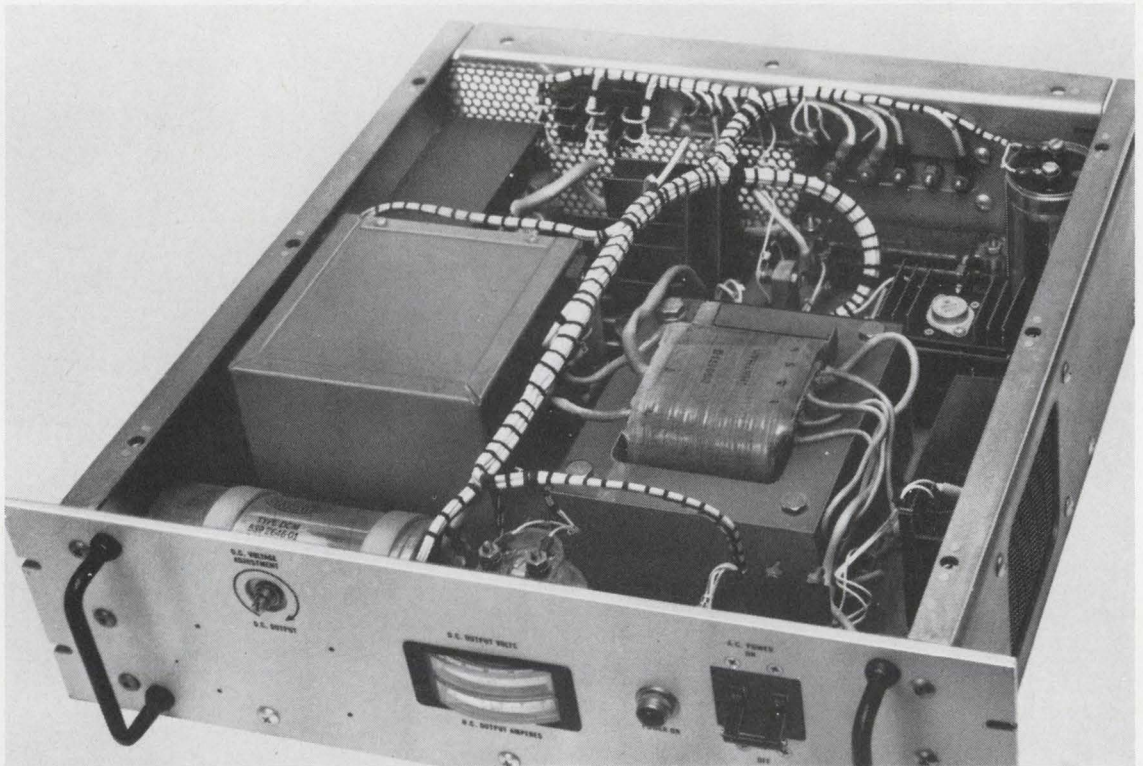

**CR27.5** High-current, adjustable, 1% regulation, 28 V.D.C. output, 50-60 Hz unit. Withstands substantial overloads.

Tung-Sol pre-engineered standard power supplies meet lots of special requirements. You'll find they offer many cost/efficiency/size-weight/availability advantages. No more shoehorning in at the last minute with a make-do power unit. No more high-cost custom or do-it-yourself designs. In all likelihood, Tung-Sol's done it before ... and can meet the specific requirements of your circuitry.

Tung-Sol pre-engineered power supplies reflect unique production abilities and in-house capabilities in solid-state components, transformers and electromagnetics which contribute added performance-value to your equipment. Units meet EMI and MIL Specs.

Talk to one of our experienced factory engineers. He's backed by a versatile line of pre-engineered, readily available, standard power supplies. Tung-Sol Division, Wagner Electric Corporation, 630 West Mt. Pleasant Ave., Livingston, N.J. 07039. Telephone (201) 992-1100.

## TUNG-SOL\*

Helps you do more  
...with less

\*Registered trademark Wagner Electric Corporation

# CROWBAR...?



## The One Inside is FREE

Not so many years ago, the prudent transmitter engineer discharged a high voltage capacitor bank by dropping a shorting "crowbar" across its terminals. Today's "crowbar" is a protective overvoltage circuit found on DC power supplies — usually at extra cost. Now HP includes a crowbar as standard on its recently updated series of low-voltage rack supplies . . . at no change in price.

Long established as preferred system supplies for component aging, production testing, and special applications, these supplies have now been redesigned and expanded to meet the stringent demands of today's power supply user. Advantages include low ripple (peak-to-peak as well as rms), well-regulated constant voltage/constant current DC with outputs to 60 volts and 100 amps.

Where loads are critical and expensive, the extra pro-

tection — say, against inadvertent knob-twiddling — from a crowbar is invaluable. On all internal crowbars in this series, the trip voltage margin is set by screwdriver at the front-panel.

Pertinent specifications are: triggering margins are settable at 1V plus 7% of operating level; voltage ripple and noise is 200  $\mu$ V rms/10mV peak-to-peak (DC to 20 MHz); current ripple is 5 mA rms or less depending on output rating; voltage regulation is 0.01%; resolution, 0.25% or better; remote programming, RFI conformance to MIL-I-6181D.

Prices start from \$350. For complete specifications and prices, contact your local HP Sales Office or write: Hewlett-Packard, New Jersey Division, 100 Locust Avenue, Berkeley Heights, New Jersey 07922 or call (201) 464-1234 . . . In Europe, 1217 Meyrin, Geneva.

**HEWLETT**  **PACKARD**  
POWER SUPPLIES

Additional data sheets available upon request

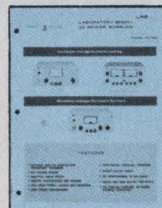

**LAB SERIES**  
smaller package,  
lower power,  
optional crowbar

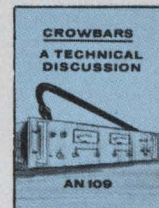

**CROWBARS**  
A Technical  
Discussion

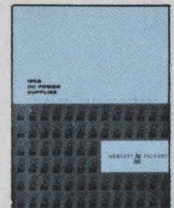

**1969 Power  
Supply Catalog**  
— includes total  
HP power supply line.

# We make 95% of the most popular types of logic transistors, RF transistors, diodes and diode arrays.

## Nobody's perfect.

We've made a heap of hullabaloo lately about what we're doing in ICs. Don't infer from this we've forgotten discrete components. We're lavishing the same technological attention on them as on ICs.

**Take core drivers.** We're off-the-shelving 10 high voltage, high current or high speed NPN drivers, including the ever popular 2N3725. Soon we'll log a 1 amp version of our 2N3735 with 20 nanosecond storage time and six new PNP models. And you get them all in a panorama of packages: TO-5 or TO-46 cans, DIPs or flatpacks, all in dual or quad versions.

**And monolithic diode arrays.** We deliver 16-diode arrays in DIPs. Flatpacks are imminent. And expect a 64-diode package for your Christmas stocking.

Or RF transistors. Today our distributors stock a 1 Watt, 1 GHz 2N5108 transistor in a TO-39 package, and sell it for \$10.70 in 100 quantities. But right around the corner we have a tighter-leakage A version looming. And then a 10 Watt model. And by year's end a 1 GHz 20 Watt device.

To prove our discrete dedication we've just moved into a shiny new facility. With quick-response special products section and fully equipped applications lab. But it's that same old knowhow that keeps our more than 400 standard and high-rel transistors and 1800 diodes hustling out the back door. Because in discrete components, too, we're the company that gets the ideas and delivers the goods. Raytheon Semiconductor, Mountain View, California. (415) 968-9211.

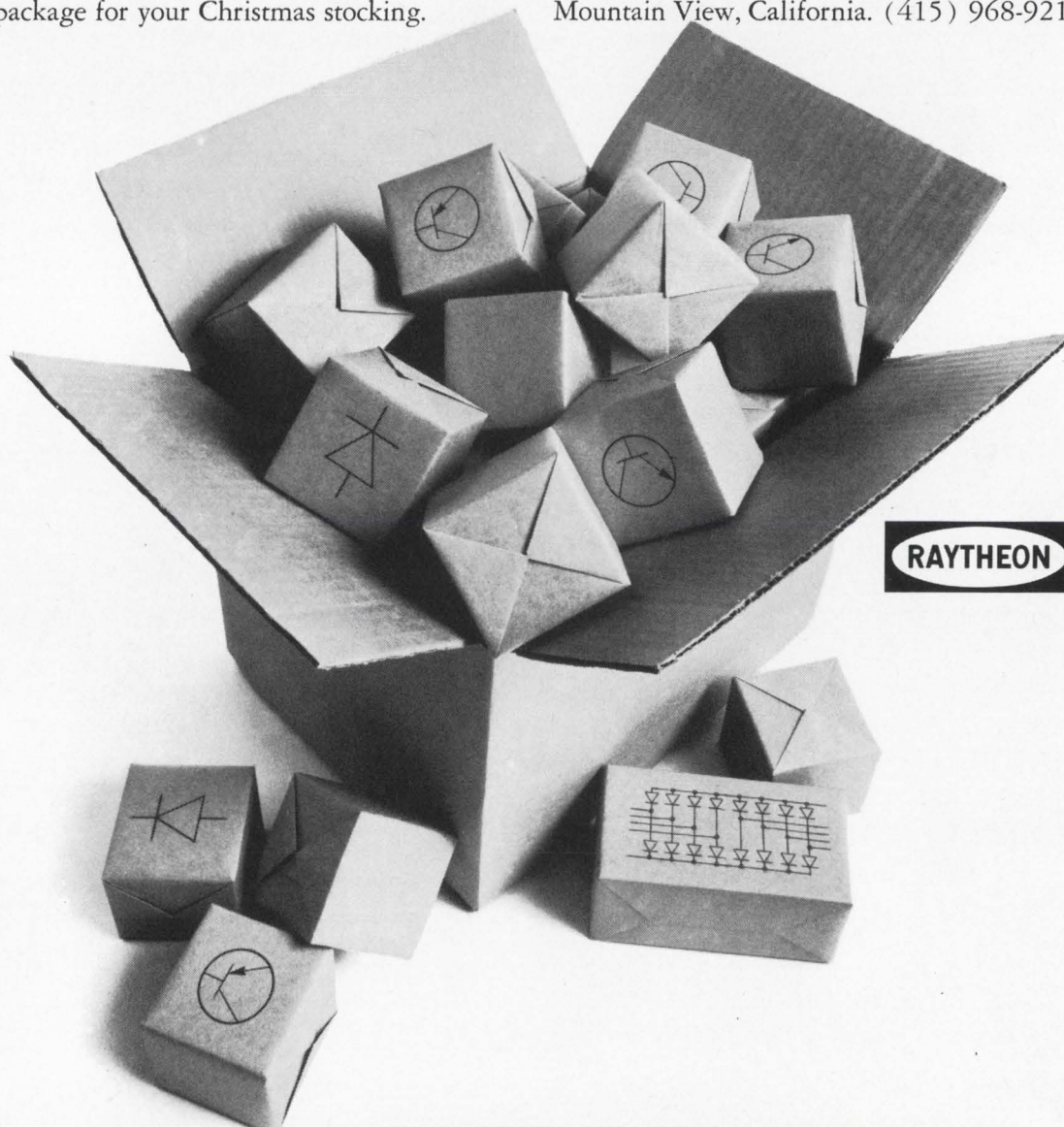

**RAYTHEON**

**Publisher**

Hugh R. Roome

**Editor**

Howard Bierman

**Managing Editor**

Frank Egan

**Technical Editors**Milton J. Lowenstein  
Michael J. Riezenman  
Raymond D. Speer  
Stella Lawrence**Management and Careers Editor**

Richard L. Turmail

**News Editors**Ralph Dobriner, Chief  
John N. Kessler**Washington News Bureau**

Charles D. LaFond, Chief

**Military/Aerospace Editor**

John F. Mason

**East Coast Editor**

Jim McDermott

**West Coast Editors**Elizabeth deAtley  
David N. Kaye**New Products Editor**

Lucinda Mattera

**Copy Editor**

Marion Allen

**Directory Manager**

Greg Guercio

**Editorial Production**Dollie S. Viebig  
Anita F. Needleman**Art Director**

Clifford M. Gardiner

**Art Assistant**

William Kelly

**Technical Illustrators**Rita Jendrzewski  
Lynn E. Thompson**Production Manager**

Thomas V. Sedita

**Asst. Production Manager**

Helen De Polo

**Production Assistants**Bernard Wolinsky  
Carl A. Merkin**Circulation Manager**

Nancy L. Merritt

**Information Retrieval**

Genate Piccinetti

## EDITORIAL



## Are you a crybaby — or a mistreated engineer?

We had a staff disagreement at *ELECTRONIC DESIGN* recently. Since it hasn't yet been resolved, I'm going to let you in on it. It concerns the article "No Engineer Wants to Be a Crybaby," on page 94 of this issue.

Our Management & Careers Editor, Dick Turmail, received the article from a contributor, received it and passed it along to me for comment. Dick thought it offered a sound indictment of engineering management, with six case histories of sins perpetrated against the design engineer.

But as I read the article, I recalled my dozen engineering years with a major corporation research laboratory and with small engineering firms, and something in the article seemed to be missing. Sure, I worked a number of overtime hours and weekends without pay—but I remember the satisfaction of completing tough jobs on schedule. Nowhere did the article describe the challenge of the assignment, the exciting group sessions as solutions were analyzed, the sigh of relief at the success.

In the cover letter accompanying the article, I noted with interest, the author called attention to what he described as 17 "management biased" articles in recent publications. It's about time the engineer's view was aired, he said.

I read the article again and told Dick that engineers would be labeled "crybabies" if the article was published. "Show it to other members of our staff who have spent years in engineering, and they'll tell you the same thing," I predicted to Dick. Well, he did, and some newcomers to our staff—experienced former industry engineers—agreed with the author of the article, not with me. Publish the article, they insisted.

The basic disagreement is this: I maintain that the managerial sins described—inconsideration, indecision, excessive paperwork, etc.—do exist in engineering but are not unique to our profession. Employed lawyers, businessmen, salesmen, accountants—you name them—all encounter the same frustrations. That doesn't excuse the sins, of course, but it does exclude the engineer from exclusive claims to such abuse.

Here's where you come in. We've put together a brief questionnaire on page 98 that should take no more than two minutes to complete. Be frank. Let me know whether you agree with me that engineers are treated no better or worse than your acquaintances in other endeavors. Or tell me that I'm all wet and completely naive in my position on this issue.

But please be specific. If you're an engineer, indicate the managerial sins you deem most common and offer suggestions for improvements. If you're a manager tell how engineers can help you improve your relationship with them.

Your responses can lead to an interesting forum on engineering management, as viewed from both sides of the desk. Don't just sit there. Turn to page 94 and get involved!

HOWARD BIERMAN

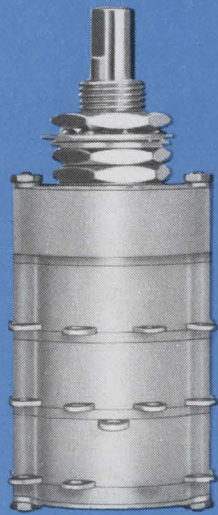

ACTUAL SIZE

## JANCO BUILDS ROTARY SWITCHES JUST A LITTLE BETTER THAN TODAY'S REQUIREMENTS!

## { HERE'S THE INSIDE STORY }

If you were to slice away half of a Janco Rotary Switch, you would see the reason why "Janco Builds Rotary Switches Just A Little Better Than Today's Requirements!"

### CONSTRUCTION

Upon examination you would immediately recognize a design simplicity meticulously constructed into a totally enclosed, explosion-proof package affording you the highest degree of protection when operating in a volatile, chemically mixed atmosphere at sea level or altitudes. It is this same design simplicity that utilizes the U-shaped rotor concept which results in low contact resistance throughout the life of the switch.

### MATERIALS

Before reaching the optimum in design simplicity a manufacturer must reach for the optimum in materials. Janco Rotary Switches are totally enclosed in high impact, glass-reinforced alkyd MAI-60 for superior mechanical and electrical characteristics. Current conduction is handled by Beryllium copper and solid silver alloy contacts.

### FREE WALL CHART

If you are interested in rotary switches that are built to exceed present day requirements, Janco Corporation will send you a wall chart of basic Janco rotary switches. From this chart you can determine the correct switch for your requirements . . . the proper degree of indexing, exact make or break current capacity, and whether single or multi pole construction is available. This chart is your building block to a rotary switch that is built a little better than today's requirements. Send for it today.

**JANCO**  
CORPORATION

3111 WINONA AVENUE ■ BURBANK, CALIFORNIA

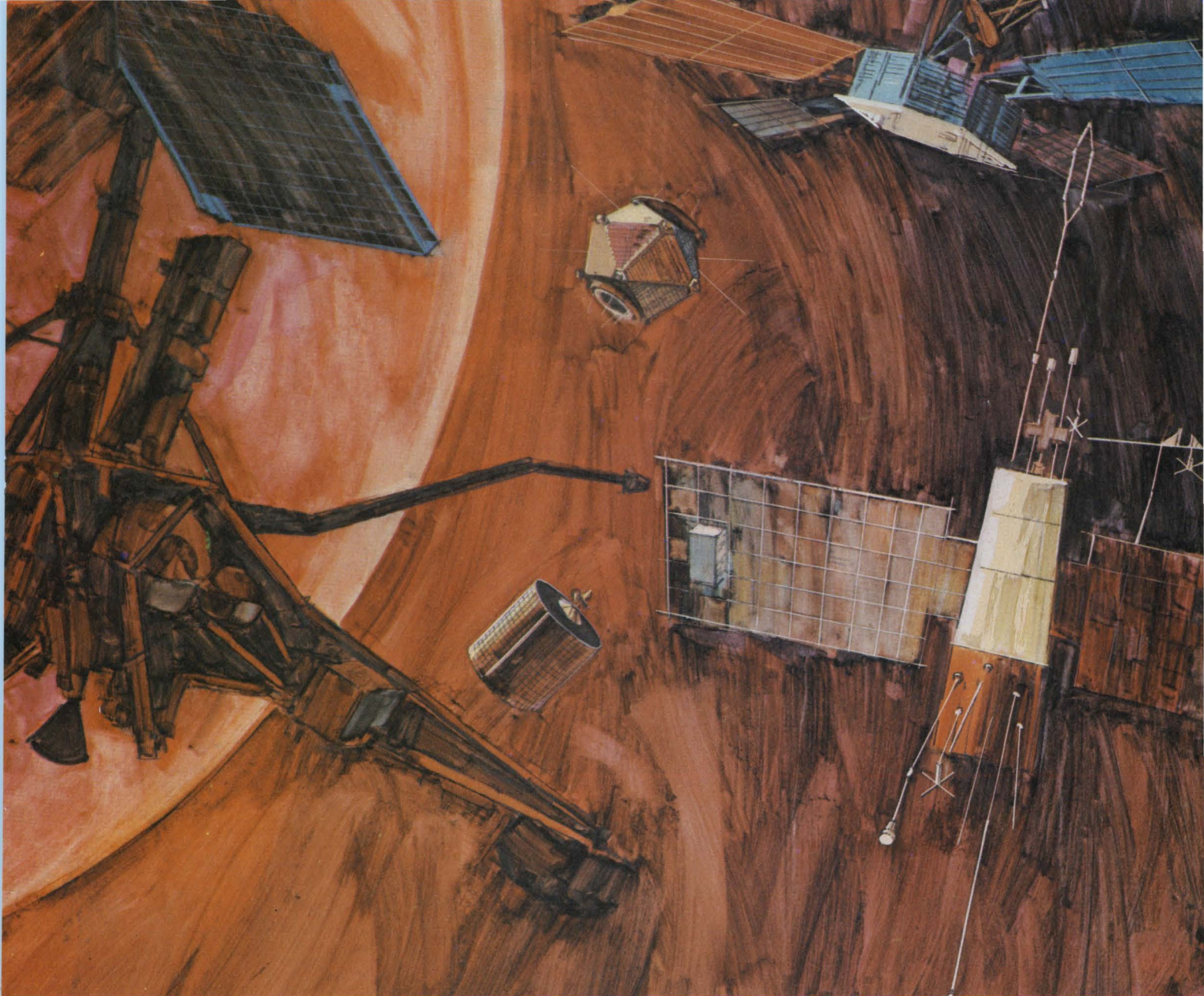

## CINCH AEROSPACE CONNECTORS GO BEYOND MIL SPECIFICATIONS

Since 1963 Cinch has been a major source for these ultimate performance rack and panel connectors. America's major space and defense spacecraft use these Cinch connectors in space and on the moon...TRW's Intelsat III, OGO, Pioneer and VELA spacecraft and JPL's Mariner satellites.

Their production involves complex quality control procedures beginning with raw material selection through every stage of fabrication and "clean room" assembly. Plating QC alone involves 119 lab measurements for 4 different characteristics, on the pre-assembled contacts. The completed connector must have a maximum residual magnetism of less than 20 gamma at the magnetometer probe and be free of visible contamination under 25x microscopic examination.

Do your connector requirements involve unusual design or production problems? Cinch can help you. For more information on Cinch aerospace connectors and the Cinch capabilities available to you, write Cinch Manufacturing Company, 1501 Morse Avenue, Elk Grove Village, Illinois 60007.

C-6810

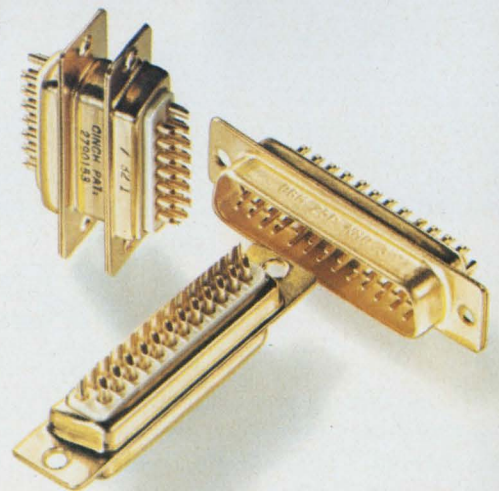

**CINCH**  
DIVISION OF UNITED-CARR

**CINCH**  
ELECTRONICS  
GROUP.

CINCH MANUFACTURING, CINCH-GRAPHIK, CINCH-MONADNOCK, CINCH-NULINE AND PLAXIAL DIVISIONS OF UNITED-CARR INC., A SUBSIDIARY OF TRW INC.



# The den mother.

She always knows where all your little printed circuits are.

So in case you want to know anything about your order, just call (213) 722-6810, ext. 513. The Lockheed computerized control system – better known as our Den Mother – will have the answer for you immediately.

She knows how to keep track of thousands of orders, involving many thousands of lots and goodness knows how many parts. We update her daily, and she likes it. This way she can be aware of what and how many have been

shipped, where parts and lots are and when others will be shipped.

So it only stands to reason. If we care enough to have a Den Mother just to look after our printed circuits – imagine our printed circuits.

## **LOCKHEED ELECTRONICS COMPANY**

 A Division of Lockheed Aircraft Corporation, Los Angeles, California

Visit our exhibit at the Electronic Manufacturing Exposition and Conference, September 16, 17, & 18, Booth Number 21.

INFORMATION RETRIEVAL NUMBER 46





## Our solid state keyboards are for locations that are expensive to go back to.

Service calls, especially to remote locations, can cost half again as much as the original cost of the keyboard.

Our inexpensive solution to this expensive problem is our new keyboard. It's all solid state.

In fact, it's the world's first use of an integrated circuit as a keyboard switching element.

Codes are transmitted electronically, not mechanically. So there's no need for mechanical linkages, electromechanical parts, contacts, buffer circuitry or any of the moving stuff that normally



wears out and causes malfunctions.

The reliability of solid state becomes an important part of the

offer you're able to make to your customers. And it helps you beat the economics of servicing remote equipment.

MICRO SWITCH can supply all standard and custom key arrays. Each with the same touch and spacing as a regular keyboard.

Our "Condensed Keyboard Guide" explains it all. We'd like to send you a copy. Just write.

### **MICRO SWITCH**

FREEPORT, ILLINOIS 61032

A DIVISION OF HONEYWELL

INFORMATION RETRIEVAL NUMBER 47

# new from the new DUMONT

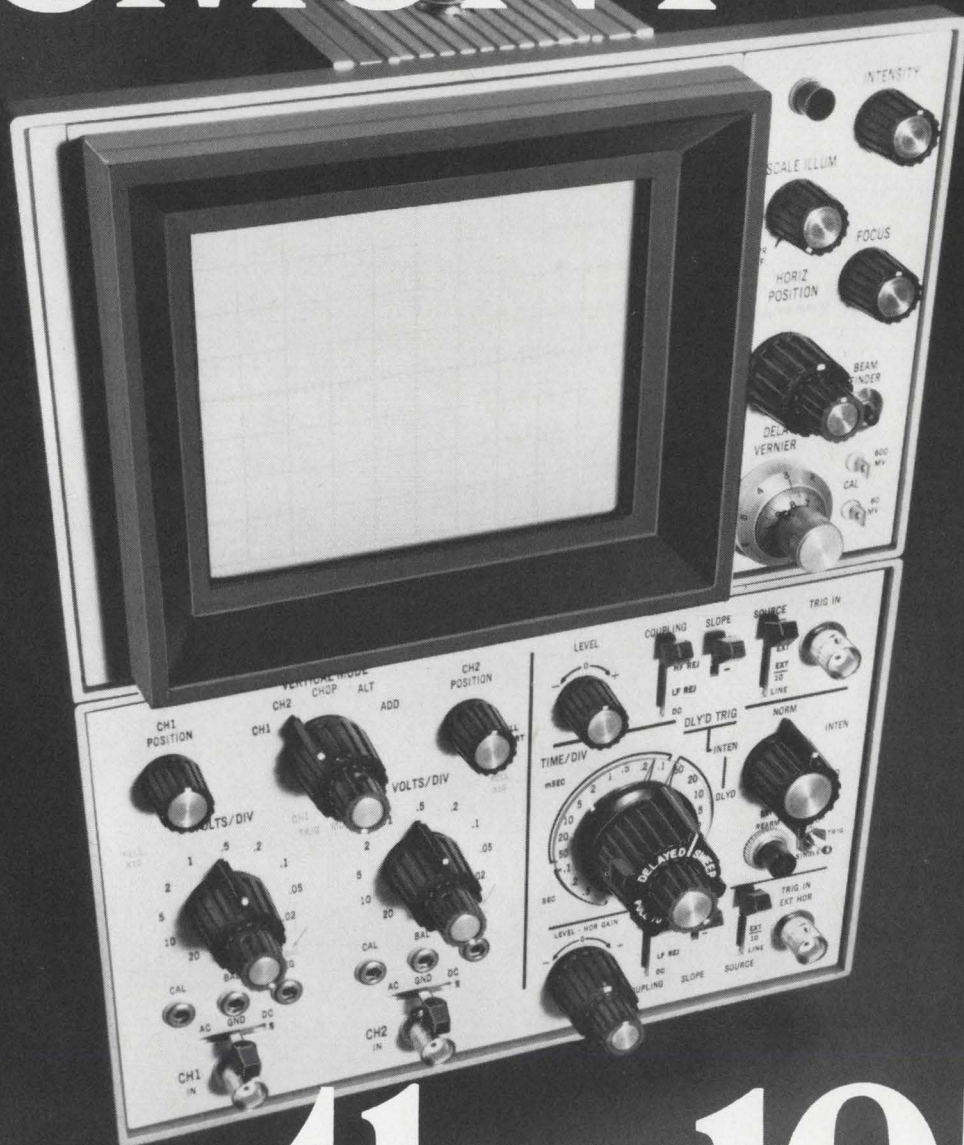

# ...the 1050

Band width to 50 MHz.  
Sensitivity to 1 MV, both channels.  
New exclusive triggering.  
More important features  
than any competitive scope.

For full information write  
**DUMONT OSCILLOSCOPE LABORATORIES, INC.**  
40 Fairfield Place, West Caldwell, N.J. 07006  
(201) 228-3665/TWX (710) 734-4308

**DUMONT**  
OSCILLOSCOPE LABORATORIES, INC.

Are the  
cabinets  
you are  
now using  
put together  
like a  
JIGSAW PUZZLE?

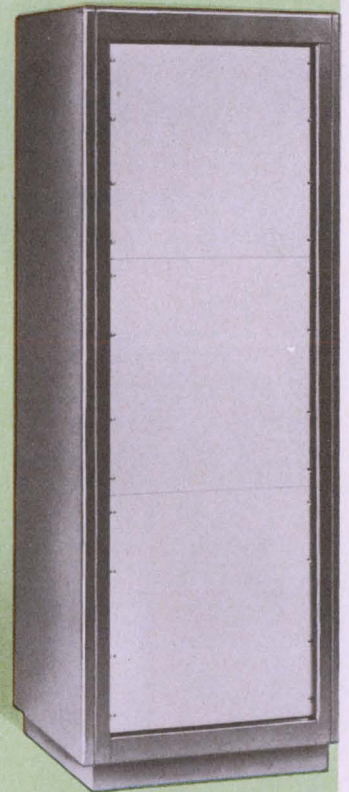
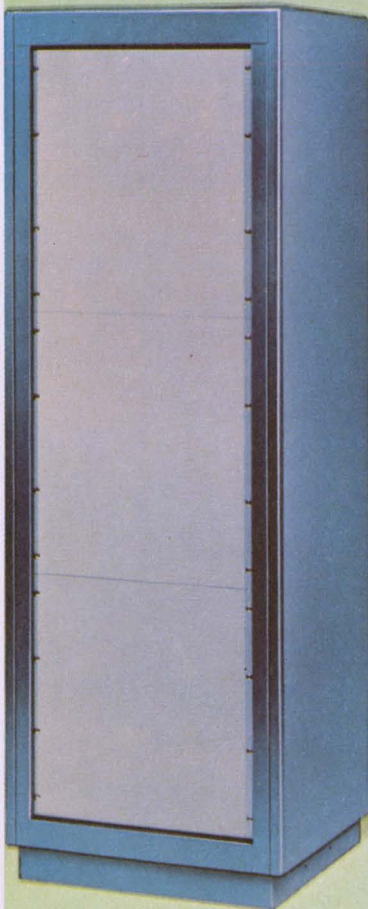
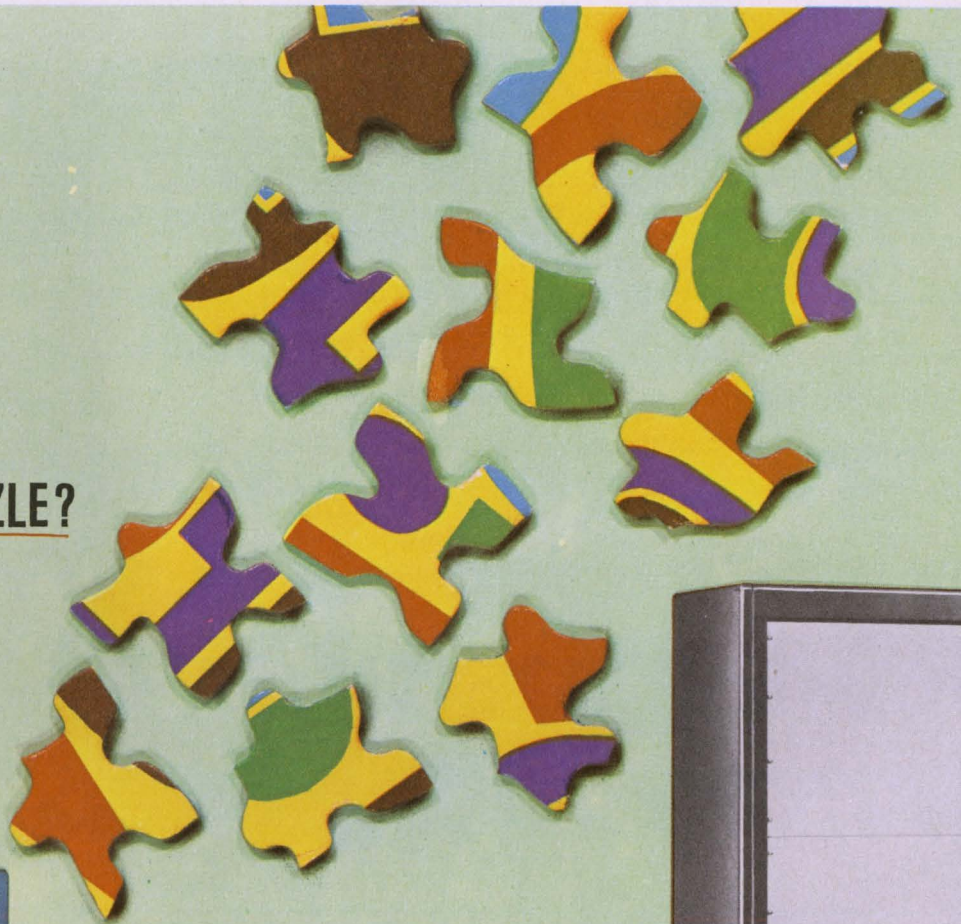

## Not if they are **SERIES SIXTY** CABINETS

You will waste a lot of time ordering from a cumbersome parts list; using expensive labor for assembly; and incur other frustrating and costly problems if you buy cabinet racks that require assembly on your part before you can put them to use.

When you buy Bud Series Sixty Cabinet Racks, one catalog number identifies your complete requirements. You encounter no extra costs or delays since they come to you completely assembled and ready for use. Furthermore, they are better made and have more useful features than any similar products.

There are types and sizes to meet most requirements — for instance, panel spaces ranging from 21" to 78" for both 19" and 24" rack panels. You can make a choice from 136 types and sizes.

Series Sixty Cabinets are available as standard stock items at Bud Distributors. Comprehensive literature and prices are available . . . write us.



**BUD RADIO, INC.**

4605 East 355 Street • Willoughby, Ohio 44094

## New from Cutler-Hammer— environmentally sealed switches built to MIL-S-3950C.

Our newest line of military switches gives you still another choice in Cutler-Hammer military toggle switches.

Built to the environmentally sealed standard of the new MIL-S-3950C specs, this new line employs a patented silicone-rubber sealing process that lasts for the life of the switch.

Double insulation is achieved because the seal covers the entire inside of the cover. Terminals are molded into the base without elastomers.

Other features include a self-extinguishing melamine base material and back-wired terminals with

molded-in identification—to simplify wiring and bussing.

The line is available with standard bat levers or lever-lock toggles in one, two and four poles.

For the ultimate in reliability, you can still choose our positive-action switches, full-size or miniature, built to MIL-S-8834. And for less demanding applications, our standard military toggle switches built to MIL-S-3950.

Contact your Cutler-Hammer Sales Office or the Cutler-Hammer Stocking Distributor near you for complete information.



Military relays, too—from a full line which includes these hermetically sealed 25-, 50-, and 100-amp relays and a 175-amp generator contactor, and a full line of dust-sealed power relays up to 400 amps.

# Newest member of an old military family.

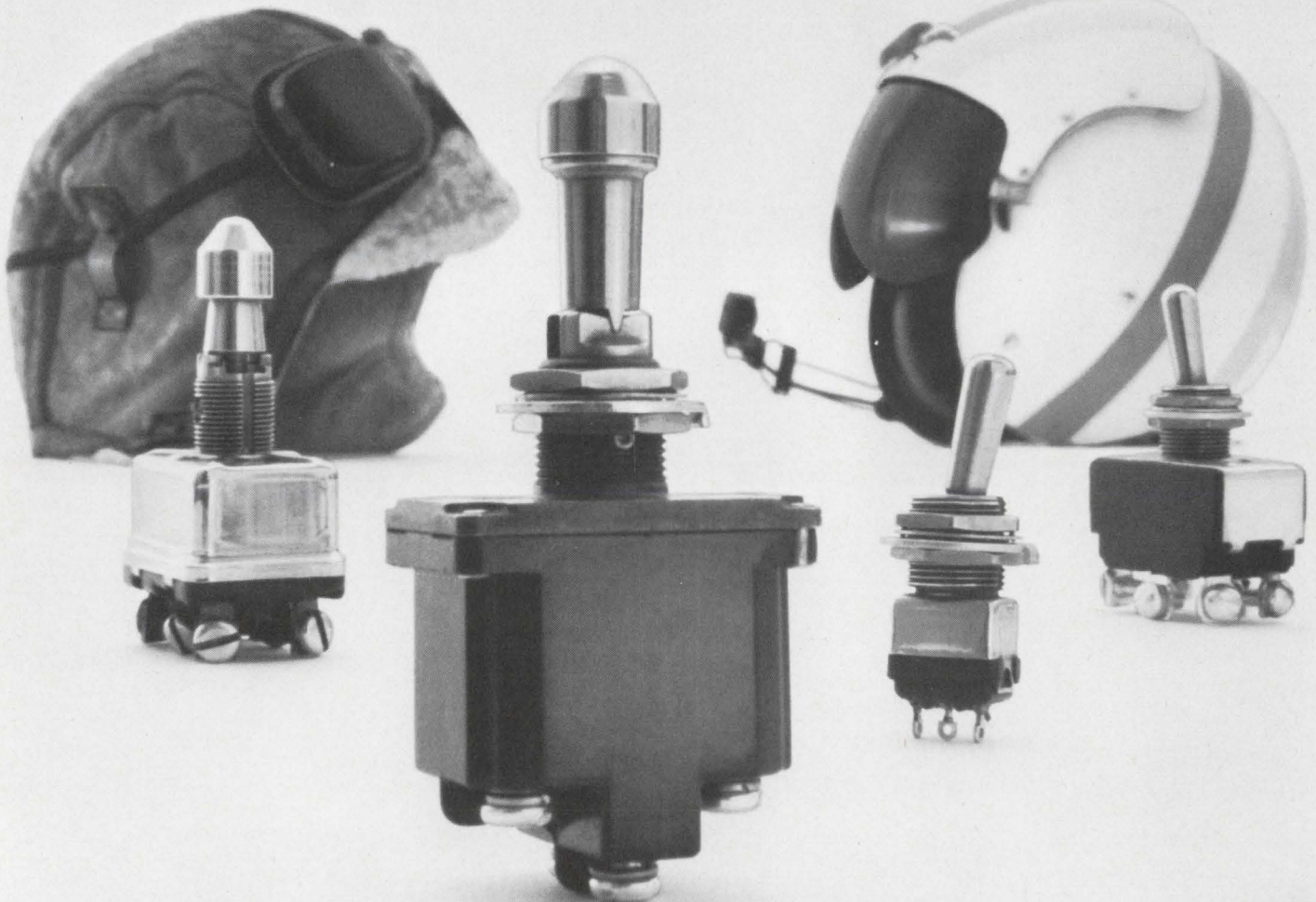

Switch  
to No. 1

More than just switches:  
prompt availability,  
field help, innovation,  
quality assurance too.

INFORMATION RETRIEVAL NUMBER 50



**CUTLER-HAMMER**  
SPECIALTY PRODUCTS DIVISION, Milwaukee, Wis. 53201

TAKE IT FROM BEETLE BAILEY:



# FOR PANEL METERS, COUNT ON GENERAL ELECTRIC'S SALES AND SERVICE ARMY!

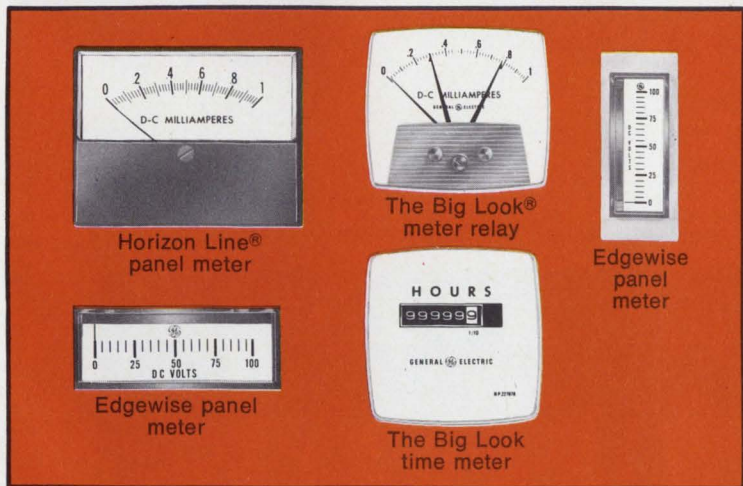
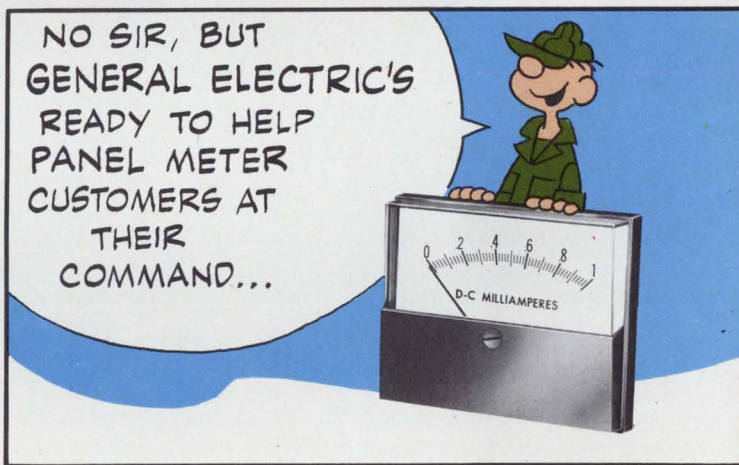
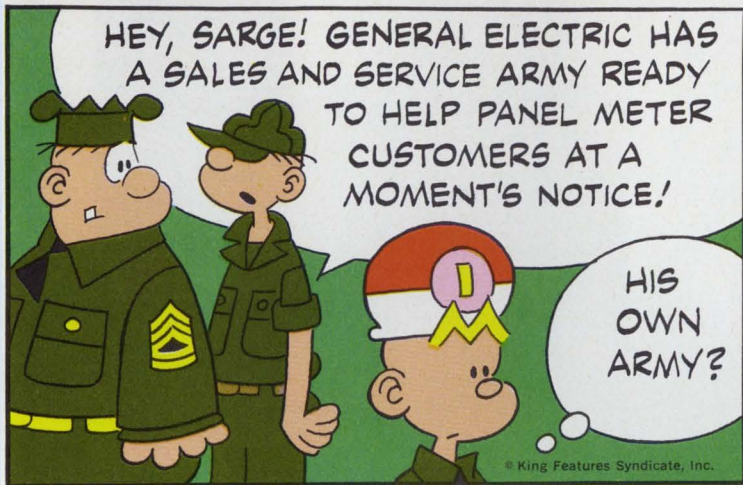

... just give the order. General Electric's Sales and Service Army is prepared to combat any panel meter problem with an arsenal of powerful, up-to-date weapons—a full line of quality panel meters and meter relays, expert application assistance, fast service across the country, and on-time delivery from a nationwide network of sales offices and distributors.

Why fight it? Surrender all your panel meter problems to General Electric's Sales and Service Army. Contact your GE Electronic Components Sales Office or your dependable General Electric panel meter distributor. 592-34

# GENERAL ELECTRIC



We just stole  
the automatic  
stick shift

## and put it on our new Counters.

The automatic stick shift. That's the whole idea behind our new family of Counters. Snap to "pre-set" for automatic, knob-free sine wave measurements to 50 MHz or go stick shift with full trigger control if your signal is unsymmetrical.

But there's a lot more to our new Counters than just convenience:

- 500 Microvolt Sensitivity from 10 MHz to 500 MHz with automatic gain control for perfect triggering.
- 8 digits in 1 second with auto-ranging, even at 1 Hz.
- Complete solid state input/output interface in systems models.

And, incidentally, automatic operation improves accuracy, too.

Prices for the DANA Model 8100 start at \$1495.

**DANA**

Dana Laboratories, Inc./2401 Campus Drive/Irvine, California 92664



# Technology



**MOS production lines hum with activity, but designers still face problems in evaluating**

**the products and applying them to their systems. Full story on page 65.**

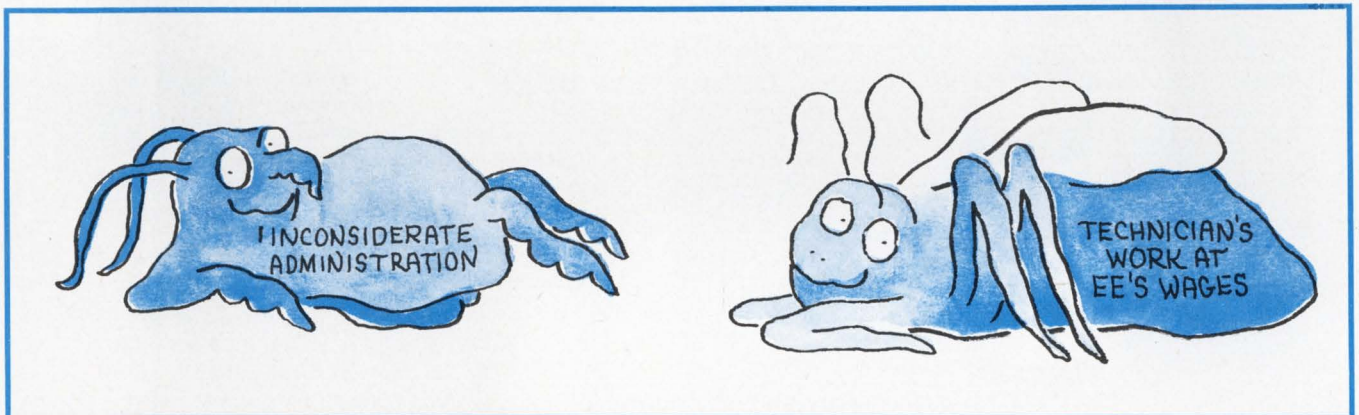

**Are you "bugged" by your boss? Do his management methods get you down? If your**

**gripe is justified it may be one of the six a designer discusses here. p. 94.**

## **Also in this section:**

**Calculate how tight a tolerance you need—and optimize circuit design. p. 82.**

**Talk it out with your computer, using conversational FORTRAN. p. 86.**

**Ideas for Design. p. 100.**

# Sonotone's Sub-C Cell.

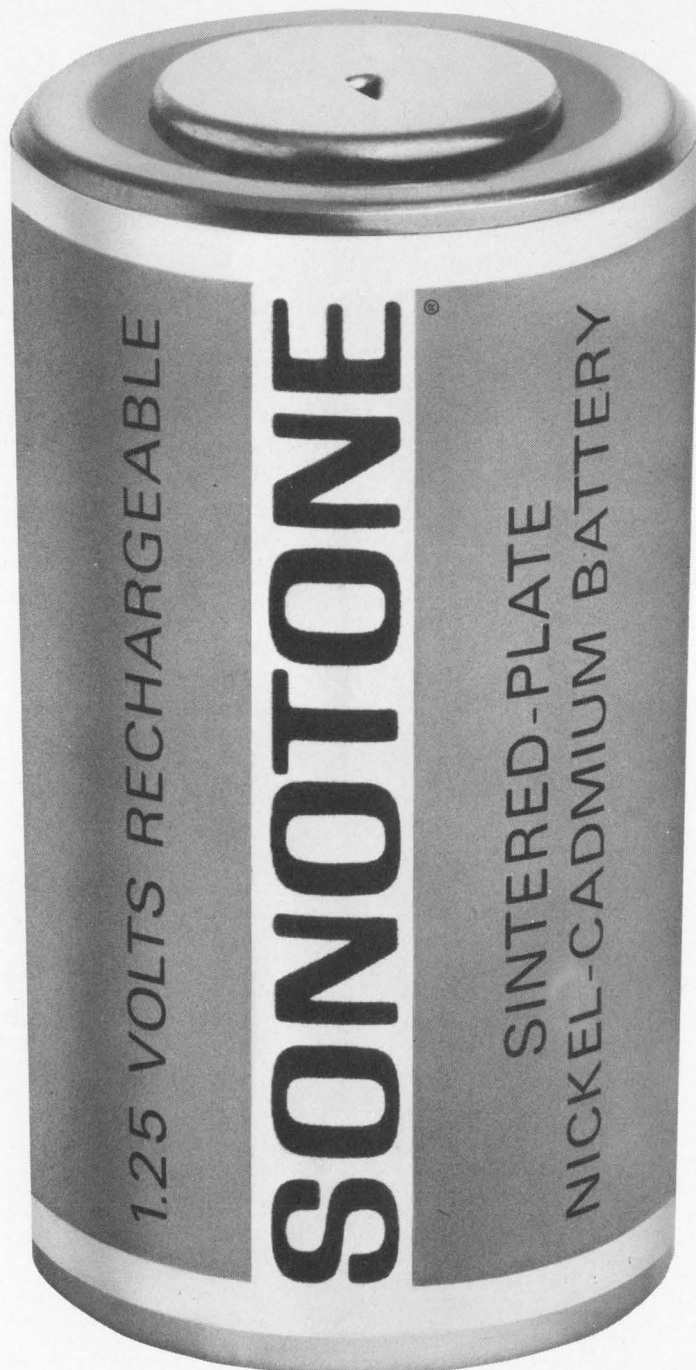

**One size, four power ratings supply the power needed for any cordless product.**

Now you can match power to product with one of Sonotone's Sub-C nickel-cadmium sealed cells. Pick from these four:

**S113, the industry standard**, is a dependable, nickel-cadmium sealed cell rated at 1.2 ampere hours. This is the one that started the cordless revolution. Now in use in cordless toothbrushes, slicing knives, communications and standby power equipment.

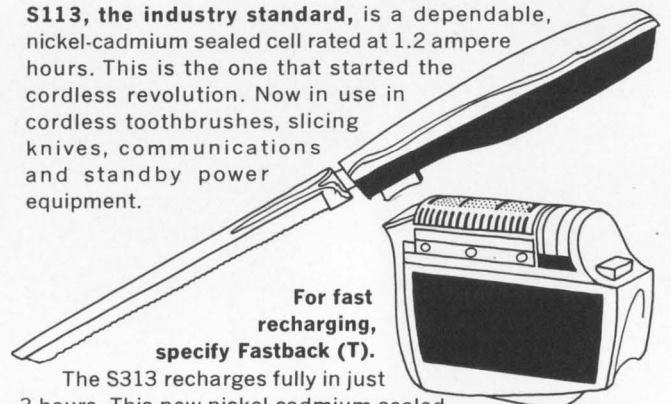

**For fast recharging, specify Fastback (T).**

The S313 recharges fully in just 3 hours. This new nickel-cadmium sealed cell is rated at 0.9 ampere hours. Currently used in cordless shavers and cordless hair clippers.

**S413 is a high rate discharge** nickel-cadmium sealed cell with 1.0 ampere hours. Puts out up to 75 amps. of surge power . . . ideal for engine-starting applications.

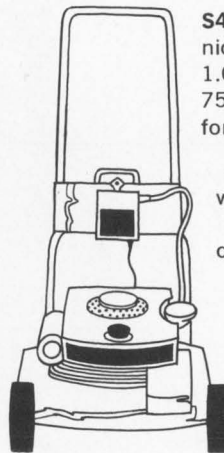

**And finally, the economical S213** with performance the same as the S113, except 0.7 ampere hour capacity. It is used in many of the same applications as the S113 where running time is less critical and economy most essential.

What we've done with the Sub-C cell, we can do with any of our battery products.

Write for full information:  
Battery Division, Sonotone Corporation, Elmsford, N. Y. 10523.



**CLEVITE SONOTONE**



An Electronic Design  
Special Report

**MOS: A Critical Review**

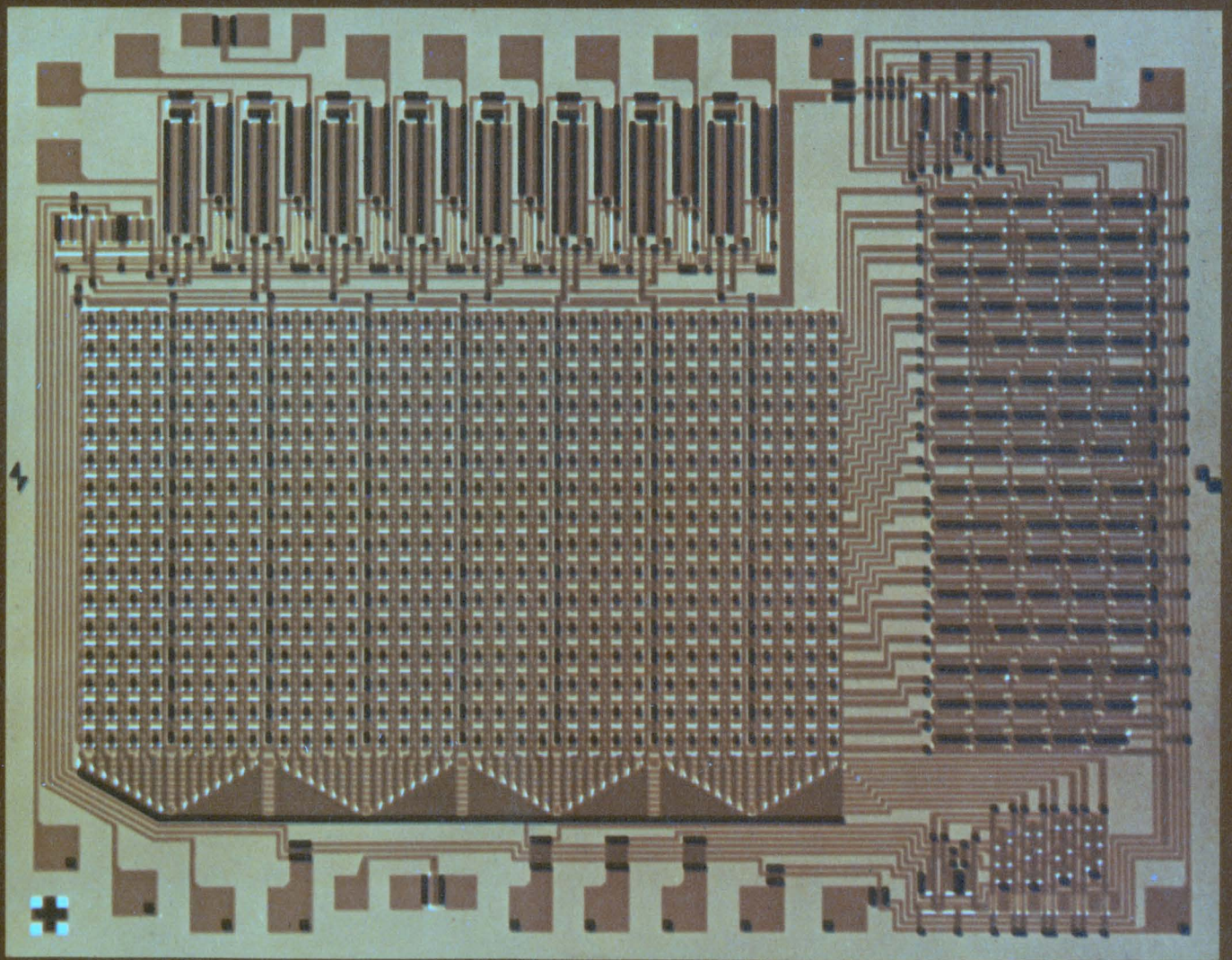

edited by Raymond Daniel Speer

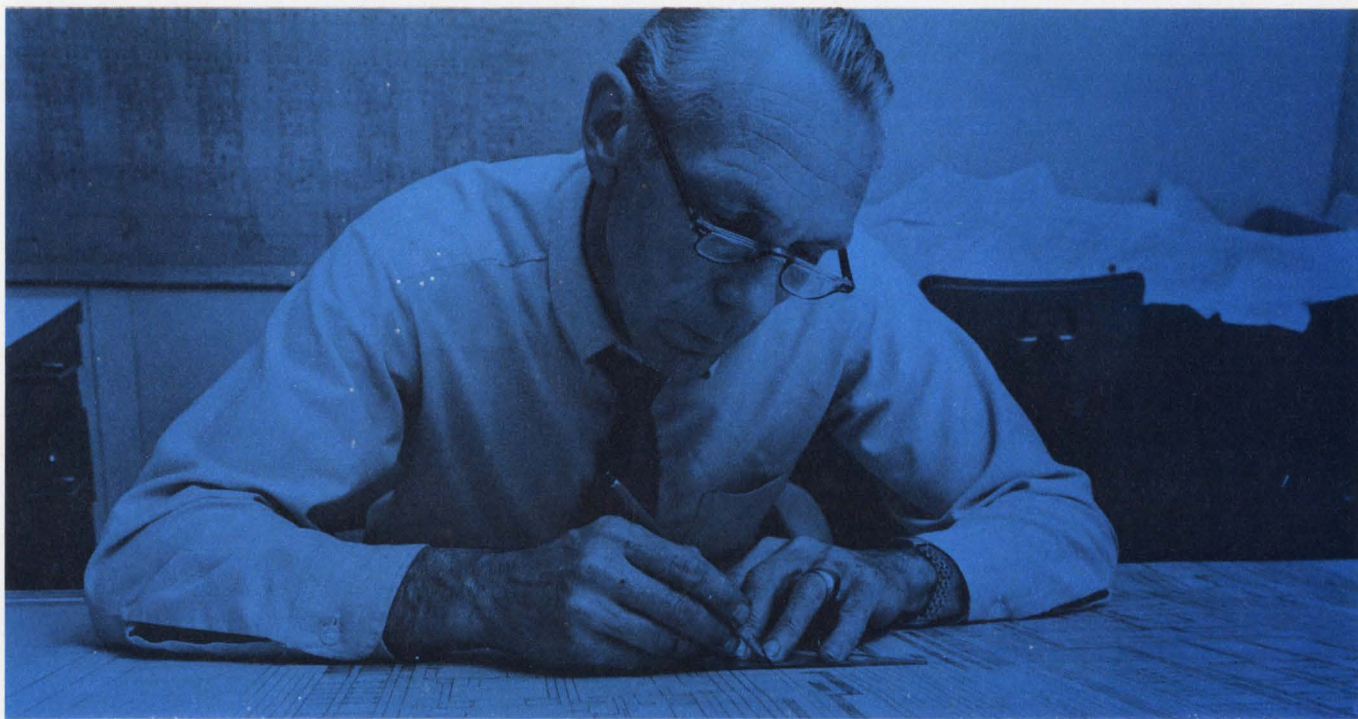

Designers weigh the many advantages of MOS against its possible shortcomings. They must learn about the MOS processes, choose a vendor, and cooperate with him to design the most efficient, reliable system possible. Here,

Charles McLean, an array systems engineer, uses a vendor's design rules to prepare a composite for an MOS array. It will be used in Viatron Computer Systems Corp.'s new "System 21" microprocessor.

# Problems for the

MOS devices are being considered for a rapidly rising number of system designs. They offer small size and low power dissipation—and, in many cases, reduced packaging and component costs. They can usually be operated at lower chip temperatures, and they require fewer interconnections, so users also expect them to be more reliable than today's bipolar IC systems.

But many problems remain to be solved before dependable production capability is achieved. Each potential user must make a careful appraisal of what can be built or bought at present.

Some feel that this is best accomplished by setting up an in-house MOS production capability and competing with the vendors for competent personnel to staff the operation. With device and

system-design groups under the same roof, these people hope to optimize combined circuit-system concepts, gain a better understanding of the devices and ultimately supply some parts.

Others feel that the appraisal can be done more effectively, at lower cost, by evaluating competitive devices from established suppliers and by placing development contracts with a number of vendors. In this way the user has access to the capabilities of the entire industry, and he is able to select the best sources for each MOS circuit that he needs. Whatever the course he takes, the user must ultimately choose an MOS process, and making the correct choice will require some serious thought.

## Look at the MOS processes

There is a great diversity of opinion among vendors and users regarding processing, but a pattern does seem to be emerging. Low-threshold processes, using 1-0-0 silicon or silicon nitride gate dielectric, are on the way up. (1-0-0 and

---

**S. Ralph Parris**, Staff Engineer, Circuits and Packaging Dept., Product Engineering, Burroughs Corp., Plymouth, Michigan.

**Report cover photo**, of a 1024-bit ROM chip, courtesy National Semiconductor Corp., Santa Clara, Calif.

1-1-1 refer to the crystal lattice orientation coordinates. 1-1-1 silicon has a higher resistivity than the 1-0-0 crystal, and results in higher threshold voltages. It was used by early manufacturers because oxide stability was a problem and with higher thresholds the percentage effect of the inevitable drift was less.)

High-threshold-voltage, p-channel devices have been popular in the past, because 1-1-1 n-doped substrate material has produced the most stable and repeatable devices for most suppliers. Circuits made with this material generally require high power-supply and clock voltages (typically 27 volts), but they offer a 2-to-3-volt noise immunity and reasonable chip size (usually 20 per cent smaller than an equivalent low-threshold circuit). This process is recommended by many vendors for systems in which interfacing with bipolar circuits is not required.

Low-threshold, p-channel devices are gaining in popularity, because recent progress in processing 1-0-0 n-doped silicon has greatly reduced both surface contamination and the accompanying threshold drift that plagued early attempts to produce them.

The low-threshold (1.5-to-2-volt) devices are

# designer

compatible with bipolar logic, which operates on a typical logic swing of 4.5 volts. High-threshold (5-volt) MOS cannot interface with bipolar circuits, because it requires a 10-volt logic swing.

An alternate approach to low thresholds—silicon nitride gate dielectric on 1-1-1 silicon—is also being used. But there is some concern that polarization phenomena in the nitride film may cause greater threshold instability than that associated with the 1-0-0 process. It is also possible that a combination silicon oxide-silicon nitride gate structure is more likely to fail under voltage stress, because of partial pinholes.

Neither of the low-threshold, p-channel processes is as generally available as high-threshold, and samples should be carefully evaluated, especially in the case of the nitride devices.

Both the low- and high-threshold p-channel MOS circuits have two shortcomings: They are slow, being useful only to a few megahertz, and they consume too much power to be operated for extended periods from battery supplies.

The power requirement—perhaps orders of

**MOS ICs offer many advantages and a raft of potential difficulties. The emphasis is on careful product appraisal.**

magnitude greater than that for an equivalent complementary MOS circuit, depending on the application and the operating frequency—becomes especially important in volatile memory applications. Systems designers often want to store programs in MOS volatile memory, and they guard against memory loss during power failures by providing battery stand-by supplies. P-channel circuits are just not suitable.

A number of new circuits and processes have been proposed to minimize these problems. N-channel devices are faster by a factor of about 3, because the mobility of the electrons in the channel is much higher than that of holes in a p-channel device. But process stability with n-channel MOS is poor. Thresholds are usually very low—well below 1 volt, and the processes yield devices that are sometimes depletion mode and sometimes enhancement mode. Often the substrate must be biased to provide a suitable threshold level.

Silicon gate structures and devices with ion-implanted drains can eliminate much of the "Miller capacitance," which slows conventional MOS circuits. But these techniques are in the research and development phase and will probably not be in volume production for a year or two. Complementary MOS circuits can be designed for extremely low standby power, but this approach requires more complex processing and greater chip area, and is therefore more expensive. Samples of complementary circuits are available, but here, too, production volume capability is limited at present. All of these techniques hold great promise, but current availability remains the designer's prime consideration.

For most systems applications, then, the designer is left with the following rules of thumb:

- Stick with high-threshold p-channel devices whenever possible.
- Use low-threshold p-channel only where you are forced to do so by a bipolar interfacing requirement.
- Don't consider n-channel or complementary MOS unless there is no other way out.

But choosing a technology is by no means the end of the designer's problems. He has to arrange for their production by a vendor, and it's important that he communicate his needs clearly.

### Cooperation is the key

A very close working relationship must be established between MOS vendors and the customer's logic designers and circuit or components group. Speed, power, pin count, logic complexity and ease of testing are all interrelated, and a decision in one area directly effects the others; no groups should make independent decisions. The

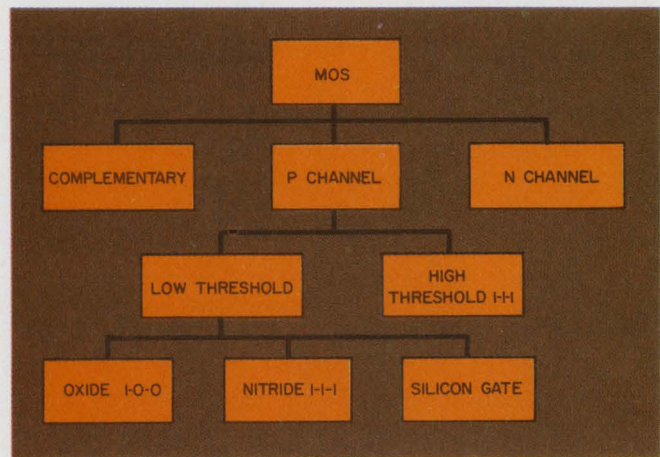

1. P-channel, n-channel, and complementary devices are available, but the designer should use high-threshold p-channel products whenever possible for their noise immunity, reasonable chip size and accurately predictable threshold. Where low threshold circuits are required, he should use p-channel to avoid the unpredictable n-channel threshold and the added expense of complementary. N-channel or complementary circuits should be used only where they are definitely required for their speed or power advantages.

effective design of a large-scale integration system depends on effective communications.

The speed, interface and power specifications for a system play an important part in determining how it will be built. Ratio-type dc circuits, for example, are the simplest to use because they are asynchronous, except for the clocking of flip-flops. Many vendors have established standard designs for these circuits, and they are readily available, but their power dissipation is high.

Clocked two-phase or four-phase circuits dissipate less power, especially at lower speeds, but they require special attention to the timing, because signal delays differ among the various signal paths. And complementary circuits provide an additional reduction in power, particularly during standby, but at present they result in larger chips, which may reduce yields.

The final decision on the type of design must be based, of course, on the best cost-performance compromise for each particular case. An optimum compromise can be made only if all facets of design and production are considered; hence the need for communication. And an important part of the decision-making is determining exactly where and how to apply MOS to the system.

### Consider MOS applications carefully

MOS circuits can be incorporated in system designs in several ways. LSI circuits can be used to replace bipolar circuits in an existing machine, for instance, to reduce packaging and interconnection costs. The design itself is usually

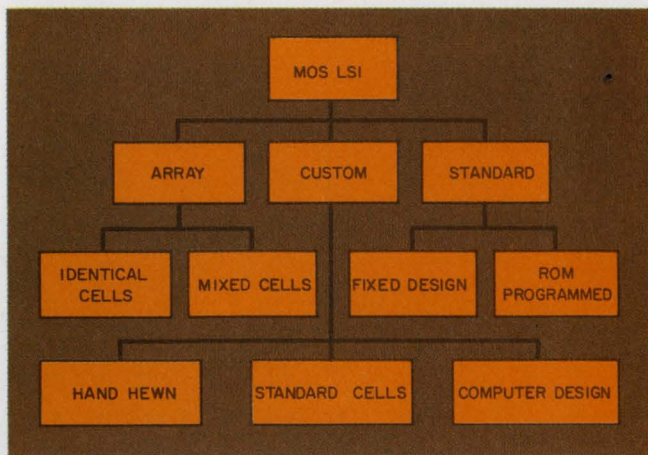

2. Designers can choose from broad lines of MOS products. Standard ICs such as shift registers, multiplex circuits, and logic elements are available in fixed designs, and standard read-only memories can be programmed to the customer's needs. Custom MOS circuits are computer designed using standard cells or designed by hand at the drafting board, and semi-custom arrays can be made up from mixed or identical cells by designing special interconnection patterns to meet the customer's logic specifications.

field-proven; it is unlikely to need the inevitable changes found in most new development programs. Unfortunately, the partitioning in an existing system was not originally designed for MOS, and the new system will not be optimized in performance, size or cost.

To use MOS circuits, it is much more desirable to plan a system from its inception. The proper emphasis can then be placed on minimizing interconnections and making the chips as large and complex as possible within the limitations of high-yield process capability.

This approach is likely to result in a much more efficient LSI system, from the point of view of over-all production cost, but it can be very inflexible. Changes that would be considered minor in present IC systems can require an extensive recycle of an LSI design—expensive in terms of both money and time. Designers beware! Perhaps there's a better way.

A compromise, to accommodate possible design changes and still obtain the eventual cost advantages of LSI circuits, is entirely feasible. Systems engineers can design new products using MOS partitioning rules, and build them using standard bipolar ICs. Although this makes the early models more expensive, it also makes changes during development and field trials much easier. And it permits a smooth conversion, with moderate tooling charges, to MOS.

Several methods of designing the actual MOS chips are in use, including manual drafting, the standard-cell or fixed array approach and some techniques for using read-only memory arrays in

the place of logic. Of these, standard cell or fixed array layout using computer aids is the most practical.

The standard-cell approach provides a library of basic gates, flip-flops and buffer circuits with standard height and voltage-bus configurations. The arrangement and interconnection of these cells is done very effectively by computer aids, with some manual intervention. The chips produced don't make the most efficient use of available area but are readily adaptable to quick-turnaround computer art-work generation. This quick-turnaround feature is increasingly desirable as larger numbers of different logic circuits are required, and is extremely important if design changes are a possibility.

An alternate approach, requiring less custom art work, uses a fixed array of standard diffusion patterns. Each element in the array contains enough MOS devices to build several gates or one output buffer. Custom design consists of specifying a two-layer pattern of interconnections. This method also tends to make inefficient use of the available "real estate," and the vendor must be able to produce reliable two-layer metal interconnections with high yield.

Two-layer metal technology is not generally available today in MOS devices, but several vendors are working on further improvements in passivation and metallization procedures. This method provides a low-cost, fast turn-around capability, but it is not economical for high-volume production, because of the inefficient use of silicon area.

The other approaches, yet to be widely exploited, use read-only memories. The first considers a combinatorial logic network as a "code converter," with prescribed responses to given signal patterns. If the number of inputs and outputs is reasonable, it is possible to program a read-only memory chip to perform the required function. It is not yet apparent to what extent this type of circuit can be used in the sequential logic found in most practical systems.

The second approach uses standard functional building blocks programmed by a self-contained read-only memory. A relatively small family of such blocks can be used to design micro-programmed computers of modest size. The applicability of this scheme to larger systems remains to be proven, but it appears that it does provide a reasonable degree of flexibility with a minimum of custom design work.

A common problem with all methods, of course, is the large number of leads required to access complex functions. In custom designs it is not unusual to require from 40 to 60 leads for each 100- to 200-gate circuit. Lower pin counts can sometimes be achieved, but only by sacrificing speed and using serial data transfer. ■■

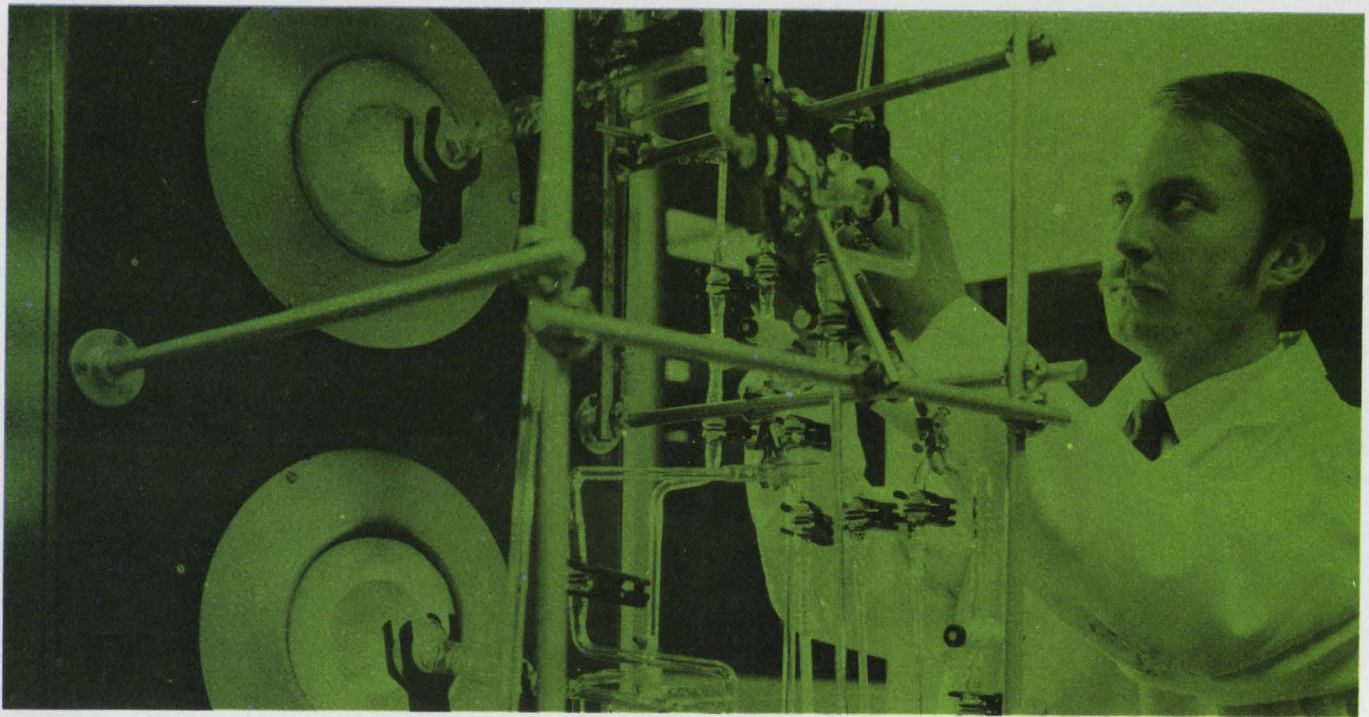

New MOS processes are solving the interface problems caused by high MOS thresholds. One process uses silicon with 1-0-0 crystal orientation to achieve a low

threshold, another uses 1-0-0 silicon and a layer of silicon nitride, with its higher dielectric constant. Photo courtesy General Instrument Corp., Hicksville, N.Y.

# TTL compatibility

One of the most serious deficiencies of MOS has been its inability to work directly with bipolar circuits, especially with TTL. Bipolar outputs don't normally supply enough voltage to operate MOS inputs, and MOS outputs don't supply enough current to operate bipolar inputs.

To overcome this dilemma, designers provide a separate special circuit at each interface between device types in their systems, modify the bipolar ICs, or modify the MOS ICs. Each of these solutions, of course, involves new problems.

Special interface circuits between TTL and MOS ICs are easy to build, but they're expensive. They dissipate power, increase propagation delay and lower system reliability. TTL could be redesigned to interface with existing MOS, but this is not practical or desirable. When the subject of interface problems between MOS and TTL comes

up, it is usually assumed that the problem lies with the MOS, and that something should be done with the MOS circuits to make them compatible with TTL. The designer wants to avoid causing deterioration of the TTL's performance by adding buffers to it, and does not want to raise the operating voltage of TTL to 26 volts.

To further penetrate the IC market, MOS must make a change. And only two alternatives exist for redesigning MOS circuits to be compatible with TTL: They are the silicon nitride and the 1-0-0 silicone processes.

## 1-0-0 silicon or silicon nitride?

The threshold voltage of the MOS device can be lowered to 2 volts by using either process, and either method is acceptable for designing input stages that can be operated from TTL. However, if special processing procedures are not used, the 1-0-0 process results in low field inversion, while the nitride process has a considerable safety margin.

---

**Dr. J. Leland Seely**, Vice President and General Manager, General Instrument Corporation, Microelectronics Division, Hicksville, New York.

In the design of compatible output stages, the nitride process reduces device size to one half that of the 1-0-0 process. And commercial devices that are truly TTL compatible at all inputs and outputs, including clocks, have been made with both processes. But to fully understand the merits of both approaches, it is necessary to look at the factors that influence threshold voltage.

### Modify the MOS IC

To be compatible with TTL, the MOS input stage must switch on only 3.7 volts. And the nominal spread of MOS threshold voltages for high-threshold devices processed in a well-controlled line is from 3.5 to 5.0 volts. The first problem to be solved, then, is to lower the nominal threshold voltage,  $V_t$ .

Equation 1 shows the dependence of  $V_t$  on various process parameters.

$$V_t = \phi_{ms} - (1/C_o) \int_0^{x_o} (X/X_o) \rho(X) dx - Q_{ss}/C_o - Q_B/C_o + 2\phi_{FN} \quad (1)$$

The first term,  $\phi_{ms}$ , is the difference in work function between the metal used as the gate electrode and the silicon substrate. For aluminum

# is here

and 12.5  $\Omega$ -cm silicon,  $\phi_{ms}$  is 0.3 volt. It can be changed somewhat by changing the metal or the doping level of the silicon, but it can't be changed enough to lower  $V_t$  appreciably.

The integral term shows the effect of an ionic or electronic charge distribution,  $\rho(X)$ , on  $V_t$ . For a clean process and a gate dielectric undamaged by radiation, this term is zero.

The last term,  $\phi_{FN}$ , is the Fermi level of the  $n$ -type silicon substrate. Its value is determined by the doping level of the silicon, and changes very little between 3 and 12  $\Omega$ -cm silicon.

$Q_B$  is the charge per unit area contained within the surface depletion region after the threshold voltage has been exceeded. Its magnitude is directly proportional to the doping level of the silicon and again, can't be varied appreciably.

This leaves only two terms to work with in lowering  $V_t$ . They are the surface-state charge per unit area,  $Q_{ss}$ , and the capacitance per unit area,  $C_o$ . For a given gate dielectric material,  $C_o$  is determined by the thickness of the material.

Historically, silicon dioxide, 1200Å thick, has

**Silicon nitride and I-O-O silicon MOS processes are making the buffer circuit a thing of the past.**

been used as a gate dielectric. The expected threshold value for various thicknesses of silicon dioxide as a function of  $Q_{ss}$  is shown in Fig. 1. A gate thickness of 1200 Å and a  $V_t$  of 3.5 volts, for example, implies a  $Q_{ss}$  of  $4.2 \times 10^{11} \text{ q/cm}^2$  ( $q$  is the magnitude of charge on one electron). To maintain the same thickness and reduce  $V_t$  to 2 volts requires that  $Q_{ss}$  be reduced to  $1.5 \times 10^{11} \text{ q/cm}^2$ .

This is easily done by using the 1-0-0 orientation of the silicon substrate instead of the conventional 1-1-1 orientation. As a matter of fact, the same process that results in a  $Q_{ss}$  of  $4.2 \times 10^{11} \text{ q/cm}^2$  with 1-1-1 material results in a  $Q_{ss}$  of only  $1.0 \times 10^{11} \text{ q/cm}^2$  when 1-0-0 material is used. The corresponding  $V_t$ 's are 3.5 volts and 1.7 volts respectively.

Thus the use of 1-0-0 material readily solves the problem of lowering  $V_t$ . Unfortunately, there are problems with this solution as it relates to the over-all goal of making a TTL-compatible MOS IC.

The first problem is field inversion. Field-inversion voltage is another name for threshold voltage except that it refers to regions other than gates. Whereas the oxide under a gate is made thin to lower  $V_t$ , the oxide in the field is made thick to raise the field-inversion voltage. The reason of course, is that if field inversion occurs, under power supply bus metallization for example, the silicon surface under the bus becomes conductive and may short together p-regions that happen to pass under the bus line. Figure 2 shows field-inversion voltage as a function of  $Q_{ss}$  for various field oxide thicknesses.

It is obvious from the curves that to get high field inversion it is necessary to have either high surface-state density or a thick field oxide, or preferably both. But for thicknesses greater than about 18,000 Å, the oxide begins to crack or craze, so this represents an upper limit. Fifteen thousand angstroms is the usual thickness. Thus the specification of the power-supply voltage at which the circuit is to operate in is, in fact, a specification of the required  $Q_{ss}$ .

For TTL compatibility, one supply must be +5 volts, and -12 volts is very convenient for the other, for a total difference of 17 volts. To allow a safety margin, the minimum field-inversion voltage ought to be at least 20 volts. This implies that the minimum  $Q_{ss}$  for a 15,000 Å field ought to be about  $2.5 \times 10^{11} \text{ q/cm}^2$ .

The tendency of the 1-0-0 material to give  $Q_{ss}$  of around  $1.0 \times 10^{11} \text{ q/cm}^2$  results in field-inversion voltages of around 10 to 15 volts—much too low. If, by one means or another,  $Q_{ss}$  is increased appropriately (and remains stable), then a 2.0-volt  $V_t$  cannot be achieved with a 1200 Å gate. At this  $Q_{ss}$ , an 800 Å gate is needed. But an 800 Å gate tends to have a fairly high incidence of pin-

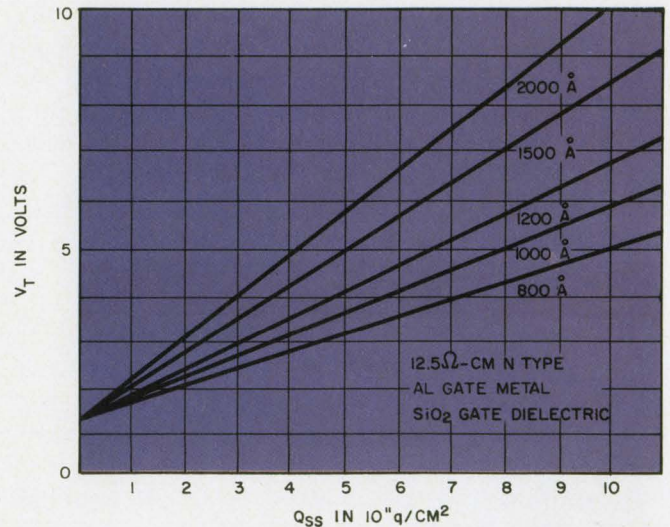

1. Threshold voltage varies with both surface state charge  $Q_{ss}$  and thickness of the silicon dioxide gate material.  $Q_{ss}$  is reduced by using a 1-0-0 crystal orientation of the silicon substrate.

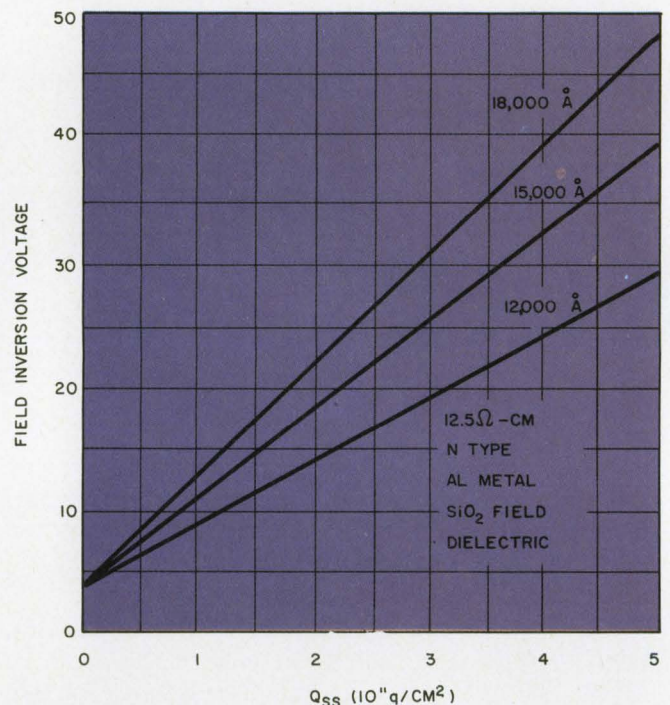

2. Unwanted field inversion can cause trouble, because conduction occurs at regions other than under the gate metallization. The silicon dioxide cannot be made thicker than 18,000 Å, because it begins to crack or craze, and this imposes an upper limit of 10 to 15 volts for 1-0-0 silicon, which has a  $Q_{ss}$  of roughly  $1.0 \times 10^{11} \text{ q/cm}^2$ .

holes, which reduce yield, and it is more subject to damage from static electricity.

If processing is done in order to overcome field inversion problems without having to increase  $Q_{ss}$  in the gate region (by perhaps guard-ring diffusions or special treatment of the field oxide), then it is possible to get a  $V_t$  of 2.0 volts and a



**Table. Comparison of low threshold processes.**

	Silicon nitride process	1-0-0 Silicon process
Gate dielectric material	Si <sub>3</sub> N <sub>4</sub> -SiO <sub>2</sub>	SiO <sub>2</sub>
Crystal orientation	(111)	(100)
Gate thickness, mechanical	1000Å	1200Å
Gate thickness, electrical	800Å	1200Å
Mobility	240cm <sup>2</sup> /V-sec	180cm <sup>2</sup> /V-sec
Surface state density	2.5 × 10 <sup>11</sup> q/cm <sup>2</sup>	1.5 × 10 <sup>11</sup> q/cm <sup>2</sup>
Field inversion voltage	22 volts	15 volts
Threshold voltage	2 volts	2 volts
k'	10.4 × 10 <sup>-6</sup> amp/V <sup>2</sup>	5.2 × 10 <sup>-6</sup> amp/V <sup>2</sup>

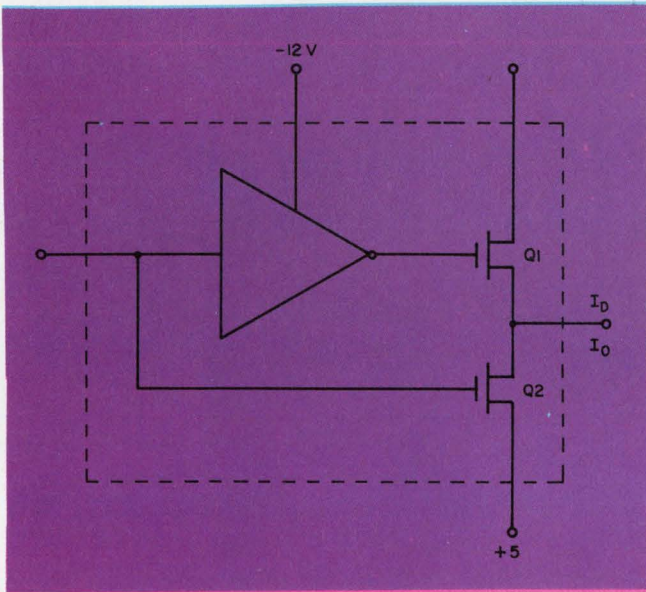

**3. This is the best available MOS output circuit configuration for several reasons: it occupies the smallest chip area for its drive capabilities; requires no external resistors; has a high capacitive drive capability; and has a comparatively low power consumption. Its wide use is expected in interface applications.**

gate thickness of 1200Å. But this leads to another problem.  $V_t$  is the most important parameter in designing an input stage that can be driven by TTL, but another parameter,  $k'$ , is of equal importance in designing an output stage capable of supplying the 1.6 mA required to drive TTL.

The most desirable type of output stage is that

shown in Fig. 3. The available drive current,  $I_D$ , is related to various process and geometrical parameters by

$$I_D = k'(W/L) [(V_{GS} - V_t)V_o - V_o^2/2], \quad (2)$$

where  $W$  is the width of the channel,  $L$  is the source drain spacing,  $V_{GS}$  is the gate-to-source voltage of  $Q_1$ ,  $V_t$  is the threshold of  $Q_1$  and  $V_o$  is the output voltage when  $I_D$  is 1.6 mA. For acceptable noise immunity,  $V_o$  should not exceed 0.5 volt. If we assume  $V_t = 2$  volts,  $V_{GS} = 9$  volts, and  $L = 0.3$  mils, we obtain

$$I_D = 11Wk', \quad (3)$$

showing explicitly that the drive current is directly proportional to the geometrical size of the device and to the parameter  $k'$ . Since it is desirable to keep the geometrical size as small as possible, it is desirable to make  $k'$  as large as possible. It is directly proportional to mobility,  $\mu$ , and to the dielectric constant,  $K_E$ , and is inversely proportional to the dielectric thickness ( $\epsilon_o$  is a universal constant, independent of the material or structure):

$$k' = \mu K_E \epsilon_o / t \quad (4)$$

If, therefore, we choose to use silicon nitride, which has a dielectric constant of 7.5 compared to 3.8 or 3.9 for silicon dioxide, the resultant  $k'$  almost doubles.

Silicon nitride does pose problems, however.

When it is deposited directly on silicon, large hysteresis effects are observed in the gate-voltage vs drain-current characteristic. To avoid this hysteresis, a certain thickness of silicon dioxide must be deposited between the silicon nitride and the silicon. This is the reason for the "sandwich" dielectric seen in cross-sectional drawings.

The equivalent dielectric thickness then depends on the total mechanical thickness and the ratio of oxide to nitride. For example, one can quite controllably achieve mechanical thickness of 1000 Å having an equivalent electrical thickness of 800 Å of silicon dioxide. A comparison of parameters resulting from the 1-1-1 nitride process and the 1-0-0 oxide process shows the distinct improvement obtained (see Table).

The nitride process gives twice the  $k'$  of the oxide process and a significantly improved field-inversion voltage. Using these values of  $k'$ , derated 40% for operation at 125°C, and Eq. 3, one can solve for the size of MOS device required to supply 1.6 mA in the steady-state condition. For the nitride and oxide processes,  $W$  equals 24 mils and 48 mils, respectively.

In actual practice, transient response is equally important as steady state, so the size of the device required is typically larger, by almost a factor of 2. When there are multiple output stages in a circuit, the advantage that the nitride process has in reducing chip size is even more evident. Reduced chip size increases yield and lowers costs. ■■

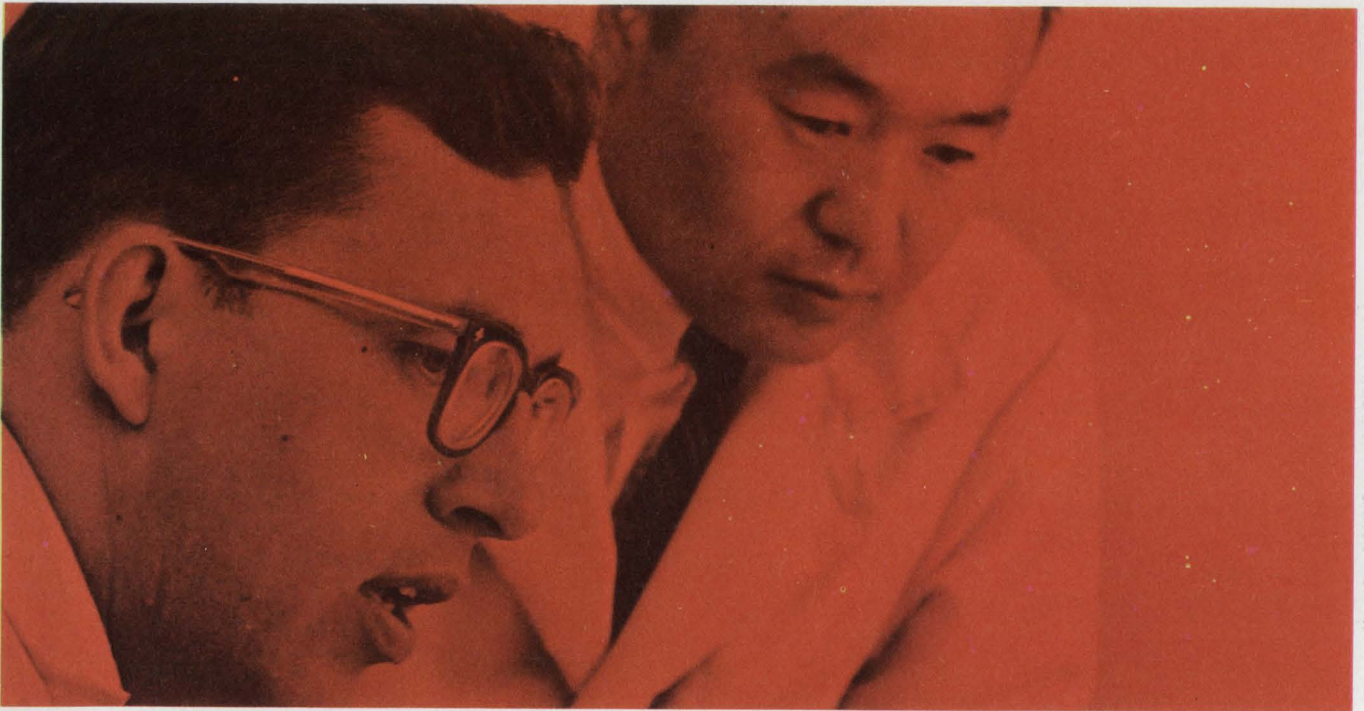

**Designers have a partitioning headache.** Complex logic, especially control logic, is very difficult to divide into blocks suitable for integration on MOS chips. In addition to minimizing the number of chips in a system, an efficient design must achieve low cost per function,

optimum component densities, and the smallest possible number of interconnections or leads on each chip. Photo of Kenneth Moyle, MOS IC Product Manager, and Dan Izumi, MOS IC Design Engineer, courtesy of National Semiconductor, Santa Clara, Calif.

# Partitioning is a

One of the biggest problems that the designer faces today is the proper application of MOS. He can't ignore its existence—it offers too many obvious advantages. Processing, once mastered, is simple, devices are small so that complexity can be high, and custom design is often very easy because only the metallization is customized. But in applying MOS he can run into serious difficulties, and one of the major trouble areas is partitioning—deciding which portions of the circuit should be integrated as IC chips.

In the past, the logic designer has accepted the “gate” as his basic building block. The old procedure is to make thousands of gates on a wafer, dice it, assemble the dice into individual packages and then further assemble these.

But all this handling is expensive and time consuming. It results in accidental damage, and every step involves a yield loss. Packaging is expensive, and difficult to automate, and reliabili-

ty is reduced by the large number of interconnections required. Clearly, larger building blocks are desirable. And MOS is making them possible.

## Larger building blocks pose problems

Increased complexity, easily achieved with MOS, results in fewer chips per system, with fewer interconnections (thus greater reliability) and a smaller, lighter product. But dividing a system up into a few chips is not easy. The larger building blocks are a particular headache.

Efforts to partition conventional large computers into repetitive functional blocks larger than gates have not been successful. Most of the gates are used in the central processor to direct and control the flow of information rather than to perform arithmetic operations. Control logic is generally customized for each system, and it has practically no regular structure. It can't be divided up into blocks with a reasonably small number of interconnections, and this is one of the main partitioning objectives.

---

**Glen Madland**, President, Integrated Circuit Engineering Corp., Phoenix, Arizona.

Partitioning can be defined as the division of schematic or logic diagrams into large-scale array chips in the most efficient possible manner. This includes satisfying the program objectives, of course, at low system cost and high component density. If system objectives are to be achieved, partitioning must:

- Minimize the number of chip types required to build the system.
- Provide low cost per circuit function.
- Provide optimum component density on each chip.
- Allow optimum area of each chip to provide high yield. (This will depend on the process used.)
- Minimize the number of interconnections between chips.
- Employ the best available state-of-the-art in processing.
- Use the most inexpensive available packaging.

#### Guides to optimize partitioning

All factors cannot be maximized simultaneously, of course, and engineering tradeoffs or

# challenge

compromises must be made. To make matters worse, most of the variables involved are interdependent.

But the problem can be simplified. Many engineers use guides—partitioning factors and ratios—to aid them in their attempt at optimizing their partitioning plan.

*The functional-usage factor*, for instance, is defined as the number of times a given functional block is used in the system divided by the total number of different blocks in the system. This factor may be increased by judicious partitioning and by the inclusion of redundant logic elements. When this factor is maximized, a smaller variety of chip types is required, but more of each type must be used.

In production, this permits concentration of effort on the narrower problems of yield improvement. And the number of types of spare parts required for field maintenance is reduced, which is a distinct advantage (Fig. 1).

*The cost-per-function ratio* is defined as the total cost per function resulting from adding

**Dividing complex logic into suitable blocks is a tough job but the efficient use of MOS arrays depends on it.**

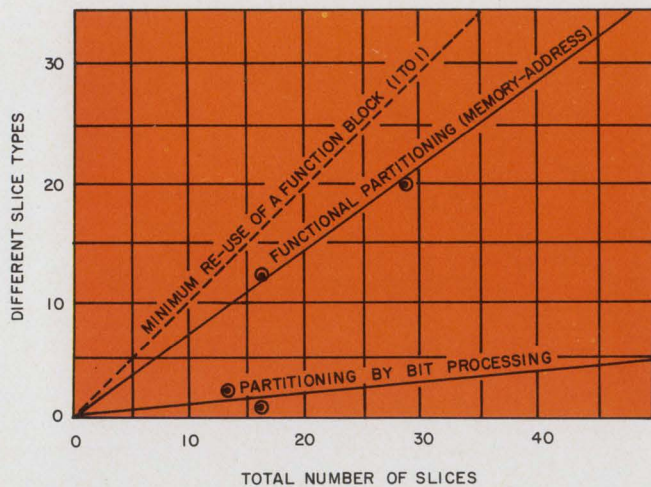

1. Functional blocks should be repeated as many times as possible in a system, to keep spare parts inventories low and to take advantage of mass production techniques. If partitioning is done so that arithmetic, memory, and control logic is combined on the chip (bit processing) the efficiency is much greater than if these functions are done on separate chips.

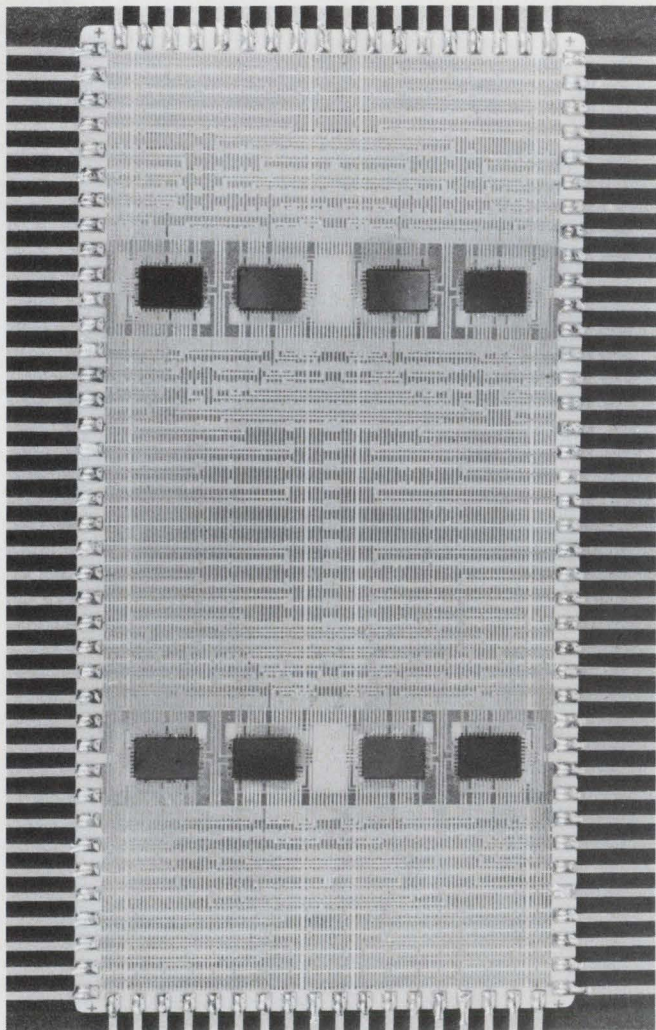

Logic circuits are partitioned into sections which can be integrated onto single monolithic chips. Here, a subsystem is built from eight chips which are interconnected on a multi-level ceramic substrate. Photo courtesy Raytheon Missile Systems Division, Bedford, Mass.

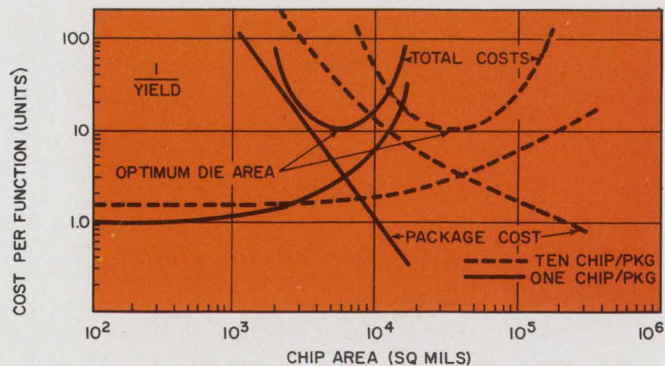

2. System costs are minimized at an optimum die area which depends on the package and chip cost curves. As chip complexity (and area) increases yield decreases and chip cost goes up, but as complexity increases the number of packages, and hence system packaging cost, goes down. Finding the resultant minimum system cost point is the designers challenge.

package, assembly, process and system hardware costs for a functional block consisting of one or more logic functions.

The cost per function is primarily dependent upon packaging cost (Fig. 2), when the package contains a relatively small number of functions per package, and is determined primarily by yield when each package contains a large number of functions. The cost-per-function curve is binomial in form, with the minimum inflection point dependent on the state of the technology.

Minimum cost per function favors standard packages. These, because of high volume, are usually most economical and involve the least expensive assembly methods.

The functions-per-pin ratio is maximized by combining circuit functions in such arrangements (arrays) that they require the fewest external connections. Carried to its logical maximum, this dictates that the whole system should be in one package ("computer on a slice"). This would require only input, output, power and reference terminals and would eliminate external interconnections, feedback, terminals, etc. When this ratio is maximized, the highest possible device density can be achieved. Optimizing this factor, of course, may not necessarily allow the use of the most economical package or result in the smallest number of package types.

For individual computer sections such as the logic or memory, the total pin count increases as shown in Fig. 3.

The chip size-to-yield ratio is critically associated with the manufacturing processes used to make large-scale arrays—material and process irregularity always cause yield losses during processing. This relation, for complex chips, is exponential in form since the irregularities are usually random functions. The limitations imposed by the manufacturing processes impose a

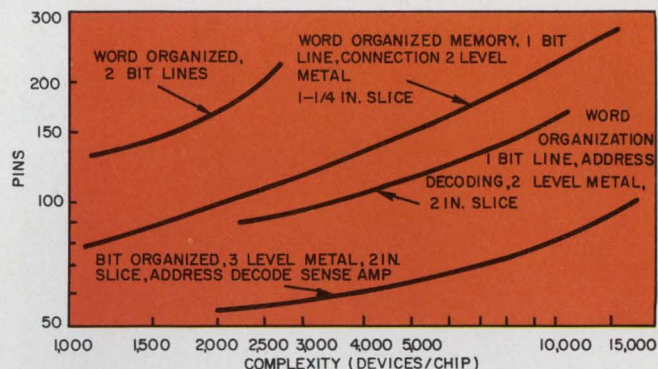

3. The number of pins needed increases with the complexity of the circuitry on an IC memory chip, and is heavily dependent on the memory organization. Word-organized memory with 2 bit-lines can require up to four times as many pins as some bit-organized memory, and address decoding schemes can reduce the total requirement by a factor of roughly two.

practical upper limit on chip size.

The goals of LSI partitioning are to reduce the over-all system cost by judicious trade-offs among the factors listed. The present cost structure of complex arrays indicates that the cost per function decreases as the array becomes more complex—up to a certain point. When chip complexity increases beyond that point, the cost per function starts to increase rapidly (Fig. 4). Actual cost figures, of course, can be obtained only from the manufacturer, and close communication is essential.

#### Tradeoffs require communication

Partitioning is not a job that the designer can do alone. He must above all else communicate with his prospective vendor about his system's needs and the capability of the MOS process.

The MOS vendor must have full control of the physical layout of his circuits if he is to maintain their quality. This being true, efficient procurement requires the systems designer to supply the complete logic design, testing requirements and perhaps actual mask drawings to the vendor. The designer prepares this material using design rules for systems optimization (such factors as electrical performance, transconductance yield versus area, etc.) provided by the vendor.

The idea of the customer supplying only a block diagram is no longer a practical one, since this takes the control of complexity per package, one of the system optimization variables, out of the designers' hands. The designer may also seek multiple sources, and to do this he must control the circuit design.

Sufficient common processing exists in MOS technology to allow this type of interchangeability to occur, with the exception of uniquely processed devices for ultra-high frequency. In such

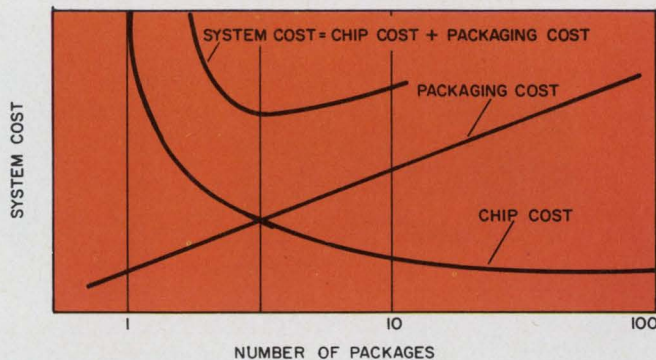

4. Minimum system cost is determined by packaging and chip costs. As chips get smaller yields get better, but the number of packages in a system rises. If the whole system is put on one chip, for instance, the chip gets very large and yields are exceedingly poor, so chip cost is unrealistically high. Again, the designers task is to find the optimum point.

cases, a single source and a considerable amount of cooperation and confidence must exist between the vendor and user.

This does not mean that the manufacturer cannot contribute to the systems design. Indeed he does, but the concept presented here is one in which the user has complete control of what he is procuring for his particular system. Failures of MOS in the past have generally been due to the overoptimism of the manufacturer. In almost all cases the user had a market for his end product and was capable of servicing that market, had he been able to produce his system.

Perhaps a transfer of systems responsibility to the vendor may be appropriate for organizations which do not currently have sufficient systems competence to design ICs—a delegation of systems responsibility. In the case where this delegation is made, the systems performance becomes the key specification and is in the control of the customer. The device design is left up to the vendor, and his only obligation is to provide complete systems or subsystems to meet the functional requirements.

If this arrangement is made, it is desirable also to leave the partitioning in the hands of the vendor and provide enough economic data so that proper partitioning decisions can be made. Since ICs will become cheaper as complexity grows, it would be desirable to have the vendor actually control the entire subsystem so that he can increase the package complexity.

At any rate, many of our important future problems will not be technical. The primary barrier that we face now seems to be one of communications. LSI engineers will have to understand chemistry, physics, metallurgy and electronics, and they'll also need a mastery of the art of communications, one of our biggest problem areas. ■■



**Daily conferences bring the experts together** to discuss contracts and to check design and production progress. Viatron has found that a project manager is an absolute must. His duties are typical of those of an in-house

project manager, but he acts, with considerable authority, as the overseer of the joint business venture between the MOS vendor and the customer. Photo courtesy Viatron Computer Systems Corp., Burlington, Mass.

# Single-sourcing causes

MOS has finally arrived. The believers have committed entire systems to MOS design, and the doubters are becoming believers. Design capacity within the industry is taxed to its limits, and production plans are being accelerated.

This acceptance of MOS, and the MOS procurement problems of the past, are forcing a drastic change in the vendor/user relationship. Vendors and their customers are becoming heavily dependent on each other, more so than at any time in semiconductor history.

The semiconductor vendor, in the past, designed piece parts to meet a broad market, and he carried a small percentage of over-all system design costs. He simply made and sold transistors and diodes. But with ICs he has begun to assume circuit design responsibilities. He is providing

transistors, diodes, resistors, and interconnections on single monolithic chips. In making four logic gates available in one package, he approaches a complexity previously found only on complete printed circuit cards.

Today, the LSI vendor is making more than 100 gates available in one package. This package is equivalent to a printed circuit board containing more than 15 simple ICs. There have been order-of-magnitude increases in the number of gates per printed circuit board, both in going from discrete components to ICs, and in going from ICs to LSI arrays (Fig. 1). Vendors are now rapidly approaching the point of placing a subsystem on a single silicon die.

## Custom design increasingly important

But if the system houses are to use LSI efficiently, a great many custom designs will be required. Modern systems use a lot of random functions, usually in control logic, which simply cannot be standardized—they are all different,

---

**Laurence C. Drew**, Manager of Engineering Development, and **James E. Sheahan**, Manager of Test Equipment Development, Viatron Computer Systems Corp., Burlington, Mass.

each designed to do one control function only. Computer peripheral equipment, for instance, is almost all control logic. (There is no question, however, that standardization has already occurred in arithmetic units, ROMs, RAMs, and shift registers.)

And since custom designs give the system houses a competitive edge, they will generally be held proprietary. Systems houses will insist on it, to protect their markets. Vendors will probably not be able to sell these parts on the general market. Also, as with any new technology, the availability of experienced manpower is limited. Though computer aids are rapidly becoming effective, even the present rate of producing new designs is taxing the vendors' resources.

These factors, coupled with the high cost of initial design, will probably limit MOS customers to single sources for some time to come. And the combination of custom designs and single sources of supply brings customers and vendors to a new interdependence. The business relationship of the system original equipment manufacturers (O.E.M.) customers and the semiconductor manufacturers is becoming a team effort, rather

# changes

than a vendor/customer relationship. And team action needs rules.

The customer and the vendor must define, from the outset, the type of business in which each wishes to be involved. Is it high volume/low cost, or low volume/high cost? Are the design goals and specifications easily attained, or do they extend beyond the state of the art? Does the customer do all design, or will the vendor contribute some design work? And if the design effort is shared, who does what? If the team is to operate efficiently, the answers to these questions must be mutually resolved before any design work has begun (Fig. 2).

Several possible levels of technical interface between customer and vendor are shown in Fig. 3. The customer can provide a black-box system description and give the vendor complete design freedom, for instance, or he can supply complete mask sets for processing. Both parties must agree to an optimum level of interface, based on their respective capabilities. Once the interface has been established, the responsibilities of each

**Customers  
and vendors  
find that  
custom MOS design  
leads to a new  
business  
interdependence.**

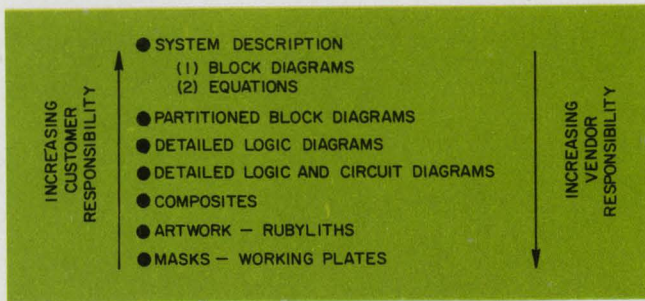

Technical interfacing can occur at any level mutually agreeable to both vendor and customer. Normally, though, the system description is entirely the responsibility of the customer and mask making is entirely the responsibility of the vendor.

party must be clearly defined.

If the customer uses a logic diagram as a contractual document, for instance, the vendor must fully understand the function to be performed by each block, and he must be made aware of operational frequency and time delays. If the logic does not perform the specified functions, then the customer is wholly responsible. If, however, the vendor has failed to implement the logic exactly as described, through modified circuit or logic approaches, then the fault is wholly his.

It is imperative that each party be willing to accept time and cost penalties for his own errors, and agreements must be concise enough so that responsibility for error can be assigned.

### Program management is a must

A joint business venture must be controlled in the same manner as any typical system project. The systems house should assign a project manager to oversee all aspects of a program. The manager must have a working knowledge of all the skill areas contributing to the success of his project, including circuit design, mechanical engineering, manufacturing, and administration. He should set schedules mutually agreeable to all groups, and should periodically review reports of progress and problems. He must also be able to properly compensate for any potential problems and monitor the interplay between design and manufacturing groups.

The project manager/customer must educate himself as to what is required to make a successful MOS/LSI part. He may accomplish this through the latest books and magazines and information from the vendors, but it may also be desirable for him to have knowledgeable semiconductor people on his staff.

In order to partition a system properly, the manager must have information on optimum chip size and process parameter variations. To project and control costs based on the above restrictions,

the manager must also be given potential yield information. Only in this way will he be able to determine that the end result of his program will come about on time, and within his budget, and that the system will perform to his original specifications.

### The project manager must be aware

The project manager must know of any changes in processing or design that will affect the operation of his system. A shift in threshold distributions, for example, may allow components to meet the agreed-on specifications, but still cause system problems. The manager may have to rewrite system wiring rules. He should at least be aware that a potential problem exists.

Changes in schedules by any group contributing to the project must be relayed to the manager so that he can compensate by changing his plans. He may decide to initiate parallel development, for instance, or to explore a different approach if serious delays appear imminent. If one vendor slips in any area, the manager must make up the time in some other step.

He may even go to a second vendor or a third to make up the slip. He must be granted the right to make such a decision, and only through proper knowledge of the over-all system concept can he make it competently.

The one major problem that can occur in any system is that of communications among various people or groups. In any given company, sadly enough, you can expect to find communications problems existing between two engineers sitting next to each other. By projecting this problem among several companies, it is obvious that the chance of error, or misinformation, becomes much greater. It is essential that a control point for clearing all written and verbal information should be established at both customer and vendor levels.

### Independent action spells trouble

The result of doing business as independent concerns, as has been done in the past, will probably leave two dissatisfied companies. The vendor may be pushed into a loss situation by low prices, tight specifications or other restrictions, and his only response can be nondelivery. The customer is in trouble if the vendor misstates his process, production or cost capabilities, and in the end he may be forced to search out a second source.

Since neither of these eventualities is desirable, it is necessary for both the customer and vendor to "tell it like it is" from the outset of their business relationship. They must work together, in their own best interests, and they each stand to gain from this close cooperation (see table). ■■





**LINEAR BRIEF 6**

R. J. Widlar  
National Semiconductor

**FAST VOLTAGE COMPARATORS WITH LOW INPUT CURRENT**

Monolithic voltage comparators are available today which are both fast and accurate. They can detect the height of a pulse with a 5 mV accuracy within 40 ns. However, these devices have relatively high input currents and low input impedances, which reduces their accuracy and speed when operating from high source resistances. This is probably a basic limitation since the input transistors of the integrated circuit must be operated at a relatively high current to get fast operation. Further, the circuit must be gold doped to reduce storage time, and this limits the current gain that can be obtained in the transistors. High gain transistors operating at low collector currents are necessary to get good input characteristics.

One way of overcoming this difficulty is to buffer the input of the comparator. A voltage follower is available which is ideally suited for this job. This device, the LM102\*, is both fast and has a low input current. It can reduce the effective input current of the comparator by more than three orders of magnitude without greatly reducing speed.

A comparator circuit for an A/D converter which uses this technique is shown in Figure 1a. An LM102 voltage follower buffers the output of a ladder network and drives one input of the comparator. The analog signal is fed to the other input of the comparator. It should come from a low impedance source such as the output of a signal processing amplifier, or another LM102 buffer amplifier.

Clamp diodes, D<sub>1</sub> and D<sub>2</sub>, are included to make the circuit faster. These diodes clamp the output of the ladder so that it is never more than 0.7V different from the analog input. This reduces the voltage excursion that the buffer must handle on the most significant bit and keeps it from slewing. If fast, low-capacitance diodes are used, the signal to the comparator will stabilize approximately 200 ns after the most significant bit is switched in. This is about the same as the stabilization time of the ladder network alone, as its speed is limited by stray capacitances. The diodes also limit the voltage swing across the inputs of the comparator, increasing its operating speed and insuring that the device is not damaged by excessive differential input voltage.

The buffer reduces the loading on the ladder from 45 μA to 20 nA, maximum, over a -55°C to 125°C temperature range. Hence, in most applications the input current of the buffer is totally insignificant. This low current will often permit

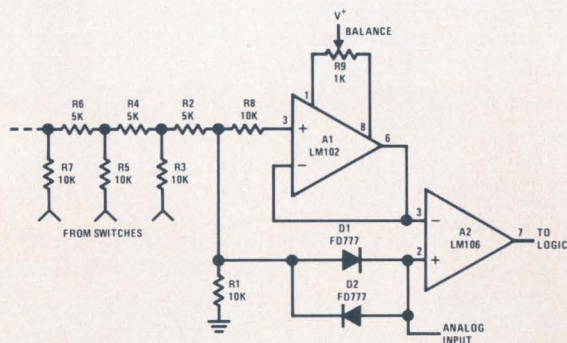

a. Using a Ladder Network

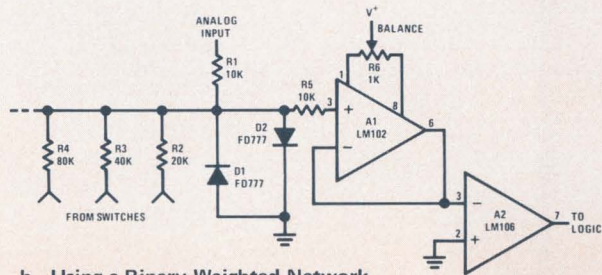

b. Using a Binary-Weighted Network

**FIGURE 1. Comparator Circuits for Fast A/D Converters**

the use of larger resistances in the ladder which simplifies design of the switches driving it.

It is possible to balance out the offset of the LM102 with an external 1 kΩ potentiometer, R<sub>9</sub>. The adjustment range of this balance control is large enough so that it can be used to null out the offset of both the buffer and the comparator. A 10 kΩ resistor should be installed in series with the input to the LM102, as shown. This is required to make the short circuit protection of the device effective and to insure that it will not oscillate. This resistor should be located close to the integrated circuit.

A similar technique can be used with A/D converters employing a binary-weighted resistor network. This is shown in Figure 1b. The analog input is fed into a scaling resistor, R<sub>1</sub>. This resistor is selected so that the input voltage to the LM102 is zero when the output of the D/A network corresponds to the analog input voltage. Hence, if the D/A output is too low, the output of the LM106 will be a logical zero; and the output will change to a logical one as the D/A output exceeds the analog signal.

The analog signal must be obtained from a source impedance which is low by comparison to R<sub>1</sub>. This can be either another LM102 buffer or the output of the signal-processing amplifier. Clamp diodes, D<sub>1</sub> and D<sub>2</sub>, restrict the signal swing and speed up the circuit. They also limit the input signal seen by the LM106 to protect it from over-

\*R. J. Widlar, "A Fast Integrated Voltage Follower," National Semiconductor Corporation AN-8, May, 1968.  
©1969 NATIONAL SEMICONDUCTOR CORP.

LINEAR BRIEF 6 JUNE 1969

loads. Operating speed can be increased even further by using silicon backward diodes (a degenerate tunnel diode) in place of the diodes shown, as they will clamp the signal swing to about 50 mV. The offset voltage of both the LM102 and the LM106 can be balanced out, if necessary, with  $R_6$ .

The binary weighted network can be driven with single pole, single throw switches. This will result in a change in the output resistance of the network when it switches, but circuit performance will not be affected because the input current of the LM102 is negligible. Hence, using the LM102 greatly simplifies switch design.

Although it is possible to use a 710 as the voltage comparator in these circuits, the LM106 offers several advantages. First, it can drive a fan out of 10 with standard, integrated DTL or TTL. It also has two strobe terminals available which disable the comparator and give a high output when either of the terminals is held at a logical zero. This adds logic capability to the comparator in that it makes it equivalent to a 710 and a two-input NAND gate. If not needed, the strobe pins can be left unconnected without affecting performance. The voltage gain of the LM106 is about 45,000, which is 30 times higher than that of the 710. The increased gain reduces the error band in making a comparison. The LM106 will also operate from the same supply voltage as the LM102, and other operational amplifiers, for  $\pm 12V$  supplies. However, it can also be operated from  $\pm 15V$  supplies if a 3V zener diode is connected in series with the positive supply lead.

It is necessary to observe a few precautions when working with fast circuits operating from relatively high impedances. A good ground is necessary, and a ground plane is advisable. All the individual points in the circuit which are to be grounded, including bypass capacitors, should be returned separately to the same point on the ground so that voltages will not be developed across common lead inductance. The power supply leads of the integrated circuits should also be bypassed with low inductance 0.01  $\mu F$  capacitors. These capacitors, preferably disc ceramic, should be installed with short leads and located close to the devices. Lastly, the output of the comparator should be shielded from the circuitry on the input of the buffer, as stray coupling can also cause oscillation.

Although the circuits shown so far were designed for use in A/D converters, the same techniques apply to a number of other applications. Figure 2 gives examples of circuits which can put stringent input current requirements on the comparator. The first is a comparator for signals of opposite

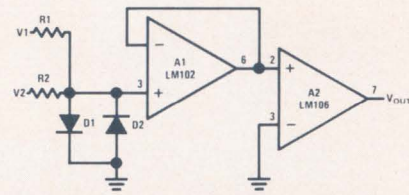

a. Comparator for Signals of Opposite Polarity

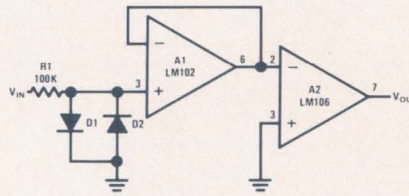

b. Zero Crossing Detector

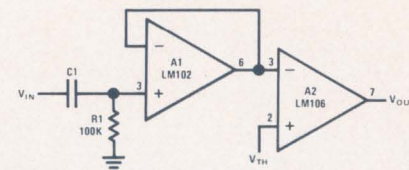

c. Comparator for AC Coupled Signals

FIGURE 2. Applications Requiring Low Input Current Comparators

polarity. Resistors ( $R_1$  and  $R_2$ ) are required to isolate the two signal sources. Frequently, these resistors must be relatively large so that the signal sources are not loaded. Hence, the input current of the comparator must be reduced to prevent inaccuracies. Another example is the zero-crossing detector in Figure 2b. When the input signal can exceed the common mode range of the comparator ( $\pm 5V$  for the LM106), clamp diodes must be used. It is then necessary to isolate the comparator from the input with a relatively large resistance to prevent loading. Again, bias currents should be reduced. A third example, in Figure 2c, is a comparator with an ac coupled input. An LM106 will draw an input current which is twice the specified bias current when the signal is above the comparison threshold. Yet, it draws no current when the signal is below the threshold. This asymmetrical current drain will charge any coupling capacitor on the input and produce an error. This problem can be eliminated by using a buffer, as the input current will be both low and constant.

The foregoing has shown how two integrated circuits can be combined to provide state-of-the-art performance in both speed and input current. Equivalent results will probably not be achievable in a single circuit for some time, as the technologies required are not particularly compatible. Further, considering the low cost of monolithic circuits, approaches like this are certainly economical.

National Semiconductor Corporation

2975 San Ysidro Way, Santa Clara, California 95051  
 (408) 245-4320/TWX (910) 339-9240



# The great digital systems kit!

## Steps 6 to 12:

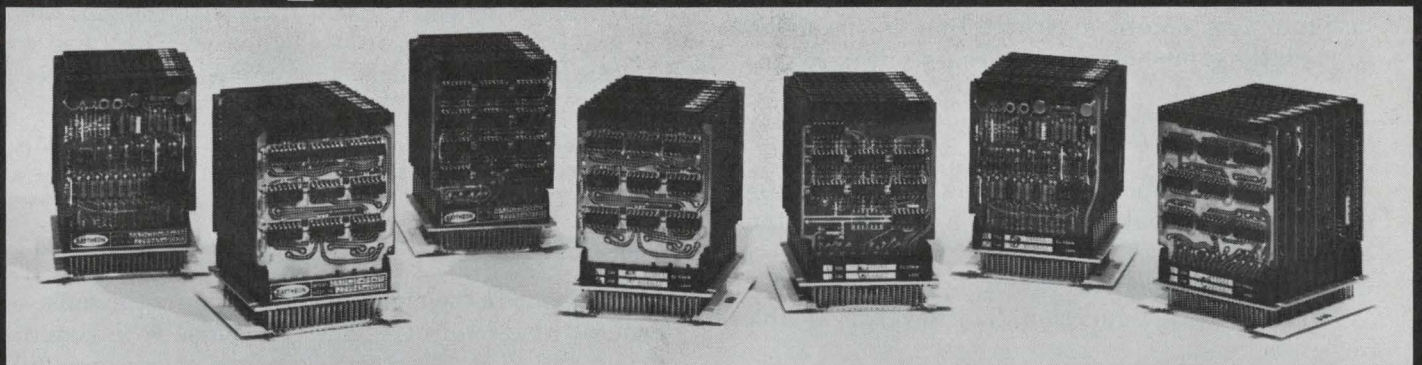

**Pick data system functions, then pick Raytheon Computer's MINI-BLOCS™. They're assembled, wired, tested, ready-to-use.**

These new MINI-BLOCS make system design and assembly as easy as calling Raytheon. Decide how your system will operate, then pick MINI-BLOCS to fit functions. Each one's on a compact connector block, wired, tested and guaranteed. Most are expandable, and they'll fit your mounting hardware or ours.

**MINI-VERTER™**—Multiplexer, Sample and Hold and ADC. 10, 12-bit binary, three digit BCD. Up to 100KHz conversion rate. 16 channels/block, expandable to 64 channels when used with MINI-MUX.

**MINI-DAC™**—10, 12-bit binary, three digit BCD. Settling time 10 usec, accuracy to 0.05%  $\pm \frac{1}{2}$  LSB. 4 channels/block.

**MINI-MUX™**—Up to 32 channels/block, expandable in 8-channel increments. 0.01% sample and hold accuracy. Sequence control, 20v input channel protection. Includes all analog power supplies.

**MINI-SAMPLE**—For simultaneous sample and hold. Up to 8 channels per block. 0.1% model has 100 nsec aperture, settles in 8 usec. 0.01% unit has 50 nsec aperture, settles in 3 usec. Input impedance  $10^8$  ohms.

**BCD to Binary Converter**—Converts 5 BCD characters to 16-bit binary word in as fast as 3 usec. Input and output are parallel form. Blocks can be combined for longer word length.

**Binary to BCD Converter**—Converts 16-bit binary word to 5 BCD characters in 3 usec. Parallel input and output. Expandable for greater word length.

**MINI-MEM**—Stores up to 32 16-bit words. Random or sequential word selection. 4 MHz transfer rate.

Write today for Data File DK177. Raytheon Computer, 2700 South Fairview Street, Santa Ana, California 92704. Phone (714) 546-7160.

**RAYTHEON**

# How tight a tolerance is really needed?

Calculating the answer may not only allow cheaper components—it may show you how to optimize your design.

At times all designers have had to discard circuit designs because of their high cost. One of the chief factors contributing to high cost is tight component tolerances. But how tight a tolerance is really required for each component in a particular application? And do all components exert the same influence on circuit operation?

A relatively easy method for calculating the effect of component variations on a circuit provides the answers to these questions. By disclosing the relationships between the different parameters, the technique allows the designer to achieve maximum cost effectiveness by allowing him to use the widest possible component tolerances consistent with the required performance.

In addition, by a correct choice of values, the designer can obtain a circuit that is insensitive to variations in some of the design parameters.

## Calculate the derivatives

The method consists of finding the total differential of the output function of a circuit and then examining it to see the effect of small changes in each of the component values.

For an arbitrary function,  $U$ , of several variables

$$U = F(x_1, x_2, \dots, x_n), \quad (1)$$

the total differential is given by

$$dU = \sum_{r=1}^n (\partial F / \partial x_r) dx_r. \quad (2)$$

In most practical cases, however, we can write

$$\delta U \cong \sum_{r=1}^n (\partial F / \partial x_r) \delta x_r. \quad (3)$$

where the  $\delta x_r$  are finite small increments and  $\delta U$  is the corresponding variation of the function itself. The accuracy of the approximation depends upon the nature of the function and the sizes of the increments  $\delta x_r$ . Where tolerances of not more than a few percent are involved, the formula will

be accurate enough for all practical purposes.

For worst-case limits of  $U$ , consider all the variables  $x_r$  to be independent. Then take the absolute values of the terms:

$$\pm \delta U \cong \sum_{r=1}^n |(\partial F / \partial x_r) \delta x_r|. \quad (4)$$

If the independent variables are random, with mean values  $x_r$  and standard deviations  $\sigma_r$ , the standard deviation  $\sigma_u$  of  $U$  is given by:

$$\sigma_u^2 \cong \sum_{r=1}^n [(\partial F / \partial x_r) \sigma_r]^2. \quad (5)$$

To apply the method to a practical problem, the output function  $U$  is first calculated. Then Eq. 4 is set up and each term is examined for its effect on  $\delta U$ . In some cases, the coefficient of a particular term can be forced to zero by having the component values satisfy certain conditions.

## Check out this pulse generator

To illustrate the method, let's examine the pulse-generating circuit of Fig. 1. The pulse is initiated by switching  $Q1$  OFF with a negative-going voltage step applied to its base. The resulting positive-going transition at the base of  $Q2$  switches it ON for a time determined by the values of  $V_1$ ,  $V_2$ ,  $R_1$ ,



A few tolerance calculations, and author Lee has an optimum design.

P. Lee, Radar Division, The Marconi Co., Ltd., Chelmsford, Essex, England

$C$  and  $R_2$ .

For simplicity, let  $V_{CE1}$  at saturation and  $V_{BE2}$  at saturation be zero. And ignore the effect of charge storage at the collector of  $Q_2$ . If known, of course, these parameters could be included.

The base current,  $i_B$ , of  $Q_2$  is given by

$$i_B = (V_1/R_1)e^{-t/R_1C} - V_2/R_2.$$

Now, if we let  $i_B = 0$ , we find that the output pulse duration,  $T$ , is given by

$$T = R_1C \log_e [(V_1/V_2) (R_2/R_1)]. \quad (6)$$

To plug into Eq. 4, the following partial derivatives are needed:

$$\partial T/\partial R_1 = C [\log_e (V_1R_2/V_2R_1) - 1]$$

$$\partial T/\partial C = R_1 [\log_e (V_1R_2/V_2R_1)]$$

$$\partial T/\partial V_1 = R_1C/V_1$$

$$\partial T/\partial V_2 = -R_1C/V_2$$

$$\partial T/\partial R_2 = R_1C/R_2.$$

Substituting them into Eq. 4 yields

$$\begin{aligned} \pm \delta T \cong & |\delta R_1C [\log_e (V_1R_2/V_2R_1) - 1]| \\ & + |\delta CR_1 [\log_e (V_1R_2/V_2R_1)]| + |R_1C\delta V_1/V_1| \\ & + |R_1C\delta V_2/V_2| + |R_1C\delta R_2/R_2|. \end{aligned} \quad (7)$$

If we divide both sides by  $R_1C$ , we get:

$$\begin{aligned} \pm \delta T/R_1C \cong & |(\delta R_1/R_1) [\log_e (V_1R_2/V_2R_1) - 1]| \\ & + |(\delta C/C) \log_e (V_1R_2/V_2R_1)| + |\delta V_1/V_1| \\ & + |\delta V_2/V_2| + |\delta R_2/R_2|. \end{aligned} \quad (8)$$

Since  $T$  varies directly as  $R_1C$  (Eq. 6), the left-hand side is a normalized measure of the sensitivity of the circuit to changes in the various parameters on the right-hand side. It is interesting to observe that the first term on the right-hand side of Eq. 8 vanishes when  $\log_e (V_1R_2/V_2R_1) = 1$  or, equivalently,

$$V_1R_2/V_2R_1 = e. \quad (9)$$

Thus, if the circuit is designed so that Eq. 9 is satisfied, the pulse length,  $T$ , will be independent of small changes in  $R_1$  (Fig. 2).

Substituting Eq. 9 into Eq. 8, we get:

$$\begin{aligned} \pm \delta T/R_1C \cong & |\delta C/C| + |\delta V_1/V_1| \\ & + |\delta V_2/V_2| + |\delta R_2/R_2| \end{aligned}$$

Typical tolerances of 5% each for  $C$ ,  $V_1$ ,  $V_2$ , and  $R_2$  lead to a tolerance of 20% for  $T$ . If  $C$ ,  $V_1$ ,  $V_2$  and  $R_2$  are independent random variables with standard deviations of 3% each, the standard deviation of  $T$  (Eq. 5) is

$$\sigma_T = 110 \times [4(0.03)^2]^{1/2}\% = 6\%. \quad \blacksquare \blacksquare$$

#### Acknowledgment:

The author wishes to thank the Director of Engineering of The Marconi Co., Ltd. for permission to publish this article.

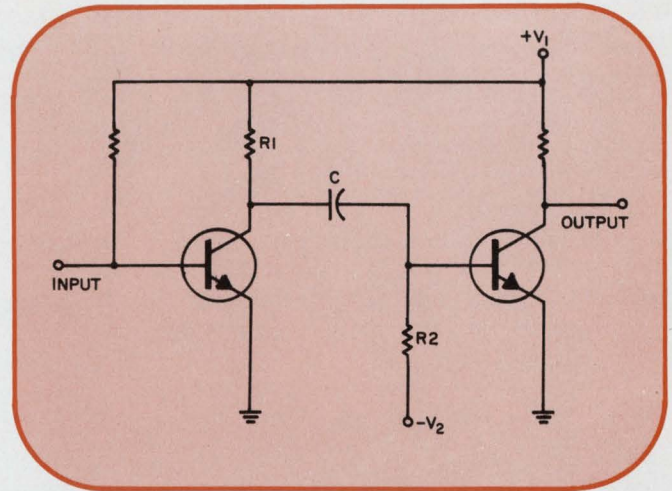

1. What is the duration of the output signal of this pulse generator? The exact answer depends upon the precise values of the parameters in Eq. 6. Choose them wisely and operate near the peak of the curve of Fig. 2.

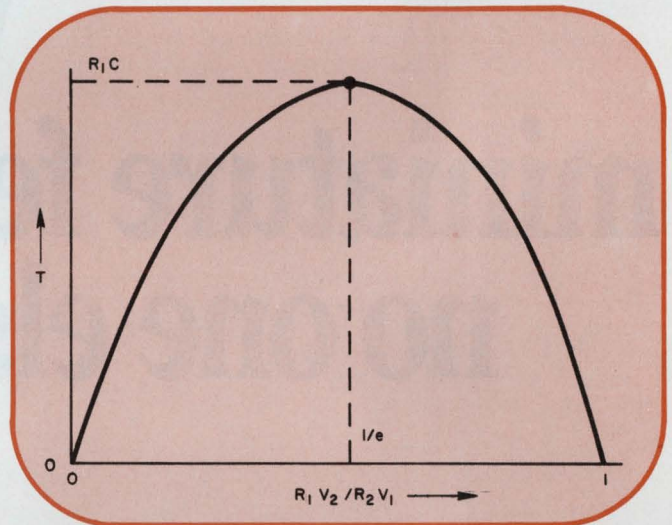

2. Pulse length,  $T$ , is independent of  $R_1$  near the apex of this curve. The plot shows how  $T$  varies with  $R_1$ . Actually,  $T$  is plotted against  $R_1V_2/R_2V_1$  with everything except  $R_1$  held constant.

#### Test your retention

Here are questions based on the main points of this article. Their purpose is to help you make sure you have not overlooked any important ideas. You'll find the answers in the article.

1. How can the design technique discussed here reduce circuit costs?

2. What conditions must be met if our expression for the standard deviation of  $U$  is to be true?

3. Note that if Eq. 9 had been substituted into Eq. 6 instead of Eq. 8, the results would have been much simpler and quite incorrect. Why?

**We polish off  
miniature ferrite devices  
no one else can make.**

**INDIANA GENERAL** *We make it easy for the design engineer.*

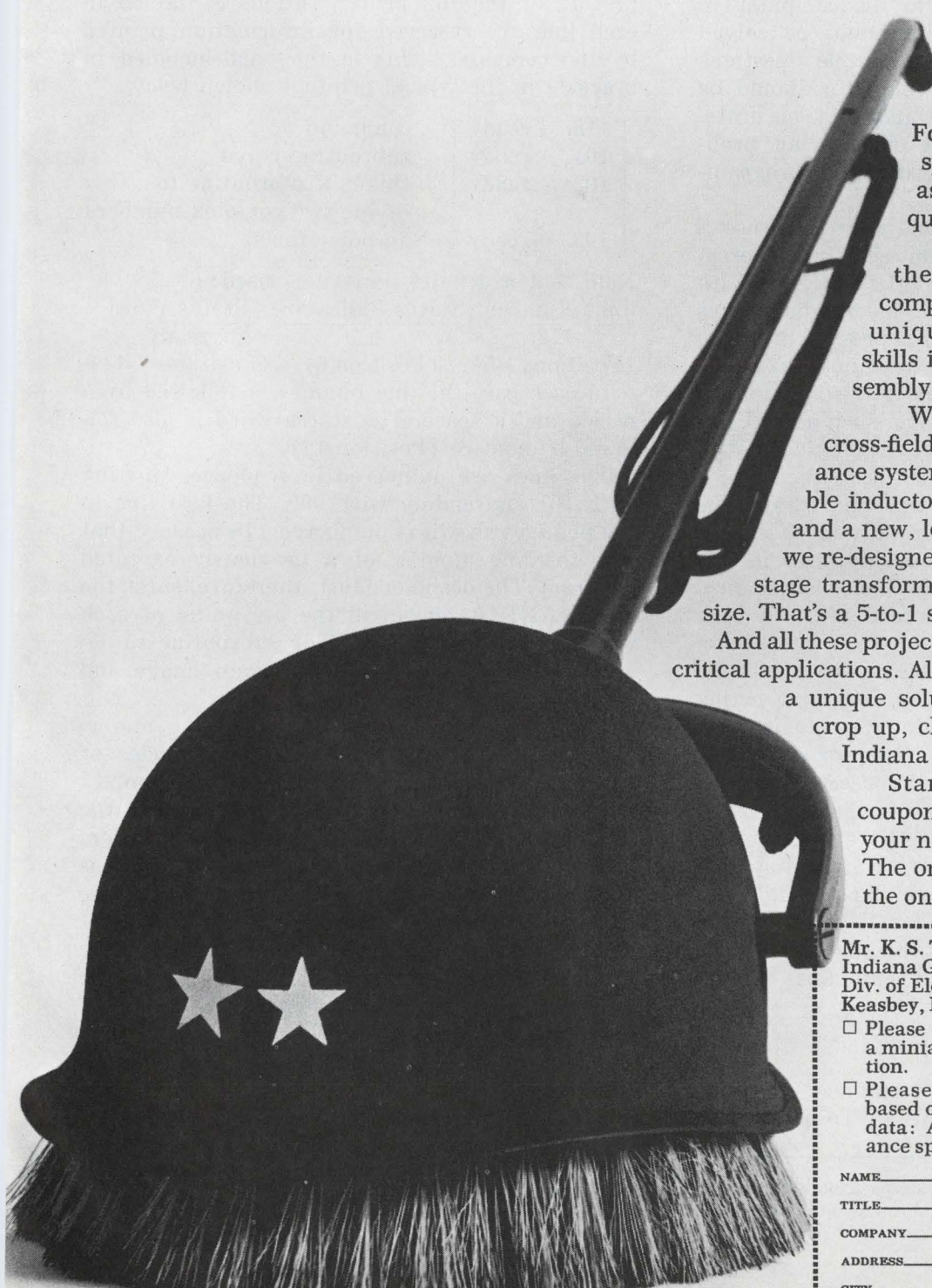

For a single qualified source for special, difficult to make ferrite assemblies, you'll probably take quite a shine to Indiana General.

We're not competing with the volume suppliers of wound components. Instead, we've got a unique capability that *combines* skills in ferrite materials, design, assembly, and testing.

We've successfully explored cross-field modulators for missile guidance systems; ferrite cross cores in variable inductors for a motor control circuit; and a new, low-pass RFI filter. In one case, we re-designed an existing broadband inter-stage transformer from TO-5 down to TO-18 size. That's a 5-to-1 size reduction.

And all these projects involved precision-regulated, critical applications. All involved a problem requiring a unique solution. Any time those criteria crop up, chances are you should talk to Indiana General.

Start the conversation with our coupon. And let us consult, or quote, on your next special project assignment. The one no one else will tackle. Even the one that seems impossible.

Mr. K. S. Talbot, Manager of Sales  
Indiana General - Electronic Products  
Div. of Electronic Memories & Magnetics  
Keasbey, New Jersey

- Please send me an application form for a miniature ferrite device design evaluation.
- Please calculate design possibilities, based on the attached requirements and data: Application description, performance specifications, drawings.

NAME \_\_\_\_\_  
TITLE \_\_\_\_\_  
COMPANY \_\_\_\_\_  
ADDRESS \_\_\_\_\_  
CITY \_\_\_\_\_ STATE \_\_\_\_\_ ZIP \_\_\_\_\_

# Talk it out with your computer.

Use conversational FORTRAN and achieve better designs quickly and easily.

Can you talk with your computer? You should be able to if it is to be a truly useful tool. Ideally, instructions should be sent to the computer in plain English, and problems should be solved conversationally, by means of simple questions and answers. Engineer and computer should be able to work together to obtain rapid, accurate, optimal solutions of difficult engineering problems. There should be no mysterious "programmer/engineer" interface.

How can this be done? One way is to use a time-shared computer system and a conversational type of language like QUIKTRAN. With such an arrangement, the engineer who wishes to work out a problem simply presses a button or switch on the computer terminal, lifts the phone and dials the computer. The computer responds by typing out a message, such as "QUIKTRAN at your service," and the engineer then enters his problem on the teletypewriter.

The unit of processing in time-shared systems is the program statement, or portion of a program, rather than an entire program, as in traditional batch processing. However, entire programs can be stored for future use. As each statement is typed by the user, it is immediately acknowledged by the system, which prints the numerical results, requests the next user action or gives a diagnostic warning as required. A problem—whether a circuit, system or subsystem design—can be coded, tested, corrected and retested in a couple of hours rather than in days or weeks. In addition QUIKTRAN<sup>1</sup> (conversational FORTRAN) possesses an extra advantage. It uses a subset of the popular FORTRAN language. Problems written in QUIKTRAN can be run, practically without modification, on a conventional, non-time-shared computer.

## How to talk in QUIKTRAN

Just how does the design engineer converse with the system in QUIKTRAN? To start with,

---

**John T. McAuley**, Director of Systems Engineering, and **Paul D. Oyer**, President, Oyer Professional Computer Services, Inc., New York, N.Y.

the conversation is on a line-by-line basis. Each line is given a number by the system, and the first 12 of the 132 print positions contained in each line are reserved for information printed by the computer. This is the part included in brackets in the typical printout shown below.

118. +ready	command
101. -ready	subroutine cdivd
102. +ready	* this is a subroutine to divide two complex numbers
103. +ready	* in polar form.

Note that a definite pattern is used:

<u>Line Number</u>	<u>Status Indicator</u>	<u>Status Word</u>
118.	+	ready

(Positions 1-5) (Position 6) (Positions 7-11).

In each case the line number is followed by a period and a space. The status word is also followed by a space (Position 12).

The lines are numbered in sequence, starting with 101 and ending with 999. The first line in the printout shown is numbered 118 because that was the line number of a previously executed program. The designer must, therefore, enter the COMMAND statement at the beginning of each new program, subprogram, or subroutine to destroy the previously active program image and reset the line counter to 101.

Three status indicators—namely, +, - and =—correspond to the three operating modes of program, command, and automatic. For example: +READY indicates that the computer is in the program mode; it is used to enter a new program or execute an old program. The command mode is indicated by -ready, which is used to execute one-line arithmetic statements (see line 101, Fig. 1) or reset the system before entering the program mode. The terminal is in the automatic mode (= sign) when the system is listing or executing a program.

Status words provide additional information.

For example:

= STOP	indicates a programed pause
= 0 30	means that an output statement has been executed according to FORMAT statement number 30.

As stated earlier, the processing unit is the



program statement and not the entire program. This is illustrated in Fig. 1, which shows the program for a subroutine designated CDIVD. When the line 105. (the COMMON statement) is entered, the system examines the statement and determines that there is a comma after the variable "angi," (see Table 1). The comma indicates that another variable is to follow. When no other variable is entered after the comma, the system rejects the entire line (105.) of coding and gives the reason for the rejection; namely, "element in field is not a variable name."

Continuing with the coding, then, the user re-enters line 105. correctly. The system examines it, accepts it, and answers "+ready," which is the standard request for the next line of coding. After the programming of subroutine CDIVD is completed, the user instructs the system to store the (currently active) program in his (the user's) library via the SAVE statement (line 113.).

Finally, the user can correct errors in logic,

**Table: Key abbreviations**

FRQRES	frequency response
c2pol	convert complex number from cartesian to polar form.
cdivd	divide complex numbers
cmult	multiply complex numbers
xreal	real part of complex number
ximag	imaginary part of complex number
xmag(i)	array of magnitudes of cx numbers
ang(i)	array of phase angles of cx numbers
angi	phase angle of complex number
xmagi	magnitude of complex number

which, if not detected by the system and left unchanged, will produce incorrect answers. For example, consider line 106., Fig. 2. Here, magi (the magnitude of the product) is set equal to zero. If undetected, this error will produce incorrect answers because, when control is returned to the

```

118. +ready  command
101. -ready  subroutine cdivd
102. +ready * this is a subroutine to divide two complex numbers
103. +ready * in polar form
104. +ready  dimension a(1),b(1),ang(1),xmag(1)
105. +ready  common a,b,n,xreal,ximag,ang,xmag,xmagi,angi,
105. +rjct   element in field ' ' is not a variable name
105. +ready  common a,b,n,xreal,ximag,ang,xmag,xmagi,angi
106. +ready  xmagi = xmag(1)/xmag(2)
107. +ready  angi = ang(1) - ang(2)
108. +ready  if(angi)5,10,10
109. +ready  5 angi = angi + 360.
110. +ready  10 continue
111. +ready  return
112. +ready  end
113. +ready  save

```

1. The processing unit in QUIKTRAN is the program statement. Format errors can be detected by the system.

Here the computer has detected a mistake in programming, "angi."

```

109. +ready  command
101. -ready *
101. -ready  subroutine cmult
102. +ready * this is a subroutine to multiply n complex numbers
103. +ready * in polar form
104. +ready  dimension a(1),b(1),ang(1),xmag(1),
105. +ready  common a,b,n,xreal,ximag,ang,xmag,xmagi,angi
106. +ready  xmagi = 0.
107. +ready  angi = 0.
108. +ready  do 10 i = 1,n
109. +ready  xmagi = xmagi * xmag(i)
110. +ready  angi = angi + ang(i)
111. +ready  10 continue
112. +ready  12 if(angi - 360.) 20,15,15
113. +ready  15 angi = angi - 360.
114. +ready  go to 12
115. +ready  20 continue
116. +ready  return
117. +ready  end

```

2. A logical error in the program statement not detected by the computer, must be found by the programmer.

program (subroutine CMULT), the value of *xmagi* will always be zero regardless of the array of complex numbers.

This error can be corrected, Fig. 3, by using the program editing statements, DELTA and ALTER. The ALTER statement permits the user to insert, replace, or delete one or more program statements. The DELTA statement controls the increment of the line counter when in the "ALTER" mode. To correct the error, the statements "DELTA (1., 1.)" and "ALTER (106., 106.)" are entered first. The correct coding for line 106. is then entered, namely *xmagi* = 1. Finally, the subroutine is saved on line 118. Note the correct version of subroutine CMULT in Fig. 4.

### Use subroutines for complex numbers

A subroutine is a subprogram used to simplify programing. Any operation used repeatedly in the solution of the same problem or commonly occurring problems can be coded as a subroutine and stored in the memory, to be called in by the main program whenever it is needed. When subroutines are used to perform a standard operation, such as the addition of complex numbers, they can be:

- programed only once
- debugged only once
- coded, compiled and debugged separately from the main program.

This saves valuable time and effort.

Despite the fact that all the variables are as-

sumed to be real, problems involving complex variables are readily processed in QUIKTRAN by means of complex number subroutines. Subroutines can readily be written, and when called by a main program they can:

- Add *n* complex numbers in Cartesian form.
- Subtract two complex numbers, in Cartesian form.
- Convert *n* complex numbers from Cartesian form to polar form.
- Convert *n* complex numbers from polar form to Cartesian form.
- Multiply *n* complex numbers, in polar form, (Fig. 4).
- Divide two complex numbers, in polar form.

Variables are passed from main program to subroutine and back by means of the COMMON statement. This statement tells the compiler to assign variables in both the main program and subroutine to the same core storage location. The CALL statement, has the form: CALL name of subroutine. It is used to bring a subroutine into operation. This is illustrated below:

```

Program FRQRES
COMMON a, b, n, xreal, ximag, ang, xmag, angi,
xmagi
.
.
.
CALL C2POL
.
.
.
END

```

118. +ready	delta(1.,1.)
118. +ready	alter(106.,106.)
106. +alter	xmagi = 1.
106. +note	mode reset - alter line number 107. has reached upper bound
118. +ready	save

3. Alter statement permits user to delete one or more program statements. Figure 4 shows corrected program.

	command
101. -ready	load (CMULT)
118. +ready	list
101. =	subroutine cmult
102. =	* this is a subroutine to multiply n complex numbers
103. =	* in polar form
104. =	dimension a(25),b(25),ang(25),xmag(25)
105. =	common a,b,n,xreal,ximag,ang,xmag,xmagi,angi
106. =	xmagi=1.
107. =	angi=0
108. =	do 10 i=1,n
116. =	return
117. =	end
118. +ready	

4. Subroutine is used for multiplication of *n* complex numbers in polar form.

RETURN  
END

Note that the COMMON statement in the subroutine does not have the same number of terms as the COMMON statement in the main program. In fact, the variable names in the two COMMON statements do not even have to be same. However, variables assigned to the same core storage location must have the same relative position in both COMMON statements.

### Sample program illustrates technique

As an application of QUIKTRAN, suppose we describe a program involving the frequency response of the open-loop transfer function of a feedback control system:

$$T(j\omega) = \frac{180}{j\omega (1 + j\omega/6) (1 + j\omega/2)}$$

The program, designated program FRQRES (Fig. 5), determines the magnitude and phase angle of  $T(j\omega)$  as a function of the frequency, in radians. Note that it uses complex variable subroutines. The multiplier ( $fm$ ) subdivides the frequency range into  $n$  logarithmic steps. It is determined from the equation:

$$fm = (f1/f2)^{(1/n-1)}$$

where  $f1$  = final frequency

$f2$  = initial frequency

$n$  = number of steps.

To execute program FRQRES, it is loaded into the system and the START (0) command is entered (Fig. 6). Examination of the printed results shows that the frequency at gain crossover is approximately 12.46 rad/s, and the phase angle is 124.78 degrees, at the crossover frequency. The actual phase angle, however, is  $(360-124.78) = 235.12$  degrees. The reason for the apparent dis-

```

*
101. -ready  program frqres
102. +ready * This is a program to determine the frequency
103. +ready * response of a transfer function
104. +ready  dimension a(25),b(25),ang(25),xmag(25)
105. +ready  common a,b,n,xreal,ximag,ang,xmag,xmagi,angi
106. +ready  print 100
107. +ready 100 Format (5x,4hfreq,6x,13h20 log /t(w)/,3x,6hang(w))
108. +ready  fm = (20./1.)**(1./19.)
109. +ready  w = 1.
110. +ready 10  if(w-20.)20,20,50
111. +ready 20  a(1) = 0.
112. +ready  b(1) = w
113. +ready  a(2) = 1.
114. +ready  b(2) = .5*w
115. +ready  a(3) = 1.
116. +ready  b(3) = .167*w
117. +ready  n = 3
118. +ready  call c2pol
118. +note  c2pol is a subroutine name
119. +ready  call cmult
119. +note  cmult is a subroutine name
120. +ready  xmag(1) = 180.
121. +ready  ang(1) = 0.
122. +ready  xmag(2) = xmagi
123. +ready  ang(2) = angi
124. +ready  call cdivd
124. +note  cdivd is a subroutine name
125. +ready  tmagn = 20.*alog10(abs(xmagi))
126. +ready  print 30,w,tmagn,angi
127. +ready 30  format(x,f8.4,x,3hr/s,3x,f7.2,x,2hdb,5x,f6.2,x,4hdegs)
128. +ready  w = w*fm
129. +ready  go to 10
130. +ready 50  stop
131. +ready  end
132. +ready  save
132. +ready ;eject

```

5. PROGRAM FRQRES is used to determine the frequency response of a transfer function.

```

101. -ready ;time
1842
                                load(frqr)
                                start(0)
132. +ready
106. =o100      freq      20 log /t(w)/  ang(w)
126. =o 30      1.0000 r/s  44.02 db    233.95 degs
126. =o 30      1.1708 r/s  42.29 db    228.59 degs
126. =o 30      3.0153 r/s  29.39 db    186.83 degs
126. =o 30      3.5302 r/s  26.71 db    179.01 degs
126. =o 30      10.6446 r/s  3.70 db     130.00 degs
126. =o 30      12.4625 r/s -0.08 db    124.78 degs
132. +ready ;time
1855

```

6. Execution of program FRQRES shows that the frequency at gain crossover is approximately 12.46 rd/s

and the phase angle is approximately 124.78° at the crossover frequency.

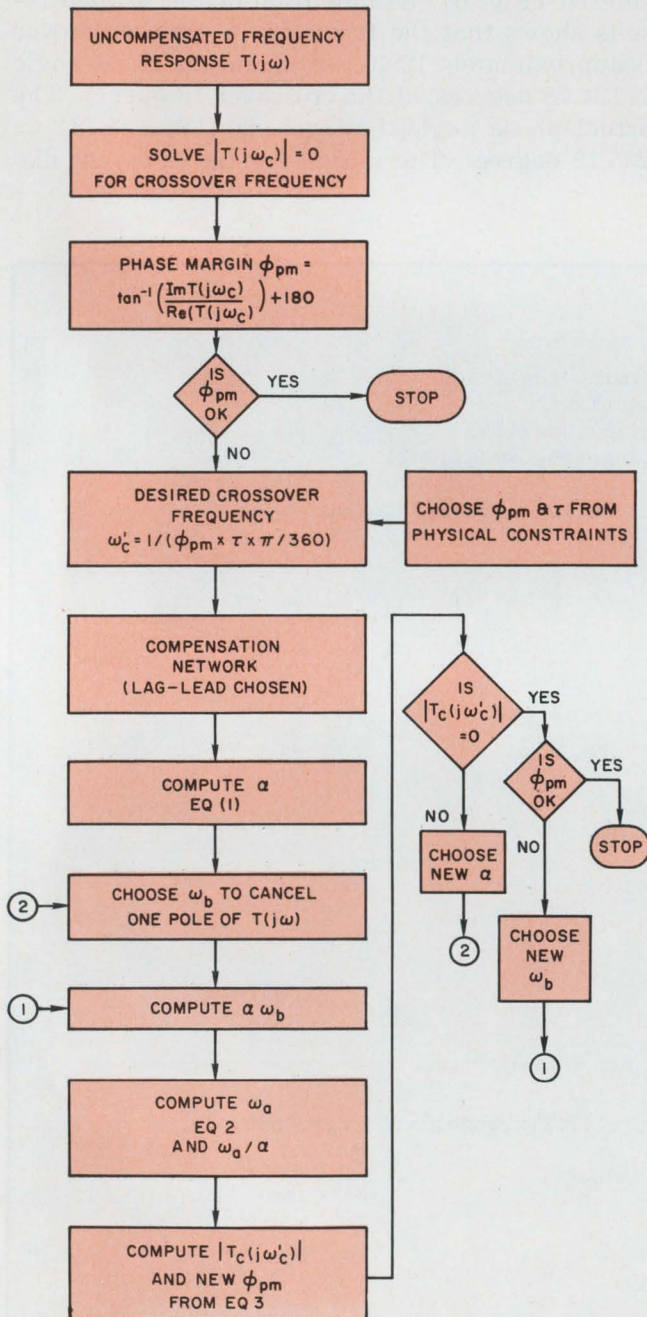

7. Flow chart shows steps in designer/computer interaction during programing.

crepancy is that in subroutine CDIVD the resultant phase angle (angi), if negative, was made positive by adding 360 to it.

The approximate phase margin of the system is  $-235 + 180 = -55$  degrees, a negative angle, indicating that the system is definitely *unstable*. We must therefore revise the program to add a compensating circuit that will assure stability. (Actually, a program might have to be revised many times before a satisfactory solution is obtained. The flow chart shown in Fig. 7 outlines the method of solution used in this problem.)

A 25% maximum overshoot and reasonable settling time require a phase margin of  $45^{\circ}$  and a predominant time constant equal to 0.75 second. The new crossover frequency,  $\omega'_c$ , is calculated from the formula

$$\omega'_c = (\phi_{pm} \times \tau \times \pi/360)^{-1},$$

where:

$\phi_{pm}$  = phase margin, in degrees

$\tau$  = predominant time constant, in seconds.

As a result,

$$\omega'_c = 3.4.$$

A lead-lag network is chosen in this case as the compensating function. Its transfer function,  $C(j\omega)$ , is given by the expression:

$$C(j\omega) = \frac{\left(1 + \frac{j\omega}{\omega_a}\right) \left(1 + \frac{j\omega}{\omega_b}\right)}{\left(1 + \frac{j\omega}{\omega_a/\alpha}\right) \left(1 + \frac{j\omega}{\alpha\omega_b}\right)},$$

where

$1/\alpha$  = attenuation factor, which

= gain of uncompensated system

at crossover frequency, and

=  $T(j\omega'_c)$ .

The gain of the uncompensated system is found by temporarily altering program FRQRES (Fig. 5) to evaluate  $T(j\omega)$  at  $\omega = 3.4$  rad/s, (Fig. 8).

Note that since the specific statements on lines 109. and 110. were not saved individually, the copy of program FRQRES in the user's library is

```

load(frques)
132. +ready delta(1.,1.)
132. +ready alter(109.,110.)
109. +alter w = 3.4
110. +alter 10 if(w-3.4) 20,20,50
110. +note mode reset - alter line number 111. has reached upper bound
132. +ready start (0)
106. =o100 freq 20 log /t(w)/ ang(w)
126. =o 30 3.4000 r/s 27.36 db 180.88 degs
130. =stop

```

8. Computer determines gain of uncompensated system at crossover frequency.

```

132. +ready save
101. -ready load(frques)
132. +ready alter(111.,121.)
111. +alter 20 a(1) = 180.
111.1+alter b(1) = 0.
111.2+alter a(2) = 1.
111.3+alter b(2) = w/.679
111.4+alter n = 2
111.5+alter call c2pol
111.6+alter call cmult
111.7+alter x = xmagi
111.8+alter y = angi
111.9+alter a(1) = 0.
112. +alter b(1) = w
112.1+alter a(2) = 1.
112.2+alter b(2) = w/6.
112.3+alter a(3) = 1.
112.4+alter b(3) = w/.029
112.5+alter a(4) = 1.
112.6+alter b(4) = w/46.6
112.7+alter n = 4
112.8+alter call c2pol
112.9+alter call cmult
113. +alter xmag(1) = x
113.1+alter ang(1) = y
113.2+alter alterx
132. +ready alter(109.,110.)
109. +alter w = 3.4
109. +rject valid statement nos. are integers 1 to 199
109. +alter w = 3.4
109.1+alter 10 if(w-3.4) 20,20,50
109.2+alter alterx
132. +ready start(0)
106. =o100 freq 20 log /t(w)/ ang(w)
126. =o 30 3.4000 r/s 6.02 db 225.48 degs
130. = stop

```

9. Revised program FRQRES is loaded and executed. Note that the w in line 109 is in the wrong print position.

Program statements must not begin before position 15. Conversational programing corrects this error.

unaltered. It remains the same as in Fig. 5. Only the copy of the program in current use is altered. When the altered program is executed, the gain of the uncompensated system at  $\omega_c$  is found to be 27.36 dB (Fig. 8). Thus,  $20 \log (1/\alpha) = -27.36$  dB, and

$$\alpha = 10^{(27.36/20)} = 23.33. \quad (1)$$

In order to cancel out the factor  $(1 + j\omega/2)$  in the denominator of  $T(j\omega)$ ,  $\omega_b$  is picked as 2 rad/s and  $\alpha\omega_b = 46.6$  rad/s.

Then,  $T_c(j\omega) = T(j\omega)C(j\omega)$ , or

$$T_c(j\omega) = \frac{180(1 + j\omega/\omega_a)(1 + j\omega/\omega_b)}{j\omega(1 + j\omega/6)(1 + j\omega/2)(1 + \frac{j\omega}{\omega_a/\alpha})(1 + j\omega/\alpha\omega_b)}.$$

The phase margin of the compensated system is the phase angle of  $T_c(j\omega_c')$ :

$$\phi_{pm} = 45^\circ = -90^\circ - \tan^{-1}(\omega_c'/6) - \tan^{-1}(\alpha\omega_c'/\omega_a) - \tan^{-1}(\omega_c'/\alpha\omega_b) + \tan^{-1}(\omega_c'/\omega_a) + 180^\circ$$

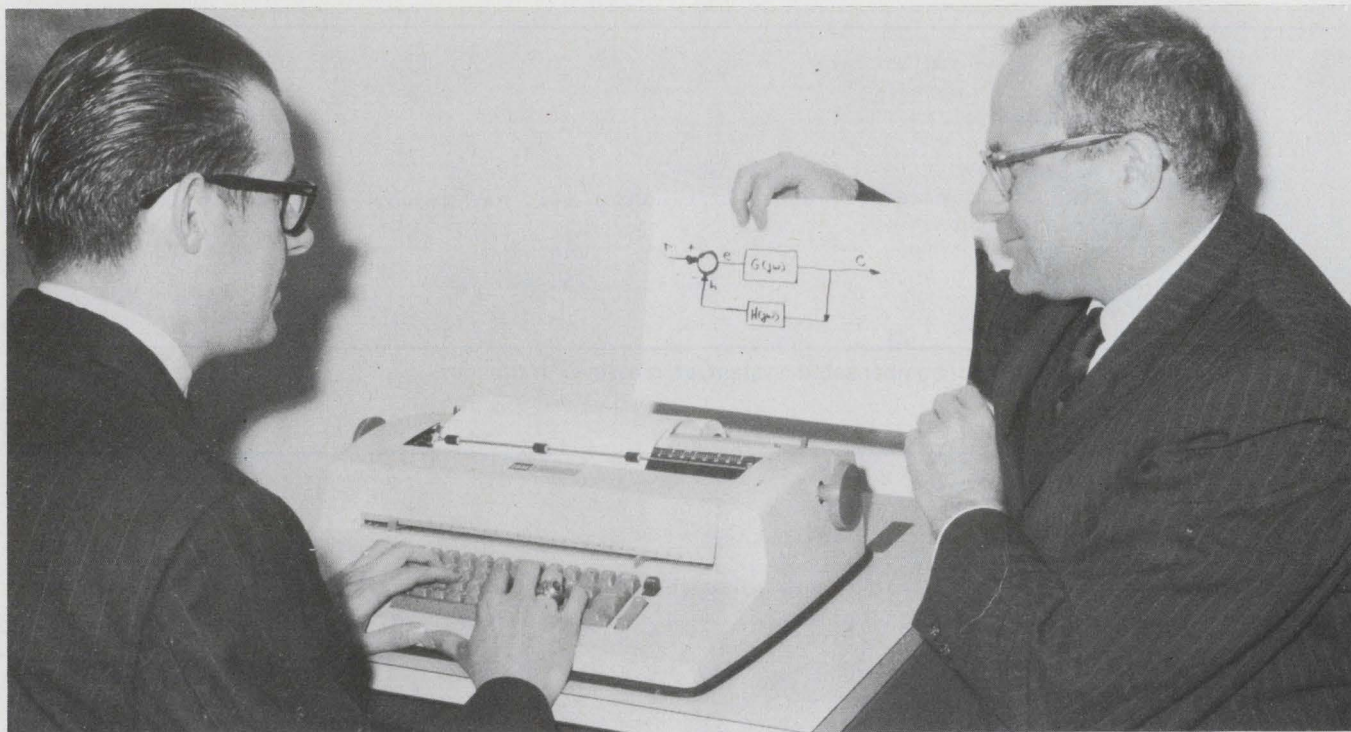

John McAuley (left) and Paul Oyer discuss loop response at a QUIKTRAN terminal.

However,

$$\tan^{-1}(\alpha\omega_c'/\omega_a \approx 90^\circ \text{ since } \alpha \gg 1 \text{ and } \omega_c'/\omega_a \gg /$$

Thus

$$\tan^{-1}(\omega_c'/\omega_a) = 45^\circ + 90^\circ - 180^\circ + 90^\circ - \tan^{-1}(\omega_c'/6) - \tan^{-1}(\omega_c'/\alpha\omega_b).$$

$$\omega_a = \omega_c' / \tan[45^\circ - \tan^{-1}(\omega_c'/6) - \tan^{-1}(\omega_c'/\alpha\omega_b)] = 3.4 / \tan(78.7^\circ) = 0.679 \text{ rad/s} \quad (2)$$

$$\omega_a/\alpha = 0.0291 \text{ rad/s}$$

and the open-loop transfer function of the compensated system becomes

$$T_c(j\omega) = \frac{180(1+j\omega/.679)}{j\omega(1+j\omega/6)(1+j\omega/.0291)(1+j\omega/46.6)} \quad (3)$$

Now, the magnitude and phase angle of the compensated system are evaluated. Program FRQRES is loaded, altered as shown in Fig. 9 and executed (START (0), line 132). The results show that at  $\omega_c' = 3.4 \text{ rad/s}$ ,  $|T_c(j\omega)| = 6.02 \text{ dB}$ . Since  $|T_c(j\omega)| = 0$  when  $\omega = \omega_c'$ , then  $\omega_c'$  must be greater than  $3.4 \text{ rad/s}$ . The design of the compensating network will therefore have to be reiterated.

For the second iteration set  $20 \log(\alpha)$  equal to  $(27.36 + 6.02) \text{ dB}$  or  $33.38 \text{ dB}$ .  $\omega_b$  is still chosen to be  $2 \text{ rad/s}$ . The new values are:  $\alpha = 0.47$ ,  $\omega_a = 0.81$ ,  $\alpha\omega_b = 93.34$  and  $\omega_a/\alpha = 0.0174$ . The revised transfer function of the compensated system after the second iteration is:

$$T_c(j\omega) = \frac{180(1+j\omega/0.81)}{j\omega(1+j\omega/6)(1+j\omega/0.0174)(1+j\omega/93.34)}.$$

To calculate the magnitude and phase angle of this transfer function, program FRQRES is again altered and executed.

For  $\omega = 3.4 \text{ rad/s}$ ,  $|T_c(j\omega)| \approx 0 \text{ dB}$

$$[T_c(j\omega)] = -135^\circ$$

$$\phi_{pm} = -135^\circ + 180^\circ = +45^\circ.$$

The frequency response of the open loop transfer function when run on the computer will now exhibit the desired response. ■■

#### References:

1. QUIKTRAN Reference Manual, (J20-0017-0), IBM Data Processing Division, White Plains, New York, 1967.
2. V. Del Toro and S. Parker, *Principles of Control Systems Engineering*, New York: McGraw-Hill Book Co., 1960.
3. QUIKTRAN: A New Time Shared Computer System, *The American Engineer*, Feb. 1966.

#### Test your retention

Here are questions based on the main points of this article. Their purpose is to help you make sure you have not overlooked any important ideas. You'll find the answers in the article.

1. What are the advantages of conversational FORTRAN?
2. How does the main program call a subroutine?
3. How are variables passed between a main program and a subprogram?
4. What features permit a designer to improve his design as part of the programming process?
5. What procedure should be used to store a program in the system memory?

# RELAYS

## NEW MIL-R-6106

- One-Inch Cube
- 4PDT-10 Amps
- 28VDC-115VAC
- All Welded

## IT'S BABCOCK'S BR30

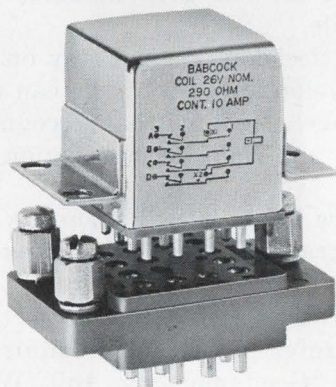

Babcock's new Model BR30 is a miniature, all-welded, 4PDT relay . . . designed specifically to meet the requirements of MIL-R-6106 (MS-27400)—and to be completely interchangeable with other models of this type. Characterized by reliable op-

eration in environmental extremes, this new relay is the first developed by Babcock to meet the needs of airframe applications. Performance is outstanding . . . to 200g's shock, 30g's vibration, over a temperature range of  $-70^{\circ}\text{C}$  to  $+125^{\circ}\text{C}$ , for a minimum of 100,000 operations. All welded construction, inside and out, assures a contaminant-free unit. Plug-in and solder-hook versions are offered; qualified relay sockets also available.

The Model BR30 is a new relay for new applications . . . and it carries the same mark of proven Babcock dependability. Your assurance that it's better because it's Babcock.

The Babcock Model BR30 is a brand new MIL-R-6106 relay . . . featuring a new symmetrical magnetic circuit. Utilizing two permanent magnets, this system provides a positive holding force, undisturbed by shock and vibration extremes . . . and

dependable switching action throughout the life of the relay.

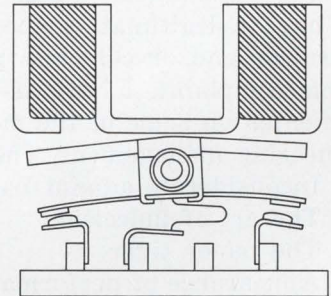

Coil design has also undergone some innovation. AC versions have been fabricated such that coil frequency is operational from 60 Hz to 400Hz, without degradation of ratings.

### SPECIFICATIONS

Contact Rating (@ 28VDC, 115/208VAC 400Hz)-----	Resistive: 10amps. Inductive: 8amps.
Overload-----	D. C. 40amps. A. C. 60amps.
Rupture-----	D. C. 50amps. A. C. 80amps.
Coil Voltages-----	6, 12 and 28VDC, 115VAC
Shock-----	200g's (6ms.)
Vibration-----	30g's, 70-3000Hz
Operation Temp.-----	$-70^{\circ}\text{C}$ to $+125^{\circ}\text{C}$
Pull-In Power-----	600mw
Operate/Release Time-----	15ms, max.
Bounce Time-----	1ms, max.
Life-----	100,000 operation, min.

Get complete information on the new Model BR30 . . . contact Babcock Electronics Corp., Relays Division, Subsidiary of Esterline Corp., 3501 Harbor Blvd., Costa Mesa, Calif. 92626. CALL COLLECT (714) 540-1234 or TWX 910-595-1517.

Challenging opportunities for relay-switch engineers.



# No engineer wants to be a crybaby!

But there are times when the EE has a legitimate gripe; one concerned designer comments on six of them.

No engineer wants to be accused of being a "chronic complainer." Occasionally, however, he will have a legitimate gripe about his job, his supervisor and/or company policy. To help him air his complaint, I have, as a design engineer, commented on some of the more common sins of engineering management. These are:

1. Inconsiderate administration
2. The art of indecision
3. The paper tiger
4. Appearance of performance
5. Two speeds—fast and faster
6. Technician's work at EE's wages

*If you are an engineer, ELECTRONIC DESIGN is interested in whether or not you feel you have been or are, a victim of the sins listed. If you are an engineering manager, has this article opened your eyes and mind to sins you have committed?*

*After you've read the article we hope you'll take time to fill out the brief questionnaire on page 98.*

It is time the engineering fraternity was heard from in the mutual interest of greater corporate profits and better engineering jobs.

The characters and situations in this article will seem familiar to you. They are all real.



Bill, a project engineer who works on expensive hardware, puts in long hours on the job. He feels he's neglecting his family and worries about it, so he finds it hard to concentrate on his work. The personal tasks he is unable to do in the

evenings he crams in on an extended lunch hour.

The company makes pointed comments if Bill arrives a few minutes late in the morning, despite the fact that he regularly works late. And to keep him more tense, the company promptly notifies him whenever his project appears to be slipping into the red. But if the project turns out to be a real profitmaker, the profit figures became classified information that he cannot obtain.

Early in the program, Bill foresaw the problems that keep him at work late, but his recommendations were given scant consideration by the company. Now that these problems have materialized, the administration is concerned mainly with pushing Bill, emphasizing that no hours are too long, no efforts too great. (Bill's hours and efforts, that is.)

Bill figures he has a list of grievances: he is convinced that the company has no consideration for his family; that his advice is disregarded by management; and that when the going is tough, the company will unhesitatingly sacrifice his well-being to expediency. He has been made to feel that he is expendable.

Bill must make a decision. He can stay on the job and possibly develop an ulcer, or he can quit and look for another company that recognizes its employees' efforts and shows consideration for them.

If Bill stays where he is, he will soon ask for higher wages and gradually diminish his extra-hour efforts.

But Bill would rather finish the project he started. He would prefer to have his administrator say, at 8 a.m., "Good morning, Bill. Work late last night? How can I help you with your problems?" Under that kind of administration, Bill would probably wait until regular review time for his raise, finish his project, and remain totally oblivious to the union talk floating around the plant.

---

**Bernard Daien**, Project Engineer, E.M.P. Electronics, Tempe, Arizona.

*The author's comments are not intended to reflect the management policies of any one company, but rather they are based on his experiences with a number of electronics firms.*

---

**If the sins of engineering management "bug" you, don't let them get you down. If you have a legitimate gripe, stand up and complain.**





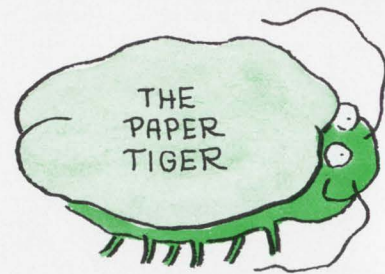
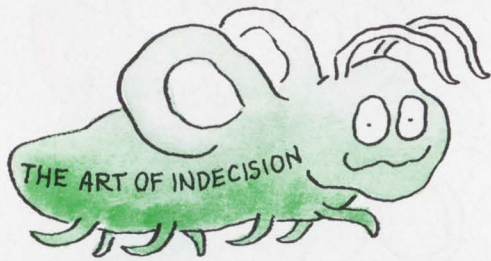

Joe is a senior engineer, handling several modest but "hot" projects simultaneously. His manager, the vice president of engineering, feels that when one project is delayed for parts procurement, another project can be worked on. "It's a good way to get efficiency out of the engineering staff," the V.P. says. "This sort of piece work might succeed except that the deadlines for several of these jobs fall at about the same time.

Joe has discussed the situation with the V.P. and pointed out that no matter which job is worked on, one or more of the other jobs will be delayed. Joe has asked for a "priority list" indicating which project should be expedited and which can be deferred. The V.P. has nodded and replied, "We must have the Jones job out first, but don't hold up the others to do it."

Joe then insisted that a job preference sheet be issued. The next day to his amazement, he received the following priority list:

- Jones .....1.1
- Harris .....1.2
- Dynamo .....1.3

Noting that all projects were listed in varying degrees of "first," Joe suddenly realized that his superior had neatly avoided making a difficult decision and was passing the buck to a subordinate engineer. One of the projects would have to be last, and late and Joe would be responsible.

If delivery was late, the V.P. could state, "Joe let me down. If he had got the Dynamo job out before the Jones job we would have been O.K. Too bad we lost the Dynamo account." Of course the V.P. did the "right thing" by Joe. He added, "But Joe is a good engineer. And we're short-handed right now. We can't afford to lose a man."

And so Joe will remain on the payroll—as long as he doesn't discuss the issue. Joe will understand that he remains on his job at the pleasure of the V.P. because, after all, Joe didn't get the Dynamo job completed on time, did he? And the V.P. will keep Joe on the job until Joe retires because he can "depend on Joe," can't he?

The company will pay for an uninspired senior engineer, and a politician who masquerades as an engineering administrator, and wonder why the competition always seems to lead the way with new ideas, better designs, and lower bids.

Much of Len's time is spent filling out numerous charts, forms, and reports, which are generated because the controller and the president of the company believe that engineering problems should be solved on a written timetable, "the way we have to pay our bills on the first of the month."

Len had estimated four months to solve a knotty problem, but management insisted on ten weeks. Yielding to heavy pressure, Len carefully stated, "I will do the best I can to meet this schedule, but it's cutting time too close."

To insure that the schedule was met management insisted upon extra paper work in order to "maintain controls over the project." Because of the reports and numerous meetings called by management, Len's engineering time was cut in half, and the ten weeks became five actual work weeks. Len finished the job in close to the four actual *work months* he had originally estimated. But because of management policy the project took eight *calendar months*.

Top brass was furious over the way "those engineers have no idea of time and money." Len was disgusted because his chance for promotion had been seriously affected, and the customer received the product months after the promised delivery date.

But the cause of the fiasco will be conveniently forgotten as management marches forward to repeat the same mistake.

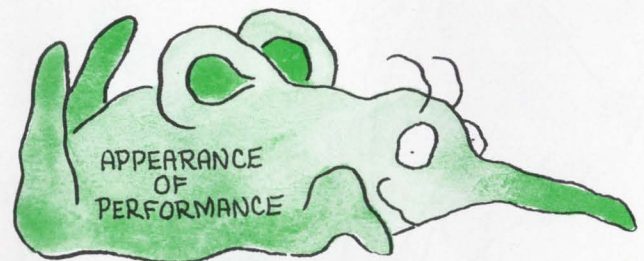

Walter is a competent engineer who spends time in thinking, planning, and scheduling before he acts. He anticipates problems in parts deliveries, machine shop work, and production. As a result, his work is performed with deceptive ease,

with very little need for overtime.

Other engineers in the department are seen continually rushing about at a frantic pace, berating the purchasing agent for failing to get parts on 24-hour notice, cajoling the machine shop foreman to push their job ahead of turn, and working overtime. They find it necessary to rework designs, and this keeps the drafting department unduly busy. Management beams benevolently upon them because they look like hard workers. And they are hard workers. They make even the simplest assignment seem like hard work.

But what about Walter? Well, it's true that Walter is dependable but he never seems to have that sense of urgency. You never see him rushing about. And it's true that his work is good—you have to expect quality when a man can't be hurried. But Walter is definitely not management material, for you can't promote a man to be a "pusher" if he never seems to push himself or anyone else.

Management must be capable of evaluating technical performance in a thorough and objective manner. Anything less is incompetence, and is dereliction of duty to the company. Unfortunately, management's performance is seldom reviewed by the stockholders, and the situation forced the competent engineer to leave the company.

Hired by a competitor with more astute management, Walter became a formidable threat to his old company, which began losing accounts to him. His old supervisor has gone through three engineers in the last 18 months and has complained that he can't understand why it is so hard to find a replacement for Walter.

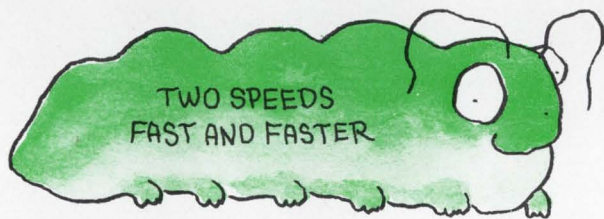

Barney was hired by the company because it felt a new engineer would bring a fresh viewpoint, and know-how into the department. Barney was able to solve many long-standing problems and management told him they felt he was very productive. Encouraged, Barney worked at full throttle.

A wise administrator would have understood that Barney could not continue indefinitely to transfer new knowledge; he would eventually be "drained." In addition, most men cannot work at full speed all of the time.

It came as something of a shock to Barney when one day he was told, "We have a crash program coming up. We'll all have to work

harder." Barney was confused. A short time before he had been praised for his production. He knew he had been doing the work of two engineers. Was he expected to do the work of three?

The "crash program" was required because an important order had lain on an administrator's desk for three weeks while he was away on a combined "business and pleasure trip." To solve the problem of delay, the administrator submitted the engineering staff to a little more pressure.

Barney now keeps a big jar of stomach pills on his desk and eats them like peanuts. "I keep getting this heartburn," he says. He has received several raises, and a very generous major medical insurance policy from the company.

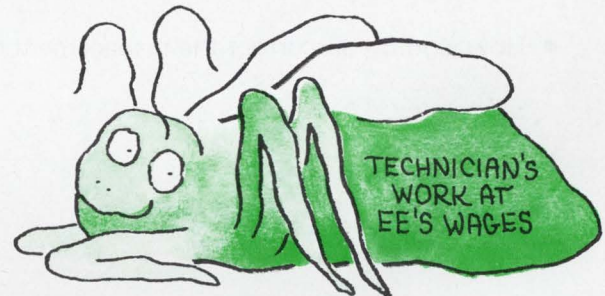

Some engineers, instead of technicians, can be found at the bench doing their own assembly, wiring, soldering, and testing, as well as running technical errands. Three reasons for an engineer doing a technician's work are:

- Many technicians eventually become engineers.
- The draft takes many young technicians into the armed forces.
- Management is reluctant to pay the wage a good technician merits today.

The project budget is drained by engineers doing technicians' work at engineers' wages. All too frequently, management takes the short view, concluding it has saved a tech's salary.

But to do this, the engineer has to put engineering chores aside. When production begins, essential data proves to be missing. The engineer must deliver a working model and the only thing he can defer is the paper work. The resulting inefficiency is blamed on production, engineering, or both, depending on which department has the greatest influence with management. When the confusion ebbs, corridors echo with the old saw, "Engineers never follow through."

Any administrator who doesn't understand that a productive engineer can keep several technicians busy, should get off the golf course and spend a few weeks in the engineering lab with his eyes and ears open and his golf bag shut.

*Get involved, please. Take a few moments to fill out the questionnaire on the next page, then cut along the dotted line, and mail.*

## Management Sins

1. Inconsiderate administration
2. The art of indecision
3. The paper tigers
4. Appearance of performance
5. Two speeds — fast & faster
6. Technician's work at EE wages

- Circle the management error(s) you accept as being valid.

1      2      3      4      5      6

- How would you correct the management error(s) you have circled?

- (For engineers only) Have you noticed other management errors on the job? If so, what are they?

- (For engineering managers only) Are any of the errors listed in the article the result of staff incompetence? If so, explain:

- Do you have any other comments?

Mail to ELECTRONIC DESIGN  
850 Third Avenue  
New York, N. Y. 10022  
Attn: Management and Careers Editor

# 100PPM/°C

---

# Ω & °C\*

\* Our diagram signifies Bourns now offers  $\pm 100$  ppm/°C TC over the entire temperature and resistance range of all its 12 cermet models

*Once you've said that,  
you've said it all...*

*...except Bourns said it first!*

Complete data on this breakthrough in Trimpot® cermet potentiometers is available from your local Bourns Sales Office, representative or the factory.



# Low-frequency multiplier uses twin-T network

An interesting function which can be obtained using the familiar twin-T RC network is that of frequency multiplication. Low frequencies can be multiplied in this manner without the use of inductors.

To obtain such a multiplier, a frequency-selective amplifier of the desired frequency is first designed. By placing the T-network in the feedback path of an inverting amplifier (Fig. 1a) an oscillator whose frequency is determined by the network may be obtained.

Oscillation can be prevented by reducing the feedback with a potentiometer (Fig. 1b). The potentiometer, or feedback control, will affect the  $Q$  of the amplifier, and should be set so that oscillations just cease. The circuit then becomes a highly selective amplifier which will not respond to harmonics of a sine-wave input. However, the amplifier will produce a sine-wave output at its tuned frequency if driven by a square-wave whose frequency is an odd submultiple of the amplifier frequency, thus multiplying the input frequency.

The circuit shown in Fig. 2 is designed to operate with an output frequency of about 1 kHz. Since this T-network is loaded by the amplifier,

the output frequency is not precisely that of the network. Because of loading, the setting of the feedback control also affects the frequency, but less than 1% in this example. Although no attempt has been made here to match the resistors and capacitors in the network, such matching will greatly enhance the network  $Q$ .

With this particular circuit, multiplication factors greater than 15 are obtainable. It appears that this range could be extended even farther by using circuits to obtain a higher  $Q$  (such as an operational amplifier) and by using fast-rise square-waves at the input.

Amplitude distortion due to the square-wave input is about 10% of the multiplier peak-to-peak output. This could be eliminated by passing the output through another tuned amplifier. By supplying the input with a differentiated square wave (or even a sawtooth), the output distortion can be substantially reduced.

*This work was performed under the auspices of the U.S. Atomic Energy Commission*

*Walter C. Dillon, Design Engineer, Oregon State University, Corvallis, Oregon.*

VOTE FOR 311

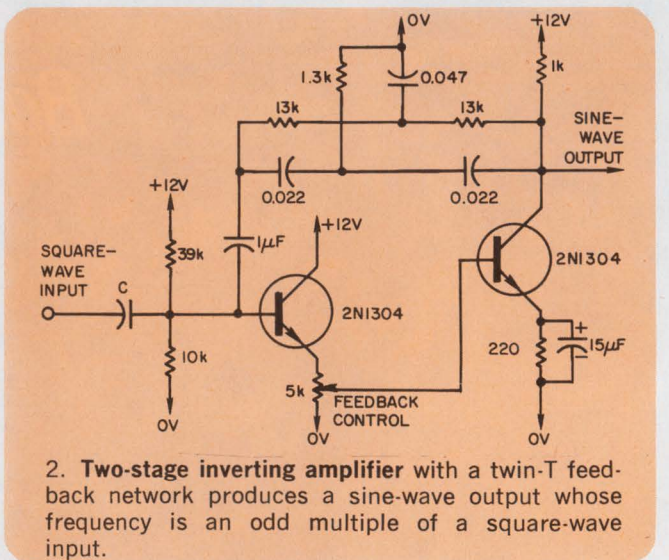
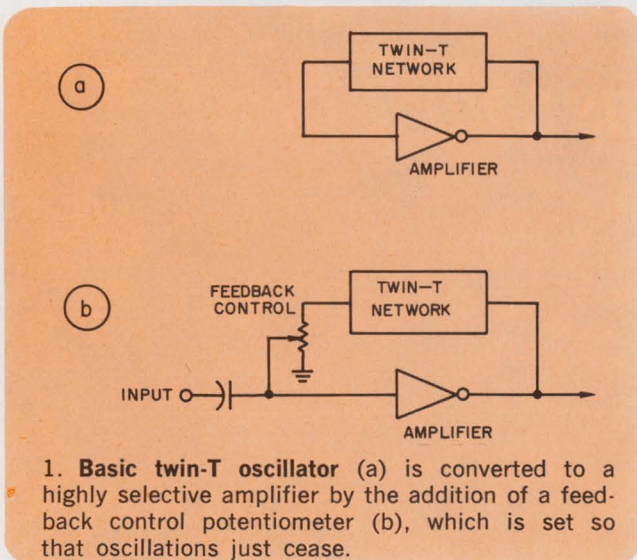

# We give it to you straight! If our new Tru-Glide® Slides didn't slide that way we would have given them another name. Honest!



Being conscientious, upright people, we simply couldn't have devised a brand new ball bearing steel slide that wouldn't have been approved by Mother. We named it "Tru-Glide" because it slides so good and so precisely. And even though we have priced it right down in the small change category you can be sure it's an OK slide. Not cheap, just inexpensive. Applicable to hundreds of design situations where space allotments are minimal and where quality action and ease of movement are of special importance. And where low cost is a factor! A big one.



Yes, Tru-Glide is a hum-dinger. A bell ringer. A true blue MADE IN THE USA slide. We hope it wobbles your clapper. How can we make such a good all-purpose industrial / commercial / etc. slide? Well, let us remark that it's not exactly easy. Six years ago we had the basic design. Since then, we've come up with some completely new concepts in part fabrication (our parts), including a whizzer of an electronically-controlled production system that assures close tolerance, volume runs. Here at Jonathan we've had plenty of practice in this sort of thing. We keep on producing our famous Thinline extruded aluminum slides that gave us our shiny bright reputation in the first place. And our respected Ultrathin steel slides that we also produce for defense, aerospace and other sophisticated-type applications. We just keep

doing our best. Tru-Glide slides come in 150 lb. capacity Type 310 three-section ( $\frac{5}{8}$ " wide x 2" high) or 100 lb. capacity Type 311 two-section ( $1\frac{15}{32}$ " wide x  $1\frac{1}{8}$ " high) versions, with or without mounting brackets. Lock-out in "open" position or disconnecting models are optional. Both models are available in standard lengths and travels, based on 2" increments. The mo-o-o-ving mechanisms are free-riding, precision-placed steel ball bearings contained in special rigid vinyl ball retainers. Lubricated bearings. Trouble-free multi-thousand cycling. Tru-Glide slides make designers happy. Just right for computers, business machines, office copiers, appliances, desks and equipment, audio/visual systems, medical-dental equipment, good furniture, telephone systems and vending machines.

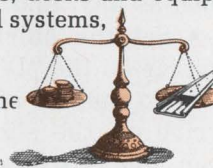

for instance. Or send along your special problems — we love 'em! So remember "Tru-Glide," an honest name for a straight-forward slide. An OK slide. Built by mothers' sons' — everyone of them!

© 1969, Jonathan

(left, Type 310; right, Type 311)

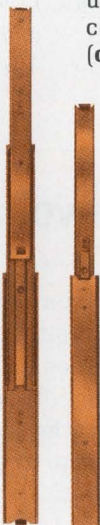

Clip, mail to: **Jonathan Mfg. Co.**  
1101 S. Acacia,  
Fullerton, Ca. 92631.

Quit fooling around, send facts.

NAME \_\_\_\_\_ TITLE \_\_\_\_\_

ADDRESS \_\_\_\_\_

CITY \_\_\_\_\_

STATE \_\_\_\_\_ ZIP \_\_\_\_\_



## Slide-rule scale converts dBV tolerance to voltage tolerance

Often it is necessary to convert a voltage having a dBV\*tolerance to a voltage range of equal units (volts, mV,  $\mu$ V, etc.). For example, suppose you wish to know what the voltage range of 8.52 mV  $\pm$ 1 dBV is. Since the voltage equivalent of the dBV tolerance is dependent on the nominal voltage, you would first have to convert the nominal voltage to dBV. Thus,

$$\begin{aligned} 20 \log V &= 20 \log (8.52) (10^{-3}) \\ &= 20 (\log 8.52 + \log 10^{-3}) \\ &= 18.61 - 60.00 = -41.39 \text{ dBV} \end{aligned}$$

The upper voltage limit is then

$$\begin{aligned} 10^{-40.39/20} &= (10^{-2}) (10^{-0.02}) = \text{antilog} (-2.02) \\ &= 9.58 \text{ mV and the lower voltage limit} \end{aligned}$$

is

$$\begin{aligned} 10^{-24.39/20} &= (10^{-2}) (10^{-1.12}) = \text{antilog} (-2.12) \\ &= 7.60 \text{ mV} \end{aligned}$$

This method can be tedious when a large set of data is to be converted—even when using a dB chart, which is not always handy.

With a colored pencil and a sharp scribing tool, such as a razor blade or the point of a compass, you can add a scale to your slide rule that will make it possible to perform this calculation in one step. The inscribed scale is made on the window of the slide rule as follows (see illustration):

- Pick a voltage, any voltage, with a 1 dBV tolerance. The one given in the example is as good as any, and will be used here.
- Set the hairline directly over the nominal voltage on the "D" scale: 8.52 mV in this case.
- To the left of the hairline very carefully inscribe on the slide rule window about a 3/16-inch line directly over 7.60 given on the "D" scale. Repeat the procedure to the right of the hairline with 9.58, making certain that the hairline is still on the nominal reading.
- Now divide each side (x on the illustration)

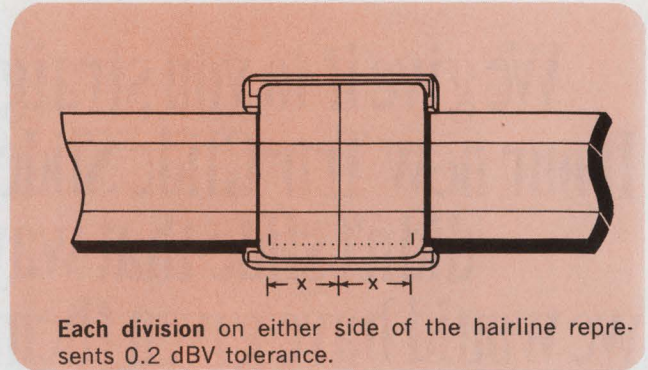

into five equal parts. Each part will then be 0.2 dBV.

For interest sake, the scale is linear, since the "D" scale and dBV's are both logarithmic relationships.

$$20 \log V = \log N$$

thus,  $\log V / \log N = 20 = \text{a constant}$

If "log V" was plotted against "log N" on linear-scale paper, a straight line would result.

The scale made in the above way is useful for any voltage having a  $\pm$ 1 dBV tolerance or tighter. For most practical purposes,  $\pm$ 1 dBV is a wide tolerance. If a wider tolerance is required, repeat the above procedure over the "A" (or square) scale for  $\pm$ 2 dBV or over the "K" (or cube) scale for  $\pm$ 3 dBV. The distance x will be the same in all three cases.

For accuracy and easy reading, it is suggested that the " $\pm$ 2 dBV" scale be divided into four equal parts on each side of the hairline and that the " $\pm$ 3 dBV" scale be divided into three equal parts on each side of the hairline.

\*By definition  $x \text{ dBV} = \log_{10} V / 1 \text{ volt}$ ; therefore  $0 \text{ dBV} = 1 \text{ volt}$ . Less than 1 volt is  $-dBV$  and greater than 1 volt is  $+dBV$ .

Louis S. Caso, Design Engineer, PRD Electronics, Inc., Westbury, N.Y.

VOTE FOR 312

## Precision voltage reference combined with voltage regulator

Many precision measuring devices rely for their accuracy on a precision voltage reference (PVR) contained somewhere in the circuitry. These PVRs usually require a fairly well regulated voltage which is then re-regulated to provide the stable voltage desired.

Here is a simple, combination voltage regulator and precision voltage reference, which can

not only compete with the best commercially available voltage references, but at the same time provides a different, finely regulated voltage for driving other circuits. In addition, both the PVR and the regulated voltage are extremely insensitive to supply voltage variations.

In operation (see illustration) the precision voltage ( $E_1$ ) is obtained by driving a constant



**Dual Differential Amplifiers for DC to 120 MHz  
RCA-CA3054 or CA3026  
@ \$1.25 (1,000 units)**

Here's new flexibility for your amplifier designs—RCA's latest addition to its line of linear "building block" IC's. It's RCA-CA3054 in a DIP package for easy handling and added accessibility. The fourteen-lead package provides access to bases and collectors of differential pairs, bases and emitters of constant-current-source transistors, and separate substrate connection.

You can design the CA3054 into a wide range of applications...including differential and/or cascode amplifiers; IF amplifiers; video amplifiers; doubly-balanced modulators and demodulators and more. If your design requires a full military tem-

perature range, then use RCA-CA3026 in a TO-5 package.

Ask your local RCA Representative or your RCA Distributor for price and delivery information. For technical data on either circuit, write: RCA Electronic Components, Commercial Engineering, Section IC69-1, Harrison, N. J. 07029.

Other RCA Linear Diff Amp Array IC's for Design Flexibility Include:

- CA3050 Two Darlington-connected diff amps with diode bias string;
  - CA3051 CA3050 in DIC, \$2.25; CA3051 in DIP, \$1.65.
  - CA3045 Three isolated transistors and a differential pair; CA3045 in DIC, CA3046 \$1.50; CA-3046 in DIP, 98¢.
  - CA3049 First 200 MHz ampl array—pair of diff/cascode amps on a single chip. In 12-lead TO-5, \$1.95.
- (All prices are at 1,000-unit level.)

Matched differential amplifiers with:  
Independent inputs and outputs  
Input offset voltage = 5 mV max.  
Max.  $V_{CE0} = 15 V$   
Max. collector current = 50 mA  
Dynamic forward current transfer ratio ( $h_{fe}$ ) (typ.) = 110 @ 1 kHz,  
 $V_{CE} = 3 V, I_0 = 1 mA$   
Operating temperature ranges:  
0°C to + 85°C (CA3054)  
-55°C to +125°C (CA3026)  
Voltage gain @ 1 kHz, 32 dB (typ.)  
single-stage, double-ended output  
CMR = 100 dB (typ.)

**RCA**  
**Integrated Circuits**

# This Flexible Linear IC "Building Block" Now Comes in Dual-In-Line Plastic

CA3054 in 14-lead Dual-In-Line Plastic (DIP) Package

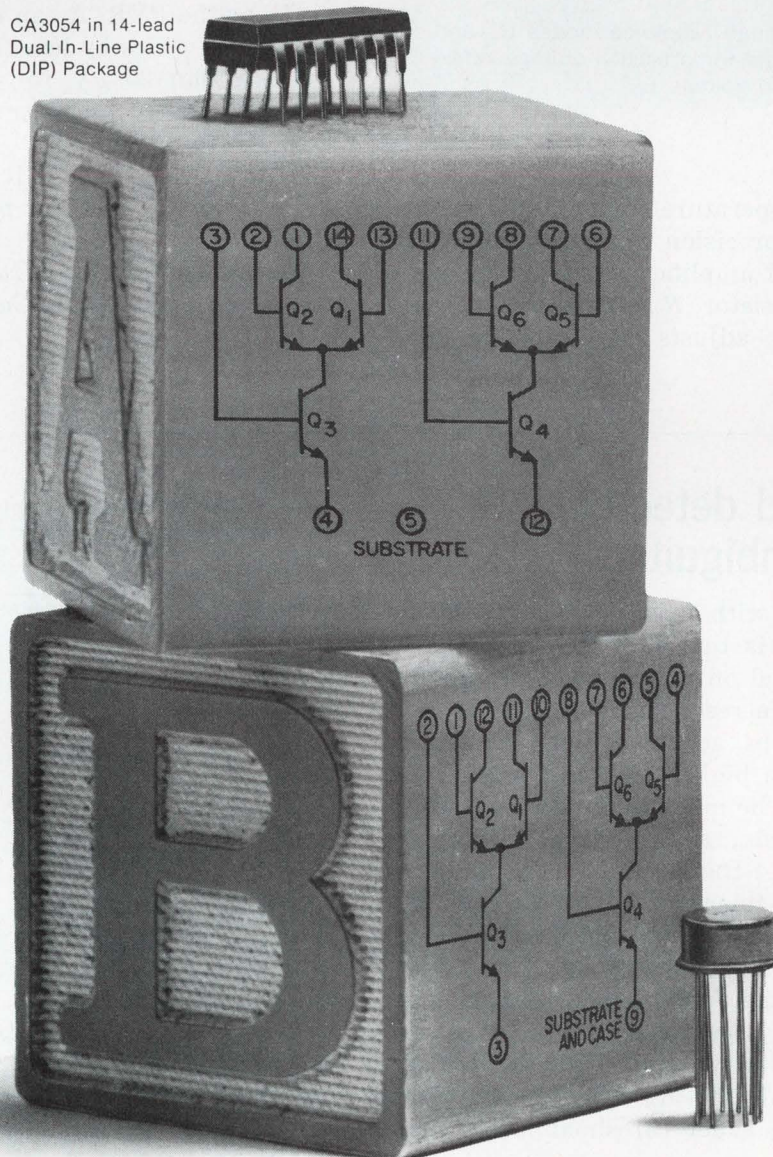

CA3026 in TO-5 Package for full military temperature range operation

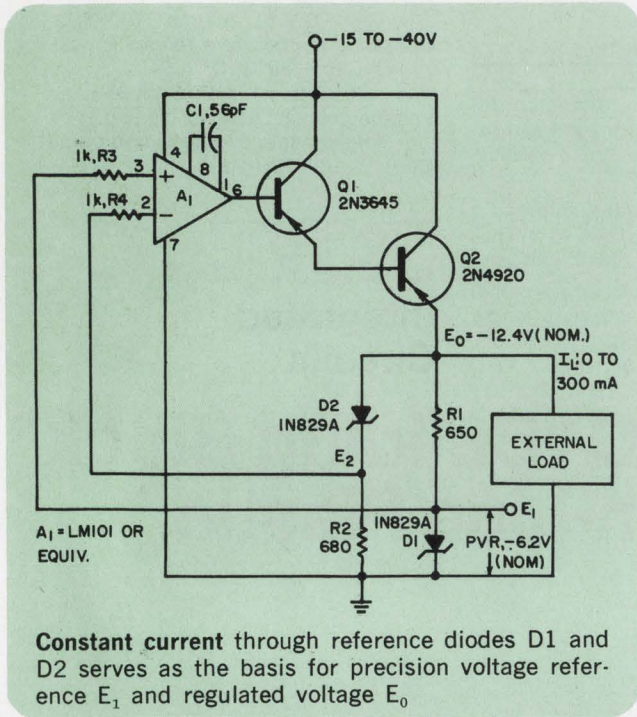

current through temperature compensated reference diode  $D1$ . This precision voltage is then compared by differential amplifier  $A_1$  with the voltage drop across resistor  $R_2$ . As a result, the differential amplifier adjusts its output to pro-

duce a constant voltage drop across  $R_2$ , which in turn drives a constant current through another reference diode,  $D_2$ .

Since in a high-gain, differential dc amplifier with feedback the differential input voltage is driven very close to zero,  $E_1$  is very nearly equal to  $E_2$ . And since there is a constant current being driven through  $D_2$ , there will be a constant voltage across it. Thus, there is a constant voltage across  $R_1$  and a constant current through  $D1$ .

The current through  $D1$  is:

$$I_{D1} = V_{D2}/R_1$$

where  $V_{D2}$  is the zener voltage of  $D2$ . Similarly, the current through  $D2$  is:

$$I_{D2} = V_{D1}/R_2$$

And the regulated voltage  $E_0$  is

$$E_0 = V_{D1} + V_{D2}$$

Notice that current variations drawn from  $E_0$  by an external load will have little effect either on  $E_0$  or the PVR. As an example, for the circuit shown,  $E_0$  varies by less than 2 mV and the PVR by less than 25  $\mu$ V for external load currents ranging from 0 to 300 mA and supply voltages from 15 to 40 V.

With no load, the PVR temperature coefficient is less than 2  $\mu$ V/ $^{\circ}$ C for temperatures from 25 $^{\circ}$ C to 75 $^{\circ}$ C.

*Sam Miller, Design Engineer, Department of the Navy, China Lake, Calif.*

VOTE FOR 313

## SCR threshold detector eliminates ambiguities

The big problem with most SCR-lamp threshold level detectors is that they can have more than one lamp turned on at a time. This unique circuit eliminates the resulting confusion by extinguishing all lamps set to trigger at lower levels when one at a higher level is triggered.

The indicator can be made to handle any number of voltage levels; a three-level circuit is shown. Let's say that the circuit is to monitor a 100 Vdc signal to a tolerance of  $\pm 2$  V. Then  $R_A$  and  $R_B$  are selected so that  $Q1$  and  $Q2$  fire when  $V_i$  is 102 V and 98 V, respectively. The values are determined by the SCR trigger voltages and the voltage divider ratios formed by the resistors and the 500-ohm pots. Values of 100 k $\Omega$  and 80 k $\Omega$  are selected for  $R_A$  and  $R_B$ . The pots are then adjusted to get the exact threshold levels that are desired.

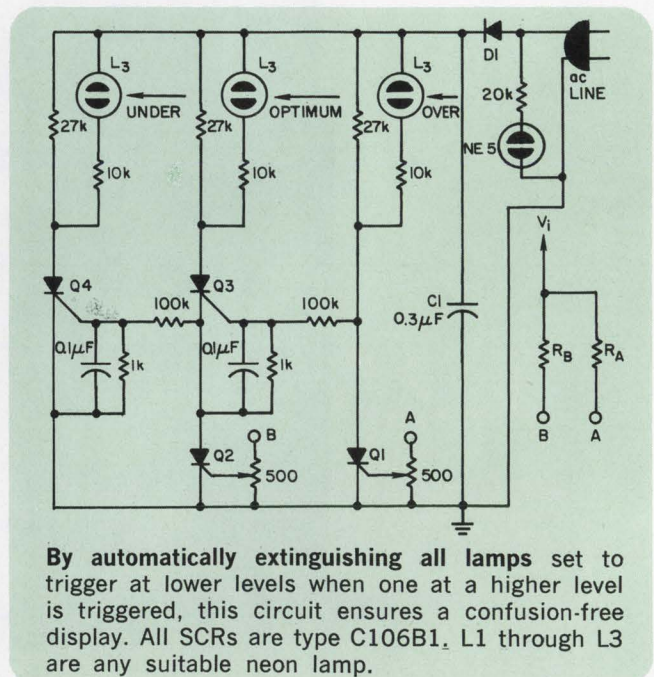

# NEW TI ELECTRONIC CHEMICALS.

They've already made  
our first customer  
very happy.

For years, Texas Instruments has been manufacturing electronic chemicals for just one customer: ourselves.

They've worked so well for us, we'd like you to try them. The same chemicals we use in silicon production, high-temperature gas reactions and epitaxial technology. All of which require, as you know, purity to parts-per-billion standards plus extremely high integrity in lot-to-lot uniformity.

Perhaps the wealth of experience behind TI chemicals can offer you some improvements... even if it's just the security of a new source. In either case, your files should contain the following data sheets:

- Epitaxy Grade Trichlorosilane (5 and 55 gallon stainless drums)
- Epitaxy Grade Silicon Tetrachloride (5 and 55 gallon stainless drums)
- Boron Tribromide Dopant (50 and 100 gram ampules)

Please write. You'll find us very eager to double our satisfied customer list.

TEXAS INSTRUMENTS INCORPORATED  
Chemical Materials Division  
P. O. Box 5621 • M/S 924  
Dallas, Texas 75222



## TEXAS INSTRUMENTS INCORPORATED

A small part of our new, high-capacity electronic chemicals facility.

Now, if  $V_i$  is 101 V,  $Q1$  is off because  $V_i$  is below 102 V. This means that  $L1$  is off. At the same time  $Q2$  is on because  $V_i$  exceeds 98 V.  $Q3$  is on because  $Q1$  is not grounding the gate of  $Q3$ . With  $Q2$  and  $Q3$  on,  $L_2$  is on.  $Q4$  is off because  $Q2$  is on—this grounds the gate of  $Q4$ . Thus,  $L3$  is off.

Obviously this technique can be extended by simply adding more sections like the middle one ( $L2 - Q3 - Q2$ ).

The  $RC$  circuits on  $Q3$  and  $Q4$  are designed to extend their turn-on times to beyond those of  $Q1$  and  $Q2$ .

The circuit can monitor ac voltages as well as dc, provided that  $C_i$  is small enough so that no SCR stays on for more than a half cycle. For 60 Hz signals,  $0.3 \mu\text{F}$  is a good value.

*Alexander Prokop, Design Engineer, SKIL Corp., Chicago, Ill.*

VOTE FOR 314

## Relay driver provides delay and controls closure time

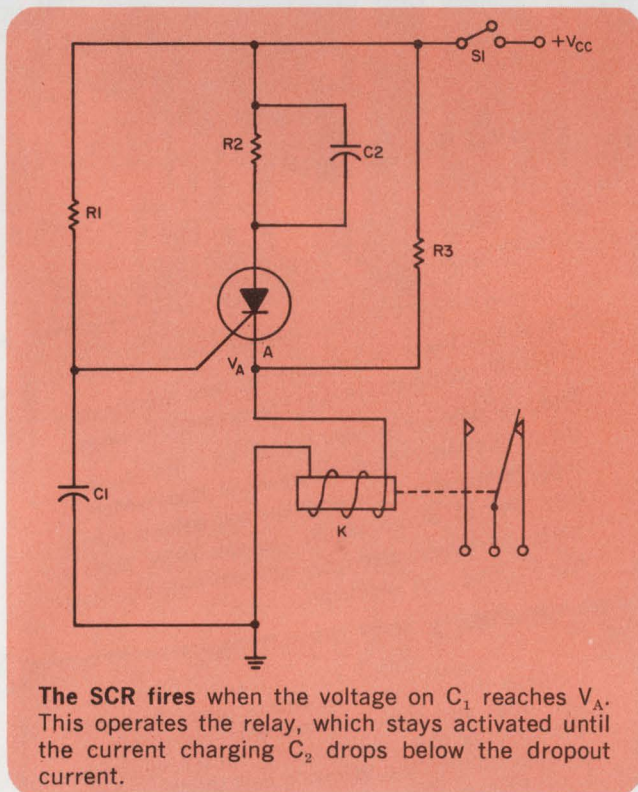

Suppose you want a relay to operate a certain time,  $t_d$ , after power is applied to it. And furthermore suppose that you only want the relay to operate for a length of time,  $t_c$ . The circuit shown will do this for you, and if  $C_2$  is eliminated,  $t_c$  can be made infinitely long.

When power is applied by closing  $S1$ , a voltage  $V_A$  appears at point A.  $V_A$  is determined by  $V_{cc}$  and the voltage divider formed by  $R_3$  and the relay coil resistance,  $R_k$ . Simultaneously with the closing of  $S1$ , capacitor  $C_1$  begins to charge toward  $V_{cc}$  with time constant  $R_1C_1$ . When the capacitor voltage reaches  $V_A$ , gate current flows through  $R_1$  and fires the SCR.

This operates the relay and also charges capacitor  $C_2$ . As the capacitor charges (with a time constant  $R_kC_2$ ) the current decays until it falls below the dropout current of the relay. Resistor  $R_2$  is chosen very large and only serves to provide a discharge path for  $C_2$  when the switch is opened.

If you want the relay to remain in its activated position indefinitely ( $t_c = \infty$ ), eliminate  $C_2$  and choose  $R_2$  just large enough to keep the relay coil current within its related limits.

Typical component values for  $t_d = 30$  seconds and  $t_c = 2$  seconds are:  $R_1 = 1.5 \text{ M}\Omega$ ,  $R_2 = 10 \text{ k}\Omega$ ,  $R_3 = 3 \text{ k}\Omega$ ,  $C_1 = 47 \mu\text{F}$ , and  $C_2 = 100 \mu\text{F}$ . The SCR is a 2N1877 and the relay is a Potter Brumfield PW-5374. A value of 12 Vdc is assumed for  $V_{cc}$ .

*John Bacon, Electronics Engineer, U. S. Naval Ordnance Laboratory, Silver Spring, Md.*

VOTE FOR 315

# VOTE

**VOTE!** Go through all Idea-for-Design entries, select the best, and circle the appropriate number on the Reader-Service-Card.

**SEND US YOUR IDEAS FOR DESIGN.** You may win a grand total of \$1050 (cash)! Here's how. Submit your IFD describing a new or important circuit or design technique, the clever use of a new component or test equipment, packaging tips, cost-saving ideas to our Ideas-for-Design editor. You will receive \$20 for each accepted idea, \$30 more if it is voted best-of-issue by our readers. The best-of-issue winners become eligible for the Idea Of the Year award of \$1000.

### IFD Winner for May 10, 1969

**Les Toth**, Project Engineer, Cohu Electronics, Inc., San Diego, Calif. His Idea, "Circuit power neon lamps from low-voltage sources" has been voted the Most Valuable of Issue award.

**Vote for the Best Idea in this Issue.**

**Where the action is...**

**is where you need Tungsten and sintered metal contacts**

Especially if the action calls for heavy duty performance. H. A. Wilson special powder metallurgy processes make possible contacts of sintered metals that cannot be alloyed. Tungsten offers the properties needed for higher voltages and currents. Contacts in rivet form, steelbacks, faced screws, discs, washers, and special shapes. Assemblies are available riveted, hot upset, welded and brazed.

Let the H. A. Wilson Technical Service Department advise you as to the best form, type and size of contact . . . type of material, method of attaching, and best spring to use.



**ENGELHARD**

**ENGELHARD INDUSTRIES DIVISION**  
 ENGELHARD MINERALS & CHEMICALS CORPORATION  
 2655 U. S. ROUTE 22, UNION, NEW JERSEY 07083

INFORMATION RETRIEVAL NUMBER 61

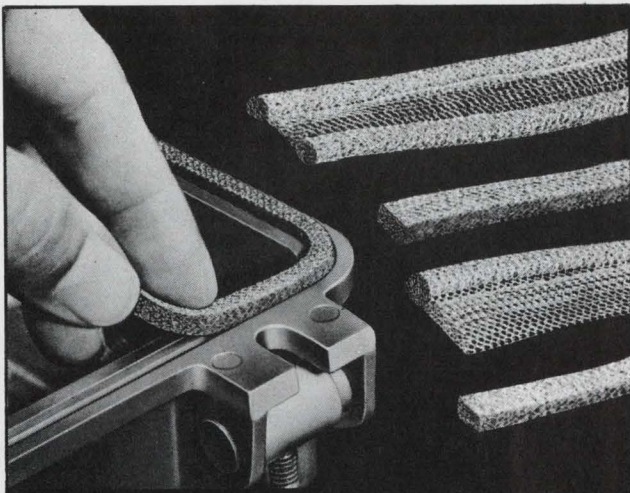

**EMI/RFI SHIELDING GASKET  
 CONDUCTIVE/RESILIENT STRIP**

**TECKNIT STRIP** ■ Total Shielding Effectiveness up to 120 dB ■ Available in Tin Coated Copper Clad Steel, Monel, Aluminum, Silver Plated Brass ■ Variety of cross sections: square, round, rectangular, single fin, double core ■ Write for data #200, and FREE sample.

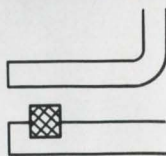

Easy groove mounting method shields flange to cover.

**TECKNIT** TECHNICAL WIRE PRODUCTS, INC.

East Division • 129 Dermody St., Cranford, N. J. 07016 (201) 272-5500  
 West Division • 427 Olive St., Santa Barbara, Calif. 93101 (805) 963-1867

INFORMATION RETRIEVAL NUMBER 62

**MICRO-SOLDERING  
 PROBLEMS!**

- flip chips
- integrated circuits
- hybrid circuits
- thick films
- thin films

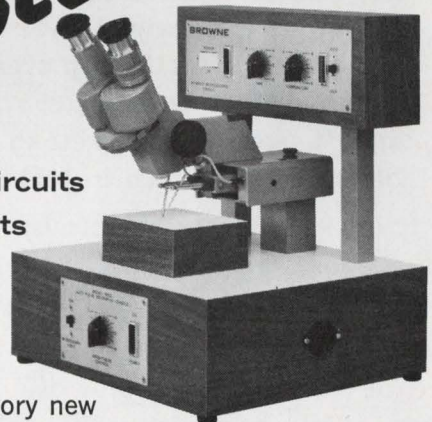

**Rent** a factory new micro-soldering system for a one month intensive production evaluation, immediate delivery. Complete purchase price \$995. **Evaluation Rental \$95.**

System shipped complete including: 10 x binocular microscope and light, multiple-lead flatpack soldering tip, alloy-loop soldering tips, thoriated tungsten resistance tips, micro-loop hand probe, and hydraulic foot actuator.

**BROWNE  
 ENGINEERING**

1727 State Street, Santa Barbara, Calif. 93101  
 Telephone (805) 965-9600

INFORMATION RETRIEVAL NUMBER 63

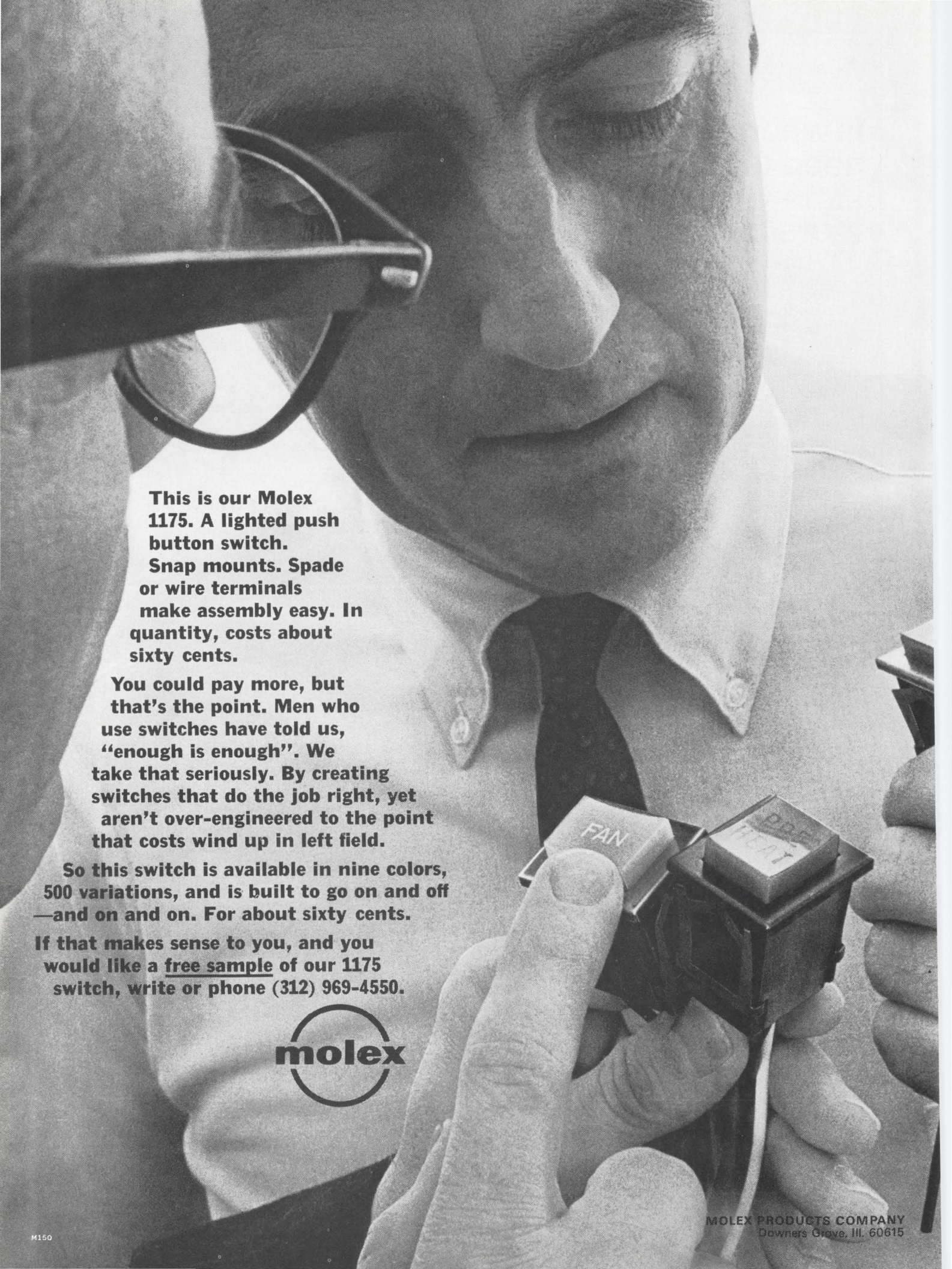

**This is our Molex 1175. A lighted push button switch. Snap mounts. Spade or wire terminals make assembly easy. In quantity, costs about sixty cents.**

**You could pay more, but that's the point. Men who use switches have told us, "enough is enough". We take that seriously. By creating switches that do the job right, yet aren't over-engineered to the point that costs wind up in left field.**

**So this switch is available in nine colors, 500 variations, and is built to go on and off—and on and on. For about sixty cents.**

**If that makes sense to you, and you would like a free sample of our 1175 switch, write or phone (312) 969-4550.**

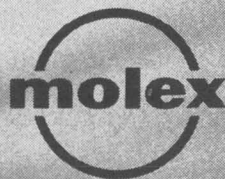

# Products

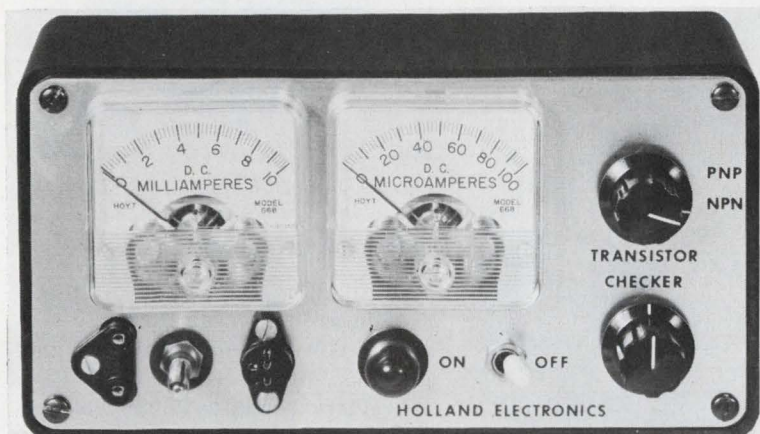

**Battery-operated transistor tester** can check unknown transistors for shorts, opens and gain, p. 115.

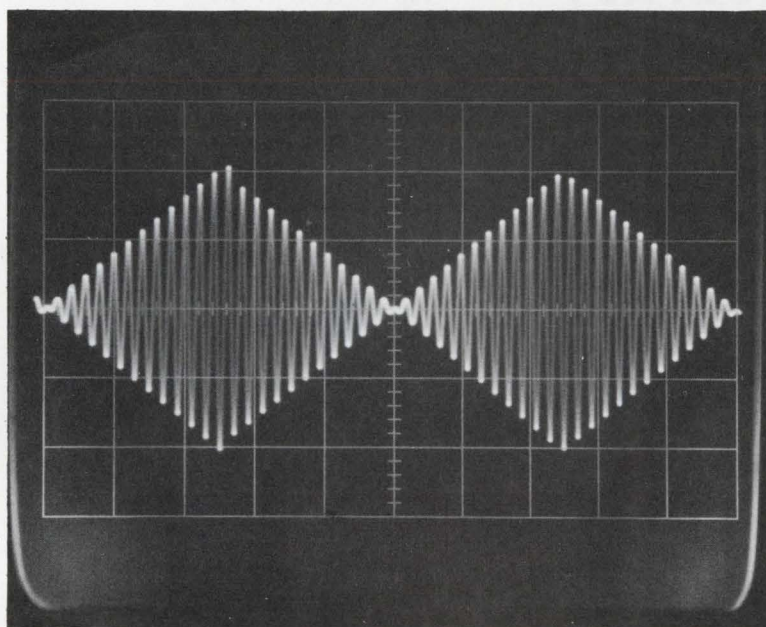

**Analog multiplier** selling for \$39 has 1% accuracy for all four quadrants without trimming, p. 110.

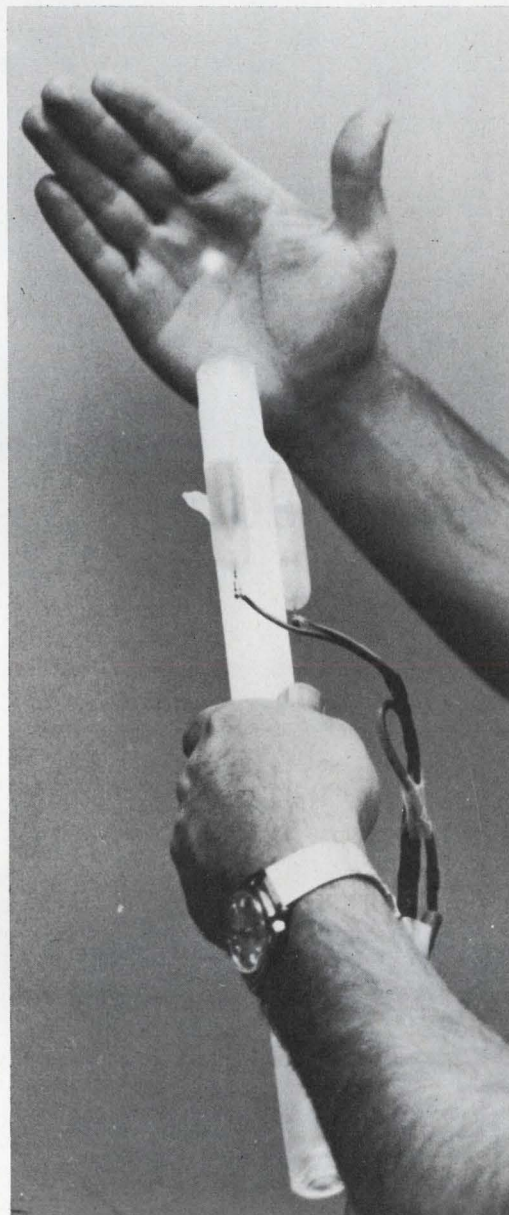

**He-Cd continuous-wave laser** needs no alignment, p. 128.

## Also in this section:

**Dc reference source** features adjustable dual-polarity outputs and remote sensing, p. 110.

**Instrumentation op amp** provides gains greater than 600 at 1  $\mu\text{A}$ , p. 112D.

**Complementary pairs** operate at currents as high as 50 A, p. 114.

**Evaluation Samples**, p. 130 . . . **Design Aids**, p. 131 . . . **Annual Reports**, p. 132.

**Application Notes**, p. 133 . . . **New Literature**, p. 134.

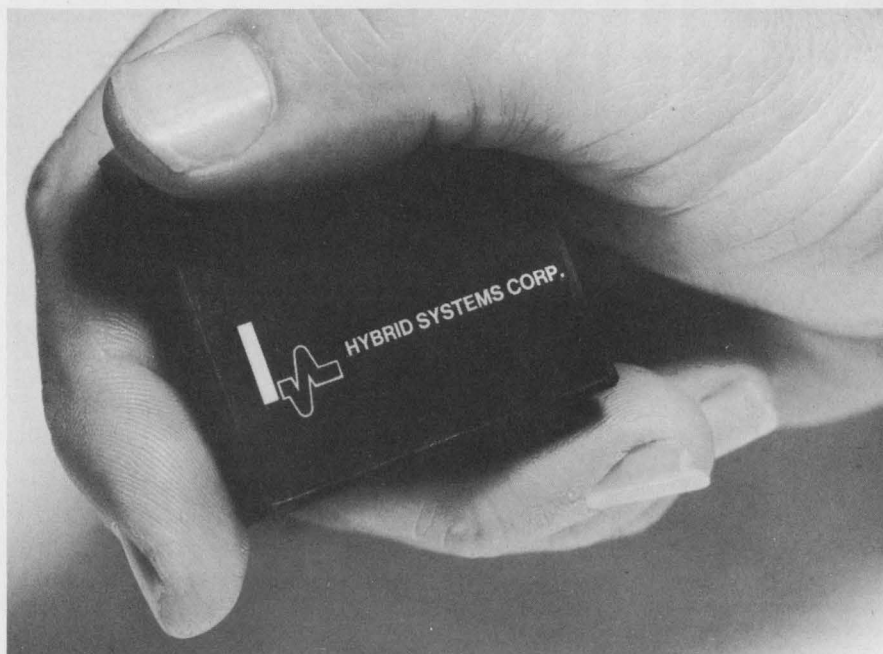

## Four-quadrant \$39 multiplier operates with 1% accuracy

Hybrid Systems Corp., 95 Terrace Hall Ave., Burlington, Mass. Phone (617) 272-1522. P&A: \$39; stock.

Costing only \$39 in single-unit quantities, a new four-quadrant analog multiplier performs with an

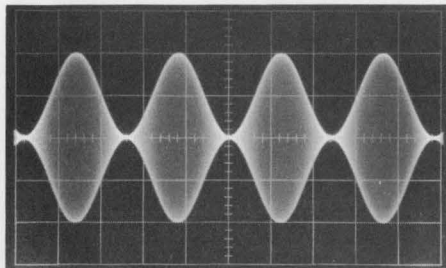

New four-quadrant multiplier can be used for clean and simple 100% amplitude modulation.

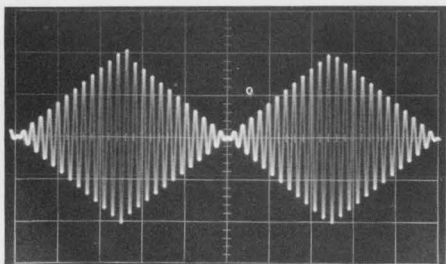

Suppressed carrier modulation shows a 100-Hz triangular wave multiplying a 10-kHz carrier.

overall accuracy of 1%. Model 107C is a completely self-contained device; it does not require any additional components to provide full four-quadrant operation.

This new multiplier achieves its 1% accuracy for all quadrants without trimming. However, its accuracy can be as high as 0.05% for one quadrant, with trimming.

With just simple pin interconnections, the unit can perform the functions of multiplying, dividing, squaring, and finding square roots. Obtaining these various functions usually requires the interconnection of only two pins.

Using the transconductance principle, the 107C can operate at millivolt signal levels, as well as at 20 V pk-pk.

The new multiplier can function from standard  $\pm 15$ -V 7-mA op-amp power supplies over its full input signal range of  $\pm 10$  V. Full-power output frequency is 100 kHz, and -3-dB bandwidth is 400 kHz.

Output impedance for the device is only 1  $\Omega$ . Input impedance is 10 k $\Omega$  for the Z channel.

The 107C weighs only 1.5 oz and measures 1.75 by 1.75 by 0.5 in. Its operating temperature range is 0 to 60°C.

CIRCLE NO. 250

## D/a converters settle in 1 $\mu$ s

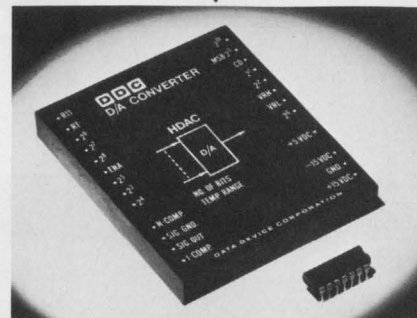

Data Device Corp., 100 Tec St., Hicksville, N.Y. Phone: (516) 433-5330. P&A: \$200; 2 to 4 wks.

Minimizing the effects of inter-system ground noise by using separate power and analog signal grounds, series HDAC modular d/a converters settle to 0.05% of full scale within 1  $\mu$ s maximum (500 ns typical). These new 8-to-12-bit units are complete systems since both their output amplifier and reference are internal. Input logic can be DTL or TTL.

CIRCLE NO. 251

## DC reference source senses load voltage



Analog Devices, Inc., 221 Fifth St., Cambridge, Mass. Phone: (617) 492-6000. P&A: \$80; stock.

Intended for use in analog and digital measuring systems, a new modular dc reference source features output voltages that are adjustable for decimal or binary systems and remote sensing (and feedback control) of the load voltage. Model 980 uses shunt rather than series regulation circuitry for fast, transient-free operation and minimum reaction with its own dc supply. It has a dual-polarity 10-V output at  $\pm 10$  mA, plus the ability to absorb (sink) up to 40 mA from active loads.

CIRCLE NO. 252



# the little giants

for  
shock and vibration  
measurements

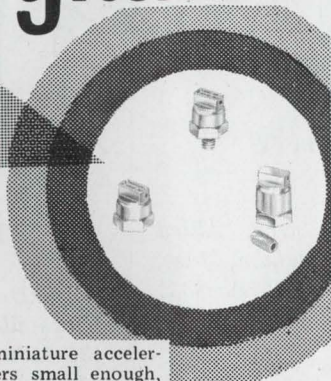

COLUMBIA piezoelectric ultraminiature accelerometers. The only accelerometers small enough, fast enough, and tough enough to go for a ride in an artillery projectile and accurately measure the shock and vibration, yet still survive to operate another day and even respond to the stroke of a feather. They frolic in the cold of liquid nitrogen or the heat of molten solder. We don't stick you with a pigtail type output cable, but remembered to design a special miniature detachable cable assembly that works beautifully. Are you interested—then write for the 606 Series specs. COLUMBIA RESEARCH LABORATORIES, INC., MacDade Boulevard and Bullens Lane, Woodlyn, Pennsylvania 19094; Telephone (215) 532-9464.



**columbia**

first for transducers

INFORMATION RETRIEVAL NUMBER 65

## PRETTY SMALL FUSE

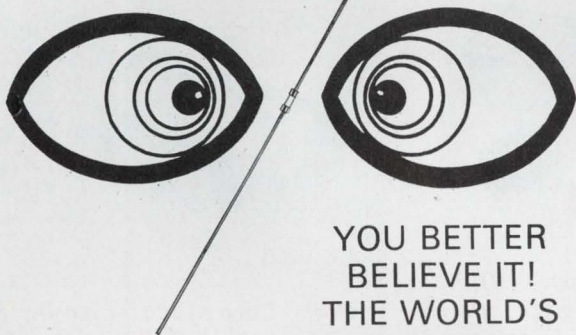

YOU BETTER  
BELIEVE IT!  
THE WORLD'S  
SMALLEST!

Picofuses by Littelfuse.  
Available from 1/8 thru  
15 amps, 125V.  
Weights only 1/6 gram.

**LITTELFUSE**  
DES PLAINES, ILLINOIS

INFORMATION RETRIEVAL NUMBER 66

ELECTRONIC DESIGN 18, September 1, 1969

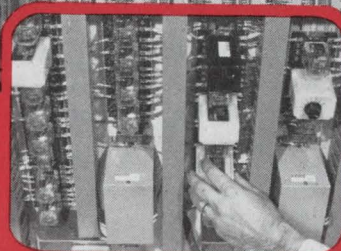
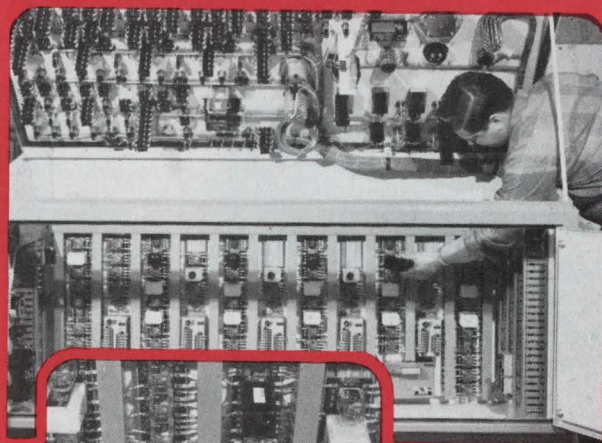

RS8 and RS14  
sockets in con-  
crete batching  
control by Wiscon-  
sin Electrical Mfg.  
Co. of Milwaukee.

## CURTIS TRACK-MOUNT RELAY SOCKET ASSEMBLIES SLASH INSTALLATION COSTS

Compact, factory-assembled printed circuit relay socket assemblies snap in (or out) vertically into pre-punched vinyl track. Lengths to 48" securely hold up to 24 relay sockets with only 2 or 3 mounting screws.

Curtis quality barrier-type terminal blocks feature screw terminals. Sockets have recessed center post chambers for easy fracture-free relay replacement. All 3 relay types mount in the same 2 7/8" wide track.

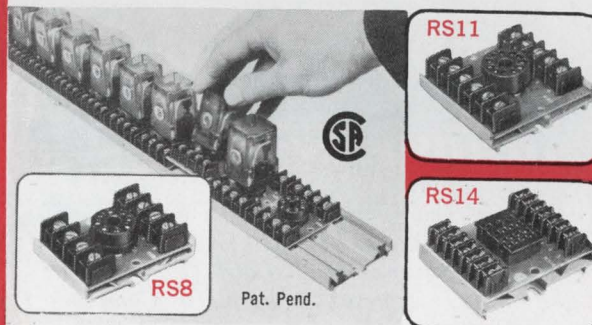

**RS8** Octal socket assembly for 8 pin 2 P.D.T. relays. Assembly 2" long. Rated: 10 amps, 250 volts.

**RS11** Socket assembly for 11 pin 3 P.D.T. relays. Assembly 2 7/8" long. Rated: 10 amps, 250 volts.

**RS14** Socket assembly for 14 pin 4 P.D.T. relays. Assembly 2" long. Rated: 5 amps, 125 volts.

Send today for **FREE** information and name of your local Curtis representative or distributor.



**CURTIS**  
DEVELOPMENT & MFG. CO.

3236 N. 33rd St., Milwaukee, Wi. 53216

INFORMATION RETRIEVAL NUMBER 67

### Band-pass filters supply ample gain



Washington Technological Associates, Inc., 979 Rollins Ave., Rockville, Md. Phone: (301) 427-7550.

Using a negative impedance converter technique, a new series of multi-pole active band-pass filters provide enough gain to overcome losses and to eliminate the need for external amplifiers. They are available with multi-pole pairs ranging from two to seven poles, and with characteristic responses equivalent to Chebyshev, Butterworth, and Bessel functions.

CIRCLE NO. 253

### Data amplifiers have gain of $10^3$

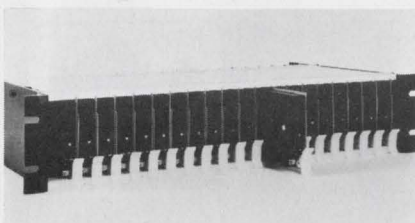

Newport Laboratories, Inc., 630 E. Young St., Santa Ana, Calif. Phone: (714) 540-4914. P&A: \$234; stock to 60 days.

Accurately amplifying low-level differential signals from transducers and similar sources, series 50/55 data amplifiers provide a rejection of up to  $\pm 300$  V peak and a common-mode ratio of 130 dB at 60 Hz with a differential gain of 1000. Their input specifications include drifts of  $0.5 \mu\text{V}/^\circ\text{C}$  and  $2 \mu\text{V}/\text{day}$ , and  $30\text{-M}\Omega$  input impedance. Linearity is 0.01%; output capability is  $\pm 10$  V at 100 mA.

CIRCLE NO. 254

### FET op amp has $10^6$ CMRR

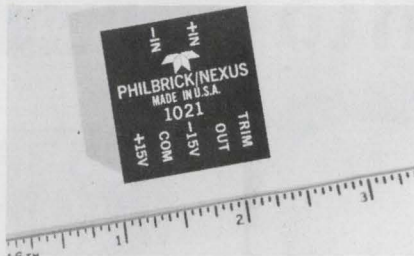

Philbrick/Nexus Research, Allied Drive at Route 128, Dedham, Mass. Phone: (617) 329-1600. P&A: \$33; stock.

Without employing complex circuit techniques, a new low-cost high performance FET-input operational amplifier boasts a typical common-mode rejection ratio (CMRR) greater than 1,000,000. Other typical characteristics of model 1021 include an output voltage of  $\pm 11$  V, an output current of  $\pm 20$  mA, and full-power output response at 125 kHz. Slew rate is  $8 \text{ V}/\mu\text{s}$ , and input offset voltage drift is  $15 \mu\text{V}/^\circ\text{C}$  from  $-25$  to  $+85^\circ\text{C}$ .

CIRCLE NO. 255

### Rack-size converter includes supplies

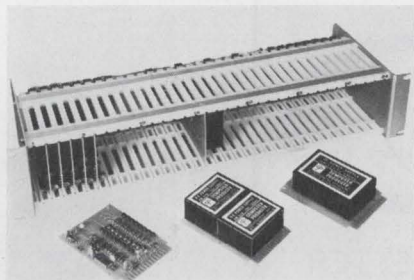

Computer Products, 2709 N. Dixie Highway, P.O. Box 23849, Fort Lauderdale, Fla. Phone: (305) 565-9565. P&A: \$1015 to \$1815 typical; 4 wks.

Wired for up to 16 channels of data, including power supplies, DAP-600 d/a conversion packages require only 3.5 in. of vertical space in a standard 19-in. rack. There can be an 8-, 10- or 12-bit binary resolution per channel, with or without input data storage, and up to  $\pm 10.24\text{-V}$  analog output capabilities.

CIRCLE NO. 256

### High-power op amps deliver 125 V at 1/4 A

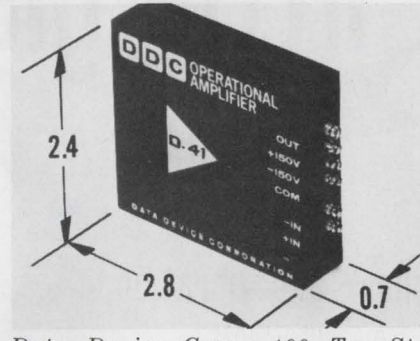

Data Device Corp., 100 Tec St., Hicksville, N.Y. Phone: (516) 433-5330. P&A: \$150; stock to 3 wks.

Able to operate from unregulated supplies, a new series of operational amplifiers with built-in current limiting provide minimum outputs of  $\pm 125$  V at  $\pm 250$  mA. Series D-41 units have an open-loop gain of 90 dB at 400 Hz and a differential input impedance of  $400 \text{ k}\Omega$ . Their input voltage stability is  $6 \mu\text{V}/^\circ\text{C}$ , while initial current offset is  $0.5 \mu\text{A}$ .

CIRCLE NO. 257

### Small sampling modules have 0.01% accuracy

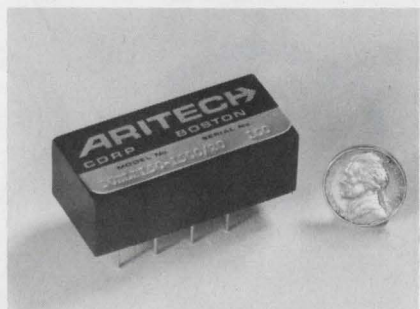

Aritech Corp., 130 Lincoln St., Brighton, Mass. Phone: (617) 254-2990. P/A: \$75; 60 days.

A new family of sample-and-hold modules features 0.01% accuracy, a 50-ns aperture time, a  $2\text{-}\mu\text{s}$  acquisition time and a  $1000\text{-M}\Omega$  input impedance. Series SH-100 units are ideal for doppler radar, multiplexer decoding, a/d conversion, telemetry and other data acquisition and data conversion applications. They offer a drift stability of  $20 \mu\text{V}/^\circ\text{C}$ .

CIRCLE NO. 258



## Amphenol has added fixed contact, high density, encapsulated contact and power

NOW AMPHENOL GIVES YOU A COMPLETE LINE of pin and socket connectors. We've added four new families to our original Poke-Home® and hard dielectric standards — fixed contact, high density, encapsulated contact and power/coax. And they'll intermate with the ones you're buying now.

EXPECT TWO BIG DIFFERENCES FROM AMPHENOL—availability and down-to-earth prices. We'll meet *your* delivery schedule and *match* prices with anyone.

SEND FOR A FREE WALL CHART showing all six families with a wide variety of pin configurations, contact types and dielectrics. Return the card in this ad or write Amphenol Industrial Division, 1830 S. 54th Ave., Chicago, Illinois 60650.

\***Fixed Contact**—Fixed solder contacts with 2-piece glass-filled nylon insulator. **High Density**—Removable crimp Poke-Home® contacts with glass-filled nylon insulator. **Encapsulated Contact**—Removable crimp or solder Poke-Home® contacts with encapsulating nylon insulator. **Power/Coax**—Removable crimp or solder Poke-Home® contacts for either power or coax with glass-filled nylon insulator. **Original Poke-Home®**—Removable crimp or solder Poke-Home® contacts with nylon insulator. **Hard Dielectric**—Removable crimp or solder Poke-Home® contacts with diallyl phthalate insulator.

## FET amplifiers hold noise down

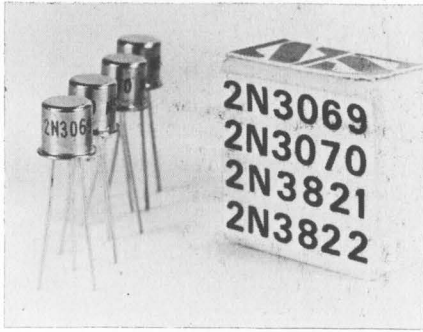

National Semiconductor Corp., 2950 San Ysidro Way, Santa Clara, Calif. Phone: (408) 245-4320. P&A: \$1.85 to \$4; stock.

A new series of general-purpose FET amplifiers provide a typical low noise figure of 0.1 dB and 20 nV per root hertz at 100 Hz. Types 2N3069, 2N3070, 2N3821 and 2N3822 also exhibit a low leakage of 20 pA and a high gain of 2000 to 4000  $\mu$ mhos. Applications include audio and video systems, and multiplexers and commutators.

CIRCLE NO. 259

## Full memory chip stores 64 bits

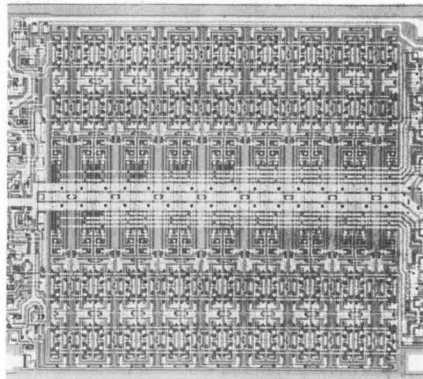

Intel Corp., 365 Middlefield Rd., Mountain View, Calif. Phone: (415) 969-1670. Price: \$99.50.

Designed for use as a high-speed scratch pad memory or general-purpose storage element, a new 64-bit random-access memory is organized as a 16 word by four-bit array. Each word is addressable through four address input leads in binary code. Model 3101 features a typical access time of 50 ns. For simple interfacing, the unit is fully decoded with on-chip address, decoding, and buffering.

CIRCLE NO. 262

## IC op amp gains $3 \times 10^6$

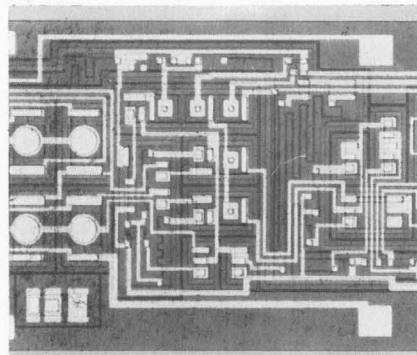

Fairchild Semiconductor, 313 Fairchild Drive, Mountain View, Calif. Phone: (415) 962-3563. Price: \$72.

Packaged in a TO-5 can, a new monolithic instrumentation operational amplifier provides gains in excess of 600 at 1  $\mu$ A. Model  $\mu$ A725 delivers an open-loop gain of 3,000,000 with a gain accuracy of 0.03% at a closed-loop gain of 1000. The noise current is held to a low 0.6 pA per root hertz; common-mode rejection is 120 dB.

CIRCLE NO. 260

## Logarithmic amplifier complements displays

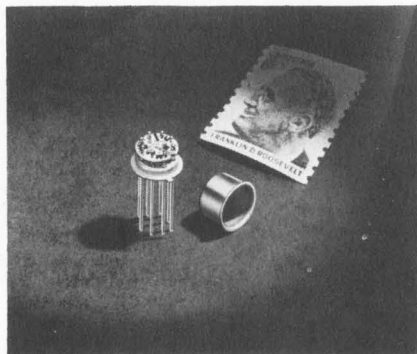

CTS Microelectronics, Inc., West Lafayette, Ind. Phone: (317) 463-2565. P&A: \$36; stock.

Designed for use in cascade as a logarithmic amplifier with a mid-band frequency between 10 and 100 MHz, a new cermet hybrid integrated circuit compresses a wide range of signal into a logarithmic scale on a display device. Model 861 log i-f amplifier features built-in power supply decoupling and a typical voltage gain of 0.6 dB from 30 to 100 MHz. It operates over the full military temperature range of  $-55$  to  $+125^\circ\text{C}$ .

CIRCLE NO. 263

## Low-cost parity trees keep delays to 22 ns

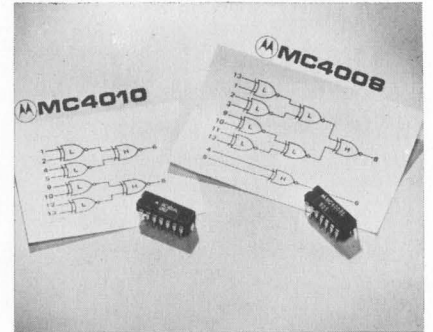

Motorola Semiconductor Inc., P.O. Box 20924, Phoenix, Ariz. Phone: (602) 273-6900. P&A: \$7.75; stock.

Economically detecting errors in computers and digital control systems, two new low-power parity trees provide typical propagation delays of only 22 or 30 ns. Model MC4008 is an eight-bit device consisting of seven two-input exclusive NOR gates. Model MC4010 consists of six two-input exclusive NOR gates connected to form two independent four-bit parity trees.

CIRCLE NO. 261

## IC operational amplifiers compensate on the chip

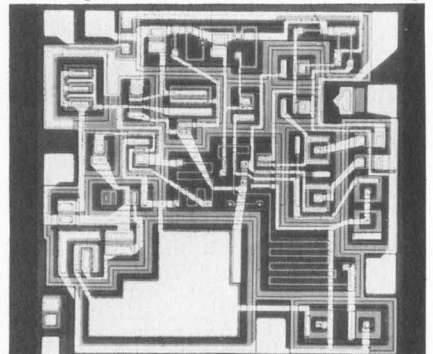

Union Carbide Electronics, 8888 Balboa Ave., San Diego, Calif., Phone: (714) 279-4500.

Two new integrated-circuit operational amplifiers, types UC4741 and UC4741C, feature large common-mode and differential-mode voltage ranges and require no external frequency range compensation. Their offset voltage is adjustable to zero with an external 10-k $\Omega$  potentiometer. Internal 6-dB/octave roll-off insures stability in closed-loop applications. Both units have continuous short-circuit protection.

CIRCLE NO. 264

# The Friden 1150 Digital Printer: fast, reliable— and inexpensive.

The Friden\* 1150 Digital Printer has a printing speed of 50 characters a second.

Because it has fewer moving parts than ordinary medium-speed printers, it is easier to maintain. This means less downtime for your OEM product. The unit contains a single 20-character print wheel and a synchronized print hammer. Both are driven across the tape from right to left at a uniform speed.

The hammer's short impact time ensures quality printing from the continuously rotating wheel. Your output looks good and is easy to read. And we have even eliminated ribbons with a disposable ink roller.

Logic requirements are simple, making it easy for you to integrate the 1150 into your OEM product.

The 1150 is a completely tested and *proven* printer—

a vital component of Friden electronic printing calculators for nearly two years. And Singer's Friden Division provides maintenance backup throughout the world.

With its low initial cost and desirable operating features, the 1150 gives you a price/performance ratio that is unique among OEM printers.

We'd like you to have complete specifications. Just write Friden Division (Component Products), The Singer Company, San Leandro, California 94577. Ask for Specification 1001.

**SINGER**  
FRIDEN DIVISION

**Friden Component Products.**

**One way Singer serves the Original Equipment Market.**

INFORMATION RETRIEVAL NUMBER 68

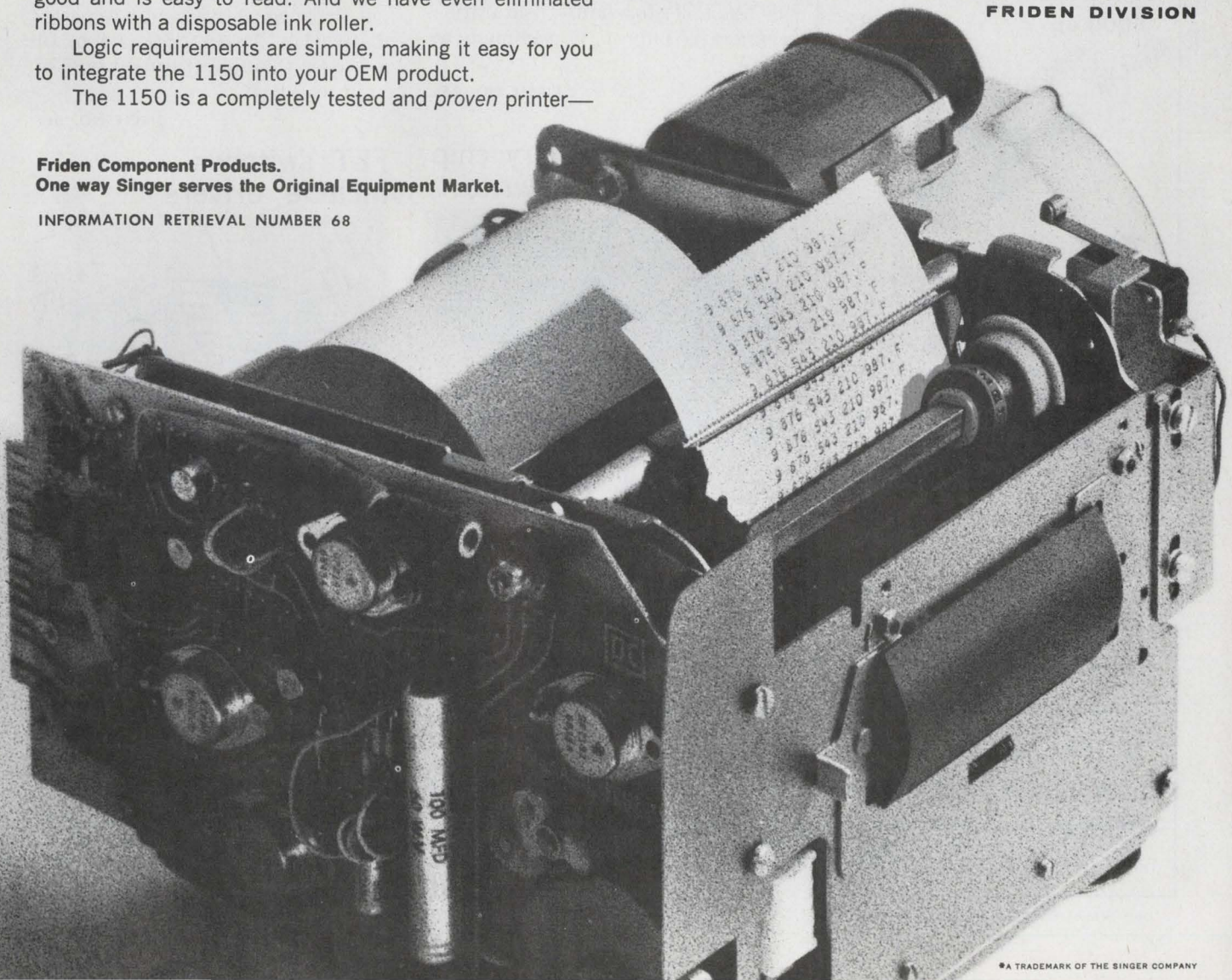

# SCHAUER

# 1%

tolerance

## 1 WATT ZENERS ARE A REAL BUY!

ANY voltage from 2.0 to 16.0  
at the industry's LOWEST  
PRICES!

Quantity	Price each
1-99	\$1.07
100-499	.97
500-999	.91
1000-4999	.86
5000 up	.82

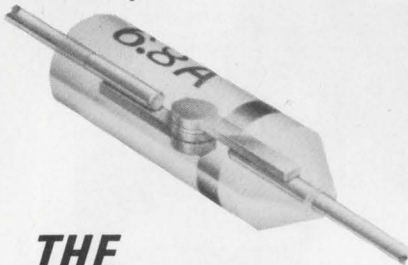

## THE HI-RELIABLE!

No fragile nail heads.  
Silicon junction aligned between two, parallel, offset tantalum heat sinks . . . great lead tension strength.  
All welded and brazed assembly.  
High pressure molded package.  
Gold plated nickel-clad copper leads.  
Write or phone for Form 68-4 for complete rating data and other tolerance prices.

Semiconductor Division

## SCHAUER MANUFACTURING CORP.

4511 Alpine Avenue  
Cincinnati, O. 45242  
Ph. (513) 791-3030

ICs & SEMICONDUCTORS

## Npn/pnp pairs can carry 50 A

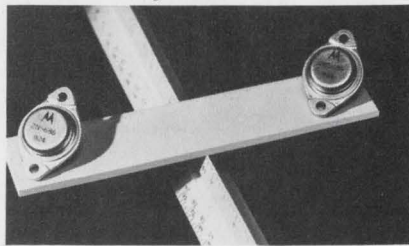

Motorola Semiconductor Products, Inc., P.O. Box 20924, Phoenix, Ariz. Phone: (602) 273-6900. P&A: \$12 or \$18; stock.

Two new pairs of complementary silicon power transistors can operate at current levels as high as 50 A. The pnp 2N5683 and 2N5684, and npn 2N5685 and 2N5686 are hybrid single-diffused transistors with collector breakdown voltages of 60 to 80 V. All four transistors are rated for a minimum current gain of 15 to 25 A, and maintain a minimum gain of 5 even at the maximum rated collector current of 50 A. Collector-emitter saturation voltage is only 1 V maximum at 25 A.

CIRCLE NO. 265

## MOS total memory chip reads without rewrite

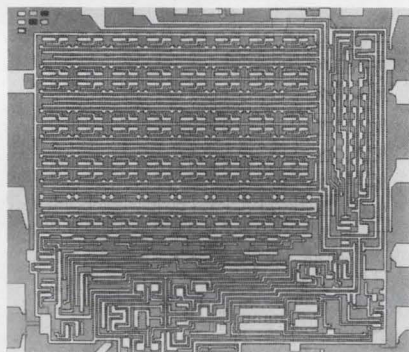

Fairchild Semiconductor, 313 Fairchild Drive, Mountain View, Calif. Phone: (415) 962-3563. Price: \$36.

Complete with decode logic, chip select, and control circuitry, a new 64-bit static random-access MOS memory reads information repeatedly without requiring rewrite. The 3530 is organized into 64 words by one bit and features a wired-OR capability that allows outputs to be connected in parallel on a common bus line.

CIRCLE NO. 266

## MOS 128-bit memory reads and writes

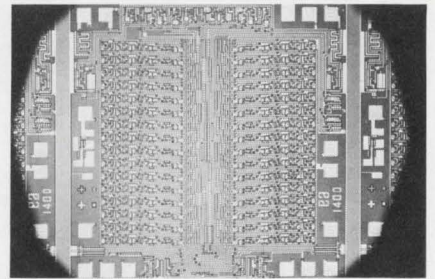

Electronic Arrays, Inc., 501 Ellis St., Mountain View, Calif. Phone: (415) 964-4321. P&A: \$35.60; stock.

Targeted primarily for applications in digital computer equipment, a new MOS read/write random-access memory provides 128 bits organized as 64 words at 2 bits per word. All decoding circuitry is included on the monolithic chip to simplify its use and to keep the number of package leads to a minimum. Model EA 1400 features nondestructive readout, bipolar output drive capability and low power dissipation. Access time is 1  $\mu$ s or less over the temperature range of  $-55$  to  $+85^{\circ}\text{C}$ .

CIRCLE NO. 267

## FET switches include drivers

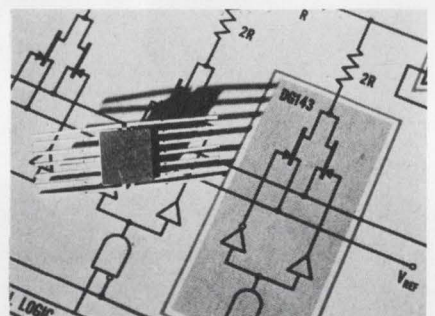

Siliconix Inc., 2201 Laurelwood Rd., Santa Clara, Calif. Phone: (408) 246-8000. P&A: \$27.40 to \$91; stock.

Six new series D139L circuits consist of a differential-input driver controlling junction FET switches in spdt or dpdt configurations. The driver inputs interface with DTL, TTL or RTL outputs for multiplexing, commutating, and d/a converter applications. No external components are required. Each circuit is capable of switching analog signals up to 20 V pk-pk.

CIRCLE NO. 268

## Small transistor tester identifies and checks

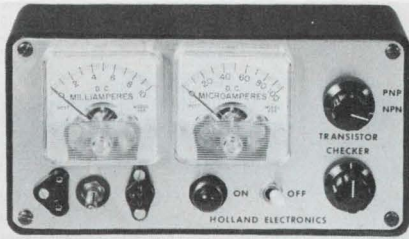

Holland Electronics, 842 E. 94th St., Brooklyn, N.Y. Phone: (212) 649-7330. P&A: \$65; stock.

A new small battery-operated transistor tester checks unknown or identified transistors for npn or pnp configurations, shorts opens and gain. Model TT285 contains two high-accuracy easily seen 1-5/8-in. square ammeters; one for base currents from 0 to 100  $\mu$ A, and the other for currents from 0 to 10 mA. It measures only 2-1/2 by 5-7/8 by 3-1/8 in. and is housed in a rugged plastic case.

CIRCLE NO. 269

## Panel accumulator counts $10^6$ events/s



Beckman Instruments, Inc., Electronic Instruments Div., 2400 Harbor Blvd., Fullerton, Calif. Phone: (714) 871-4848. Price: \$425.

Measuring only 3 by 6 in., a new panel-mounted accumulator can count events at rates up to one million per second. Designed primarily for systems applications, model 4038 can count events that are repetitive, intermittent or random. It starts to count the instant an internal gate is opened, either by a remote contact closure or by an IC voltage-level change. The count continues until the gate is closed. A front-panel light indicates whether the gate is open or closed.

CIRCLE NO. 270

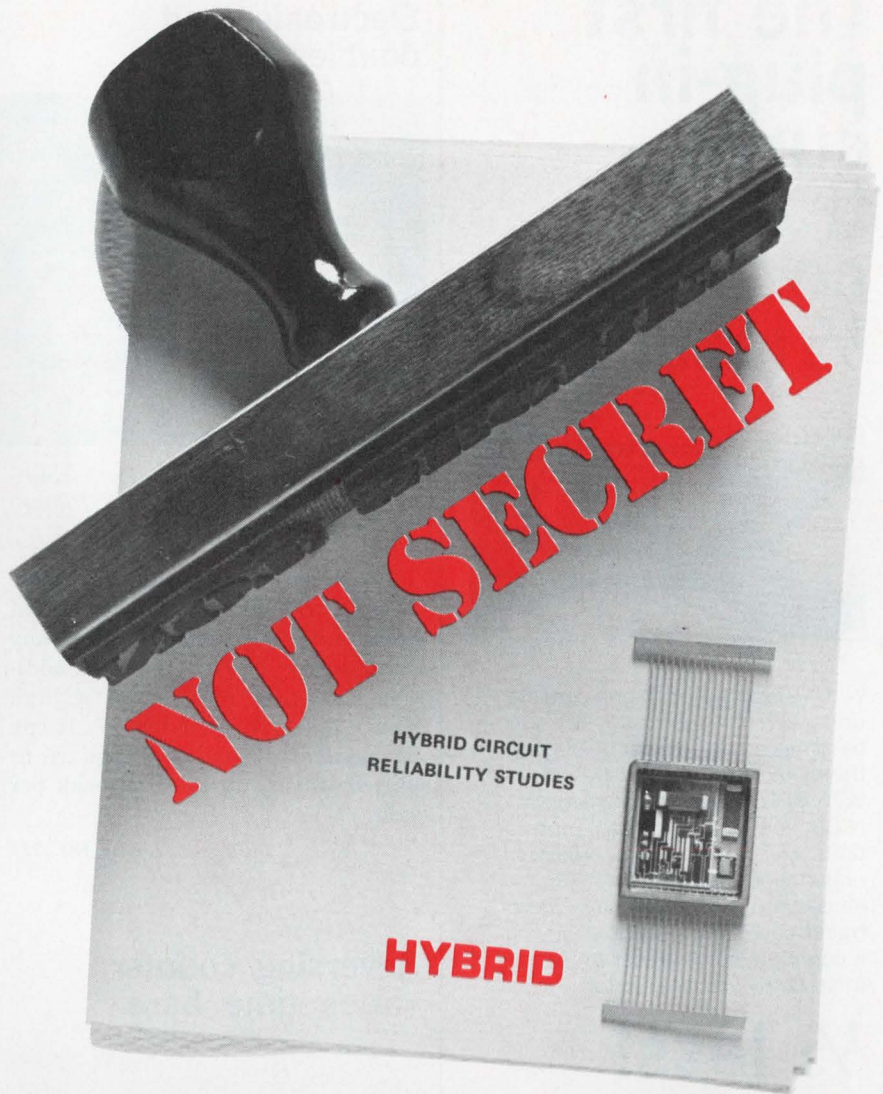

Come see for yourself!

At WEMS we have no secrets. Our vast microelectronic packaging experience is yours-for-the-asking.

Working together we can produce the best hybrid circuits for your applications. Your engineers know the system requirements; our engineers know hybrid technology and how to meet those requirements.

Write or call for further information.

- An equal opportunity employer.



**WEMS, INC.** 4650 WEST ROSECRANS AVENUE

HAWTHORNE, CALIF. 90250 ■ TELEPHONE (213) 679-9181

INFORMATION RETRIEVAL NUMBER 70

# The first plug-in curve tracer costs 1/3 less!



With U-Tech's plug-in and console units, any X-Y oscilloscope becomes a curve tracer displaying the dynamic characteristics of both NPN and PNP transistors, N Channel and P Channel junctions, FET's, MOS-FET's, bipolars, unijunctions, diodes, tunnel diodes and SCR's. You have curve tracer capabilities, without buying a complete curve tracer unit. In so doing you pay up to:

## 1/3 less!

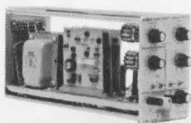

U-Tech plug-in **MODEL 681**: \$655.00\*. For use with Tektronix 560 Series Oscilloscopes.

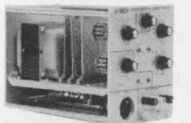

U-Tech plug-in **MODEL 682**: \$675.00\*. For use with Tektronix 530, 540, 550, 580 Series Oscilloscopes.



U-Tech console **MODEL 683**: \$685.00\*. For use with any X-Y Oscilloscope.

Ask your distributor about these U-Tech curve tracer units or order direct from:

## U-TECH

A DIVISION OF INDUSTRIAL PHYSICS AND ELECTRONICS COMPANY  
4190 SOUTH STATE STREET  
SALT LAKE CITY, UTAH 84107  
(801) 262-2663

\*Prices apply to purchase and shipments within U.S.A. fob Salt Lake City, Utah

## INSTRUMENTATION

### Electronic load doubles output

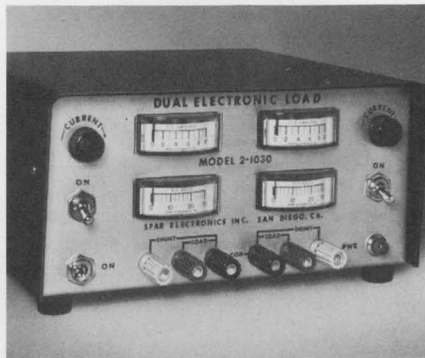

Spar Electronics, Inc., 7969 Engineer Rd., San Diego, Calif. Phone: (714) 279-1641.

A new dual electronic load, model 2-1030, provides a constant current from 1 to 30 V dc, without any drift due to line changes. In addition, the new unit offers a high power dissipation of 600 W. It can be modulated with sine, square or pulsed waves, up to 10 A peak per side.

CIRCLE NO. 271

### Reversing counter varies time base

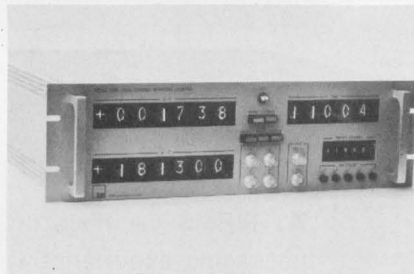

Itron Corp., 11675 Sorrento Valley Rd., San Diego, Calif. P&A: \$4500; 60 days.

Model 6502 dual-channel variable-time-base reversing counter displays the algebraic totals of X-Y and X'-Y' on separate six-digit-plus-sign readouts. Set by front-panel thumbwheel switches, the events are algebraically accumulated during an elapsed time. A separate five-decade numerical display continuously indicates the elapsed time. Anti-coincidence circuitry prevents loss of data when simultaneous signals are seen by the counter.

CIRCLE NO. 272

### Up/down counters uphold accuracy



Advance Industrial Electronics, Raynham Rd., London, England.

Series RC6000 bidirectional counters offer true up and down counting through zero, without any loss of count. Their input circuits are designed so that there is absolutely no restriction on the coincidence of pulses occurring on the inputs, thereby maintaining an absolute count. Operating modes are selected by front-panel push-buttons, and overflow indication is automatic.

CIRCLE NO. 273

### Universal counter goes out to 32 MHz

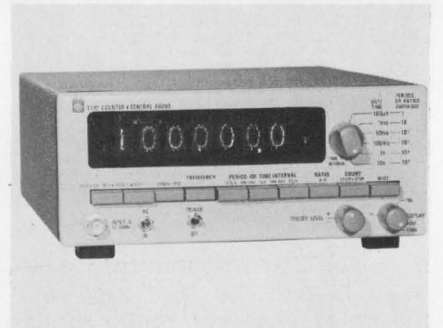

General Radio Co., 300 Baker Ave., West Concord, Mass. Phone: (617) 369-4400. Price: \$575 to \$845.

A new universal counter, model GR 1192, measures frequency from dc to 32 MHz, single and multiple period, time interval, frequency ratio, or can simply count. This new instrument has a 10-mV sensitivity (up to 20 MHz), and controllable trigger threshold and attenuation. Bench or rack models are available with five, six, or seven digits, and optional BCD output.

CIRCLE NO. 274



## EIA synchronizer is self-contained



*bge Digital Communications, P.O. Box 607, Northbrook, Ill. Phone: (312) 423-1331.*

Completely self-contained, a new synchronizing generator, which uses DTL and TTL ICs, produces standard composite synch, composite blanking, vertical drive, and horizontal drive signals in accordance with EIA RS-170. Each output develops a negative 4-V pk-pk signal across a 75-Ω load. There are two modes of operation via selection by a front-panel switch: line lock or internal crystal lock.

CIRCLE NO. 275

## Multi-axis counters suit industrial needs

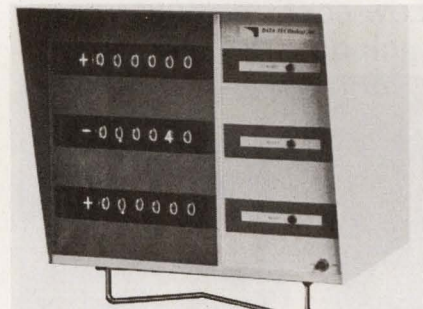

*Data Technology, Inc., 65 Grove St., Watertown, Mass. Phone: (617) 924-1773.*

Using all-TTL integrated circuitry on plug-in PC cards, a new line of single- and multi-axis bi-directional counters offer the high noise immunity needed in industrial environments and high-speed capability as well. Their input section accepts feedback or readout transducer digital signals to provide a net count of position increments from any starting point. Application areas include position or speed measurement and control for machines, as well as numerical and process control systems.

CIRCLE NO. 276

# shape IS NO PROBLEM

when specifying Pulse Code Modulation (PCM) systems from Radix Telemetry Corp. All system components are packaged as separate functional modules, and can be arranged to meet a wide variety of envelope requirements. Or, if volume is insufficient to accommodate a complete system in one location, various subsystems can be located remotely from each other. Minimum system volume is achieved by micropackaging techniques, 0.3 cubic inches per channel is typical.

✈ **FOR AIRCRAFT...** RADIX PCM SYSTEMS are available for operation over full MIL-E-5400 environments. Modular construction allows the user to re-program the system with simple patch board techniques.

✈ **FOR MISSILES...** RADIX PCM SYSTEMS have been qualified to 300 G shock and 125 G acceleration levels. Modular construction results in extremely rugged and versatile systems.

✈ **FOR SPACECRAFT...** Power consumption as low as 3.0 watts. RADIX PCM SYSTEMS have operated successfully in a hard vacuum.

■ Specify RADIX PCM (or PAM) SYSTEMS for your airborne data acquisition requirements.



*Demonstrations of the Modular PCM SYSTEMS and other RTC Systems arranged at your facility.*

**RADIX TELEMETRY CORP.**  
A SUBSIDIARY OF RADIX CORPORATION

1600 ORANGETHORPE WAY | ANAHEIM, CALIF. 92801 | (714) 879-4360

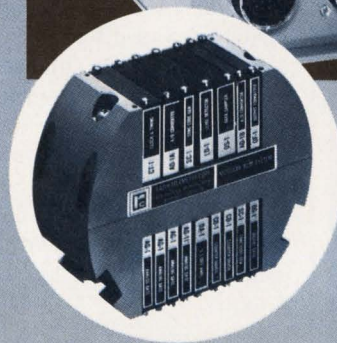
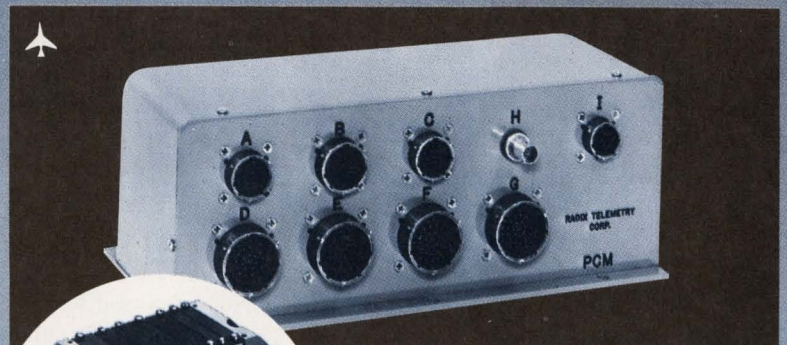

# Need Space-Age Precision in Lapping or Grinding? use **SPITFIRE!**



## THE MICRO-LAP 15"\*

Engineered to standards of the highest quality, the Micro-Lap 15" unit is outstandingly precise in producing laboratory quality work in normal production quantities. Operator fatigue is minimal because of waist-high construction. In addition to handling piece parts 5 7/16" in diameter, the Micro-Lap 15" also provides:

- Optical flatness to 1 light band. — .0000116" or less
- Positive plate flatness and advanced truing action
- Pressurized, infinite variable abrasive feed control
- Fully automatic lapping cycle
- Ample work table . . . controlled stock removal
- High volume production . . . shop proven performance

\*All machines equipped with exclusive "caliper adjustment controls" for critically precise operations.

Have You Seen Our NEW  
**MICRO-LAP 12" Machine?**

### FREE CATALOG . . .

For the full story of CAC (Caliper Adjustment Control) and the entire Spitfire line of automatic lapping or grinding machines up to 96" capacity call or write for new catalog today.



**SPITFIRE LAPPING DIVISION**  
**SPITFIRE TOOL & MACHINE CO.**

4020 North Tripp Avenue  
Chicago, Illinois 60641  
Phone 312/286-1610

INFORMATION RETRIEVAL NUMBER 73

## COMPONENTS

### Metal glaze trimmers are tiny rectangles

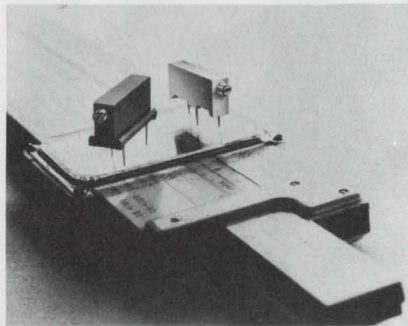

IRC St. Petersburg Div. of TRW Inc., 2801 72nd St. North, St. Petersburg, Fla. Phone: (813) 347-2181. P&A: \$1.55; stock.

Housed in a 3/4-in. rectangular package, a new series of miniature trimming potentiometers contain an infinite-resolution metal-glaze element. Series 950 units are available with resistances from 10  $\Omega$  to 1 M $\Omega$  and standard tolerances of  $\pm 10\%$ . Their temperature coefficient is rated at  $\pm 250$  ppm/ $^{\circ}$ C over a temperature range of  $-65$  to  $+125^{\circ}$ C.

CIRCLE NO. 277

### Small rif/emi filters protect 200-V lines

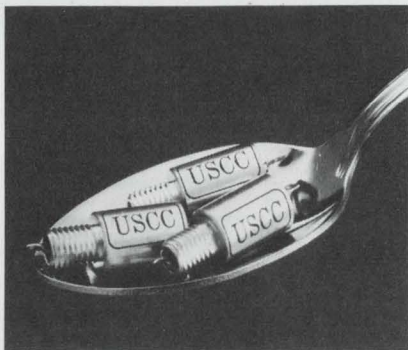

United States Capacitor Corp., 2151 N. Lincoln St., Burbank, Calif. Phone: (213) 843-4222.

Designed to effectively block rfi and emi in 200-V dc lines, a new series of L-section miniature low-pass filters offer superior attenuation over the frequency range 10 kHz to 10 GHz. A minimum attenuation of 70 dB is attained at the higher frequencies. Series 2220 units operate from  $-55$  to  $125^{\circ}$ C, with specified attenuation guaranteed over the entire temperature range.

CIRCLE NO. 278

### Air-variable capacitors trim from 0.35 to 3.5 pF

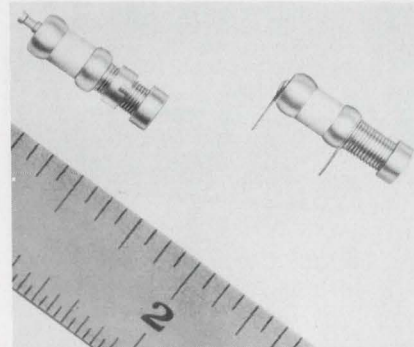

JFD Electronics Co., Components Div., 15th Ave at 62nd St., Brooklyn, N. Y. Phone: (212) 331-1000.

Offering a variable capacitance of 0.35 to 3.5 pF, two new miniature all-metal air trimmer capacitors measure only 9/64 inch in diameter and 1/2 inch long. The MVM 003 is made for panel mounting with a turret terminal, and the MVM 003W is made for printed-circuit-board mounting. Their Q factor, measured at 3.5 pF and 100 MHz, is 5000.

CIRCLE NO. 279

### Low-cost readout includes decimal

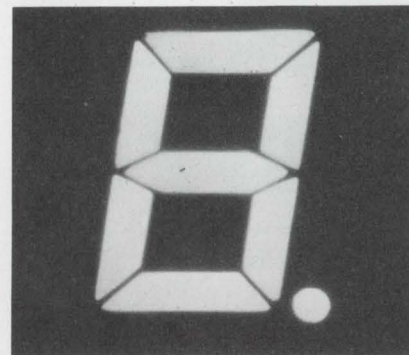

Readouts, Inc., 217 15th St., P.O. Box 149, Del Mar, Calif. Phone: (714) 459-6473. P&A: \$8; stock.

Model 110 low-cost segmented digital readout features easy lamp replacement from the front panel, a decimal point or degree sign as standard, and low voltage and current operation. Its light source, which may be any T-1 flanged-based lamp, may be dimmed from full brightness to 10% of original brightness with all segments remaining equally lighted.

CIRCLE NO. 280

**Pulse counter works at 15 MHz**

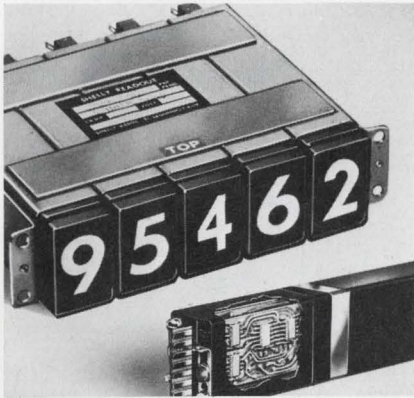

Shelly Associates, Inc., 111 Eucalyptus Drive, El Segundo, Calif. Phone: (213) 322-2374.

A new electronically controlled rear-projection readout decade pulse counter performs at the rate of 15 MHz. Model P611 is a synchronous counting device that features internal carry gating, one independent display position, asynchronous zero reset, and a binary preset. It can count both up and down, and will count from zero or a preset number.

CIRCLE NO. 281

**Readout assembly enhances panels**



Integrated Circuit Electronics, Inc., 237 Riverview Ave., Newton, Mass. Phone: (617) 899-2700. P&A: \$10.50 typical; 1 to 2 wks.

Adding a custom-built appearance to any instrument or test/control panel, a new compact bezel assembly for model D200 decode/display modules consists of a filter, front bezel, and housing. The bezel is brushed aluminum and, when completely assembled, gives an attractive appearance without any visible mounting screws.

CIRCLE NO. 282

# Trump-Ross breaks the price barrier!

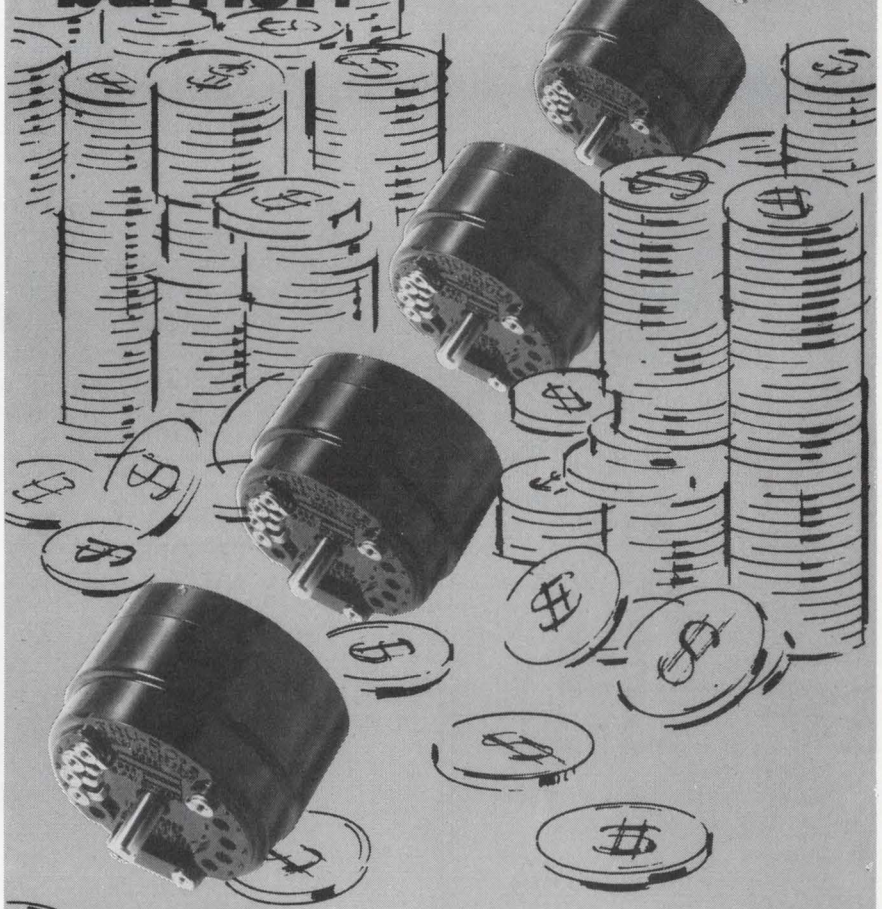

**The T-Series Optical Rotary Pulse Generator**

For only \$80 you can get a high quality single-output Rotary Pulse Generator delivering up to 200 square waves per revolution. That is for one unit; if you want 1,000 or 20,000 units, you will be surprised at the low prices.

The TRU-ROta T-Series offers full output down to zero speed, virtually unlimited life, and outputs which interface with standard logic systems. Pulses per revolution range from 10 to 2048 at the lowest prices ever. Industrial Enclosures available.

For full data, please contact

**TRUMP-ROSS INDUSTRIAL CONTROLS, INC.**

265 Boston Road, North Billerica, Mass. 01862/617-663-3451

# LOGIC POWER FOR LESS

**\$9960\***



Typical  
uncased  
module

**COMPACT,  
REGULATED  
5-6V @ 3A**

## DC POWER SUPPLY

Designed primarily for digital IC applications, but well qualified for many other applications.

- Adjustable from 4.8 to 6.3 VDC @ 0-3 amps
- Output fused to protect supply
- Overvoltage sensing circuit and SCR crowbar protect external circuits
- Remote sensing
- Convection cooled — heat sink included
- Regulation: Line, Load — 0.05% each
- Temp. Coeff. 0.05%/°C
- Only 3" x 3.7" x 8.4"
- Direct operation from 115VAC, ±10VAC, 60-400 Hz

### MODEL PM 728

1-3	*4-9	100 up
\$124.90	\$99.60	\$84.20

Shipment within 10 days ARO

Need less power? Try our small, encapsulated 5V 250 mA modules.

**For complete information or fast delivery, call or write**

Computer Products, Inc.  
Post Office Box 23849  
Fort Lauderdale, Florida 33307  
Phone: 305/565-9565



**COMPUTER  
PRODUCTS™**

FORT LAUDERDALE

## COMPONENTS

### Passive/active filters come in SHP modules

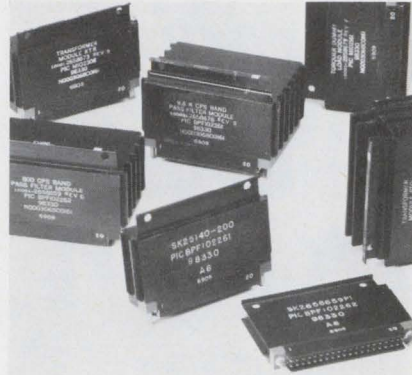

*Polyphase Instrument Co., E. 4th, Bridgeport, Pa. Phone: (215) 279-4660.*

Standard or custom engineered filters, both passive LC and active types, are available in Naval Standard Hardware Program (SHP) modules. Many sonar and other Navy programs utilize this unique packaging technique. These new SHP modules meet the requirements of NAVORD-WS-6116D.

CIRCLE NO. 283

### Power resistors hold 1% tolerances

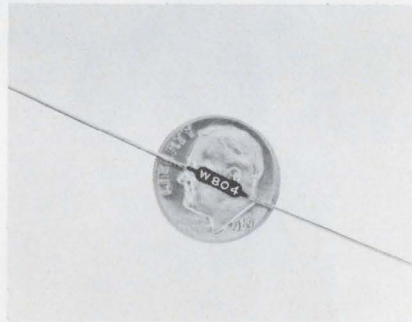

*Nytronics, Inc., Standard Components Group, 550 Springfield Ave., Berkeley Heights, N. J. Phone: (201) 464-9300. Availability; stock.*

Designed to meet circuit designer requirements for closer tolerance components, a new line of wire-wound power resistors have a standard total resistance tolerance of only 1%. Series WP units are available in nine sizes and styles, ranging from a miniature 0.078-in. dia by 0.250-in. long device to a 0.375-in. dia. by 1.780-in. long one. Ratings range from 0.4 to 11 W and maximum resistance values go from 3.5 to 200 kΩ.

CIRCLE NO. 284

### Pneumatic counter can predetermine

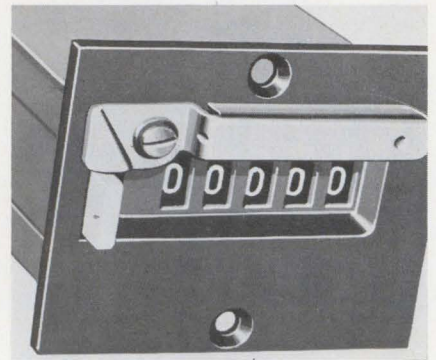

*Kessler Ellis Products Co., 120 First Ave., Atlantic Highlands, N.J. Phone: (201) 291-0500.*

Operating on 15 to 20 psi, a new pneumatic predetermining counter can function at speeds as high as 50 counts per second. In use, a preselected number is first set into the counter; the counter then counts downwards one count for each air pulse. Upon reaching zero, a built-in valve opens to provide a control function.

CIRCLE NO. 285

### Lever switch eases setting

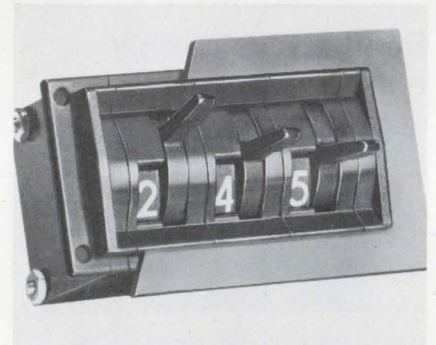

*Digitran Co., 855 S. Arroyo Parkway, Pasadena, Calif. Phone: (213) 449-3110.*

Called Minilever, a new thumb-wheel switch employs a ratchet-type setting lever to actuate an internal gear. This permits the operator to rotate the display wheel a full 360° by moving the lever only 90°. A quick sweep of the hand across the levers rapidly resets an assembly of the new switches. This allows the operator to return all switches to position zero before encoding any new information.

CIRCLE NO. 286

### Card transmitter works 2400 bits/s

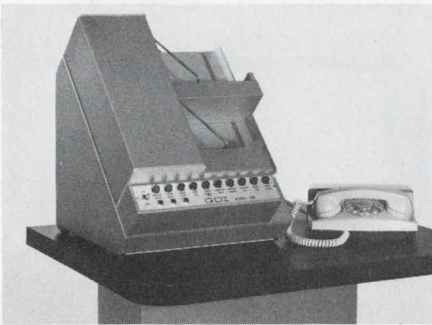

GDI Inc., P.O. Drawer 70, Melbourne, Fla. Phone: (305) 727-3191.

Designed to transmit punched-card data at a rate of up to 2400 bits per second over standard dial-up or private lines, model CT-300 card transmitter will directly interface with a Bell 202E2 or 202C or data equivalent set. The interface conforms to EIA standard RS-232B and transmits data in standard bit serial USASC II language.

CIRCLE NO. 287

### Versatile data coupler broadens performance



Control Equipment Corp., 32 Kearney Rd., Needham Heights, Mass. Phone: (617) 444-7550. P&A: \$1400 to \$3500; stock.

A new data coupler can accept digital data from DVMs, counters, and converters for translation to computer-compatible magnetic tape, paper tape or teleprinter. Model 310 can handle numeric and alphanumeric characters and binary groups from several sources, can group characters into words in any order, can insert punctuation and housekeeping characters where needed, and can group words into records, blocks and messages. An optional digital clock, keyboard input, buffer store, DVM and level converters are available.

CIRCLE NO. 288

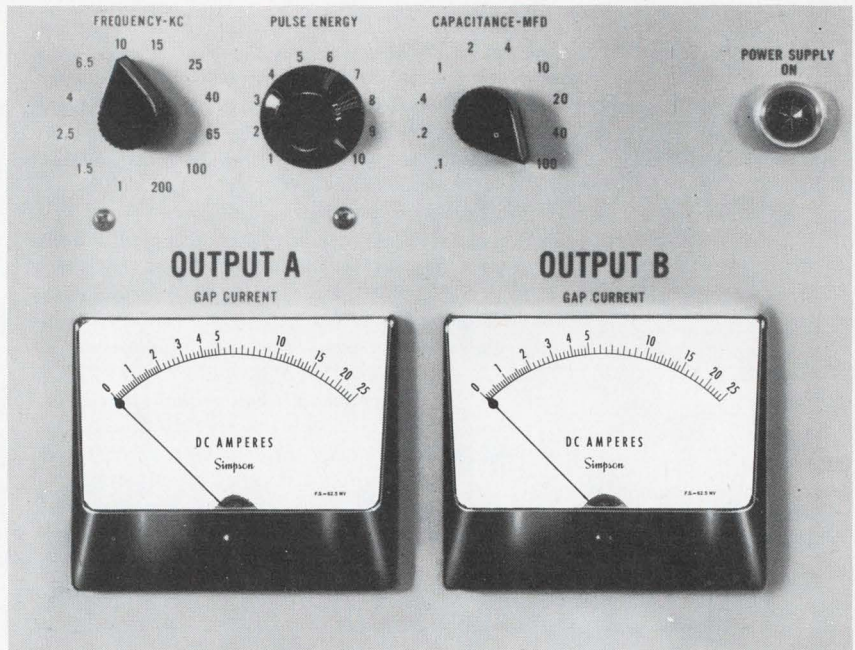

# the sure way to let customers know you care about quality...

## Simpson panel instruments on your equipment

Simpson's advanced self-shielding annular and core magnet construction provides optimum torque-to-mass ratio. Rugged Taut Band and Pivot & Jewel movements can withstand punishing shock and vibration. Your assurance of an instrument that will *stay* accurate. No wonder so many manufacturers with reputations to protect (or build!) specify Simpson.

Over 1,400 stock ranges, sizes, and types. Get "off the shelf" delivery from your local electronic distributor.

For special needs contact your local Simpson Representative. He's ready to help.

# Simpson

**ELECTRIC COMPANY**



5200 W. Kinzie Street, Chicago, Illinois 60644 • Phone (312) 379-1121

EXPORT DEPT.: 400 W. Madison Street, Chicago, Illinois 60606. Cable Simelco  
IN CANADA: Bach-Simpson Ltd., London, Ontario • IN INDIA: Ruttonsha-Simpson Private Ltd., International House, Bombay-Agra Road, Vikhroli, Bombay

**INSTRUMENTS THAT STAY ACCURATE**

INFORMATION RETRIEVAL NUMBER 76

The Model 912 Digital Data Generator is the most versatile, multi-purpose unit on the market today. With its 960 bit capacity, at clock rates from DC to 10 MHz in serial data stream or 5 MHz in parallel, it is ideal for exercising core memory logic, checking data communications lines, or computer interfaces; for exercising LSI's, IC's, MOS and logic cards. It's even a programmer — it replaces a paper tape reader for industrial control applications. Other functions include testing D to A converters and CRT displays for example.

No other Digital Data Generator can provide 12 independent data streams in parallel (simultaneously) with capacities of 80 bits each, or 960 bits in a serial data stream without repetition.

For detailed description and specifications on the Model 912 Digital Data Generator, contact Jerry Heyer, SRC Division, Crescent Technology Corp., 2222 Michelson Drive, Newport Beach, California 92664, (714) 833-2000.



## Start testing those LSI's, IC's, MOS & Logic Cards with this!

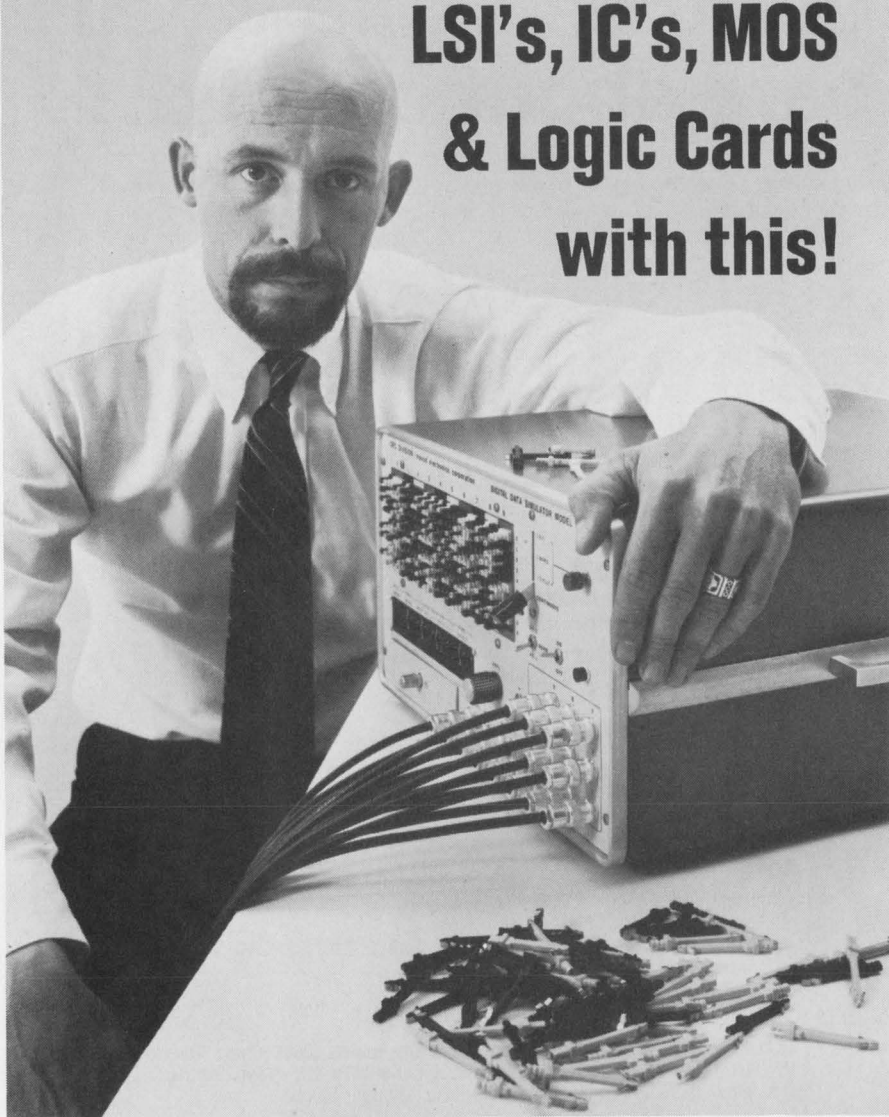

INFORMATION RETRIEVAL NUMBER 77

## DATA PROCESSING

### Fast a/d converter operates in 200 ns

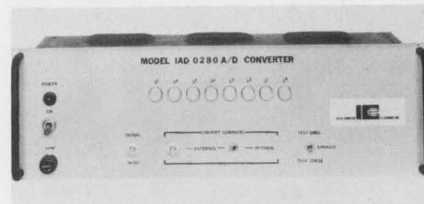

Inter-Computer Electronics Inc.,  
1213 Walnut St., Lansdale, Pa.  
Phone: (215) 855-0922.

Intended for use with wide-bandwidth data processing systems and data acquisition systems, a new 5-MHz a/d converter features a total conversion time for an eight-bit resolution, including sample and hold, of 200 ns. Model IAD-0280 performs with an over-all accuracy of  $\pm 0.2\%$  of full scale,  $\pm 1/2$  least significant bit, for analog signals with bandwidths of 2.5 MHz or less. The system includes a reference power supply as well as sample-and-hold circuitry.

CIRCLE NO. 289

### Disc recorder tapes transients

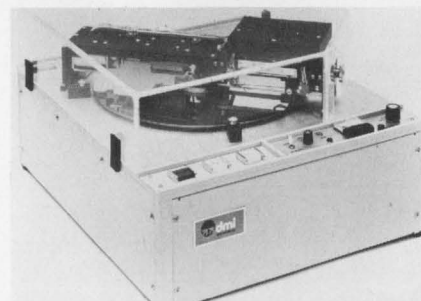

Data Memory Inc., Instrumentation Div., 1255 Terra Bella Ave., Mountain View, Calif. P&A: \$8975; 30 days.

Especially designed for instrumentation use and priced competitively with tape-loop devices, a new magnetic disc recorder will record real-time transient signal events over 20-second durations. Upon command, model IDR-100 will replay the entire disc or repetitively reproduce any 25-ms window for hours, or even weeks, of constant analysis without signal degradation.

CIRCLE NO. 290

## Small data set senses $-40$ dBm

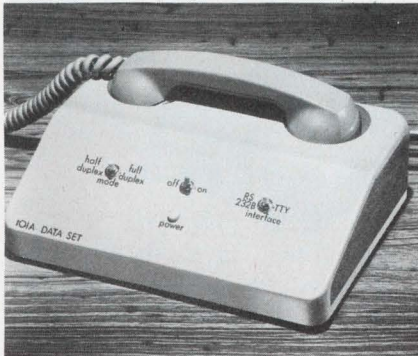

Electronic Voice, Inc., 1901 Ave. of the Stars, Los Angeles, Calif. Phone: (213) 879-0275.

Designed for use over switched telephone networks, a new data set achieves  $-40$ -dBm receive sensitivity in a full-duplex mode at speeds of 300 bits per second. Model 101A incorporates standard ICs for high reliability and low maintainence. This use of ICs allows direct substitution of IC modules in the unit for self test—resulting in a maximum ten-minute service. The unit provides EIA RS-232B or TTY 33, 35 or 37 interfaces.

CIRCLE NO. 291

## Multiplexing modem transmits 600 baud

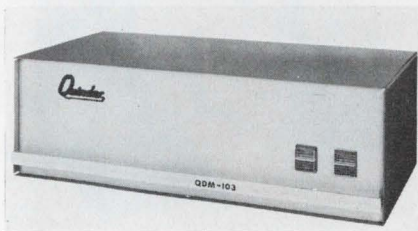

Quindar Electronics, Inc., 60 Fadem Rd., Springfield, N.J. Phone: (201) 379-7400.

Model QDM-103 data modem provides full-duplex or half-duplex serial data transmission over voice-bandwidth private or leased lines at up to 600 baud. In addition, this new data set has channel filters of teletype quality that permit the multiplexing of several independent channels over one voice-grade circuit. The exact number of these channels depends on the bandwidth (and data rate) selected.

CIRCLE NO. 292

## Meet the Members of The Board...

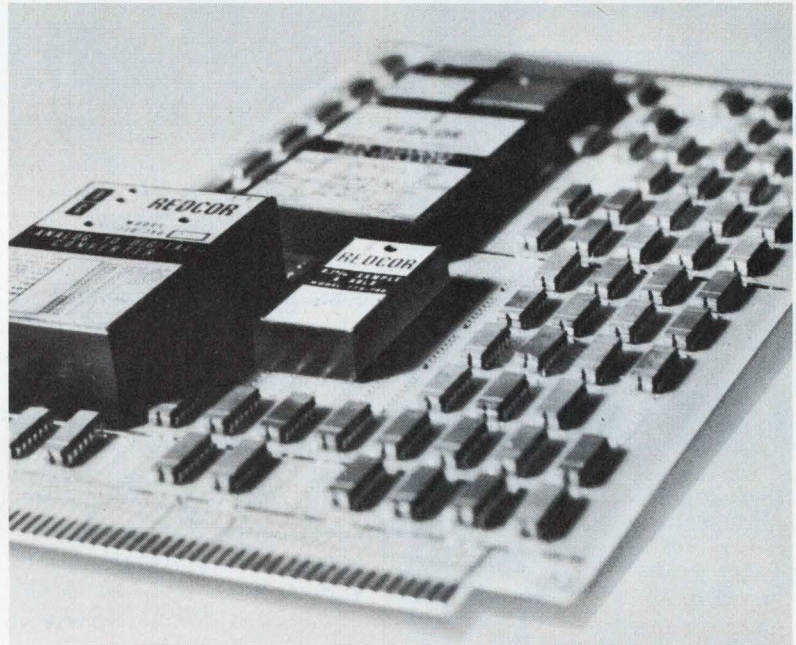

## ...Dual In-Line Conference

For the successful management of analog circuit design, the designer's board members must have background characteristics based upon dynamic response specifications and a proven performance with known sources and loads. The designer's board members must also have the ability to "fit in" with the others whether they be dual in-lines, discrete or flat-pack components. Our packaging configuration allows the designer this freedom.

The guaranteed performance of REDCOR's closed loop module concept frees the system designer from the concern, risk and expense normally experienced with other analog modules.

To support those special circuit and system design requirements, REDCOR can supply not only the modules, but the boards, chassis, and power supplies.

Analog-to-Digital Converters	BUF-FET Ultra Fast Settling Amplifiers
Digital-to-Analog Converters	Dynamic Bridge Amplifiers
Multiplexers	REDIREF Voltage Reference
Sample and Hold Amplifiers	Supplies
TRICON Fast Settling Amplifiers	Comparators

REDCOR's board members come prepared to meet any situation. For a complete catalog listing specified performance, write or call:

**R** **REDCOR**  
**C** **CORPORATION**

Complete Systems Capability / 7800 Deering Avenue, P.O. Box 1031, Canoga Park, California 91304—(213) 348-5892

INFORMATION RETRIEVAL NUMBER 78

**RX Bridge  
spans the  
500 kHz  
to 250 MHz  
range  
...precisely**



### oscillator, bridge and null detector all-in-one

The 250B RX Meter is a self-contained RF bridge that reads impedance in terms of  $R_p$  and  $X_p$  from 500 kHz to 250 MHz. It consists of an accurate, continuously tuned oscillator, Schering bridge, amplifier-detector and null indicating meter.

Ruggedly constructed, the 250B bridge assures the user of the stability necessary for precise measurements. A front panel control adjusts the RF excitation signal to as low as 20 mV, permitting measurement of input and output "Y" parameters of transistors with the accessory 13510A Transistor Test Jig, and use of the bridge for other low-level measurements. Another accessory, the 00515A Coax Adapter Kit, provides a convenient means for adapting the bridge terminals to type "N" connectors for measuring devices with coaxial connections.

The 250B RX Meter is especially useful in determining electrical characteristics of devices and circuits such as inductors, capacitors, transformers; and filters. Price: \$2050.

For complete information and a copy of the 250B Technical Data Sheet, contact your Hewlett-Packard field engineer or write: Hewlett-Packard, Green Pond Road, Rockaway, New Jersey 07866. In Europe: 1217 Meyrin-Geneva, Switzerland.

**HEWLETT  PACKARD**

IMPEDANCE INSTRUMENTS

10908

## PRODUCTION

### Cleaning system doubles capacity

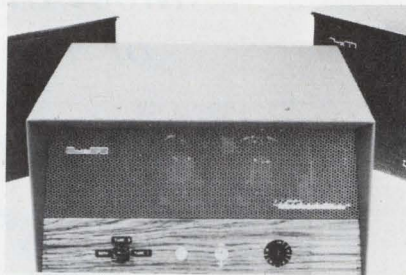

*L & R Manufacturing Co., 577 Elm St., Kearny, N. J. Phone: (201) 991-5330. Price: \$1249.*

A new ultrasonic cleaning system offers the capability of two transducerized tanks operating simultaneously or independently. The 660B system consists of a fan-cooled generator and two 5-gallon stainless-steel tanks with stainless-steel covers. Features include a multi-selector switch for dual- or single-action cavitation, an electrical timer, automatic tuning and a pilot light.

CIRCLE NO. 293

### PC-board maskers do both sides at once

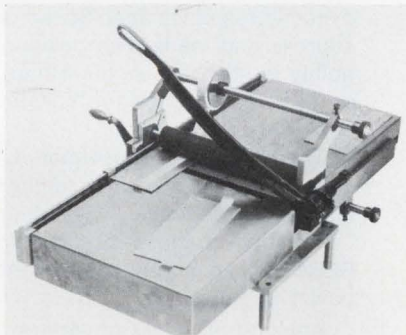

*Magnum Industries, 15204 Stagg St., Van Nuys, Calif. Phone: (213) 785-8631.*

Containing an integral tape cutter, two new manual PC-board masking machines simultaneously mask boards on both sides. Model 100 is a side indexing machine; model 125 is a pin indexing machine. Model 125 has two pins that can be adjusted between 1 and 8-in. centers in 1-in. increments. Both models accommodate 1/32 to 1/8-in. thick boards up to 16-in. wide.

CIRCLE NO. 294

### Roller kit mixes resins

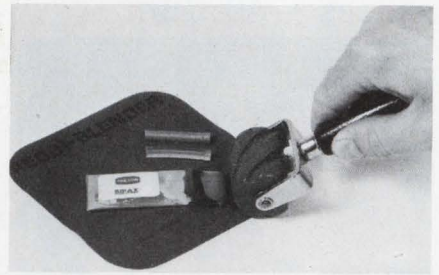

*Tra-Con, Inc., 55 North St., Medford, Mass. Phone (617) 391-5500. P&A: \$3.50; stock.*

Reddi-Blender kit simplifies and speeds the mixing of premeasured two-component resin systems. The specially shaped roller for this new tool allows more homogeneous mixing action in less time than when done by hand. The new kit consists of the specially designed hand roller and a resilient non-slip pad. Both are constructed of durable materials for many years of use with minimum care.

CIRCLE NO. 295

### Substrate sectioner speeds wafer tests



*Wentworth Laboratories, Inc., Route 7, Brookfield, Conn. Phone: (203) 775-1750.*

Model SS-2015 substrate sectioner provides precision and speed when preparing a substrate or semiconductor wafer for inspection of diffusion and epitaxial layer depths. Sectioning can be accomplished at any location on the wafer surface; groove depth, cutting time and cutting force can be preset. No bonding agents or vacuum are required to hold the wafer in place.

CIRCLE NO. 296



## Conductive tape shields and seals

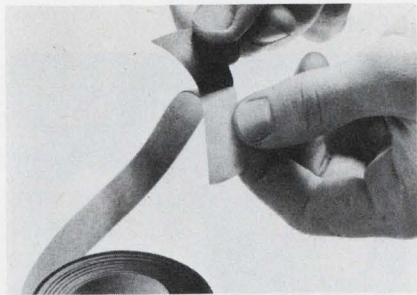

Chomerics, Inc., 85 Mystic St., Arlington, Mass. Phone: (617) 648-8650.

Both electrically and thermally conductive, a new resilient pressure-sensitive tape acts as both an emi/rfi shield and an environmental seal. Cho-Tape is a Dacron-reinforced conductive silicone elastomer containing a homogeneous dispersion of silver-plated copper particles, with an adhesive backing on one side. The Dacron reinforcement results in a tensile strength of 1270 psi. Dc volume resistivity is less than 0.01 ohm-cm.

CIRCLE NO. 297

## Degreasing solvent withstands 20 kV

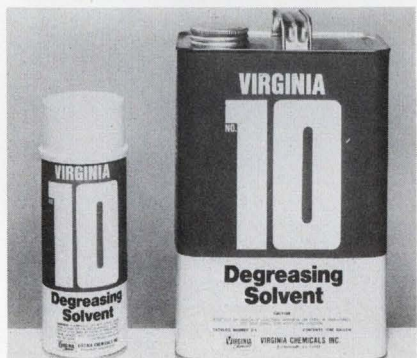

Virginia Chemicals Inc., Portsmouth, Va. Phone: (703) 484-5000.

With a dielectric strength of greater than 20 kV, a new degreasing solvent removes oil, grease and grease-bound dirt from machined metal parts, motor armatures, coils, relay contacts, switches, breakers, connectors and electronic components. Number 10 solvent leaves no current-conducting residues and is not harmful to most electrical insulation materials. As shipped, its flash point is above 165°F.

CIRCLE NO. 298

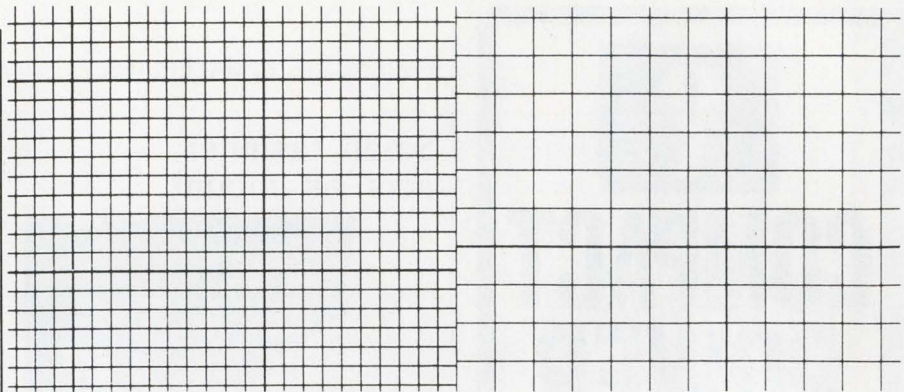

# How accurate can you get?

(You'll never know till you try new K&E STABILENE® Precision Grids.)

Our new grids are individually made from precision original-negative masters under carefully controlled conditions of temperature and humidity. The masters have a line-to-line accuracy of .0005", and a total accumulated accuracy of .002" over 48".\* When you're making (or checking) large precision layouts and artwork for printed circuits you just can't get any closer.

New K&E Precision Grids are produced on K&E STABILENE®, the Mylar-based film that is the most dimensionally stable design media other than glass.

K&E Precision Grids are available in opaque black line or non-reproducible blue line, in standard sizes up to 36" x 48" and a large variety of configurations.

They're the world's most accurate grids from a company with a century of experience in supplying the creative engineer and draftsman. These precision grids are only one product in a wide range of stable base materials, including the CUT 'N STRIP type most often used for electronic circuitry layouts.

For further information see your K&E representative, or write Keuffel & Esser Company, 20 Whippany Road, Morristown, N.J. 07960.

**K+Σ** CREATIVE PRODUCTS FOR THE CREATIVE ENGINEER  
**KEUFFEL & ESSER CO.**

\*For comparable accuracy, grids must be used at prescribed ambient conditions.

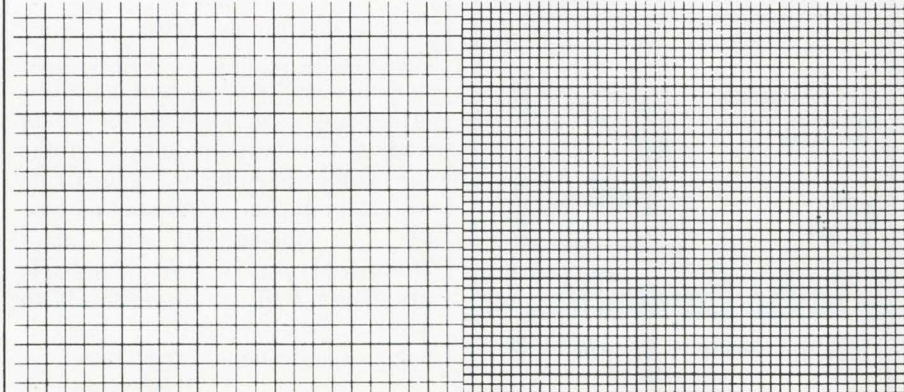



# COMPACT POWER PACKS

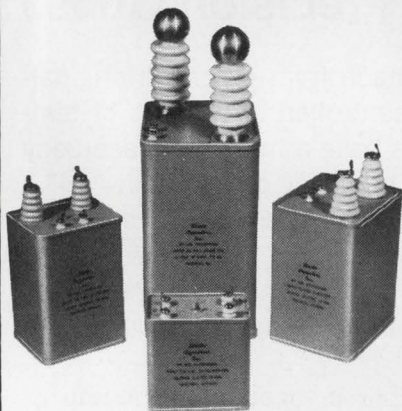

## The new Compact "M" Series Power Packs offer you:

- Rated output voltages from 1000 to 75,000 DC
- Rated output currents of 1.5, 5, and 10 milliamperes
- Input voltages of 118, 220, 230, and 240 volts AC
- Variable output from 0 to rated voltage
- Input frequency range 50 to 500 CPS  
output ripple 1% RMS at rated voltage
- Hermetically sealed construction

Why pay more, and settle for less... PC's new compact power packs give more quality, more versatility, more dependability, plus smaller size, and best of all, most sizes are available in stock to meet your immediate needs.

Write for complete information and new catalog today!



**Plastic Capacitors, Inc.**

2620 N. Clybourn • Chicago 14, Ill.  
DI 8-3735

## PACKAGING & MATERIALS

### Small fastener acts as mount

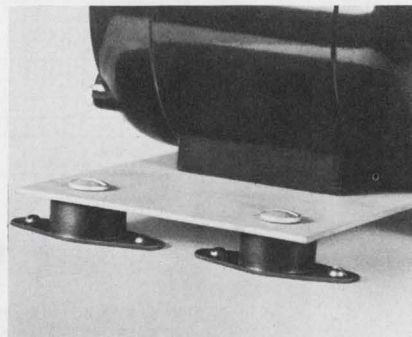

Southco, Inc., 200 Industrial Highway, Lester, Pa. Phone (215) 521-0800.

A new quarter-turn fastener can also function as a quick-change isolation mount. The receptacle is molded within a vibration-isolating synthetic rubber pad. A quick 90° turn instantly releases the attachment, facilitating fast removal and substitution of such units as small motors, pumps, fans, etc. Stud sizes are available to accommodate most panel thicknesses.

CIRCLE NO. 299

### Flexible silicone is aerospace resin



Dow Corning, Midland, Mich. (517) 636-8510. Price: \$6/lb.

Designed for use with aerospace equipment, a new two-part flexible silicone potting and encapsulating resin is a syntactic foam with a density of only 0.67 grams per cubic centimeter. The lightweight material, designated as type 3101, is formulated with glass micro-spheres. It has a specific gravity of 0.67, only two-thirds to one-half the weight of general-purpose silicone encapsulants.

CIRCLE NO. 340

### Press-fit jack accepts diodes

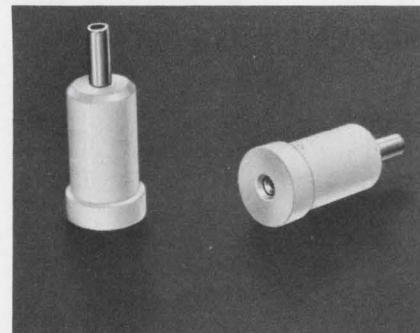

Sealectro Corp., Circuit Hardware Div., 225 Hoyt St., Mamaroneck, N.Y. Phone: (914) 698-5600.

Designed to accept 0.029-in.-diameter leads, a new press-fit non-floating jack can be used as a socket for diodes and crystals. Type SKT-0290 has a 0.172-in.-diameter shoulder, a minor diameter of 0.148 in., and a length of 0.2 in. Made of pure virgin Teflon, it is available in any of the standard EIA colors for easy circuit coding.

CIRCLE NO. 341

### Universal carrier accepts flatpacks

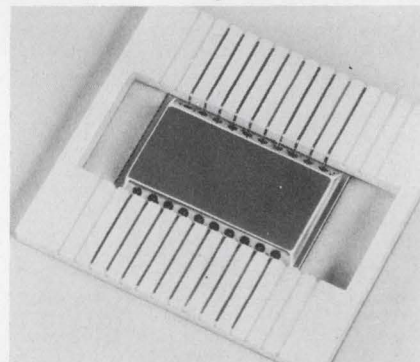

Robinson-Nugent, Inc., 802 E. 8th St., New Albany, Ind. Phone: (812) 945-0211.

A new molded universal carrier accepts most metal-can flat packages, from 1/2 to 1-1/2 in., square or rectangular in shape, with up to 26 leads or 13 per side. It locks the package in by supporting off the lip and side of the flange on a can. Its two-piece construction allows its width to be adjusted from 1/2 to 1 in. and locked at any width in between.

CIRCLE NO. 342

Glass-base laminate  
withstands 220°C

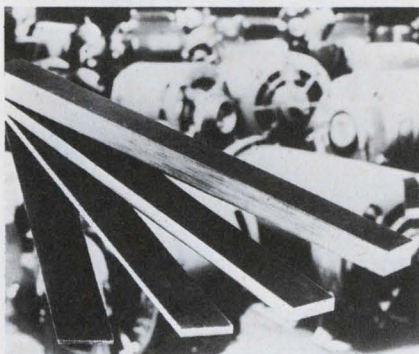

General Electric Co., Laminated  
Products Dept., Coshocton, Ohio.  
Phone: (614) 622-5310.

Rated for continuous operation at 220°C, a new glass-polyamide-imide laminate has a bonding strength more than twice that of silicone laminates. Texolite grade 11689 can be used in any application requiring Class H insulation, as well as for many applications requiring Class C insulation. It is made with a straight-weave glass cloth base.

CIRCLE NO. 343

### Miniature connectors have removable contacts

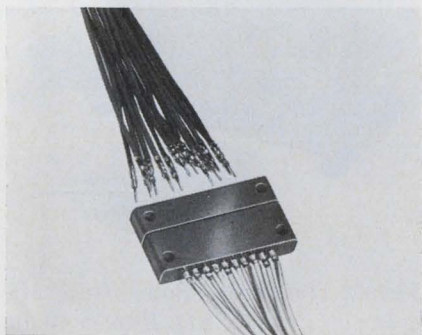

Continental Connector Corp., 34-63  
56th St., Woodside, N.Y. Phone:  
(212) 899-4422.

Supplied as plug and socket types in several sizes and configurations, series 25SMM and MMM micro-miniature connectors feature removable contact terminations. The 25SMM strip connectors can be molded in any number of practical sizes from three to 21 contacts and more. All types are molded from glass-filled diallyl phthalate; contacts are gold-plated phosphor bronze or copper alloy.

CIRCLE NO. 344

# We've never met an AC motor problem we couldn't lick...

## Almost.

At Diehl we solve better than 90% of the AC motor problems presented to us by designers. Sometimes right out of our vast stock. Very often by special design. With our long experience, our fine engineering and designing staff and our extensive production facilities, we can produce AC induction, reluctance or hysteresis synchronous motors to meet any specifications.

#### FOR EXAMPLE:

This **Spindle Drive Motor**. The problem was a motor to be used as a spindle drive in memory files having minimum shaft runout and concentricity tolerance.

The result was a motor with constant speed that is noise and vibration free and has total shaft runout and concentricity error of less than .0005.



If you have a motor in mind you'll find dealing with Diehl a profitable experience. Whether your design calls for an induction motor or a synchronous motor of the hysteresis or reluctance type, remember, our stock runs from 1/770 horsepower on up. Or we'll design one for you.

Call your Diehl representative today.

## THE SINGER COMPANY Diehl Division

Finderne Avenue, Somerville, N.J. 08876/(201) 725-2200 • TWX 710-480-9325  
2221 Barry Avenue, Los Angeles, Calif. 90064/(213) 478-0896

## He-Cd cw laser needs no alignment



University Laboratories Inc., 733 Allston Way, Berkeley, Calif. Phone: (415) 848-0491.

Incorporating an adjustment-free mirror design, a new helium-cadmium continuous-wave laser offers an output in the deep blue region at 4416 Å. The design of this new laser involves a dc plasma tube with vaporized metallic cadmium in an atmosphere of helium gas. The resonator reflectors are permanently aligned and attached to the discharge tube during the manufacture. This eliminates the need for resonator adjustments by the user and assures permanent mirror alignment even in hostile environments.

CIRCLE NO. 345

## Solid-state sources generate pure noise



International Microwave Corp., 33 River Rd., Cos Cob, Conn. Phone: (203) 661-6277. Availability: 30 to 60 days.

Covering the frequency range from 0.1 to 18 GHz, a new series of solid-state noise generating modules produces accurate, pure-white, broadband noise. The units have an operating voltage of 28 V dc at 10 mA, in addition to rapid gating characteristics. They permit continuous monitoring of receiving systems.

CIRCLE NO. 346

## Tunable L-band source integrates isolator

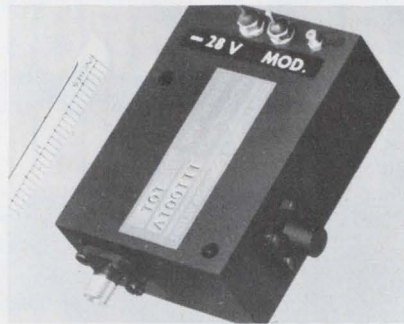

Centilabs Corp., 2455 Old Middlefield Rd., Mountain View, Calif. Phone: (415) 969-0427. Availability: 1 to 4 wks.

Miniature and lightweight, a new voltage-tunable L-band power source with an integrated isolator operates at frequencies between 1025 and 1150 MHz at an operating voltage of -28 V, 150 mA maximum. Model 11001 V has a power output of 1 W minimum with a 1-dB flatness over the band. It weighs only 10 oz and occupies less than 4.5 cubic inches.

CIRCLE NO. 347

## Spectrum analyzer is computer controlled



Fairchild Electro-Metrics Corp., 88 Church St., Amsterdam, N.Y. Phone: (518) 843-2600.

Computer-control of spectrum analysis on a full closed-loop basis is now available. A computer-controlled spectrum analyzing receiver, model CCR-300, includes full interfacing between a digital computer and the model EMC-25R programmable swept receiver, which covers the range of 14 kHz to 1 GHz. The CCR-300 consists of the receiver interconnected with a digital interface unit, the DIU-125.

CIRCLE NO. 348

## Quadrature coupler isolates to 20 dB

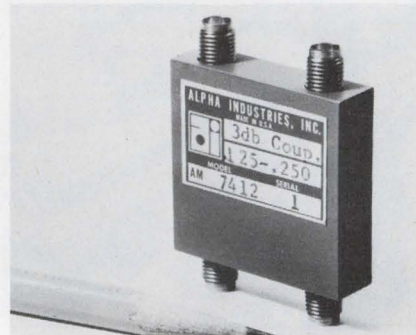

Alpha Industries, Inc., 381 Elliot St., Newton Upper Falls, Mass. Phone: (617) 969-8480.

Useable for phase shifting, balanced mixing and duplexing, a new 3-dB low-frequency quadrature coaxial coupler covers the frequency range from 125 to 250 MHz with a minimum isolation of 20 dB. Its maximum VSWR is 1.3. Model AM7412 measures 1.38 by 0.88 by 0.38 in. and weighs 1.5 oz.

CIRCLE NO. 349

## X-band oscillator socks out 10 mW

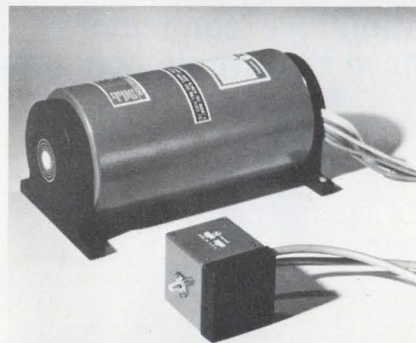

Varian Associates Solid State Microwave Project, 611 Hansen Way, Palo Alto, Calif. Phone (415) 326-4000. P&A: \$1950; 75 days.

Capable of electronically sweeping all of X-band, a new solid-state YIG-tuned Gunn-effect oscillator delivers a minimum power output of 10 mW. Model VSX-9070 has sweep rates that approach several hundred cycles for all of X-band. It operates the frequency range of -8 to 12.4 GHz and requires a maximum tuning current of 1 A. Maximum tuning voltage is 6 V dc; maximum bias voltage ranges from 8 to 12 V dc.

CIRCLE NO. 350

FOR ACCUTRONICS, INC., CIRCLE INFORMATION RETRIEVAL NUMBER 155 ►

# OSCILLATORS

Oct  
goe



Elpac,  
18651  
Calif.

A ne  
coupler  
from 4  
a maxi  
maxim  
Its isol  
output  
designe  
environ

SEE PAGES 1058 - 1067

## 1 Hz to 250 MHz

YOU HAVE AN IMMEDIATE REQUIREMENT?  
Great . . . our **new** catalog is now in EEM.

YOU DON'T HAVE AN EEM?

Then circle the reader service number, on the other side, and we will send you our new catalog.

YOU JUST CAN'T WAIT FOR THE NEW CATALOG?

O.K. . . . then call one of our engineering service engineers and we will give you immediate information and price.

THE PROTOTYPE SPECIALISTS . . .

. . . WITH PRODUCTION FACILITIES



accutronics, inc.

628 NORTH STREET • GENEVA, ILL. 60134 • 312-232-2600

## Rf power meters have 5% accuracy



Marconi Instruments, 111 Cedar Lane, Englewood, N.J. Phone: (201) 567-0607. Price: \$1195 to \$1485.

A new range of accurate portable rf power meters incorporates the advantages of both basic methods of rf power measurement—the thermocouple and diode. This gives the user the advantage of the fast reaction time of the diode detector as a peaking indicator for checks on transmitter power output and alignment, together with a fast acting thermocouple for accurate measurement of true mean power. Models 2501, 2502, and 2503 measure full-scale powers from 1 to 100 W with 5% accuracy.

CIRCLE NO. 352

FOR LEACH CORPORATION, CIRCLE  
◀ INFORMATION RETRIEVAL NUMBER 196

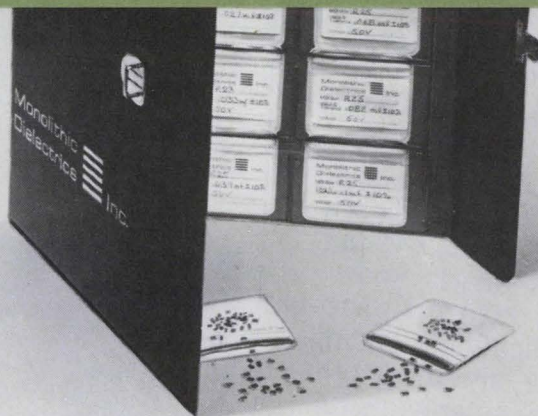

**Chip Kit.** 300 monolithic ceramic capacitor chips for hybrid circuits. Browse, examine, and test. There are 10 chips of each standard RETMA values from 1.2 pf to 330 pf in  $\pm 10\%$  tolerances at 50 VDCW.

But, that's just Kit No. 1. If you need more, Kit No. 2 will give you this much more: 300 sample chips, 10 chips each of all standard RETMA values from 390 pf to .1 MFD in  $\pm 10\%$  tolerances at 50 VDCW.

To get your chip off the old Monolithic Dielectrics' block real fast, call direct and ask for Gordon, he's the "Chief Chipper."

KIT No. 1 or KIT No. 2 . . . \$49.50 each  
— DELIVERY FROM STOCK —

Monolithic Dielectrics Inc.

P.O. Box 647, Burbank, California 91503 • (213) 848-4465

INFORMATION RETRIEVAL NUMBER 83

# More than a CATALOG



on

## VITREOSIL<sup>®</sup> PURE FUSED QUARTZ

More complete than most text books, the 48 pages cover Vitreosil pure fused quartz and Spectrosil, synthetic fused silica, the purest form of quartz known. Complete data on properties, applications, chemical behavior, and many others. Thermal American's full lines of products for industry, laboratory and special applications are illustrated and described. A 16 page list is pocketed in the rear cover.

If you use quartz—this book is a must for your library.

Write for your free copy today.

58



**THERMAL AMERICAN  
FUSED QUARTZ CO.**  
RT. 202 & CHANGE BRIDGE RD.  
MONTVILLE, NEW JERSEY  
ZIP CODE 07045

INFORMATION RETRIEVAL NUMBER 84

## Evaluation Samples

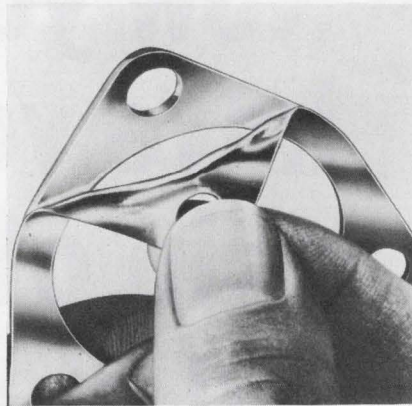

### Shielding foil

Supplied in tape and roll form to simplify operations performed in R & D and on the production line, series 8100 magnetic shielding foil is available with or without adhesive backing, in thicknesses of 0.002, 0.004 and 0.006 in. Widths range from a 1/2-in. tape, ideal for wrapping cable assemblies, to a 15-in. roll that may be cut and formed to shield cathode-ray tubes or larger components. The foil is available in any practical length, and is sold by the linear foot. A free evaluation sample is available. Rayseel Corp.

CIRCLE NO. 353

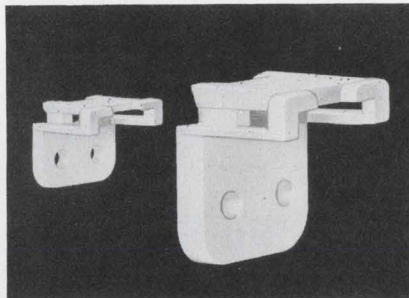

### Harness mounts

New right-angle mounts for both through-hole and surface-wiring runs secure harnesses away from sharp edges, thus eliminating the need for harness protectors such as grommets. Variable-diameter cable ties can be removed and replaced to facilitate harness revisions while the mount remains installed. Three different versions are offered, depending on harness size or mounting preference. A free sample is available. Panduit Corp.

CIRCLE NO. 354

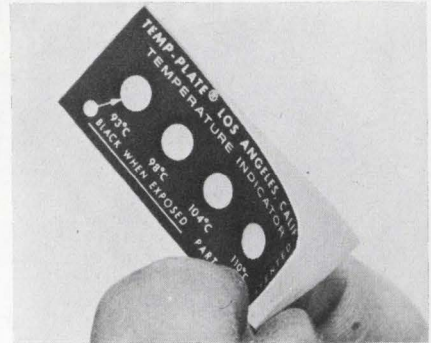

### Temperature indicators

Designed to monitor and detect overheating in electronic components, Temp-Plate stickers record surface temperatures to  $\pm 1\%$  accuracies in ranges from 100 to 1100°F. These heat-sensitive indicators turn permanently black upon exposure to their critical temperature. There are 83 standard models, from 3/16-in.- diameter units to 3/4 by 1-3/4-in. units with from one to eight calibrated indicators. They are self-sticking devices with a maximum thickness of 0.010 in. Free samples are available. William Wahl Corp.

CIRCLE NO. 355

### Transmission cables

Three new 90-, 50- and 75- $\Omega$  fixed-impedance round-conductor flat transmission cables are designed to replace coaxial lines in computer and related electronic equipment. Available in three-wire ground-signal-ground modules with 30-gauge ground wires and 33-gauge conductors, the cables are made from flame-retardant polyolefin and operate at a maximum continuous temperature of 80°C. All cables are 0.028-in. thick and retain electrical characteristics when stacked. The 50- $\Omega$  cable, Scotchflex 3358, comes in 1 to 30 module widths with 0.013-in. spacing between adjacent wires within each module. Spacing in the 90- $\Omega$  cable, Scotchflex 3359, is 0.025-in. and 0.018-in. in the 75- $\Omega$  cable, Scotchflex 3409. Electrical characteristics include a dielectric constant of 2.6, a dielectric strength of 500 V/mil and a volume resistivity of greater than  $10^{10}$   $\Omega$ -cm. 3M Company.

CIRCLE NO. 356

# Design Aids

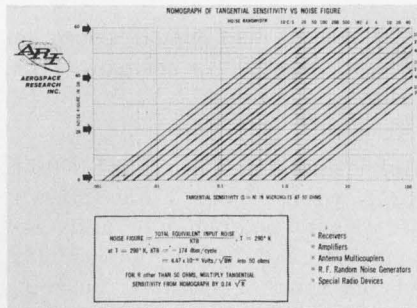

**Noise figure nomograph**

Putting the relationship between tangential sensitivity and noise figure in graphic form, an easy-to-use nomograph for 50-Ω systems shows noise figure in decibels and tangential sensitivity in microvolts. There is also a correction factor to adjust results for impedances other than 50 Ω. Aerospace Research, Inc.

CIRCLE NO. 357



**Tape wound cores**

A sturdy plastic-coated tape wound core calculator provides a rapid means of solving equations relating voltage to flux, current to magnetizing force, and wire to space factor. Particularly useful for transformers, coils and magnetic amplifier circuits, the calculator comes with its own detailed instruction booklet, showing basic formulae and examples of operation, and core and fire tables. This design aid is available free to qualified engineers. Magnetics Inc., Components Div.

CIRCLE NO. 358

# a complete digital system

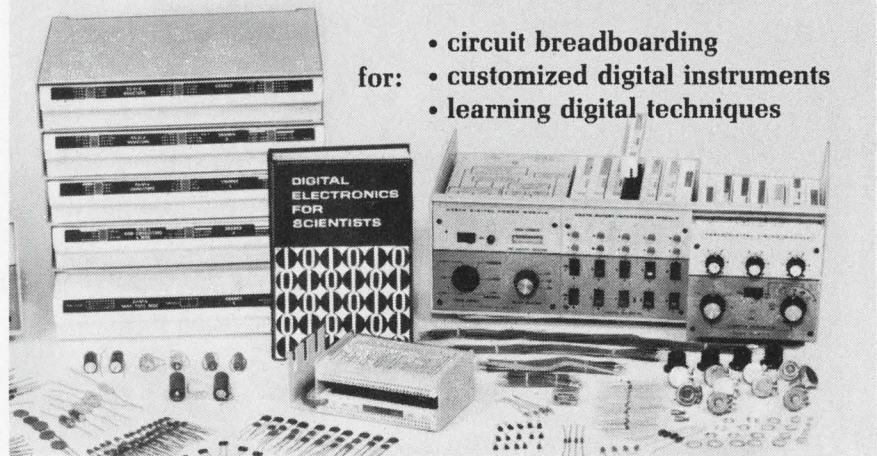

- circuit breadboarding
- for: • customized digital instruments
- learning digital techniques

## HEATH 801 Digital System...

**buy the complete system or discrete components**

Now... A Complete System to Enable You to Get the Most Out of Digital Electronics. Here is a system that is revolutionizing instrumentation in labs and classrooms throughout the world. The basic design concepts of Professors H. V. Malmstadt and C. G. Enke combined with the engineering of Heath's scientific instrument group have resulted in the unique 801 Analog Digital Designer (ADD) and the EU-51A breadboard and parts group. This versatile system can perform equally well in constructing high performance research-quality instruments, in performing hundreds of experiments in the teaching laboratory, in rapid testing of new digital ideas, or in interfacing to computers.

Start... By Learning the New Digital Electronics. Drs. Malmstadt and Enke have written a pioneering new text "Digital Electronics for Scientists" (published by W. A. Benjamin, Inc.) that provides a systematic introduction to the digital circuits, concepts and systems that are basic to the new instrumentation — computation revolution. The book is written for engineering and science students and for practicing engineers, scientists, and technicians so that all may effectively utilize the startling recent advances in digital electronics.

Never before have the latest "state-of-the-art" methods been made so rapidly and conveniently accessible through an integrated combination of new text and versa-

tile equipment. The experimental section of the text is written specifically for utilizing the Heath 801A and 51A to provide experience and working knowledge with hundreds of digital and analog-digital circuits, instruments and systems.

Write... for Complete Information on Cards, Modules and Parts in the Heath Digital System. The basic Analog-Digital Designer (EU-801A) contains 3 modules (power supply, binary information, and digital timing) and 13 circuit cards including TTL gates, flip-flops, monostable MVs, relays, op amps, and V-F converter. The EU-51A Experimental Parts Group is a highly flexible breadboard system for circuit design and teaching. The group includes a desk chassis, 493 components, a patch card accepting these components, and a power patch card.

The system is open-ended. New cards and modules are continuously being introduced so you can construct your own special frequency meters, counters, timers, DVMs, rate meters, and many dozens of other instruments.

Take... advantage of the digital revolution — order your Heath Digital System now.

- EU-801A, Analog-Digital Designer... \$435.00\*
- EU-51A, Experimental Parts Group... \$135.00\*
- EUP-19, text "Digital Electronics For Scientists" by H. V. Malmstadt and C. G. Enke (published by W. A. Benjamin, Inc.)... \$9.50\*

### FREE Heath Scientific Instrumentation Catalog



Describes these and other precision instruments for laboratory, engineering, education and R & D applications. Send for your FREE

copy now... just write on your school or company letterhead.

HEATH COMPANY, Dept. 586-21  
Benton Harbor, Michigan 49022

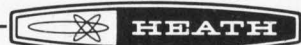

a Schlumberger company

Please send FREE Heath Scientific Instrumentation Catalog

Name \_\_\_\_\_

Address \_\_\_\_\_

City \_\_\_\_\_ State \_\_\_\_\_ Zip \_\_\_\_\_

Prices and specifications subject to change without notice.

EK-278

\*Mail Order Prices; F.O.B. Factory

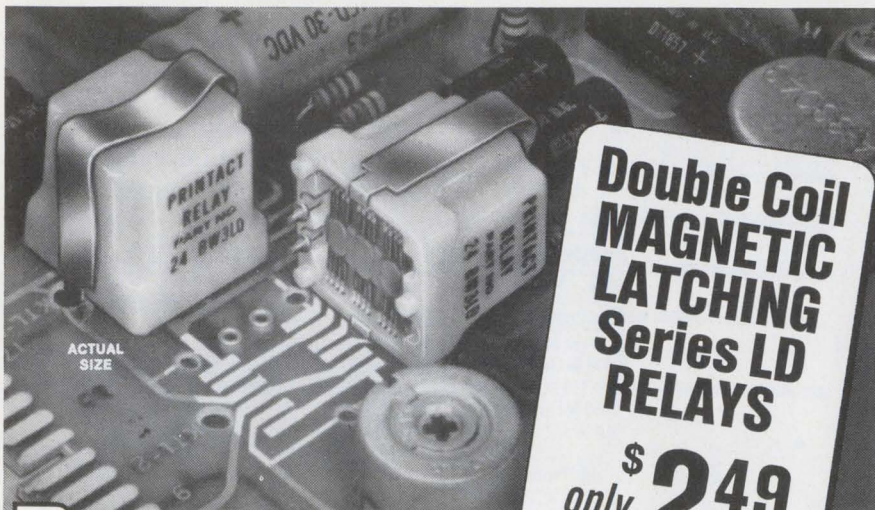

**Double Coil  
MAGNETIC  
LATCHING  
Series LD  
RELAYS**

**\$ 249**  
EACH  
(IN LOTS OF 5,000)

# Printact®

**Plugs into your PC board... mates with plated conductors**

Where **memory without power** is a requirement in the design of control circuitry, the use of the "LD" relay results in a **compact-low cost module**. Reliability is assured by the unique design which includes, as standard, many features not generally available in commercial relays.

Encapsulated coil, bifurcated gold or palladium contacts, low thermal EMF, plug-in without sockets or soldering, low bounce and chatter, series-break switching eliminates pig-

tails, permanent magnet avoids return spring and mechanical linkage—all of which assures continuous performance for many millions of cycles.

Available with 6, 12 or 24 VDC 1 watt coil (AC operation with series diode) in 2, 3 and 4 pole configuration. Series break swingers permit each pair of fixed contacts to be etched with common (Form C) or isolated (Form A plus Form B) switching between make and break circuits.

For data write or call 212-EX 2-4800.

Printact Relay Division, Executone, Inc., Box 1430, Long Island City, N.Y. 11101  
INFORMATION RETRIEVAL NUMBER 86

# Annual Reports

Learn how to read annual reports in "How to investigate a company." For a copy, circle no. 474.

**Alpha Industries, Inc.**, 381 Elliot St., Newton Upper Falls, Mass.: microwave components and assemblies; net sales, \$4,705,008; net earnings, \$323,997; assets, \$4,109,967; liabilities, \$566,328.

CIRCLE NO. 359

**Computer Industries Inc.**, 14724 Ventura Blvd., Sherman Oaks, Calif.: data-communication systems, graphic systems, field services; sales and revenues, \$11,226,753; net earning (loss), \$929,690; assets, \$9,283,970; liabilities, \$2,028,811.

CIRCLE NO. 360

**Management Data Corp.**, 1424 Walnut St., Philadelphia, Pa.: management, computer, and financial services; total revenues, \$5,035,672; net income \$448,558; assets \$27,326,625; liabilities, \$9,617,244.

CIRCLE NO. 361

**National Beryllia Corp.**, Greenwood Ave., Haskell, N.J.: ceramics and ceramic components; net sales, \$2,056,283; net earnings, \$128,116; assets, \$1,058,000; liabilities, \$451,000.

CIRCLE NO. 362

**San Fernando Electric Manufacturing Co.**, 1501 First St., San Fernando, Calif.: electronic components; net sales, \$6,744,368; net income, \$701,497; assets, \$6,493,276; liabilities, \$2,821,470.

CIRCLE NO. 363

**The Singer Co.**, 30 Rockefeller Plaza, New York, N.Y.: sewing machines, power tools, defense and space electronic systems, instrumentation, office equipment and industrial controls; net sales, \$1,755,000,000; net income, \$69,400,000.

CIRCLE NO. 364

## where to buy

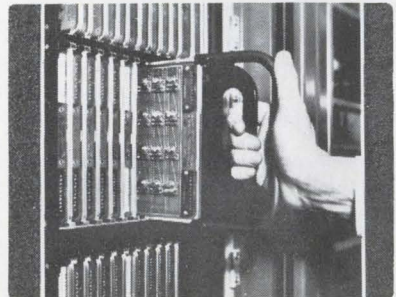

### PRECISION CIRCUIT BOARD EXTRACTION

Anybody can pull a card from a rack and probably drop it, damage it, or bend something. Not with a Protolab Circuit Card Extractor. A Protolab Extractor distributes and balances removal force across the connector. It removes the card squarely from the guides and it's used with only one hand. Ideal for maintenance of aircraft, space, military support systems, computer and data handling systems, etc. Prototypes to your specifications only cost \$35.00. (Send specifications on your letterheads.)

For further information, contact:

#### PROTOLAB

295 Polaris Ave., Mountain View, Calif.  
Phone: (415) 961-8033

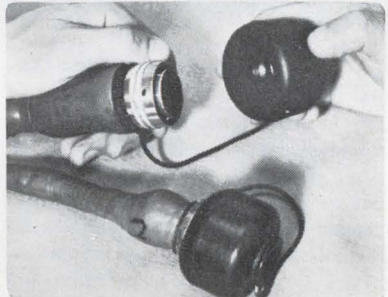

### CONNECTOR PROTECTION

Connector protection comes from Bean Rubber Company in 33 standard sizes made of MIL-R-3065, Type SC420 flexible neoprene. A Bean Connector Protector eliminates broken connectors, bent pins, jammed rings and threads. They absorb heaviest handling shock. Available now for many popular brand connectors. Special configurations handled with ease, too. For perfect protection of costly and precision connectors, remember to specify Bean.

For further information, contact:

#### BEAN RUBBER COMPANY

1623 South 10th St., San Jose, Calif.  
Phone: (408) CY 3-2790



He has  
a new view  
of life



He's had a heart attack, but he's back on the job. He saw for himself how modern drugs, coronary care units, and new methods of rehabilitation are helping doctors fight the Nation's Number 1 killer.

Heart scientists predict many exciting advances in the foreseeable future, provided more funds are available for research, education and community service. Help make these predictions come true. Give generously to fight the Number 1 threat to your life.

GIVE...  
so more will live  
**HEART  
FUND**

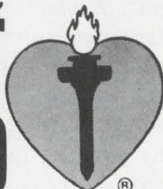

Contributed by the Publisher

## Application Notes

### Thin-film hybrids

Reprints of three technical papers originally presented at IEEE and EIA symposiums are now available. They are "Thin-Film Hybrid Micro-circuit Design," "Thin-Film Network Processing," and "The Role of Thin-Film Hybrid Micro-circuits." Hallex, Inc.

CIRCLE NO. 365

### Cam generation

Intended for engineers responsible for designing or specifying cams, a new technical bulletin analyzes parallel curves and cutoff in the generation of cam contours. After explaining cutoff lost motion in a groove cam, the bulletin deals with near-cutoff surfaces that appear discontinuous and where to look for cutoff conditions. Cam Technology, Inc.

CIRCLE NO. 366

### Power amplifiers

"Solid-state kilowatt amplifiers" is an 11-page tutorial article on high-power amplifiers for driving sonar transducers. It is a guide for specifying and evaluating large amplifiers that discusses such factors as dissipation, distortion, output impedance, power line requirements, temperature effects, and emergency protection. Instruments, Inc.

CIRCLE NO. 367

### Op amps and noise

Noise and operational amplifier circuits are the subject of the Vol. 3, No. 1 issue of "Analog Dialogue." Discussed are noise and signal gain, how noise is characterized, common forms of random noise, and noise density spectrum. In addition, practical methods show how to compute total noise and noise figure. Analog Devices.

CIRCLE NO. 368

# the im-possible ALCOSWITCH

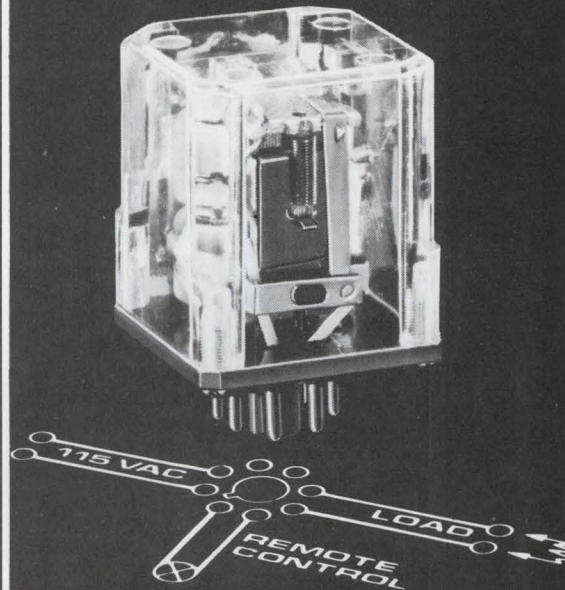

Since when does ALCOSWITCH make relays? Since we learned how to make the impossible switch. All we've done is to combine a step-down transformer and a relay in a single core, all in miniature.

If your product operates on 115 VAC and has possibilities of remote operation chances are you could use this ALCOSWITCH-RELAY!

Refer to the figure below: by simply shorting the remote control leads "xx" the flux path changes thereby closing the relay armature.



The only product in the world of this type that allows you to control up to 600 watts remotely, safely, and economically.

Whether you manufacture hi-fi amplifiers, electric fans, vacuum cleaners, projectors, thermostat controls, consumer appliances or industrial equipment, you may have a need for this revolutionary switching product.

If you are seeking a marketing advantage for your products, we will be happy to assist you by suggesting one of our ALCOSWITCH-RELAYS.

# ALCO

ELECTRONIC PRODUCTS, INC.

Lawrence, Massachusetts 01843

INFORMATION RETRIEVAL NUMBER 88 ►

# New Literature

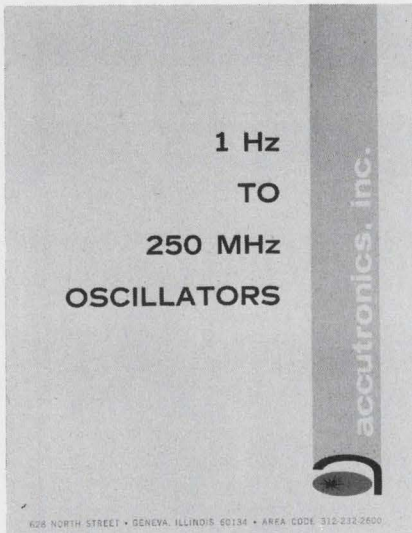

## Oscillators

A complete line of oscillators is described in a new 16-page catalog. It includes crystal, tuning-fork, voltage-controlled and high-stability types. The latest technical advances in the state of the art of oscillators are covered. Accutronics, Inc.

CIRCLE NO. 369

## Lafayette catalog

A 496-page catalog features high-fidelity/stereo equipment, the latest in citizens band two-way radios, test equipment, ham gear, optics, tools, books, musical instruments, tape recorders, and a complete listing of all major lines of electronic components. The book is fully illustrated. Lafayette Radio Electronics.

CIRCLE NO. 370

## Contact test sockets

A two-page bulletin describes contact test sockets that accommodate 16-lead as well as 14-lead dual-in-line IC packages with spacing of 0.300 in. between rows, 0.100 in. between leads and minimum lead lengths of 0.093 in. The sockets, which are designed for production testing, incorporate chamfered lead entrances for fast, easy insertions and a socket design that maintains the correct lead taper of the dual-in-line packages. Barnes Corp.

CIRCLE NO. 371

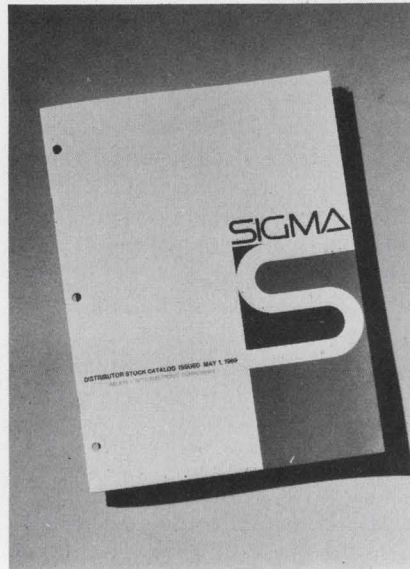

## Relay data

A new 20-page distributor stock catalog provides technical data on more than 500 electromechanical relays and optoelectronic components. All products are illustrated, dimensioned and described. A relay selection guide cross-references desired performance features to specific relays, and includes engineering considerations in relay selection. Sigma Instruments, Inc.

CIRCLE NO. 372

## Resistor networks

Precision wire-wound resistor networks are the subject of a new 12-page catalog, which describes in detail the advantages of using standard case configurations for these network applications. Comprehensive technical information is provided for engineers designing resistor networks of all types. Complete electrical and environmental specifications are indicated, and a unique tear-out ordering information chart is provided. Kelvin.

CIRCLE NO. 373

## TTL-IC guide

A TTL-integrated-circuit specifying guide contains power-dissipation, propagation-delay and other data on 40 different types of circuits. National Semiconductor Corp.

CIRCLE NO. 374

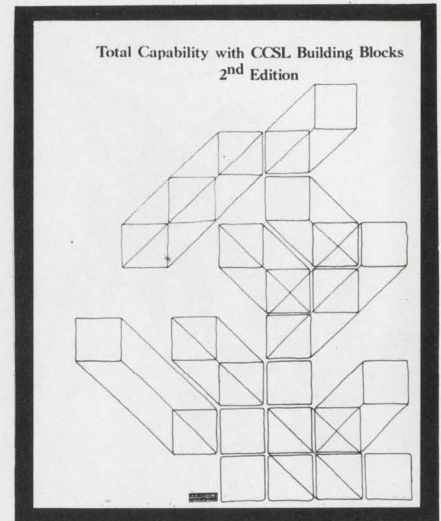

## CCSL building blocks

A complete line of standard, off-the-shelf integrated circuits designed for compatibility with all major logics is described in a 54-page brochure, a second edition specially prepared for design engineers. It gives full-page descriptions of more than 40 CCSL (compatible current sinking logic) building blocks. A major portion of the brochure is devoted to a digital MSI family, which includes decoders and demultiplexers, counters, multiplexers and encoders, adders, parity devices, comparators, function generators and latches. Fairchild Semiconductor.

CIRCLE NO. 375

## Data acquisition

A new analog and digital data acquisition and control system, with plug-in expandability, is described in a 16-page brochure. The system is said to be ideal for remote data-gathering facilities or for portable field applications, due to its small package size. It acquires low- and high-level analog signals, provides on-line monitoring and control, and produces a digitized computer-compatible output. A small, general-purpose digital computer incorporated as system controller forms the heart of the system. The unit can be interfaced to all typical peripheral units by a "plug-in" intercoupler. Astrodata, Inc.

CIRCLE NO. 376



### Power outlet boxes

A 16-page catalog provides full information on more than 400 standard pre-wired power outlet boxes and illustrates nearly 150 of them. Included is a variety of multiple pre-wired power outlet boxes for industry, institutional, school, home and laboratory use. Waber Electronics, Inc.

CIRCLE NO. 377

### Automation dictionary

A new 47-page illustrated dictionary defines more than 200 terms common to the field of automation, including 147 terms not found in the first edition, published in 1955. Other expressions that are no longer part of the rapidly evolving language of the field have been deleted. In addition to definitions, the book contains historical data on important events in the field of automation, including computer development. Honeywell, Inc.

CIRCLE NO. 378

### Digital filtering

A new software package that generates many types of low-pass, high-pass, bandpass and band-reject filters is described in a 4-page brochure that lists full capabilities, and price and terms of the package. University Software Systems.

CIRCLE NO. 379

### Laser components

Laser optical components are described in a 26-page catalog that includes a wide variety of precision substrates and high-efficiency laser coatings. The laser cavity components consist of end mirrors, Brewster windows and Littrow prisms. Components for use with laser beams include beam splitters, first surface reflectors, precision windows as well as corner cube, roof and dispersing prisms. Oriel Optics Corp.

CIRCLE NO. 380

### PC boards

A new six-page brochure details the facilities and capabilities of a company for quantity production of single, double and multilayer PC boards. Emphasis is placed on the controls taken to assure high quality, and on capabilities to solve problems concerning board design, cost and tight schedules. Superior Circuits Div. of Resalab, Inc.

CIRCLE NO. 381

### Spectrophotometers

A 20-page fully illustrated brochure describes the model 14 recording spectrophotometer. The instrument is widely used for studies in the physical and life science fields. Complete technical information is provided, with all standard modifications and available accessories. Cary Instruments.

CIRCLE NO. 382

### Computer for students

Up to 64 students, working with remote, desktop terminals, can have time-shared access to a central analog/hybrid computer. The students can gain direct experience in solving a wide range of problems in mathematics, engineering and the physical sciences, and no programming training is required. A new 16-page brochure tells the whole operating and applications story. Applied Dynamics Inc.

CIRCLE NO. 383

# the twisters

The twist of the fingertips tells the user that he is handling quality.

A lot of effort has gone into making these aluminum knobs the best money can buy. ALCOKNOBS have been painstakingly machined and anodized to a high satin finish. A wide choice of stock knobs are now available to compliment your equipment design. All are available at a reasonable cost and competitive to plastics.

Send for the new ALCOKNOB catalog describing a wide variety of stock knobs and with particulars whereby ALCO can customize knobs to create your own individual image.



# ALCO

ELECTRONIC PRODUCTS, INC.  
Lawrence, Massachusetts 01843

# Uncommonly good sense

from our Tachometer Generators. They're temperature-compensated, miniaturized, and perfect for precision indicators and velocity servos requiring a highly linear speed/voltage relationship with minimum ripple. Linearity from 0 to 12,000 rpm is better than 1/10 of 1% of voltage output at 3600 rpm. The ripple value will not exceed 3% rms of the D-C value at any speed in excess of 100 rpm. The low-driving torque makes them excellent as damping or rate signals in all types of servos. Brushes and commutators are guaranteed for 100,000 hours of operation — more than ten years — at 3600 rpm. Various models are available with outputs as high as 45v/1000 rpm and can be supplied with an indicator as a complete Speed Indicating System.

SERVO-TEK PRODUCTS COMPANY  
1086 Goffle Road, Hawthorne, New Jersey 07506.

**SERVO-TEK**  
PRODUCTS COMPANY

For full technical details  
write for Catalog 1163  
with Test Report  
and show  
good sense.



## NEW LITERATURE



### Solid-state modules

A new 186-page indexed catalog describes 30 types of solid-state choppers, frequency-to-dc converters, discriminators, voltage-to-frequency converters, voltage-controlled oscillators, dc amplifiers, and many other solid-state modules designed for aerospace, military, industrial and ground-support applications. Each data sheet gives a complete description of the product, including electronic data, mechanical data, and typical applications. Solid State Electronics Corp.

CIRCLE NO. 384

### Cable catalog

Summarizing numerous types of coaxial cable, special hook-up wire, and assemblies and harnesses, a new 26-page brochure contains descriptions, specifications and engineering data. Included are micro-miniature dual-shielded coaxial cable, twinaxial and triaxial cable, and special hoop-up types. Micro-dot Inc.

CIRCLE NO. 385

### Plastic hardware

An illustrated 14-page plastics pricing guide describes plastic sheets, rods, pipe, fittings, tanks and cabinet-type work stations for corrosion-proof electrochemical work requirements. There are 38 tables of specifications and prices for such plastics as polyvinyl chloride, polypropylene and polyethylene in standard shapes and sizes. Aztec Products Inc.

CIRCLE NO. 386



### Packaging techniques

Modern packaging techniques using various forms of plastics and paper are illustrated and described in a new brochure. Full color illustrations show ways in which these packaging materials may be used, alone or combined, to enhance the market value and provide protection for a wide variety of products. Shown are folding cartons, thermoformed plastic components, molded polystyrene foam products, stock plastic boxes, custom injection-molded packages, and polyvinyl chloride containers. Creative Packaging Co.

CIRCLE NO. 387

### Gasket materials

Twelve outstanding characteristics of Accopac fiber gasket materials are discussed in a 20-page booklet. These characteristics include dimensional stability, torque retention, heat resistance, compressibility, sealability, uniformity, anti-stick properties, resistance to crushing and extrusion, and resistance to moisture and weather. A table in the back provides a brief description of the typical properties of all Accopac gasket materials. Armstrong Cork Company.

CIRCLE NO. 388

### Switching components

Brief details of a range of electromechanical switching components are contained in a new 14-page catalog. The company's extensive line of reed switches has recently been supplemented with high-voltage vacuum relays, mercury film switches, reed scanners, hybrid solid-state relays, and others. FR Electronics, a Div. of Flight Refuelling Ltd.

CIRCLE NO. 389

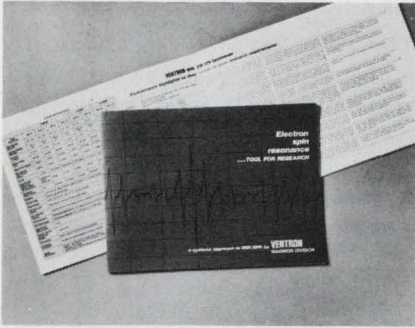

### Spectrometer brochure

An eight-page illustrated brochure describes a new second-generation ESR/EPR spectrometer system, packaged to suit research requirements for X, K or Ka-band frequencies. The brochure includes complete documentation of performance parameters such as stability, sensitivity, resolution, homogeneity, scan linearity, field scanning and field-set accuracy. Ventron, Magnion Div.

CIRCLE NO. 390

### Synchronous controllers

A four-page illustrated brochure describes a new line of synchronous proportional temperature controllers. Solid-state throughout, the units have standard sensitivities of 0.01°F. Proportional band is adjustable by external resistance and is controllable from 0 to 2°F. Applications include refrigeration, heating, alarm systems, strain-gage controls, etc. The two-color brochure includes test curves, application notes and electrical specifications. Victory Engineering Corp.

CIRCLE NO. 391

### Rf power measurement

Coaxial load resistors, absorption wattmeters, and directional wattmeters are the subject of a new four-page short-form catalog. The feature product is a new series of miniature insertion wattmeters for maintenance of communications systems. In addition to basic performance specifications and prices, the literature describes related custom-built accessories such as coaxial filters. Bird Electronic Corporation

CIRCLE NO. 392

### Incremental recorders

Using photos and diagrams, a 41-page brochure describes digital incremental magnetic tape recorders that accept parallel or serial data. The recorders are available in a number of configurations for data logging, data terminals, and billing and inventory controls. Mobark Instruments Corp.

CIRCLE NO. 393

### Resistance bridges

A new 12-page brochure describes a line of stop-and-test bridges specifically designed for use in the trimming of thick-film resistors. The booklet discusses the Kelvin double bridge circuit used in these instruments; factors affecting productivity, accuracy and reliability; and programmability. Detailed descriptions of these stop-and-test bridges are also given. Teradyne, Inc.

CIRCLE NO. 394

### Cable systems

Depicting cabling systems designed specifically for extreme temperature, pressure, and radiation environments, a new brochure describes magnet wire, thermocouple cable, coaxial cable, signal lead wire and multi-conductor cable. These systems can withstand temperatures from -425 to +2000°F and gamma radiation as high as  $1 \times 10^{14}$  rads. Physical Sciences Div, The Singer Co.

CIRCLE NO. 395

### Strain-gage selector

Describing a full line of foil and wire strain gauges, a 16-page catalog assists the user in selecting the best type of gauge for his particular needs in static and dynamic test programs. The catalog includes an introductory section that outlines the significant factors influencing static and dynamic strain, operating temperature ranges, strain range, current carrying capacity, strain sensing materials, lead wire materials and insulation, and temperature compensation. BLH Electronics, Inc.

CIRCLE NO. 396

# build with ALCOSWITCH

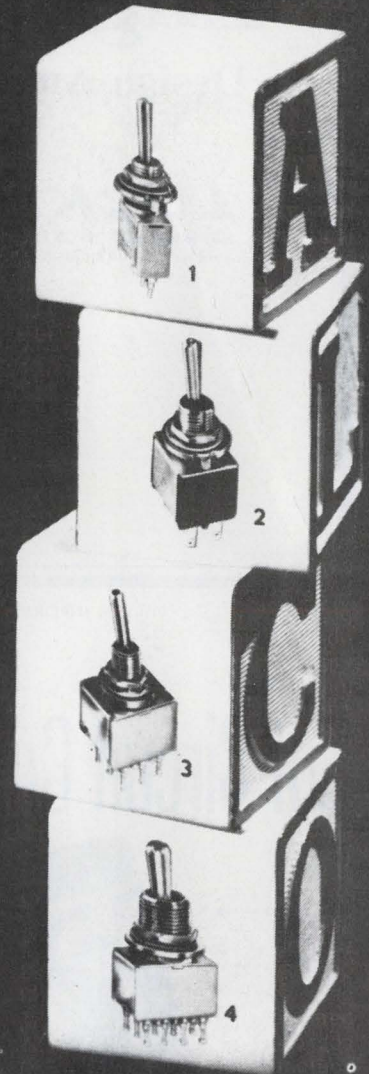

Build quality and reliability into your equipment with top performing ALCOSWITCH® miniatures. Here are representative models from the many families of ALCOSWITCH® which you can select:

- #1 — SPDT "A" SERIES
- #2 — DPDT "MST" SERIES
- #3 — 3PDT "E" SERIES
- #4 — 4PDT "MUSTANG"

If you are looking to build a fine product you'll find the answer in the broad ALCOSWITCH® line.

There is a miniature switch to fit your particular budget and design.

# ALCO

ELECTRONIC PRODUCTS, INC.

Lawrence, Massachusetts 01843

# Electrical/Electronic Engineers

## Design/Analysis/Test

**LOCKHEED**  
MISSILES & SPACE COMPANY  
A GROUP DIVISION OF LOCKHEED AIRCRAFT CORPORATION

• BSEE, plus  
• appropriate  
• experience in any of  
• the following areas:

• **Communications — RF**  
• **Computer Software**  
• **Sensors**  
• **Antennas**  
• **Circuits/Systems**  
• **Test**  
• **Electro-optics**  
• **Microwaves**  
• **Power Systems**  
• **Instrumentation**  
• **Guidance & Controls**

• For complete  
• information, write  
• Mr. H. W. Bissell,  
• Professional  
• Employment  
• Manager, P. O. Box  
• 504, Sunnyvale,  
• California 94088.  
• An equal opportunity  
• employer.

INFORMATION RETRIEVAL NUMBER 910

# Cut Circuit Costs

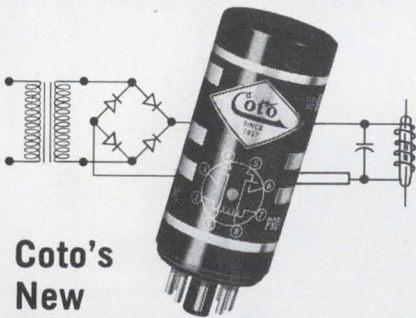

**Coto's  
New**

## A.C. Reed Relay

**Replaces Costly AC/DC Circuits!**

**Contacts:** Forms A or C with single or multiple poles.  
**Ratings:** to 3 amperes or up to 5000 volts D.C.  
**Inputs:** 60-800 Hz voltages available.

**Physical:** Available in 8 and 11 pin plug-in housings with electromagnetic shielding. Electrostatic shielding available on order.

Write for complete specifications. For special requirements, give complete details for quotation.

**Coto-Coil COMPANY, INC.**  
59 Pavilion Ave.  
Providence, R. I. 02905  
Phone (401) 941-3355

INFORMATION RETRIEVAL NUMBER 93



## HEAT REACTIVE VINYL ZIPPERTUBING®

best for skin-tight jacketing  
of cables and wire bundles  
in minutes!

HRV is made from material that  
shrinks when heat is applied.  
(Also available to meet military  
specifications.)

For full information on specialized,  
high-performance jacketing, contact

THE **ZIPPERTUBING**® CO.

**CORPORATE HEADQUARTERS**  
13000 S. BROADWAY  
LOS ANGELES, CALIF. 90061  
Los Angeles Phone: (213) 321-3901  
New Jersey Phone: (201) 256-4980



BALTIMORE • BOSTON • CHICAGO • CLEVELAND • DALLAS  
NEW YORK • ORLANDO • PHOENIX • SAN FRANCISCO • WEST GERMANY

INFORMATION RETRIEVAL NUMBER 94

## NEW LITERATURE

### Quick-set adhesive

The characteristics and uses of a quick-setting cyanacrylate adhesive are described in a 10-page two-color catalog. Typical applications, technical data, directions for use, and performance of type 404 adhesive are presented. This adhesive makes high-strength bonds on rubber, glass and metal. It requires no mixing, and sets in seconds without heating or clamping. Loctite Corp.

CIRCLE NO. 397

### Power connectors

Covering rectangular plug and socket power connectors, a 36-page catalog contains complete electrical and mechanical specifications, illustrations, outline drawings and ordering information. Aluminum hoods, polarizing screwlocks, protective shells and mounting plates are some of the optional accessories that can be supplied with most styles. Terminations include turret type, solder cup and taper pin wiring. Continental Connector Corp.

CIRCLE NO. 398

### Resolver catalog

Showing full electrical and mechanical specifications, as well as outline and mechanical dimensions, a new four-page folder describes representative size 11 data transmission resolvers. The accuracy of these resolver transmitters, resolver differential transmitters and resolver control transformers is held within  $\pm 7$  minutes as standard performance. Weston-Transicoil, Components Div. of Weston Instruments, Inc.

CIRCLE NO. 399

### Hydraulic control

A water hydraulic proportional control system for rolling mills, large presses and other applications requiring large volumes of fluid at high pressure is described in an eight-page brochure. Economic and safety benefits of the system are outlined along with techniques for reducing oxidation and overcoming cavitation (wire-drawing) while maintaining lubricity through addition of 5% soluble oil. Sanders Associates, Inc.

CIRCLE NO. 400

# Free Career Inquiry Service

## Absolutely Confidential

Respond to the career opportunities advertised in this issue. Fill out and send us this handy resume. **Electronic Design** will do the rest – neatly typed copies of this form will be mailed to the companies of your choice, indicated by the circled Career Inquiry Numbers at the bottom of this page.

# 18

<b>Name</b>		<b>Home Phone</b>	
<b>Home Address (Street)</b>		<b>City</b>	<b>State</b>
		<b>ZIP Code</b>	
<b>Age</b>	<b>U.S. Citizen</b> <input type="checkbox"/> Yes <input type="checkbox"/> No	<b>Security Clearance</b>	

Prime Experience	Secondary Experience

<b>Desired Salary</b>	<b>Availability Date</b>
-----------------------	--------------------------

**Employment History – present and previous employers**

Company	City, State	Dates	Title
		to	
		to	
		to	

**Education – indicate major if degree is not self-explanatory**

Degree	College	City, State	Dates
			to
			to
			to

**Additional Training – non-degree, industry, military, etc.**

---



---

**Professional Societies**

---

**Published Articles**

---

- Career Inquiry Numbers:**
- |     |     |     |     |     |     |     |     |     |     |     |
|-----|-----|-----|-----|-----|-----|-----|-----|-----|-----|-----|
| 900 | 901 | 902 | 903 | 904 | 905 | 906 | 907 | 908 | 909 |     |
| 910 | 911 | 912 | 913 | 914 | 915 | 916 | 917 | 918 | 919 | 925 |

**ELECTRONIC DESIGN**  
850 Third Avenue  
New York, New York 10022

# Electronic Design

ELECTRONIC DESIGN'S function is:

- To aid progress in the electronics manufacturing industry by promoting good design.
- To give the electronic design engineer concepts and ideas that make his job easier and more productive.
- To provide a central source of timely electronics information.
- To promote two-way communication between manufacturer and engineer.

**Want a subscription?** ELECTRONIC DESIGN is sent free to qualified engineers and engineering managers doing design work, supervising design or setting standards in the United States and Western Europe. For a free subscription, use the postfree application form inside the back cover. If none is included, write to us direct for an application form.

If you do not qualify, you may take out a paid subscription for \$25 a year in the U.S.A., \$35 a year elsewhere. Single copies are \$1.50 each.

**If you change your address,** send us an old mailing label and your new address; there is generally a prepaid postcard for this inside the back cover. You will have to requalify to continue receiving ELECTRONIC DESIGN free.

**The accuracy policy of ELECTRONIC DESIGN is:**

- To make reasonable efforts to ensure the accuracy of editorial matter.
- To publish prompt corrections whenever inaccuracies are brought to our attention. Corrections appear at the end of the Letters column.
- To refuse any advertisement deemed to be misleading or fraudulent.

Microfilm copies are available of complete volumes of ELECTRONIC DESIGN at \$19.00 per volume, beginning with Volume 9, 1961. Work is now in process to complete the microfilm edition of Volumes 1-8. Reprints of individual articles may be obtained for \$2.00 each, prepaid (\$.50 for each additional copy of the same article) no matter how long the article. For further details and to place orders, contact the Customer Services Department, University Microfilms, 300 North Zeeb Road, Ann Arbor, Michigan 48106; telephone (313) 761-4700.

**Want to contact us?** If you have any comments or wish to submit a manuscript or article outline, address your correspondence to:

Howard Bierman, Editor,  
ELECTRONIC DESIGN,  
850 Third Avenue,  
New York, N.Y. 10022.

# Design Data from

## Microminiature DC-DC Power Supplies



Powercube offers a 24 page designers aid catalog for help in specifying subminiature high power supplies. The catalog features data on a complete line of subminiature modules which can be easily connected to meet any power supply requirement. Available from stock, these uniquely constructed, high reliability Powercube® modules achieve many times the power handling capability than that of conventional equipment in a small fraction of their size and weight. Designed for the engineer faced with critical size and weight requirements, the Powercube catalog is available upon request. Send for a free copy today.

**POWERCUBE CORPORATION**  
214 CALVARY STREET  
WALTHAM, MASSACHUSETTS 02154  
PHONE: (617) 924-1758

174

## How To Write Technical Articles



A guide for the engineer-author, "How to Write Articles for Electronic Design" shows how easy it is to write for publication—once the engineer knows what to write and how to write it. The Author's Guide includes a complete run-down of the types of articles published by Electronic Design—plus detailed instructions on how to prepare technical articles and short special features. A MUST for every "would-be-writer" in the electronics industry. Send for your complimentary copy by circling the number to the right.

**Electronic Design**  
850 Third Avenue  
New York, N.Y. 10022

175

## FUNDAMENTALS OF INTEGRATED CIRCUITS

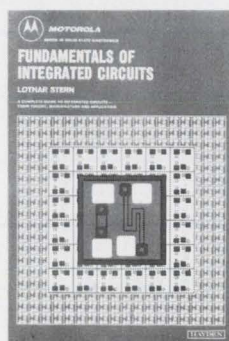

A practical guide to integrated circuits, their theory, manufacture, and applications. This new guide by Lothar Stern offers complete, highly readable coverage of the various techniques of circuit fabrication, and their effect on circuit design and performance. As to marketing considerations, it compares the characteristics of the numerous IC structures devised to date in terms of economics and logistics. A volume in the **Motorola Series in Solid-State Electronics**. 198 pages, 7 x 10, illustrated. \$8.95, clothbound. Send for 15-day examination copies.

**Hayden Book Company, Inc.**  
116 West 14th Street  
New York, N.Y. 10011

176



# Manufacturers

Advertisements of booklets, brochures, catalogs and data sheets. To order use Reader-ServiceCard.  
(Advertisement)

## Clamp or Tie Wire Bundles In Seconds!

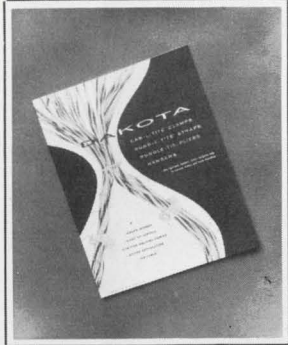

Six-page catalog contains complete ordering information for CAB-L-TITE® clamps and BUND-L-TITE® straps, devices which provide a fast and reliable means of securing wires and wire bundles. Units withstand loadings greater than 50 G's, are removable in seconds for re-routing wires, and are self-locking—no tying, no knots, no hitches to come loose. Lightweight Du Pont Zytel meets MIL-P-17091 and MIL-P-20693. Proved in aircraft and missiles. Photos, dimensional drawings, tables, physical properties, specifications, price list. Request catalog A.

**Dakota Engineering, Inc.**  
4315 Sepulveda Blvd.  
Culver City, California 90230

177

## Terminal Block Selector



A new 24-page, completely illustrated catalog contains photos, descriptions, ratings, engineering drawings, and prices of the complete line of Curtis terminal blocks. Included are printed circuit, insulated feed-thru, quick disconnect, track type, and high current terminal blocks. Handy selection chart quickly locates the perfect block for your particular requirements. Send today for your free copy.

**Curtis Development & Mfg. Co.**  
3236 North 33rd Street  
Milwaukee, Wisconsin 53216

178

## PEM Self-clinching Fasteners



"Clinched by a squeeze with the greatest of ease," PEM captive fasteners save time, labor and weight on any job where load-bearing threads are required in panels too thin to thread. The original means of providing threaded holes in thin panels, PEM Type CL fasteners are available in steel, stainless, aluminum and Monel for permanent mounting in panels as thin as .032". They provide thread sizes from #0-80 to 3/4-16. With the same back-tapered shank for self-clinching permanency as Type CL fasteners, PEM Type S fasteners are also offered with knurled retaining rings for maximum torque-resistance. Send for free Bulletin CL-1063.

**Penn Engineering & Mfg. Corp.**  
Box 311  
Doylestown, Pa. 18901

179

# Electronic Design

## Advertising Sales Staff

**New York 10022**  
Edward F. Clancy  
Sales Service Manager  
Robert W. Gascoigne  
Thomas P. Barth  
Samuel M. Deitch  
Byron Adams  
850 Third Avenue  
(212) Plaza 1-5530  
TWX: 867-7866

**Philadelphia 19066**  
William C. Repetto  
P. O. Box 206  
Merion Station, Pa.  
(215) MA-3-5888

**Boston 02110**  
Richard Parker  
P.O. Box 645  
Clifton Station  
Marblehead, Mass.  
(617) 742-0252

**Chicago 60611**  
Thomas P. Kavooras  
Berry Conner, Jr.  
200 East Ontario  
(312) 337-0588

**Cleveland**  
Thomas P. Kavooras  
(Chicago)  
(312) 337-0588  
(call collect)

**Los Angeles 90303**  
Stanley I. Ehrenclou  
John V. Quillman  
W. James Bischof  
2930 Imperial Highway  
Inglewood, Calif.  
(213) 757-0183

**San Francisco 94022**  
Arthur R. Shields, Jr.  
175 San Antonio Rd., S 243  
Los Altos, Calif.  
(415) 941-3084

**London W. 1**  
For United Kingdom & Holland  
Brayton C. Nichols  
44 Conduit Street  
Tel: REGent 4714

**Verviers, Belgium**  
For Continental Europe  
Andre Jamar  
1, Rue Mallar, 1  
(087) 253.83 Telex 41563

**Tokyo**  
Yoshiro Takemura  
IPS Group Ltd.  
Box 36, Ohsaki Post Office  
Phone (504) 1485  
Cable Joshplans, Tokyo



**AMERICAN BUSINESS PRESS, INC.**

# HANSEN'S NEW 900 SERIES



gives you  
standard Synchron®  
reliability with up  
to 98 oz.-in. torque

Now, without sacrificing compact size, you can get high torque even at higher speeds—from 1 to 900 RPM. Synchron® 900 Series has thick, wide gears, specially designed to give the added gear strength that makes full use of its power increase. Highest quality instrument gear train for all speeds below 900 RPM.

The new self-starting hysteresis motor has positive direction of rotation—right or left hand. Plus extra heavy phenolic first gear for low noise level. It can be stalled continuously without electrical or mechanical damage.

Added strength in both the rotor and gear train enables 900 Series to handle your toughest timing and control jobs. Because of its compact dimensions, it is often interchangeable with motors of lower torque. To find out what 900 SERIES can do for you, write or phone today to have a representative contact you.

VISIT BOOTH No. 3133,  
DESIGN ENGINEERING SHOW



**HANSEN MFG. CO., INC.**  
Princeton, Indiana 47570

**HANSEN REPRESENTATIVES:** CAREY & ASSOCIATES, Houston and Dallas, Texas; R. S. HOPKINS CO., Sherman Oaks, Calif.; MELCHIOR ASSOCIATES, INC., San Carlos, Calif.; THE FROMM CO., Elmwood Park, Ill.; JOHN ORR ASSOCIATES, Grand Rapids, Mich.; H. C. JOHNSON AGENCY, INC., Rochester, N.Y.; WINSLOW ELECTRIC CO., Essex, Conn.; Villanova, Pa., and New York, N.Y.

**EXPORT DEPARTMENT:** 2200 Shames Drive, Westbury, N.Y. 11590

INFORMATION RETRIEVAL NUMBER 95

## Advertisers' Index

Advertiser	Page	Advertiser	Page
ACDC Electronics, Inc. ....	49	Leach Corporation .....	128CD
Accutronics, Inc. ....	128AB	Littlefuse .....	111
Airco Speer .....	47	Lockheed Electronics Company .....	10, 56
Alco Electronic Products, Inc. ....	133, 135, 137		
Allen-Bradley Co. ....	37, 39	Magnecraft Electric Company .....	48A—X
Allen Organ Company, Inc. ....	48	MicroSwitch, A Division of Honeywell .....	57
Amphenol Industrial Division, The Bunker-Ramo Corporation .....	113ABC	Minelco, A Subsidiary of General Time .....	48D
Amphenol, The Bunker-Ramo Corporation .....	23	Molex Products Company .....	108
Arnold Engineering Company, The .....	42, 43	Monolithic Dielectrics, Inc. ....	129
		Monsanto Company .....	7
Babcock Relays, Division of Babcock Electronics Corporation .....	93	National Semiconductor Corporation .....	80AB
Bean Rubber Company .....	132	Nytronics, Inc. ....	31
Beckman Instruments, Inc., Helipot Division .....	29	Ogden Technology Laboratories, Inc. ....	44
Bourns, Inc. ....	99		
Browne Engineering .....	107	Penn Engineering and Manufacturing Corp. ....	141
Bud Radio Company, Inc. ....	59	Plastic Capacitors, Inc. ....	126
Burroughs Corporation .....	20	Powercube Corp. ....	140
		Protolab .....	132
Cambridge Thermionic Corporation .....	48A		
Cinch Manufacturing Company .....	55	RCA Electronic Components and Devices .....	4, 5, 48AB, 103, Cover IV
Clare & Co., C. P. ....	32AB	Radix Telemetry Corp. ....	117
Columbia Research Labs. ....	111	Raytheon Company, Computer Division .....	81
Computer Products Inc. ....	120	Raytheon Company, Semiconductor Operation .....	52
Corning Glass Works .....	34, 35	Redcor Corporation .....	123
Coto Coil Company, Inc. ....	138	Schauer Mfg. Corp. ....	114
Crescent Technology Corp. ....	122	Servo-Tek Products Company .....	136
Curtis Development & Mfg. Co. ....	111, 141	Signetics Corporation .....	27
Cutler-Hammer Inc. ....	60	Simpson Electric Company .....	121
		Singer Company, Friden Division .....	113
Dakota Engineering, Inc. ....	141	Singer Company, The Diehl Division .....	127
Dale Electronics, Inc. ....	Cover III	Sonotone Corporation Battery Division .....	64
Dana Laboratories, Inc. ....	62	Sprague Electric Company .....	18
Digital Equipment Corporation .....	6	Spitfire Tool and Machine Co. ....	118
Dow Corning Corporation .....	16	Sylvania Electric Products, Inc. Metals & Chemicals Parts Division .....	17
Dumont Oscilloscope Laboratories, Inc. ....	58	Systron-Donner Corporation .....	2
ENM Company .....	143	Technical Wire Products, Inc. ....	107
Eastman Chemical Products, Inc. ....	143	Telonic Systems, Division of Telonic Instruments, Inc. ....	16A—D
Electronic Design .....	140	Texas Instruments Incorporated, Components Group .....	40, 41
Engelhard Industries, Inc. ....	107	Texas Instruments Incorporated Chemical Materials Division .....	105
Executone, Inc. ....	132	Thermal American Fused Quartz Co., Inc. ....	130
		Trump-Ross Industrial Controls Inc. ....	119
General Electric Company .....	11, 61	Tung Sol Division, Wagner Electric Corporation .....	50
General Radio Company .....	1		
		U-Tech .....	116
Hansen Manufacturing Co., Inc. ....	142	Union Carbide Electronics Division Components Department .....	15
Hayden Book Company, Inc. ....	140		
Heath Company .....	131	W & G Instruments Inc. ....	12, 13
Hewlett-Packard .....	Cover II, 8, 9, 24, 48BC 51, 124	WEMS, Inc. ....	115
Indiana General Corporation .....	84, 85	Zippertubing Corp., The .....	138
Janco Corporation .....	54		
Johnson Company, E. F. ....	14	<i>Career Advertising</i>	
Jonathan Manufacturing Company .....	101	Lockheed Missiles & Space Company .....	138
Keuffel & Esser Co. ....	125		

## EASTMAN 910® Adhesive bonds cellulose nitrate to acetal plastic, lets small hearing aid do big job.

Hearing aids manufactured by Dicton Horetchnik of Copenhagen, Denmark, are small, but powerful. They're also rugged and easy to assemble, thanks to EASTMAN 910 Adhesive.

In the assembly, one drop of this unique adhesive securely bonds a miniature potentiometer to the interior of the amplifier casing. The materials bonded are a cellulose nitrate and an acetal plastic. The bond formed is electrically non-conductive, and is resistant to changes in temperature and moisture.

Since hearing aids are normally subjected to hard, constant use, the fact that Dicton has used EASTMAN 910 Adhesive in this application for three years speaks for itself.

EASTMAN 910 Adhesive is versatile, will form a bond with almost any kind of material. It requires no heat, solvent evaporation, or catalyst. Offers fast setting, high strength and low shrinkage. Comes ready to use, cures at room temperature with only contact pressure. And gives approximately 20 one-drop applications for only a nickel.

Try EASTMAN 910 Adhesive on your toughest bonding jobs. For technical data and further information, write Chemicals Division, EASTMAN CHEMICAL PRODUCTS, INC., Kingsport, Tennessee. EASTMAN 910 Adhesive is distributed by Armstrong Cork Company, Industry Products Division, Lancaster, Penna.

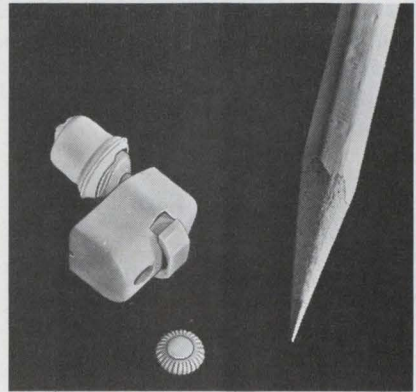

Here are some of the bonds that can be made with versatile EASTMAN 910 Adhesive: Among the stronger, steel, aluminum, brass, copper, vinyls, phenolics, cellulose, polyesters, polyurethanes, nylon; butyl, nitrile, SBR, natural rubber, most types of neoprene; some woods. Among the weaker, polystyrene, polyethylene (shear strengths up to 150 lb/sq. in.).

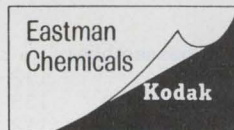

See Sweet's Product Design Catalog File

INFORMATION RETRIEVAL NUMBER 96

"IT'S GOOD BUSINESS  
TO HIRE THE HANDICAPPED."

ISN'T THAT A GREAT IDEA, SNOOPY?



THE PRESIDENT'S COMMITTEE ON EMPLOYMENT  
OF THE HANDICAPPED, WASHINGTON, D. C.

SERIES P  
**THE**  
MOST  
COMPLETE  
LINE OF  
**PANEL  
MOUNTED  
COUNTERS**



Model P-4A

Key resettable counter. U.L. listed. Lock on counter permits reset by key only for security measures. 115 V., 60 Hz. std.

ENM now offers the most complete line of panel mounted counters manufactured by a single source in the U.S.A.

Seven separate and distinct panel mounted models encompassing both resettable and non-resettable counters, key lock types and elapse time indicator with 9999.9 time scale.

All units feature six digits with a standard counting speed of 500 cpm. Higher speeds and various voltages available. Specials on request.

Write for 4-page full line panel mounted counter brochure. ▶



**ENM COMPANY**

5306 W. Lawrence Ave., Chicago, Ill. 60630

PHONE: (312) 282-8787

Representatives in principal cities

INFORMATION RETRIEVAL NUMBER 98

# Information Retrieval Service

All products, design aids (DA), application notes (AN), new literature (NL), and reprints (R) in this issue are listed here with Page and Information Retrieval numbers. Reader requests will be promptly processed by computer and mailed to the manufacturer within three days.

Category	Page	IRN	Category	Page	IRN	Category	Page	IRN
<b>Components</b>			recorders,			dictionary,		
boxes, power outlet (NL)	135	377	incremental (NL)	137	393	automation (NL)	135	378
capacitors, air-variable	118	279	spectrometer (NL)	137	390	masking machines	124	294
connectors, power (NL)	138	398	spectrophotometers (NL)	135	382	resin mixer	124	295
controllers,			transistor testers	115	269	substrate sectioner	124	296
synchronous (NL)	137	391						
counter, pneumatic	120	285	<b>Microwaves &amp; Lasers</b>			<b>New Literature</b>		
counter, pulse	119	281	coupler, octave-band	129	351	adhesive, quick-set	138	397
filters, rfi/emi	118	278	coupler, quadrature	128	349	automation dictionary	135	378
filters, SHP	120	283	laser, components (NL)	135	380	cable	136	385
generation, cam (AN)	133	366	laser, He-Cd	128	345	cable systems	137	395
indicators,			measurement,			CCSL building blocks	134	375
temperature (ES)	130	355	rf power (NL)	137	392	computer for students	135	383
networks, resistor (NL)	134	373	noise sources	128	346	contact test sockets	134	371
readout assembly	119	282	oscillator, X-band	128	350	data acquisition	134	376
readout, segmented	118	280	power meters, rf	129	352	digital filtering	135	379
relay (NL)	134	372	source, power	128	347	gasket materials	136	388
resistors, power	120	284	spectrum analyzer	128	348	hydraulic control	138	400
resolver (NL)	138	399				incremental recorders	137	393
selector,			<b>Modules &amp; Subassemblies</b>			Lafayette catalog	134	370
strain-gage (NL)	137	396	amplifiers, data	112	254	laser components	135	380
switching (NL)	136	389	amplifiers, power (AN)	133	367	oscillators	134	369
switch, lever	120	286	converter, d/a	112	256	packaging techniques	136	387
test sockets,			converters, d/a	110	251	PC boards	135	381
contact (NL)	134	371	filtering, digital (NL)	135	379	plastic hardware	136	386
trimmer pots	118	277	filters, active	112	253	power connectors	138	398
			modules, solid-state (NL)	136	384	power outlet boxes	135	377
<b>Data Processing</b>			multiplier, analog	110	250	relay data	134	372
acquisition, data (NL)	134	376	op amp, FET	112	255	resistance bridges	137	394
card transmitter	121	287	op amps, and noise (AN)	133	368	resistor networks	134	373
computer, students (NL)	135	383	op amps, power	112	257	resolver	138	399
converter, a/d	122	289	reference, dc	110	252	rf power measurement	137	392
data coupler	121	288	sampling modules	112	258	solid-state modules	136	384
data set	123	291				spectrometer	137	390
data set	123	292	<b>Packaging &amp; Materials</b>			spectrophotometers	135	382
recorder, disc	122	290	adhesive, quick-set (NL)	138	397	strain-gage selector	137	396
			boards, PC (NL)	135	381	switching components	136	389
<b>ICs &amp; Semiconductors</b>			cable (NL)	136	385	synchronous controllers	137	391
amplifier, log	112D	262	cables, transmission (ES)	130	356	TTL-IC guide	134	374
amplifiers, FET	112D	259	carrier, flatpack	126	342			
building blocks,			connectors, miniature	127	344	<b>Application Notes</b>		
CCSL (NL)	134	375	cores, tape wound (DA)	131	358	cam generation	133	366
hybrids, thin-film (AN)	133	365	fastener/mount	126	299	op amps and noise	133	368
memory, 64-bit	112D	260	foil, shielding (ES)	130	353	power amplifiers	133	367
memory, 128-bit	114	267	gasket (NL)	136	388	thin-film hybrids	133	365
memory, random-access	114	266	hardware, plastic (NL)	136	386			
op amp, IC	112D	261	jack, press-fit	126	341	<b>Design Aids</b>		
op amp, IC	112D	264	laminare, high-temp	127	343	noise figure nomograph	131	357
parity trees	112D	263	mounts, harness (ES)	130	354	tape wound cores	131	358
switches, FET	114	268	nomograph, noise					
transistors, power	114	265	figure (DA)	131	357			
TTL ICs (NL)	134	374	packaging techniques (NL)	136	387			
			resin, potting	126	340			
<b>Instrumentation</b>			solvent, degreasing	125	298			
accumulator	115	270	systems, cable (NL)	137	395			
bridges, resistance (NL)	137	394	tape, conductive	125	297			
counter, 32-MHz	116	274						
counter, reversing	116	272	<b>Production</b>					
counters, multi-axis	117	276	cleaning system	124	293			
counters, up/down	116	273	control, hydraulic (NL)	138	400			
generator, synchronizing	117	275				<b>Evaluation Samples</b>		
load, electronic	116	271				harness mounts	130	354
oscillators (NL)	134	369				shielding foil	130	353
						temperature indicators	130	355
						transmission cables	130	356

# Can a low-cost trimmer succeed in a high-class job like this?



*Mohawk Data-Recorders speed input preparation by transferring data direct from source document to computer-compatible magnetic tape. Dale Econo-Trims are used here to control gain in a number of amplifier circuits.*

## Dale Econo-Trims do!

Specify Dale Econo-Trims for handling important circuit adjustments at a budget price. They combine dependability with prices that start under a dollar. Mohawk Data Sciences uses the 2317 Econo-Trim to control gain in vital tape readback amplifiers. Sealed to withstand automatic soldering, fluxing and total immersion, this 1/2-watt wirewound is noted for its good setting stability. It's just one of 12 Econo-Trim models now available. You can select from 1/2, 3/4 or 1 watt models...film or wirewound elements...sealed or unsealed. Count on good delivery, too—less than 2 weeks in 1,000 piece quantities. Give Econo-Trims the chance to succeed in your circuits. They can help you get ahead, too!

### SPECIFICATIONS

#### 2300-2400 Series/Wirewound 8300-8400 Series/Film

**Dimensions:** 2300 & 8300 = .36" H x .28" W x 1.00" L;  
2400 & 8400 = .31" H x .16" W x .75" L

**Standard Resistance:** Wirewound models = 10 ohms to 50K ohms;  
film models = 10 ohms to 2 Meg.

**Resistance Tolerance:** Wirewound models =  $\pm 10\%$ ; film models =  $\pm 10\%$   
100 ohms thru 500K ohms,  $\pm 20\%$  all other values

**Power Rating:** 2300 = 0.5 watt at 25° C; 2400 = 1 watt at 40° C;  
8300 & 8400 = .75 watt at 25° C

**Operating Temperature Range:** 2300 & 8300 = -55° C to 105° C;  
2400 & 8400 = -55° C to 125° C

**Mechanical Adjustment:** 2300 & 8300 = 15 turns; 2400 & 8400 = 20 turns

**Mechanical Stops:** None. Clutch permits overtravel without damage

**Models:** Sealed or unsealed. Gold-plated PC terminals or gold-plated hook type solder lugs (2300/8300 only).

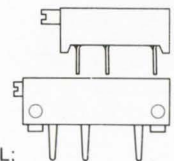

Get samples and a quote quick—  
Call Dale Now: 402-564-3131



**DALE ELECTRONICS, INC.**

1328 28th Ave., Columbus, Nebr. 68601  
In Canada: Dale Electronics Canada, Ltd.



Study events never "seen" before

**NEW RCA-C70133B  
QUANTACON  
PHOTOMULTIPLIER**

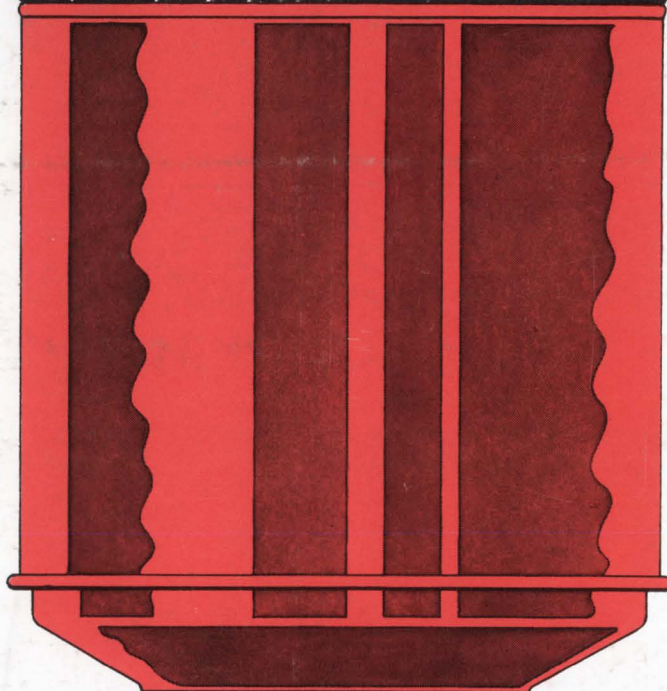

Here's an exciting new light sensitive device from RCA—the C70133B, an RCA QUANTACON photomultiplier—that can open up for study events never "seen" before.

Gallium Phosphide boosts the single electron resolution of this newest QUANTACON photomultiplier as much as 10 times over that of tubes using conventional dynode materials. As a result, it is possible for this device to discriminate between light-producing phenomena that generate one, two, three, or four photoelectrons.

Gallium Phosphide QUANTACON photomulti-

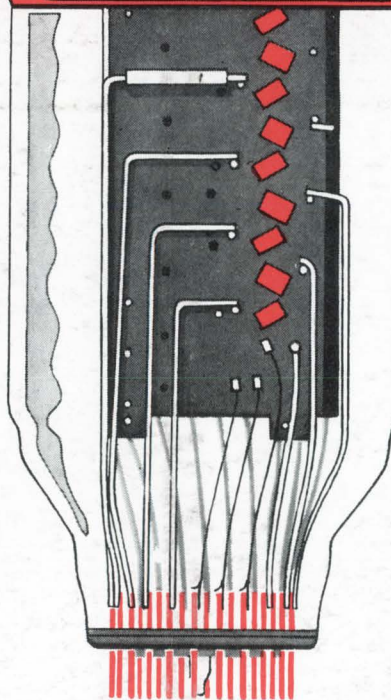

pliers are at the forefront for applications in scintillation counting, biochemistry, and nuclear physics. C70133B offers greatly improved low-light-level performance.

C70133B is a high-speed RCA QUANTACON photomultiplier with an irradiation area of 15.9 square inches. This 5-inch device is an important tool for scientists studying low-light-level phenomena.

For more information on this and other RCA QUANTACON photomultipliers, see your local RCA Representative. For technical data, write: RCA Electronic Components, Commercial Engineering, Section I-18P-1, Harrison, N.J. 07029.

**RCA**