

RECEIVED
SEP 02 1970

CALMA CO.

Pick the right op amp for your precision dc measurement. But be careful: A unit with a low voltage drift may surprise you with current-drift errors. And the right choice for a low-impedance circuit may be all wrong when the impedance is high. Listen to an expert's advice on amplifier selection in the article on p. 54

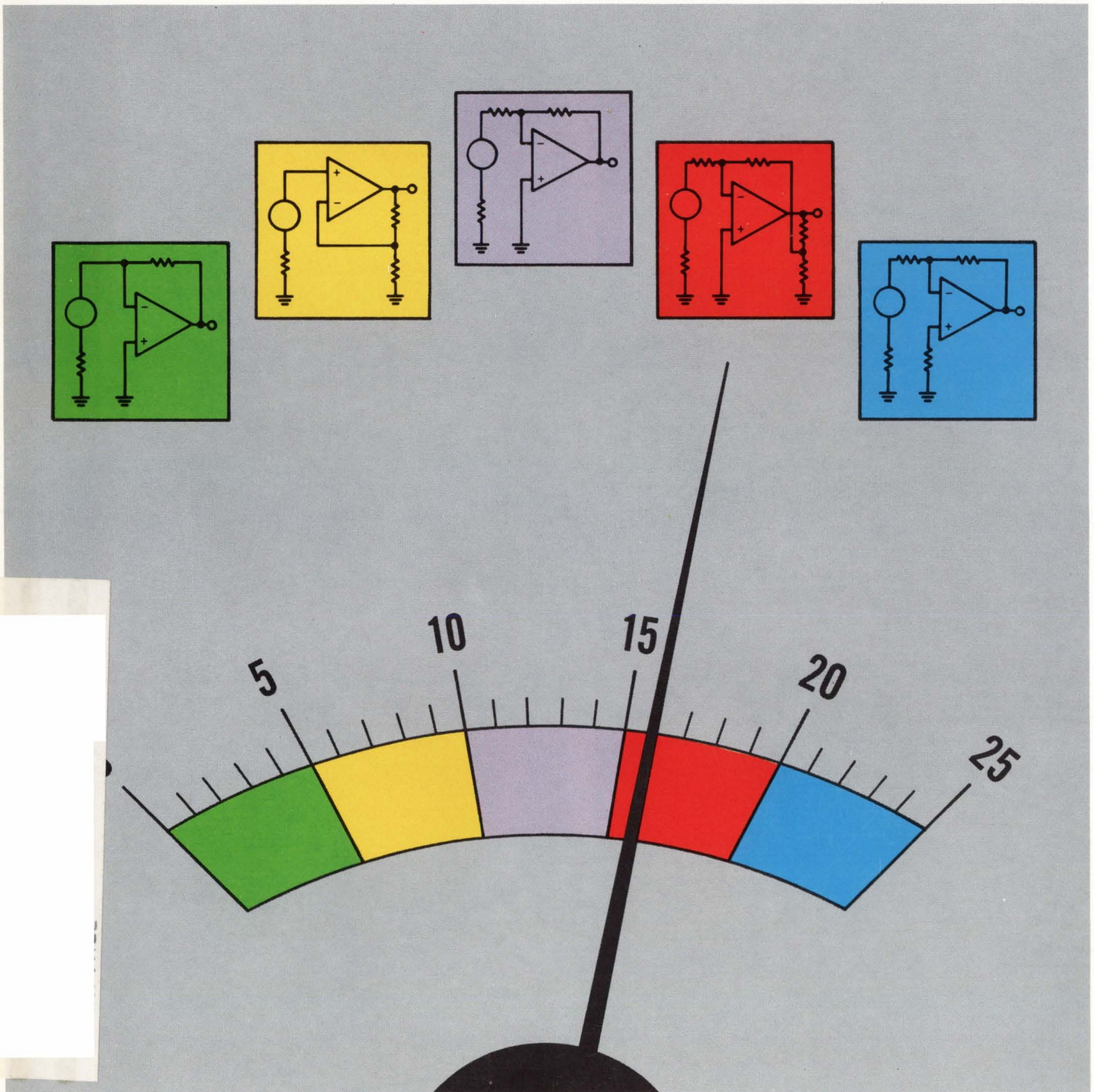

What's a 500 kHz plug-in doing in a 100 MHz mainframe?

Increasing its versatility, that's what!

When you need 100 μV sensitivity, rather than 100 MHz bandwidth, HP's new dual-channel 1806A plug-in lets your 180 Scope System do the job. With the 1806A, the versatile 180 Mini-Giant becomes a powerful tool for measuring and analyzing low-level signals up to 500 kHz.

A 100 $\mu\text{V}/\text{div}$ deflection factor lets you see beyond the surface of a signal — to detect ripples, discontinuities and harmonics invisible at less sensitive levels. To get the most out of the 100 μV sensitivity, drift is typically $<50 \mu\text{V}/\text{hr}$, CMRR is 100 dB, noise is $<20 \mu\text{V}$ tangential at full BW — and a pushbutton lets you limit bandwidth to 50 kHz, when you need to.

For applications where you need high-bandwidth capabilities, there are a host of other plug-ins for the versatile 180 System. There's a 50 MHz, 5 mV/div plug-in for only \$695. 100 MHz with 10 mV/div and 50 Ω input, \$1200 (10 M Ω active probe, \$95 extra).

Other available plug-ins include: a differential/dc-offset amplifier, a 4-channel amplifier, and a 35 ps time-domain reflectometer that doubles as a 12.4 GHz sampler.

Today, oscilloscope technology is at a crossroads. The HP direction points to getting the best, now, at a low price — with assurance of increased measurement capabilities down the road, using existing mainframes. The new 1806A plug-in is the latest example of this approach at work.

To see the 180 System, call your local HP field engineer. Or, write to Hewlett-Packard, Palo Alto, California 94304. In Europe: 1217 Meyrin-Geneva, Switzerland.

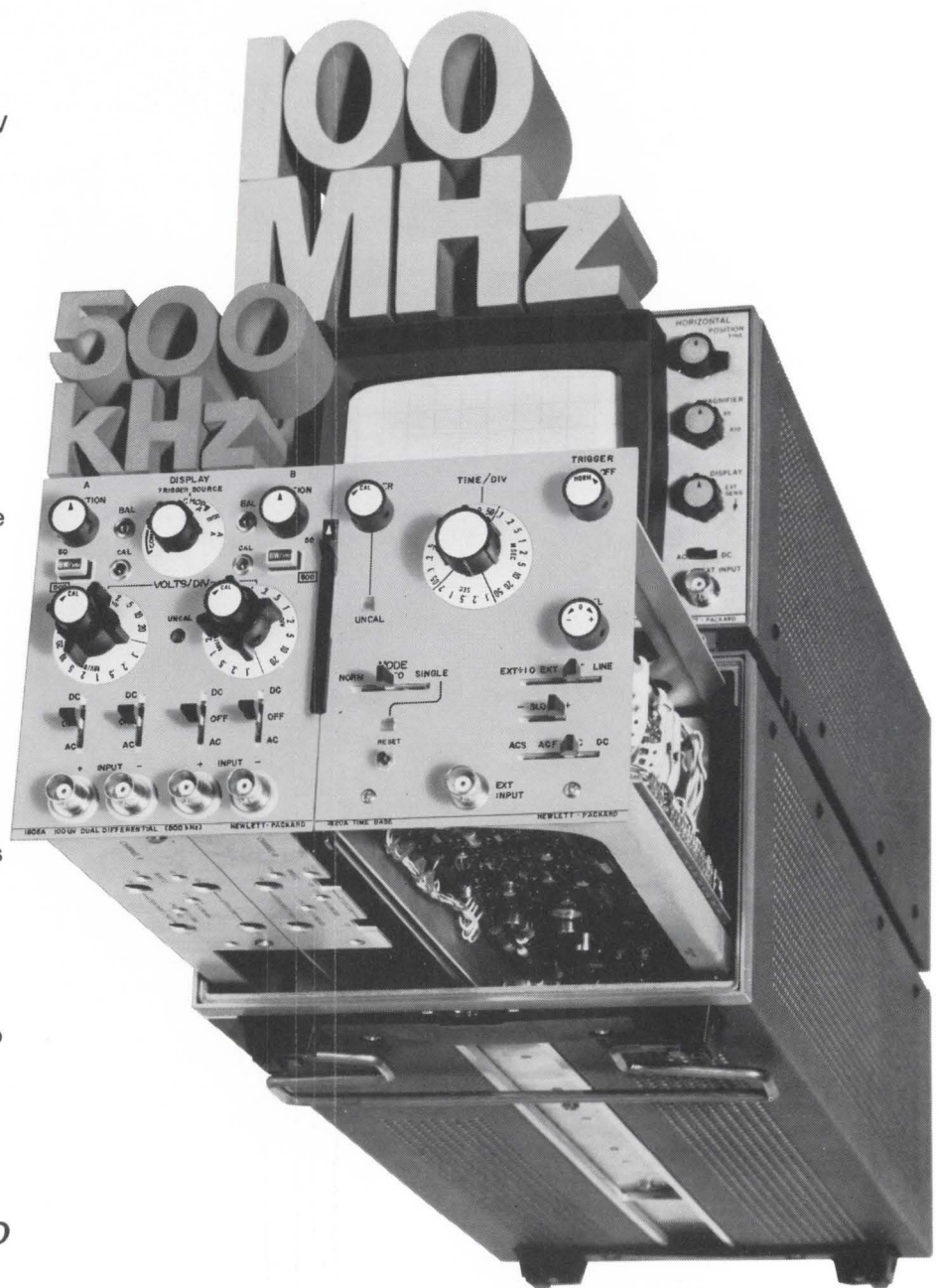

080/15

HEWLETT  PACKARD

OSCILLOSCOPE SYSTEMS

INFORMATION RETRIEVAL NUMBER 245



THE 0.1% PORTABLE IMPEDANCE BRIDGE

...in the GR tradition of better measurements

GR's new 1656 Impedance Bridge rounds out the General Radio family of impedance bridges. Now there's a choice of three to suit your exact needs for accuracy and economy. All three measure broad ranges of C, L, R, G, D, and Q, while each has its own distinctions. The new portable 1656 offers 0.1% accuracy for only \$700 (price in the U.S.), the 1650 features 1% accuracy in a portable package for \$545, and the 1608 is a bench-type instrument with 0.05% accuracy for \$1675. All three are self-contained 1-kHz instruments; external oscillators and detectors will extend their ac testing capability to a 20 Hz-to-20 kHz range.

The 1656, like the other two bridges, measures C up to 1100 μF , L up to 1100 H, and R to 1.1 M Ω . With the 1656, G can be measured up to 1.1 Ω ; D and Q cover over-all ranges of 0 to 50 and 0.02 to ∞ , respectively. The 1656 resolves C down to 0.1 pF, L to 0.1 μH , R to 0.1 m Ω , and G to 0.1 n Ω . Your best bet, anywhere, for dc measurements is the 1656: consider the 10- $\mu\text{V}/\text{mm}$ detector sensitivity and the wide resistance and conductance ranges.

Measurement of the new high-precision components demands an accurate bridge. With four-decade lever balancing, the 1656 achieves *true* 0.1% basic accuracy and a direct and easy readout of all four digits, without the need

for interpolation or vernier interpretation. A rack version of the 1656 is available for \$735; GR also makes an accessory \$45 test jig for connecting axial-lead components.

Know all the members of our impedance-bridge family by name:

1656—0.1% accuracy, portable, \$700.

1608—0.05% accuracy, bench, \$1675.

1650—1% accuracy, portable, \$545.

Whichever degree of measurement performance you require, you can get complete specifications from your nearest GR District Office or from 300 Baker Avenue, Concord, Massachusetts 01742. In Europe write to Postfach 124, CH 8034, Zurich, Switzerland.



General Radio

ATLANTA 404 633 6183 / BOSTON 617 646 0550 / CHICAGO 312 992 0800 / CLEVELAND 216 886 0150
 DALLAS 214 637 2240 / LOS ANGELES 714 540 9830 / NEW YORK (N.Y.) 212 964 2722 (N.J.) 201 943 3140
 PHILADELPHIA 215 646 8030 / SAN FRANCISCO 415 948 9233 / SEATTLE 206 747 9190 / SYRACUSE 315 454 9323
 WASHINGTON, D.C. 301 881 5333 / TORONTO 416 252 3396 / ZURICH (051) 47 70 20

INFORMATION RETRIEVAL NUMBER 2

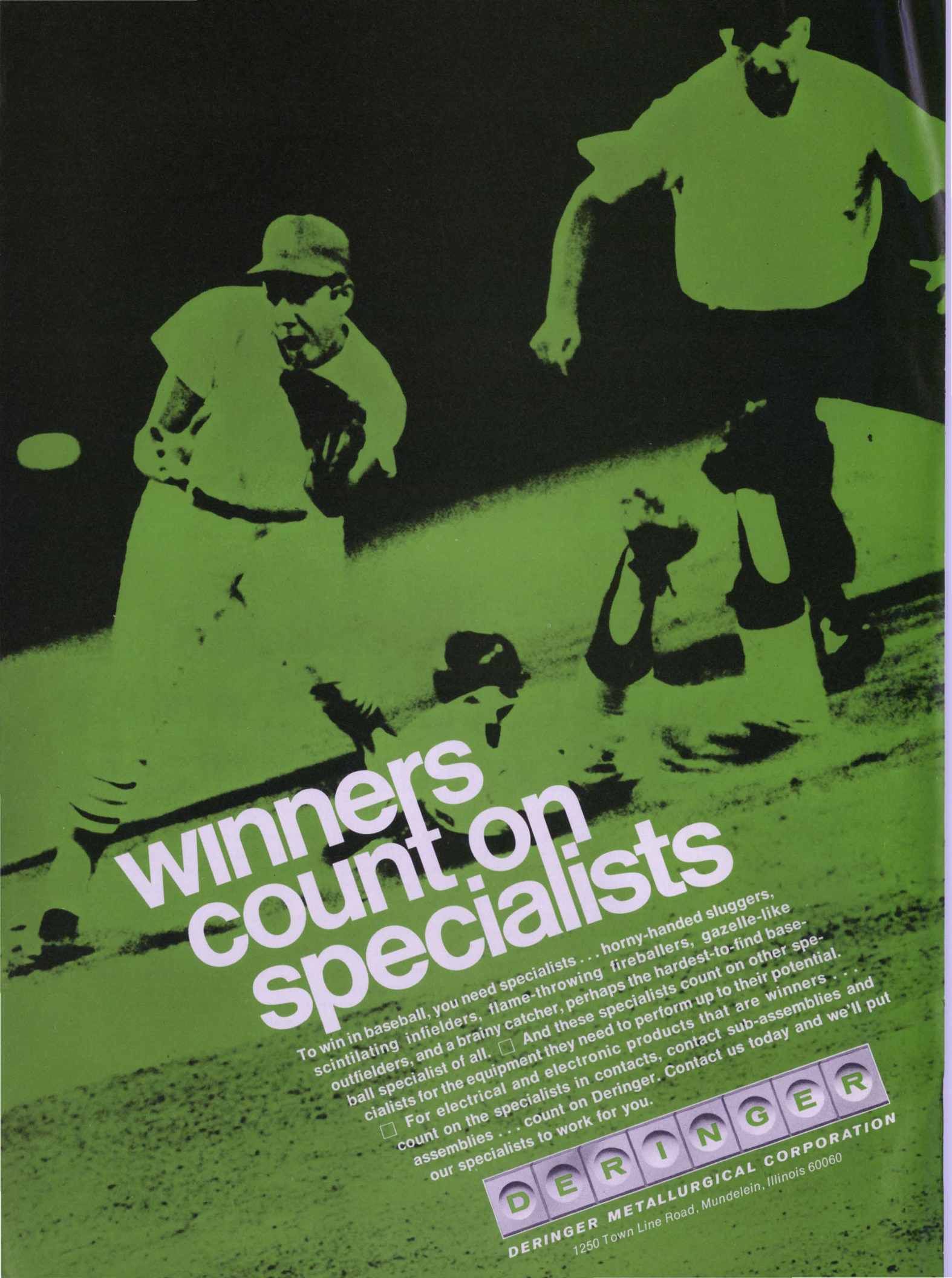

winners count on specialists

To win in baseball, you need specialists . . . horny-handed sluggers, scintillating infielders, flame-throwing fireballers, gazelle-like outfielders, and a brainy catcher, perhaps the hardest-to-find baseball specialist of all. □ And these specialists count on other specialists for the equipment they need to perform up to their potential. □ For electrical and electronic products that are winners . . . count on the specialists in contacts, contact sub-assemblies and assemblies . . . count on Deringer. Contact us today and we'll put our specialists to work for you.

DERINGER

DERINGER METALLURGICAL CORPORATION
1250 Town Line Road, Mundelein, Illinois 60060

Electronic Design 18

VOL. 18 NO.

FOR ENGINEERS AND ENGINEERING MANAGERS

SEPT. 1, 1970

NEWS

- 21 **News Scope**
- 25 **Air Force to test EL for jet cockpit lighting**
Year-long study of night-vision problems may lead to replacement of incandescent bulbs by electroluminescent devices
- 26 **New computer keeps 747 jet engines cool**
Jumbo-jet pilots save engines by throttling at 'red-line' value calculated by on-board system
- 28 **Laser heat—not light—makes holograms**
RCA method produces optical read-only memories with potential for storing 300 million bits on a card
- 30 **'Listening' to metal for telltale signs of wear**
Cracks give off ultrasonic energy, labs report, and it can be detected by sensors and analyzed
- 32 **Quick-change simulator is easy to build**
- 38 **Technology Abroad**
- 41 **Washington Report**

TECHNOLOGY

- 54 **Pick the right op amp** to make your precision dc measurement. Many factors can complicate the decision when high performance is desired.
- 62 **Shift phase independent of frequency.** Nonminimum-phase networks exhibit constant phase difference and all-pass characteristics.
- 69 **Compare reliability at a glance.** Computer-generated, direct-reading curves show the effect of redundant units.
- 74 **Contraction puts the squeeze on managers.** This company president's greatest headache is maintaining pace and growth during the 'slump.'
- 78 **Ideas for Design**
- 88 **Product Source Directory:** Trimmer Potentiometers

PRODUCTS

- 99 **ICs & Semiconductors:** Low-cost transistors' performance is improved.
- 102 **Data Processing:** Flat two-layer card translates telephone pulses.
- 108 **Microwaves & Lasers:** A communications laser kit costs only \$150.
- 104 **Modules & Subassemblies** 112 **Tools & Engineering Aids**
- 106 **Instrumentation** 114 **Packaging & Materials**
- 110 **Components**

Departments

- 53 **Editorial:** Take time out to quiz engineers in Congress
- 13 **Designer's Calendar** 119 **Application Notes**
- 46 **Sidelights** 120 **New Literature**
- 116 **Evaluation Samples** 123 **Bulletin Board**
- 117 **Design Aids** 126 **Advertisers' Index**

Information Retrieval Service Card inside back cover

Cover: Designed by William Kelly, assistant art director

ELECTRONIC DESIGN is published biweekly by Hayden Publishing Company, Inc., 850 Third Avenue, New York, N.Y. 10022. James S. Mulholland, Jr., President. Printed at Brown Printing Co., Inc., Waseca, Minn. Controlled circulation postage paid at Waseca, Minn., and New York, N.Y. Copyright © 1970, Hayden Publishing Company, Inc. 82,501 copies this issue.

**National sells
MOS than Fairch
TI and Signetics**

**Guess which one
is selling shift
registers at
a penny a bit.**

more solid, Motorola, combined.

Who else?

National just came out with the MM5016, a bipolar compatible 512-bit dynamic shift register with a five dollar price tag (in quantities of 100). The MM5016 should interest designers of CRT refresh memories, radar delay lines or fast access drum memories. And engineers looking for a small and stable replacement for glass and magnetostrictive delay lines.

Now guess who's selling 600ns ROM's.

National again. We just introduced the MM5240, a bipolar compatible, 2560 bit character generator that offers you off-the-shelf standard fonts in addition to its blazing speed. We've priced the MM5240 at \$30.00 (in quantities of 100) and now await orders from people involved in character generation, random logic synthesis, micro-programming and table look-up.

What else?

Well, National recently introduced still another MOS, the MM5001. The MM5001 is

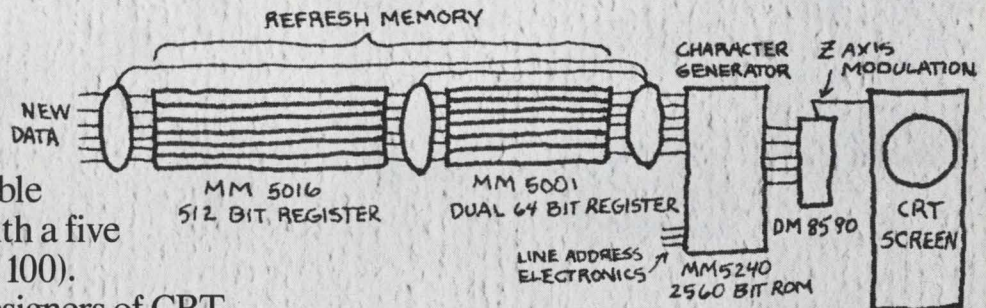

a dual, 64-bit dynamic shift register. Like the MM5016 and the MM5240, it's bipolar compatible. It costs just \$10.80 (in quantities of 100), and you'll find the MM5001 handy in a variety of data handling and computer type applications.

All three of National's new MOS products have application in CRT refresh memories. We've written an application brief to give you all the details. The brief awaits you now at your National distributor. So do the products. National Semiconductor Corporation, 2900 Semiconductor Drive, Santa Clara, California 95051/Phone (408) 732-5000, TWX (910) 339-9240.

National

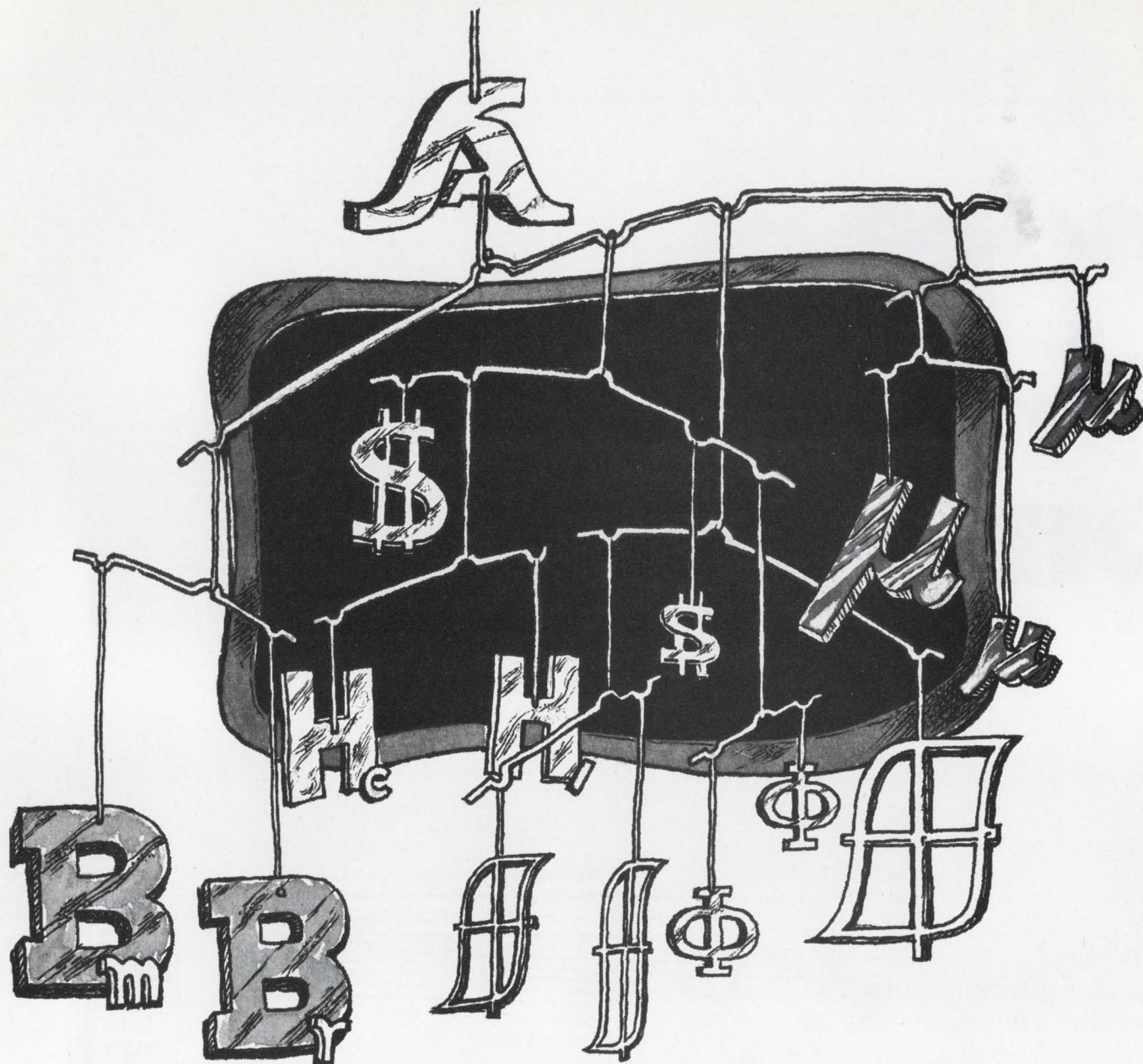

Customagnetics.

Made-to-order tape and bobbin wound cores. Consistent quality, too. Especially from Arnold.

You *can* get what you want in a tape or bobbin wound core. When you come to Arnold. We're specialists in matching the core to the customer. (And you can take advantage of Arnold's unique ability to cut tape-wound cores.)

Name your properties. High permeability at low magnetization. Or highest initial permeability. Or low hysteresis loss. Or a more rec-

tangular hysteresis curve. Or high flux density. And, of course, economy. We'll tailor cores to fill the bill.

Choose from cores of Deltamax, 4-79 Permalloy, Square Permalloy, Supermalloy, and ultra-high-induction Supermendur. In the broadest variety of case selections. Start by getting all the facts. Just call or write.

ARNOLD
SPECIALISTS IN MAGNETIC MATERIALS

The Arnold Engineering Co., Dept. F1, Marengo, Illinois 60152 • Member Company of Allegheny Ludlum Industries • Branch Offices and Representatives in Principal Cities

INFORMATION RETRIEVAL NUMBER 5

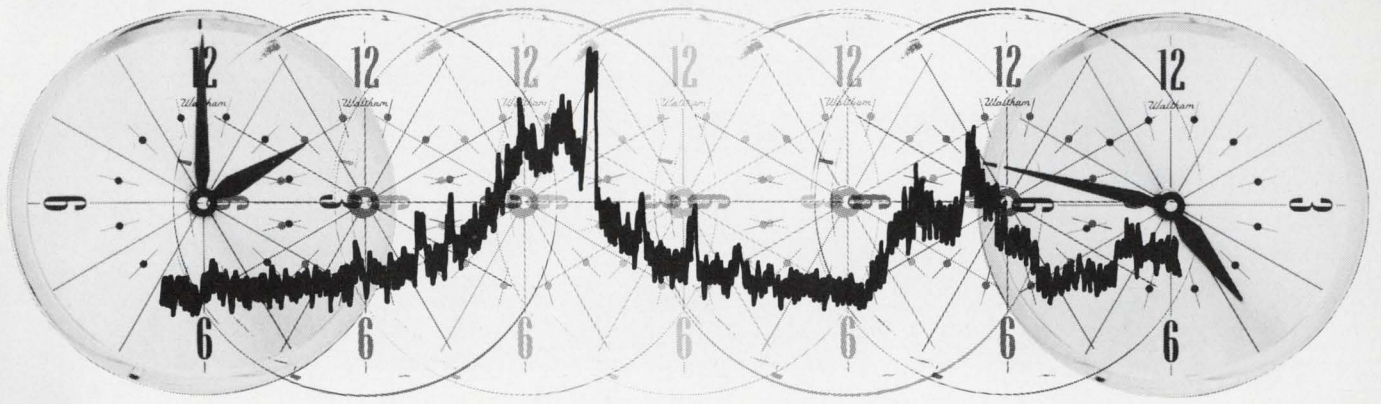

A wave analyzer with a 10,000-second sweep time? Why?

090/6

...because, in low-frequency spectrum analysis work, you need to use a narrow-bandwidth window. The narrower the window you use, the slower you must sweep it across the frequency range to be analyzed. And the slower you sweep, the smaller a frequency range you can cover in any given time. Thus, until now, your choice has been either accuracy or range but not both.

The new HP 3590A/3595A system solves that dilemma. The HP 3595A plug-in is a sweeping local oscillator

with 10,000 seconds of sweep time available. By using it with the HP 3590A Wave Analyzer mainframe, you can scan the entire three-decade audio frequency range at 2 Hz per second, in one sweep. And, by adding an HP X-Y recorder, you can see the results on a single 11 x 17-inch graph.

In addition to extended sweep time, the 3590A/3595A combination also gives you a choice of five sweep rates (from 1 Hz to 1,000 Hz per second) and four filter bandwidths (from 10 Hz to 3,100 Hz), an 85 dB dynamic range

over either of two frequency ranges (20 Hz to 62 kHz and 200 Hz to 620 kHz), 3 μ V to 30 V sensitivity, and built-in autoranging for ease of operation.

The result is a systems-analysis tool ideally suited for work in the lower frequency ranges, with the capability to work in higher frequency ranges as well!

The 3590A Wave Analyzer mainframe is \$3200; the new 3595A plug-in with the 10,000-second sweep time is \$1250. Other plug-ins available for the 3590A are: the 3592A slave and program unit, for use with a second mainframe, \$80; the 3593A with 3-digit mechanical display and 620-second maximum sweep time, \$1100; and the 3594A with 5-digit electronic counter frequency display and 620-second maximum sweep time, \$1600.

To get complete information on the HP 3590A and the various plug-ins, contact your local HP field engineer. Or, write to Hewlett-Packard, Palo Alto, California 94304. In Europe: 1217 Meyrin-Geneva, Switzerland.

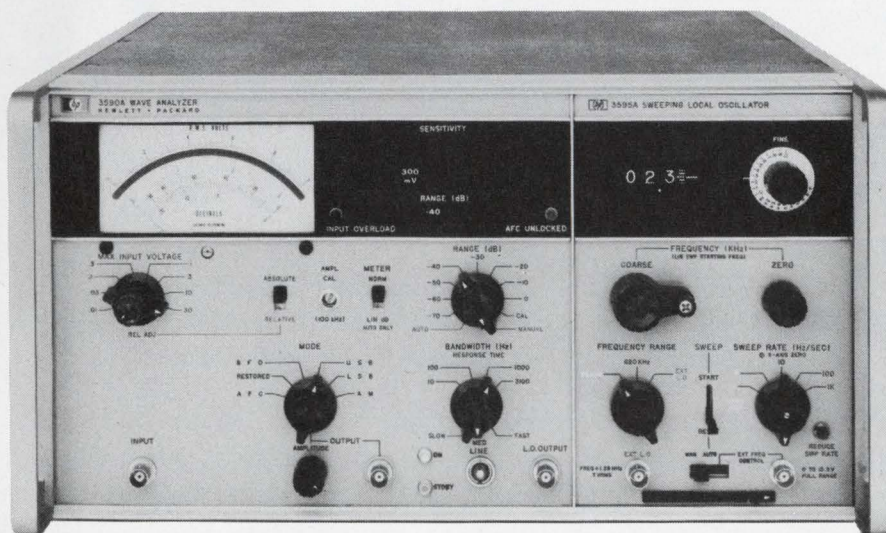

HEWLETT  **PACKARD**

SIGNAL ANALYZERS

INFORMATION RETRIEVAL NUMBER 6

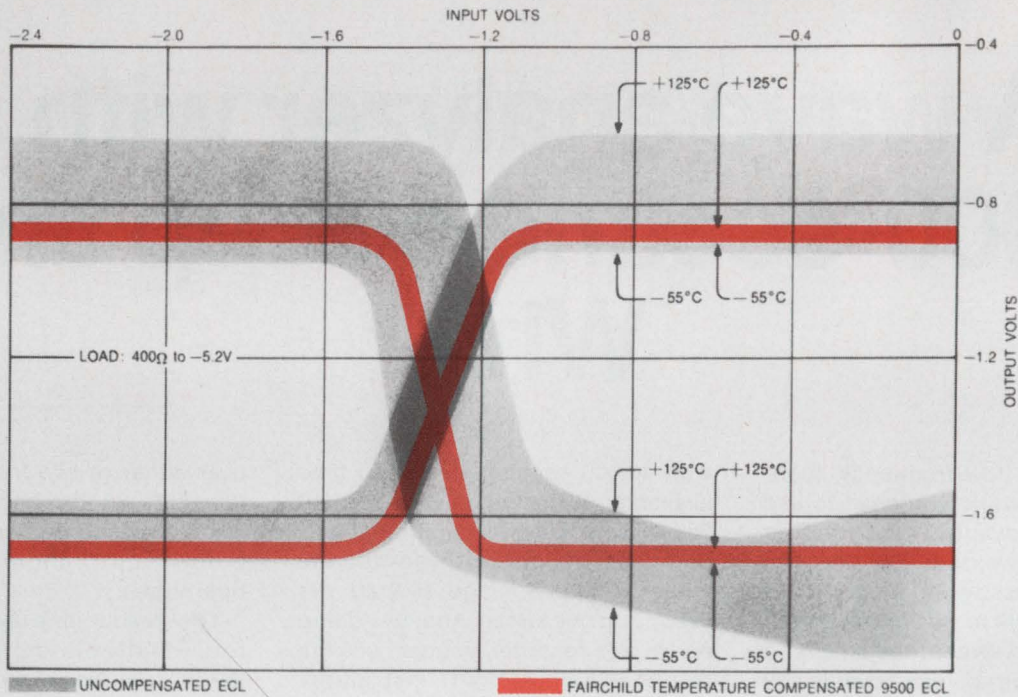

CHANGE IN ECL LOGIC LEVELS WITH TEMPERATURE

EASY TO USE:

Simplified wiring rules. Standard double-sided PC boards. Underterminated lines. Logic levels constant over temperature range.

HIGH SPEED:

2nS gate delay (even faster *system* speeds with MSI elements).

LOW COST:

Low unit cost for gates and MSI. Low design and manufacturing costs with conventional board assembly and wiring techniques.

Easy ECL.

New 9500 ECL Family.

The temperature compensation in our 2nS ECL makes it so nifty to use.

Until 9500 ECL, emitter coupled logic was the prima donna of the industry: a dazzling performer, but so temperamental to work with. As one of the major ECL manufacturers pointed out, "ECL requires a higher degree of sophistication—in printed-circuit board design, thermal/mechanical design, and in designing to minimize noise. But," he concludes on a melancholy note, "the main problem is in getting people to accept this." The fact is, with the advent of the 9500, people don't *have* to accept these trade-offs any longer.

It's the temperature compensation in our new 9500 ECL that makes it the first low-cost non-saturating high-speed digital IC family that's *easy to use*.

Elaborate system cooling designs are unnecessary because a unique on-chip temperature compensation network maintains logic levels constant over the temperature range. This, in turn, means that noise margins remain constant with temperature. Constant logic levels also reduce the danger, common in other ECLs, that additional time delays may be introduced by driving input transistors into saturation. And finally MSI functions, such as the 9581,

become easy to use, thus reducing system complexity and cost.

Layouts are simplified and PC board manufacturing costs reduced because 9500 can drive up to 8 inches of unterminated line using on-chip input and output pull-down resistors. Standard double-sided PC boards can be used.

In addition, the circuits are stable because these internal resistors maintain the real part of the input impedance positive across the operational frequency range.

If desired, 9500 can drive 50 ohm lines up to 10 feet long.

These 9500 ECL devices — 16-pin, hermetically-sealed, ceramic DIP, 0° to 75°C—are now available from your friendly Fairchild distributor (others to follow shortly):

	1-24	25-99	100-999
9502 Dual 4 I/P OR/NOR Gate	2.95	2.35	2.05
9503 Triple 2 I/P OR/NOR Gate	3.10	2.50	2.15
9504 Quad 2 I/P NOR Gate	3.25	2.60	2.30
9528 Dual D Flip-Flop	9.75	7.80	7.05
9581 One of Eight Multiplexer	24.50	19.50	17.50

Send for data sheets and applications information on the new 9500 Easy ECL Family.

FAIRCHILD
SEMICONDUCTOR

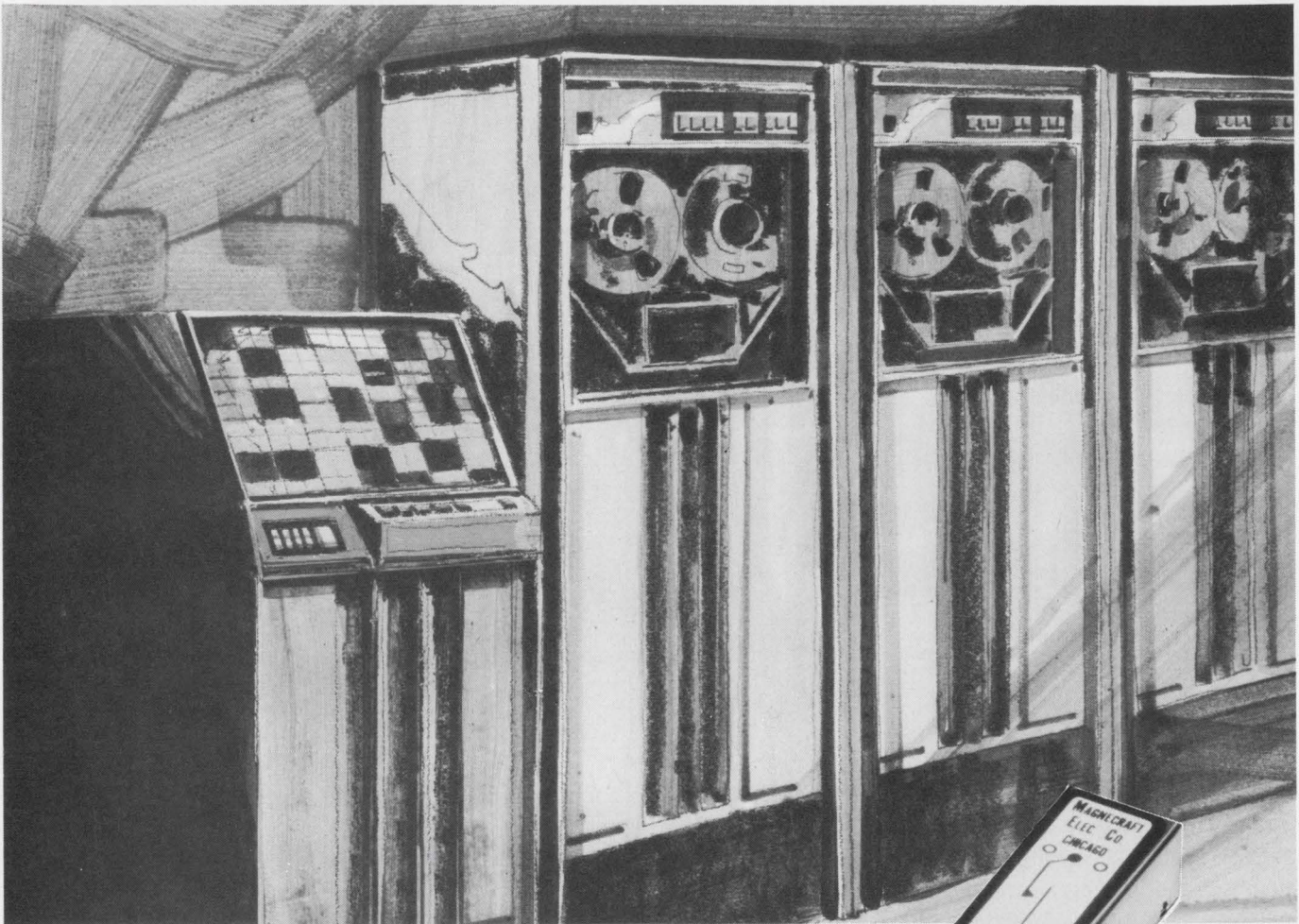

NEW! IC COMPATIBLE REED RELAYS

***Let Magnecraft relays work, while
your integrated circuits think...***

Our new IC compatible reed relays offer total isolation of the integrated circuit. These relays are capable of switching higher voltages, for example a neon lamp readout, while operating at the low input voltage of the IC, 2.5 volts or 5.0 volts.

Best of all, Magnecraft stocks the IC compatible reed relays for immediate delivery. They're priced right, too—as low as \$1.54 in 1000 quantities and even lower for larger quantities.

Contacts are rated 10 VA at 0.5 amp max. or 100 VDC max. resistive load with a configuration of SPST-NO (1 form A), and 3 VA at 0.25 amp or 28 VDC max. resistive load with a configuration of SPDT (1 form C). Two package designs for mounting are available: in-line axial leads; and low profile printed circuit type.

For all the facts on the new IC relays and Magnecraft's 512 other in-stock relays, send for our new Stock Catalog No. 271.

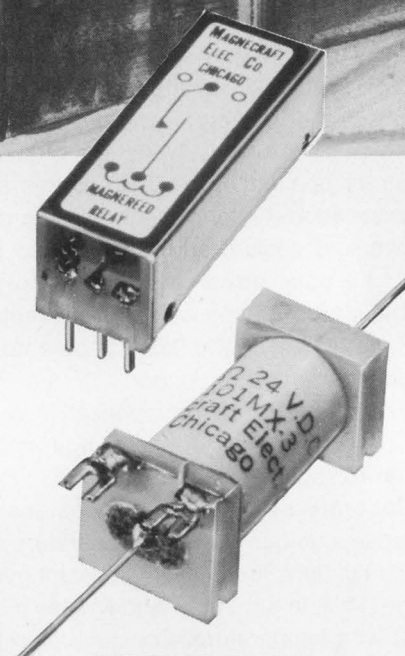

See our product data in EEM

Magnecraft[®] ELECTRIC CO.

5575 NORTH LYNCH AVENUE • CHICAGO, ILLINOIS 60630 • 312 282-5500

See us in Booth #6122 at Production Engineering Show.

INFORMATION RETRIEVAL NUMBER 8

INFORMATION RETRIEVAL NUMBER 9 ►



the DART

DIGITAL AUTO-RANGING TESTER

\$795

- 4 Ranges – DC Volts
- 4 Ranges – AC Volts
- 5 Ranges – Ohms
- Ratio Capability
- Automatic Range and Polarity
- Printout Option
- Battery Option

RIGHT ON TARGET is the latest addition to the growing line of high quality, low cost, digital meters from NLS. Continuing the tradition of, "the finest instruments available at sensible prices," Non-Linear Systems is proud to announce the availability of the *NEW, LOW-COST SERIES LX-2 AUTO-RANGING MULTIFUNCTION DIGITAL VOLTMETER*. This superior instrument, born of engineering and manufacturing know-how, is sure to please the eye and the budget of the discerning instrument buyer. See it soon!



NON-LINEAR SYSTEMS, INC.
DEL MAR, CALIFORNIA

4 Turns for \$1.46

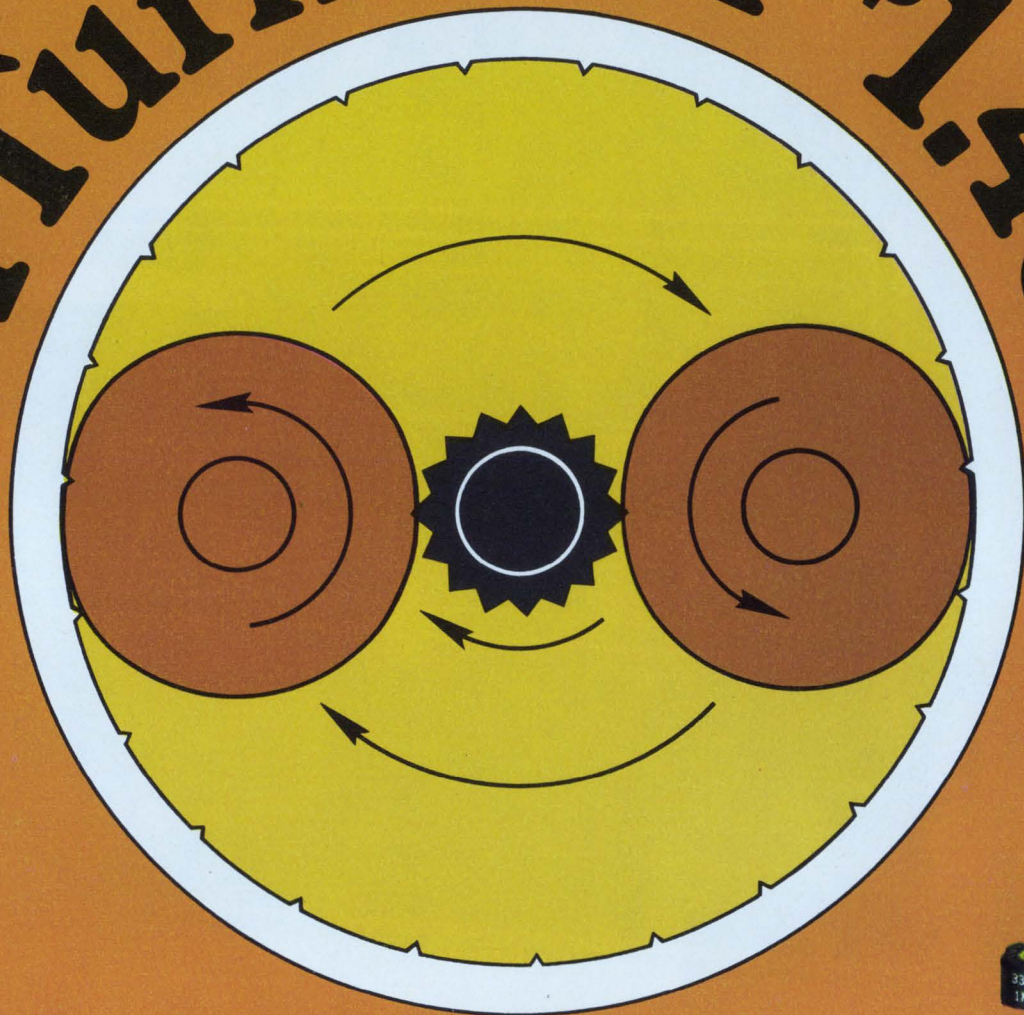

• MODEL
3339



ACTUAL
SIZE

Meet a model of setability...

the smallest low-price multi-turn potentiometer on the market.

You can be four times as sure of balancing critical circuitry with this new cermet trimmer, Model 3339. Why? An ingenious drive mechanism (patent pending) gives you four mechanical turns to traverse the element.

And that element! Cermet provides the temperature coefficient (± 100 ppm/ $^{\circ}\text{C}$) and total resistance stability you need for temperature extremes (-55° to $+150^{\circ}\text{C}$ if need be). Choose your resistance—10 to 2,000,000 ohms. Count on quality. Model 3339 has a thermo-setting plastic housing, sealed for extra protection. And, the wiper assem-

bly idles at both ends, eliminating possibility of damage to end stops.

All for only \$1.46 in 1,000-piece quantity.

Call or write your nearest Bourns sales office for more data on this new multi-turn in single-turn package size (.30" dia. x .25" high). Also available in a side adjust model.

In stock at Bourns distributors nationwide.



Designer's Calendar

SEPTEMBER 1970

S	M	T	W	T	F	S
		1	2	3	4	5
6	7	8	9	10	11	12
13	14	15	16	17	18	19
20	21	22	23	24	25	26
27	28	29	30			

For further information on meetings, use Information Retrieval Card.

Sept. 21-24

International Conference on Engineering in the Ocean Environment (Panama City, Fla.). Sponsor: IEEE. Lewis Winner, 152 W. 42nd St., New York, N. Y. 10036.

CIRCLE NO. 403

Sept. 23-24

Electron Device Techniques Conference (New York City). Sponsor: IEEE. Mayden Gallagher, Hughes Res. Labs., 3011 Malibu Canyon Rd., Malibu, Calif. 90265.

CIRCLE NO. 404

OCTOBER 1970

S	M	T	W	T	F	S
				1	2	3
4	5	6	7	8	9	10
11	12	13	14	15	16	17
18	19	20	21	22	23	24
25	26	27	28	29	30	31

Oct. 7-9

Allerton Conference on Circuit & Systems Theory (Monticello, Ill.) Sponsors: IEEE, Univ. of Illinois. G. Metzger, Univ. of Illinois, Urbana, Ill. 61801.

CIRCLE NO. 405

Oct. 13-15

International Telemetering Conference (Los Angeles). Sponsors: International Foundation for Telemetering, et al. J. Wayne Matthews, c/o Electronic Resources, 4561 Colorado Blvd., Los Angeles, Calif. 90030.

CIRCLE NO. 406

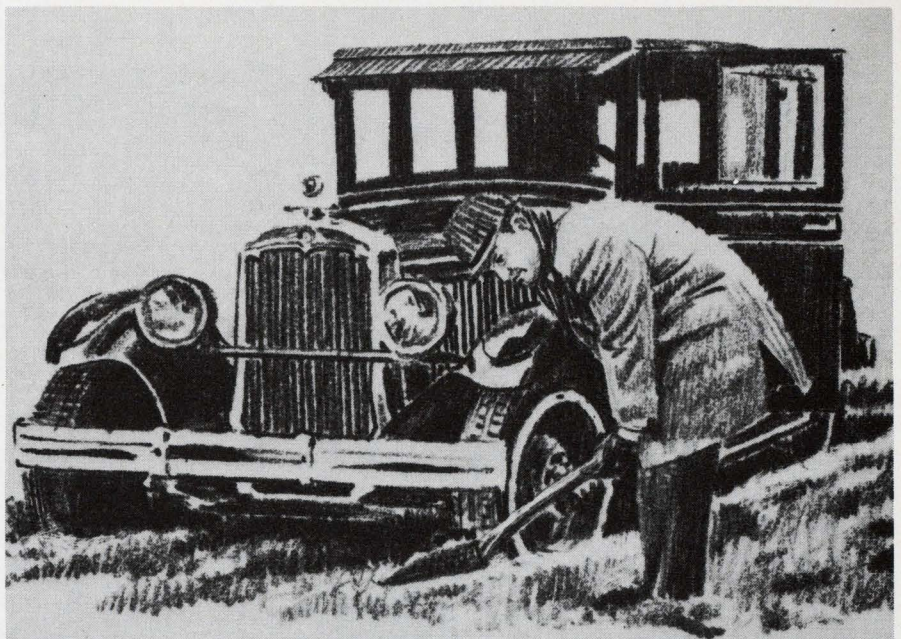

Slot supplies have you in a rut? GET OUT OF IT!

Replace obsolete, narrow-range slot supplies with POWER/MATE CORP.'s UniPower Series. These nine all-purpose, wide voltage range power supplies can replace thousands of narrow-range slot supplies and give you these big advantages: current output up to 34 amps • adjustable to any range from 0-34 volts • regulation to 0.005% • ripple a low 250 microvolts. The wide voltage range of the UniPower Series simplifies your power supply requirements because you can stock fewer units. In addition, these modules can be mounted in standard size racks or on any of three surfaces and in any position!



UNI-30F

The UniPower Series of Nine

- Uni-76 — 0-34 volts, 0.5 amps — \$76.00
- Uni-88 — 0-34 volts, 1.5 amps — \$99.00
- Uni-30C — 0-30 volts, up to 5 amps — \$134.00
- Uni-30D — 0-30 volts, up to 8 amps — \$151.00
- Uni-30E — 0-30 volts, up to 12 amps — \$174.00
- Uni-30F — 0-30 volts, up to 18 amps — \$205.00
- Uni-30G — 0-30 volts, up to 24 amps — \$265.00
- Uni-30H — 0-30 volts, up to 34 amps — \$315.00
- UniTwin-164 — dual output 0-25 volts, 0.75 amps — \$164.00

OUTPUT VOLTAGE vs. OUTPUT CURRENT FOR VARI-RATED UNI SERIES

VOLTAGE MODEL	0-6V	8	10	12	14	15	16	18	20	22	24	26	28	30
UNI-76	0.05 amp throughout range													
UNI-88	1.5 amps throughout range													
UNI-30C	5.0	4.6	4.4	4.2	4.1	4.0	3.8	3.6	3.4	3.2	3.0	2.8	2.6	2.5
UNI-30D	8.0	7.6	7.3	6.9	6.6	6.4	6.2	6.0	5.7	5.3	5.0	4.7	4.4	4.0
UNI-30E	12.0	11.2	10.8	10.3	9.8	9.5	9.2	8.8	8.3	7.9	7.4	6.9	6.4	6.0
UNI-30F	18.0	16.9	16.2	15.5	14.8	14.4	14.0	13.3	12.6	11.9	11.2	10.5	9.8	9.0
UNI-30G	24.0	22.5	21.6	20.6	19.6	19.1	18.6	17.7	16.7	15.8	14.8	13.8	12.9	12.0
UNI-30H	34.0	31.9	30.5	29.2	27.8	27.1	26.4	25.0	23.7	22.4	21.0	19.7	18.3	17.0

SPECIFICATIONS: Regulation — up to $\pm 0.005\%$ or 1 MV for line and load; Ripple — Less than 250 microvolts; Response Time — Less than 20 microseconds; Overload and Short Circuit Protection — Solid state. Instantaneous recovery, and automatic reset. Cannot be damaged by prolonged short circuit or overload. Internal or External Adjustable OVP Available.

FREE: Send for complete catalog. Write to:



POWER/MATE CORPORATION
514 S. RIVER ST., HACKENSACK, NEW JERSEY 07601
PHONE: (201) 343-6294 TWX: (710) 990-5023

Fight noise pollution

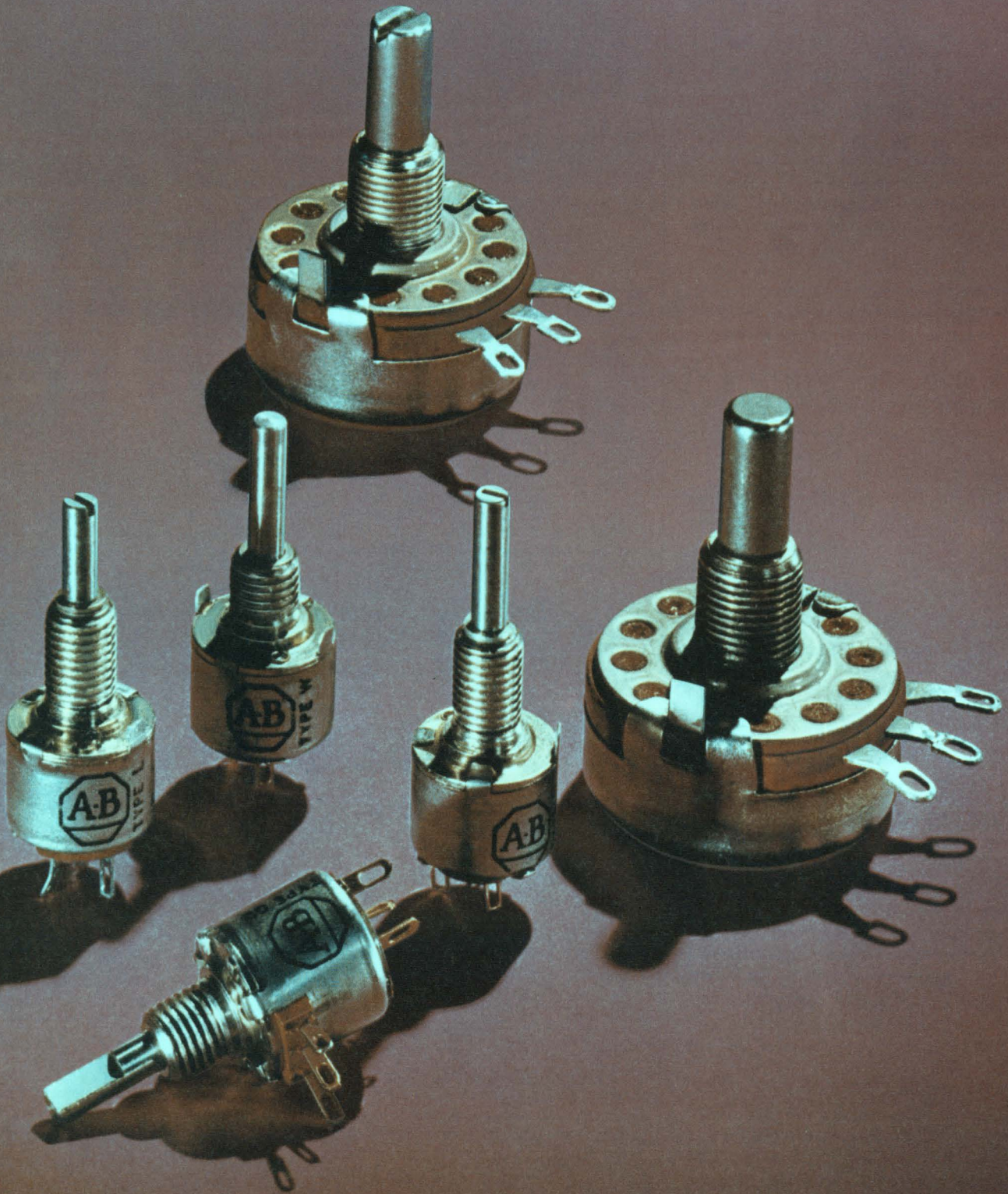

with this quiet family.

Hot Molding with Allen-Bradley's exclusive technique, gives these composition variable resistors an unusually low noise level. And importantly, this low noise level actually decreases in use. Under tremendous heat and pressure the resistance track is molded into place. A solid element with a large cross-section is produced.

This important Allen-Bradley difference means better short-time overload capacity and a long operating life. Control is smooth, resolution almost infinite. These variable resistors are ideal for high frequency circuits. Why should you trust the performance of

your designs or your reputation to anything less than Allen-Bradley quality? Use the most thoroughly "field tested" (over 20 years) variable resistors available today. Quantity stocks of popular types J, G, W and GD available for immediate delivery from your appointed A-B industrial electronics distributor.

For information write: Marketing Department, Electronics Division, Allen-Bradley Co., 1201 South Second Street, Milwaukee, Wisconsin 53204. Export office: 1293 Broad Street, Bloomfield, N. J. 07003, U.S.A. In Canada: Allen-Bradley, Canada Ltd., 135 Dundas Street, Galt, Ontario.

SPECIFICATIONS

	TYPE J— STYLE RV4	TYPE K	TYPE G— STYLE RV6	TYPE L	TYPE W	TYPE GD
CASE DIMENSIONS	5/8" deep x 1-5/32" dia. (single section)	5/8" deep x 1-5/32" dia. (single section)	15/32" deep x 1/2" dia.	15/32" deep x 1/2" dia.	15/32" deep x 1/2" dia.	35/64" deep x 1/2" dia.
POWER at + 70°C	2.25 W	3 W	0.5 W	0.8 W	0.5 W	0.5 W
TEMPERATURE RANGE	-55°C to +120°C	-55°C to +150°C	-55°C to +120°C	-55°C to +150°C	-55°C to +120°C	-55°C to +120°C
RESISTANCE RANGE (Tolerances: ±10 and 20%)	50 ohms to 5.0 megs	50 ohms to 5.0 megs	100 ohms to 5.0 megs	100 ohms to 5.0 megs	100 ohms to 5.0 megs	100 ohms to 5.0 megs
TAPERS Linear (U), Modified Linear (S), Clockwise Modified Log (A), Counter-Clockwise Modified Log (B), Clockwise Exact Log (DB). (Special tapers available from factory)						
FEATURES (Many electrical and mechanical options available from factory)	Single, dual, and triple versions available. Long rotational life. Ideal for attenuator applications. Snap switches can be attached to single and dual.	Single, dual, and triple versions available. Long rotational life.	Miniature size. Immersion-proof. SPST switch can be attached.	Miniature size. Immersion-proof.	Commercial version of type G. Immersion-proof.	DUAL section version of type G. Ideal for attenuator applications. Immersion-proof.

ALLEN-BRADLEY

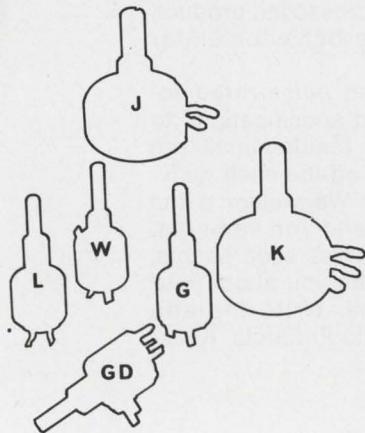

INFORMATION RETRIEVAL NUMBER 12

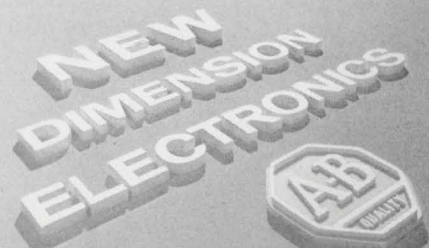



All toroids look alike.

Our PULSE-RATEDTM toroids really are alike.

We developed the concept of *pulse rated* toroids to eliminate tedious selection problems. Now we've developed new materials. Fully proven. Component tested. So you get guaranteed performance over a temperature range of 0° to 60° C.

Pulse-rated toroids not only simplify your selection process, they practically eliminate scrap. So you get 100% yield in your pulse transformer production.

Specifications provided for every *pulse-rated* toroid include pulse in-

ductance, volt-microsecond product, and temperature behavior under pulse conditions.

Parylene-coated *pulse-rated* toroids in sizes and specifications to suit your design requirements are now available for off-the-shelf delivery. Want some? We welcome the opportunity to send you samples. And hot-off-the-press spec sheets. And to consult with you about your design problems. Write Indiana General, Electronic Products, Keasbey, N. J. 08832.

indiana general 

a division of Electronic Memories & Magnetics Corporation

INFORMATION RETRIEVAL NUMBER 13

INFORMATION RETRIEVAL NUMBER 14 ►

We've got the dope on 26 companies at Spring Joint.



Twenty-six companies were in on it. They didn't breathe a word.

You wouldn't either, if you had something special going for you to give you lower development costs, quicker start-up, and more competitive pricing.

We won't tell you who these companies were.

But we will tell you their secret.

Every one of them utilized advanced, off-the-shelf MOS circuits from the same source—Electronic Arrays.

Fifteen of these 26 companies were less than three years old, which points out that EA's broad line of off-the-shelf MOS registers, ROMs, Read/Write RAMs and logic arrays are especially suited to companies needing low-cost product development and sure-fire delivery.

Now that we have your ear, we'd like to keep you clued in. Whisper the password—MOS—to your EA distributor or representative. Or write directly to the source: Electronic Arrays, Inc., 501 Ellis Street, Mountain View, Calif. 94040. (415) 964-4321.



**electronic
arrays, inc.**

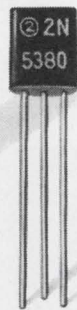
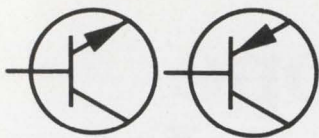

GOOD NUMBERS TO KNOW: 2N5381 2N5383

REPLACE OLD 2N3904 and 2N3906 PLASTIC TRANSISTORS AND GAIN 3 WAYS. 360 mW P_D vs 310. T_j (max) = 150°C vs 135. TO-18 PINNING.

These two new Sprague plastic transistors give you 20% more power dissipation, 15° C higher junction temperature, and industry standard TO-18 pinning when used as direct electrically interchangeable replacements for 2N3904 and 2N3906.

The 2N5381 and 2N5383 are two of twenty new TO-18 pinned plastic transistors from Sprague. Check the replacement chart, then make your move. Sprague industrial distributors have stock. The sales offices listed below can supply samples. Call them now. Or get complete specifications by writing Technical Literature Service, Sprague Electric Company, 347

OLD NUMBERS	NEW SPRAGUE TYPES	OLD NUMBERS	NEW SPRAGUE TYPES
2N3903	2N5380	MPS6514	TPS6514
2N3904	2N5381	MPS6515	TPS6515
2N3905	2N5382	MPS6516	TPS6516
2N3906	2N5383	MPS6517	TPS6517
2N4123	TP4123	MPS6518	TPS6518
2N4124	TP4124	MPS6519	TPS6519
2N4125	TP4125	MPS6520	TPS6520
2N4126	TP4126	MPS6521	TPS6521
MPS6512	TPS6512	MPS6522	TPS6522
MPS6513	TPS6513	MPS6523	TPS6523

Marshall Street, North Adams, Mass. 01247, or use the reader service number below.

SPRAGUE ELECTRIC CO., SEMICONDUCTOR DIV., CONCORD, N.H. 03301 (603) 224-1961

ALA. Huntsville, no charge call operator, WX4000 ARIZ. Phoenix (602) 279-5435 CALIF. Burlingame (415) 347-7701 Los Angeles, Bell Tel., (213) 870-0161, Gen. Tel., (213) 391-0611 San Diego (714) 278-7640 COLO. Denver (303) 756-3611 CONN. Trumbull (203) 261-2551 DC. Washington (202) 244-6006 FLA. Orlando (305) 831-3636 ILL. Schiller Park (312) 678-2262 IND. Indianapolis (317) 253-4247 MASS. Newton (617) 969-2520 North Adams (413) 664-4411 MICH. Jackson (517) 787-3934 MINN. Minneapolis (612) 335-7734 MO. St. Ann (314) 291-2500 N.J. Cherry Hill (609) 667-4444/(215) 467-5252 Wayne (201) 696-8200 N.M. Albuquerque (505) 265-1579 N.Y. Melville (516) 549-4141 Syracuse (315) 437-7311 N.C. Winston-Salem (919) 722-5151 OHIO Chagrin Falls (216) 247-6488 Dayton (513) 223-9187 Cincinnati, no charge call operator, Enterprise 3-8805 TEX. Richardson (214) 235-1256 WASH. Seattle (206) 632-7761.



155-0133

INFORMATION RETRIEVAL NUMBER 15

ELECTRONIC DESIGN 18, September 1, 1970

Highlighting

THE ISSUE

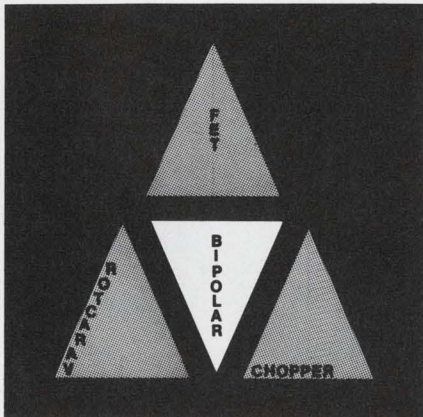

To measure a dc voltage to within 0.1% when it's across a fairly low impedance is no great feat. The cheapest reasonable monolithic IC operational amplifier can do the job. But when an accuracy of 0.001% is needed and the source impedance is on the order of hundreds of kilohms, some very interesting and subtle problems can arise.

To make the optimum choice of an amplifier for a given precision measurement, the drift characteristics of the various types of op amps should be considered, along with the nature of the source. Only when both factors are taken into account can a wise decision be made.

Page 54



If test results justify it, present incandescent lights in Air Force jet cockpits will give way to EL phosphor panel displays.

An EL lamp consists of a light-emitting phosphor sandwiched between two electrodes. The green EL light—emitted when the proper voltage is placed across the electrodes—is filtered to make it white.

Page 25

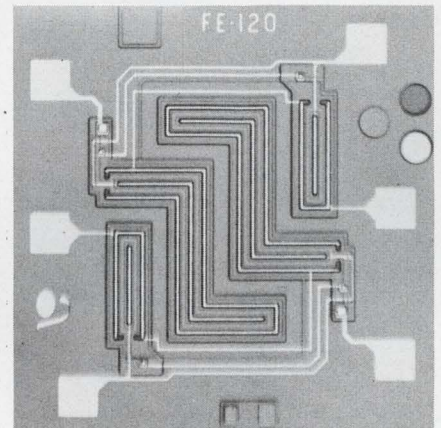

Consisting of npn and pnp bipolar and field-effect types, two new series of monolithic dual transistors offer superior temperature tracking and high current gain at low costs.

One series of bipolar dual transistors exhibits typical tracking (base-voltage differential drift) of $3 \mu\text{V}/^\circ\text{C}$ and a typical base-voltage differential of 2 mV.

Another series of dual FETs exhibits tracking of $1 \mu\text{V}/^\circ\text{C}$ over the temperature range of -55 to $+125^\circ\text{C}$, a gate-to-source breakdown voltage of 30 V, source transconductance of $2 \mu\text{mhos}$ and gate-to-gate breakdown voltage of over 60 V.

Page 99

234816968+70

5 8 1 6

INTRODUCING PANAPLEX™ NUMERIC DISPLAY

UNITIZED, 9 to 16 DIGIT NUMERIC PANEL DISPLAY

LOWEST COST-PER-DIGIT READOUT AVAILABLE

Burroughs' PANAPLEX panel display is a totally new, state-of-the-art advance in numeric readouts. It requires less than two connecting terminals per digit. One-piece, common-segment construction assures digit alignment — makes possible significantly improved resistance to shock and vibration. In-plane character display provides 150° viewing angle. Unitized packaging reduces display length by 25% with no reduction in digit size. Input

power required is less than for any competitive readout panel and the display has superior brightness characteristics. What's more, reliability of PANAPLEX numeric panel display is comparable to that of Burroughs' NIXIE® tubes.

For additional information write: The Burroughs Corporation, Electronic Components Division, P. O. Box 1226, Plainfield, New Jersey 07061.



Only Burroughs manufactures NIXIE® tubes, SELF-SCAN™ panel displays and PANAPLEX™ numeric panel displays.

Burroughs

Microwave scanning may replace vhf landing systems



WASHINGTON, D.C. — Elimination of the present problem-ridden vhf instrument landing systems and ultimate replacement with C and Ku-band microwave scanning-beam systems is the aim of a new Government committee: the Microwave Landing System National Planning Group. Headed by Alexander B. Winick, chief of the navigation division of the Federal Aviation Administration's research and development service, the committee includes members from the Departments of Transportation and Defense and the National Aeronautics and Space Administration.

Committee objectives, according to Winick, are the development, test, and acceptance of a new microwave system—as yet undefined—that will be compatible with both civil and military aircraft requirements.

The prime reason for substituting a microwave system for the present landing system is to eliminate false, off-course signals generated by reflections from buildings and structures on the airport,

and from planes flying overhead.

The microwave system is also superior in that interference between two or more of them is minimal. The systems as projected could be placed as close as 750 feet from each other, permitting simultaneous landings on parallel runways.

The only real problem at the higher frequencies is attenuation from heavy rain, but FAA officials say that this can be solved by using the C-band as the primary-system frequency with guidance in both azimuth and elevation. For landing in zero-visibility weather, short-range Ku-band equipment would provide precise guidance in elevation, down to flare-out, touchdown and rollout. Signals from the scanning system would be fed to the autopilot system, as with today's method of operation.

Research and development on both C-band and Ku-band systems is planned over the next five years at a cost of about \$27 million. Current cost goal for the complete system is about \$500,000.

Using a computer, researchers estimated the reverberation of the acoustic system originally used to record the voice. Then recorded sound waves of Caruso's voice were digitized and fed into the computer, which reprocessed them to remove the reverberations.

The restored voice was then re-recorded. The results sound like a much younger Caruso, who is much nearer the listener than in the original recording and sings with a much wider dynamic range.

Dr. Thomas Stockham Jr., associate professor of engineering who spearheaded the work, points out that although the digitally "restored" voice sounds far more natural than the original recording, the process does not replace high frequencies that were not picked up in the first place. He plans therefore to improve the sound still more by extrapolating the missing frequencies from the known "signature" of Caruso's voice.

Dr. Stockham speculates that recording companies may someday use computer programs to retrieve the true sounds of recordings that contain unwanted reverberations—such as voice recordings in large convention halls where engineers cannot control the acoustics.

2 conferences to explore environmental problems

Growing interest in the use of electronics to solve environmental problems is reflected in two conferences planned this fall: the IEEE International Conference on Engineering in the Ocean Environment, Sept. 21-24 in Panama City, Fla., and the 25th National Conference of the Association for Computing Machinery, Sept. 1-3 in New York City.

The IEEE meeting features several sessions on "Monitoring Techniques in Coastal Waste Management." The panels were organized by Dr. Russell Keim, executive secretary of the Committee on Ocean Engineering in the National Academy of Engineering, Washington, D. C.

"This area," says Dr. Keim, "has long been the province of civil, mechanical and chemical engineers

Computer helps restore Caruso's fuzzy voice

The voice of Enrico Caruso has been successfully separated from the vibrations of early recording

equipment by a signal processing technique developed at the University of Utah, Salt Lake City.

who developed systems for measuring physical, chemical and biological aspects of ocean wastes and ocean environment."

Now, he adds, there is a pressing need for electronic engineers to join in designing measuring systems at reasonable cost.

A massive problem, Dr. Keim points out, is the tremendous amount of data gathered that must be monitored and evaluated.

In agreement with Dr. Keim is Thomas L. Brewer, organizer of earth-resources sessions at the computing machinery conference.

Brewer says: "The amount of real-time data that must be generated in the operation of an earth-resources management system defies the imagination. And this is where the computer industry faces a major challenge."

The sessions organized by Brewer, who is manager of systems engineering, Re-entry and Environmental System Div., General Electric, will present the system requirements for the exploration and management of earth resources and environmental control.

British computer gets the sack

In Birmingham it was pay checks that came out wrong too often that caused 4000 workers to strike unless the computer was fired. The factory promised a return to a manual payroll "as soon as possible."

Seems the electronic age is on the spot in the old country.

Artery disease study to use doppler method

With a new ultrasonic pulsed-doppler instrument developed at the University of Washington, researchers hope to detect the first signs of deterioration in the artery walls due to atherosclerosis and to monitor the course of the disease.

Operating on the same principle as radar, the instrument emits ultrasonic pulses into the body, and,

from the doppler shift in reflected pulses, determines the velocity of the blood particles. When atherosclerosis attacks the cardio-vascular system, calcium forms in the artery linings. This makes the passage narrower and causes the blood to flow faster at the center of the artery. The instrument pinpoints the damaged areas by plotting blood flow vs. artery diameter.

According to Dr. Curtis Johnson, assistant director of the Center for Bioengineering at the university, even a slight deterioration of the artery walls alters the velocity profile. Thus it will be possible, he says, to study the development of atherosclerosis and to evaluate the effect of treatment. This has never been possible before.

The instrument will be manufactured by Parks Electronics, Beaverton, Ore. A similar device is under study at Guy's Hospital in London, England.

New system fights credit-card fraud

A new weapon against credit-card fraud instantly checks whether a card is valid, lost, stolen or canceled. The computer terminal that does the job reads both standard credit cards or new magnetically coded ones. It is being tested at a number of locations selected by the American Express Company.

Developed by Penril Data Communications, Inc., Rockville, Md., for American Express, the new terminal is linked—via a national telephone network—to a newly developed credit authorization and financial data system using twin IBM 360 computers at American Express headquarters in New York City. The system remembers details on over three million credit card-member accounts.

The new terminal accommodates up to six different charge-card plans. Inserting the card in a tray and pushing a button automatically dials the computer and gives the identification number of the creditor (hotel, airline, etc.).

With the magnetically encoded cards, the user simply enters the amount of the purchase on the keyboard and presses a key. The ter-

terminal then reads and verifies the account number and transmits this to the central computer.

On an approved transaction, it then imprints on a record-of-charge form the card member name, account number, service-establishment identification, and the dollar amount and approval code. If the charge is denied, the terminal ejects both the card and the form without printing.

Cannons accelerate high-shock tests

The latest example of turning swords into plowshares is the use of artillery to perform high-shock testing by Sandia Laboratories, Albuquerque, N. M.

The advantage of the technique is the ease of accelerating a shell containing electronic test components to 16,500g. In addition, if the field piece is rifled, angular spin velocities of 240 rps can also be obtained.

Sandia's location in the desert southwest has one big advantage: there is no nearby population to complain of the noise. Other problems, such as recovering the test vehicle (shell) without allowing deceleration to obscure the effects of acceleration, and obtaining telemetering from the inside of the cannon barrel were solved by thoughtful design: Firing the shell at 85 degrees and then lowering it to the ground by parachute solved the first problem. The latter was solved by loosely attaching a wire to the nose of the shell. This furnished a link to the telemetry receiver.

Sandia spokesmen disclaim any originality in the idea. "After all," they said, "Jules Verne used a cannon to launch his spaceship to the moon in 1865."

IEEE seeks panelists on computer testing

A new IEEE subcommittee on computer logic testing is being set up. Interested? If you can "contribute to and stimulate development" of the group, the IEEE requests that you write to P. J. Scola, LSD-C-78, General Electric Co., 13430 North Black Canyon Highway, Phoenix, Ariz. 85029.

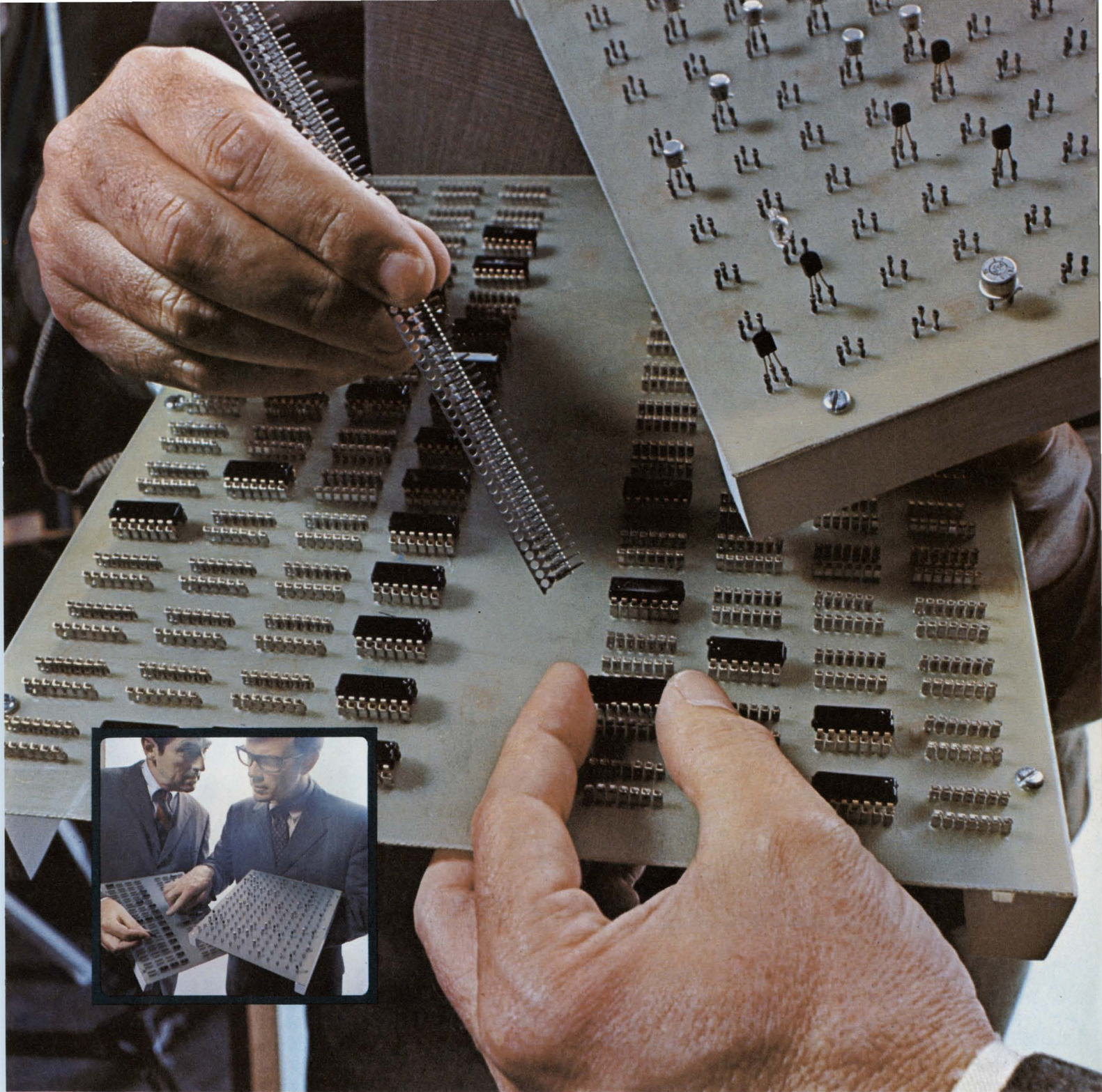

HERE'S A NEW AND BETTER WAY: To make printed circuit board connections. Reliably. At low, low cost. They're Molex Soldercon[®] terminals. Integrated circuit and transistor terminals. Offering the convenience of plug-in I.C.'s and transistors *without* the cost of insulators. They fit directly on the board. And there is equipment available to do the job *automatically*. Fast! Soldercon terminals save time. Money. Speed installation. Make

testing easier, too. And simplify service problems. It's another example of Molex ingenuity . . . in creating components that simplify circuitry. Molex has the know-how and facilities to provide the interconnecting system you need. You can make connections by calling (312) 969-4550. Or write . . . Molex Incorporated, Downers Grove, Illinois 60515.

*... creating components that
simplify circuitry*



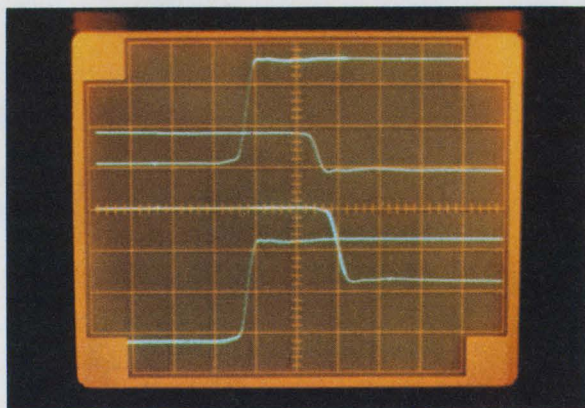
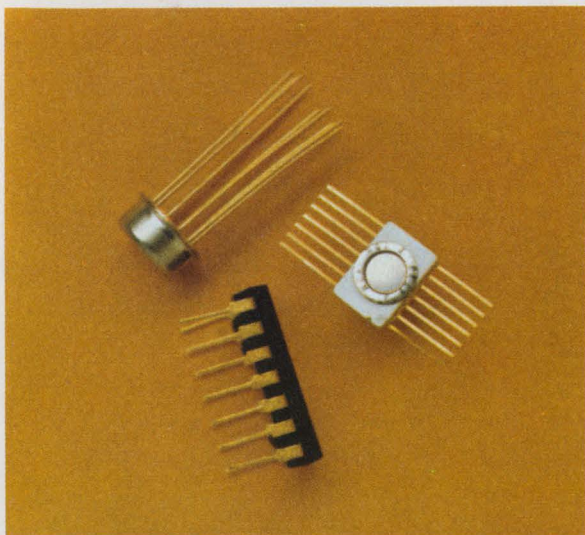

E-H the simple solution

If you want to simplify your testing operations to the point where a relatively untrained technician can make sophisticated tests with complete confidence and accuracy, E-H Research Laboratories, Inc., and its subsidiary, Automated Measurements Corporation, offer the simple solution.

First, take a look at the **AMC Model 1100 Digital Readout Oscilloscope**. It's the only four-channel, four-trace digital readout oscilloscope on the market. It was developed for the most versatile laboratory and benchtop applications, using remote sampling units to give you greater freedom in your testing operations. It has the capability for simultaneous viewing of four waveforms. And the digital display can show time accuracy to 1% f.s. and voltage accuracy to 1% f.s.

The ideal driver for the AMC Model 1100 is the **E-H 135 Pulse Generator**. It's fondly called the Universal Pulser because of its great versatility and capability of handling just about any pulser requirement you might have today and for some time to come. The E-H 135 is the only 50 MHz pulser available that has unattenuated baseline offset to $\pm 5V$ into 50 ohms. It also features rise and fall times of from 3 ns to greater than 8 ms.

The two instruments mentioned above are just a sample of a complete line of E-H and AMC equipment available. So no matter how complex your testing problems are, get to the simple solution fast. Contact your E-H representative today.



E-H RESEARCH LABORATORIES, INC.

515 Eleventh Street • Box 1289, Oakland, California 94604 • Phone: (415) 834-3030 • TWX 910-366-7258
 In Europe: E-H Research Laboratories (Ned) N.V., Box 1018, Eindhoven, The Netherlands, Telex 51116
 In Japan: Iwatsu Electric Company, Ltd., 7-41, 1-Chome Kugayama Suginami-Ku, Tokyo 167, Japan

INFORMATION RETRIEVAL NUMBER 19

Air Force to test EL for cockpit lighting

Study of night-vision problems may lead to replacement of bulbs by electroluminescent devices

John N. Kessler
News Editor

An Air Force pilot in Vietnam flying low on a night mission, nears his target. The cockpit lights of his jet are blacked out to preserve his night vision and to prevent "canopy glow"—a dead giveaway of the plane's position to the enemy on the ground. But occasional instrument checks are essential, and for these the pilot beams a small flashlight on the cockpit panel. It isn't the best arrangement—because it reduces night vision momentarily and the fleeting light might just be spotted—but it's the best available in combat today.

This is the basic reason why the Air Force is investigating the use of light-emitting phosphors to replace incandescent bulbs in aircraft cockpits: Electroluminescent phosphor displays can be dimmed so as not to impair night vision and not be visible from the ground, yet still provide a readable display for the pilot. An experimental program has been set up at Wright-Patterson Air Force Base, Ohio, to determine the best phosphor lighting and to evaluate EL solid-state instrument displays.

If the results justify it, present

incandescent lights for aircraft instruments will give way to EL phosphor panel displays.

An EL lamp consists of a light-emitting phosphor sandwiched between two electrodes. The green EL light—emitted when the proper voltage is placed across the electrodes—is filtered to make it white.

According to Lt. David L. Turney, project engineer at Wright-Patterson, EL phosphors have these advantages over incandescent lights:

- Greater uniformity—rather than having a pinpoint source, the light is spread equally over an area.

- No color shift—with present incandescent bulbs, the color of the source changes with filament temperature (which varies as light intensity is adjusted).

- Low current—which results in a cold light source.

Although EL displays are not new—Cessna Aircraft Co. has been using EL phosphors in its heavier civilian aircraft for nearly three years—the benefits of redesigning cockpit displays have not been clearly established, Turney says.

The EL panel being evaluated by the Air Force was built by the Instrument Div. of Lear Seigler,

Inc., Grand Rapids, Mich. Three techniques of lighting are under study:

- Light-reflection—where EL lamps mounted on a light wedge reflect light on the instrument panel.

- Light-transmission—where light through plastic panels illuminates each legend or scale.

- Light-emission—where the light itself is the display element as it shines, for example, through a stencil.

Four tests next year

Four series of tests are planned in the next year by the Air Force Flight Dynamics Laboratory.

According to the Air Force, the pilot will be able to adjust each instrument to the lighting brightness required by him for day or night conditions. An experimenter seated at a console in the passenger cabin will monitor and record all lighting voltages, which will be correlated with display brightness by periodic checks with a photometer.

Outside brightness, says the Air Force, will be "recorded by receptors which pick up the light and channel it through fiber-optic bundles to a photometer, where the light energy is converted to electrical energy and amplified." ■■



How electroluminescent phosphors respond under day and night background conditions is being studied by the Air Force. They seek instrument displays that do not



degrade night vision or create a glow in the canopy of a plane. Tests will be completed at Wright-Patterson Air Force Base in July, 1971.

New computer keeps 747 jet engines cool

Jumbo-jet pilots save engines by throttling at a 'red-line' value calculated by on-board system

Jim McDermott
East Coast Editor

When jetliners fly, engine thrust must be held below a maximum "red-line" value to prevent overstressing the turbine blades and shortening engine life. Thrust is usually displayed to the pilot as an "engine-pressure ratio"—the difference in pressures between the inlet air and outlet jet blast. And maximum values are in the order of 2.00 engine-pressure-ratio units.

To set the throttles properly, the pilot determines this red-line value—engine-pressure-ratio limit (EPRL)—and adjusts the throttles to bring the displayed actual value into agreement.

With the older and slower jets, the crew determined the limit by in-flight consultation of charts or tables, using panel readings of altitude and air temperature. But with the new, high-powered jumbo jets—the Boeing 747s, the Lockheed L-1011, and the Douglas DC-10—EPRL is a complicated function of air speed (Mach No.), altitude,

temperature, flight mode (takeoff, climb, cruise, etc.) and other factors. As a result, the tables and charts are more complicated, and excessive time can be consumed in using them.

To supply this need for continuous, updated values of engine-pressure-ratio limit, Hamilton Standard, Windsor Locks, Conn., has developed a new digital EPRL computer and display. It will be placed aboard 747s owned by TWA, according to William Blake, supervisor, aircraft instrumentation and avionics development, TWA, Kansas City. Thirty-one systems have been ordered, but TWA is currently performing flight-acceptance tests of the first two systems for the Federal Aviation Agency.

System is nonconventional

Choice of a 16-bit serial computer for the system, instead of conventional parallel configuration, provided significant advantages, according to Robert Donner, pre-

liminary-design engineer at Hamilton Standard. Initial study of use of a 16-bit parallel computer showed that development and prototyping would exceed TWA's deadline in time as well as cost.

But required system speeds were slow—calculations were to be performed and displayed once each half second, and system self-tests performed every other half-second. This permitted the use of a 16-bit, modified serial computer, comprised of two 8-bit strings.

This not only made time and cost goals feasible but other advantages were gained as well. Less hardware was required, reliability was improved through use of fewer parts and bit lines, maintenance was simplified, and self-test features were easily implemented.

"The machine is designed as a 16-bit serial computer that works as two 8-bit machines in parallel," Hamilton's Donner told ELECTRONIC DESIGN. "For computation and other operations, the 16-bit words are split into 8 bits of odd and 8 bits of even serial data. After computation, they are recombined into a 16-bit serial string.

"This gives us the speed of an 8-bit computer with the accuracy of a 16-bit machine."

The new system, designed and prototyped for delivery within 4-1/2 months, consists of three replaceable units: (1) a flight-mode selector panel; (2) an indicator unit with digital displays of EPRL, total air temperature, and any one of six flight modes; and (3) a computer with a read-only memory (ROM) storing the various values of EPRL for any of the various flight modes. The ROM also contains programmed instructions for computer and system self-testing.

A complete system self-test is performed every half second. If two consecutive test cycles contain one or more out-of-limit conditions, failure warnings are activated. The test system includes protection against false EPRL values due to noise or to data. ■■

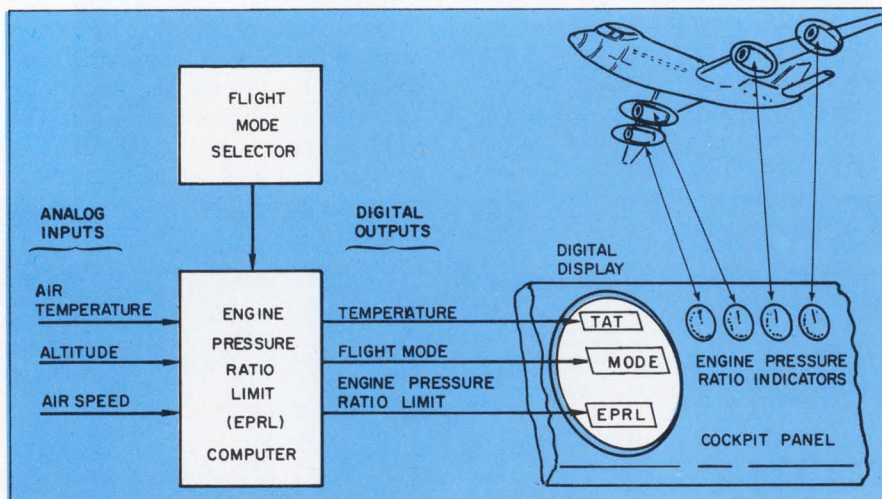

To prevent overloading TWA's 747 jet engines, a new serial computer by Hamilton Standard gives a "red-line" value—engine-pressure-ratio limit (EPRL)—to which throttles may be advanced. EPRL varies with the analog inputs, with air bled off for deicing, as well as the flight mode—climb, cruise, etc. It is calculated and digital displays are updated every half second, while the system is completely self-tested every other half-second.

Some MOS static from Signetics.

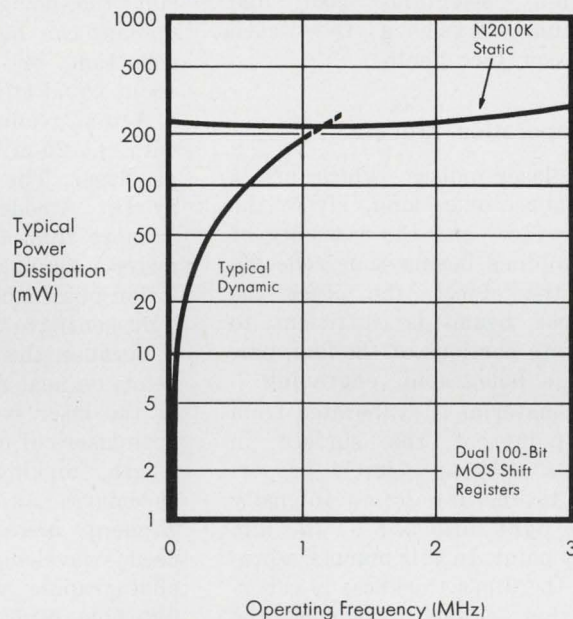

Our new 3 MHz static shift register.

That's some static!

Now you don't have to be stuck with dynamic shift registers simply because of their price, speed and power advantages. You can head in new directions. With Signetics new MOS dual 100-bit static shift register.

We call it the N2010K for short.

In short, it is easier to use than a dynamic device. Works in the same applications. Doesn't need any more power. Operates at higher speeds than most dynamic shift registers. And it's competitively priced: \$4.00 each for 100 to 999 units.

Our N2010K comes in a 10-pin TO-5 package and you can buy it off the shelf from Signetics or Signetics Distributors. Now.

Some other Signetics MOS dual static shift registers also available off the shelf: S2002K/3000 25-bit, S2003K/3001 32-bit, S2004K/3002 50-bit, S2005K/3003 100-bit. Buy them by the numbers: ours first/theirs second.

Plus the S2001K, a dual 16-bit device compatible with the aforementioned devices.

Our MOS data sheets are yours for the writing. Or better yet, buy sample devices for evaluation.

Give yourself some static. You deserve it.

Signetics

Signetics Corporation / 811 E. Arques Ave., Sunnyvale, California 94086 / A subsidiary of Corning Glass Works

INFORMATION RETRIEVAL NUMBER 20

Laser heat -- not light -- makes holograms

RCA method produces optical read-only memories with potential for storing 300 million bits on a card

A new technique for making holograms uses a high-powered laser as an optical branding iron that burns the image into the surface of a film 30 to 40 atoms thick—all in a few nanoseconds.

The method eliminates conventional film exposure and development, as well as the use of massive, costly vibration-damped tables.

Developed by RCA as a method of making high-capacity read-only memories, it may also find use in nondestructive testing and scientific measurement, according to Dr. William Webster, vice president of RCA Laboratories, Princeton, N.J. He says about 300 million bits of data could be stored on a single holographic card, in contrast with about 2 million bits for a magnetic memory card of the same size.

The new technique records the holograph structure on the surface of a thin film by vaporization. In developing the method, Dr. Juan A. Amodei and Dr. Reuben S. Mez-

rich at RCA made holograms on a variety of thin films—bismuth, tellurium, selenium, gold and aluminum—using a Q-switched ruby laser (see photo).

An evaporation process

The laser pulses, which are a few nanoseconds long, strike the film surface, and the intensity of the combined beams—one reflected from the object, the other the reference beam—is sufficient to evaporate portions of the film, producing a holographic engraving.

The material is evaporated from each point of the surface in amounts that are closely proportional to the integrated intensity of the light absorbed by the film at that point. In this manner a profile of the film's thickness is generated that closely resembles the spatial intensity variations of the recording light.

Such a pattern is essentially an

amplitude hologram, because while the absorption is considerable, the film is not thick enough to significantly affect the phase of the light passing through it. As a result, the holograms made in this manner can be read out by either reflection or transmission with about equal efficiencies.

Actual readout has been done with a 20-mW, helium-neon cw gas laser. The resolution obtained by Dr. Amodei and Dr. Mezrich is more than 1000 lines per millimeter—equivalent to the best resolution obtainable with conventional light-sensitive holographic film.

Because the new technique depends on heat rather than the light of the laser beam, it can be used with lasers of essentially any wavelength, making the system panchromatic. As a result, the more efficient infrared lasers can be used—wavelengths not suitable for photographic work. The metallic film holograms are free of "grain noise" that normally limits the storage capacity of photographic holograms. ■■

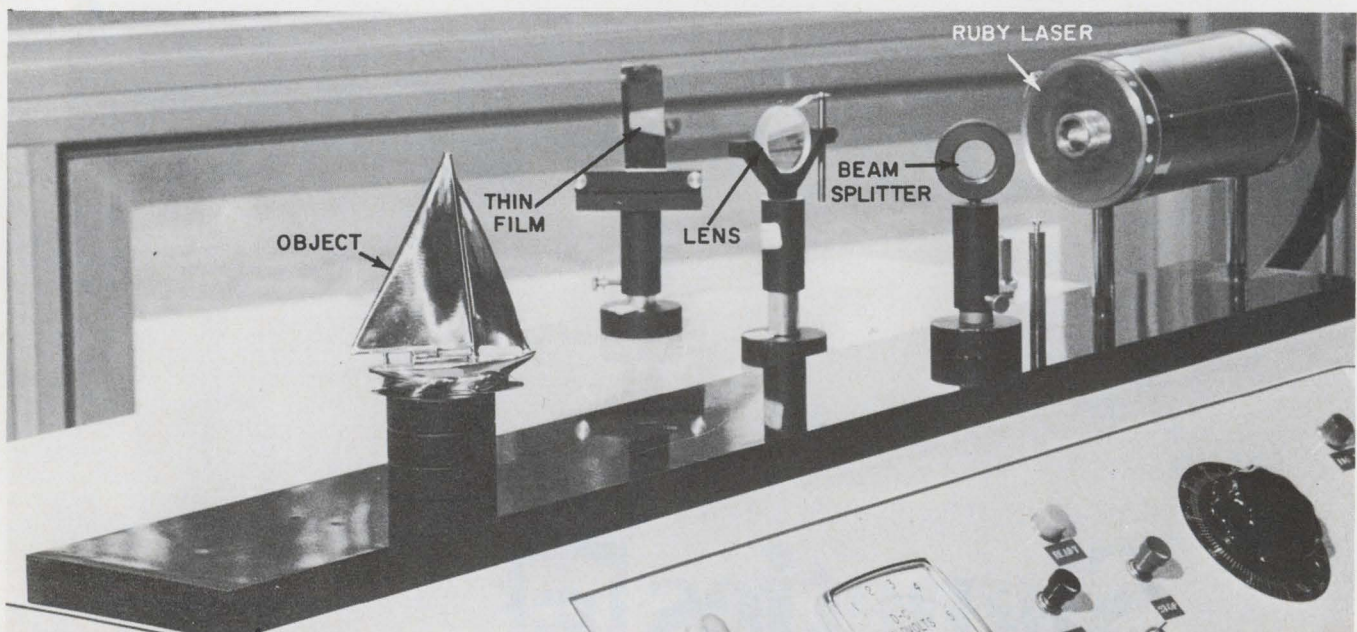

RCA's method of making holograms by heat rather than by light converts the Q-switched laser beam into a refer-

ence and a direct beam, which is reflected from the object. These combine to burn the thin film.

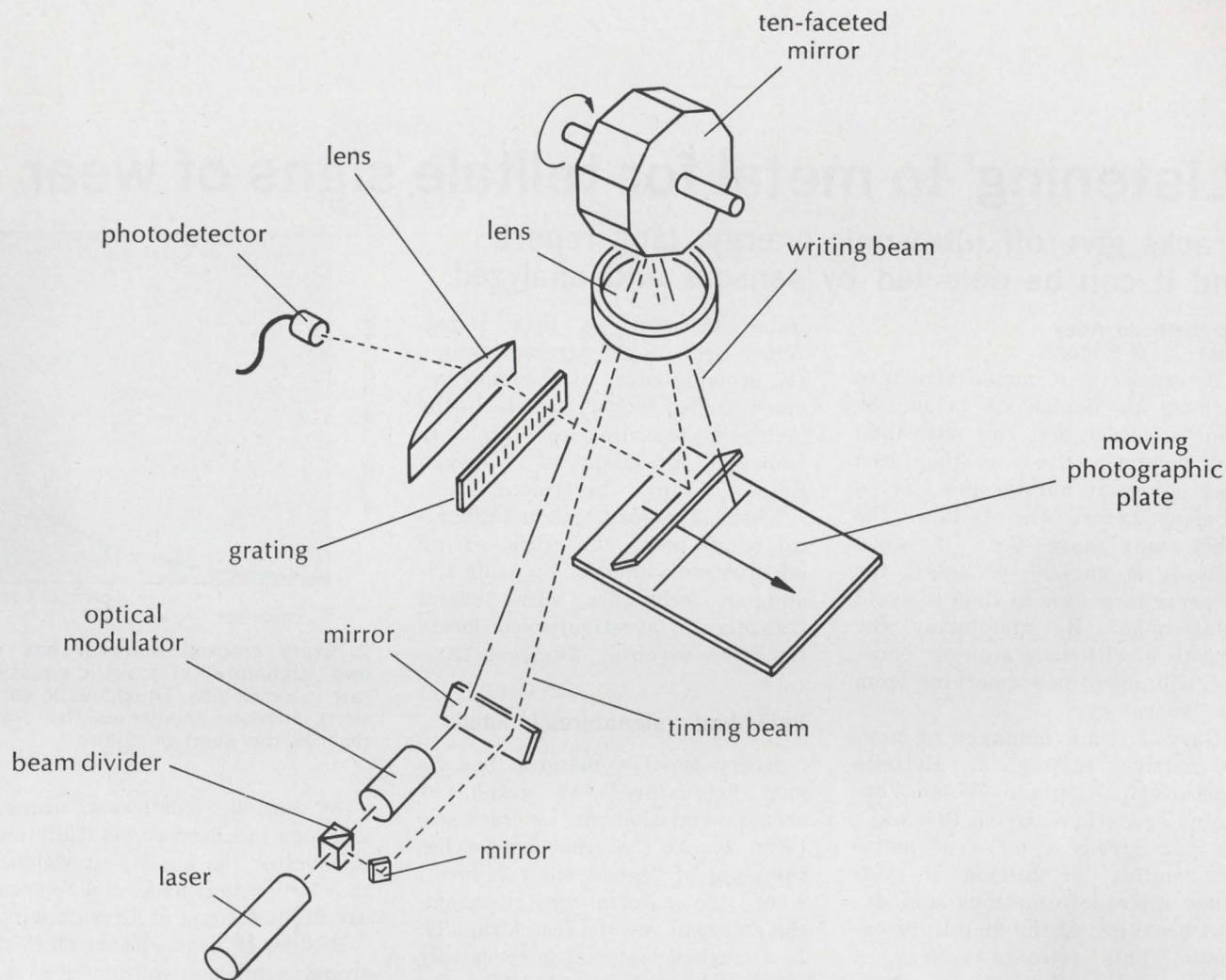

Better circuit masks exposed

Making integrated semiconductor and thin-film circuits requires a set of photographic masks to outline the application or removal of materials during processing. The demand for these masks has increased as integrated electronics has come of age and it will continue to grow with the technology.

Mask-making has long been automated. The engineer feeds a geometric description into a standard program and a computer generates a tape. The tape controls a machine which moves a light beam or a knife along coordinate axes to draw the mask. This takes many hours.

Now, Bell Labs has developed a machine which can produce complex masks in under 10 minutes. The machine contains an argon-ion laser.

The laser beam is scanned across an 8 by 10 inch photographic plate and switched on and off to expose the emulsion on the plate according to the mask pattern. As each scan is completed, the plate is shifted one linewidth. Scanning time—20 milliseconds per line—is independent of the number of times the beam is switched on and off.

Each facet of a ten-faceted rotating mirror (above) sweeps the beam once across the plate. At the same time, each facet sweeps an auxiliary laser beam across a grating, generating 26,000 timing pulses for each scan. A digital computer processes the pulses to determine the position of the scanning beam and to generate control signals for an acousto-optic modulator

which switches the beam on and off.

The laser beam can be directed with an accuracy better than 2 arc-seconds, the equivalent of a mile-long straight line with less than $\frac{5}{8}$ inch deviation. For such precision, the machine is operated in a special controlled-environment chamber where temperature is maintained within $1/7^\circ\text{C}$ and a cubic meter of air contains fewer than 3500 dust particles larger than one micron.

These high-speed, precise machines will supply the Bell System's mask needs for several years. As integrated circuits gain wider telephone use, this will keep costs down.

From the Research and Development Unit of the Bell System:



Bell Labs

'Listening' to metal for telltale signs of wear

Cracks give off ultrasonic energy, labs report, and it can be detected by sensors and analyzed

Elizabeth de Atley
West Coast Editor

A crack in a metal structure such as an airplane, a bridge, or even a skyscraper, can withstand just so much stress at the rated load before it bursts open. Yet a moment before the failure, the crack may have been invisible. How is it possible to detect the presence of a flaw in time to avoid catastrophe? By monitoring the structure with new acoustic emission equipment now emerging from the laboratory.

Gary J. Dau, manager of non-destructive testing at Battelle Northwest, Richland, Wash., explains acoustic emission this way: "If you stress a piece of metal by bending or hitting it, you cause microdeformations and actual breaking of the metallurgical bonds. This releases energy, a large portion of which is ultrasonic. We attach a sensor to the surface of the material and detect the energy (Fig. 1)."

A "perfect" material—one that contains no cracks or other flaws—must undergo considerable stress before it will emit any appreciable ultrasonic energy. But cracked materials emit such energy when sub-

jected to relatively little stress. Why? Because the stresses around the growing edges of the crack are much higher than elsewhere in the material, according to Harold L. Dunegan, president of Dunegan Research Corp., Livermore, Calif.

These stresses break metallurgical bonds along the crack, giving off ultrasonic energy. By using triangular techniques with several transducers, investigators can locate the crack precisely, Dunegan says.

Individual "signatures" noted

Every type of material has its own "signature," or graph, of acoustic emission rate vs crack size (Fig. 2). As the crack approaches the point of "catastrophic failure," where the material will rip apart, the emission rate increases rapidly. If a cracked material is repeatedly stressed beyond its rated load and the ultrasonic pulses that are emitted by the growing edge of the crack during each stress cycle are summed, it is possible to estimate the size of the crack from the signature of the material and to predict the number of cycles the material can withstand before ripping open.

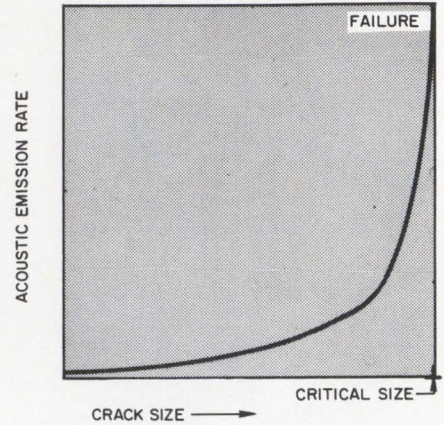

2. Every cracked material has its own "signature" of acoustic emission rate vs crack size. The acoustic emissions increase rapidly as the crack reaches the point of failure.

At Battelle Northwest, acoustic emission has been successfully used to monitor the quality of welds as they are being made and to measure flight fatigue in aircraft wings.

Besides Dunegan Research Corp., acoustic-emission equipment is also being manufactured by Nortec Corp., Richland, Wash. The equipment consists of transducers that convert the ultrasonic bursts into analog electrical signals. These are amplified and filtered, then put into a digital counter that sums the pulses and produces a dc output that is proportional to the number summed. This output can be displayed on an X-Y plot.

Probably the biggest problem in designing the equipment, says Mike King, applications engineer at Nortec, is background noise. That's why most acoustic emission systems operate at ultrasonic frequencies, where background noise is attenuated.

Even the noise in the semiconductor amplifier can be a problem, King says, because it is of the same magnitude as that of the breaking metallurgical bonds, which give rise to the acoustic emissions. One way to get rid of background noise, he says, is to use two transducers and to subtract the noise in one from the noise in the other. ■■

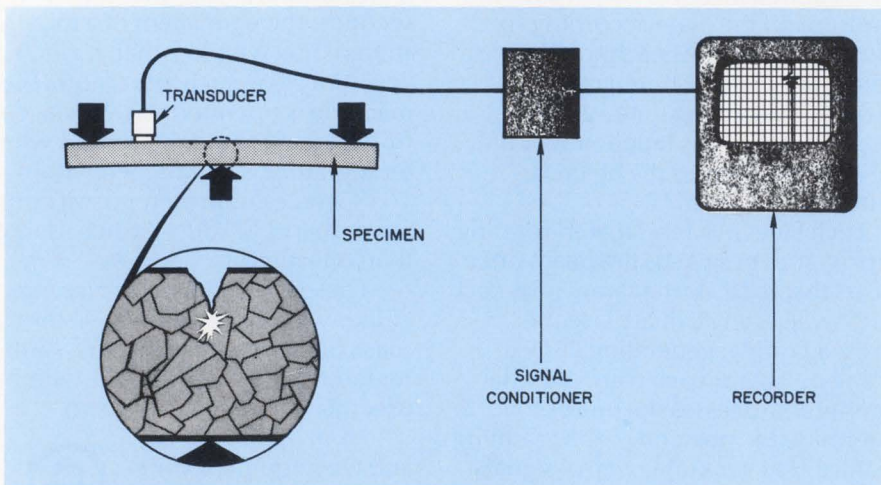

1. The growing edge of a crack breaks metallurgical bonds and releases ultrasonic energy that can be detected by electronic equipment.

PLATED WIRE

Read Only

Read Fastly

Read Mostly
Read Randomly

Read Fastly
Read
Read

Fastly
Mostly Randomly
Only

QTY. PRICE:
4c-8c/bit

9c-18c/bit

NM-1000 CAPACITY:
4K to 16K words
o 8 to 40 bits per word

NM-5000 CAPACITY:
1K to 4K words
o 8 to 40 bits per word

SPEED:
Access: 200ns
o Read: 300ns
o Write: 500ns

Access: 150ns
o Read: 250ns
o Write: 600ns

Nemonic Data Systems, Inc., announces the NM-1000 and NM-5000 High Speed Plated Wire Memory Systems.

These systems feature Non-Destruct Readout (NDRO). Read when you want. As often as you want. Write only when necessary to store. Non-volatility and NDRO provide program integrity against power failure and power transient. These systems offer you semiconductor speeds at core prices. And, they are available now!

- Systems Applications**
- Main frame memory
 - Read-only memory
 - Electrically alterable read-only memory
 - Character generation
 - Peripheral control memory
 - Buffer memory
 - Numerical control memory
 - Complete memory systems. Our technical staff is available to discuss your unique requirements. Write or call for technical bulletins.

Nemonic Data Systems, Inc., is now offering plated wire, stacks and complete memory systems. Our technical staff is available to discuss your unique requirements. Write or call for technical bulletins.

Nemonic Data Systems, Inc., 1301 West Third Avenue, Denver, Colorado 80223 (303) 892-7012

nemonic
DATA SYSTEMS INC.

Quick-change simulator is easy to build

A "cheap and dirty" way of simulating a system—whether it's an airplane cockpit, a police dispatch network or a new computer terminal—has been developed by the Boeing Co.'s Aerospace Group in Seattle. It's called the Man-Machine Interface (MMI). Minor changes in the arrangement of switches and displays on the console can be made in half an hour, and the system being simulated can be changed overnight. The console is built out of inexpensive plywood or foam core that is easy to cut and patch.

Most of the electronics that control the input/output devices at the console are in a display control exchange that is physically and electrically separated from both the console and the central processor (see block diagram). So all that is needed to change the system being simulated is a new program in the central processor and a change in hardware at the console.

The MMI looks like a programmable peripheral to the central processor, says Richard C. Landgraf, research engineer at Boeing. Because the central processor

can talk to it in general terms, it is very flexible, he explains. "For example, the processor just says, 'Put Image A on Indicator B using Generator C,' and the system takes care of the details itself."

This takes the burden of many housekeeping chores off the central processor. For example, says Landgraf, the mechanism that keeps track of the position indicator (such as a joystick) and updates the cursor image on the screen is contained in the MMI. In earlier systems these functions took 80 to 90% of the processor's time. ■■

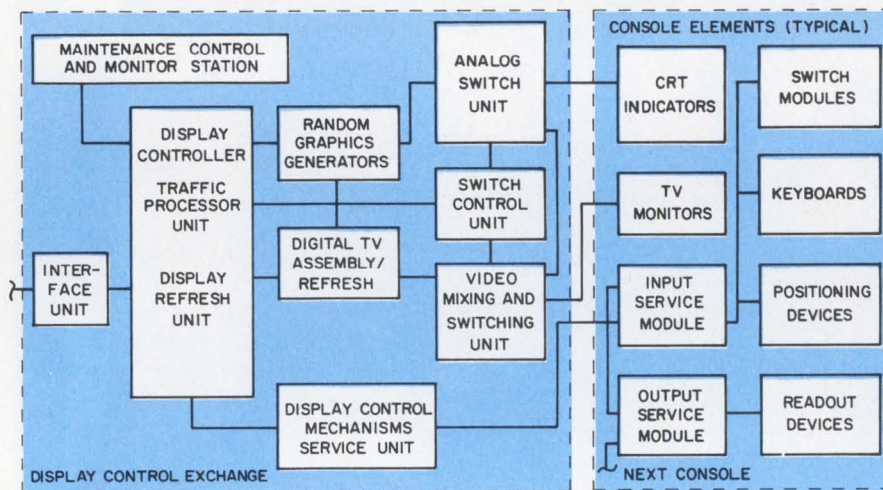

The heart of Boeing's Man-Machine Interface is the display control exchange, which contains most of the electronics that control the input/output console elements.



Typical console in the unusual Man-Machine Interface can be built in less than a week.

Telling component heat failures by color

Packets of fiber optics attached to electromechanical components have been used experimentally by IBM to predict temperature-related failure.

Engineers at the company's Systems Development Div. in Boulder, Colo., say that if such components as servomotors, rectifiers, transformers and transducers are coated with a temperature-sensitive material, fiber optic bundles could be used to transmit probable failure conditions to a display station.

The use of a paint, wax or decal that would change, for example, from a clear color to black in the presence of excessive heat could

alert operators or engineers and permit them to change the temperature conditions or replace the component.

IBM suggests that a photoelectric detector could provide a means of monitoring several units from a central station. The company says that fiber optic light monitoring is an engineering concept only and that IBM is not using it in its current product line. ■■

Fiber optic branches from a typical group of electromechanical components would transmit color changes caused by excessive temperature to a monitoring station.

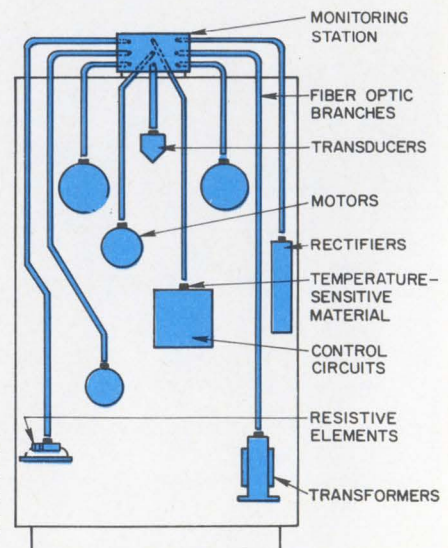

did you know?



General Electric **volt-pac**[®] variable transformers help you vary voltage dependably...year after year,* after year, after year, after year, after year, after year, after year, after year...

Send in this coupon for free bulletin giving complete details on Volt-Pac transformer features, ratings and application data; or see your GE sales representative today.

* Laboratory tested for over one million failure-free operations.

GENERAL  ELECTRIC

.....

- Section 413-34
- General Electric Company
- Schenectady, New York 12305
- Please send me free bulletin GEA-8110 on Volt-Pac Variable Transformers.
- NAME _____
- COMPANY _____
- TITLE _____
- ADDRESS _____
- CITY _____ STATE _____ ZIP _____

.....

When you're known for Rolls-Royces,

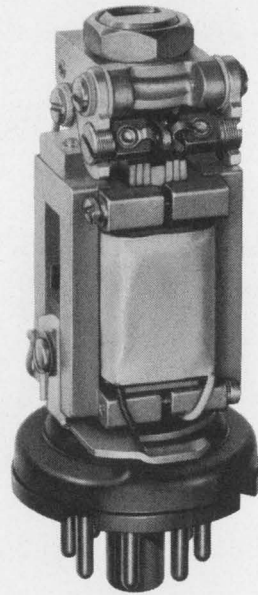

Series 72 Pulse and
Telegraph Polar Relay
... pulse repetition to
400/sec., life in hun-
dreds of millions of
operations

it's hard to get Volkswagen buyers to think of you.

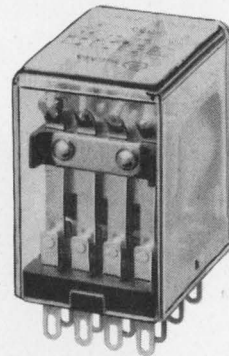

Series 67
General purpose
AC & DC, 4PDT, 5A

SIGMA has 2000 good, different general-purpose relays— many for 50¢/pole.

If you think of Sigma as a sensitive, close-differential relay house, you're partly correct. We're also a low-priced, general purpose relay house — as a substantial number of vending machine, alarm system, industrial control, copier and communications equipment manufacturers will attest.

For demanding applications such as computer peripherals, you can have one-cubic-inch 4PDT switching, on AC or DC coil signals, of low-level to 5-amp. loads at least 100,000 times with the Series 67. Fast wiring, mounting and interchangeability results from PC or solder terminals, or in sockets with PC or solder terminals.



Single-, two- or three-pole switching of loads up to 10 amps, for one million operations at 28 VDC or one-half million at 115VAC, is provided by the versatile and quickly-installed Series 68.

For up to 6PDT switching of low-level to 5 amp. loads by voltage adjustment, or 1-amp. loads on sensitive current adjustment, the Series 62 combines long life (up to 50 million operations with bifurcated contacts) with moderate cost.



For positive response to coil signals as low as 50 mw, at a cost of under 75¢/relay in quantity, the Series 65 is well-suited to TV channel selectors, slide projectors, vending machines and similar uses involving SPDT switching of 1-amp. loads.

Up to 3PDT switching of 5- or 10-amp. loads, on AC or DC voltages, is available in the compact and low-cost Series 50; wide application in automated equipment, switching small motors, solenoids and other relays.

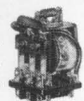

We'll be glad to supply detailed technical data on any of the general-purpose relays mentioned, with complete price and delivery information on standards. Better yet, tell us your requirements (load, life, cost, driving signal, operating speed and environment) and let us recommend the relay best suited to the job. We can save you time, disappointment and perhaps some money as well. Sigma Instruments, Inc., 170 Pearl St., Braintree, Massachusetts 02185.

SIGMA

INSTRUMENTS INC

did you know?



General Electric **AC VOLTAGE STABILIZERS** respond instantly* to give you voltage that is constant... constant, constant, constant, constant, constant, constant, constant, constant, constant...

Send in this coupon for free bulletin giving complete details on GE AC Voltage Stabilizer features, ratings and application data; or see your GE sales representative today.

* Output voltage is stabilized in less than 2 cycles for transient line drop of 30%.

GENERAL  ELECTRIC

.....
• Section 413-35
• General Electric Company
• Schenectady, New York 12305
• Please send me free bulletin GEA-7376 on AC Line Voltage Stabilizers.
• NAME _____
• COMPANY _____
• TITLE _____
• ADDRESS _____
• CITY _____ STATE _____ ZIP _____

circuit problems?



ultra-high leakage resistance

Devices with leakage resistance in excess of 10^{12} ohms are available for circuits requiring this property. Such applications would include sample and hold for A to D conversion, and capacitor memory systems. See Signalite Application News for typical applications.



voltage regulators better than 1% accuracy

These subminiature voltage regulators are used in regulated power supplies, as reference sources, photomultiplier regulators, oscilloscopes, calibrators, etc. They are available in voltages from 82 to 143 V. They are used in multiples as regulators in KV ranges. See Signalite Application News for typical applications.



photo-cell applications

The A074 and A083 have been designed for use with Cadmium Sulfide or Cadmium Selenide photo-cells. Applications include photo choppers, modulators, demodulators, low noise switching devices, isolated overload protector circuits, etc. Speed of operation is limited only by the photo-cells. See Signalite Application News for typical applications.



neon timers

The bi-stable characteristics and high leakage resistance of Signalite's special glow lamps make them ideal as a component for timing circuits. The basic circuit resembles a relaxation oscillator network. See Signalite Application News for typical applications.

Signalite

glow lamps have solved problems in these areas:

- Voltage Regulation & References
- Photo-Cell Drivers
- SCR Triggering
- Timing
- Photo Choppers
- Oscillators
- Indicator Lights
- Counters
- Voltage Dividers
- Surge Protectors
- Logic Circuits
- Flip-Flops
- Memory
- Switching
- Digital Readouts

Signalite glow lamps combine long life, close tolerance and economy, and are manufactured with a broad range of characteristics to meet individual application requirements. For a creative approach to your design problem . . . contact Signalite's Application Engineering Department.

SIGNALITE APPLICATION NEWS —



is used to communicate new and proven techniques and applications of Signalite's neon lamps and gas discharge tubes. Signalite Application News provides a forum for an exchange of ideas to keep the design engineer aware of the versatility of neon lamps and their many applications. Copies are available from your Signalite representative or contact Signalite.

INFORMATION RETRIEVAL NUMBER 123

Signalite



A DIVISION OF
GENERAL INSTRUMENT

1933 HECK AVE., NEPTUNE, N.J. 07753
(201) 775-2490

319

did you know?

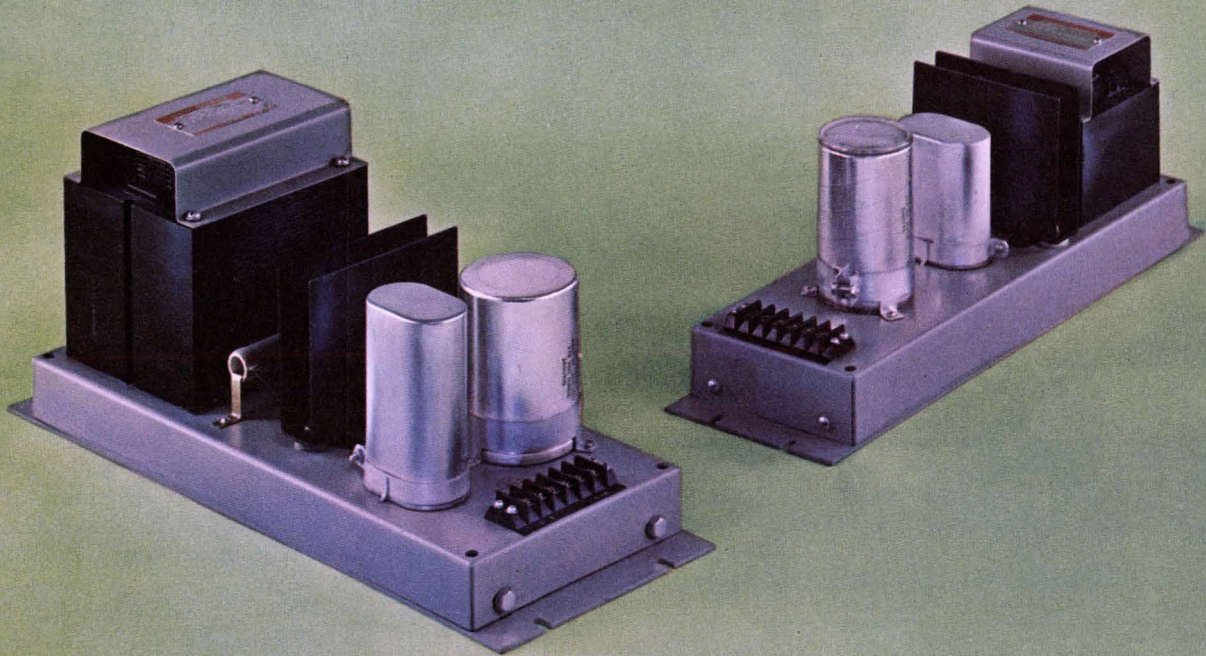

General Electric **REGULATED DC POWER SUPPLIES**
maintain DC load voltage precisely*...
precisely, precisely, precisely, precisely, precisely,
precisely, precisely...

Send in this coupon for free bulletin giving complete details on GE Regulated DC Power Supply features, ratings and application data; or see your GE sales representative today.

* Maintains $\pm 1\%$ output voltage for a variation in input voltage of $\pm 15\%$.

GENERAL  ELECTRIC

Section 413-36
General Electric Company
Schenectady, New York 12305
Please send me free bulletin GEA-7353B on
Regulated DC Power Supplies.

NAME _____

COMPANY _____

TITLE _____

ADDRESS _____

CITY _____ STATE _____ ZIP _____

TOLEDO SCALE USES VISHAY LOW TC TRIMMERS to obtain accuracies down to $\pm 0.01\%$ in their platform weighing system.

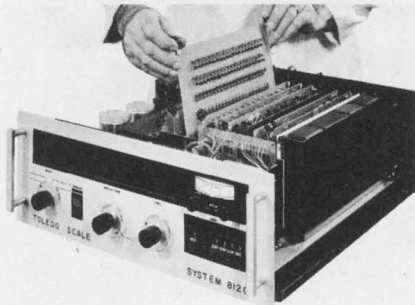

Toledo Scale load cell circuits operate at low resistance. To provide high accuracy and long term stability, they needed a system-adjust trimmer that would combine the high resolution of cermet with the low TC of wirewounds. VISHAY'S unique process of bulk metal film set on glass provided a trimmer which met their requirement with specs to spare.

ONLY VISHAY MAKES TRIMMERS WITH ALL THESE SPECS

Lowest temperature coefficient – 10 ppm/°C

Lowest resistance values – down 2 ohms

Lowest dynamic noise – 10Ω ENR max.

Lowest setability less than .05%

VISHAY trimmers combine precision/stability/TC/and resolution to eliminate the need for padding resistors, decrease test time, and improve product performance. Request bulletin TR-101 for complete technical details and typical application circuits.



VISHAY RESISTOR PRODUCTS

A DIVISION OF VISHAY INTERTECHNOLOGY, INC.

63 LINCOLN HIGHWAY ■ MALVERN, PENNA. 19355
TELEPHONE: (215) 644-1300 ■ TWX: 510-668-8944

PRECISION RESISTORS • NETWORKS • DECADE BOXES • TRIMMERS

INFORMATION RETRIEVAL NUMBER 28

Technology Abroad

A LOW-COST SYSTEM FOR HOME TV PROGRAMMING has been announced by Teldec, an organization jointly owned by AEG Telefunken of Germany and Decca of Britain. Known as Videodisc, the development makes program selection much like choosing what record to play on the living-room phonograph. An eight-inch TV record made of 0.10-mm, flexible polyvinyl chloride is placed on a specially designed turntable. The system is attached to a standard TV set. The turntable revolves at 1500 rpm, using a specially shaped diamond stylus that drives a small piezoelectric ceramic element. The record grooves are packed at a density of between 120 and 140 per millimeter, providing about five minutes of TV time. Teldec expects the discs to be on the market in about two years, with black-and-white program costs comparable to those for ordinary phonograph records and color program costs about double that. The TV playback portion will cost around \$120.

BRITAIN'S ROYAL AIRCRAFT ESTABLISHMENT IS EVALUATING A NEW BINOCULAR HEADS UP DISPLAY developed by Elliott Flight Automation of Rochester. Two matching groups of signals, positioned to form a single image, are projected from parallel cathode-ray tubes to a see-through reflector placed close to the pilot's eyes. The system is compact and features a foldaway screen. The dual-CRT arrangement offers redundancy in case of failure.

BRAZIL PLANS TO PUT A SATELLITE INTO SYNCHRONOUS ORBIT IN 1976. The space vehicle would be used to relay radio and TV educational programs to remote parts of the country, working in conjunction with American ATS satellites.

A NEW INFRARED SYSTEM

THAT SENSES HEAT RADIATED FROM THE GROUND AND TRANSFORMS IT INTO A CONTINUOUS PICTURE on photographic film will be developed by Britain's Hawker Siddely Dynamics Ltd. for the Royal Air Force. Called **Linescan**, this night-vision equipment follows successful development of a Type 201 infrared Linescan for the AN/USD Airborne Surveillance Drone, developed by Canadair for the Canadian, West German and British forces. **The new system is said to be superior in terms of price, performance and weight.**

A STUDY OF MICROWAVE TRANSMISSION IN THE 7.5-TO-5-CM BAND will be performed by the British Post Office with a new 6-meter dish radar antenna at the University of Birmingham. The \$96,000 university antenna will transmit and receive from 3 cm to 7 mm for atmospheric studies. **The Post Office is interested in the communications possibilities of very-short wavelengths**—the range in which the Birmingham antenna works, for instance, theoretically could hold around 5000 TV channels or 7 million telephone channels. The Post Office is building its own antenna at Marlesham, Essex.

OVER A QUARTER OF A MILLION COMPONENTS AND 14 MILES OF WIRING ARE USED in a new solid-state electronic scoreboard now in operation at Scotland's \$5.5 million Meadowbank Sports Center in Edinburgh. **The scoreboard—claimed to be one of the most advanced of its type anywhere—has 208 alphanumeric display boxes, each 15-3/4 inches high and 11-1/4 inches wide.** Each box contains a 7x5 matrix of individual lights. Control is by a typewriter-style keyboard, and a memory bank is incorporated so that information can be stored for later use.



Would you believe they'll do the job for a fraction of SMA prices?

Until now you've had to buy SMA connectors built to MIL specification. And pay the price. There just wasn't any other kind.

Johnson has changed that. With this new series of JCM miniature RF coaxial connectors. Up to 3 GHz you get the same electrical performance as with the expensive SMA types. Only we don't overbuild them. That way we don't have to charge as much for them.

We make 7 types—for panel and PC mounting and for flexible cable assemblies. All are interchangeable and intermateable with the standard, expensive SMA connectors. So you can use them without making any changes . . . and without compromising required performance. And JCM connectors accept virtually any size cable, so you don't have to stock a big variety. **It's worth looking into, isn't it? All it costs is a stamp.**

E. F. JOHNSON COMPANY / Waseca, Minnesota 56093

Please send technical information and test samples of your new low-cost series 142-0200-001 JCM connectors. Specify model #: _____.

NAME _____

FIRM _____

TITLE _____

ADDRESS _____

CITY _____

STATE _____

ZIP _____



E. F. JOHNSON COMPANY

INFORMATION RETRIEVAL NUMBER 29

JEWELL'S SPACE-SAVING little meters

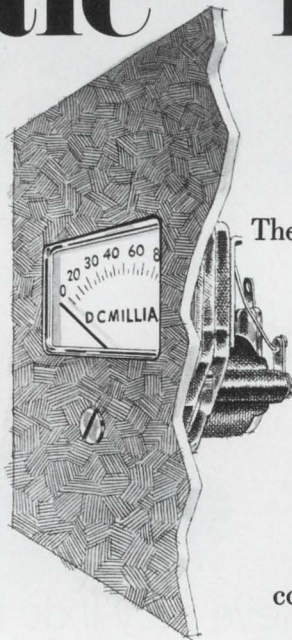

The Jewell Series 80T panel meters combine maximum readability with minimum panel space. That big plastic barrel has been eliminated making the Series 80T a little meter on both sides of the panel.

Don't let the size fool you! You'll see the large easy to read scale on an uncluttered dial. Behind the dial, Jewell's efficient taut-band mechanism is completely frictionless and self-shielded. Since Series 80 meters cost no more than conventional meters you don't have to pay a lot to get a little.

actual size

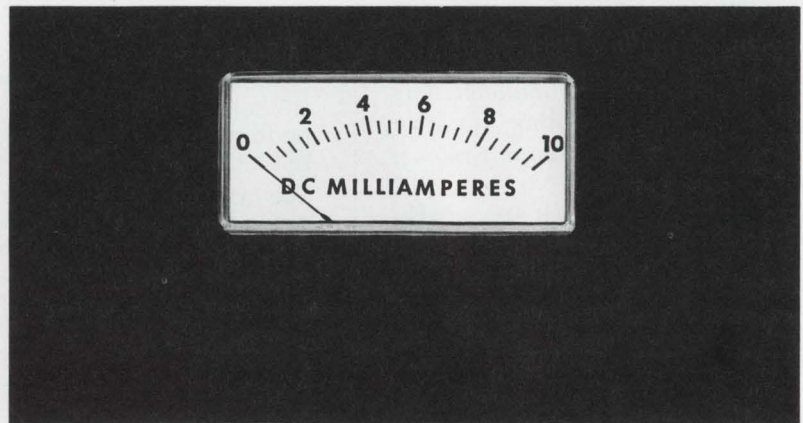

Want more facts about the "Space saving little meters"? Write for our new catalog . . . or get in touch with your nearest Jewell representative, distributor, or modification center.

Jewell

JEWELL ELECTRICAL INSTRUMENTS, INC. • GRENIER FIELD • MANCHESTER, N.H. 03105 • PHONE 603/669-6400

INFORMATION RETRIEVAL NUMBER 30

Washington Report

DON BYRNE, WASHINGTON BUREAU

A new communication system for TV envisioned

A report prepared at the request of the three major television networks concludes that ABC, CBS and NBC could save \$15-million to \$20-million a year by putting up their own satellite system or microwave system. Page Communications Engineers, a Washington-based subsidiary of the Northrop Corp., in a \$100,000 study, concludes that the three networks now pay AT&T about \$70-million a year in interconnection fees. Page estimates the AT&T facilities could be replaced by a microwave system at an initial cost of \$160-million to \$215-million—or by a satellite system costing \$145-million to \$160-million initially but with higher annual maintenance costs. The annual cost of operating either system, Page says, would run about \$50-million to \$55-million.

The satellite system envisioned would include three satellites in fixed orbit, each with a capacity of 12 color channels plus radio and other communications facilities. Approximately 160 ground stations, costing \$600,000 to \$800,000 each, would be required. The alternative microwave system would have about 18,000 "system miles" and would require 600 microwave towers.

Page, since 1962, has been the prime contractor for the communications network in Vietnam but in recent months has been moving toward civilian communications areas. It specializes in building systems such as it recommended to the television networks.

Defense contractors endorse fly-before-buy policy

The National Security Industrial Association, a group of more than 400 defense contractors, has endorsed the announced Defense Dept. switch back to a fly-before-buy procurement policy and has recommended additional changes in the procurement practices. In a 103-page report, the association recommended, among other things, more consultation between the military and industry when a weapons systems is in the concept stage, a reduction in Defense Dept. "management" personnel and a corresponding reduction in industry of like personnel. The report also asked that Government managers of weapons programs be given greater authority and a clearer definition from Congress of the information the lawmakers need on weapons systems.

Off-the-shelf avionics slated for new attack aircraft

Six major aerospace concerns have submitted bids for development of the Air Force's new A-X close-support aircraft, intended to be the service's low-cost, but highly effective, daylight attack aircraft from the mid-1970s until the end of the 1980s. Major cost-cutting decisions of the program called for the elimination of all-weather and night-vision capability, the use of a fixed noncomputing gunsight and the use of only off-the-shelf avionics and communications systems. The Air Force esti-

mates R&D costs for the airplane at \$194-million. A production run of 600 aircraft is expected to cost slightly more than \$1.12-billion. Two of the competing bidders will be chosen around Nov. 1 to develop and test aircraft for a fly-before-buy evaluation. Bidders are The Boeing Co.'s Vertol Div., General Dynamics Corp.'s Convair Div., Lockheed Aircraft Corp., Cessna Aircraft, Fairchild Hiller Corp.'s Republic Div. and the Northrop Corp.

Japan seeking U.S. rockets for satellite launching

Japanese Government officials are talking with NASA and the U. S. State Department about the purchase of Titan III rockets to launch broadcast satellites. The Japanese plan to use the satellites for a direct exchange of programs between countries in East Asia and Oceania. One of the proposed satellites reportedly would relay television signals to 11 countries simultaneously. Japan plans to submit her proposals for the system at a meeting of the Asia Broadcasting Union, to be held later this month in Istanbul.

Hughes wins major Navy radar contract

The Hughes Aircraft Co., of Fullerton, Calif., will conduct the engineering development phase of the target acquisition system for the Navy's improved point defense surface missile system. This radar is also intended for universal use aboard Navy surface ships in the next decade and will be compatible with all types of air defense weapons. The development work will be performed under a \$24.3-million, fixed-price, incentive-fee contract.

Capital Capsules: Competitive flight tests of the Hughes and Westinghouse radar systems for the F-15 fighter are expected to be finished this month and a contractor selected for the development by Nov. 1. McDonnell Douglas, the prime contractor, has been conducting the tests in two RB-66 aircraft.... Before the end of the year communications common carriers with more than 16 employees must file with the Federal Communications Commission a statement specifying hiring practices to be followed, to prevent discrimination because of sex, race, color, religion or nationality. Forms must be filed annually under the new FCC ruling.... Watch for an announcement that Great Britain and Belgium will undertake a joint project to develop a low-cost anti-tank weapon in which laser reflections from the target will be used to guide the warhead. The system is expected to be adaptable to artillery as well as missiles.... The president's Advisory Council of Executive Organization has recommended that the Interstate Commerce Commission, Civil Aeronautics Board and Federal Maritime Commission be unified in one new agency. The council also expressed concern over the ability of regulatory agencies to represent the public interest adequately.

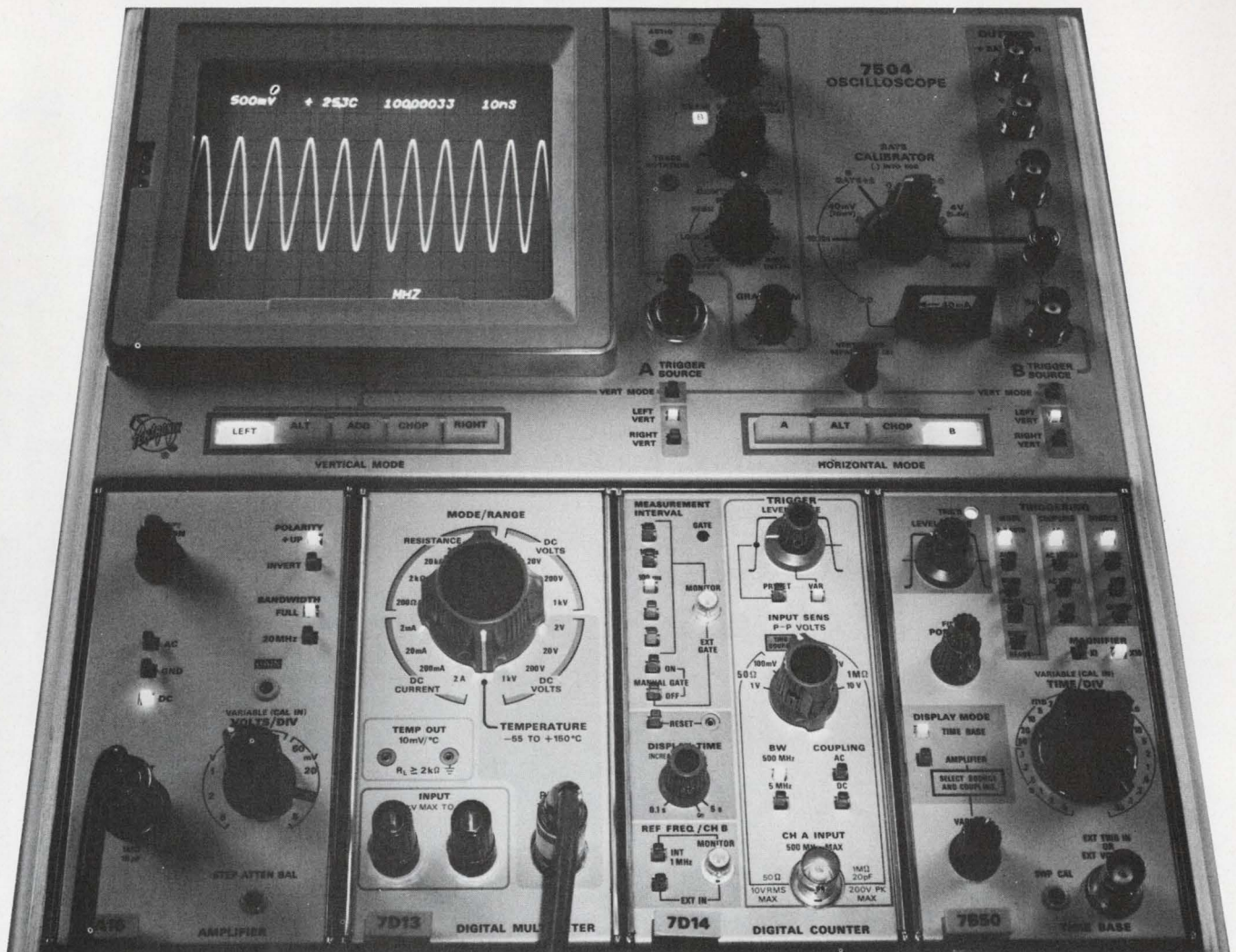

introducing the **Integrated Test System**

Measures: • *Frequency* • *Time* • *Resistance*
 • *Temperature* • *Voltage* • *Current*

With the introduction of two new digital plug-ins, a 500-MHz Direct Counter (no prescaling) and a versatile Digital Multi-meter, it is even more apparent that the Tektronix 7000 Series was intended to be more than just another oscilloscope . . . ITS much more!

There are already 5 mainframes and 17 plug-ins in the 7000 Series . . . with more to come.

Consult your August Catalog Supplement for complete information. If you do not have a Supplement, check the inquiry card, we will send you one promptly.



TEKTRONIX®

committed to progress
in waveform measurement

INFORMATION RETRIEVAL NUMBER 31

**Everyone talks
correed reliability,**

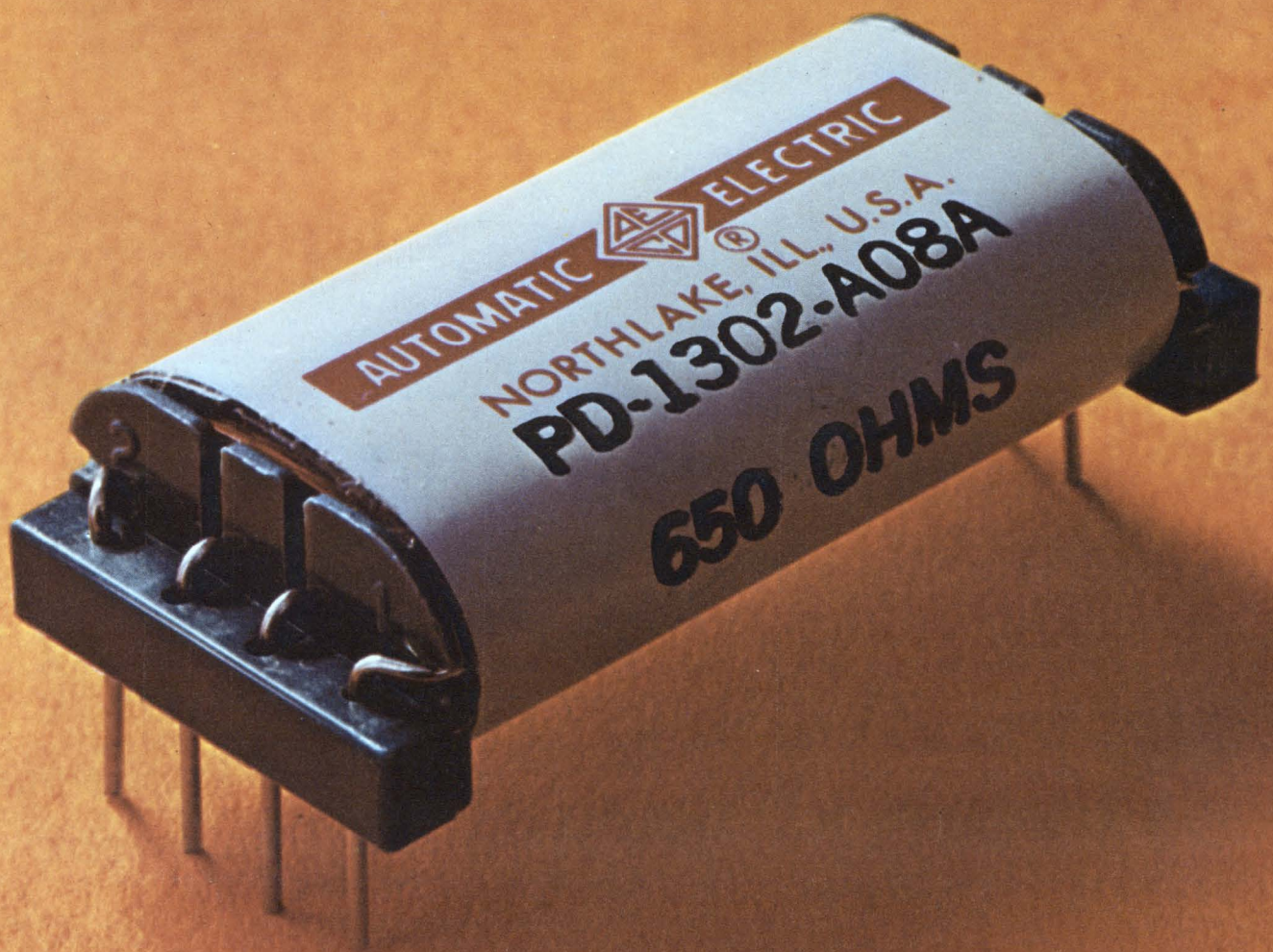

here's the way it looks.

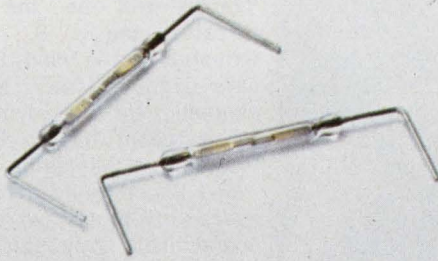

Switches under glass.

The heart of every AE correed is a reed switch consisting of two overlapping blades. For protection, we seal them inside a glass capsule. But only after we pull out all the dirty air and pump in a special, pure atmosphere. That way there's no chance of contact contamination or oxidation. Ever.

Notice our terminals are one piece. A special machine delicately forms them to precision tolerances. It's a lot of work, but one-piece terminals have distinct advantages over the two- and three-piece kind.

For one thing, there's no extra joint so you're always assured of a positive contact. Also, one piece terminals are more reliable when the correed is used to switch low-level analog signals. That's because thermal EMF is reduced to practically zero.

A different kind of bobbin.

Since we go through so much trouble with our correed capsules, we designed a special bobbin to protect them.

It's molded of glass-filled nylon. (You know how plastic chips and cracks.) Moisture and humidity have no effect on this stubborn material. No effect means no malfunctions for you to worry about. No current leakage, either.

Running the full length of the bobbin are a series of slots. They pamper the capsules and keep them from getting damaged or jarred.

And to help you remember which terminal is which, we mold the terminal numbers into the end of the bobbin. You can read them at a glance.

Little things mean a lot.

Reliability means that we pay attention to the little things. Like the tiny pressure rods we use in every miniature correed. They're placed at

each end of the bobbin, across the one-piece terminals. What they do is prevent stresses from being transmitted from the terminals to the reed blades. This keeps the contact gap right on the button. All the time.

The contacts are normally open. To provide them normally closed, we employ another little device—a tiny magnet. It's permanently tucked into a slot next to the reedcapsule. The magnetic action keeps the contacts normally closed.

Coiled by computer.

Once all the parts are secure in the bobbin, we cover them with protective insulation. Around this, we wind the coil. You can be sure the coil winding is correct. It was all figured out for us by computer.

Our next step is to protect the coil. We do that with more protective insulation.

A coat of iron.

On top of the insulation goes a layer of annealed iron. It acts as a magnetic shield and minimizes interaction between coils. Also, it improves the sensitivity of the entire unit. A coat of iron is standard on all AE correeds.

Finally comes super wrap.

To wrap it all up, we use some very special stuff. A layer of mylar laminated material.

It's so tough we guarantee it to withstand all cleaning solvents known to man.

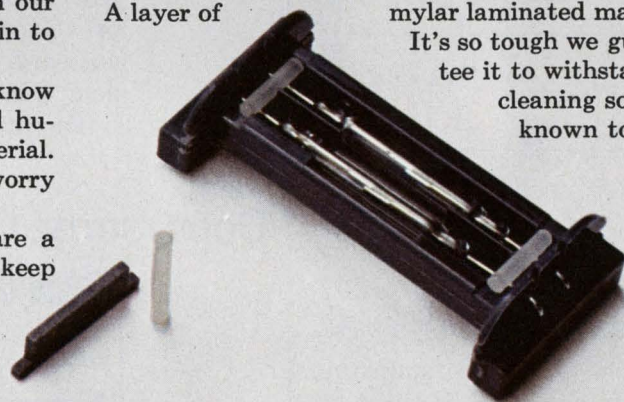

It's attention to detail that helps us keep our miniature relays miniature. Now we're just waiting to show you how perfectly it measures up to your specifications. Automatic Electric Company, Northlake, Illinois 60164.

AUTOMATIC ELECTRIC

SUBSIDIARY OF GENERAL TELEPHONE & ELECTRONICS

INFORMATION RETRIEVAL NUMBER 32

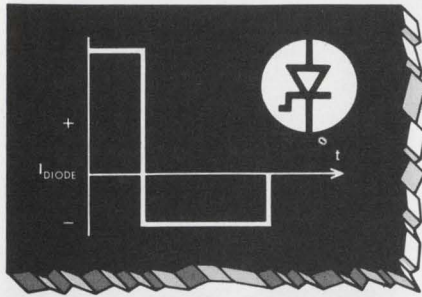

PULSE SNAP DIODE

Problem: You need to sharpen a high amplitude pulse to picosecond speeds.

Solution: The Siliconix PSD. Here's a typical application, a pulse sharpener:

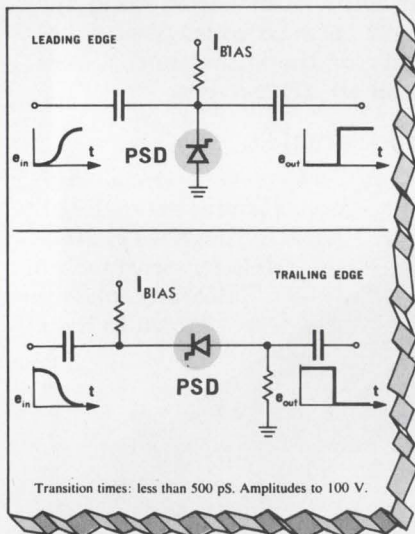

Use the PSD for pulse squaring, delaying, area limiting and other applications, too.

Write for instant data and applications information.

Siliconix
incorporated

2201 Laurelwood Rd. • Santa Clara, Calif. 95054
(408) 246-8000 Ext. 201 • TWX: 910-338-0227

In Europe: Siliconix Limited, Saunders Way, Sketty, Swansea, Great Britain

The world of electronics is shrinking

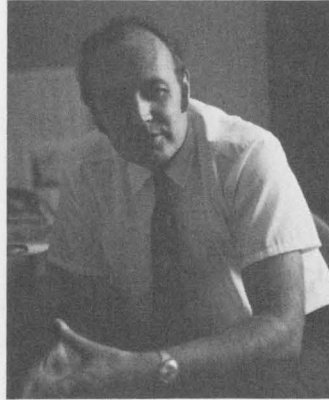

"Japan will be the strongest threat to the U. S. electronics industry in the next few years," says Graham Miller, left, project engineer for Teradyne, Boston. On a recent trip to Boston and Washington, Managing Editor Raymond Speer found company managers very much aware that fast, economical transportation and communications are bringing foreign markets ever closer. Marketing managers are keenly eyeing Japanese competition and sales opportunities in Europe.

Progress can be an editor's headache

The electronics field is moving ahead fast—almost too fast, according to Mike Riezenman, technical editor, who handled the op-amp article featured on the cover of this issue. Three times the article was complete—and three times author Bob Demrow called to tell him of changes in the state of the art that had recently taken place. Lower prices, improved specs and increased versatility kept Mike revising and re-revising—right up to deadline date.

"Our final product," says Mike, "is as up-to-date as we could make it. The picture will change, again and again, because of the rapid growth of advances in the op-amp field. But in spite of price and performance data revisions the relative differences between op-amp types will remain reasonably stable, and this article should prove to be a reliable selection guide for some time. It's not easy," Mike added, "to keep up with the electronics field, but it's a challenge."

The article begins on p. 54.

Oops, sorry! Our memory slipped

Electronic Design 15

Semiconductor memories are in—most experts will agree. They can be tailored for speed, size or low cost, and are already widely used in read-only applications.



But for random-access, read-write use, core memories are still king, and plated wire is making strides. How, then, can a designer best choose a memory? See page xx.

We forgot to credit the manufacturer of the semiconductor memory (shown with superimposed cores) on the July 19, 1970, cover of Electronic Design. It's a 1024-bit MOS random-access memory made by Advanced Memory Systems, Sunnyvale, Calif., and its dimensions are 120 by 150 mils. The cores superimposed on it are 18 mils in diameter, which is the standard size for high-speed production cores today.

How the Wizard of Barnes helped the ugly bug.

ONCE UPON A TIME there was a homely little electronic bug. He was so ugly that he hid himself under a large hat so that just his long skinny legs stuck out at the bottom. People laughed and called him T.O. (meaning Terribly Objectionable). With complete disregard for his feelings, they brutally stuffed him into P/C boards and other electronic things. Sometimes his legs got so bent and twisted he couldn't function at all. "Because I'm so ugly, people really push me around," whimpered the bug. "While I don't do plastic surgery," said the kindly old Wizard, "I can protect your fragile little frame from damage." Waving his magic wand, the Wizard produced a row of little plastic



carriers to protect the electronic bug on his trips around the country, and a series of magic sockets and contactors for protection during burn-in and testing. "Marvelous," exclaimed the ugly bug, "but what about on the job protection?" "No problem, bug," replied the Wizard, again waving his magic wand. There appeared before the bug, a series of magic sockets.

"Now bug, the socket can be dip soldered to a P/C board or mounted in the equipment and you can do your electronic thing in complete safety." "Gee, Mr. Wizard, you're the greatest," cried the ugly little bug, "what can I ever do to repay you for the kindness?" "Just tell all the folks out there in electronics land about me bug, and everything will be really beautiful!"



barnes
CORPORATION

LANSDOWNE, PA. 19050 ■ (215) MA 2-1525

Dynamic duo.

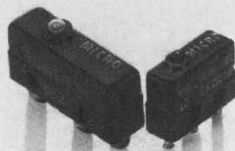

Dynamic variety in subminiature switches. Our SM and 1SX switches.

Take our SM series with a complete variety of integral or auxiliary actuators, bifurcated gold contacts for improved reliability and quick-connect

detent terminals. It's temperature resistant and meets Military Specification 8805.

And if our SM won't fit your needs, try our tiny 1SX. It's the smallest of the snap-action switches, and has low differential—.001 inch max. And it has all the features of the SM.

For more information on these dynamic subminiatures, contact your MICRO SWITCH Branch Office, Authorized Distributor or write for Catalog 50.

MICRO SWITCH

FREEPORT, ILLINOIS 61032
A DIVISION OF HONEYWELL

HONEYWELL INTERNATIONAL: Sales and service offices in all principal cities of the world.

Our new line of amplifiers and oscillators are as small as, or smaller than the competition's. But they're a big thing to us because this is the first time we've ever offered them to you. After years of making them for our own use, we decided to make them generally available. And we've formed a new Microwave Products Division just to handle them.

What does this mean to you? It means that you can now buy sub-assemblies from the people who are famous for high quality transistors and diodes. And it means that you're assured of the same high quality, because KMC transistors and diodes are used throughout.

For example. Our RF, IF and wide band amplifiers are ultra-low-noise and cover a frequency range from 2 to 1200 MHz. And our oscillators cover a frequency range from 100 MHz to 18 GHz.

The selection, as you can see, is quite complete, and KMC will further assemble these components into sub-systems (such as receiver front ends).

Of course, there are some of you who'd rather buy our transistors and diodes for in-house assembly. Fine. We have Applications Notes that tell you, in detail, how to fabricate these components.

If you'd like more information — on either the sub-assemblies or the Application Notes — write:



KMC Semiconductor Corporation
a subsidiary of Harvard Industries, Inc.
Parker Rd., Long Valley, N.J. 07853.
Telephone number, (201) 876-3811.



**UNTIL NOW,
WE'VE NEVER MADE
A BIG THING
OUT OF
KMC TRANSISTORS
AND DIODES.**

**INTRODUCING
SOME BIG THINGS.**



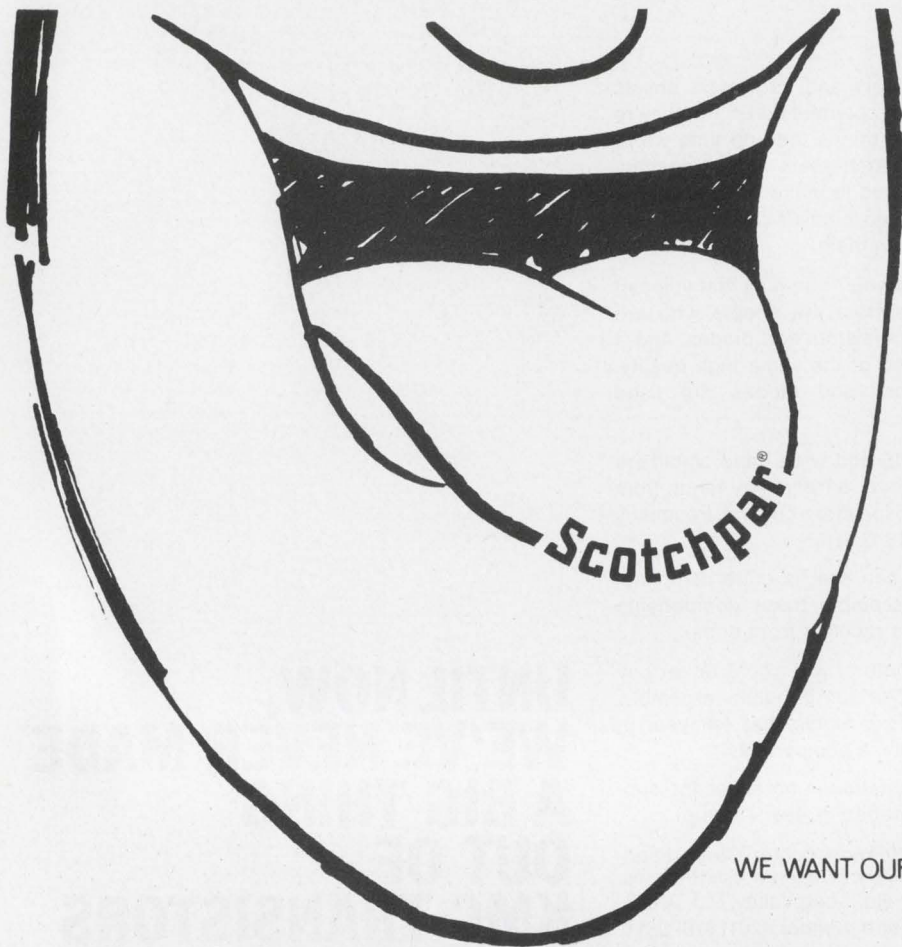

WE WANT OUR NAME ON THE TIP OF YOUR TONGUE!

Scotchpar 3M
BRAND POLYESTER FILM COMPANY

INFORMATION RETRIEVAL NUMBER 36

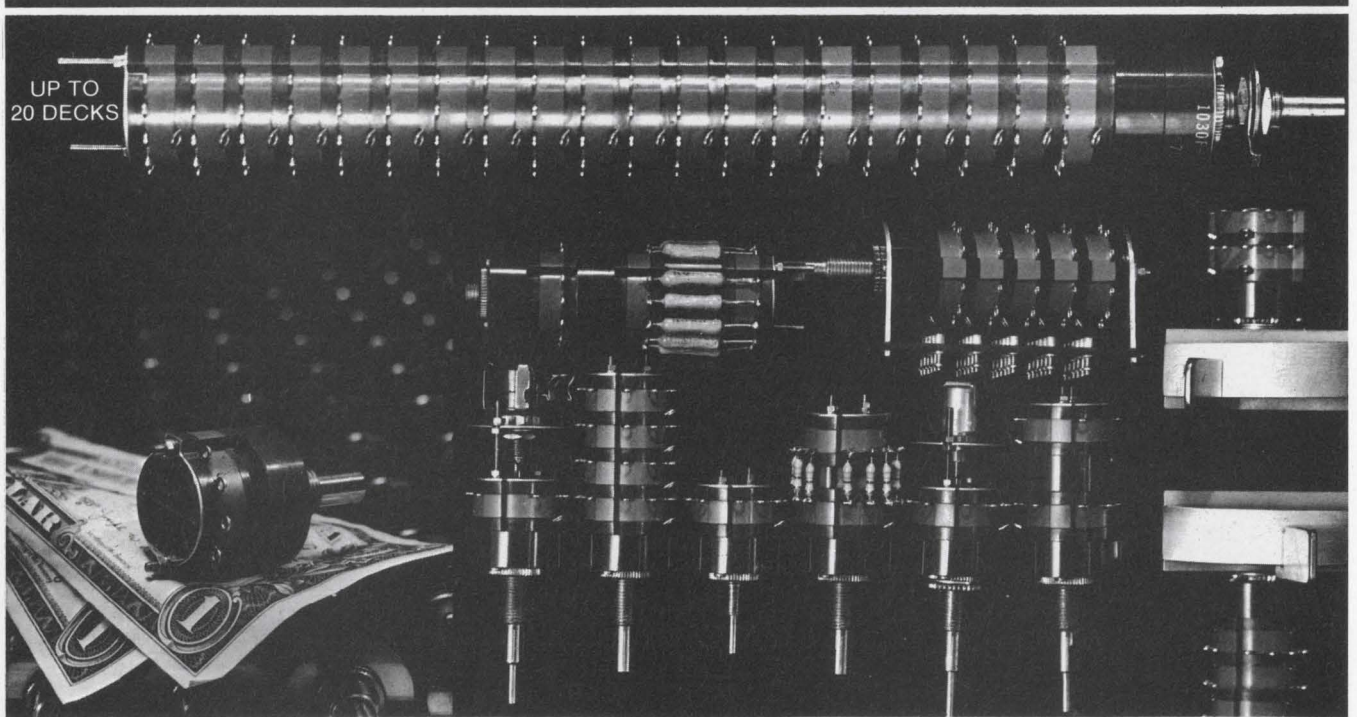

ASM INVITES COMPARATIVE EVALUATION
COMPARE ASM PRICES, DELIVERY, EXCELLENCE

(DESIGNED TO MEET MIL-S-3786)

THE **ASM** CORPORATION

Post Office Box 860

Smithfield, North Carolina 27577

INFORMATION RETRIEVAL NUMBER 37

Guess the price of HP's new counter

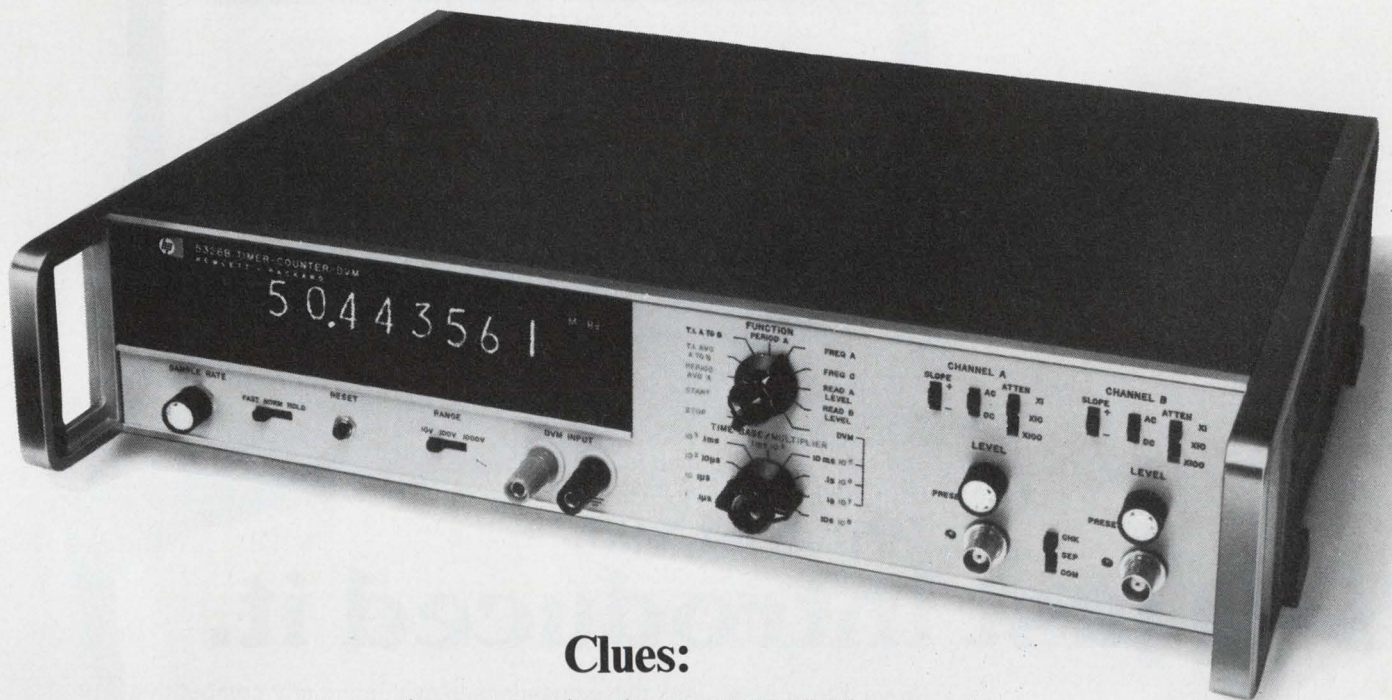

Clues:

it averages time intervals to 10 picoseconds
it has a built-in 0.05% integrating DVM
it's dc to 50 MHz, CW or burst
its counter and DVM are easily programmable

Surprise: \$1550. That modest amount buys a Hewlett-Packard timer/counter that does things universal counters never did before. For example, it averages time intervals as short as 0.15 nanoseconds. So you can resolve to 10 picoseconds on repetitive signals.

That modest sum also buys a counter with a built-in integrating digital voltmeter. So it's the only counter that can measure internal trigger level settings or other inputs with DVM precision. Now you can measure 10 to 90% rise times, half power points and other voltage-dependent time intervals. That means unprecedented simplicity, for example, in propagation

delay measurements. The counter also features four integration times. As a DVM, it provides three voltage ranges, 60 dB noise rejection and 0.05% accuracy.

Even without these exclusive features, the 5326's are real bargains. They count to 50 MHz direct with seven-digit resolution (eight digits optional), measure period and multiple period average and scale input frequencies by any power of 10 up to 10^8 . They measure ratio and they totalize.

With programming and BCD output options, the 5326's fit easily into systems applications. Counter and DVM are DTL programmable through a common connector.

You can get all of these benefits in the 5326B for \$1550, or buy the same counter, less the DVM, in the 5326A for \$1195. Any way you look at the 5326 A or B—either is a great counter value. Your local field engineer has all the facts about HP's new IC counter line. Give him a call or write to Hewlett-Packard, Palo Alto, California 94304; Europe: 1217 Meyrin-Geneva, Switzerland.

HEWLETT  PACKARD
ELECTRONIC COUNTERS

Which 5-digit multimeter is your best buy?



The new S-D 7005 offers five-digit resolution and accuracy. Designed for top performance in actual laboratory use.

Price: \$1,295.

S-D just introduced it.

Prove it to yourself. Ask these questions in evaluating any competitive DVM:

Does the basic DVM include **four dc ranges** from 1 V full scale to 1,000 V full scale?

Can all **optional functions** be added by means of individual cards at any time? (Auto-ranging, AC volts, DC millivolts, ohms, DC current and digital outputs?)

Is the **input impedance** greater than 10,000 megohms on 1 V and 10 V ranges? Is **feedback noise** at the input terminals less than 1 mV? Is full scale **response time** less than 400 milliseconds?

Does the unit use **dual slope integration** for max noise immunity at line frequencies? Are **plug-in cards** used for easy maintainability of all measurement circuitry?

Does it have an **annunciator** to remind you what measurement you're making? Are its **digital outputs** compatible with both IC logic and discrete component logic?

The S-D 7005 offers all these features and more for just \$1,295. Request technical data or a demonstration from your local Scientific Devices office or contact: Concord Instruments Division, 888 Galindo St., Concord, California 94520. Phone: (415) 682-6161. TWX: 910-481-9478.

SYSTRON  **DONNER**

Another S-D instrument first! Electronic counters/Digital voltmeters/Pulse generators/Data generators/Time code generators/Sweep generators/Spectrum analyzers/Digital panel meters/Digital clocks/Signal generators/Oscillators/Laboratory magnets/Precision power supplies/Analog & analog-hybrid computers/Data acquisition systems.

Publisher

Hugh R. Roome

Editors

New York Office
850 Third Ave.
New York, N.Y., 10022
(212) 751-5530

Editor: Frank Egan
Managing Editor: Ralph Dobriner
Managing Editor: Raymond D. Speer
Microelectronics, Steven A. Erenburg
Computers, Milton J. Lowenstein
Microwaves, Michael J. Riezenman
Management, Richard L. Turmail
News, John N. Kessler
Military-Aerospace, John F. Mason
New Products, Roger Allan
New Products, Lucinda Mattera
Copy, Marion Allen

Field Offices

Massachusetts
Jim McDermott
P.O. Box 272
Easthampton, Mass. 01027
(413) 527-3632

San Francisco
Elizabeth de Atley
2051 Wellesley St. (Suite D)
Palo Alto, Calif. 94306
(415) 321-7348

Los Angeles
David Kaye
2930 Imperial Highway
Inglewood, Calif. 90303
(213) 757-0183

Washington
Don Byrne
1425 N St. NW
Washington, D.C. 20005
(202) 667-6568

Editorial Production

Dollie S. Viebig
Richard D. Grissom

Art

Art Director, Clifford M. Gardner
Assistant, William Kelly
Rita Jendrzewski
JoJo Miskimmon
Jack Weissman

Production

Manager, Thomas V. Sedlta
Helen De Polo
Kathleen McConkey
Leslie Stein

Circulation

Manager, Nancy L. Merritt

Information Retrieval

Peggy Long

EDITORIAL



Take time out to quiz engineers in Congress

- What could the U. S. Government do to help stabilize employment in the electronics industry?
- Does the present Administration have a feeling for technology and where it's taking us?
- Which government-sponsored engineering projects are under the most attack in Congress, and why?

These are just a few of the questions that are going through the minds of today's aware engineer. Answers to many of them can be obtained by writing to one's Congressman.

Or you can write to ELECTRONIC DESIGN, instead.

We'll select the questions asked most often and send them to the seven engineer-Congressmen we interviewed recently (see "Seven Engineers Help Design Our Laws," ED 14, July 5, 1970, p. 60.) Worthwhile exchanges between you and the Congressmen will appear in a future Management article.

We think that communication between our readers and Congress is important. Our Government works only as long as we allow it to. If we're too busy to stay informed and get involved, we deserve to lose the right to govern ourselves.

Most of the legislators we talked to when we wrote the article said that they rarely hear from the engineers in their constituencies. Sen. Symington of Missouri, for instance, says that he hears from engineers only when the most publicized projects, like the Safeguard antiballistic missile system, are being discussed. Sen. Mansfield says that engineers have a responsibility to write their representative to let him know whether an engineering project before Congress is good or bad. Engineers' should share their expertise, other Congressmen say, by speaking with authority, at local hearings on technical issues.

So get involved and write to us at:

Hayden Publishing Co.
ELECTRONIC DESIGN
850 Third Ave.
New York, N. Y. 10022

Take time out to talk it over with the engineer/Congressmen.

RICHARD L. TURMAIL

Pick the right op amp to make your precision dc measurement. Many factors can complicate the decision when truly high performance is desired.

Part one of a two-part article

To measure a dc voltage to within 0.1% when it's across a fairly low impedance is no great feat. The cheapest reasonable monolithic IC operational amplifier can do the job. But when an accuracy of 0.001% is needed and the source impedance is on the order of hundreds of kilohms, some very interesting and subtle problems can arise. If the optimum choice of op amp and op-amp circuit is not made, the required performance may be impossible to obtain.

An analogous situation comes up in selecting an op amp to make highly accurate current measurements on fairly low-impedance sources. In both cases the biggest problem is temperature drift, although supply-voltage variations and component aging also play roles.

In addition to drift, there are initial imbalances in the various op-amp components that lead to a substantial zero offset. Most discrete-component op amps have provision for adjusting this initial offset to zero; monolithic IC units tend to be not so easily adjustable.

To make the optimum choice of an amplifier for a given precision measurement, the drift characteristics of the various types of op amps should be considered, along with the nature of the source. Only when both factors are taken into account can a wise decision be made.

For example, the low voltage drift of a chopper-stabilized operational amplifier makes it the preferred choice for extremely accurate voltage measurements across low impedances.

However, when the voltage source has an im-

Written by: **Robert I. Demrow**, Manager of Applications Engineering, Analog Devices, Inc., 221 Fifth Street, Cambridge, Mass. 02142.

Edited by: **Michael J. Riezenman**, Technical Editor

pedance on the order of hundreds of megohms (or higher) the varactor-bridge type of op amp is better. The extremely low current drift of the varactor-bridge amplifier gives it the edge, even though its voltage drift is about 100 times worse than that of the chopper-stabilized variety.

Two ways to fight drift

To gain insight into the characteristics of various types of op amps let's consider the two most common types of circuits used to reduce drift:

- Balanced differential circuits.
- Chopper-stabilized circuits.

A simple single-ended dc amplifier stage (Fig. 1a) is highly vulnerable to supply voltage variations. Any change in supply voltage changes the collector current, producing a variation in base-emitter voltage. By contrast, an equivalent differential amplifier stage (Fig. 1b) resists the effects of supply voltage variation because both transistors in each stage tend to be influenced equally, resulting in only minor net output variations. In fact, the very high levels of stability and regulation available in op-amp power supplies (0.01% to 0.1%) coupled with the excellent power-supply rejection of modern op amps make

Editor's Note:

Because of the rapid rate at which advances are continually being made in the op-amp field, much of the numerical price and performance data in this article will probably change before very long. However, the relative differences between op amp types will be reasonably stable and should provide a reliable guide to the selection of op amps for some time to come.

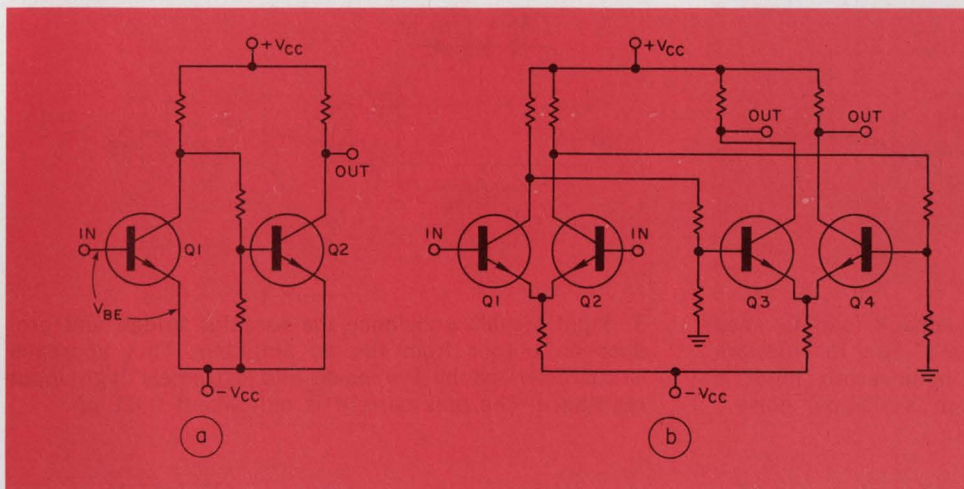

1. Supply-voltage variations cause collector-current changes in Q_1 of the single-ended amplifier (a). This, in turn causes changes in V_{BE} . The differential circuit (b) overcomes this problem since its errors depend upon differences between matched components.

this source of error a relatively minor worry to circuit designers.

The use of transistors in matched pairs also minimizes the errors caused by component variation. If the collector resistor of one transistor changes by 1% during the course of a year it is highly likely that the other transistor's collector resistor will change by a similar amount.

This leaves the effects of temperature upon amplifier stability. And temperature is usually the design engineer's main concern. It is instructive to consider the degree of matching that must be maintained for a differential amplifier to achieve a drift specification of $0.5 \mu\text{V}/^\circ\text{C}$. This consideration will also reveal how precarious a $0.5 \mu\text{V}/^\circ\text{C}$ drift specification actually is—it is really a statement of the amplifier's steady-state stability rather than its maximum drift specification throughout normal operation.

Let's consider voltage offset and drift first, because this parameter depends upon component matching. Current drift, by contrast, is a function of the bias-current stability for each individual transistor. The base-emitter voltage vs temperature relationship for an ordinary transistor is approximately $2400 \mu\text{V}/^\circ\text{C}$. When two matched transistors are connected as a differential pair, both base-emitter voltages must vary in unison to leave a negligible differential voltage offset.

When one considers the degree of matching and temperature tracking required for a voltage drift specification of $0.5 \mu\text{V}/^\circ\text{C}$, the magnitude of the differential amplifier designer's task can be appreciated. The specification requires the two junctions to track within 0.5 parts in 2400, which is almost 0.02%. Yet amplifiers with this specification are available.

However, the user should be alerted to some of the pitfalls in a differential amplifier's voltage-drift specification. While it is true that an

amplifier with $0.5 \mu\text{V}/^\circ\text{C}$ maximum drift specification will produce only $10 \mu\text{V}$ offset for a 20°C temperature change, it would very likely produce considerably greater offsets while arriving at this steady-state condition. The reason is that the input transistors would probably be at slightly different temperatures during the change. The tight drift specifications do not refer to dynamic temperature conditions, but instead define the offsets that can be expected after circuit components have attained temperature equilibrium.

An important difference between low-cost discrete op amps and the more sophisticated variety is that the economy types usually use separate matched transistors for the differential gain stages while the more expensive units use dual transistors. The intimate physical spacing of the two junctions, along with the high temperature conductivity of the common substrate, provides excellent base-emitter voltage tracking between the two junctions of the dual transistor over wide temperature ranges. They are also responsible for the speed with which the junction reaches a steady-state condition after subjection to a temperature transient.

Unlike the voltage-drift specifications just discussed, good current-drift specifications do not result from careful tracking between two different sets of transistor-current values. Rather, the current drift of the simplest bipolar transistor op amp refers to the variations in base current drawn by each input-stage transistor.

Since there are two transistors in each gain stage, it is possible to utilize the tracking tendency of the two base currents (called bias currents) to minimize the effects of current drifts by properly designing the external circuit. Hence op amp manufacturers frequently list the difference current and its temperature coefficient, along with the bias current and bias-current

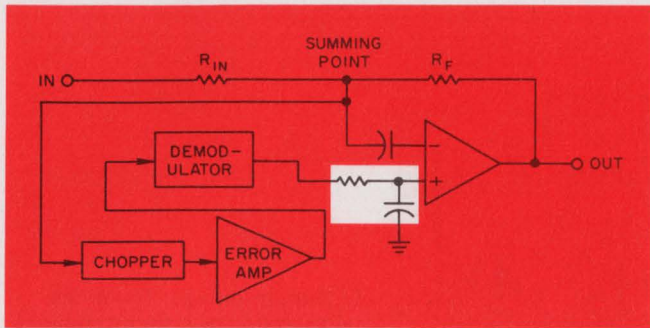

2. Chopper stabilization uses a feedback loop to keep the summing-point voltage near zero. The RC network between the demodulator and the noninverting input is a low-pass filter. A potential problem is chopper noise.

drift specs. Typically, for well matched pairs over wide temperature ranges, difference current varies at about one-fifth the rate of bias current.

The chopper-stabilized amplifier

The chopper-stabilized op amp (Fig. 2) uses a built-in error-correcting loop that monitors dc offsets regardless of their source (initial offsets, steady-state offsets and transient offsets), then injects an error-correcting bias voltage into the amplifier to bring the summing-point error to the correct dc level (zero).

The advantages of the chopper-stabilized amplifier are numerous and include considerably better steady-state voltage drift specifications than differential types ($0.1 \mu\text{V}/^\circ\text{C}$ vs $0.5 \mu\text{V}/^\circ\text{C}$), as well as rapid automatic correction for offsets caused by temperature transients, load changes, localized heating, temperature gradients, long-term component variations and so forth. Then, too, the chopper-stabilizing circuit holds initial voltage, and current offsets orders-of-magnitude lower than the comparable initial conditions for even the best bipolar differential amplifiers.

Also, because the chopper amplifier's stability does not depend so crucially upon matching between input transistors, resistors, and so forth but instead depends upon the error-correcting feedback, it is possible for the unit to be assembled from relatively economical components. Thus, for example, Analog Devices can offer a chopper-stabilized op amp using monolithic IC circuitry but featuring $0.25 \mu\text{V}/^\circ\text{C}$ maximum drift for \$62, while a comparable bipolar unit with $0.5 \mu\text{V}/^\circ\text{C}$ maximum drift costs \$75.

The stabilizing circuit of Fig. 2 illustrates the automatic drift-correction process, and at the same time reveals one of the most serious drawbacks of many chopper amplifiers: Only one input terminal is available for the application of input signals; the other is "used up" in receiving

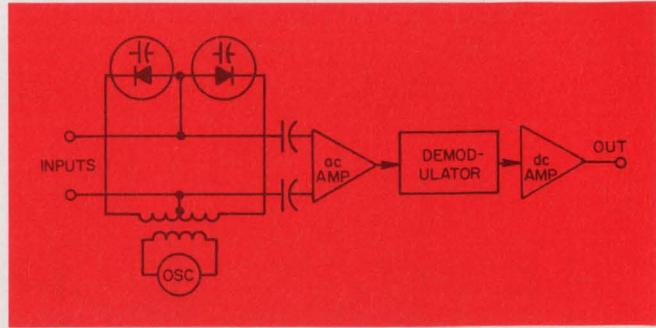

3. Input signals unbalance the varactor bridge and produce an output from the ac amplifier. This approach is characterized by low noise and extremely high input resistance. The bias current is only about 0.01 pA.

the drift-correcting voltages. (Note: Very recently, several manufacturers have introduced chopper-stabilized noninverting and differential op amps, but most available chopper units are of the single-ended inverting variety.)

The single-ended types of amplifiers are pretty much confined to circuits that operate with one input terminal grounded, as will be discussed subsequently.

Another limitation of the single-ended units is input impedance. Since the device is confined primarily to inverting circuits, the over-all circuit impedance is set by the value of input resistance, R_{in} , chosen. The differential and non-inverting types can be operated in noninverting circuits, where the input impedance is not limited to the resistance levels of available high-stability resistors. Also, the relatively low input resistance of the single-ended type can wipe out the advantages of chopper stabilization in applications that need high resistance levels for their external circuitry.

Another important chopper amplifier limitation is noise induced by the modulation-demodulation process. Sometimes the chopper process will create intermodulation problems when low-frequency signals are being measured. In such cases, it is possible for the chopper frequency to beat with the input signal resulting in low-frequency output perturbations at the difference frequency. This effect can be cured by filtering, but it can create surprises for the unwary user.

Two newer types

In addition to the differential-input and chopper-stabilized types discussed above, two newer op-amp varieties that should be considered are the FET input differential type and the varactor-bridge op amp.

FET op amps provide very high input impedance, excellent bias current and difference current stabilities, but relatively poor voltage-drift

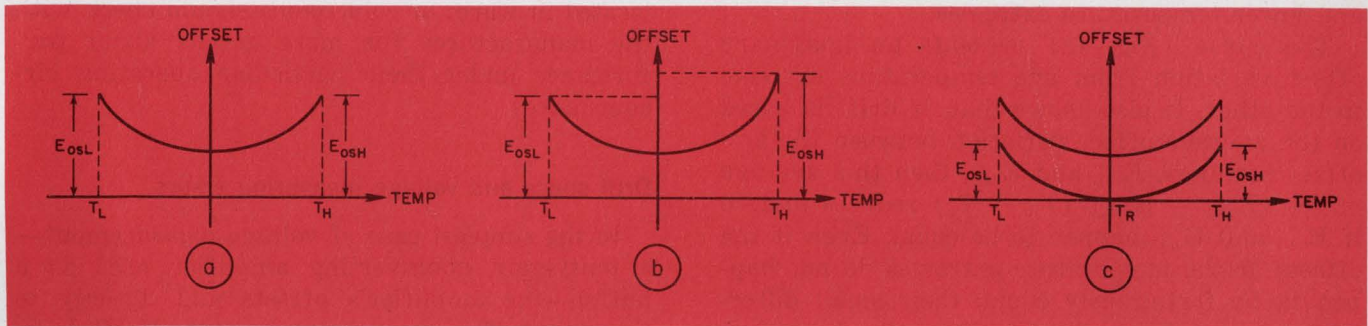

4. "Specsmanship" is the name of this game. If the offset difference between the two temperature extremes is zero (a) a drift spec of zero could be cited as the average offset variation. Even if the offsets at the tem-

perature extremes are not equal (b) an enormously understated drift spec can result. Zeroing the offset at room temperature (c) and quoting the worst-case average drift is a much more meaningful approach.

and common-mode characteristics. Since FET amplifiers are intended for high-impedance circuits in which the current of bipolar types is by far the predominant source of error, modest voltage drift performance is less of a drawback than it might appear.

It is worth noting that the FET amplifier's bias current varies nonlinearly with temperature, and in fact doubles with approximately every 10°C temperature rise. This nonlinearity makes it difficult for the op-amp manufacturer to give a hard and fast picoamps-per-degree specification for current drift. (The drift rate also doubles with every $+10^\circ$.) Instead, most FET op-amps manufacturers list initial bias current and difference current values and then point out that both values rise exponentially.

An approximate figure for the FET amplifier's current drift in the vicinity of a given temperature can be obtained quite simply. For example, if the unit has a 20-pA initial bias current at 25°C , then the bias current will have doubled to 40 pA at 35°C . This is a 20-pA change. The average current drift over this 10°C interval is thus $20 \text{ pA}/10^\circ\text{C} = 2 \text{ pA}/^\circ\text{C}$. For the next 10°C temperature rise, the drift will average 4 pA/ $^\circ\text{C}$, thence to 8 pA/ $^\circ\text{C}$, and so on. At 85°C the bias current will have increased from 20 pA to 1280 pA, and the current drift in the 75°C - 85°C interval will have risen to 64 pA/ $^\circ\text{C}$.

Varactor-bridge op amps harness the parametric amplification principle and apply it to low-noise dc measurements. The physical embodiment of the varactor-bridge amplifier (Fig. 3) also provides excellent voltage stability, because of the use of a pair of matched varactor diodes, while the ultra-low current drift and noise permit fractional picoamp resolution.

The device is operated by applying input signals to alter the capacitance values of the two voltage-sensitive varactor diodes. In turn, this unbalances the bridge configuration, which then feeds a fraction of the auxiliary carrier voltage

to the ac amplification stage, thence via the demodulator to the output dc amplifier. Ideally, the bridge section of this amplifier is devoid of ohmic resistance, so the Johnson noise is totally eliminated.

In other words, the bridge consists only of capacitive and inductive (transformer secondary) components, which do not generate noise. In practice, of course, the two halves of the transformer secondary have finite resistance, while the varactor diodes have leakage resistance and nonlinearities. Despite these deficiencies, however, the varactor-bridge op amp is on the way to displacing electrometer tubes—one of the last holdouts from the vacuum-tube era.

The varactor-bridge amplifier differs from previous types in that it does not have a difference current. This comes about because bias current flows in series through the bridge configuration, entering at one terminal and emerging from the other.

The varactor-bridge amplifier's bias current is nonlinear, somewhat like the FET's, leading to doubled bias current for every 7°C temperature increment. Nevertheless, with a bias current of 0.01 pA at room temperature, the amplifier has a wide lead over any existing semiconductor device for accurate measurement of fractional picoamp current signals, and resolving fractional millivolt signals developed by multi-megohm sources.

The many ways to specify drift

There are a number of ways for an op-amp manufacturer to measure and present the drift specifications for a particular op-amp type. He can use a seemingly rigorous maximum drift level (averaged over the permissible temperature range). But even the apparently straightforward maximum drift spec leaves some potential pitfalls. For a start, consider the least effective method for drift determination, based

simply upon the measurement of offsets at upper and lower temperature extremes.

The curve (Fig. 4a) presents an imaginary offset variation from one temperature extreme to the other. It also shows that, if drift is based on the average offset variation between the two offset readings, E_{osL} and E_{osH} , then this average offset $(E_{osH} - E_{osL}) / (T_H - T_L)$ reduces to zero if E_{osL} and E_{osH} happen to be equal. Even if the offsets at the temperature extremes do not happen to be fortuitously equal, their small differences can easily lead to an enormously understated actual drift performance as Fig. 4b shows.

The next step toward better drift specification is to take the same two offset readings but with the amplifier previously zeroed at room temperature (Fig. 4c). This more critical method for drift determination specifies drift as the sum of the absolute values of the two offset readings, divided by the total temperature excursion. Voltage drift is then expressed as the average value: $(|E_{soH}| + |E_{osL}|) / (T_H - T_L)$, while current drift would be defined similarly. However, even this improved method for averaging drift over the whole temperature interval can give overoptimistic results. For example, if the offsets for a 50°C temperature excursion on either side of room temperature are $-100 \mu\text{V}$ and $+150 \mu\text{V}$, the average drift will work out to $2.5 \mu\text{V}/^\circ\text{C}$. In reality, the offset varies at an average rate of $150 \mu\text{V}/50^\circ\text{C} = 3 \mu\text{V}/^\circ\text{C}$ for positive temperature excursions.

Another method for drift presentation specifies amplifier performance in terms of the worst-case (average) drift for either positive or negative temperature excursion. This method, called the "True Butterfly" technique, states that the average drift anywhere within the amplifier's working range will be less than either $E_{osH} / [T_H - T_R]$ or $E_{osL} / [T_R - T_L]$, whichever is worse. (T_R is room temperature). This method for drift presentation would show that the amplifier cited previously had a maximum drift figure of $3 \mu\text{V}/^\circ\text{C}$ for the full $\pm 50^\circ\text{C}$ range, even though the drift remained within $2.5 \mu\text{V}/^\circ\text{C}$ for temperature decreases.

Even then, of course, the drift performance remains an average value, albeit a maximum average, for the $\pm 50^\circ\text{C}$ temperature environment. In reality, the offset curve could exhibit steep slopes between zero and either offset extreme. As a general rule, the offset curve is shallowest around room temperature, so that stability for small temperature excursions is usually better than specified for a wider temperature range. On the other hand, if an amplifier is to operate in an elevated temperature environment, the offset slope, or true incremental drift can actually be worse than the figure listed as maximum average. Consequently, users intending to

make sensitive measurements with the amplifier located in warm or cold rooms should check with the manufacturer for more details about performance under their particular operating circumstances.

Drift specs and voltage measuring errors

In the simplest case of voltage measurement—a unity-gain noninverting amplifier used as a buffer—the amplifier's offsets add directly to the output. Thus, an op amp with $3 \mu\text{V}/^\circ\text{C}$ drift, used in a unity-gain noninverting voltmeter input stage operating over a $\pm 10^\circ\text{C}$ range, would add $30 \mu\text{V}$ of offset voltage to the output signal. If the circuit happened to be measuring a 10-mV dc level, the $30 \mu\text{V}$ would create an error of 0.3%.

If the noninverting configuration were set for a gain of 50, the output error caused by voltage drift would be increased 50-fold, but the signal would also be amplified 50-fold so the proportion of error would remain constant.

However, if the noninverting circuit is used to measure the same 10-mV signal from a high-impedance source, a new set of errors will get into the act. Base currents (bias currents) drawn by the amplifier's input transistors would be sucked through whatever external impedance was inserted in series with the amplifier's input terminals. If the signal source had resistance R_s , the bias current I_b flowing through this resistance would produce a voltage of $I_b R_s$ across it, which in turn would be applied to the amplifier's input terminal, adding to the error produced by voltage offsets.

It is, of course, a simple matter to zero the amplifier for any specific level of the combined $E_{os} \pm I_b R_s$ offsets, but neither offset voltage nor bias current remains constant in an operating equipment. Hence, the amplifier's measuring accuracy will vary with both voltage and bias current drift.

If the amplifier cited previously exhibited a $1\text{-nA}/^\circ\text{C}$ bias current drift, as well as the $3 \mu\text{V}/^\circ\text{C}$ voltage drift, and was used to measure a 10-mV signal from a 10-k Ω source, the bias current variation would apply a voltage signal to the amplifier that drifted at the rate of $10 \mu\text{V}/^\circ\text{C}$. This bias-current error would considerably outweigh the $3 \mu\text{V}/^\circ\text{C}$ voltage drift of the same circuit, creating a total error for the specified $\pm 10^\circ\text{C}$ range of $\pm 130 \mu\text{V}$, or $\pm 1.3\%$ total error.

Composite drift curves

There is a method of graphical presentation for the total drift performance of a given amplifier that combines voltage and current drift errors for any value of resistance in series with

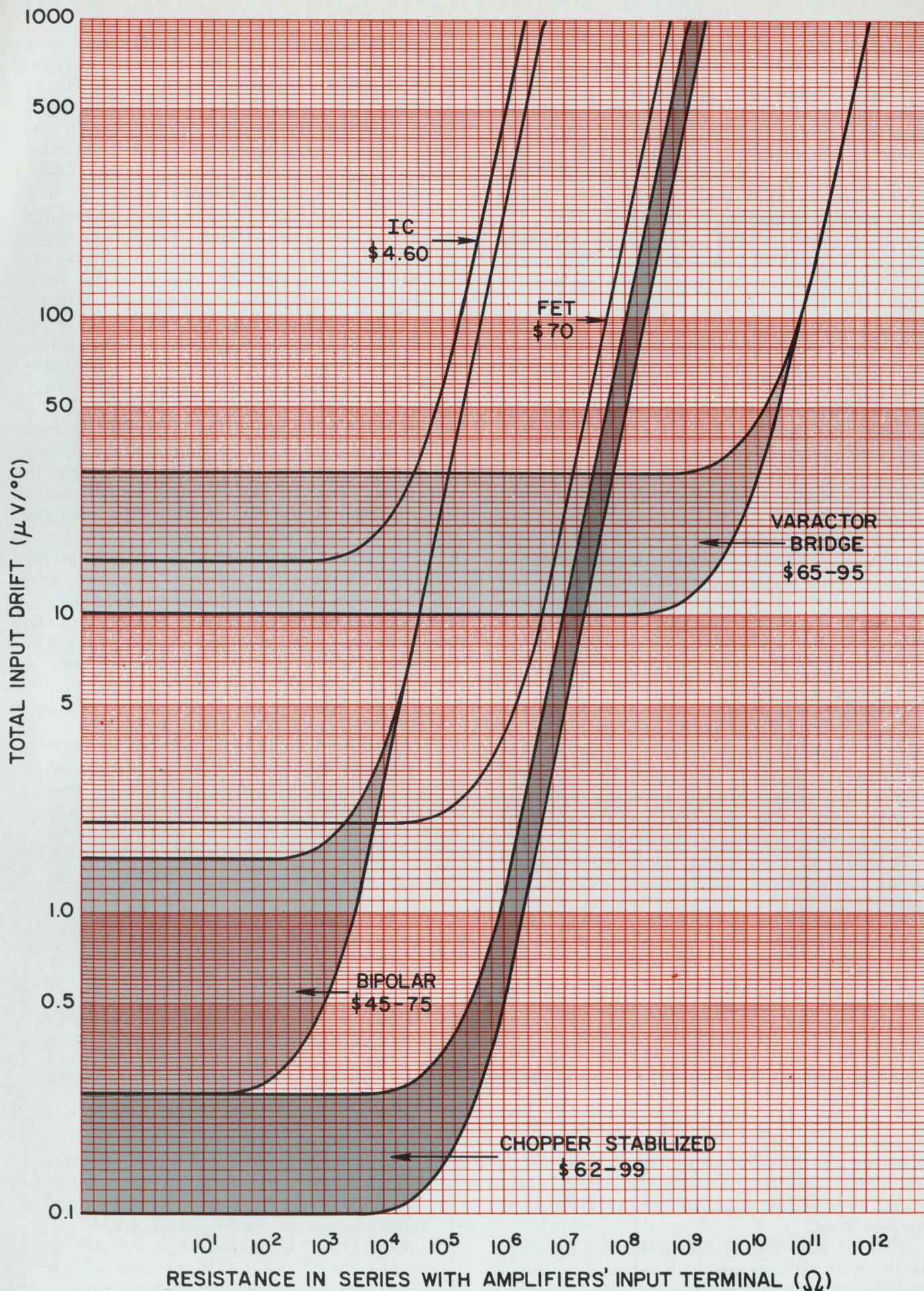

5. Compare op amps at a glance with this total-drift chart for five basic types. (The IC unit, which is not suitable for most precision measurements, is included for comparison.) All of the amplifiers shown here are

by Analog Devices, but the reader can easily generate similar curves for other units. Note: All of these curves are based on bias-current drift, not on difference-current drift which can be five times smaller.

the amplifier's terminal. Although every individual amplifier has its own characteristic curve for the combined drift effects, it is possible to span the whole range of today's drift performance with curves for merely half a dozen representative amplifiers of various types. If the curves for these representative amplifiers are plotted on the same sheet, the engineer has a very speedy method for comparing widely different amplifier types and quickly deciding whether to use a bipolar transistor, FET input, chopper-stabilized, varactor-bridge, or even a monolithic IC op amp.

The composite drift curves (Fig. 5) display series input resistance on the horizontal axis and total drift (referred to the input) along the ordinate. As one might expect, the curves remain flat at a value of $\Delta E_{os}/\Delta T$ for low values of resistance. They don't begin to rise until the current drift component, $R_s \Delta I_b/\Delta T$, becomes comparable to the voltage-drift component. Then, for larger resistance values, the current component predominates.

This graph provides the circuit designer, who proposes to measure voltage signals from a known source resistance, with a convenient tool that will tell him at a glance whether a given op amp is suitable for his purposes, or not. Any specific op amp not included on the chart can be added by the designer by using the manufacturer's voltage and current drift specs.

Note that in some applications it is possible to use measuring circuits that make the errors dependent upon the amplifier's difference current drift, $\Delta(I_{b1} - I_{b2})/\Delta T$, rather than upon the bias current drift itself. In such cases, the difference current drift rather than the bias current drift should be used to make up the graph.

Actually, in most cases, the current-compensating method cannot be used. For example, the introduction of a compensating resistor in series with the amplifier's noninverting terminal raises the whole amplifier off the ground and adds common-mode problems to the existing drift errors. The compensating resistor also multiplies the noise voltage caused by current noise.

Furthermore, the compensating resistor must be exactly equal to R_s . And this isn't an easy condition to meet if R_s varies, as source resistances often do.

It is evident from Fig. 5 that the high-stability dual-transistor input amplifiers provide good performance at modest cost, provided that circuit impedance levels are relatively low. Beyond about 10 k Ω , the designer must begin to consider alternative types.

FET amplifier drift characteristics are close to those of the less costly dual-transistor input bipolar transistor types for low circuit resistances. However, the FET's ultra-low bias current

allows this amplifier to gain a distinct edge over the bipolar types beyond 100 k Ω . Still, with bipolar transistor amplifiers listing from \$45 or so, compared with \$70 for a high-performance FET amplifier, the designer should use all possible tricks, including bias-current compensation, to get the most from the bipolar amplifiers.

Chopper-stabilized amplifiers show up very well on the drift chart. They are unsurpassed for measuring low-level voltages from low-impedance sources, while their low initial offsets, excellent long-term stability, and freedom from warmup errors make them a wise choice in many other circuits. Of course, it must be borne in mind that most chopper units cannot be used in the noninverting configuration needed for high-impedance voltage measurements unless they employ a costly isolated power supply.

Varactor-bridge amplifiers are the obvious choice when it comes to handling voltage signals from impedance levels beyond approximately 10 M Ω . Their relatively low cost may actually make them a better choice than an FET type, even for impedance levels below 10⁷ ohms.

Low current noise, which is another major attribute of the varactor-bridge amplifier, cannot be shown on this drift curve; nevertheless, low noise and excellent current stability are the key characteristics in resolving microvolt signals from sources of 10 M Ω and upward. ■■

This first part of the two-part article concentrates mainly on voltage measurements. Part two will discuss the basics of current measurements and will go into some detail about inverting and noninverting circuits.

Test Your Retention

Here are questions based on the main points of this article. Their purpose is to help you make sure you have not overlooked any important ideas. You'll find the answers in the article.

- 1. How does input-current drift affect the accuracy of voltage measurements?*
- 2. In what two respects does the varactor-bridge op amp outperform all other types?*
- 3. What are the major strengths and weaknesses of the FET-input op amp?*
- 4. How can a compensating resistor in series with the noninverting input reduce the effects of bias-current drift?*

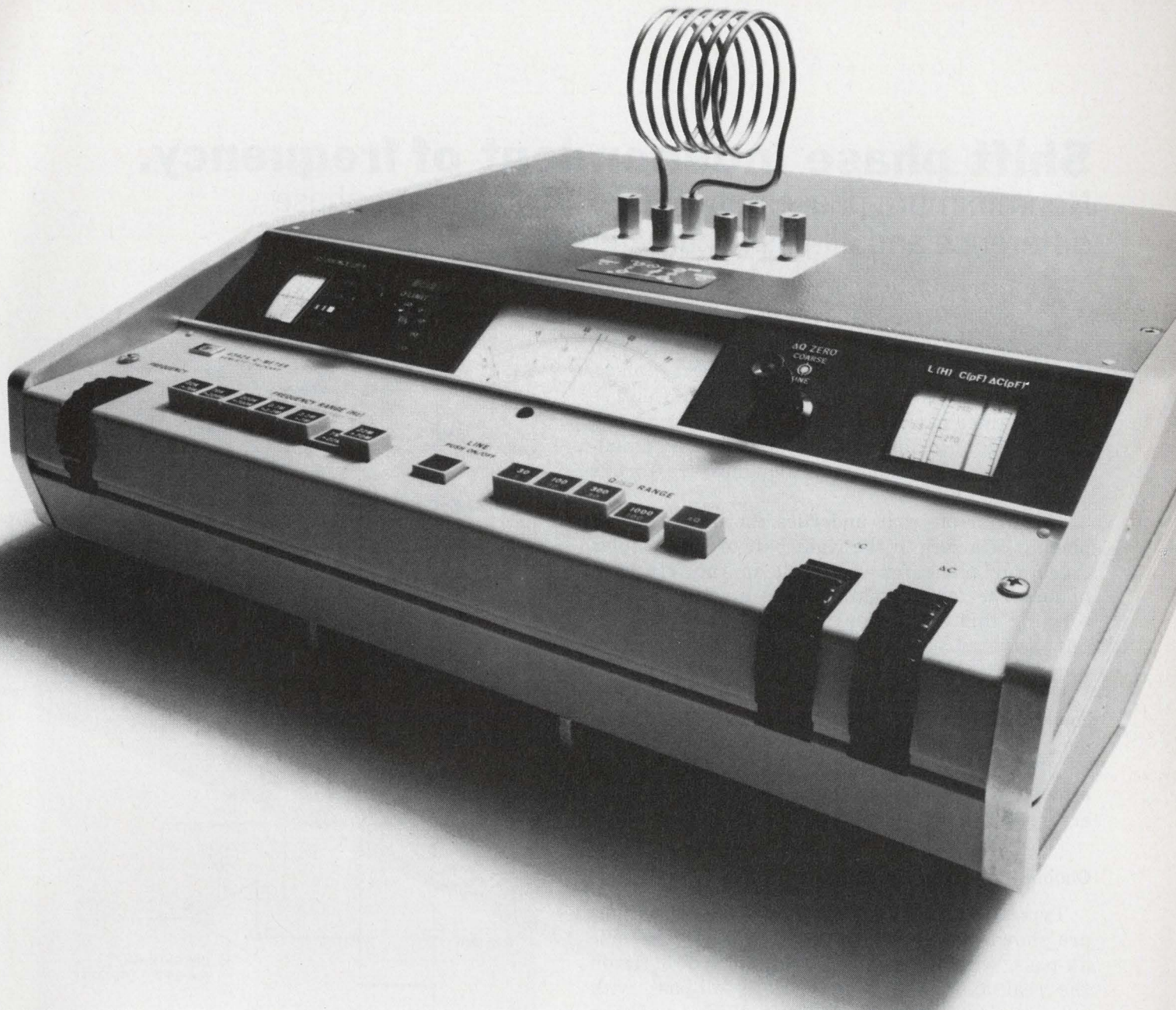

We've just advanced the Q-meter 17 years.

For lab and production-line work, our new Model 4342A Q-meter measures Q faster and easier than its classic predecessor, HP's Boonton 260A.

It measures Q values from 5 to 1000 in a frequency range of 22 kHz to 70 MHz.

Automatic leveling of oscillator source eliminates need for Q-Multiplier controls.

Speedy GO/NO-GO selector reduces component testing time.

High impedance voltmeter virtually

eliminates frequent zero reset.

New solid-state circuitry eliminates unreliable thermocouple.

Pushbutton controls give fast frequency and Q range switching.

All this means shorter measurement time and a big boost for high-volume testing and lab use.

It's versatile, too. You can detect extremely small changes in Q. Or measure coil, capacitor and resistor parameters. And the price? Just \$1500.

Okay. You want to measure up to

peak production. Dial your nearby Hewlett-Packard field engineer. He'll give you all the specs on HP's newest Q-meter in 17 years. Or write: Hewlett-Packard, Palo Alto, California 94304; Europe: 1217 Meyrin-Geneva, Switzerland.

HEWLETT  PACKARD

IMPEDANCE INSTRUMENTS

18002

Shift phase independent of frequency.

Nonminimum-phase networks exhibit constant phase difference and all-pass characteristics.

A pair of nonminimum-phase networks with the same input can provide a 90-degree phase difference between their outputs. This difference is maintained over a wide band of frequencies and is very useful in single sideband and other signal-processing applications where quadrature signals are needed.

The principle that underlies the design is the placing of a zero in the right half of the complex frequency plane for each pole in the left half-plane.¹ The tedious mathematics involved in performing this calculation is avoided by programming the problem in BASIC and using a computer to perform the routine arithmetic.

Each of the two networks is all-pass with constant insertion loss, but the phase shift varies over the pass band. However, they are so designed that one of the networks always lags the other by the desired 90 degrees, with a small error, through five octaves.

Choose the poles for optimum phase

Typical networks and their pole-zero locations are shown in Fig. 1. The A network is two-pole all-pass, with poles at -44 Hz and -715 Hz on the real axis. The B network is all-pass with poles at -205 Hz and -3307 Hz. With a common input signal, the phase difference between the outputs of the two networks is also an all-pass function, with poles at -44 Hz, $+205$ Hz, -715 Hz and $+3307$ Hz (Fig. 1c). The right half-plane poles imply that the one network has more phase delay than the other (not that either output anticipates the input signal).

The phase characteristic of each network decreases monotonically with frequency. Figure 2 is a plot of phase vs frequency for the two networks. Note that because of lower frequency poles, the phase of the A network is always greater in magnitude than that of the B network. The A-minus-B phase shift can be read from Fig. 2 by finding the difference between the two

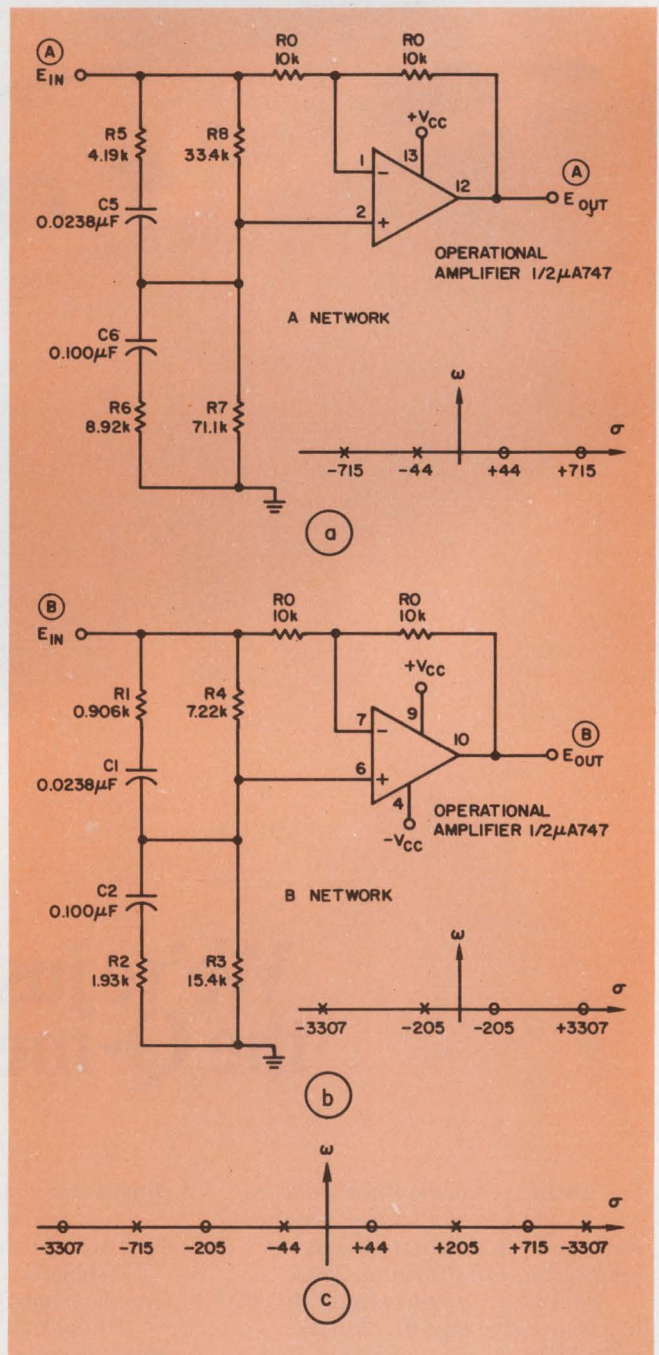

1. Two all-pass networks with the same input signal have the pole-zero locations in "a" and "b." Their outputs are 90 degrees apart through five octaves. The pole-zero locations of the difference is shown in "c."

Frederick R. Shirley, Technical Staff, Sanders Associates, Inc., 95 Canal St., Nashua, N.H. 03060.

curves. This theoretical difference characteristic is computer-plotted² in Fig. 3 and is within ± 3.8 degrees of 90 degrees from 70 to 2100 Hz.

For narrower frequency ranges the phase tolerance is reduced, and for wider ranges it is increased. The relationship between phase tolerance and frequency range is given in the curve of Fig. 4. For applications where the four-pole phase tolerance is too wide, a six or eight-pole¹ phase shifter can be used instead.

Frequency is key variable

The variables in the phase-shifter design are frequency band and circuit impedance level. Its frequency band is specified by the upper (F_2) and the lower (F_1) frequency limits, while impedance level is specified by the maximum capacitance value, C_0 . Frequency range R and mean frequency W in radians/second are defined as

$$R = F_2/F_1$$

and

$$W = 2\pi\sqrt{F_2F_1}$$

The frequency range of a two-pole 90-degree phase shifter with the same desired phase accuracy but a narrower frequency range is used to help locate the poles and zeros of the four-pole circuit. This two-pole frequency range, R_2 , is

$$R_2 = (R^{1/2} + R^{-1/2})/2$$

The two-pole phase shifter is further reduced to a one-pole phase shifter with a frequency range¹ of

$$R_1 = (R_2^{1/2} + R_2^{-1/2})/2$$

In order to locate the poles, we define

$$K_2 = -R_2^{1/2} [R_1^{1/2} + (R_1 + 1)^{1/2}]$$

and

$$K_1 = -R_2/K_2$$

The pole and zero locations¹, L_i , in hertz are given by

$$L_1 = \frac{W}{2\pi} \left[\frac{1}{\sqrt{1 + K_2^2} - K_2} \right],$$

$$L_2 = \frac{W}{2\pi} \left[\frac{1}{\sqrt{1 + K_1^2} + K_1} \right],$$

$$L_3 = \frac{W}{2\pi} \left[\frac{1}{\sqrt{1 + K_1^2} - K_1} \right],$$

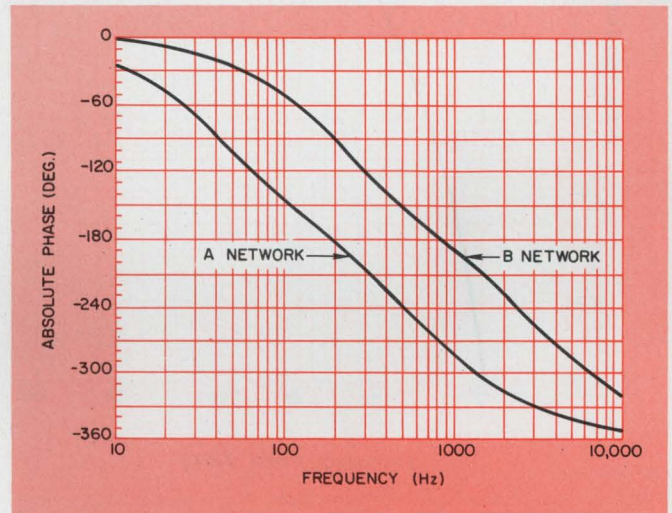

2. A plot of the calculated phase response of the A and B networks of Fig. 1 illustrates the 90-degree differential phase shift from 70 Hz to 2.1 kHz.

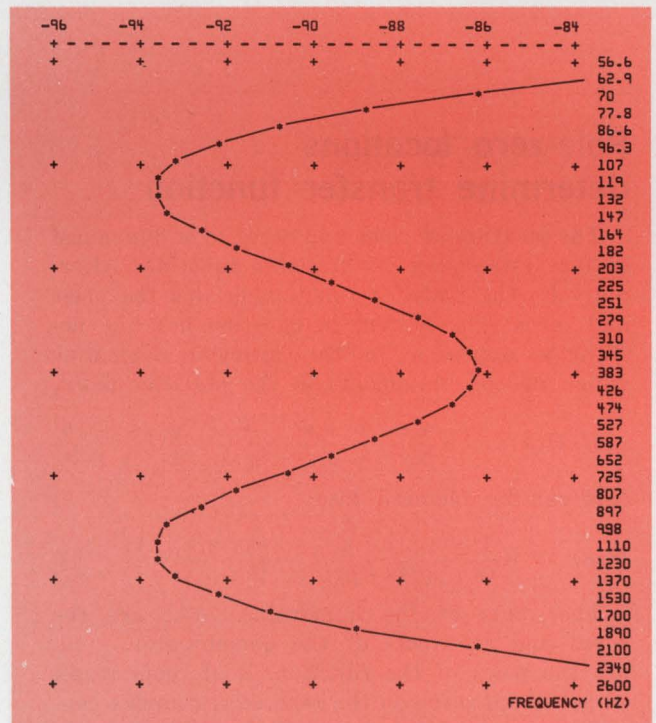

3. A computer plot of the A and B network differential phase demonstrates that the tolerance on the desired 90 degrees does not exceed 3.8 degrees over the frequency band of interest.

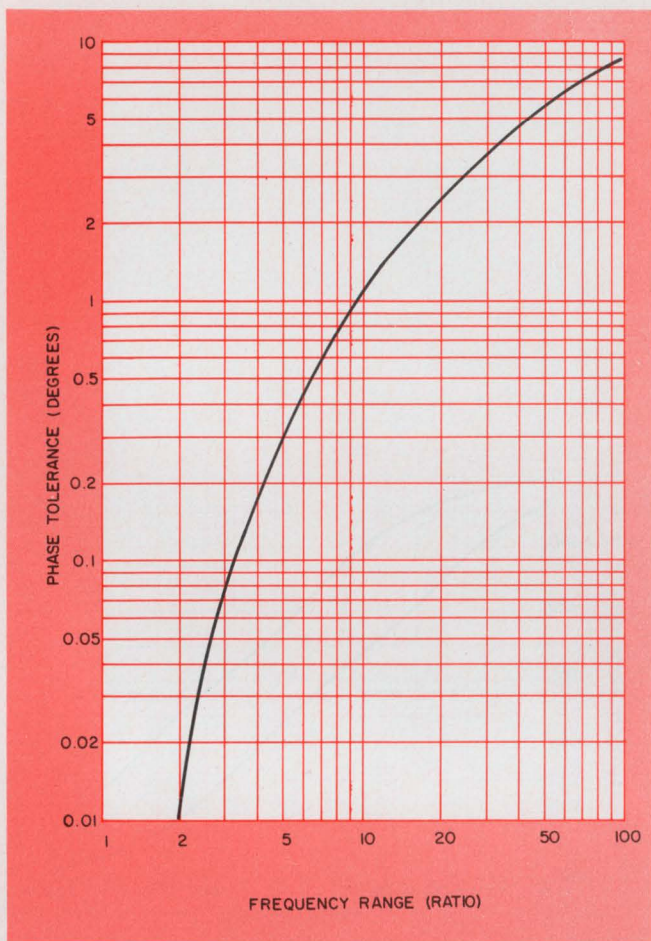

4. A four-pole phase shifter exhibits this theoretical relationship between frequency range and phase tolerance. If a tighter tolerance is required, more poles must be incorporated into the circuit.

Pole-zero locations determine transfer function

The location of poles and zeros of a dynamical system establishes its transfer function. Alternatively, the transfer function locates the poles and zeros. The system in question and the designer's approach to the problem determine which of the statements is the starting point.

$$\text{If } H(s) = K \frac{a_0 s^n + a_1 s^{n-1} + \dots + a_{n-1} s + a_n}{b_0 s^m + b_1 s^{m-1} + \dots + b_{m-1} s + b_m}$$

this can be factored into

$$H(s) = K \frac{(s+z_1)(s+z_2)\dots(s+z_i)\dots(s+z_n)}{(s+p_1)(s+p_2)\dots(s+p_j)\dots(s+p_m)}$$

The roots of the numerator, $-z_i$, are the zeros and the roots of the denominator, $-p_j$, are the poles of the function. Real roots result in poles and zeros on the real axis; complex conjugate root pairs result in poles and zeros in the complex plane and, if the real part is zero, on the imaginary axis.

and

$$L_i = \frac{W}{2\pi} \left[\frac{1}{\sqrt{1 + K_2^2} + K_2} \right]$$

The L_i are all positive numbers, and $L_4 > L_3 > L_2 > L_1$. Each L_i represents a pole-zero pair on the real axis of the complex-frequency plane, with the pole located at a distance $-L_i$ in the left half-plane and the zero at $+L_i$ in the right half-plane. The odd L_i , L_1 and L_3 , are realized in the A network of Fig. 1 and the even L_i , L_2 and L_4 , are realized in the B network.

The phase difference between the A and B networks is within a tolerance of $\pm E_2$ degrees of -90 degrees over the frequency range. The precise phase at any given frequency can be found by summing the phase contributions of the four poles and four zeros in the network pair. In particular, the value of E_2 can be found by evaluating the phase at the frequency-range limit F_1 .

$$E_2 = 2 \sum_{i=1}^4 (-1)^i \tan^{-1} \left(\frac{F_1}{L_i} \right) + 90^\circ$$

The arctangent is multiplied by two because each zero in the right half-plane adds as much phase as the corresponding pole in the left half-plane. The negative sign for odd values of i in the summation represents the subtraction of the B network phase from that of the A network. The phase offset of $+90$ degrees is required because E_2 is the tolerance around -90 degrees rather than 0 degrees.

Pole locations determine components

Since the A and B networks are identical in form, the same synthesis procedure can be used for both. The transmission gain of the B network can be expressed in terms of the component values of Fig. 1b.

$$\frac{E_{out}}{E_{in}} = \frac{Q(s) - 1}{Q(s) + 1}$$

$$Q(s) = \frac{R_3 [1 + (R_1 + R_4)C_1s] [1 + R_2C_2s]}{R_4 [1 + (R_2 + R_3)C_2s] [1 + R_1C_1s]}$$
(1)

and $s = \sigma + j\omega$.

The desired transmission gain of the B network can also be expressed in terms of the theoretical pole locations, with a constant scale factor K .

$$\frac{E_{out}}{E_{in}} = K \frac{(s - 2\pi L_2)(s - 2\pi L_4)}{(s + 2\pi L_2)(s + 2\pi L_4)}$$

This equation for E_{out}/E_{in} can be expressed in the same form as Eq. 1 by multiplying out the factors and collecting terms.

Let $K = (H - 1)/(H + 1)$ where H is also a constant. Then

```

100 PRINT "  ", "90-DEG PHASE-DIFFERENCE NETWORKS"
110 PRINT
120 PRINT
130 PRINT
140 PRINT"  FREQ LIMITS (HZ)";
150 INPUT F1,F2
160 PRINT
170 PRINT"  MAX C (NANOFARADS)";
180 INPUT C0
190 PRINT
200 LET R=F2/F1
210 LET W=SQR(F2*F1)*6.2831853
220 LET R2=(R+.5+1/R+.5)/2
230 LET R1=(R2+.5+1/R2+.5)/2
240 LET K(2)=-.5+(R1+.5)/(R1+.5)*R2+.5
250 LET K(1)=-R2/K(2)
260 PRINT"  POLE-ZERO LOCATIONS (HZ):"
270 PRINT
280 LET J1=0
290 LET E2=90
300 FOR I=1 TO 4
310 LET J1=J1+(-1)^(I+1)*(3-I)
320 LET L(I)=W/6.2831853/(SQR(1+K(J1)^2)+(-1)^I*K(J1))
330 PRINT"  ";L(I)
340 LET E2=E2+(-1)^I*ATN(F1/L(I))*360/3.14159265
350 NEXT I
360 PRINT
370 PRINT"  PHASE TOLERANCE (DEG): ";INT(E2*100+.5)/100
380 PRINT
390 LET H=(L(4)+L(2))/2/SQR(L(4)*L(2))
400 FOR Z=0 TO 4 STEP 4
410 LET V1=W/6.2831853/SQR(L(4-Z/4)*L(2-Z/4))
420 LET V3=M+2+SQR(H^4-1)
430 LET C(2+Z)=C0/1E9
440 LET R(2+Z)=V1/C(2+Z)/W
450 LET R(3+Z)=R(2+Z)*(V3-1)
460 LET R(1+Z)=R(2+Z)/H
470 LET C(1+Z)=V1/V3/R(1+Z)/W
480 LET R(4+Z)=R(3+Z)/H
490 NEXT Z
500 LET K=(H-1)/(H+1)
510 PRINT"  INSERTION LOSS (DB): ";-INT(2000*LOG(K)/LOG(10)+.5)/100
520 PRINT
530 PRINT"  COMPONENT VALUES (KILOHMS AND NANOFARADS):"
540 PRINT
550 PRINT"  'B' NETWORK","'A' NETWORK"
560 PRINT
570 FOR I=1 TO 4
580 PRINT"  R";I;R(I)/1E3,"R";I+4;R(I+4)/1E3
590 NEXT I
600 PRINT
610 FOR I=1 TO 2
620 PRINT"  C";I;C(I)*1E9;"  ", "C";I+4;C(I+4)*1E9
630 NEXT I
640 PRINT
650 PRINT"  ('A' LAGS 'B' BY 90 DEG)"
660 END

```

5. This BASIC program can compute the component values for a four-pole phase shifter. The LET statements

translate design equations into computer form. The other statements cover control and input/output.

$$\frac{E_{out}}{E_{in}} = \frac{Q'(s) - 1}{Q'(s) + 1}$$

where

$$Q'(s) =$$

$$H \frac{1 + \frac{s}{2\pi H} \left(\frac{1}{L_2} + \frac{1}{L_4} \right) + \left(\frac{s}{2\pi} \right)^2 \left(\frac{1}{L_2 L_4} \right)}{1 + \frac{sH}{2\pi} \left(\frac{1}{L_2} + \frac{1}{L_4} \right) + \left(\frac{s}{2\pi} \right)^2 \left(\frac{1}{L_2 L_4} \right)} \quad (2)$$

In order to be able to compare this equation with Eq. 1, it must be factorable into positive real roots. This sets an upper limit on the value of H and hence a minimum insertion loss for the B network of Fig. 1b. The limiting value H_{max} is found by solving the numerator of Eq. 2 for the value of H, which produces a double root:

$$H_{max} = (L_2 + L_4) / (2\sqrt{L_2 L_4}).$$

It is desirable to use H_{max} as the value of H in Eq. 2 because this minimizes the network insertion loss and also minimizes the sensitivity of the network response to component value variations. Using $H = H_{max}$, Eq. 2 may again be rewritten:

$$Q'(s) = H \frac{\left[1 + \frac{V_1}{W} s \right] \left[1 + \frac{V_1}{W} s \right]}{\left[1 + \frac{V_1 V_3}{W} s \right] \left[1 + \frac{V_1}{V_3 W} s \right]}$$

where the intermediate variables are

$$V_1 = W / (2\pi \sqrt{L_2 L_4}).$$

$$\text{and } V_3 = H^2 + \sqrt{H^4 - 1}.$$

Because Q(s) and Q'(s) are in identical form, these equations can be compared term by term

in order to derive the component values in the circuit of Fig. 1 from the L_i pole locations. This comparison yields five equations, but one degree of freedom remains since six component values are to be determined. The sixth constraint scales the network impedance to a convenient level by specifying the value of the largest capacitor as C_0 in nf. Solving the six equations gives the following values for the six components in the B network:

$$C_2 = C_0, R_2 = V_1 / (W C_2),$$

$$R_3 = R_2 (V_3 - 1), R_1 = R_2 / H,$$

$$C_1 = V_1 / (W V_3 R_1), R_4 = R_3 / H$$

The value of the two R_0 resistors may be chosen independent of the values of the other components as long as they are closely matched for unity gain inversion.

The component values in the A network are found by a similar synthesis. In order to solve the A network, odd pole-zero locations are used rather than the even ones. The value of H_{max} does not have to be recalculated because it is the same as that for the B network due to the symmetry of the L_i pole locations. The same equations may be used to find the A network components if each component subscript is increased by four (R_1 becomes R_5 , etc.) and each pole location subscript is decreased by one (L_2 becomes L_1 , etc.).

BASIC program automates the design

A computer program to automate the phase-shifter design is given in the listing of Fig. 5.

```
FREQ LIMITS (HZ) ? 70, 2100
```

```
MAX C (NANOFARADS) ? 100
```

```
POLE-ZERO LOCATIONS (HZ):
```

```
44.4505  
205.458  
715.475  
3307.05
```

```
PHASE TOLERANCE (DEG): 3.71
```

```
INSERTION LOSS (DB): 8.85
```

```
COMPONENT VALUES (KILOHMS AND NANOFARADS):
```

'B' NETWORK		'A' NETWORK	
R 1	0.906219	R 5	4.1887
R 2	1.9308	R 6	8.92451
R 3	15.3838	R 7	71.1065
R 4	7.22034	R 8	33.3737
C 1	23.7592	C 5	23.7592
C 2	100	C 6	100

```
('A' LAGS 'B' BY 90 DEG)
```

6. A printout of the solution of a phase-shifter design problem requires the user to enter frequency limits and impedance level after the question marks. The rest of the printout gives circuit values.

This program is written in BASIC.^{3,4} LET statements implement the design solution derived above. Most of the remaining statements in the program are input/output control to enter parameters and printout the final design solution (Fig. 6). The parameter input is accomplished in lines 100-190. The INPUT statement in line 150 causes a question mark to be printed, after which the computer pauses until two numbers corresponding to the values of F_1 and F_2 are typed by the user. Similarly, lines 170-180 allow the user to input the third design variable, the maximum capacitance value C_o .

The printout of the design solution begins in lines 260 and 330 where the four pole-zero locations are listed. Lines 300-350 contain an iteration loop, with I varying from 1 to 4. Each time the computer passes through this loop the value of I is increased by one, and the value of another pole location is printed. The dummy variable J1 defined in lines 280 and 310 is used to properly select either K_1 or K_2 in line 320. The next portion of the solution printout is the phase tolerance E_2 and insertion loss K; and the final portion of the solution printout is the component values. A Z iteration loop from line 400 to 490 uses the same statements to calculate the component values for both the B network and the A network.

These 12 component values are then printed out in lines 580 and 620.

Values are calculated for example

The printout in line 650 gives the direction of the differential phase shift between the outputs of the two networks. Because the poles of the A network are closer to the origin in the complex frequency plane, the A network experiences more phase delay than the B network at any given frequency. Therefore, the A-minus-B phase difference is approximately -90 degrees rather than $+90$ degrees.

The circuit values for the pole-zero configuration of the design example are shown in Fig. 1. Here, R_o was chosen to be 10k for optimum biasing of the op amps. A single integrated circuit, $\mu A747$, is used for both active elements in the phase shifter design. The component values have been rounded to three significant figures, thus causing a slight variation from the ideal phase and gain response. Care must be taken that tolerance and temperature variations are kept within acceptable limits. Computer programs, such as ECAP, can be used to determine response sensitivity and to minimize the effects of component variation. ■■

References

1. Albersheim, W., and Shirley, F., "Computation Methods for Broad-Band 90° Phase-Difference Networks," *IEEE Transactions on Circuit Theory*, May, 1969, pp. 189-196.
2. Shirley, F., "Program a Time-Shared Computer Terminal for Easy Curve Plotting," *Electronic Design*, December 6, 1969, pp. 99-100.
3. Shirley, F., "You Don't Have to be a Programmer," *Electronic Design*, April 12, 1967, pp. 54-60.
4. *BASIC Language Reference Manual*, General Electric Information Service Department Publication 202026A, January, 1967.

Test Your Retention

Here are questions based on the main points of this article. Their purpose is to help you make sure you have not overlooked any important ideas. You'll find the answers in the article.

1. What are the gain vs frequency characteristics of the phase-shifter networks?
2. What effect does the number of poles have on phase-shifter performance?
3. Which component determines circuit impedance level?
4. How are the pole-zero pairs determined and realized?

New low prices for RCA's COS/MOS IC'S

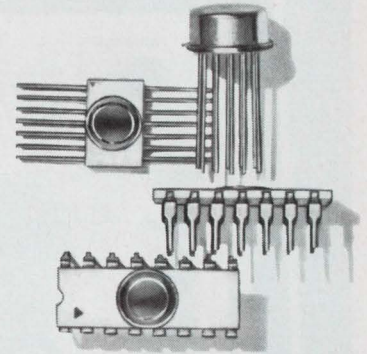

Once again, as production volume follows market demand, RCA has substantially reduced COS/MOS IC prices. Result: more engineers can take advantage of the unique performance features of the COS/MOS technology in their new and existing logic-circuit designs. Before you begin a new design, evaluate the exceptionally high performance and outstanding reliability of COS/MOS IC's: check cost, check power requirements, check cooling requirements, check noise sensitivity. You'll find many reasons for incorporating RCA's COS/MOS IC's in today logic-circuit designs for tomorrow's production savings.

COS/MOS FEATURES— Typical Values at $V_{DD}=10V$

- Extremely low quiescent-power dissipation
Gates— $P_T = 10 \text{ nW/pkg}$
MSI circuits— $P_T = 5 \mu\text{W}$
- Speed
Gates—propagation delay (t_{pd}) = 50 ns @ $C_L = 15 \text{ pF}$
MSI circuits—clock pulse frequency (f_{CL}) = 2.5 MHz
- Excellent dc and dynamic noise immunity, 4.5 V over full operating - temperature range
- High dc fanout > 50
- Simple circuit and subsystem design
- Compatible gate-level and MSI functions
- Operation from one unregulated power supply 6 to 15 V
- Full military operating-temperature range -55°C to $+125^\circ\text{C}$
- Stable performance over wide ranges of supply voltage and temperature

For further information on COS/MOS integrated circuits, see your local RCA Representative or RCA Distributor. Ask for the following COS/MOS application information: "Noise Immunity", ICAN 6176; "Astable and Monostable Oscillator Designs", ICAN 6267; "COS/MOS IC Reliability Data", RIC 101. Or write: RCA, Commercial Engineering, Section 571-1 /CD46, Harrison, N. J. 07029. International: RCA, 2-4 rue du Lièvre, 1227 Geneva, Switzerland, or P.O. Box 112, Hong Kong.

Flat Pack Type No.	DIC Type No.	Description	Flat Pack Price-Each (1000 or more quantities)	DIC Price-Each
Gates				
CD4000	CD4000D	Dual 3-input NOR plus inverter	\$ 3.90	\$ 3.25
CD4001	CD4001D	Quad 2-input NOR	4.10	3.45
CD4002	CD4002D	Dual 4-input NOR	4.25	3.60
CD4007	CD4007D	Dual complementary pair plus inverter	3.40	2.75
CD4011	CD4011D	Quad 2-input NAND	4.10	3.45
CD4012	CD4012D	Dual 4-input NAND	4.25	3.60
—	CD4019D	AND-OR select gate	—	5.25
Flip-Flops				
CD4013	CD4013D	Dual-D with set/reset capability	5.60	4.95
Hex Buffers/Logic-Level converters				
—	CD4009D	Inverting	—	5.50
—	CD4010D	Non-inverting	—	5.50
Multiplexers				
CD4016	CD4016D	Quad bilateral switch	6.00	5.40
Memories—MSI				
CD4005	CD4005D	16-bit NDRO	10.00	9.45
Static-Shift Registers—MSI				
CD4006	CD4006D	18-stage register	10.00	9.50
—	CD4014D	8-stage synchronous parallel or serial input/serial output	—	10.55
—	CD4015D	Dual 4-stage serial-input/parallel-output	—	10.55
Counters—MSI				
CD4004	—	7-stage ripple counter/freq. divider	8.20	—
—	*CD4004T		—	7.50
—	CD4017D	Decade counter/divider with 10 decoded outputs	—	11.00
—	CD4018D	Presetable divide by "N" counter	—	9.65
—	CD4020D	14-stage ripple-carry binary counter/divider	—	12.50
Adders—MSI				
—	CD4008D	4-bit full adder with parallel carry out	—	10.60

*TO-5 package
(COS/MOS IC's listed in bold-face type are recent additions to the line.)

RCA Integrated Circuits

PULSE

FIDELITY

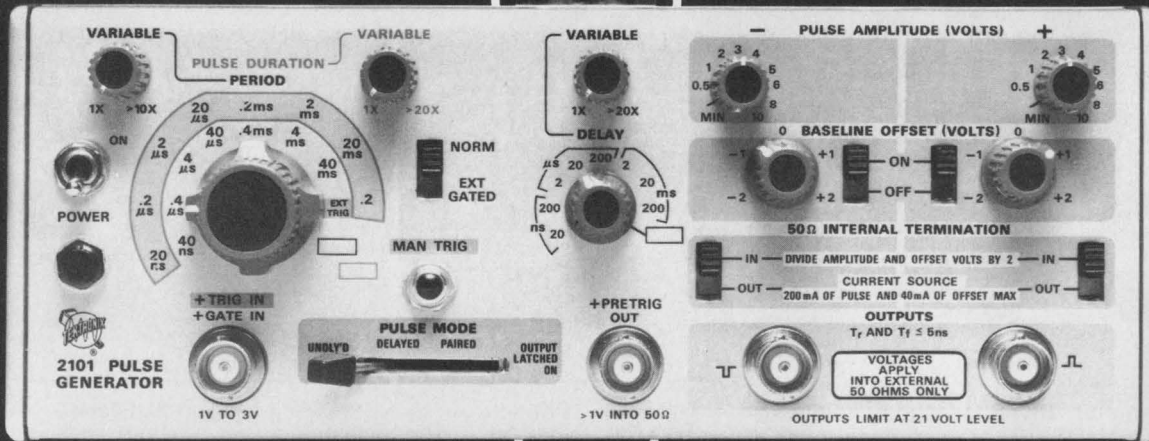

3%

Simultaneous Positive and Negative Pulses

This 25-MHz, 10-volt, general-purpose generator produces exceptionally clean pulses with aberrations not exceeding 3%. Positive and negative-going pulse outputs are simultaneously available and independently variable from 0.5 V to 10 V. (See photo at right.) Each output is provided with a continuously variable baseline offset of +2 V to -2 V.

A choice of paired, delayed and undelayed pulses, as well as a DC output is provided by the four operating modes.

Pulse duration, period and delay are separately variable; pulse duration from 20 ns to 400 ms, period from 40 ns to 400 ms, and delay from 20 ns to 4 s. Mechanical coupling prevents the duration from exceeding the period for all calibrated positions.

Risetime and falltime of 5 ns (2.5 Hz to 25 MHz rep rate), simultaneous positive and negative outputs, with aberrations less than 3%, make the 2101 an ideal pulse source for logic testing or wherever the need for clean pulses exists.

A demo of the 2101 will prove its merits — call your local Tektronix Field Engineer. Have you

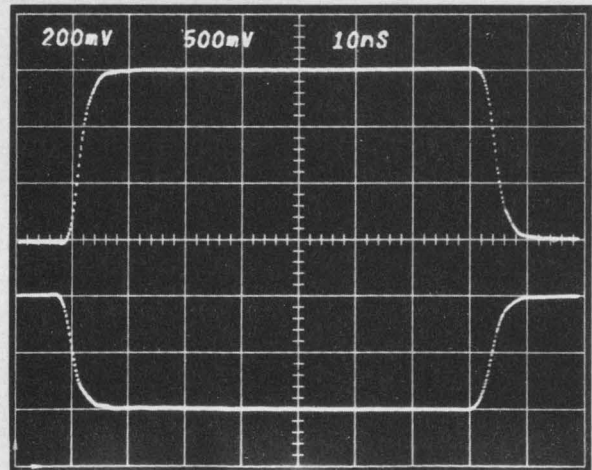

seen the new 7000-Series Oscilloscopes? For complete specifications on these instruments, consult your 1970 Tektronix Catalog, or write P. O. Box 500, Beaverton, Oregon 97005.

All these new instruments are available under our new Leasing Plan.

2101 Pulse Generator \$700

U.S. Sales Price FOB Beaverton, Oregon

Tektronix, Inc.



*committed to progress
in waveform measurement*

Compare reliability at a glance.

Computer-generated, direct-reading curves show the effect of redundant units.

System reliability can be improved by using redundant components, and its numerical value can be calculated by using the binomial expansion. However, the analytic approach can be tedious. Here is a set of computer-generated curves that makes system reliability comparisons possible at a glance.

The curves can be applied to two types of redundancy calculation: back-up and back-off. Back-up redundancy means that incremental or fractional spares are available to replace failed units in order to maintain a given capability. Back-off redundancy refers to the probability of meeting a degraded requirement—something less than a desired goal.

A trivial example of back-up redundancy is the availability of two 10-W power supplies to supply a 10-W load. More involved is the fractional back-up redundancy involved in having three 5-W supplies for a 10-W load. In the first case there are incremental spares. In the second case, there is reserve power, but it is a fraction of the requirement rather than an increment.

A case of back-off redundancy exists if there are three 5-W supplies for a 15-W load, but it is later decided that only 10 of the 15 W are critical. The interpretation of the needs is different, but the calculation is carried out in the same way as the back-up case.

Use redundancy curves

For instance, the redundancy curves in Figs. 1-4 relate three variables. The units above the minimum required are plotted along the abscissa. The ordinate represents probability of system success, R_s . The parameter for each individual curve is the reliability of a unit of equipment, R_u . Note that the lowest value plotted on the abscissa is the number of units required as a back-up minimum or a back-off limit. Therefore, a separate set of curves is needed for each minimum value. Four such curve families are given here. If additional ones are necessary, the equations

Charles H. Karr, Senior Engineer, Reliability Engineering, Aerospace & Electronic System Div., Westinghouse Electric Corp., PO Box 746, Baltimore, Md.

Derivation of reliability curves

R_u = single-unit reliability
 $1-R_u$ = single-unit unreliability
 n = number of redundant paths
 j = number of unit failures

Then: $(1-R_u) + R_u = 1$

$[(1-R_u) + R_u]^n = 1$ and can be expanded into:

$$R_u^n + n R_u^{n-1}(1-R_u) + \dots + \binom{n}{j} R_u^{n-j} (1-R_u)^j + \dots + (1-R_u)^n = 1$$

The left side of the final equation represents all possible combinations of success and failure. By subtracting all cases of failure from both sides of the equation, the left-hand side then represents all chances for success and the right-hand side all chances of failure subtracted from unity.

Each solution of the expanded equation gives one point on one curve. If, for example, $n=3$;

$$R_u^3 + 3R_u^2(1-R_u) + 3R_u(1-R_u)^2 + (1-R_u)^3 = 1.$$

Now, if at least two successes are required to make the system successful, the first two terms on the left are equated to R_s , the probability of system success is

$$R_s = R_u^3 + 3R_u^2(1-R_u) \text{ or}$$

$$R_s = 1 - [3R_u(1-R_u)^2 + (1-R_u)^3]$$

If $R_u = 0.95$, $R_s = 0.993$ and one point has been calculated. The only way to expedite this tedious procedure is to program the calculation on a computer.

in the box can be used to construct them.

Suppose a mission reliability requirement for a power-supply system is $R_s = 0.85$ to deliver at least 18 W. How many back-up units are needed if each can deliver 6 W with a unit reliability of 0.65? Refer to Fig. 3, because at least three units must be used. Follow the 0.85 ordinate until it intersects the 0.65 unit reliability curve. The corresponding abscissa is 5.7. Therefore, six units are required to meet the specified reliability.

As a second example, consider a requirement

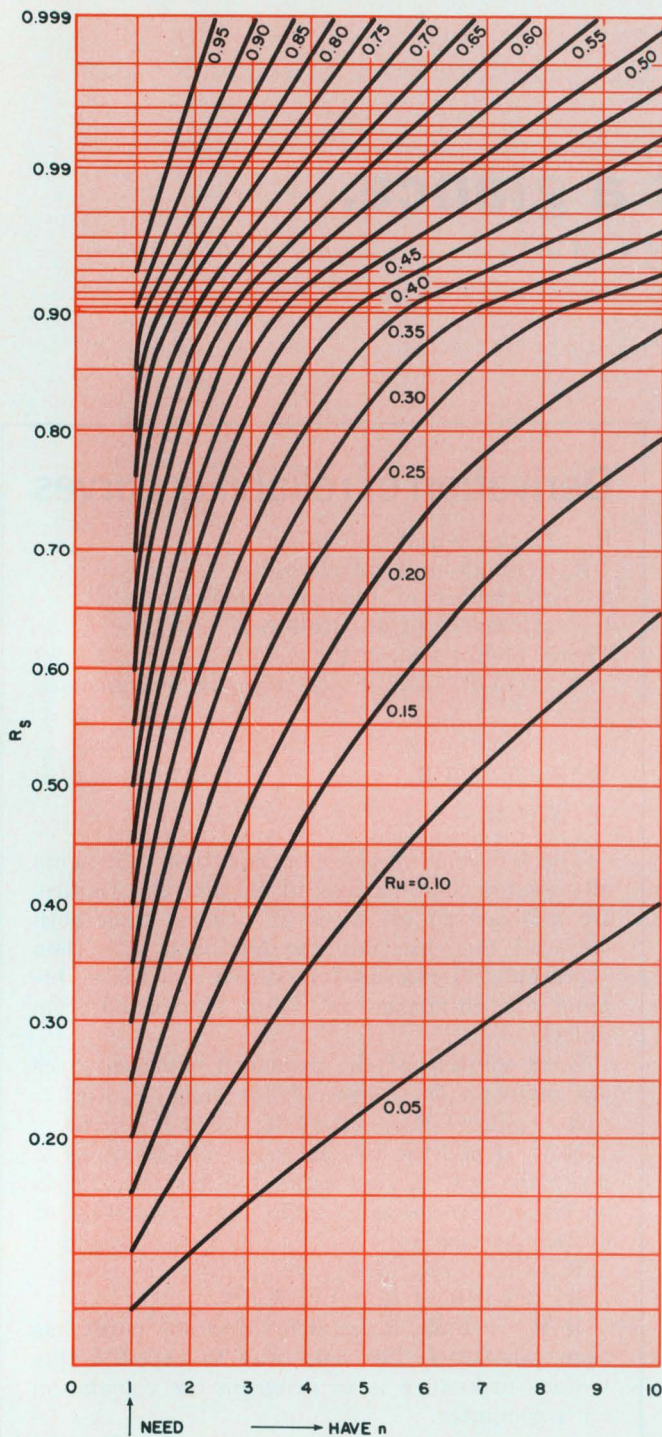

1-4. This set of curves relates system reliability (R_s) to unit reliability (R_u) based on the number of spare units available. In Fig. 1, one unit is needed and one to ten are available. In Figs. 2, 3, and 4, the number of required units are two, three, or four, respectively, and up to 10 are on hand.

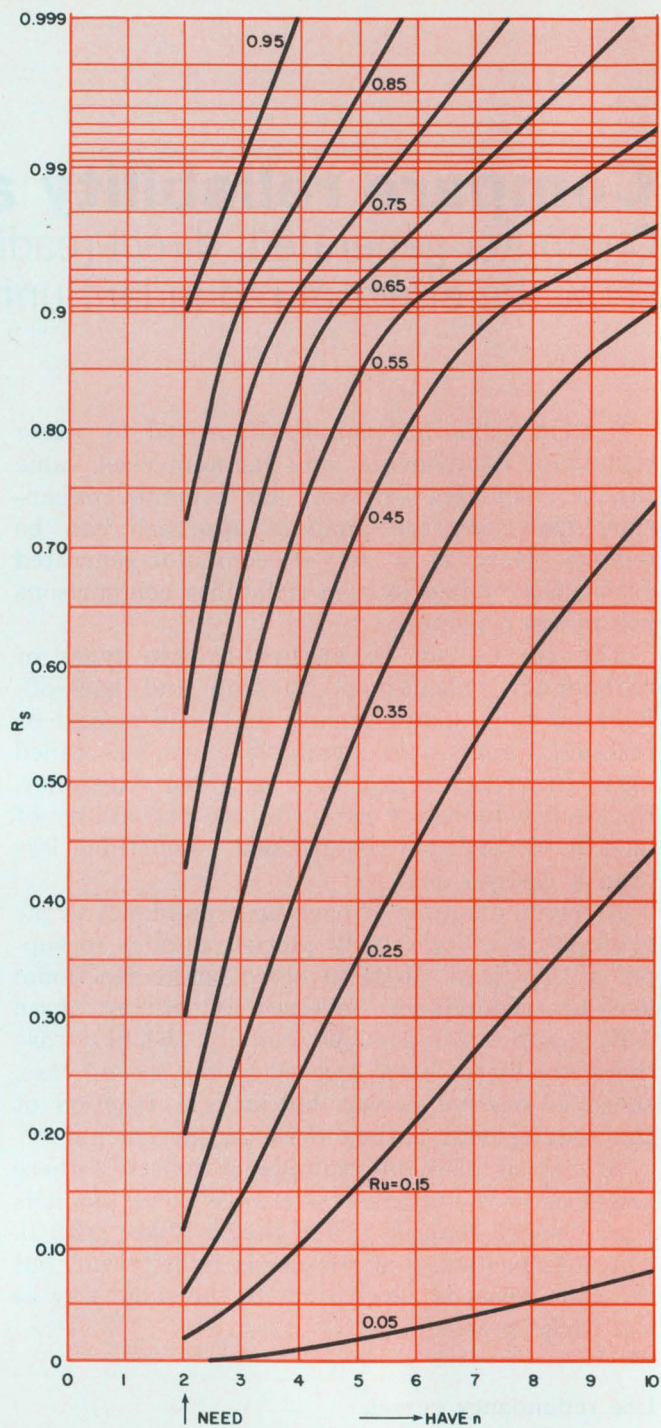

for 90 W with $R_s = 0.86$. If three 30-W units are chosen, each must have a reliability of at least 0.95 in order to meet the system requirement. Now, if only 60 W are needed to supply critical loads, what is the back-off reliability of the system?

Since two units can meet the reduced specification, refer to Fig. 2. Follow the abscissa for three units until it intersects $R_u = 0.95$. The corresponding ordinate, 0.993, is system reliability for the reduced backed-off power level.

If an orbiting satellite is to perform five experiments ($n=5$), each with an equal probability of success of 0.55, the over-all probability of

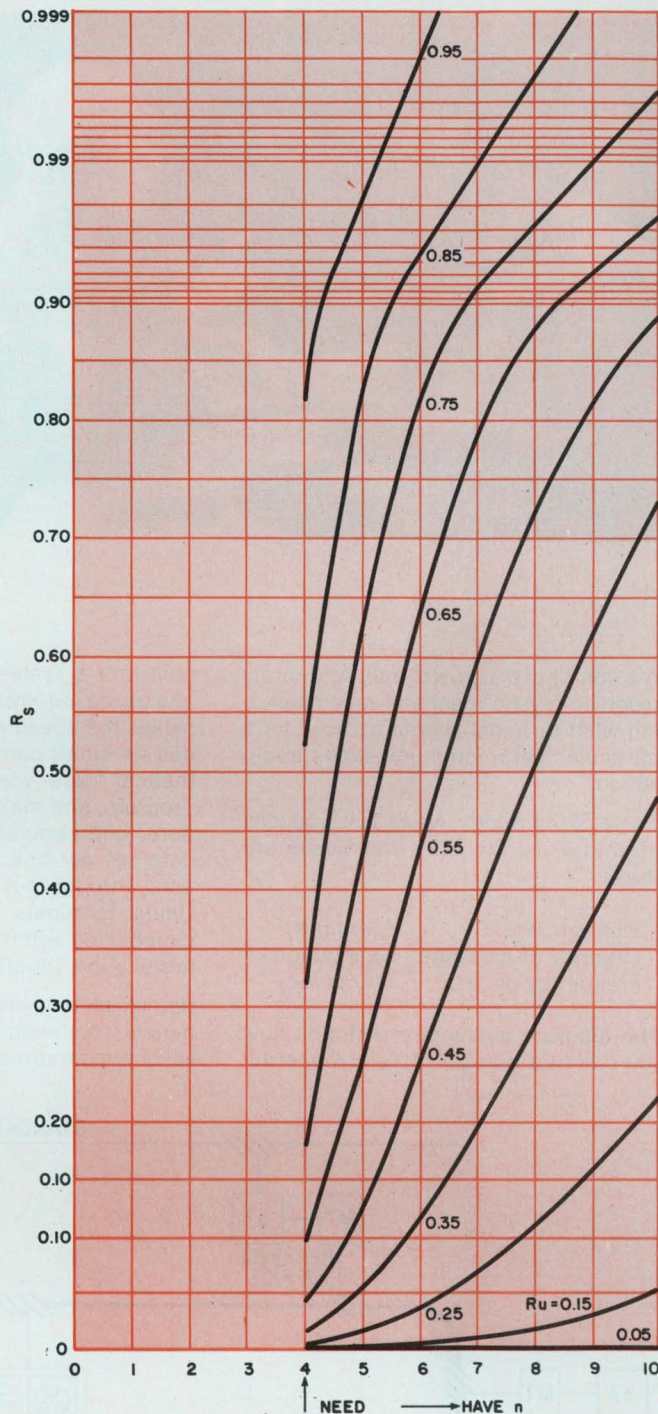
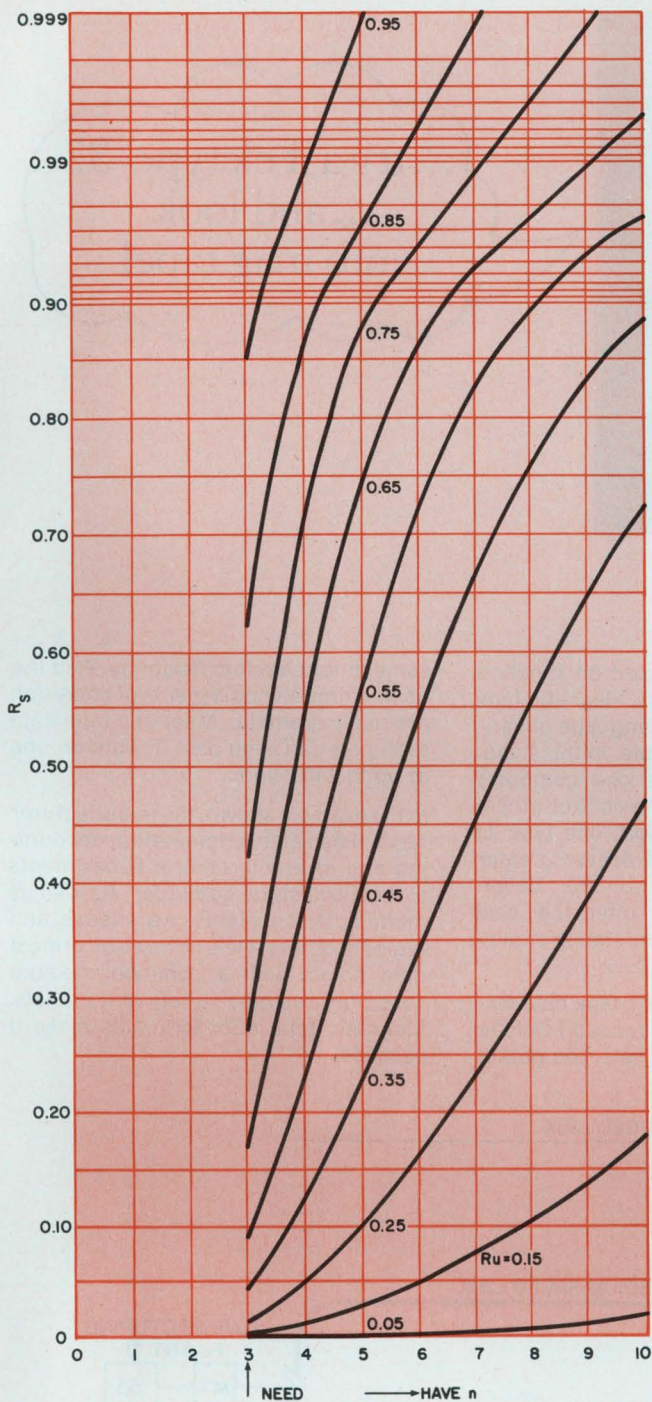

success is $0.55^5 = 0.05$. What is the probability of completing at least two experiments?

For the solution, again refer to Fig. 2 and follow abscissa 5 to the $R_u = 0.55$ curve, at which point the ordinate is 0.87. Thus, backing off the requirement has increased the probability of success from 5 per cent to 87 per cent. ■■

Bibliography

Huber, William H., "Yes, Redundancy Increases Reliability," *Electronic Design*, June 7, 1970, pp. 70-77.
Karr, Charles H., "Systems Redundancy Can Be a Mixed Blessing," *Electro-Technology*, April 1969.

Test your retention

Here are questions based on the main points of this article. Their purpose is to help you make sure you have not overlooked any important ideas. You'll find the answers in the article.

1. What is back-up redundancy?
2. What is back-off redundancy?
3. On what mathematical function is the calculation of redundant reliability based?
4. What are incremental spares?



...try a Teletype® 37
...and look
into mag tape!

We don't have a crystal ball. And rarely resort to mystic means in recommending what terminal should be used for a particular data communications application.

Some of the things, we at Teletype look at, that make the job a little easier are these:

- | | |
|--------------------|----------|
| Distribution | Volume |
| Urgency of message | Language |
| Frequency of use | Accuracy |

The diagram below demonstrates how you can fit a number of Teletype terminals

into a system based on function and usage requirements. Magnetic tape makes the speed and language of various terminals compatible. In this hypothetical case we use one computer program, one major line control procedure, one computer port, one type of data set per link. And deliver greater data through-put per on-line dollar. Using terminals that offer the best capabilities within each station's communication situation.

Using Teletype magnetic tape data terminals, combined with various Teletype keyboard send-receive sets, you obtain

some unique system flexibility. And the on-line time saving aspects of operation are really dramatic. Magnetic tape data terminals can keep data flowing on-line at up to 2400 wpm.

In the example shown, the manufacturer has linked sales, engineering, accounting and inventory control departments to a central office computer. As well as manufacturing plants, warehouse and regional offices. He's covered all critical data points with a common medium speed link, using a variety of terminals. Magnetic tape data terminals make it possible.

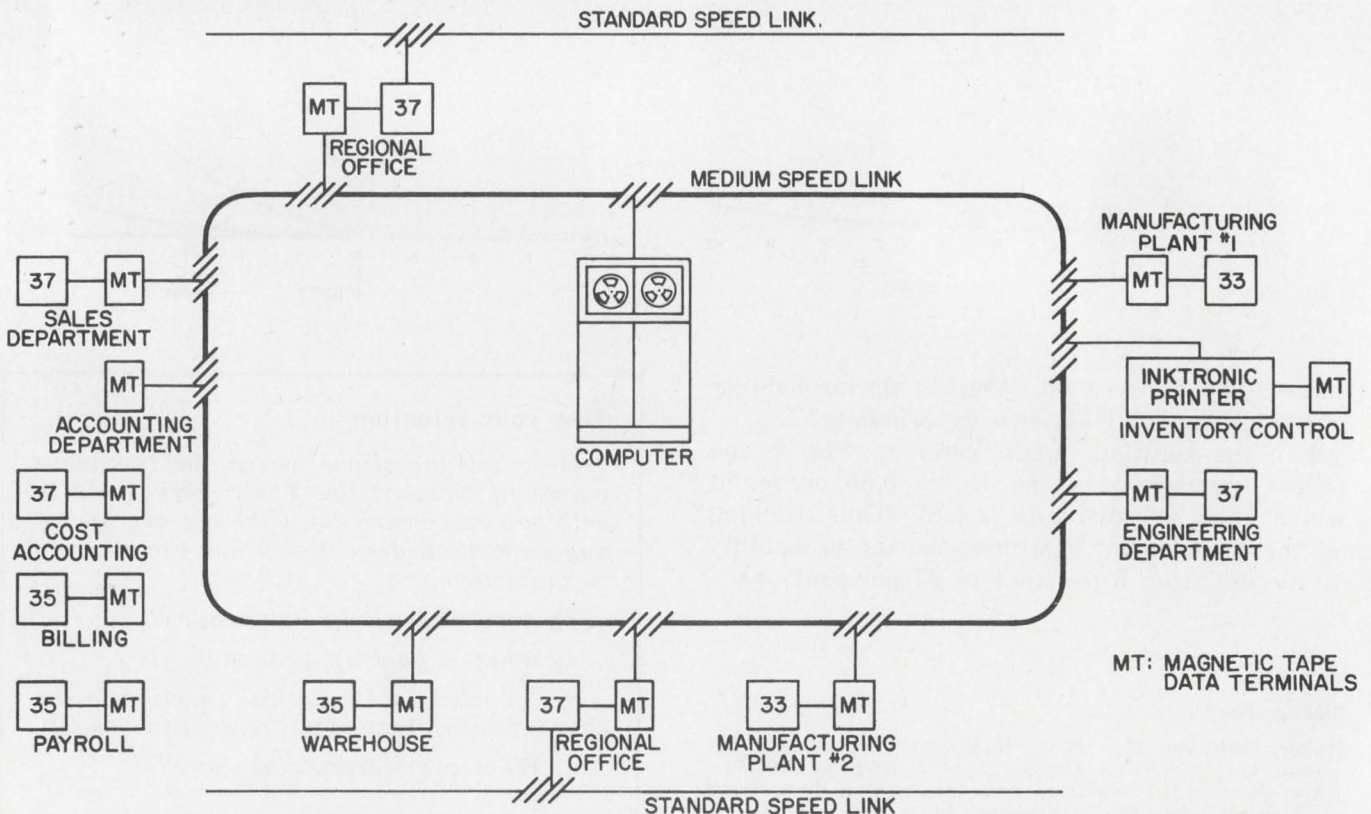

DATA COMMUNICATIONS

equipment for on-line, real-time processing

Routine aspects of the system are maintained in standard speed links. Branch offices are tied into the regional office terminals on standard speed networks. Regional offices batch routine branch office data on one magnetic tape. Transmit the data to the central office processor at one time. Saving a number of additional computer port requirements.

Since data generated at manufacturing plants is urgently needed, but volume is low, low-cost model 33 terminals are used here. The warehouse data volume is higher, but not complex, so a heavy-duty model 35 is working here.

Volume requirements are heaviest in the accounting department. Cost accounting, payroll, billing and invoice payment functions generate data all day long. Here magnetic tape is prepared off-line at various terminals. And an on-line stand-alone magnetic tape terminal is used to transmit data to and receive data from the central processor.

Sales and engineering departments are equipped with Teletype 37 terminals. But for different reasons.

This terminal offers engineering people some unique format flexibility. Half-line and full-line forward and reverse line feed can be used to communicate complex equations and engineering formulae to the processor. It is possible to add special graphic engineering symbols to the normal compliment of letters, numbers and punctuation marks found in the typebox (up to 32).

The sales department uses the model 37 for order processing. It has on-line vertical and horizontal tab set control, and form feed platen (optional) which makes data transmission and reception on multiple copy business forms easy and economical.

At the inventory control point, this manufacturer has an urgent need to obtain printed page copy of large volumes of inventory items. Magnetic tape is used to feed data to the processor and a Teletype Inktronic® KSR set receives data and prints page copy on-line up to 1200 words per minute.

As you can see, Teletype's modular terminal design allows you to use vari-

ous units as building blocks to meet the most demanding system needs. Teletype also has the station and error control accessories necessary for more efficient and economical data communications operations. Since cost is a very important part of the mix, Teletype offers greater terminal capabilities on a price/performance basis than any other manufacturer.

If you're involved in designing a teleprocessing, time-sharing, remote batch or computer switched system; looking into a multi-point private line, point-to-point private line or switched data communications network; talk to Teletype about terminals. For ideas, equipment and understanding, you'll find no better source. Anywhere.

Teletype data communications equipment is available in send-receive capabilities of up to 2400 words per minute. If you would like specific information about any of the equipment described here, write: Teletype Corporation, Dept. 89-16, 5555 Touhy Ave., Skokie, Ill. 60076.

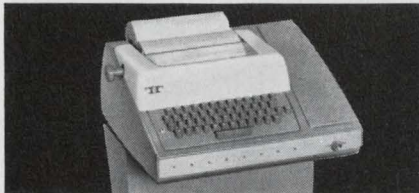

model 33 series: An extremely low-cost 100 wpm terminal line. Uses ASCII. The most widely used terminal in time-sharing systems today.



model 35 series: A rugged, heavy-duty line of 100 wpm terminals. Uses ASCII.



model 37 series: One of the most versatile heavy-duty terminal lines going. Generates all 128 characters of ASCII. Operates at 150 wpm. Prints in upper and lower case.

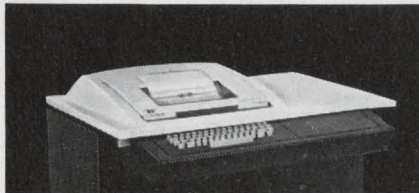

Inktronic® data terminals: A unique electronic, solid state terminal. Prints up to 1200 wpm. Forms characters through electrostatic deflection (no typebox). ASCII compatible.



magnetic tape data terminals: Use compact reusable tape cartridges. Operate on-line at up to 2400 wpm, and connect "locally" to lower speed Teletype terminals using ASCII.

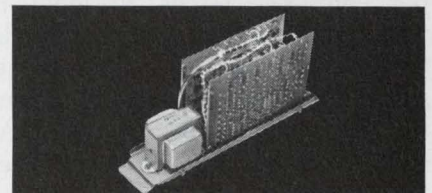

Stuntronic™ accessories: Electronic solid state terminal logic devices offering many control options. Such as, automatic station control, error detection and correction capabilities.

Teletype is a trademark registered in the U.S. Pat. Office

machines that make data move



INFORMATION RETRIEVAL NUMBER 43

Contraction puts a squeeze on managers.

A slowdown of company pace and growth rate is the most troublesome management problem of the 'slump,' says this president.

Richard L. Turmail, Management Editor

Because technology in the electronics industry is constantly and rapidly changing, the job of managing an electronics firm is difficult, even during business weather that's fair. During a business drought the problems change and multiply.

An example of how management problems can increase during such a dry spell is found at Analog Devices, a highly successful and expanding producer of analog-function modules and digital-computer interface equipment for the scientific, industrial and Government markets.

The company, with net sales of nearly \$10.4 million last year, has grown out of its random cluster of century-old buildings on Fifth Street in Cambridge, Mass., and is constructing a new plant in Westwood, Mass. Yet its president, Emil B. Rechsteiner, says that one of his most troublesome management headaches is trying to maintain the pace and growth the company had before the present general business slump. And he believes that these headaches could have been avoided if the stock market was not the object of so much misunderstanding.

According to Rechsteiner, the present slump is the result of what happens when people equate the economy with the stock market. He pointed out that, while the market has dipped 30 or so per cent, the Gross National Product (GNP), "the only reliable picture of the economy," is just leveling out. But Rechsteiner sees decreases in sales in the third quarter, and blames the contraction on a "market" psychology. And the combination is discouraging to employees.

Slump slows company growth

"Most electronics companies that were founded in the last ten years have never experienced a serious business contraction," Rechsteiner said. "Never before had there been such an expansion of the GNP as from 1959 to 1969." Founded in 1965, Analog Devices is experiencing its first contraction—and finding it frustrating.

The obvious pace problem common to most

electronics companies now is that they have cash tied up in inventory that doesn't move.

To counter this problem, Rechsteiner said that his company has been forecasting more frequently by taking a closer look at its past product models and more thoroughly scrutinizing the competition. The company has also promoted the product lines it believes will sell best during the business slump by writing a brochure listing new applications that make the product more economical.

Another problem that hampers a company's pace is the problem of mounting account receivables. With business slowed down, the company needs more cash on hand to operate.

One way to shrink the pile of receivables, according to Rechsteiner, is doing a bit of research to eliminate those new customers who would be most prone to become debtors.

"When we dug beneath the surface," he said, "we found that, of the customers who don't pay their bills, a large number are small companies that are undercapitalized."

Growth depends on capable employees

Part of the management problem of pace is a leveling off of the company's growth rate.

Rechsteiner said that, although for the first half of this fiscal year the company is 42% ahead of last year, the third quarter won't match the level of the second quarter.

"For the first time," he said, "we're not expanding as we previously have." And he explained that a slowdown in expansion can have a negative effect on the employees.

"Employees get used to expansion, and they become discouraged when it doesn't happen. Ironically, they become more discouraged than employees of a company that hasn't had a history of continual expansion." The employees' main worry, Rechsteiner says, is whether they'll be laid off, or not promoted.

Management tries to dissuade employees from leaving. It highlights the company's good points and compares it with similar companies. Analog's future growth rate depends on its ability to at-

tract, train and develop capable employees. At the end of 1969, the company had a staff of 380 full-time employees, compared with around 255 at the end of 1968.

Problem as old as the industry

Rechsteiner's other major management problem is shifting prices. It's a chronic problem of the electronics industry—one that is not necessarily brought on by the slump, but isn't helped by it, either.

"There aren't many industrial markets," Rechsteiner said, "in which the price is constantly changing as rapidly as it does in the electronics industry."

He indicated that consumer products are less prone to fluctuate in price, but that the price of components, functional circuits and, to a lesser degree, instruments, changes frequently.

One example of changing prices is the computer field in which the cost to the user has gone down tremendously in a short time. Rechsteiner said that four to five years ago computers were confined to business and industrial usage, but with the introduction of minicomputers with applications for home use, the costs have come down. Why? As the computer industry matures, the cost of materials is subject to the same sort of competitive action as products are. And there's a lot of competition because it's still fairly easy to enter the computer market with very little capital.

Production—a must capability

"Our company has recognized," Rechsteiner continued, "that although it was possible to operate inefficiently initially and still survive, we must now maintain a strong manufacturing



President Emil B. Rechsteiner (standing) is shown with other members of the Analog Devices, Inc., corporate staff group, including (left to right) James Hackbush, director of industrial relations; Ray Stata, senior vice president and company co-founder; and Richard I. Krieger, treasurer.

operation to match our marketing and engineering capability."

Intrinsic to all manufacturing operations is the problem of trying to stretch the design specs of the product, although the parts may not be improved enough to do so. Rechsteiner says that, when Analog makes a product composed of other companies' components, it has found the following decisions were necessary for success in production:

- Building a new plant in Westwood, Mass., that will give them much-needed space for production work.

- Hiring an experienced production manager and giving him full authority to operate.

- Formalizing meetings and forecasts for the sake of efficiency.

This last decision, according to Rechsteiner, has resulted in weeding out unprofitable custom-made devices and concentrating on standard products and the introduction of new ones.

"We have found," Rechsteiner said, "that by putting restraints on custom product expansion we can benefit from purchasing large volumes of parts for standard products. We found it necessary to curtail production of custom-made products because even when we got the cost down on a custom product, the customer would often either change his specs or find a manufacturer that would produce the item for less."

Rechsteiner believes half his management problems would clear up if employee stockholders, industry-wide, would wait out the stock market and realize that it's subject to cycles.

"Because of the erroneous equation people form between the market and the Gross National Product," he said, "events in the market are going to be acutely felt in our industry, because a large number of electronics companies are either employee-owned or the employees have equity at stake due to the stock options they hold."

"Unfortunately," Rechsteiner continued, "employees forget that the current stock quotation for our company, for instance, does not reflect its true worth. Because the stock is down, they feel that the company is less strong—which is not true—and if they need the money, they sell out, causing the stock to fall further.

Rx for half a headache

"Many branches of the electronics industry did so well in terms of expansion during the past ten years," said Analog's president, "that they find it difficult to cope with the changed conditions at this time. Perhaps the unwarranted optimism that accompanied the rapid growth of the recent past is now matched by an equally unwarranted pessimism at a time when the economy is leveling out." ■■

If you make a product no matter what, we can

From space capsules to computers to consumer appliances . . . Dow Corning silicone materials add a critical measure of reliability to designs. They improve the performance and service life so vital to your product's function, be it aerospace, industrial or entertainment.

Dow Corning silicone rubber RTV adhesive/sealants bond, seal and insulate. Cured materials give excellent resistance to breakdown by harsh environments. An adhesive/sealant is shown here sealing feed-through wires where they enter a high-vacuum test chamber. Units remain leak free under severe vacuum, wide temperature changes and wire flexing. Choose from several adhesive/sealants . . . some offer choice of color; some are non-corrosive to copper.

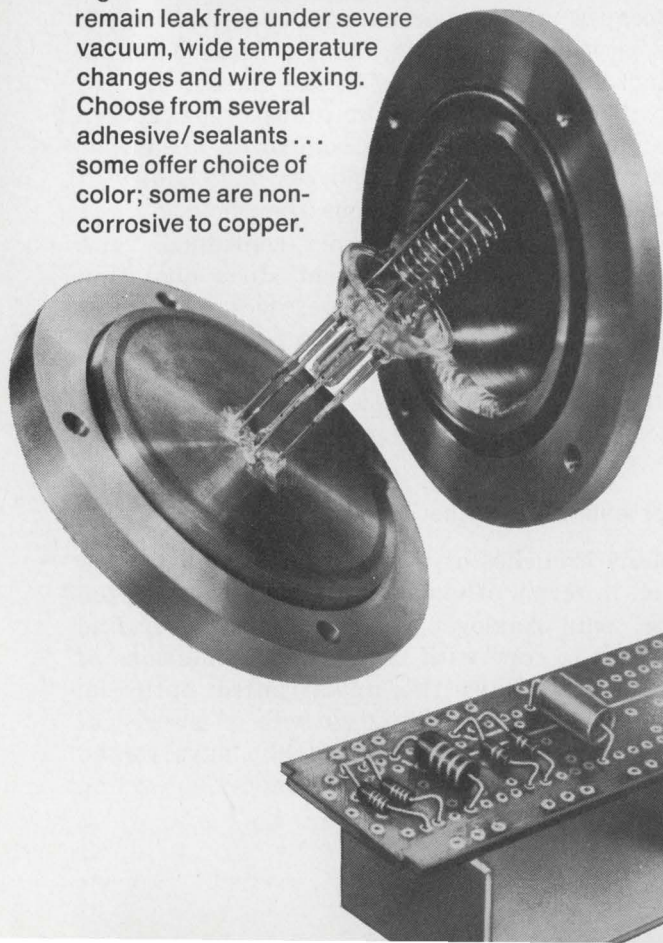

Dow Corning® protective coatings cure at room temperature to form tough, noncorrosive coatings on components, subassemblies and circuit boards. Coatings have excellent resistance to moisture, dust, dirt, abrasive materials, ozone, radiation and many solvents and industrial chemicals. There are several to choose from . . . some are transparent, others opaque.

that's got to perform, protect it.

Effective heat transfer and protection from corrosion are properties of **Dow Corning heat sink compound**. Diodes, transistors and rectifiers last longer and are more stable in operation when nondrying silicone paste provides full contact with heat sink for optimum thermal conductivity. Other compounds prevent corrosion of connectors, lamp bases . . . lubricate gaskets.

Outstanding environmental protection for electronic components and assemblies—that's what **Dow Corning RTV encapsulants** provide. These materials cure to tough, yet flexible, silicone rubber that protects components from moisture, dirt, corona, weathering and corrosive atmospheres. Applications are almost endless, ranging from encapsulating printed circuit boards to encapsulating the glass-enclosed image-intensifier tubes of U.S. Army helicopters' night vision units. There's a variety to choose from . . . Some are transparent for easy visual inspection; others can be color coded . . . and they're adaptable to a wide variety of processing requirements.

When total reliability is essential in electronic parts and finished products, count on high-performance silicones from Dow Corning. Write for information, Dept. B-0321 Dow Corning Corporation, Midland, Michigan 48640.

*Electrical | electronic
materials from*

DOW CORNING

DOW CORNING

INFORMATION RETRIEVAL NUMBER 44

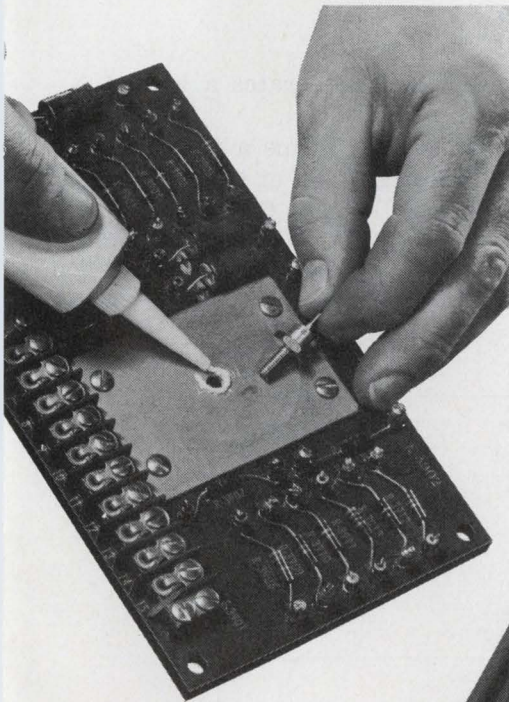

Ideas For Design

Standby power source uses diodes and battery

Here's an easy way to provide an instantaneous emergency power supply for small electronic devices—say a transistor radio—normally operated from a battery eliminator.

Two diodes, D_1 and D_2 , are connected as shown in the diagram. When the receiver is operated from the power supply, D_2 is reverse-biased. The battery will not be drained, since the power supply output voltage, 12.5 V, is kept slightly higher than the nominal battery voltage, 12 V.

Should the ac power fail, the D_2 reverse-bias voltage is removed. This forward-biases D_2 , and the 12-V battery then powers the receiver.

Diode D_1 prevents battery drain through the power supply when the receiver is off.

Thus a simple combination of two diodes, properly rated for the maximum current drain, provides automatic changeover from ac mains to

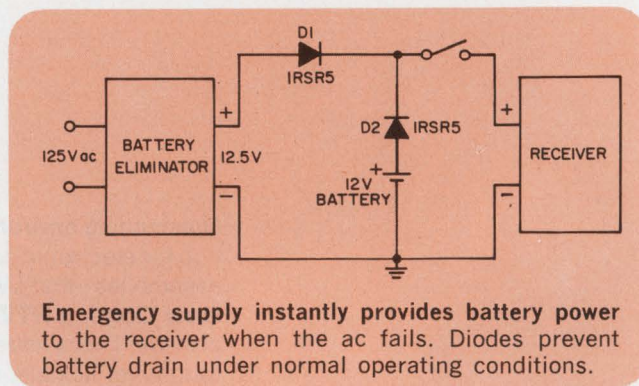

Emergency supply instantly provides battery power to the receiver when the ac fails. Diodes prevent battery drain under normal operating conditions.

a battery supply. This principle can be extended to cover other types of electronic equipment and instruments.

G. N. Sharma and G. N. Acharya, Design Engineers, Central Electronic Engineering Research Institute, Pilani, India.

VOTE FOR 311

Frequency discriminator generates logical output

This circuit, consisting of one dual flip-flop, a unijunction transistor (UJT), Q_1 , and a bipolar transistor, Q_2 , decides within a single period of the input if this signal's repetition frequency is above or below a desired threshold.

According to the decision, it generates a logical ONE or ZERO output.

Q_1 together with R_1 and C_2 , forms a free-running oscillator, but the beginning of Q_1 's charging period is synchronized through Q_2 by the in-

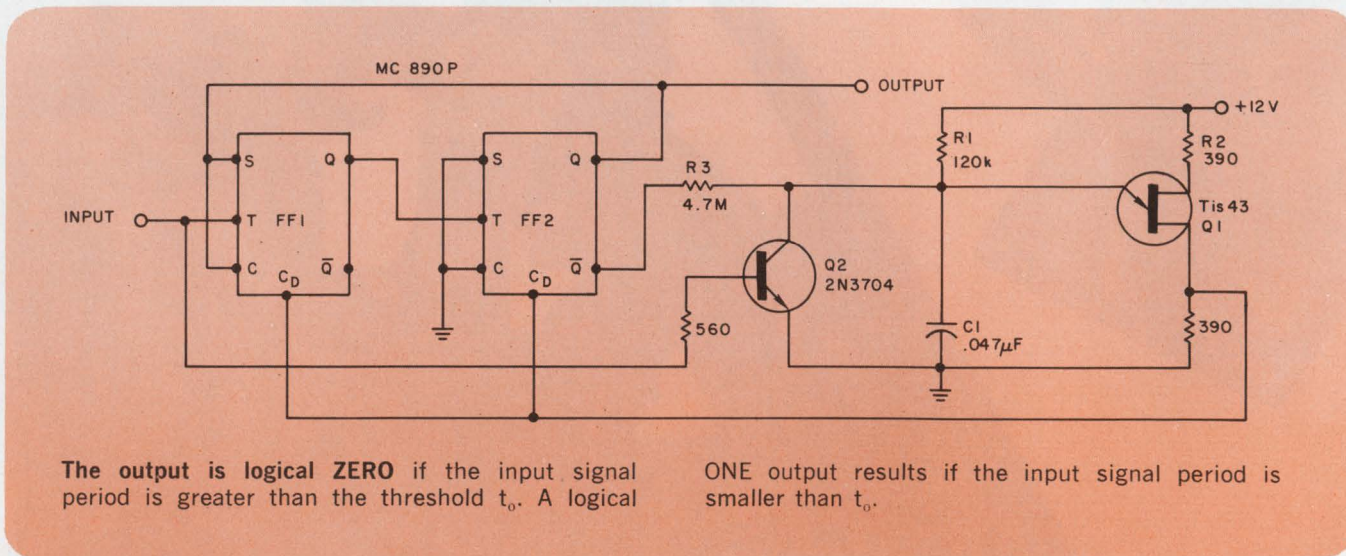

The output is logical ZERO if the input signal period is greater than the threshold t_0 . A logical

ONE output results if the input signal period is smaller than t_0 .

Helipot Trims Price & Profile

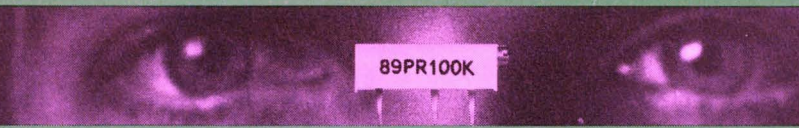

89PR100K

The new Helipot Series 89 industrial
cermet trimmers feature:

Low Cost:

\$1.35 each in 1-9 quantities;
less than \$1.00
in quantities over 1,000.

Low Profile:

Maximum height of .250 inches
allows for closer p-c board stacking.

Series 89 trimmers with two different pin spacings
are available "off-the-shelf"
from 17 locations across the country.

Beckman®

INSTRUMENTS, INC.
HELIPOT DIVISION
FULLERTON, CALIFORNIA

INTERNATIONAL SUBSIDIARIES: AMSTERDAM; CAPE TOWN; GENEVA; GLENROTHES,
SCOTLAND; LONDON; MEXICO CITY; MUNICH; PARIS; STOCKHOLM; TOKYO; VIENNA.

put signal. The input signal should consist of short pulses that, if not directly available, can be generated by using a Schmitt trigger and differentiating capacitor for input wave shaping.

If the period of the input signal is greater than period t_0 , where:

$$t_0 = R_1 C_1 \ln [1 / (1 - \eta)]$$

(η = intrinsic standoff ratio of UJT Q_1), then Q_1 has time to fire and set both flip-flops simultaneously to ZERO. This will happen at least once over every period of the input signal; therefore flip-flop FF2 will never be able to switch to a logical ONE.

If the period of the input signal is smaller than t_0 , then the second input pulse will switch FF1 off, causing a negative-going voltage on FF1's Q output, which triggers FF2 to the logical ONE state. A logical ONE on output Q of FF2, which appears exactly one period after signal is supplied to the input, denotes that the input

signal has a repetition frequency larger than the threshold frequency $1/t_0$. After this decision has been made, the feedback loop from FF2 to FF1 keeps FF1 from switching. This forces a continuous logical ONE on FF2.

As long as the input signal's period remains shorter than t_0 , Q_1 will never fire. C_1 cannot acquire charge since it is constantly shunted by Q_2 . If at any time the input period exceeds t_0 , Q_1 fires and sets both flip-flops back to ZERO.

Hysteresis is introduced by means of resistor R_3 to provide reliable switching even when there is jitter on the input frequency. When R_2 is chosen for proper UJT firing-period temperature compensation, a threshold stability of better than 1% over 0°C to 70°C is obtained.

J. Diggelmann, Design Engineer, Institut fur Technische Physik an der ETH, Zurich, Switzerland.
VOTE FOR 312

Stable, low-cost dc restorer uses a single transistor

A simple, economical improvement can be made over the standard dc restorer (Fig. 1) by using a transistor as a combination diode and emitter follower (Fig. 2). The base/collector junction of Q_1 serves as the rectifier (similar to D_1 of Fig. 1). C_1 and R_1 form the circuit time constant. R_1 also provides base drive for Q_1 , holding it in saturation under static conditions.

Under signal conditions, negative input forward-biases the Q_1 collector/base junction, clamping the most negative peaks below ground by the base/collector voltage drop. Positive signals drive Q_1 out of saturation into the active region where normal emitter follower action takes place.

There are three main advantages to this circuit:

- The two voltage drops across the transistor junctions effectively cancel each other (both statically and driftwise), and the output is a low-temperature coefficient signal with negative peaks referenced to ground.

- The buffering action of the emitter follower configuration provides a low impedance output that does not affect the input time constant and can drive a wide variety of loads.

- The circuit is simple and inexpensive.

Although the connection shown in Fig. 2 is a pnp negative clamp, positive signals can be easily accommodated by reversing supply polarity and

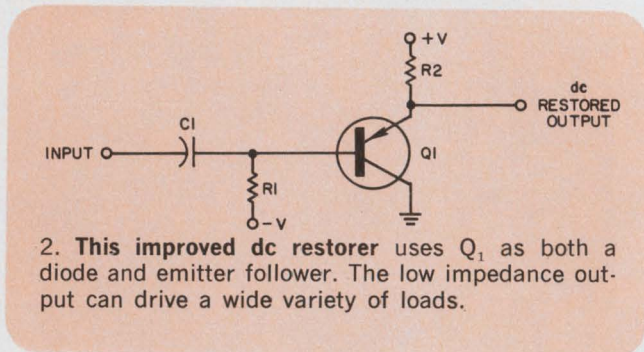
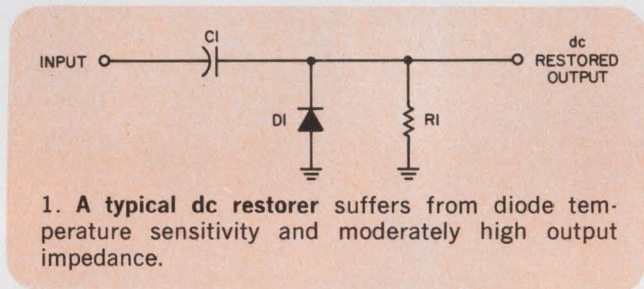

substituting an npn transistor. Best performance is realized by using low $V_{ce\ sat}$ devices such as germanium-alloy switching transistors.

Walter G. Jung, Engineering Consultant, Forest Hill, Md.
VOTE FOR 313

New TRW Broadband RF Amplifier

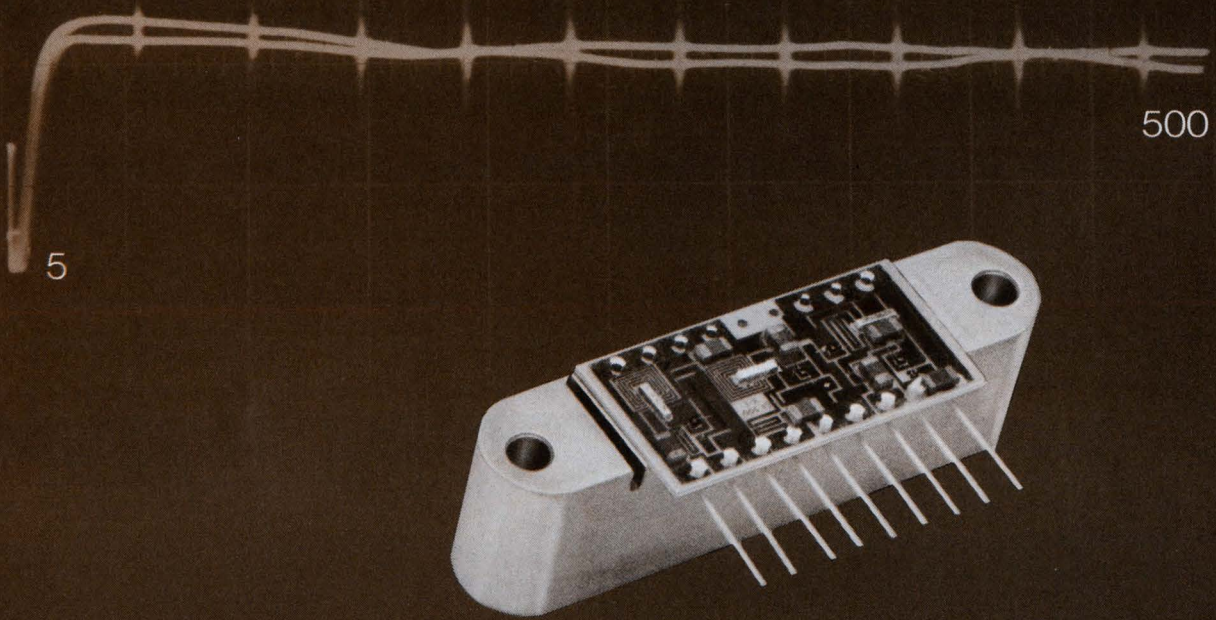

#8-69

From 5 to 500 MHz.....400 mW output

This hybrid microelectronic amplifier module for broadband RF service provides extreme stability and the most reliable performance obtainable. The versatile CA 800 provides power and bandwidth previously unattainable with this hybrid circuitry.

With a 28 volt supply...over a 5 to 500 MHz bandwidth...the CA 800 provides a gain of 25 dB at a maximum output of 400mW. Distortions, such as noise, cross

modulation, and second order beat are at new lows for this type of circuitry.

The class "A" bias network has $\pm .003\%$ per $^{\circ}\text{C}$. stability, while the transistor chips have a proven 1,000,000 hours MTBF. Advanced packaging features eliminate all bond-wire lead connections, provide a large combination heat sink-mounting spacer, and compatibility with pc board assembly.

Order from the factory or any TRW distributor. For application assistance, contact TRW Semiconductor Division, 14520 Aviation Boulevard, Lawndale, California 90260. Phone: (213) 679-4561. TWX: 910-325-6206.

TRW[®]

INFORMATION RETRIEVAL NUMBER 46

Digital tape channel converted for analog record/playback

Standard digital tape recorders are designed to accept pulses and are useless for recording analog data unless a/d conversion is employed. Special units, which have separate analog channels, can be purchased at considerable expense. But here is a simple technique for recording an-

alog signals (such as voice) that contain frequency components several times below the digital record head's maximum writing rate. Since the digital recorder cannot respond to amplitude information, a novel frequency modulator is used as the source encoder.

The heart of the record channel is the voltage-controlled squarewave oscillator (VCO) which is used as the frequency modulator (Fig. 1).¹ As the control voltage from the input amplifier increases, the repetition rate of the oscillator decreases, and vice versa.²

The logic level shifter serves two purposes. It adjusts the output levels to be compatible with the particular digital recorder employed, and it also removes the amplitude modulation inherent in the oscillator output. The dc bias input to the amplifier sets the VCO center frequency.

During playback, the one-shot multivibrator lengthens the narrow pulses received from the read circuits in the digital recorder. The machine for which this system was designed already has a one-shot in the read channel. Thus, only an additional capacitor is necessary to increase the pulse width.

The one-shot output is a frequency-modulated wave of constant pulse width. Hence, the information is contained in the instantaneous dc level.

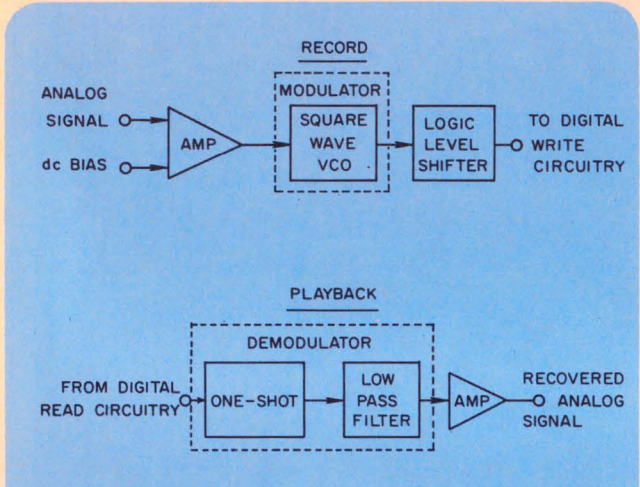

1. During recording the VCO center frequency is set by dc bias, and analog input is converted to square-wave FM. Playback recovers the analog signal by responding to the filtered dc level of the one-shot's output.

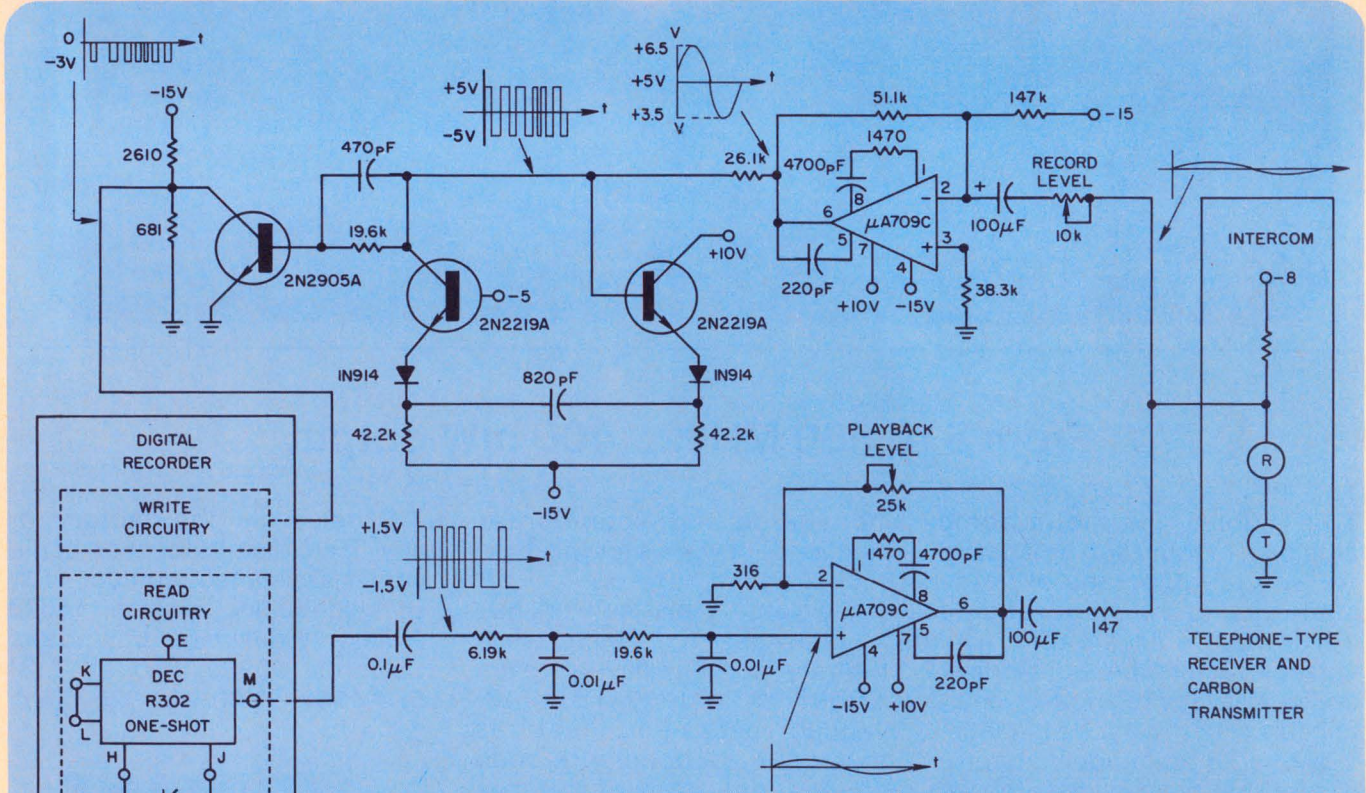

2. Intercom interfaces with a digital recorder. Here's the complete system, which allows the ninth channel of a Datamec D2020 to record and play back analog (voice) information.

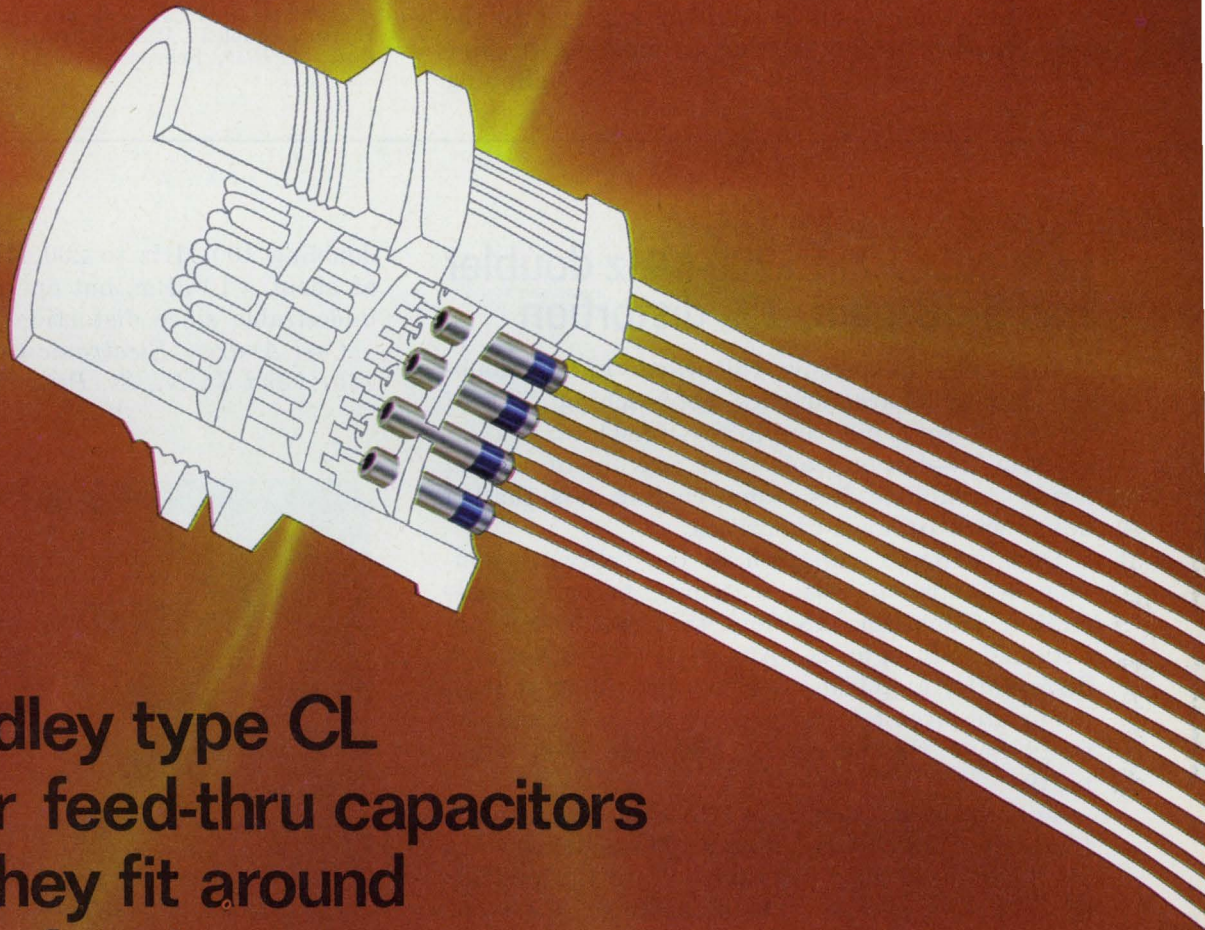

Allen-Bradley type CL multi-layer feed-thru capacitors so small they fit around the head of a pin.

VOLUMETRIC EFFICIENCY. Big words that explain why Allen-Bradley type CL feed-thru capacitors are so small. Our unique multi-layer concept shaves size to a minimum, without affecting performance. It took Allen-Bradley to get filter capacitors down to their fighting weight. Now rolled capacitors are no longer a design alternative.

Concentric layers of proprietary Allen-Bradley ceramic and noble metal electrodes are fired together for unmatched protection against moisture and contamination. Rugged. Non-polar. With lower inductance and far less noise.

Voltages to 200 WVDC. Temperatures to 125°C. Capacities to 1.0 μ F. High dielectric strength and reliability.

Several styles and sizes are available through your appointed A-B industrial electronic distributors. For further information write: Marketing Department, Electronics Division, Allen-Bradley Co., 1201 South Second Street, Milwaukee,

Wisconsin 53204. Export office: 1293 Broad Street, Bloomfield, N.J. 07003 U.S.A. In Canada: Allen-Bradley Canada Ltd., 135 Dundas St., Galt, Ontario.

ALLEN-BRADLEY

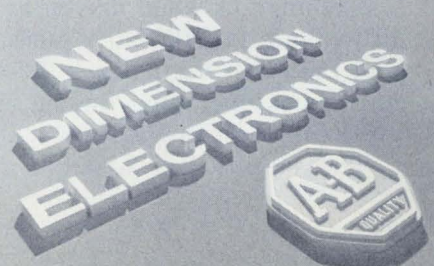

The low-pass filter extracts this dc level, completing the demodulation process.

The system shown in Fig. 2 was designed to record voice from a simple intercom onto the ninth channel of a Datamec D2020 digital tape unit used as part of a PDP-9 computer system. Recorded data can also be played back through the intercom. The center frequency of the modulator is approximately 18 kHz. The frequency deviation is about ± 3 kHz.

This method yields results far superior to the zero-crossing technique that symmetrically clips the voice signal. While symmetrical clipping

theoretically removes amplitude information only, in practice frequency distortion results from slight imbalances in the zero-crossing detector.

Louis A. Campolo, *Electronics Engineer, RCA Defense Electronic Products, Missile and Surface Radar Div., Moorestown, N.J. 08057.*

References

1. Zangrillo, S., "Get Wide-Range or VCO Capability From the Basic Astable Multi." *Electronic Design*, March 15, 1969, pp. 272-274.
2. Beneteau, P. J., and Evangelisti, A., "An Improved Emitter-Coupled Multivibrator," *Fairchild Application Data, APP-59*, February, 1963, pp. 1-4.

VOTE FOR 314

Low-cost 100-to-200-MHz doubler has 5-dB gain, 1% distortion

A simple, inexpensive full wave vhf/uhf doubler, having characteristics approaching that of an ideal squaring amplifier— $f(\omega t) = (1 - \cos 2\omega t)/2$ —can be made from any one of several readily available ICs, some costing less than a dollar each in large quantities.

Odd harmonic rejection in the full-wave doubler depends on close matching between base-emitter transistor junctions that can be cheaply obtained only in an IC. Any of several integrated differential amplifiers will do, providing the appropriate circuit terminals are available and the units have the necessary high-frequency capability.

For example, the RCA CA3026 has enough transistors for two doublers. These transistors are to be used as a push-push class B amplifier so that it is necessary to saturate or short out the current source transistor normally found in this IC.

To achieve class B operation, a stable, temperature-compensated bias source is necessary for the common emitter transistors. The CA-3026's current-source transistor (when saturated) makes an ideal bias supply. This biasing produces a small quiescent current that has a slight negative temperature coefficient.

The balanced doubler shown is designed with a broadband input transformer (Balun) and a tuned, narrowband output. An additional 25 dB of fourth harmonic and fundamental attenuation is provided by the output tank circuit. The output waveform of this doubler has less than 1% distortion when driven at about 0 dBm. The third and fourth harmonics are 45 dB down, and the sixth harmonic is 50 dB down. All other harmonics, including the fundamental, are greater than 50 dB down.

The circuit has about 5-dB net gain when

doubling 100 MHz to 200 MHz. Limiting begins at about +10 dBm, but operation at this level is undesirable since distortion here is about 10%.

Carl Andren, *Electronic Communications, Inc., 1501 72nd St. N., St. Petersburg, Fla. 33733.*

VOTE FOR 315

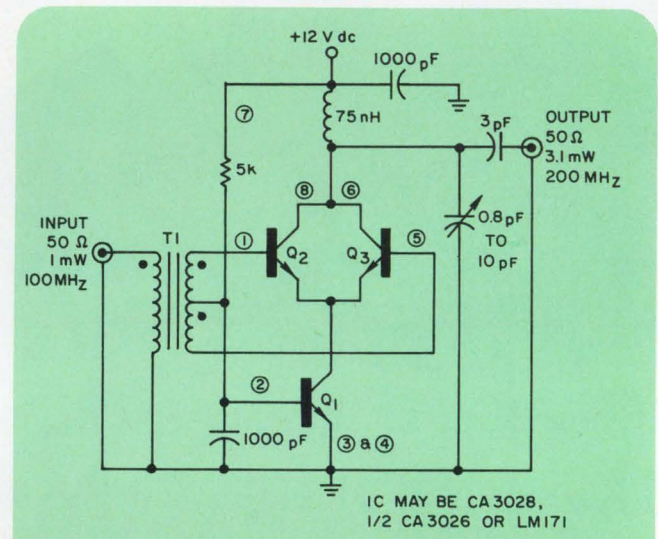

This doubler can be built from any of several suggested ICs. With a broadband Balun input and a tuned narrowband output it provides low distortion, gain and economy at 100 MHz. The Balun has 6 turns of trifilar no. 32 transmission line on a Micrometals T-25-22 core.

VOTE! Go through all Idea-for-Design entries, select the best, and circle the appropriate number on the Reader-Service-Card.

SEND US YOUR IDEAS FOR DESIGN. You may win a grand total of \$1050 (cash)! Here's how. Submit your IFD describing a new or important circuit or design technique, the clever use of a new component or test equipment, packaging tips, cost-saving ideas to our Ideas-for-Design editor. You will receive \$20 for each accepted idea, \$30 more if it is voted best-of-issue by our readers. The best-of-issue winners become eligible for the Idea Of the Year award of \$1000.

We've upped the line to 7 pin spacings without upping the price.

CTS cermet industrial trimmers
still **50¢** each.*



Stability of $\pm .03\%$
and environmental
performance requirements
of characteristic
C of MIL-R-22097D plus:

- 1.5% average equivalent noise resistance
- 0.5% average CRV
- $\frac{1}{2}$ watt @ 70°C
- TC ± 150 ppm/°C

Now you can choose from an expanded line of compact CTS Series 360 single-turn cermet trimmers. Seven pin spacings: .150"-.125"-.100" in both top and side adjust, plus TO-5 arrangement in side adjust only. (TO-5 style at extra cost.) All available from your CTS Distributor, still at the lowest cost in the industry: **just 50¢ each**: CTS of Berne, Inc., Berne, Indiana 46711. Phone: (219) 589-3111.

*in 50,000 quantity for $\pm 20\%$ tolerance. Add 4¢ for 10% tolerance. Comparably low prices for smaller quantities.

CTS CORPORATION
Elkhart, Indiana



Your CTS Answer Man stands ready to fit our expanded trimmer line into your application.

Film-Mets? Wirewounds? Or Cermet's?

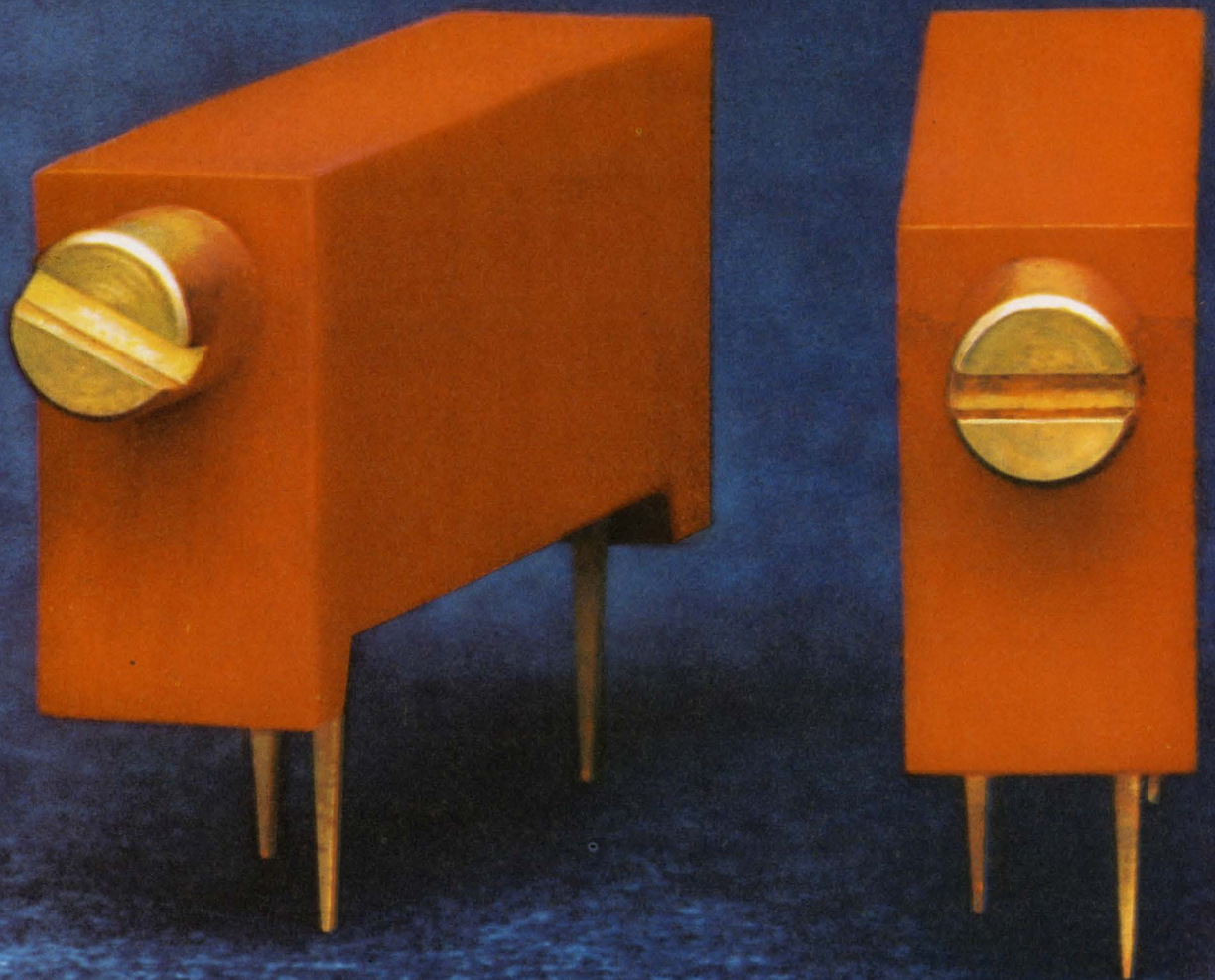

What our extra choice means to you.

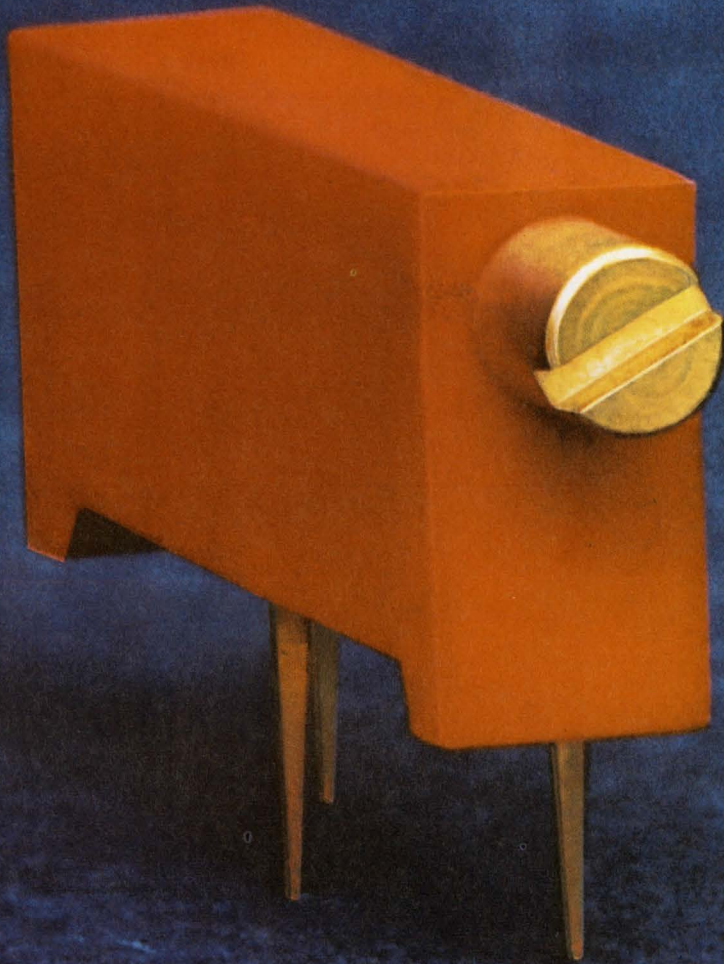

It ends circuit design compromise.

Because now you can get the perfect match between design needs and trimmer performance.

Suppose you need infinite resolution, lowest noise characteristics and maximum contact setability. Then Film-Met™ would be your best choice.

But if it's infinite resolution and the widest resistance ranges you're after, then cermet would be best.

And of course, good old wirewounds still reign

supreme in lowest temperature coefficient of resistance and lowest contact resistance variation.

Only Amphenol has all three types—and in all the popular military and commercial sizes.

But you'll need more specs than this to determine the best trimmer for your application.

So send today for your free catalog. Or call your nearest Amphenol distributor. Amphenol Controls Division, Janesville, Wisconsin 53545.



AMPHENOL
THE BUNKER-RAMO CORPORATION

Product Source Directory

Trimmer Potentiometers

This Product Source Directory covers trimmer potentiometers.

Units are listed in ascending order according to their maximum resistance value. Each maximum-resistance group is then arranged alphabetically according to manufacturer, and further subdivided numerically per the manufacturer's model number.

All popular trimmer types are included: wire-wound, conductive plastic, cermet, and metal and carbon film. The price figures shown represent the cost of a single unit when buying in quantities of 1000.

Manufacturers are identified by the abbreviations shown in the Master Cross Index below. The abbreviation "req" means request.

Abbrev.	Company	Information Retrieval No.
Ace	Ace Electronic Assoc., Inc. 99 Dover St. Somerville, Mass. 02143 (617) 623-3800	448
AB	Allen-Bradley Co. 1201 S. Second St. Milwaukee, Wis. 53204 (416) 671-2000	449
Amphenol	Amphenol Corp. Controls Div. 120 S. Main St. Janesville, Wis. 53545 (608) 754-2211	450
Beckman	Beckman Instruments Inc. Helipot Div. 2500 Harbor Blvd. Fullerton, Calif. 92633 (714) 871-4848	451
Bourns	Bourns, Inc. Trimpot Div. 1200 Columbia Ave. Riverside, Calif. 92506 (714) 684-1700	452
Centralab	Centralab Electronics Div. of Globe-Union Inc. 5757 N. Green Bay Ave. Milwaukee, Wis. 53209 (414) 228-1200	453
Clarostat	Clarostat Manufacturing Co., Inc. Washington St. Dover, N.H. 03820 (603) 742-1120	454

Abbrev.	Company	Information Retrieval No.
CTS	CTS Corp. 905 N. West Blvd. Elkhart, Ind. 46519 (502) 513-0210	455
CTSB	CTS of Berne, Inc. 406 Parr Rd. Berne, Ind. 46711 (219) 589-3111	456
Dale	Dale Electronics Inc. Box 609 Columbus, Neb. 68601 (402) 564-3131	457
Diploh	Diplohmatic Div. Harry Levinson Co. 1211 E. Denny Way Seattle, Wash. 98122 (206) 323-5100	458
Electra	Electra/Midland Corp. Cermetrik Div. 3347 Industrial Ct. San Diego, Calif. 92121 (714) 453-0353	459
Fairchild	Fairchild/Controls 225 Park Ave. Hicksville, N.Y. 11802 (516) 938-5600	460
Fluke	John Fluke Manufacturing Co., Inc. Box 7428 Seattle, Wash. 98133 (206) 774-2211	461

Abbrev.	Company	Information Retrieval No.
Mark	Mark Micro-Electronics Mfg. Co. Potentiometer Products Div. 21 Cottage St. Bayonne, N.J. 07002 (201) 339-2121	462
Maurey	Maurey Instrument Corp. 4555 W. 60th St. Chicago, Ill. 60629 (312) 581-4555	463
Minelco	Minelco 600 South St. Holbrook, Mass. 02343 (617) 963-7717	464
NEI	New England Instrument Co. 14 Kendall Lane Natick, Mass. 01760 (617) 873-9711	465
Ohmite	Ohmite Manufacturing Co. 3635 Howard St. Skokie, Ill. 60076 (212) 675-2600	466
PEC	Precision Electronic Components, Ltd. 19 Hafis Rd. Toronto, Ontario, Canada (416) 249-7103	467
Spectrol	Spectrol Electronics Corp. 17070 E. Gale Ave. City of Industry, Calif. 91745 (213) 964-6565	468
Stackpole	Stackpole Components Corp. P.O. Box 14466 Raleigh, N.C. 27610 (919) 828-6201	469
Techno	Techno-Components Corp. 7803 Leona Ave. Van Nuys, Calif. 91405 (213) 781-1642	470
TRW	TRW Inc. IRC Div. 1100 Glendon Ave. Los Angeles, Calif. 90024 (213) 477-6061	471
Vishay	Vishay Instruments Resistor Products Div. 64 Lincoln Hwy. Malvern, Pa. 19355 (215) 644-1300	472
Waters	Waters Manufacturing 533 Boston Post Rd. Wayland, Mass. 01778 (617) 358-2777	473
Weston	Weston Instruments Archbald Div. Archbald, Pa. 18403 (717) 876-1500	474

a little about pots.



When space is limited, buy the Weston ¼-inch trimmers. The 566-569 Series is a new ¼-inch round, single-turn, CERMET, commercial, trimming potentiometer rated at 0.50 watts at 70°C.

The main features are:

small size

¼-inch round

wide resistance range

10Ω to 1 meg

low-cost

only \$1.11 in 500 quantities, with substantial reductions in larger quantities

temperature coefficient

±100 ppm/°C, maximum

delivery from stock

You have two configurations to choose from. The Models 566-567 are ¼-inch round top adjust, with PC pins base mounted. The Models 568-569 are side adjust with PC pins edge-mounted. To provide a model for your design, several pin arrangements are available.



For samples, or complete details, call 717-876-1500 or write Weston Components Division, Archbald, Pa. 18403, a Schlumberger company.

WESTON®

INFORMATION RETRIEVAL NUMBER 50

Trimmer Potentiometers

120

Manufacturer	Model	Type	Resistance Range (Min-Max, kΩ)	Tolerance %	Power Rating (Watts at °C)	Number of Turns	Operating Range °C	Notes	Price \$/1000
Clarostat	39	wirewound	0.004-5	±20	2 at 40	1	105 max		0.165
Techno	RT27	wirewound	0.01-5	±5	0.5 at 85	25	-50 to +175	h (19)	req
Amphenol	2301	metal film	0.01-10	±10	0.5 at 85	26	-55 to +150	f (28) (29)	4.81
CTS	110	wirewound	0.0005-10	±20	2 at 55	1	105 max	(8)	0.14
Maurey	25-M11	wirewound	0.025-10	±10	0.3 at 85	1	-55 to +150		2
Maurey	37-M13	wirewound	0.05-10	±5	0.5 at 85	1	-55 to +135		5
NEI	C	plastic	1-10	±20	1 at 70	1	-65 to +125	(10)	4.99
Techno	1175, 1265, 1335, 1515, 1765, RT24	wirewound	0.01-10	±5	0.5 at 85	25	-65 to +175	h (11)	req
Techno	RTR24	wirewound	0.01-10	±5	0.5 at 85	25	-65 to +175	(20)	req
Vishay	1202	metal film	0.002-10	±5	0.5 at 85	25	-55 to +150	adhi (30)	4.55
Waters	JP/2C	wirewound	0.02-10	±10	2 at 40	1	-55 to +105	g	req
Minelco	MP2, 5	wirewound	0.02-15	±10	0.25 W	1	-55 to +125	(16)	5.50
Minelco	MS1, 2, 4, 5, 7	wirewound	0.02-15	±10	0.25 W	1	-55 to +150		8
Amphenol	2300	wirewound	0.01-20	±5	0.75 at 85	26	-55 to +150	fh	4.10
Amphenol	2600	wirewound	0.01-20	±10	1 at 40	22	-55 to +125	b (28)	1.06
Amphenol	2610	wirewound	0.01-20	±10	1 at 40	22	-55 to +125	b (28)	1.43
Amphenol	2851	metal film	0.02-20	±10	0.75 at 85	22	-55 to +150	d (28) (29)	4.28
Amphenol	2901	metal film	0.01-20	±10	0.75 at 85	25	-55 to +150	e (28) (29)	4.70
Amphenol	3600	wirewound	0.1-20	±10	0.5 at 40	23	-55 to +125	f (28)	1.77
Amphenol	3610	wirewound	0.01-20	±10	0.5 at 40	23	-55 to +125	f (28)	2.13
Amphenol	3800	wirewound	0.01-20	±10	1 at 40	23	-55 to +125	b (28)	1.06
Amphenol	3810	wirewound	0.01-20	±10	1 at 40	23	-55 to +125	b (28)	1.29
Amphenol	3811	metal film	0.01-20	±10	0.75 at 40	15	-55 to +125	b (28)	1.77
Bourns	3065	wirewound	0.05-20	±10	0.5 at 25	15	-55 to +85	c	1.23
Bourns	3067	wirewound	0.05-20	±10	0.5 at 25	15	-55 to +85	c	1.14
CTS	P115	wirewound	0.0005-20	±10	2 at 55	1	105 max	(8)	0.21
CTS	117	wirewound	0.0005-20	±10	2 at 55	1	105 max	(8)	0.22
Clarostat	76	wirewound	0.1-20	±5	0.75 at 85	11.5	150 max		4.75
Minelco	MP32	wirewound	0.01-20	±10	0.5 W	1	-55 to +150		4.50
Spectrol	51	wirewound	0.01-20	±5	0.75 at 85	23	-65 to +150	f (28) (29)	3.31
Spectrol	94	wirewound	0.05-20	±10	0.5 at 70	22	-65 to +105	(28)	1.85
Techno	755-CT	wirewound	0.1-20	±5	0.5 at 85	25	-65 to +175		req
TRW	300	wirewound	0.05-20	±5	0.6 at 60	1	-55 to +150	e	2.60
TRW	650	cermet	0.01-20	±5	0.75 at 85	22	-65 to +150	du	3.43
TRW	800	wirewound	0.01-20	±5	0.6 at 70	15	-65 to +150	(13)	2.22
TRW	900	wirewound	0.01-20	±10	1 at 40	20	-65 to +125	b	1.23
TRW	940	wirewound	0.01-20	±10	1 at 40	18	-65 to +125	(15)	2.25
Vishay	1201	metal film	0.002-20	±5	0.75 at 85	25	-55 to +150	adi (30)	6.40
Waters	APD 1/2	wirewound	0.01-20	±5	1 at 60	1	-65 to +125	g (16)	req
Waters	JP/2	wirewound	0.02-20	±5	2 at 85	1	-65 to +150	g	req
Waters	JPD/2	wirewound	0.02-20	±5	1 at 85	1	-65 to +150	g (22) (28)	req
Waters	PT 3/4C	wirewound	0.025-20	±10	2 at 85	1	-65 to +150	(8) (28)	req
Weston	313, 318	wirewound	0.2-20	±5	0.75 at 85	45	-55 to +150	e (29)	7.05
Weston	501, 502	wirewound	0.01-20	±5	0.6 at 70	15	-55 to +150	(13)	1.96
Weston	504, 505	wirewound	0.01-20	±5	0.6 at 70	1	-55 to +150	(13)	1.89
Weston	561, 562	wirewound	0.01-20	±5	0.25 at 85	13	-55 to +150	(3) (29)	4.14
Ace	CP05	plastic	1-25	±10	0.3 at 70	1	-65 to +125	g	req
Bourns	3005	wirewound	0.01-25	±10	1 at 40	20	-55 to +125	b	1.30
Bourns	3260	wirewound	0.01-25	±5	0.2 at 70	11	-65 to +175	(3)	4.63
Bourns	3300	wirewound	0.01-25	±5	0.5 at 70	1	-65 to +175	(4)	3.96
Bourns	3305	wirewound	0.01-25	±5	0.5 at 70	1	-55 to +125	(4)	1.17
Diploh	301	wirewound	0.01-25	±10	0.5 at 40	(12)	-50 to +125		0.40
Maurey	50-M124	wirewound	0.05-25	±5	1.5 at 125	1	-55 to +175		11
Minelco	MS37	wirewound	0.02-25	±10	0.75 W	1	-55 to +150		7.95
Techno	125, 145, 155	wirewound	0.01-25	±5	0.5 at 85	25	-50 to +175	h	req
Techno	175, 185	wirewound	0.01-25	±5	0.5 at 85	25	-65 to +175	h	req
Weston	561, 562	wirewound	0.01-25	±5	0.25 at 70	13	-55 to +175	(3)	4.14
Weston	510	wirewound	0.01-30	±5	1 at 50	1	-55 to +175	(27)	3.77-5.29
Ace	CP08	plastic	1-50	±10	0.5 at 70	1	-65 to +125	(8)	req
Amphenol	992	wirewound	0.01-50	±5 or ±10	1 at 40	22	-55 to +125	d (28)	1.82
Amphenol	994	wirewound	0.01-50	±10	1 at 40	22	-55 to +125	d (28)	1.85
Amphenol	2700	wirewound	0.01-50	±5	0.75 at 85	15	-55 to +150	chp	3.64
Amphenol	2750	wirewound	0.01-50	±5	0.75 at 85	22	-55 to +150	chr	3.05
Amphenol	2850	wirewound	0.01-50	±5	0.75 at 85	22	-55 to +150	dhq	3.05
Amphenol	2860	wirewound	0.01-50	±5	0.75 at 85	22	-55 to +150	d (28)	2.90
Amphenol	2900	wirewound	0.01-50	±5	0.75 at 85	25	-55 to +150	ehs	2.65
Amphenol	6900	wirewound	0.01-50	±10	1 at 40	1	-55 to +125	g (28)	1.94
Bourns	271, 3, 5	wirewound	0.01-50	±10	0.5 at 20	25	-55 to +105	d	1.96
Bourns	3250	wirewound	0.01-50	±5	1 at 70	25	-65 to +175	e	4.14
Bourns	3255	wirewound	0.01-50	±5	1 at 50	25	-65 to +150	e	1.96
Bourns	3280	wirewound	0.01-50	±5	1 at 70	25	-65 to +175	f	4.66
Bourns	3290	wirewound	0.01-50	±5	1 at 70	25	-65 to +175	f	4.52
Bourns	3365	wirewound	0.01-50	±5	1 at 25	1	-55 to +125	g	2.05
Bourns	3367	wirewound	0.01-50	±5	0.5 at 70	1	-55 to +105	g	3
Dale	2300	wirewound	0.01-50	±10	0.5 at 25	15	-55 to +105	c	req
Dale	2400	wirewound	0.01-50	±10	1 at 40	20	-55 to +125	b	req
Dale	5000	wirewound	0.01-50	±5	1 at 70	25	-65 to +175	s	req
Dale	5800	wirewound	0.01-50	±5	1 at 70	25	-65 to +175	(11)	req
Maurey	50-M7	wirewound	0.05-50	±5	1.5 at 85	1	-55 to +135		5

- a. infinite resolution
- b. 3/4-in. rectangular
- c. 1-in. rectangular
- d. 1-1/4-in. rectangular
- e. 1/2-in. square
- f. 3/8-in. square
- g. 1/2-in. round
- h. meets MIL-R-27208
- i. meets MIL-R-22097
- j. front-panel mounting
- k. rear-panel mounting
- m. top adjust
- n. side adjust
- p. style RT10
- q. style RT11
- r. style RT12
- s. style RT22
- t. style RJ24
- u. style RJ11
- v. style RJ22
- w. style RJ50
- x. thumbwheel adjust
- y. leads
- z. pins
- 1) solder lugs
- 2) style RJ12
- 3) 1/4-in. square
- 4) 5/16-in. round
- 5) 1/2-in. rectangular
- 6) 1/4-in. round
- 7) 11/32-in. round
- 8) 3/4-in. round
- 9) 19/32-in. round
- 10) bushing mounting
- 11) style RT24
- 12) linear slider
- 13) 5/16-in. square
- 14) 1.5-in. round
- 15) 3/4-in. dual-in-line
- 16) PC-board mounting
- 17) 7/8-in. round
- 18) TO-9 transistor can
- 19) style RT27
- 20) meets MIL-R-39015
- 21) dual unit
- 22) meets MIL-R-39002
- 23) meets MIL-E-5272
- 24) concentric shafts
- 25) 1-1/8-in. round
- 26) 1-1/16-in. round
- 27) TO-5 transistor can
- 28) industrial/commercial grade
- 29) military grade
- 30) temperature coefficient of ± 10 ppm/ $^{\circ}\text{C}$
- 31) temperature coefficient of ± 150 ppm/ $^{\circ}\text{C}$
- 32) temperature coefficient of ± 100 ppm/ $^{\circ}\text{C}$
- 33) 1-7/16-in. round
- 34) 1-3/4-in. round
- 35) 2-in. round
- 36) 3-in. round
- 37) 3/8-in. round
- 38) 0.516 by 0.68 by 0.25 in.
- 39) 0.406 by 0.438 by 0.12 in.
- 40) 0.923 by 1.91 by 0.506 in.
- 41) 0.702 by 0.75 by 0.6 in.
- 42) triple unit
- 43) 0.6-in. round

a little more about pots.



When you need a wide range of resistance with high resolution in a 3/8-inch Squaretrim® buy Weston's CERMET 546-548 Series. These 25-turn trimming potentiometers are rated at 0.50 watt at 85°C with a temperature coefficient of ± 100 ppm/ $^{\circ}\text{C}$ maximum, from -55°C to $+150^{\circ}\text{C}$. Prices are as low as \$3.81 each in quantities of 500 units, with substantial reductions in larger quantities. Delivery is from stock.



The 520-523 Series is a NEW, 1/2-inch commercial, rectangular trimming potentiometer. Models 520 and 521 are wirewound units and Models 522 and 523 are CERMET. All models are rated at 0.3 watts at 85°C. Write for samples.

The 561-562 Series are 1/4-inch square, multiturn, wirewound trimmers designed to meet MIL-R-27208 Style RT26. The main features are: small size; excellent resolution; a temperature coefficient of ± 50 ppm/ $^{\circ}\text{C}$ maximum; low cost, only \$4.40 each in quantities of 500, lower prices in larger quantities. Delivery is from stock. MIL qualification is in process.



For samples or complete details please call 717-876-1500 or write Weston Components Division, Archbald, Pa. 18403, a Schlumberger company.

WESTON®

Trimmer Potentiometers

Manufacturer	Model	Type	Resistance Range (Min-Max, kΩ)	Tolerance %	Power Rating (Watts at °C)	Number of Turns	Operating Range °C	Notes	Price \$/1000
Maurey	50-M34	wirewound	0.05-50	±5	1.5 at 85	1	-55 to +135		8
Maurey	50-M128	wirewound	0.05-50	±5	1.5 at 85	1	-55 to +135		8
Maurey	50-M149	wirewound	0.05-50	±5	1.5 at 135	1	-55 to +135		8
Spectrol	55	wirewound	0.01-50	±5	1.5 at 70	23	-65 to +150	s (28) (29)	3.63
Spectrol	74	wirewound	0.01-50	±10	1 at 70	22	-65 to +125	(28)	2.90
Spectrol	80	wirewound	0.01-50	±5	1 at 50	1	-65 to +150	(18)	2.20
Spectrol	84	wirewound	0.01-50	±5	1.5 at 70	1	-65 to +125	x (10)	1.95
Techno	101S, 104S	wirewound	0.01-50	±5	0.5 at 85	25	-65 to +175	y	req
Techno	191S, 192S, 193S	wirewound	0.01-50	±5	1 at 50	25	-65 to +175	(21)	req
Techno	105S, 160S	wirewound	0.01-50	±5	0.5 at 85	25	-65 to +175	iy (1)	req
TRW	60	wirewound	0.01-50	±10	1 at 70	22	-55 to +125	dq	2.12
TRW	100	wirewound	0.01-50	±5	1 at 70	1	-55 to +150	g	2.05
TRW	205	wirewound	0.01-50	±5	1 at 70	25	-65 to +175	es	3.16
TRW	500	wirewound	0.01-50	±10	0.5 at 70	1	-55 to +105	g	1.30
TRW	700	wirewound	0.01-50	±5	0.75 at 85	21	-65 to +175	f (11)	4.55
TRW	5001	wirewound	0.01-50	±5	2 at 40	1	-55 to +150	g	7
TRW	7501	wirewound	0.05-50	±5	2.25 at 40	1	-55 to +150	(8)	7
Weston	517	wirewound	0.01-50	±5	1 at 55	1	-55 to +125	g	1.19-1.51
Weston	530, 531	wirewound	0.01-50	±10	1 at 40	15	-55 to +125	b	0.97-1.07
Weston	543, 544, 545	wirewound	0.01-50	±5	1 at 70	25	-55 to +175	f	3.57
Weston	543, 544, 545	wirewound	0.01-50	±5	0.75 at 85	25	-55 to +150	f (29)	3.95
Weston	550, 551, 552	wirewound	0.01-50	±5	1 at 70	35	-55 to +150	e	1.86
Weston	553, 554, 555	wirewound	0.01-50	±5	1 at 70	35	-55 to +175	e	2.99
Weston	553, 554, 555	wirewound	0.01-50	±5	0.75 at 85	35	-55 to +150	e (29)	3.16
Weston	701	wirewound	0.01-50	±5	1 at 70	37	-55 to +175	e	1.79
Weston	701	wirewound	0.01-50	±5	0.75 at 85	35	-55 to +150	e (29)	2.29
Weston	534, 535, 539	wirewound	0.01-50	±5	1 at 70	24	-55 to +175	d (28)	3.41
Weston	534, 535, 539	wirewound	0.01-50	±5	0.75 at 85	24	-55 to +150	d (29)	3.41
Fairchild	6010	wirewound	0.01-75	±5	0.75 at 85	22	-55 to +175	d	2.41
Fairchild	6020	wirewound	0.01-75	±5	0.75 at 85	22	-55 to +175	d	2.56
Ace	CP09	plastic	0.5-100	±10	0.5 at 70	1	-65 to +125	(17)	req
Bourns	200	wirewound	0.01-100	±10	0.5 at 70	25	-65 to +125	d	3
Bourns	224	wirewound	0.01-100	±20	1 at 70	22	-65 to +175	d	4.33
Bourns	260	wirewound	0.01-100	±10	1 at 70	25	-65 to +175	d	3.66
Bourns	3010	wirewound	0.01-100	±5	1 at 70	25	-65 to +175	d	4.33
Dale	100	wirewound	0.01-100	±5	0.8 at 70	25	-65 to +135	d	req
Dale	200	wirewound	0.01-100	±10	0.5 at 70	25	-65 to +105	d	req
Dale	300	wirewound	0.01-100	±15	0.25 at 70	25	-65 to +85	d	req
Dale	600	wirewound	0.01-100	±5	1 at 70	15	-65 to +175	p	req
Dale	1100	wirewound	0.01-100	±10	1 at 70	25	-65 to +175	d	req
Dale	1200	wirewound	0.01-100	±5	1 at 70	15	-65 to +175	q	req
Dale	1600	wirewound	0.01-100	±5	1 at 70	22	-65 to +175	r	req
Dale	2100	wirewound	0.01-100	±10	1 at 70	25	-65 to +125	q (28)	req
Dale	2200	wirewound	0.01-100	±10	1 at 70	15	-65 to +125	p (28)	req
Fluke	23A, 24A	wirewound	0.1-100	±3	3 at 25	1.5	100 max		7
Fluke	30A	wirewound	1-100	±5	5 at 20	2.5	100 max		20
Maurey	50-M123	wirewound	0.05-100	±5	1.5 at 88	1	-55 to +135		5
Minelco	MF2	metal film	0.01-100	±10	0.25 W	1	-55 to +125		6.75
Ohmite	ANP	wirewound	0.1-100	±20	0.33 at 50	25	-55 to +100		req
Spectrol	42	wirewound	0.01-100	±5	1 at 70	22	-65 to +175	r (28) (29)	3.27
Spectrol	44	wirewound	0.01-100	±5	1 at 70	22	-65 to +175	q (28) (29)	3.27
TRW	151	wirewound	0.1-100	±5	3.5 at 40	1	-55 to +125	(14)	7
TRW	400	wirewound	0.01-100	±5	1 at 70	22	-65 to +150	dr	3.25
TRW	600	wirewound	0.01-100	±5	1 at 70	22	-65 to +150	dq	3.25
Waters	AP 1/2	wirewound	0.01-100	±5	2 at 60	1	-65 to +125	g (29)	req
Waters	APH 1/2	wirewound	0.01-100	±5	2 at 60	1	-55 to +125	g (23)	req
Waters	APR 1/2	wirewound	0.01-100	±5	2 at 60	1	-65 to +125	g	req
Waters	APW 1/2	wirewound	0.01-100	±5	2 at 60	1	-65 to +125	g (23)	req
Weston	534, 535, 539	wirewound	0.01-100	±5	1 at 70	24	-55 to +175	q	3.41
Weston	534, 535, 539	wirewound	0.01-100	±5	0.75 at 85	24	-55 to +150	d (29)	3.41
Ace	CP11	plastic	0.5-200	±10	0.75 at 70	1	-65 to +125	(26)	req
Ace	CP15	plastic	0.5-200	±10	1 at 70	1	-65 to +125	(33)	req
Ace	CP18	plastic	0.5-200	±10	1.5 at 70	1	-65 to +125	(34)	req
Waters	APC 7/8	wirewound	0.01-250	±5	3 at 60	1	-65 to +150	(17) (24)	req
Waters	MAP 1/2	plastic	0.5-250	±10	1 at 65	1	-65 to +125	g	req
Waters	MAPW 1/2	plastic	0.5-250	±10	1 at 65	1	-55 to +125	g	req
Waters	PT 112-M	plastic	0.01-250	±10	2 at 40	1	-55 to +125	(25)	req
Waters	PT 112W	wirewound	0.05-250	±10	2 at 40	1	-55 to +125	(25) (28)	req
Waters	RT 7/8	wirewound	0.01-250	±5	2 at 85	1	-65 to +150	(17) (29)	req
Waters	RT 7/8M	plastic	0.5-250	±10	1 at 60	1	-65 to +125	(17)	req
Ace	CP20	plastic	0.5-300	±10	2 at 70	1	-65 to +125	(35)	req
Waters	AP 1 1/16	wirewound	0.025-300	±5	4 at 60	1	-65 to +125	(26) (27)	req
Waters	AP 1 1/8	wirewound	0.025-300	±5	4 at 60	1	-65 to +125	(25) (29)	req
Waters	APC 1 1/8	wirewound	0.025-300	±5	4 at 60	1	-65 to +150	(24) (25)	req
Ace	APO5	wirewound	0.01-500	±5	2 at 85	1	-65 to +125	g	req
Ace	APO8	wirewound	0.02-500	±5	2 at 85	1	-65 to +125	(8)	req
Ace	APO9	wirewound	0.02-500	±5	2.5 at 85	1	-65 to +125	(17)	req
Ace	AP11	wirewound	0.025-500	±5	3 at 85	1	-65 to +125	(26)	req
Ace	AP15	wirewound	0.025-500	±5	3 at 85	1	-65 to +125	(33)	req
Ace	AP18	wirewound	0.025-500	±5	3.5 at 85	1	-65 to +125	(34)	req

lots more about pots.



When you need a trimming potentiometer to meet *any* configuration, you can depend on WESTON to supply the right unit. Volume production of 3/4-inch rectangular pots, the 530-533 Series enables Weston to supply these models at the lowest prices in the industry. We'll supply them in wirewound with a temperature coefficient of ± 70 ppm/ $^{\circ}$ C maximum, or CERMET with a T.C. of ± 100 ppm/ $^{\circ}$ C, maximum. Prices are as low as \$1.09 each in quantities of 500 units, with substantial reductions in larger quantities. Delivery is from stock.



Then, too, it's hard to beat our 1/2-inch 701 Series Squaretrim[®] potentiometer available with either commercial or military specs. Prices are as low as \$1.85 each in quantities of 500 units.

When you want a small, single-turn, wirewound Squaretrim[®] potentiometer, order the 501-505 Series. Prices are as low as \$1.95 each in quantities of 500 units.

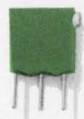

Buy them all from WESTON.

For samples or complete details on any or all of these units, call 717-876-1500, or write Weston Components Division, Archbald, Pa. 18403, a Schlumberger company.

WESTON[®]

INFORMATION RETRIEVAL NUMBER 52

Trimmer Potentiometers

Manufacturer	Model	Type	Resistance Range (Min-Max, K Ω)	Tolerance %	Power Rating (Watts at $^{\circ}$ C)	Number of Turns	Operating Range $^{\circ}$ C	Notes	Price \$/1000
Ace	CP30	plastic	1-500	± 10	3 at 70	1	-65 to +125	(36)	req
CTS	385	cermet	0.02-500	± 10	0.125 at 125	1	175 max	(7)	3.35
CTSB	190	cermet	0.05-500	± 20	0.5 at 85	20	-55 to +150	b	1.20
CTSB	195	cermet	0.05-500	± 20	0.75 at 85	23	-55 to +150	d	2.71
CTSB	340	cermet	0.05-500	± 20	0.75 at 25	1	-55 to +150	m (3)	1.25
CTSB	385	cermet	0.02-500	± 20	0.125 at 125	1	-55 to +150	(7)	3.10
Ace	AP20	wirewound	0.025-750	± 5	4 at 85	1	-65 to +125	(35)	req
AB	S	cermet	0.05-1000	± 10	0.5 at 85	1	-65 to +150	(37)	1.15
AB	Z	cermet	0.05-1000	± 10 or ± 20	0.5 at 70	1	-55 to +125	(3)	1.20-1.40
Ace	AP30	wirewound	0.025-1000	± 5	6 at 85	1	-65 to +125	(36)	req
Amperex	EQ86	carbon film	0.1-1000	± 20	0.1 at 40	1	-10 to +70		8
Amphenol	2305	cermet	0.02-1000	± 10	0.5 to 85	26	-55 to +150	fit	4.34
Amphenol	2855	cermet	0.1-1000	± 10	0.75 at 85	22	-55 to +150	d	3.32
Beckman	61	cermet	0.01-1000	± 10	0.5 at 85	1	-65 to +150	aijkmnw	4.13-4.88
Beckman	62	cermet	0.01-1000	± 10	0.5 at 70	1	-25 to +125	amnx	1.31-1.88
Bourns	3012	cermet	0.01-1000	± 10	1 at 70	22	-65 to +175	d	3.96
Bourns	3052	cermet	0.01-1000	± 10	1 at 70	22	-65 to +175	d	3.96
Bourns	3068	plastic	20-1000	± 20	0.2 at 25	15	-55 to +85	c	1.14
Bourns	3251	plastic	20-1000	± 20	0.5 at 50	25	-65 to +150	e	4.83
Bourns	3262	cermet	0.01-1000	± 10	0.25 at 85	12	-65 to +175	(3)	4.08
Bourns	3281	plastic	20-1000	± 20	0.5 at 50	25	-65 to +150	f	4.66
Bourns	3282	cermet	0.01-1000	± 10	0.5 at 85	25	-65 to +175	f	4.34
Bourns	3292	cermet	0.01-1000	± 10	0.5 at 85	22	-65 to +175	f	4.34
Bourns	3329	cermet	0.01-1000	± 20	0.5 at 85	1	-55 to +150	(6)	1.22
Bourns	3339	cermet	0.01-1000	± 20	0.5 at 85	4	-55 to +150	(6)	1.46
CTS	175	cermet	0.05-1000	± 10	0.5 at 85	35	150 max		3.25-3.45
CTS	185	cermet	0.025-1000	± 10	1 at 85	25	175 max		2.28-2.58
CTS	195	cermet	0.02-1000	± 10	0.75 at 85	23	150 max		2.86
CTS	340	cermet	0.01-1000	± 20	0.5 at 85	1	150 max	(3)	1.25
CTS	360	cermet	0.05-1000	± 20	0.5 at 70	1	125 max	mn	0.66
CTS	RJ22	cermet	0.05-1000	± 10	0.5 at 85	35	150 max		3.60-3.70
CTS	RJ24	cermet	0.05-1000	± 10	0.5 at 85	25	150 max		3.70-3.75
CTS	RVC6	cermet	0.1-1000	± 10	0.75 at 85	1	175 max	(10)	2.94
CTSB	165	cermet	0.05-1000	± 20	0.5 at 85	25	-55 to +150	f	3
CTSB	170	cermet	0.05-1000	± 20	0.75 at 85	42	-65 to +150	e	4.05
CTSB	175	cermet	0.05-1000	± 20	0.5 at 85	35	-55 to +150	iv	2.95
CTSB	185	cermet	0.025-1000	± 20	1 at 85	25	-55 to +150	(10)	2.18
CTSB	360	cermet	0.05-1000	± 20	1 at 25	1	-55 to +125	mn	0.65
Clarostat	371	carbon film	0.1-1000	± 20	0.375 at 70	1	120 max		0.65
Centralab	Centrim	carbon film	0.1-1000	± 20	0.5 at 70	1	-55 to +150	(38)	0.30
Diploh	311	cermet	0.1-1000	± 10	1 at 25	(12)	-55 to +125		0.75
Fairchild	6011, 21, 22	metal film	0.01-1000	± 10	0.75 at 85	22	-55 to +175	d	3.60
Fairchild	6023	metal film	0.01-1000	± 20	0 at 125	22	-25 to +125	d	2.15
Fairchild	6031	metal film	0.01-1000	± 10	0.5 at 85	15	-55 to +125	b	1.55
Fairchild	6033	metal film	0.01-1000	± 20	0.5 at 85	15	-55 to +125	b	1.20
Fairchild	6035	metal film	0.01-1000	± 30	0.5 at 85	15	-55 to +125	b	1.20
Fairchild	6121	metal film	0.01-1000	± 5	0.5 at 85	27	-55 to +150	f	2.60
Fairchild	6123	metal film	0.01-1000	± 10	0.5 at 85	27	-55 to +150	f	2.20
Fairchild	6125	metal film	0.01-1000	± 20	0.5 at 85	27	-55 to +150	f	2.20
Mark	B	cermet	0.01-1000	± 1 to ± 20	0.5 at 85	1	-55 to +150	h	0.47
PEC	AC	cermet	0.1-1000	± 10 or ± 20	1 W	22	-50 to +125	(28)	1.25
PEC	RJ11	cermet	0.1-1000	± 10	1 W	22	-65 to +150	i (29)	2.05
Spectrol	41	cermet	0.1-1000	± 10 or ± 20	0.75 at 25	15	-65 to +125	uz (16)	1.25
Spectrol	53	cermet	0.1-1000	± 10 or ± 20	0.5 at 85	1	-65 to +125	mn	1.10
Spectrol	62	cermet	0.1-1000	± 10 or ± 20	0.75 at 25	1	-65 to +125	mnw (16)	1.15
Spectrol	78	cermet	0.1-1000	± 20	0.75 at 70	22	-25 to +125	(2)	2.01
Spectrol	949	cermet	0.1-1000	± 20	0.75 at 70	22	-25 to +105	(28)	1.78
Techno	226, 251, 276	cermet	0.2-1000	± 10	0.5 at 85	25	-65 to +175	i	req
TRW	450	cermet	0.01-1000	± 10	0.75 at 85	22	-55 to +150	d (2)	3.43
TRW	750	cermet	0.01-1000	± 10	0.5 at 70	19	-65 to +150	ft	4.86
TRW	850	cermet	0.01-1000	± 10	0.3 at 70	13	-65 to +150	(13)	3.42
TRW	950	cermet	0.01-1000	± 10	0.75 at 25	20	-65 to +150	b	1.14
TRW	990	cermet	0.01-1000	± 10	0.75 at 40	18	-65 to +150	(15)	2.25
Waters	AP 1 1/16-M	plastic	1-1000	± 10	2 at 60	1	-65 to +125	(26)	req
Waters	AP 1 1/8-M	plastic	1-1000	± 10	2 at 60	1	-65 to +125	(25)	req
Weston	532, 533	cermet	0.01-1000	± 10	0.75 at 25	15	-55 to +125	b	1.07
Weston	546, 547, 548	cermet	0.01-1000	± 10	0.5 at 85	25	-55 to +150	f (29)	3.49
Weston	566, 567, 568, 569	cermet	0.01-1000	± 10	0.5 at 70	1	-55 to +150	(6) (28)	1.04-1.60
Beckman	50	cermet	0.01-2000	± 10	1.5 at 125	32	-65 to +200	ay	6.00
Beckman	53	cermet	0.01-2000	± 10	1.5 at 125	32	-65 to +200	az	5.62
Beckman	54	cermet	0.01-2000	± 10	1.5 at 125	32	-65 to +200	a (1)	5.62
Beckman	55	cermet	0.01-2000	± 10	1 at 85	22	-65 to +175	aiuyz (1)	4.13
Beckman	56	cermet	0.01-2000	± 10	1 at 85	22	-65 to +175	aiyz (2)	4.13
Beckman	58	cermet	0.01-2000	± 10	1 at 85	22	-65 to +175	aiz (1) (2)	4.13
Beckman	63	cermet	0.01-2000	± 10	0.5 at 85	20	-65 to +150	ait	4.88
Beckman	66	cermet	0.01-2000	± 10	0.5 at 25	20	-25 to +105	at	2.62
Beckman	76	cermet	0.01-2000	± 10	0.75 at 25	15	-55 to +105	auz	1.46
Beckman	77	cermet	0.01-2000	± 10	0.75 at 25	15	-55 to +105	az	1.46
Beckman	78	cermet	0.01-2000	± 10	0.75 at 70	22	-25 to +125	a (2)	2.25
Beckman	79	cermet	0.01-2000	± 10	0.75 at 25	15	-55 to +105	az	1.46
Beckman	89	cermet	0.01-2000	± 10	0.75 at 25	15	-55 to +105	a	1.01

Refractory metallization—
the new breakthrough technology in
pellet processing in the TA7706—leads the way
to high-temperature, high-reliability
designs in RF communications.

TA7706, the first of a new generation
of high-power, high-frequency transistors
using this new refractory-metal process,
can revolutionize your RF power equipment
designs and provide long-life performance
under all rated conditions.

Exemplifying the high state of the "overlay"
art in transistor design, the TA7706 features
emitter ballasting, improved overdrive capability,
and a ruggedized ceramic-metal package
suitable for both stripline
and lumped-constant circuits.

Power output is 30 W (minimum) at 40 MHz
with a minimum gain of 5 dB.

Efficiency is in excess of 65%.

The TA7706 is excellent for
broadband applications, and is designed to
provide rated output with
infinite VSWR under full modulation.

For more information,
see your local RCA Representative
or your RCA Distributor.

For technical data, write:

RCA, Commercial Engineering,* Harrison, N. J. 07029.

International: RCA 2-4 rue du Lièvre,
1227 Geneva, Switzerland, or P. O. Box 112, Hong Kong.

RCA

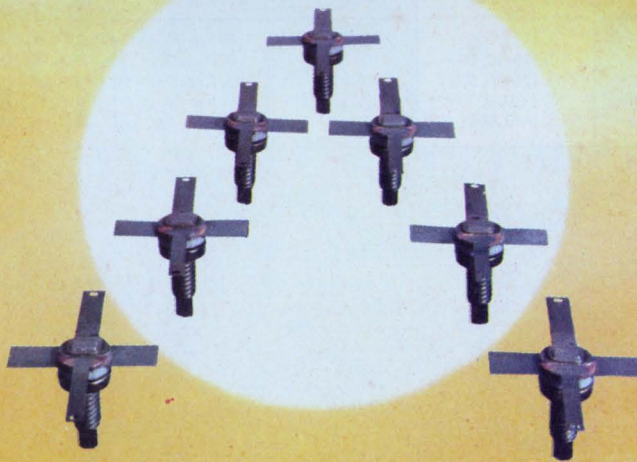

TA7706 Reliability Squadron

Trimmer Potentiometers

123

Manufacturer	Model	Type	Resistance Range (Min-Max, kΩ)	Tolerance %	Power Rating (Watts at °C)	Number of Turns	Operating Range °C	Notes	Price \$/1000
Bourns	3009	cermet	0.01-2000	±10	0.75 at 25	20	-55 to +125	b	1.29
Bourns	3059	cermet	0.01-2000	±10	1 at 70	22	-55 to +150	d	1.99
Bourns	3069	cermet	0.01-2000	±10	0.75 at 25	20	-55 to +125	b	1.29
Bourns	3082	cermet	0.01-2000	±10	0.3 at 85	10	-65 to +150	(5)	4.75
Bourns	3099	cermet	0.01-2000	±10	0.75 at 25	20	-55 to +125	(15)	2.25
Bourns	3252	cermet	0.01-2000	±10	1 at 70	25	-65 to +150	e	3.45
CTS	170	cermet	0.02-2000	±20	0.75 at 85	42	150 max		4.05-4.40
CTS	190	cermet	0.02-2000	±10	0.5 at 85	20	150 max		1.31
CTS	191, 2	cermet	0.02-2000	±10	0.5 at 85	20	150 max		1.35
Dale	8100	cermet	0.01-2000	±10 or ±20	0.75 at 70	25	-65 to +125	d	req
Dale	8300	cermet	0.01-2000	±10 or ±20	0.75 at 25	15	-55 to +105	c	req
Dale	8400	cermet	0.01-2000	±10 or ±20	0.75 at 25	20	-55 to +125	b	req
Electra	ET12	cermet	0.01-2000	±20	1 at 85	22	-55 to +150	(31)	1.99
Electra	ET24	cermet	0.01-2000	±20	0.5 at 85	25	-55 to +150	(31)	3.10
Electra	ET34	cermet	0.01-2000	±20	0.5 at 85	15	-55 to +150	(31)	1.20
Electra	ET50	cermet	0.01-2000	±20	0.5 at 85	1	-55 to +150	(31)	1.20
Electra	RJ12	cermet	0.01-2000	±10	1 at 85	22	-55 to +150	(32)	3.84
Electra	RJ24	cermet	0.01-2000	±10	0.5 at 85	25	-55 to +150	i	4.55
Electra	RJ26	cermet	0.01-2000	±10	0.25 at 85	15	-55 to +150	(32)	5.25
Fairchild	6201	metal film	0.01-2000	±30	0.25 at 85	1	-25 to +125	(6)	0.88
Fairchild	6203	metal film	0.01-2000	±20	0.25 at 85	1	-25 to +125	(6)	0.98
Fairchild	6205	metal film	0.01-2000	±10	0.25 at 85	1	-25 to +125	(6)	1.15
TRW	150	cermet	0.01-2000	±10	0.75 at 70	1	-55 to +150	g	3.08
TRW	255	cermet	0.01-2000	±10	0.75 at 70	24	-55 to +150	ev	3.78
TRW	550	cermet	0.01-2000	±30	0.5 at 70	1	-25 to +105	g	1.31
Weston	518	cermet	0.05-2000	±10	0.5 at 70	1	-55 to +125	g (28)	1.19-1.51
Weston	546, 547, 548	cermet	0.01-2000	±10	0.5 at 85	1	-55 to +150	f	3.39
Weston	556, 557, 558	cermet	0.05-2000	±10	0.5 at 85	35	-55 to +150	e	2.99
Amperex	2322-412	carbon film	0.1-2200	±20	0.125 at 70	20	-30 to +70		0.45
AB	N	carbon	0.1-2500	±10 or ±20	0.33 at 50	25	-55 to +100	d (12)	1.20-1.35
AB	R	carbon	0.1-2500	±10 or ±20	0.25 at 70	25	-55 to +125	d (12)	2.50-2.65
CTS	165	cermet	0.02-2500	±10	0.5 at 85	25	150 max		3.10-3.20
CTS	630P	cermet	0.02-2500	±10	0.5 at 85	1	150 max	g	1.85
CTS	220	carbon film	0.1-2500	±20	0.125 at 55	1	85 max		1.09
CTS	330P	carbon film	0.1-2500	±10	0.375 at 85	1	150 max	g	0.95
Clarostat	63M	carbon film	0.1-3000	±10	0.25 at 70	1	120 max		1
Amperex	EO97	carbon film	0.1-4700	±20	0.25 at 40	1	-10 to +70		8
AB	F	carbon	0.1-5000	±10 or ±20	0.25 at 70	1	-55 to +120	g	1-1.15
AB	O	carbon	0.1-5000	±10 or ±20	0.4 at 70	1	-55 to +150	g	1.20-1.40
AB	Y	carbon	0.1-5000	±10 or ±20	0.25 at 70	1	-55 to +120	g	0.90-1.05
Amphenol	2905	cermet	0.02-5000	±10	0.5 at 85	25	-55 to +150	eiv	3.82
Amphenol	3805	cermet	0.02-5000	±10	0.75 at 40	22	-55 to +125	b (28)	1.13
Amphenol	3815	cermet	0.02-5000	±10	0.75 at 40	22	-55 to +125	b (28)	1.32
Amphenol	6905	cermet	0.02-5000	±10	0.5 at 40	1	-55 to +125	g (28)	2.40
Bourns	215	plastic	5-5000	±20	0.25 at 50	22	-65 to +135	d	3
Bourns	272, 4, 6	plastic	5-5000	±20	0.2 at 20	25	-55 to +105	d	2.33
Bourns	3051	plastic	5-5000	±20	0.25 at 50	22	-65 to +150	d	4.33
CTS	201	carbon film	0.1-5000	±20	0.25 at 40	1	85 max	(9)	0.16
Ohmite	AFR	wirewound	0.1-5000	±20	0.25 at 70	1	-55 to +120		req
Centralab	3TR	carbon film	0.1-10,000	±30	0.5 at 70	1	-55 to +150	(3)	0.15
Centralab	4TR	carbon film	0.1-10,000	±30	0.1 at 70	1	-55 to +150	(39)	0.15
Centralab	5ATR	carbon film	0.125-10,000	±30	0.25 at 70	1	-55 to +150	(40) (42)	0.12
Centralab	5TR	carbon film	0.125-10,000	±30	0.25 at 70	1	-55 to +150	(41)	0.12
Centralab	Slim-Trim	carbon film	0.1-10,000	±30	0.4 at 70	1	-55 to +150	(38)	0.085
Stackpole	Minipot	carbon film	0.1-10,000	±30	0.25 at 50	1	-30 to +100	(43)	0.11

Amperex high quality trimmer pots priced to help you beat inflation.

When you buy trimmer pots from a volume producer you have a right to expect volume prices. And here are three groups of carbon film preset trimmer pots that meet your expectations. They are all top quality in design and manufacture, available off-the-shelf in production quantities... and they sell at prices lower than anything the competition has to offer.

SMALL

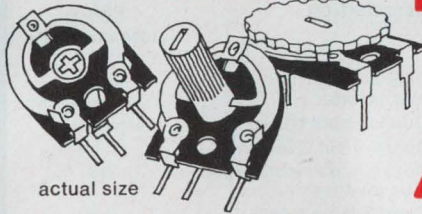

actual size

7^{1/2}¢ TO 9¢ each
IN PRODUCTION LOTS

Resistance range: 100Ω to 4.7megΩ;
Tolerance: ±20%; **Dissipation:** 0.25 watt.

Available for horizontal or vertical mounting on printed circuit boards with pitch of 0.200 inch. The slider is equipped with a central screwdriver slot or plastic knob to facilitate adjustments. Designed for radio and television receivers and industrial applications.

MINIATURE

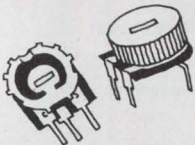

actual size

7^{1/2}¢ TO 9¢ each
IN PRODUCTION LOTS

Resistance range: 100Ω to 1megΩ;
Tolerance: ±20%; **Dissipation:** 0.1 watt.

Completely new design. No price penalty for miniaturization of our standard trimmer. Height: 0.4", Width: 0.4". Available for horizontal or vertical mounting on printed circuit boards with pitch of 0.100 inch. Adjustment by a central screwdriver slot or a plastic knurled wheel. Designed for new products in which small size is a necessity... transceivers, portable TV's, etc.

20-TURN PRESET

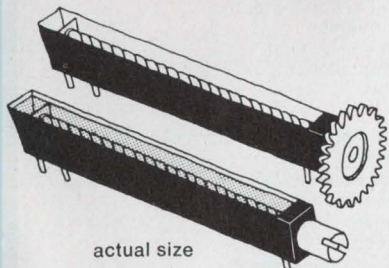

actual size

33¢ TO 41¢ each
IN PRODUCTION LOTS

Resistance range: 100Ω to 2.2megΩ;
Tolerance: ±20%; **Dissipation:** 0.125 watt.
Adjustment range: 20 turns full-scale;
linear or non-linear resistance curve.

Brand new in concept. They break the "dollar apiece" barrier without yielding an inch in performance.

Available with knurled thumbwheel or with screwdriver slot in shaft. (Thumbwheel is actually a spur gear to allow indirect drive where desired.) Dust cover of unique design can also be supplied; seals carbon track and slider against contamination. These 20-turn pots are suitable for use in TV and radio fine tuning, precision instruments, tape recorders, servomechanisms, etc.

Write for detailed data sheets on these three examples of Amperex quality and pricing and for our catalog on the complete Amperex line of components... carbon film resistors, non-linear resistors, electrolytic capacitors, film dielectric capacitors... and much more. Amperex Electronic Corporation, Component Division, Hauppauge, New York 11787.

Amperex®

TOMORROW'S THINKING IN TODAY'S PRODUCTS

A NORTH AMERICAN PHILIPS COMPANY

Here's important news for every cost-conscious designer—RCA's COS/MOS line in dual-in-line plastic packages, at prices you can't afford to overlook.

This new COS/MOS line, RCA's CD4000E series, offers a broad range of gate-level and MSI devices with the low-power, high-noise-immunity features of hermetically packaged COS/MOS devices. And this plastic package gives you a broad operating temperature range and built-in reliability for industrial, commercial, and consumer applications. Look into RCA's CD4000E series for automotive systems, appliances, avionics applications, alarm systems, communications equipment, computers, industrial controls, and instrumentation.

This new low-cost, high-performance COS/MOS line offers you wide design flexibility in 19 application-oriented devices in 14- or 16-

lead dual-in-line plastic packages. Check them now...and check our reliability report (listed below). Here are some important CD4000E series highlights:

- Wide operating-temperature range: -40°C to $+85^{\circ}\text{C}$ (-65°C to $+150^{\circ}\text{C}$ storage)
- Ultra-low quiescent-power dissipation—Gates— $P_T = 50 \text{ nW/pkg. (typ) @ } V_{DD} = 10 \text{ V}$
MSI circuits— $P_T = 10 \text{ } \mu\text{W/pkg. (typ) @ } V_{DD} = 10 \text{ V}$
- Operation from single unregulated voltage supply: 5 to 15 V range
- Excellent dc and dynamic noise immunity—gate level and MSI circuits— $4.5 \text{ V (typ) @ } V_{DD} = 10 \text{ V}$ over full operating-temperature range
- Speed
Gates—propagation delay (t_{pd}) = $50 \text{ ns (typ) @ } V_{DD} = 10 \text{ V, } C_L = 15 \text{ pF}$

MSI circuits—clock pulse frequency (f_{CL}) = $2.5 \text{ MHz (typ) @ } V_{DD} = 10 \text{ V}$

- Single phase clock
- Clock voltage equal to supply voltage
- Compatible gate level and MSI functions
- Protected inputs and outputs

For further information, see your local RCA Representative or RCA Distributor. Ask for technical bulletin File No. 445, and the following publications: "RCA CD4000E Series COS/MOS IC Reliability Data," RIC 103; "Counters and Registers," ST-4166; "Noise Immunity," ICAN-6176; "Astable and Monostable Oscillator Designs," ICAN-6267. Or write: RCA, Commercial Engineering, Section 571-1/CD47, Harrison, New Jersey 07029. International: RCA, 2-4 rue du Lièvre, 1227 Geneva, Switzerland, or P.O. Box 112, Hong Kong.

Now! COS/MOS Goes Plastic for a Brand New Approach to Logic Circuits at Low Cost.

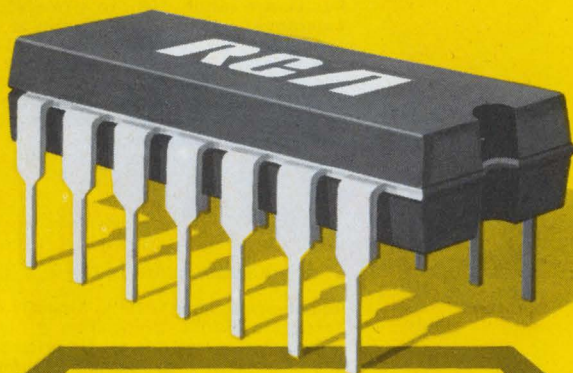

TYPE	DESCRIPTION	PRICE (1000 Unit level)
Gates		
CD4000E	Dual 3-input NOR plus inverter	\$2.20
CD4001E	Quad 2-input NOR	2.30
CD4002E	Dual 4-input NOR	2.50
CD4007E	Dual complementary pair plus inverter	2.30
CD4011E	Quad 2-input NAND	2.30
CD4012E	Dual 4-input NAND	2.50
CD4019E	Quad AND-OR select gate	3.70
Flip-Flops		
CD4013E	Dual "D" with set/reset capability	3.30
Hex Buffers/Logic-Level Converters		
CD4009E	Inverting	3.60
CD4010E	Non-inverting	3.60
Multiplexer		
CD4016E	Quad bilateral switch	3.30
Static-Shift Registers — MSI		
CD4006E	18-stage register	7.75
CD4014E	8-stage synchronous parallel or serial-input/serial-output	7.75
CD4015E	Dual 4-stage serial-input/parallel-output	7.75
Counters — MSI		
CD4004E	7-stage ripple counter/frequency divider	5.60
CD4017E	Decade counter/divider with 10 decoded outputs	8.00
CD4018E	Presetable divide-by "N" counter	7.00
CD4020E	14-stage ripple-carry binary counter/divider	9.50
Adder — MSI		
CD4008E	4-bit binary full-adder with parallel carry-out	7.50

RCA

Integrated Circuits

New Products

Low-cost IC transistors increase performances

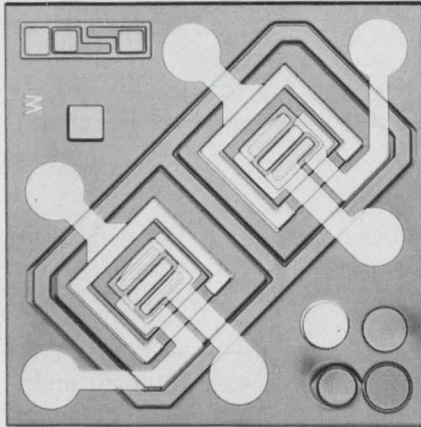

Amelco Semiconductor, 1300 Terra Bella Ave., Mountain View, Calif. Phone: (415) 968-9241. P&A: \$2 to \$8; stock.

Consisting of npn and pnp bipolar and field-effect types, two new series of monolithic dual transistors offer superior temperature tracking and high current gain at low costs.

SA2913 through SA2920, SA2453 and SA2453A bipolar dual transistors exhibit typical tracking (base-voltage differential drift) of $3 \mu\text{V}/^\circ\text{C}$ and a typical base voltage differential of 2 mV.

Dc current gains range from 150 to 600 while collector-to-base breakdown voltage is rated at 60 V.

Prices range from \$2 to \$4.50 in quantities of 100 units. Packaging is in six-lead TO-18 cans.

SU2365 through SU2369 dual FETs exhibit tracking of $1 \mu\text{V}/^\circ\text{C}$ over the temperature range of -55 to $+125^\circ\text{C}$, a gate-to-source breakdown voltage of 30 V, source transconductance of $2 \mu\text{mhos}$ and gate-to-gate breakdown voltage of over 60 V.

Other characteristics include a common-mode rejection ratio of 100 dB and output impedance of $1 \text{ M}\Omega$.

Prices range from \$2 to \$8 in quantities of 100 units. Packaging is also in six-lead TO-18 cans.

CIRCLE NO. 250

LSIs for calculators cut size to 1-1/2-in²

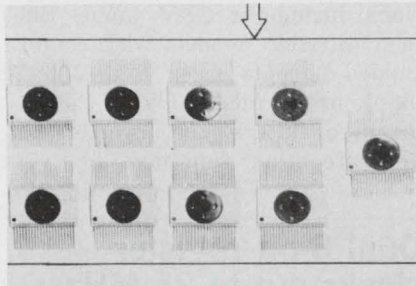

Hitachi America, Ltd., 437 Madison Ave., New York, N. Y. Phone: (212) 758-5255.

Nine LSI circuits, each only 1-1/2-in. square, mount on a single base to form all the electronic circuitry for a 16-digit desk-top calculator that measures 9-1/2 by 12 by 4-1/4 in. The new LSI circuits are available in 8 types: 2 memory, 5 calculation control, and 1 display control unit. They can be used for various mathematical calculations.

CIRCLE NO. 251

Adjustable regulator stays flat to 0.03%

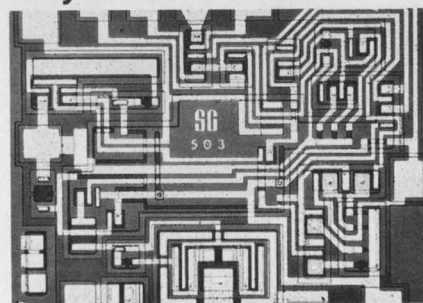

Silicon General Inc., 7382 Bolsa Ave., Westminster, Calif. Phone: (714) 839-6200. P&A: \$3.05; stock.

With either positive or negative supply operation, a new linear IC voltage regulator offers 0.03% line and load regulation and an output that is adjustable from 2 to 37 V. The SG723/723C may be used as a series, shunt, switching or floating regulator with currents up to 150 mA. External power transistors can boost output current.

CIRCLE NO. 252

High-power SCR turns on in 3.5 μs

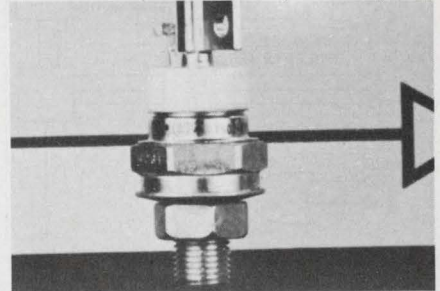

Westinghouse Electric Corp., Semiconductor Div., P.O. Box 868, Pittsburgh, Pa. Phone: (412) 391-2800. P&A: \$43.50; 2 wks.

Handling frequencies up to 10 kHz for half sine-wave operation and up to 7 kHz for rectangular-wave operation, the T507 SCR turns on in $3.5 \mu\text{s}$. Its dynamic forward voltage drop is 4.5 V maximum and it can handle a forward current of up to 100 A. Di/dt is $800 \text{ A}/\mu\text{s}$, turn-off time is $30 \mu\text{s}$, and gate current is 150 mA.

CIRCLE NO. 253

Phase-locked ICs multiply frequency

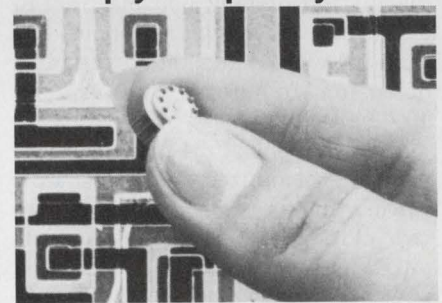

Signetics Corp., 811 E. Arques Ave., Sunnyvale, Calif. Phone: (408) 739-7700. P&A: \$6.35 or \$18; stock.

Going from subaudio frequencies to vhf, two phase-locked-loop linear integrated circuits can accurately multiply, divide or even fractionalize frequencies—virtually in any ratio. Operating range of the model 562 is 0.1 Hz to 50 MHz, while the model 565 performs from 0.1 Hz to 500 kHz.

CIRCLE NO. 254

TTL read-only memories access in only 40 ns

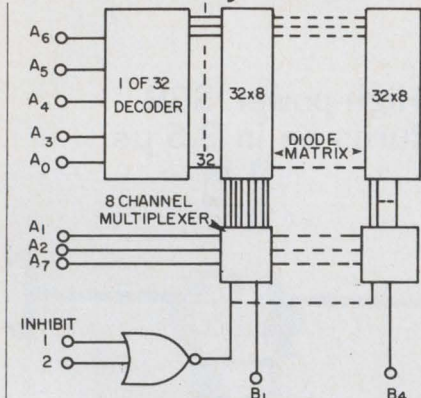

Computer Microtechnology, 610 Pastoria, Sunnyvale, Calif. Phone: (408) 736-0300. Price: \$36 to \$76.

Three new high-speed TTL read-only memories, the CM2900 1120-bit character generator and the CM2850 and CM2800 1024-bit code converters, offer fast access times of typically 40 ns.

The CM2900 1120-bit memory can directly drive light-emitting-diode displays without a driver for each output and contains logic circuitry on the chip.

The logic circuitry, which is normally built by the user, senses the memory input to determine whether or not an incoming signal represents a character for display or a non-display control signal.

Other features include power dissipation of only 500 mW, a fan out of 10, an organization of 224 by 5-bit words, and the availability of custom font for 5 by 7 or 7 by 10 characters.

The CM2850 1024-bit code converter is organized as 256 by 4-bit words, and is easily expandable to two chip select inputs or tie outputs. Other features include a power dissipation of 460 mW, and a fan out of 10.

The CM2800 1024-bit code converter is organized as 128 by 8-bit words and except for its organization, is similar to the CM2850 in its characteristics.

Prices for the CM2900 are \$76 each for 1 to 9 and \$43 each for 25 to 99. The CM2850 costs \$65 each for 1 to 9 and \$36 each for 25 to 99. The CM2800 costs \$69 each for 1 to 9 and \$39 each for 25 to 99.

CIRCLE NO. 255

Tecnetics, Inc., Boulder Industrial Park, Boulder, Colo. Phone: (303) 442-3837. Price: \$79.

Featuring 80% full-load efficiency, a new hermetically sealed, hybrid microelectronic dc/ac square wave inverter for on-card mounting dissipates 3 W. Specifications include a 20-V input. Sixteen different models with center-tapped outputs from 5 to 300 V pk-pk are available. With the addition of filters, the inverter can generate other functions.

CIRCLE NO. 256

Hybrid dc/ac inverter dissipates 3 watts

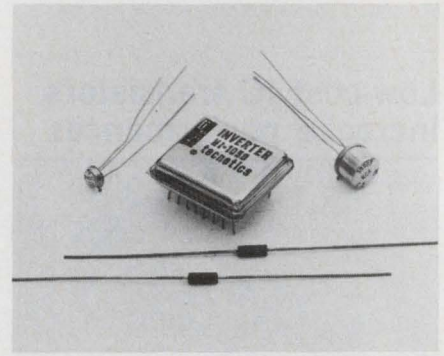

Dual 8-bit register clocks out to 25 MHz

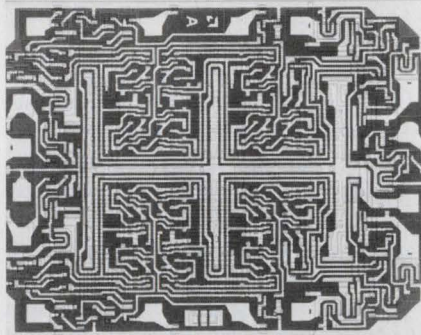

Beckman Instruments, Inc., Helipot Div., 2500 Harbor Blvd., Fullerton, Calif. Phone: (714) 871-4848. Price: \$225; \$175.

Models 871 a/d and 847 d/a cermet thick-film converters offer accuracies of $\pm 0.05\%$. The 871 consists of an MOS/LSI circuit, a ladder, a translator, and a flip-flop. Its resolution is up to 12 bits. The 847 consists of an MOS/LSI circuit, a ladder, an output amplifier, and output resistors. Its resolution is 10 bits.

CIRCLE NO. 258

Thick-film converters offer $\pm 0.05\%$ accuracy



Texas Instruments, Inc., 13500 N. Central Expwy., Dallas, Tex. Phone: (214) 238-2011. P&A: \$1; stock.

A new plastic-encapsulated replacement for the popular 2N3055 metal-can power transistor features better construction to reduce costs. The TIP3055 has a glass-passivated chip for lower leakage, improved moisture resistance and stability, soldered contacts, and copper heat sinks. These combine to reduce costs to \$1 (100-999 quantities).

CIRCLE NO. 259

Replacement transistor improves construction

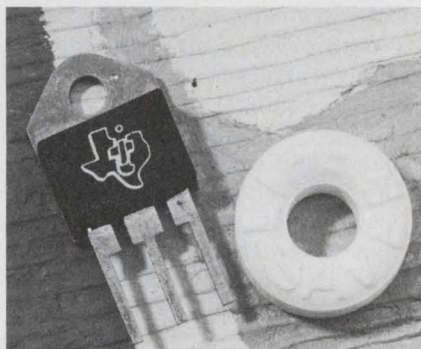

Bench or System — the HP 3450A gives you maximum performance in a minimum space.

A quick look at the unfolding dodecahedron shows each of the 12 functions the Incredible Dodecameter performs. What it doesn't show is just how well this 5-digit multifunction meter performs each function.

For instance, you not only get true rms capability—you also get value-plus features like true 4-terminal ac ratio testing and 4-terminal ohms measurements.

And, accurate, fast measurements in each of these twelve categories is

only the start. You can add digital output and directly control external equipment like a printer. Or, add remote control and get full programmability for system use.

No matter what the application, you get more for your money with the HP 3450A.

This Incredible Dodecameter lets you start with the basic dc meter and add the capability that best fits your requirements. If your needs change, any of the options (except the rear

input terminals) can be easily installed in the field.

For more information on this outstanding 12 in 1 bargain, just call your local HP field engineer. Or, write Hewlett-Packard, Palo Alto, California 94304. Europe: 1217 Meyrin-Geneva, Switzerland.

Price Basic HP 3450A, \$3300; AC Option 001, \$1250; Ohms Option 002, \$425; Limit Test Option 003 \$375; Digital Output Option 004, \$190; Remote Control Option 005, \$245; Rear Input Terminal Option 006, \$70.

090/8A

The Incredible Dodecameter — A 12-in-1 way to better measurements!

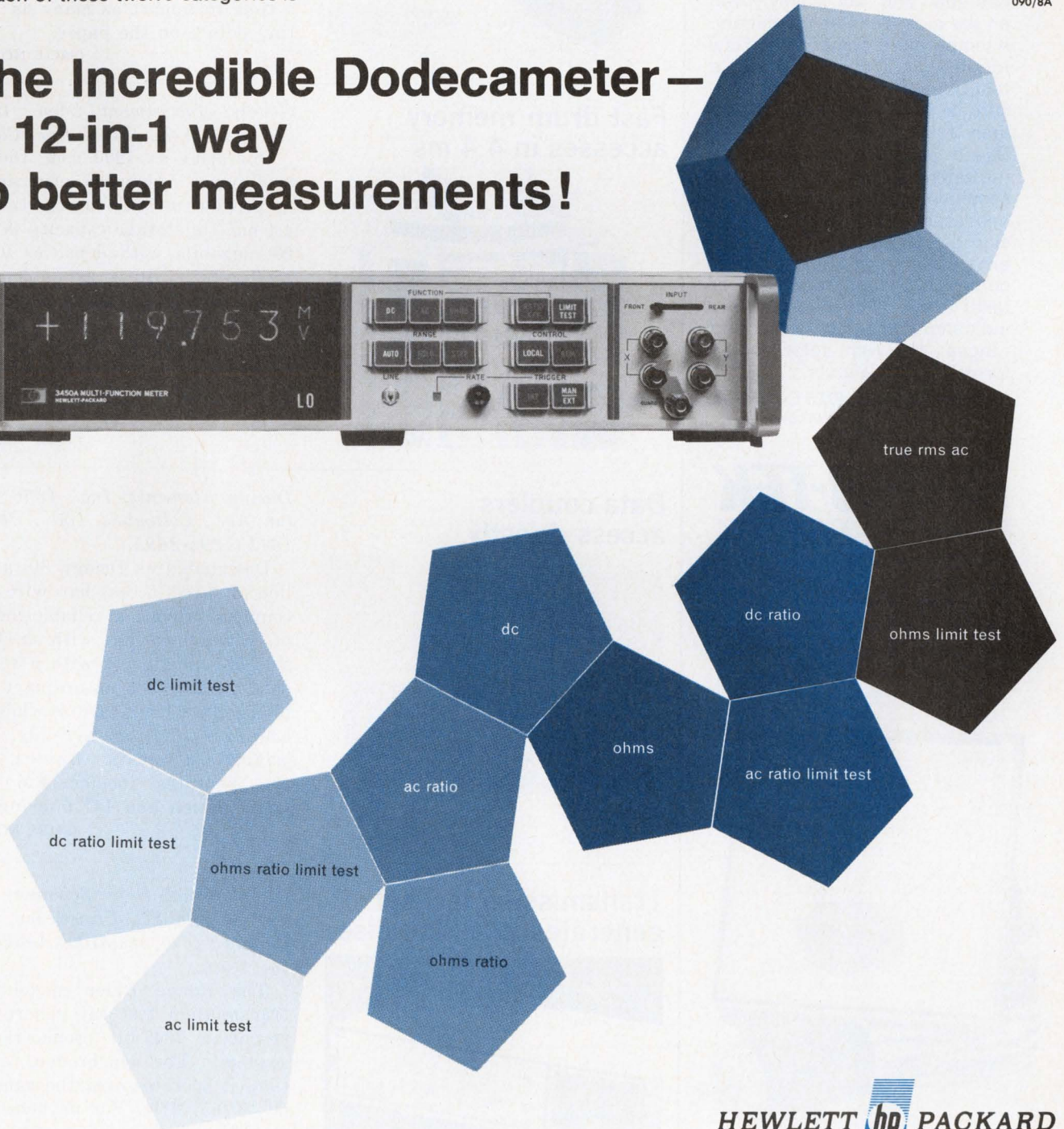
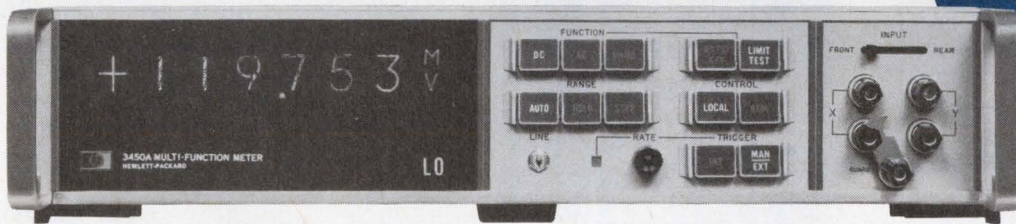

HEWLETT  PACKARD
DIGITAL VOLTMETERS

Exactly your speed.

Servo-Tek's Speed Indicating System takes the precise rotational speed of your application and displays it on an easy-to-read meter. And it tells you repeatedly and accurately even on the most delicate machinery. A temperature-compensated low torque d-c generator and a taut-band meter movement assure a maximum error of less than 1% of full scale reading. Use it as a watchdog on any industrial application where sensitive speed indication is necessary. The attractive design of our Model ST-926 modernizes any application and comes in a standard version or tailor-made with bi-directional indication, special scales and ranges, and with color coding for multiple readouts.

SERVO-TEK PRODUCTS COMPANY
1086 Goffle Road, Hawthorne,
New Jersey 07506.

SERVO-TEK

PRODUCTS COMPANY

For complete specifications
write for our colorful
technical sheets.

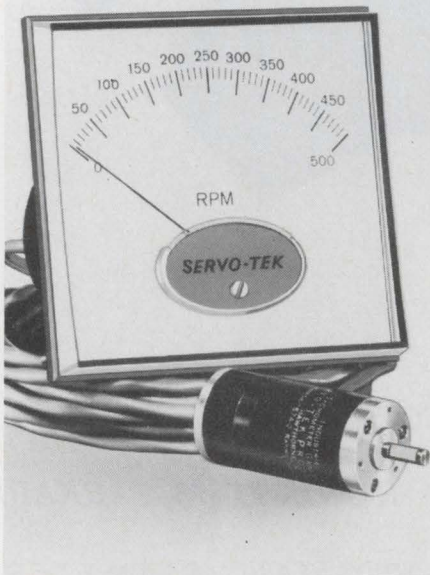

INFORMATION RETRIEVAL NUMBER 57

DATA PROCESSING

Flat 2-layer coil card types out phone pulses

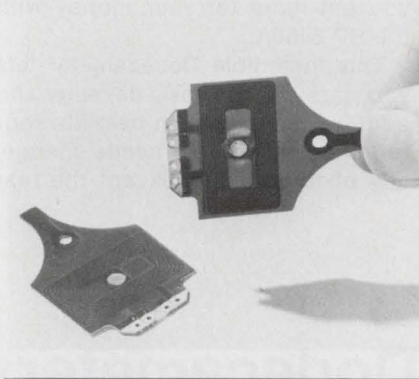

Rogers Corp., Rogers, Conn. Phone:
(203) 774-9605.

A new flat two-layer coil card translates electrical pulses received by telephone into duplicate copies of typed or printed documents or photographs. Direct current entering the card creates a magnetic field and causes the card tip to strike a stylus. The stylus, moving axially on a rotating drum of sensitized paper, proceeds a line at a time to impart as many as 1200 tiny dots/s on the paper.

CIRCLE NO. 260

Fast drum memory accesses in 4.4 ms

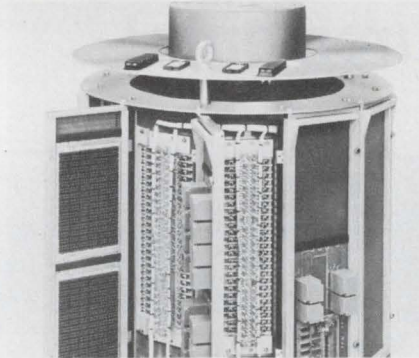

General Instrument Corp., 13040
S. Cerise Ave., Hawthorne, Calif.

Operating at 7200 rpm, the SA 8000 series high-speed drum memory provides average access time of 4.4 ms. Its storage capacity is 5 to 20 megabits with densities up to 1800 bits/in. It is available with 256, 512, or 1024 tracks, each with its own read/write flying head. The drum features 360-degree access to all circuits. Controller logic for interfacing with a central processor is optionally available.

CIRCLE NO. 261

Data couplers access directly

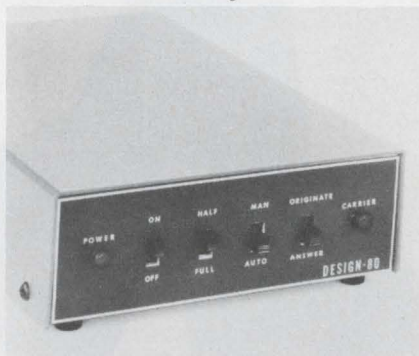

Design Elements, Inc., 1356 Nor-
ton Ave., Columbus, Ohio. Phone:
(614) 294-2694.

Designated as Design 80, a new line of direct-access hardware data couplers provide a reliable method of communicating with a time-shared computer or with a remote data terminal via an ordinary telephone line. Units are available in originate-only, answer-only, and originate/automatic-answer models. Features include FM data transmission and LC filtering.

CIRCLE NO. 262

Transmission test set generates pseudo noise



International Data Sciences, Inc.,
100 Nashua St., Providence, R. I.
Phone: (401) 274-5100. Availabili-
ty: stock.

The Range Rider model 1100 transmission test set generates a repeating 2047-bit pseudo-random sequence. For synchronous operation, it operates over the range of dc to 0.5 MHz. For asynchronous operation, data rates can be selected up to 9600 bits/s.

CIRCLE NO. 263

Need a hybrid op amp with 2 watts power output? **DICKSON** has it!

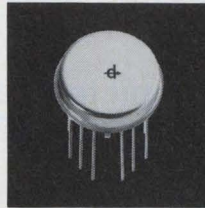

That's right!
A hybrid op amp with up to 2 watts power output in a 12-lead TO-8 package.

This new Dickson unit, the DPA 500, combines a standard monolithic operational amplifier with a complementary current amplifier. It has internal frequency compensation, a large input voltage range, and there's no danger of latch-up.

The price is just \$14.50 (in 100 unit quantity) and it's in stock for immediate delivery.

EASILY CUSTOMIZED IN OEM QUANTITIES
The DPA 500's unique design also enables Dickson to supply customized units in OEM quantities at reasonable prices.

To meet your special requirements, a wide selection of resistors, voltage regulator diodes and voltage reference devices can be easily mounted inside the can without extensive engineering changes.

FOR COMPLETE DETAILS
on the DPA 500 including application information, use this publication's reader service card or phone Dickson Electronics Corporation.

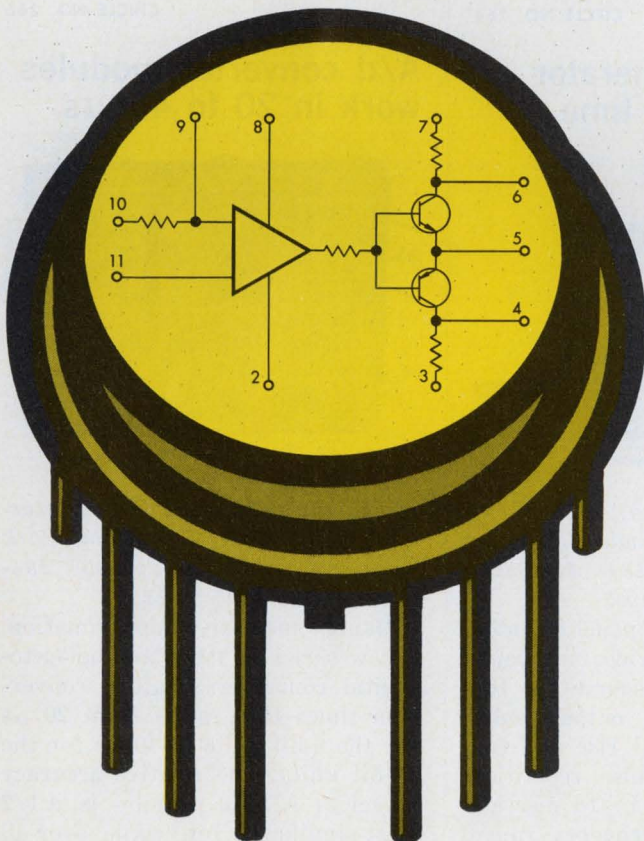

DPA 500 POWER OPERATIONAL AMPLIFIER

- INTERNAL FREQUENCY COMPENSATION
- NO LATCH-UP
- LARGE INPUT VOLTAGE RANGE
- CAPABLE OF DRIVING EXTERNAL HIGH-POWER TRANSISTORS

ELECTRICAL CHARACTERISTICS

(Closed Loop, $1 \leq A_v \leq 10$) (Power Supplies = ± 15 Volts)

Input Voltage		± 15 Volts
Power Dissipation	@ $T_A = 25^\circ\text{C}$	1.25 Watts
	@ $T_C = 25^\circ\text{C}$	2.0 Watts
Harmonic Distortion		.2%
Output Voltage		26 Volts (P-P)
Output Current	DC	200 mA
	AC	500 mA pk
Offset Voltage		5 mV
Output Impedance		4.0 ohms



DICKSON
ELECTRONICS CORPORATION

PHONE (602) 947-2231 TWX 910-950-1292 TELEX 667-406
P. O. BOX 1390 • SCOTTSDALE, ARIZONA 85252

NEW Mini-Module Regulated dc POWER SUPPLIES

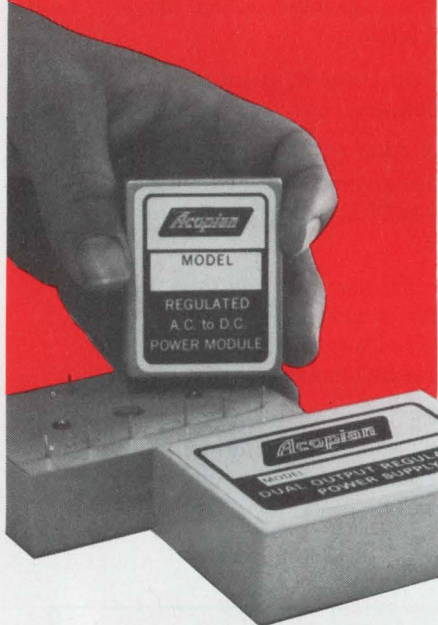

Now you can save space and improve reliability by mounting an Acopian mini-module power supply directly into a printed circuit board. Sizes start at 2.32" x 1.82" x 1". Both single and dual outputs are available. And the duals can be used to power op amps or for unbalanced loads. Other features include:

- Choice of 58 different single output modules ranging from 1 to 28 volts, 40 ma to 500 ma
- 406 combinations of dual output modules with electrically independent, like or different outputs in each section
- 0.02 to 0.1% load and line regulation, depending on model
- 0.5 mv RMS ripple
- Prices as low as \$39 for singles, \$58 for duals

Do you have the latest Acopian catalog? It lists over 82,000 AC to DC power modules for industrial or MIL-spec applications. For your copy, write Acopian Corp., Easton, Pa. 18042, or call (215) 258-5441. And remember, every Acopian power module is shipped with this tag . . .



MODULES & SUBASSEMBLIES

Complete d/a converter comes on a \$275 PC card

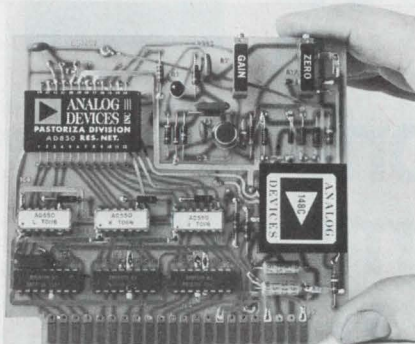

Analog Devices, Inc., Pastoriza Div., 221 5th St., Cambridge, Mass. Phone: (617) 492-6000. P&A: \$185 to \$275; stock.

Based on earlier announced μ Dac monolithic packages, the model DAC-12Q 12-bit d/a converter on a single PC card retails for only \$275. Accuracy is 1/2 the least significant bit, settling time is 2.5 μ s and temperature coefficient is ± 7 ppm/ $^{\circ}$ C. The \$275 price includes a reference source, a ladder network, an input register and an output amplifier.

CIRCLE NO. 264

Tiny pulse generator has 10-ns rise time

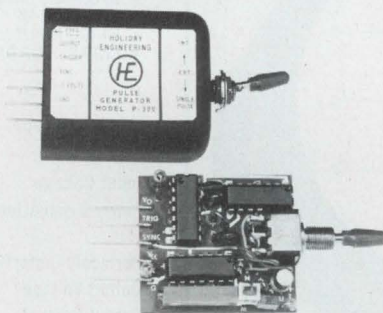

Holiday Engineering, 2540 Teresina Drive, Hacienda Heights, Calif. Phone: (213) 336-0821. P&A: \$79.95; 10 days.

The series 300 panel-mounted pulse generator provides an adaptable compact clock source for ICs with an undelayed output pulse duration of 50 ns at rise and fall times of 10 ns. Pulse repetition rates are available in 16 discrete steps within the frequency range of 100 Hz to 10 MHz. Frequency stability is $\pm 1\%$.

CIRCLE NO. 265

Voltage-standard module stabilizes to ± 50 ppm



CODI Semiconductor, Pollitt Dr., Fairlawn, N. J. Phone: (201) 797-3900. P&A: \$99.50; stock.

Called the Certavolt, a new voltage-standard module has a guaranteed output voltage of 10.000 V ± 50 ppm (0.005%) for an input variation of $\pm 5\%$ and a load variation of from 0 to 10 mA. Operating temperature range is 15 to 55 $^{\circ}$ C and noise is 10 μ V rms and 100 μ V pk-to-pk from dc to 1 MHz. Applications include calibration of voltmeters and digital panel meters.

CIRCLE NO. 266

A/d converter modules work in 20 to 40 μ s

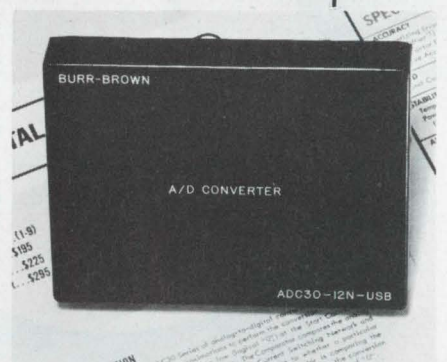

Burr-Brown Research Corp., International Airport Industrial Park Tucson, Ariz. Phone: (602) 294-1431. Price: \$195 to \$345.

Using successive-approximation, a new series of modular analog-to-digital converters feature conversion times that range from 20 μ s for the 8-bit units to 40 μ s for the 12-bit units. The relative accuracy of series ADC30 modules is $\pm 1/2$ least-significant bit, while over-all relative accuracy is ± 1 least-significant bit.

CIRCLE NO. 267

5 ways to kill Trigger Trauma without killing your budget.

Only DUMONT's extraordinary new independent, setable triggering kills trigger trauma. Now you can choose from five models and get just the scope you need starting at \$1845.00 complete for unsurpassed 50 MHz, dual channel performance.

Write or call for details now.

DUMONT OSCILLOSCOPE LABORATORIES, INC.
40 Fairfield Place, West Caldwell, N.J. 07006
(201) 228-3665/TWX (710) 734-4308

DUMONT
OSCILLOSCOPE LABORATORIES, INC.

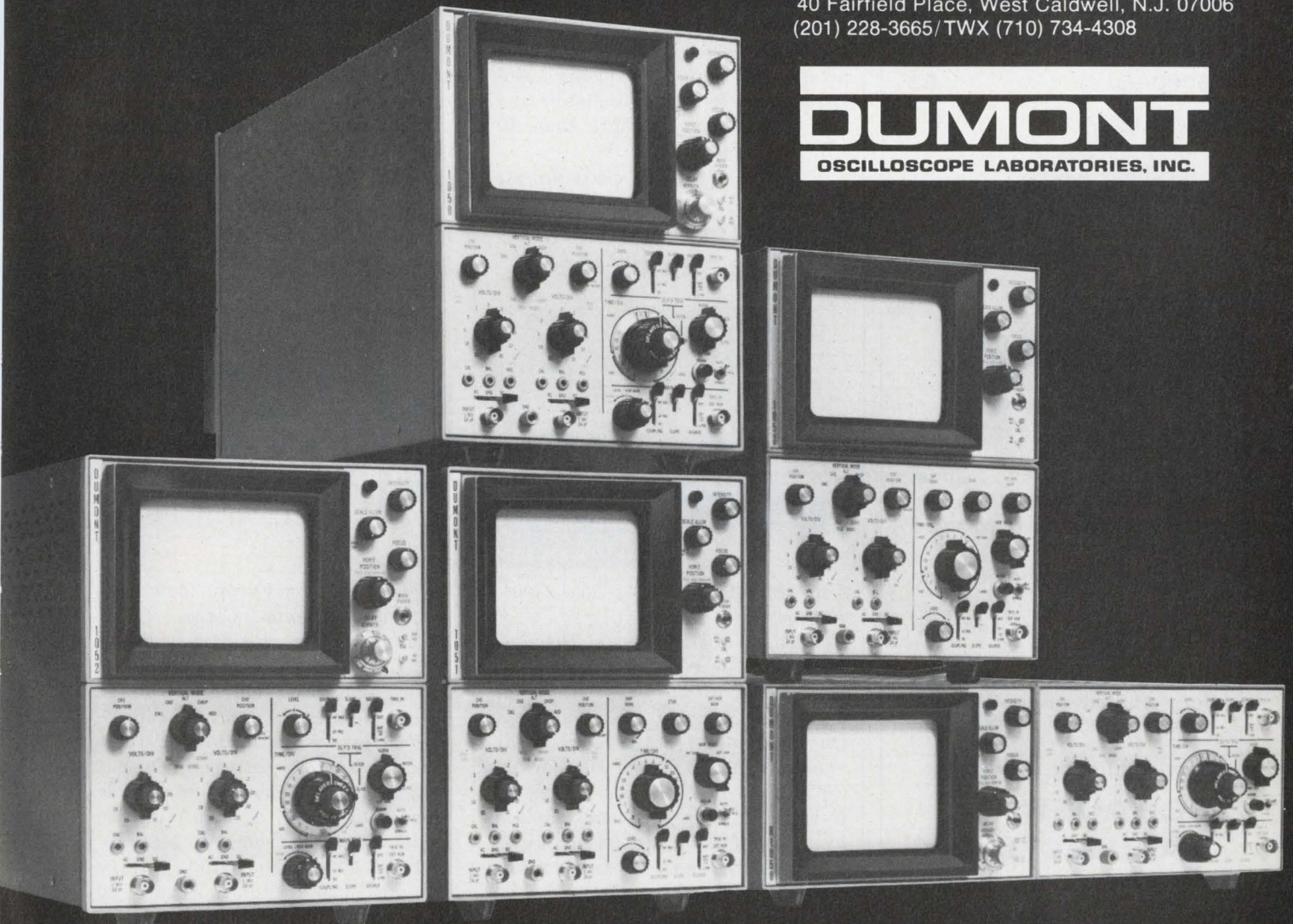

SCHAUER

1%

tolerance

1 WATT ZENERS ARE A REAL BUY!

ANY voltage from 2.0 to 16.0
at the industry's LOWEST
PRICES!

Quantity	Price each
1-99	\$1.07
100-499	.97
500-999	.91
1000-4999	.86
5000 up	.82



THE HI-RELIABLE!

No fragile nail heads.
Silicon junction aligned between two, parallel, offset tantalum heat sinks . . . great lead tension strength.
All welded and brazed assembly.
High pressure molded package.
Gold plated nickel-clad copper leads.
Write or phone for Form 68-4 for complete rating data and other tolerance prices.

Semiconductor Division

**SCHAUER
MANUFACTURING
CORP.** 4511 Alpine Avenue
Cincinnati, O. 45242
Ph. (513) 791-3030

INSTRUMENTATION

Single-sweep generator scans 1 to 125 MHz

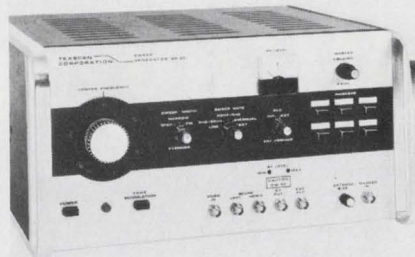

Telexan Corp., 2446 N. Shadeland Ave., Indianapolis, Ind. Phone: (317) 357-8781. P&A: \$3000; 6 wks.

The SS-25 high-power sweep generator covers the entire frequency range of 1 to 125 MHz with only one sweep. Center frequency dial adjustments aren't necessary as the sweep width is adjusted because the sweep is symmetrical about the center frequency. Isolation between the oscillator and the output load is more than 40 dB. Power output is 5 W.

CIRCLE NO. 268

0.1-mV/in. recorders increase slewing speed

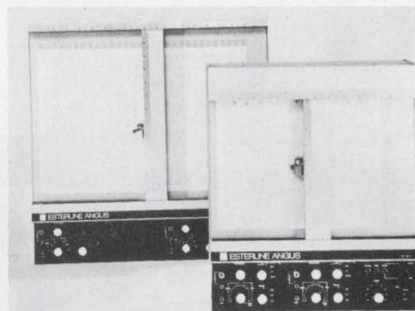

Esterline Angus, P.O. Box 24000, Indianapolis, Ind.

With a 0.1-mV/in. sensitivity, two new X-Y recorders have slewing speeds of 35 in./s in the X axis and 50 in./s in the Y axis. One accepts 8-1/2 by 11-in. paper (model X-Y 8511) and another accepts 11 by 17-in. paper (model X-Y 1117). Paper is held in place by a vacuum. Source impedance is 25 k Ω on the most sensitive range (0.1 mV/in.). Zero offsets can be set to 0.1% accuracies.

CIRCLE NO. 269

\$95 scope-input probe converts impedances

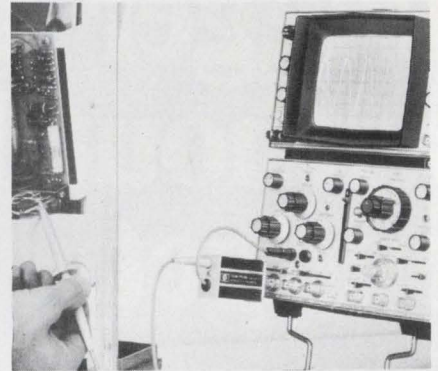

Hewlett-Packard, 1501 Page Mill Rd., Palo Alto, Calif. Phone: (415) 326-7000. P&A: \$95; stock.

A new low-cost active probe converts a high-frequency oscilloscope's 50- Ω input to a 10-M Ω -10 pF impedance at the probe tip for \$95. The model 1124A probe has two switch-selected voltage ranges: ± 10 V with an attenuation factor of 10, and ± 100 V with an attenuation factor of 100. Maximum steady-state input is ± 350 V (10-V range) and ± 500 V (100 V range).

CIRCLE NO. 270

Precision HV supplies are accurate to 0.25%



Velonex, sub. of Varian, 560 Robert Ave., Santa Clara, Calif. Phone: (408) 244-7370. P&A: \$1895, \$2295; stock to 90 days.

Two new precision high-voltage power supplies have output voltage accuracies within 0.25% of their selector switch settings. Output voltage is continuously adjustable from 1 to 20 kV at 3 mA on the model 180, and from 10 to 30 kV at 1 mA on the model 190. Voltage line and load regulations are 20 ppm, and 25 ppm, respectively.

CIRCLE NO. 271

10 microvolt sensitivity with a lot of numbers.

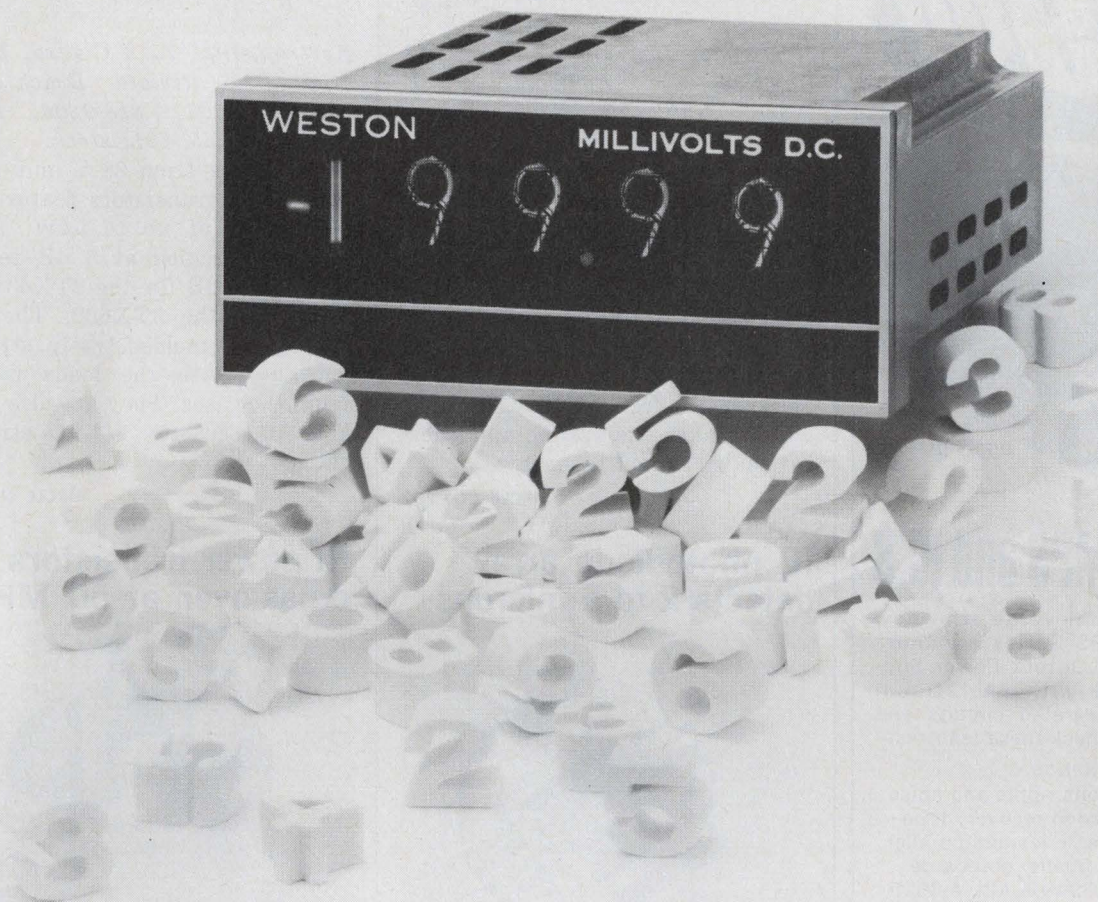

40,000 to be precise.

Our latest bi-polar Model 1294 packs more numbers than any other into industry's smallest package! And it reads them with a sensitivity of *10 microvolts!* The 1294 is a true bi-polar 4½-digit instrument with a display capability of 19999 and out-of-range indication. Its state-of-the-art electronics utilizes T'L logic and unique time-sharing circuitry that cuts power consumption to less than six watts. BCD output is optional. Input impedance is high: 10 meg-

ohms on the 100 millivolt range. Reading rate is 5 per second. Response time is well under one second. Accuracy is .05% of reading, ± 1 digit.

Housed in the same 7 sq. in. front-panel-mountable case as our five other DPM's, the 1294 offers all the features that have distinguished this line . . . Weston's patented dual slope* integration, plug-in Nixie** tubes, repairable (non-potted) circuit boards, and ten standard voltage and current ranges.

If you're sensitive about your numbers, Weston Model 1294 provides the ultimate at a reasonable price. See how the 1294 complements industry's broadest DPM line. Write for details from the DPM originators.

WESTON INSTRUMENTS DIVISION,
Weston Instruments, Inc., Newark, N.J.
07114

a Schlumberger company

WESTON®

*U.S. Pat. #3,051,939

**Registered trademark, Burroughs Corp.

DELIVERY FROM STOCK

a series of
**DUAL OUTPUT
POWER
SUPPLIES**

FROM
\$49.00



for OP AMPS and IC'S

An exceptional value, the new Deltron OS/PS Series are Independent Dual Output Power Supplies for use with operational amplifiers, integrated circuits and digital logic. Check these features—

- 0.02% regulation
- 500 microvolts ripple and noise
- 10 microsecond recovery time
- Master-slave series and parallel
- Built to top quality standards . . . MIL P-13949 & MIL A-8625
- Plug/wire in — compact design
- All Silicon . . . 71°C operation

OS/PS SERIES—RATINGS AND PRICES

MODEL	Each Output		Price
	Volts	Amps	
OS6-0.2D	5-6	0.2	\$49.
PS6-0.2D	5-6	0.2	\$69.
OS6-0.6D	5-6	0.6	\$69.
PS6-0.6D	5-6	0.6	\$89.
OS15-0.1D	8-15	0.1	\$49.
PS15-0.1D	8-15	0.1	\$69.
OS15-0.3D	8-15	0.3	\$69.
PS15-0.3D	8-15	0.3	\$89.

WRITE FOR TECHNICAL BULLETIN

Deltron

WISSAHICKON AVE., NORTH WALES, PA. 19454
PHONE: (215) 699-9261 TWX: (510) 661-8061

D 117

INFORMATION RETRIEVAL NUMBER 63

MICROWAVES & LASERS

Communications laser costs \$150 in kit form

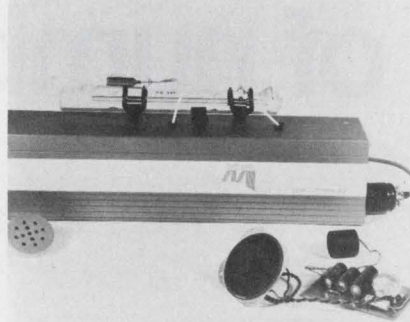

Metrologic Instruments, Inc., 143 Harding Ave., Bellmawr, N. J. Price: \$150 (kit) \$200 (assembled).

A practical, low-cost laser system provides two-way communication over laser beams at less than \$150 in kit form and less than \$200 assembled. The system modulates a laser beam with voice, video, or data signals and transmits the beam for distances of several miles. A 0.75-MHz bandwidth makes the system applicable for multichannel telemetry.

CIRCLE NO. 272

IR photodiode array detects 2 to 5 microns

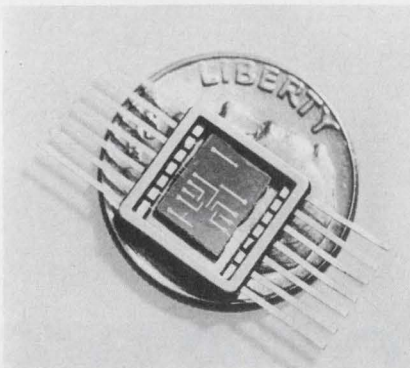

Spectronics Inc., 541 Sterling Dr., Richardson, Tex. Phone: (214) 231-9381.

Featuring a choice of three different types of packages, a new IR detector array using InSb and InAs photodiodes exhibits a response ranging from 2 to 5 microns. Packaging choices include flat-pack, glass dewar or metal dewar cases. The new array also features such optional features as cold shielding, cold filters, and adapters for mechanical coolers.

CIRCLE NO. 273

470-MHz transistors provide 5-W outputs

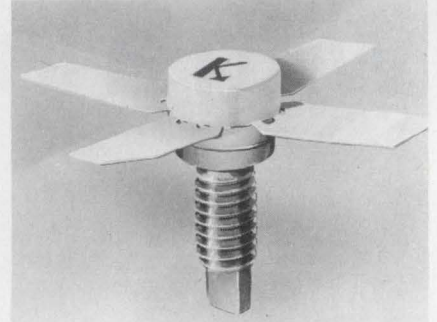

Kertron, Inc., 7516 Central Industrial Dr., Riviera Beach, Fla. Phone: (305) 848-9606. P&A: \$10.80, \$12.55, \$21; stock.

Operating from 28 V and at 470 MHz, 3TX transistors feature output power of up to 5 W. Power gain is specified at 8 dB for the 3TX630, 7 dB for the 3TX631, and 6 dB for the 3TX632. They are packaged in molded 1/4-in. stripline packages with the leads isolated from the cases. They are also available in ceramic 1/4-in. stripline cases.

CIRCLE NO. 274

Rf power transistors cross-over at 50 MHz

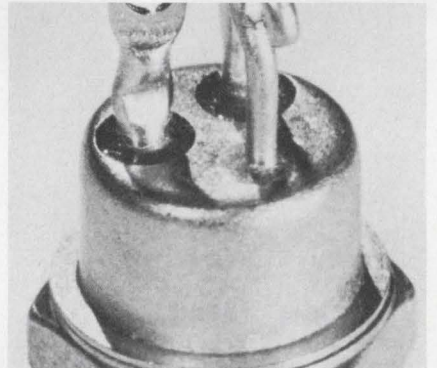

General Semiconductor Industries, 230 W. Fifth St., Tempe, Ariz. Phone: (602) 966-7263. P&A: \$11.95; stock.

Rated at 30 W, a new line of rf power transistors offer a unity-gain cross-over frequency as high as 50 MHz with collector-emitter voltages up to 80 V. Types 2N2877, 2N2878, 2N2879 and 2N2880 are housed in a standard hermetically sealed TO-111 package. Applications include high-frequency inverters and converters.

CIRCLE NO. 275

INFORMATION RETRIEVAL NUMBER 64 ►

The new PDP-8/e: Its own mother wouldn't know it.



The PDP-8/e is a radical departure in computer design. There's no back panel wiring — everything plugs into the OMNIBUS,[™] even the CPU. In any order. It's completely flexible; you buy only what you need. And if you need more later, just buy it and plug it in. And the PDP-8/e is easier to interface and easier to maintain than old-style computers.

We've made a few other changes. Easier programming. 1.2 μ sec memory cycle time. 15 added instructions. 256 words of read-only memory. 256 words of read/write memory.

Yet there's no generation gap between the PDP-8/e and the rest of the PDP-8 family computers in 7500 world-wide installations. They all use the same peripherals (over 60 of them). They're all program and interface compatible, they all have extensive applications and documentation. PDP-8/e was born with a silver software package in its mouth.

The basic 4K machine sells for less than \$5000. With teletype, less than \$6500. Quantity discounts available.

digital
COMPUTERS • MODULES

Digital Equipment Corporation
Maynard, Mass. 01754 (617) 897-5111

More than a CATALOG



on VITREOSIL® PURE FUSED QUARTZ

More complete than most text books, the 48 pages cover Vitreosil pure fused quartz and Spectrosil® synthetic fused silica, the purest form of quartz known. Complete data on properties, applications, chemical behavior, and many others. Thermal American's full lines of products for industry, laboratory and special applications are illustrated and described. A 16 page list is pocketed in the rear cover.

If you use quartz — this book is a must for your library.

Write for your free copy today.

Free catalog Contact us

Name _____

Company _____

Address _____

59-

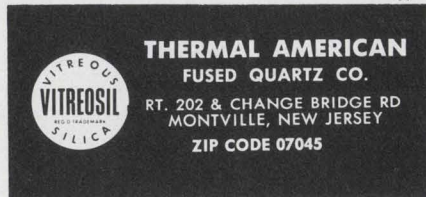

INFORMATION RETRIEVAL NUMBER 65

COMPONENTS

Plastic potentiometer has vernier control

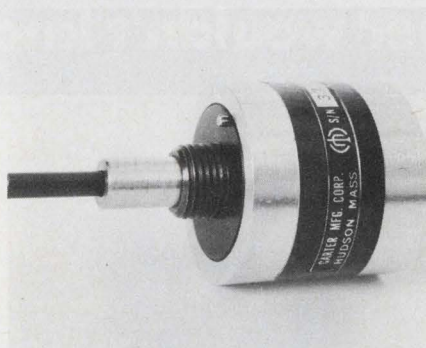

Carter Manufacturing Corp., 23 Washington St., Hudson, Mass. Phone: (617) 562-6987.

A new conductive plastic instrument potentiometer consists of a direct drive on its outer shaft and a 10:1 or 5:1 vernier ratio on an inner shaft to provide for smooth control adjustments. Standard total resistances are 1000, 2500 and 5000 Ω with special values available. Linearity is $\pm 1\%$ and linearities of ± 0.5 or $\pm 0.25\%$ are available. The electrical angle is 300 degrees.

CIRCLE NO. 276

Eight-decade totalizer has electronic decades

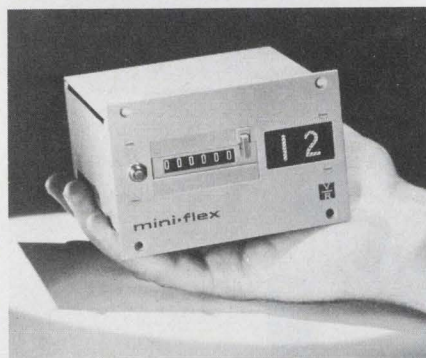

Veeder-Root, 70 Sargeant St., Hartford, Conn. Phone: (203) 527-7201. Price: \$150 (1 decade), \$185 (2 decade).

The new series 7124 Mini-Flex counter combines two electronic counting decades with a six-figure electromechanical totalizer for high-speed counting. It operates from switch closures or pulse inputs. When a pulse input is used, speed is 400 counts/s with one electronic decade and 4000 counts/s with two electronic decades.

CIRCLE NO. 277

Latching 2-pole relays come in flatpack cases

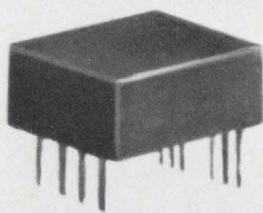

Deutsch Relay Div., 65 Daly Rd., East Northport, N. Y. Phone: (516) 266-1600.

The MLL series two-pole double-throw latching relays are available in flatpack cases and are designed to meet MIL-R-5757. Life expectancy is 150,000 operations with a 1-A contact load. Contact resistance is 100 m Ω maximum. Each relay is less than 0.1 cubic in. in size and lays flat on a 0.1-in.-grid PC board. Each requires a 2.5 ms pulse at 145 mW for actuation.

CIRCLE NO. 278

Low-outline inductors span 0.1 μ H to 10 mH

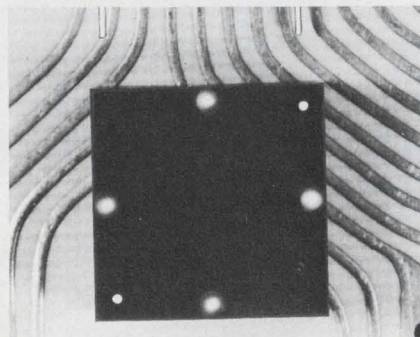

Engineered Components Co., 2134 W. Rosecrans Ave., Gardena, Calif. Phone: (213) 321-6565.

A new line of low-silhouette toroidal inductors features 89 models covering the range of 0.1 μ H to 10 mH. SPL units are designed to provide minimum distributed capacitance, maximum Q, and high self-resonant frequency commensurate with minimum size. Standard tolerance is $\pm 5\%$. Sizes range from 0.2 by 0.2 by 0.125 in. to 0.55 by 0.55 by 0.3 in.

CIRCLE NO. 279

Plastic capacitors withstand 12.5 kV

Film Capacitors, Inc., 100 Eighth St., Passaic, N. J.

Housed in specially treated plastic tubes and end-filled with epoxy resin, type KM9 high-voltage capacitors are available in voltage ratings from 1 to 12.5 kV. They are designed to operate over a temperature range of -55 to $+85^{\circ}\text{C}$ without derating. Standard tolerance is $\pm 20\%$, with closer tolerance available upon request. Dissipation factor is a maximum 0.8% at 1000 Hz.

CIRCLE NO. 280

Power thick films supply to 10 M Ω /square

TRW Inc., IRC Div., 401 N. Broad St., Philadelphia, Pa. Phone: (215) 922-8900. Availability: 3 wks for prototypes.

Metal-glaze cermet thick-film power resistors are available in a resistance range of 0.1 Ω /square to 10 M Ω /square with tolerance to $\pm 1\%$ ($\pm 5\%$ for beryllia). Power loading to 100 W/square in. with suitable heat sinking is possible. Temperature coefficient is ± 200 ppm/ $^{\circ}\text{C}$. A variety of configurations can be supplied.

CIRCLE NO. 281

Electrolyte batteries operate at 350 $^{\circ}\text{F}$

Gould Ionics Inc., P.O. Box 1377, Canoga Park, Calif. Phone: (213) 341-1040.

Month-long battery power at 350 $^{\circ}\text{F}$ is now possible with the HTB series of prototype solid-electrolyte batteries. Shelf life is projected for more than 10 years. For lower temperature operation, lower available energy can be increased by merely heating the batteries. They can be custom-packaged in a wide range of voltages (multiples of 5/8 V), capacities (from a few milliamperes-hours) and sizes. 1/2 and 1-in. dia versions will be offered initially.

CIRCLE NO. 282

There are other 10Amp Relays like these...

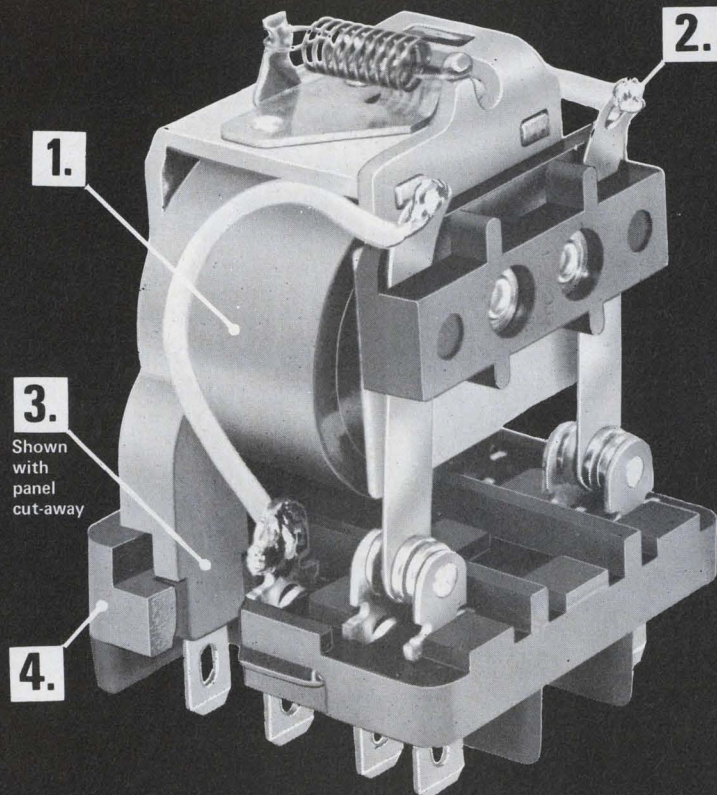

Two Models:
160 without cover
165 with Lexan dust cover

but not with these Exclusive Features...

1. Molded nylon coil for stronger terminals, fungus and moisture resistance, cleaner appearance.
2. Fewer solder joints for more reliable construction.
3. Coil terminates in panel for extra strength, eliminates coil terminal breakage.
4. Frame locked into panel for superior rigidity.

Other features include blade-type terminals for higher current-carrying capacity; 5 & 10 amp contact ratings; SPDT, DPDT, 3PDT contact configurations.

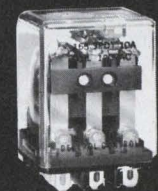

Model 165 with Lexan dust cover.

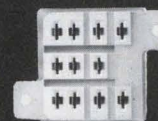

Optional nylon mounting sockets.

1431

DELTROL CONTROLS

2745 So. 19th St., Milwaukee, Wis. 52315, Phone (414) 671-6800, Telex 2-6871

Synchron[®] motors help money make money



In the vending business, a would-be customer with dollar bills and no coins might just as well be flat broke. Unless there's a bill changer around. Like this one made by Rowe International.

Feed it a dollar bill and, presto! Instant alchemy. That useless paper is turned into spendable change.

The acceptance of the bill provides a signal which is transformed into multiple pulses in a Hansen-actuated electromechanical pulse chopper. Impulses are then sent to a memory unit and the payoff is actuated. The major reason why Hansen motors are specified: "Dependability."

Contact your Hansen man and find out how Hansen dependability can help you.

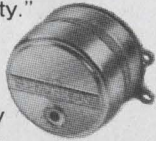

HANSEN
Manufacturing Company, Inc.
Princeton, Indiana 47570



HANSEN REPRESENTATIVES: CAREY & ASSOCIATES, Houston and Dallas, Texas; R. S. HOPKINS CO., Sherman Oaks, Calif.; MELCHIOR

ASSOCIATES, INC., San Carlos, Calif.; THE FROMM CO., River Forest, Ill.; JOHN ORR ASSOCIATES, Grand Rapids, Mich.; H. C. JOHNSON AGENCY, INC., Rochester, N.Y.; WINSLOW ELECTRIC CO., Essex, Conn.; Villanova, Pa., and Teaneck, N.J.
EXPORT DEPARTMENT: 2200 Shames Drive, Westbury, N.Y. 11590

TOOLS & ENGINEERING AIDS

Cordless soldering unit uses Ni-Cd batteries

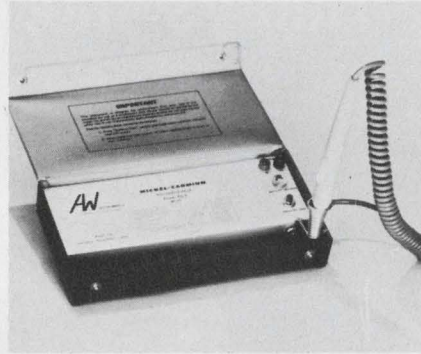

Vapo-kleen Products Co., 824 N. Hollywood Way, Burbank, Calif. Phone: (213) 849-1471. Price: \$78.50.

Completely self-contained, the model 43A portable cordless soldering unit operates on high-energy nickel-cadmium batteries. Controlled heat is achieved instantly by means of a hermetically sealed miniature coaxial heater in the tip assembly. The heater permits operation at very high temperatures within 3 to 5 s.

CIRCLE NO. 283

IC breadboarding kit is assembled in 1 hour

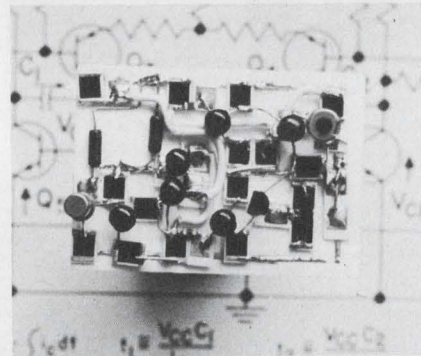

Epitek Electronics Ltd., 19 Grenfell Crescent, Ottawa, Ontario, Canada. Phone: (613) 825-3911.

With the Epichip breadboarding kit, microelectronic circuits can be laid out, assembled and tested in one hour using standard bench tools. The microcircuit kit contains a wide selection of thick-film chip resistors, ceramic substrates and metallized mounting pads offering experimenters and designers a new fast and economical way to build their circuits.

CIRCLE NO. 284

Manual plotter makes 3-D graphs



Dimension, Inc., 95 Madison Ave., Hempstead, N. Y. Phone: (516) 483-3636.

Dimen-Plot manual plotter makes true three-dimensional graphs through the insertion of long headed-pins, with the aid of a guide, into graph paper mounted on a plastic base. The X and Y coordinates are determined by the graph paper; the Z coordinate is determined by the height of the pins above the paper. Resolution in all three directions is infinite.

CIRCLE NO. 285

Template holder speeds drafting

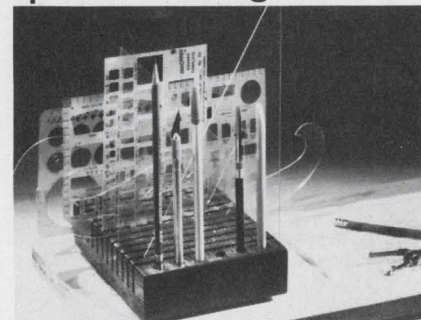

Tempate, 562 N. Madison Ave., Pasadena, Calif. Phone: (213) 254-9203. Price: \$4.95.

The new model 410 template holder is specifically created for use by designers, engineers, draftsmen and architects whose work requires quick and easy access to drafting tools. It eliminates drafting-table clutter and keeps tools clearly visible. It is fabricated of high-quality hardwood and features a hand-rubbed natural-oil finish.

CIRCLE NO. 286

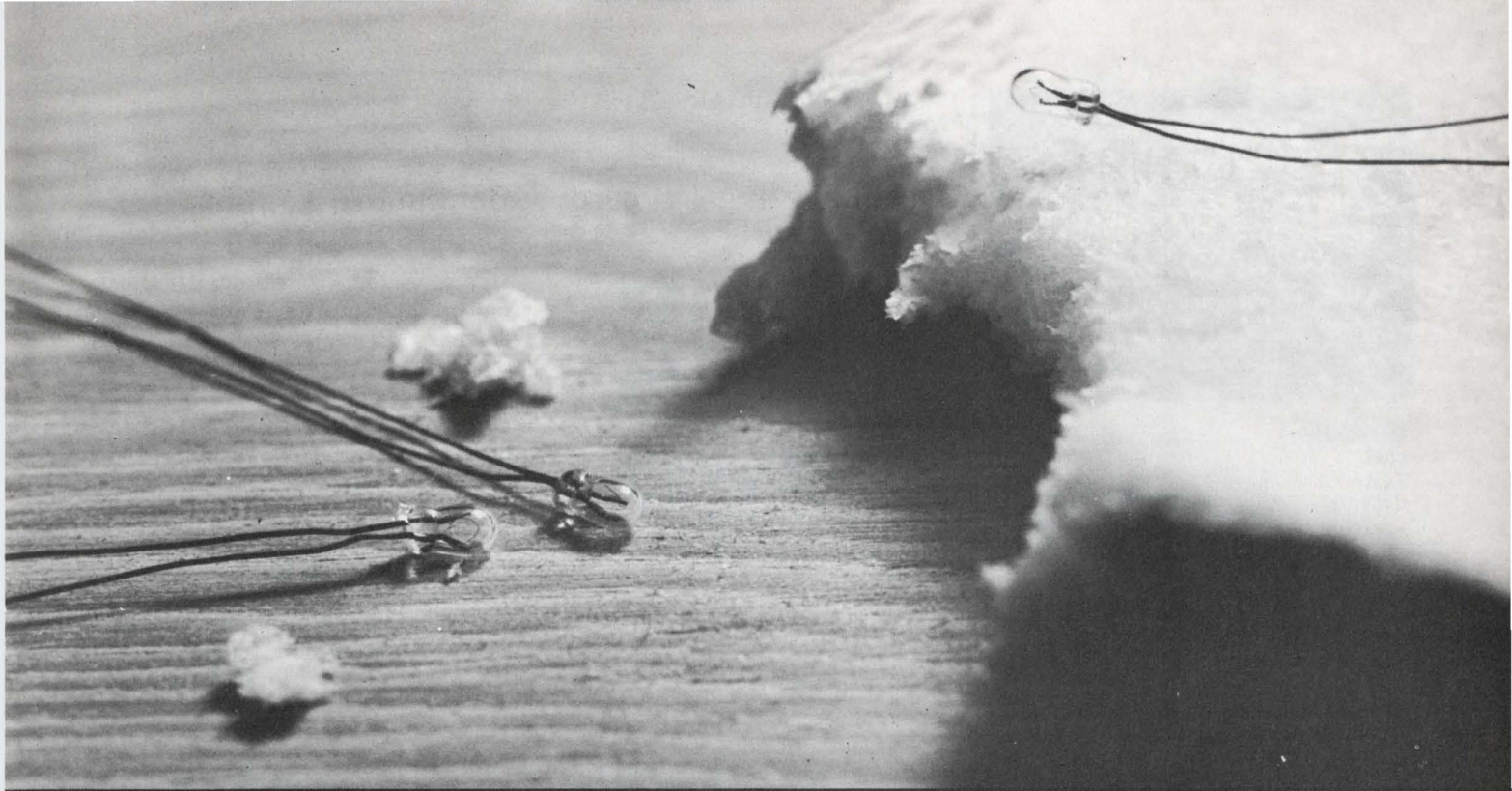

Chicago Miniature's new low current, fine wire lighting bugs need only a fraction of the current normally required for sub-miniature lamps.

These T-1 and T-3/4's have an average current drain of only 8-21 ma., and are specifically designed for applications requiring illumination from low current level circuits.

A new process developed by Chicago Miniature gives our bugs well shaped, stress-free fine wire filaments which result in superior

reliability and life performance.

Their ability to be driven directly from low output integrated circuitry eliminates the need for separate driver circuits. And, all of these lamps are aged for a minimum of 16 hours to insure long lamp life and dependable operation.

For complete information on these low current, fine wire Lighting Bugs, circle the reader service number or write for catalog CMT-3A.

For application assistance contact your Chicago Miniature Sales Representative. For off-the-shelf delivery, contact your local authorized Chicago Miniature Electronic Distributor.



CHICAGO MINIATURE
LAMP WORKS
4433 N. Ravenswood Ave.
Chicago, Illinois 60640
(312) 784-1020

a GENERAL INSTRUMENT company

THE LIGHTING BUGS

This bug
feeds on practically
nothing.

instant CRT Display

We meet your special needs by assembling custom units from our large stock of subassemblies.

Reasonable cost.
Fast delivery.



STANDARD MODELS are available with 3" and 5" rectangular, and 5" circular screens, bandwidth to 4 MHz, with and without sweeps, many options.

Complete literature on request. Inquiries for special scopes will receive prompt attention.

INFODEX

INCORPORATED

7 CHERRY AVE., WATERBURY, CONN. 06702

203-757-9291

INFORMATION RETRIEVAL NUMBER 69

A mouse has already been saved from leukemia.

Help us save a man.

For years, you've been giving people with leukemia your sympathy. But sympathy can't cure leukemia. Money can. Give us enough of that, and maybe we'll be able to do for a man what has already been done for a mouse.

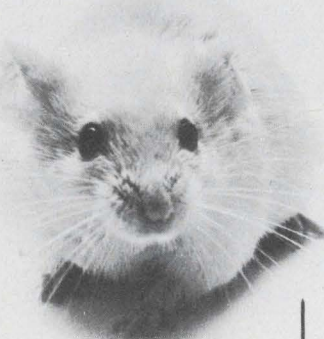

American Cancer Society

Space Contributed By
Hayden Publishing Company, Inc.

PACKAGING & MATERIALS

Breadboarding PC card accepts 12 DIP sockets

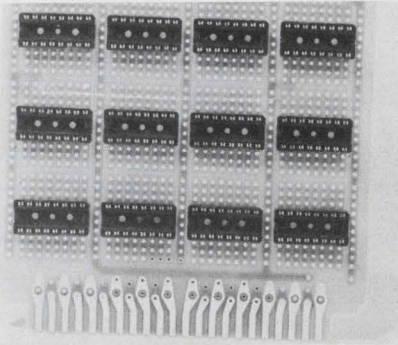

Douglas Electronics, Inc., 718 Marina Blvd., San Leandro, Calif. P&A: \$19.50; stock.

Model 11-DE-1-S is a new PC card that accepts 12 DIP sockets and associated components. Its circuit layout includes two power supply lines which are not connected to DIP pins and are adjacent to each package location. It has three additional 0.038-in.-dia holes on each DIP pad. It is made of FR-4 glass epoxy and is laminated on both sides with copper.

CIRCLE NO. 287

Plastic carrier protects TO-5 ICs

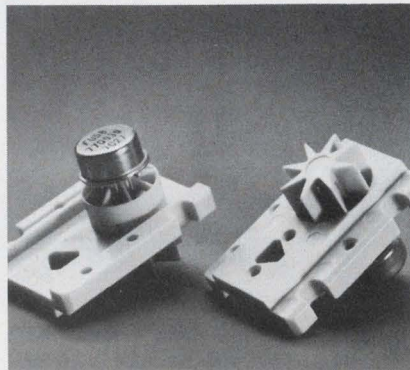

Fairchild Semiconductor, 313 Fairchild Dr., Mountain View, Calif. Phone: (415) 962-3563.

The Stoppenfloppen is a new plastic carrier that protects the leads of TO-5 linear ICs against damage during shipping, testing and handling. It holds a TO-5 package snugly in place and allows inspection and testing of the circuit in the carrier. Measuring 1-in. long and 3/4-in. wide, it is designed to engage guide pins in automated insertion equipment.

CIRCLE NO. 288

Conductive coating grips surfaces

Dynalog, Inc., 7 Great Meadow Lane, Hanover, N.J. Phone: (201) 887-9270. Price: \$9.50 for 3 oz.

Dynalog 479 is an electrically conductive silver-alloy polymer coating that readily adheres to metals, plastics, glass, rubber and ceramic surfaces. The material gives good environmental protection and can easily be soldered with conventional solders. It is easily applied by dip, brush, roller coating or spraying. Applications include printed circuit repair.

CIRCLE NO. 289

New kind of Teflon enhances insulation

Chapman Industries, Avondale, Pa. Phone: (215) 268-2252.

A new Teflon product, trade-named Fepline, is said to offer excellent release and protective surface properties for all types of electronic equipment. One use is as a boot which has no seams or welds, and which withstands dielectrical testing at 10,000 V. The interior surface of the equipment or device to which the boot is applied can be etched so that the boot can be permanently bonded to the element it protects.

CIRCLE NO. 290

MIC substrates offer variety

Surface Technology Inc., Mountain View, Calif.

Thin-film metallized substrates for hybrid microwave integrated circuits are now available. These chrome/gold metallized 99.5%-pure aluminum-oxide substrates measure 1 by 1, 1 by 2, or 2 by 2 in. The intermediate resistor film which is sputtered directly onto the substrate surface provides a resistivity of 50 ohms per square. High-purity gold is then sputtered directly over the chrome to a minimum thickness of 250 micro-inches.

CIRCLE NO. 291

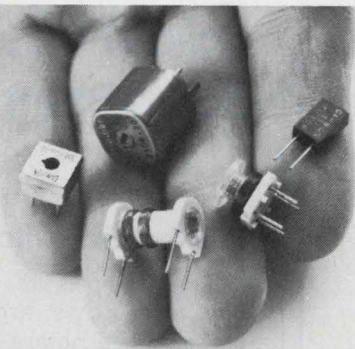

small wonders: big news

Denser PC packaging at low cost is now possible . . . thanks to CAMBION's low-profile standard variable inductors. They're wound on new, thin wall coil forms that allow higher Q's and inductance values.

Ultra-reliable as well as miniature, these high performance inductors are built for longer life . . . longer by a factor of ten in tuning torque. They have an operating temperature range of -55° to 125°C and a tuning range of ±20% from the mean inductance.

For total circuit reliability - at a small price - it pays to choose CAMBION inductors. They're available in a wide choice of values, sizes, styles and finishes for immediate delivery.

Cambridge Thermionic Corporation, 445 Concord Ave., Cambridge, Mass. 02138. Phone: (617) 491-5400. CAMBION Electronic Products, Ltd., Castleton, Near Sheffield, England. Phone: Hope 406/407.

Standardize on

CAMBION®

The Guaranteed Electronic Components

INFORMATION RETRIEVAL NUMBER 70

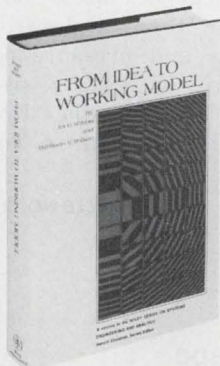

The newest volume in the Wiley-Interscience Series on Systems Engineering and Analysis...

FROM IDEA TO WORKING MODEL

By IRA G. WILSON and MARTHANN E. WILSON

A volume in the *Wiley Series on Systems Engineering and Analysis*, edited by Harold Chestnut

From Idea to Working Model is a practical, non-mathematical guide to assist the innovator or designer systemize his work, and to help the supervisor/manager evaluate progress and avoid stumbling blocks. The authors discuss design problems, the steps in system design, the end results of design, system organization, design theory concepts, information handling, system design procedure, techniques of design, and human factors. Recommendations are given to managers on what characteristics they should look for in selecting prospective innovators.

1970

320 pages

\$12.95

wiley

WILEY-INTERSCIENCE a division of
JOHN WILEY & SONS, Inc.
605 Third Avenue, N.Y., N.Y. 10016

In Canada: 22 Worcester Road, Rexdale, Ontario

INFORMATION RETRIEVAL NUMBER 71

ELECTRONIC DESIGN 18, September 1, 1970

LOWEST Ripple 5Mv

EM LEADS IN 5 SIGNIFICANT SPECIFICATIONS: POWER SUPPLIES

TYPICAL EXAMPLE 10-KW	Mv RIPPLE	WATTS PER CU. IN.	SIZE (CU. IN.)	WEIGHT	CONSTANT CURRENT REGULATION
		2.15	4,655	365	0.2% Total
		1.07	11,221	400	1.5% Total
E/M	5	.96	10,374	485	0.4% Total
		.96	11,221	420	1.0% Total
Christie	30				
Sorensen	160				
H-P	220				

Focusing Coils for Accelerators - Burn-in & Life Testing Semiconductors - CW Lasers - Capacitor Forming & Aging - General Purpose

Write today for your free Quick-Selector Guide to our complete line of power supplies offering detailed specifications, application notes, accessories and prices.

(Data compiled from the latest available specification sheets)

Call Toll FREE (800) 631-4298





ELECTRONIC MEASUREMENTS INC.

405 Essex Road, Neptune, New Jersey 07753

INFORMATION RETRIEVAL NUMBER 72

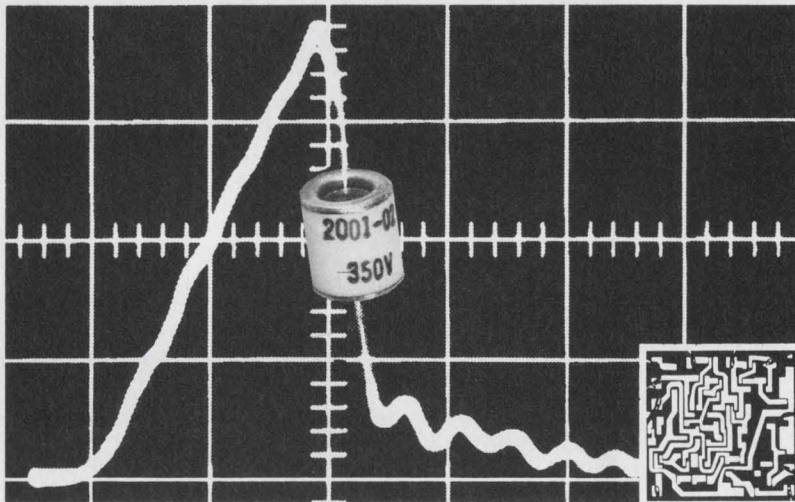
THE COCKY LITTLE TRANSIENT QUENCHER FROM JOSLYN



 Transients have never been able to knock off solid-state electronics when Joslyn precision protection devices are on guard duty. *Never! They quickly extinguish damaging transients with extreme accuracy, nano-second response, and high repeatability over an unequalled period of time. Ideal for protecting AC and DC input lines, RF systems (transmitting or receiving), balanced and unbalanced transmission lines, radar modulators, traveling wave tubes, and cathode ray tubes. Contact Joslyn today for full information and delivery from stock for the field-proven cocky little spark gap that will solve your particular protection problem. Full line includes surge protectors and lightning arresters. *when properly selected and connected



JOSLYN

ELECTRONIC SYSTEMS

Joslyn Electronic Systems Santa Barbara Research Park
P.O. Box 817 Goleta, Calif. 93017 Tel. (805) 968-3551

1813

INFORMATION RETRIEVAL NUMBER 73

Evaluation Samples

Pushbutton switches

Free samples of lighted pushbutton switches are available in personalized colors to match any equipment. The switches, designated the 1820 series, are available in any color or combination of colors for the individual buttons, nylon bezels and housings. Metal bezels are available in chrome, black-oxide or brass-plated steel styles. Ratings include 2 to 9 A at 125 or 250 V ac. Molex, Inc.

CIRCLE NO. 292

Mounting clips

To speed up the anchoring of cable, tubing, pipe or rod up to 1-in. in dia, Self-Stik mounting clips have an adhesive backing that gives permanent holding on any smooth surface without any special surface treatment or tools. They are available in three styles—top clips, side clips and pressure-lock clips. There are 13 holding sizes from 1/8 to 1-in. in dia. Free samples are available. Lorain Tool & Mfg. Co.

CIRCLE NO. 293

Conductor tape

A universal conductor line tape for PC artwork preparation is available as a free sample. The LA550 tape replaces individual requirements for separate crepe and matte-finish tapes by combining the best characteristics of both into a single opaque black tape. The completely opaque LA550 tape returns a clean and sharp reproduction image. Backing is of a transparent adhesive that permits repositioning during application and provides a permanency that will not lift after final positioning. Widths from 1/64 to 4 in. in 20-yard rolls are available. By-Buk Co.

CIRCLE NO. 294

Design Aids

Wire and cable chart

Measuring 15 by 22 in., a new four-color wire and cable reference chart lists the electrical, physical and chemical properties of over 21 commonly available wire insulation materials. Graphs and sketches included in the chart show common conductor materials, coatings and configurations, bare copper wire characteristics, current carrying capacities and correction factors. Other characteristics shown include stranding, color coding, shielding and jacketing. Judd Wire Div. of Electronized Chemicals Corp.

CIRCLE NO. 295

Headline lettering

The Formatt Headline-Setter is a new device for simplifying and speeding up the setting of headline lettering. Guide lines are printed along its leading edges and it is made of rigid vinyl. With its use, letters are easily applied to its guide lines. The complete headline can then be moved in its entirety and positioned precisely onto reproduction art and drawings. After the headline is rubbed down, the Headline-Setter is cut away from the letters and is ready for reuse. Graphic Products Corp.

CIRCLE NO. 296

Waveguides & switches

Featuring listings of waveguides and coaxial switches, a new wall chart measuring 16 by 22 in. simplifies the selection of microwave components. It features the electrical and mechanical specifications of various waveguides and coaxial switches. It also includes numerous photographs of the listed products. In addition to these listings, a brief outline of the manufacturing company's facilities and capabilities is included. Waveline, Inc.

CIRCLE NO. 297

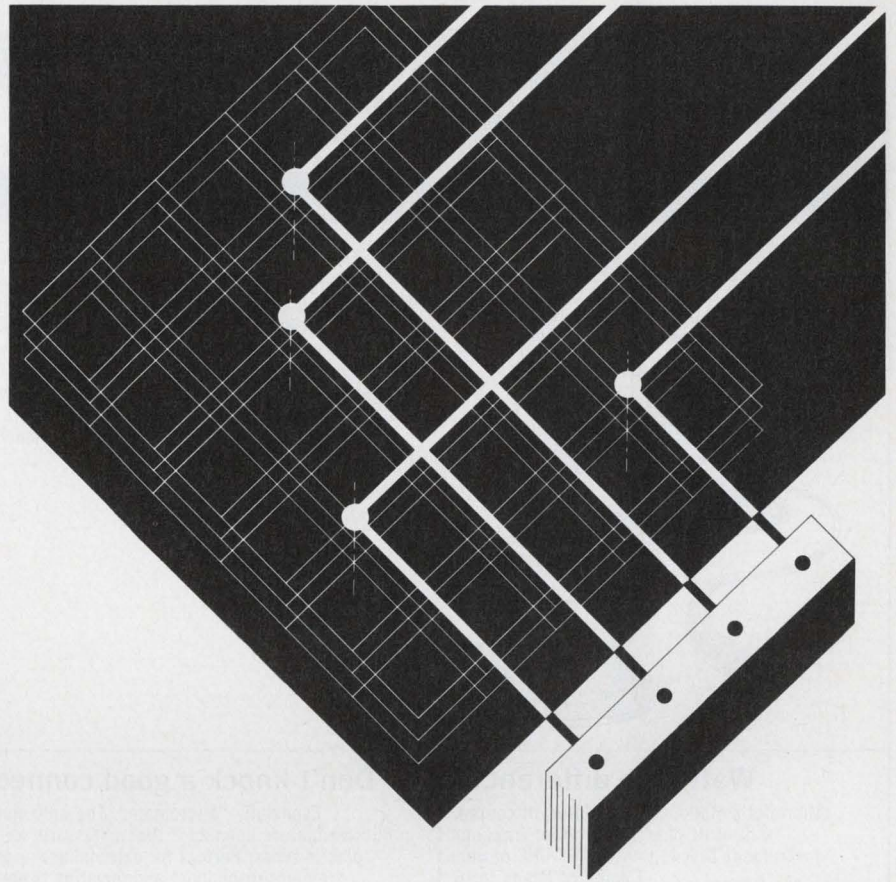

**What multi-point switch
is so reliable that more than 20 million
closures per crosspoint are common?**

The Cunningham Crossbar

This high performance, electro-mechanical switch assures long life with minimum signal distortion for the full range of switching applications—from very low voltage up to 1000 volts.

A unique contact structure is the main reason for the crossbar's reliability. Twin gold contacts, high tension, low mass and friction levels, self-wiping action... all assure superb low-level switching down to micro-volt level—at high speed.

Inherent in the crossbar design is exceptional isolation of each signal path from other paths and from the control circuits. The crossbar is not susceptible to major failure from erroneous voltages or circuit breakdown—nor to chain type failures as in solid state circuitry.

Two matrix patterns: Type A for group-to-group switching; Type F for group-to-one switching. Each covers a specific segment

of data acquisition or broadband switching and is readily programmable by every control device from tape to direct computer input.

Uses include:

- Switching video, radar and antenna signals.
- Memory and logic functions.
- Machine tool programming.
- Data acquisition systems such as outputs from strain-gages, transducers, thermocouples, component test devices, or where signal levels are in the micro-volt range.

Write or phone for Bulletin No. 130, Cunningham Corporation, 10 Carriage Street, Honeoye Falls, New York 14472. Phone (716) 624-2000.

Cunningham Corporation

SUBSIDIARY OF GLEASON WORKS

INFORMATION RETRIEVAL NUMBER 74

Very, Very Microdot.

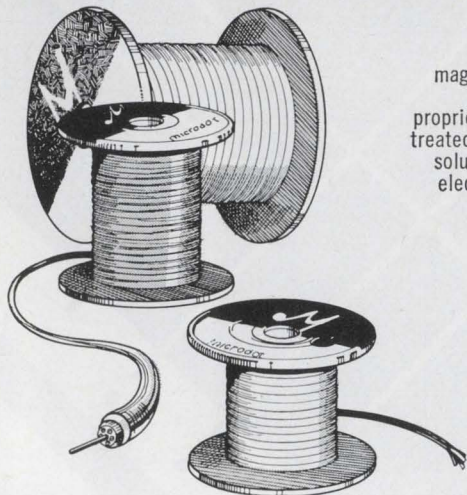

Able cable.

"Mini-Noise" coaxial reduces noise voltage magnitude by a factor of 100 to 1 compared with other cables. Reason: Our Cable Division's proprietary process of coating cable with specially treated Teflon* or polyethylene dielectrics. A great solution to audio noise problems encountered by electronic component manufacturers and users.

*Du Pont Trademark

We present, for your pleasure and profit, a sampling of the superb in electronics and aerospace products. Engineered by divisions and companies of Microdot Inc. Designed to solve specific problems. For lack of space, your particular problem may not be discussed here. Don't fret. Call us. For some very, very interesting solutions.

Watts the difference?

Microdot's Model 445 oscillator, of course. A 50-watt plug-in performer from our Instrument Division. With VHF-UHF power.

Choice of heads for 6 frequency ranges. From 2-2500 MHz.

Has positive no-load protection. Must equipment for everything from power meter calibration to antenna pattern measurements.

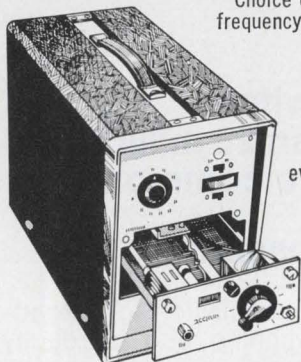

Don't knock a good connection.

Especially "Micromate." The only metal shell microminiature connector that mates with all existing plastic types. Perfect for external use — and when frequent disconnect and remating is needed. No retrofiting required, either.

In standard pin sizes (9, 15, 21, 25, 31, 37, 51).

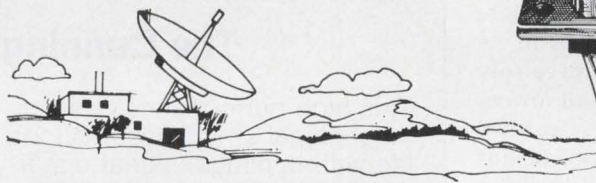
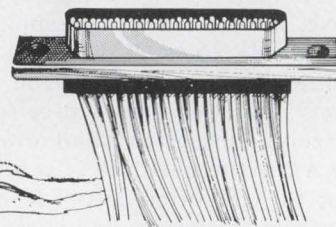

Decisions. Decisions.

You now have a choice in helically coiled threading inserts.

Plus good reasons for deciding on Perma-Thread from our Kaynar Manufacturing Division.

Available in Std. 208 Free-running and Pitch-Lok 209 Locking series. Inserts increase assembly reliability, eliminate thread failures, stay securely in place.

They're the lightest, smallest inserts on the market. Interchangeable with all other coiled inserts.

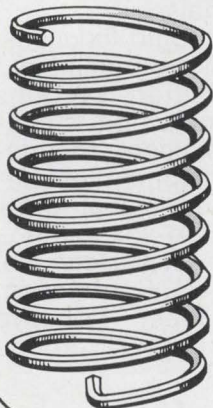

Testing: 1-2-3-4-5.

Microdot's Instrument Division is offering a new line of general test oscillators and waveform generators. Five in each series. Waveforms cover frequency spectrum of .005 Hz to 3 MHz. Output signals: sine, square, triangle, ramp and sync pulse. Oscillator frequencies range from 10 Hz to 10 MHz. Each has an output signal monitor. Amplitude is controlled by precision step attenuation.

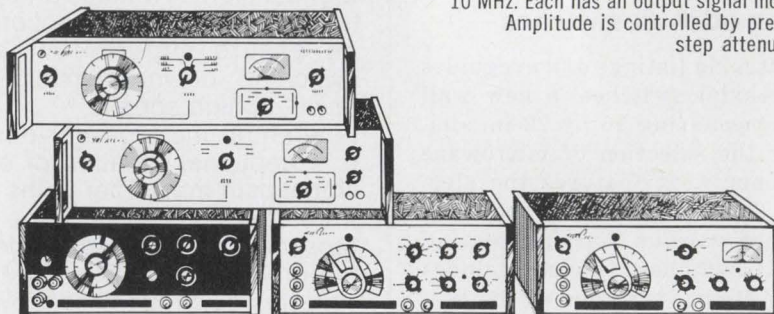

MICRODOT INC.

220 Pasadena Ave., South Pasadena, Calif. 91030

etc.

First things first.

Like "Minimate." It's the first connector to meet MIL-E 5400 K on 0.050" centers. Ideal miniature edgeboard connector for tape recorders, computers — wherever disconnect and connect occur often. Edgeboard connector normally used on mother/daughter board concept.

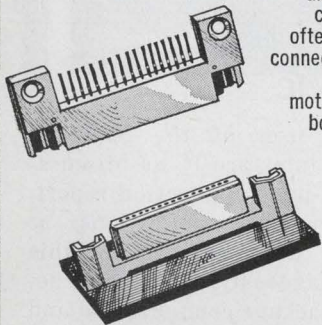

How low can we get?

Plenty low, if handling costs are high on an assembly line for electronics products. We streamline the operation with Speed-Feed system vibratory parts feeders, storage hoppers and inline feeders. From Speed Feed Systems, a division of Microdot's Kaynar Company.

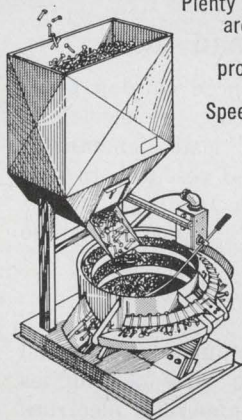

Easy reader.

All the news that's fit to print about these products can be yours. Free. (Unless you're upset by the price of postage stamps.) Just check the items you're interested in. Mail this coupon. And we'll send literature.

- Perma-Thread inserts.
- Speed-Feed system
- Connectors
- Cable
- Testing equipment
- Model 445 oscillator

Name & Company _____

Address _____

City _____

State _____ Zip _____

Application Notes

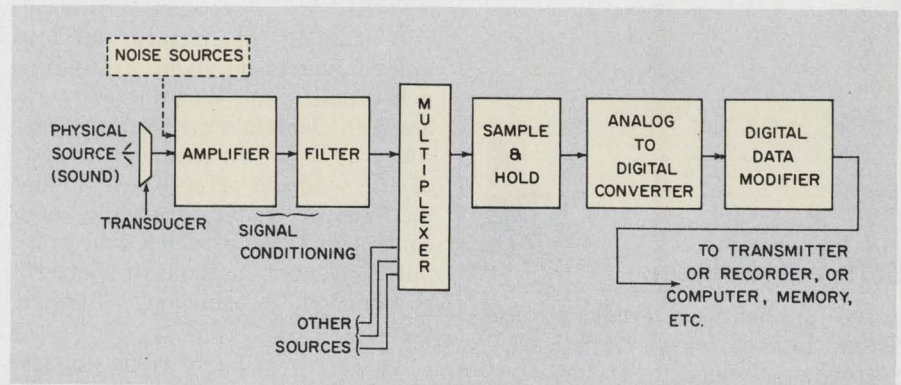

A/d converters

Three publications give a thorough treatment of the subject of signal conditioning. One discusses what's wrong with a/d converter specifications. It explains analog errors, problems encountered in designing precision a/d converters, whether one should build or buy a converter and what a/d converter specifications really mean to the user. The second publication discusses techniques of digital sam-

pling and recovery of analog signals, and includes a glossary of terms. The third publication talks about signal conditioning for a/d conversion in instrumentation systems, and shows various conversion methods used—such as successive-approximation and integrating converters and sample-and-hold circuits. All discussions are fully illustrated with block diagrams, operating curves and pertinent circuits. Analogic Corp.

CIRCLE NO. 298

Impedance measurements

Detailed methods of ratio-type measurements of swept-impedance are given in a new application note. Where traditional techniques, such as those employing Smith charts, usually restrict measurement to the vicinity of 50 or 60 Ω , the swept technique provides wide dynamic range around virtually any impedance level between 10 and 1000 Ω . Hewlett-Packard.

CIRCLE NO. 299

Wideband op amps

The practical and theoretical considerations necessary in applying wideband amplifiers to high-speed analog circuitry are outlined in a new 12-page brochure. It details basic theory and key parameters such as closed-loop bandwidth, damping ratio, delay and rise and fall times. Intronic.

CIRCLE NO. 300

Noise data

Entitled "Noise Engineering Data," a six-page brochure describes desirable noise in terms which permit the engineer to analyze his needs and make best use of the data presented. It indicates several applications in which noise is desirable—as the carrier for secure communications and as a jamming signal. In addition, the brochure explains how to purchase noise as in raw diodes, in modules or in systems. Solitron/Microwave, Microwave Semiconductor Div.

CIRCLE NO. 301

IC notes

Two sets of application notes show 11 different uses for various types of integrated circuits. Each application is presented on a separate sheet with supporting schematics and logic drawings. Pennsylvania.

CIRCLE NO. 302

New Literature

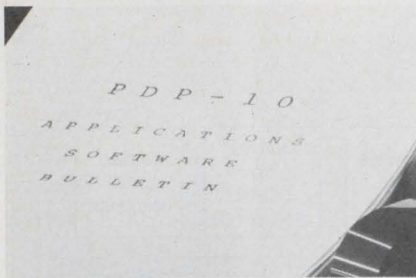

Software bulletin

700 applications programs are listed in the new "Application Software Bulletin." Included is software available either through the Digital Equipment Computer Users Society, (DECUS), or through sale or trade, and programs presently under development. Revisions of the bulletin are planned quarterly. Digital Equipment Corp.

CIRCLE NO. 320

Timers

A 40-page illustrated catalog offers fundamental timer information and a glossary of industrial timer terminology. Raymond Controls Corp.

CIRCLE NO. 321

Rotary switches

An eight-page rotary switch bulletin includes 32 standard circuit configuration examples, available options, clip information and printed circuit clip patterns. Oak Manufacturing Co.

CIRCLE NO. 322

Power semiconductors

A four-page selection guide features high-power and high-speed semiconductors with current and voltage spectrums of 5 to 50 A and 70 to 300 V. Detailed specifications are given for 140 silicon devices. TRW Semiconductors Inc.

CIRCLE NO. 323

IC notes

Six integrated-circuit application notes describe logic gates, adders, decade counters, shift registers and binary counters. Sprague Electric Co.

CIRCLE NO. 324

Lectures

A catalog of lecture surveys and courses to be given in Los Angeles, Calif., and Washington, D.C. between September 1970 and February 1971 is now available. A few of the subjects offered are fundamentals of radar, modeling and control of large systems, and computer-oriented methods in pattern recognition. Technology Service Corp.

CIRCLE NO. 325

Software packages

New data sheets on software packages discuss both basic and application software. Included is an engineering drafting package designed to produce detailed drawings on a digital plotter with input easily coded by a draftsman or an engineer using English statements. Milgo Electronic Corp.

CIRCLE NO. 326

Connectors and sockets

A 28-page catalog, listing 2000 interconnection devices, contains technical data and specifications on stock printed-circuit edge and rack-and-panel connectors, integrated-circuit sockets and a wide variety of other sockets for tubes and transistors. Cinch Manufacturing Company.

CIRCLE NO. 327

Roadway safety handbook

A pictorial catalog of highway conditions which might cause an accident or contribute to its severity, published by the Highway Users Federation for Safety and Mobility, is available. Entitled "Maintenance and Highway Safety Handbook," it is intended to help point out road hazards so that they can be corrected before they become a factor in a crash. It includes nearly 100 photographs of typically poor road conditions. Highway Users Federation for Safety and Mobility.

CIRCLE NO. 328

Application Report

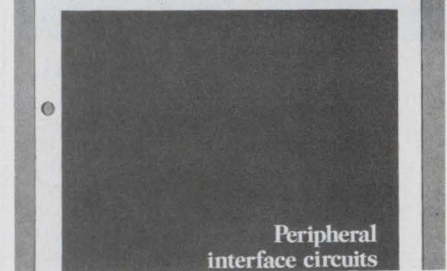

Interface IC

Multiple uses of the SN75450 peripheral interface IC are discussed in a six-page application report. In 23 separate applications, it shows how designers can use this IC advantageously. Circuit schematics, a package configuration and a functional block diagram are illustrated. Texas Instruments Inc.

CIRCLE NO. 329

Components and tools

A cross-referenced catalog gives a complete selection of electronic components, test leads, chemicals, TV hardware, and research in new products. GC Electronics.

CIRCLE NO. 330

Flexible wire

A 16-page brochure describes all types of flexible wire assemblies for computer, commercial electronics, aerospace and military applications. Ansley Div. of Thomas & Betts Corp.

CIRCLE NO. 331

Tunnel diodes

Tunnel diodes are described in a four page brochure. It features performance curves, typical circuit configurations and general engineering data on amplifier, switching, oscillator, mixer and detector diodes. KMC Semiconductor Corp.

CIRCLE NO. 332

Relays and switches

An eight-page catalog features PC relays and switches. It also includes magnetic-counter and standard relays and PC track switches. ITT Corp.

CIRCLE NO. 333

The IC troubleshooters.

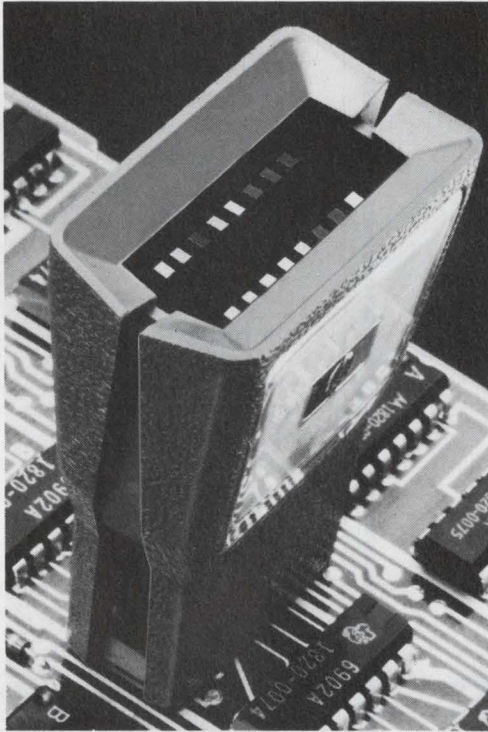

For \$125, it lets you see logic states at a glance.

Engineers testing the logic states of DTL or TTL IC packages no longer have to go the troublesome voltmeter route. The new HP 10528A Logic Clip shows you the state of all 16 (or 14) pins. This simple tool clips over the IC package, uses the circuit's power, is auto-seeking of Vcc and ground.

Bright LED's light up, indicating a high logic state. All this for just \$125. Or less in quantity.

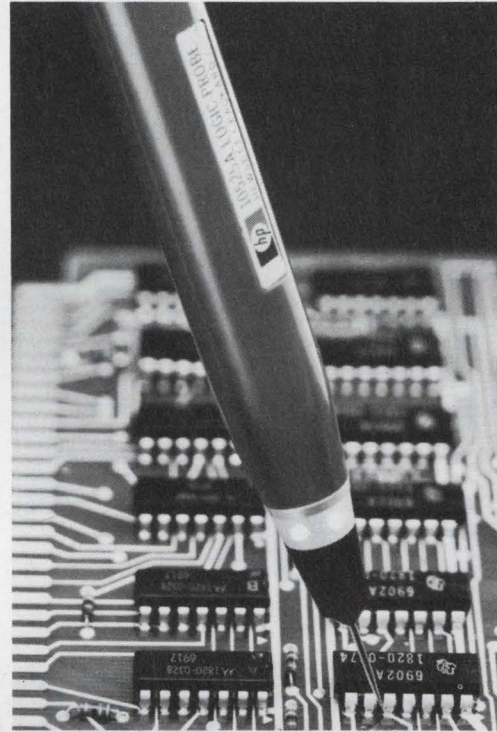

For \$95, it lets you see pulse activity at a glance.

The HP 10525A Logic Probe makes tracing pulses through integrated circuits a painless task. Just touch the DTL or TTL circuit with the probe, and the tip flashes a signal for pulses as narrow as 25 nsec. A light in the tip indicates pulse, polarity, pulse trains, logic state.

It's almost like having an oscilloscope squeezed into a ball-point pen. And it only needs 5 volts and \$95 to start troubleshooting your circuits.

Your local HP field engineer is your source for the clips and probes to speed up your IC testing. So give him a hurry-up phone order. Or you can write for full information from Hewlett-Packard, Palo Alto, California 94304; Europe: 1217 Meyrin-Geneva, Switzerland.

HEWLETT  PACKARD

INFORMATION RETRIEVAL NUMBER 86

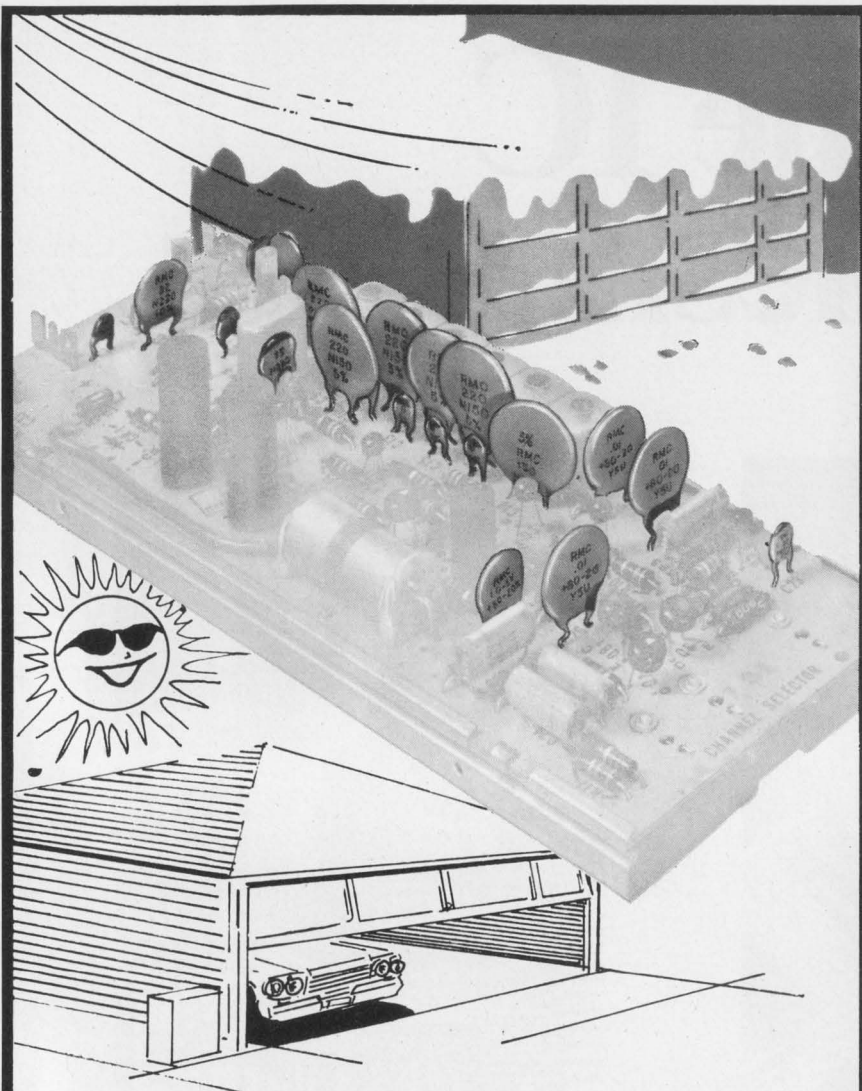

RMC DISCAPS FOR TEMPERATURE SENSITIVE APPLICATIONS

Perma-Power, a division of Chamberlain Mfg. Corp., a leading manufacturer of radio controlled garage door openers, specifies RMC DISCAPS to assure reliability under extreme environmental conditions.

RMC produces a full range of DISCAPS for temperature sensitive circuitry or applications requiring exact temperature compensation. Frequency and temperature stable types, as well as units of predictable variability, are available.

DISCAPS are produced to the highest standard of quality and may be specified with complete confidence.

If your application requires special physical or electrical characteristics, contact RMC's Engineering Department.

*Write today on your company letterhead
for your copy of the complete RMC catalog.*

DISCAP
CERAMIC
CAPACITORS



RADIO MATERIALS COMPANY
A DIVISION OF P. R. MALLORY & CO., INC.
GENERAL OFFICE: 4242 W. Bryn Mawr Ave., Chicago 46, Ill.
Two RMC Plants Devoted Exclusively to Ceramic Capacitors
FACTORIES AT CHICAGO, ILL. AND ATTICA, IND.

NEW LITERATURE

Microwave devices

A new 43-page microwave components catalog describes and illustrates microwave devices. Featured are engineering data and diagrams showing dimensions for each component. Bendix Microwave Devices Division.

CIRCLE NO. 334

Coaxial shunts

Coaxial shunts for surge and high-frequency current measurements are described in a catalog. They provide an inductance-free output voltage directly proportional to circuit current. T&M Research Products, Inc.

CIRCLE NO. 335

Silicones

"Silicones for the Electronic Equipment Industry" is a 20-page bulletin detailing a variety of silicone products for improving the performance, reliability, safety and service life for electronic products. Dow Corning Corp.

CIRCLE NO. 336

Instrument rental

A 4-page brochure provides economic justifications for renting electronic equipment such as DVMs, oscilloscopes, counters, power supplies, recorders and generators. Electro Rents, Inc.

CIRCLE NO. 337

Transistor tester

A brochure outlines means to test and sort all ranges of transistors and diodes on a go/no-go basis according to predetermined sets of specifications. Also included are techniques used to measure transistors and diodes with 1% accuracy. Lorlin Industries.

CIRCLE NO. 338

Stereo accessories

A catalog contains a wide variety of accessories and equipment for the care and maintenance of audio tape recorders and phonographs. Audiotex, GC Electronics.

CIRCLE NO. 339

Bulletin board

of product news
and developments

When connected to the speaker of any audio equipment (stereo, TV or tape recorder) a new wireless speaker adapter broadcasts the sound to any regular or portable radio within 100 feet. The unit includes automatic volume control to prevent distortion for overmodulation, resulting in a good clear sound. It needs only two wires, clipped to either the speaker terminals or to the ear-phone jack. This battery-powered speaker adapter from Herbert Salch & Co., Marketing Div. of Tompkins Radio Products, Wood-sboro, Tex., costs \$19.95. An optional power supply is available for \$3.95.

CIRCLE NO. 340

A price reduction on its premium-grade operational amplifiers has been announced by Precision Monolithics, Inc., Santa Clara, Calif. Prices for the SSS101A amplifier have dropped from \$45 to \$36 for quantities of 10 to 24, and from \$30 to \$18 for quantities of 500 to 999. The SSS107 amplifier has dropped in price from \$50 to \$40 for quantities of 10 to 24, and from \$33 to \$19 for quantities of 500 to 999.

CIRCLE NO. 341

Printout speeds of IBM 360 and 370 computer systems can now be increased with the **Compuspeed software package** of Computing Efficiency Inc., Bohemia, N. Y. The package maximizes I/O processing overlap when using the IBM 1403, 1443, and 3211 printers.

CIRCLE NO. 342

The IVC-870 is a new color videotape recorder with both insert and assemble editing features. The 1-in.-format recorder of International Video Corp., sells for \$8000 (color version) and \$7500 (monochrome version).

CIRCLE NO. 343

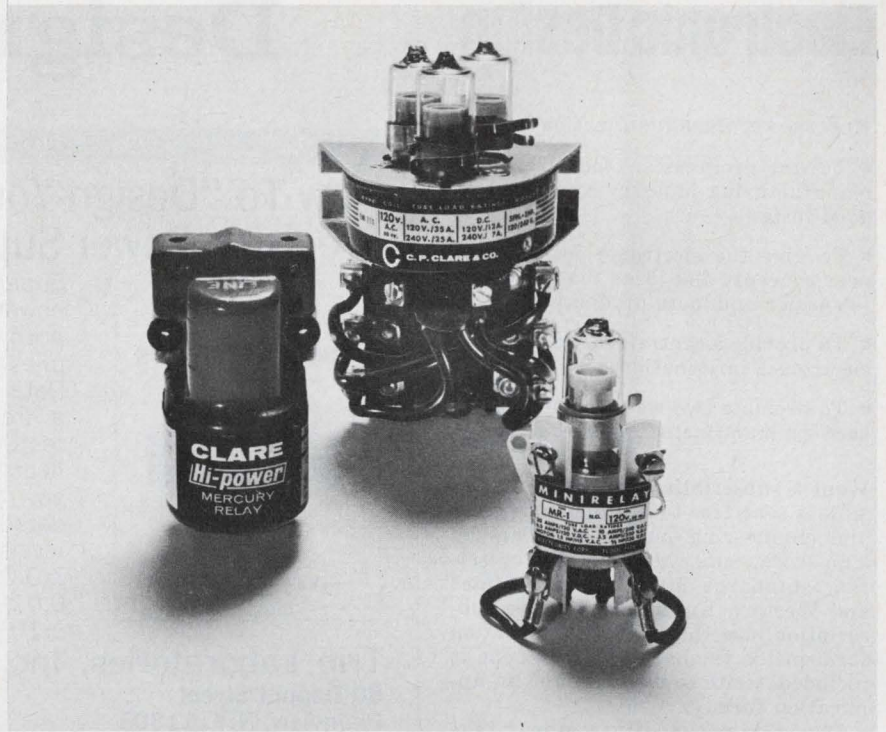

Take the plunge to the big new source for quality mercury plunger relays.

Think there's only one source for *quality* mercury displacement (plunger) relays? Think again.

Now Clare, the leader in mercury-wetted contact relays, can give you plunger relays that will handle 20-100 amps, up to 550 vac. What's more, only Clare gives you the extra long life, high reliability, and silent, service-free operation of Clare's exclusive Teflon* TF Roto-Plunger. Choose from a wide variety of models, including multi-pole units for switching both sides of ac line and three-pole units for three-phase operation. Your choice: economical glass-tube or high-power metal-tube devices. Also available: solid-state hybrid devices for time-delay, high-sensitivity, and temperature-control applications. No maintenance, no environmental problems, long life, immediate delivery, competitive pricing.

That's right: immediate delivery and competitive prices.

Don't get caught with that old single source. Take the plunge. Get all the facts. Mail the Reader Service card today!

*DuPont trademark



C. P. Clare & Co.,
Chicago 60645 and worldwide,
a General Instrument company

INFORMATION RETRIEVAL NUMBER 76

ELECTRONIC DESIGN's function is:

- To aid progress in the electronics manufacturing industry by promoting good design.
- To give the electronic design engineer concepts and ideas that make his job easier and more productive.
- To provide a central source of timely electronics information.
- To promote two-way communication between manufacturer and engineer.

Want a subscription? ELECTRONIC DESIGN is sent free to qualified engineers and engineering managers doing design work, supervising design or setting standards in the United States and Western Europe. For a free subscription, use the postfree application form inside the back cover. If none is included, write to us direct for an application form.

If you do not qualify, you may take out a paid subscription for \$25 a year in the U.S.A., \$35 a year elsewhere. Single copies are \$1.50 each.

If you change your address, send us an old mailing label and your new address; there is generally a prepaid postcard for this inside the back cover. You will have to requalify to continue receiving ELECTRONIC DESIGN free.

The accuracy policy of ELECTRONIC DESIGN is:

- To make reasonable efforts to ensure the accuracy of editorial matter.
- To publish prompt corrections whenever inaccuracies are brought to our attention. Corrections appear at the end of the Letters column.
- To refuse any advertisement deemed to be misleading or fraudulent.

Microfilm copies are available of complete volumes of ELECTRONIC DESIGN at \$19.00 per volume, beginning with Volume 9, 1961. Work is now in process to complete the microfilm edition of Volumes 1-8. Reprints of individual articles may be obtained for \$2.00 each, prepaid (\$.50 for each additional copy of the same article) no matter how long the article. For further details and to place orders, contact the Customer Services Department, University Microfilms, 300 North Zeeb Road, Ann Arbor, Michigan 48106; telephone (313) 761-4700.

Want to contact us? If you have any comments or wish to submit a manuscript or article outline, address your correspondence to:

Editor
ELECTRONIC DESIGN,
850 Third Avenue,
New York, N.Y. 10022.

How To "Design-Your-Own" Precision Power Supply In Minutes.



Trio Laboratories, Inc.
80 Dupont Street
Plainview, N.Y. 11803

Super/reg® miniature, pre-packaged, precision power regulators (series and shunt types) make possible design/fabrication of **custom** power supplies with virtually no engineering time or effort. Data Sheets S201A, S202A, S204 show how just a front end of raw DC or a transformer with rectifying diodes and filter capacitor — and a heat sink mounting area — are all that are needed. Single or multiple outputs easily accommodated. 104 models provide wide range of voltage levels, maximum layout flexibility, low output Z(0.01% regulation), temperature compensation 0.01%/°C, 125°C operation, output adjustability ±10%, short circuit protection.

CIRCLE NO. 171

IC Controlled, Field-Serviceable Power Modules Featured in Comprehensive New Catalog/Designer's Handbook



Technipower, Inc.
a subsidiary of Benrus Corporation
Benrus Center, Ridgefield, Conn. 06877

Technipower's Catalog No. 701 gives complete data, electrical and mechanical, on more than 3000 power modules and accessories, including: **New PK Series**, 0-32 VDC, to 80 watts, designed to meet MIL specs (vibration, shock, moisture, RFI), have IC control circuitry, are field serviceable, multi-surface mounting, ideal computer supply; **New OP Series** low cost over-voltage protective devices for above; **New Logic Card Supply** provides regulated 5VDC/1ADC, with overvoltage protection, at very low cost; **Plus** many fully-described options, expanded thermal applications data, and glossary.

CIRCLE NO. 172

FUNDAMENTALS OF INTEGRATED CIRCUITS

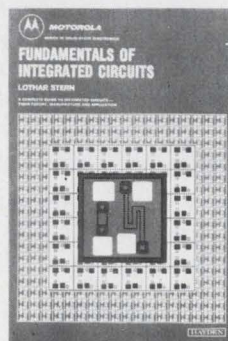

Hayden Book Company, Inc.
116 West 14th Street
New York, N.Y. 10011

A practical guide to integrated circuits, their theory, manufacture, and applications. This new guide by Lothar Stern offers complete, highly readable coverage of the various techniques of circuit fabrication, and their effect on circuit design and performance. As to marketing considerations, it compares the characteristics of the numerous IC structures devised to date in terms of economics and logistics. A volume in the **Motorola Series in Solid-State Electronics**. 198 pages, 7 x 10, illustrated. \$8.95, clothbound. Circle the reader-service number below for 15-day examination copies.

CIRCLE NO. 173

Manufacturers

Advertisements of booklets, brochures, catalogs and data sheets. To order use Reader-ServiceCard.
(Advertisement)

New Monograph on Real-Time Data Processing Techniques

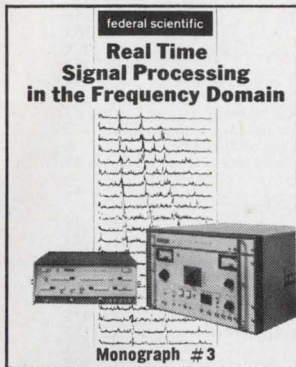

A new publication by Federal Scientific, originators of the Ubiquitous® Spectrum Analyzer, covers general and specific signal processing techniques and theoretical constraints.

- Random data processing and statistical certainty of Power Spectral Density Estimates
- Constraints in frequency analysis due to bandwidth, sampling and signal length
- Time domain weighting, with charts of theoretical performance using different weighting functions
- Theory of operation of time-compression analyzers
- Cross-property analysis and application in determining transmission and transfer functions by correlation and cross-power spectral density
- Processing of Transient data

CIRCLE NO. 174

Federal Scientific Corporation
a subsidiary of Elgin National Industries, Inc.
615 West 131st Street, New York, N. Y. 10027

Clamp or Tie Wire Bundles In Seconds!

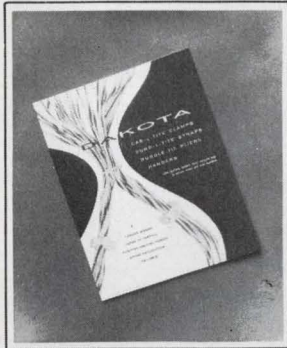

Six-page catalog contains complete ordering information for CAB-L-TITE® clamps and BUND-L-TITE® straps, devices which provide a fast and reliable means of securing wires and wire bundles. Units withstand loadings greater than 50 G's, are removable in seconds for re-routing wires, and are self-locking—no tying, no knots, no hitches to come loose. Lightweight Du Pont Zytel meets MIL-P-17091 and MIL-P-20693. Proved in aircraft and missiles. Photos, dimensional drawings, tables, physical properties, specifications, price list. Request catalog A.

CIRCLE NO. 175

Dakota Engineering, Inc.
4315 Sepulveda Blvd.
Culver City, California 90230

How To Write Technical Articles



A guide for the engineer-author, "How to Write Technical Articles for Electronic Design" shows how easy it is to write for publication—once the engineer knows what to write and how to write it. The Author's Guide includes a complete run-down of the types of articles published by Electronic Design—plus detailed instructions on how to prepare technical articles and short special features. A MUST for every "would-be-writer" in the electronics industry. Send for your complimentary copy by circling the number to the right.

CIRCLE NO. 176

Electronic Design
850 Third Avenue
New York, N.Y. 10022

Electronic Design

Advertising Sales Staff

Keith Aldrich
Sales Manager

New York 10022

Robert W. Gascoigne
Samuel M. Deitch
Daniel J. Rowland
850 Third Avenue
(212) Plaza 1-5530
TWX: 867-7866

Philadelphia 19025

Mort Sullivan
P.O. Box 126
Dresher, Pa.
(215) 884-6880

Boston 01945

Joseph F. Palmer
14 Peter Hobart Drive
Hingham, Mass.
(617) 742-0252

Chicago 60611

Thomas P. Kavooras
Berry Conner, Jr.
200 East Ontario
(312) 337-0588

Cleveland

Thomas P. Kavooras
(Chicago)
(312) 337-0588
(call collect)

Los Angeles 90303

Stanley I. Ehrenclou
W. James Bischof
2930 Imperial Highway
Inglewood, Calif.
(213) 757-0183

San Francisco 94022

Arthur R. Shields, Jr.
95 Main Street
Los Altos, Calif.
(415) 941-3084

London W. 1

For United Kingdom and Holland
Brayton C. Nichols
44 Conduit Street
Tel: REGent 4714

Verviers, Belgium

For Continental Europe
Andre Jamar
1, Rue Mallar, 1
(087) 253.83 Telex 41563

Tokyo

Haruki Hirayama
Electronic Media Service
5th Floor, Lila Bldg.,
4-9-8 Roppongi
Minato-ku
Phone: 402-4556
Cable: Electronicmedia, Tokyo



New! Zenith's colorful two gun CRT

Where precise, high resolution color displays are essential, Zenith Dual Neck, Flat-Face Two Color CRTs offer the best answer. Independent operation of two guns allows different scan formats and rates without the need of complex switching circuits . . . assuring excellent color purity from edge to edge. Details are easily separated by variations of vivid color. For specifications, write for Zenith's new Dual Neck product file.



ZENITH RADIO CORPORATION
THE RAULAND DIVISION
5616 W. JARVIS AVE. • CHICAGO, ILL. 60648 • 312-647-8000
INFORMATION RETRIEVAL NUMBER 77

The thermistors VECO produces
Will suffer a lot of abuses.
They quickly defeat
Any problems of heat
In Mil. & Industrial uses. *



Got a special thermistor application problem? Victory Engineering's complete lines of thermistor disks and rods are manufactured to meet or exceed MIL-T-23648 standards. Instant response coupled with precision measurement makes them ideal for temperature control uses, such as transistor circuitry. VECO produces positive and negative temperature coefficient thermistors in a wide range of body styles and resistance values. Every Victory thermistor is backed by a long-held reputation as the industry leader solely devoted to the research, development and manufacture of temperature and voltage sensitive components.

* ENGINEERS ARE INVITED TO SUBMIT VECO LIMERICKS. BEST WILL RECEIVE A VECO THERMISTOR DESIGN KIT AND/OR HAVE LIMERICK APPEAR IN FUTURE ADVERTISING.



VICTORY ENGINEERING CORPORATION
VICTORY ROAD, SPRINGFIELD, NEW JERSEY 07081 • (201) 379-5900 • TWX 710-983-4430

INFORMATION RETRIEVAL NUMBER 78

Advertisers' Index

Advertiser	Page
ASM Corporation, The	50
Acopian Corporation	104
Alco	96A
Allen-Bradley Co.	14, 15, 83
Amperex Electronic Corporation	97
Amphenol Controls Division, The Bunker-Ramo Corporation	86, 87
Amphenol, The Bunker-Ramo Corporation	127
Arnold Engineering Company, The	6
Automatic Electric Company	44, 45
Barnes Corporation	47
Beckman Instruments, Inc., Helipot Division	79
Bell Laboratories	29
Bourns, Inc.	12
Burroughs Corporation	20
CTS Corporation	85
Cambridge Thermionic Corporation	115
Chicago Miniature Lamp Works	113
Clare & Co., C. P.	123
Cratex	127
Cunningham Corporation	117
Dakota Engineering, Inc.	125
Dale Electronics, Inc.	Cover III
Deltron Controls	111
Deltron, Inc.	108
Deringer Metallurgical Corporation	2
Dickson Electronics Corporation	103
Digital Equipment Corporation	109
Dow Corning Corporation	76, 77
Dumont Oscilloscope Laboratories, Inc.	105
E-H Research Laboratories, Inc.	24
Electronic Arrays, Inc.	17
Electronic Design	125
Electronic Measurements, Inc.	115
Fairchild Semiconductor, A Division Fairchild Camera and Instrument Corporation	8, 9
Federal Scientific Corp.	125
General Electric Company	33, 35, 37
General Radio Company	1
Hansen Manufacturing Co., Inc.	112
Hayden Book Company, Inc.	96B, 124
Hewlett-Packard	Cover II, 7, 51, 61, 101, 121, 128
Indiana General, Electronic Products	16
Infodex, Incorporated	114
Jewell Electrical Instruments Inc.	40
Johnson Company, E. F.	39
Joslyn Electronic Systems	116
KMC Semiconductor Corporation	49
3M Company, Scotchpar	50
Magnecraft Electric Co.	10
Microdot, Inc.	118, 119
MicroSwitch, A Division of Honeywell	48
Molex, Incorporated	23
National Semiconductor Corporation	4, 5
Nemonic Data Systems	31
Non-Linear Systems, Inc.	11
Power/Mate Corporation	13
RCA Electronic Components and Devices	67, 95, 98, Cover IV
Radio Materials Company	122
Schauer Manufacturing Corp.	106
Servo Tek Products Company	102
Sigma Instruments, Inc.	34
Signalite, a Division of General Instruments	36
Signetics Corporation	27
Siliconix Incorporated	46
Soshin Electric Co., Ltd.	127
Sprague Electric Company	18
Syston-Donner Corporation	52
TRW Semiconductor Division of TRW, Inc.	81
Technical Wire Products, Inc.	124
Tektronix, Inc.	43, 68
Teletype Corporation	72, 73
Thermal American Fused Quartz Co., Inc.	110
Trio Laboratories, Inc.	124
Victory Engineering Corporation	126
Vishay Resistor Products, A Division of Intertechnology, Inc.	38
Weston Instruments, Inc.	107
Weston Instruments, Inc., Archbald Division	89, 91, 93
Wiley & Sons, Inc., John	115
Zenith Radio Corporation	126

RUBBERIZED ABRASIVES

DEBURR SM-O-O-TH POLISH



COMPLETE KIT \$750

CONTENTS: 8 tapered edge wheels 3/8" dia. x 3/32"; 16 cylinder points 1/4" dia. x 3/8" long; 16 bullet points 3/32" dia. x 1" long; 8 bullet points 3/8" dia. x 1/4" long; 8 straight wheels 1/2" x 1/8" x 1/16" hole; 16 straight wheels 3/8" x 1/8" x 1/16" hole; 8 straight wheels 1" x 3/16" x 1/16" hole; 2 wheel mandrels 1/8" shank; 2 point mandrels 1/8" shank. For use at speeds up to 25,000 RPM.

\$7.50 BUYS IT ALL — 80 piece introductory Kit 777 equally assorted in 4 grit textures: coarse, medium, fine and extra fine. **TRY IT** — Cratex Rubberized Abrasives improve the surface while preserving critical workpiece dimensions by its unique cushioning action. **FINISH THE JOB** — to your most exacting specifications—often in a single operation. **SEND FOR KIT 777** — or your **FREE SAMPLE** and catalog illustrating the full Cratex product line and its applications.

CRATEX[®] RUBBERIZED ABRASIVES

1600 Rollins Road • Burlingame, Calif. 94010
Sold through leading industrial distributors

INFORMATION RETRIEVAL NUMBER 79

**Soshin's One Finger Speciality
Mica Capacitors**

The only mica capacitors to pass
evaluation testing by Japanese Government
equivalent to **MIL-C-5D**

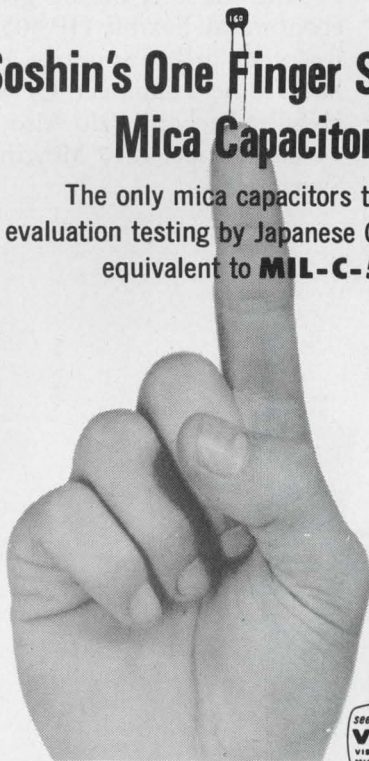

1970 EDITION

SOSHIN SOSHINELECTRIC CO., LTD.

18-18, Nakamagome 1-chome, Ohta-ku, Tokyo, Japan
Cables: SOSHINCAP TOKYO Telex: 246-6377

Hi-Ho ASTROplate[®]

"No need
silver
now—
ASTROplate
better...
Cost
same!"



ASTROplate[®] COSTS YOU NO MORE. Despite its many obvious advantages in commercial applications, ASTROplate costs no more than its silver counterpart. Even the part numbers are identical to the traditional silver finishes with one exception. We simply add the suffix 1050 to the part number to indicate an ASTROplate finish.

MIX THEM OR MATCH THEM—anywhere in your system (old or new) with silver finishes *without galvanic reaction*. Solderability performance meets MIL Spec. QQ-S-365.

Ask your Amphenol Distributor for ASTROplate[®]—the **PERMANENT FINISH** in RF connectors.



INFORMATION RETRIEVAL NUMBER 81

INFORMATION RETRIEVAL NUMBER 80

What makes this the best low-priced digital printer you can buy?

Printing wheels, not drums. Each wheel is interchangeable so you can alter any individual column and include special characters at minimal cost. Tailor your printer to your individual needs.

Prints with or without ink. Rotating ink roller means reliable ink printing. No intricate ribbon advance mechanism. If you'd rather use pressure-sensitive paper and no ink, just take out the roller.

10 lines/second printing. Prints ten columns three times faster than any other low-priced printer. Free your system from long print cycles.

Field-proven heavy-duty mechanism. It's the one used for years in our 20 lines/second printer so at 10 lines it's just coasting. Moving parts are held to a minimum. In a word, what you get is reliability.

Price: \$1150 complete. Beat that value!

For the full story on this great new economical, flexible HP 5055A Digital Recorder, call your nearby Hewlett-Packard field engineer. Or write to Hewlett-Packard, Palo Alto, California 94304; Europe: 1217 Meyrin-Geneva, Switzerland.

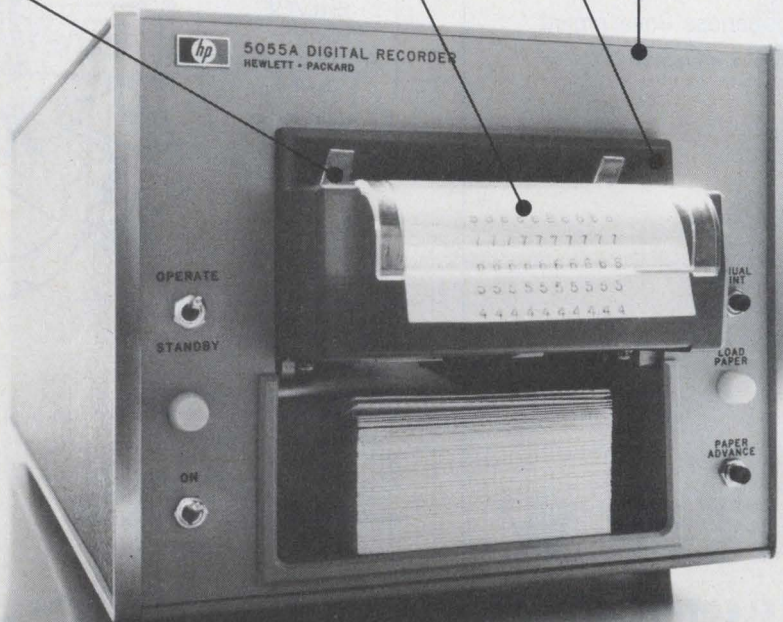

HEWLETT  PACKARD

AST



DALE NEXT RIGHT

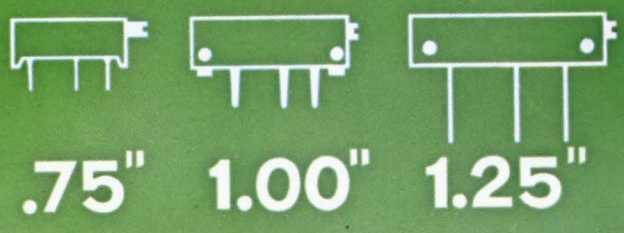

Take the Dale Interchange for a better deal in low-cost trimmers

Dale commercial and industrial trimmers interchange with scores of competitive models—including the ones you aren't totally satisfied with right now. Dale pricing is intensely competitive... and delivery is hard to beat. Quality is so high that we average less than 1% customer rejection for *all* causes. In three basic rectilinear sizes: 1.25", 1.00" and .75" Dale trimmers offer the versatility of wirewound or film elements—standard to handle normal production environments—sealed to approximate MIL-R-27208A standards. Consider all your circuit adjustment trade-offs—then call Dale for a better deal. Phone 402-564-3131.

Choice of element in 3 body styles

FILM ELEMENT

8400 SERIES Sealed/Unsealed; 10Ω to 2 Meg., ±10% 100Ω thru 500K, ±20% all other values; .75 watt at 25°C, derated to 0 at 125°C; T.C. 150 ppm/°C, 100 ppm available; .31 H x .16 W x .75 L.

8300 SERIES Sealed/Unsealed; 10Ω to 2 Meg., ±10% 100Ω thru 500K, ±20% all other values; .75 watt at 25°C, derated to 0 at 105°C; T.C. 150 ppm/°C, 100 ppm available; .36 H x .28 W x 1.00 L.

8100 SERIES Industrial counterpart RJ-11; 10Ω to 2 Meg., ±10% 100Ω to 500K, ±20% other values; .75 watt at 70°C, derated to 0 at 125°C; T.C. 150 ppm/°C, 100 ppm available; .28 H x .31 W x 1.25 L.

WIREWOUND ELEMENT

2400 SERIES Sealed/Unsealed; 10Ω to 50K, ±10%; 1 watt at 40°C, derated to 0 at 125°C; .31 H x .16 W x .75 L.

2300 SERIES Sealed/Unsealed; 10Ω to 50K, ±10%; 0.5 watt at 25°C, derated to 0 at 105°C; .36 H x .28 W x 1.00 L.

2100 SERIES Industrial counterpart RT-11; 10Ω to 100K, ±10%; 1 watt at 70°C, derated to 0 at 125°C; .28 H x .31 W x 1.25 L.

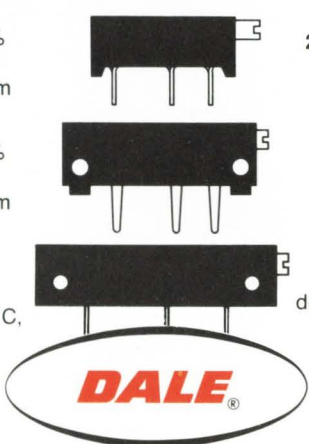

Write for Catalog B

INFORMATION RETRIEVAL NUMBER 246

DALE ELECTRONICS, INC.

1300 28th Ave., Columbus, Nebr. 68601
In Canada: Dale Electronics Canada Ltd.
A Subsidiary of The Lionel Corporation



RCA is the first tube manufacturer to offer power tubes for SSB applications whose distortion characteristics have been tested by "white noise".

This means that RCA power tubes intended for multiplex service can be checked out under field use conditions before they are shipped. Thus, RCA tubes can meet conditions for distortion as it relates to noise loading procedures set forth by Mil Std 188C and Mil Std 1311.

Under these test conditions, you can forget questions of definition between peak envelope power and peak side-band power, of peaking characteristics taking on average characteristics in multiplex services, of intermodulation performance ratings and how they relate to power output. RCA power tubes for SSB when tested for "white noise" at

average power output will supply the information to fulfill your application requirements.

Whether speech, teletype, data transmission or any combination is your SSB application, see your local RCA Representative or your RCA Industrial Tube Distributor about RCA power tubes. For technical data on specific types, write: RCA, Commercial Engineering, Section 57I-1/ZR4, Harrison, N. J. 07029.

International: RCA, 2-4 rue du Lièvre, 1227 Geneva, Switzerland, or P.O. Box 112, Hong Kong.

RCA

Now, RCA tubes for SSB can be "White Noise" tested

RCA-8792, typical of the RCA Line of SSB Tubes for RF Power.

