

# Electronic Design 8

VOL. 20 NO.

FOR ENGINEERS AND ENGINEERING MANAGERS

APRIL 13, 1972

You'll find complementary MOS in watches and clocks as well as portable instruments. And the list of uses is growing. TTL is cheaper and faster, and PMOS has the edge in costs. CMOS, however, features good switching speeds, high noise immunity and  $\mu\text{W}$  power dissipation. For the latest in CMOS, see page 54.

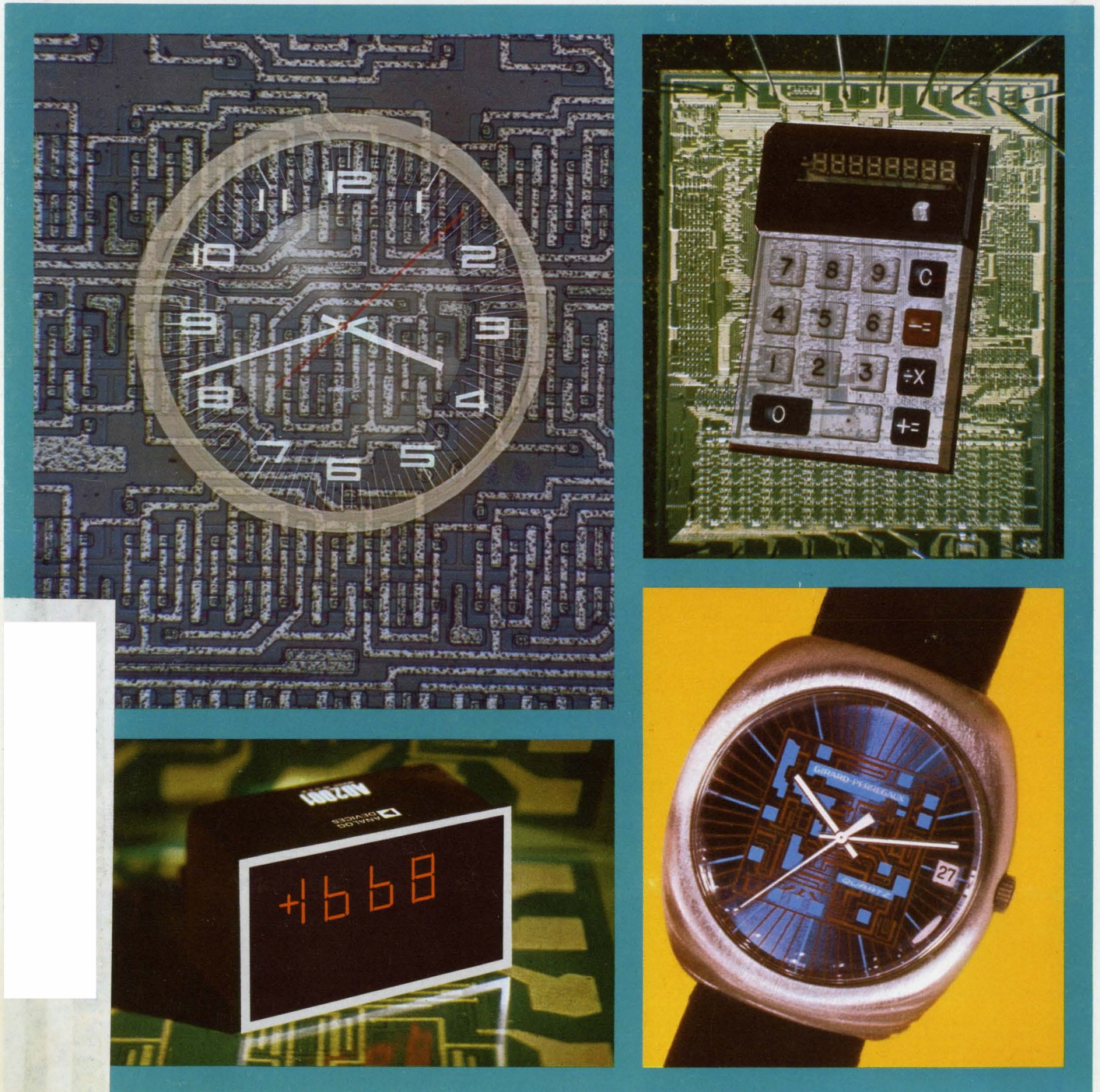

Do you face a make or buy decision on power supplies?

# USE LAMBDA POWER HYBRID VOLTAGE REGULATORS—AND BUILD YOUR OWN.

(\$16 in quantities of 1000)

ACTUAL SIZE

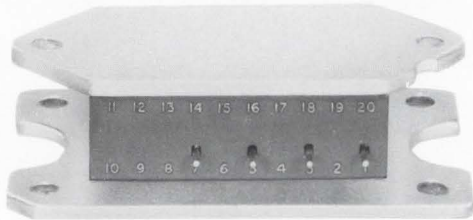

**FROM MELVILLE, N.Y.  
1-DAY DELIVERY**

ACTUAL SIZE

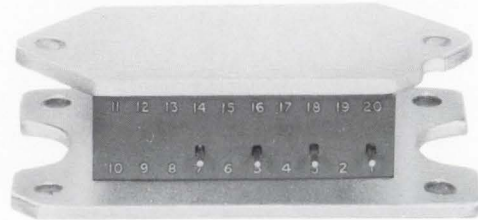

**FROM CHICAGO, ILL.  
1-DAY DELIVERY**

ACTUAL SIZE

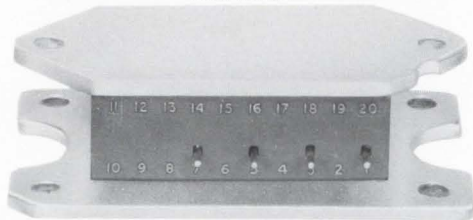

**FROM N. HOLLYWOOD, CAL.  
1-DAY DELIVERY**

ACTUAL SIZE

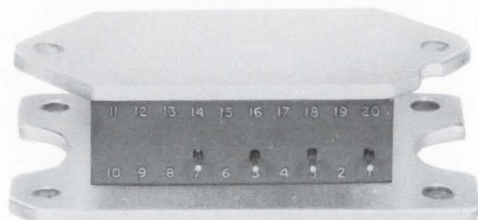

**FROM MONTREAL, QUE.  
1-DAY DELIVERY**

The world's first Power Hybrid Voltage Regulator, the biggest advance in power supply design since the silicon power transistor, is now available for 1-day shipment from four Lambda distributing points.

**22 models provide up to 28 VDC, up to 5 A output, 85 watts dissipation, 0.2% line or load regulation . . . @ \$16 in quantities of 1000.**

If you build your own power supplies, the Power Hybrid Voltage Regulator will save you money at every step from design through production. And now Lambda will save you time as well. Call or write for Brochure L-10.

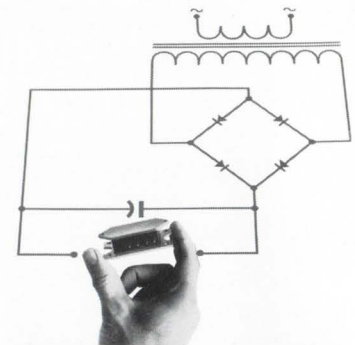

**WHETHER  
YOU MAKE  
OR BUY...**

**LAMBDA  
ELECTRONICS CORP.**

A  Company

MELVILLE, NEW YORK 11746, 515 Broad Hollow Road, Tel. 516-694-4200  
 ARLINGTON HEIGHTS, (CHICAGO) ILL. 60005, 2420 East Oakton St., Unit Q, Tel. 312-593-2550  
 NORTH HOLLYWOOD, CALIF. 91605, 7316 Varna Avenue Tel. 213-875-2744  
 MONTREAL, QUEBEC, 100C Hymus Blvd., Pointe-Claire, Quebec-730, Tel. 514-697-6520

# Discover the value of power...

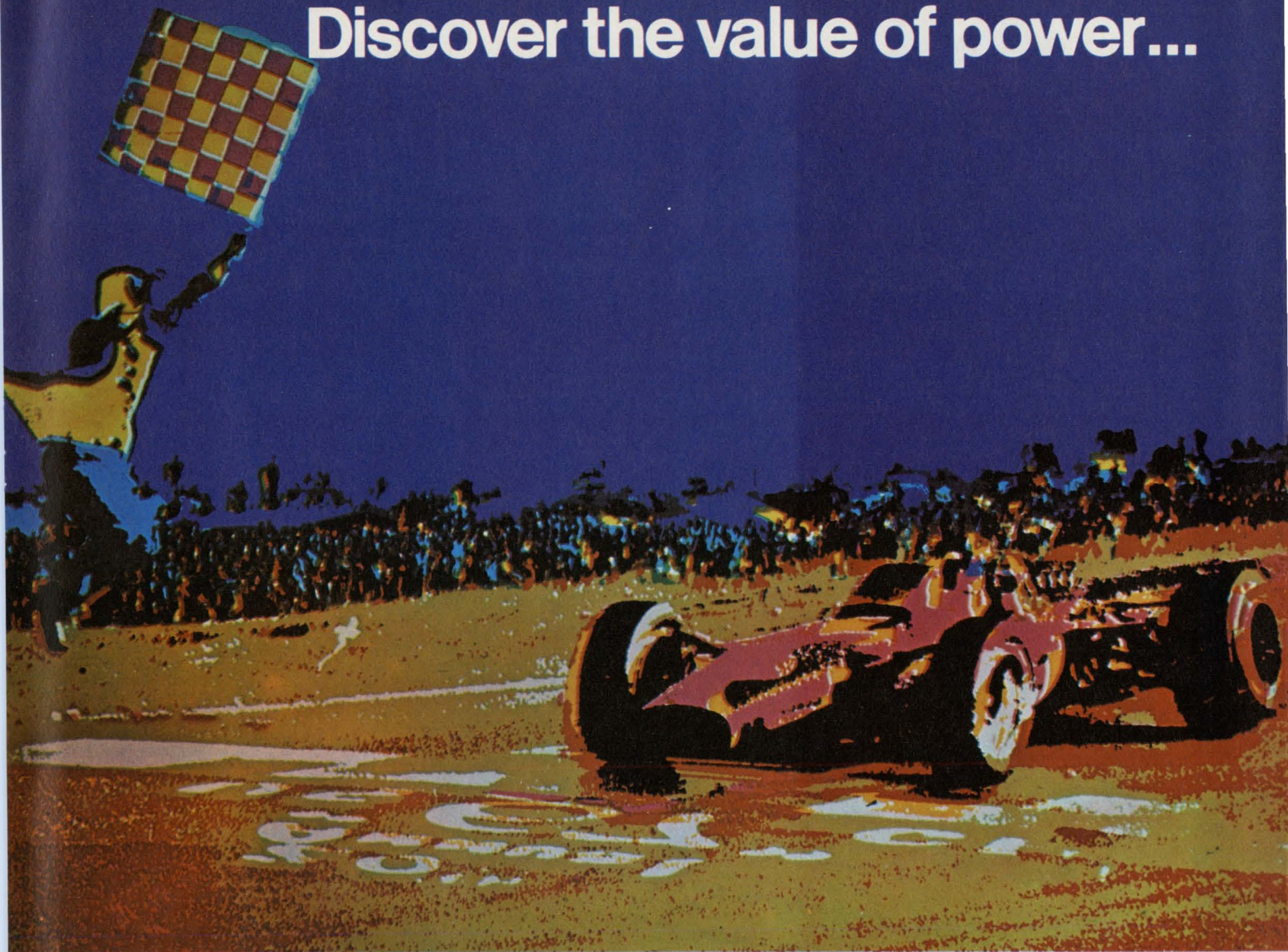

## and how it saves you money on your mini.

Discover the all-new SPC-16 family of minicomputers. The first minis to save you substantial money in system implementation. They're from General Automation... the fast-growing, pace-setting mini maker.

If you compare SPC-16's with those other two much-ballyhooed brands of minis, you'll discover it's no contest. In overall performance, SPC-16's win every time. And no wonder. The SPC-16's ultra-fast interrupt response system for multilevel interrupt response is one winning feature. Another is base relative addressing. Another is a unique one-word Load All Registers/Store All Registers capability. Plus eight (16 optional) true general purpose registers that can save you up to 4K (about \$2500 worth) of core. And much more.

Including the right price, the best quantity discounts in the industry and the easiest OEM buying policy of all.

SPC-16's are available as I/O and memory-integrated models for dedicated in-house applications. Or as unbundled versions for OEM users or large system applications requiring up to 65K of memory. Six models in all, in three speeds.

No other minis come close to SPC-16's in giving you so much performance for your money. Give us a benchmark, we'll prove it. Meantime, send today for a detailed brochure.

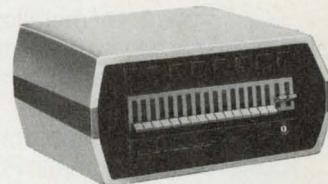

**GENERAL AUTOMATION, INC.** 1055 So. East Street, Anaheim, Ca. 92805 (714) 778-4800 TWX 910-591-1695  
'Discover The Value Of Power'

INFORMATION RETRIEVAL NUMBER 2

# Siemens

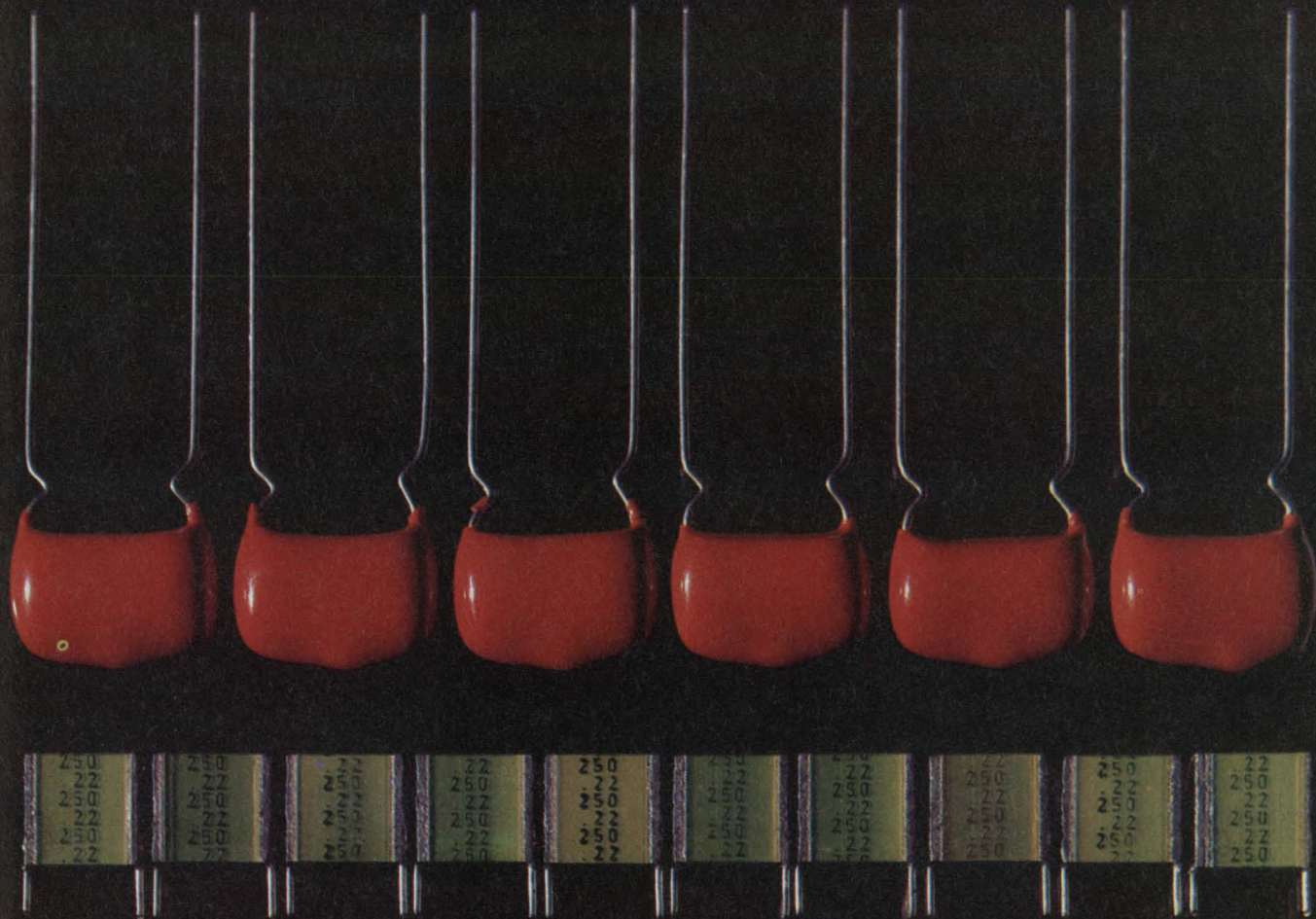

## The square vs. the bulbous. The story of the shrinking film capacitor.

As you can see, ten Siemens .22 $\mu$ F  $\pm$ 5%/250V metallized stacked foil polycarbonate capacitors fit in the same space as six competitive .22 $\mu$ F  $\pm$ 10%/200V units.

The Siemens capacitors are designed for automatic PC board insertion. Their  $\pm$ 5% tolerance is standard. And they cost less.

All of this is possible because of Siemens unique stacked foil construction.

We can show you equally impressive advantages in our other capacitor lines.

Join the growing number of engineers who specify Siemens capacitors. Call us for film and

metallized film with dielectrics of paper, lacquer, polyester, polycarbonate, polypropylene, and polystyrene; tantalum and aluminum electrolytics. Contact Ken Liddane, Siemens Corporation, 186 Wood Avenue, So., Iselin, N.J. 08830. Call 201-494-1000.



**SIEMENS**

# Electronic Design

FOR ENGINEERS AND ENGINEERING MANAGERS

VOL. 20 NO.

# 8

APRIL 13, 1972

---

## NEWS

- 23 **News Scope**
- 26 **Thermal printers**, a new generation of electronic printers, are beginning to challenge traditional mechanical methods.
- 28 **In the race to develop a cleaner car engine**, Volkswagen thinks big with a new exhaust-test center on wheels.
- 30 **Single-crystal, zinc-oxide optical waveguide** developed as key to integrated-circuit light devices.
- 31 **Infrared scanning instrument checks tires.**
- 34 **Technology Abroad**
- 37 **Washington Report**

---

## TECHNOLOGY

- 54 **Focus on CMOS:** A special report on an IC technology that is being considered for applications once dominated by TTL or PMOS.
- 64 **Penetrate the mystique of MOS specs** by examining those for popular shift registers. There's a resemblance to bipolar specs, but definitions can differ.
- 72 **Measure phase instead of amplitude.** It provides greater sensitivity and resolution, and makes frequency-response analysis a lot easier.
- 76 **Define before you design**, advises this instrument manager, and you'll be able to use production methods that will save you time, money and headaches.
- 84 **Semiannual Index of Articles:** July through December, 1971
- 88 **Ideas for Design**

---

## PRODUCTS

- 97 **ICs and Semiconductors:** Dual-tracking voltage regulator extends operating range to 90 V.
- 104 **Data Processing:** Kit patches peripherals to popular PDP-8 mini.
- 106 **Data Processing:** Fast printer/plotter makes neat mate to mini.
- 110 Modules & Subassemblies
- 111 Packaging & Materials
- 112 Components
- 114 Instrumentation

---

## Departments

- 53 **Editorial:** Advance to the rear?
- 7 Across the Desk
- 116 Evaluation Samples
- 116 Application Notes
- 118 New Literature
- 123 Bulletin Board
- 126 Advertisers' Index
- 126 Information Retrieval Card

**Cover:** (top left) clock from Westclox, Div. of General time Corp., a Talley Industries Co., with RCA COS/MOS chip; (bottom left) digital panel meter from Analog Devices; (top right) calculator from Ragen Semiconductor; (bottom right) watch from Girard Perregaux with Motorola Semiconductor McMOS chip.

---

ELECTRONIC DESIGN is published biweekly by Hayden Publishing Company, Inc., 50 Essex St., Rochelle Park, N.J. 07662. James S. Mulholland, Jr., President. Printed at Brown Printing Co., Inc., Waseca, Minn. Controlled circulation postage paid at Waseca, Minn., and New York, N. Y., postage pending Rochelle Park, N. J. Copyright © 1972, Hayden Publishing Company, Inc. 82501 copies this issue.

**P&B solid state  
hybrid relays work  
up to 100 times longer  
than conventional relays.  
More than  $10^7$  operations.**

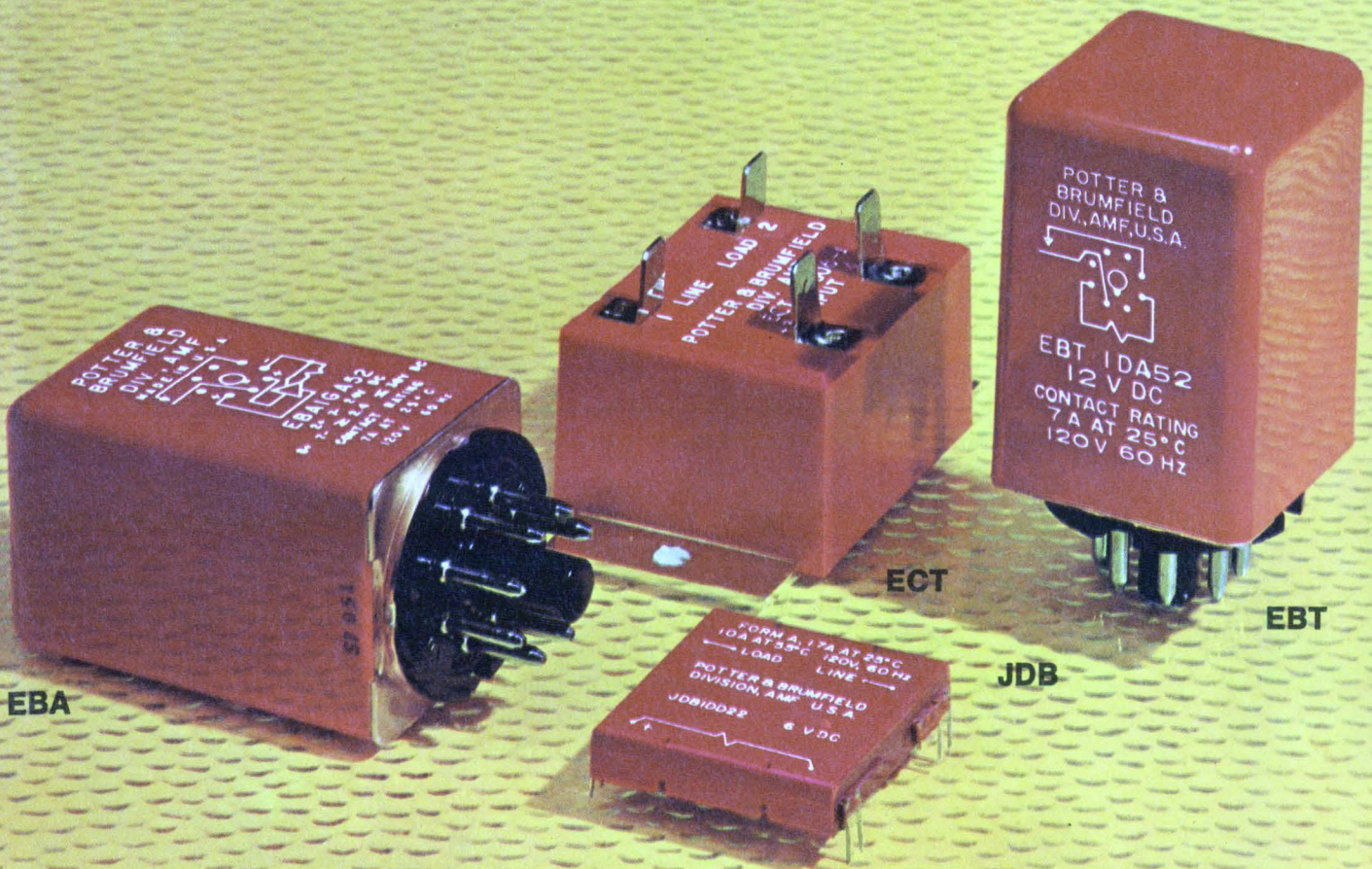

The expected minimum life of P&B Solid State Hybrid Relays is in excess of 10 million operations for standard load current and ambient temperature combinations.

This uncommon longevity, plus exceptional reliability and a wide range of switching options, offers solutions to many critical switching problems. For example, you can interface semiconductor logic circuits with inductive loads like motors, solenoids and contactors.

P&B Solid State Hybrids will switch up to 7 ampere loads with input control signals as low as 60 microwatts. And they come in a variety of package sizes and terminal styles.

**Special triac, special reed**

P&B Hybrids owe much of their reliability and outstanding performance to the combining of a reed relay and triac, each having characteristics specially selected to complement the other. This careful mating of semiconductor and relay greatly enhances the reliability of each and, in combination, produces a switching function of consistently superior performance.

**Special snubber network**

The internal RC network across the "contact" is tailored to the

triac specifications and "contact" load ratings to limit sporadic, transient-induced conduction, to provide reliable turn-off of inductive loads, yet to minimize the off-state 60 Hz leakage current.

**EBT Series** switches 7 amps, 60 Hz @ 25° C ambient with normal load voltage of 120 V. Rated 5 amps. rms 60 Hz @ 55° C ambient. Operate time, 2

msec. Release time, 10 msec. Coil voltages from 6 to 48 VDC at nominal power of 290 mW. Has conventional octal-type plug-in terminals for mounting convenience. Fits P&B KR Series 8-pin sockets for conversion to screw terminals.

**EBA Series** has the same switching characteristics, package and mounting of EBT, but with control signal amplifier. Standard sensitivity is 60 microwatts. Requires 12, 18, or 24 VDC supply.

**ECT Series** has similar specifications as EBT but with a special

package designed for direct to chassis mounting. Widely used in business machines and appliances. The ECT has quick-connect terminals. Screw-terminal adapters available.

**JDB Series** is a Dual Thin-Line reed-triggered triac for use on printed circuit boards. Designed for interfacing solid state circuits to 120 V 60 Hz loads such as contactors, fractional HP motors and solenoids. Form A contacts will switch 1.7 amps. at 25° C ambient or 1.0 A rms 60 Hz at 55° C ambient.

Potter & Brumfield Solid State Hybrid relays are available from leading electronic parts distributors. For complete information call or write your nearest P&B representative or Potter & Brumfield Division of AMF Incorporated, Princeton, Indiana 47670. Telephone 812 385-5251. In Europe, AMF International Limited, Oxford, Oxon, England and AMF Elettica, S.p.A., Milan, Italy.

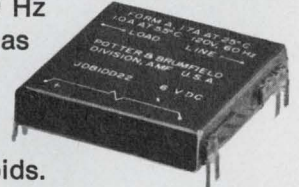
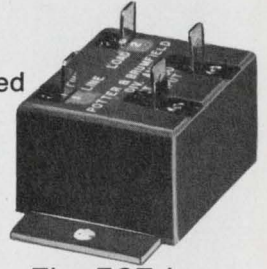

**Potter & Brumfield**

**P&B makes more of more kinds of relays than anybody in the business.**

**Anybody.**

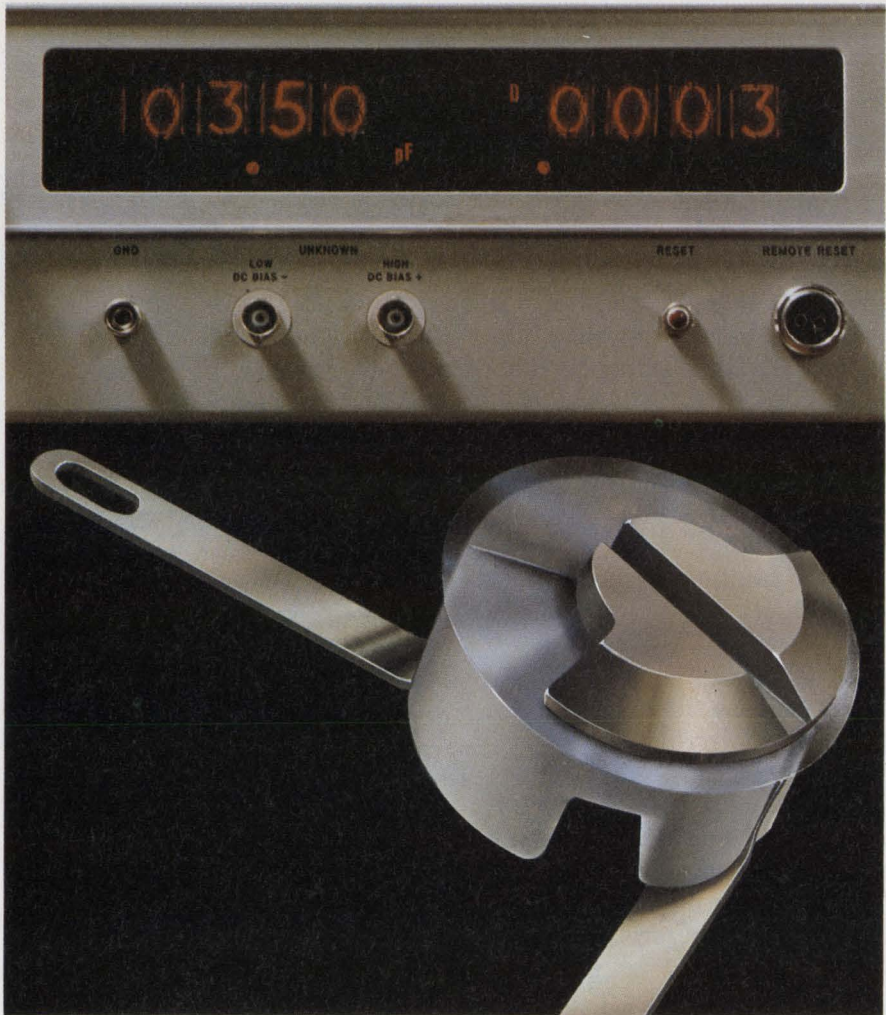

Teflon\* gives you capacity to save a lot of money!

1.1 to 3.5 is a fairly narrow capacity range. But many applications fall within it.

And within that range, our new Teflon dielectric trimmer capacitors are every bit as reliable as capacitors costing a lot more money. So it makes sense to design with them in mind.

We make them for both stripline and PC mounting. And we make them miniature—just 0.250" diameter. With Q typically 2500 at 1MHz and temperature characteristics like these:

Max. % Capacitance Change from value at 25 °C.

-55°C		+85°C		+125°C		 Actual Size
Max.	Min.	Max.	Min.	Max.	Min.	
+3.0	-0.5	+1.0	-3.0	0	-5.0	

Worth looking into? All it costs is a stamp.

\*Registered trademark of DuPont.

E. F. JOHNSON COMPANY / 3304 Tenth Ave. S.W. / Waseca, Minn. 56093

Please send technical information and test samples of your new low-cost Teflon dielectric trimmer capacitors.

NAME \_\_\_\_\_

FIRM \_\_\_\_\_

TITLE \_\_\_\_\_

ADDRESS \_\_\_\_\_

CITY \_\_\_\_\_

STATE \_\_\_\_\_

ZIP \_\_\_\_\_



**E. F. JOHNSON COMPANY**

INFORMATION RETRIEVAL NUMBER 5

## Publisher

Peter Coley

## Editors

Editorial Offices  
50 Essex St.  
Rochelle Park, N.J. 07662  
(201) 843-0550  
TWX: 710-990 5071  
Cable: Hydenpubs Rochellepark

Editor: George Rostky

## Managing Editors:

Ralph Dobriner  
Michael Elphick

## Associate Editors:

Jules H. Gilder  
Richard Lee Goldberg  
Morris Grossman  
John F. Mason  
Stanley Runyon  
Edward A. Torrero  
Richard L. Turmail

## Contributing Editor:

Peter N. Budzilovich

## Editorial Field Offices

### East

Jim McDermott, Eastern Editor  
P.O. Box 272  
Easthampton, Mass. 01027  
(413) 527-3632

### West

David N. Kaye, Senior Western Editor  
2930 West Imperial Highway  
Inglewood, Calif 90303  
(213) 757-0183  
Les Brock, Western Editor  
95 Main St.  
Los Altos, Calif. 94022  
(415) 941-3084

### Washington

Don Byrne, Washington Editor  
1111 S. Army Navy Drive  
Arlington, Va. 22202  
(202) 296-8982

## Editorial Production

Dollie S. Viebig

## Art

Art Director, William Kelly  
Richard Luce  
Anthony J. Fischetto

## Production

Manager, Thomas V. Sedita  
Helen De Polo  
Maxine Correal  
Anne Molfetas

## Circulation

Manager, Nancy L. Merritt  
Joan Licari

## Information Retrieval

Peggy Long



## across the desk

### Competition questions truth of op-amp ad

It would seem that to establish oneself as an industry leader, all one has to do is advertise. The item that has brought pen to hand is a recent advertisement by Burr-Brown Research Corp. claiming: "These new IC op amps have the lowest drift yet!" Further, the ad "backed" the claim with a  $1\text{-}\mu\text{V}/^\circ\text{C}$  max specification. While this is certainly good performance, it is neither novel nor "the lowest drift yet."

Since June, 1971, Precision Monolithics, Inc., has offered monolithic operational amplifiers that have performance significantly superior to this, including models guaranteeing  $0.6\text{-}\mu\text{V}/^\circ\text{C}$  drift (for both 0 to 70 C and  $-55$  to  $+125$  C). One low-drift version (SSS-725EJ) has been advertised since September, 1971, and at much lower prices than the Burr-Brown units.

My point is that any company claiming industry leadership should check its facts before letting its ad agency get out of hand.

*Jerry Zis*

*Product Marketing Manager*  
Precision Monolithics, Inc.  
1500 Space Park Drive  
Santa Clara, Calif. 95050

### The advertiser replies

Normally I prefer not to reply to competitors' claims, because I believe it to be nonprofessional. In this case I am answering because I generally agree with Mr. Zis that we should strive for "truth in advertising" and more credibility in advertising claims.

There is an area of disagreement with Mr. Zis' contentions, however.

At the time the Burr-Brown ad was designed, a reasonable amount of time was spent in determining the validity of the claim that the BB3500E and BB3500MP were the "lowest drift" op amps. At that time the investigation revealed a PMI op-amp ad that claimed lower drift—but only if the user offset nulled the unit. If the PMI was not offset-nulled, then it had worse drift. The PMI unit also required four components for external compensation. This contrasts with Burr-Brown's 3500E and 3500MP, which do not require offset nulling to obtain  $1\text{ }\mu\text{V}/^\circ\text{C}$  and which also do not require external compensation.

*James J. Burns*

*Director of Marketing*

Burr-Brown Research Corp.  
International Airport  
Industrial Park  
Tucson, Ariz. 85706

### Italian reader offers op-amp circuit tip

When using IC op amps, many engineers overlook an important point concerning the effects of offset and drift current on the output of an integrator. If the amplifier's offset is compensated by an external biasing network, as is often done, drift in bias current can still cause an error in the output.

For the circuit shown in Fig. 1, we can write:

$$E_o(s) = \frac{Z_2 \cdot I_2}{s} \left( 1 + \frac{1}{sR_1 \cdot C} \right) - \frac{I_1 \cdot R_1}{s} \cdot \frac{1}{sR_1 \cdot C}$$

$$E_o(s) = \frac{I_2 \cdot Z_2}{s} + \frac{Z_2 \cdot I_2}{s^2 R_1 \cdot C} - \frac{I_1}{s^2 C}$$

*(continued on p. 10)*

Electronic Design welcomes the opinions of its readers on the issues raised in the magazine's editorial columns. Address letters to Managing Editor, Electronic Design, 50 Essex St. Rochelle Park, N. J. 07662. Try to keep letters under 200 words. Letters must be signed. Names will be withheld on request.

## giga-trim capacitors for microcircuit designers



Actual size



**Giga-Trim®** (gigahertz-trimmers) are tiny variable capacitors which provide a beautifully straight forward technique to fine tune RF hybrid circuits and MIC's into proper behavior. They replace time consuming cut-and-try adjustment techniques and trimming by interchange of fixed capacitors.

**Applications** include impedance matching of GHz transistor circuits, series or shunt "gap-trimming" of microstrips, external tweaking of cavities, and fine tuning of crystal oscillators.

*Johanson*

MANUFACTURING CORPORATION

ROCKAWAY VALLEY ROAD  
BOONTON, NEW JERSEY 07005

(201) 334-2676

**For years,  
people thought  
Teletype<sup>®</sup>  
machines only  
talked to  
themselves.**

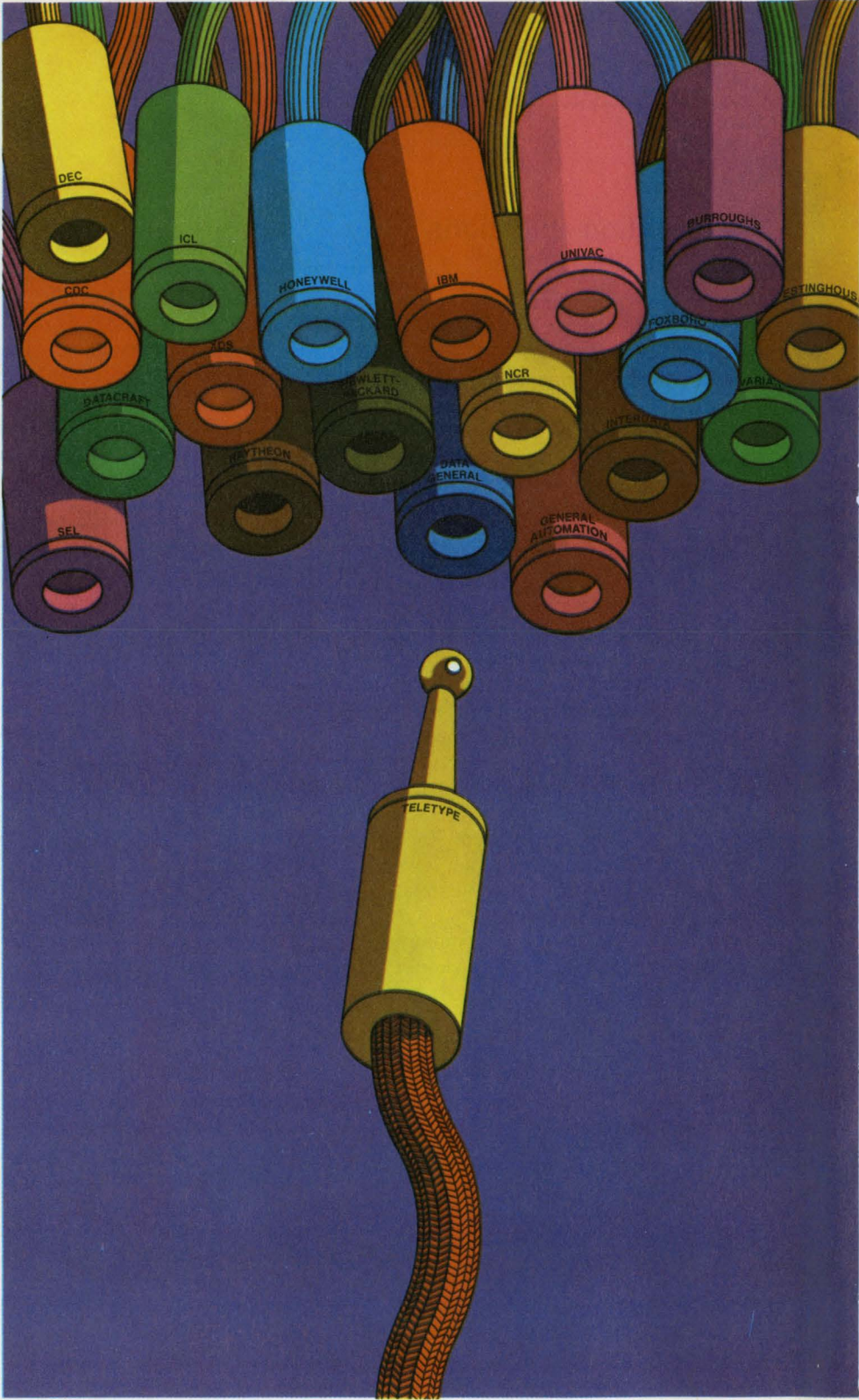

Ever since the information explosion and solid-state technology, our machines have been running in a very fast crowd.

With computers.

In fact, Teletype equipment is compatible with practically every computer-based communications system. For proof, you don't have to look any further than our product line.

We built the model 33 to offer economy and reliability. For an economical wide-platen terminal, look at our new model 38. If you need heavy-duty operation, we make the model 35. And for the utmost in flexibility and vocabulary, check out our model 37.

Teletype's keyboard terminals operate at standard speeds. But if your speed requirements are greater, all our terminals are compatible with the 2400 wpm Teletype 4210 mag tape unit. We

also manufacture a series of paper tape senders and receivers with speeds up to 2400 wpm.

When you look into our product line-up, you'll find we're very big on flexibility. In assembled ASR, KSR and RO terminals. Or in individual components—printers, keyboards, readers and punches.

Take interface options. We offer three. Built-in modems, current interfaces and EIA Standard R-232-C interfaces.

We offer platen widths that range all the way up to 15 inches.

And optional character sets. Like Greek letters, algebraic and chemical symbols, as well as other graphics for charts and molecular structures.

We also cover error detection and station control with a complete group of solid-state accessories.

We're big on economy, too. Because on a price/performance basis, you won't find a better buy than Teletype equipment.

And we didn't forget service. Our applications engineers will work with you to make sure what you get is exactly what you need. And after the sale, we'll set up a maintenance program for you. Or, if you prefer, we'll train your people in the proper maintenance procedures.

It takes more than manufacturing facilities to build the machines Teletype Corporation offers. It also takes commitment. From people who think service is as important as sales. In terminals for computers and point-to-point communications.

That's why we invented a new name for who we are and what we make. The computercommunications people.



For more information about any Teletype product, write or call TERMINAL CENTRAL: Teletype Corporation, Dept. 89F, 5555 Touhy Avenue, Skokie, Illinois 60076. Phone 312/982-2500

Teletype is a trademark registered in the United States Patent Office.

# New Miniature PC Board BABCOCK REED RELAYS...

## More Reed Combinations, Low Cost, Dry or Mercury-Wetted Reed.

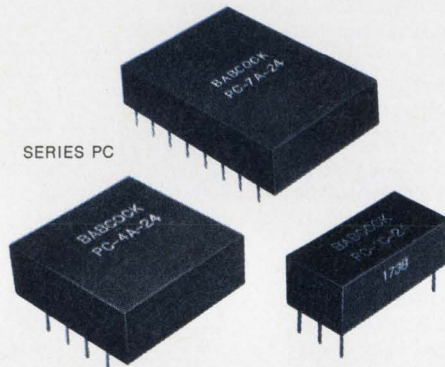

Order this miniature, fully-encapsulated, low cost reed relay series with from 1 to 12 reeds — or in combinations — and a large assortment of options for your PC board applications. Both dry reed and mercury-wetted versions are available, with low power requirements and life expectancies to 100,000,000 operations. Dry reed units are rated at 4 and 10 watts, 28 to 250 VDC, at 0.25 and 0.50 amp.;

mercury-wetted relays are rated at 50 watts, 500 VDC, at 1 amp. The many optional features include magnetic and electrostatic shielding, switching speeds to 250  $\mu$ s., operating temperatures of  $-65^{\circ}\text{C}$  to  $+125^{\circ}\text{C}$ , and provisions for magnetic or electric latching.

**And there's fast delivery — off-the-shelf for standard models, and a short 2-week wait for specials.**

Write for detailed technical data on these miniature Babcock PC board reed relays today from Babcock Control Products, Babcock Electronics Corp., Subs. of Esterline Corp., 3501 No. Harbor Blvd., Costa Mesa, Calif. 92626 — or better still, call (714) 540-1234.

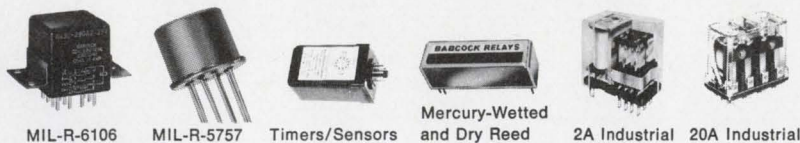

# BABCOCK

A UNIT OF ESTERLINE CORPORATION

INFORMATION RETRIEVAL NUMBER 8

(continued from p. 7)

For  $Z_2 = R_2 = R_1$

$$E_o(s) = \frac{I_2 \cdot R_1}{s} + \frac{I_2}{s^2 C} - \frac{I_1}{s^2 C}$$

$$E_o(s) = \frac{I_2 \cdot R_1}{s} + \frac{1}{s^2 C} (I_2 - I_1)$$

$$E_o(s) = \frac{I_2 \cdot R_1}{s} + \frac{I_{\text{offset}}}{s^2 C}$$

Therefore:

$$e_o(t) = I_{\text{Bias}} \cdot R_1 + \frac{I_{\text{offset}}}{C} t$$

Thus the term  $I_{\text{Bias}} \cdot R_1$  is un-compensated. If we zero the output with an external biasing network, the drift  $\Delta I_{\text{Bias}} / \Delta T$  will cause an error in the output.

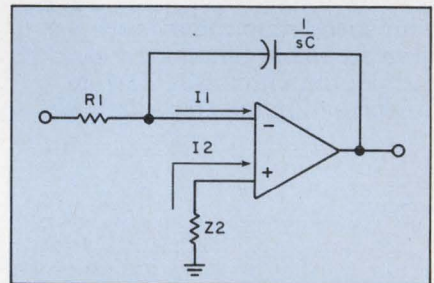

1. Op amp is used as an integrator.

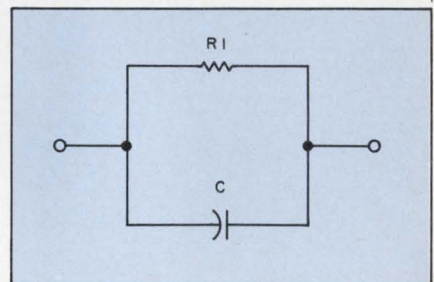

2. Biasing network replaces  $Z_2$ .

For  $Z_2$  of Fig. 2, we have:

$$E_o(s) = \frac{I_2}{s} \cdot \frac{R}{(1 + sRC)} + \frac{1}{s^2 C} \cdot \frac{I_2}{(1 + sRC)} - \frac{I_1}{s^2 C}$$

$$E_o(s) = \frac{I_2 s R_1 \cdot C + I_2}{s^2 C (1 + sRC)} - \frac{I_1}{s^2 C}$$

$$E_o(s) = \frac{I_2 (1 + sRC)}{s^2 C (1 + sRC)} - \frac{I_1}{s^2 C}$$

$$e_o(t) = \frac{I_{\text{offset}}}{C} t$$

The term  $I_{\text{Bias}} \cdot R_1$  is now compensated.

Vittoria Pomo

Olivetti Ricerche & Sviluppo  
Laboratorio Circuiti & Memorie  
B157X  
ICO 2°.  
Via Jervis 11.  
I10015 Ivrea.  
Italy

# Why invest in wire-wrapping facilities,



## when you can use ours?

We can handle your complete back-panel wire-wrapping including all inventories right up to and including final inspection. You just have to bolt it in. And you can be sure of a completely tested, 100%-error-free back panel.

All your back panels can be tested with an Omnitester 900 Wiring Analyzer. This unit, pictured here in the center, has forward scan capabilities to determine, for example, whether a missing wire went to some other point. It then identifies that point.

The unit further tests for continuity resistance,



insulation resistance, DC hipot, and features programmable dwell time.

All this at a price less than in-house fabrication. No costly inventories, no capital tied to costly equipment. You can furnish the back panels or we can supply our own.

Delivery? Just 2 to 8 weeks, depending on the job and material availability. And we have two locations: Longmont, Colorado or Endicott, New York. For more details just call your nearest Amphenol sales office or write us direct. Amphenol Cadre Division, Bunker Ramo Corporation, 20 Valley St., Endicott, N.Y. 13760.



# AMPHENOL

# Isolate It Optically

...solid-state lights on using the ideal switch - optoelectronic couplers

## Pulse Stretcher

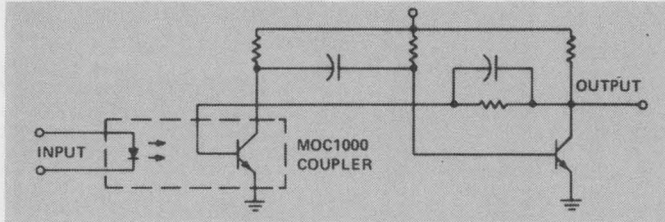

Very short input pulses can be adjusted to any desired pulse width in this circuit with the output completely independent of the input.

## Load-To-Logic Translation

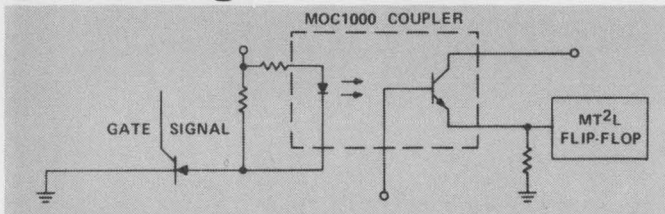

Monitoring an SCR-controlled load with an optical coupler provides a count of load operations each time the flip-flop is toggled through load activation.

## Computer / Peripheral Interconnect

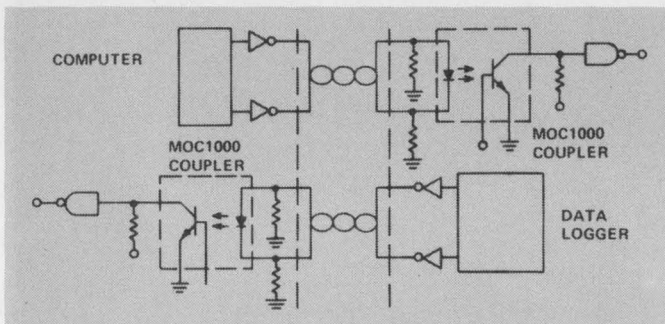

Couplers detect differential signals from twisted-pair lines and translate to single-ended output which provides complete ground-loop isolation.

## Power Amplifier

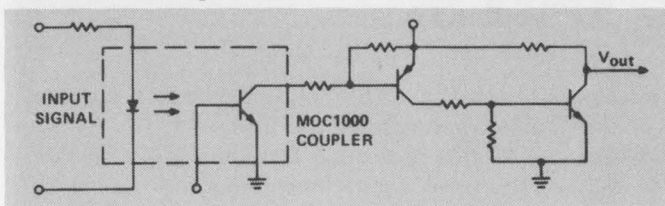

Couplers amplify low-level logic to drive large loads and accomplish interfacing between logic power supplies and load power supplies.

## Logic-To-Load Translation

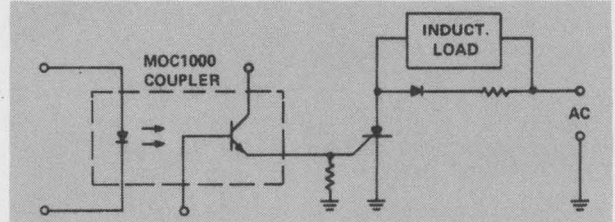

When the T<sup>L</sup> gate input goes high, the SCR is activated and logic-to-load translation is achieved through optical coupling.

## Logic-To-MOS Interfacing

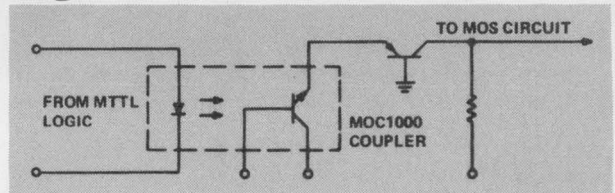

Easy interfacing between various logic forms (in this case T<sup>L</sup>-to-MOS circuitry) can be achieved through optical coupling without regard to differences in logic swings.

Lights on: switch on. Lights off: switch off. Quickly. Simply. Reliably.

Optoelectronic couplers give you nearly perfect input/output isolation . . . 100 billion ohms. They afford 1,500 V minimum dielectric isolation. They provide 300 kHz typical frequency response and 60% typical transfer ratios. They furnish complex signal transmission without RFI at micro-second speeds. They offer low coupling capacitance: 1.3 pF typical.

They don't wear out, they don't use much power and they're immune to bouncing, arcing, shock and vibration. They're light, compact and have closed construction. They're IC-compatible and cost as little as \$3.35, 100-999.

They're obvious replacements for mechanical relays.

Use them in interface and coupling systems, phase and feedback controls, amplifiers and general purpose switching.

To find out how, there's a new data sheet waiting through Box 20912, Phoenix, AZ 85036. Complete specs and a lot of applications information.

See your Motorola distributor or factory representative for prototype or production needs.

Lightly switch on today.

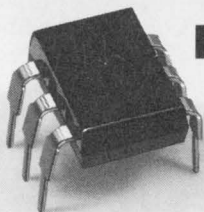

**MOC1000 - the optoelectronic coupler**



**MOTOROLA OPTO**  
*Let There Be Light* ¶¶

# Someday other switches may have it.

*But until then, only Licon can build and sell patented double-break Butterfly® switching.  
(Type 16 switch Butterfly mechanism shown twice its actual size.)*

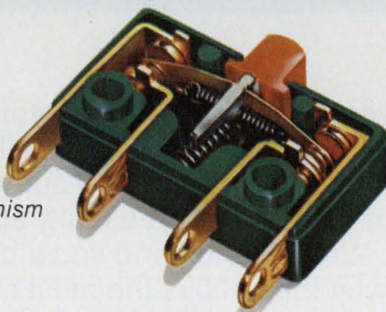

Why are Licon patented double-break Butterfly® switches better? Because they give a degree of reliability you simply can't get in single-break switches. It's inherent in the design. There are other advantages, too. A higher current rating than comparably-sized single-break switches. Two-circuit control with one switch. High shock and vibration resistance. And Licon's exclusive Butterfly wiping action which resists contact welding ... minimizes mechanical bounce to increase electrical life. And there's a

versatile variety of low-cost Butterfly switches available immediately. In sub-miniature switches, our Type 16 SPDT series offers a wide choice of terminal styles. With our Type 26 DPDT series you can control up to four isolated circuits. Type 36 3PDT series controls multipole circuits. Or try our sub-miniature Type 18 SPDT series which packs super reliability into super small volume. All these switches are snap action. All meet MIL specs. And all offer choice of contact arrangements, case and contact

materials. Check them out with your Licon distributor or representative. Or call or write for a Licon Switch Catalog. **Licon, Division Illinois Tool Works Inc., 6615 W. Irving Park Road, Chicago, Illinois 60634. Phone (312) 282-4040. TWX 910-221-0275.**



**i t** **LICON**

*The Innovating Electronic Group of ITW... LICON* ■ ELECTRO MATERIALS ■ PAKTRON

# Teradyne's L100 Automatic Circuit Board Test System speaks for itself.

```

PASSED

GOOD: 43
BAD: 8
    
```

```

FAILED
FAILURE COUNTERS (BAD/TOTAL):
FTEST 0/36
MTEST 5/83
BTEST 0/1
TTEST 0/2
    
```

```

MT44 D8
THIS TEST PASSED

MTEST ON PINS: M

LIMIT :+ 500. MV
ACTUAL:+ 248. MV
    
```

```

TT39
THIS TEST FAILED

TIME FROM PIN 18 TO 21
ACTUAL: 00.195 US
TMIN: 00.050 US
TMAX: 00.190 US
    
```

```

FT35
THIS TEST FAILED
<ALARMS>51
FAILING PINS: 20 Z K
    
```

```

FT15
THIS TEST FAILED
FAILING PINS: 5 R P N M L J
    
```

If you test circuit boards, you get the message. The L100 doesn't just tell you a bad board is bad. It helps you find out why. And in a fraction of the time you'd usually spend troubleshooting. We'd like to send you a brochureful of reasons why the L100 is the most money-saving system you can buy.

Write: Teradyne  
183 Essex Street  
Boston, Mass. 02111

**TERADYNE**

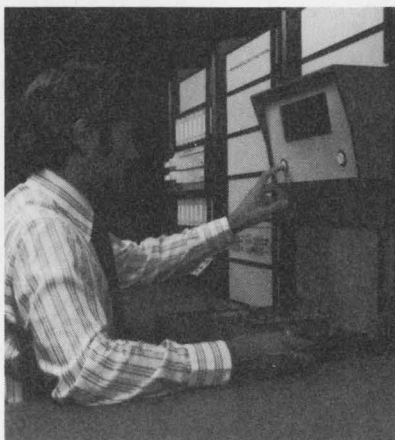



# 5 new capacitor ideas.

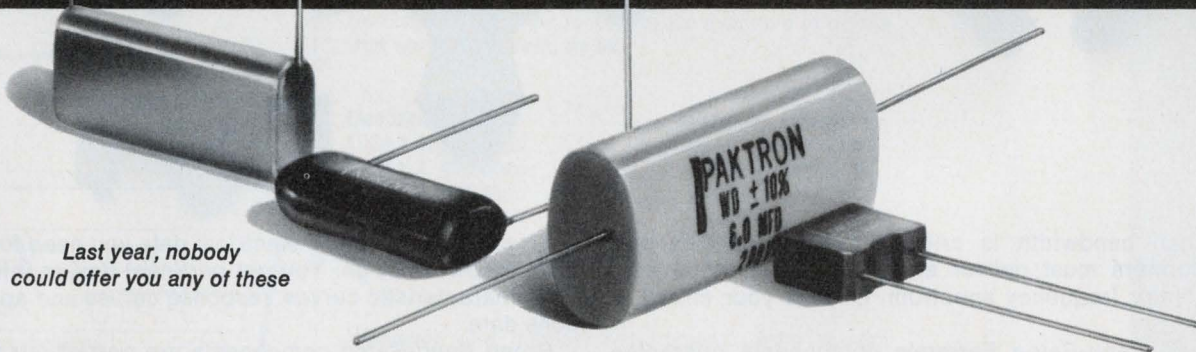

Last year, nobody could offer you any of these

From Paktron, the one U.S. company that keeps making news in film capacitor development and manufacturing automation advances. *Metalized Film Capacitors* for use in voltage multiplier circuits to replace and outperform more expensive ceramic disc capacitors. New *Paktron® Metalized Polypropylene Capacitors* for high voltage/high current application — up to 1200 volts. *Molded Polyester Capacitors*

designed for PC board use in the widest possible capacitance range and popular voltage ratings. *Micromatic® Type PP Polypropylene Capacitors* for specialized applications in the instrumentation and telecommunications industries. *Wrap and Fill Capacitors* that combine polycarbonate type performance with metalized type stability and miniaturization. For details on any of these — plus a long

line of standardized film capacitors — write to the domestic leader in film capacitors: **Paktron, Division Illinois Tool Works Inc., 1321 Leslie Ave., Alexandria, Va. 22301. Phone (703) 548-4400. TWX 710-832-9811.**



**itw** PAKTRON

The Innovating Electronic Group of ITW... PAKTRON ■ LICON ■ ELECTRO MATERIALS

# Do you want to have the whole picture on Japan's great leap forward?

## The Japanese Miracle and Peril Willard Price

Leading the world's nations in electronics, shipbuilding, cameras, watches, literacy rate . . . gaining rapidly in other areas, Japan has risen meteorically from the ashes of World War II. Such is the Japanese miracle. Within it looms the peril, expansionism, a Japanese passion that has recurred throughout her history. Willard Price, who has been interpreting Japan to the West for more than half a century, provides a fascinating, informative account of these inter-related themes as he probes Japan's history and the Japanese character for the root explanations of her dynamism.

256 pages, #6103-x, paperback

\$3.85

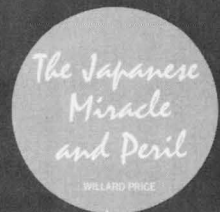

*IF the next hundred years prove to be the Japanese century, it need be no surprise to those who pay heed to what is going on in Japan today. Only twenty-five years after her utter military defeat, Japan stands first before all the world.*

WILLARD PRICE (continued on back)

## Other New and Informative Books from Hayden

### Eight Lives in Jazz: Combo U.S.A.

RUDI BLESCH

Here are the stories behind the music, intimate portraits of the people who put their genius and dreams into a distinctly American sound. They all come alive in these pages: the late, legendary Louis "Satchmo" Armstrong; Sidney Bechet, Jack Teagarden; Lester Young; the bitter-sweet "Lady Day", Billie Holiday; Gene Krupa; Charlie Christian; and Eubie Blake.

240 pages, illustrated, #6104-8, paperback

\$3.65

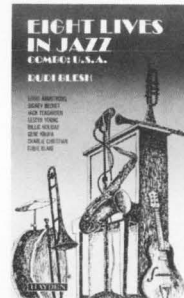

### America the Vanishing: Rural Life and the Price of Progress

Edited by SAMUEL OGDEN

From paradise to pollution-riddled land, the sorry fate of the American countryside is recounted by some of the best-known writers. Audubon, Muir, Twain and others evoke the small-town and rural life that has virtually disappeared. In stark contrast, E. B. White, Rachel Carson and other contemporaries portray the impact of progress on our environment and way of life.

256 pages, illustrated, #6105-6, paperback

### The Due Process Revolution: The Warren Court's Impact on Criminal Law

FRED P. GRAHAM

Demolishing the myth that the Supreme Court handcuffed the police, New York Times Supreme Court reporter Fred P. Graham reveals the background of such landmark decisions as Mapp, Escobedo, Miranda, and Wade. He places in perspective the Warren Court's courageous affirmation of the Constitution's promise of equality to all Americans.

377 pages, #6101-3, paperback

\$3.75

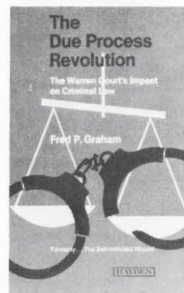

### The Politics of Fear:

### Joseph R. McCarthy and the Senate

ROBERT GRIFFITH

This compelling, award-winning study of a shocking episode in recent American history views McCarthy as a political phenomenon created and sustained by politicians hungry for power or fearful of the party aroused in a divided nation. In its eventual collapse the Senate side-stepped the real issues and assumed upon which McCarthy built his career.

376 pages, #6100-5, paperback

### The Electronic Invasion

ROBERT M. BROWN

Anyone concerned with Big Brother's methods will find this best-selling exposé fascinating and instructive. It details all types of snooping gadgetry, names major manufacturers and buyers. The extent of governmental and corporate bugging is surveyed, and legal strictures are fully covered.

188 pages, illustrated, #0779-5, paperback

\$4.95

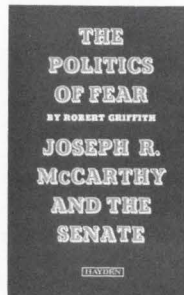

### Humanizing Schools: New Directions in New Decisions

DOUGLAS H. HEATH

A disturbing analysis of today's youngsters and of their schools are failing them. Reporting as one intimately involved as both educator and psychologist, Douglas Heath presents a realistic framework for deciding what must be done, and a compelling argument, why?

240 pages, #6003-3, cloth

At your bookstore or by mail with this convenient coupon.



**HAYDEN BOOK COMPANY, INC., 116 W. 14th St., New York, N.Y. 10011**

Please send the book(s) whose code numbers I have circled below. Enclosed is my check for the total amount, plus 25¢ to cover postage and handling on my order.

6103-X 6101-3 6105-6 6003-3 6104-8 0779-5 6100-5

If not satisfied, I may return the book(s) for full refund.

Amount enclosed: \$ \_\_\_\_\_

Send free 96-page catalog of all Hayden Books.

Name \_\_\_\_\_

Address \_\_\_\_\_

City \_\_\_\_\_

State \_\_\_\_\_ Zip \_\_\_\_\_

7:

When I transform your entire dead.

Broad B the electric communic: telemetry, a

First, we cifically for design latit

Then, we as ordinary ponents.

So we c your circuit

# CUTLER-HAMMER'S BIG NEW LINE OF COMMERCIAL MINIATURES.

Toggles. Pushbuttons. Rockers. Rotaries. Available in a vast array of operator styles, colors, and shapes. Including illuminated pushbuttons and rockers. Many featuring snap-in mounting. And all in stock for fast delivery!

Now the same great quality, service and availability you've come to expect from Cutler-Hammer is available in miniature size—at a competitive price!

Make your selection. Standard or watertight. Single or multiple pole. A wide range of decorator caps, buttons, bezels that extend application flexibility. And for their size, hefty electrical/mechanical ratings.

Before you place that next order, check with your new source for commercial miniature switches—your nearest Cutler-Hammer Sales Office or Authorized Stocking Distributor.



**CUTLER-HAMMER**  
SPECIALTY PRODUCTS DIVISION, Milwaukee, Wis. 53201



Switch  
to No.1

More than just switches;  
prompt availability,  
field help, innovation,  
quality assurance, too.

INFORMATION RETRIEVAL NUMBER 15

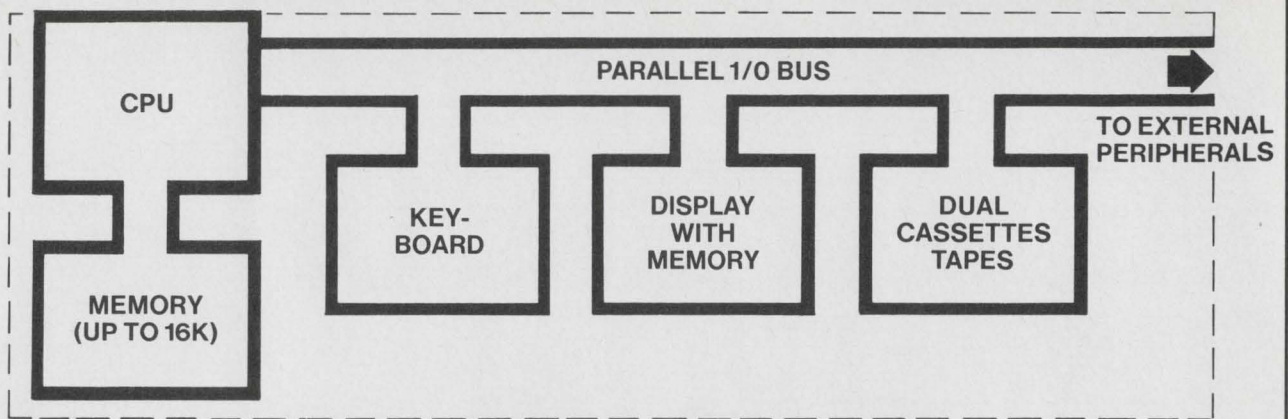

## A complete mini computer system



## in an integrated, attractive package.

Why start from scratch every time you build a mini system? You're going to need an operator console, display and bulk storage in addition to the processor. The Datapoint 2200 has all these built right in along with the computer. And the computer will satisfy the most demanding programmer. Fourteen general purpose registers, push-down stack, interrupts, and up to 16K bytes of fast read-write memory give it plenty of power.

If you spend your time with paper tapes you'll like the cassette magnetic tape operating system. Without touching anything but the keyboard, you can edit, assemble, run and debug in either assembler language or DATABUS, the Datapoint 2200 high-level language. There's nothing else required but the 2200 to generate applications software.

Software doesn't stop with essentials. The cat-

alog has fixed and floating arithmetic routines, communications handlers, terminal simulators plus a high-level language system, DATABUS.

Expand the computing capability when you need it. Add memory, 30 c.p.s. and 135 l.p.m. printers, an 8½" industry-compatible tape and a cartridge disc. If you need to hook up with someone else, communications adaptors will get you on line from 37.5 to 9600 Baud asynchronous or synchronous. There's even a parallel data interface for interfacing to instrumentation or other data processing equipment.

Call your Datapoint man—he'll tell you how to get your system out of the box and into the action. Price begins at \$6040 (even less for OEM's).

Hundreds of Datapoints 2200s installed worldwide. Sales and systems engineering available in all major cities with service nationwide.



**Computer Terminal Corporation**  
(the people who took the terror out of computers)

**Home Office:**  
9725 Datapoint Drive/San Antonio, Texas 78284/(512) 696-4520

**Field Offices:**

Boston/(617) 359-4296	Denver/(303) 244-2451	Minneapolis/(612) 854-4626
Chicago/(312) 671-5310	Detroit/(313) 557-6092	New York/(212) 541-9205
Cleveland/(216) 831-1777	Houston/(713) 626-0010	Portland/(503) 289-9655
Dallas/(214) 637-4166	Los Angeles/(213) 645-5400	San Francisco/(408) 732-9953
		Washington, D.C./ (301) 587-3910

**International Representative:**  
TRW Communications/Toronto, Ontario, Canada/(416) 481-7288  
TRW Communications/Lyss/Berne, Switzerland/Telex: 34446  
TRW Electronics-International/Los Angeles, California/Telex: 674593



# THREE + ONE = FIVE

... of the most versatile and competitively priced 50 MHz test instruments you're ever likely to encounter. Even if the headline seems confusing, it isn't really ... we're simply announcing **FIVE NEW INSTRUMENTS** in **FOUR ATTRACTIVE BOXES** ... three extremely flexible new pulse generators, plus a data generator and a pulse generator neatly combined in one compact box. We like to call it a data/pulse generator.

Sitting atop the stack of three pulsers (below left) is the Model 115, a 50 MHz design featuring simultaneous positive/negative pulse outputs, each with variable baseline offset,

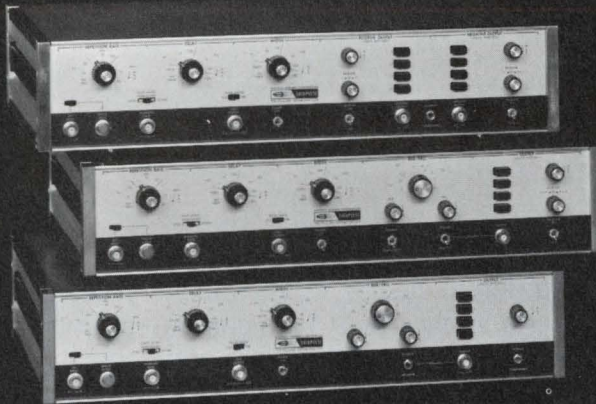

3.5 nanoseconds rise time and an unbeatable \$600.00 price tag. Center position is occupied by the super flexible Model 116, which, in addition to 50 MHz rep rates offers variable rise and fall times from  $<5$  ns to  $>0.5$  sec., variable baseline offset, switch selectable pulse polarity and many useful supporting features. The price is a low \$850.00. At the bottom of the stack is the Model 117, a \$750.00 unit designed for those who don't need baseline offset, but do require rep rates to 50 MHz, variable rise/fall times

from  $<5$  ns to  $>0.5$  second, and switch selectable pulse polarity. The 115, 116 and 117 all offer additional features including delays and widths to 1 second, external triggering, synchronous and asynchronous gating, square wave output, single cycle operation, double pulse mode and provision for external drive inputs.

The Model 218 (below right) is a two-for-the-price-of-one data/pulse generator combination, unbelievably priced at \$925.00. The 218 brings you the benefits of a high speed pulse generator and the versatility of a 16-bit data generator, producing words in either NRZ or RZ format. A combination 218/116 or 117 provides data with variable transition times. Multi-channel outputs or longer word lengths are obtainable by inter-connecting two or more units. Data content may be externally controlled. Pulse output is up to 5 volts

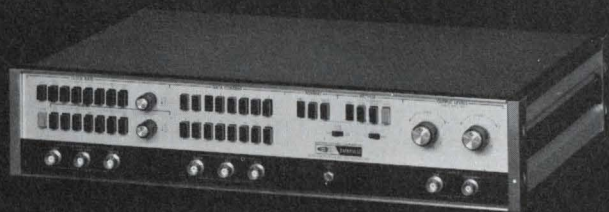

into 50 ohms, (10 volts open circuit) from a 50 ohm source impedance, with both upper and lower voltage levels variable. Positive true and complement outputs with transition times of 5 ns are simultaneously available.

Data sheets furnishing complete details on all models are yours for the asking, so call us direct or contact your nearby Scientific Devices man. Overseas customers are invited to contact their nearest Systron-Donner rep.

DATAPULSE DIVISION, SYSTRON-DONNER CORPORATION  
10150 West Jefferson Boulevard, Culver City, California 90230. Tel. (213) 836-6100  
TWX: 910-340-6766



# Custom credo.

Our custom philosophy is pretty simple. Sometimes you need a custom MOS/LSI or hybrid circuit to get the job done.

We want your custom business too.

So, we've expanded our very complete standard circuit design and volume production capability to include a very complete *custom* circuit design and production capability.

**CUSTOM MOS/LSI** We have all the processes (metal gate, silicon gate, ion implantation and C-MOS), so we can use whichever is most cost-effective for your program. We've also got the best designers, computer-aided graphics system and LSI testers available.

**CUSTOM HYBRID** You name it (Digital, Linear, MOS, Transistors and FETs), we've got the die capability in-house, in

addition to custom chips specially designed for hybrid applications. Plus computer-controlled laser trimming of resistors and capacitors and computer-controlled final test equipment.

From us, you'll get a great custom circuit.

And you'll get it fast. For specifics (including a copy of our new Custom MOS/LSI or Hybrid Capability Brochures), write on your letterhead to: National Semiconductor Corporation, 2900 Semiconductor Drive, Santa Clara, California 95051.

**JOIN THE NATIONAL LIBRARY.** Ask for your official National Library Card and current-selection bibliography. Your passport to a veritable wealth of Digital, Linear, MOS and Transistor/FET product, application and design information from a single source.



## National

INFORMATION RETRIEVAL NUMBER 18

# 75-Ω Coaxial Components

General Radio's 75-Ω equivalents to the long popular and thoroughly refined 50-Ω GR874® and GR900® series of coaxial components bring new confidence and flexibility to your 75-Ω work.

**The general-purpose GR874 (75-Ω)** Known 75-Ω characteristic impedance and low SWR to 2000 MHz assure repeatable results. Unique hermaphroditic design and a broad selection of adaptors permit easy interconnection among a variety of connector types. Reliable quick-connect/disconnect simplifies use. Nominal cost and generous quantity discounts provide the utmost in value, especially for OEM applications.

The basic connector is only \$3.60 in lots of 100 (net FOB Concord, Mass.). Also available: • Panel and cable connectors • Adaptors to BNC, N, F, Western Electric large and small, and GR900 connectors • Matched, open-circuit, and short-circuit terminations • 6- and 10-dB attenuators • Air lines • Inner-conductor rod • 50-Ω to 75-Ω matching pad.

**The precision GR900 (75-Ω)** SWR of less than  $1.0015 \pm 0.0015 f_{GHz}$  and repeatability of better than  $\pm 0.002$  dB and  $\pm 0.01^\circ$  ensure the precision necessary for standards work at 75 ohms.

The series includes • Precision connectors • Precision adaptors to F, Western Electric large and small, and GR900 (50-Ω) connectors • Precision terminations • Precision 50-Ω to 75-Ω matching pad.

**Detailed answers** to your 75-Ω or 50-Ω problems are available from your GR sales engineer; from GR, Concord, Mass. 01742 or, in Europe, from Postfach CH 8034, Zurich, Switzerland.



## General Radio

NEW YORK (N.Y.) 212 964-2722 (N.J.) 201 791-8990 • BOSTON 617 646-0550  
CHICAGO 312 992-0800 • WASHINGTON, D.C. 301 881-5333  
LOS ANGELES 714 540-9830  
TORONTO 416 252-3395 • ZURICH (01) 55 24 20  
GRASON-STADLER 617 369-3787 • TIME/DATA 415 327-8322



FOR 75-Ω COMPONENTS CIRCLE 198

FOR 50-Ω COMPONENTS CIRCLE 199

# 0.1pA I<sub>g</sub> dual FET.

**AD830 TRAK-FETS.<sup>T.M.</sup>**  
**Their performance is so revolutionary,  
we gave them a new name and came up with  
a new way to measure them.**

This AD830 series is the newest addition to our family of monolithic dual junction FETs.

They offer gate leakage current of 0.1pA which is the lowest ever. Are optimized for 30μA operation. Have typical breakdown voltage of 80V. Excellent thermal transient rejection. And tight  $G_{fs}$  and  $Y_{os}$  matching.

Tracking linearity is so excellent, we're calling our AD830 series TRAK-FETS. And have created a new TDN spec to measure them.

TDN stands for Temperature Drift Nonlinearity. To get it we have to measure  $V_{GS1-2}$  at -55°C, +25°C, and +125°C.

Typical values of TDN are  $\pm 1\mu V/^\circ C$ . (Max is  $\pm 5\mu V/^\circ C$ ). Which means you can routinely adjust for 1 to 5μV/°C performance. While paying for a 50μV/°C device.

We get this remarkable tracking without resorting to interdigitation and its common-back-gate problems. The secret is a high-

quality silicon nitride process.

TRAK-FETS can be applied anywhere high impedance and low drift are important. In electrometers, pH meters, photo and ion current transducers, sample and holds, and low drift integrators.

Besides our AD830 series, we have AD5906 with gate leakage current of 1pA maximum. And AD3954 which are optimized for 200μA

operation with  $I_g$  typical of 5 pA.

All models are ready now. And we'll be glad to send you an evaluation package of five at our hundred piece price. As well as our 1972 Product Guide which shows all the things we make to solve more of your problems better than anyone else.

Analog Devices, Inc.,  
Norwood, Mass. 02062.  
Tel. (617) 329-4700.

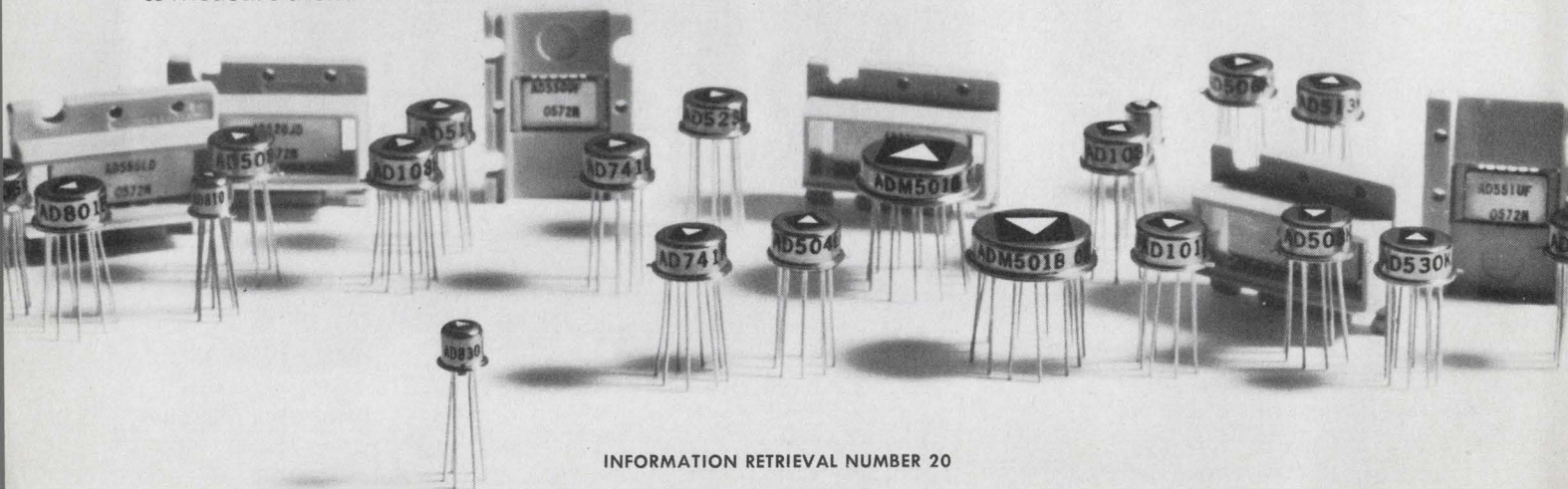



## IEEE announces major changes for next year

The Institute of Electrical and Electronics Engineers plans four innovations for next year's IEEE show in an effort to reverse the poor turnout for the show this year. Only 25,000 people passed in and out of New York City's Coliseum in 1972 compared to 35,000 the year before, and only 258 exhibitors turned up compared to 426 in 1971.

Next year, the IEEE will play up the 25th anniversary of the transistor—probably to lure back major semiconductor firms; put out a call for papers instead of limiting those the association chooses to invite; group the exhibits according to 10 product areas; and provide special centers for discussing specific engineering disciplines.

The exhibit groups will include communications and systems; components and microelectronics; data processing and transmission; electromechanical design; electro-optical technology; energy utilization and control; fabrication and pack-

aging; instruments and instrumentation; and solid state and circuits.

In a related development, the IEEE Board of Directors have agreed to recommend to the membership that it expand its activities to include political and economic matters.

The announcement was made by IEEE president Robert H. Tanner after the Board had analyzed 57,000 replies to a questionnaire mailed earlier this year. The main question asked was should the IEEE continue to be concerned with purely technical matters or should it interest itself purely in professional matters. Tanner noted that U.S. members favored the IEEE becoming more active in political and economic matters by a vote of better than 2 to 1. He pointed out, however, the proposed amendment to the constitution would expressly bar the IEEE from engaging in collective bargaining.

## Charge-transfer ICs compete as TV sensors

The development of charge-transfer devices as the video sensors in small, solid-state TV cameras took two steps forward with almost simultaneous announcements from RCA Corp. and Bell Telephone Laboratories of prototype models—RCA using the bucket-brigade scanning array and Bell Labs employing a charge-coupled scanning array.

RCA announced the delivery of a small bucket-brigade camera to the Air Force late last month (see "TV cameras getting tinier," p. 33) with RCA engineers claiming that the design could lead to a battery-powered TV as small as a wrist watch.

The charge-coupled array camera announced by Bell Laboratories has been demonstrated in the labs. According to Bell's engineers, their device, which is a flat chip of silicon covered with an insulating array, has a number of advantages over existing vacuum-tube and solid-state vidicons used in present TV systems. Because the charge-coupled sensor has no electron scanning beam, scanning is performed by electron transfer within the chip. As a result, the device is not susceptible to damage from "burn-in". It is not subject to lag or smearing caused by bright moving areas, and it is unaffected by external magnetic fields.

The present Bell camera has an array of 128 by 196 light-sensitive cells, with an active area of

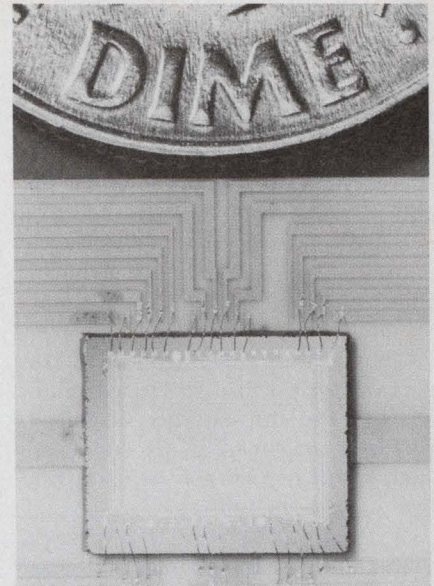

Charge-coupled IC is the image sensor for Bell's new TV camera.

3 by 5 mm.

To produce a video output, an image is focussed on one half the sensitive area. The electrical charge pattern due to the image is integrated over 64 by 106 of the light-sensitive cells.

The picture signal of an entire image frame is then transferred—at a 60-Hz rate—to a 64-by-106 element storage area on the other half of the device. The frame signal is shifted down, line by line, to be read out through a serial register.

By the time the new charge pattern has been formed, the preceding frame has been read out and the storage areas are ready to receive the next frame.

While the present model has a resolution of one-fourth that of the Bell Picturephone, its developers say that substantially higher resolution is feasible.

## High-density IC process announced by Motorola

A new, high-density IC fabrication process has been developed by Motorola Semiconductor Products. It is said to offer some of the same advantages as Fairchild's Isoplanar and Raytheon's V-ATE processes but avoids some of their limitations.

Termed VIP, for V-groove isolation polycrystalline backfill, the Motorola process achieves a den-

sity increase in much the same manner as used in the Isoplanar and V-ATE processes, by reducing the separation between devices.

Normally when this spacing is reduced, inversion effects result leading to a deterioration of circuit performance. This problem is avoided in all three processes by using a barrier between devices, thus avoiding the need for a greater separation.

The barrier in Fairchild's Isoplanar process is a diffused channel and the chip surface is planar. In Raytheon's V-ATE process, a V-shaped open channel is used and the surface is uneven.

With Motorola's VIP approach, a V-shaped channel, like that used for V-ATE, is first etched out. Then, an oxide-nitride insulating layer is formed on the channel sides. Finally, polycrystalline silicon is backfilled into the V, leaving a flat surface as in Isoplanar fabrication.

Because of the flat surface, a VIP chip can accept single or multilayer metallization providing an additional means for obtaining high densities. In addition, Schottky diodes can be readily incorporated into the circuit. This feature allows the fabrication of high-density Schottky-TTL or perhaps Schottky-ECL ICs.

Many of these features could also be obtained with the Isoplanar process. But the VIP process reportedly offers an important simplification in fabrication—the critical time-temperature cycle needed to form the isoplanar diffusion channel is eliminated.

Motorola expects to introduce VIP products by July. The company says it will start with a high-density bipolar memory to be followed with a line of high-density ECL products.

## RCA to market magnetic tape color video player

RCA plans to produce and market by late 1973 a magnetic tape color video player that will enable home television viewers to watch pre-recorded tapes on their standard color sets without receiver modification. It will also permit them to record and play back programs, tapes and movies taken

with home TV cameras. The SelectaVision MagTape recorder and player will retail for \$700. RCA says it is continuing development work on its SelectaVision holographic recording and playback system.

Bell & Howell will manufacture the precision tape transport component of the system for RCA, and Magnavox will offer a compatible, low-cost color camera.

## Liquid-core optic fiber has lowest loss yet

A new liquid-filled, quartz optical fiber with unusually low loss has been developed by Bell Telephone Laboratories for use in future optical communications systems. The fiber transmits infrared signals of 1.08- $\mu\text{m}$  wavelength with a loss of only 13.5 dB per kilometer, the lowest yet reported says Dr. Julian Stone, the fiber developer and staff member of Bell's Crawford Hill Laboratory, Holmdel, N.J.

Light-carrying fibers with losses of less than 20 dB per kilometer are expected to be useful in long-distance optical transmission systems, Stone notes.

The new fiber consists of a hollow, fused-quartz tube filled with tetrachloroethylene. Core diameter of the fiber is about 65  $\mu\text{m}$ , and the fiber's quartz wall is about 15  $\mu\text{m}$  thick.

Broad-band loss characteristics of the fiber is 20 dB per kilometer or less, says Stone, between wavelengths of 0.84 to 0.86  $\mu\text{m}$  and between 0.98 and 1.10  $\mu\text{m}$ .

These regions are important, Stone points out, because two promising radiation sources suitable for optical communications—gallium arsenide diodes and the neodymium: Yag laser operate within these bands.

Loss measurements were made using two light sources—a helium-neon laser of 0.6328  $\mu\text{m}$  operating in the TEM<sub>00</sub> mode, and a high-pressure xenon arc lamp. With the arc, optical filters of 0.0100  $\mu\text{m}$  bandwidth were used every 0.0200  $\mu\text{m}$ , between 0.6000 and 1.1000  $\mu\text{m}$ .

In the interval between 0.7000 and 0.7600  $\mu\text{m}$  and between 0.8200 and 1.1000  $\mu\text{m}$  the transmission losses are as low or lower than any previously reported says Stone.

## Radar for Awacs system about to be selected

The radar for the Air Force's airborne warning and control system, Awacs, may be selected sooner than previously planned. The flight tests of the two competing systems which began March 14 on two modified Boeing 707s will still continue until July 23. But prime contractor Boeing, will now be asked to choose one of them in one month instead of two. And the Air Force, which was also going to spend two months to make its decision, will now do it in one.

A firm contract to Hughes Aircraft or Westinghouse Electric may now come by Sept. 23. The initial order, according to present plans, calls for six radars for test and evaluation followed by 36 production models.

## News briefs

North American Rockwell Microelectronics Co. will begin delivery in June of MOS/LSI calculators with liquid crystal displays. Contracts for over 150,000 calculators have already been placed by Sears Roebuck, Lloyds of California and others.

Ted Shields, assistant general manager for Wescon predicts (with fingers crossed) that attendance at the 1972 Wescon show—to be held in Los Angeles Sep. 19 to 22—could match the 1970 figure of about 36,000. The

reasons? A brand new L.A. convention center, the switch in show dates from August to September and a continued upturn in the economy.

RCA's Solid State Div., Somerville, N.J. has just received an order for 3 million power transistors from the Chrysler Corp., Detroit. The transistors will be used in an electronic ignition system—two per system—that Chrysler is including as standard equipment on all domestic models of its 1973 cars.

# NEW

5th edition from the leading SCR and triac supplier incorporates 15 years of application experience.

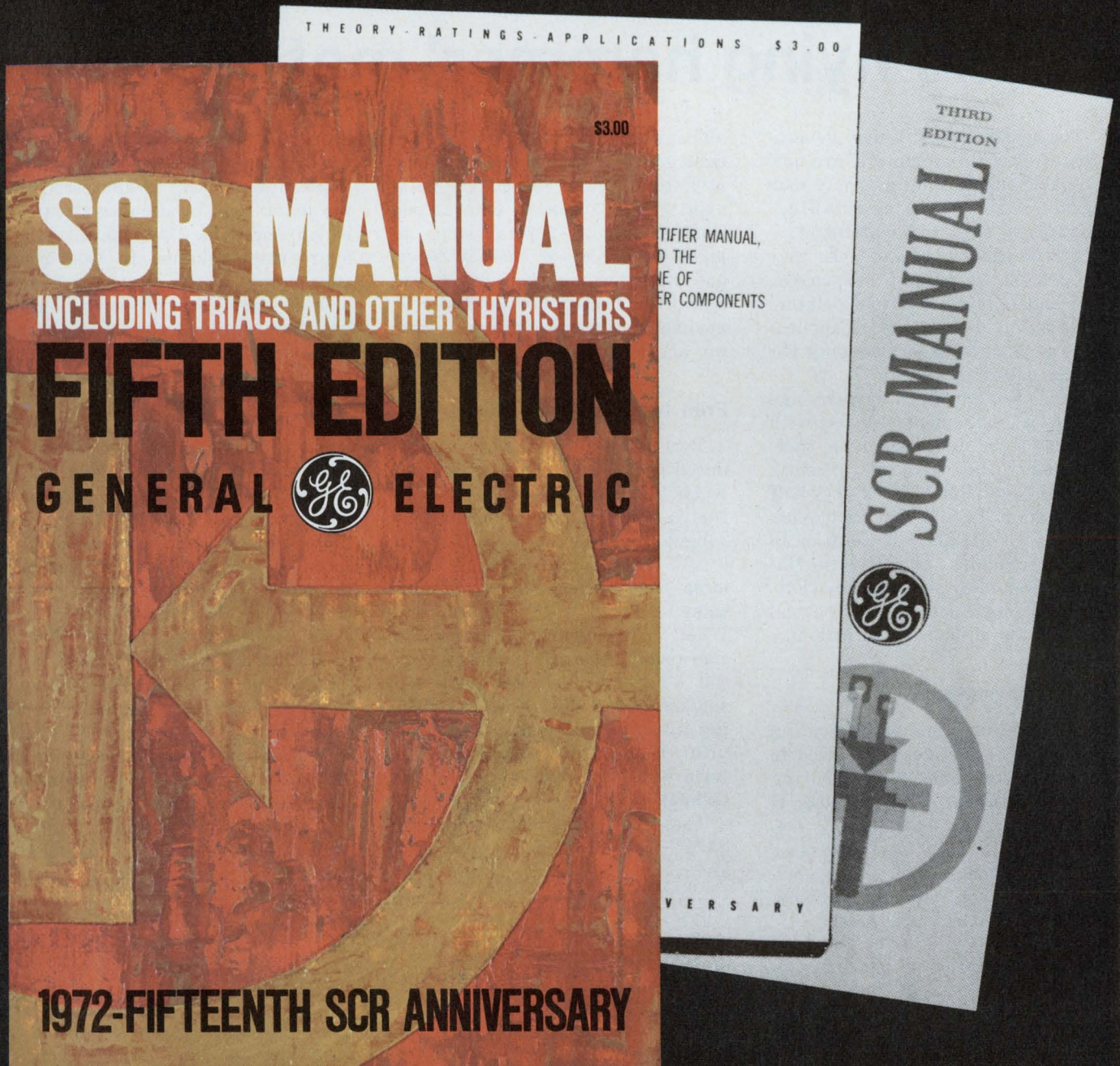

To get your copy, contact any authorized General Electric distributor or any General Electric Electronic Component Sales office.

**GENERAL  ELECTRIC**

Semiconductor Products Department  
Electronics Park, Syracuse, New York  
13201

# Thermal printer: Hot challenger to the 'flying hammer' method

Thermal printers, a new generation of electronic printers, are now available off-the-shelf and may soon replace traditional mechanical printers in some applications.

At the same time—because they are compact, quiet, inexpensive, fast and reliable—thermal printers are opening new areas of application, such as hard-copy readout for pocket calculators.

Developed almost three years ago by Texas Instruments for use with its Silent 700 data terminals, thermal print heads have only recently become available as off-the-shelf items from TI and the Displaytek Corp., both of Dallas. In addition to these companies, two others—National Cash Register and Hewlett-Packard—have developed thermal printers for in-house applications.

## No impact needed

In operation, a matrix of heating elements is selectively energized to heat thermochromic paper. During printing the heat-sensitive paper is in contact with the heating elements of the print head, and each energized element then forms a dot. The dots form letters, numbers, punctuation marks or symbols.

The method eliminates the need for "flying hammers," now used in impact printers, and thus makes for quieter operation. There is also a decrease in the number of mechanical parts and linkages that are needed. The result is a smaller, lighter, more reliable printer.

Two basic character formats are used in thermal print heads: bar segment and dot matrix. The seven-segment format is used for numerics only, while 16-segment or dot-matrix formats are used for

alphanumerics. At present bar-segment units print a single character at a time, while dot-matrix units print either a line of dots at one time—requiring several steps to print a full line of characters—or one character at a time. But decode and drive electronics can easily be modified to provide different printing arrangements.

## Print heads made of silicon

Two new print heads to be introduced by TI this month use silicon technology and consist of crystal-line semiconductor elements arranged in either a  $4 \times 5$  or a  $5 \times 7$  matrix. Each element has a mesa—or plateau—shape and contains a transistor-resistor pair. When an element in the array is energized, power is dissipated by the resistor, which heats the top surface of the mesa—the latter being in contact with the paper. The print head is fabricated in slice form with standard semiconductor technology.

The device can print a character all at once, or it can use a row-and-column addressing scheme to

energize the different elements of the array. With the latter technique, information is addressed to the print head by decoder circuits, which select one row, energize the appropriate columns in that row (depending on the character to be printed) and then proceeds to the next row until all rows have been energized. The head is then moved to the next position, where the process is repeated to print the next letter. Maximum printing speed is 30 characters per second.

Displaytek also uses silicon technology in the fabrication of print heads. However, unlike the TI unit, these devices have a maximum speed of 60 characters per second for a  $5 \times 7$  matrix. Both TI's and Displaytek's devices are MOS-compatible. Displaytek's print head costs \$30 in quantities of 5000, but price drops to \$15 for orders of 100,000. TI's units haven't been priced yet.

In addition to the dot matrix, a device that prints a seven-segment character is produced by Displaytek. This, says Ed Ruggiero, president of the company, is aimed at the strip-printer or data-logger

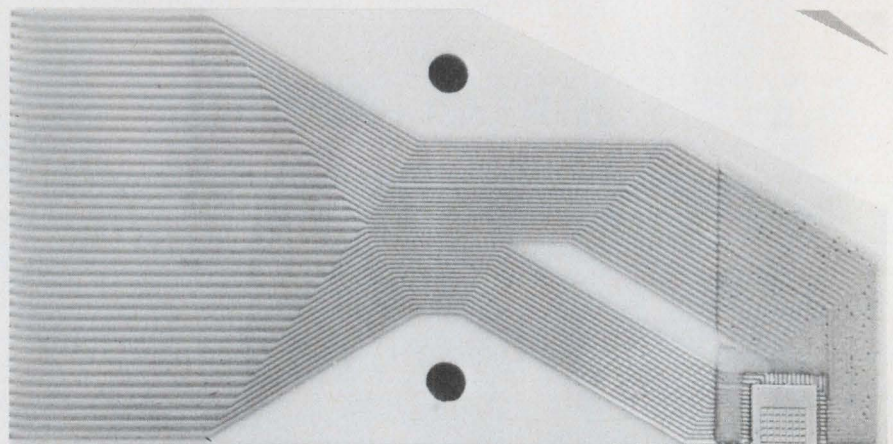

Displaytek's 35-element printing matrix can print all 96 ASCII characters at a maximum speed of 60 characters per second.

Jules H. Gilder  
Associate Editor

market. The device, the DC 4180, is a numeric display of from four to 16 characters, constructed in multiples of four digits.

Unlike the two dot matrices, the seven-segment print head is constantly in contact with the paper. The only mechanical component required in a printing system that uses this device is a solenoid to move the paper, Ruggiero says. Printing speed, he continues, ranges from one to six lines per second.

### Thick-film technology used, too

A different approach was taken by Hewlett-Packard for the thermal printer used in its 9800 series of calculators. The HP print head uses thick-film technology instead of silicon.

The device is a line printer, and, like Displaytek's seven-segment device, it is in constant contact with the paper. It prints a maximum of 16 characters per line and has 80 elements spaced in groups of five. A line is produced by printing the top row of all 16 characters, then the second row, and so on, until seven rows have been printed, thus completing the  $5 \times 7$  matrix required for each character. The print speed is a little more than

four lines per second.

The print head produced by National Cash Register, like the HP device, uses thick-film technology. The head has been installed in a compact, 80-column NCR printer and is being tested in a Pan American World Airways 747 jetliner. The printer is said to speed the airline's takeoff procedures by printing pre-departure and en route clearances for the crew. Normally these clearances are read over the radio and must be copied manually.

The printer has a  $5 \times 7$  matrix and prints an entire character at once. The maximum speed is 30 characters per second.

James Ingledue, regional sales manager for NRC, sees a big market for thermal printers as replacements for teletypewriter terminals. He points out that thermal-printer terminals are smaller, weigh less, are more reliable and are faster. They are also competitive in price, he says, with an OEM range of \$900 to \$1500.

Data terminals, calculators and communications equipment are not the only uses for thermal printers. Look for them soon in adding machines, instrumentation readouts and cash registers, says Displaytek's Ruggiero. ■■

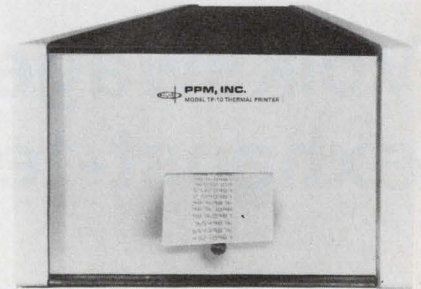

A thermal strip printer that uses a seven-bar-segment print head is manufactured by PPM, Inc. A Numitron display can also be included.

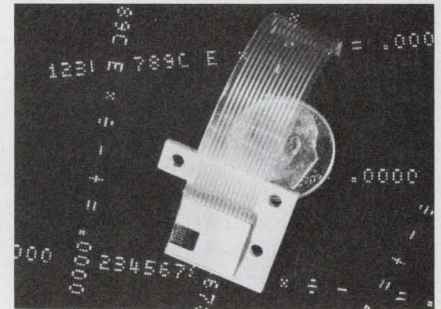

A  $4 \times 5$  array print head made by TI has alphanumeric capability.

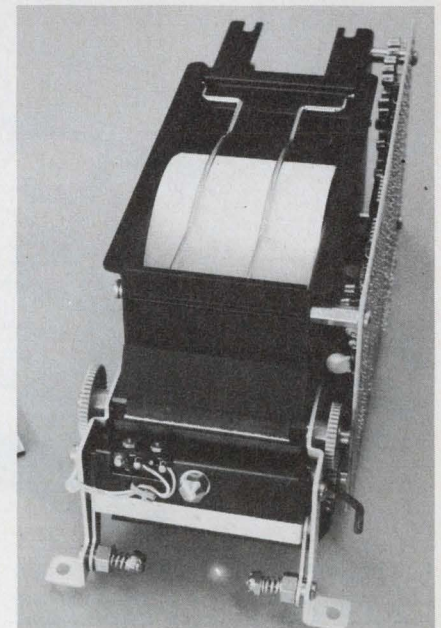
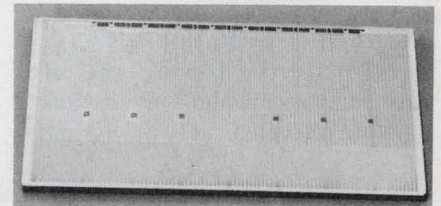

HP's printer (bottom) has a head (top) with 80 dots in groups of five.

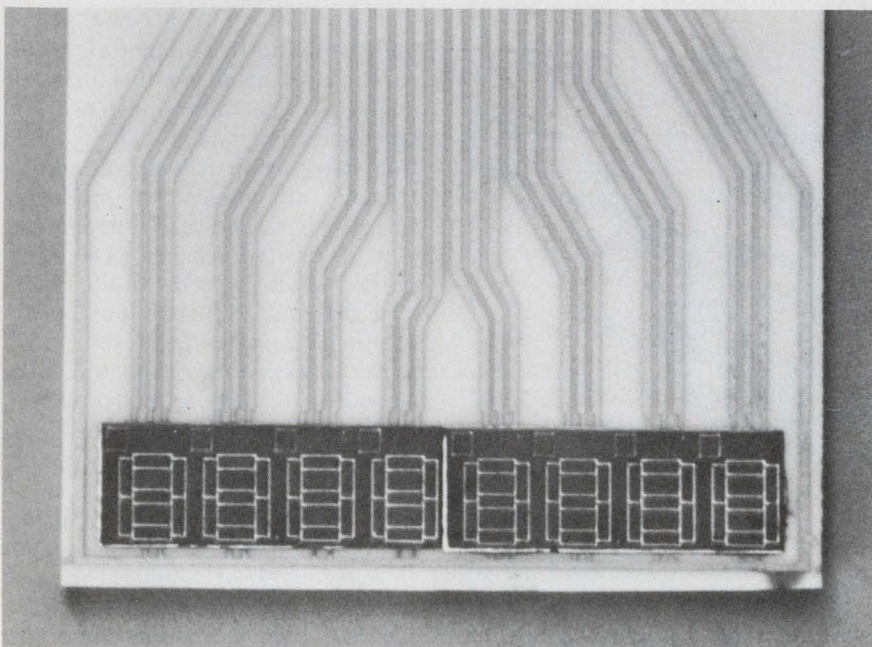

Eight-digit print head from Displaytek uses seven-bar-segment format. In use, the head is in contact with the paper. Characters are printed serially.

# Volkswagen thinks big with a new exhaust-test center on wheels

In the manufacturers' race to develop a cleaner car engine, Volkswagen of America has decided to invest vigorously in data. The giant importer of diminutive cars has put together one of the most sophisticated laboratories yet developed to measure automobile exhaust emissions—and it's all on wheels.

The \$400,000 mobile laboratory consists of a 44-foot-long trailer test center, with pull-out sides, and a 33-foot bus that carries electronic and electro-chemical measuring instrumentation.

The testing center, which started on a cross-country tour late last month, is measuring exhaust emissions of new and used Volkswagens at various authorized VW dealerships and is spot-checking cars at ports of entry. During the five-year survey emissions from Volkswagens operated at various alti-

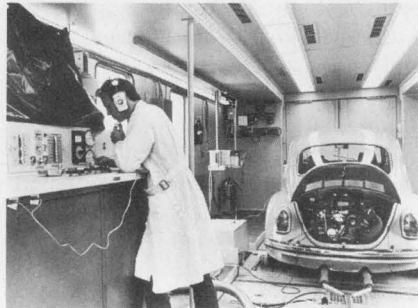

Technician in the trailer unit checks constant-volume-sampling instrument, which collects exhaust gases from the car undergoing test on the dynamometer.

tudes and in virtually every kind of climate will be tested. The purpose of the checks, the company says, is to determine whether VW exhaust emissions are conforming to Federal Government emission standards—which become increasingly stringent year by year until

1976, when the full effects will be felt. For example, the standards require that the exhaust from a 1972 car contain no more than 1.5 grams of hydrocarbons per mile. By 1976 this figure declines to only .41 gram per mile.

## Strict test sequence used

Cars being tested in the Volkswagen mobile center are driven into the trailer and onto a chassis dynamometer. Then they are "driven" in that fixed position to a prescribed schedule of speeds and times. An electronic device built by Process Computer Systems of Flint, Mich., helps the car's operator drive a test sequence specified by either the Federal Environmental Protection Agency or the State of California, depending on where the test is being conducted.

Emissions from the exhaust are transferred to the instrumentation bus by an "umbilical tube" or by a collecting bag. Inside the bus, the gas is collected by a constant-volume-sampling instrument and passed through nondispersive infrared analyzers, chemiluminescence instrumentation and a flame ionization detector to determine concentration of oxides of nitrogen, hydrocarbons and carbon monoxide.

A Hewlett-Packard 2116 computer—an 8-k word, 16-bit scientific machine with 16 input/output channels—analyzes the data and, with Teletypewriter, prints out the emissions of each exhaust constituent in terms of grams per mile.

Transducers are placed in the car to measure such parameters as oil temperature and intake manifold vacuum, as well as in the trailer to keep track of temperature and humidity.

Power for the mobile laboratory is supplied by a 75-kW ac generator. ■■

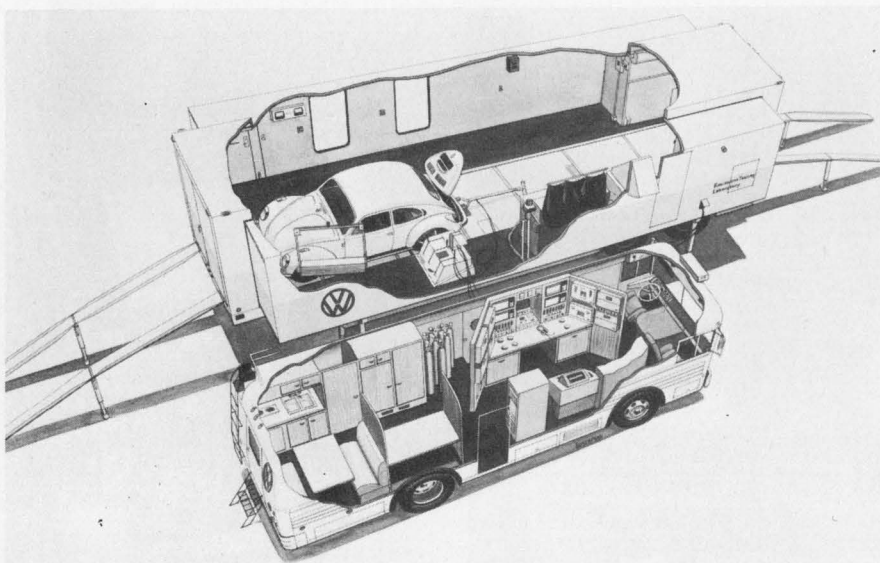

Mobile automobile exhaust emission laboratory consists of a trailer testing unit (top) in which Volkswagens are placed on a chassis dynamometer and "driven" over a prescribed "road course." Exhaust emissions are measured in the bus (bottom) by a battery of testing instruments. A computer analyzes and prints out the results.

# Another Sprague Breakthrough!

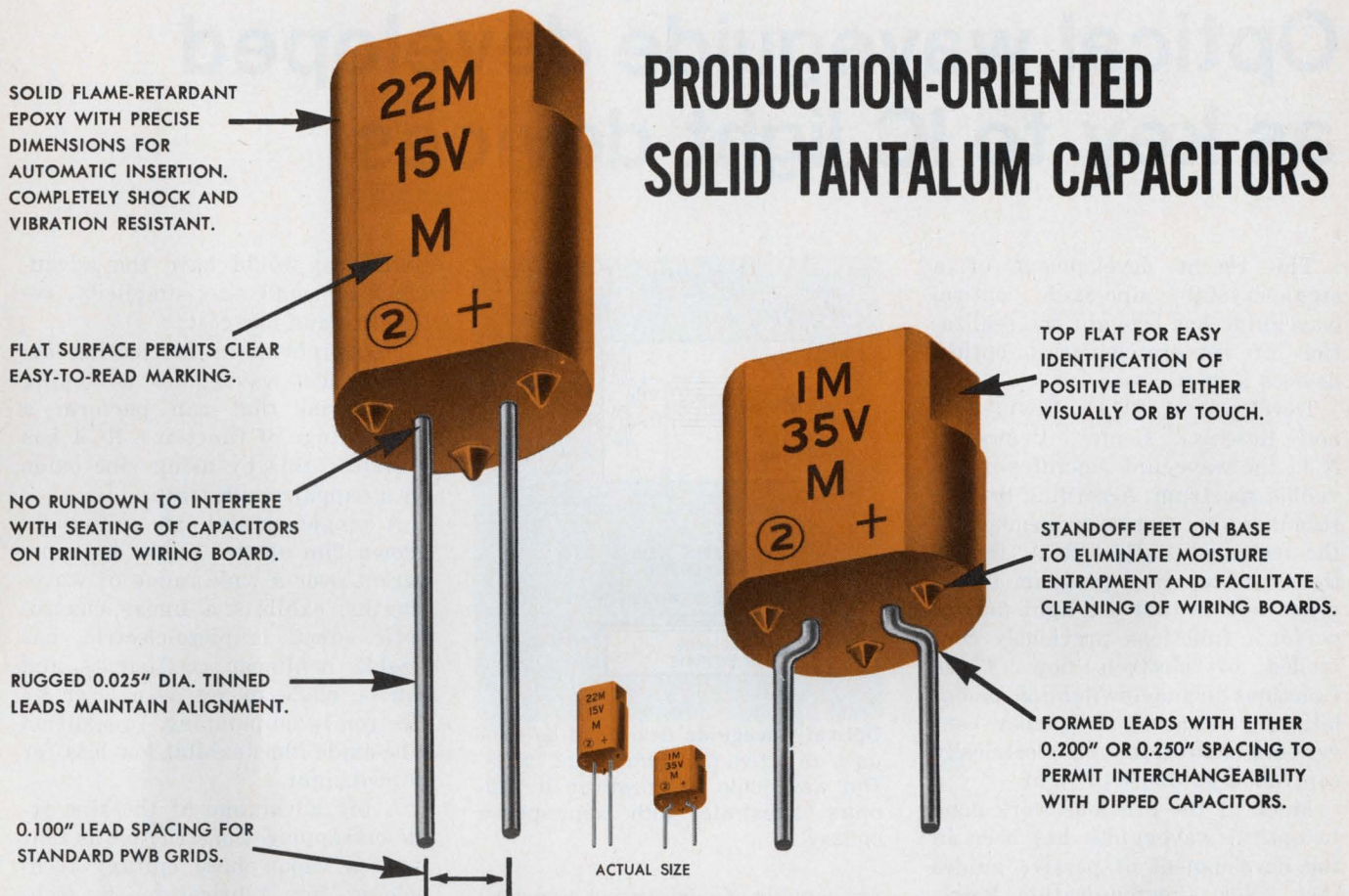

## Type 198D **Low-cost** Econoline<sup>★</sup> Tantalum Capacitors Lead in Performance!

When it comes to low-cost solid tantalum capacitors, the new Sprague Type 198D Econoline Capacitors outperform all other designs. Here are some additional advantages:

- Low d-c leakage
- Low dissipation factor
- Wide voltage range, 4 to 50 VDC
- Capacitance range from 0.1 to 100 $\mu$ F
- Withstand severe temperature cycling and temperature shock over  $-55$  C to  $+85$  C
- Speedier handling for insertion
- Easier-to-read markings

The new Sprague Type 198D epoxy-encased Econoline Capacitor is tooled for mass production and priced competitively with imported dipped units. Investigate this new Sprague breakthrough without delay.

*Call your nearest Sprague district office or sales representative, or write for Engineering Bulletin 3546 to: Technical Literature Service, Sprague Electric Co., 347 Marshall Street, North Adams, Mass. 01247.*

★ Trademark



**THE BROAD-LINE PRODUCER OF ELECTRONIC PARTS**

INFORMATION RETRIEVAL NUMBER 22

# Optical waveguide developed as key to IC light devices

The recent development of a single-crystal, zinc-oxide optical waveguide has brought the realization of integrated-circuit optical devices a step closer.

Developed at RCA's David Sarnoff Research Center, Princeton, N.J., the waveguide operates in the visible spectrum. According to Jack Hammer, an engineer member of the technical staff at RCA, this is the first step in a program to develop devices that use light flow to perform functions previously controlled by electron flow. These functions include switching, modulation, generation, frequency conversion, deflection and electrically controlled guidance of light.

Much of the previous work done in optical waveguides has been in the development of passive guides (see "New Communication Possibilities Flowing From IC Optoelectronics," ED 6, March 16, 1972, p. 32). However, to build an optical integrated system, it is necessary to use active waveguides that

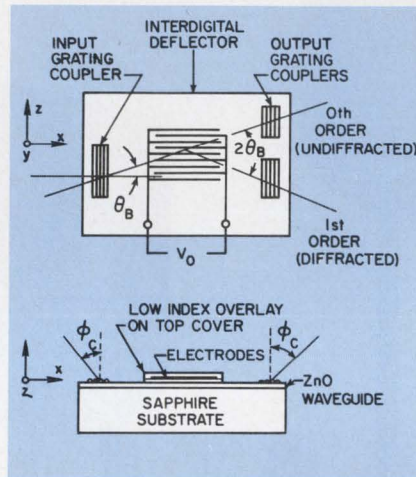

**Optical waveguide** developed by RCA uses an active thin film of zinc oxide. The waveguide is grown on a sapphire substrate with vapor-phase epitaxy.

are capable of performing a variety of functions. By combining a number of these functions on a single chip, Hammer explains, it is possible to construct an integrated optical system. Such a system, he

continues, would have the advantages of small size, simplicity, reliability and low cost.

One problem in fabricating active optical waveguides is finding a material that can perform a broad range of functions. RCA has overcome this by using zinc oxide on a sapphire substrate.

A single crystal, an epitaxially grown film of zinc oxide, is transparent over a wide range of wavelengths, exhibits a linear electro-optic effect, is piezo-electric, has sizable nonlinear coefficients and can be made to act as a laser by electron beam pumping. In addition zinc-oxide films exhibit low loss for guided light.

A big advantage of the zinc-oxide-on sapphire construction is that it uses vapor-phase epitaxy technology for fabrication—a technique familiar to IC manufacturers.

Another device under development at RCA is an electro-optic modulator that uses what is known as a Bragg-regime diffraction grating (see photo). This modulator is said to be almost ideally suitable for integrated optics in that the electrode structure is planar and it can be fabricated with well-known photolithographic techniques.

In addition to obvious communications applications, optical integrated circuits also have a big potential in digital logic circuits, Hammer says. Although their application here is still far away, he continues, they offer the possibility of logic circuits that operate at the speed of light.

At present, the RCA engineer explains, the speed of digital devices is governed by the time associated with circuit capacitances. For optical devices, speed will be limited only by the amount of time it takes for light to travel from one element to the next. ■■

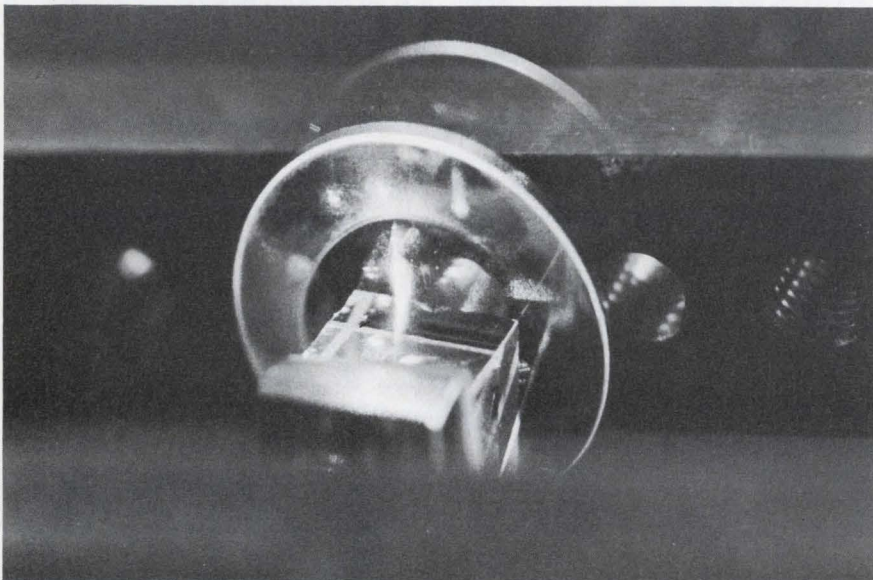

**RCA's electro-optic grating modulator** is capable of 100% modulation at 10 MHz. The electrode structure is planar.



## IR scanner checks tires

A rapidly spinning tire's internal structure can be checked by means of a fast-scanning infrared microscope and display originally developed by the National Aeronautics and Space Administration.

Built by Dynarad, Inc., Norwood, Mass., the non-destructive testing device is used by the B. F. Goodrich Co., at its Brecksville, Ohio, research center to produce a real-time cathode-ray tube display of the heat in tires as they are spun at speeds as high as 400 miles an hour.

Hot spots in a tire are viewed

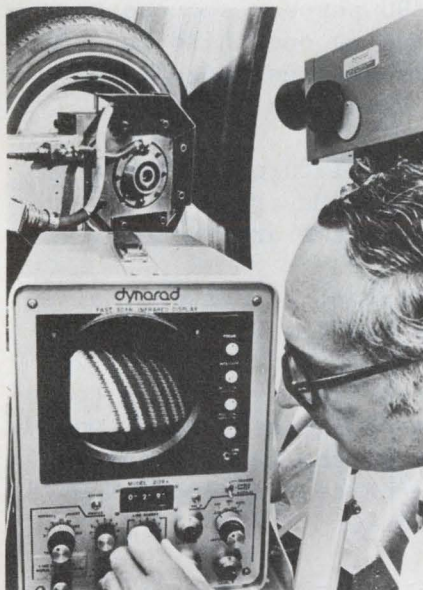

Internal structure of a rapidly spinning tire is checked on a fast-scanning infrared microscope. Hot spots are seen as bright areas on the display.

as bright areas on the display, indicating design or construction flaws that require correction.

The equipment can read the heat from 600,000 points on a tire every second presenting a view as if the spinning tire were stopped, according to Dr. Jacob Jansen, Goodrich vice president.

The testing device weighs less than 40 pounds, is small enough to be mounted on test automobiles and can be operated from an automobile electrical system. ■■

## Great buy for the money:

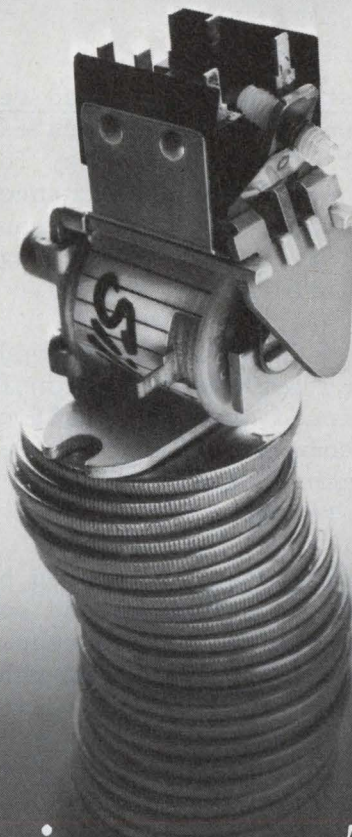

## The Heinemann Type B time-delay relay.

**Its continuous-duty coil and 5-amp contact capacity could spare you the need for a separate load relay.**

The continuous-duty coil enables the relay to remain energized indefinitely after actuation. If the load to be switched can be handled by SPDT or DPDT contacts of up to 5-amp capacity (125V or 250V AC or 30V DC, resistive), you can get by very nicely without a load relay.

The Type B is definitely in the moderate-price category, yet it isn't cheaply built. It has enclosed snap-action contacts of gold-plated fine silver, a vibration-resistant balanced

armature and, of course, a Heinemann hydraulic-magnetic delay element.

The Type B is one of five models in our Sillic-O-Netic® time-delay relay line. All are available in any of sixteen standard timings, from 1/4 second to two minutes, with any of nine 60Hz AC or DC coil voltage ratings. Our Bulletin 5006 will give you full technical data. Yours for the asking, of course. Heinemann Electric Co., 2616 Brunswick Pike, Trenton, N.J. 08602



# HEINEMANN

5320

INFORMATION RETRIEVAL NUMBER 23

# SCIENCE/SCOPE

The mobile earth station that linked Peking with the world during President Nixon's historic mission was built and operated by Hughes, under contract to Western Union International. It provided capacity for one color TV channel, nine voice commentaries, and 60 two-way telephone channels for use by the Presidential party and by the press to transmit teletype, telephotos, and radio reports. The air-portable terminal was similar to those which Hughes operated in Bogota, Colombia in 1968 for Pope Paul's visit and in Iran last year for that country's 2500th anniversary.

Communications from China were received by Intelsat IV satellites built by Hughes for Comsat, manager for the 83-nation International Telecommunications Satellite Consortium. Stationed over the Pacific and the Atlantic, these satellites carried TV and all press communications from Peking and relayed them to Intelsat's worldwide satellite communications network. Each satellite can carry 5,000 phone conversations, or 12 television programs, or tens of thousands of teletype circuits.

The first 27 Maverick missiles tested by the U.S. Air Force Systems Command surpassed all contract requirements and scored a better than 90 percent success rate in flight tests, enabling USAF to reduce the missile firings by one-third and complete the tests two months ahead of schedule. Maverick also demonstrated lower maintenance requirements and faster aircraft loading time than required.

The air-to-ground missile, built by Hughes, is guided by a miniature TV camera in its nose which the pilot locks onto the target. After launch, Maverick is independently guided to the target and the pilot is free to leave the area safely.

Fingerprint facsimiles and criminal records were sent via satellite between California and Florida recently in a two-week test directed by Project Search (System for Electronic Analysis and Retrieval of Criminal Histories), a consortium of 20 states that account for 80 percent of U.S. crime. Project Search was formed to develop a prototype communications system for law enforcement agencies which would make it possible to exchange police records more rapidly than the 10 days to two weeks it now often takes. Hughes-built equipment used in the test included NASA's 5-year-old ATS-1 satellite and three portable ground stations.

Opportunities for graduate engineers: The continued growth of Hughes' solid-state microwave product line has created an immediate need for engineers with experience in the design and development of either 1) microwave transistor amplifiers, phase lock sources and multipliers, and Gunn and IMPATT diode sources and amplifiers; or 2) millimeter-wave mixers and detectors. U.S. citizenship is required. Please write: Mr. R. F. Wolfe, Hughes Electron Dynamics Division, 3100 W. Lomita Blvd., Torrance, CA 90509. Hughes is an equal opportunity M/F employer.

A target acquisition system, now in engineering development at Hughes, will give individual ships of the U.S. Navy a new means of defending themselves against surprise attack. Integrated with the NATO Sea Sparrow missile, it will enable each ship to defend itself against threats that penetrate the umbrella-like fleet area defenses. The Hughes system integrates a short-range radar and infrared sensors with an IFF system that separates enemy targets from friendly aircraft. It will employ the latest techniques for cancelling out natural and man-made "clutter".

Creating a new world with electronics

**HUGHES**  
HUGHES AIRCRAFT COMPANY

# Radio dish gets a home

The National Science Foundation announced selection of a 3000-acre desert site, 50 miles west of Socorro, N.M., as the proposed location of a Very Large Array (VLA) radio telescope. The instrument, it is reported, would be the most sensitive and accurate of its kind in the world.

As one of the major instruments of the National Radio Astronomy Observatory, plans call for the array to consist of 27 dish-shaped radio telescopes, each 82 feet in

diameter. These antennas would be movable along each of three 13-mile arms of a Y-shaped layout of railroad track. The array, it is hoped, would provide scientists with an instrument having a sensitivity and resolution 10 to 100 times greater than any existing antenna array.

The facility, which will be owned by the National Science Foundation, is expected to go into partial operation in 1976 and in full operation in 1982. ■■

# TV cameras getting tinier

A miniature black and white television camera has been developed by RCA Laboratories, Princeton, N. J., with bucket-brigade technology. Instead of the vacuum tubes used in conventional TV cameras, the new camera has a bucket-brigade silicon IC that consists of a  $32 \times 44$  array of photosensitive elements. When an image strikes the array, an electrical charge proportional to the light intensity is

produced in each element. Another 32-stage bucket-brigade register on the same chip vertically scans the array and selects the rows to be read out, one at a time, to form the over-all picture. The new camera weighs less than a pound and has a volume of 17 cubic inches. Spokesmen for RCA say that the camera could be the forerunner for future TV cameras the size of a wristwatch. ■■

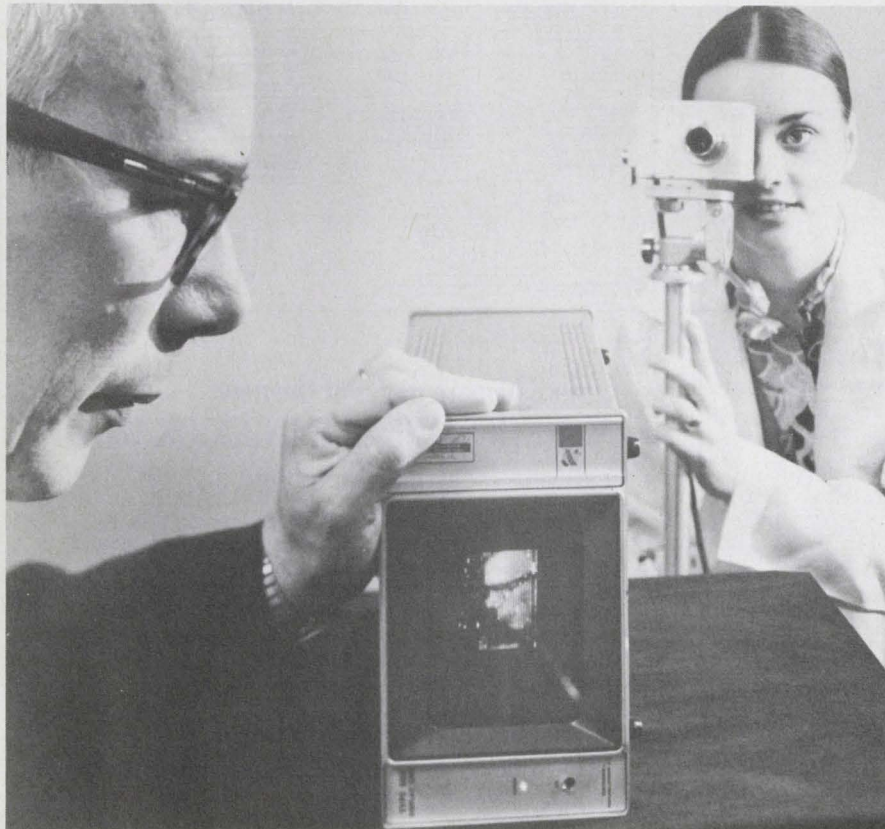

# Hughes is in industrial electronics, too: components, equipment and systems.



Microwave diodes (RS 282)

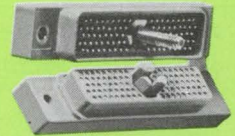

Electrical connectors (RS 287)



Microwave TWTs, TWTAs and solid state products (RS 289)



Direct view and scan converter storage tubes (RS 290)



Wire terminating and harness laying systems (RS 296)

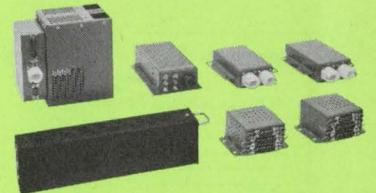

Multiplex systems for remote communications/control (RS 292)

For complete information, write Bldg. 100, Mail Station C-512, Culver City, CA 90230. Or request by Reader Service (RS) numbers.

## HUGHES

HUGHES AIRCRAFT COMPANY

### Industrial Electronic Products



## SIGNETICS

Linear Handbook Vol. I,  
with Bonus coupon,  
\$2.00 from your distributor:

ARIZONA  
Phoenix: Hamilton/Avnet Electronics  
(602) 269-1391  
CALIFORNIA  
Burbank: Compar Corp.  
(213) 843-1772  
Burlingame: Compar Corp.  
(415) 347-5411  
Culver City: Hamilton Electro Sales  
(213) 559-3311  
El Monte: G. S. Marshall  
(213) 686-1500  
Los Angeles: KT/Wesco Electronics  
(213) 685-9525  
Mountain View: Hamilton/Avnet Electronics  
(415) 961-7000  
Palo Alto: Wesco Electronics  
(415) 968-3475  
San Diego: G. S. Marshall  
(714) 278-6350  
San Diego: Kierulff Electronics  
(714) 278-2112  
CANADA  
Downsview: Cescio Electronics, Ltd.  
(416) 638-5250  
Montreal: Cescio Electronics, Ltd.  
(514) 735-5511  
Ottawa: Cescio Electronics, Ltd.  
(613) 729-5118  
Quebec: Cescio Electronics, Ltd.  
(418) 524-3518  
COLORADO  
Denver: Hamilton/Avnet Electronics  
(303) 433-8551  
FLORIDA  
Hollywood: Hamilton/Avnet Electronics  
(305) 925-5401  
Orlando: Hammond Electronics  
(305) 241-6601  
ILLINOIS  
Elmhurst: Semiconductor Specialists, Inc.  
(312) 279-1000  
Schiller Park: Hamilton/Avnet Electronics  
(312) 678-6310  
MARYLAND  
Hanover: Hamilton/Avnet Electronics  
(301) 796-5000  
Rockville: Pioneer Washington Electronics, Inc.  
(301) 424-3300  
MASSACHUSETTS  
Burlington: Hamilton/Avnet Electronics  
(617) 272-3060  
Needham Heights: Kierulff/Schley  
(617) 449-3600  
MICHIGAN  
Livonia: Hamilton/Avnet Electronics  
(313) 522-4700  
Detroit: Semiconductor Specialists, Inc.  
(313) 255-0300  
MINNESOTA  
Minneapolis: Semiconductor Specialists, Inc.  
(612) 854-8841  
MISSOURI  
Hazelwood: Hamilton/Avnet Electronics  
(314) 731-1144  
NORTHERN NEW JERSEY  
Cedar Grove: Hamilton/Avnet Electronics  
(201) 239-0800  
SOUTHERN NEW JERSEY  
AND PENNSYLVANIA  
Cherry Hill: Hamilton/Avnet Electronics  
(609) 662-9337  
Cherry Hill: Milgray-Delaware Valley  
(609) 424-1300 Phila. (215) 228-2000  
NEW YORK  
Buffalo: Summit Distributors, Inc.  
(716) 884-3450  
Hauppauge: Semiconductor Concepts, Inc.  
(516) 273-1234  
Woodbury: Harvey Radio  
(516) 921-8700  
New York: Terminal-Hudson Electronics  
(212) 243-5200  
OHIO  
Cleveland: Pioneer Standard Electronics  
(216) 587-3600  
Kettering: Arrow Electronics  
(513) 253-9176  
TEXAS  
Dallas: Hamilton/Avnet Electronics  
(214) 638-2850  
Dallas: Solid State Electronics Company  
(214) 352-2601  
Houston: Hamilton/Avnet Electronics  
(713) 526-4661  
WASHINGTON  
Seattle: Hamilton/Avnet Electronics (206) 624-5930

## technology abroad

To overcome one drawback of light-activated switches—the fact that they generally fire at an absolute light level—England's Integrated Photomatrix has produced a photo-IC that senses the background level of illumination and switches if a rapid change of 5% in the background light occurs. This overcomes false triggering of some light-activated switches by changes in the ambient light level. The new device has a sampling amplifier that produces a current proportional to the light that the integrated photodiode sees. This current is passed through an external resistor, and the dc voltage across the resistor modifies the switching threshold of the photo device in accordance with the illumination level.

CIRCLE NO. 441

A Gunn oscillator with 2.5-mW output is the key element in a small, portable British microwave communications system designed to transmit high-speed, broadband data from one side of an airport to another. Developed by the MEL Co. for the English Royal Radar Establishment, the system can transmit a TV picture up to five miles, operating within the 10.5-to-11-GHz band. The transmitter weighs 11 pounds and the receiver 13. Power requirements are 14 W for the receiver and 10 W for the transmitter, with a 22-to-24-V dc source.

CIRCLE NO. 442

An integrated-circuit gyrator has been produced by engineers at Philips Research Laboratories in Eindhoven, The Netherlands, to simulate large inductors in telephone-filter circuits. The gyrator circuit combines a number of active circuit elements in such a way that the device's output voltage depends solely on the input current, and the output current is dependent on the input voltage. If a capacitor is connected across the gyrator input terminals, the

phase relationship between gyrator output voltage and current is the same as that of an inductor. Precision inductors have been simulated over a wide frequency range by the Philips engineers. For a typical telephone application, an IC gyrator filter passes signals below 3415 kHz and suppresses signals above 3984 kHz, with 44 dB attenuation.

CIRCLE NO. 443

A new British high-speed mechanical Q switch for high-powered lasers has high optical efficiency and is relatively low in cost, according to its developers, the National Research and Development Corp. Most Q switches use an opaque dye material that absorbs the laser energy in a resonant cavity, until the build-up saturates the dye. At saturation, the dye switches from opaque to transparent, releasing the laser energy in a burst. In the new system, being marketed by Westward Turbines Ltd., Dorset, the laser beam passes through a spinning pentagonal quartz prism that is supported on air bearings. The prism is driven by an air turbine at 250,000 rpm. At this speed the Q-switched pulse-repetition rate is 20 kHz—suitable for operation of ruby lasers.

CIRCLE NO. 444

A new, light-sensitive British IC, combining a photodetector and radiation-level circuitry, provides a TTL-compatible output when the incident light level reaches a predetermined, adjustable level. The new device—Ferranti Semiconductor's first standard IC made by the collection diffusion isolation process—uses one 5-W supply. The IC sensitivity is variable between 10 and 10,000  $\mu\text{W}/\text{cm}^2$ . Triggering hysteresis levels can be adjusted, and TTL inputs can be supplied with up to 4.8-mA drive current. The IC can be used singly or in arrays for tape and card readers and similar applications.

CIRCLE NO. 445

Nobody  
can match  
Allen-Bradley's  
resistor cost

...on the board.

If you're really  
serious about cost,  
be serious about quality.

Paying the lowest price doesn't mean you're getting the lowest cost. Many fixed resistor brands lose their identification in the PC board cleaning process. Some don't have true colors to begin with. Or the color bands darken and become illegible from the heat produced in normal

usage. The result is costly identification errors. Contrast this with the bright, crisp identification of Allen-Bradley's specially formulated paints. Baked on to resist aging, rough handling and solvents. Why gamble with questionable quality that can lead to unforeseen costs?

Learn the facts. Ask your nearest A-B distributor for our free booklet, "7 ways to tell the difference in fixed resistors." Or write Allen-Bradley Electronics Division, 1201 S. Second St., Milwaukee, WI 53204. Export: Bloomfield, N. J. 07003. Canada: Galt, Ont. U.K.: Bletchley, Bucks.

**ALLEN-BRADLEY**  
QUALITY ELECTRONIC COMPONENTS



INFORMATION RETRIEVAL NUMBER 27

EC72-6 © Allen-Bradley 1972

# washington report



Don Byrne  
Washington Bureau

## **Domestic satellite program on the home stretch**

Within approximately six weeks the Federal Communications Commission is expected to wrap up the domestic communications satellite issue which it has been considering in one form or another for almost seven years. Discussion before the commission will start on May 1 and Chairman Dean Burch says he expects to have a decision by the end of May. These actions came hard on the heels of a decision by the FCC Common Carrier Bureau staff to recommend authorization of a "limited open entry" policy for the domestic satellite system. The decision would limit AT&T to providing noncompetitive long distance telephone service, require Comsat to choose between two proposals it made and urge applicants for similar systems to come up with some sort of joint ownership proposals. If adopted by the Commission the recommendation would mean construction of four, perhaps five, systems.

## **President's message on technology answers few questions**

President Nixon's recent message to Congress on science and technology, long awaited as a definitive statement on national goals and the means of attaining them through science and technology, contained little more than the Administration had already put forth through the State of The Union and the budget messages. The President did spell out, however, plans to liberalize loans through the Small Business Administration to enable small R&D firms to secure financing and to ease patent license rulings to make government information more readily available to private firms. The message said that strong defense and space research programs were as vital as the support of basic scientific research. But as to the previously stated goals of greater cooperation on R&D efforts between industry and government, both federal and local, little was explained.

## **Japanese barriers cost \$1.1-billion, committee claims**

Restrictive trade practices of the Japanese government cost the U.S. electronics industry \$1.1-billion in potential exports last year, according to a brief filed with the U.S. Tariff Commission of the Electronic Industry Committee for Fair International Trade (see "Industry Group Formed to Fight Trade Barriers," ED 4, Feb. 17, 1972, p. 23). The Tariff Commission is exploring trade policies at the request of the

Senate Finance Committee which is considering legislation in that field. The commission is considering tariff and nontariff barriers, the nature and extent of tariff agreements, customs evaluation procedure and the impact of multi-national companies on international trade.

The Electronic Industries Association was also asked to contribute to the committee's study but a spokesman said that no plans were made to respond. The Fair International Trade Committee filed a brief which contains "...procedures, regulations, and the practices of the government of Japan" which the committee asserts "significantly impeded or distorted the normal flow of U.S. exports and imports of electronic components." The four product categories which suffered the \$1.1-billion loss in potential exports last year are computers; communications, broadcast equipment and navigational aids; transistors and integrated circuits; and radio and TV sets, the committee said. The four main impediments to U.S. exports, it said, were import licensing, the "restructuring" of Japanese industry to strengthen its ability to withstand foreign competition, restrictions of U.S. investments in Japan and import duties. The committee concluded that directly competitive U.S. electronics products are virtually excluded from the Japanese market.

## **Congress checking two Navy projects**

Congressional critics are zeroing in on the Navy's Mark 48 torpedo and F-14 fighter contract costs. Rep. Clarence B. Long (D.-Md.), a member of the House Appropriations Committee, says the Navy underestimated the cost of the \$2.2-billion torpedo contract by at least \$800-million and there is still some doubt as to whether the torpedo is "workable or produceable." Long cited a report by the General Accounting Office as the basis for saying that the Navy underestimated inflation costs by \$390-million, that it did not include a claim for \$74-million in additional funds by Westinghouse and that it had included a \$372-million "saving" for not planning to outfit surface ships with the torpedo when in fact no such decision had ever been made. GAO would not comment on Congressman Long's statement because, it said, the GAO report Long was quoting was classified. On the Senate side the Armed Services Committee has opened an investigation on the F-14 contract which Grumman Aerospace Corp. has said that it cannot fulfill because of rising costs unless the Navy "restructures" the agreement.

**Capital Capsules:** NASA expects answers to its request for proposals on the solid-fueled recoverable booster for the space shuttle within 90 days. McDonnell Douglas, Grumman and Boeing, and North American Rockwell and General Dynamics are bidding. Selection of the solid-fueled booster will mean a reduction in development costs to \$5.15-billion from an original estimate of \$5.4-billion. However, the cost per mission will rise. Cape Kennedy now appears a certainty to be the site. . . . Lewis Branscomb, director of the Bureau of Standards of the Commerce Dept., is quietly kicking off a drive to get congressional approval for a switch to the metric system. Bills are pending in both House and Senate and the White House is expected to join in the push for action. . . . Dr. George F. Mansur, Deputy Director of the Office of Telecommunications Policy, has resigned and will return to private industry. . . . **The Airlines Electronic Engineering Committee will meet May 17-19** in Montreal to review items such as data-link, an electronic chronometer system, collision avoidance and passenger entertainment multiplex systems.



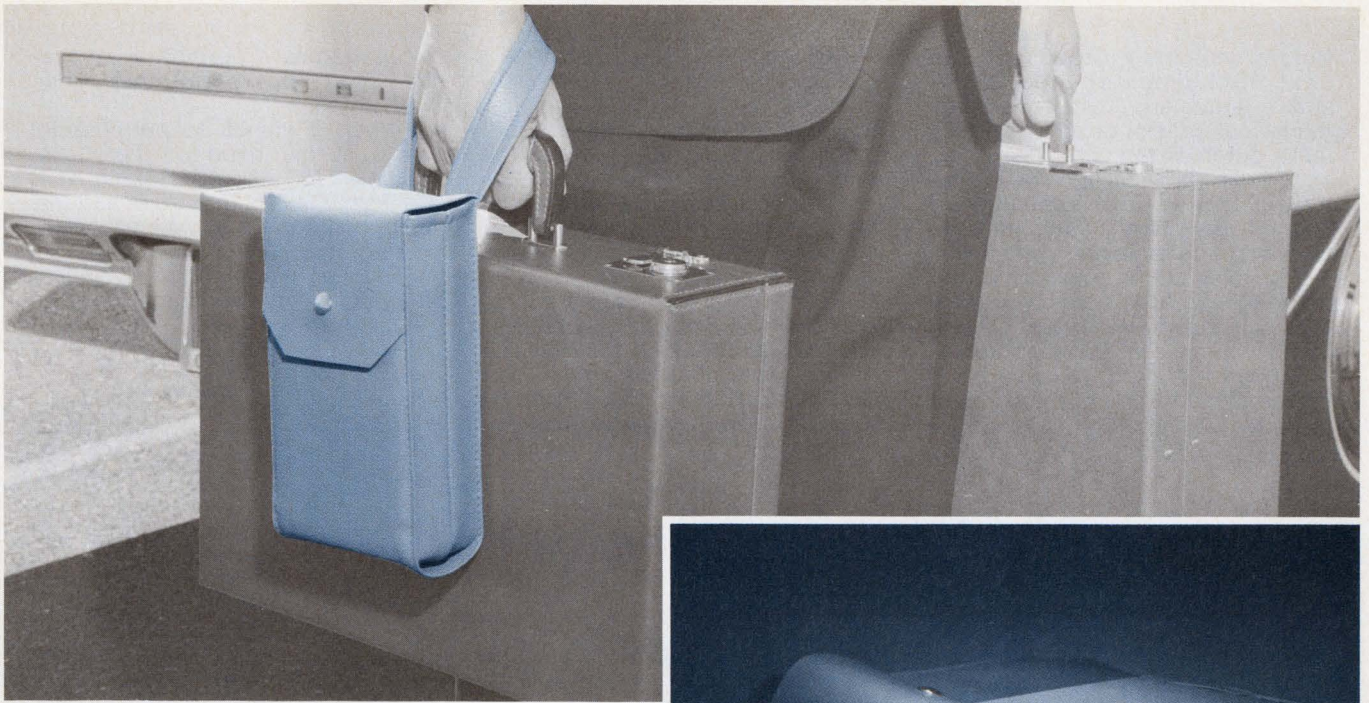

**See how easy  
it is to carry  
a suitcase,  
a tool kit ...**

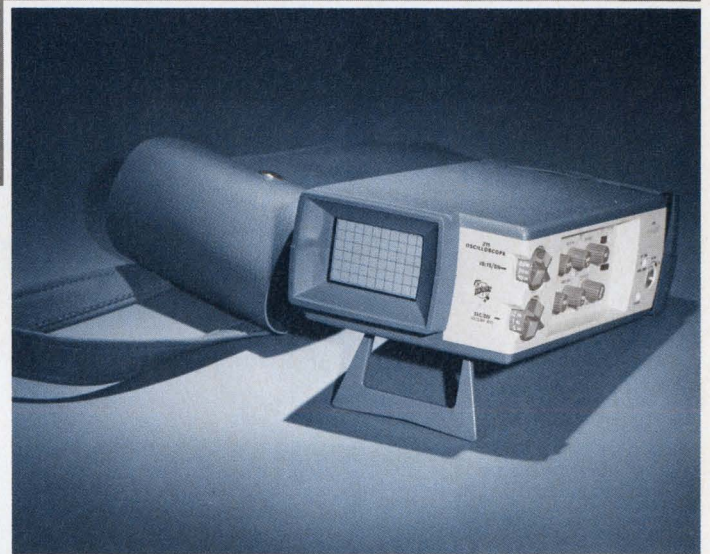

**... and a scope!**

Now there's a 3-pound scope that can be carried in your tool kit, suitcase, briefcase, glove compartment . . . almost anywhere.

It's the **211**, our first laboratory-quality miniscope. Size is only 3 x 5¼ x 9 inches. Bandwidth is 500 kHz. A lot of scope in a small package.

The **211** is easy to use. You spend your time solving measurement problems, not studying scope operation. Deflection factors from 1 mV/div and sweep rates from 5  $\mu$ s/div are read out from controls easily related directly to the CRT. One rotary control does all the triggering.

Ever wanted to float a scope? Here's one that floats to 500 volts RMS when operated from its internal batteries.

How many times have you misplaced a probe or power cord? There's no chance of that with the **211**. The probe and cord are attached and stored in a convenient, recessed area of the case. When you arrive on the job, both are right there, where you can find them.

And the **211** is built to take rugged trips. The double insulated high-impact plastic case takes tool kit knocks and bangs. Knobs are recessed for added protection. It's packaged in a real survival kit.

Need battery operation? The **211** operates from internal rechargeable batteries for up to 5 hours, and from AC.

Price? It's lower than many other 500-kHz scopes. Only \$545, FOB Beaverton, Oregon.

For a demo, just contact your local TEKTRONIX Field Engineer. He probably has a **211** in his briefcase. Ask him for complete information or write Tektronix, Inc., P.O. Box 500, Beaverton, Oregon 97005.



**TEKTRONIX®**

committed to  
technical excellence

Before you start designing your next minicomputer, phototypesetter, automatic test equipment, numerical control or other system, let us get in on the act.

We can show you several bright, imaginative ways of adapting our line of peripheral equipment to whatever you're working on now.

For example, it could be a digital magnetic tape cassette system that will cut down errors to less than 1 in 100,000,000 bits (computer verified). And, you've got the broadest modular line in the industry to pick from.

Or, it could be one of our many compact perforator/reader combinations with 75 cps punching capacity and 300 cps reading capability, for the price of some perforators alone.

Or select from a wide range of tape readers or reader/spooler combinations that has made us number one in this field.

Remex has a full line of products that will interface with whatever you're building. If we don't have it on the shelf, chances are we can adapt a unit to fit. Over the past decade that's how we've built our

reputation as a peripheral innovator. Our price/performance has helped too.

When it comes to peripherals, we're at the head of the class. Remex, 1733 Alton St., Santa Ana, California 92705. In Europe and the U.K., contact S.p.A., Microtecnica, Torino, Italy.

Give us a call (714) 557-6860. If a genius answers, hang on.

**REMEX**

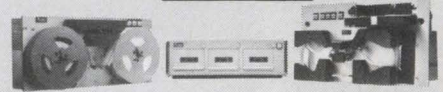

## Use our imagination.

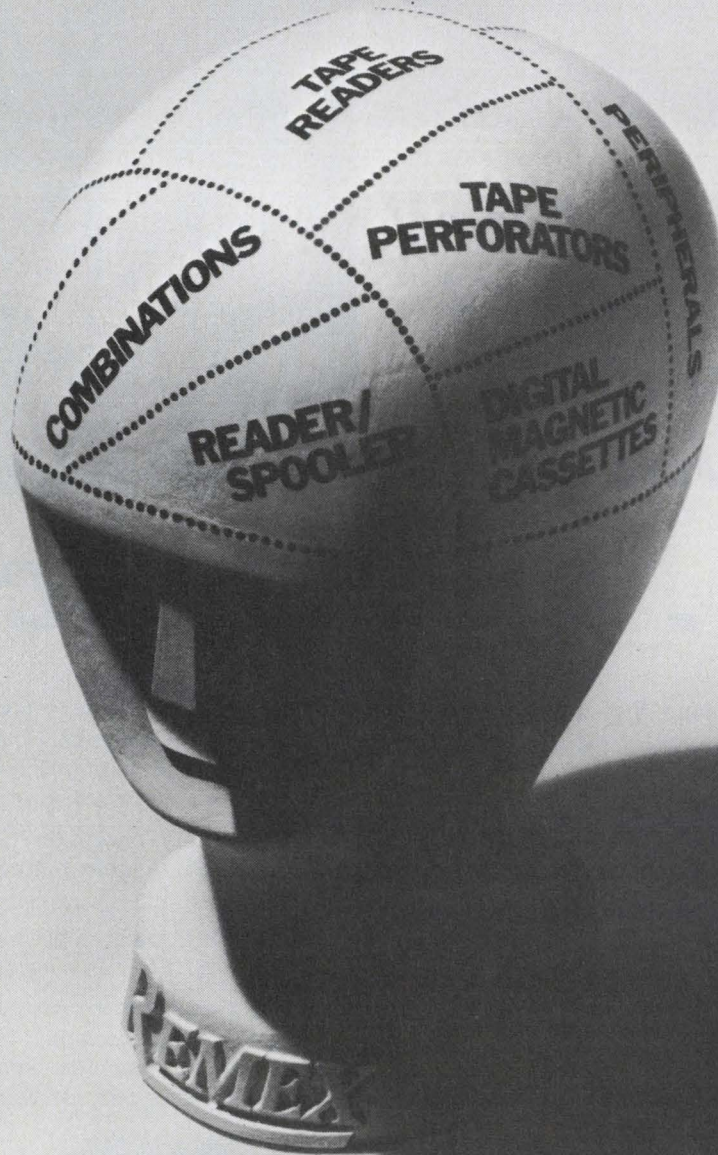

A UNIT OF



EX-CELL-O CORPORATION

# hp MEASUREMENT NEWS

information for better measurement

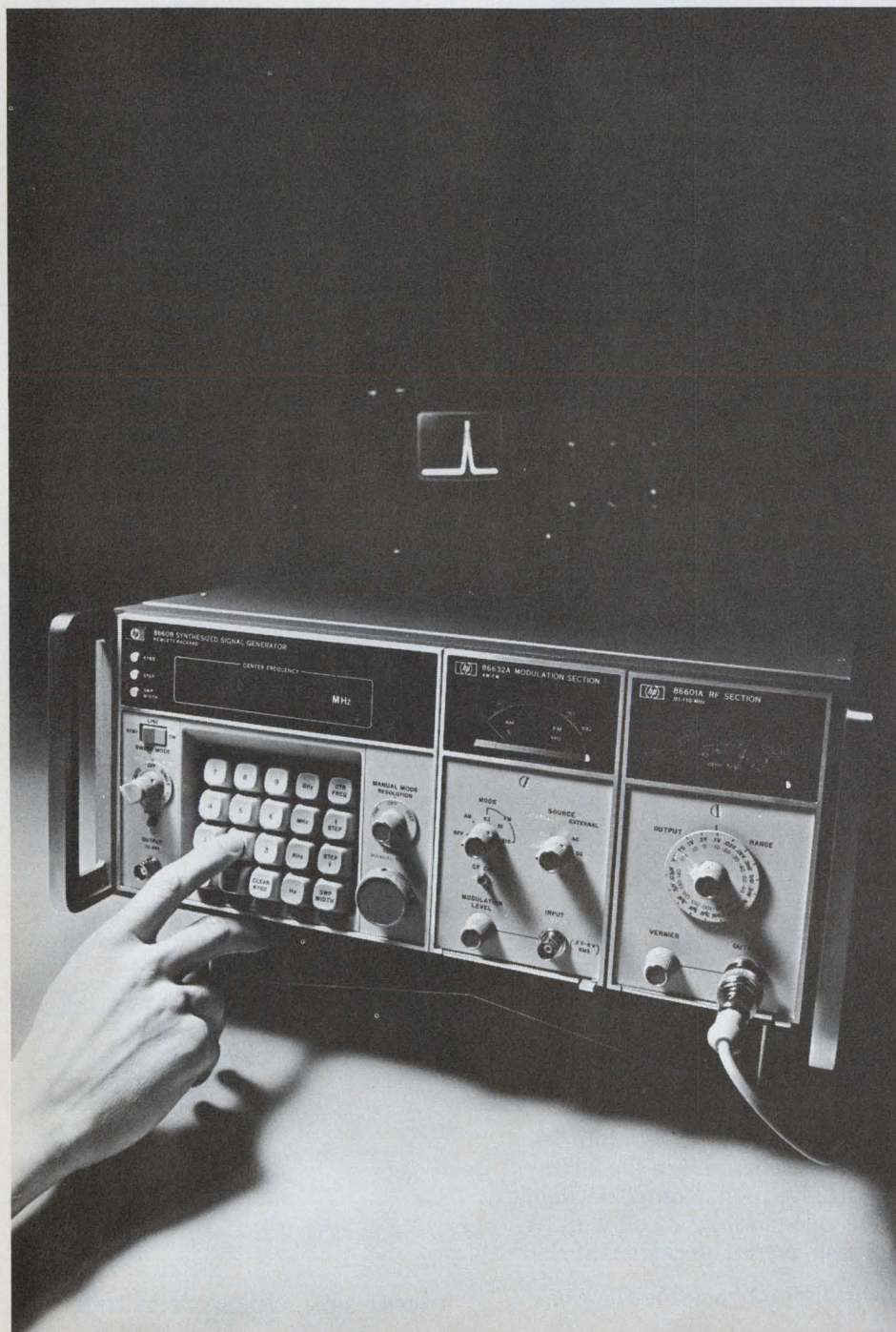

## in this issue

The new HP-35  
pocket calculator

First battery-powered  
storage scopes

A calculator  
that speaks algebra

## RF signal generator keyed for the future

An RF signal generator with synthesizer stability and spectral purity plus keyboard entry for frequency commands.

Unprecedented operator control is one of the new dimensions in RF signal generators provided by the keyboard-entry HP 8660B synthesized signal generator. All frequency commands are directly entered—not only CW, but also incremental frequency stepping and digital sweeping. Synthesized “continuous tuning” can also be achieved.

Whether you are stepping, sweeping, or tuning, the RF signal retains its synthesizer qualities: high stability, low residual FM, and low spurious content. The 8660 system also has advanced modulation capabilities (AM and FM) plus precise output level calibration and control.

*(continued on page 3)*

# Meet HP's powerful new pocket calculator

The HP-35 is a revolutionary approach to personal computation. Our new pocket calculator has the portability of a slide rule, the ease of an adding machine, and the problem-solving power of a small computer.

This innovative "answer machine" is helpful to anyone who uses advanced math whether in science, engineering, statistics, mathematics, education or finance. The 9 oz. wonder does far more than ordinary four functions; it handles logarithms, exponents, and trigonometric functions each with one keystroke.

Enter values in either floating-point or scientific notation. The operational stack of four registers plus a solid-state memory holds intermediate solutions to problems, then later automatically brings them back for further processing. You do not have to input recurring figures over and over.

The calculating range extends



This handful of solutions displays answers to ten significant digits, plus sign and two-digit exponents of 10. The decimal point is automatically positioned.

from  $10^{-99}$  to  $10^{99}$ . And the price is within your range—only \$395.

To find out how to get one, check the HP Reply Card.

# Wide dynamic range for the sight of sound

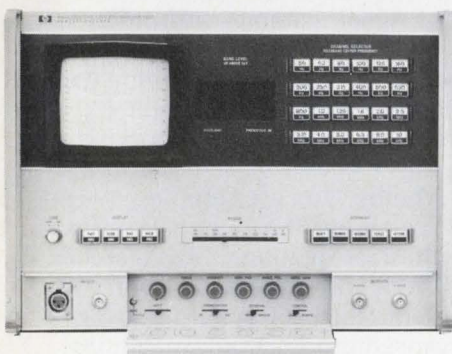

The 8064A has complete programmability built in for easy computer interface.

Displaying the frequency spectra of sounds as they occur, the 8064A audio spectrum analyzer operates independently or as part of an automatic data acquisition, processing or recording system. Active filters divide the spectrum into 24 third-octave channels in the 2 Hz to 40 KHz frequency range. Dynamic range is outstanding: 84 dB with 60 dB displayed. The price is \$9,950.

To learn more, check the HP Reply Card.

# Collision avoidance role for cesium beam clock

HP's atomic frequency standards play a major role in new air collision avoidance system (CAS) successfully tested by the Air Transport Association and a commercial airline. In CAS each aircraft sends a coded message every three seconds. Time-synchronized equipment in other listening aircraft computes (a) the distance to the transmitting aircraft, (b) the closing rate, and (c) altitude difference to determine collision threat and indicate proper evasive maneuvers.

For ultra-precise CAS time-keeping, HP developed a rugged miniaturized cesium beam atomic frequency source for aircraft use. This HP 5062B "clock" is only 5 by 8 by 19½ in. (123 by 194 by 495 mm) and makes CAS independent of ground stations.

Because CAS is a navigation system, the small CAS cesium beam standard is creating interest among people involved in navigation, tracking and communication systems of other types.

The HP 5061A cesium beam standard, a larger version, has been available for eight years. Absolute accuracy is  $1 \times 10^{-11}$  ( $7 \times 10^{-12}$  optional). Price: \$15,500.

For more about precision frequency sources, check the HP Reply Card.

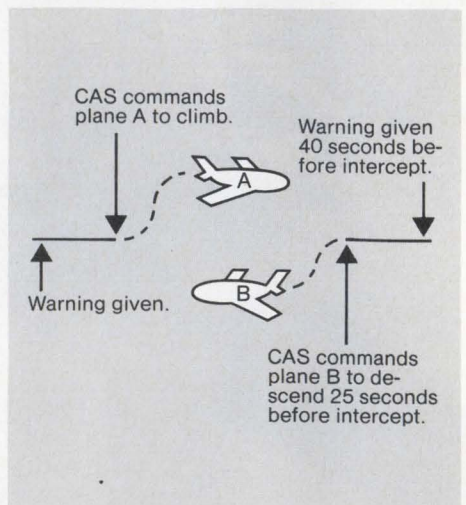

**COLLISION AVOIDANCE SYSTEM**  
Evasive Action Sequence

## Powerful plug-in with selectable impedance

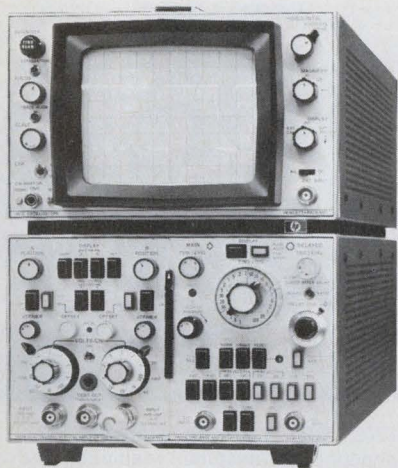

The 1805A (lower left panel) has dc offset that eliminates dc reference on logic and noise pulses yet maintains low deflection factors for maximum amplitude displays.

A new 100-MHz vertical amplifier plug-in for 180-series oscilloscopes packs more measurement capability into one plug-in than any previous unit. The dual-channel 1805A has selectable 1 megohm/50 ohm inputs, 5 mV/div deflection factors from dc to 100 MHz, up to  $\pm 200$  divisions of offset, and a vertical signal output that allows cascaded operation to 250  $\mu\text{V}/\text{division}$ .

Use 1 megohm input for general purpose probing or the 50-ohm impedance for transmission-line measurements. The low capacitance doubles the frequency range over which probing can be performed without serious loading of the circuits. Price: \$1400.

Check the HP Reply Card for details.

*continued from page 1*

The 8660B is ideally suited for the most demanding measurements; e.g., narrow-band receiver testing and crystal filter tests. In addition to keyboard control, it features 10 digit LED readout of frequency, TTL programmability and computer compatibility. And there is plug-in RF coverage, 0.01–110 MHz and 1–1300 MHz.

Prices of the 8660 systems start at less than \$6000; the 8660B keyboard mainframe costs \$6000.

## Synthesizer for precise amplitude and frequency control

The ideal signal source should have excellent frequency accuracy and stability, precise amplitude control, a reasonable price tag, and the ability to interface easily with systems. The HP 3320 A/B frequency synthesizers have all these features, plus spectral purity of a quality RC oscillator and low signal-to-phase noise.

The 3320A adds synthesizer quality to production and design work yet does not distort your budget. The 3320B is a precision bench instrument as well as a quality programmable signal source. With amplitude accuracy, resolution and frequency response measured in a few hundredths dB over a 100 dB attenuation range, the 3320B is both a frequency standard and a very precise level generator. It is the standard low frequency source in HP's 9500 automatic test systems.



Synthesizer options include remote control, two lower frequency ranges, 75-ohm output, crystal oven, and marked card programmer.

The 3320 has the widest frequency range of any test oscillator, programmable oscillator or low cost frequency synthesizer on today's market—0.01 Hz to 13 MHz.

Prices: 3320A, \$1900; 3320B, \$2400.

For details, send the HP Reply Card.

## How to achieve low-cost data reduction



You can interface a 9100, 9810 or 9820 calculator to the highly-diverse coupler/controller system.

Many people who could benefit by automating data collection and testing shy away from it because they believe it would be too complicated and expensive.

Not any more. HP has developed a calculator-based instrumentation system—low cost and easy to use—for on-line data acquisition and

automatic testing. You can program from the keyboard within a few hours; there are no special languages to learn.

It's basically a computing system (in the form of a powerful calculator) attached to a measurement system through a versatile coupler/controller. The calculator interfaces with up to seven devices—DVMs, scanners, teletypewriters, tape punches and readers, recorders, etc.—through cards plugged into the coupler/controller. The calculator serves as the system program source and data processor. Results can be plotted simultaneously with printed, tabulated reports.

Automate your lab experiments and production testing at a fraction of the "computer price." Calculators begin at \$2975; coupler/controllers start at \$1275.

For all the details, send the HP Reply Card.

## A first: do-it-yourself microprogramming



No extra cables or power supplies—the single Writable Control Store card contains 256 24-bit words and all required address and read/write circuitry.

Now you can have a computer with Writable Control Store capability. You can test and debug preliminary microprograms, alter or extend the instruction set—under actual run conditions, and just as fast as operating from read-only memory.

Program execution in the 2100A is controlled by a computer within a computer. The internal computer, or microprocessor, executes microcode stored in its extendable read-only memory. With WCS, you can check this microcode before committing it permanently to ROM. You can also output, debug and alter microcode subroutines dynamically, during run time.

Specially developed software—including a micro-assembler, utility and I/O routines, drivers, and diagnostics—automatically puts your microprogram into the required form. And an optional PROM Writer commits the debugged microprograms permanently to read-only memory.

Prices: 12908A Writable Control Store, \$3500; 12909 PROM Writer, \$500.

For WCS information and a copy of our "Microprogramming Guide," use the HP Reply Card.

## New persistence/storage scopes that work wherever you do

Only our new 35-MHz portable oscilloscopes give you variable persistence/storage *anywhere* and *everywhere*. They are battery-powered and smaller than a suitcase. The 1703A scope has a burn-resistant CRT, along with main and delayed time base sweep speeds to 10 ns/div and a 10 mV/div deflection factor. Model 1702A is identical, but without delayed sweep.

Variable persistence lets you preserve low rep-rate signals and read the CRT display without clutter from old traces. Trace retention time is adjustable, from less than 1 second to over an hour. Use variable persistence as a pseudo-normal write mode when you need extra brilliance, or use it anytime a low sweep speed causes annoying flickering.

The storage holds single-shot phenomena or other infrequent events for over an hour. Writing speed is 100 div/ms; push the Max

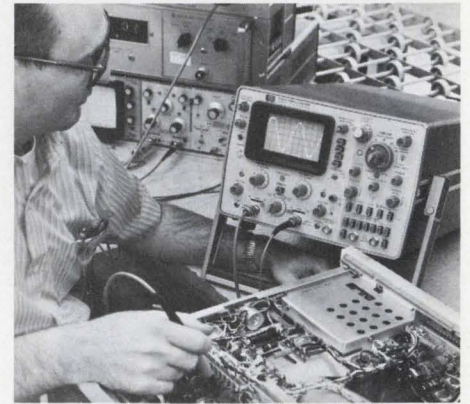

The 1703A CRT is burn-resistant and uses P31 phosphor for excellent resolution and sharp spot size.

Write button, and the speed is 1000 div/ms.

Both scopes operate on 11.5 to 36 Vdc, any ac outlet, or from a battery pack that fits snugly inside.

The 1703A costs \$2725; the 1702A (nondelayed), \$2375.

Interested? Check the HP Reply Card.

## New high-speed x-y recorder especially for OEMs

Pulmonary testing is just one application for the new high-speed OEM 7041A recorder. Original equipment manufacturers also use it in correlators, Fourier analyzers, pulse-height analyzers, wave analyzers, and

The 7041A writing area is 10 by 15 in. (25 by 38 cm) with an autogrip for 11 by 17 in. or international A3 size paper.

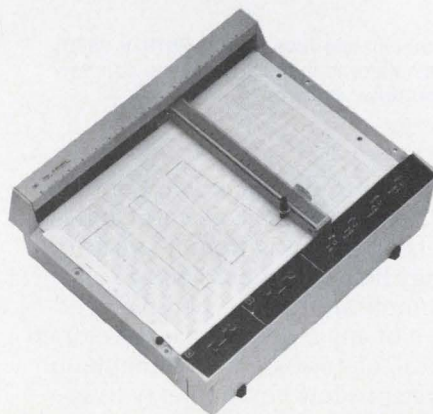

calculator plotters. By high-speed, we mean a minimum slewing speed of 30 in/sec and acceleration of 3000 in/sec<sup>2</sup> on the Y axis, 2000 in/sec<sup>2</sup> on the X axis.

This recorder is designed for OEMs who need speed and precision, but don't want costly features irrelevant to end-use. The one-piece aluminum mainframe is rugged, yet shock-resistant. The circuitry contains only ten hand-soldered connections; no expensive maintenance or special calibration is required. A new motor design lets the recorder pen be driven offscale for an indefinite period of time without noise or damage.

You select only what you need from almost 40 available options. The 7041A recorder costs \$1050. OEM discounts are available.

To learn more, check the HP Reply Card.

## Nifty new options for HP strip chart recorder

HP's 7123 linear motor recorder, enhanced by three new options, now writes without ink, quantifies peak areas, and has four-speed transmission.

Electric Writing (Option 036) is a low voltage system that provides a clear, permanent trace on electro-sensitive paper.

The Electronic Chart Integrator (Option 035) computes complex peak area measurements and averaging. Integration is continuous; there is no lag time between main pen and integrator pen responses. Compare this with the time it takes you to read the chart, calculate mathematically, and write the results—not to mention eliminating human error, too.

Our own version of "four on the floor" is an Incremental Chart Drive (Option 045) which provides four speeds (selectable from the front panel) and an external input. Match the chart speed with other recorders, correlate it with computer output, or synchronize it with pulse output from flow meters. The 7123A costs \$750. For electric writing, add \$35; the integrator, \$750; and the chart drive, \$155.

*For more details, send the HP Reply Card.*

The 7123 10-in. strip chart recorder with integrator and incremental chart drive fits neatly in a spectrum analyzer.

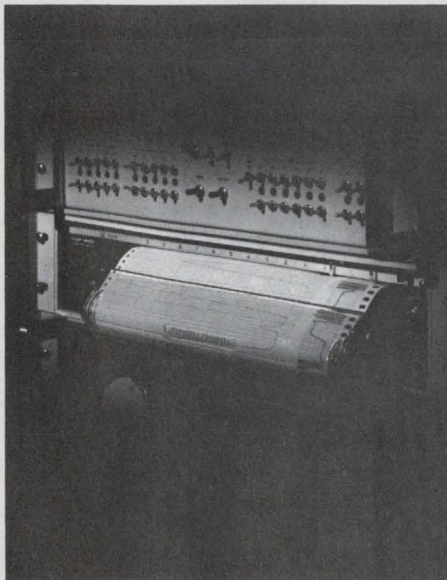

## Automatic microwave test system costs much less than you'd expect

The 8545A has the speed, accuracy and versatility you need to solve measurement problems in production test and the design lab—with visual answers on the console graphics display.

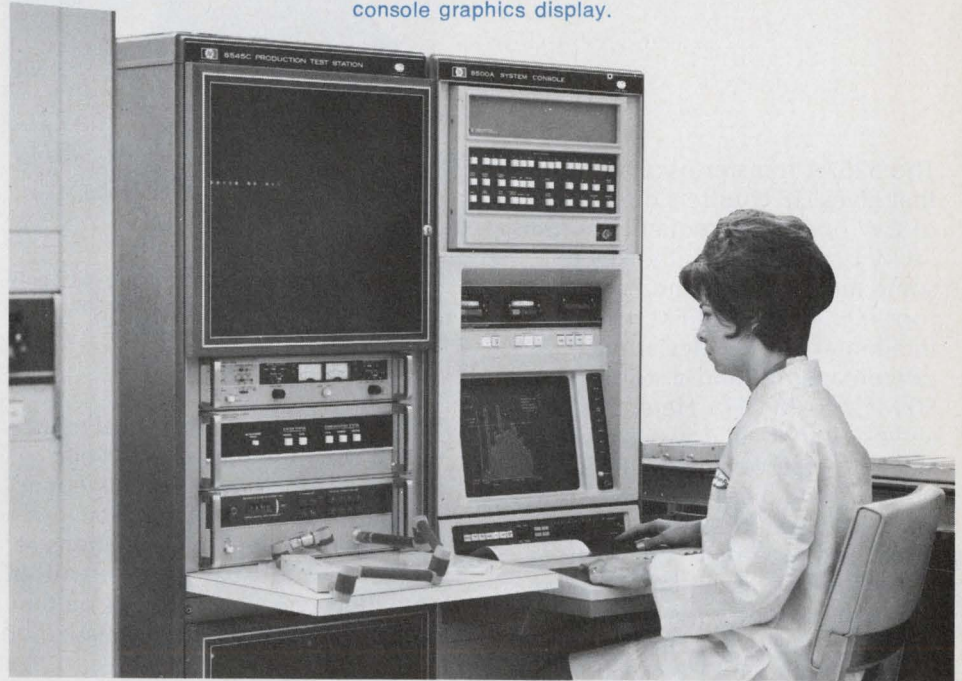

Let us surprise you with the low price and high cost-effectiveness of our new 8545A Automatic Network Analyzer. Modular in concept, a basic system can be linked to your existing timeshare facilities—for less than \$50K.

Extend its frequency coverage and measurement capabilities incrementally and expand to an independent dedicated system with BASIC language software control. You can then add the high-speed interactive graphics display and enhanced operator control capability of the system console. You buy only the capability you need now, and add to the system as your needs increase.

The system measures amplitude and phase-related parameters of one- or two-port devices under automatic control in single or multiple frequency bands from 100 MHz to 12.4 GHz. Measurement accuracy difficult to achieve with manual methods is provided by system calibration and error correction techniques. The computer handles data conversions ranging from the s-h-y and z parameters of active

devices to gain, loss, VSWR and impedance.

Test fixtures and adapters let you measure active and passive components: transistors, amplifiers, antennas, cables, waveguide and stripline components.

For production testing, the timeshare system provides a low-cost solution to automating those difficult tests even with small variable test runs. Timeshare allows you to store many different user-written programs that the operator can call by typing a name. These same advantages apply to your design lab. Each engineer can develop his own program series to suit his particular measurement needs.

The dedicated system gives you high-speed measurements for large test runs and built-in programming capability with HP BASIC software, together with a flexible operator interface through the use of a magnetic tape cassette unit, high-speed printing and interactive graphics display.

*Interested? Send the HP Reply Card.*

## New capabilities in AM, FM measurements

The 5257A transfer oscillator plug-in that gives HP counters direct readout of CW or pulsed frequencies from 50 MHz to 18 GHz is the key to some more difficult measurements too; e.g., incidental FM, rms incidental FM, FM deviation, percentage AM and distortion from 50 MHz to 18 GHz. Here, the 5257A serves as an ideal down-converter since it preserves the input signal's noise, AM and FM characteristics and, in pulsed RF signals, the pulse width and repetition rate.

A wide-band sampler gives the 5257A its unique wide range, constant sensitivity, and one-dial tuning. Use it with HP's well-known 5245, 5246 and 5248 electronic counters. They accept any of 12 frequency or function-extending plug-in accessories for almost any frequency or time interval measurement you are likely to need. Their outstanding reliability is documented by 40 million hours of operating data.

Prices: \$2450 for the 5257A; the counters start at \$2000.

*For more information on AM and FM measurements, check the HP Reply Card.*

### 5257A Transfer Oscillator



## New desktop calculator that converses in algebra



**Design your own calculator. Three read-only-memory function blocks plug into the left side of the Model 20 keyboard.**

Program ten times faster in algebra with a machine that speaks *your* language—the new 9820A algebraic programmable calculator. You merely enter algebraic equations at the keyboard just as they are written on paper; check expressions on the exclusive alphanumeric display; then

press another key to store or execute the program.

Full editing capability lets you press a key to delete, change or insert characters, lines or statements. When a line is added or deleted, the program automatically adjusts to occupy minimum memory.

The basic 173 registers can solve 17 simultaneous linear equations with 17 unknowns. Or, expanded to 429 registers, it is capable of 36 linear equations with 36 unknowns. An optional mathematics plug-in block adds log and trig functions; a user-definable block lets you "personalize" up to 25 keys; and a peripheral control block interfaces with plotters, typewriters, and card readers.

Price: \$5475, including thermal printer and magnetic card reader. Functional plug-ins cost \$485 each.

*For more information, check the HP Reply Card.*

## Now you can digitize low frequency waveforms

Two new 3480 DVM options, Sample-and-Hold and Data Storage, store up to 50 readings made on a changing input voltage. Sample-and-Hold freezes a changing input voltage at one instant in time; storage enables use of Sample-and-Hold at high speeds (1000 readings/sec) yet lets the data be printed economically on a low speed printer.

This pair of options opens up new applications including vibration analysis, servo system analysis, and ramp linearity tests. Repetitive wave shapes can be digitized or peak readings can be made. Entire wave shapes up to 410 Hz may be digitized with four-digit resolution.

Both options fit into the 3480 mainframe. Three signal conditioning plug-ins are available for the 3480, including the new 3485A scanning unit with up to 50 input

channels. The 2070A Data Logger puts it all together in the form of a self-contained data acquisition system complete with printer.

The 3480A costs \$800; the 3480B, \$900. For Sample-and-Hold, add \$500; Data Storage, \$1000. The 2070A starts at \$2870.

*For details, check the HP Reply Card.*

**Add a few options and the 3480A DVM becomes a handy data logging system.**

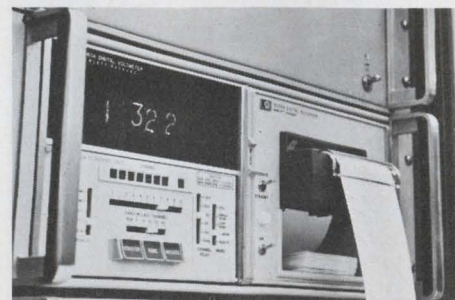



## New IMPATTs simplify microwave design

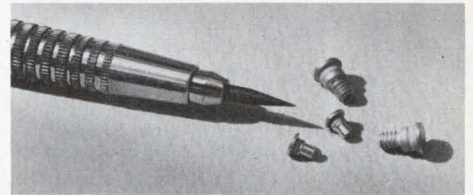

The 5082-0420 series silicon IMPATTs

## Microwave transistors: the best cost less

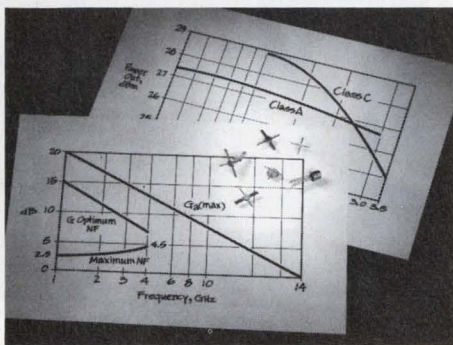

The sturdy HP 21, noise-quashing HP 22, and powerful HP 11 belong in your amplifier design.

Three new high frequency transistors mean you don't have to trade performance for low cost in amplifier and oscillator design. The HP 22 offers a typical noise figure of 4.0 dB at 4 GHz (with a guaranteed maximum of 4.5 dB) without relinquishing gain. At the optimum noise bias (10V, 5 mA), gain at 4 GHz is 6.5 dB. When matched for gain, this 14 GHz  $f_{max}$  device has 14.5 dB gain at 2 GHz and 9.3 dB gain at 4 GHz. Price: \$75.

The HP 21 gives low cost gain with no mid-stage amplifier noise penalties. This 12 GHz  $f_{max}$  device gives a gain of 12 dB at 2 GHz with 4.2 dB NF. Characteristic of all HP transistors, it is reliable; the HP 21 has demonstrated a 10 million hour MTBF. Price: \$19.

More Class A and C power per dollar is the strength of the HP 11. It features 27.5 dBm saturated, and 27.0 dBm linear power out at 2 GHz. Price: \$19.

Check the HP Reply Card for complete technical information.

## Small, new, low-powered LED display

Hewlett-Packard has developed a nifty five-digit LED display for designs where space and power are limited. This 5082-7405 solid-state numeric display package is 0.75 inch wide and requires only 7 mW per digit. Its compact size and low power requirements are ideal for battery-powered or hand-held multimeters, probes and miniature calculators.

This is one miniature display that is easy to read. Bright red numbers contrast against the dark lead frame. A self-magnifier enlarges each digit to 0.112 in. high, and one digit is dedicated to the decimal point for excellent display legibility.

Installation is quick. Simply plug the display into a standard DIP socket or a printed circuit board.

Prices: \$32.50 each (1-19), \$22.50 (20-99), \$17.50 (100-199) and \$16 (200).

To learn more, send the HP Reply Card.

The 5082-7405 LED numeric display

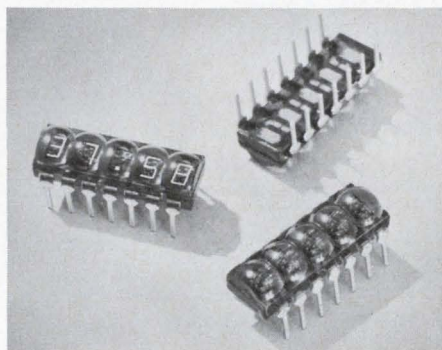

HP's 5082-0420 series diodes are the first silicon IMPATTs to achieve microwave power levels of 1.5 W at 7 GHz and 1 W at 13.5 GHz. These silicon devices simplify the design of telecommunication repeaters, telemetry transmitters, and doppler navigational radars. Instead of costly gallium-arsenide devices or frequency multiplier chains, these silicon IMPATTs can be used as the active element in oscillators and amplifiers from C through K $\mu$  band, when power, efficiency and reliability are critical. HP IMPATT diodes are rugged and reliable devices that meet MIL-S-19500.

Prices are \$150 each (1-9), \$110 each (10-99), and \$75 each (100).

For complete information on our IMPATTs, check the HP Reply Card.

## Counter options for high stability, sensitivity

Already they are probably the most versatile medium-priced, general-purpose counters available, but now HP's 5326/5327 universal counters can have higher input sensitivity and stability. Option H60 increases sensitivity to 25 mV rms, 0° to 50°C (10-15 mV rms typical at 25°C). Long term stability becomes  $3 \times 10^{-9}$ /day with Option H49 and  $5 \times 10^{-10}$ /day with Option H50. Temperature effect is  $<1 \times 10^{-8}$  total, -20° to +65°C.

Option prices: H60—\$125; H49—\$300; and H50—\$450.

Check the HP Reply Card for details.

# Now, get HP performance and reliability from 44 new modular power supplies

You've undoubtedly heard of HP laboratory power supplies; now you can get the same HP quality in **modular** power supplies. Hewlett-Packard has introduced 44 new competitively-priced models for use wherever a dedicated source of dc power is required.

The 62000-series covers eleven popular voltage ratings from 3 to 48Vdc, with four output current ratings at each voltage rating. For example, at 5V there are 2.0, 4.0, 8.0, and 16.0A supplies. Intermediate output voltage ratings are also available on a special handling basis.

The units are packaged in three uniform height and depth cases which are fractions of standard 19-inch rack width: 1/8-width, 1/4-width, and 1/2-width. Combinations of the three packages can be mounted in an accessory rack tray, or the supplies can be mounted individually on various sides.

These series-regulated supplies provide 0.01% line and load regulation, with ripple and noise of less than 1mV rms and 2mV p-p (up to 20MHz).

What makes these power supplies different? For one, they're thoroughly protected, which means

Three of HP's 44 new 62000-series modular power supplies.

you are too, even if you misapply them. If high ambient temperatures overheat the supply, a thermostat opens the fused ac line automatically. Critical loads are protected from receiving excessive output voltage if a remote sensing terminal is accidentally disconnected. Reverse voltage and current protection is also built in. Should something short the power supply output, adjustable cutback current limiting will restrict current to approximately 10% of rated output. Overvoltage protection (an internal, adjustable, overvoltage crowbar) is also available as a separate option.

This unique combination of protection features helps make HP modular supplies an exceptional value. Excellent reliability, achieved through a trouble-free design utiliz-



ing conservatively rated, high-quality components, adds even more value. And should you run into a tough applications problem, every one of HP's 172 field offices stand ready to assist you or provide service support.

Prices range from \$89 to \$195, depending on power output and package size. OEM and quantity discounts are available.

*For full details, return the HP Reply Card.*



Measurement, Analysis, Computation

**East**—W 120 Century Road, Paramus, N.J. 07652, Ph. (201) 265-5000.  
**South**—P.O. Box 2834, Atlanta, Ga. 30328, Ph. (404) 436-6181.  
**Midwest**—5500 Howard Street, Skokie, Ill. 60076, Ph. (312) 677-0400.  
**West**—3939 Lankershim Boulevard, North Hollywood, Calif. 91604, Ph. (213) 877-1282.  
**Europe**—Rue du Bois-du-Lan 7, CH-1217 Meyrin 2, Geneva, Switzerland, Ph. (022) 41 54 00.  
**Canada**—275 Hymus Boulevard, Pointe Claire, Quebec, Canada, Ph. (518) 561-6520.  
**Japan**—Ohashi Building, 59-1, Yoyogi 1-chrome, Shibuya-ku, Tokyo 151, Japan, Ph. 03-370-2281/92.

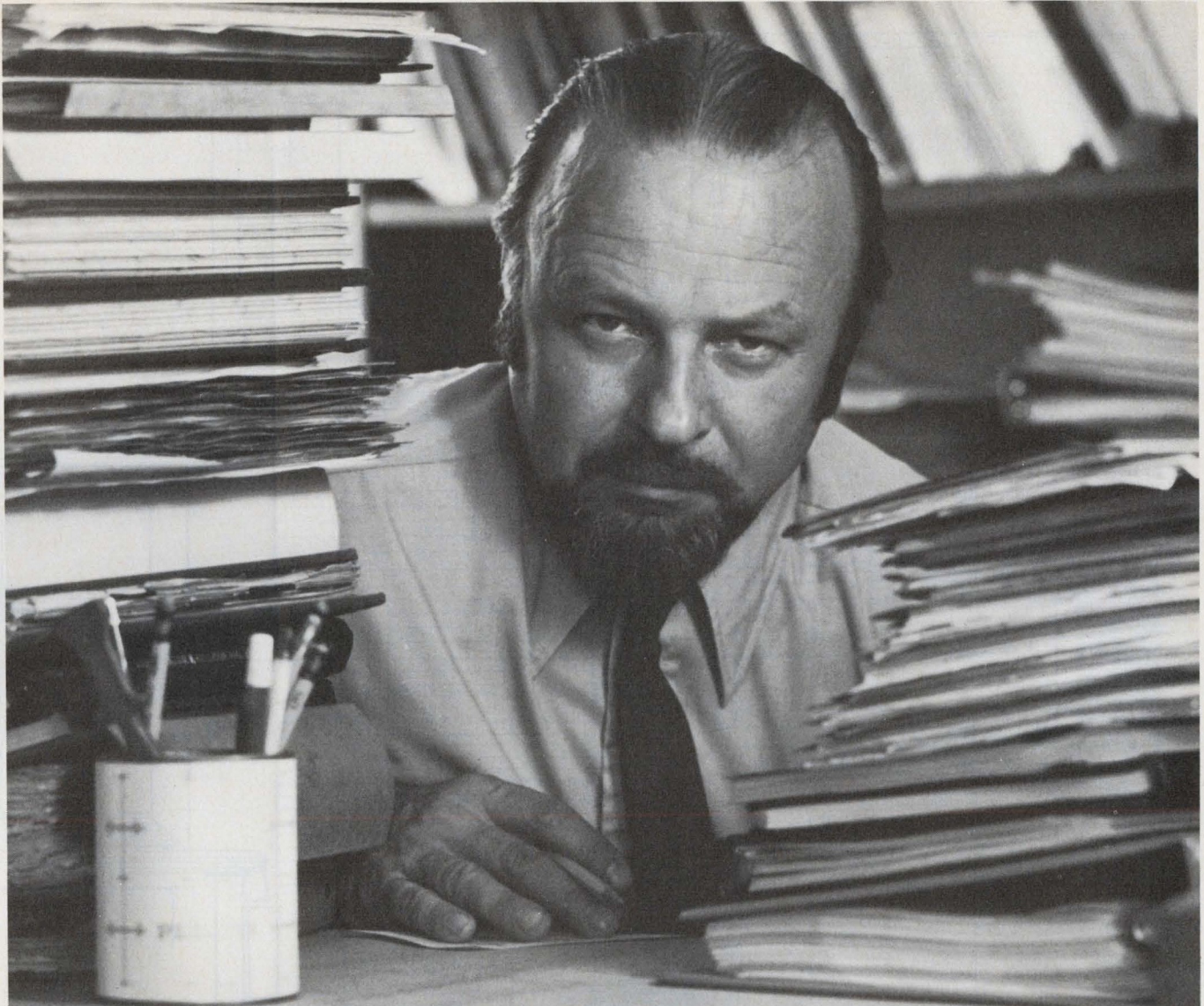

## Talk to this guy long enough and he'll tell you where to go.

Dr. J. Myron Johnson, Research Professor of Psychology, heads the Laboratory of Psychological Studies at Stevens Institute of Technology in New Jersey. And he indeed tells people where to go—very successfully. Dr. Johnson's project is typical of the dynamic R&D activities that abound in New Jersey. In this case, Dr. Johnson and his staff have developed a method for career counseling that helps take most of the risk out of changing jobs.

They also provide counseling on management development and employee appraisal and selection for private industry. It's all part of a major program at Stevens to continuously study the problem of directing human energies. It's also a typical example of New Jersey's colleges and universities working

closely with private industry. This rapport is one important reason why New Jersey is a leader in research and development.

Talk about leadership, about one-fourth of America's private research and development is carried on in New Jersey. In fact, New Jersey has the nation's greatest concentration of research workers. And more trained technicians are being made available to the R&D industry through a system of new, progressive two-year community colleges in the state.

If you ask Dr. Johnson where to go to find a climate that's right for research and development activities, very likely he'd tell you New Jersey. Our new booklet, "Brainpower-New Jersey" shows you why.

Mail the coupon for your free

copy. Naturally, if you don't agree with us after reading it, you always have the prerogative of telling us where to go.



### PSE&G

Public Service  
Electric and Gas  
Company

**Mail This Coupon Now!**  
PSE&G, 82 Park Pl., Newark, N.J. 07101

Please rush my free copy of your new in-depth report of R&D in New Jersey

Name \_\_\_\_\_  
Company \_\_\_\_\_  
Address \_\_\_\_\_  
City \_\_\_\_\_ State \_\_\_\_\_ Zip \_\_\_\_\_

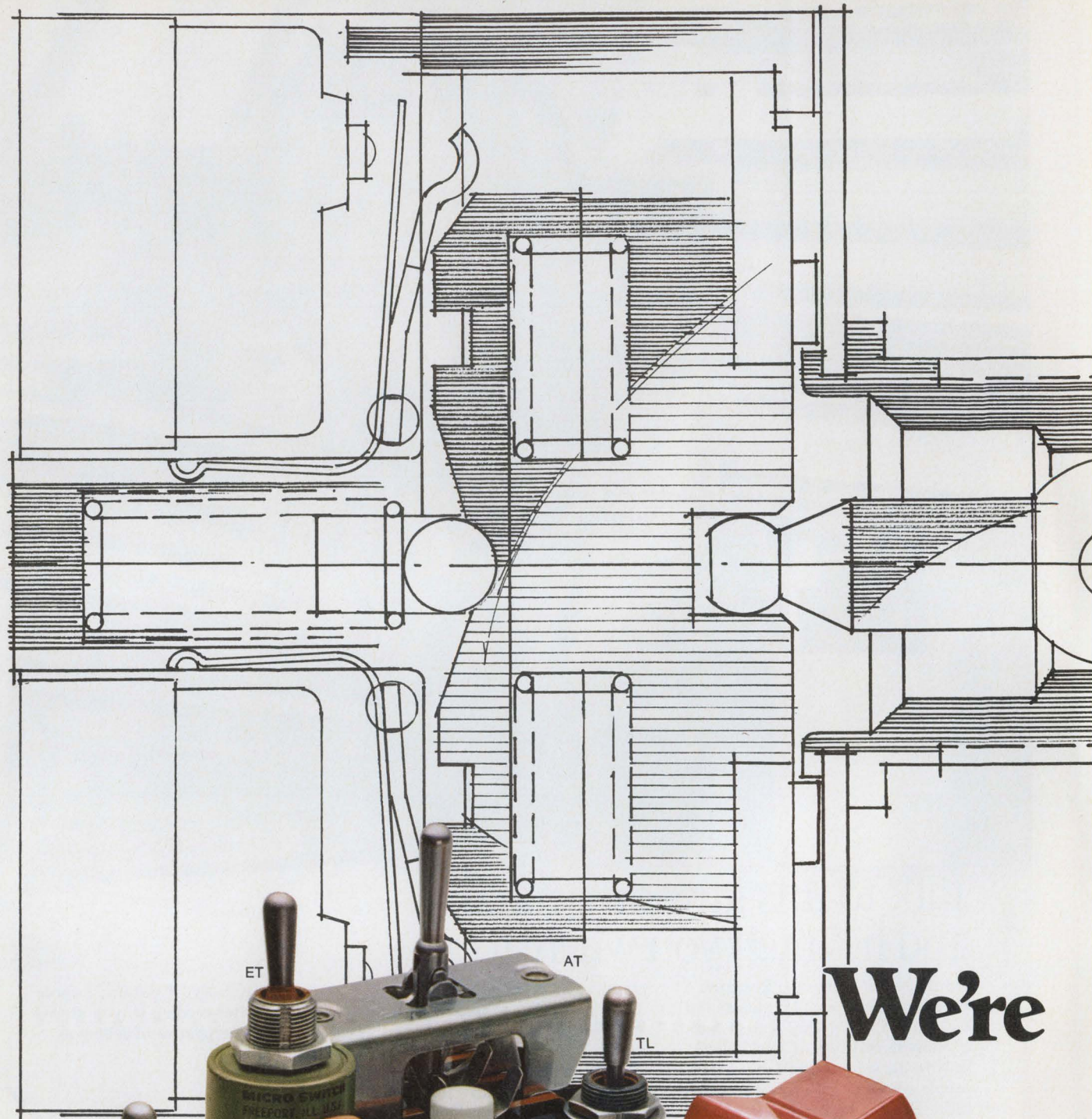

**We're**

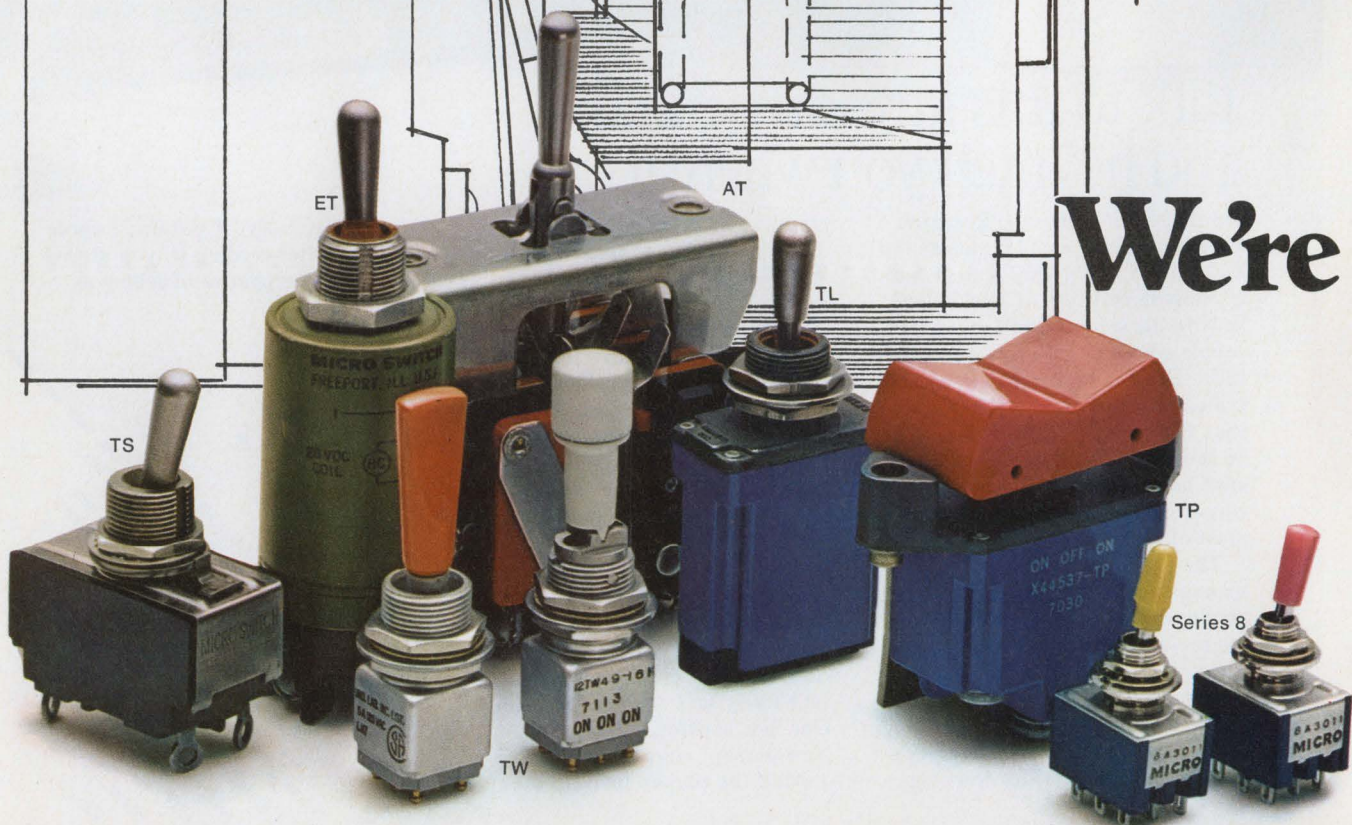

MICRO SWITCH products are available worldwide through Honeywell International.

**T**hink MICRO SWITCH when you're in the market for toggle switches. Because we offer one of the biggest selections in the world. With an almost limitless choice of size, circuitry, capacity and toggle action.

#### CHOICE NOT CHANCE.

If space is a problem, miniature TW's can provide versatility comparable to many larger switches. When cost is a problem, the new Series 8 features quality construction at a low cost. Standard-size TS toggles are excellent, moderately-priced switches available for both military and commercial use.

For environmental sealing, consider either the magnetically held ET (MIL-E-5272 and MIL-S-3950A) or the tough TL (MIL-S-3950A).

If you're looking for the versatility and styling of pushbuttons, but require toggle circuitry, take a long look at the TP or our new Series 8 rocker switches.

#### A CHOICE OF ASSEMBLIES, TOO.

AT toggle assemblies use snap-action switches to perform the switching operation. Up to twelve switches can be operated by one toggle. Choose from subminiature, high capacity, as well as sealed types.

There are plenty more. For information on any or all of them, see your MICRO SWITCH Branch Office or Authorized Distributor (Yellow Pages, "Switches, Electric"). Or write for our literature.

*MICRO SWITCH makes your ideas work.*

## **MICRO SWITCH**

FREEPORT, ILLINOIS 61032  
A DIVISION OF HONEYWELL

INFORMATION RETRIEVAL NUMBER 32

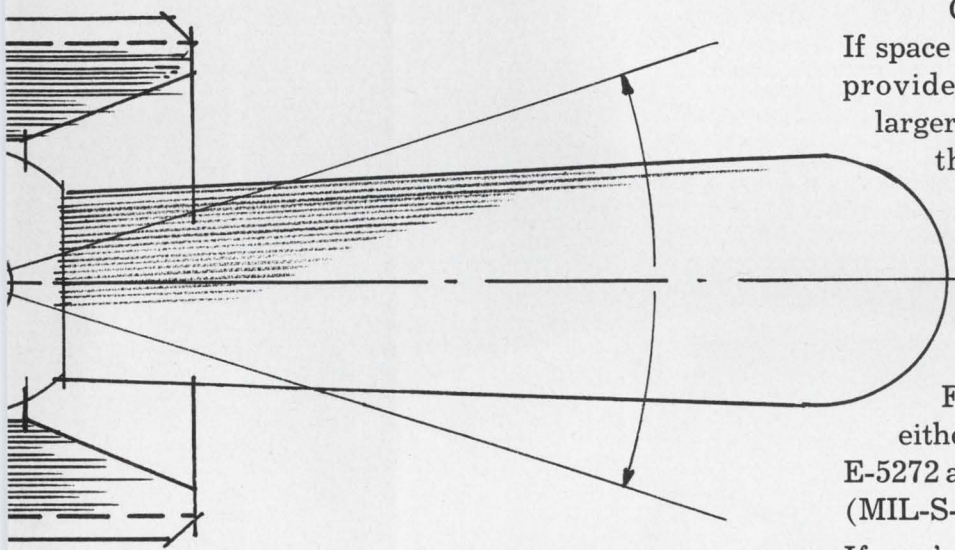

# big in toggle switches.

# VACTEC PHOTOCELLS

## boiled to perfection

Heat, water, steam, or a combination of all three, can't penetrate Vactec's positive hermetic seals. Even the passivated plastic types are exceptionally stable. Vactec Photocells not only endure boiling water temperatures (100° C), but also other environmental extremes down to liquid nitrogen cold (-196° C).

Long term moisture like 500 to 5000 hours in a humidity chamber can be even more destructive than boiling. If you put Vactec to this test, be sure to include some competitive cells for comparison.

You simply can't buy a better photocell *anywhere*, and Vactec is competitive with import prices because of automated processing, assembling, and testing. Take advantage of Vactec engineering, research, and manufacturing in the heart of America. Because Vactec has 249 different types of cells in stock, we can ship before your order reaches an overseas supplier. Included is a complete line of visible detectors: photoconductors (CdS and CdSe); photovoltaic cells (Se and Si); couplers of LED's or lamps and photoconductors called Vactrols. Vactec also has a photometer which measures from .0002 to 10,000 fc, for as little as \$300.00.



### VACTEC, INC.

2423 Northline Industrial Blvd.  
Maryland Heights, Mo. 63043  
Phone (314) 872-8300

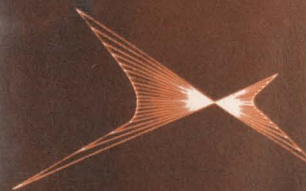

## Advance to the rear?

The past two years were pretty rotten for our industry. Understandably, many engineers adopted recession tactics. They stuck with old equipment as long as they could. And when they bought new stuff, they pinched pennies and avoided unnecessary performance.

Many vendors, sensing the new attitude, designed minimum-performance equipment for this minimum-dollar customer. That was fine, because the vendor made a sale and the customer got some equipment. But it created a problem, because both parties began to think this was a new and normal way of life that could go on forever. And that's not so.

The wave of the future isn't reduced performance. In the long run, engineers won't be paid to design out performance that other engineers were paid to design in. And customers won't buy the lowest performance possible.

Some of the movement toward low-cost, low-performance equipment is an overreaction to absurdities of the past. There were many. Engineers fell in love with speed and bought fast devices, despite the penalties of price, heat and noise. They fell in love with component density, when they had plenty of space available. They bought vhf scopes to look at audio signals. And they bought power sources with regulation far beyond what they needed. Said one power-supply vendor: "Nobody in his right mind needs 0.01% supplies. But I make them. I'm no psychiatrist."

Most of the movement towards low performance is due to what Wall Street calls the crowd reaction. The "crowd" buys stocks at the top and sells at the bottom. And this is what many of us are doing now. We're hopping on the bandwagon after it has rolled past our destination.

The "free money days" are behind us, but so is the recession. "Cost is the whole game" is just as dangerous an attitude as "money is no object." Let's get back on our historic course. Let's design better equipment at reasonable prices as part of our move into the future.

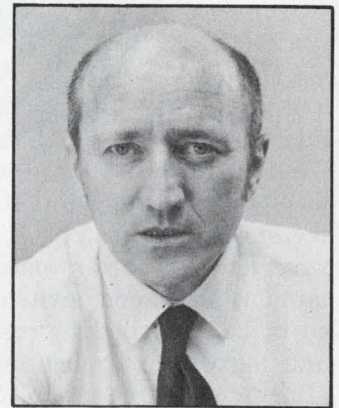

A handwritten signature in cursive script that reads "George Rostky".

GEORGE ROSTKY  
Editor



# F C M O S

on  
CMOS

## C M O S

(c o m p l e -  
m e n t a r y m e t a l - o x -  
i d e s e m i c o n d u c t o r)

has always been an IC technology to watch. It has very low power dissipation, very high noise immunity and good switching speeds. But higher costs have tended to restrict CMOS to military and aerospace applications. And the scarcity of alternate sources has discouraged widespread commercial and industrial usage.

That picture is changing now. Increased yields are helping to reduce unit costs, while a growing number of IC manufacturers are developing at least a custom-CMOS capability. On the design level, CMOS is being considered more and more for applications once dominated by TTL or PMOS (p-channel MOS), as well as for applications that open up new areas for ICs.

### Unique features of CMOS

Much of the interest in CMOS is based on features like these:

- Power dissipation per device during switching is typically in the microwatt region. In the quiescent mode, leakage power is measured in nanowatts.

- Noise immunity reaches 45% of the supply voltage and increases with increasing supply voltages.

- Circuit performance is basically insensitive to wide supply-voltage variations. A standard CMOS circuit can operate from a supply of 3 to 15 V.

- Temperature stability of the switching threshold voltage—from -55 to 125 C and as a percentage of the supply voltage—is about 1.5%.

- Switching speeds of typically 2 and 5 MHz can be achieved with supply voltages of 5 and 10 V, respectively. In terms of propagation de-

lays, typical listed values for the same two supplies are 35 and 25 ns (a load capacitance of 15 pF is assumed).

### CMOS needs least power

A basic circuit in CMOS is a p-channel transistor and an n-channel transistor in series (Fig. 1). With the input connected to the gates of the transistor pair, the output to the drains, an inverter circuit is formed. In operation, only one transistor—the driver—is ON at any time. An arriving pulse switches the OFF transistor—the load—ON and the driver OFF. The instant of change is the only period of significant dissipation. And since the circuit does not contain any direct paths from supply to ground, the dissipation is the lowest of any IC technology.

The transient power dissipated is capacitive, rather than resistive, and results from the charging of input and output capacitances. It increases linearly with the switching frequency and the square of the supply voltage.

One result is that higher speeds are obtained with increased power dissipation. In general, at about 10 MHz, the low power advantages are neutralized when compared to other IC technologies.

Under quiescent conditions—the driver transistor ON and the load transistor OFF—the power drain is due to leakage. The product of leakage current and the supply voltage, this power is about 5 nW for a standard NAND gate.

### Switching is good, too

A number of additional impressive features in CMOS result from the transfer characteristics of the basic CMOS inverter circuit.

---

Edward A. Torrero  
Associate Editor



The circuit is characterized by a high input impedance—typically,  $10^9 \Omega$ . As a result, the input and output signals swing completely from 0 V (logic ZERO) to the supply voltage,  $V_{DD}$  (logic ONE). The transitions are steep—an ideal characteristic for switching—with the switching point at 45 to 50% of  $V_{DD}$ .

Accordingly noise spikes, either ac or dc, must be greater than 45% of  $V_{DD}$  to cause a false change of state. For a CMOS chip requiring a 10-V supply, up to 4.5 V of noise can be tolerated easily without adverse effects to the circuit performance.

The effect of temperature variations in this push-pull type of circuit is also slight. In the  $-55$ -to- $125$ -C MIL-spec range, a given transfer characteristic changes hardly at all. The major alteration is in the transition region of the curve. The effect is limited to 1.5% change in the switching point.

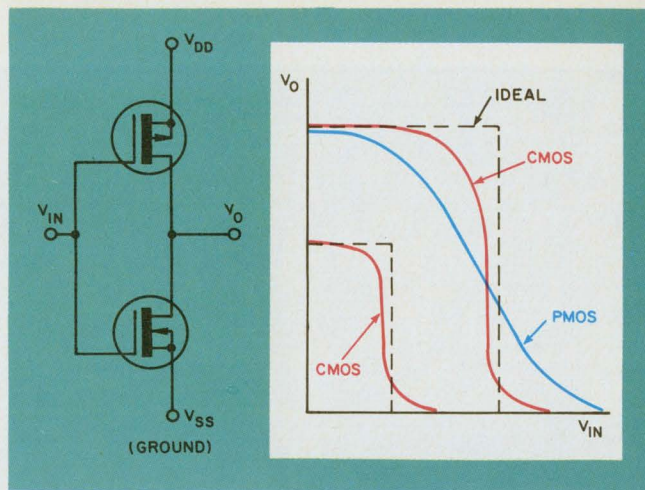

1. The transfer characteristics of a CMOS inverter are a closer approximation to the ideal switch than are those of a PMOS device. In addition, only one supply is needed for CMOS if the input voltage swing is positive; if it's also negative, you need two.

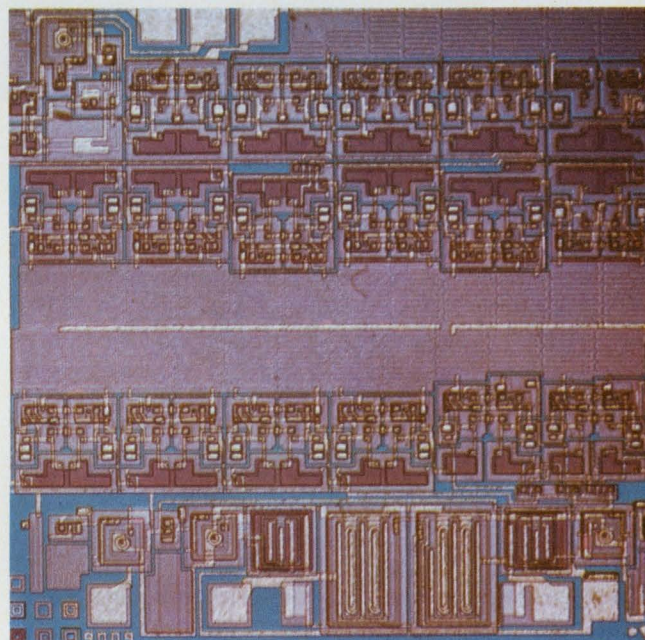
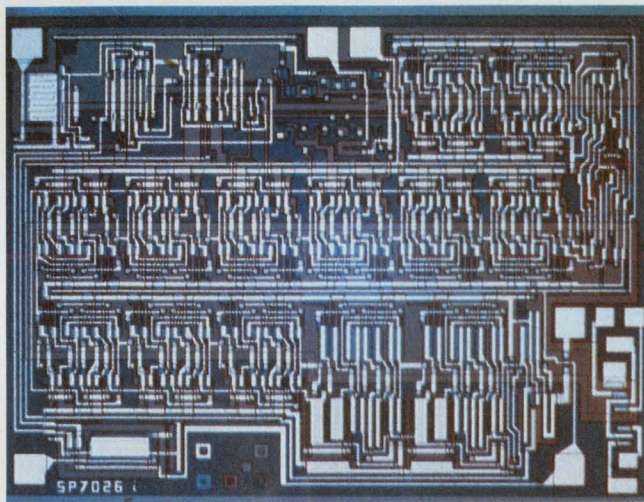

Intersil's watch circuits come in CMOS form (above) as well as bipolar (right). Both use a 1.5-V supply. The bipolar chip has thin-film resistors (middle area) and costs about 25% less. But the power requirements are about 25% higher.

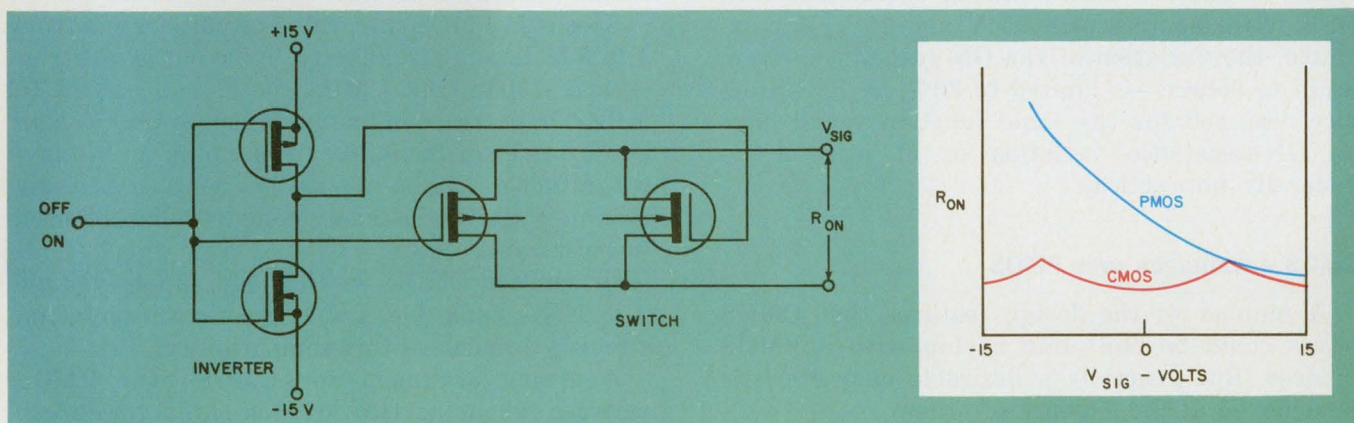

2. The CMOS transmission gate—a basic building block in digital systems—is a switch in analog applications. Performance characteristics for the simplified circuit pro-

vided by Siliconix illustrate the major advantage over PMOS: more uniform ON resistance. Variations in resistance value are minimized by the transistor pair.

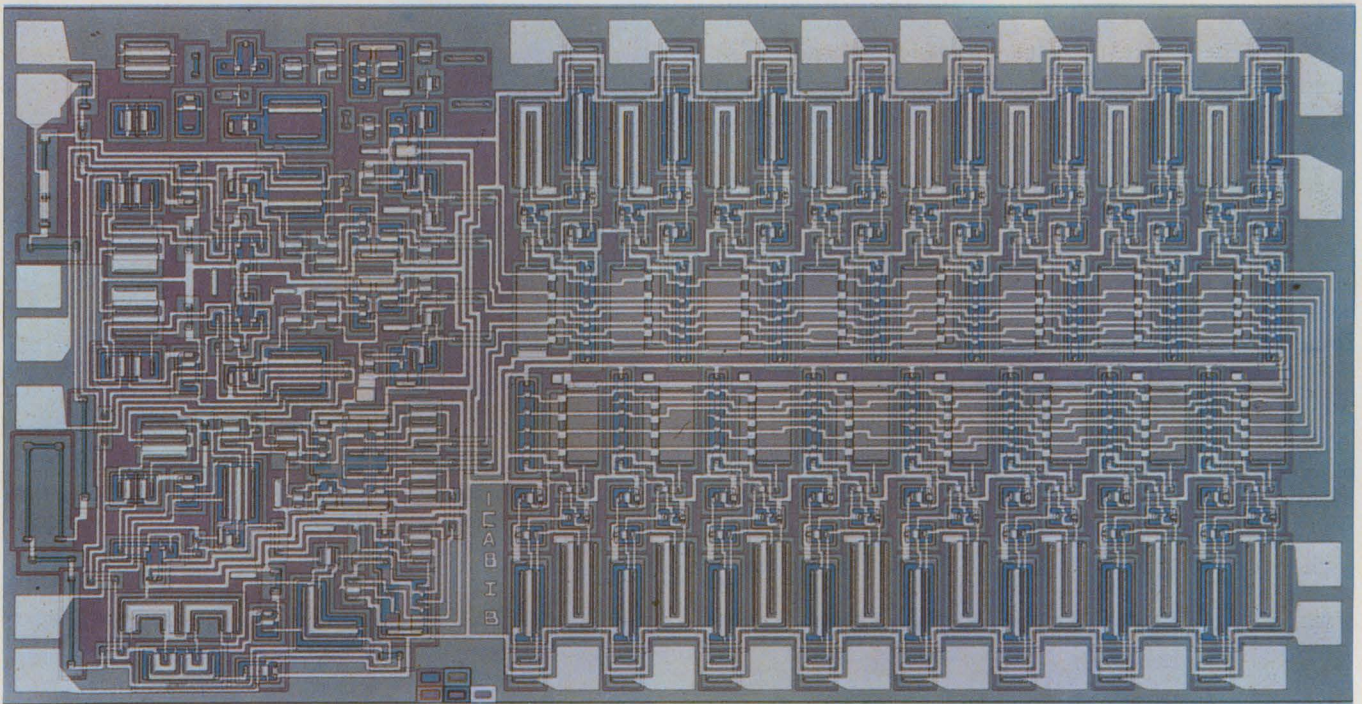

Siliconix offers the DG 507, a differential eight-channel multiplexer in CMOS. The analog input signal range is  $-15$  to  $+15$  V, with an ON resistance of less than 500

$\Omega$  over the MIL-spec temperature range. Switching action is break-before-make, and standby power is listed at 36 mW. Interfacing to TTL systems is direct.

Changes in  $V_{DD}$  cause a corresponding change in end values of the transfer characteristic. However, the shape of the curve is not basically altered—hence the large range of  $V_{DD}$  that can be tolerated.

Another basic circuit is the transmission gate: the p-channel and n-channel transistors are connected in parallel (Fig. 2). This configuration is used in analog multiplexing and switching circuits, as well as digital systems.

As an analog switch, the transmission gate offers the widest dynamic range currently available with semiconductor switches. An analog signal can vary anywhere between the two power supply voltages without having the circuit turn OFF. With sources of  $-15$  V and  $15$  V, for example, the variation of the ON resistance—from drain to source—is limited to 30%. A PMOS device designed for the same function would have an ON-resistance variation of at least 4:1—generally impractical.

### CMOS advantages over PMOS

A number of the design features that CMOS offers could be built into a chip with a PMOS process. But generally a desirable characteristic is achieved at the expense of others.

CMOS chips are manufactured for operation from a 1.5-V supply. The PMOS device, rated for the same power supply, suffers from speed limi-

tations and power dissipation when compared with CMOS.

Toggle rates, for example, can reach 300 kHz in CMOS; the corresponding figure in a 1.5-V PMOS device is 50 to 100 kHz. And the power consumption in PMOS can be orders of magnitude higher than the microwatts needed for complementary MOS.

Noise immunity, at 50% of the supply voltage, could also be built into a PMOS integrated circuit. But for the same  $V_{DD}$ , the PMOS device would have less than 1/10 the speed.

The case for complementary MOS over conventional PMOS includes higher speed and greater design flexibility, as well as lower power.

Speeds in PMOS integrated circuits range from 1 to 5 MHz and are affected by layout geometries—as is CMOS. But CMOS speeds can exceed 10 MHz. The increase in maximum speed provides an extra degree of flexibility in planning a chip layout, although this is not always needed. Actually minimum CMOS internal geometries can be used in most applications.

In addition CMOS—with a 5-V supply voltage—is TTL-compatible. PMOS requires interfacing circuitry to achieve this compatibility.

A strong argument for CMOS over PMOS emerges when the two are compared for larger arrays, such as shift registers. CMOS usually requires only one supply and no external clocks. The required two-phase clock signals are easily gener-

ated internally. By comparison, a PMOS device generally requires two supplies, and the necessary clock signals must be generated externally.

### PMOS advantages

Favoring PMOS over CMOS is cost and chip size. Where a comparison in prices is possible, CMOS chips cost about 50% more than an IC made with the PMOS process and performing a similar function.

One factor in the price differential is the processing required. Where PMOS manufacturing involves about five masking steps, CMOS—which can be thought of as a combination of p-channel and n-channel MOS—requires seven to eight masking steps.

A second factor is the increase in chip area with CMOS. The increase can be 50 to 80% when the layout is repetitive—as in a shift register.

The area increase is a result of the p-bucket, or well, that forms part of the n transistor, as well as the isolation requirements between the transistors. The use of channel stoppers is a common technique to limit inversion effects caused by insufficient isolation. In addition CMOS often requires more contacts, especially to the silicon. In PMOS much of this is done by diffusion.

For ICs with random logic patterns, there is not always an increase in chip size. The layout can be developed with minimization techniques. For example, a static shift register in CMOS could possibly be 80% larger than the corresponding PMOS device. But for a full adder, the CMOS version could be 20% smaller in area.

### CMOS over TTL

One of the most interesting aspects of the CMOS story is the competition that is developing between CMOS and TTL. Not surprisingly, the major interest for CMOS among TTL users is the low power needs of CMOS. Typically, TTL power dissipation is on the order of milliwatts per gate. Even low-power TTL is about 1 mW per gate.

The reduced heating means less cooling required. And since CMOS can operate with a low-voltage, variable power supply, there is a saving in voltage regulators, as well as batteries.

This saving is reflected directly in reduced weight and cost. In one case a manufacturer of point-of-sale systems was able to reduce the cost of a power supply by \$70 and to eliminate a cooling fan and hold the weight of a portable data recorder to four pounds.

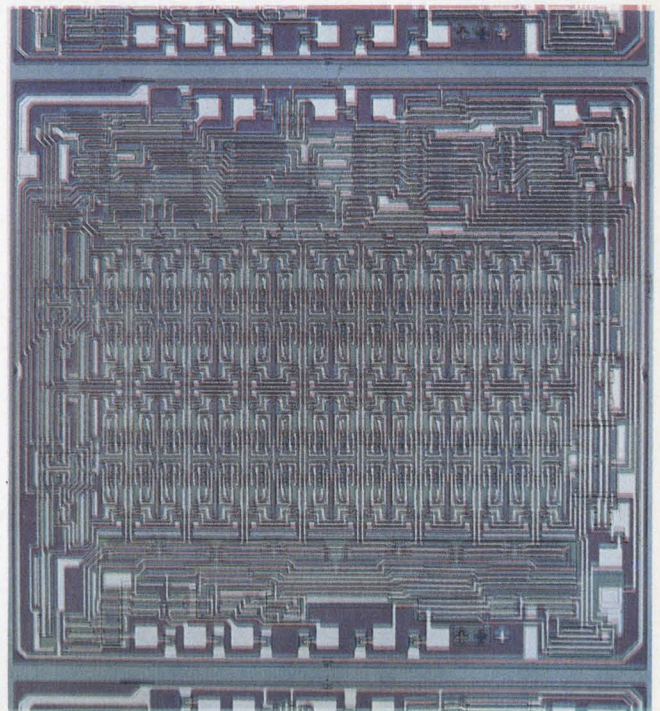

Motorola Semiconductor's McMOS line includes a 64-bit static RAM designated MC 14505. The quiescent power is less than 1  $\mu$ W with a typical access time of 200 ns.

There are other advantages of CMOS over TTL. With respect to noise immunity, low-power TTL can tolerate only 0.4 V of noise when operating off a 5-V supply. The value for CMOS is 1.5 V; with a 10-V supply, it's about 3 V. At the higher supply voltage, low-power TTL is not operable.

The power-supply range of low-power TTL is limited to 4.5 to 5.5 V with  $\pm 0.5$ -V regulation required (compared with 3 to 15 V for CMOS). The switching-point variation is 10% over the MIL-spec temperature range (compared with 1.5%). And the dc fanout is 10 (compared with up to 1000, but with a corresponding drop in speed).

### TTL for speed

Where TTL dominates, it's probably because of speed, cost per package or drive capability. And of the three, speed is the reason most heard as the main advantage of TTL.

A speed of 20 MHz for standard TTL is readily achieved, while 10 MHz is common for the low-power family. In either case, CMOS speeds generally lag by a factor of at least 2.

In costs, a useful CMOS reference is the RCA 4000 series. RCA—whose complementary MOS is designated COS/MOS—is probably responsible for at least 70% of all CMOS products.

In quantities of 1000, and with plastic pack-

## CMOS: It calls for tradeoffs in fabrication

Complementary MOS—a basic IC process, along with p-channel and n-channel MOS—can be fabricated in many ways. Two types of gate electrodes may be used. Standard lines, such as the COS/MOS CD 4000 series, use metal-gate. Custom devices sometimes use silicon-gate.

There is also a choice of diffusion processes. The threshold level ( $V_t$ ) can be set with standard chemical techniques or by ion implantation.

In addition there are now variations in the substrate that can be used. Silicon is by far the most common. However, silicon-on-sapphire CMOS is also being fabricated.

In most processes approximately seven masking steps are required. Each normally begins with the formation of a silicon-dioxide layer on the substrate by exposure of the wafer to a dopant atmosphere. A pattern is then etched on the layer in the usual way with photoresist processing techniques. The pattern selectively exposes the substrate at small windows.

Through the openings p or n-type pockets are diffused into the substrate. Generally an n-substrate is used, so that at the end of the first masking step, p-regions or p-wells have been formed. These wells become the source and drain regions of the p-channel transistor.

In succeeding masking steps, the source, drain and gate regions are diffused to form the p-channel and n-channel transistors. In the final step, the contact areas are opened to provide interconnection with an appropriate metallization.

In metal-gate CMOS, aluminum is normally used as the gate electrode. In silicon-gate CMOS, polycrystalline silicon replaces the aluminum. Prior to diffusion of the source and drain pockets, the polycrystalline silicon is formed in the gate areas. Self-alignment occurs because the silicon itself acts as a mask, thus providing alignment with minimum overlap.

The advantages of silicon-gate, as compared to metal-gate, include lowered threshold voltage and lowered interconnect capacitance. Also, greater packing densities are possible, since the silicon-gate itself provides an additional level of interconnections.

Threshold voltages ( $V_t$ ) are sometimes set by ion implantation. This adjusts  $V_t$  electrically

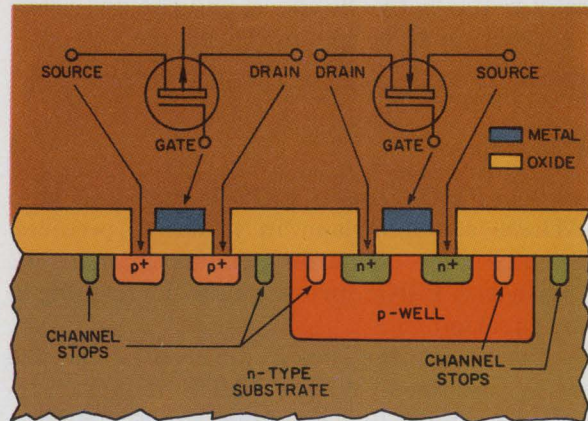

A p-channel device (left) and an n-channel (right) together form the basic element in complementary MOS. The fabrication process shown is metal-gate, which normally requires channel stops to limit inversion effects.

rather than chemically. A common procedure is to start with a high  $V_t$  device and implant sufficient ions in the channel region until the specified  $V_t$  is achieved. Normally the source and drain beds are already diffused. No additional masking step is required.

Though ion implantation allows precise control of threshold voltage, some manufacturers argue that the same objectives can be achieved with lower cost techniques.

A fundamental alteration in the CMOS process is the use of silicon-on-sapphire (SOS). In this case the starting substrate is sapphire, an insulator, rather than silicon. For CMOS/SOS, a layer of silicon is epitaxially grown on the sapphire.

From this point on, the fabrication follows conventional CMOS procedures. An important difference, however, is that the device has small p and n-type islands rather than large areas of silicon. Because excess silicon is etched away, and because of the insulating substrate, isolation and capacitance problems are minimized.

The cost of CMOS/SOS tends to be higher than conventional CMOS, but the technique allows improved performance. This includes higher speeds, no dc leakage to ground and higher voltage capacities.

aging, the cost of COS/MOS small-scale-integration devices is just under \$1 a package. In the MSI range, it's \$3 to \$5. For ceramic packaging, the corresponding prices are 2-1/2 to three times greater.

By comparison, Texas Instruments' lower-priced 7400 series, in plastic packaging, begins at 48 cents for a quad, two-input NAND gate (quantities of 100). A dual J-K master-slave flip-

flop sells for 98 cents, and an up-down binary counter for \$4.95 each (quantities of 100).

The low-power version, the 7400L series, is somewhat higher in cost. Starting at 64 cents for quantities of 100 in plastic, the highest unit price reaches \$6.27.

Another factor favoring TTL is drive capability. The bipolar sinking current is about 20 mA—that's around 10 times the current available in

CMOS. Where CMOS interfaces directly with TTL, one CMOS driver can be used with a single, low-power TTL device. But a single TTL device can drive several CMOS devices.

### CMOS applications

While TTL and PMOS offer some advantages over CMOS, a growing list of uses for CMOS is developing. The applications are not restricted to low-power conditions but extend to high-voltage and high-speed uses, and in analog as well as digital systems. In some cases CMOS is the only technology being considered.

Of course, the main interest remains in the advantages of microwatt dissipation and low-voltage supply ratings—around 1.5 V. A major application here is in quartz wristwatches, where product size and low-power requirements are constant design considerations. Most CMOS manufacturers are involved in some fashion with CMOS chips for watches.

Most watches use a quartz-crystal oscillator to generate an 8, 16 or 32-kHz reference signal. CMOS dividers bring the frequency down for the operation of miniature motors that turn the hands on the watch face. The supply for the entire system is usually a small mercury or silver oxide battery. The current drain on the battery is well under 20  $\mu$ A, and the bulk of that is for the motors.

Quartz watches offer accuracies of 10 seconds or less per month—a significant advance over the minute-per-month accuracy of conventional mechanical watches. But retail prices start at around \$200 and continue past \$2000. For the moment, electronic watches may have limited appeal.

Beyond watches, but still in the area of timing devices, the applications for complementary MOS include portable clocks of all types. The reason is the same: very low power needs.

The power advantages of CMOS are also used in medical systems. Already heart pacers feature CMOS chips. And there are potential uses in bladder controls, lung stimulators and prosthetic devices.

In military and aerospace applications, which motivated the original development of complementary MOS, many devices are being designed with the low-power dissipation of CMOS in mind. They include demolition fuse detonators, satellite subsystems, warhead locks and personnel monitors. In each case, batteries are the only power supplies possible, and with CMOS you get extended lifetimes.

The communications and data acquisition fields are sprouting CMOS applications as well. Where portability is a must, low-power CMOS seems to be the way to go. The list of potential uses here is enormous and includes analog systems (Fig. 3).

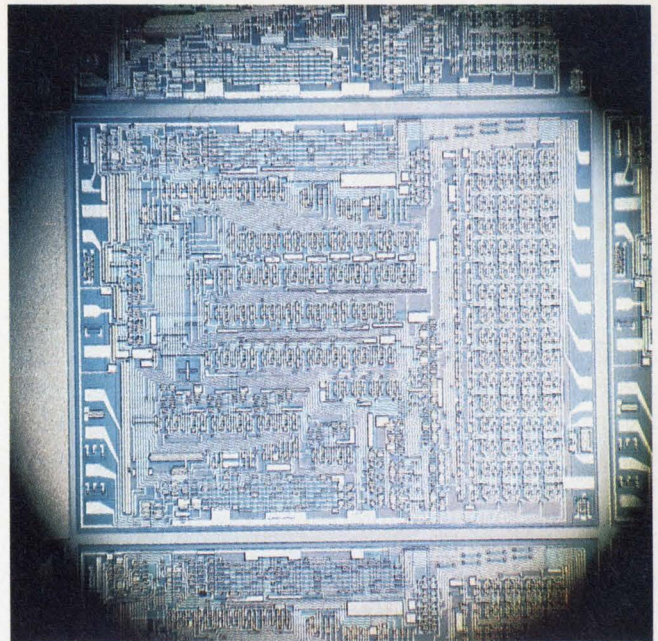

Ragen Semiconductor's touch-tone converter for telephone systems has 1150 transistors on a 169 × 137-mil chip. A custom circuit, the chip includes two oscillators, a 64-bit read/write memory and dial-interrupt conditioning circuitry.

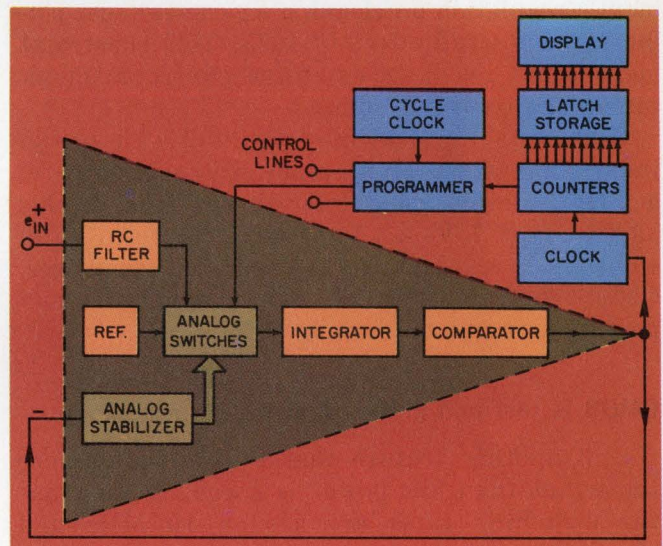

3. Analog Devices' DPM, the AD 2001, uses CMOS in its analog switch and stabilizer sections (green boxes) because of the low power requirements. A dual-slope converter, the AD 2001, features dc-error compensation through the use of the company's Analok circuit (high-lighted by the triangle).

Examples include remote tuning devices, pocket pagers and CATV converters. To implement a number of these products, CMOS is used to fabricate such devices as phase-locked oscillators, analog multiplexers and frequency synthesizers.

Still another potentially large field is meter readers to measure water, electric or gas consumption. Several systems are undergoing field tests. In one a CMOS memory is used to store electric meter readings. A dry-cell battery powers the

volatile memory for about a month. A teletypewriter at the utility obtains readings by phoning an accumulator's number. Information is received over the same telephone lines. The system is automatic. Manual meter reading, used in conventional billing, is eliminated.

### Beyond low-power advantages

A somewhat unexpected development has been consideration of CMOS for systems that do not require low-power dissipation. In one area, the features of interest are high tolerance to variable supply voltages and very high noise immunity. In these cases high-voltage CMOS—of about 15-V supply ratings—is coming to the fore.

Perhaps the most talked of use for CMOS is in automobiles. Standard 12-V car batteries have voltages that range from 3 to 17 V. Because of its present wide range of operating voltages, CMOS is being hailed as the only suitable technology for automotive electronics. But, as of now, unit costs are holding back any substantial application of CMOS—or of ICs in general.

Certainly the pressure is there. The Government's regulation on cleaning up car-exhaust pollutants takes full effect in 1975. This constraint alone could result in extensive electronic monitoring and control systems.

High-voltage CMOS may also find wide use in industrial systems. With a power supply of 15 V, a CMOS device could tolerate spurious signals as strong as 7 V—an impressive figure in noisy environments. And for consumer appliances, CMOS controls offer the simplicity of an inexpensive unregulated supply.

### CMOS is fast and getting faster

Still another feature that is sometimes more important than low power is speed. In this case the switching rates are around 10 MHz and above.

Ragen Semiconductor of Whippany, N.J., offers 64, 96 and 128-bit static shift registers in CMOS. The 64-bit array—the MS612—with serial input and output, lists a range of operation of dc to 25 MHz. The chip requires only one supply—5 to 16 V, typically—and an external clock.

In the wings, but expected shortly, are a host of CMOS devices fabricated with silicon-on-sapphire (SOS). The use of SOS extends the frequency range of CMOS to the point where it is competitive in speed with slower TTL arrays. All the other advantages of CMOS, like low power and high density, are maintained—though, of course, the highest speed and lowest dissipation are not available at the same time.

Already RCA has announced a CMOS/SOS fre-

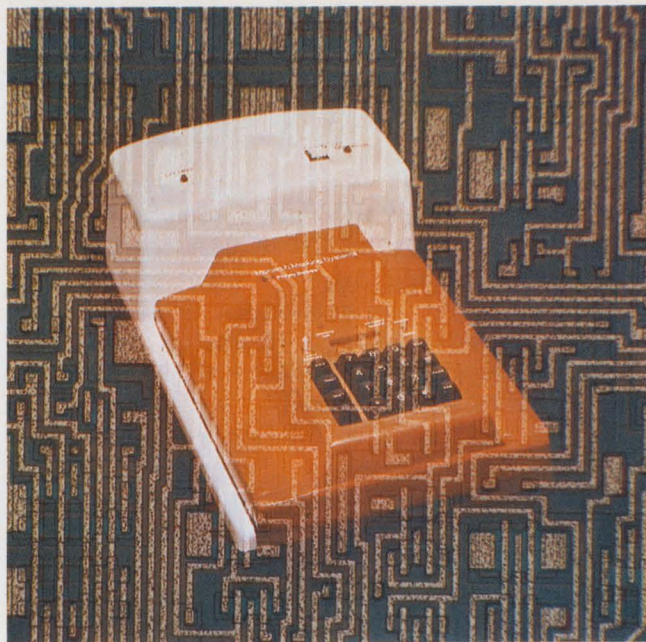

**A portable data recorder also uses CMOS.** Produced by Monarch Marking Systems, a subsidiary of Pitney-Bowes, the MDR-2100 system includes an RCA COS/MOS chip. CMOS is used primarily for low power.

quency counter capable of operating up to 40 MHz. The seven-stage counter contains 162 transistors of both conductivity types on a  $114 \times 104$ -mil chip.

From Inselek of Princeton, N.J., comes the promise of a CMOS/SOS line, with the debut of a family of logic functions expected soon. The company expects to follow that with products in the linear and memory areas. CMOS/SOS memories would feature typical pair delays of 20 ns.

Of course, the degree of acceptance of these new products depends in part on how high the prices are going to be. But one sign of a price trend is the growing number of SOS wafer suppliers. If the demand is there, prices could come down in a relatively short time.

### Who makes CMOS?

All CMOS manufacturers are involved in some custom work. And the great bulk of that is watch circuitry. In the custom-only field are the following: American Micro-systems, Cal-tex Semiconductor, Micro Power Systems and Nortec Electronics Corp., all of Santa Clara, Calif.; Intersil and MegaByte Associates, both of Cupertino, Calif., and Texas Instruments in Houston.

Of the remaining companies offering a standard line, the RCA Solid State Div. in Somerville, N.J., is the biggest producer and offers the largest line. RCA's COS/MOS CD 4000 line was made commercially available in 1968. The first on the market, it is today the basis for the industry's

CMOS alternate sourcing.

The 4000 series is a full line of small-scale-integration devices and a growing number of MSI products. Starting with gates and gate arrays, the series includes decoders, multiplexers, arithmetic devices, counter/dividers and static shift registers. The 4000 line operates from a single 5-to-15-V supply. A 4000A line operates off a 3-to-15-V source. The two lines are designed to be interchangeable. The CD series is available in plastic or ceramic packaging, in flat packs or as bare chips.

The alternate sources include Hughes Microelectronics Product Div., Newport Beach, Calif.; National Semiconductor, Santa Clara, Calif.; Motorola Semiconductor, Phoenix, Ariz.; Solid State Scientific, Montgomeryville, Pa., and Solitron Devices, San Diego.

Hughes is alternate-sourcing eight devices in the CD 4000 series, including gates, flip-flops and shift registers. A 7000 line is also being offered, and it features threshold voltages of 0.5 to 1 V. In addition the standard line has a 16-stage counter for watches. This circuit operates from a 1.2-to-3-V supply.

At National Semiconductor, plans for a standard line center on its 54C/74C line, which features TTL-pin compatibility. The company expects to introduce a number of popular gate and counter functions by the middle of the year. In addition a 5600 series will alternate-source parts of the CD 4000A line.

From Motorola Semiconductor—where CMOS is designated McMOS—comes the MC 14000 series. In ceramic packages this line offers an alternate source to RCA's 4000 series. A 14500 series represents original CMOS devices. Some

new products in this line are two 4 to 16 line decoders with high and low level outputs, and a 64-bit static RAM.

The SCL 4000 series, from Solid State Scientific, alternate-sources the CD 4000A line up to 4030, the latter being a quad EX-OR gate. And an SCL 5000 series includes original devices, such as a 256 × 1-bit static RAM, featuring 100-ns access and 150-ns cycle times. Also offered by the same company are watch circuits. A 16-stage divider/driver, the SCL 5423, for example, operates from a 1.3-V supply and can be used to drive watch motors directly.

At Solitron Devices the alternate line is designated the CM 4000. The company expects to catch up to RCA shortly in catalog items. In its CM 4100 series, Solitron offers original CMOS products. To be introduced soon are a 16-channel multiplexer, a dual 128-bit static shift register and a 256 × 1-bit static RAM.

At Ragen Semiconductor a major product is a two-chip CMOS portable calculator that features a liquid-crystal display. The company expects deliveries of the calculator to begin shortly. The eight-digit device has four-function capability with a floating decimal point. It will retail for around \$100.

Analog multiplexers and switches form the standard CMOS line of Harris Semiconductor, Melbourne, Fla., and Siliconix, Santa Clara, Calif. The Harris devices, designated HI-1818 and HI-1800, are, respectively, an eight-channel multiplexer and a four-channel switch. The Siliconix line includes the DG506, a 16-channel multiplexer and the DG 507, an eight-channel differential multiplexer. The series features ON resistance of less than 500, 250 and 100 Ω. ■■

## Need more information?

The products and services cited in this report don't represent manufacturers' full lines or capabilities. Readers may consult with the following for additional details:

- American Micro-systems, Inc., 3800 Homestead Rd., Santa Clara, Calif. 95051. (408) 245-0330. (Don Trotter, Director of R&D) **CIRCLE 401**
- Cal-tex Semiconductor, 3090 Alfred St., Santa Clara, Calif. 95050. (408) 247-7660. (Robert C. Harper, Marketing Manager) **CIRCLE 402**
- Harris Semiconductor, P.O. Box 883, Melbourne, Fla. 32901. (305) 727-5400. (John T. Corser, Advertising and Sales Promotion Manager) **CIRCLE 403**
- Hughes Microelectronics Products Div., 500 Superior Ave., Newport Beach, Calif. 92663. (714) 548-0671. (Richard Belardi, MOS Manager) **CIRCLE 404**
- Inselek, University Park Plaza, 743 Alexander Rd., Princeton, N.J. 08540. (609) 452-2222. (Edward C. Ross, Vice President) **CIRCLE 405**
- Intersil, Inc., 10900 N. Tantau Ave., Cupertino, Calif. 95014. (408) 257-5450. (Harry Neil, Director, MOS Product Marketing) **CIRCLE 406**
- MegaByte Associates 10925 N. Wolfe Rd., Cupertino, Calif. 95014. (408) 252-0561. (John Smith, President) **CIRCLE 407**
- Micro Power Systems, Inc., 3100 Alfred St., Santa Clara, Calif. 95050. (408) 247-5350. (John H. Hall, President) **CIRCLE 408**
- Motorola Semiconductor Products Div., 5005 E. McDowell Rd., P.O. Box 2953, Phoenix, Ariz. 85036. (602) 273-6900. (Jim George, Products Manager, CMOS ICs) **CIRCLE 409**
- National Semiconductor Corp., 2900 Semiconductor Dr., Santa Clara, Calif. 95051. (408) 732-5000. (Jon C. Stemples, MOS Product Marketing Manager) **CIRCLE 410**
- Nortec Electronics Corp., 3697 Tahoe Way, Santa Clara, Calif. 95051. (408) 732-2204. (Michael E. Harris, Product Marketing Engineer) **CIRCLE 411**
- RCA Solid State Div., Route 202, Somerville, N.J. 08876. (201) 722-3200. (Andrew J. Bosso, MOS ICs Marketing Manager) **CIRCLE 412**
- Ragen Semiconductor, Inc., 53 S. Jefferson Rd., Whippany, N.J. 07981. (201) 887-4141. (Albert H. Medwin, President) **CIRCLE 413**
- Siliconix Inc., 2201 Laurelwood Rd., Santa Clara, Calif. 95054. (408) 246-8000. (Lorimer K. Hill) **CIRCLE 414**
- Solid State Scientific, Montgomeryville Industrial Center, Montgomeryville, Pa. 18936. (215) 855-8400. (Oolep Indreko) **CIRCLE 415**
- Solitron Devices, Inc., 8808 Balboa Ave., San Diego, Calif. 92123. (714) 278-8780. (Carol Perkins, MOS Product Manager) **CIRCLE 416**
- Texas Instruments, Inc., P.O. Box 1443, Houston, Tex. 77001. (713) 494-5115. (Frank Krch, MOS Marketing Manager) **CIRCLE 417**

*snap,  
lock,  
index,  
punch...*

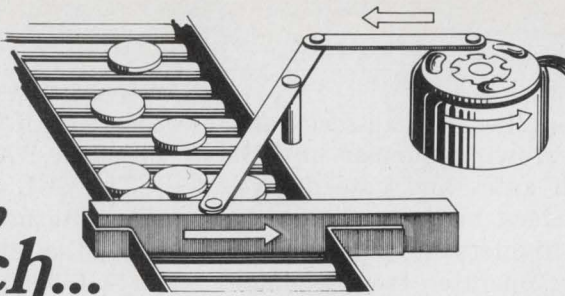

To move a load in an arc or a straight line  
... consider a Ledex rotary solenoid

**A Ledex rotary solenoid gives you a down-hill solution to an up-hill problem.**

The force of an electromagnet is inversely proportional to the square of the distance between the pole faces. Most solenoids live with this problem, which means less force in the beginning, where you need it, and wasted energy at the end, where you don't need it.

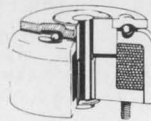
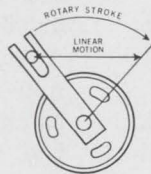

The Ledex rotary solenoid starts off working where the force is really at, about .030" between the pole faces. Then the armature rides a helical ramp, to distribute the force over the stroke you need. It gives you efficient, direct rotary action and uniform linear movement.

The Ledex rotary solenoid delivers a lot of power for its size. That's because it works in the tiny area where magnetic attraction is highest. It's efficient because it spreads this high concentration of energy over a longer useful stroke.

For rotary or linear positioning it's hard to beat its simplicity and high output. Choose from a family of eight models, with strokes from 20° to 95° and torque to 117 pound-inches. For a quick prototype, there are over 250 shelf models. Then, for a custom snap / lock / index / punch solution, you just talk to our positioning technology people.



*the total technology people*

**LEDEX INC.**  
123 Webster Street  
Dayton, Ohio 45401  
(513) 224-9891

**POSITIONING · SWITCHING · MICROELECTRONICS**

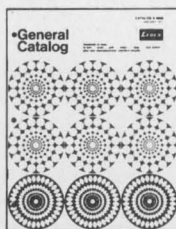

Over 400 ways to turn . . . push . . . pull . . . index . . . step . . . and switch, plus new microelectronic interface circuits. All from the shelf.

Ask for Catalog A-9500

*new things  
keep  
happening  
at Ledex*

**... push solenoids**

Push action quick, with three new Ledex shelf model solenoids.

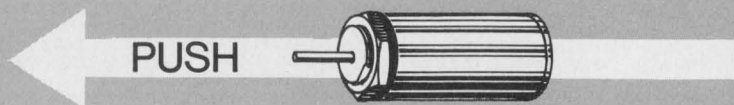

	1/2" dia x 1"	3/4" dia x 1 1/2"	1" dia x 2"
force, .050" stroke	15 ounces	3 pounds	7 pounds
force, .750" stroke	_____	0.6 pounds	2 pounds
weight	24 grams	3 ounces	6 ounces

**Standard features:**

- 1—Electroless nickel plated plungers, for smooth performance
- 2—Built-in impact cushions, for pole face protection
- 3—Flatted bushings, for positive alignment and ease of assembly



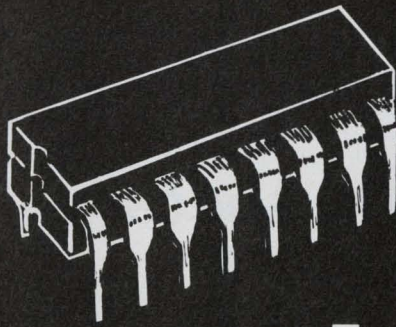

# This CMOS LSI chip makes the \$25 panelmeter possible

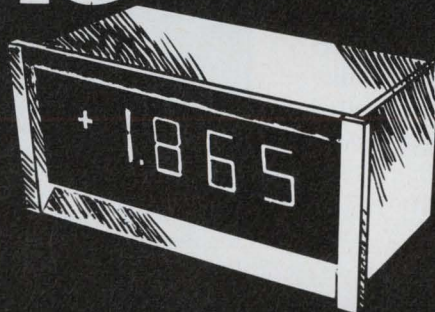

All that's needed is five volts to drive this CMOS LSI chip that uses less than five milliwatts of power . . . it's ideal for battery operation. The new Solitron CM4100, 3½ digit counter circuit is available with 7-segment decoder. Packaging is 24-pin DIP.

The CM4102, 3½ digit counter allows 16-pin, dual-inline packaging by eliminating the 7-segment decoding and providing BCD outputs only.

Remember, Solitron is the center for original custom work in CMOS LSI technology . . . and new circuits will be available soon including shift registers, ROMS and RAMS.

Solitron is a whole generation ahead in CMOS. You can stay ahead, too, by getting on the Solitron information program. Write today. Solitron Devices, Inc., P.O. Box 1416 San Diego, California 92112, Telephone 714 - 278-8780, TWX 910-335-1221.

Give us a quick call today, and test our producibility.



Solitron sales offices are located in: Canoga Park, Cal. (213) 883-3822 • Riviera Beach, Fla., (305) 848-4311 • Des Plaines, Ill. (312) 824-8127 • Towson, Md. (301) 821-1282 • Tappan, N.Y. (914) 359-5050 • Needham, Mass. (617) 444-1152 • Dallas, Tex. (214) 341-1180 • Kent, England (0732) 57541 • Tokyo, Japan (03) 436-2261-2 • Munich, Germany (0811)-608-755.

INFORMATION RETRIEVAL NUMBER 101

ELECTRONIC DESIGN 8, April 13, 1972

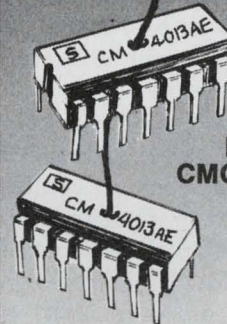

CM4013AE  
DUAL TYPE D  
CMOS FLIP FLOP  
EPOXY DIP

## ANY QUANTITY FROM ONE UP

To order, call your nearest SOLITRON distributor listed below by state.

<b>Arizona, Phoenix</b> Kierulff (602) 273-7331 Moltronics (602) 272-7951	<b>California, Culver City</b> Avnet (213) 836-7200 JSH Elec. (213) 837-0177 Los Angeles Kierulff (213) 685-5511 Menlo Park Bell (415) 323-9431 San Carlos Intermark Electronics (415) 592-1641 San Diego Intermark Electronics (714) 279-5200 Kierulff (714) 278-2112 Santa Ana Intermark Electronics (714) 540-1322 Van Nuys Intermark Electronics (213) 782-0362	<b>Needham Heights</b> Kierulff/Schley (617) 449-3600 <b>New Jersey, Pennsauken</b> Resco (609) 662-4000 <b>New York, Binghamton</b> Federal (607) 748-8211 Farmingdale, Long Island Arrow (516) 694-6800 Hauppauge Semiconductor Concepts (516) 273-1234 Hicksville Kierulff/FJR (516) 433-5530 <b>Ohio, Dayton</b> Kierulff (513) 278-9411 Kettering Arrow (513) 253-9176 <b>Pennsylvania, Treose</b> Hallmark (215) 355-7300 <b>Texas, Dallas</b> Component Spec. (214) 357-4576 Houston Component Spec. (713) 772-5127
<b>Colorado, Denver</b> Intermark Electronics (303) 936-8284 Kierulff (303) 343-7090 <b>Illinois, Elk Grove Village</b> Lakeland (312) 595-1000 <b>Maryland, Baltimore</b> Radio Electric Service (301) 823-0070 Savage Pytronics, Inc. (301) 792-7000 <b>Massachusetts, Boston</b> DeMambo Electronics (617) 787-1200	<b>Washington, Bellevue</b> Farwest (206) 747-1515 Seattle Intermark Electronics (206) 767-3160 Kierulff (206) 763-1550 <b>CANADA</b> <b>Quebec, Montreal</b> Prelco Electronics, Ltd. (514) 389-8051	

Sale ends May 15, 1972.



Give us a quick call today, and test our producibility. We also excel in RAMS, ROMS, FETs, and LIC's. Solitron Devices, Inc., P.O. Box 1416, San Diego, California 92112. Telephone (714) 278-8780 TWX 910-335-1221.

INFORMATION RETRIEVAL NUMBER 102

63

# Penetrate the mystique of MOS specs

by examining those for popular shift registers. There's a resemblance to bipolar specs, but definitions can differ.

While MOS integrated circuits are starting to make inroads into former bipolar territory because of their lower cost, reduced power consumption and simpler construction—many engineers are troubled by MOS specifications. Misinterpretation of the specs has often caused confusion and has led to conflicts between users and manufacturers. One big reason for such impasses is that MOS data sheets include a mixture of bipolar and MOS terminology.

For a speed course in MOS specification interpretation, let's consider two common shift registers—static and dynamic. They're excellent examples because they're among the most popular MOS circuits in use today and because they also demonstrate most of the problems that engineers encounter in MOS specmanship.

The major specifications for MOS shift registers are these:

- Absolute maximum ratings.
- Operating voltages.
- Clock-pulse levels.
- Clock-pulse widths.
- Clock-pulse spacing.
- Pulse-repetition frequency.
- Electrical characteristics, including input leakage current, output voltage levels, power-supply current drain, output logic delay and input capacitance.

Questions like these immediately arise: What are the absolute maximum ratings? What happens at higher or lower operating voltages or clock levels? What is meant by TTL interfaceable? While the discussion centers on shift registers, most comments apply to other circuits built with p-channel MOS devices.

## First, absolute maximum ratings

Consider first the operation of MOS shift registers (see box). Then, in analyzing the specs, start with absolute maximum ratings.

---

**Kenneth A. Blair**, Manager of Advanced Development, Digital Systems Engineering Dept., Submarine Signal Div., Raytheon Co., P.O. Box 360, Portsmouth, R.I. 02871.

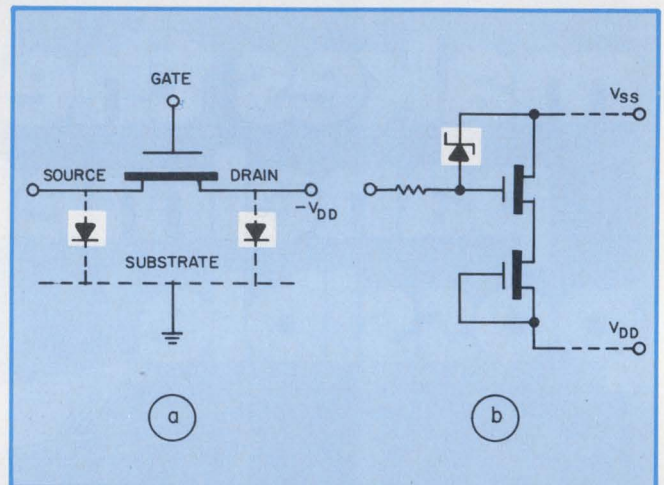

1. The substrate of a p-channel MOS should always be connected to the most positive voltage in the circuit. If not, the parasitic diodes will become forward-biased, and the device will be damaged. In the case of register input terminals (b), protective diodes prevent damage caused by the build-up of static charge.

Here are the maximum ratings for a typical high-threshold, p-channel MOS device:

Drain-supply voltage ( $V_{DD}$ ):	−30 to 0.3 V dc.
Gate-supply voltage ( $V_{GG}$ ):	−30 to 0.3 V dc.
Clock-input voltage:	−30 to 0.3 V dc.
Data-input voltage:	−30 to 0.3 V dc.
Maximum power dissipation:	450 mW.
Operating free-air temperature:	−55 to 85 C.
Storage temperature:	−65 to 150 C.

All voltages are referred to the substrate. In early devices the substrate connection was called the ground terminal. The substrate is now listed as the  $V_{SS}$  terminal, since it is often connected to a positive voltage for TTL interfacing.

In a p-channel device, the substrate is always connected to the most positive voltage in the circuit. When the device is used with negative operating voltages, the  $V_{SS}$  terminal is connected to ground.

For operation with both positive and negative power supplies (for TTL interfacing), the  $V_{SS}$

# Static and dynamic shift registers: How they work

How do static and dynamic shift registers work?

In Fig. A, a simplified schematic of a typical MOS static shift register, we see that Q1 transfers data into each stage, or bit location. Transistors Q2 and Q3 are cross-coupled by means of Q4 and Q5. The latter transistors insure proper data transfer from Q3 to Q2 and also provide the feedback that is required for static operation. Transistors Q6 and Q7 serve as load resistors for Q2 and Q3.

Of the three required clock pulses, at least one—and sometimes two—pulses are generated internally on the MOS chip. When clock pulse  $\phi_1$  is at a negative voltage with respect to the substrate, clock pulses  $\phi_2$  and  $\phi_3$  are at substrate level and only Q1 is turned ON. At this time data can be transferred into the gate capacitance of Q2. Cross-coupling transistors Q4 and Q5 are OFF, so that the state of Q2 is determined solely by the input data.

When clock pulse  $\phi_1$  returns to substrate level, Q1 is turned OFF, inhibiting further data transfers. The charge on the gate capacitance of Q2 maintains the state of the transistor. Clock pulse  $\phi_2$  then goes negative, turning ON cross-coupling transistor Q4. The data at the output of Q2 are then transferred to the gate capacitance of Q3. Clock pulse  $\phi_3$  is a delayed replica of  $\phi_2$ , and it is normally generated on the chip from clock pulse  $\phi_2$ . When clock pulse  $\phi_3$  goes negative, coupling transistor Q5 turns ON, and the output of Q3 is connected back to the input

of Q2. The data bits are now locked into the register stages and will remain there until the sequence of clock pulses is repeated. This condition is the essence of static operation.

In the dynamic shift register (Fig. B) there is no feedback. The circuit has fewer elements than the static unit. Each register bit has two inverter stages, Q1 and Q4, with their corresponding loads, Q2 and Q5. Transistors Q3 and Q6 are the coupling devices.

Two clock pulses are required to operate this basic dynamic shift register. Input data are initially stored on the gate capacitance of Q1, and clock pulse  $\phi_2$  is at substrate level. When  $\phi_1$  goes negative, active resistor Q2 of the inverter stage and coupling transistor Q3 are turned ON. This couples the input data, in inverted form, to the gate capacitance of inverter Q4.

When  $\phi_1$  returns to substrate level, Q2 and Q3 are turned OFF, inhibiting the transfer of input data. The state of Q4 is maintained by the charge on its gate. Clock pulse  $\phi_2$  then goes negative with respect to the substrate, turning ON Q5 and Q6. The inverted data at the gate of Q4 are now transferred to the next stage. The data at this point have undergone two inversions, leaving a true replica of the input data.

Note that without feedback, the data held on the gate capacitances of inverters Q1 and Q4 will eventually leak off unless the gate capacitances are continuously recharged. This leakoff rate determines the minimum operating clock frequency for the dynamic register.

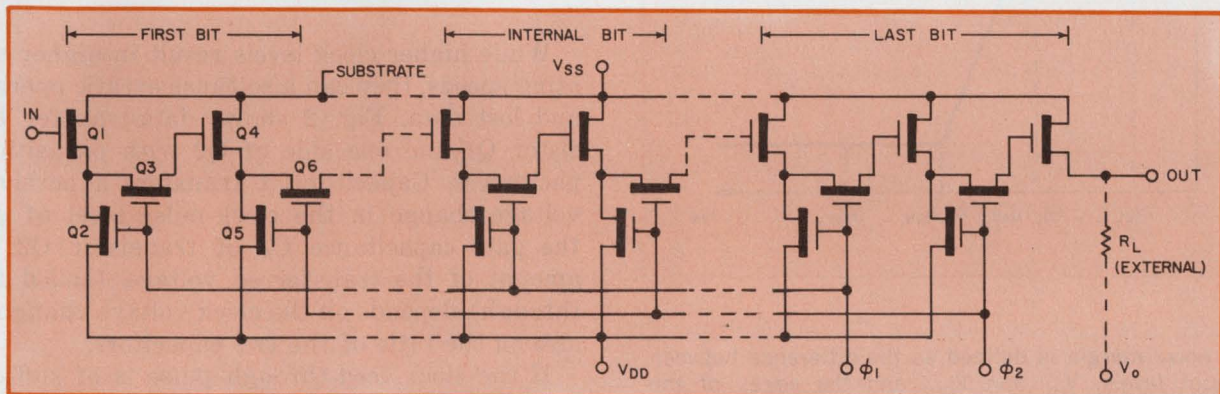
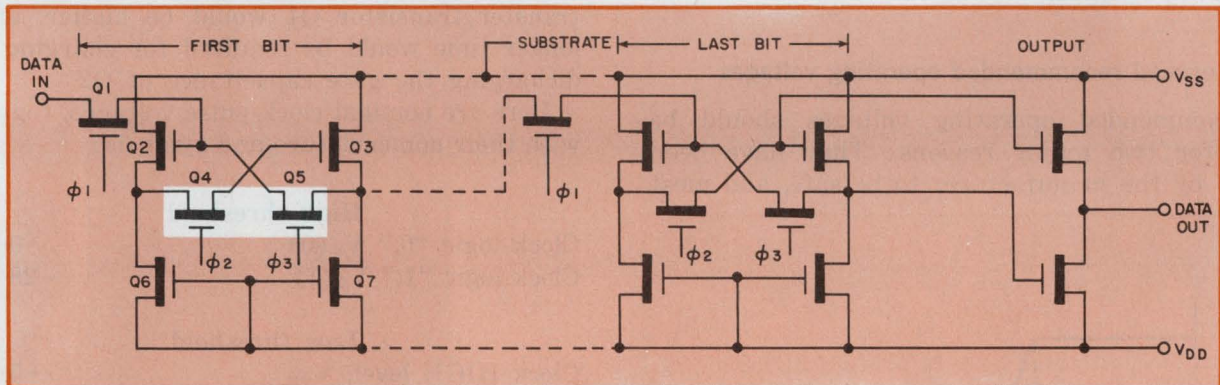

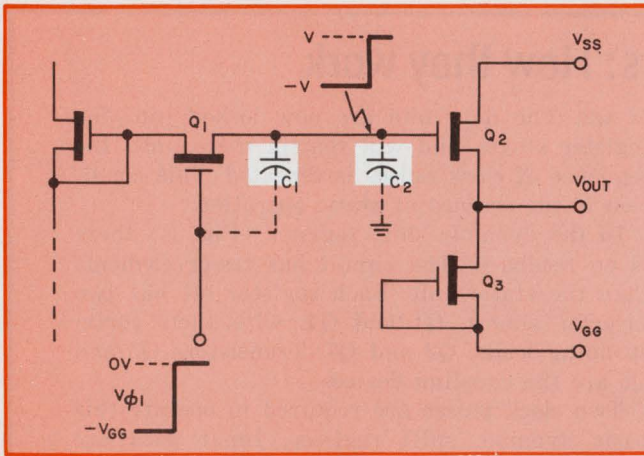

2. Loss of data can occur if clock pulses of excessive amplitude are used, because of a so-called feed-through problem—transfer of a portion of the clock voltage into data via the parasitic capacitors.

terminal is connected to the positive voltage. If the substrate were at a voltage that was lower than that of either the source or drain, the parasitic diodes (Fig. 1a) would be forward-biased and abnormal operation or permanent device damage could occur.

A similar situation exists at the register input terminals—data, clock, control, etc. They should contain protective diodes to prevent damage from the buildup of static charge (Fig. 1b). The reverse breakdown voltages of these protective diodes should never be exceeded, nor should they be forward-biased.

### Don't exceed recommended operating voltages

Recommended operating voltages should be used for two major reasons: They have been found by the manufacturer to be safe, and most

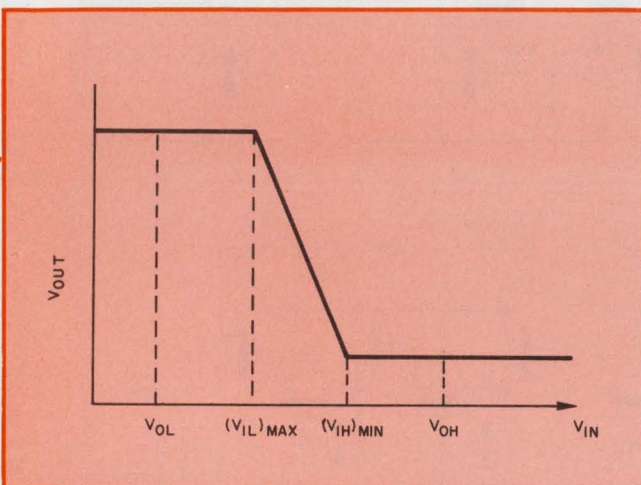

3. Dc noise margin is defined as the difference between the input levels,  $V_{OL}$  and  $V_{OH}$ , and the edges of the transfer characteristic,  $(V_{IL})_{MAX}$  and  $(V_{IH})_{MIN}$ .

other device characteristics are usually specified within these values. While higher operating speeds can be achieved at higher voltages, power consumption will also increase.

Here are typical nominal recommended operating voltages for high and low-threshold shift registers (most data sheets usually provide three values for each parameter: minimum, nominal, maximum) :

	High threshold	Low threshold
$V_{SS}$	0	+5.0
$V_{DD}$	-14	0
$V_{GG}$	-28	-12

As already noted, all voltages are referenced to the  $V_{SS}$  terminal. If desired, either type of shift register can be biased to other voltage levels, so long as the voltage differences between the individual terminals are maintained.

For example, the high-threshold register can be interfaced with TTL logic by connecting  $V_{SS}$  to the +5 V dc TTL supply and then making  $V_{DD} = -9$  V dc and  $V_{GG} = -23$  V dc.

### Set the clock-pulse levels

Input and clock voltage levels are also referenced to  $V_{SS}$  and must be modified accordingly if the terminal voltages are changed. In general, operating speed of a shift register is proportional to clock levels.

For example, if clock pulse  $\phi_1$  in Fig. A were reduced in amplitude, the ON resistance of data-transfer transistor Q1 would be higher, and a longer time would be required for charging and discharging the gate capacitance of Q2.

Here are nominal clock-pulse voltages, together with their nomenclature and symbols:

#### High threshold

Clock logic "0," $V_{\phi}(0)$	0 V dc
Clock logic "1," $V_{\phi}(1)$	-28 V dc

#### Low threshold

Clock HIGH level, $V_{\phi H}$	+5 V dc
Clock LOW level, $V_{\phi L}$	-12 V dc

While higher clock levels result in higher operating speeds, they can also cause erratic operation and lost data. Fig. 2 shows data-transfer transistor Q1 and one side of Q2 with parasitic capacitances. Capacitor C1 transfers a portion of voltage change in the clock-pulse level of  $\phi_1$  to the gate capacitance C2 of transistor Q2. The amount of the transferred voltage (called feed-through) depends on the clock voltage change and also on the ratio of the two capacitors.

If the clock feed-through pulse is of sufficient amplitude, it can alter the data-voltage level at

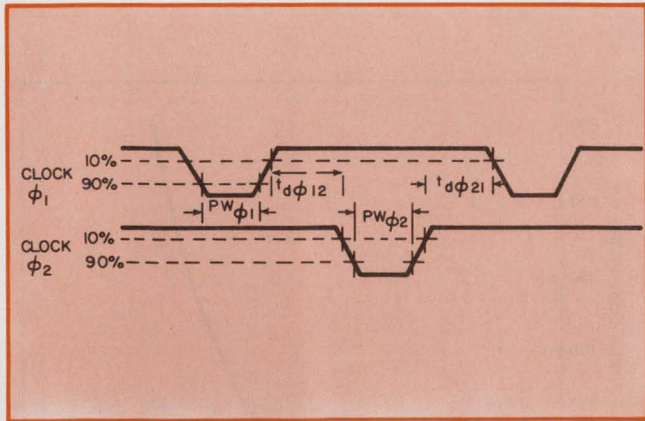

4. Minimum clock pulse widths,  $PW_{\phi_1}$  and  $PW_{\phi_2}$ , must be sufficient to permit charging and discharging of internal gate capacitors. Clock-pulse spacings,  $t_{d\phi_{12}}$  and  $t_{d\phi_{21}}$ , must always be larger than, or equal to, zero. This prevents the occurrence of two clock pulses at the same time.

the gate of Q2, thus producing a false output. This problem can be minimized by the MOS device designer by adjustment of the capacitor ratio for specified operating voltages.

#### Watch input logic levels

The main reason for using the recommended input logic levels is to insure that signal levels are never close to the dc noise margin. In Fig. 3 the input voltage levels,  $(V_{IL})_{MAX}$  and  $(V_{IH})_{MIN}$ , define the worst-case threshold limits for the register. If the input logic swing is between  $V_{OL}$  and  $V_{OH}$ , the register will have a dc noise margin of  $[(V_{IL})_{MAX} - V_{OL}]$  and  $[V_{OH} - (V_{IH})_{MIN}]$ . Thus if noise were riding on level  $V_{OL}$ , it would have to have an amplitude of  $[(V_{IL})_{MAX} - V_{OL}]$  before data errors could occur.

Since MOS threshold voltages are not as temperature-sensitive as in the case of bipolars, tem-

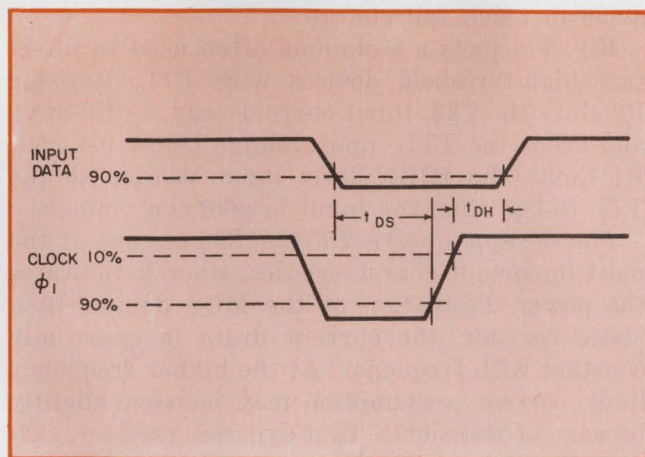

5. The data setup,  $t_{ds}$ , and hold time,  $t_{dh}$ , indicate how close to the clock-pulse transition the corresponding data can change and still be valid.

perature effects can be neglected in calculating noise margins.

#### Defining clock pulse widths

Clock pulse widths ( $PW_{\phi_1}$ ,  $PW_{\phi_2}$ , etc.) are defined in Fig. 4. The minimum clock pulse widths are determined by internal propagation delays of the stages. They must be adequate to permit charging and discharging of internal gate capacitances.

The minimum pulse widths of the two clock pulses are different; clock pulse  $\phi_1$  usually can be narrower than  $\phi_2$ . The maximum pulse widths of  $\phi_2$  can be infinite in the static register, since it sets up the static operating conditions. In the dynamic register,  $\phi_2$  must have a finite width determined by internal leakages. After initiation of clock pulse  $\phi_2$  in the static register, the register status remains unchanged until the arrival of  $\phi_1$ . The width of clock pulse  $\phi_1$  for both registers is finite because the capacitance of Q3 would discharge as a result of internal leakage.

In Fig. 4 note that the pulse widths are not measured at the 50% levels but rather at the 90%. This definition is a carry over from the high-threshold devices, where the 50% level was so far removed from the thresholds as to be meaningless. The most realistic point of reference is at the device threshold.

Registers operating with only one external clock usually require established pulse widths for each logic state of the clock. This is to allow internal clock-pulse generation and timing on the chip.

Clock-pulse spacing (Fig. 4) is determined by internal-capacitance leakage rates, and if it exceeds the specified values, data can be lost. The spacing is often defined as the time interval between the 10% levels on the clock waveshapes. In any shift register it can be down to zero, but two clock pulses can never be ON at the same time, since input data would be coupled in at the same time that other data were being cross-coupled.

A relation between input data and  $\phi_1$ , called "data setup and hold time," is shown in Fig. 5. This relationship is also known as "write-and-overhang time" or "lead-and-lag time."

#### Factors that affect pulse-repetition frequency

The minimum frequency for a static shift register is zero (dc). There is a finite minimum frequency for the dynamic register, and it is a function of temperature (Fig. 6). The maximum frequency is determined by minimum clock pulse widths, clock spacing and output loading. The latter factor is often quite important, since capacitance generally will limit the frequency of

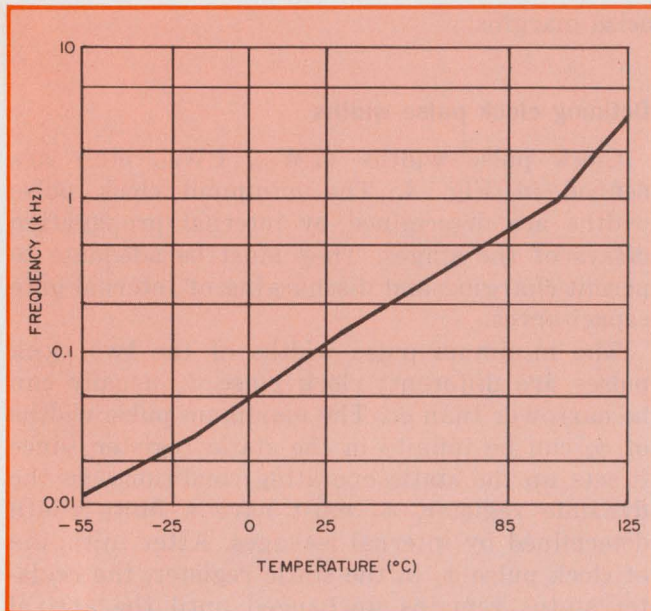

6. The minimum operating frequency in a dynamic shift register is temperature-dependent. (The minimum operating frequency for a static register is zero.)

operation. The higher operating frequencies of low-threshold devices are caused by smaller logic-level swings.

### Understand the electrical characteristics

The term "electrical characteristics" defines several MOS parameters, including the following:

*Input leakage currents.* These are seen by the drive circuits connected to the input or clock terminals. They are reverse-biased currents, since these terminals are never forward-biased, and the significance of leakage currents is twofold:

First, the leakage-current magnitude is a good indication of device status. Currents that are higher than specified or unstable are a sign of internal problems, and devices with these symptoms should be screened carefully.

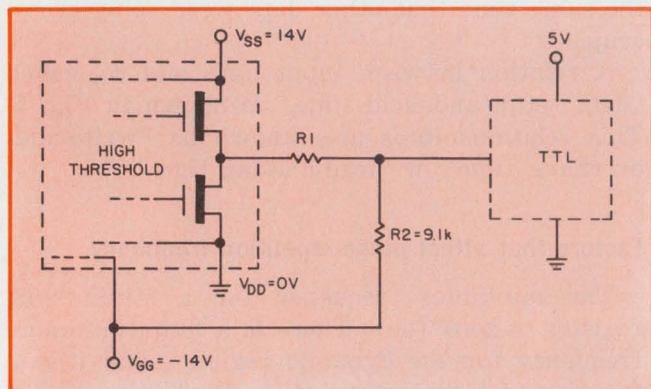

7. A simple circuit for interfacing MOS with TTL logic. An interface circuit is required because of the difference between MOS and TTL voltage levels. Note that  $V_{SS} = +5$  V dc,  $V_{DD} = -9$  V dc and  $V_{GG} = -23$  V dc, there would be no need for R1.

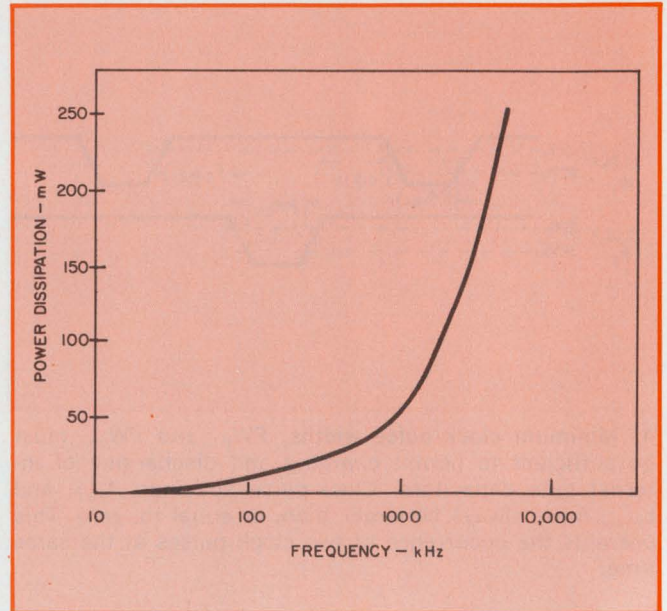

8. Operating frequency of a dynamic register sometimes is limited by the internal dissipation rather than by the internal propagation delays.

Second, excessive leakage currents can reduce the drive circuitry logic levels and noise margins. For example, an external driver with high fan-out (required for driving a cascade of registers) will end up putting out a lower driving signal unless it has a very low output impedance.

In general, clock leakage currents are substantially higher than the input currents because of internal fanout.

*Output voltage levels.* They must have adequate separation, so the two logic levels are reliably distinguishable by the load—another MOS device, a TTL gate or a discrete transistor.

Output voltages should be measured at the maximum operating frequency and with maximum capacitive loading. At higher frequencies the output resistance can increase and the output voltage can decrease, if internal time constants will not permit the gate voltage on the output stage to reach full charge.

Fig. 7 depicts a technique often used to interface high-threshold devices with TTL. Resistor R2 sinks the TTL input current (say,  $-1.6$  mA) and keeps the TTL input voltage below 0.4 volt. R1 limits the HIGH level input voltage to the TTL to less than the input breakdown voltage.

*Power-supply current drain.* This is one of the most important characteristics, since it indicates the power dissipation of the MOS device. In a static register, the current drain is essentially constant with frequency. At the higher frequency limit, current consumption may increase slightly because of transients. In a dynamic register, current drain rises sharply with increasing frequency (Fig. 8), so it must be checked carefully over the complete range of operating frequencies. In

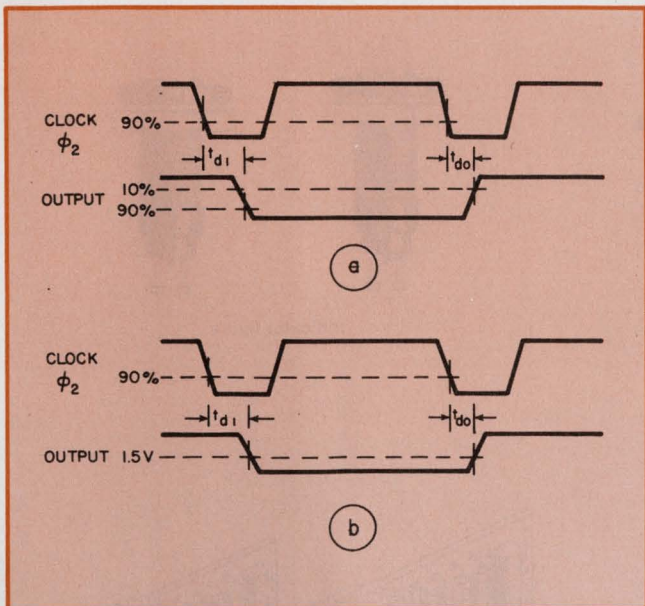

9. Output logic delays for a high-threshold MOS device are referenced to MOS levels (a), while in the case of a low-threshold device (b), they are referenced to TTL levels because these devices drive TTL.

fact, the operating frequency in some registers is limited by the internal power dissipation rather than by the delays between stages. Current drain, however, decreases with increasing temperatures.

*Output logic delay.* Sometimes not given in the specs, this is the propagation delay between the occurrence of the clock shift pulse and the time when the new logic level becomes valid (Fig. 9). Output logic delay can determine the maximum operating frequency, depending on the loading.

The terminology and reference levels used to measure output logic delay are almost as numerous as the types of available devices. In Fig. 9a the delays for the high-threshold device are referenced around MOS levels. In Fig. 9b the delays are referenced to TTL levels, since the device is designed for direct interfacing with TTL.

In evaluating logic delays, it is important to know the manufacturer's test conditions, since there are many variables that can affect the delay times—clock levels, loading, temperature, to name a few. Reduced delay occurs at higher voltage levels (at the expense of higher power dissipation). Logic delays increase at higher temperatures because of increased internal resistances.

*Input capacitance.* This affects the driving circuits at the input clock terminals, and it establishes the current requirements for the input drive circuits. The capacitance is caused by protective devices, parasitic elements and strays. Clock-input terminals normally have higher capacitance than the signal input terminals, unless the clock has input buffer stages. For example, while an input capacitance might be 5 to 7 pF, the clock capacitance for the same device might be between 50 and 60 pF. ■■

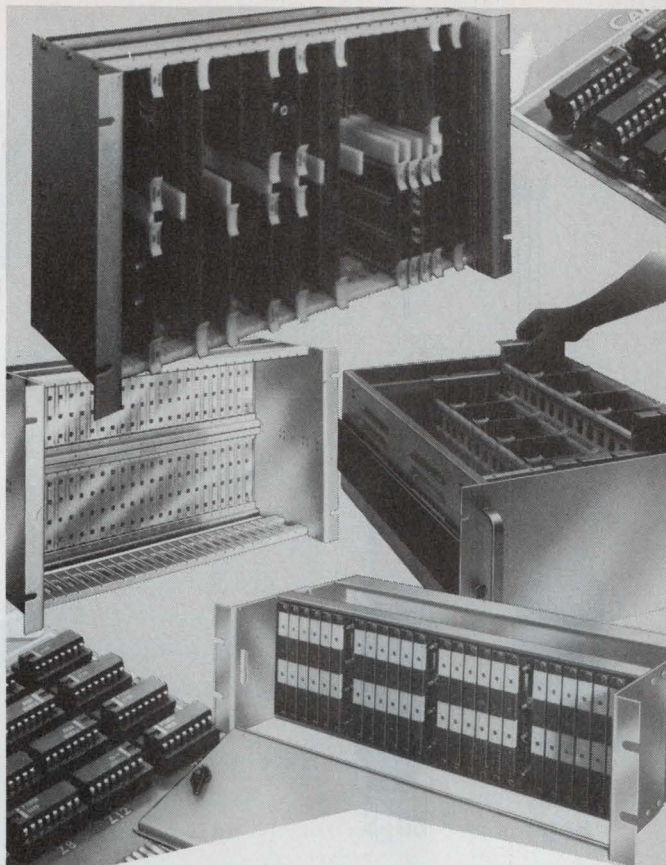

## designing with IC's? Cambion's expanded "works" solve more packaging puzzles

We've added extensively to our hot line of IC accessories to make your expanding work with IC's easier, faster, and simpler.

Strip connectors, cable assemblies, integrated socket strips, component socket adapters, cable cards, and card extenders are but a start. In addition, totally new Cambi-Cards®, card files, drawers, universal panels with and without pre-mounted socket strips and power planes, specific logic function cards for intermixing with Cambi-Cards plus the standbys you're using of high density sockets, wire-wrappable Cambi-Cards, logic cards, general purpose and discrete component cards, and more.

A complete NC Wire-Wrap\* service is available to speed economical production of your IC system designs.

Now, you can solve more digital system packaging puzzles with CAMBION's expanded "works". Our new catalog 99 tells the up-to-date story. It's got 40 more pages than its predecessor and we'll send it to you free, if you'll send us your name and address. Cambridge Thermionic Corporation, 445ED Concord Avenue, Cambridge, Massachusetts 02138. Phone: (617) 491-5400. In Los Angeles, 8703 La Tijera Boulevard, 90045. Phone: (213) 776-0472.

\*Registered Mark of Gardner-Denver Co.

Standardize on

# CAMBION®

The Guaranteed Electronic Components

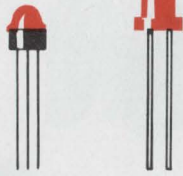

DIODE-LITES

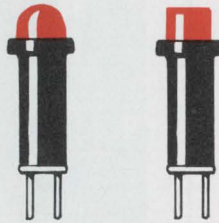

Cartridges

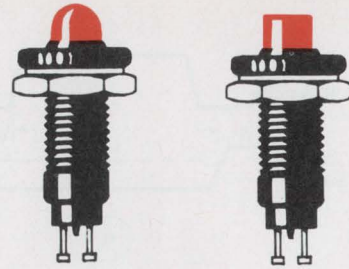

Indicator lights

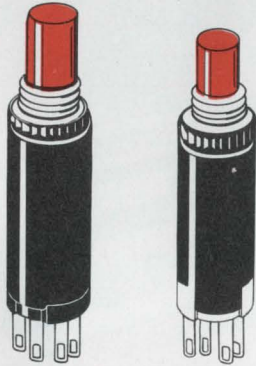

Lighted push button switches

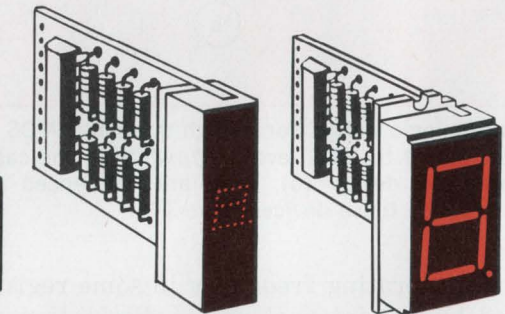
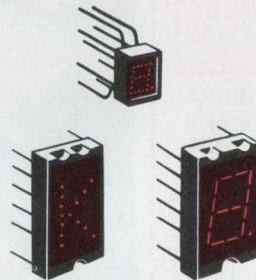

Readout modules and packages

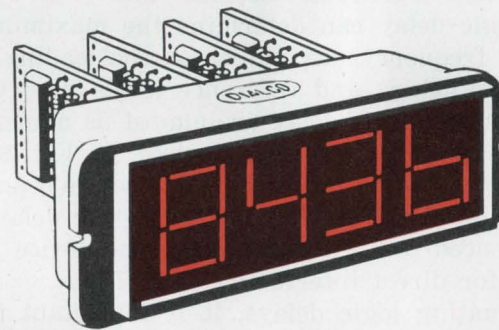
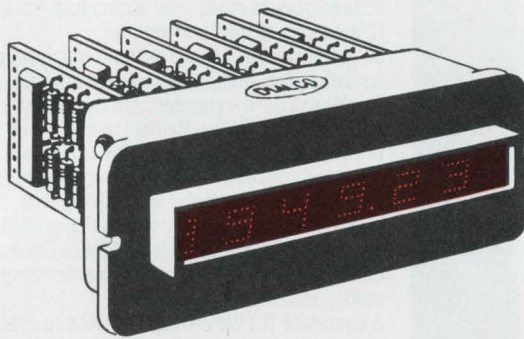

Readout assemblies

## LED displays?

**Talk to the specialists at Dialight first.  
You won't have to talk to anyone else.**

Whether you're looking for LEDs as light sources for build-your-own displays or for a variety of products that utilize LEDs, bring your requirements to us. Dialight is a major supplier of both LEDs (we call ours DIODE-LITE™) and of indicator lights, readouts and lighted push button switches that incorporate

DIODE-LITES. We can even give you a contactless solid state switch that uses a DIODE-LITE in the circuit to provide cleaner, faster switching than any mechanical switch. Dialight can help you do more with LEDs than anyone else because we've done more with them. Write for LED Data File.



DIALIGHT CORPORATION, A NORTH AMERICAN PHILIPS COMPANY • 60 STEWART AVENUE, BROOKLYN, N.Y. 11237 • (212) 497-7600

INFORMATION RETRIEVAL NUMBER 37.



# Complete RF Network Analysis

## 50/75 $\Omega$

400 kHz to 500 MHz with 115-dB dynamic range and 0.005-dB resolution. Precise measurements of transmission and reflection properties — magnitude, phase, group delay, and S-parameters — all direct reading and neatly displayed on a built-in scope. Complete characterization of filters, amplifiers, cables, antennas, delay lines, transistors, or most anything else that comes to mind — all at the push of a button.

50 and 75  $\Omega$ ! Measurement impedance is changed by a

change of external accessories (not by a change in the basic instrument or even a part of it), and your application is matched exactly with a host of GR 50-ohm and 75-ohm components. There's more, of course, including computer-controlled systems or other versions tailored to your needs. Look into it. Better yet, see it — in action — in your application.

For a demonstration of this remarkable system, call your local GR center. The price for the basic 1710 RF Network Analyzer? Only \$6850 (truly remarkable).

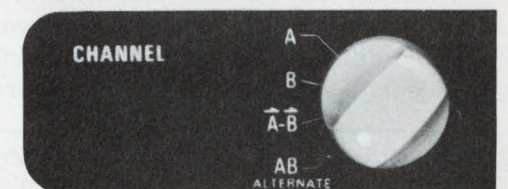
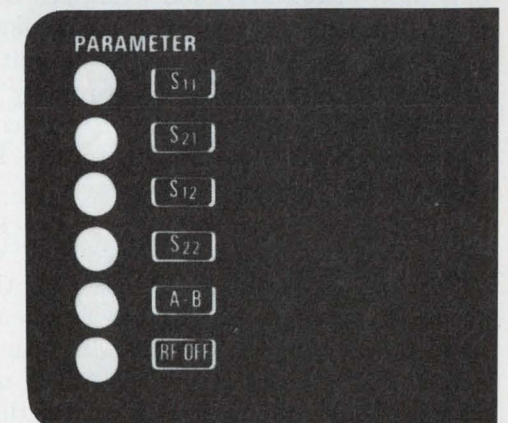
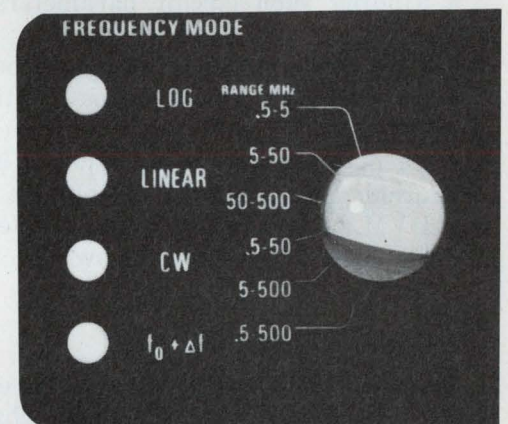
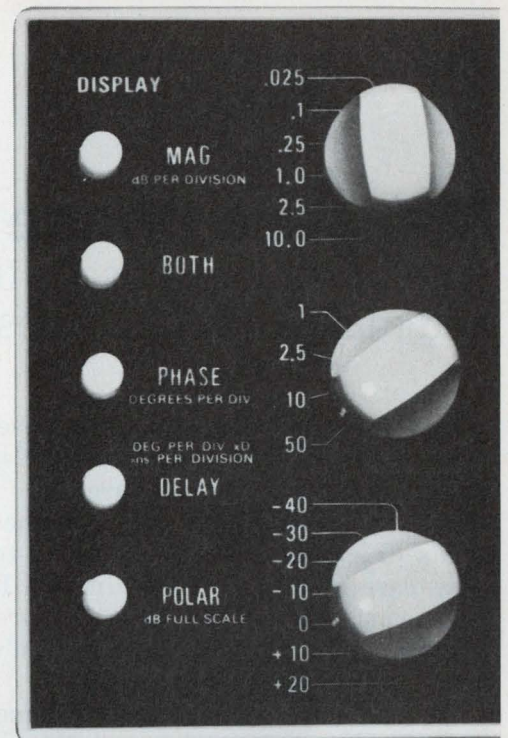

For High-Frequency Measurements



300 BAKER AVENUE, CONCORD, MASSACHUSETTS 01742  
 NEW YORK (N.Y.) 212 964-2722 (N.J.) 201 791-8990 • BOSTON 617 646-0550  
 CHICAGO 312 992-0800 • WASHINGTON, D.C. 301 881-5333 • LOS ANGELES 714 540-9830  
 TORONTO 416 252-3395 • ZURICH (01) 55 24 20  
 GRASON-STADLER 617 369-3787 • TIME/DATA 415 327-8322

INFORMATION RETRIEVAL NUMBER 38

# Measure phase instead of amplitude.

It provides greater sensitivity and resolution, and makes frequency-response analysis a lot easier

In comparing the actual response of a new circuit with the theoretical, the odds are you've been using amplitude measurements about 90% of the time. You've probably used phase measurements in special applications only—to determine gain margin and phase margin, say. It may come as a surprise to you, but phase measurements have advantages in everyday design. You've probably been overlooking them.

For example, here are three common problems that phase measurements can help you overcome:

- Finding such circuit parameters as  $Q$  and natural frequency.
- Detecting small changes in a response curve.
- Locating poles and zeros in the complex plane.

Each of these problems requires considerable resolution. You can get it by buying more digits in a DVM, or you can solve the problem by measuring phase. Let's examine how.

## Phase gives greater resolution

Consider low- $Q$  networks, which exhibit slow amplitude changes with frequency changes. High resolution is needed to detect any change. Active bandpass filters are good examples of this situation.<sup>1</sup> Finding the natural frequency isn't easy when the frequency can be varied with no apparent change in amplitude. Fortunately the changes in phase can be very large. Fig. 1 contrasts the small amplitude changes with the large phase changes of one possible network.

As a numerical example of the possible improvements, a phase meter that can resolve 1/10th of a degree of phase has the inherent ability to resolve the natural frequency to  $\pm 7\%$  when  $Q=1/100$ . In contrast, amplitude is within 0.1 dB of its peak for  $Q=1/100$  over a two-decade frequency range. For the less extreme case, Fig. 1 shows the results when  $Q=2$ .

Finding the natural frequency may be only part of the problem. The measurement of  $Q$  itself may be difficult in practice. It should be possible to calculate  $Q$  from only three measurements. One

is needed to find the natural frequency. Two more measurements will determine bandwidth. The equation  $Q = \text{natural frequency} / \text{bandwidth}$  gives the value of  $Q$ .

In trying to measure the bandwidth, you may run into problems, since the source voltage is not flat for changes in frequency. The problem is that the  $-3\text{-dB}$  point of the output is not independent of the changing input (nonconstant input impedance of the network can be the source of this problem). The source and output voltages must be measured by the designer to find the true  $-3\text{-dB}$  points. Fewer measurements need be made if the ratio of the source to output voltages is measured. A gain-phase meter can perform this measurement and display dB ratio. Such an in-

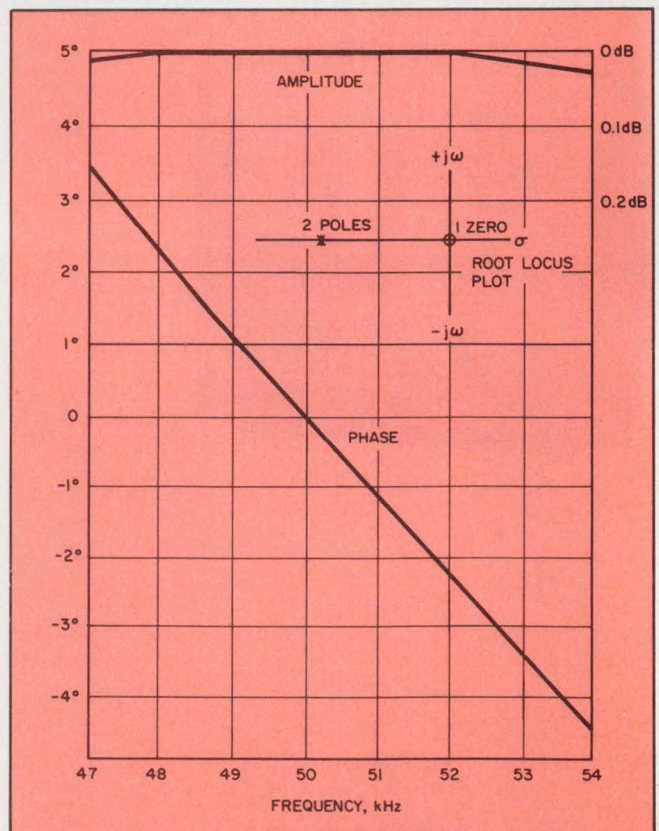

1. Comparison of phase and amplitude changes as a function of varying frequency. For  $Q=2$  amplitude remains within 1/100 dB of its maximum, while phase changes  $7.9^\circ$ .

Dave Luttrupp, Products Manager, Hewlett-Packard Co., 815 Fourteenth St., S.W., Loveland, Colo. 80537.

strument makes these measurements easier because the basic equipment setup doesn't have to be changed.

### Phase gives greater sensitivity

The need to detect small changes in circuit response is another situation that is encountered regularly. You may know there is a glitch in the response curve, but measuring its size and location may be difficult because it is so small. In practice, this situation is encountered when the rolloff of an unwanted low-frequency pole is to be compensated for by a zero at the same frequency. Tailoring the response of an op amp is another application of pole-zero compensation.<sup>2</sup> And a similar situation exists when the characteristics of a simple lead or lag network are being investigated. In any of these applications the pole-corner frequency depends on component values, which may vary. Therefore to achieve maximum compensation, we must adjust the corner frequency of the zero.

This can be done by looking for amplitude changes. When the amplitude remains flat, the best compensation has been achieved. The resolution and accuracy of the measuring instrument determine the degree to which compensation can

be achieved by measuring amplitude. However in this case, if phase remains flat, compensation will also have been achieved.

There are two advantages to using phase. One is greater sensitivity; the other is narrower bandwidth measurements. It is apparent from Fig. 2 that 75% of the change in phase can be observed with a measurement at either 0.1 f or 10 f and a measurement at 1 f. Measurements of amplitude at the same frequencies show only 50% of the total change. The conclusion is that to get better sensitivity in a narrow bandwidth, the change should be investigated with phase. Why is narrow bandwidth important? If the pole to be compensated occurs at 1 Hz, it may not be possible to make a measurement at 0.1 Hz because of limited low-frequency meter response. The phase measurement, however, could be made at 1 Hz and 10 Hz.

The many articles which cover the design of active filters don't usually tell how to compare actual and theoretical response.<sup>3</sup> Many of these filter designs use complex roots to achieve their performance.

How do you measure the location of the complex poles? On the surface this would appear to be a simple problem since only two quantities need be measured to locate the roots.

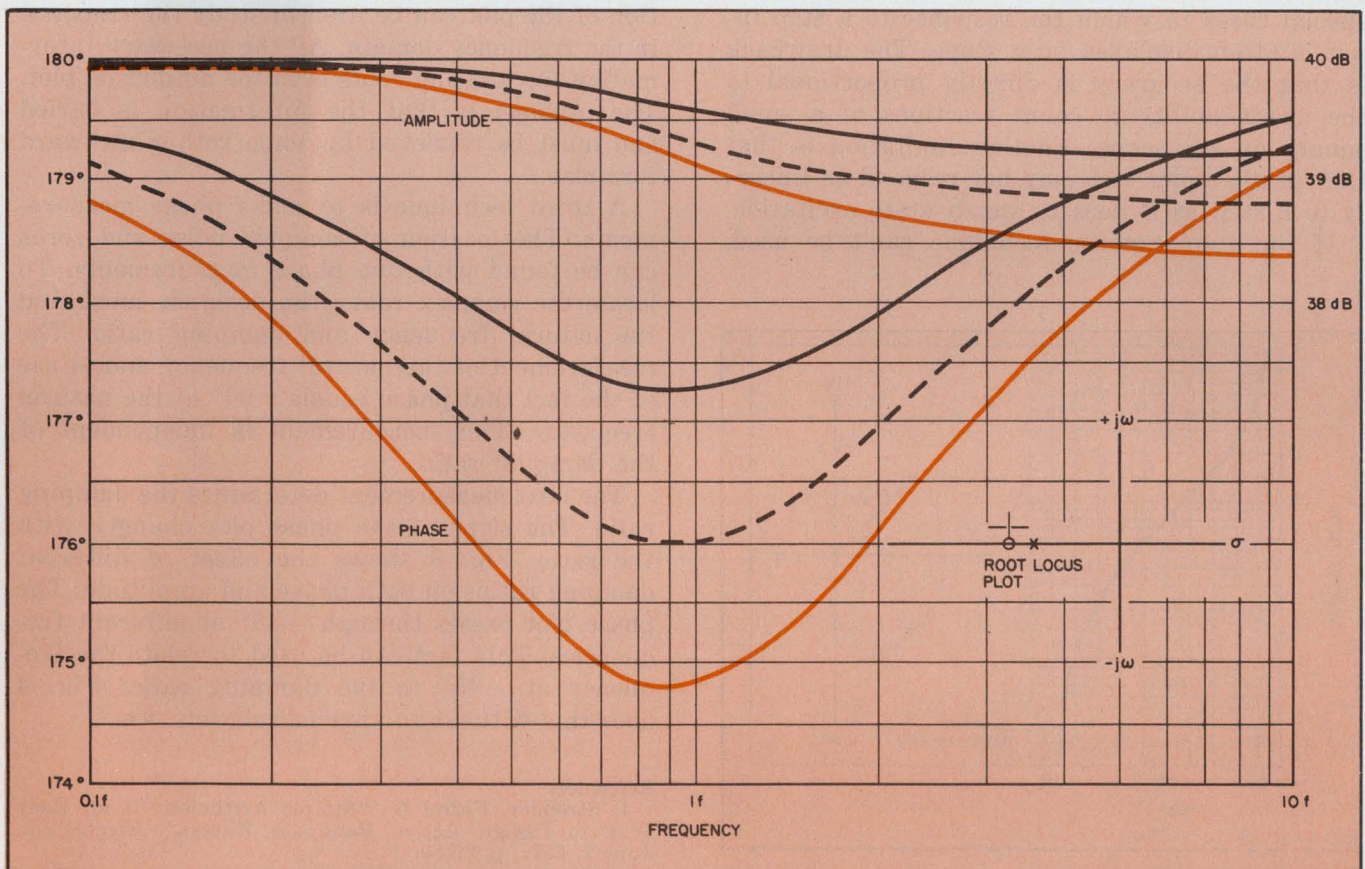

2. Pole-zero compensation using phase measurements. Phase change is much larger than amplitude

change over the same frequency range. Greater sensitivity is obtained over a narrow bandwidth.

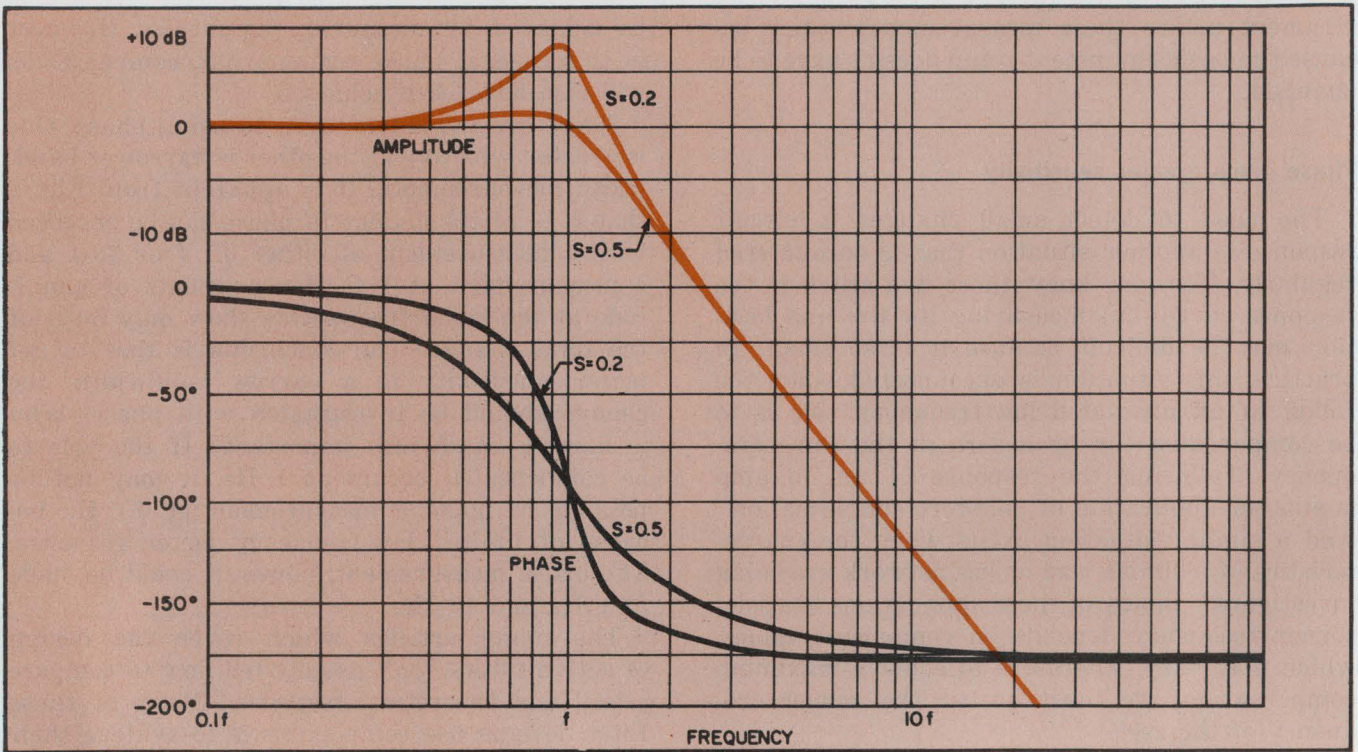

3. Amplitude and phase vs frequency plots, with damping ratio as a parameter. Note that peak amplitude does not necessarily occur at the natural frequency. Phase, however, always crosses  $-90^\circ$  at the natural frequency. This measurement is independent of the damping ratio.

frequency. Phase, however, always crosses  $-90^\circ$  at the natural frequency. This measurement is independent of the damping ratio.

Amplitude measurements are satisfactory for special cases in which the response to a step input is often displayed on a scope. The drawback is that the accuracy is directly proportional to the user's ability to count fractions of a small square on the scope. Another limitation is that the circuit under test may not respond as linearly to a step as it does to steady-state excitation. If the step-response technique can't be used,

a Bode plot may be feasible. The amplitude portion of the plot can be used to study the response in the frequency domain. All the necessary information for locating roots is in the amplitude plot. The problem is that the information is buried and must be retrieved by some rather awkward formulas.

A third technique is to make phase measurements. The location of complex poles and zeros can be found with two phase measurements. To locate the complex roots, the designer must find the natural frequency and damping ratio. The measurement of the natural frequency makes use of the fact that phase equals  $\pm 90^\circ$  at the natural frequency. This measurement is independent of the damping ratio.

The next measurement determines the damping ratio. The slope of the phase plot changes with the ratio. Fig. 3 shows the effect of different damping ratios on both phase and amplitude. The phase plot passes through  $-45^\circ$  at different frequencies. This fact can be used to relate the frequency at  $-45^\circ$  to the damping ratio. Fig. 4 does this without further calculation. ■■

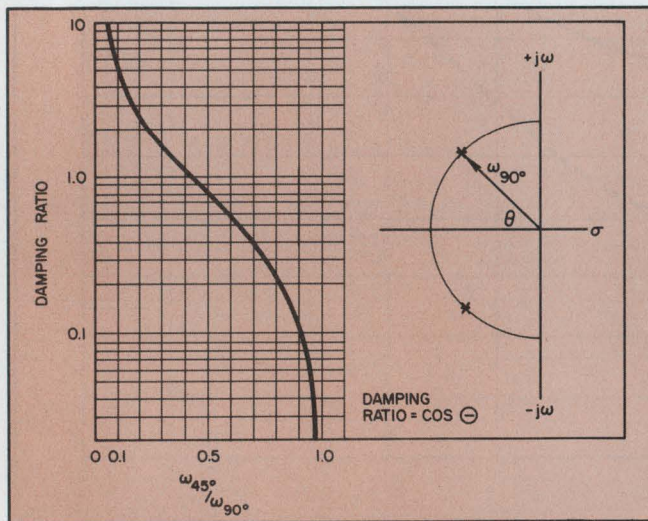

4. Damping factor is found from Figure 3 by forming the ratio of the frequencies at  $-45^\circ$  and  $-90^\circ$ , i.e.,  $\xi = (1-U^2)/2U$  where  $U = \omega_{45^\circ}/\omega_{90^\circ}$ .

#### References

1. Stremmer, Ferrel G., "Simple Arithmetic is an Easy Way to Design Active Bandpass Filters," *Electronics*, June 7, 1971, p. 86-89.
2. Payton, Gary L., Warren, Morris I., "Custom Compensate Your Op Amp," *Electronic Design* Jan. 7, 1971, p. 92-95.
3. Russell, Howard T., "Design Active Filters with Less Effort," *Electronic Design*, Jan. 7, 1971, p. 82-85.

# Imagination and Stackpole ferrites can cut a power supply down to size

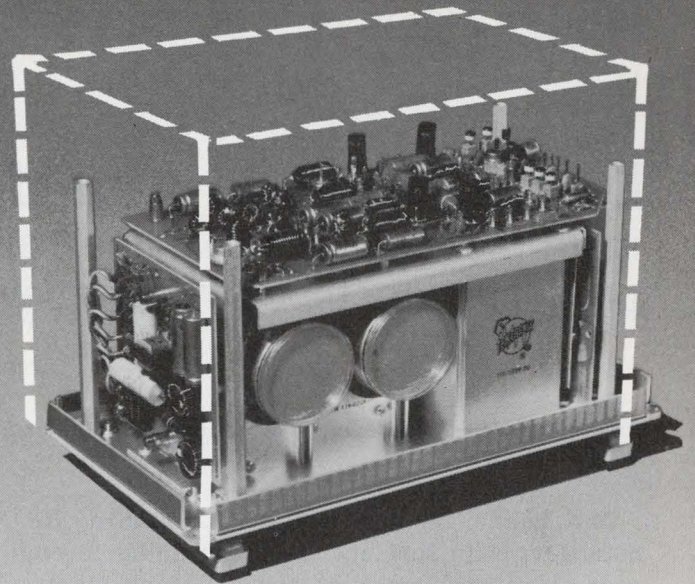

**Tektronix, Inc. uses Ceramag® ferrite materials to achieve efficiency and significant savings.**

Conventional power supplies are bulky, heavy and inefficient. Tektronix, Inc. changed all that. With ferrites and a fresh idea.

By rectifying line voltage, converting it to 25kHz and rectifying it again, Tektronix, Inc. engineers produced a power supply that was 50% lighter, over 25% smaller and consumed  $\frac{1}{3}$  less power. And the overall operating efficiency of 70% is a big improvement over the 50% typical of conventional power supplies.

Ferrites can offer the unique advantages, design freedoms and electronic characteristics that produce exciting new ideas. Stackpole Ceramag ferrites were used throughout the power supply design. Because Stackpole has a wide variety of materials and configurations, designers can unleash their imaginations.

**Ceramag 24B**



Tektronix, Inc. selected 24B for their "U" and "E" cores. This proven material has seen years of service in flybacks for television. Ideal for power applications, it can be operated at higher frequencies than laminated steel. It is cool running, due to low losses under power conditions and controlled power permeability. Tooling is available for a wide range of "U", "E" and "I" configurations.

**Ceramag 24**



Toroids of Ceramag 24 were used by Tektronix, Inc. for transformer cores. Again, this is a proven material, widely used by the computer industry for pulse transformer cores. It has a tightly controlled initial permeability, and tooling for a variety of sizes is also available.

**Ceramag 7D and 27A**

Multiple material selection for coil forms allowed Tektronix, Inc. maximum flexibility and design freedom. Proper inductance values could be achieved in the allotted amount of room. In addition, the high resistance of 7D

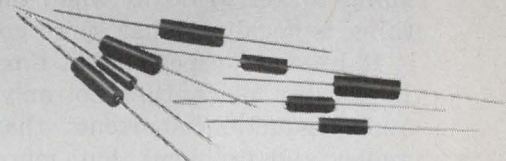

material prevents accidental shorting on printed circuit boards.

Great new designs happen when you start with the idea of ferrites. Particularly Stackpole Ceramag ferrite components. Why? Because Stackpole offers the variety of materials, numerous tooled configurations and the technical back-up you need. Twenty-four years of television and computer experience makes Stackpole one of the largest and most experienced domestic suppliers of quality ferrites.

Consider ferrites on your next prototype or redesign. But give us a call when you start. Perhaps we (and some Ceramag® ferrites) can help you cut a problem down to size. Stackpole Carbon Company, Electronic Components Division, St. Marys, Pa. 15857. Phone: 814-781-8521. TWX: 510-693-4511.



**STACKPOLE**  
ELECTRONIC COMPONENTS DIVISION

**Define before you design,** advises this instrument division manager, and you'll be able to use engineering production methods that will save you time, money and headaches.

**Dick Moore,** R&D Manager, Hewlett-Packard, Loveland, Colo.

My challenge, as a Hewlett-Packard R&D manager, is to sort out what I'm going to engineer. That problem is so basic, I think many of us who manage often overlook it. We talk about how we're going to do the job, and who we're going to get to do it, when the most important thing is deciding what we're going to work on.

If I define properly what I'm going to engineer in the first place, then not only can I use design and production shortcuts that save me time, money and problems, but, more importantly, I'll design a product that sells.

Defining a product line takes thought, planning and research—and, most important, the cooperation of all departments. Because the needs of customers change, because the economy changes and because our product lines change, our R&D continuously generates product-line alternatives. Then the Marketing Dept. runs them through its filter, and we both decide what looks good. When I get together with my staff, we know what the marketing situation is and what those in the field are concerned about. We also know what our technology is, not only in-house but what other HP labs are doing and what the other major organizations are doing. We brainstorm, we float, and about every six months we update our brainstorming. We document our ideas and go over each point with our marketing managers, division managers and group managers. Essentially what we generate is a family of alternatives.

---

*Keep the initial research group small in number. A large group of investigators is like a flywheel turning, which is hard to move in a new direction.*

---

At the division level, we're responsible for updating some of the products that were originally defined by the company. The updating of the oscillator line is a good one to help explain how I define what to engineer. I had to solve two problems: how to define the product line and how to program the instruments for a computer model. We felt that the communications industry

was going to expand, and that the frequency range of the products we had were just right for some very dramatic communications needs. Also, because of a decline in military spending, we thought we'd revise our signal-generator product line from the ground up and diversify from the oscillator and function-generator business into frequency synthesizers. It was a full product-line look, and it was a generic problem that is common to all instrumentation: How are we going to make things more easily programmed than they have been in the past without having each instrument have a different interface?

My responsibility was to decide what we were going to do and how we were going to do it. About 35 engineers—EEs, MEs and industrial designers were under my direction. Most were working for me on other product lines at the start of the signal generator project. I kept most of them on those projects during the investigation phase of the project, because if too many people join an investigation, it becomes extremely hard to manage. You tend to get a flywheel turning; it's hard to move the flywheel. And I wanted to be sure that I could look into all ideas personally without committing myself to any one of them prematurely.

After we had wrung each other's brains out, we conducted a full search of everything we thought we knew that would help define the product line, so we wouldn't pick false paths. We looked at instruments already in production that were similar to the types of things we wanted to do—how they were used and what the customers' criticism of them was. We studied all the requests for special versions of these instruments. We read the letters of objections to the product.

And we were lucky, too. We had introduced an analog sweeper at about the same time we were researching the generator, and I got personally involved in the field training and selling of it. I watched the customers' reaction to it, to see what kind of problems there were with an instrument that was related to the signal generator. It was a full sweeper, and we were trying to make a digital sweeper out of a synthesizer.

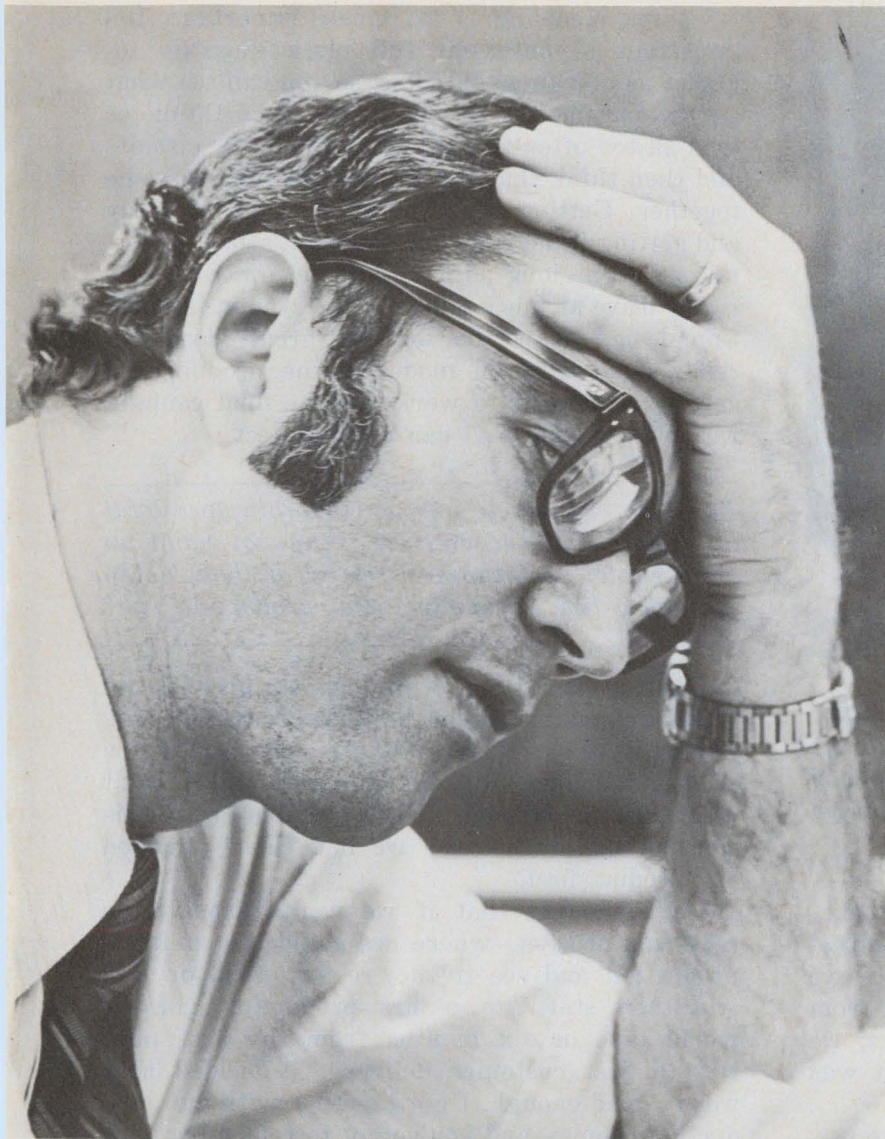

## Dick Moore

**Education:** BSE, Princeton; MSEE, University of California at Berkeley.

**Experience:** Engineering manager; engineering section manager; production engineering manager; production module leader; engineering group leader; design engineer.

**Achievements:** Distortion analyzer line; ac voltmeter line; wave analyzer design; synthesizer and DVM product line definitions.

**Personal:** Married; two children—a boy and a girl; interests include sailing; fishing; hiking; history.

**Employer:** Hewlett-Packard is one of the world's leading designers and manufacturers of electronic, medical analytical and computing instruments and systems. Founded in 1939, the company has become a worldwide organization with annual sales in excess of \$375-million. HP's 16,000 employees staff 14 domestic divisions and five overseas plants. The company's products are marketed in more than 100 countries.

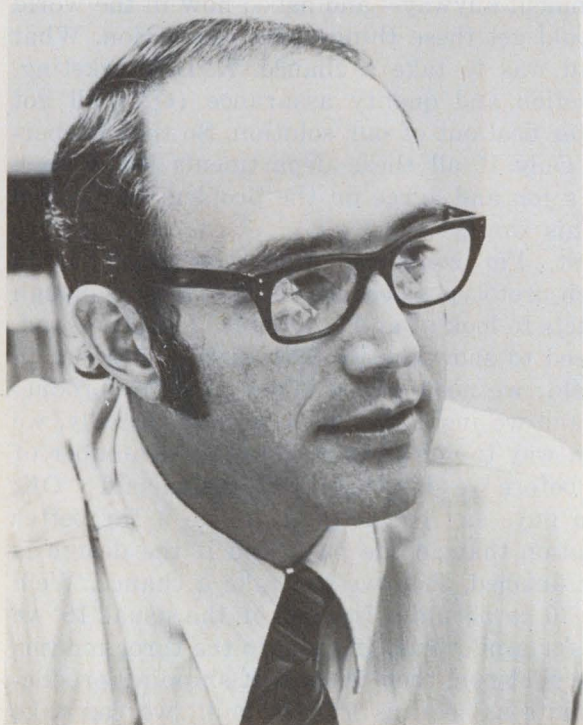

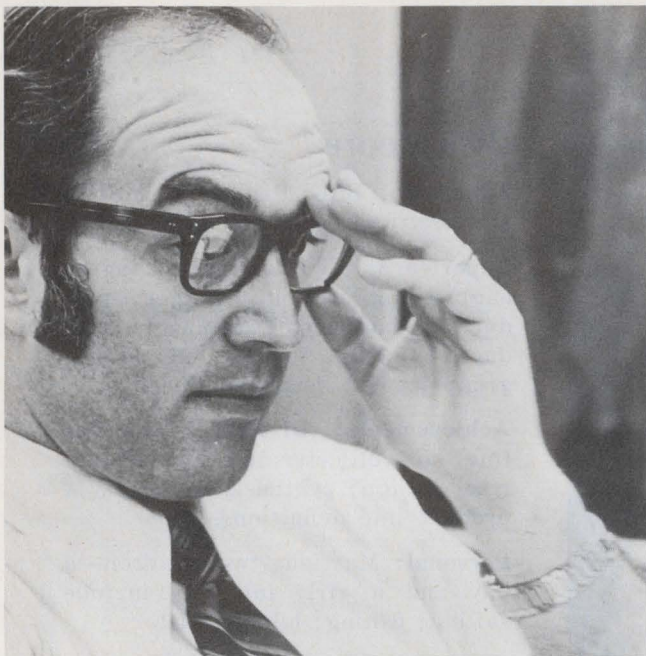

---

*We tend to wring out our circuits and think the system will always come together easily. A model of the product is surer and will quickly reveal important system parameters.*

---

After about a year of investigation, we realized, among other things, that a frequency synthesizer isn't very easy to use manually. Since we wanted to be competitive across the board, from bench use to controlling tracking analyzers, we knew we had to build the thing so that it was easy to program.

So we said, well, if the panel is that hard to use, let's do it digitally, especially now that we know the analog world is becoming more and more expensive, on a comparative basis with the digital world, to achieve the same function. So we had a calculator designer who was a member of the investigation team design a keyboard control on the main instrument.

One of the management decisions I made at this point that saved time and minimized our headaches was to model our problem. We model so the staff can see the product, interact with it and come up with ideas for it. We bought synthesizers that were already available and used our computers. Essentially we tried to model what we were trying to build, instead of breadboarding and prototyping. Our whole staff was involved. Our mechanical engineers were building up a keyboard, so that when we had the software written for simulating what we wanted to do with this new front panel, we were actually able to control the synthesizer with a keyboard. We actually had to build up a little hardware to get the feel of the keys, to see if the thing would feel like an analog sweeper.

I think modeling is extremely important. It's important to put your full block diagram together as quickly as possible, so you can see what all the parameters are going to be. I think we tend all too often to really wring out our circuits and then think that the system is going to come together. Getting the system to work properly and getting it defined properly, so it's easy to use, takes just as long as a circuit design. Since we rarely leave as much time for the system integration design as we do for the circuit design, I really push hard on modeling the product and getting something to work like the final configuration as quickly as I can on a project.

---

*There never seem to be enough prototypes built to analyze and characterize. Why not build an extra run of prototypes in the lab without going through a time-consuming pilot production run?*

---

When it came time to produce our product, we found we could sidestep the pilot production run. That little shortcut saved two months and a few thousand dollars. But there's one point I can't emphasize too strongly: We were able to use this shortcut mainly because we had clearly defined our product first.

We thought that if we went through the pilot-run process—where we build 10 units in production and see if they're any good or not, and then start up a first-production run—it would take us six months from the first pilot run to first customer delivery. I decided that wasn't good enough. I got together with our production people—and you've got to remember that about 50% of them were R&D people on short assignment anyway—and asked how in the world we could get these things into production. What we did was to take a chance. R&D, marketing, production and quality assurance (QA) all got a better deal out of our solution. So they cooperated. Only if all these departments know each other's job and agree on the problem can a deal like this work.

First, I'm convinced that you never build enough prototypes because you don't have enough products to look at and characterize. And second, we need to show the prototypes to customers in the field; we need demos and wiring for production, and we just never have enough. Finally, we need a way to get life test hours on a number of units before we ship them. Production said: "OK, if you guys say you're going to do a far better evaluation than in the past, and if the design is really finished, then we can take a chance. We'll build 30 to 35 units instead of the usual 10 we build for a pilot run. If we skip the three months of the pilot run, then instead of shipping production units as soon as they're built, we can take



those 35 units and store them in heat chambers, temperature-cycle them and do any doggone torture thing we want to. And, according to the size of the production run, we can accumulate between 10,000 and 30,000 hours of life-test data before we ever ship a production unit."

Needless to say, our QA people and our production people were just absolutely delighted. With this kind of testing, we were confident that if the instrument crapped out, it would be component-related, not design-related, because the design would have withstood the testing. The Marketing Dept.'s biggest headache is not knowing when they're going to get the first delivery of demos to their field guys. But, under our plan, the marketing people could still take the first five instruments off the line, the same as they did with the pilot run.

Now we can have 30 to 35 units sitting in a rack getting AQL (accepted quality level) testing, and when we begin to see that the failures are at a level we can absolutely predict, that's when they'll be deliverable. When they're that reliable, we can train our field guys with them. We also have enough demos to leave at all our field training locations. We're also getting the product out four months earlier than before. We've saved production money, R&D money and marketing money. In other words, we just made sure that the job was designed before it went into production.

We agreed to pay any cost over what a normal first production run would cost. We made the agreement before the run so there'd be no argument later.

It turned out that we paid about \$5000 less on the first production run than we normally would have paid on a pilot run. We know we didn't spend that much money building prototypes in the lab.

---

*Some companies keep their engineering and production in separate buildings. I gamble by transferring people across department lines.*

---

One reason for the success of the signal generator project is that we cross-train heavily. There's not one engineering manager at HP Loveland who hasn't had a year in production. Our production people also train with us. There's a complete overlap. At the end of a project we transfer one of our design engineers to production, and maybe one of the engineers who we think will be getting in lab management. Probably about a third of our R&D staff is in production on a temporary basis.

I was the first engineer to go through the production aspect. It made it easier for the company to transfer people when they saw I was promoted

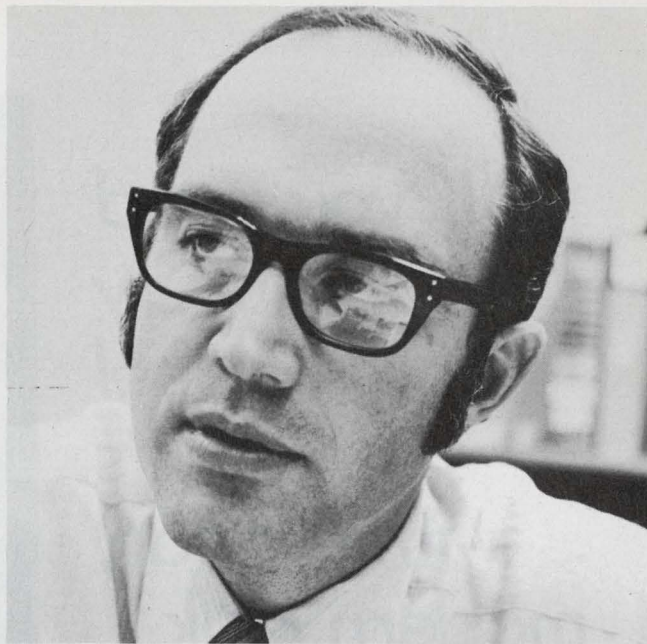

to a section manager after spending a year in production. Now I transfer an EE and an ME to production at the end of each project. My division—the Loveland Instrument Div.—is the only one sending engineers to production.

When the guy's sent, it's a shock to him. But we tell him that if we didn't think he was a good engineer to begin with, we wouldn't send him. Then we say that if he really wants to get back into engineering, then get the job done in production—and, boy, that sure closes the loop. The experience really stretches them; they know that they are the cream.

When I was working on the oscillator, I had 35 engineers as a section leader and five group leaders reporting to me. How did I make the adjustment from engineering to management? We have three levels of lab management—group leader, section leader and lab manager. Going from the group-leader job to the section-leader job is where you make the big transition from engineering to managing. The year I had in production helped a lot. Before that I was really pretty much a bench guy and proud of the fact that I had advanced degrees in engineering. I felt in my bones that I could solve any technical problem. When I went into production, the wool was pulled from my eyes, because I had never known how the gears of all the departments meshed. They put me in charge of the production lines, which was revolutionary. I gained a tremendous respect for the people in production.

Going from a design engineer to group leader or from three to 10 people isn't really too hard a transition. The next step, when you're working through group leaders, is tough. I just think that a guy needs some kind of discontinuity in his training to grasp it. ■■

If you need  
**top-quality**  
**panel**  
**instruments**  
with a clean,  
modern look...

Buy  
**Triplett's**  
Series GL  
or GL/B

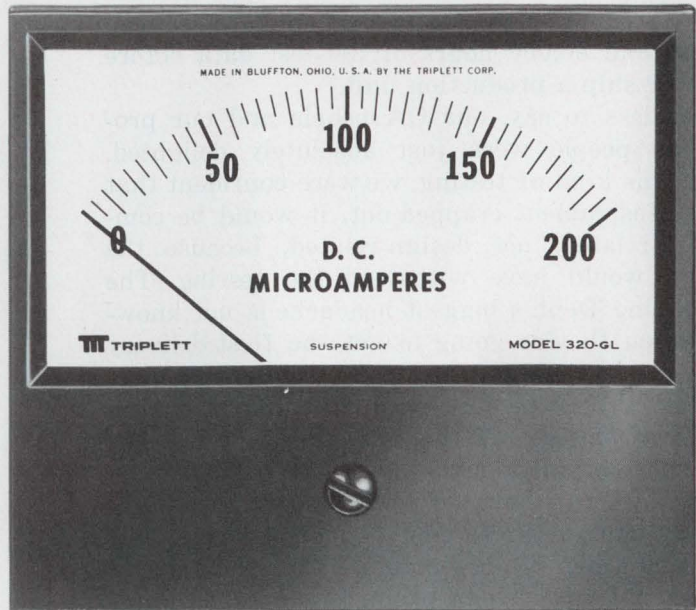

GL

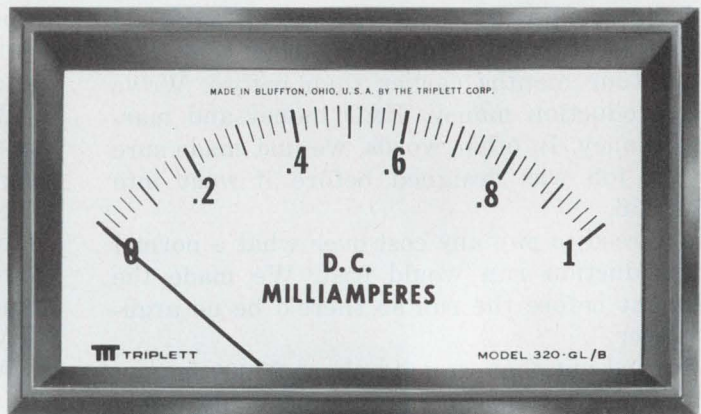

GL/B (mounted appearance)

Triplett's newest panel instruments, the Series GL and GL/B, feature glass windows, matte-finish phenolic cases and a dial design that can readily accommodate multiple scales. They are available in 3½", 4½" and 5½" sizes.

The GL Series features a standard 2-stud mount with 3- and 4-stud mounts available.

The feature of the GL/B Series is behind-the-panel mounting with a bezel which is an integral part of the case.

There's a choice of more than 275 stock sizes and ranges — in DC microammeters, milliammeters, ammeters, millivoltmeters and voltmeters; AC milliammeters, ammeters, and voltmeters; RF thermoammeters; dB meters and VU meters. For those who need special instruments . . . custom dials, pointers, scales, accuracy, tracking, resistance, response time or practically any combination of unusual specs can be put into these new cases. For quick, dependable delivery

of small quantities of these adaptable new instruments, contact your Triplett Sales/Service/Modification Center or distributor. For prototypes or production quantities, contact your Triplett representative. Triplett Corporation, Bluffton, Ohio 45817.

**TRIPLETT**  
BLUFFTON, OHIO 45817

Manufacturers of the World's  
most complete line of V-O-M's

# Sorensen solutions to line voltage problems.



Whether you have brownout, line noise, or other AC problems, Sorensen has the solutions... ACR regulators and FR conditioners. Both help end costly equipment downtime, or even catastrophic failure. □ The ACR Series is an amazing combination of price, power, performance, packaging, and ruggedness. Eight models cover the field. With 0.5 to 15 kVA, remote sensing and programming, and full load efficiency to 95%. □ FR's are something else.

Fast! Response and impulse settling time: 50 microseconds or less. 100 decibels of common mode rejection. Harmonic distortion of 0.2%. Regulation to 0.05%. Peak amplitude instability of less than 0.01%. 2.5 crest factor. With FR, you get just what you want — pure AC power. □ Sorensen offers more. Solid state circuitry, conservative thermal design, compact packaging. See the table below. For more complete data, write Sorensen Power Supplies, Raytheon Company, 676 Island Pond Road, Manchester, N.H. 03103. Telephone (603) 668-1600.

ACR Series							
Model	Output		Input		Voltage Regulation		Price*
	Voltage (Vac) (Settable Range)	VA	Voltage (Vac)	Freq (Hz)	Line	Load	
ACR500		500			±0.1%	±0.1%	\$ 380
ACR1000		1000			±0.1%	±0.1%	\$ 450
ACR2000		2000			±0.1%	±0.1%	\$ 575
ACR3000	110	3000	95	47-53	±0.1%	±0.1%	\$ 700
ACR5000	to	5000	to	or	±0.15%	±0.15%	\$ 850
ACR7500	120	7500	130	57-63	±0.15%	±0.15%	\$1025
ACR10000		10000			±0.15%	±0.15%	\$1450
ACR15000		15000			±0.15%	±0.15%	\$1775

FR Series						
Model	Output		Input		Combined Regulation	Price*
	Voltage (Vac)	VA	Voltage (Vac) (Switch Selectable)	Freq (Hz)		
FR516A **	115	500	95-115/105-125/115-135	59-61	±0.05%	\$ 925
FR1016A	115	1000	95-115/105-125/115-135	57-63	±0.05%	\$1500
FR1015A	115	1000	95-115/105-125/115-135	47-53	±0.05%	\$1500
FR1026A	230 (115 opt.)	1000	190-230/210-250/230-270	57-63	±0.05%	\$1650
FR1025A	230 (115 opt.)	1000	190-230/210-250/230-270	47-53	±0.05%	\$1650
FR2516A	115	2500	95-115/105-125/115-135	57-63	±0.05%	\$3425
FR2515A	115	2500	95-115/105-125/115-135	47-53	±0.05%	\$3425
FR2526A	230 (115 opt.)	2500	190-230/210-250/230-270	57-63	±0.05%	\$3650
FR2525A	230 (115 opt.)	2500	190-230/210-250/230-270	47-53	±0.05%	\$3650
FR5016A	115	5000	95-115/105-125/115-135	57-63	±0.05%	\$6800
FR5015A	115	5000	95-115/105-125/115-135	47-53	±0.05%	\$6800

\*\*No CM Rejection

\*USA List

## Sorensen POWER SUPPLIES

INFORMATION RETRIEVAL NUMBER 41

# ELECTRONIC DESIGN

## semiannual index of articles

### Circuits & Circuit Theory

- Build a digital clock without BCD conversion in the design . . . IFD, ED 25, p. 70
- Build a dual voltage regulator for \$11 . . . IFD, ED 26, p. 70
- Build gated video amplifiers . . . ART, ED 22, p. 58
- Building-block power supply covers -300 to +25,000 V dc . . . PF, ED 18, p. 74
- Circuit inhibits transmission on busy digital party line . . . IFD, ED 19, p. 84
- Cut noise in switching regulator . . . ART, ED 22, p. 49
- Demultiplexer uses minimum pulse width . . . IFD, ED 18, p. 60
- Design active elliptic filters easily . . . ART, ED 21, p. 76
- Electronically varied attenuator eliminates the need for two p-i-n diodes . . . IFD, ED 24, p. 76
- Final-value detector indicates when analog system reaches final state . . . IFD, ED 23, p. 62
- Fix lag/lead relation in digital 90° phase shifter . . . IFD, ED 20, p. 67
- Guarantee signal timing relationship . . . ART, ED 19, p. 66
- Here's a better way to design a 90° phase-difference network . . . IFD, ED 15, p. 18
- High-level analog-gate circuit reverses polarity without operational headaches . . . IFD, ED 25, p. 70
- If back intermodulation is a problem . . . ART, ED 23, p. 48
- Inexpensive circuit extends low-cost unijunction range . . . IFD, ED 21, p. 90.
- Line regulator achieves 85% efficiency with control electronics on pcb . . . IFD, ED 24, p. 78
- Long-period analog timer uses small capacitors . . . IFD, ED 20, p. 62
- Low-speed modems are easy to design . . . ART, ED 18, p. 50
- Multivoltage monitor for power supply . . . IFD, ED 26, p. 72
- Nanosecond pulser gives a 4-A output . . . IFD, ED 23, p. 64
- Need a good sweep circuit? . . . ART, ED 18, p. 46
- Need a tone decoder? . . . ART, ED 21, p. 66

### Departments key

ART	Technical Article
IFD	Idea for Design
NEWS	News
PF	Product Feature
SR	Special Report

- Nomograph speeds design of lag/lead network . . . IFD, ED 21, p. 88
- Obtain asymmetric control in adjustable multivibrator . . . IFD, ED 22, p. 68
- Philips vies with Dolby over noise circuitry . . . NEWS, ED 16, p. 19
- Prevent polarization fading . . . ART, ED 17, p. 68
- Programmable phase shifter operates from dc to 100 kHz . . . IFD, ED 14, p. 78
- Reconnect this IC multiplexer and get a flip-flop circuit . . . IFD, ED 15, p. 76
- Reset dividers faster with a single flip-flop . . . IFD, ED 16, p. 60
- Signal decoder eliminates jitter . . . IFD, ED 24, p. 74
- Simple sequential circuit designs . . . ART, ED 14, p. 70
- Simplify sample-and-hold design . . . ART, ED 20, p. 50
- Start bridged-T equalizer designs easily . . . ART, ED 25, p. 66

- Subtract two digital signals with an easy-to-build circuit . . . IFD, ED 14, p. 80
- Subtract two pulse trains having random distribution . . . IFD, ED 22, p. 72
- Sure-start multivibrator offers wide output with fast rise and fall times . . . IFD, ED 26, p. 70
- This voltage-controlled rf antennuator . . . ART, ED 15, p. 66
- Use an N-bit detector for phase-locking . . . ART, ED 20, p. 44
- Variable-modulus up-down counter is self-reversing with two chips . . . IFD, ED 23, p. 58
- Voltage-regulator circuit improves performance . . . IFD, ED 22, p. 70
- 1-GHz oscillator can be made with a FET and microstrips . . . IFD, ED 16, p. 60

### Civionics

- Air Pollution Control: Measurement techniques track down contamination . . . SR, ED 17, p. W11
- Broader role urged for city communications . . . NEWS, ED 14, p. 20
- Cable summons aid for stranded-motorists . . . NEWS, ED 22, p. 30
- Depressed aerospace giants turning to civionics for a lift . . . SR, ED 17, p. W16
- Electronic key system may curb hotel thefts . . . NEWS, ED 24, p. 20
- Holographic system to detect sky-jackers? . . . NEWS, ED 14, p. 20

### Subject Listing

Circuits & Circuit Theory	General Industry
Civionics	Industrial Electronics
Communications, Microwaves & Lasers	Management
Components	Materials & Packaging
Computers & Data Processing	Medical Electronics
Consumer Electronics	Military & Aerospace
Displays	Semiconductors
Electro-optics	Test & Measuring

Holography system proposed to detect airline hijackers . . . NEWS, ED 23, p. 24

Infrared security system offered by Westinghouse . . . NEWS, ED 21, p. 20

Laser system detects air pollution fast . . . NEWS, ED 16, p. 26

New group seeks industry help for urban problems . . . NEWS, ED 16, p. 19

Pollution analyzer uses 2nd-derivative technique . . . NEWS, ED 15, p. 20

Untangling traffic with sensors and computer cops . . . ART, ED 15, p. 50

Water pollution checked by an electronic buoy . . . NEWS, ED 16, p. 20

### Communications, Microwaves & Lasers

Abolishing laser-display "speckle" . . . NEWS, ED 16, p. 24

Acoustic holography picks up where medical X-rays leave off . . . NEWS, ED 15, p. 24

Antenna-voltage nomograph gives the field strength . . . IFD, ED 16, p. 62

Any microwave diode will work . . . ART, ED 22, p. 42

Balky antenna control knocks out ATS-3 . . . NEWS, ED 20, p. 20

Broader role urged for city communications . . . NEWS, ED 14, p. 20

Circuit inhibits transmission on busy digital party line . . . IFD, ED 19, p. 84

Demultiplexer uses minimum pulse width . . . IFD, ED 18, p. 60

Digital data 'hitchhiking' suggested on MW band . . . NEWS, ED 23, p. 20

Digital multiplexing without a multiplexer . . . IFD, ED 20, p. 66

Doubts raised on future of world satcom net . . . NEWS, ED 21, p. 20

Duplex receiver/transmitter occupies a single DIP IC . . . PF, ED 18, p. 72

EIA sees civionics spending doubling in next five years . . . NEWS, ED 23, p. 28

High power laser for aerial recon studies . . . NEWS, ED 15, p. 20

High-voltage ionic discharges provide silent, efficient cooling . . . NEWS, ED 20, p. 22

Holograms reproduced faster and better . . . NEWS, ED 26, p. 28

Holographic displays in real time move from dream to development . . . NEWS, ED 15, p. 28

Holographic system to detect sky-jackers? . . . NEWS, ED 14, p. 20

Holography system proposed to detect airline hijackers . . . NEWS, ED 23, p. 24

Improve MOS multiplexing with a precision system . . . IFD, ED 21, p. 92

Improve vhf amps with an attenuator . . . ART, ED 20, p. 56

Improve your communications flexibility . . . ART, ED 19, p. 70

'Instant' holograms produced with a new thin-film material . . . NEWS, ED 25, p. 30

Intelsat is getting advanced modem . . . NEWS, ED 23, p. 20

Land mobile gets piece of uhf spectrum . . . NEWS, ED 15, p. 19

Laser rangefinder built in binocular form . . . NEWS, ED 23, p. 23

Laser safety standard disputed by industry . . . NEWS, ED 22, p. 20

Laser system detects air pollution fast . . . NEWS, ED 16, p. 26

Low-speed modems are easy to design . . . ART, ED 18, p. 50

Microwave industry sees market gain this year . . . NEWS, ED 14, p. 19

Microwaves: A look at new trends in Impatts . . . SR, ED 17, p. W7

More power added to Arecibo antenna . . . NEWS, ED 19, p. 20

MW system increases transmissions to CATV . . . NEWS, ED 20, p. 19

Philips vies with Dolby over noise circuitry . . . NEWS, ED 16, p. 19

Powerful laser communicator put in 3-lb binocular package . . . NEWS, ED 25, p. 32

RCA network to offer video unit for phone . . . NEWS, ED 14, p. 19

Remote optical device extends uses of laser interferometer . . . NEWS, ED 17, p. 26

Semiconductor laser efficiency doubled . . . NEWS, ED 21, p. 30

Shift in FCC policy on cable vs. satellite? . . . NEWS, ED 22, p. 20

Small active-electronic antenna offers big-league TV reception . . . NEWS, ED 16, p. 22

Snapshot holography developed by Hughes . . . NEWS, ED 17, p. 19

This voltage-controlled rf attenuator . . . ART, ED 15, p. 66

TV links to Red China foreseen with Nixon visit . . . NEWS, ED 18, p. 20

Western Union files for new digital link . . . NEWS, ED 14, p. 20

Xerox copiers to get electronic logic . . . NEWS, ED 25, p. 19

14 to 18 GHz obtained with transistor amplifier . . . NEWS, ED 19, p. 19

### Components

Baluns cut ground noise . . . ART, ED 15, p. 62

Cut battery size in portable equipment . . . ART, ED 24, p. 70

Digital filter design can be simplified if binary rate multipliers are used . . . IFD, ED 23, p. 60

Don't write off the reed relay; it's faster, tinier and cheaper . . . NEWS, ED 21, p. 28

MAG head solves a tilt problem . . . NEWS, ED 19, p. 24

Magnavox cuts its buying of Japanese components . . . NEWS, ED 15, p. 20

Mercury wetted switch withstands 50 g's . . . PF, ED 26, p. 76

Micro-power, state-variable filter decodes tones over two octaves . . . PF, ED 21, p. 95

Microstrip amplifiers can be simple . . . ART, ED 14, p. 66

Monsanto offers LEDs in yellow and green . . . NEWS, ED 26, p. 19

New family of rugged switches promised . . . NEWS, ED 26, p. 28

Paris components show wide open to U.S. in '72 . . . NEWS, ED 20, p. 19

Solid-state LED switch eliminates contact bounce . . . PF, ED 15, p. 86

Thermoelectric source not fussy on fuel . . . NEWS, ED 16, p. 24

Use the two-stage RC low-pass approximation for matched filters . . . IFD, ED 26, p. 68

Voice-operated switch dissipates only 600 W . . . IFD, ED 20, p. 68

### Computers & Data Processing

BASIC helps you trade off active-filter gain and phase . . . IFD, ED 15, p. 74

Blank detector checks data ONE/ZERO message gaps . . . IFD, ED 19, p. 84

Bucket-brigade device said to cut audio delay-line costs drastically . . . NEWS, ED 24, p. 34

But for future, NASA seeks bubble computers . . . NEWS, ED 23, p. 19

Calculator on a chip available off the shelf . . . NEWS, ED 21, p. 19

Compute Laplace transform and Bode response with BASIC . . . IFD, ED 26, p. 74

Compute the arctangent for any argument with BASIC . . . IFD, ED 18, p. 64

Computer conferences to shift their emphasis . . . NEWS, ED 26, p. 20

Computer researchers achieve their fastest switching so far . . . NEWS, ED 26, p. 22

Computer shows output visually and by touch . . . NEWS, ED 18, p. 20

Constructing the primitive flow table . . . ART, ED 25, p. 62

Correcting false combinations gets you the fastest BCDC . . . IFD, ED 22, p. 66

Digital equipment goes from minis to whoppers . . . NEWS, ED 20, p. 19

FOCUS on Semiconductor memories . . . SR, ED 19, p. 50

For buyers of computing equipment: More power at less cost . . . SR, ED 23, p. C8

For long space missions: a new computer . . . NEWS, ED 16, p. 25

How minis can unknot communications . . . NEWS, ED 25, p. 24

Large-memory calculator uses plug-in function blocks . . . PF, ED 17, p. W30

LSI arrays to give NASA a 10-pound, 15-W computer . . . NEWS, ED 23, p. 19

Minicomputers: How to buy a good one . . . SR, ED 17, p. W6

New era in detail design; program-it yourself memories . . . NEWS, ED 17, p. 22

Plessey out to capture U.S. memory market . . . NEWS, ED 15, p. 20

Printer called much faster than Teletype . . . NEWS, ED 22, p. 30

Read-time software for 620 computers . . . PF, ED 25, p. 92

Report form NEREM '71—Coming in computer memories: semis plus magnetic domains . . . NEWS, ED 25, p. 22

Software simulation program simplifies circuit analysis . . . PF, ED 20, p. 78

Start logic designs with flow diagrams . . . ART, ED 25, p. 56

Suddenly, everybody is building microprogrammed computers . . . NEWS, ED 24, p. 23

Technicians talk English to IC tester's computer . . . NEWS, ED 16, p. 20

To simplify digital logic design . . . ART, ED 16, p. 50

Transmission-line problems solved fast with BASIC . . . IFD, ED 17, p. 76

Tri-state 256-bit RAM chip selects in 12 ns . . . PF, ED 15, p. 83

Ultra-fast 16-bit computer has 300-ns operating speed . . . PF, ED 23, p. C32

Universal field programmer programs all types of ROMs . . . PF, ED 19, p. 91

Use statistics in your logic design . . . ART, ED 26, p. 60

Use time-sharing to program your mini . . . ART, ED 18, p. 40

3 computer companies offering new systems . . . NEWS, ED 24, p. 20

### Consumer Electronics

AF synthesizer for less than \$200 . . . ART, ED 17, p. 62

All-solid-state TV set wins a rave for easy servicing . . . NEWS, ED 20, p. 26

Cable TV pack expected to open up huge market . . . NEWS, ED 25, p. 19

Coast-to-coast TV to present MOS course . . . NEWS, ED 18, p. 28

Device speeds speech without distortion . . . NEWS, ED 23, p. 19

Electric commuter car passes all road tests . . . NEWS, ED 25, p. 20

Electronic coverage of '72 Olympics due . . . NEWS, ED 17, p. 20

Eliminate alignment problems in FM detectors . . . IFD, ED 20, p. 70

FCC adopts new rules for remote TV stations . . . NEWS, ED 20, p. 20

FM radio pager can store beeps . . . NEWS, ED 18, p. 20

Home tape recorder stores binary data . . . IFD, ED 17, p. 78

IC-module plant opened by RCA for color TV . . . NEWS, ED 21, p. 20

Improve wideband FM recordings . . . ART, ED 15, p. 58

Mere touch sets off new burglar alarm . . . NEWS, ED 21, p. 32

MW system increases transmissions to CATV . . . NEWS, ED 20, p. 19

New image enhancer developed for TV . . . NEWS, ED 20, p. 20

Quadrasonics advances with 4 developments . . . NEWS, ED 24, p. 19

Quadrasonics giving consumer industry a new sound to sell . . . NEWS, ED 18, p. 22

Small active-electronic antenna offers big-league TV reception . . . NEWS, ED 16, p. 22

Solid-state film transport developed . . . NEWS, ED 15, p. 26

SSB-FM: When should you use it? . . . ART, ED 14, p. 74

TV image sensor uses bucket-brigade circuit . . . NEWS, ED 24, p. 20

TV link to Red China foreseen with Nixon visit . . . NEWS, ED 18, p. 20

Weather forecasters to get better technique . . . NEWS, ED 26, p. 20

Wescon planning a consumer show . . . NEWS, ED 23, p. 20

What time is it? Your TV set may tell . . . NEWS, ED 19, p. 24

### Displays

Abolishing laser-display "speckle" . . . NEWS, ED 16, p. 24

Computer shows output visually and by touch . . . NEWS, ED 18, p. 20

Convert your scope to a display terminal . . . ART, ED 23, p. C20

CRT faceplate screens out glare and RFI . . . NEWS, ED 19, p. 25

FOCUS on Industrial Chart Recorders . . . SR, ED 25, p. 48

FOCUS on Readouts . . . SR, ED 24, p. 52

Graphics/alphanumerics display terminal costs as low as \$3400 . . . PF, ED 23, p. C30

High-performance display panels for only \$1/digit . . . PF, ED 22, p. 77

Large LED numeric display holds 0.77-in. characters . . . PF, ED 21, p. 98

LED display replaces dial on new ADF tuning indicator . . . NEWS, ED 26, p. 26

Use your oscilloscope for numeric display . . . ART, ED 26, p. 64

64-gun cathode-ray display increases readout density . . . PF, ED 21, p. 96

### Electro-optics

FOCUS on Readouts . . . SR, ED 24, p. 52

High-performance display panels for only \$1/digit . . . PF, ED 22, p. 77

Holographic system to detect sky-jackers? . . . NEWS, ED 14, p. 20

Large LED numeric display holds 0.77-in. characters . . . PF, ED 21, p. 98

LED display replaces dial on new ADF tuning indicator . . . NEWS, ED 26, p. 26

LED makers reaching for consumer markets . . . NEWS, ED 19, p. 19

Light-pulse generator works on variable supply voltage . . . IFD, ED 19, p. 86

Low-light camera advance increases sensitivity tenfold . . . NEWS, ED 26, p. 19

Measure rpm accurately with an optical counter . . . IFD, ED 18, p. 66

Monsanto offers LEDs in yellow and green . . . NEWS, ED 26, p. 19

Optoelectronics: Solid-state memories . . . SR, ED 17, p. W9

Photomultiplier amplifier subtracts logarithms . . . IFD, ED 19, p. 82

Remote optical device extends uses of laser interferometer . . . NEWS, ED 17, p. 26

### General Industry

Airlines seek doubling of FAA spending plans . . . NEWS, ED 16, p. 20

Anxiety in Japan, Part 1 . . . SR, ED 26, p. 52

Better use of spectrum urged by EIA chairman . . . NEWS, ED 18, p. 19

Economist sees threat to electronics industry . . . NEWS, ED 20, p. 19

Electronics at Mid-1971—The silver lining begins to appear . . . NEWS, ED 14, p. 22

Industry leaders laud Nixon's economic moves . . . NEWS, ED 19, p. 19

New firm offers stock for scrap metal parts . . . NEWS, ED 16, p. 20

New technology office proposed in Congress . . . NEWS, ED 17, p. 19

New U.S. patent policy draws mixed reviews . . . NEWS, ED 19, p. 20

RCA transistor cutback doesn't faze competitors . . . NEWS, ED 18, p. 19

Rise in R&D spending trails growth of GNP . . . NEWS, ED 22, p. 19

Threefold rise foreseen in Japanese exports . . . NEWS, ED 19, p. 20

U.S. concerns step up sales pitch to Soviet . . . NEWS, ED 18, p. 19

U.S. Industry cautious on Red China trade . . . NEWS, ED 14, p. 19

U.S. plans a mass study of antarctic environment . . . NEWS, ED 21, p. 19

Wescon 71 . . . SR, ED 17, p. W2

7% industry growth in 1972 predicted by OEM companies . . . NEWS, ED 19, p. 28

### Industrial Electronics

- Air industry assailed on its medical efforts . . . NEWS, ED 15, p. 19
- Automatic controls run entire railroad line . . . NEWS, ED 22, p. 20
- Electronics-laden ship to drill for oil in 2000-foot waters . . . NEWS, ED 22, p. 28
- Machine-tool makers see spurt in sales to Red bloc . . . NEWS, ED 19, p. 20
- Oil drillers look to electronics to help them strike it richer . . . NEWS, ED 21, p. 22
- Power industry asks engineers to fill urgent need for equipment . . . NEWS, ED 24, p. 30
- 3 U.S. concerns bid for Mexican contract . . . NEWS, ED 26, p. 20

### Management

- Brush up on your proposal preparations . . . ART, ED 22, p. 62
- Engineer job study finds electronics hit hardest . . . NEWS, ED 22, p. 20
- For a higher yield from exhibit visits . . . ART, ED 15, p. 70
- Going through a career conversion? ART, ED 17, p. 72
- Help yourself to jobs and re-training . . . ART, ED 18, p. 54
- If your document release system is sick . . . ART, ED 19, p. 76
- Let an administrator do it! . . . ART, ED 16, p. 56
- Man-man interface . . . ART, ED 23, p. 52
- Marketing & Management: The trick is to turn the negative into positive . . . SR, ED 17, p. W13
- Want to hire that elusive executive? . . . ART, ED 21, p. 82

### Materials & Packaging

- And now, PC boards with built-in resistors . . . NEWS, ED 26, p. 30
- Finally, a low-cost linear MIL package . . . NEWS, ED 26, p. 24
- FOCUS on packaging . . . SR, ED 16, p. 36
- In consumer packaging, it's modules, modules everywhere . . . NEWS, ED 15, p. 22
- Lf quartz crystal size cut drastically . . . NEWS, ED 15, p. 26
- New high-k ceramic materials make smaller MICs possible . . . NEWS, ED 19, p. 26
- Slotted coax breaks an rf barrier . . . NEWS, ED 25, p. 28
- Thick films deposited onto PC board . . . NEWS, ED 16, p. 23

### Medical Electronics

- Acoustic holography picks up where medical X-rays leave off . . . NEWS, ED 15, p. 24
- Acoustic microscope aids medical research . . . NEWS, ED 17, p. 20

# the original **ME-2 Socket** only from Scanbe

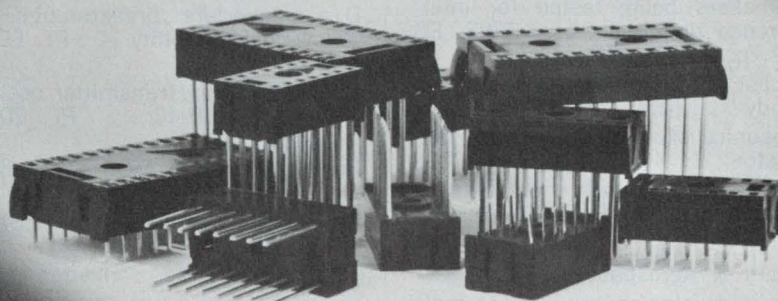

## a dozen configurations...

with exclusive features from Scanbe's dual inline ME-2 Sockets. Four pin lengths, solder tail, one, two and three level solderless wrap in 14, 16 or 24 pin models.

Exclusive features include:

- Closed entry design means precision alignment for DIP leads
- Side gripping contacts means 80% more contact pressure
- Low insertion force means no damage to DIP's
- Highest reliability means Scanbe

Solder relief, replaceable pins, optional screw mountings and U.L. approved molded nylon for caps and bodies are other customer benefits along with Scanbe's quality and experience. The best contact your DIP can make is a Scanbe ME-2 Socket.



**SCANBE MANUFACTURING CORP.**

*"The Packaging People"*

3445 Fletcher Ave • El Monte, Calif. 91731  
Telephone: (213) 579-2300

Automated health center may generate big market . . . NEWS, ED 16, p. 20

Defects in medical electronics draw heavy fire from hospitals . . . NEWS, ED 22, p. 22

EKG detector improves heart-rate measurement . . . IFD, ED 20, p. 64

Hospital maintains largest patient monitoring systems . . . NEWS, ED 19, p. 22

Mechanical arm can even thread needles . . . NEWS, ED 23, p. 30

Medical Electronics: Information nets that really work are still sorely needed . . . SR, ED 7, p. W10

More hope for heart patients—the bifocal demand pacemaker . . . NEWS, ED 17, p. 28

New device controls intravenous feeding . . . NEWS, ED 21, p. 20

Pacemaker recharging done without surgery . . . NEWS, ED 21, p. 19

Pacemakers being tested for interference potential . . . NEWS, ED 17, p. 20

Telecast of surgery originates in body . . . NEWS, ED 15, p. 20

Ultrasonics explored as a cancer detector . . . NEWS, ED 20, p. 20

3-D image technique could replace X-rays . . . NEWS, ED 25, p. 20

#### Military & Aerospace

Army is developing new vhf-FM radio . . . NEWS, ED 15, p. 19

But for future, NASA seeks bubble computers . . . NEWS, ED 23, p. 19

Combat pilots in training to fly an all-electronic 'range' . . . NEWS, ED 18, p. 26

Depressed aerospace giants turning to civionics for a lift . . . SR, ED 17, p. W16

FAA presses research on new landing system . . . NEWS, ED 18, p. 20

For long space missions: a new computer . . . NEWS, ED 16, p. 25

High power laser for aerial recon studies . . . NEWS, ED 15, p. 20

Laser rangefinder built in binocular form . . . NEWS, ED 23, p. 23

LSI arrays to give NASA a 10-pound, 15-W computer . . . NEWS, ED 23, p. 19

NASA seeks solution's to problems on earth . . . NEWS, ED 26, p. 20

NASA's earth research stirring wide interest . . . NEWS, ED 15, p. 19

New electronics to make ICBMs more blastproof and easier to aim . . . NEWS, ED 23, p. 22

Pentagon shifts its policy on weapons procurement . . . NEWS, ED 17, p. 19

Pre-installation engineering cuts costs on military systems . . . NEWS, ED 17, p. 24

Robot worker being developed to assist space-station crews . . . NEWS, ED 20, p. 28

Space shuttle may use off-the-shelf electronics . . . NEWS, ED 22, p. 19

'Stabilized' employment foreseen in aerospace . . . NEWS, ED 24, p. 19

#### Semiconductors

Bucket-brigade device said to cut audio delay-line costs drastically . . . NEWS, ED 24, p. 34

Calculator on a chip available off the shelf . . . NEWS, ED 21, p. 19

Clamping varied with transistor . . . IFD, ED 23, p. 65

Coast-to-coast TV to present MOS course . . . NEWS, ED 18, p. 28

Conference will feature charge-coupled devices . . . NEWS, ED 25, p. 19

Custom bipolar IC design lowers cost and turn-around . . . PF, ED 21, p. 112

D/a converters breakthrough with low-cost reliability . . . PF, ED 20, p. 72

Duplex receiver/transmitter occupies a single DIP IC . . . PF, ED 18, p. 72

Ensure error-free MOS IC operation . . . ART, ED 17, p. 58

Establish the reliability of LSI ICs . . . ART, ED 24, p. 66

Fast, 12-bit a/d converter carries low price of \$300 . . . PF, ED 22, p. 78

FOCUS on Linear ICs . . . SR, ED 21, p. 52

FOCUS on Semiconductor memories . . . SR, ED 19, p. 50

GE halt in IC output laid to profit squeeze . . . NEWS, ED 23, p. 20

High-speed SOS devices drop power dissipation . . . PF, ED 22, p. 84

IC amp with 200-V output uses few components . . . IFD, ED 17, p. 82

IC-module plant opened by RCA for color TV . . . NEWS, ED 21, p. 20

IC sets camera opening at very low light levels . . . NEWS, ED 26, p. 19

Low cost, a/d converters offer substantial savings . . . PF, ED 17, p. 102

Low-cost, monolithic compensated 15-MHz op amp slews at 70 V/ $\mu$ s . . . PF, ED 17, p. 91

Low-current comparators cut propagation to 10 ns . . . PF, ED 17, p. 92

Low-power monolithic op amp is completely programmable . . . PF, ED 18, p. 69

Microelectronics: Stress is on MOS . . . SR, ED 17, p. W4

Monolithic dual JFETs drop input current to femto-amps . . . PF, ED 19, p. 106

MOS power converter is small and costs \$30 . . . IFD, ED 21, p. 86

New logic gates need 1 picojoule to switch . . . NEWS, ED 22, p. 19

Op amp doubles as rf detector . . . IFD, ED 17, p. 80

P-channel JFETs switch  $\pm 15$  V analog at 4 MHz . . . PF, ED 14, p. 92

RCA transistor cutback doesn't faze competitors . . . NEWS, ED 18, p. 19

Replace UJT and SCR in a timing circuit with a programmable uni-junction transistor . . . IFD, ED 25, p. 74

Schottky barrier TTL ICs upgrade 54/74 line . . . PF, ED 23, p. 70

Stable 1- $\mu$ V/ $^{\circ}$ C FET op amp comes down in price to \$45 . . . PF, ED 23, p. 67

Substitute proposed for vacuum deposition . . . NEWS, ED 25, p. 26

To use Gunn or Impatt diodes . . . ART, ED 21, p. 70

Transistors in breakdown reveal negative resistance . . . IFD, ED 20 p. 68

Tri-state 256-bit RAM chip selects in 12 ns . . . PF, ED 15, p. 83

Use a FET to improve uhf amp performance . . . IFD, ED 22, p. 68

Vhf FET with 75- $\Omega$  input lowers VSWR to 1.25:1 . . . PF, ED 16, p. 63

Very fast, stable op amp can handle 1800 V/ $\mu$ s . . . PF, ED 17, p. 102

1-GHz oscillator can be made with an FET and microstrips . . . IFD, ED 16, p. 60

#### Test & Measuring

Counter tester checks critical parameters . . . IFD, ED 15, p. 72

Current-controlled oscillator sweeps five-decade band . . . IFD, ED 14, p. 82

DPM circuit allows direct display of nonlinear data . . . PF, ED 15, p. 79

Five-digit 50-MHz counter is made for panel mounting . . . PF, ED 18, p. 76

FOCUS on Instrumentation . . . SR, ED 14, p. 50

Indicator checks relative frequencies . . . IFD, ED 22, p. 74

Make sampled-signal analysis easier . . . ART, ED 23, p. 42

Select-Reset IC channels with a parity checker . . . IFD, ED 16, p. 58

Smallest low-cost DPM introduced by Analog . . . NEWS, ED 24, p. 19

Smallest-size DPM family is also the lowest in cost . . . PF, ED 26, p. 75

Smallest-volume 3-1/2-digit DPM features the lowest price of \$89 . . . PF, ED 25, p. 77

Triphasic-conversion DMMs reduce costs over 50% . . . PF, ED 14, p. 85

Trouble-shoot logic systems with a concise fault chart . . . IFD, ED 17, p. 78



# New line of solid-state devices will broaden your choice of microwave sources and amplifiers

Are you ready to make the design jump from tubes to solid-state in your low-power microwave applications? Sperry Electronic Tube Division is ready to help you.

We've recently acquired the microwave solid-state capability of a sister division, and we're melding that with our own field proved knowledge of microwave systems requirements. Working from that base, company-funded R&D will soon be bringing you a whole generation of solid-state devices.

In the very near future, you can expect both fixed frequency and voltage-controlled transferred electron (Gunn effect) oscillators and a new breed of IMPATT oscillators. A little later, you'll see transferred electron amplifiers, IMPATT amplifiers and a full line of TRAPATT devices. Our R&D efforts will continue in silicon and GaAs technology and other aspects of microwave solid-state.

We'd like to keep you abreast of what's happening in solid-state at Sperry. How about filling in the coupon above, so that we can add you to our mailing list. We'll update you regularly. While you're at it, jot down the details of your thorniest application problem. Maybe we can aim our R&D efforts directly at you. Sperry Electronic Tube Division, Gainesville, Florida 32601.

 SPERRY RAND

**SPERRY  
CAN GET  
YOU IN  
SOLID**

Please help me get in solid.

- Add my name to your solid-state mailing list.  
 I'm attaching the details of an application problem. Let me know what you think about a solution.

NAME \_\_\_\_\_ TITLE \_\_\_\_\_  
COMPANY \_\_\_\_\_  
ADDRESS \_\_\_\_\_  
CITY \_\_\_\_\_ STATE \_\_\_\_\_ ZIP \_\_\_\_\_

 **SPERRY**  
ELECTRONIC TUBE DIVISION

## Auto-crossover power supply uses single reference

For power supplies, auto crossover from constant-voltage to constant-current operation normally requires separate reference voltages for the two modes. Also, a floating supply for the reference voltages is usually needed. Both of these unnecessary additions may be eliminated by arranging the voltage amplifier to operate in the inverting mode.

This approach allows the voltage and current amplifiers to share the same reference, and thus the need for a floating power supply for the reference circuits is avoided.

The circuit nominally provides 0-30 and 0-1 A, depending on the setting of the two 5-k $\Omega$  trimmer resistors and the balance achieved between the differential pairs. Line regulation is such that a 10% line change produces a 0.2% change in  $V_{out}$  or  $I_{out}$ . The supply has a temperature coefficient of 0.05%/ $^{\circ}$ C, using a standard 6.2-V breakdown diode. With a temperature-compensated refer-

ence diode and an IC op amp, the coefficient improves to 15 ppm/ $^{\circ}$ C and line/load regulation becomes 50 ppm. The transient response enables the supply to recover from a 1-A load change to within 50 mV in less than 50  $\mu$ s.

Crossover occurs when  $R_A I_L \approx I_C R_C$ , where  $R_L$  is the front panel current limit control. The output voltage  $V_{out} = I_V R_V$  is determined by the programming constant  $I_V$ , which can be set to 1 mA.

When  $V_{out}$  is set to 30 V, a 1-A change in load current produces a 30-mV change in  $V_{out}$ . The same current change at  $V_{out}$  equal to 1 V produces a 2-mV change. A 30-V change in  $V_{out}$  with the constant current set at 1 A produces a current variation of less than 5 mA.

*John A. Roberts, Design Engineer, ADM Electronics, Sketty, Swansea, SA28BA, U.K.*

CIRCLE NO. 311

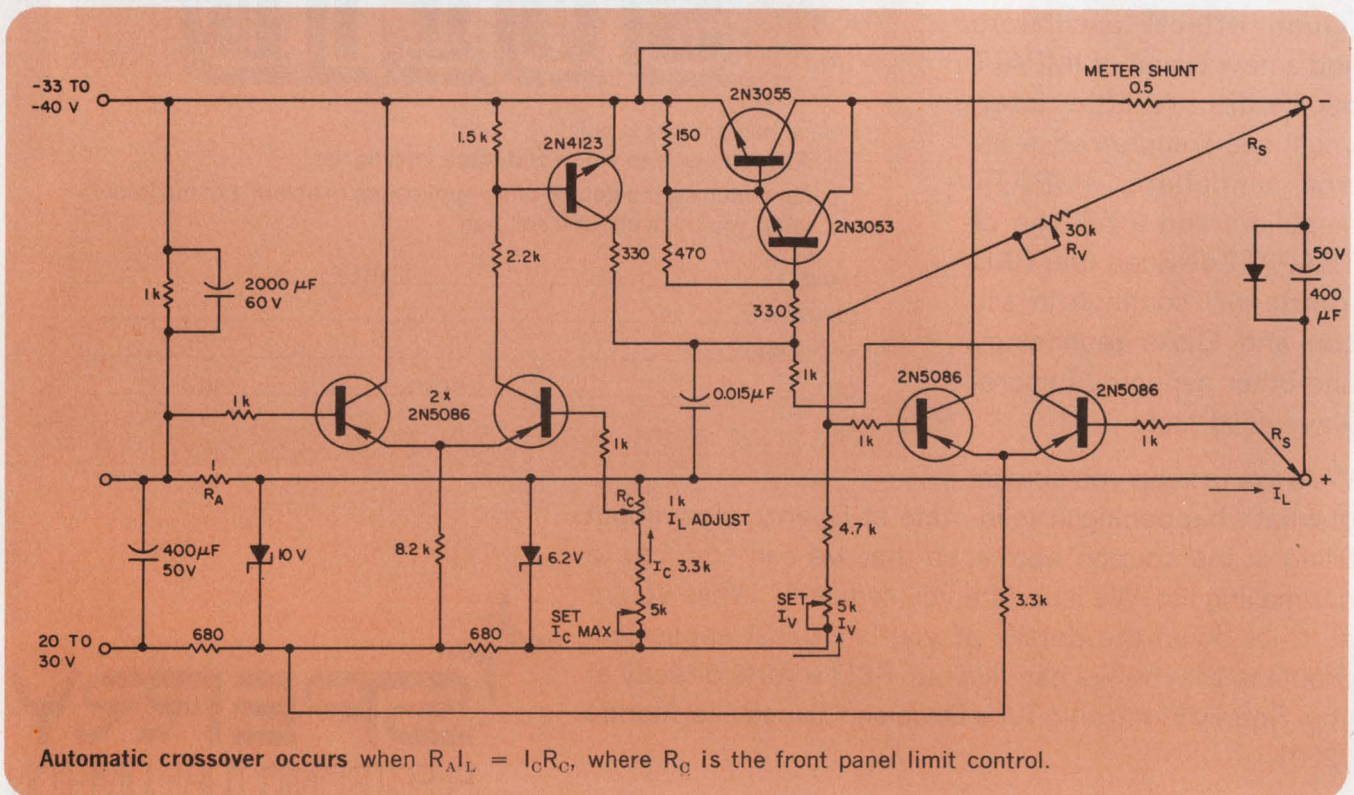



## Now, Helipot offers covered cermet trimmers for low-budget projects.

There's not much sense in using cheap wirewound or carbon trimmers anymore. Not when the new Helipot Series 91 Cermet Trimmers are available *off-the-shelf* for a few cents more.

These single-turn,  $\frac{3}{8}$ " , covered trimmers come in 10 different mounting styles and 19 standard resistance values from 10 ohms to 2 megohms. Covered construction helps protect against moisture, corrosive atmospheres, dust, oil and other

contamination. Which means, in addition to cermet stability and better resolution, you get long-term dependable performance.

The breakthrough price is just 35¢ each in the 50,000 piece quantity, and they're equally well-priced in other quantities.

Send now for complete data on the Series 91 Trimmers... the finest of their class. We've made them for your projects where the budget may be tight, but you don't want to compromise performance.

**Beckman®**

INSTRUMENTS, INC.  
HELIPOT DIVISION  
Fullerton, California

HELPING SCIENCE AND INDUSTRY IMPROVE THE QUALITY OF LIFE

INTERNATIONAL SUBSIDIARIES: AMSTERDAM, CAPE TOWN, GENEVA, GLENROTHES, SCOTLAND, MEXICO CITY, MUNICH, PARIS, STOCKHOLM, TOKYO, VIENNA

INFORMATION RETRIEVAL NUMBER 44

# LED-phototransistor couplers isolate analog signals

Analog signals of frequencies from dc to several hundred kilohertz may be isolated with the circuit shown. If the two LED-phototransistor couplers have well-matched characteristics, linearity of  $\pm 1\%$  over a  $\pm 2\text{-V}$  range is possible.

Op amp A1 drives photodiode D1 so the current generated in phototransistor T1 equals the current through input resistor  $R_{in}$ . Photodiode D2 is driven by op amp A1 in a similar manner. The current through T2 is thus a function of the

input current, and the output of op amp A2 follows the input to A1.

Resistor R3 can be adjusted to make the current gains of the two couplers equal. The linearity of the circuit depends primarily on the similarity of the characteristics of the two couplers.

A. Vaisnys, Jet Propulsion Laboratory, M.S. 161-228, 4800 Oak Grove Dr., Pasadena, Calif. 91103.

CIRCLE NO. 312

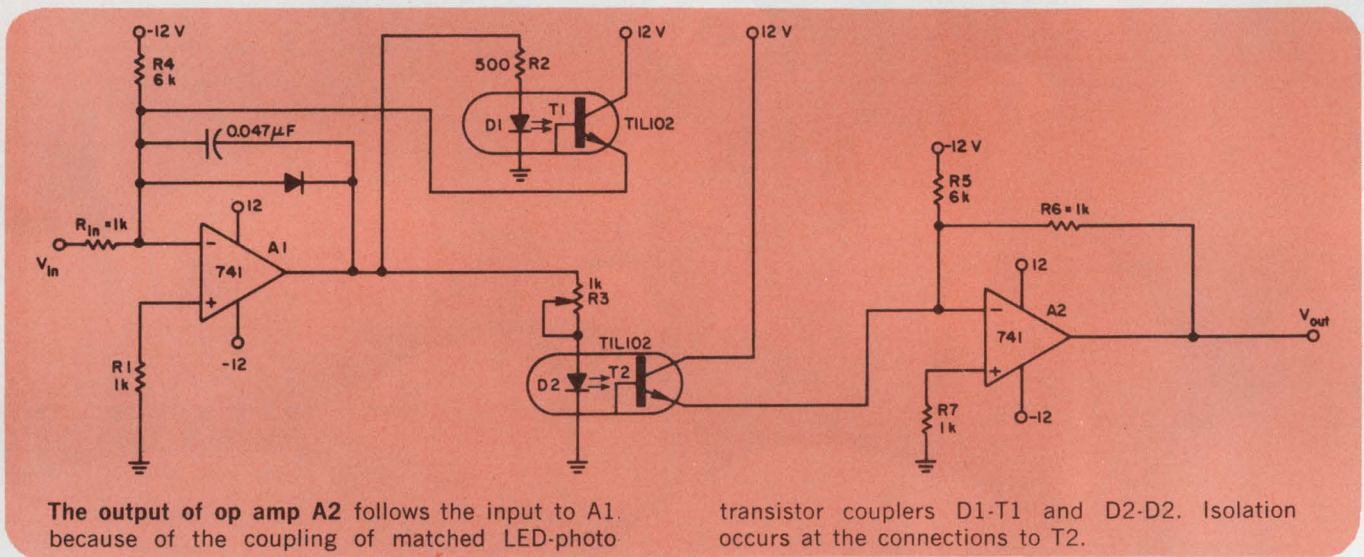

## Digital tone-burst generator uses 4 ICs

A digital tone-burst generator produces gated square-wave outputs with fundamental frequencies up to 15 MHz and can be driven by a sinusoidal input at frequencies to 30 MHz. It uses only four inexpensive digital ICs.

Both the length and duty-cycle of the tone burst are adjustable. The generator is particularly useful for testing data-acquisition or processing systems, if the versatility of a commercial function generator is not needed, and, hence, the cost is not justified.

The signal source required can be any waveform, including a sine wave (Fig. 1) of amplitude between 2 and 5 V. This signal forms the clock for an eight-bit ripple counter (the two

cascaded MC839s). The first output (Q1) of the counter is a square wave at half the input frequency. After gating, this forms the output signal.

The gating scheme uses a single NAND gate (1/2 of an MC830), with the Q1 square wave as one input. The other inputs are selected by toggle switches from the available counter outputs (Fig. 2). Outputs Q6, Q7 and Q8 were used in the application shown in the diagram. Since the modulus of the complete counter is 256 (or  $2^8$ , excluding Q1), combinations of the switches A, B and C provide the various burst-length and duty-cycle capabilities shown in the table.

As an added feature the circuit generates sync

# Those high-flying thumbwheel prices just came DOWN



New lower prices... better discounts on every Cherry thumbwheel & leverwheel switch

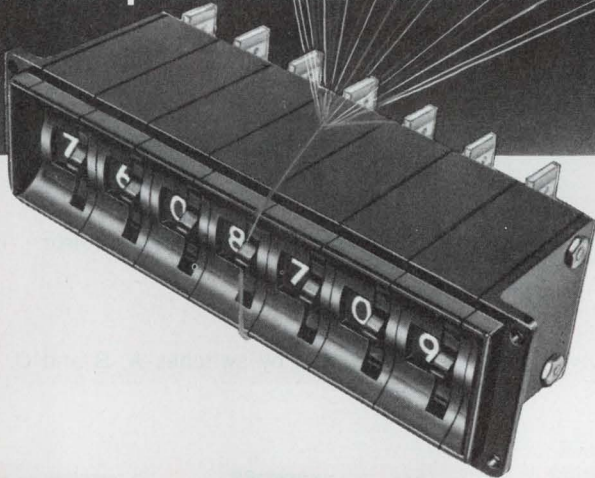

Cherry's new down-to-earth prices are an average reduction of 24%—as much as 46% reduction on some models. Prices are down on every Cherry Thumbwheel and Leverwheel Switch. On every one of the infinite variations in coding, termination, mounting and readout symbols.

Now you get 20% discount on as few as 50 pieces . . . 25% on 100 pieces . . . 27% on 200 pieces . . . 30% on 500 pieces . . . 32% on 1000 pieces and 34% on 2000 pieces.

Everything has been reduced except the size of the new, larger, easier-to-read digits. Everything cut except the quality—which is the same high level you expect, and get, from Cherry.

FOR NEW PRICE LIST and CATALOG  
TWX 910-235-1572 or PHONE (312) 689-7600  
extension 7703 and ask for Walt or Frank

\*Prices shown are for 2000 piece quantity. Lower prices on larger quantity.

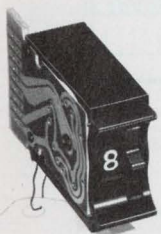

T20-04A  
BCD+Comp.  
~~\$6.13~~

**\$3.30\***



T20-01A  
10 Position  
Decimal  
~~\$3.29~~

**\$2.64\***

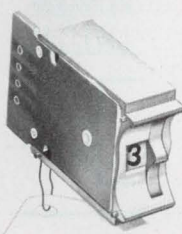

T20-07A  
Binary Coded  
Octal  
~~\$3.65~~

**\$2.64\***

# CHERRY



**CHERRY ELECTRICAL PRODUCTS CORP.**

3600 Sunset Avenue, Waukegan, Illinois 60085

Makers of patented Leverwheel/Thumbwheel Switches, Matrix Selector Switches, Snap-Action Switches and Keyboards.

IDEAS FOR DESIGN

signals. The sync generator produces either a positive or negative edge at the onset of the burst. A single-transistor output buffer allows high fan-out and amplitude control. Since all eight counter outputs (Q1 through Q8) are avail-

able, other possible gating combinations fulfill particular burst requirements.

*J. W. Foltz and H. A. Kuhn, Motorola Semiconductor Products, Inc., 5005 E. McDowell Rd., Phoenix, Ariz. 85008.* CIRCLE NO. 313

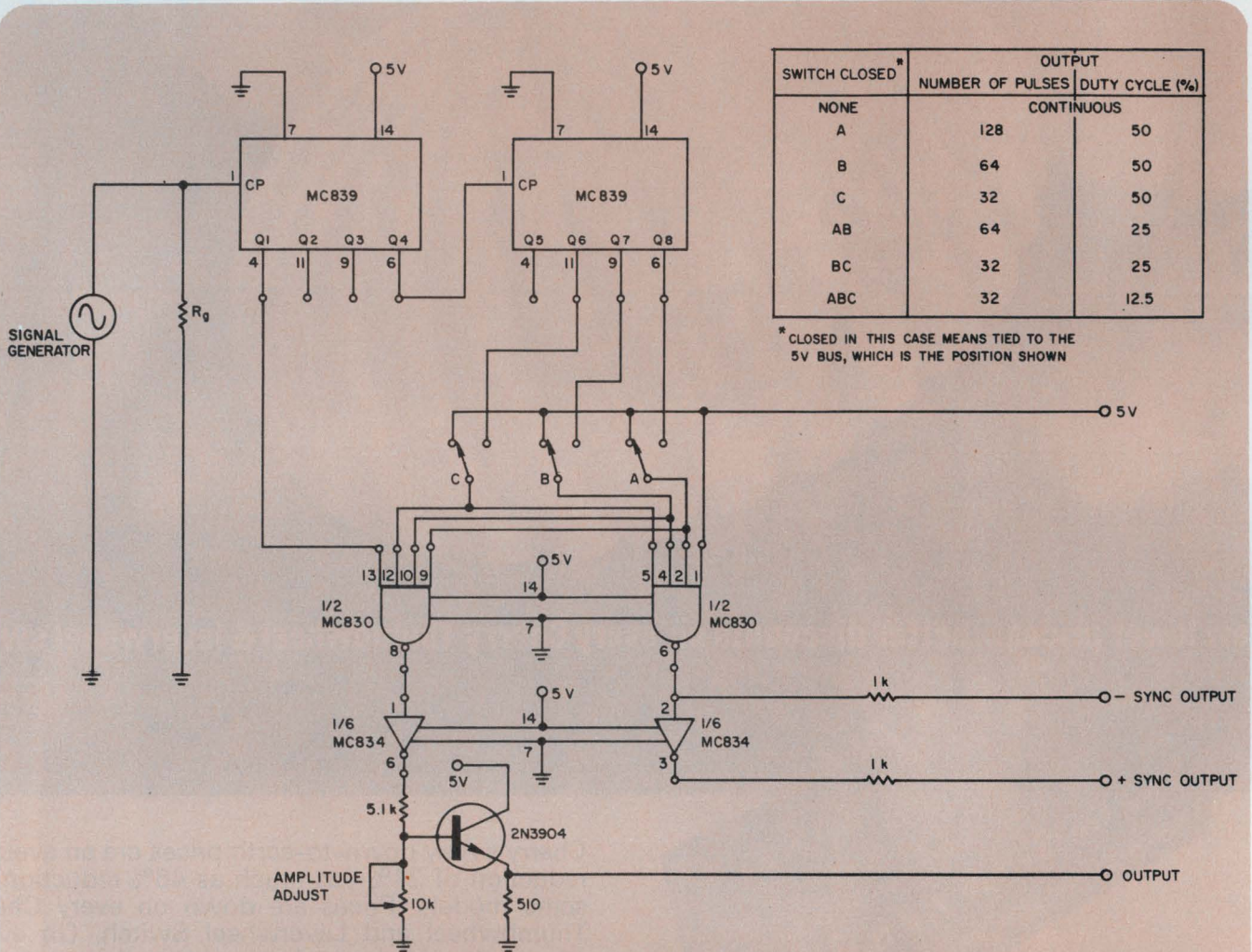

1. Tone-burst generator provides the burst lengths and duty cycles that are selected by switches A, B and C.

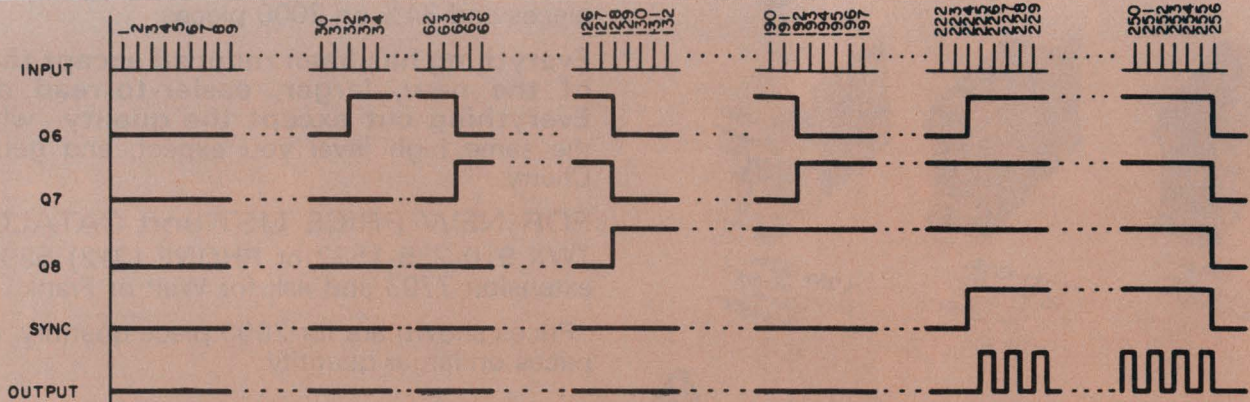

2. Timing diagram for 32-bit burst length and 12.5% duty cycle. The input signal can be any waveform.

# C-LINE POWER DARLINGTONS

more types to choose from  
at less cost...

and we're only beginning.

The Unitrode Darlington transistor line is expanding. It now includes eight types. New are 5 Amp and 150 V Darlington transistors in two hermetically sealed metal packages — a lead-mounted TO-33 and a chassis-mounted TO-66 — available in power ratings up to 25 watts. They're ideal for high gain switching and amplifying applications such as print hammer, solenoid, servo, and relay drivers and motor controls. The wider choice of alternative types available, coupled with an across-the-board price reduction, can help you realize savings of up to 50%. (For example, U2T301 is \$1.25 ea. in lots of 100) They're all available off-the-shelf at your local Unitrode distributor.

For fast action, call Sales Engineering collect at (617) 926-0404 Unitrode Corporation, Dept. 4 X, 580 Pleasant St., Watertown, Mass. 02172

Application note U64 available on request.

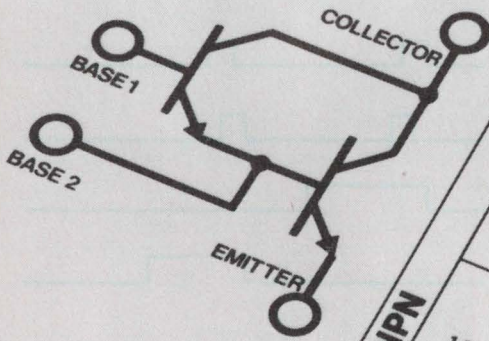
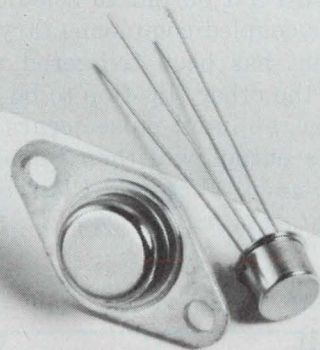

## C-LINE POWER DARLINGTONS

Ic Amps	Type	Package	V <sub>CE</sub> Volts	h <sub>FE</sub> min	V <sub>sat</sub> max	t <sub>on</sub> ns	t <sub>off</sub> ns
5	U2T301	TO-33	60	1000 @2A	1.5 @2A	300 @2A	1000 @2A
	U2T401						
	U2T305	TO-33	150	1000 @2A	2.5 @2A	400 @2A	1000 @2A
	U2T405						
10	U2T101	TO-33	80	2000 @5A	1.5 @5A	400 @5A	1000 @5A
	U2T201						
	U2T105	TO-33	150	1000 @5A	2.5 @5A	500 @5A	1000 @5A
	U2T205						
20							
5							
10							
20							



UNITRODE quality takes the worry out of paying less.

# Circuit tells which pulse occurs first in two trains

When two pulses occur almost simultaneously on different lines, it may be necessary to determine which pulse occurred first. A circuit that will do the job (Fig. 1) is essentially independent of the width of the pulses. The circuit is triggered by the leading (or positive) slope of the pulses (Fig. 2).

The only constraint on input pulse width is that it should not be less than 30 ns. Also, for

reliable performance, the leading edges of the pulses should be more than 40 ns apart.

The circuit requires a single 7474 dual, D-type, edge-triggered flip-flop. After the logic ZERO clear pulse, the two D inputs will be at logic ONE. When the first input pulse, which may be either A or B, occurs, the logic ONE on the D input is transferred to the output on the leading edge of the input pulse. This changes either the A-First or B-First output to a logic ONE.

The cross-coupled complementary output of the flip-flop that has been triggered will cause the D input of the other flip-flop to be a logic ZERO. If, and when, an input pulse occurs at this second flip-flop, its output will then remain unchanged.

*F.N. Malaney, Western Electric Corp., 6200 E. Broad St., Columbus, Ohio 43212*

CIRCLE No. 314

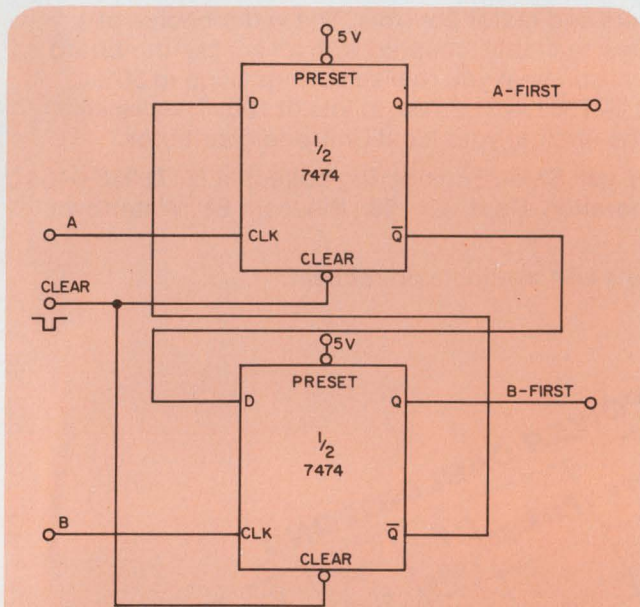

1. The first pulse appearing at the A or B input changes the logic state of either the A-First or B-First outputs. A second pulse will not change the output states.

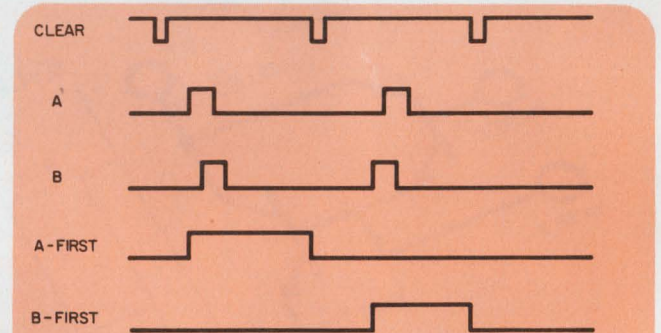

2. Input and output waveforms illustrate detection of the leading edge of whichever pulse occurs first.

### IFD Winner for December 9, 1971

**Walter L. Rutchik**, Associate Research Engineer, Corporate Development Dept., Cutler-Hammer, Inc., 4201 N. 27 St., Milwaukee, Wis. His idea, "Build a digital clock without BCD conversion in the design," has been voted the Most Valuable of Issue award.

**Vote for the Best Idea in this issue.**

**SEND US YOUR IDEAS FOR DESIGN.** You may win a grand total of \$1050 (cash)! Here's how. Submit your IFD describing a new or important circuit or design technique, the clever use of a new component or test equipment, packaging tips, cost-saving ideas to our Ideas for Design editor. Ideas can only be considered for publication if they are submitted exclusively to ELECTRONIC DESIGN. You will receive \$20 for each published idea, \$30 more if it is voted best of issue by our readers. The best-of-issue winners become eligible for the Idea of the Year award of \$1000.



# Complete Trimmer Satisfaction

One design...9 pin styles

Still the industry's best trimmer value  
... Less than **50¢** each in production quantities



Stability of  $\pm 0.03\%$  and environmental performance requirements of characteristic C of Mil-R-22097

- 1.5% average ENR noise resistance
- 0.5% average CRV
- 1/2 watt @ 70°C

You can choose from an expanded line of compact trimmers. .150" — .125" — .100" in-line terminal spacing and TO-5 pin spacing all available in top and side adjust. Plus .200" delta (.100 grid) in top adjust. All available from your CTS Distributor. **Still the best value in the industry.** CTS of Berne, Inc., Berne, Indiana 46711. Phone: (219) 589-3111.

**CTS CORPORATION**  
Elkhart, Indiana



A world leader in cermet and variable resistor technology

# INDICATORS

Unlimited Variety

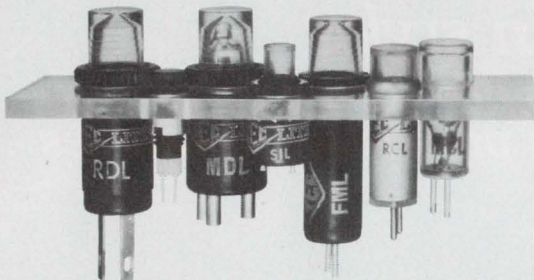

What's your need? TEC has it . . . electrically designed to cover most supply voltages. Neon or incandescent lamps; wide choice of options including integral switch. Some so compact they mount on 1/4" centers. For information about TEC's complete line of indicators and switches • readouts • display panels • data entry keyboards • CRT display terminals, call (602) 297-1111 or write: **TEC, Incorporated, 9800 N. Oracle Road, Tucson, Arizona 85704.**



INFORMATION RETRIEVAL NUMBER 48

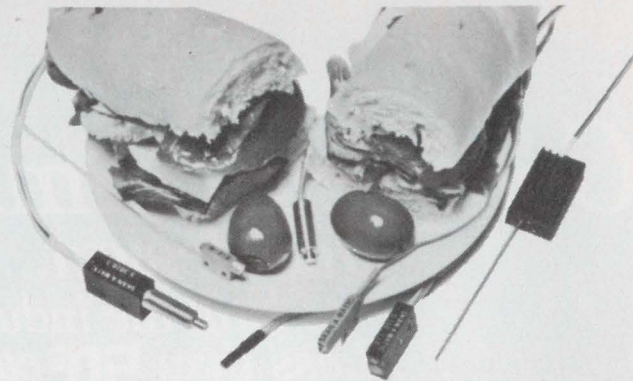

## A Hero Is No Sandwich When It Detects .001" Targets

Here are a few Skan-a-matic photoelectric devices. Like the rest of the line, complete with matching electronics, these units are all heart. Diverse application includes machine indexing, beginning/end of tape, code reading, counting cartons and spotting surface defects. Detect high speed targets—like turbine blades whirling at 23,000 rpm. Repeat object position to .000005"! Now add the convenience of 3 day, off-the-shelf shipment on all cataloged items to Skan-a-matic's international reputation for quality and precise performance. ASK FOR CATALOG.



P. O. Box S, Elbridge, N. Y. 13060 Phone (315) 689-3986

INFORMATION RETRIEVAL NUMBER 50

## 8 digits, TCXO, 120 MHz, all for 349<sup>95\*</sup> ...It's in the new FREE Heathkit catalog

The new Heathkit IB-1102 Frequency Counter has 120 MHz measurement capability with eight-digit display, 1 Hz resolution without switching time base. Sensitivity is 50 mV to 100 MHz and 125 mV above 100 MHz. It will accept inputs up to 120 V rms from 1 Hz to 150 Hz, 50 V at 4 MHz, and 3 V at 120 MHz. Overall accuracy is assured by a temperature-compensated clock, and the high impedance, low capacitance input circuit presents minimum loading to the circuit under test. Features include automatic triggering level for "hands-off" operation, cold-cathode display tubes, indicator lamps for range, overrange, and gating conditions. The new IB-1102 Frequency Counter is just one of the money-saving instruments you'll find in the free '72 Catalog. Not to mention the acclaimed line of Heathkit stereo and 4-channel components, color TV, fishing and marine gear—plus 350 other kits for home, shop and hobby. Send for your FREE copy, NOW.



HEATH COMPANY, Dept. 60-4  
Benton Harbor, Michigan 49022

Please send FREE Heathkit Catalog.

Name \_\_\_\_\_  
Address \_\_\_\_\_  
City \_\_\_\_\_ State \_\_\_\_\_ Zip \_\_\_\_\_

Prices & specifications subject to change without notice.  
\*Mail order prices; F.O.B. factory.

TE-261

INFORMATION RETRIEVAL NUMBER 49

## COMBINATION TEMPLATE Electrical / Electronic / Logic

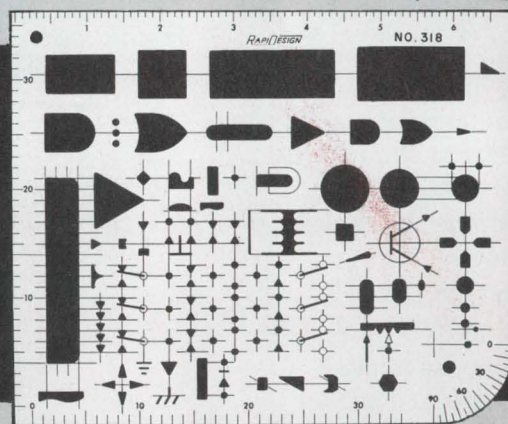

**RAPIDESIGN** template, No. 318, provides the symbols you need for both electronic and electrical circuit diagrams. Based on line spacing of 0.15 inch grid, it combines the most used circuit designs and logic symbols. The 318 has milled edges like all RapiDesign templates and is specifically designed for microfilming. Symbology conforms to ANSI Y32.2.

Ask for RapiDesign templates at your drafting supply store, or contact the factory direct.

RAPIDESIGN, INC., P.O. BOX 6039, BURBANK, CA. 91505  
A SUBSIDIARY OF BEROL CORPORATION



INFORMATION RETRIEVAL NUMBER 51

ELECTRONIC DESIGN 8, April 13, 1972

## Dual-tracking voltage regulator extends operating range to 90 V

Raytheon Co., Semiconductor Div., 350 Ellis St., Mountain View, Calif. (415) 968-9211.

A dual-tracking, voltage-regulating IC—Raytheon's RM/RC 4194—accepts a wider range of input voltages than any other dual-polarity IC regulator. And it requires only four external components for most regulating applications.

The new regulator has an input voltage range of 90 V and an output load rating of 250 mA. Its nearest competitor—Silicon General's SG 3501, the only other dual-output IC regulator—has corresponding ratings of 60 V and 100 mA. In addition the maximum internal power dissipation for the 4194 is 3 W (TO-66 package), against 1 W for the 3051 (DIP package).

When compared with Fairchild's widely used  $\mu$ A723, a single-output regulator, the Raytheon regulator offers still more striking advantages. One 4194, together with four external components, does the job of two 723s plus 12 external components in holding line regulation to 0.02% and load regulation to 0.05%. Also, the 723 has lower ratings. Its input voltage range is

40 V, load current is 150 mA and maximum internal power dissipation is 900 mW.

The Raytheon, Silicon General and Fairchild ICs are all general-purpose regulators: Each can be used for positive/negative, current/voltage regulation, or as reference units. The 723 is a single voltage regulator, for positive or negative-supply operation. The RM/RC 4194 and SG 3501 dual-voltage regulators can regulate both positive and negative supplies; each has positive as well as negative amplifiers on the same chip.

In addition to the wider operating range of the 4194, a key difference between these two dual-voltage regulators is the output voltage. The 4194 has a variable output that is set by an external resistor. Its value is calculated from the calibration factor 2.5 k $\Omega$ /V. The user simply multiplies the required voltage by 2.5 to get the necessary resistance in kilohms.

The output voltage of the SG 3501 is fixed at  $\pm 15$  V. However, it is possible to connect an external resistor to the chip to get output voltages in the range  $\pm 8$  to  $\pm 28$  V.

The 4194 regulator consists of

three basic blocks: a reference section, a positive amplifier and a negative amplifier (see diagram). The reference section provides a temperature-compensated stable voltage. It also performs the function of thermal shutdown. At about 175 C, a thermal-shutdown transistor is turned on, resulting in complete shutdown of the regulator. The performance of the regulator is not affected at temperatures that are more than two degrees below the shutdown temperature.

The reference circuit needs two external resistors. Resistor  $R_{SET}$  (71.5 k $\Omega$  for all applications) enables the user to match the temperature coefficients of the two external resistors. The second resistor,  $R_0$ , fixes the output levels.

The positive regulating block uses a noninverting differential-error amplifier, A1, as the basic control; for negative regulation, an inverting amp, A2, is used. Internal short circuit current-limiting takes effect when the load current for either side reaches 300 mA.

Resistors  $R_{F1}$  and  $R_B$  provide the balance, or matching, of the positive and negative outputs. The usual case is for the currents through the two resistors to be equal, to obtain balanced supply lines. For unbalanced lines, the balance terminal is connected to a potentiometer that is applied across the output terminals.

The rated regulations of the 4194 are as follows: Load regulation is 0.05% for a 1 to 200 mA change in load current; line regulation is 0.02% for a  $\pm 12$  to  $\pm 40$ -V change in input voltage.

The 4194 is expected to be available in May. Unit prices, in very high volumes, are expected to reach \$1.25 to \$1.50.

For Raytheon RM/RC 4194

For Silicon General SG 3501

For Fairchild  $\mu$ A723

CIRCLE NO. 253

CIRCLE NO. 254

CIRCLE NO. 255

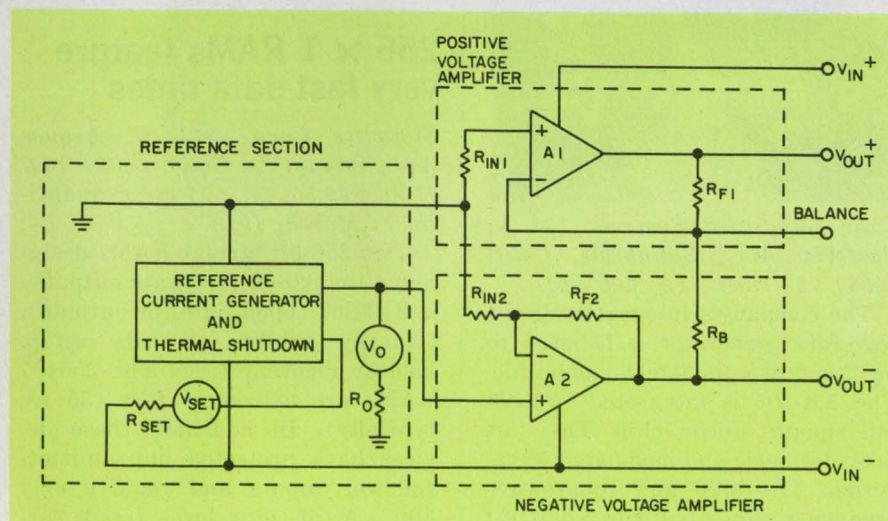

Positive and negative output voltages track within 1% over the operating temperature range with Raytheon's 4194, a dual-voltage regulator. The close tracking is possible because the circuit is all on one chip.

AMPERITE

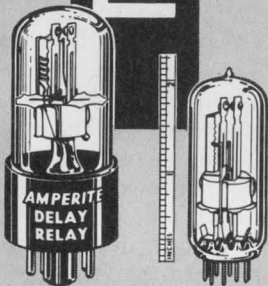

## Thermostatic DELAY RELAYS

*Glass enclosed*

For TRUE HERMETIC SEALING

**Delays: 2 to 180 seconds\***

Actuated by a heater, they operate on A.C., D.C., or Pulsating Current... Being hermetically sealed, they are not affected by altitude, moisture, or climate changes... SPST only — normally open or normally closed... Compensated for ambient temperature changes from -55° to +80°C... Heaters consume approximately 2 W. and may be operated continuously. The units are rugged, explosion-proof, long-lived, and inexpensive!

TYPES: Standard Radio Octal and 9-Pin Miniature.  
List Price, \$4.00

\*Miniatures Delays: 2 to 120 seconds.

All Amperite Delay Relays are recognized under component program of Underwriters' Laboratories, Inc. for all voltages up to and including 115V.

PROBLEM? Send for Bulletin No. TR-81.

## AMPERITE BALLAST REGULATORS

Hermetically sealed, they are not affected by changes in altitude, ambient temperature (-50° to +70°C.), or humidity... Rugged, light, compact, most inexpensive.

List Price, \$3.00

Write for 4-p. Bulletin No. AB-51.

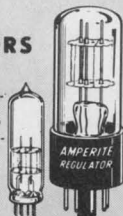

# AMPERITE

600 PALISADE AVE., UNION CITY, N.J. 07087

Telephone: 201 UNION 4-9503

In Canada: Atlas Radio Corp., Ltd.,  
50 Wingold Ave., Toronto 10

## ICs & SEMICONDUCTORS

### 4-quadrant multipliers priced at low \$95

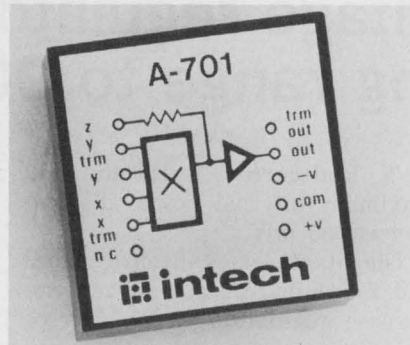

Intech, Inc., 1220 Coleman Ave., Santa Clara, Calif. (408) 244-0500.

Two fast four-quadrant multipliers, Intech's A-701 and A-702, are priced at \$95 per unit. That's less than the AD 426 and Burr-Brown 4029 multipliers. It's more than the Philbrick 4450, but this unit requires an external amplifier for division and has 1/4 the bandwidth. The A-701/702 have an 80 V/ $\mu$ s slew rate and a 7-MHz bandwidth. The new devices can double frequencies, divide, do square root and other mathematical computations. The A-701 and A-702's accuracy is better than 0.5% at  $\pm 10$  V input when externally trimmed.

CIRCLE NO. 256

### Monolithic waveform generator on the scene

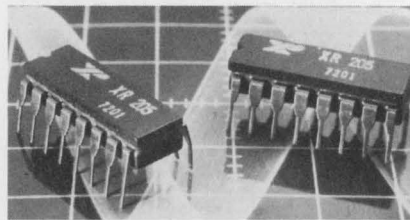

Exar Integrated Systems, 733 N. Pastoria Ave., Sunnyvale, Calif. (408) 732-7970. \$12 (100 up).

The company's integrated-circuit waveform generator is believed to be the first completely monolithic. The XR-205 is integrated on a 78 mil square silicon chip. The unit provides basic and modulated waveforms. The sine and squarewave frequency range is 0.1 to 5.0 MHz; for triangle and ramp forms, it's 0.1 Hz to 500 kHz.

CIRCLE NO. 257

### First ECL 256-bit RAM has 25-ns access time

Fairchild Semiconductor Components Group, 464 Ellis St., Mountain View, Calif. (415) 962-3816.

The first ECL 256-bit RAM to be announced is Fairchild's 95410. The memory—with a typical access time of 25 ns and typical chip select access time of 7 ns—is the fastest 256-bit RAM on the market. Production quantities are expected in the second quarter of 1972. The 95410 is organized as 256 words by one bit and is fully decoded on chip. The memory is fabricated using the company's isoplanar process for greater density.

CIRCLE NO. 258

### TTL logic line extended by 8 ICs

Motorola Semiconductor Products, Inc., P.O. Box 20912, Phoenix, Ariz. (602) 273-6900.

Two integrated circuits have been added to Motorola's TTL logic line. The new ICs are the MC7494/5494 4-bit shift register, and the MC9602/8602 dual retriggerable, resettable, monostable multivibrator. Characteristics of the shift register include these: toggle frequency up to 10 MHz; serial or parallel in, serial out and total power dissipation of 175 mW typ/package. The MC9602/8602 multivibrator produces an accurate output pulse width determined by external RC timing components.

CIRCLE NO. 259

### 256 $\times$ 1 RAMs feature very fast data times

Signetics Corp., 811 E. Arques Ave., Sunnyvale, Calif. (408) 739-7700. \$39.50 ea. (25-piece quantities); March, 1972.

Two 256-bit bipolar RAMs designated the 82S06 (tri-state outputs) and 82S07 (open collector outputs), typically exhibit no data setup, hold or recovery time. The 256  $\times$  1 RAMs are extremely fast (35 ns, typically). In addition, these devices have protected pnp emitter-follower inputs and require only 100  $\mu$ A of zero level input current, providing unusually low "fan-in."

CIRCLE NO. 260

# This is all there is to this high resolution dual-slope A/D converter. It can save you money.

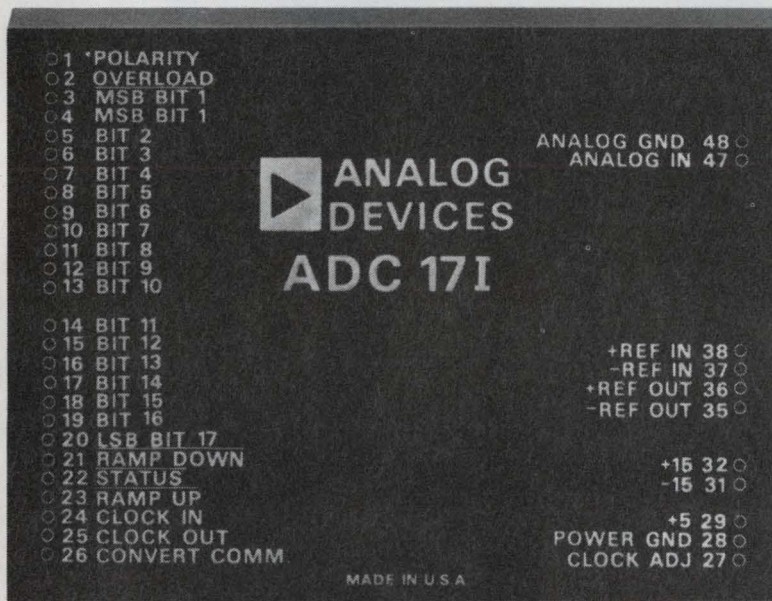

(actual size)

We're the only ones to put a complete high resolution dual-slope analog-digital converter in a single module.

We did it to make ours a lot smaller and easier to use and to save you some money.

There are no extras to buy. Even the counter is included in our compact module.

And this goes for both models of this

converter. Our ADC 171 with a 4½ digit BCD output. And our ADC 141 with a 14-bit binary word output.

We used the dual-slope integrating process to maintain high resolution in the presence of noise and to get really excellent stability and temperature performance.

It also gives you .01% accuracy, automatic zero correction and guaranteed monotonicity. And can be easily optimized for normal mode rejection at 60 Hz or 50 Hz.

Because your readings are true at any time, our ADC 171 is perfect for ratiometric measurements, process control, biomedical data transmission, and weighing system applications.

We can send you both converters right now. As well as our 1972 Product Guide which shows you all the other things we make to solve more of your problems better than anyone else.

Analog Devices, Inc., Norwood, Mass. 02062. Tel. (617) 329-4700.



# Centralab Rotary Switches... in line with your design requirements



Write  
Centralab  
for  
Bulletin  
No. 1101S(R)3

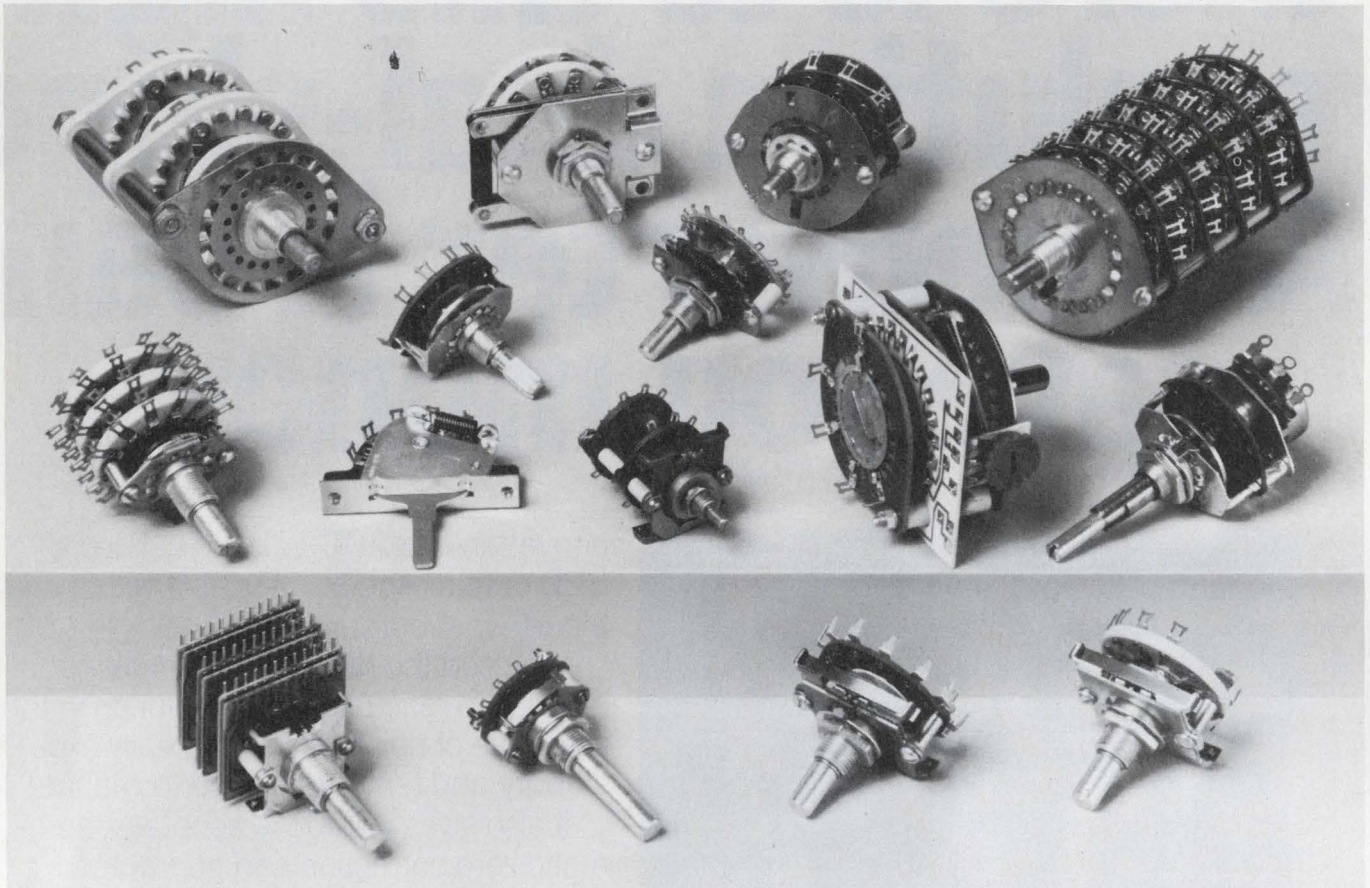

## Do you identify with this group?

The group is Centralab's rotary switch line—preferred by over half of today's design engineers. In unbiased product preference studies conducted annually by several leading electronics magazines, design engineers identified Centralab rotary switches as their first choice by a 2 to 1 margin.

And for good reason, too! Because most of you came to Centralab for a special rotary switch capability. And you got it.

Over 35 years of experience in solving switching problems is the reason Centralab can offer you a most extensive and growing line of standard switches. Now, for example, you can select from four new series of miniature and subminiature switches that feature a dual-ball sidethrust mechanism

for top index performance and exceptionally good torque and feel. Adjustable stop models require no disassembly or removal of stop tabs. You can easily change stops by varying the placement of one or two stop rings in the front plate. For torque adjustment you just change index springs on an otherwise completed switch. You can choose from a wide variety of section materials too, including diallyl phthalate for the highest insulation resistance.

When you come to Centralab you widen your choice of rotary switches—types, sizes, configurations, ratings and other options. You get the right switch at the right price. If you're not in that group, find out how the other half lives. Write Rotary Switch Sales Manager, Centralab.

### GET CENTRALAB THE "IN" LINE FOR YOUR DESIGN

Hybrid Microcircuits  
Pushbutton & Rotary Switches  
Capacitors  
Potentiometers  
Technical Ceramics  
Ceramic Packages  
Semiconductor Devices



**CENTRALAB**

Electronics Division  
GLOBE-UNION INC.

5757 NORTH GREEN BAY AVENUE  
MILWAUKEE, WISCONSIN 53201

# Centralab distributors identify with your switch requirements

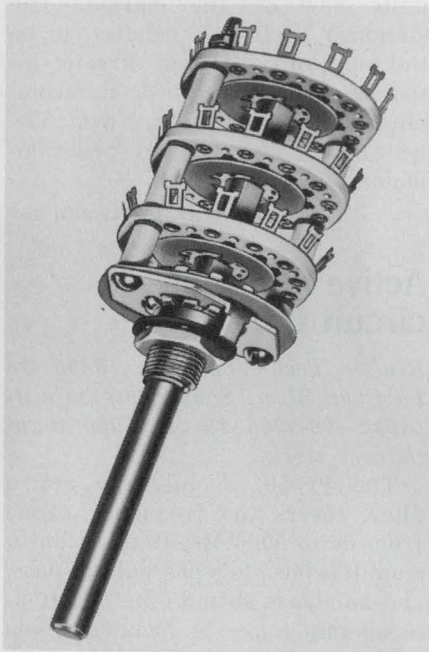

Centralab Distributors are your number one source for the number one line of standard rotary switches. You can select the switch you need — off the shelf — from all sizes and types, in prototype or small production quantities with immediate delivery. It's this kind of availability that lets you obtain the right switch for your design requirements every time. And, it's been that way for over 35 years.

Centralab Distributors also carry component switch parts in kit form for convenient field repair and economical prototype switch assembly.

When you need a rotary switch, look to your Centralab Distributor first. For a complete catalog of Centralab switches and switch kits, see your distributor or write Centralab Distributor Products, Dept. RS-1.

DISTRIBUTOR PRODUCTS



INFORMATION RETRIEVAL NUMBER 55  
ELECTRONIC DESIGN 8, April 13, 1972

## ICs & SEMICONDUCTORS

### Chopper op amp has low noise, no spikes



Analog Devices, Inc., Route 1 Industrial Park, P.O. Box 280, Norwood, Mass. (617) 329-4700. \$54 (1-9 units); stock.

A low noise, wideband, virtually spikeless, chopper-stabilized op amp, suitable for high source impedance applications—above 100 k $\Omega$ —is the Model 234. Operating at frequencies to 2.5 MHz ( $-3$  dB), the unit is specified with 0.7  $\mu$ V, pk-pk input noise, and 2 pA pk-pk current noise in a 0.01 to 1 Hz bandwidth. The Model 234 also features 4  $\mu$ s settling to 0.01% for data acquisition applications. The op amp is available as an inverting amplifier in three drift selections: 1, 0.3 and 0.1  $\mu$ V/ $^{\circ}$ C (J/K/L), and has long-term stability of  $\pm 2$   $\mu$ V/month.

CIRCLE NO. 261

### Charge-coupled shift register has 0.01% loss

RCA Solid State Div., David Sar-noff Research Center, Princeton, N.J. (609) 452-2700.

A 1-MHz, charge-coupled, 128-stage, two-phase shift register with a transfer loss of approximately 0.01% per stage has been developed by RCA. This device is a closely spaced charge-coupled structure using polysilicon gates overlapped by aluminum gates operating as a two-phase shift register. It is fabricated by standard silicon technology presently being used for fabrication of MOS ICs. The shift register operates by transferring packets of electrical charge along a silicon surface between MOS capacitors, or gates, powered by a two-phase clock voltage pulse train.

CIRCLE NO. 262

### 28-V rf power transistor covers 30-80 MHz range

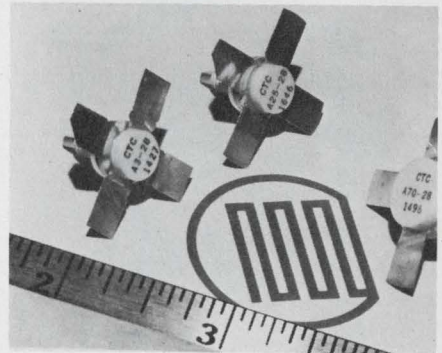

Communications Transistor Corp., 301 Industrial Way, San Carlos, Calif. (415) 591-8921. A3-28, \$8.15; A25-28, \$24.10; A70-28, \$65; 1-99. Stock.

A complement of three communications transistors are designed for operation in the low vhf range. Operating from 28 V and covering the frequency range of 30 to 80 MHz, the devices are the 3-W A3-28, the 25-W A25-28, and the 70-W A70-28. When used in a chain consisting of one 3-W, one 25-W, and two 70-W devices, a 140-W output is achieved from an 0.2-W input. All devices are guaranteed to withstand infinite VSWR when operated at 80 MHz and 28-V.

CIRCLE NO. 263

### Improved version of 9244 multiplier

Fairchild Semiconductor Components Group, 464 Ellis St., Mountain View, Calif. (415) 962-3816. \$17.50 (100-999 quantities).

An improved version of the company's 9344  $2 \times 4$ -bit TTL multiplier is designed for general power, low cost applications. The 9334 is a combinatorial multiplier using internal carry lookahead and has sufficient carry inputs to combine all equal weight outputs. This permits the design of iterative multiplication arrays without using any other components. Each device generates eight partial products and sums the carries from adjacent cells. It is expandable to any size array. For example, using eight 9344s, two 8-bit numbers can be multiplied in only 150 ns. A  $16 \times 16$ -bit multiplication scheme would require only 32 9344s.

CIRCLE NO. 264

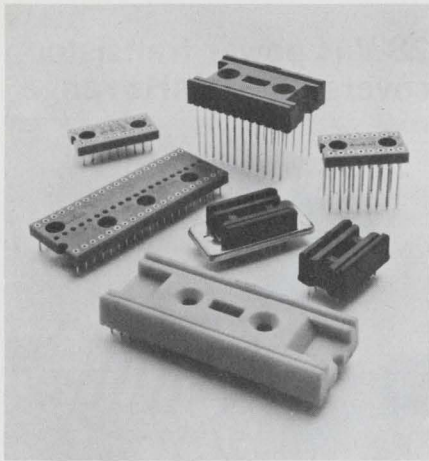

## If you've got the circuit, we've got the socket.

We ought to.

After all, Augat conceived and pioneered the socket panel for dual-in-line IC's. So why wouldn't we make other sockets for printed circuit boards as well?

We do. Low profile types, ultra-low profile types, MSI and LSI types, even LED sockets. More important, Augat design and quality standards provide for longer life, better retention and greater reliability.

There's more to Augat than sockets. As the leader in electronic interconnection, we also offer a broad selection of accessories. For quick information on price and delivery, call us at (617) 222-2202. Or write for our catalog. Augat Inc., 33 Perry Ave., Attleboro, Mass. 02703. Our representation and distribution is nationwide and international.

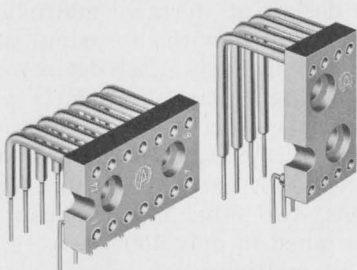

Plug into Augat®

INFORMATION RETRIEVAL NUMBER 56

## ICs & SEMICONDUCTORS

### FET op amp boasts bias current under 1 pA

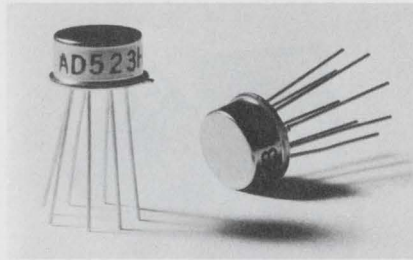

Analog Devices, Inc., Route 1 Industrial Park, P.O. Box 280, Norwood, Mass. (617) 329-4700. Stock.

Analog Devices' IC JFET op amp provides an order of magnitude lower bias current than any other high performance IC op amp, and an order of magnitude faster slew rate than most sub-picoampere discrete modules, according to the company. The AD523 achieves a maximum bias current of 0.25 pA in the L version under warmed-up conditions and slews at the rate of 3 V/ $\mu$ s. Available in J, K, and L versions, the AD523 is short-circuit protected and offset-voltage nullable. It offers maximum input voltage drift of 30  $\mu$ V/ $^{\circ}$ C, minimum common mode rejection of 80 dB, and minimum gain of 25 V/mV. The AD523 J, K and L are specified for operation over the 0 to +70 C temperature range.

CIRCLE NO. 265

### SOS/MOS RAM has 60 ns access time

Inselek, University Park Plaza, 743 Alexander Rd., Princeton, N.J. (609) 452-2222. 1-9-\$65; 10-24-\$50; 25-99-\$40.65; 100-999-\$32; stock.

A 64-bit static silicon-on-sapphire MOS RAM is now available. Designated the A01, it has a typical access time of 60 ns. It is organized as 16 words  $\times$  4 bits complete with decode logic, chip select and control circuitry. This device, according to the company, is the first RAM in the industry utilizing MOS enhancement mode active devices. The access time is equivalent to bipolar memory limits, while the functional density and low power dissipation—1 mW/bit—is that of MOS devices. The A01, a pin-for-pin replacement of standard 64-bit bipolar RAMs, has a temperature rating of 0 to 75 C.

CIRCLE NO. 266

### Receiver/transmitter has 20 kilobaud rate

Standard Microsystems, 1101 San Antonio Rd., Mountain View, Calif. (415) 965-0575. \$20.50 (100-999).

A high-speed MOS universal asynchronous receiver transmitter (U-ART) subsystem has a 200 ns strobe rate and 20 kilobaud rate—both specs surpass competitive units now on the market. The standard UAR-T is believed to be the only unit that will directly interface with advanced minicomputers like the Super Nova. The new device is externally programmable.

CIRCLE NO. 267

### Active filter has circuit Qs to 500

Kinetic Technology, Inc., 3393 De La Cruz Blvd., Santa Clara, Calif. (408) 296-9305. \$9 ea. (5000 quantities); stock.

The FS-50, a universal active filter, covers the frequency range from dc to 5000 Hz. In addition to simultaneous low-pass, high-pass, and bandpass outputs, an additional op-amp stage is included. This can be used to provide another real or complex pole, gain, buffering, threshold detection, or a high impedance notch filter configuration. Independent tuning of gain, center frequency, and Q is accomplished with the addition of external resistors. Stable Qs as high as 500 can be obtained. The operating temperature range is 0 to 70.

CIRCLE NO. 268

### 7-stage divider for electronic organs

European Electronic Products Corp., 10180 W. Jefferson Blvd., Culver City, Calif. (213) 838-1912. \$3 (100 and up).

A seven-stage divider, the DM-8410N, has been developed for use as a frequency divider in electronic organs. Seven flip-flops are connected in 5 groups on one chip. The input and the output of each flip-flop is externally accessible. Input and supply voltages are 14 V, with an output current of 5 mA. Power dissipation at 70 C is 0.5 W. The operating temperature range is 0 to 70 C.

CIRCLE NO. 269



## Differential op amp is low cost, general purpose

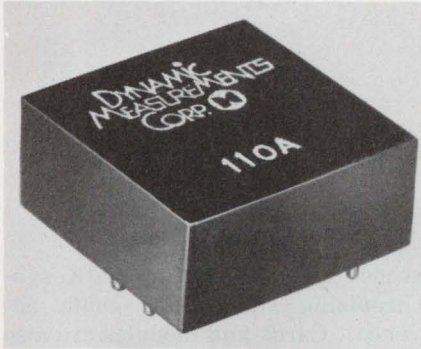

Dynamic Measurements Corp., 6 Lowell Ave., Winchester, Mass. (617) 729-7870. \$9.65; stock.

The low cost differential op amp, designated Model 110A, can be purchased for a unit cost of \$6.95. The device features a dc gain of 250,000, bandwidth of 1.5 MHz, full power response of 100 kHz, slew rate of 6 V/ $\mu$ s and 1  $\mu$ V rms of noise. At a size of 1 $\times$ 1 $\times$ 1/2 inches, the op amp can be used for summing, active filtering, isolation, voltage references and in closed-loop circuits.

CIRCLE NO. 270

## 16-bit a/d converter sells for \$1350

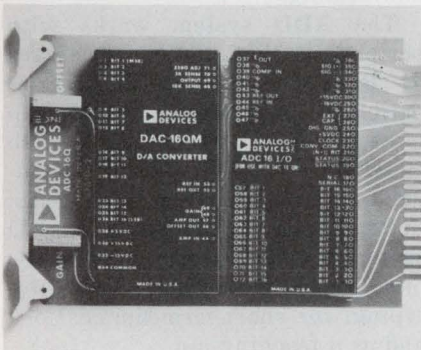

Analog Devices Inc., Route 1 Industrial Park, P.O. Box 280, Norwood, Mass. (617) 329-4700.

A 16-bit binary, analog-to-digital converter features a relative accuracy of 0.0015% and a 400  $\mu$ s conversion rate. Priced at \$1350 (1-9 units) the unit is one-half the cost of other devices of comparable precision, according to the company. Designated the ADC-16Q, the unit is a successive approximation type converter and is comprised of two modules on a 4-1/2  $\times$  6 inches printed circuit board.

CIRCLE NO. 271

This  
Sweet  
**MICROVOLT  
MULTIMETER** is  
SENSITIVE to 1  $\mu$ V,  
STABLE within 2  $\mu$ V/day  
and easy on the budget at  
**\$560**

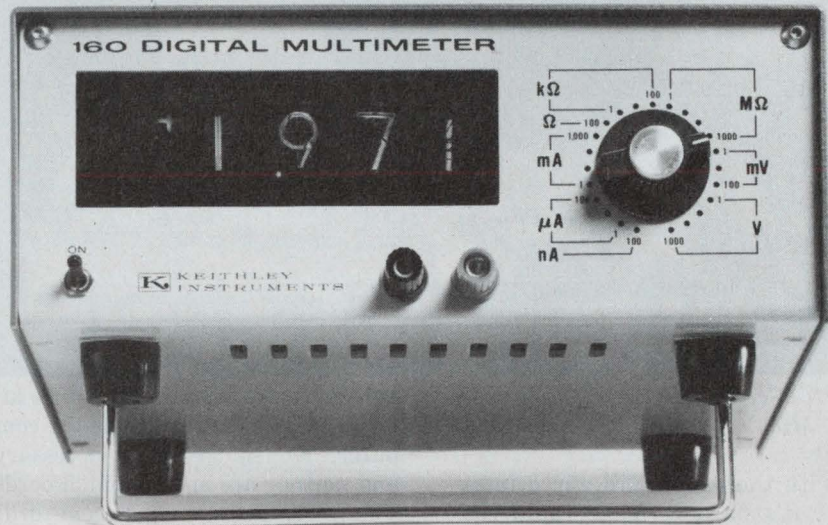

Users call it "the-how-sweet-it-is-meter". But it's really the Model 160 that . . .

- MEASURES WITH DIGITAL ACCURACY
  - Voltage** — 1  $\mu$ V to 1000V
  - Current** — 0.1 nA to 2A
  - Resistance** — 0.1  $\Omega$  to 2000 M $\Omega$
- 100% OVERRANGING
- ANALOG and OPTIONAL BCD OUTPUT
- AC/DC PROBE ACCESSORY
- MANY MORE SWEET PERFORMANCE FEATURES



**KEITHLEY  
INSTRUMENTS**

U. S. A.: 28775 Aurora Road, Cleveland, Ohio 44139  
Europe: 14, Ave. Villardin, 1009 Pully, Suisse

SEND FOR FULL DETAILS AND YOUR FREE "HOW SWEET IT IS" BUTTON

## Kit patches peripherals to popular PDP-8 mini



Heath/Schlumberger, Benton Harbor, Mich. (616) YU3-3961. \$1250; stock.

With the usual hard-wired interface, it's hard to make rapid configuration changes of a minicomputer's peripherals. But you may find it necessary to use one minicomputer in many different systems with different interfacing requirements. To make the necessary configuration changes quickly and conveniently, Heath/Schlumberger is offering the EU-801E ADD computer interface kit. It was designed specifically for the popular PDP-8 family of minicomputers. The ADD kit makes input-output equipment change a do-it-yourself affair.

There is nothing to construct. The kit is a set of pre-wired cards and modules that fit into a metal cabinet. Simple data transfer circuits can be patched in a few minutes. Testing and modifying the resulting set-up is convenient, because all connecting points neces-

sary for a functioning interface are now accessible and outside the computer. No soldering is necessary, and neither are special patch cords. The receptacles even accept ordinary hook-up wire. The ADD system groups signals for I/O data transfers into logical combinations, and the top of each plug-in card systematically presents the signals at clearly marked patch receptacles.

The ADD system buffers all the PDP-8 family's input and output busses, preventing possible damage to the computer or excess loading of the I/O power supplies.

The foundation set of modules and cards for the ADD system provides the user with the most commonly required interface functions—such as input and output accumulators, a buffered memory bus (for 12-bit digital signals), three control lines and seven timing lines. Also included are a d/a converter interface, for analog outputs, and complete interfacing for an oscillo-

scope or X-Y plotter (with synchronizing signals for chart advance). Cards and modules are also available for many other functions.

A workbook is supplied with the system, to provide progressive instructions on a range of applications.

The ADD system is largely compatible with the computer manufacturer's standard DECUS software. And Heath offers additional software packages to supplement those supplied by the computer manufacturers. Typical Heath programs can do the following:

- Accept and store data from keyboards, a/d converters, DVMS, data modems, etc.
- Output digital data to a variety of devices and analog data from d/a converters to plotters and other analog displays.
- Process and compute data for averaging, curve fitting, smoothing and scaling.

The ADD system works with peripherals that use either binary or BCD data and is TTL-compatible. It interfaces directly with most standard I/O equipment, such as teletypewriters, paper-tape readers and punches and cassette decks.

Heath points out that the ADD system is widely useful not only for breadboarding but also for prototyping, for short-term applications and as a teaching aid.

For \$1250, you get a basic set of three ADD modules, a cabinet to house them in, the computer-interface-buffer assembly, and nine plug-in circuit cards; plus some miscellaneous items and instructional materials. Not included in the basic set are interconnect cables that bring the PDP-8 I/O bus out to the computer interface buffer.

All individual components of the ADD system are available separately, since expansion and flexibility is the basis of the ADD concept.

CIRCLE NO. 272

# A NEW FIELD-OF-ONE IN LIGHTED PUSHBUTTON SWITCHES.

*Switchcraft's "PUSH-LITE" switch offers reliable leafspring switching in a neat little package.*

This whole new field of compact (1" x 1 1/16" x 1 3/4") pushbutton switches reduces the size of your control panels, consoles—and cost, too! Our new field-of-one consists of 6 series—including non-illuminated and illuminated single and twin-lamp units in two housing colors (black or grey). Up to 4PDT switching in momentary and push-lock/push-release functions. Ratings range from dry circuit switching, up to 3 amps., A.C., non-inductive load.

A rugged molded housing encloses the highly reliable leafspring switching and protects against dust, dirt and mishandling.

Pick from flange or barrier mounting—individually or in matrix configurations. Series PL "PUSH-LITE" switches mount from front of panel with clamp brackets, simply and quickly. No mounting screws show!

Design with up to two lamps and either full or split display screens—vertically or horizontally. Full display provides up to 3 lines of 6 characters each. Virtually unlimited lighting versatility

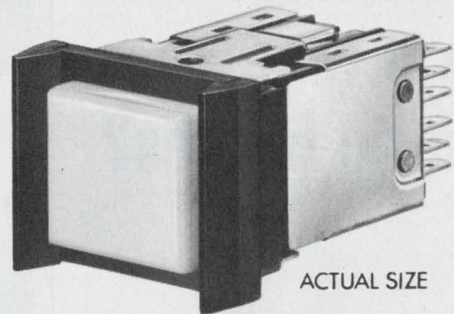

ACTUAL SIZE

provided by 7 different colors of pushbuttons, insert filters and silicone boots.

"PL" indicators that match "Push-Lite" switches in appearance and size, utilize same display screens, filters and barriers give you design freedom in control panel layout.

For additional information, contact a Switchcraft Representative or write for Catalogs S345a, S346. SWITCHCRAFT, INC. 5583 N. Elston Avenue Chicago, Illinois 60630

**SWITCHCRAFT**  
INC.

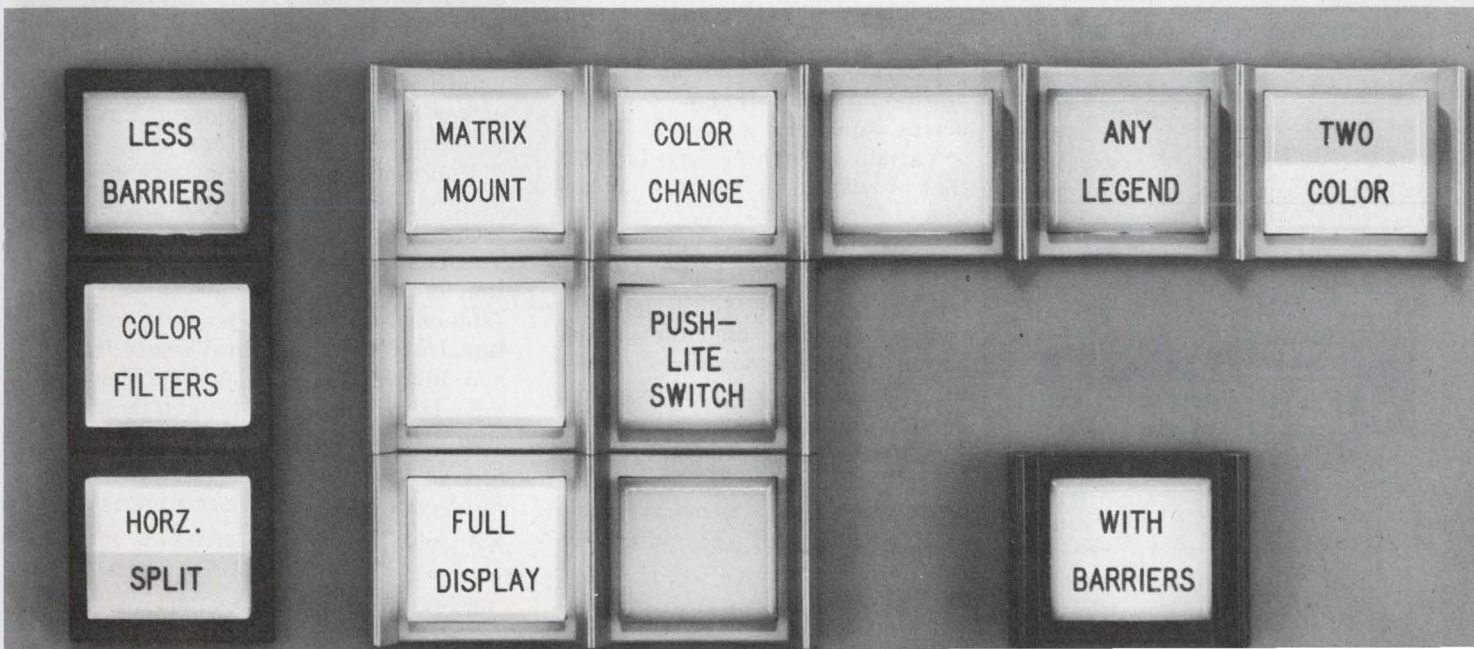

# Who Put a 14 Pin DIP Clock Oscillator in 0.16 Cubic Inches?

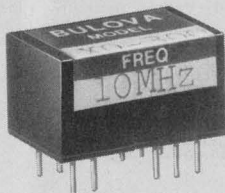

**Bulova did . . .  
in a package  
.8"x.5"x.4"**

It's the XO-300 Series with frequency ranges from 1 MHz to 4 MHz and 4 MHz to 25 MHz, an accuracy of  $\pm 15$  PPM, the series has been specially designed to meet the requirements of medium and high speed digital applications. Outputs are directly compatible with DTL and TTL digital integrated circuits.

From Specs to Size, the Series XO-300 can be your clock oscillator answer for data handling, computing and control systems. Write for the complete data story to



61-20 Woodside Avenue  
Woodside, N. Y. 11377  
(212) DE 5-8000

## DATA PROCESSING

# Fast printer/plotter makes neat mate to mini



*Varian Data Machines (Graphics and Data Systems Div.), 611 Hansen Way, Palo Alto, Calif. (415) 493-4000. Price: see text; June 1972 (60 days)*

Though not as fast as the quickest, Varian's new electrostatic printer/plotter, the Statos 30, can record 1000 lines per minute of alphanumeric characters. All 96 of the ASCII set, both upper and lower case, plus 24 other specials are available.

It is more than twice as fast and has about twice as many characters as Versatec's 1100A, in the same price range (\$8800), with better definition too— $7 \times 11$  vs  $7 \times 9$  dot-matrix characters for Versatec.

Gould's 4800-11 is much faster, at 2500 lines per minute. But the price is much steeper, at \$12,400, and Gould's definition,  $5 \times 7$  characters is poorer.

Varian uses three key features that provide some important advantages.

Unlike the Gould or Versatec machines, Varian's machine uses data bus architecture which is more compatible with computer organization and thus permits easier interfacing with fewer interconnecting wires.

Autostep, a second feature, allows the Statos 30 to accept data over the direct memory access (DMA) channel of a computer. The

internally hardware-programmed structure of the Autostep system demands much less detailed instructions from the computer. This results in a substantial saving in programming and core-capacity requirement.

The reduction in core-capacity demands makes the Statos 30 particularly suited to mating with minicomputers, whose core capacity is generally limited. A complete array of interfaces is available for major minicomputers. They are supplied with a comprehensive set of software and test/diagnostic routines.

In many printers, the print is too dark when the paper moves slowly, or too light when the paper speed is high. Varian's dual-stage toning, a third feature, eliminates the need for continuous adjustment to produce good and consistent recording density over a wide dynamic range of speeds. At the same time, costly mechanisms required in other systems have been replaced with a simpler and inherently less troublesome method.

The Statos 30 operates on a high speed raster-scanning principle. This enables characters or diagrammatic material to be reproduced with equal ease. Printouts of 132 or 140 columns of hardware-generated alphanumeric data on a paper width of 15 inches, or line drawings (including graph plots), or (as an option), combinations of both can be produced. In simultaneous character and plot data printing, characters can be placed at any location on the plot, not just in fixed printing locations.

Diagrams of any complexity can be produced on an area of  $14 \times 11$  inches in less than five seconds. The continuous or controlled motion of the roll paper or fan-fold (standard in Varian's machine, optional at extra cost in Versatec's, and unavailable in Gould's), permits large amounts of data to be recorded unattended.

For Varian

**CIRCLE NO. 250**

For Versatec

**CIRCLE NO. 251**

For Gould

**CIRCLE NO. 252**

## Tape perforator/reader has fan-fold tape feed

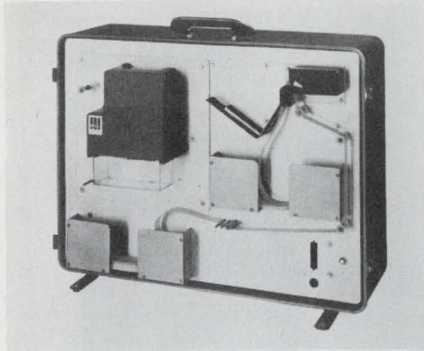

Data Specialties, Inc., 1548 Old Skokie Rd., Highland Park, Ill. (312) 831-3750. Under \$850 (OEM quantities).

The Model PR-2060 is a combination paper-tape punch and reader with fan-fold paper handling. It is panel mounted inside a heavy-duty enclosure. The unit is portable and compact due to use of common mounting, power supplies, electronics, and enclosures.

CIRCLE NO. 273

## Cassette replaces paper tape for PDP-8

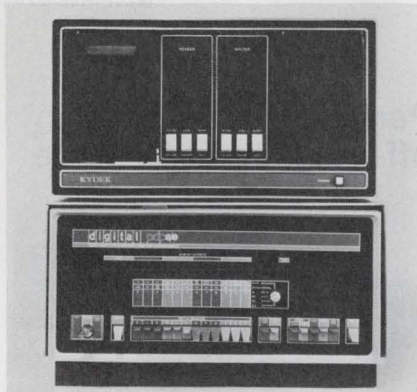

KYBE Corp., 132 Calvary St., Waltham, Mass. (617) 899-0012. \$3495; 30-60 days.

Designed for direct paper tape replacement, the Kydek cassette system is now available for users of DEC's PDP-8/e minicomputer. Two transport cassette systems are provided. The Kysette specifications comply with the proposed ANSI/ECMA standard for information interchange. No new software is required and it has plug-to-plug compatibility.

CIRCLE NO. 274

## Concerned about power?

Now RCA offers three series of digital readout devices that feature high brightness and excellent contrast at all light levels.

Take your choice! RCA can now make available to you the new DR2200 Series of NUMITRON Digital Display Devices that need only 2.5 V at 14 mA per segment — with power consumption of only 35 mW per segment, the lowest average power requirement of any digital readout device of comparable size and brightness.

RCA's expanding NUMITRON line today consists of a complete selection of low-voltage/low- and moderate-power displays. Character heights are 0.4" for the DR2100 and DR2200 series; 0.6" for the DR2000 series. All three series of rugged, long-lived NUMITRON devices are compatible with IC decoder/drivers.

Bright, sharp, dependable — for use with all color filters — RCA's digital displays feature performance advantages important to many leading designers of such units as counters, marine instruments, medical equipment, tachometers, police

VASCAR instruments, stock quotation readouts, store scales, cash registers, and industrial controls . . . to name just a few.

Talk to your local RCA Representative or your RCA Industrial Tube Distributor. Be sure to ask for the latest information on the new DR2200 Series for portable and battery-operated equipment. You will learn, for example, that the DR2200 can withstand shock of 200g and vibration of 20g peak over a 5- to 500-Hz frequency range. And their solderable base pins permit direct PC board mounting. These devices also fit into popular TO-5, 10-pin sockets.

For technical data on all three series of NUMITRON devices, write: RCA, Commercial Engineering, Section 57D-13/CN7, Harrison, N.J. 07029. International: RCA, 2-4 rue du Lièvre, 1227 Geneva, Switzerland, or Sunbury-on-Thames, U.K. or P.O. Box 112, Hong Kong.

## RCA NUMITRON Display Devices

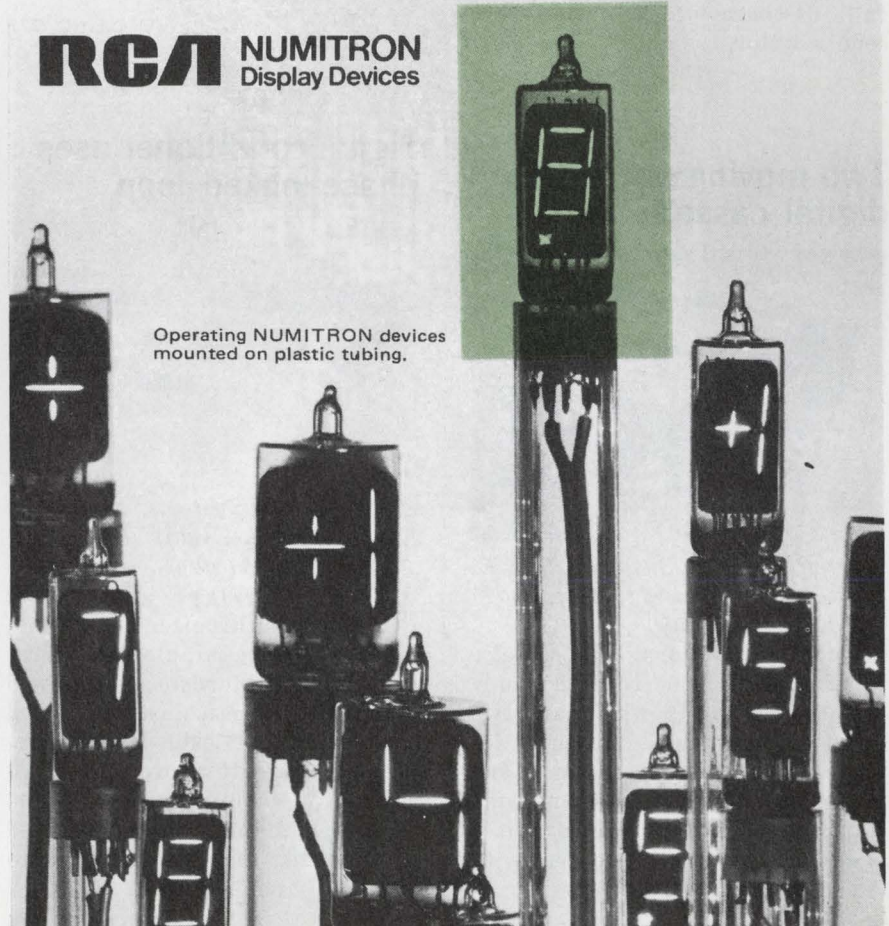

Operating NUMITRON devices mounted on plastic tubing.

INFORMATION RETRIEVAL NUMBER 60

## Line printer uses 9x7 matrix at 165 cps



Centronics Data Computer Corp., One Wall St., Hudson, N.H. (603) 883-0111. \$4130.

The 101A line printer is a low-cost impact printer that uses a 9x7 dot-matrix character at speeds of 165 characters per second. It "produces very high quality printing impressions," according to the company. Important standard features of the printer are: paper run-away control, single-line spacing, full 64-character set, hardware code selector.

CIRCLE NO. 275

## Two moving parts drive digital cassette tape

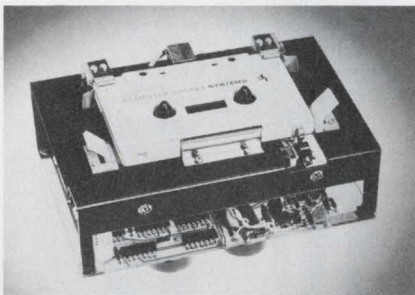

Computer Access Systems, 2645 E. Buckeye Rd., Phoenix, Ariz. (602) 267-1444. \$300 (500).

Fully bi-directional, this cassette tape transport, model 260, has only two moving parts which are two small dc motor-tachs. Features include: tape speeds between 5 and 40 ips; 60-ms max start and stop time; DTL or TTL compatibility; single track, phase encoded with densities up to 800 bits/in.

CIRCLE NO. 276

## Data terminal includes calculator functions



Viatron Computer Systems Corp., Route 62, Bedford, Mass. (617) 275-6100. \$4960.

The Model 2113 terminal is designed for data-entry applications requiring addition or subtraction ability in a manual or a batch mode. Model 2113 updates earlier 2111 to incorporate a wired 1024-word ROM microprocessor and modified keyboard for the calculating functions. The system can accumulate totals up to 40 fields with up to 79 digits in any one total.

CIRCLE NO. 277

## Signal conditioner uses phase-locked loop



ELPAC Data Systems, 18651 Von Karman, Irvine, Calif. (714) 833-1717. \$5400; 60 days.

Model DS2071 programmable PCM bit synchronizer/signal conditioner with guaranteed bit-error probability performance within 0.5 dB of the theoretical curve is based on a modified "Costas-loop" phase-lock technique. It recovers all standard IRIG 106-69 formats, accepts any input signal between 0.5 and 60 V pk-pk, and can be tuned to any rate from 1 bit to 2 Mb/s.

CIRCLE NO. 278

## Multiplexer saves on phone line costs

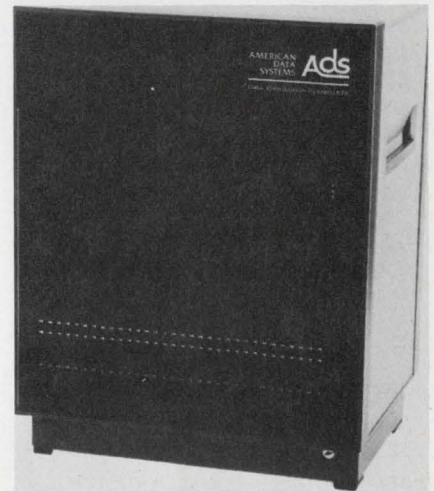

American Data Systems, 8851 Mason Ave., Canoga Park, Calif. (213) 882-0020.

A 128-channel time division multiplexer allows data transmission users to realize dramatic savings on telephone line costs. Called the ADS 670, the unit multiplexes up to 128 low-speed data channels over as many as six single voice-grade telephone lines. It is said to intermix seven different baud rates (46 to 1200 Baud), and accept code levels of five through eight bits.

CIRCLE NO. 279

## Portable data unit has off-line Mag-Tape Mode



Data Access Systems, Inc., 100 Route 46, Mountain Lakes, N.J. (201) 335-3322. \$5045; 10 days.

Model 4125 operates at speeds up to 30 characters a second, over any standard telephone line, and uses an off-line mode to prepare and edit magnetic-tape cassettes which store up to 70,000 characters each. Featuring non-impact printing, it uses USACII code, operates in half or full duplex, with built-in acoustic coupler.

CIRCLE NO. 280

**NEW...**

*A complete family  
of low-cost,  
high performance  
packaged AC-DC  
regulated power supplies*

**"THE PRACTICALS™"**

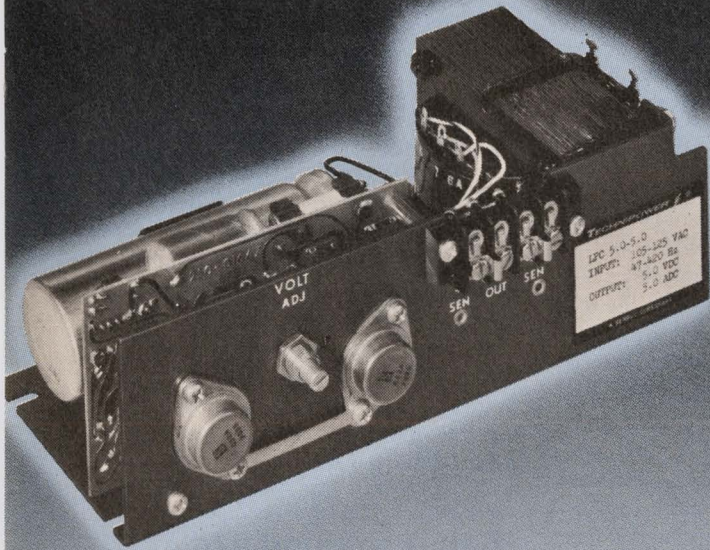

**They make systems engineers  
cost efficiency experts**

Today's OEM Engineer must assume many responsibilities beyond the pure design of systems.

He must realistically specify the components and sub-systems; buy the required performance specifications at competitive prices; package the system in its most compact form. In short, he must achieve the greatest cost-efficiency and reliability per dollar invested.

Just compare the basic specifications and prices of "The Practicals" with other open construction power supplies. Then consider that we give "The Practicals" the identical 5-Year Warranty as our premium mil-spec units.

Standard output voltages and power availabilities satisfy the most popular circuits. Custom specification can easily be adapted to order.

"The Practicals" are an OEM Engineer's most realistic answer to any power supply need. Call, wire or write today for immediate delivery.

**U.L. APPROVED. BACKED BY TECHNIPOWER  
5-YEAR WARRANTY**

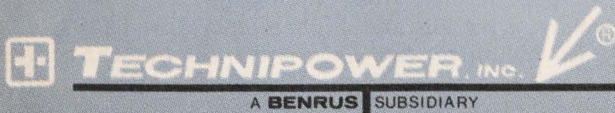

Benrus Center, Ridgefield, Ct. 06877  
203-438-0333 TWX: 710-467-0666

**TECHNIPOWER "PRACTICALS"  
STANDARD SPECIFICATIONS**

**Single, Dual, Triple, and Quadruple Output Models**

Input voltage range: 105-125 volts  
Input frequency range: 47-420 Hz.  
Regulation-Line and Load Combined:  $\pm 0.5\%$   
Ripple (RMS): (with either positive or negative terminal grounded): 10mv.  
Temperature Coefficient: (TYP.) 0.05%/°C or 5 mv/°C whichever is greater.  
Polarity: May be used positive or negative.  
Output voltage and current: See model listing.  
Short circuit protection: Automatic circuit protects the power supply if the output is shorted continuously. Automatic return upon removal of short circuit.  
Remote sensing: Provisions are made for remote sensing to eliminate effects of lead resistance on dc regulation.  
Ambient Operating Temperature: 0°C to +55°C for current ratings specified in model listings.  
Storage temperature: -20°C to +85°C.  
Recovery time: (TYP.) Less than 50 usec, 1/2 L to FL.  
Fixed output voltage: Can be pre-set at the factory with a setting accuracy of  $\pm 2\%$  of nominal output for any or all of the outputs at slight additional cost.  
OEM quantity and less than 10 unit prices quoted upon request.  
Custom specifications easily adapted to order.

**Single Output Series designed for logic, op-amp,  
signal and other commercial applications**

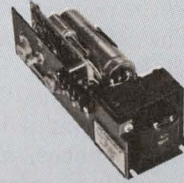

Length 8 1/2"  
Width 3 1/8"  
Height 2 5/8"

Adjustable Output Voltage	Output Current Amperes	Standard Model No.
5.0 $\pm 5\%$	5.0	LP5.0-5.0
6.0 $\pm 5\%$	4.5	LP6.0-4.5
12.0 $\pm 5\%$	2.5	LP12.0-2.5
15.0 $\pm 5\%$	2.0	LP15.0-2.0
24.0 $\pm 5\%$	1.5	LP24.0-1.5
28.0 $\pm 5\%$	1.2	LP28.0-1.2

**\$39<sup>75</sup>**

10 or more combined units

Overvoltage protection available on all models, add \$5.00.

**Dual Output Tracking Series designed for op-amp and  
other commercial applications**

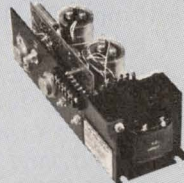

Length 8 1/2"  
Width 3 1/8"  
Height 2 5/8"

Adjustable Output Voltage	Output Current Amperes	Standard Model No.
$\pm 12.0 \pm 5\%$	1.2	LPDT-12.0-1.2
$\pm 15.0 \pm 5\%$	1.0	LPDT-15.0-1.0

**\$64<sup>75</sup>**

10 or more combined units

Overvoltage Protection available on all models, add \$10.00. Independent output adjustment (non-tracking) provided at slight additional cost. Modification of standard output voltages can be provided over the range of  $\pm 5$  to  $\pm 28$  volts at slight additional cost. Voltages below  $\pm 7$  volts not available in Tracking models.

**Triple Output Series combines single and  
dual output functions**

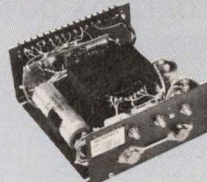

Length 8 1/4"  
Width 7 1/2"  
Height 3 3/8"

Adjustable Output Voltage	Output Current Amperes	Standard Model No.
+5.0 $\pm 5\%$	5.0	LPM-1
+12.0 $\pm 5\%$	1.2	
-12.0 $\pm 5\%$	1.2	
+5.0 $\pm 5\%$	5.0	LPM-2
+15.0 $\pm 5\%$	1.0	
-15.0 $\pm 5\%$	1.0	

**\$124<sup>75</sup>**

10 or more combined units

Overvoltage Protection is standard on 5 Volt Output at no additional cost. Available on the  $\pm 12$  or  $\pm 15$  volt output, add \$10.00. Modification of standard output voltages can be provided at slight additional cost.

**Quadruple Output Series combines triple output  
functions plus output for indicator or drive voltage**

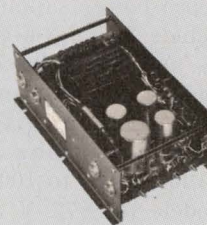

Length 14"  
Width 8 1/2"  
Height 5"

Adjustable Output Voltage	Output Current Amperes	Standard Model No.
+5.0 $\pm 5\%$	10.0	LPQ-1
+15.0 $\pm 5\%$	2.0	
-15.0 $\pm 5\%$	2.0	
+28.0 $\pm 5\%$	1.0	
+5.0 $\pm 5\%$	7.5	LPQ-2
+15.0 $\pm 5\%$	4.0	
-15.0 $\pm 5\%$	4.0	
+28.0 $\pm 5\%$	1.0	
+5.0 $\pm 5\%$	5.0	LPQ-3
+15.0 $\pm 5\%$	6.0	
-15.0 $\pm 5\%$	6.0	
+28.0 $\pm 5\%$	1.0	

FROM  
**\$203<sup>75</sup>**

10 or more combined units

Overvoltage Protection is standard on 5 Volt Output at no additional cost. Overvoltage Protection is available on the  $\pm 12$  or  $\pm 15$  volt output, add \$10.00. Modification of standard output voltages can be provided at slight additional cost. See TechniPower products in Volume 1 of the 1971/72 EPC. Page 205-209.

# Best Buy

in 1% Tolerance  
1-Watt Zeners  
**SCHAUER**  
Immediate Shipment

No fragile  
nail heads

All welded and  
brazed assembly

Gold plated  
leads



## Low Prices

ANY voltage from 2.0  
to 18.0

Quantity	Price each
1-99	\$1.07
100-499	.97
500-999	.91
1000-4999	.86
5000 up	.82

Write for complete rating data and  
other tolerance prices.

## Buy The Kit!



A  
\$54.57  
value  
for  
only

**\$24<sup>50</sup>**

Kit contains a 51-piece assortment  
of SCHAUER 1% 1-watt zeners  
covering the voltage range of 2.7  
to 16.0. Three diodes of each voltage  
in reusable poly bags. Stored  
in a handy file box. Contact your  
distributor or order direct.

Semiconductor Division

### SCHAUER

Manufacturing Corp.

4511 Alpine Ave. Cincinnati, Ohio 45242

Telephone: 513/791-3030

## MODULES & SUBASSEMBLIES

### 8-bit d/a converter settles quickly



*Datel Systems, 1020 Turnpike St.,  
Canton, Mass. (617) 828-6395. \$19;  
stock.*

The 198B is a complete 8-bit digital-to-analog converter in a compact module, 2 x 2 x 0.4 in. It includes input buffer logic, electronic switches, a ladder network and a voltage-reference source. The low-cost unit settles to within 0.2% in 300 ns. Full-scale output is  $\pm 2.5$  mA with a voltage compliance of  $\pm 1.2$  V. Other key specs include: over-all accuracy of  $\pm 0.2\%$ , tempo of  $\pm 15$  ppm/ $^{\circ}$ C, long-term stability of  $\pm 0.05\%$  (6 month), and output linearity of  $\pm 5$   $\mu$ A. Input coding is straight binary of unipolar output or two's complement for bipolar output, and inputs are compatible with TTL/DTL logic.

CIRCLE NO. 300

### Digital front end programs power supply

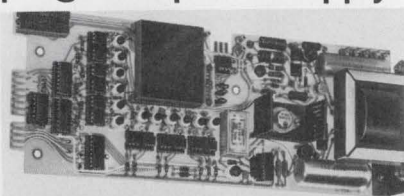

*Kepeco, Inc., 131-38 Sanford Ave.,  
Flushing, N.Y. (212) 461-7000.  
2-digit-\$305; 12 bit-\$472.*

The SN series are line-powered, optically isolated, digital-to-analog devices which permit control of Kepeco power supplies. Five models include 2 and 3-digit BCD and 8-, 10- and 12-bit binary units which store parallel-format data in a latch-memory. With Kepeco's unipolar, dc supplies from 0-6 V to 0-1000 V, up to 1000 W, or bipolar models to  $\pm 72$  V at  $\pm 5$  A, engineers can configure a high speed power control system.

CIRCLE NO. 301

### DPM to teleprinter with preset format

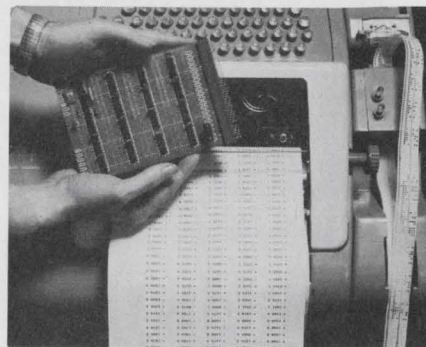

*Digital Laboratories, 377 Putnam  
Ave., Cambridge, Mass. (617) 876-  
6220. Under \$200 in quantity;  
stock to 30 days.*

The DPT-415 module converts DPM BCD outputs to teleprinter/punch inputs. The low cost and size result from a factory wired, fixed format controller. The DPT-415 automatically generates spaces, carriage returns, and line feeds and prints five readings per line. It also prints plus or minus symbols under control of the DPM polarity signal. An additional character—representing range, mode, etc., controlled by the user—is printed with each reading.

CIRCLE NO. 302

### High resolution a/d converter in module

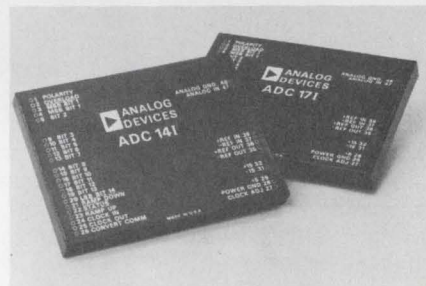

*Analog Devices, Inc., Route 1 In-  
dustrial Park, P.O. Box 280, Nor-  
wood, Mass. (617) 329-4700. \$259  
(1-9 units); stock.*

A high-resolution dual-slope, integrating analog-to-digital converter is the first in modular form, according to Analog Devices. Available in either 17-bit BCD output (ADC-171) or 14-bit binary output (ADC-141), the new unit features 0.01% accuracy, 40 ms total conversion time, automatic error correction and high temperature stability and noise rejection. It can measure at the rate of 25 samples per second.

CIRCLE NO. 303



## Floating resin resists hydrostatic pressures

Castall, Inc., Weymouth Industrial Park, E. Weymouth, Mass. (617) 337-6075. \$15/gallon.

Castall 463, a new electrical embedding compound that weighs half as much as conventional filled resins, is an epoxy resin filled with microscopic glass spheres. Because of the good compressive strength and closed cell structure of these filter particles, the compound has excellent resistance to hydrostatic pressures up to about 10,000 psi. The dielectric constant of the compound is exceptionally low at 2.9 at 25 C, 100 kHz. Cured, the embedding compound has a density of slightly more than 45 lbs/ft<sup>3</sup>. It can be used for potting electronic components for airborne and oceanographic applications.

CIRCLE NO. 304

## DIP mounting socket claims lowest profile



Barnes Div., Bunker Ramo Corp., 24 N. Lansdowne Ave., Lansdowne, Pa. (215) 622-1525.

The industry's lowest profile 18-lead production mounting socket for random access and dual-in-line packages, designated as series 821-20, offers wire-wrappable terminations or solder tab terminations of beryllium copper or phosphor bronze for dip or wave soldering. The series 821-20 has a body profile of 0.160-in. above board including a standoff height of 0.020-in. The sockets can be mounted on a grid of 0.100-in. centers between devices in both X and Y axes, thus simplifying programming and operation of automatic wire wrapping machines.

CIRCLE NO. 305

# think woven

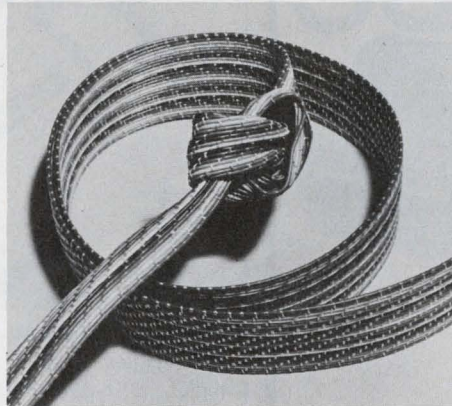

## for flexibility

It rolls, bends and folds for turns, tight spots and small spaces, without lead damage or signal distortion. Woven goes from "Point A" to "Point B" like no other cable can!

## WOVEN ELECTRONICS

A DIVISION OF SOUTHERN WEAVING COMPANY

P.O. Box 189, Mauldin, S.C. 29662. (803) 288-4411

INFORMATION RETRIEVAL NUMBER 63

# ENGINEERS WHO KNOW TANTALUMS SPEC DICKSON

Because Dickson is a specialist in solid tantalum capacitors! This specialization means more quality in every unit produced from MIL-C-39003 types to low-cost commercial units. With over 4,000 standard catalog items, you can always depend upon Dickson to supply the right tantalum unit at the right price.

Try us! Write, today, for our 6-page Tantalum Capacitor Short Form Catalog.

"The Specialists"



"Where Quality Makes The Difference"



**DICKSON**  
ELECTRONICS CORPORATION

PHONE (602) 947-2231 TWX 910-950-1292 TELEX 667-406  
P.O. BOX 1390 • SCOTTSDALE, ARIZONA 85252

INFORMATION RETRIEVAL NUMBER 64

# 5VDC/ ±15VDC

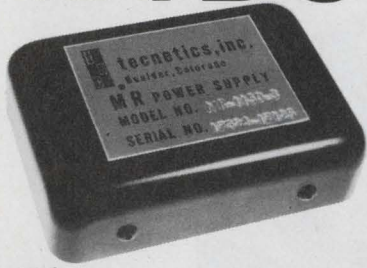

# 1" x 2 1/2" x 3 1/2" x \$45.00

## AC-DC REGULATED POWER SUPPLIES

Powerful little packages with small prices.

The MR Series of Tecnetics AC-DC Regulated Power Supplies starts as small as 3 1/2" x 2 1/2" x 1" with prices as low as \$45.

### MR Series features:

- . triple output. Logic voltage of 5 volts in addition to  $\pm 15$  volts
- . single and dual outputs continuously and individually adjustable
- . repairable
- . ambient operating temperature continuous duty from 0° C to 50° C
- . black anodized aluminum case
- . easily mounted to heat sink for greater heat dissipation
- . three packages—3, 5, 8 watts
- . short circuit protected

Now available, the new Tecnetics catalog featuring the full line of AC-DC, DC-DC Power Supplies, Regulators and accessories.

(See EEM Cat., pp. 180-185, vol. 2)

## tecnetics inc.

P.O. Box 910, Boulder Industrial Park, Boulder, Colorado 80302  
(303) 442-3837 TWX 910-940-3246

## COMPONENTS

### Reed relays replace entire IBM line

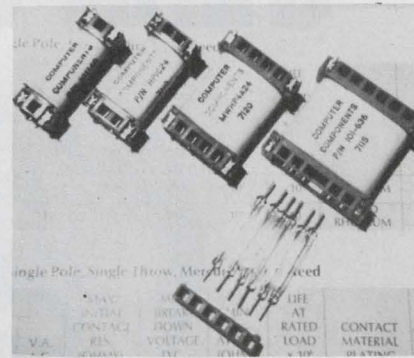

Computer Components Inc., 88-06 Van Wyck Expwy., Jamaica, N.Y. (212) 291-3500. \$2.50 (1-24) and up.

Reed relays directly interchangeable with the entire IBM Reed Relay line have a low profile, (0.350 high) and the features of plug-gability and removable reed switches. Spst (Form "A") dry reed switches up to 6 poles, spdt (Form "C") dry reed capsules up to 3 poles, spst (Form "A") mercury capsules up to 6 poles and spdt (Form "C") mercury capsules up to 3 poles are available.

CIRCLE NO. 306

### Slide-n-switch decade used for programming

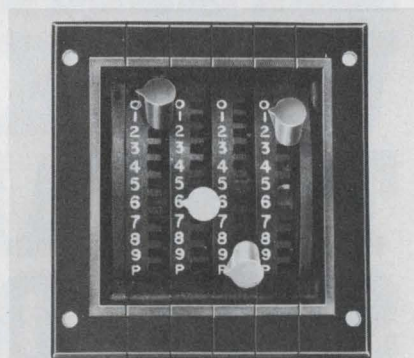

Seaelectro Corp., Programming Devices Div., 225 Hoyt St., Mamaroneck, N.Y. (914) 698-5600.

An 11-position decade switch provides direct access programming. Operated by a simple pull-slide-push of its lever, the 2-5/8-in. high by 11/32-in. wide module switches from any circuit to any other without contact with those in-between. Contacts will carry 2 amps static, 250 mA during switching and are rated for 250,000 operations minimum each.

CIRCLE NO. 307

### LED PB switch has long life, hi-brightness

Marco-Oak Industries, 207 S. Helena, Anaheim, Calif. (714) 535-6037. \$2.25 (1000 quantities); stock.

Millions of noise-free operations, improved light dispersion and substantially greater brightness, with a wide angle of visibility are provided by the momentary, LED illuminated pushbutton switch, designated the Series 590/D. It is designed for IC signal level switching in computer and control applications, where long life, maintainability and visibility are primary. Bifurcated, wiping, double-break contact switching is rated from dry circuit to 1/2 amp. (resistive), at 30 V dc.

CIRCLE NO. 308

### Read-after-write heads feature 3200 FRPI

American Magnetics Corp., 2424 Carson St., Torrance, Calif. (213) 775-8651. Stock.

Two precision read-after-write digital cassette heads, the AMCH-12RAW (single channel) and the AMCH-22RAW (dual channel) feature all metal face, and meet standards of ANSI and ECMA for digital data recording. Recording density up to 3200 FRPI, with a performance resolution greater than 85% are provided. Crossfeed (write-to-read) is 5% maximum. No adjustment before mounting is required.

CIRCLE NO. 309

### Capacitor features high voltage stability

Sprague Electric Co., 347 Marshall St., North Adams, Mass. (413) 664-4411.

A line of small, light-weight, metallized polyester-film capacitors have been developed for electrostatic copier and television power supplies (4000 volts and up). They are axial-lead polyester-film capacitors with no leakage problem, have capacitance stability with time, temperature, and voltage, and there are virtually no catastrophic failures.

CIRCLE NO. 310

now...you  
can test  
digital  
IC's...  
economically...  
to manufacturer's specs



New Kurz-Kasch Model IC-590 is the first economically priced digital IC analyzer for accurate testing in the lab, shop, inspection, production, field or any other location.

The Model IC-590 is a completely portable, battery powered digital IC tester for use in conjunction with published IC specification sheets for static and dynamic testing of all 14 and 16 pin dual in-line IC modules of the DTL and TTL, 5 and 15 volt families. Flat pack and TO-5 modules may also be tested by using appropriate adapters. Price \$169.95.

A unique sister Model IC-591 is also available. It comes complete, as IC-590 above, internal power supply for highly regulated 5 volt, 1 amp operation and adapter cable for firing-up complete card units containing as many as 15 or more mounted IC's. Price \$295.00.

For complete technical data, write or call now: Tom Barth, Marketing Manager



ELECTRONICS DIVISION  
**Kurz-Kasch, Inc.**  
1421 S. Broadway,  
Dayton, Ohio 45401

(513) 223-8161

INFORMATION RETRIEVAL NUMBER 66

curtis  
relay socket  
assemblies



Type RS assemblies:  
Widest choice available from any source

Almost any relay or timer can be mounted in these compact assemblies that feature printed circuit boards of glass epoxy G-10. Barrier-type screw, or clamp-type terminal blocks are highly break-resistant. Terminals are permanently numbered for quick identification. Highest quality sockets provide great conductivity, relay retention, and protection. Up to 24 sockets snap in/out of 48" pre-punched vinyl track using only 2 or 3 mounting screws.

Contact factory for your nearest local Curtis representative, distributor, or for additional information.

**CURTIS DEVELOPMENT & MFG. CO., INC.**  
NEMA MEMBER 3236 N. 33rd St. • Milwaukee, Wis. 53216

INFORMATION RETRIEVAL NUMBER 67

ELECTRONIC DESIGN 8, April 13, 1972

# BOURNS VARIABLE NEW RESISTOR JACKPOT

CERMET OR COMPOSITION

MODEL  
3359

MODEL  
3353

MODEL  
3351

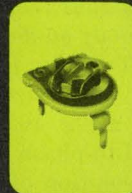

3 WINNERS FROM THE  
"QUALITY" PEOPLE

WIN 7 WAYS!

- 1 SUPERIOR MOISTURE RESISTANCE—Bourns actually calls out this important specification.
- 2 MULTIPLE TEMPERATURE RANGE — Why bear the cost of more operating temperature range than you need? Bourns offers you a choice of three.
- 3 TAILORED POWER—Again, Bourns gives you a chance to save. Select from three different power/temperature capabilities for the one closest to your specific application.
- 4 SOLVENT-RESISTANT—Bourns specifies less than 1% resistance change after normal circuit-board solvent cleaning processes; that's the best in the industry.
- 5 PIN AND MOUNTING VERSATILITY — Select from popular pin patterns in both vertical and horizontal mounting configurations.
- 6 PRICES YOU CAN'T IGNORE — Bourns has priced these new products very competitively; in 1000-1999 quantities \$.15 to .50, depending on the model you need.
- 7 FAST DELIVERY—That means fast, not next week. In-depth stocking is the key.

## SPECIFICATIONS:

	MODEL 3359	MODEL 3353	MODEL 3351
RESISTANCE RANGE	100Ω-2 megohms	500Ω-5 megohms	500Ω-1 megohm
RESISTANCE MATERIAL	CERMET	COMPOSITION	COMPOSITION
POWER	½ watt at 70°C	⅓ watt at 60°C	⅓ watt at 60°C
OP. TEMP.	-65 to +125°C	0 to +100°C	0 to +70°C
HUMIDITY	±1% T.R. Change	±12.5% T.R. Change	±7.5% T.R. Change
LOAD-LIFE	1000 hrs at 70°C	500 hrs at 60°C	100 hrs at 60°C
RESISTANCE CHANGE AFTER CLEANING	1%	1%	1%
PRICES*	.50	.20	.15

\*1000-1999 quantity prices, U.S. dollars, F.O.B., U.S.A.

KEEP OUR COMPETITION ON THEIR TOES . . . ENTER YOUR ORDER NOW AT A LOCAL BOURNS SALES OFFICE, REPRESENTATIVE, OR THE FACTORY-DIRECT.



TRIMPOT PRODUCTS DIVISION • 1200 COLUMBIA AVE., RIVERSIDE, CALIF. 92507

INFORMATION RETRIEVAL NUMBER 68

**New  
from  
General  
Electric**



**Goldtop** Rechargeable  
Nickel-cadmium  
**Batteries**  
for elevated  
temperature  
applications



Here's the rechargeable battery for your tough, high-temperature design applications. General Electric's new Goldtop nickel-cadmium batteries have a maximum sustained temperature capability of 65°C — permitting their use in spots previously too hot for nickel-cadmium batteries. And, at 65°C cell temperature, Goldtop batteries have a longer life expectancy than conventional units at 50°C cell temperature. Goldtop batteries are also available in a quick-charge version that can be recharged in 3½ to 4 hours using a standard charger. These cylindrical cell batteries are available in a wide variety of sizes and ratings.

For more information, write Section 452-02, General Electric Co., Schenectady, New York 12345, or circle reader service card.

452-02

**GENERAL  ELECTRIC**

INFORMATION RETRIEVAL NUMBER 69

**INSTRUMENTATION**

**Frequency synthesizers  
give 0.1-Hz resolution**

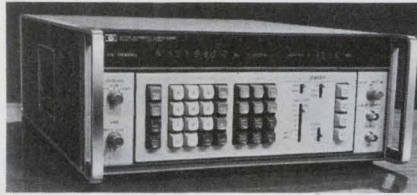

Hewlett-Packard Co., 1601 California Ave., Palo Alto, Calif. (415) 493-1501. 3330A, \$5100; 3330B, \$6000; 60 days.

Two new programmable frequency synthesizers feature a stability of  $\pm 1 \times 10^{-8}$  per day, -50-dB signal-to-phase noise and a constant resolution of 0.1 Hz up to 13 MHz. The Models 3330A and 3330B have ROMs to control all operations. The ROM remembers the sweep parameters, as programmed from the keyboard. Four-digit amplitude control, with a resolution of 0.01 dB over a 100-dB range, is standard on the Model 3330B.

The Model 3330A has a manual control for amplitude, and output is leveled to  $\pm 0.5$  dB. Its amplitude range is from zero to approximately +13 dB. Both instruments are fully programmable, except for the amplitude of the Model 3330A. Solid-state displays show frequency and amplitude on the Model 3330B, and frequency only on the Model 3330A. Nine digits of frequency are displayed on both instruments, and four digits of amplitude on the Model 3330B.

CIRCLE NO. 320

**Pulse generator is  
fully programmable**

E-H Research Labs., P.O. Box 1289, Oakland, Calif. (415) 843-3030. \$3500; April, 1972.

The Model 1501 offers pulse repetition frequencies from 0.5 Hz to 50 MHz, with 10-V output into 50  $\Omega$ . All parameters are programmable, including risetime/fall-time from 3 ns to 1 ms, delay and width from 10 ns to 10 ms, baseline offset from -5 V to +5 V, and internal/external clock, single/double pulse, and positive/negative pulse polarity. Programming is accomplished by external contact closure or DTL/TTL compatible logic levels.

CIRCLE NO. 321

**Differential plug-in  
costs only \$150**

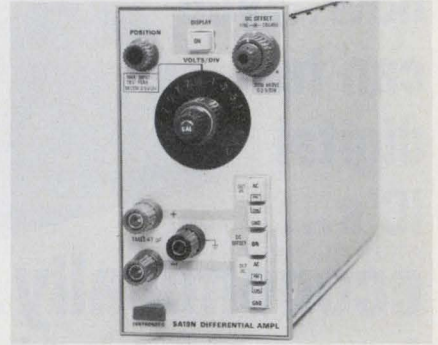

Tektronix, Inc., P.O. Box 500, Beaverton, Ore. (503) 644-0161. \$150; April 1, 1972.

The 5A19N is a low-cost differential plug-in unit for Tektronix 5100-Series oscilloscopes. The unit has deflection factors from 1 mV/div to 20 V/div, accurate within 2%. Bandwidth is 2 MHz. An internal, continuously variable offset voltage may be used to display low-level (millivolt) variations on signals up to 15 V, or 1/2-V variations on signals up to 350 V.

CIRCLE NO. 322

**Voltage calibrator  
provides 0.05% accuracy**



Pioneer Magnetics, Inc., 1745 Berkeley St., Santa Monica, Calif. (213) 829-3305.

The Model PM2330, a pocket-sized voltage calibrator designed for computer field service, can eliminate the need for a 4-digit DVM. The battery operated device has a LED readout which indicates when a voltage is within 0.5% of a preset value, and a slide switch to determine if a voltage is within a specified error band. Two, three, and four calibrated voltages with ranges up to 500 V dc are available. Accuracies are maintained from 3 to 500 V dc.

CIRCLE NO. 323

## Portable FET VOM draws only 10 $\mu$ A

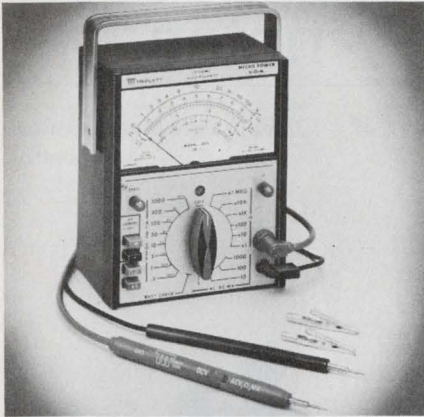

Triplett Corp. Dept. PR, Bluffton, Ohio. (419) 358-5015. \$150.

The low current drain of the model 603 results in a battery life that approaches shelf life even if the unit is left on continuously. Other features include: a Low-Power-Ohms circuit which permits measurements without biasing semiconductor device junctions; auto polarity circuit to measure positive or negative voltages without having to switch leads; linear meter tracking; and automatic temperature compensation from 32 to 120 F.

CIRCLE NO. 324

## Digital IC tester handles SSI/MSI/LSI



Alma Corp., 1061 Terra Bella Ave., Mountain View, Calif. (415) 961-9837. \$8750.

The Model 480B can test LSI memories as well as MSI and SSI devices. The instrument automatically measures noise margin and fan-out, to specified limits. It performs both functional and parameter tests on ICs with up to 16 pins. Featuring independent input-current testing and a Kelvin-wired device matrix, it can be programmed manually and used for engineering evaluation as well as for incoming inspection.

CIRCLE NO. 325

## Logic probe bleeps ones and zeros

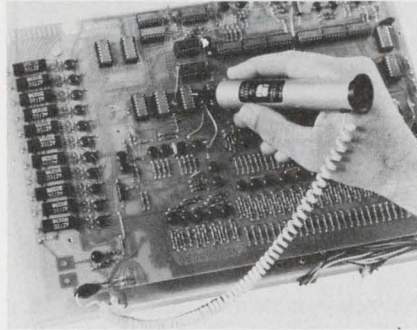

Production Devices, 7857 Raytheon Rd., San Diego, Calif. (714) 278-1141. \$19.95

The Model 95 logic tester can be used to troubleshoot 5-V digital logic circuits in computers, telephone systems, digital test equipment, and desk calculators. No visual observation is required when checking a circuit. Instead, audio signals are used to indicate the logic status; a high tone indicates logic "1" and a low tone indicates logic "0".

CIRCLE NO. 326

# Encapsulated Subminiature Toroidal Coils

## For High Density Component Packaging

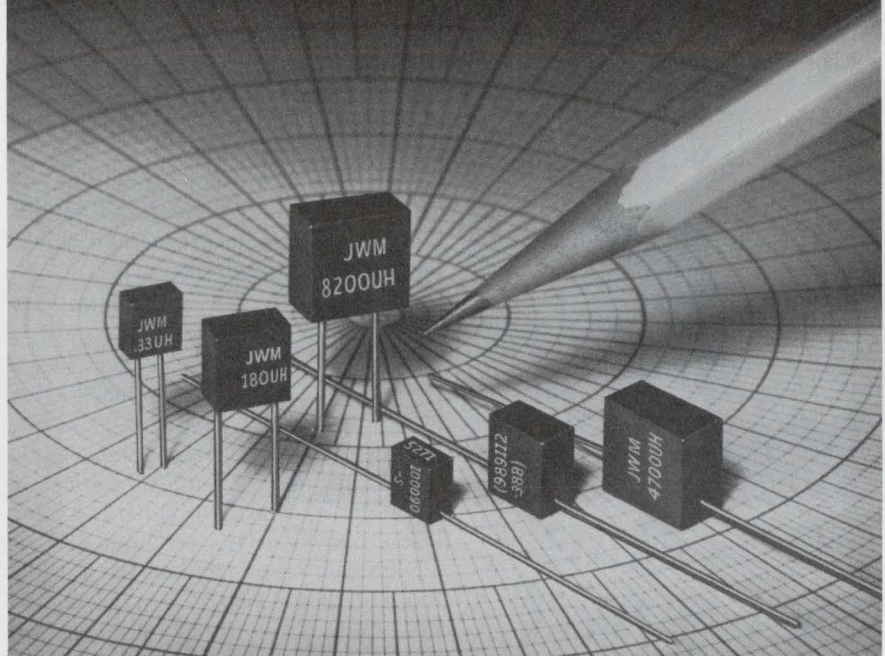

Write for 16-page brochure.

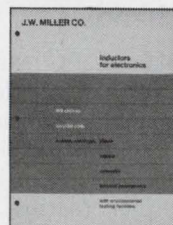

- Self shielding property and small size permit high density packaging on PC boards and welded modules.
- Closed magnetic path confines flux . . . provides greater inductance in a smaller package . . . minimizes stray fields . . . lowers magnetic pickup.
- Most part numbers are available from stock; delivery on special units is 4-6 weeks.



## J.W. MILLER COMPANY

19070 REYES AVE. ■ P.O. BOX 5825 ■ COMPTON, CALIF. 90224

INFORMATION RETRIEVAL NUMBER 70

# The do-it-yourself connector kit.



With our Universal Connectors, you decide what goes where. The crimp removable contacts are interchangeable in either body. The big difference at Hughes is the positive way they get together. The PolarHex way.



INFORMATION RETRIEVAL NUMBER 71

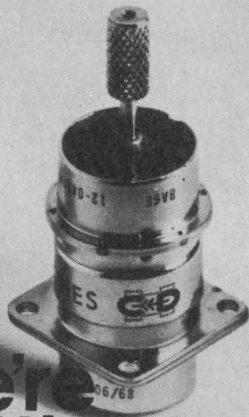

# We're getting to be known as rounders.

We invented the BULLS-EYE Connector and created a reputation as circular subminiature specialists. Goes to show you what a little concentration can do. (Like 102 contacts in a #18 shell.)



Newport Beach, Calif. 92663  
(714)-548-0671

INFORMATION RETRIEVAL NUMBER 72

## evaluation samples

### Reed relay

A commercial reed relay features 1 A or 20 W switching up to 250 V. Coil voltages are available for 1, 3, 5, 6, 10, 12, 15, and 24 V. The relay measures only 0.275 in. dia by 0.95 in. long and may be PC board mounted on 1-in. centers with 0.1-in. or 0.15-in. spacing. The relay sells for \$0.29 ea in quantities of 1 million, \$0.39 in 100,000, \$0.56 in 10,000 and \$0.80 in 1000 lots. These prices are possible by a new patented process whereby flanges are molded directly onto the glass reed capsule eliminating the coil bobbin and allowing the use of automatic tooling. Electronic Applications Co.

CIRCLE NO. 327

### Moldable thermoplastic

Udel polysulfane, a thermoplastic designed for the conveying and testing apparatus for IC chips, has an operating temperature range of -65 to 150 C. The plastic can be molded to 2 mil tolerances, and is rated SE-0 or SE-1 self-extinguishing depending on grade and thickness. Union Carbide Corp.

CIRCLE NO. 328

### Plastic trim

Thermoplast plastic decorative trim, instruction plates and nameplates offer the designer and engineer an almost infinite choice of materials, textures, finishes, color and reproduction techniques. Park Nameplate Co. Div. of Park Electrochemical Corp.

CIRCLE NO. 329

### PC card handles

Three plastic PC card handles come in a variety of colors to suit the requirements of most equipment. Two of the handles, models 10035 and 10037, have a specially designed clip-on feature, which enables them to be assembled into a PC board without any mounting hardware, since they snap into pre-drilled holes on the PC board. Vero Electronics, Inc.

CIRCLE NO. 330

## application notes

### Temperature Measurement and Control

by James A. Brown

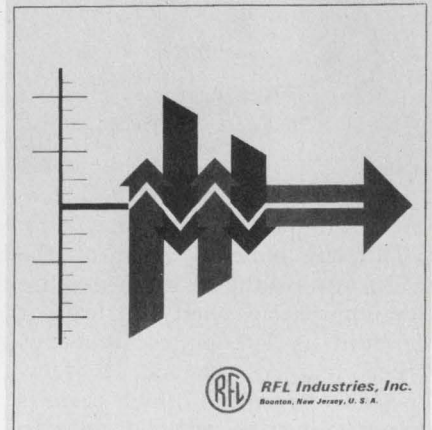

### Temperature measurement

A temperature measurement and control handbook presents a technical dissertation on the theory of temperature measurement and control. Included is information pertaining to electronic controllers, types of proportional controllers, and component selection for thermocontrol systems. RFL Industries, Inc., Boonton, N.J.

CIRCLE NO. 331

### Lock-in amp

An eight-page application note (IAN-22) discusses the theory and operation of the new and highly versatile logarithmic lock-in amplifier. Starting with basic lock-in theory, this note shows how the new techniques are used to provide precise logarithmic outputs over a 10,000:1 signal range. Ithaco, Inc., Ithaca, N.Y.

CIRCLE NO. 332

### Switch drivers

An application note assists in defining the range of applicability of SD 1000, SD 1200 and SD 1300 Series switch drivers. The drivers, which will drive series, shunt and series/shunt microwave switches, can be used in a wide variety of switch types, such as spst, spdt and sp3t. LRC, Inc., Hudson, N.H.

CIRCLE NO. 333

**At 4 cents a terminal,  
it's easy  
pin money.**



Cut terminal connection costs with Lear Siegler Pin Bars.<sup>TM</sup>\* Unlike most common connection methods, no soldering is required, so installation time and production costs are significantly reduced. In fact, Pin Bars offer more current-carrying ability, equalized resistance, enhanced terminal contact, and minimum electrical noise — for as low as 3 or 4 cents per terminal.

If you'd like to simplify your bussing operation while increasing your electrical integrity, pin us down for details and a free sample.

LEAR SIEGLER, INC.



ELECTRONIC INSTRUMENTATION DIVISION

714 NORTH BROOKHURST STREET  
ANAHEIM, CALIFORNIA 92803  
PHONE (714) 774-1000

\*Patented

TWX 910-591-1157

INFORMATION RETRIEVAL NUMBER 73

**NEW**  
(hybrid)  
**REGULATOR**



- JEDEC TO-3
- High Performance
- Low Cost
- Made in Japan by Sanken Electric...
- Stocked and delivered in U.S.A. by

**AIRPAX<sup>TM</sup>**

For specifications call or write ...

**5V**  
**THREE AMPS**

**12V**  
**ONE AMP**

**15V**  
**ONE AMP**

**24V**  
**ONE AMP**

**AIRPAX ELECTRONICS**  
**INTERNATIONAL DIVISION**  
P. O. Box 8488  
Ft. Lauderdale, Fla. 33310  
PHONE: (305) 587-1100  
TWX: 510-955-9866  
TELEX: 51-4448

INFORMATION RETRIEVAL NUMBER 74

ELECTRONIC DESIGN 8, April 13, 1972

# Rotron Power Conversion Devices

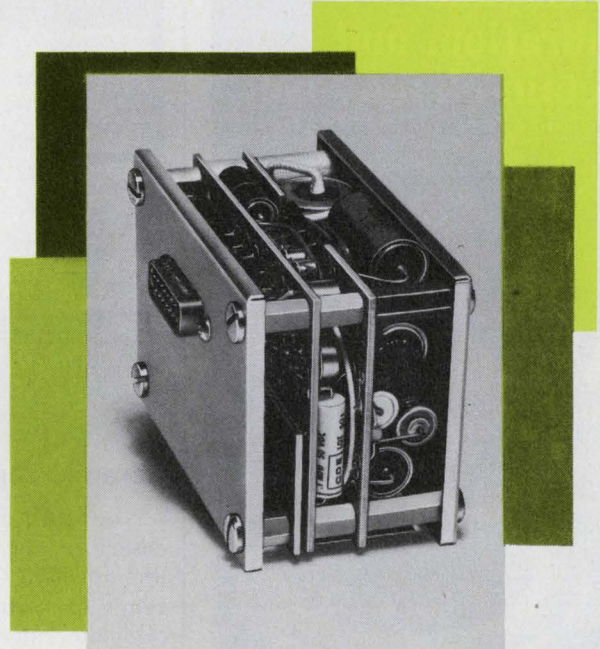

**Custom-built to match your own  
voltage/frequency requirements.**

What you need is what you get from Rotron. Because Rotron<sup>®</sup> will build a solid state converter to meet your most specific requirements — of size, weight, configuration, environmental conditions, and, of course, output. And, with many years experience in matching solid state converters to specific loads, Rotron will do it at reasonable cost.

For computer, aerospace, medicine, marine, instrument, tele-communications, and avionic equipment. AC to AC frequency converters, AC to DC converters (regulated or unregulated) with single or multiple voltage outputs. DC to AC inverters, with optional reverse polarity protection, high voltage protection and RF suppression to MIL specifications.

Before you compromise your system power requirements, learn how the power conditioning pros at Rotron can give you exactly what you do need, at a price you can afford. Contact Wes Riley at Rotron today.



POWER CONVERSION PRODUCTS DIVISION  
**ROTRON INC.**, Woodstock, N. Y. 12498  
914-679-2401 TWX 510-247-9033

Pacific Div., Burbank, Cal. 91506 213-849-7871  
Breda, Netherlands, Tel: 49550, Telex: 844-54074

INFORMATION RETRIEVAL NUMBER 75

A customer asked us to design a washer that would: provide a high pressure seal, withstand vibration, and retain clamp load.

We did!

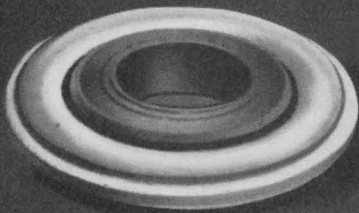

## The TWIN SEAL™ Washer

The Twin Seal Washer combines a metal stamping and a molded neoprene washer interlocked to seal against the work surface and under the head of the fastener. Efficient rough surface sealing and vibration resistance result. The metal stamping can provide metal to metal contact for high clamp load and clamp load retention.

IT'S AVAILABLE RIGHT NOW!

The Twin Seal™ Washer

Send for samples and catalog.

Covered by the following U. S. Patent: 3,500,712

**itw** SHAKEPROOF  
DIVISION ILLINOIS TOOL WORKS INC.  
ST. CHARLES ROAD • ELGIN, ILLINOIS 60120

Copyright 1972 Illinois Tool Works Inc.

## new literature

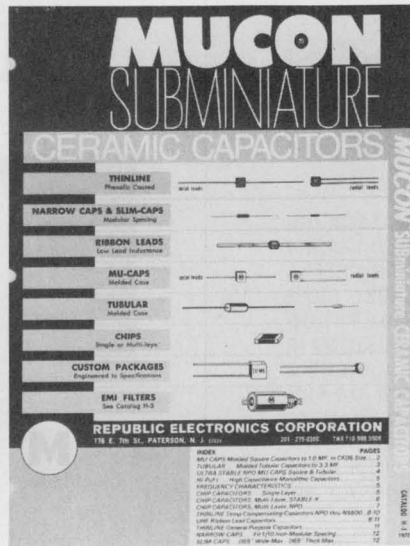

### Ceramic capacitors

New 1972 catalog H-1, 12-pages, describes the company's complete line of MUCON subminiature ceramic capacitors, which includes a complete range of temperature coefficients from NPO through N5600 with capacitance values as low as 1/2 pF. Republic Electronics Corp., Paterson, N.J.

CIRCLE NO. 334

### Tandem slide switches

Details of a new series of tandem (two-gang) slide switches, which provide "two switches in one" for quicker production line installation, are presented in an 8-page bulletin. The switches feature "double-wipe" slide action. Switchcraft, Inc., Chicago, Ill.

CIRCLE NO. 335

### RFI/EMC filters

Short-form RFI/EMC filter and feedthru capacitor catalog provides application data and design details for more than 300 standard filter and capacitor types ranging from milliamper ratings to several hundred amperes, in both single circuit and multi-circuit types. In addition, filters on the Qualified Products List of MIL-F-15733E are also described. RF Interionics, Bay Shore, N.Y.

CIRCLE NO. 336

### Data transmission testing

A 4-page brochure describes the DETECT data transmission test system and how it can be used with any existing network, on a plug-in basis, to pinpoint data transmission line, data modem, or data terminal equipment. Data Products, Woodland Hills, Calif.

CIRCLE NO. 337

### Slotted line

Information on the performance and evaluation of a slotted line is contained in a 4-page illustrated brochure. Alford Manufacturing Co., Winchester, Mass.

CIRCLE NO. 338

### Ceramic data sheet

A data sheet describes the company's steatite ceramics line. A widely used high frequency ceramic insulating material, steatite is used for insulators, lead-in bushings, vacuum tube spacers, filament supports, coil forms, switch wafers, substrates, and high temperature lamp sockets and has excellent mechanical properties and fabrication to relatively close tolerances. GTE Sylvania Inc., Exeter, N.H.

CIRCLE NO. 339

### Powder coatings

A new brochure details use areas, production line performance, and physical, chemical and electrical characteristics for the company's new line of "Flintflex" dry epoxy powder coatings for electrostatic spray and electrostatic fluidized bed applications. The range of 22 high-gloss colors is shown in bar graph form, along with a chart indicating bake times at various metal temperatures. The 8-page booklet also includes recommendations for substrate pretreatment, application and handling procedures, and powder storage. Du Pont Co., Wilmington, Del.

CIRCLE NO. 340



## Laser eye protection

A booklet describing in detail a complete line of laser eye protection is available to users. The protective equipment available incorporates technological and manufacturing knowledge. American Optical Corp., Southbridge, Mass.

CIRCLE NO. 341

## RCA RF Power Transistor Manual

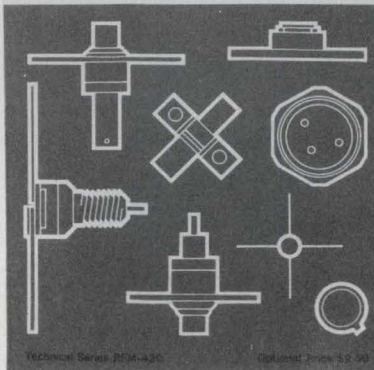

### Rf power transistors

The RCA RF Power Transistor Manual, Technical Series RFM-430, provides detailed information on the use of rf power transistors in a variety of power-circuit applications at frequencies that extend from the vhf range to well within the microwave region. This 176-page manual explains the basic design features, characteristics, and capabilities of commercially available rf power transistors and describes current design techniques and practices employed in the application of such devices in many widely high-frequency power circuits. The manual includes a general review of the basic requirements of all power transistors and explanations of the special features required of transistors that are especially designed for use in rf power applications. The special requirements, device selection criteria, and design techniques are described for rf transistor power-amplifier, oscillator and frequency-multiplier circuits. Practical examples are shown and performance data are given. Copies can be obtained by sending \$2.50 to RCA Solid State Div., Box 3200, Somerville, N.J.

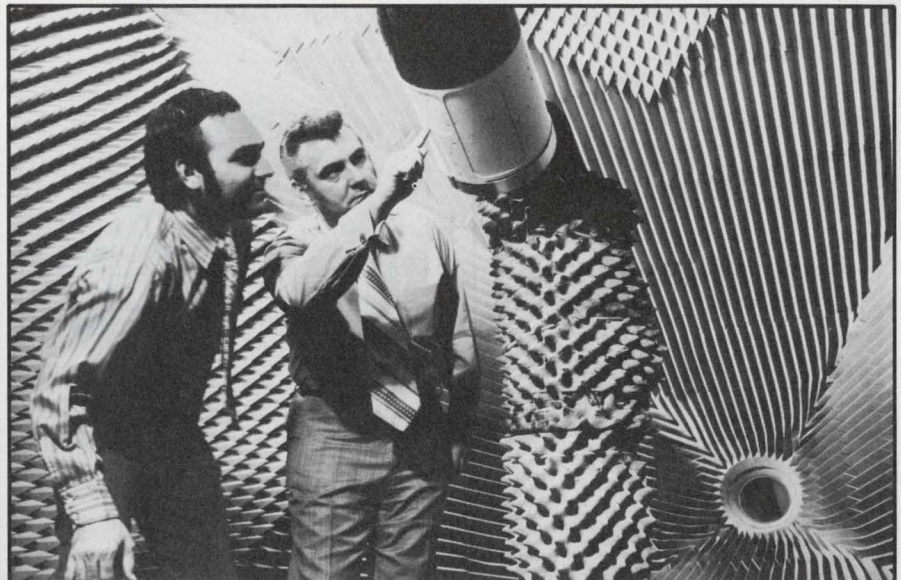

## What is required to develop/produce ANTENNAS?



Experience, equipment, engineering expertise. We have over 30 years experience, radiation labs equipped thru Ku Band, 3 anechoic chambers...plus a highly qualified engineering staff.

Transco Products, Inc., 4241 Glencoe Ave., Venice, Calif. 90291

INFORMATION RETRIEVAL NUMBER 77

## All 10,000 gain indicators are not alike... INSIDE OR OUT

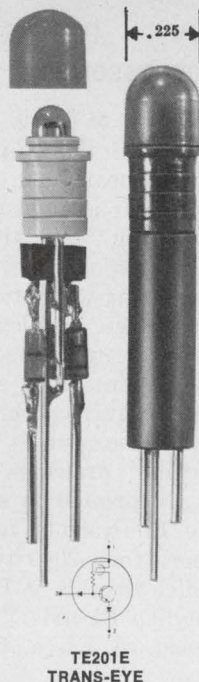

Inside a Shelly TRANS-EYE, you can pick one of 16 transistor/diode/resistor combinations and turn on 0.008A to 0.115A indicators with logic levels low as 250 $\mu$ A. Here is more inside data.

- TE201 & TE202** — Transistor driven lamp — requires ext. base current limiting resistor.
- TE201A & TE202A** — Internal base current limiting resistor. Requires 1.6mA max. base drive. Any value resistor can be specified.
- TE201B & TE202B** — Internal pull up resistor. Requires a —1.6mA sink. Use with external open collector transistor.
- TE201C & TE202C** — Internal pull up and limiting resistors. Use with circuitry that both sinks and sources current or circuitry that cannot supply adequate "on" current.
- TE201D & TE202D** — Internal diode in series with base. Increases noise immunity and defines turn-on threshold voltage.
- TE201E** — Compatible with most TTL, DTL and current sinking logic families.
- TE202E** — Compatible with positive inverted logic.
- TE201F & TE202F** — General purpose with provision for biasing external circuitry.
- TE201G & TE202G** — Same as TE201E except with lower logic "1" threshold —1.3V min.

Bases are either black or white and there are 70 lens cap colors and styles to fit your exact need.

For the complete story, inside-out, contact your local rep. or the factory.

**SHELLY**

**SHELLY ASSOCIATES, INC.**

A Datatron Company  
1562 Reynolds Ave., Santa Ana, Calif. 92711  
Phone: (714) 557-3942, TWX: 910-595-1589

INFORMATION RETRIEVAL NUMBER 78

# 20% - 30%

## MORE PERFORMANCE IN STANDARD BRIDGE PACKAGES

The packages are standard size. It's the current ratings and forward surge ratings that are larger. They give you added performance reliability—and at no additional cost!

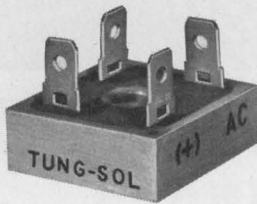

### B-10 series

DC rating — 30A @ 55°C.  
Forward surge rating—400A @ rated load. B-10 series replace similar bridges rated from 8 to 25A and from 50 to 1,000 PRV per leg.

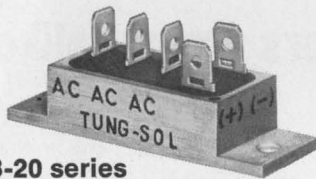

### B-20 series

DC rating — 35A @ 55°C.  
Forward surge rating—400A @ rated load. B-20 series replace similar bridges rated up to 25A and from 50 to 1,000 PRV per leg.

## SILICON POWER RECTIFIERS

*Tung-Sol makes a complete line of high reliability silicon power rectifiers in the DO-4, 5, 8, 9 and 21 configurations.*

WRITE FOR TECHNICAL INFORMATION.  
SPECIFY BRIDGES, OR POWER RECTIFIERS.

### SILICON PRODUCTS SECTION TUNG-SOL DIVISION WAGNER ELECTRIC CORPORATION

630 West Mt. Pleasant Ave. Livingston, N.J. 07039  
TWX: 710-994-4865 PHONE: (201) 992-1100  
(212) 732-5426

Trademark TUNG-SOL Reg. U. S. Pat. Off. and  
Marcas Registradas

INFORMATION RETRIEVAL NUMBER 79

## NEW LITERATURE

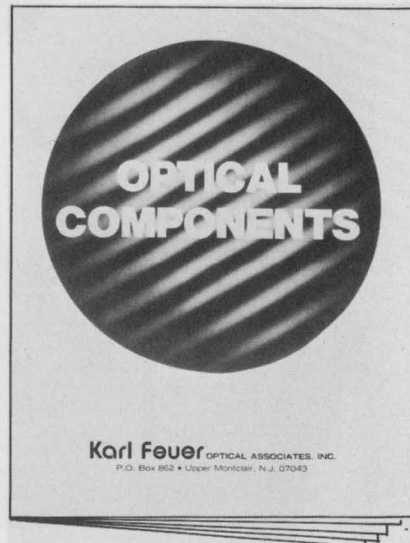

### Optical components

Optical filters, polarizers, retardation plates, Fabry-Perot interferometer Etalon plates, mirrors, prisms, lenses, crystals, and other quartz, silica, and magnesium fluoride materials are described in a new 12-page catalog. About half of the catalog presents sizes, prices, transmissions, bandwidths, blocking and other data concerning multilayer optical filters for infrared, visible and ultraviolet spectra. Also described are economy filters for use in the visible range, a cell repolishing service in the infrared area and replacement crystals for the most commonly used cells. Karl Feuer Optical Associates, Inc., Upper Montclair, N.J.

CIRCLE NO. 342

### Tubes and accessories

Almost 650 types of tubes and devices are detailed in this 92-page booklet, including nearly 60 new types covering ignitrons, industrial thyratons, hydrogen thyratons, industrial triodes, reflex klystrons, magnetrons, traveling-wave tubes, TR tubes, balanced duplexers, monitor diode kit, image isocon and sidicon TV camera tubes, storage tube, laser, vacuum capacitors and a range of noise sources and mounts. Outline drawings of selected tubes are printed to scale and a separate Equivalents Index section lists more than 2000 types of tubes for which there is an EEV equivalent. English Electric Valve Co., Ltd., Chelmsford, Essex, England.

CIRCLE NO. 343

# A precision pair... for tone signaling, coding and decoding.

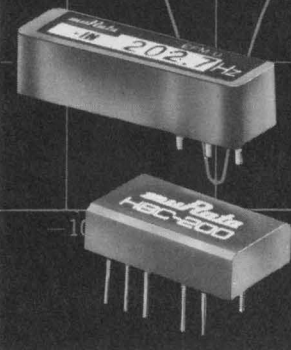

## The New Microfork EFM-U Tuning Fork and Companion H8C-200 Hybrid Amplifier.

Murata's new EFM-U piezoelectric tuning fork — hybrid amplifier combination is designed to provide a new era in precision and flexibility for audio frequency coding and decoding applications. Designed to provide exceptional performance as a pair, these two units operate well as a transmitter for coding and as a receiver for decoding while providing outstanding reliability and accuracy over a wide range of environmental conditions.

Additional applications for these new units include:

- Traffic Signal Controllers
- Paging Systems
- Remote Control Systems
- Sound Multiplexing Devices
- Garage Door Openers
- Alarm Systems

A complete selection of standard audio frequencies, ranging from 150 to 1700 Hz, is available to meet virtually every application requirement. All E.I.A. standard frequencies in this range are also available.

Write today! We'll send along complete technical information that, we're sure, will impress you with the capabilities of our new precision pair.

# muRata

MURATA CORPORATION OF AMERICA  
2 Westchester Plaza, Elmsford, New York 10523  
Telex: Murata EMFD 137332  
Phone: 914-592-9180  
Subsidiary of Murata  
Manufacturing Co., Ltd., Japan

INFORMATION RETRIEVAL NUMBER 80  
ELECTRONIC DESIGN 8, April 13, 1972

## DPM handbook

A digital panel meter handbook contains 60 pages of specific information on how to use digital panel meters. Specifications and pitfalls are thoroughly explained and related to common applications. Also described are various forms of analog-to-digital conversion with the advantages and disadvantages of each shown. The Appendix shows some of the add-on options available—such as amplifiers, active filters, linearizers, and others. Copies are available at \$3 each from Digin, Inc., Glendale, Calif.

## Pushbutton switches

A new series of single-lamp illuminated pushbutton switches and matching indicators are described in Bulletin 73. Designed and priced for commercial and industrial applications, the 168 units shown include bushing and snap-in mounting styles with self-aligning lenses that won't seat unless lamps are in place. In addition to technical specifications, the bulletin contains complete part numbers for all combinations of switch actions and circuits, lens styles and colors and mounting methods. Control Switch Inc., Folcroft, Pa.

CIRCLE NO. 344

## A/d converters

A 6-page brochure describes the company's high-speed a/d converters, computer interface systems and digital signal processing. Specifications, photographs and drawings are provided. Inter-Computer Electronics, Inc., Lansdale, Pa.

CIRCLE NO. 345

## Numerical control system

An illustrated 4-page brochure details the standard features and options for the firm's new computerized, soft-wired universal numerical control system. The 7300 Series is said to combine all the conventional elements of numerical control with the inherent flexibility of computer software and can be used in DNC systems for factory-wide automation as well as a stand-alone unit for later integration into a DNC system. Allen-Bradley Co., Highland Heights, Ohio.

CIRCLE NO. 346

# Smallest, High Speed A/D Converters in the world!



ADC 540WB-8

- 2" x 2" x 0.4"
- 8-Bit
- Complete and Ready to Use
- \$195

## Converts in 2 $\mu$ Sec

Others, in the same size . . . Not in such a hurry? The ADC 540-8 converts in 5 $\mu$ Sec and is only \$95. For general purpose usage, the ADC 590-8 with 200 $\mu$ Sec conversion is ideal — \$59.

All three units are complete with built-in reference, logic, clocks, etc., with full DTL, TTL compatibility — just apply  $\pm 15V$ , +5V power. All pretrimmed and ready to convert. Contact us for full details.



### HYBRID SYSTEMS CORPORATION

87 Second Avenue, Northwest Industrial Park, Burlington, Mass. 01803  
Telephone: 617-272-1522 TWX: 710-332-7584

INFORMATION RETRIEVAL NUMBER 81

## Staggered fingers let case-mounted semi's work harder in less space

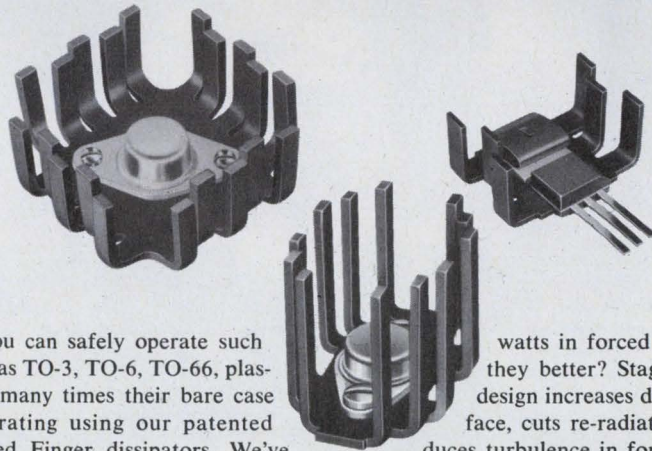

Now you can safely operate such devices as TO-3, TO-6, TO-66, plastics, at many times their bare case power rating using our patented Staggered Finger dissipators. We've got over 70 different models with dissipation capabilities ranging from 3 to 35 watts in natural convection, up to 125

watts in forced air. Why are they better? Staggered Finger design increases dissipating surface, cuts re-radiation, and produces turbulence in forced air. Send for catalog. IERC, 135 W. Magnolia Blvd., Burbank, Calif. 91502, a Corporate Division of Dynamics Corporation of America.

## IERC



## Heat Sinks

INFORMATION RETRIEVAL NUMBER 82

# Faratron lowers the price on 2½ digit DPM's to \$65\* and packs in more features.

Dimensionally, Faratron 2500 series DPM interchanges with Weston's. Financially, it costs less. Functionally, it's ahead with a standard 7-segment incandescent display and an LED option; over/under-range indicator; three power options. BCD output option. Also available: 2¾ digit 2700 series. Faratron Corp., 290 Lodi St., Hackensack, N.J. 07601, area 201-488-1440.

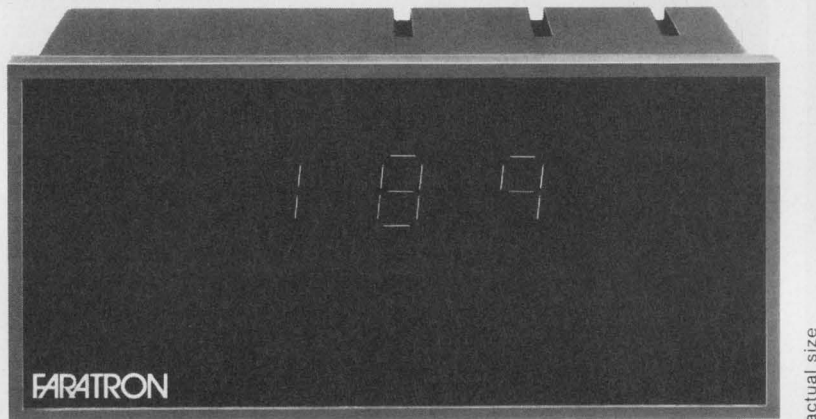

\*in OEM quantities with AC or +5V power

INFORMATION RETRIEVAL NUMBER 83

## NEW LOW PROFILE. NEW LOW COST.

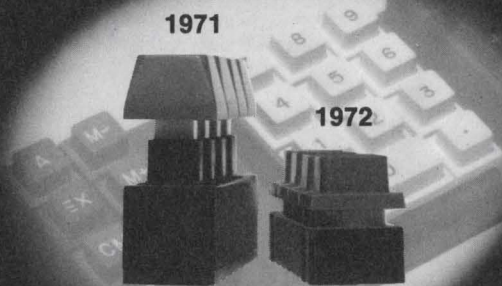

The switch is called BI-PAC Phase 2. It saves space... only 0.580" behind the panel with 0.150" stroke and 0.075" overtravel. Our latest 2-shot Keycap is low profile too. Even the touch is low... 2½ ounces.

It saves money... less than 25c per key for 500,000 positions. That's because it's simple. Dual cross-wire gold contacts with wiping action provide high reliability.

Want more savings? Buy CRC completely assembled Keyboards. A dozen leading U.S. calculator manufacturers are already using BI-PAC Keyboards in high volume.

To get all the Phase 2 savings, write or call.



**Controls Research Corporation**

2100 S. Fairview, Santa Ana, Calif., 92704  
Phone: (714) 557-7161

INFORMATION RETRIEVAL NUMBER 84

## NEW LITERATURE

### Lafayette catalog

Spring catalog, No. 723, includes stereo quadrophonic 4-channel stereo systems and components, and features a complete selection of 2-channel stereo components, Citizens Band radio, cassette and cartridge tape recorders, ham gear, test equipment, radios, and accessories; cameras, fiber optics, and computer kits. Lafayette Radio Electronics Corp., Syosset, N.Y.

CIRCLE NO. 347

### Dc voltage regulators

A series of hybrid, cermet, thick-film, dual voltage dc regulators are featured in a 4-page brochure. The brochure includes complete performance specifications, diagrams and mechanical characteristics on the Series 844. Helipot Div., Beckman Instruments, Inc., Fullerton, Calif.

CIRCLE NO. 348

### Timing instrumentation

A comprehensive, 16-page brochure deals with equipment and methods for time-tagging analog data for correlation and indexing. The brochure describes each of the six different models in the line. Dataron, Inc., Santa Ana, Calif.

CIRCLE NO. 349

### High-power laser systems

A data sheet describes the latest in high-power laser systems featuring extra-high power supply voltages for reliable triggering and efficient pumping. Information presented in a concise format describes these systems with power level to 100 joules or more. Apollo Lasers, Inc., Los Angeles, Calif.

CIRCLE NO. 350

### Product handbook

A 16-page pocket-size product hand-book provides descriptions of the company's new SPC-16 and SPC-12 minicomputers, System 18/30 Supervisory Computer—a replacement for IBM-1130 and IBM-1800 computers—software, disc monitor system and interface modules (minicontrollers) for OEM and systems users. General Automation, Inc., Anaheim, Calif.

CIRCLE NO. 351

# bulletin board

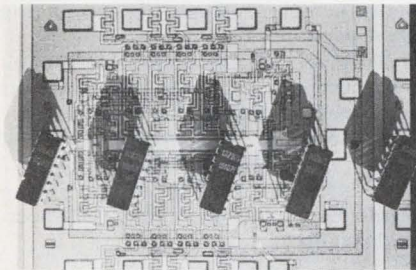

The first ten of Signetics high speed ECL 10,000 series emitter-coupled logic elements are now available. The ECL 10,000 series includes many second-source equivalents for Motorola's MECL 10,000 series and a number of Signetics-originated 10,000 series designs. The initial family includes a basic dual gate (10109), an exclusive OR/NOR element (10107), three triple-output power gates, including a Signetics-originated design (the 10110, 10111, and 10112), two AND-OR complex gates (10117 and 10118), a dual D-type latch (10130), and two MSI elements (the 10161 and 10162) 1-of-8 decoder/demultiplexers. Prices range from \$1.60 to \$5.90 in quantities of 100 to 999.

CIRCLE NO. 352

A videotaped course on MOS technology is being offered for sale by Texas Instruments. Titled The MOS Course, the videotapes consist of more than nine hours of tightly edited instruction. Complementing the instructional tapes are two hours of videotaped panel discussion representing the most generally encountered questions and answers regarding the use of MOS ICs. The course costs \$3565 in the 1/2-inch EIAJ videotape format, plus \$10 each for student literature packets.

CIRCLE NO. 353

## Price reductions

Unitrode Corp. has reduced prices on a number of high voltage stacks, in some cases up to 48%. The price reductions cover 14 models in its US and USR series.

CIRCLE NO. 354

Motorola has cut prices on a line of linear rf power transistors providing from 25 to 80 watts of output power. For quantities of 25-99, the 2N5070 now costs \$17.70, the 2N5941 now costs \$26.00, the 2N5942 now costs \$49.50. Old prices were \$21.85, \$45.40, and \$90.85 respectively.

CIRCLE NO. 355

Cal-Tek has reduced the price of the CT5001 chip to \$8.00 in lots of 50,000 or more. The CT5001 chip performs all add-subtract, multiply-divide functions for a twelve-digit display calculator. This price adjustment represents a \$4-\$5 reduction below present market structure.

CIRCLE NO. 356

Prices for trichlorosilane and dichlorosilane for the electronics industry have been reduced by Union Carbide Corp. The price of trichlorosilane has been lowered from \$0.575 to \$0.56/lb, in bulk (3000 gallons minimum) for contract customers. The non-contract bulk price has been reduced from \$0.64 to \$0.62/lb. These price reductions are a result of increased operating efficiencies. New dichlorosilane prices are \$22.50 per pound (100 lb cylinders).

CIRCLE NO. 357

Intel Corp. has reduced prices on four electrically-programmable 2048-bit MOS ROMs, two of which may be erased and reprogrammed in the field. In 100-piece quantities, prices have been reduced by at least 32% and as much as 63%. The type 1701 has been reduced from \$176 to \$64, the type 1702 from \$160 to \$58, the type 1601 from \$88 to \$58, the type 1602 from \$80 to \$54, in quantities of 100.

CIRCLE NO. 358

DEC's PDP-8/M minicomputer, a model intended for systems configured by OEMs, has been reduced in price from \$4095 to \$3990. A PDP-8/M with 4096 words of core memory, teletypewriter interface, and programmer's console is now available for less than \$2500 in quantities of 100.

CIRCLE NO. 359

# Precision Miniature CRT Power Supplies

H-15 10 to 15KV @ 650ua  
H-20 10 to 20KV @ 500ua  
"H" SERIES

- Compact 30 cu. in.
- Remotely Adjustable
- Short Circuit and Reverse Polarity Protection
- Low Ripple .05% P-P @ 500ua
- Tightly Regulated - .05%, 0-500ua
- MTBF 58,200 Hours
- Airborne Applications to 50,000 Ft.
- Immediate Delivery

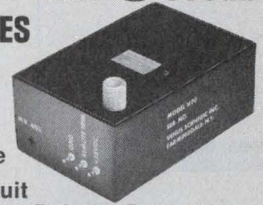

Model	Output Voltage Range	Output Current	Price
H-15	+10KV to +15KV	650ua	\$680
H-20	+10KV to +20KV	500ua	\$680
H-15N	-10KV to -15KV	650ua	\$680
H-20N	-10KV to -20KV	500ua	\$680

## "G" SERIES

- Miniature 15 cu. in.
- Remotely Adjustable
- Short Circuit & Reverse Polarity Protected
- MTBF 42,000 Hrs.
- Airborne Applications to 50,000 Ft.



Model	Output Voltage Range	Reg L/L	Ripple P-P	Price
G-5	500V to 5000V	0.1%	0.15%	\$450
G-10	1000V to 10,000V	0.1%	0.15%	\$490
G-12	1200V to 12,000V	0.1%	0.15%	\$550

The G and H Series precision regulated high voltage power supplies are mil type DC to DC converters featuring high efficiency and reliability in miniature packages. These units are particularly useful in airborne applications. Send for our new catalog.

# Venus Scientific Inc.

399 SMITH STREET  
FARMINGDALE, N.Y. 11735  
Telephone (516) 293-4100  
TWX: 510-224-6492

INFORMATION RETRIEVAL NUMBER 85

# Design Data from Manufacturers

Advertisements of booklets, brochures, catalogs and data sheets. To order use Reader-Service Card.  
(Advertisement)

## Free Wallchart Of Waveform Comparisons

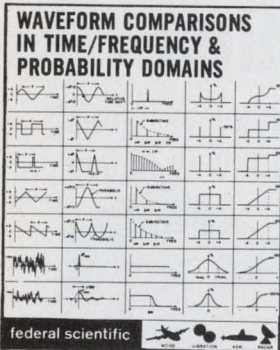

For analyzing random data such as noise, vibration, shock, underwater acoustic signals, and radar, this unique new engineering tool is a convenient picture-reminder of how 10 different basic waveforms look in terms of 5 different processing domains. The waveforms consist of 5 examples of repetitive waveshapes & 5 different random signals. The typical functions shown are: time, auto-correlation, averaged frequency spectrum (PSD), probability density, & cumulative distribution. Printed on heavy glossy stock, the 10" x 12" wallchart is free by writing directly to Federal Scientific, originators of the Ubiquitous® brand of real-time spectrum analysis equipment.

### FEDERAL SCIENTIFIC CORP.

a subsidiary of Elgin National Industries, Inc.  
615 West 131st Street, New York, N.Y. 10027

CIRCLE NO. 171

## PC Drafting Aids Catalog

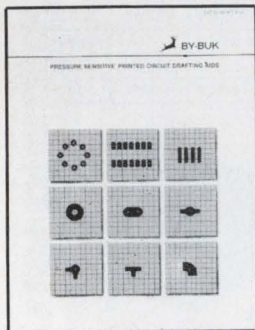

Thousands of time saving, cost saving artwork ideas are found in the By-Buk P-50 catalog of pressure sensitive printed circuit drafting aids. With the most practical artwork patterns for: TO cans, multi-pads, dual-inlines and flat packs featured. Donuts, connector strips, teardrops, ovals, tapes, tees, elbows, etc., by the hundreds are included in the most comprehensive list of sizes. Opaque black, transparent red and transparent blue materials for one and two-sided board designs. For a free copy and samples, write today.

### By-Buk Company

Subsidiary of Webtek Corp., 4326 W. Pico Blvd.  
Los Angeles, California 90019 (213) 937-3511

CIRCLE NO. 172

## Measure Vector Angle, Magnitude And Components

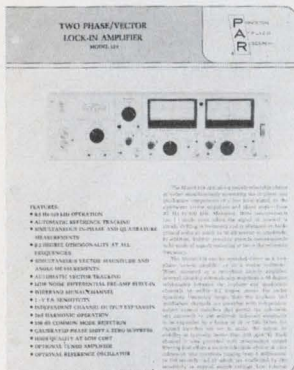

The new PAR™ Model 129 Two Phase Lock-In/Vector Voltmeter, enables you to simultaneously measure the magnitude and phase angle with respect to a reference signal of virtually any low-level signal within its range of 0.5 Hz to 100 kHz—even if the signal is buried 60 dB beneath background noise. At the flip of a switch, you can also measure the in-phase and quadrature components of the vector. The Model 129 features fully automatic reference tracking, independent output expansion and filtering for each channel. Complete specifications are contained in bulletin T-314, available on request.

### PRINCETON APPLIED RESEARCH CORPORATION

P.O. Box 2565  
Princeton, New Jersey 08540

CIRCLE NO. 173

# Electronic Design

ELECTRONIC DESIGN's function is:

- To aid progress in the electronics manufacturing industry by promoting good design.
- To give the electronic design engineer concepts and ideas that make his job easier and more productive.
- To provide a central source of timely electronics information.
- To promote communication among members of the electronics engineering community.

**Want a subscription?** ELECTRONIC DESIGN is sent free to qualified engineers and engineering managers doing design work, supervising design or setting standards in the United States and Western Europe. For a free subscription, use the application form bound in the magazine. If none is included, write to us direct for an application form.

If you do not qualify, you may take out a paid subscription for \$25 a year in the U.S.A., \$35 a year elsewhere. Single copies are \$1.50 each.

**If you change your address,** send us an old mailing label and your new address; there is generally a postcard for this bound in the magazine. You will have to requalify to continue receiving ELECTRONIC DESIGN free.

**The accuracy policy** of ELECTRONIC DESIGN is:

- To make diligent efforts to ensure the accuracy of editorial matter.
- To publish prompt corrections whenever inaccuracies are brought to our attention. Corrections appear in "Across the Desk."
- To encourage our readers as responsible members of our business community to report to us misleading or fraudulent advertising.
- To refuse any advertisement deemed to be misleading or fraudulent.

Microfilm copies are available of complete volumes of ELECTRONIC DESIGN at \$19.00 per volume, beginning with Volume 9, 1961. Work is now in process to complete the microfilm edition of Volumes 1-8. Reprints of individual articles may be obtained for \$2.00 each, prepaid (\$.50 for each additional copy of the same article) no matter how long the article. For further details and to place orders, contact the Customer Services Department, University Microfilms, 300 North Zeeb Road, Ann Arbor, Michigan 48106 telephone (313) 761-4700.

**Want to contact us?** If you have any comments or wish to submit a manuscript or article outline, address your correspondence to:

Editor  
ELECTRONIC DESIGN  
50 Essex Street  
Rochelle Park, N.J. 07662

# Electronic Design

## Advertising Sales Staff

Bryce Gray  
Sales Manager

### Rochelle Park, N.J. 07662

Robert W. Gascoigne  
Daniel J. Rowland  
50 Essex Street  
(201) 843-0550  
TWX: 710-990-5071

### Philadelphia

Thomas P. Barth  
50 Essex Street  
Rochelle Park, N. J. 07662  
(201) 843-0550

### Boston 02154

Joseph F. Palmer  
1268 Main Street  
Waltham, Mass.  
(617) 894-2700

### Chicago 60611

Thomas P. Kavooras  
Berry Conner, Jr.  
200 East Ontario  
(312) 337-0588

### Cleveland

Thomas P. Kavooras  
(Chicago)  
(312) 337-0588  
(call collect)

### Los Angeles 90303

Stanley I. Ehrenclou  
Burt Underwood  
2930 Imperial Highway  
Inglewood, Calif  
(213) 757-0183

### San Francisco 94022

Jerry D. Latta  
95 Main Street  
Los Altos, Calif.  
(415) 941-3084

### London W. 1

For United Kingdom and Holland  
Brayton C. Nichols

For Eastern Europe

Peter Kehr

The American Magazine Group

27 Maddox Street  
London, W. 1, England  
Phone: 499-0180  
Cable: Ammagnic, London

### Verviers, Belgium

For Continental Europe

Andre Jamar  
1, Ru Mallar, 1  
(087) 253.83 Telex 41563

### Tokyo

Haruki Hirayama  
Electronic Media Service  
5th Floor, Lila Bldg.,  
4-9-8 Roppongi  
Minato-ku  
Phone: 402-4556  
Cable: Electronicmedia, Tokyo



## Optima 17 The Total Package

Style and Function are masterfully combined in this concept  
Body + Chassis + Dress Panel + Rear Panel + Liftoff Cover +  
4 Models + 4 Heights + Rack Adaptable + Vinyl Finish.

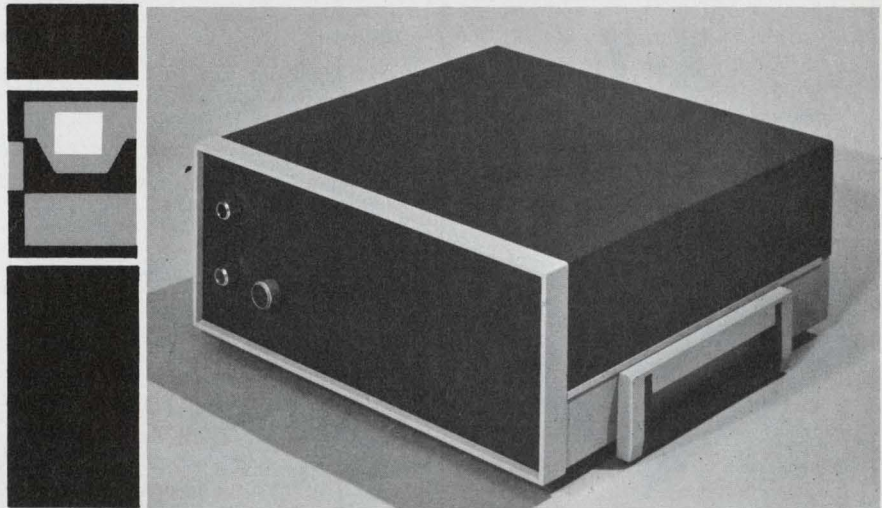

optima enclosures  
a division of Scientific-Atlanta, Inc.

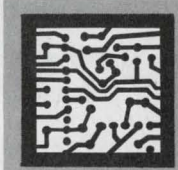

2166 Mountain Industrial Blvd. Tucker, Georgia 30084 Telephone 404-939-6340

INFORMATION RETRIEVAL NUMBER 91

**\$66.** (1-9)

**5V/5A  
COMPUTER  
OEM SUPPLY**



**Hard to believe? Then read on.** Our ELV Series supplies (available in ratings of 25W, 75W, 125W and 250W) reduce your power costs with no reduction in quality.

Every supply is put together under stringent QC with American-made transformers, capacitors, semiconductors, IC's and G-10 quality boards.

Every supply delivers all the power we promise

with no temperature derating, even with 50 Hz input.

Regulation, ripple and noise are specified by the book. Spike-suppression and short-circuit protection are standard, OVP optional. And deliveries are off-the-shelf for most configurations.

And the same is true for all our other supplies, open or enclosed, single- or multiple-output.

Check it out today. Call  
(714) 833-2950.

ELV-25	
Output:	3V/5A to 28V/1.3A (16 models avail.)
Temp range:	0-55°C
Line & load reg:	0.1%
Ripple & noise:	0.1%

## ELEXON POWER SYSTEMS

18651 Von Karman, Irvine, Calif. 92664

An Elpac division.

INFORMATION RETRIEVAL NUMBER 92

# 27 Plug-in Modules make the

OMNIGRAPHIC®

# X-Y RECORDER

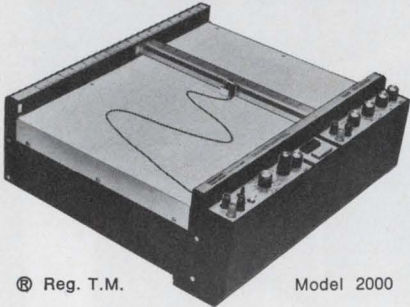

® Reg. T.M.

Model 2000

a terrific value at

**\$795** plus modules

Why? Because now there's a module for AC to DC conversions, another for both AC and DC... plus more for every function you may require. What's more, they're all interchangeable. And just look at these features:

- 30 in./sec. speed
- $\pm 0.2\%$  accuracy
- local/remote pen control
- electric pen lift
- high input resistance
- interchangeable amplifiers
- \$795 plus modules

A companion strip chart recorder, model 3000, now is available with a full span automatic integrator for gas chromatography and with modules for point plotting.

Write for brochures today.



**houston**  
instrument

DIVISION OF BAUSCH & LOMB

4950 Terminal Avenue, Bellaire, Texas 77401  
(713) 667-7403 Cable Hoinco

**houston** | **European Office**  
instrument

Johanneskirchner Strasse 17, 8043 Unterferhring  
München, W. Germany (0811) 97-1673

# advertiser's index

Advertiser	Page
AMI Micro-Products .....	16K
Airpax Electronics, International Division .....	117
Allen-Bradley Co. ....	36
Amperite .....	98
Amphenol Components Group .....	11
Analog Devices, Inc. ....	22, 99
Augat, Inc. ....	102
Babcock Control Products, Babcock Electronics Corp. ....	10
Beckman Instruments, Inc., Helipot Division .....	89
Bourns, Inc., .....	113
Bulova Watch Company, Electronics Division .....	106
By-Buk Company .....	124
CTS Corporation .....	95
Cambridge Thermionic Corporation ..	69
Centralab, the Electronics Division of Globe-Union, Inc. ....	100, 101
Cherry Electrical Products Corp. ....	91
Computer Terminal Corporation .....	18
Controls Research Corporation .....	122
Curtis Development & Mfg. Co. ....	113
Cutler-Hammer .....	17
Datapulse/Division of Systron- Donner Corporation .....	19
Dialight Corporation .....	70
Dickson Electronics Corporation .....	111
Elexon Power Systems .....	125
Faratron .....	122
Federal Scientific Corporation .....	124
General Automation, Inc. ....	1
General Electric Company .....	114
General Electric Company, Semiconductor Products Department .....	25
General Radio Company .....	21, 71, 128
Hayden Book Company, Inc. ....	2, 16L, 98D, 127
Heath Company .....	96
Heinemann Electric Company .....	31
Hewlett-Packard .....	41, 42, 43, 44, 45, 46, 47, 48, 48A-B
Houston Instrument, A Division of Bausch & Lomb .....	126
Hughes Aircraft Company .....	32, 33
Hughes Aircraft Company, Connecting Devices .....	116
Hybrid Systems Corp. ....	121
Indiana General, A Division of Electronic Memories & Magnetics Corporation .....	16
International Electronic Research Corporation .....	121
Johanson Manufacturing Corp. ....	7
Johnson Company, E. F. ....	6
Keithley Instruments, Inc. ....	103
Kurz-Kasch, Inc. ....	113
Lambda Electronics Corp. ....	Cover II
Lear Siegler Inc. ....	117
Ledex, Inc. ....	62
Licon, Division Illinois Tool Works, Inc. ....	13

Advertiser	Page
MicroSwitch, A Division of Honeywell .....	50, 51
Miller Company, J. W. ....	115
Molex, Incorporated .....	Cover III
Motorola Semiconductor Products, Inc. ....	12
Murata Corporation of America .....	120
National Semiconductor Corporation	20
Optima, A Division of Scientific Atlanta, Inc. ....	125
Paktron Division, Illinois Tool Works, Inc. ....	15
Philips Industries, Test and Measuring Instruments .....	96C
Potter & Brumfield Division of AMF Incorporated .....	4, 5
Princeton Applied Research Corp. ....	124
RCA Numitron Display Devices .....	107
RCA Solid State Division .....	Cover IV
RFL Industries, Inc. ....	128
Rapidesign, Inc. ....	96
Raytheon Company, Sorensen Power Supplies .....	81
Raytheon Company, Semiconductor Operation .....	16A-H
Remex, A unit of Ex-Cell-O Corporation .....	40
Rotron, Incorporated .....	117
Scanbe Manufacturing Corp. ....	85
Schauer Manufacturing Corp. ....	110
Schweber Electronics .....	96A-B
Shakeproof, Division Illinois Tool Works, Inc. ....	118
Shelley Associates, Inc. ....	119
Siemens Corporation .....	2
Signetics Corporation .....	34, 35
Skan-A-Matic Corp. ....	96
Solitron Devices, Inc. ....	63
Sprague Electric Company .....	29
Sperry Electronic Tube Division, Sperry Rand Corporation .....	87
Stackpole Carbon Company .....	75
Switchcraft, Inc. ....	105
TEC, Incorporated .....	96
Tecnetics, Inc. ....	112
Technipower, Inc., A Benrus Subsidiary .....	109
Tektronix, Inc. ....	39
Teletype Corporation .....	8, 9
Teradyne .....	14
Transco Products, Inc. ....	119
Triplet Corporation .....	80
Tung Sol Division, Wagner Electric Corporation .....	120
Unitrode Corporation .....	93
Universal Instruments Corporation ..	128
Vactec Inc. ....	52
Venus Scientific, Inc. ....	123
Victoreen Instrument, Div. of VLN Corp. ....	128
Weatherford .....	127
Woven Electronics .....	111



# Advanced Memory Systems giant kickoff sale.

**AMS memories  
available now from  
10 western locations.**

Good news for memory users. Advanced Memory Systems, Inc. has appointed Weatherford to stock and distribute their complete line of MOS and bipolar memory components:

AMS Part No.	Organization	Access Time (Max. ns)
<b>Bipolar RAM</b>		
1001	16x1 (ECL)	8
1002	64x1 (ECL)	10
1003	128x1 (ECL)	15
1503	128x1 (TTL)	25
<b>MOS RAM</b>		
6001	1024x1	350*
6002	1024x1	150

\*Sense Amp included on-chip.

And if you want to think big, you can get these AMS components already pre-mounted on memory cards. Ask us about them.

**New low prices on the whole line.**

To make this an event to remember, Weatherford's presenting major price reductions on them all . . . reductions up to 65% in many cases. To give you an idea, here's the new price on the Model 6002 1024-bit MOS RAM, AMS's 150 nanosecond superstar.

	100-249	250-999
6002 MOS RAM	\$18.50	\$16.50

**From more than just a distributor.**

Get them from Weatherford. Ten locations throughout the West, all providing prompt, courteous service and lightning-fast delivery on Advanced Memory Systems' complete line of the industry's fastest random access memories. Call us today.

- Albuquerque: (505) 265-5671
- Anaheim: (714) 547-0891
- Dallas: (214) 231-7141
- Denver: (303) 427-3736
- Glendale: (213) 849-3451
- Palo Alto: (415) 493-5373
- Phoenix: (602) 272-7144
- Pomona: (714) 623-1261
- San Diego: (714) 278-7400
- Seattle: (206) 762-4200

# WEATHERFORD

# AC Voltage Control

Large or small, routine or special — there is a General Radio Variac® adjustable autotransformer for your application. Premium materials, quality workmanship, and 39 years of design refinement for smooth, precise control without SCR-generated noise. Rugged construction, conservative ratings, and a two-year warranty, for long, worry-free operation. Special units tailored to your specific needs, plus hundreds of standard models from 0 to 480V, 50 to 1200 Hz, for an unparalleled choice. Fast delivery on all units. Low-cost per ampere and generous quantity discounts for excellent value. New! A 2-amp unit for only \$13.00. FREE catalog and applications handbook for full line on request.

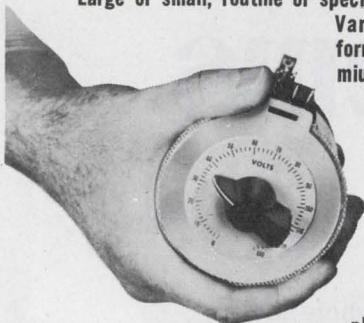

NEW YORK (N.Y.) 212 964-2722 (N.J.) 201 791-8990 BOSTON 617 646-0550 CHICAGO 312 992-0800 WASHINGTON, D.C. 301 881-5333 LOS ANGELES 714 540-9830 TORONTO 416 252-3395 ZURICH (01) 55 24 20

for Line-Voltage Control



**General Radio**

CONCORD, MA 01742

INFORMATION RETRIEVAL NUMBER 87

## FREE! NEW INSERTION HANDBOOK

FOR AXIALS, DIP'S, TRANSISTORS

New, comprehensive, 16 page technical bulletin covering today's industry standards and design parameters for automatic insertion of electronic components into PC boards. Over 30 detailed schematics. Send for it now. Dept. ED-72

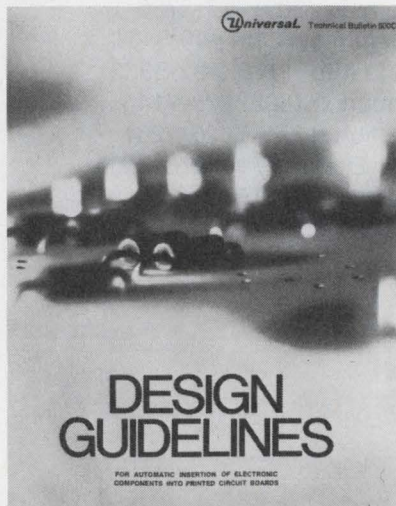

**Universal** INSTRUMENTS CORPORATION  
East Frederick St., Binghamton, N.Y. 13902  
(607) 772-1710/TWX 510-252-1990

INFORMATION RETRIEVAL NUMBER 89

## Meet the Extremists:

Measure from  
1 Gamma  
to  
50,000  
Gauss!

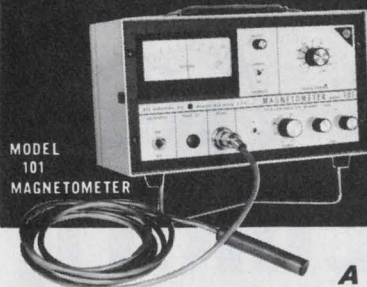

MODEL 101  
MAGNETOMETER

A complete line of  
precision magnetic measuring equipment.



MODEL 505 GAUSSMETER  
• Lowest cost  
• Self-contained

A completely self-contained instrument for magnetic field measurement.



MODEL 750 GAUSSMETER  
• Wide range  
• Versatile

Features wide measurement range, high accuracy and ease of operation.



MODEL 3265 GAUSSMETER  
• Unexcelled readability  
• High precision

Features absolute, differential and incremental measurement operations.

Send for Free technical booklet on  
RFL Magnetics equipment.



**RFL Industries, Inc.**

Instrumentation Division • Boonton, N. J.

INFORMATION RETRIEVAL NUMBER 88

## Compare Maxi-Mox to whatever resistor you're using now.

Our Metal Oxide Resistors Offer You Small Size and Reliability at High Voltage.

Compare Maxi-Mox vs wire wound. Our Maxi-Mox gives you equal stability and power capability in half the size and even greater stability and service life at high voltages.

Maxi-Mox resistors have resistance and voltage capabilities that far exceed metal film types. And size . . . Maxi-Mox resistors are three to ten times smaller than comparable value metal film units.

Maxi-Mox is available for fast delivery from stock in five standard sizes. With 100 ppm TCR available.

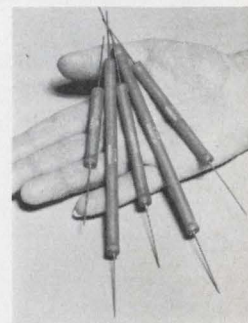

Model	Resistance Range	Power Rating @ 70°C	*Max. Oper. Volts	Length Inches	Diameter Inches
MOX-1	10K—500 megs	2.50W	7,500V	1.062	.284
MOX-2	20K—1000 megs	5.00W	15,000V	2.062	.284
MOX-3	30K—1500 megs	7.50W	22,500V	3.062	.284
MOX-4	40K—2000 megs	10.00W	30,000V	4.062	.284
MOX-5	50K—2500 megs	12.50W	37,500V	5.062	.284

For detailed specifications on Maxi-Mox, send for this technical bulletin. Victoreen Instrument Div. of VLN Corp. 10101 Woodland Avenue, Cleveland, Ohio 44104. Telephone: 216/795-8200.

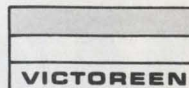

DMA 686

Expertise in high voltage.

INFORMATION RETRIEVAL NUMBER 90

ELECTRONIC DESIGN 8, April 13, 1972



**THEY'RE MOLEX EDGE CONNECTORS.** "Straight-on" or "right-angle" types for printed circuit boards. Terminals crimped to wires automatically. Reliable? And how! Connector terminals are bifurcated. Provide a really solid contact. Yet you can slip the connector on and off time after time without any damage to the printed circuits. And it's not a preload unit. Carries only contacts required. From six to twenty-four. Comes in white or six other colors. Terminals available in tin-plated brass with gold plating or selec-

tive gold plating. ■ A good example of how Molex helps create high-speed low-cost devices that simplify circuitry. If you want to save assembly time, steps and money, take a close look at these Molex edge connectors. For free samples write: Molex Incorporated, Downers Grove, Illinois 60515. Or you can make connections by calling (312) 969-4550.

*...creating components that  
simplify circuitry*



# Call RCA if you want to talk about **MIL-M-38510** COS/MOS

Now, for high-reliability types in COS/MOS ICs — for full MIL-STD-883 — call RCA.\* And let's talk about advanced MIL-M-38510 techniques. In RCA's rapidly evolving 38510 program, high-reliability type product becomes not just the result of screening, it will be built in, through procedures being developed to the specification:

- Scanning electron microscope (SEM)
- Radiographic inspection
- Product traceability for permanent product control
- Rigorous operator training to maintain high quality-control standards

The COS/MOS CD4000A series is available in high-reliability types now being produced under MIL-STD-883, with SEM inspection specified in NASA-Goddard Space Flight Center specification GFSC-311-P12A, on special order.

And, since RCA's COS/MOS production is a single, integrated process, process advances that are developed for high-reliability product are automatically reflected in the commercial type you specify.

If you want the leader's standard of quality plus volume capability and systems cost effectiveness, go COS/MOS. See your RCA Representative or your RCA Distributor. Or write, RCA Solid State, Section 57D-13, Box 3200, Somerville, N.J. 08876. International: RCA, Sunbury-on-Thames, U.K., or P.O. Box 112, Hong Kong. In Canada: RCA Limited, Ste. Anne-de-Bellevue 810, Quebec.

*\*For information on high-reliability COS/MOS and our MIL-M-38510 progress, call RCA's high-reliability marketing specialist, Garry Miller (201) 722-3200 Ext. 2805.*

**RCA** Solid State  
products that make products pay off

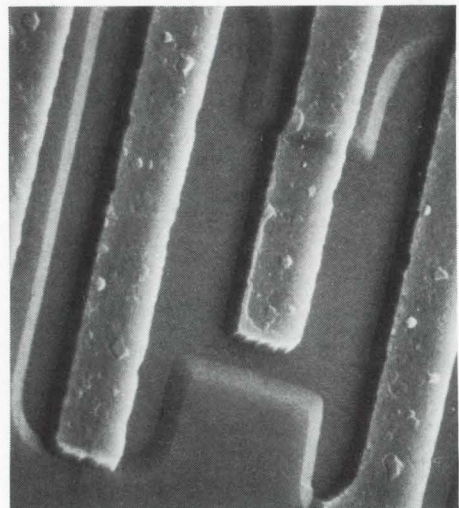

RCA's scanning electron microscope at 1000 X magnification shows excellent conformity of conductors over wafer contours, assuring continuity and reliability of metal interconnects. This is a dramatic example of process refinements achieved under the RCA high-reliability program which are automatically applied to commercial products.

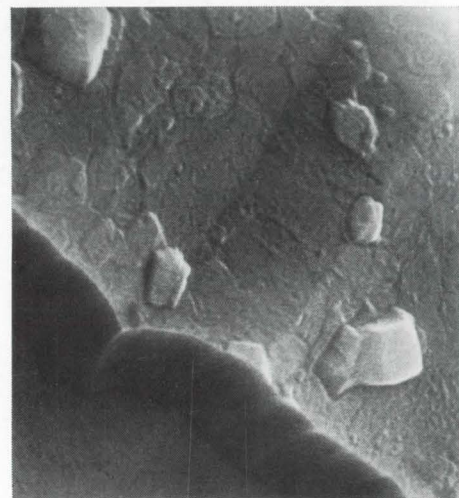

6000 X magnification shows excellent metal coverage over an oxide step. The scanning electron microscope has become a major tool in RCA's diagnostic and high-reliability procedures.